

MAY 1948

electronics

A MCGRAW-HILL PUBLICATION



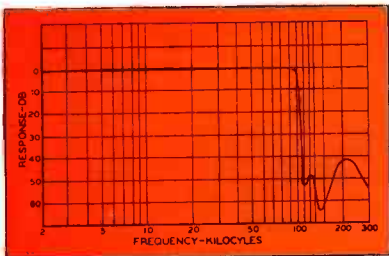
SELECTIVE SEQUENCE CALCULATOR



for DIFFICULT COMPONENTS

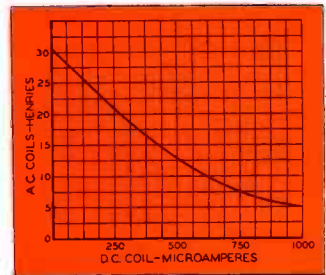
FILTERS

UTC manufactures a wide range of filters for virtually every application. The unit illustrated is for supersonic service. The high Q toroid dust structure effects flat response to 100 KC with 50 DB cutoff at 108 KC.



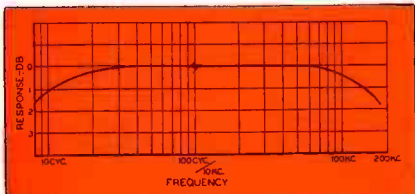
SATURABLE REACTORS

Saturable reactors are used for phase control as well as for power control and magnetic amplifier applications. The reactor illustrated is hermetically sealed... weighs 2 oz. . . gives 6:1 change in inductance for IMA DC saturation.



WIDE FREQUENCY RANGE

UTC Linear Standard components are ideal for high fidelity applications. The 10 watt output transformer illustrated, however, meets a frequency response requirement of plus or minus 2DB—9 cycles to 180,000 cycles.



MINIATURE COMPONENTS

This miniaturized modulation transformer is $\frac{3}{4}$ inch in diameter . . . 1 inch high . . . weighs .7 oz. It handles 250 MW in the speech range.

This reactor provides 20 henrys in $\frac{1}{2}$ cubic inch . . . weighs .9 oz. For minimum hum pickup, it is wound hum balanced and shielded in a mu-metal case.



Write for our new catalog PS-408

United Transformer Corp.

150 VARICK STREET

NEW YORK 13, N. Y.

EXPORT DIVISION: 13 EAST 40th STREET, NEW YORK 16, N. Y. CABLES: "ARLAB"

electronics

A McGRAW-HILL
PUBLICATION



MAY • 1948

SELECTIVE SEQUENCE CALCULATOR	Cover
Control console and two of the many bays of tubes employed in the International Business Machines Corporation device designed to handle complex mathematical problems (see April <i>ELECTRONICS</i> , p 138)	
IRE NATIONAL CONVENTION—1948	72
Review of highlights of New York meeting	
BLIND GUIDANCE BY ULTRASONICS , by Frank Slaymaker and Willard F. Meeker.....	76
Echoes from obstacles up to 30 feet away give distinctive tones at different distances	
VACUUM FURNACE CONTROL , by Frank F. Davis.....	81
Tungsten heaters are automatically safeguarded against burnout due to excessive gas pressure	
SIMPLIFIED SINGLE-SIDEBAND RECEPTION , by Oswald G. Villard, Jr.	82
Accessory for conventional communications receiver is described in detail	
ACOUSTIC PROBLEMS IN STUDIO DESIGN , by George M. Nixon.....	86
Acoustical considerations in attenuating airborne sounds and vibration	
THICKNESS GAGE FOR MOVING SHEETS , by J. W. Head.....	90
Glass and other nonmagnetic sheets can be continuously gaged to close tolerances	
LOW-IMPEDANCE REACTANCES FOR VHF , by E. K. Stodola and Henry Lisman.....	93
Design of transmission-line sections made of flat plates	
ANTENNAS FOR CITIZENS RADIO , by Howard J. Rowland.....	96
Designs of broadcast and point-to-point antennas for <i>ELECTRONICS</i> development project	
STAGGER-TUNED AMPLIFIER DESIGN , by Henry Wallman.....	100
Methods of designing cascaded stages for desired bandwidths	
DIRECTION FINDER FOR LOCATING STORMS , by William J. Kessler and Harold L. Knowles.....	106
Flash lines on cathode-ray tube screen indicate direction from which static is received	
BRIDGE-BALANCED AMPLIFIERS , by Y. P. Yu.....	111
Maximum stability despite tube and supply-voltage variations is achieved	
MEASURING LIQUID FLOW BY WEIGHT , by Donald B. Kendall.....	114
Photoelectric attachment enables conventional scales to check fuel consumption of airplane and automobile engines	
ELECTRONIC ORGAN , by T. H. Long.....	117
Keyboard controls 167 Hartley oscillators having high stability of tuning, low cost, and low upkeep	
DESIGN OF COUNTER CIRCUITS FOR TELEVISION , by Allan Easton and Paul H. Odessey.....	120
Frequency division by means of step-type counter circuits using diodes	
DESIGN OF D-C ELECTRONIC INTEGRATORS , by G. A. Korn.....	124
Conditions for most accurate integration and a circuit giving perfect integration are analysed	
BUSINESS BRIEFS	66
CROSSTALK	71
TUBES AT WORK	128
ELECTRON ART	132
NEW PRODUCTS	136
NEWS OF THE INDUSTRY	140
NEW BOOKS	
BACKTALK	
INDEX TO ADVERTISERS	

DONALD G. FINK, Editor; **W. W. MacDONALD**, Managing Editor; John Markus, Vin Zeluff, Frank H. Rockett, A. A. McKenzie, Associate Editors; William P. O'Brien, Assistant Editor; Hal Adams, Jean C. Brons, Elaine Weber, Editorial Assistants; Gladys T. Montgomery, Washington Editor; Harry Phillips, Art Director; Eleanor Luke, Art Assistant; R. S. Quint, Directory Manager; John Chapman, World News Director; Dexter Keezer, Director Economics Department

KEITH HENNEY, Consulting Editor

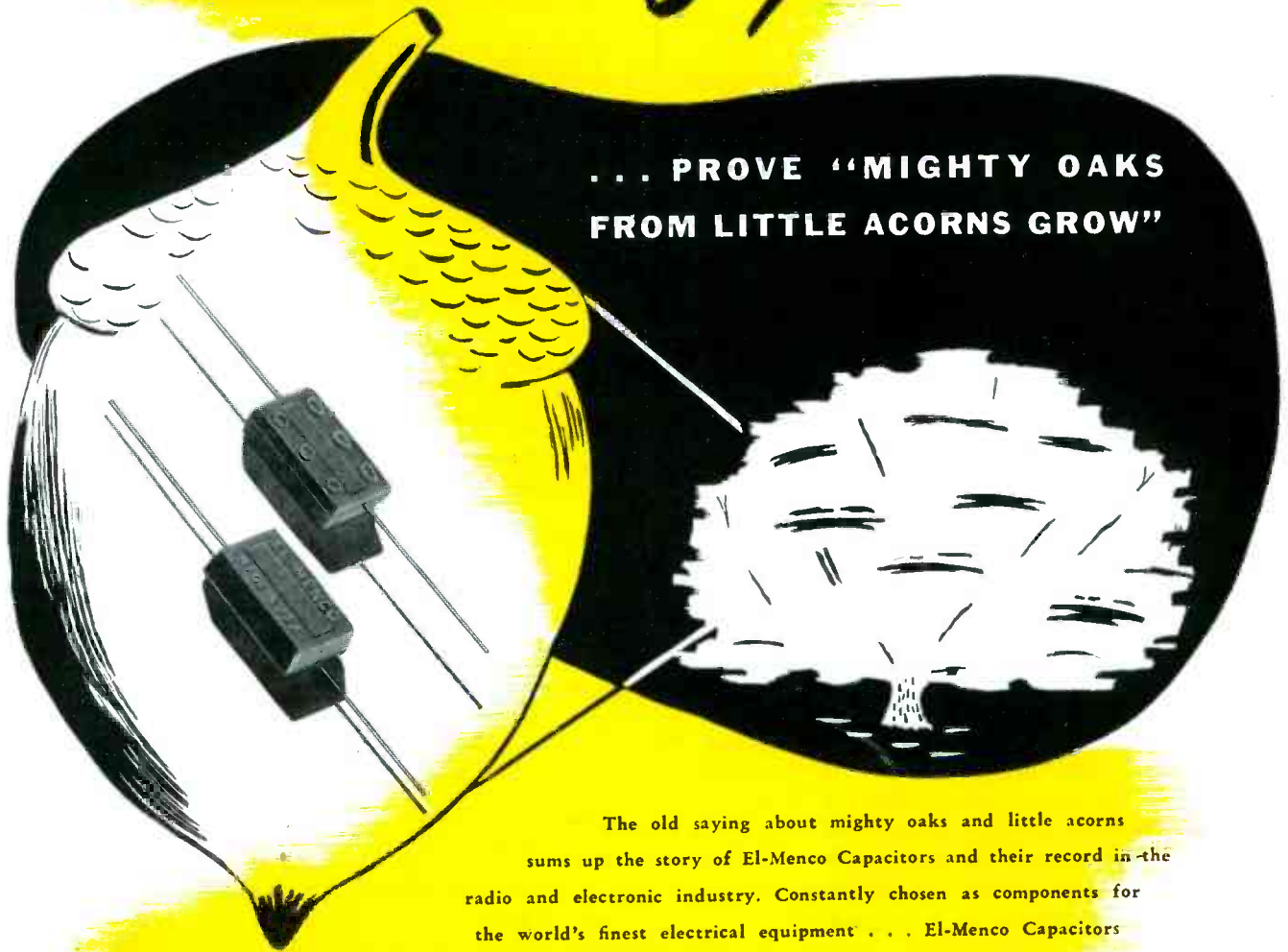
H. W. MATEER, Publisher; **WALLACE B. BLOOD**, Manager; D. H. Miller, H. R. Denmead, Jr., New York; Wm. S. Hodgkinson, New England; F. P. Coyle, Warren Shew, Philadelphia; C. D. Wardner, Chicago; J. L. Phillips, Cleveland; J. W. Otterson, San Francisco; Roy N. Phelan, Los Angeles; Ralph C. Maultsby, Atlanta; Paul West, London, England; J. E. Blackburn, Jr., Director of Circulation

Contents Copyright 1948, by McGraw-Hill Publishing Company, Inc. All Rights Reserved. **McGRAW-HILL PUBLISHING COMPANY, INCORPORATED**, JAMES H. McGRAW (1860-1948), Founder • PUBLICATION OFFICE 99-129 North Broadway, Albany 1, N. Y., U. S. A. EDITORIAL AND EXECUTIVE OFFICES, 330 West 42nd St., New York 18, N. Y., U. S. A.—Member A. B. P. Member A. B. C.

James H. McGraw, Jr., President; Curtis W. McGraw, Senior Vice-President and Treasurer; Nelson Bond, Director of Advertising; Eugene Duffield, Editorial Assistant to the President; Joseph A. Gerardi, Secretary; and J. E. Blackburn, Jr., Vice-President for circulation operations.
ELECTRONICS, May, 1948, Vol. 21; No. 5. Published monthly, with an additional issue in June, price 75c a copy. Directory issue \$2.00. Allow at least ten days for change of address. All communications about subscriptions should be addressed to the Director of Circulation.
Subscription rates—United States and possessions, \$6.00 a year, \$9.00 for two years, \$12.00 for three years. Canada (Canadian funds accepted), \$7.00 a year, \$11.00 for two years, \$14.00 for three years. Pan American countries \$10.00 for one year, \$16.00 for two years, \$20.00 for three years. All other countries \$15.00 for one year, \$30.00 for two years, \$45.00 for three years. Entered as Second Class matter August 29, 1936, at Post Office, Albany, New York, under the Act of March 3, 1879. **BRANCH OFFICES**: 520 North Michigan Avenue, Chicago 11, Ill.; 68 Post Street, San Francisco 4; Aldwych House, Aldwych, London, W. C. 2; Washington, D. C. 4; Philadelphia 3; Cleveland 15; Detroit 26; St. Louis 8; Boston 16; Atlanta 3, Ga.; 621 So. Hope St., Los Angeles 14; 738-9 Oliver Building, Pittsburgh 22.

El-Menco Capacitors

... PROVE "MIGHTY OAKS
FROM LITTLE ACORNS GROW"



The old saying about mighty oaks and little acorns sums up the story of El-Menco Capacitors and their record in the radio and electronic industry. Constantly chosen as components for the world's finest electrical equipment . . . El-Menco Capacitors contribute immeasurably to product performance.

Put the dependability into your product that will establish it as a leader in its field . . . put El-Menco Capacitors to work for you!

Send for samples and complete specifications. Foreign Radio and Electronic Manufacturers communicate direct with our Export Department at Willimantic, Conn., for information.

JOBBERS AND DISTRIBUTORS
ARCO ELECTRONICS

135 Liberty St. New York, N. Y.
is Sole Agent for El-Menco Products in United States and Canada.



Write on firm letterhead for catalog and samples.

MOLDED MICA

El-Menco CAPACITORS

MICA TRIMMER

MANUFACTURERS

Our silver mica department is now producing silvered mica films for all electronic applications. Send us your specifications.

HELIOS HELIOS HELIOS HELIOS HELIO
S HELIOS HELIOS
a new partner in creating

You Get Finest Prints From Your Dry Diazo Equipment With Helios Papers, Cloths, Film

Exclusive Erasing Feature!

Users of dry diazo positive reproductions frequently make drawing changes on transparent intermediate originals, rather than on original drawings. Such changes are easier and quicker on Helios† transparent prints, made on either of the amazing new K&E products—Helios Tracing Cloth or Helios Albanized* Paper—because you can actually erase image lines from them with an ordinary soft ink or typewriter eraser. No inconvenient, time-wasting eradicating fluids are needed.

A Complete Line!

You can make positive line reproductions—working prints on opaque Helios papers or cloth—directly from original drawings, layouts, letters, documents, forms. Or else you can save your originals and reproduce your positive line working prints directly from positive line intermediate originals, made on Helios transparent papers, cloth or films. These Helios materials are available in rolls or cut sheets and they can be printed and developed in the dry diazo process machine you are now using.

K & E Quality Guaranteed!

More than any other reproduction process for drafting room use, the manufacture of diazo process materials demands, from start to finish, the utmost chemical and technical skill. For this reason, a new K&E plant was established to manufacture all the image-forming components essential to Helios products. Helios Positive Printing, Dry Developing Reproduction Materials are offered to you with the assurance that they conform in every way to K&E standards.

Write to Keuffel & Esser Co., Hoboken, N. J. for samples to test on your own equipment, or ask your nearest K & E Dealer or K & E Branch for a demonstration. Once you've tried Helios, you will agree that it pays to be positive with Helios!

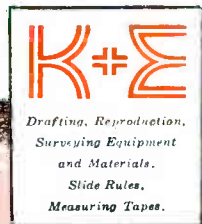
KEUFFEL & ESSER CO.

EST. 1867

NEW YORK • HOBOKEN, N. J.
CHICAGO • ST. LOUIS • DETROIT • SAN FRANCISCO
LOS ANGELES • MONTREAL

*Trade Mark

†Reg. U. S. Pat. Off.



FOLLOW THE LEADER

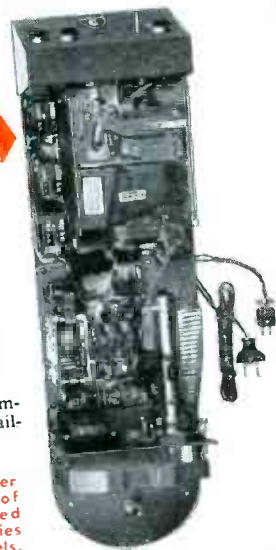
OF *Electrical Control* IN VENDING MACHINES

GUARDIAN selected by HOT BEVERAGE VENDORS for complete coordination of circuit and design

You're looking at a tough control problem. Automatic beverage vendors that dispense hot coffee (black coffee, coffee with sugar only, coffee with cream only, or coffee with cream and sugar). A real challenge to electrical control. Yet, Guardian equips such vendors from top to bottom for these multiple operations:



- 1 **SELECTION:** A Guardian Interlock Relay or Interlocking Switches permit one selection, only.
- 2 **COIN INSERTION** opens solenoid valves, actuates a Guardian vending cycle relay, pours the drink of your choice and makes change!
- 3 **ANTI-JACKPOT RELAY** locks the vending cycle, prevents duplicate sales from one coin.
- 4 **LIQUID LEVEL** of all ingredients is maintained by a Guardian Liquid Level Control.
- 5 **EMPTY** ingredients, absence of cup, or lack of change stops or alters the vending cycle.
- 6 **A COMPLETE PACKAGE CONTROL** combining most of the above units is available ready to plug-in.



Guardian Change Maker

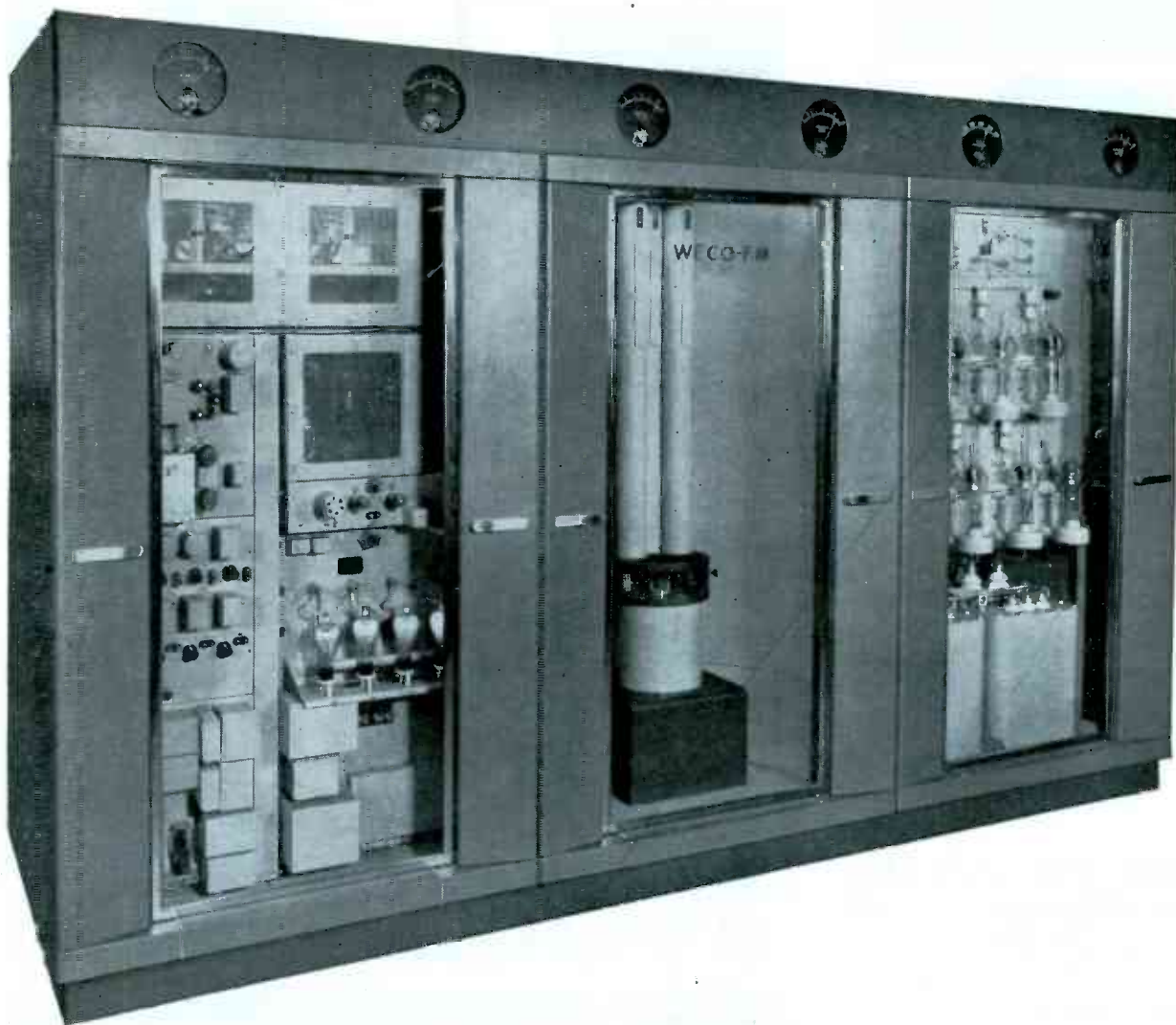
Guardian leads in supplying ninety percent of the manufacturers in the billion dollar vending machine market. Why Guardian by so wide a margin? This one source assumes full responsibility for all controls, from a single switch to packaged plug-in controls that cut labor costs, design costs, speed assemblies. Write today.

The Guardian Change Maker shown to right consists of motor-driven cam-operated switches and Guardian Series 600 Relays. It accepts nickels, dimes and quarters, starts the vending cycle and automatically makes correct change.

GUARDIAN  **ELECTRIC**
 1625-F W. WALNUT STREET CHICAGO 12, ILLINOIS
 A COMPLETE LINE OF RELAYS SERVING AMERICAN INDUSTRY

FELLER

You get two complete transmitters . . .



. . . when you buy the Western Electric 10KW FM!

In this 10 kw transmitter the 1 kw driver is your standby equipment. If your final amplifier or its power supply should fail, a simple operation (taking less than a minute) puts you back on the air—with the driver itself as your emergency transmitter!

This Western Electric feature gives you still another safeguard against off-the-air time. If your main source of power fails, your

emergency power source may be too small to handle a 10 kw transmitter. In that case, just cut back to 1 kw operation!

This is only one of many reasons why you should consider Western when you go to 10 kw FM. For complete information, please call your local Graybar Broadcast Representative—or write Graybar Electric Co., 420 Lexington Ave., New York 17, N. Y.

Western Electric
— QUALITY COUNTS —

DISTRIBUTORS: IN THE U. S. A.—Graybar Electric Company. IN CANADA AND NEWFOUNDLAND—Northern Electric Company, Ltd.

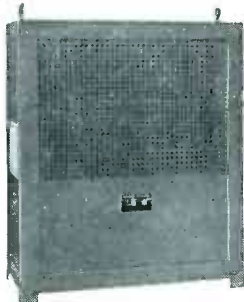




3-Phase Regulation

MODEL	LOAD RANGE VOLT-AMPERES	*REGULATION ACCURACY
3P15,000	1500-15,000	0.5%
3P30,000	3000-30,000	0.5%
3P45,000	4500-45,000	0.5%

• Harmonic Distortion on above models 3%.
Lower capacities also available.



Extra Heavy Loads

MODEL	LOAD RANGE VOLT-AMPERES	*REGULATION ACCURACY
5,000*	500 - 5,000	0.5%
10,000*	1000-10,000	0.5%
15,000*	1500-15,000	0.5%



General Application

MODEL	LOAD RANGE VOLT-AMPERES	*REGULATION ACCURACY
150	25 - 150	0.5%
250	25 - 250	0.2%
500	50 - 500	0.5%
1000	100-1000	0.2%
2000	200-2000	0.2%

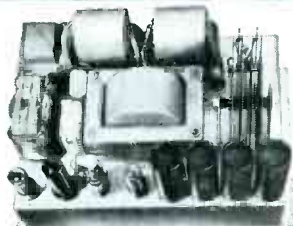


400-800 Cycle Line INVERTER AND GENERATOR REGULATORS FOR AIRCRAFT.

Single Phase and Three Phase

MODEL	LOAD RANGE VOLT-AMPERES	*REGULATION ACCURACY
D500	50 - 500	0.5%
D1200	120-1200	0.5%
3PD250	25 - 250	0.5%
3PD750	75 - 750	0.5%

Other capacities also available



The NOBATRON Line

Output Voltage DC	Load Range Amps.
6 volts	15-40-100
12 "	15
28 "	10-30
48 "	15
125 "	5-10

• Regulation Accuracy 0.25% from 1/4
to full load.

SORENSEN

The First Line of standard electronic AC Voltage Regulators and Nobatrons

GENERAL SPECIFICATIONS:

- Harmonic distortion max. 5% basic, 2% "S" models
- Input voltage range 95-125: 220-240 volts (-2 models)
- Output adjustable bet. 110-120: 220-240 (-2 models)
- Recovery time: 6 cycles: † (9 cycles)
- Input frequency range: 50 to 65 cycles
- Power factor range: down to 0.7 P.F.
- Ambient temperature range: -50°C to +50°C

All AC Regulators & Nobatrons may be used with no load.

*Models available with increased regulation accuracy.

Special Models designed to meet your unusual applications.

Write for the new Sorensen catalog. It contains complete specifications on standard Voltage Regulators, Nobatrons, Incevolts, Transformers, DC Power Supplies, Saturable Core Reactors and Meter Calibrators.

.....

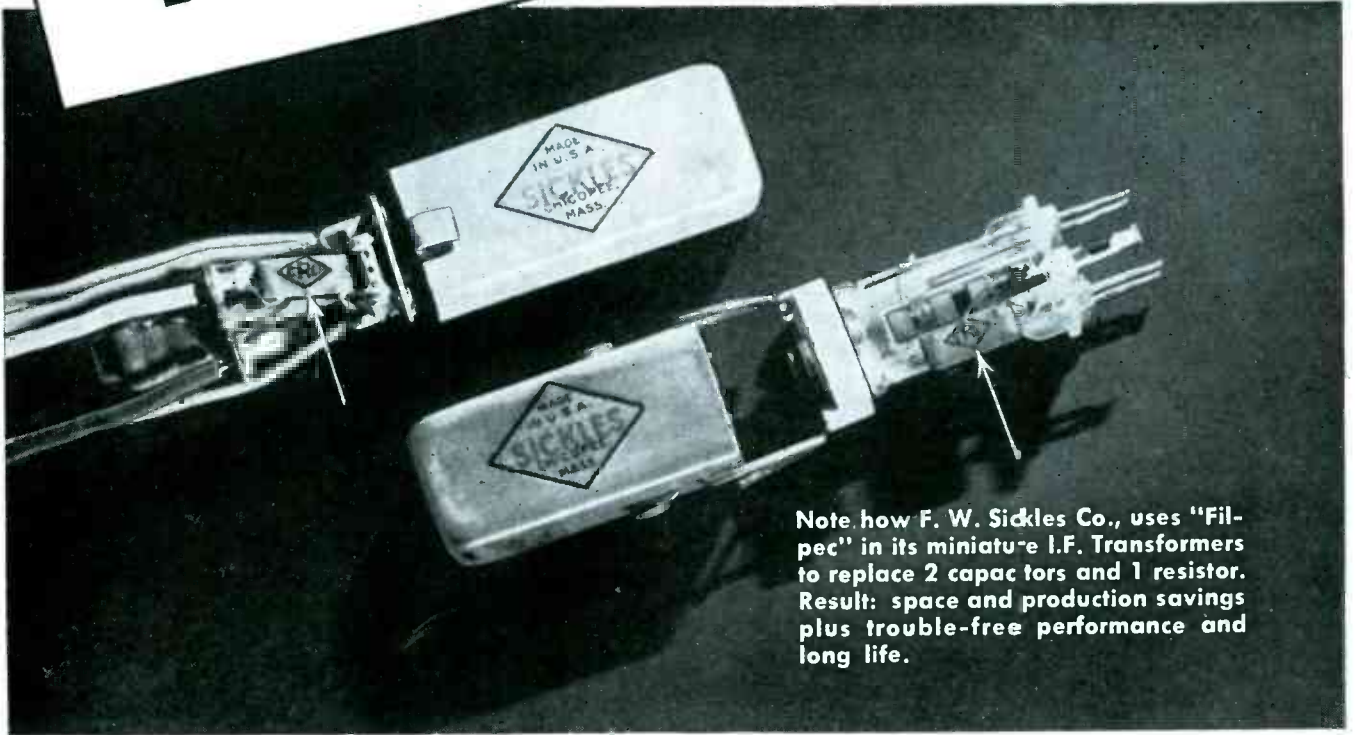
SORENSEN & CO., INC.

STAMFORD CONNECTICUT

Represented in all principal cities.

PROGRESS REPORT ON P.E.C.*

How Sickles engineers
put Centralab's "Filpec" to work
to save space, save weight
on miniature
I. F. Transformers



Note how F. W. Sickles Co., uses "Filpec" in its miniature I.F. Transformers to replace 2 capacitors and 1 resistor. Result: space and production savings plus trouble-free performance and long life.

Transformers courtesy of F. W. Sickles Co.

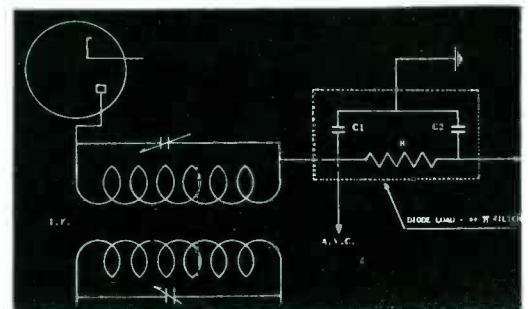
*Centralab's revolutionary Printed Electronic Circuit — Industry's newest method for stepping-up manufacturing efficiency!

COMPARE THE SAVINGS in size and weight which Centralab's new printed electronic circuit filter gives you, and you'll see why F. W. Sickles Co., Chicopee, Mass. is taking advantage of it in its new miniature I.F. Transformers. And that's not all: Centralab's *Filpec* can be soldered into place easily and quickly without tricky bending or fitting, assures more dependable performance, as well as a reduction of line operations.

Secret of *Filpec's* amazing performance is its integral ceramic construction which combines two capacitors and one resistor into one tiny balanced load filter unit, saves space, cuts inventory, and is highly adaptable to a variety of circuits. Capacitor values 50 to 200 mmf. Resistor values from 5 ohms to 5 megohms. Resistance rating: 1/5 watt 100 WVDC. Flash test 200 VDC. For complete information about *Filpec* see your Centralab representative, or write for Bulletin 976.



"Filpec" gives you integral construction! Made with high dielectric Ceramic-X, CRL's *Filpec* assures long life, low internal inductance, resistance to humidity and vibration. Note schematic diagram below, showing typical application.



LOOK TO **Centralab** IN 1948!

Division of GLOBE-UNION INC., Milwaukee

WHAT
MAKES A GOOD
RECORDING-BLANK
GOOD*
?

PREPARATION OF RECORDING LACQUER

Quite apart from the chemistry of good recording lacquer are the mechanics of tailoring it to the coating process and to the requirements of the disc itself.

Control of coating uniformity and elimination of objectionable outer-edge ridge demand, among other things, laboratory-accurate viscosity control. The correct amounts of solvent must be mixed into daily supplies of new lacquer. Electric agitators then so thoroughly stir this mixture that uniform viscosity is assured throughout the entire system. There is thus no possibility of hard or soft spots on any Soundcraft disc.

Because the high viscosity of fine-grain lacquer retards natural dispersal of air bubbles, *forced* debubbling methods are necessary. Soundcraft combines two methods, each of which alone is usually considered adequate. First, the lacquer is subjected to vacuum; second, it is allowed to rest. This double debubbling removes not only the visible bubbles, but also the noise-making *invisible* ones.

Commercial lacquer ingredients often contain hard foreign particles dangerous to styli. While the larger of such particles are commonly removed by conventional cloth and paper filter presses, Soundcraft uses two additional stages of filtering—first, coarse porous stone filters, then fine ones right at the point of coating—to trap microscopic particles even as small as one micron.

Elaborate preparation to be sure, but what better way to assure a good recording every time?

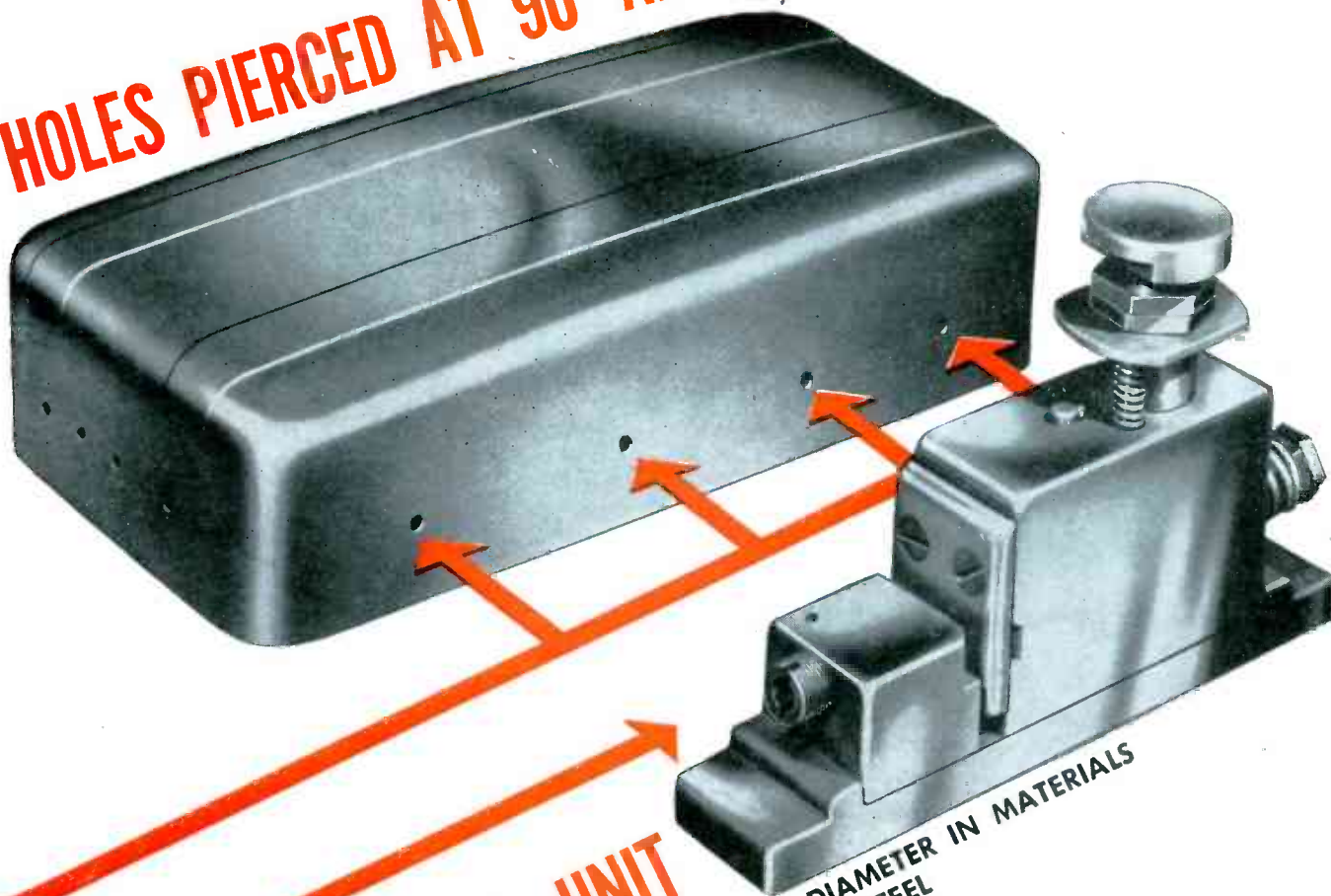
**No. 5 of a series *Watch this space for succeeding ads on how Soundcraft discs are made.*

REEVES **Soundcraft** CORP.
10 EAST 52nd STREET • NEW YORK 22, N. Y.



The 'Broadcaster' The 'Playback' The 'Audition' The 'Maestro'

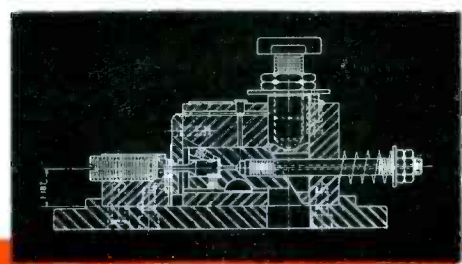
HOLES PIERCED AT 90° ANGLE ...



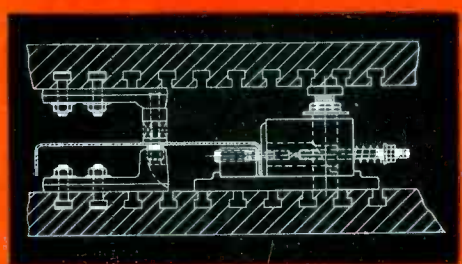
with NEW

WHISTLER UNIT

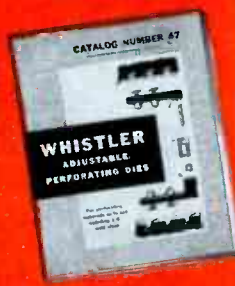
PERFORATES HOLES UP TO 1/2" IN DIAMETER IN MATERIALS TO 1/16" THICK MILD STEEL



Detailed drawing showing operation of HU-50 90° Perforating Unit.



Typical set-up shows 90° perforating unit operated in conjunction with standard perforating equipment.



DETAILS EXPLAINED IN CATALOG NO. 47

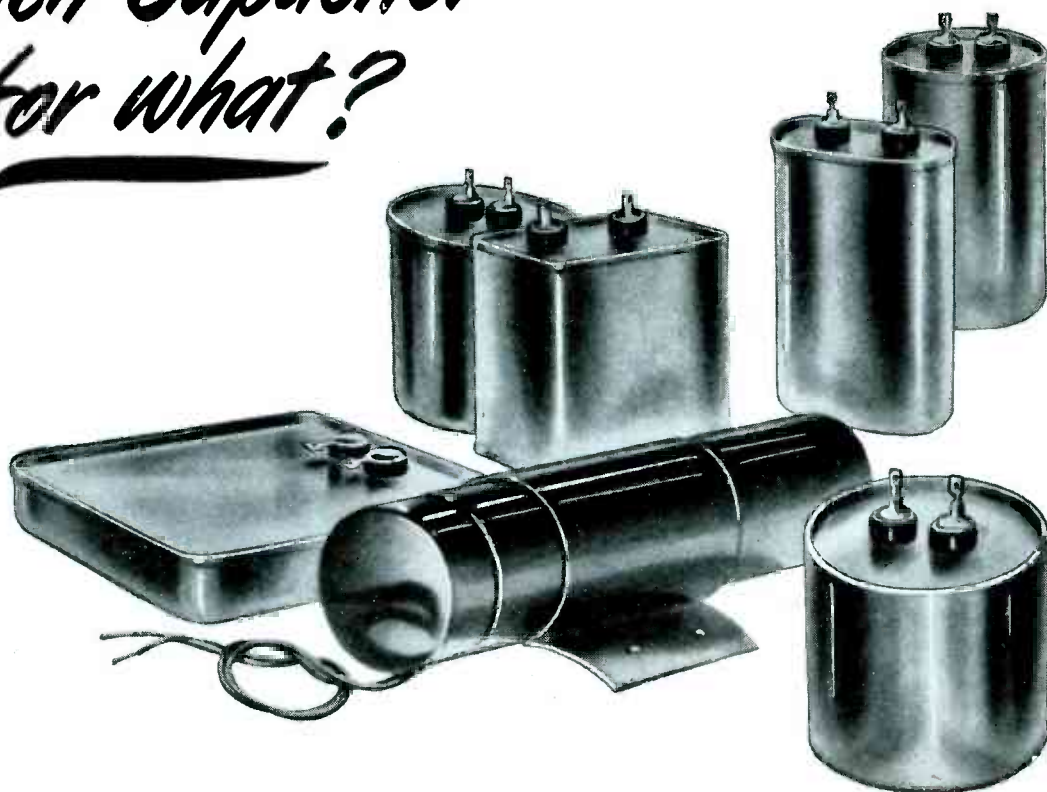
Get the facts about this 90° perforating unit in a hurry. Your copy of this catalog will be sent at once upon request.

Extruded shapes, ells, angles and other molded, shaped or fabricated pieces are easily pierced from the side at 90° with HU-50 Perforating Units. Quickly set up and adjustable, these units may be used separately or with standard perforating equipment. The advantages provided by other Whistler Adjustable Dies are retained. Absolute accuracy is assured. Quick change-over of hole arrangements can be made ... in many cases, on the press. Production economies and speeded up operating schedules are effected. Continued re-use of units in different groupings spreads initial cost.

It makes sense to look into the use of Whistler Adjustable Dies for all perforating, notching, slitting, or rounding operations.

S. B. WHISTLER & SONS, INC.
 746 MILITARY ROAD
 BUFFALO 17, NEW YORK

Which Capacitor for what?



These capacitors are identical, electrically. The different case styles were, most of them, developed for specific applications. However, since the capacitors *are* electrically the same, it is perfectly practical to use them interchangeably—to use a ballast capacitor on a motor, or a motor capacitor with a sign transformer.

We have made just such proposals at times—and have frequently been

able to help manufacturers solve an unusual mounting or space problem, and cut their capacitor costs by recommending a unit not normally thought of for the application.

The capacitor that *you* should use of course depends on your own problem. For assistance in any specific case, get in touch with the nearest G-E Apparatus Office, or write *General Electric Company, Pittsfield, Massachusetts.*

GENERAL ELECTRIC

407-151

*Specialty
Capacitors*
FOR

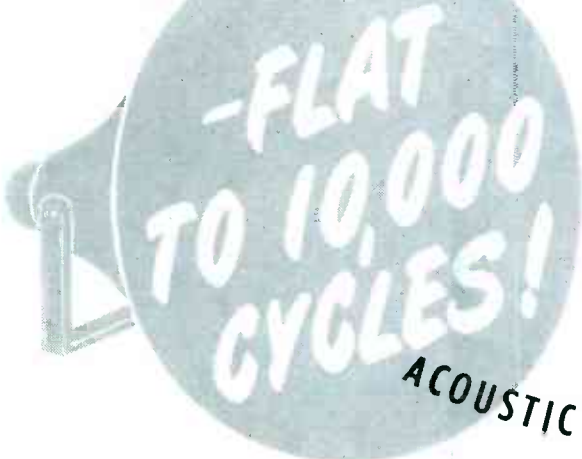
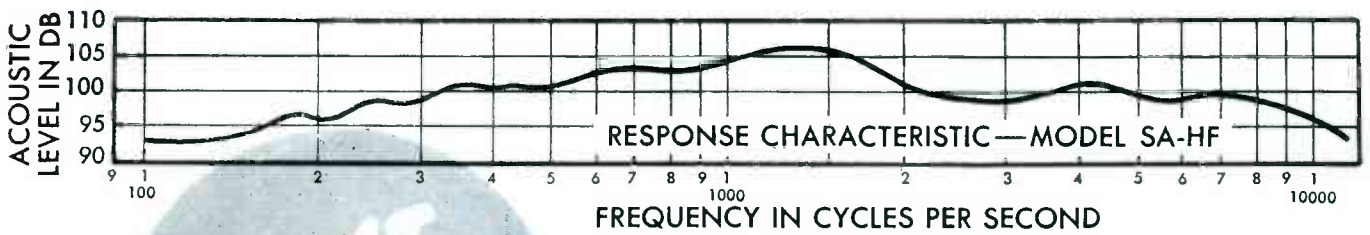
Motors
Luminous-tube
transformers
Fluorescent lamp
ballasts

Industrial control
Radio filters
Radar
Electronic equipment
Communication
systems
Capacitor discharge
welding

Flash photography
Stroboscopic
equipment
Television
Dust precipitators
Radio interference
suppression
Impulse generators

AND MANY OTHER APPLICATIONS





UNIVERSITY LEADERSHIP—Electrically and mechanically right to the last detail, every UNIVERSITY Loudspeaker reflects the fact that UNIVERSITY has been chiefly responsible for every worthwhile development in reflex loudspeakers. Among these pioneering developments of UNIVERSITY are the first high efficiency Alnico PM driver unit; first 25 watt breakdown-proof unit with bakelite diaphragm and dural voice coil suspension; first unit to incorporate battleship ruggedness and efficiency due to exclusive "rim-centering"; first hermetically sealed waterproof driver unit; first driver unit covered by a one year unconditional replacement guarantee.

ACOUSTIC REPRODUCERS OF QUALITY AND EFFICIENCY FOR EVERY NEED

MODEL SA-HF

The Model SA-HF is the product of exhaustive research aimed at developing a driver unit capable of meeting present day high fidelity standards. How well UNIVERSITY engineers succeeded in this undertaking is best indicated by the characteristics of the Model SA-HF. Acoustic response is essentially flat through the entire range of audible frequencies to 10,000 cycles. Conservative continuous power rating is 25 watts. Completely weatherproof and ruggedly constructed for heavy duty, the SA-HF is a high-efficiency unit for every sound requirement.

\$37.00



ACOUSTIC REPRODUCERS OF QUALITY AND EFFICIENCY FOR EVERY NEED

MODEL MA-25

Like all UNIVERSITY Driver Units, the MA-25 is designed to withstand continuous outdoor exposure to wind, rain, sleet and snow. The dual features of rim-centering construction and powerful Alnico permanent magnet provide exceptional efficiency and permanent alignment. Conservatively rated for continuous duty at 25 watts, the MA-25 covers the standard frequency range to 6,000 cycles. It is recommended for all applications requiring flawless reproduction within this frequency range.

\$25.00



WRITE FOR CATALOG!

ACOUSTIC REPRODUCERS OF QUALITY AND EFFICIENCY FOR EVERY NEED

DRIVER UNITS—UNIVERSITY offers a complete line of high-efficiency driver units with power rating up to 25 watts and frequency response to 15,000 cycles. All are unconditionally guaranteed for one year.

REFLEX TRUMPETS—Construction is all-weather type, exceptionally rugged. Rubber rim damping eliminates acoustic resonance and vibration. Reflex construction provides maximum air-column length in minimum space.

University Loudspeakers, Inc

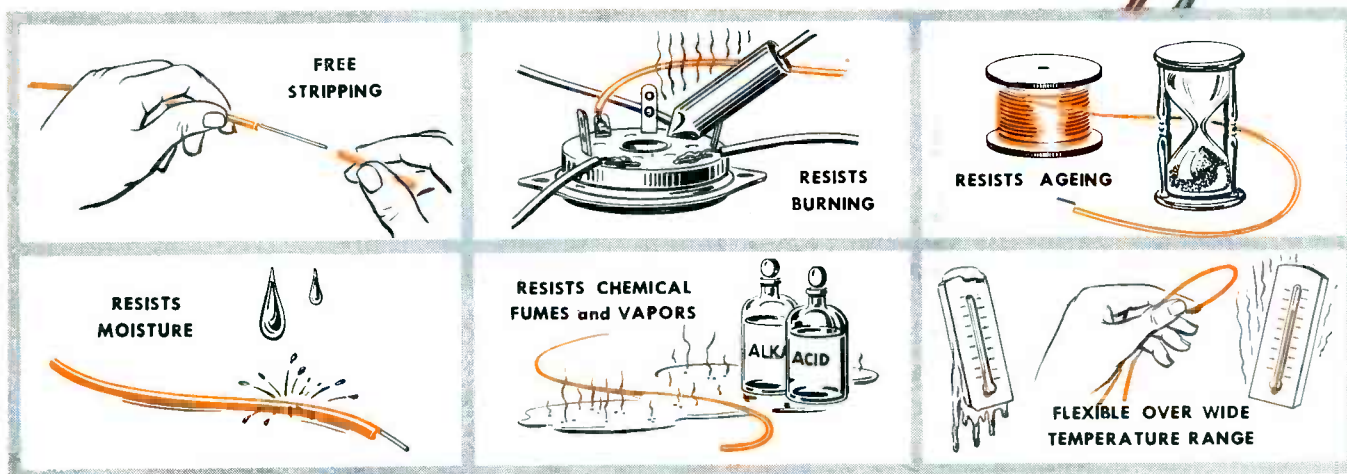


80 SO. KENSICO AVENUE • WHITE PLAINS • NEW YORK

Federal's **Intelin** Thermoplastic

HOOK-UP WIRE

gives these **6 PLUS VALUES**



Assures maximum performance and long-range economy for your electronic equipment

NO MATTER what your radio or electronic product, it will pay you to hook it up with Federal's Intelin wire. It's easier to install—gives a neater chassis wiring job that stands up longer under severe service conditions.

This Intelin hook-up wire has the finest quality thermoplastic, thin-wall insulation, with high dielectric and mechanical strength. It strips freely, leaving the conductor clean for soldering or splicing—and has outstanding resistance to temperature, ageing, moisture and chemicals.

Send for your free samples today. Write Federal, Dept. D413.

*Reg. U. S. Pat. Off.

Available in 8 colors, with solid or stranded conductors, for 300 or 600 volt service. Standard sizes — 22 to 18 (larger on request).



Federal Telephone and Radio Corporation

SELENIUM and INTELIN DIVISION, 900 Passaic Ave., East Newark, New Jersey

KEEPING FEDERAL YEARS AHEAD... is IT&T's world-wide research and engineering organization, of which the Federal Telecommunication Laboratories, Nutley, N. J., is a unit.

In Canada: Federal Electric Manufacturing Company, Ltd., Montreal, P. Q.
Export Distributors: International Standard Electric Corp. 67 Broad St., N. Y.

THORDARSON



**CONTINUOUS
DEVELOPMENT
ASSURES**

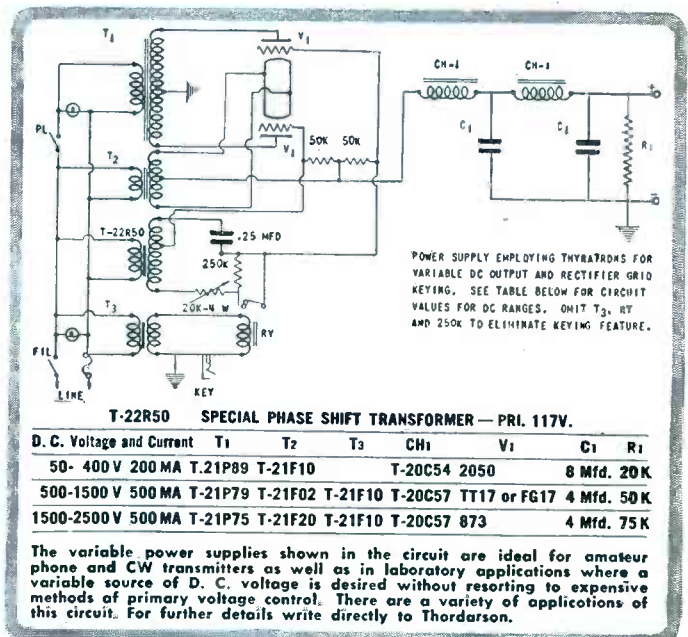
Lasting Leadership

Progress is dependent upon advancement and development. Here at Thordarson, we are never satisfied with a "status quo" position. That is why we have a staff of highly qualified engineers who are pioneering improvements in power circuits involving transformers . . . for the amateur . . . as well as highly specialized industry. As a result, our "in stock" list of transformers are transformers that incorporate every new development. This creative thinking by Thordarson engineers eliminates costly suppositional thoughts in the resolution of new products. Let Thordarson engineers translate your needs into practical, workable shop specifications that make development jobs easier for all industry.

Shown on this page is a typical variable power supply . . . Write for our latest catalog showing a variety of matched components.



**The New Thordarson
Catalog Is Now Available,
Send For Your Copy Today.**



THORDARSON

Manufacturing Quality Electrical Equipment Since 1895
500 WEST HURON CHICAGO 10, ILLINOIS
 A Division of Maguire Industries
Export - Scheel International Inc.

Centralab reports to

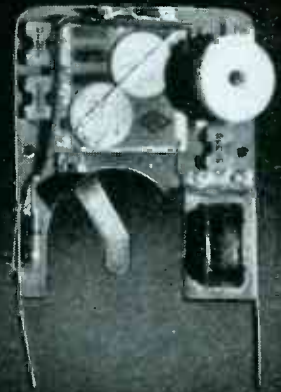
MAY, 1948

How Beltone uses
"Printed Electronic
Circuit" to design
and produce "the
world's smallest
hearing aid"!



PROBLEM:

How to overcome size and weight limitations of ordinary electronic components and design a smaller, lighter Beltone hearing aid.



SOLUTION:

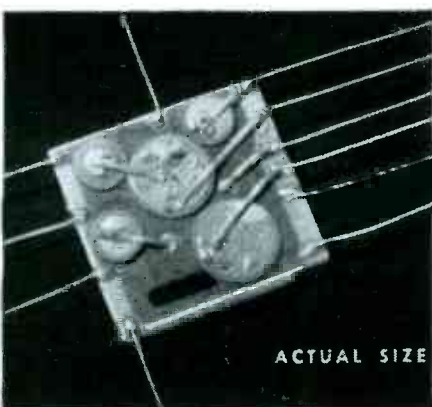
Using Centralab's "Printed Electronic Circuit", 45 parts, including capacitors and resistors, have been combined into one compact chassis.

RESULT:

The new, vastly improved 1948 Beltone Hearing Aid — smaller and lighter with improved performance and important production savings.

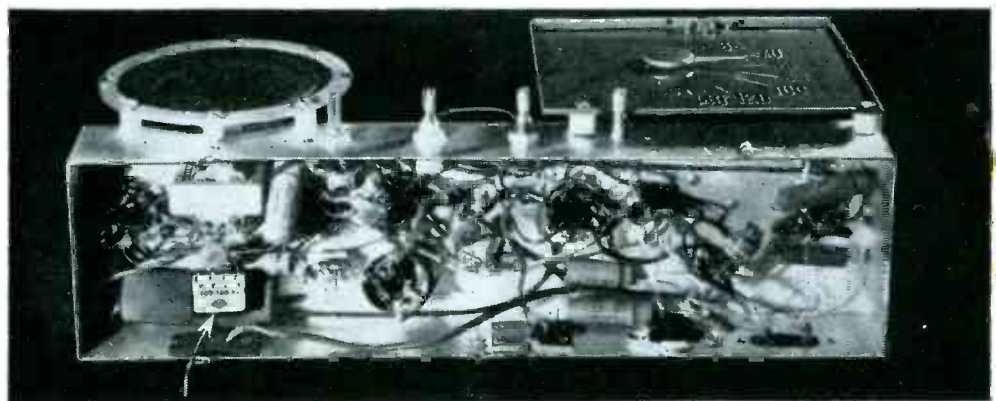
1 Where miniature size is of the utmost importance, nothing else combines ruggedness, dependability, and resistance to humidity and moisture in such a small unit package. That's what Beltone engineers say about Centralab's *Printed Electronic Circuit* and

Models courtesy of Beltone Hearing Aid Co., Chicago that's what you will say when you have seen and tested this amazing new electronic development. Working with your engineers, Centralab may be able to fit its *Printed Electronic Circuit* to your specific needs. Write us today for further information.



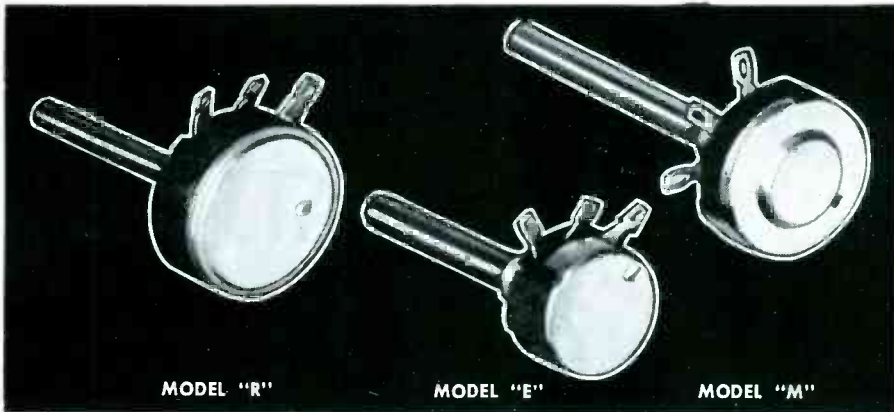
ACTUAL SIZE

2 Rear view of Beltone-CRL unit shows integral construction — ceramic disc capacitors, "printed" silver leads and resistors (black paths).



3 Engineers of Sonora Radio and Television Corp., Chicago, use CRL's *Couplate* ("printed" interstage coupling plate) to improve manufacturing, reduce servicing. *Couplate's* long life, high efficiency, mechanical strength and resistance to humidity mean more dependable performance, simplified production for Sonora Radios.

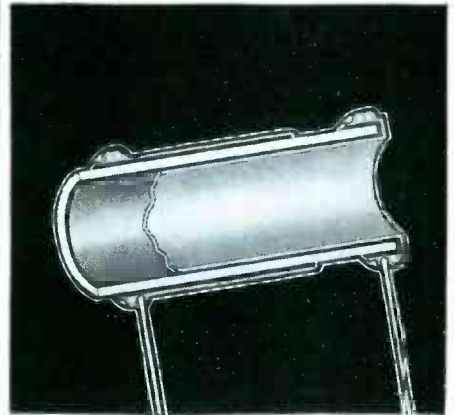
Electronic Industry



MODEL "R"

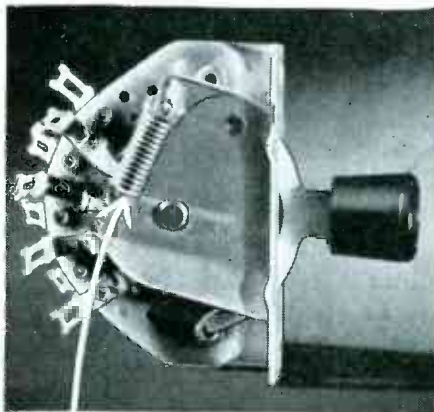
MODEL "E"

MODEL "M"

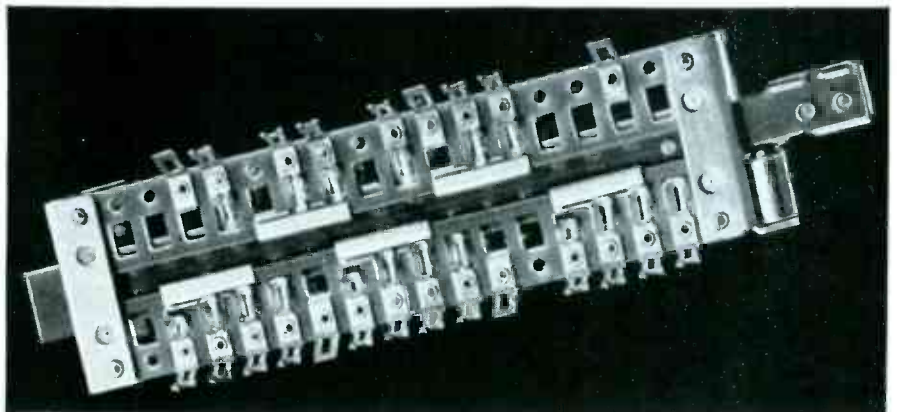


4 Let Centralab's complete Radiohm line take care of your special needs. Wide range of variations: *Model "R"* — wire wound, 3 watts; or composition type, 1 watt. *Model "E"* — composition type, 1/4 watt. Direct contact, 6 resistance tapers. *Model "M"*—composition type, 1/2 watt. For complete information, write for Bulletin 697.

5 For quality and dependability, more and more manufacturers are switching to Centralab's line of ceramic capacitors. Order Bulletin 933.



6 In its new *Lever Switch*, Centralab guarantees a minimum life of 50,000 cycles. Reason: an exclusive, new coil spring index. Write for Bulletin 970.



7 Centralab's development of a revolutionary, new *Slide Switch* promises improved AM and FM performance! Flat, horizontal design saves valuable space, allows short leads, convenient location to coils, reduced lead inductances for increased efficiency in low and high frequencies. Rugged, efficient. Write for Bulletin 953.

LOOK TO CENTRALAB IN 1948! *First in component research that means lower costs for the electronic industry. If you're planning new equipment, let Centralab's sales and engineering service work with you. Get in touch with Centralab!*

Centralab

DIVISION OF GLOBE-UNION INC., MILWAUKEE, WIS.



**EXPERIENCE
PLUS
COOPERATION
*DOES IT!***

There's a lot of satisfaction in working with radio engineers who know exactly what they need to get top efficiency from the transmitter. To their specifications Blaw-Knox applies an experience in antenna tower building that dates back to the days of "wireless" . . . Together we get results that reflect credit on our structural designers and the station's technical experts . . . If your plans call for more effective coverage or directional changes we would welcome an engineering interview at your convenience.

BLAW-KNOX DIVISION

OF BLAW-KNOX COMPANY

2077 FARMERS BANK BUILDING
PITTSBURGH 22, PA.

◀ Blaw-Knox 550' Heavy Duty Type H40 Tower supporting a Federal 8 square loop FM antenna 74' high. Station WTMJ-FM, Richfield, Wisconsin.

BLAW-KNOX ANTENNA TOWERS

Plastics where plastics belong



The best applications for Synthane laminated plastics stem from Synthane's combination of properties . . . chemical, electrical and mechanical. For example, Synthane is moisture and corrosion resistant, hard, dense, easy to machine and has unusual electrical insulating qualities.

In addition, Synthane is structurally strong, light in weight and an excellent anti-friction material. The set plastic, Synthane is stable over wide variations in temperature.

Here is our type of technical plastics at work in a television channel selector . . .

for low power factor high dielectric strength and ease of machining



The ANDREA channel selector turret (right) is the nerve-center of any television receiver, contains thirteen channel tuning circuits and an FM tuning circuit, each one electrically independent of the other.

Synthane is employed for a number of the intricate parts to insure extreme electrical and mechanical precision and rugged operation. It's an appropriate job for useful, hard-working Synthane . . . a timely example of plastics where plastics belong.

If there's a use for Synthane in your product, why not let us help you before you design? Write for our complete catalog of Synthane plastics today! Synthane Corporation, 6 River Road, Oaks, Pa.



where Synthane belongs

DESIGN • MATERIALS • FABRICATION • SHEETS • RODS • TUBES
FABRICATED PARTS • MOLDED-MACERATED • MOLDED-LAMINATED

These Electrical Applications for

SYNTHANE

Will Give You Ideas for Other Uses



High dielectric strength, low power factor, low dielectric constant are but a few of the characteristics that qualify Synthane for so many electrical purposes. However, use of Synthane in these and similar electrical applications is due, not only to its effective insulating qualities, but also to its combination of other properties. Synthane is light in weight, moisture and corrosion resistant, structurally strong, quickly and easily machined and stable over a wide temperature range.

Here in one material are the requirements for making many products better, faster, more easily or more economically.

If Synthane's properties suggest a use in your product, let us work with you before you design... we can help you find what you want in plastics, we may save you considerable time, trouble and money. Send for your copy of the Synthane plastics catalog today.

● ● ● ● ● TO FIND OUT HOW SYNTHANE CAN HELP YOUR PRODUCT ● ● ●

SYNTHANE CORPORATION, 6 RIVER ROAD, OAKS, PA.

Gentlemen:

Please send me without obligation a complete catalog of Synthane technical plastics.

Name _____

Company _____

Address _____

City _____ Zone _____ State _____



PLAN YOUR PRESENT AND FUTURE WITH SYNTHANE TECHNICAL PLASTICS • SHEETS • RODS • TUBES • FABRICATED PARTS • MOLDED-LAMINATED • MOLDED-MACERATED



Thank you, thank you, COMPETITORS

We are flattered

**that after years of Solar pioneering
you, too, are molding paper tubulars**

LET'S LOOK AT THE RECORD



In 1935 Solar made its first phenolic-molded paper capacitor—the “Domino,” then a revolutionary step in the capacitor art. Some had said Bakelite-molding of paper capacitors was impossible. But Solar did it!

Then in 1939 Solar again pioneered with its famous molded paper tubular, the Type S SEALDTITE*. Wax molding was chosen for Sealdtites because the industry’s field experience with thermo-setting molded capacitors was not entirely satisfactory. Humidity-cycling tests, which correlate with actual service conditions, showed that wax-molded capacitors stood up where thermo-setting units failed. “Molded Sealdtites” came to mean “the best tubulars.” Export receiver manufacturers specified Sealdtites *exclusively* for sets going to the world’s worst climates. Many quality approval lists have carried them at the top because “Molded Sealdtites” have longest life under tests.

In 1947, to meet the post-war trend toward ultra-compact sets and operation at higher temperatures, Solar introduced the first satisfactory plastic-housed tubular capacitors — All-Purpose, Hi-Temp* Sealdtites (Type ST). These units are encased in a plastic molding compound, which resists temperatures up to 100°C and still maintains the same inherent resistance to moisture as molding wax.

Throughout all of 1947, as production was being built up, these new Hi-Temp Sealdtites were channeled to export and auto receiver manufacturers; in their products several million are now in use. *They stand up fine.* We are flattered that Solar molded tubulars are now imitated. The record shows that Sealdtites are millions ahead in satisfactory field experience among molded capacitors.

Bulletin SPD-200 tells the Sealdtite Story. Write for your copy *today*.

SOLAR MANUFACTURING CORPORATION
1445 Hudson Boulevard • North Bergen, N. J.

★ Trade Mark

SOLAR CAPACITORS
“Quality Above All”



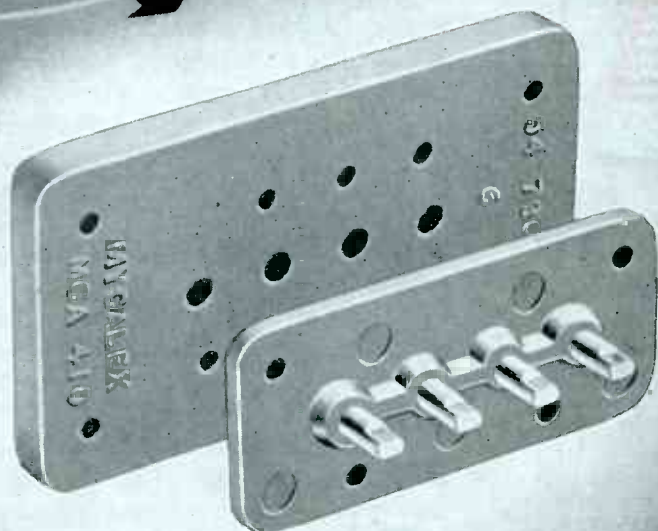
See why Leaders in

TELEVISION

choose

MYCALEX 410

insulation



In television seeing is believing . . . and big name makers of television sets are demonstrating by superior performance that MYCALEX 410 molded insulation contributes importantly to faithful television reception.

Stability in a television circuit is an absolute essential. In the station selector switch used in receivers of a leading manufacturer, the MYCALEX 410 molded parts (shown here) are used instead of inferior insulation in order to avoid drift in the natural frequency of the tuned circuits. The extremely low losses of MYCALEX at television frequencies and the stability of its properties over extremes in temperature and humidity result in dependability of performance which would otherwise be unattainable.

Whether in television, FM or other high frequency circuits, the most difficult insulating problems are being solved by MYCALEX 410 molded insulation . . . exclusive formulation and product of MYCALEX CORPORATION OF AMERICA. Our engineering staff is at your service.

Specify MYCALEX 410 for:

1. Low dielectric loss
2. High dielectric strength
3. High arc resistance
4. Stability over wide humidity and temperature changes
5. Resistance to high temperatures
6. Mechanical precision
7. Mechanical strength
8. Metal inserts molded in place
9. Minimum service expense
10. Cooperation of MYCALEX engineering staff

MYCALEX CORP. OF AMERICA

"Owners of 'MYCALEX' Patents"

Plant and General Offices, CLIFTON, N. J.

Executive Offices, 30 ROCKEFELLER PLAZA, NEW YORK 20, N. Y.

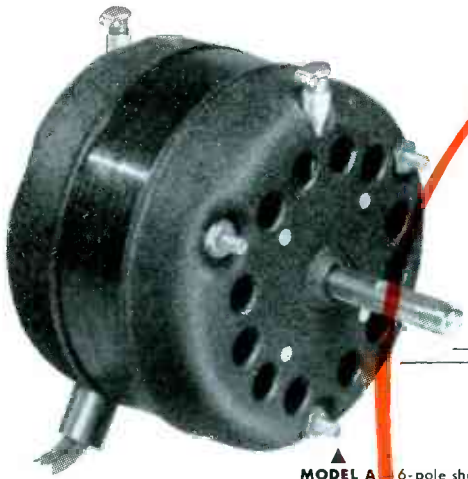


MAKE THINGS

GO!

with

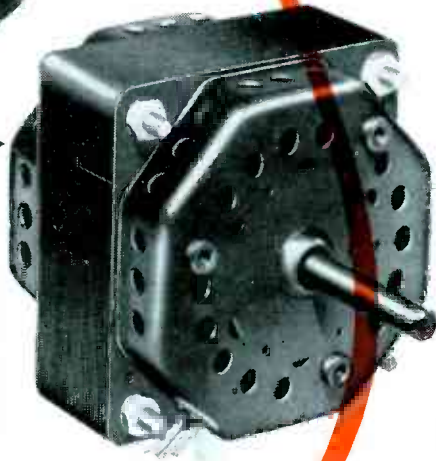
alliance motors



MODEL A—6-pole shaded pole induction motor • 60 and 50 cycles • Approx. 1000 R.P.M. full load speed • Size—4½" O.D. • Length—2¾" to 4¾" depending on variable stack length • Rated at approx. 1/30th h.p. • Comes semi-open or fully enclosed with or without oilers.



MODEL K—Used in all 25 cycle and some 50 and 60 cycle Alliance Phonomotors. This basic 2-pole induction type motor will adapt to any standard AC voltage or frequency. Develops up to 1/100 h.p. Drives the heavier type record changers, radio-phonograph turntables, tuning devices and operates many other controls and automatic devices.

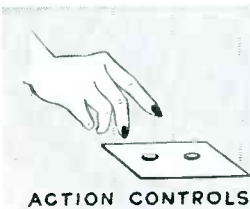


MODEL B—New type 4-pole shaded pole fan motor made in three standard lamination stack thicknesses. Power range is from 1/100th h.p. to 1/25th h.p. Size, 3¾" square. Especially adapted for fans, it will drive a wide variety of mechanical devices and is ideal for sound recorders. Full load speed 1550 R.P.M.—clockwise or counter clockwise rotation—not reversible. Made for 115 volts, 60 cycles—can be wound for 50 cycles and for other voltages.

Reliable, high-speed mass production of motors at low cost—that's the big job at Alliance! Makers of mass consumer products need Alliance motors for their small load tasks. Noted for long life, they are compact and light weight. Many weigh less than a pound! Power ratings range from less than 1/400th h.p. to 1/20th h.p. Some are uni-directional—others are reversible and can be made for continuous or intermittent duty.

Practical uses for Alliance motors are to power automatic controls, switches, valves, motion displays, movie projectors, vending and business machines, toys, record players, and radio tuning devices. The newer Alliance Model A and Model B motors are especially built for driving fan blades in air circulators, room heaters, hair dryers, coolers, and air conditioning appliances. Model B is also an excellent power source for sound recorders.

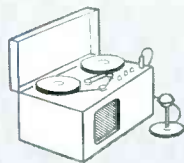
Alliance Motors pack more motion and automatic action into new products!



ACTION CONTROLS



AIR CIRCULATOR



SOUND RECORDERS



AIR CONDITIONER



BUSINESS MACHINES

WHEN YOU DESIGN—KEEP

alliance motors

IN MIND

ALLIANCE MANUFACTURING COMPANY • ALLIANCE, OHIO
Export Department: 401 Broadway, New York 13, N. Y., U. S. A.

ONE Button —

... clears every switch setting
... ready for the next tube test

Model 335 Plate Conductance Tube Tester

The Simpson Automatic Reset is just another of the practical refinements that make Simpson tube testers serve you better than other testers. When you finish a test, just press the Automatic Reset button and instantly all switches, both push button and rotary, return to normal. This not only saves time but prevents error due to previous settings being left in position at the beginning of the new test. The Reset mechanism, in whose design and tooling many thousands of dollars have been invested, is Simpson patented. No other switch control mechanism is so completely automatic.

Simpson Model 335 adds the Automatic Reset to its many other features. It tests tubes in percentages of rated plate conductance, also indicating that tube is good, fair, doubtful, or definitely bad. Only a few settings are necessary for the most complicated tube. Sockets for all types of tubes are provided, including the new 9-pin miniature; also the sub-miniature as used in hearing aids, etc.

For 105-130 volts, 50-60 cycle. Size: 15 1/2" x 9 1/2" x 6 1/4"
Dealer's Net Price, complete with 12-page Operator's Manual\$85.00



Model 340 SIGNAL GENERATOR— 75 Kilocycles to 120 Megacycles Fundamentals to 30 MC.

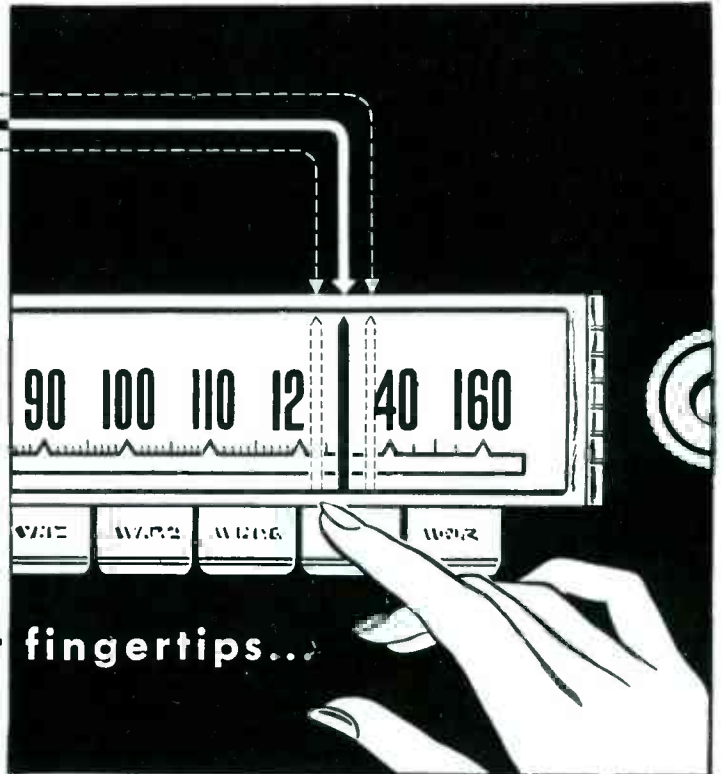
Electron coupled circuit assures extreme stability and output uniformity, throughout the band. Standard 30% modulation at 400 cycles. Coll. attenuator and signal selector individually shielded. Effective shielding throughout. Each coil individually calibrated to close tolerances against crystal standards by means of variable inductance and variable minimum capacitance. For 105-130 volts, 50-60 cycle. Size: 16" x 10" x 6".
Dealer's Net Price, complete with 44-page Operator's Manual\$69.85

Simpson

INSTRUMENTS THAT STAY ACCURATE

SIMPSON ELECTRIC COMPANY
5200-5218 W. Kinzie St., Chicago 44, Ill.





STRAIGHT LINE TRACKING at her fingertips...

A station comes in at the number it's supposed to . . . IF the tuner gives straight line tracking.

TO GET perfect tracking — straight line tracking — in your inductance tuners, the electrical characteristics of the cores have to be *uniform throughout the entire core-length*.

But a core can be no more uniform than the powder it's made of. That's why it's important to use the uniquely uniform G. A. & F. Carbonyl Iron Powder.

Made with great care — and by G. A. & F.'s exclusive, patented carbonyl process — G. A. & F. Carbonyl Iron Powders are uniform, not only within a batch, but from one batch to another. For example, the permeability of different batches over a period of years has been held *within plus or minus one percent*.

G. A. & F. Carbonyl Iron Powders for high frequency cores offer these advantages to the electronics industry:

1. When used at radio frequency, G. A. & F. Carbonyl Iron Powders are superior in coefficients of eddy current loss and residual loss. These low losses make for higher Q.
2. G. A. & F. Carbonyl Iron Powders stand alone

in co-efficients of magnetic and temperature stability.

3. In comparison with air-cored coils, G. A. & F. Carbonyl Iron Powder-cored coils permit savings in volume, weight, and wire-length, along with great increases in inductance and Q.

➔ Ask your core manufacturer for information about G.A.&F. Carbonyl Iron Powders. Or write direct to: Antara Products, 444 Madison Avenue, New York 22, N. Y. Dept. 52.

These unique properties tell why G. A. & F. Carbonyl Iron Powders are superior:

PROPERTY	ADVANTAGE
Spherical structure	Facilitates insulation and compacting
Concentric shell structure (some types only)	Low eddy current losses
High purity	Exceptional permeability and compressibility
Absence of non-ferrous metals	Absence of corresponding disturbing influences
Relative absence of internal stress; regular crystal structure	Low hysteresis loss
Spheres of small size	Low eddy current losses; usable for high frequencies
Variations of sphere size	Extremely close packing

G. A. & F. CARBONYL IRON POWDERS

An Antara® Product of General Aniline & Film Corporation

TO MEASURE...TO INDICATE...TO WARN...AT A DISTANCE

Bendix Pacific

Engineered

TELEMETERING



- ★ Flight Tested Components and Assemblies
- ★ Experienced Application Engineering
- ★ Component Field Testing



Complete 6-channel Telemetering System ready to install in vehicle.



Model TI-2 Accelerometer



TT-2 80 mc. f.m. transmitter



Installation Engineering



Mobile Receiving/Recording Station

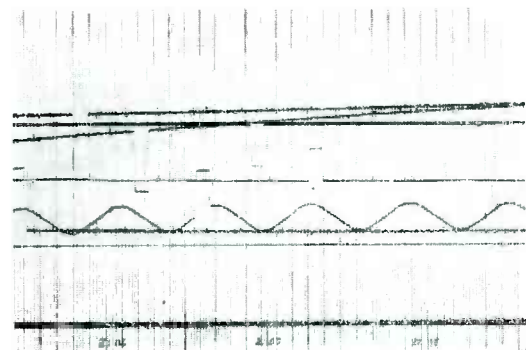
Bendix Pacific offers the aircraft industry the fully tested and approved FM/FM Subminiature Telemetering System.

Bendix-Pacific Telemetering is a practical engineering tool with reliability and performance that has been demonstrated in over 600 channels fired in nine different vehicles during the past two years. This unmatched record of experience has been accomplished with better than 90% performance on Army and Navy missiles and pilotless planes.

The complete Telemetering Service offered by Bendix-Pacific includes:

1. Application engineering to adapt the Bendix-Pacific System to each specific problem.
2. Standard and special FM/FM Subminiature components and assemblies.
3. Installation and calibration services.
4. Aircraft and missile antenna design and radiation analysis.
5. Flight testing, providing all ground station facilities and reduction and analysis of data.

Indicative of the engineering leadership which Bendix-Pacific has attained is the fact that a typical six-channel telemetering system complete with power supply weighs 12 pounds and occupies only 120 cubic inches. Inquiries from qualified companies and agencies for complete engineering data are invited.

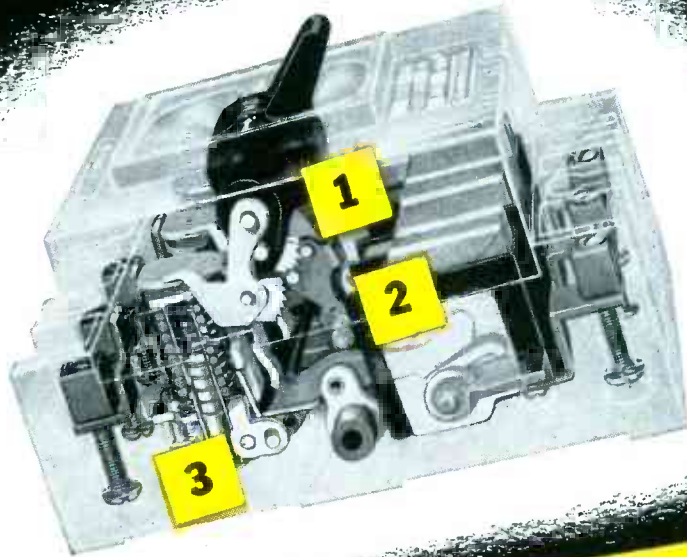


Data Reduction



East Coast Offices: 475 Fifth Ave., New York 17, N.Y.

3 UNIQUE ADVANTAGES OF THE **HEINEMANN** *MAGNETIC CIRCUIT BREAKER*



1 —HIGH SPEED LATCH

One of the fastest operating latch mechanisms known. It functions with minimum friction, opening the breaker with the least mechanical delay and independently of handle operation.

2 —MAGNETIC HIGH SPEED BLOWOUT

It adds speed to the arc interruption. Magnetic blowout contacts are mounted in individual arcing chambers carefully insulated from each other. As the value of the current to be interrupted increases, the quenching effect becomes greater due to the intensified magnetic blowout field.

3 —MAGNETIC-HYDRAULIC TIME DELAY

HEINEMANN Magnetic Circuit Breakers are available with any one of three different inverse time delays controlled by a hermetically sealed trip unit. The breaker acts instantly on excessive overload or short circuit, but is not affected by minor overloads or temporary inrush current.



HEINEMANN ELECTRIC COMPANY

97 PLUM STREET

TRENTON, N. J.

100 feet of film is a lot of film to handle . . .
 yet it's done conveniently with
DU MONT OSCILLOGRAPH-RECORD EQUIPMENT



◆ Film rolled on spools is easily inserted and removed when making oscillograms with Type 314 Oscillograph-record Camera. Up to 100 feet of 35-mm. film is readily accommodated by this camera designed for both single-frame and continuous-motion recording of oscillograph patterns.

CAT. NO. 1217-E (f/2.8 coated lens) \$ 980.00
 CAT. NO. 1366-E (f/1.5 coated lens) \$1,155.00

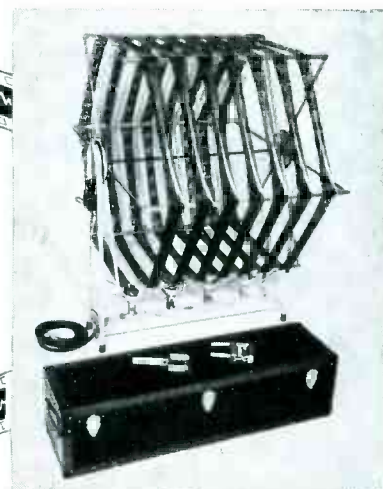


◆ And after exposing the film, the Type 2512 Motor-driven Processing Unit is available for developing the entire 100-foot roll with minimum of bother and without danger of scratching the emulsion. Merely insert film in processing unit and start the motor. Provision is made in this unit for adding and pouring off processing solutions.

CAT. NO. 1372 (115 volts 50-60 cps) \$231.00

◆ For utmost convenience in drying processed film, the Type 2514 Portable Drying Rack accommodates up to 200 feet of film at one time, automatically unwinding and rewinding the film during the drying process. For maximum convenience, the unit is folded when not in use. A carrying case is provided.

CAT. NO. 1375 (115 volts 50-60 cps) \$232.00



◆ **DU MONT CATALOG SENT ON REQUEST**

© ALLEN B. DU MONT LABORATORIES, INC.

DU MONT

Precision Electronics & Television

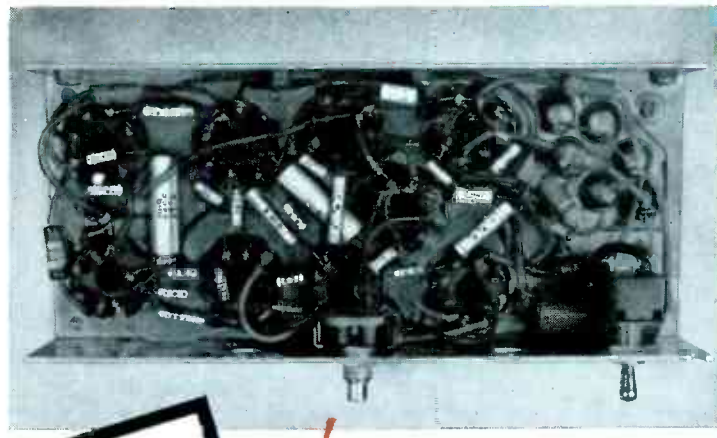
ALLEN B. DU MONT LABORATORIES, INC., PASSAIC, NEW JERSEY • CABLE ADDRESS: ALBEEDU, PASSAIC, N. J., U. S. A.

Specify
for



COMPONENTS

MINIATURIZATION

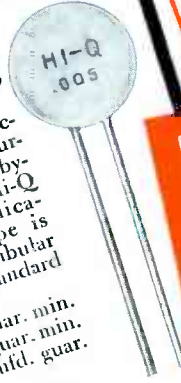


HI-Q MINIATURE G. P. TUBULARS



G. P. Miniatures providing capacities from 5 mmf to 33,000 mmf will cover the majority of your by-passing problems. By the use of our new body 41 the above extended capacity ranges are now available. These smaller units provide closer coupling of leads thus insuring the minimum of inductance and highest self resonant frequencies.
Illustration at left is actual size.

HI-Q DISK CAPACITORS



BPD Another example of accurate and dependable miniaturization is this high dielectric by-pass, blocking or coupling Hi-Q Disk Capacitor. Many applications where physical shape is more adaptable than the tubular unit. Available in two standard capacities:
Type BPD-5: .005 mfd guar. min.
Type BPD-10: .01 mfd. guar. min.
Type BPD-1.5: .0015 mfd. guar. min.
Illustration at right is actual size.

FOR superior performance in a limited space, the utilitarian compactness of **HI-Q** components is sure to meet your enthusiastic approval. Although **HI-Q** components are compact, there is no sacrifice of accuracy, dependability or uniformity. Each component meets or surpasses rigid standards for capacity, tolerance and performance. This compactness is accomplished through application of up-to-the-minute processing techniques, combined with use of highest quality materials and complete control of quality throughout all stages of manufacture. Specify **HI-Q** for maximum efficiency in a minimum amount of space.

**HI-Q COMPONENTS
BETTER 4 WAYS**

- PRECISION** Tested step by step from raw material to finished product. Accuracy guaranteed to your specified tolerance.
- UNIFORMITY** Constancy of quality is maintained over entire production through continuous manufacturing controls.
- DEPENDABILITY** Interpret this factor in terms of your customers' satisfaction . . . Year after year of trouble-free performance. Our Hi-Q makes your product better.
- MINIATURIZATION** The smallest **BIG VALUE** components in the business make possible space saving factors which reduce your production costs . . . increase your profits.

HI-Q

Electrical Reactance Corp.

FRANKLINVILLE, N. Y.

Plants: FRANKLINVILLE, N. Y.—JESSUP, PA.

Sales Offices: NEW YORK, PHILADELPHIA, DETROIT, CHICAGO, LOS ANGELES

**THERE'S PROFIT FOR YOU IN
THE TIME AND MONEY-SAVING QUALITIES OF**

ARNOLD

PERMANENT MAGNETS



Several avenues of profit are open to you in Arnold Permanent Magnets. You can improve the performance and overall efficiency of equipment. You can increase production speed, and in many cases reduce both weight and size. And most important, you can maintain these advantages over any length of production run or period of time, because Arnold Permanent Magnets are completely quality-controlled through *every* step of manufacture—from the design board to final test and assembly. You'll find them unvaryingly uniform and reliable in every magnetic and physical sense.

It's our job to help you discover and then fully attain these benefits. Arnold Products are available in all Alnico grades and other types of magnetic materials—in cast or sintered forms, and in any size or shape required. Our engineers are at your command—check with our Chicago headquarters, or with any Allegheny Ludlum branch office.

W&D 1298



THE ARNOLD ENGINEERING CO.

Subsidiary of **ALLEGHENY LUDLUM STEEL CORPORATION**

147 East Ontario Street, Chicago 11, Illinois

Specialists and Leaders in the Design, Engineering and Manufacture of PERMANENT MAGNETS

NEW GL-5544 THYRATRON

Serves longer in motor-control work!



"GENEROUS GAS CHARGE
OFFSETS 'CLEAN-UP' LOSS
— GREATLY INCREASES
PERFORMANCE LIFE."



SOMEWHAT smaller than its well-known companion tube, the GL-5545, and with half the current capacity—otherwise identical in design—this new General Electric thyatron has the same precision and dependability, the same extended service life.

Anode gas absorption, so prevalent in tubes in motor-control circuits and a prime factor in reducing length of tube service, meets its match in the larger inert-gas content of the GL-5544, which is twice that of former types. Consequently, no snubber circuit is required for most motor-control applications, saving substantially in installation and power costs.

Teamed with this advantage are new design characteristics that make possible improved performance all along the line. Check the GL-5544's operating features listed at the right; study the tube's high ratings. Then add top-to-bottom *sturdiness*, with strongly braced internal structure and a wide, heavy-duty base.

Your next motor-control circuit... before your designers get to work on it, *call in a G-E tube engineer* to discuss applying this fine new thyatron for greater efficiency! Wire or write your nearby G-E electronics office, or *Electronics Department, General Electric Company, Schenectady 5, New York.*

3.2-AMP TUBE WITH THESE PLUS FEATURES

- High peak voltage
- High peak-to-average current ratio
- Stable control characteristics
- Short heating time
- "Climate-proof" ambient temperature range

Filament voltage	2.5 v
Filament current	12 amp
Peak anode voltage, forward and inverse	1,500 v
Peak cathode current	40 amp
Avg cathode current	3.2 amp
Current averaging time	15 sec
Ambient temp range	-55 to +70C

GENERAL  ELECTRIC

161-027-0050

FIRST AND GREATEST NAME IN ELECTRONICS



A TOUGH ASSIGNMENT

Down in the tropics that blazing equatorial sun and that dripping jungle humidity promise a short life for the average transmitter... but this is just the type of assignment that Aerocom's tropicalized communications equipment takes right in stride... You can depend on it to give long, trouble free, economical service.

If yours is a tough communications assignment, Aerocom invites your inquiry.

Model 12ACX-2A

The model illustrated is a dual channel crystal controlled radio telegraph transmitter rated at one Kilowatt carrier. Frequency Range from 1.6 to 24 Megacycles. The design stresses reliability, low operation and maintenance costs, and operation in unattended service under most adverse climatic conditions. Accessory unit; High Level Modulator Model GM8 providing telephone operation with carrier power of 750 Watts. Other units: Models VH-50 and VH-200 transmitters, operating range, 118-165 Mcs. (crystal controlled) carrier power 50 and 200 Watts respectively, (A-3, AM.).

**COMPLETE ENGINEERING
DATA ON REQUEST.**

CONSULTANTS, DESIGNERS AND MANUFACTURERS OF
STANDARD OR SPECIAL ELECTRONIC, METEOROLOGICAL
AND COMMUNICATIONS EQUIPMENT.

AER - O - COM
(Reg. U. S. Pat. Off.)

AERONAUTICAL COMMUNICATIONS EQUIPMENT, INC.
3090 Douglas Road, Miami 33, Florida

Dealers: Equipeleto, Ltda., Caixa Postal 1925, Rio de Janeiro, Brasil ★ Henry Neuman, Jr., Apartado Aereo 138, Barranquilla, Colombia

For Broadcast Quality it's..



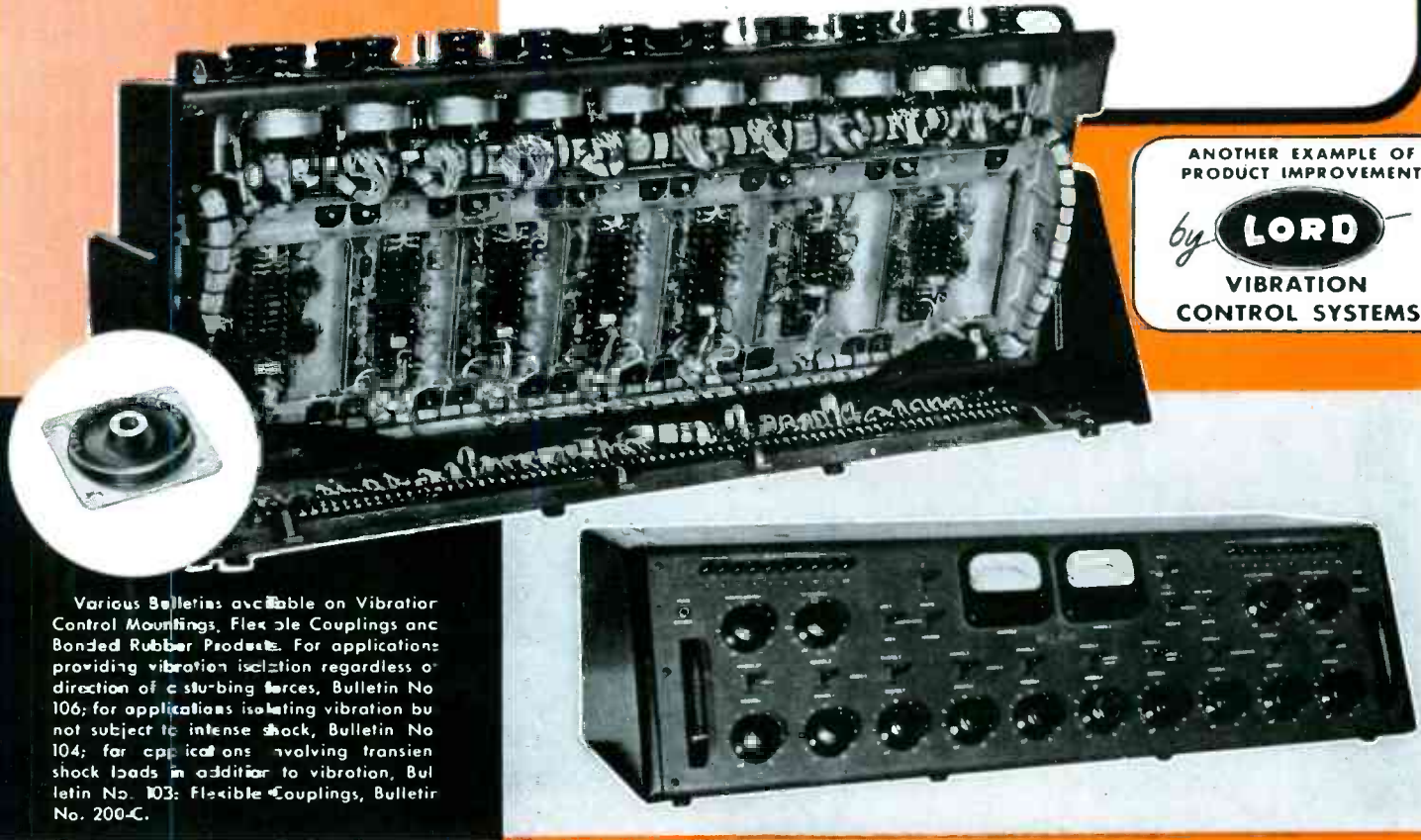
and that
Quality is
helped by a

LORD VIBRATION CONTROL SYSTEM

High fidelity audio frequency electronic equipment must be isolated from vibration and shock. Many manufacturers of such delicate equipment have found in Lord Vibration Control Systems the answer to the problem of providing efficient vibration isolation and control.

Collins Radio Company adds further testimony in the selection of a Lord Vibration Control System for its 212A-1 Broadcast Station Speech Input Console. Twenty-eight Lord Standard Square Plate Form Mountings are used to mount each amplifier stage individually, thus preventing mechanical interaction between stages and lessening acoustical feed-back effects.

It will pay you to consult Lord—Vibration Control Headquarters. Your product's sales can be increased, its service improved, its life lengthened, by a Lord Vibration Control System.



ANOTHER EXAMPLE OF
PRODUCT IMPROVEMENT

by **LORD**
VIBRATION
CONTROL SYSTEMS

Various Bulletins available on Vibration Control Mountings, Flexible Couplings and Bonded Rubber Products. For applications providing vibration isolation regardless of direction of disturbing forces, Bulletin No 106; for applications isolating vibration but not subject to intense shock, Bulletin No 104; for applications involving transient shock loads in addition to vibration, Bulletin No. 103; Flexible Couplings, Bulletin No. 200-C.

MAKE GOOD PRODUCTS BETTER

with *Vibration Control*

LORD MANUFACTURING CO. • ERIE, PA.

Field Offices: Detroit • Chicago • New York • Washington, D.C. • Providence, R.I.

Burbank, Cal. • Philadelphia, Pa. Canadian Representative: Railway & Power Engineering Corp., Ltd.



STUPAKOFF

KOVAR-GLASS TERMINALS

Give Permanent....

Hermetic....Pressure-tight Seals

Stupakoff hermetic seals are the answer where products must have permanently vacuum- and pressure-tight insulated electrical lead-ins. They seal against atmosphere, dirt, dust, fungus, and other foreign substances that normally cause failures.

Available from stock or specially made to suit your needs, Stupakoff metal-glass seals can be supplied

with single or multiple, hollow or solid electrodes.

The metal Kovar is available in sheets, rod, wire, tubing and special shapes for manufacturers having glass working facilities.

We will gladly send literature, recommendations and prices on your hermetic seal requirements. Write today.



Write for literature.

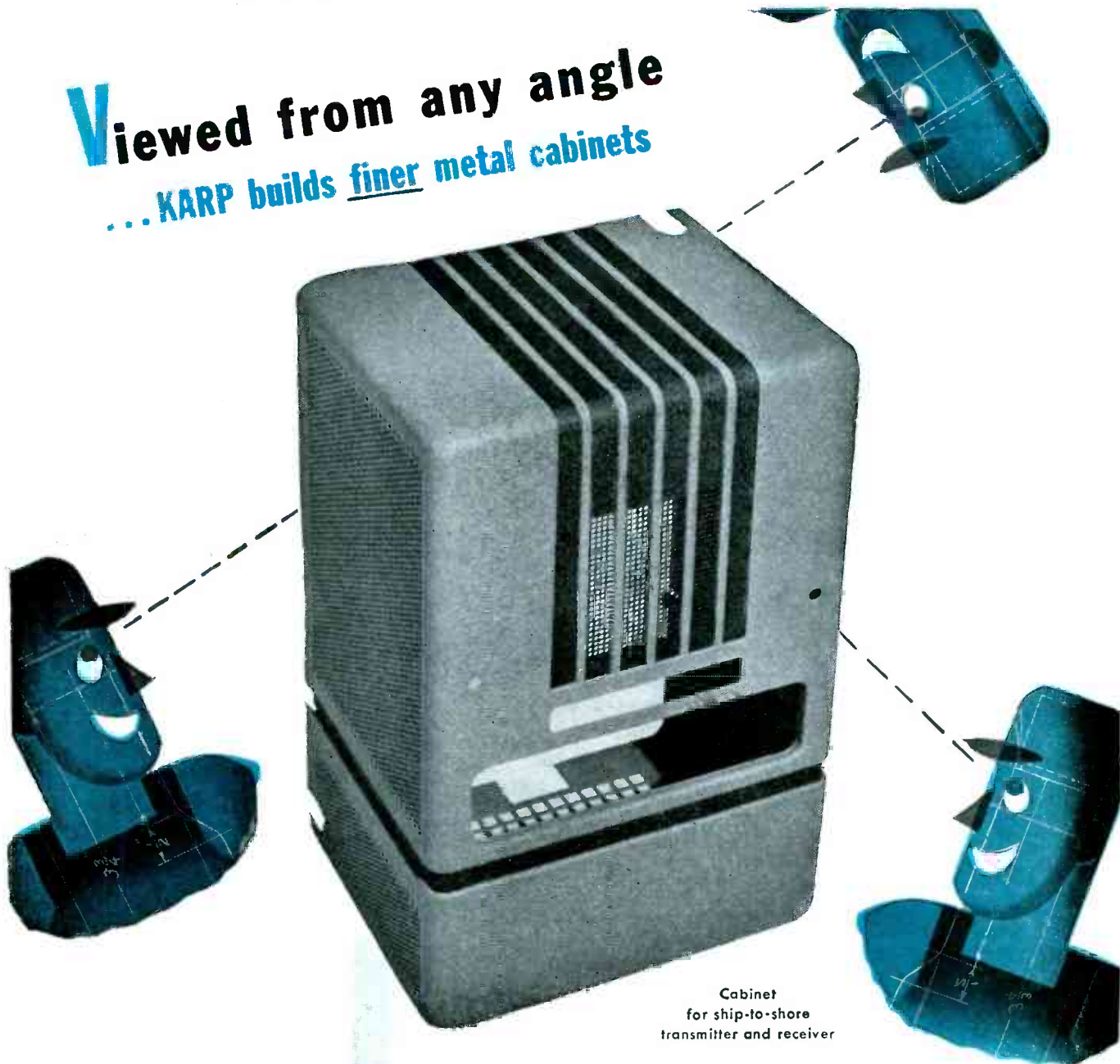


STUPAKOFF

CERAMIC AND MANUFACTURING CO.

LATROBE, PENNSYLVANIA
Cable Address: Stupakoff, Latrobe, Pa.

Viewed from any angle
...KARP builds finer metal cabinets



Cabinet
for ship-to-shore
transmitter and receiver

No matter how you look at it, you'll find many reasons why Karp-built cabinets, housings and enclosures will add value to completed equipment assemblies.

We will follow your designs with fidelity, or our design specialists can suggest design ideas which will enhance appearance, achieve ruggedness, save space or weight. Our work insures uniformity and accuracy—which mean production economy both in the fabrication and in your own assembling operations.

At your service is our staff's combined "know-how" gained in 23 years of specialization. Our tool and die

department is so complete that we often save customers special die costs. We make our own dies and do all our own finishing. We do all kinds of welding—including spot-welding of aluminum with electronic timing controls.

It's the hard-to-do type of craftsmanship that brings out the best in our trained minds and skilled hands. We invite your inquiries on any sheet metal fabrication.

Any Metal • Any Gauge • Any Size
Any Quantity • Any Finish

KARP METAL PRODUCTS CO., INC.

124 - 30th STREET, BROOKLYN 32, NEW YORK

Custom Craftsmen in Sheet Metal

New Proof of Wilco Versatility

Wilco Thermometals regulate heat in 5 famous Automatic Toasters . . . each with individual heat control requirements

29 WILCO THERMOMETALS MEET ALL BIMETAL APPLICATIONS

Each of the five famous brands of electric toasters mentioned is an *individualized* product with exclusive features of design and operation. In the versatile line of 29 Wilco Thermometals (Thermostatic Bimetals), each toaster manufacturer found one that met his heat regulator requirements *precisely*.

Wilco Thermometals are designed for a wide variety of bimetal applications including . . . Heat regulation (automatic toaster) . . . Temperature indication (thermometer) . . . Temperature Control (room thermostat or hot water heater) . . . Temperature Compensation (voltage regulators and various other instruments) . . . Control of a Function with temperature change over a range of temperatures or by auxiliary heating of the Thermometal.

Wilco Thermometals have the *adaptability* to meet every condition of bimetal application . . . the *quality* to meet the highest standards of *precision* performance . . . plus *availability* in every desirable shape.

Whatever your requirements for Wilco Thermometals, Wilco engineers will gladly help you meet them successfully.

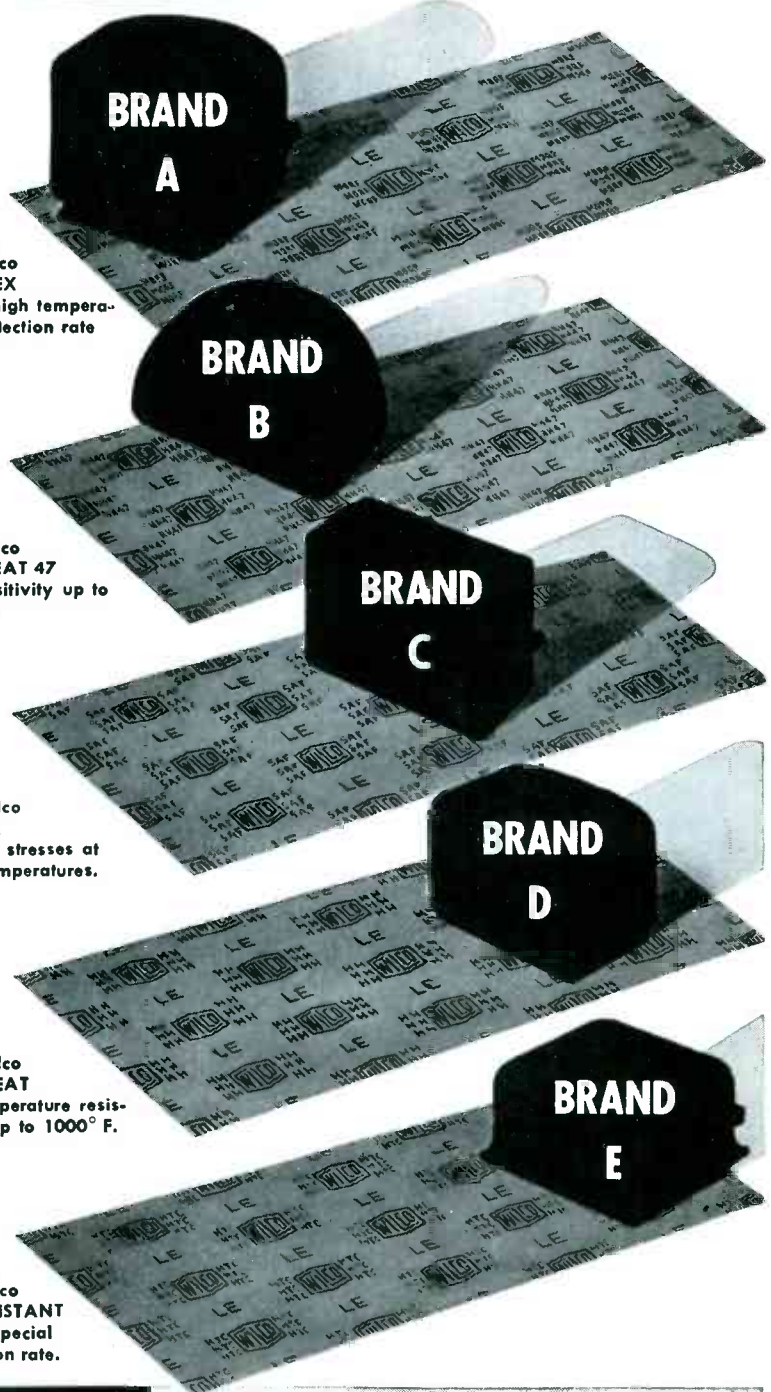
uses Wilco MORFLEX for its high temperature deflection rate

uses Wilco HIGHHEAT 47 for sensitivity up to 600° F.

uses Wilco SAFLEX for low stresses at high temperatures.

uses Wilco HIGHHEAT for temperature resistance up to 1000° F.

uses Wilco HT CONSTANT for its special deflection rate.



THE H. A. WILSON COMPANY
105 CHESTNUT STREET, NEWARK 5, NEW JERSEY
Branch Offices: Chicago, Detroit, Los Angeles, Providence



SPECIALISTS FOR 34 YEARS IN THE MANUFACTURE OF THERMOMETALS - ELECTRICAL CONTACTS - PRECIOUS METAL BIMETALLIC PRODUCTS AND SPECIAL ALLOYS

WILCO PRODUCTS INCLUDE:

THERMOSTATIC BIMETALS All temperature ranges, deflection rates and electrical resistivities. **ELECTRICAL CONTACTS** Silver—Platinum—Tungsten—Alloys—Sintered Powder Metal. **SILVER CLAD STEEL** For industrial use. **NI-SPAN C*** Constant Modulus Alloy; also low and high expanding Ni-Span Alloys. **JACKETED WIRE** Silver on Steel, Copper, Invar and many other combinations. **SPECIAL ALLOYS** Including high conductivity, high strength, Copper Alloys. **ROLLED GOLD PLATE AND GOLD FILLED WIRE.**

*Reg. Trade Mark, The International Nickel Co., Inc.

Explosion-Proof Power for a Niagara of Gasoline



Leland Polyphase Integral
Horse Power Fan-Cooled
Explosion-Proof Motor



SURE—in hazardous locations. Leland explosion-proof motors are approved for use in atmospheres containing gasoline, common petroleum, ethyl and methyl alcohol, acetone, and lacquer solvent vapors. (Underwriters' Listing—Class 1, Group D.)



QUET! Exceptionally close tolerances eliminate vibration, prolong motor life. Engineered throughout for smooth, silent operation under most exacting conditions.



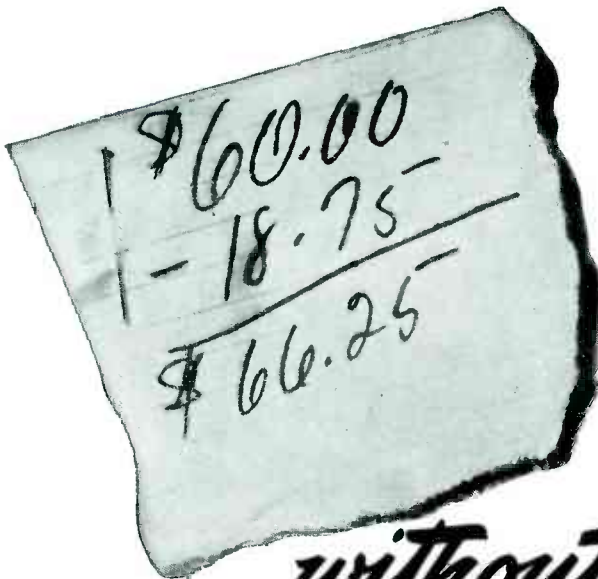
SELECTION! 1/6 to 5 HP. Types—Single Phase (Repulsion start, Induction Run and Repulsion Induction); Polyphase Direct Current. Open, enclosed, explosion-proof; sleeve and ball bearing; horizontal and vertical.

FROM THE TIME oil is brought from the depths, through refinery, transport, bulk plant and service station, motors keep it on the move till it leaves the nozzle for the tank. All along this hazardous route, explosion-proof motors justify in safety the standards set for them. Leland motors have won acclaim in these exacting explosion-proof applications—yet, since developing the first explosion-proof gasoline dispensing pump motor with Underwriters' Listing, Leland has far outsold the rest of the field combined. Other Leland motors of all types—built to the same exacting standards—command in industrial applications of all kinds an established user loyalty that *helps you sell*. Specify Leland for HP per cubic inch as high as any—for HP per pound higher than most.

**THE LELAND ELECTRIC COMPANY, DAYTON 1, OHIO, and
LELAND ELECTRIC CANADA, LTD., GUELPH, ONTARIO • Branches in all Principal Cities.**

LELAND MOTORS

MOTORS OF ALL TYPES—ENGINEERED TO INDUSTRY'S SPECIFIC NEEDS



How 19,000 companies up take-home pay *without upping payrolls*

Can you deduct \$18.75 from \$60.00 and get \$66.25? Yes. And the way you can do it is mighty important to your company—and to the nation!

You start with \$60, representing someone's weekly take-home pay. You deduct \$18.75 for the purchase of a U.S. Savings Bond. That leaves \$41.25. But \$41.25 isn't what the worker takes home. He takes home \$41.25 *plus a \$25 Savings Bond*. Total (assuming he holds the Bond till maturity): \$66.25.

WHAT 19,000 COMPANIES HAVE LEARNED

In the 19,000 companies that are operating the Payroll Savings Plan for the regular purchase of Savings Bonds, employees have been more contented in their jobs—absenteeism has decreased—even accidents have been fewer!

Those are the "company" benefits the Plan provides, in addition to extra security for individual employees.

But the Plan has other, far-reaching benefits of basic importance to both your business and the national economy...

SPREADING THE NATIONAL DEBT HELPS SECURE YOUR FUTURE

The future of your business is closely dependent upon the future economy of your country. To a major extent, that future depends upon management of the public debt. Distribution of the debt as widely as possible among the people of the nation will result in the greatest good for all.

How that works is clearly and briefly described in the free brochure shown at the right. Request your copy—*today*—from your State Director of the U. S. Treasury Department's Savings Bonds Division.

ACTION BY TOP MANAGEMENT NEEDED

The benefits of regular Bond-buying are as important today as ever—but war-time emotional appeals are gone. Sponsorship of the Payroll Savings Plan by a responsible executive in your company is necessary to keep its benefits *advertised to your employees*.

Banks don't sell Savings Bonds on the "installment plan"—which is the way most workers prefer to buy them. *Such workers want and need the Payroll Savings Plan.*

Those are the reasons why it's important to make sure that the Plan is adequately maintained in your company.

The State Director will gladly give you any assistance you wish.

"The National Debt and You,"

a 12-page pocket-size brochure, expresses the views of W. Randolph Burgess, Vice Chairman of the Board of the National City Bank of New York—and of Clarence Francis, Chairman of the Board, General Foods Corporation. Be sure to get your copy from the Treasury Department's State Director, Savings Bonds Division.



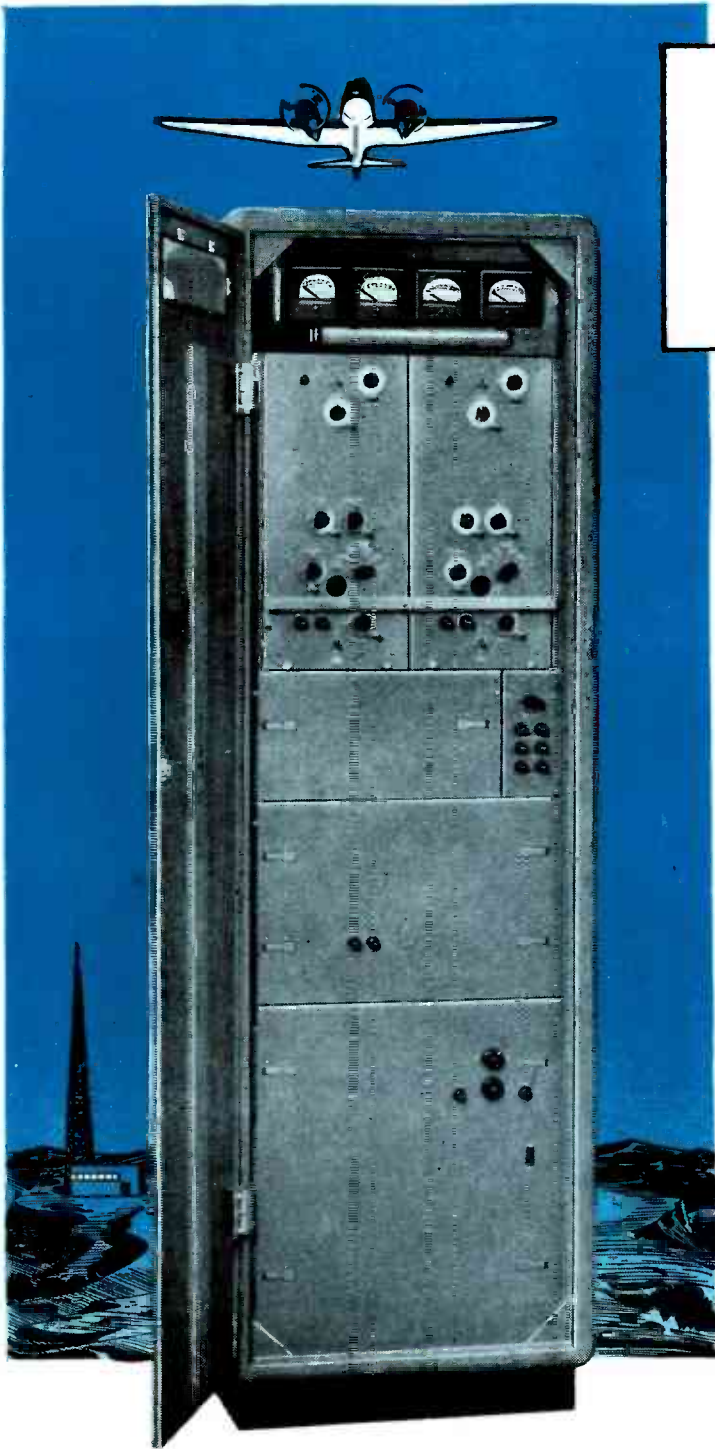
The Treasury Department acknowledges with appreciation the publication of this message by

ELECTRONICS

This is an official U. S. Treasury advertisement prepared under the auspices of the Treasury Department and the Advertising Council



NEW FLEXIBILITY IN GROUND-TO-AIR COMMUNICATION



ONE UNIT PROVIDES
TWO CHANNELS on any of
THREE FREQUENCY BANDS

It's FEDERAL'S New Radio Transmitter 186-A

With this one Federal transmitter, you can get *dependable* ground-to-air communication, over two separate channels in the LF, HF or VHF bands. As the radio-frequency units are completely self-contained and operate independently, the two channels can be on the same or *different* frequency bands.

Interchangeable unit construction permits RF units, modulator, keyer, and power supply to be removed and replaced individually for faster, more economical maintenance. At unattended installations, an emergency control unit can be provided, so that in the event of tube failure, a stand-by RF unit will be automatically put into operation.

Write Federal today for detailed specifications. Dept. A613.

DATA

FTR-186-A GROUND-STATION TRANSMITTER

Complete transmitter includes two RF units, one Audio Amplifier, and one Power Supply.

RF UNITS

- 101-A ... HF, 2.0-20.0 MC-500 Watts, CW and Phone
- 102-A ... VHF, 108-140 MC-200 Watts, Phone
- 103-A ... LF, 200-540 KC-400 Watts, CW and Phone

AUDIO AMPLIFIER

- 136-A ... Provides voice modulation of any one RF unit at full rated output.

POWER SUPPLY

- 125-A ... Provides power for simultaneous operation of 2 RF units on CW or 1 RF unit on CW and 1 RF unit on phone.

Equipment operates from 220-volt, 50-60 cycle, single-phase power source, with 95% power factor.

Overall cabinet dimensions — 74" high, 22" wide, 28½" deep.



An IT&T Associate

Federal Telephone and Radio Corporation

100 KINGSLAND ROAD, CLIFTON, NEW JERSEY

In Canada:—Federal Electric Manufacturing Company, Ltd., Montreal, P. Q.
Export Distributors:—International Standard Electric Corp. 67 Broad St., N. Y.

KEEPING FEDERAL YEARS AHEAD... is IT&T's world-wide research and engineering organization, of which the Federal telecommunication laboratories, Nutley, N. J., is a unit.

A MINIMUM OF OPERATIONS MADE THESE CONNECTORS



THESE electrical connectors are but a few out of the hundreds of types being made today out of Revere copper and copper alloy tube, strip and rod.

Soldering lugs are made of Revere seamless tube, and are finished by simple stamping and punching. Solderless connectors are manufactured of tube, strip, bar and rod. The easy workability of the metal, plus the fact that it is supplied in forms requiring a minimum of operations, make Revere a favorite source of supply.

Other Revere products for electrical purposes include: Electrolytic and silver bearing copper commutator bar and segments; O.F.H.C., silver bearing, and electrolytic copper for armatures and rotors of micromotors and fractional h-p motors; Specially Prepared Switch Copper for switches, bus bars and similar applications; Extruded copper shapes for contacts, contact arms, solderless connectors, etc.,

Free Cutting Rod for parts machined to close tolerances; Tubular rivet wire.

The Revere Technical Advisory Service will gladly work with you in studying your requirements and determining the Revere mill products that lend themselves to the most economical manufacture and best service.

REVERE

COPPER AND BRASS INCORPORATED

Founded by Paul Revere in 1801

230 Park Avenue, New York 17, New York

Mills: Baltimore, Md.; Chicago, Ill.; Detroit, Mich.; New Bedford, Mass.; Rome, N. Y. — Sales Offices in Principal Cities, Distributors Everywhere

NOW!

A GREAT NEW **hp** OSCILLATOR FOR THE LOW-FREQUENCY FIELD

1/2 to 1000 CYCLES



-hp- 202B LOW-FREQUENCY OSCILLATOR

Now, for the first time in history, you can make low frequency measurements with all the precision and stability associated with audio frequency work. This great new *-hp-* oscillator blankets the low-frequency spectrum from 1/2 to 1000 cps. Throughout this range it provides better wave form, higher stability and greater measuring accuracy than any comparable in-

strument ever manufactured for industrial, field or laboratory use.

Compact, sturdy, easy-to-operate, this *-hp-* 202B spans the low-frequency band in 4 ranges. Frequency is read on a large, illuminated dial, which is controlled by a direct or a 6 to 1 vernier drive. Frequency stability is within $\pm 5\%$, including initial warm-up drift. Output is 10 volts maximum into a 1000 ohm resistive load.

The rugged practicality, low cost and unusual versatility of this brand new *-hp-* oscillator make it an essential instrument for any operation involving low frequency work. The *-hp-* 202B is ready for early shipment. Write or wire for full information.

HEWLETT-PACKARD COMPANY
1470A Page Mill Road • Palo Alto, California

This *-hp-* 202B gives maximum speed and accuracy for these important tests

Vibration or stability characteristics of mechanical systems

Electrical simulation of mechanical phenomena

Electro-cardiograph and electro-encephalograph performance

Vibration checks of aircraft structural components

Checking geophysical prospecting equipment

Response of seismographs

SPECIFICATIONS

FREQUENCY RANGE: 1/2 cps to 1000 cps in 4 ranges

Range	Frequency
A	1/2 - 1 cps
X1	1 - 10 cps
X10	10 - 100 cps
X100	100 - 1000 cps

FREQUENCY DIAL: 6" diameter. Reads directly in cps for two lower ranges. Dial is back of panel, illuminated, and is controlled by direct drive as well as a 6 to 1 vernier.

ACCURACY OF CALIBRATIONS: $\pm 2\%$

FREQUENCY STABILITY: $\pm 5\%$ under normal temperature conditions (including warm-up drift). Less than $\pm 1\%$ for power voltage changes of $\pm 10\%$.

OUTPUT: 10 volts into a 1000 ohm resistive load over the entire frequency range. Internal impedance approximately 25 ohms at 10 cps.

FREQUENCY RESPONSE: ± 1 db 10-1000 cps
 ± 2 db 1-1000 cps

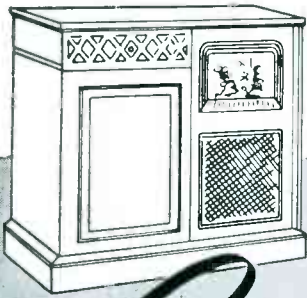
DISTORTION: Less than 1% total distortion 1 cps to 1000 cps.

HUM VOLTAGE: Less than 0.1% of rated output voltage.

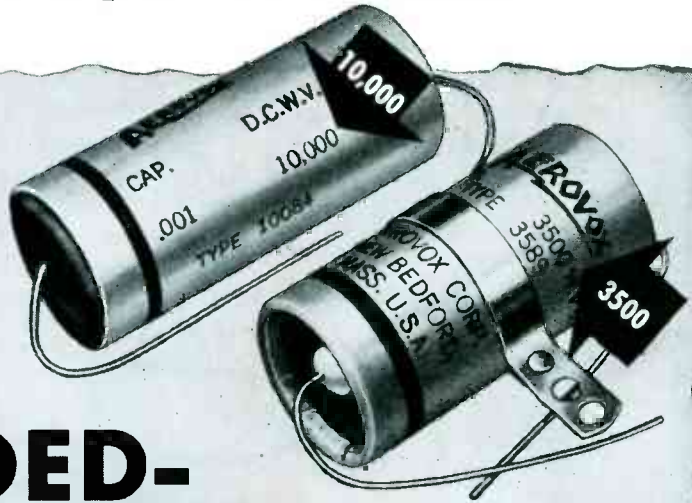


- | | | |
|--------------------------------|-------------------------|------------------------|
| Noise and Distortion Analyzers | Wave Analyzers | Frequency Meters |
| Audio Frequency Oscillators | Audio Signal Generators | Vacuum Tube Voltmeters |
| Amplifiers | Power Supplies | UHF Signal Generators |
| Square Wave Generators | Frequency Standards | Electronic Tachometers |
| | | Attenuators |

And now — Kilovolt ratings matching the elevated peaks and transients of television and other cathode-ray tube circuits . . .



Typical high-voltage ratings—
Series "84" tubular paper capacitor rated at 10,000 volts DCW, and Series "89" midget oil-filled tubular rated at 3500.



Aerovox

**EXPANDED-
VOLTAGE RANGE**

Capacitors



Series "14" oil-filled capacitor, usually with single pillar terminal, now available in double-ended design for maximum insulation at higher potentials. This and the popular Series "12" double-pillar ribbed-cap oil capacitor, are available in voltage ratings up to 10,000 volts DCW.

• Before and since the advent of the first practical television receiver in 1939, Aerovox capacitors have marched along with the television pioneers.

Inherent Aerovox quality, PLUS Aerovox extra-generous safety factor, has successfully met the surges and transients, the heat and the humidity, and the other trying conditions of the twilight zone of television development. And that goes likewise for the severe service requirements of cathode-ray

oscillography.

With larger and more brilliant screen images calling for still higher working voltages, Aerovox is again ready with expanded voltage ratings. The Series "84" paper tubulars, the Series "89" midget oil capacitors, the Series "14" and other can-type oil capacitors are now available in higher voltage ratings to meet post-war television, oscillograph and other electronic needs.

• *Submit your higher-voltage circuits and constants for our engineering collaboration, specifications, quotations. Literature on request.*



FOR RADIO-ELECTRONIC AND INDUSTRIAL APPLICATIONS

AEROVOX CORPORATION, NEW BEDFORD, MASS., U.S.A.

SALES OFFICES IN ALL PRINCIPAL CITIES • Export: 13 E. 40th St., NEW YORK 16, N. Y.

Cable: 'ARLAB' • In Canada: AEROVOX CANADA LTD., HAMILTON, ONT.

URANIUM
U-235

detector employs
NICHROME V* exclusively



60° Mass Spectrometer Tube



Ionization Source



Mass Spectrometer—Model M60
(Process & Instruments,
Brooklyn, N. Y.)

THE Mass Spectrometer, which has played vital roles in the discovery of U-235 and its subsequent applications in fields of atomic energy and cancer research, is one of the most important measuring instruments of the modern age. Its ability to crack molecules and then sort them according to mass makes it unique for analytical purposes.

Materials entering into its construction must be superlatively stable, assuring the highest degree of accuracy at all times, and retain their characteristics unflinchingly throughout a long life of trouble-free service.

Specifications for the metal used in the Ionization Source and Collector System typify the super-critical requirements that have to be met. The metal must be:

- (a) non-magnetic (i.e. remain unmagnetized in the presence of the powerful magnet used in the Mass Spectrometer);
- (b) able to withstand temperatures of approximately 665°F. in a vacuum of 10^{-7} mm. mercury *without deformation or evaporation*;
- (c) non-porous, and non-absorbent of gases;
- (d) easily machined, drilled, tapped, threaded, and spot welded;
- (e) available in wire, sheet and rod forms.

"Of all available metals" states Process & Instruments Inc., of Brooklyn, N. Y., makers of Mass Spectrometers, "Nichrome V most satisfactorily meets all these requirements and hence, with the exception of the tungsten filament, is exclusively used by us in the construction of the Mass Spectrometer. In addition, a Nichrome heating element is used for outgassing the Spectrometer Tube of absorbed moisture".

If you have particularly exacting specifications to meet, consult with us. There are more than 80 Driver-Harris alloys specifically designed to fill the requirements of the Electrical and Electronic Industries. The fruits of our 48 years of specialized research experience are at your service.

Exclusive Manufacturers of Nichrome

Driver-Harris Company

HARRISON, NEW JERSEY

BRANCHES: Chicago, Detroit, Cleveland, Los Angeles, San Francisco, Seattle
Manufactured and sold in Canada by
The B. GREENING WIRE COMPANY, LTD., Hamilton, Ontario, Canada



*T.M. Reg. U. S. Pat. Off.

For greater brilliance and greater DEFLECTION SENSITIVITY—



CHARACTERISTICS . . .

Deflection and Focus Electrostatic
 Screen: Choice of P1, P2, P4, P7
 and P11 Screens

RATINGS:

Heater Voltage 6.3 a.c. or d.c.
 Current 0.6 ampere
 Anode #3 (Intensifier) 4400 volts max.
 Anode #2 (Accelerating) 2200 volts max.
 Anode #1 (Focusing) 1100 volts max.
 Grid (Control Voltage) Never Positive
 Peak Voltage between Accelerating
 Electrode and Any Deflecting
 Electrode 550 volts max.
 Grid Circuit Resistance 1.5 meg. max.
 Impedance of Any Deflecting
 Electrode Circuit at Heater Supply
 Frequency 1.0 meg. max.
 E_{b3}/E_{b2} Ratio 2.3 max.

MECHANICAL CHARACTERISTICS:

Overall Length 10"
 Maximum Diameter 3"
 Base Med. 12-pin diheptal

Here's the logical successor to the wartime Types 3BP and 3FP, combining the high deflection sensitivity of the 3BP with the higher operating voltage and brightness of the 3FP. Thus, it is the ideal tube for test equipment which is operated under high ambient light.

The new DuMont Type 3JP is designed for oscillographic and other applications requiring a small, short tube with very high light output and high deflection sensitivity. The focusing electrode current under operating conditions is negligible, thereby simplifying bleeder design. The 2" dia. neck and diheptal base provide adequate insulation between electrode leads for high-altitude insulation.

For applications where deflecting voltages are under suitable control, the 3JP is directly interchangeable with the 3FP. Equipment using the 3BP may be readily adapted to use the 3JP by providing for connecting the intensifier electrode of the 3JP either to the second anode potential or to a higher potential than the second anode. Due to the higher deflection sensitivity, the 3JP can be utilized with intensifier potential equal to twice the second anode potential without reduction in sensitivity, as compared with the 3BP operating with the same second anode potential.

◆ TECHNICAL DATA ON REQUEST.

© ALLEN B. DUMONT LABORATORIES, INC.

two *Brilliant* new stars
in the microphone world



Turner
Cardiod
MODEL 77

Impressively styled . . . brilliantly engineered with a combination two-element interior structure of improved design. Sound is effectively controlled to produce the true Super-Cardioid pickup pattern which reduces feedback to the minimum. The Model 77 features a wide-range pickup at the front and a sharply attenuated output at the rear . . . with approximately 15 db discrimination between front and rear at all frequencies. Response: ± 5 db from 70 to 10,000 c.p.s. Level: 62 db below 1 volt/dyne/sq.cm. at high impedance. Built-in switch giving 50, 200, 500 ohms, or high impedance output permits use with any standard equipment. Smooth, tilting action and quick-disconnect plug. Standard $\frac{5}{8}$ "—27 mounting. Finished in gun-metal gray and chrome. Recommended for recording studios, commercial broadcasting, and high quality public address systems.

Send for literature

Visit the Turner Exhibit at the Parts Show,
Booth 146. Stevens Hotel, Chicago
May 11-14

THE TURNER COMPANY
905 17th Street N. E., Cedar Rapids, Iowa

LICENSED UNDER U. S. PATENTS OF THE AMERICAN TELEPHONE AND
TELEGRAPH COMPANY, AND WESTERN ELECTRIC COMPANY, INCORPORATED



Turner
Velocity
MODEL 87

An outstanding new microphone, developed to bring world famous Turner *dependability* to the velocity microphone field. Exceptional quality and trouble-free operation. Engineered with single element ribbon supported in high quality Alnico V magnet for maximum sensitivity. Well shielded output transformers exclude hum pickup. Bi-directional pickup pattern with smooth response within ± 5 db from 80 to 10,000 c.p.s. for most exacting studio work. Level: 62 db below 1 volt/dyne/sq.cm. at high impedance. 4-position output switch permits use with any 50, 200, 500 ohm, or high impedance input. Equipped with Universal swivel mounting, $\frac{5}{8}$ "—27 thread. Richly finished in gun-metal gray with polished chromium screen. Attached 20 ft. balanced line shielded cable. Recommended for broadcast and recording studios where highest quality performance is required.

Write for Complete Details



Microphones
BY TURNER

For low resistance,
high stability
in printed circuits...

Use DU PONT CONDUCTIVE COATINGS

FOR MANY electronic circuits, there is profitable economy in the use of flexible, high conductivity Du Pont Conductive Coatings in place of solder wire connections.

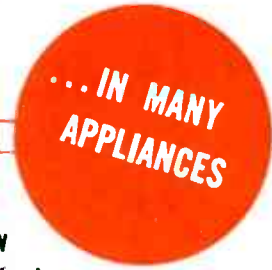
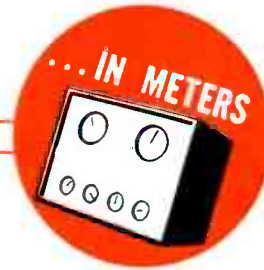
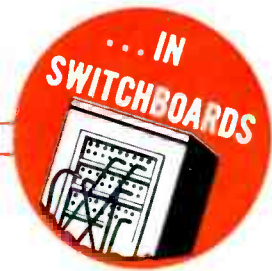
WHAT THEY ARE—Du Pont Conductive Coatings are carefully formulated compositions which contain specially prepared silver powder. They are designed to produce a surface of low electrical resistance when applied to metals and to non-conductive materials, such as: glass, porcelain, steatite, plastics, wood, cloth, paper, etc.

HOW THEY ARE USED—By spraying, dipping, brushing or stenciling at approximate paint thicknesses. A troy ounce covers about 3 square feet of material. Conductivity of the coating is only slightly affected by aging or exposure to sulfides. Applied to metal, the conductive coating inhibits rust and maintains inherent surface conductance.

WHERE THEY ARE USED

Printed Circuits—For radios, switchboards, meters, hearing aids, and a variety of equipment now using conventional solder wire connections.

High Voltage Capacitors—For television, FM and AM radios where economy, compactness, light



(and for high or low voltage ceramic and mica capacitors, shieldings, resistors and solder seals.)

weight and extreme stability are essential.

Static Shielding—The air-dry type is an efficient, practical replacement for foils and cans.

Electrical Equipment—For printed circuit amplifiers, and couplings.

ADVANTAGES of Du Pont Conductive Coatings

- 1—High conductivity (low resistance).
- 2—Flexible application—Composition may be formulated in suitable vehicles for desired methods.
- 3—Fired-on types are not affected by contaminating atmospheres.
- 4—Elimination of poor connections.
- 5—Easily applied with simple economical equipment.
- 6—Assist high-speed production.

Two types of Du Pont Conductive Coatings are available:

Type "F," the fired-on type, specifically designed for bonding metals to ceramic bases.

Type "A," which may be air-dried or baked on, is used chiefly for printed circuits and for electrical shielding by the radio industry.

For further information, clip the coupon below. E. I. du Pont de Nemours & Co. (Inc.), Electrochemicals Dept., Wilmington 98, Delaware.

Tune in Du Pont "Cavalcade of America" Monday Nights—NBC Coast to Coast

Du Pont Electrochemicals



BETTER THINGS FOR BETTER LIVING... THROUGH CHEMISTRY

E. I. du Pont de Nemours & Co. (Inc.), Electrochemicals
Dept., Wilmington 98, Delaware.
Please send me Conductive Coatings Bulletin CP-2-1247

Name _____

Address _____



MODEL VH-24
List Price, \$74.50

MODEL VH-20
List Price, \$63.00

MODEL VH-15
List Price, \$47.00

MODEL VH-91
List Price, \$32.50

Listen 4 New
Jensen
Hypex
PROJECTORS

AFTER months in the laboratory and a long and costly tooling program, this dominant new line of HYPEX Projectors is now ready. In their design, JENSEN engineers started with complete recognition of the shortcomings of all equipment of this kind and then added their own high concepts of performance and convenience requirements. The result is a striking new high in every detail of design and performance, and a new low in price.

Generous use of such materials as stainless steel and other corrosion-resistant materials, plus elaborate treatment of necessary steel parts, insures against weather exposure. Mounting brackets using clutch-type, heavy trunnion mountings (on all except VH-91), solve finally the problem of adjustment and positive locking into position.

Weatherproof terminal boxes provide a long needed feature in equipment of this kind. The completely new driver unit with molded plastic diaphragm is entirely enclosed within the one-piece rigid horn. And, of course, the recognized superiority of the Hypex formula is employed in the reflexed horn design.

The sound industry has long deserved equipment of this kind. Now it is here and at prices right back to prewar levels.

Write or wire for complete information, we haven't space here to give more than an outline of the features and performance ability of these outstandingly new products.

JENSEN MANUFACTURING COMPANY
6607 S. LARAMIE AVE., CHICAGO 38

In Canada: Copper Wire Products, Ltd., 11 King St., W., Toronto

*PATENT 2,338,262. TRADE MARK REGISTERED.

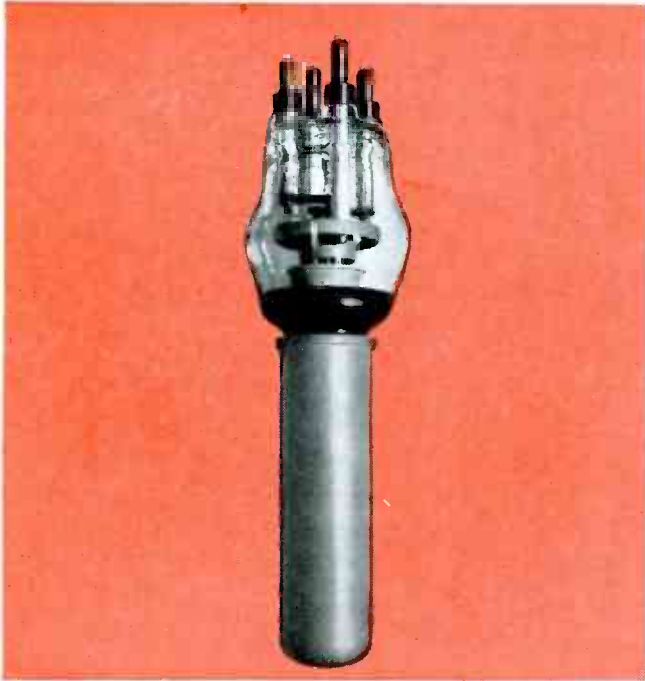


FOR RF HEATING—
BETTER PERFORMANCE
LONGER LIFE

ML-5668

(REPLACES TYPE 892 FOR ELECTRONIC HEATING)

AND UNIQUE MACHLETT AUTOMATIC SEAL WATER JACKET*



ML-5668—Water-cooled RF Heating Triode. With Machlett Automatic Seal Water Jacket is directly interchangeable with Type 892. Max. Input—28 kw. Max. Plate Dissipation—20 kw. For equivalent anode dissipation requires less than ½ water flow needed by the 892.

*Pat. applied for

MACHLETT AUTOMATIC SEAL WATER JACKET* No tools needed to open and close this new jacket. No worry about tube breakage or water leakage. Jacket cannot be opened unless water pressure is off, nor closed unless tube is properly seated. Your hand opens and closes a perfectly safe seal with just a single twist.

THE new Machlett ML-5668 is of special and direct interest to every operator of electronic heating equipment using the 892 type of tube. The ML-5668, in combination with the Machlett Automatic Seal Water Jacket, is directly interchangeable with the 892 and its jacket, and, since it is designed specifically for this type of service, will provide greater effectiveness and increased economy on both induction and dielectric heating applications. RF heating requires the very best in tube design, construction, and processing, and the ML-5668, with its extra-heavy and uniquely-processed anode, its mechanically-sturdier grid, cathode and terminal construction, truly meets the need. This tube, and those who use it, benefit fully from Machlett's advanced techniques of design and manufacture.

For better, more consistent performance—for lower operating costs—for longer tube life—replace the 892 with the ML-5668.

* * *

The advantages offered by ML-5668 are also available to manufacturers and users of equipment employing other communication-type tubes, such as the 889A and 880, through the *new* Machlett Types ML-5604, ML-5619, ML-5666 and ML-5658. These RF heating tubes were designed, built and rated for electronic heating service, without compromise with the needs of other applications. For the complete story of the improved performance and lower costs offered by these tubes, write Machlett Laboratories, Inc., Springdale, Connecticut.



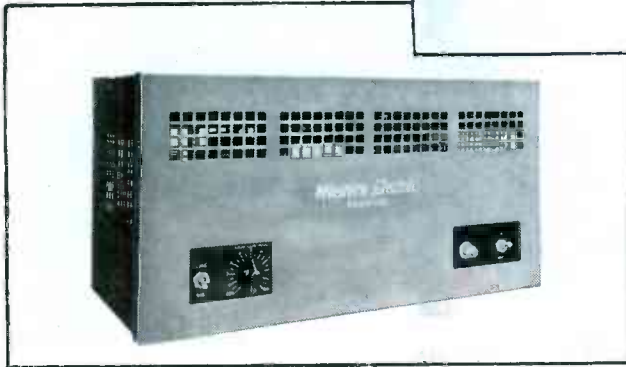
Over 50 Years
of Electron Tube Experience

M A C H L E T T L A B O R A T O R I E S , I N C .
Springdale, Connecticut

To deliver **WIRED MUSIC** at its finest . . . **Western Electric's complete line!**

AMPLIFIERS

1140A (at right), for either a-c or d-c, is free from noise usually found in this type amplifier. Designed to operate directly from telephone wires without separate isolating coils. Delivers 10 watts from a-c source; 6 from d-c. Meets needs of 85% of subscribers. Most other requirements are met by the 124H (below) or 124J, a-c amplifiers rated at 12-20 watts.



MICROPHONES

The 633A Microphone permits subscribers to use system for announcements or paging, or to pick up musical programs originating on their own premises. The popular 639 Type Cardioids, too.



WITH Western Electric's complete line of equipment—engineered to provide quality reproduction and dependable, trouble-free operation—an ideal system can be planned for any requirement.

Your local Graybar Representative will be glad to give you details. Or write Graybar Electric Co., 420 Lexington Ave., New York 17, N. Y.

LOUDSPEAKERS



The 755A 8-inch direct radiator gives high quality reproduction with exceptional tonal brilliance. 8 watts, 70-13,000 cycles. For higher power, the 20-watt 756A or 30-watt 728B.

AUTOTRANSFORMERS

Specially designed for matching multiple loudspeakers in wired program and sound distribution systems. 25A—4 watts; 26A—16 watts; 27A—64 watts.



FOR THE PROGRAM CENTER



In addition to the 1304 Reproducer Set shown—incorporating 2-speed turntable and 9 Type Reproducer, Western Electric offers for the program center a full line of integrated equipment, including microphones, amplifiers, line coils and associated apparatus. Remember . . . the two major wired music program studios use Western Electric recording equipment. Get the most out of these fine recordings with Western Electric reproducing equipment!



Western Electric

— QUALITY COUNTS —

DISTRIBUTORS: IN THE U.S.A.—Graybar Electric Company. IN CANADA AND NEWFOUNDLAND—Northern Electric Company, Ltd.

dependable

POWER CONVERSION

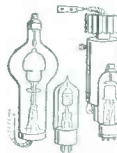


WITH WESTINGHOUSE RECTOX

JOB-FITTED RECTIFIERS FOR EVERY NEED



WESTINGHOUSE SELENIUM RECTIFIERS... are the result of more than nine years of continuous research. Available in a wide variety of sizes and capacities, they do a big job where small size and minimum weight are prime factors.



ELECTRONIC TUBE RECTIFIERS... are quietly and efficiently converting a-c to d-c in such applications as radio, speed controls, welding apparatus and x-ray equipment. Westinghouse manufactures electronic tubes in a multitude of ratings.

Dependability and long life are realized when you design Rectox Copper-Oxide Rectifiers into your equipment. Original Rectox units installed 20 years ago are still in use today . . . a service record not duplicated by any other metallic rectifier.

Westinghouse Copper-Oxide Rectifiers assure the durability and stability required in their broad field of application in industrial, communication, power, transportation and other fields.

Westinghouse offers a *complete* line of rectifiers . . . thoroughly field-tested and backed by thousands of installations in every application. Now manufacturers can design and build their products around the long-life rectifier that is sure to deliver the most dependable performance . . . for every job!

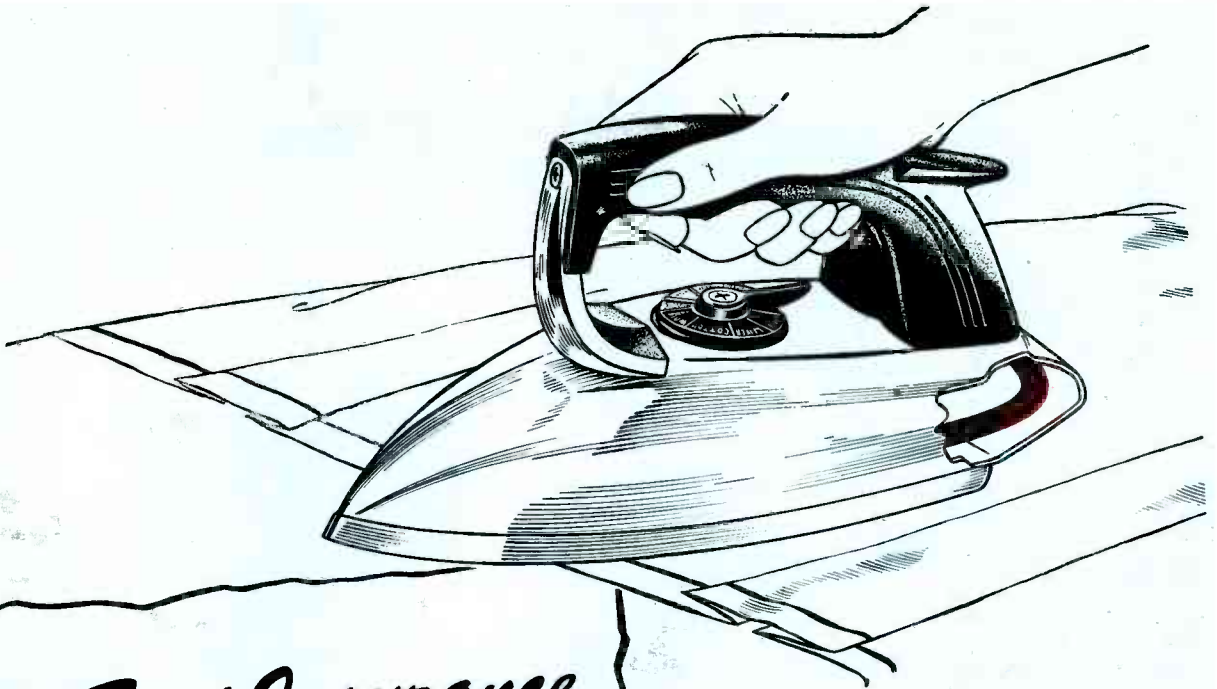
For complete details, call your nearest Westinghouse office or write for booklet B-3626 to Westinghouse Electric Corporation, P. O. Box 868, Pittsburgh 30, Pa.

J-21419



Westinghouse Rectifiers
PLANTS IN 25 CITIES . . . OFFICES EVERYWHERE





Hot Foot Insurance and How It Pays

When Birtman Electric Company embedded the heating element in the sole plate of their new electric iron, they began looking for "hot foot insurance." Temperatures up to 575° F. in the normal ironing range and 800° F. or better in contact with the heating element made a high heat insulation a necessity.

In BH Fiberglas Sleeving, they found the required thermal insulation; dielectric strength demonstrated under 1000-1500 volts during insulation breakdown test; *plus* these important assembly advantages:

- (1) 1-inch lengths of BH Fiberglas Sleeving slip on with ease over the heating element leads—the cut ends do not "feather" and slow down assembly. BH Fiberglas Sleeving cuts without fraying.
- (2) BH Fiberglas Sleeving stays flexible as string—no hardening varnish or lacquer is used. Will not split or crack when bent. Assembly made easy.

BH Fiberglas Sleeving is made in standard 36" lengths and 500' coils, or it may be supplied in short lengths to meet specific requirements. Try it in your plant, in your product.

BENTLEY, HARRIS MFG. CO., CONSHOHOCKEN, PA.

BH *Fiberglas** SLEEVINGS

*BH Non-Fraying Fiberglas Sleevings are made by an exclusive Bentley, Harris process (U. S. Pat. No. 2393530). "Fiberglas" is Reg. TM of Owens-Corning Fiberglas Corp.

-----USE COUPON NOW-----

Bentley, Harris Mfg. Co., Dept. E-22, Conshohocken, Pa.

I am interested in BH Non-Fraying Fiberglas Sleeving for _____ (product)

operating at temperatures of _____°F. at _____ volts. Send samples so I can see for myself how BH Non-Fraying Fiberglas Sleeving stays flexible as string, will not crack or split when bent.

NAME _____ COMPANY _____

ADDRESS _____

Send samples, pamphlet and prices on other BH Products as follows:

- Cotton-base Sleeving and Tubing
- Ben-Har Special Treated Fiberglas Tubing

Minimize Control Size!

REDUCE COST!

WITH THESE NEW ALLIED RELAYS

The Allied PO and POY relays, replacing the DO and DOY relays, save space, save cost. These advantages will have special appeal for engineers in electronic, aircraft and other industries requiring medium power, all-purpose relays.

POY RELAY

A semi-sensitive, dual coil relay for operation in vacuum tube or other limited power circuits. Same contact rating and arrangement as PO.

DIMENSIONS:

Same as PO.

COIL RATING:

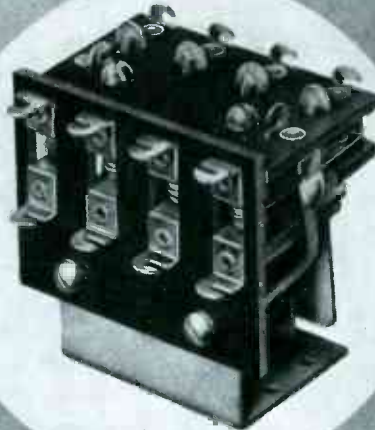
Up to 110 volts D.C. at 600 milliwatts. Not supplied for A.C.

MOUNTINGS:

Standard, #6-32 tapped holes. Not supplied with stop nuts.

The PO & POY relays are adaptations of the well-known general purpose Allied BO relay, and like all other Allied relays may be obtained hermetically sealed.

Every part in these precision-built relays is designed to deliver thoroughly dependable service with extra long life. For complete information and operating characteristics of the new PO and POY and other precision-built Allied Relays, write us for latest Allied catalog.



PO RELAY

This relay, shown above in the 4-pole model and shown below in the 3-pole model, is supplied in 2-, 3- and 4-pole normally-closed, normally-open or double-throw contacts. Its standard silver contacts have carrying capacity of 15 amperes at 24 volts D.C. or 110-volts A.C. non-inductive.

COIL RATING: A.C. 10.5 volt-amperes nominal or 17.5 volt-amperes maximum at 25 to 60 cycles and up to 220 volts.

D.C. Up to 120 volts at 1 watt minimum or 8 watts maximum.

MOUNTING. Standard #6-32 tapped holes. Also supplied with #6-32 stop nuts.



ALLIED CONTROL COMPANY, INC.

2 EAST END AVENUE, NEW YORK 21, NEW YORK

You can depend on these
electronic tube alloys
 for better tube performance

GRID WIRE:

MANGRID

GRADE A NICKEL:

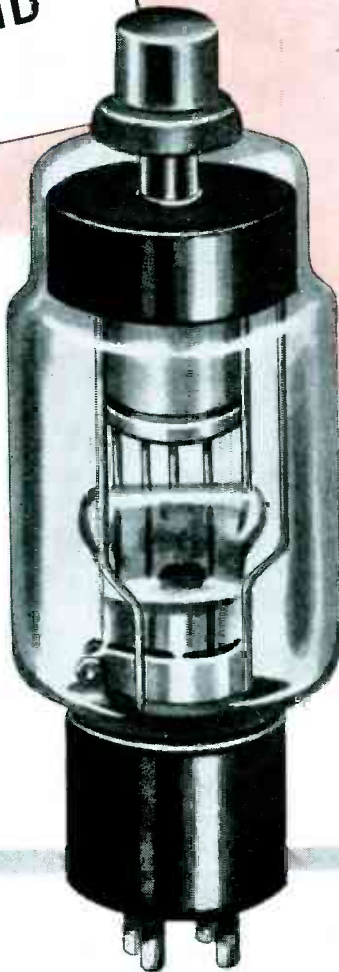
NICKEL WIRE
 FOR SUPPORTS
NICKEL RIBBON
 FOR ANODES

CARBONIZED NICKEL RIBBON:

RADIOCARB A
POLICARB
DUOCARB

FILAMENT BASE METALS:

SYLVALOY, HILO
MODIFIED HILO
COBANIC, TENSITE
BALLAST



From the beginning of the industry Wilbur B. Driver Co. has been the leading supplier of alloys for Radio and Electronic uses. Constant development of new alloys and adoption of better processes has maintained this leadership.

Wilbur B. Driver alloys are made from the purest raw materials available and are melted in induction furnaces of the most modern type. The aim of the Wilbur B. Driver Co. is to aid in your technical development by continuing to supply alloys to match the demands of progress.

WILBUR B. DRIVER CO.
 150 RIVERSIDE AVE., NEWARK 4, NEW JERSEY



Many Sunlamp Makers
 (and users, too)
 are "Seeing
 the Light"



...by insisting on **AMERICAN PHILLIPS SCREWS**

PRODUCTION-WISE add sunlamp manufacturers to the host of stove, refrigerator, furniture and other modern-minded makers who are cutting production costs via American Phillips Screws. How? By straight, sure-fire, speedy, *automatic* driving that's proof against scars, scuffs, work spoilage. No matter what the pace, the 4-winged American Phillips Driver "stays put" — can't harm or hinder work or worker . . . and you can count on *time savings up to 50%*!

PROMOTION-WISE American Phillips Screws lend a modern touch — step up the "sell" of whatever you make. They can't snag clothes but they *do* snag orders! Showmanship and serviceability both say "specify American Phillips."

4-WINGED DRIVER CAN'T SLIP OUT
 OF PHILLIPS TAPERED RECESS

AMERICAN SCREW COMPANY, PROVIDENCE 1, RHODE ISLAND

Chicago 11: 589 E. Illinois St.

Detroit 2: 502 Stephenson Bldg.

AMERICAN
PHILLIPS *Screws*



ALL TYPES
 ALL METALS: Steel,
 Brass, Bronze, Stain-
 less Steel, Aluminum,
 Monel, Everdur (sili-
 con bronze)

A sure-fire combination
for fast-selling combinations



... these **GI** HOME RECORDING Units



There's *extra* customer-appeal in combination radio-phonographs which offer the added feature of *Smooth Power* home recording. Here, indeed, is the answer to your ever-increasing competition in the home-entertainment field . . . the answer, too, for prospective

buyers who want *more* than just an *ordinary* combination set.

Both the GI Dual Speed Recording and Phonograph Assembly (upper right) and the ever-popular GI Record-Changer Recorder Combination (lower left) have ample power for noiseless, vibration-free recording and reproducing . . . both are simple to operate, and sturdily built for trouble-free long life.

And equally important—*both units are remarkably low-priced to fit into your volume sales picture.*

For complete information on this popularity-building combination that can add new sales appeal to your radio-phonograph combinations, write us *today.*



The GENERAL INDUSTRIES Co.

DEPARTMENT A • ELYRIA, OHIO

presenting the NEW

"NOFLAME-COR"

the TELEVISION hookup wire

by



approved by
Underwriters' Laboratories at

90° CENTIGRADE _____ **600** VOLTS

This is IT! Tops in hookup wire for television, F-M, quality radio and all exacting electronic applications. Available for immediate delivery in all sizes, solid and stranded, in over 200 color combinations . . . ready to demonstrate anew the Efficiency and Economy of CORNISH WIRES AT WORK

- Flame Resistant • Heat Resistant • High Insulation Resistance
- High Dielectric • Easy Stripping • Facilitates Positive Soldering

COMPLETE ENGINEERING DATA AND SAMPLES ON REQUEST

RUBBER _____	75°
PLASTIC _____	80°
"NOFLAME-COR" _____	90°

"made by engineers for engineers"



CORNISH WIRE COMPANY, Inc.

605 North Michigan Avenue,
Chicago 11

15 Park Row, New York 7, N. Y.

1237 Public Ledger Bldg.,
Philadelphia 6

MANUFACTURERS OF QUALITY WIRES AND CABLES FOR THE ELECTRICAL AND ELECTRONIC INDUSTRIES

TUBES ARE KNOWN BY THE COMPANY THEY KEEP



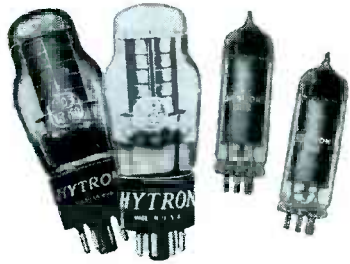
Farnsworth

Remler



Rauland

hallicrafters



"WHEN WE THINK OF V-R TUBES, WE THINK OF HYTRON."

When leaders automatically order their gaseous voltage-regulator tubes from Hytron, there must be a reason. Companies with top names can afford to select only top quality components. To have sold over 2,500,000, these Hytron OA2, OB2, OC3/VR105, and OD3/VR150 tubes must offer something special. They do! Better performance. Their advanced engineering—rigidly controlled processing and assembly—and tougher-than-JAN factory tests make these apparently simple tubes actually easy to make—better.

Yes, you are in good company if you instinctively associate V-R tubes with Hytron. Army, Navy, Air Force, AEC, famous university research laboratories—as well as industrial leaders—repeatedly order Hytron V-R tubes. Pick either the standard OC3/VR105 and OD3/VR150 or the space-saving OB2 and OA2; you, too, will prefer Hytron. That goes double, if you're "from Missouri." Find out for yourself why so many turn automatically to Hytron.

Motorola



DU MONT



The Fisher



SETCHELL CARLSON, Inc.



General Communication Company



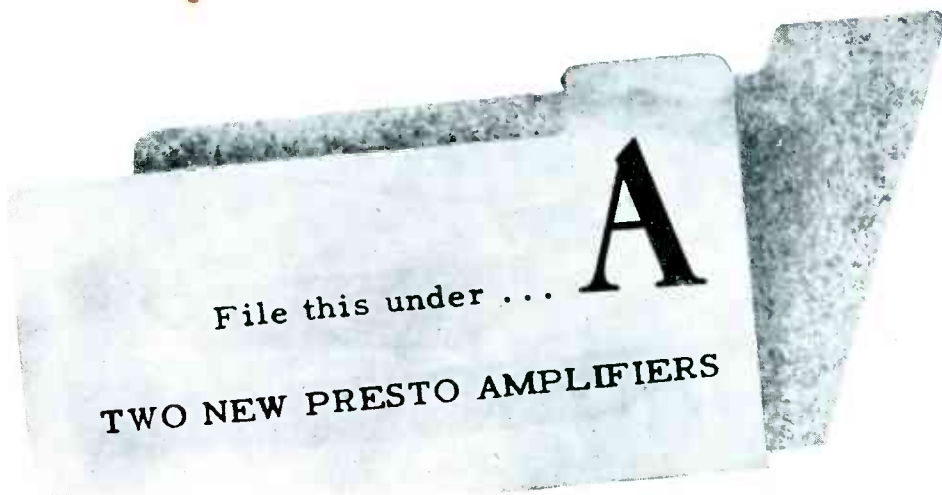
SPECIALISTS IN RADIO RECEIVING TUBES SINCE 1921

HYTRON

RADIO AND ELECTRONICS CORP.

MAIN OFFICE: SALEM, MASSACHUSETTS





Engineers will welcome these two new additions to the PRESTO line of superior equipment.

Presto Peak Limiting Amplifier (Type 41A)

DESIGNED to control program peaks, Type 41A removes the cause of overcutting and distortion in recording and over-modulation in broadcasting. Proper degree of peak limiting permits an appreciable increase of the average signal with consequent improvement of signal to noise ratio. Serves simultaneously as a line amplifier; its 60 db gain adequately compensates for line losses due to pads, equalizers, etc.

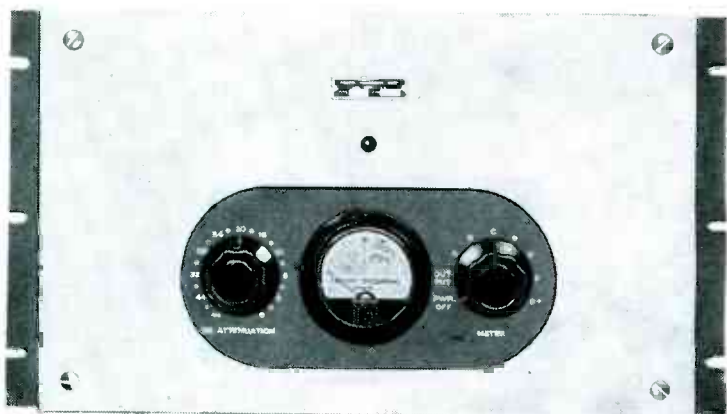
Presto Power Amplifier (Type 89A)

FOR recording, or monitoring use, 89A is the perfect high fidelity, medium power unit. 25-watt output, it fills the need for an amplifier between Presto 10-watt and 60-watt units. All stages are push-pull and sufficient feedback is provided to produce a low output impedance and general performance of the type 807 tubes which is superior to that of triodes.

FULL SPECIFICATIONS OF THESE TWO NEW AMPLIFIERS WILL BE SENT ON REQUEST.



Type 41A. Chassis construction is for vertical mounting in standard racks. Removable front panel gives access to all circuits. Meter and selector switch indicate amount of limiting taking place and current readings of all tubes.

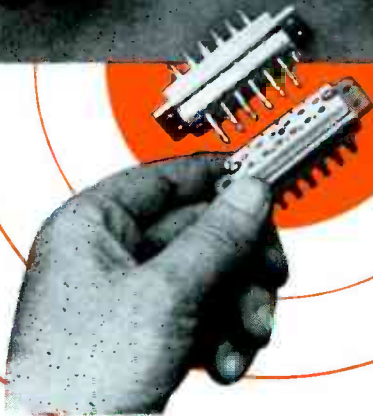
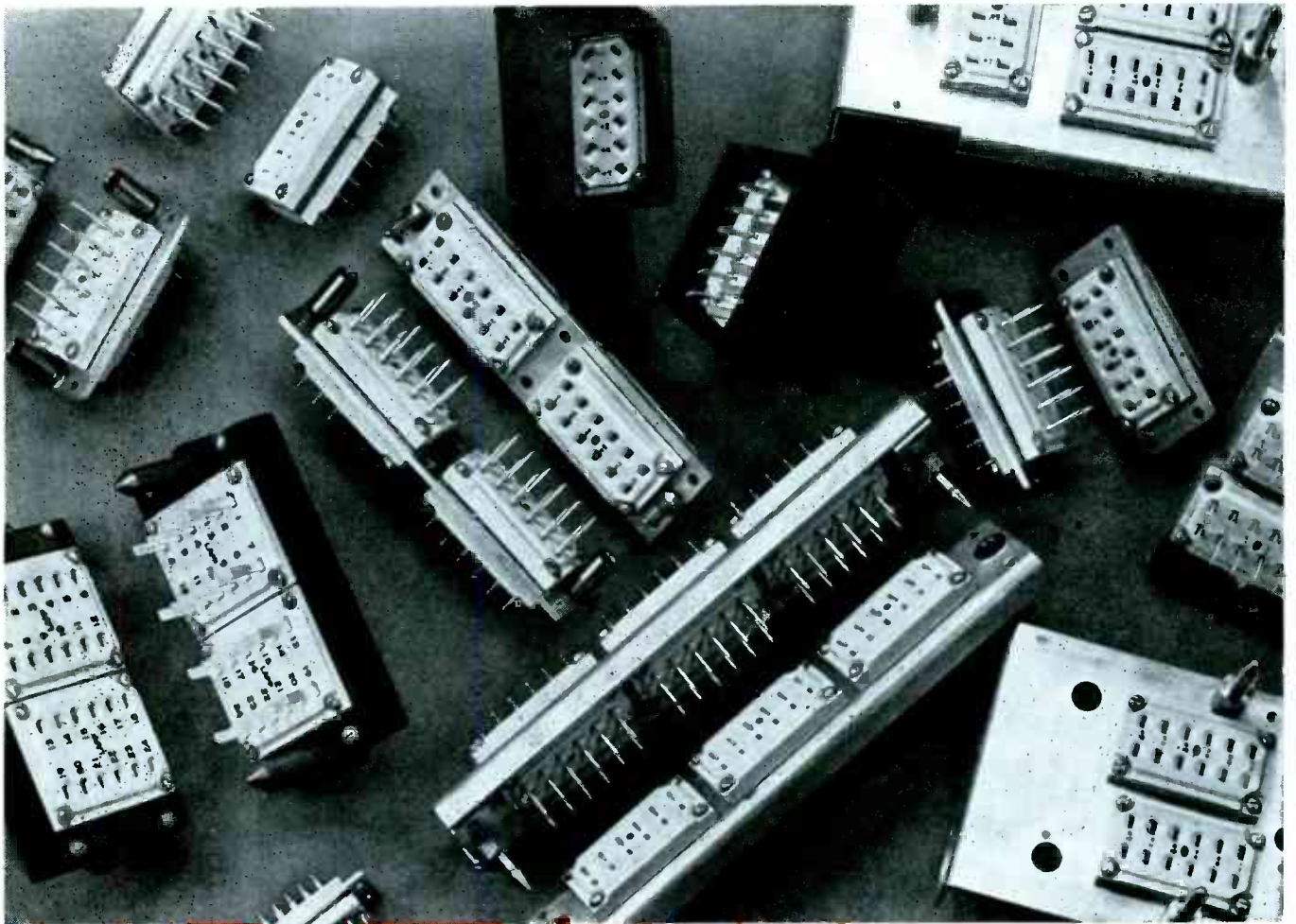


Type 89A. Chassis construction is for vertical rack mounting. Removable front panel for easy access to all circuits. Meter and selector switch provide convenient indication of output level at 1000 cps and current readings of all tubes.

PRESTO

RECORDING CORPORATION
248 WEST 55TH STREET, NEW YORK 19, N. Y.
Walter P. Downs, Ltd., in Canada

WORLD'S LARGEST MANUFACTURER OF INSTANTANEOUS SOUND RECORDING EQUIPMENT & DISCS



MULTIPLE-CONTACT PLUG-RECEPTACLE UNITS FOR SECTIONALIZING CIRCUITS

FOR panel-rack or other sectionalized circuits, Lapp offers a variety of plug-and-receptacle units, some of which are shown above. Any number of contacts can be provided (in multiples of twelve). Male and female contacts are full-floating for easy alignment and positive contact. Contacts are silver-plated, terminals tinned for soldering. Polarizing guide pins are provided where desired. Insulation is Steatite, the low-loss ceramic which is non-carbonizing even under leakage flashover resulting from contamination, moisture or humidity. Write for complete electrical and mechanical specifications of available units or engineering recommendations for an efficient component for your product.

Lapp

LAPP INSULATOR COMPANY, INC., LE ROY, NEW YORK

AS NEW AS THE FUTURE!

... the only transformer
line of its kind

*Advanced, practical
engineering
gives you*

THESE OUTSTANDING FEATURES



CHICAGO TRANSFORMERS

Sealed in Steel

1 SEALED IN STEEL CONSTRUCTION

Chicago Transformer's drawn steel cases provide convenient, compact mountings; seamless steel-wall protection against atmospheric moisture and corrosion; unsurpassed strength and rigidity to withstand shock and vibration; clean, streamlined appearance that adds eye-appeal to any equipment.

2 CHOICE OF CONNECTORS

Solder lugs or wire leads. Most units are available with identical ratings in two base styles to fit your price and/or wiring preference.

3 CHARACTERISTICS KEYED TO MODERN TUBES

Voltage, current, and output ratings have been designed for one purpose only—to fill the requirements of the receiving, transmitting, and industrial electronic tubes currently most in demand. No listings wasted on obsolete circuit needs. Result—a condensed, yet comprehensive, line that's right in step with today's new circuit designs.

4 EXACT MATCHING OF REACTORS

with power transformers. Current ratings of plate and filament supply transformers and of the high voltage plate transformers are matched by choke capacities specially designed for the purpose. Mountings match, as well, for uniform, "tailored" good looks.

5 TRUE HIGH FIDELITY THROUGHOUT 3 RANGES

Frequency response within $\pm 1/2$ db; distortion exceedingly low, even at low frequencies. These are the characteristics of the input and output transformers. Driver and modulation transformers provide response within ± 1 db. All audio units are designed for frequency ranges that fit three classes of up-to-date audio application. Full Frequency Range: 30-15,000 cycles (good up to 20,000 cycles, where required). Public Address Range: 50-10,000 cycles. Communications Range (voice): 200-3,500 cycles.

Have Complete Details On Hand For Your New Equipment Planning

WRITE TODAY FOR CATALOG

CHICAGO TRANSFORMER Division, Essex Wire Corporation

3501 ADDISON STREET, CHICAGO 18, ILLINOIS

4 New Ways to put live quality into transcriptions...



G-E VARIABLE RELUCTANCE PICKUP NOW WITH DIAMOND STYLUS!

Virtually banishes Needle Scratch, Needle Talk, and Distortion! Rides lightly in the grooves—responds only to lateral motion. Rugged mechanically... built to stand abuse... practically unaffected by temperature or humidity. Available with the long-wearing Diamond Stylus with either of 2 Stylus radii—2.5 & 3 mil. (G-E Sapphire Stylus pickups are all 3 mil). Net to broadcasters.....\$29.63.



G-E TRANSCRIPTION TONE ARM

Especially adapted for use with the G-E Pickup. Newly designed in strong, feather-light magnesium, this low mass tone arm is easily mounted on a standard turntable. Offered now by General Electric at an economical price to broadcasters.....\$35.00.



G-E EQUALIZED TRANSCRIPTION PRE-AMPLIFIER

This high quality AC operated audio amplifier enables broadcasters to take full advantage of the superior performance of the G-E Variable Reluctance Pickup. A switch mounted on the turntable permits selection of 4 types of reproduction. Net to broadcasters.....\$125.00 (less tubes). Set of tubes for pre-amplifier.....\$8.00.



G-E TRANSCRIPTION EQUALIZER

For use with your present unequalized pre-amplifier. This equalizer is expertly engineered to complement present record and transcription frequency characteristics when used with the G-E Pickup mounted in the G-E Tone Arm. Extra magnetic shielding reduces hum pickup. Price net to broadcasters.....\$45.00.

USE THIS CONVENIENT COUPON TO ORDER THIS G-E AUDIO EQUIPMENT TODAY!

If you want further information, consult your nearest General Electric transmitter representative, or write: *General Electric Company, Transmitter Division, Electronics Park, Syracuse, N. Y.*

LEADER IN RADIO, ELECTRONICS AND TELEVISION

GENERAL  ELECTRIC
160-G1A-6914



General Electric Company, Transmitter Division,
Electronics Park, Syracuse, N. Y.

Please ship me, subject to your standard conditions of sale,
the items checked below:

- G-E Pickup (diamond stylus)
(specify which model) 2½ mil stylus 3 mil stylus
- G-E Tone Arm (Pickup not included)
- G-E Equalized Transcription Pre-Amplifier
 (set of tubes for Pre-Amp)
- G-E Transcription Equalizer
- Send me descriptive bulletins on all of these items
- Check or M.O. enclosed. Bill me.

NAME.....

STATION..... ADDRESS.....

CITY..... STATE.....

Mail this coupon today.

DOLLAR SAVER

... for electric vending machines



ACTUAL SIZE

RELIABLE OPERATION

SMALL SIZE

EASY TO MOUNT

ACCESSIBLE WIRING TERMINALS

UNDERWRITERS APPROVED



HAVE YOU GOTTEN YOUR COPY?

This 640-page RELAY ENGINEERING HANDBOOK brings you full benefit of Struthers-Dunn's 25 years of specialized relay experience — in terms of helping you design suitable relay circuits, select suitable relays, then install and maintain them properly. Over 15,000 Handbooks already in use. Price \$3 per copy.

STRUTHERS-DUNN RELAY TYPE 119BX

Double-pole Double-throw • 5 amperes (1/4 h.p.)
Operating coils for any a-c voltage to 115 V., 60 cycles
(115 volt relays adjusted to operate at 85 volts)

DOLLARS are doubly important in choosing relays for electric vending machines.

First, the relays must be priced so low that, even though many of them are used in a single machine, the machine will not be "priced out of its market".

Second, and equally important, these low cost relays must be unfailingly dependable. They must permit no errors such as false operation of the machine, failure to deliver the merchandise, or duplicate sales with resulting actual cash loss.

Type 119BX Relay was de-

signed to these exacting specifications. As in many similar instances, the background of 5,348 Relay Types which made it readily possible for Struthers-Dunn to "tailor" exactly the right relay for a specific application. Today, this little unit is more widely used in leading vending machines than any other relay of its general characteristics — and it likewise holds interesting possibilities for other electrical equipment where relays of this type are required. Full details on request — or samples sent for test and approval to quantity users.

STRUTHERS-DUNN

STRUTHERS-DUNN, INC., 150 N. 13TH STREET, PHILADELPHIA 7, PA.

Most prominent position in any parade is
UP FRONT

featuring
**"Built-In"
CONSTANT
VOLTAGE**

For the Protection of Our Customers



With power shortages playing hob with line voltages all over the country—isn't it about time that you too joined the parade of manufacturers who are featuring constant voltage as a built-in component in their products.



This preamplifier phasing control section of a medium power, low distortion restricted band audio-amplifier employed in a new printing plate engraving system couldn't operate satisfactorily on available line voltages. Robert H. Rigby Corp., solved the problem with a "built-in" SOLA CONSTANT VOLTAGE TRANSFORMER.

Unstable voltages varied the light output essential for satisfactory operation of this precision instrument. High voltages burned out the light source. "Built-in" SOLA CONSTANT VOLTAGE TRANSFORMERS now provide a constant source of light and enable R. S. Wilder Company to guarantee the life of the lamps.



The H. C. Schildmeier Co. says, "We have found the SOLA CONSTANT VOLTAGE TRANSFORMER to be the solution to many of our troubles, by maintaining a constant output voltage to actuate a unit that is direct meter reading" . . . a SOLA CV transformer is a built-in component of every Seal Line Balancer produced by this company.



**SOLA HANDBOOK
BULLETIN DCV-102**

A complete, and authoritative treatise on voltage regulation. Write for your copy.



SOLA

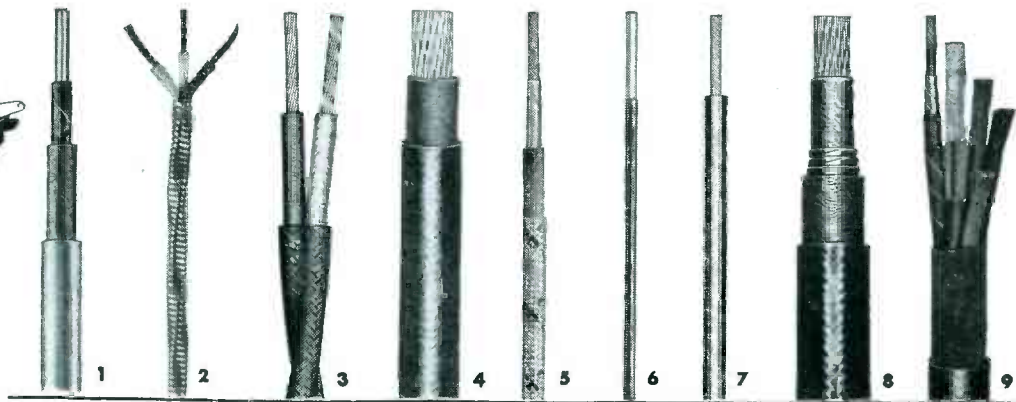
Constant Voltage
TRANSFORMERS

Transformers for: Constant Voltage • Cold Cathode Lighting • Airport Lighting • Series Lighting • Fluorescent Lighting • Luminous Tube Signs • Oil Burner Ignition • X-Ray • Power • Controls • Signal Systems • etc. • **SOLA ELECTRIC COMPANY, 4633 W. 16th Street, Chicago 50, Illinois**

Manufactured under license by: ENDURANCE ELECTRIC CO., Concord West, N. S. W., Australia • ADVANCE COMPONENTS LTD., Walthamstow, E., England • UCOA RADIO S.A., Buenos Aires, Argentina • M. C. B. & VERITABLE ALTER, Courbevoie (Seine), France

Here Are 9 Repeat-Sales Specialists

... they work for you every time a switch is flicked on one of your products!



(1) Rockbestos A.V.C. Switchboard Wire. (2) Thermostat Control Wire. (3) Duplex Heat Resisting Flexible Cord. (4) Flexible Apparatus Cable. (5) Rockbestos Firewall Hookup Wire. (6) All-Asbestos Magnet Wire. (7) All-Asbestos Lead Wire. (8) Rockbestos A.V.C. Motor Lead Cable. (9) A.V.C. Multi-Conductor Control Cable.

These nine Rockbestos wires, cords and cables are a few of our 125 "specialists." They do three big jobs:

Permanent insulation is the big wiring-plus Rockbestos gives to your products. *Dependability* is the big plus Rockbestos gives to your customers. *Repeat sales* are what Rockbestos wiring gives to you.

Impregnated asbestos insulation means wires, cords and cables that operate *continuously* at high rated temperatures without failure. Rockbestos insulation *won't* dry out, become brittle, crack or flow . . . *won't* rot or swell from exposure to oil, grease and fumes . . . *will* provide longer life and greater current carrying capacity through high heat resistance.

For whatever you make, from cookers to cranes — remember there's a *permanently insulated* Rockbestos wire, cable or cord that will help your product do a better job for your customer and for you. For recommendations or engineering assistance, write to the nearest district office.

WRITE TODAY—for your copy of the new No. 10-F Catalog, sectioned for easy reference to permanently insulated Apparatus Wires & Cables; Lighting Wires, Power and Control Cables; Switchboard, Appliance, Fixture, Electronic, Aircraft and Magnet Wires.

ROCKBESTOS PRODUCTS CORPORATION

459 NICOLL STREET, NEW HAVEN 4, CONN.

NEW YORK BUFFALO CLEVELAND DETROIT
CHICAGO PITTSBURGH ST. LOUIS
LOS ANGELES OAKLAND, CAL.

ROCKBESTOS



The Wire with Permanent Insulation

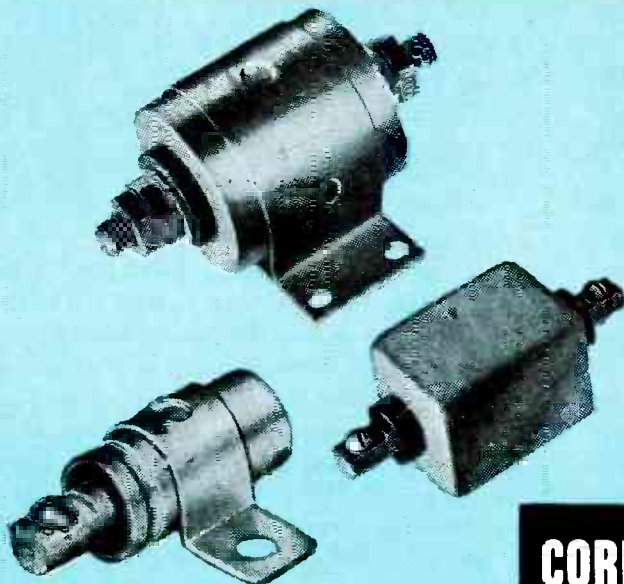
quiet

as a

goldfish



with **C-D Quietones***



NICKEL • STYRANOL • PAPER • ELECTROLYTIC

A lot of electronic and electrical equipment is going to sea these days. But it won't stay there long—in fact, it won't even stay sold—unless it is Noise-Proofed against radio interference.

To you—the manufacturer—this means that your product should include C-D Quietones in its basic design. With safety at sea—as well as listening pleasure—at stake, your marine customers demand the kind of interference-free equipment operation C-D Quietones are designed to give. Of the hundreds of Quietone types available, there may be one which will fit your needs to a "T"; if not, our sleeves are rolled up and we're ready in our modern and complete Radio Noise-Proofing Laboratory—to design the specific filter you need. C-D Quietones will solve your radio noise and spark suppression problems speedily, permanently and effectively. Your inquiry is invited. Cornell-Dubilier Electric Corporation, Dept. K-5, South Plainfield, New Jersey. Other large plants in New Bedford, Worcester, and Brookline, Massachusetts, and Providence, R. I.

Make Your Products More Saleable with C-D Quietone Radio Noise Filters and Spark Suppressors.

An Invitation from C-D
WORLD'S MOST ADVANCED RADIO
"NOISE-PROOFING" LABORATORY
IS AT YOUR SERVICE
without obligation

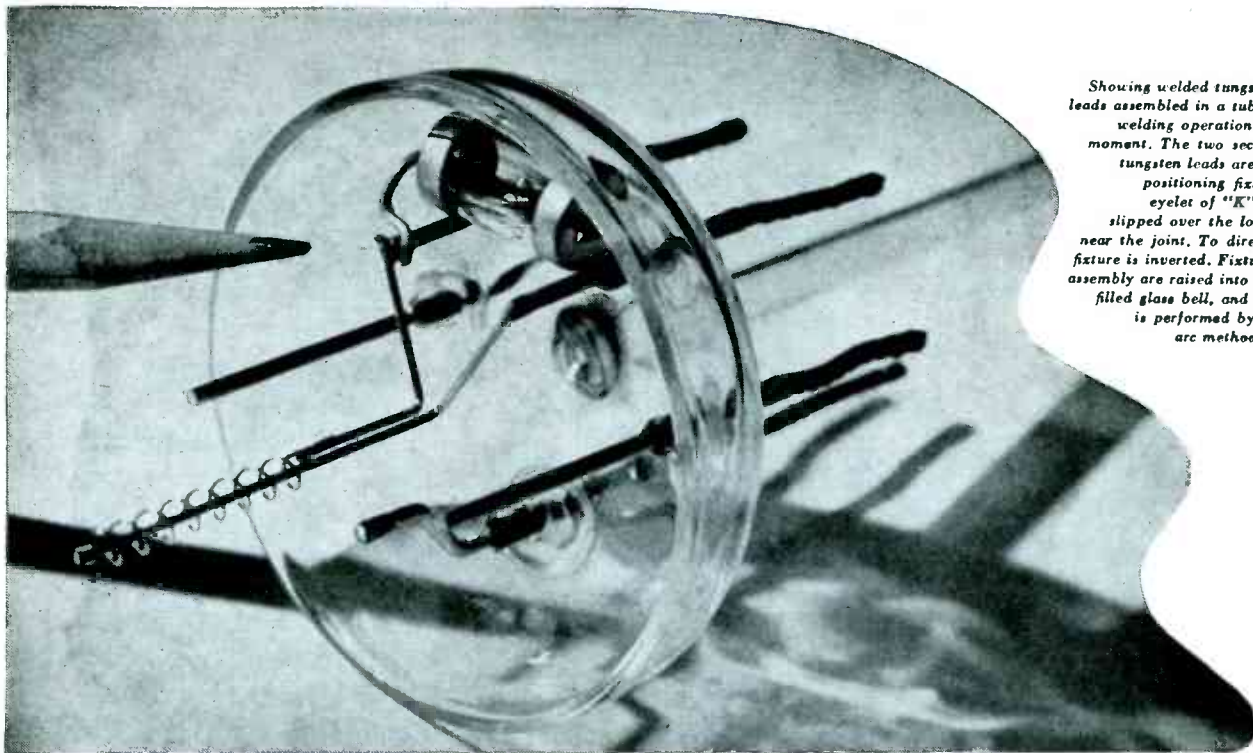


* Reg. U.S. Pat. Off.

CORNELL-DUBILIER

WORLD'S LARGEST MANUFACTURER OF

CAPACITORS



Showing welded tungsten filament leads assembled in a tube base. The welding operation takes but a moment. The two sections of the tungsten leads are placed in a positioning fixture. A tiny eyelet of "K" MONEL is slipped over the lower section, near the joint. To direct flow, the fixture is inverted. Fixture and lead assembly are raised into a hydrogen-filled glass bell, and the welding is performed by the carbon arc method.

How a problem in welding tungsten was solved

While improving the design of their VHF beam tetrodes, the United Electronics Company ran into a difficult technical problem.

In their tube types 5D22 and 4D21, tungsten filament leads are brought out to conventional base prongs. However, to locate the filament at the center of the structure, the two internal filament leads had to be sharply offset. It was necessary, also, that the leads be accurately aligned with the base outlet holes, to eliminate stresses which might crack the glass envelope when the tube was put in service.

Bending the tungsten leads to shape proved too inaccurate a method. So it was decided to make the leads in two sections — one straight, and one bent — welding them together in precision positioning fixtures.

This method of assembly proved satisfactory, but difficulty was immediately encountered in finding a suitable joining metal.

Several metals were tried without success. Either they failed to "wet" the tungsten, or caused it to embrittle.

VHF beam tetrode tube, manufactured by the United Electronics Co., Newark, N. J.



Finally, United Electronics Company engineers tried "K"* MONEL — and it proved to be the answer to their problem.

"K" MONEL "wet" the tungsten satisfactorily; flowed well; made strong, smooth joints; was resistant to oxidation and corrosion. In addition, "K" MONEL's melting point was safely above both exhausting and tube operating temperatures.

This is but one of countless ways that Nickel and its alloys are helping industry to build better products. If you have a problem in metal selection, get to know the family of INCO Nickel Alloys with their unique combination of properties. Our technical department is always ready to assist you. Write for "Inco Nickel Alloys for Electronic Uses."

The International Nickel Company, Inc.

67 Wall Street • New York 5, N. Y.

EMBLEM OF SERVICE
NICKEL  **ALLOYS**

MONEL • "K"* MONEL • "S"* MONEL • "R"* MONEL • "KR"* MONEL • INCONEL • NICKEL • "L"* NICKEL • "Z"* NICKEL
*Reg. U. S. Pat. Off.

Only

PHILCO

- Gives you the experience of the world's largest radio manufacturer.
- Backed by the facilities of the world's largest radio engineering organization.
- Serviced by a nation wide service organization.
- Plus a Free Engineering Consultation Service to analyze your requirements.

See

**PHILCO FM RADIOPHONE
COMMUNICATIONS SYSTEMS**

Prompt Delivery on All Models

PHILCO

INDUSTRIAL DIVISION

PHILADELPHIA 34 • PENNSYLVANIA

Industrial Division, Dept. M2
Philco Corporation
C and Tioga Streets
Philadelphia 34, Penna.

Gentlemen:

Please send me information about the new
PHILCO FM Radiophone Communications
Systems.

NAME _____

ADDRESS _____

CITY _____



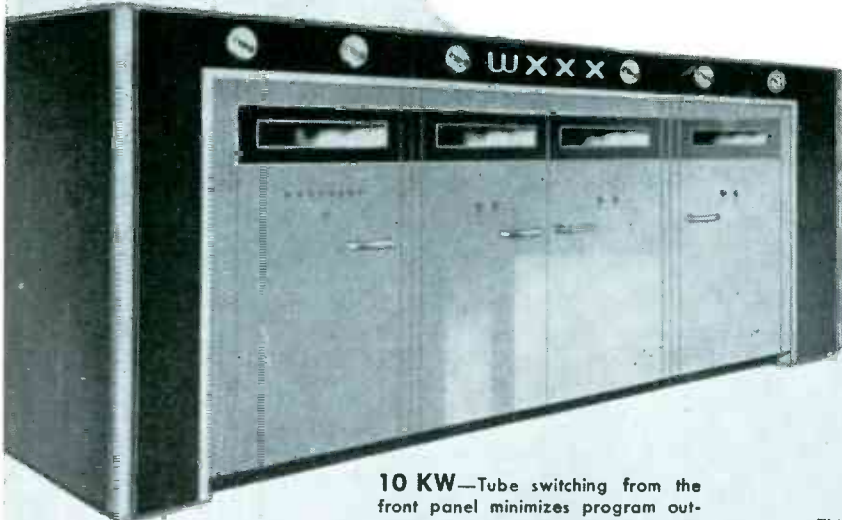
50 KW—One of the larger members of the G-E transmitter family. Note wide doors, providing full accessibility for "walk-in" maintenance. Like all high-power G-E transmitters, this model uses transformers filled with a non-inflammable liquid. This eliminates necessity for fireproof vault and lowers installation costs and insurance.

POWER for every

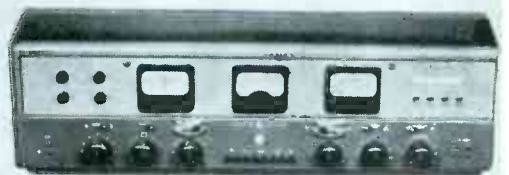
**General Electric's
complete new line of
AM TRANSMITTERS—
now in production**



1 KW—Compactness is an outstanding quality of this sturdy equipment. Reliable, high-standard performance makes it an ideal transmitter in its power class. Now in stock and ready for immediate delivery.



10 KW—Tube switching from the front panel minimizes program outages. This model is a unified assembly of exciter-modulator, power amplifier, and rectifier-control units.



TRANSMITTER-CONTROL CONSOLE

This versatile unit can be used to control a transmitter of any power rating. The de luxe version includes a separate clock panel for timing transmitter interruptions; also, an executive type desk and chair of matching color.

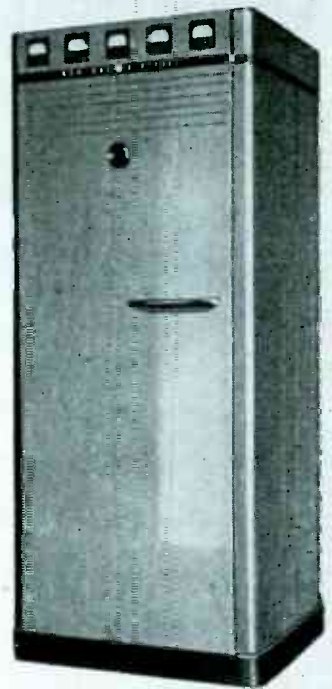
broadcast need!

HERE are five outstanding AM units that will help you profit from your station investment. Featuring lower cost per hour of broadcast service, these transmitters are built to one high standard of quality, backed by one source of responsibility. Every detail of this completely new line reflects the unequalled engineering and operating experience of the General Electric Company.*

The G-E line of broadcast equipment covers all your station needs—transmitters from 250 watts to 50,000 watts, complete studio equipment, the AM station monitor and accessory units to fit every requirement.

Whether you are planning a new station or modernizing an existing one, take a big step in the right direction by calling your nearby General Electric broadcast representative (see list below), or write to Transmitter Division, General Electric Co., Electronics Park, Syracuse, N. Y.

*G.E. built its first commercial broadcast transmitter in 1922. Since that time the company has produced broadcast transmitters whose combined power ratings total over 2,500,000 watts.



250 Watt—Highest quality performance at lowest operating cost—you profit both ways with this 250-watt AM transmitter. Simplified circuits. Numbers and types of tubes minimized. Immediate delivery from stock.



5 KW—An exclusive G-E feature of this transmitter is the spare tube switching of all high-power stages from front panel. Air-cooled throughout, as are all G-E standard broadcast transmitters.

ATLANTA 3, GA.
187 Spring Street
Walnut 9767

BOSTON 1, MASS.
140 Federal Street
Hubbard 1800

CHICAGO 54, ILL.
1122 Merchandise Mart
Whitehall 3915

CINCINNATI 2, OHIO
215 W. 3rd Street
Parkway 3431

DALLAS 2, TEXAS
1801 N. Lamar Street
LD 224

DENVER 2, COLO.
650 17th Street
Keystone 7171

KANSAS CITY 6, MO.
106 W. 14th Street
Victor 9745

CLEVELAND 4, OHIO
710 Williamson Bldg.
Euclid & Public Square
Superior 6822

LOS ANGELES 14, CALIF.
Suite 1300-1301
Security Title Insurance Bldg.
530 West Sixth Street
Trinity 3417

MINNEAPOLIS 2, MINN.
12 Sixth Street
Main 2541

NEW YORK 22, N. Y.
570 Lexington Avenue
Wickersham 2-1311

PHILADELPHIA 2, PA.
1405 Locust Street
Pennypacker 5-9000

SAN FRANCISCO 4, CALIF.
235 Montgomery Street
Douglas 3740

SCHENECTADY, N. Y.
Bldg. 267, Rm. 105
Schenectady 4-2211

SEATTLE 4, WASH.
10 Second Avenue
Main 7100

WASHINGTON 5, D. C.
806 15th Street N. W.
Executive 3600

SYRACUSE 1, N. Y.—Syracuse 6-4411

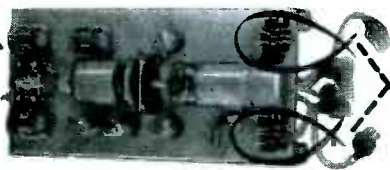
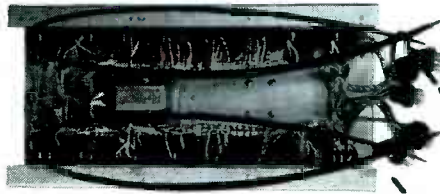
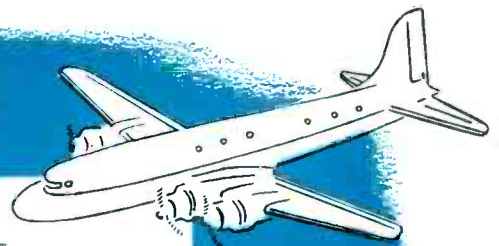


LEADER IN RADIO, TELEVISION AND ELECTRONICS

GENERAL ELECTRIC

160-F-10-6914

WHERE CONTROL IS VITAL . . .



. . . in air-conditioning control for aircraft
BARBER-COLMAN
chooses compact, dependable

Phil-trol RELAYS

It takes a good relay to meet the exacting requirements of aircraft service, with its extremes of temperature, high degree of vibration, difficult service conditions, and the necessity for complete reliability. Barber-Colman Company, a leading manufacturer of temperature and air-conditioning control systems for aircraft, selected Phil-trol Type 27 Relays for one of their more comprehensive units, as illustrated above. The 18 relays mounted under the chassis of the ATR-type control unit serve such purposes as emergency throw-over, emergency cutout, hold-in, heater cycling, and the actuation of condenser fans, evaporators, and compressors on the air conditioning system.

This is but one striking example of dependable

Phil-trol application. Phil-trol Relays are designed not only for aircraft and mobile equipment but are highly recommended for communication service or other uses where positive and reliable operation is required.

There is a complete line of Phil-trol Relays, all engineered to the highest standards, to meet the exacting demands of electronic and industrial control, signal and traffic control, radio, communication, aircraft, and other applications. All Phil-trol relays feature versatility of coil and contact arrangements for adaptability to specific requirements. Our engineers, located in principal cities listed below, will be glad to discuss your relay requirements.

Send for
the new Phil-trol Relay catalog
showing the complete line.



Phil-trol PRODUCTS

Relays, Actuators, Solenoids, Contactors,
Starting Switches, Focus Coils, Ion Traps
and Special Process Control Assemblies.

PHIL-TROL ACTUATORS



Exclusive design and superior construction give the Phil-trol Actuator more power than the ordinary solenoid of the solid-frame type. A number of desirable features make them ideal for industrial use. Five standard sizes are available . . . Send for details.

SEND FOR NEW BULLETIN!

PHILLIPS CONTROL CORPORATION • 612 NORTH MICHIGAN AVENUE • CHICAGO 11, ILLINOIS
PLANT: Joliet, Illinois • SALES OFFICES: New York, Boston, Philadelphia, Buffalo, Cleveland, Charlotte, St. Louis, Kansas City, Los Angeles, Toronto

WHERE can you get all these features in one loudspeaker?

Amazingly high quality

Surprisingly low cost

Small size (8³/₈" diam., 3¹/₈" depth)

ONLY in the Western Electric **755A**

Immediate shipment from stock



Compare for yourself the quality of music reproduction that you get from the 755A with that of other speakers on the market. We think you'll agree that it's tops.

Combining outstanding quality with small space requirements, the 755A is a leading choice for broadcast stations, wired music, program distribution and sound systems. Ideal for home radios and record players, too. In fact, name *any* spot where you want the finest quality at low cost—it's a job for the 755A.

Details? 8 watts continuous capacity. Frequency range 70 to 13,000 cycles. Coverage angle 70 degrees. Weight only 4³/₄ pounds. Size: 8³/₈" diameter, depth 3¹/₈". Only 2 cubic feet of enclosure space needed.

Don't forget—this amazing speaker is ready *right now* for immediate shipment from stock—in quantity! Call your nearest Graybar Representative—or write to Graybar Electric Company, 420 Lexington Ave., New York 17, N. Y.

—QUALITY COUNTS—



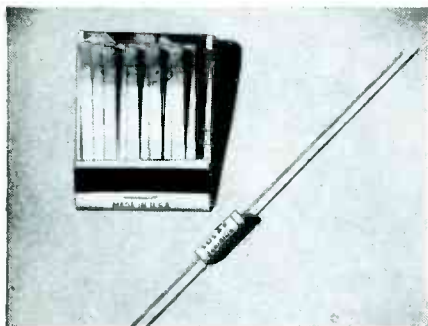
DISTRIBUTORS: IN THE U. S. A.—Graybar Electric Company. IN CANADA AND NEWFOUNDLAND—Northern Electric Company, Ltd.

Western Electric



electronics edition • May 1948

NEW ANOTHER SOLAR DEVELOPMENT



TINY SEALDTITE* MOLDED TUBULARS

FIRST miniature molded paper tubulars to be made are Solar's Type TST Tiny Sealdtites, now in mass production for manufacturers of personal radios and hearing aids. These new capacitors are molded in Solar's new Hi-Temp plastic compound.

Type TST Capacitors are the first truly reliable miniature paper tubulars developed to meet the trend toward miniaturization of radios and electronic equipment with its attendant high operating temperatures.

Type TST Tiny Sealdtites are miniature in size only. They are full size in performance, achieving identical electrical characteristics with full size standard Hi-Temp Sealdtite tubulars through careful design and processing.

With these capacitors, designers of all types of compact electronic equipment have, for the first time, miniature capacitors that are both uniform in quality and consistently dependable in service under extremes of temperature and humidity. Type TST Capacitors may be operated at 85°C.

The photograph above shows a .0008 mf, 200 vwdc, Type TST Tiny Sealdtite. This capacitor is only 3/16" in diameter and 5/8" long. Compare this with conventional paper tubulars!

A complete series of miniature capacitors from .0001 to .1 mf in 100, 200, 400 and 600 volt ratings is described in Solar's Catalog Bulletin SPD-200. Write today for your personal copy.

Solar Manufacturing Corporation
1445 Hudson Blvd., North Bergen, N. J.

★ Trade Mark



BUSINESS BRIEFS

By W. W. MacDONALD

Employees in Broadcast Stations and networks totalled 34,720 in 1,260 stations in October last year, according to the FCC. This is an increase of 15 percent since the previous February. These people were paid an average wage of \$72.40 for an average 39 hour week. The 7,902 technical employees averaged \$91 a week in supervisory jobs, \$70 in non-supervisory spots. Technicians in the networks and their key stations were paid about 50 percent higher wages than the average.

ARRL says that in half the cases of television interference so far reported to radio amateurs the fault has been traced to inadequate receiver design or construction. Which reminds us that an informal survey around New York City last year listed causes of tele interference in the following order:

- Diathermy
- F-M Broadcasting
- Radiation by Other Sets
- Amateurs
- I-F Pickup
- All Others

High-Fidelity Amplifiers offered to phono and f-m fans for home use generally put out umpty-ump watts of audio. Few living rooms are large enough to handle such power, even if there are no neighbors to object. How about someone designing a high-quality amplifier that delivers just a watt or two, with resulting savings in power supply and other costs?

Letting the Cat In is now on an electronic basis. W. K. Kearsley of Schenectady has a photoelectric door opener which permits his black cat to enter the cellar but bars felines of lighter color.

Broadcast Station Revenue is very important to television these days, since a large part of television program costs are paid out of sound broadcast profits. In 1946, income went up 8 percent over 1945, but expenses went up 14 percent, as reported here in January.

In 1947, according to a preliminary NAB report, revenues hiked up another 8 percent, but expenses gained 9 percent over 1946. The latest word from FCC says the four networks and their ten key stations had net time sales of 72.3 million dollars in 1947, only 3 percent above 1946. A similar index of newspaper revenues and expenses would be interesting, since about half the video stations on the air are owned by newspapers. Radio Corporation of America, whose stake in television is bigger than any other, reported net earnings in 1947 at \$1.12 per share of common stock, just double the figure for 1946.

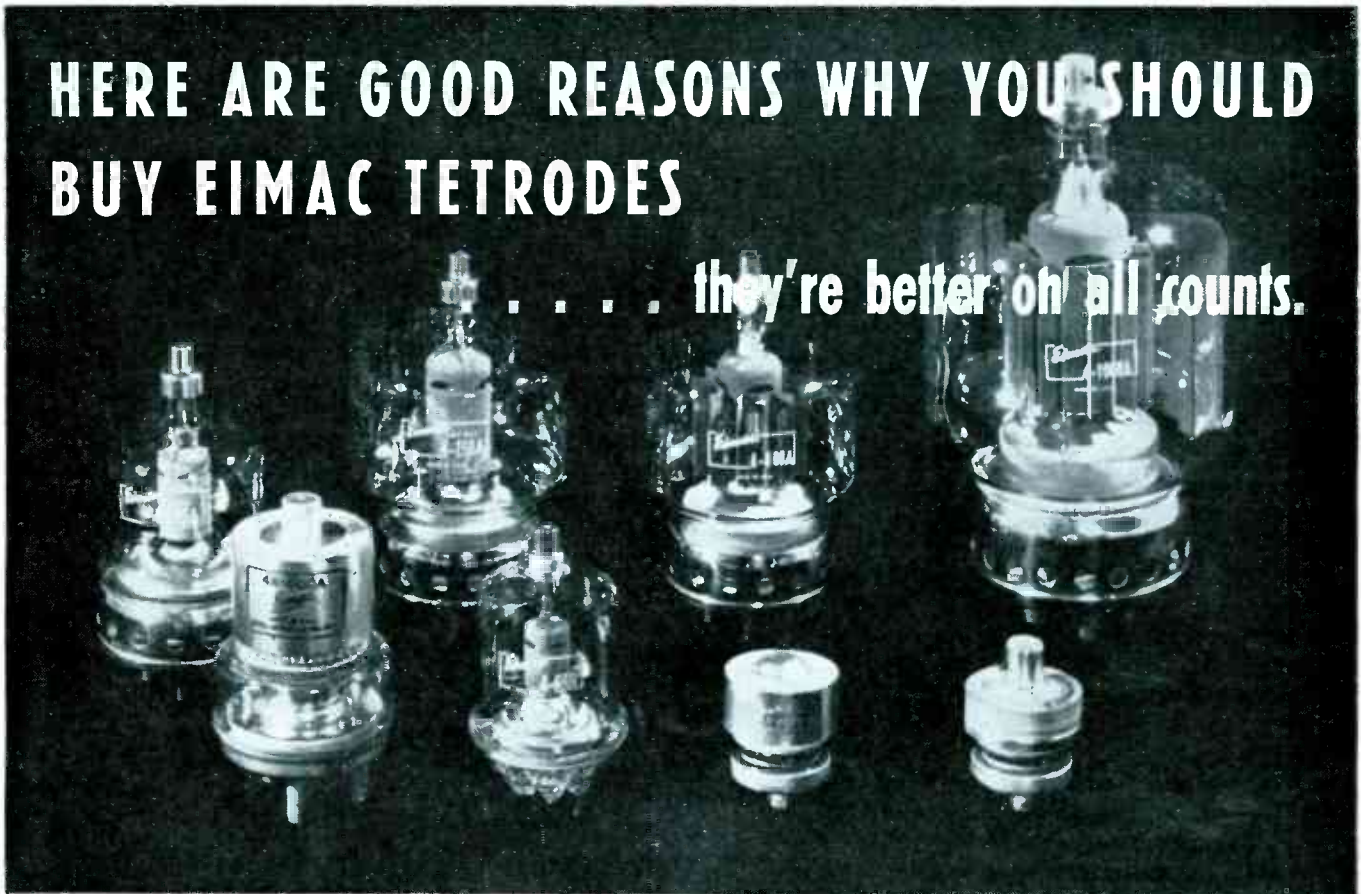
Great Britain's Radio Exports are going great guns. In December 1947 the million-pounds-a-month goal for radio exports was reached for the first time. The 1947 export total was 10.3 million pounds, compared with 8 million in 1946 and 2 million in 1938. Half of the 1947 exports were in radio receivers and phonographs, one-sixth in tubes, and an equal amount in communications, navigational and industrial electronic equipment combined. India is the biggest customer, taking one-fifth of current production.

Electronic Control of Humidity may prove to be a potent protector of health. Two U. of Chicago scientists reveal that germs causing pneumonia, scarlet fever and sore throats are highly vulnerable to the dehydrating action of salt in saliva. Such germs spread through the air, but only if the relative humidity is very close to 50 percent (which incidentally, is a comfortable value for humans). The required accuracy of humidity control can be had only by electronic means.

Cathode-Ray Tubes are mounted too close to the floor in most television consoles, making it hard for a plurality of people to see the show. This is just one of

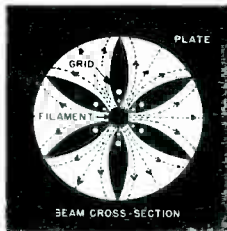
HERE ARE GOOD REASONS WHY YOU SHOULD BUY EIMAC TETRODES

... they're better on all counts.



CONSIDER THESE FACTORS . . . contributing to better tetrode performance . . . they are the result of extensive research plus the ultimate in vacuum tube "know-how" and they are your assurance of a tetrode tops in performance, mechanically and electrically rugged, stable in operation and with long life.

BEAM POWER . . . controlled by electron optics, and the placement of grids and plate alone. Electrons are emitted from the entire length of the filament and are actually channeled between the grid and screen bars. Careful engineering lowers internal feedback capacitances and increases screen-grid effectiveness.

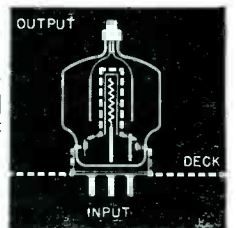


SYMMETRY OF DESIGN . . . enables manufacture of a mechanically rugged tetrode, with self-supporting internal elements. Gassy, inactive, internal insulators, shields and ineffective portions of the elements are eliminated.

PYROVAC* PLATES . . . are incorporated in all radiation cooled Eimac tetrodes. This new material contributes a mechanically rugged plate structure, high resistance to overloads, and exceptionally long life. The use of Pyrovac also enables the elimination of "getters" likely to form troublesome conductive deposits on the inner surfaces of the glass envelope.

PROCESSED GRIDS . . . by an exclusive Eimac technique . . . possess a high degree of stability and desirable non-emitting characteristics that contributes to over-all circuit stability.

INPUT-OUTPUT SHIELDING . . . plus inherent operational stability enables simplification of the associated circuits. Effectiveness of the shielding is so complete that mounting procedures require only that the bottom of the base shell be flush with the top of the deck and grounded.



Further comprehensive data on Eimac tetrodes or other Eimac vacuum tubes is yours, by writing direct.

EITEL-McCULLOUGH, INC.

196 San Mateo Avenue, San Bruno, California

EXPORT AGENTS: Fraxar & Hansen—301 Clay St.—San Francisco, Calif.

Follow the Leaders to

Eimac
TUBES
The Power for R-F

*Trademarks reg. US Patent Office.

several facts passed along to us by King Electronics' J. H. Robinson, who has made a survey of customer reactions.

Current Quotations: "Price goods too low and the customer questions its quality. Price it too high and you price it out of the market."

Busman's Holiday for many in our business is amateur radio. Of the nine men on *ELECTRONICS'* editorial staff in New York five have licenses, one will soon reapply, and another is learning the code.

Motorola has 53 amateurs in its Chicago plant . . . 11 inactive at present, 5 building gear, 7 on 2 meters, 5 on 10, 4 on 40, 1 on 80, and the rest operating on several bands.

How about vital statistics on some other plants?

Electronic Autopilots and turbo superchargers made by Minneapolis-Honeywell went into 35,000 B17, B24, B29 and B32 bombers during the war. Each plane carried six amplifiers for the two systems.

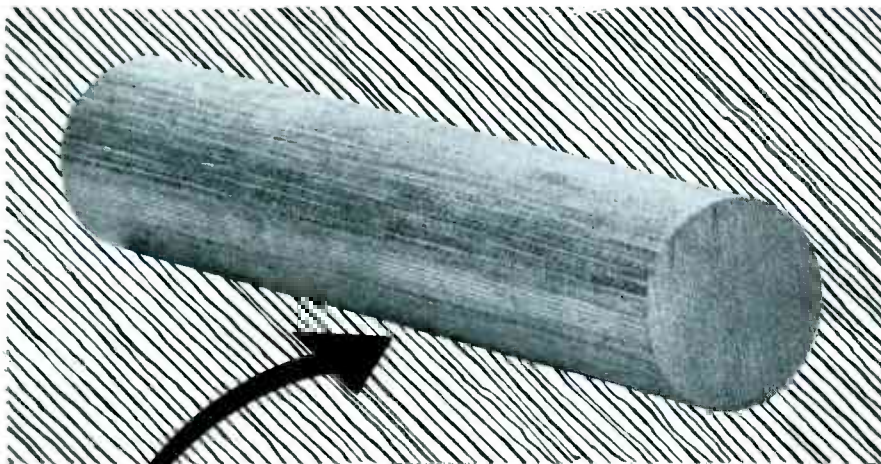
Some 1,000 AT11's carried autopilots for training purposes, and the last of the A26's were similarly equipped.

Television Test Equipment required by an adequately equipped installation and servicing organization costs from \$4,000 to \$5,000, according to Bill Jones of Amie Associates, who should know because he has been in the game for lo these many years.

English and North Irish radio receiver licenses totalled 11,056,900 at the end of 1947, an increase of 278,950 over the previous year. Included in the total were 32,700 television receiver licenses.

Commercial Marine Radar sold by Raytheon since VJ Day totals 450 units.

A New 50-KW Magnetron now undergoing test generates enough power at microwaves to explode tinfoil like a firecracker, scramble eggs in about two seconds.



FROM ROD STOCK TO SUPPORT BLOCK

That smooth cylinder of Taylor Phenol Fibre pictured above doesn't appear very complex.

But with a few deft motions in the machine shop, it becomes the hinge support block shown below . . . intricate, carefully engineered, highly specialized.

Sheets, rods, and tubes of Taylor Laminated Plastics, in various formulations, are serving industry in more ways every day. Their machineability is a paramount factor.

For a dependable source of supply for Phenol Fibre, Vulcanized Fibre, or special laminates . . . get in touch with Taylor. For fabricating service, too . . . with on-schedule deliveries . . . depend on Taylor. You'll get the kind of service that eliminates production headaches. As a starter, send a sketch or blueprint today. We'll tell you exactly what we can do for you.

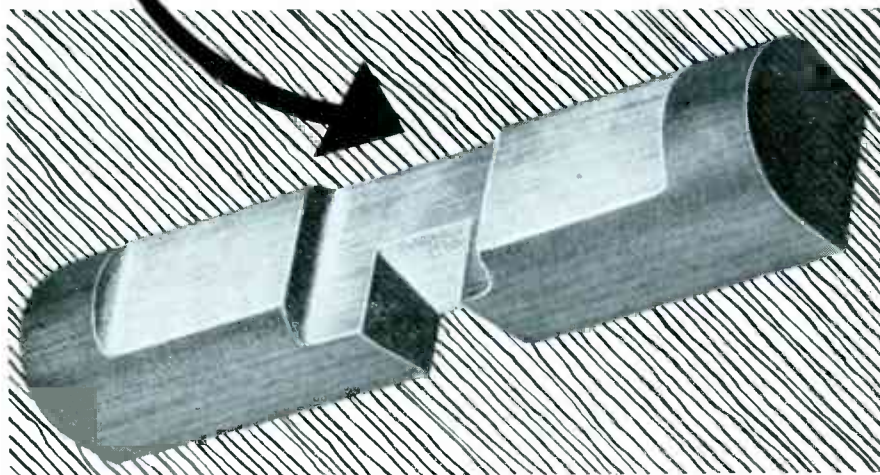
TAYLOR FIBRE COMPANY

LAMINATED PLASTICS: PHENOL FIBRE • VULCANIZED FIBRE

Sheets, Rods, Tubes, and Fabricated Parts

NORRISTOWN, PENNA.

Offices in Principal Cities • Pacific Coast Plant: LA VERNE, CAL.



Television Set Production since the war passed 250,000 sets in February, and the production rate was then at the rate of 430,000 sets a year, according to RMA figures. Two-thirds of the production was in table models.

What's - Wrong - Here - Department: Two papers presented on the same program at a recent meeting of servicemen were titled *How I Made \$50,000 Net in Servicing Radios Last Year*, and *I Spent \$91,000 to Earn \$90,000 in TV Service*.

Auto Radios were installed in 84 percent of the new cars sold during 1947, Sylvania's Frank Mansfield estimates.

Employee Suggestions pay off, and ought to be paid for. Stromberg-Carlson's Lee McCanne tells us that his company has had a suggestion-compensation plan in effect since 1917, and that much of its success is due to the fact that the employee's foreman, as well as the employee, collects on each idea.

Civil Aeronautics Administration hopes to complete installation by July of 396 vhf radio ranges for which funds have been appropriated. Delivery to airlines of 1,000 receivers began last month.

All Over Suburbia we hear the same story: baby sitters can be had if you have a television set. Otherwise you find yourself in the open market with no sales talk. Since video sets are going into homes at the rate of about 40,000 a month, it won't be long before your set must have all channels and a 15-inch tube to command any attention at all.

Story Of The Month: E. U. Condon of the National Bureau of Standards tells about two partners who decided to hire a research engineer. Along about 11 a. m. of the first day of his employment one partner said to the other: "Shall we go see whether that research man has discovered anything?" "No," replied his partner, "let's wait until after lunch."

TESTED! PROVED! SPECIFIED!



QUALITY SPEAKERS

The Drive-In Theatre Equipment Company, Inc.
Manufacturers of NATIONAL AUTO VOICE in-car Speaker Units

TELEPHONE CLEVELAND 8873

2110-2130 SUPERIOR AVENUE
CLEVELAND 14, OHIO

January 20, 1948

Mr. R. S. Fenton, Sales Manager
Parts Section, Receiver Division
Electronics Department
General Electric Company
1001 Wolf Street
Syracuse, New York

Dear Mr. Fenton:

We would like at this time to express our appreciation for your expeditious handling of our recent rush order for 5 1/4" PM Speakers.

The speakers used in the Drive-In Theatre in-car units must meet more rigid standards than those ordinarily required commercially. The Drive-In Speaker is subjected to the most adverse weather conditions, and must be able to stand up over a period of years without appreciable impairment of its electrical characteristics. The voice coil form, and the cone proper, must be impervious to moisture or direct rainfall.

It may be of interest to you to know that after a survey of the speaker field, we chose the GE Speaker as the one best able to meet our exacting requirements. The aluminum voice coil form is ideal for our work, since there is no danger of expansion due to moisture absorption. The speakers met Navy type tests such as shock, vibration, temperature, salt spray, and frequency response requirements.

Since standardizing on GE speakers, our customer reaction has been entirely satisfactory.

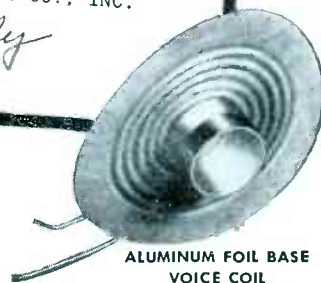
Very truly yours,
DRIVE-IN THEATRE EQUIPMENT CO., INC.

E. B. Brady

President

THE LETTER above speaks for itself— simply, forcibly, directly. It tells the story of standard, untreated, G-E speakers from an impartial point of view. Widely varying degrees of dryness and humidity in different sales areas, as well as in the individual home, can affect receiver performance. The aluminum voice coil construction which makes these production line G-E speakers ideal for this rugged, outdoor application can make them a feature of your home receivers. Specify G-E speakers— order today.

For complete information write:
General Electric Company, Electronics
Park, Syracuse, New York.



ALUMINUM FOIL BASE
VOICE COIL



GENERAL ELECTRIC

168-G2

What do you want to know about Vibrator Power Supply Design?



All the answers
are in this unique
new book



Here's the world's first "book of knowledge" about vibrator power supplies: a volume by the country's largest manufacturer of vibrators . . . a book that shares sixteen years of highly specialized experience with you . . . that answers every question on the subject, including mistakes to avoid in designing your new equipment. The information brought you in this volume is compact, complete, entirely original. It can not be duplicated anywhere else. It is as unique in its field as the Mallory Electrical Contact Data Book or the Mallory Resistance Welding Data Book are in theirs.

Although just published, demand for the Vibrator Data Book is already large. You can be sure of getting your copy by ordering *now*—before the first edition runs out. The price is only \$1.00. Free to recognized engineers and teachers when requested on your letterhead.

Basic Vibrator Structures
Mallory Standard Vibrators
Preliminary Design Considerations
The Choice of a Vibrator
Basic Power Transformer Characteristics
Tables, Charts, Graphs and Formulas
Development of Basic Transformer Formula with Design Examples
Timing Capacitor Considerations
Vibrator Power Supply Construction and Interference Elimination
Vibrator Power Supply Circuits
Inspection of Vibrators

P. R. MALLORY & CO. Inc.
MALLORY VIBRATORS
AND VIBRATOR POWER SUPPLIES

P. R. MALLORY & CO., Inc., INDIANAPOLIS 6, INDIANA

**MORE MALLORY
VIBRATORS ARE IN USE
TODAY THAN ALL
OTHER MAKES COMBINED**



CROSS TALK

►**PREPAREDNESS** . . . It is clear that the people of America have embarked on a program of preparedness for war as the best insurance against war now available. One part of this program is the research and development work in our colleges and industrial laboratories supported by military funds, the annual cost of which is budgeted at approximately one-half billion dollars. A large portion of this amount is currently expended in the field of electronics. Many indirect benefits to the arts of peace will come of this, but the direct and primary purpose of this work is to **keep** the peace by preparing against the contingencies of war. Apparently the importance of the research and development portion of the preparedness program is recognized. But in assessing the adequacy of the program other aspects must be judged.

Unless we can capitalize on research and development, unless we are able to carry the results through to quantity production when needed, preparedness is an empty word. This ability can be gained only by industrial mobilization planning, an essential element of the preparedness program which has not been given the recognition or support it deserves. Whether we like it or not, industrial mobilization must be the concern of our industry as well as every other.

One of the Services has a sizeable staff at work on electronic mobilization planning and is making a determined effort to keep the plan abreast of developments both technically and strategically. The other two Services have few men devoting full time to this work and, so far as we know, the electronic industry represented by the RMA and other groups is not concerned with the problem at all. To

attain the objective of electronic preparedness, a sustained and coordinated attack must be made on the problem by **all** members of industry and **all** the Services. Busy as the Services and our industry are today, neither can escape the responsibility for intelligent planning for future wartime military needs.

One pattern has already been established in the aircraft industry, which devotes many hours of excellent talent to the problem of matching production facilities to possible military requirements. The cost is borne by the Services under contracts with the manufacturers and selected research groups. It may be that similar contracts should be written for electronic industrial mobilization planning. In any event, a plan of attack on the problem should be worked out by the industry and Government in close cooperation. To do this, more talent should be assembled on the Government side and the industry will have to reserve sufficient time of its top personnel to work with them. With industry and Government actively collaborating, this chink in our defense can be filled.

A Communications and Electronic Equipment Committee has been established in the Munitions Board. The Committee is made up of representatives from each of the interested Services. Its task is to assist and advise the Munitions Board in establishing a realistic mobilization plan for the electronic industry. This Committee, therefore, should be the central point of contact. A constructive step would be for the Communications and Equipment Committee to request the cooperation of the industry in all phases of the plan. Such a request should be welcomed by our industry.

I. R. E.

National Convention—1948

New York meeting presents 130 papers to an attendance of 15,000, awards to Horle, Seeley, Huggins and 26 fellows. Accelerated activity evident in television, computers, superregeneration, tubes, and nucleonics. Equipment valued at six million shown

EVIDENCE that postwar activity in the field of electronics continues at a level three or four times the prewar level was offered at the National I.R.E. Convention, held March 22-25 in New York. For the second year in a row, I.R.E. put on a show which far outranked the conventions of the old-line technical societies in size and vigor. A program of 130 papers, an attendance of 15,000, and exhibits by 196 manufacturers and government organizations of equipment valued at six million dollars, provided an overpowering experience for the engineer who tried to take it all in.

When the I.R.E. national convention stepped into high gear in 1947 there were many complaints that the occasion was too elaborate. This year this feeling had given way to resignation that the art was moving so fast there was no way to cope with it. No reporter, or group of reporters, could hope to cover all the sessions or report all the significant advances. What follows here is a fragmentary account of some of the highlights.

Institute Awards

The highest award of the Institute, the Medal of Honor, was conferred on L. C. F. Horle, consulting engineer and head of the RMA Data Bureau. This award recognized the years of service Larry Horle has given the industry in guiding its standardization work, and in coordinating the committee activity and

publications of the National Television System Committee and the Radio Technical Planning Board.

The Morris Liebmann Memorial prize went to Stuart W. Seeley, head of the RCA Industry Service Laboratory in New York, for his development of ingenious circuits for frequency modulation, including the discriminator and ratio detector. The recently established prize in memory of Browder K. Thompson, who lost his life in action in World War II, was awarded to William H. Huggins, of the Cambridge Field Station, Air Materiel Command, for his paper on broadband short circuits for coaxial lines.

Twenty-six fellowships were awarded to members of the Institute. Reflecting the trend of the times, seven of these awards cited work in the field of television, five in communications, four in general engineering, three in military activity, and two each in measurements, development of vacuum tubes, and navigation.

The President's Luncheon featured a speech by Wayne Coy, newly elected chairman of the FCC. Mr. Coy drew applause for his plea for care in the engineering design of two classes of radio equipment, lack of which may seriously impede the future progress of the art. No new design of a transmitter, he said, can be considered adequate if it neglects the suppression of harmonics, and no receiver design is ade-

quate if it neglects suppression of oscillator radiation. He questioned the adequacy of a television allocation plan restricted to city districts, and predicted that all the channels allocated to the 140 metropolitan districts would be assigned by the end of the year. Mr. Coy announced that the FCC had given type approval to the first Citizens Radio equipment, that production was underway and that a simplified licensing procedure was being worked out.

The Annual Banquet was addressed by W. R. G. Baker, outgoing president, who drew the parallel between the frontiers of territorial expansion and the frontiers of electronic science. Noting that nucleonics and electronics were inextricably interwoven, he reminded his audience expanding knowledge is fruitless and dangerous unless it is available to everyone who can use it for human betterment.

A. N. Goldsmith, noting that the Institute's membership had doubled between 1927 and 1937, quadrupled between 1937 and 1947, gave evidence that I.R.E. activities are now big business. One hundred thousand man hours of effort were expended in I.R.E. Committee work in 1947, representing an investment on the part of the members and their employers of nearly a million dollars.

Contrasting with present activity, John V. L. Hogan outlined the frontiers of the industry in 1912,



View of some main floor exhibits during a lull in traffic. Over \$6,000,000 worth of electronic equipment was displayed on the three floors and balcony of Grand Central Palace

when the spectrum extended from 50 to 1500 kc, radio-frequency amplification was unknown, and the triode vacuum tube was not popular because it required batteries. Max Balcom, president of RMA, predicted an eventual expansion of the industry to an annual value of goods and services of five billion dollars.

Organization of Technical Program

The 130 technical papers were arranged in quintuplicate sessions on the following topics: frequency modulation, networks, systems, navigational aids, antennas, amplifiers, tube design, superregeneration transmission, nuclear studies, industrial electronics, components, supersonics, television, synthetic crystals, broadcasting and record-

ing, tube manufacture, measurements, computers, propagation, microwaves, receivers and active circuits.

The first paper on the program, by H. B. Richmond of General Radio, discussed the position of the engineer in the electronics industry. Approximately one-quarter of all college trained engineers are in the field of electrical engineering, and the majority of this group are in electronics and communications.

A 20-fold increase in available electronic engineers is to be expected in the twenty year period from 1938 to 1958. Even in the next 2 years, a four-fold increase may occur. This is in itself not cause for concern, but it is certain that research jobs cannot be found for all the recent graduates now

demanding this type of work. Work in design and production engineering, maintenance and operation should be plentiful, however.

Mr. Richmond's researches indicated that the average B.Sc. graduate starts at about \$250 per month, somewhat higher if he has had useful military experience. An M.Sc. degree is worth about \$50 additional to start, a D.Sc. or Ph.D. about \$100 over a B.Sc. Engineers with doctors' degrees tend to stay in research, scientific and design engineering jobs longer than those with lower degrees. Most of the engineering administrative and sales engineer jobs are filled with lower-degree men. A research man in electronics must be supplied with about \$15,000 worth of equipment, and is likely to cost his employer

about \$10,000 a year if he is to be effective.

A new type of beam tube intended to serve as a frequency-modulation detector was described by Robert Adler of Zenith. The tube performs the functions of a grid-bias limiter and a discriminator, using a single tuned circuit and an ingenious beam structure within the tube. The limiting occurs instantaneously, since there is no energy storage in associated circuits. A beam-forming cathode at r-f ground passes a beam through a positive slot aperture and thence to a control grid connected to the i-f input signal. The electron beam, emerging from the grid, passes another positive slot aperture through a second grid and thence to the anode.

If the control grid is negative, the trajectories of the beam electrons are curved back toward the cathode in such a way that they cannot pass through the second slot. At positive grid potentials however, the electron beam passes through to the anode. The limiting action is extremely sharp and occurs at an input signal of about one volt. The second grid is connected to a single tuned circuit to introduce the quadrature component necessary for f-m detection. The audio output appears directly at the anode. Since the output-vs-frequency curve of the gated beam tube has no negative slope within several hundred kc of the midfrequency, the tuning of the receiver is simplified.

Simplified Selective Sideband

Another paper which excited particular interest was presented by D. E. Norgaard of General Electric, describing simple methods of selective sideband transmission and reception. Using the wideband phase-shift circuits described by R. B. Dome in *ELECTRONICS* in 1946 (December, p 112), it has been possible to construct simple and practical single sideband systems, useful with any type of modulation (a-m, f-m or p-m, with the carrier suppressed, attenuated or exalted). Moreover restriction of audio bandwidth does not occur; response flat within 0.1 db from 30 to 15,000 cps is possible in single sideband operation. Low-level modulation is used,



Broadcast engineers Glenn Koehler and Harold Engel of WHA, Madison, Wisconsin, measure distortion and noise in an audio signal while Bill Broughton of GE (at left) explains the operation of the equipment

followed by linear amplification.

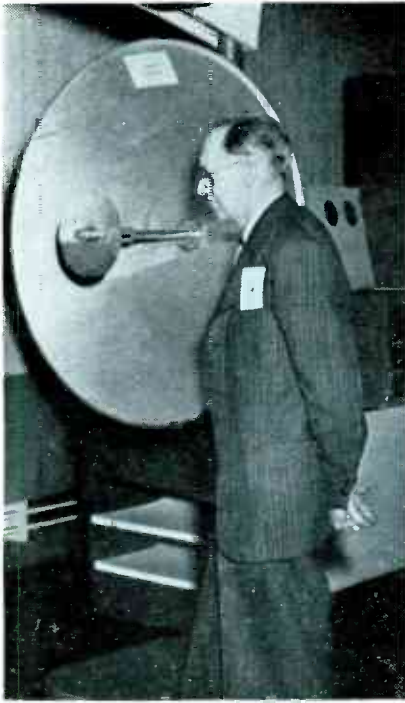
In the receiver, conventional circuits are used up to the second detector. At this point two detectors are used in conjunction with a locked-in second local oscillator. The outputs of the detectors drive Dome phase-shift networks, producing sum and difference frequencies corresponding to the respective sidebands. Two audio amplifiers develop these signals separately. One of the most interesting practical applications suggested was the use of the two sidebands in conventional broadcasting to supply binaural reception, two microphones controlling each sideband independently. In shortwave communication, where selective fading is severe, single sideband operation produces a substantial improvement in intelligibility.

Low-Noise Amplifier

An ingenious double-triode amplifier originally developed at the Radiation Laboratory in 1944 was described for the first time by Messrs. Wallman, Macnee and Gadsden of MIT. The two triodes are connected in cascade, the first tube operating as a normal grounded-cathode stage directly coupled to the cathode of the second, which operates as a ground-

ed-grid stage. Used as i-f amplifiers, each stage has a single-tuned circuit in its input, and the first stage has in addition a small inductance between grid and anode. The second stage, being grounded grid, presents a very low impedance to the plate of the first stage. As a result the gain of the first stage is about unity and its operation is correspondingly stable over a wide band. The gain of the grounded-grid (second) stage is about equal to the product of its transconductance and load resistance, whereas the overall gain is the product of the first tube transconductance and the second tube load resistance.

The overall power gain of the two tubes is of the order of 200 using typical tubes and this makes the noise contribution of the following stages negligible. Typical tubes used are a 6AK5 connected as a triode for the first stage and one-half of a 6J6 double triode as the second stage. Typical stages operating at mid frequencies of 6, 30 and 180 mc have exhibited noise factors 0.25, 1.35 and 5.5 db above theoretical respectively, at bandwidths of 2, 12 and 30 mc respectively. One of the lowest noise figures ever obtained in a 10-cm radar receiver, 8.7 db above theoretical, was achieved by the authors



The radiator for a big-dish antenna displayed at the IRE meeting is examined by George McIntire of WJEJ, Winchester, Virginia

using a cascade amplifier of this type at 30 mc.

Diode Rectifier Motor Control

Thyratron motor controls to secure a high value of torque at low speeds in motors, now commonly used in machine tool drives and other industrial applications, can be improved to the extent of a 50 percent increase in torque, by the circuit described by W. N. Tuttle of General Radio. In this circuit a variable transformer (Variac), a choke and a full-wave vacuum diode rectifier are used to feed the armature of a d-c shunt motor. The low cost of vacuum full-wave rectifier tubes makes it possible to provide current capacity sufficient for instant starting, and the space requirements for the control are considerably less than that of the equivalent thyatron control. A one-third h-p motor can be controlled by such a circuit in a case 9 by 5 by 12 inches. By reversal of the armature current it is possible to provide dynamic braking in addition to speed control. A constant increment in speed from no load to full load is obtained over the full range of speed control, which may cover a range as wide as 20 to 1.

Two well known figures in radio, Knox McIlwain and Harold A.

Wheeler addressed themselves to an old problem: Can radio waves be transmitted deep in the earth? Calculations had indicated subsurface exploration as deep as 5,000 feet might be possible by reflection of radio waves from strata, assuming a system amplification of 150 db. The Bureau of Mines had received radio waves at broadcast frequencies several hundred feet below the surface under circumstances which indicated direct passage through the earth. A joint investigation by Seaboard Oil Company and Hazeltine was set up to determine what might be done, using wave frequencies from 0.5 mc to 1,000 mc. Initial successful transmission through 600 feet of earth proved impossible to repeat. Later it was noted that the first observation had been made following a prolonged dry spell, whereas later attempts had followed heavy rain fall. A final determination was made by lowering a transmitter and receiver through separate drill holes, with the holes capped so that any energy detected would have to pass through the ground. Variations in loss as high as 1 db per foot were observed between layers of shale and sand, and the variations were closely correlated with changes in structure. Ground moisture introduces such losses that it was concluded that this method of geophysical prospecting was impractical. The method has some chance of success when used to locate water in very dry regions, however.

New Microwave Oscillator

E. D. McArthur of General Electric described a new type of triode, now in the development stage, which may prove useful as a generator of microwaves for such purposes as local oscillation and signal generation. The tube, called a dyotron, is a conventional triode containing a bypass capacitor of about 70 $\mu\mu\text{f}$ within the envelope connected directly between grid and cathode, thus effectively removing any r-f potential between grid and cathode. The tube then becomes a two-terminal device, so far as r-f is concerned. Oscillation occurs as a result of the penetration of the grid-anode field through the grid

structure so that it affects the cathode current. No external feedback circuit is required. D-c bias may be applied between grid and cathode to regulate the frequency of oscillation.

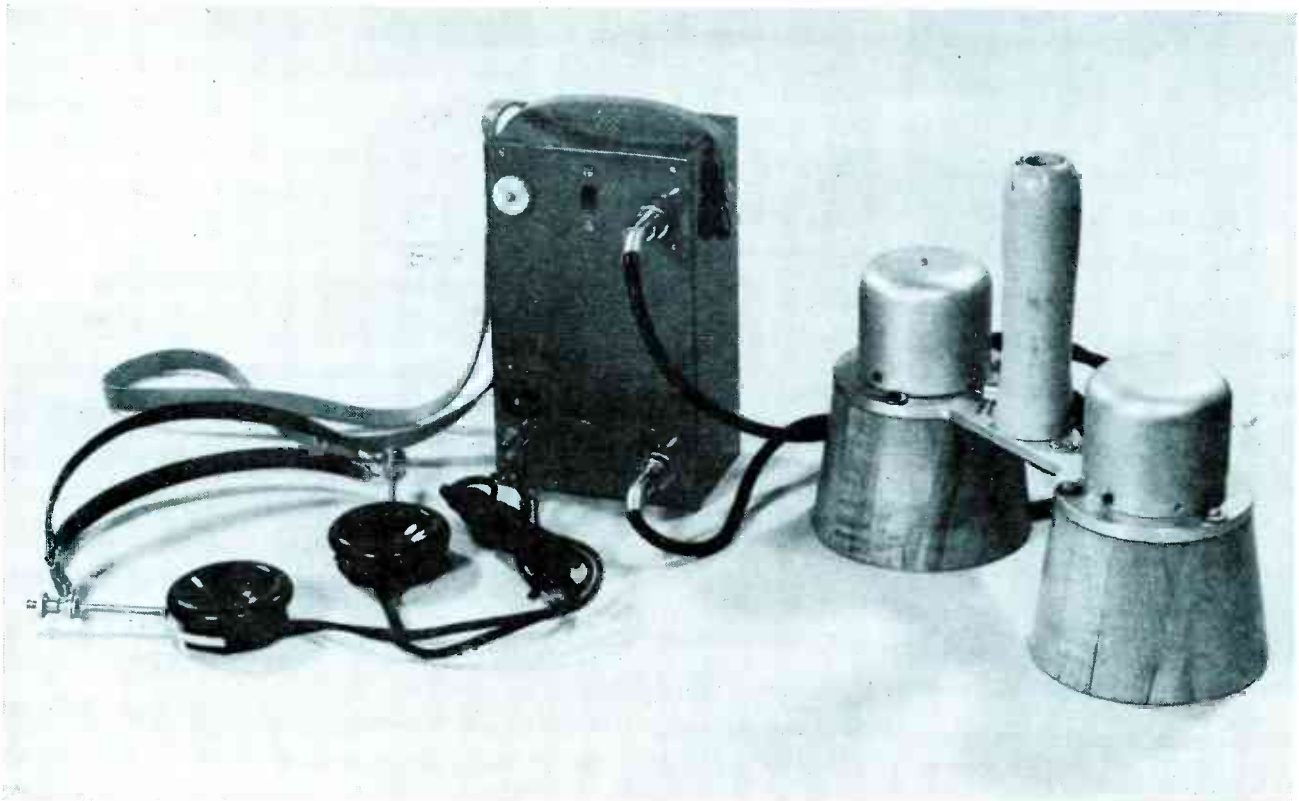
The frequency range depends on the transit angle relations. By placing such a tube in a coaxial cavity, and by adjusting a piston in the cavity, a tuning range of 1,800 to 2,800 mc, with a power output varying from 100 to 350 milliwatts was obtained, with excellent frequency stability. In a signal generator, a single tube covers the range from 1,400 to 3,200 mc. Electronic tuning is possible by changes in grid bias at a rate of about 0.5 mc per volt, over a total range of 3 to 4 mc at 1,000 mc.

Superregeneration

A rebirth of interest in superregenerative receivers was evidenced by a session of five papers on this subject. W. E. Bradley of Philco presented a unified theory of this circuit drawing a causal connection between the shape of the time variation in the conductance of the tube, determined by the shape of the quench waveform, and the resulting selectivity curve. A Fourier transform is employed to convert from the time function to the frequency function. An example of this technique, the design of the Fremodyne circuit for f-m reception, was given by B. D. Loughlin of Hazeltine. Harold Wheeler reviewed the recent history of this circuit and opined that new uses would be found for it, now that the basic theory is better understood.

The growing importance of electronics in nuclear studies was reviewed in two sessions, and announcement was made of the cooperative effort of several technical societies to set up a uniform glossary of nuclear terms.

A new branch of communications technology, christened cybernetics, was discussed by Norbert Wiener of M. I. T. This system brings the nervous system and its psychological attributes explicitly into the communications system as a functional element and studies the capacity of the individual to assimilate and use the information offered by the system.—D.G.F.



Experimental model of a 32-kc pulsed frequency modulation blind guidance system. Headphones can be replaced with bone conduction unit, and use of 65 kc allows smaller double-transducer assembly (see Fig. 1).

BLIND GUIDANCE

To investigate the possibilities of developing artificial devices to aid the military blind, the Committee on Sensory Devices was organized in 1944 under the jurisdiction of the Office of Scientific Research and Development. The Haskins Laboratories of New York City was selected by the Committee on Sensory Devices to serve as a central laboratory for the Committee in guiding the efforts of various groups doing the research and development and also to carry on tests with blind subjects. The Stromberg-Carlson Company was one of three industrial organizations chosen to develop blind guidance devices using ultrasonic echo-ranging techniques. In September 1945, the

Committee on Sensory Devices was transferred to the National Research Council and the financial support of the research program was taken on jointly by the Surgeon General of the War Department and by the Veterans Administration.

While the idea of a person's carrying around a portable radar-like device originally seemed rather fantastic, there was the precedent of the bat's use of an acoustic form of echo ranging^{1,2} and of a blind person's use of audible sounds to locate walls and other fairly large obstacles.³

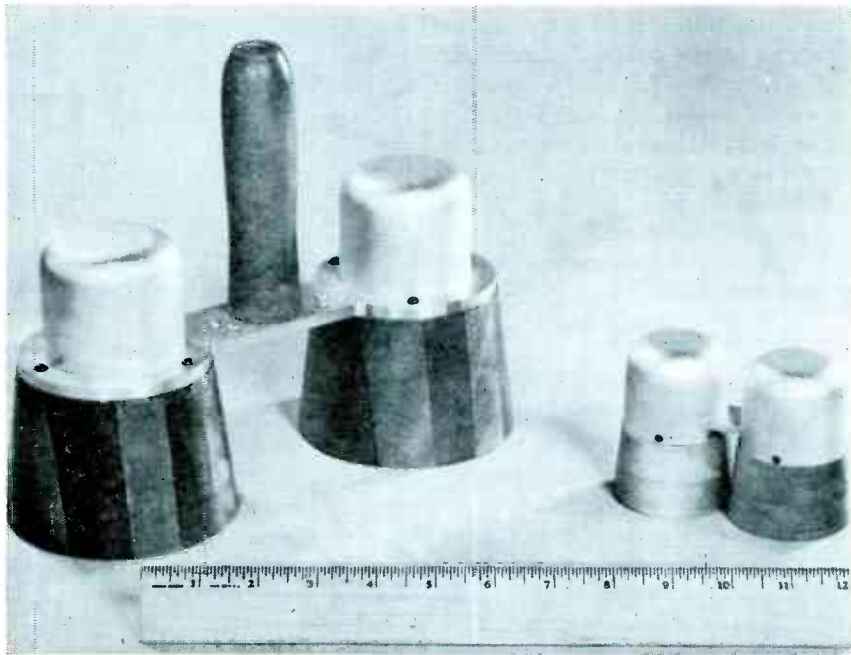
System Limitations

Although at first the form of the guidance device was only loosely defined, it was natural to assume that

it would be something like a flashlight which the user could point in various directions. The signal would probably be some audible indication of the distance to the obstructing object. The maximum distance range that seemed desirable changed with experience.

At first, the tentative specifications called for a maximum range of at least twenty-five feet, and fifty feet if possible. Later experience with systems which did have a range of fifty feet or more showed that there was a large amount of information about distant objects that was of no immediate use and actually caused confusion. A blind subject, for example, walked with much more confidence if the guidance device gave no indication of objects beyond eight feet than he

From a paper presented at the 1947 National Electronics Conference in Chicago.



By **FRANK H. SLAYMAKER**
and
WILLARD F. MEEKER
*Research Department
Stromberg-Carlson Co.
Rochester, N. Y.*

FIG. 1—Magnetostriction transducers used in the 32-kc (left) and 65-kc devices

Portable radar-like device employing pulsed frequency modulation gives a single audio frequency tone corresponding to any given obstacle distance. Simultaneous echoes from different distances are identified by combinations of individual tones. Complete experimental equipment weighing $5\frac{1}{2}$ pounds operates at 65 kc to detect obstacles up to 30 feet

by ULTRASONICS

did if he had to sort out and interpret information indicating many distant objects. Whether a prolonged training period would make it possible for the subject to ignore the distant signals, except when they were of real interest, is open to question.

A fundamental limitation of any echo-ranging system is the fact that the type of information which a blind person expects from a guidance device can not always be obtained by echo-ranging. An open door, for example, is difficult to find from the opposite side of a room. Unless the beam of ultrasonic sound is very narrow, the echoes from the posts at each side of the door mask the lack of an echo between them. A closed door, it would seem, could not be found at all. Conditions that

are hazardous are sometimes difficult to find by echo-ranging, since not all hazards are caused by the presence of obstacles. An open manhole, a sudden step-down or a curb are as dangerous as solid obstacles,

yet it is difficult to identify either the hole or the step-down by echo-ranging. From the point of view of acoustic field theory, there is always a scattered wave whenever there is a discontinuity of any kind

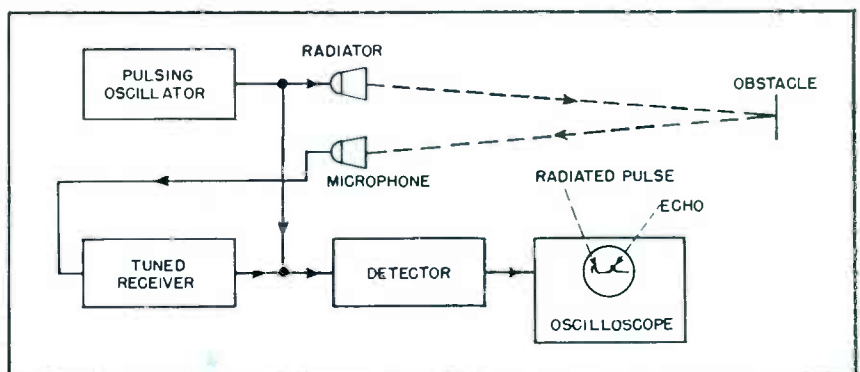


FIG. 2—Block diagram of a simple pulsed blind guidance system

in the path of the sound wave. The wave scattered back from a step-down, however, is so small that it might easily be mistaken for the wave scattered from a crack in the sidewalk.

Signal Presentation

Even if the desired information can be obtained by echo-ranging, there is still the problem of the presentation of this information to the blind subject. With the sense of sight no longer available, the information must be presented to one or more of the remaining senses. The most obvious method of presenting direction is to allow the transducer unit to be held in the hand so that the subject can scan his environment with the projected ultrasonic beam. When an obstacle is detected, its direction is thus the direction in which the transducer unit is pointed. This method is used in all systems described here.

Perhaps the most obvious method of distance presentation is aural. However, other types of presentation are possible and in some circumstances may be more desirable.

Ultrasonic systems have been built that present the range information either aurally or tactually. Some of these systems have been modified so that the information is presented by direct electrical stimulation; for example, a controlled shock. Of the three methods, the most information can be presented aurally. However, blind subjects prefer not to use earphones since they interfere with normal hearing cues. While the use of a bone conduction receiver may be the most satisfactory compromise, the decision between types of presentation can only be made after tests with blind subjects.

A number of difficulties exist in ultrasonic systems, the main one being specular reflection of sound from large, smooth surfaces. Such a surface, unless it contains irregularities that scatter the sound, can be detected only when it is oriented normal to the beam. Fortunately, most flat surfaces encountered can be detected by the scattered sound. Ambient noise in the ultrasonic range can, occasionally, interfere with the desired signal. For ex-

ample, the jingling of keys, if the keys are in the path of the beam, or the blast of air from an air hose can cause trouble.

The complete evaluation of any blind guidance device is in itself a major psychological problem. Since this phase of the work is carried on by the Haskins Laboratories, it will be reported elsewhere.

Transducers

While the requirements of efficiency, bandwidth, transient response, small size and light weight are stringent, magnetostriction transducers have been developed that have given satisfactory performance. The magnetostriction transducers for use at 32 kilocycles have been described elsewhere;⁴ these transducers were satisfactory for experimental use but would be too large for a practical device. Magnetostriction transducers for use at 65 kilocycles have also been developed. These are similar to the 32-kilocycle transducers but are correspondingly smaller so that their directional characteristics are approximately the same.

Separate but identical transducers are used for radiator and microphone. The transient response of the units does not permit use of a single unit for both functions. Figure 1 is a photograph of the double transducer units for 32 kilocycles and for 65 kilocycles.

The beam width of a single transducer is about 6.5 degrees at the half-power point. The on-the-axis sensitivity as a microphone is 60 to 70 decibels below one volt per dyne per square centimeter. The bandwidth of a single unit is 300 to 500 cycles. In a pulse ranging system, this bandwidth is sufficient to resolve two objects spaced from $1\frac{1}{2}$ feet to one foot apart.

Simple Pulse System

The simplest type of pulse echo-ranging system is shown in Fig. 2. A pulsing oscillator generates short pulses of ultrasonic frequency separated by a constant interval of time. The distance from the transducers to an object which reflects the ultrasonic pulses is determined by measuring the elapsed time between the radiation of a pulse and



FIG. 3—Oscillogram showing echo fluctuations as a person approaches

the return of its echo. For studying the properties of ultrasonic sound fields it is convenient to use an oscilloscopic presentation similar to the A-scan of radar. Such a presentation is, of course, useless to a blind man, but the information obtained from the simple pulse systems has been invaluable in the laboratory. By means of such systems it has been possible to measure the magnitude of the scattered wave from a sharp step-down.⁵ It was also apparent, after working with the pulse system for a while, that the echo from an object as small as a fine thread might, under certain circumstances, be greater than the echo from a large, flat wall. At 65 kilocycles, an ordinary sewing thread at a distance of a foot or two and held normal to the beam produces an easily detectable echo, while a very smooth wall at an angle to the beam may give no detectable echo at all. Inhomogeneities in the air cause the echoes from objects ten or twenty feet away to fade and flicker, and at 30 kilocycles the echo from a wall about thirty feet distant may vary from zero to a strong echo that fills the whole oscilloscope screen. Echoes from objects having a complex shape are even more susceptible to flickering than the echoes from a simple object such as the flat wall. Sound reflected from various portions of the complex object may reinforce or cancel as the atmospheric conditions vary, and in such an instance it takes a very small change in the properties of the acoustic path to cause violent fluctuations of the echo. Most unstable of all is the echo from a complex moving object. Figure 3 shows the fluctuations that occur as a person walks toward the transducers. The frequency is 32

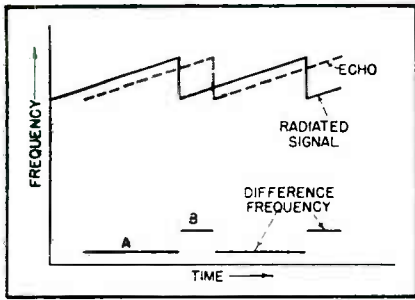


FIG. 4—Graphical representation of the sawtooth frequency modulation system

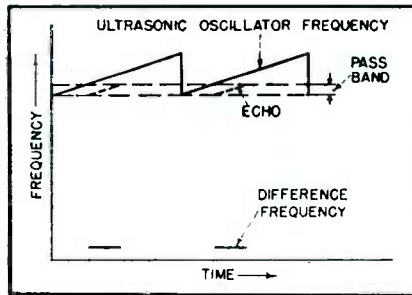


FIG. 5—Pulsed frequency modulation system employing ultrasonic oscillator

kilocycles and the total length of the sweep is equivalent to 18 feet. To obtain this photograph, the camera shutter was left open for the entire time it took the subject to walk up to the transducers.

First-Echo Pulse System

One type of pulse system often proposed for blind guidance causes the outgoing pulse to be initiated or triggered off by the echo. In such a system the repetition rate gives an indication of the distance, a fast repetition rate indicating a nearby object and a slow repetition rate indicating a distant object. This type of system should operate satisfactorily if only one echo is received for each radiated pulse. However, it often happens that echoes from more than one object are received in a single period. For example, if three echoes return after the first pulse, each of these three echoes will trigger off a pulse, and for each of these pulses there will be three more returning echoes. It is apparent that there results a continual multiplication of the number of pulses sent out so that the system quickly saturates and no useful information is obtained.

A system has been developed to avoid this difficulty by responding to the first echo only. It has a repetition rate that is a function of distance. This short-range obstacle-location system meets the following specifications: (1) the device responds to the first echo only; (2) the presentation is tactile; (3) the range is limited; (4) there is no detectable signal when no echo is received; (5) the frequency of the tactile presentation decreases with distance.

The range indication as given by the repetition rate varied in the

first-echo pulse system developed from about 30 pulses per second for nearby objects to about five per second for distant objects. The maximum range could be limited to any value between six and 20 feet. This system, however, had two important fundamental limitations.

First, the frequency range of the distance indication was insufficient for tactile presentation. The maximum repetition rate could not be increased since the period must be sufficiently long for all echoes to return in the same period in which the corresponding pulse was radiated. Reports from the testing psychologists indicate that a frequency range of 20 to 200 cycles per second should be provided for tactile presentation.

The second limitation was the effect of fluctuation of the echoes mentioned earlier. These fluctuations produced an instability in the signal which made it difficult to interpret. As the echo flickered, there was an occasional period in which the significant echo did not appear. In such event, the radiation of the next ultrasonic pulse did not take place until the normal idling period had passed. The pulses were thus unevenly spaced, making it

difficult to recognize any definite repetition rate.

To be sure that the range indication will be independent of the way in which the echoes might flicker, the indication of the distance to the reflecting obstacle should be definitely established by one sequence of events consisting of the radiation of the ultrasonic signal and the return of the echo. It should not be necessary for subsequent cycles of events to repeat consistently. In an oscilloscopic presentation, the position of the echo on the horizontal axis is fixed by the time that elapses between the radiation of the pulse and the return of the echo. No matter how violently the amplitude of the returning echo may fluctuate, the position of the echo on the oscilloscope remains substantially unchanged.

F-M Systems

A similar independence of range indication and echo amplitude can be attained with a frequency modulation ranging system. In such a frequency modulation system, the frequency of the ultrasonic signal is varied cyclically as a function of time. Since the echo is delayed by the time required for the signal to travel to the reflecting object and back to the transducers, there is a difference between the echo frequency and the frequency of the ultrasonic oscillator at the time the echo returns. This difference in frequency is also a function of the distance to the reflecting object. If the rate of change of frequency is chosen properly, the difference frequency can be made audible by mixing the oscillator signal and the echo in a nonlinear circuit. To de-

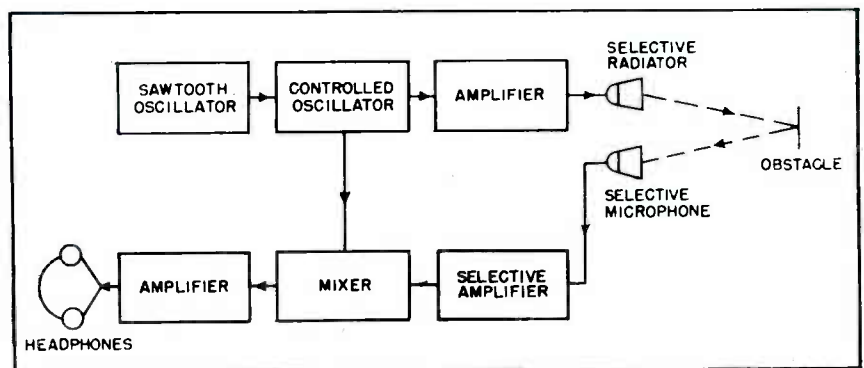


FIG. 6—Block diagram of the pulsed frequency modulation system

termine the distance to the reflecting obstacle, the only requirement is that the duration of the audible signal within one repetition period be great enough to permit recognition of the pitch. The duration of the signal can thus be as short as 40 milliseconds for the recognition of the pitch of signals above 100 cycles per second.⁶ It will not matter if, in the next repetition period, the echo fades out completely, for the accurate interpretation of the range signal does not depend upon the consistent repetition of the signal in every period.

The most common types of modulation used in f-m ranging systems are sinusoidal and sawtooth modulation. Sinusoidal modulation results in an unnecessarily complex signal, and consequently will not be considered here. Sawtooth frequency modulation is illustrated in Fig. 4.

The radiated signal is represented by the heavy line that varies up and down in frequency as a function of time. The echo, shown by the dotted line, is delayed by the length of time required for the radiated signal to reach the reflecting obstacle and return. The difference in frequency between the radiated signal and the echo is shown as the solid lines A and B. It is seen that there are present in the beat note two frequencies. Frequency A rises as the distance between the radiator and the obstacle increases while frequency B becomes less. If we call the repetition period T and the delay time Δt , the beat note corresponding to an echo which is delayed by a length of time Δt will be indistinguishable from the echo which is delayed by an interval equal to $(T - \Delta t)$. The problem of finding one's way about with any ranging device is difficult enough without forcing the user to interpret contradictory signals.

PFM System

A system known as the pulsed-frequency modulation system or pfm has been developed to eliminate the confusing characteristics of the f-m systems described above. Figure 5 shows the way in which the pfm system functions. The ultrasonic oscillator varies in frequency following the sawtooth

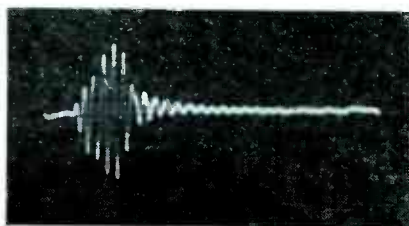


FIG. 7—Oscillogram of audible signal from pfm guidance system

curve. The frequency band of the sound actually radiated and received is limited by the pass band of the ultrasonic transducers. The received echo, then, is a pulse of ultrasonic energy of changing frequency that lasts about 50 milliseconds. A block diagram of the pfm system is shown in Fig. 6. The echo and the original oscillator frequency are combined in a mixer stage and the audible beat note is fed into a headset. The beat note appears as a series of pulses, as illustrated in the oscillogram in Fig. 7.

In the pfm system there is a single audio frequency corresponding to any given distance, and as long as the repetition rate is sufficiently slow that even the most distant echoes return before the new repetition period starts, there is no contradictory information supplied. Even when echoes from different distances arrive during the same period, the subject can learn to identify the different distances by listening for the various individual frequency components in the audio output. It is much the same sort of situation as learning to identify the notes of a musical chord, with the exception that in the output of the pfm system the low frequencies that correspond to nearby objects are heard first, and the higher frequencies that correspond to the more distant objects are heard slightly later.

The photograph shows an experimental version of the pfm system. The case houses a four-tube receiver, a six-tube transmitter, and batteries. Subminiature tubes are used in all positions except the ultrasonic output stage which employs a 3Q4. Filament drain is 370 milliamperes at 1.5 volts; plate drain is approximately 5 milliamperes at 45 volts. Total power demand is about 0.75 watt. The

weight of the complete system, including transducers, headphones and batteries, is $5\frac{1}{2}$ pounds. This particular system was designed to operate near 30 kilocycles. The maximum range depends upon the size and nature of the obstacle. A person in an open area can be detected at distances up to about 30 feet. In the judgment of blind subjects it was the most useful of the systems tested for actual outdoor situations.⁷

The two most obvious disadvantages of this model of the pfm system were the size of the transducers and the use of headphones. These disadvantages have, to a large extent, been overcome in a more recent model that operates at 65 kc and uses the smaller transducers shown in Fig. 1. A bone-conduction receiver is used instead of headphones. Although this model has not been completely tested by Haskins Laboratories, its performance appears to be at least equivalent to that of the 32-kilocycle model.

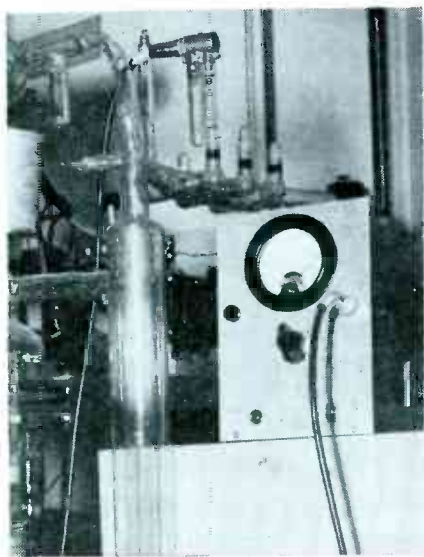
Although these units are larger than hearing aids and their power requirements are greater, neither their size nor their power requirements are unreasonable, especially at 65 kc. The information provided by such an echo-ranging system is different from that provided by a Seeing-Eye dog or a cane. Consequently the usefulness of such a system must be evaluated both by psychological tests and extensive use of the system by blind subjects. It is entirely possible that the information provided by any echo-ranging system may not be sufficiently valuable to a blind person to outweigh its inconvenience.

REFERENCES

- (1) D. R. Griffin and R. Galambos. The sensory basis of obstacle avoidance in flying bats, *Jour. Exp. Zool.*, 86, p 481-506, 1941.
- (2) R. Galambos, Flight through the dark; a study of bats, *The Scientific Monthly*, 56, p 155-162, 1943.
- (3) M. Supa, M. Cotzin and K. M. Dalenbach, "Facial Vision": the perception of obstacles by the blind, *Am. Jour. Psychol.*, 57, p 133-183, 1944.
- (4) F. H. Slaymaker, W. F. Meeker, and L. L. Merrill, The directional characteristics of a free-edge disk mounted in a flat baffle or in a parabolic horn. *J. Acous. Soc. Am.*, 18, p 355, 1946.
- (5) H. D. Polster and F. H. Slaymaker, Diffraction at a step-down, *J. Acous. Soc. Am.*, 19, p 732, 1947. Abstract.
- (6) Stevens and Davis, "Hearing," John Wiley & Sons, New York, N. Y., 1938, p 102.
- (7) Haskins Laboratories, Research on Guidance Devices for the Blind Committee on Sensory Devices, Report CSD-47-1, p 137, December 1946.

Vacuum Furnace Control

Tungsten heaters are automatically safeguarded against burnout due to excessive gas pressure. A thermistor, used as the sensing element, operates a calibrated indicating meter and a relay. Unit is used in the manufacture of electron tubes



Vacuum furnace control unit, installed adjacent to the system's diffusion pump

By **FRANK F. DAVIS**

*Electronic Engineer
Eitel-McCullough, Inc.
San Bruno, California*

similarly-mounted thermistors are used. One is mounted in a tube which has been pumped down to approximately 10^{-6} mm Hg and sealed off, and serves as a standard. The other is connected to the vacuum system of the furnace diffusion pump.

Operation

In operation, the vtvm is adjusted to full scale with the pushbutton pressed to place the sealed-off thermistor in the circuit. Then, when the button is released, the measur-

ing thermistor is connected and vacuum is read on the meter scale in terms of the vacuum sealed in the calibrating thermistor.

A small non-linearity in the vtvm is used to provide some compensation for crowding of the vacuum scale which is ordinarily found at the high end of the range. The relay in the circuit with the indicating meter provides the automatic switching that turns on heaters at a pre-determined vacuum level and turns them off again if that level is later exceeded.

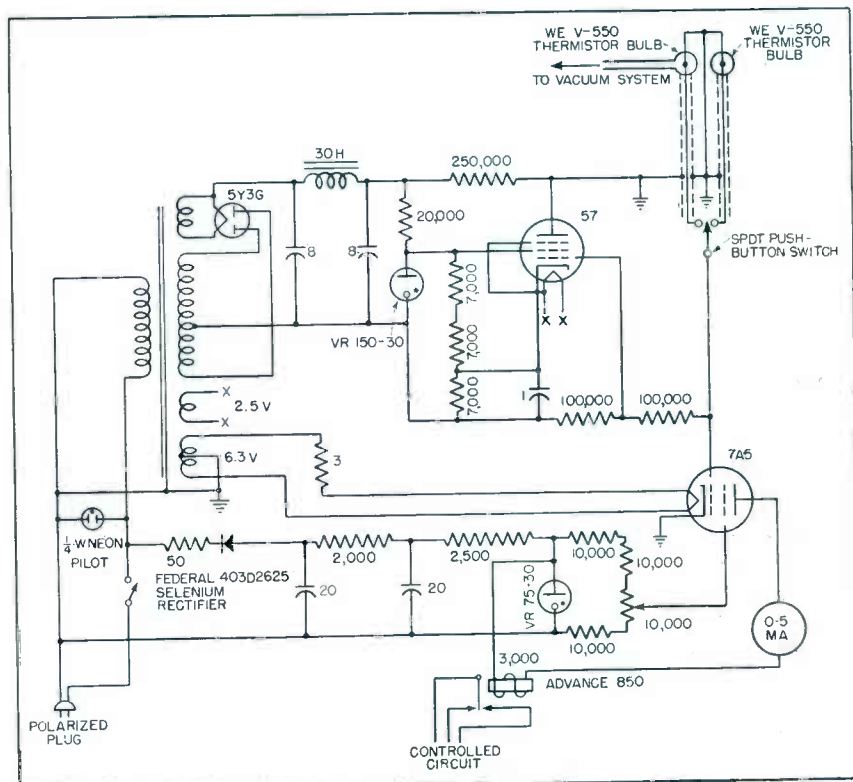
WHEN OPERATING a high vacuum electric furnace the tungsten radiant-heating elements must not be turned on until pressure is low enough to permit safe operation. Also, power must be instantly turned off in the event that pressure rises during operation.

Both of these functions are automatically handled by the electronic control illustrated.

Design Details

When a thermistor is suitably mounted in a tube connected to a vacuum system and heated by a small constant current its equilibrium resistance depends on the heat taken away by convection. As the molecular concentration in the furnace is reduced by pumping, convection heat loss drops and temperature rises. The thermistor undergoes a corresponding resistance change which can be calibrated in terms of vacuum.

In this control, two identical and



Circuit of the automatic control. Incorporated is a vtvm and power supply

Simplified Single-Sideband Reception

Accessory designed for use with a conventional communications receiver exhibits advantages when receiving ordinary code signals, as well as single-sideband phone. Selectivity is approximately doubled by employing a demodulating oscillator, balanced detector, two 90-degree audio phase-shift networks and a low-pass filter

By **OSWALD G. VILLARD, Jr.**

*Department of Electrical Engineering
Stanford University
Stanford, California*

ATENTION has recently been drawn to 90-degree wideband audio phase-shift networks as a means of generating single-sideband radio signals.^{1,2} Filters of the R-C type, such as those described by Dome³, are simple and inexpensive to make. Moreover, radio transmitters incorporating them are flexible and easier to adjust than the conventional variety using sharp band-pass filters. It is reasonable to expect, in the light of these and other developments^{4,5}, a re-evaluation of the possibility of applying single-sideband transmission to a much wider group of radio services (aircraft, police, military and amateur) than those at present enjoying its advantages.

Practical 90-degree networks make possible an equally important simplification in single-sideband receiving technique. An arrangement is described in this article whereby the effective intermediate-frequency bandwidth of a radio receiver can be made exactly that of the passband of a low-pass audio filter, instead of approximately twice that passband as in conventional a-m practice. This technique, in effect, makes possible the design of single-sideband receivers in which audio selectivity is the equivalent of i-f selectivity. As a result, the cost of receivers having a square-sided band-pass response of sufficient sharpness to take full advantage of the saving in band-

width afforded by single-sideband transmission need not be greater than that of present-day communi-

cation receivers. In addition, it is possible to convert existing equipment to take advantage of the new system.

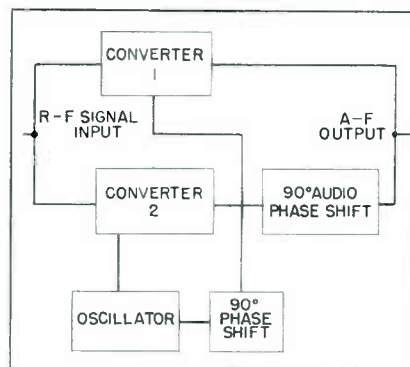


FIG. 1—Block diagram illustrating basic system

Advantages

The circuit to be described offers some advantages in the reception of conventional code signals. All incoming noise or code signals higher, or lower, in frequency than the final beating oscillator can be virtually eliminated from the output. The effective bandwidth of the receiver is thereby halved, since signals are heard on one side of zero beat only. Moreover, it is possible to select the side of zero

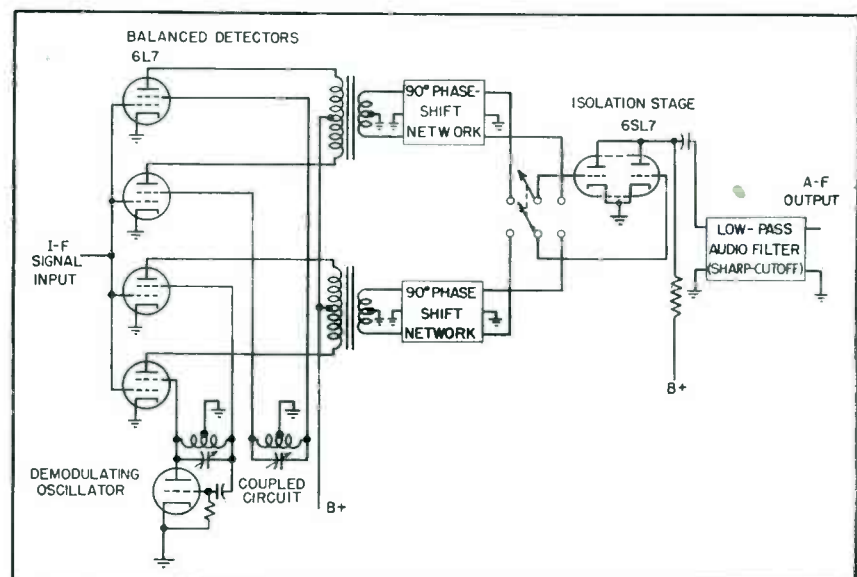
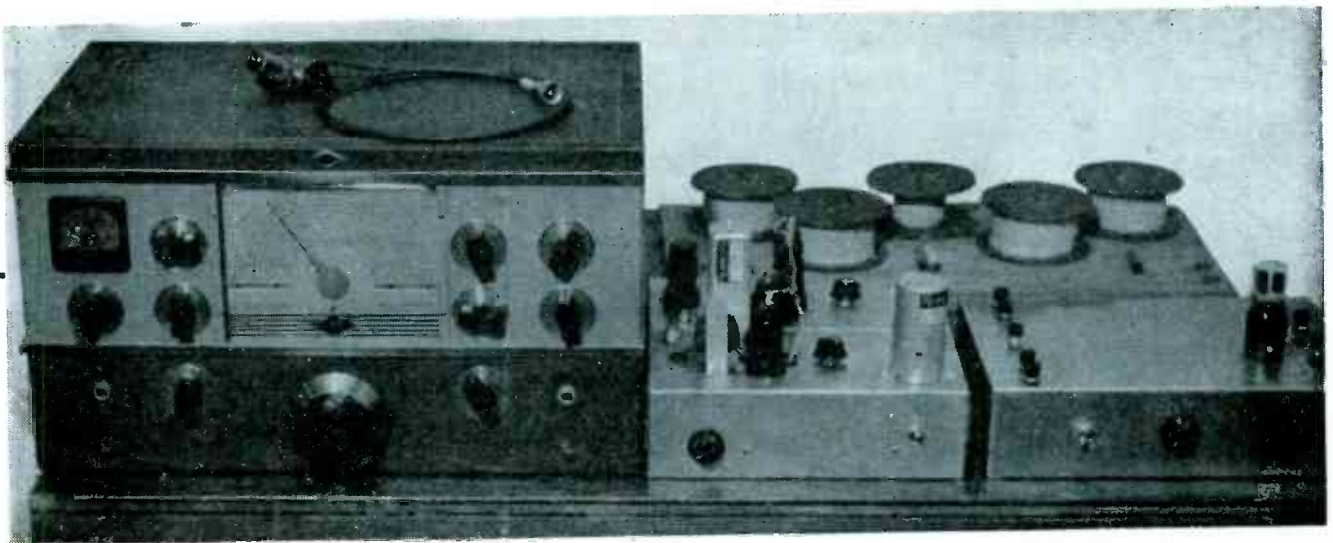


FIG. 2—Simplified schematic of single-sideband detector circuit



Laboratory model of accessory equipment used with a communications receiver for single-sideband reception

beat on which signals are heard simply by throwing a switch. Alternatively, it is possible to listen to signals on the two sides separately and simultaneously. Two operators can listen without mutual interference to two different sets of transmissions coming from the output of a single receiver, one hearing all signals higher in frequency than that of the beating oscillator and the other hearing all signals lower in frequency. In the same way the system may be used to separate multiple single-sideband transmissions; conversations carried by the lower sidebands of a given suppressed carrier appear in one output channel, while those carried by the upper sidebands appear in the other.

Circuit Operation

Operation of the circuit is easily explained. First, it must be remembered that detection is essentially a process of frequency conversion. Signals become intelligible as soon as they are translated from the radio-frequency spectrum down to their correct place in the audio-frequency range.

Frequency conversion can be accomplished by either of two methods that are ordinarily equivalent but which have an important distinction from the standpoint of the present discussion. Basically, it is desired to generate difference frequencies falling in the audio range by combining an incoming radio-frequency signal with a local

oscillation. The desired difference frequencies can be generated by superposition of signal and local oscillation and rectification of the resulting envelope, or by modulation of signal by local oscillation (or vice versa) whereby the lower sideband is the desired difference frequency. It is important, in single-sideband detection, to avoid the production of beats between the sidebands themselves or beats between the sidebands and adjacent interfering signals which might produce spurious audio-frequency output. Because this effect may readily take place with the first method as a consequence of the rectification process the second method is to be preferred for the present purpose because the incoming signal which is modulated by the local oscillation can be handled in a class-A amplifier possessing as nearly linear a grid voltage-plate current characteristic as possible.

Let the demodulating oscillator voltage be expressed by $E_1 \sin \omega_1 t$, and let an incoming sinusoidal single-sideband signal be $E_2 \sin \omega_2 t$. The incoming signal is fed simultaneously to two frequency converters. One of the converters is supplied with oscillator voltage and the other receives the same voltage shifted 90 degrees in phase, or $E_1 \cos \omega_1 t$. The output of the first converter is then

$$e = m E_1 \sin \omega_1 t E_2 \sin \omega_2 t = \frac{m E_1 E_2}{2} \cos (\omega_1 - \omega_2) t -$$

$$\frac{m E_1 E_2}{2} \cos (\omega_1 + \omega_2) t \text{ where } m = \text{modulation factor (a constant)}$$

The right-hand portion of the second expression is the upper sideband, in which we have no interest. If $\omega_1 > \omega_2$, the left-hand portion is positive; if $\omega_1 < \omega_2$, it remains positive because $\cos (-\alpha) = \cos \alpha$. The output of the second converter is

$$e = m E_1 \cos \omega_1 t E_2 \sin \omega_2 t = -\frac{m E_1 E_2}{2} \sin (\omega_1 - \omega_2) t + \frac{m E_1 E_2}{2} \sin (\omega_1 + \omega_2) t$$

If $\omega_1 > \omega_2$, the left-hand portion of the second equation is negative; if $\omega_1 < \omega_2$, it becomes positive, because $\sin (-\alpha) = -\sin \alpha$.

Thus the first converter gives a difference-frequency output whose relative phase may be thought of as not changing as the incoming frequency passes from lower to higher than that of the oscillator. The second converter on the other hand gives an output whose relative phase does change by 180 degrees as zero beat is crossed. Now, by means of a 90-degree wideband phase shifter it is possible to delay the audio output of the second converter until it becomes

$$-\frac{m E_1 E_2}{2} \cos (\omega_1 - \omega_2) t.$$

This voltage, if added to the output of the first converter when $\omega_1 > \omega_2$, will produce cancellation, whereas if $\omega_1 < \omega_2$ direct addition results. Thus, by means of a 90-

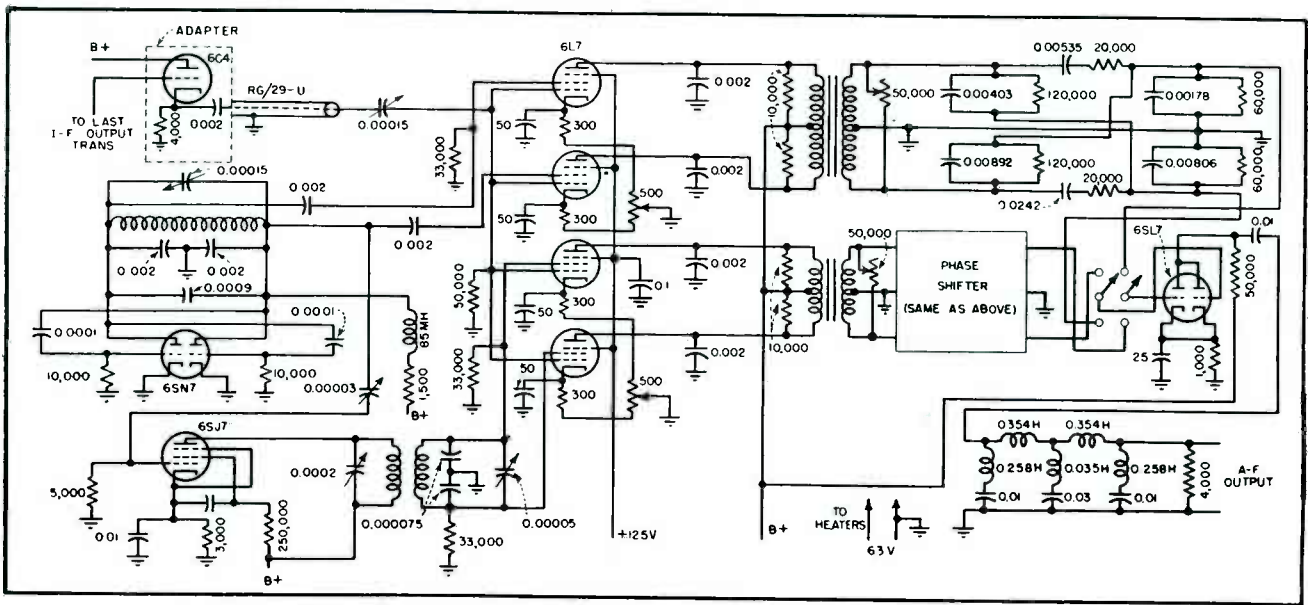


FIG. 3—Complete schematic of single-sideband reception accessory for communications receiver

degree wideband phase-shift network and two detectors fed by radio-frequency voltages in phase quadrature, it is possible to reject signals on one side of the beating oscillator and pass those on the other.

A block diagram of the basic method is shown in Fig. 1.

Practical Application

Balanced detectors are used in the practical circuit in order to reduce the likelihood of demodulating beats between components of the incoming signals, in addition to the beats between this incoming spectrum and the local oscillator. The balanced arrangement is particularly important where strong adjacent-channel interference may be encountered and where detection is done at relatively high signal levels (of the order of tenths of a volt.) Under these conditions curvature of the grid-voltage plate-current characteristic of most vacuum tubes will produce appreciable even-order distortion and even-order sum-and-difference frequencies. These effects result in spurious audio output since they may be produced by two radio frequencies anywhere in the input signal spectrum.

The balanced detector arrangement eliminates even-order distortion but does not affect odd-order distortion and odd-order sum-and-difference frequencies arising from the rate of change of curva-

ture of the grid-voltage plate-current characteristic. However, odd-order distortion may be minimized by using tubes of the remote-cutoff type which are especially designed to have a low rate-of-change of curvature. The balanced detector using remote-cutoff tubes such as the 6L7 makes it possible virtually to dispense with i-f selectivity provided a highly selective audio filter is used, since only those beats between local oscillator and incoming signals which fall within the passband of the audio filter will be heard.

The 90-degree phase shift between the demodulating voltages fed to the injector grids of the pairs of detector tubes in Fig. 2 is conveniently obtained by taking advantage of the quadrature relationship between voltages across two coupled circuits tuned to resonance. For convenience in adjustment, a buffer tube is employed between the oscillator and the coupled circuits in the actual unit, since tuning the coupled circuit would otherwise affect the oscillator frequency.

The two 90-degree audio phase-shift networks shown are identical. While a network of this type produces two output voltages having a phase difference of nearly 90 degrees over a wide range of frequencies, the phase of these output voltages themselves bears no fixed relationship with that of the common input. It is therefore necessary

to use two identical networks in order to obtain two voltages between which a 90-degree phase exists, assuming the two separate input channels to be in phase. In practice the phase of the two channels may be arbitrary, and a quadrature relationship is actually used.

Employment of two identical 300 to 3,000-cps networks connected to the outputs of the two balanced detectors also prevents any amplitude unbalance affecting the degree of undesired-signal cancellation arising from the variation in input impedance of each filter with frequency. Variation may affect the overall frequency response, since the 6L7 tubes may be considered as constant-current generators whose output voltage is proportional to the output impedance, but it does not affect the ratio of the outputs of the two detectors and therefore cancellation of the undesired signal. When the primaries of the audio transformers are loaded with resistances low enough to damp out transformer resonances, it is found that the input impedance of the phase-shift networks has a negligible effect on the overall frequency response.

Figure 3 shows the complete schematic diagram of a single-sideband detector which may be added to a standard communications receiver. Connection is made by removing the receiver's second detector tube, plugging in an

adapter, and then plugging the detector tube into the adapter. A 6C4 cathode follower couples i-f output into the single-sideband detector circuit without disturbing normal operation of the receiver except for a slight retuning of the secondary of the last i-f transformer.

Balancing controls for the two detectors are potentiometers in their cathode circuits. The secondary of the i-f transformer connected to the 6SJ7 buffer tube is resistance-loaded in order to broaden the tuning and make the phase setting less critical. Variable resistors shunted across the secondaries of the output transformers provide a convenient means of equalizing the magnitude of the detector outputs. The low-pass filter used in the common output is a home-made m -derived affair cutting off at 2,500 cycles per second and designed for a 4000-ohm characteristic impedance.

Circuit Adjustment

Tuning up the circuit is straightforward. The beat-oscillator voltage at the 6L7 grids can be set at 15 volts just as in conventional converter service. Detector balance is determined by turning off the oscillator and removing or disconnecting one pair of 6L7's. A strong steady signal, such as that from a broadcasting station, is tuned in and the balancing resistor of the remaining pair of tubes adjusted for minimum audio output. This process is then repeated with the first pair of tubes. With the correct adjustment the detector should produce a deafening output with the oscillator turned on, whereas there should be no audible output at all with it off.

Adjustment of the radio-frequency phase of the local-oscillator signal at the second balanced detector is easily made. With the secondary of the i-f transformer tuned for maximum voltage at the 6L7 injector grids the phase is approximately correct. This condition can be verified by connecting the horizontal and vertical plates of an oscilloscope to the secondaries of the audio-output transformers. If the amplitude balance is approximately correct a steady a-m signal

such as a broadcast station will give a weaker beat note on one side of resonance than on the other. Tuning to the weaker side, the amplitude balance is set for greatest rejection and likewise the radio-frequency phase setting touched up. For any given pitch of beat note the balance may be made complete and the beat eliminated completely by adjustment of phase and amplitude. The procedure is exactly like that of balancing a bridge. However, since the 90-degree networks do not give a perfect 90-degree phase shift as well as a perfect amplitude balance at all frequencies it will be

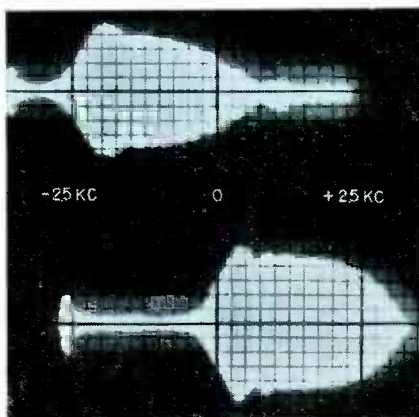


FIG. 4—Oscillograms showing rejection of upper sideband (top) and lower sideband (bottom)

found that the rejection, while perfect at one frequency, is imperfect at others. As a compromise, it is best to adjust for complete cancellation at a frequency in the vicinity of 1,000 or 2,000 cycles, where the ear is most sensitive.

The laboratory model for which the schematic is given could be considerably simplified. Dual triodes or even detector crystals could be substituted for the 6L7 mixers. If mixing is done at low enough levels the balanced connection could probably be dispensed with. The local oscillator could be simplified and the buffer tube eliminated by making the oscillator a pentode tube with electron coupling between the frequency-determining elements and the plate circuit to which the i-f transformer would be connected.

Figure 4 is an attempt to illustrate the properties of the circuit by means of the familiar fre-

quency-modulated oscillator technique. Owing to the presence of the demodulating oscillator there is displayed on the oscilloscope screen a continuously-varying audio beat between the frequency-modulated test oscillator and the steady demodulating oscillator. The audio-frequency waveform has random phase because the two oscillator phases are unrelated, and hence does not remain stationary. The envelope of this waveform is an indication of the overall selectivity curve of the detector circuit. It is not entirely representative because at the oscillator sweep speeds available, transient response effects in the sharp-cutoff audio filter considerably distort the envelope. The patterns show spurious humps and are not as symmetrical as would be the case if the response curve had been plotted with a very slow rate-of-change of sweep-oscillator frequency. Rejection of the undesired signal is illustrated by the oscillograms, the first of which was made with the sideband-selector switch set at one position, and the second at the other. The amount of rejection shown is sufficient to be quite useful in practice. For example, the reduction in receiver thermal noise output is very marked when the 90-degree networks are added and cancellation takes place.

Transmission tests with an experimental single-sideband phone transmitter on the Stanford University campus have verified the rejection ratio observed in the laboratory measurements. It is quite startling to hear a signal drop out when the selector switch is thrown to the position that rejects the sideband being radiated. Another interesting test is to listen in at a busy hour on one of the crowded amateur c-w bands. By throwing the switch, two entirely different sets of incoming signals can be selected at will.

REFERENCES

- (1) M. A. Honnell, Single Sideband Generator, *ELECTRONICS*, p 166, November 1945.
- (2) B. E. Lenahan, A New Single Sideband Carrier System for Power Lines, *Elec. Eng.*, 66, p 549, June 1947.
- (3) R. B. Dome, Wideband Phase Shift Networks, *ELECTRONICS*, p 112, December 1946.
- (4) *Tele-tech*, Vol. 7, No. 1, p. 63, January 1948.
- (5) O. G. Villard, Jr., Single-Sideband Operating Tests, *QST*, p 16, January 1948.

Acoustic Problems

By **GEORGE M. NIXON**

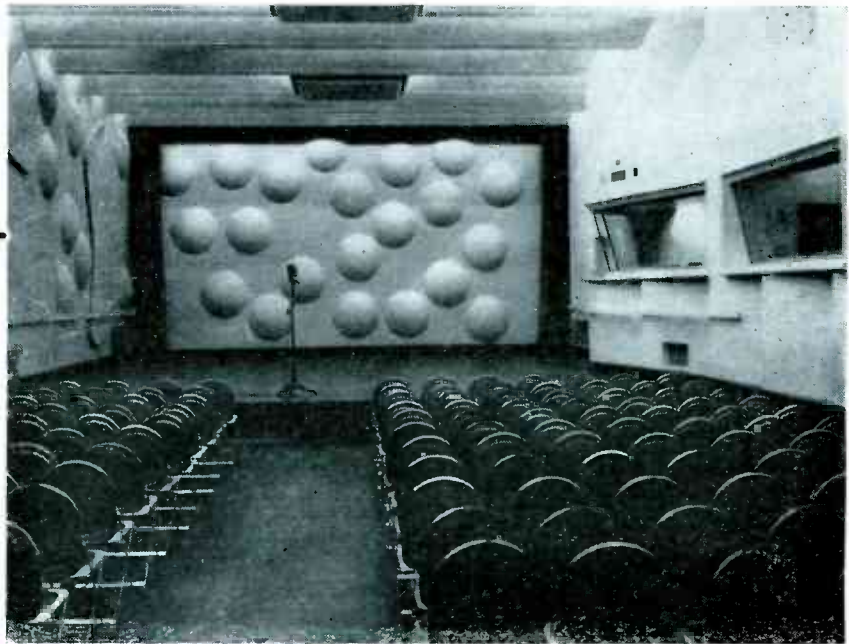
*Assistant Director
of Technical Development
National Broadcasting Company, Inc.
New York, N. Y.*

EXPANSION of present studio facilities or construction of new stations enables the radio engineer to utilize many proven techniques in the control of sound. The technical problem to be considered here is that of noise.

Airborne sounds exterior to the plant include those due to thunder, railways, buses, aircraft, streetcars, industrial activities and automobile traffic. Certain of these, such as railways, streetcars and industrial activities, may transmit sound by vibration of the ground to the studio plant. The rental of space in an existing structure requires investigation of the activities of present tenants, and also the restriction placed on future tenants as to their noise-producing activities. Major sources of noise within the building may include printing presses, pumps, industrial machinery, punch presses and the like. Conversely, noise from a broadcast plant can be just as annoying to others, particularly doctors, or dentists, in the conduct of their work.

A survey with a sound-level meter is preferable but if one is not available, some indication of the noise level may be obtained by the use of a portable field amplifier. The magnitude of the noise may be calculated approximately by obtaining the sensitivity of the microphone from the manufacturer.

If the noise is from a source which develops considerable vibration, the solution may not be economically feasible. The location of the studios on the floor directly above or below a bank of large printing presses is such an example.



Modern studio constructed in accordance with the principles outlined in the text. A measure of sound control is provided by the randomly spaced curved surfaces

The amount of vibration generated by the presses is of such a magnitude that there is no practical and economic means to reduce it to a satisfactory value. Further, it is not possible to predict accurately the reduction which will be effected because of the many related factors.

Studios have been built in substantially this type of location and, as far as is known, trouble has always ensued—sometimes to the extent of making necessary the installation of a high-pass filter in the program circuit to reduce the noise and compromise the overall quality.

The maximum tolerable noise level in studios is as follows: Sound-level meter on Scale A—less than 25 db above the threshold of hearing, on Scale B—less than 35 db, and on Scale C—less than 45 db. Scale C is substantially flat as regards frequency response and Scales B and A correspond respectively to the loudness intensity curves of the human ear. These curves show that the ear at moderate intensities is less sensitive at the lower frequencies than at medium and high frequencies. This

is fortunate as the lower frequencies are most difficult to control.

Boundary Surfaces

The attenuation of airborne sounds is usually dependent on mass of insulating material rather than other characteristics. The increase in attenuation with mass is at a relatively slow rate as may be seen in Fig. 1. For example, a 6-inch wall (45 pounds per square foot) of solid cinder concrete may be expected to have an average attenuation (128 cycles to 4,096 cycles) of about 48 db and a 12-inch wall (90 pounds per square foot) about 54 db.

Two 6-inch solid cinder concrete walls with an intervening air space of more than 6 inches may be expected to produce an attenuation of about 60 db. Double walls are preferable to single walls, because of the increased sound attenuation over a single wall, the reduction of impact sounds, and the lesser weight for a given degree of sound attenuation.

Partitions should extend from the floor slab to the under portion of the

in Studio Design

Planning a broadcast studio involves considering noise originating both inside and outside the building. Construction of walls, ceiling and floor should attenuate airborne sounds and those due to transmission of vibration

floor slab above. Cinder block walls have appreciable sound-absorbing properties which absorb sound in the intervening space between walls and also are fairly free from pronounced resonances which are manifest as reduced attenuation over a band of frequencies.

The use of two 6-inch solid cinder block partitions (each plastered on the outside) separated by an air space is the minimum that should be provided between adjacent studios. The use of partition block of smaller dimensions, say of 4 inches thickness and hollow instead of solid, permits transmission of more sound than is desirable.

Commercial sound isolation systems are effective in attenuating airborne sounds but experience has shown them to be less effective than is desirable in reducing the transmission of vibration at frequencies of about 100 cycles and lower. There are advantages in their use where weight becomes a factor. Construction details of sound isolation systems for walls, floors, and ceilings are shown respectively in Fig. 2, 3 and 4.

Multiple wall structures of light weight are effective in reducing sound transmission but usually such walls occupy appreciable space, are relatively expensive and require careful supervision of their installation to insure proper performance.

Attention must also be given to the ceiling and floor surfaces to insure the maintenance of the high degree of sound attenuation provided by the partitions. In buildings with stone concrete floor slabs of adequate thickness (4 to 6 inches), adequate isolation from the floor above is usually obtained

by the installation of a suspended ceiling if the occupants of the floor above are engaged in relatively quiet activities. Such a ceiling is required for light fixtures, concealing duct work and the like. The ceiling should be supported on resilient mountings and covered by loose rock wool fill, blanket or similar sound-deadening material.

The floor on which the studios are mounted should be also studied as to noise coming from the floor below and additional cinder fill topped by smooth concrete finish added or a sound-isolated floor installed.

Buildings with wooden floors present some problems as to load-bearing capabilities which may require rearrangement of the studio grouping to obtain isolation by separation rather than structural means.

Wall Openings

In dealing with surfaces pierced by windows, doors, and duct work, every precaution must be exercised to maintain the sound isolation provided originally.

Entrance to a studio should be effected through two doors separated by a vestibule which is acoustically treated over as much area as is possible. Experience has shown satisfactory performance with 2½-inch solid wood doors fitted with an automatic bottom closer and gasketed on the head and side, at each end of the vestibule.

In windows of the control booth and public observation booths, the use of double glass of ¼" and ½" thickness respectively, separated as widely as possible, provides sufficient isolation. The isolation is improved to the extent of 6 to 10 db by acoustical treatment of the boundary surfaces between the panes or lights of glass.

Outside windows should be sealed by masonry or treated in the same general manner as control booth windows if retained, to prevent transmission of sound between the studio and outside spaces.

Ventilating Systems

All rotating and reciprocating machinery of air-conditioning and

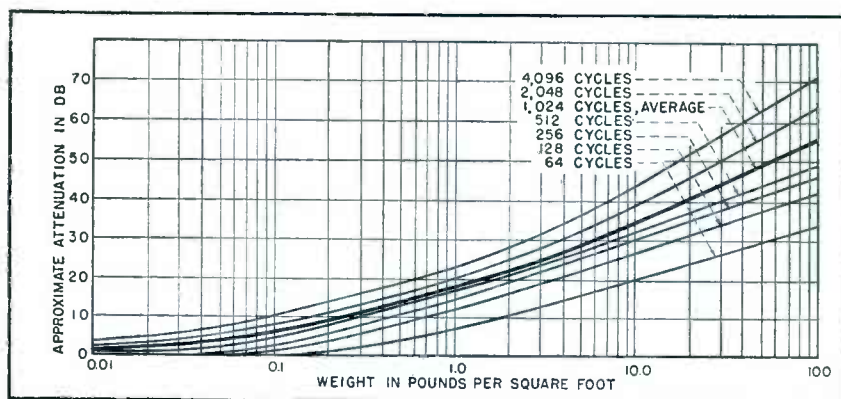


FIG. 1—Sound attenuation in terms of weight of various homogeneous materials. The average curve of loss from 128 to 4,096 cycles is the same as the 1,024-cycle curve

ventilating systems should be mounted on a vibrator-isolated base. Suitable isolation materials or springs include rubber in shear, metallic coil or leaf springs and cork. The performance of practically all these materials is dependent on loading and the material should be deflected as much as possible to obtain a low natural resonant frequency and to provide the greatest amount of isolation. All connections to the equipment should be flexible, and electrical wiring enclosed in flexible armor rather than conduit.

Duct work should be connected to the fan through a canvas collar and the same procedure employed in connecting the duct work to the supply and return outlets. The duct work should be wrapped where it pierces the wall and wrapped within the confines of the studio. A duct of dimensions of 12 × 12 inches or smaller should be lined for a distance of 16 feet between the fan and the first outlet; and between outlets in studio and other spaces. Duct work to listening areas, such as control booths when of this dimension or smaller, should be lined for a distance of at least 8 feet. The lining should bridge partitions which are pierced by several feet on each side of the partition.

In the case of a duct 12 × 48 inches, it should be lined as indicated above and divided at 12-inch intervals or less by absorbing material so that in effect four small ducts in parallel are created.

The supply and return outlets are another source of noise if the air velocity is too high or the duct work is not arranged for a smooth flow of air. Guiding radial vanes should be employed as required which will aid in the distribution of the air in the studio and also result in quieter conditions.

Air velocities which have been found satisfactory are 1,200 feet per minute or less in main duct work; 500 feet per minute or less for supply outlets, and 300 feet per minute at return outlets.

Recessed light fixtures can be arranged to pierce the ceiling construction and the manner of mounting to observe sound precautions is shown in Fig. 5.

There remains the selection of

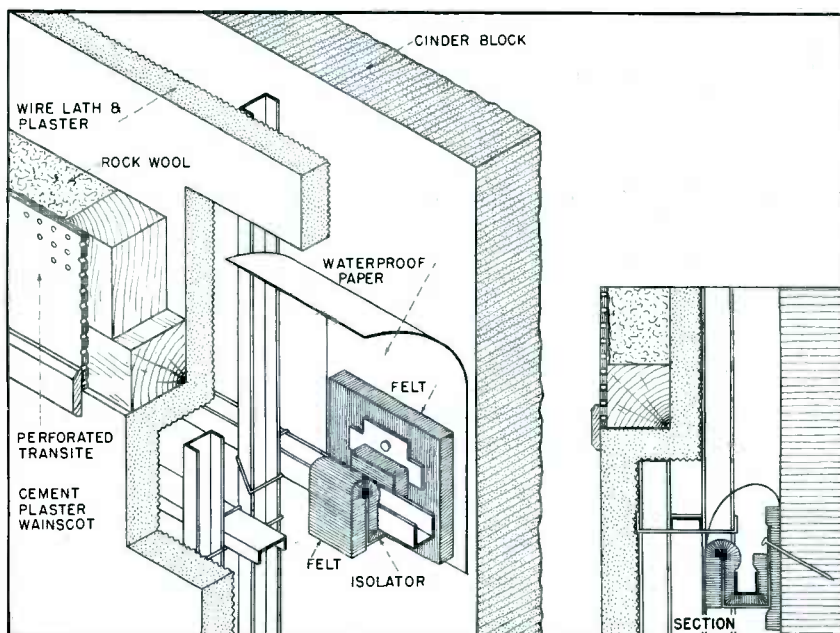


FIG. 2—Construction of a wall for sound isolation between studios

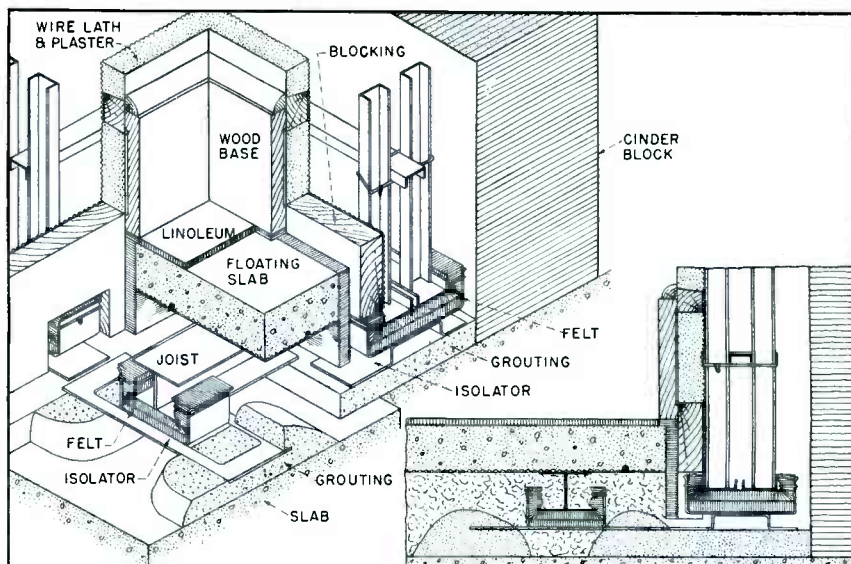


FIG. 3—Typical acoustic treatment for a floor to isolate sound from below

the type and thickness of material and its distribution in conjunction with reflective areas. Acoustical plaster is usually of only moderate absorbing efficiency at medium and high frequencies but the absorption is subject to some variation dependent on job conditions such as the manner of mixture, pressure of the trowel or applicator. Its relatively poor resistance to abuse restricts its use to ceilings, if used at all, in studios.

Draperies and carpets in general have little absorption at the lower frequencies and the absorption increases with the frequency. Draperies, lined and interlined, hung

100-percent full (twice the area of material is required for the area of wall to be covered) and one foot or so from a wall will have very appreciable low-frequency absorption.

Carpeting is useful in seating sections on the walking area of auditorium studios, on the floor of speakers' studios, under a microphone stand to reduce scuffing of feet, and in certain cases to reduce the noise of footsteps.

Acoustical tiles provide fairly high absorption at medium and high frequencies and a lesser degree at low frequencies dependent on the manner in which they are mounted on ceilings or walls. Certain types

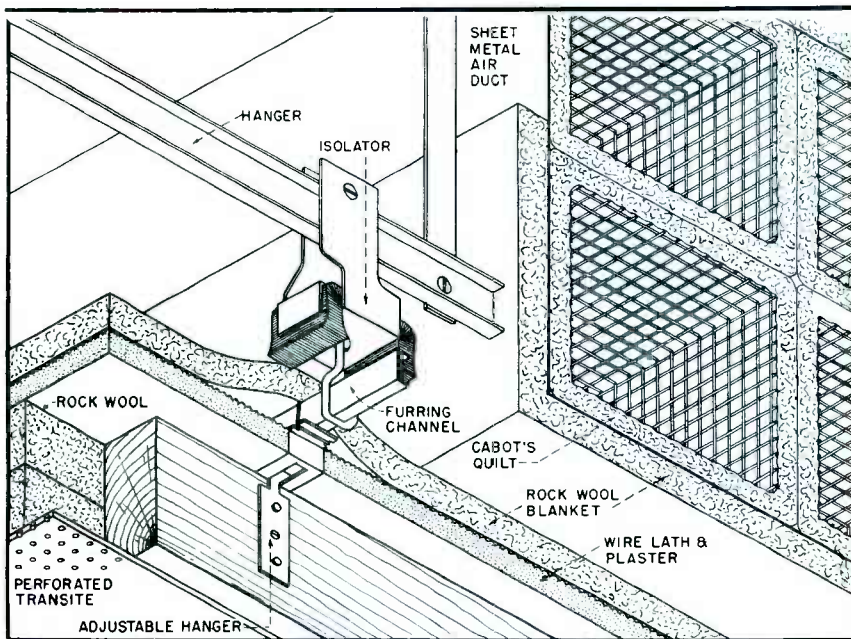


FIG. 4—Mechanical details of a suspended ceiling and acoustically treated air duct

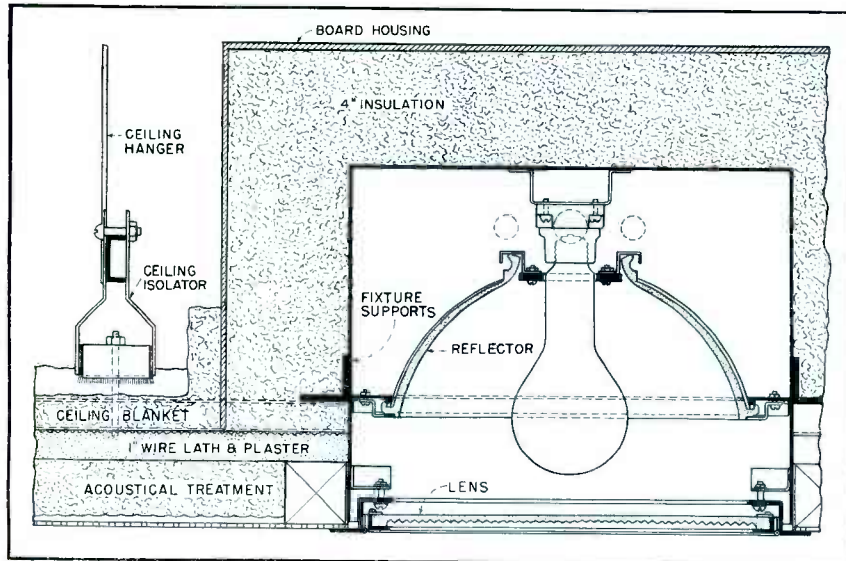


FIG. 5—Detail of acoustical treatment around recessed lighting fixtures

which are homogeneous and rely on the porosity of the material for absorption tend to be fragile and subject to discoloration due to breathing, discoloration due to temperature and pressure differentials which tend to entrap the dirt on surfaces due to the passage of air through the tile near the exposed surface. Acoustical plaster is also subject to this effect.

Porous tiles, like acoustical plaster, may be subjected to indiscriminate painting when redecoration is necessary and even careful painting invariably substantially reduces the absorbing efficiency. Typical cases have shown a reduc-

tion from 50 to 60 percent down to 20 to 30 percent.

Membrane-covered absorbing materials are those in which the perforated membrane whether it be metal, asbestos board, or hardboard, serves as an acoustically transparent covering of the absorbing material up to about 4,000 cycles after which the covering becomes increasingly reflective. These coverings are fairly abuse-resisting and capable of painting several times without adverse effects on the absorbing efficiency.

The control of absorption at the low frequencies can be accomplished by an increase in thickness of one or

more of the materials selected, the furring or mounting of the treatment at some distance from the wall or the use of large areas of generally reflective curved surfaces which have appreciable absorption at low and medium frequencies and almost none at high frequencies.

Studio Furnishings

Speakers' studios intended to resemble a living room should employ a carpeted floor with lining and an untreated ceiling. The walls may be treated with an appropriate area of commercial acoustical treatment or heavy draperies. Since these rooms may be small and used mostly for speech, particular attention should be given to provide adequate low-frequency absorption to avoid boomy and unnatural speech sounds. Where draperies are employed it may be necessary to mount two inches or more of rock wool blanket or similar material behind the drapery to raise the low-frequency absorption.

General purpose studios should have a floor covering of linoleum or similar sound-reflective material. The wainscot or chair rail should be of abuse-resisting material such as cement plaster about 3 feet 6 inches or 4 feet high.

There is a variety of arrangements of wall and ceiling treatments and only generalized suggestions can be made. The peripheral area of the ceiling may be untreated so long as the distance from the side walls is less than 3 to 4 feet. If this distance becomes larger the area should be convexly curved, splayed or a band of acoustical treatment provided.

Large areas of reflective surfaces parallel to the floor centrally located must be avoided, because of the danger of persistent vertical reflection in the microphone field. The wall treatment should be arranged in some decorative pattern of curved or serrated reflective surfaces alternated with absorbing areas.

The importance of proper planning in matters of sound control cannot be too greatly emphasized. Many problems may be anticipated and the solution effected before the trouble develops which will later prove to be more economical, practical and convenient.

Thickness Gage for Moving Sheets

Glass and other nonmagnetic sheets ranging in thickness from one-eighth inch to one inch can be continuously gaged to close tolerances. Material is run between primary and secondary of a measuring transformer. Variations in material thickness change coupling, upset bridge balance and are directly indicated

By J. W. HEAD

*President
Industrial Electronics, Inc. and
Electronics Institute, Inc.
Detroit, Michigan*

AN ELECTRONIC GAGE has been designed to fill the need for an instrument that will continuously measure the thickness of glass or any other nonmagnetic material.

The gage consists of standard and measuring heads, a source of power for energizing the two sets of heads which are continuously balanced against each other in a bridge arrangement, a phase-inversion system, an amplifier, and an indicator. The instrument may be used in conjunction with a high-speed recorder when permanent records are desired.

Standard and Measuring Heads

The standard and measuring heads comprise the primary and secondary windings of special audio-frequency transformers. They are energized by a stabilized oscillator built into the system. Changes in the spacing between a primary and secondary vary the degree of coupling. The relationship between change of spacing and change in secondary voltage is approximately linear for base separations ranging from $\frac{1}{8}$ inch to 1 inch. Gage sensitivity is sufficient to give full-scale meter readings with as little as plus



Electronic thickness gage. The indicating meter may be seen at the upper right. Standard and measuring heads, shown without their mounting fixtures and roller wheels, are at the lower right

or minus 0.0005 inch from the mean thickness. The usable range of the instrument is approximately 0.001 inch to more than 1 inch.

In order to provide a reading representing deviation from standard thickness rather than total thickness the secondary voltage of the measuring head is displaced 180 degrees and balanced against the secondary voltage of the standard head. Standard head spacing is set by inserting a standard-thickness flat. This form of pickup makes the instrument suitable for measuring any nonmagnetic material.

Balance is established by adjusting front-panel controls with identical standard flats in both heads. The measuring head is then placed on the work. So long as the work remains on thickness, the voltages from the measuring head and the standard head balance to zero. If the work goes undersize, voltage from the measuring head predominates and the resulting signal reduces the final meter reading below midscale or zero deviation position. If the work goes oversize, the voltage from the standard head predominates and the resulting signal

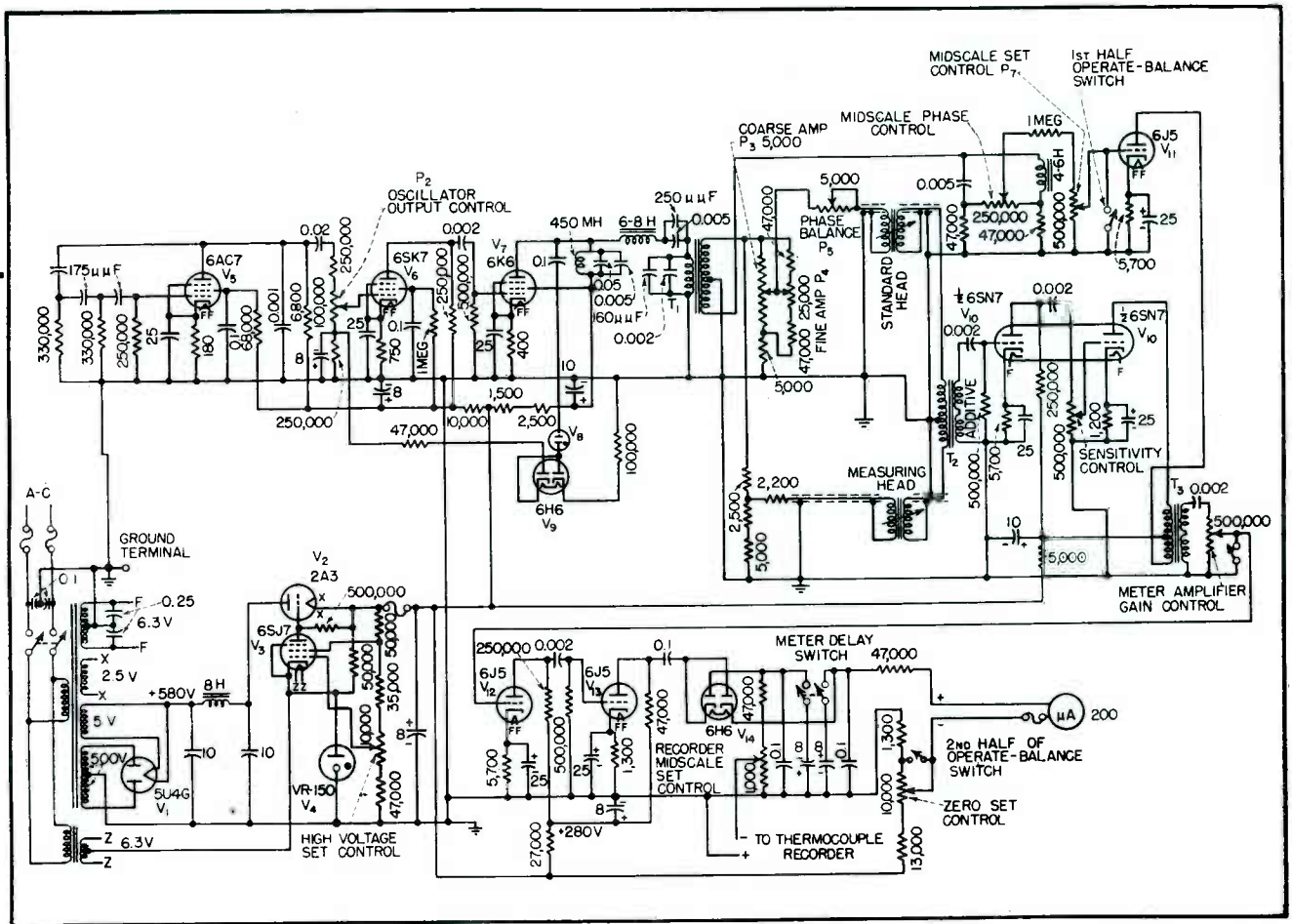


FIG. 1—Circuit of the gage, including voltage-regulated power supply. A high-speed recorder can be used externally

increases the final meter reading above midscale.

Oscillator and Amplifier

The built-in oscillator is a phase-shift type consisting of a three-mesh resistance-capacitance phase-shifting network, shown in Fig. 1, and produces a sine-wave voltage of 1,000 cps. Gain of the oscillator stage V_5 is held to a value which is just sufficient to maintain oscillation. Almost pure sine-wave output is obtained, along with good frequency stability.

The amplifier stage V_6 , following the oscillator, uses automatic gain control to provide a signal voltage of constant amplitude. Even though voltage regulation is employed for the plates and screens of all tubes, large changes in heater voltage would otherwise result in some change in oscillator output amplitude.

Automatic gain control is obtained by supplying V_6 with a negative grid bias proportional to the

signal amplitude in the plate circuit of amplifier V_6 . The avc circuit consists of V_8 , a $\frac{1}{2}$ -watt neon bulb used as a voltage regulator and V_9 , a diode connected as a full-wave rectifier. Full-wave rectification of the signal voltage at the plate of V_6 is used to provide a symmetrical and constant load for V_8 . Negative alternations are used to supply automatic bias for V_6 .

The oscillator output control, P_2 , is adjusted so the ionization of the neon bulb V_8 ceases when the line voltage is reduced to approximately 95 volts. When so adjusted, the amplitude of the signal at the plate of V_6 will remain substantially constant for line voltage variations down to approximately 95 volts and up to 130 volts.

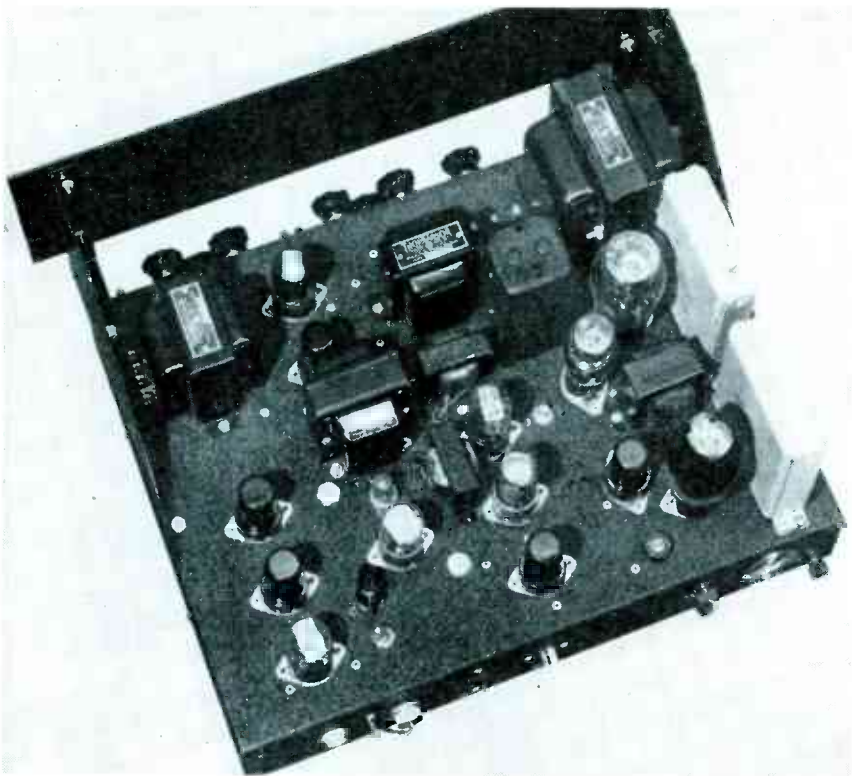
Bridge Circuits

Output of V_7 is coupled to the heads and V_{11} through T_1 . The plate circuit of V_7 contains three resonant circuits, each tuned to 1,000

cps, for preventing the transmission of harmonics.

The two heads are connected to one side of transformer T_1 secondary through their respective voltage-divider networks. The measuring head is supplied with a fixed-amplitude voltage, while the voltage applied to the standard head, is adjustable in amplitude and phase for bridge alignment and calibration. Amplitude adjustment of signal voltage applied to the standard head is obtained by means of two controls, P_3 and P_4 , for coarse and fine amplitude adjustment.

Phase adjustment of the input voltage to the standard head is provided by a simple L-R circuit. The inductance of the head and P_5 , the phase-balance control, serve as the elements in the phase-shift circuit. Phase adjustment of voltage to one of the heads is necessary to compensate for small circuit differences in the two branches. The phase balance is adjusted until the secondary voltage of transformer



Chassis of the thickness gage

T_2 is zero when the heads have the same spacing.

When the spacing between the primary and secondary of the measuring head is changed, an unbalance exists in the input of transformer T_2 , resulting in a secondary voltage which is amplified by both sections of V_{10} , the output of which is applied to one-half of the primary of transformer T_3 . The other half of the primary is supplied with a voltage at the same frequency from amplifier V_{11} . Input for V_{11} is supplied from the same transformer, T_1 , that supplies voltage to the measuring heads. The input is supplied through an L-C-R phase-shifting network. Adjustment of phase of the input voltage to V_{11} is necessary so that the input voltage to each half of transformer T_3 is exactly in, or 180-degrees out of, phase. Any voltage appearing in the secondary of T_3 will therefore result from the sum or difference, depending upon phase, of the amplitude of the two primary voltages.

Indicator and Power Supply

Under normal conditions P_7 , the midscale set control, is adjusted to give half-scale reading of the indicating meter when the heads are in

a balanced condition. If measuring-head spacing increases it results in a voltage, applied to transformer T_3 , of such polarity as to add to the voltage supplied by V_{11} . This results in an increase in secondary voltage and, hence, in higher meter reading. If measuring-head spacing decreases, output from V_{10} results. However, under these conditions, the voltage supplied to transformer T_3 , from V_{10} , is now 180-degrees out of phase with the voltage supplied the transformer from V_{11} , resulting in a decrease of secondary voltage, hence a reduction in meter reading.

Output of transformer T_3 is applied to a conventional two-stage voltage amplifier consisting of V_{12} and V_{13} , which drives V_{14} , consisting of two half-wave rectifiers. These rectifiers are series connected so that they conduct on alternate half cycles, but carry the same average current at all times. This current is drawn through the indicating meter and returned to ground through a potentiometer across which is obtained the voltage output for a high speed recorder.

The meter rectifier circuit is provided with a long and a short-time constant R-C filter, either of which

may be selected by the meter delay switch. With this switch in one position, the meter and recorder readings represent an average over a period of approximately one second. This position is desirable to average out the effects of vibration or small irregularities in the material being measured. The other switch position provides a minimum response time of one-hundredth of a second. Both the inertia of the meter movement and the response-time limit of the eye prevent observation of such rapid changes. If it is desired to obtain an indication of roll vibration or ripple down to one-hundredth of a second variations, an oscilloscope is connected in place of the recorder.

The power supply is a conventional electronic-regulated type obtaining all voltages for its operation from the regulated side.

Other Details

A hinged mounting is provided for each head, to permit variation of spacing between primary and secondary. This is rigid enough so that there is no lateral or angular displacement of secondary with respect to primary. The mounting is spring-loaded to press wheels supporting the two halves of the head against the work. These wheels may be of nonmagnetic metal, or they may be faced with live rubber, so long as the spring loading remains constant for the balance and working positions and does not change appreciably with temperature. The mounting is insulated from the core of the head by plastic, fiber, or hard-rubber washers and is electrically grounded to the supporting machine or to the ground of the electrical power system.

For both balancing and operating positions the heads are placed at least one foot, and preferably two feet away from any iron or steel. Proper pairing of the heads in the mounting is essential. The measuring head and the standard head are located about two feet apart to prevent intercoupling, but are close enough together to experience approximately the same ambient temperature variations.

The main unit may be mounted in any convenient position.

Low-Impedance Reactances for VHF

Flat-plate transmission lines make convenient low impedances at vhf. Such reactances are mechanically large enough even at 1,000 mc to be readily fabricated. Design requirements are developed, and applications to an amplifier and to a matching section are described

By E. K. STODOLA and HENRY LISMAN

*Signal Corps Engineering Laboratories
Bradley Beach, New Jersey*

TRANSMISSION LINE SECTIONS are used in very-high-frequency circuits in the same way that lumped reactances are used at lower frequencies. Although open and coaxial lines are frequently employed, flat-plate lines can conveniently be used in both balanced and unbalanced circuits, especially in the region from 300 to 1,000 megacycles. To illustrate the utility of this type of transmission line, design considerations of several circuits using it are described here.

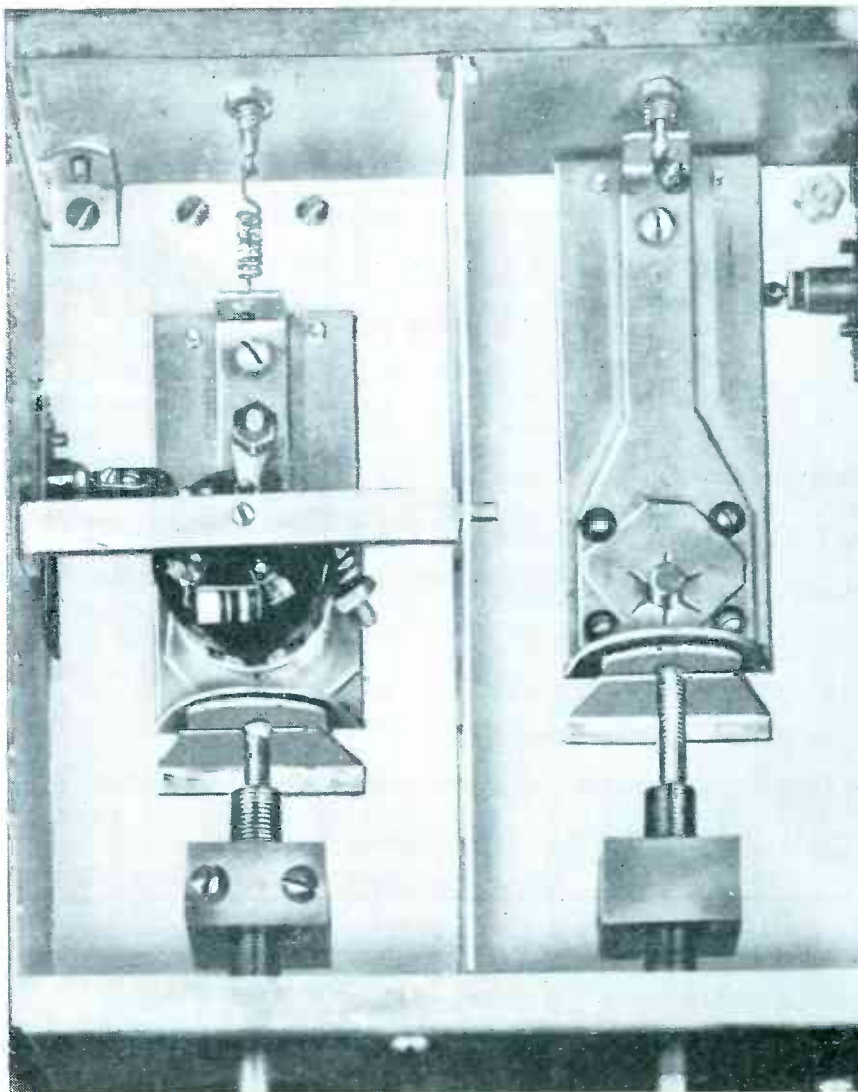
Transmission Line Parameters

At the high frequencies, sections of open or short circuited transmission lines are used as circuit elements in place of lumped reactances because of their negligible losses compared to other circuit elements (input conductance of tubes, antenna radiation resistance, and such). The losses are kept small by using line sections longer than 0.1 wavelength and with spacings between conductors and other dimensions small enough compared to a wavelength so that simple current distributions are maintained.

Reactance of a short-circuited transmission line is

$$X_{sc} = Z_0 \tan (2\pi l/\lambda)$$

where l is electrical length of the line, λ is wavelength of the current involved in the same units of length as l , and Z_0 is characteristic impedance of the line in ohms. The term $(2\pi l/\lambda)$ is the electrical length in



Two-stage amplifier for 600 mc uses flat-plate lines. One stage is built upside down with respect to the other for simplicity. Consequently this one view shows, in effect, construction of input (left) and output (right) circuits

radians of the transmission line.

For lines such as are considered here, using air dielectric, and with negligible lumped capacitance introduced by mechanical supports, the wavelength is practically the free-space wavelength; the electrical length and the mechanical length of the line are equal.

The above relation shows that, if a low value of reactance is desired for a circuit element, either the line section must have a low Z_0 or it must be very short. If the line section is not to be too short; for example, at least 0.1 wavelength long, there is a maximum.

With conventional round-conductor open lines it is difficult to obtain a low enough characteristic impedance to be able to use a reasonably long section of line and still produce the low reactance required for circuit elements. However, for a transmission line with a parallel return and perfect conductors, regardless of their shapes, the characteristic impedance is

$$Z_0 = V_0/C_0'$$

where V_0 is the velocity of propagation, and C_0' is the capacitance per unit length of line. Substituting the value of V_0 for air, and changing units of length to inches yields

$$Z_0 = 84.7/C_0'$$

where C_0' is the capacitance in picofarads per inch length of line.

This last relation applies to any parallel-conductor air-dielectric line. It shows that, to obtain a low Z_0 , a high capacitance per unit length is required. A flat parallel-plate line affords a more efficient means of obtaining this capacitance than round rods, and therefore such lines are the basis of this approach to vhf circuit design.

Designing Flat-Plate Circuits

The capacitance per inch of length for two parallel plates in air

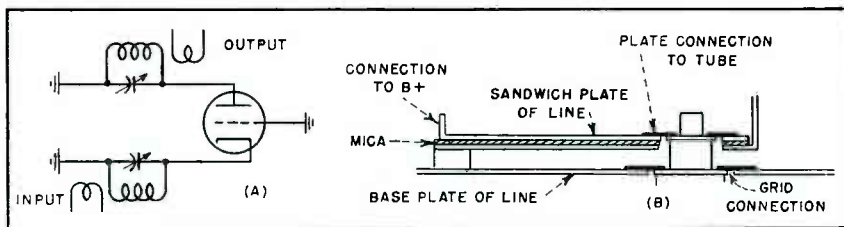
$$C_0' = 0.225 (W/D)$$


FIG. 1—Basic grounded-grid tuned amplifier (A) for very high frequencies can be made using flat plates (B) one leg of which is built as a sandwich to provide d-c feed

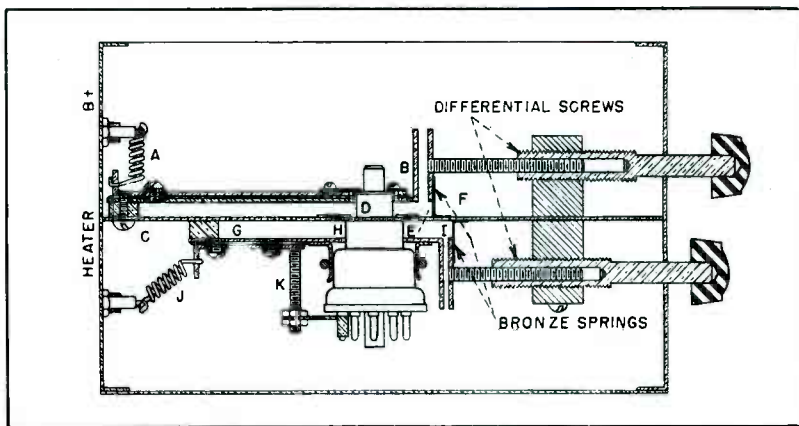


FIG. 2—Cross section of amplifier shows mechanical simplicity of flat-plate construction

where W is width of the plates in inches, D is spacing between the plates in inches, and C_0' is in picofarads. The characteristic impedance in ohms of a parallel-plate line is thus

$$Z_0 = 377(D/W)$$

neglecting fringe effects. If the width and length of the plates are large compared to their spacing, fringing can be neglected. Because there would be little object in using flat plates unless they were to be closely spaced, the foregoing equation is reasonably accurate for practical applications. The impedance of a shorted parallel-plate line section is thus

$$X_{sc} = 377(D/W) \tan(2\pi l/\lambda)$$

and of an open parallel-plate line

$$X_{oc} = -377(D/W) \cot(2\pi l/\lambda)$$

so that, for a line less than 0.25-wavelength long, the shorted line gives an inductive reactance and the open line gives a capacitive reactance.

Beyond these basic design requirements there are certain practical considerations. To illustrate these practicalities, consider a 600-mc grounded-grid amplifier using a planar triode, such as in a receiver preamplifier. Although these tubes are designed for use with coaxial lines, they lend themselves to flatline construction.

The basic r-f circuit of such an amplifier, with the plate and heater power feeds omitted, is shown in Fig. 1A. Two resonant circuits are required. The inductive element of each resonant circuit is to consist of a section of shorted flat-plate transmission line enough less than 0.25-wavelength long to present an inductive reactance equal to the capacitive reactance of the tube capacitance.

The plate-grid resonant line is designed as follows: The grid-plate capacitance of the tube is 1.4 pf. It is tentatively assumed that an added variable tuning capacitance of about the same value will be used for adjustment of the resonant frequency of the circuit. The total capacitance is then 2.8 pf. At 600 mc this capacitance has a reactance of 95 ohms.

Primarily because of mechanical considerations involving the diameter of the vacuum tube and the spacing between plates and grid discs, a line having a spacing of 0.2 inch and a width of 1.5 inches is chosen for initial consideration. These dimensions give the line a characteristic impedance of 50 ohms. The wavelength in inches is

$$\lambda = 11,800/f$$

where f is frequency in megacycles. For 600 mc, λ is 19.7 inches, or a quarter wavelength is 4.93 inches. Use of the previous equation for X_{sc} shows that the length of line to give 95 ohms is slightly less than 3.5 inches, or about 0.2 wavelength.

A suitable length of line has been determined, but no consideration has been given to the feeding of d-c to the plate connection. It is advantageous to have the line plate

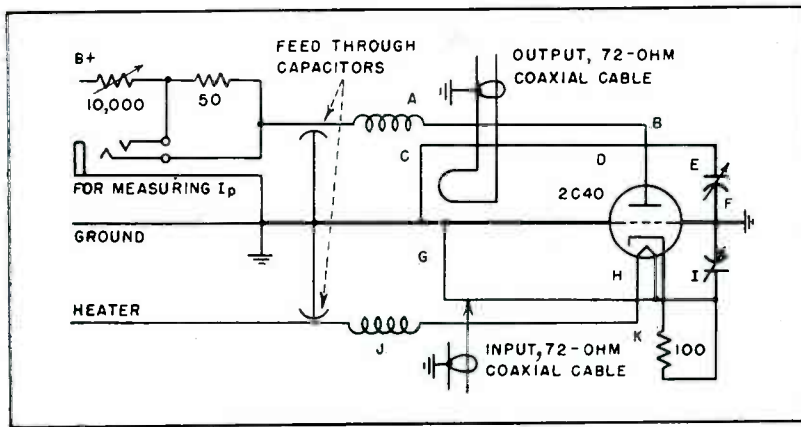


FIG. 3—Points on this schematic diagram are labeled by letters in accordance with Fig. 2

solidly grounded to the main ground plate of the amplifier. A construction that achieves this goal is shown in Fig. 1B. A sandwich type of line is used in which the plate line consists of the main plate which is grounded, and an auxiliary plate which is bonded to the other plate insofar as r-f is concerned but is insulated for d-c by being separated from the main plate by a thin strip of mica.

Tuning of this system is relatively critical and it is necessary to provide a fine tuning arrangement for the variable capacitor at the end of the line, such as a differential screw shown in Fig. 2. As the knob is turned, the inner shaft moves in opposition to the outer shaft so that the resultant movement of the capacitor plate is the difference of the two axial motions.

Numerically, if there are T_1 turns per inch on the outer shaft and T_2 turns per inch on the inner one, the capacitor plate will move as if driven by a simple screw having T_3 turns per inch where

$$T_3 = T_1 T_2 / (T_2 - T_1)$$

so that, even with coarse threads for T_1 and T_2 , the capacitor is driven with a fine motion. For example, if T_1 and T_2 are 24 and 28 turns per inch, respectively, T_3 is 168 turns per inch.

A flat spring is soldered between the movable capacitor plate and the base plate to serve three purposes. (1) It prevents the inner screw from rotating. (2) It takes up backlash in the differential screw so that precision parts are unnecessary. (3) It provides a low-impedance r-f path to the movable plate.

Size of the capacitor plate that is

required for this tuning can be computed from the relation for parallel plate capacitors

$$C = 0.225 (A/D)$$

where C is capacitance in picofarads, A is area of one plate in square inches, and D is spacing between plates in inches. The area of the plates should be chosen to give a reasonable spacing.

The cathode-grid line can be designed similarly. By operating with one side of the heater grounded and by mounting the cathode-bias resistor directly on the tube base, the bypass capacitor for this resistor being inside the tube, only a single-layer sandwich plate is required. A multiple layer sandwich could be used to allow using an ungrounded heater or measuring cathode current. In constructing an amplifier using the 2C40, the tube is mounted through a large base plate to which the grid is grounded. On each side of the base are mounted the smaller flat plates that form the other halves of each line, as shown in Fig. 2. Figure 3 shows the circuit. Coupling to the plate line is provided by an adjustable loop at the edge of the line. Input coupling to the cathode line is obtained by a sliding clip on the edge of the line.

Two stages of preamplification were built using this amplifier design. They satisfactorily replaced a more complicated coaxial-cavity amplifier. The noise factor of the flat-line preamplifier was 9.7 db, the gain of the two stages between 72-ohm input and 72-ohm output was 28 db, and the bandwidth between half-power points with both stages tuned to the same center

frequency was 1.67 mc. Wider bandwidth with some loss in gain could be obtained by slight staggering of the tuning.

Other Applications

While the use of flat-plate lines at very high frequencies has been emphasized, this type of line has applications at lower frequencies where low impedances are necessary. For example, it was necessary to match a 17-ohm generator output to a 250-ohm load at 100 mc. A quarter-wavelength matching section was to be used. The characteristic impedance of such a section must be the geometric mean between the two impedances involved, or

$$Z_{OM} = (Z_{OG} Z_{OL})^{1/2}$$

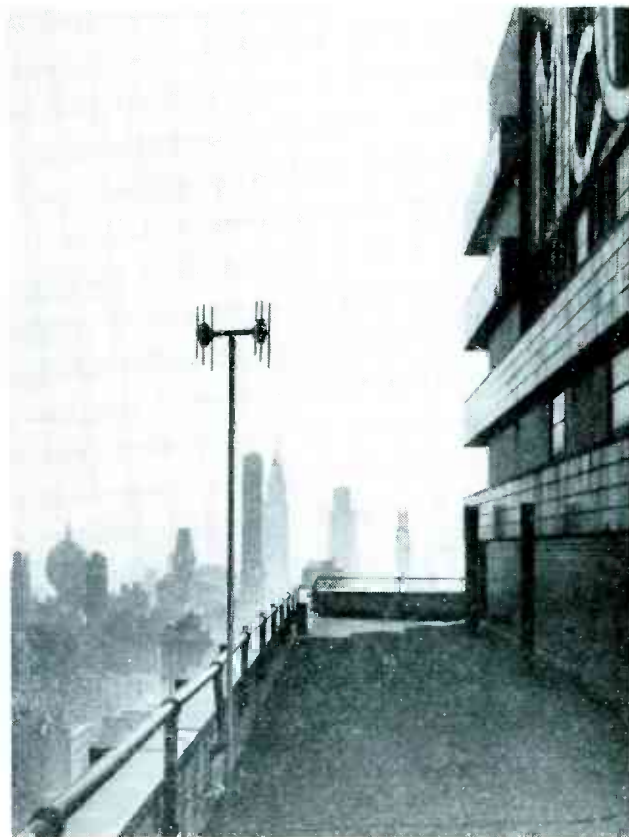
where Z_{OM} is the characteristic impedance of the matching section, Z_{OG} is the impedance of the generator, and Z_{OL} is the impedance of the load. In this case the matching section should have a characteristic impedance of 65 ohms. It can be constructed easily with flat plates 1-inch wide, spaced 0.173-inch, and 29.5-inches long. If the spacing of the line is maintained by insulating washers, they should be as small as possible in order to minimize lumped capacitances.

An incidental advantage of the flat-plate line is its power-handling ability. For the same characteristic impedance, the spacing of a flat-plate line, having plates of the same width as the diameter of the elements of a comparable parallel-wire line, is greater. Hence the flat-plate line will withstand higher voltages without flashover. This is an important consideration in lines for transmitting high power or for sections used as tuning elements in high-voltage circuits.

It should also be noted that, particularly for transmitting r-f power, a flat-plate line can be made of a center plate and a plate on each side, in which case the characteristic impedance will be half that given previously. To increase rigidity, or for some other reason, the line can be made from angle metal. The plate-type line can thus be considered, and used, as an intermediate form between the conventional open-wire line and that of the coaxial line.



Colinear array installed on roof of McGraw-Hill Building for long-distance tests of citizens band coverage



Six-element array installed for coverage tests using receiving locations in New Jersey and Long Island

ANTENNAS for

Antenna gain, readily obtained in small structures at 460-470 mc, is particularly important for the citizens service because of transmitter power limitations. Designs for broadcast and point-to-point service are presented as part of **ELECTRONICS'** development program

THE DESIGN of transmitting and receiving antennas for the citizens radio service is a matter deserving more attention than is usually paid to this subject in the development of communications equipment. This is true because the transmitter power obtainable from conventional tubes as well as the receiver sensitivity, are low in the 460 to 470-mc band.

Antennas of high gain can be constructed of such small size as to be useful on mobile, as well as fixed, stations. Only in the man-portable equipment is a high-gain antenna apt to prove unwieldy and even then it is possible to use high-gain antennas at certain fixed locations where set is most often operated.

The initial testing of the **Electronics** transmitter was carried out

with a very simple antenna, a quarter-wave rod against a ground plane. The antenna itself is a $\frac{1}{4}$ -inch brass rod, 6 inches long and mounted vertically in the center of a 12-by-12 inch solid brass plate. The rod is supported in a polystyrene bushing within a standard male fitting for RG-8/U cable. The brass plate is supported with a half-inch brass post at each corner, each

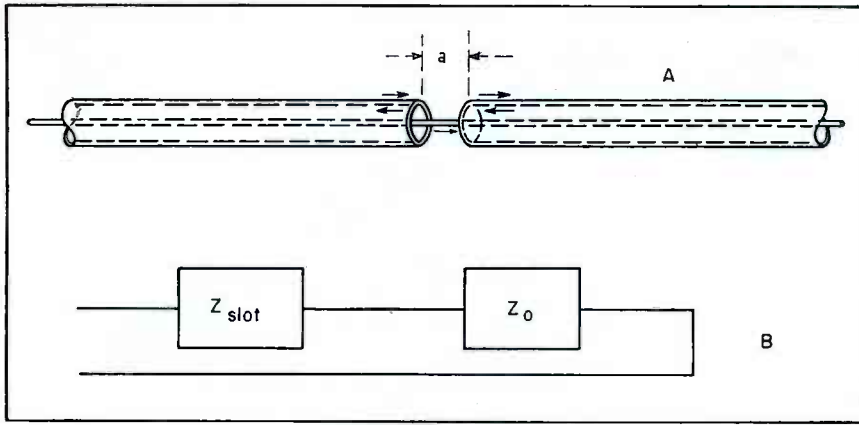


FIG. 1—Slot in coaxial line (A) introduces impedance in series with characteristic impedance (B)

By **HOWARD J. ROWLAND**

*Chief Engineer
Workshop Associates
Newton Highlands
Massachusetts*

Part III of a series

Citizens Radio

three inches long and fitted with three-inch suction cups so it can easily be attached to the roof of a car. However, actual experience has shown that it is desirable to have more gain in the antenna system.

When ELECTRONICS' citizens radio project was announced last November, the writer and his associates became interested in the problem of antennas for this service and offered to assist in the project. As a result two types of antennas were constructed and supplied to the editors for use, with equipment previously described,^{1, 2, 3} in field tests of the system. The first antenna, a colinear array giving 360-degree coverage, was adapted from designs previously produced under military auspices. The second, a six-element array for point-to-point service was

specially designed for the ELECTRONICS project.

Design Requirements

In view of the wavelength employed and the power limitations of the equipment, the following requirements were set up: The antenna should concentrate the radiated power on the horizon and should direct power only in the desired direction or directions of coverage. The standing-wave ratio should be kept to a minimum to avoid power loss and to assist in stabilizing the tuned circuits. For mobile use the antenna should be as light as possible, weatherproof, and able to withstand vibration and shock associated with vehicles moving over broken terrain.

For fixed-station use the forego-

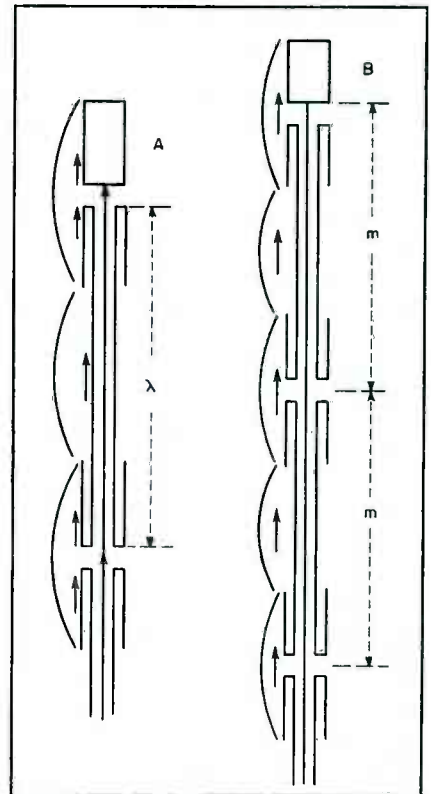


FIG. 2—Three in-phase halfwave radiating elements (A) and five elements (B)

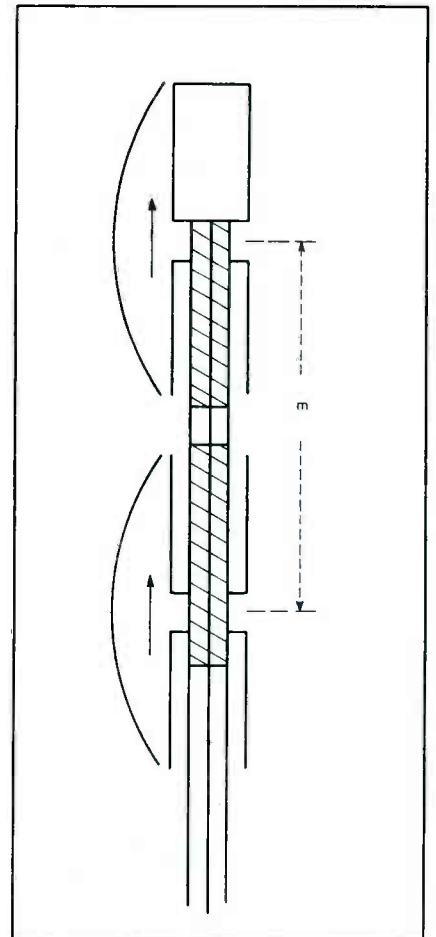


FIG. 3—Internal dielectric slugs preserve electrical spacing at full wavelength

ing mechanical requirements are not so severe, but higher gain is desired to permit simpler antennas to be used in the associated mobile or portable units. Since such fixed antennas are often mounted in exposed locations at high elevations, ability to withstand high wind velocities is also an important consideration. Based on these requirements, the antennas described below were designated. Vertical polarization was chosen in the expectation that whip antennas would be most convenient in mobile installations.

Colinear Array

The vertical-polarized colinear array illustrated (Fig. 3 and 5) is intended primarily for fixed station use when coverage must extend over the whole horizon. The principle of operation is as follows: Consider an infinite coaxial cable (Fig. 1A) in which a slot, small compared with the wavelength, has been cut. The slot presents an impedance in series with the characteristic impedance of the line as shown in Fig. 1B. The current flow is then as indicated by the arrows. If the line is then terminated with a halfwave skin-back antenna as shown in Fig. 2A, we may slot the



Internal view of two-section colinear array for broadcast service. A cover of fiberglass tubing protects the array from the weather

line one wavelength back from the termination and employ phase-reversing skirts to produce the direction of current flow shown by the arrows. This is, in effect, three stacked dipoles in line, fed in phase, producing a concentration of radiated power at right angles to the array. A second slot may be added as in Fig. 2B to add two additional in-phase radiating elements, producing a higher concentration of

In practice it has been found that the spacing m between the slots (Figs. 2 and 3) should be 0.7 wavelength to keep the side lobes 15 to 20 db below the main lobe. To assure a full electrical wavelength within the structure, as required to produce the in-phase condition, the line is partially filled with polystyrene dielectric, as shown in Fig. 3.

The measured vertical coverage diagram at 465 mc of the two-section array is shown in Fig. 4, together with computed diagrams for an array having three sections (Fig. 2B) and four sections, all compared with a half-wave dipole. The corresponding power gains, relative to the dipole, the 1.9 for the two-section, 3.2 for a three-section, 4.4 for a four-section and 5.3 for the five-section array. The standing wave ratio in voltage for the two-section antenna is from 1.2 to 1.0 over the band from 460 to 470 mc. The azimuth pattern of the array is circular if the array is mounted well in the clear.

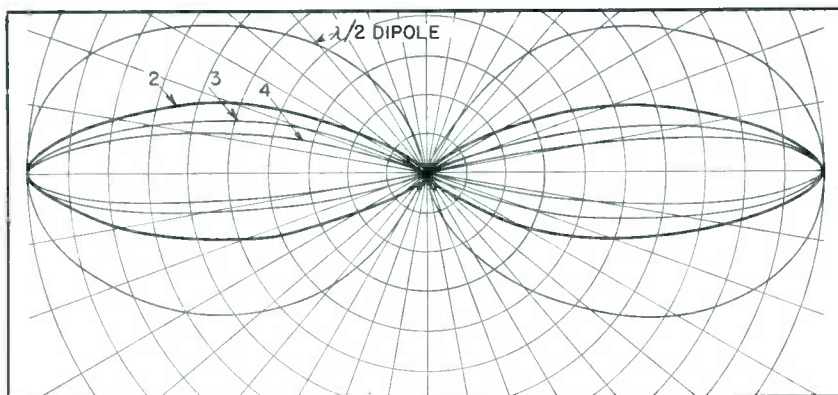


FIG. 4—Vertical coverage diagrams (in power) for two-section colinear broadcast-type arrays of 2, 3 and 4 elements at 465 mc, compared with half-wave dipole

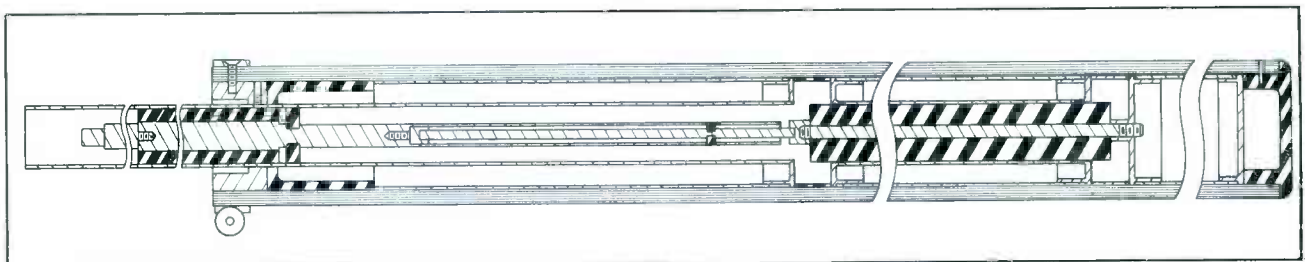
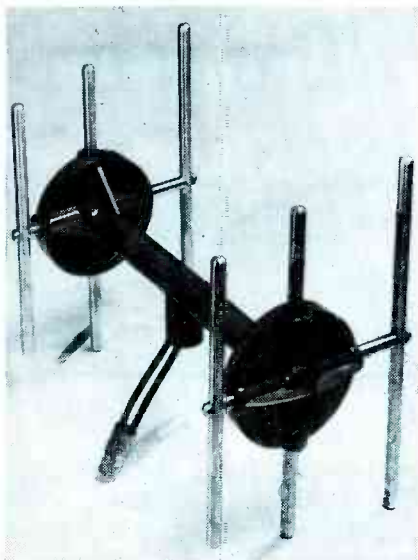


FIG. 5—Internal mechanical structure of the two-section colinear antenna. The heavy cross hatching indicates polystyrene dielectric



Six-element array designed especially for Electronics citizens radio project

The mechanical features of a two-section array are shown in the accompanying photographs. A weatherproof shield (actually a radome) of compressed fiberglass tubing is mounted over the array to protect it. This covering has negligible effect on the performance. Polystyrene spacers are used to keep the elements in proper relative positions. The two-section array is about 30 inches long. A five-section array, having a power gain of over five would extend about 6½ feet. While the colinear array is intended primarily for broadcast coverage, several arrays may be placed parallel to one another, or in front of a reflector, to produce a narrow pattern in azimuth.

Six-Element Array

A more conventional design suffices for a multi-element array for point-to-point service. A six-element array designed for the project is illustrated in the photographs. The elements are of half-inch aluminum tubing, the driven elements being mounted in molded low-loss plastic. The lengths of the elements are: director, 10½ inches; driven element, 12 inches; reflector, 13 inches. The spacings are: director to driven element, 3 inches; driven element to reflector, 4½ inches. The two sets of elements are parallel, 12½ inches apart.

The driven elements are fed by two one-foot lengths of 70-ohm polyethylene insulated coaxial cable,

which are connected in parallel across the standard female fitting for RG-8/U cable. This array has a vertical beam width of 68 deg between half-power points and a horizontal width of 64 deg, with negligible side lobes, as shown in Fig. 6. The corresponding power gain is about 7 to 8 db relative to a single dipole. If two such antennas are used at the terminals of the communications system, the overall gain is 15 db, or 30 times in power, relative to dipoles. The voltage standing wave ratio lies between 1.0 and 1.2 over the band from 460 to 470 mc.

Both types of antenna are intended for convenient mounting on a hollow pole or pipe as shown in

the accompanying illustrations. As tenna is shunted across both transmitter output and receiver input, impedance matching difficulties are encountered. However, this problem can be circumvented by the use of switching.

Coaxial Switching

A satisfactory manually-operated switch is available (Bird coaxial switch, model 74), which consists of a short section of coaxial line, within a housing, which can be rotated by hand. The inner conductor is indexed to engage standard female fittings for RG-8/U cable attached to the housing. A six-position switch of this type has been employed successfully with four of the six terminals left unconnected.

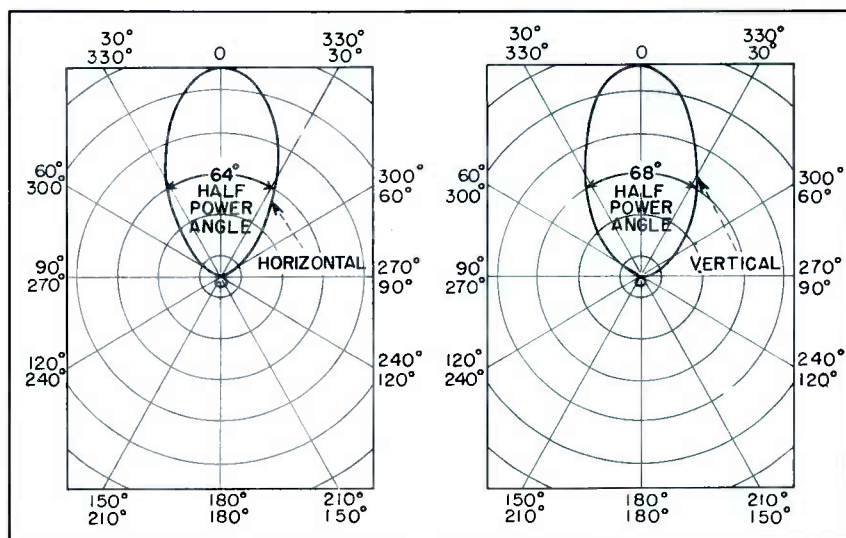


FIG. 6—Vertical and horizontal power directivity diagrams of 6-element array for point-to-point service

the accompanying illustrations. As used in current tests, the radiators are mounted on a setback on the north face of the McGraw-Hill Building in New York, about 450 feet above street level. Standard RG-8/U 52-ohm cable is used for the transmission lines. The nominal attenuation of this cable at 465 mc is 5 db per hundred feet, so cable lengths have been kept under 20 feet. Tests now under way will be reported in an early issue.

One problem in the application of antennas to the citizens service is the question of switching between transmitter and receiver. In mobile installations it is desirable to employ but one antenna. If the an-

Manual operation is satisfactory for testing purposes, but for simplicity in operation an automatic switch is desirable. An investigation of the availability of such switches, with six-volt actuating relay coil, has revealed that at least one manufacturer has a coaxial switch of suitably low loss for the purpose. It is planned to secure such a switch and test it with the antennas here described.

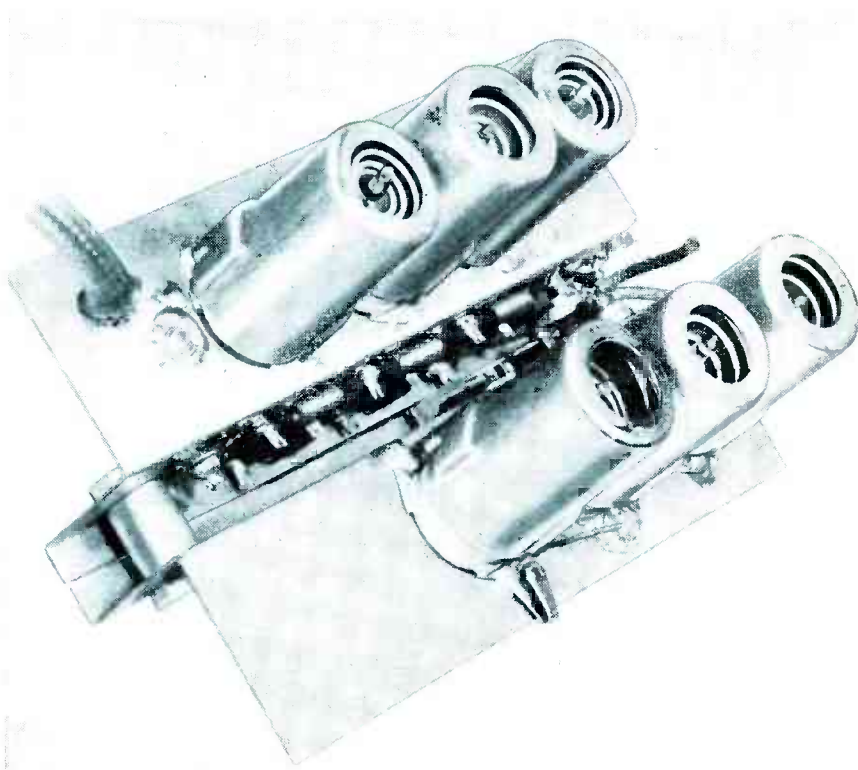
REFERENCES

- (1) Electronics Sponsors Citizens Radio Project, *ELECTRONICS*, p 80, November 1947.
- (2) W. C. Hollis, Transmitter for the Citizens Radio Service, *ELECTRONICS*, p 84 November 1947.
- (3) W. C. Hollis, Receiver for the Citizens Radio Service, *ELECTRONICS*, p 80, March 1948.

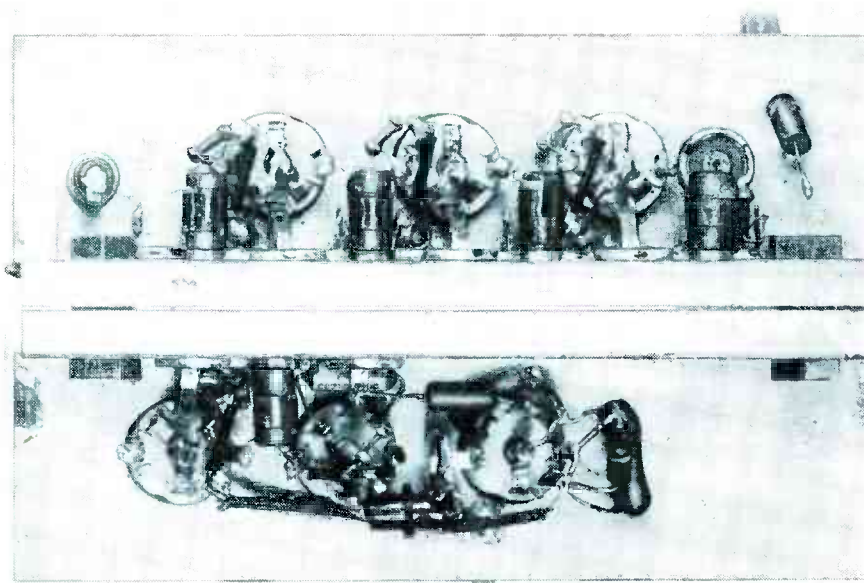
STAGGER-TUNED

By HENRY WALLMAN

Associate Professor of Mathematics
Department of Mathematics
Massachusetts Institute of Technology
Cambridge, Massachusetts



Four-stage, staggered, flat quintuple using 6AK5 tubes has a 10-mc bandwidth, a center frequency of 30 mc, and a gain of 10,000



View of underside of 30-mc amplifier shows how layout simplifies construction; a 6AL5 detector and 6AK5 pulse amplifier are included

STAGGER-TUNED intermediate-frequency amplifiers were extensively employed in radar receivers designed at the MIT Radiation Laboratory. These amplifiers had gains of 100 db and bandwidths (between low and high frequencies at which the gain was 3 db down from maximum) from 6 to 12 mc, although one amplifier had a bandwidth of 35 mc. Such amplifiers were satisfactorily produced in quantity by factory methods. This article summarizes design formulas for simple stagger-tuning schemes, presents curves of step response of certain of these circuits, and discusses practical considerations^{1, 2}.

Single-Tuned Circuit

The simplest i-f interstage network is a single-tuned circuit the usual connection of which is shown in Fig. 1A, and the equivalent form in Fig. 1B. The effective load resistance R is the parallel combination of the plate resistor R_p , the plate resistance of the first tube, the input resistance of the second tube, and the equivalent parallel loss resistance of the inductance L . The capacitance C is the sum of the output capacitance of the first tube, the apparent input capacitance of the second tube, the self capacitance of L , and the wiring capacitance. With careful wiring and a fixed tuned inductor about the size of a one-watt resistor, the value of C between two 6AG5 tubes is about 12 pf (picofarad is a micromicrofarad).

The bandwidth of the single tuned circuit is $1/(2\pi RC)$ and is independent of center frequency. The voltage amplification at band center is $g_m R$ where g_m is the tube

AMPLIFIER DESIGN

Practical wideband amplifier considerations, limits to overall bandwidth of cascaded stages, and transient response characteristics of stagger-tuned circuits are prevented. Curves and tables give design criteria. Comparisons are made to other coupling circuits

transconductance. The amplification-bandwidth product (figure of merit), denoted by AB , is $g_m/(2\pi C)$. For a $g_m = 4,500$ micromhos and $C = 12$ pf, as with conservatively rated 6AG5 tubes, AB is 60. An amplification of 6 with a bandwidth of 10 mc, or an amplification of 15 with a bandwidth of 4 mc is thus attainable in this case. Because the AB product depends only on the tube, being independent of center frequency, it is no easier to build a single-tuned amplifier covering the band from 28 to 30 mc ($B = 2$ mc) than one from 8 to 10 mc ($B = 2$ mc) with a given tube (except for the effect of smaller inductor size on interstage capacitance).

Synchronous Single Tuning

The simplest wideband i-f amplifier employs cascaded single-tuned stages all of the same bandwidth and resonant frequency. This synchronous tuning method is simple, noncritical, and has excellent transient response. Figure 2 shows the envelopes of the responses of combinations of synchronous single-tuned stages of 2-mc bandwidth to a step function of a sinewave at the center frequency of the amplifier. (All transient responses shown in this paper can be applied to other bandwidths by using the fact that speed of response is inversely proportional to bandwidth; the responses are for the centered, or double-sideband case.)

The disadvantage of the synchronous single-tuned amplifier is its low efficiency, resulting from the rapidity with which overall bandwidth shrinks as stages are cascaded. For example, for an overall amplification of 10,000, a synchron-

ous single-tuned amplifier employing a tube that gives an $AB = 60$ has a maximum overall bandwidth of 7.1 mc, and requires 18 stages; the use of more stages yields an even smaller bandwidth.

Overall bandwidth for N synchronous single-tuned stages is to a very good approximation

$$\frac{\text{bandwidth of single-tuned stage}}{1.2 (N^{1/2})}$$

To illustrate this relation, consider a cascade of 5 synchronous 6AG5 single-tuned stages, each of 10-mc bandwidth. If AB is taken to be 60 and the amplification per stage to be 6 (giving a bandwidth per stage of 10 mc), the overall amplification is 7,800, but, from the above expression the overall bandwidth is only 3.5 mc.

Stagger-Tuned Coupling

This shrinkage of bandwidth can be avoided while preserving the simplicity and low cost of single-tuned coupling by stagger tuning. For an overall bandwidth B , it is possible to stagger tune N single-tuned stages so as to achieve a center-frequency stage-amplification of A with AB still equal to $g_m/(2\pi C)$. Note that here B is the overall bandwidth and A the gain per stage.

The stagger-tuned passband for which $AB = g_m/(2\pi C)$ has a selectivity characteristic $1/(1 + x^{2N})^{1/2}$ where x is a variable proportional to the deviation of the frequency from resonance. The general shape of curves of this sort, which are called maximally flat, is shown in Fig. 3 for a common bandwidth of 2 mc. As N increases, the curves become squarer and flatter. Stagger-tuned couplings of this sort

where $N = 2, 3, 4, \dots$, are called staggered pairs, triples, quadruples, etc.

Figure 3 also shows envelopes of responses to a step function of the band-center frequency. For the same bandwidth, but with increasing N , these envelopes show increasing overshoot, increasing delay, and somewhat slower rise.

In almost all cases, a passband with small dips is substantially superior for either optimum selectivity or optimum AB to a maximally flat passband, while for small overshoot, a more rounded curve is preferable. The only advantage of the maximally flat curve, apart from its mathematical simplicity, is its easily recognized shape when aligning amplifiers with a swept-frequency generator.

Table I shows the center frequencies and bandwidths to which individual coupling circuits should be designed to obtain flat-staggered amplifiers of overall bandwidth B at center frequency f_0 . The data are presented in terms of the fractional bandwidth B/f_0 . The values shown are valid only when B/f_0 is small, less than 0.3 for practical purposes. The exact case, which holds even for B/f_0 greater than unity, is fully considered elsewhere.^{1,2}

An example will make the use of Table I clear. Suppose a flat-staggered quintuple consisting of an input circuit and four interstage circuits is desired at $f_0 = 30$ mc with an overall bandwidth $B = 10$ mc. Then $B/f_0 = 0.3$, and the quintuple consists of four tubes and five single-tuned circuits that satisfy the following conditions:

(1) the first should have a bandwidth of 19 mc at 30.0 mc, and

Table I—Flat Staggered Combinations

Bandcenter = f_0 , overall bandwidth = B , and $B/f_0 < 0.3$		
NUMBER OF CIRCUITS	COMPONENT SINGLE TUNED CIRCUITS Center frequency	TUNED CIRCUITS Bandwidth
Staggered pair (2)	$f_1 = f_0 + 0.35B$ $f_2 = f_0 - 0.35B$	$0.71(B/f_0)f_1$ $0.71(B/f_0)f_2$
Staggered triple (3)	f_0 $f_1 = f_0 + 0.43B$ $f_2 = f_0 - 0.43B$	B $0.5(B/f_0)f_1$ $0.5(B/f_0)f_2$
Staggered quadruple (4)	$f_1 = f_0 + 0.46B$ $f_2 = f_0 - 0.46B$ $f_3 = f_0 + 0.92B$ $f_4 = f_0 - 0.92B$	$0.38(B/f_0)f_1$ $0.38(B/f_0)f_2$ $0.19(B/f_0)f_3$ $0.19(B/f_0)f_4$
Staggered quintuple (5)	f_0 $f_1 = f_0 + 0.29B$ $f_2 = f_0 - 0.29B$ $f_3 = f_0 + 0.48B$ $f_4 = f_0 - 0.48B$	B $0.81(B/f_0)f_1$ $0.81(B/f_0)f_2$ $0.31(B/f_0)f_3$ $0.31(B/f_0)f_4$

Table II—Bandwidth vs Amplification

Tube type assumed to have $g_m/(2\pi C) = 60$; listed amplifications do not include effect of input network

Number of Amplifier States	Over-shoot (see text) in percent	Bandwidth in mc for Gain of		Gain for Bandwidth of		
		10^3	10^4	2.5 mc	4 mc	10 mc
Input plus 2 interstages						
3 synchronous single tuned	0	0.9	0.3	150	58	9
flat staggered triple	8.2	1.9	0.6	580	225	36
over staggered triple with 1 percent dips	10.2	2.2	0.7	800	310	50
3 flat double tuned with equal Q loading	7.7	1.9	0.6	580	225	36
3 flat double tuned with one sided loading	7.7	2.7	0.8	1,200	450	72
Input plus 3 interstages						
4 synchronous single tuned	0	2.6	1.2	1,100	290	19
2 flat staggered pairs	6.2	4.8	2.2	7,000	1,700	110
flat staggered quadruple	10.9	6.0	2.8	14,000	3,400	220
4 flat double tuned with equal Q loading	8.4	5.6	2.6	11,000	2,800	180
4 flat double tuned with one sided loading	8.4	7.9	3.7	32,000	7,800	510
Input plus 4 interstages						
5 synchronous single tuned	0	4.2	1.9	7,700	1,200	30
flat staggered pair plus flat staggered triple	10	8.9	5	16×10^4	25,000	630
flat staggered quintuple	12.8	10.7	6	33×10^4	50,000	1,300
5 flat double tuned with equal Q loading	9.2	9.4	5.3	20×10^4	30,000	770
5 flat double tuned with one sided loading	9.2	13.2	7.4	79×10^4	12×10^4	3,100
Input plus 5 interstages						
6 synchronous single tuned	0	5.3	3.3	42,000	4,000	41
3 flat staggered pairs	7.7	10.7	6.8	14×10^5	14×10^4	1,400
2 flat staggered triples	11.2	13.0	8.2	37×10^5	36×10^4	3,600
2 over staggered triples with 2 percent overall dips	14.5	16.1	10.2	11×10^6	11×10^5	11,000
6 flat double tuned with equal Q loading	10	12.6	8.0	32×10^5	31×10^4	3,200
6 flat double tuned with one sided loading	10	17.8	11.2	18×10^6	17×10^5	18,000

(2) the second, a bandwidth $0.81 \times 0.3 \times 32.9 = 8.0$ mc at 32.9 mc
 (3) the third, a bandwidth $0.81 \times 0.3 \times 27.1 = 6.6$ mc at 27.1 mc
 (4) the fourth, a bandwidth $0.31 \times 0.3 \times 34.8 = 3.2$ mc at 34.8 mc
 (5) and the fifth, a bandwidth $0.31 \times 0.3 \times 25.2 = 2.3$ mc at 25.2 mc
 If each tube has an AB of 60, the amplification per stage is 6 and the overall amplification is $6^5 = 1,296$.

Staggered Pairs and Triples

A flat-staggered pair has the same selectivity curve ($N = 2$ in Fig. 3) as a critically coupled double-tuned circuit. For such circuits, the overall bandwidth shrinks less rapidly as stages are cascaded than for synchronous

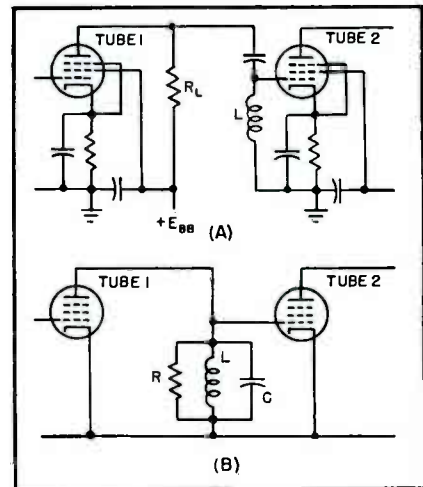


FIG. 1 (A) Single-tuned wideband amplifier coupling, and (B) its equivalent circuit

single-tuned circuits. The overall bandwidth for M flat pairs is

$$\frac{\text{bandwidth of single flat pair}}{1.1 (M^{1/4})}$$

To illustrate this relation, consider a 6-circuit amplifier consisting of 3 flat-staggered pairs ($M = 3$). For an overall bandwidth of 10 mc, each pair must have a bandwidth of $10 \times 1.1(3^{1/4}) = 14.5$ mc. If AB is 60, the stage amplification is therefore 4.1.

A flat-staggered pair, a flat double-tuned circuit, and a flat inverse-feedback pair have the same transient response, because they are of the minimum phase shift type and have the same amplification-vs-frequency curves. The envelopes of the response to a step function of band-center frequency of amplifiers consisting of 1, 2, 3, 4,

and 6 flat-staggered pairs, or flat double-tuned circuits, or flat inverse-feedback pairs, each of 2-mc bandwidth, are given in Fig. 4.

It is interesting to examine the transient response of a staggered pair as the amount of staggering increases (or equivalently, of a double-tuned circuit as the coupling is increased above the critical value). Figure 5 shows the fractional overshoot of the response envelope to a step function of band-center frequency. The curve shows that, from the viewpoint of transient response, there is nothing critical about the flat selectivity curve.

A flat-staggered triple has the same selectivity curve ($N = 3$ in Fig. 3) as a flatly coupled triple-tuned circuit. For such circuits, the overall bandwidth for M flat triples is

$$\frac{\text{bandwidth of single flat triple}}{1.06 (M^{1/6})}$$

To illustrate this expression, consider a 6-stage amplifier consisting of 2 flat-staggered triples ($M = 2$). For an overall bandwidth of 10 mc, each triple must have a bandwidth of $10 \times 1.06(2^{1/6}) = 11.9$ mc. For $AB = 60$ the amplification per stage is therefore 5.1. Figure 6 shows the envelope of the response of 1, 2, and 4 flat-staggered triples (or flat triple-tuned circuits, or flat inverse-feedback triples) of 2-mc bandwidth to a step function of band-center frequency.

Overstaggered Circuits

Appreciable increases in AB result from overstaggering the stages to yield pass bands with slight dips. For example, if a 6-stage amplifier consisting of 2 triples is over staggered so as to have 2 percent dips in the overall passband of the composite amplifier, there results an increase of fully 25 percent in amplification per stage over the flat-staggered triple amplifier of the same overall bandwidth; however, the transient response is degraded.⁸ Table II summarizes the characteristics of various coupling combinations, showing, for 5 interstage networks, the effect of overstaggering. (For values of AB other than 60, for which the table is computed, the bandwidths should be multi-

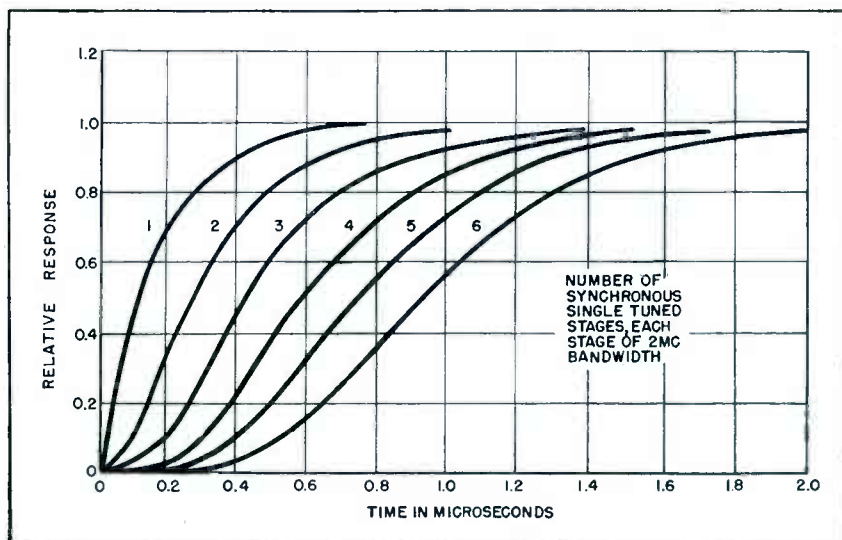


FIG. 2—Envelopes of the responses by various numbers of synchronously tuned stages to a step function input on a carrier at band-center frequency indicate the degree to which sharp pulses will be degraded in the amplifier. This family of curves should be compared to those of Fig. 3, 4, and 6. For example: the time taken for the outputs to rise through the middle 60 percent of their amplitudes are: about 0.5 microsecond with no overshoot for synchronous tuning, 0.3 microsecond with 10 percent overshoot for minimum phase shift networks, 0.4 microsecond with 12 percent overshoot for flat staggered pairs, and 0.4 microsecond with 8 percent overshoot with flat triples, all having a 2-mc bandpass. Table II gives the gains obtainable from these amplifiers

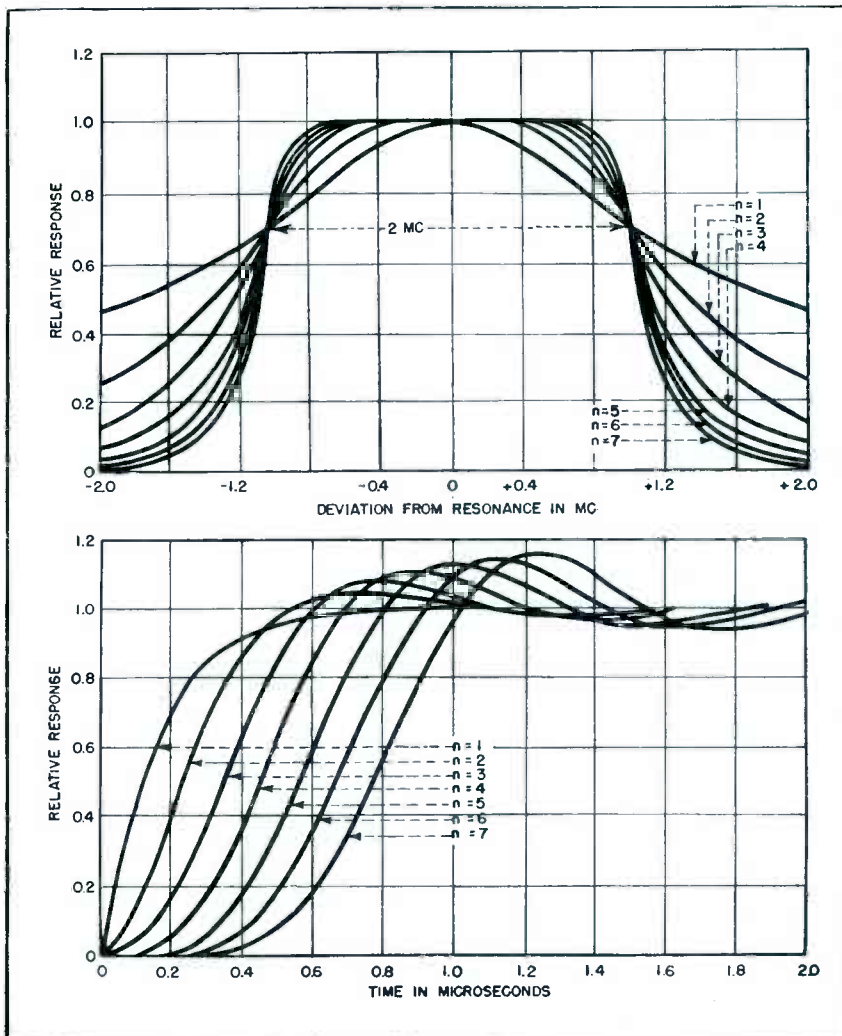


FIG. 3—Frequency responses of maximally flat bandpass networks are shown at the top; below are step responses for comparable minimum phase shift networks

plied by the ratio of actual AB to 60. Similarly, the overall amplifications for given bandwidth should be multiplied by the N th power of this ratio, where N is the number of amplifier stages.)

Many variations of overstaggering are possible, but a simple approximate procedure for converting a stagger-tuned amplifier of given bandwidth that has a flat passband into one having the same bandwidth but with small dips is to narrow the individual stage bandwidths all in the same ratio, leaving the individual resonant frequencies unchanged. Considerable narrowing is necessary to produce any effect; thus, in a flat-staggered triple, the individual stage bandwidths have to be reduced 30 percent to produce 1-percent dips.

Practical Considerations

For a given overall bandwidth, a staggered sextuple has somewhat greater amplification than two staggered triples. However, as a practical matter, the combination of two staggered triples is probably preferable because of the smaller overshoot and less critical reaction to misalignment, unless the fractional bandwidth is close to unity. For such reasons, most stagger-tuned amplifiers employ pairs or triples, although sometimes quintuples are used.

For reasons of noise figure, it is desirable to have a centered input circuit, and overload considerations suggest a centered circuit driving the detector, if possible; otherwise the order of staggering is unimportant. Gain control can be applied to any stage or combination of stages in the staggered amplifier. Except for detuning resulting from changes in input capacitance with variation of grid bias, which was never serious in Radiation Laboratory experience, there is no reason for applying gain control to pairs.

The plate resistor R_L in a stagger-tuned stage should have whatever value yields the design bandwidth for that stage. Usually R_L is somewhat greater than the effective damping resistance R , but it can be less if the input resistance of the following tube is negative. Because of grid-plate capacitance,

a tube having a resonant plate circuit has a negative input resistance at frequencies somewhat below resonance of its plate circuit. This condition occurs for the tube between the low- and high-frequency circuits of a staggered pair.⁴

A four-stage, staggered, flat quintuple using 6AK5's was designed. The final circuit is shown in Fig. 7, the indicated center frequencies and bandwidths having been obtained from Table I for $N = 5$, with a 10-mc bandwidth at 30 mc. To obtain the required amplification of 10,000, an amplification of 10 per stage was necessary. The 6AK5 tubes had to be operated with $AB = g_m / (2\pi C) = 100$. In this amplifier C was 10 pf; therefore g_m had to be 6,280 micromhos, exceeding the rated value by 25 percent. The special application of this amplifier justified operating the tubes in such a manner as to produce the required g_m . Had they been operated at a g_m of 5,000 micromhos, the same bandwidth would have been attained with an amplification per stage of about 8, or an overall amplification of only 4,000.

The tuning coils were fixed tuned on powdered-iron cores, and bifilar wound, that is, unity coupled, thereby eliminating blocking capacitors.

The space available necessitated folding the amplifier back on itself, with the input connection and the first three stages on half of the

chassis, and the fourth i-f amplifier, detector, and pulse amplifier on the other half, as shown in the pictures. The two halves were separately wired, each half having greater accessibility than otherwise because of its open L-shaped chassis. The two halves were then connected with metal bushings, and the cover put over the combination. The only wire connecting the two halves is that from the secondary of the transformer following the third stage to the grid of the fourth, the return path being the inside of the metal bushing containing this wire. Use of feed-through, button, bypass capacitors mounted in the chassis wall made it possible to have only two components (tuning

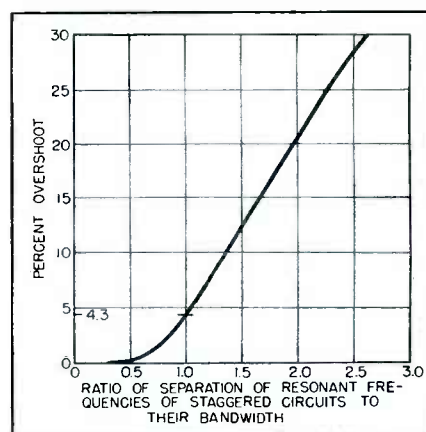


FIG. 5—Fractional overshoot of a flat-staggered pair or a double-tuned circuit as a function of separation of resonant frequencies. A ratio of unity corresponds to a flat response

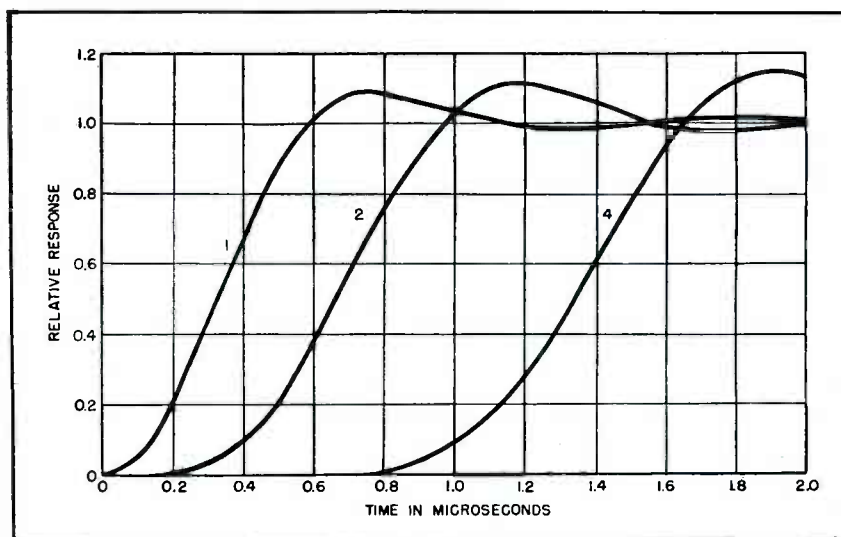


FIG. 4—Response envelope of flat-staggered pairs, flat double-tuned circuits, or flat inverse-feedback pairs

Direction Finder for Locating Storms

Two loop antennas placed at right angles to each other feed vertical and horizontal deflecting plates of a cathode-ray tube through separate amplifiers. Flash lines on tube screen indicate direction from which static is received

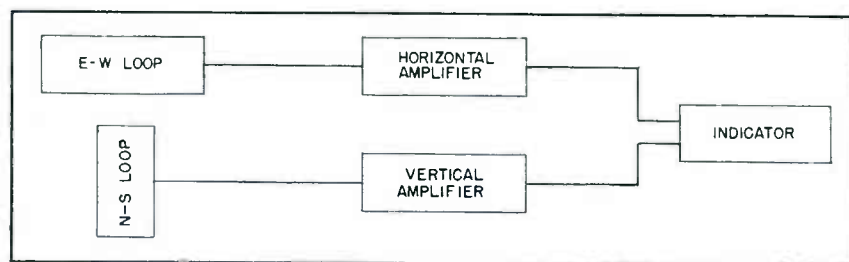


FIG. 1—Block diagram of the equipment. One of two identical amplifiers is shown

By **WILLIAM J. KESSLER**

*Electronics Research Laboratory
Engineering and Industrial Experiment
Station*

and

HAROLD L. KNOWLES

*University of Florida
Gainesville, Florida
Department of Physics*

LOCATING storm areas by means of the associated atmospheric static was first carried on in Europe about fifty years ago by Popoff, as mentioned by Bureau.¹ Twenty years later, the accuracy of measurement was greatly increased by Watson-Watt^{2,3} and his co-workers in England. Subsequent work has been carried on by Munro⁴ and co-workers in Australia, by Henderson⁵ and his group at the National Research Council in Ottawa, by Lugeon⁶ in Switzerland, and Weil⁷, Mason⁸, and Sashoff⁹ at the University of Florida.

At the request of the Army Signal Corps, the equipment previously used at the University of Florida was redesigned and new units built for the location of storms.

Fundamental Principles

Atmospheric direction finding involves determining the direction of arrival of electromagnetic pulses associated with certain types of meteorological phenomena. The time variation of these pulses is of short duration and wide variety.

The transient nature of atmospherics makes it inadvisable to use

conventional null-type direction finders for two reasons: first, the short duration of these pulses, rarely exceeding 5 milliseconds, makes impractical the proper orientation by either manual or mechanical means of the receiving antenna system within the time involved; second, the antenna system should not exhibit a blind azimuth in any direction at any instant if static pulses arriving at a rapid rate from random directions are to be received. The direction-finding device should be capable of indicating the direction of approach of the electrical disturbance at the instant the wave front sweeps past the point of observation. Consequently, the device to be described is an instantaneous direction finder.

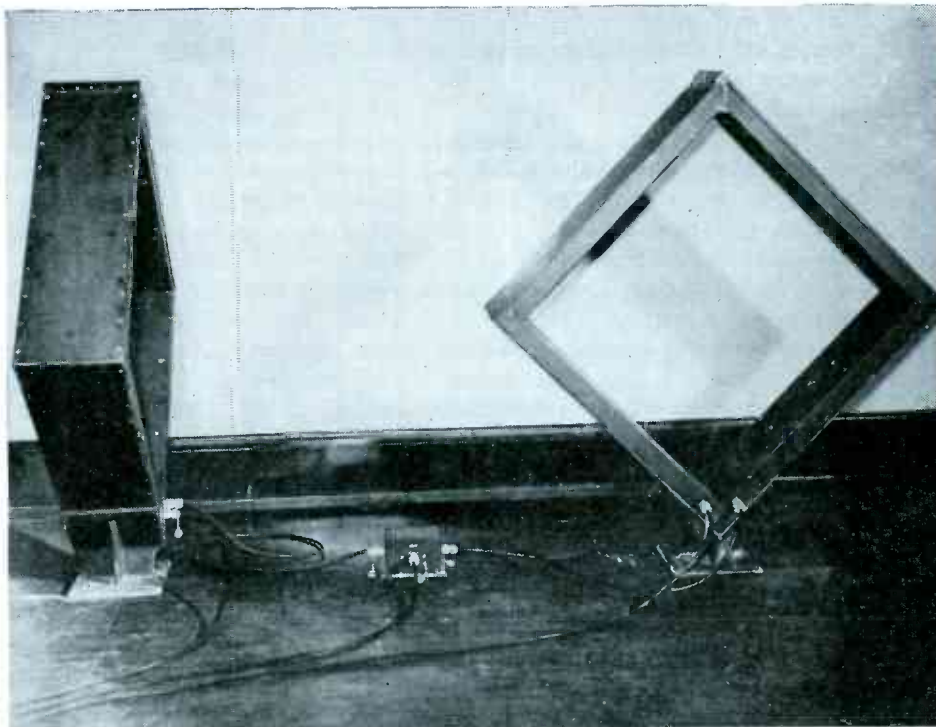
Basically, the instantaneous static direction finder consists of two mutually perpendicular loops, the planes of which are oriented vertically in the north-south and east-west directions, two amplifiers and an indicating cathode-ray tube. See Fig. 1.

The signal voltages appearing across the output terminals of each loop are applied to the inputs of two

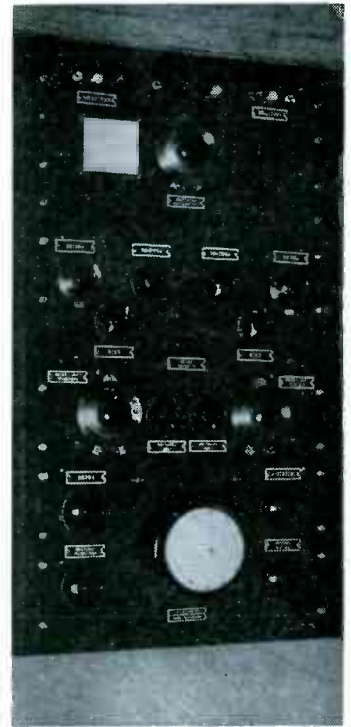
nearly identical amplifiers. After suitable amplification, the output voltages corresponding to the north-south and east-west loops are applied to the vertical and horizontal deflecting plates, respectively, of the cathode-ray tube, giving a visible indication of the bearing of the incoming signal. See Fig 2.

Operating Frequency

Work by Austin¹⁰ has indicated that the energy associated with atmospherics increases with decreasing frequency, at least to frequencies somewhat below 15 kc. Norinder¹¹ and others have shown that the quasi-periods of atmospherics range from 50 to 250 microseconds, with those pulses in the 150-microsecond category occurring most frequently. The energy contained in these pulses occupies a wide frequency spectrum, with most of the energy concentrated at the end of the spectrum corresponding to the quasi-frequency of about 7 kc. Since it is well known that such low-frequency electromagnetic waves are propagated with minimum attenuation over great distances, and since few longwave stations which would



East-west and north-south loops of the static direction finder



Developmental direction finder

produce interference operate at frequencies below about 20 kc, the choice of an operating frequency for the static direction finders of about 10 kc seemed advisable. Operations at frequencies below 10 kc would increase the bulk of the component parts of the resonant circuits and further decrease the effective height of the loop antennas.

Tuned circuits are used in the static direction finder to give the necessary selectivity for preventing interference from commercial stations and to increase the sensitivity. With tuned circuits the trace obtained on the face of the cathode-ray tube is not a reproduction of the incoming signal, but is a damped oscillation. This has the advantage of increasing the sensitivity, since the electron beam of the indicating tube makes a large number of excursions over the same path for each atmospheric pulse, building up the brilliancy of the indicated bearing. A single, or very few excursions of the electron beam would require greater accelerating voltages in the cathode-ray tube, with accompanying decrease in tube sensitivity. Both loops and one

stage of amplification associated with each loop are tuned, with the loop circuits having the higher Q. Identical values of Q for both loops and for both tuned amplifier circuits are necessary if the received pulse is to produce a linear trace on the indicating tube.

Directional Antenna System

It was decided to use a multi-turned, electrostatically shielded, balanced loop. Bearing angle tests with the loops were performed using the continuous-wave signals from NSS, located near Annapolis, Maryland, which operates on a frequency of 18.6 kc. The results of these tests showed that during the daytime the indicated bearing remained accurate and fixed to within 0.5 degree. At night, during turbulent ionospheric conditions, the indicated bearing was found to vary as much as 30 degrees from the fixed daytime value.

The loop antennas used with the AN/GRD-1 static direction finder (production models, designated AN/GRD-1A, were later made by the Airplane and Marine Instru-

ment Company) are about three feet square and wound with 400 turns of No. 20 enameled-copper wire. There are four layers spaced 0.375-inch apart, each layer wound in two sections. The winding density of 20 turns per inch is obtained by grooved Formica spacers at the corners of the aluminum container which serves as the electrostatic shield. Additional spacers are used at the center of the span of each layer. The loops are wound in halves and grounded at the electrical centers. A 1-ohm precision resistor is placed on either side of the center tap to allow the injection of a signal from the calibration oscillator. The voltages appearing across these resistors simulate the induced electromotive force for alignment purposes. The buffer unit, two 100-ohm resistors between the loops in Fig. 3, provides sufficient attenuation between loops to reduce conductive coupling to negligible proportions.

Each loop has an inductance of 0.22 henry, a distributed capacitance of about 140 micromicrofarads and a measured Q of 40 at 10 kc. The loops are connected to the

input of each amplifier by means of two fifty-foot RG-22/U low-capacitance Twinax cables. Each loop is wound in an aluminum container whose cross section is broken in the usual manner to prevent the flow of currents reacting unfavorably upon the effective Q of the windings. These shields are sealed to keep out moisture. The loops are mounted ten feet apart, or more, since greater spacing has the advantage of making the mutual inductance adjustment for a minimum much less critical.

The Amplifiers

The final indicating device requires voltages whose components are in phase and whose magnitudes bear a direct relationship to the bearings of the approaching signal. These deflection voltages appear at the output of each amplifier and are the direct result of the loop voltages applied to the input of each channel.

Since the output voltage in an amplifier differs both in magnitude and phase from the input voltage, both the magnitude and phase of the output voltage must be easily and accurately controllable if the requirements imposed by the indicator are to be satisfied. Actually, because of a difference in deflection sensitivities of the cathode-ray tube, the gains of the amplifiers are not identical, but are so related to the deflection sensitivities as to compensate for this characteristic.

The effective bandwidth of each amplifier extends over a finite range and is designed to pass a damped wave train of various frequency components, so it is essential that the phase and amplification conditions at the center of the operating range be maintained in both channels over their effective bandwidths. A difference in phase shift between the two channels, or relative phase shift, may be due to three factors: first, the tuned circuits in the two channels may not be resonated to the same frequency; second, the tuned circuits may exhibit different values of Q ; and third, the plate load impedance associated with each untuned stage may have a different time constant. These effects are indistinguishable from each other on the indicator at any fixed frequency; however, they are read-

ily isolated by sweeping the frequency of the calibration oscillator through the central point of the operating range.

Since both channels are identical in construction, only one is reproduced in its entirety in Fig. 3. Across each loop is placed a large variable shunt resistance which makes possible a Q adjustment. The loop signal is coupled to each amplifier by means of a cathode follower which provides a high input impedance and a low output impedance. The high input impedance minimizes the loading effect on the high-impedance loop circuit, while the low-impedance output enables the coupling to be altered by a conventional potentiometer without intro-

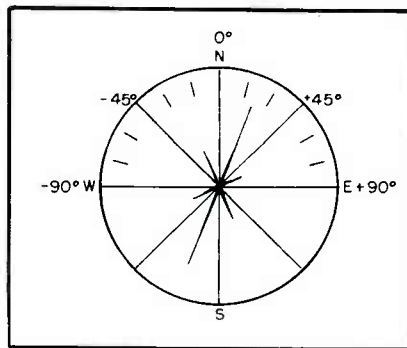


FIG. 2—Bearing indications for three successive static discharges

ducing an objectionable phase displacement. Since the center of each loop is grounded, only half of the voltage developed by the loop is applied to the grid of the cathode follower. The grid resistor for this tube has a very high resistance, as its only function is to prevent the grid from becoming ungrounded if the loops are detached.

From the cathode-follower stage, the signal goes to contacts on switch SW_1 , which is used during the alignment process and whose positions are indicated on the diagram. During normal operation this switch applies the signal to the grid of the untuned amplifier, a resistance-capacitance coupled stage in which the variable gain and a phase-shift control are placed. The gain of this stage is controlled by means of a variable cathode-dropping resistor which provides a variable positive voltage on the cathode. To prevent the tube from ever operating with zero bias, a fixed cathode resistor provides a small amount of

self bias. This type of gain control was adopted in preference to conventional types since phase-shift difficulties were experienced with resistance variations across high-impedance grid circuits. The gain control is placed in the untuned stage since a change in transconductance is accompanied by a change in effective plate resistance. Should this variable plate resistance be placed across the resonant network, the damping, and hence the Q , of this circuit would be a function of the gain setting, which would be undesirable.

The possible difference in the time constants of the plate loads, due to a difference in the wiring capacitance, may be responsible for unequal phase shifts occurring in the untuned stages. To correct this difficulty, variable capacitors across the grid circuits of the tuned stages have been included. A correction made at any one frequency will hold over a wide range of frequencies.

From the untuned stage the signal is applied to a stage of tuned amplification employing a 6SK7 tube. This stage provides additional selectivity over that afforded by the tuned loops alone. As in the case of the tuned-loop circuit, this circuit must be provided with means for adjusting its Q . This is accomplished by placing a high variable resistance in shunt with the tuned circuit.

The signal is then applied to the transformer-coupled stage, which is used to provide a signal level adequate to deflect the beam of the cathode-ray oscilloscope. It is necessary to employ a series resistor in the grid circuit of this stage to eliminate the possibility of sustained oscillations which might result from the use of reactive elements in both the input and output circuits. The output transformer is mounted in the indicating unit in order to place the interconnecting cable on the low-impedance side of the transformer. The voltage from the secondary of this transformer is applied directly to the deflecting plates of the cathode-ray tube. The deflecting plates are driven through a balanced network to minimize defocusing of the electron beam. The manufacturing tolerances of the transformers are

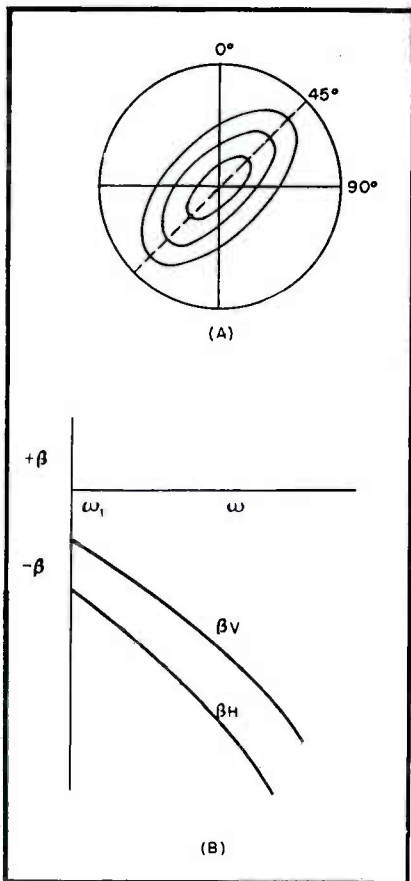


FIG. 4—(A) Pattern for various calibration oscillator frequencies when product of reactance and resistance, or time constant of untuned N-S amplifier stage plate load impedance is not equal to that of E-W amplifier. (B) Corresponding phase variation

herent symmetry of the response curve and because the response of one channel falls off more rapidly than the other.

Networks for Storm Location

For the location of storm areas a network of three, or preferably four, stations with base lines 500 to 1,000 miles long is employed. The storm areas are located by triangulation of the data obtained by the network stations.

The angular orientation of a flash on the face of the scope can be determined either visually or photographically. The visual method of observation has the obvious advantage of being rapid, with data on simultaneous flashes immediately available at the end of each run. The disadvantages of visual observations are the uncertainty of accurately reading the flashes and the question as to whether the method of sampling used was adequate for location of storms within

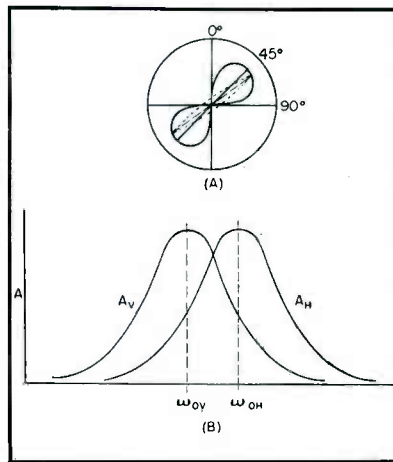


FIG. 5—(A) Pattern for successive settings of calibration oscillator frequency when resonant frequency of vertical amplifier differs from that of horizontal amplifier. (B) Corresponding gain variation between amplifiers

the range of the network. In general, only a small percentage of the total number of flashes appearing on the scope are read by the visual method. The photographic method has the advantage of recording all flashes, but the film record requires processing before the information can be transmitted to a central point for triangulation.

The operational procedure of the development network was as follows. Runs of from 10 to 20 minutes duration were made every two hours, while all stations were in constant radio communication with one acting as the control station. When the observer at the control station noted an observable flash, a signal was transmitted to the network stations where each observer recorded the angular orientation of the flash immediately preceding the signal. This was possible with the use of the long-persistence cathode-ray tube. In case of doubt, where multiple flashes were observed at one or more stations, no readings were recorded. Immediately after the conclusion of each run, the data were transmitted to the control station where they were plotted on gnomonic projection maps. In general, only those readings were used which resulted in three-station intersections.

Acknowledgment

The authors wish to express their indebtedness to O. R. Gano and C. A. Moreno for valuable contributions,

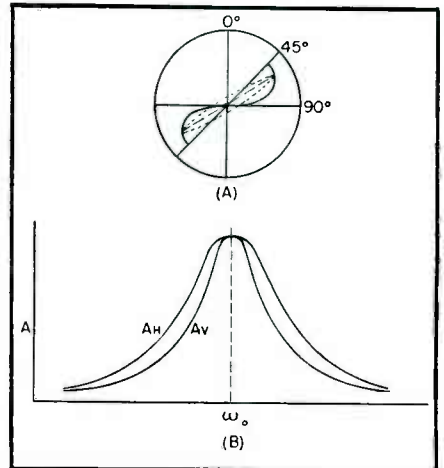


FIG. 6—(A) Pattern for successive settings of the calibration oscillator frequency when the Q of the resonant circuit in the vertical amplifier is not equal to that of the horizontal amplifier. (B) Corresponding gain variation between amplifiers

and their appreciation of the work done by others engaged on this project. In particular, their appreciation is expressed to Joseph Weil, Dean of the College of Engineering, whose knowledge and continued guidance made possible the completion of the project.

The authors also wish to thank the personnel of the Sferics Section of the Evans Signal Laboratory, Belmar, New Jersey, under the direction of Captain A. C. Trakowski and Sholom Kass, for their willing cooperation throughout the progress of the work.

REFERENCES

- (1) R. Bureau, *Atmospherics, L'onde Elec.*, 5, p 301, 1926.
- (2) R. A. Watson-Watt, *Directional Observations of Atmospherics—1916-1920, Phil. Mag.*, 45, p 1010, 1923.
- (3) R. A. Watson-Watt, J. F. Herd and Bainbridge-Bell, "Applications of the Cathode Ray Oscillograph in Radio Research." His Majesty's Stationery Office, London, 1933.
- (4) G. H. Munro, H. C. Webster and A. J. Higgs, *Australian Radio Research Board Report No. 8*, p 9, 1935.
- (5) J. T. Henderson, *Direction Finding of Atmospherics, Canad. J. of Research*, 13, p 34, 1935.
- (6) J. Lugeon, "The Goniograph of the Swiss Central Meteorological Station and its Utilization for Weather Forecasting," Report 10, *Annalen der Schweizerischen Meteorologischen Zentralanstalt, Jahrgang*, 1933.
- (7) S. P. Sashoff and J. Weil, *On Static Emanating from Six Tropical Storms and its Use in Locating the Position of the Disturbance, Proc IRE*, 17, p 696, 1939.
- (8) J. Weil and W. Mason, "The Locating of Tropical Storms by Means of Associated Static," *Engineering and Industrial Experiment Station Bulletin No. 3*, University of Florida, 1936.
- (9) S. P. Sashoff and W. K. Roberts, *Directional Characteristics of Tropical Storm Static, Proc IRE*, 30, p 131, 1942.
- (10) L. W. Austin, *Atmospheric Disturbances and Wavelengths, Proc IRE*, 9, p 28, 1921.
- (11) H. Norinder, *Lightning Discharges and Atmospherics in Radio Receiving, Jour Frank Inst*, 221, p 555, 1936.

Bridge-Balanced AMPLIFIERS

Inherently stable with respect to tube and supply-voltage variations, the d-c voltage and current amplifier circuits described lend themselves ideally to the design of vacuum-tube voltmeters and photoelectric light meters

By Y. P. YU

Associate Professor
Electrical Engineering Department
North Dakota State College
Fargo, North Dakota

THE MAXIMUM sensitivity obtainable with a vacuum-tube voltmeter is limited by the stability that can be achieved. The difficulty in maintaining an accurate zero base line is due to these major causes: (1) variations in values of the circuit parameters, such as resistances; (2) variations of supply voltages; (3) variations of tube factors, such as plate resistance and amplification factor.

Variations in circuit parameters result chiefly from changes in temperature of resistors. They can be minimized by the use of thermally compensated resistors and the proper placement of component parts. Fluctuations of line voltages affect both the heater and the plate supply voltages. Tube factors are dependent upon operating voltages, upon cathode emission, and upon the aging of the tube. The effect of variations in supply voltages and tube factors on zero deflection of the output meter can be minimized by the use of balancing circuits.

Voltage Amplifier

Figure 1 shows the basic circuit of a d-c bridge-balanced voltage amplifier. Tube T_N serves as an inverse-feedback amplifier in which

the degeneration is provided by the I-R drop across the bias resistor R . Other tubes, T_1 to T_{N-1} , serve to balance out variations of tube factors and supply voltages.

The cathodes of all tubes are heated from the same source. The balance will be perfect if all tubes remain identical in characteristics as supply voltages and other conditions change. Physically, R_1 , R_2 ,

T_N , and other tubes of the amplifier circuit perform as the four arms of a balanced bridge, in which R_1 and R_2 correspond to the ratio arms, T_N to the unknown arm, and $T_1 - T_{N-1}$ to the standard arm. Any change in voltage drop across the arm T_N due to variations in tube factors or in supply voltages will be accompanied by an identical change in voltage drop across each tube of the

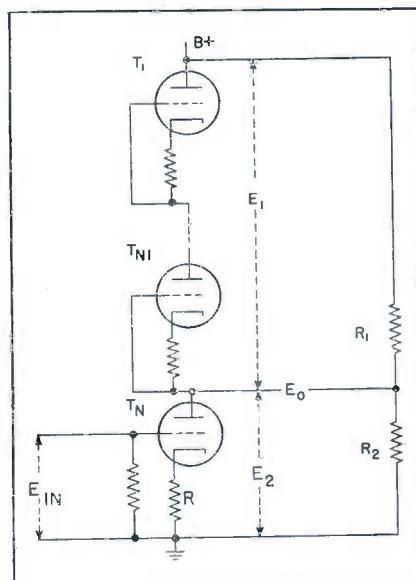


FIG. 1—Basic circuit of d-c bridge-balanced voltage amplifier

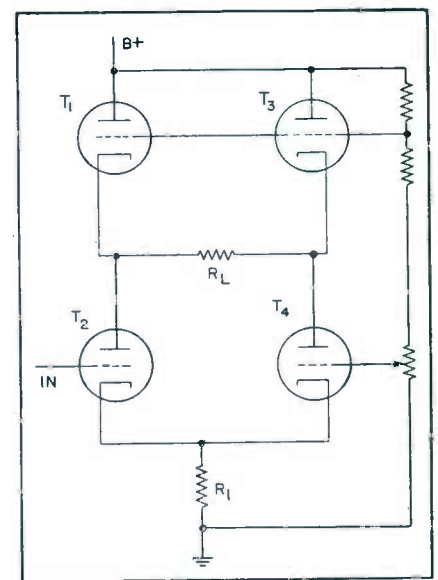


FIG. 2—Basic circuit of d-c bridge-balanced current amplifier

This instrument gives a full-scale meter reading of one millivolt d-c on its most sensitive voltage range. In conjunction with a special probe (diode detector), the instrument may be used to make exact measurements from d-c up to radar frequencies. By connecting the instrument across proper resistors a very sensitive microammeter is obtained. For example, it is possible to obtain a full-scale deflection for 0.001 microampere by connecting the instrument across a 1.111 megohm resistor, making the resultant input resistance one megohm. When used with an external battery and proper resistors, the instrument will measure resistances from 0.001 ohm up to 1,000,000 megohms. Line-voltage variations from 105 volts to 120 volts will affect the meter reading by less than 4 percent.

Coupling Between Stages

When a single plate supply is employed, coupling between stages is one of the major difficulties in the design of multistage d-c amplifiers. Three methods which are particularly adaptable in bridge-balanced arrangements will be described here.

One method utilizes a cold-cathode voltage regulator tube as shown in Fig. 4. When all the tubes in the circuit are similar, the overall voltage gain of this amplifier is $\mu^2/3$, where μ is the amplification factor of the tubes. A voltage gain

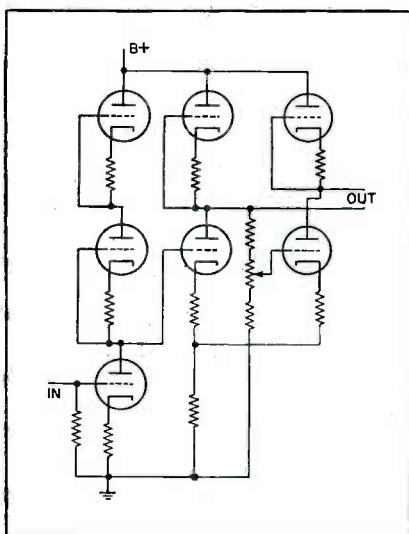


FIG. 6—Using a phase inverter to couple two stages improves amplifier performance

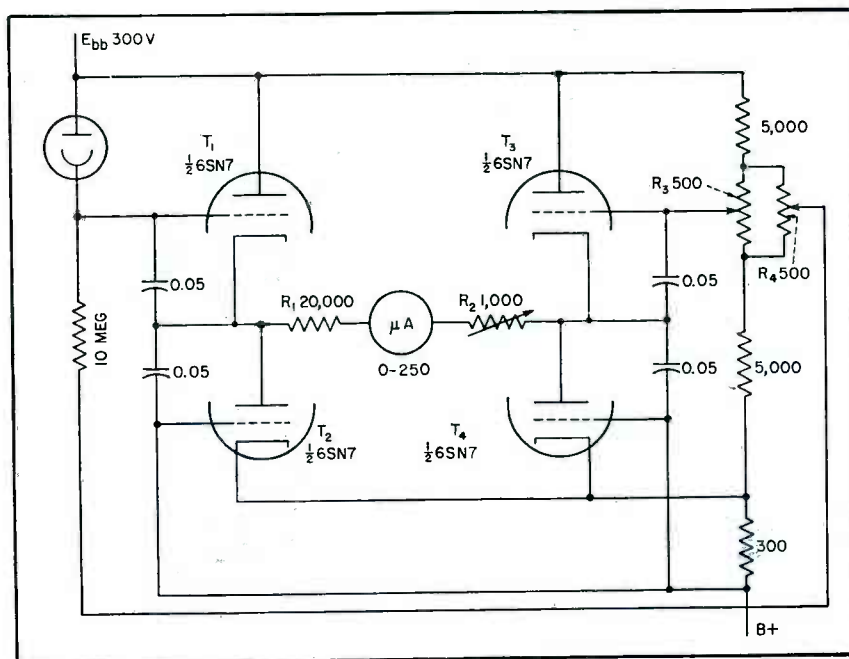


FIG. 7—Degenerative-balance light meter circuit employing a balanced amplifier to obtain high stability

of 64 db with good stability was obtained from this amplifier circuit by using two and one-half 6SL7's. But noise is generated by glow discharge in the voltage regulator tube, and a highly regulated plate-supply is needed to give good stability to this amplifier.

The second method employs a separate bias-supply, as shown in Fig. 5. When all tubes are similar, the design equation of this amplifier is

$$R_1/R_2 = E_{b0}/E_c = N - 2$$

where N is the number of tubes in series, and E_{b0} is the quiescent plate voltage. The overall voltage amplification of this circuit is $\mu^2/2$, where μ is the amplification factor of the tubes. The disadvantage is that two highly regulated power supplies are needed.

The third method employs a push-pull phase-inverter arrangement wherein a large cathode bias may be employed without the usual attendant disadvantage of excessive negative feedback. The basic circuit of this type of arrangement is shown in Fig. 6. The overall voltage gain of this amplifier is $2\mu_1\mu_2/3$, where μ_1 and μ_2 are the amplification factors of the tubes employed in the first and the second stages respectively. A voltage gain of 56 db with very low noise level was obtained from this circuit by using one and one-half 6SL7's as the first

stage and two 6SN7's as the inverter stage.

Light-Meter Circuit

A bridge-balanced circuit with negative feedback, for measurement of very small illumination, is shown in Fig. 7. The bridge arrangement of the circuit makes zero setting practically independent of supply-voltage variations. The amount of degeneration developed by resistor R_1 is sufficient to prevent tube changes from affecting the calibration of the instrument. This circuit can measure illumination with full-scale sensitivity corresponding to a phototube current of 0.5 microampere.

The process of balancing the circuit is simple. Connect the grid of T_1 to the center tap of potentiometer R_3 , and adjust R_3 to bring the meter reading to its zero position. Then reconnect the grid of T_1 to its original position, and again bring the meter reading to zero by adjustment of R_4 . The circuit is then ready for operation. Variable resistor R_2 is used for adjusting the calibration of the output meter in case it is necessary to change the phototube. Potentiometer R_4 is used as a panel zero control. This circuit has proved itself simple to build, reliable in indication, and stable in operation.

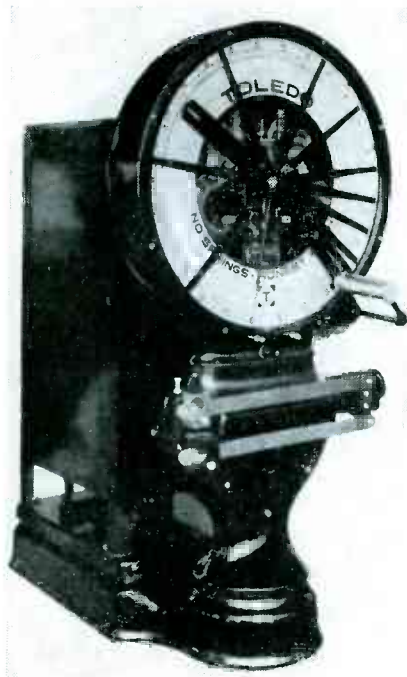


FIG. 1—Conventional scale equipped with light source, phototube, interceptors, timer and tank to measure fuel used by airplane engines under test



FIG. 2—Scale modified to check fuel consumption of automobile engines. Weights are automatically added as tank empties, to spread out readings

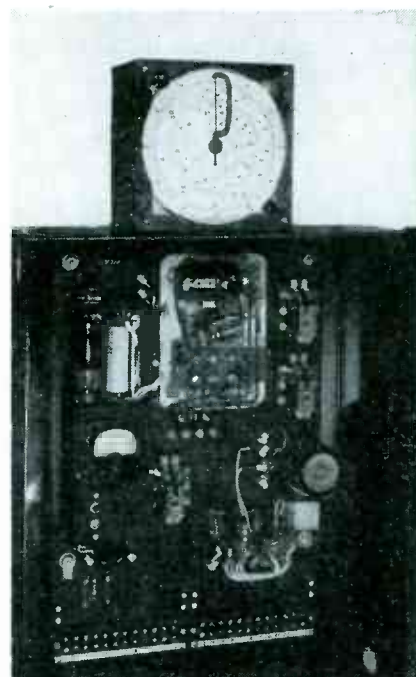


FIG. 3—Amplifier and relays of the scale used to measure fuel consumption of automobile engines. The timer, a separate unit, may be seen on top

Measuring Liquid Flow by Weight

Conventional scales are modified to accurately, automatically and quickly check fuel consumption of airplane and automobile engines under test by adding a photoelectric attachment, timer and tank. Method also lends itself to testing of pumps

DURING THE WAR a number of manufacturers expressed the need for an accurate means of measuring the fuel consumption of aircraft engines undergoing laboratory dynamometer tests. Scales such as the one shown in Fig. 1 were built for this application.

A narrow beam of light is focused on a slot in the scale chart and a phototube is mounted behind the slot. Interceptors which rotate with the scale indicator intercept the light beam at fixed intervals of weight. A synchronous motor-driven timer runs for a selected

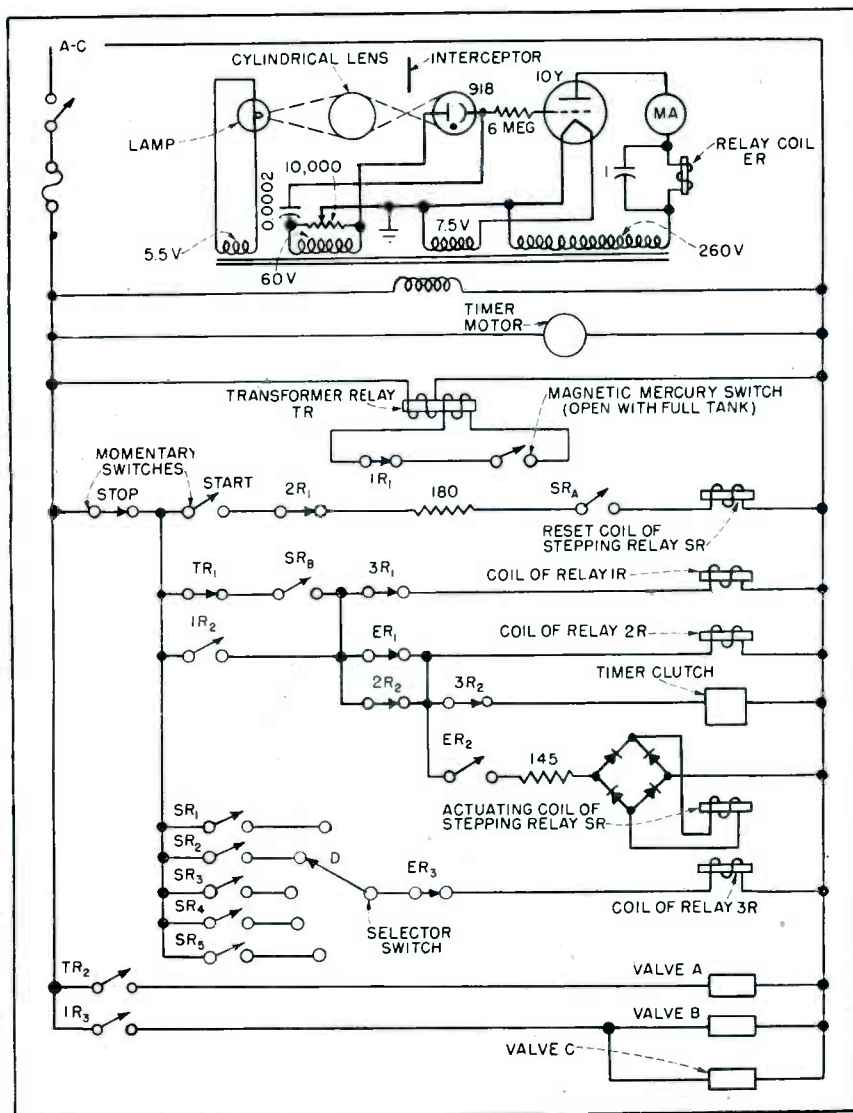
number of interceptions (selected weight sample). The fuel consumption is calculated from the size of the sample and the time required to use it.

A tank on the scale platform holds sufficient fuel for the maximum test sample. This tank is kept full, between tests, by means of a float valve. When the operator starts a test by pressing a button, a solenoid-operated valve in the tank supply line closes, so that all fuel used by the engine must come from the tank. The scale indicator moves clockwise and at the first

interception of the light beam (zero reading on the scale) the timer starts and continues to run for the number of pounds the operator has chosen for the test (number of interceptions of the light beam). The timer stops at the end of the test and the solenoid valve opens to refill the tank.

Automobile Engine Tester

Since the war, several automobile companies have become interested in accurate methods of determining the fuel consumption of passenger-car and truck engines. The rate of



By DONALD B. KENDALL

Engineering Department
Toledo Scale Company
Toledo, Ohio

flow is much smaller than for large airplane engines, so special scale equipment is used as shown in Fig. 2.

A small tank is placed on the platform of the scale. Auxiliary weights are automatically added to the scale as the platform moves up with removal of fuel from the tank. This achieves an indicator travel of about two inches per ounce while weighing samples up to two pounds. The operation of the photoelectric attachment will repeat within less than ten-thousandths of an inch of indicator

movement, so very accurate weighing of the sample can be accomplished.

To eliminate the need for computing rate of flow, a special timer was developed. This timer has five rows of graduations, one for each sample value, and is calibrated in pounds per hour. A sample weight is chosen which will require between one minute and two minutes for the test. With the following sample values, liquid flow in the range of five to 120 pounds per hour can be read directly on the proper timer dial circle:

FIG. 4—Simplified circuit of the fuel-consumption tester. Six relays are used (ER, SR, TR, 1R, 2R and 3R). The various contacts of these relays are shown separated from their coils for clarity and are identified by subscript letters or numerals

Weight of Sample	Range per Hour
2 lb	120 to 60 lb
1.075 lb	64.5 to 32.25 lb
0.578 lb	34.7 to 17.35 lb
0.310 lb	18.6 to 9.3 lb
1/6 lb	10.0 to 5.0 lb

By using a straight time circle also printed on the timer dial, higher and lower values of flow can be computed.

It is not practical to use a float valve in a small tank, so the tank is filled to a definite weight between tests. A magnetically operated mercury switch is mounted inside the scale housing. This switch is operated by a permanent magnet on the scale indicator when the indicator has moved to a position corresponding to the full weight of the tank. The switch operates the transformer-type relay shown on the panel in Fig. 3 and this relay operates a solenoid valve in the supply line.

Circuit Principle

The photoelectric attachment is used for only on and off operation and the frequency of operation is quite low, so the equipment is quite simple. A simplified wiring diagram is shown in Fig. 4.

A gas-filled type 918 phototube is used with a single-stage amplifier, operating on alternating current. A telephone-type relay is used, with two snap-action switches as double-pole double-throw contacts, in the plate circuit of the amplifier tube. A plate-current milliammeter assists in focusing the light source

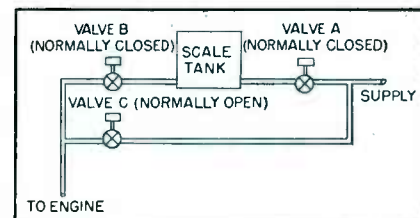


FIG. 5—Tank valve setup of Fig. 4

and also serves as an indication of when tube replacement is necessary. A filament-type amplifier tube is used in preference to a heater type so the equipment can be put into operation with no long wait for the cathode to heat up.

An available stepping relay had coils for 24 volts d-c. It was found that the reset coil would work satisfactorily on a-c for the momentary service required, so a series resistor was used to reduce the 110 volts to a satisfactory value. A copper-oxide rectifier, with resistor in series, was used to energize the stepping coil. Contacts SR_A and SR_B are off-bank contacts, SR_A opening and SR_B closing when the stepping relay is reset. Normally, before a test is started, SR_A will be closed, SR_B open and SR_1, SR_2, SR_3, SR_4 , or SR_6 closed.

Operating Details

With power on the equipment, if the tank is not full the magnetic mercury switch is closed, so the transformer relay is operated, TR_1 being open and TR_2 closed. The engine can draw fuel through valve C , as shown in Fig. 5.

When the start button is pressed, the stepping relay resets, opening SR_1 through SR_5 and SR_4 and closing SR_B . When the tank is full the magnetic mercury switch opens, dropping out the transformer relay to close valve A and close TR_1 . Relay contact $1R_2$ now comes in to seal around TR_1 and SR_B , open $1R_1$ to prevent the transformer relay operating and close $1R_3$ to open valve B and close valve C so all fuel comes from the scale tank.

While the scale tank is full, the phototube is illuminated. This reduces the negative bias on the grid of the amplifier tube, so the plate

current pulls in the relay ER , opening ER_1 and ER_3 and closing ER_2 . As fuel is drawn from the scale tank, the interceptor assembly moves and cuts off the light from the phototube, reducing its current to practically zero. This increases the negative bias on the amplifier tube grid and the plate current drops to zero (the bias-adjusting 10,000-ohm potentiometer permits adjustment to this value). Contact ER_2 opens and ER_1 and ER_3 close, pulling in $2R_2$ to seal around ER_1 and energizing the timer clutch to start the timer. This is the start of a test.

When the first interceptor passes the light beam, the phototube is again illuminated, ER is again energized by the plate current, ER_1 and ER_3 open and ER_2 closes to energize the stepping relay coil. SR_A closes, SR_B opens and SR_1 closes. If the selector switch was set to position D , as shown (Fig. 4), nothing further would happen. At the next interception of the light beam, ER_2 opens to deenergize the stepping coil. When the interceptor passes the light beam, ER_2 again closes to step the stepping relay from SR_1 to SR_2 , but ER_3 is open at this time. When the next interceptor darkens the phototube, ER_3 closes to energize $3R$. The opening of $3R_2$ deenergizes the timer clutch to stop the timer, and $3R_1$ opening deenergizes $1R$, breaking the $1R_2$ seal to drop out $2R$ for another test. The closing of $1R_1$ permits the transformer relay to come in, opening valve A to refill the scale tank. The opening of $1R_3$ closes valve B and opens valve C so the engine continues to run from the main supply. The operator records the fuel consumption (from the timer reading) and resets the timer to zero. He may then readjust the load on the engine, set the selector switch for a new value and press the start button for another test. The test will start as soon as the scale tank is filled and TR_1 closes.

Simplification

Although some users prefer a selector switch, a readily adjustable contact-operating magnetic counter shown in Fig. 6 and developed by the Eagle Signal Corporation permits simplification of the control.

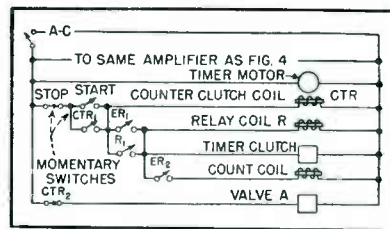


FIG. 7—Simplified circuit used with the magnetic counter

Figure 7 is a simplified wiring diagram of a method using this device when the tank is maintained full between tests by a float valve.

The operator sets the counter pointer to a position corresponding to the weight of the sample to be used for the test. This means that the counter is set for the number of operations corresponding to the number of interceptions of the light beam before that weight has been drawn off the scale.

With power on the equipment, the timer motor is running and valve A is energized through CTR_2 to fill the scale tank. When the operator presses the start button, energizing the counter clutch coil, CTR_1 seals and CTR_2 opens, closing valve A . All fuel used comes out of the scale tank.

When the first interceptor darkens the phototube, closing ER_1 , relay R seals in and the timer clutch is energized to start the timer. When the interceptor passes the light beam, illumination of the phototube closes ER_2 to energize the count coil. Succeeding interceptions of the light beam deenergize and energize the count coil. When the count coil is deenergized after the preset number of operations, CTR_1 opens to drop out R and deenergize the timer clutch to stop the timer and CTR_2 closes to open valve A to refill the tank.

Other Uses

Equipment similar to that described is also used to test the performance of pumps. In this case, however, the liquid is generally weighed into the scale tank.

The valve is in the discharge line from the scale tank, so that between tests the liquid flows through the tank. When a test is started, the valve closes and interceptions of the light beam occur as the weight of liquid on the scale increases.

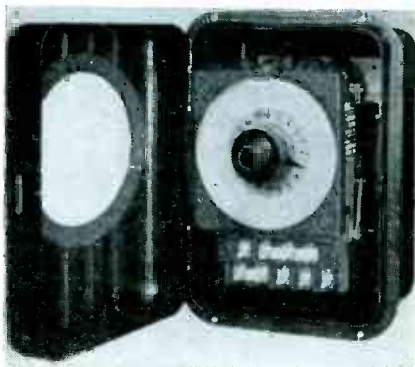


FIG. 6—Magnetic counter applicable to modified scale



New organ-type electronic instrument uses conventional keyboard; and pipe organ playing and control techniques are directly applicable. Contacts located under the keys control individual vacuum-tube oscillators. To avoid humidity problems in hot and humid areas, windings have been potted where convenient, and coils have been wax impregnated

ELECTRONIC ORGAN

Keyboard controls 167 Hartley oscillators designed for grid-circuit keying and high stability of tuning. Separate loudspeaker channels minimize Doppler-effect distortion at cone. Power amplifiers have low intermodulation distortion

IN the organ-type electronic musical instrument to be described, each note of the keyboard corresponds to a Hartley oscillator arranged to provide a sinusoidal fundamental, devoid of harmonics, and a pulse signal that is rich in harmonics. Twelve additional oscillators provide an octave extension of the treble on the swell (upper) manual.

The various voices are derived from mixer circuits that mix the fundamentals and pulse signals in the proper proportions and subject the resultant to appropriate frequency-discriminating circuits to produce the desired formant. The outputs of the several mixers asso-

By T. H. LONG

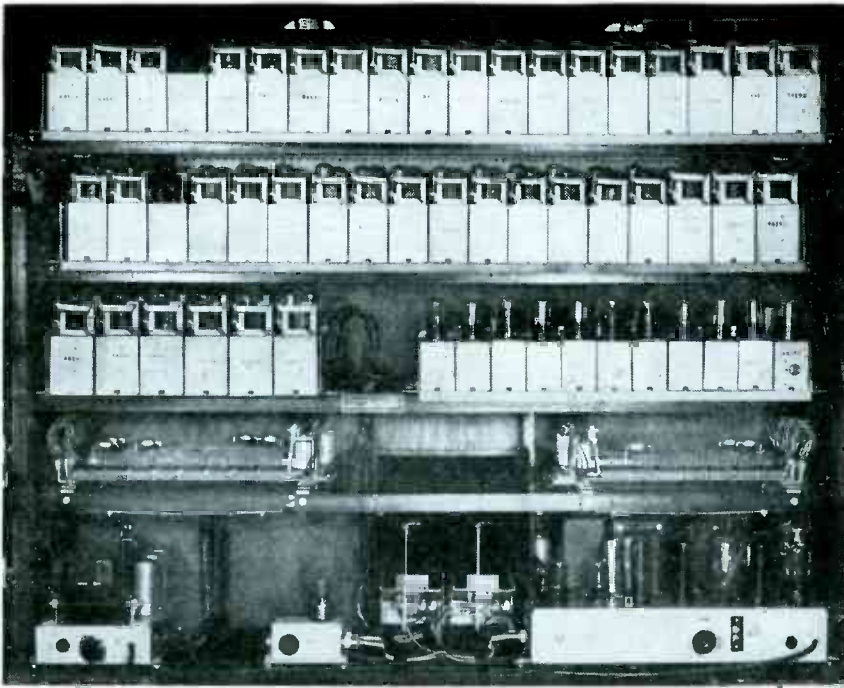
*Electrical Engineer
C. G. Conn Ltd.
Elkhart, Indiana*

ciated with any division of the organ (swell, great, or pedal) are mixed through buffer amplifiers. The resultant signal from each division is further amplified to recover the mixing loss and is passed through the volume control associated with the expression pedals.

The expression pedal controlling the volume of the swell manual voices also controls some of the pedal voices by means of a separate potentiometer having a range of

control which is less than the range used on the manual voices. This compensates for reduced sensitivity of the ear at low sound levels in the pedal tones and maintains a satisfactory balance between these voices in the swell division and those in the swell division over the complete range of the expression pedal. The other pedal voices are handled similarly on the expression pedal used for the great manual.

Following the expression pedals the outputs of the three organ divisions may be mixed together or kept separate as the installation may require. For a small room all three outputs may be mixed at the input of a power amplifier. For in-



Rear view of Consonata with back panel removed to show assemblies of oscillators, mixers, and couplers. At bottom, left to right, are the coupler power supply, isolation amplifier, expression pedals, and power amplifier

installations requiring more than one loudspeaker the signals from the pedal voices are amplified and fed to one or more pedal loudspeakers while the signals from the manual voices are either mixed into a common power amplifier and loudspeaker system or are fed into two separate systems.

The lowest frequency available in the pedal oscillators is the musical note C₁ (32.703 cycles per second). The lowest frequency produced by the manual oscillators is one octave higher, or 65.406 cycles per second. It has been found desirable to use separate power amplifiers and loudspeakers for the manuals and for the pedals. Power input to the pedal loudspeakers is limited by the cone excursion at the lowest frequency and the power input to the manual loudspeakers tends to be limited by the power-handling capacity of the voice coils.

This separation of loudspeaker channels practically eliminates the distortion inherently produced by the Doppler effect when medium or high frequencies are being radiated by a cone that is simultaneously executing low-frequency vibrations of appreciable amplitude. The further separation of the signals from the manuals, though not so necessary, does contribute to the elimination

of this distortion that has long been associated with electronic instruments when played at high sound intensities, and also lends to the space effect that is highly desirable especially in large installations.

Oscillators

The Hartley type of oscillator with grid circuit keying was selected for a number of reasons: (1) such an oscillator provides a dependable tone signal generator that produces transient and steady-state effects in an independent fashion comparable to the tone generators generally used in the production of orchestral, vocal, or pipe organ music; (2) the oscillator can be

keyed with the simplest type of switch and permits use of conventional pipe-organ couplers; (3) the oscillator can be produced and maintained at a reasonable cost.

Oscillator design requirements included: (1) high stability of tuning, especially with time and with temperature variations; (2) good keying characteristics for natural attack and release of tone; (3) satisfactory tremolo having the proper amount of amplitude, frequency, and quality change to compare with the tremolo or vibrato generally used in vocal music or by orchestral instruments; (4) proper and uniform tonal qualities with adequate amounts of natural harmonics available; (5) easy tunability; (6) simple, inexpensive construction.

The resulting oscillator, using half of a twin triode, is assembled on a four-note chassis as indicated in Fig. 1. The organ described here has 167 oscillators. Of these, 32 are associated with the pedals (notes C₁ to G₃), 61 are in the great division (C₂ to C₇), 73 are in the swell division (C₂ to C₆), and a special type of low-frequency oscillator is used as a source of tremolo frequency. The fundamental tone signals generated in the tank circuits

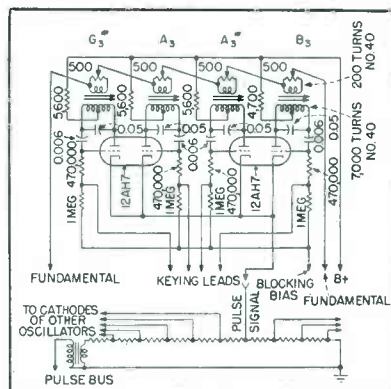


FIG. 1—Circuit of typical four-note oscillator chassis

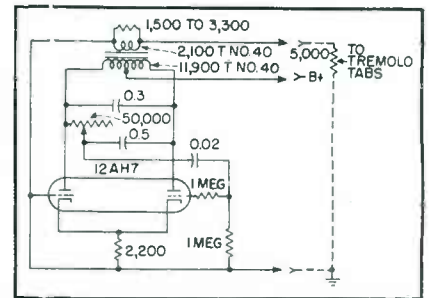


FIG. 2—Tremolo oscillator circuit

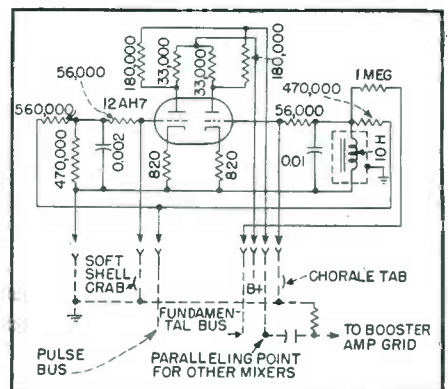


FIG. 3—Great soft string tab and chorale mixer circuit

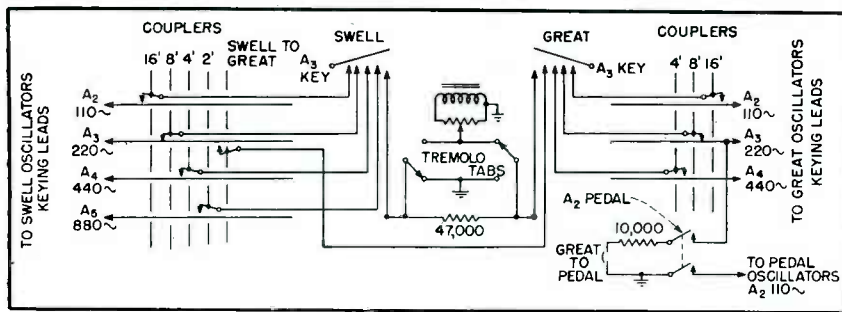


FIG. 4—Typical coupler circuit, with keying details for one key in each manual and one pedal key

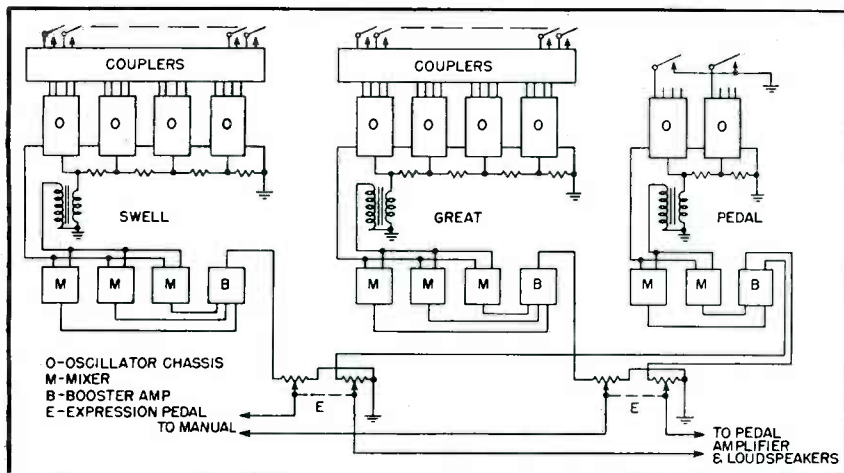


FIG. 5—Block diagram of model 2A, showing substantial independence of swell, great, and pedal organs. Most of the oscillators have been omitted here

are mixed in series for a given rank of oscillators, and the pulse signals are parallel-mixed.

The oscillator circuit constants are so chosen that plate and heater voltage variations will not appreciably affect tuning of the oscillators. The oscillator plate supply is, however, taken from a voltage-regulated source in order to provide a source having a low apparent impedance. This eliminates a tendency that would otherwise exist for the several ranks of oscillators to synchronize when the same note is played in each or to lock in exact octave relationship when octaves are played. This synchronization, if permitted by a sufficiently large common impedance in the plate voltage source, would seriously reduce the grand celeste or chorus effect that depends upon independent tone generators.

Tremolo Oscillator

The tremolo oscillator circuit in Fig. 2 feeds approximately 5 volts of low-frequency signal into a 1,500-ohm resistance. The tremolo

frequency is adjustable through the range of 4.7 to 6.5 cycles per second by a resistance control.

Mixers

The mixers are single-stage amplifiers that mix the proper amounts of fundamental and pulse signals together and determine the formant for the proper tonal character of each voice. Each voice is controlled from a conventional tablet switch on the console. This switch short-circuits the grid of any mixer to ground when the voice is not wanted. The output circuits of the mixers associated with one division are paralleled. The circuit of a typical mixer chassis which includes two mixers, soft string, and chorale is given in Fig. 3.

The coupler arrangement, as applied to the A_3 keys of the great and swell manuals and the A_2 key of the pedals, is shown in Fig. 4. The oscillators are keyed by grounding the keying leads either directly or through the tremolo generator output. Any key is able to control several oscillators through appropriate

couplers. Tremolo can be obtained in either manual independently of the other manual, since the manuals have independent keying busses.

When the swell-division oscillators are keyed from the great manual they sound with the voices set up for the swell manual, which may be quite different from those selected for the great manual. The same considerations apply when the great oscillators are keyed from the pedal clavier through the great to pedal coupler. However, there is no provision for tremolo to the pedal oscillators since tremolo in the low-frequency range is not desirable. The block diagram in Fig. 5 shows the substantial independence of the swell, great, and pedal organs.

Loudspeakers and Power Amplifiers

The loudspeaker and power amplifier problems associated with this electronic musical instrument are almost unique since substantial amounts of power must be delivered with low distortion at frequencies down to 32 cycles per second. Much less intermodulation can be tolerated in an electronic organ than in more conventional applications. Music that is quite acceptable at low intensity levels will become intolerable at high levels if the usual harmonic distortion is permitted.

The power amplifiers were designed to have harmonic distortion below one percent at full power output. Great care was used in the choice and arrangement of loudspeakers. The manual loudspeakers are provided with diffraction devices that satisfactorily spread the high-frequency components of sound energy through a large horizontal angle. This arrangement avoids the beaming effect that is undesirable in organ music, without the energy loss and time lag that would be associated with diffusion of the high-frequency sounds by bouncing them off the ceiling.

Acknowledgments

Important contributions to the development of this electronic organ were made by Messrs. L. B. Greenleaf, E. L. Kent, S. L. Krauss, R. T. Bozak, S. W. McKellip, J. R. Ford, R. G. Campbell, W. J. Harness, and A. W. Harrison.

Counter Circuits

Basic step-type counter circuit is analyzed to determine design criteria. Its limitations, possible improvements and the relationships between parameters that govern the most stable operation are discussed

By **ALLAN EASTON** and **PAUL H. ODESSEY**

*Long Island City
New York*

*Polarad Electronics
New York, N. Y.*

STEP-TYPE counter circuits are widely used as frequency dividers in the design of television synchronizing generators where stability of division, accuracy of phase and freedom from jitter are of paramount importance. Mention will be made of some artifices for increasing the stability and frequency-division product.

The basic circuit arrangement of the step-type counter is shown in Fig. 1A. It contains a source of periodic pulses (all of equal height) at a frequency f_0 , the step-type counter, and a discharge device operating at a frequency f_0/n . The counter circuit shown consists of two capacitors and two diodes.

When a positive pulse is impressed between terminals A-O, capacitors C_1 and C_2 are charged through diode V_1 . During this interval V_2 is nonconducting. As the charging time constant is usually very small, both capacitors attain the maximum charge in a relatively short time and the impressed voltage, E_p , is divided between the two capacitors in a definite manner. When the individual impressed pulse decreases in voltage from E_p to zero, capacitor C_1 is discharged through the input circuit by means of diode V_2 , while C_2 is prevented from losing its acquired charge by the fact that V_1 is nonconducting during this part of the cycle.

A second impressed pulse will deposit an additional increment of charge on C_2 . Thus, corresponding to a regular succession of impressed pulses, the voltage across C_2 builds up step-wise and approaches, asymptotically, the value of the impressed voltage E_p , unless interrupted by the discharge device which discharges C_2 completely and causes the process to begin anew.

The manner in which the voltage builds up on capacitor C_2 is shown in Fig. 2 for three values of the ratio C_2/C_1 . Curve A illustrates the case where the ratio is relatively low resulting in large steps of voltage initially and then smaller incremental changes as the count approaches the desired order of division, in this instance, five to one. Curve C illustrates the case where the ratio is relatively high and indicates an almost uniform, but very small, incremental change in capacitor voltage from the first to the n^{th} step. Curve B represents the charging curve using optimum parameters, and differs notably from curves A and C in that the n^{th} or fifth step is much greater than in either of the other cases, and is the maximum value possible.

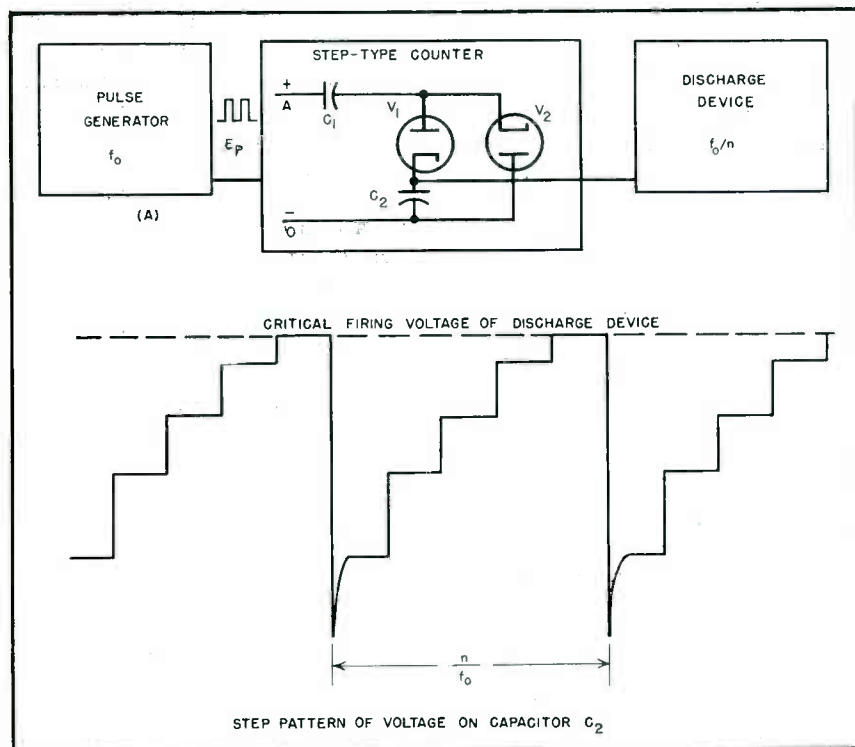


FIG. 1—Elements of the basic counter circuit and output waveforms applied to the discharge circuit

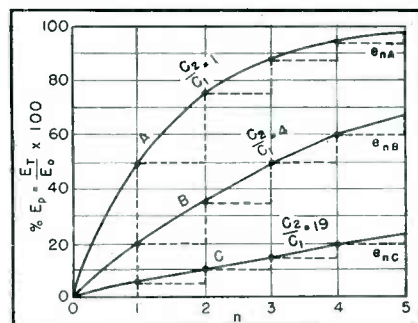
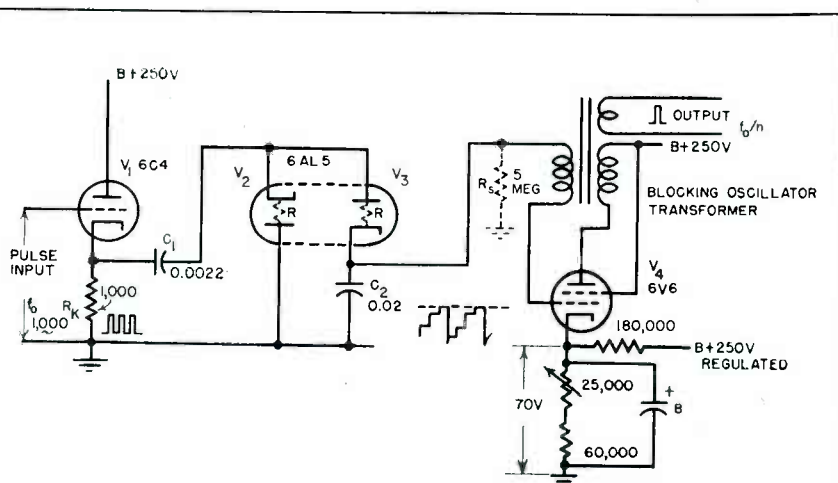


FIG. 2—Charging waveform indicating effect of choice of ratio of C_2/C_1

for Television



PRACTICAL FREQUENCY DIVIDER CIRCUIT

A typical design of the step-type frequency divider presents the following specifications:

- Desired division n = 10
- Initial frequency, f_0 = 1,000 cycles per second
- Pulse amplitude, E_p = 100 volts peak
- Pulse width = 100 microseconds
- Critical Firing Voltage = -10 volts
- Shunt Leakage, R_s = 5 megohms
- Effective series resistance = 1,000 ohms (Source plus diodes)

A suitable circuit is shown above. Tube V_1 is a cathode-follower pulse source, type 6C4.

Tube V_4 is a 6V6 blocking oscillator.

From Eq. 7

$$C_2 = (n - 1) C_1$$

$$C_2 = 9 C_1$$

From Eq. 14

$$\text{Minimum } C_2 = \frac{10n}{f_0 R_s} = \frac{10 \times 10}{10^3 \times 5 \times 10^6}$$

and $C_2 = 0.02$ microfarad
 $C_1 = 0.0022$ microfarad

With these values, the height of the tenth step will be 3.9 volts and the value of capacitor C_2 voltage about 63 volts. This requires a negative bias of approximately 70 volts on the discharge tube grid. The bleeder circuit in the cathode of tube V_4 can be adjusted to provide the correct bias.

The charging time constant based on an effective series resistance of 1,000 ohms is approximately 2 microseconds.

From the practical point of view, greatest stability of a step-type counter is attained when the voltage increment corresponding to the n^{th} step of capacitor, C_2 , voltage is a maximum. Graphically, this corresponds to the point of maximum slope of the charging envelope at the specified order of division. Thus, in curve B the last increment of

voltage is larger than are those of curves A and C . This condition of stability arises from the fact that it is the n^{th} increment of voltage which is utilized to actuate or trigger the following discharge circuits.

The conditions for obtaining the maximum increment, the size of that increment, and the magnitude of the voltage across C_2 when the

n^{th} increment is reached, are all of importance when the designer wishes fullest utilization of the step-type counter.

Analysis

In the basic circuit, Fig. 1, the increment of voltage appearing across capacitor C_2 (initially without charge) corresponding to the first of a series of narrow impressed pulses of equal magnitude, is:

$$e_1 = E_p \frac{C_1}{C_1 + C_2} \quad (1a)$$

$$\text{or } e_1 = E_p K \quad (1b)$$

$$\text{where } K = \frac{C_1}{C_1 + C_2}$$

E_p = magnitude of impressed pulses; e_1, e_2, e_3, \dots = increment of voltage corresponding to first, second, third, . . . pulses.

The second increment of voltage is

$$e_2 = (E_p - e_1) K \quad (2a)$$

$$\text{or } e_2 = E_p K (1 - K) \quad (2b)$$

The third increment of capacitor voltage is

$$e_3 = [E_p - (e_1 + e_2)] K \quad (3a)$$

$$\text{or } e_3 = E_p K (1 - K)^2 \quad (3b)$$

Similarly the n^{th} increment of voltage across C_2 , corresponding to the n^{th} pulse is

$$e_n = E_p K (1 - K)^{n-1} \quad (4)$$

Curves representing Eq. 4 are shown in Fig. 3 for several values of n and clearly indicate the existence of a maximum value of e_n/E_p for each order of division, and that greatest stability may be realized by employing the optimum value of K .

The maximum value of e_n may be determined in the conventional fashion:

$$\frac{de_n}{dK} = \frac{d}{dK} \left[E_p K (1 - K)^{n-1} \right] = 0 \quad (5)$$

from which is obtained the optimum value of K , that is

$$K = \frac{1}{n} \quad (6)$$

Now since

$$K = \frac{C_1}{C_1 + C_2}$$

$$\text{Then } \frac{C_2}{C_1} = (n - 1) \quad (7)$$

$n > 1$

Substituting the above criterion for maximum into Eq. 4 results in

$$e_{n(max)} = \frac{E_p}{n} \left(\frac{n-1}{n} \right)^{n-1} \quad (8)$$

The total potential E_T to which C_2

is charged at the end of n pulses of impressed voltage is

$$E_T = \sum_{1}^n e_n = E_p K [1 + (1 - K) +$$

$$(1 - K)^2 + (1 - K)^3 \dots (1 - K)^{n-1}] \quad (9a)$$

From the methods of series summation

$$E_T = E_p [1 - (1 - K)^n] \quad (9b)$$

Equation 9B may be transformed into a more familiar form

$$E_T = E_p (1 - e^{-n \ln \frac{1}{1-K}}) \quad (10)$$

Equation 10 is clearly of the same form as the well-known equation for growth of capacitor voltage in a series R-C circuit, that is

$$E_T = E_p (1 - e^{-\alpha t}) \quad (11)$$

in which t is replaced by n and minus alpha by the natural logarithm of $1/(1-K)$.

If the criterion for maximum is substituted into Eq. 10, there results

$$E_T = E_p \left[1 - \left(\frac{n-1}{n} \right)^n \right] \quad (12)$$

Examination of Eq. 12 indicates that when optimum conditions are employed, E_T is always less than E_p , in fact

$$0.75 E_p \geq E_T > 0.636 E_p \quad (13)$$

The curves in Fig. 4 summarize the relationships derived thus far.

Practical Limitations

The analysis presented to this point has stated an optimum value of the ratio of C_2 to C_1 . However, knowledge of this ratio is not enough, since the magnitudes of the two capacitors have not yet been determined. Practical circuit considerations dictate the maximum and minimum values which may be assigned. The important factors which limit the choice of values are as follows: (1) The leakage resistance shunting C_2 ; (2) The perveance of the diodes; (3) The effective resistance of the pulse source; (4) The stability of the power supply; (5) The stability and resettability of the discharge device; (6) The recovery time of the discharge device; (7) The stability of the pulse source; (8) The highest and lowest frequency of operation; (9) The width of the impressed pulses; (10) The minimum phase shift permissible between

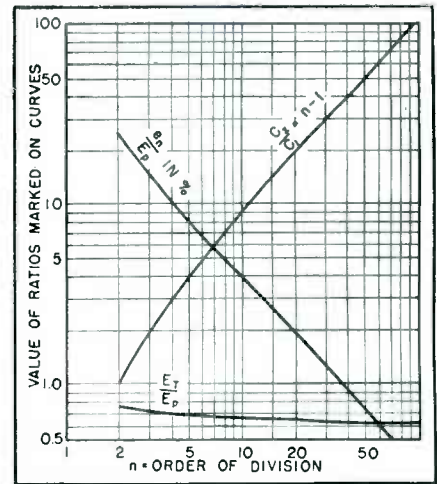


FIG. 4—Set of design curves for diode counters

input and output pulse; (11) The minimum jitter permissible between input and output pulses.

Every practical circuit has intimately associated with it leakages, which in this case may be represented as a definite resistance R , shunting the storage capacitor C_2 . The effect of R is to partially discharge C_2 in the time between successive steps. If the frequency f_0/n is low, C_2 must, of necessity, be made large, so that the shunt discharge time constant, $R_2 C_2$, will be sufficient to maintain the charge on C_2 . The appearance of the step wave form with a short time constant is shown in Fig. 5. A good rule of thumb is to make C_2 sufficiently large, so that the discharge time constant, $R_2 C_2$, is at least ten times the period of the lowest operating frequency. That is

$$R_2 C_2 \geq 10 \frac{n}{f_0} \text{ seconds} \quad (14)$$

It was assumed in the earlier analysis that the time for C_2 to acquire an increment of charge is negligibly small. Actually, this may not always be the case, as the series resistance of the pulse source and the perveance of the diodes will slow up the rise time appreciably. Figure 6 shows the wave form during the charging interval at the n^{th} increment.

The finite rise time has two undesirable effects. It prevents the increment of charge from ever reaching the value predicted by Eq. 8 during the charging interval, especially if narrow pulses are used. This effect reduces the ap-

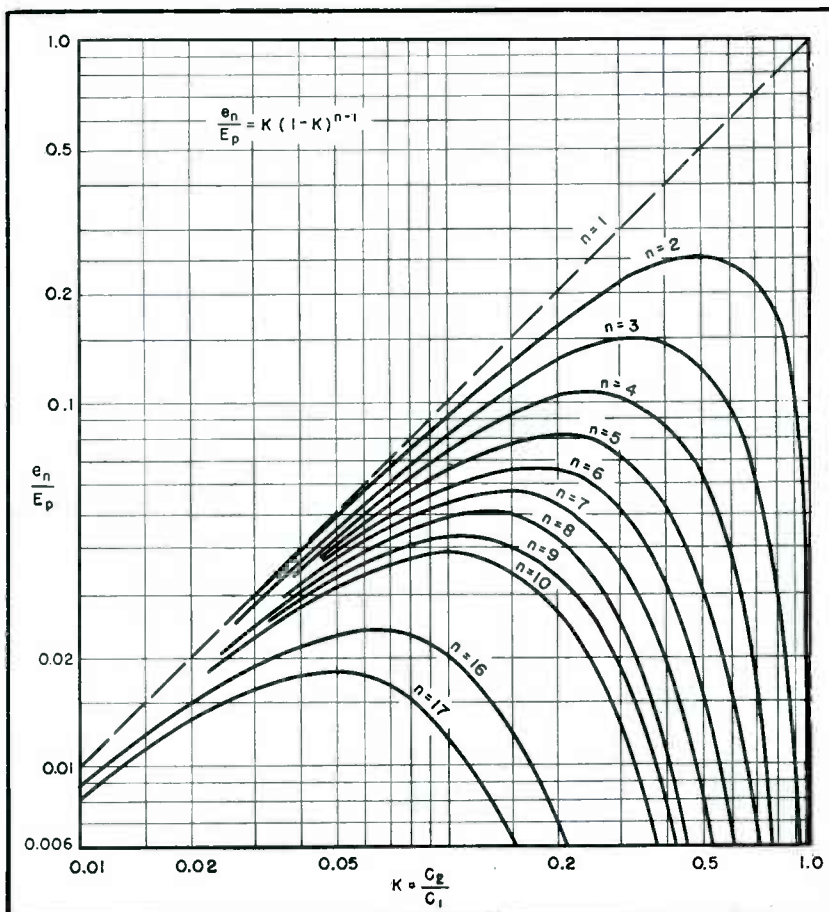


FIG. 3—Curves of various values of n for determining the optimum value of K

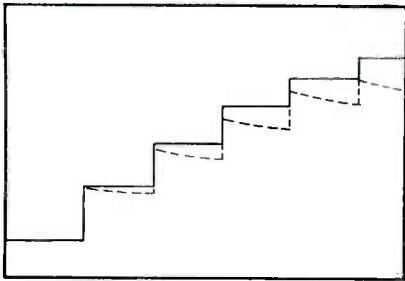


FIG. 5—The solid line represents the normal charging waveform and the dashed line shows the effect of shunt leakage across C_2 .

parent pulse voltage by some definite amount and thereby makes the frequency division somewhat dependent on pulse width and operating frequency. A satisfactory design rule which produces a negligible loss in voltage because of charging time constant is to make the series time constant less than ten percent of the pulse width.

A more important difficulty introduced by the finite rise time is the irreducible phase delay. Phase delay, in itself, may not be objectionable in many designs, but what is troublesome is the jitter resulting from minute fluctuations in pulse height and power supply variations. The net effect is to cause slight shifts in the time of firing of the discharge device. The series charging time constant of the R-C circuit, made up of the source resistance, diode resistance, C_1 , and C_2 should be very small. This requirement dictates the use of high-perveance diodes, low-impedance pulse sources and minimum values of C_1 and C_2 .

Earlier in this discussion it was stated that periodically capacitor C_1 was discharged by means of diode V_2 through the pulse generator impedance. Consideration of the time intervals involved as well as the circuit constants shows that this statement is only approximately correct. It takes an infinite time to discharge C_1 completely; a finite time to reduce the voltage across C_1 to some predetermined value. The effect of this residual charge is to oppose the pulse voltage which is trying to produce voltage increments on C_2 . This effect becomes more pronounced as the pulse width is increased or as the pulse repetition frequency is raised; that is, as the duty cycle is

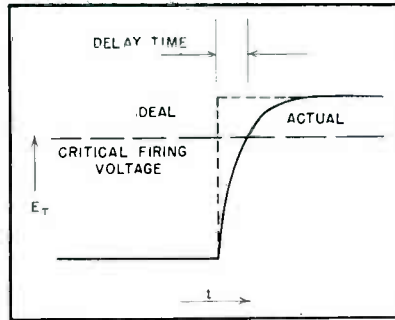


FIG. 6—Effect of finite rise time in producing delays between initiating pulses and output pulses. Small changes in pulse height or of critical firing voltage will cause changes in delay time, causing jitter in the output pulses

made larger. The cumulative result is to make the stability of division dependent upon frequency and pulse duty cycle. To minimize this phenomenon, C_1 should be chosen as small as possible and the circuit resistance held down.

The recovery time of the discharge circuit places an upper limit on the frequency of operation; but many suitable discharge circuits are known to the art, so that a suitable one can be selected for the particular frequency range.

It has been shown that low-frequency considerations dictate large values of the counter circuit capacitances, whereas high-frequency work requires just the opposite. Evidently, the designer must reconcile the conflicting requirements and effect a suitable compromise.

Conclusions

Having achieved the optimum choice of circuit parameters, the maximum order of frequency division which may be attained with good stability depends upon the amplitude of the n^{th} increment of voltage on capacitor C_2 and on the nature of the discharge device. The previous analysis has shown that as the magnitude of n is increased, the size of the step decreases to the point where the discharge device may trigger erratically because of noise, line voltage fluctuation, or power supply ripple. Thus, the size of the n^{th} step must be sufficiently large to make negligible these inevitable disturbances. Some allowance must also be made for ageing of the circuits which may change the operation and critical firing voltage of the discharge device.

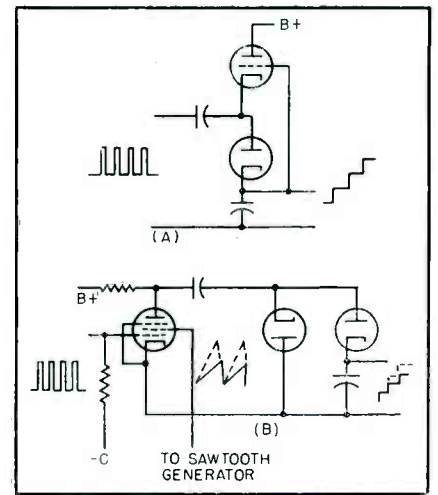


FIG. 7—Two proposed circuits for improving counter stability. Shown at A is the Hallmark system using a triode for linearization of the staircase charging curve. In circuit B, a sawtooth waveform on the screen grid of a pentode driver tube causes the transconductance of the tube to rise with time, and cause heights of steps to increase instead of decrease. By proper selection of waveform of screen grid voltage, any type of charging characteristic may be obtained

The curves in Fig. 2 show that the envelope of the charging curve of capacitor C_2 voltage is an exponential function of the form

$$y = K(1 - e^{-\alpha t})$$

where K and α are constants. One of the inevitable characteristics of such a function is that successive increments of y must become progressively smaller as time elapses. As shown for a count of ten to one the size of the n^{th} step cannot exceed approximately 3.9 percent of the impressed pulse voltage. To improve the stability of counter performance, some means for making the tenth step larger than 3.9 percent of E_p is needed. Graphically, the envelope of the charging curve must be made less concave downward, perhaps more closely linear, or best of all, concave upward. At the same time, the charging curve should attain the same or even greater value at the end of n steps than does the normal curve.

Several methods are known for accomplishing the desired distortion of the charging curve. Figure 7 shows some of the possible methods. In a particular design, the availability of auxiliary pulses and waves will suggest other methods of approach.

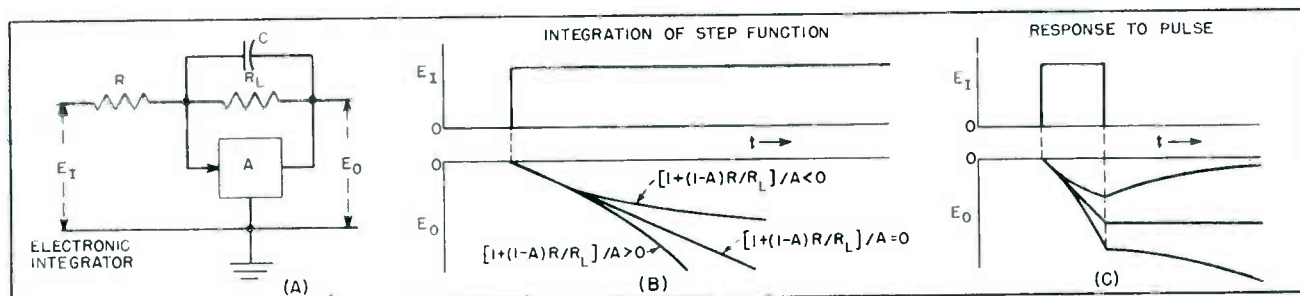


FIG. 1—The basic electronic integrator (A) uses an amplifier having negative gain. If an amplifier having positive gain is used, the factor affecting the accuracy of integration can be made zero (B) giving exact integration holding its output from a pulse (C)

Design of D-C Electronic Integrators

Effects on the accuracy of integration of amplifier gain, capacitor leakage, input and output resistance are analysed. A compensated circuit capable of exact integration is developed

INTEGRATORS, as was pointed out in a previous article, are the most critical components of d-c analog computers. These circuits are also useful in instrumentation, especially for determining averages. Hence the analysis and design of high-performance integrators and the circuits directly associated with them are important to engineers.

Basic R-C Integrator

The d-c integrator of Fig. 1A is at present the most commonly used type. It consists of an integrating network comprising resistance R and capacitance C in conjunction with a d-c amplifier of gain A . Because the leakage resistance R_L of the integrating capacitor constitutes an additional feedback path across the amplifier, it must also be taken into consideration. The problem is to adjust the design factors to make the output voltage E_o of the integrator as nearly proportional to the time integral E_i/p of the input voltage E_i as is possible.

This article is based on Report 5256-2061, Electronic Solution of Differential Equations, prepared by the author while with Sperry Gyroscope Co., Great Neck, N. Y. The author is grateful to Sperry and in particular to W. L. Barrow, Chief Engineer, for making publication possible. Due to classification of much associated material, it is regrettably impossible to credit individuals and organizations with earlier work on d-c analog computers.

By GRANINO A. KORN

Computer Laboratory
Airplane Division
Curtiss-Wright Corp.
Columbus, Ohio

In the circuit of Fig. 1A, the current through R must equal the sum of the currents through R_L and C , exclusive of currents circulating through the amplifier. Thus the nodal equation for the integrator is

$$E_o(1 - 1/A)(Cp + 1/R_L) = -(E_i - E_o/A)/R \quad (1)$$

so that

$$E_o = \frac{AE_i}{(1-A)RCp - 1 + (1-A)R/R_L} \quad (2)$$

The action expressed by Eq. 2 approximates true integration if

$$[1 + (1-A)R/R_L]/A \rightarrow 0 \quad (3)$$

which can be achieved in practice by making the gain A large (10^4 to 10^5) and by using capacitors with as low leakage as possible. In the ideal case $R_L = \infty$ and Eq. 2 reduces to the simplified formula given in the previous article. In the event that A is very large, Eq. 2 simplifies to

$$E_o \approx \frac{A}{1-A} \frac{1}{RCp} E_i \approx \frac{E_i}{RCp} \quad (4)$$

indicating that the circuit performs true integration.

In general, the integration will be in error due to finite gain and leakage. A quantitative estimate of the quality of integration can be

found by applying Eq. 2 to a step function input for which

$$E_i = 1(t) = 0 \text{ for } t < 0 \\ = 1 \text{ for } t > 0 \quad (5)$$

so that the step response is

$$E_o(t) = - \left\{ \frac{1}{A-1} \frac{t}{RC} + \frac{A[1 + (1-A)R/R_L]}{(A-1)^2} \frac{t^2}{2(RC)^2} + \dots \right\} \quad (6)$$

where the first term of the series is the integral term (compare with Eq. 4), and the second term is the significant error term. Fig. 1B is a graph of the step response showing the effect of the error. The respective curves for positive or negative values of

$$[1 + (1-A)R/R_L]/A$$

differ appreciably only for large values of the computing time t . If the above factor is negative, the error is somewhat smaller being in fact smaller than the first error term in Eq. 6. This condition will be assumed henceforth.

The percentage error due to finite gain and leakage is, therefore

$$\frac{[1 + (1-A)R/R_L]t}{2RC(A-1)} \approx \frac{P}{100} \quad (7)$$

so that if $E_o(t)$ is to be within P percent of the integral term (Eq. 4), it is necessary that

$$t_{MAX} \approx \frac{PRC}{50} \frac{A-1}{[1 + (1-A)R/R_L]} \quad (8)$$

Because the networks are linear,

this criterion applies to any input.

Compensated Integrator

The electronic integrator discussed so far gives only an approximation to integration, an approximation that is made better as the amplifier gain and leakage resistance are made higher. Usually the gain used in d-c integrators is negative. In this case, the effect of leakage can be interpreted as degenerative feedback which decreases the effective gain of the integrating amplifier. The foregoing analysis shows that leakage can seriously reduce the quality of integration even with amplifiers of extremely high gain.

If the amplifier gain is made positive, the capacitor leakage constitutes regenerative feedback. By choice of A and R_L make

$$[1 + (1 - A)R/R_L] = 0 \quad (9)$$

in which case such a compensated integrator performs accurately even for small A , as shown by substituting Eq. 9 into Eq. 2. The compensation (Eq. 9) constitutes a striking means for overcoming the effects of finite amplifier gain and capacitor leakage.

It is important to note (Eq. 2) that the compensated amplifier need not be unstable despite the regeneration, because the latter is counteracted by degenerative feedback through C . The seemingly unstable case of $p = 0$ has no practical meaning because to investigate the effect of zero frequency would require an infinite computing time.

Figure 1C shows the integration of a square pulse for various

$$[1 + (1 - A)R/R_L]A$$

and indicates how the compensated integrator holds the output after the pulse has passed. Unavoidable changes in gain and leakage make it impossible to maintain Eq. 9 indefinitely and thus achieve perfect compensation. Nevertheless, considerable improvement in integrator performance is obtained even by approximate compensation. For estimating error, it is only necessary to know within what limits A and R_L may vary during computation; Eq. 7 now applies only to the most unfavorable combination of A and R_L .

Changes of amplifier gain A will alter the proportionality factor $A/(1 - A)$ of Eq. 4 and, in the

case of the compensated integrator, will disturb the compensation (Eq. 9). Differentiation of Eq. 6 with respect to A will give a detailed indication of the error caused by changes in gain. Thus a change in the gain A of ϵA percent will cause a percentage error less than

$$\frac{\Delta A}{A - 1} \left\{ 1 + \frac{t}{2RC} \left[\frac{A + 1}{A - 1} - \frac{R}{R_L} \right] \right\}$$

where, as before

$$[1 + (1 - A)R/R_L]/A < 0$$

Changes in leakage such as those due to atmospheric moisture have a similar effect. However, in the usual case of large R_L , the change may be so large that the errors have to be estimated from Eq. 7. In any case, errors due to changes in gain and leakage are minimized by making A large.

Distortion and Drift

An amplitude distortion may be interpreted as due to a change in gain occurring over certain portions of the signal. The error incurred in integrating a simple step function due to a percentage of distortion can thus be estimated from the same relation that applies to error from changes of gain. Likewise, error due to distortion can be minimized by making the amplifier gain high. It is also necessary to operate the output tube well within its linear range.

In d-c analog computers, the output of each amplifier is balanced to zero before computation so that, in the ideal case, only the desired signal voltages are applied to the integrators. Actually stray voltages due to noise, unbalances, grid current and drift occur during computation and they are integrated, leading to errors in the output. A single noise pulse will be integrated as in Fig. 1C, but high-frequency random noise will tend to cancel itself. Integrators of the d-c type are fairly susceptible to interference from power line frequencies, which should be kept out of the equipment by shielding and placement of components.

A steady unbalance voltage due to grid current or unidirectional drift at the input of an isolated integrator introduces an absolute error approximately equal to $E_d At / (A - 1)RC$ where E_d is the drift voltage. To minimize such error it may be expedient to balance each

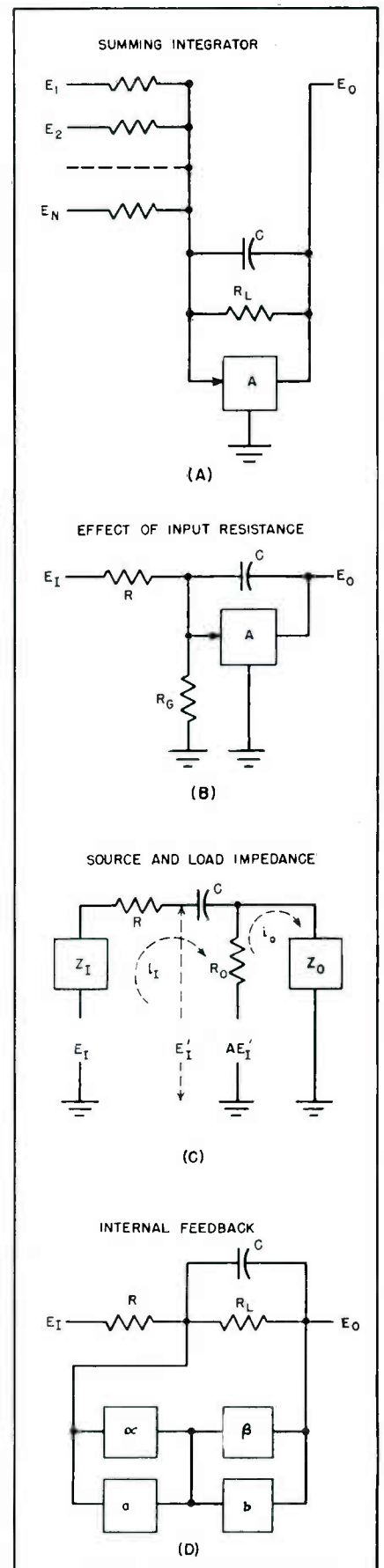


FIG. 2—All components must be considered in analysing integrators

amplifier, not for zero output, but for zero drift.

In most computer applications the d-c integrators are not isolated but are interconnected in feedback loops to simulate stable, damped oscillations. In such systems temporary unbalance tends to damp out; the amplifiers in such a system need only be balanced for output at some convenient reference level for zero output and the system will tend to settle back to this condition. Steady inputs or unbalances, after an initial transient, will only change the reference level.

Additional Resistances

There are several other resistances in the circuit whose effects need to be considered. Figure 2A shows the intentional inclusion of several resistances in the integrator input so that it will add several inputs and multiply each by a constant, giving an output

$$E_o = \sum \frac{E_k}{R_k} \frac{A}{(1-A)Cp + \frac{1-A}{R_L} + \sum \frac{1}{R_k}} \approx \frac{A}{1-A} \sum \frac{E_k}{R_k C p} \quad (10)$$

The error analysis and methods of compensation discussed previously can be applied to the summing integrator if R is replaced by

$$[\sum(1/R_k)]^{-1}$$

in the respective formulas.

The integrating amplifier has a finite input resistance R_o as shown in Fig. 2B; it may be considered as a grounded input terminal in a summing amplifier. The results of the preceding considerations show that, so far as the quality of integration is concerned, R_o decreases the effective value of R as if R_o were connected in parallel with it. Accordingly, it is desirable to make R_o as large as possible and to use a cathode-follower input.

In general, the integrator will be connected to a source of impedance Z_i and a load of impedance Z_o . The output impedance of the amplifier R_o is effectively the resistance formed by the plate and load resistances of the output stage in parallel. When Z_i and Z_o are resistive the equivalent circuit Fig. 2C shows that the approximate effect of the impedance ratio R_o/Z_o is to reduce the effective amplifier gain in the ratio $1/(1 + R_o/Z_o)$

if the absolute magnitudes of AR and AZ_o are both much greater than R_o , while Z_i contributes to the time constant of the integrator and may have to be considered when calibrating it.

Usually the input and output of the integrator will be connected to similar integrators or to summing amplifiers. In such systems R_o is 20 to 50 kilohms and R is of the order of 5 megohms, so that presumably the effects of Z_i and Z_o are small. However, because of the complex feedback paths in computers, it may be necessary to solve the very complex network equation for the complete computer to gain exact information on its performance. The possibility of neglecting the output impedance of one integrator as compared to the input impedance of the one following it has great practical importance; it enables one to compute the transfer functions of cascaded integrators by simply multiplying the transfer functions of individual integrators.

In calibrating the integrator, Eq. 4 may be taken as the transfer function. The value of $A/(1-A)RC$ is found by actually measuring the output-input ratio (at 60 cps with a calibrated potentiometer). Errors in measurement and slight changes in R and C make the calibration accurate within about 0.5 percent; the effect of A has been discussed above. For large A , Eq. 4 may be approximated by $-1/RCp$, where R and C can be found by accurate bridge measurement.

Optimum Conditions

Whether the integrator is compensated or not, most of the errors are reduced by decreasing t/ARC and $1/R_o$, which means using short computing times, high gain, high leakage and long integrator time constant. Even in the compensated integrators, high gain is useful to reduce errors from distortion and gain changes. High gain or compensation and feedback can make errors from finite gain, gain changes and distortion very small.

The most serious errors, those that are difficult to minimize, are drift due to unbalances and changes in leakage resistance. Drift errors can be minimized by careful balancing (for zero drift) and stable

amplifiers and power supplies. Reduction of t/RC may also help, but is limited by scale factor. Reducing the computing time reduces most of the errors, but it is limited by the frequency response of recorders and associated servos.

Feedback in the integrating amplifier can (1) decrease amplifier distortion and instability if it is degenerative, or (2) increase the gain if it is regenerative. However, if feedback over the entire amplifier is used, the accuracy of integration will be unaffected because the improvements in the amplifier will be offset by impairments in the integrator due to reduced gain. Nevertheless, degeneration is advantageous because by it the amplifier gain of a compensated integrator can be reduced without increasing instability and distortion, and a low leakage resistance can be used (Eq. 9). The possibility of connecting a stable resistor across the capacitor affords a means of decreasing changes in R_o due to humidity.

Even more interesting results can be obtained if feedback is used around portions of the amplifier. In a two-stage amplifier having an overall gain A and the stage parameters shown in Fig. 2D.

$$A = \frac{ab}{(1-a\alpha)(1-b\beta)} \quad (11A)$$

$$\Delta A, B = \frac{\Delta a}{1-a\alpha} + \frac{\Delta b}{1-b\beta} \quad (11B)$$

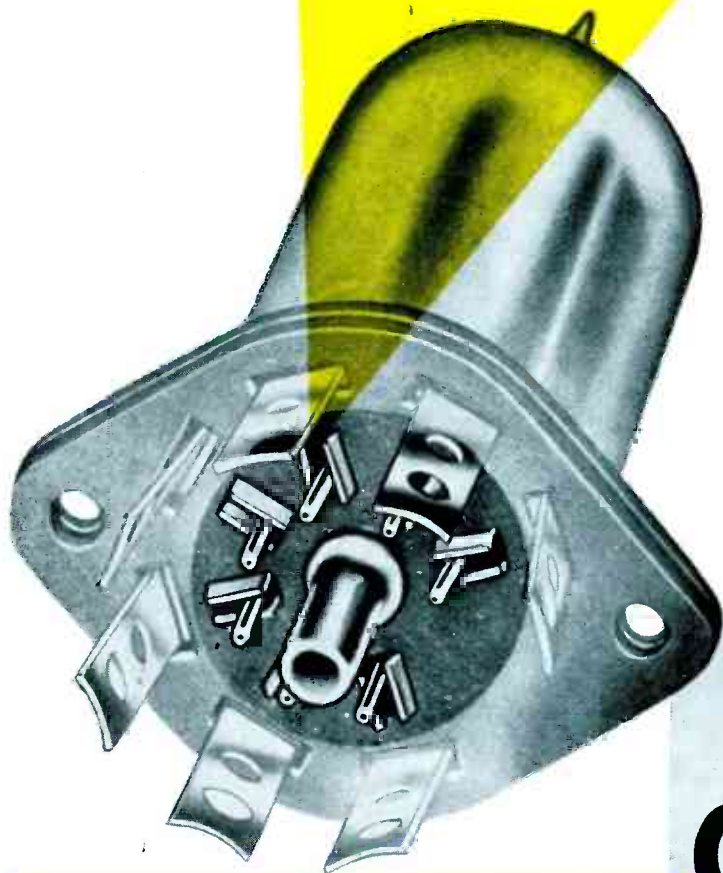
$$\Delta A, B = \frac{\Delta D_a}{1-a\alpha} + \frac{\Delta D_b}{1-b\beta} \quad (11C)$$

where ΔA , Δa , and Δb are the percentage gain changes, and ΔD , ΔD_a , and ΔD_b are the distortion percentages. Feedback around the individual stages thus makes it possible to greatly reduce effect of gain changes and distortion in the power stage by using nearly critical regeneration on the voltage stage, as well as high gain in both stages. Similarly the effects of gain changes and distortion in the voltage stage can be made small by nearly critical regeneration on the power stage, although this will usually be unnecessary. The very high gain resulting from the regeneration can be reduced by overall degeneration. The feedback networks should be arranged so as not to decrease the input resistance of the amplifier.

THIS GIVES YOU THE IDEA



Another Cinch First!



- No. 56F12865 1" Mtg Center
- No. 56F12866 1" Mtg Center with shield
- No. 56G13078 1-5/16" Mtg Center
- No. 56G13043 1-5/16" Mtg Center with shield

Also available in grounded types or with 8 contacts

- Patent applied for -

NEW CINCH SOCKET

— the long sought for locking grip type miniature socket for automotive sets.

Precision tooled — contacts provide high extraction pull out . . . supplying maximum tube retentivity, mandatory in automotive set production.

— multiple tooled . . . available in any quantity at once.



AVAILABLE AT LEADING ELECTRONIC JOBBERS . . . everywhere

CINCH MANUFACTURING CORPORATION

2335 WEST VAN BUREN STREET



CHICAGO 12, ILLINOIS

Subsidiary of United-Carr Fastener Corporation - Cambridge 42, Massachusetts

TUBES AT WORK

Including INDUSTRIAL CONTROL

Edited by VIN ZELUFF

Metal Detector for Cows.....	128
Sprayed Wiring for Control Amplifier.....	128
Beat Frequency Tone Generator with R-C Tuning.....	130
Capacitors and Selenium Rectifiers.....	146
Automatic Lighting Switch.....	155
Electronic Lightning Alarm.....	158

Metal Detector for Cows

Being coarse feeders, cows are prone to swallow small pieces of wire or other metal, with possibly serious results. When this is suspected, the use of a Cintel metal detector made in Britain enables a diagnosis to be made accurately and quickly. As a result, many veterinary surgeons are now regular users of the instrument.

The detector can also locate to within an inch or two, pipes buried up to 2 feet, 9 inches below ground and will detect small pieces of metal embedded in timber or other materials to a depth of 9 inches.

If used in conjunction with an oscillator, the instrument will detect such things as pipes and

cables buried up to 30 feet below ground but exposed at one point. It can also follow pipes for long distances and a six-inch pipe buried three feet can easily be traced up to 300 yards on each side of the point where the oscillator is connected.

Sprayed Wiring for Control Amplifier

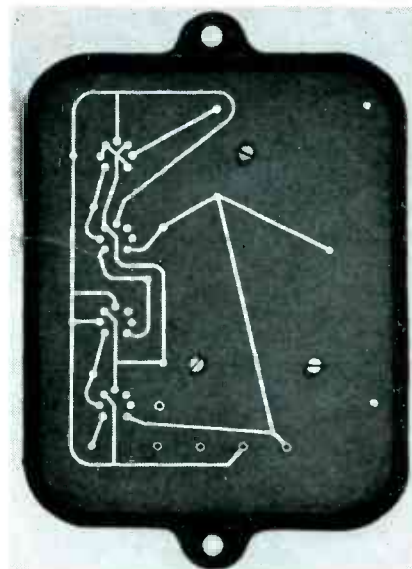
By RALPH T. SQUIER

*Assistant Director of Research
Minneapolis-Honeywell Regulator Co.
Minneapolis, Minn.*

INVESTIGATING new means of mechanizing electrical wiring has resulted in development of several techniques that can be applied to manufacture of electronic control

units. The illustrations show one of these, an experimental amplifier with sprayed copper leads in grooves on a plastic base.

Grooves were made in the base, first by milling and later by molding, into which the metal was sprayed. It was found that the metal impinging upon the lands between the grooves could be easily



Sprayed wiring on the plastic base of the amplifier. Terminals and wiring of the miniature sockets show clearly at left

wiped off. There were, however, some problems that immediately presented themselves concerning spacing, width, depth, bottom surface, and shape of the groove.

Certain minimum separations between leads must be maintained in electronic circuits to eliminate electrical leakage. Using a groove width of $\frac{1}{16}$ inch, even with miniature tubes having closely-spaced pins, resulting separations were within these limits. This groove width is more or less arbitrary, being wide enough to allow ample room for spraying to the bottom of the groove and to provide sufficiently high conductivity while leaving adequate spacing between leads.

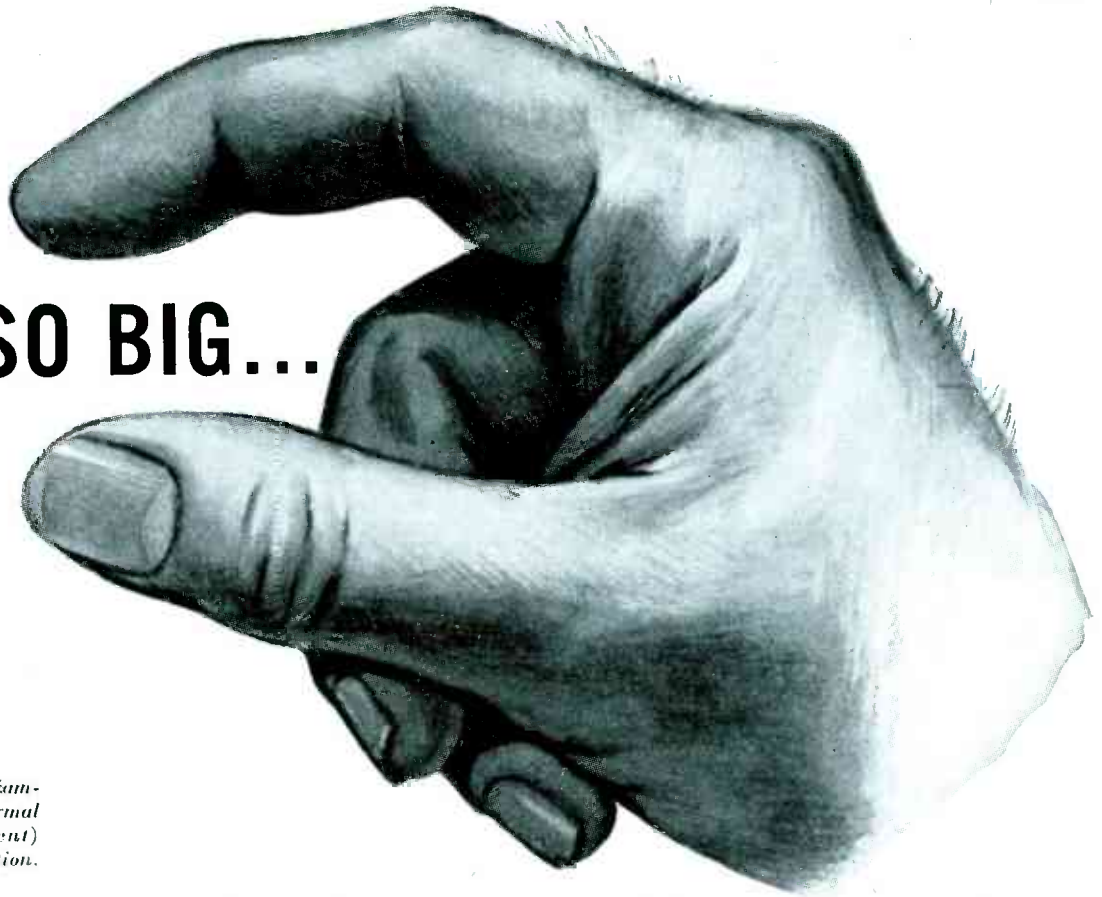
A series of tests was conducted to determine optimum groove depth for adhesion of the copper to the base. This depth seems to be critical and should be maintained at 0.040 ± 0.005 inch.

Measurements made on the bonding of the copper to the bottom of a molded plastic groove show conclusively that some sort of rough-

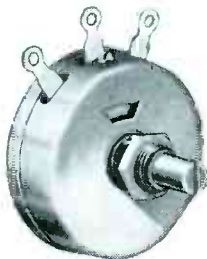


Metal detectors offer a means of diagnosis for sick cows who swallow stray bits of metal with deleterious effects

ONLY SO BIG...



TYPE C—Only $1\frac{1}{2}$ " in diameter. Full two watts normal rating (entire element) for continuous operation.



TYPE M—Normal rating of 4 watts. Diameter $1\frac{3}{8}$ ". Insulated for 1,000 volt DC breakdown to ground.



TYPE E—Dissipates 7 watts. Diameter $2\frac{3}{16}$ ". Supplied with grounded contact arm.

*... they have everything you want
in a wire-wound control!*

Size is always an important matter when you're designing products like radio and television receivers, testing equipment, light dimming devices and miniature motor controls. That's why Mallory makes its wire-wound variable resistors good *and small*—the type C control being the smallest two-watt control of its kind available today.

On the plus side, too, is the fact that all Mallory wire-wound controls are designed for maximum heat dissipation. In addition, the M and E types are metal-enclosed to provide electrostatic shielding... all types are tapered with extreme accuracy (linear taper tolerance is within 3%)... precision-wound to give extremely long, noise-free service. A special feature of the M and C type controls is a spring clamp which maintains positive pressure between silver-plated terminals and silver element terminations, insuring extremely low terminal resistance.

The M type Variable Resistor is also available in a complete line of Mallory T and L Pad Attenuators, designed to provide impedance matching in audio circuits or resistive networks to secure maximum power transfer and minimum distortion.

It's a story on a par with that of so many other precision electronic products—

YOU EXPECT MORE AND GET MORE FROM MALLORY

P. R. MALLORY & CO. Inc.
MALLORY RESISTORS
(FIXED AND VARIABLE)

P. R. MALLORY & CO., Inc., INDIANAPOLIS 6, INDIANA

ening is desirable. Longitudinal and diagonal ridges gave much better results than a smooth surface. To determine the bonding of the copper to the panel, a small circular hole of the same width as the groove was drilled through the panel prior to spraying. A steel pin was inserted through this hole flush with the bottom of the groove. After spraying, this pin was removed and one of slightly smaller diameter inserted in the hole and the force required to dislodge the copper conductor was measured. The average of these forces for smooth grooves was 100 grams and for roughened grooves, 600 grams. The groove must have a sharp edge at its top so that the copper lead is automatically severed from the lands at the time of deposit.



Top view of control amplifier with sprayed wiring

After spraying, the plastic and copper are painted with a mixture of Durez and varnish that further improves the bonding of the copper to the plastic.

Sprayed copper leads in grooves on a plastic base were subjected to the following conditions without detectable change in electrical or physical characteristics:

1. Temperature variation in 10 cycles from -65°F to $+160^{\circ}\text{F}$.
2. Pressure variation from normal atmospheric to that prevailing at 50,000 feet.
3. Vibration in a 0.020-inch diameter circle inclined at 45 degrees for one hour each at 10, 30, and 50 cycles per second.

The amplifiers constructed have been subjected to all the conditions noted above and to extremes of humidity. They have operated under moderate conditions for months with no change whatever that could be attributed to deterioration of the sprayed copper leads.

Beat Frequency Tone Generator with R-C Tuning

THE PRINCIPLES of resistance-capacitance tuning of oscillators may easily be adapted to the design of tone generators using the heterodyne technique. Such a circuit has several advantages over tuned-circuit generators. For example, no difficulty is experienced in covering wide frequency bands with good frequency stability and low distortion and with simple frequency control. Furthermore, there is an extremely

BY J. W. WHITEHEAD
Central High School
Leeds, England

low degree of coupling with neighboring components. Remote control of frequency can also be arranged.

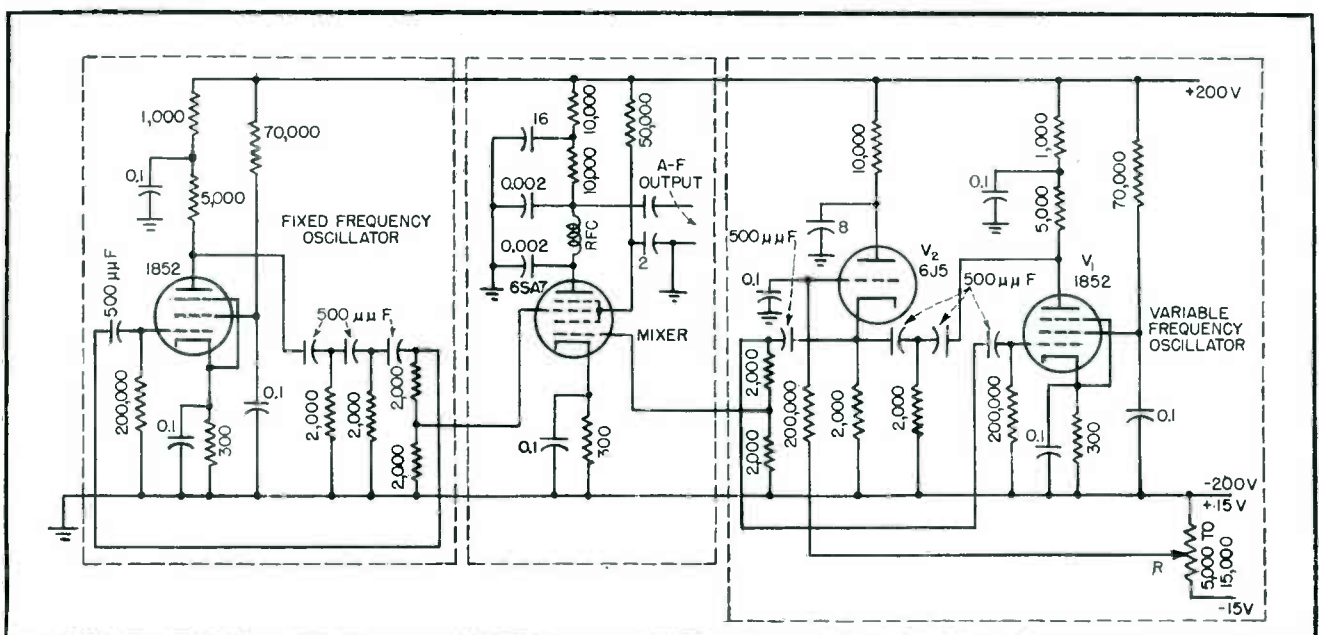
Circuit Details

The circuit shows two R-C tuned oscillators feeding the appropriate grids of a hexode mixer. The out-

put from each oscillator is obtained by a suitable tap on the final resistance of each of the phase-shifting networks. A refinement (not shown) would be to leave a portion of the automatic bias resistance to each oscillator tube unshunted in order to introduce a degree of feedback for the purpose of limiting the amplitude of oscillation.

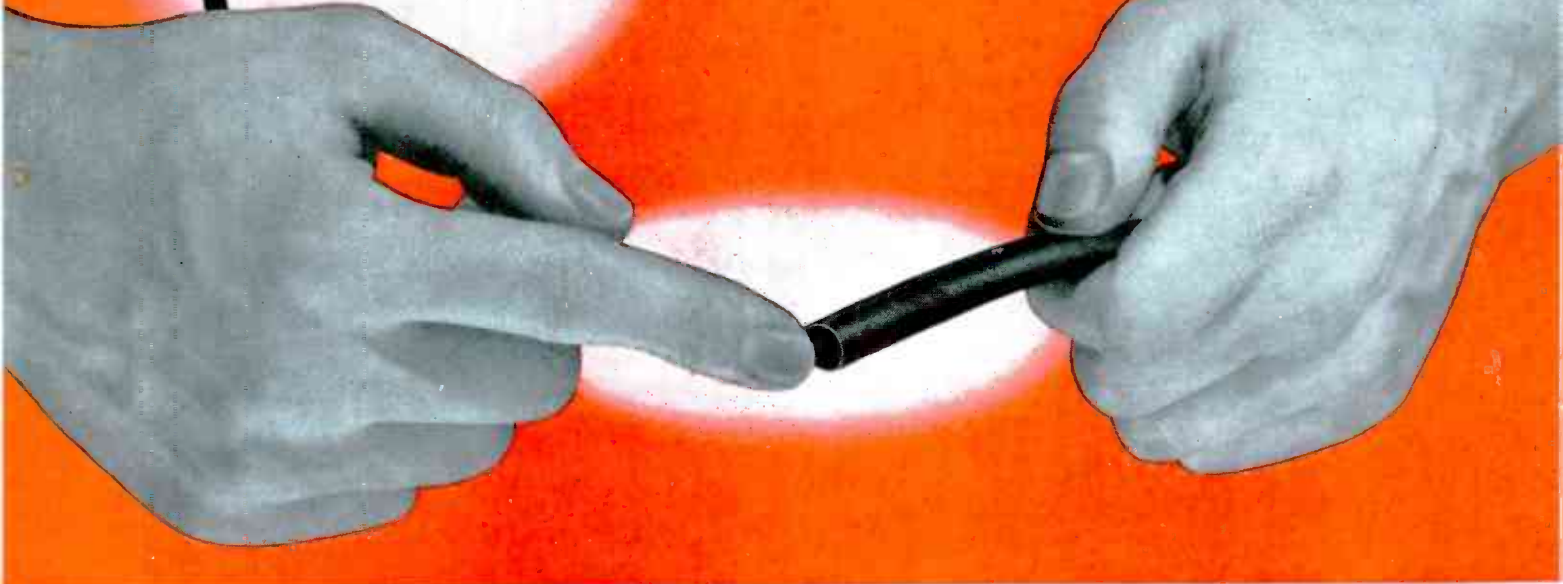
Control of the frequency gener-

(continued on p 146)



The values shown in the diagram provide oscillator frequencies of about 92 kc and the resulting beat-frequency variation is from a few cycles to over 20 kc. A voltage-regulated plate supply is preferable

**SPEED
ELECTRICAL
ASSEMBLY...**



with non-fraying

You can eliminate many assembly problems if you specify a varnished tubing that does not fray during assembly operations. Fraying not only slows production but is a source of electrical trouble. Dieflex varnished tubing products are noted for their ability to be cut evenly and cleanly, to return to roundness after cutting, and to withstand handling and the rough usage of product assembly without back-raveling or fraying. They save you assembly time and cut your costs because you won't need to do the same job twice.

Dieflex varnished tubings and saturated sleeveings of finely braided cotton or inorganic glass fiber have this non-fraying characteristic in all grades and sizes. In addition, all Dieflex products have extreme flexibility, high dielectric strength, smooth inside bore, excellent push-back quality, and many other superior features. You can't go wrong when you specify Dieflex on every job.

DIEFLEX
VARNISHED TUBING PRODUCTS

DIEFLEX PRODUCTS LIST

MADE WITH BRAIDED COTTON SLEEVING BASE

- VTA Grade A-1 Magneto Grade Varnished Tubings
- VTA Grade B-1 Standard Grade Varnished Tubings
- VTA Grades C-1 and C-2 Heavily Coated Saturated Sleeveings
- VTA Grade C-3 Lightly Coated Saturated Sleeveings
- Heavy Wall Varnished Tubings and Saturated Sleeveings

MADE WITH BRAIDED GLASS SLEEVING BASE

- VTA Grade A-1 Magneto Grade Varnished Fiberglass Tubings
- VTA Grade C-1 Extra Heavily Saturated Fiberglass Sleeveings
- VTA Grade C-2 Heavily Saturated Fiberglass Sleeveings
- VTA Grade C-3 Lightly Saturated Fiberglass Sleeveings
- Silicone-Treated Fiberglass Varnished Tubings and Sleeveings

**INSULATION
MANUFACTURERS CORPORATION**

*CHICAGO 6 • 565 W. Washington Blvd.

MILWAUKEE 2
312 E. Wisconsin Ave.

DETROIT 2
15 Lawrence Ave.

*Local Stocks Available



*CLEVELAND 14
1231 Superior
Ave., N.E.

DAYTON 2
1315 Mutual Home
Building

IMC Representatives

PEORIA 5—101 Heinz Court • MINNEAPOLIS 3—1208 Harmon Place

Authorized Distributors

INSULATION and WIRES INCORPORATED

St. Louis 3, Mo. • Atlanta, Ga. • Boston 20, Mass.
Detroit 2, Mich. • Houston 2, Tex. • New York 7, N.Y.

TRI-STATE SUPPLY CORPORATIONS

Los Angeles 13, Cal. • San Francisco 7, Cal. • Seattle 4, Wash.

THE ELECTRON ART

Edited by FRANK ROCKETT

An Image Storage Tube	132
Extending Linear Range of Reactance Modulators	134
Characteristics of Some Oil Impregnated Capacitors	168
End Resistance Materials	172
Null Temperature Bridge	180
Survey of New Techniques	186

An Image Storage Tube

LONG-TERM OBSERVATION (up to three weeks) of events occurring in 10^{-8} seconds is made possible by the Krawinkel storage tube, which was developed in Germany. The tube is the embodiment of a new technique that, after further research and development, makes possible retention of images for detailed evaluation that are conventionally produced on cathode-ray tubes. The storage tube is therefore applicable wherever the cathode-ray tube is used. For example, the indicator of a search radar set may show only a few widely separated spots along the trajectory of a missile. To recognize that these indications all relate to the same moving target, and to determine its position of origin, the screen image needs to be stored long enough for the controller to study it.

Characteristics of Storage Tube

This image storage tube, at its present stage of development, has electrostatic deflection with magnetic focusing of the 0.2 to 0.3-millimeter diameter writing beam, and magneto-optical projection of the stored image onto the viewing screen. Writing and erasing speed

is 20,000 meters per second. The storage time, with the image illuminated for observation, is 15 minutes; with it unilluminated it is three weeks. The image can be erased intentionally at any time. The stored elements are 0.0036 square millimeters in area.

The image is electrically stored in small capacitors. The foundation for the storage surface is a photosensitive layer. On this base are small insulated islands which act as capacitors, one plate being the common photosensitive base, the other being the surface of the insulation. Each capacitance is about 0.002 μf , and will retain a charge of 5×10^{-14} coulomb for the three weeks. Using secondary emission of the insulated islands, either a positive or a negative charge relative to the photosensitive cathode, depending on the velocity of the cathode-ray electrons, is painted on the island capacitors to form the stored image. When the image is to be viewed, the storage surface is illuminated by invisible light, from outside the tube. Thus electrons are emitted photoelectrically from the cathode in proportion to the positiveness of the charges on the adjacent ca-

pacitors, and are projected to a fluorescent viewing screen to reproduce the image.

Constructional Features

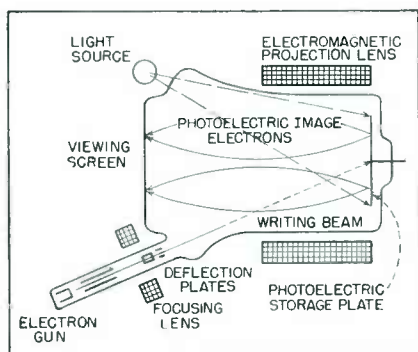
Although the foregoing description of insulated islands on a photocathode explains the action of the storage plate, the plate is made by depositing photosensitive islands on a fused quartz plate. First a narrow metallic frame is evaporated around the edge of the insulating quartz plate. Then a grid of very fine conducting lines is evaporated onto the surface. Last a great number of photoelectric



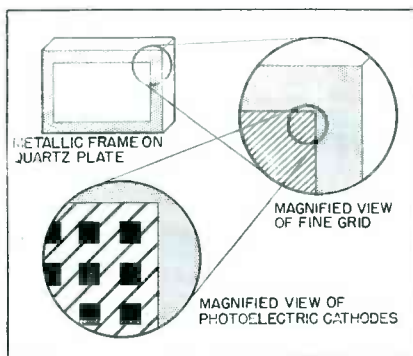
Getter is an auxiliary triode

cells are evaporated through holes of a fine mesh net. Thus, each photocell contacts at least one line of the grid so that all the photocells are connected together and to the metallic border. The small uncoated areas of the quartz plate constitute the capacitors.

To prevent leakage of the charges from the capacitors, a very high vacuum of 5×10^{-7} millimeters of mercury is maintained inside the tube. To do this, a getter tube is incorporated inside the storage tube. The getter tube is a triode, the plate of which has a surface of getter material. The grid is made positive, the plate negative. Electrons from the thermal cathode positively ionize the gas molecules in the getter tube. The ions are then actively attracted to the getter material to assure their removal from the storage tube (An Image

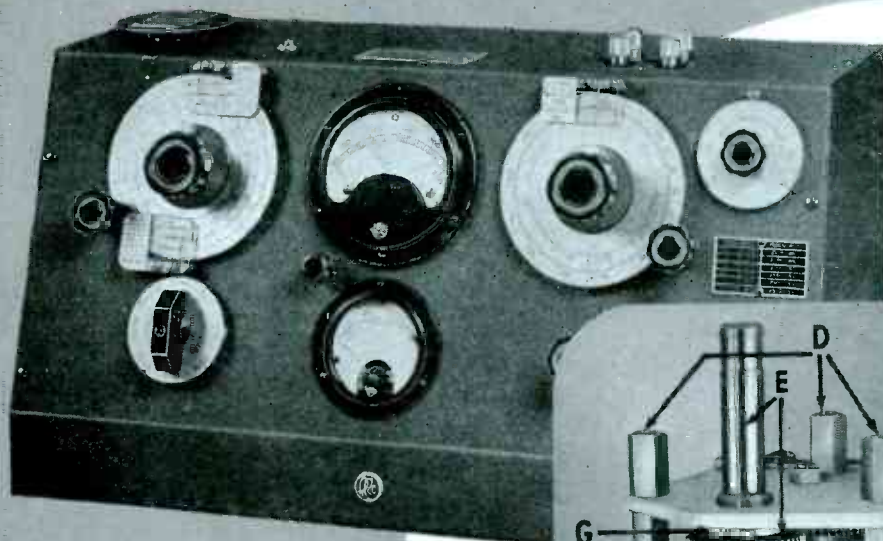


Operation of image storage tube

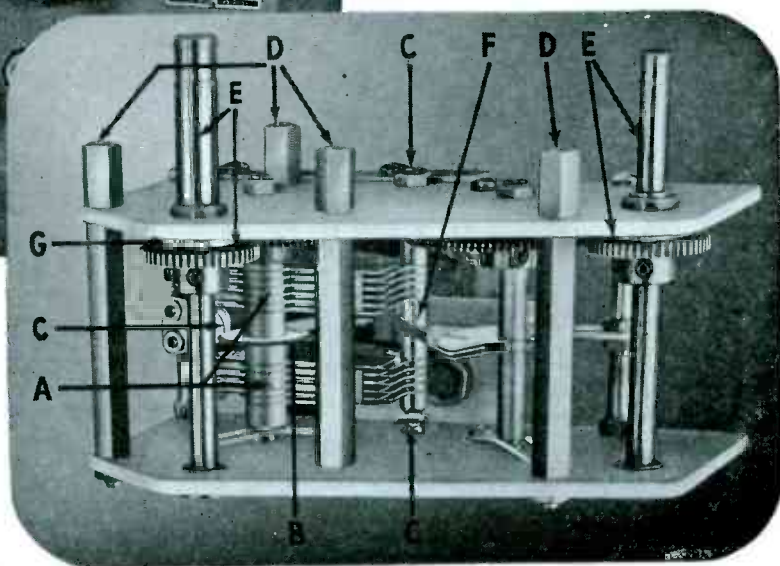


Construction of storage plate

For the MEASUREMENT of Q, INDUCTANCE and CAPACITANCE



The
160-A Q-METER
50 KC. to 75 MC.



Radio frequency circuit design often requires the accurate measurement of Q, inductance, and capacitance values. For this application, the 160-A Q-Meter has become the universal choice of radio and electronic engineers throughout the country.

Each component part and assembly used in the manufacture of this instrument is designed with the utmost care and exactness. Circuit tolerances are held to values attainable only in custom built instruments.

Consider, for example, the Q tuning capacitor assembly of the 160-A Q-Meter, specially manufactured for maximum range, low loss, and minimum residual inductance. The ultimate design of this unit was reached only after months of intensive engineering research to produce the finest in performance, quality, and workmanship.

This is but one of the many desirable features of the 160-A Q-Meter which contribute to its outstanding accuracy and dependability.

Be sure to include the 160-A Q-Meter in your new equipment plans for 1948.

Write for Catalog "E"

BOONTON RADIO

BOONTON · N · J · U · S · A ·

Corporation



Shown above is the Q tuning capacitor assembly of the 160-A Q-Meter. Note the following design features of this unit—features which insure reliable, trouble-free operation.

- A. Parallel connection of dual rotor and stator assemblies minimizes internal inductance and resistance.
- B. Spring silver fingers contact both sides of silver disc to provide low series resistance.
- C. Three point pyrex ball stator suspension reduces losses and permits accurate stator alignment.
- D. Four point panel mounting designed to produce maximum structural rigidity and capacitance stability.
- E. Precision-cut brass spur gears and stainless steel shafts, mounted in oversize bearings, assure long, trouble-free service.
- F. Common stator mounting for main and vernier stator plates reduces loss and internal series resistance of vernier capacitor section.
- G. Positive shaft stop protects main rotor assembly and gears against mechanical overload.

SPECIFICATIONS

Oscillator Frequency Range: 50 kc. to 75 mc. in 8 ranges.

Oscillator Frequency Accuracy: $\pm 1\%$, 50 kc.—50 mc.
 $\pm 3\%$, 50 mc.—75 mc.

Q Measurement Range: Directly calibrated in Q, 20-250. "Multiply—Q—By" Meter calibrated at intervals from x1 to x2, and also at x2.5, extending Q range to 625.

Q Measurement Accuracy: Approximately 5% for direct reading measurement, for frequencies up to 30 mc. Accuracy less at higher frequencies.

Capacitance Calibration Range: Main capacitor section 30-450 mmf, accuracy 1% or 1 mmf whichever is greater. Vernier capacitor section ± 3 mmf, zero, -3 mmf, calibrated in 0.1 mmf steps. Accuracy ± 0.1 mmf.

DESIGNERS AND MANUFACTURERS OF THE Q METER · QX CHECKER
FREQUENCY MODULATED SIGNAL GENERATOR · BEAT FREQUENCY
GENERATOR AND OTHER DIRECT READING INSTRUMENTS

Extending Linear Range of Reactance Modulators

By FRITZ BRUNNER

Dipl. Electr. Engr.
Swiss Federal Inst. of Tech.
Muttetz, Baselland, Switzerland

LARGE FREQUENCY DEVIATION can be obtained directly from a frequency modulated oscillator by interposing a stage of amplification between the oscillator tank and the grid of the reactance tube.

Principle of Operation

In the basic reactance tube frequency modulated oscillator, a variable reactive current I_r whose magnitude is controlled by the mod-

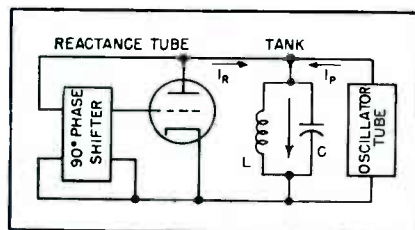


FIG. 1—Basic reactance modulators

ulating signal is supplied through a reactance tube to the tank circuit. The oscillator tube supplies a constant in-phase current I_p to the tank circuit as shown in Fig. 1. Under these conditions the instantaneous frequency is

$$f = \frac{1}{2\pi(L(C + I_r/2\pi f E))^{1/2}}$$

where L is the inductance of the tank, C is its capacitance, and E is the voltage across it. If the resonant frequency of the tank circuit is

$$f_0 = 1/2\pi(LC)^{1/2}$$

the deviation frequency approximates

$$\Delta f = f - f_0 \approx -I_r/4\pi EC$$

which shows that the extent of the deviation is directly proportional to the reactive current supplied by the reactance tube.

In conventional reactance tube f-m oscillators I_r is obtained by shifting the phase of the tank circuit voltage as near as possible to 90 degrees by a resistance-reactance circuit, and using this voltage to control the reactance tube. Unfortunately considerable attenu-

ation is associated with the phase-shifting network, so that the I_r available from the reactance tube is small in comparison to the voltage across the tank circuit. The frequency deviation that can be produced, especially at vhf, despite the greatest possible L/C of the tank circuit, is small. The oscillator must often be followed by several multiplier and converter stages to yield the necessary frequency deviation.

The introduction of an amplifier before or after the phase splitter makes possible greater deviation. Because the phases in this amplifier affect the stability of the oscillator, only one stage can usually be used.

Circuit Simplification

The simplest arrangement is to use the dynamic plate resistance of the amplification tube as the resistance of the phase shifter as is done in Fig. 2A. If this tube has a high plate resistance, the voltage appearing across the reactance is shifted nearly 90 degrees. This reactance can be either an inductance or a capacitance. The reactive current delivered to the tank circuit

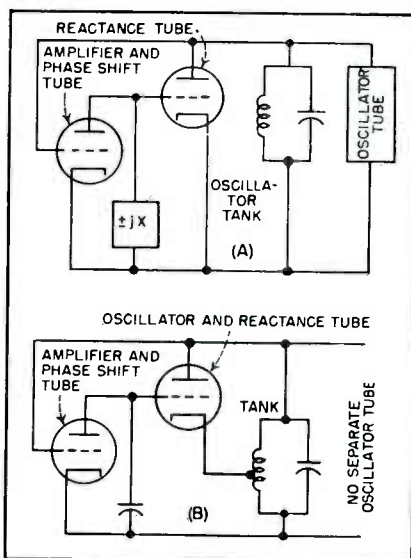


FIG. 2—Improved f-m oscillators

can be modulated by changing the effective mutual conductance of one or more of the tubes associated with it.

At very high frequencies only the tube capacitances need be used for the reactive component of the phase shifter. At higher frequencies the transit time in the reactance tube can supply the 90 degree phase shift so that a single transit-time reactance tube replaces the two tubes. Otherwise the effect of transit time can be counteracted by adjustment of the phase shifter.

The circuit can be simplified still further by using the oscillator tube simultaneously as the reactance tube as shown in Fig. 2B.

Practical Execution

To obtain the largest possible frequency deviation with good stability, it is necessary to limit the amplitude of operation to the linear portion of the grid characteristic of the amplifier. A crystal diode

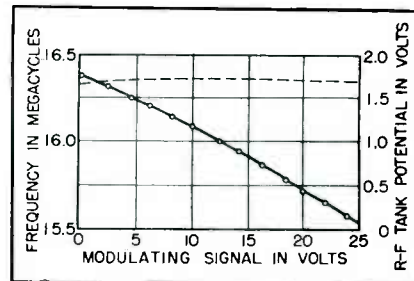


FIG. 3—Typical experimental results

can provide this limiting.

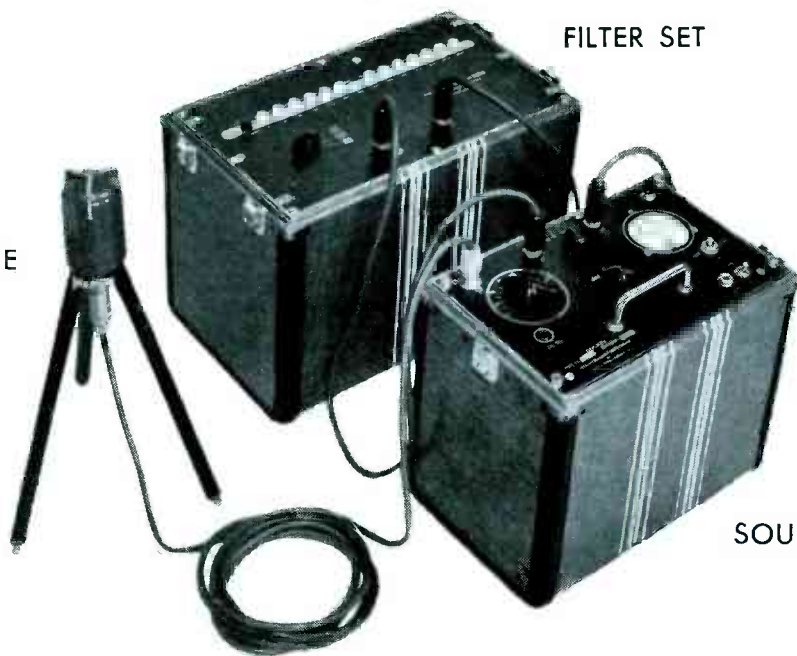
The fact that the tank circuit capacitance is distributed over the several tubes of the system must be taken into consideration. If, at vhf, the inductances of the tube connections are too near that of the tank circuit, and the reactance tube supplies a strong reactive current, oscillation may be unstable. This condition can be avoided by increasing the inductance of the tank circuit, decreasing the tube capacitances, and decreasing the inductances of the connections, possibly by concentrating all the tubes in one envelope.

Using the oscillator tube as the reactance tube also, and using low transconductance tubes, linear deviation and constant amplitude of

(Continued on p 168)

Ready to help you lick noise and vibration problems!

633A
MICROPHONE



FILTER SET

SOUND LEVEL METER

A sturdy, dependable, portable noise analyzer

This Western Electric Noise Analyzer is ideal for noise measurement and analysis (where a detailed analysis of the noise into specific frequency components is not required) and for acoustic testing and inspection.

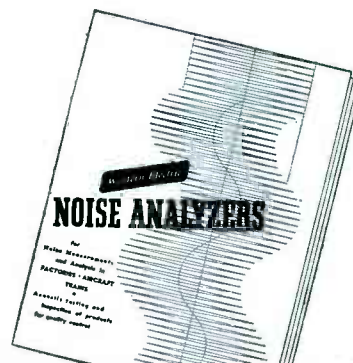
This analyzer helps you solve many problems where a sound level meter *alone* would be of little value. A multiple push-button switch permits selection of any one of 13 high pass or 13 low pass filters at approximately half octave spacing, or the 12 octave bands between the high and low pass sec-

tions. The insertion loss of the filter set is automatically compensated for and no corrections to readings are required.

In addition to the non-directional moving coil mike provided with the Noise Analyzer, you may also wish to order a Vibration Pick-up to measure vibrations not accompanied by noise.

The Noise Analyzer is available in A-C line and battery operated models. For full information, send the coupon or call your Graybar Representative.

Send for this
Bulletin today



Western Electric

— QUALITY COUNTS —



DISTRIBUTORS: IN THE U. S. A.—Graybar Electric Company. IN CANADA AND NEWFOUNDLAND—Northern Electric Company, Ltd.

Graybar Electric Company
420 Lexington Ave., New York 17, N. Y.

E-36

Please send me Bulletin T-2260B describing
Western Electric Noise Analyzers.

Name _____

Company _____

Address _____

City _____ State _____

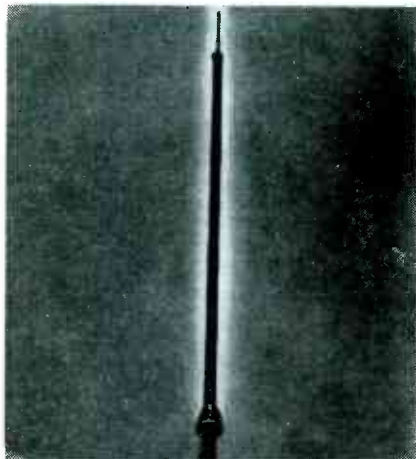
NEW PRODUCTS

Edited by A. A. McKENZIE

New equipment, components, tubes, testing apparatus and products closely allied to the electronics field. A review of catalogs, handbooks, technical bulletins and other manufacturers' literature

High-Gain Antenna

THE WORKSHOP ASSOCIATES, INC., 66 Needham St., Newton Highlands 61, Mass. Model 3HW high-gain beacon antenna was designed for the 152- to 162-mc mobile communication band. The unit comprises three half-wave dipoles



stacked 0.7 wavelength apart and driven in phase. It can be fed with various types of transmission lines by means of special connector adaptors. Total weight is less than 40 pounds and price is \$300.

STL for F-M

RADIO ENGINEERING LABORATORIES, 35-54 Thirty-Sixth St., Long Island City 1, N. Y. Model 694 studio-transmitter link equipment operating in the frequency range between 940 and 960 megacycles comprises special receiving equipment and an entirely new transmitter. Overall system performance from transmitter input to receiver output gives signal-noise ratio bet-

ter than 75 db below 100 percent modulation. Audio response is within 0.3 db from 50 to 15,000 cycles. Distortion is no greater than 0.3 percent at 100 percent modulation over the entire audio range. With the unique Serrasoid modulator only 750 watts of total transmitter input power is required for adequate signalling over a 30-mile path. Frequency is directly crystal controlled.

High-Level Speaker

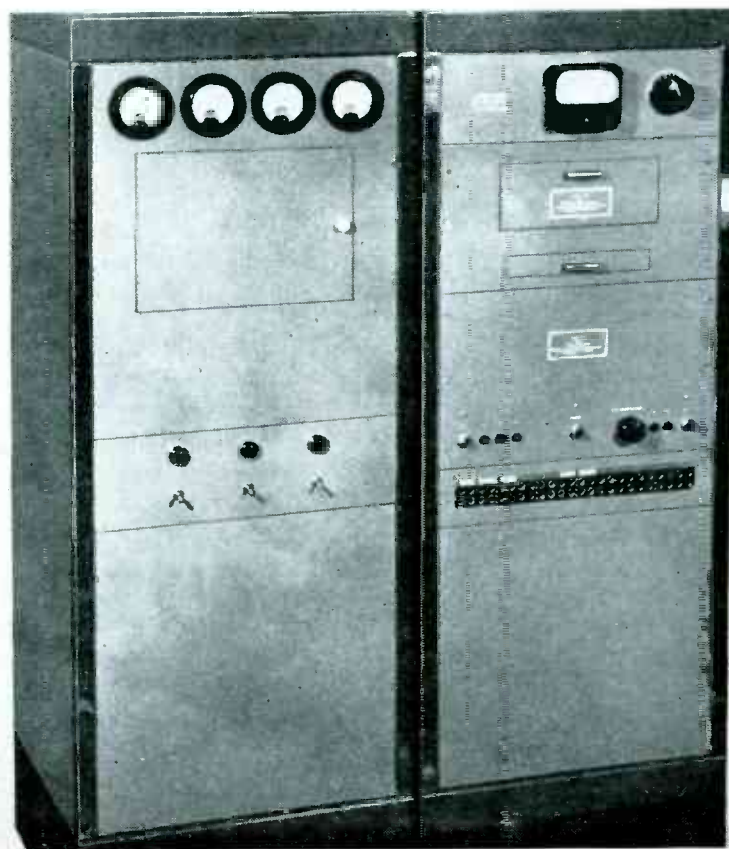
STEPHENS MANUFACTURING CORP., 10416 National Boulevard, Los Angeles 34, Calif. Designed for deluxe

home installations, Tru-Sonic model P-63HF speaker system is built along the lines of commercial theater equipment. Two speakers are used with crossover at 600 cycles. Overall frequency range is from 30 to beyond 15,000 cycles. The equipment described in Bulletin 109 weighs 245 pounds.



Ultrasonic Sound Pressure

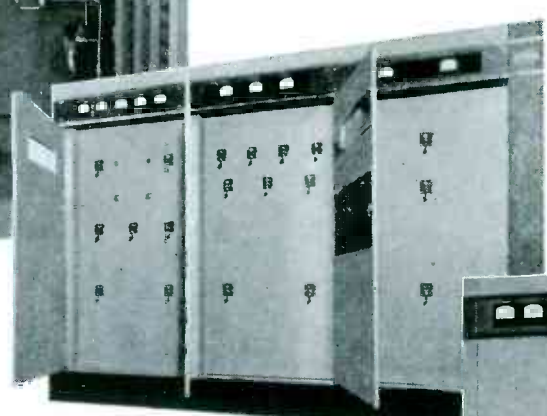
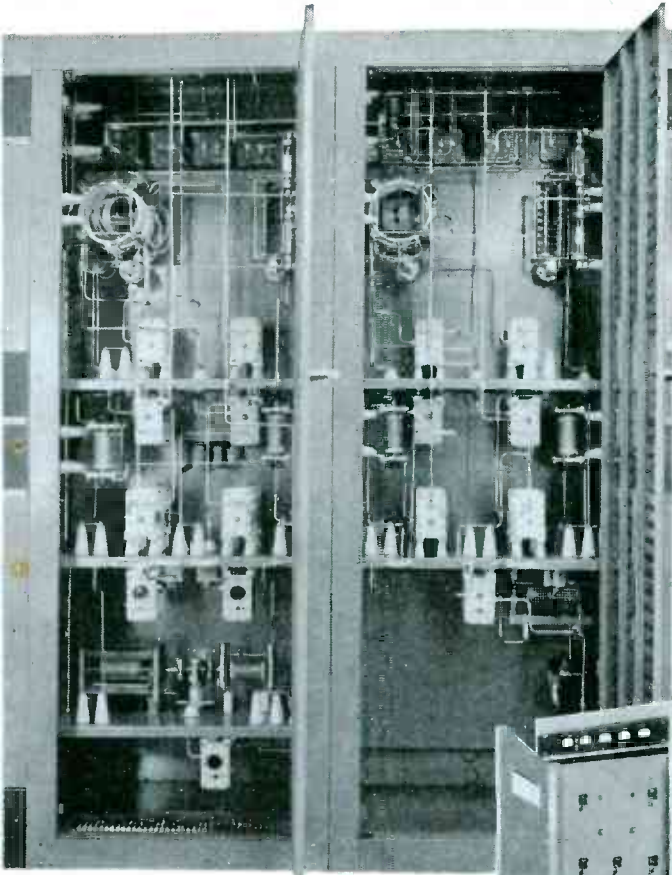
MASSA LABORATORIES, INC., 3868 Carnegie Ave., Cleveland 15, Ohio. Model GA-1005 sound pressure measurement system comprises model M-113 microphone, M-114





*Excellence in Electronics
and in Directional Antenna*

PHASING EQUIPMENT



TRIPLE CUBICLE, 10 KW UNIT shows convenient arrangement of power and phasing controls, line current and input meters. Counters and panel lights indicate the setting and directional pattern in use. Safety doors exclude unauthorized personnel. NOTE: Cabinet design and number of cubicles is determined by equipment required — not necessarily by KW output.

DOUBLE CUBICLE, 5 KW UNIT, rear view, showing the compact but uncrowded arrangement of components. Large rear doors are interlocked for safety, provide easy access for maintenance or adjustment.

Raytheon's specialists, cooperating with your consultant and station engineers, are prepared to custom-build directional antenna phasing and tuning equipment that will produce optimum results with your proposed or existing transmitting equipment. Engineered for maximum efficiency and stability . . . designed for utmost ease, economy and safety of operation . . . styled for ultimate appearance, convenience and accessibility — in the size to suit the power and special characteristics of your installation.



SINGLE CUBICLE, 1 KW UNIT illustrates the handsome appearance of the heavy gauge steel and channel iron cabinet. Modern two-tone chrome-trimmed design adds smart style to any station.

PROMPT DELIVERY . . . usually in 60 days or less. Call your Raytheon Broadcast Representative for complete information or — Write for Bulletin DL-R-444.

RAYTHEON MANUFACTURING COMPANY

COMMERCIAL PRODUCTS DIVISION · WALTHAM 54, MASSACHUSETTS

Industrial and Commercial Electronic Equipment, FM, AM and TV Broadcast Equipment, Tubes and Accessories

BOSTON, MASSACHUSETTS

Chris F. Brauneck
1124 Boylston Street
KE. 6-1364

CHICAGO 6, ILLINOIS

Warren Cozzens, Ben Farmer
COZZENS & FARMER
222 West Adams Street
Ran. 7457

LOS ANGELES 15, California

Emile J. Rome
1255 South Flower Street
Rich. 7-2358

SEATTLE, WASHINGTON

Adrian VanSanten
135 Harvard North
Minor 3537

CHATTANOOGA, TENNESSEE

W. B. Taylor
Signal Mountain
8-2487

DALLAS 8, TEXAS

Howard D. Crissey
414 East 10th Street
Yale 2-1904

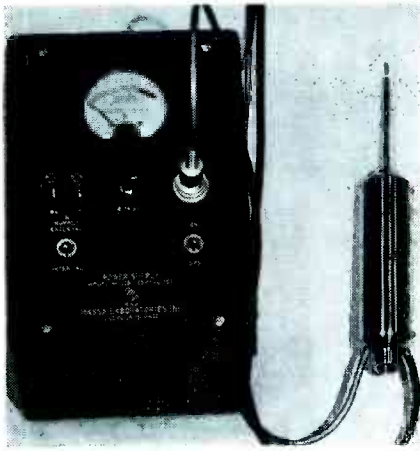
NEW YORK 17, NEW YORK

Henry J. Geist
60 East 42nd Street
MU. 2-7440

WASHINGTON 4, D. C.

Raytheon Manufacturing Co.
739 Munsey Building
Republic 5897

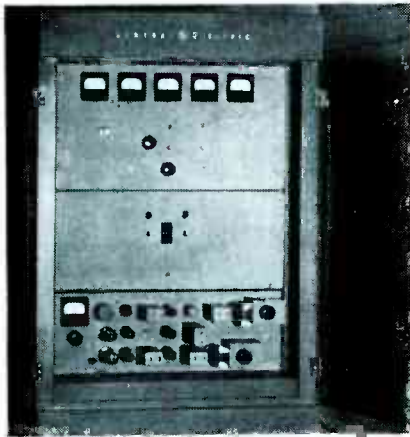
EXPORT SALES — Raytheon Manufacturing Company, International Division, 60 East 42nd Street, New York 17, N. Y., MU. 2-7440



preamplifier, and model M-116 power supply. Precise measurements of absolute sound pressure over the range 50 cycles to 250 kilocycles are possible. The equipment permits special acoustic measurements such as analysis of the sound spectrum from jet engines.

Relay Link

GENERAL ELECTRIC Co., Syracuse, N. Y. Studio-transmitter relay link equipment type BL-2-A operates in the band between 920 and 960 megacycles. Noise level is at least 65 db below 100 percent modulation. Harmonic distortion is less



than 1 percent from 50 to 15,000 cycles, and audio response is within plus or minus 1 db, these measurements being overall from transmitter input to receiver output. Two 40-inch parabolic antennas are used.

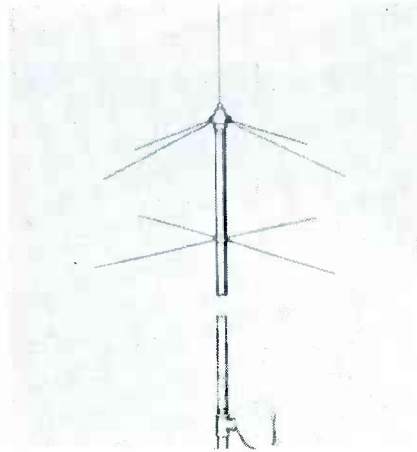
Audio Tape

AUDIO DEVICES, INC., 444 Madison Ave., New York, N. Y. Audiotape

is a vinyl plastic tape treated with a magnetic oxide. When run at a speed of 150 feet per minute it has a frequency response flat to above 15,000 cycles. It can be supplied in limited quantities for test purposes and full production is expected soon.

Ground Plane Antenna

MOTOROLA INC., 4545 Augusta Blvd., Chicago 51, Ill. The Isoplane antenna designed for the frequency



band between 152 and 162 megacycles is an inexpensive device for pickup, monitor receiver, or central station antenna. The design permits exact matching of antenna and leadin cable for low standing wave ratio.

Distortion-Noise Analyzer

GENERAL ELECTRIC Co., Syracuse, N. Y. Type YDA-1 distortion and noise analyzer will measure distortion down to 0.1 percent, measure hum or noise present on an audio signal, act as a high-sensitivity vacuum-tube voltmeter, perform as a frequency meter over the range



50 to 15,000 cycles. It is designed for television broadcast, and research applications.

Group Audiometer

GRAYBAR ELECTRIC Co., 420 Lexington Ave., New York, N. Y. Model 4CA is a group audiometer providing facilities for testing the hear-



ing of from one to forty persons at a time. It is independent of external power sources. A spring-wound motor maintains constant record speed, and long-life batteries supply steady voltage to the vacuum-tube amplifier.

Hydraulic Oscilloscope

K & K ENGINEERING Co., Bolton, N. Y. The Strobeflow comprises a precision turbine that rotates at the



speed of liquid flow. Rotor's speed is determined from the stroboscopic

(continued on page 190)



Voice of America!...

... ON **audiodiscs** *

The Voice of America gives to other nations a full and fair picture of American life, aims and policies, plus factual news of the world and the United States.

Broadcast in twenty-three languages, these programs blanket Europe, Latin America and the Far East, with a potential radio audience of more than 150,000,000 persons.

Of the thirty-two hours of daily broadcast, approximately one-fourth of the time is devoted to

news, one-half to additional comment and informational programs, and the remainder to music and entertainment.

A substantial part of these daily programs is recorded and, due to the excellent quality of these transcriptions, such recorded portions cannot be distinguished from the *live* transmissions.

Today, as from the beginning, the recorded parts of these broadcasts are on AUDIODISCS.

AUDIO DEVICES, INC., 444 Madison Avenue, New York 22, N.Y.

Export Department: Roche International Corp., 13 E. 40th Street, New York 16, N. Y.

Audi discs are manufactured in the U.S.A. under exclusive license from PYRAL, S.A.R.L., Paris ^{REG. U. S. PAT. OFF.}



they speak for themselves **audi discs**

NEWS OF THE INDUSTRY

Edited by JOHN MARKUS

IRE seeks new frequency designations; programs of spring conferences; new FCC questions for operator exams

Citizens Radio Equipment Approved by FCC

THE FCC has issued the first certificate of type approval for equipment to be used in Citizens Radio Service—a radio transceiver designed by Citizens Radio Corp., Cleveland, Ohio, to operate on a frequency of 465 megacycles. Tests show the unit complies with the provisions of Part 19 of the Commission's rules governing Citizens Radio Service. The apparatus weighs about 2½ pounds with batteries and is comparable in size to a camera and carrying case.

Issuance of this type-approval certificate marks the advent of a new service which will be available to individual citizens for personal use in the 460 to 470-mc band. Stations now in operation are authorized as class 2 experimental stations. This approval of the FCC forecasts early availability of manufactured units suitable for this service. The Commission has under consideration establishment of additional rules to provide for simplified licensing for operation by individuals.

Medical Education by Television

NORTHWESTERN UNIVERSITY medical school will use television to bring to the estimated 18,000 physicians and surgeons attending the American Medical Association meeting in Chicago, June 21 through 25, five days of programs showing both surgical procedures and clinical demonstrations.

Among the televised programs will be obstetrical and gynecological procedures, including a caesarian

section; the blue-baby operation; early skin grafting in severe burns; gastric resection; hand surgery and chest surgery. The video camera will also reproduce clinical material in the fields of internal medicine, orthopedics, cancer, dermatology, endocrinology and neurology.

Radio for Circus Traffic

RINGLING BROTHERS Barnum and Bailey Shows, Inc., was granted a construction permit for 15 portable and mobile radio units in the experimental service for use in directing the loading, unloading and

transporting of exhibition equipment. Radio transmitter-receivers will be installed on railroad cars and circus vehicles which move equipment between railroad sidings and show grounds.

Radar-Mapping Australia

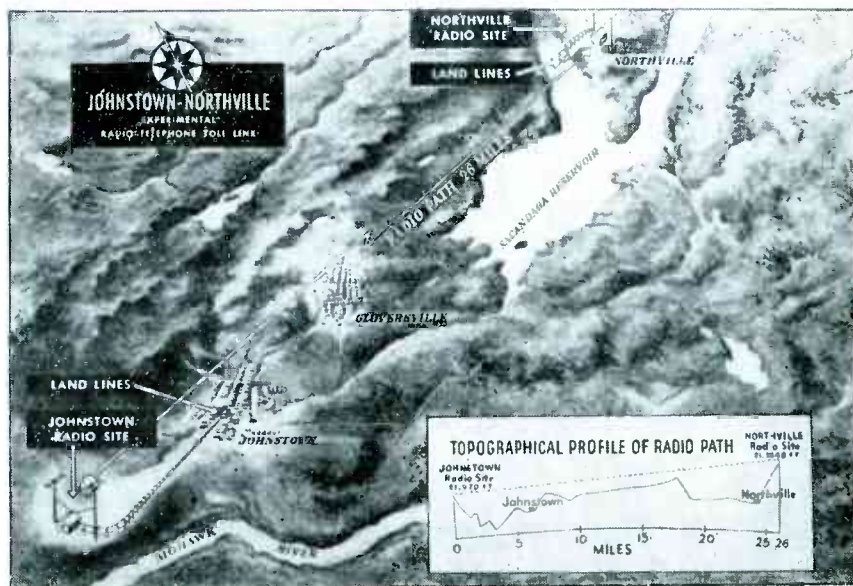
LINCOLN BOMBERS, assisted by mobile radar stations, will soon photograph the terrain and establish radar control suitable for small-scale mapping of Australia.

To ensure that there are no gaps in aerial photography, British equipment, involving the use of one or more G-H stations, will be used in the radar photographic program. To determine the actual position of each photograph it is necessary to have a second G-H station in operation simultaneously.

Television Network Extensions

PLANS HAVE BEEN made by the American Telephone and Telegraph Company to provide additional intercity network facilities this year from the east coast to the Mississippi River. New networks to be built in the midwest and the east will be linked by connecting Phila-

MICROWAVES CLEAR MOUNTAINS



An experimental multichannel vhf radiotelephone toll link has been set up between Johnstown and Northville, New York. Elevation of both ends of the radio link, as indicated on map (lower right), provides a line-of-sight path for the 26-mile stretch

Larvie

UHF PRECISION INSTRUMENTS



HARMONIC FREQUENCY GENERATOR

PROVIDES output voltages in 10 or 40 megacycles with CRYSTAL-CONTROLLED accuracy.

SELECTS 10 or 40 megacycle series by means of front panel switch. IDENTIFIES any one of these harmonics by means of a Frequency Identifier* which consists of a filter providing high attenuation of all voltages except that of frequency to be identified.

USED FOR calibration of receivers, wavemeters, or (with Beat Detector built into instrument) for calibration of oscillators and signal generators.

* Specify frequency.



PRECISION FREQUENCY METER

Completely portable Accuracy 0.1%
Battery or AC-Operated

Models available from 100 to 1500 megacycles with 2 to 1 frequency coverage on each model. Available only on high priority while nation is at war.

RECOMMENDED FOR:

- Production testing
- Measurement of oscillator drift
- Independent alignment of transmitters and receivers
- Precise measurements of frequencies

FULL DETAILS ON REQUEST



Larvie Laboratories

RADIO ENGINEERS AND MANUFACTURERS

MORGANVILLE, N. J.

Specialists in the Development of UHF Equipment

delphia and Cleveland with coaxial cable. Other sections will use both coaxial cables and microwave radio relay systems. It is expected that by the end of the year the same television program can be broadcast simultaneously by stations in cities linked to the network from Boston to St. Louis.

Facsimile for Newspapers

SPECIAL TESTS were recently conducted by the Miami Herald to determine the feasibility of facsimile in newspaper production. Favor-



Facsimile transmitter rolls out newspaper

able reaction was indicated when a picture of an accident casualty being placed in an ambulance was printed on a facsimile receiver before the victim had reached the hospital.

The southern newspaper will place several General Electric sets in operation in a study of editorial production methods and problems.

Broadcast Promotion Via Tape

RADIO STATION KDKA, Pittsburgh, Pa., recently attempted a novel promotional stunt with gratifying results. Each telephone call to the station was answered immediately by a featured NBC performer promoting the evening's broadcast, and then the regular operator would cut in. In a short time the switchboard was overloaded with calls.

The trick programming was accomplished by tape recording. Some twenty of NBC's outstanding stars

MEETINGS

APRIL 24: Spring Technical Conference of IRE Cincinnati Section, featuring television papers, at Engineering Society Headquarters.

APRIL 26-28: IRE-RMA spring meeting on transmitters, Syracuse Hotel, Syracuse, N. Y.

APRIL 28-30: AIEE North Eastern District Meeting, New Haven, Conn.

MAY 3-5: URSI-IRE joint meeting, Washington, D. C.

MAY 9-14: 1948 Radio Parts Show, Hotel Stevens, Chicago.

MAY 11-16: Engineering Progress Show, Franklin Institute, Philadelphia, Pa.: exhibits and two evening lectures.

MAY 17-21: 63rd semiannual convention of the Society of Motion Picture Engineers, at the Ambassador Hotel, Santa Monica, Calif.

MAY 19: Meeting, American Ceramic Society; at 1 West 52nd St., New York City; 5:00 p.m.—The Chemistry of Glass-Metal Seals, by A. J. Monack, consulting engineer; dinner; Ceramic Developments in the Electronic Field, by B. S. Ellefson of Sylvania.

MAY 20-21: Broadcast Engineering Conference, Los Angeles, Calif. (NAB Convention).

MAY 22: Second New England Radio Engineering Meeting, sponsored by North Atlantic

Region of IRE, at Hotel Continental, Cambridge, Mass.

JUNE 21-25: 51st annual meeting of the American Society for Testing Materials, at Detroit, Michigan.

JUNE 21-25: AIEE Summer General Meeting, Mexico City.

JULY 14-16: International symposium on noise, held by the Acoustics Group of the Physical Society and the Royal Institute of British Architects, at the Royal Institute, Portland Place, London, W. 1.

AUG. 20-29: All-Electrical Exposition, Pan-Pacific Auditorium, Los Angeles, Calif.

AUG. 24-27: AIEE Pacific General Meeting, Spokane, Wash.

SEPT. 13-17: Third Instrument Conference and Exhibit, Convention Hall, Philadelphia, Pa.

SEPT. 27-OCT. 2: Third National Plastic Exposition, Grand Central Palace, New York City.

SEPT. 30-OCT. 2: Pacific Electronic Exhibition and IRE west coast Annual Convention, Biltmore Hotel, Los Angeles, Calif.

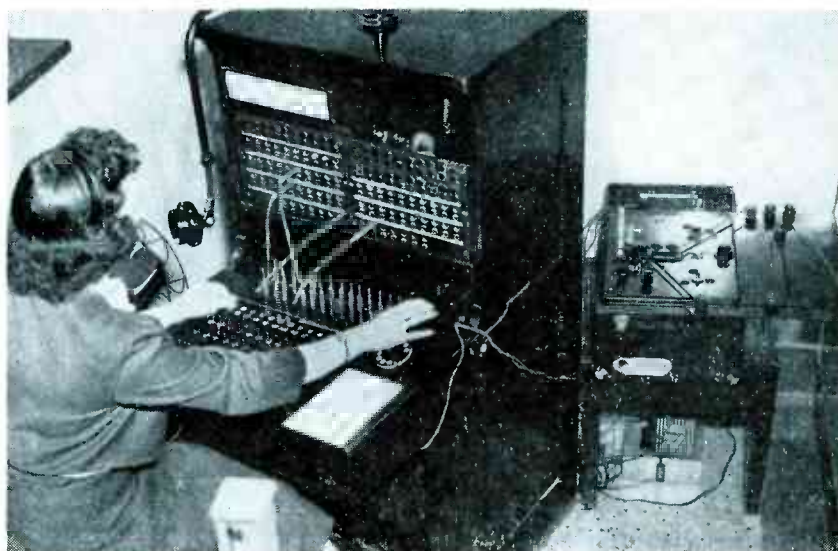
OCT. 5-7: AIEE Middle-Eastern District Meeting, Washington, D. C.

OCT. 11-12: FM Association Second Annual Convention, Sheraton Hotel, Chicago.

made recordings of a few seconds and each record was later transferred to an individual strip of magnetic tape. The tape recorder was connected with the switchboard

after engineers had arranged for the tape to pass through automatically and continuously. When the board buzzed, the operator

(continued on page 238)



Tape recorder feeds voices of radio favorites into switchboard at the press of a button

for A-F DISTORTION and NOISE MEASUREMENTS



... in Sound on Film and Disc Recordings
... in Production Tests on Radio Transmitters & Receivers

FROM necessity, because of war production, the pre-war very popular Type 732-B Distortion & Noise Meter was dropped from the G-R line. It is now in production again to meet an insistent demand for a meter to supplement the new Type 1932-A which is designed primarily for broadcast and communication applications.

The Type 732-B is equipped with a 400-cycle high-pass L-C filter so that harmonic content measurements of a 400-cycle signal can be made rapidly. Because of the width of the pass band, unsteady signals, "wows" and other irregularities do not affect the accuracy of measurement.

The ease with which accurate measurements can be made over the distortion range of 0.25 to 30% and noise range of 30 to 70 db below 100% modulation, make it very valuable in these types of production testing:

ON RADIO TRANSMITTERS

- Signal-to-noise ratio
- Distortion vs.
 - power
 - r-f levels
 - frequency
 - percentage modulation

- A-F response
- Noise vs carrier level
- Hum modulation
- Hum level

ON RADIO RECEIVERS

- Distortion & noise vs a-f output
- Whistle output at 2nd and 3rd harmonic of i.f.
- Two-signal cross-talk

The broad pass band characteristic of this meter is particularly useful when making distortion measurements on sound on film or on disc recordings where the fundamental frequency is not constant.

The Type 732-P1 Range Extension Filter is available as an auxiliary unit so that measurements at additional frequencies of 50, 100, 1000, 5000 and 7500 cycles can be made.

TYPE 732-B DISTORTION and NOISE METER \$374.00
(For either 0.5 to 8 Mc or 3 to 60 Mc carrier range, specify which)

TYPE 732-P1 RANGE EXTENSION FILTER \$209.00

WE HAVE A FEW IN STOCK. ORDER NOW FOR PROMPT SHIPMENT



GENERAL RADIO COMPANY

Cambridge 39,
Massachusetts

90 West St., New York 6

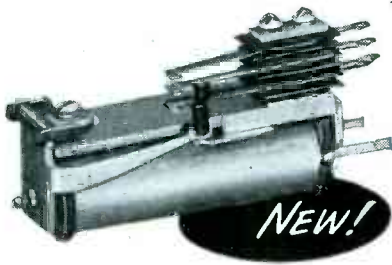
920 S. Michigan Ave., Chicago 5

950 N. Highland Ave., Los Angeles 38



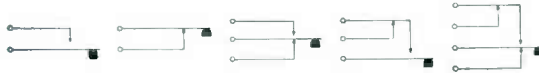
Designers

RELAYS ... for any duty, any duty cycle



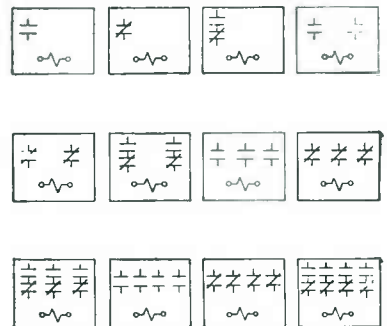
COMMUNICATIONS AND SIGNALING Designed specifically for use in industrial electronic equipment, communications and signaling equipment, this General Electric telephone-type relay has a service life measured in many millions of operations. Working from five basic contact arrangements, combinations can be stacked to satisfy intricate circuit switching requirements.

Welded-crossbar palladium contacts, new-type molded insulation and stainless steel bearings contribute to this d-c relay's longevity. Coils rated 1 to 250 volts, 0.1 to 26,000 ohms; contacts 3 amps maximum. Bulletin GEA-4859.



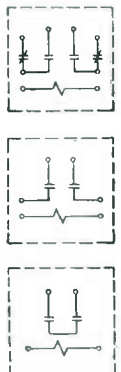
VENDING MACHINES AND DISPENSERS

Designers of coin changers, coin-operated phonographs, drink dispensers, and similar automatic devices will soon be familiar with G.E.'s new appliance relay, an inexpensive multi-contact unit. Featuring quiet operation, reliability and compactness, the CR2790G relay is available in ratings of 24 and 115 volts a-c, 24 volts d-c, 5 amps continuous. Bulletin GEA-4864.



HEAVY-DUTY GENERAL-PURPOSE Three contact arrangements—spst, dpst, and dpdt—plus four mounting arrangements give the CR2790E real versatility. Mounting arrangements available are the enclosed form shown here, open form, back-connected form for panel mounting, and a plug-in form for use in process control equipment.

Its heavy silver contacts are rated 10 amps continuous at 115/230 volts, 60 cycles; normally open contacts will make and break 45 amps, normally closed contacts 20 amps. Bulletin GEC-257 gives full details.



Digest

TIMELY HIGHLIGHTS ON G-E COMPONENTS



DYNAMOTORS FOR QUICK DELIVERY!

Shopping for fractional-hp dynamotors? General Electric can now supply you on a short-shipment basis! Production has finally caught up on these d-c



to a-c converters for communications service. Standard dynamotors are available in ratings of 200 and 500 volt-amperes, 60 cycles, continuous duty. Specials are also available, but on a slightly longer shipment. For more complete information on these fhp equipments, contact your G-E representative or write Fractional-horsepower Motor Div., General Electric Co., Fort Wayne, Indiana.

MORE PULL IN LESS SPACE

You'll find these new, small, all-welded solenoids useful in any application where a straight-line thrust is required... they're a natural for vending machines. The small unit requires only three cubic inches of space, and develops 0.26 pounds pull at 1/2-inch stroke; its "big brother" produces 3.7 pounds at 3/4-inch stroke.

Brazed-in pole shader increases efficiency, insures quiet operation. Varnish-impregnated coil provides high resistance to shock, splashing water, oil. Check Bulletin GEA-4897.



SHOW IT, THEN THEY'LL KNOW IT

If your organization has an educational program underway, or plans one, ask your G-E representative to show you the Industrial Electronics Training Course. Rated tops in visual training by the nation's industrials, schools and institutions now using it, the complete kit contains twelve half-hour slide films with records, individual lesson guides keyed to the film, and a manual for the course instructor.

Everything from fundamental electronics to up-to-the-minute electronic



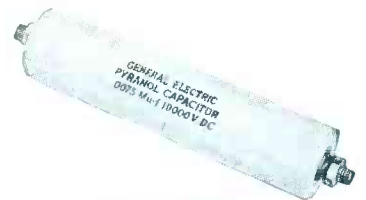
production tools are forcefully described and explained in this easy-to-take visual course. Check Bulletin GES-3303.

NEED SOMETHING SPECIAL IN CAPACITORS?

Here's a new .0075-muf, 10-kv d-c capacitor for television, precipitation, and similar electronic equipment requiring filtering in high-voltage power supply. Other capacitances (.0005 to .01 muf) and voltages (3 to 30 kv) can be supplied.

Ceramic container acts as insulator, simplifies mounting, cuts size (volume) to 1/5th without lowering quality in any

way. Ingenious internal hermetic silicone seal eliminates solder. Pyranol filled. Contact your G-E representative or write Transformer Div., General Electric Co., Pittsfield, Mass., for quotation.



LOOKING FOR

PERMANENT MAGNET DATA?

These two new bulletins are packed full of application and design information to help you build magnets into your electronic equipment. CDM-1 covers "Permanent Magnets"; CDM-2 describes "Cast and Sintered Alnico Magnets." Coupon below will bring this valuable information to your desk quickly. Check it now.



GENERAL ELECTRIC COMPANY, Section A642-17
Apparatus Department, Schenectady, N. Y.

Please send me the following bulletins:

- GEA-4859 Telephone-type Relay GES-3303 Electronics Training Course
 GEA-4864 Appliance Relay CDM-1 Permanent Magnets
 GEC-257 General-purpose Relay CDM-2 Cast & Sintered Alnico Magnets
 GEA-4897 Solenoids

Name.....

Company.....

Address.....

City..... State.....



LOW-RESISTANCE TEST SET # 670C
1,000 to 500,000 micro-ohms
(Other ranges from 200 micro-ohms
to 100 ohms)



KILOVOLT METER # 785P
AC-DC 5-10-20 KV
(Other ranges from 1.5 to 200 KV)

Shallcross



KELVIN-WHEATSTONE BRIDGE # 638-2
0.0001 ohm to 11.11 megohms
7 additional designs and 15 types of
percent limit bridges



DECADE BOX # 825
11,110 ohms in 1 ohm steps
(Other designs, 1 to 7 dials, from
0.1 to 11,111,110 ohms)

... for electrical measurements



VOLTAGE DIVIDER (Decade Potentiometer)
10,000 ohms total. Voltage ratio: 0.001 to 1.0
(Other 3- and 4-dial designs, 1,000
to 100,000 ohms)

Shallcross Electrical Measuring Instruments are made in many types — from sturdy, inexpensive bridges for school and production use, to fault location bridges, high-voltage test equipment, low-resistance test sets and numerous others.

Write for Bulletin on any type.

AKRA-OHM PRECISION RESISTORS
14 Standard Types.
50 available special designs.

PRECISION SWITCHES
350 designs for instruments and high-grade electrical apparatus.

ATTENUATORS & CONTROLS FOR COMMUNICATION EQUIPMENT

Shallcross Manufacturing Co.

Electrical Measurement Specialists
Dept. E-58 Collingdale, Pa.

TUBES AT WORK

(continued from p 130)

ated by the tube V_1 in the variable frequency section is achieved by altering the effective resistance of one element in the phase-shifting network. This could be done by inserting a normal variable resistance in series with one of the fixed resistances, but here the same effect is secured by varying the grid bias of tube V_2 . This tube is a cathode follower, the output impedance of which shunts the center resistance of the phase-shift network. The output impedance is a function of the grid bias on the tube that is controlled by potentiometer R . In short, the frequency of the oscillations generated by the variable oscillator, and hence the resulting tone frequency, is determined by the setting of R .

Potentiometer R may be mounted at any desired distance from the apparatus. The lead from its slider carries no current and can therefore cause no instability, however long it is. The potentiometer dial can be calibrated in frequency.

In practice, both oscillators are set to the same frequency (about 100 kc) with V_2 biased almost to cutoff, but if V_2 has a variable- μ characteristic it need not be biased so far back as might otherwise be necessary.

Instead of a cathode follower for frequency control, a negative-resistance transitron could be used and in this case the magnitude of the negative resistance is a function of the grid bias.

Capacitors and Selenium Rectifiers

BY F. FARMLY AND E. SHERICH
*Engineering Department
Cornell-Dubilier Electric Corp.
South Plainfield, N. J.*

WHEN electrolytic capacitors are used in rectifier circuits with selenium cells, the capacitors are often subjected to severe operating conditions, including high values of ripple current.

Ripple voltage has the effect of decreasing the life of the electrolytic capacitor by increasing the heat generated and therefore the leakage current. It also tends to reduce the effective value of the capacitance. This effect is caused by

Why slow down the whole assembly line?



For continuous performance use the only 3 core solder made with ERSIN FLUX--The original non-corrosive, extra-active flux

ERSIN

Multicore



One tough soldering operation can slow the pace of a whole assembly line. Try Ersin Multicore on the toughest soldering job in your plant. Note how the incomparable Ersin Flux reduces the surface tension of molten solder, — how it wets metals faster, — how it gives maximum and speedy fluxing action and greater coverage in less time.

A number of the industry's most prominent manufacturers have tested Multicore, seen for themselves, and are now using it exclusively.

AVAILABLE IN ALL ALLOYS AND GAUGES.

Address U.S.A. and Canadian inquiries to:

BRITISH INDUSTRIES CORP.
315 Broadway, New York 7, N. Y.

Inquiries regarding other territories to:

MULTICORE SOLDERS LTD.
Mellier House, Albemarle Street, London, W. 1, England

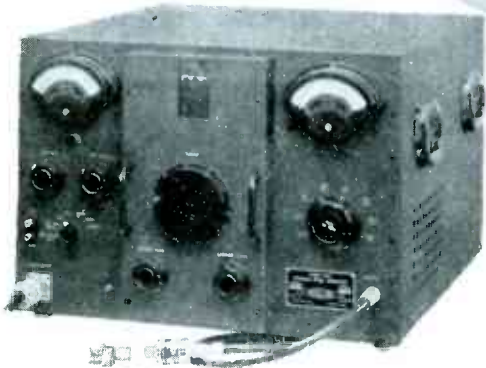
SOLDERS and SOLDERING
Complete and full



Write for He pfu Booklet,
"SOLDERS AND SOLDERING"

VHF-UHF WATTS "BOTTLED UP"!

M. O. P. A.
2C39 OSCILLATOR
2C39 AMPLIFIER



POWER
TO DRIVE AN
ANTENNA
160 db
MICROVOLTS
TO MEASURE
RECEIVER
SENSITIVITY

40MC-400MC

MODEL 30

ROLLIN POWER TYPE STANDARD SIGNAL GENERATOR

- ▶ 5 WATTS NOMINAL R-F OUTPUT — 50 OHM IMPEDANCE.
- ▶ 160 DB RANGE OF ATTENUATION — 15.0 VOLTS TO 0.10 UV.
- ▶ CW — AM — PULSE OPERATION.
- ▶ MASTER OSCILLATOR — TUNED POWER AMPLIFIER CIRCUIT.
- ▶ CONTINUOUS TUNING 40MC TO 400MC — SPIRAL DIAL SCALE 4 FEET LONG
- ▶ DIAL CALIBRATED AT INTERVALS OF 1% IN FREQUENCY.
- ▶ LEAKAGE FIELDS LESS THAN .1 UV/METER.

Write for details



THE ROLLIN COMPANY
2070 N. FAIR OAKS AVE. • PASADENA 3, CALIF.

cathode foil formation which acts as a capacitance in series with the original anode capacitance, thus reducing the overall effective capacitance. The use of a too-low capacitance in a circuit must be avoided, since the lower the capacitance, the higher the ripple voltage.

Current-limiting Resistors

Whenever practicable, the use of a current-limiting resistor in selenium rectifier circuits is recommended. Without a protective resistor, charging current of the capacitor may reach an excessive value that may ruin the selenium cell and cause untimely failure of

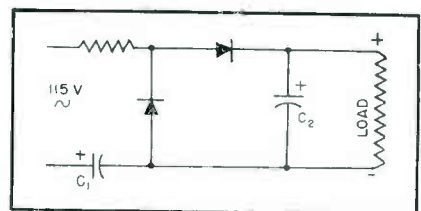


FIG. 1—Series line-feed voltage doubler

the capacitor. Since the peak charging current increases with the size of the capacitor, the size of the capacitor must be limited so that failure of the selenium cell will not be accelerated.

Severe reverse current surges, which occur in all selenium cells during re-formation of the barrier layer, may last for several minutes. During such periods, associated capacitors are subjected to abnormal reverse currents and voltages. Excessive heating and tendency to cathode foil formation take place much as when ripple currents are too large.

An adequate protective resistor limits charging current and reverse current surges to values which are within reasonable safety limitations.

Capacitor ratings are based also upon maximum ripple voltages, which in turn depend upon normal line voltages. A resistor included in the circuit guards against damage from high line voltages.

With current-limiting resistors, there is a slight decrease in output voltage and slightly poorer voltage regulation. For improvement in output voltage and regulation, the resistance used may be decreased; but this is at the cost of less safety,

SELECT from the

Techniquality

GROUP



Bliley CRYSTALS

Many Bliley crystal units are first produced on a custom-built basis for special application. Quite often these designs contain outstanding features that are desirable in many applications and when this occurs the unit is included in our catalog listing. Our Bulletin 36 contains 22 standard crystal units, all widely used in commercial and governmental applications.

Bliley engineers are constantly utilizing

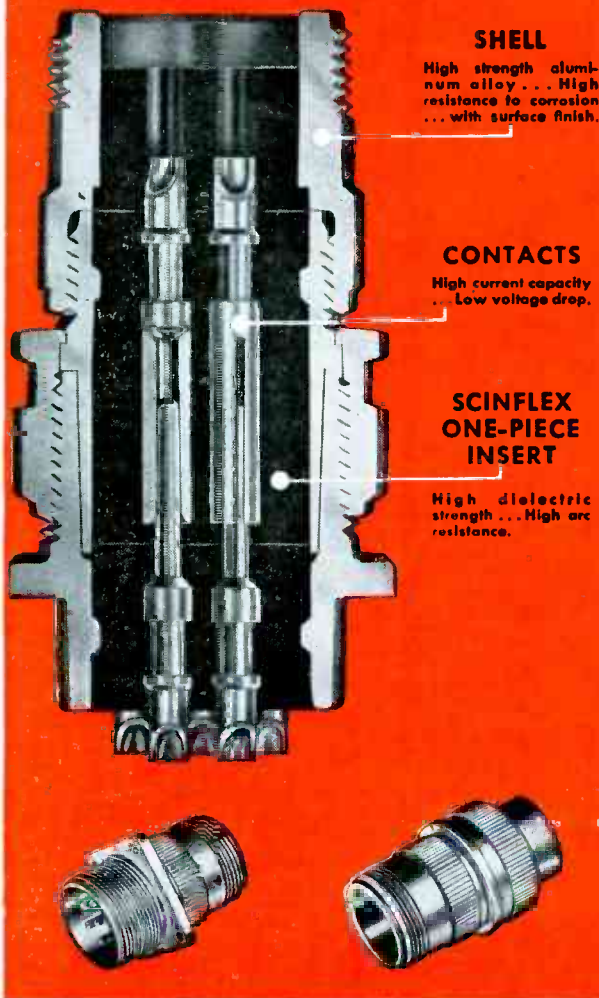
our many years of specialized experience to solve new frequency control problems. If you have a frequency control application, whether standard or specialized, we can probably come up with the right answer. Remember to specify Bliley TECHNICALITY crystals for greater accuracy, stability, quality, and advance design.

WRITE FOR YOUR COPY OF BULLETIN 36

BLILEY ELECTRIC COMPANY • UNION STATION BUILDING • ERIE, PENNSYLVANIA

BENDIX-SCINTILLA

the finest ELECTRICAL CONNECTORS
money can build or buy!



SHELL

High strength aluminum alloy... High resistance to corrosion... with surface finish.

CONTACTS

High current capacity... Low voltage drop.

SCINFLEX ONE-PIECE INSERT

High dielectric strength... High arc resistance.

AND THE SECRET IS SCINFLEX!

Bendix-Scintilla* Electrical Connectors are precision-built to render peak efficiency day-in and day-out even under difficult operating conditions. The use of "Scinflex" dielectric material, a new Bendix-Scintilla development of outstanding stability, makes them vibration-proof, moisture-proof, pressure-tight, and increases flashover and creepage distances. In temperature extremes, from -67° F. to $+300^{\circ}$ F., performance is remarkable. Dielectric strength is never less than 300 volts per mil.

The contacts, made of the finest materials, carry maximum currents with the lowest voltage drop known to the industry. Bendix-Scintilla Connectors have fewer parts than any other connector on the market—an exclusive feature that means lower maintenance cost and better performance.

*REG. U.S. PAT. OFF.

Write our Sales Department for detailed information.

- Moisture-proof, Pressure-tight • Radio Quiet • Single-piece Inserts
- Vibration-proof • Light Weight • High Arc Resistance • Easy Assembly and Disassembly • Less parts than any other Connector

Available in all Standard A.N. Contact Configurations



TUBES AT WORK

(continued)

greater capacitor ripple current and therefore greater capacitor size and cost.

A value of 50 ohms has been found generally acceptable; this conservative figure may be reduced where current demand is not excessive.

Capacitor Selection

The following factors determine the capacitor suitable for a particular selenium rectifier circuit: no-load and full-load d-c working voltage, full-load rms ripple current through the capacitor, ripple frequency, and maximum ambient temperature at which the capacitor will operate.

Where high ripple current is encountered, an aluminum-contained capacitor is recommended. The heavy ripple currents cause cardboard-contained capacitors to dry out quickly.

Half-Wave Circuit

The choice of a capacitor suitable for the half-wave circuit depends chiefly upon d-c output current desired and maximum permissible ripple voltage.

The capacitance needed for a particular value of ripple voltage can be calculated. In the time $1/f$ (for one cycle) the capacitor discharges through the load at an approximately constant rate, I_{D-c} . The capacitor loses an amount of charge I_{D-c}/f . Therefore its voltage changes by the amount $V = I_{D-c}/fC = Q/C$. Hence the ripple voltage is: $V_R = I_{D-c}/fC$. And the capacitor needed is: $C = I_{D-c}/fV_R$.

Since the discharge current does not decrease exactly linearly with time, but varies exponentially, a slight error is introduced. The error is on the side of caution, since the calculated value will be slightly larger than the C actually required. Thus the C used may be slightly lower than the value calculated, but too great a reduction will result in larger ripple currents and voltages and a shorter capacitor life.

In simple half-wave circuits, all electrolytic capacitors, including filter and bypass sections, may be incorporated into the same container, as a common negative terminal may be used for all sections.

In full-wave doubler circuits, two rectifiers operate alternately on



ATV LEAD-IN LINES

Get Good Receptions!

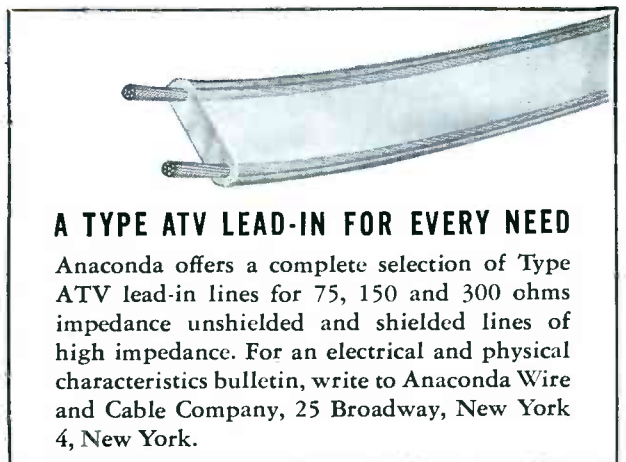
YOU WILL BE MORE CERTAIN to get the best receptions from your television or FM set when you specify ATV[®] lead-in lines.

The effects of attenuation and impedance mismatch on FM and Television reception are minimized by Anaconda Type ATV lead-in lines.

The satin-smooth polyethylene insulation of Type ATV line sheds water readily, thus avoiding subsequent impedance discontinuities. This material also has exceptionally high resistance to corrosion. Count on Anaconda to solve your high-frequency transmission problems—with anything from a new-type lead-in line to the latest development in coaxial cables.

48446

*An Anaconda Trade-Mark



A TYPE ATV LEAD-IN FOR EVERY NEED

Anaconda offers a complete selection of Type ATV lead-in lines for 75, 150 and 300 ohms impedance unshielded and shielded lines of high impedance. For an electrical and physical characteristics bulletin, write to Anaconda Wire and Cable Company, 25 Broadway, New York 4, New York.



Anaconda Wire and Cable Co.

The ADC of the ELECTRONICS INDUSTRY

TRANSFORMERS

CATALOG TRANSFORMERS . . . that meet our catalog specifications.

SPECIAL TRANSFORMERS . . . that meet your specifications.

● A wide range of stock transformers is accompanied by an engineering service that offers industry a dependable source of special transformers for every requirement. Write for catalog or supply specifications for special transformers.

FILTERS

Engineering to provide any filter that you will need. Manufacturing facilities that assure you dependable production schedules and uniformly dependable filters.

Illustrated band pass filter is typical of the unusual engineered filters that ADC produces for electronics industry. Write ADC for prompt and efficient engineering and production service for filters.

PATCH CORDS and JACK PANELS

ADC patch cords are used as standard by hundreds of broadcast stations over the country. They are preferred for their dependability and quality. Write for catalog.

Jack panels . . . companion to patch cords. Molded plastic for better insulation. Used where quality and durability are needed. Mount on 19" relay rack. Furnished with jacks assembled or panels only. Write for ADC catalog for complete specifications.



Foreign INQUIRIES SOLICITED

. . . please direct foreign inquiries to the ADC foreign export office same address.

CABLE ADDRESS: AUDEVCO MINNEAPOLIS

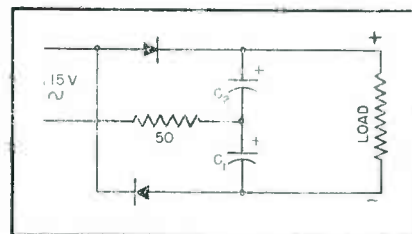


FIG. 2—Full-wave symmetrical voltage doubler

the positive and negative loops of the a-c line voltage to charge the input capacitors, which discharge additively into the load.

In the series line-feed circuit of Fig. 1, the first capacitor C_1 is in series with one leg of the line. It doubles the load voltage by charging up to peak line voltage and then adding its charge to the line during each succeeding cycle. However C_1 impresses a large ripple voltage upon the load. To reduce this ripple voltage C_2 is added. Usually an additional L-C line filter is placed before the load.

A common container for all the capacitors is not advisable. The ripple currents in C_1 are much higher than any others and cause greater heating of C_1 , and if C_1 and C_2 were in the same container C_2 would become unnecessarily heated in circuits having large load and ripple currents. Filter and further bypass capacitors may be put in one container.

For small load and ripple currents, the peak voltage rating of C_2 and following bypass capacitors must be almost double peak line voltage, if no 50-ohm resistor is used, and may be about 10 percent less if a resistor is used (depending upon circuit constants.) The peak voltage rating of C_1 must be at least peak a-c line voltage.

Symmetrical Doubler Circuit

In symmetrical voltage-doubler circuits, such as Fig. 2, each of the two capacitors alternately charges to the peak a-c line voltage while the other is discharging through the load. Thus, their voltage rating need equal only the peak line voltage.

The ripple voltage across each of the input capacitors is equal, unlike the series line-feed circuit.

It is recommended that C_1 and C_2 not be placed in the same container, since they are connected in

American Lava production ranges from production of "impossible" highly complex shapes with very special physical characteristics to mass production of simple shapes at lowest cost.



**YOU GAIN
by Our
Experience**

● In its 47th year of specialization in custom made technical ceramics, American Lava Corporation offers you a combination of research, technical skill, practical experience and economical manufacture which is not available from any other source . . . Whatever your problem, if it involves technical ceramics, this is your best source of information and your best source of supply. Your inquiry will have prompt attention.

PROPERTY CHART giving the physical characteristics of the more frequently used Alsimag Technical Ceramic Compositions sent without cost on your request.



47TH YEAR OF CERAMIC LEADERSHIP

AMERICAN LAVA CORPORATION

CHATTANOOGA 5, TENNESSEE

SALES OFFICES: ST. LOUIS, MO., 1123 Washington Ave., Tel: Garfield 4959 • CAMBRIDGE, MASS., 38-B Brattle St., Tel: Kirkland 4498 • PHILADELPHIA, PENNA. 1649 N. Broad St., Tel: Stevenson 4-2823
NEWARK, N. J., 671 Broad St., Tel: Mitchell 2-8159 • CHICAGO, 9 S. Clinton St., Tel: Central 1721 • SAN FRANCISCO, 163 2nd. St., Tel: Douglas 2464 • LOS ANGELES, 324 N. San Pedro St., Tel: Mutual 9076

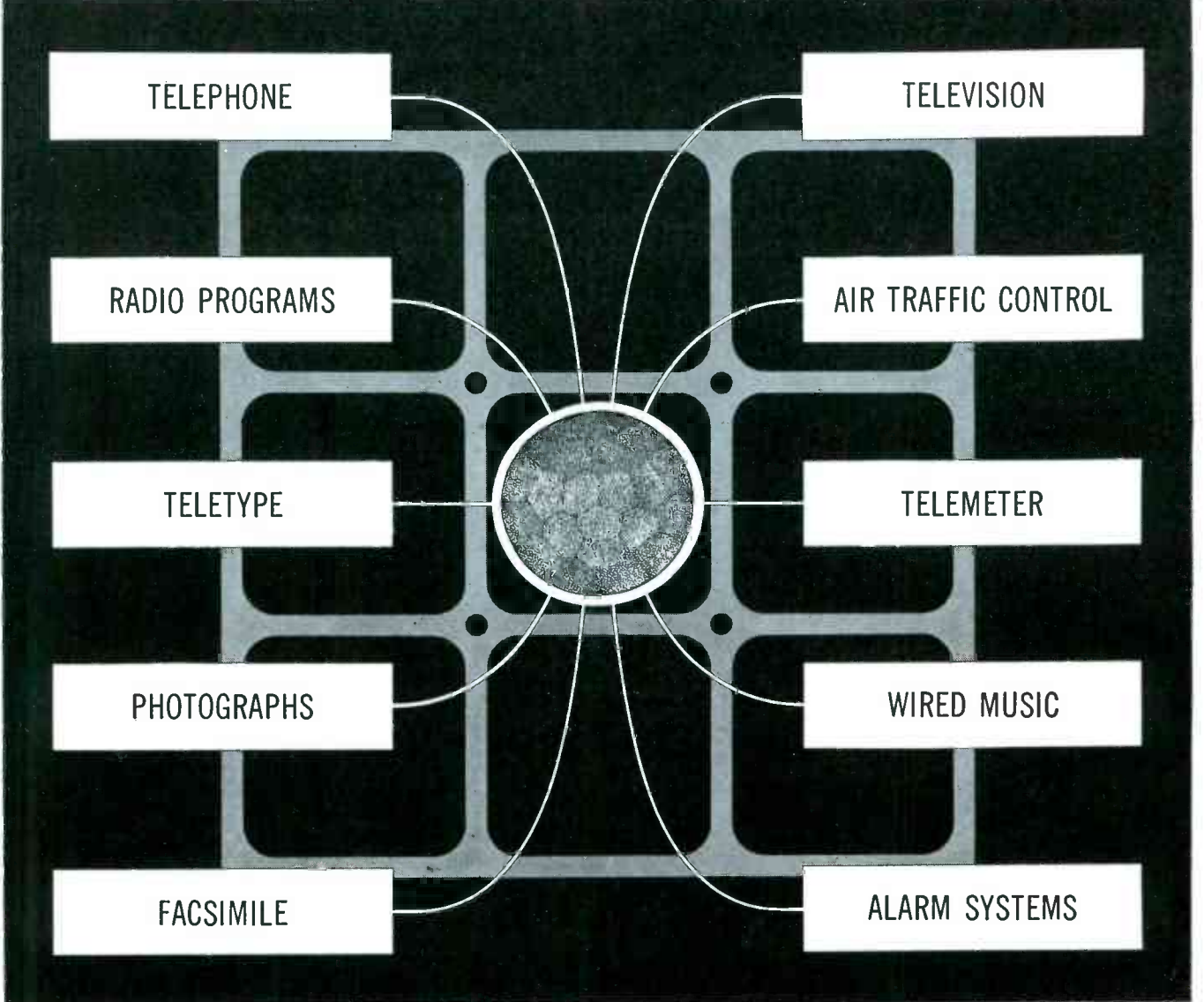
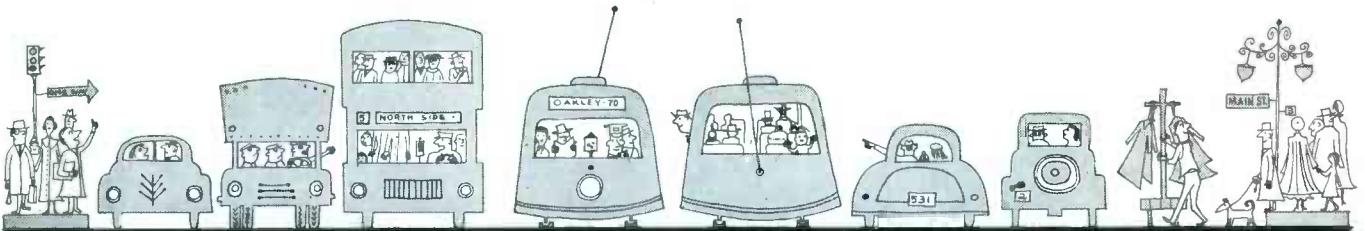
Traffic is heavy under the street, too

Surely the busiest thoroughfare in the world is a telephone cable. But it is more than "telephone"; for these thousand or more wires, carrying sound and pictures at lightning speed, are highways for many different services.

Each one of these presents its own problems to Bell Laboratories scientists and engineers: for the telephone differs from television, and television differs from a radio program. And yet they have an essential unity: they

involve transmission of alternating currents, with frequencies from zero up to several million cycles. Each calls for new thinking, new ideas, new goals of accomplishment.

The diversity of the cable's many services speaks for the unity of Bell Laboratories' purpose. That is, to know the theory of communication so thoroughly, to practice the art so skilfully, that any transmission of sight or sound can reach its destination clearly, quickly, economically.



BELL TELEPHONE LABORATORIES

Exploring and inventing, devising and perfecting for continued improvements and economies in telephone service



series in the circuit and leakage currents between them would be high. However *C* and any additional bypass capacitors may be placed in the same container, because they have a common negative terminal.

Automatic Lighting Switch

BY CARL C. SMITH
*Electronic Consultant
Niagara Falls, Canada*

MANY circuit arrangements designed for automatic control of lighting circuits with decreasing daylight incorporate time-delay networks, inverse feedback and a number of other auxiliary circuits to improve the overall response of the equipment to the initiating variable for which they are designed. The equipment to be described affords reliable operation over long periods of time with minimum tube or accessory replacements.

Essentially, the unit consists of a photoemissive tube of selected spectral characteristics whose output is amplified to a current value sufficient to operate a sensitive relay in the plate circuit of the output tube. The value of this relay current is adjustable over a wide range by means of a current-adjusting potentiometer in this circuit.

The input sensitivity of the device is adjustable by means of a bias potentiometer in the grid circuit of the input tube. Since, in this amplifier, the output (and relay) current increases with increased light on the photoelectric surface, the armature of the sensitive relay is pulled in with light values on the phototube which exceed a predetermined value.

The controlled lighting circuits are opened or closed by auxiliary magnetic contactors capable of handling the lighting load to be controlled, the sensitive relay operating the coil of the magnetic contactors only. With normal values of light on the phototube, the sensitive relay contacts which operate the auxiliary relays are opened, thereby deenergizing the circuits. When the daylight value decreases below the preset value, the sensitive relay armature drops out, closing the load circuit contac-



UNLIMITED applications

Ward Leonard 130 Relay easily adapted to a wide variety of requirements

The principle of using one basic construction makes Ward Leonard's 130 Relay both versatile and economical. Merely by the selection of certain interchangeable parts in the assembly we can adapt it to a thousand and one applications.

Here again is Result-Engineering . . . modifying a basic design to give you the results of a special . . . at the price of a standard.

Write for Relay Catalog. Ward Leonard Electric Co., 31 South Street, Mount Vernon, New York. Offices in principal cities of U. S. and Canada.

WHERE
BASIC
DESIGNS
IN
ELECTRIC
CONTROLS
ARE
RESULT
ENGINEERED
FOR
YOU



WARD LEONARD ELECTRIC COMPANY

RESISTORS • RHEOSTATS • RELAYS • CONTROL DEVICES

8
OF
13
MAJOR
TYPE
SERIES



TYPE "AN"
AN3101
Extension Cord Receptacle



TYPE "K"
WK-21C Plug
Integral Clamp Type
(shell only shown)



TYPE "DP"
DP-S10-33
DP-S10-34
Both Panel Mounted

CANNON PLUGS



TYPE "TQ"
TQ-1-13B
Receptacle



TYPE "P"
P-CG-15
Angle 90° Plug

ALL TOLD
IN THE
C-47
CATALOG
Address
Dept.
E-120



TYPE "O"
O3-13
Receptacle



TYPE "AP"
AP-5-23-5/8 Plug



TYPE "XK"
XL-13L
Receptacle

ASK THE
MEN
WHO
USE
THEM

CANNON ELECTRIC



SINCE 1915

Development Company

IN CANADA & BRITISH EMPIRE:
CANNON ELECTRIC COMPANY, LTD.
TORONTO 13, ONTARIO

3209 HUMBOLDT ST., LOS ANGELES 31, CALIF.

WORLD EXPORT (excepting British Empire):
● FRAZAR & HANSEN, 301 CLAY STREET
SAN FRANCISCO 11, CALIFORNIA

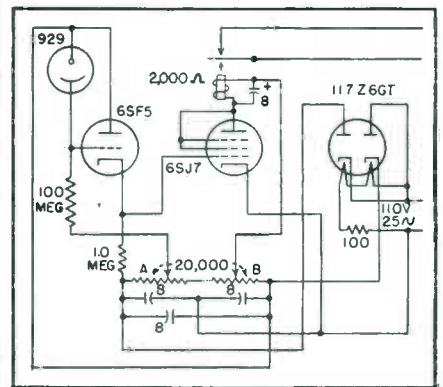
TUBES AT WORK

(continued)

tors. This feature offers the advantage that with tube or certain other component failure, the operation of the lighting circuits is assured and areas designated to be lighted by this control will not be left in darkness.

Operation

The operating characteristics of the circuit are such that full pre-adjusted relay current is obtained above a small value of daylight intensity on the phototube. This value of daylight is adjustable to a minimum value of approximately 0.5 foot-candle. At or above whatever level of daylight to which the device is adjusted to operate, the final tube current remains constant at



Circuit of simple lighting control. Potentiometer A provides adjustment of input sensitivity and potentiometer B the relay current

the pre-set value, neither increasing nor decreasing from this value, over a wide variation in light on the phototube. Smoke from locomotives, heavy rain, fog or dense cloud formation does not cause sporadic operation of the device and time-delay circuits or mechanisms are not required.

The phototube, hooded for an angle of view of approximately 60 degrees, is mounted to obtain an uninterrupted view of the northern sky and located where extraneous light from indoors or the controlled lighting units is a minimum. The entire unit can be mounted indoors and the phototube, connected by a length of shielded cable to the amplifier, mounted on a bracket at a window or transom affording a northern exposure.

The sensitivity control is adjusted to permit drop-out of the sensitive relay armature at the

Put This Formula To Work For You

$$I = \frac{E}{IRC}$$

The formula $I = \frac{E}{IRC}$ is a favorite and easily-remembered solution to resistance problems. Radio and electronic Engineers know that IRC offers the most complete line of resistance products in the industry . . . a fixed or variable resistor for most every requirement . . . with uniform dependability proved by years of rigorous laboratory and field tests. Purchasing Agents and material control executives like IRC's service . . . "on-time" deliveries . . . factory stock-piles of the most popular types and ranges from which they can draw in emergency . . . IRC's distributor network, providing speedy, round-the-corner service for small order requirements.

Put this formula to work for you . . . check below the catalog bulletins in which you are interested, and write for them today on your letterhead, giving your name and title. International Resistance Company, 401 N. Broad Street, Philadelphia 8, Pennsylvania. In Canada: International Resistance Company, Ltd., Toronto, licensee.



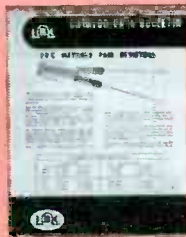
INSULATED COMPOSITION INSULATED WIRE WOUND RESISTORS
IRC types BT & BW



FINGER-TIP CONTROLS AND SWITCHES
IRC types H & SH



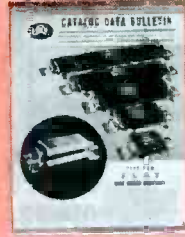
WIRE WOUND RESISTORS
IRC type MW



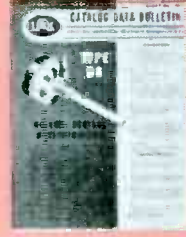
MATCHED PAIR RESISTORS



POWER RESISTORS



FLAT POWER RESISTORS
IRC type FRW



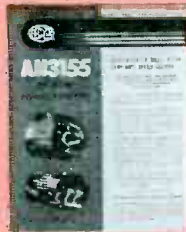
VOLUME CONTROLS
IRC type DS



WIRE WOUND POTENTIOMETERS
IRC type W



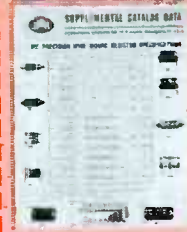
VOLTMETER MULTIPLIERS
IRC types MFA & MFB



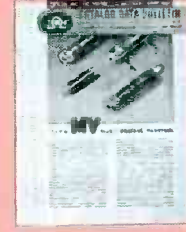
POWER RHEOSTATS
IRC types PR & PRT



WATER-COOLED RESISTORS
IRC type LP



PRECISION RESISTORS



HIGH VOLTAGE RESISTORS
IRC type MV



HIGH POWER RESISTORS
IRC type MP

INTERNATIONAL RESISTANCE COMPANY

Wherever the circuit says \sim

Power Resistors • Precision • Insulated Composition Resistors • Low Wattage Wire Wounds • Rheostats • Controls • Voltmeter Multipliers • Voltage Dividers • HF and High Voltage Resistors

Did You Know...



THAT IN 2 MINUTES
AN AVERAGE RADIO
SPEAKER EXERTS
ENOUGH ENERGY TO
HIT A BASEBALL
OVER 850 FEET?

That's a homerun in any ball game but of course you can't put a loudspeaker in as a pinch-hitter. However, it is true that the amount of energy exerted by an average radio speaker in just 2 minutes could hit a baseball 850 feet! This means that although OPERADIO builds speakers with the skill and care of a watchmaker... these speakers are sturdily constructed to stand up under heavy, continuous use. OPERADIO speakers are delicately balanced to authentically reproduce the sweetest high notes of a piccolo, yet, carry the tremendous power of a full orchestra crescendo.



ASK FOR OPERADIO SPEAKERS —
A FULL LINE OF OUTSTANDING
SPEAKERS FOR EVERY PURPOSE!

OPERADIO

RADIO REPLACEMENT and PUBLIC ADDRESS SPEAKERS

OPERADIO MFG. COMPANY • St. Charles, Illinois

value of daylight at which operation is desired. With full normal daylight value on the phototube, the relay current is adjusted to 5 milliamperes. With darkness, by which is meant light values below the pre-determined operating value, the output current should be checked with any extraneous light on the phototube to insure that current due to this light is not of sufficient value to pull in the sensitive relay.

Controls of this type have been applied to neon and advertising signs, unattended transformer and switching stations and street and schoolroom lighting. One unit has been successfully employed as a burglar-alarm system, using an infrared sensitive phototube and a filtered light source, and a number of them have been in continuous operation for periods as long as two years without maintenance or component replacement of any kind.

Electronic Lightning Alarm

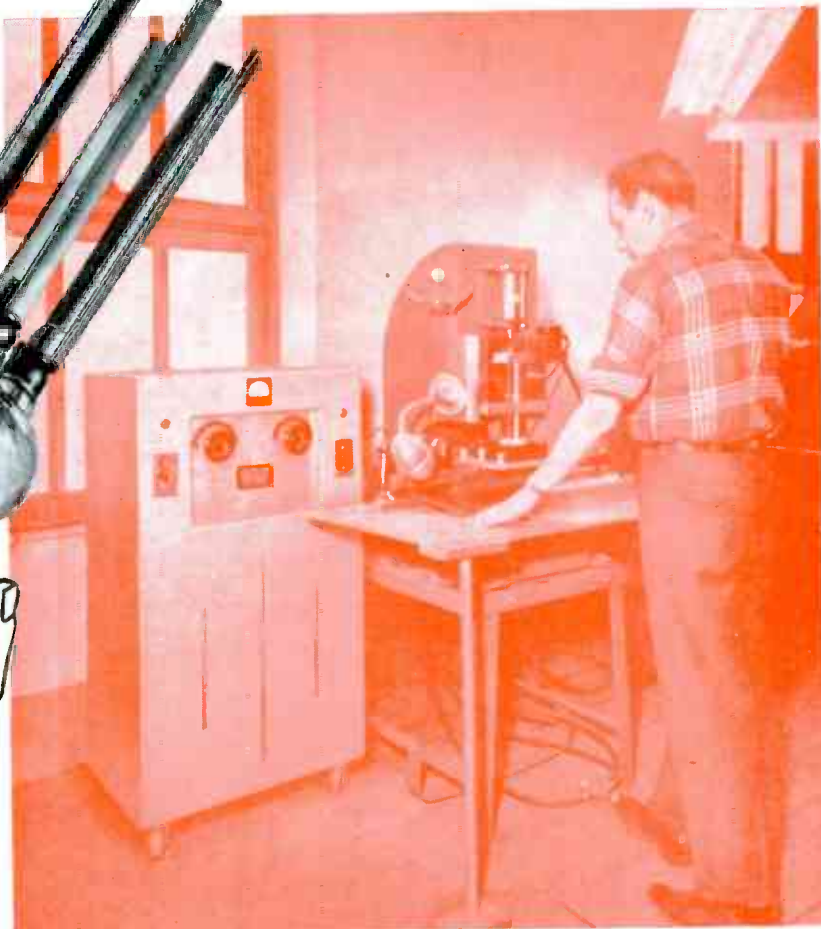
SOUTH AFRICAN engineers B. F. J. Schonland and P. G. Gane have developed an electronism that warns of the approach of thunderstorms. The device provides two degrees of warning: (1) that lightning flashes have occurred within a radius of either 7 miles or 20 miles, depending upon the setting of a near-far



Witwatersrand gold miners are warned to store their explosives when this electronic lightning alarm sounds. It gives a short ring for each positive pulse due to a lightning flash and intermittent rings when the antenna current exceeds $2 \mu\alpha$. A flasher tube also operates

PLASTICS SEALED IN 2 SECONDS

with the aid of this
**FEDERAL
7C25 TUBE**



One Federal 7C25 tube provides ample power for this 2½ Kw electronic heater, made by the Kabar Manufacturing Corp., N. Y. C., for Plastitronics, Inc. This machine is used for super-fast bar sealing of synthetic rubber toys and novelties.

AT Plastitronics, Inc., in New York City, Federal's 7C25 tubes are on the job—delivering the H-F power for electronic heaters that seal 12 to 20 gauge plastics in 2 seconds.

In this kind of rugged industrial service, the tube—virtually the heart of the entire dielectric heating equipment—has to withstand the stress of sudden load changes, mechanical shocks, and vibration. Jobs like this, in all types of industrial electronic equipment, call for the extra *stamina*, the inherent *overload*

capacity, and enduring *performance* of Federal tubes. For every Federal industrial tube is designed to stay on the job *longer* under the most severe operating conditions—to keep production lines rolling, with fewer shut-downs for tube replacements.

To give *your* electronic equipment the added advantage of longer life, with reserve power for emergency overloads, specify Federal industrial tubes. Write today for complete catalog of Federal tube specifications. Dept. L913.



Federal Telephone and Radio Corporation

100 KINGSLAND ROAD, CLIFTON, NEW JERSEY

KEEPING FEDERAL YEARS AHEAD... is IT&T's world-wide research and engineering organization, of which the Federal Telecommunication Laboratories, Nutley, N. J., is a unit.

In Canada:—Federal Electric Manufacturing Company, Ltd., Montreal, P. Q.
Export Distributors:—International Standard Electric Corp. 67 Broad St., N. Y.

The Life of Your Product Hangs by a **THREAD**

The screws, bolts, nuts or other threaded fastenings used in the assemblies of your product are determining factors in the length of its consumer service.

HOLTITE Engineered Fastenings REG. U.S. PAT. OFF.

are precision-made of the finest materials to insure speedy application and enduring service. Accurate and rugged they effect production economics by reducing driving time, waste and spoilage. But most important, in the assemblies of your product their precise, uniform thread form and structural strength defy the loosening effects of vibration to assure long, trouble-free service. Specify HOLTITE for your next fastening requirements.



CONTINENTAL
SCREW CO. New Bedford, Mass., U.S.A.

TUBES AT WORK

(continued)

switch, or (2) that a lightning flash in the immediate neighborhood of the instrument is imminent. This lightning alarm was designed for the protection of personnel involved in the manufacture, storage and use of explosives.

The meteorological conditions on which operation of the device depends are as follows: A thundercloud carries a charge that is negative relative to ground and which produces an electrostatic field between the cloud and grounded objects. Under these conditions, a positive charge will reside on a grounded antenna in the field. When a discharge between the cloud and ground occurs, the charge on the antenna will flow toward ground. Therefore, if a resistor of suitable value is connected between antenna and ground, the flow of current from the antenna will produce a positive voltage pulse which can be used to trigger the warning device.

The average field change due to flashes which are not extremely near is of the order

$$E = \frac{9 \times 10^6}{L^2} \text{ volts per meter}$$

where L is in kilometers.

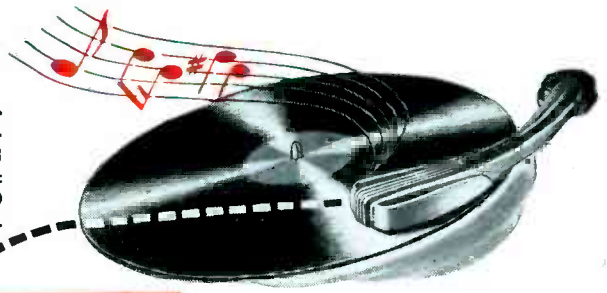
Another effect takes place when the thundercloud approaches close enough so that a lightning flash in the immediate vicinity can occur. This effect is the flow of corona current from the antenna to the cloud overhead. Note that the direction of flow of corona current is opposite to that of the antenna discharge current discussed above. In this instrument with the particular antenna used, corona current amounted to about 2 microamperes.

Circuit Operation

The circuit of the electronism is given in Fig. 1. The input circuits have a resistance to ground of about 0.5 megohm and are connected to the grid of V_1 . The network comprising R_1 , R_2 , C_1 , C_2 form an attenuator to reduce the transient due to a flash about 27 times when required for near sensitivity. It can be seen from the equation that this reduction in sensitivity corresponds to a reduction in range by a factor of about 3.

Tube V_1 performs two functions. It transmits transients, amplified in

The G-E Electronic Reproducer, which magnetically re-creates the full recorded sound, derives its magnetic field from a G-E SINTERED ALNICO 5 permanent magnet.



Announcing...

A NEW

**G-E DEVELOPMENT
SINTERED ALNICO 5**



Actual size of G-E SINTERED ALNICO 5 permanent magnet used in the G-E Electronic Reproducer is shown in red.

NEW ENGINEERING DEVELOPMENT
SINTERED ALNICO 5, General Electric's newest magnetic material, now enables you to design intricate shapes with higher external energy than ever before. The minimum guaranteed available energy is 3,500,000 gauss oersteds for most sizes and shapes. New G-E SINTERED ALNICO 5 possesses tensile properties several times those of CAST ALNICO 5 and can be produced economically in small size parts. You get better surface finish plus closer dimensional tolerances with new G-E SINTERED ALNICO 5.

NEW DESIGNS POSSIBLE
New SINTERED ALNICO 5 has higher external energy than either SINTERED ALNICO 2 or 4. This makes possible new designs heretofore impossible or impractical. It is especially adaptable where small powerful magnets having high magnetic properties are required. Because of their great stability and external energy, SINTERED

ALNICO 5 magnets can save valuable space in your product. You can usually improve your product by re-designing to use high energy G-E SINTERED ALNICO 5. Typical applications now in production which use G-E SINTERED ALNICO 5 include the following: meters, relays, fountain pens, electronic reproducers, and compasses.

ENGINEERING SERVICE

G-E application and development engineers, working closely together, are ready to advise you on new SINTERED ALNICO 5 and other G-E magnetic materials. Our engineers are backed by years of research and the development of thousands of magnetic applications. They will be glad to work with you on your product design. For more information, please mail the coupon shown below.

YOU GET 5 ADVANTAGES

1. Higher external energy than either SINTERED ALNICO 2 or 4.
2. Tensile properties are several times greater than CAST ALNICO.
3. Excellent surface finish.
4. Close dimensional tolerances.
5. Intricate shapes possible.

METALLURGY DIVISION, Sec CM-5
 CHEMICAL DEPARTMENT
 GENERAL ELECTRIC COMPANY
 PITTSFIELD, MASS.
 Please send me:
 Technical Report on new SINTERED ALNICO 5;
 Bulletin, CDM-4, "G-E Permanent Magnets."
 NAME _____ TITLE _____
 COMPANY _____
 PRODUCTS MFRD. _____
 ADDRESS _____
 CITY _____ STATE _____



**PERMANENT
MAGNETS**

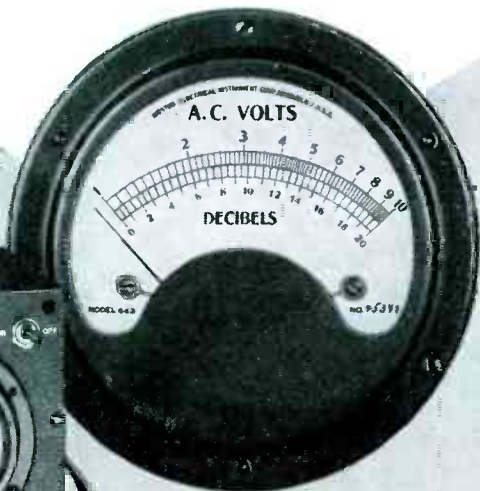
GENERAL ELECTRIC

CD48-V2

1,000,000,000 to one!

with these **BALLANTINE** instruments

MODEL 300
ELECTRONIC
VOLTMETER



MODEL 220
DECADE
AMPLIFIER

MODEL 402
MULTIPLIER

since 1935
the only VOLTMETER
featuring a simplified
LOGARITHMIC SCALE



10 MICROVOLTS to 10,000 VOLTS

ONE BILLION TO ONE—This enormous range of AC voltages—is easily covered by the Model 300 Voltmeter, Model 220 Decade Amplifier and Model 402 Multipliers illustrated above. The accuracy is 2% at any point on the meter scale, over a frequency range of 10 cycles to 150 kilocycles. The Model 300 Voltmeter (AC operated) reads from .001 volt to 100 volts, the Model 220 Amplifier (battery operated) supplies accurately standardized gains of 10x and 100x and the Model 402 Multipliers extend the range of the voltmeter to 1,000 and 10,000 volts full scale.

Descriptive Bulletin No. 10 Available

BALLANTINE LABORATORIES, INC.

BOONTON, NEW JERSEY, U. S. A.

TUBES AT WORK

(continued)

normal fashion, via C_4 to V_2 . In addition, d-c potential changes on the grid are amplified and passed via point A to V_3 . Point A is tied to ground by the large capacitor C_5 , which, with its associated resistors, has a time constant of about one second, and which eliminates rapid

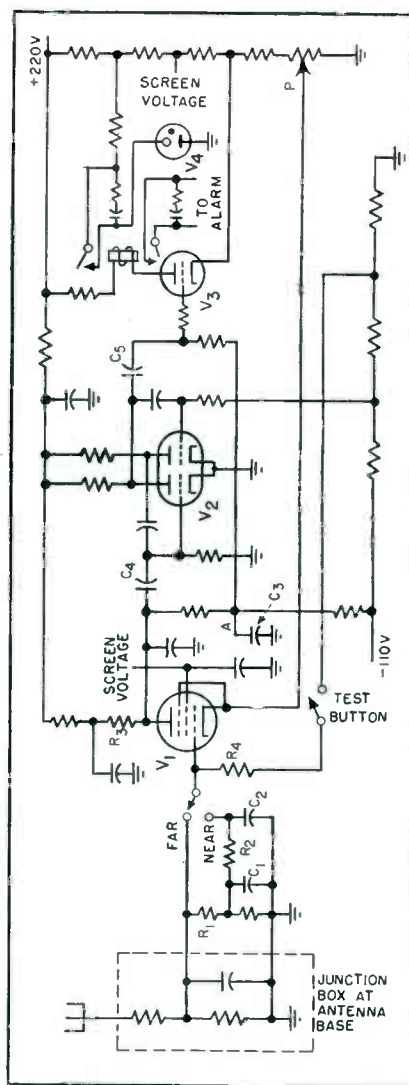


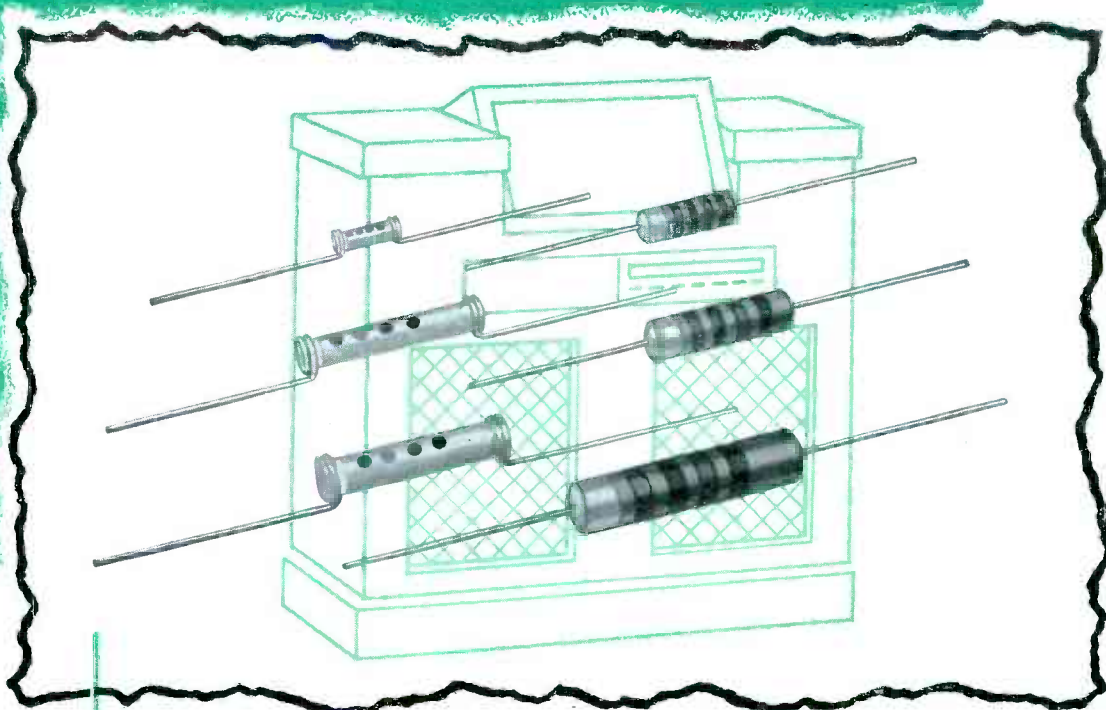
FIG. 1—Circuit of the electronic lightning alarm

signals so that the potential of A fluctuates slowly in accordance with the corona current in the antenna system.

Tube V_2 is connected in a flip-flop circuit arranged to give a positive pulse through C_5 lasting about 0.1 second. This arrangement is necessary because the transient due to a lightning flash may be too brief to operate the relay.

Bias for V_2 is obtained from point A. By means of potentiometer P the current through R_5 is so adjusted that A is at a suitable

Erie "GP" Ceramicons*



Going Places

... in FM and Television

The basic, simple construction of ERIE "GP" Ceramicons give them higher resonant frequencies, which make them the ideal condensers for FM and Television applications.

The same basic, simple construction makes possible the mass production which accounts for the surprisingly economical cost of high quality condensers. They are designed for practically all applications in which the condenser is not definitely frequency determining.

ERIE "GP" Ceramicons are not only cheaper to buy—they are cheaper to use than other types of condensers. Their wide range of adaptability reduces the number of condensers necessary to stock. Their compact tubular form and their sturdy construction make them easy to install on the assembly line.

ERIE "GP" Ceramicons are made in insulated styles in popular capacity values up to 5,000 MMF, and in non-insulated styles up to 10,000 MMF. If you are not already using them, write for detailed information.



*Ceramicon is the registered trade name of silvered ceramic condensers made by Erie Resistor Corporation.



Electronics Division

ERIE RESISTOR CORP., ERIE, PA.

LONDON, ENGLAND • TORONTO, CANADA

GRID-CONTROL RECTIFIER TUBE
EL 66J
Tantalum anode and Xenon Gas Filling

D-c. Amperes Output (Max. Rate)	6.4
D-c. Meter Value (continuous)	2.8
D-c. Meter Value (over-load less than 1 sec.)	97
Oscillograph Peak Continuously recurring	750
Peak Forward Volts (Max. Instantaneous)	1250
Peak Inverse Volts (Max. Instantaneous)	9
Average A-c. Drop Volts	12
Average Tube	2.5
Highest Tube at end of life	21-24
Filament	Approx. 60 sec.
Volts	
Amperes	
Heating Time	
Grid Characteristics	
Critical Grid Volts at 750 p.f.v.	-3.5 ± 1.5
Critical Grid Current (Max. I _g)	100
Maximum Negative Grid Volts	40
Starting Volts (instantaneous)	75
Average Tube	Approx. 1 millisecond
Highest Tube	
Maximum Ionization Time	Approx. 4 muf
Grid-anode Capacitance	Approx. 21 puf
Grid-filament Capacitance	
Max. A-c. Short-circuit Current (100 p.f.v.)	770A
General Dimensions	
Electrons & Grid	441 - American Industrial Base
Heating	2103 - Max. Temp 10.55" dia. 1
Ambient Temperature	55 to +70°C

The filament must be 1.5 hours before drawing 50% load current.
Filament prong 4 - in course of 20 hrs. shield.
All of the above values are for ratings to the filament transformer center tap.
The anode is designed to operate at full red heat at 50% load in order to take full advantage of the gettering properties of tungsten.

ELECTRONS, INC.
27 Sussex Avenue
Newark, N. J.

ELECTRONS INCORPORATED
127 SUSSEX AVENUE
NEWARK, N. J.

*Quick-heating, temperature free
thyatron for precise control*

potential when no d-c is flowing in the antenna. When the grid of V_1 goes negative, the potential of A rises until V_2 conducts sufficiently to cause the relay to close. At this stage, owing to the fact that the current through V_2 is now sensitive to small changes of potential on its grid, and owing to the feedback from its cathode via



The lightning-warning antenna is omnidirectional. With the associated electronic equipment it also permits measurement of corona current

the bleeder resistors to the cathode of V_1 , the whole system oscillates with a period associated with the circuits of V_2 (about 2 cps). This oscillation causes the relay to open and close periodically as long as the point A is at an adequately positive potential. It should be noted that this corona current warning is effective in either position of the near-far switch.

The instrument gives a brief sharp ring on the electric bell attached to the relays for each positive impulse due to a lightning flash, and gives a continuous intermittent ringing like that of a telephone when the direct antenna current exceeds about 2 microamperes. An additional signal is given by means of the neon tube V_3 , which flashes each time the relay closes.

The operation of the instrument can be tested by means of the test button. This button applies a suitable negative voltage to the grid of

EM

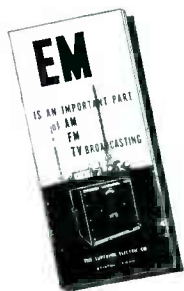
IS AN IMPORTANT PART of AM FM TV BROADCASTING



STABILINE Automatic Voltage Regulators Type EM (Electromechanical) are the answer to regulation problems in radio and television transmitting stations . . . high frequency relay stations.

The FCC recommends adequate voltage regulation equipment where the power supplied by the utility varies more than 3% from nominal over a 24 hour period. The STABILINE Voltage Regulator Type EM is ideally suited for this regulation task. Some of the outstanding features include . . . zero waveform distortion, complete insensitivity to the magnitude and power factor of the load, no effect on system power factor, high efficiency and no critical adjustments. Its long-term stability for 24 hour line correction means that Type EM requires negligible attention. Under normal conditions, the output voltage need not be adjusted more than once a month.

The STABILINE Voltage Regulator Type EM consists of an electronic detector circuit controlling a motor-driven POWERSTAT variable transformer. The moving parts are rugged, quality manufactured components which require a minimum of service and attention. The electronic control circuit itself is plug-in type and incorporates the latest advances in detector circuit design. This plug-in feature, combined with the convenient replacement service agreement made at the time of purchase, eliminates maintenance difficulties. The attractive black wrinkle-finished front panel has a 4 inch output voltmeter and screw driver adjustment controls for sensitivity and output voltage setting. Numerous models are available in ratings from 1 KVA to 100 KVA to meet most requirements. Rely on the experience of the Superior Electric Company's staff of voltage control engineers to assist with your voltage regulation problems.



Request Bulletin #448 for detailed information on the STABILINE Type EM and its application in the broadcast field.

Write The Superior Electric Co., 405 Meadow St., Bristol, Conn.

THE SUPERIOR ELECTRIC CO.
BRISTOL, CONNECTICUT



Powerstat Variable Transformers • Voltbox A C Power Supply • Stabiline Voltage Regulators.

This beats a magic carpet!



Air Express can bring you supplies and equipment from any U.S. point—*overnight*. And that's better than old-style magic! Air Express is the fastest way you can find to ship or receive. No delays, because shipments go on every flight of the Scheduled Airlines.

What's more you get special door-to-door service at no extra cost. With low Air Express rates, you can use this fastest service as a regular procedure. Let Air Express keep your business running fast—and smoothly.

Specify Air Express—World's Fastest Shipping Service

- Low rates—special pick-up and delivery in principal U.S. towns and cities at no extra cost.
- Moves on all flights of all Scheduled Airlines.
- Air-rail between 22,000 off-airline offices.

True case history: Rubber equipment users regularly get replacement parts by Air Express so machines won't stand idle. Recent shipment: 102-lb. carton picked up 5 P.M. the 18th in Noblesville, Ind. Air-rail to Dallas, delivered 9 A.M. following day. 799 miles, total cost only \$26.78. Any distance inexpensive, too. Phone local Air Express Division, Railway Express Agency, for fast shipping action.



AIR EXPRESS, A SERVICE OF RAILWAY EXPRESS AGENCY AND THE
SCHEDULED AIRLINES OF THE U.S.

TUBES AT WORK

(continued)

V_1 through a large resistor R_2 . When the test button is pressed and released rapidly, the brief warning signal is given each time it is released. When the test button is held down for longer than a second or so then the continuous warning operates.

Antenna

The antenna consists of an un-guyed vertical rod 1 inch in diameter, 8 feet high, attached to a plate at its base, which is supported by three insulators fixed at ground level. The plate keeps the insulators dry. A weatherproof junction box adjacent to the plate contains the two resistors, and from it a concentric cable is taken underground to the chassis.

By this means, any possibility of the lead-in acting as an additional antenna is avoided, and the cable capacitance becomes an essential part of the input circuit. This circuit is arranged to reduce high-frequency components in the signal such as may arise from a leader flash or from local sparks, so that the effective signal is that due to the main field change on which the rough estimation of distance depends.

This development was reported in the *Transactions of the South African Institute of Electrical Engineers*, April 1947.

Correction

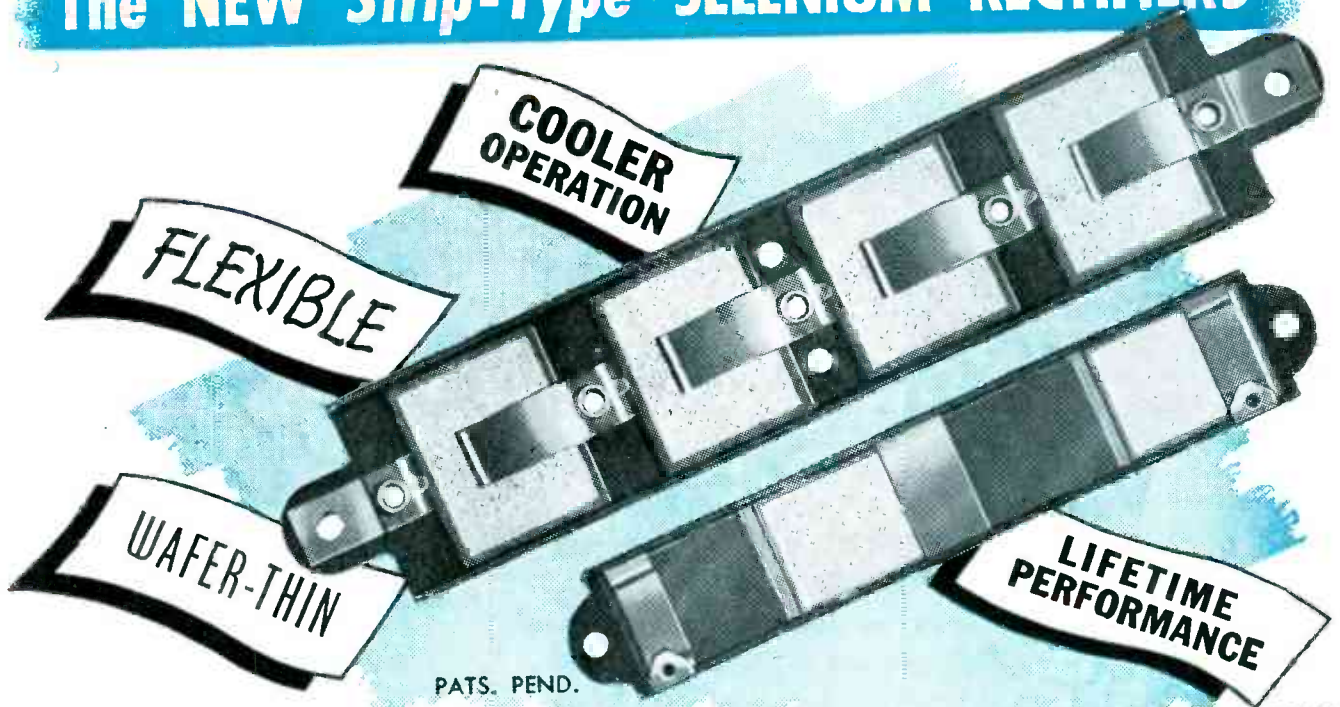
Mr. T. Kite Sharpless, author of the article "High-Speed N-Scale Counters", March 1948, has pointed out an error in the footnote published in this article which gives the impression that the counters described in the article were developed while Mr. Sharpless was Technical Director of the Computer Project at the Moore School. The counters were actually developed through the joint efforts of J. Presper Eckert, Jr., John W. Mauchly, John Davis, and Frank Mural, during the period when Mr. Eckert was technical director of the ENIAC program. The Editors regret this error.

**STANDARD
ARCTURUS
CORPORATION**

Introduces

KOTRON

The NEW Strip-Type SELENIUM RECTIFIERS



The KOTRON Rectifier is a thoroughly performance-tested, flat, series connected half-wave selenium rectifier. It gives these marked advantages over conventional type selenium rectifiers.

More Efficient Cooling: Strip (one plane) construction provides for direct heat dissipation instead of passing heat on to other plates. KOTRON used at its proper rating will last indefinitely.

Saves Valuable Space: The wafer-thin KOTRON Rectifier fits anywhere on the chassis.

Less Voltage Drop: Requiring no more than four rectifying elements in contrast to the usual five or six, KOTRON is more efficient in circuits.

As Full-Wave Rectifier or "Doubler": In combinations, KOTRON Rectifiers fill a variety of needs, in less space.

Write for complete technical data

ARCTURUS
"KNOWN THE WORLD OVER"

STANDARD ARCTURUS CORPORATION

54 CLARK STREET • NEWARK 4, NEW JERSEY

HUMboldt 2-2400

ELECTRICAL CHARACTERISTICS

75 MA. SIZE

Maximum A.C. line voltage input
130 volts, rms.
Maximum inverse peak voltage 360.
Maximum continuous D.C. current 75 Ma.
Maximum instantaneous peak current
750 Ma.
Average operating temperature 100
degrees F

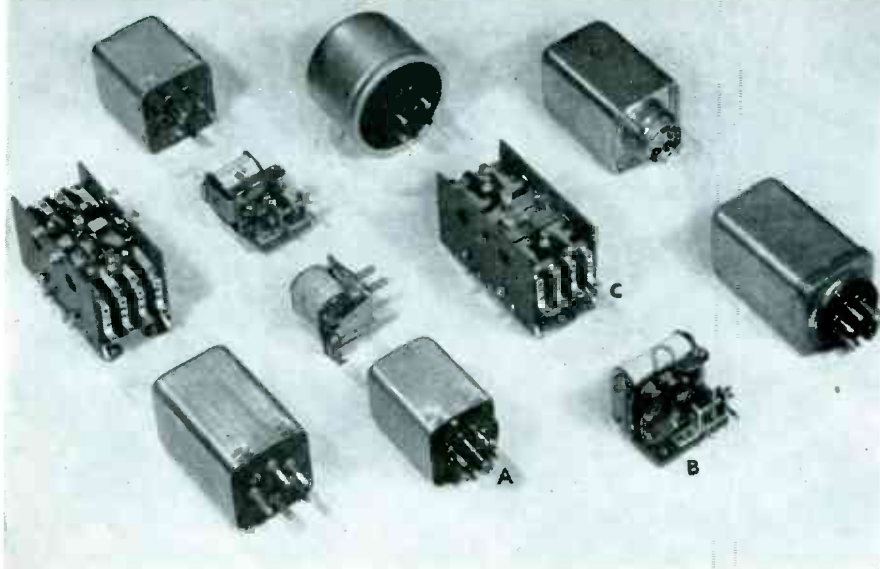
100 MA. SIZE

Maximum A.C. line voltage input
130 volts rms.
Maximum inverse peak voltage 360.
Maximum continuous D.C. current 100 Ma.
Maximum instantaneous peak current
1000 Ma.
Average operating temperature 105
degrees F

200 MA. SIZE

Maximum A.C. line voltage input
130 volts rms.
Maximum inverse peak voltage 360.
Maximum continuous D.C. current 200 Ma.
Maximum instantaneous peak current
1500 Ma.
Average operating temperature 110
degrees F.

HIGH PERFORMANCE



SPECIAL PURPOSE STANDARD RELAYS

In the preparation of relay specifications for particular functions, cases frequently arise which appear to have widespread occurrence.

We have adopted a policy of listing certain of these special purpose relay specifications as standard, especially when the performance results are exceptionally good.

FOR HIGH-SPEED KEYING OR DIALLING
on low to medium dc power, 50-250 volts supply:

Type 41RO-72327-X (A in cut) List \$3.80

- SPDT Relay, 2000 ohm dc coil
- Operate, 4 ma. or less; 5-10 ma. normal current
- Contacts: Tungsten (standard) for 0.5 amp or less, moderate to high voltage, long life; fine silver for higher current, lower voltage, moderate life (e.g. 5,000,000).

Typical timing: Milliseconds

Final coil current 7.5 ma *:	source 50V	100V	200V
Open N.C. contact	4 ms.	2.5 ms.	1.5 ms.
Transfer to N.O.	1.5	1.0	.7
Open N.O. contact	1.0	1.0	1.0
Transfer to N.C.			
(Includes Bounce)	3-5	3-5	3-5

*Sufficient external series resistance employed to limit current to this value.

Write for additional data
and timing curves

AC — DC — POLAR TYPES



Sigma Instruments, Inc.
Sensitive RELAYS

62 CEYLON ST., BOSTON 21, MASS.

- HIGH SPEED
- LONG LIFE
- LOW INPUT
- PRE-ADJUSTED

THE ELECTRON ART

(continued from p 134)

oscillation were obtained. Figure 3 shows typical experimental results. At frequencies where the reactances are concentrated in the tank circuit, frequency deviations of 10 percent of the mean frequency can be obtained with reasonably magnitude. Even in the uhf range frequency deviations commonly obtained at lower frequencies can be produced, so that the mean frequency can be regulated without inertia in a wide range by superimposing a control voltage on the modulating voltage.

Characteristics of Some Oil Impregnated Capacitors

By BURGESS DEMPSTER
Los Angeles, Calif.

FACTORS that ultimately control the size of capacitors operating at high voltages are primarily the internal losses. The capacitor must be large enough to dissipate the heat generated internally, without becoming dangerously hot. Because losses increase very rapidly with temperature, internal heating can become a runaway effect.

Principal Losses

There are two principal losses: (1) d-c loss in the dielectric because of leakage current, and (2) a-c loss in the dielectric because of the alternating current flowing through the capacitor. Heat gen-

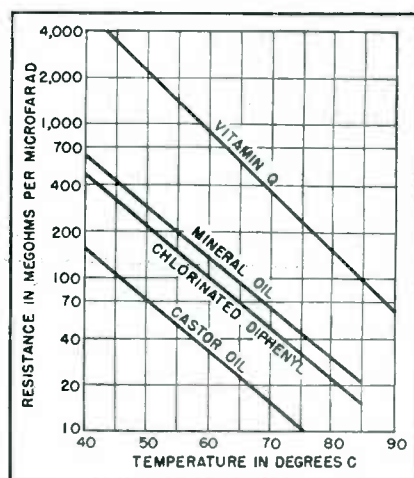


FIG. 1—Minimum insulation resistance

erated by the first cause is equal to the square of the applied voltage divided by the insulation resistance of the capacitor. Heat produced by the second cause is equal

For Certified Performance...

**PERFORMANCE
CERTIFIED BY
MORE THAN 400
MAJOR
INSTALLATIONS**

*TRADE MARKS
REGISTERED

SEAL-O-FLANGE*
AIRCORE*
**TRANSMISSION
LINES**



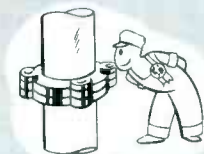
...for AM-FM and TV

Seal-O-Flange Transmission Lines incorporate exclusive features that have practically revolutionized previous concepts of coaxial line installation and operating efficiency. They eliminate special sections—anti-creep devices, anchor sections, differential expansion fittings—completely. Gas-tight seals are attained without the use of torches or painstaking cleaning operations. The only tool required to assemble these lines is a pair of small hand wrenches—an important factor when working on a tower. Seal-O-Flange performance is time-proven in over 400 major installations all over the world.


Seal-O-Flange Transmission Lines are sold by RADIO CORPORATION of AMERICA and GENERAL ELECTRIC COMPANY. They are distributed nationally by GRAYBAR ELECTRIC CO., and internationally by WESTREX CORPORATION.



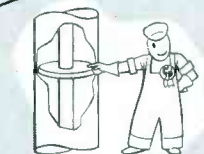
Small hand wrenches are the only tools required to assemble a SEAL-O-FLANGE line.



Differential expansion is automatically compensated at 20 foot intervals in SEAL-O-FLANGE lines.



Gas seals are permanent weather-proof, immune to temperatures from -40°F to 150°F.



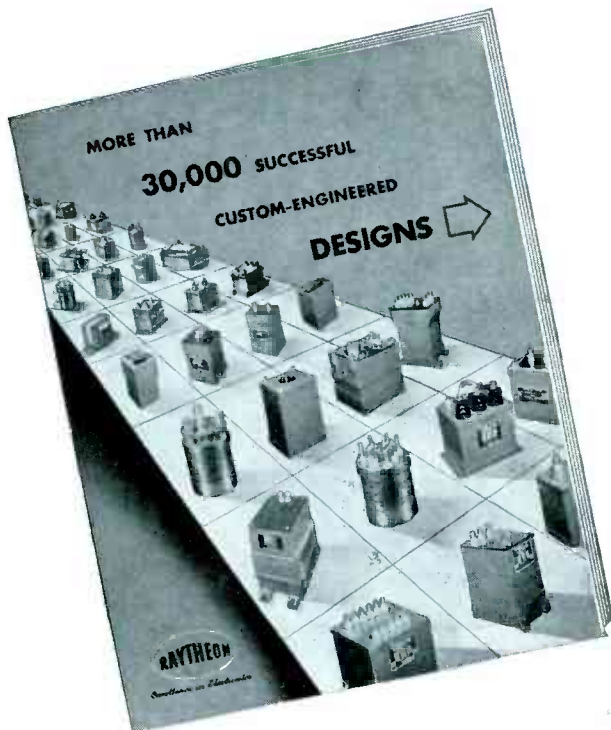
Inner conductor is securely anchored inside each section for fixed electrical characteristics.

*Communication
Products Co., Inc.*

KEYPORT • NEW JERSEY



IF YOU USE CUSTOM-BUILT TRANSFORMERS

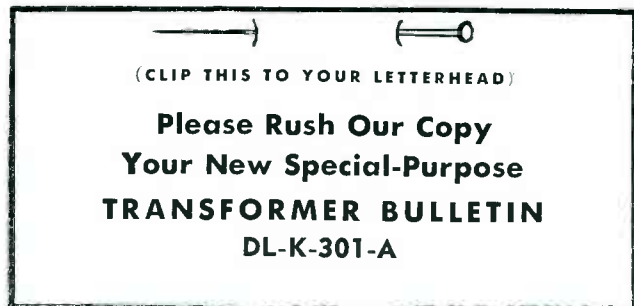


TAKE A LOOK AT THIS BULLETIN

Here's help you can use in visualizing magnetic components to meet your special requirements. Time-saving forms make it easy to specify your needs. Write for it today.



Sales Offices:
Atlanta, Boston, Chicago, Cleveland, Detroit, New York, Washington, D. C.



to the product of the alternating current and the alternating voltage times the power factor of the capacitor. Both of these factors cause a serious amount of heat in high voltage capacitors and both increase rapidly with temperature.

Figure 1 shows the decrease of minimum insulation resistance with temperature for several types of oil. At 85 C the heating power generated in a 10 μ f capacitor operating at 5,000 volts with a leakage of 20 megohms is 12.5 watts. The increase of power factor with temperature is shown in Fig. 2. Above

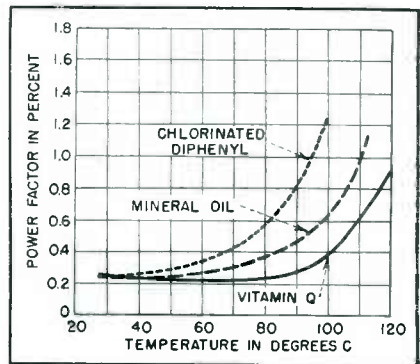


FIG. 2—Power factor at 60 cps

about 85 C the power factor of all the oils increase quickly. However, at 85 C, which is not an unusual operating temperature in many applications, the power factor of so-called Vitamin-Q, which is a synthetic hydrocarbon with great chemical stability, is only a little more than half that of mineral oil, which is the next best material in this regard. It is because of these rapidly rising losses as the temperature increases that capacitors must be derated for use at high temperatures. Figure 3 shows the derating percentages for most types of capacitors.

Because Vitamin-Q capacitors need less derating than most other types, their use in installations operating at high temperatures represents a saving in both space and weight. At 85 C the volume of a

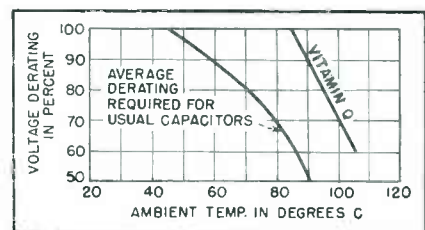
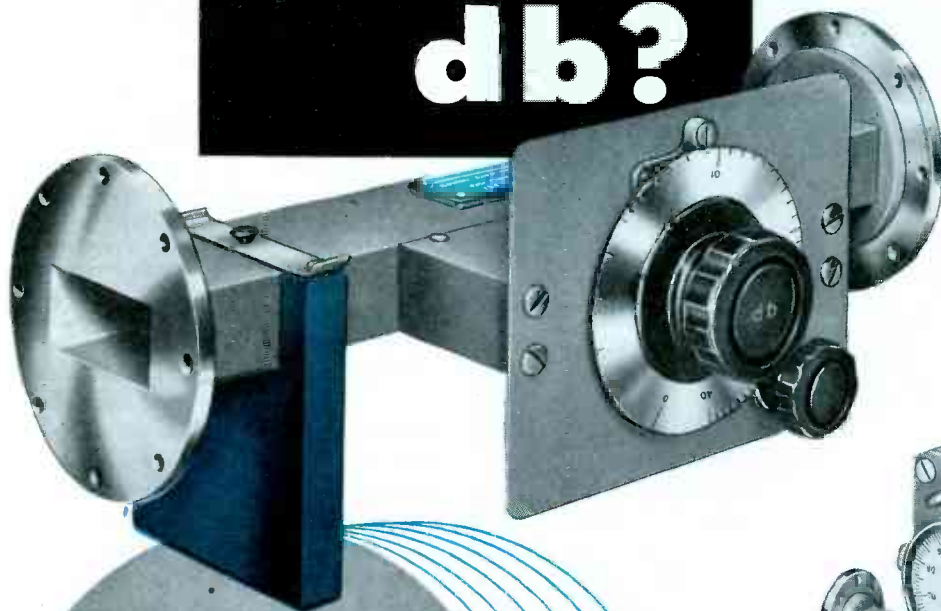


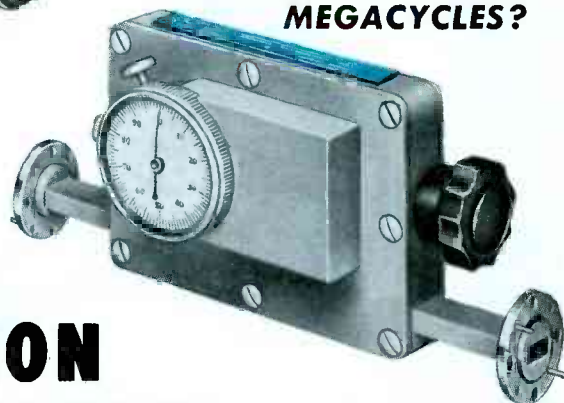
FIG. 3—Ambient temperature deratings

HOW MANY
db?



..AT 5,000
MEGACYCLES?

..AT 25,000
MEGACYCLES?



PRECISION VARIABLE ATTENUATORS

Features:

METALLIZED-GLASS
ATTENUATING ELEMENTS
PRECISE AND PERMANENT
CALIBRATION
BROADBAND
CHARACTERISTICS
NEGLIGIBLE INSERTION LOSS
BACKLASH-FREE
VERNIER DRIVE
LOW REFLECTION
WELL SHIELDED CASING

These attenuators, utilizing metallic-film-on-glass resistive elements, are of the most advanced design now available. Broadband matching, minimum frequency sensitivity, and constancy of attenuation with time, are but a few of the advantages which this technique affords. Casing designs available cover requirements from that of a simple power control attenuator to that of a precisely calibrated secondary standard.

Metallized glass attenuators are an important type of microwave measurement component in the complete PRD line. Available also are precision slotted sections and probes, impedance matching devices, frequency meters and standard cavities, and all of the other items which make up a complete measurements bench. An illustrated catalog and price list may be obtained by writing to Department E-5, on company letterhead.

66 COURT STREET
BROOKLYN 2, N. Y.



Polytechnic **RESEARCH
& DEVELOPMENT COMPANY, Inc.**

For the first time



(Actual Size)

1 mc.

... a stable crystal unit in a miniature holder manufactured to tolerance of 0.005% over an extreme range of -55° C to +90° C. The new RH-7B crystal exhibits 50% to 80% less frequency shift with a given change in oscillator input capacity. Hermetically sealed, the RH-7B produces high activity (series resistance less than 400 ohms) and meets Army and Navy specifications.

For detailed specifications write for bulletin RMC-X.

REEVES  HOFFMAN CORPORATION
CHERRY AND NORTH STREETS • CARLISLE, PA.

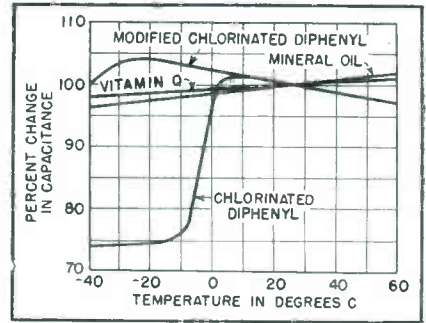


FIG. 4—Rate of capacitance change

synthetic hydrocarbon filled capacitor is only about a fourth that of a similar one with chlorinated-diphenyl, and one-sixth the size of a mineral oil unit. This characteristic is particularly important in airborne equipment, where temperatures may be high and where space and weight are at a premium.

Another important factor in choosing a capacitor for a given application is the change of capacitance with temperature, shown in Fig. 4. The rapid change of capacitance of chlorinated-diphenyl capacitors is due to the change in dielectric constant of this material. Mineral oil and Vitamin-Q are more stable in this respect. The advantages of Vitamin-Q as a dielectric are realized in capacitors rated at as low as 330 volts a-c.

One especially interesting application of capacitors where stability and high insulation resistance are important is in computing circuits. In such applications, high leakage resistance, in effect, increases the sensitivity of circuits where the final reading depends on the charge built up across the capacitor.

End Resistance Materials

BY PAUL G. WEILLER
Industrial Engineer
New York, N. Y.

ELECTRICAL PROPERTIES of non-metallic semiconductor materials suit them for various applications. As will be explained later, the resistance of these materials appears to be concentrated mostly at their ends, hence the term "end resistance".

Possible Applications

Detailed investigation of the properties of these materials has been undertaken recently, but much remains to be learned of their behaviors. However, enough has

The search is ended *Permanent Flexibility*

TURBO



In his search for the fountain of perpetual youth, Ponce de Leon would have found a perfect analogy in the improved Turbo Varnished Sleeving in which there is inherent, in its flexibility constituted insulating varnish, the antidote to hardening of the arteries.

Besides this great step of advance in the varnishing process of cotton sleeving, there are insured in this Turbo Varnish Impregnant topmost electrical insulating requisites—stabilized increased dielectric values, greater resistance to elevated temperatures, practical resistance to the effects of soldering-iron operations, acids, oils, alkalies, and electro-chemical influences.

Non-cracking, non-chipping, non-peeling regardless of angle of bend or twist. A knock-out to commonly encountered insulation failures accruing from embrittlement resulting due to the effects of aging.

Thermoplastic Insulated Wire;
Thermoplastic Insulated Sleeving;
Mica, block, films; Mica-Plate,
segments. Markers; Wire

WILLIAM BRAND & COMPANY

276 FOURTH AVENUE, NEW YORK 10, N. Y.—325 W. HURON STREET, CHICAGO 10, ILL.

REDUCE "DOWN-TIME" LOWER WIRING COSTS, SAFEGUARD PERSONNEL



WITH **AMPHENOL** INDUSTRIAL SOCKETS

The advanced design of these sockets and the well known high integrity of Amphenol materials and production can save you thousands of dollars in "down-time." Another economy is the speed and simplicity of installation wiring. And these Amphenol sockets are *safe*—they guard highly trained workers and valuable tubes, so don't rely on makeshift equipment!

Included in the wide Amphenol industrial tube socket line is the Super Jumbo 4 pin socket for top or bottom mounting. The exclusive Cloverleaf contacts provide four full lines of contact with tube pins to carry heavy current loads. Outstanding in performance they are equally attractive in appearance—quality on all counts!

So insist on Amphenol when you buy. Write today for complete and well illustrated specifications.

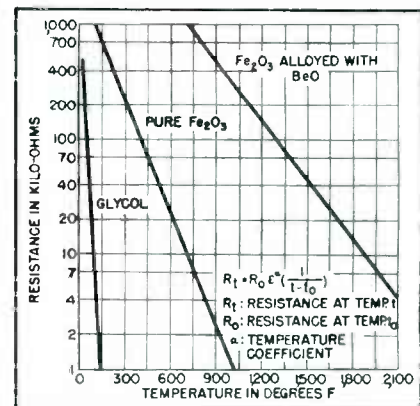
AMERICAN PHENOLIC CORPORATION

1830 South 54th Avenue, Chicago 50, Illinois

COAXIAL CABLES AND CONNECTORS • INDUSTRIAL CONNECTORS, FITTINGS AND CONDUIT • ANTENNAS • RADIO COMPONENTS • PLASTICS FOR ELECTRONICS

been discovered to indicate that, for example, because of their high temperature coefficient of resistance, up to five percent per degree Centigrade, they are ideal sensing units for resistance thermometers. By choosing suitable materials for particular temperature ranges as illustrated in the accompanying graph, sensitivities 1,000 times those of elements using metallic wires can be obtained. Some organic liquids have high coefficients below the ice point. Some oxide mixtures have high coefficients at room temperature, others at a few hundred degrees Centigrade. However most materials follow the relation given on the graph.

Some nonmetallic materials are excellent pressure sensitive devices. A small bar with a metallic coating on one end and shaped to a spherical



Measurements show that characteristics of end resistance materials change greatly with temperature

surface on the other end which bears on a metallic surface with the lightest pressure presents a contact resistance of several megohms. A weight of a gram reduces the resistance to less than a tenth megohm.

Some end resistance materials have high conductivity. If added to silver, they are suitable for long-life nonsticking electrical contacts. Similar materials can be used for electrodes in electrolytic processes, replacing carbon in many applications.

Characteristics of Matter

It is best to summarize the properties of metallic conductors to provide a background against which to describe nonmetallic conductors. In the infancy of the art, substances were classified as either conductors or insulators. Later, materials

NEED

germanium
crystal
diodes?

NEED

more
information?

for
General-
purpose
applications?

Use
the
1N34



The popularly-priced answer to diode problems involving up to 40 ma. D.C. and up to 60 volts in the reverse direction. Requires no heater supply.

for
Very high
rectification
efficiencies?

Use
the
1N38



Provides back resistance above 2 megohms at low voltages, yet withstands peak back voltages as high as 100 volts. Has extremely low shunt capacity.

for
Reverse
voltages
up to 200?

Use
the
1N39



Mechanically identical to the 1N34 and 1N38 but designed for exceptionally high back voltages. Has no contact potential.

GET THIS HELPFUL LITERATURE!



To assist you in engineering germanium crystal diodes into your products, Sylvania will gladly send you a catalog listing detailed specifications on both crystal diodes and duodiods; a booklet giving circuit diagrams of 21 typical applications; and two Engineering News Letters describing crystal diode usage and applications.

MAIL COUPON FOR YOUR COPIES

SYLVANIA ELECTRIC

Electronics Division, 500 Fifth Ave., New York 18, N. Y.

MAKERS OF ELECTRONIC DEVICES; RADIO TUBES; CATHODE RAY TUBES; FLUORESCENT LAMPS, FIXTURES, WIRING DEVICES; ELECTRIC LIGHT BULBS

Sylvania Electric Products Inc.
Electronics Division, Room E-1005
500 Fifth Avenue, New York 18, N. Y.

Gentlemen: Please send me information on Sylvania Germanium Crystal Diodes, their specifications and their uses.

Name
Position
Company
Street Address Zone No.
City State

that were intermediate between these two types were classed as semiconductors. This latter classification embraces the majority of materials.

The theory of conduction by an electronic gas describes the observed characteristics of metallic conduction quite well. Metallic conductors form a well defined class. Resistance is a minimum for the pure metals, being greater for alloys than for their constituents. In fact, small additions of other metals to a pure metal increase the resistance quite out of proportion to their quantity.

Temperature coefficients of resistance of pure metals are always positive and below one per cent per degree Centigrade; the coefficient of alloys is generally lower. Metallic conductors follow Ohm's law, the resistance of a bar being proportional to its length and inversely proportional to its cross section. That is, resistance is a characteristic of the body of the material.

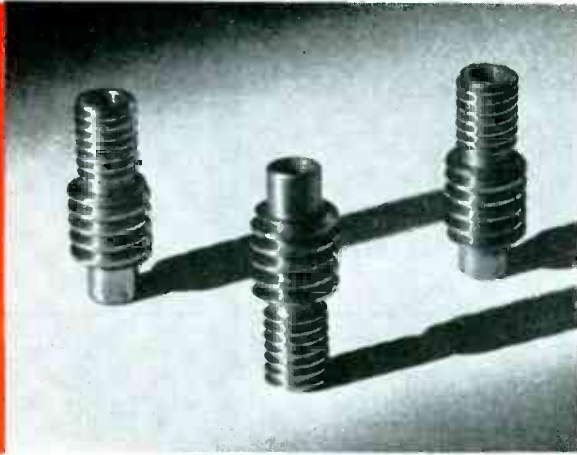
Nonmetallic Conductors

The large class of nonmetallic conductors, the properties of which are only now beginning to be explored, comprises those substances with resistivities higher than metals but which nevertheless are not insulators. This group contains most of the known substances.

In measuring characteristics of about 100 organic materials and also distilled water, several effects were observed. Later the same range of properties was found in metallic oxides and their mixtures, in ceramics, and in glasses. Some of these nonmetallic conductors display erratic or unstable behaviors; others fit the general pattern, or are stable enough for practical use.

Resistance depends on the method of applying electrodes to the samples under test, and sometimes on the electrode material. If the area of the interfaces at the ends of the sample are unequal, or if the surfaces are uneven, rectification occurs, the ratio of the resistances in the two directions being a function of the ratio of the areas of the interfaces, but also depending on the electrode material. To get consistent results, the ends of the test bar must be coated with a metal that adheres to the material and

GROUND WORMS



Hard or soft worms, lead screws, etc. ground to your exact specifications in small lots or production runs. We invite you to submit your prints for quotation without obligation.

MEMBER OF



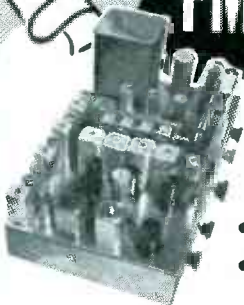
- SPUR
- WORM
- SPLINE
- HELICAL
- SPROCKET
- STRAIGHT BEVEL
- GROUND THREADS

Beaver Gear Works Inc.

1021 PARMELE STREET, ROCKFORD, ILLINOIS

COLLINS

"Custom Built" FM-AM TUNER



FLAWLESS Frequency Response

- A. M. Up to 10,000 cycles without loss.
- F. M. High Fidelity 10 Tube Armstrong.

Designed for those who demand the highest possible fidelity in radio reception, the Collins FM-AM Tuner utilizes the most advanced engineering principles and finest in component parts. Two separate and distinct tuners are used having only the audio and power supply common to both. This 17-tube quality tuner features voltage stabilization; and a specially developed tuning eye in the F.M. circuit. A full line of accessories is available for the Collins Tuner.

Write today for full details.

COLLINS Audio Products Co., Inc.
P. O. BOX 368 • WESTFIELD, N. J. • WE-2-4390



Yours

FOR THE ASKING

...Free upon written request!

COMPOUNDS

PHYSICAL CHARACTERISTICS · ACTIVE FORMULAS · ELECTRICAL WAX AND COMPOUNDS

MITCHELL-RAND INSULATION CO., INC., NEW YORK, N. Y.

CONTENTS

FILLING AND POTTING MATERIALS
 Potting Compounds (filled)
 Potting Compounds (un-filled)
 Rubberseals
 Storage Battery Seals
 Comparison of Ther-mometrical Scales

HARD SEALS

Capacitor End Seals
 Dry Battery Seals
 Screw Hole Fills and Socket Cements
 Oil Resistant Seals

WAXES

Impregnating and Dipping Waxes (S.M.P.)
 Impregnating and Dipping Waxes (H.M.P.)
 Cable Saturating and Finishing Waxes
 Synthetic Ceresines

FACTS & FIGURES

	1436 EX	1366 EX	3179
Cold Flow	213/218° F	238/243° F	233/238° F
S.P.(R&B)	218/223° F	250/255° F	258/262° F
Pouring Temp.	315/360° F	350/400° F	400/450° F
Color	Brown	Tan	Gray
Adhesion	Good	Satisfactory	Satisfact
Penetration 77/100/5	0	0	
Chloride Free	Yes	Yes	
Spec. Grav.	1.54	1.55	
Flash Point	390° F	450° F	

TEST METHODS

RING AND BALL SOFTENING POINT
 MELTING POINT DRIP METHOD
 COLD FLOW TEMPERATURE
 POURING TEMPERATURES
 PENETRATIONS
 VISCOSITY

The formula of 1366EX CAPACITOR END SEAL is typical of the detailed data published in this important reference book. 1366EX has unusual characteristics and is one of the latest developed by Mitchell-Rand. It embodies the advantageous combination of high cold flow temperature with low viscosity, also good impact strength and good adhesion to cardboard are inherent qualities.

YOURS' FOR THE ASKING is this COMPOUND DATA BOOK. The latest work of its kind, it is a comprehensive manual containing all the data, facts and figures, physical characteristics, test methods, active formulas and general applications for Mitchell-Rand's extensive line of Compounds, Waxes, etc. It's free upon written request.

Mitchell-Rand, headquarters for electrical insulations, has developed more than 3500 compound and wax formulae . . . there is one to fit every known requirement . . . and when special conditions arise Mitchell-Rand will meet the challenge to develop the formula to meet the requirement.

M-R THE ELECTRICAL INSULATION HEADQUARTERS FOR 59 YEARS



MITCHELL-RAND INSULATION CO. Inc.

51 MURRAY STREET · CORtlandt 7-9264 · NEW YORK 7, N. Y.

A PARTIAL LIST OF M-R PRODUCTS: FIBERGLAS VARNISHED TUBING, TAPE AND CLOTH · INSULATING PAPERS AND TWINES · CABLE FILLING AND POTHEAD COMPOUNDS · FRICTION TAPE AND SPLICE · TRANSFORMER COMPOUNDS · FIBERGLAS SATURATED SLEEVING · ASBESTOS SLEEVING AND TAPE · VARNISHED CAMBRIC CLOTH AND TAPE · MICA PLATE, TAPE, PAPER, CLOTH, TUBING · FIBERGLAS BRAIDED SLEEVING · COTTON TAPES, WEBBINGS AND SLEEVINGS · IMPREGNATED VARNISH TUBING · INSULATED VARNISHES OF ALL TYPES · EXTRUDED PLASTIC TUBING

perhaps wets it. Resistance is almost proportional to the interface between the electrode and the bar, about 80 percent of the resistance being in the interface. For example, if the bar is broken in half and the new surface coated, the resistance of the half will be but about 90 per cent of the original resistance.

Instead of being higher, as with metallic mixtures, the resistance of mixtures of nonmetallic conductors is lower than that of the pure compounds. Thus it is possible in some cases to reduce resistivity of end resistance materials to as little as 0.00004 of its uncontaminated value.

In measuring resistivity of non-metallic materials on a bridge, it is necessary to balance a capacitance as well as a resistance component. The material behaves as if there were substantial capacitance at the interfaces. In liquids, spurious dielectric constants of 3,000 have been observed. It is likely that dielectric constants of 500,000 observed in some ceramics arise from a similar effect.

Whether capacitance at the interface is genuine or not is unknown. However, if the end resistance material is placed across a direct potential for a short time and then switched quickly off and across a microammeter, current flow will be indicated for an appreciable interval. That the charging and discharging takes a finite period suggests that the phenomena is frequency sensitive. This assumption was confirmed experimentally.

In liquids another peculiar phenomena was observed. The resistance is affected by movement of the liquid with respect to the electrodes. Even a slow flow appreciably decreases the resistance.

Temperature coefficient of end resistance materials is generally negative. Resistance decreases at first rapidly with increasing temperature at from two to five percent per degree Centigrade, then less rapidly in the manner of an exponential curve dropping to less than one per cent at high temperatures. In one case the temperature coefficient dropped to zero and then became positive. It is however unknown whether this phenomena was due to a change in the material;



The Heart of a Fishing Reel

Fishing reel gears must operate smoothly at a speed of 3000 revolutions per minute or more, when a cast is executed. These gears must also withstand the strain of hauling in a fighting fish of unpredictable size and strength, thus rendering a dual purpose: speed and velvety smoothness in one direction—strength and durability in the other.

Instruments and machines have individual gear problems. For over a quarter of a century, Quaker City Gear Works has solved thousands of them and produced millions of gears of every description up to 60" in diameter for manufacturers in many diversified industries.

Aircraft controls, dental drills, electric clocks, gauges, indicators, heat controls, machine tools, radar, radios, washing machines and motion picture projectors are but a few of the many conveniences of modern progress which depend upon the heartbeat of Quaker City Gears. Your gear problem is our business, our large productive capacity is at your service.

YOUR INQUIRIES WILL RECEIVE PROMPT ATTENTION

The heart of the Outdoorsman Customatic reel illustrated above is but one of many gear trains developed by our engineers and produced in our fully equipped plant.

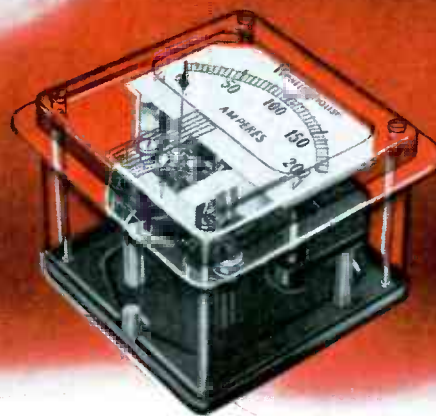


Quaker City Gear Works

INCORPORATED

1910 N. Front Street, Philadelphia 22, Pa.

What is one of the basic requirements of a "good" instrument?



SPRINGS that remain constant for life

...one of the reasons why Westinghouse instruments are good!

Westinghouse-made springs keep their shape and torque for life. "Spring set" is eliminated. Phosphor-bronze alloys are precision-rolled to extremely close tolerances. Calibration accuracy is uniform and permanent over the entire scale length. Rigid torque inspection assures uniform tension characteristics for every type of service. Each spring is tested individually.

And so it is with every other component of Westinghouse instruments . . . each part especially perfected for harmonious relation with all other parts . . . and all parts designed and built by one

manufacturer . . . Westinghouse. Such undivided responsibility of manufacture accounts for the life-long accuracy of all Westinghouse instruments.

For any problem concerning electrical instruments and their application, consult a Westinghouse instrument specialist. Call your nearest Westinghouse office or write Westinghouse Electric Corporation, P. O. Box 868, Pittsburgh 30, Pennsylvania. J-40351

★ ★ ★
IMMEDIATE DELIVERIES on many instruments . . . others up to 90 days.



Westinghouse INSTRUMENTS
PLANTS IN 25 CITIES . . . OFFICES EVERYWHERE

Built for Unfailing Performance

New WILEY BOOKS

THE ELECTRON ART

(continued)

changes in structure with temperature may account for several of the observed anomalies. Apparent capacitance also changes with temperature, but irregularly.

For accurate reproducibility of results all measurements should be made with alternating current. Many of the materials undergo electrolytic changes when exposed to direct current. It is possible that these changes do not occur below a temperature threshold, but the latter is difficult to determine with certainty. In general, d-c resistances differ from a-c resistances, but this point has not been thoroughly investigated.

A great many materials will have to be studied to find which ones are end resistors. Also, considerable correlation will have to be sought before generalizations can be made. Nevertheless, enough has been found to indicate that these materials have useful properties and that further extensive investigation is worthwhile.

Null Temperature Bridge

By E. L. DEETER
*Naval Gun Factory
 Naval Ordnance Laboratory
 Washington, D. C.*

SENSING ELEMENTS for temperature measurement must frequently be located at a distance from the indicator. When the separation is several hundred feet, thermocouples are difficult to use because the lead resistance is high compared to that of the thermocouples. In the application for which this bridge was designed, temperature of an underwater device connected to the monitoring station by a maximum of 1,000 feet of multiconductor cable was readily sensed by a high-resistance Thermistor rod. (The Western Electric type 9-A, which, for instance, is 0.9 inch long and 0.1 inch in diameter, has a resistance at 25 C of about 32,000 ohms.) In comparison, the resistance of the No. 20 B & S cable conductor is small, and its temperature coefficient can be neglected entirely if a dummy resistance equal to the nominal cable value is included when the bridge is calibrated.

Indicating Circuit

Figure 1 shows the Wheatstone bridge, one leg of which includes

VACUUM TUBE CIRCUITS

By LAWRENCE B. ARGUIMBAU

Contains the most recent information on the subject. The treatment is carefully developed from simple circuits to those of a more complex nature. Emphasis is given to frequency modulation as opposed to amplitude modulation. Also includes much basic material on transient response and the generation of micro-waves.
 1948 668 Pages \$6.00

RADIO RECEIVER DESIGN, Part II

By K. R. STURLEY

Covers audio frequency amplifiers, power supplies, receiver measurements, television and frequency modulated receiver design. In press.

BATTLEFRONTS OF INDUSTRY

By DAVID O. WOODBURY

The dramatic story of Westinghouse at war. The book stresses the ingenuity of engineers and scientists, the application of mass production techniques to war machines, and the speedy completion of "impossible" assignments.
 Ready in May 333 Pages Probable Price \$3.50

INDUSTRIAL ELECTRONICS REFERENCE BOOK

By Electronic Engineers of the Westinghouse Electric Corp.

This book was written to satisfy the need for a digest covering the application as well as design data for industrial electronic equipment. It gives sufficient theoretical data and application information on electronic subjects to enable the reader to have a better understanding of the possibilities and limitations of new electronic devices.
 Ready in June. Approx. 719 Pages Probable Price \$7.50

ULTRAHIGH FREQUENCY TRANSMISSION & RADIATION

By NATHAN MARCHAND

A book for practicing engineers who have to use UHF in systems of mobile and relay communications; frequency modulation; relay and color television; pulse time modulation, etc. M.K.S. units have been used throughout.
 1947 322 Pages \$4.50

NOMOGRAPHY

By ALEXANDER S. LEVENS

A study of the fundamentals of nomography and graphical methods. Includes nomographs which will be valuable to workers in many fields not only directly, but as indicators of what can be done to eliminate tedious mathematical computations.
 1948 176 Pages \$3.00

ELECTRIC TRANSFORMERS AND CIRCUITS

By REUBEN LEE

Presents material directly related to radar and communications. The author stresses applications rather than pure theory, and clarifies each point by illustrations.
 1947 284 Pages \$4.50

PREPARATION AND CHARACTERISTICS OF SOLID LUMINESCENT MATERIALS

Edited by GORTON R. FONDA and FREDERICK SEITZ

Twenty-nine papers by leaders in the field covers theory of various phenomena connected with luminescence; the purification; crystallization and constitution of luminescent materials; new information collected during the war years; summary of the present status of luminescence, etc.
 1948 459 Pages \$5.00

ELECTRONICS FOR INDUSTRY

By WALDEMAR I. BENDZ, assisted by CHARLES A. SCARLOTT

Clearly and concisely explains the principles of industrial electronics, describing the various types of electronic tubes, their functioning, and the basic circuits in which these are used in many industrial devices.
 1947 501 Pages \$5.00

TECHNIQUES IN EXPERIMENTAL ELECTRONICS

By C. H. BACHMAN

A practical working aid which discusses control, assembly, utilization, and techniques of working with controlled beams of charged particles in vacua or at very low pressures. Supplemented by numerous charts, tables, and illustrations.
 1948 252 Pages \$3.50

ON APPROVAL COUPON

EL-5-48

JOHN WILEY & SONS, INC.
 440 Fourth Ave., New York 16, N. Y.

Please send me, on ten days' approval, the books I have checked in this advertisement (or I am attaching to this coupon a separate list of the books I want). At the end of that time, if I decide to keep the books, I will remit indicated price plus postage; otherwise I will return the books postpaid.

Name
 Address
 City & State
 Employed by

(Offer not valid outside U. S.)

This
 (2¾" x 2½" x 1½")
**"Assembly
 Hall"**
 provides "reserved
 seats" for all parts
 in "Diamond H"
 Thermostats
 (Types 25 and 252)

Interior, same-size
 view of housing molded
 for the "Diamond H" Ther-
 mostat, as designed by
 and produced for
 The Hart Manufac-
 turing Company,
 Hartford 1, Connecticut.



Reduced size repro-
 duction — Front face of
 "Diamond H" Thermostat
 Housing.

**The Intricate Specifications for the Front, too,
 Required Strict Adherence to Closest Tolerances**

To best appreciate the intricacies of exterior and interior pattern involved in a thermostat base, you must see it as we show it here — before the multiple of electrical components take their allotted positions. Here, one structurally strong piece of molded phenolic with insulating qualities provides, to exacting precision, each specified requirement as to holes, recesses, elevations, slots and wall thicknesses.

It exemplifies the type of molding in which Consolidated excels. Through experience, as pictured hereon, Consolidated is able to successfully and consistently solve broadly diversified industrial problems. We are confident that this evidenced know-how can be advantageously applied to your particular planning. Our sales engineers are readied to serve your inquiry.



*"Your
 Blueprint
 in Plastic"*

PRODUCT DEVELOPMENT • MOLD DESIGN • MOLD CONSTRUCTION • PLUNGER MOLDING • TRANSFER MOLDING • INJECTION MOLDING • COMPRESSION MOLDING
 Branches: NEW YORK, 1790 Broadway • CHICAGO, 549 W. Randolph St. • DETROIT, 550 Maccabees Bldg. • CLEVELAND, 4614 Prospect Av. • BRIDGEPORT, 211 State Street.

You Can Get TRUE FACTS ON PERFORMANCE

with these
TESTING UNITS

ACME VOLTROL



The Acme Voltrol provides a full range stepless control from 0 to 135 volts. Its regulation is accurate to within 4/10 volt adjustment. Unlike resistance regulators, the output voltage is practically independent of the load. Voltrol is the ideal testing instrument for predetermining the performance of any electrical device or product under voltage fluctuation conditions. Available in portable model (illustrated) and panel mounting types. Write for Bulletin 150.

ACME BREAKDOWN TESTER



An entirely new kind of testing unit that provides for actual checking of circuits at approved standard testing voltages and in addition indicates grounds, shorts or opens. 100% leakage type transformer limits current under short circuit conditions, thereby preventing needless destruction to materials at point of breakdown.

Instead of simply indicating the resistance value of the insulation, which serves no practical purpose, the Acme Insulation Tester permits the application of high voltages to positively prove the safety qualifications of the electrical device or apparatus under test. The Acme Insulation Breakdown Tester may be adjusted to supply voltages of double the rated voltage plus 1000 in accordance with Underwriters' Laboratories testing recommendations.

ACME ELECTRIC CORPORATION

31 WATER ST.

CUBA, N. Y.

Acme **ACME** Electric
TRANSFORMERS

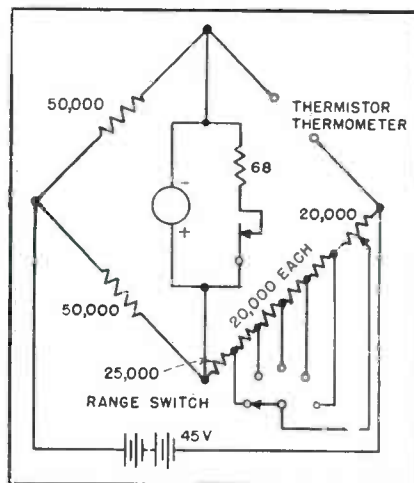


FIG. 1—Circuit of temperature bridge

the Thermistor detector. After the Thermistor detector is connected and the on-off switch is closed, the selector switch is set to one of five positions to bring the meter near to zero. The 20,000-ohm potentiometer is then adjusted to bring the meter needle within one division of zero before pushing the button that removes the meter shunt. The final balance position of the large potentiometer dial, at full meter sensitivity, is referred to one of the five calibration charts to obtain the temperature indication.

There are 14 inches of graduation on the large dial. The total temperature range is divided into 5 scales, so that 70 inches of scale are obtained. The instrument is used for a temperature range from 32 to 102 F, or a spread of 70 F. Thus there is a mean of one inch of scale per degree Fahrenheit. The scale can be read easily to within 2 percent of a degree. The accompanying photograph shows the construction of the bridge and positions of the controls.

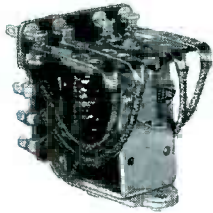
The resistance-temperature curve of the Thermistor used is shown in Fig. 2. Because of the flattening at the cold end, a 500,000-ohm shunt is connected across the Thermistor terminals at the bridge when the selector position is in position 5. With this arrangement (not shown in the circuit), the bridge covers a 10-degree range in the cold position.

Battery drain is small, the battery life being several months even under constant use. Decay in battery voltage does not affect the accuracy of the bridge. The 20,000-ohm potentiometer (General Radio

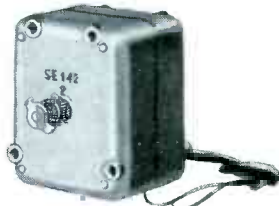


Potter & Brumfield

A GOOD COMPANY TO DO BUSINESS WITH



RELAYS



SMALL MOTORS



PROCESS TIMERS



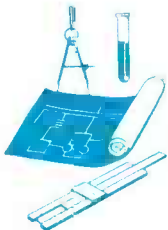
ELECTRO MECHANICAL ASSEMBLIES

● If you use any of these component parts in finished assemblies, it will pay you to investigate the facilities that Potter & Brumfield offers. In the days of keener competition ahead, the character and stability of your suppliers will become increasingly important. Since you are certainly interested in cost, quality and service, we suggest you investigate P&B.



MANAGEMENT—All of the officers of P&B are men with long experience in the manufacture of electrical equipment. R. M. Brumfield, president, was one of the founders of P&B 15 years ago in 1933. Under the guidance of these men, all efforts are directed to the design of high quality special and standard relays and assemblies which can be manufactured on a high production basis at low unit cost.

MANUFACTURING FACILITIES—P&B fabricates almost every part used in relays and other assemblies from raw material to finished product. Quality control over all the many parts of each assembly is maintained. Highly specialized quantity production has enabled P&B to install the best suited, high speed automatic equipment for maximum efficiency in the processing of parts used in these assemblies.



ENGINEERING AND RESEARCH—Complete research and laboratory facilities under the supervision of James F. Rinke, Chief Engineer, are available to solve your problems. Models and pilot runs can be completed quickly and at reasonable cost. In addition, P&B has sales engineering offices in all principal cities. Trained technical men work closely with you in development problems.

KNOW HOW—P&B not only knows how to design relays and similar electro-mechanical assemblies to meet your operational requirements, but also how to design the assembly so that it can be produced on a low cost production basis. Years of specialized experience has created this important practical knowledge. In addition, these years of specialized manufacturing have produced a great stock of tools, dies, jigs, and fixtures which are available for new jobs.



LOCATION AND LABOR—The Potter & Brumfield factory is located in Princeton, Indiana. The company is one of the town's primary industries and a stable supply skilled labor is available. Intelligent design, favorable labor market and low overhead are combined to enable P&B to deliver quality products at low unit cost.

CUSTOMERS—Nationally known electrical appliance and equipment manufacturers are users of P&B components. Among them are: The P. R. Mallory Company, Continental X-Ray Corporation, The Lincoln Electric Company, Operadio Manufacturing Company, Belmont Radio Corporation, Federal Telephone & Radio Corporation, Radio Corporation of America, Westinghouse Electric Corporation, Stewart-Warner Corporation, Admiral Corporation, Stromberg-Carlson Company, Fansteel Metallurgical Corporation, J. P. Seeburg Corporation, Servel, Inc., and a host of others.



CALL IN A P&B TECHNICAL ENGINEER FOR ASSISTANCE IN WORKING OUT YOUR PROBLEM

Electronic Parts Distributors Stock P&B Standard Relays and Timers.

Write for the new Product Catalog No. 148

Potter & Brumfield

SALES COMPANY

549 WEST WASHINGTON BOULEVARD, CHICAGO 6, ILLINOIS—FACTORY AT PRINCETON, INDIANA

MEMBER — THE NATIONAL ASSOCIATION OF RELAY MANUFACTURERS

"SILVER-CLAD"

THE COST SAVING, VERSATILE LAMINATED METAL

Save on costs, gain in performance with silver-clad base metals which offer a diversity of operating characteristics.

FOR ELECTRICAL APPLICATIONS



A part made from silver laminated to a base metal makes an ideal electrical contact. The essential electrical properties of the silver alloy are obtained at minimum cost. At the same time, the most advantageous characteristics of the desired base metal can be utilized. Many engineers feel the most important feature of silver-clad is the absence of a mechanical bond between silver and base metal. Typical examples of the advantage of silver-clad material are found in parts made from silver on phosphor bronze or nickel silver where spring temper is required in the blade, this spring to be obtained by work hardening. We can supply these laminated metals in any temper. For special uses, silver or beryllium copper may be formed soft, then hardened to maximum strength and spring temper. For rugged construction, where heavy loads are carried, silver on pure copper is generally considered most desirable.

FOR CHEMICAL APPLICATIONS



Silver-clad metal is non-corrosive and resistant to organic acids. For food processing equipment and general chemical usage, we have developed new tubing. It may be silver-clad on the inside, or outside, or both, in lengths up to 20 feet, and diameters up to 1 1/2 inches. If demand warrants, diameters of 2 or more inches could be made. The precious metal ratio is closely controlled, the silver surface is hard and free from porosity, and it is economical.

Any alloy of silver will be furnished upon request. Your further investigation is invited. Our chemists, metallurgists, and sales engineers are at your service.



Makepeace PRODUCTS

SHEETS • WIRE • TUBING • SOLDERS • FABRICATED PARTS AND ASSEMBLIES

D. E. MAKEPEACE COMPANY
Main Office and Plant, Attleboro, Massachusetts

NEW YORK OFFICE, 30 CHURCH ST. • CHICAGO OFFICE, 55 EAST WASHINGTON ST.

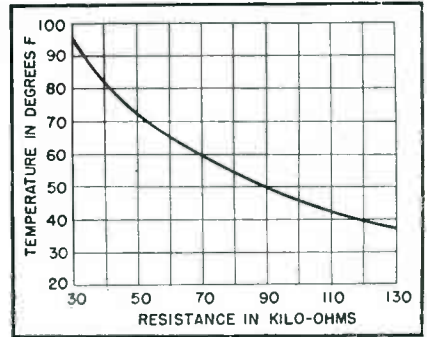


FIG. 2—Characteristic of Thermistor

314-A) is always a fraction of the leg resistance, so smooth control is obtained. Precision resistors are used throughout.

After the bridge was completed, a 50,000-ohm resistor was placed across the Thermistor terminals and the bridge balanced on the sensitive position. The unit was then placed in a controlled cabinet and the temperature varied between 30 and 140 F. The movement of the meter needle was barely perceptible, indicating that the operating temperature of the bridge does not interfere with the indication.

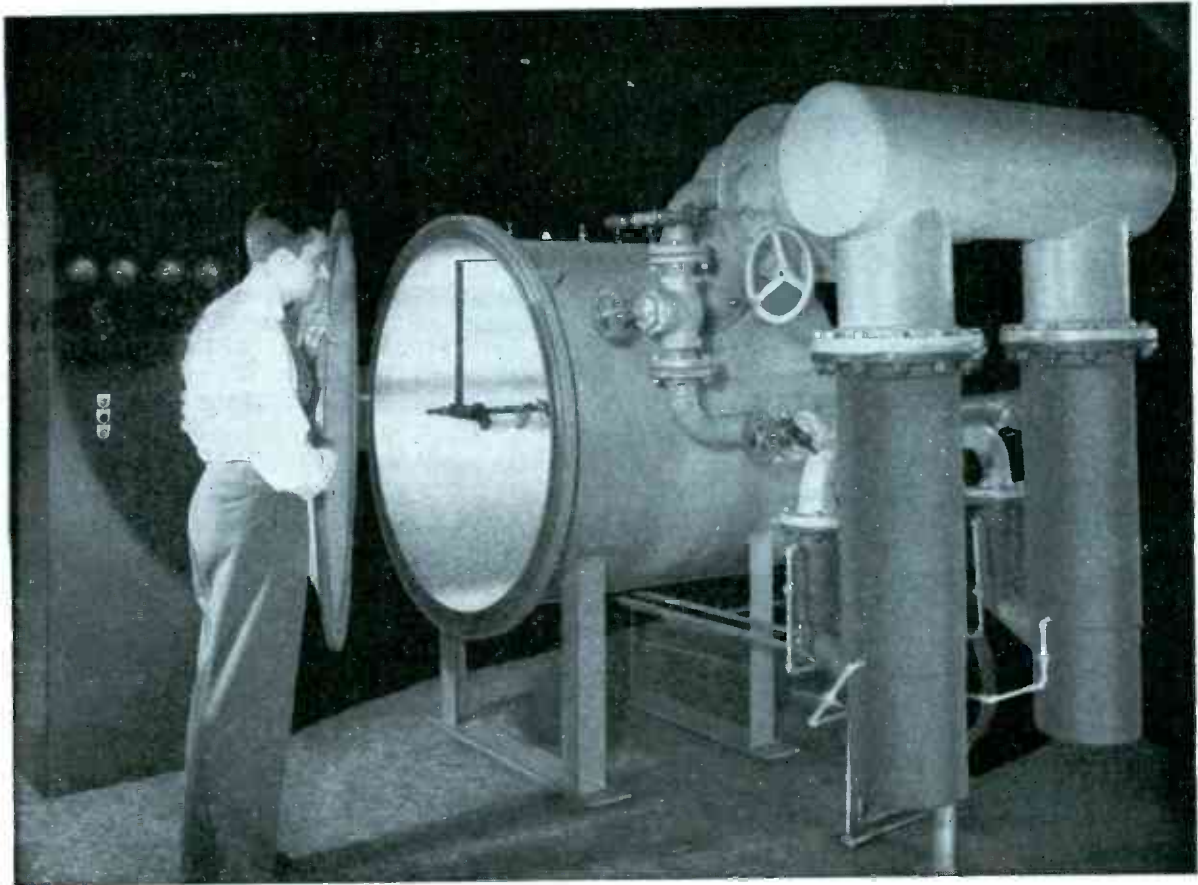
Sensing Element

The Thermistor should be protected against surface leakage when used in a humid atmosphere. Two types of housings were made. For immersion in water, a thin-walled nickel-plated brass cylinder filled with Toluene is used. For checking temperature in a cold atmosphere, a thin-walled brass tube with fins and containing dry air is used. The main consideration in constructing the housing is thermal conduction between the medium to be checked and the sensing element.

Thermal time constant, which is the exponential coefficient of the law of cooling for a body at a different temperature from that of its surroundings, is the time required for the Thermistor to change 63 percent of the difference between its initial level and that of its surroundings, if no electrical power is being dissipated in the Thermistor. The detectors just described have thermal time constants of about 155 seconds.

Stability of a Thermistor depends not only on the materials and process used in manufacturing it, but also on the aging. A preaged unit shows very little aging in use, sometimes as little as 0.2 percent in

INDUSTRIAL HIGH VACUUM COATING UNIT NO. 3103



This High Vacuum Coating Unit is designed for low-cost production of evaporated films on glass and plastics.

The capacity of the stainless steel tank—48" diameter, 48" long—makes possible processing of large batches and large pieces on a production basis.

The pumping system has ample speed to handle the outgassing of plastics and consistently maintains rapid coating cycles.

For further details, write VACUUM ENGINEERING DIVISION, National Research Corporation, Cambridge 42, Massachusetts.

HIGH VACUUM FOR INDUSTRY
NATIONAL RESEARCH CORPORATION
Vacuum ENGINEERING DIVISION



IN WESTINGHOUSE TUBERCULOSIS CONTROL

Tuberculosis detected in time can be cured . . . Westinghouse Electric's new portable, high speed X-ray unit is designed for mass chest examinations — 360 pictures an hour. A picture every ten seconds requires accurate timing — and at the heart of the PFX unit is a Haydon timer — a precision device for retarding the X-ray exposure until the rotating anode in the tube attains proper operating speed — a factor in prolonging tube life . . . a factor in protecting human life with Westinghouse Electric's PFX equipment.

This and thousands of other Haydon timing applications — not only in the medical field, but throughout all industry — demonstrate the trend to Haydon for timing quality.

If your requirements include timing devices, ask for Haydon's Engineering Data Catalog, or request a personal demonstration by a Haydon representative. For immediate reference, see Haydon Catalog, Sweet's File.

Write 2405 Elm Street, Torrington, Connecticut.

HAYDON

MANUFACTURING COMPANY, INC.

TORRINGTON

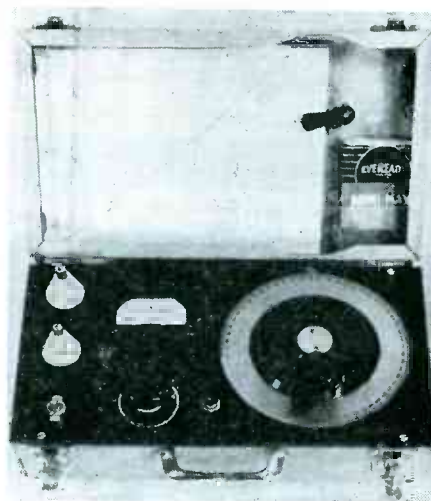


CONNECTICUT

HARNESS TIME TO

YOUR PRODUCTS

SUBSIDIARY OF GENERAL TIME INSTRUMENTS CORPORATION



Carrying case for bridge consists of two plated steel chassis hinged bottom to bottom

a year. This change corresponds to about 0.05 C in this bridge.

Some early Thermistors, when used in this bridge, produced a hysteresis loop. A continuous line could be obtained as the temperature was increasing or decreasing, but when the direction of temperature change was reversed, a new parallel line was followed. If the temperature change was stopped at any point and later resumed in the original direction, the line was a smooth continuation. However, three Thermistors of the type used in this bridge were picked at random and given cycling tests totaling around 150 hours, over a period of three months. Over the temperature range that this bridge was designed to cover, their stability was very good and no hysteresis or fatigue was evident. The thermal lag was consistent with the time constant.

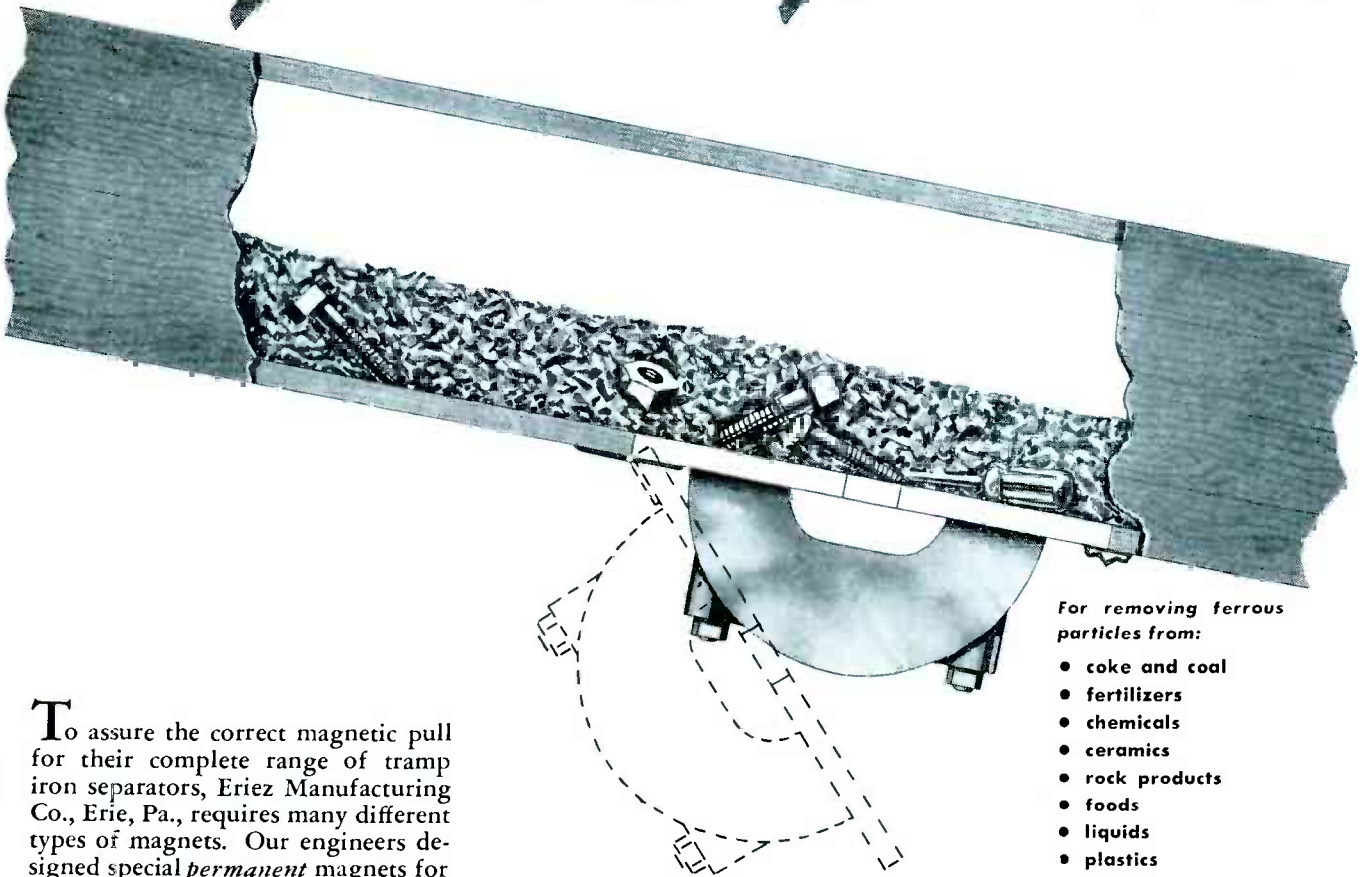
SURVEY OF NEW TECHNIQUES

SPACER COMBS FOR TUNING CAPACITORS made of Nylon have reduced rejects on the production line, and also make the capacitor less subject to damage in use. In adjusting assembled variable capacitors it is necessary to move the plates slightly. Spacers made of conventional brittle materials frequently break during adjustment, resulting in the entire unit having to be scrapped. Although Nylon combs, made by The Polymer Corp., are 5



Permanent Magnets do it Better in

Magnetic Separators



For removing ferrous particles from:

- coke and coal
- fertilizers
- chemicals
- ceramics
- rock products
- foods
- liquids
- plastics
- textiles

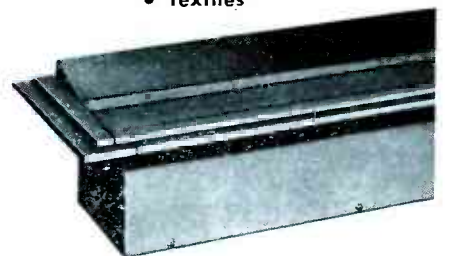
To assure the correct magnetic pull for their complete range of tramp iron separators, Eriez Manufacturing Co., Erie, Pa., requires many different types of magnets. Our engineers designed special *permanent* magnets for the entire Eriez line, bringing *high efficiency* and *low cost* to the removal of ferrous particles from such diverse materials as air, liquids, coal, and rock products. Materials and processing equipment *in many industries* are now protected by Eriez job-fitted separators using *Indiana Steel* permanent magnets.

Only permanent magnets offer these advantages:

1. Steady, everlasting strength.
2. No wiring or electrical current needed.
3. Minimum installation cost.
4. No operating cost.

5. Cool running—no temperature effects.
6. Not affected by moisture.
7. Easily installed in original equipment.
8. Uninterrupted operation.

Perhaps *you* have a job that permanent magnets can do better. Our forty years' experience in permanent magnets and our exceptional design service are at your call. A discussion with our engineers may develop unexpected savings and increased efficiency in your product. Write for complete information.



Eriez "Giant" Magnetic Separator
The largest Alnico magnetic separator produced

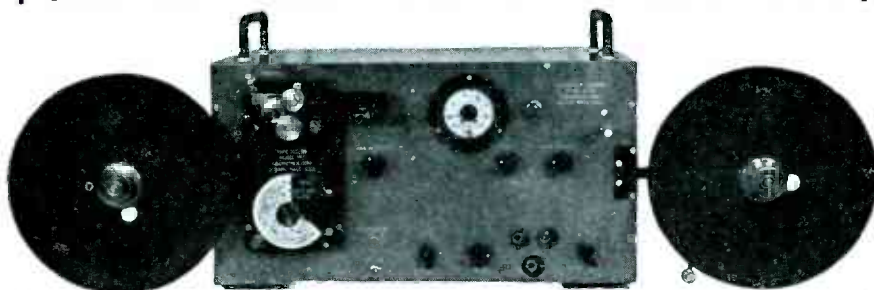


THE INDIANA STEEL PRODUCTS COMPANY

PRODUCERS OF "PACKAGED ENERGY"
6 NORTH MICHIGAN AVENUE • CHICAGO 2, ILL.
SPECIALISTS IN PERMANENT MAGNETS SINCE 1910

PLANTS { VALPARAISO, INDIANA
CHAUNCEY, N. Y.

Mecanitron Presents the New and Versatile SCP-25 SCANNER TRANSMITTER



Mecanitron SCP-25 converts Morse or teletype characters originating on inked slip into electrical equivalents. It has a wide variety of uses on radio telegraph circuits.

TWO types of scanner head are supplied with the SCP-25. Known as the SH-4 and SH-5, they can be instantly interchanged.

... **The SH-4 Scanner Head** — a complete photo-electric unit. It will accurately scan any tape on which any shade of blue or black ink is used.

... **The SH-5 Scanner Head** — uses the conduction principle in a completely contained unit. When the use of conducting ink on tape is desirable, the SH-5 Scanner Head reproduces an extremely accurate grade of copy. The SH-5 is easily adapted to scan *three* separate and distinct messages originating on a standard $\frac{3}{8}$ " slip. Scanning is accomplished either *alternately* or *simultaneously*.

... **The 15-tube electronic circuit offers the following features:**

1. High impedance, bridge-type input circuit.
2. Three-stage, phase-inverted DC amplifier with screen grid feedback to produce controlled, trigger-action.
3. RC coupled, constant-amplitude tone generator, operating from 800 to 3000 cycles, feeding a transient, free-balanced modulator output circuit.

... **The following outputs are available:**

1. On/off direct current up to 80 milliamps with phase-reversing switch.
2. Polar DC up to 40 milliamps with phase-reversing switch.
3. Tone output up to 14 VU with phase-shift switch, output impedance 500 ohms.

... **Tone** is available either alternately or simultaneously with other outputs. DC outputs are suitable for direct connection to existing teletype printers. Individual voltage regulators provided for all circuits.

... **Speed Control** — SCP-25 is available complete with Mecaniclip take-up and storage reels and the famous Mecanitron YY-2 Tape Puller featuring constant, pre-set speeds accurately calibrated in a continuous range from six feet to 148 feet per minute.

YOUR BEST BET FOR INCREASED TRAFFIC ON HIGH-SPEED RADIO, TELETYPE OR MORSE CIRCUITS IS THE SCP-25 COMBINED WITH THE INTERNATIONALLY FAMOUS MECANITRON HIGH-SPEED RECORDER, MODEL MA-126.

Write for additional information today!

MECANITRON CORPORATION

General Offices: 8 Irvington Street, Boston 16, Mass.

Phone: Commonwealth 6-2639

BRANCHES: 1011 New Hampshire Avenue, Washington 7, D. C., Phone: National 0310
142 Bank Street, Ottawa, Ont., Canada, Phone: Ottawa 5-5590

to 10 percent costlier than conventional combs, the reduced breakage is great enough to absorb a 500 percent increase in cost of material. Expansion of the combs due to moisture absorption compares with that of other plastics.

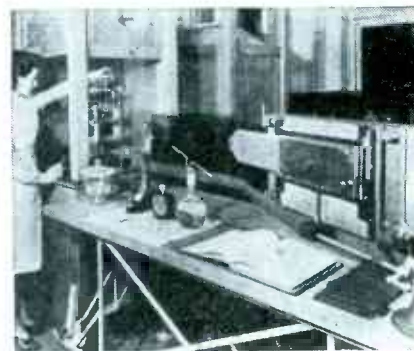
DESIGNED FOR LABORATORY and industrial research, a universal oscilloscope, shown at Brettenham House, London, presents five traces



Six-inch crt presents five traces

simultaneously. Units of the equipment are interchangeable; plugging facilities make possible addition to other units to adapt the oscilloscope to future developments.

LUMINESCENT MATERIALS for cathode-ray tubes are vaporized in a 4,400-volt a-c arc for spectrographic analysis of their characteristics at North American Philips Labs. This



Phosphors are spectrographed

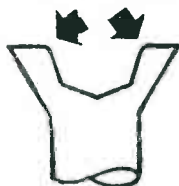
type arc is stable and results in low background on the spectrum plate. Results of the spectrographic investigation will provide background data for designing television picture tubes.

ONLY PHILLIPS

CROSS RECESSED HEAD SCREWS

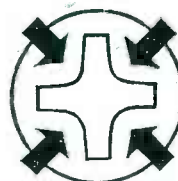
ARE ENGINEERED FOR PRACTICAL PRODUCTION DRIVING

RECESS EDGE ROUNDED AT TOP

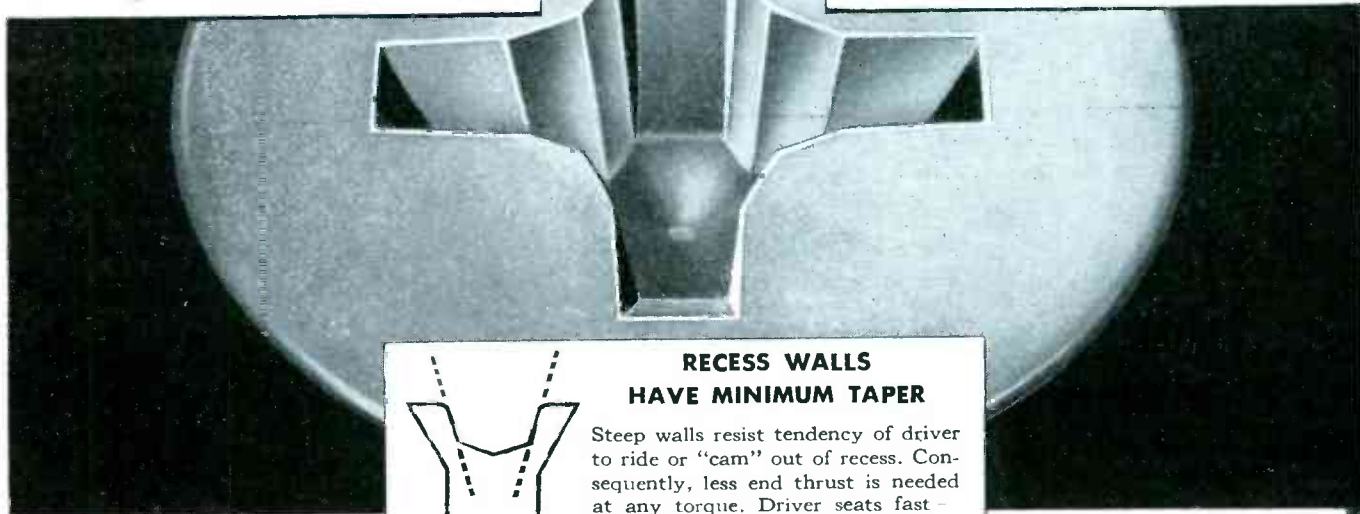


Prevents pushing up burrs because contact with driver begins just below top surface of screw head. Easy for driver to "ride in" to a firm seat, without excess strain on driver point wings.

WIDER OPENING AT RECESS CENTER



Absence of sharp corners provides wider center opening. This recess shape aids self-centering of driver. It also permits driving tool contour that insures maximum strength.



RECESS WALLS HAVE MINIMUM TAPER



Steep walls resist tendency of driver to ride or "cam" out of recess. Consequently, less end thrust is needed at any torque. Driver seats fast - stays seated.

LOOK CLOSELY at the Phillips Recess. No sharp corners to burr easily - require slowed-down, fussy starting - or to "beat up" bits.

Phillips Engineers shaped this recess according to job conditions, not on abstract theory. They know

assembly workers are fast moving, often "heavy-handed," cannot always be as fully trained as desired.

That's why Phillips Recessed Head Screws not only promise, but *deliver* all advantages of the cross recessed head on any assembly job.

GET ALL THE ADVANTAGES OF ASSEMBLY WITH CROSS RECESSED HEAD SCREWS... GET

GET THIS NEW BOOKLET to guide you in selecting the right cross recessed head screws for your assembly... "Why Phillips is the STANDARD Cross Recessed Head Screw". It's free.

USE THE COUPON

PHILLIPS Recessed Head SCREWS

Wood Screws • Machine Screws • Self-tapping Screws • Stove Bolts

25 SOURCES

American Screw Co.
Central Screw Co.
Continental Screw Co.
Corbin Screw Div. of
American Millw. Corp.
Elco Tool & Screw Corp.
The H. M. Harper Co.
Lamson & Sessions Co.
Millford Rivet and Machine Co.
National Lock Co.

National Screw & Mfg. Co.
New England Screw Co.
Parker-Kalon Corporation
Fawtucket Screw Co.
Rheol Manufacturing Co.
Feeding Screw Co.

Russell Burdall & Ward Bolt & Nut Co.
Seavill Manufacturing Co.
Seaboard Screw Corp.
Shakeproof Inc.
The Southington Hardware Mfg. Co.
The Steel Company of Canada, Ltd.
Sterling Bolt Co.
Stronghold Screw Products, Inc.
Wales-Beech Corp.
Wolverine Bolt Company



Phillips Screw Mfrs.,
c/o Horton Noyes Co.
1800 Industrial Trust Bldg.
Providence, R. I.

Send me the new booklet - "Why PHILLIPS is the STANDARD Cross Recessed Head Screw".

E-27

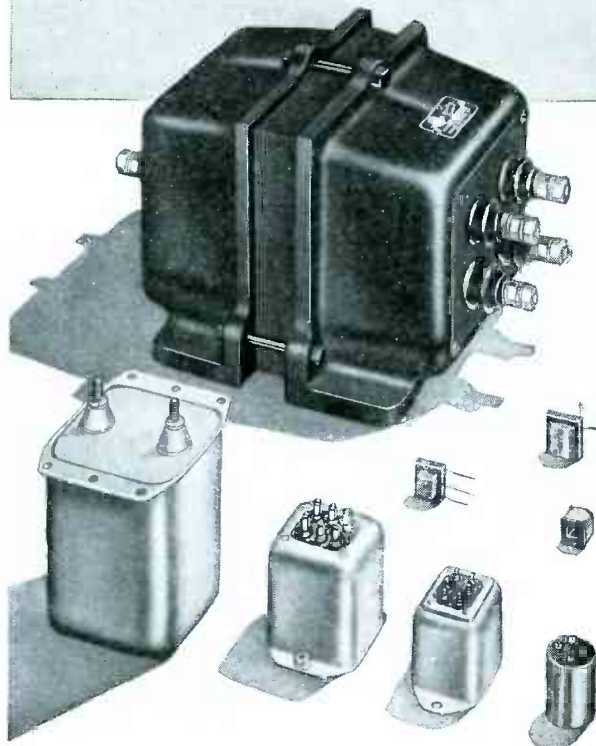
Name

Company

Address

**SPECIFIED PERFORMANCE
PROMPTLY DELIVERED!**

Insist Upon Genuine
STANCOR
TRANSFORMERS



STANCOR has the ability to meet the most exacting demands for all specialized transformer needs . . . expertly . . . immediately. The combination of superior engineering, streamlined plant facilities and mass production unite to guarantee transformers that will give you the utmost in efficiency—at the lowest cost to you.

Our Competent and Versatile Engineering Staff Is Available Now to Meet Your Most Exacting Transformer Requirements . . . Write or Wire Us Today.



STANDARD TRANSFORMER CORPORATION

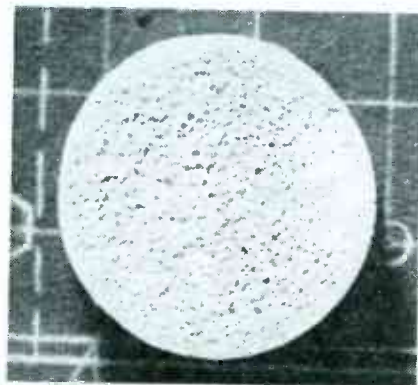
ELSTON, KEDZIE & ADDISON • CHICAGO 18, ILL.

NEW PRODUCTS
(continued from p 138)

effect of light viewed through an aperture in the turbine disc.

Silicone Sponge

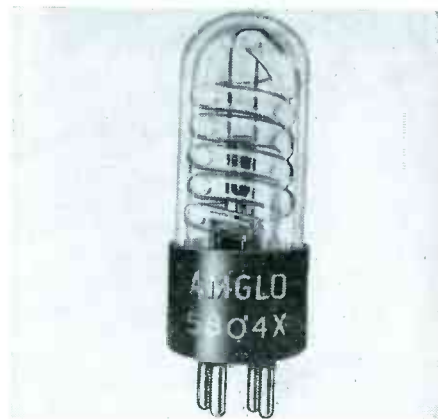
CONNECTICUT HARD RUBBER Co., 407 East St., New Haven 9, Conn. Silicone rubber sponge for sealing and



vibration damping can be used in the temperature range from 500 to minus 70 F. It is available in extruded shapes, sheets, or as molded items.

High Speed Flash

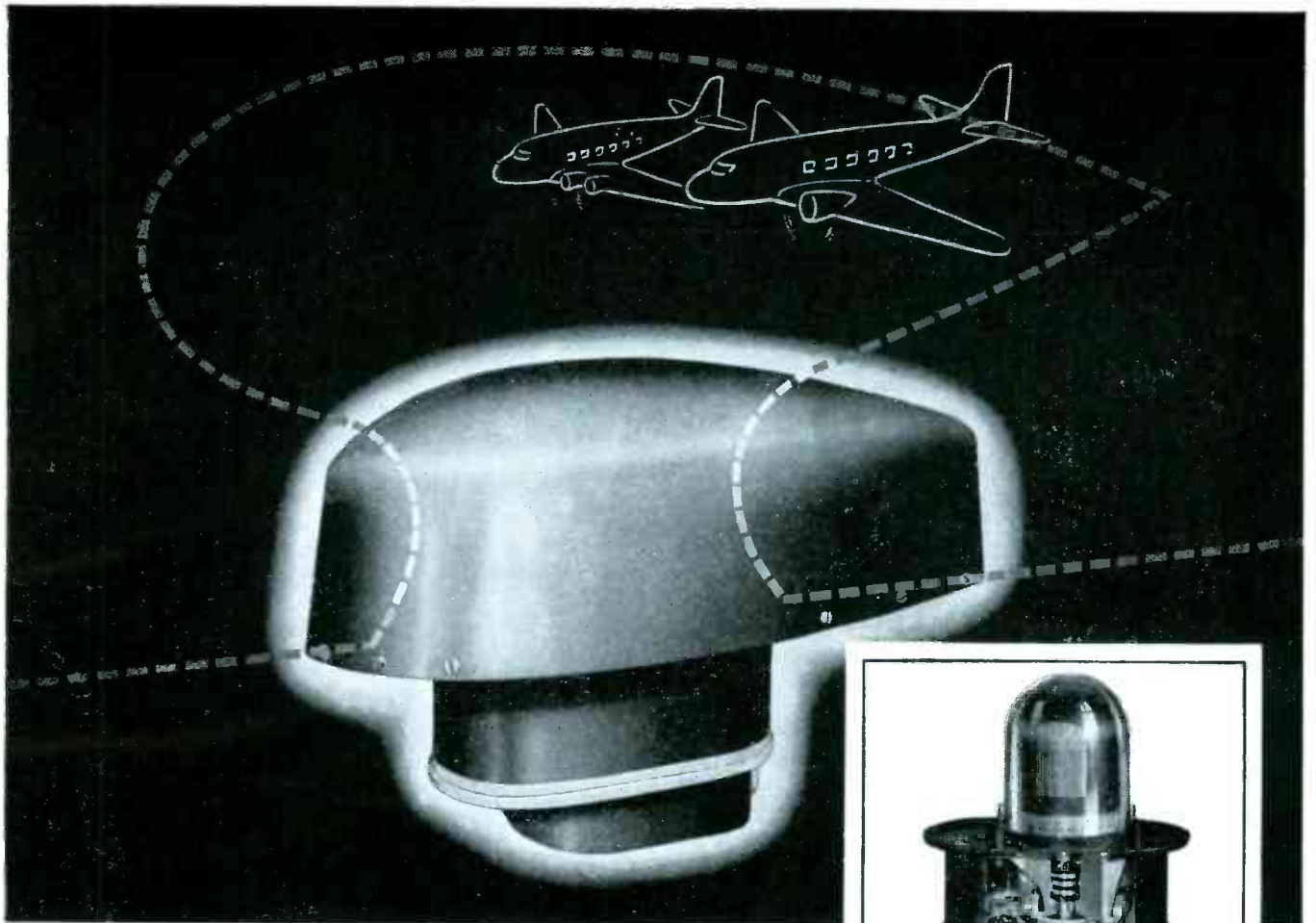
AMGLO CORP., 4234 Lincoln Ave., Chicago 18, Ill. Amglo 5804X lamp has a peak lumen output of approximately 40 million. Maximum en-



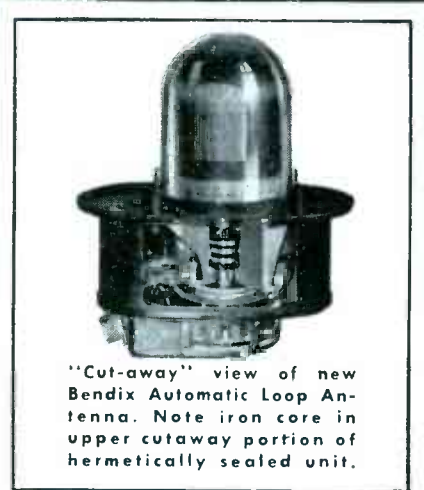
ergy input is 100 watt-seconds with recommended operating voltage between 2,250 and 2,850 volts. It does not require an auxiliary high voltage pulse to initiate ionization.

R-F Oscillator

TECHNICAL INSTRUMENT CORP., 1058 Main St., Waltham 54, Mass. Type



The new, smaller Bendix Iron Core Loop shown here, superimposed in proper proportion on the outline of the air core type that it replaces, is visual evidence of reduction in size accomplished by the use of Stackpole Iron Cores. Air drag is reduced 72% because of this more efficient loop.



"Cut-away" view of new Bendix Automatic Loop Antenna. Note iron core in upper cutaway portion of hermetically sealed unit.

STACKPOLE IRON CORES REDUCE AIR DRAG 72%

Unusual as it may seem, careful research and modern electronic design has shown that the use of Stackpole Powdered Iron Cores increases the pay load of regular commercial aircraft.

The new Bendix Automatic Loop Antenna as used in Bendix Radio Division's Navigational System is smaller in size and more efficient than the air loop it replaces. Stackpole Iron Cores permit this reduction in size and also increase the efficiency of the loop. Air drag, an all important consideration in aircraft design, is one of the determining factors in establish-

ing the allowable "Pay Load." Air drag at 250 mph, has been reduced by more than 72% by use of this new Bendix loop!

Stackpole Powdered Iron Cores are performing miracles like this for many other manufacturers, too. Improved performance, reduced costs, smaller physical sizes—these are some of the advantages that usually result when Stackpole Iron Cores are designed into inductive circuits. Write on your company letterhead today for full information. Ask for STACKPOLE Bulletin No. RC7B.

STACKPOLE CARBON COMPANY, ST. MARYS, PA.

STACKPOLE

IRON CORE HEADQUARTERS



Present 3 clean-cut Advantages

1. EXTREME UNIFORMITY
2. SUPERIOR STAKING QUALITIES
... ends will roll without splitting.
3. BETTER FOR MOLDED PARTS
.. closed end keeps compound out.

If you use pins for vacuum tubes, adapters, fluorescent lamps, plugs, or electrical equipment of any kind, the chances are you'll save time, money and rejections by using these super-smooth, *seamless*, patented Radio Pins. They are available in a wide variety of styles and sizes, with staking end either closed or open. For a quotation, simply send a sketch, sample or description and state the quantity you need.

Radio or Radar Equipment?

In addition to Radio Pins, we produce large quantities of top caps, base shells and adapter shells for vacuum tubes; also a wide variety of other metal products including deep drawn shells and cups, blanks and stampings, ferrules, grommets, washers, vents, fasteners—and, for almost every manufacturing requirement, the world's largest assortment of eyelets. 47420



THE AMERICAN BRASS COMPANY Waterbury Brass Goods Branch

General Offices: Waterbury 88, Connecticut
Subsidiary of Anaconda Copper Mining Company
In Canada: ANACONDA AMERICAN BRASS LTD., New Toronto, Ont.



410-A r-f oscillator is a general purpose laboratory instrument and a signal source for r-f bridges. It is provided with output voltmeter and a continuously adjustable level control. Frequency range is 100 kc to 10 mc in six bands. Internal modulation at 1,000 cycles is provided. Output impedance is approximately 50 ohms.

Leak Detector

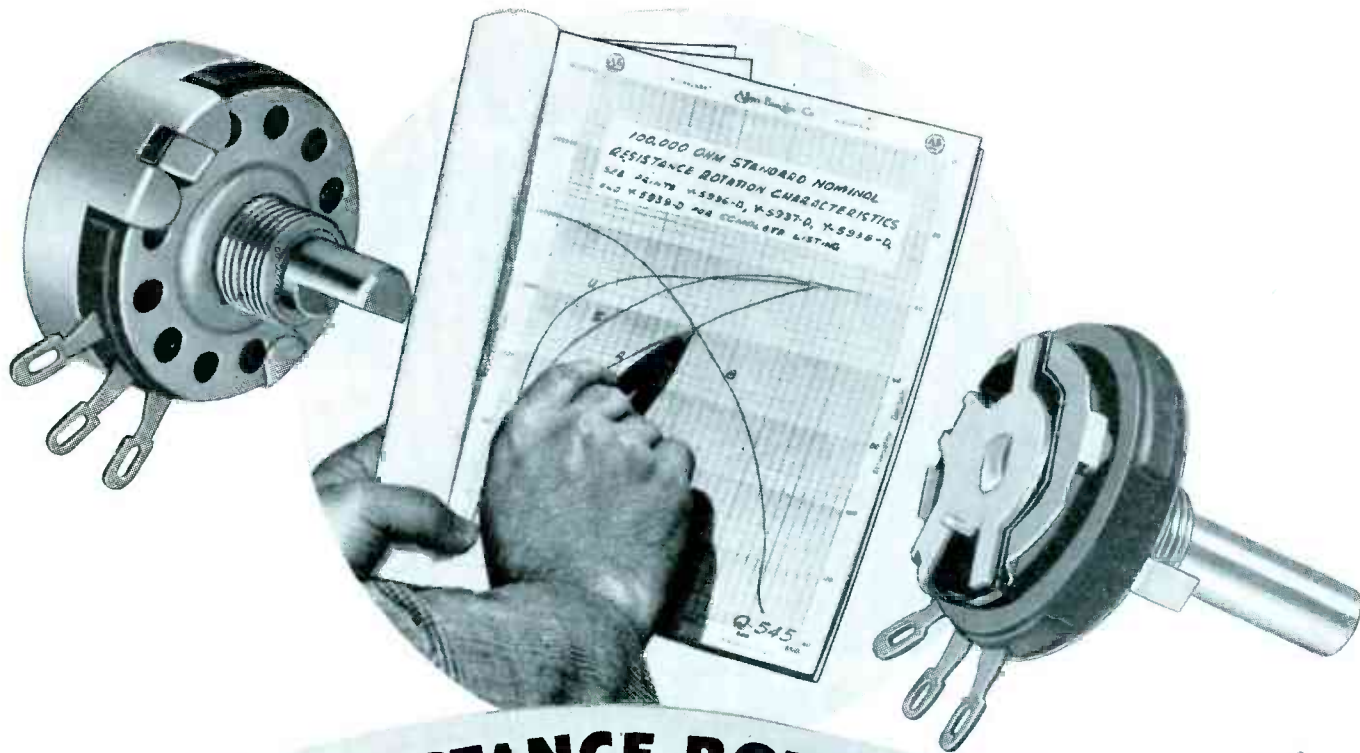
GENERAL ELECTRIC Co., Schenectady 5, N. Y. A new portable leak detector designed for production testing of hermetically sealed units in which halogen compounds are used as refrigerant will detect a



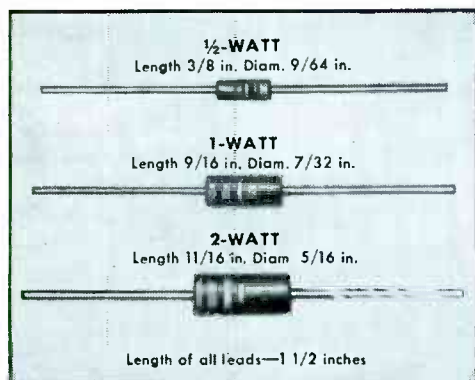
leak so small that it will release only 1/100 ounce of Freon per year. Detector unit weighs 3 pounds and the control unit 15. Earphone or loudspeaker indication is provided as well as a meter deflection. Bulletin GEC-233 tells more.

Micrometer

STEVENS-ARNOLD INC., 22 Elkins St., South Boston 27, Mass. A new electric micrometer can be used for measuring, gaging, comparison, and telemetering up to 100 feet. The equipment comprises a control unit with zero-center meter and a transmitter with plunger that will accept motion of plus or minus 0.010 inch



ANY RESISTANCE-ROTATION CURVE



ALLEN-BRADLEY FIXED RESISTORS

Bradleyunit solid-molded, fixed resistors are not rated on the basis of the conventional 40C ambient temperature . . . instead, they are rated at 70C ambient temperature. They will operate at full rating for 1000 hours in an ambient temperature of 70C with a resistance change of less than 5 per cent.

The 1/2-watt and 2-watt sizes are available in standard R.M.A. values from 10 ohms to 22 megohms. The 1-watt size from 2.7 ohms to 22 megohms.

Such "extra" performance guarantees dependability for your electronic equipment.

The Type J Bradleyometer can be built to produce any resistance-rotation curve because, during manufacture, the solid-molded, ring-type resistor can be varied in resistance throughout the circumference of the ring.

It is not a film- or paint-type resistor. The resistor unit is molded as a one-piece ring with terminals, face plate, and threaded bushing imbedded in the molded piece. After molding, the resistor material is no longer affected by heat, cold, moisture, or age. The contact brush actually improves with age.

In the Type JW Bradleyometer a resilient, watertight packing is placed around the shaft to exclude moisture.

Type J Bradleyometers can be supplied in single-, dual-, or triple-unit construction for rheostat or potentiometer applications. A built-in line switch is an optional feature on single and dual models. Specifications sent upon application.

Allen-Bradley Co., 110 W. Greenfield Avenue
Milwaukee 4, Wisconsin


ALLEN-BRADLEY
FIXED & ADJUSTABLE RADIO RESISTORS
 QUALITY



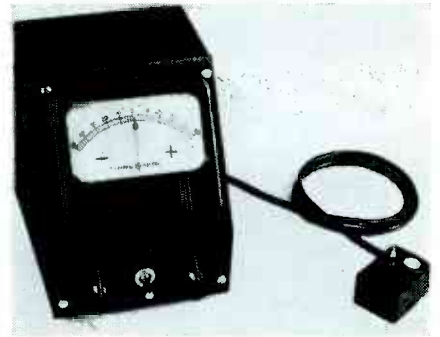
MOSINEE

"More than Paper"

In the field of electronics and the electrical goods industry, MOSINEE stands for paper-base processing materials with scientifically controlled chemical and physical properties, high quality standards and dependable uniformity... with good dielectric strength, high tensile or tear strength; proper softness or stiffness; creped with controlled stretch or flexibility; specified pH for maximum-minimum acidity or alkalinity; accurate caliper, density, liquid repellency or absorbency... or other technical characteristics vital to your quality standards and production requirements.

MOSINEE PAPER MILLS COMPANY • MOSINEE, WIS.

"Essential Paper Manufacturers"



from the center position or a total of 0.020 in one direction.

Miniature P-A Pentode

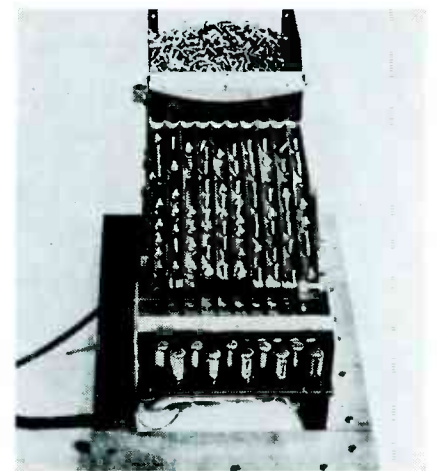
RADIO CORP. OF AMERICA, Harrison, N. J. Type 6AR5 is a new miniature power amplifier pentode in-



tended for use in the output stage of automobile and a-c operated receivers and within its maximum ratings is the performance equivalent of type 6K6-GT.

Ten-Eye Counter

POTTER INSTRUMENT CO., INC., 136-56 Roosevelt Ave., Flushing, N. Y. Counting of small parts is accom-



FEATURES AND SPECIFICATIONS

1 EQUIPMENT. Designed to give any power output in multiples of 20 watts, i.e. two driver units will give 40 watts, three driver units will give 60 watts, etc. Push-pull output tubes for adequate economical power output to drive one or two speakers. Additional driver stages available to drive any number of speakers. Note: We do not, however, carry a stock of panels or racks for purposes of installation.

2 GAIN. Adjusted for crystal pickup, adequate to allow the use of variable reactance pickup and low sensitivity microphone.

3 HUM. Less than .5 microwatts at 1 watt level—so low as to be inaudible in a quiet room with the ear 12 inches from the speaker.

4 POWER OUTPUT. Uniform within plus or minus 1.25 db from 40 to 20,000 cps at the 20-watt rating.

5 ACOUSTICAL RESPONSE. With a properly selected loud-speaker system, the equipment will produce a 20 to 20,000 cycle response.

6 NEGATIVE FEEDBACK of 8 db is incorporated. This reduces any tendency for distortion and hum.

7 PHONO INPUT. When the phono input is used, the pre-amplifier is adjusted for use with a crystal pickup. However, the separate stage of amplification provided in the MICROPHONE circuit allows a low output pickup (variable reluctance type) to be connected here without requiring additional amplification. A simple equalization network comprising resistance and capacitance is required, of values depending on the characteristics of the pickup selected.

8 TWO OUTPUT IMPEDANCES of 8-16 ohms are available to match several speaker arrangements.

9 BUILT-IN DYNAMIC NOISE SUPPRESSOR uses 4 tubes incorporating three gate circuits, all dynamically controlled. Two circuits control the high frequency, wide band response, and one controls the low frequency, narrow band response. The high frequency and low frequency responses are individually controlled from two separate circuits incorporating individual voltage and timing constants. Five positions of control are provided: two for noisy records, one for the off (or disconnect) position, and two for records that need noise suppression only at times. When the volume level of the record is such that the scratch might be apparent, the dynamic action will automatically allow the reproduction of all the tones to be heard in the acoustical system. The bass gate works the same way, protecting against any rumble or low frequency noises.

10 FIVE CONTROLS for simplicity:

- Full range volume control.
- Bass control continuously variable. A total variation of 28 db at 100 cps allowing for individual choice of bass boost or cut.
- Treble control continuously variable. A total variation of 25 db at 5000 cps allowing for individual choice of treble boost or cut.
- Selector control selecting the choice of inputs.
- Music control giving the choice of the degree of suppression of noise or the expansion of the tonal range when the noise components are not objectionable.

11 TUBE COMPLEMENT

- 1 6SJ7 Microphone or high gain pre-amplifier
- 1 6B8 Noise amplifier and diode gate control voltage rectifier
- 1 6SG7 High frequency sharp cut-off gate control tube
- 1 6SG7 High frequency control tube
- 1 6SJ7 Bass frequency control tube
- 1 6SJ7 First audio amplifier tube
- 1 6SL7 Tone control tube
- 1 6J5 Second audio amplifier tube
- 1 6J5 Third audio amplifier tube
- 1 6SN7GT Phase inverter and driver tube
- 2 6L6G Power output tubes
- 2 5Y3 Voltage rectifiers.

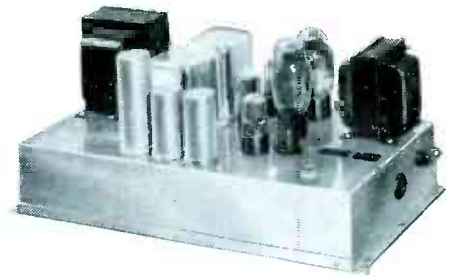
12 ADDITIONAL FEATURES

- Auxiliary AC outlet internally controlled by on-off switch.
- Socket for 6.3 volt pilot light.
- Recorder output terminal.
- Microphone shorting type terminal.
- Separately fused for protection.
- Tapped AC line transformer. Low line tap for voltages of 103 volts to 117 volts and a high line tap for line voltages of 118 to 132 volts. This will give maximum performance of the amplifier regardless of the line voltage by the adjustment of the line tap.

This equipment is designed to conform to the regulations of the Board of Fire Underwriters.



PRE-AMPLIFIER CHASSIS — 15¼" x 7¼" x 2½" — aluminum, finished in an aluminite finish.



POWER AMPLIFIER CHASSIS — 16" x 10½" x 2" — base is steel, chromium plated and polished.

Make your own record player or sound system deliver fidelity, volume, beauty "out of this world" with a

SCOTT Amplifier

Here is the amplifier you have always wanted for your own record player, loud-speaker installation, or sound system.

Now you can have a Scott—an amplifier used in one of the finest Scott instruments—designed to deliver fidelity, tonal quality, volume, range, and beauty of performance never before available.

Features of Two Units

The amplifier comprises two units—a pre-amplifier chassis (including the famous Scott Music Control with Dynamic Noise Suppressor*), and a power amplifier chassis. Fourteen tubes, including two rectifiers—two preliminary stages of audio amplification—a driver audio amplifier—a push-pull power output stage—suitable controls for volume regulation and continuous adjustment of bass and treble response are among the features.

This fine instrument, because of its power handling capacity and wide audio range, delivers reproduction of voice and music with fidelity and range which satisfy the most critical listener. The power output allows reproduction of musical

selections regardless of dynamic range, because even on the peaks of volume the capacity of the amplifier is seldom used. The instrument will transmit the entire range of frequencies between 20 and 20,000 cycles without distortion.

No Blast or Distortion

This extremely wide range, beyond that of the average human ear, means that the sheer beauty of the music is undisturbed, without blast, distortion, or a tendency to "spill over" even on fortissimo passages.

The famous Scott Music Control, with the Dynamic Noise and Scratch Suppressor*, brings out soft musical passages in all their delicate beauty, free from annoying scratch and rumble. In loud, brilliant passages, the circuits permit full passage of all the tonal range built into the record. This control, used with the Scott infinite bass and treble controls and volume control, gives you command of performance second only to that of the conductor who presented the music when recorded.

Limited quantity available. Order now for immediate delivery.

SPEAKERS—For balanced performance with Scott Amplifiers. Prices on request.

RECORD CHANGERS—Special prices for Garrard Record Changers.

* Hermon Hosmer Scott Patents Pending.

Send us this coupon with your certified check or money order and we will ship this amplifier express prepaid to any place within the continental United States at a price of \$180.00. Test it for five days and if you are not entirely satisfied, return it to us express collect and we will cheerfully refund your money, providing the instrument reaches us in the same condition in which it was sent.

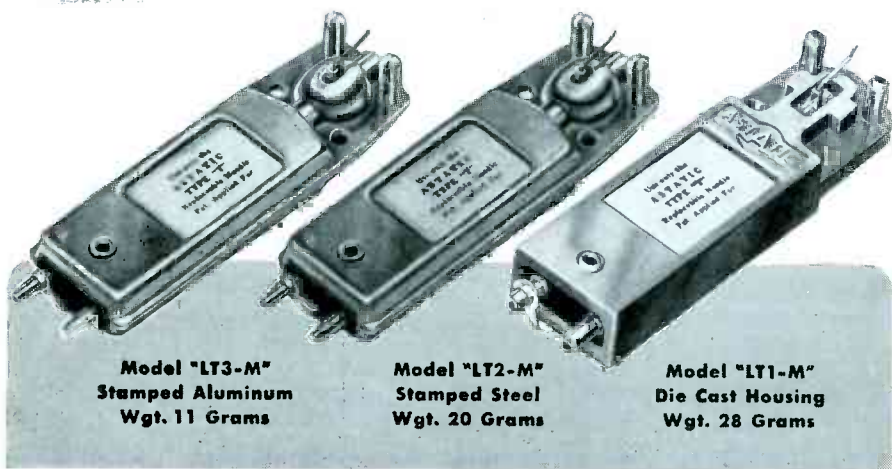
Scott Radio Laboratories, Inc.
4541 Ravenswood Avenue, Chicago 40

FIVE DAYS' TRIAL MONEY-BACK GUARANTEE

NAME _____

ADDRESS _____

CITY-ZONE _____ STATE _____



Model "LT3-M"
Stamped Aluminum
Wgt. 11 Grams

Model "LT2-M"
Stamped Steel
Wgt. 20 Grams

Model "LT1-M"
Die Cast Housing
Wgt. 28 Grams

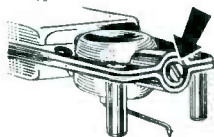
There's an Astatic Model "LT" CARTRIDGE For Every Pickup Arm

IN ORDER that radio-phonograph engineers may select a cartridge of the proper weight to provide optimum needle pressure and pickup inertia characteristics with various types of arms, Astatic's new low pressure, low needle talk "LT" Series Cartridges are now supplied in three different type housings. For improved clarity and quiet of phonograph reproduction, Astatic "LT" Cartridges are highly recommended for new installations in all types of automatic record changers and manually operated phonographs. The response of these cartridges is exceptionally smooth over the entire frequency range from 50 to 10,000 c.p.s., with a gradual roll-off commencing at approximately 4,000 c.p.s. Minimum Needle Pressure, 3/4 oz. Output Voltage, 1.0 Volt average at 1,000 c.p.s.

BOOTH 125 at the PARTS SHOW
Chicago • May 11-14

TYPE "T" Replaceable NEEDLE

This stainless steel type "T" Needle with electro-formed precious metal tip is used with all "LT" Cartridges.



Needle quickly and easily released for replacement by loosening set screw in head of Cartridge.

Also highly recommended is Astatic's de luxe "QT" Series (Quiet Talk) Cartridge, employing a matched, replaceable Type "Q" Needle with sapphire or precious metal tip.



Literature is Available



NEW PRODUCTS

(continued)

plished in a new detection system with circuits designed to resolve simultaneous or random counts in ten channels. Correct count is attained even though parts fall past the ten photoelectric detectors at the same instant.

Pocket Multimeter

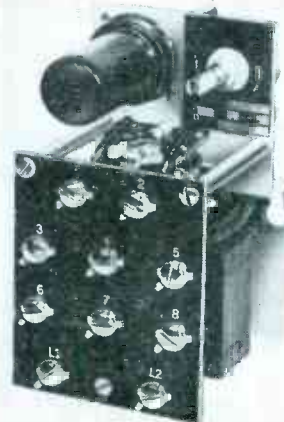
TRIPLETT ELECTRICAL INSTRUMENT CO., Bluffton, Ohio. Model 666-HH volt-ohm-milliammeter is a pocket-



size unit designed to fill the usual measurement needs of industrial engineers, laboratory technicians, and the like.

Relay Control

R-S PRODUCTS CORP., Philadelphia, Pa., announces the new Leveltronic relay with double-pole, double-throw action for pressure, liquid



Electronic Equipment Manufacturers-



A Newly Perfected Cord Label
RECOGNIZED BY
Underwriters' Laboratories

**To Match the Perfection
Of Your New Products!**

Specify

**PRESSURE SENSITIVE
Underwriters' Approval Labels**

On All Cord Sets or Power Supply Cords You Order!

Protect product quality! Give consumers the approved cord label they prefer! The PRESSURE SENSITIVE UNDERWRITERS' APPROVAL LABEL won't fall or wear off the cord, won't nick hands, clothing or drapes, will keep its handsome appearance for the cord's life!

REMEMBER, PRESSURE SENSITIVE UNDERWRITERS' APPROVAL LABEL IS THE LABEL RADIO BUYERS WILL LOOK FOR.

Ask for names of manufacturers supplying pressure sensitive underwriters' approval labels or fill in and send coupon below to your present cord supplier.

Gentlemen:

We'd like to see a Pressure Sensitive Underwriters' Approval label on a sample of the cord set you regularly supply. Please rush sample.

Firm Name

Address

Your Name Position

Pressure Sensitive

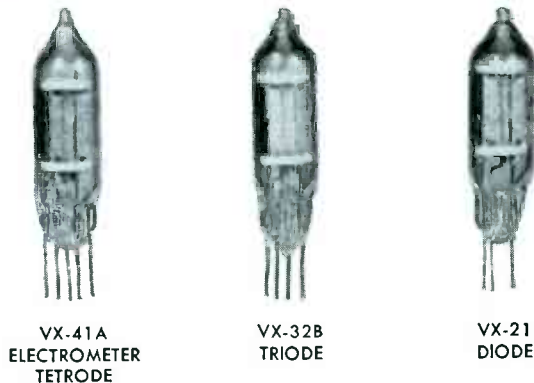
Labels

P. O. Box 305, Providence

Rhode Island

There is big news in these small packages

Subminiature vacuum tubes which provide an expanding horizon for the development of many new and unique electronic circuit requirements.



Actual sizes

VX-41A ELECTROMETER-TETRODE

10 ma. filament current at 1.25 volts
1.5 to 1.1 filament voltage
 10^{-15} amperes grid current
2,000 hours minimum life test
13 amplification factor

VX-32B TRIODE

10 ma. filament current at 1.25 volts
1.5 to 1.1 filament voltage
 10^{-13} amperes grid current
25,000 ohms plate resistance
65 micro mhos transconductance

VX-21 DIODE

10 ma. filament current at 1.25 volts
1.5 to 1.1 filament voltage
3,000 volts inverse peak
 10^{14} ohms insulation resistance
600 microampere emission

Data sheets on subminiature tubes, hi-megohm resistors, and our complete line of radiation measuring instruments available on request.

Department A

THE VICTOREEN INSTRUMENT CO.
5806 HOUGH AVE., CLEVELAND 3, OHIO

NEW PRODUCTS

(continued)

and temperature controls. In operation of the unit, the circuit uses a positive-acting thyatron with the tube current limited to less than $\frac{1}{3}$ its maximum value. Two models cover a range of 20 ohms to above 2 megohms with continuously variable sensitivity giving 2 to 1 discrimination over the full range.

Sealed Midget Relay

PRICE ELECTRIC CORP., Frederick, Md. Made with coil resistances up to 9,500 ohms and contact combina-



tions including 4pdt a new Husky type sealed midget relay is available with mounting feet at the armature end. Palladium silver, and tungsten contacts are supplied to fit load requirements.

13-Channel Marker

KAY ELECTRIC Co., 23 Maple Ave., Pine Brook, N. J. Mega-Marker Sr. provides accurate sound carrier frequencies for all thirteen television channels crystal controlled



to an accuracy of 0.01 percent. Single-dial control avoids necessity for calibration charts. Price is \$195 fob.

Small Motor

T. C. SMITH MFG. Co., Springfield, Ill., has a new fractional horsepower

THIN METHACRYLATE SHEET IS HERE

NO, NO ILLUSTRATION

We're leaving it up to you to fill this space with mental pictures of ways you can use this new Plax product.

Add another first to Plax's long list of innovations. This time it is methacrylate sheet that is really *thin*. It is available now and you can order for immediate delivery. Thicknesses range from .010" through .045."

You know methacrylate — its crystal clarity, brilliance of finish, dimensional stability and durability. Well, here are

these advantages under your hand for the first time in *thin* sheet form. You can have it run-of-mill or press polished.

You probably have had all sorts of ideas for a material like this. It lends itself admirably to numberless applications like boxes, radio dial coverings, spacers, watch crystals, other drawn parts, light louvres, etc.

CHART ON "HOW TO USE PLASTICS"

Now available for the asking is a table of properties for six materials available from Plax in various forms and formulae. This has been incorporated in the Plax catalog, which also contains helpful information on the primary uses of each material.

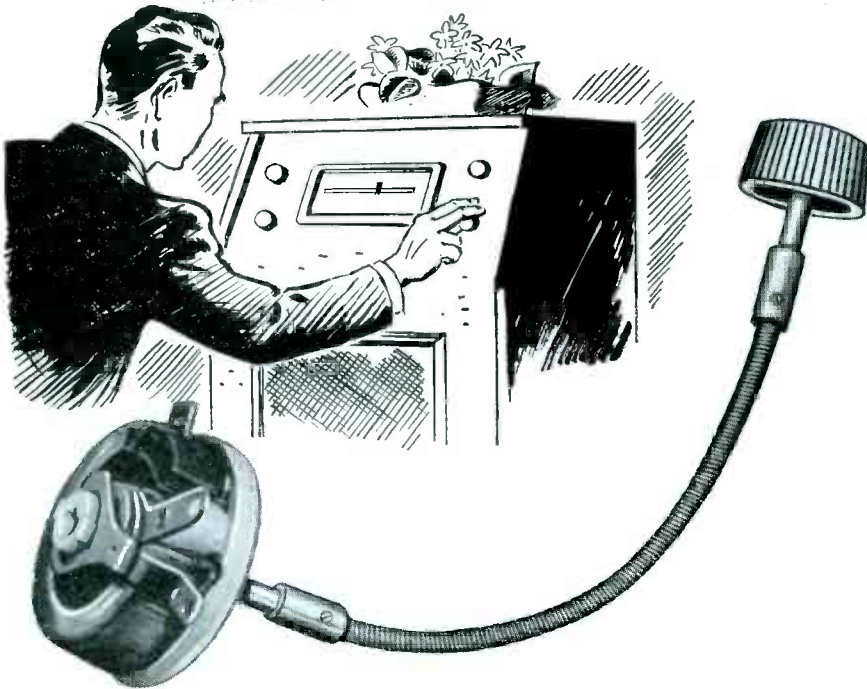
A copy will be sent promptly upon receipt of your request.

Between the resources of Shaw Insulator Company, Irvington 11, N. J., and Plax Corporation, Hartford 1, Conn., you can find help on virtually every material and method in plastics today.



P. O. BOX 1019 ★ HARTFORD 1, CONNECTICUT
In Canada — Canadian Industries, Ltd., Montreal

Simplify WITH S.S. WHITE FLEXIBLE SHAFTS



HOW TO MEET 6 "MUSTS" IN EQUIPMENT DESIGN

Certain electrical and physical requirements must be met in creating radio and electronic equipment that will be satisfactory from the standpoint of both production and use. The 6 principal "musts" are these

- | | |
|--|---|
| 1 <u>Optimum circuit efficiency</u> | 4 <u>Convenient operation</u> |
| 2 <u>Easy assembly and wiring</u> | 5 <u>Accessibility for servicing</u> |
| 3 <u>Space saving</u> | 6 <u>Orderly panel arrangement</u> |

With respect to variable elements, you can satisfy all six by coupling such elements to their control knobs with S.S.White remote control flexible shafts, because this *allows you to locate both elements and controls in their most advantageous positions*. And you sacrifice nothing in the quality of control, because, with proper application, S.S.White remote control shaft operation is every bit as smooth, easy and sensitive as a direct connection.

THIS 260-PAGE FLEXIBLE SHAFT HANDBOOK WILL GIVE YOU FULL DETAILS—

A free copy will be mailed, if you write for it on your business letterhead and mention your position.

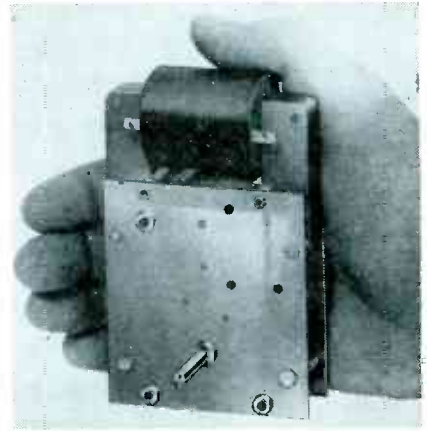


S.S. WHITE INDUSTRIAL DIVISION
THE S. S. WHITE DENTAL MFG. CO. DEPT. E 10 EAST 40th ST., NEW YORK 16, N. Y.



FLEXIBLE SHAFTS • FLEXIBLE SHAFT TOOLS • AIRCRAFT ACCESSORIES
SMALL CUTTING AND GRINDING TOOLS • SPECIAL FORMULA RUBBERS
MOLDED RESISTORS • PLASTIC SPECIALTIES • CONTRACT PLASTICS MOLDING

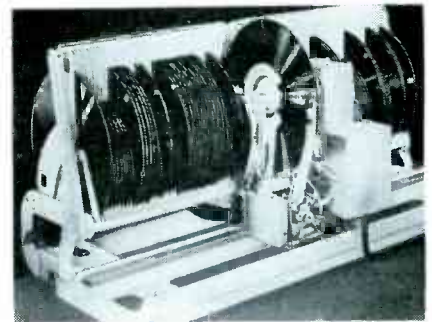
One of America's AAAA Industrial Enterprises



motor of the shaded-pole, induction type. With 20 watts input at 115 volts, 60 cycles, the no-load speed is 20 rpm on the output shaft. Performance curves and other information will be supplied on request.

Superchanger

J. P. SEEBURG CORP., 1500 N. Dayton St., Chicago 22, Ill. A library of 100 records to give 200 selections



can be played continuously with the new mechanical brain shown. The unit moves back and forth along a track to select the desired record, plays it vertically, and then returns it to the rack. The pickup arm has a double stylus.

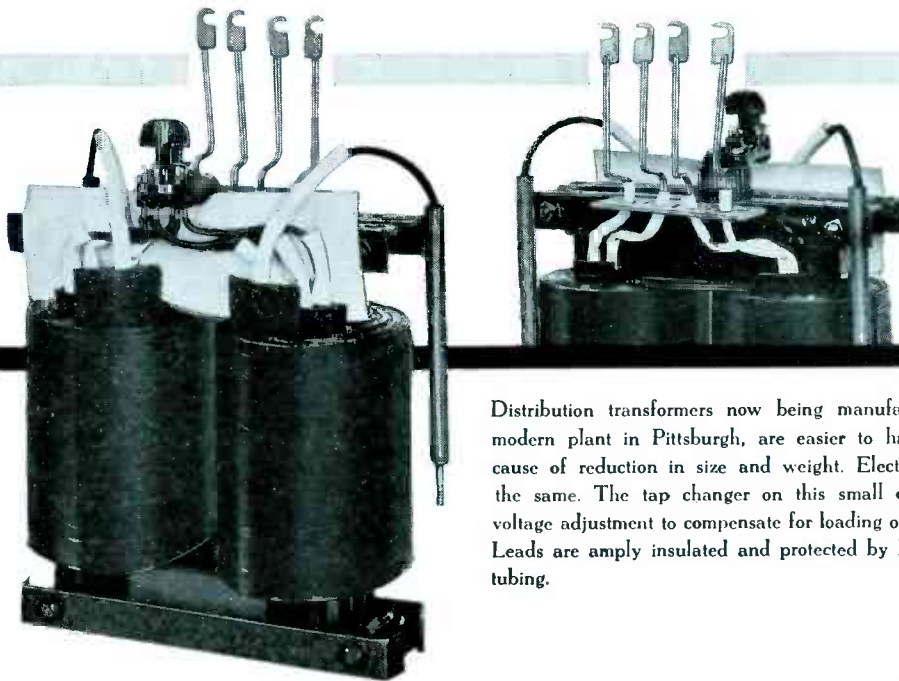
High Temperature Tubulars

SOLAR MFG. CORP., 1445 Hudson Blvd., North Bergen, N. J. Types ST and STM tubular capacitors are plastic encased and heat resistant



ALLIS-CHALMERS INSULATES AND PROTECTS TRANSFORMER LEADS

WITH **NATVAR 400**



Distribution transformers now being manufactured in Allis-Chalmers modern plant in Pittsburgh, are easier to handle and look better because of reduction in size and weight. Electrical characteristics remain the same. The tap changer on this small oil-filled type permits easy voltage adjustment to compensate for loading or length of service entrance. Leads are amply insulated and protected by Natvar 400 extruded vinyl tubing.

With capacity at an all-time high, utilities are doing an outstanding job of keeping up with the relentlessly increasing demand.

Allis-Chalmers distribution transformers, in serving widening areas and areas of increasing density, have handled loads far in excess of their rated capacity for considerable lengths of time without interruption.

Natvar 400, approved for continuous operating temperatures of 105°C., gives lasting insulation and protection to the leads because of its uniformly superior resistance both to high temperatures and to oil.

Prompt deliveries — either from the stock of a wholesaler near you — or direct from our own. Full Underwriters' report on request.



Natvar Products

- Varnished cambric—straight cut and bias
- Varnished cable tape
- Varnished canvas
- Varnished duck
- Varnished silk
- Varnished special rayon
- Varnished Fiberglas cloth
- Silicone coated Fiberglas
- Varnished papers
- Varnished tubings and sleeveings
- Varnished identification markers
- Lacquered tubings and sleeveings
- Extruded vinyl tubing
- Extruded vinyl identification markers

Ask for Catalog No. 21

THE NATIONAL VARNISHED PRODUCTS

TELEPHONE
RAHWAY 7-2171

CABLE ADDRESS
NATVAR: RAHWAY, N. J.

Corporation

201 RANDOLPH AVENUE ★ WOODBRIDGE NEW JERSEY

ELECTRONICS — May, 1948

201

1001 USES IN THE ELECTRONICS INDUSTRY

COAXITUBE



Here's a new "performance-proved" metal shielded wire . . . Precision Coaxitube. Consists of an inner conductor, insulation and a seamless metal tubular shield. Coaxitube is available in a wide range of characteristic impedances, capacity and power ratings with single or multiple inner conductors. You have your choice of any seamless non-ferrous metal shield.

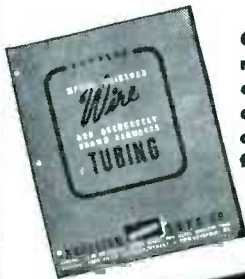
SEAMLESS SHIELD reduces leakage and transmission loss, eliminates interference.

PROTECTION AGAINST CORROSION, abrasion, acids and dirt afforded by solid shield.

TAKES ANY SHAPE and still remains coaxial, due to unique construction.

FORMED COMPONENTS such as closely coupled coils of inner and outer conductors, shielded grid and plate leads, available on good delivery.

APPLICATION ENGINEERED to suit your performance requirements.



Get all of the facts on this new development for the electronics and instrument industries. Write for your free copy of the booklet giving full details on COAXITUBE.

PRECISION TUBE CO.

Factory: 3824-26-28 TERRACE ST., PHILADELPHIA, PA.



Copyright, 1947

NEW PRODUCTS

(continued)

up to 100 degrees C. They are also impervious to moisture. Write for descriptive bulletin.

Crystal Mike

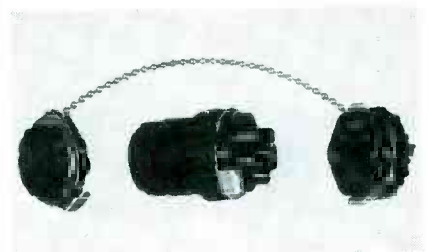
TURNER Co., Cedar Rapids, Iowa. Model 35X Fireball microphone is recommended for home recording,



paging systems, public address, and amateur communications. The base is detachable.

H-V Connector

WINCHESTER ELECTRONICS Co., 6 East 46th St., New York 17, N. Y. A 6-contact, high-voltage miniature connector for photoflash, aircraft,



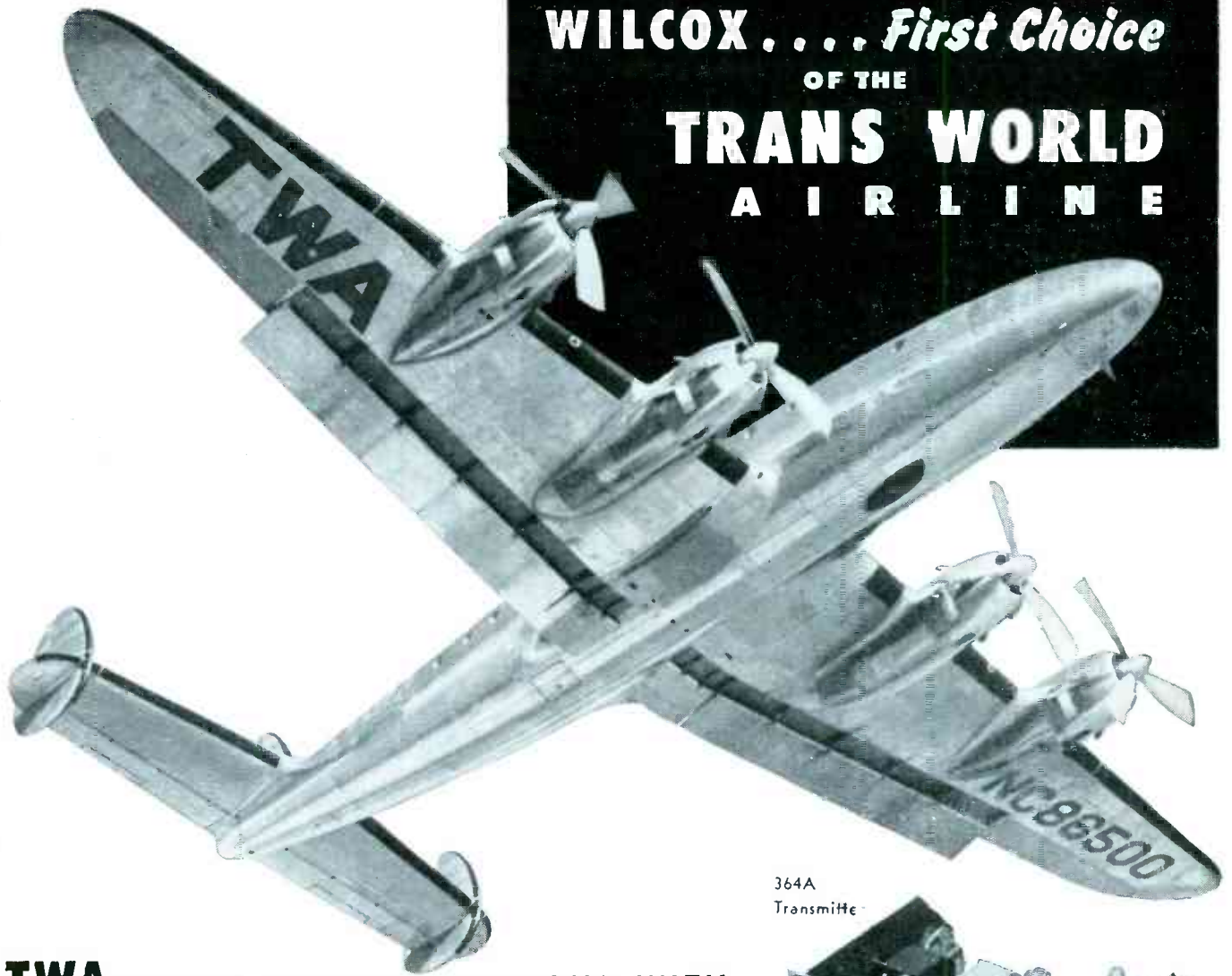
and other equipment has precision machined and silver plated contacts. Polarization is positive and a spring lock prevents accidental disconnection. A weatherproof cover is provided.

Reproducer

AUDAK Co., 500 Fifth Ave., New York 18, N. Y. Audax model 79-G



WILCOX First Choice
OF THE
TRANS WORLD
A I R L I N E

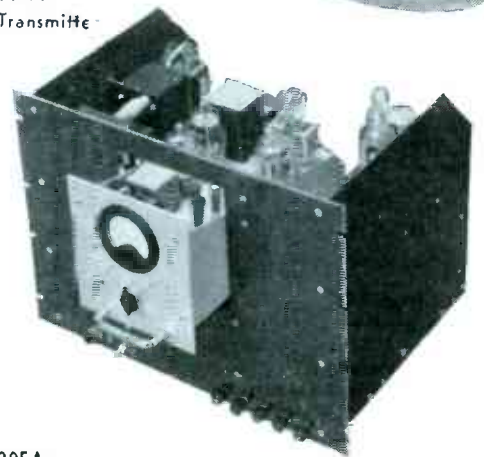


TWA EQUIPS GROUND STATIONS WITH
NEW WILCOX VHF RECEIVERS AND TRANSMITTERS

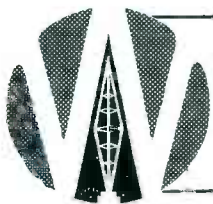
*New Fixed Frequency Equipment Offers New
Performance Features in the 118-136 Mc. Band*

- Selectivity Permits 100 Kc. Adjacent Channel Operation
- Co-Axial Transmission Line Relay Allows Common Antenna
- .005% Frequency Stability Without Temperature Control
- New Noise Limiter Means Better Reception
- Design Simplicity Simplifies Service

364A
Transmitter



305A
Receiver



Write Today For Complete Information on the
WILCOX 305A Receiver and 364A Transmitter

WILCOX MEANS
Dependable Communication

WILCOX ELECTRIC COMPANY • Kansas City 1, Missouri

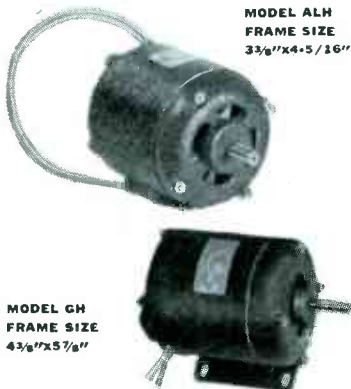
TWO

TWO OUTSTANDING DEVELOPMENTS IN THE DESIGN OF FRACT. H.P. INSTRUMENT-TYPE MOTORS

1

DUAL-SPEED

**HYSTERESIS TYPE
SYNCHRONOUS MOTOR**



Rated for 115 v. and 220 v., a.c., from 1/50 to 1/150 H.P., depending on speed and frame size; base or face mounted.

REVERSIBLE WHILE RUNNING!

CHANGES SPEED WHILE RUNNING!

Simple SPDT switch instantly reverses motor while running, at either speed. Speed control by DPDT switch . . . for 900 and 1800 rpm (also will be for 600 and 1200, 1800 and 3600, and combinations as 900 and 3600 rpm). Combine for low speed forward, high speed reverse, and vice versa. Absolutely constant torque thruout rotor revolution, eliminating "wows". 1-phase and 2-phase in either frame, and also 3-phase in 'G' frame. Single-speed units available at higher H.P. ratings.

2

DUAL-VALUE

**CAPACITOR TYPE
SYNCHRONOUS MOTOR**



In our opinion Model GS295 delivers more power for its size and weight than any other motor of this type.

EFFICIENCY 53% AT FULL LOAD

Rated at 1/12 HP at 1800 rpm, 110 v. and 220 v., a.c., with high starting torque exceeding full load. Shows only 40° temperature rise up to full load and is, therefore, rated for continuous service. **INSTANTLY REVERSIBLE WHILE RUNNING**; extremely quiet in operation and highly economical in use.

ENGINEERED BY ELINCO . . . DESIGNERS AND MANUFACTURERS OF PRECISION FRACTIONAL H.P. MOTORS AND GENERATORS OF INSTRUMENT TYPE TO MEET SPECIAL REQUIREMENTS.

ELECTRIC INDICATOR CO.

PARKER AVENUE

STAMFORD, CONN.

NEW PRODUCTS

(continued)

is one of nine tuned-ribbon units available for Garrard changers. The unit is linear from 50 to 10,000 cycles. Point pressure is about 24 grams. Output is about minus 30 db.

Mass Spectrometer

GENERAL ELECTRIC CO., Schenectady 5, N. Y. A new recording mass spectrometer is used to determine



the composition of material. It can measure over the mass range from 1 to 350 and is adjustable to begin recording at any required mass. The instrument is built in two parts, a control unit and tube rack. Additional information is given in GEA-4907.

Miniature Battery

OLIN INDUSTRIES, INC., New Haven, Conn. The plastic cells illustrated interlock with each other to form a battery that requires few of the





Frequency Standards



**GUARANTEED
ACCURACY**
1 part in 100,000
(.001%)

Uses

Time bases, rate indicators, clock systems, chronographs, geo-physical prospecting, control devices and for running small synchronous motors.

Features

1. Bimetallic, temperature-compensated fork, no heating or heat-up time is required.
2. Fork is hermetically sealed, no barometric effects on frequency.
3. Precision type, non-ageing, low coefficient resistors used where advantageous.
4. Non-linear negative feedback for constant amplitude control.
5. No multi-vibrators used.
6. Synchronous clock simplifies checking with time signal.

Specifications

Accuracy—1 part in 100,000 (.001%).
Temperature coefficient—1 part in 1,000,000 per degree centigrade (or better).

Outputs—

1. 60 cycles, sine wave, 0-110 volts at 0 to 10 watts (adjustable).
2. 120 cycle pulses, 30 volts negative.
3. 240 cycle pulses, 30 volts positive and negative. Pulse duration, 100 micro-seconds.

product of

**AMERICAN TIME PRODUCTS
INC.** New York 19, N. Y.
Operating under patents of the Western Electric Company

Type 2121 A.

TERMINATION

Front and Rear

CONSTRUCTION

Standard 8 $\frac{3}{4}$ " x 19" Panel

HOUSING

8 $\frac{3}{4}$ " x 19" x 8" Metal Cabinet

WEIGHT

25 pounds

American Time Products, Inc.,
580 Fifth Ave., New York 19, N. Y.

Gentlemen:

Please send descriptive folder, No. 2121A.

Name.....

Company.....

Address.....

City..... State.....

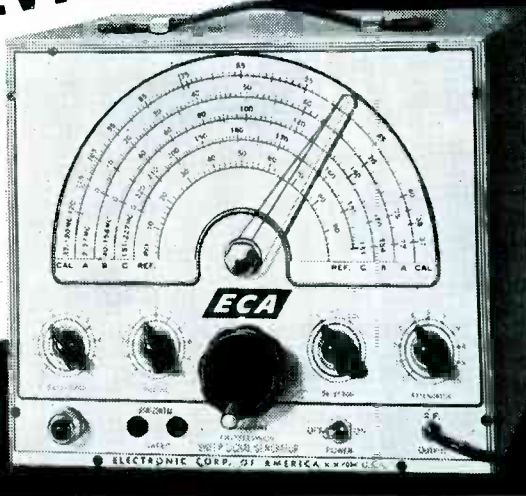
Now... at a sensationally
LOW PRICE!
 ECA QUALITY
FM & TELEVISION

Sweep Signal
GENERATOR

\$34⁹⁵ COMPLETE

ECA
 ELECTRONIC CORP. OF AMERICA

**A MUST
 FOR FM
 & TELEVISION
 SERVICE
 SHOPS!**



Here's great news for FM and TV Service Shops! A new, top quality sweep signal generator—product of a manufacturer with vast resources, advanced engineering "know-how", and wartime experience in producing test equipment. **DIRECT FROM THE FACTORY—at a phenomenally low price!**

FRONT PANEL CONTROLS

- Sweep width 500 KC to approx. 10 MC
- Phasing control
- Tuning vernier control 10 to 1 ratio
- Selecto switch FM—RF—CAL
- RF Output control
- 60 cycle horizontal sweep output
- Amphenol RF output shielded connector

**FREQUENCY RANGE
 3 BANDS**

- (No band switching necessary)
 (2 to 227 Megacycles)
- 2—77 MC
 - 40—154 MC
 - 151—227 MC
 - Calibration and reference scales
 - Dial scale length

TUBE LINEUP

- 6C4—Fixed frequency modulated oscillator
- 6C4—Continuously variable beat frequency oscillator
- 6C4—Mixer—Cathode follower output tube
- 5Y3—Rectifier tube

GENERAL INFORMATION

- High frequency insulation throughout
- Maximum output 500,000 U/V
- Power required 105-125 Volt 50-60 AC 35 Watts
- Power line filter built in
- Special Midline capacity tuning condenser
- Pilot light line indicator
- Generator output can be used either frequency modulated or pure RF



**RADIATION LOOP AND
 ALIGNMENT WAND**

Provides loose coupling. Checks loop-oscillator tracking. Increases efficiency of receiver's alignment or mistracking. Enables the service engineer to make gain measurements. Professional appearance and results. May be used on any signal generator. Complete with operating instructions.

\$5⁹⁵

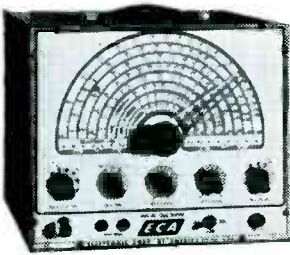
FM FRONTEND

Complete with 3 tubes, including Magic Eye. 88-108 MC.

For use with 10.7 MC I.F.S., high Q resonant tuned lines. Heavy silver overlay on lines and contactors. High frequency insulation throughout. 1-RF stage, detector, and oscillator. Large 7" sliderule dial. Chassis floated, non-microphonic.



\$15⁹⁵



AM SIGNAL GENERATOR

8 RF bands. Frequency coverage 100KC-75 MC. External modulation from 40 to 30,000 cycles. Internal modulation at 440 cycles. Phase shift audio oscillator and internal modulator. A.C. 105 to 120 volts. 50 to 60 cycles. Special Hammarlund variable condenser; 3 step RF attenuator. Continuously variable RF-AM attenuator control. Ultra stable two terminal RF oscillator. Pilot light line indicator. Cathode follower output tube. Modulator percentage continuously variable from front panel. Internal or external. 0 to 100%. Heavy 16-gauge steel cabinet. Complete with 4 (stand, hard brand) tubes. Amphenol co-axial connecting cable, ground cable, operating instructions and guarantee.

\$32⁵⁰

BACKED BY ECA WITH R.M.A. GUARANTEE. FOR PROMPT DELIVERY. RUSH YOUR ORDER TO-DAY TO DEPT. E-5. 20% DEPOSIT WITH ORDER REQUIRED. F.O.B. NEW YORK CITY

ELECTRONIC CORPORATION OF AMERICA
 353 WEST 48th STREET • NEW YORK 19, N. Y. • PHONE: CIRCLE 6-1985

Write for ECA circular on parts and additional equipment.

soldered connections made in a more conventional type. It is expected that the improved construction will result in 20 percent longer life. A new 67½-volt B battery is made of three 15-cell stacks.

Television Capacitors

CORNELL-DUBILIER ELECTRIC CORP., South Plainfield, N. J. A new line



of television capacitors, DSTH, operate in the voltage range 3,000 to 6,000. They are oil-impregnated and wax-filled. A strap bracket can be furnished.

Ion Bender

CLAROSTAT MFG. Co., INC., 130 Clinton St., Brooklyn, N. Y. The Beam Bender consists of two ring

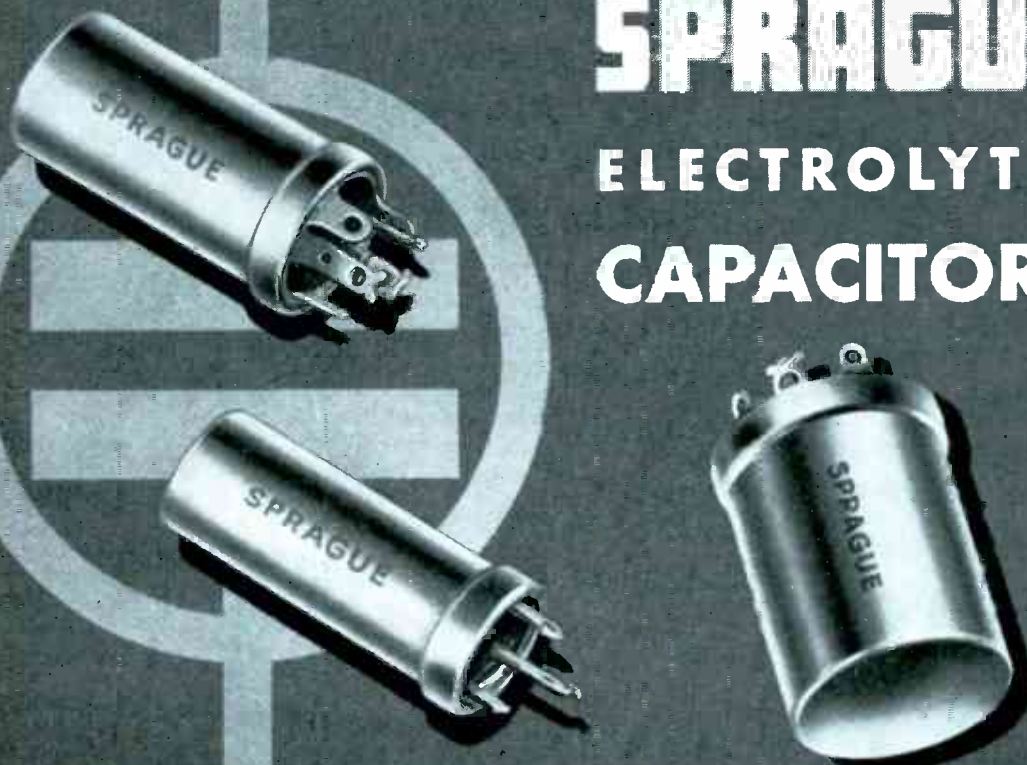


magnets held in a nonmagnetic mounting collar. Three spring fingers provide an adjustable fit on the neck of 7 or 10-inch television cathode-ray tubes employing electromagnetic deflection. The device acts as an ion trap.

Testing Meter

TRIPLETT ELECTRICAL INSTRUMENT Co., Bluffton, Ohio. Model 2405-A

Announcing A NEW LINE OF SPRAGUE ELECTROLYTIC CAPACITORS



**For operation up
to 450 volts at 85° C.**

With some 7 times as many components in a television receiver as in the average radio, the possibility of service calls is greatly increased. The new SPRAGUE ELECTROLYTIC line offers the first practical solution to this problem.

Designed for dependable operation up to 450 volts at 85° C. these new units are ideally suited for television's severest electrolytic assignments. Every care has been taken to make these new capacitors the finest electrolytics available today. Stable operation is assured even after extended shelf life, because of a new processing technique developed by Sprague research and development engineers, and involving new and substantially increased manufacturing facilities. More than ever before your judgment is confirmed when you SPECIFY SPRAGUE ELECTROLYTICS FOR TELEVISION AND ALL OTHER EXACTING ELECTROLYTIC APPLICATIONS! Sprague Electric Company invites your inquiry concerning these new units.

SPRAGUE ELECTRIC COMPANY • NORTH ADAMS, MASS.

**WORTHY
COMPANIONS
FOR THE NEW
ELECTROLYTICS!
SPRAGUE MOLDED
TUBULARS . . .**

Highly heat- and moisture-resistant
Non-inflammable • Moderately priced
Conservatively rated for -40°C to
+85°C operation
Small in size • Completely insulated
Mechanically rugged
Write for Engineering Bulletin No. 210A

SPRAGUE

Capacitors
* Koolohm Resistors

PIONEERS OF

ELECTRIC AND ELECTRONIC PROGRESS

•Trademarks reg. U. S. Pat. Office

Designed for



Application



92101

The No. 92101—Antenna Matching Preampfier

The Millen 92101 is an electronic impedance matching device and a broad-band pre-amplifier combined into a single unit, designed primarily for operation on 6 and 10 meters. Coils for the 15 and 20 meter bands as well as television channel 2 thru 6 inclusive also available. This unit is the result of combined engineering efforts on the part of General Electric Company and the James Millen Manufacturing Company. The No. 92101 is extremely compact, the case measuring only 6 1/4" x 5 3/4" x 3". The band changing inductor unit plugs into the opening in the front of the panel. Plug is provided for securing power requirements for the 6AK5 tube from the receiver. Coaxial connectors and plugs are furnished for the antenna and receiver connections.

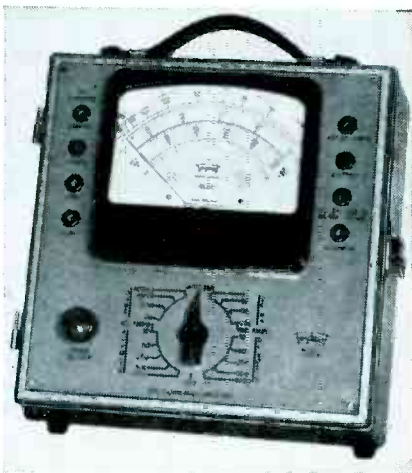
JAMES MILLEN MFG. CO., INC.

MAIN OFFICE AND FACTORY
MALDEN
MASSACHUSETTS



NEW PRODUCTS

(continued)



meter has 35 ranges including voltages to 1,000 volts. Direct current ranges are 0 to 50 microamperes up to 10 amperes; alternating current up to 10 amperes. Output and capacitor testing can also be performed. Resistance in the usual ranges can be measured accurately on the 6-inch meter.

Industrial Speaker

RACON ELECTRIC Co., Inc., 52 East 19th St., New York 3, N. Y. A new radial re-entrant horn speaker suit-



able for all types of industrial sound and public address installations can be mounted to cover all directions. It handles 25 watts continuous power and peaks of 35 watts. Frequency response is from 300 to 6,000 cycles.

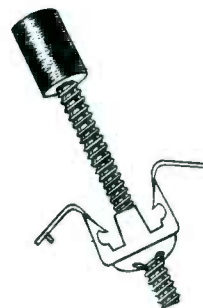
Fuse Clips

AMERICAN MOLDED PRODUCTS Co., 1652 N. Honor St., Chicago 22, Ill. A new low-cost fuse clip tinned for

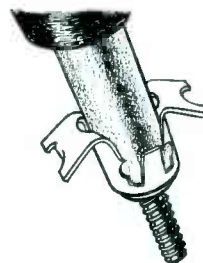
Big Savings with
PALNUT
Trademark
Coil Tube Fasteners.



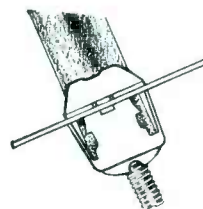
DOES **3** JOBS!



1. Provides required tension on iron core adjusting screw to maintain accurate setting, thru use of specially designed "Palnut" thread form.



2. Provides support for the RF or IF coil tube. All coil tube length above chassis is usable electrically, as fastener does not extend above chassis.

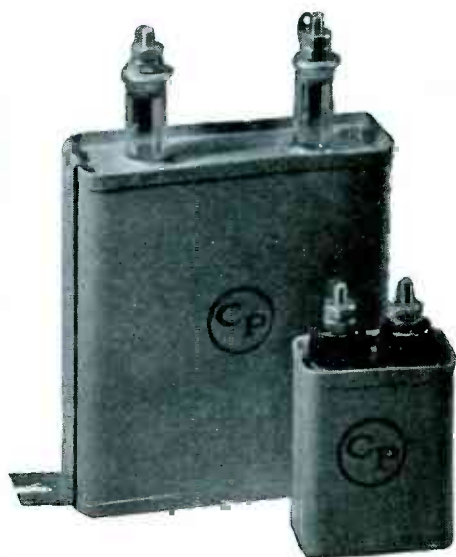


3. Snap the assembly into chassis, shield can or terminal board. Provides absolute security and rapid assembly.

SAMPLES of this speedy, efficient "Palnut" Coil Tube Fastener, plus engineering data, sent upon request on your business stationery.

The PALNUT Co.

77 CORDIER ST. IRVINGTON 11, N. J.



PLASTICON

Plastic Film Oil-Filled

CAPACITORS —

1. **More Economical**
2. **Smaller—Lighter**
3. **Better Electrical Characteristics**

1. MORE ECONOMICAL

MFD.	VOLTS DC	List Price PAPER CAPACITOR	List Price PLASTICON AOC	SAVING
10	1000	\$15.18	\$10.67	\$4.51
4	2000	13.67	9.24	4.43
2	3000	22.78	15.40	7.38
1	4000	33.54	27.50	6.04
2	5000	48.73	41.25	7.48

Above are typical examples.

PLASTICONS are the result of technological advances . . . cost less to manufacture, give better performance.

2. SMALLER—LIGHTER

MFD.	VOLTS DC	Approx. Weight		Approx. Cubic Dimensions	
		PAPER CAPACITORS	PLASTICONS	PAPER CAPACITORS	PLASTICONS
10	1000	1.95 lbs.	1.7 lbs.	31 cu. in.	30 cu. in.
4	2000	2.0	1.23	31	23
2	3000	2.0	1.21	31	19
1	4000	1.77	.94	28	19
2	5000	5.2	2.9	70	60

3. BETTER ELECTRICAL CHARACTERISTICS

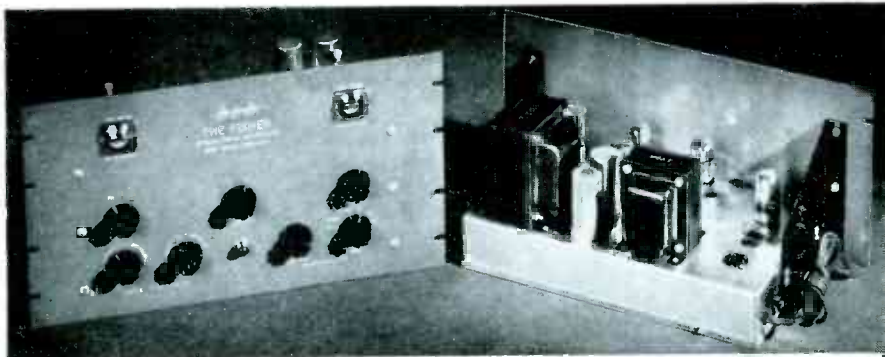
	Paper Capacitors	Plasticons
Power Factor at 85° C 60 cycles	0.7%	0.3%
Resistance at 85° C megohms per Mfd.	40	100
Capacitance/Temp. Coefficient 100% at 25°	- 40° C = 73% + 85° C = 97%	- 40° C = 94% + 85° C = 103%

PLASTICON CAPACITORS given are Type AOC, mineral oil-filled.
 PLASTICON ASC silicone-filled have better characteristics.
 Paper Capacitors given are chlorinated diphenyl impregnated.

CP **Condenser Products Company**

1375 NORTH BRANCH STREET • CHICAGO 22, ILLINOIS

MANUFACTURERS of GLASSMIKE CAPACITORS and HIGH VOLTAGE POWER SUPPLIES.



TWO-CHASSIS CONSTRUCTION OFFERS HIGHEST QUALITY, MAXIMUM FLEXIBILITY

Record Scratch Banished!

The Fisher

DYNAMIC NOISE SUPPRESSOR WIDE RANGE AMPLIFIER

If you seek the finest in dynamic noise suppression, coupled with an amplifier that is precision built to exceptional, laboratory standards, there can only be one choice—THE FISHER Dynamic Noise Suppressor-Wide Range Amplifier,* custom constructed on two chassis. Here is its pedigree:

THE FISHER Wide Range Amplifier

1. A man's size amplifier with only 1% distortion at twenty watts!
2. Intermodulation distortion less than 1/2% at 5 watts output.
3. Uniform response from 20 to 20,000 cycles, plus or minus 1 db.
4. Hum level warranted less than 0.5 microwatts for one watt output.
5. Internal impedance less than 1.25 ohms.
6. 18 db of negative feedback.
7. Phono preamplifier and first audio operated entirely on DC to reduce hum.
8. Phono preamplifier comprises two triode stages operated in cascade, to minimize tube noise.
9. Phono circuit compensated for G. E. and Pickering pickups.
10. Exclusive, two-position pickup compensation for pre-emphasized recordings as well as recordings without rising characteristic at high end.
11. Two, medium gain auxiliary inputs for radio, etc., with selector switch on front panel, for convenience of use.
12. Output impedances 8 and 16 ohms. Professional quality line matching transformer for 125 and 500 ohms available at additional cost. (NOTE: Our experience has shown that it is not practical to design a high quality output transformer including both voice coil and line matching windings.)
13. Push-pull parallel output tubes, for conservative operation and superior output transformer design.

THE FISHER Dynamic Noise Suppressor

1. Incorporates six tubes, for optimum flexibility and effectiveness.
2. Two high frequency gates, dynamically controlled.
3. One switch position (see below) provides fixed filter tuned to 18 Kc. (Readily tuned to 10 Kc. by simple screw adjustment.)
4. Independent control voltage amplifier for operation of gates.
5. Double diode tube to provide DC control voltage for gate circuits.
6. Two cathode ray indicators to show

*Licensed under Hermon Hosmer Scott patents pending for use only in phonograph and phonograph distribution systems.

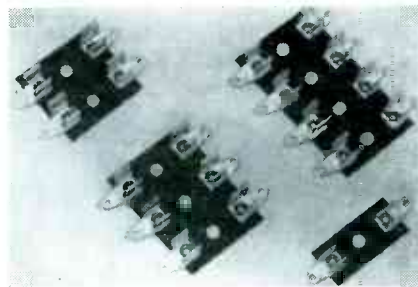
PRICE \$254.50 • LIMITED QUANTITY AVAILABLE FOR IMMEDIATE DELIVERY

FISHER RADIO CORPORATION • 43 EAST 47TH ST., NEW YORK

- individually the dynamic operation of high and low frequency gate circuits.
7. Muting circuit and connecting plug for complete silencing of needle swish in run-off groove and "blop" when the pickup lands on the next record.

GENERAL FEATURES

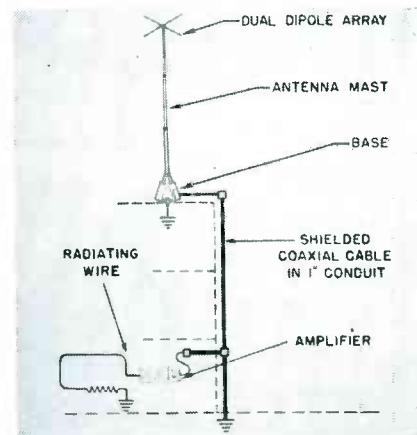
1. TWO-chassis construction, for optimum electrical performance and ease of installation in limited space—without undesirable long leads. Chassis constructed of 16-gauge steel.
2. Power available for external microphone preamplifier, etc., 250 volts at 50 ma. DC and 6.3 volts at 3 amperes AC.
3. SEVEN CONTROLS. (a) Volume Control. (b) Three-position switch for phono and two auxiliary inputs. (c) Six-position, On-Off and Range Switch (20-20,000 cycles, 20-10,000 cycles, 70-4000 cycles*, 90-3200 cycles*, 120-2700 cycles*.) *Frequency response with gates in fully closed position. With gates fully open, response is that in position 2, except that in position 5 response is limited to 6000 cycles. (d) Treble Control, continuously variable with maximum boost 16 db at 10,000 cycles, maximum cut 20 db at 10,000 cycles. (e) Bass Control, continuously variable with maximum boost 16 db at 100 cycles, maximum cut 32 db at 20 cycles. (f) Gate Sensitivity Control on front panel. Varies dynamic range of suppression for positions 3 to 5 of Range Switch and permits optimum adjustment for various input levels and background noise characteristics, instantly and easily. (g) Phono Equalization Switch, two-position.
4. Tube Complement, Suppressor-Voltage Amplifier Chassis: 2-12AT7, 1-6C4, 3-6BA6, 1-6AL5, 1-6AQ6, 2-6E5. Panel: 10 1/2" x 19", height 8 3/4", width 13", depth 8". Power Chassis: 4-7C5, 1-7A4, 2-5Y3. Panel: 8 3/4" x 19", height 7 3/4", width 14 1/2", depth 8 1/2".
5. Auxiliary AC Outlets: Two available, for tuner, turntable, etc., controlled by master On-Off Switch.
6. Jewel pilot light on front panel.



soldering is available for type 3AG fuses. From one to four gangs are stocked; other sizes to order.

Static Remover

L. S. BRACH MFG. CORP., Newark 4, N. J., has developed the Puratone signal booster system shown



in the accompanying sketch. The system covers a frequency range of 0.3 to 20 mc for a-m, and 85 to 110 mc for f-m operation. It was designed to aid in demonstrating radio receivers in noisy city locations.

Contact Cleaner

WALTER L. SCHOTT Co., 9306 Santa Monica Blvd., Beverly Hills, Calif.



GLOBAL TYPE "CX" RESISTORS

Solving Many Resistance Problems

Excellent voltage and temperature characteristics are provided by GLOBAL Type CX Resistors. These characteristics make them especially suited for many applications including Dummy Antenna... Rhombic Antenna Termination... Parasitic current suppression... Voltage dropping devices... Induction and R. F. Heating.

An extremely small voltage and temperature

coefficient together with an ability to carry loads up to 3 watts per square inch of radiating area puts these resistors in a class by themselves. When equipped with special terminals, they can be loaded to 10 watts per square inch. For immediate attention to inquiries write Dept. V-58. The Carborundum Company, GLOBAL Division, Niagara Falls, New York.

RESISTANCE RANGE AND RATING IN WATTS FOR STANDARD SIZES

TABLE I

Part Number	Rating in Watts	Resistance Range*	Overall Length in Inches	Overall Diameter in Inches	Tinned Copper Wire Leads	
					Length	Diameter
997-CX	1/4	1 ohm to 150 ohms	2 1/64	7/64	1 1/8"	0.016"
763-CX	1/2	1 ohm to 47 ohms	5/8	7/32	1 1/2"	0.032"
759-CX	1	1 ohm to 33 ohms	3/4	1/4	1 1/2"	0.032"
766-CX	2	1 ohm to 47 ohms	1 1/8	1/4	1 1/2"	0.032"
792-CX	4	1 ohm to 22 ohms	1 7/8	15/32	1 1/2"	0.040"
774-CX	6	1 ohm to 33 ohms	2 5/8	15/32	1 1/2"	0.040"

*RMA Values only, Tolerances $\pm 10\%$, and $\pm 20\%$.

TABLE II

Diameter in inches	Resistance in Ohms per Inch of Length		Length in Inches		RATING
	Minimum	Maximum	Minimum	Maximum	
1/2	0.10	100	2	8	Continuous duty rating is based on 3 watts per square inch of external radiating surface.
5/8	0.10	100	2	10	
3/4	0.10	75	4	18	
1	0.05	50	4	18	

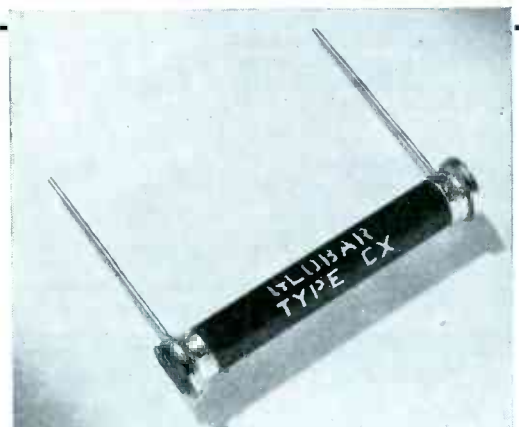
Type "CX" power resistors can be supplied with metallized ends of brass, copper, nickel, monel, aluminum, tinned brass or tinned copper, also with tinned copper wire (No. 14 B & S Gage) leads, approximately six inches long. Resistance tolerances are limited to $\pm 10\%$ and $\pm 20\%$ only.



GLOBAL Ceramic Resistors BY CARBORUNDUM

TRADE MARK

"Carborundum" and "Global" are registered trademarks which indicate manufacture by The Carborundum Company



Metallic Rectifiers Since 1923

Selenium



Copper Sulphide

A modern plant plus a resourceful engineering staff and a quarter century of experience

provide the "know-how" and facilities to serve YOUR AC to DC power conversion requirements.

Manufacturers of selenium and copper sulphide rectifiers, rectifier-transformer assemblies and AC-DC power supply units for every requirement.

Consulting service available without obligation

THE BENWOOD-LINZE CO.

Division of the Sperry Corporation

1815 Locust St.

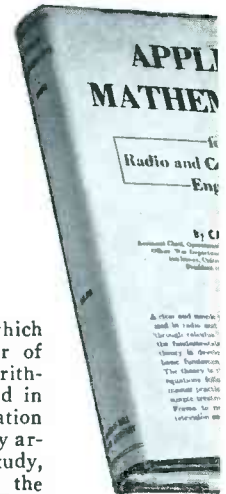
St. Louis 3, Mo.

Long Distance Telephone Central 5830

Teach yourself MATHEMATICS

for big new jobs in

- radio
- television
- radar



Here's the manual which can make you master of mathematics, from arithmetic to calculus, used in radio and communication engineering. Especially arranged for home study, the book gives all the mathematics you need, from basic fundamentals to more detailed concepts—to help you get ahead in radio, television, frequency modulation, radar development.

APPLIED MATHEMATICS

For Radio and Communication Engineers

By CARL E. SMITH

Assistant Chief, Operational Research Branch, Office of the Chief Signal Officer, War Department; Development and Research Engineer (on leave), United Broadcasting Co., Cleveland.

336 pages, 5 1/4 x 8 1/4, \$3.50

You will find it easy to learn by yourself through this method of presentation. Useful design equations are solved in the text, and 150 exercise problems help you build a sure working knowledge of each subject. There is a simplified treatment of calculus and the last chapter on series and wave forms meets the modern trends to frequency modulation, television and radar development. An unusually full appendix of useful charts and tables contains all necessary reference material.

CHAPTERS

- | | |
|------------------------|-------------------------|
| Arithmetic | Quadratic Equations |
| Logarithms | Hyperbolic Trigonometry |
| Algebra | Differential Calculus |
| Geometry | Integral Calculus |
| Trigonometry | Series and Wave Forms |
| Vector Addition | |
| Complex Quantities | |
| Curves and Graphs | |
| Simultaneous Equations | |

Includes 97 figures, 20 tables and charts. The presentation has been streamlined to include only the subject matter most useful in the field of radio and communication engineering.

See it 10 days FREE—Mail Coupon Today

McGraw-Hill Book Co., Inc., 330 W. 42nd St., N.Y.C. 18
Send me Smith's Applied Mathematics for Radio and Communication Engineers for 10 days examination on approval. In 10 days I will send \$3.50, plus few cents postage, or return book postpaid (postage paid on cash orders.)

Name
Address
City and State.....
Company
Position L-5-48

(\$3.85 in Canada; order from McGraw-Hill Co. of Canada Ltd., 12 Richmond St. E., Toronto 1.)

EDL LEADERS IN THE DEVELOPMENT OF ELECTRONIC INSTRUMENTS

Announcing THE EDL WIDE RANGE OSCILLOSCOPE

PERMITS DIRECT OBSERVATION OF COMPOSITE VIDEO SIGNAL

Embodying many recent developments is the new EDL, Model 75, wide range oscilloscope. Vertical amplifier response is ± 2 DB from 10 cycles to 5 MC — permitting study of television signals and all waveforms with high harmonic contents.

An extremely desirable feature of this versatile instrument is a self contained voltage calibrator with an accuracy of $\pm 5\%$. Test probe has shielded cable to eliminate stray pickup.



Model 75

FEATURES

- | | |
|---|---|
| Vertical Amplifier: | Horizontal Amplifier: |
| Response — ± 2 DB 10 cycles to 5 MC | Response — ± 2 DB 10 cycles to 200 kc |
| Sensitivity — Direct — .1 volt RMS per inch | Sensitivity — .5 volts RMS per inch |
| Sensitivity With Probe — 1.0 volts RMS per inch | |
| Sweep Frequency — 10 cycles to 60 kc. | |

WRITE FOR FURTHER DETAILS

EDL Instruments

MFR'D. BY

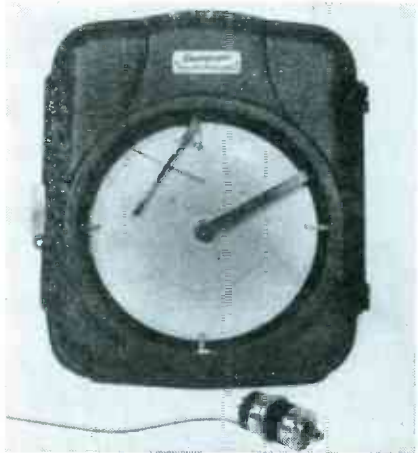
2655 W. 19th ST.
CHICAGO 8, ILL.

ELECTRONIC DEVELOPMENT LABORATORY

No-Ox contact cleaner is a neutral chemical cleaner and lubricant for bearings and shafts, volume and tone controls, band switches and tuning capacitors.

Position Recorder

SERVO-TEK PRODUCTS Co., INC., 247 Crooks Ave., Clifton, N. J. Servo-graph position recorder utilizing a synchro transmitter and repeater has a variable ratio device that al-




lows compression or expansion of the transmitted signal to fill a 10-inch circular chart. The inking type recorder will record any variable that can be converted to angular rotation. A four-page brochure illustrates its use and gives specifications.

Vacuum Coater

DISTILLATION PRODUCTS, INC., 755 Ridge Road West, Rochester 13, N. Y. A table model vacuum unit





TUNED-RIBBON

reproducers



TUNED-RIBBON Pick-up model SA-79
(Actual Size—Special STUDIO-arm not shown)

- A model for every purpose

Jewel Stylus EASILY REPLACED BY USER

ADMIRABLY this revolutionary NEW line by Audax bears out the business maxim:—

“LOOK TO THE LEADER FOR LEADERSHIP”

* Because a “permanent-point”—be it diamond, sapphire or metal—will maintain its original shape for only a limited number of plays, after which it progressively erodes the record grooves, the importance of being able to replace it has always been of primary consideration. Heretofore such replaceability entailed severe penalties in range, compliance and point-pressure. Most of the TUNED-RIBBON models provide the all-important replaceability without those penalties.

SPECIFICATIONS TUNED-RIBBON SA-79

- Linear 50 cyc. to over 10 k.c.
- Point Pressure—about 24 grams
- Genuine Sapphire Stylus—**EASILY REPLACED BY USER**
- Output—about—30 db
- Impedance—200 ohms to 500 ohms
- Vibratory Momentum—very low
- Quick plug-in connectors
- Arm is aluminum, Special Studio Design, Tangent-Tracking, ball-thrust and pivot-point bearings in gimbals mounting—eliminating side thrust and drag.

TUNED-RIBBON delivers not only Wide Range, (which is but one link in the chain)—but also the vital factors so necessary for quality performance and EAR-acceptability . . . proving anew AUDAX right to the slogan:—

“The Standard by Which Others Are Judged and Valued”

Yes, Audax TUNED-RIBBON has put something into reproduced music that was not there before . . . let YOUR ears be the final judge.

* SEND FOR COMPLIMENTARY PAMPHLET ON THIS VITAL SUBJECT

AUDAK COMPANY

500 Fifth Avenue

New York 18

CREATORS OF FINE ELECTRO-ACOUSTICAL APPARATUS SINCE 1915

"DIE-LESS" DUPLICATING

SAVES MAN HOURS AND DELAYS

DIE ACCURACY WITHOUT DIES

Send for CATALOG

BENDER

SHEAR

BRAKE
DI-ACRO is Pronounced "DIE-ACK-RO"

"DIE-LESS" DUPLICATING
The DI-ACRO System of METAL DUPLICATING Without Dies
DI-ACRO
PRECISION MACHINES
DIE-LESS DUPLICATING

O'NEIL-IRWIN MFG. CO.

321 Eighth Avenue Lake City, Minnesota

with Pyrex bell jar seven inches in diameter and ten inches high can attain a pressure of 0.1 micron. Complete apparatus for coating lenses and mirrors, preparing surface replicas for the electron microscope, and for demonstrations is available at \$725.

Portable Transcription Unit

BELL SOUND SYSTEMS, INC., 555 Marion Road, Columbus 7, Ohio. Model 2079 transcription phono and p-a system has a dual-speed turntable for both 16-inch transcrip-



tions and commercial recordings. It is supplied with an 8-inch p-m speaker that furnishes 5 watts audio power. Other features of the unit can be obtained upon request to H. H. Seay.

Pocket Signal Generator

RADEX CORP., 2076 Elston Ave., Chicago, Ill. Pockettracer is an r-f and



audio signal source that operates from a single penlight cell. Oscillations radiated by the metal tip are picked up by antenna or other circuits and a modified signal-tracing technique is employed.

Redesigned Relay

ALLIED CONTROL Co., INC., 2 East End Ave., New York 21, N. Y. Earlier relays types DO and DOY have been redesigned as illustrated to

NOW! SELF-CONTAINED, EXPERIMENTAL SCHOOL & INDUSTRIAL LAB EQUIPMENT

Kepeco Laboratory Multiple Power Supply Model 103, available separately.

Kepeco Electronic Instruction Panel Model 104, available separately.

Now you can perform electronic experiments simply, easily with the Kepeco Electronic Instruction Panel. Here is a teaching aid that graphically illustrates vacuum tube principles — enables all students to grasp fundamentals in the laboratory.

Extremely versatile, the Kepeco Electronic Instruction panel covers a wide range of tubes, comes with a packet of 23 keyed interchangeable circuit charts, 3 master charts and 12 blank keyed sheets for additional experiments. Panel contains 3 octal tube sockets, 18 binding posts. By placing a keyed circuit diagram on the panel and wiring the circuit, students determine tube and circuit characteristics.

For a basic electronic instructional aid that vastly simplifies the teacher's task, it's the Kepeco Electronic Instruction Panel!

Now you can eliminate the use of cumbersome separate voltage supplies with the Kepeco Laboratory Multiple Power Supply. Designed to be used with the Kepeco Electronic Instruction Panel, this versatile, compact, easy-to-use unit supplies four commonly used voltages, is invaluable for the school or industrial laboratory.

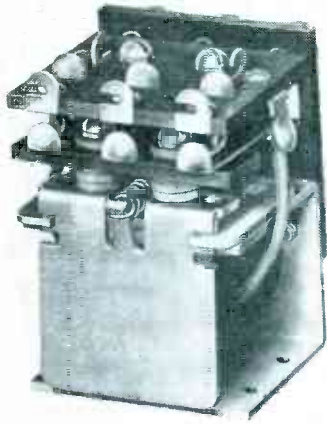
CHECK THESE FEATURES:

- Two continuously variable B supplies, adjustable from 0-300 volts at 120 m.a.
- Variable (grid) supply, adjustable from minus 50 to plus 50 volts at 5 m.a.
- 6.3 volt filament supply at 5 amperes.
- All connections made to sturdy, front panel binding posts.
- Input: 105 to 125 volts, 50 to 60 cycles.
- Two 5Y3 rectifiers, Two 6Y6 control tubes.
- 16" long, 8" high, 8 3/4" deep. Wgt.: 28 lbs.

WRITE FOR FULL INFORMATION TODAY!

Kepeco LABORATORIES INC.
Electronic Instruments

149-14 41st Avenue
Flushing, New York



make the types PO and POY. The latter type is intended for operation in the plate circuit of a vacuum tube and is a dual-coil device for d-c only. A catalog description is available.

Geiger Scaler

BERKELEY SCIENTIFIC Co., Sixth and Nevin Ave., Richmond, Calif. The decimal Geiger scaler model 1000 employs an electronic scale of 1,000 and a system of decimal in-



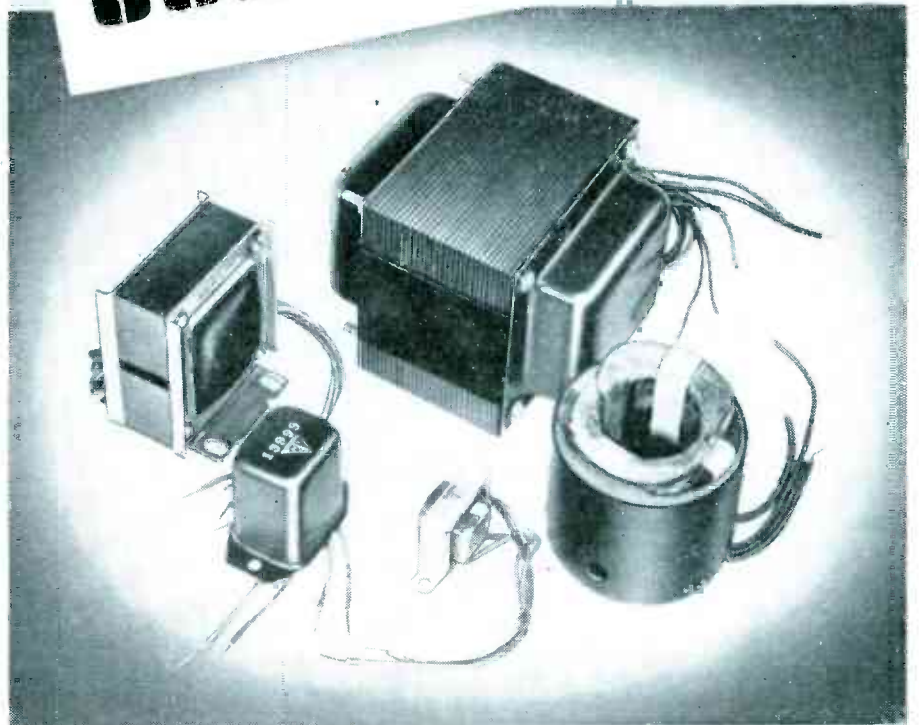
duction. Counts are shown by a single illuminated number on the front panel with a built-in mechanical register recording thousands. A self-contained high-voltage supply is adjustable from 100 to 2,500 volts. Other accessories for flexibility of operation are available and described in a bulletin.

Tiny Relay

ADVANCE ELECTRIC & RELAY CO., Los Angeles, Calif. A new miniature relay type 000 occupies 0.35 cubic inch and has spdt contacts rated at 0.35 amp at 60 volts d-c

***Here's your supply of N.Y.T**

TELEVISION COMPONENTS



Available Now!

- ★ TELEVISION POWER TRANSFORMERS
- ★ DEFLECTION COILS
- ★ VERTICAL OUTPUT TRANSFORMERS
- ★ HORIZONTAL BLOCKING OSCILLATOR TRANSFORMERS
- ★ VERTICAL BLOCKING OSCILLATOR TRANSFORMERS

N.Y.T. facilities are now expanded to supply all types of inductive television components in quantity. Estimates will be supplied promptly on standard units or types wound to your exact specification. In addition to television components, N.Y.T. offers complete manufacturing service on power transformers, chokes, and audio transformers. Modern plant and winding equipment assures finest quality at low cost. Call or write today for information.

* IN ANY QUANTITY!



NEW YORK TRANSFORMER CO.

A L P H A • N E W J E R S E Y

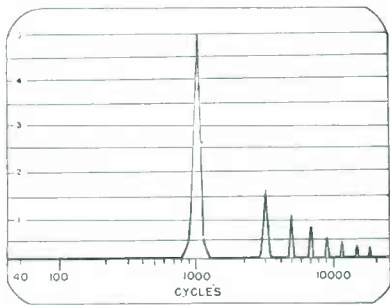
At last...

AN IMPROVED AND FASTER MEANS
FOR AUDIO WAVEFORM ANALYSIS

PANORAMIC SONIC ANALYZER

Model AP-1

Now, in a matter of seconds, you can observe differences in waveform content produced by parameter variations. Model AP-1 indicates graphically the frequency distribution and amplitude of audio wave components. Slow painstaking point-by-point frequency checks are eliminated. Ease of operation and simplicity of presentation make Model AP-1 ideally suited for production line as well as for laboratory usage.



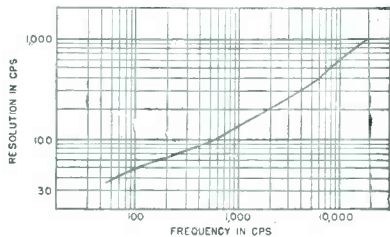
CHECK THESE FEATURES...

- Panoramic graphic presentation of frequency versus voltage amplitude
- Continuous scanning from 40-20,000 c.p.s. in one second
- Wide voltage range 0.05V to 500V
- Simple operation
- Direct simultaneous reading of voltage and frequency
- Automatic variable selectivity for optimum resolution throughout frequency range (see graph below)
- Both linear and log voltage calibrations
- Built-in voltage calibrator
- Frequency scale closely logarithmic

APPLICATIONS...

- Intermodulation measurements
- Harmonic analysis
- Noise investigations
- Acoustic studies
- Vibration analysis
- Material testing

Write now for detailed specifications, price and delivery



PANORAMIC

RADIO CORP.

92 Gold St.
New York 7, N. Y.

Cable Address
PANORAMIC, NEW YORK

Exclusive Canadian Representative: Canadian Marconi, Ltd.

Remember this Name

Jerry WEISS

When you need

Leading manufacturers in the Radio and Electronics field regularly place their orders with us for:

RADIO CHASSIS HOUSINGS	TRANSFORMER CASES	METAL STAMPINGS
MISCELLANEOUS SHEET METAL PARTS	BOXES	

Let our modern plant help you in fabrication and assembly. Our Drafting and Model Depts. co-operate on engineering problems. Every facility for pilot and production quantities. Oxyacetylene and electric welding; aluminum spot welding; sand blasting.

Write or phone your requirements.

JERRY L. WEISS, 212, 240 Jamaica Ave., Queens Village, Long Island, N. Y. HO Ills 5-0575.

MODEL 2B 0.45
Actual size illustrated

RECHARGEABLE • NON-SPILL

VITAMITE

1 OZ. BATTERIES
(Smaller Than 2 Pen-Lights)

IDEAL FOR USE WITH
Miniature And Sub-Miniature Filament Type Tubes
for HEARING AIDS, PORTABLE EQUIPMENT, ETC.

LARGER MODELS ALSO AVAILABLE
Write for Data and Literature

THE VITAMITE COMPANY
227 West 64th Street New York 23, N. Y.

**"But you can't
buy that kind
of a motor..."**



How many times have you heard somebody that ought to know better say something like that about motors, pumps, compressors or what-have-you? And how many times you heard somebody else say, "Oh yes you can! I saw just what we need in Blank Company's ad yesterday."

Advertising pages in this magazine are packed with news about your business. They contain information about products and services designed to help you do your job quicker, better and cheaper.

To be well-informed about the latest developments in your business, your industry... and to stay well-informed... read all the ads too.



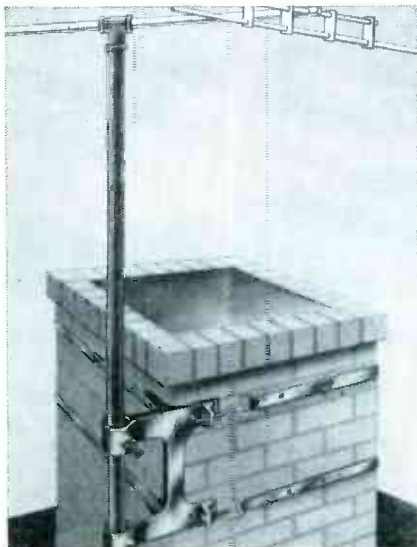
McGraw-Hill PUBLICATIONS



or 115 volts a-c. Average power requirement is about 0.5 watt. Coil resistance from 1 to 2,000 ohms can be supplied.

Chimney Antenna Mount

SOUTH RIVER METAL PRODUCTS Co., South River, N. J. The chimney mount antenna base can be installed with screwdriver and pliers



without damage to property. It will find particular application in the erection of television and f-m antennas.

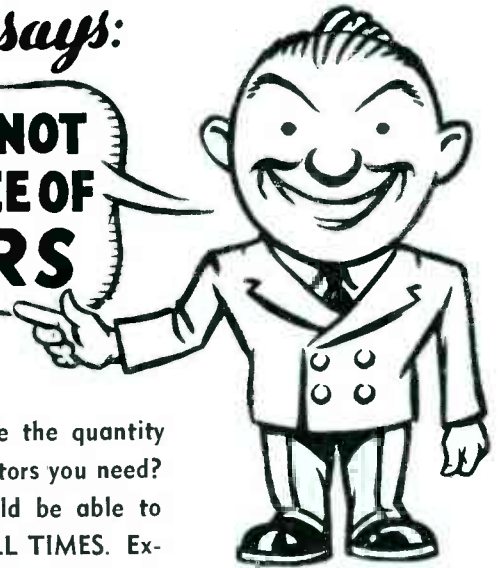
Phase Monitor

ANDREW CORP., 363 E. 75th St., Chicago 19, Ill. The type 40-C phase monitor is designed to facilitate adjustment and maintenance of



Ralph Resistor says:

EXCUSES CANNOT TAKE THE PLACE OF RESISTORS



ARE you unable to procure the quantity of Allen-Bradley or other Resistors you need?

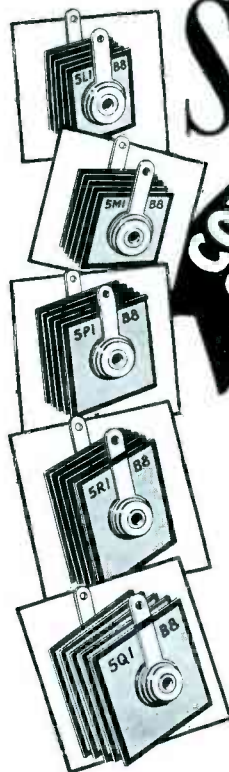
Your source of supply should be able to meet your requirements **AT ALL TIMES**. Excuses cannot take the place of Resistors.

Our ample warehouse stocks assure immediate deliveries. Write, phone or wire your orders. You'll find us ready to ship promptly . . . **AS RESISTORS IS OUR BUSINESS***.

*Also —
MICA CAPACITORS

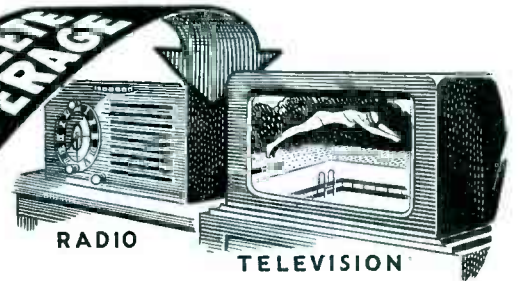
LEGRI S COMPANY, Inc.

846 Amsterdam Ave., New York 25, N. Y.
Telephone: ACADEMY 2-0018



Seletron SELENIUM RECTIFIERS

COMPLETE COVERAGE



THE complete family of miniature Seletron Selenium Rectifiers is designed for use on a nominal 115 Volt A-C line, to provide direct current for radios, television sets, amplifiers, and other low power applications.

Instant starting, small size, long life and simplicity of installation are a few of many features of the Seletron Family.

Under all service conditions they have established a record for dependability. Accepted and recommended by leading engineers and manufacturers.

CODE NUMBER	5L1	5M1	5P1	5R1	5Q1
Current Rating	75 ma.	100 ma.	150 ma.	200 ma.	250 ma.
Plate Height	1"	1"	1 3/16"	1 1/2"	1 1/2"
Plate Width	7/8"	1"	1 3/16"	1 1/4"	1 1/2"

Write for booklet. Address Dept. ES-1



SELETRON DIVISION RADIO RECEPTOR COMPANY, Inc.

Since 1922 in Radio and Electronics
251 WEST 19TH STREET, NEW YORK 11, N. Y.



PIPE COUPLINGS



ELECTRICALLY HEATED PRESSURE HEADS



CONTINUOUS FILM RECORDING CAMERAS

AND EQUIPMENT FOR CATHODE RAY

OSCILLOGRAPHY, ETC.



We undertake the Design, Development and Manufacture of any type of Optical—Mechanical—Electrical Instrument. Including Cameras for special purposes.

Avimo Limited, Taunton, England · Telephone Taunton 3634

Over 20 years of fabricating experience

PLASTIC FABRICATING

BAKELITE SHEETS, RODS, TUBES.

BAKELITE AND FIBRE FABRICATED PARTS.

PUNCHING, DRILLING, MILLING AND ENGRAVING



Mail Us Your Prints or Samples for Quotations

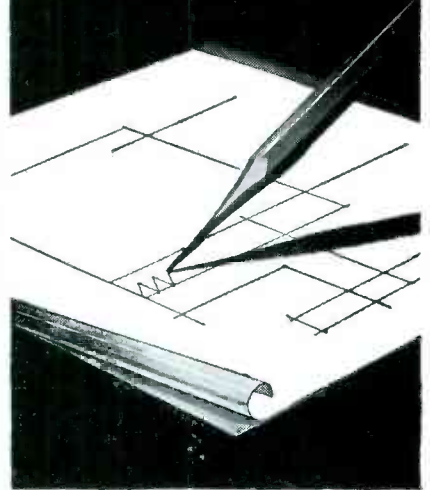
ELECTRICAL INSULATION CO., INC.

12 VESTRY ST., NEW YORK 13, N. Y.

TRACING CLOTH

for

HARD PENCILS



• Imperial Pencil Tracing Cloth has the same superbly uniform cloth foundation and transparency as the world famous Imperial Tracing Cloth. But it is distinguished by its special dull drawing surface, on which hard pencils can be used, giving clean, sharp, opaque, non-smudging lines.

Erasures are made easily, without damage. It gives sharp, contrasting prints of the finest lines. It resists the effects of time and wear, and does not become brittle or opaque.

Imperial Pencil Tracing Cloth is right for ink drawings as well.



IMPERIAL PENCIL TRACING CLOTH



SOLD BY LEADING STATIONERY AND DRAWING MATERIAL DEALERS EVERYWHERE.

broadcast directional antenna arrays. Current ratios and phase angles in degrees are measured on a single meter. Bulletin 47 gives complete details.

Precision Drill

TELELECTRONICS LABORATORY, Westbury, N. Y. The Microdrill is a precision instrument for rapid drilling of small holes. Vertical movement of the drill is accomplished by electronically controlling the amount of



electric power fed into a spring-loaded thermal unit. As power is increased, the unit elongates allowing a powerful spring to lower the spindle. Lamps indicate the position of the spindle. A collet for 0.004 to 0.025 inch pivot drills is provided on standard models.

D-C Timing Motor

A. W. HAYDON Co., Waterbury, Conn. Series 6300 motors operating on direct current are designed to integrate small instantaneous energy from a receiving type tube in order to perform greater amounts



it's **KESTER** for real soldering efficiency!



QUALITY — UNIFORMITY

Improve performance and decrease rejects by standardizing on Kester Rosin Core Solders. When manufacturing costs and maintenance operations are high, it will pay dividends to use the best cored solder made.

There is a Kester Rosin Core Solder that can be fitted to your needs. Troubled with a difficult soldering operation? Consult our engineers on any soldering problem. No obligation to you.



KESTER SOLDER COMPANY

4204 WRIGHTWOOD AVE., CHICAGO 39, ILLINOIS

Factories also at

NEWARK, NEW JERSEY

BRANTFORD, CANADA

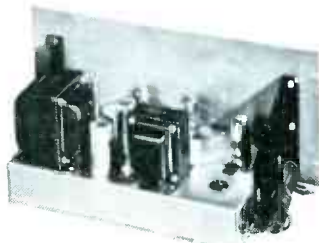
HARVEY

for GOOD REPRODUCTION



GOODSELL DYNAMIC NOISE SUPPRESSOR AMPLIFIER

18 watts with less than 2% harmonic distortion. Incorporates Scott noise suppression circuit; frequency range 20-20,000 cycles; 15 tubes; rack or cabinet mounting. \$248.00



FISHER DYNAMIC NOISE SUPPRESSOR WIDE RANGE AMPLIFIER

20 watts with only 1% distortion. Uses Scott noise suppression circuit; frequency range 20-20,000 cycles; 8 & 16 ohms output, line matching transformer extra \$254.50

GRAY Transcription Arm—for your favorite cartridge; has adjustment and scale for ideal operating conditions. . . \$35.00

Vibromaster Type K Arm—for GE and Pickering Cartridges; flat resonance characteristic. 34.50

Livingston Arm—A good arm at an economical price. 10.00

GE Reluctance Cartridge—with sapphire needle. 4.77

GE Reluctance Cartridge with diamond needle. 29.70

GE Pre-amplifier to match GE Reluctance Cartridge to amplifiers not equipped with built-in pre-amplifier. 5.95

Pickering Cartridge gives professional quality, with sapphire needle (S120M). 15.00

Pickering Cartridge with diamond needle (D120M). 39.75

Pickering Equalizer-Amplifier. 19.50

Gray Equalizer Model 601, 42.50

All prices Net, F.O.B., N.Y.C.
Subject to Change Without Notice

Telephone: **1-3-1-800** Longacre 3-1800

HARVEY
RADIO COMPANY INC.
103 West 43rd St., New York 18, N. Y.

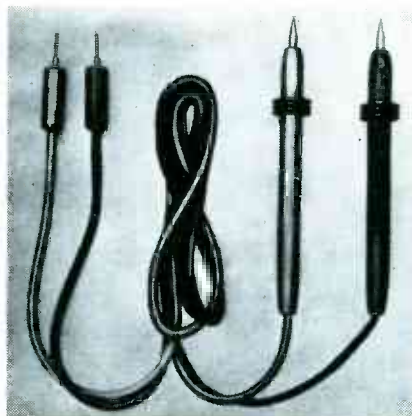
NEW PRODUCTS

(continued)

of work than relay devices. The high-impedance winding requires less than 270 milliwatts power input. A special rotor winding has approximately 7,000 ohms running impedance and draws 6 milliamperes at 45 volts d-c.

H-V Test Leads

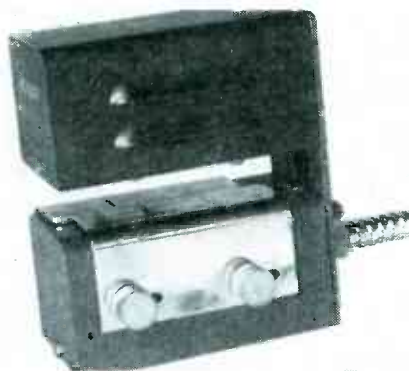
REINER ELECTRONICS Co., 152 West 25th St., New York 1, N. Y. Model 910 high-voltage heavy-duty test



leads are tested at 20,000 volts and are rated for 15,000-volt service. Tips are case hardened steel. Net price is \$4.95.

Photo Edge Guide

LANGEVIN MFG. CORP., 37 West 65th St., New York 23, N. Y. Scanner type SC 311 is used to create a sig-



nal when the edge of a sheet moves from an established center line. It can be connected to a control relay or alarm. The photoelectric scanner will detect as little movement as 1/32 inch.

Cardioid Mike

TURNER Co., Cedar Rapids, Iowa. An improved cardioid microphone for commercial broadcast and

SUPERIOR ELECTRONIC PRODUCTS

used in the GUN STRUCTURE OF TELEVISION TUBES



ANODE AND GRID CYLINDERS—



Straight cut, angle cut or rolled edge
Tubing produced to very close tolerances.

DISC CATHODE ASSEMBLY—

Precision made and laboratory controlled to assure correct emission and cut-off characteristics.

Write for Print ED1-1.

The expanding television industry has turned to Superior's Electronic Division for the conception and production of these vital parts within the television tube.

THE BIGGER NAME IN SMALL TUBING
Superior

TUBE COMPANY

ELECTRONIC DIVISION
2500 GERMANTOWN AVENUE
NORRISTOWN, PENNA.

What?

A plastics advertisement
with no parts illustrated?

No, we didn't forget to show a group of electrical parts molded to precision and within specified tolerances demanded by the manufacturer. Watertown has hundreds, yes, thousands of such parts which could be pictured here. But they wouldn't be the part you are now drawing blueprints for. That is the part we want to convince you we can make for you to meet your needs on the nose.

Why do we know we can do it? Because for thirty-five years Watertown has consistently been first in the development of new molding techniques, new equipment, laboratory testing and engineering. Over the years Watertown has saved hundreds of customers many thousands of dollars by their Watertown "know-how". We can do the same for you whether it requires injection, transfer or compression molding.

Write us concerning that plastic part you are contemplating and let Watertown engineers give you their ideas on how it can be done better. It will save you money.

A "PLUS" Watertown Service

Periodic testings of all molded parts from basic material to finished product are routine in Watertown's completely equipped laboratory. Accurate readings in flexural, tensile and compressive strengths, as well as stress and strain curves are obtained from a machine specifically designed for the fatigue testing of plastics. Fissures, porosity and stray metal inclusions are detected by a new electronic X-ray unit.

THE WATERTOWN MANUFACTURING CO.
777 ECHO LAKE RD., WATERTOWN, CONN.



AMPERITE MICROPHONES

The ultimate in microphone quality, the new Amperite Velocity has proven in actual practice to give the highest type of reproduction in Broadcasting, Recording, and Public Address.

The major disadvantage of pre-war velocities has been eliminated—namely "boominess" on close talking.

- Shout right into the new *Amperite Velocity*—or stand 2 feet away—the quality of reproduction is always excellent.
- Harmonic distortion is less than 1% (Note: best studio diaphragm mike is 500% higher).
- Practically no angle discrimination . . . 120° front and back. (Best studio diaphragm microphones—discrimination 800% higher).

● One Amperite Velocity Microphone will pick up an entire symphony orchestra. **STUDIO VELOCITY**, finest in quality; ideal for broadcasting and Recording. Models R30H, R30L. List \$80.00. There is an Amperite Microphone for every requirement.

WRITE FOR ILLUSTRATED 4-PAGE FOLDER giving full information and prices.

P. G. Dynamic
Models PGH, PGL
List \$32.00

Address inquiry
attention Dept. E

AMPERITE Company, Inc.

561 BROADWAY NEW YORK 12, N. Y.



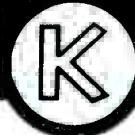
AMPERITE
Velocity Microphones
for Public Address
Models RBHG, RBLG
List \$42.00



"Kontak" Mikes
Model SKH, list \$12.00
Model KKH, list \$18.00

In Canada:
Atlas Radio Corp.
560 King St. W.
Toronto, Ont.

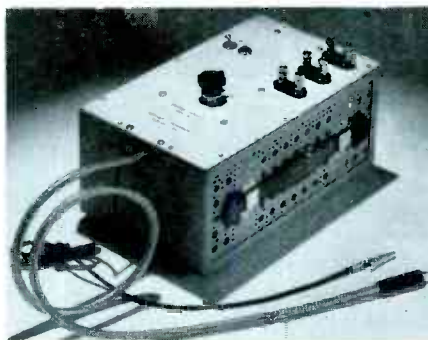
QUANTITATIVE MEASUREMENTS ON HIGH IMPEDANCE CIRCUITS



MODEL 102

PHANTOM REPEATER

AN INSTRUMENT AMPLIFIER WITH
200 MEGS.—6.0 MMF INPUT IMPEDANCE



The Phantom Repeater bridges voltmeters and cathode ray oscilloscopes, which have inputs of 1 megohm and 30 mmf, onto signal circuits of 50,000 ohms and higher—such as a pentode amplifier stage with its high resistance plate load—without the loss of voltage and high frequency response which would result if the measur-

ing instruments were connected directly. Input Impedance: 200 megohms shunted by 6 mmf. Output Impedance: 300 ohms. Gains of 1.00, 10.0, and 100. Frequency Range from 5 cps to 150,000 cps within 2%. Background noise equivalent to 40 to 70 microvolts at the input.

Descriptive Bulletin Sent Upon Request

KEITHLEY INSTRUMENTS

1508 CRAWFORD RD.

CLEVELAND 6, OHIO

ULTRA SENSITIVE D. C. AMPLIFIER



An Electronic Replacement For Sensitive Galvanometer Systems

The Model 53 Breaker-type D.C. Amplifier was developed for the measurement of d. c. and low frequency a. c. voltage in the microvolt and fractional microvolt region. It is compact, portable, and makes an excellent replacement for the suspension galvanometer. The output of the amplifier is sufficient to operate standard meters and recording devices directly.

It has been employed for the amplification of infra-red detectors, thermocouples, voltaic photocells, and the like, both in research and industrial applications.

Among the advantages of this amplifier are the following:

1. Noise level that approaches the theoretical limit imposed by Johnson noise.
2. Extremely low zero drift (less than .005 μ V after warmup).
3. Freedom from the effects of vibration such as found in moving vehicles.
4. Response characteristics permitting overall amplification flat from 0 to 10 cycles per second.
5. Reliability, as demonstrated by units which have been in continuous operation for several years.

NEW PRODUCTS

(continued)



recording work is designated model 77. Discrimination between front and rear is approximately 15 db at all frequencies. Response is within plus or minus 5 db from 70 to 10,000 cycles. Level is 62 db below 1 volt per dyne per square centimeter. Output can be selected from high impedance through 50, 200, or 500 ohms.

THE PERKIN-ELMER CORPORATION

GLENBROOK • CONNECTICUT



Maintenance Meter

PRECISION APPARATUS CO., INC., 92-27 Horace Harding Blvd., Elmhurst, L. I., N. Y. Series 85 bakelite-cased meter provides 34 self-

More than 14 years of know-how and experience in every

PYROFERRIC IRON CORE

Pyroferric Iron Cores were first made in 1933 and the experience and know-how gained in each succeeding year are inherent in every powdered iron product today produced by the Pyroferric Company, including: a full line of standard sized Powdered Iron Screw-Type Cores of varying lengths, with standard threads, as well as a complete line of powdered iron cores, with and without inserts.

For Powdered Iron Cores to meet your specifications, address your inquiry to

PYROFERRIC Co.

621 East 216 Street, New York City 67

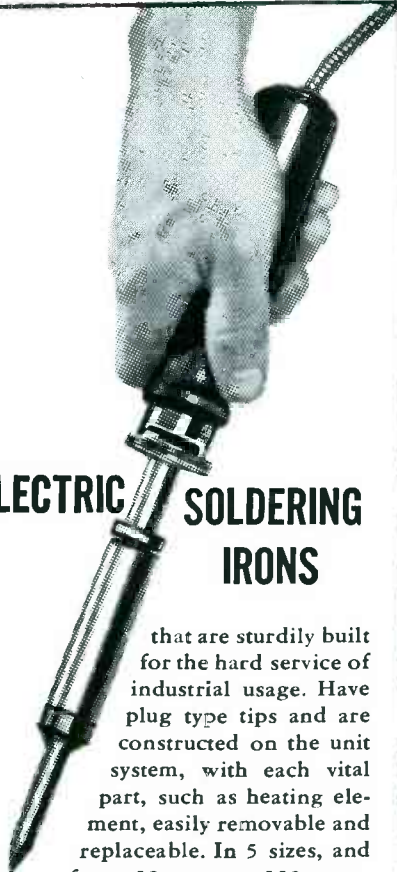


contained ranges up to 6,000 volts, 120 microamperes, 12 amperes, plus 70 db, and 60 megohms. Sensitivity is 20,000 ohms per volt d-c, and 1,000 ohms per volt a-c.

Suppressor Coils

BURNELL & Co., 45 Warburton Ave., Yonkers 2, N. Y. Now in stock are high-Q toroidal coils employed in the Scott dynamic noise suppressor. Type TC-1 800 (0.8 henry) and TC-

ELECTRIC SOLDERING IRONS

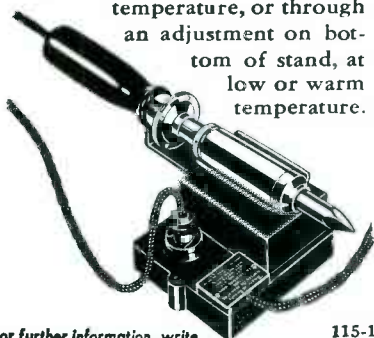


that are sturdily built for the hard service of industrial usage. Have plug type tips and are constructed on the unit system, with each vital part, such as heating element, easily removable and replaceable. In 5 sizes, and from 50 watts to 550 watts.

American Beauty

TEMPERATURE REGULATING STAND

This is a thermostatically controlled device for the regulation of the temperature of an electric soldering iron. When placed on and connected to this stand, iron may be maintained at working temperature, or through an adjustment on bottom of stand, at low or warm temperature.



For further information, write

115-1

AMERICAN ELECTRICAL HEATER COMPANY
DETROIT 2, MICHIGAN
established 1894

Cellusuede FLOCKED-FILM

... the Solution to Many Finishing Problems

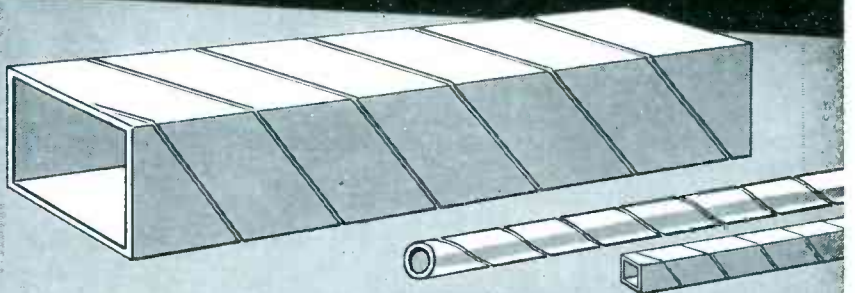
In instances where spraying Cellusuede Flock is not entirely practical, you will find flocked-film ready to do the job simply and effectively. Cellusuede Flocked-film is a pliant surface (of varying degrees of flexibility to meet certain conditions) evenly coated with millions of tiny flock fibres.

Film can be die-cut to meet specifications, and is easily applied with suitable adhesives. Sound deadening gaskets, box interior coatings, mar-proofing of external surfaces, and light-absorbing trim for backs of radio dials are but a few examples how Cellusuede Flocked-film can be used.

Precision-cut from new rayon filament in a wide range of lengths, Cellusuede Flock serves to increase the market value of thousands of products. Write today for booklet, color card, samples, prices, and other details.



Over 1000 Sizes



PARAMOUNT SPIRAL WOUND PAPER TUBES

Square • Rectangular • Triangular
Round and Half-Round

With a wide range of stock arbors... plus the specialized ability to engineer special tubes... PARAMOUNT can produce the exact shape and size you need for coil forms or other uses. *Hi-Dielectric*, *Hi-Strength*. Kraft, Fish Paper, Red Rope, or any combination, wound on automatic machines. Tolerances plus or minus .002". Made to your specifications or engineered for YOU.

Inside Perimeters from .592" to 19.0"

SEND FOR ARBOR LIST
OF OVER 1000 SIZES
Convenient, helpful listing
of over 1000 stock ar-
bors. Includes many odd
sizes of square and rec-
tangular tubes. Write for
Arbor List today. No
obligation.

PARAMOUNT PAPER TUBE CORP.

616 LAFAYETTE ST., FORT WAYNE 2, IND.

Manufacturers of Paper Tubing for the Electrical Industry

Make your tedious weighing job
Simple and Routine with
Roller-Smith
PRECISION BALANCES



SAVE TIME SAVE MONEY
IN ASSAYING — RESEARCH — PRODUCTION
CONTROL — ANALYTICAL WORK

In the Manufacture of
Chemicals - Textiles - Lamp Filaments - Radio Tubes - Explosives - Watches - Paints - Biologicals

The Roller-Smith Precision Balance is universally used for weighing within the range of 3 mg to 150 grams. Everyday applications include the measurement of liquid surface tension, yarn numbering, counting extremely small parts by weight, assaying precious ores, weighing diamonds and specific gravity determinations.

The Roller-Smith Precision Balance is the result of careful research and painstaking design to produce a better means for rapid weighing, quality control and uniformity in the manufacture of your products.

The Roller-Smith Precision Balance is backed by over 40 years of research and development experience in the engineering of fine products. Let Roller-Smith help you with your weighing problems.

Write now for the Roller-Smith Precision Balance Catalog.

ROLLER-SMITH

BETHLEHEM, PA.

Visit the Third National Instrument Exhibit, Convention Hall, Philadelphia, Pa., Sept., 13-17, 1948. See our display in Booth 515.



ELECTRICAL INDICATING INSTRUMENTS • AIR-CRAFT INSTRUMENTS • SWITCHGEAR • AIR & OIL CIRCUIT BREAKERS • ROTARY SWITCHES
RELAYS • PRECISION BALANCES

NEW PRODUCTS

(continued)



1 2400 (2.4 henries) are available either cased or uncased.

Coaxial Line

PRODUCT DEVELOPMENT Co., INC., Arlington, N. J. A special pin-type Teflon-insulated coaxial line is available in RMA sizes together with fittings and accessories. The line has an essentially constant characteristic impedance with its frequency limitations well beyond 1,000 megacycles. Detailed data are available from the manufacturer.

Horn Driver

RACON ELECTRIC Co., INC., 52 East 19th St., New York 3, N. Y. A special permanent-magnet horn driver



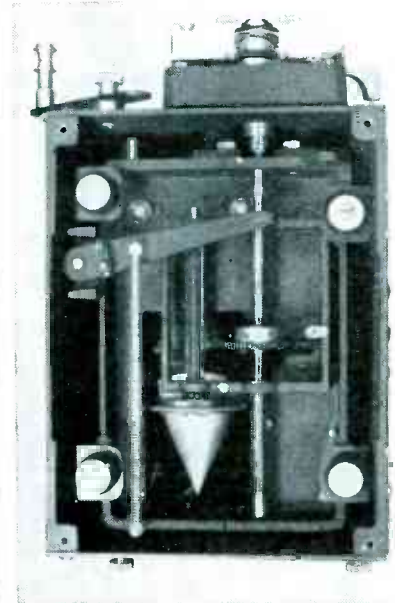
unit has a rated capacity of 35 watts continuous duty and 60 watts peak. An Alnico V magnet is used in a watertight assembly.

Regulated H-V Supply

INSTRUMENT DEVELOPMENT LABORATORIES, 223 W. Erie St., Chicago 10, Ill. Model 1090 is a reactance-



A Really Good A C DRIVE



McElroy engineers have now completed design on the new AC drive shown above. This unit is the heart of the high speed equipment now being produced at the factory. It is used in the high speed recorder, the keying heads and in our high speed tape puller such as the CTP. Speed ratio is 50 to 1.

Precision machined, the unit will not vary in speed once set, regardless of normal load. A strobotac will show no variation in speed at loads up to 15 times the force required to break tape. Pulling as a tape puller, the rate will be within one percent.

An ingenious cradle increases friction with load, and a DC solenoid insures that the drive and idlers will be out of contact when the drive stops, thus preventing flats on the drive wheel.

Made at Telegraphers Lodge,
LITTLETON, MASSACHUSETTS
by the

**McELROY
MFG. CORP.**

SALES DEPARTMENT
453 W. 47th St. • New York 19, N. Y.

Ceiling unlimited!

with the new

UNIVERSITY TWEETER



FULL RANGE
RESPONSE TO THE
LIMIT OF AUDIBILITY

Don't let your loudspeaker put a ceiling on the frequency response of your radio or phono equipment. Enjoy full range reproduction right up to 15,000 cycles by connecting one of these tweeters to your present cone speaker. Perfect for FM and the latest full frequency range recordings. Available in single or dual unmounted types and in walnut cabinet models. Prices from \$20.00. Write today to UNIVERSITY LOUDSPEAKERS, INC., 80 South Kensico Avenue, White Plains, New York.

University Loudspeakers

PROJECTION TELEVISION!

30 KV RF POWER SUPPLY

Dimensions —
Length 14",
Width 11",
Height 11 1/4".

This unit has a low voltage supply separate from high voltage pack. Low voltage DC supply has control which enables you to vary voltage from approximately 12 KV to 40 KV. Unit has focus control built in for use with 5TP4 projection tube. Price, complete,..... **\$99.50**



F 1.9 TELEVISION PROJECTION LENS

Dimensions—Length 7", Diameter 4 1/4".

F 1.9 EF. 5 in. (127.0 mm). This lens incorporates in barrel a corrective lens for use with a 5TP4 projection tube. It is easily removable for use with flat type tubes. Lens can be utilized to project picture sizes from several inches to 7 x 9 feet. Made by Bausch & Lomb Optical Co.....Price **\$125.00**



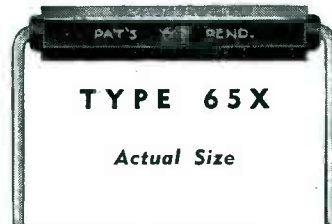
Include 25% Deposit With Order. Balance C.O.D.

Pioneers in Projection Television
SPELLMAN TELEVISION, INC.
130 WEST 24th STREET * NEW YORK 11, N. Y.

MOLDED S.S. White RESISTORS

The "All-Weather" Resistors

Of particular interest to all who need resistors with inherent low noise level and good stability in all climates



TYPE 65X

Actual Size

STANDARD RANGE

1000 OHMS TO 10 MEGOHMS

Used extensively in commercial equipment including radio, telephone, telegraph, sound pictures, television, etc. Also in a variety of U. S. Navy equipment.

HIGH VALUE RANGE 15 to 1,000,000 MEGOHMS

This unusual range of high value resistors was developed to meet the needs of scientific and industrial control, measuring and laboratory equipment—and of high voltage applications.

SEND FOR
BULLETIN 4505

It gives details of both the Standard and High value resistors including construction, characteristics dimensions, etc. Copy with Price List mailed on request.



S.S. WHITE INDUSTRIAL

THE S. S. WHITE DENTAL MFG. CO. DEPT. R. 10 EAST 40th ST., NEW YORK 16, N. Y.



FLEXIBLE SHAFTS • FLEXIBLE SHAFT TOOLS • AIRCRAFT ACCESSORIES
SMALL CUTTING AND GRINDING TOOLS • SPECIAL FORMULA RUBBERS
MOLDED RESISTORS • PLASTIC SPECIALTIES • CONTRACT PLASTICS MOLDING

One of America's AAAA Industrial Enterprises

KNOW ACTUAL RF POWER FED TO FM ANTENNA—WITH *MicroMatch*



Glancing at Micro-Match Model MM-200 indicator unit at WHT's new FM transmitter is Charles S. Masini, Chief Engineer of station. Above, coupler unit in standard 1 1/2" dia. coaxial line.

Micro-Match gives you direct, continuous accurate reading in kilowatts. Also gives precise, continuous reading of SWR of antenna system.

MICRO-MATCH models available for operation at 500 KC to 250 MCS. and power levels of 2 to 50,000 watts.

Write for complete descriptive literature

M. C. JONES ELECTRONICS COMPANY

96 North Main Street

Bristol, Connecticut

Distributed outside continental U.S.A. by RCA International Division Radio Corporation of America.

For **LONG**

TROUBLE-FREE OPERATION

Specify

N·W·L

**CUSTOM-BUILT
TRANSFORMERS**

AND ELECTRICAL COILS

Over 25 years' experience in the manufacture of specials at cost that compares favorably with standard types. Built-in quality proved by years of actual use.

From 10VA to 300
KVA Dry-Type Only,
Both Open and En-
cased, 1, 2, & 3 Phase 25
to 400 Cycles.

PROMPT DELIVERIES!

**NOTHELPER
WINDING LABORATORIES**

9 ALBERMARLE AVE., TRENTON 3, N. J.



NEW PRODUCTS

(continued)

regulated d-c supply for use by re- search physicists. Output varies less than 0.01 percent with input variation between 90 and 130 volts. Output voltage is continuously var- iable between zero and 5,000 volts d-c.

Milliwattmeter

ROWE ENGINEERING CORP., 2422 North Pulaski Road, Chicago 39, Ill. Type MW55 vhf and uhf milli- wattmeter can be used in the range from 50 to 500 megacycles to meas- ure powers in the order of 2 to 1,000



milliwatts. Filament brilliance compar- ison and a thermistor bridge ar- rangement are used. Power indi- cations are from meter readings and a calibration chart. Accessory probes provide a variety of meth- ods of circuit coupling.

Bombarder

S CORRUGATED QUENCHED GAP Co., 107 Monroe St., Garfield, N. J. A new 3½ kw bombarder or high-fre-



HEAT RESISTANT WIRES FOR EVERY APPLICATION . . .

DESIGN ENGINEERS . . .

Do those new circuit designs present new wire problems?

Then check with Lewis Engineering for an economic solution and fast delivery. For twenty years we've successfully been solving the heat and age resist- ance wire problems of industry. We don't stock wire—we make it to your specs—for an experimental run or for the production line. If you're designing in the electronic, electrical or appliance field . . .

- HEATING UNITS
- HEATING ELEMENTS
- RESISTANCE LINE CORD
- THERMOCOUPLE WIRE
- ASBESTOS LEAD & FIXTURE WIRE
- INSULATED RESISTANCE WIRE
- FIBERGLAS INSULATED WIRE
- WIRE TO ANY SPECIFICATIONS

Let Lewis Build The Wire For You

Send your electronic control, communications or appliance wir- ing specifications for a recommended solution by our engineers.

FOR A TRIAL ORDER OR A CARLOAD consult



THE LEWIS ENGINEERING CO.

Wire Division
NAUGATUCK CONNECTICUT

KENYON TRANSFORMERS

Engineers specify Kenyon Transformers for dependable performance. Famous for conservative ratings and rugged construction, Kenyon transformers are preferred for long, trouble-free service in quality equipment.

TERMINAL carries a complete stock of Kenyon transformers and chokes for power and audio requirements.

Catalog on request.

TERMINAL

RADIO CORPORATION

Distributors of Electronic Equipment

85 CORTLANDT ST.
NEW YORK 7, N. Y.
Phone: WOrth 2-4415



PILOT LIGHT ASSEMBLIES

PLN SERIES—Designed for NE-51 Neon Lamp



Features

- THE MULTI-VUE CAP
- BUILT-IN RESISTOR
- 110 or 220 VOLTS
- EXTREME RUGGEDNESS
- VERY LOW CURRENT

Write for descriptive booklet

The DIAL LIGHT CO. of AMERICA

FOREMOST MANUFACTURER OF PILOT LIGHTS
900 BROADWAY, NEW YORK 3, N. Y.

Telephone—SPring 7-1300

See us at Booth 255 at the I.R.E. Show in N.Y.C., March 22-25

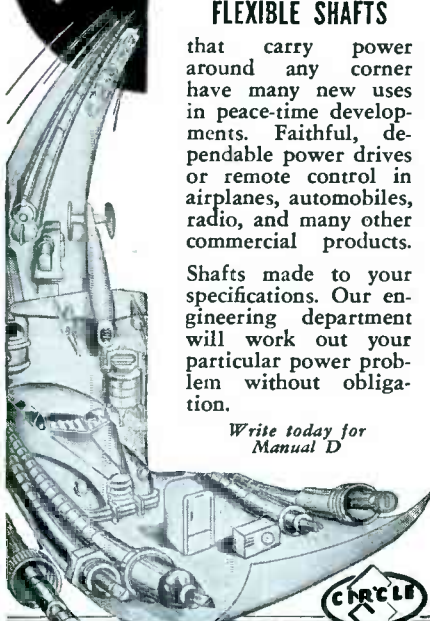
Flexible SHAFTS

FLEXIBLE SHAFTS

that carry power around any corner have many new uses in peace-time developments. Faithful, dependable power drives or remote control in airplanes, automobiles, radio, and many other commercial products.

Shafts made to your specifications. Our engineering department will work out your particular power problem without obligation.

Write today for Manual D



F. W. STEWART MFG. CORP.
4311-13 RAVENSWOOD AVE.
CHICAGO 13, ILL.
WEST COAST BRANCH:
431 Venice Blvd., Los Angeles 15, Cal.

New . . . Improved ATTENUATORS by TECH LABS

TYPE 800 and 900

Type 800

Type 900

"New Times—New Modes", says old proverb. These new attenuators were born to meet new war-created demands. They represent a new medium frame size: Type 800 (2 1/4" dia.) and a larger size: Type 900 (3" dia.). The Type 800 is supplied as potentiometer, rheostat, ladder and T-pad up to 20 steps. The larger size Type 900 is similarly furnished with up to 45 steps. Write for new bulletin.

TECH
LABORATORIES, INC.

Manufacturers of Precision Electrical Resistance Instruments
337 CENTRAL AVE. • JERSEY CITY 7, N. J.

JUST OUT! ENERGY UNLIMITED

THE ELECTRON AND ATOM IN
EVERYDAY LIFE



by
Harry M. Davis
Science Editor of Newsweek

323 pages—104 illustrations
many of them but recently re-
leased from secrecy restrictions

\$4

KEEP abreast of all the developments in these fields of current scientific achievement and challenging future. This new book covers the whole range of electronic and atomic development particularly in their peacetime and industrial applications—from power sources to super X-rays and microscopes, the "brainplane," radio-isotope medical research, induction heating, and many others. "Up-to-date—indeed, almost ahead of the times—and it is accurate." . . . *New York Times*. "Pleased with the clarity of his presentation and the accuracy of his treatment of atomic physics." . . . Professor Henry Semat. Use coupon below to send for a copy subject to your examination, today.

CHECK LIST of other Murray Hill Books in ELECTRONICS and ELECTRICITY

1. RADIO PHYSICS COURSE, Ghirardi, \$5.00 (Outside U.S.A. \$5.50).
2. MODERN RADIO SERVICING, Ghirardi, \$5.00 (Outside U.S.A. \$5.50).
3. RADIO TROUBLESHOOTER'S HANDBOOK, Ghirardi, \$5.00 (Outside U.S.A. \$5.50).
4. THE ELECTROLYTIC CAPACITOR, Georgiev, \$3.00 (Outside U.S.A. \$3.25).
5. ELECTRIC MOTOR REPAIR, Rosenberg, \$5.00 (Outside U.S.A. \$5.50).
6. INDUSTRIAL ELECTRIC WIRING, Lincoln, \$2.75.
7. CONDUCTORS AND WIRING LAYOUTS, \$2.75.
8. ELECTRIC MOTORS AND GENERATORS, Lincoln, \$2.75.
9. INDUSTRIAL ELECTRIC CONTROL, Lincoln, \$2.75.
10. ELECTRICAL MEASURING INSTRUMENTS, \$2.50.
11. ELECTRIC PROTECTIVE EQUIPMENT, Lincoln, \$2.50.
12. PRIMARY AND STORAGE BATTERIES, Lincoln, \$2.25.
13. SWITCHBOARDS AND PANELBOARDS, Lincoln, \$2.25.
14. INDUSTRIAL ELECTRIC LAMPS AND LIGHTING, Lincoln, \$2.75.
15. INDUSTRIAL ELECTRIC HEATING, Lincoln, \$2.25.
16. RADIO'S CONQUEST OF SPACE, McNicol, \$4.00 (\$4.35).



5 DAY MONEY-BACK GUARANTEE

Dept. E-48, Murray Hill Books, Inc.,
232 Madison Ave., New York 16, N. Y.

Enclosed find \$..... for books checked below or, send C.O.D. (in U.S.A. only) and I will pay postman this amount plus postage upon delivery. In either event, it is understood I may return any book within 5 days for refund of the purchase price.

ENERGY UNLIMITED (\$4)

Circle the numbers (see above list) of books desired:

1	2	3	4	5	6	7	8
9	10	11	12	13	14	15	16

Name

Address

City & Zone State

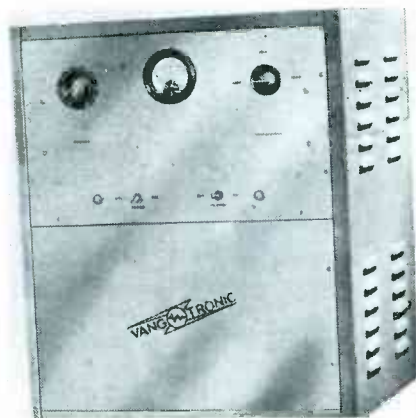
NEW PRODUCTS

(continued)

quency induction heater operates from a 220-volt line. The apparatus weighs 300 pounds.

Spot Welder Converter

VANGTRONIC CORP., 237 John St., Bridgeport 3, Conn. A-c spot welders can be converted to the stored-



energy type for spot-welding aluminum and other high conductivity metals. The unit illustrated gives speeds from 30 to 180 spots per minute.

Strain Amplifier

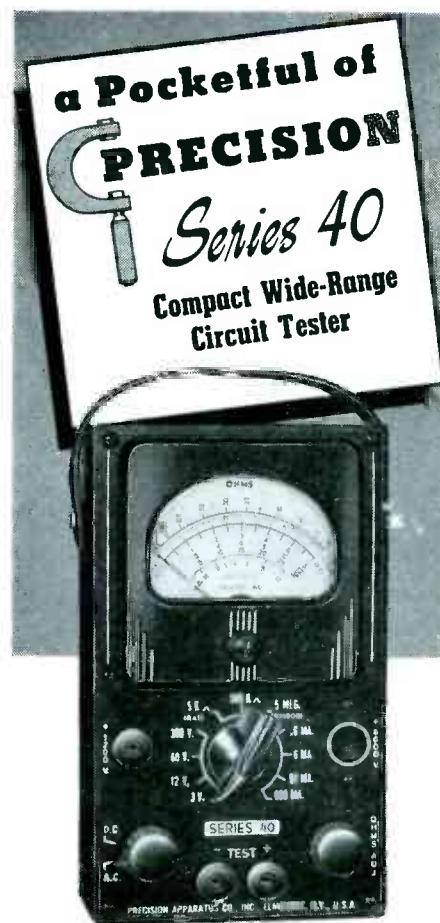
BRUSH DEVELOPMENT Co., 3405 Perkins Ave., Cleveland 14, Ohio. Model BL-310 strain amplifier designed for use with the direct inking oscil-



lograph illustrated can be used with Baldwin SR-4 strain gages, Statham Lab pickups, and many other types of resistance-sensitive gages. Specifications are in catalog sheet F-376.

Photoelectric Wattmeter

GENERAL ELECTRIC Co., Schenectady 5, N. Y. A new photoelectric recording wattmeter for analysis of



Self-Contained to 6000 V
5 Megs, 600 MA, +70 DB,
with full size
3" Rectangular Meter

Series 40 Complete with ohmmeter batteries and test leads.
Net Price **\$2475**

In custom molded carrying case, Series 40 is ideally dimensioned and engineered as a portable, compact test set to withstand hard usage as imposed by the maintenance engineer, production inspector, trouble-shooter, etc.

Series 40 offers features and components as incorporated in "Precision's" larger test sets, including: Rotary Selection—1% shunts and multipliers—heavy duty insulated pin jacks—Large numerals, easy reading meter.

ALL RANGES are SELF-CONTAINED.
NO EXTERNAL BATTERIES
OR MULTIPLIERS ARE REQUIRED.

RANGE SPECIFICATIONS

- ★ 6 A.C.-D.C. & Output Voltage Ranges: all at 1000 ohms per volt. 0-3-12-60-300-1200-6000 volts.
- ★ 4 D.C. Current Ranges: 0-6-60-600 MA.
- ★ 3 Resistance Ranges: self-contained batteries. 0-5000-500,000 and 0-5 megohms.
- ★ 6 Decibel Ranges from -22 to +70
- ★ Full Size 3" Rectangular Meter: 400 microamperes ±2% accuracy.
- ★ 1% Wirewound & Metallized Resistors.
- ★ Only 2 Pin Jacks serve all standard functions.
- ★ Recessed 6000 volt safety jack.
- ★ Anodized, etched aluminum panel: resistant to moisture and wear.

See this new "Precision" Test Set now on display at all leading radio parts and equipment distributors, or write directly for the Precision 1948 catalog describing the complete Precision line of quality Electronic Test Instruments for all phases of modern radio-electronics—A.M., F.M. and TV.

PRECISION

APPARATUS CO., Inc.
92-27 Horace Harding Blvd.
Elmhurst 10, N. Y.

Export Division: 458 Broadway, N. Y. City, U.S.A.
Cables: MORHANEX

Maybe “more production” isn't the answer to all our problems

AMERICAN INDUSTRY is already producing at almost double its pre-war rate. Yet with labor and material costs at an all-time high, the experts insist that we must produce still more goods, faster, more efficiently, if we are to avoid another boom-and-bust cycle.

We'll buy that—as far as it goes.

But let's never lose sight of the fact that production is only half the problem. Because for every increase in our rate of production, there must be a comparable rise in our *rate of sales*.

Actually, of course, there is no such thing as producing goods at a profit. Goods are *sold* at a profit—yes. And while production line savings are vitally important, it is of equal importance to keep down the

cost of *manufacturing sales*.

That is the function of *mechanized selling*—to produce sales on a mass production basis, and at the lowest possible cost per unit. Translated into more familiar terms, it simply means advertising to the right market, in the right way, at the right time.

Like the machine on the production line, good advertising is a multiplier of men's efforts, for it enables us to produce (and *earn*) far more than we could alone. And when it goes to work in business papers—with their tremendous concentration of hand-picked readers—advertising becomes the most efficient machine at our disposal for *manufacturing sales at a profit*.

What are the ten ways to measure the results of your business paper advertising? You'll find the answers in a recent ABP folder, which we'll be glad to send you on request. Also, if you'd like reprints of this advertisement (or the entire series) to show to others in your organization, you may have them for the asking.



ELECTRONICS

is one of the 129 members of The Associated Business Papers, whose chief purpose is to maintain the highest standards of editorial helpfulness—for the benefit of reader and advertiser alike.

THE MOST OF THE BEST

Gothard
DYNAMOTORS



are proved
to have . . .

Prompt
Delivery

- Added safety factors for overloads.
- Smoother and quieter operation.
- Double varnish impregnation of windings.
- Precision machining.
- Rugged, lightweight.
- Rigid visual and electrical inspection.
- Range—Continuous up to 175 watts. Intermittent up to 250 watts.

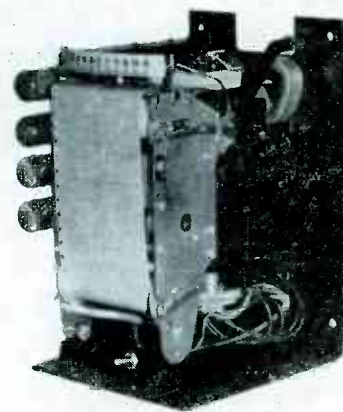
IN SHORT . . .

Tops in DYNAMOTORS
Ask for literature on Gothard Dynamotors, Rotary Converters, Motor Generators and Generators.

Gothard MANUFACTURING CO.
2114 Clear Lake Avenue EXPORT DIVISION
Springfield, Illinois 25 Warren St., New York 7, N. Y.

NEW PRODUCTS

(continued)



special power loads can be used on d-c or a-c up to 10,000 cycles. The instrument comprises a high-speed photoelectric recorder and a new wattmeter measuring unit. Charts speeds of a half inch per hour up to 72 inches per minute can be obtained.

Tape Recorder

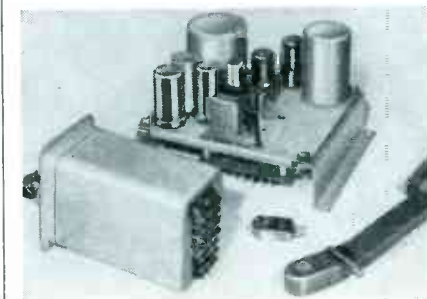
McELROY MFG. Co., Telegraphers Lodge, Littleton, Mass. A new inked tape recorder is capable of



Morse code speeds up to 1,500 words per minute. Tone input is accepted by the self-contained amplifier. A siphon inkwell is used.

Diamond Pickup

GENERAL ELECTRIC Co., Syracuse, N. Y. A diamond stylus variable reluctance pickup with either 2.5 or



MEASUREMENTS CORPORATION MODEL 80 STANDARD SIGNAL GENERATOR



2 to 400 MEGACYCLES

MODULATION: Amplitude modulation is continuously variable from 0 to 30%, indicated by a meter on the panel. An internal 400 or 1000 cycle audio oscillator is provided. Modulation may also be applied from an external source. Pulse modulation may be applied to the oscillator from an external source through a special connector. Pulses of 1 microsecond can be obtained at higher carrier frequencies.

**FREQUENCY
ACCURACY ±.5%**
OUTPUT VOLTAGE
5.1 to 100,000
microvolts

**OUTPUT
IMPEDANCE**
50 ohms

MANUFACTURERS OF
Standard Signal Generators
Pulse Generators
FM Signal Generators
Square Wave Generators
Vacuum Tube Voltmeters
UHF Radio Noise & Field
Strength Meters
Capacity Bridges
Megohm Meters
Phase Sequence Indicators
Television and FM Test
Equipment

MEASUREMENTS CORPORATION

BOONTON  NEW JERSEY

PREMAX

Adjustable V Dipole Antennas For FM Insure Better Reception!

Actual operation proves the Premax FM-130 Adjustable Dipole Antenna with its exclusive 3d dimensional adjustment materially reduces man-made electrical noise in FM reception.

This Antenna has been found to be the dealer's and service man's solution to poor reception because he can adjust this antenna to cope with local conditions and cancel out noise and reflected signals.

Send for special Bulletin FMT-148, telling why an adjustable V antenna is best for FM and TV reception.

Premax Products

Div. Chisholm-Ryder Co., Inc.
4810 Highland Ave. Niagara Falls, N. Y.

FOR PUBLIC ADDRESS, RADIO, and kindred fields, **JONES 400 SERIES PLUGS & SOCKETS**

of proven quality!



P-406-CCT



S-406-AB

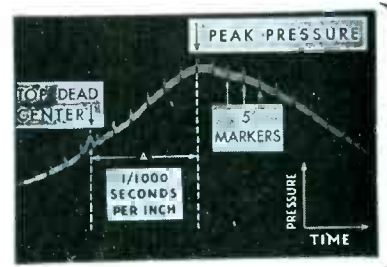
Socket contacts phosphor bronze cadmium plated. Plug contacts hard brass cadmium plated. Insulation molded bakelite. Plugs and sockets polcrized. 2, 4, 6, 8, 10, 12 contacts. Steel caps with baked black crackle enamel. Catalog No. 16 gives full information on complete line of Jones Electrical Connecting Devices — Plugs, Sockets and Terminal Strips. Write

HOWARD B. JONES DIVISION
Cinch Mfg. Corp.
2460 W. GEORGE ST. CHICAGO 18, ILL.

Have you ever seen the INSIDE of an EXPLOSION?

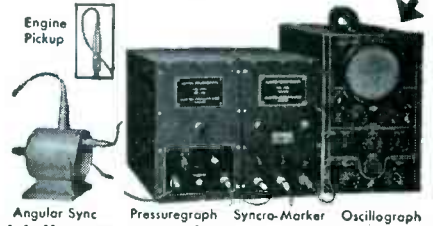
or the rate of engine flame propagation

Seeing now made possible by remarkable new electronic features, embodied in



PRESSUREGRAPH with Syncro-Marker

Reproduces on oscillograph screen, accurate picture of pressures during and after explosion, relates pressure variations to time, top dead center, angular velocity, etc. Also accurate tracing of rate of flame propagation with relation to top dead center and peak pressure. See pressure-time characteristics of automotive, jet and Diesel engines, also compressors, pumps, etc. Operates over range from static up to 10,000 cycles at pressures from 0 to 10,000 lbs.



Send for description and full engineering data.

ELECTRO PRODUCTS LABORATORIES
549 W. Randolph St., Chicago 6, Ill. Phone ST ate 7444

FOR WIDE ADAPTABILITY

These Amrecon multiple purpose relays are designed for either A.C. or D.C. operation. Each is available in a variety of contact combinations and capacities. Most units are available in light and heavy duty contacts nominally rated from 5 to 15 amps, 115 volts A.C., noninductive. Others are rated as high as 50 amps, at 115 volts A.C., noninductive. The relays illustrated are but a few of our many types.

We are especially well equipped to assist you in your engineering problems and can supply special units to meet your most exacting relay requirements.

Your inquiry will receive prompt and courteous attention.

Write for our 4-page illustrated bulletin

American Relay & Controls, Inc.
4909 Flournoy St. • Chicago 44, Ill.



Type CR

Type QC

Type CRU

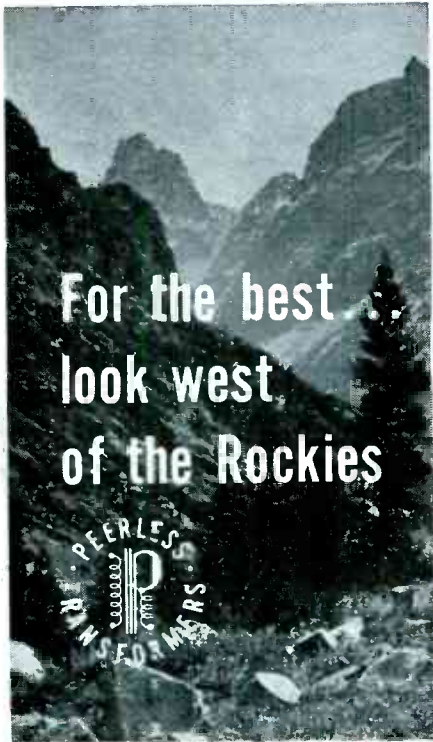
Type TG

Type DOS

Type DO

ENGINEERING
"KNOW-HOW"





For the best
look west
of the Rockies

**FLAT
WITHIN 1DB
from 20 cycles
to 20,000 cycles**

Altec Lansing presents the new Peerless "20-20 Line" to meet today's need for audio transformers incorporating the admittedly superior principles of Altec Lansing design and engineering know-how, at prices attractive to present day manufacturing and replacement markets. Transportation prepaid anywhere in the U. S. on orders totaling 100 lbs. or more.



**The NEW
PEERLESS
"20-20 LINE"**

A new Peerless catalogue, presenting the complete line of Peerless audio, power, and special purpose transformers, will be sent on request. Write to Dept. L.

**PEERLESS
ELECTRICAL PRODUCTS
DIVISION**



6920 McKinley Avenue • Los Angeles 1, Calif.
Frazar & Hansen, Ltd., 301 Clay St.,
San Francisco 11, exclusive export agent

NEW PRODUCTS

(continued)

3 mil radius and associated transcription equipment is available for use by broadcast stations. The lateral-reproducing pickup provides a usable frequency response from 50 to 10,000 cycles. Ask for information on type FA-21-A arm, type FA-12-A equalizer, and preamplifier BA-3-A.

Literature

Wire Recording. Wire Recording Corp. of America, 1331 Halsey St., Brooklyn 27, N. Y., has issued a pamphlet on Wireway, the combination recorder and playback. Vital features and various uses are set forth.

Conduit Fittings. Cannon Electric Development Co., 3209 Humboldt St., Los Angeles 31, Calif. Catalog sheets are now available showing AN3060 45-degree conduit coupling, AN3064 box connector, and AN3068 conduit coupling adapter.

Tube Applications. Radio Corp. of America, Harrison, N. J. Application notes on the new Special Red tubes, a-c/d-c f-m/a-m receivers, preventing kinescope damage, and the use of miniature tubes in stagger-tuned i-f circuits have recently been printed.

Resistance Wire. Wilbur B. Driver Co., 156 Riverside Ave., Newark 4, N. J. All types of resistance wire manufactured by the company are described and their prices given in a new resistance handbook recently published.

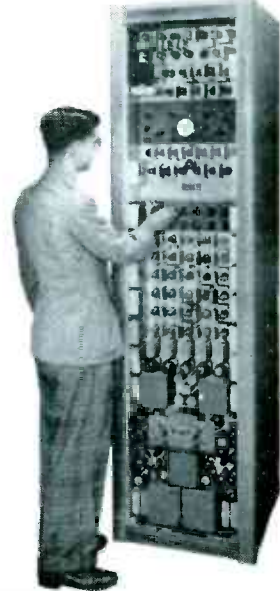
F-M Broadcaster. Radio Engineering Laboratories, Inc., 35-54 36th St., Long Island City 1, N. Y., has issued bulletin 5012A with complete details of their 10-kw f-m broadcast transmitter employing a Quadriline amplifier.

Vibration Detection. Consolidated Engineering Corp., 620 North Lake Ave., Pasadena 4, Calif. Bulletin CEC-1510 covers the model 4-102 vibration pickup and the type 1-110B vibration meter. Complete

**POLARAD
TELEVISION Equipment
for studio • laboratory • manufacturer**

SYNCHRONIZING GENERATOR

Model PT 101—Television



FEATURES

- Built-in 3" oscilloscope with synchronized sweeps for viewing Timing and Video Output pulse wave forms.
- Synchronized marker system for checking pulse width and rise time.
- Extreme stability. Insured by deriving all pulses from leading edge of master oscillator pulse.
- Means for checking synchronizing pulses in odd and even fields.

SPECIFICATIONS

525 line, interlaced, 60 fields, 30 frames, RMA Synchronizing pulses held to tolerance specified in the NCTPB report of 1945. Output Pulses: Synchronizing, Video Blanking, Camera Blanking, Horizontal Driving, Vertical Driving Pulses. 5 volts across 100 ohm termination. Dual output jacks. 115 volts 50/60 cps. Complete with tubes.

**TELEVISION
MONOSCOPE
SIGNAL
SOURCE**

Model PT 102

- Composite Video Signal.
- Wide Band Video Amplifier, 6 DB down at 10MC
- Dual outputs for feeding two 75 or 100 lines
- Black positive or Black negative output
- Resolution greater than 600 lines

INPUT: Vertical and Horizontal Driving pulses, Camera and Kinescope Blanking Pulses.

OUTPUT: Composite Video Signal, 3 volts, 100 ohm line 115 volts 50/60 cps. Complete with tubes and including high and low voltage power units.

9 FERRY STREET
NEW YORK 7, N. Y.



Television engineers and consultants to
the nation's great television stations.

for the *FINEST*
**Wide Range,
 Hi-Fidelity**

insist on

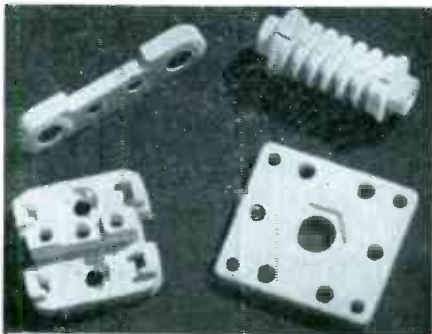
**RACON'S
 Hi-Frequency
 TWEETER**



- Simply connect this tweeter in parallel with your present speaker, using a cross over network, and you will obtain perfect sound reproduction throughout the entire audible frequency range.
- RACON's tweeter is designed so that **only one unit is needed** to assure optimum performance.
- Level response 500 to 14,000 cps with cutoff at 18,000 cps. Uses 17 oz. Alnico V magnet. Continuous power handling capacity 8 watts enabling its use with multi-cellular horns if desired.

Write for free catalog

RACON ELECTRIC CO., INC.
 52 E. 19th St. N. Y. 3, N. Y.



Lavite **STEATITE
 CERAMIC**

**Properties and Characteristics of Our
 LAVITE S1-5 Steatite Ceramic Body**

Compressive Strength	96,000 lbs. per square inch
Tensile Strength	7,200 lbs. per square inch
Flexural Strength	10,500 lbs. per square inch
Modulus of Rupture	20,000 lbs. per square inch
Dielectric Strength	235 volts per mil
Dielectric Constant	6.42
Loss Factor	7.90
Power Factor	4.46
Bulk Specific Gravity	2.664%
Density (from above gravity)	0.096 lbs. per cubic inch
Hardness (Mohr scale)	7.0
Softening Temperature	2,350°F.
Linear Coefficient of Expansion	8.13x10 ⁻⁶
Moisture Absorption (ASTM D-116-42-A)	0.009%

Design engineers and manufacturers in the radio, electrical and electronics fields are finding in LAVITE the precise qualities called for in their specifications . . . high compressive and dielectric strength, low moisture absorption and resistance to rot, fumes, acids, and high heat. The exceedingly low loss factor of LAVITE plus its excellent workability makes it ideal for all high frequency applications.

We will gladly supply samples for testing.

D. M. STEWARD MFG. COMPANY
 Main Office & Works: Chattanooga, Tenn.
 Needham, Mass. • Chicago • Los Angeles
 New York • Philadelphia

**CURRENT
 CONVERSION**

ATR "A" BATTERY ELIMINATORS

**VISIT
 ATR Booth 137
 AT RADIO PARTS
 AND EQUIPMENT
 SHOW
 May 11th-14th**



for DEMONSTRATING AND TESTING AUTO RADIOS

New Models . . . Designed for Testing and Operating Auto Radios and D. C. Electrical Apparatus from 110 Volt A. C. Lines. Equipped with Meter, Voltage Control, and Selenium Rectifier, Assuring Noiseless, Interference-Free Operation, and Extreme Long Life and Reliability.

ATR New Models
AUTO RADIO VIBRATORS
A Complete Line of Vibrators . . .
 Designed for Use in Standard Vibrator-Operated Auto Radio Receivers. Built with Precision Construction, featuring Ceramic Stack Spacers for Longer Lasting Life.

ATR VIBRATOR GUIDE
a complete line

New 34 page VIBRATOR GUIDE FREE

ATR New Models
STANDARD AND HEAVY DUTY INVERTERS

For Inverting D. C. to A. C. . . .
 Specially Designed for operating A. C. Radios, Television Sets, Amplifiers, Address Systems, and Radio Test Equipment from D. C. Voltages in Vehicles, Ships, Trains, Planes and in D. C. Districts.

**NEW MODELS
 NEW DESIGNS
 NEW LITERATURE**
See your jobber or write factory

AMERICAN TELEVISION & RADIO Co.
Quality Products Since 1931
 SAINT PAUL 1, MINNESOTA-U. S. A.

specifications for both instruments are given.

Engineering Bulletin. American Phenolic Corp., 1830 South 54th Ave., Chicago 50, Ill., will send upon request its monthly engineering bulletin of technical information. Each month's issue is devoted to one major subject in detail. It can be filed in a standard three-ring binder.

Crystals. Clark Crystal Co., Marlboro, Mass. Four new series of crystals are described complete with technical data on a single sheet. Various types of each series are treated in tabular form.

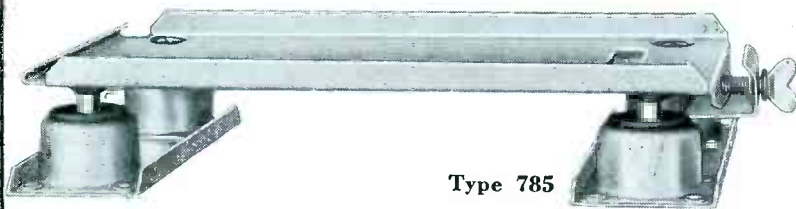
Motor Control Sheets. Square D Co., 4041 N. Richards St., Milwaukee 12, Wis. A series of sheets is now available for insertion in the electric motor control catalog. Revised terms of sale and prices as well as new products are included.

Projection Television. Spellman Television Co., 2898 Jerome Ave., New York 58, N. Y. Five catalog sheets describing projection television components sum up what is necessary to convert certain sets for large-audience viewing.

Products Reference Listing. Federal Electric Products Co., 50 Paris St., Newark 5, N. J. The latest edition of the Federalog may now be obtained on request. It offers a quick reference listing of motor controls, safety switches, switch boards, and is profusely illustrated.

RCA Index. RCA Laboratories, Princeton, N. J. Technical papers appearing in all publications by authors employed at RCA are listed for the year 1947 in Vol IIB. The booklet supplements a previous similar listing for the period 1919 to 1945.

Instrumentation. Statham Laboratories, Inc., 8222 Beverly Blvd., Los Angeles 36, Calif. The first issue of a bi-monthly publication



Type 785

Standard MTS Size Aircraft Mounting Rack with revolutionary air-damped vibration isolators

Control of VIBRATION and IMPACT

*... with special emphasis
on the field of electronics*

We offer a complete line of highly engineered Vibration and Impact isolators for commercial, industrial and military applications . . . also an Engineering consulting service on special problems.

A letter from you will give us the opportunity to demonstrate how we can help you.

Catalogue on request

THE BARRY CORPORATION

Formerly L. N. BARRY CO., INC.

177 SIDNEY STREET
CAMBRIDGE, MASS.

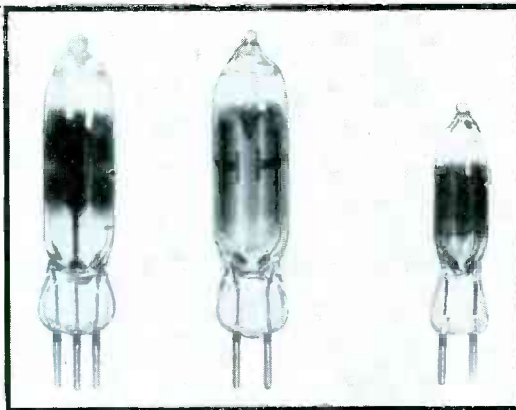


Photo shows actual sizes of our new miniature and sub-miniature tubes

Write our Engineering Division on tubes best suited to your needs

CONTINENTAL PHOTO TUBES ARE *LEADING* THE FIELD

DESIGN ENGINEERS are showing ever increasing interest in Continental Lead Sulfide Cells because of their compactness, high sensitivity and good frequency response. Ideal for Sound Reproduction, Burglar Alarms, Door Openers, Tabulating Machines, Phonograph Pickups, Controls and Counters and many other types of devices and equipment. These Continental photo-conductive tubes are your assurance of steadier, more dependable performance.

Write or
Wire

CONTINENTAL ELECTRIC CO.

Highly Engineered Tubes & Electronic Specialties

GENEVA, ILLINOIS

TERMINALS for ELECTRIC WIRES

Banding Clips
Small Metal Stampings

• in accordance with
Customer's Prints

- ACCURACY
- PRECISION
- REASONABLE
DIE CHARGES

Modern Equipment and Factory
No Screw Machine Parts

**PATTON-MacGUYER
COMPANY**

17 VIRGINIA AVENUE
PROVIDENCE, R. I.

IRN

magnetic iron powders

MEPHAM
hydrogen
reduced

IRN magnetic iron powders (Mephram hydrogen reduced) are available in 10 different types for high-frequency cores, core material, tele-communication and magnetic applications. . . . All are described in a revised technical bulletin, containing 28 pages of comprehensive data, including performance graphs and engineering reference material of value to designers, manufacturers and users. Your copy of this bulletin will be mailed on request.

Metallurgical and Electronic Division

IRN

C. K. WILLIAMS & CO.

2001 Lynch • • • East St. Louis, Ills.



There's a
**SPECIALTY
DRY BATTERY**

for every special need!



If you are looking
for hard-to-get
or special purpose
dry batteries,
write for our
catalog —
it's free!

SPECIALTY BATTERY COMPANY

A Ray-O-Vac Subsidiary

RAY-O-VAC

MADISON 4, WISCONSIN

"RANGE MASTER" MODEL 10

The 8-in-1 Service Instrument

A precision instrument for RADIO TESTING, Appliance Repairing, Service Calls, Amateur and Experimental Work. Covers these 25 ranges.

- (1) CAPACITY .001-1, .01-1, 1-10 Mfd.
- (2) A.C. CURRENT 0-.150, 0-.1.5, 0-15 amps.
- (3) A.C. VOLTAGE 1 10 100 500 1000 volts.
- (4) D.C. VOLTAGE 10 100 500 1000 volts.
- (5) D.C. CURRENT 1 10 100 1000 milliamps.
- (6) RESISTANCE 0 to 10,000 100,000 1 megohm.
- (7) Special High range ohmmeter to 2 megs and 20 megs.
- (8) Sensitive A.C. microammeter to 1100 microamps.

TELEVISION TECHNICIANS and Servicemen . . . why guess, measure! The RANGE MASTER can also be used as an OSCILLOSCOPE CALIBRATOR.

Portable and Fuse Models of the RANGE MASTER are also available. Portable model has polished oak carrying case with tool compartment. Fuse Model has built-in fuse to protect meter and rectifier.



Bench Model 23.50 net
Foundation Meter with 3-color scale schematic and operating instructions . . . 7.85 net
Portable Model 26.95 net
Fuse Model 24.70 net

Prices 5% higher west of the Rockies

Ask your local distributor, **BRADSHAW INSTRUMENTS CO.** 348 Livingston Street or write to Dept. E, Brooklyn 17, New York

PAMARCO DE-REELING TENSION

PAMARCO tensions are the perfect answer to lower coil winding costs!

- * FINGER-TIP TENSION CONTROL
- * OPERATOR MAKES OWN ADJUSTMENTS
- * NO TOOLS OR ACCESSORIES NEEDED
- * FITS ALL COIL WINDERS

**SHORT CUT TO
PERFECT COILS!**

The free-running action of the PAMARCO tension practically eliminates defective coils. Their compact size permits more simultaneous coil winds on any machine. Operator makes all adjustments for any gauge wire with simple thumbscrew.

Write Dept. E-1 for Literature Today

PAPER MACHINERY & RESEARCH, INC.
1014 OAK STREET • ROSELLE, NEW JERSEY



"Instrument Notes" promises short articles on theory and practice interesting to users and designers of precision instruments. The pamphlet will be sent free upon request.

Insulation Material. New England Mica Co., Inc., Waltham, Mass. A four-page folder discusses Super-Nemcoite, a composite bonded mica insulation for use in electrical equipment and machinery.

Step-Down Transformers. Elec-tran Mfg. Co., 4587 N. Elston Ave., Chicago 30, Ill. Bulletin 47A gives a four-page description of air-cooled step-down transformers for power circuit installations. Ratings, physical data and wiring diagrams are included.

Control Unit. R-S Products Corp., Wayne Junction, Philadelphia 44, Pa., recently published catalog No. 27 on the Leveltronic relay, designed for basic applications in the control of liquid level, interface, pressure and temperature.

Electrical Insulation. Insulation Manufacturers Corp., 565 W. Washington Blvd., Chicago 6, Ill. A single-sheet mailing piece describes the outstanding features of Dieflex tubing and sleeving. The products are designed to answer specific manufacturing and use problems of electrical insulation.

Insulation Tester. Herman H. Sticht Co., Inc., 27 Park Place, New York 7, N. Y. Bulletin 441 describes the B-6 Megohmer, a non-cranking tester with a steady test potential. Source of power are two No. 6 dry-cell batteries which are stepped up to 500 volts d-c by means of a special vibrator-transformer circuit. Also featured on the instrument's face is a triple-color grading scale classifying insulation as good, fair or doubtful.

Intermodulation Measuring. Western Electric Co., 233 Broadway, New York 7, N. Y. A six-page



**MICRODIMENSIONAL
WIRE & RIBBON
FOR VACUUM TUBES**

WOLLASTON PROCESS WIRE
drawn as small as .000010";
Made to your specifications
for diameter and resistance

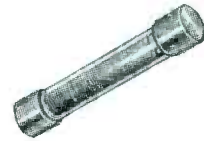
WRITE for list of products.

SIGMUND CORN CORP.
44 GOLD ST., NEW YORK

SINCE 1901

BRADLEY RECTIFIERS

HIGH VOLTAGE SELENIUM RECTIFIERS



Hermetically sealed in 1/2" diameter glass tubes, Bradley SE 6M high voltage selenium rectifiers are rated at 5 ma D.C. They are polarized for fuse clip-type mounting. Available for 1000, 2000, 3000 and 4000 volts peak inverse. Bradley engineers can quickly specify the right type of selenium or copper oxide rectifier for your need.

PHOTO CELLS

SIMPLIFY PHOTO CELL CONTROL



Luxtron* photo cells convert light into electrical energy. No external voltage is required to operate meters and meter relays directly from Bradley photo cells, improving control over your processes, reducing your costs. Housed model shown. Many different sizes and shapes, mounted and unmounted.

*T. M. REG. U. S. PAT. OFF.

Illustrated literature, available on request, shows Bradley's full line of photo cells and copper oxide and selenium rectifiers.

Write for "The Bradley Line"

BRADLEY
LABORATORIES, INC.
82 Meadow St. New Haven 10, Conn.

folder describes two intermodulation instruments, the RA-1258 signal generator and the RA-1257 analyzer, together with their mode of operation.

High-Vacuum Pumps. W. M. Welch Scientific Co., 1515 Sedgwick St., Chicago 10, Ill. Duo-Seal pumps, capable of producing a vacuum of 0.05 micron and better, are described and illustrated in a 32-page, slick-papered, spiral-bound booklet.

Relay Catalog. Potter & Brumfield Sales Co., 549 West Washington Blvd., Chicago 6, Ill. Relays and electrical timing devices are listed in new catalog 148. Power, plate-circuit, latching, and midget types are exhaustively described.

Coils. J. W. Miller Co., 5917 South Main St., Los Angeles 3, Calif. R-f and i-f coils, radio interference filters, special chokes, dividing-network coils, tower-lighting chokes, and carrier-circuit coils are among the products listed in the 36-page catalog 48.

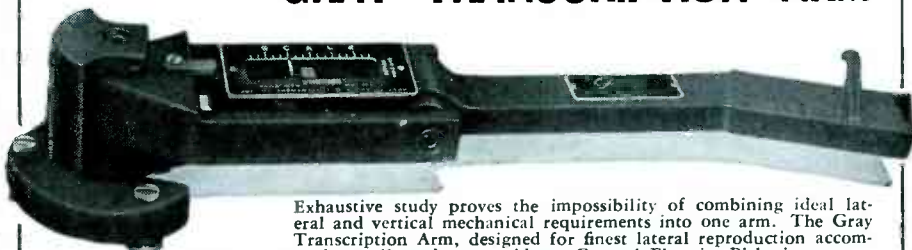
Radio Generator. American Bosch Corp., Springfield 7, Mass., offers a reprint of one of its advertisements describing the type GRB mobile radio generator which has a 45-ampere output at a speed of from 10 to 15 mph. List price complete with regulator, harness and single-groove pulley is \$125.

D-C Power Supply. Rowe Engineering Corp., 2422 North Pulaski Road, Chicago 39, Ill. Two sides of a loose-leaf perforated sheet give a thorough treatment of the type IPS10000 10-kv d-c power supply. Applications, general description, operation and circuitry, and technical data are given.

Precision Instruments. Associated Research, Inc., 231 S. Green St., Chicago 7, Ill. Many types of precision testing instruments are listed in a new catalog. Among these are the Keeler Polygraph (lie detector). Technical and engineering data are also included.

... an advancement in the art of high quality reproduction

GRAY TRANSCRIPTION ARM



Featherweight magnesium, frictionless motion, adjustable stylus pressure, self-leveling base.

Exhaustive study proves the impossibility of combining ideal lateral and vertical mechanical requirements into one arm. The Gray Transcription Arm, designed for finest lateral reproduction accommodates all modern cartridges—General Electric, Pickering, etc.—has been adopted as standard equipment by national radio networks including CBS, ABC and numerous independent radio stations. Arm less cartridge \$35.00.

Gray Equalizer For G.E. Cartridge



FOR RADIO STATION USE. No. 601, 4-position Equalizer (Flat, N.A.B., etc., etc.) expertly engineered for use with the G.E. Variable Reluctance Cartridge Matches pick-up to microphone channel. Adopted by radio networks. Complete \$42.50.

DIAMOND G.E. CARTRIDGES!

At last a permanent solution to the quality pick-up problem. We are now supplying selected G.E. Cartridges with finest quality Diamond Styli mounted and wired in the Gray Transcription Arm at \$29.63 additional. The practically unlimited life of a Diamond Stylus makes this an exceptionally economical investment.

GRAY RESEARCH & DEVELOPMENT CO.

565-5TH AVENUE, NEW YORK 17, N. Y.

Sensitive MULTIPLE ARM RELAYS

A. C. and D. C.
adaptable to a wide variety
of circuit arrangements.

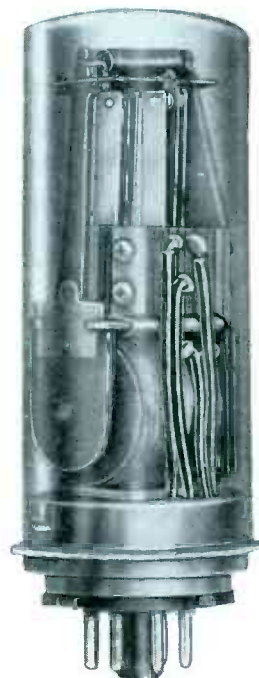
FEATURES: Mounting area minimized. Vertical, balanced armature. Interchangeable unit contact pile-ups. Unusually high contact pressures. Shock and vibration resistant. Three styles of assemblies: 1. Octal Base and removable cover. 2. Octal Base and hermetically sealed cover. 3. Header type container, hermetically sealed.

Also furnished with multiple pin plugs for more than eight circuits.

Available in Series 63—Surface Mounting type with removable cover, and solder terminals.

Write for Bulletin 50-6

Relays • Signals • Code Call • (Interior) FIRE ALARM SYSTEMS and DEVICES for Controlling Electrical Equipment



Series 61 Octal Base—removable metal cover (Appr. 3/4ths actual size.)

SIGNAL ENGINEERING & MFG. CO.

154 WEST 14th St., NEW YORK 11, N. Y.

FOUR NEW **B&W** INSTRUMENTS

B & W SINE WAVE CLIPPER

Model 250

A device for generating a test signal particularly useful for examining the transient and frequency response of audio circuits.

B & W FREQUENCY METER

Model 300

An accurate and convenient means of making direct measurements of unknown audio frequencies up to 30,000 cycles. Integral power supply.

B & W AUDIO OSCILLATOR

Model 200

A source of stable, accurately calibrated frequencies between 30 and 30,000 cycles. Self-contained power supply.

B & W DISTORTION METER

Model 400

Ideal for measuring low level audio voltages and determining their noise and harmonic content. Self-contained power supply.



Write for descriptive folders and prices.

BARKER & WILLIAMSON

237 Fairfield Ave., Dep't EL-58, UPPER DARBY, PA.

Now ready for you . . .

FACTS ABOUT A NEW SILVER BRAZING ALLOY THAT STREAMLINES DESIGN, PRODUCTION, COSTS

EASY FLO 45

A modern, versatile silver brazing alloy . . . brings New Speed - New Economy to metal-joining!

WRITE FOR A COPY TODAY
... ASK FOR BULLETIN 15

HANDY & HARMAN
82 FULTON ST., NEW YORK 7, N. Y.
Bridgeport, Conn. • Chicago, Ill. • Los Angeles, Cal. • Providence, R. I. • Toronto, Canada
Agents in Principal Cities

NEWS OF THE INDUSTRY

(continued from p 142)

pressed a button starting the tape, at the end of which she answered the caller.

Frequency Designations

AT THE meeting of the Wave Propagation Committee of the IRE on February 2, the following two motions were passed:

(1) The present system of naming bands (h-f, vhf, uhf) is unsatisfactory and should be discouraged.

(2) Frequency bands should be designated by the characteristic of the logarithm to the base 10 of the frequency in cycles per second. Thus

FREQUENCY		BAND NO.
1 cps	— 10 cps.	0
10 cps	— 100 cps	1
100 cps	— 1,000 cps	2
1 kc	— 10 kc	3
10 kc	— 100 kc	4
100 kc	— 1,000 kc	5
1 mc	— 10 mc	6
10 mc	— 100 mc	7
100 mc	— 1,000 mc	8
1 kmc	— 10 kmc	9
10 kmc	— 100 kmc	10

Spring Technical Conference

PROGRAM of the Spring Technical Conference of the IRE, held in Cincinnati, Ohio, April 24, is as follows:

- 10:00 a. m.—Moderator—W. C. Osterbrock of the U. of Calif.
Cathode Compensation of Video Amplifiers, by A. B. Bereskin of the U. of Calif.
Television Test Equipment for the Receiver Designer, by Jerry Minter of Measurements Corp.
Television Transcription by Film, by T. T. Goldsmith of Allen B. DuMont Lab.
Microwave Radio Relay Facilities of the Bell System, by J. Harold Moore of A. T. & T. Co.
2:15 p. m.—Moderator—L. M. Clement of the Crosley Div., Avco Mfg. Corp.
Overall Systems Problems in Improving Television Quality, by Robert E. Shelby of National Broadcasting Co., Inc.
A Symposium on Television Tuners, by Sarkes Tarzian of Tarzian Associates; J. A. Stewart of General Instrument Corp.; John Rankin of Belmont Radio Corp.; and Nelson Case of Hallicrafters Co.
The 44-216 Megacycle Inductuner, by Myron F. Melvin of P. R. Mallory & Co. Inc.

Supplement to Study Guide

AS THE FCC revises its commercial radio operator examinations it will issue supplements to its study guide on the subject. Supplement No. 1, now available at the Commission's field examination offices and at its Washington offices, contains 114 additional questions dealing with new material in Element 4 (advanced radio-telephone theory and practice) of the examination to be held on July 1. Approximately half

BECAUSE...

Cost is a Factor

CONSIDER



SINCE 1922

"Controlled Performance"

**COILS
TRANSFORMERS**

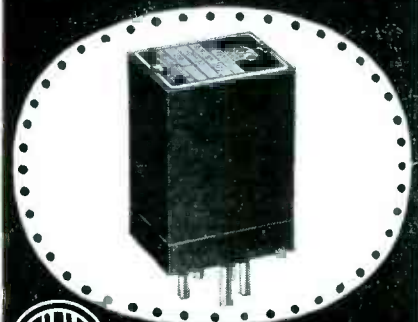
Consistent high quality in Transformers and "made-to-specification" Windings for over a quarter of a century.

**SPECIFICATION DATA INVITED
FROM LARGE VOLUME USERS**

BEST MANUFACTURING CO. INC.
1203 GROVE ST.
IRVINGTON 11, NEW JERSEY

Foreign Division
25 WARREN ST. • NEW YORK, U. S. A.
Cable Address SIMONTRICE, NEW YORK

Crystals for the Critical



"STABILIZED"

JK STABILIZED JKO-3

This is a crystal oven designed to accommodate the following JK crystals: H7, H15, H17 and others. Operating temperature is adjustable and temperature stability is plus or minus 1° C. Heater is 6.3 volt and consumption is approximately 1 amp. Others on special order.

The JAMES KNIGHTS CO.
SANDWICH, ILLINOIS

PRECISION POTENTIOMETERS

Toroidal and Sinusoidal

For use in computing and analyzing devices; generation of low frequency saw tooth and sine waves; controls for radio and radar equipment; position indicators; servo-mechanisms; electro medical instruments, measuring devices—telemetering; gun fire control where 360° rotation, high precision and low noise levels are essential.

The type RL14MS sinusoidal potentiometer is illustrated. It is wound to a total resistance of 35,400 ohms and provides two voltages proportional to the sine and cosine of the shaft angle. It will generate a sine wave true within $\pm 6\%$. Overall dimensions are $4\frac{3}{8}$ " diameter x $4\frac{11}{32}$ " long plus shaft extension $\frac{1}{4}$ " diameter x $1\frac{1}{4}$ " long.



Write for Bulletin F-68

THE GAMEWELL COMPANY

Newton Upper Falls 64, Massachusetts



QUADRIGA WASHERS

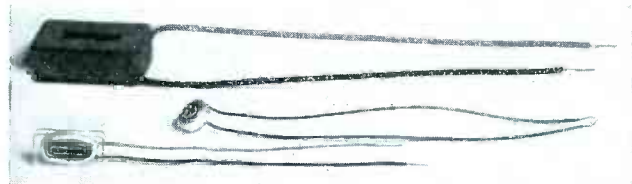
WRITE FOR CATALOG

SMALL METAL
STAMPINGS
TO YOUR
SPECIFICATIONS



THE QUADRIGA MANUFACTURING CO. 221A West Grand Ave.
Chicago 10, Illinois

Inc. 1894 • "Half a Century"



Looking For
Dependable Coils?
LOOK TO DANO
Every Job to
YOUR OWN DESIGN

THE DANO

The success of an electrical operation is dependent on the right coil. Nobody realizes this fact more than production-wise engineers. That's why they specify DANO COILS. They know that they can Depend on Dano.

ALSO TRANSFORMERS MADE TO ORDER

ELECTRIC CO. 93 MAIN ST.
WINSTED, CONN.

A basic
book for
communications
technicians

VACUUM TUBE CIRCUITS

By **LAWRENCE B. ARGUIMBAU**,
Assistant Professor,
Department of Electrical Engineering,
Massachusetts Institute of Technology

This book has been written in answer to the need for up-to-date literature on the subject of vacuum tube circuits. The selection of material contained in the book, and its presentation, have been carefully designed to cover the problems encountered in the field of communications.

The most recent information on the subject has been compressed and edited so that topics of major importance receive more detailed attention. The first chapter comprises an overall introduction with a comprehensive presentation of the interrelation of the various component parts to be discussed.

The treatment is developed carefully from simple circuits to those of a more complex nature. Emphasis is given to frequency modulation as opposed to amplitude modulation. In view of the rapid developments in the field of television, the book also includes much basic material on transient response and on the generation of micro-waves. Unusually full explanations throughout insure readability and understanding.

Contents: Radio Communication; Diodes and Rectifiers; Triodes, Pentodes, and Linear Amplifiers; Transient Response of Video Amplifiers; Amplitude Modulation and Tuned Amplifiers; Power Amplifiers; Oscillators; Inverse Feedback; Amplitude Modulation; Frequency Modulation; Pulses and Television; Micro-waves.

1948 668 Pages \$6.00

ON APPROVAL COUPON

JOHN WILEY & SONS, INC.
440 Fourth Ave., New York 16, N.Y.
Please send me, on ten days' approval, a copy of Arguimbau's VACUUM TUBE CIRCUITS. If I decide to keep the book, I will remit price plus postage; otherwise I will return the book postpaid.

Name

Address

City..... Zone..... State.....

Employed by

(Offer not valid outside U.S.A.) E-5-48

of the new questions deal with f-m and television. Other examination elements will be covered in different supplements to be issued from time to time and furnished without cost.

Mail requests for supplements should indicate the examination elements the person wishes to study. Such requests are to be addressed to the Secretary, Federal Communications Commission, Washington 25, D. C.

Copies of the study guide itself may be purchased from the Superintendent of Documents at \$.25.

RMA-IRE Spring Meeting

THE TECHNICAL program for the RMA-IRE spring meeting, held April 26-28 at the Hotel Syracuse, Syracuse, N. Y., is as follows:

MONDAY, April 26—An Integrated Line of FM Broadcast Transmitters, by J. E. Young of RCA.

A New FM Antenna, by H. J. Howland of The Workshop Associates, Inc.

The Right Way to an RMA Standard, by L. C. F. Horle, Chief Engineer of RMA Engineering Department.

Audio Frequency Measurements, by H. H. Scott of Heriman Hosmer Scott, Inc.

TUESDAY, April 27—Spectrum Analysis Applied to a Variable Speech Amplifier, by R. Whittle of Federal Telephone & Radio Corp.

Development and Application of Railroad VHF Communication Equipment, by A. A. Curry of Farnsworth Television & Radio Corp.

A New Design of Point-to-Point Communication Equipment, by Coleman London of Westinghouse Electric Corp.

The Engineer and his Neighbor, by E. Finley Carter of Sylvania Electric Products Inc.

WEDNESDAY, April 28 — Lighthouse Tube Life, by H. D. Doolittle of Machlett Laboratories, Inc.

A Review of Crystal Saver Circuits for VHF Receivers, by Dr. H. W. Hedeman, Jr. of Bendix Radio, Division of Bendix Aviation Corp.

Commercial Applications of Klystrons, by Coleman Dodd of Sperry Gyroscope Company, Inc.

A Broad Band Microwave Relay System Between New York and Boston, by A. L. Durkee of Bell Telephone Laboratories, Inc.

Radar as an Aid to Airline Navigation, by R. C. Jensen of General Electric Company.

Sunspots Affect Radio

SCIENTISTS at the National Bureau of Standards report that the peak of sunspot activity for the present 11-year cycle has passed. The trend will be downward for about seven years and will have an important effect on worldwide radio communication.

As the number of sunspots de-



Multiple
CONTROLS

For three or more controls in tandem, Clarostat Type 42 is the logical choice.

Bakelite cases nest and lock together for a virtually solid casing. Metal end-plates and tie-rods insure rigidity.

Single shaft passes through and locks with rotor of each unit. Up to 20 units in tandem! No back lash.

Each unit wound to desired resistance, taper, tap, hop-off, for given circuit.

Such controls now found in many radio and electronic circuits.

CLAROSTAT



★ Bulletin 142 for detailed data, sent on request. Let us quote.

Controls and Resistors

CLAROSTAT MFG. CO., Inc. · 285-7 N. 6th St., Brooklyn, N. Y.

In Canada: CANADIAN MARCONI CO., LTD.
Montreal, P.Q., and branches

clines there is less reflection of the higher radio frequencies from the ionosphere back to the earth. The first effects will be felt on the 50-mc band where dependable range will be reduced to about 75 miles in a few months. The overall effect at sunspot minimum will narrow the band to an upper limit of about 20 mc for continent-to-continent transmission.

New England IRE Meeting

THE SECOND annual New England Radio Engineering Meeting sponsored by the North Atlantic Region of the IRE will be held on Saturday, May 22, at the Hotel Continental, Cambridge, Mass.

Plans include technical sessions, manufacturers' exhibits, trips to points of current electronic interest, a luncheon and a banquet.

Four of the six technical papers will be:

A Standard Signal Generator for FM Broadcast Service, by Donald B. Sinclair of General Radio Co.

The Boston-New York Microwave Radio Relay Link, by a representative of Bell Telephone Laboratories.

Certain Aspects of Pulse Modulation, by E. R. Kretzmer of the Research Laboratory of Electronics.

Studio Acoustics, by Leo Beranek of MIT.

New England members will receive a detailed program and registration card through the mail. Nonmembers can obtain this material and other information by addressing the registration chairman, Harold Dorschug, Radio Station WEEI, 182 Tremont St., Boston, Mass.

Canadian IRE Convention

The Canadian IRE Convention, to be held at the Royal York Hotel, Toronto, April 30 and May 1, will include technical sessions and an exhibition of component parts, test apparatus and allied products. The tentative program of papers is as follows:

Narrow Beam Radar Recording Altimeter, by B. J. McCaffrey of National Research Council, Ottawa.

Frequency Allocations, by L. E. Coffey and C. J. Acton of Department of Transport, Ottawa.

Industrial Electronics, by J. T. Thwaites of Canadian Westinghouse Co., Ltd., Hamilton.

A Direct Reading Phase Monitor, by D. P. Wright of Canadian Marconi Co., Montreal.

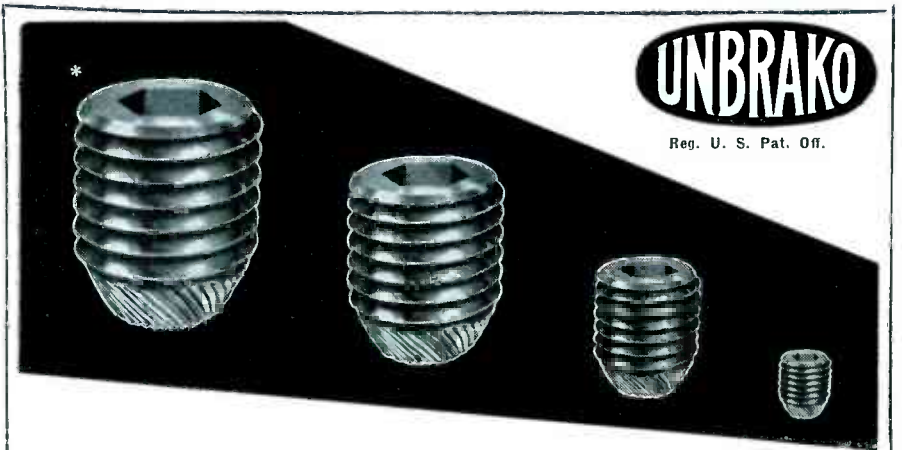
F. M. Field Intensity Measurement, by J. E. Hayes of Canadian Broadcasting Corp.

Recent Developments in Facsimile, by F. A. Hester of Radio Inventions, New York.

The Reproduction of Sound, by E. O. Swan of Radio Station CKEY, Toronto.

New Measuring Equipment in the Radio Industry, by B. DeF. Bayly of Bayly Engineering Limited.

25 Cycle Operation of Television Re-



Self-Locking SOCKET SET SCREWS

... it's the knurled cup point that digs-in and "stay dug"—regardless of the most extreme vibration—and the "Unbrako" Self-Locker can be used over again and again! Sizes from #4 to 1½", in a full range of lengths. For full information on this and other "Unbrako" Socket Screw Products, ask for your copy of the "Unbrako" Catalog. We are prepared to furnish "Unbrako" Socket Screw Products in Stainless Steel.

Write us for the name and address of your nearest "Unbrako" Industrial Distributors.

Knurling of Socket Screws originated with "Unbrako" in 1934.

*Pat'd & Pats. Pend.

OVER 45 YEARS IN BUSINESS

All of our patented "Unbrako" Set Screws, regardless of point, are excellent Self-Lockers—so, if it is imperative that your Set Screws stay-put, write us—because we can lock most any Set Screw application.

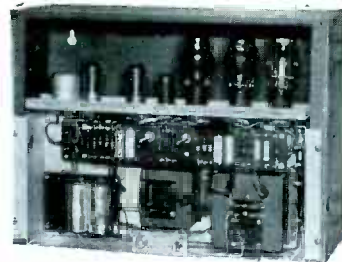
STANDARD PRESSED STEEL CO.

Jenkintown, Penna., Box 596 • Branches: Boston • Chicago • Detroit • Indianapolis • St. Louis • San Francisco

New!

RMC aural AMPLIFIERS

TYPE 115 SERIES



Interior view. Note front serviceability feature.



Exterior view

Sold through local Jobber

Write for Bulletin AI-6

Export: Rocke International Corporation, 13 East 40th Street, New York 16, N. Y.

Here is a three-stage, push-pull throughout Amplifier with high gain, low noise and distortion, the result of engineers' twenty years' experience, and long study of customers' needs before perfection. Designed for many uses in high quality sound systems, such as: (1) Reproducing systems for Vertical and Lateral disc reproduction. (2) Public address system working from Microphone to Speakers. (3) Used with bridging input attenuator as Monitor Amplifier for broadcast stations. (4) With bridging attenuator as Subscriber Amplifier for wired music installations. (5) For sound distribution systems in locations where available space is limited. Installation, service and maintenance operations all facilitated from front of Type 115 Amplifier. Can be permanently installed in wall cabinet; or for standard rack mounting.

TYPICAL ELECTRICAL CHARACTERISTICS

Gain 100 DB maximum with provision for reduction in gain to 64 DB.

Frequency Response plus and minus 1 DB over range 30 to 16,000 cycles.

Operates from 150 or 600 ohm source.

Operates into 4 ohm (2 to 8 ohm).

Operates into 16 ohm (8 to 32 ohm).

Operates into 150 ohm (75 to 300 ohm).

Operates into 600 ohm (300 to 1200 ohm).

Output power approximately 15 watts, 5% total harmonic distortion.

Output noise equivalent to an input signal of minus 120 DB below .006 W. at maximum gain unweighted (approx. minus 130 DB weighted). Frequency characteristic plus and minus 1 DB over the range 30 to 16000 cycles.

RADIO-MUSIC CORPORATION
PORT CHESTER • NEW YORK

Silicone News



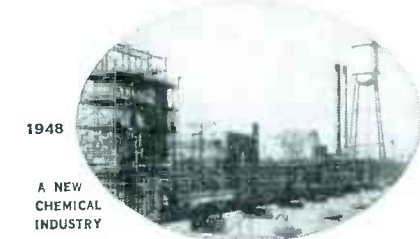
This is your party, too!

Now we're five years old. We can look back with some pride on what we've accomplished in that time. We look with equal satisfaction on the work done by our customers. Without their initiative no new material could have been adapted to so many different uses in so short a time. Working together, we have built a new chemical business to serve all industry.



1943

A PLOT OF GROUND



1948

A NEW CHEMICAL INDUSTRY

1943—We started with a legacy of some silicone fluids, 2 electrical insulating resins, a valve lubricant and an ignition sealing compound.

1948—We are now producing 60 different Dow Corning Silicone Products in the form of fluids and oils, greases and compounds, resins and varnishes and Silastic* all of which will do many things no other materials can do.

1943—We had essentially one customer and his name was Uncle Sam.

1948—Among our 7500 industrial customers are concerns in almost every major industry. Recently, we entered the consumers' market to bring silicones home to John Q. Public.

1943—We started to build a plant and a main office in Midland, Michigan.

1948—We have a large plant, now almost twice its original size, working full time to supply you with the silicone products you have come to depend upon. It's the first plant of its kind ever built. To pace our increasing productive capacity we now have branch offices in four major cities and two new ones about to be opened. In **1948** as in **1943**, we look forward, with your help, to a future busy with new silicone products and to a plant several times the size of our present one.

*TRADEMARK FOR DOW CORNING SILICONE RUBBER

DOW CORNING CORPORATION
MIDLAND, MICHIGAN

New York • Chicago • Cleveland • Los Angeles
Toronto • London • Paris • Stockholm • Oslo



NEWS OF THE INDUSTRY

(continued)

ceivers, by Orin Dakin of Canadian General Electric Co. Ltd.
Theatre Television Systems, by H. Goldin of Gaumont-Kalee Ltd.

Papers will be presented during the technical sessions each morning and afternoon. A banquet to be held on Friday, April 30, will have B. E. Shackelford, IRE president, as guest speaker.

BUSINESS NEWS

C. K. WILLIAMS & Co. is the new firm name of the Geo. S. Mephram Corp. of East St. Louis, Ill. The company continues to manufacture magnetic iron powders.

KAAR ENGINEERING Co., manufacturers of radiotelephones and marine direction finders, recently moved into a 35,000-sq ft building in Palo Alto, California, which



New Kaar plant

permits doubling production capacity. Kaar equipment will also be manufactured in Canada under a new agreement with Measurement Engineering, Ltd., Toronto.

ALLIS-CHALMERS MFG. Co., supplementing its regular line of electronic heating equipment, is now distributor for RCA h-f heating equipment and metal detectors.

NATIONAL RESEARCH CORP., manufacturers of high-vacuum apparatus, recently moved into its new

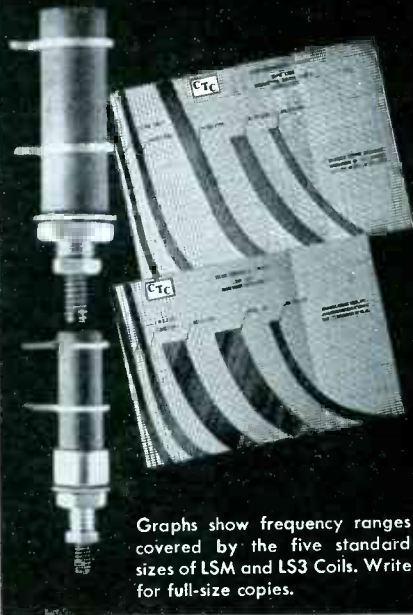


New plant of National Research Corp.

three-story building at 70 Memorial Drive, Cambridge, Mass.

SYLVANIA ELECTRIC PRODUCTS, INC. has acquired an interest in Thorn Electrical Industries Ltd. of Lon-

THESE EXTRA SMALL COIL FORMS FIT INTO TIGHT PLACES



Graphs show frequency ranges covered by the five standard sizes of LSM and LS3 Coils. Write for full-size copies.

If small space is your problem — as in peaking coils in strip amplifiers, chokes, R. F. coils, oscillator coils, single-turned I. F. coils, etc.—you'll find space-saving one of many advantages in CTC Slug Tuned Coil Forms.

Coil forms are of quality paper-base phenolic, high frequency grade. Mounting bushings and ring-type terminals are brass, the bushings cadmium plated and terminals silver plated. Necessary mounting hardware is supplied.

DIMENSIONS

LSM — Extreme small size; only 27/32" high when mounted; coil form, 1/4" diameter; mounts in single #18 hole; mounting bushing has 8-32 thread.

LS3 — Moderate small size; 1 1/8" high when mounted; coil form, 3/8" diameter; mounts in single 1/4 hole; mounting has 1/4-28 thread.

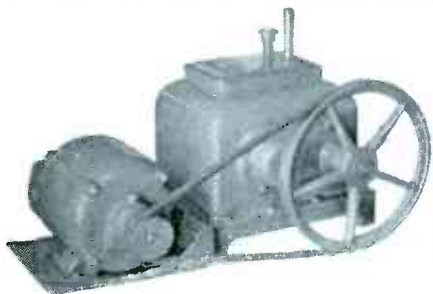
WINDINGS

CTC LSM and LS3 Coil Forms are available unwound or in any of five standard windings: 1, 5, 10, 30 and 60 megacycles. They are also wound to specifications. (Standard slug is high-frequency type.) CTC will custom-engineer special coils of practically any size and winding . . . Let us talk over your requirements.



Custom or Standard
The Guaranteed
Components

CAMBRIDGE THERMIONIC CORPORATION
437 Concord Avenue, Cambridge 38, Mass.



BAACH-INTERNATIONAL COMPOUND HIGH VACUUM PUMP

This high vacuum pump is widely known and used extensively in the manufacture of electric lamps, radio tubes, fluorescent lamps, for laboratory work and for many industrial applications where high vacuum, plus rapid exhausting are essential requirements in processes of manufacturing.

In free air capacities ranging from 1 cubic foot to 50 cubic feet per minute.

Readings on all sizes guaranteed 0.50 microns or better.

Operates quietly. Prompt deliveries
Write for details.

INTERNATIONAL MACHINE WORKS

Manufacturers of Baach-International Hot Cut Flare machine.

2027 — 46th STREET

NORTH BERGEN, N. J., U.S.A.

Tel. UNION 3-7412

Cable Address "INTERMACH" North Bergen, N. J.

for
FLIGHT RESEARCH

... For all high-speed
Recording requirements
where PORTABILITY
and ACCURACY
are Required!

... There is
only one answer...

The Hathaway Type S12-A Oscillograph

- High-frequency response
- 12 elements
- Internal Governor Drive Motor
- Gear-driven chart, 1/3 to 48 inches per second
- Accurate time lines
- Automatic record length control
- Consecutive record numbering

SIMPLE TO OPERATE
SMALL-LIGHT-WEIGHT

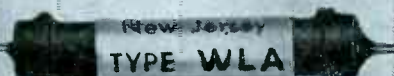
WRITE FOR BULLETIN SP 167-A



IN-RES-CO WIRE WOUND RESISTORS

WL 5/8-5/8" x 3/16" (Radial Lead) .01 Ohms
min. 3,000 Ohms max.

WLA 5/8-5/8" x 3/16" (Axial Lead) .01
Ohms min. 3,000 Ohms max.



WL-1" x 3/16" (Radial Lead) { .01 Ohms min.
WLA-1" x 3/16" (Axial Lead) { 10,000 max.



New Economy Line!

Here's a new line of resistors priced for real economy. Wire wound to a tolerance of 1% — higher accuracy on special order at slightly higher cost. Write today.

INSTRUMENT RESISTORS CO.

1036 COMMERCE AVE.
UNION, NEW JERSEY

APPLICATION-DESIGNED RESISTORS!

COMPOUNDS

Scientifically compounded for specific applications from waxes, resins, asphalts, pitches, oils, and minerals. Available in wide range of melting points and hardnesses. Special potting compounds are heat conducting and crack resistant at extremely low temperatures. Recommendations, specific data, and samples will be furnished on request.

for

IMPREGNATING

radio coils
transformer coils
ignition coils
wire coverings
paper tubes and forms
porous ceramics

DIPPING

Coils
Transformers
Condensers

SEALING

condensers
batteries
switch base terminals
socket terminals
light fixtures

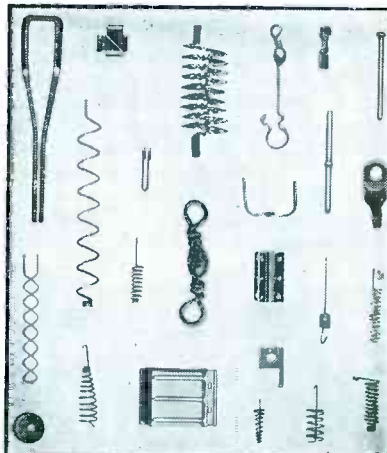
POTTING

Radio Transformers
Light Units
Loading Coils
Condensers



BIWAX CORPORATION

3445 HOWARD STREET
SKOKIE, ILLINOIS



SMALL PARTS

Filaments, anodes, supports, springs, etc. for electronic tubes. Small wire and flat metal formed parts to your prints for your assemblies. Double pointed pins. Wire straightened and cut diameter up to 1/4 inch. Any length up to 12 feet.

LUXON fishing tackle accessories.

Inquiries will receive prompt attention.

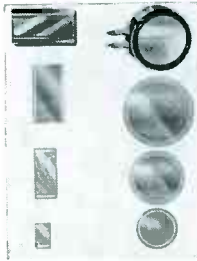
ART WIRE AND STAMPING CO.

227 High St.

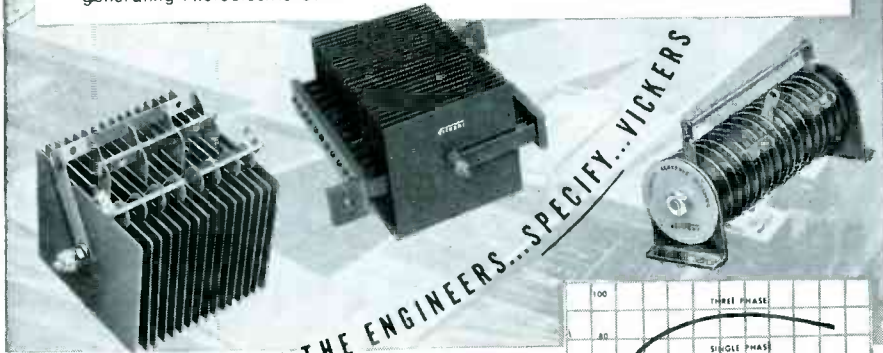
Newark 2, N. J.

LINKING FUNCTION TO DESIGN

Engineers and Designers who insist on dependable components have adapted Vickers Selenium Rectifiers into their circuits. They are specifying Vickers products, and are submitting their rectifier problems to us. Our greatly expanded plant facilities, plus the recognized dependability of Vickers products, make it possible for us to offer the most complete line of Selenium Rectifiers and self-generating Photoelectric Cells.



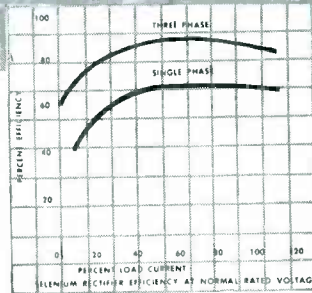
PHOTOELECTRIC CELLS



3-1

VICKERS ELECTRIC DIVISION

2160 EAST IMPERIAL HIGHWAY • EL SEGUNDO, CALIF.

EXPORT: Frozar & Hansen, Ltd., 301 Clay St., San Francisco 11, Calif.
CANADA: Powertronic Equipment Ltd., 494 King St., E. Toronto 2, Canada

FOR LOW HUM... HIGH FIDELITY

SPECIFY KENYON TELESCOPIC SHIELDED HUMBUCKING TRANSFORMERS



For low hum and high fidelity Kenyon telescopic shield transformers practically eliminate hum pick-up wherever high quality sound applications are required.

✓ CHECK THESE ADVANTAGES

- ✓ **LOW HUM PICK-UP** . . . Assures high gain with minimum hum in high fidelity systems.
- ✓ **HIGH FIDELITY** . . . Frequency response flat within ± 1 db from 30 to 20,000 cycles.
- ✓ **DIFFERENT HUM RATIOS** . . . Degrees of hum reduction with P-200 series ranges from 50 db to 90 db below input level . . . made possible by unique humbucking coil construction plus multiple high efficiency electromagnetic shields.
- ✓ **QUALITY DESIGN** . . . Electrostatic shielding between windings.
- ✓ **WIDE INPUT IMPEDANCE MATCHING RANGE.**
- ✓ **EXCELLENT OVERALL PERFORMANCE** . . . Rugged construction, lightweight-mounts on either end.
- ✓ **SAVES TIME** . . . In design . . . in trouble shooting . . . in production.

Our standard line will save you time and money. Send for our catalog for complete technical data on specific types.

For any iron cored component problems that are off the beaten track, consult with our engineering department. No obligation, of course.

KENYON TRANSFORMER CO., Inc.

840 BARRY STREET NEW YORK, U. S. A.

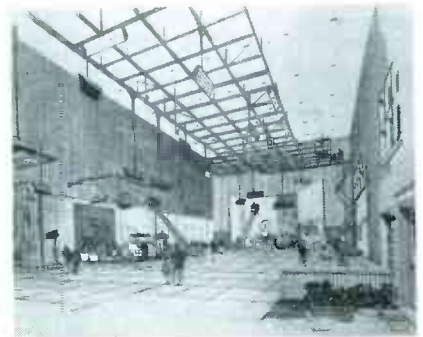
don, England, manufacturer of lamps, lighting products and radio sets.

THE YANKEE NETWORK of Boston, Mass., has the exclusive New England franchise for Transit Radio, Inc., a company organized to develop and perfect f-m receivers for surface transportation systems.

ELECTRICAL REACTANCE CORP., Franklinville, N. Y., manufacturers of high-Q components, will soon open a Canadian plant at Prescott, Ontario.

THE YMCA TRADE AND TECHNICAL SCHOOL of New York City now has courses in television and f-m radio set servicing and installation added to its curriculum. Courses will be given in the radio laboratories of Walter Hervey Junior College, New York City.

COLUMBIA BROADCASTING SYSTEM is now building the largest television studio plant in the U. S. as part of its plans to establish nationwide television service. The new



Artist's conception of one of main studios in new television studio plant

studios and their associated facilities occupy more than 700,000 cubic feet in New York's Grand Central Terminal Building.

SYLVANIA ELECTRIC PRODUCTS INC., New York City, has doubled production floor area to handle the manufacture of large television viewing tubes.

AMERICAN STANDARDS ASSOCIATION has issued the fifth edition of the Specification for Dry Cells and Batteries, known as American Standard C18-1947. The 18-page booklet covers definitions, nomenclature, standard voltages of dry batteries,



All in one package!

You must have thought often of the mighty important role shipping plays in your business and private life, for you depend on shipping for practically everything you eat, wear or otherwise use . . .

We of Railway Express know how diverse shipping requirements can be. With the addition of hundreds of new express cars, motor vehicles and other equipment, we are building our service to meet every one of your transportation needs.

Such improvements, as well as rising maintenance and operating costs, have made higher charges inevitable—but these charges will aid us in making Railway Express the *high standard* shipping service for you and for all America.



RAILWAY EXPRESS



. . . Maintains 23,000 offices (there's one near your factory, office or home) . . . Uses 10,000 passenger trains daily . . . Has 18,000 motor vehicles in its pick-up and delivery services . . . Offers extra-fast Air Express with direct service to 1,078 cities and towns.



NATION-WIDE RAIL-AIR SERVICE

NEWS OF THE INDUSTRY (continued)

standard sizes, markings, terminals, tests, and performance requirements. Copies may be obtained from the ASA, 70 E. 45th St., New York, N. Y., at a cost of ten cents.

DON FOSTER, INC., Cincinnati, Ohio, has been formed to engage in maintenance and servicing of electronic equipment. It will specialize in the installation of television, radiotelephone and medical equipment.

GENERAL ELECTRIC Co. now operates a new radio set manufacturing plant at Clyde, N. Y.

ALTEC SERVICE CORP., New York City, formed a decade ago to service and install sound equipment in motion picture theatres, has expanded its operations to include servicing of industrial electronic equipment in manufacturing and processing plants.

RAYTHEON MFG. Co., Waltham, Mass., has announced a new line of television station equipment including low and high-power transmitters, as well as portable camera chain equipment.

PERSONNEL

JOHN M. RICHARDSON has been named sales manager of the recording wire division of Spencer Wire Co., West Brookfield, Mass. During the war he was with Sperry Gyroscope Co. and the MIT Radiation Laboratory as a radar engineer.



J. M. Richardson



J. F. McAllister

JOHN F. M. MCALLISTER has been appointed designing engineer of the specialty division of General Electric Co. at Electronics Park, Syracuse, N. Y. He has been with the company since 1939, four years being spent teaching advanced



HERE'S A NEW MATERIAL that can cut costs and ease production problems wherever ultra-high-frequency insulation is required. It's G-E #1422 . . . a new development in plastics.

LOWER COST

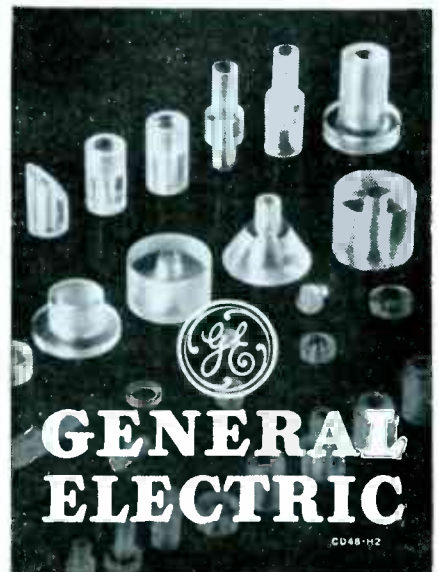
G-E #1422 answers the need for a low-cost material for structural components in ultra-high-frequency equipment. Use G-E #1422 where a low power factor is required . . . where high operating temperatures prevent the use of commercially available materials such as polystyrene.

EASY TO MACHINE

G-E #1422 can easily be machined. And it's available in rod or plate stock.

Send for more technical data. Write Section AF-5, Chemical Department, General Electric Company, Pittsfield, Massachusetts.

Connector beads for RG type coaxial cables machined from G-E #1422 rod stock.



CD48-H2

radio and radar engineering courses at the Schenectady plant. For six months in 1945 he was in charge of electronic remote control equipment for V-2 rockets at White Sands, New Mexico.

LEOPOLD M. KAY has been promoted from chief engineer to vice-president in charge of engineering at Air King Products Co., Inc., Brooklyn, N. Y.

GEORGE F. PLATTS recently became executive vice-president of Clippard Instrument Laboratory, Inc., Cincinnati, Ohio. During World War II he served as a naval officer in connection with the development of the proximity fuze.

J. E. HOBSON, formerly director of the Armour Research Foundation of the Illinois Institute of Technology, has been appointed director of the Stanford University Research Institute. He received the Eta Kappa Nu award in 1940 as the outstanding young electrical engineer of the U. S., and in 1942 co-authored the book "Power Transmission and Distribution."



J. E. Hobson



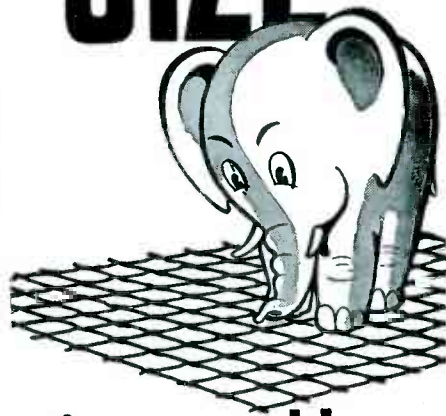
R. E. Dorrell

RUSSELL E. DORRELL, formerly with Naval Research Laboratory, was recently appointed to the staff of the National Bureau of Standards. He has joined the Electron Tube Laboratory as an electronics engineer working on test methods and equipment for evaluating tube performance.

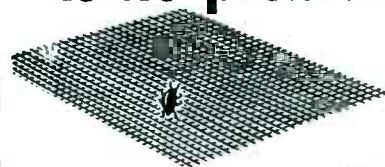
NORMAN B. KRIM is the newly appointed manager of the receiving tube division of Raytheon Mfg. Co., in Newton, Mass.

DAVID R. HULL, Captain U. S. N. (retired), has been appointed assistant technical director of the International Telephone and Tele-

MESH SIZE



is no problem



for JELLIFF

For quality wire mesh — contact Jelliff — makers of wire mesh products for over sixty years. Commercial sizes available in standard lengths of 100 feet and widths of 24 to 72 inches. Meshes of specified gauge and weave made and cut to order. Available crimped, calendered and rolled. Jelliff engineers keep abreast of current developments in new alloys, coatings and processes and apply them when studying your requirements. For best results and maximum economies, look to Jelliff.

Write DEPT. L-201 For Literature



If you need
Radio Parts...



in quantities

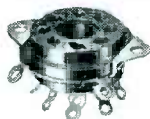
suitable to Volume

Production...it may

pay you to call upon

the Design Engineers

of United-Carr and its



subsidiaries.

They have helped many

manufacturers



★ CUT COSTS

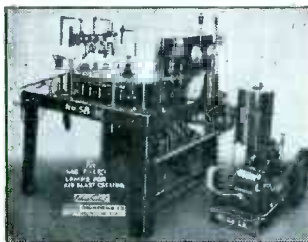
★ SPEED PRODUCTION

★ TURN OUT FINER
FINISHED PRODUCTS

**UNITED-CARR
FASTENER Corp.**
CAMBRIDGE 42, MASSACHUSETTS

MAKERS OF **DOT** FASTENERS

**EISLER
ELECTRICAL & ELECTRONIC
EQUIPMENT
ELECTRONIC TUBE EQUIPMENT**



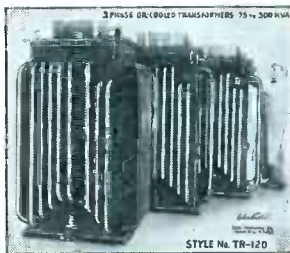
**36 HEAD
RADIO TUBE
EXHAUSTING
MACHINE**

We Make Complete Equipment For The Manufacture Of Incandescent Lamps Radio and Electronic Tubes.

TRANSFORMERS OF ALL TYPES

For LIGHTING POWER FURNACES PHASE CHANGING DISTRIBUTION ETC.

Air, Oil, or Water Cooled



3 PHASE OIL COOLED TRANSFORMERS 75 to 300 KVA
STYLE No. TR-120

SIZES 1/4 to 250 KVA
SPOT WELDERS
OF ALL TYPES
FOR ALL PURPOSES
SIZES 1/4 to 250 KVA

Butt Welders - Gun Welders
Arc Welders
Neon Sign Units
Fluorescent Tube
Manufacturing Equipment



CHAS. EISLER
EISLER ENGINEERING CO., INC.
75 So. 13th St. (Near Avon Ave.), Newark 3, N. J.

ANOTHER SPECIAL BY PROGRESSIVE

CATALOG SHOWS DOZENS MORE
Special heads, threads and finishes on any metal or alloy adapted to cold upset. Weekly output: 25,000,000 pieces. Many specials, suggesting production savings for you, illustrated in latest catalog. Includes weights per 1M standard pieces, dec. equivs. of fractions, other purchasing and engineering helps. Write for Catalog 19.

The PROGRESSIVE MFG. CO.
59 NORWOOD ST. TORRINGTON, CONN.

METAL MERCHANDISERS SELL
your product CONSTANTLY!

These "silent salesmen" are on the job always . . . creating a desire for your product at the point of sale. Any size, shape or design can be created for you by our master designing department. We have 36 years of "know-how" and have created metal products and displays for the top manufacturers. Write today for descriptive folder.

CENTRAL
Sheet Metal Works, Inc.
2645-49 Ciybourn Ave.
Chicago 14, Ill.

"Where Professional Radiomen Study"

CAPITOL RADIO ENGINEERING INSTITUTE
An Accredited Technical Institute
16th and Park Rd., N. W.
Dept. E-1
Washington 10, D. C.

Home Study and Residence Courses in Practical Radio-Electronics and Television. Approved for Veteran Training.

If You Are Having Difficulty Maintaining Your Mailing Lists . . .

for Results

Mc GRAW-HILL
DIRECT MAIL LIST SERVICE

Probably no other organization is as well equipped as McGraw-Hill to solve the complicated problem of list maintenance during this period of unparalleled change in industrial personnel. McGraw-Hill Mailing Lists cover most major industries. They are compiled from exclusive sources, and are based on hundreds of thousands of mail questionnaires and the reports of a nation-wide field staff. All names are guaranteed accurate within 2%. When planning your direct mail advertising and sales promotion, consider this unique and economical service in relation to your product. Details on request.

McGraw-Hill Publishing Co., Inc.
DIRECT MAIL DIVISION
330 West 42nd Street New York, 18, New York

From AUDIO to TELEVISION

Molded-iron cores and core assemblies in a wide range of sizes and styles for frequencies from 100 cps to 200 mc. Lenkurt Trancors excel because they are made to the exacting requirements of Lenkurt carrier telephone gear. Lenkurt knows how to reduce losses, minimize distortion, tailor permeability and Q to your needs. Write for catalog.



**LENKURT
ELECTRIC CO.**

SAN CARLOS, CALIFORNIA



D. R. Hull



W. B. Haliday

WILLIAM B. HALIDAY, previously with the physics department of the University of Minnesota and with the Naval Research Laboratory, was appointed engineer in charge of model tube construction at the Electron Tube Laboratory of the National Bureau of Standards.

A. M. SKELLETT has advanced from chief engineer and director of research to vice-president in charge of the research division of National Union Radio Corp., Orange, N. J. He previously spent fifteen years as a member of Bell Telephone Laboratories' technical staff.



A. M. Skellett



D. T. Ferrier

DAVID T. FERRIER, formerly navy liaison officer at the MIT Radiation Laboratory and at the Radio Research Laboratory of Harvard U., is now assistant to president at Servo Corp. of America, Lindenhurst, New York.

OTIS S. FREEMAN, with television station WABD for four years as chief operating engineer, has joined the engineering staff as assistant for operations of WPIX, the News

LENKURT KNOWS HOW

Studio Quality
AMPLIFIERS

WITH CUSTOM-BUILT FEATURES

Designers and Manufacturers
of Broadcast Speech Equip-
ment, School Sound Systems
and Recording Equipment.

Designed and Fabricated by
the Manufacturers of High
Quality Sound and Recording
Equipment for the Motion
Picture Industry.



Bardwell & McAlister's new line of Commercial Amplifiers answers the great demand of sound engineers for commercial amplifiers embodying the principles used in "custom-built" units which have been successful in the sound equipment of the motion picture industry. These principles result in high fidelity reproduction at any setting of volume controls up to full rated output with less than 4% distortion, versatility of application, ease of operation and the longer life found only in Bardwell & McAlister Studio Quality Amplification Systems. Manufactured by Union Craftsmen and fully licensed.

*Write for our sound equipment catalog and
technical bulletins. Dealer inquiries invited.*



PRODUCT

ELECTRONIC DIVISION
BARDWELL & McALISTER, INC.

BOX 1310, HOLLYWOOD 28, CALIFORNIA

13

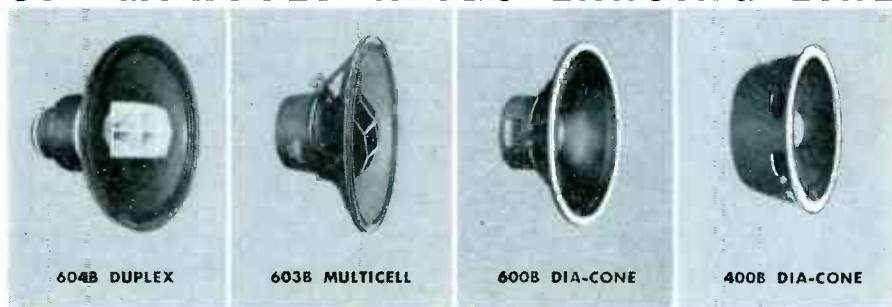
ONE STANDARD
OF QUALITY
ONLY...THE
HIGHEST



DEDICATED TO
THE CONSTANT
BETTERMENT
OF SOUND

1161 N. VINE ST., HOLLYWOOD 38 • 250 W. 57th ST., NEW YORK 19

INDUSTRY WELCOMES HIGH QUALITY OF IMPROVED ALTEC LANSING LINE



Altec Lansing scientists who developed the revolutionary new improvements in speaker design presented in the new Altec Lansing line of speakers are overwhelmed by the response of quality-conscious engineers throughout industry to the remarkable improvement in efficiency, smoothness of frequency response, and performance of the new speakers. Al-

though the consensus of industry opinion placed the previous Altec Lansing speakers in the front rank of high quality speakers, the new line of Altec Lansing speakers, basically re-engineered and fundamentally improved, has immeasurably widened the gap between Altec Lansing performance and the performance of even remotely comparable speakers.

SEND FOR BROCHURE

An illustrated brochure describes the new line of Altec Lansing speakers in detail, shows exact, dependable, scientifically accurate frequency response curves. Use address nearest you: Altec Lansing Corporation, 250 West 57th St., New York 19, or 1161 North Vine St., Hollywood 38. Write Dept. 51.

NEW BOOKS

Theory of Servomechanisms

Volume 25 of the MIT Radiation Laboratory Series. EDITED BY HUBERT M. JAMES, NATHANIEL B. NICHOLS, AND RALPH S. PHILLIPS. McGraw-Hill Book Company, 1947, 375 pages, \$5.00.

"It is nearly as hard for practitioners of the servo art to agree on the definition of a servo as it is for a group of theologians to agree on the definition of sin."

This beguiling and justifiable sentence opens a treatise on servomechanisms which is several times more ambitious and more advanced than any which has thus far been published. It is based principally on the intensive studies and developments carried out at MIT Radiation Laboratory during World War II. The general presentation can best be indicated and accounted for by noting that all the authors are mathematically articulate and that two of them are recognized as mathematicians of parts.

On the other hand, much practical and detailed data are given of servo components, and such extremes typify the book's large scope. But it is bound to be a rude shock to most practitioners to come upon the Parseval theorem and Laguerre functions in company with spur-gear trains, discriminator circuits, and manufacturer's data on synchros and motors.

Speaking generally, this treatment rephrases, applies, and extends the fundamental work of Brown, Harris, and Hall on servomechanisms, and is influenced considerably by that of Black, Guilleman, Bode, and Wiener in the allied field of communication networks. Compiled out of several contributions covering many phases of the subject, the book needed much coordinating editorial work to achieve unity. It is evident that this work was not only conscientiously done, but that it was applied at an early stage.

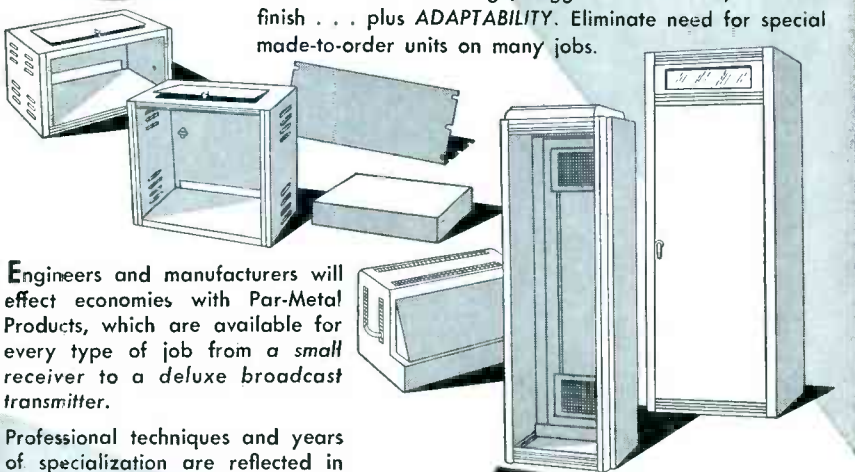
Following an introductory discussion of servo systems, an unusually thorough presentation is included of the mathematical background behind the modern usages of transfer loci and stability criteria. Notable as a departure, and



STANDARDIZED READY-TO-USE METAL EQUIPMENT

ADAPTABLE FOR EVERY REQUIREMENT

Par-Metal Equipment offers many features, including functional streamlined design, rugged construction, beautiful finish . . . plus ADAPTABILITY. Eliminate need for special made-to-order units on many jobs.



Engineers and manufacturers will effect economies with Par-Metal Products, which are available for every type of job from a small receiver to a deluxe broadcast transmitter.

Professional techniques and years of specialization are reflected in the high quality of Par-Metal. . .

CABINETS • CHASSIS
PANELS • RACKS

Write for Catalog

PAR-METAL
PRODUCTS CORPORATION
32-62 - 49th STREET
LONG ISLAND CITY 3, NEW YORK
Export Dept.: Rocke International Corp.
13 East 40 Street, New York 16

Edison Model 501
Thermal Relay
PROTECTS Electronic
Tube Cathodes



Delays application of plate voltage. Timing varies with line voltage, as does cathode heating time.

Sealed-in-Glass

Hermetic sealing excludes dust and corrosion. Arc-quenching atmosphere minimizes contact pitting or transfer. Contacts actuated silently and positively by an electric heater. Insensitive to transients or momentary power interruptions. Operates in any position. A simple, inexpensive relay for continuous operation.

GENERAL SPECIFICATIONS

Delay: 5 sec. to 8 min. Preset as required.	Ambient Range: -60° C to +60° C
Contacts: SPST, normally open or closed.	Size: 1 1/4" dia.; 3 1/2" high, seated.
Contact Rating: 6 amps. at 250 volts AC/DC	Weight: 0.08 lb. to 0.14 lb.
Heater: 5 watts. 115 volts max. AC/DC	Mounting: Std. Octal or 4-prong tube base.

Write for Publication No. 3007

202 Lakeside Avenue • West Orange, New Jersey



INSTRUMENT DIVISION

THOMAS A. EDISON Incorporated



Saves Space

THE JOHNSON
N250 CONDENSER

Extremely High Voltage Rating
In Proportion To Size

When space is limited, yet you need extremely high voltage rating, fine adjustment with uniform voltage breakdown rating throughout the full capacity range, the JOHNSON Type N Neutralizing Condenser is the perfect answer.

Because of their design, these condensers will withstand much higher voltage than conventional flat plate condensers of the same spacing.

High in quality—low in cost, JOHNSON condensers are always a wise choice.

For Complete Details Write For
Latest JOHNSON Catalog



E. F. JOHNSON CO.
WASECA, MINNESOTA

If you Manufacture...



AUTOMOBILES



TRUCKS AND BUSES



WASHERS



COMMUNICATION
TRANSMITTERS



DISPENSERS

YOU CAN SAVE

3 Ways

WITH ESSEX "PACKAGED"
WIRING HARNESS.....

1 Engineering 2 First Cost 3 Installation

Scores of users have found that they save time, trouble and money by turning their electrical wiring harness problems over to Essex specialists.

Essex *One-Source* service handles the intricate job of producing lighting, ignition and control harness assemblies *custom-built* to your exact specifications and *complete* with all

manual and electrical control devices for quick, efficient installation.

Through intensive specialization in wiring harness assemblies, Essex has developed line production methods of manufacturing, assembly and inspection, for economical production of high grade, individually tested, specially engineered assemblies.

INVESTIGATE ESSEX "ONE-SOURCE" SERVICE TODAY!



ESSEX WIRE CORPORATION

WIRE ASSEMBLY AND CORD SET DIVISION
SALES DEPARTMENT

MONTICELLO, INDIANA

Sales Offices: Chicago, Ill.; Cleveland, Ohio; Dayton, Ohio; Detroit, Mich.; Kansas City, Mo.; Los Angeles, Calif.; Milwaukee, Wis.; Newark, N. J.; Philadelphia, Pa.; San Francisco, Calif.; St. Louis, Mo.



CUP WASHERS
for Binding Screws



WHITEHEAD STAMPING CO.

1691 W. Lafayette Blvd.

Preferred

as a source of precision-made
WASHERS and
STAMPINGS
manufactured to
your specifications

Detroit 16, Michigan

For Originality

LOOK TO



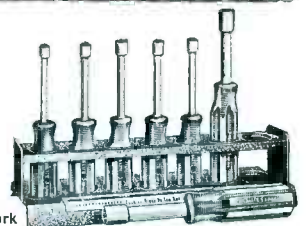
NEW! No. 137

XCELITE NUT DRIVER SET

It's one of the new sets of XCELITE nut drivers which we will exhibit at the Radio Parts Show, Chicago, May 11th through the 14th. See it—also other new items at Booth 126. P. S. If you can't wait, ask for special bulletin describing the above.

*Originators—not Imitators
PARK METALWARE CO., INC.

Dept. C Orchard Park, New York



Quality Tools **PREFERRED BY EXPERTS**
*FIRST TO USE PLASTIC FOR SCREWDRIVER HANDLES

TECHNICAL MANUALS

CUSTOM DESIGNED
TO YOUR SPECIFICATIONS

Planned, written and illustrated by a select staff . . . experts in creating radio and electronic manuals for civilian & military use.

When you call upon Boland & Boyce to create your manuals you are relieved of every detail in their preparation. The entire operation is taken over and completed by a specialized staff with years of experience in publishing books & manuals.

First the requirements for your manual are completely surveyed. The working conditions to which they will be put are studied and the operations or equipment described in the manual are thoroughly analyzed. A complete outline is then prepared and submitted for your approval, along with a dummy of the manual as it will appear when finished. Upon your approval the job is completed and delivered with your satisfaction guaranteed.

Boland & Boyce manuals incorporate only the most modern editorial and illustrative style. Each project is treated with individual attention in technique of presentation and editorial approach. The Boland & Boyce military and civilian manuals now in use throughout the world are our best recommendations.

U. S. Navy
U. S. Signal Corps.
Sylvania Electric Products, Inc.
The National Company
Western Electric Co.
Bell Telephone Laboratories
Maguire Industries, Inc.
Allen B. Dumont Laboratories, Inc.
General Electric Co.
Mine Safety Appliances Co.

Write or wire Boland & Boyce today
for more information.

BOLAND & BOYCE INC., PUBLISHERS

Manual Division M-1 Montclair, N. J.

NEW BOOKS

(continued)

of significance for the rest of the book, is the concept of weighting function. For any linear filter, the relation of the input x_1 to the output x_2 is given by the convolution integral

$$x_2 = \int_0^t W(t-t') x_1(t') dt'$$

where the weighting function $W(t)$ is the response of the filter to a unit pulse. Incidentally, an unusual convention is adopted in writing integrals: all integrands are placed after the differential. This practice might be found acceptable in general, particularly from the standpoint of symbolic operators.

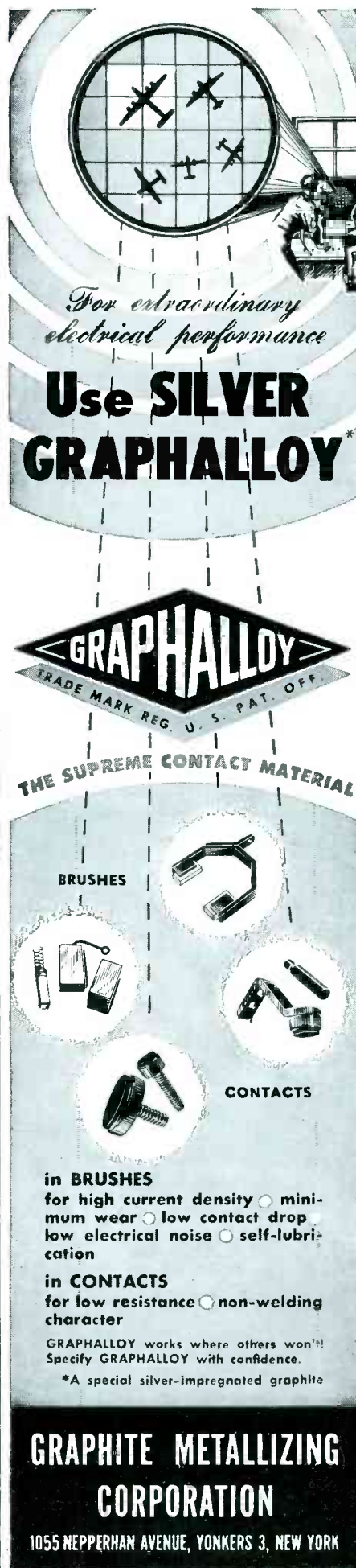
Next come servo elements, including error sensors, repeater and transmitter components, modulators, discriminators, gear trains and motors. Much new material is included, and some in surprising detail. Correcting networks are discussed for both a-c and d-c signals. Naturally the choice of components is limited to those most significant for radar systems.

A chapter of 90 pages covers general design principles. The engineering techniques now in use are given through a review of the available methods of analysis (leading to application of decibel-log-frequency and decibel-phase charts), and covering multiple-loop as well as single-loop systems (leading finally to practical examples in the SCR-584 radar with amplidyne, and also in servos with two-phase motors).

New theories are given on servos fed with pulsed data, and on the employment of filters with clamping. The revised stability criteria are elegantly derived, and the analogy with continuous servo theory very effectively brought out.

A fundamental presentation is included of the statistics of random processes, with applications to the problems of noise and fading in servo design. There is also a thorough demonstration of the new minimum-rms-error criterion, augmented by a table of definite integrals of special type for computation in the case of systems up to the 8th order. A final chapter applies many of the above design techniques to typical problems.

It is mild criticism to point out that this book, which contains much that has been unavailable, follows



For extraordinary
electrical performance

Use SILVER GRAPHALLOY*

GRAPHALLOY
TRADE MARK REG. U. S. PAT. OFF.

THE SUPREME CONTACT MATERIAL

BRUSHES

CONTACTS

in BRUSHES
for high current density ◯ minimum wear ◯ low contact drop ◯ low electrical noise ◯ self-lubrication

in CONTACTS
for low resistance ◯ non-welding character

GRAPHALLOY works where others won't!
Specify GRAPHALLOY with confidence.

*A special silver-impregnated graphite

GRAPHITE METALLIZING CORPORATION

1055 NEPPERHAN AVENUE, YONKERS 3, NEW YORK

most other servo literature in two respects. First, many pages are devoted to material which applies far more generally than to the closed loop structures of the servomechanism or of automatic controls generally. Secondly it is almost exclusively concerned with the linear theories. The simplest control law of all, for example, that of the on-off regulator, is basically non-linear, and high-performance servos of this type have been developed and described by both British and American groups. But the substantial omission of inherently non-linear systems, and of tools such as analog devices for their study and development, simply indicates pioneering directions for the future.

The authors and editors must be congratulated on their handling of a large and difficult task. As to the publication itself, relatively few errors have been discovered in typesetting or proofreading. This volume will remain within easy reach in the library of the present reviewer.—**GEORGE A. PHILBRICK**, research consultant, *The Foxboro Co., Foxboro, Mass.*, and president, *George A. Philbrick Researches, Inc., Boston, Mass.*

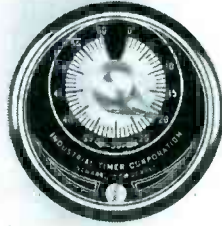
Theory and Application Of Microwaves

By **ARTHUR B. BRONWELL** and **ROBERT E. BEAM**, *Northwestern University*. McGraw-Hill Book Co. Inc., New York, N. Y., 1947, 470 pages, \$6.00.

THE NEED for a single book combining the essential information on microwave tubes, transmission, and propagation is well filled by this new text. Although the book is predominantly theoretical, the authors have succeeded in their goal of simplifying the presentation and expressing the results in a form convenient for engineering use. MKS units are used throughout the text.

The fundamental laws of electron motion are reviewed as a preliminary step in the analysis of microwave tubes. These basic concepts are then applied to the analysis of negative-grid triodes, Barkhausen oscillators, klystrons, and magnetrons. Discussion of resonators and traveling-wave tubes is also included. Transmission lines are in-

be exact...



with this industry-accepted TIME DELAY TIMER

Synchronous motor driven, automatic reset, designed to delay closing or opening of a timed electrical circuit for electronic equipment, heat application, conveyors, X-ray equipment, plastic extrusion and molding, and for recycling operations. Available in maximum intervals of 15, 30 and 60 seconds, 3 or 5 minutes. Bakelite cased, 3 in. diameter.

A few of the timers we build for industry:

- Automatic Reset
- Signaling
- Push-button Automatic Reset
- Panel-mount Time Delay
- Behind-the-panel-mount Time Delay
- Running Time Meters
- Others for special purposes.

We have more than 400 types of timers for you to choose from. Write us your requirements.

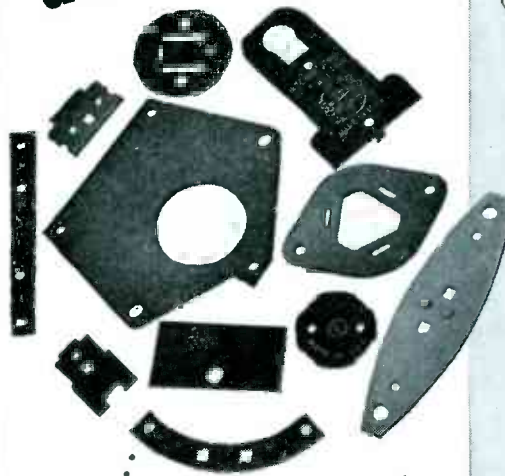
INDUSTRIAL TIMER CORPORATION

111 Edison Place, Newark, New Jersey



Baer

can supply your vulcanized
and phenol fibre fabrications



* Baer fibre is versatile... can be stamped, punched, drilled, tapped, milled, sheared, sawed and shaved to specification.



SEND BLUEPRINTS
AND SPECIFICATIONS—
NO OBLIGATION!

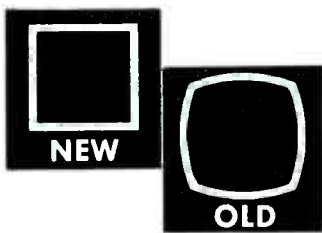
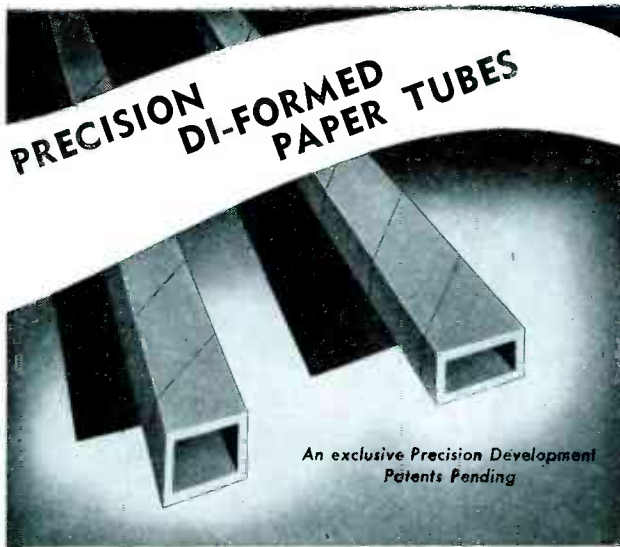
When you use these tough, light-weight and inexpensive parts, you build their many advantages into your own product. Fabricated to order. BAER FIBRE washers, special shapes, terminal boards, and other parts are accurately and uniformly produced to specification in any quantity. Selection of grades by physical and electrical qualities, permits application to a wide range of operating conditions and requirements. Investigate now!

LITERATURE ON REQUEST

**N. S. BAER
COMPANY**

MONTGOMERY ST., HILLSIDE, N. J.

NEW PROCESS CUTS COIL WINDING COSTS 4 WAYS



At no extra cost, all Precision tubes are now Di-Formed under heat and pressure. This means 1) Greater strength at no increase in weight. 2) Automatic stacking made possible. 3) Coils need not be formed after winding. 4) Cores can be engineered closer. The saving in wire, labor, extra operations; and the greater coil efficiency can readily be seen. Send for samples of Di-Formed tubes, and new Mandrel List.

PRECISION PAPER TUBE CO.

2041 WEST CHARLESTON STREET CHICAGO 47, ILL.
Plant #2 • 79 Chapel St. • Hartford, Conn.

VHF COMMUNICATION and LF NAVIGATION SYSTEMS

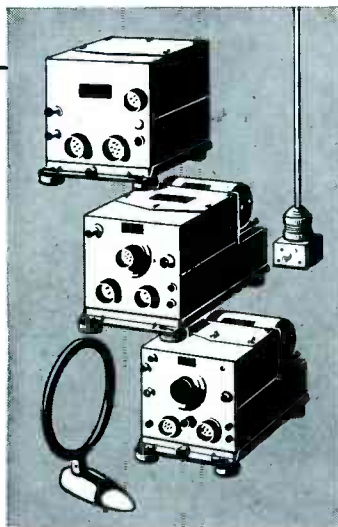
meet every Operational Need

THE A.R.C. TYPE 11A

Meets basic needs by providing for VHF Transmission, LF Range Reception and Rotatable Loop Navigation.

THE A.R.C. TYPE 17

A 2-way VHF equipment, including a tunable VHF Receiver and a 5-channel, crystal controlled VHF Transmitter.



THE A.R.C. TYPE 12 (Above)

Combines the advantages of the Type 11A and the Type 17, offering 2-way VHF, together with LF Range Reception and Rotatable Loop Navigation.

All units of these systems have been Type-Certificated by the CAA. For the highest standards of design and manufacture and the finest in radio equipment, specify A.R.C.



Aircraft Radio Corporation

BOONTON, NEW JERSEY

DEPENDABLE ELECTRONIC EQUIPMENT SINCE 1928

troduced in the conventional manner, but the application to microwave problems is stressed and the graphical solution of problems is emphasized. The chapters on microwave systems briefly describe the combination of these principles with low-frequency practice.

A more advanced level of analysis using Maxwell's equations has been adopted in the last chapters of the book. An analysis of wave guides and cavity resonators is followed by material on the application of these devices. Theoretical material predominates in the final chapters on antennas and radiation.

Although the book was prepared for senior and graduate students in electrical engineering at the present time, it will prove particularly attractive to engineers who graduated before this wealth of material became available. The numerous problems will be equally valuable to students and engineers reviewing this field. Whether they are engaged in microwave relaying or not, most engineers will find this combination of simplicity and broad coverage of the field ideal.

There are few criticisms to offer. Some mistakes do occur, but they are often of the type that will be recognized readily by the reader. More adequate discussion of grounded-grid amplifiers and paraboloidal antennas should have been included, and a greater number of references would be desirable.—A. E. HARRISON, *Princeton University, Princeton, N. J.*

High Vacua

BY SWAMI JNANANANDA, *Randall Laboratory of Physics, University of Michigan. D. Van Nostrand Company, Inc., New York, N. Y., 1947, 310 pages, \$5.50.*

THE FIRST portion of this book contains a useful review of gas laws, kinetic theory, and free path phenomenon. Tables are included with information on mean free path, rates of evaporation, coefficients of viscosity, thermal conductivity, and other information of general value to workers concerned with flow of gases and vapors at low pressures.

The information on the production and measurement of high vacua is entirely restricted to reviews of early workers in the field and is pri-

New AM SUPERHET TUNER
with self-contained Power Supply
by "Adaptol" has
numerous valuable applications
for MANUFACTURERS.
Efficient and Economical



"Adaptol" AM Superhet Tunner (540 to 1700 KC) is compact. Highly suitable for use in conjunction with Wire and Tape Recorders. Has many Experimental uses . . . Tuner for Custom-Built Radios & PA systems . . . Has many "conversion" uses.

CIRCUIT FEATURES: Self-contained power supply for 110V AC-DC 50-60 cycles . . . Three tube circuit of conventional deskn. using the latest miniature and dual purpose tubes. Oscillator-converter: I.F.-2nd detector: A.C. rectifier . . . Permeability tuned drift-free I.F.'s . . . Approx. 5 volt audio output across interval 5 megohm internal load resistor, on average B.C. signal with five foot antenna . . . Units individually tracked at FOUR points through tuning range of 540-1700 kc . . . COMPACT: Approximately 4 1/2" x 3 1/2" x 3-3/4".

Write for prices and further details to:

ADAPTOL CO.

Dept. E.

120 New Lots Ave. Brooklyn, N. Y.

FORD

Telesyn

AC - 60~ - 400~
DATA TRANSMISSION SYSTEMS

GENERATORS (Transmitters)

MOTORS and DIFFERENTIALS
(Mechanical Indication)

CONTROL TRANSFORMERS
(Electrical Indication)



- PRECISION BUILT
- UNSURPASSED ACCURACY
- RUGGED CONSTRUCTION
- SERVICE SPECIFICATIONS

Complete Descriptive Literature on Request

FORD INSTRUMENT CO., INC.

DIVISION OF THE SPERRY CORPORATION

31-10 THOMSON AVENUE
LONG ISLAND CITY 1, N. Y.



also

FRACTIONAL H.P.
SERVO MOTORS
DEFLECTION COILS
MECHANICAL
▶ DIFFERENTIALS
▶ INTEGRATORS
▶ RESOLVERS
▶ MULTIPLIERS
▶ INTERMITTENTS
▶ COMPUTERS



Linde

ARGON
HELIUM
KRYPTON
NEON
XENON

and Standard or Special
MIXTURES

LINDE rare gases are spectroscopically pure—argon, helium, neon, and standard mixtures are available in one- and two-liter glass bulbs and in cylinders; xenon and krypton are available in liter and fractional-liter bulbs.

The word "Linde" is a trade-mark of

THE LINDE AIR PRODUCTS COMPANY

Unit of Union Carbide and Carbon Corporation

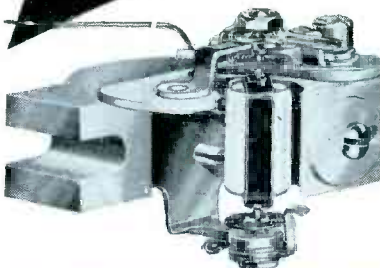
30 East 42nd St. UCC New York 17, N. Y.

ONE OF A SERIES



GAUGED ALIGNMENT

**WHY BURLINGTON PANEL
INSTRUMENTS PROVIDE
UTMOST RELIABILITY . . .**



JEWEL SUPPORTS are machined and assembled with aid of precision gauging fixtures to assure perfect alignment. All ranges AC and DC available in 2 1/2", 3 1/2", 4 1/2" rectangular or round case styles and are fully guaranteed for one year against defects in workmanship or material. Refer inquiries to Dept. F58.



Burlington

INSTRUMENT COMPANY
BURLINGTON, IOWA

3½ KW
VACUUM TUBE
BOMBARDER
or
INDUCTION
HEATING UNIT



Only \$975

Never before a value like this 3½ KW bombarder or high frequency induction heater . . . for saving time and money in surface hardening, brazing, soldering, annealing and many other heat treating operations. Is

Portable . . . mounted on four rubber casters. Width 14½"; depth 27"; height 42½"; weight 300#.

Operates from 220 volt line. Complete with foot switch and one heating coil made to customer's requirements. Send samples of work wanted. We will advise time cycle required for your particular job. Cost, complete, only \$975. Immediate delivery.

Scientific Electric Electronic Heaters are made in the following ranges of power: 1-2-3-5-7½-10-12½-15-18-25-40-60-80-100-250. KW.

*Scientific
Electric*

Division of

"S" CORRUGATED QUENCHED GAP CO.

105 - 119 Monroe St. Garfield, N. J.

NEW BOOKS

(continued)

marily an early historical treatment of the art. The author has drawn heavily upon the early books and articles, many of which were published prior to 1930. As a compilation of the early development of diffusion pumps and gages, the book will find a useful purpose, but as an aid to physicists or engineers familiar with developments in vacuum technology during the past ten years, it will be found of very little value.

In describing the possibility of employing metal as a construction material, the author states: "systems can also be made from plates and cylinders of yellow brass, screwed together and rendered vacuum-tight by a fine coating of beeswax and rosin mixture on the outside to close the intervening cavities and leaks." This approach to the problems of high vacuum engineering, which have advanced so rapidly during the war years, is indicative of the type of information to be found in this volume.

—RICHARD S. MORSE, *president, National Research Corporation, Cambridge, Mass.*

Books Received for Review

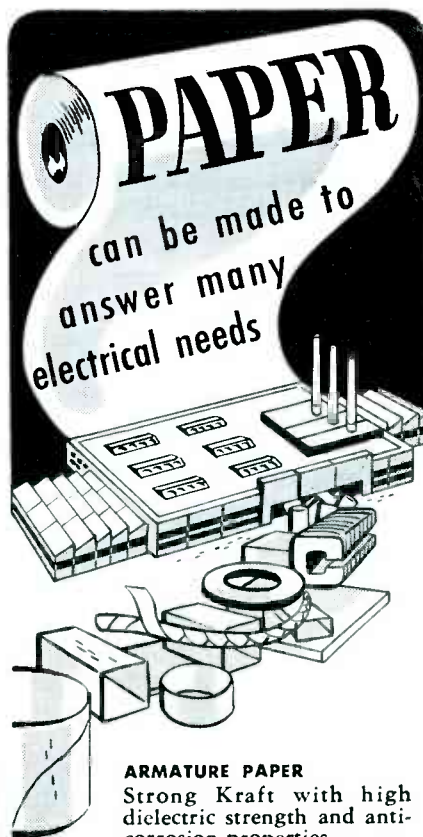
PREPARING FOR FEDERAL RADIO OPERATOR EXAMINATIONS. By Arnold Shostak. Prentice-Hall Inc., New York, 1948, 404 pages, \$3.75. Answers to questions in FCC Study Guide, for students preparing to pass any or all of the six classes of examination elements. Diagrams do not follow ASA symbol standards. New I-in and television questions are not covered.

RADIO RECEIVER TUBE PLACEMENT GUIDE. Compiled and published by Howard W. Sams & Co., Inc., Indianapolis, Ind., 1948, 192 pages, \$1.25. Collection of top-of-chassis diagrams showing placement of tubes in approximately 5,400 radio receivers manufactured between 1938 and 1947.

FRACTIONAL HORSEPOWER ELECTRIC MOTORS. By Cyril G. Veinott. McGraw-Hill Book Co., Inc., New York 1948, Second Edition, 554 pages, \$5.00. Types available, operating principles, performance characteristics, and instructions for repairing, rewinding, and reconnecting. Eight chapters have been largely rewritten, and all others brought up to date.

PRACTICAL AMPLIFIER DIAGRAMS. By Jack Robin and Chester E. Lipman. Os-tronic Publications, 196 W. 37th Place, Los Angeles 7, Calif., 1947, 55 pages, \$2.00. Spiral-bound collection of 23 audio-amplifier circuits with parts lists, plus 13 pages of general comments on amplifier servicing, reproduced from typed copy.

ELEMENTS OF RADIO. By Abraham and William Marcus. Prentice-Hall Inc., New York, 1948, Second Edition, 751 pages \$4.25. Revised and expanded new edition of an elementary radio text that has sold over 500,000 copies (including military printings) since it came out in 1943. Intended for home study as well as radio school classroom use, covering principles of radio operation from crystal sets through modern superheterodynes and including questions and suggested classroom demonstrations for each chapter.



PAPER
can be made to
answer many
electrical needs

ARMATURE PAPER

Strong Kraft with high dielectric strength and anti-corrosion properties.

CABLE WRAP

Flat or creped Kraft; can be water-proofed or made anti-corrosive as required.

CORE BASE PAPER

Controlled conductivity; free from harmful chemical action.

INSULATION PAPER

High physical strength, high dielectric strength.

ANTI-RUST PAPER

Treated to prevent rusting of metal with which it is in contact.

ANTI-CORROSIVE PAPER

Chemical properties carefully controlled to assure neutrality.

Centraline Engineered Electrical Papers are designed especially to solve your particular problem. They can replace more expensive materials, improve product design, increase production and reduce manufacturing costs. Uniformity and adherence to specifications is assured by laboratory control from pulp to finished Electrical Paper.

Consult a Central Paper Engineer—he will be glad to discuss your problem with you and provide samples for testing. No obligation of course.



REG. U. S. PAT. OFF.

CENTRAL PAPER COMPANY
INCORPORATED

2442 LAKESHORE DRIVE, MUSKEGON, MICH.

Backtalk

This department is operated as an open forum where our readers may discuss problems of the electronics industry or comment upon articles which ELECTRONICS has published.

More Hartley Law

DEAR SIRs:

PUBLISHED accounts of the symposium on "Bandwidth vs Noise in Communication Systems" tend to obscure the fact that the Tuller-Shannon-Sullivan-Wiener-etc. law does not represent in fact a revision of the Hartley law; rather, the "new" law represents a somewhat more explicit formulation of the latter.

Hartley's law, as stated in his paper, can be expressed in the following form

$$C = 2W \log_m \frac{M}{S} \quad (1)$$

where C is the capacity of the channel to carry information per unit time, W is the bandwidth of the channel, S is the number of what came to be known as quantum levels, and M is an arbitrary base of logarithms. Furthermore, as Hartley pointed out, in practice the number of quantum levels, and hence the capacity of the system, is limited by the distortion (random and non-random) introduced by the transmission channel.

A comparison of Eq. 1, with the expression for the "new" law which is

$$C = W \log_2 \left(1 + \frac{P}{N} \right) \quad (2)$$

where P/N is the signal-noise ratio expressed in power units, shows that the "new" law could be obtained from Eq. 1 by the mere substitutions

$$S = \left(1 + \frac{P}{N} \right)^{\frac{1}{2}} \text{ and } M = 2$$

The fact that S is actually equal to $(1 + P/N)^{\frac{1}{2}}$ is readily deduced by the following reasoning:

Under the condition of full use of the capacity of the transmission channel, separation between successive quantum levels is equal to $(N)^{\frac{1}{2}}$ while the total height of the levels

We want you to see

"PREMIER-TONE"*

for yourself!

You can appreciate this new Premier finish only by *seeing* it, *touching* it! That's why we'd like to send you an actual sample—solid proof of its eye-appeal and sales potentials. We want you to judge its quality and beauty—to see for yourself how "Premier-tone" can improve your product's appearance.



SEND FOR YOUR FREE SAMPLE — TODAY!

* A distinctive hammered finish offering unusual beauty for nameplates, dials and panels.

PREMIER METAL ETCHING COMPANY

Quality Products Since 1910

21-07 44th AVENUE LONG ISLAND CITY 1, N. Y.

Unsurpassed

... in quality
... in performance



- STAINLESS STEEL • ERASABLE
- PERMANENT RECORDING • HIGH FIDELITY
- REPLAYS INDEFINITELY • FITS ALL STANDARD RECORDERS

Available in ¼-hour, ½-hour, and 1 hour periods

SPENCER WIRE COMPANY WEST BROOKFIELD MASSACHUSETTS

LONG RECOGNIZED AS A LEADER IN THE MANUFACTURE OF PRECISION STEEL AND ALLOY WIRE



COSMALITE* TUBES FOR

Television DEFLECTION YOKES

These spirally laminated paper base, Phenolic Tubes are delivered already punched and notched to meet the exact requirements of the customer. Ask also about . . .

#96 COSMALITE for coil forms in all standard broadcast receiving sets.

SLF COSMALITE for Permeability Tuners.

Spirally wound kraft and fish paper Coil Forms and Condenser Tubes.

*There is a definite saving to you
in specifying and using Cosmalite.*

* Trade Mark Registered

The CLEVELAND CONTAINER Co.

6201 BARBERTON AVE. CLEVELAND 2, OHIO

- All-Fibre Cans • Combination Metal and Paper Cans
- Spirally Wound Tubes and Cores for all Purposes
- Plastic and Combination Paper and Plastic Items

PRODUCTION PLANTS also at Plymouth, Wisc., Ogdensburg, N.Y., Chicago, Ill., Detroit, Mich., Jamesburg, N.J.
PLASTICS DIVISION at Plymouth, Wisc. • ABRASIVE DIVISION at Cleveland, Ohio
SALES OFFICES: Room 5632, Grand Central Term. Bldg., New York 17, N.Y., also 647 Main St., Hartford, Conn.
CANADIAN PLANT: The Cleveland Container Canada, Ltd., Prescott, Ontario



BACKTALK

(continued)

is equal to $(P + N)^{\frac{1}{2}}$. Therefore the number of quantum levels is given by

$$S = \frac{(P + N)^{\frac{1}{2}}}{(N)^{\frac{1}{2}}} = \left(1 + \frac{P}{N}\right)^{\frac{1}{2}}$$

Thus, the "new" law can be obtained directly from Hartley's law through calculation of the maximum permissible number of quantum levels.

It should also be pointed out, that in the derivation of the "new" law it is tacitly assumed that the bandwidth of the transmission channel is at least as large as that of the message. Thus, statements to the effect that the "new" law indicates the possibility of transmitting speech on a bandwidth of only a few hundred cycles, are completely unfounded. True, it might be possible to do so by using a method of frequency compression described by D. Gabor in the November issue of the *Journal of I.E.E.*, but this and other similar schemes have nothing in common with the "new" law.

LOTFI A. ZADEH
Department of Electrical Engineering
Columbia University, New York

Gigacycles

DEAR SIR: READING about the suggestion *kilomegacycle* in Cross talk, February *ELECTRONICS*, I cannot suppress my opinion that this term sounds stilted to me indeed.

May I remind you that the following abbreviations are shorter, printed in text books, and even used. The extreme ones are, of course, less known since the limited number of potential applications does not justify their use:

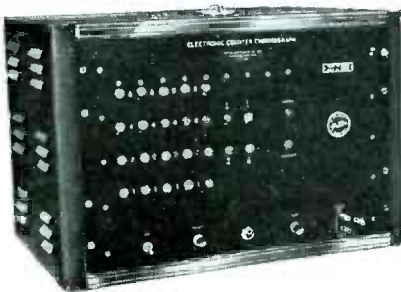
10 ³ kilo	10 ⁻³ milli
10 ⁶ mega	10 ⁻⁶ micro
10 ⁹ giga	10 ⁻⁹ nano
10 ¹² terra	10 ⁻¹² pico

The new field of vhf, as pointed out, makes a new power-of-ten multiple highly desirable. So, why not be consistent and call it a *gigacycle*?

A similar, even more urgent, necessity exists for the subunit of 10⁻¹² farad which is so commonly used in electronic work.

I have a small Bakelite molded condenser, it reads "00037". The decimal point is not easily found. You start counting the zeros in order to find out—after 15 to 30 sec, depending upon the mental alertness of the tested person—that this is most probably a condenser

MICROSECOND TIMING! THE NEW 1.6 mc INTERVAL TIMER (COUNTER CHRONOGRAPH)



...measures and
records time intervals
with a resolution of
1/1,600,000
seconds

This instrument determines and indicates directly the elapsed time between electrical "Start" and "Stop" signals derived from the beginning and ending of a time interval to be measured. A 1,600,000 c.p.s. crystal oscillator is used as the time base. The instrument, which is completely self contained, counts the number of cycles from this time base which occurs during the time interval measured. Price \$925.00

- ★ Extremely High Accuracy — 1.6 Megacycle crystal oscillator time base.
- ★ Direct Indication of Intervals up to one second — recycling of the counter can be observed or recorded for longer intervals.
- ★ High Resolution measures intervals in steps of 0.625 microsecond.
- ★ Retains Indication of Measurement until reset.
- ★ Easy to Actuate — positive pulses from common or separate sources can be used.
- ★ Stable — no adjustments required.

High Speed Electronic Counters and Precision Internal Timers for All Applications — Address Inquiries to Dept. 6J

POTTER INSTRUMENT CO.
INCORPORATED
136-56 ROOSEVELT AVE., FLUSHING, NEW YORK



CONTACTS

FOR THE FIELD OF ELECTRONICS

BALL BEARINGS

MPB makes more than **40** different types and sizes ...

For precision instruments, laboratory equipment, electronic devices, to minimize friction, space, weight, and to overcome starting torque specify MPB bearings. Radial · Pivot · Angular Contact · Thrust. Promptly Available · Ask for catalog EL.

MPB MINIATURE Precision BEARINGS
INCORPORATED
KEENE, NEW HAMPSHIRE, U.S.A.

MICROMETER FREQUENCY METER

for Checking Transmitters from 100 Kc to 175 Mc. within 0.01 per cent.

LAMPKIN LABORATORIES, INC.
Bradenton, Fla., U. S. A.

FLUXES
SODERING BRAZING & WELDING
I. B. ALLEN CO. INC. Chicago 31, Ill.
6671 Bryn Mawr Ave.

THIS

CONTACTS

SECTION

Supplements other advertising in this issue with these additional announcements of products essential to efficient and economical production and maintenance. Make it a habit of checking this page, each issue.

Classified Advertising Division

ELECTRONICS

Kahle

ELECTRON TUBE MACHINERY OF ALL TYPES

STANDARD AND SPECIAL DESIGN

.....

We specialize in Equipment and Methods for the manufacture of

- RADIO TUBES
- CATHODE RAY TUBES
- FLUORESCENT LAMPS
- INCANDESCENT LAMPS
- NEON TUBES
- PHOTO CELLS
- X-RAY TUBES
- GLASS PRODUCTS

Production or Laboratory Basis

.....

Kahle ENGINEERING CO.
1309 SEVENTH STREET
NORTH BERGEN, N. J., U. S. A.

FINE RIBBONS OF TUNGSTEN and MOLYBDENUM

Quality and accuracy in our fabrication of Tungsten & Molybdenum Ribbons have characterized our service to the Electronic industry.

A development of

H. CROSS Co.
5 Beekman St., New York 7, N. Y.

Solve Wire Stripping Problems with "SPEEDEX" WIRE STRIPPER

The famous "Speedex" Wire Stripper complete with 7 interchangeable blades for stripping any size wire from No. 8 to No. 30 will be the handiest tool in the shop. Strips 800 to 1000 wires per hour—cuts wires too. Just press the handle and the job is done. For use with solid or stranded wires. Write today for catalog of 3,000 electronic products.

GENERAL CEMENT MFG. CO.
ROCKFORD, ILLINOIS, U. S. A.

WE manufacture a complete line of equipment

- SPOT WELDERS, electric from ¼ to 50 KVA
- TRANSFORMERS, special and standard types
- INCANDESCENT LAMP manufacturing equipment
- FLUORESCENT TUBE MAKING EQUIPMENT
- ELECTRONIC EQUIPMENT, vacuum pumps, etc.
- WET GLASS SLICING and cutting machines for laboratory use
- GENERAL GLASS working machines and burners
- COLLEGE GLASS WORKING units for students and laboratory

EISLER ENGINEERING CO.
731 So. 13th St. (near Avon Ave.) Newark, New Jersey

LET US DEVELOP THAT NEW VACUUM TUBE FOR YOU.

We specialize in the research, development and production of all types of vacuum tubes. Laboratory or Production basis.

ULLMAN RESEARCH CORPORATION
Ullman Building Brooklyn 15, New York

ELECTRONIC EQUIPMENT
Custom Built for Your Job

BUCK ENGINEERING CO., Inc.
37 Marcy St. Freehold, N. J.

UTL SILVER PLATING FLUID

Plates brass, copper, bronze, alloys with pure bullion silver. No batteries or generators. Just rub on with cloth. Quick plating action saves time, money. Hundreds of uses in shops, production, labs. Trial size, \$1.00, pint \$3.75 postpaid. Write for circular. Results guaranteed.

UNITED TECHNICAL LABORATORIES,
Morristown 6, N. J.

D61B CONSTANT VELOCITY FREQUENCY RECORD

Here's an indispensable guide for fast, accurate, direct checking of phono pick-ups and indirect checking of recording heads, loud speakers, p. a. equipment, etc. 12" double-faced Vinylite record. 78 RPM—recorded in 3 sections, 50-10,000 cps, 400 cps, 1,000 cps. Lists \$3.50 ea.—see your distributor or write—

UNIVERSAL MICROPHONE CO.
INGLEWOOD CALIFORNIA

ELECTRO ENGINEERING WORKS
4021 COLLEGE AVENUE · OAKLAND 16, CALIFORNIA

Specializing in High Voltage Filament and Plate Transformers for Electronic Projects

Prompt Deliveries

A WORKSHOP HIGH-GAIN ANTENNA

will . . .

More than triple the effective power of the transmitter.

Increase the effective power of the mobile transmitter.

Increase the operating area.

Permit the use of low power, low cost equipment.

Workshop High-Gain Beacon Antennas are designed specifically for the 152-162 megacycle band—taxicab, fire, police, and private fleet communications.

Design Features

- Low angle of radiation concentrates energy on the horizon.
- Symmetrical design makes azimuth pattern circular.
- Can be fed with various types of transmission lines. Special fittings are available for special applications.
- Enclosed in non-metallic housing for maximum weather protection.

Available for immediate delivery through authorized distributors or your equipment manufacturer.

—THE—
**WORKSHOP
ASSOCIATES**
INCORPORATED

Specialists in High-Frequency Antennas

64 NEEDHAM STREET
Newton Highlands 61, Mass.



PAT. APP. FOR

BACKTALK

(continued)

of 370 pf, assuming that the missing decimal point usually proceeds the row of zeros and that the value of its capacity is given in μf .

Within the same space the manufacturer might have printed the above given abbreviation, and would have been explicit.

The word *pico* is used as my information goes, in printing, meaning a twelve-point letter, and is supposed to be taken from medieval Latin. It has the definite advantage over the μf that it is shorter and can be typed on any typewriter. The latter obstacle leads to the abbreviation *mmf*, which is outright faulty, since *m* stands for *milli*.

Electronics is the one branch of industry (known to me), where the metric system has beaten the British System of Units. At least, I do not expect the change from wavelengths in meters and centimeters into feet and inches in the near future—even, if the convenience of the frequency-wavelength conversion should prove to be the sole shield against such a change.

Your magazine is the outstanding representant in its field. That means educational responsibilities are *nolens-volens* conferred upon it; and it is in this particular sense, when I say that I appreciate Mr. McGraw's excellent articles very much, indeed.

Assume that your magazine would pursue the ultimate goal—a complete conversion from British to Metric Units—a part of its policy. More optimistically, assume the change can be accomplished within a hundred years from now.

Just realize the obtained increase in learning efficiency for the lucky student of nucleonic industry of that age. It doesn't take too much imagination that, by that time, he will need the amount of saved time for more productive studies in order to become a useful member of the more and more complex industrial machine. . .

And it should be timely also at a moment when all former international Electric Units are officially dropped and the new ones rebased on the fundamental metric units of mass, length, and time.

HORST M. SCHILLBACH

Assistant Professor in Physics
Michigan College of Mining and
Technology
Houghton, Michigan

NOW



Electronic-tube
SOCKETS IN ALL
POPULAR TYPES



104J50

BUY quality throughout! Your G-E tube investment will be doubly guarded when you use General Electric sockets. They're designed and built to team with G-E tubes for dependable service and long life.

Also, a General Electric source of supply for tubes and sockets alike, makes ordering easier for you . . . simplifies record-keeping . . . provides one-manufacturer responsibility that stands solidly behind both products.

G-E tube sockets are stocked in a wide range of types. They're convenient to buy and install. For prices and information on fast deliveries, address your nearest G-E electronics office or *Electronics Department, General Electric Company, Schenectady 5, N. Y.*

183-G3-8850

GENERAL  ELECTRIC

SEARCHLIGHT SECTION

EMPLOYMENT • BUSINESS • OPPORTUNITIES • EQUIPMENT—USED or RESALE

UNDISPLAYED RATE:

1.20c a line, minimum 4 lines to figure advance payment count 5 average words as a line.

POSITIONS WANTED (full or part-time salaried individual employment only), 1/2 above rates.

PROPOSALS 1.20 cents a line an insertion.

INFORMATION:

BOX NUMBERS in care of any of our New York, Chicago or San Francisco offices count 1 line additional in undisplayed ads.

DISCOUNT of 10% if full payment is made in advance for four consecutive insertions of undisplayed ads (not including proposals).

DISPLAYED—RATE PER INCH

The advertising rate is \$9.00 per Inch for all advertising appearing on other than a contract basis. Contract rates quoted on request.

AN ADVERTISING INCH is measured 7/8 inch vertically on one column, 3 columns—30 inches—to a page.

NEW ADVERTISEMENTS received by 10 A.M. May 3rd will appear in the June issue, subject to limitation of space available.

ENGINEERS - PHYSICISTS

The Aeronautical Research Center of the University of Michigan at Willow Run, Michigan, has several openings for engineers and physicists with experience in the fields of servo-mechanisms, electronics, and instrumentation. Interested applicants should furnish complete outline of experience with letter of application.

UNIVERSITY OF MICHIGAN

Personnel Office

208 University Hall Ann Arbor, Mich

ELECTROLYTIC CAPACITOR ENGINEER

Exceptional opportunity for right man who can qualify for development engineering post with leading manufacturer. Please send complete particulars in first letter. Our men know of this advertisement.

P-4546, Electronics
330 West 42nd Street, New York 18, N. Y.

REPLIES (Box No.): Address to office nearest you
NEW YORK: 330 W. 42nd St. (18)
CHICAGO: 520 N. Michigan Ave. (11)
SAN FRANCISCO: 68 Post St. (4)

POSITIONS VACANT

ELECTRICAL, CHEMICAL Engineer or Physicist: For development of chemical process control instrumentation. Radar and general electronics experience desirable. Large chemical industry in southwest. P-4271, Electronics.

ALLEN B. Du Mont Laboratories, Inc., have several openings in their Clifton plant for intermediate and senior engineers. Must have B.S. degree in physics or electrical engineering and experience in V.H.F., television deflection or general circuit development. Apply Personnel Department, 100 Main Avenue, Clifton, N. J.—9:00 a.m. to 3:00 p.m.

EMPLOYMENT SERVICES

SALARIED POSITIONS \$3,500 and up. If you are considering a new connection communicate with the undersigned. We offer the original personal employment service (35 years recognized standing and reputation). The procedure of highest ethical standards is individualized, to your personal requirements and develops overtures without initiative on your part. Your identity covered and present position protected. Particulars on request. R. W. Bixby Inc., 278 Dun Bldg., Buffalo 2, N. Y.

EXECUTIVES \$3,000 - \$25,000. This reliable service, established 1927, is geared to needs of high grade men who seek a change of connection under conditions assuring, if employed, full protection to present position. Send name and address only for details. Personal consultation invited. Jira Thayer Jennings, Dept. E, 241 Orange St., New Haven, Conn.

POSITION WANTED

TELEVISION ACCOMPLISHED executive with 15 years British and U. S. experience. High definition Video desires association with reputable organization. Experience covers home-set and technical apparatus, product design, manufacture, installation, service, Video distribution, movie type projection, transmission equipment, marketing, commercial operation. PW 4594, Electronics.

(Continued on page 262)

LOS ALAMOS SCIENTIFIC LABORATORY

Has present need for physicists of Ph.D grade with research and development experience in various phases of nuclear physics, electronics, optics, and physical chemistry. Both field and laboratory experimentation involved, depending on interests and capabilities. Also included is design and development of special laboratory electronic, mechanical and optical apparatus. Interviews at project expense can be arranged for qualified applicants.

Write direct to

EMPLOYMENT DIRECTOR

P.O. Box 1663, Los Alamos, New Mexico

for further particulars, giving brief resume of education and experience.

INVESTIGATE THIS OPPORTUNITY

To join the staff of one of the largest research organizations in the country devoted exclusively to

VACUUM TUBE RESEARCH

Working conditions are ideal in these laboratories which are located in the New York Suburb of Orange, New Jersey. Your associates will include men of many years experience in vacuum tube research and development.

This rapidly expanding organization is devoted to both commercial and military research. It is a division of one of the oldest vacuum tube manufacturers in America. Security and stability for the years to come are assured. You will have an opportunity to gain experience with the different kinds of vacuum tubes, receiving, power, cathode ray, sub-miniature, micro-wave, radial beam and various special types.

If you can qualify as a

PHYSICIST • MATHEMATICIAN • ELECTRICAL ENGINEER
CIRCUIT TECHNICIAN • VACUUM TUBE TECHNICIAN

write at once to

RESEARCH DIVISION

NATIONAL UNION RADIO CORPORATION

350 SCOTLAND RD.

ORANGE, NEW JERSEY



(Continued from page 261)

SELLING OPPORTUNITIES WANTED

PRACTICAL RADIO Engineer desires position as sales engineer with reputable company selling industrial electronic control equipment. 9 years experience, research, development, production. 31, single, will travel anywhere. SA-4512, Electronics.

ELECTRONIC ENGINEER—South American with long experience, excellent references, taking graduate courses in U.S., desires sales or service position here or in Latin America. Now available. RA-4331, Electronics.

SPECIAL SERVICE

Consulting Engineer

(Ph.D.) maintaining own independent Electronics Development Laboratory and Showroom in London, frequently visiting Continent of Europe, offers services in any capacity. SS-4406, Electronics.

PHYSICIST

Desires to improve his position. U. S. citizen. Veteran. Graduate of a European college. Degree equivalent to M.S. Approximately ten years' experience (electrical, magnetic, electronic, servo-control, infra-red, and related subjects) in testing, development, research (experimental & theoretical), and otherwise. Has experience in planning and completing his projects and in directing an entire research and development group.

He is now connected since several years with a commercial Research Laboratory as a Project Engineer and looks ahead toward a position of more responsibility, incl. a higher salary, in a similar but larger organization, either a commercial or non-commercial institution. He is able and competent, versatile in his approach to problems, reliable, and "sticks" to work he begins.

Date when available open, but not before July 1948. If you are able and willing to make an excellent offer, address your inquiry to:

PW-4578, Electronics

330 West 42nd Street, New York 18, N. Y.

FOR SALE

Electronic Manufacturing Plant

Transformers-Amplifiers-assembly.

Real bargain for quick sale.

BO-3525, Electronics

330 West 42nd Street, New York 18, N. Y.

OSCILLOSCOPES SYNCHROSCOPES

Complete repair service for all types of scopes

LERU LABORATORIES, INC.

360 Bleecker St., N. Y. 14. WA-9-4194

THE LOG LOG SLIDE RULE

A new and complete instruction book with decimal point charts for exponential and logarithmic calculations. Invaluable for those using exponentials infrequently.

PRICE \$1.00

EDWARD C. TAYLOR
Woodstock, Vermont

TANTALUM METAL

CLEARANCE SALE OF 20 KILOGRAMS Sheet (.006"), Misc. Ribbon, and Wire (.012"). All at \$55 per kg. f.o.b. your plant. Mfd. by Fansteel. Send for our stock list.

J. M. HIRSCH COMPANY

622 Washington St. San Francisco 11, Cal.

RADIO CABINETS

and wood cabinets of all types built to your specifications. Twenty-four hour estimating service.

"Engineered Wood Production"

THOMAS MANUFACTURING CO.
NEENAH, WISCONSIN

Available

Sales and Development Engineer

5 years experience with a leading manufacturer of Industrial Electronic Equipment. 10 years as maintenance and equipment engineer with a large manufacturer of vacuum tubes and electronic equipment. At present employed in the New York-New England area but due to health of a member of the family must transfer to warm climate. Prefer West Coast. Age 39. Interview arranged anywhere in United States.

PW-4379, Electronics

330 West 42nd Street, New York 18, N. Y.

COMMUNICATIONS RECEIVERS

All types expertly repaired and rebuilt to rigid factory specifications or better. Calibration, alignment, image rejection measurements etc., to highest standards. All service work guaranteed. Workmanship you can measure.

Authorized Hallicrafters and National Service Center

WINTERS RADIO LABORATORY

11 Warren Street

New York 7, N. Y.

Cortlandt 7-1361

WANTED

WANTED

All Types Autosyns, Selsyns and Synchros, Transmitters or Indicators 60 or 400 Cycle.

Also Pioneer Torque Units, Inverters, Gyros, Two-Phase Control Motors, Fractional H. P. Motors AC or DC, and Similar Equipment.

W4175 ELECTRONICS

330 West 42nd Street,

New York 18, N. Y.

WANTED

Western Electric Carrier Telephone, Carrier Telegraph Equipment and Components. Filters, repeating coils, transformers, equalizers. Types CF1, CF2, H, C, and other carrier equipment. Telephone and telegraph repeaters.

W-4435, Electronics

330 West 42nd Street, New York 18, N. Y.

WANTED WESTERN ELECTRIC VACUUM TUBES

Types 101F, 102F, 272A, 274A or B, 310A or B, 311A, 313C, 323A, 328A, 329A, 348A, 349A, 352A, 373A, 374A, 393A, 394A, 121A Ballast Lamps.

W-4493, Electronics

330 West 42nd Street, New York 18, N. Y.

WANTED

Type 101B 1000/20 cycle ringers manufactured by Federal. Type J68602 Ringer-oscillators manufactured by Western Electric.

W-4471, Electronics

330 West 42nd Street, New York 18, N. Y.

WANTED TEST EQUIPMENT

All Types of Laboratory Test Equipment, New, Used or Surplus. Send full description and price to

W-4170, Electronics

330 West 42nd Street, New York 18, N. Y.

MICRO SWITCHES

WANTED

Large Surplus Lots
Also Mu & Acro Switches

U. S. SURPLUS CO.

1896 Walton Ave. N. Y. C., N. Y.

"SEARCHLIGHT"

IS

Opportunity Advertising

—to help you get what you want.
—to help you sell what you no longer need.

Take Advantage Of It

For Every Business Want

"THINK SEARCHLIGHT FIRST"

ELECTRICAL AND MECHANICAL ENGINEERING POSITIONS OPEN

FOR ELECTRICAL AND MECHANICAL ENGINEERS EXPERIENCED IN DESIGN OF HOME, TELEVISION AND AUTO RADIO RECEIVERS.

COLLEGE EDUCATION DESIRABLE BUT NOT NECESSARY IF SUFFICIENTLY EXPERIENCED. PLEASANT AND ATTRACTIVE WORKING CONDITIONS. PENSION AND INSURANCE PLANS.

Write Details of Education, Experience and Salary Required

QUALIFIED INDIVIDUALS WILL BE GRANTED APPOINTMENTS FOR INTERVIEWS IN BUFFALO AT OUR EXPENSE

COLONIAL RADIO CORPORATION

ENGINEERING DIVISION

1280 MAIN ST.

BUFFALO 9, N. Y.

ELECTRICAL ENGINEER

To prepare technical manuscripts covering certain operations of the Los Alamos Laboratory. Applicant should have B.S. degree in Electrical Engineering with considerable experience in engineering and technical writing, although any mechanical or electrical training and/or experience would be helpful. Interested persons may write directly to

PERSONNEL MANAGER
P. O. Box 5800, Albuquerque, New Mexico

WANTED

Electronic Design Engineer

Production Facilities . . . Capital . . . National Distribution Available for New Products in Television Field.

Write full details in first letter.

P 4313 Electronics
330 West 42 Street, New York 18, N. Y.

SCIENTISTS and ENGINEERS

Wanted for research and advanced development work in the fields of microwaves, radar circuits, gyroscopic systems, servomechanisms and general Electronics. Scientific or Engineering degrees required. Salary commensurate with experience and ability. Inquiries should be directed to Mgr.-Eng. Personnel.

BELL AIRCRAFT CORPORATION
Buffalo 5, N. Y.

Wanted

- ★ PHYSICISTS
- ★ RADAR ENGINEERS
- ★ SYSTEMS ENGINEERS
- ★ ELECTRONIC ENGINEERS

To enable us to carry out our long-term engineering program on missiles, radar, communications, etc., we must add a considerable number of qualified graduate engineers with electronic, research design and/or development experience to our staff. Please furnish complete resume of education, experience and salary expected to: Personnel Manager

BENDIX RADIO DIVISION

Bendix Aviation Corporation

Baltimore 4, Maryland



Panel Meters

All meters are white scale, with conventional calibrations, in round flush bakelite cases unless specified otherwise.

D.C. MILLIAMMETERS

- MINIATURE MILLIAMMETER 2 M.A. 20 M.V. mvt Scale calibrated 0-10, Roller Smith 1 1/2" square flush meter mounted in small bakelite box with lead and plug, used as a tuning meter \$2.50
- 1 MA G.E. DO-41 Special black scale, supp. with paper VOMA sc. \$4.50
 - 1 MA Sun 3AP259 3 1/2" rd fl bake case.....\$3.00
 - 1 MA Simpson 125 2 1/2" Rd fl bake case.....\$3.50
 - 1 MA MOVEMENT W.H. NX-33 black scale calibrated "PA plate Grid 0-200" supplied with paper VOMA scale. 2 1/2" Rd fl bake case.....\$3.00
 - 1 MA G.E. DW-51 100 MV mvt. sc cal 0-50 MA 2 1/2" rd fl bake case.....\$3.50
 - 1 MA MOVEMENT Dejur S-210 special scale 2 1/2" Rd fl bake case.....\$3.00
 - 50 MA G.E. DO-41 black scale, 3 1/2" rd fl bake case.....\$3.25
 - 50 MA Weston 506 2 1/2" rd fl bake case.....\$3.95
 - 150 MA Gruen 508 2 1/2" rd fl bake case.....\$3.00
 - 200 MA Gruen 511 2 1/2" rd fl bake case.....\$3.00
 - 200 MA Weston 506, black scale 2 1/2" rd fl bake case.....\$3.50
 - 200 MA W. H. NX-35 3 1/2" rd fl bake case.....\$3.95
 - 200 MA Simpson 25 3 1/2" rd fl bake case.....\$4.50
 - 1000 MA Dejur Amco 310 (1 Amp) 3 1/2" rd fl bake case.....\$3.00
 - 50-050 MA Westinghouse NX-35 3 1/2" Rd fl bake case.....\$3.95

RADIO FREQUENCY AMMETERS

- 250 MA G.E. DW-52 black sc, sc cal 0-5 mkd "Antennae Current" 2 1/2" rd fl bake case.....\$3.50
- 250 MA W.H. NT-33 black sc, sc cal 0.5 mkd "Antennae Current" 2 1/2" rd fl bake case.....\$3.50
- 1A Weston 507 2 1/2" Rd fl metal case.....\$3.50
- 1 A G.E. DW-44. 2 1/2" Rd fl bake case.....\$3.50
- 1 A G.E. DW-44 black scale, 2 1/2" rd fl bake case.....\$2.95
- 1 A R.F. G.E. DW-52 2 1/2" metal case.....\$3.00
- 1.5 A Weston 507 black scale, 2 1/2" rd fl metal case.....\$2.50
- 2 A Simpson 135 2 1/2" rd fl bake case.....\$3.50
- 3 A G.E. DW-52 black scale 2 1/2" rd fl bake case.....\$2.95
- 3 A Weston 507 black scale, 2 1/2" rd fl bake case.....\$3.50
- 4 A G.E. DW-44 black scale, 2 1/2" rd fl bake case.....\$2.95
- 6 A G.E. DW-44 black scale, 2 1/2" rd fl bake case.....\$2.50
- 8 A G.E. DW-44 black scale, 2 1/2" rd fl bake case.....\$2.95
- 8 A Simpson 135 2 1/2" rd fl bake case.....\$3.50
- 9 A W.H. NT-33 bl sc, 2 1/2" rd fl bake case.....\$2.50
- 9 A Weston 507 black scale, 2 1/2" rd fl bake case.....\$2.50
- 20 A G.E. DO-44 3 1/2" rd fl bake case.....\$4.95

A. C. AMMETERS

- 50A-G.E. AO-22—3 1/2" Rd fl bake case.....\$4.50
- 60 A-Simpson—3" sq fl bake case.....\$3.50
- 75 A-Triplett 331-J.P.C. 3 1/2" Rd fl bake case \$3.50

A. C. VOLTMETERS

- 8 V. Weston 476 3 1/2" Rd fl. bake case.....\$3.50
- 15 V. G.E. AO-22 3 1/2" Rd fl. bake case.....\$3.95
- 75 V. Weston 517 2" Rd fl. ring mounted metal case.....\$2.95
- 150 V. Weston 476 Calibrated for use from 25 to 500 cycles 3 1/2" Rd fl bake case.....\$6.50
- 150 V. Triplett 331-JP 3 1/2" Rd fl. bake case.....\$4.50
- 150 V. Burlington 32XA 3" Sq. fl. bake case.....\$4.00
- 300 V. Weston 517 2 1/2" Rd fl metal case.....\$6.00

SPECIAL METERS

- MARION "S" METER Made for National Co. 1 MA mvt. sc. cal. 1-9 units S and 0.40 DB above S 6 2" ring mt'd fl metal case.....\$3.50
- Simpson, 25 SIGNAL STRENGTH "S" METER 3 1/2" rd fl bake case. Use this on the plate circuit of your receiver to show the relative strength of incoming signals. Sc calibrated —6 to 100 DB above 1 microvolt. 5 MA Zero right mvt with translucent sc. for internal se. illumination from rear of meter. Comp. with socket, lamp and leads. For further details refer to pages 164-165 and Fig. 730 B of Radio Amateur's Handbook.....\$4.50
- DECIBEL METER—Weston, 301 Type 21 3 1/2" rd fl bake case minus 10 to plus 6, 6 M.W. 600 ohms; General purpose type 0.5 - 0.7 Second to final reading, 45-62% overthrov, 5000 ohms internal resistance at ODB, Zero DB = 1.9 Volts.....\$8.50
- DECIBEL METER—Westinghouse TC-35 —10 to +6 DB 3" SQ. fl bakelite case 6 M.W. 500 ohms zero DB = 1.732 volts. Full scale = 3.45 volts.....\$5.95

D.C. VOLTMETERS

- 5 V W.H. NX-33 200 ohms per volt 2 1/2" bake case.....\$3.50
- 10 V Sun 2 AP458 100 ohms per volt, 2 1/2" rd fl bake case.....\$2.50
- 15 V D.C. McClintock D-100-R-1, 1000 r/v bl sc, 2 1/2" Rd fl bake case.....\$3.00
- 15 V Gruen, GW 505 2 1/2" Rd fl bake case.....\$3.50
- 30 V G.E. Dw-41, Approx. 250 ohms per volt, 2 1/2" Rd fl bake case.....\$2.95
- 30 V W.H. NT-33 200 ohms per volt 2 1/2" Rd fl bake case.....\$3.50
- 50 V W.H. NX-35 200 ohms per volt, 3 1/2" rd fl bake case.....\$3.95
- 0-50 Triplett 521 1000 r/v, 5 1/2" rd fl bake case.....\$5.50
- 200 V W.H. NX-35 200 ohms per volt 3 1/2" rd fl bake case.....\$3.95
- 200 V W.H. NX-35 200 ohms per volt, mounted on 45 degree metal angle panel with binding posts.....\$4.95
- 20 KV W.H. NX-35 with ext. prec. wire wound 1000 ohms per volt resistor and intg. clips \$21.00

D.C. AMMETERS

- 15 A Triplett 0321-T 3 1/2" Rd fl bake case \$4.00
- 30-0-30 A. G.E. DW-51 2 1/2" Rd fl metal case.....\$3.50
- 50-0-30 A. Beede 2 1/2" Rd fl metal case.....\$3.00
- 50 A Hoyt 2 1/2" Rd fl metal case.....\$2.95
- 150 A W.H. F-1 (NX-33) black scale, comp with ext. 50 MV (Aircraft Style) shunt 2 1/2" Rd fl bake case.....\$2.50
- 200 A Weston 506 Comp with ext 50 MV shunt, 2 1/2" Rd fl bake case.....\$7.50

D.C. MICROAMMETERS

- 150 MICROAMPERE McClintock No. 2001 approx. 740 ohms resistance black scale, 2 1/2" Rd fl bake case.....\$3.50
- 500 MICROAMPERE MOVEMENT G.E. DW-51 scale calibrated 0-10 2 1/2" Rd fl bake case Supplied with paper VOMA scale.....\$3.50
- 500 MICROAMPERE UNDAMPED MOVEMENT W.H. IX-35 scale calibrated 0-25. Watts 3" Sq. fl bake case Supplied with paper VOMA scale.....\$4.95

PORTABLE CHROMOMETRIC TACHOMETER

To measure speeds from 0 to 20,000 R.P.M. with scale calibrations in 10 R.P.M. divisions. Divide scale reading by 2 when using the peripheral wheel and you can read surface speeds up to 10,000 F.P.M.

A 2" open face dial provides unequaled readability. Each division on large dial indicates 10 R.P.M. & each division on small dial indicates 1000 R.P.M. Readings are similar to those made on kilowatt hour meters. Results of tests remain on dial until next test taken.

Complete with 2 tips, peripheral wheel, & operating instructions—No stop watch or other timing mechanisms required. Made by Jaeger Watch Co. model 43 A-6. Complete in velvet lined case 5" x 3 1/2" x 1 1/2". List Price \$75.00.

Surplus—New—Guaranteed \$24.50 f.o.b. N. Y.

MULTIPLE RANGE, CONTINUOUS INDICATING PORTABLE TACHOMETER

Three ranges in R.P.M. & three ranges in F.P.M. 300-1200, 1000-4000, 3000-12,000 R.P.M.

Large 4" dial shows INSTANTANEOUSLY & CONTINUOUSLY the speed or change in speed of any revolving shaft or surface.

Complete with 4 tips, peripheral wheel, extension rod and operating instructions. No stop watch or other timing mechanisms required.

Made by Jones Motorola, Stamford, Conn. Comes complete in velvet lined case 7 1/8" x 4" x 5". List price \$75.00.

Surplus—New—Guaranteed \$24.50 f.o.b. N. Y.

MULTI-RANGE PORTABLE A.C. VOLTMETER

Weston Model 433, 150/300/600 volts AC. Accuracy within 1/4% of 1% from 25 to 125 cycles. Hand calibrated mirror scale 4.04" long with 150 scale divisions; Knife edge pointer. Moving Iron Band type. Magnetically shielded. Dimensions 6"x8"x3 1/2".....Net \$47.50

PORTABLE D.C. AMMETER 0-50 MILLIVOLT MOVEMENT

Weston Model 45 for use with external shunts. Accuracy within 1/2% of 1%; Hand calibrated mirror scale 5.18" long with 100 scale divisions (Scale calibrated 0-25 Amps.) Knife edge pointer; magnetically shielded; Complete with external 25 Amp 50 MV shunt and leads. (We also have other external shunts for use with this meter). In hardwood carrying case 8" x 8" x 4 1/2" with hinged cover. Complete @.....\$32.50

- 1000 Amp 50 MV shunt @ \$12.00
- 2000 Amp 50 MV shunt @ \$20.00
- 4000 Amp 50 MV shunt @ \$40.00

PORTABLE D.C. AMMETER MULTI-RANGE 0-3, 0-30, 0-300 AMPERES

General Electric DP-9 (50 MV movement) Accuracy within 1/2% of 1%; Hand calibrated mirror scale; Knife edge pointer, magnetically shielded. Complete with leads and external shunts for 3, 30 and 300 Amps. Plastic case with hinged cover. Dimensions 2 7/16" x 6 9/16" x 4 13/16", @.....\$37.50

THERMAL CIRCUIT BREAKER

120 Volt, 15 Amp. A.C. Double pole. Single throw. Curve D. Made by Heineman Circuit Breaker Co. Catalog #0322. Overall Dim. 5 1/2" L x 3" W x 4" D new—individually boxed. EACH \$3.50 F.O.B. N.Y. 10 for \$29.50

All items are Surplus-New-Guaranteed. C.O.D.'s not sent unless accompanied by 25% Deposit. Orders accepted from rated concerns, public institutions, etc., on open account. We carry a complete line of surplus new meters suitable for every requirement, such as portable, panel, switchboard, recording instruments, laboratory standards, etc. Over 50,000 Meters in Stock. We also stock various surplus components, tubes, parts, and accessories and can supply large quantities for manufacturers, exporters, etc. Send for free circular Manufacturers, Exporters, Dealers—We invite your inquiries.

MARITIME SWITCHBOARD

338 Canal Street

Worth 4-8216-7-8-9

New York 13, New York

TELL US—TELL OTHERS—SAY YOU SAW IT IN ELECTRONICS!

HIGH ALTITUDE ALTIMETER

Radio Set SCR-518

GENERAL DESCRIPTION

Radio Set SCR-518-A consists of a complete set of apparatus for installation on aircraft for use in determining the height above the terrain. The nominal range of the equipment is from 0 to 20,000 feet, but it is operative to an altitude of approximately 30,000 feet. The complete set of main components when equipped with tubes and fuses, with cable interconnections, with antenna arrays, and primary power source connections, properly made, constitutes a complete and operative equipment. All necessary voltages, other than the primary source, are generated within the equipment. The source of power is an aircraft d-c supply of 24 to 28.6 volts. The total power consumed is approximately 300 watts.



RADIO RECEIVER BC-688-A

This unit amplifies the reflected signals picked up by the receiving antennae and converts them into a form suitable for operating the indicator. Operates at approximately 515 megacycles. Uses the following tubes:

- 6 # 6AU7, 2 # 6J5, 1 # 954, 1 # 955, 1 # 956
- Measures approximately 23" L x 10 1/2" W x 9" H.

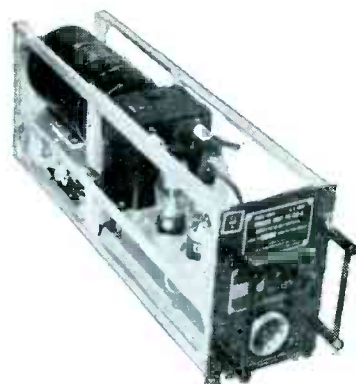


RADIO TRANSMITTER BC-689-A

This unit contains the power oscillators, timing oscillators and circuits for modulating the R.F. Carrier operates at approximately 515 megacycles. Uses the following tubes:

- 1 # 23D4, 1 # 6C8, 2 # 6SJ7, 1 # 6SK7, 1 # 6SN7, 1 # 6V6, 1 # 6F8, 1 # 6AC7, 1 # 646, 2 # 8012.

Measures approximately 23" L x 10 1/2" W x 9" H.



POWER UNIT PE-112-A

This component converts the 24-28.6 volt d-c power supplied by the aircraft d-c supply system, into suitable potentials for operation of Radio Transmitter BC-689-A, Radio Receiver BC-688-A, Indicator I 102-A and Radio Control Box BC-690-A.

Dynamotor input 27 volts 6.05 Amps; Output 300 volts 200 MA DC and 18 volt, 2.2 Amps at 100 cycles.

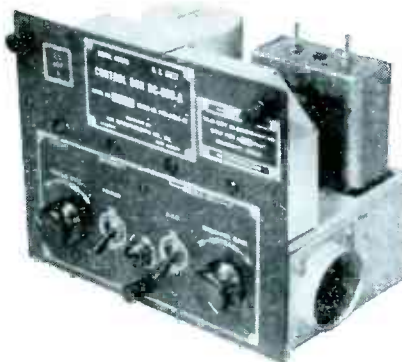
This unit contains 3 # 2 x 2 tubes. Measures approximately 21 1/2" L x 5 1/4" W x 7 1/2" H.



INDICATOR I-102-A

This indicator is an electrostatic focus and deflection type cathode-ray tube. When in operation two circles are traced on the screen by the electron beam, and two lobes appear in each circle traced, the arc of each scale between lobes being proportional to the height above the terrain. The position of one of these lobes on each circle is at zero and that of the other depends on the time elapsed between transmission and reception and hence each gives a direct reading on the calibrated scale in terms of altitude. The 2000 foot inner circle or vernier scale is for interpolation readings ("Hundreds of Feet") and the outer circle or scale is for 0 to 20,000 foot and higher readings ("THOUSANDS OF FEET").

Contains the following tubes: 1 # 6AC7, 1 # 1808P1 Cathode Ray. Measures approximately 13 1/4" L x 5" W x 5 1/2" H.



RADIO CONTROL BOX BC-690-A

On the panel of the control box are the following controls:

- "ON-OFF" Switch
- "Circle Size" Control
- "AVC-ON-OFF" Switch
- Receiver Gain Control

This unit energizes all components of the altimeter equipped except the Automatic Volume Control which is controlled by a separate switch.



JUNCTION BOX JB-46-A

This box with cables is used for interconnections between the various units of the equipment.

This equipment comes complete with 1 Receiving Antenna with cord, 1 Transmitting antenna with cord, connecting cords, mounting brackets, connectors, etc. Brand New in original factory cartons. Made by RCA—govt. cost of approximately \$900.00. Complete with operating instructions. Can be used as is for use as an altimeter, or for adaptation to radar for marine use, protective or police systems, television etc.

The many valuable parts in this set alone are well worth many times this low price of Only

\$2450

Shipping weight approximately 150 lbs.

F.O.B. N.Y.

All items are Surplus-New-Guaranteed. C.O.D.'s not sent unless accompanied by 25% Deposit. Orders accepted from rated concerns, public institutions, etc., on open account. We carry a complete line of surplus new meters suitable for every requirement, such as portable, panel, switchboard, recording instruments, laboratory standards, etc. Over 50,000 Meters in Stock. We also stock various surplus components, tubes, parts, and accessories and can supply large quantities for manufacturers, exporters, etc. Send for free circular Manufacturers, Exporters, Dealers—We invite your inquiries.

MARITIME SWITCHBOARD

338 Canal Street

Worth 4-8216-7-8-9

New York 13, New York

TELL US—TELL OTHERS—SAY YOU SAW IT IN ELECTRONICS!



LOOK TUBES! TUBES! TUBES! Thousands of Tubes— ALL BRAND NEW — STANDARD BRANDS

Minimum Order \$5.00

Quantity Prices on Request

IF YOU DON'T SEE WHAT YOU WANT LET US KNOW YOUR REQUIREMENTS

Table with 12 columns: Type, Price, Type, Price, Type, Price, Type, Price, Type, Price, Type, Price. Lists various vacuum tube types and their prices.

INDUSTRIAL TRANSFORMERS

110-220 v. Primary—General Electric Cat. #748925 1.0 KVA 50/60 cycles... \$17.95

TRANSFORMERS

ALL 110 V. 60 CY. UNLESS OTHERWISE SPECIFIED

Filament Transformer 2 windings each 2.5 v. a 10 A. Ceramic Terminals—High-voltage insulation—ideal for 806A's Wt. 8 lbs.

Jefferson Electric Hermetically sealed grey, ceramic insulator, 6.3 v. @ 12 amps. 8 lbs. Western Electric D Spec. D161937

CONDENSERS

Dual .05 @ 9000 volts DC working #PC-2151-1 14.50

20% DEPOSIT WITH ORDERS UNLESS RATED

NIAGARA RADIO SUPPLY CORP.

160 GREENWICH STREET

NEW YORK 6, N. Y.

Phone DLgby 9-1132-3-4 All Prices F.O.B. N. Y. C.

Your INDUSTRIAL and TELEVISION HEADQUARTERS

MASTER OSCILLATOR MI-19427-B

This unit was built for R.C.A. Add a final—becomes a complete transmitter with signal shifter. Perfect for Television sweep circuits for field or station use or wherever 300 v. must be maintained under varying load conditions—**\$225.00**
COMPLETE (less tubes)

TECHNICAL SUMMARY

ELECTRICAL CHARACTERISTICS
 Output Frequency 2 to 20 megacycles
 Output Level, Buffer Amplifier Sufficient to drive an RCA-807
 Modulation Frequency 650 cycles \pm 150 cycles
 Frequency Deviation (maximum) \pm 500 cycles
 Power Consumption 200 watts
 Power Supply 115 230 volts, 50/60 cycles
 Oscillator Filament Current 0.05 ampere d-c
 Amplifier and Tone Generator Filament Voltage 6.3 volts a-c

TUBE COMPLETE
 Electron-Coupled Oscillator 2 RCA-3Q5-GT
 Buffer-Amplifier 1 RCA-807
 Tone Generator 1 RCA-6AB7, 1 RCA-6F6
 Regulated Power Supply 2 RCA-5U4-G, RCA-6Y6-G
 1 RCA-1852, 2 RCA-VR-150 30



MECHANICAL SPECIFICATIONS
 Dimensions Height, 66 9/10 in.; Width, 22 in.; Depth, 17 1/2 in.
TYPICAL PERFORMANCE DATA
 Line voltage change \pm 10 per cent 0.0005 per cent
 Temperature change, per degree Fahrenheit 0.0007 per cent
 Relative humidity change of 1 per cent over the range of 30 to 95 at a dry bulb temperature of 110 degrees F. 0.0003 per cent
 Drift from cold start, first reading taken within 1 minute after applying power:
 Frequency deviation at the end of the first hour
 a negative drift of 100-400 cycles (measured at 7 mc)

TRANSMITTER BUY OF 1948 MODEL ATD AIRCRAFT TRANSMITTER

**Built
 to Rigid
 Navy
 Specifications**



This unit covers 540 Kc. to 9050 Kc. C.W. or tone, designed for Dynamotor Operation. Power supply requirements are 380 volts and 1000 volts DC. Separate Ant. Tuning units covering the following frequencies:

540-1500 Kc.
 1500-3000 Kc.
 3000-9050 Kc.

Tube line-up as follows: BF Osc. 6L6-RF Amp. 814—Audio—6SL7 Pre Amp. into 6L6 driver and side tone amplifier with pair of 6L6 modulators, screen oscillator tube, regulated with VR 150 tube. All circuits are metered.

10 1/2" high, 12 1/2" deep, 21 1/2" long. Shipping weight 100 lbs. Price, F.O.B. New York City
FOR QUICK SALE—COMPLETE . . . \$49.50

SELENIUM RECTIFIERS FOR ALL APPLICATIONS

Full Wave Bridge Types

Input From	Output From	Current	Price
0-18 V.A.C.	0-14 V.D.C.	1 AMP	\$1.95
0-18 V.A.C.	0-14 V.D.C.	5 AMP	4.45
0-18 V.A.C.	0-14 V.D.C.	10 AMP	7.45
0-18 V.A.C.	0-14 V.D.C.	15 AMP	9.95
0-18 V.A.C.	0-14 V.D.C.	20 AMP	13.95
0-18 V.A.C.	0-14 V.D.C.	25 AMP	16.95
0-18 V.A.C.	0-14 V.D.C.	30 AMP	14.95

Full Wave Center Top

Input From	Output From	Current	Price
0-100 V.A.C.	0-350 V.D.C.	600 Mils	\$5.95

Half Wave Types

Input From	Output From	Current	Price
0-18 V.A.C.	0-7 V.D.C.	3 AMP	\$2.25
0-18 V.A.C.	0-7 V.D.C.	5 AMP	2.95
0-18 V.A.C.	0-7 V.D.C.	10 AMP	4.95
0-18 V.A.C.	0-7 V.D.C.	15 AMP	6.95
0-18 V.A.C.	0-7 V.D.C.	20 AMP	8.95
0-18 V.A.C.	0-7 V.D.C.	25 AMP	10.95

Input From	Output From	Current	Price
0-36 V.A.C.	0-28 V.D.C.	3 AMP	\$5.95
0-36 V.A.C.	0-28 V.D.C.	5 AMP	7.45
0-36 V.A.C.	0-28 V.D.C.	10 AMP	12.45
0-36 V.A.C.	0-28 V.D.C.	15 AMP	18.95
0-36 V.A.C.	0-28 V.D.C.	20 AMP	25.95
0-120 V.A.C.	0-100 V.D.C.	2 AMP	14.95
0-120 V.A.C.	0-100 V.D.C.	5 AMP	19.95

Input From	Output From	Current	Price
0-36 V.A.C.	0-14 V.D.C.	3 AMP	\$2.95
0-36 V.A.C.	0-14 V.D.C.	5 AMP	4.95
0-36 V.A.C.	0-14 V.D.C.	10 AMP	7.95
0-36 V.A.C.	0-14 V.D.C.	15 AMP	10.95
0-36 V.A.C.	0-14 V.D.C.	20 AMP	13.95
0-36 V.A.C.	0-14 V.D.C.	25 AMP	16.95

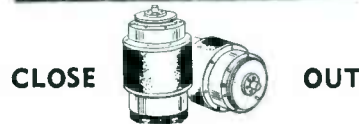
*USE with capacitor to obtain any voltage up to twice rated output.

AMPHENOL COAX CONNECTORS

83-1SPN	\$0.45	83-1AP	.79
83-1R	.45	UG-28-U	1.49
UG-12 U	.59	83-1F	.99
83-1T	1.49		

Write for Quantity Discounts

SELSYN MOTORS



CLOSE OUT

SPECIAL

Synchronous Type

Pair in Series for 110 v. AC.
 Type 1—5 1/2" long, 3" dia.—50 v. AC.
 50 cy.—1 lbs. \$ 9.95 pr.
 Type 11—6 1/2" long, 4 1/4" dia.—115 v. AC.
 50 cy. 11 oz. 12.95 pr.

SYNCHRO—DIFFERENTIAL

Model #1943 — C78249 - CAL - 11280 Bendix
 Aviation 115 v.—60 cy. 6" length to end of shaft x 4 1/4" diameter \$9.95

HI-VOLTAGE POWER SUPPLY



Hi & Low Voltage Rectifier Power Supply Model C F T—20169 formerly used with the DAQ Direction Finder. This power supply contains 2500 v. at 3 mils—325 v. at 100 mils. Also contains a sweep amplifier, voltage regulated from 110 v 60 cy AC. source.

Power Supply can be used to power a television receiver or perfect power supply for an Oscilloscope, or General Lab. use. Unit is mounted in a cabinet with all controls including pilot lights & switches on front panel. Wt. approx. 40 pounds

\$29.95

LIMITED QUANTITY

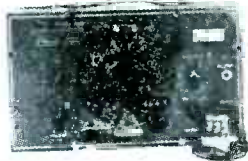
McMurdo Silver Co. Model 909 FM and Television Sweep Signal Generator with a frequency range of 2 mc. through 225 mcs. with true electronic FM sweep variable from 40 kc. to 9 mc.

Power required is 105/125 v., 50/60 cycles a.c. at 35 watts. With this new unit one can visually align FM and TV receivers quickly and perfectly with simple but complete instructions supplied for FM and TV servicing.

Priced at Only

\$48.50

McMURDO SILVER AM-FM 906 SIGNAL GENERATOR



**Available
 Now**

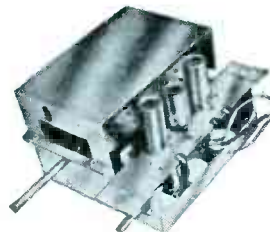
What an instrument:
 90 kc through 170 mc. on fundamentals . . . 8
 air-trimmed bands . . . variable % 400—amplitude modulation . . . built-in variable electronic
 FM sweep . . . laboratory triply adjustable
 attenuator . . . metered microvolts . . . output
 1/2 microvolt to over 1 volt . . . multiply shielded
 strays lower than \$500.00 laboratory generators! Yet all this costs you **\$99.50**
 only

SWEEP SIGNAL GENERATOR



5TP4 PROJECTION TUBE

Perfectly operating condition but with very slight imperfection. Ideal for engineers, experimenters, inventors, or school instructors. Regular price of these tubes is \$65.00—**\$20.00**
 Special Bargain



ALL CHANNEL R. F. UNIT FOR USE IN BUILDING YOUR OWN CUSTOM-MADE TELEVISION RECEIVER— ANY SIZE or TYPE

This all-channel R.F. unit is factory pre-wired and tuned for 7 channels* (covers all channels in lower and higher bands in any single area operating presently or in the future). Average sensitivity 20 microvolts; has R.F. stage before oscillator; complete with 3 tubes: 1—6AK5, 1—6AK6, 1—6C4; input impedance 300 ohms, balanced to ground. Size 9 1/2" deep, 4 1/2" high, 6 3/8" wide.
 * NOTE: No single area is scheduled for more than 7 channels. However, 6 more channels can be added to this unit, if desired, at nominal factory cost. It is not expected that these additional 6 channels will be required for several years **\$31.95**

All Prices f.o.b. N. Y. C.

NIAGARA RADIO SUPPLY CORP.

160 GREENWICH STREET, NEW YORK 6, N. Y.

**CREDIT EXTENDED
 TO RATED ACCT'S.**

LOOK AT THESE LOW PRICES FOR FAMOUS MAKE PRECISION RESISTORS

¼ WATT—30¢

Resistance	Tolerance	Quantity
6.68 OHMS	¼%	142
10.48	¼	1224
10.84	¼	664
11.25	¼	160
11.74	¼	303
12.32	¼	455
13.02	¼	163
13.52	¼	2500
13.89	¼	190
14.98	¼	737
16.37	¼	83
20.	1	175
62.54	¼	135
79.81	¼	148
105.8	¼	682
123.8	¼	692
125	¼	20
147.5	¼	1090
220.4	¼	543
301.8	¼	310
366.6	¼	667
414.3	¼	740
705	1	140
2193	¼	614
3500	10	278
10,000	1	66
59,148	¼	790

½ WATT—30¢

Resistance	Tolerance	Quantity
.250 OHMS	1%	424
.334	1	462
.502	1	290
.557	1	32
.827	1	2500
.76	1	2500
1.01	½	1445
1.53	1	2500
2.04	1	722
2.25	1	126
11.1	1	472
13.15	1	2500
20	1	6
46	1	100
52	¼	2500
55.1	1	108
66.6	5	30
75	1	1155
97.8	¼	1295
125	¼	2064
180	1	1155
210	1	1038
235	2	2500
235	2	2350
235	1	1120
260	1	1095
270	1	1432
298.3	¼	1267
320	1/10	12
400	1	1270
400	1	49
400	1	551
723.1	¼	474
900	5	11
1500	1	77
2500	1	1092
2500	1	1056



SPECIAL
1 MEGOHM—1 WATT
 1% Tolerance
 List Price \$5.00
 Our Net **75¢**

Resistance	Tolerance	Quantity
2500 OHMS	1%	2200
2850	1	2500
3427	¼	900
4,000	2	2500
4,000	2	615
4,000	1	1139
4,300	2	1245
4,451	¼	608
5,000	1	990
5,000	1	492
5,900	1	225
6,500	1	545
7,000	1	2500
7,000	1	20
7,300	2	39
7,500	1	2500
7,500	1	2002
8,000	1	535
8,000	1	736
8,500	1	149

½ WATT—35¢

Resistance	Tolerance	Quantity
10,000 OHMS	1%	362
10,000	1	1048
14,825	¼	85
15,000	1	895
15,000	1	2168
15,750	1	1100
17,000	1	1295
20,000	1	380
25,000	1	242
30,000	1	2500
37,000	1	1615
40,000	1	17
50,000	2	1747

Resistance	Tolerance	Quantity
50,000 OHMS	2%	2500
50,000	1	3
68,000	5	1300
100,000	1	315
100,000	1	2500
100,000	5	1490
150,000	½	20
150,000	½	1110
180,000	5	1590
500,000	3	419

1 WATT—30¢

Resistance	Tolerance	Quantity
.5 OHMS	2%	24
1.01	1	1255
2.58	1	209
5	1	198
3.39	1	380
5.05	1	106
5.21	1	385
10.1	1	465
10.9	1	432
100	1	409
270	1	760
420	2	79
1250	1	319
3300	1	585
5000	1	363
7000	1	221
9000	1	1351

1 WATT—35¢

Resistance	Tolerance	Quantity
10,000 OHMS	1%	91
12,000	2	736
18,000	1	454
20,000	1	389
30,000	1	10
50,000	10	2300
50,000	1	1269
55,000	1	1736
56,000	10	2127
65,000	1	251
68,000	5	1362
70,000	1	617
75,000	1	818
84,000	2	128

1 WATT—45¢

Resistance	Tolerance	Quantity
100,000 OHMS	1%	2500
120,000	1	585
125,000	1	538
128,000	1	1192
130,000	1	1948
158,000	2	115
160,000	1	136
180,000	1	514
250,000	1	1090
250,000	1	450
320,000	1	710
470,000	1	420
522,000	½	983
522,000	¼	525
525,000	1	21
600,000	1	2159
700,000	1	842
1 meg	5	2600

Any order for 100 pieces or more—10% off • Any order for 1000 pieces or more—20% off

RELIANCE *Merchandizing Company*

ARCH STREET COR. CROSKY, PHILADELPHIA 3, PA.

f.o.b. Phila., Pa.

Rittenhouse 6-4927

MINIMUM ORDER \$3.

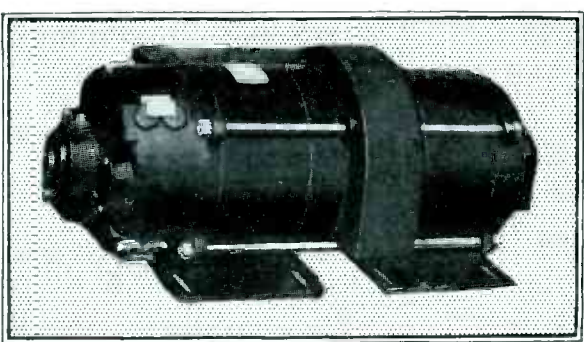
FLASH!

**SENSATIONAL BARGAINS
IN
SURPLUS EQUIPMENT**

BIG SAVINGS at ELECTRO SALES CO.

**GENERAL
ELECTRIC**

amplidyne



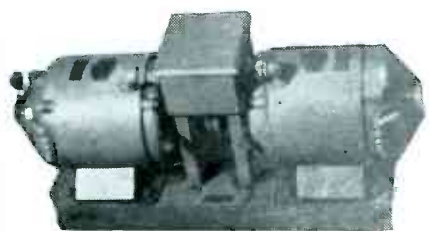
MODEL
5 AM73AB76

INPUT
440 volts, 3 ϕ , 60 cycles, 2.1 amps.

OUTPUT
250 volts, 3 amps.
750 watts; cont. duty, 3450 RPM; 45 C.—Temp. Rise.

Special Price **\$85.**

**Marathon 32-Volt
Motor-Generators**



Rebuilt like new. Two separate units coupled together on a common bed-plate. MARINE TYPE, with voltage regulator and frequency controller.

MOTOR: 32 volts, Comp. Wind. 25.4 Amperes, 3600 RPM.

GENERATOR: .3 KVA; 115 volts, AC, single phase, 60 cycles.

A Remarkable Value at **\$54.**

MODEL 5AM49AB3
INPUT: 440 volts, 3 ϕ . 60 cycles, 1 ampere
OUTPUT: 250 volts, 1.5 amps. 375 watts, cont. operation, 40 c.—Temp. Rise. 3450 RPM.

Special Price **\$53.50**

MODEL 5AM45DB20
INPUT: 115 volts, 1 ϕ , 60 cycles, 5 amps.
OUTPUT: 250 volts, .6 amp. 150 watts, cont. duty. 40 C.—Temp. Rise 3450 RPM.

Special Price **\$53.50**

**Raytheon Recticharger
BRAND
NEW**



In steel cabinet 21" x 17" x 11", individually packed in original wooden cases. Designed for operation on 110 volts, AC and will charge up to 23 cells at one time. Can also be used as a DC supply at 3 amps.

With meter 0-100 DC volts and rheostat to control voltage output. Shipping weight, 236 pounds.

Specially Priced **\$23.00**

New 112 Page Catalog
Must be limited to requests made on company's letterhead. Address DEPT. E 5, Boston 10, Mass.

All prices F.O.B. Boston. Orders accepted from rated concerns with open accounts. Net 30 days.

SPECIAL PURCHASE

GENERAL ELECTRIC TRANSFORMERS

G. E. Line Transformers, 1 Kva. 60 cycle, 490, 330, 115 volt. G. E. catalogue No. 51G29. All new. Quoted job Boston

IMMEDIATE DELIVERY!

\$19

**General Electric
Rotary Converters**



78 Volts, DC input; 110 Volts, 60 cycle, Output. 1.5 amperes

Remarkable Value at **\$9.95**

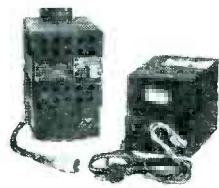
HELIPOTS
Model A - 10 Turns, 20,000 ohms, 5 watts.

SPECIAL \$4.50

**Electronic Laboratories
Inverters**

**BRAND
NEW**

Operative at 12 volts, DC to deliver 110 volts, AC, giving a maximum output of 150 watts.



\$11.95

**GENERAL ELECTRIC
TRANSFORMERS**

7.5 KVA; 120/240/480 Primary
120/240 Secondary

These are Type TF Transformers Catalog No. 75G379. Used in transforming alternating-current voltages varying between 108 volts and 528 volts to voltages of 120 volts two-wire, or 240 volts three-wire. These transformers can be used for step-down or step-up service by applying the proper input voltage to either winding and securing the corresponding voltage from the other winding.

35" x 13" x 11 1/2" Shipping Weight 326 pounds.

BRAND NEW IN ORIGINAL FACTORY CASES \$77

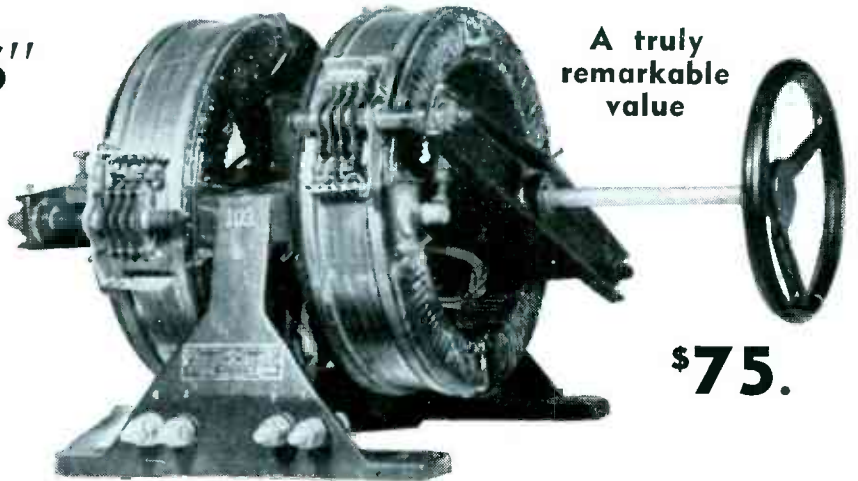
ELECTRO SALES COMPANY
110 PEARL STREET, BOSTON 10, MASS.

MORE Electro Sales Co. BARGAINS

"TRANSITATS"

Amertram Voltage Regulator
(Variable Transformers)

11.5 KVA; Fixed Winding; 115 Volts; Commutator Range 0-115 Volts, Maximum Amperage 100. Can be reconnected for 230 volts with maximum amperage of 50. Blue print of connections supplied.



A truly remarkable value

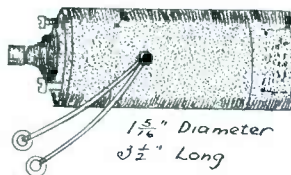
\$75.

BRAND NEW and in the original factory cases

GENERAL ELECTRIC DC Aircraft Motors

27 Volts, DC; 110 RPM; 1 oz. ft. 1 1/16" diameter, 3 1/2" long. Series winding.

Special Price **\$1**



ELECTRIC SPECIALTY CONVERTERS

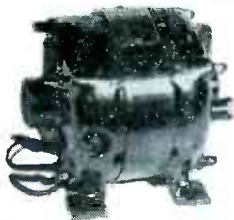
32 Volts DC to deliver 350 Volts, 1500 cycles; 275 va. Ball bearings. Frequency controller built-in.

Special Price **\$25**



Same machine with frequency control built-in, operative at 32 volts to deliver 110 volts, 60 cycles; 165 va. **\$22**

General Electric DC to AC Converters

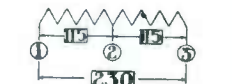


Has name plate designated as Markum (Multi-plex Rotor). This little converter operates at 115 Volts, DC.

Delivers at 70 Volts, AC. 10 3600 speed. Output 100 F. **\$4.40**

GENERAL ELECTRIC

Autotransformers for General Light and Power Service
Autotransformers are more economical and smaller than a two-winding transformer designed to carry the same load. They cannot be used for insulating one circuit from another, but will perform all of the other functions when the voltages involved are either 230 or 115 volts.



VOLTAGE (Auto Type)
220 - 110
230 - 115
240 - 120

Special Price **\$21.45**

Brand New **5 KVA**

Fig. 1 Type M transformer
Care should be exercised before installing autotransformers to be sure that the installation will meet local electrical inspectors' requirements.

An auto transformer consists of a single winding on a laminated steel core which is connected across the two-wire alternating current supply line. A midway tap, providing predetermined voltage is used as one of the secondary lead connections. For use only on two-wire circuits, auto transformers provide extremely high efficiency.

HOLLOW CAPACITORS



Unusual do-nut design of these capacitors affords opportunity to save considerable space by placing this capacitor over

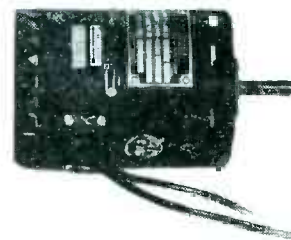
another part in the same manner as placing sleeving. Manufactured by leading named concerns. Two ratings are available 1.0 mfd @ 120 V.D.C., and .92 mfd @ 120 V.D.C. When ordering please specify ratings desired.

10 for 25¢ 100 for \$1.75 1000 for \$10.

BAKELITE SHEETS

Black laminated paper base. 38" long x 40" wide x .0136" thick. Manufactured by U. S. Plywood Corp. Have many uses.
Sheet **45c** 10 sheets **\$4.00**

WESTINGHOUSE MOTORS



Series wound, 24 Volts DC, rated at 1/8 HP, 6.5 amperes, 5800 RPM, cont. duty flange mounted. Physical size 4 3/8" long x 3 1/8" diam.

eter with shaft 1 1/4" long x 5/16" diameter. On rear of motor is attached an impeller assembly for cooling off the motor

Our Special Price, Each **\$3.15**

NEW 112 Page Catalog

Packed from cover to cover with thousands of amazing values in a \$500,000 stock. Distribution must be limited to requests on company letterheads. Address Dept. E. 5 Boston 10, Mass.

All prices F.O.B. Boston. Orders accepted from rated concerns with open accounts. Net 30 days.

ELECTRO SALES COMPANY

110 PEARL STREET, BOSTON 10, MASS.

"TAB"

That's A Buy

STROBO FLASH AN/#1503/TWO LAMPS
Invt 12V, Complete power supply, Cables & batteries & 2 KRYPTON lamps intensity lamps 12,000,000 lumens..... \$98.50

STROBO FLASH #1503 CONVERTED TO 115VAC & 3 KRYPTON lamps mtd in Reflectors & check bulbs..... 198.50

STROBOFLASH KRYPTON lamps & Inghtn Transf. ; 12,000,000 LUMENS/15 to 30,000 flashes, sealed New..... 2 for 21.00

CONDENS STROBOFLASH 8mf & 660 VAC/2000WVDC/32mf/4 units..... 11.50

EXT CORD Hvy Duty/SJ/16/M&E Plugs..... .98

MILLEN 150mmf/3000V Variable Condns..... 1.00

CERAMICONS .001 or .0001mf..... 12 for 1.00

E6E6E TELEPHONE TEST SET & RINGER..... 19.95

EES TELEPHONE W/HANDGEN RINGER..... 2 for 9.95

WE D168435 1/2microsecond,555ohms 30MMF..... 4.50

Millen 1Microsecond delay line..... 2.95

XBAND WAVEMTR 9290-9470 Mc's..... 16.95



PRECISION RESISTORS for METERS BRIDGES, AMPLIFIERS ALL STANDARD MAKES

*.34%	*.5%	1.0%	(Rest 1%)
2000**	4300**	5100**	12000**
30000**	84000**	150000**	230000**
245000**	250000	950000	1155
ABOVE SIZES 20c. EA ASSTD.....10 FOR \$98			
.116	89.3	580	2580 8500
.42	100	1150	2600 9000
.7	105	612	2635 9445
1.3	101	640	2700 9710
1.75	107	700	2860 10,000
2	113.1	733	2900 10,500
3	120	750	3000 12,000
4	125	800	3100 14,460*
4.35	150	910	3384 15,000
5	160	1000	3500 15,000
5.025	165	1030	3730 17,000
6	170	1110	4000 17,000
7	182.4	1150	4300 18,000
7.5	200	1155	4440 19,000
7.8	209.4	1175	4444 20,000
8	230	1225	4500 20,520*
8	235	1250	4720 21500
10	240	1260	4850 22,000
12	245.4	1320	4885 23,000
14.5	260	1350	4900 24,000
20	260	1500	5000 25,000
25	280	1510	5000 29,900
26	286	1600	5100 30,000
30	299	1640	5270 33,000
37	300	1700	5300 37,000
40	320	1800	5730 40,000
45.1	340	1830	6000 50,000
49	400	1865	6200 54,400*
49	418.8	1900	6300 60,000
50	426.9	2000	6500 65,000
55	440	2080	7000 68,000
58.7	452	2142	7500 75,000
60	480	2300	7700 80,000
71.4	487	2400	7950 84,000
75	500	2485	7950 90,000
80	520	2490	8000 91,000
81.4	540	2500	8250 95,000
ABOVE SIZES EACH .45c.....TEN FOR \$3.00			
0.1 MEG	16675	MEG.25	MEG.4
1	176	.254	.402
1.12	.185	.265	.422
1.13	.201	.268	.458
1.135	.22	.294	.478
1.14	.229	.314	.57
1.14	.245	.335	.575
1.15	.25	.335	.9
ABOVE SIZES EACH 60c.....TEN FOR \$6.00			
1 MEG	2	4	5
1.2	2.855	4.23	9.05
1.579	3	4.5	10
1.8	3.673		
ABOVE SIZES EACH 90c.....TEN FOR \$6.95			

VICTOREEN VACUUM PRECISION RESISTORS

83MEG, 1MEG, 1.5MEG, 2MEG, 3MEG, 3.75MEG, 1/2 of 1% ACCY H1VOLTS AT \$1.00, TEN FOR \$7.50

IRC NAVY PRECISION 1MEG, 1/2 OF 1%..... 1.69

IRC NAVY WW 2MEG, 1/5 OF 1% HV..... 4.95

GE RF METER I or 5 Amp/2 1/2 B/C ea..... \$3.95

GE GALVO 2.5&25ma 0 Center/3 1/2 B/C..... 3.95

GE 2KV/1000ohmsV & RESISTOR..... 5.95

WESTGHE 30VDC/2 1/2 B/Cased..... 2.49

WST IND 0-100&100-60/200microma..... 3.95

WST 0-150VAC/2 1/2 B/Csd..... 4.50

W.E. 200 or 500VDC/1000ohmsV/3 1/2 B/C..... 4.95

WESTON 4" TWIN GALVO 10&40ma/5%..... 12.95

SYNCH CLOCK MOTOR IRPM/115V/60cy..... 2.49

SYNCH CLOCK MTR 24RPM/10V/60cy 89c..... 10 for 7.50

DYNMTR 6Vin/Out240V/100ma or 12&24 Vin 500V/50ma PM New Navy..... 3.49

DYN 28 Vin/outs/10V/250ma used LN*..... 2.50

DYN 12&24Vin/275V/110ma/P/Magnet..... 1.95

DYN 28Vin/Out250V/60ma..... 2 for 1.98

DYN 12&24Vin/220V/100ma&440V/200ma..... 5.95

DYN 24Vin/300V/260ma/150V/10ma 14.5V/5 Amp..... 4.95

PE 94 Same as above Plus Filters & Start..... 9.95

GE GLYPTAL #1276 Cement GALLON..... 4.95

RELY ALLIED JB/OPDT/6VDC/5A..... .95

7500V or 15000V Doubler/35ma..... \$15.95

10800VCT or 21600V Doubler/95ma..... 19.95

3000V/10ma \$4.50; 2100/10ma..... 3.95

1320V/375VCT/110ma 5V/3A, 2.5V/3.25A & 3.3V/2.75A Cased HV Instd..... 7.95

1350VCT/150ma, 6.3V/5A, 5V/2A UTC..... 6.95

640VCT & 1250V/250ma \$4.95..... 2 for 8.95

500VCT/60ma, 6.3V/4A Hmtelly Cased..... 1.29

1100VCT/212ma \$5.95; 10V/8A/12KV..... 6.95

5V/115 Amp..... 9.95

1000VCT/45ma, 795VCT/80ma; 3x5V/3A & 6.3 VCT/1A, 6.3VCT/3A HV/Hmtelly Csd..... 4.95

7.5VCT/6.5A, 6.3VCT/3A..... 3.75

700VCT/150ma; 10V/3.25A, 2.5V/10A & 6.3VCT/2A, 5V/3A HV Instd CASED..... 5.50

115 or 230V/10Amp/2KW Transformer..... 19.95

115 or 230V/8Amp/1.8KW Auto Transf..... 14.95

110 or 220 or 220 or 440V/190W..... 4.50

2.5V/1.75A, 4V/6A/20KV Cased..... 5.50

TRANSFORMER ONLY for Two 866A's..... 3.95

872A's COMBINATION TRANS Sockets..... 12.00

872A TRANSFORMER 115 60cy..... 6.95

866A COMBINATION Tubes, Sockets..... 5.95

720/20ma, 5V/3A, 6.3V/3A CASED..... 2.95

220Vin/7.5V 21A/HV CASED..... 2.95

220Vin/10VCT/5A or 110Vin/15VCT/5A..... 3.95

570VCT/180ma, 5V/3A, 12V/4A CSD..... 2.95

510VCT/125ma, 5V/2A, 6V/4A CSD..... 3.25

TRIPLET TUBE CHECKER TRANSF..... 2.95

220 to 440V-or-110 to 220V/250 Watt..... 4.95

AUTOTRAN 6V/2A, 150V/1.6A, 35V/1.2A..... 3.95

SEL RECT TR/115V/60c. 42.5V/2A..... 4.25

CHOKES

15-29HY/150ma SWINGING CASED..... 2.95

12Hy/300ma \$3.95; 3Hy/40ma..... 3 for 1.00

15Hy/400ma or 20Hy/300ma/15KVins..... 7.95

RS4/APR4-UHF RCVR&COIL RANGE 300 to 4400mc's NEW COMPLETE With TUBES & POWER SUPPLY 115V/60 VAC/60at200cy's Includes COIL RANGES TN18-19 & 5A..... \$398.50

TN19 TUNING COIL & OSCILLATOR ASSY RANGE 1000 to 2200mc's for 30mc's IF..... 49.95

ANTENNA TUNING UNIT & PI NETWORK 1001A/1500 to 7000 KC/1KWRF-adjustable in & Outpt. Complete Meter, Coils, Condenser CASED NEW & Tech Manual..... 12.95

EEL8 SOUND POWERED RINGER & HANDSET NEW GTD..... 39.95

SOUND POWERED HAND SET..... 21.95

BATTERY STORAGE BB52/BR18 nonspil Plastic 36 Volts designed for portability & Guided missiles \$3.95 @ Five for 18.00

CONDENSER OIL RATED WVDC CD TAPPED 2.5 & 3mf/200 V..... 15 for \$1.50

CD 2mf/330VAC/1000WVDC..... 5 for 1.98

5mf/600VDC/220VAC & brackets..... 2 for 1.49

7mf/600V 89c; 10mf/600V..... 1.25

3.3mf/225VAC \$1.25; 4mf/600V..... .49

20mf/600V \$2.50; 4mf/330VAC/1000V..... 1.39

15mf/330VAC/1000V \$3; 2mf/2000V..... 2.25

3mf/200V \$3; 4mf/3000V..... 5.00

2mf/5000V \$10; 4mf/5000V..... 15.00

2mf/12500V \$25; 1mf/2500V..... 75.00

1mf/4000V \$3.75; .00025mf/25KV..... 4.95

2x1mf/400V/12 for \$1; 3x.1mf/400V/10..... 1.00

1mf/400V/12 for \$1; 2mf/400V/5 for..... 1.00

1mf/500V/10 for \$1; 1mf/500V/8 for..... 1.00

.05mf/600V/30 for \$1; 2x.05mf/600V/25 for..... 1.00

3x.05mf/600V/15 for \$1; 3x.2mf/600V/12..... 1.00

1mf/600V/10 for \$1; 2x.1mf/600V/8 for..... 1.00

3x.1mf/600V/8 for \$1; 2x.25mf/600V/6 for..... 1.00

1mf/1000V/4 for \$1; .25mf/1000V/4 for..... 1.20

GIBSON G1FL SCR 278 COMPLETE..... 19.95

BALLON 4 Ft & Hydrogen Gas Generator..... 4.50

BOX KITE NYLON..... 3.00

BC1073 WEMETER 150-210mc's LN*..... 10.95

BC230 XMTR 2.5 to 7.7mc's LN*..... 5.95

RADIO COMPASS RCVR BC133/MN26 LN..... 21.95

AP513/RCVR&XMTR 410mc's/Less Tbs..... 12.95

RT-APN-1 ALTIMETER LESS TUBES LN*..... 6.95

BC457-458 LN* W/CONVERSION TO 40 MTR or 80 MTR..... 5.95

BC456 MODULATOR LESS TUBES LN*..... 1.69

BC212 TANK INTERPHONE&TUBES DYN..... 3.95

BC191/BC375 ONE TU & TUBES LN*..... 9.95

FM TUNER & TUBES HI GAIN & PWR..... 69.95

SELENIUM 40SD2625/100ma SEL RECT..... .90

SELENIUM 300V/40 ma Rectifier F'Wave..... .81

***LN-Like New Used GOOD GUARANTEED. PRICES SUBJECT TO CHANGE**

"TAB" MONEY BACK GUARANTEE. \$5 MIN. ORDER F.O.B. N.Y.C. ADD SHIPPING CHARGES & 25% DEPOSIT. \$5 MIN. ORDER.

"TAB" X'DIODE & FUSE HOLDER. 4 for \$ 1.00

CRYSTAL DIODE IN21A 22 23A, 25 26..... 1.00

NEW boxed lead sealed G'Insp \$1@..... 12 for 1.00

IN23B X'DIODE \$2.00@..... TEN for 17.50

IN34 GERMANIUM DIODE \$1.10@..... 10 for 9.80

THERMISTOR WE/D168391 DISC @\$.2..... 3 for 5.00

THERMISTOR WE/D170396 BEAD..... 3 for 2.50

THERMISTOR WE/IC VACUUM BULB @90c..... 3 for 2.50

MICROSWITCH NEW SPST..... 2 for .39

MICROSWITCH SPDT 40c@..... 10 for 4.00

MICROSWITCH LEAF or ROLLER 85c..... 2 for 1.50

MICROSWITCH PLUNGER TYPE..... 2 for 1.50

85c@..... 2 for 1.50

MICROSWITCH INDUSTRIAL CASED \$1@..... 2 for 1.75

SWITCHETTE GE 49c@..... 5 for 2.00

TOGGLE SWITCH SPST 25c@..... 10 for 2.15

TOGGLE SWITCH SPDT 29c@..... 10 for 2.50

TOGGLE SWITCH SPDT/off pos 45c@..... 10 for 4.00

TOGGLE SWITCH SPST/15A/UL..... 10 for 3.65

TOGGLE SWITCH 3PDT/6A 98c@..... 10 for 7.95

TOGGLE SWITCH DPST 25A/125V \$1.25@..... 10 for 10.00

SWITCH DPDT/60A/600V, 250A, 125V \$2.49@..... 2 for 4.49

"TAB" FOR TUBES

0A4G..... \$.90	35Z5..... \$.61	9003..... \$.49
OZ4..... 1.20	35L6..... .74	9004..... .49
1B3/801B..... 2.00	50L6..... .72	9006..... .49
1B7G..... .98	80..... .52	2AP1..... 1.95
1L4..... .98	83V..... 1.25	2AP1A..... 4.95
1P5G..... .79	OC3 VR105..... .74	3AP1..... 3.25
2C4C..... .73	OC2 VR150..... .74	3BP1..... 1.98
2D21..... .98	211..... 1.98	3DP1..... 2.98
2X2..... .45	250TH..... 18.00	3FP1..... 2.98
2Y3G..... .98	250TL..... 18.00	3GP1..... 3.95
3A4..... .75	304TH..... 3.95	3JP12..... 3.95
3B7/1291..... .95	304TL..... 2.49	5AP1..... 2.75
3D6/1299..... .95	307A..... 3.75	5BP1..... 3.75
384..... .90	393..... 5.95	5BP4..... 3.75
5R4G..... 1.00	446A..... 1.98	6CT1..... 3.75
5T4G..... 1.53	450TH..... 25.00	6FP1..... 3.95
5W1..... .69	450TL..... 29.95	5HP1..... 3.95
6Y1..... .95	W1L531..... 9.95	7BP7/1813..... 3.95
6Y3G..... .53	703A..... 4.95	9JP1..... 3.95
5V4G..... 1.00	717A..... .89	12DP7..... 5.95
5Z3..... .80	723..... 2.95	1B24..... 2.95
6A4..... 1.00	723AB..... 4.95	1B24..... 2.95
6A4Z..... .98	725..... 4.95	1P24..... 2.95
6AC7..... .72	803..... 7.95	2E22..... 1.50
6AC5..... .97	804..... 8.95	10Y..... .59
6AG7..... .98	805..... 4.95	15E..... 1.49
6AJ5..... .98	807..... 1.49	2C28..... 3.95
6AK5..... .81	808..... 1.95	2C34 MK31..... 4.9
614G..... 1.29	810..... 5.75	3B24..... .74
618G..... .98	811..... 2.49	3C23..... 4.95
6C4..... .39	813..... 8.90	24G/3C24..... .67
6C5..... .75	814..... 2.92	2J21..... 12.75
6C6..... .73	815..... 3.95	2J32..... 16.95
6C8G..... .98	816..... 2.15	2J34..... 18.00
6C9..... .81	817..... 1.45	2K09..... 4.95
6D6..... .74	828..... 10.00	HK24/3C24..... 8.1
6E5..... .98	829B 3E29..... 3.90	631P1/8N4..... 3.75
6E6 1613..... .69	832..... 2.25	CK1005..... .30
6F6..... 1.20	836..... 1.00	CGJ..... 4.95
6F8..... .98	837..... 2.25	12T7A..... 12.00
6G5 6115..... 1.08	845..... 4.95	T200..... 12.00
6H6..... .48	860..... 2.49	4J47..... 35.00
6H6M..... .68	861..... 9.00	RN215..... 9.95
6J4..... 1.98	864..... 1.00	CE215..... 5.95
6J5..... .72	865..... 1.00	CE208..... 3.95
6J6..... .81	868..... 1.00	FG14..... 14.95
6J7..... .98	872A..... 2.20	FG105..... 16.95
6K5G..... 1.10	884..... 1.10	5D21..... 19.00
6K7..... .78	922..... 1.49	TUNING R*.....
6K8..... 1.20	923..... 1.39	19969R*..... 2.95
6L6..... 1.24	931A..... 2.49	20X672*..... 2.95
6L7..... 1.16	954..... .49	289881*..... 2.50
6L7..... 1.23	955..... .49	MAZDA PL*.....
6N7..... 1.20	956..... .49	44*B*Box..... .40
6N7..... .98	957..... .49	47*B*Box..... .50
6N7..... .84	958A..... .49	49*B*Box..... .60
6N7..... .95	1613..... .69	59*B*Box..... 1.40
6N7..... .38	1614..... 1.50	SOCKETPS.....
6N7..... 1.79	1616..... 2.75	60M 6 for 1.00
6N7..... 1.00	1619..... .39	866..... .24
6N7..... 1.49	1822..... 1.49	872/211..... .49
6N7G..... .69	1624..... .79	803/301..... .40
6N7..... .89	1625..... .39	813..... .90
6N7..... .74	1626..... .45	829/832..... .25
6N7..... .98	1629..... 1.39	807..... .24
6U7G..... .78	1635..... 1.90	705/715..... .69
6X5..... .87	1641..... .84	Magnal..... .49
6Y6G..... .88	2050..... 1.18	Dheptal..... .69
12A6..... .29	2051..... .88	2X218V..... .30
12A7..... 1.00	7193..... .49	
12A7..... .79	8005..... 4.25	TUBES GTD.....
12SH7..... .88	8012..... 3.95	except open Fil.
12SK7..... .88	9001..... .49	
25Z5..... .70	9002..... .59	& breakage

FO

SURPLUS BARGAINS!

WESTON MODEL 271

Large Fan Shaped Microammeter



Another of the famous Weston fan shaped line. Very large scale 5.8" long. These meters were made by Weston to General Radio specifications, with special mirrored scale and knife edge pointer. Accuracy 1%.
0-600 Microamps
170 M.V.
Coil Res: 250 Ohms

Your Price \$12.50
10 for \$100.00



PORTABLE A.C. AMMETER WESTON #528

Double range ammeter. 0-3 Amps and 0-15 Amps. Two of the very useful ranges for your Lab. or shop. Complete in genuine leather case with test leads.

Your Price \$12.25

TRANSTATS—3 K. V. A.



Type RH Input: 115 V 10%. Output: 115 V. Max. Amps: 26 A. Made as a line voltage corrector 10% of input voltage, or can be connected to give plus 20% or minus 20% of input. Can also be reconnected to be used as an isolated type stepdown with variable secondary. Input: 115 V. Output: 0-30 Volts at 30 Amps. No Knob.

A Real Buy at \$18.00
(same type, but .25 KVA. Input: 103-126 V. Output: 115 V.-2.17 A.)

Price \$6.50

STEPDOWN TRANSFORMER



Made by General Electric. Heavy duty stepdown transformer, with considerable overdesign. Ideal for rectifier applications, low voltage heating, general laboratory use, etc. Open frame type.

Input: 115 Volts—60 Cycles
Output: 15 Volts (at full load)
Capacity: 180 V.A.
Size: 3 1/2" x 3 1/2" x 4"

Your Cost \$3.75

Quantity prices available

HEAVY DUTY STEPDOWN TRANSFORMERS

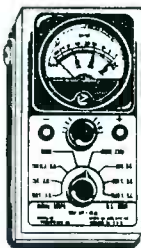
Input: 115 V. (with 8 taps in primary).
Output: from 18 to 10.5 V. (in 8 steps).
Capacity: 1.25 KVA—Sec. Amps: 100.
Size: 13"x10"x5". Approx. Weight: 30 Lbs.
Open Frame Construction.

Your Cost \$12.50
10 for \$100.00

POWER TRANSFORMER

Pri—440/220 V 60 Cy Sec—125/115/105 V
Rating .3 KVA RCA Open construction.
Bracket mounted, pri & sec terminal boards.
Overall dimensions: 5 1/2" H x 7 1/2" W x 8"D.
Mounting dimensions: 6 3/4" x 5 3/8". Price

\$12.50



VOLT—OHM—MILLIAMMETER

Made by Triumph Mfg. Co. to Signal Corps Specs—Test Set 1-77-H.
Ranges:
Volts DC—0-30/300/1500
Volts AC—0-15/150
Ohms—0-1000
0-300,000
M.A., DC—0-150
Equipped with snap-on carrying handle—size 5 1/4" x 3 1/2" x 2 3/8". Your Price \$8.50

D.C. MICROAMPS 0-100 Microamps, res. 100 Ohms 3" Rd. Westinghouse NX/35 \$7.95

D.C. AMPS & MILLS

0-1 Ma 2" G.E. DW41 (special scale)	\$2.95
0-1 Ma 2" Weston 506	3.75
0-2 Ma 2" Sun 1AP525-5	2.25
0-2 Ma 3" Weston 301	5.95
0-3 Ma 2" Weston 506 with metal case	1.85
0-5 Ma 2" Dejur S-210	1.95
0-25 Ma 2" G.E. DW41	2.95
0-30 Ma 2" G.E. DW41	2.95
0-100 Ma 2" sq. Simpson 127	2.95
0-100 Ma 3" Weston 301	4.95
0-500 Ma 2" G.E. DW41	3.25
0-1 Ma 3" sq. Westhe RX-35 (Scale: 1.5 KV)	4.25
0-1 Ma 3" G.E. DO-41	4.95
0-15 Ma 3" Westhse NX-35 (scale: 15/150/300)	2.95
0-30 Ma 3" Weston 301 (Metal)	3.75
0-1 A. 3" sq. Weston 301	5.50
0-10 A. 3" sq. Triplett	2.50
0-10 A. 3" Simpson #25	4.50
0-30 Ma DC G.E. DO-58, 4 1/2" x 4" (Black or White Scale)	4.95
20-0-30 A. 3" Simpson 25	4.50
0-30/120/600 Ma Weston Portable-Model 280—Precision Type	5.95
0-300 A. 3" Roller-Smith (fl. bake. Type TD-50 MV) (with ext. shunt)	4.95
0-300 A same as above. (without shunt)	2.25

D. C. VOLTS

0-15 V. 2" Westhse BX-33 (Black scale)	2.75
0-20 V. 2" Weston 506 (1000 Ohms per Volt)	2.95
0-15 V. 3" Westhse. CX-35 (with ext. shunt)	3.95
0-40 V. 2" Weston 506	2.95
0-150 V. Weston 301 (Black scale-metal case)	4.50
0-150 V. 3" G.E. DO-41	4.75
0-150 V. 4" Weston 643 (Black scale—flush—metal)	6.75

A. C. VOLTS

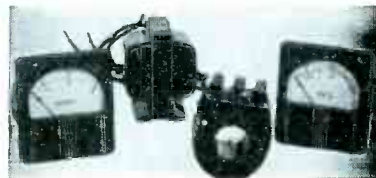
0-10 V. 2" G.E. AW-42	\$2.95
0-10 V. 3" G.E. AD 25	3.75
0-150 V. 2" Simpson 155 (metal case)	2.95
0-150 3" G.E. AO-41	4.50
0-150 V. 3" Simpson 55	5.95
0-300 V. 4" sq. Triplett (431A 300/600 V. scale)	3.25

A. C. AMPS

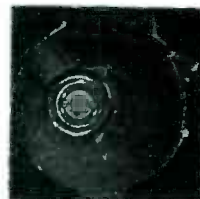
0-1.5 A. 2" Weston 507 (RF)	\$3.50
0-3 A. 3" Westhse NA-35 (scale: 120 A.)	3.95
0-30 A. 3" Triplett (metal)	2.95
0-5 A. 4" Weston 642 (surf.) (Surface-metal)	7.95
0-5 A. 4" sq. Triplett 431A (scale: 150/300)	2.95
0-75 A. 4" Weston 642 (Surface Metal Case)	6.75

All meters are white scale flush bake-lite case unless otherwise specified.

A.C. VOLT-AMMETER SET



Westinghouse RA-37—4" Sq. 0-300 Volts AC Scale: 300/600 Volts A.C. With Potential Transformer for 600 Volt Range \$10.00
Westinghouse RA-37—4" Sq. 0-5 Amps AC. Scale: 75/150 Amps A.C. With Donut Current Transformer for Double Range 75/150 to 5 \$10.00
Price: for ALL 4 PIECES \$17.50



HEAVY DUTY RHEOSTAT

10 ohms — 9.2 Amps — 9.2 Amps (Not tapered). 1 1/2" Dia. Complete with handle and legs for rear of panel mounting.

Your Cost \$5.95

RECTIFIER TUBES

6 Amp. (Tungar type) for battery chargers, rectifiers, etc.

Your Cost \$1.50
(minimum order of 10 tubes)

SELENIUM RECTIFIERS

Full Wave Bridge

Approximate Rating

Federal Type #	Input Max.	Output Max.	Amps.	Price
10B1CV1	18 V.	14 V.	.5	\$3.98
10B2CV1	36 V.	28 V.	.5	1.50
4B3CV2	48 V.	36 V.	1.6	2.75
5B2AV1	36 V.	28 V.	1.6	4.25
5B2AV5	36 V.	28 V.	8	11.75
11BAFAM1	120 V.	100 V.	1.6	11.95
9DO612R	150 V.	115 V.	1.6	14.50

CAPACITORS

Cap. Mfd.	Volts D.C.	Height	Weight	Length	Price
10	1000	5-7/8 x 1-3/4 x 3-7/8"			\$1.85
4	1000	5-7/8 x 2-3/4 x 1-1/4"			.85
1	1000	3-5/7 x 2 x 1-1/16"			.50
1	500	2" x 1-1/4" x 1-1/16"			.25
25	1000	1-1/2 x 1" x 3/4"			.25

CAPACITORS

.001 Mfd.—50 K.V. DC.—5 1/2" x 7 3/4" x 4" \$12.50
Insulators 4" Dia. x 7" High.

.1 Mfd.—25 K.V. DC.—13" x 7" x 4" \$9.85

STRUTHERS-DUNN RELAYS

D.P.S.T. Normally open, 115V, 60 Cycle, A.C. coil, 30 Amp contacts, fibre base with 4 holes for mounting. Dimensions: 4 1/2" L x 3 1/2" W x 2 3/8" H.

A Real Buy At \$2.50

OHMITE POWER TAP SWITCH

Non-Shorting, Model 312, Cat. #312-10, 25 Amps A.C., 10 taps, without knob. Dimensions: 3 1/2" H x 4" D x 1" W.

Your Price \$1.50

HEINEMAN CIRCUIT BREAKER

For use with low voltage, D.C., 100 Amps. Dimensions: 3 1/2" H x 4" D x 1" W.

Your Price \$1.75

FREQUENCY METER

Range 58-62 Cycles, Biddle type mfg. vibrating reed, 9 reeds, 115 V, 3 1/2".

Your Price \$5.95

FREQUENCY METER

Range 350-450 Cycles, Weston 637, air-craft type, 3 1/2".

Complete \$4.95

ALL PRICES INDICATED ARE FOB, OUR WAREHOUSE, NEW YORK, N. Y.

Shipments Transportation Charges Collect Will Be Made Via Railway Express Unless Sufficient Postage Is Included, Or Other Instructions Issued. We Will Refund Excess Postage In Stamps.

POWERTRON Electrical Equipment Co.

117 LAFAYETTE STREET

Phone: Worth 4-8610

NEW YORK 13, N. Y.

SPECIALIZED ELECTRONIC MATERIAL

HIGH QUALITY • LOW PRICE • IMMEDIATE SHIPMENT

RELAYS

Isolantite Relay D.P.D.T. Heavy Contacts Coil 100 ohms, 12 Volts D.C. Price \$.75

Telephone-Type Relay #452-1043 Single Throw—Normally open Dual winding coils 180 ohms each Price \$.95

Telephone Type Relay #D4544 D.P.S.T. Coil 1000 ohms Price \$.95

Heavy Duty Relay Consists of two S.P.D.T. Micro-switches mounted on a 3000 ohm telephone-type relay. Microswitch Contact ratings 10 amps at 120 volts A.C. Price \$1.25

G.M. Relay D.P.D.T. plus S.P.S.T. Normally open coil 30 ohms Price \$.65

Western Electric #KS 10149 60 second Time Delay Relay Cramer Motor 115 volts 60 cycles Switch S.P.S.T. 15 amps Price \$4.95

Telephone Type Relay—Western Electric Dual Contacts D.P.S.T. normally closed Coil 200 ohms Price \$1.25

Telephone Type Relay #D161984 Dual Contacts Six Pole Double Throw Coil 700 ohms Price \$1.25

Telephone Type Relay 4 P.S.T. Normally open Dual Winding Coils 200 ohms each winding Price \$.95

Telephone Type Relay #DB28091 Dual Contacts 4 P.S.T. Normally open Dual Winding Coil 175 ohm and 180 ohm Price \$.95

Miniature Relay #D4913 S.P.D.T. Coil 300 ohms Price \$.55

Relays Allen Bradley Bulletin-810 Magnetic Overload Relay Dashpot type 28 amps continuous adjustable range 15-43 amperes, S.P.S.T. N.C. 600 Volts Max. Price \$1.95

Allen Bradley Bulletin-810 Magnetic Overload Relay Dashpot type, 15 amps, continuous adjustable range .095-.28 amps, D.C. Resistance 300 ohms S.P.S.T. N.C. 600 Volts Max. Price \$1.25

Western Electric Stepping Selector Relay #D86522 20 position indicating switch coil resistance 20,000 ohms Price \$6.25

Struthers Dunn S.P.D.T. Relay 36 Volt coil—20 ma. Contacts 2 amps at 115 V.A.C. Price \$.95

Relay—D.P.D.T. Heavy contacts Coil 6 volts D.C. 18 ohms Price \$.95

Allied Control #B06D35 D.P.D.T. Coil 26 Volts D.C. Contacts 10 amps. A.C. at 115 Volts Price \$.95

Allied Control #BOY-X5 Coil 6 Volts D.C. Contacts D.P.D.T. plus SPST N.C. Heavy contacts Price \$.95

Aircraft-type Starter Relay Hermetically sealed coil 12 Volts 18 ohms Very heavy contacts Price \$.75

Aircraft-Type Starter Relay Leach type #7220-3-24 Coil 24 Volts D.C. Res. 132 Ohms Very Heavy Contacts Price \$.75

Adlake Relay #2011 S.P.S.T. N.O. Coil Volts 9 50/60 cycles Price \$.95

Weston Sensitrol Relay Mod. 705 7-0-7 Micro-amperes Price \$3.95

Cramer Time Delay Relay #44SP3 N.L. Motor 115 Volts 60 cycles Two Poles Switch 115 Volts at 10 amps Price \$4.95

Relay S.P.S.T. WE Co. #D163781 Coil with special glass sealed switch. Whole unit encased in vacuum tube shell which is filled with wax & attached to a 4 pin octal base. 2 pins term for coil, two for switch, 2500 ohm 10 V.D.C. Operating current 4.3 ma, release current 2.5 ma, cont. rating 1 amp. Price \$1.95

Relay-Switchboard WE Co. #D164816 3 windings Price \$2.95



TRANSTAT VOLTAGE REGULATORS

Manufactured by Amertran, three Models are available

Model #TH 2 1/2 B
Fixed Winding 230/130
Commutator range 0-260 Volts. .65 KVA.
Max. amp. 2 1/2 Price \$19.95

Model #29144
Fixed Winding 115 Volts—60 cycles
Commutator range 103-126 Volts
Maximum output .25 KVA
Housed in shielded case 5" x 6" x 6" Price \$8.95

Type RH
Fixed Winding 115 Volts—400 cycles
Commutator range 75-120 Volts
Load — .72 KVA
Housed in Shielded case 5 1/2" x 6" x 6 1/2" Price \$3.95

TUBES

(New surplus priced for quick sale)

Type	Price	Type	Price
1B24	\$2.95	801A	\$.45
2C46	4.95	954	.45
2134	9.75	957	.45
2155	9.75	1629	.20
3B24	.55	9002	.35
3B25	.55	9003	.18
3C23	2.45	9006	.35
4B27	2.95	50	1.25
5D21	9.95	VR90	.75
4C33	2.95	VR105	.75
5U4	.45	VR78	.65
6E5	.60	1626	.65
6F8	.95	1629	.25
6H6	.45	1R4	.65
6S17	.45	1631	.65
6Y6	.65	1632	.25
23D4	.35	1633	.65
45	.55	1644	1.25
RK60	2.95	7193	.45
VR78	.45	866 A	.95
HY114B	.45	28D7	.45
350B	4.95	724B	1.95
388A	4.95	RK72	.75
394A	2.95	RK73	.45
705A	1.95		
RCA 836			.75
Sylvania 3 D6/1299			.75
GE VU111/10E146			.45
Raytheon CK1005			.85
Raytheon 2J37 Magnetrans			6.50
872A	1.95	EIMAC-KY21	1.95
Amperite Regulator		(Grid-Controlled	
13-4	.65	Mercury-Vapor	
SCPI	4.95	Rectifier)	
725A	4.95	Sylvania SC968	.25
GE PJ23			
Phototube 2.95			

RELAYS

G.E. 2 circuit; coil 10 volts DC contacts 50/20 amps 115 volts AC Price \$.85

Oak Rotary type 8-28 volts DC 3 single break, 3 make—1 break and make. Price \$.85

G.E. #D106F3, coil 180 ohm, 24 volts DC Double Pole, Double throw Price \$.65

Allied #B012D 180 ohm coil, 20 volts DC 4 Pole double Throw Price \$.65

Allied #73B60, miniature type 26 volts Double Pole, Double throw, Isolantite spacer Price \$.95

Clare #814680—Miniature, 300 ohms, 24 volts DC Four Pole—two throws Price \$.95

Leach #1054, coil 260 ohms, 24 volts DC Heavy contacts, two pole single throw + Holding contact Price \$.95

RCA Vacuum Relay, Relay contacts will break 3000 volts and carry 10 amperes Solenoid resistance 200 ohms, 24 volts DC—Excellent as R.F. antenna relay Price \$.95

Clare #818062—2 Pole single throw, Miniature type, Resistance 140 ohms. Will operate from 10 volts DC or 20 Volts AC. Price \$.95

Telephone type RBM #556-881
Double contacts, double-pole, double-throw Coil 14000 ohms. Price \$.95

Telephone type RBM #556-882
Double contacts, double-pole, double-throw, plus single-pole, single-throw normally open. Dual winding coil, each winding 170 ohms. Price \$.95

Telephone type RBM #556-883
Double contacts D.P.D.T. plus 2 S.P.S.T., one normally open, other normally closed. Dual winding coil, each winding 170 ohms. Price \$.95

Telephone type RBM #556-884
Double contacts, 2- S.P.S.T., one normally open, other normally closed. Dual winding coil, each winding 170 ohms. Price \$.95

TIME DELAY RELAY

Thermal vacuum type
S. P. S. T. 100 ohm coil
24 Volts AC/DC
90 second delay Price \$.95

Leach type 1154 D.P.S.T. Heavy contacts coil 50 Volts 50/60 cycles Price \$1.25

Leach type 1054-32 D.P.S.T. Heavy contacts Coil 32 volts D.C. 675 ohms. Price \$.75

Struthers Dunn #61BX104 D.P.S.T. Coil 12 Volts D.C. Contacts 25 amperes at 12 Volts D.C. Price \$.95

Struthers Dunn CDBX-1 D.P.D.T. Coil 115 Volts 60 cycles Contacts 115 Volts A.C. At. 6 A. Price \$1.25

Allied Control #D0X8 4 Make 4 Break, Heavy Contacts Coil 18 turns # 10 enamelled wire Price \$.75

HIGH FIDELITY INPUT TRANSFORMERS

Ferranti #4794 Balanced winding, shielded type. Description—Turns ratio step-up 2/1 primary inductance 133 Henrys ± 1 DB 60-9000 cycles. Can be used to match any single or push-pull plates to any single or push-pull grids—overall dimensions 2 1/4" x 3" x 2 1/2". Price \$1.75

400 CYCLE TRANSFORMERS

Brand New, Surplus, Standard Manufacturers.

Filament—Primary 115 Volts 400 cycles, Secondary 6.3 volts 2.5 amps. Price \$.75

Scope Transformers—Primary—115 Volts 400 cycles, Secondary 3300 Volts 5 MA 2.5 Volts 1.75 amps Price \$2.95

4000-6000 VOLT LOW CURRENT DC SUPPLY

These units have been designed for use with television, cathode ray, electron multiplier and other types of equipment requiring high voltage with currents up to 1 milliamperes. Brand new completely wired and tested. Ready to operate from 115 volt power line. D.C. output is filtered. Price Complete \$12.50

2000-3000 Volt D.C. Supply, similar to above, but with lower output voltage. Ready to operate from 115 Volt power line. Price Complete \$7.95

Write for Descriptive Catalog Listing a Large Variety of Electronic Components

EDLIE ELECTRONICS, INC.

131 LIBERTY STREET

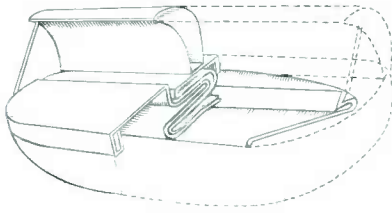
Telephone: Worth 4-1169

NEW YORK 6, N. Y.



EXPERIMENTAL EQUIPMENT

MICROWAVE ANTENNA EQUIPMENT



AN/MPG-1 ANTENNA. Rotary feed type high speed scanner antenna assembly, including horn, parabolic reflector, as illustrated. Less internal mechanisms. 10 deg. sector scan. Approx. 12" L x 4" W x 3" H. Unused... \$250.00

AS 125/APR Cone type receiving antenna. 1000 to 3200 megacycles. New... \$4.50

APS-4 3 cm. antenna. Complete. 1 1/2" dish. Cutler feed dipole directional coupler, all standard 1" x 1/2" waveguide. Drive motor and gear mechanism for horiz. and vert. scan. New, complete \$65.00

AN/TPS-3. Parabolic dish type reflector approx. 10" diam. Extremely lightweight construction. New in 3 cases 32 cu. ft. ... \$96.45

RELAY SYSTEM PARABOLIC REFLECTORS: approx. range: 2000 to 6000 mc. Dimensions: 4 1/2" x 3", rectangle, new... \$85.00

TDY "JAM" RADAR ROTATING ANTENNA. 10 cm. 30 deg. beam, 115 v.a.c. drive. New... \$100.00

140-660 MC. CONE TYPE ANTENNA, complete with 25" sectional steel mast, guys, cables, carrying case, etc. New... \$49.50

SO-13 ANTENNA. 24" dish with feedback dipole. 360 deg. rotation, complete with drive motor and selsyn. New... \$75.00 Used... \$45.00

S.F. Radar Antenna. 10 cm. approx. 30" dish comp. with Selsyn and 150V drive motor... \$55

With motor driven tunable eho box... \$70

RADAR SETS

SN RADAR-GE. low power, 5 and 25 miles ranges. Uses GL448 as pulsed oscillator, 5" "A" scope, "S" band. Extremely compact, ideal for demonstration and laboratory work. 115V 60C operation. Used, Excel. cond. \$600.00

SE 10 cm. Surface Search Radar. W.E. 20,000 to 80,000 yds. range. 250 KW. pk. power input to 706 magnetron. Thyatron modulator, variable pulse rate. Complete set including spare parts, tubes, waveguide and fittings. Send for price and additional information.

SPECIALS

10 Cm. RF Package. Consists of: SO Xmtr.-receiver using 2J27 magnetron oscillator, 250 KW peak input, 707-B receiver-mixer... \$150.00

Modulator-motor-alternator unit for above \$75.00

Receiver rectifier power unit for above... \$25.00

Rotating antenna with parabolic reflector. New \$75.00. Used, \$45.00

IT 39/APG-15 Transmitter-receiver. 2C43 Light-house tube oscillator. 5 KW. App. 2700 Mc operation... \$100.00

POWER EQUIPMENT

Step down transformer: Pri: 440/220/110 volts a.c. 60 cycles, 3 KVA. Sec. 115 v. 2500 volt insulation. Size 12"x12"x7" \$40.00

PLATE TRANSFORMER. Pri: 117 v. 60 cy. Sec. 17,000 v. @ 144 ma. with choke. Oil immersed. Size: 26"x29"x13". Amertran... \$65.00

PLATE TRANSFORMER. Pri: 220 v. 60 cy. 3 phase. 30 KVA. Sec: 6150, 5620, 5050, 4500 volts. Oil filled, 89 gal. Size: 54"x32"x23". Amertran. Approx. wt. 1500 lbs. \$185.00

REGULATORS

LINE VOLTAGE REG 2 KW Saturable reactor type Pri 95-130 v. 60 cy Sec 115 v. 60 cy. 17.4 amp. 2 Kw 100% PF. \$160.00

LINE VOLTAGE REG Pri 92-138v 57/63 cy 1ph15A See 115v 7.15 amp. .82 Kw 96% PF. \$135.00

MICA CAPACITORS

STANDARD BRAND

.08 mf @ 1500 VDC, M1X60... \$11.50

.08 mf @ 2000 VDC, 551A-50... 12.75

.045 mf @ 2000 VDC, C1... 12.75

.00015 mf @ 20 KV, 1970-404... 25.00

.0001 mf @ 20 KV, G3... 25.00

.002 mf @ 15 KV... 20.00

CONNECTORS

UG 10/U, type "N" chassis receptacle... \$1.00

UG 14/U type "N" receptacle... \$.85

UG 21/U, type "N" male connector... \$.85

UG 35/U, chassis receptacle, gold plated... \$.95

Homediel male to type "N" male adapter... \$1.25

AMPHENOL "83" SERIES

831R chassis receptacle... \$.35

831SP male connector... \$.35

831AP, right angle adapter... \$.35

VARIATORS

Standard Brand

D-168687... \$1.25

D-167176... .95

D-170225... .95

D-171121... .95

All merchandise guaranteed. Mail orders promptly filled, prices F.O.B. N. Y. C. Send Money Order or Check. Rated Concerns send P.O. Shipping charges only send C.O.D. Send for Microwave Flyer.

"Communications"

MICROWAVE PLUMBING

10 CENTIMETER

Sand Load (Dummy Antenna) Wave guide section with cooling fins, app. 23" high... \$28.00

10 cm. waveguide, 5/8" choke to cover Per section \$12.00 Per set of 4 sections... \$45.00

Pick-up loop with adjustable tuning section. \$1.50

Waveguide to flexible coax coupler (RG 18/U), with flange. Gold plated. App. 10" high (as shown). \$17.50

Magnetron to waveguide coupler with 721-A duplexer cavity, gold plated. \$45.00

1/8" RIGID COAX 3/8" I.C.

Right angle bend, with flexible coax output pickup loop... \$3.00

Short right angle bend, with pressurizing nipple... \$2.00

Rigid coax to type "N" adapter... \$5.00

Rigid coax slotted section, CU-60/AP... \$5.00

Stub-supported rigid coax, gold plated, 5' lengths. Per length... \$5.00

Rt angle for above... \$2.50

3/4" coax, rotary joint... \$8.00

Magnetron coupling to 3/8" rigid coax... \$4.00

3/8" coax, rt. angle bend, 15" L. O.A. \$2.00

3/8" RIGID COAX, 1/4" I.C.

Short right angle bend... \$2.50

Rotating joint, with deck mountings... \$5.00

3 CM PLUMBING

(Standard 1" x 1/2" Guide Unless otherwise specified)

TR cavity for 724-A TR tube, transmission or absorption types. \$3.50

724-A TR tube. \$2.50

150 deg. bend, with 90 deg. twist, type "N" output pick-up loop pressurizing nipple. \$2.50

Waveguide sections, CG 251/APS-15A, 26" long choke to cover, with 180 deg. bend of 2 1/2" rad. at one end. \$4.00

Rotary joint with slotted section and type "N" output pickup. \$8.50

Waveguide sections, 12" long choke to cover, 45 deg. twist, & 2 1/2" radius 90 deg. bend. \$4.50

Stabilizer cavity feeding waveguide section, with filtered output and attenuating slugs. \$20.00

Slug tuner/attenuator, W. E. guide, gold plated. \$3.75

TR-/ATR DUPLEXER section with wavemeter iris flange. \$4.00

CG/APS-3, straight waveguide section, 10" choke to cover. \$1.75

Right angle elbow, 5/8" choke to cover, 2 1/2" radius. "E" or "H" plane. \$5.00

Twist, 90 deg., 6" choke to cover. \$5.00

Waveguide sections 2 1/2' long, silver plated, with choke flange. \$3.50

Waveguide, 90 deg. bend, E plane, 18" long. \$4.00

Rotary joint, choke to choke. \$6.00

Rotary joint, choke to choke, with deck mounting. \$6.00

S-curve waveguide, 8" long cover to choke. \$2.50

DUPLEXER section using 1B24 \$10.00

3 cm. waveguide, 1 1/8" x 1/2" ID, 1/16" wall per ft. \$1.25

Circular Choke flanges, solid brass. .55

"T" section (TR-ATR) 7-1/8" choke to choke, square flanges. \$3.50

Bend, 180 deg., 2 1/2" radius ea. curve, 12" cover to cover, with pressurizing nipple. \$3.00

Directional coupler, CG 124 APS-15A on 16" section cover to cover, 15 deg. bend. \$5.00

Feedback dipole with 90 deg. twist, 7 1/2" long O.A. \$3.50

Waveguide to Type "N" coax adapter. \$6.50

1.25 CENTIMETER

Wave Guide Section 1" cover to cover... \$2.00

T section choke to cover... \$4.50

Mitted Elbow cover to cover... \$3.00

Mitted Elbow and "S" sections choke to cover \$3.50

Flexible Section 1" long choke to choke... \$3.00

RADAR AIRCRAFT INDUSTRIAL

PULSE TRANSFORMERS

GE #K2731 Repetition Rate: 635 PPS. Pri. Imp: 60 Ohms. Sec. Imp: 450 Ohms. Pulse Width: 1 Microsec. Pri. Input: 9.5 KV. P.K. Sec. Output: 28 KV. P.K. PWR Out: 800 KW. Htflar: 2.75 Amp. \$19.50

Type G.E. K2450A Will receive 131KV, 4 micro-second pulse on pri., secondary delivers 14KV peak power out 100KW GE... \$15.00

WE #D169271 Hi Volt input pulse Transformer... \$9.95

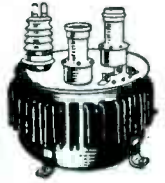
GE #K2748-A Pulse Input, line to magnetron... \$12.00

Utah Pulse or Blocking Oscillator Transformer Freq. limits 700-310 cy-3 windings turns ratio 1:1-1 Dimensions 1 13/16x1 1/4x1 9/32... \$1.50

705-A Rectifier Tube, with Ceramic Socket. \$1.25

WE #D166173 111-Volt input transformer. Impedance ratio 50 ohms to 900 ohms. Freq. range: 10 kc to 2mc. 2 sections parallel connected, pot-tered in oil... \$12.50

W. E. KS 9800 input transformer. Winding ratio between terminals 3-5 and 1-2 is 1:1:1, and between terminals 6-7 and 1-2 is 2:1. Frequency range: 380-520 c.p.s. Permalloy core... \$2.00



PULSE NETWORKS

G.E. #25E5-1-350-50P2T. 25 KV, 5 sections, "E" circuit, 1 microsecond pulse length, 500 PPS, 50 ohms impedance... \$45.00

G.E. #6E3-5-2000-50 P2T. 6KV, "E" circuit, 3 sections, 5 microsecond pulse, 2000 PPS, 50 ohms impedance... \$6.50

LABORATORY ACCESSORIES

Pressurizing unit MK 23/AP. Transmission line pressurizing unit, used with APS-15... \$12.50

Sperry klystron tuner, model 12. \$2.00

30 mc. receiver I.F. strip, 2 mc. band-width, 20 db gain per stage, 120 db gain overall. \$25.00

***Sine potentiometers, GE#251 x 96 or W.E. #KS 15138 L01** type "N" cable assy, 3' long, male to female... \$2.50

872 fl. ximr, with socket mounted atop. Pri: 115 v. 60 cy. sec. 5 v. @ 10 amps, 35 KV RMS test. \$12.00

Ph.-shifting cap., 180 deg. W.E. #D-150734 \$2.50

Klystron sockets for 723 A.B. and similar types. \$1.00

10 cm. McNally cavity type SG. Ea. \$3.00

Crystal mixer "S" band. Complete with type "N" fitting and 1N22 crystal. \$3.85

ANTENNA HEADS

TS 115/APS-20, 10 cm antenna in lucite ball, with type "N" fitting... \$4.50

OA Navy type CYT66ADL, antenna in lucite ball, with Sperry fitting. \$4.50

10 cm. feedback dipole antenna, in lucite ball, for use with parabola. \$8.00

INVERTERS

PE 206-A. Input: 28 VDC @ 38 amp. Output: 80 volts @ 500 volt-amp. 500 cy. Leland Electric. New complete with instruction book, relays, filters, etc. \$12.50

PE 218-Input: 25-28 VDC @ 92 amp. Output: 115 volts, 1500 volt-amps, 380/500 cy. Leland Electric. New \$35.00

MICROWAVE TUBES

MAGNETRONS

TUBE	FREQ. RANGE	PK. PWR.	OUT. PRICE
2131	2820-2860 mc.	265 K.W.	\$15.00
2121A	9345-9405 mc.	50 K.W.	\$25.00
2122	3267-3333 mc.	265 K.W.	\$15.00
2123	2992-3019 mc'	275 K.W.	\$15.00
2127	2965-2992 mc.	275 K.W.	\$15.00
2132	2780-2820 mc.	285 K.W.	\$15.00
2133 Pkg.	3249-3263 mc.	5 K.W.	\$25.00
2155 Pkg.	9345-9405 mc.	50 K.W.	\$25.00
3131	24,000 mc.	35 K.W.	\$17.50
W.E. 700A	680-710 mc.	100 K.W.	\$35.00
W.E. 7201Y	2800 mc.	1000 K.W.	\$25.00

Mfrs. Note: Many types available in 1000 lots.

MAGNETS

For 2J21 (725-A), 2J22, 2A26, 2J27, 2J31, 2J32, and 3J31... Each \$ 8.00

4850 Gauss, 3/8" bet. pole faces, 3/8" pole diam. \$8.00

1500 Gauss, 1/2" bet. pole faces, 1/8" pole diam. \$8.00

1000 Gauss, electromagnet, adjustable 2 3/4" to 3" bet. pole faces, 2 1/8" pole diam. \$12.00

2100 Gauss, 1 1/8" bet. pole faces, 3/4" pole face diam. \$4.00

MICROWAVE TEST EQUIPMENT

W.E. 1-138A. Signal generator, 2700-2900 Mc. range. Lighthouse tube oscillator with attenuator & output meter. 115 VAC input, regulated PWR, supply. With circuit diagram... \$50.00

10 cm oscillator cavity for 2C40 lighthouse tube, with attenuator, thermistor pickup loop. Heavy silver-plated casting... \$50.00

TS 238/GP. 10 cm. Echo box with resonance indicator and micrometer adjust cavity... \$85.00

3 cm. Wavemeter; transmission type with square flanges (also available in absorption type with circular flanges) \$15.00

THERMISTORS

(\$.95 ea.)

Standard Brand

D-167332 (Bead)

D-170396 (Bead)

D-168392 (Button)

D-168391 (Bead)

COMMUNICATIONS EQUIPMENT CO.
131-E LIBERTY ST., NEW YORK 7, N. Y.
TELEPHONE DIGBY 9-4124

SEARCHLIGHT SECTION

METER
WESTON #467

Whiteface
0.160 V.A.C.

\$3.25



TUBE TYPE
7193/2C22
29c each

5 for \$1

ATR INVERTER
Model RSA

Input 12 v DC—output 110 v 60 c. 125 w Int.
100 w Cont. **\$18.95**
Special

SELENIUM RECTIFIERS
Full Wave Bridge Type

INPUT	OUTPUT	
up to 18v A.C.	up to 12v D.C.	1 Amp. \$1.95
up to 18v A.C.	up to 12v D.C.	5 Amp. 4.45
up to 18v A.C.	up to 12v D.C.	10 Amp. 7.45
up to 18v A.C.	up to 12v D.C.	15 Amp. 9.95
up to 18v A.C.	up to 12v D.C.	30 Amp. 14.95
up to 36v A.C.	up to 28v D.C.	1 Amp. 3.45
up to 36v A.C.	up to 28v D.C.	5 Amp. 7.45
up to 36v A.C.	up to 28v D.C.	10 Amp. 12.45
up to 36v A.C.	up to 28v D.C.	15 Amp. 18.95
up to 54v A.C.	up to 36v D.C.	.25 Amp. .98
up to 115v A.C.	up to 100v D.C.	.25 Amp. 2.95
up to 115v A.C.	up to 100v D.C.	6 Amp. 6.95
up to 115v A.C.	up to 100v D.C.	5 Amp. 19.95

BC 733
RECEIVER

A Western Electric 10 tube Receiver cover 100-120 Mc. Complete with 10 tubes, crystals, etc.
New **\$12.95**
Used **\$ 7.95**

GLIDE PATH RECEIVER R-89/ARN-5

Glide Path Receiver used in the Instrument Landing System covering the frequency range 332 to 335 mc; complete with the following tubes: 7-6A15, 1-12SR7, 2-12SN7, 1-28D7, including three crystals 6497KC, 6522K, 6547 KC.
Brand New **\$14.95**
Used **\$ 9.95**

PERMALLOY SHIELDS
for CATHODE RAY TUBES

3" Shield **\$1.49**
5" Shield **1.98**

TUBES (Brand New)

Standard Brands

1N21	\$.39	F-127A	\$22.50
2AP1	2.25	371B	5.95
2C40	1.19	450TH	39.95
2D21	.89	703A	7.95
2V3G	1.25	715B	7.95
2X2	.84	721A	4.35
3AP1	3.00	723A/B	23.50
3BP1	2.95	726A	23.50
3E29	2.95	801	1.49
3GP1	3.95	802	1.98
5BP1	4.94	803	8.95
5CP1	3.95	804	9.95
5JP1	11.95	805	4.95
5LP1	8.95	806	14.95
5R4GY	.98	807	1.15
5X3	.41	808	2.95
6A17	.99	809	1.50
6AC7	.99	810	5.95
6AG5	.99	811	1.95
6AG7	.99	812	3.15
6AJ5	.99	813	8.95
6AK5	.90	814	4.45
6AL5	.99	815	3.95
6A06	1.09	829-A-B	3.00
6AR6	1.29	832	2.25
6B4G	1.29	833A	39.50
6C1	.69	836	1.75
6C5	.49	837	2.50
6D4	.99	838	3.95
6E6	.89	861	69.50
6E6G	.59	866	.75
6J4	1.50	872A	2.50
6J5	.55	884	.98
6J6	.89	885	.98
6L6	1.23	902P1	8.45
6L7	.98	954	.75
6N7	1.02	955	.75
6SH7	.59	956	.75
6SL7	.89	957	.75
6SN7	.69	958	.75
6SR7	.89	959	.75
7A4/XXL	.81	1005	.69
7F7	1.25	1616	2.95
7L7	1.59	1619	.75
10Y	.98	1622	1.98
15E	1.50	1624	.90
HK24G	1.75	1625	.75
28D7	.98	1626	.75
30	.75	8001	6.49
35T/TG	3.50	8005	4.95
VR75	.99	8011	3.75
VR90	.75	8016	1.65
VR105	.75	8025A	4.95
VR150	.75	1654	1.98
100TH	12.95	9001	1.15
100TS	3.00	9002	.98
211	1.25	9003	.98
75T	2.95	9004	.98
250TH	17.50	9005	.98
257B	6.49	9006	.98
304TH	9.95	F-128A	75.00

TRANSFORMERS—115 V 60 Cyc.
HI-VOLTAGE INSULATION

3170v @ 10 ma.; 2x2½v @ 3A	\$9.95
2500v @ 15 ma.	6.50
2500v @ 4 ma.; 2½v @ 2A; 6.3v @ 1 amp.	9.95
2150v @ 15 ma.	6.50
1750v @ 4 ma.; 6.3v @ 3A	7.50
1700v @ 4 ma.; 6.3v @ 6A; 2½v @ 1.75A	8.50
1600v @ 4 ma.; 700v CT @ 150 ma.; 6.3v @ 9A	8.50
1600v @ 2 ma.; 6.3v @ 6A; 2½v @ 17.5A	8.50
1200v CT @ 400 ma.; 10v CT @ 10A	9.95
550-0-550 @ 150 ma.; 5v @ 3A; 2x6.3v @ 5A CT	7.95
525-0-525v @ 60 ma.; 925v @ 10 ma.; 2x5v @ 3A; 6.3v @ 3.6A; 6.3v @ 2A; 6.3v @ 1A	8.95
525v @ 35 ma.; 5v @ 35 ma.; 2½v @ 1.75A	1.98
520-0-520v @ 120 ma.; 5v @ 2A; 6.3v CT @ 2A	1.98
500-0-500v @ 25 ma.; 262-0-262v @ 55 ma.; 6.3v @ 1A; 2x5v @ 2A	4.49
500-0-500v @ 100 ma.; 5v CT @ 3A	4.95
400-315-0-100-315 @ 200 ma.; 2.5v @ 2A; 5v @ 3A; 6.3v @ 9A; 6.3v @ 9A	7.50
400-230-0-230-400v @ 250 ma.; 3x5v @ 3A; 6.3v @ 5A; 6.3v @ 3A; 6.3v @ 1A	7.95
400-0-400v @ 200 ma.; 5v @ 3A	4.95
375-0-375v @ 400 ma.	1.95
350-0-350v @ 150 ma.; 5v @ 3A; 6.3v @ 6A; 78v @ 1A	4.95
350-0-350v @ 45 ma.; 675v @ 5 ma.; 2½v @ 2A; 2x6.3v @ 1A; 6.3v @ 2A	4.95
350-0-350v @ 80 ma.; 6.3v @ .6A; 6.3v @ 3.75A; 2x5v @ 3A	3.98
385-0-385-550 @ 200 ma.; 2½v @ 2A; 5v @ 3A; 3x6.3v @ 6A—PRI 110/220	9.95
350-0-350v @ 150 ma.; 5v @ 3A; 6.3v @ 7.5A; 6.3v @ 3A	5.95
350-0-350v @ 35 ma.; 1540v @ 5 ma.	1.49
340-0-340v @ 300 ma.; 1540v @ 5 ma.	7.50
335-0-335 @ 60 ma.; 5v @ 3A; 6.3v @ 2A; 0-13-17-21-23v @ 70 ma.—PRI 110/220	5.49
325-0-325v @ 120 ma.; 10v @ 5A; 5v @ 7A	3.49
300-0-300v @ 65 ma.; 2x5v @ 2A; 6.3v @ 2½A; 6.3v @ 1A	3.49
250-0-250v @ 100 ma.; 2x6.3v @ 4A; 6.3v @ 5A; 6.3v @ 1A	4.95
200-0-200v @ 140 ma.; 6.3v @ 4A; 5v @ 2A	1.98
120-0-120v @ 50 ma.	.98
24v @ 6A	3.50
3x10.3 @ 7A; CT	9.95
6.3v @ 10A; 6.3v @ 1A	3.50
6.3v @ 1A; 2½v @ 2A	3.98
6.3v @ 21½A; 6.3v @ 2A; 2½v @ 2A	6.95
6.3v @ .25A; 6.3v @ 3A; 5v @ 12A; 6.3v CT @ 9A	4.95
5v CT @ 16A. \$3.49	6.3v @ 6.6A. 2.95
5v—190A	17.50
5v—115A	14.95
220v to 110v @ 75 kv	2.98
6.3v CT @ 3A; 5v CT @ 4A	4.25

FILTER CHOKES

HI-VOLTAGE INSULATION

10 hy @ 400ma.	\$1.95	10 hy @ 250ma.	\$2.49
8 hy @ 300ma.	3.95	10 hy @ 200ma.	1.98
25 hy @ 160ma.	3.49	10/20 @ 85ma.	1.59
12 hy @ 150ma.	2.25	15 hy @ 125ma.	1.49
12 Hy @ 100ma.	1.39	15 hy @ 100ma.	1.39
30 hy @ 70ma.	1.39	3 hy @ 50ma.	.29
120 hy Dual@17ma	1.39	30 hy Dual @ 20ma	1.49
1 hy @ 5 amps.	6.95	10/20 hy @ 85ma.	1.49
4 hy @ 600ma.	5.95	10 hy @ 100ma.	1.29

OIL CONDENSERS

NATIONALLY ADVERTISED BRANDS

All Ratings, D. C.

2x.1mfd. 600v	\$0.35	1mfd. 2000v	\$0.95
.25mfd. 600v	.35	3mfd. 2000v	2.75
.5 mfd. 600v	.35	4mfd. 2000v	3.75
1mfd. 600v	.35	15mfd. 2000v	4.95
2mfd. 600v	.35	25mfd. 2500v	2.49
4mfd. 600v	.60	1mfd. 2500v	1.25
8mfd. 600v	1.10	.25mfd. 2500v	1.45
10mfd. 600v	1.15	.5mfd. 2500v	1.75
3x.1mfd. 1000v	.45	.05mfd. 3000v	1.95
.25mfd. 1000v	.45	1mfd. 3000v	2.25
1mfd. 1000v	.60	.25mfd. 3000v	2.65
2mfd. 1000v	.70	.5mfd. 3000v	2.85
4mfd. 1000v	.90	1mfd. 3000v	3.50
8mfd. 1000v	1.95	12mfd. 3000v	6.95
10mfd. 1000v	2.10	2mfd. 4000v	5.95
15mfd. 1000v	2.25	1mfd. 5000v	4.95
20mfd. 1000v	2.95	1mfd. 7000v	2.95
24mfd. 1500v	6.95	3mfd. 4000v	6.95
.25mfd. 2000v	1.05	2mfd. 3000v	3.45
.5mfd. 2000v	1.15	2x.1mfd 7000v	3.25

HIGH CAPACITY CONDENSERS

2x3500 mfd.—25WVDC	\$3.45
1000 mfd.—15WVDC	.99
100 mfd.—50WVDC	.49
4x10 mfd.—400VDC	.89

CODE KEYSER TG-10

This practice Code Keyer contains a 7 tube 110 volt 60 cycle Amplifier plus an electric eye tube. It also contains a 110 volt 60 cycle motor which runs your code tape through at the rate of 5 to 25 words per minute. The amplifier would make an excellent P.A. system and the motor would turn a timetable very nicely.

NEW — \$24.95

(Less Tubes)

R5/ARN-7 RADIO COMPASS RECEIVER

Three bands 200 to 1750 K.C. Complete with 17 tubes required. This set is ideal for conversion to home broadcast Receiver, addition to ham shack, etc. Reported sold for many times the price when brand new. A Receiver that would be hard to pick up at this price.

Only **\$31.95 NEW**

USED—\$17.95

ALL PRICES SUBJECT TO CHANGE WITHOUT NOTICE

All merchandise guaranteed. Mail orders promptly filled.
All prices F.O.B. New York City. Send money order or check.
Shipping charges sent C.O.D. Minimum order \$5.00.
20% Deposit required with all orders

ATTENTION!

INDUSTRIALS — LABS —
SCHOOLS — AMATEURS

Let us quote on components and equipment that you require. We have too many items to be listed on this page. Place your name on our mailing list now for new catalog.

RADIO HAM SHACK Inc.
63 DEY STREET • NEW YORK 7, N. Y.



**HIGH PRECISION
100 KC CRYSTALS**

Exceptional Frequency Stability
 ± 15 cycles from -50° to $+80^{\circ}$ c. (.0015) 10 G Vibration Test. Calibrated at 30° c. Brand New. Mounted in Sealed Cases as Shown.

(No C. O. D.'s Please include 25c for postage and handling.)

\$3.95



**STEPDOWN
TRANSFORMERS**

Input: 115 V. -60 cy-Output: 20 V., at 12 amps. Also tapped at 6V. for pilot light. Ideal for Selenium Rectifier Applications

Price \$2.45



**APPROACH
INDICATOR**

1D-24/ARN-9
Brand new.

Price \$3.95



20,000 ohm. De Jure Potentiometer and Dial Assembly. Brand New.

Price \$2.75



STROBOTRONS

Type SS501
Brand New

Price \$6.45



SOLAR

Elim-O-Stats
115 V., 20 amps.

Price \$2.25



**PHONE JACK
ADAPTER P-106**

Phone jack, one end. Coax Receptacle other end

Price \$1.35



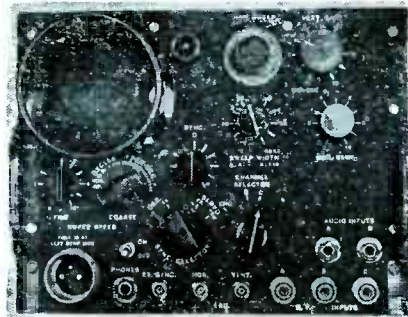
**BRITISH COAX
CONNECTOR**

Right angle Type 10H-701.

Price \$.25

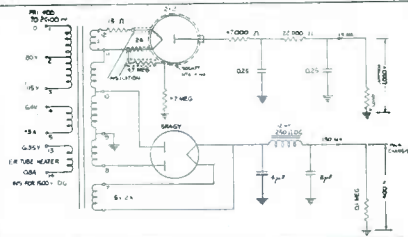
RIGID COAX ASSEMBLIES

- 9/16" dia. Brass Couplings at each end—24" lengths \$1.90
- 9/16" dia. Brass Couplings at each end—30" lengths \$1.05
- 9/16" dia. Brass Couplings at each end—48" lengths \$1.80



**PANORAMIC ADAPTER
AN/APA-10**

Total 21 tubes including 3" scope tube. Converted for operation 115 v. 60 cycles. Tested and guaranteed in perfect operating condition. **\$97.50**



Power supply for type AN/APA-10 Panoramic adapter.
Input: 115 V., 400/2600 cy. 1000 VDC @ 1.5 MA. and 400 V.DC. @ 130 MA. Brand new units as per above circuit diagram. Complete with tubes.

Price \$13.75

Power Transformers only for AN/APA-10 **Price \$4.75**



**VOLTAGE
REGULATOR
CHASSIS**

For AN/APA-10

Consists of 3 filter capacitors, choke, 2-VR150 tubes, etc. Can be used to regulate any 300 volt power supply and provides 300 and 150 volt regulated taps. Complete as shown.

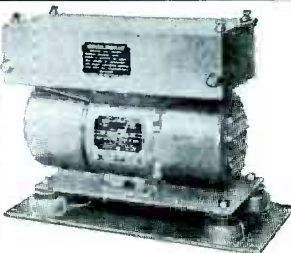
Price \$5.75



D.P.S.T. RELAY

115 volts—60 cycles—Cont. 10 amps.

Price \$1.45



**U. S. NAVY
TYPE CAJO-211444
DYNAMOTOR
and
SWITCH BOX**

Input: 105/130 V.DC at 6 amps.
Output: 13 V.DC. at 40 amps or 26 volts at 20 amps.
Designed for radio use. Fully R.F. filtered. Complete with Square "D" switch box, spare fuses, brushes etc. Brand New, packed in original wooden cases.

Price \$59.50



400 CYCLE INVERTERS
Pioneer type 12123-1-A. Input: 24 V.DC. 12 amps. Output: 115 V., 400 cy., 3 ph. Capacity 100 va. New Price \$49.50
Pioneer Type 12121-1-A. Input: 24 V.DC., 18 amps. Output: 115 V., 400 cy., 3 ph. Capacity 250 va. New Price \$59.50

G. E. AMPLIDYNES
Type 5AM21J7 Price 49.50
Type 5AM45D320 Price 89.50

**W.E. TYPE D-168479
MERCURY CONTACT RELAY
Brand New War Surplus
in Original Cartons**



For application in all types of high speed switching devices. Long service life, high operating speeds. Large current and voltage handling capacity, uniform and constant operating characteristics under adverse atmospheric conditions. Hermetically-sealed mercury-wetted contacts in gas-filled glass envelope. Free from moisture, dirt, corrosion and atmospheric pressure.

1000 hours life at 60 operations per second. Two coils of 700 ohms. and 3300 ohms. Operating current, coils series aiding—6.6 mls. Release current, coils series aiding—5.2 mls. Four page Technical Data on request.

Price \$4.75



**SELENIUM
RECTIFIER**

Bridge Type: Input 36 volts—Output 28 volts 1.1 amps.

Price \$2.75



**SELSYN
GENERATOR**

Type 211F3—115 volts—400 cycles. Brand New.

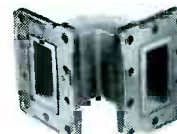
Price \$1.95



MOTOR GENERATORS

Brand New War Surplus Machines built by Allis Chalmers Co. to U. S. Navy Specifications.

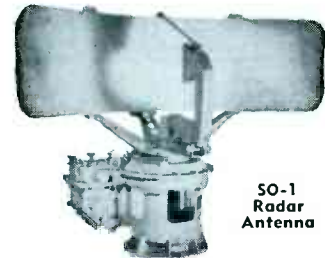
Input: 115V. D.C. at 14 amps., 3600 rpm. Output: 120 V. A.C. 60 CY. 1 ph. at 10.4 amps., 1000 Watts continuous duty. Ball bearings. Splashproof. Fully enclosed. Centrifugal starter. Frequency adjustable to load. **Price \$97.50.**
Same machine but for 230 V. D.C. input. Price \$125.00. Spare parts kit with extra brushes, brush-holders, field coils, bearings, etc., for either machine, \$29.50.



**10 CM
WAVEGUIDE**

90 degree elbow—Bronze—Brand New

Price \$20.00



**SO-1
Radar
Antenna**

RADAR ANTENNAS

Type SO—\$90.00. Type SO-1—\$125.00
Type SO-8—\$120.00—Type SO-13—\$70.00
TDY—\$95.00

All prices quoted are fob Tuckahoe, N. Y. About 20 miles N. of N. Y. C.)

5 WAVERLY PLACE

ELECTRONICRAFT, INC.

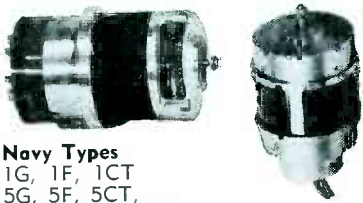
PHONE—TUCKAHOE 3-0044

TUCKAHOE 7, NEW YORK

All merchandise guaranteed. Immediate delivery, subject to prior sale.

NEW GUARANTEED SURPLUS!!

SYNCHROS



Navy Types
1G, 1F, 1CT
5G, 5F, 5CT,
5DG, 5HCT, 5SG,
5HSF, 6G, 6DG, 7G
7DG, etc.

Pioneer Autosyns—AY-1, AY-14,
AY-20, AY-30, AY-54, AY-101D,
851, CTC.

Elinco M1-1, M1-2, **Kollman** 775-01.
G. E. 2J5HA1, 2J5FB1, 2J6F3,
2JD5HB1, etc.

DC MOTORS

John Oster. Series wound. 27 V. 7,000
rpm. 1/100 H.P. Stock #SA-30. Price
\$2.75 ea. net.

Westinghouse 1171391. 27 V. 6.5
amps. Series-fan cooled. 3" diam.
4 1/2" lg. 1/8 H.P. Cont. Duty. Stock
#SA-156. Price \$6.75 ea.

Delco 5069370. 27.5 V. Alnico field.
10,000 rpm. Similar to S-65 but has
straight shaft extension. Stock
#SA-16. Price \$4.75 ea. net.

DC Timing Motor—Haydon 1/2 rpm.
29 volts, 100 mills. Stock #SA-157.
Price \$3.75 each net.

Constant Speed D.C. Motor—G.E.
5BA25MJ24. 24 V. D.C. 7100 rpm.
RC noise filter. Stock #SA-100. Price
\$3.50 ea. net.

Radio Compass Loop LP-21-LM. Stock
#SA-99 Price \$9.50 ea. net.

Phase Shift Capacitor—4 stator single
rotor. 0-360° phase shift. Stock #SA-
114. Price \$4.75 ea. net.

Magnesy—Pioneer CL-3. 6 power.
Transmitter or receiver. Stock #SA-6.
Price \$3.75 ea.

NULL TYPE SYNCHRO INDICATOR



Precision position indicator. Uses Bendix
size 5 Selsyn, rectifier tube, transformer,
magic eye tube and illuminated 360°
dial. Ideal for Hams, labs and experimen-
ters. May be used

with SD-43 Synchro transmitter. Stock
#SA-119. Price \$6.95 each

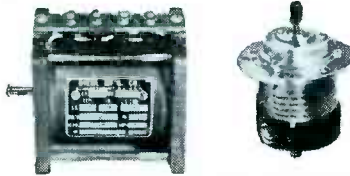


Size 5
Synchro
Generator

Similar to Navy Ordnance type 5G
with shaft detail per Army Ordnance
Dwg. C-78414. 115 v. 60 cy. Stock
#SA-43. Price \$9.50 ea.

Write or call for
complete listing.

SERVO MOTORS



Pioneer CK-2, CK-5, 10047-2-A and
Kollman 776-01 for 400 cycles.
Diehl FP-25-3, **FPE-25-11** (CDA-
211052) and **ZP-106-8** (CDA-
211377) for 60 cycles. Qty. Prices
on Request.

400 Cycle Motors

E.A.D. J-33. 115 V. 3 phase. Synchro-
nous. 8000 rpm. 2" x 3". Stock #SA-
59. Price \$6.75 ea. net.

E.A.D. J-72B. 115 V. 2 phase induc-
tion motor. 4700 rpm. Stock #SA-140.
Price \$9.75 ea. net.

Westinghouse Blower. Type FL. 6700
rpm. Capacitor type motor. 2 inch Sir-
rocco blower. Outlet 3/4" x 1 1/8". In-
cludes capacitor. Stock #SA-144. Price
\$6.75 ea. net. Quantity prices on re-
quest.

D.C. Motor-Delco 5069466

Alnico field. 27.5 V. 10,000 rpm.
1" x 1" x 2". Use as motor or as tach-
ometer generator. Stock #SA-65.



Price \$1.95
each net.

Include 15¢
for P. P. hnd'g

Micro Wave Antenna

AS-217A/APG-
15B. 12 CM dipole
and 13 inch para-
bola housed in 16"
weatherproof Ra-
dome. DC spinner
motor for conical
scan. Shipping
weight 70 lbs.
Stock #SA-95. Price \$9.50 each.



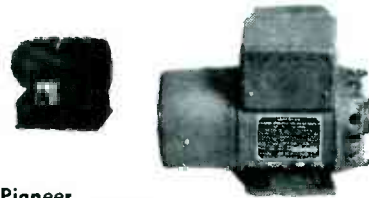
Remote Position
Indicating System



Ideal for Ham Beam Position Indicator
or industrial uses. 6-12 volts 60
cycles. 5-inch indicator with 0-360°
dial. Heavy duty transmitter. Stock
#SA-115. Price \$9.95 per system.

ALL PRICES F.O.B. CLIFTON, N. J.

INVERTERS



Pioneer
12116, 12117,
12121, 12123, etc.
Holtzer Cabot MG-149F, MG-149H,
MG-153F, etc.
General Electric 5D21NJ3A, etc.
Leland 10563, etc.

60 CYCLE AC MOTORS

G.E. Reversible. 1/150 H.P. Shunt
wound. 40 volts 5000 rpm. Split field.
Stock #SA-18 Price \$4.75 ea. net.
Stock #SA-19. Similar to above but
not split field. Price \$2.75 ea. net.
Barber-Colman. 0.001 H.P. wound
shaded pole type. Reversible by relay
or s.p.d.t. switch. Stock #SA-27 Price
\$3.75 ea.

60 cy. G. E. Amplidyne—5AM45-
DB15. Input 115 v. Output 250 v. DC
at 0.6 amps. Cont. Duty. Stock
#SA-147 Price \$59.50 each.

DC Selsyn System—24 V. DC trans-
mitter and indicator. Indicator cali-
brated for flap position. 360° dial
easily added. Stock #SA-129 Price
\$9.50 per system.

Pioneer Magnetic Amplifier Assembly.
Saturable core type output trans-
former. 400 cycle. Operates from
plates of 6SN7 to supply 1 phase of
servo motor. Stock #SA-44. Price
\$8.75 ea. net.

Sinusoidal Potentiometer—Navy Type
CFW-631539. 32000 ohms. 2 output
voltages. Sine and Cosine function of
shaft position. D.C. input. Stock #SA-
124. Price \$12.50 ea.

Timing Motor—Haydon 1 rpm. 115
V. A.C. Stock #SA-133. Price \$2.85
ea. net.

**Minneapolis - Honeywell Stabilized
Aerial Camera Mount.** Complete with
amplifier, inverter, and carrying case.
Stock #SA-9. Price \$125.00 ea.

Tachometer Generators

Elinco PM-2. 1.75 V
D.C. per 100 rpm.
Use to 2000 rpm.
Stock #SA-53. Price
\$6.25 ea.

Elinco FB-55. 4.7 V.
per 100 rpm. Use to
10,000 rpm. Stock #SA-3. Price
\$12.50 ea. net.

**PIONEER SERVO AMPLIFIERS
PIONEER TORQUE UNITS
KOLLSMAN COMPASS SYSTEMS
SINE COSINE GENERATORS**

Open account shipments
to rated concerns,
others may order C.O.D.

SERVO-TEK PRODUCTS CO.

INCORPORATED

Surplus Division

247 CROOKS AVE.

ARMory 4-2677

CLIFTON, N. J.

Finest of surplus
at a fraction of cost

PEAK ELECTRONICS CO.

Industrials
Schools - Labs

DAVEN AUDIO FREQUENCY METER Model 837E



Direct reading from 0-30 KC in 4 separate ranges on 6" Weston Model 271 Fan Meter. Built-in voltage regulated power supply operates from 115 volts 60 cycles, has high input impedance. With pick-up can be used to determine frequency in vibration tester. With suitable mixer can check deviation of R.F. carrier from standard. Mounts on 8 3/4"x19" rack panel. Complete with tubes. Slightly used but perfect. Only \$59.50

LINK BC 438 FREQUENCY METER

195-215 mcs. Built in 110 volt 60 cycle power supply. Complete with tubes and crystal. Slightly used. Limited quantity. \$9.95

MEGOHM METER

Industrial Instruments Model L2AU 110/220 volts 60 cycle input. Direct reading from 0-100000 megohms on 4" meter. Can be extended to 500000 megohms with external supply. Sloping hardwood cabinet 15"x8"x10". Brand new with tubes plus running spare parts including extra tubes. Great value only \$69.95



MIDGET VARIABLE BARGAINS

Hammarlund MC 250S 250 mfm. \$.69
Hammarlund MC 320S 320 mfm. .79
Hammarlund APC 100 100 mfm. .39
Bud MC 913 Dual 35 mfm. D.S. 1.25

"A CLOSEOUT"

AMERTRAN TRANSTAT or Stepdown Transformer

110/220 volts 60 cycle input. Output variable plus or minus 10% of 115 volts at 8.5 amps. Also can be connected to give different voltage combinations. Brand newonly \$12.95
Limited Quan.



AMERTRAN VOLTAGE REGULATOR

130/230 volts 50/60 cycles input. Output variable from 0-260 volts. 1.3 KVA, single phase. Used but good \$29.50

U. H. F. COAX. CONNECTORS

UG12U-831R-831J-U621U-831AP-831SP
.39 ea.
Large stocks of Coax, and A/N connectors.

OIL CONDENSERS STANDARD BRANDS

2mfd 600 vdc. \$.39	1 mfd 5000 vdc. \$4.50
4mfd 600 vdc. .59	.1 mfd 7500 vdc. 1.95
3/3 mfd 600 vdc. .79	1/1 mfd 7500 vdc 2.45
14 mfd 600 vdc. 1.35	.01/.01 12 KV dc 5.75
2 mfd 1000 vdc. .79	.005/.01 12 KV dc 5.50
4 mfd 1000 vdc. .95	.65 mfd 12500 vdc 12.95
2 mfd 1500 vdc. 1.25	.75/.35 mfd (dual)
1 mfd 2000 vdc. 1.15	8/16 KV dc. 14.95
3 mfd 3000 vdc. 3.95	

SPERTI RF

VACUUM SWITCH

9200 volts peak, 8 amps. Used as antenna switch in Collins ART 13. BRAND new \$1.75



MISCELLANEOUS SPECIALS

2-11 mfm. Butterfly with ball bearings. \$.59
G.E. S.P.D.T. Relay 10000 ohm coil. .59
Heineman Circuit Breaker 5 amp. 110V. A.C. .89
G.E. Solenoid W/Microswitches 24 V. D.C. .69
25 ohm 25 watt Rheostat. .39
Microswitch 10 amp. (interlock) .59
C.H. Bat Handle Switch-D.P.S.T. 1/2 H.P. .95
Veeder Root Counter. .95
Single Plate to P.P. input 3:1 ratio trans. .49
500 foot Drums R G/8 U Coax. 24.50
4 Quadrant Phasing Condenser. 1.95
Trim Commercial Phones (High Imp.) 4.50

4 METER BARGAINS FOR THIS MONTH

**\$2.95 EACH
10 FOR \$24.75**

- 2" GE 0-1 Amp RF (Internal Thermo)
- 2" Weston 150-0-150 Microamps (Sperry Scale)
- 2" GE 0-30 Amps DC (Internal shunt)
- 2" Sun 0-1 MA Basic (Volt Scale)

WHERE SPACE IS LIMITED

This tiny GE motor only 1 1/2 inches square. Basic movement 0-1 ma. Ideal as "S" meter for BC348, etc. Only \$3.95 ea.



METER SPECIALS

(Brand new)

- 2" GE 0-5 ma (amp scale) \$1.95
- 2" GE 0-1.2 ma (0-100 scale) 2.49
- 2" McClintock 0-50 microamps 7.50
- 2" Weston type 507 0-120 ma RF. 4.95
- 2" GE 0-1 MA (Volt Scale) 2.95
- 3" Westinghouse 0-50 amps AC. 4.95
- 3" Triplett 0-75 amps AC. 3.95
- 3" WE 0-80 ma DC. 2.95
- 3" GE 200-0-200 volts DC. 2.95
- 3" McClintock 0-1 ma. 3.95
- 3" Westinghouse 0-2 ma DC. 3.95
- 3" Westinghouse 0-20 ma DC. 3.95
- 3" GE 0-15 ma DC (square) 3.95
- 3" Westinghouse 0-150V AC. 3.95
- 3" Westinghouse 0-150 volts AC Rectifier type (Linear) 5.95
- 3" WE 0-50 microamps. 9.95
- 3" GE Running Time Meter. 7.95
- 4" GE 1-0-1 ma DC (Blank scale) 3.95

Scope Transformer hermetically sealed 1800 volts, 4 ma, 6.3 volts, .9 amp. 2 1/2 volts, 2.5 amps., 5 x 3 1/4 x 3 3/4 \$5.95

FEDERAL SELENIUM RECTIFIER

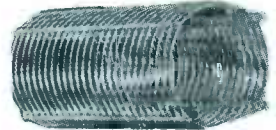
Full wave. 36 volts input. 28 volts output at 6.1 amps. Brand new \$7.95

ELECTROLYTIC CONDENSERS STANDARD BRANDS

25 mfd 25 v.w. tubular. \$.25
50 mfd 50 v.w. tubular. .29
8 mfd 450 v.w. tubular. .37
12 mfd 450 v.w. tubular. .44
500 mfd 15 v.w. tubular. .49
10 mfd 450 v.w. can. .49
16 mfd 450 v.w. can. .69
20x20 mfd 450 v.w. can. 1.05
80 mfd 200 v.w. can. .69
200 mfd 200 v.w. can. .98
1000 mfd 25 v.w. can. .95

Tremendous stocks on hand.
Please send requests for quotes.
Special quantity discounts.
Prices f.o.b. N. Y. 20% with
order unless rated, balance COD.
Minimum order \$3.00.

"QXL AIRWOUNDS"



High Quality Coils designed for industrial applications and built to "Take It".

STOCK SERIES

QXL 1 1/2" I.D. 4-8-16-32 turns per inch #22 wire.
QXL 15 1 1/2" I.D. 4 to 11 turns per inch. #14 wire.
QXL 2 2" I.D. 4 to 11 turns per inch #14 wire.
Please send us your requirements for quotation. Airwound made to your specifications.

LIMITED QUANTITY CLOSE OUTS

196-A S.G. generator (for aligning SCR522) 79.50
WE BC 1091A-Radar RF unit—with magnetron, etc., in pressurized tank. 59.50
CWI 60 AAG range calibrator and power supply, book, cables, etc. 29.50

WIRE WOUND RESISTORS

Standard Make

5 watt type AA, 20-25-50-200-470-2500-4000 ohms	.09 ea.
10 watt type AB, 25-40-84-400-470-1325-1900-2000-4000 ohms	.15 ea.
20 watt type DG, 50-70-100-150-300-750-1000-1500-2500-2700-5000-7500-10000-16000-20000-30000 ohms	.20 ea.
30 watt type DI, 100-150-2500-3000-15000-5300-7500-18000-40000 ohms	.24 ea.

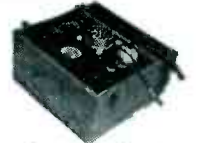
1% PRECISION RESISTORS

Standard Make

200-2500-5000-8500-10000 ohms	.39 ea.
50000-95000 ohms	.49 ea.
100000-750000-1 meg	.89 ea.

S.C. TEST SET—1-114

in portable wood case 6" x 6" x 10" (including cover not shown). Has Weston 0-150 volt A.C. meter 60 cycle, 2 switching circuits. Complete with line and test cables. A bargain at only \$3.95



CHOKE BARGAINS

WE 4.3 hy 620 42 ohms	\$ 4.95
N.Y.T. 8 henry 160 ma. 140 ohms D.C.	1.39
C.T.C. 1.5 henry 250 ma. 72 ohms	.60
R.C.A. 50 henry, 680 amps. high voltage	19.50

HIGH VOLTAGE MICAS

C.D. .002 2500 W.V. 5000 V.T. type 9	.49
C.D. .002 3500 W.V. 7500 V.T. type 9	.69
Micamold .005 2500 W.V. type 4	.69
Sofar .005 10 KV. D.C. 11 amp. 3000 K.C.	7.95
C.D. .006 6 KV. D.C. 20 amp 400 K.C.	5.95
C.D. .004 3KV. D.C. 20 amp. 18000 K.C.	2.50
R.C.A. .02 2000V. D.C. 10 amp. 300 K.C.	1.75
Sanganio (F2L) .015 2000V. D.C.	1.50
C.D. (6H) .0013 5000V. D.C.	1.00
C.D. (6H) .005 5000V. D.C. 11 amp. 1000 K.C	2.50
R.C.A. .0002 2500 W.V. 5000 V.T.	.30

POWER PLANT (PE 197)

4 cylinder Hercules Gas driven engine. Output 110 volts 60 cycles, voltage regulated, 5KW-6.3KVA at 80% Pwr. Ftr. Single phase, complete with running spare parts, meter panel, battery, tools, re-mote cable, etc.
Weight 1200 lbs. Export Packed. Excellent for emergency power. Brand new \$575.00

Phone Cortlandt 7-6443

PEAK ELECTRONICS CO.
188 Washington St., New York 7, N. Y.

DEPARTMENT EA
SEND FOR BULLETIN

BRAND NEW EQUIPMENT

Available for Immediate Delivery

Pioneer Torque Units Types 12602-1-A, 12606-1-A and 12627-1-A.

Pioneer Torque Unit Amplifiers Type 12073-1-A.

Pioneer Autosyn Motors Types AY1, AY5, AY6, AY10, AY14, AY20, AY21, AY27, AY30, AY38 and AY 54.

Pioneer Precision Autosyn Type AY101D.

Pioneer Magnesyn Indicator Type 13318, dial graduated 0 to 360°, 26 volts 400 cycle.

Pioneer Autosyn Single Indicators Type 5907-17, dial graduated 0 to 360°, 26 volts 400 cycle.

Pioneer Autosyn Dual Indicators Type 6007, dial graduated 0 to 360° and other ranges, 26 volts 400 cycle.

Pioneer Two-Phase Low-Inertia Servo Motors Types CK1, CK2 and CK5, 400 cycle.

Diehl Two-Phase Low-Inertia Servo Motors Types CDA211052, 75 volts 60 cycle and FP-25-2 and FP-25-3, 20 volts 60 cycle. Will also operate on 115 volts 400 cycle.

Eastern Air Devices Permanent Magnet Generators Type J36A, 10 to 5000 RPM, .02 volts per revolution.

Eastern Air Devices Synchronous Motors Type J33, 115 volts 400 cycle, 3 phase.

Inverters—Three-Phase 400 cycle. Pioneer Type 12121 and 12123 and Holtzer Cabot Type 153F.

Inverters—Single-Phase 400 cycle. Pioneer Types 12116 and 12117. Holtzer Cabot Types 149F and 149H. General Electric Type 5D21-NJ3A. Wincharger Type MG750 PU/16 and Winco Type MG2500 PU-7.

Delco Permanent Magnet Field Motors Types 5069370, 5069466, 5069600, 5069230, 5067125 and Diehl Type SS-FD6-16.

Weston Frequency Meters Model No. 637, 350 to 450 cycle.

Synchros—Sizes 1F, 1CT, 5G and 5SG.

Pioneer and Kollsman Remote Indicating Magnesyn Compass Sets with or without 12 or 24 volt input 400 cycle inverters.

Gyros—Schwein Rate Types 45600D and 46800, Pioneer Servo Unit Type 12800-1-D, Sperry A4 and A5 units, Norden and Minneapolis Honeywell units.

WRITE FOR OUR COMPLETE LISTING!

INSTRUMENT ASSOCIATES

40-37 172nd STREET

FLUSHING, L. I., N. Y.

Telephone Flushing 7-8718

HEADQUARTERS FOR TRANSMITTERS, FOR MARINE, AVIATION AND COMMERCIAL APPLICATIONS

TELEMARINE

FOR VALUE, CONDITION & USEFULNESS

CAREFULLY SELECTED SURPLUS ELECTRONIC EQPT.,

5-Meter Walkie-Talkie



Model BC-322 Transceiver: simple, popular communications unit. Freq. range 52-65 mc. Uses only two tubes, types 33 and 30. Includes a 5 KC crystal in a crystal calibrator circuit. Range 5 to 150 miles, depending upon location and altitude. Operates from single battery block (not supplied) available from mfr., or other sources. Supplied with telescoping antenna and headset, almost new condition.

PRICE, EACH \$24.95

110 DC to 110 AC Converter



Mfd. By ESCO, Type R182, for marine use. Converts 115 V. DC to 115V. AC, very conservatively rated at 135 watts. Tests show that it is satisfactory for service up to 260 watts. Self-ventilated, semi-enclosed, wool-oiled bearing construction. Includes filter condensers and choke coils in base, as well as small condensers across each brushholder, for filtering purposes. Provided with rubber connecting cords, and standard outlet receptacle.

NEW, PRICE EACH... \$29.00

32-110 AC CONVERTER

Mfd. by Kato Engineering, for marine or farm installation. Rotary type, compact and ruggedly built for continuous duty. Rubber shock mounting on filter case, with complete input and output filtering. Output-110 volts, 60 cycles AC, 225 KVA, but will operate efficiently on loads up to 300 watts. New units only.

PRICE, EACH... \$39.95

Quantities, 10 or more, Each \$34.95

AMPLIDYNE MG SET



For Automatic or Remote Control of heavy equipment. Mfd. by General Electric. Generator is Type V-5875877, motor 73AB58; Navy type CG-21ABU. Generator delivers 250 volts DC, 375 watts. Motor—115 or 230 volts, 1-phase, 60 cycles AC, rated at 3/4 HP RPM-1725. Includes capacitor for starting, and instructions for 115 or 230 volt connections. All new.

PRICE, EACH... \$60.00

RADAR EQUIPMENT

Navy Model SF, NEW and Complete with all spares and accessories. Price, Complete Set...\$2,500.00
 SCR-717-B, Army-Bomber Type, PPI, New and Complete with all spares and accessories...\$850.00
 EACH
 Radar Transmitter Type CRV-52AAY, for SD-3, excellent condition but less tubes...EACH...\$150.00
 Model YJ Automatic-Responding Radar Beacon, RF and Power Supply Units only (transmitter) with tubes. Good condition...PRICE, EACH...\$150.00

FM-AM SIGNAL GENERATOR

For Servicing FM and Television

Known as Test Oscillator TS-32/TRC-1, and mfd. by LINK, this item is a bargain for servicemen, laboratories, and production testing dep'ts. Frequency range 70 to over 100 mc. Small, well-built, uses only 3 tubes (6S17, 6SN7GT, and 6SN7GT) to a crystal osc.-buffer amplifier, phase modulator—frequency multiplier, and audio frequency stages respectively. Modulation frequency (FM) is 1,000 cps, and a toggle switch in front permits "On or Off" modulation. A 2 ft. rubber cable with central male plug permits ready connection to chassis (television or radio) for power. With circuit diagram, instructions, tubes, but less crystal.

PRICED, LOW!!! EACH... \$5.95

RADIO TRANSMITTERS

Immediate Delivery from Stock

10 KW Low and Intermediate Frequency Bunnel Transmitter, 150 to 550 KC. A1 emission. Consists of BC-365F Exciter-Driver (300 watts), PA-1A Power Amplifier, RA-1A Rectifier, AP-1A Antenna Tuning Unit with pre-tap (knock-down) tuning "house", with all spares such as tubes, meters, capacitors, resistors, transformers, etc. All NEW Equipment, in original factory packing. Operates from 220 volts, 3-phase, 50-60 cycles AC. COMPLETE EACH...\$9,000.00

2-KW Hi-Frequency Transmitter: 4-Bands, 2 to 18 mc. Model H-2000, mfd by Radio Laboratories, Inc. Consists of P.A. unit using 2-833A tubes, in cabinet 36x36x7 1/2" high, and Power Supply using 4-872A and 2-866 tubes, in cabinet 24"x36"x7 1/4" high. Operates from 110 or 220 volts, 50-60 cycles, 1-phase AC. Driving power required, 70-125 watts. New condition: with tubes. COMPLETE, EACH \$2,100.00

Exciter-Driver, for Above. Either Model 300-B 4-Channel Radio Laboratories unit designed to operate with above; or BC-447, 300 watts, 2-channel transmitter (described below). Complete with tubes. Each...\$600.00

BC-325 Transmitter, 400W.-A1, 100 W.-A2 & A3. 1.5 to 18.0 mc. M.O. or X'tal control on 6 frequencies. Operates from 110/220V/1/50-60 c. AC. With tubes, in excellent condition. Price, each \$750.00

BC-447, 300 W. A1, 2-Channel Transmitter. Complete and self-contained in one cabinet, 36x29x7 1/2". Includes HF sections, power supplies, and control equipment. Freq. range 4.0 to 13.3 mc. Operates from 110/220V/1/50-60 c. AC. With tubes. Excellent condition. PRICE, EACH...\$600.00

Model 600-B, 600 Watt Radiotelephone transmitter, mfd by Temco for the Navy (shore station). 600 watts on phone, 1 KW on CW; frequency range 1.5 to 20.0 mc. Provision for multi-channel operation. Includes separate Remote Control and Speech Amplifier unit. Operates from 220 volts, 1-phase, 50-60 cycles AC. With tubes—no spares. Price...\$2,000.00

Collins 75 Watt Autotune Transmitter. Model TCB, 10-channels instantly available by dial-telephone selection at transmitter or remote position. A1, A2, or A3 emission. Freq. range 1.5 to 12.0 mc. Operates from 110 volts, 1-phase, 50-60 cycles AC. Complete with all spares (tubes, transformers, autotune motors, capacitors, etc.), remote operating unit, handsets, etc. Excellent condition. Priced way below cost at \$750.00 each.

50 Watt Radiotelephone, Model ATD, designed for airplane installation. Useful also for ship, shore or barn installation. Conservatively rated at 50 watts output. A1, A2, and A3. Instant selection of any one frequency in 3 bands, 540 to 1500, 1500 to 3000, and 3000 to 9050 kc. Complete with 24 to 28 v.d.c. dynamotor, remote control, channel indicator unit, plug connectors, spares, instruction book. Uses high-level plate modulation for A2 and A3. PRICE, COMPLETE EACH...\$110.00

12-Volt MOBILE P. A.



Brand new, RCA, complete 25 watts peak, 12 - 15 watts average, Amplifier and close - talking Pressure type (moving coil) Micro phone Operates from 12-14 volts DC. Self - contained vibrator power supply. Tubes supplied: 6J7, 6SN7, and 2-6L6. Flat response to 5,000 cps. Output impedance to 15 ohms (2-8 ohm voice coils). Shock mounting employed throughout. Designed for airplane installation, to withstand shock and vibration. Ideal for soured trucks, boats, portable P.A., etc. Conversion to 110V. AC. operation easily accomplished. Drain 2 amps standby, 6 amps. operate.

PRICE, with Dyn. Microphone \$59.25

FREQUENCY METER TS-69/AP

Frequency range 400 mc to 1,000 mc, continuous. Black-crackle finished metal case, dim: 6"x6"x2 1/2". contains variable length coax resonating cavity with crystal rectifiers and 0-200 microammeter. Year Root counter and calibration charts insure extreme precision. Telescopic antenna, and coax line probe, with metal carrying case for entire equipment. All New Equipment.

COMPLETE, EACH... \$42.50

MODEL 78E SIGNAL GENERATOR

Mfd. by Measurements Corp., of Bonton. Calibration curve supplied covers 50 to 75 mc., but can be extended at least 20 mc each side. Includes micrometer type tuning dial, output meter, micro-volt calibrated attenuator, modulation on-off switch. A real precision laboratory instrument, for television, FM, or HF communications work. Complete with tubes, each in excellent condition.

PRICE, EACH... \$59.95

SCR-536 HANDY-TALKIES

We have just a few hundred of these popular Handy-Talkies, and they won't last long. All are in very excellent condition, and complete with crystals (receiving and transmitting) and batteries. All are in top operating condition, and preset at various operating frequencies ranging from 3.5 to 6.0 mc. We will supply units with matched frequencies as long as quantity permits. First come, first served!

Price, Each... \$50.00

Extra Set Batteries (A&B), Export Packed \$3.00

X'MTTNG X'FORMERS CHOKES, ETC.

Inca Heavy Current Plate X'former, has tapped primary to 240 volts, 50/60 cycles AC, and 1100 volt secondary, tapped for reducing voltage. Output 3000 KVA. Model 035499. Shng. wt. 300 lbs. New condition. PRICE EACH...\$74.95
 Amertran Filter Choke, Type W, 0.04 henries at 2.4 ampe dc, max test 10 kv, dc resist, 0.24 ohm. NEW. PRICE EACH...\$4.95
 Adlake Time-Delay Relay, Model 902-72-1, 220 volts 50-60 cycles, normally open, seconds operate—30 (max), release—5 (max). New. PRICE EACH...\$4.95
 Adlake Time-Delay Relay, Type 1040-65-4, 110 volts 50-60 cycles AC, normally open, operate min. 30 secs., max. 40 secs., release 0.3 secs. New. Each...\$3.10

All Prices F.O.B. N.Y.C. All Material offered subject to Prior Sale. Prices Quoted Supersede Previous Advertised Prices, and Effective Until Next Issue Only.

TELEMARINE COMMUNICATIONS COMPANY
 PHONE WATKINS 4-7021 533 W. 24th St., N. Y. 11, N. Y.

"ARROW" leads with Better Buys!

BRAND NEW!

TUBES

BRAND NEW!

304TL
Transmitting
Tube \$195
ea.

CATHODE RAY TUBES
5CP1 5FP7 }
5BP1 7BP7 } \$119
3FP7 } each

5BP4
Cathode Ray
Tube \$195
ea.

39c
each
lots of 50—
10% discount

RECEIVING TUBES

954
957
9003
9006
35W4

2051
12AT6
12SR7
12C8
12K8
12BE6

864
RK34
12A6
6SJ7
12J5

6AT6
6SF7
5R4
36
6G6

Amperite
10T1
110AC
Neon
Light

39c
each
lots of 50—
10% discount

1629 19c each 1625 19c each 7193 19c each

SPECIAL TUBE OFFERS

841—79c ea.	837—\$1.95 ea.	869B—\$25.00
839—\$2.95 ea.	832A—\$2.95 ea.	
2C26A—49c ea.	2J32—\$19.95 ea.	



BIAS METER
Brand New

Originally used for measuring voltages and teletype and telephone equipment. Can be used for measuring DC voltages and bias voltages; also checking polarity of DC voltages. Complete with adaptor plug and schematic. Enclosed in metal carrying case. Requires no batteries for operation \$4.95 ea.

WAVE METERS

Freq. range: 22 to 30 meg. }
Freq. range: 37 to 53 meg. } **\$7.95**
Freq. range: 155 to 230 meg. } each

AC operated, complete with carrying case and magic eye for tuning indicator, vernier tuning dial.

DYNAMOTORS

PE 101C, Input: 13/26 VDC at 12.5/6.3A.
Output: 400 VDC at 135 Ma.,
800 VDC at 20 Ma.
9 VAC at 1.21 A. **\$2.95**

DM 53 A, Input: 28 VDC at 1.4A.
Output: 220 VDC at 80 Ma. **\$2.95**

INVERTER

PE 206-A, Input: 28 VDC at 38 amp.
Output: 80 volts at 500 volt-amp.
800 cycles.
Leland. New, complete with enclosed relay, filter, instruction book. **\$3.95**
BRAND NEW **\$3.95**

OIL-FILLED CONDENSER

.25 MFD at 15,000 VDC **\$4.95**

REMOTE POSITION INDICATING SET



6-12 V. 60 cycles. 5 inch indicator with 0-360° dial. Heavy duty transmitter.
Indicator **\$2.95 ea.**
Transmitter **\$2.95 ea.**
Set **\$5.50**

SPRAGUE PULSE FORMING NETWORKS

Used in small radar modulators, available in 3 sizes, 67 ohms impedance. 7.5 Kilo-watt rating.
H-603, one micro second, 200 pulses per second **\$1.95**
H-601, 3 micro seconds, 200 pulses per second **2.95**
H-602, 16 micro seconds, 60 pulses per second **3.95**

Plug-In Vacuum Capacitor

50 mmf. designed to work with voltages up to 5000 volts. Will handle 5 amps—don't change the final when switching bands, just plug in condenser—size 1 3/4 x 1 1/2. **\$1.19**
BRAND NEW

GLIDE PATH RECEIVER
R-89/ARN-5

Glide Path Receiver used in the Instrument Landing System covering the frequency range 332 to 335 mc; complete with the following tubes: 7-6AJ5, 1-12SR7, 2-12SN7, 1-28D7, and including three crystals 6497KC, 6522KC.

BRAND NEW **\$9.95**
In excellent condition..... **\$6.45**

ANTENNA RELAY UNIT

0-10 Meter Weston Thermocouple unit with 50 MMF, 5000v Vacuum Condenser, and heavy duty relay **\$1.95**

All Shipments F.O.B. Chicago. Minimum order \$5.00. 20% deposit on all orders. DEPT. EL.

ARROW SALES, INC.

MAIN OFFICE

SOUTH SIDE BRANCH
8310 SOUTH HALSTED ST.

59 WEST HUBBARD ST., CHICAGO 10, ILL.

Telephone SUPERior 5575

NORTH SIDE BRANCH

1802 NORTH HUMBOLDT BLVD.

NOW

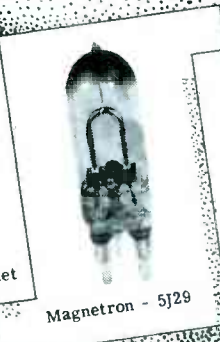
is your
**OPPORTUNITY
TO BUY TUBES**

at
Ridiculously Low Prices
Transmitting - Special Purpose

Every tube is *Brand New* in original unbroken factory package.



Magnetron - 2J38 w/magnet



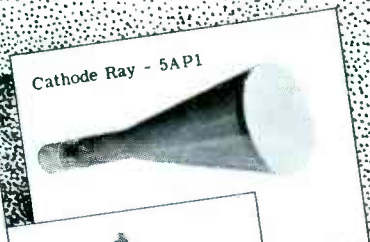
Magnetron - 5J29



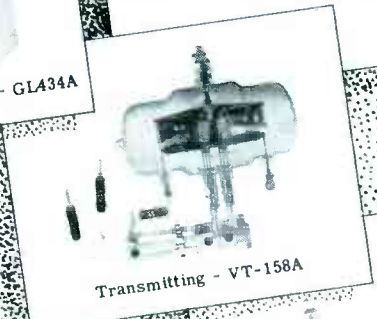
Rectifier - 250R



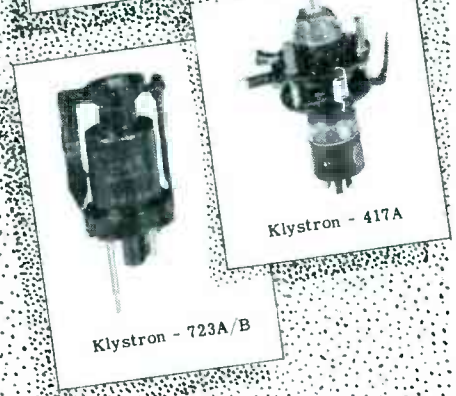
Transmitting - GL434A



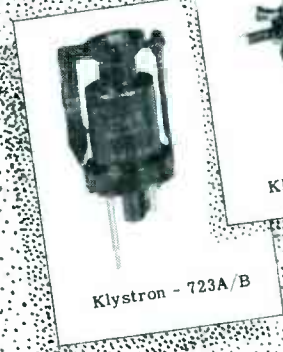
Cathode Ray - 5AP1



Transmitting - VT-158A



Klystron - 417A



Klystron - 723A/B

Magnetrons		Klystrons	
2J22	\$15.00	417A	\$9.80
2J38 w/magnet	15.95	723A/B	3.95
2J48	15.95	726A	4.75
4J26	15.95		
5J23	15.95		
5J29	15.95		
714AY	9.80		
725A	12.50		
Cathode Ray		Rectifiers	
3CP1/S1	\$.95	CRP-72	\$2.95
5AP1	2.49	250R	4.95
5JP2	3.95	WL531	29.95
12GP7	12.50	866A/86698
		WL869B	29.95
		1641/RK6069
Receiving			
VT-25A	(Special 10)		.69
VT-52	(Special 45)		.69
6J6	Twin Triode69
717A	(6AK5 w/octal base)		.98
9002	Miniature UHF Triode		.95
Special Purpose			
1B24	T-R Tube		2.95
724B	Spark Gap Tube		1.95
2051	Thyratron49
"	" (in lots of 100) ea.		.35
VR-150	Voltage Regulator69
6AMP	Tungar Rectifier		3.00

Transmitting	
5D21	Tetrode 9.95
15E	UHF Triode 2.95
24G	UHF Triode . Plate Diss. 25W . 2000V at 75 ma good up to 300 Mc. 69
VT-158A	UHF Triode with Tuned Circuits Built-in 4.90
388A	Door Knob Triode 4.95
GL434A	Lighthouse 7.95
GL446A	Lighthouse (2C40)74
WL530	Water Cooled Triode 39.50
715B	Tetrode 9.95
804	Pentode 3.75
807	Beam Power Tetrode 1.19
813	Beam Power Tetrode 6.95
829	Beam Power Tetrode 2.95
841	Triode69
1625	Beam Power Tetrode49
1626	Low Drift Osc. Triode49
7193	UHF Triode39
8011	(VT-90) Micro-Pup98

TERMS - Orders under \$3.00, cash with order; orders over \$3.00 require 20% deposit, balance C.O.D.
ALL PRICES ARE NET, F.O.B. DAYTON, O.

Everything in Electronics

SREPCO
STANDARD RADIO & ELECTRONIC PRODUCTS CO.
135 E. SECOND ST. DAYTON 2, OHIO.

Don't Delay - Order Today!



SIGNAL GENERATOR for the range of 1000-4000 megacycles, used by producer of the APR-4 tuning units, uses a 1000-3000 megacycle cavity & 2C40, below cutoff attenuator, crystal and 50 microamp meter at output connector, TFS-5 coaxial wavemeter, sine wave modulation, 115 v, 60 cps.

HARMONIC GENERATOR, good output in range of 300 to 2000 megacycles, uses 300-1000 mc butterfly, 703 A tube, and distorter crystals, waveguide below cutoff attenuator, used, 110 v 60 cps.

TEST SET TS-278/AP, for AN/AP5 13, synchronized, delayed pulse signal generator, 400-430 megacycles, calibrated waveguide below cutoff attenuator, synchronized marker generator, 115 v 60 cps, new and complete, \$75.00.

A quantity of incomplete APR-4 tuning units, TN-19 975-2200 mc, and TN-54 2000-4000 megacycles are being completed, and will be ready for delivery during May, 1948.

X BAND POWER METER, TS 36/AP, complete with accessories, new.

WAVEMETER TS 69/AP, 350-1000 megacycles, calibrated, new.

X BAND POWER LOAD, TS 108/AP complete with case and accessories, \$10.00.

CALIBRATED S BAND fixed attenuator, 19.8-20.2 db, type N fittings, \$10.00.

PANORAMIC ADAPTER, BC-1032, input frequency 5.25 mc, sweepwidth 1000 kc, 115 volts, 60 cps, new, \$85.00.

TRANSMISSION MEASURING SET, W. E. D165655, minus 45 db to plus 10 db, 30-15000 cps, 110 v 20-60 cps, new, \$100.00.

RESISTANCE LIMIT BRIDGE, Industrial Instruments model LB-3, good working order, \$75.00.

GENERAL RADIO PRECISION WAVEMETER, type 724A, range 16 kc to 50 megacycles, 0.25% accuracy, V. T. V. M. resonance indicator, complete with accessories and carrying case, new, \$200.00.

AUDIO SIGNAL GENERATOR, 20-20,000 cps, R C tuned, Hickok model 198, good working order \$45.00.

RCA 5" Cathode Ray Scope, model 160 B, new \$135.00.

CLOUGH BRENLE, Resistance. Capacity and Turns Ratio Bridge, model 230, new \$55.00.

TELEPHONE TEST SET EE-65-F, complete, new, \$30.00.

TEST OSCILLATOR TS-47/APR, 40-500 megacycles pulse, and sine wave modulation, 110/220 v 60-2600 cps, \$100.00.

TS-184/AP, TEST SET for AN/AP5-13 \$75.00.

TS-10/AP, TEST SET for AN/APN-1 \$40.00.

TS-203/AP, SELSYN with accurately calibrated dial, 30 degree rotation, \$13.00.

CGI-60 ABC FREQUENCY METER, 150-240 megacycles, cavity type with micrometer adjustment, calibrated, 115 v 60 cps, \$35.00.

OAP WAVEMETER AND OSCILLATOR, 145-235 megacycles, calibration charts, 115 v 60 cps \$50.00.

MODULATOR BC-423, tweeter, range 145-250 megacycles, pulsed R.F. 110 v 60 cps, slight external damages, \$15.00-\$25.00

MICROWAVE TEST CABLE, 15' RG-9U cable with UG-24U connectors 15 feet long \$4.00, 8 feet long \$3.50.

LOSSY CABLE, 10 db at 3300 megacycles, type N connectors \$3.00.

83-1AP UHF right angle adapters, 10 for \$2.50, 100 for \$12.00.

TYPE N CONNECTORS, UG-10, 12, 21, 22, 24, 25, 27, 30, 58, 59, 83, 86, 190, 201, 245, and UHF connectors SO 239, PL 259 83 1AP, UG 266, complete with center contacts, immediate delivery.

CRYSTAL MIXER ASSEMBLY, 10 cm, type N fittings, \$3.00.

RADIO RECEIVER TRANSMITTER BC-800-AM, P/O SCR-729-A, receives on 2 and transmits on 1 preset frequency in range of 160-180 megacycles, 115 v 400 cps, new \$30.00.

COMPACT RADAR RECEIVER TRANSMITTER AND INDICATOR, AN/APG-13A, 2400-2700 mc, 115 v 400 cps, new, export packed \$125.00.

RADAR TRANSMITTER, BC 947-A, 10 cm, 115 v 60 cps, less HV supply, \$40.00.

COMPLETE MARINE RADAR, Navy SD 3, 220 megacycles, 115 v 60 cps, new, export packed.

COMPLETE 10 CM RADAR SETS, SL-1 and SQ.

RADAR RECEIVER BC 1068-A, 150-230 megacycles, individual tuning for the r.f. stages, bandwidth 4 megacycles, 115 volts, 60 cps, 14 tubes, \$45.00.

RADIO COMPASS RECEIVER, Bendix MN26A, 150-1500 kc, 12 v, new, \$40.00.

RADIO DIRECTION FINDER EQUIPMENT, Model DP-15, 100-1500 kc, receiver, power supply, operating pedestal azimuth scale, loop pedestal loop assembly, used, 110 v, 60 cps, \$160.00.

RADIO COMPASS RECEIVER BC-A, B, C, G, Bendix, used, 150-1500 kc, \$15.00.

BENDIX AIRCRAFT TRANSMITTER TA-12, 24 v, \$40.00.

MARINE RECEIVER MACKAY 128-AW, 15-650 kc, 115 v 60 cps, \$50.00.

MARINE RECEIVER ARB-1, 15-600 kc, \$50.00.

TRANSFORMERS, 115 volts 60 cps primaries:

1. 7500 volts 35 ma, ungrounded Thor-darsen, \$15.00.
2. 6250 volts 80 ma, ungrounded, G. E., \$12.00.
3. 6250, 3250, and 2000 volts, tapped primary, \$14.00.
4. 2 secondaries at 500 volts 5 amps each, wt 210 pounds, \$50.00.

Pulse Input Transformer, permalloy core, 50 to 4000 kc, impedance ratio 120 to 2350 ohms. \$3.00.

Pulse Transformer, Westinghouse 145-EWP, \$3.00.

Pulse Transformer, Utah 9280, \$1.00. Magnetron 3J31, \$17.00.

W.E. 704-A HIGH FREQUENCY DIODE, plate to cathode capacity 0.55 mmfd. 1" x 3/8". \$2.00.

OSCILLATOR BUTTERFLY, 300 1000 mc, mounted socket and W.E. 703-A tube, \$11.00.

MIXER BUTTERFLY, 80-300 mc, \$3.00.

High Voltage Switch, motor actuated, 18000 v peak at 5 amps, DP-ST, \$18.00.

High Voltage Relay, 25000 volts 35 amps, 60 cps, DP-DT, 220 volt 60 cps, Coil, \$50.000.

Ceramic double cap, capacitor, 50 mmfd, 10,000 volts, 50c.

Ceramic feed thru capacitor, 50 mmfd, 1000 volts, 15c.

Silver button mica, disc type, 300 mmfd, 20c.

Silver button mica, stud mounted by 3-48 screw, 500 mmfd, 20c.

Pulse Forming Network, 20 kv, .92 micro-second, 50 ohms, \$25.00.

Varistors WE D171528, D171628, D-161871-A. 75c ea.

0-350 volts, 1000 ohms per volt meter, Westinghouse NX 35, \$4.50.

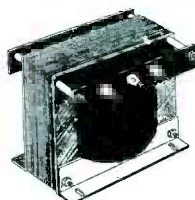
HARRISON

SELECT

SURPLUS

Good, usable equipment—
accurately described—
sensationally low priced—
that's HSS!

HEAVY DUTY HIGH VOLTAGE TRANSFORMER



Primary: 115 or 230 volt, 60 cycle. Has taps which can reduce output voltages by 10% and 20%.

Secondary: 1170 volts, with center tap. Will deliver up to 500 volts DC at 750 MA with choke input filter, or 600 volts DC at 600 MA with condenser input filter. (Use duplex or branch rectifiers and/or filters for added flexibility and stability). With half-wave or bridge rectifier will give 1200 volts DC, 300 Ma.

Two transformers, with secondaries in series, will economically make available 1000 volts at 750 MA, or 1200 volts at 600 MA. Excellent regulation!—plenty of good grade core and copper.

Compact!—6 3/4" wide x 6" high x 6 1/2" deep (overall, including ceramic HV feed thru insulators). Husky!—22 1/2 lbs.

Dependable!—made to Gov't spec by reputable manufacturer.

Sensationally Priced!— (plus repacking charge of 80¢ each.)

\$5.94
Item TP6

FILTER REACTOR

15 Henry 175 MA
200 ohm DC resistance

Well made, of best materials, by one of our good manufacturers (you'll recognize the name plate)! Fully shielded. 3 1/2" x 3 1/2" x 4 3/4" high. Weighs 5 lbs., each.

\$1.94

Two, or more, at—**\$1.69** each
Item CH7



CONDENSERS

2 MFD, 1000 VOLT. The popular oilfilled cylindrical type that mounts upright in one 3/8" hole. Aluminum case 1 1/2" x 4 1/2". Complete with nut lock, washer, and lug. List price \$4.75. Item CP15

SIX OR MORE AT ONLY 49¢ each

2 MFD, 600 VOLT. Bathtub oils. 2" x 2" x 1 1/4". Side lugs. Item CP12

Six or more, at 29¢ each

(Millions of surplus capacitors on hand! What do you need?)

Don't forget to include in your order the rest of the items you need for those new power supplies—filament transformers, rectifiers, sockets, bleeders, condensers, switches, chassis, etc.!

Harrison has it!

HSS DIVISION

Every item guaranteed perfect. Prices are net, FOB NY 7. COD shipments to rated firms only.



12 WEST BROADWAY • NEW YORK CITY 7
BARCLAY 7-9854

JAMAICA BRANCH — 172-31 Hillside Ave. — REPUBLIC 9-4102

Since 1925 —We have been supplying Electronic Parts and Equipment to Laboratories, BC Stations, Amateurs, Schools, Factories, Exporters, Dealers, etc.—in all parts of the world. As Authorized Distributors for practically every leading Manufacturer we maintain a most complete inventory for your immediate convenience—at lowest trade prices. Our Industrial Department invites your inquiries and orders.

ELECTRO IMPULSE LABORATORY

66 Mechanic Street

Red Bank, New Jersey

Telephone: RED BANK 6-4247

RADIOMEN'S HEADQUARTERS * WORLD WIDE MAIL ORDER SERVICE !!

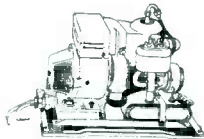
Sensational Selenium Scoop

SELENIUM RECTIFIERS

The new miniature rectifier that more and more manufacturers are using. Order some of each type so you will be ready when these receivers require servicing. Make extra money by installing them in old sets. All types are rated at 180 V. RMS and will withstand an inverse peak of 380 v. The 25 ma is for phono osc and bias supplies and converting relays.

25 ma.....\$0.45.....10 for \$ 4.00	100 ma......75.....10 for \$ 7.00	200 ma.....\$1.05.....10 for \$10.00
75 ma......70.....10 for 6.50	150 ma......80.....10 for 7.50	250 ma.....1.25.....10 for 11.50
1000 ma. 35V. 1.00.....10 for 9.00	Full Wave Meter Rectifiers.....1.25	Half Wave Meter Rectifiers......75

PE-109 32-VOLT DIRECT CURRENT POWER PLANT



This power plant consists of a gasoline engine that is direct coupled to a 2000 watt 32 volt DC generator. This unit is ideal for use in locations that are not serviced by commercial power or to run many of the surplus items that require 22V DC for operation. The price of this power plant is only \$58.95. We can also supply a converter that will supply 110V AC from the above unit or from any 16-32V DC source for \$12.95.

Due to the fact that the PE-109 comes to us sealed in a heavy steel-strappped gov't. case, it is impossible to inspect the individual units to determine if they are new or used, or what the condition is if used. Consequently we must sell them "as is". In general they represent a terrific bargain.

GENERAL ELECTRIC RT-1248 15-TUBE TRANSMITTER-RECEIVER

TERRIFIC POWER—(20 watts) on any two instantly selected, easily re-adjusted frequencies from 435 to 500 Mc. Transmitter uses 5 tubes including a Western Electric 316 A as final. Receiver uses 10 tubes including 955's as first detector and oscillator, and 5-7H7's as IP's with 4 slug-tuned 40 Mc. IF transformers, plus a 7HT, 766's and 757's. In addition unit contains 8 relays designed to operate any sort of external equipment when actuated by a received signal from a similar set elsewhere. Originally designed for 12 volt operation, power supply is not included, as it is a cinch for any amateur to connect this unit for 110V AC, using any supply capable of 400V DC at 1.5 MA. The ideal unit for use in mobile or stationary service in the Citizen's Radio Telephone Band where no license is necessary. Instructions and diagrams supplied for running the RT-1248 transmitter on either coil or voice in AM or FM transmission or reception, for use as a mobile public address system, as on 80 to 110 Mc. FM broadcast receiver, as a Facsimile transmitter or receiver, as an Amateur Television transmitter or receiver for remote control relay hookups, for Geiger-Mueller counter applications. It sells for only \$29.95 or two for \$53.90. If desired for marine or mobile use, the dynamotor which will work on either 12 or 24V DC and supply all power for the set is only \$15.00 additional.

AT LAST YOU CAN AFFORD A LABORATORY STANDARD MICROVOLTER

The famous Measurements Corp. Model 78E, 5 Tube Laboratory Standard Signal Generator (that sold new, FOB, Broomton, N. J. for \$310.00 net), is available in perfect condition for 25 to 60 cycles, 115V AC operation. Until now this is the sort of top-flight lab equipment that discriminating buyers have only vainly hoped would be released at a bargain price. Worth every cent the manufacturer asks, but available FOB Buffalo while our limited supply lasts for only \$79.95.

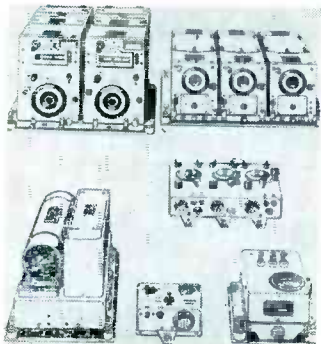


78E Standard Signal Generator. 50 to 70 Mc. Unmodulated or with 400 cycle modulation.

Such companies as Admiral Corp. and John Meek, Inc., have ordered from us and repeated many time on these 78 generators for use in their labs and production line testing.

Uses 1-9002, 1-7Y4, 1-VR 150-30, 1-767, and 1-7C5 tubes output continuously. Variation from 0 to 100,000 Microvolts, 34° output.

RT 1463 7 tube amplifiers containing 3-7F7, 1-7Y4, 3-7N7, 4 potentiometers, numerous resistors, filter and bypass condensers, filter chokes, power and audio transformers, and six sensitive plate relays. A military development that provided amazing stepless control proportional to correction required for ailerons, rudder and elevator, in the original application. A control amplifier of the ordinary type would deflect the rudder by some arbitrary amount when the ship was blown off the course to port or starboard. The result would either be that the correction was insufficient and the plane continued off course, or the correction would be too great starting a series of tacking and would greatly increase fuel consumption and elapsed time in reaching the objective. This phenomenal unit, with its 3 amplifiers and six 5000 ohm, relays in time in reaching the objective. This phenomenal unit, with its 3 amplifiers, related or un-related, in minutely adjustable bridge circuits, will accurately control any 3 operations, related or un-related, in minutely adjustable uniquely quantitative variations in either forward or reverse directions. 9"x7"x8" black crackle aluminum case. Brand new in original carton. \$12.95, or used \$9.95.

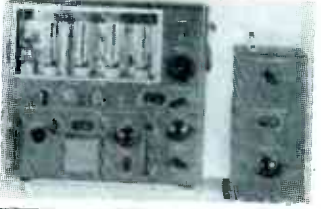


SCR-274N COMMAND SET

The greatest radio equipment value in history

A mountain of valuable equipment that includes 3 receivers covering 190 to 550 KC; 3 to 6 MC; and 6 to 9.1 MC. These receivers use plug-in coils, and consequently can be changed to any frequencies desired without conversion. Also included are two Tuning Control Boxes; 1 Antenna Coupling Box; four 28 V. Dynamotors (easily converted to 110 V. operation); two 40-Watt Transmitters including crystals, and Preamplifier and Modulator, 29 tubes supplied in all. Only a limited quantity available, so get your order in fast. Removed from unused aircraft and in guaranteed electrical condition. A super value at \$29.95, including crank type tuning knobs for receivers. Without these knobs the receivers can't be tuned, and are only useful for parts. Don't buy without knobs! We also include one 60 cycle, 110 to 24 V. filament transformer for receiver—FREE.

RECORDING AMPLIFIER. 3 stage, 110 V., 25 or 60 cycle high gain amplifier built by recently bankrupt manufacturer specifically for recording use. Transformer for low impedance wire recording head or magnetic use as public address amplifier. Com. lets with tubes—\$9.95 Speaker—\$2.40 Beautiful original portable case \$5.95. Mike Stand \$5.95.



GENERAL ELECTRIC 150 WATT TRANSMITTER
Cost the Government \$1800.00 • Cost to You— BRAND NEW—\$67.50

This is the famous transmitter used in U.S. Army bombers and ground stations, during the war. Its design and construction have been proved in service, under all kinds of conditions, all over the world. The entire frequency range is covered by means of plug-tuning units which are included. Each tuning has its own oscillator and power amplifier coils and condensers, and antenna tuning circuits— all designed to operate at top efficiency within its particular frequency range. Transmitter and accessories are finished to operate at top efficiency within its meter, and IP' ammeter are mounted on the front panel. Here are the specifications: **FREQUENCY RANGE:** 200 to excited, therm compensated, and hand calibrated. **POWER SUPPLY:** Supplied complete with dynamotor which furnishes 1000V at 350 MA. Complete instructions are furnished to operate set from 110V AC. **SIZE:** 21 1/2"x23 1/4". Total shipping wt. 200 lbs., complete with all tubes, dynamotor power supply, seven tuning units, antenna tuning unit and the essential plugs.

1948 MODEL MUTUAL CONDUCTANCE TUBE TESTER \$49.95

No possibility of good tubes reading "Bad" or bad tubes reading "Good" as on dynamic conductance testers or other ordinary emission testers. Attractive panel and case equal to any on the market in appearance. Large 4 1/2" meter. Calibrated micromho scale as well as a Bad-Good scale. Front panel fuse. Individual sockets for all tube base types— voltages from .75 volts to 117 volts and complete switching flexibility allow all present and future tubes to be tested regardless of location of elements on tube base. Indicates gas content and detects shorts or opens on each individual section of all local, octal and miniature tubes including cold cathode, magic eye and voltage regulator tubes as well as all ballast resistors. Name of the nationally known manufacturer withheld because of special price offer. **Model "C"**—Sloping front counter case. \$49.95 **Model "P"**—Handsome hand rubbed portable case. \$49.95 Built-in roll chart with either of above \$5.00 extra.

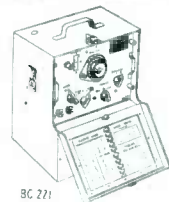
Minimum order \$3.00—All prices subject to change—25% deposit with COD orders.

TERRIFIC VALUE— PORTABLE ELECTRIC DRILL

(Sold at less than established factory price so we cannot mention brand name) Only \$19.95 equipped with 3/4" Jacobs Geared Chuck and Key. Not an intermittent duty drill, but a full size rugged tool. Most convenient type switch, natural grip handle, and balance like a six shooter. Precision cut gears—turbine type cooling blower—extra long brushes. No stalling under heaviest pressure because of powerful 110 Volt AC-DC motor and multiple ball thrust bearing. Other bearings self-aligning lifetime-lubricating Chrysler Oilite type. Made for toughest year-in and year-out service in plant or on construction jobs. Amazing perpetual factory guarantee assures you of a lifetime of trouble-free use. 25% deposit on C.O.D.'s. Full refund (you pay transportation) if not pleased with drill after trial.

BC-221 FREQUENCY METERS

with calibrating Crystal and calibration charts. A precision frequency standard that is useful for innumerable applications for laboratory technician, service man, amateur, and experimenter at the give away price of only \$36.95.



TRANSFORMERS—All types in stock. **AUTO-TRANSFORMERS:** Steps up 110v to 220v, or steps down 220v to 110v—\$1.95. **FIL. TRANS:** 6.3v, 8 Amps—\$1.98; 5v, 10 Amps—\$1.98; Universal Output Trans 8 Watt—89c; 18 Watt—\$1.29; 30 Watt \$1.69. **AUDIO TRANSFORMERS:** S. Plate to S. Grid, 3:1—79c; S. Plate to P. P. Grids—\$79c; Heavy Duty Class AB or B, I.P. inputs—\$1.49; Midget Output for AC-DC sets—69c; **MIKE TRANSFORMER** for T-17 Shure microphone, similar to UTC announcer type—\$2.00. Stancor SB or DB make to line or grid—\$1.95.

POWER TRANSFORMERS—Half-shell type, 110V, 60 cv. Center-tapped HV winding. Specify either 2.5 or 6.3V filament when ordering.
 For 4-5 tube sets—650V, 40MA, 5V & 2.5 or 6.3V.....\$1.49
 For 5-6 tube sets—650V, 45MA, 5V & 2.5 or 6.3V.....1.75
 For 6-7 tube sets—675V, 50MA, 5V & 2.5 or 6.3V.....1.90
 For 7-8 tube sets—700V, 70MA, 5V & 6.3 or two 25V.....2.35
 For 8-9 tube sets—700V-90MA, 5V-3A, 2.5V-3.5A.....2.85
 For 9-11 tube set—700V, 100MA, 5V & 6.3V-4A.....2.85
 For 9-15 tube sets—600V, 150MA, 5V & 6.3V.....2.95

RT1655. An 11 tube crystal controlled superhet receiver for 24-25V DC operation. Beautiful chassis and cabinet. Uses latest tube types including 7 miniature 6AJ5's. Tubes and schematic supplied. Only a few available at \$14.95.

1948 MODEL OUTBOARD MOTOR AT DEALER WHOLESALE PRICE!!

Powerful deluxe twin cylinder outboard motor with automatic starter (no fumbling for a rope), 2 positive cooling unbreakable water pump, and an improved magneto for sensationally quick starts as well as smooth, efficient operation at slowest trolling speed or with the throttle wide open. Dozens of additional outstanding features are provided, such as corrosion resistant aluminum alloy castings, to protect the engine and give the unit a sleek, streamlined appearance; hardened alloy steel connecting rods with roller bearings, and a rugged, perfectly balanced crankshaft. Delivers a full 7.5 H.P. as rated by the Outboard Boating Club of America. Net weight—52 lb. Gross shipping weight including free steel storage stand—100 lb. For a limited time we are selling this motor, which is produced by the world's second largest maker of outboards to sell for more than \$30.00 above our price—or only \$139.00, brand new, FOB Buffalo.



WAR SURPLUS ITEMS

That Are Worth Looking Into
EVERYTHING BRAND NEW

METERS

- 2" Triplett Bakelite Case 0-35 Mill. D.C. in Black Wrinkle Finish. Round Metal Box **2.25**
- 3" Round Beede 0-1000 Mill. D.C. Bakelite Case **1.95**
- 3" Round Western Electric 0-1000 Mill. D.C. Bakelite Case **2.25**
- 3" Round Westinghouse Bakelite Case 0-1 Mill. D.C. with bad & good colored scale can be used in tube checker **3.45**
- 3" Round Burlington Bakelite Case 0-75 Amperes A.C. **3.45**
- 3" Round Triplett Bakelite Case 0-150 Volt A.C. **3.45**
- 3" Square Triplett Model 327A Bakelite Case 0-200 Milliamps D.C. **3.45**
- 4 1/4" Weston Panel Board flush metal case 0-5 amp. A.C. with a 0-200 amp. scale. **3.95**
- Roller Smith portable lab: 0 to 150 Mill. D.C. Bakelite Case with handle: 5 1/2 x 6 x 3 1/2 **19.50**
- Roller Smith portable lab: 0 to 15V D.C. Bakelite Case with handle: 5 1/2 x 6 x 3 1/2 **19.50**
- Jefferson step down (or step up) power circuit Transformer, double wound 230V input 50-60 cycles, to 115V output, 250KVA; Weight 17 lbs. **7.95**
- Standard rack cabinets heavy gauge steel, gray crackle finish; panel opening 19" wide, 27" high **12.95**
- Parallel No. 18 Zip wire, 10 feet lengths, with lugs on each end. Each **.10**
- Hammerlund variable AFC210 micro microfarad **.50**
- Blank Calibration books for RC 221-Frequency from 125KC to 20000KC printed in 10 divisions-98 pages, aluminum cover, spiral bound **1.50**
- RCA-CRV-51019 Hand Sets, self contained battery operated. Uses 4 pen light batteries, excellent for Television Antenna installation; sold in pairs only **15.00**
- Hipover quartz Crystal units: type CF5, 5000KC, complete with holder **1.95**
- 1N21 & 1N23 Western Electric Crystals **35c each**

3 for \$1.00

OIL CONDENSERS

Nationally Advertised		
1 Mfd. 600V DC		\$.35
2 Mfd. 600V DC		.40
4 Mfd. 600V DC		.50
10 Mfd. 600V DC		.95
15 Mfd. 600V DC		2.25
Bathtub. 1 Mfd. 1000V DC		.40
Nat. adv. 35 Mfd. 5000V DC		1.50
Nat. adv. 4 Mfd. 1500V DC		1.50
Nat. adv. 1 Mfd. 2000V DC		.95
Nat. adv. 1 Mfd. 3600V DC		.95

RAYTHEON Rectifiers

W-3155
\$49.50



Supply current at a constant voltage and supplies current to a storage battery, providing an automatic AC-DC power system. Has no moving or expendable parts—therefore no frequent adjustment or maintenance is necessary. The life of the battery increases as much as 40%. Eliminates voltage variations. Range of unit 11/12 cells, 22 to 24 volts @ 3 amp. output. Input supply source 95 to 130 volts, 60 cycles. Weight 180 lbs.



OUR MONTHLY SPECIAL

5 inch Cathode Ray Type 5 BPI tubes. In their original cartons; Brand New. At this price every scope owner should buy a few, and keep in reserve. How can you go wrong for only **\$1.95** Prompt Delivery—Write Dept. EL5 25% deposit required on C.O.D. order Shipped F.O.B. New York. Min. Order \$2.00

MICHAEL STAHL, INC.

39 VESEY ST.
Tel. WOrth 4-2882-3-4 New York 7, N. Y.

OVERSTOCK SALE ON ITEMS LISTED

All New—
Not Government Surplus

	Unit Price
500—Hytron, 2E25 Tubes	\$2.35
150—Hytron, HY69 Tubes	2.25
200—Hytron, HY1269 Tubes	3.00
600—Lewis, 3D23 Tubes	6.50
1,000—Raytheon, 0Y4 Tubes	.45
50—Carter 420 Dynamotors, 12 Volt input, 400 Volt output @200 MA	30.00
2,000—1 Mid Metal Cased Paper Condenser, Standard Brand	.25
3,000—50 Mfd, 150 Volt Dry Electrolytic Condensers — Standard Brand	.22
1,200—10 Mmfd. Type PQ Standard Brand Condensers	.14
5,000—1.5-7 Mmfd. Trimmer Condenser Standard Brand	.28
2,000—1/2 Amp, 1,000 Volt Fuse—Little fuse #2102	.21
1,000—Each SPDT, DPDT, TPDT—Clare Relays 500 or 1,000 Ohm Coils—Type A26112, B26112	2.50
50—T-152 Kenyon Chokes	2.00
4,000—Miniature Sockets — # 9 8 2 0 Cinch	.10
3,000—Miniature Sockets — # 9 8 3 4 Cinch	.25
100—Each I.F. Trans-Aladdin 41-344, 41-392, 41-393, 41-394	2.25
100—T-2 Audio Transformer-Kenyon	3.25
200—VM-O Modulation Transformer—UTC	3.35
150—A-4350 Line Transformer—Stancor	1.75
60—T-655 Power Transformer—Kenyon	4.35

Many more standard transmitter, receiver parts available. Write for complete listing.

Orders not accepted for less than 10% of each quantity listed. Terms—Cash with order or c.o.d.

COMMUNICATIONS COMPANY, Inc.

300 Greco Ave., Coral Gables 34, Florida
Telephone 4-0846

TRANSFORMERS

- PRI:115V., 60 cy., Sec:5V., 30 amps. 150V.A., mfd. by Westinghouse. Price \$4.95
- PRI:115V., 60 cy., Sec:800V.C.T. 800V.A., mfd. by Acme. Price \$27.50
- PRI:115V. 60 cy., Sec: 240/240V., 750V.A., mfd. by Westinghouse. Price \$16.00

CHOKES

- 10 Henry 400 mil. Cased Price \$4.95
- Thyratrons Type FG-172 G. E. Price \$18.50

PARABOLOIDS

- 20 inch Magnesium spun dishes—Used with 3 CM., Radar. Price \$2.25

LABORATORY EQUIPMENT

- Millen Synchrosopes—type 5" CRO \$235.00
- Ferris Model 34-A, Crystal Calibrator \$145.00
- Hewlett Packard—Model 6225-B. Interpolation Osc. \$95.00
- Hewlett Packard, Model 505 A, Electronic Tachometer Complete with model 506 optical assembly \$195.00
- Du Mont Model 185-A, Electronic Switch and Square wave Generator. \$65.00
- TS-487/U Peak to Peak, V. T. Voltmeter. \$49.50
- Distillation Product Corp. Pirami Gauge. \$49.50
- Shallcross 621-H, Limit Bridge \$75.00

*All above except TS-487/U used but guaranteed in perfect condition.

Immediate Delivery FOB Tuckahoe, N. Y.

Subject to Prior Sale

ELECTRONICRAFT, INC.

5 Waverly Place Telephone Tuckahoe 3-0044 Tuckahoe, N. Y.

FOR SALE COPPER SHIELDING

1/4"	\$1.20 per 100 ft.
3/8"	3.75 per 100 ft.
1/2"	5.10 per 100 ft.

UNIVERSAL WIRE & CABLE CO.
2668 NO. CLYBURN AVE.
CHICAGO, 14, ILLINOIS

ELECTRONIC TUBE-MAKING MACHINERY

For manufacturing radio tubes, electronic tubes, cathode-ray tubes, lamps. New and used. Reasonably priced, satisfaction guaranteed.

AMERICAN ELECTRICAL SALES CO.
67 E. 8th St. New York, N. Y.

SURPLUS

Laboratory Equipment

General Radio: 107M Var. Inductor; 224 Wave Meter; P-522A VHF Sig. Gen.; 561D V.T. Bridge; 583A Output Meters; 602D, F & 670F Decade Resistances; 619E Heterodyne Detector; 722M, NQ. Precision Condensers; 724A Precision Wave Meter; 732B Noise & Distortion Meter; 736A Wave Analyzer; 740 BG Cap. Test Bridge; 304A UHF Sig. Gen.; 821A Twin-T Bridge; 901A RF Bridge.

Ferris: 1 B, 18D Microvolts; 33A Calibrator; Measurements: 62 V.T.V.M., 71 sq. Wave Gen., 75 Sig. Gen., 84 VHF Sig. Gen. Boonton: 110A QX Checkers; 120A VHF Circuit Checkers; 155A FM Sig. Gen., 140A BFO.

RCA: MI-18720 Microwave Sig. Gen. Leeds & Northrup: 4750 Shielded Decade Resis. Boxes; 4221—0.1 ohm, 4222—0.01 ohm, 4223—0.001 ohm Pwr. Resis. Stds., 7655 DC Null Indicator.

Western Electric: D-151512 Synchrosopes 3-15 Micro Seconds, 60-250 Micro Seconds; V.T. Volt Reg. Pwr. Supplies (+ 300V @ 60 Ma., + 150V @ 120 Ma., 300V @ 60 Ma.); TS5/AP Range Calibrator (Sweep Marker Generator) W 2765 & W 2752 Network Test Sets, RA, 90A (+ 4900, 1500 V) H.V. Power Supplies; Modulator Oil Units; 730A Magnetron RF unit, 3 CM.

Many others, 20-60% Discount. Send for complete list.

All Equipment Guaranteed: FOB NYC Subject to Prior Sale

THE NATIONAL INSTRUMENT CO.

Far Rockaway, N. Y.



**YOUR DOLLAR
BUYS MORE AT
MID-AMERICA**

Stromberg-Carlson DYNATENNA

This famous-make FM antenna has been advertised and sold for many times the low price MID-AMERICA asks! Covers both FM bands. Delivers FM reception at its best. Complete with 60 ft. of 300-ohm twin lead-in. Line is standard approved flat-type, solid dielectric with weather-resisting insulation. Mounts anywhere easily... vertically or horizontally to match polarization of transmitting station. Illustrations and all necessary hardware. A screw-driver is only tool needed for assembly. Dynatenna is seamless, heat-treated, all aluminum... will withstand severest weather.

\$4.95
each
\$4.45 each
in lots of 3



PERMEABILITY TUNER

Build a really HOT 5 or 6 tube AG-DC superhet receiver! Takes place of old-style gang condenser, rf and antenna coils; regular 455 KC intermediate frequency. Complete with permeability tuned oscillator coil, 4"x2 1/2"x2 1/2" diameter dial drum. Order MA-2169 Loop Antenna 15c; and MA-2914 drilled, punched Chassis 39c. MA-2167.

\$1.24

CONTROL BOXES—19c Each!

MA-2135—5 position switch, volume control and jacks for PL-55 and PL-68. 3 1/2"x4 1/2"x2 1/2". Aluminum finish.
MA-2093—3-position switch, two wired jacks for PL-55 plugs, internal jack strip, circuit diagram. 3"x3 1/2"x2". Aluminum finish.

MA-2095—6-position, 5-prong female receptacle. Black crackle finish. 2 1/2"x4 1/2"x1 1/2".
MA-2136—Volume control, jacks for PL-55, PL-68. 2 1/2"x3 1/2"x1 1/2". Aluminum finish.
MA-2092—4-position switch. Aluminum finish. 2 1/2"x2 1/2"x1 1/2".

RG-8-U COAXIAL CABLE

Get your share of this fine-quality coaxial cable. Solid, moisture-proof polyethylene dielectric; fully shielded. 52 ohms nominal impedance. Not sold in less than 100-foot lengths.
MA-5018—100 feet.....\$2.89

Coaxial Cable Connectors

PL-259—Low-loss connector for RG-8/U and RG-11/U, or use adapter for other coaxial cables. Silver-plated, machined brass. Inserts are low-loss mica. Exceptional quality at a low price. MA-2828. **29c ea.**

Use a PUNCHED CHASSIS!

Save time and effort with a punched chassis. Takes the hard work out of building receivers, amplifiers, etc.

- | | |
|---|---|
| MA-2913—16"x5"x2"
10 tube.....59c | MA-2907—10 1/4"x3 3/4"x
1 1/2", 6 tube.....29c |
| MA-2910—14"x6 3/4"x2 1/2"
8 tube.....49c | MA-2911—10 1/4"x3 1/2"x
1 1/2", 7 tube.....29c |
| MA-2903—10 1/2"x5 1/2"x
3 1/2", 7 tube.....29c | MA-2912—10"x3 1/2"x2"
5-tube (for chassis
lock sockets).....29c |
| MA-2914—10"x5"x2"
6 tube.....39c | MA-2915—5 1/2"x1 1/2"
3 tube.....15c |

ORDER FROM THIS AD!

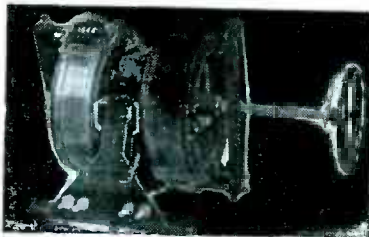
Quantities are limited, so get your order in now! Minimum order shipped, \$2.50. Send 25% deposit, balance COD. Get on our mailing list to receive BIG BARGAIN BULLETINS that list latest, greatest buys in radio parts, electronic equipment. Send orders to store address, Desk G-58.

MID-AMERICA CO. Inc.

2412 S. Michigan Avenue
Chicago 16, Ill.

Industrial Power Supply Equipment

TRANSFORMERS



T-103 (above) Voltage regulator transformer. Max KVA output 11.5, 50/60 cyc. 0-115 V. 100 amps or 230 V. 50 amps
Net Wt. 134# \$75.00

T-101 (left) 60 Plate Transformer. Amertran. Primary 115 V. 60 cyc. 10.4 KVA. Secondary 17600 V. 520 Ma. 35 KVA test.....\$65.00
Net Wt. 500#

T-102 Filament Transformers. Amertran Transformer. Type former KVA. 50/60 cyc. Single phase, WS .050 KVA. 50/60 cyc. Single phase, 35 KVA test. 12 KV D.C. operating. Primary 115 V. Secondary 5 V, 10 amps with integral stand-off insulator and socket for #371, 872 etc. rectifier tubes.
Net Wt. 15 1/2# \$12.50

T-104 Voltage Regulator Transformer. 115 V. 60 cyc. Max. KVA .25. Single phase, voltage range 103-126 volts max. amps 2.17 for filament voltage control.....\$9.50
Net Wt. 15#



**CAPACITORS
STANDARD MAKE**

1 mfd. 25000 V. D. C.\$36.00
10 mfd. 600 volt. D.C. Oil filled....\$1.00

CHOKE COIL

K-106 Amertran Disc Type. Line volts 15000 V. D. C., Ripple frequency 120, 149 ohms resistance, .020 D.C. amps at 900 henrys 48% ripple, .52 amps D.C. at 25 henrys 48% ripple.....\$12.00
Net Wt. 280#

RESISTORS

R-123 160,000 ohm wire wound resistors, 200 watts\$8.90
R-148 5000 ohm wire wound resistors, 200 watts\$9.90
R-153 1000 ohm wire wound resistors, 200 watts\$9.90

RELAYS—CONTACTORS

RC-110 I.T.E. Magnetic contactor. Cat. #KJ4206. 115 V. 60 cyc. coil. Single pole 115 A. 600 V. with barriers. Adj. time delay and remote contact control trip\$10.95
Net Wt. 47 1/2#
RC-117 Westinghouse Time Delay, current relay. Type SC-M. 2 to 1 amp A.C. or D.C.\$12.95
Net Wt. 3#
RC-112 Allen-Bradley, Cat. #810. Magnetic overload relay. 6.3—18.1 amps. 600 v. max.\$7.95
New Wt. 2 1/2#
RC-111 Allen-Bradley. 115 V. 60 cyc. coil. D.P.S.T. Contactor 15 amps. \$4.95
Net Wt. 1 1/4#
RC-105 Monitor Controller Co. Magnetic Contactor. 115 V. 60 cyc. coil, 100 amp. 600 V. Double Pole with barriers. 150 A. & 30 A. Renewable fuses\$8.95
Net Wt. 32#
RC-115 R. W. Cramer Co. Time Delay Relay. Type TD2 120S. 1 min. interval, 115 V. 60 cyc. Synchronous motor driven. Contact rating 10 amp. 115 V. Single Pole\$4.95

TUBES

TU-147 #371A or 371B High Voltage. High vacuum rectifier tubes (used). Filament guaranteed\$1.50
T-147 New\$5.95

METERS

M-114-5 R. W. Cramer Co. Running Time Meter. Type RT2H. 115 V. 60 cyc. Flush mounting. 9999.9 hr.\$5.95
M-111 Weston Model 476, 0.130 V. A.C. voltmeter. Flush type, calibrated for steel panel mounting\$4.95
M-110AB Weston Model 476 Full scale A.C. Ammeter, 3 amp. Calibrated 0-120 V. Flush mounting, with Weston 40/1 current trans.\$8.50
M-146 Weston Model 471 Filament voltage indicator, 0-130 V. Movement with 115 V. mark, flush mounting, calibrated for steel panel\$3.95
M-113AB Weston Kilovoltmeter, Model 301, 20 KV. 1000 ohms per volt. Flush type calibrated for steel panel mounting, with 20 meg. 20 KV. Weston resistor. Complete with clips and stand-off insulators\$18.00
M-142 Weston Model 301 D.C. Milliammeter, 0-800 MA. Flush type. Calibrated for steel panel mounting\$4.45

MOTOR AND BLOWER

MB-156 Motor blower units. Direct connected, 4" inlet, 4" exhaust, 1/20 H.P., 115 V. 60 cyc., 1750 R.P.M. Capacitor start. Mfg. by Champion Blower Co. Cat. #0-CE\$21.50
Net Wt. 39 1/2#

HEATERS

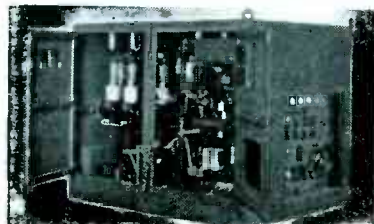
H-149 Chromolox Strip Heaters, 300 W. 115 V. (1/2"x1 1/2"x12")\$1.00

**STANDARD BRAND KILOVOLT
METER MULTIPLIER RESISTOR**

1 megohm unit, type R-5, molded case, 1/10 of 1%, non-inductive, wire wound. Each unit will provide 1,000 V. indications on a 0-1 M.A. meter movement. As many units as desired may be screwed togetherSpecial \$1.25

POWER SUPPLY UNIT

P-100 High Voltage D.C. Power Supply Unit. Primary 115 V. 60 cyc. Output 0-15000 V. A.C. or D.C. @ .5 amps.... \$200.00
Net Wt. 2040#



All merchandise guaranteed in "as new" condition. Add approximately 20% to net weights for estimated shipping weights. Terms are 30% with order, balance C.O.D. All prices are f.o.b. Los Angeles Warehouse. Write for additional detailed information on any of the above items and for special quantity discounts.

1527 E. Seventh St.

EPCO

Los Angeles 21, Calif.



BARGAINS! BARGAINS!

CLARE RELAYS

No R30 3500 ohm 6MA SPDT 3a cont \$70/c
 No R13 200 ohms 24v SPST Norm open 15a cont \$20/c
 No R58 150 ohm 12v DPDT & SPST Norm clsd 3a cont \$45/c

ALLIED RELAYS

No RO4 230 ohms 24v DPDT 10A cont \$23/c
 No RO6 230 ohms 24v SPDT Dble Br 2 A Cont \$24/c
 No R12 220 ohms 24v SP 2CKT 3000v 40ma cont 9000v insl \$55/c
 No 66 150 ohms 12v DPST N.O. 3a cont \$45/c

G.M. Relay No R16 240 ohms 24v 4PDT 10 A cont \$60/c
 G.E. Solenoid No R 59 50 ohms 24v SPST N.O. 300 A cont \$55/c
 Guardian No R31 40 ohms 12v SPST N.O. 3 A cont \$18/c

CAPACITORS

Close Tolerance Silver Micas 1500 MMF ± 1% \$50/M
 Close Tolerance Silver Micas 125 MMF ± 1 MMF \$50/M
 Transmitting Micas 0.01 MF 600 WVDC; 0.00003 MF 1200 WVDC; 0.00008 MF 1200 WVDC \$50/M
 BATHTUB LYTICS 50 MF 25 WVDC \$130/M

CHOKES

10 hy 50 ma 350 ohms Genrl Trans Herm Seald 2"d X 2 1/2" h \$25/c
 20 hy 15 ma 975 ohms G.E. Herm Seald 2 1/4" X 1 7/8" X 2 1/4" \$22.50/c
 1 hy 25 ma 90 ohms Ceramic Ins'l Shldd 1 1/4" d X 2" h Wstghse \$22.50/c
 3 hy 5 ma 325 ohms ARL Shldd 1 9/16" d X 1 1/2" h \$19.00/c
 15 hy 15 ma 500 ohms Hvy Shld \$22.50/c
 UTC 1 3/4" X 2" X 2 1/2"

MISCELLANEOUS

PILOT LAMPS 12V 0.1 A Min Bay Base T3/4 Bulb \$39/M
 VIBRATORS 115v DC to 90cy AC 115v OAK No. V6429 6 prong \$23/M
 Send for Complete Lists to Dept. G

Universal/general corp.

365 Canal St., New York 13 Walker 5-9642

MICROWAVE

Surplus test equipment and misc. components for microwave frequencies. We have waveguide sections, crystal holders, matched loads, attenuators, wavemeters, directional couplers, rotating joints, antennas, bends, twists, flex. waveguides, duplexer sections, coax. to waveguide adapters, sand loads, tube mounts, waveguide conns., coaxial conns., and other components. Also: Signal generators, receivers, scopes, pulse trans., tubes, magnetrons, complete radar systems, etc.

SEND FOR COMPLETE ILLUSTRATED CATALOG

MICROWAVE EQUIPMENT CO.

Offices and Showroom now located at
 397 BLOOMFIELD AVENUE
 VERONA, NEW JERSEY

MARINE RADIO

HI-20 with 12 volt power supply; two unit compact; 4 channel transmitter and receiver crystal controlled. Tunable standard broadcast band 550 to 1500 K.C. Complete \$357.50.

HI-10 is similar to above except 6 volt power supply; slightly lower R.F. output. Complete \$305.80. All FCC approved. Mfg. by F. E. Dine & Co., Inc.

WALTER H. SWITZER
 E. 9 Riverside Spokane 8, Wn.

SURPLUS TEST EQUIPMENT

HEWLETT - PACKARD INTERPOLATION OSCILLATOR, Model 6225A, 320-630, 2040-3960 CPS—Rack Mtg. \$100.00
 OSCILLOSCOPE, TS34/AP, Triggered and Continuous Sweep to 100 KC. Used. Perfect \$225.00
 VACUUM TUBE VOLTMETER - OHM-METER, Electronic Designs, Model 100, New \$39.95
 OSCILLOSCOPE, Dumont 224A 3". "Like New" \$225.00
 TUBE CHECKER, Espy 105, Mutual Conductance, Roll chart. Used. Perfect \$60.00
 WESTON I-56L TEST SET, Combination analyzer Tube checker—V-O-M—capacity tester—output meter, complete in carrying case. New \$100.00
 TRIPLET I-176-V-O-M, 20,000 OPV, Portable Case. Unused \$35.00
 All Equipment guaranteed . . . F.O.B., N.Y.C.

Standard Radio-Electrical Products
 2505 White Plains Rd. New York 67, N. Y.

BRAND NEW! Delco Constant Speed Motor

Type 5069625, 120 R. P. M.

Has built in reduction gearing and governor. Operates on 27 volts AC or DC. Size—overall length 4 1/2" by 1 3/8" in diameter. Weight 7.5 ounces. Price \$4.25 each net.

INSTRUMENT ASSOCIATES
 40-37 172nd Street,
 FLUSHING, L. I., N. Y.

INSTRUMENTS

Dual Autosyn Fuel Pressure Indicators. Many types of G.E. DC Selsyn position Indicators. Manifold Pressure-vacuum gages 0-75 Hg. C-1 Autopilot gyros and servos. Liquidometer fuel quantity gages. Mine Safety Appliance Carbon Monoxide Signal Assemblies. Many others. Write for List.

MARINE ELECTRIC & SUPPLY
 Box 201, Pt. Loma Station, San Diego, Calif.

Delivery
 vs.
Delay...

K NOWING where to find some specific material, part or instrument may be the difference between DELIVERY and DELAY. If the advertisements in this issue do not cover your requirements, write

ELECTRONICS

Coming

The Mid-June BUYER'S GUIDE Issue of ELECTRONICS

The Buyer's Guide is the universally recognized, authoritative Reference Book for all who use electronic components, packaged equipment and allied products. Packed brimful with technical data and information it is of lasting value for everyone in or associated with the industry. Certain to be kept and used throughout the year the Buyer's Guide is the only comprehensive, complete and easy to use reference book of its type available in the field. Use the

SEARCHLIGHT SECTION

of this outstanding issue to get immediate attention and to keep your name at the fingertips of buyers for a year to come—right at the time they are thinking of buying.

Closing date, SEARCHLIGHT SECTION, May 21st



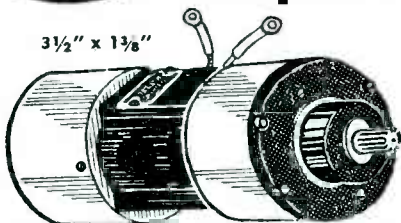
GRAIN OF WHEAT LAMPS



Photograph 3 times actual size. Soldering iron removes lamp from base. Glass bulb 1/8" x 3/16". As big as the "B" in our name Mazda G. E. 323 3v., 19A and G. E. 328 6v., 2A. Used for Illuminating Meters, Compass Dials, and Airplane Instruments. Great for Models, Doll Houses, Miniature Trains, etc.

Dozen **\$1.50** Post Paid

3 1/2" x 1 3/8"



Operates on Flashlight batteries, speed depending on the voltage. Fairly strong on 6 volts, full power and speed on 27 volts. Designed to be used in bombsights, automatic pilots, etc., 250 RPM. FEW MORE at **\$5.00**

HAYDON SYNCHRONOUS TIMING MOTOR



to operate switches, etc. can be had either 1 Rev. per hour or 1 Rev. per minute at this SPECIAL PRICE **\$3.85**

Many other speeds available at \$4.95

EST. 1923

BLAN

EST. 1923

Experimenters and Inventors Supplies

64 Day St., New York 7, N. Y.

MOBILE 600 MC. RADAR

Complete new radar with antenna on trailer. 115 volt 60 cycle operation. Contains the following: Console BD-107-T2, Rectifier RA45-T2 rated 15KV, Receiver BC-663, Pulse Generator BC-666, Radar Transmitter BC-664, Oscilloscope Indicator BC-665, Antenna Remote Control Unit RM-16-T2 two Motor Generator Sets.

Complete equipment mounted on 4 wheel, dual-tired Fruehauf Trailer, 106" wheel base, capacity 11 tons, 8 by 13 ft. flat bed, height 39", electrical and air brakes, 8-6 ply 600-20 tires, 4 outrigger jacks, front truck rotates, tongue hitch, 2 safety chains, connections for air and lighting cables, Signal Corps Type KT-49. Complete \$800.00 each. F.O.B. Pompton Plains, New Jersey.

THERMIONIC ENGINEERING CORP.
POMPTON PLAINS, NEW JERSEY

SURPLUS TUBES

New, Cartoned, Guaranteed

7C7, 6F7, 6R7G, 801A, 841
\$.55 ea. \$35.00 per 100. Post Paid

714AY MAGNETRONS

3280-3320 MC; 450 KW Peak Pulse

\$7.50 ea.; \$6.50 ea. lots of 10;

\$5.00 ea. lots of 100

Shipped Prepaid

AL WILLIAMS

31-D Victory Hts., Spokane 9, Wash.

SELENIUM RECTIFIERS

FULL WAVE BRIDGE TYPES

Input	Output	Current	Price
From 0-18 V.A.C.	From 0-14 V.D.C.	1 AMP.	\$2.49
0-18 V.A.C.	0-14 V.D.C.	3 AMP.	3.49
0-18 V.A.C.	0-14 V.D.C.	5 AMP.	4.95
0-18 V.A.C.	0-14 V.D.C.	10 AMP.	7.95
0-18 V.A.C.	0-14 V.D.C.	15 AMP.	10.95
0-18 V.A.C.	0-14 V.D.C.	20 AMP.	13.95
0-18 V.A.C.	0-14 V.D.C.	30 AMP.	19.95

HALF WAVE TYPES*

Input	Output	Current	Price
From 0-18 V.A.C.	From 0-7 V.D.C.	3 AMP.	\$2.25
0-18 V.A.C.	0-7 V.D.C.	5 AMP.	2.95
0-18 V.A.C.	0-7 V.D.C.	10 AMP.	4.95
0-18 V.A.C.	0-7 V.D.C.	15 AMP.	6.95
0-18 V.A.C.	0-7 V.D.C.	20 AMP.	8.95
0-18 V.A.C.	0-7 V.D.C.	25 AMP.	10.95

Input	Output	Current	Price
From 0-36 V.A.C.	From 0-28 V.D.C.	150 MA	\$1.25
0-36 V.A.C.	0-28 V.D.C.	2 AMP.	4.95
0-36 V.A.C.	0-28 V.D.C.	5 AMP.	7.95
0-36 V.A.C.	0-28 V.D.C.	10 AMP.	13.95
0-36 V.A.C.	0-28 V.D.C.	15 AMP.	19.95
0-36 V.A.C.	0-28 V.D.C.	20 AMP.	25.95
From 0-120 V.A.C.	From 0-100 V.D.C.	2 AMP.	14.95
0-120 V.A.C.	0-100 V.D.C.	2 AMP.	19.95

Input	Output	Current	Price
From 0-36 V.A.C.	From 0-14 V.D.C.	3 AMP.	\$2.95
0-36 V.A.C.	0-14 V.D.C.	5 AMP.	4.95
0-36 V.A.C.	0-14 V.D.C.	10 AMP.	7.95
0-36 V.A.C.	0-14 V.D.C.	15 AMP.	10.95
0-36 V.A.C.	0-14 V.D.C.	20 AMP.	13.95
0-36 V.A.C.	0-14 V.D.C.	25 AMP.	16.95

*Use with capacitor to obtain any voltage up to twice rated output.

RAYTHEON RECTIFIER CHOKES

.03 Henry at two amperes.....	\$2.25
.02 Henry at five amperes.....	3.25

CAPACITORS

1000 MFD., 15 V.D.C.....	98c
3000 MFD., 35 V.D.C.....	\$2.45
100 MFD., 350 V.D.C.....	1.69

FULL WAVE BRIDGE RECTIFIER TRANSFORMERS

PRIMARY	SECONDARY	TO DELIVER	CURRENT	PRICE
115 V.A.C. 60 cy.	10 V.A.C.	7 V.D.C.	18 AMP.	\$3.75
115 V.A.C. 60 cy.	15 V.A.C.	12 V.D.C.	12 AMP.	3.75

To obtain 24 V.D.C. at 12 AMPS., Use two 15 V.A.C. Transformers in series

It would be impossible to give a complete listing of all our rectifier types. Our engineering staff is at your service to help you work out the application of selenium rectifiers to your specific problems. Write us for quotations or further information on capacitors and transformers to be used in conjunction with selenium rectifiers.

25% Required on all C.O.D.'s—Add 10% for Parcel Post.

OPAD GREEN COMPANY • 191 GREENWICH ST. Dept. 3
NEW YORK 7, N. Y. • Phone: BEEKMAN 3-7385

13,000 NEW STORAGE BATTERIES

PORTABLE TYPE

Plastic and Hard Rubber Containers

waterproof, lead acid type terminals, 6 volts, 15 amp. hrs., 3 cells, 2 volts each, 1 1/2 amps. for 10 hrs., size 4 1/2" width by 4 1/2" length by 5 1/2" height, manufactured by Willard and Gould, packed in wood boxes of 9, 12, and 18 each. At \$2.00 each, f.o.b. Allentown, subject to prior sale.

Sample orders upon request

PHONE
3-7497

Wm. Rabinowitz & Sons

PHONE
3-7498

214-222 HAMILTON STREET • ALLENTOWN, PA.

Special Values

D. C. MICROAMMETERS

0-100 ua. 4" sq. G.E. DO58	\$12.00
0-200 ua. 4" sq. G.E.	9.00
0-100 ua. 2 1/2" Gruen	4.00
0-150 ua. Weston fan sh. 7" sc.	27.50
0-100 ua. Weston fan sh.	30.00
0-50 ua. Weston fan sh.	35.00
0-25 ua. Weston fan sh.	40.00

R. F. MILLIAMMETERS

0-100 Ma. 3 1/2" Weston 425	\$9.00
0-120 Ma. 2 1/2" Weston 507	7.00

PRECISION ELECTRICAL INSTRUMENT CO.
146 Grand Street New York 13, N. Y.

TELEVISION EQUIPMENT

2 BC1212 Block III Airborne television transmitters each \$200

1 RMA Sync Generator and pulse distribution system

1 Monoscope camera and monitor unit
1 High Definition Iconoscope camera on dolly with shading and control unit

1 Film and Still camera and shading console
3 Iconoscope tubes

This equipment can be seen operating, by appointment.

Price for lot \$10,000; or will sell separately.

Village Radio Equipment Company
201 West 16 Street New York City



BOONTON 120A VHF CIRCUIT CHECKER

This instrument was developed by the Boonton Radio Corporation for aligning an adjustable resonant circuit to 2 spot frequencies (such as those in a Television Tuner). It also may be used to check frequency range limits, tracking at two spot frequencies, etc. We have three models (24-54 Mc.) (70-160 Mc.) (120-210 Mc.). They are used in good operating condition. Catalog price is \$320.00—Our price is \$120.00, f.o.b. New York City; subject to prior sale.

THE NATIONAL INSTRUMENT CO.
FAR ROCKAWAY, N. Y.

SHEET METAL MACHINERY

NEW and Used — Brakes — Shears
Forming Rolls — Folders — Punches —
Di-Acro, Pexto, Niagara & Whitney Equipment.

R. D. BROOKS CO., INC.

Han. 5226

361 Atlantic Ave., Boston, Mass.

PROFESSIONAL SERVICES

Consulting — Patents — Design — Development — Measurements

in

Radio, Audio, Industrial Electronic Applications

THE BARRY CORPORATION

Specialists in the Control of
VIBRATION IMPACT NOISE

*Engineering Development
Manufacturing*

179 Sidney Street Cambridge, Mass.
Telephones: ELiot 0861-0140

Consult these Specialists

when you need professional assistance in solving difficult problems. Their specialized knowledge and broad experience can prove invaluable in saving both time and money for you.

Eugene Mittlemann, E.E., Ph.D.

Consulting Engineer & Physicist

High Frequency Heating — Industrial Electronics
Applied Physics and Mathematics

549 W. Washington Blvd. Chicago 6, Ill.
State 3021

H. RUSSELL BROWNELL

Consultant

Specializing in Measurements & Testing
Instruments & Techniques - Electrical - Electronic - Magnetic

189 West 4th St. New York 14, N. Y.
Chelsea 2-4208

PAUL GODLEY CO.

Consulting Radio Engineers

GREAT NOTCH, N. J.

Est. 1926 Little Falls 4-1000

THE POINT CONSULTING COMPANY

Specialists In

ELECTRICAL ENGINEERING AND
ELECTRONICS

5448 Wilkins Avenue — Pittsburgh 17, Pa.
Phone MU 4687

STANLEY D. EILENBERGER

Consulting Engineer

INDUSTRIAL ELECTRONICS

Design—Development—Models
Complete Laboratory and Shop Facilities

6309-13—27th Ave. Kenosha, Wis. Telephone 2-4213

HANSON-GORRILL-BRIAN INC.

Product & Mfg. Development

ELECTRICAL - ELECTRONIC
HYDRAULIC - MECHANICAL

One Continental Hill Glen Cove, N. Y.
Glen Cove 1922

ALBERT PREISMAN

Consulting Engineer

Television, pulse Techniques, Video
Amplifiers, Phasing Networks,
Industrial Appliances

Affiliated with
MANAGEMENT-TRAINING ASSOCIATES
3308-14th St., N.W. Washington 10, D. C.

ELECTRO IMPULSE LABORATORY

Consulting Physicists

Radio Interference and Noise Meters; Interference
Suppression Methods for Ignition Systems and
Electrical Devices.

P.O. Box 250 Red Bank, New Jersey
Red Bank 6-4247

I. JORDAN KUNIK

Registered Patent Attorney

ELECTRONICS - ELECTRICITY

Mechanics — Chemistry — Metallurgy

75 E. Pearl Street Hartford 3, Connecticut
Telephone 7-9535

JOSEPH RAZEK, Ph. D.

Consulting Physicist

Electric and Mechanical Engineering Problems
Instruments and Control Devices Electronics
Specialists in Colorimetry, Spectrophotometry and
Industrial Color Control

Laboratory and Shop Facilities
202 Darby Road Llanerch, Pa.
Phone Hilltop 6910

ELECTRODYNE CO.

Electronics Mechanics Optics

RESEARCH AND DEVELOPMENT

Cathode ray recorders custom built to your own
specifications. Prompt delivery.
Specialists in psychological and biological instrumentation and industrial problems.
Literature available on request.

899 Boylston St., Boston 15, Mass. Phones: Conley 7-0055
Conley 7-0056

LERU LABORATORIES, INC.

Design and Development of Electronic Equipment for industrial and scientific purposes

Special experience in microwaves, spectrum analyzers, photo-electric circuits, test equipment, etc.

360 Bleecker Street New York 14 Watkins 9-4194

A. F. SMUCKLER & CO.

Electronic Engineers

Electronic Product Manufacturing
Contractors to United States Government

338-346 East 23rd St. New York 10, N. Y.
GR amercy 5-8151

ELECTRONIC ENGINEERING CO. of CALIFORNIA

Radio and Electronic Consulting and
Designing.

2008 W. Seventh St. Los Angeles
DRexel 8323 California

GEORGE J. MAKI

Radiotelegraph Consultant

Design & Application Engineering

FSK Systems

Moraga, California

ULLMAN RESEARCH CORPORATION

VACUUM TUBES — ALL TYPES
DEVELOPMENT - RESEARCH
PRODUCTION

Ullman Bldg. B'klyn (15) N. Y.
South—8-6200

PAUL E. GERST & CO.

CONSULTING ENGINEERS

*Specialists in
Electrical Product Design*

El. Machinery Apparatus & Applications
El. Appliances, Hi-Frequencies Apparatus
Electronics, Radio Communications

11 So. Desplaines St. Chicago 6, Ill.

MEASUREMENT ENGINEERING LIMITED

Consultants on Special Equipment for measurements and production tests, communications and audio systems.

41 Duke St. Toronto, Ont. 2235 Addington Ave. Montreal, Que.

YARDENY ENGINEERING CO.


CONSULTATIONS AND APPLICATIONS
in connection with
YARDENY REMOTE CONTROL SYSTEMS
(WIRE — WIRELESS)


105 Chambers Street New York City
WOrth 2-3534, 3535

"By reason of special training, wide experience and tested ability, coupled with professional integrity, the consulting engineer brings to his client detached engineering and economic advice that rise above local limitations and encompasses the availability of all modern developments in the fields where he practices as an expert. His services, which do not replace but supplement and broaden those of regularly employed personnel, are justified on the ground that he saves his client more than he costs him."

INDEX TO ADVERTISERS

Acme Electric Corp.	182	Electro Products Laboratories	231
Adaptol Co.	255	Electronic Corporation of America	206
Aeronautical Communications Equip- ment, Inc.	28	Electronic Development Laboratory	212
Aerovox Corporation	36	Electrons, Inc.	164
Aircraft Radio Corp.	254	Erie Resistor Corporation	163
Allen Co., Inc., L. B.	259	Essex Electronics	291
Allen-Bradley Co.	193	Essex Wire Corp.	251
Alliance Mfg. Co.	19		
Allied Control Co., Inc.	46		
Altec Lansing Corp.	250		
American Brass Co.	192	Federal Tel. & Radio Corp.	12, 33, 159
American Electrical Heater Co.	223	Fisher Radio Corp.	210
American Lava Corp.	153	Ford Instrument Co., Inc.	255
American Phenolic Corp.	174		
American Relay & Controls Inc.	231		
American Screw Co.	48		
American Television & Radio Co.	233		
American Time Products, Inc.	205		
Amperite Company	221		
Anaconda Wire & Cable Co.	151		
Arnold Engineering Co.	26		
Art Wire & Stamping Co.	243		
Astatic Corporation	196		
Atlas Sound Corp.	292		
Audak Company	213		
Audio Development Co.	152		
Audio Devices, Inc.	139		
Avimo, Ltd.	218		
Baer Co., N. S.	253		
Ballantine Laboratories, Inc.	162		
Bardwell & McAlister, Inc.	248		
Barker & Williamson, Inc.	238		
Barry Corp.	234		
Beaver Gear Works, Inc.	176		
Bell Telephone Labs.	154		
Bendix Aviation Corp., Pacific Div.	22		
Bentley, Harris Mfg. Co.	45		
Benwood-Linze Co., The	212		
Best Mfg. Co., Inc.	239		
Biwax Corp.	243		
Blaw-Knox Company	16		
Bliley Electric Co.	149		
Boland & Boyce, Inc. Publishers	252		
Boonton Radio Corp.	133		
Bradley Laboratories, Inc.	236		
Bradshaw Instruments Co.	235		
Brand & Co., Wm.	173		
British Industries Corporation	147		
Buck Engineering Co., Inc.	259		
Burlington Instrument Co.	255		
Cambridge Thermionic Corporation	242		
Cannon Electric Development Co.	156		
Capitol Radio Engineering Institute	247		
Carborundum Co.	211		
Cellusuede Products, Inc.	223		
Central Paper Co., Inc.	256		
Central Sheet Metal Works, Inc.	247		
Centralab, Div. Globe-Union, Inc. 7, 14,	15		
Chicago Transformer, Div. of Essex			
Wire Corp.	54		
Cinch Manufacturing Corp.	127		
ClaroStat Mfg. Co., Inc.	240		
Cleveland Container Co.	258		
Cohn Corp., Sigmund	236		
Collins Audio Products Co., Inc.	176		
Communication Products Co., Inc.	169		
Concord Radio Corporation	249		
Condenser Products Co.	209		
Consolidated Molded Products Corp.	181		
Continental Electric Co.	234		
Continental Screw Co.	160		
Cornell-Dubilier Electric Corp.	59		
Cornish Wire Co.	50		
Cross Co., H.	259		
Dano Electric Co.	239		
Daven Company	Inside Back Cover		
Dial Light Company of America	227		
Dow Corning Corporation	242		
Driver Co., Wilbur B.	47		
Driver-Harris Co.	37		
Dumont Laboratories, Inc., Allen			
B.	24, 38		
du Pont de Nemours & Co., (Inc.),			
E. I.	40		
Edison, Inc., Thomas A.	251		
Eisler Engineering Co.	247, 259		
Eitel-McCullough, Inc.	67		
Electric Indicator Co.	204		
Electrical Insulation Co., Inc.	218		
Electrical Reactance Corp.	25		
Electro Engineering Works	259		
Electro Motive Mfg. Co., Inc.	2		
Electro Products Laboratories	231		
Electronic Corporation of America	206		
Electronic Development Laboratory	212		
Electrons, Inc.	164		
Erie Resistor Corporation	163		
Essex Electronics	291		
Essex Wire Corp.	251		
Federal Tel. & Radio Corp.	12, 33, 159		
Fisher Radio Corp.	210		
Ford Instrument Co., Inc.	255		
Gamewell Company, The	239		
General Aniline & Film Corp.	21		
General Cement Mfg. Co.	259		
General Electric Co.			
Apparatus Dept.	10, 144, 145		
Chemical Dept.	161, 245		
Electronics Department	27, 55, 62		
	63, 69, 260		
General Industries Co.	49		
General Radio Co.	143		
Gothard Mfg. Co.	230		
Graphite Metallizing Corp.	252		
Gray Research and Development Co.	237		
Guardian Electric Mfg. Co.	4		
Handy & Harman	238		
Harvey Radio Company, Inc.	220		
Hathaway Instrument Co.	243		
Haydon Manufacturing Co., Inc.	186		
Heinemann Electric Co.	23		
Hewlett-Packard Company	35		
Hytron Radio & Electronics Corp.	51		
Imperial Tracing Cloth	218		
Indiana Steel Products Co.	187		
Industrial Timer Corp.	253		
Instrument Resistors Company	243		
Insulation Manufacturers Corp.	131		
International Machine Works	243		
International Nickel Co., Inc.	60		
International Resistance Co.	157		
Jelliff Mfg. Corp., C. O.	246		
Jensen Manufacturing Co.	41		
Johnson Co., E. F.	251		
Jones Div., Howard B., Cinch Mfg.			
Co.	231		
Jones Electronics Co., M. C.	225		
Kahle Engineering Co.	259		
Karp Metal Products Co., Inc.	31		
Keithley Instruments	221		
Kenyon Transformer Co., Inc.	244		
Kepeco Laboratories	211		
Kester Solder Co.	219		
Keuffel & Esser Co.	3		
Knights Co., James	239		
Lampkin Laboratories	259		
Lapp Insulator Co., Inc.	53		
Lavoie Laboratories	141		
Legri S Company, Inc.	217		
Leland Electric Company	32A		
Lenkurt Electric Co.	248		
Lewis Engineering Co.	226		
Linde Air Products Co.	255		
Lord Mfg. Co.	29		
Machlett Labs, Inc.	42		
Makepeace Co., D. E.	184		
Mallory & Co., Inc., P. R.	70,		
McElroy Manufacturing Corp.	224		
McGraw-Hill Book Co.	212		
Measurements Corporation	230		
Mecanitron Corp.	188		
Millen Mfg. Co., Inc., James	208		
Miniature Precision Bearings	259		
Mitchell-Rand Insulation Co., Inc.	177		
Mosinee Paper Mills Co.	194		
Multicore Solders, Ltd.	147		
Murray Hill Books, Inc.	228		
Mycalex Corporation of America	18		





NEW!

I. F.

TRANSFORMER

Latest Design

(ENTIRELY NEW)

SPECIFICATIONS

- Top Tuning
- Solder Terminals
- Suitable for high Temperatures
- Wound to your Electrical Specifications
- 3/4" x 3/4" x 2" high

ESSEX

ELECTRONICS

Berkeley Heights, New Jersey

New ATLAS sound ALNICO-V-PLUS

A great step forward . . . Atlas Alnico-V-Plus Super-efficient magnetic assembly. Energy per unit volume over three times as great as any used before. Traditional Atlas Quality and Fidelity to Precision are incorporated in all these new developments. Keep step with Sound Advancement with Atlas Sound.



PD-8V New Atlas streamlined Hi-Fidelity Alnico-V-Plus Driver Units.

TP15V New Atlas Alnico-V-Plus Dual Projector. Also in larger model TP24V.



PD-5V All Atlas PD-V Driver Units are completely Magnetically Shielded . . . entirely Hermetically Sealed.



HU-24V All Atlas Speakers have new unbreakable Alnico-V-Plus Driver Units.



HU-15V Maximum efficiency as reproducer, utmost performance as microphone in talk-back.

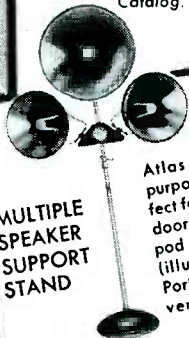


PD-3V All Atlas PD-V Driver Units have full phenolic unbreakable diaphragms.



Write for New Illustrated Catalog.

MICROPHONE STANDS—Atlas is outstanding in quality, completeness and variety of models produced.



MULTIPLE SPEAKER SUPPORT STAND

Atlas Sound's dual purpose value. Perfect for powerful outdoor (collapsible tripod model) or indoor (illustrated) array. Portable. Quick, convenient, practical.

ATLAS SOUND CORP.

1449—39th Street,
BROOKLYN 18, N. Y.

National Research Corp.	185
National Varnished Products Corporation	201
New York Transformer Co.	215
Nothelfer Winding Laboratories	226

O'Neill-Irwin Mfg. Co.	214
Operadio Mfg. Co.	158

Palnut Co.	208
Panoramic Radio Corp.	216
Paper Machinery & Research, Inc.	235
Paramount Paper Tube Corp.	223
Park Metalware Co., Inc.	251
Par-Metal Products Corp.	250
Patton-MacGuyver Co.	235
Peerless Electrical Products Div., Altec Lansing Corp.	232
Perkin-Elmer Corp.	222
Phileo Corporation	61
Phillips Control Corp.	64
Phillips Screw Mfrs.	189
Plax Corporation	199
Polarad Electronics Co.	232
Polytechnic Research & Development Co., Inc.	171
Potter Instrument Co., Inc.	258
Potter & Brumfield Sales Co.	183
Precision Apparatus Co., Inc.	228
Precision Paper Tube Co.	254
Precision Tube Co.	202
Premax Products, Div. of Chisholm-Ryder Co.	231
Premier Metal Etching Co.	257
Pressure Sensitive Labels	197
Presto Recording Corp.	52
Progressive Mfg. Co.	247
Pyroferic Co.	222

Quadriga Mfg. Co.	239
Quaker City Gear Works, Inc.	178

Racon Elec. Co., Inc.	233
Radio Corp. of America	Back Cover
Radio-Music Corp.	241
Radio Receptor Co., Inc.	217
Railway Express Agency	245
Railway Express Agency, Air Express Div.	166
Raytheon Mfg. Co.	137, 170
Reeves-Hoffman Corp.	172
Reeves Soundcraft Corp.	8
Revere Copper & Brass, Inc.	34
Rockbestos Products Corp.	58
Roller-Smith Co.	224
Rollin Co.	148

Scientific Electric Div. of "S" Corrugated Quenched Gap Co.	256
Scintilla Magneto Div., Bendix Aviation Corp.	150
Scott Radio Labs, Inc.	195
Shalleross Mfg. Co.	146
Sigma Instruments, Inc.	168
Signal Engineering & Mfg. Co.	237
Simpson Electric Company	20
Sola Electric Co.	57
Solar Manufacturing Corporation	17, 66
Sorensen and Co., Inc.	6
Specialty Battery Co.	235
Spellman Television, Inc.	225
Spencer Wire Co.	257
Sprague Electric Co.	207
Stackpole Carbon Co.	191
Standard Areturus Corp.	167
Standard Pressed Steel Co.	241
Standard Transformer Corp.	190
Steward Mfg. Co., D. M.	233
Stewart Mfg. Corp., F. W.	227
Struthers-Dunn, Inc.	56
Stupakoff Ceramic and Mfg. Co.	30
Superior Electric Co.	165
Superior Tube Company	220
Sylvania Electric Products, Inc.	175
Synthane Corporation	16A, 16B

Taylor Fibre Company	68
Tech Laboratories, Inc.	227
Terminal Radio Corp.	227
Thordarson, Div. of Maguire Industries	13
Turner Co.	39

Ullman Research Corp.	259
Union Carbide and Carbon Corp.	255
United-Carr Fastener Corporation	246
United Technical Laboratories	259
United Transformer Corp.	Inside Front Cover
Universal Microphone Co.	259
University Loudspeakers, Inc.	11, 225

Vickers, Inc.	244
Victoreen Instrument Co.	198
Vitamite Company	216

Ward Leonard Elec. Co.	155
Watertown Mfg. Co., The	221
Weiss, Jerry L.	216
Weller Mfg. Co.	249
Western Electric Co.	5, 43, 65, 135
Westinghouse Electric Corp.	44, 179
Whistler & Sons, Inc., S. B.	9
White Dental Mfg. Co., S. S.	200, 225
Whitehead Stamping Co.	251
Wileox Electric Co.	203
Wiley and Sons, Inc., John	180, 240
Williams and Co., C. K.	235
Wilson Company, H. A.	32
Workshop Associates, Inc.	260

PROFESSIONAL SERVICES . . . 290

SEARCHLIGHT SECTION

(Classified Advertising)

EMPLOYMENT	
Positions Vacant	261, 263
Positions Wanted	261, 262
Selling Opp. Wanted	262
Employment Services	261
SPECIAL SERVICES	
Repairing	262
BUSINESS OPPORTUNITIES	
Offered	262
EQUIPMENT	
(Used or Surplus New)	
For Sale	262, 289
WANTED	
Equipment	262

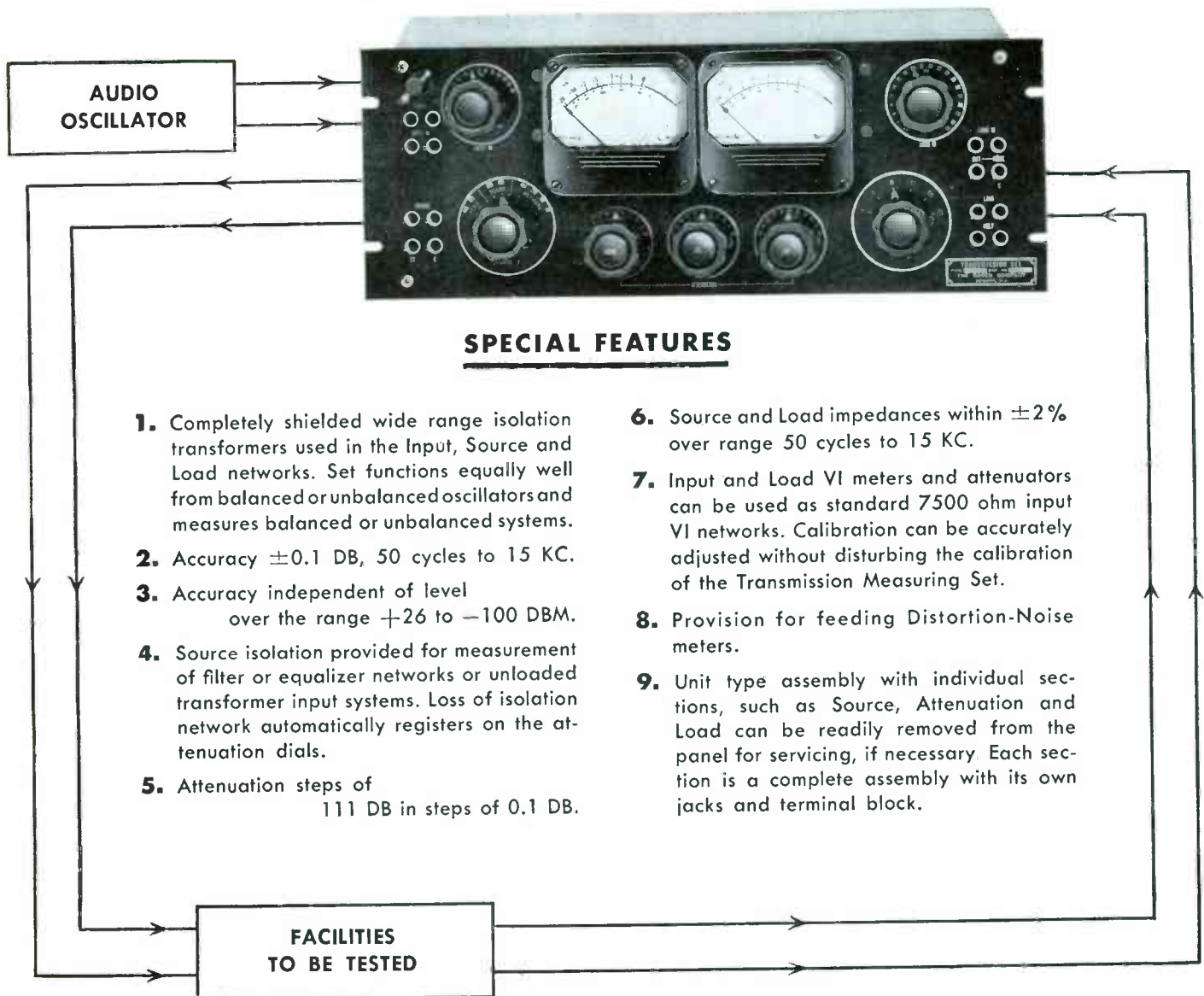
ADVERTISERS INDEX

American Electrical Sales Co., Inc.	286
Arrow Sales, Inc.	282
Bell Aircraft Corp.	263
Bendix Aviation Corp.	263
Blair	289
Brooks Inc., B. D.	289
Buffalo Radio Supply Co.	285
Colonial Radio Corp.	263
Communications Co., Inc.	286
Communications Equipment Co.	275
Edlie Electronics Inc.	274
Electro Impulse Laboratory	284
Electro Sales Co.	270, 271
Electroncraft Inc.	277, 286
Harrison Radio Corp.	284
Hirsch Co., J. M.	262
Instrument Associates	280, 288
Leru Laboratories, Inc.	262
Los Alamos Scientific Laboratory	261
Marine Electric and Supply	288
Maritime Switchboard	264, 265
Microwave Equipment Co.	288
Mid-American Co., Inc.	287
National Instrument Co.	286, 289
National Union Radio Corp.	261
Niagara Radio Supply	266, 267
Opal-Green Co.	289
Peak Electronics Co.	279
Pope Co., Edker	287
Powertron Electrical Equipment Co.	273
Precision Electrical Instrument Co.	289
Rabinowitz & Sons, Wm.	289
Radio Ham Shack, Inc.	276
Reliance Merchandising Co.	268, 269
Servo-Tek Products Co., Inc.	278
Stahl, Inc., Michael	286
Standard Radio & Electronic Products Co.	283, 288
Switzer, Walter H.	288
Tah	272
Taylor, M., Edward C.	262
Telemarine Communications Co.	281
Thomas Manufacturing Co.	262
Thermionic Engineering Corp.	289
Universal General Corp.	288
Universal Wire & Cable Co.	286
University of Michigan	261
U. S. Surplus Co.	262
Village Radio Equipment Co.	289
Williams, A. F.	289
Winters Radio Laboratory	262

VERSATILE *New* TRANSMISSION MEASURING SET*

Frequency Range 30 CY to 17 KC

This gain set has been designed for the accurate and rapid measurement of the transmission characteristics of audio systems and their components. It is a direct reading instrument, entirely eliminating laborious calculations and complex set-ups. This unit is arranged so that the meters and their associated range controls can be independently used as VU meters in program monitoring.



SPECIAL FEATURES

1. Completely shielded wide range isolation transformers used in the Input, Source and Load networks. Set functions equally well from balanced or unbalanced oscillators and measures balanced or unbalanced systems.
2. Accuracy ± 0.1 DB, 50 cycles to 15 KC.
3. Accuracy independent of level over the range $+26$ to -100 DBM.
4. Source isolation provided for measurement of filter or equalizer networks or unloaded transformer input systems. Loss of isolation network automatically registers on the attenuation dials.
5. Attenuation steps of 111 DB in steps of 0.1 DB.
6. Source and Load impedances within $\pm 2\%$ over range 50 cycles to 15 KC.
7. Input and Load VI meters and attenuators can be used as standard 7500 ohm input VI networks. Calibration can be accurately adjusted without disturbing the calibration of the Transmission Measuring Set.
8. Provision for feeding Distortion-Noise meters.
9. Unit type assembly with individual sections, such as Source, Attenuation and Load can be readily removed from the panel for servicing, if necessary. Each section is a complete assembly with its own jacks and terminal block.

APPLICATIONS

1. Audio Gain Measurements.
2. Audio Loss Measurements.
3. Complex Circuit Measurements.
4. Measurements of matching and bridging devices.
5. Measuring Mismatch Loss.
6. Frequency Response Measurements.
7. May be used as two Volume Level Indicators.
8. Provision for feeding Distortion-Noise meters.

Always Specify Daven For Precision Equipment

*Patent Pending

THE **DAVEN** CO.
191 CENTRAL AVENUE
NEWARK 4, NEW JERSEY

This unit was developed in cooperation with the General Engineering Department of the Columbia Broadcasting System.

82- ssb reception adapter
 106- storm direction locator, GRD-1 loop
 267 ATD ad



Representative RCA types standardized for future equipment designs

Tubes for today and tomorrow

HERE ARE power tubes, phototubes, and c-r tubes to serve the major requirements of equipment manufacturers for a long time to come. The tubes listed are those you can depend on now, and for your future designs.

These RCA types are especially recommended because their wide-spread application permits production to be concentrated on fewer types. Such longer manufacturing runs reduce costs—lead to improved quality and greater uniformity. Resultant benefits are shared alike by the equipment manufacturer and his customers.

RCA Application Engineers are ready to suggest suitable tube types for your design requirements. For further information write RCA, Commercial Engineering, Section ER-40, Harrison, N. J.

THE FOUNTAINHEAD OF MODERN TUBE DEVELOPMENT IS RCA

Preferred List of RCA Non-Receiving Types				
CATHODE-RAY TUBES AND CAMERA TUBES				
Kinescopes (Projection)	Camera Types	Oscillograph Types	Monoscope	
5TP4	5527	2BP1	2F21	
(Directly Viewed)	2P23	3KP1		
	5655	5UP1		
7DP4	1850-A			
7JP4				
10BP4				
PHOTOTUBES				
Gas Types	1P41	921	927	930
Vacuum Types	922	929		
Multiplier	931-A			
GAS TUBES				
Thyratrons	2D21	3D22	884	2050
Ignitrons	5550	5551	5552	5553
Rectifiers	3B25	673	816	857-B
	8008			866-A
Voltage Regulators	0A2	0C3/VR105	0D3/VR150	869-B
POWER AMPLIFIERS AND OSCILLATORS				
(Air-Cooled)	TRIODES (Forced-Air-Cooled)		(Water-Cooled)	
811	6C24		9C21	
812	7C24		9C27	
826	9C22		889-A	
833-A	9C25		892	
8000	889R-A			
8005	892-R			
8025-A	5588			
	5592			
	TETRODES	BEAM TUBES	PENTODES	
(Air-Cooled)	(Water-Cooled)	(Air-Cooled)	(Air-Cooled)	
4-125A/4D21	8D21	2E24	802	
		2E26	828	
		807		
		813		
		815		
		829-B		
		832-A		

The world's most modern tube plant . . .
 RCA, Lancaster, Pa.



TUBE DEPARTMENT
RADIO CORPORATION of AMERICA
 HARRISON, N. J.