

electronics

MAGNETRON

APRIL · 1946

A MCGRAW-HILL
PUBLICATION

New Vacuum Condenser Cuts Frequency Drift



GENERAL CHARACTERISTICS
 Capacitance...50 uuf ±2% • Maximum Peak Voltage...30,000
 Maximum RMS Current...65 Amps at 10 Mc. • 40 Amps at 60 Mc.

Higher current handling ability and lower I²R losses in reduced space simplify equipment design — meets new FCC frequency stability regulations for industrial and electro-medical oscillators using Amperex-developed circuits

Design and manufacturing techniques evolved for high power copper anode tubes were successfully brought to bear in developing the unusual qualities of the Amperex VC50 Vacuum Condenser. This unique all-copper construction with large area seals, no welds and increased mechanical ruggedness insures efficient and economical operation.

READY FOR YOU: Detailed technical rating and data sheets.

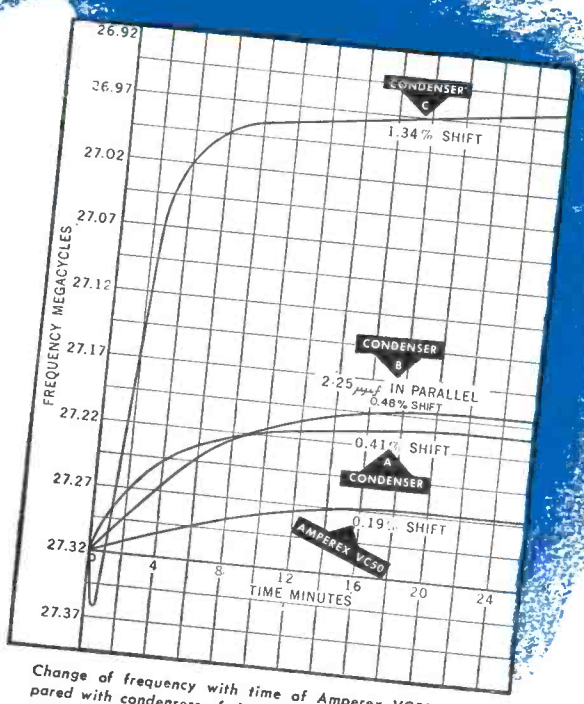

Change of frequency with time of Amperex VC50 compared with condensers of three other leading manufacturers in a typical piece of industrial equipment operating at 27.32 MC with a 50 uuf vacuum tank condenser and 2000 V.D.C. plate supply under no-load conditions.

POWER TUBE SPECIALISTS SINCE 1925

COMMUNICATION
 RECTIFICATION
 INDUSTRIAL
 ELECTRO-MEDICAL
 SPECIAL PURPOSE

AMPEREX

ELECTRONIC CORPORATION



25 WASHINGTON STREET, BROOKLYN 1, N. Y. CABLES: "ARLAB"

In Canada and Newfoundland: ROGER MAJESTIC LIMITED, 622 Fleet Street West, Toronto 2B, Canada

electronics

A McGRAW-HILL
PUBLICATION



APRIL • 1946

MAGNETRON		Cover
Signal Corps engineer assembling a tube which delivers 1 kw of pulsed output between 1,500 and 1,650 mc		
RADAR ECHOES FROM THE MOON, by Jack Mofenson		92
Detailed description of the techniques underlying the first recorded radio transmission through outer space		
SONAR FOR SUBMARINES, by R. S. Lanier and C. R. Sawyer		99
Technical details of JP sonar gear used for underwater listening, and tracking of surface vessels		
PRINTED ELECTRONIC CIRCUITS, by C. Brunetti and A. S. Khouri		104
Details of silk-screen technique used for applying wiring directly on a steatite chassis		
COLOR TELEVISION FOR ULTRAHIGH FREQUENCIES		109
525-line images broadcast on 490 mc show high quality		
ULTRASONIC GENERATOR, by Frederick W. Smith, Jr. and Paul K. Stumpf		116
Provides ultrasonic energy for disintegration of bacterial cells and other unique physical and chemical effects		
AFC FOR R-F HEATING, by S. Ivan Rambo		120
Tubes, relays and an electric motor automatically control the frequency of an r-f oscillator		
SPECTROGRAPH EXPOSURE CONTROL, by J. R. Cosby		123
Semi-automatic phototube device permits duplication of exposure despite arc variations		
VIBRATION AND SHOCK TESTING OF MOBILE EQUIPMENT, by John H. Best		126
Methods of testing mobile communications equipment for vibration and shock fatigue		
F-M RADAR ALTIMETER		130
Beat note between transmitted and received f-m signals is utilized as indication of altitude		
HIGH SPEED OSCILLOGRAPH, by N. Rohats		135
Direct optical-viewing film-recording oscillograph for studying high-speed transients		
GROUND-GRID POWER AMPLIFIERS, by E. E. Spitzer		138
Characteristics, advantages and design for television, f-m and industrial applications		
RADIUM-TYPE VACUUM GAGE, by Glenn L. Mellen		142
Alpha particles from pellet of radium ionize gas particles in linear relation to pressure		
TRANSIENT DELAY LINE, by John M. Lester		147
Simple graphical solution for proper value of inductance and capacitance in a network to delay pulses		
FOUR-CHANNEL ELECTRONIC SWITCH, by N. A. Moerman		150
Four waveforms are shown simultaneously on a cathode-ray tube when inputs are fed through a switching unit		
THE SONOBUOY		154
Expendable radio-equipped buoy used to detect submerged enemy submarines		
COAXIAL BUTTERFLY CIRCUITS, by Ervin E. Gross, Jr.		156
Coaxial versions fit over type 2C43 lighthouse tube and serve as signal generator up to 1,600 mc		
BEAT-FREQUENCY INTERFERENCE CHART, by Don Barton		162
Points in the standard band where interference may be heard from stations operating between 100 and 4,000 kc		
CROSSTALK	91	ELECTRON ART
INDUSTRIAL CONTROL	164	NEW PRODUCTS
TUBES AT WORK	208	NEWS OF THE INDUSTRY
		230
		268
		308
		NEW BOOKS
		350
		BACKTALK
		354
		INDEX TO ADVERTISERS
		361

KEITH HENNEY, Editor; DONALD G. FINK, Executive Editor; W. W. MacDonald, Managing Editor; John Markus, Vin Zeluff, Associate Editors; Frank Rockett, A. A. McKenzie, Assistant Editors; J. A. Myers, Chicago Editor; Frank Haylock, Los Angeles Editor; Gladys T. Montgomery, Washington Editor; Jeanne M. Heron, Make-up Editor; Jeanne E. Grolmund, Editorial Assistant; Harry Phillips, Art Director; Eleanore Luke, Art Assistant

H. W. MATEER, Publisher; J. E. Blackburn, Jr., Director of Circulation, Electronics; Stacy May, Director of Economic Staff; Wallace B. Blood, Manager

D. H. Miller, H. R. Denmead, Jr., New York; Ralph H. Flynn, H. D. Randall, Jr., New England; F. P. Coyle, R. E. Miller, Philadelphia; C. D. Wardner, A. F. Tischer, Chicago; E. J. Smith, Cleveland; J. W. Otterson, San Francisco; Roy N. Phelan, Los Angeles; Ralph C. Maulsby, Atlanta

Contents Copyright, 1946, by McGraw-Hill Publishing Company, Inc., All Rights Reserved

McGRAW-HILL PUBLISHING COMPANY, INCORPORATED

JAMES H. McGRAW, Founder and Honorary Chairman

PUBLICATION OFFICE 99-129 North Broadway, Albany 1, N. Y., U. S. A.

EDITORIAL AND EXECUTIVE OFFICES 330 West 42nd St., New York 18, N. Y., U. S. A.

James H. McGraw, Jr., President; Curtis W. McGraw, Senior Vice-President and Treasurer; Howard Ehrlich, Vice-President and General Business Manager; Eugene Duffield, Editorial Assistant to the President; Joseph A. Gerardi, Secretary; and J. E. Blackburn, Jr., Vice-President (for circulation operations).
ELECTRONICS, April, 1946, Vol. 19; No. 4. Published monthly, price 50c a copy. Directory issue \$1.00. Allow at least ten days for change of address. All communications about subscriptions should be addressed to the Director of Circulation.
 Subscription rates—United States and possessions, Mexico, Central and South American countries, \$5.00 a year, \$8.00 for two years, \$10 for three years. Canada (Canadian funds accepted) \$5.50 a year, \$9.00 for two years, \$11.00 for three years. All other countries \$7.00 for one year, \$14.00 for three years. Please indicate position and company connection on all subscription orders. Entered as Second Class matter August 29, 1936, at Post Office, Albany, New York, under the Act of March 3, 1879. BRANCH OFFICES: 320 North Michigan Avenue, Chicago 11, Ill.; 68 Post Street, San Francisco 4; Aldwych House, Aldwych, London, W.C. 2; Washington, D. C. 4; Philadelphia 2; Cleveland 15; Detroit 26; St. Louis 8; Boston 16; Atlanta 3, Ga.; 621 So. Hope Street, Los Angeles 14; 738-9 Oliver Building, Pittsburgh 2.



FOR COMPACT HIGH FIDELITY EQUIPMENT

Ultra compact, lightweight, these UTC audio units are ideal for remote control amplifier and similar small equipment. New design methods provide high fidelity in all individual units, the frequency response being ± 2 DB from 30 to 20,000 cycles. There is no need to resonate one unit in an amplifier to compensate for the drop of another unit. All units, except those carrying DC in Primary, employ a true hum balancing coil structure which, combined with a high conductivity outer case, effects good inductive shielding. Maximum operating level +10 DB. Weight—5½ ounces. Dimensions—1½" wide x 1½" deep x 2" high.

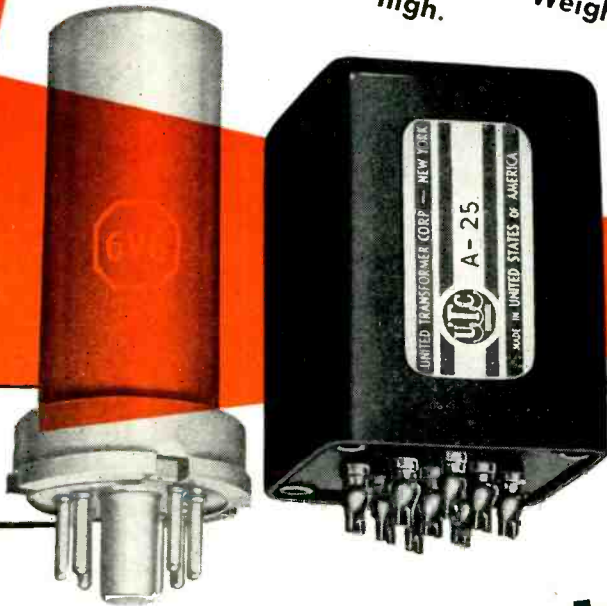

Unit shown is actual size. 6V6 tube shown for comparison only.

FOR IMMEDIATE DELIVERY

From Your Distributor

ULTRA COMPACT HIGH FIDELITY AUDIO UNITS

Type No.	Application	Primary Impedance	Secondary Impedance	± 2 DB from	List Price
A-10	Low impedance mike, pickup, or multiple line to grid	50, 125, 200, 250, 333, 500 ohms	50,000 ohms	30-20,000	\$12.75
A-11	Low impedance mike, pickup, or line to 1 or 2 grids	50, 200, 500 ohms	50,000 ohms	50-10,000 multiple alloy shield for extremely low hum pickup	13.90
A-12	Low impedance mike, pickup, or multiple line to push pull grids	50, 125, 200, 250, 333, 500 ohms	80,000 ohms overall in two sections	30-20,000	12.75
A-18	Single plate to two grids	8,000 to 15,000 ohms	80,000 ohms overall, 2.3:1 turn ratio overall	30-20,000	11.60
A-24	Single plate to multiple line	8,000 to 15,000 ohms	50, 125, 200, 250, 333, 500 ohms	30-20,000	12.75
A-25	Single plate to multiple line 8 MA unbalanced D.C.	8,000 to 15,000 ohms	50, 125, 200, 250, 333, 500 ohms	50-12,000	11.60
A-26	Push pull low level plates to multiple line	8,000 to 15,000 ohms each side	50, 125, 200, 250, 333, 500 ohms	30-20,000	12.75
A-30	Audio choke, 300 henrys @ 2 MA 6000 ohms D.C., 75 henrys @ 4 MA 1500 ohms D.C., inductance with no D.C. 450 henrys				8.70

The above listing includes only a few of the many Ultra Compact Audio Units available . . . write for more details.

United Transformer Corp.
 NEW YORK 13, N. Y.
 150 VARICK STREET
 EXPORT DIVISION: 13 EAST 40th STREET, NEW YORK 16, N. Y. CABLES: "ARLAB"



● So clearly and unmistakably are draftsmen able to express their ideas on paper that their drawings have re-shaped the world. Through line, figure and symbol, draftsmen define the work to be done by the labor and machines of a nation. Assisting them to attain precision and clarity are drafting instruments that act almost as living extensions of their own hands...instruments that function figuratively as their partners in creating.

For 78 years Keuffel & Esser Co. drafting equipment and materials have been partners, in this sense, in shaping America, in making possible its swift-moving highway traffic, its speed in conducting business, its victorious might in war ... So universally is K & E equipment used, it is self-evident that every engineering project of any magnitude has materialized with the help of K & E. Could you wish any surer guidance than this in the selection of your own "drafting partners"?

You will find special advantages, for example, in PHOENIX* Tracing Cloth, which K & E has made almost "ghost-proof." Here is a cloth from which you can erase either pencil or ink lines without risking untidy "ghosts" on the prints, a cloth practically immune to stains from perspiration and water. You can even soak it in water for ten minutes at a time without harm! For further details about PHOENIX* Tracing Cloth, write on your letterhead to Keuffel & Esser Co., Hoboken, N. J.

partners in creating

*REG.U.S. PAT. OFF.

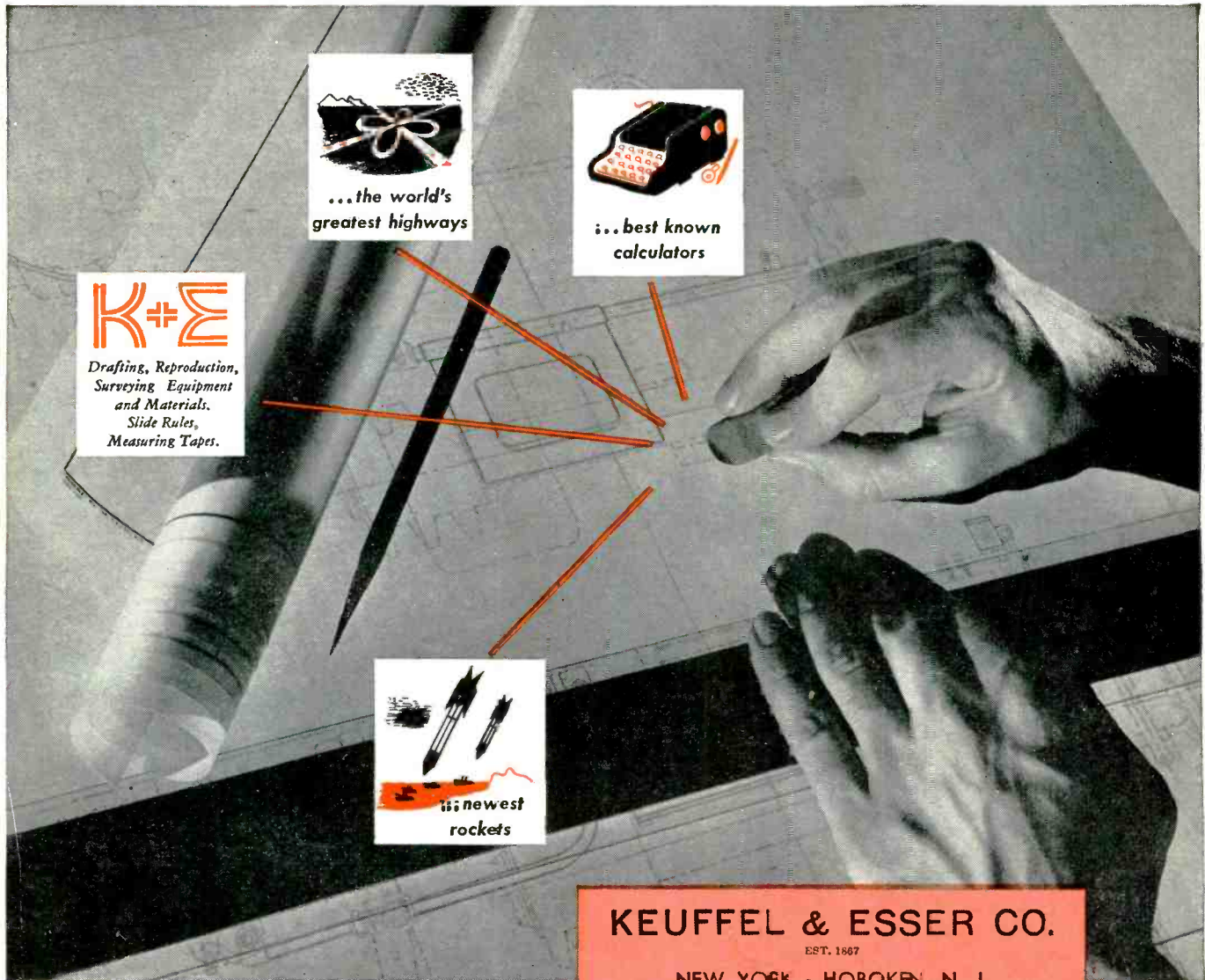

KEUFFEL & ESSER CO.
EST. 1867
 NEW YORK • HOBOKEN, N. J.
 CHICAGO • ST. LOUIS • DETROIT • SAN FRANCISCO
 LOS ANGELES • MONTREAL

RCA's *Dual-purpose*



New RCA "image-orthicon" camera with sensitivity 100 times greater than conventional television cameras.

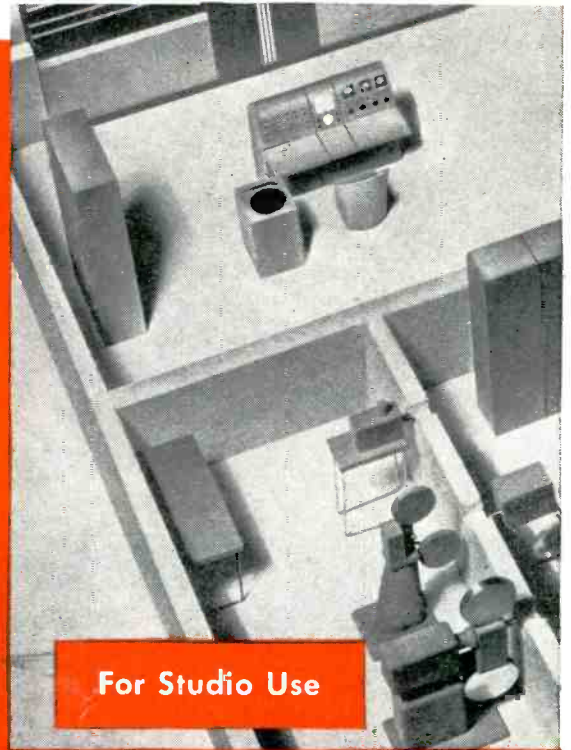

For Studio Use



Camera control (left) with power supply

Duplicate camera control used for two-camera operation

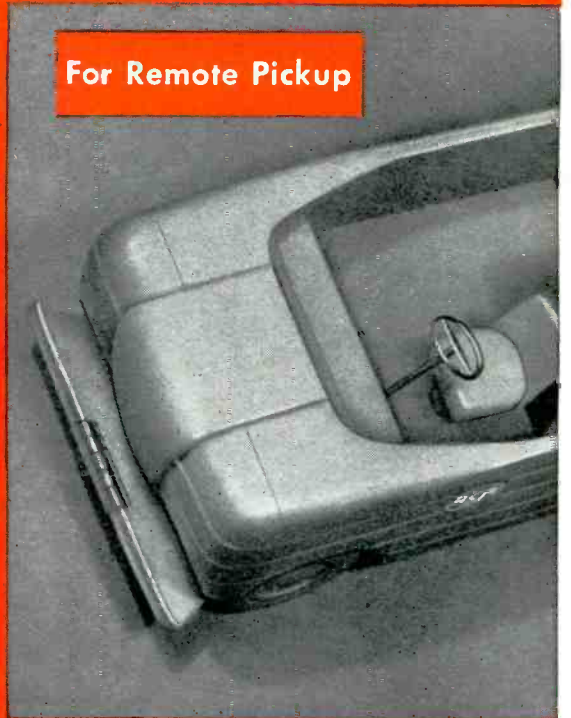

For Remote Pickup



Master control (left) with power supply



Shaping unit (left) and pulse unit

The average small station starts with two field cameras, two control units (one for each camera) for monitoring the pictures picked up by each camera, a master control and switching unit which contains push buttons to permit operator to select the camera pickup desired, a field synchronizing generator (shaping and pulse unit shown above) to provide standard sweep frequencies for the cameras as well as the synchronizing pulses transmitted with the video signal, and various auxiliary switching, control and audio equipments (not shown).

Portable Pick-up Equipment...

a new, low-cost way to get started in Television

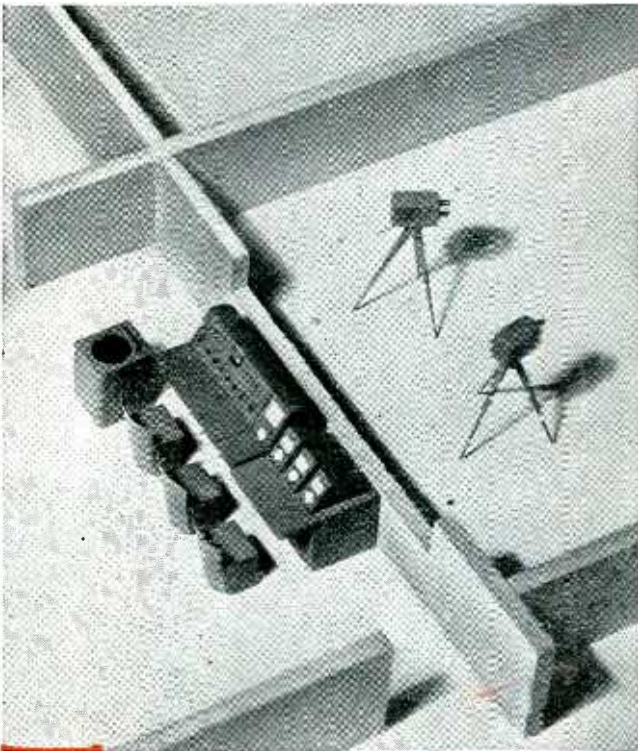

IF YOU PLAN to start a television station on a modest scale, you will find this equipment a real money-saver. With it you can enjoy the economies of using already prepared program material such as, baseball games, boxing and concerts—which do not require expensive rehearsals and where lighting is seldom a problem. And you can use it in place of *fixed studio equipment* until you want to expand your station facilities.

When used as studio equipment, the small, lightweight camera-control units can be mounted on tables or slid into console-type racks (see models) that RCA will have available for this purpose. The same field cameras are used.

For remote pickup, a station wagon or light truck is used to transport the suitcase-type units to the program location. With a station wagon, the equipment is removed, carried to the program area, and connected for operation. A light truck offers greater flexibility in that the equipment can be operated from the truck if shelter is non-existent, or if brilliant illumination makes monitoring difficult. As with the station wagon, where advantageous, the equipment can be removed and set up at the program scene.

Setup can be accomplished in a short time. *Quality* is comparable to that obtained from standard studio equipment. Best of all, it's *easy to operate*.

Write for these 8 helpful bulletins:

"Locating the Television Studio," "Locating the Television Transmitter," "A Television Transmitter Building," "A Television Broadcasting Studio," "Equipment Layout for a Standard Television Station," "Equipment Layout for a Master Television Station," "Equipment Layout for a Small Television Station with Live-Talent Studio," "Equipment Layout for a Small Television Station with Provision for Film and Network Programs Only." Write: Radio Corporation of America, Dept. 30-D, Television Broadcast Section, Camden, N. J.

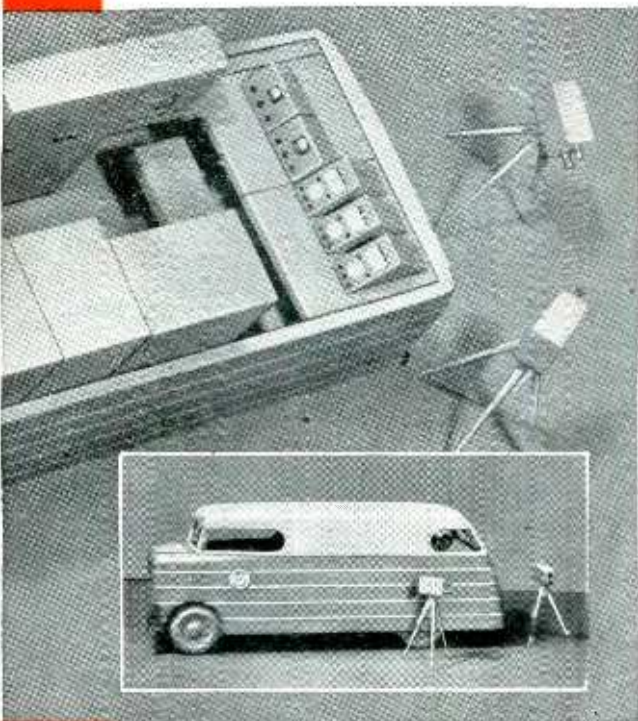

TELEVISION BROADCAST EQUIPMENT

RADIO CORPORATION of AMERICA

ENGINEERING PRODUCTS DEPARTMENT, CAMDEN, N. J.

The CAPACITOR FOR *Super-Speed Flash*

HIGH ENERGY STORAGE
100 watt-seconds at 2500 volts d-c

LIGHT WEIGHT • only 6 1/4 pounds

COMPACT • 6 1/2 inches high;
3 3/4 by 4 5/8 inch base

STURDY • hermetically sealed steel
case; heavy-duty screw terminals
in cup bushings

HIGH CURRENT
negligible inductance and resistance
in windings and connections

LONG LIFE • 10,000 charge-discharge
cycles at peak rating

*Ask for "N-ERG-Y"
... the capacitor for
super-speed flash*



BUILDERS OF CAPACITORS ENGINEERED FOR LONG LIFE



**WE BUILD 'EM
HUSKY and
HANDSOME!**

Cabinets and housings fabricated by KARP are distinguished for superior sturdiness that insures longer life, and handsome, custom-crafted appearance.

This "plus" in both utility and beauty gives your finished assembly added market value. It easily justifies a higher selling price if that is your aim — or gives you competitive advantage without higher price.

KARP builds in this extra worth by painstaking skill and care to the most minute detail—a result of superior specialized experience and ability, to-

gether with the finest of modern plant equipment and facilities. You get a de luxe, custom job at a cost that compares with that of ready-made stock items.

Our large store of dies and tools is available to save you the expense of many special dies. Yet your job is individualized to your exact specifications.

Tell us your needs. Bring us your tough problems in cabinets, enclosures, chassis, racks, panels and housings. ANY METAL • ANY SIZE • ANY GAUGE • ANY QUANTITY

All Types of Welding, Including Master-Craft Spot-Welding of Aluminum

KARP METAL PRODUCTS CO., INC.

124-30th Street, Brooklyn 32, N. Y.

Custom Craftsmen in Sheet Metal



SERIES 400

"SUPER-PRO"

TUNING RANGE .54-30 mc.



The "400" has high image rejection, high sensitivity, low noise level. It is designed for weak signal reception — puts new life in your 10-meter activity.

ASK THE MEN IN THE AACs WHO USE THEM . . .

The Series 400 postwar "Super-Pro" stands by itself, a leader in the field of communications. The reason of course is continual improvement in design through years of service under a wide variety of operating conditions. The people who know most about receivers choose "Super-Pros."

SEND FOR TECHNICAL DATA



HAMMARLUND

THE HAMMARLUND MFG. CO., INC., 460 W. 34TH ST., NEW YORK 1, N. Y.
MANUFACTURERS OF PRECISION COMMUNICATIONS EQUIPMENT

PIERCING 1/4" STEEL

... EASY WITH WHISTLER
HEAVY DUTY ADJUSTABLE
DIES

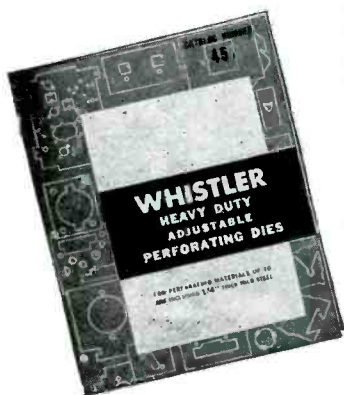

Manufacturing costs can be materially reduced and conversion speeded up by putting the "SX" series of heavy duty adjustable perforating dies to work in your plant.

Available from stock in standard sizes and shapes from 1/8" to 1 1/2". Continued reuse in different groupings spreads original costs over a multitude of jobs. Closer centers permit more perforations per press operation. Absolute accuracy on

short or long runs. Quick changeover of hole arrangements contributes to greater production from your presses.

If perforating, notching, slitting or rounding dies are used in the manufacture of your products and you are working with materials up to 1/4" steel, then good business dictates that you write for the Whistler catalogs and know the time and money saving advantages of Whistler Heavy Duty Adjustable Dies.

S. B. WHISTLER & SONS, Inc.

752-756 MILITARY ROAD

BUFFALO 17, NEW YORK

DUMONT

PAPER

CAPACITORS

HEATPROOF

Dumont condenser ends are sealed with bakelite resinoid to withstand 350° F. continuous operation.

SMALL SPACE

1/4" OD x 3/4" LONG
AT 600 VOLTS
Compact . . . solves space problems

MOISTUREPROOF

UP TO 100% HUMIDITY
Sealed under vacuum. No air voids to cause entry of moisture

LONG LIFE

NO HIGH TEMPERATURE
OR HIGH PRESSURE

Used in the manufacture of these condensers . . . thus assuring long life and High Surge Rating to these units.

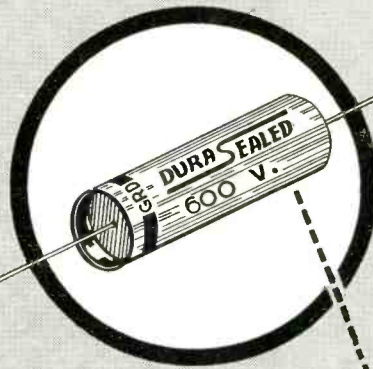

DUMONT
TYPE P6

DUMONT
TYPE P2

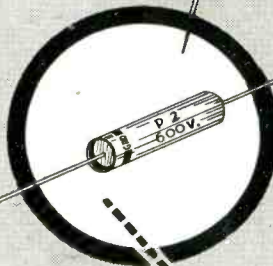

Sealed with DUMONT
BAKELITE RESINOID

DUMONT
ELECTRIC CORP.
MFR'S OF
CAPACITORS FOR EVERY REQUIREMENT
34 HUBERT STREET NEW YORK, N. Y.

for UNVARYING SPEED!

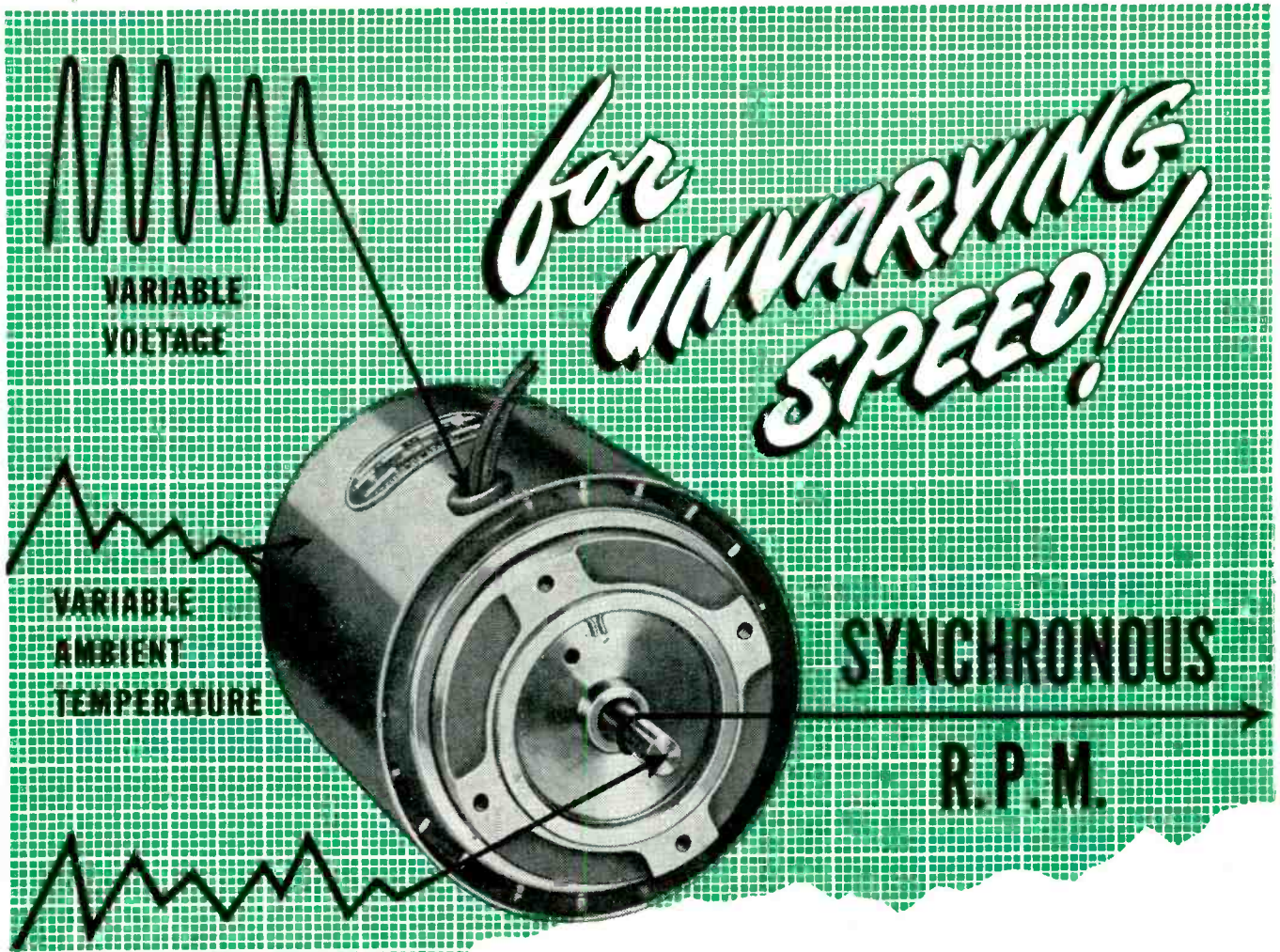

Where truly fixed unvarying speed is imperative for proper performance, the E.A.D. SYNCHRONOUS MOTOR will do what the so-called "Constant Speed Motor" cannot achieve . . . maintain the speed tied to the line frequency regardless of load and voltage variations within the limits of its power.

115 VOLTS—60 CYCLES—CONTINUOUS DUTY			
CLASSIFICATION	H.P.	SPEED	REMARKS
SYNCHRONOUS (Capacitor start and run)	1/50, 1/100,	1800 RPM and 3600 RPM	Totally enclosed. Sleeve or ball bearings.
	1/200		
OTHER EAD MOTORS			
INDUCTION (Capacitor start and run)	1/15, 1/20,	1600 RPM and 3200 RPM	Totally enclosed. Sleeve or ball bearings.
	1/30, 1/50		
SHADED POLE	1/30, 1/50, 1/100	1500 RPM	Totally enclosed. Sleeve or ball bearings.

TYPICAL APPLICATIONS

- Cameras and Projectors
- Chart Recorders
- Facsimile
- Sound Recorders
- Television
- Timing Apparatus
- Turntables



EASTERN AIR DEVICES, INC.

585 DEAN STREET • BROOKLYN 17, N. Y.

An Affiliate of THE FRED GOAT CO., INC., Est. 1893

MAKING TUBES IS EASY *If* YOU KNOW HOW!

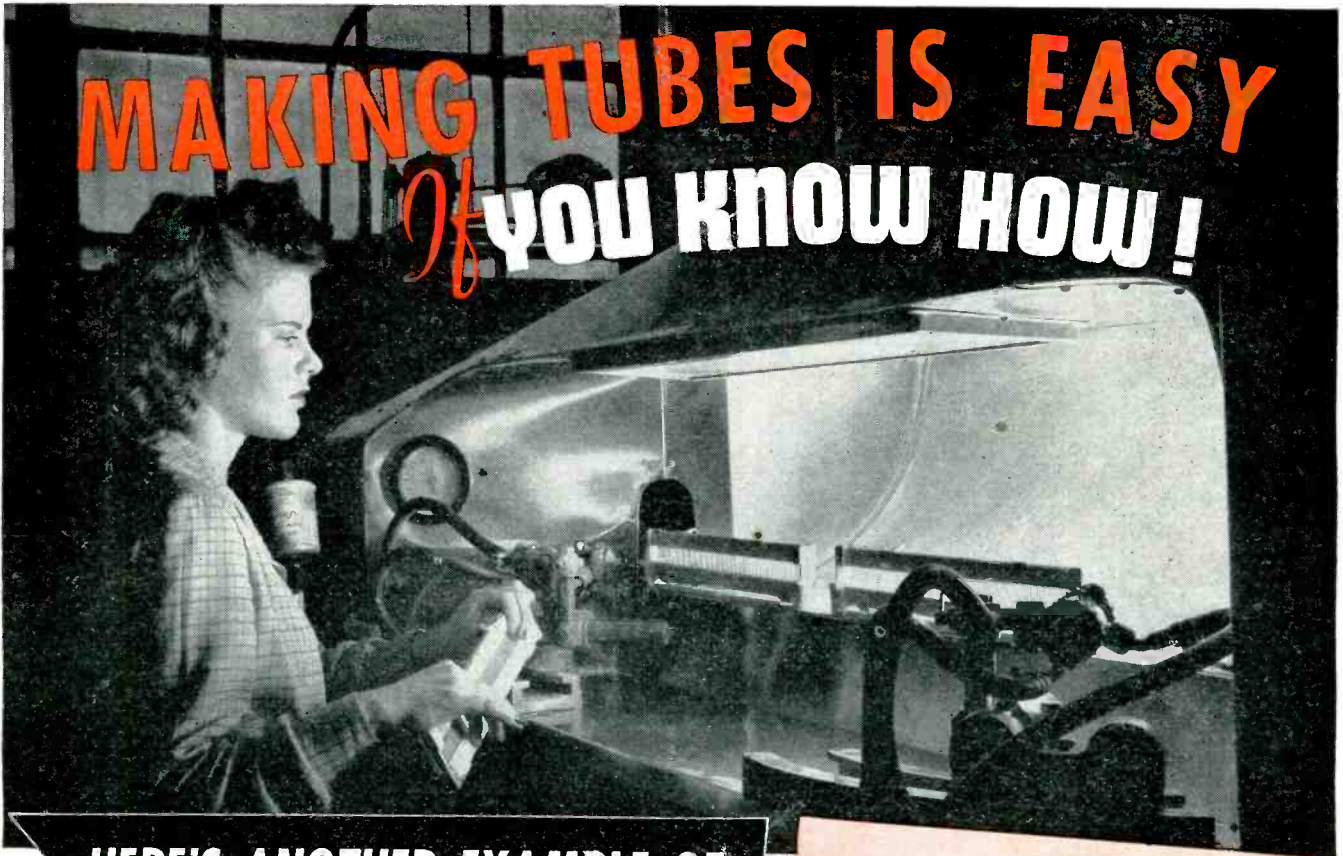

HERE'S ANOTHER EXAMPLE OF

UNMATCHED HYTRON KNOW-HOW

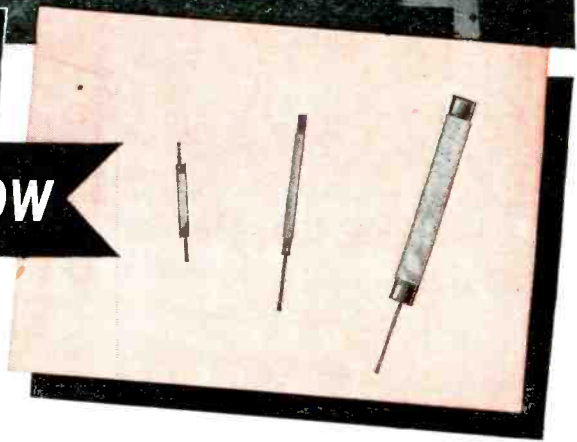

A GAIN a painstaking, tough job is made easy. This Hytron electronically-controlled cathode-spray machine minimizes the element of human error always present with hand spraying. Evenly applied emissive coating of exactly the right weight and density is obtained hour after hour. Number and speed of coating passes, distance from spray guns to cathode sleeves, and intensity of the spray are precisely controlled.

An endless belt, with 8 racks each containing 40-100 bare cathode sleeves, travels before the two spray guns at 37-112 racks per minute. These guns are fired electronically only while racks appear before their nozzles. Each gun can be aimed through an arc of 0-45° to accommodate flat, oval, or round sleeves. Distance between gun and rack is finely adjustable. Number of passes is electronically controlled between 2 and 32.

An ingenious device automatically reverses—at each revolution of the endless belt—the side of a given rack exposed to the guns. A bank of infra-red lamps

dries each layer of coating immediately after its application.

Intensity and width of spray are regulated by pressure and nozzle adjustments. A continuously circulating system (instead of suction or gravity feed) maintains the coating fluid in the necessary state of suspension, and prevents clogging by coagulation.

Cathode coatings are held to such close tolerances that they must be measured by weight—on balances capable of reading .1 milligram. Yet this machine can apply accurately over 100,000 of such fine coatings daily. Another example of Hytron's mass production with precision—the Hytron know-how which gives you better tubes.



OLDEST MANUFACTURER SPECIALIZING IN RADIO RECEIVING TUBES

HYTRON

RADIO AND ELECTRONICS CORP.

MAIN OFFICE: SALEM, MASSACHUSETTS



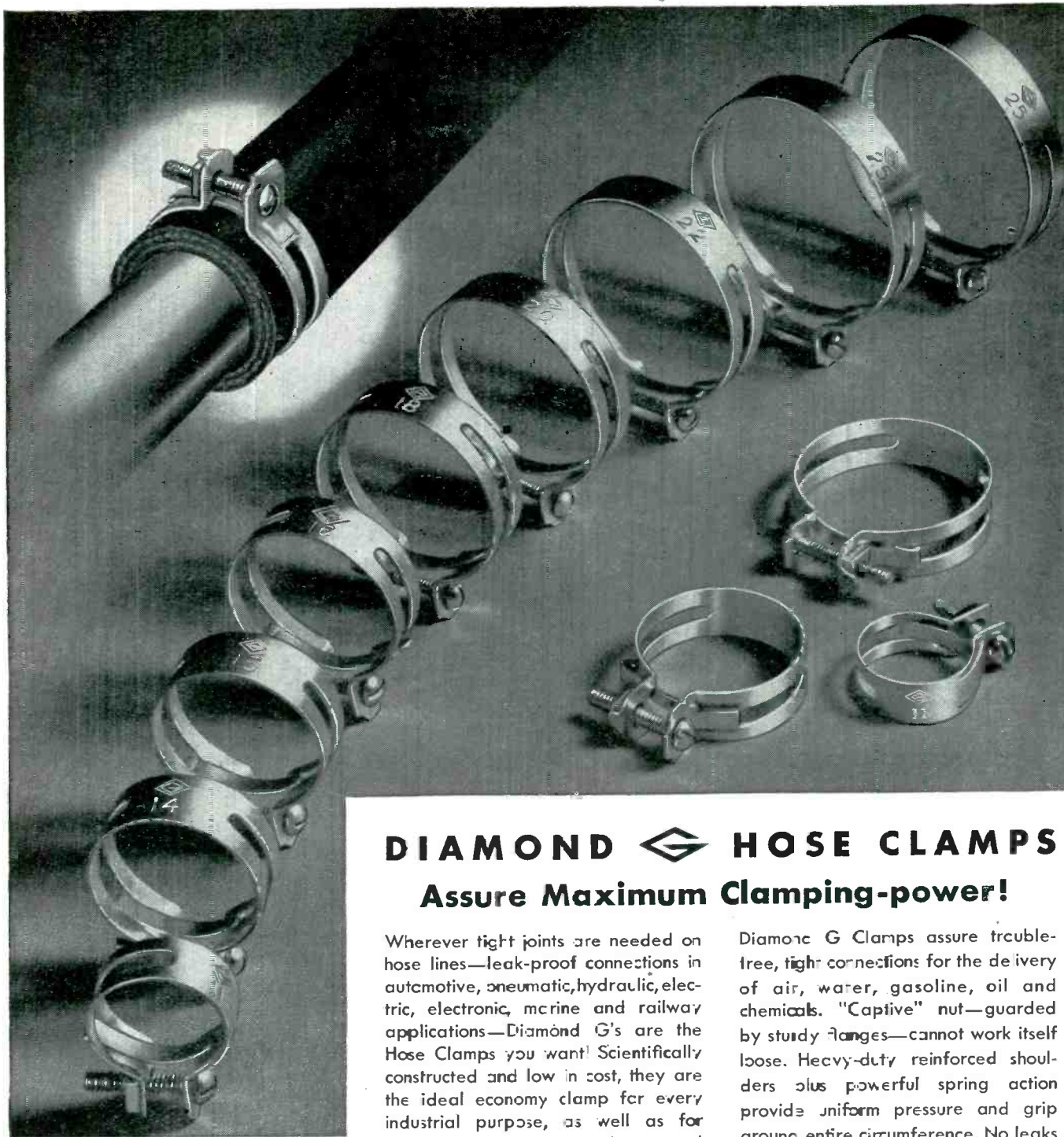

DIAMOND HOSE CLAMPS Assure Maximum Clamping-power!

Wherever tight joints are needed on hose lines—leak-proof connections in automotive, pneumatic, hydraulic, electric, electronic, marine and railway applications—Diamond G's are the Hose Clamps you want! Scientifically constructed and low in cost, they are the ideal economy clamp for every industrial purpose, as well as for garden hose, spraying equipment and household use.

Rust-proofed throughout — quickly and easily adjusted for all types and sizes of rubber hose and tubing—

Diamond G Clamps assure trouble-free, tight connections for the delivery of air, water, gasoline, oil and chemicals. "Captive" nut—guarded by sturdy flanges—cannot work itself loose. Heavy-duty reinforced shoulders plus powerful spring action provide uniform pressure and grip around entire circumference. No leaks—no losses—no replacements!

Diamond G Hose Clamps are available in a complete range of sizes. Write today for full details.

GEORGE K. GARRETT CO., INC.

1421 CHESTNUT STREET, PHILADELPHIA 2, PA.

MANUFACTURERS OF



DIAMOND  PRODUCTS

LOCK WASHERS • • FLAT WASHERS • • STAMPINGS • • SPRINGS • • HOSE CLAMPS • • SNAP AND RETAINER RINGS

Hold Your Thumb UP...

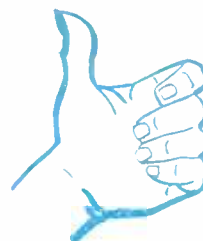

It is about the same size as a LEACH MIDGET RELAY.  We'll wager that these little control

devices will cut down your design headaches



for a host of products. MIDGETS can handle up to two

amperes.



at 115 volts



AC, non-inductive.



Economical—Lightweight



—and engineered

for long-life



MIDGETS are backed by three decades



of production and design experience in relay

engineering. Contact arrangements from single-pole,



single-throw to four-pole,



double-throw, with coils

for both AC or DC are available. We want you to know

about and use LEACH MIDGETS. Write

NOW for descriptive literature.



JUST OUT!

Our NEW 1946 catalogue is now available. Send for your copy.

Address
Department L

LEACH RELAY CO.

5915 AVALON BOULEVARD, * LOS ANGELES 3, CALIF.



INDUSTRY



ELECTRONICS



COMMUNICATIONS



AIRCRAFT



TRANSPORTATION



POWER

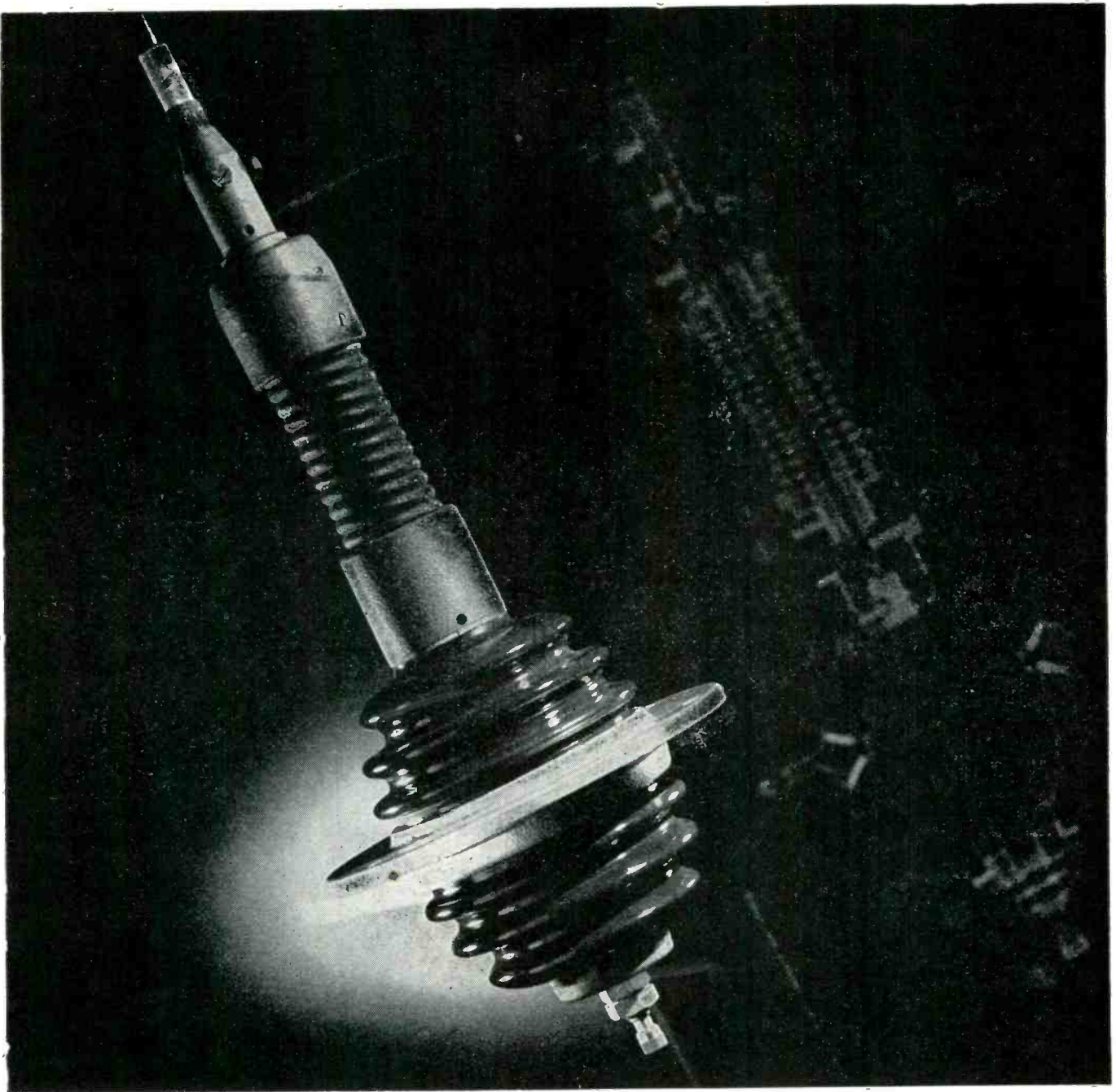

LAPP-DESIGNED, LAPP-BUILT—TO DO A SPECIFIC JOB

This is an antenna base insulator for use on a communications center transmitter. It is one of several Lapp designs for transmitter and receiver mast bases for military vehicular radio—on jeeps, halftracks, tanks and other rolling equipment.

Whether or not this special-purpose gadget has application to anything you build or propose to build, there's a moral in it for you. In this case, as in hundreds of others, an original and impractical design was modified by Lapp engineers—to provide a part that meets all electrical and mechanical requirements, and that Lapp can build economically and efficiently.

Lapp engineering talent and Lapp production methods are such that we can say, "If it's an assembly that can be made of porcelain or steatite and metal parts, tell us what

the requirements are and how you think it might be made; Lapp will tell you how it can best be made—and will make it." Our right to that claim has been proved over and over in military electronic production; it's going to be a competitive advantage to smart post-war electronic producers. *Lapp Insulator Co., Inc., LeRoy, N. Y.*



Celanese*

*Serve the Product
Designer with these
Important Properties . . .*

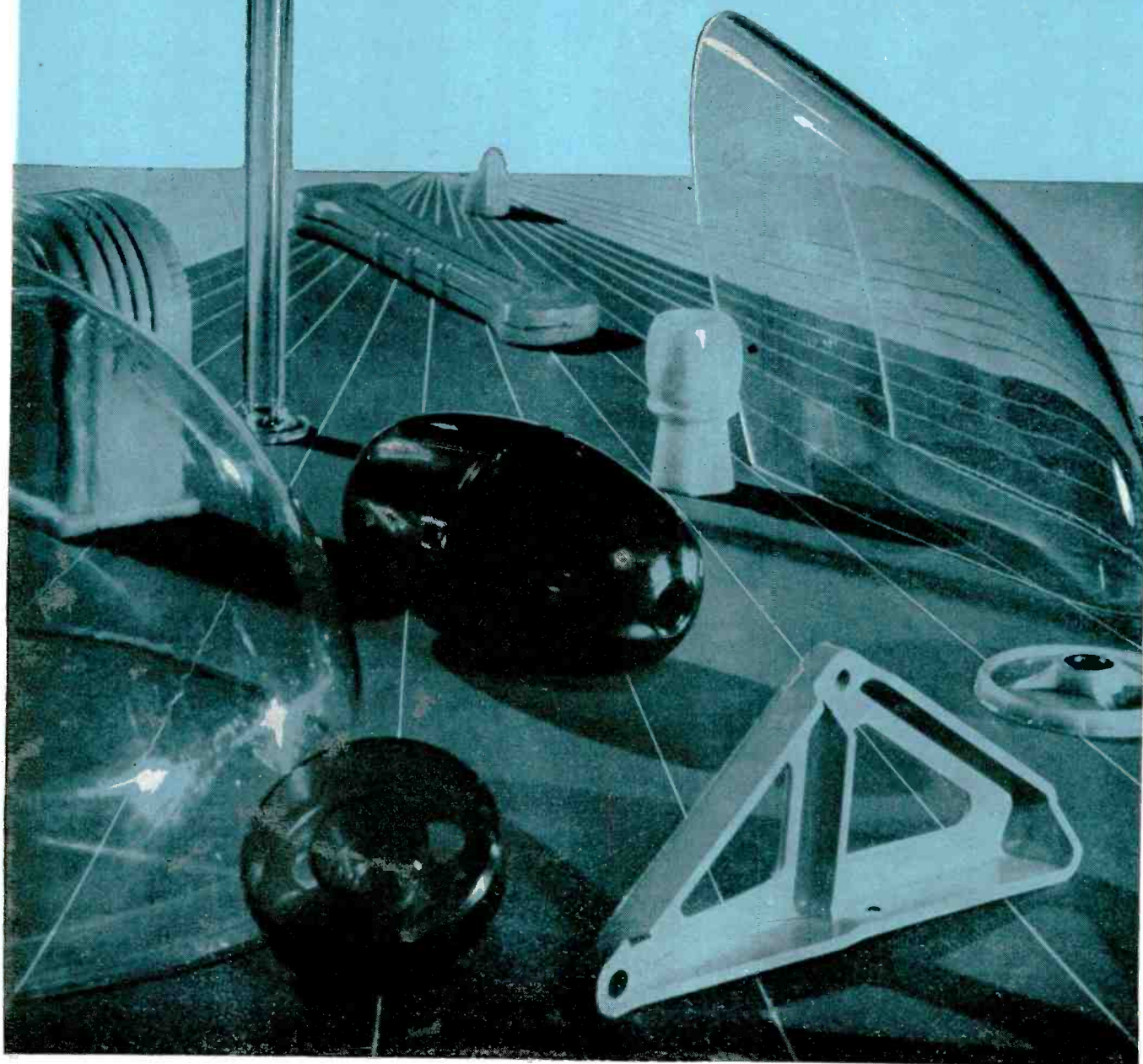

Plastics

UNLIMITED COLOR AND DENSITY CONTROL
TRANSPARENCY AND COLOR CONFIGURATIONS
TOUGHNESS WITH LIGHTNESS AND FLEXIBILITY
MOLDABILITY OVER METAL
TOUCH COMFORT
EXACT FORMULATION
CLEAR-THROUGH COLOR AND SURFACE PERMANENCE
EASY FABRICATION

The warmth and character of Celanese Plastics are working tools for the product designer. The esthetic qualities of limitless clear-through color, transparency and touch comfort go far in promoting consumer acceptance of new product designs.

But of equal importance to the product engineer are the rigidly controlled physical properties that make Celanese plastics No. 1 materials for creative design: *Celanese plastics are produced according to A.S.T.M. standards—thus giving the designer a ready check on performance in advance . . . The desired combination of physical characteristics can be obtained by formulation . . . Spectrum color control permits exact color determination . . . Color density control assures uniformity in parts regardless of size or cross-sectional thickness.*

These controlled characteristics of Celanese plastics are a potent force for sound design during the drawing board stage of product planning—the time, too, when the Celanese technical service staff can be of greatest service. Write for Celanese Plastics Designer's Booklet. Celanese Plastics Corporation, a division of Celanese Corporation of America, 180 Madison Avenue, New York 16, N. Y.

*Reg. U. S. Pat. Off.
†Trade Mark

LUMARITH* CA

FORTICEL†

LUMARITH X

LUMARITH EC

CELLULOID*

VIMLITE*

TYPICAL APPLICATIONS OF CELANESE PLASTICS

AUTOMOTIVE & AVIATION steering wheels, instrument panels, radio grills, controls, switch buttons, door handles, radiator ornaments, bezels, lighting fixtures, antennae housings, ventilator tubes, transmitter guards, interior trim, cockpit enclosures.

RADIO & ELECTRICAL molded parts and fittings, panels, bezels, instrument housings, insulation, plugs, jacks, molded trim, knobs, dials, coils, lighting fixture parts, switch plates, instrument housings, fuse plug windows, toggle switches, condensers.

HARDWARE tool handles, mallet heads, motor tool housings, drawing instruments, transparent oil cans, architectural moldings, hinges, door knobs, threshold strips, transparent safety shields, transparent eye protectors, industrial chart covers, piano keys, lunch boxes, plastic glazing.

APPLIANCES telephone handsets, shaver housings, parts for refrigerators, washers, dryers, mixers, vibrators, sunlamps.

HOUSEHOLD ACCESSORIES coat hangers, closet hooks, blanket boxes, shower curtain rings, toilet seat veneering, bath wall fixtures, towel racks, mailboxes, drawer pulls, closet accessories, lamp shades, clothespins, bookends, table mats, table decorations.

COSMETICS compacts, lipstick cases, powder boxes, puff boxes, tissue holders.

PERSONAL ITEMS pencil cases, pencils and pens, beads, tooth brush handles, eyeglass frames, combs, handkerchief boxes, picture frames, shoes, slippers, toilet sets, jewel boxes, buttons, belt buckles, costume jewelry, millinery trimming, handbags, hatboxes, transparent bibs, artificial flowers.

SPORTING GOODS fishing tackle boxes, tennis rackets, gun stocks, fish net floats, artificial lures, camera housings, photographic equipment, films, sun glasses.

GAMES & TOYS dominoes, chess and checker sets, dice, table tennis balls, shuttlecocks, billiard balls, rattles, teething rings.

PACKAGING film wraps, window cartons, set-up boxes, all transparent bags and envelopes, transparent rigid containers, molded containers, decorative and protective laminations, reuse containers.

OKay

this team is a leader in VHF

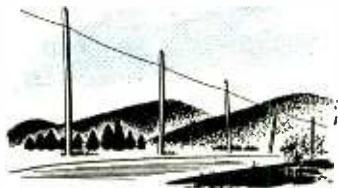

1. First voice circuits were single iron wires with ground return. Frequency limitations, noise and high losses soon ruled them out.



2. Big improvement was the all wire circuit—a pair of wires to a message. Later came carrier which stepped up frequency and permitted several messages per circuit.

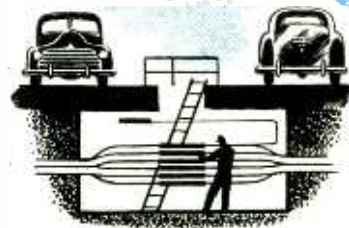

3. Lead covered cable compressed many wire circuits into small space—took wires off city streets. But losses are prohibitive at very high frequencies.

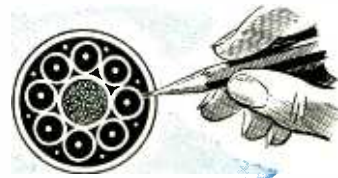

4. Coaxial cable—a single wire strung in a pencil size tube—extended the usable frequency band up to millions of cycles per second and today carries hundreds of messages per circuit, or the wide bands needed for television.

transmission



5. Wave guides, fundamentally different in transmission principle, channel energy as radio waves through pipes; vary in size from several inches to under 1 cm.; become smaller as frequency rises.



6. Late model radar wave guides, similar to that used to feed the antenna above, can carry $3\frac{1}{2}$ cm. waves at more than eight billion cps. Experimental guides for still shorter waves are being tested.

Back in 1933, Bell scientists established an historic first when they transmitted very high frequency radio waves for hundreds of feet along hollow pipes called wave guides. For them it was another forward step in their long research to make communication circuits carry higher frequencies, broader bands and more messages per circuit.

Continuing Research showed the way

From the days of the single open wire line—through all-metallic circuits, phantoming, cable, carrier systems and coaxials—up to today's wave guides, every improvement has been the result of continuous fundamental study.

When Bell Laboratories started work on wave guides, there was no immediate application for the microwaves they guided. But the scientists foresaw that *some day* wave guides would be needed—so they kept on working until they had developed the wave guide into a practical device.

With the war came radar—and the problem of conducting microwave frequencies. Bell Laboratories had the answer—wave guides—without which radar at the higher frequencies would have been impractical.

What this means to YOU

Year after year, Bell Laboratories have continued to develop methods for handling higher and higher frequencies. Year after year Western Electric has provided equipment putting these scientific advances to work. This team has become the natural leader in the field.

When your requirement dictates the use of VHF—in mobile communications, broadcasting, or point-to-point radio telephony—depend on Western Electric to supply the latest and best equipment for your needs.



BELL TELEPHONE LABORATORIES

World's largest organization devoted exclusively to research and development in all phases of electrical communication.

Western Electric

Manufacturing unit of the Bell System and nation's largest producer of communications and electronic equipment.

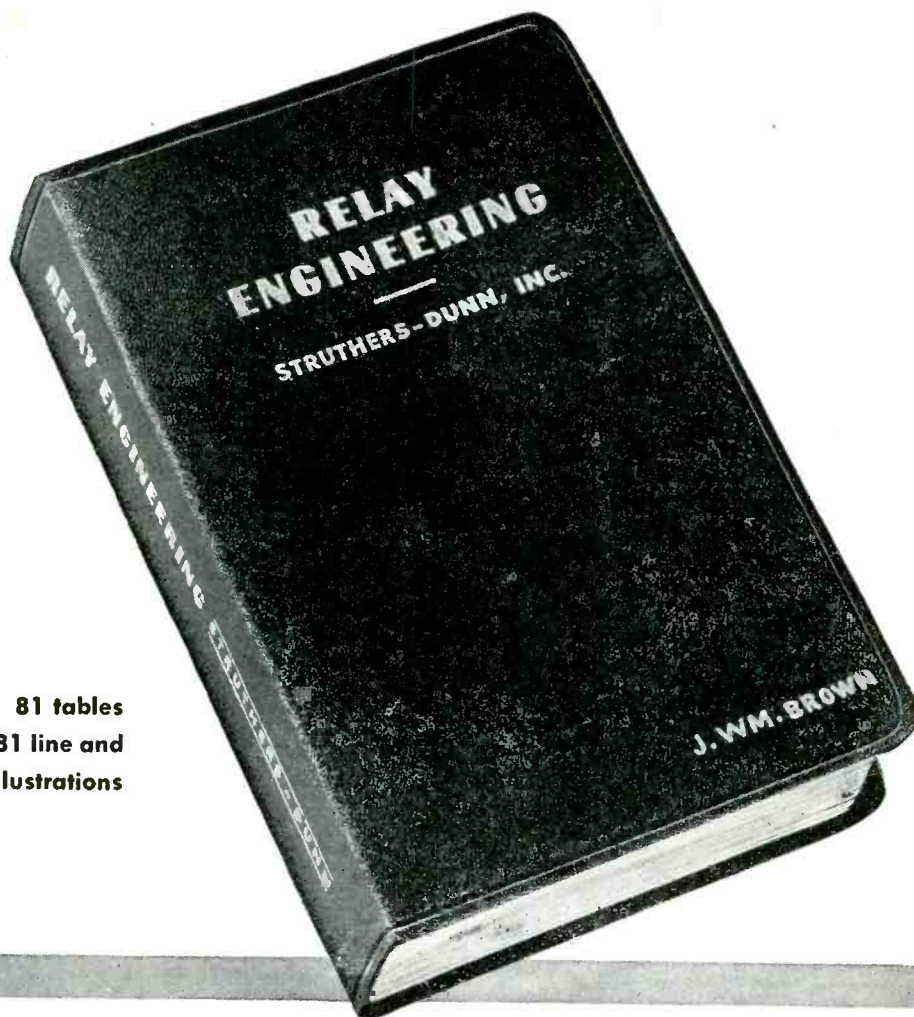

150,000 words • 81 tables
863 diagrams • 181 line and
89 photographic illustrations

The handbook that tells you what you want to know about Relays and Timers

... Selection ... Application ... Use ... Servicing and Main-
tenance ... 640 pages ... Handy manual size ...

Have you gotten your copy? ... Price \$3.00

STRUTHERS-DUNN, INC.
1321 Arch Street, Philadelphia 7, Penna.

STRUTHERS-DUNN

5,327 RELAY TYPES

ATLANTA • BALTIMORE • BOSTON • BUFFALO • CHICAGO • CINCINNATI • CLEVELAND • DALLAS
DENVER • DETROIT • HARTFORD • INDIANAPOLIS • LOS ANGELES • MINNEAPOLIS • MONTREAL
NEW YORK • PITTSBURGH • ST. LOUIS • SAN FRANCISCO • SEATTLE • SYRACUSE • TORONTO

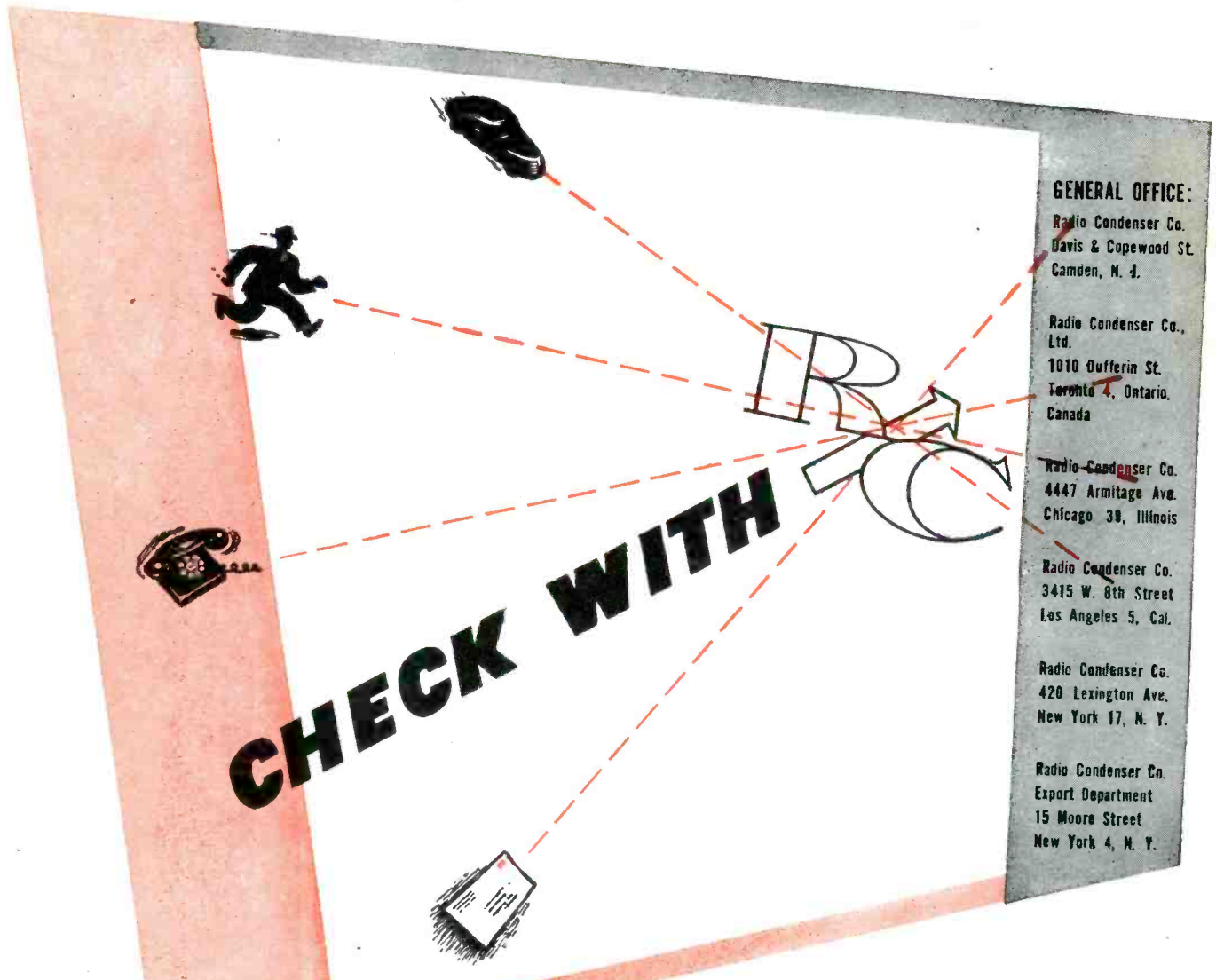

GENERAL OFFICE:
 Radio Condenser Co.
 Davis & Copewood St.
 Camden, N. J.

Radio Condenser Co.,
 Ltd.
 1010 Dufferin St.
 Toronto 7, Ontario,
 Canada

Radio Condenser Co.
 4447 Armitage Ave.
 Chicago 39, Illinois

Radio Condenser Co.
 3415 W. 8th Street
 Los Angeles 5, Cal.

Radio Condenser Co.
 420 Lexington Ave.
 New York 17, N. Y.

Radio Condenser Co.
 Export Department
 15 Moore Street
 New York 4, N. Y.

**... when Variable Capacitor
 KNOW-HOW makes a difference!**

We design and build **ONLY** variable capacitors and mechanical tuning devices.

This factor, more than any other, has contributed to the high degree of R/C specialized knowledge in the field of variable capacitor design and manufacture.

With a history of almost a quarter of a century as suppliers to the set manufacturing industry, Radio Condenser Company offers the most complete engineering background in variable capacitors and mechanical tuning devices.

RADIO CONDENSER COMPANY
 CAMDEN, N. J.
 RADIO CONDENSER CO., Ltd., Toronto, Canada



RADIO CONDENSER COMPANY

SUPPLIERS TO SET MANUFACTURERS ONLY

Stupakoff Ceramics



Export Department
13 E. 40th St., New York 16, N.Y.

Cable Address:
ARLAB All Codes

**STUPAKOFF CERAMIC
AND MANUFACTURING CO.**
LATROBE, PENNSYLVANIA

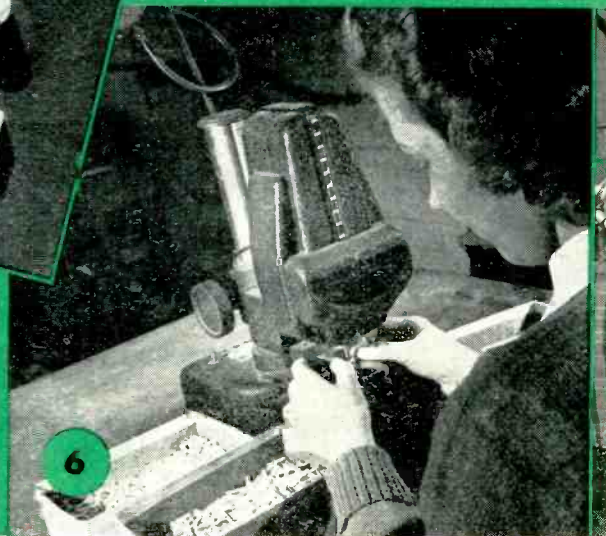

Precision - Made to meet your most exacting needs

1. **ENGINEERING** of Stupakoff products is based upon practical experience in the application and manufacture of industrial ceramics.
2. **FORMULAS** are carefully worked out to produce a material that fulfills the special requirements of each particular application.
3. **FORMING** by extrusion, pressing or molding, insures the selection of the process best suited to the product being made.
4. **FIRING**, an extremely important operation, is done at controlled temperatures, cycles, atmospheres and other closely regulated conditions.
5. **MACHINING** by modern precision equipment assures dimensional accuracy of finished pieces.
6. **INSPECTION** assures dimensional accuracy, clean edges, correct color of finished parts, dielectric and mechanical strength.

When you use Stupakoff Ceramics, these facilities assure correct application, highest quality and complete satisfaction.

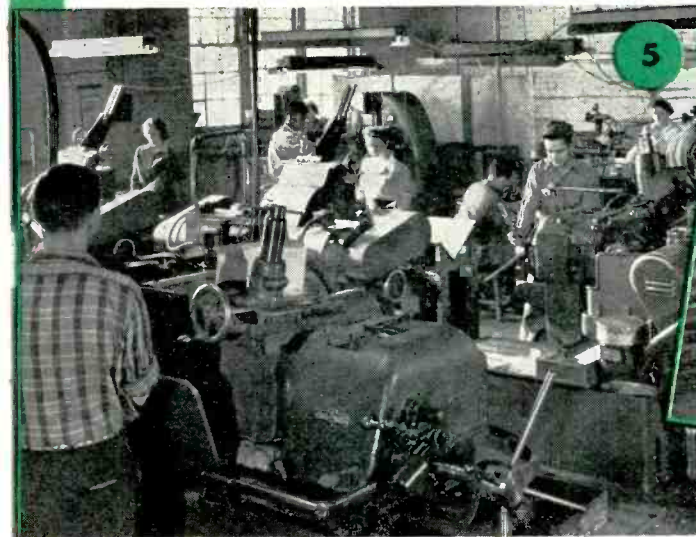
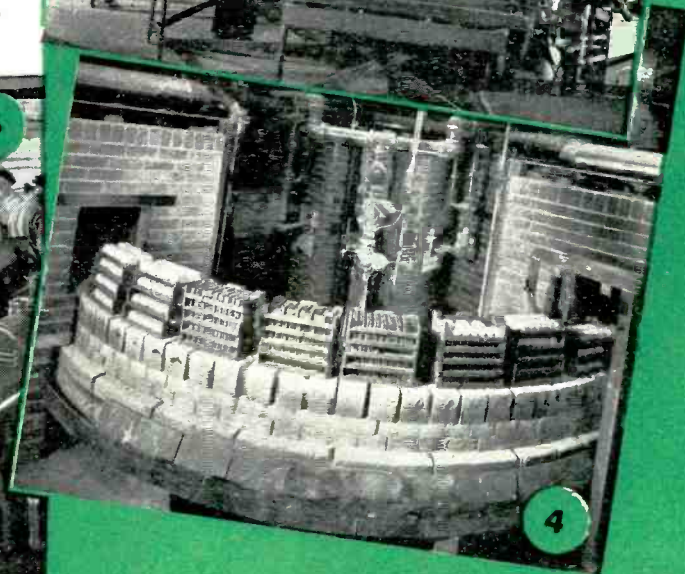
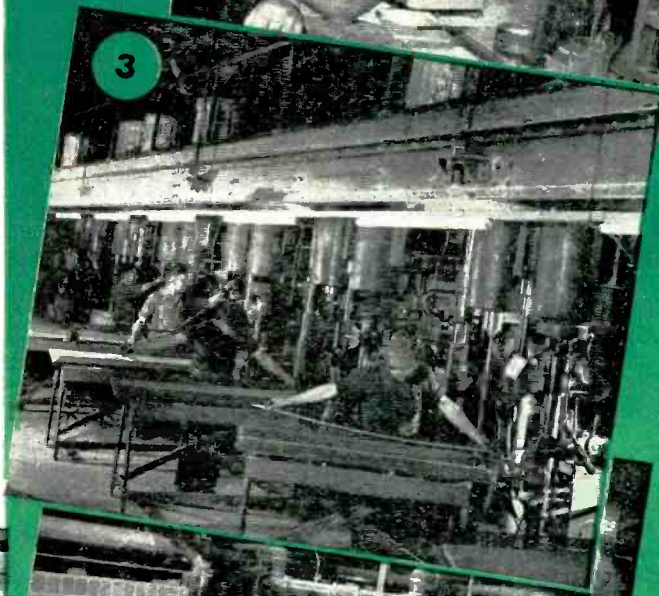
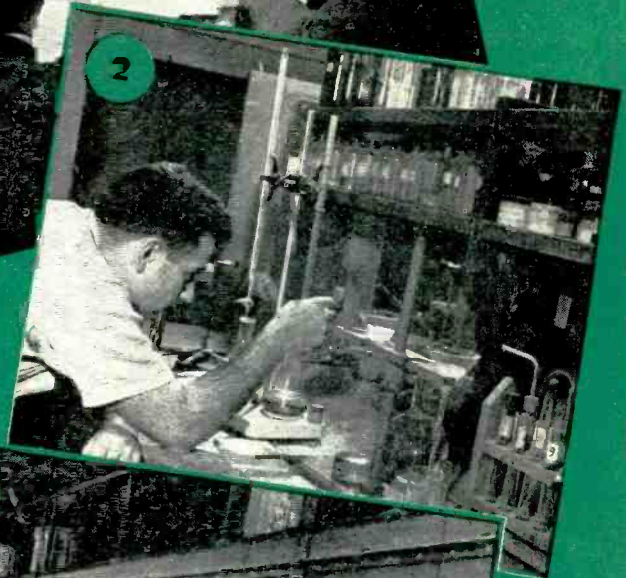
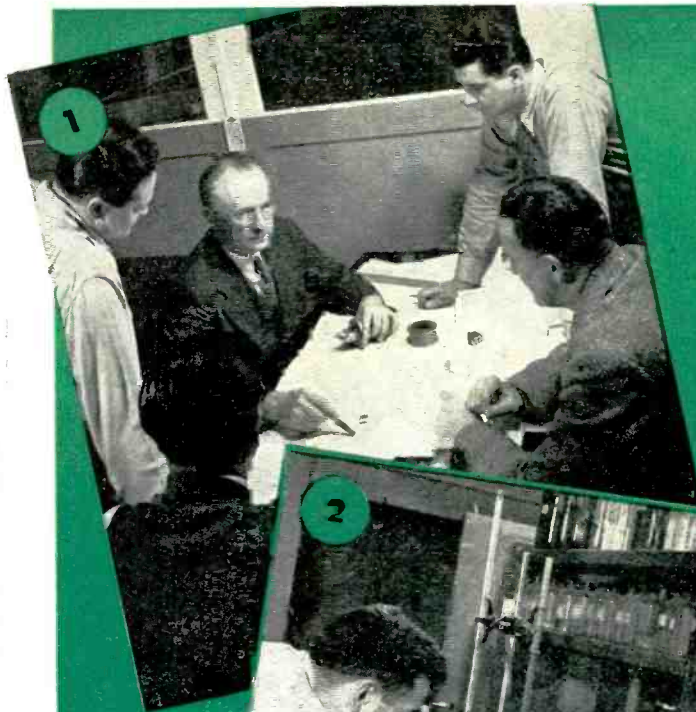

3 old timers
in a new dress

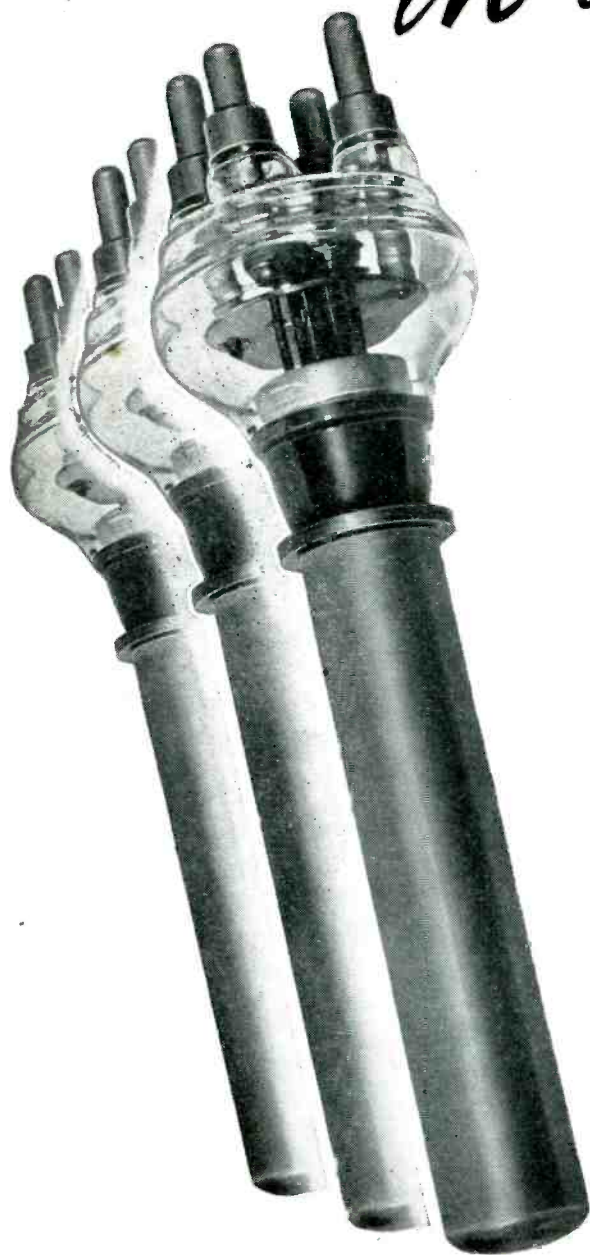

**207M, 891M and 892M
POWER TUBES—Especially
for Electronic Heating**

- ADVANCED DESIGN in these new E.P. tubes employs the latest results of research . . .
- NEW PRECISION PRODUCTION METHODS insure uniformly top-quality performance and longer life . . .
- SMALLER OVERALL SIZE without loss of power, gives extra ruggedness and new latitude to heating equipment design-engineers . . .
- DESIGNED AND MANUFACTURED by engineers with a background of over 20 years experience in the electron tube field.

! FULL DETAILS NOW AVAILABLE!

Get complete information about this new line of power tubes. Ask also about the advantageous new *replacement* policy. Write today.

ELECTRONIC PRODUCTS COMPANY

111 EAST THIRD STREET - - - MT. VERNON, N. Y.

PRECISION MANUFACTURERS OF HIGH PERFORMANCE POWER TUBES

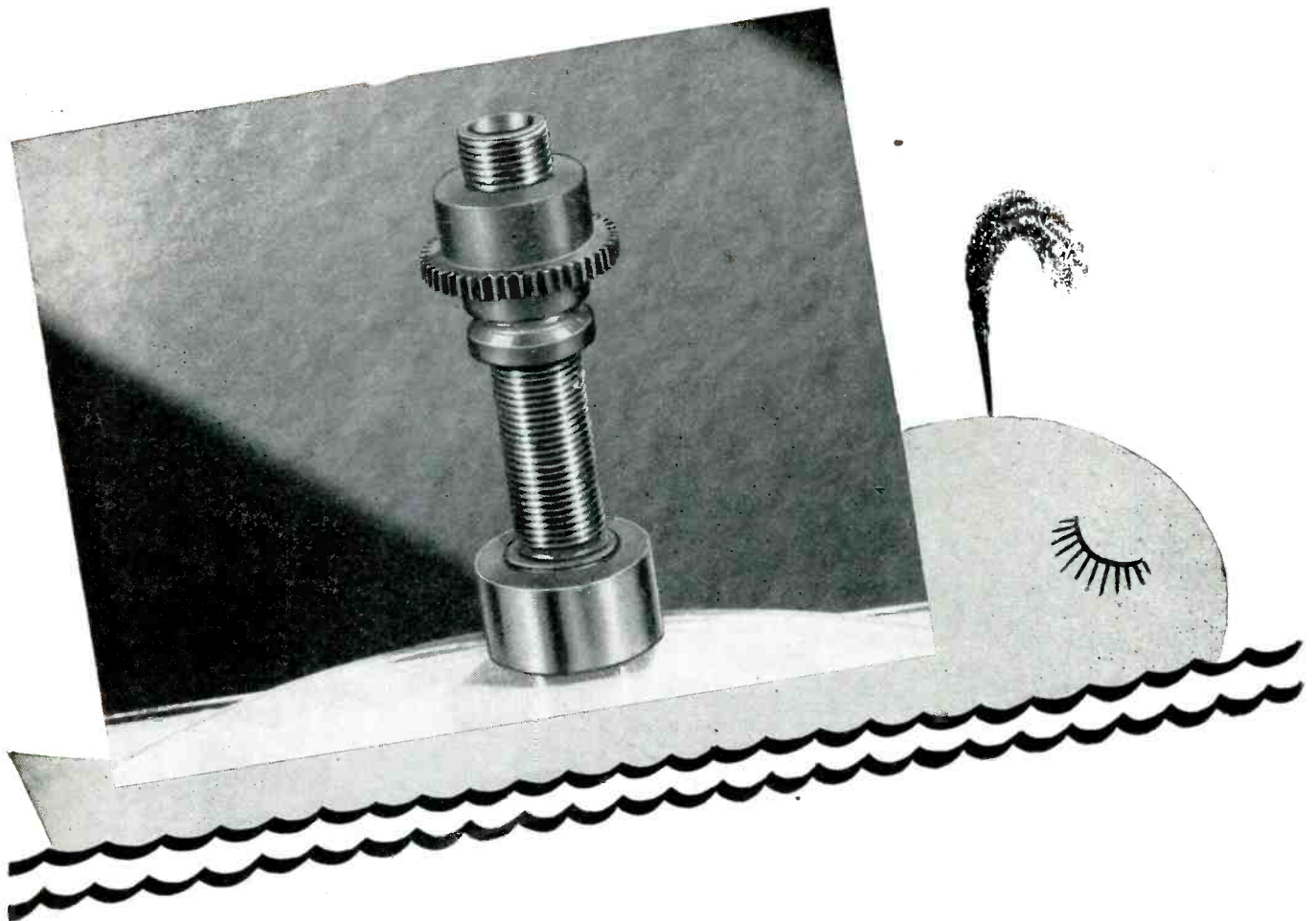

There's a **WHALE**
of a difference
in **GEARS** by ---



The quantity production of GS custom-made small gears has been developed we believe, to a degree of *uniform* excellence unapproached in the history of the industry! The most extreme precision characterizes every operation. If you must achieve the utmost in smooth, dependable, economical performance, ask a GS engineer about the fractional horsepower gears you need. We can apply to *your* problem, all the skill, the experience, the exclusive methods and machinery developed thru a quarter century of specialization in the manufacture of *better* small gears.

GEAR Specialties
Spurs • Spirals • Helicals • Bevels • Internals • Worm Gearing • Racks • Thread Grinding
2635 WEST MEDILL AVENUE • CHICAGO 47, ILLINOIS

⚙️ WORLD'S LARGEST EXCLUSIVE MANUFACTURERS OF FRACTIONAL HORSEPOWER GEARS ⚙️

Wilcox Type 99A Transmitter

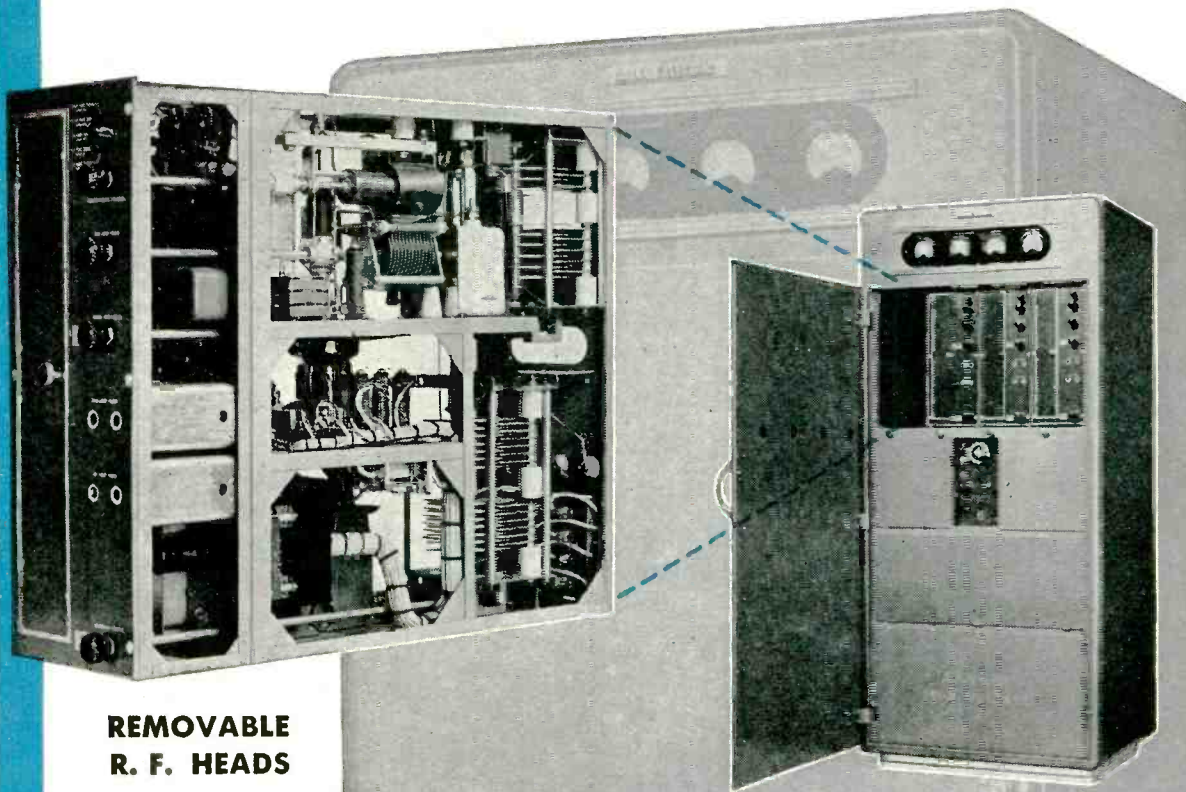

REMOVABLE R. F. HEADS

All radio frequency circuits are included in the 2-20 Mc. R.F. head shown above. All connections to the transmitter cabinet are by means of plugs and receptacles.

A medium power transmitter, designed particularly for aeronautical service. Equally adaptable to other fixed services. Check these features for their application to your communication problems:

- ★ Four transmitting channels, in the following frequency ranges:
 - 125-525 Kc. Low Frequency.
 - 2-20 Mc. High Frequency.
 - 100-160 Mc. Very High Frequency.
 - Other frequencies by special order.
- ★ Simultaneous channel operation, in following maximum combinations:
 - 3 Channels telegraph.
 - 2 Channels telephone.
 - 1 Channel telephone, 2 Channels telegraph.
- ★ Complete remote control by a single telephone pair per operator.
- ★ 400 Watt plus carrier power.
- ★ Low first cost. Removable radio frequency heads are your protection against frequency obsolescence.
- ★ Reliability backed by two years of engineering research, one year of actual field operation.
- ★ Available with all-steel, or wood pre-fabricated transmitter house complete with primary power, antenna, and ventilation fittings.
- ★ Not a "post-war plan," but a field-tested transmitter now in production.

An inquiry on your letterhead outlining your requirements will bring you complete data.

WILCOX ELECTRIC COMPANY, INC.

Manufacturers of Radio Equipment

Fourteenth and Chestnut Kansas City, Missouri



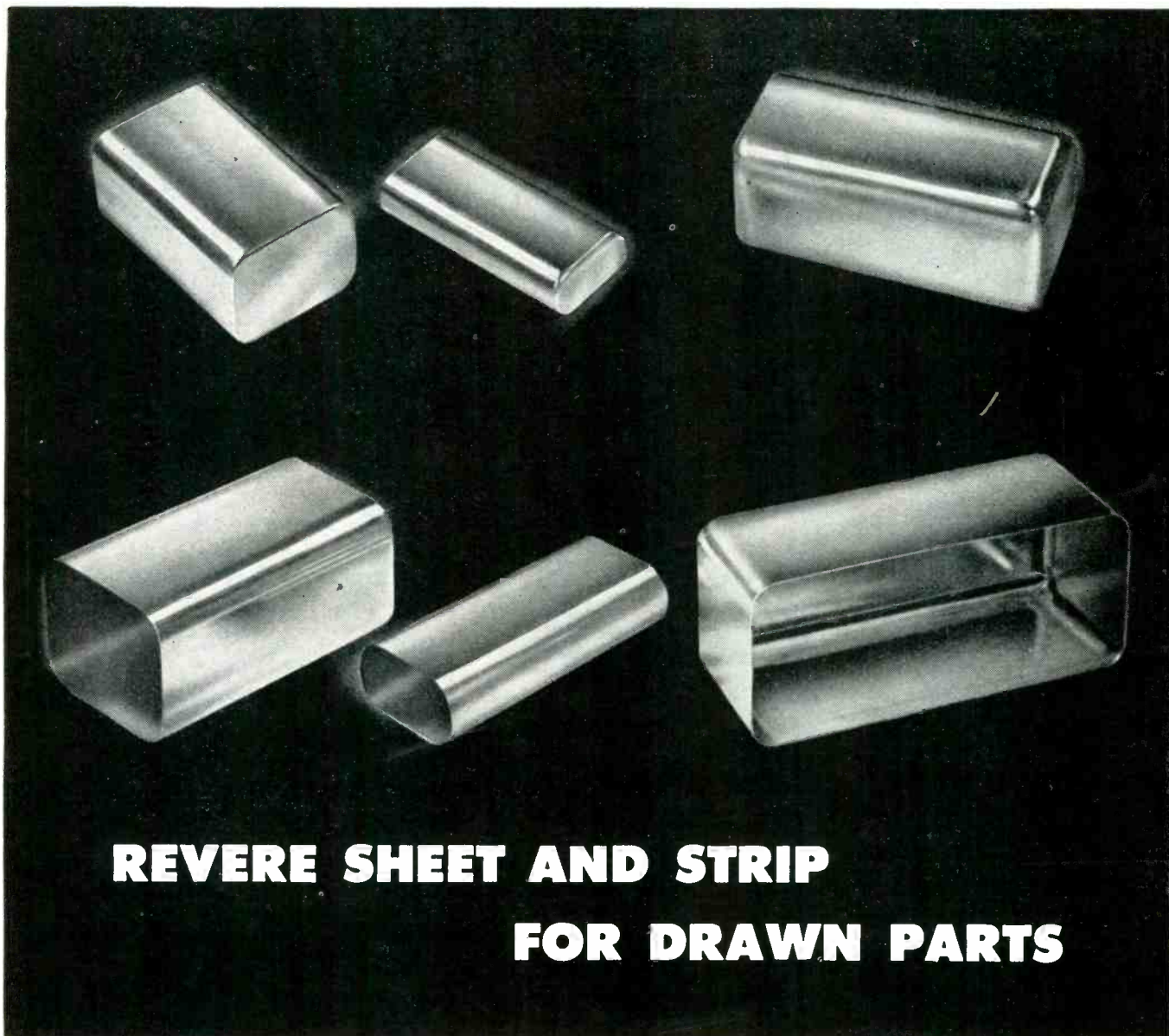

REVERE SHEET AND STRIP FOR DRAWN PARTS

FOR all products to be made by drawing, stamping and similar sheet metal operations, Revere sheet and strip of copper or brass offer maximum ease of fabrication. Not only are these metals naturally ductile, but they benefit further from the metallurgical skill which Revere has gained in 145 years of experience.

In composition, mechanical properties, grain size, dimensions and finish, you will find Revere metals highly uniform. They enable you to set up economical production methods and adhere to them. They can help you produce better products at faster production rates, with less scrap and fewer rejects.

Revere copper, brass and bronze lend themselves readily to the widest variety of finishing operations—polishing, lacquering, electro-plating. With these superior materials it is easy to make radio shields and similar products beautiful as well as serviceable.

That is why wise buyers place their orders with Revere for such mill products as—*Copper and Copper Alloys*: Sheet and Plate, Rolls and Strip, Rod and Bar, Tube and Pipe, Extruded Shapes, Forgings—*Aluminum Alloys*: Tubing, Extruded Shapes, Forgings—*Magnesium Alloys*: Sheet and Plate, Rod and Bar, Tubing, Extruded Shapes, Forgings—*Steel*: Electric Welded Steel Tube. We solicit your orders for these materials.

REVERE

COPPER AND BRASS INCORPORATED

Founded by Paul Revere in 1801

230 Park Avenue, New York 17, New York

*Mills: Baltimore, Md.; Chicago, Ill.; Detroit, Mich.;
New Bedford, Mass.; Rome, N. Y.*

Sales Offices in principal cities, distributors everywhere



to Exploring the Unknown on the Mutual Network every Sunday evening, 9 to 9:30 p.m., EST.

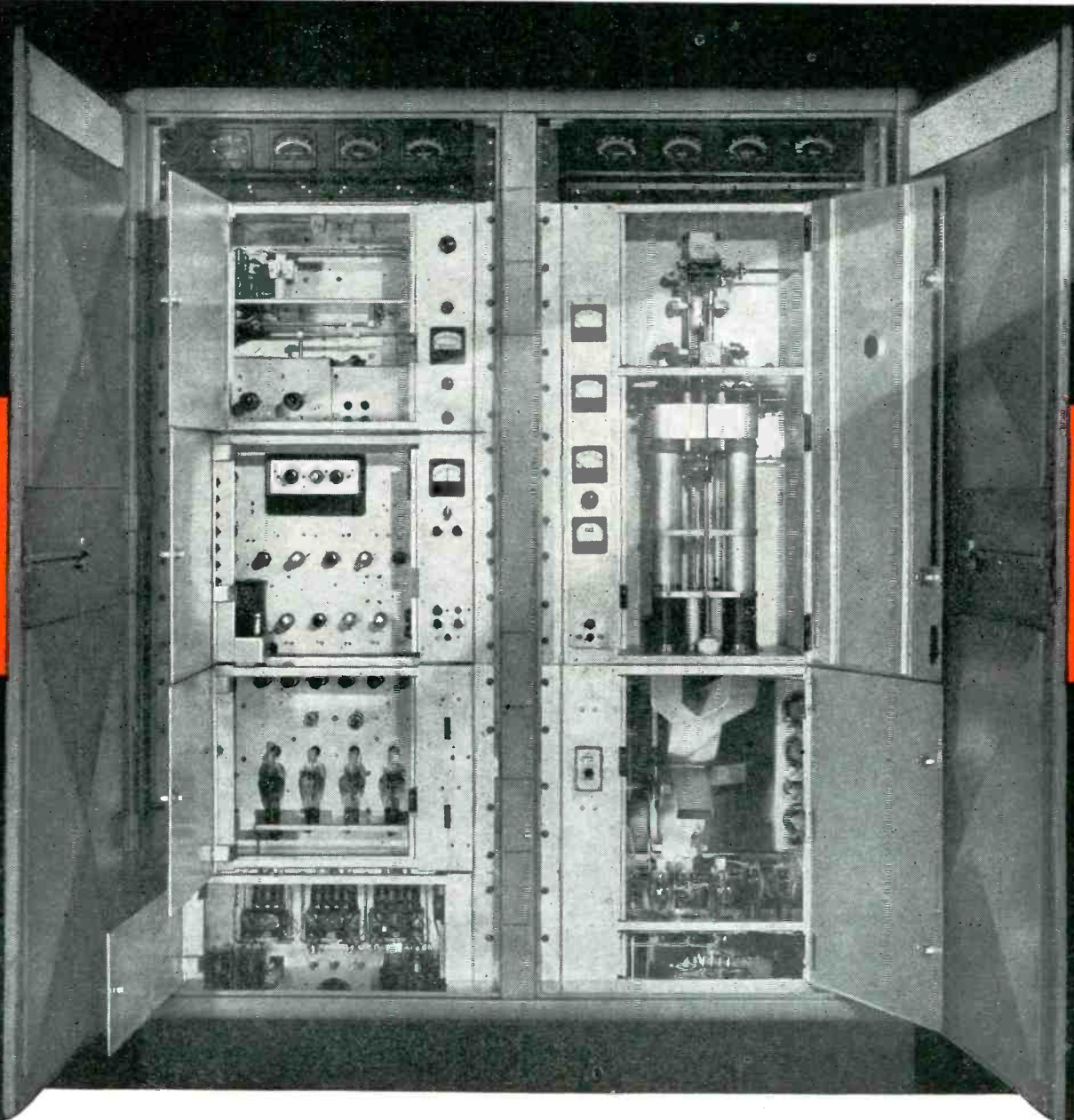

6 DESIGN FEATURES THAT MEAN BIG NEWS IN FM

- 1 The circuits that stabilize modulation are completely isolated from the direct carrier path, allowing no variation in the quality of program transmission.
- 2 Improved method of direct frequency modulation and stability of the mean carrier frequency is accomplished by an all electronic system. No mechanical regulators to wear out of adjustment.
- 3 Mean carrier frequency is maintained within close limits of assigned channel, with an immediate and automatic control circuit employing a crystal oscillator.
- 4 Federal's "FREQUEMATIC" Modulator circuit has a greater dynamic range of modulation. No distortion over the entire range of modulation.
- 5 Utilizing a discriminator circuit, frequency of the master oscillator is stabilized to exactly that of a standard crystal through a method of frequency division. The unit has a spare crystal readily accessible for instant use.
- 6 Frequency division is accomplished through multi-vibrator circuits with stable and rugged mechanical as well as electrical characteristics.



Federal

HERE'S THE BIG NEWS IN FM!

...it's FEDERAL's new
"FREQUEMATIC"*
MODULATOR

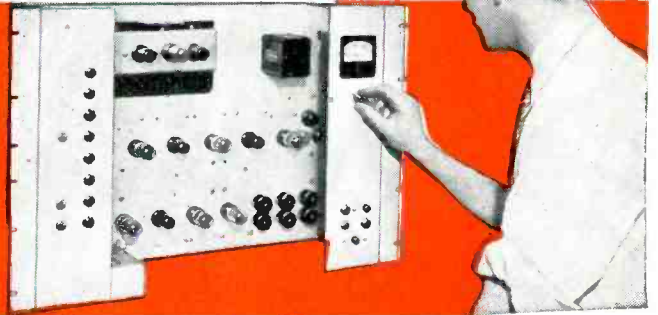

1-3-10 and 50 KILOWATT FM RADIO EQUIPMENT

The "FREQUEMATIC" Modulator takes its place as part of the complete "package" of FM broadcasting equipment offered by Federal. From one source, you get every piece of broadcasting gear to set up operation now ... from studio equipment to transmitting tower ... all precision-engineered, all matched, all of highest quality. No more piecemeal assembly of components, and uncertainties of divided responsibility. Federal assumes full responsibility for delivery and *installation* of a complete FM Broadcasting System. For complete details, write: Federal Telephone and Radio Corporation, Newark 1, New Jersey.

*Trade Mark

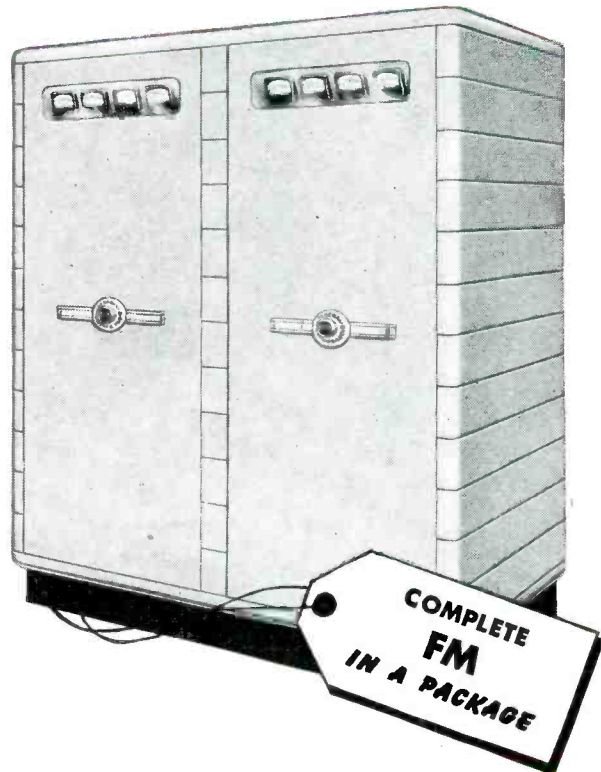

Telephone and Radio Corporation

Newark 1, New Jersey

Export Distributor:
International Standard Electric Corporation



HOW TO SEW UP A WALKIE-

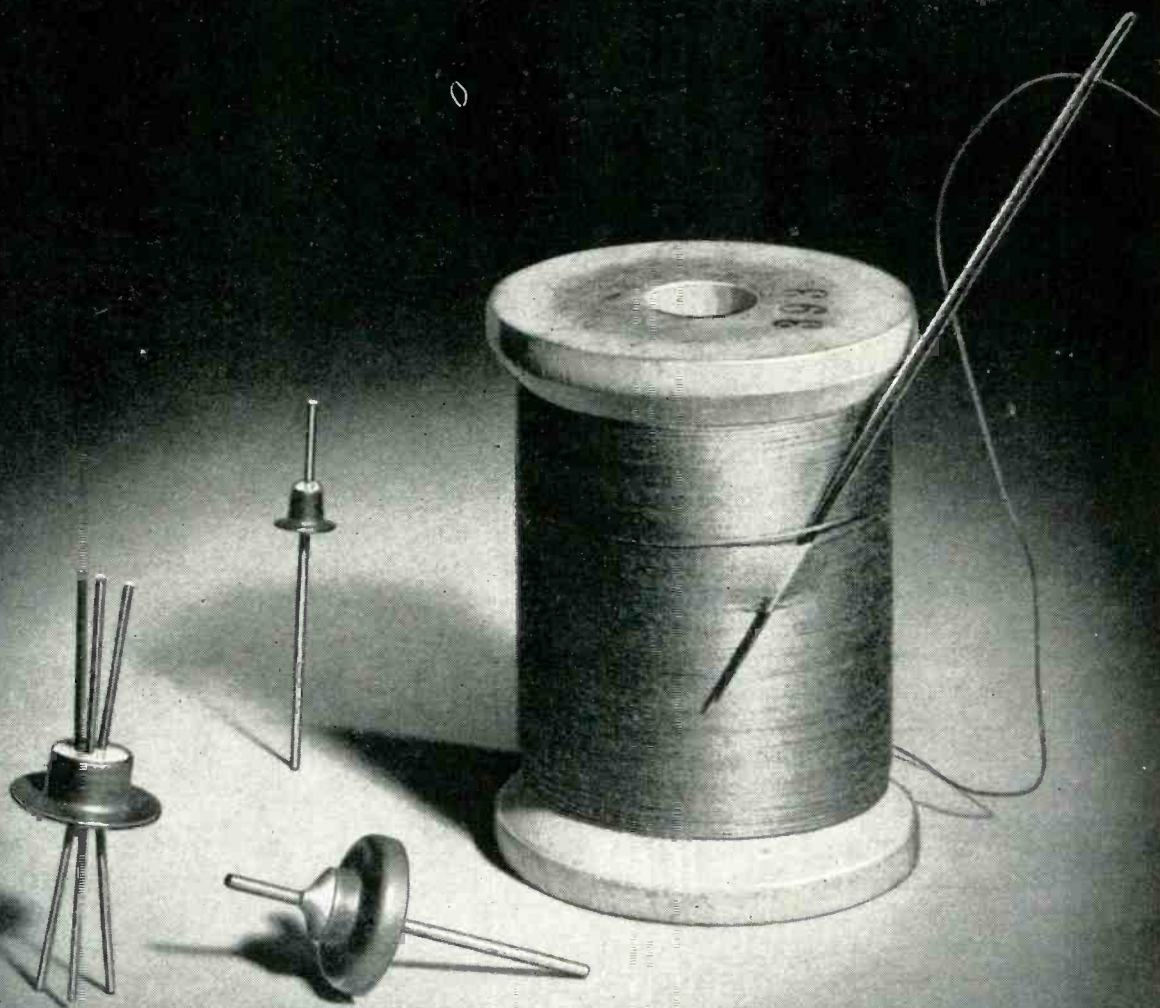

CORNING
— *means* —
Research in Glass

TALKIE SALE!

ONE thing we've learned during the war—almost every small electronic device should be able to work anywhere under any climatic condition. People are going to expect their personal walkie-talkies, plane radios, hearing aids, etc., to be as tough and durable as the stuff the industry developed for the armed forces. The more punishment they take, the better they'll sell.

And that's where these funny-looking little eyelet terminals may be able to do you a lot of good. They're used to carry one or more leads into very small openings. The wires pass through tiny glass beads surrounded by metal collars, which you can solder into place in the twinkling of an eye. They form permanent

hermetic seals, resist surface contamination, thermal shock and weathering. They have high mechanical strength and are chemically stable. All standard items are readily produced in quantity.

These Eyelet Terminals are another example of the breadth and versatility of Corning's line of electronic products. Some of them are pictured below with a brief description. Maybe they'll point to a possible solution for a problem that's been bothering you. If so, write, wire or phone The Electronic Sales Department, E-4, Technical Products Division, Corning Glass Works, Corning, New York. One of our engineers will be calling on you in record time to help solve your difficulties.

NOTE—The metallized Tubes and Bushings, Headers and Coil Forms below are all made by the famous Corning Metallizing Process. Can be soldered into place to form true and permanent hermetic seals. Impervious to dust, moisture and corrosion.



Metallized Tubes for resistors, capacitors, etc. 20 standard sizes $\frac{1}{2}$ " x 2" to $1\frac{1}{4}$ " x 10". Mass-produced for immediate shipment.



Metallized Bushings. Tubes in 10 standard sizes, $\frac{3}{16}$ " x $2\frac{1}{2}$ " to 1" x $4\frac{1}{2}$ " in mass production for immediate shipment.



Headers—The best way to get a large number of leads in a small space for assembly in one operation.

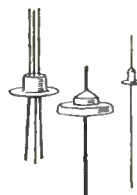

Eyelet Terminals—Single or multiple eyelets permit design flexibility. Standard items readily available in quantity.

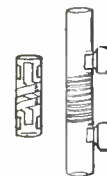

Coil Forms—Grooved for ordinary frequencies—metallized for high frequencies. In various designs and mountings.



VYCOR Brand cylinders—very low loss characteristics. Stands thermal shock up to 900°C. Can be metallized.

"VYCOR", "CORNING" and "PYREX" are registered trade-marks and indicate manufacture by Corning Glass Works, Corning, N. Y.

Electronic Glassware



ELECTRONIC BRAZING

UNIT

with

24 Station

INDEXING

Work Carrier

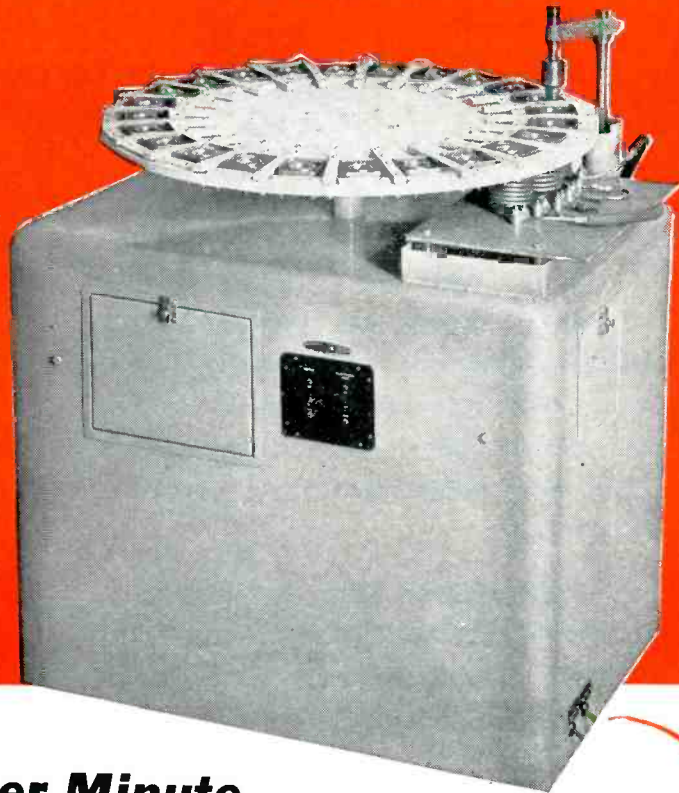

Delivers 5 Complete Assemblies Per Minute

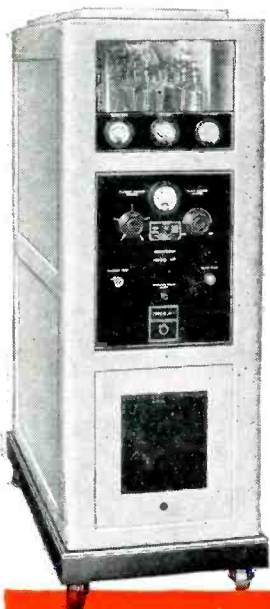

HERE'S a striking example of how Scientific Electric Engineers increased brazing production output by designing a special automatic machine to operate in conjunction with Electronic heating.

A manufacturer of weather-proof control box covers was already using electronic heat to speed up production in the brazing operation involved. But greater production was urgently needed. Each assembly was being inserted and removed from a single heater coil . . . one at a time.

To increase output Scientific Electric engineers designed this compact circular, 24 station indexing work carrier which operates from the 18 KW electronic generator at the left.

The operator merely loads the stations as they come around empty. Heat is applied by three water-cooled induction coils under three of the work positions. The coils are followed by the vertically operating ejecting mechanism and a complete assembly is ejected from the carrier each 12 seconds.

The carrier, which is operated by a small motor can be applied to any of our electronic generators depending upon the heat input requirements of the work to be handled. Normal output of the unit illustrated is at 200 to 600 kc.

Workpiece output up to 20 per minute can be obtained and carriers, custom tailored to your requirements, can be delivered within 30 days. Send us your requirements today.

Scientific Electric Electronic Heaters are made in these power sizes... and a range of frequencies up to 300 Megacycles depending upon power requirements.

3 KW	18 KW
5 KW	25 KW
7½ KW	40 KW
8 KW	60 KW
10 KW	80 KW
12½ KW	100 KW
15 KW	250 KW

Scientific Electric

Division of

"S" CORRUGATED QUENCHED GAP COMPANY

119 MONROE ST.  GARFIELD, N. J.

Manufacturers of

Vacuum Tube and Spark Gap Converters Since 1921

hallicrafters *new Model* S-40

New beauty and perfect ventilation in the perforated steel top

Separate electrical bandspread with inertia flywheel tuning.

Tuning range from 540 kc to 42 Mc continuous in four bands

Self-contained, shock mounted, permanent magnet dynamic speaker

All controls logically grouped for easiest operation. Normal position for broadcast reception marked in red, making possible general use by whole family.

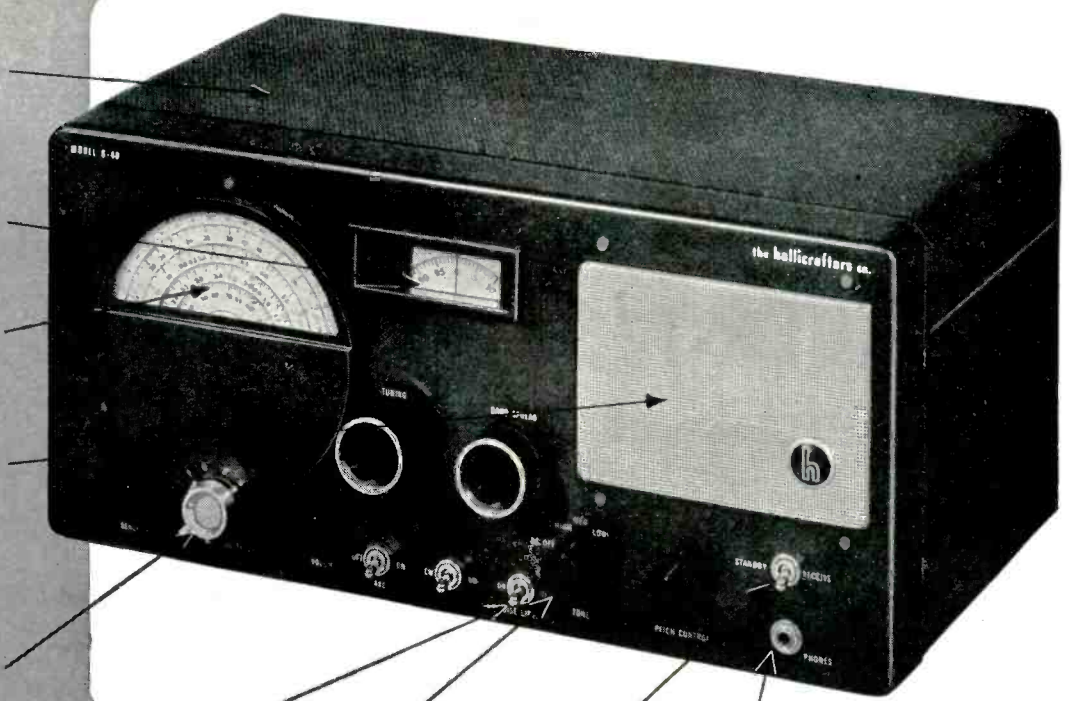

Automatic noise limiter

3-position tone control

Standby receive switch

Phone jack

New design, new utility in a great \$79⁵⁰ new communications receiver . . . (APPROXIMATELY)

Here is Hallicrafters new Model S-40. With this great communications receiver, handsomely designed, expertly engineered, Hallicrafters points the way to exciting new developments in amateur radio. Read those specifications . . . it's tailor-made for hams. Look at the sheer beauty of the S-40 . . . nothing like it to be seen in the communications field. Listen to the amazing performance . . . excels anything in its price class. See your local distributor about when you can get an S-40.

INSIDE STUFF: Beneath the sleek exterior of the S-40 is a beautifully engineered chassis. One stage of tuned radio frequency amplification, the S-40 uses a type 6SA7 tube as converter mixer for best signal to noise ratio. RF coils are of the permeability adjusted "micro-set" type identical with those used in the most expensive Hallicrafters receivers. The high frequency oscillator is temperature compensated for maximum stability.

From every angle the S-40 is an ideal receiver for all high frequency applications.

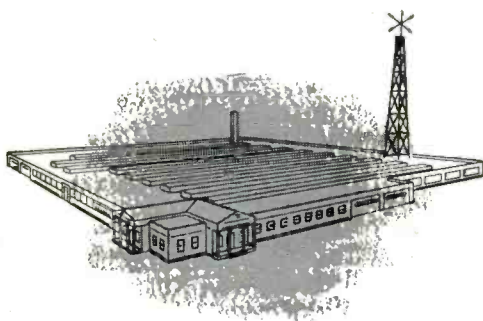

COPYRIGHT 1945 THE HALLICRAFTERS CO.

hallicrafters RADIO

THE HALLICRAFTERS CO., MANUFACTURERS OF RADIO AND ELECTRONIC EQUIPMENT, CHICAGO 16, U. S. A.

Sole Hallicrafters Representatives in Canada: Rogers Majestic Limited, Toronto - Montreal



FOR SAFE, ECONOMICAL, AUTOMATIC

Power Control at All Times...

GET ADLAKE PLUNGER-TYPE RELAYS!

HERE'S WHY Adlake Plunger-Type Mercury Relays assure safe, economical, automatic power control under any condition:

All contact mechanism is *hermetically sealed* in armored glass or metal cylinders so dirt, dust, moisture or oxidation can't possibly interfere with operation.

Liquid metal mercury is *positive* in action, chatterless, silent, impervious to burning, pitting or sticking.

They're absolutely *safe*, and since they're hermetically sealed, Adlakes perform without servicing or maintenance—no periodic cleaning of contacts needed.

And Adlakes are *dependable*—simple in design and principle, no complicated parts to wear out or get out of order!

There's an Adlake Relay for every need. May we suggest the type best suited for yours? Write today for free bulletin.

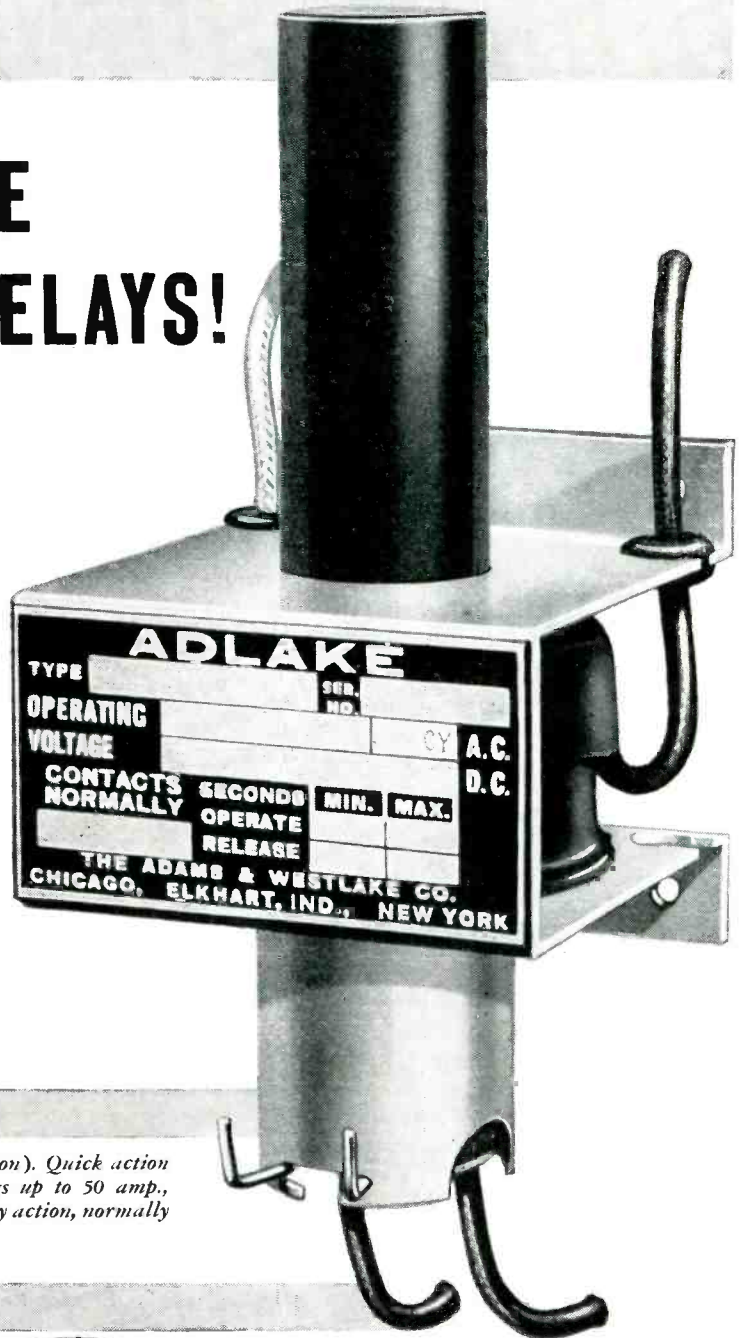

Model 1040 (for A. C. operation). Quick action available with contact ratings up to 50 amp., A. C. Either quick or time delay action, normally open or closed.



THE ADAMS & WESTLAKE COMPANY

ESTABLISHED IN 1857

ELKHART, INDIANA

NEW YORK • CHICAGO

Manufacturers of Adlake Hermetically Sealed Mercury Relays for Timing, Load and Control Circuits

Special CAPACITORS

... engineered by **AEROVOX**

Aerovox Series 20 Hyvol impregnated and filled capacitors in ratings up to 50,000 v. in hermetically sealed welded steel cases.

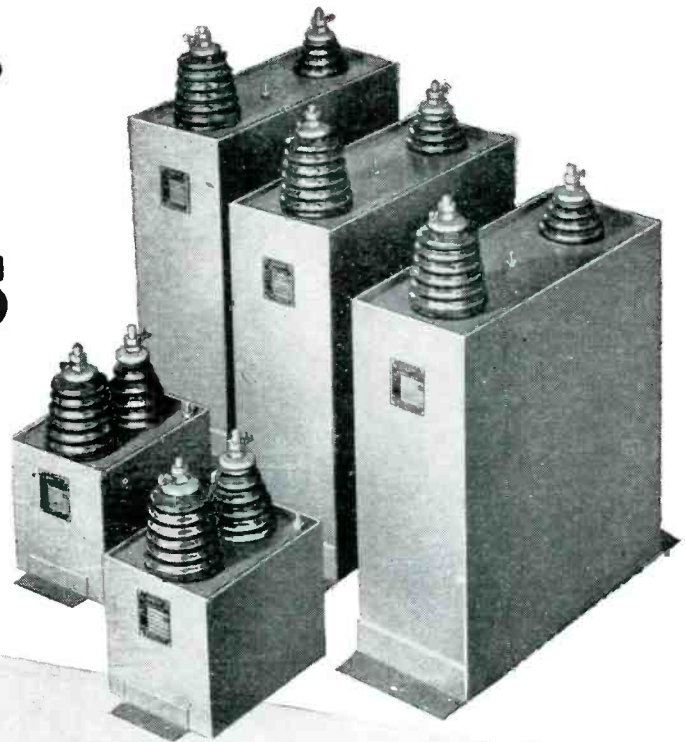

Aerovox Series 26 stack-mounting Hyvol impregnated and filled capacitors in ratings up to 150,000 v. Laminated bakelite cases. Cast-aluminum terminal ends.



● For those extra-severe-service applications on the largest capacitors, as well as others, Aerovox units have the extra stamina that makes them last. Decades of specialization provide an experience background second to none in solving all kinds of capacitor problems; unexcelled production facilities assure **QUALITY** as well as quantity. Aerovox capacitors are liberally engineered for

their individual applications. Special multi-layer capacitor tissues... long-life, non-inflammable Hyvol impregnant and fill... constant filtration and testing of impregnant as regular production routine... thorough evacuation and impregnation... positive hermetic sealing—these facts of Aerovox craftsmanship spell long, trouble-free service. Aerovox capacitors in daily use speak for themselves. No finer capacitors are built. Aerovox engineers stand ready to meet your most severe requirements.

Submit your capacitor problem. The tougher the better! Write for literature.



FOR RADIO-ELECTRONIC AND INDUSTRIAL APPLICATIONS

AEROVOX CORPORATION, NEW BEDFORD, MASS., U. S. A.

SALES OFFICES IN ALL PRINCIPAL CITIES • Export: 13 E. 40th ST., NEW YORK 16, N. Y.

Cable: 'ARLAB' • In Canada: AEROVOX CANADA LTD., HAMILTON, ONT.

✓ CHECK THESE FEATURES...

—features that emphasize the versatility of The DUMONT TYPE 247 OSCILLOGRAPH



all these features *plus...*

exceptionally fine quality . . . well planned mechanical design . . . and completely dependable electrical performance . . . all of which make the DuMont Type 247 Cathode-Ray Oscilloscope the logical choice for all applications that require a measuring instrument of fine accuracy.

★ WRITE FOR DESCRIPTIVE LITERATURE

© ALLEN B. DUMONT LABORATORIES, INC.

1 ✓ AUTOMATIC BEAM CONTROL FOR PHOTOGRAPHIC PURPOSES

Permits high-contrast photographic recordings by holding the spot brightness at zero until the transient under study is initiated — then the spot is automatically raised to full brilliance.

2 ✓ EXTENDED TIME BASE RANGE 0.5 to 50,000 C. P. S.

A compensated circuit assures a linear sweep at all operating frequencies. The single sweep operates over a range corresponding to 0.5 to 10,000 c.p.s. The sweep is initiated by the controlling signal.

3 ✓ VERTICAL AMPLIFIER RESPONSE UNIFORM—2 to 200,000 C. P. S.

The response curve does not exhibit a positive slope above 1,000 c.p.s., thus assuring a linear phase-frequency relationship for the amplifier.

4 ✓ HORIZONTAL AMPLIFIER MAY BE USED AS A D-C AMPLIFIER

This amplifier is direct-coupled throughout, with the exception of an input capacitor which can be shorted out by operating a front-panel switch.

5 ✓ 3,000-VOLT ACCELERATING POTENTIAL PROVIDES BRIGHTER CRT PATTERN

Sufficient brilliance for all but the highest writing rates without using special equipment.

DUMONT

Precision Electronics & Television

ALLEN B. DUMONT LABORATORIES, INC., PASSAIC, NEW JERSEY • CABLE ADDRESS: ALBEEDU, PASSAIC, N. J., U. S. A.

INDEPENDENT INVESTIGATOR FINDS

*Sonotone uses Phillips Screws
to reduce case breakage 90%*

This investigator from James O. Peck Co., industrial research authorities, is visiting a number of representative plants to get authentic FACTS on assembly savings.



**GET HIS FACT FILLED REPORTS
... GET THE COMPLETE STORY**

**Every driver skid eliminated
saves \$1.35 reclaiming costs!**

SONOTONE CORPORATION uses Phillips Screws because they lower costs and improve the product... the same simple but all-important reason why thousands of other successful manufacturers use them.

TO GET THE FACTS, to determine the actual savings, the investigator studied Sonotone's assembly methods, asked the same questions you would ask. He was told that, with slotted screws, breakage of the fine, hard plastic case of the Sonotone hearing aid would be ten times greater than with Phillips screws. Reclaiming, which involves not only the cost of a new case half, but also the cost of disassembly, reassembly and careful matching up of

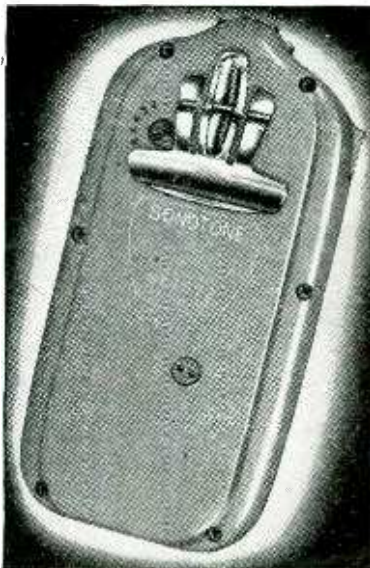

case halves, amounted to \$1.35 per unit. The burr-free, ornamental Phillips recess is another reason why Sonotone chose Phillips Screws. Read the complete, revealing story in the Sonotone report.

THE ASSEMBLY STUDIES cover all types of products—metal, plastics, wood—show how the many Phillips Screw advantages add up big savings you can make in your assemblies.

THE REPORTS now ready—and more to come—comprise a practical manual of modern assembly methods, never-before-printed information, inside facts you'd pay good money to get,—and it's yours, now, **FREE!**

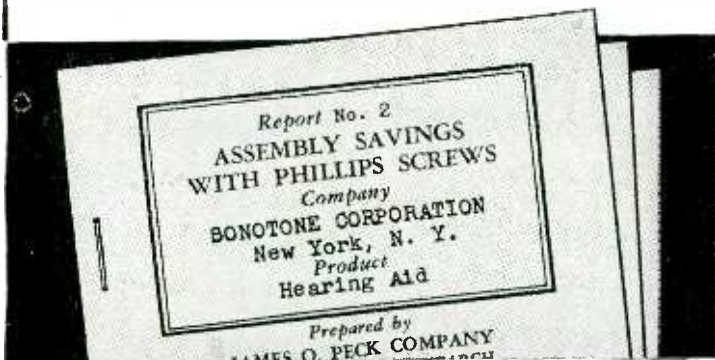

**PACKED WITH IDEAS
FOR SAVINGS IN
YOUR ASSEMBLIES!**

Whatever you make you'll find how all assemblers licked problems like your own. Get these reports. The coupon will bring those ready now, and the rest as they are issued. Fill it in and mail it—**TODAY!**



PHILLIPS Recessed Head SCREWS

Wood Screws • Machine Screws • Self-tapping Screws • Stove Bolts

27 SOURCES

- American Screw Co.
- Atlantic Screw Works
- Atlas Bolt & Screw Co.
- Central Screw Co.
- Chandler Products Corp.
- Continental Screw Co.
- Corbin Screw Div.
- Eleo Tool & Screw Corp.
- The H. M. Harper Co.
- International Screw Co.
- Lamson & Sessions Co.

- Manufacturers Screw Products
- Millford Rivet and Machine Co.
- National Lock Co.
- National Screw & Mfg. Co.
- New England Screw Co.
- Parker-Kalon Corp.

- Pawtucket Screw Co.
- Pheoff Manufacturing Co.
- Reading Screw Co.
- Russell Burdsall & Ward Bolt & Nut Co.
- Scovill Manufacturing Co.
- Shakeproof Inc.
- The Southington Hardware Mfg. Co.
- The Steel Company of Canada, Ltd.
- Sterling Bolt Co.
- Wolverine Bolt Co.

PHILLIPS SCREW MFRS.,
c/o Horton-Noyes
2300 Industrial Trust Bldg., Providence, R. I.

Please send me the reports on Assembly Savings with Phillips Screws

Name

Company

Address

Now - 3

FERRANTI DIVISIONS OFFER
LOW COST PRODUCTS

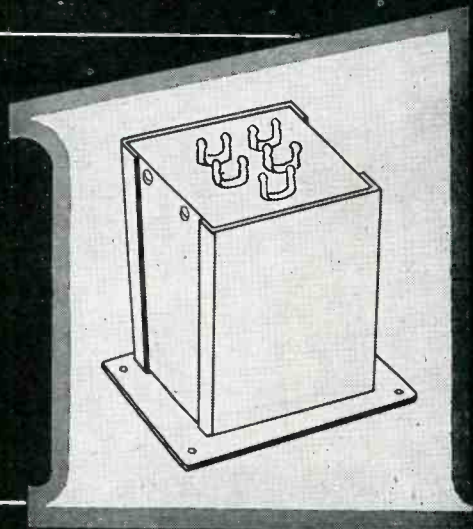

FERRANTI HIGH QUALITY

TRANSFORMERS

AUDIO AND POWER TRANSFORMERS
CHOKES · FILTERS · COILS · ETC. ETC.

STOCK UNITS

HERMETICALLY SEALED—CUSTOM BUILT
LARGE OR SMALL QUANTITIES

FERRANTI HIGH QUALITY

WIRING & ASSEMBLIES

ELECTRONIC AND MECHANICAL ASSEMBLIES
SUB-ASSEMBLIES · COMPONENT PARTS

FERRANTI NOW OFFERS
THE BENEFITS OF WAR-GAINED EXPERIENCE
ON ALL TYPES OF
ASSEMBLY JOBS—LARGE OR SMALL

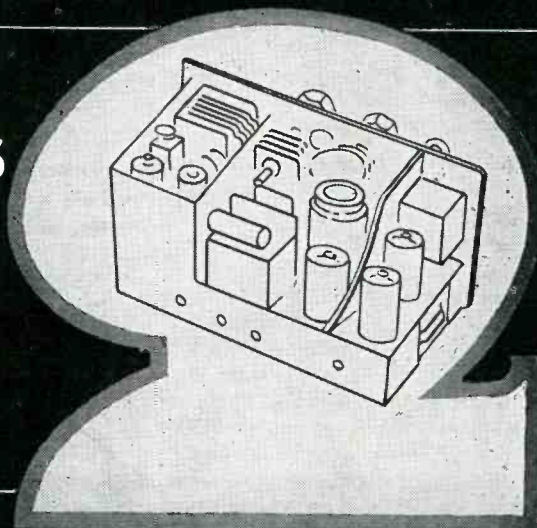

FERRANTI HIGH QUALITY

SHEET METAL & BAKELITE FABRICATION

FROM SHEETS, RODS AND TUBES—PANELS
CASES, TERMINAL BOARDS, RACKS, CHASSIS, ETC.
CUT — PUNCHED — DRILLED — ENGRAVED
FINISHED TO SUIT YOUR NEEDS

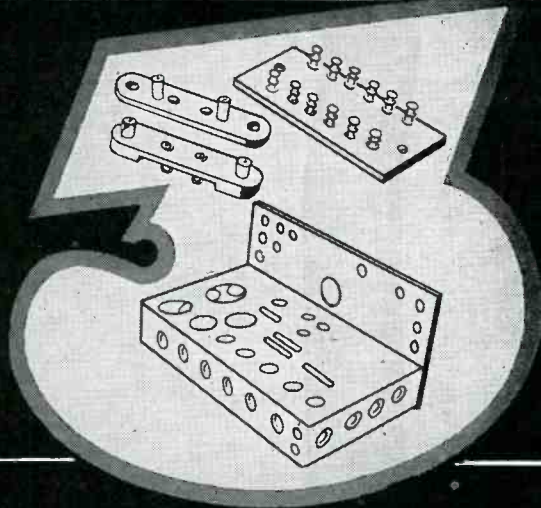

QUALITY—AT LOW COST . . . PROMPT DELIVERY

FERRANTI ELECTRIC, INC. • RCA BUILDING

NEW YORK 20, NEW YORK

SEND US YOUR SPECIFICATIONS FOR IMMEDIATE ATTENTION

RAYTHEON

Standardized

SUB-MINIATURE TUBES

FIRST DEVELOPED TO BE SHOT FROM GUNS—
NOW DESIGNED FOR RADIO RECEIVER USE

In October, 1940, Raytheon was the first tube manufacturer to take an NDRC contract to develop tubes for the Proximity Fuze project. In March, 1941, these tubes were successfully shot from guns and the Fuze project was established as being practical and effective. Late in 1941 Raytheon contributed a basically improved type of filament suspension which has since been employed in all vacuum tubes for the VT Fuze.

Since VT Fuzes could be used but once, the tubes were soldered in directly. This method is uneconomical for radio applications. With this in mind, Raytheon then developed a plug-in feature and low-loss socket which allows all the space-saving which characterizes these tubes. Today there are four basic types in the Raytheon line of sub-miniature tubes—all specifically designed for low-voltage radio receiver applications. Standard sockets are available permitting easy tube replacement and low cost chassis assembly operations.

These tubes have been standardized and registered with RMA. The day of pocket superheterodyne receivers for police patrol, fire-fighting, railroad operation and sport and entertainment reception is here. *now*. For long life, rugged construction, low assembly and maintenance costs—with user acceptance assured—use Raytheon Standard Sub-Miniature tubes. Technical data sheets available on request.

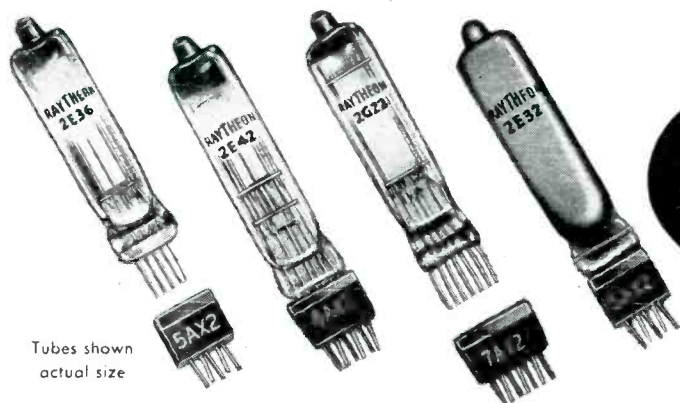

Tubes shown
actual size



Excellence in Electronics

RADIO RECEIVING TUBE DIVISION
Newton, Mass. • New York • Chicago

MANY FEATURES IN ONE INSTRUMENT!

The **METER**

TYPE 160-A

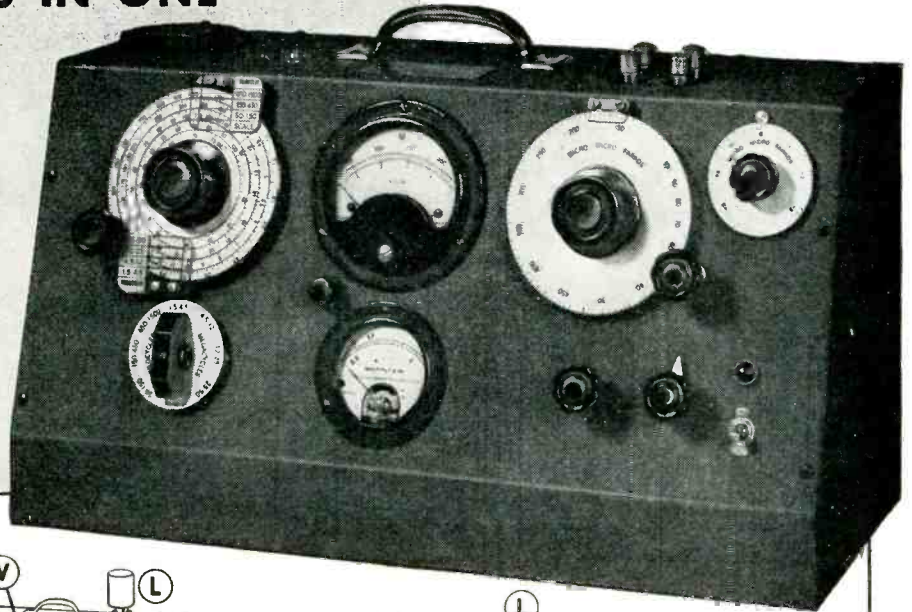

A dependable test and measuring instrument that should be included in your new equipment plans.

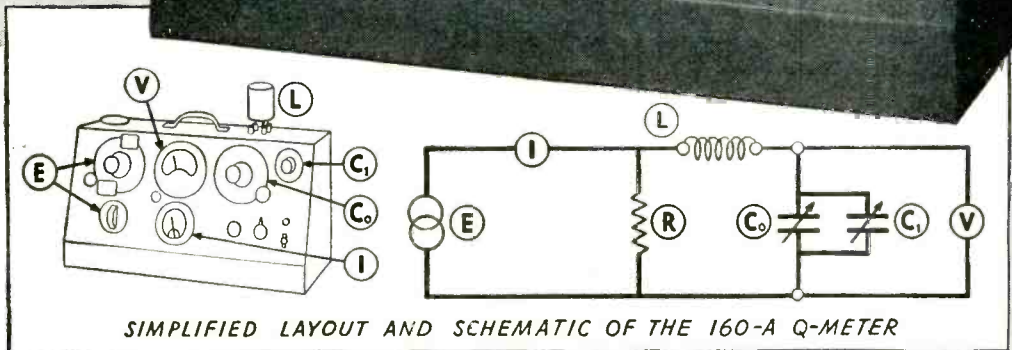

SIMPLIFIED LAYOUT AND SCHEMATIC OF THE 160-A Q-METER

For many years the Q-Meter has been an outstanding contribution to the field of radio frequency measuring equipment. It is an indispensable instrument to engineers, manufacturers, research laboratories and to the whole radio and electronics industry. Because of its simplicity and ease of operation, it replaces many costly pieces of apparatus with which the radio laboratory is customarily equipped. More than one radio engineer has told us that "The Q-Meter is the most valuable instrument that we have in our laboratory".

A FEW USES OF THE 160-A-Q-METER

- Q and inductance measurement of coils.
- Q and capacitance measurement of capacitors.
- Dielectric and power factor measurements of ceramics, plastics and other insulating materials.
- Measurement of circuit losses.
- Interelectrode capacitance measurements.
- Measurement of input impedance of vacuum tubes.
- Measurement of high frequency cable characteristics.
- Measurement of characteristics of small antennae.
- Measurement of coefficient of coupling of R.F. Transformers.
- Measurement of transmission line characteristics.
- The measurement of frequency with negligible loading on circuit under test (50 kc.—75 mc.).

Write for catalog and supplement.



BOONTON RADIO
BOONTON · N · J · U · S · A · Corporation



THE BASIC METHOD OF MEASUREMENT EMPLOYED IN THE 160-A Q-METER

An 8 range R.F. oscillator (E) supplies a heavy current (I) to an extremely low resistance load (R), the value of which is accurately known. The calibrated voltage thus developed across the load resistance (R) is coupled to a series circuit consisting of the inductance under test (L) and a calibrated variable air capacitor (C₀), having a vernier section (C₁). When this series circuit is tuned to resonance by means of the capacitor (C₀ + C₁), the "Q" of the inductance under test is indicated directly by the vacuum tube voltmeter (V). Variations of this basic method of measurement are used to measure inductance, capacitance and resistance.

SPECIFICATIONS

Oscillator Frequency Range: 50 kc. to 75 mc. in 8 ranges.

Oscillator Frequency Accuracy: ± 1%, 50 kc. — 50 mc.

± 3%, 50 mc. — 75 mc.

Q-Measurement Range: Directly calibrated in Q, 20-250: "Multiply-Q-By" Meter (I) calibrated in tenths from x1 to x2, and also at x2.5; extending Q range to 625.

Q-Measurement Accuracy: Approximately 5% for direct reading measurement, for frequencies up to 30 mc. Accuracy less at higher frequencies.

Capacitance Calibration Range: Main capacitor section (C₀) 30-450 mmf accuracy 1% or 1 mmf whichever is greater. Vernier capacitor section (C₁) +3 mmf, zero, -3 mmf, calibrated in 0.1 mmf steps. Accuracy ± 0.1 mmf.

DESIGNERS AND MANUFACTURERS OF THE "Q" METER . . . QX-CHECKER . . . FREQUENCY MODULATED SIGNAL GENERATOR . . . BEAT FREQUENCY GENERATOR . . . AND OTHER DIRECT READING TEST INSTRUMENTS

PACK PUSH BUTTON

POWER

INTO YOUR PRODUCT
WITH
alliance
MOTORS

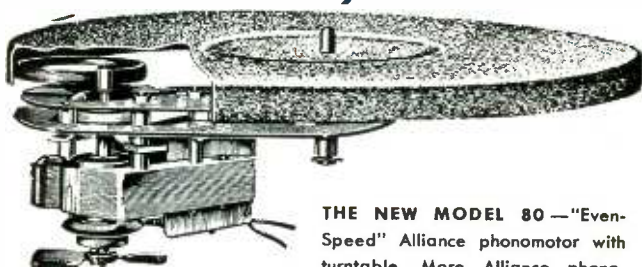

THE NEW MODEL 80 — "Even-Speed" Alliance phonomotor with turntable. More Alliance phonomotors are used in the radio industry than any other kind.

Alliance Powr-Pakt Motors are manufactured in shaded pole induction and split phase resistor types. Frequencies range from 40 to 60 cycles, voltages from 24 to 250 and power ratings from less than 1-300th on up to 1-20th horsepower.

New Uses for the Powr-Pakt Line! Electronic and electric controls, time, temperature, pressure and humidity controls, coin operated phono-graphs, drink and merchandise dispensers, fans, valves and blowers, door openers, signals, motion displays, movie projectors and scores of industrial applications.

Hook up your electronic, electrical and radio controls with Alliance Powr-Pakt Motors! They'll increase the flexibility and usefulness of any mechanical process.

Millions of Alliance Phonomotors are driving turntables, record changers, and radio tuning devices for the radio industry. With a few design variations Alliance is now mass producing Powr-Pakt motors at the same low prices. They'll actuate all kinds of moving parts and controls.

WHEN YOU DESIGN—KEEP

alliance

MOTORS IN MIND

ALLIANCE MANUFACTURING COMPANY • ALLIANCE, OHIO
ALLIANCE TOOL AND MOTOR LTD., TORONTO 14, CANADA

to Streamline ELECTRICAL TEST PROCEDURE



★ **the simplified
AC CLAMP AMMETER**
(Model 633)

◆ provides the simplest, quickest means for determining circuit conditions, loads taken by motors and other electrical equipment — all during normal operation without circuit interruption. The clamping jaws are simply placed over the conductor or bus, and current reading taken.

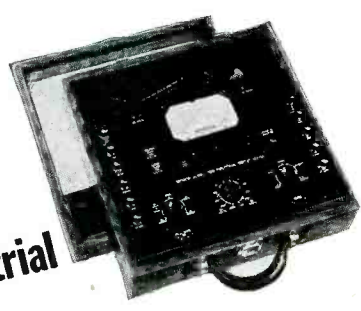

★ **the complete industrial
CIRCUIT TESTER**
(Model 785)

◆ 27 meters in one — with selected AC and DC voltage, current, and resistance ranges. With DC voltage sensitivity of 20,000 ohms per volt, it is ideal for testing photo-cell and sensitive relay circuits, alarm systems, electronic equipment etc., as well as small motors and controls, lighting circuits, etc. Can be used with current transformers and voltage multipliers.



★ **the versatile
SIGHT METER**
(Model 703)

◆ direct-reading, pocket size meter calibrated to measure light values in foot-candles, and in "seeing tasks". Equipped with the WESTON VISCOR filter, it measures all light values direct, without correction factors. Models for other requirements.

For complete information on these, and other time-saving WESTON instruments write . . . Weston Electrical Instrument Corporation, 628 Frelinghuysen Avenue, Newark 5, New Jersey.

Weston *Instruments*

Albany · Atlanta · Boston · Buffalo · Chicago · Cincinnati · Cleveland · Dallas · Denver · Detroit · Jacksonville · Knoxville · Los Angeles · Meriden · Minneapolis · Newark · New Orleans · New York · Philadelphia · Phoenix · Pittsburgh · Rochester · San Francisco · Seattle · St. Louis · Syracuse · In Canada, Northern Electric Co., Ltd., Powerlite Devices, Ltd.

MODERN ALCHEMIST

...producing the world's foremost resistance alloy!

Nichrome[®]

Unlike the ancient alchemist who unsuccessfully sought to create gold from base metals, this modern metallurgist is fusing nickel and chromium to produce Nichrome—the world's foremost heat and corrosion resistant alloy!

But it takes more than a balanced union of nickel and chromium to produce the superior properties of genuine Nichrome. For one, there is the all-important factor of exclusive Driver-Harris techniques. In every manufacturing and processing operation, from furnace to spool, exacting metallurgical controls and checks operate to

assure the peerless and enduring qualities of Nichrome. These quality controls represent 46 years of continuous alloy research that have established Nichrome as the time-tested standard by which other electrical resistance alloys are measured.

Although there are other excellent nickel and chromium combinations, there is only one Nichrome . . . and it is made only by Driver-Harris . . . thus Nichrome is at once the registered Trade Mark and symbol of service and belongs wholly and solely to the Driver-Harris Company.

Nichrome is made only by



Driver-Harris
COMPANY

HARRISON • NEW JERSEY

*Trade Mark Reg.
U. S. Pat. Off.

BRANCHES: Chicago • Detroit • Cleveland • Los Angeles • San Francisco • Seattle

www.americanradiohistory.com



Engineered

VIBRATION CONTROL

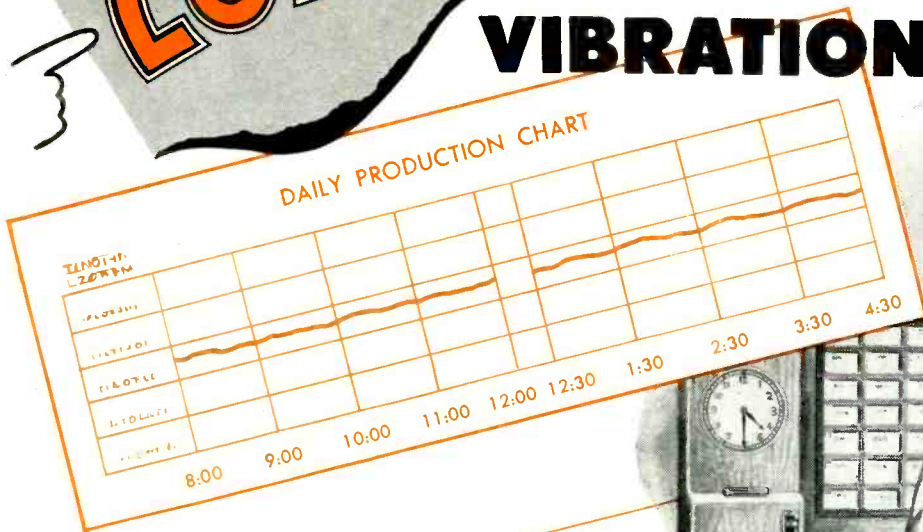

REDUCES INDUSTRIAL FATIGUE
IMPROVES PRODUCTION RECORDS

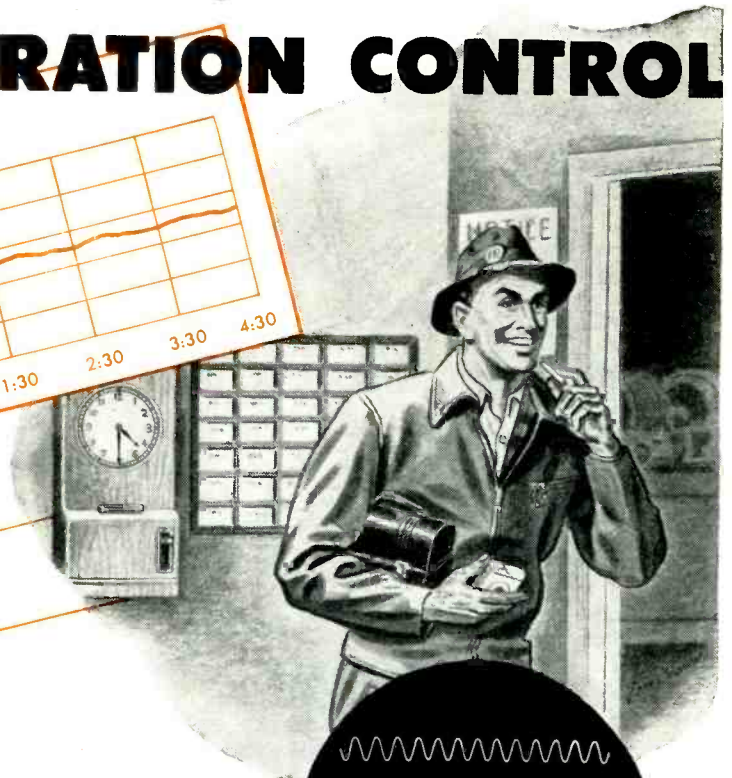

"Vibration nerves" are a chief cause of industrial fatigue, with all its attendant troubles: employees who are tired before lunch-time; supercritical foremen and quickly resentful workers; confusion; lowered production; increased absenteeism and labor turnover; all cutting deep into company profits.

An investment in Lord Engineered Vibration Control is an investment in improved morale of men as well as improved performance of machines. When you call in a Lord Engineer, you are calling on a generation of experience and research in the field of vibration control. Lord has a larger line of scientifically designed mountings and a larger library of experimental data and field studies, than all other companies combined.

When you come to Lord, you are coming straight to Vibration Control Headquarters.

Every genuine Lord Mounting carries the name "LORD" embossed in the rubber or in raised letters on the forgings.

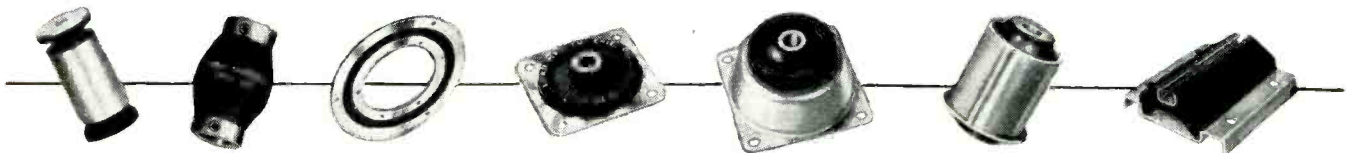

IT TAKES BONDED RUBBER *In Shear* TO ABSORB VIBRATION

★ BUY VICTORY BONDS ★

LORD MANUFACTURING COMPANY
 ERIE, PENNSYLVANIA

SALES REPRESENTATIVES
 NEW YORK - 280 MADISON AVE.
 CHICAGO - 520 N. MICHIGAN AVE.
 DETROIT - 7310 WOODWARD AVE.
 BURBANK, CAL. - 245 E. OLIVE AVE.
 CANADIAN REPRESENTATIVES
 RAILWAY & POWER ENGINEERING CORP., LTD.
 TORONTO, CANADA

Originators of Shear Type Bonded Rubber Mountings

Presto Cutting Needles
 in a "Trouble-Proof" Container
at no extra cost



FOR YOUR CONVENIENCE! Presto Sapphire Recording Needles *now* come to you in a *new* package, designed for utmost needle protection in shipping and handling.



NEW! A transparent Lucite container keeps Presto Cutting Needles *safe*. Nothing can harm the precision ground point and cutting edges.

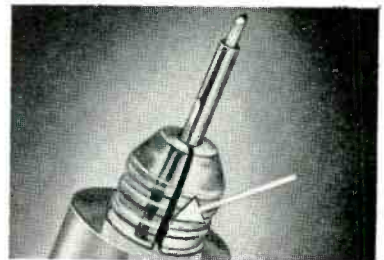

TIGHT! This ingenious chuck holds the needle *tight*—no chance of damage to the point in shipment.



EASY! Just slip used needles (safe in their containers) into this handy mailing bag and send them off to Presto for resharpening.

FREE! To Presto-equipped recording studios: a convenient rack holding six Presto Cutting Needles, with special "point-control" chart recording number of hours each needle is used.

PRESTO Cutting Needles are packed in a Distributor's Carton of six. Each needle container is individually boxed with mailing bag. Order a dozen. Keep 6 in use—6 in transit.



PRESTO

RECORDING CORPORATION
 242 W. 55th St., New York 19, N.Y.
 WALTER P. DOWNS, LTD., in Canada
 WORLD'S LARGEST MANUFACTURER OF INSTANTANEOUS SOUND RECORDING EQUIPMENT AND DISCS

REMEMBER FOR PRECISION-BUILT

MEISSNER
THORDARSON
RADIART

Look!

FASTER • BETTER • MORE
COMPLETE SERVICE BECAUSE ALL 3
ARE NOW SOLD FROM A SINGLE SOURCE

**ELECTRONIC DISTRIBUTOR AND
INDUSTRIAL SALES DEPARTMENT**

THESE 3 NAMES ELECTRONIC PRODUCTS

— MEMO —
REMEMBER . . .
MEISSNER

FOR
✓ Service Instruments, including the famous Meissner Analyst and Meissner Signal Calibrator.

✓ Components . . . R.F. and Oscillator Coils; Standard, Plastic and Ferronart Transformers; Windings, Chokes, Coils, Etc.

— MEMO —
REMEMBER . . .
THORDARSON

FOR
✓ Quality-built Transformers for all requirements.

✓ True-Fidelity Amplifiers in new, modern designs and containing many exclusive features and improvements.

— MEMO —
REMEMBER . . .
RADIART

FOR
✓ Correct Replacement Vibrators . . . individually-engineered to meet exactly the physical as well as the electrical requirements.

✓ Rust-Proof Aerials . . . newly designed to fit all cars . . . cowl, hood and under-hood types.

IMPORTANT! The Electronic Distributor and Industrial Sales Department of Maguire Industries, Incorporated, was formed primarily to offer better, faster service . . . to assume all merchandising, sales and customer relation duties and responsibilities essential in marketing the combined, precision-built products of the Thordarson Division, Meissner Division and Radiart Corporation . . . For complete information, write to the address below . . . today.

MAGUIRE INDUSTRIES, INC.

936 NORTH MICHIGAN AVENUE, CHICAGO 11, ILLINOIS

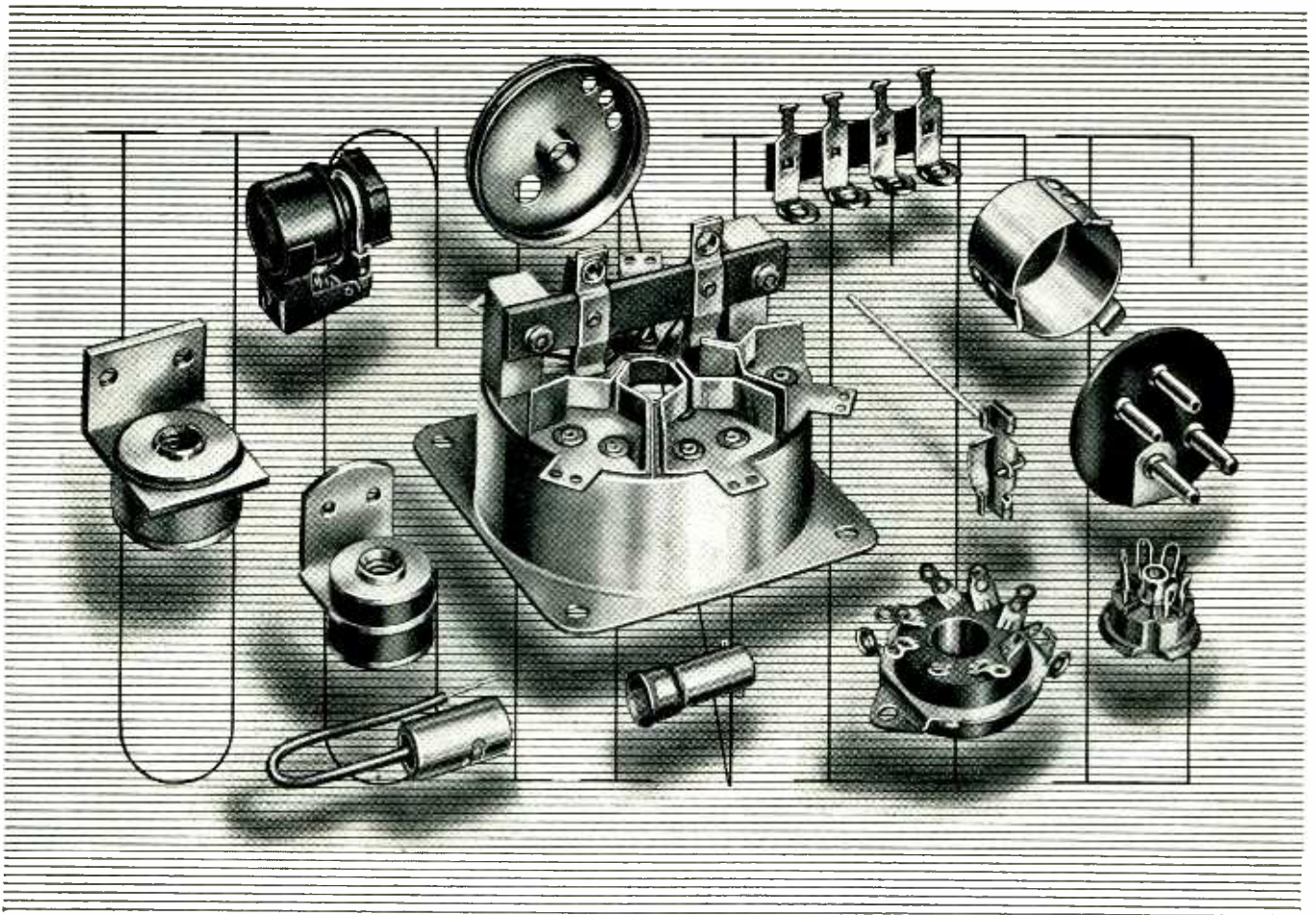

Assemblies... Assemblies... Assemblies

Large and small . . . simple and complex—we make all kinds and we like to make 'em. We're especially interested in assemblies combining metal parts with insulation. They're the bread and butter of our business. Whether you're after a radar tube socket or a pilot lamp, you'll probably find what you need in the long line of standard assemblies we have developed for numerous electronics uses. If none of them is exactly the answer to your current problem, chances are we can adapt or design one to fill your bill. We're not satisfied to "make it do" . . . our aim is the right assembly in the right spot every time.

The UCINITE CO.

Newtonville 60, Mass.

Division of United-Carr Fastener Corp.

**Specialists in RADIO & ELECTRONICS
LAMINATED BAKELITE ASSEMBLIES
CERAMIC SOCKETS • BANANA PINS &
JACKS • PLUGS • CONNECTORS • ETC.**

Longer life and better performance from vacuum tubes protected with built-in CONSTANT VOLTAGE

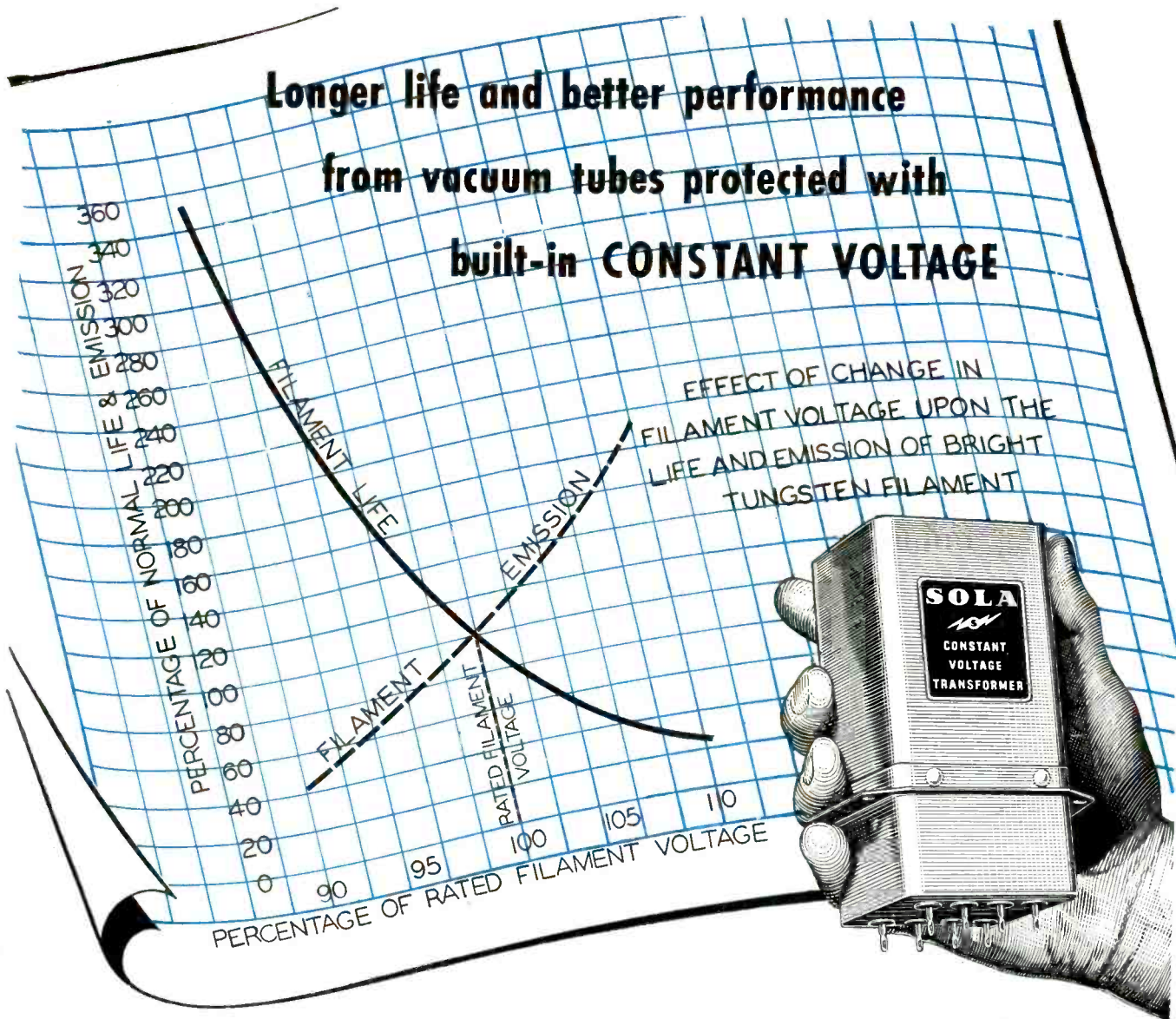

A 5% over-voltage will reduce the life of a tungsten filament by 50%.

A 5% under-voltage will cut filament emission by 33%.

Commercial line voltages today may vary as much as $\pm 20\%$.

With a SOLA Constant Voltage Transformer as a built-in component of your equipment, these line voltage variations can be ignored. No need to depend upon operator adjustments. No need to worry about operator forgetfulness. You

can depend on it—the right voltage is *always* there.

Vacuum tubes protected by SOLA Constant Voltage Filament Transformers require no starting resistors or high reactance transformers. Filaments are automatically and positively protected against damaging inrush currents. Tube life is noticeably prolonged.

SOLA Constant Voltage Transformers require no supervision, or manual adjustments by the oper-

ator. They eliminate the need for voltmeters. They are fully automatic, have no moving parts, tubes or networks, and are self-protecting against short circuit.

Standard units are available in capacities from 10 VA to 15 KVA either for the operation of equipment now in use or as built-in units. Where special problems confront the designer, consultation with SOLA engineers may provide a positive and economical solution.

Constant Voltage Transformers

To Manufacturers:

Built-in voltage control guarantees the voltage called for on your label. Consult our engineers on details of design specifications.

Ask for Bulletin DCV-102

Transformers for: Constant Voltage • Cold Cathode Lighting • Mercury Lamps • Series Lighting • Fluorescent Lighting • X-Ray Equipment • Luminous Tube Signs
Oil Burner Ignition • Radio • Power • Controls • Signal Systems • Door Bells • and Chimes • etc. SOLA ELECTRIC CO., 2525 Clybourn Ave., Chicago 14, Ill.

complete plastic production...

all under one roof

CASE HISTORY No. 1

This Bakelite and Polystyrene assembly was produced as part of the now-famous proximity fuse. Designed to close tolerances, this complex little job employed a combination of Printloid's extensive facilities. It was designed, milled, drilled, tapped, cut, shaped, sanded, polished and assembled, "all under one roof."



Printloid is a four-in-one outfit that brings you complete plastic fabrication in one plant. Experts handle your job from the initial design through final assembly.

Results? No shopping around, no wasted time. Instead, better design, uniform control and lower costs with Printloid engineering supervision at every step of the job.

FORMING

Radio Dial windows are a Printloid specialty, and we have made millions for the country's largest radio manufacturers. Printloid has worked for every industry, producing finished products as well as sub-assemblies.



PRINTING AND DIE CUTTING

Limitless possibilities of printing, from line cuts to four color process printing, are yours at Printloid. Die Cutting facilities range from steel rule dies to hydraulic presses for heavy plastic sheets.



MACHINING

Printloid is experienced in precision work to .001" in all machining and finishing operations. Typical of our complete facilities is 2½ inch through spindle lathe capacity for machining.

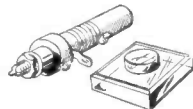

DESIGN AND ASSEMBLY

Printloid experts work to your specifications or execute your original designs. Displays have been created for leading national advertisers. Our engineers invite you to consult them on your problems.



PRINTLOID, INC., DEPT. E.

93 Mercer Street

New York 12, New York

The new Printloid catalog tells the story of complete plastic production under one roof. Includes a useful Plastics Glossary. Write for your copy.

Printloid INC.
PLASTIC FABRICATION



...All of a sudden,
there's a whispering campaign

IT'S SO SIMPLE. One day the bridge club goes without ice cream because a refrigerator broke down. First thing they want to know: "What make refrigerator is it?" You don't hear them ask: "Whose motor is it . . . whose capacitors?" It's always: "Whose refrigerator?" . . . or whose electric iron or radio or whatever it is *you* manufacture. That, without question, makes you responsible for every single part that goes into your product.

But ban whispering campaigns? Never! They create business for you, too. They can inspire

more confidence in a name than a million-dollar advertising campaign.

So when you buy components, they've got to be as good as you, yourself, would make them. And just as your best bet in hiring an employee is the man with the most experience, your best buy in components are those offered by the company that has devoted more years to research, development and manufacture than anyone else in the field. In capacitors, that company is Cornell-Dubilier Electric Corporation.



CORNELL - DUBILIER
world's largest manufacturer of
CAPACITORS

MICA • DYKANOL • PAPER • ELECTROLYTICS



Our engineers will be glad to cooperate with you. Send for our catalog. Cornell-Dubilier Electric Corporation. South Plainfield New Jersey. Other plants in New Bedford, Brookline, Worcester, Massachusetts and Providence, R. I.

Available Now

POTTER & BRUMFIELD "MT" TELEPHONE RELAYS

ONE OF THE FINEST, MOST VERSATILE RELAYS
EVER MANUFACTURED

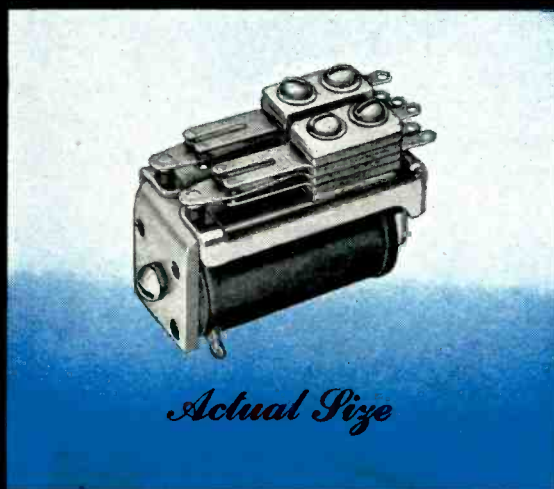

Actual Size

YOUR ORDERS FOR "MT" RELAYS CAN BE PROMPTLY
FILLED. FORWARD YOUR ORDERS TODAY.

IT'S GOT
EVERYTHING

DUAL PALLADIUM
CONTACTS

HIGH CONTACT
PRESSURE

CONTACT CAPACITY
100 WATTS

100% EFFICIENCY

BAKED VARNISHED
COILS

VIBRATION
RESISTANT

LONG LIFE

PROVEN DESIGN
EFFICIENCY

COMPACT AND
RUGGED

Overall dimensions,
as illustrated:

1 1/2" LONG

1 7/32" HIGH

11/16" WIDE

Weight 1 3/4 oz.

Windings up to 6000
ohms

Operating voltages
up to 85 volts DC,
wattage 1.25 to .3

Contact arrange-
ments in all variations
of forms A-B-C to
maximum of 12
springs

OTHER STANDARD P & B RELAYS AVAILABLE NOW

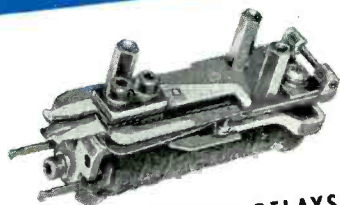

"LT" TELEPHONE RELAYS

4" long. Operating voltages up to 220
volts DC—time delay—palladium contacts
carry 175 watts—up to 24 springs.



"ST" TELEPHONE RELAYS

2 3/8" long. Operating voltages up
to 110 volts DC—palladium con-
tacts carry 175 watts—up to 12
springs.



"PR" POWER RELAYS

Designed for such power circuits as
motor starting up to 1 hp., heater
loads up to 20 amperes, or any con-
trol circuit requiring fast, positive
switching. Contact arrangements up
to DPDT.

● Build P & B standard relays into your design and take advantage of the low cost, quick delivery, that mass production offers. Forward your specifications today for price and delivery estimates. Large quantities of standard parts are stocked for quick assembly. Write for 1946 catalog illustrating a full line of "Standard Relays." Most types are carried in stock by your local electronics parts jobber.

Potter & Brumfield SALES CO., 549 West Washington Blvd., Chicago 6, Ill.

EXPORT DEPARTMENT, 2020 ENGINEERING BUILDING, CHICAGO 6, U. S. A.

RAYTHEON'S NEW STUDIO CONSOLE

For AM or FM



Easily Controls Two Studios, Announcer's Booth and Fourteen Permanently Wired Remote Lines

COMPLETE high-fidelity speech-input facilities for the modern station; this single compact unit contains all the control, amplifying and monitoring equipment. Any combination of studios, remote lines or turntables may be broadcast and auditioned simultaneously through the two high quality main amplifier channels. On-coming programs may be cued and the volume pre-set while on the air.

Its modern functional beauty in two-tone metallic tan will blend with other equipment and yet add a definite air of quality and distinction to your studio. Sloping front panel combines maximum visibility of controls with ease of operation. Sloping top panel gives operator an unobstructed view into the studio.

Engineered for dependability and built of finest quality components throughout. Telephone-type lever action, 3 position key switches assure trouble-free operation and *eliminate nineteen controls*. This simplified switching reduces operational errors. All controls are standard, simple and positive—easy to operate.

Inquire! The low price of this Raytheon Console will amaze you. The first orders are now being delivered. Write to:

RAYTHEON MANUFACTURING COMPANY

Broadcast Equipment Division

7517 N. Clark Street, Chicago 26, Illinois

Devoted to Research and Manufacture for the Broadcasting Industry

Compare THESE OUTSTANDING FEATURES WITH ANY OTHER CONSOLE

1. **Seven built-in pre-amplifiers**—more than any other console—making possible 5 microphones and 2 turntables, or 7 microphones, on the air simultaneously.
2. **Nine mixer positions**—more than any other console—leading to 5 microphones, two turntables, one remote line and one network line.
3. **Fourteen remote lines**—more than any other console—may be wired in permanently.
4. **Telephone-Type lever-action key switches** used throughout—most dependable, trouble-free switches available. No push buttons.
5. **Frequency Response** 2 DB from 30 to 15,000 cycles. Ideal speech input system for either AM or FM.
6. **Distortion** less than 1%, from 50 to 10,000 cycles.
7. **Noise Level** minus 65 DB's or better. Airplane-type four-way rubber shock mounting eliminates outside noise and operational "clicks."
8. **All FCC Requirements** for FM transmission are met.
9. **Dual Power Supply** provides standby circuit instantly available for emergency use.
10. **Power Supply** designed for mounting on desk, wall or relay rack.
11. **Instant Access** to all wiring and components. Top hinged panel opens at a touch. Entire cabinet tilts back on sturdy full-length rear hinge.

RAYTHEON

Excellence in Electronics



**Ends your search for a versatile
HARD AS DIAMOND CERAMIC**

Conjured up in the crystal ball lies the answer to your radio frequency insulation and industrial ceramic problems. Consult with us on the possibilities of using STEATITE... the material of the future... TODAY.

Centralab

Division of GLOBE-UNION INC., Milwaukee

PRODUCERS OF



Ceramic Trimmers
Bulletin 695



Ceramic High Voltage Capacitors
Bulletin 814



Variable Resistors
Bulletin 697

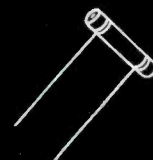

Tubular Ceramic
Capacitors
Bulletins 630 and 586



Selector Switches
Bulletin 722

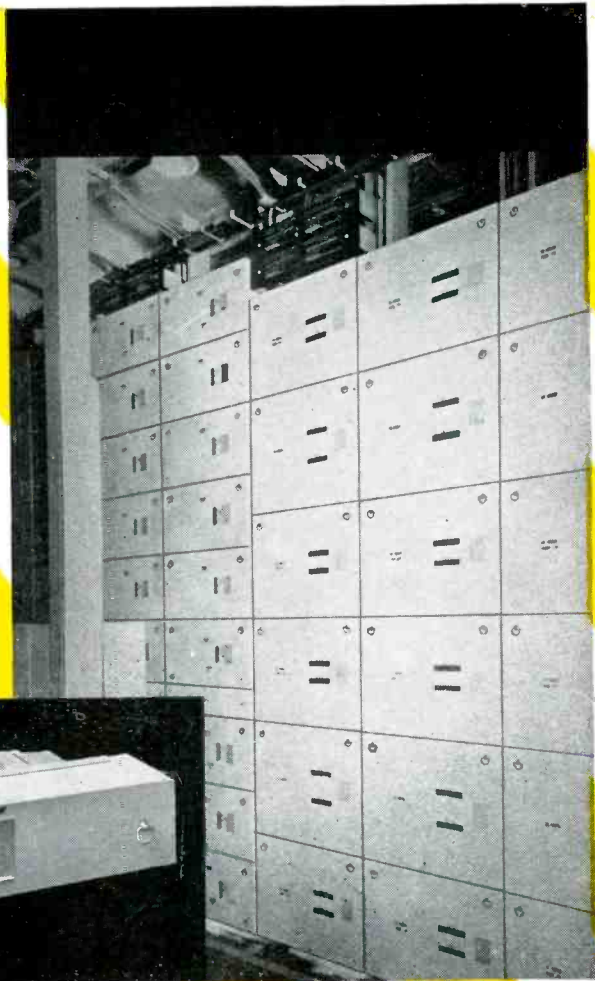

Toll Systems Broad Band Carrier Telephone, as developed by Bell Telephone Laboratories, must be readily accessible for inspection and maintenance. Close-up of Line Amplifier used in multi-channel Carrier Telephone Systems, showing ring type Dzus fasteners, which permit quick removal of telephone equipment covers.

DZUS* FOR ACCESSIBILITY

Saves time and money

The rapid, positive-action of these fasteners speeds up accessibility to vital parts and thus reduces inspection and maintenance time and cost. It is easy to install on any hinged or removable part. The Dzus spring and stud are permanently attached—no parts to get loose or lost. For speedy, dependable fasteners—always specify Dzus spiral cam fasteners. Dzus Fastener Co., Inc., Babylon, New York. In Canada: Railway and Power Engineering Corp., Ltd.



STUD

NEW GROMMET

SPRING ASSEMBLY

CUT-AWAY VIEW OF COMPLETE DZUS ASSEMBLY

SEND for a copy of the new Dzus brochure. More and more manufacturers in all fields of industry are adopting Dzus spiral cam fasteners because of their outstanding advantages.

*The word Dzus is the registered trade mark of the Dzus Fastener Co., Inc.



Why are Carbonyl Iron Powders better?



IN ILLUSTRATION, note regularity of pattern. This is due to uniform shape, density, size, and purity of each particle.

These factors account for high "Q" value—the combination of maximum magnetic permeability and minimum power loss. This is why carbonyl iron powders are better.

The following text gives a brief, complete outline of G.A.F. Carbonyl Iron Powders for those desiring more information.

G.A.F. Carbonyl Iron Powders are obtained by thermal decomposition of iron penta-carbonyl. There are

five different grades in production, which are designated as "L," "C," "E," "TH," and "SF" Powder. Each of these five types of iron powder is obtained by special process methods and has its special field of application.

The particles making up the powders "E," "TH," and "SF" are spherical with a characteristic structure of increasingly larger shells. The particles of "L" and "C" are made up of homogenous spheres and agglomerates.

The chemical analysis, the weight-average particle size, the "tap density," and the apparent density are given in the following table for the five different grades:

TABLE 1

Carbonyl Iron Grade	Chemical Analysis		% Nitrogen	Wt. Ave: diameter microns	Tap Density g/cm ³	Apparent Density g/cm ³
	% Carbon	% Oxygen				
L	0.005—0.03	0.1 —0.2	0.005—0.05	20	3.5—4.0	1.8—3.0
C	0.03 —0.12	0.1 —0.3	0.01 —0.1	10	4.4—4.7	2.5—3.0
E	0.65 —0.80	0.45—0.60	0.6 —0.7	8	4.4—4.7	2.5—3.5
TH	0.5 —0.6	0.5 —0.7	0.5 —0.6	5	4.4—4.7	2.5—3.5
SF	0.5 —0.6	0.7 —0.8	0.5 —0.6	3	4.7—4.8	2.5—3.5

With reference to the chemical analysis shown above it should be noted that spectroscopic analysis shows the rest to be iron with other elements present in traces only.

Carbonyl Iron Powders are primarily useful as electromagnetic material over the entire communication frequency spectrum.

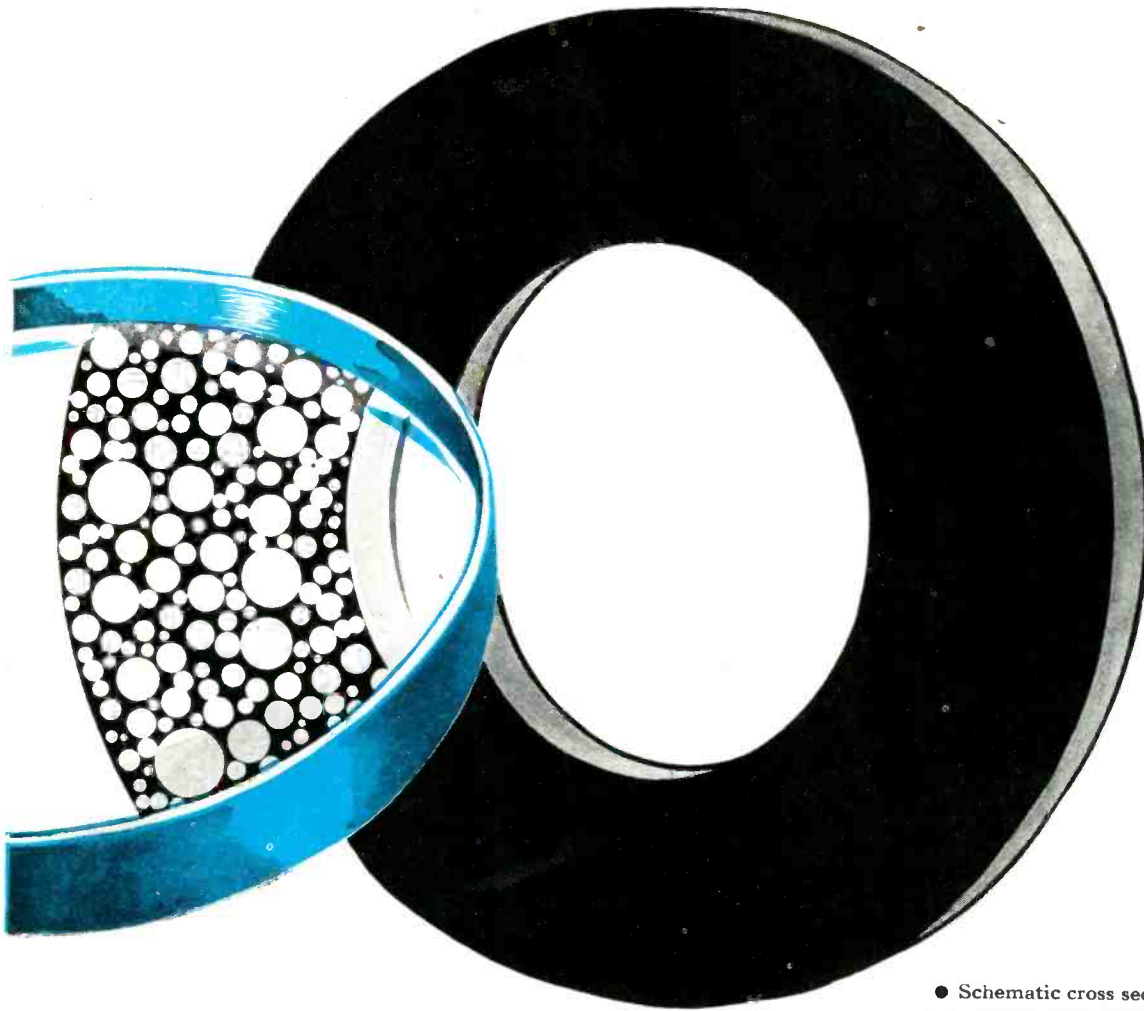

● Schematic cross section of powdered iron core made with carbonyl iron powder.

Table 2 below gives relative Q values (quality factors) and effective permeabilities for the different grades of carbonyl iron powder. The values given in the table are derived from measurements on straight cylindrical cores placed in simple solenoidal coils. Although the

data were not obtained at optimum conditions, the Q values as expressed in percentage of the best core give an indication of the useful frequency ranges for the different powder grades.

TABLE 2

Carbonyl Iron Grade	Effective Permeability at 1 kc	Relative Quality Factor at				
		10 kc	150 kc	200 kc	1 Mc	100 Mc
L	4.16	100	96	90	43	1
C	3.65	94	100	98	72	3
E	3.09	81	94	100	97	30
TH	2.97	81	93	98	100	54
SF	2.17	62	71	78	84	100

(Note: The actually measured Q values can be obtained by multiplying the rows respectively with: 0.78, 1.09, 1.25, 2.63, and 1.62.)

“L” and “C” powders are also used as powder metallurgical material because of their low sintering temperatures, high tensile strengths, and other very desirable qualities. (Sintering begins below 500° C and tensile

strengths reach 150,000 psi.)

Further information can be obtained from the Special Products Sales Dept., General Aniline & Film Corporation, 270 Park Avenue, New York 17, N. Y.

G.A.F. CARBONYL IRON POWDERS

What's Jack & Heintz doing?

Busy manufacturing the things you see on this page. All (except the engine, which is still under test) are pouring off our production lines—lines that the war proved can turn out precision products in mass-production speed and quantity.

During the war Jack & Heintz made many of the most delicate instruments our Air Forces used—and had to make them in larger quantity and less time than had ever before been possible. And Jack & Heintz did it.

This skill-in-quantity, this precision-in-volume, is now being applied to the products shown here, and will be used to manufacture others soon.

Our pledge to peacetime customers is the same as our pledge to the Air Force—every product bearing our name will be made with the same skill and care as the products on which lives depended—and depended safely—in the war. Jack & Heintz, Inc., Cleveland, Ohio.

J & H Ball Bearings

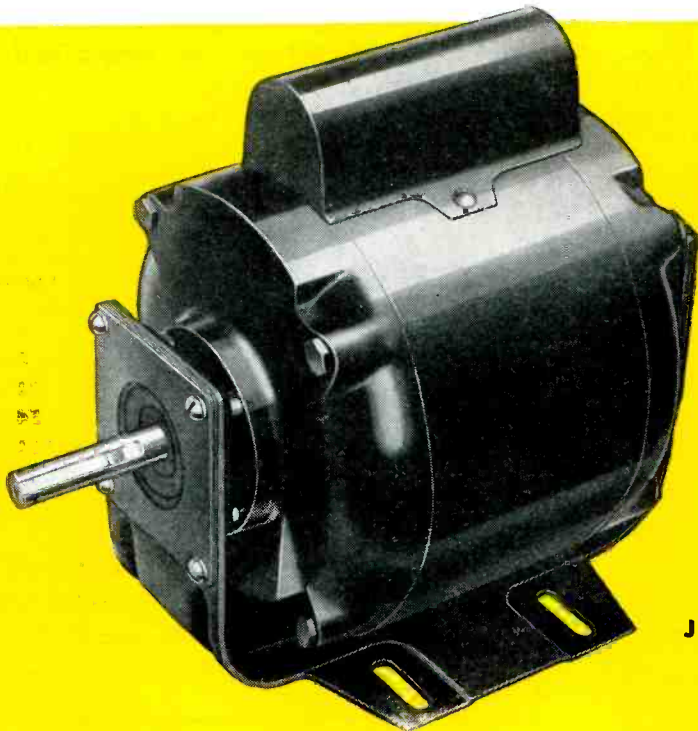
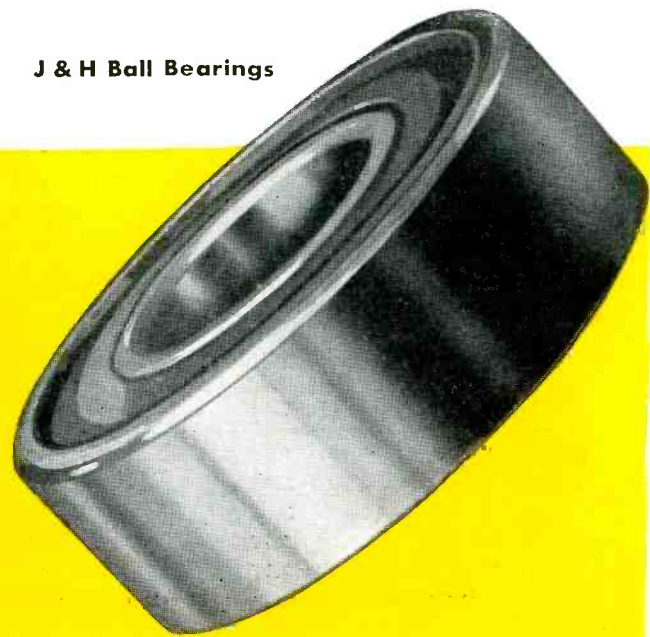

**J & H Fractional Horse Power
Electric Motors**

2500 Volt Ampere Inverter



J & H Electronic Gages

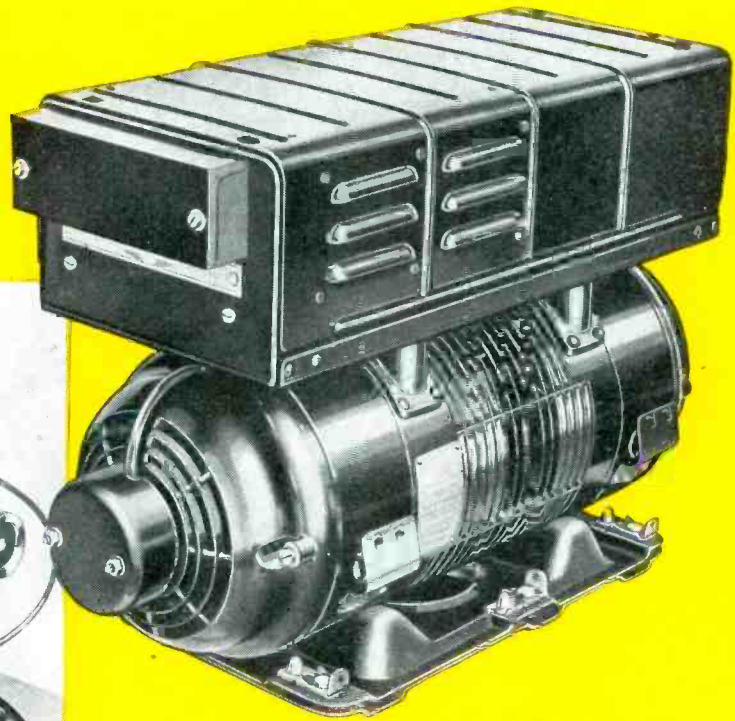

J & H Gasoline Engines

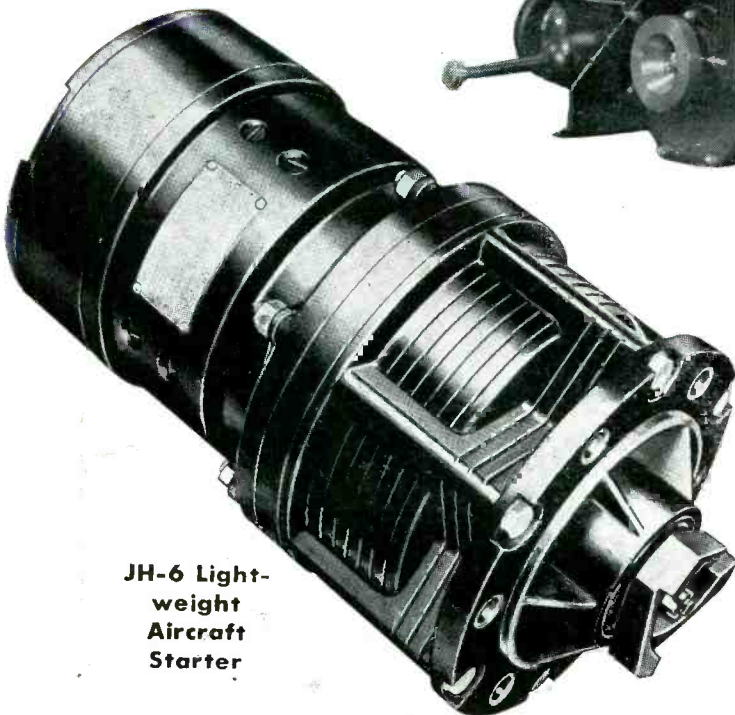
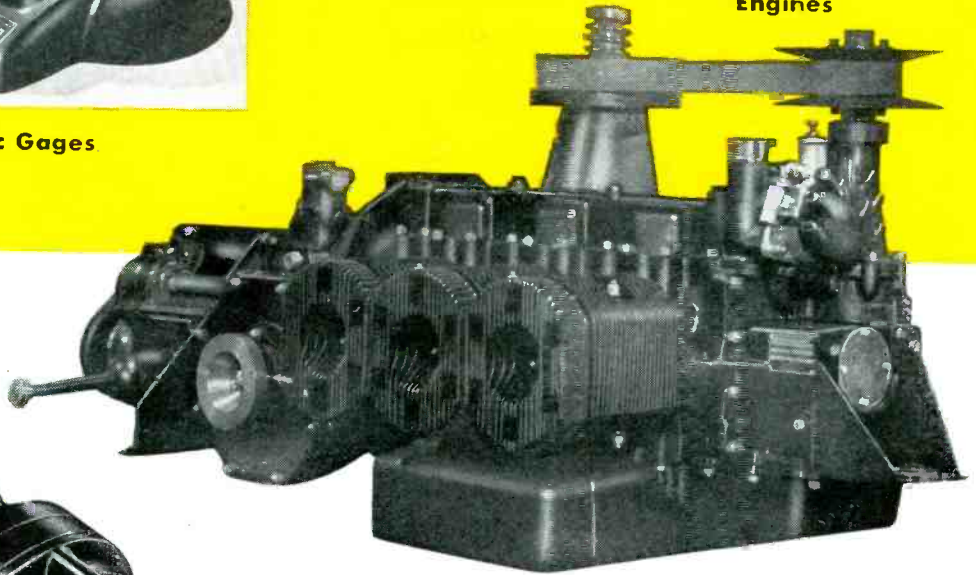

JH-6 Light-weight Aircraft Starter



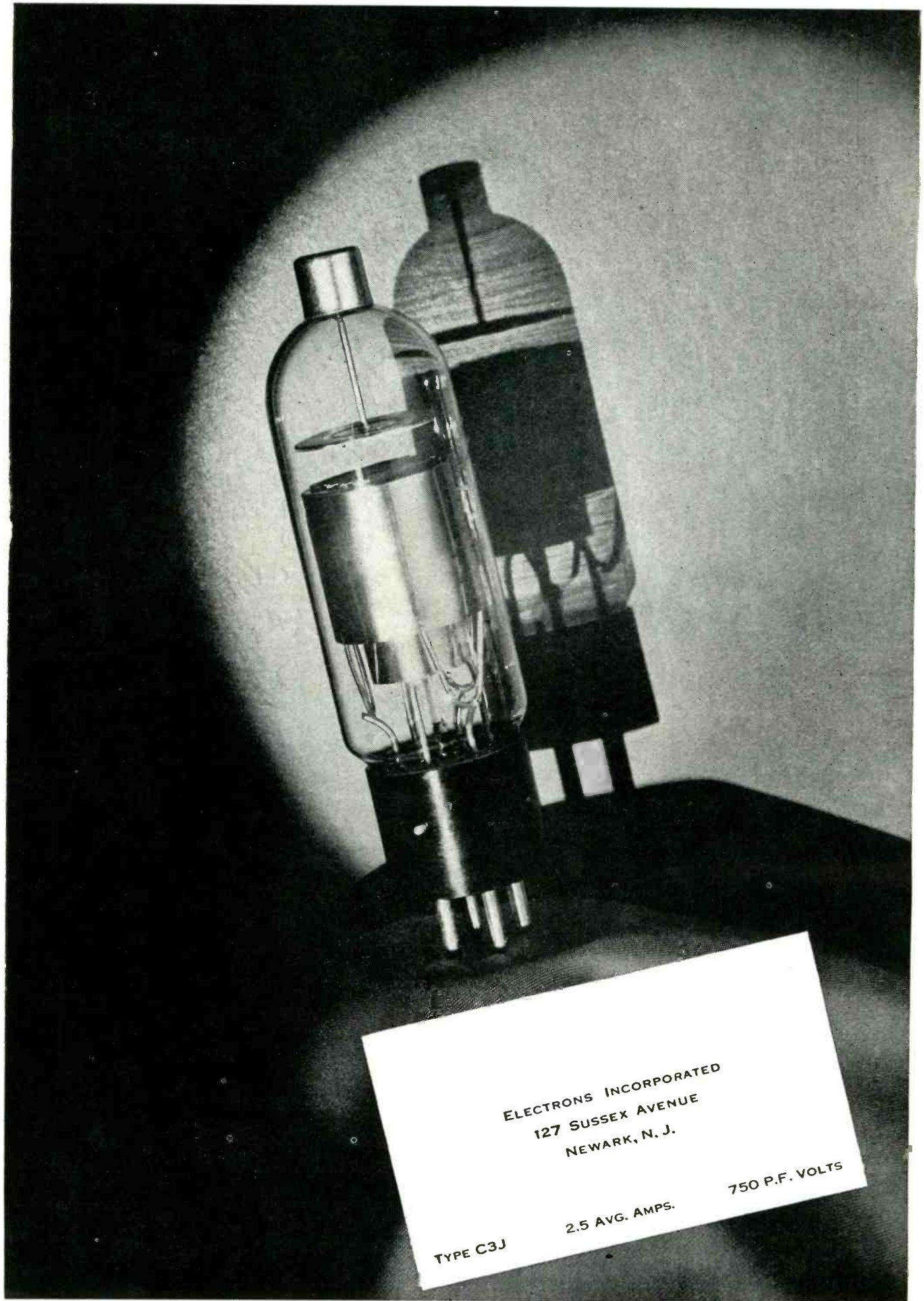

ELECTRONS INCORPORATED
127 SUSSEX AVENUE
NEWARK, N. J.

TYPE C3J

2.5 AVG. AMPS.

750 P.F. VOLTS



NEW ECONOMY, LIGHT WEIGHT, SERVICE WHATEVER YOUR LINE!

THIS POWER CABLE was installed in an unfavorable situation. Part of it runs adjacent to high pressure steam lines. Part lies in sump water containing cresylic acid waste. The cable itself is a 300,000 CM power cable used on 4,160 volt Delta, 3 phase, 60 cycle - 300 ampere average service. It is cycled periodically from a no load condition to full load. Replacing a heavy cable sheathed with paper and lead, in July, 1944, the new conductor is insulated with polyethylene, a plastic so light it floats in water. Only 6/64-inch thick, this insulation has remarkable low loss elec-

trical characteristics, an extremely low water vapor transmission coefficient, and exceptional resistance to water and chemicals. It is tough and impact resistant; inherently flexible and extensible; has a wide temperature working range.

Polyethylene insulation should rapidly supplant many older types - yield longer service and bring freedom from many causes of failure. Engineers, designers, and manufacturers will find, too, that the unique properties of this new plastic will bring economy and improved characteristics to an almost limitless line of products. Polyethylene resins can be molded as well as extruded; calendered onto cloth and paper; made into monofilaments, flexible sheets and film.

Write Department 18-P for Booklet V-2, "Polyethylene Resins." Experimental samples of this new plastic are also available upon request.

BAKELITE CORPORATION

Unit of
Union Carbide and Carbon Corporation



30 E. 42ND ST., NEW YORK 17, N.Y.

POLYETHYLENE

 7,000,000 of these Callite filament springs weigh one ounce!

and
one
is in
this

RAYTHEON
CK505AX

pentode...

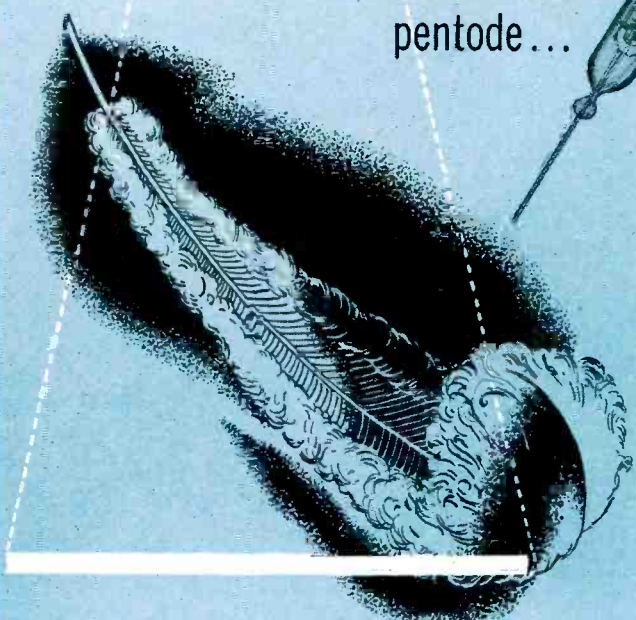

This tiny Raytheon flat pentode in its entirety weighs only 0.07 of an ounce and is designed for applications where very low battery drain as well as minute size are important. The CK505AX tube was developed by Raytheon for use in hearing aids, electronic stethoscopes, portable measuring instruments and for amplifiers in geophysical apparatus.

Processing the tungsten wire for a filament spring weighing seven-millionths of an ounce is only one of many difficult assignments given Callite by tube-makers like Raytheon. Callite's pioneering in tungsten metallurgy has kept pace with the requirements of leading tube manufacturers—often anticipating them.

Our engineers are ready to help you with the design and production of metallurgical components for your electrical and electronic products. Callite Tungsten Corporation, 547 Thirty-ninth St., Union City, N. J. • Branch Offices: Chicago, Cleveland.

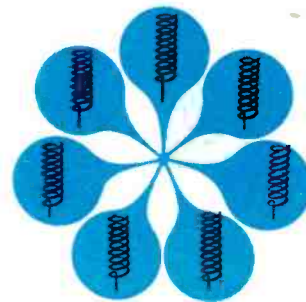

Callite
tube components



Hard glass leads, welds, tungsten and molybdenum wire, rod and sheet, formed parts and other components for electron tubes and incandescent lamps.

STACKPOLE

MOLDED IRON CORES

STANDARD AND HIGH-FREQUENCY TYPES

A pioneer in Iron Core production, Stackpole can supply practically any desired type from 100 cycles to upward of 175 megacycles and in an infinite variety of shapes, sizes and characteristics. Also available are High-Resistivity Cores showing a resistance of practical infinity; Insulated Cores wherein the screws are kept out of the coil field and "Q" consequently increased; Iron Cores for choke coils; and Side-Molded Iron Cores featuring uniform permeability with respect to linearity. Write for details and samples of any type.

for higher "Q" STACKPOLE SCREW-TYPE MOLDED CORES

These Stackpole developments are proving highly popular for circuits where small assemblies are the order of the day, and where "Q" must be kept at an absolute minimum. The cores themselves are threaded, thus eliminating the conventional brass core screw. Tubes can be threaded to fit cores if desired. More economical, however, is the use of a wire C-spring clip placed (obtainable from usual sources of supply) in a slot in an unthreaded tube. Stackpole Screw-Type Cores are ideal for the design of I-F and dual I-F Transformers for AM and FM.

IRON SLEEVE TYPES

... for better coils in less space

By use of Stackpole Sleeve Cores, much smaller cans of any material may be used to provide "Q" that is equal to, or better than, that of conventional cores and cans. Thus they facilitate an exceptionally high order of tuning unit efficiency in greatly reduced size. Cans are not always necessary — and, where they are, inexpensive aluminum containers may often be used.

LOOK FOR THE
STACKPOLE MINUTE MAN
... your assurance of
the highest in
molded materials
quality.

STACKPOLE CARBON CO., Electronic Components Division, ST. MARYS, PA.



**HERE'S THAT NEW
TRIPLITT
625-N**

LONG SCALE, WIDE RANGE VOLT-OHM-MILLIAMMETER

DOUBLE SENSITIVITY D. C. VOLT RANGES

0-1.25-5-25-125-500-2500 Volts,
at 20,000 ohms per volt for greater accuracy on
Television and other high resistance D.C. circuits.

0-2.5-10-50-250-1000-5000 Volts,
at 10,000 ohms per volt.

A. C. VOLT RANGES

0-2.5-10-50-250-1000-5000 Volts,
at 10,000 ohms per volt.

OHM-MEGOHMS

0-400 ohms (60 ohms center scale)
0-50,000 ohms (300 ohms center scale)
0-10 megohms (60,000 ohms center scale)

DIRECT READING OUTPUT LEVEL DECIBEL RANGES

-30 to +3, +15, +29, +43, +55, +69 DB

TEMPERATURE COMPENSATED CIRCUIT FOR ALL CURRENT RANGES D. C. MICROAMPERES

0-50 Microamperes, at 250 M.V.

D. C. MILLIAMPERES

0-1-10-100-1000 Milliampere, at 250 M.V.

D. C. AMPERES

0-10 Amperes, at 250 M.V.

OUTPUT READINGS

Condenser in series with A.C. Volts for output
readings.

ATTRACTIVE COMPACT CASE

Size: 2½" x 5½" x 6". A readily portable, completely
insulated, black, molded case, with strap handle.
A suitable black, leather carrying case (No. 629)
also available, with strap handle.

LONG 5" SCALE ARC

For greater reading accuracy on the Triplet
RED • DOT Lifetime Guaranteed meter.

SIMPLIFIED SWITCHING CIRCUIT

Greater ease in changing ranges.

Write for descriptive folder giving full technical details



Triplet

ELECTRICAL INSTRUMENT CO. BLUFFTON, OHIO

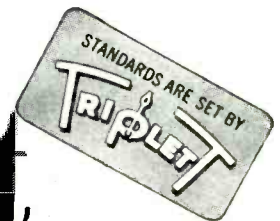

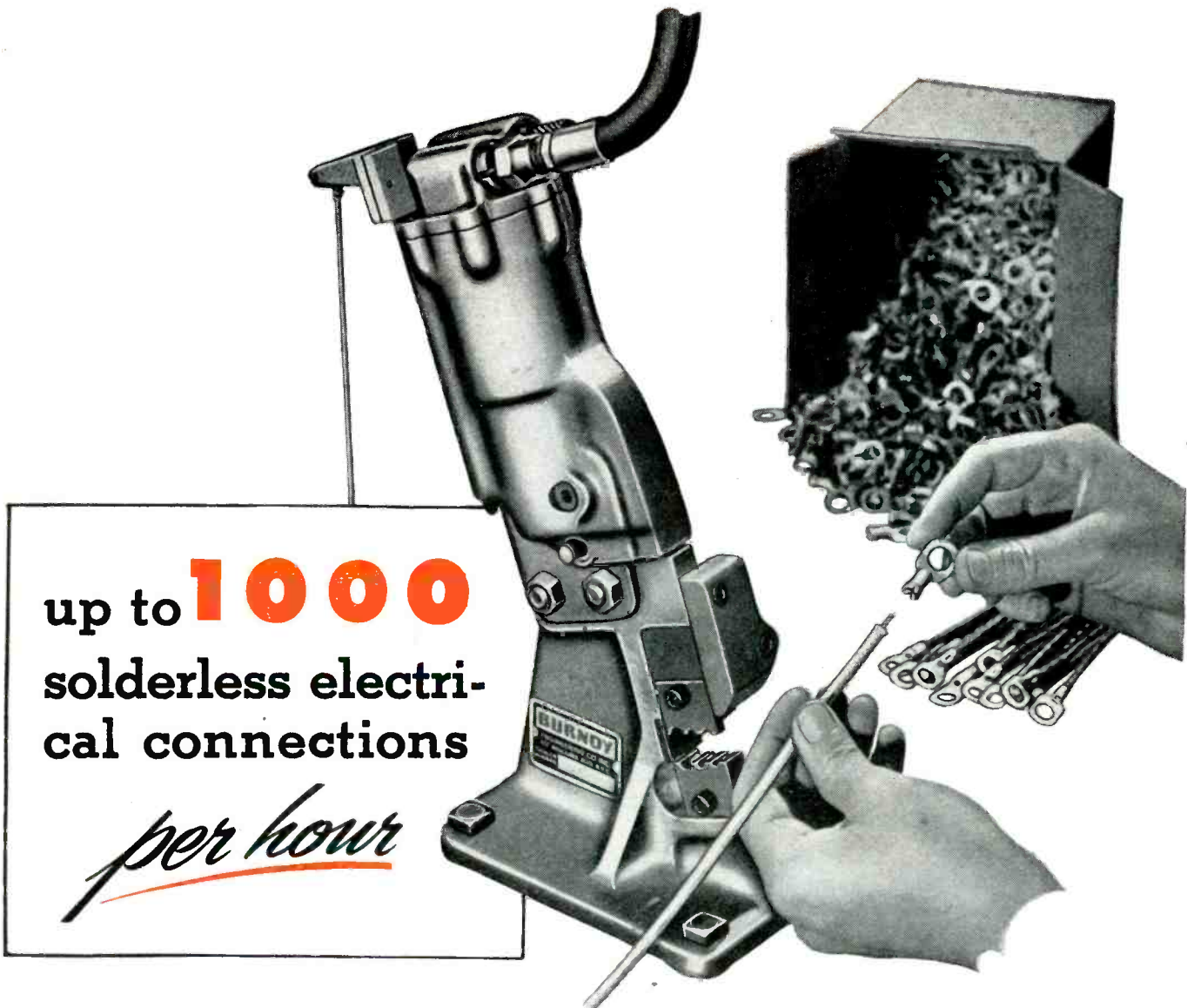

up to **1000**
 solderless electrical
 connections
per hour

Burndy HYPRESS

(Pneumatic Foot Operation)

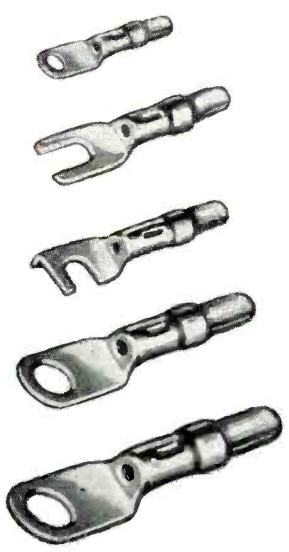

Make your own cost comparison. With this new Burndy No. Y10NCP HYPRESS one operator can attach up to 1000 Burndy HYDENT connectors per hour! *Compare for efficiency too,* remembering that the HYDENT connector is of one-piece pure copper construction, and that each connection is uniform in mechanical strength and electrical efficiency. For complete information write for the HYDENT catalog. Burndy Engineering Co., Inc., 107-L Bruckner Blvd., New York 54, N. Y.

BURNDY ENGINEERING COMPANY, INC.

In Canada: Canadian Line Materials, Ltd., Toronto 13

Sealed-In ELECTRICAL

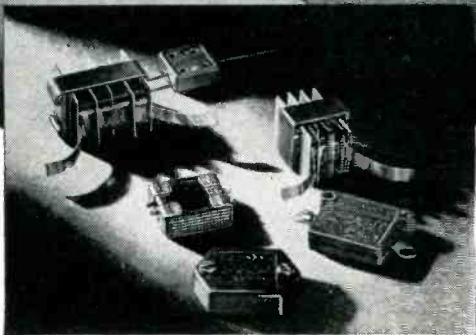
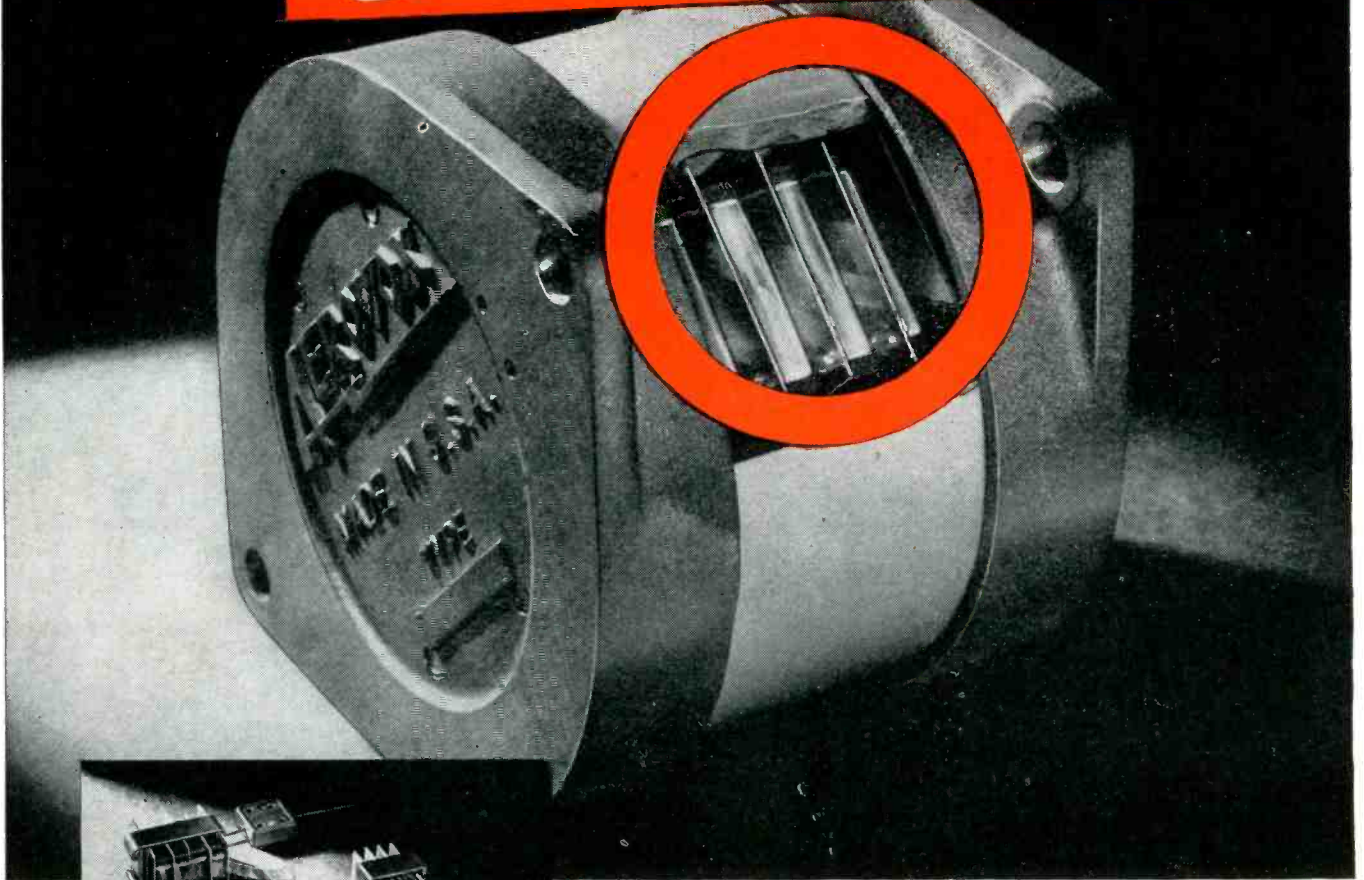

(Top) Aerovox Type 1970 Capacitor cutaway to show sections formed of alternate layers of Mica and foil. Also shown (left) are Aerovox Types 1467, 1455 and 1650, before and after molding or potting. Clear and slightly stained sheet mica is employed because it is free of all cracks, waves and buckles, providing an even insulating surface with strong, uniform dielectric characteristics.

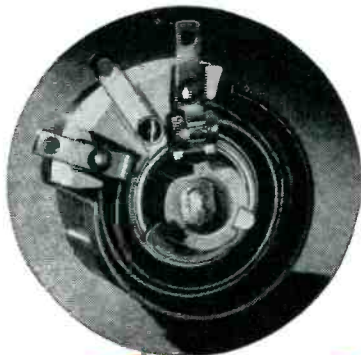

For this metallic rheostat, the DeJur Amsco Corporation required a thin, flexible insulating material that would not break down under temperatures up to 300° F. Micanite tubing was slit and inserted between resistance element and metal case. Complete electrical and thermal insulation was provided.

MUNSELL
MICA

MICANITE
Built-Up Mica

LAMICOID
Laminated Plastics

EMPIRE
Varnished Cloths and Tapes

MICO
Insulating Specialties

INSULATION CAN BE DEPENDABLE

That's why the Aerovox Corporation specifies Mica for many of its molded, ceramic cased and other type capacitors. Mica seldom breaks down. Under almost any conditions Mica's dielectric strength, uniform dielectric constant and unusual capacitance stability provide dependable sealed-in insulation. Its inherently low dielectric loss and temperature coefficient are additional safeguards to maintain product quality and longevity. And Mica's chemical stability and natural resistance to heat permit its use in the most humid climates.

All of Mica's durable physical and electrical qualities are available to you in two basic forms—as sheet mica or as Micanite (thin Mica splittings bonded together into tubes or sheets). Either form is supplied pre-fabricated to your specifications. Con-

sult our engineers with your next insulation problem. Their long experience with every type of insulating material assures you of an unbiased recommendation. Mica Insulator Company sales offices and distributors are conveniently located throughout the United States.

PROPERTIES OF SHEET MICA		
	Muscovite	Phlogopite
Specific Gravity	2.76—3.0	2.78—2.85
Hardness, Moh's scale	2.8—3.2	2.5—2.7
Max. temperature at which employable	1,027 F	1,832 F
Power factor at 1,000 kc	.0001—.0004	.004—.07
Dielectric constant	6.0—7.0	5.0—6.0

In processing, the RCA 829 transmitting tube is subjected to temperatures much higher than encountered in normal service in order to release unwanted gases. Because clear sheet mica is free of gaseous inclusions of its own and can withstand much higher temperatures, it was specified for the combined functions of grid and plate spacer and insulator.



EUGENE MUNSELL DIVISION OF

MICA *Insulator* COMPANY

797 Broadway, Schenectady 1, N. Y.

SALES OFFICES: Boston: 285 Columbus Ave. • Chicago: 600 West Van Buren St. • Cincinnati: 3403 Hazelwood Ave. • Cleveland: 1276 West 3rd St. • Detroit: Beak Building • Houston: Bakoring, Inc., 1020 Houston Ave. • New York: 200 Varick St. • St. Louis: 455 Paul Brown Bldg. • Triangle Pacific Co. at Los Angeles: 340 Azusa St. • San Francisco: 1045 Bryant St.

JUST OUT

A new 4-page bulletin on mica insulation. Contains application data and characteristics for the seven different grades of mica available from us.



Mica Insulator Company, Dept. 22
797 Broadway, Schenectady 1 N. Y.

Gentlemen:

- () Please rush my copy of your new 4-page bulletin on electrical mica.
- () Enclose price list.
- () Please have your application engineer see me when in my vicinity.

Name _____
 Position _____
 Company _____
 Address _____
 City _____ State _____

For tubes of Uniform Performance . . . **BEAT THE HEAT**

with SPEER GRAPHITE ANODES

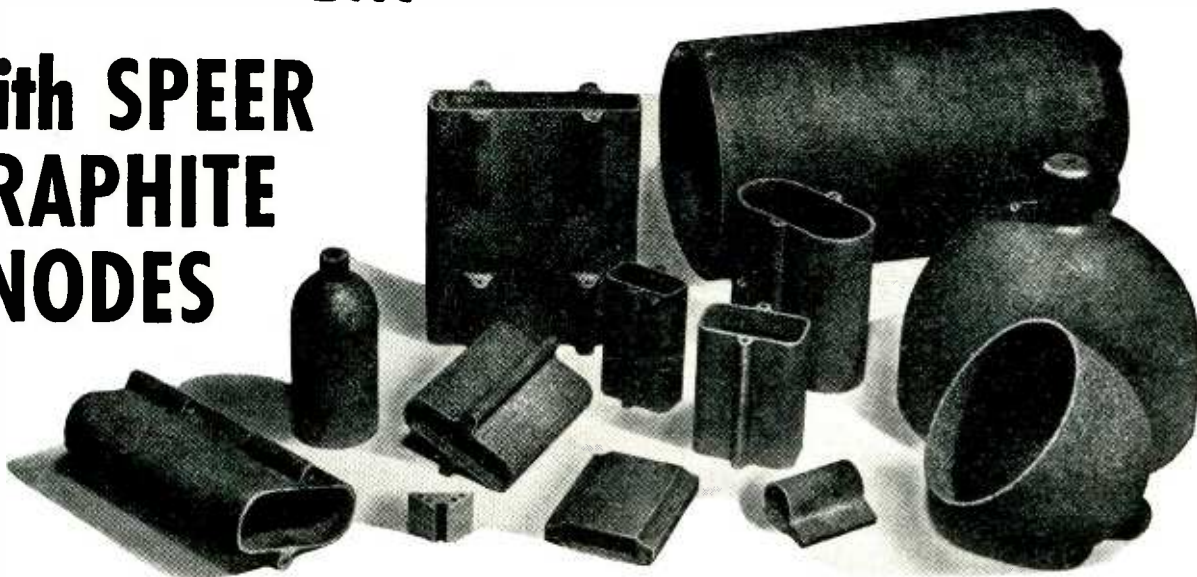

In manufacturing transmitter and rectifier tubes that are truly uniform in performance, the high heat dissipation value of SPEER Graphite Anodes is an important factor. It's one of the many reasons why SPEER Anodes are consistently specified by so many leading tube manufacturers and tube users.

Tubes containing SPEER Graphite Anodes can handle greater plate power dissipation as they disperse the heat of operation faster, and because SPEER Anodes minimize heat transfer to other component parts of the tube. SPEER Graphite Anodes will withstand any temperature up to 3500° F. without warping—temperatures at which many anode materials may soften and distort.

SPEER Anodes are carefully processed and are 99.9% pure electro-graphite. They can be machined to extremely close tolerances to conform with your tube design. Internal face spacings of SPEER Graphite Anodes can be held to .002 inch.

The many advantages of SPEER Graphite Anodes listed here are available to manufacturers and users of almost every type of electronic tube. Write today for further details, without obligation.

Do You Know?

SPEER GRAPHITE ANODES

- Lower temperatures of associated tube parts.
- Withstand severe overloads.
- Defy warping.
- Prevent hot spots or fused holes.
- Minimize bulb darkening and insulator leakage.
- Improve degassing qualities.
- Decrease gas troubles.
- Enhance tube appearance.
- Provide precise anode dimensions.
- Produce uniform tube characteristics.
- Retain original dimensions in service.
- Maintain normal tube characteristics.
- Allow wide latitude of anode design.

⊕ 595

CHICAGO • CLEVELAND • DETROIT
MILWAUKEE • NEW YORK • PITTSBURGH

SPEER

CARBON COMPANY
ST. MARYS, PA.

Ex-G.I. Seeks Job



Can you use this finger-size 10 kw Triode?

Doubtless there are many electronic experimenters and designers working in the intermediate micro-wave range with need for just such a triode. Designed and built by National Union for advanced radar installations, this N. U. 3C37 should prove a "natural" for engineers concerned with instruments for aircraft, navigation, railroads, communication relay transmission and many related applications. Here is the only tube of its kind—a newcomer to electronics, yet an experienced veteran proved under the most rigorous service conditions. There are electronic jobs it can do better than they have ever before been done—problems it can solve for the first time. Why not write us about the N. U. 3C37? Or come to our laboratories and talk it over with a National Union engineer.

Qualifications of the N. U. 3C37

- Delivers 10 KW peak RF power output at frequencies as high as 1150 megacycles.
- Anode and grid dissipation capabilities are adequate to enable the tube to withstand large momentary overloads without damage or distortion of electrical characteristics.
- Internal and external surfaces are silver plated to minimize skin resistance and RF losses.
- Specially constructed radiator greatly reduces RF losses. Permits operation at duty cycles of 1% with air-blast cooling.
- Anode radiator of silver plated copper efficiently transfers heat to any resonator of which it becomes a part.
- Negligible frequency drift due to cylindrical construction and closely controlled mechanical tolerances.
- Maximum mechanical strength.

**NATIONAL UNION
RADIO AND ELECTRON TUBES**

NATIONAL UNION RADIO CORPORATION • NEWARK 2, N. J.

YOUR FILTER PROBLEMS

SOLVED...



Our Specialties:
**ELECTRIC WAVE
 FILTERS**

**RESONANT CIRCUITS
 & TRANSFORMERS**

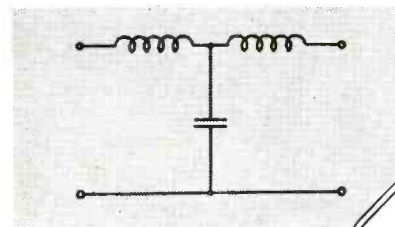
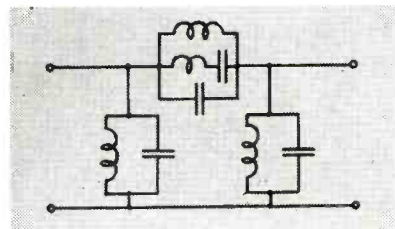
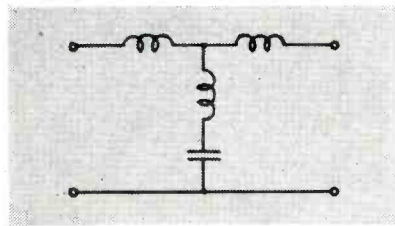
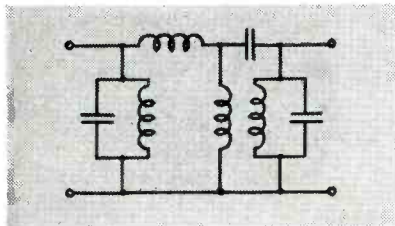
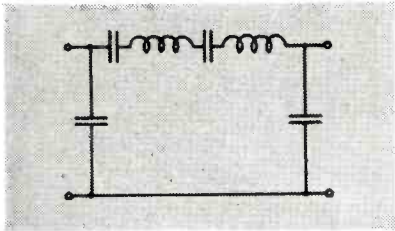
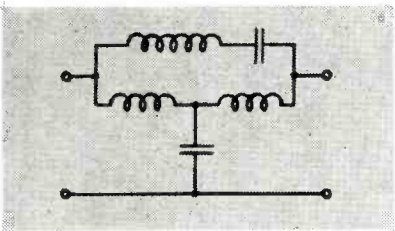

Kenyon's always progressive engineering staff has created a wide range of *Special Design Laminations* employing practical application of the very latest steel alloys. As a result, efficient, low cost and compact space saving equipment are all now available.

Because standard transformer cases are not usually suitably shaped for *Filter Components*, Kenyon's engineers have developed a wide range of special designs guaranteed to deliver maximum efficiency.

Diligent research has given Kenyon's engineers a vast and an intimate knowledge of filters and filter components. As your advisors, these experts can usually recommend minor changes in specifications that allow major saving in **COST, EFFICIENCY or SIZE** — or all three.

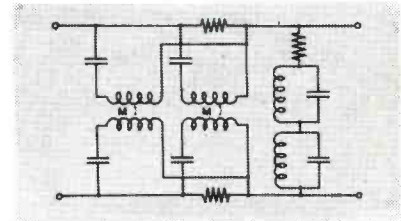

Inquiries Invited



THE MARK OF EXCELLENCE

KENYON TRANSFORMER CO., Inc. 840 BARRY STREET
 NEW YORK, U. S. A.

MAN HITS MOON

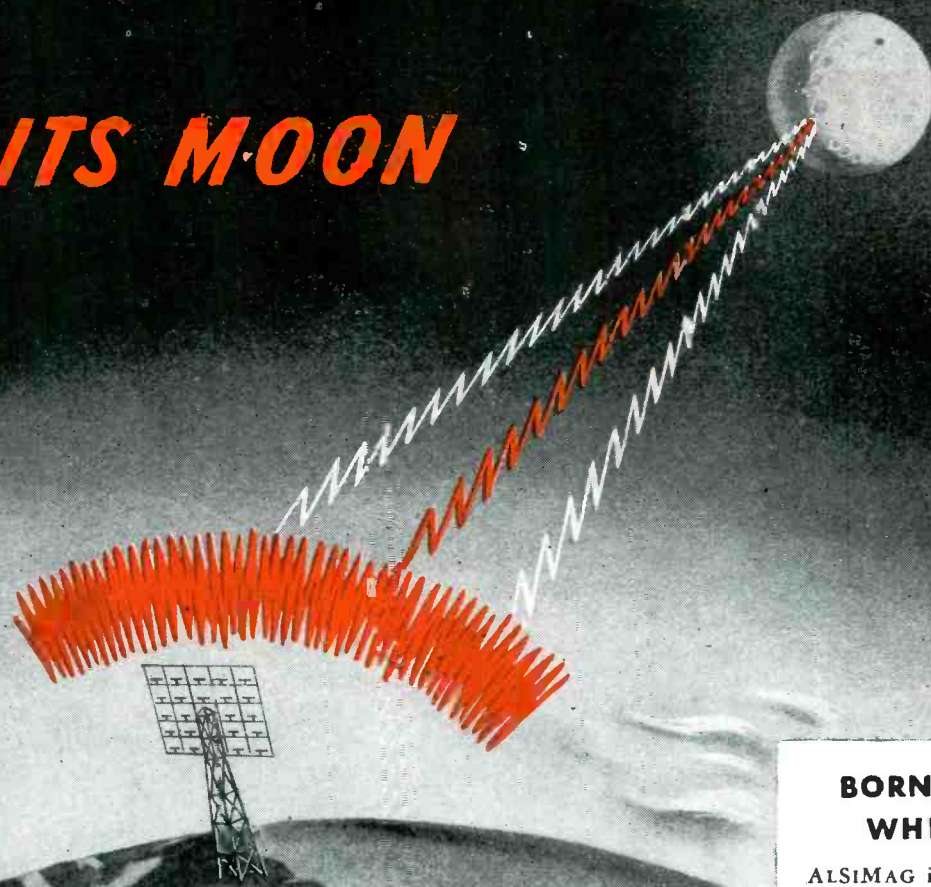

BORN AT WHITE HEAT

ALSiMAG insulators take their final, strong, hard, rigid form in furnaces at the white heat of 2500°F. Such temperatures would consume all inorganic materials. ALSiMAG cannot char and is impervious to constant temperatures of 1800°F.

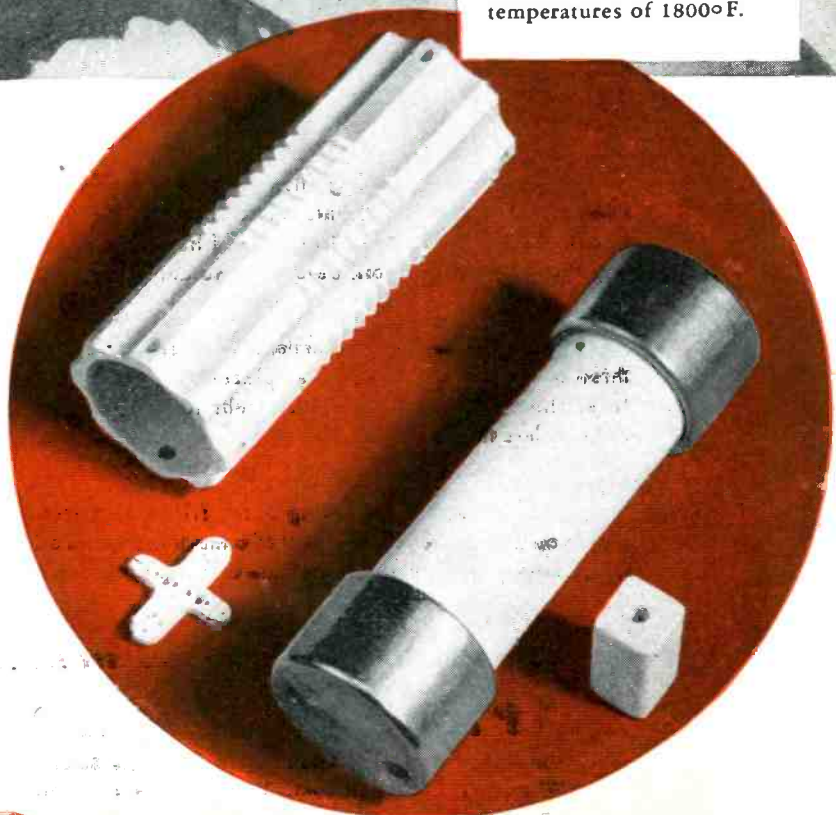

THE radar experiment which resulted in the first contact with the moon is still another revelation of the brilliant advances made in electronics during the war.

The high standards of radio, radar and other war equipment for controls and communications, which called for extensive use of ALSiMAG Steatite Ceramics, will be carried forward into many peacetime products of QUALITY.

There will be no compromise with QUALITY in the production of ALSiMAG insulators for electronic and electrical uses. Write today for technical literature.

AMERICAN LAVA CORPORATION
CHATTANOOGA 5, TENNESSEE

THIRTIETH YEAR OF CERAMIC LEADERSHIP



Original Award July 27, 1942
Second Award February 13, 1943
Third Award September 25, 1943
July 7, 1944

ALSiMAG

TRADE MARK REGISTERED U. S. PATENT OFFICE

New—Immediate Deliveries

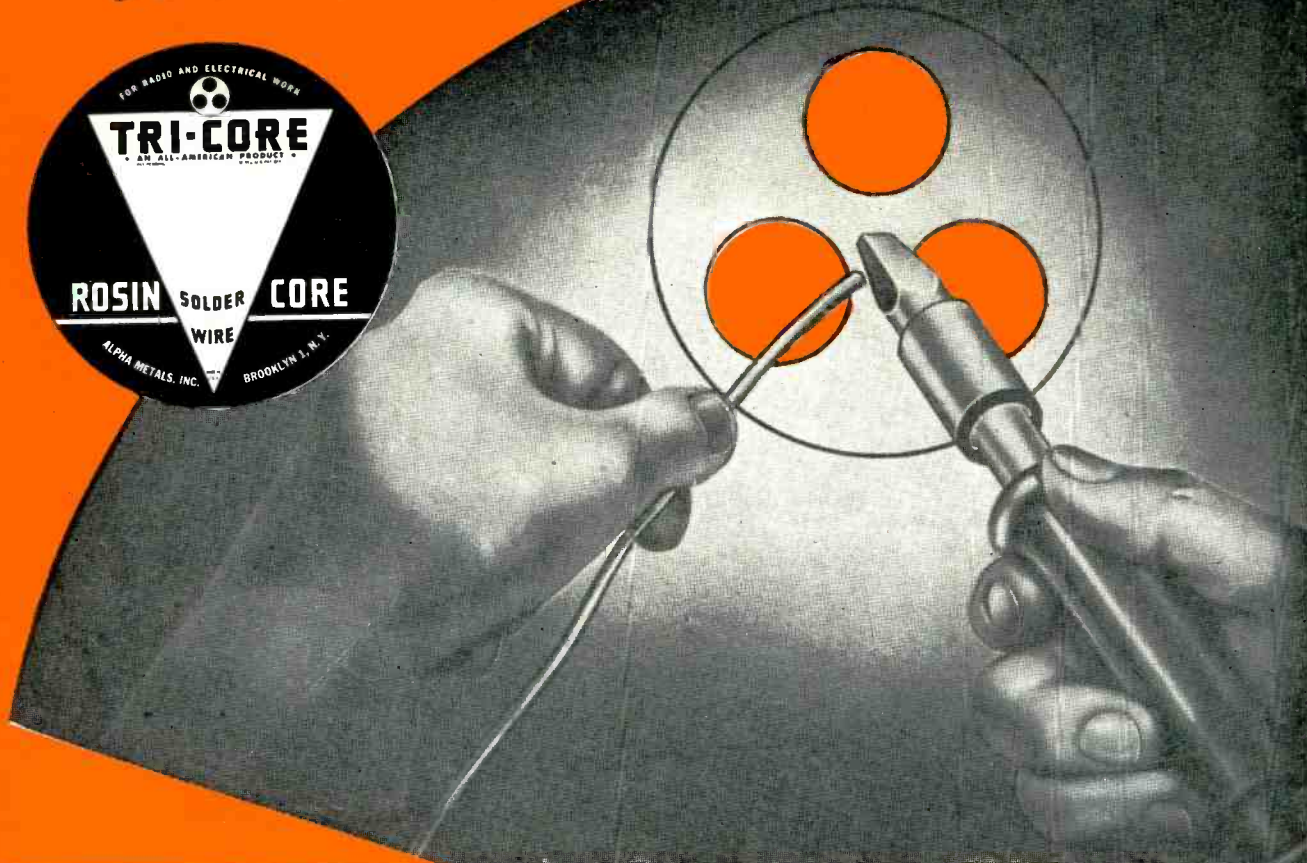

You Get More with TRI-CORE Solder

MORE . . . in faster, thorough fluxing. That's because Tri-Core's thinner walls make for instantaneous penetration of heat to the flux. Result—a continuous, free flow of high-grade, non-corrosive flux goes on the work before the solder melts.

MORE . . . in speedier production. Tri-Core's arrangement of three independently filled cores places them closer to the surface. That means that the solder melts faster. More work gets done in less time.

MORE . . . in measurable saving of tin. Tri-Core's faster melting gives you the results you'd expect of a much higher tin alloy content. Consequently, there's a definite and desirable saving in tin.

Alpha quality and high engineering efficiency is the result of our more than 40 years of research and experience in the manufacture of lead and tin products. TRI-CORE Solder exceeds A.S.T.M. Class A specifications and is available in all alloys, all flux percentages, all gauges.

WRITE FOR BULLETIN AND ENGINEERING TEST SAMPLE

ALPHA METALS, Inc.

Single Core, Rosin and Acid Filled, Special Core Solder, Wire, Bar, Sheet, Preforms. Lead and Tin Products.

371 Hudson Avenue • Brooklyn 1, N. Y.



EACH OF THESE THYRATRONS

does a specific job well!

Self-excited parallel-type inverter circuit

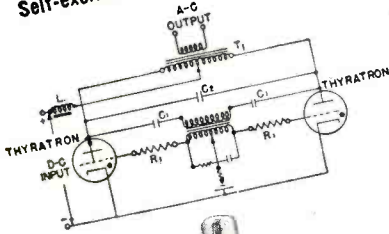

TYPE FG-67

A very short deionization time adapts this thyatron directly to inverter (d-c to a-c current) applications.

Contact amplifier circuit

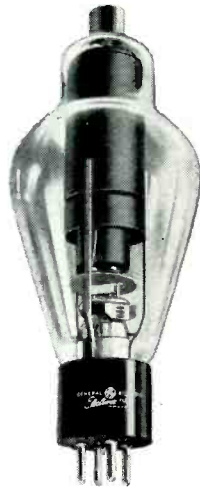
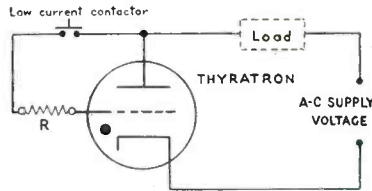

TYPE FG-33

Here positive grid-voltage characteristics are helpful in circuits which must be both simple and sure-acting.

Ignitor firing circuit

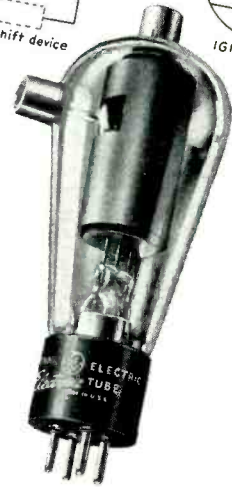
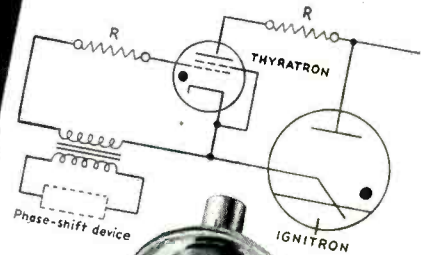

TYPE FG-95

This tube's negative grid characteristics mean lower over-all power requirements for heavy-duty control work.

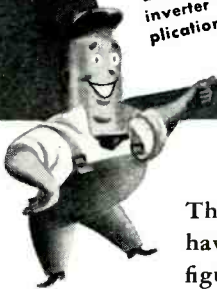

The three G-E thyratrons shown here have similar ratings. Voltage and current figures are alike: for anode, peak voltage 1,000 v, peak current 15 amp, avg current 2.5 amp (except that the FG-95, when used for ignitor firing, is rated at 30 amp peak and 0.5 amp avg).

Yet . . . each tube is "tailor-made" for a different electronic requirement and type of circuit, meeting the needs of that circuit as no other thyatron can do!

General Electric—which built thyratrons first, which

today builds *the most* thyratrons—can supply control or other tubes to *do the job right* in any type of electronic equipment now on your drawing-board. Furthermore—by reason of branch, distributor, and dealer stocks in hundreds of cities—G. E. can assure spot service on replacement tubes for users of your equipment!

Toward these ends, G-E tube engineers are ready to work closely with you. Contact your nearest G-E office, or write *Electronics Department, General Electric Company, Schenectady 5, New York.*

GENERAL ELECTRIC

162-E4-6680

FIRST AND GREATEST NAME IN ELECTRONICS

**FOR FM RADIOS
IT'S
ERIE RESISTOR**



*Electronic Components
and Products*

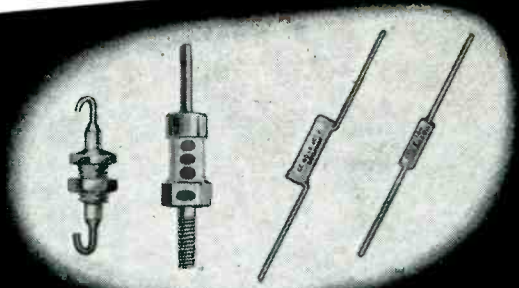

FEED-THRU, STAND-OFF, PIGTAIL CERAMICONS

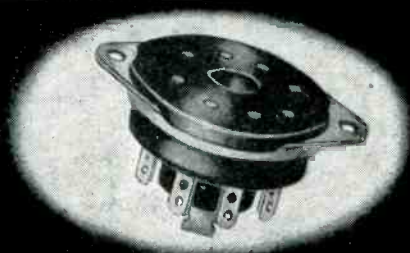

CINCH-ERIE PLEXICON TUBE SOCKETS
with built-in By-Pass Ceramicons

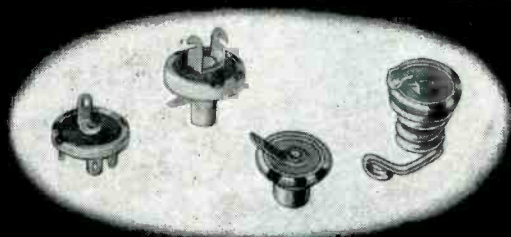

ERIE BUTTON MICA CONDENSERS

Due to the high operating frequencies of FM, many electrical and mechanical characteristics not ordinarily considered in condensers, become of paramount importance. The most important of these is low inductance, both in leads and in the basic construction of the condensers themselves.

The condensers illustrated on this page fulfill this requirement through simplicity of design and low internal inductance. For by-pass applications, Erie Stand-Off Ceramicons and Erie Feed-Thru Ceramicons are most efficient for carrying off R.F. current to ground. Heavy terminals, with direct connection to ground, reduce external and internal inductance to a minimum. Available capacities, up to 1,000 MMF, are usually sufficient to efficiently by-pass frequencies of 80 MC or higher. Tubular Ceramicons, shown at the top right, have the same internal advantages as the Stand-Off and Feed-Thru type Ceramicons, because of their simplicity of construction, but are provided with regular pigtail leads necessary for many installations where

some moderate lead inductance can be tolerated.

The Cinch-Erie Plexicon Tube Socket, shown in the center photograph, with built-in by-pass Ceramicons, puts the condensers around the tube pins—where they belong. Leads are practically eliminated, and other components can be installed closer to the socket, further increasing efficiency. Any tube pin or groups of pins can be by-passed with condensers having up to 1,000 MMF capacity.

Erie Button Mica Condensers were designed specifically for high frequency work. Ribbon type leads, plus circular design, gives extremely short electrical path-to-ground through the entire area of the condenser. These compact units are available in a number of different mounting styles and in capacity ranges up to .006 mfd.

You can stake your reputation on these condensers for dependable use in tuned circuits, for by-pass applications, or as coupling condensers, in all FM applications. Write for complete details, giving desired operating characteristics.



Electronics Division

ERIE RESISTOR CORP., ERIE, PA.

LONDON, ENGLAND . . . TORONTO, CANADA



LABORATORY INSTRUMENTS FOR SPEED AND ACCURACY

HOW -hp- INSURES ACCURACY OF EACH MODEL 400A VACUUM TUBE VOLTMETER

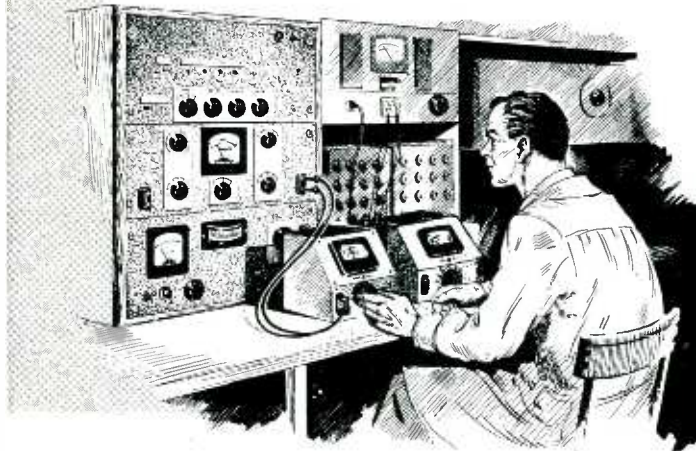

The accuracy of -hp- instruments begins with the engineers' blueprints, but it does not stop there. Precision assembly, individual hand calibration for each instrument, and pre-calibration tests over the entire range of the instrument are your assurance that speed and accuracy will be maintained under all operating conditions.

UNIQUE VOLTAGE GENERATOR

Take the -hp- Model 400A Vacuum Tube Voltmeter for example. This measuring instrument is unusually versatile, because of its wide frequency range, wide voltage range, and high order of accuracy. For adequate production tests of the 400A, it was necessary to develop known voltages ranging from 3 millivolts to 300 volts, at frequencies from 10 cycles to 1,000,000 cycles. HP engineers solved the problem by building a unique voltage generator

which would function as a test set by generating known voltages over the entire range of the Model 400A. Circuits were devised to develop 160 different combinations of voltages and frequencies, each a separate calibration point for the 400A. Each of these voltages is related to the other with an accuracy of better than 1/2%. The absolute magnitude of each voltage is held to better than ±1%. This voltage is compared regularly with standard laboratory instruments of high accuracy. The voltages which are developed are sinusoidal so that no error in calibration is introduced by poor wave form.

DEPENDABLE ACCURACY

Because of this careful checking and re-checking, you can depend on the operating efficiency and accuracy of the Model 400A Vacuum Tube Voltmeter for many measuring jobs, including measuring voltages in

the audio, supersonic, and lower rf regions; amplifier gain; network response; output level; hum level; power circuit, high frequency, video, and carrier current voltages; capacity; and coil figure of merit. An outstanding feature of the -hp- Model 400A is that voltage indication is proportional to average value of the full wave.

For complete data on the Model 400A, and on other -hp- laboratory instruments, write today to Hewlett-Packard Company.

These -hp- Representatives Are at Your Service

Eastern Representative:

Burlingame Associates, Ltd.
11 Park Place
New York 7, N. Y.—Worth 2-2171

Midwestern Representative:

Alfred Crossley
549 West Randolph Street
Chicago 6, Illinois—State 7444

Western Representative:

Norman B. Neely Enterprises
7422 Melrose Avenue
Hollywood 46, California—Whitney 1147

Canadian Representative:

Atlas Radio Corporation
560 King Street West
Toronto 2, Canada—Wa 4761

HEWLETT-PACKARD COMPANY.

BOX 1199A • STATION A • PALO ALTO, CALIFORNIA

Audio Frequency Oscillators

Signal Generators

Vacuum Tube Voltmeters

Noise and Distortion Analyzers

Wave Analyzers

Frequency Meters

Square Wave Generators

Frequency Standards

Attenuators

Electronic Tachometers



More Efficient Production — Better Finished Product

AMPHENOL

One of the latest Amphenol developments is a loop antenna wire insulated with low-loss Copolene. The production advantages and the electrical superiorities of this wire are many, and the cost compares favorably with that of conventional wire commonly used for the purpose.

The Copolene dielectric acts as a flux during soldering operations — no stripping is necessary. It remains flexible and is easily wound on coil-

winding equipment. Best of all, it can be heat-treated for self-supporting coils and the finished coils may be heat-sealed to mounting boards — no cementing or stitching required. Copolene insulation is non-hygroscopic — saves labor and cost of impregnation with lacquer or waxes.

Radio set manufacturers and coil winders have found it profitable to take advantage of this new wire. Write today for complete information.

Basket-Weave
Type

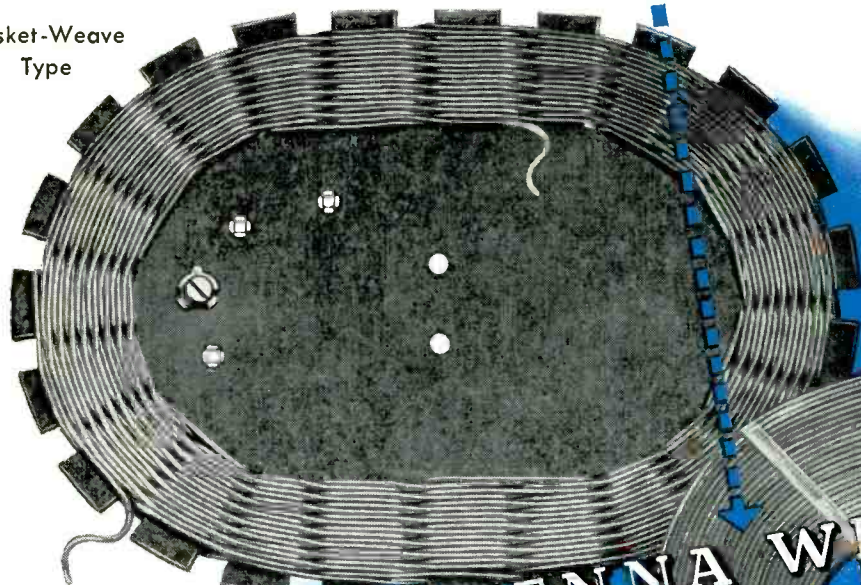

Other Special Properties of Amphenol Loop Antenna Wire:

Physical — Impervious to oil, solvents, moisture, sunlight • Remains flexible down to -70°F • #24 solid wire, covered with Copolene in wall thicknesses of .005", .010", .015" and .020" • Other wire sizes and dielectric wall sizes in production or available on special order.

Electrical — Lower distributed capacity • Higher Q than cotton or paper covered wire • Every foot spark tested • Copolene has a power factor of .00035 to .00045 and a dielectric constant of 2.29.

LOOP ANTENNA WIRE

Self Supporting,
Heat Sealed



AMERICAN PHENOLIC CORPORATION

Chicago 50, Illinois

In Canada • Amphenol Limited • Toronto

COAXIAL CABLES AND CONNECTORS • INDUSTRIAL CONNECTORS, FITTINGS AND CONDUIT • ANTENNAS • RADIO COMPONENTS • PLASTICS FOR ELECTRONICS

ANNOUNCING—THE RCA ELECTRONIC METAL DETECTOR



See it at the Plastics Show

... Protects product quality, prevents machinery damage

This new unit provides a quick, sure way to detect metal particles, of any kind, in non-metallic materials.

The product being inspected—such as plastic preforms—is conveyed by belt or other means through the inspection aperture.

Here it is screened by a high-frequency electromagnetic field and, if metal is present, causes a reaction which is detected by an electron-tube amplifier. This, in turn, triggers a bell or lamp and the faulty product is automatically rejected and/or marked.

Small, as well as large pieces of metal, are detected even when deeply embedded in the material. Discrimination can be adjusted to fit condi-

tions. Operation is rapid—conveyor speeds up to 600 feet a minute are possible without loss of efficiency. It is easy to operate. Operating costs are low—uses only 140 watts. Installation is easy—"all-in-one" construction simplifies wiring, saves space. Available in 4-, 7-, and 12-inch aperture heights to meet varying product requirements.

You will find that this RCA electronic metal detector will quickly pay for itself by preventing machinery damage, reducing lost production time, and increasing customer good-will. Write for new bulletin *today*. Radio Corporation of America, Dept. 30-D, Electronic Apparatus Section, Camden, N. J.

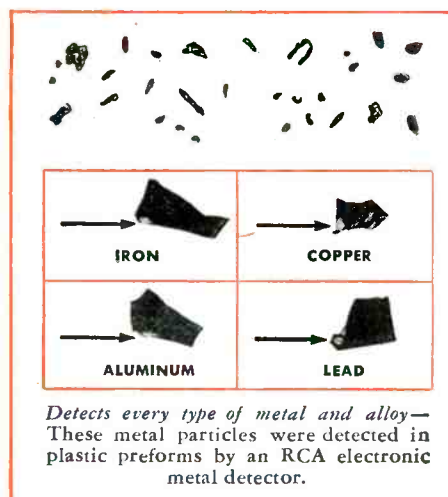

Detects every type of metal and alloy—
These metal particles were detected in plastic preforms by an RCA electronic metal detector.



ELECTRONIC EQUIPMENT

RADIO CORPORATION of AMERICA

ENGINEERING PRODUCTS DEPARTMENT, CAMDEN, N. J.

1921

YESTERDAY

This generator cutout (replacement) for the automotive industry was the original product of R-B-M in 1921. Soon other automotive electrical control devices were added.

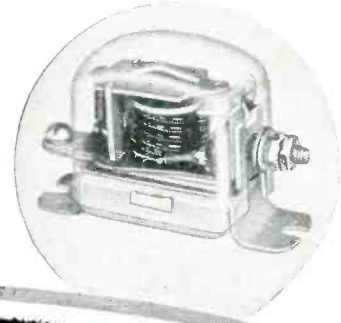

A QUARTER CENTURY OF PROGRESS

1946

TODAY

R-B-M has grown steadily through the years, building an enviable reputation as a leading manufacturer of manual and magnetic controls for a wide variety of applications that are known for their sound engineering, good construction and reliable performance.



Heavy Duty Toggle Switch



Multi-pole A. C. Relay



Heavy Duty Starter Button



Magnetic Starting Solenoid

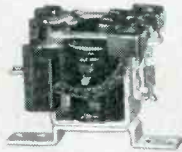

D. C. Magnetic Relay



A. C. Magnetic Relay



Standard Duty Push Button



Reverse Current Contactor



Electronic Relay

These are but a few representative products made by R-B-M.

Write for FREE catalog of complete line. Address Dept. A-4.



R-B-M DIVISION
ESSEX WIRE CORPORATION
LOGANSPORT, INDIANA

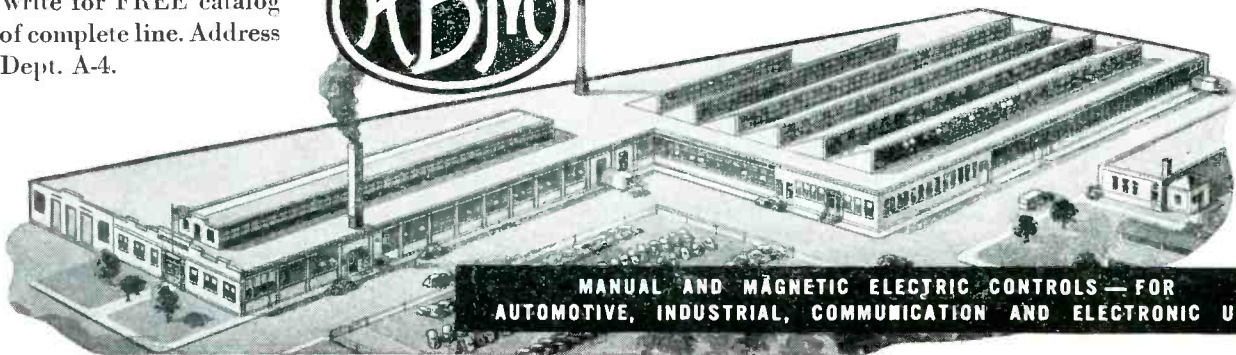

MANUAL AND MAGNETIC ELECTRIC CONTROLS — FOR
AUTOMOTIVE, INDUSTRIAL, COMMUNICATION AND ELECTRONIC USE

DESIGNED AND ENGINEERED AT NO. 1 PLASTICS AVENUE

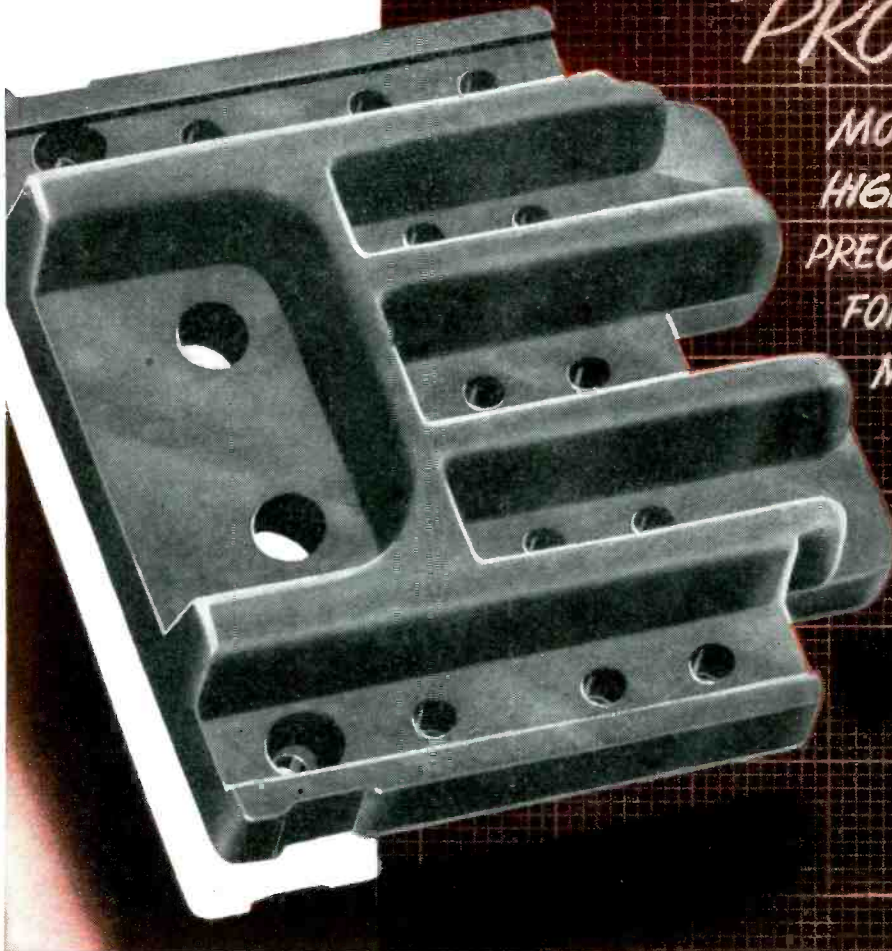

PROBLEM—

MOLD END SHIELD FOR
HIGH-FREQUENCY RELAY—
PRECISION HOLE ALIGNMENT
FOR EASY ASSEMBLY OF
MOVABLE CONTACTS.

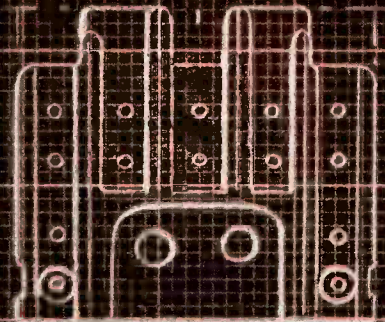

G-E mycalex lines up another high-frequency job

● A sensitive high-frequency relay that operates under high temperatures needed an end shield. This plate had to be made of low-loss insulating material . . . flat . . . and with accurate hole "line-up" for the assembly of many electrical contacts.

This problem was solved at No. 1 Plastics Avenue by new techniques in molding G-E mycalex—compound of glass and powdered mica with a unique combination of properties.

Note the sixteen holes—they are molded into this rigid material. And the part, as it comes from the mold, is *finished* with all tolerances satisfactory for

trouble-free mass assembly methods. Why not find out more about G-E mycalex and the techniques which have been developed for molding it?

SEND FOR YOUR OWN COPY. A new bulletin on G-E mycalex is just off the press. A helpful design handbook, it contains complete and up-to-date information for solving your high-frequency insulation problems with G-E mycalex—a hard gray-colored, stonelike material with a unique combination of properties. Find out about new grades of G-E mycalex and new G-E mycalex molding techniques which make wider and more economical applications now possible. Fill in the coupon and mail it today.

GENERAL  **ELECTRIC**

CI-46-M9



PLASTICS DIVISIONS (S-9), GENERAL ELECTRIC COMPANY
1 Plastics Avenue, Pittsfield, Mass.

Please send me the new G-E mycalex Bulletin.

Name _____

Firm _____

Address _____

City _____ State _____

★

YOU SELL IT... WE'LL MAKE IT!

★

Maybe it was Napoleon—or was it Washington . . . but no matter who said it, any military strategist knows you have a better chance of winning if you “divide to conquer”. That goes for business and industry too! And particularly during “re-conversion”.

If you are in the race to get those new products of yours to the market . . . to entrench yourself with the best distributors and dealers . . . you may find it good strategy to divide the problem into its two principal theaters—production and marketing. *Then concentrate!*

Why not by-pass the production bottle-necks?

Undoubtedly some of your products, or at least certain assemblies, will be delayed by in-plant problems. Why not isolate them?

Then by-pass them by calling in a good contract manufacturer and putting the problem on his shoulders. If he's *good* he'll probably have some short-cuts up his sleeve that may cut tooling-up time—yes, and costs, too! And you'll get that finished product of yours off the line and to the market ahead of the other fellow, while he's still sweating out his production head-aches.

“Let Lewyt Do It” and maybe even save you money

Contrary to the war-time experience of some primes, sub-contracting is not wasteful or inefficient. Quite the contrary.

A *good* contract manufacturer who has had long experience in making parts, assemblies and even complete products for others, can integrate his production with the other fellow's assembly line, and even improve the delivery schedule.

Here at Lewyt we've been at this business of contract manufacturing for over fifty years. We are no war-baby. The stop watch and a sharply pointed pencil are no strangers to us.

Maybe we can turn a trick for you. Why not call us in and see what it is we've got, that makes a lot of America's top-drawer industries say it pays to “Let Lewyt Do It”.

* * *

Write on your business stationery for 48-page book, “Let Lewyt Do It”—the story of the Lewyt organization in pictures. Lewyt Corporation, 62 Broadway, Brooklyn 11, N. Y.



FOR MORE THAN 50 YEARS A CONTRACT MANUFACTURER . . . EXPERTLY STAFFED TO PRODUCE COMPLETE ELECTRONIC AND MECHANICAL ASSEMBLIES, COMPONENT PARTS, SUB-ASSEMBLIES AND METAL PRODUCTS TO THE MOST EXACTING REQUIREMENTS

AGAIN! MB MAKES NEWS IN VIBRATION CONTROL!

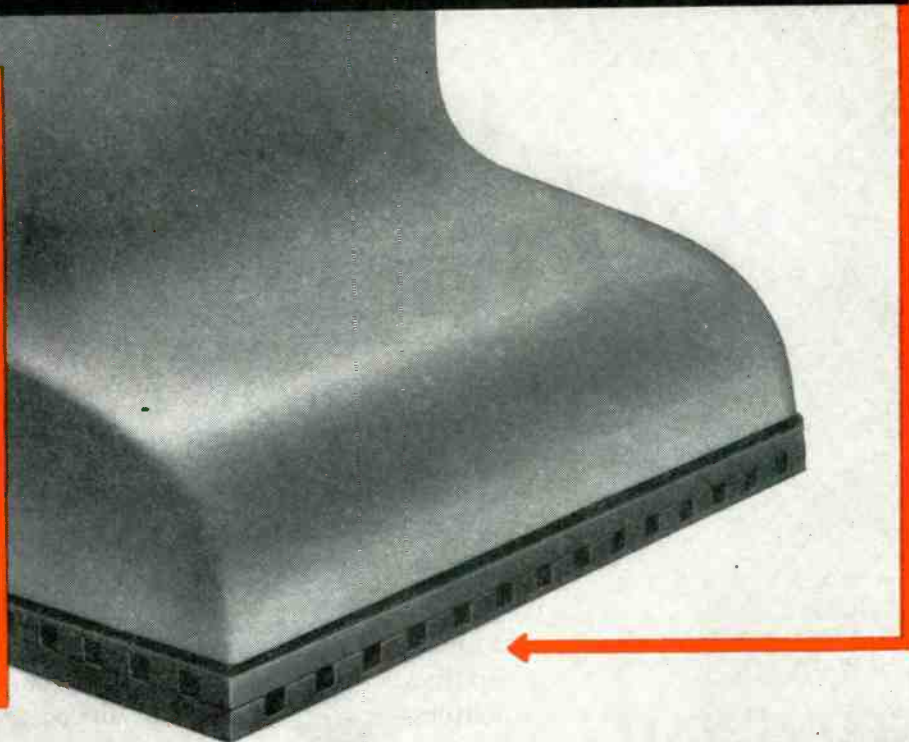
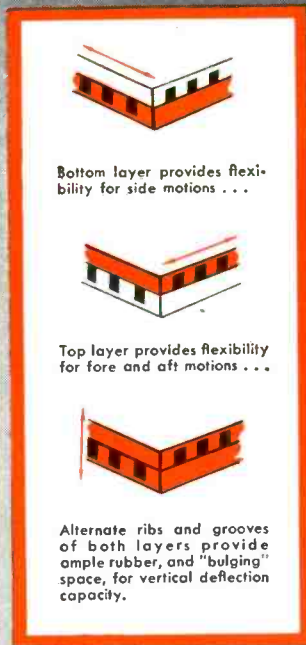

MB PADS cushion and control vibration in flat-based products!

EASY, ECONOMICAL REMEDY for your products with the "shakes"—this new development by MB vibration specialists. Simply installed, MB isolating pads effectively confine vibrations normally transmitted through the base.

Deadening these disturbing, and oft-times destructive, impulses is accomplished with minimum computation . . . and with no design changes! Total area of pads is determined by weight to be supported. (A loading of 50 lbs. per sq. inch gives a deflection of 1/16 in. per pad thickness.)

Though simple in construction, its operating principle is unusual. Two accurately ribbed layers of resilient, long-lived, oil-resisting synthetic rubber are cemented together so that ribs are mutually perpendicular. Flexibility is thus combined with stability in *all* directions. The ratio of vertical to horizontal spring rate is small, for efficient absorption of both vertical and side-thrusting impulses!

Net result: unusual noise reduction, increased physical comfort, minimum disturbance effects. Added to which is the elimination of anchoring requirements . . . MB Pads stop "creeping" machines in their tracks.



Versatile, adaptable MB Pads have unlimited uses. They can be applied between automotive frame and body for cushioned comfort . . . to textile machines . . . to punch presses, lathes, and other machine tools . . . even to business machines.

These product-improvers will fit into your plans at low cost. Let MB engineers point out how. Write for full information.

THE
MB MANUFACTURING COMPANY, INC.
327 East Street, New Haven 11, Conn.



VIBRATION ISOLATOR UNITS AND MOUNTINGS • SPECIAL VIBRATION TEST EQUIPMENT

The Seven Keys to **BETTER PROPERTIES!**

This new insulating material with the resins and glass base developed for many war applications presents many advantages.

**FORMICA
LAMINATED
PLASTICS**

MF-66

1 Its power factor and dielectric constant closely approaches that of many ceramics and other high quality insulators, and it can perform many of the functions it was once thought only ceramics could fulfill.

2 At the same time MF-66 has the special advantage of mechanical strength to stand up under sharp blows.

3 It withstands vibration that is so often present where airplanes, ships, and ground installations are concerned.

4 MF-66 dimensions are stable under changes of humidity.

5 It withstands changes of temperature.

6 MF-66 also resists the growth of fungi as it contains no cellulose.

7 MF-66 has the characteristic Formica machinability and workability which permits fast mass production and notable labor saving.



THE FORMICA INSULATION COMPANY, 4661 SPRING GROVE AVENUE, CINCINNATI 32, OHIO

THIS NEW WESTINGHOUSE THYRATRON PROVIDES A

12 to 1

RATIO OF PEAK TO AVERAGE ANODE CURRENT

The new Westinghouse WL 624 is capable of delivering 6.4 amperes average and 77 amperes peak current at 2500 volts peak inverse. The 12 to 1 ratio of peak to average anode current when considered with its averaging time of 15 seconds, is of great importance in motor-speed control applications. It is important also in welding applications where the thyatron conducts the actual current to the welder. The tube utilizes a shield grid which reduces the anode to control grid capacitance, enabling the designer to minimize the possibility of the tube losing control because of surges in the anode circuit. The shield grid also makes possible the use of very low control power.

The WL 624 employs a control-grid structure of very large area which radiates directly through the glass envelope rather than into the other metal parts—an important feature for a shield-grid tube.

The tube is designed for the rough service encountered in many industrial applications and is equipped with a rugged industrial base.

For further information, call your nearest Westinghouse Office or write Electronic Tube Sales Department, Lamp Division, Westinghouse Electric Corporation, Bloomfield, N. J.



General Characteristics

Air cooled tetrode	
Heater voltage	5.0 volts
Heater current	10.0 amperes
Cathode heating time	5 minutes
Tube voltage drop	15 volts
Control characteristics	negative

Maximum Ratings Up to 150 Cycles

Anode voltage, peak forward	2500 volts
Anode voltage, peak inverse	2500 volts
Anode current, average	6.4 amps.
Anode current, peak	77 amps.
Anode current, surge, for design only	770 amps.
Averaging time, anode and grid currents	15 seconds
Temp. range, condensed mercury	+ 40°C to + 80°C

Westinghouse

Electronic Tubes at Work

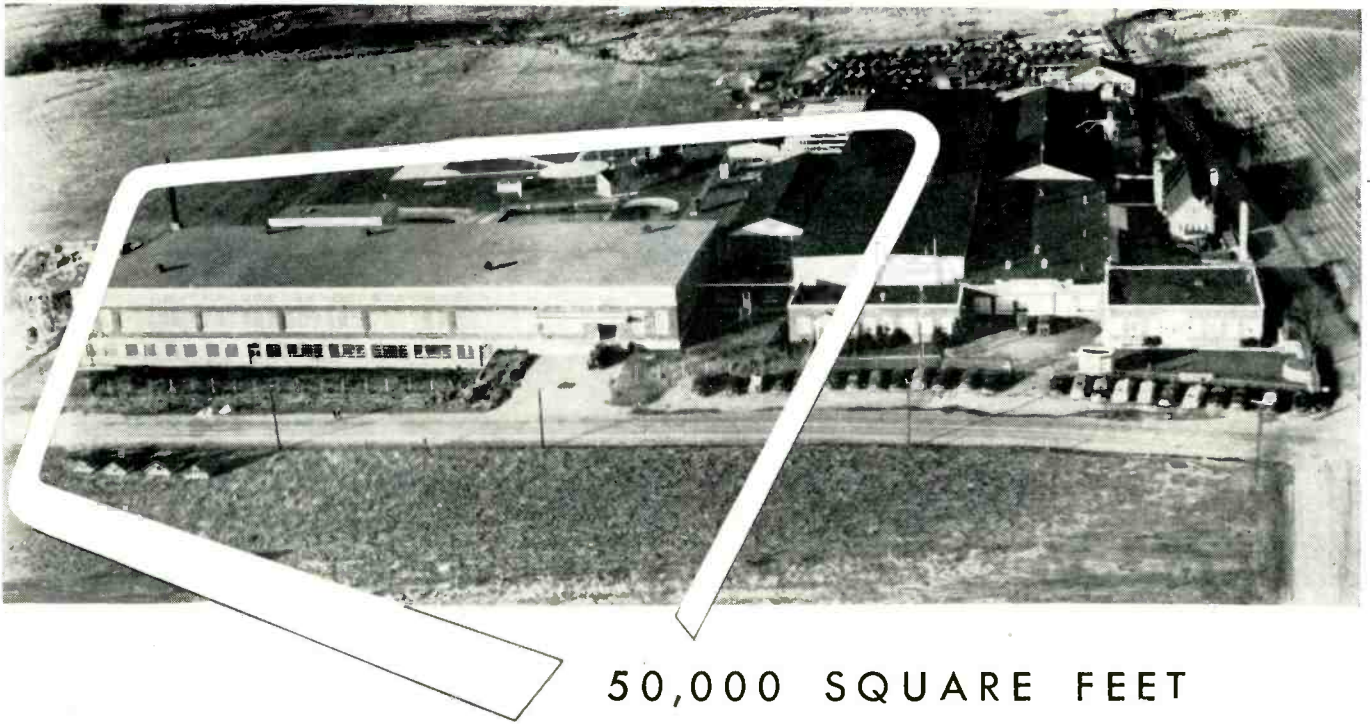

50,000 SQUARE FEET

A Monument to Quality

We present a new mill, set aside for the production of metal tubing for the electronics industry.

Control of analysis, dimensions and tolerances — uniformity in performance of cathodes, anodes, Seamless and Lockseam* and other parts — laboratory for development of new materials and for exhaustive study of present ones — a mill to which the industry can look for leadership in the solving of tubing problems.

Production experience is joined with the most modern equipment, to supply you with Superior tubing.

The size range is still $\frac{5}{8}$ " OD down to the smallest.

*U. S. Patented

THE BIGGER
NAME IN SMALL TUBING
Superior



SUPERIOR TUBE COMPANY
NORRISTOWN • PENNSYLVANIA

NOW, THEY'RE HERE!



**PRICE
CO-AXIAL
RELAYS**

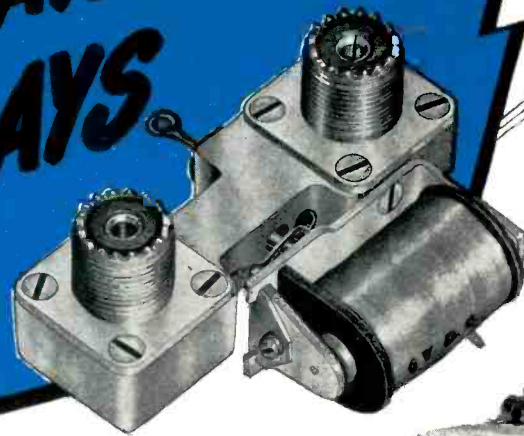
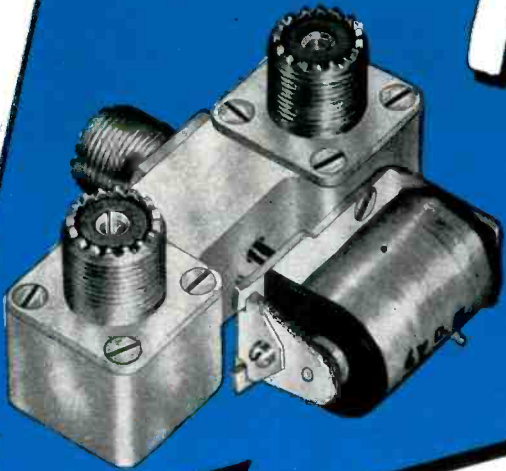

Recommended for:
RAILROAD COMMUNICATION
POLICE RADIO
TELEVISION
AIRCRAFT RADIO
PHOTO - CELL
 And Other Mobile Or
 Stationary Applications

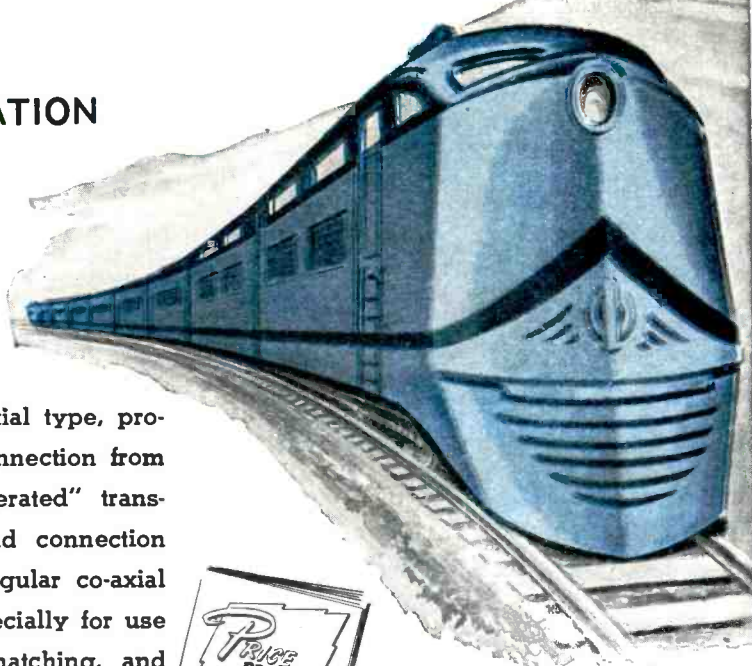

A compactly designed relay of co-axial type, providing for the transfer of antenna connection from "normal" receiving position to "operated" transmitting position, with receiver-ground connection when transmitting. Equipped with regular co-axial type cable fittings and designed especially for use in applications where impedance matching, and standing-wave ratio are of primary importance.

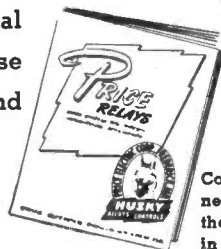

Complete details of our new co-axial relays and the many other relays in the Price line are given in our catalog. Write for it today.



PRICE ELECTRIC CORPORATION
 (Formerly Price Bros. Co.)
RELAYS AND OTHER DEVICES FOR ELECTRONIC AND INDUSTRIAL APPLICATIONS
FREDERICK, MARYLAND

**Engineered by AMP—Specialists
in Solderless Wiring Devices**

Whatever your product — toasters, airplanes, or electron microscopes — there is an AMP Solderless Wiring Device that is **JUST RIGHT** for every connection in it.

Whatever your wiring problem, AMP has the answer. AMP engineers have pioneered the major developments in solderless wiring. They are specialists. Their knowledge and experience are yours for the asking. Let them show you how AMP Solderless Wiring Devices can speed up your production, reduce your costs, improve the quality of your product. Write today.

**An AMP Solderless
Connection
FOR EVERY PURPOSE
AMP TERMINALS
for { Super Performance
General Purpose Uses
Low Cost Competition**

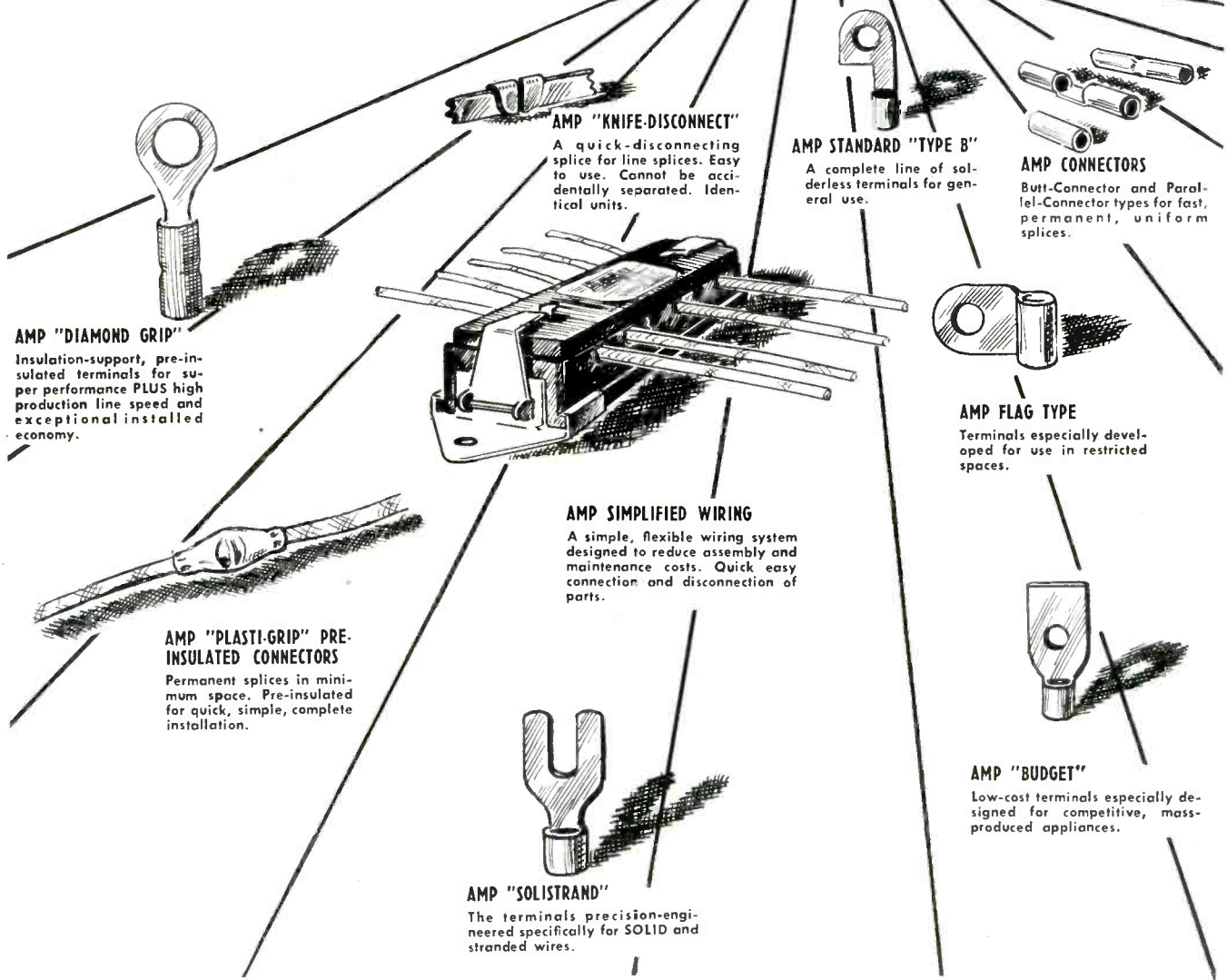

Any of these types of AMP terminals are available in a wide range of wire sizes, stud sizes, and tongue shapes.



AIRCRAFT-MARINE PRODUCTS Inc.
1521-53 NORTH FOURTH STREET, HARRISBURG, PA.
DAVID C. ORROCK, 1405 Bishop St., Montreal, Que.
In Canada: F. N. ADAMS, 726 Homer Street, Vancouver, B. C.
F. MANLEY CO., 43 Victoria Street, Toronto, Ont.

**PROMPT DELIVERY ASSURED -
ANY QUANTITY ON SHORT NOTICE!**

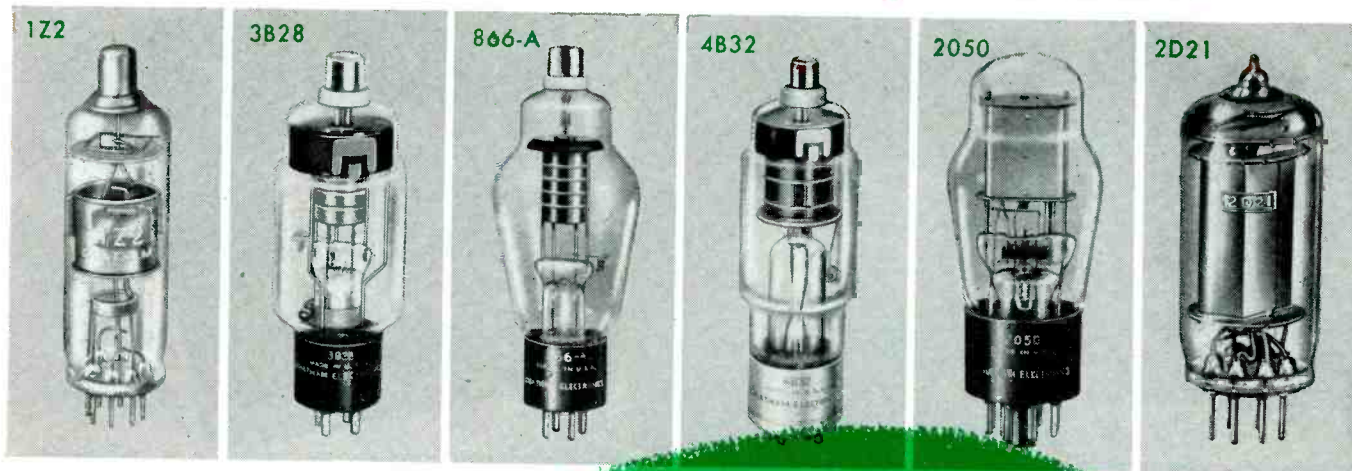

FOR INDUSTRY...

CHATHAM
HIGH VACUUM • MERCURY VAPOR • INERT GAS
RECTIFIERS

...FOR COMMUNICATIONS

These popular types and many other CHATHAM rectifiers can be supplied direct from stock to meet immediate needs. Because CHATHAM production is devoted exclusively to producing vacuum, mercury vapor and inert gas rectifiers, these tubes embody many special mechanical and

electrical features that lengthen life and improve performance. As a result of specialized rectifier engineering and production, this plus factor in design and construction involves no price premium. For complete details on CHATHAM rectifiers and thyratrons, call or write today.



CHATHAM ELECTRONICS

475 WASHINGTON STREET, NEWARK 2, NEW JERSEY

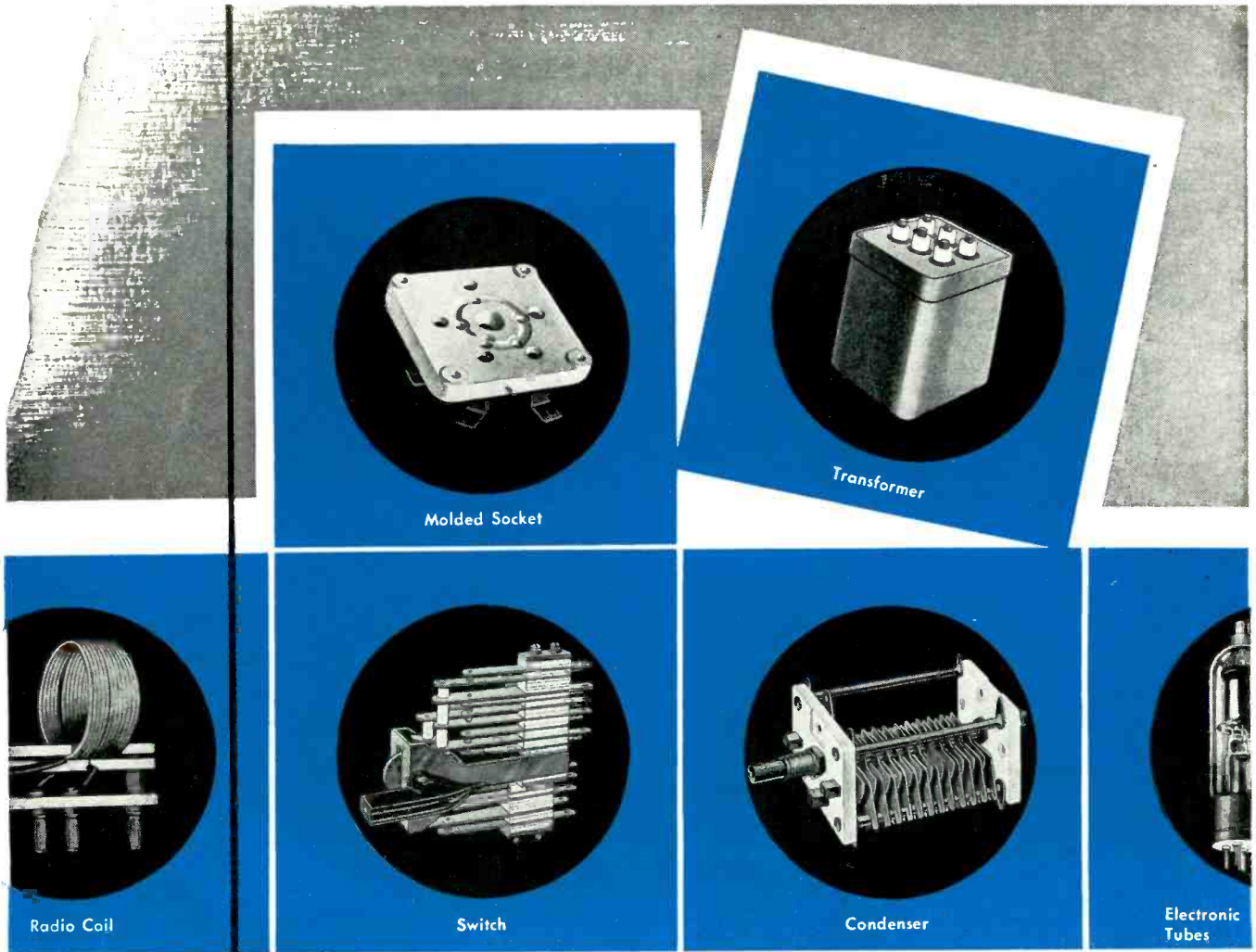

HOW MYCALEX BUILDS BETTER PEACETIME PRODUCTS

As high frequency insulating standards become more exacting, the more apparent become the many advantages of MYCALEX over other types of materials . . . in building improved performance into electronic apparatus.

For 27 years MYCALEX has been known as "the most nearly perfect" insulation. Today improved MYCALEX demonstrates its superior properties wherever low loss factor and high dielectric strength are important . . . where resistance to arcing and high temperatures is desired . . . where imperviousness to oil and water must be virtually 100%.

New advancements in the molding of MYCALEX now make available the production of a wide variety of parts with metal inserts or electrodes molded in to create a positive seal.

It pays to become familiar with the physical and electrical properties of all three types of MYCALEX — MYCALEX 400, MYCALEX K and MYCALEX 410 (MOLDED). Our engineers invite your inquiries on all insulating problems.



MYCALEX CORPORATION OF AMERICA

"Owners of 'MYCALEX' Patents"

Plant and General Offices, CLIFTON, N. J.

Executive Offices, 30 ROCKEFELLER PLAZA, NEW YORK 20, N. Y.

LOAN TO BRITAIN

... Investment in World Economic Unity

CONGRESS should give swift and confident approval to the proposed loan to Great Britain.

Few other issues of foreign policy in the present troubled world lend themselves to such clear appraisal of where our National interest lies.

In simplest terms, the question is whether we should extend to Great Britain a credit of \$3¾ billions (plus \$650 millions in payment for lend-lease balances) in return for her promise to repay principal with interest over a fifty year period starting at the end of 1951, and her pledge to give the fullest possible support to the kind of world trading system which it is the declared policy of both the United States and the United Nations Organization to promote.

We Can Afford to Make It

The sum we hazard is not inconsiderable, but financial risks have meaning only when related to resources. The line of credit provided by the loan will amount, at most, to a claim on 2/5 of 1 per cent of our gross output for the five to six year period over which it may be used. The interest rate charged, while moderate, is higher than our Treasury is paying upon current borrowings. The risk entailed is well within our resources as a creditor. In the considered judgment of the American and British technical experts who thrashed through the intricate accounting for three painful months, the amount and terms offered will suffice to allow Britain, under rigid austerity, to relax her system of foreign trade restrictions, and to expand exports sufficiently to pay her debt commitments.

Against the considered risks of extending the loan, there must be weighed the certain costs of refusing it. Without the loan, Britain has no recourse but to maintain and extend the system of bloc trading which she adopted under stress of world depression and world war. If that is the route Britain follows, she will carry with her a large part of the sterling area countries—all British Commonwealth and Empire countries (except Newfoundland and Canada) plus Egypt, Iraq, and Iceland—and many of the nations with which the United Kingdom has payment agreements (Argentina, Bolivia, Brazil, Chile, Paraguay, Peru, Uruguay, Belgium, Czechoslovakia, Denmark, Finland, France, Netherlands, Norway, Portugal, Spain, Sweden, and Turkey).

Altogether, the United Kingdom's orbit accounts for more than half of the world's imports

and exports combined. It likewise is crucial to the trade of the United States. In the years immediately preceding the war, the sterling area and payment-agreement countries provided just under one-half of both the import and export trade of this country.

Russia, of course, will continue to conduct her foreign commerce exclusively upon a state-trading basis. Before the war, the Soviet Union transacted only a little more than 1 per cent of foreign trade business, but its future sphere of influence will be large—conceivably embracing as much as 30 per cent of total international trade.

We Cannot Afford to Refuse It

If the weight of British influence in foreign trade is thrown toward the Russian pattern rather than toward ours, it is apparent that bloc trading, with all of its supporting devices—bilateral deals, exchange controls, import and export quotas, subsidies, currency manipulations and the like—will be the prevailing pattern for foreign transactions.

In self-protection, the United States would have no alternative but to conform to the dominant pattern. We should be forced to form our own bloc, and to enter into active economic warfare in bidding for trade concessions against the offers of our rivals. How well we would do this is problematical. To the game we would bring the largest economic potential in the world. But our handicaps would be equally impressive.

First, under a system in which political and economic motivations are inextricably fused, a democratic nation, and particularly one with a tradition of freedom in its domestic enterprise, would operate at a great disadvantage. We should inevitably be driven toward more and more government control of our entire economy.

Second, with a pattern of foreign trade in which our exports habitually are greater than our imports, our bargaining position in international trade is much weaker than our over-all economic strength would suggest. Under state-controlled trading we should still find it difficult to compete successfully without resort to loans, and under these conditions our loans would be supporting a system alien to our choice and interest.

Third, under a regimented system which made economic decisions subservient to political considerations, it is virtually certain that the volume of world trade would shrink. That was the clear experience of the nineteen-thirties. Thus, the

standard of living in the United States would suffer in common with all others, and we would be forced into a particularly drastic curtailment of certain war-expanded segments of our economy, at the very time when a large portion of the world is most in need of the products they can produce.

Weighing the Alternative Costs

In the years immediately ahead it is certain that from two-thirds to three-quarters of all international trade will be transacted either in pounds or dollars. If both circuits are linked in a determined effort to restore competitive world markets, to which buyers and sellers alike have access without discrimination, that will be the dominant system of foreign trade. If the sterling group with its satellites organizes a closed grid, our exclusive effort cannot preserve the trade pattern that we believe offers most to us and to the world.

No one can accurately measure the costs to the United States of refusing the loan and accepting the consequences. But unquestionably they would dwarf to insignificance the sum risked in the proposed credit. We would lose through the shrinkage of our trade, through the wrench of violent readjustments in our production patterns, and eventually through the curtailment of our over-all output below what it would be under an open rather than a closed system. We would lose heavily in economic liberty under a procedure that can be followed with success only by a close regimentation of production as well as trade.

Most of all, we would lose in prestige, through demonstrating that we are still unprepared to exercise a world leadership to which our giant stature as the possessor of almost half of the world's economic capacity entitles us. Once again we would be exhibiting to the world political feet of clay supporting an economic frame of heroic proportions.

It Is Far from a "Soft" Bargain

There has been some disposition in this country to regard the loan to Britain as a somewhat "soft" and generally unprecedented transaction that smacks of charity. This is the sheerest nonsense.

In the first place, the kind of economic system we want has never functioned and cannot operate now without a lender. For many decades prior to World War I Great Britain filled the creditor role. In 1913 her foreign investments totaled \$19 billions, and she not only made such transactions pay, but they proved her salvation through two grim wars. Her credits helped in the industrial development of a large segment of the world, including the United States. Of all the nations in the world, only the United States can assume now the mantle which Britain no longer can support.

In the second place, the terms of our proposed loan to the United Kingdom are far from easy. Britain put a substantially greater proportion of her relatively meager resources into the war than we did, and dissipated a large share of her foreign holdings in the process while accumulating an outside debt of crushing magnitude. On a per capita basis her internal debt is greater than ours. Many Britons feel that our proposed loan is too small, and its terms too rigorous. If the amount proves to be inadequate, we shall have to consider supplemental aid at a later date. But the majority believe that the present offer gives a fighting chance to restore the system of world trade that we and they both want, and upon which the World Bank, the Monetary Fund, and the International Trade Organization under United Nations aegis are based. It is certain that without our loan all of this will go by the board.

In the third place, our proposed loan is far from being without precedent. Canada, which is linked by far closer economic ties to us than to the Empire, already has provided for a loan to Britain of \$1,200,000,000. This amounts to almost a third of what we propose to lend, although Canada's population is less than 10 per cent, and her income is little more than 5 per cent of ours.

Shall the United States Lead or Follow?

The way to exercise leadership is to lead. Nothing could be more futile than to go half way toward establishing the economic order for which we stand, and then withhold the crucial measure that will make it work. Failure to approve the loan to Britain will be a clear default of leadership. Failure to approve it promptly will dissipate its effectiveness.

It has been officially stated that the British loan is a unique case that will establish no precedents for further credits to other nations. It is exceptional in its importance to our aim. But if the United States expects to make its economic program the dominant one for world trade, it must continue to exercise the creditor function without which that program cannot persist.

The most that we should ask is that future loan transactions be scrutinized as was this one to see that they offer comparable security and comparable return in support of the program for which we stand.

For the loan to Britain, it can be said that never before has one nation had an opportunity to gain so much at so little risk as has the United States in this uniquely decisive case.

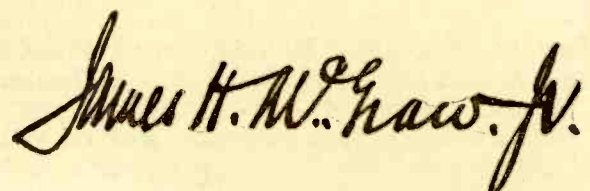

President, McGraw-Hill Publishing Co., Inc.



THE COUNTERSIGN OF DEPENDABILITY IN ANY ELECTRONIC EQUIPMENT

NEW ELEMENTS IN THIS EIMAC TRIODE ADD MANY EXTRA HOURS PERFORMANCE

- NEW** NON-EMITTING GRID!
- NEW** LOW-TEMPERATURE PLATE!
- NEW** FILAMENT STRUCTURE!

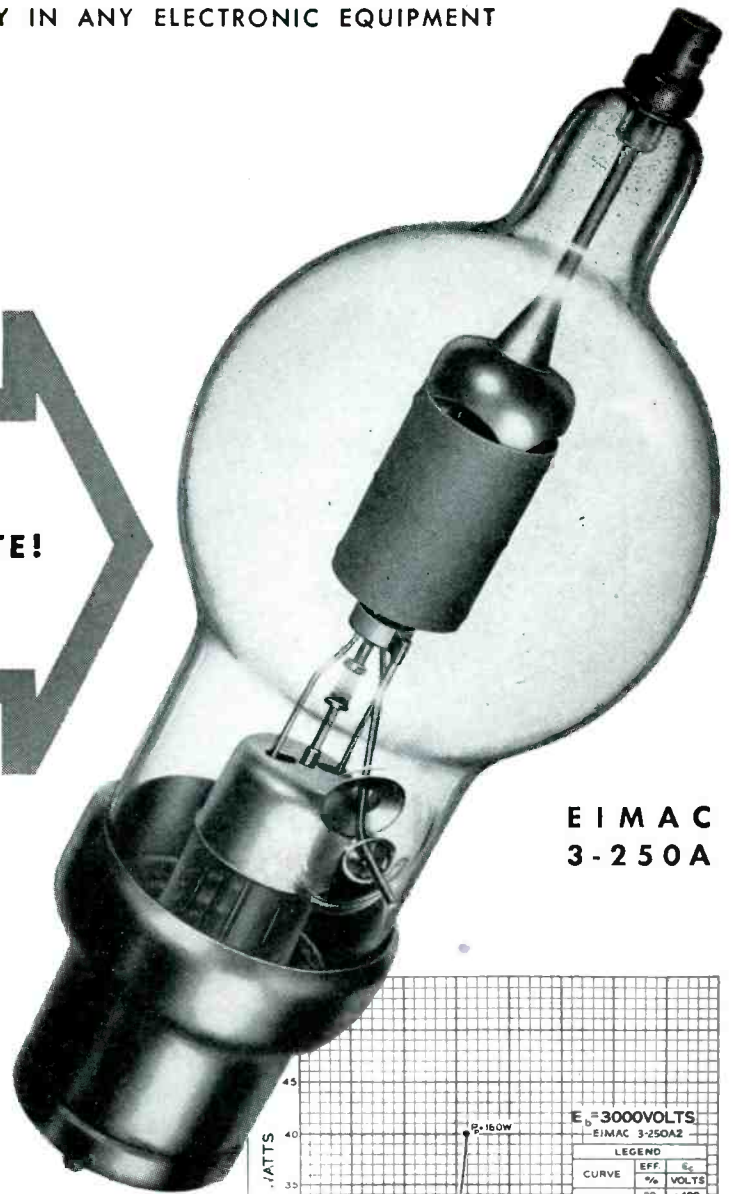

**EIMAC
3-250A**

Physically the new Eimac 3-250A triode is interchangeable with the old Eimac 250T. The new elements result in better performance and even longer life in a tube that has long been famous for its long life and stamina. This new tube is available in both low mu (3-250A2) and high mu (3-250A4) tube versions.

Its outstanding performance characteristics are exemplified by its low driving power requirements. For example, in Class C telegraphy, with 3000 plate volts on a single tube, the Eimac 3-250A2 (low mu) will deliver 750 watts output with only 29 watts (approx.) of driving power. (See chart.)

You can depend upon Eimac year in and year out for leadership in vacuum tube developments.* That's one reason why Eimac tubes are today, and have been for years, first choice of leading electronic engineers throughout the world.

*Ask your dealer to give you a copy of "Eimac Electronic Products" just off the press. Or write direct.

Follow the leaders to



EITEL-McCULLOUGH, INC., 1211 E San Mateo Ave., San Bruno, California

Plants located at: San Bruno, Calif. and Salt Lake City, Utah

Export Agents: Frazar and Hansen, 301 Clay St., San Francisco 11, California, U. S. A.

CALL IN AN EIMAC REPRESENTATIVE FOR INFORMATION

ROYAL J. HIGGINS (W9A10)... 600 South Michigan Avenue, Room 818, Chicago 5, Illinois. Phone: Harrison 5948.

V. O. JENSEN, General Sales Co., 2616 Second Avenue, Seattle 1, Washington. Phone: Elliott 6871.

M. B. PATTERSON (W5C1)... 1124 Irwin-Kessler Building, Dallas 1, Texas. Phone: Central 5764.

ADOLPH SCHWARTZ (W2CN)... 220 Broadway, Room 2210, New York 7, New York. Phone: Cortland 7-0011.

HERB BECKER (W6QD)... 1406 So. Grand Avenue, Los Angeles 15, California. Phone: Richmond 6191.

TIM COAKLEY (W1KKP)... 11 Beacon Street, Boston 8, Massachusetts. Phone: Capitol 0050.

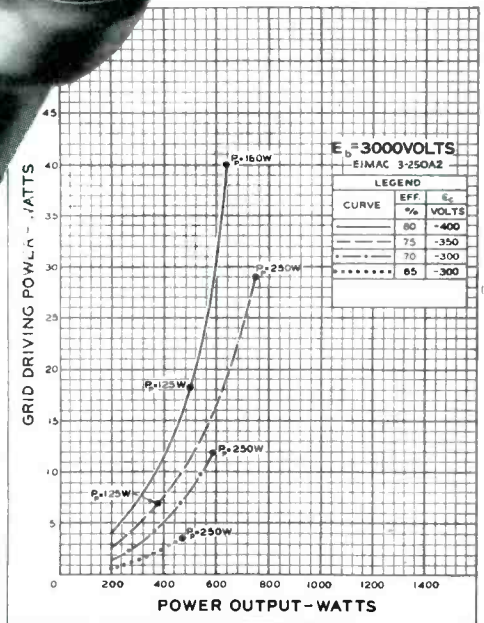

ELECTRICAL CHARACTERISTICS

	3-250A2	3-250A4
Filament: Thoriated tungsten	3-250A2	3-250A4
Voltage	5.0 volts	5.0 volts
Current	10.5 amperes	10.5 amperes
Amplification Factor (Average)	14	37
Direct Interelectrode Capacitances (Average)		
Grid-Plate	3.1 uuf	2.9 uuf
Grid-Filament	3.7 uuf	5.0 uuf
Plate-Filament	0.7 uuf	0.7 uuf

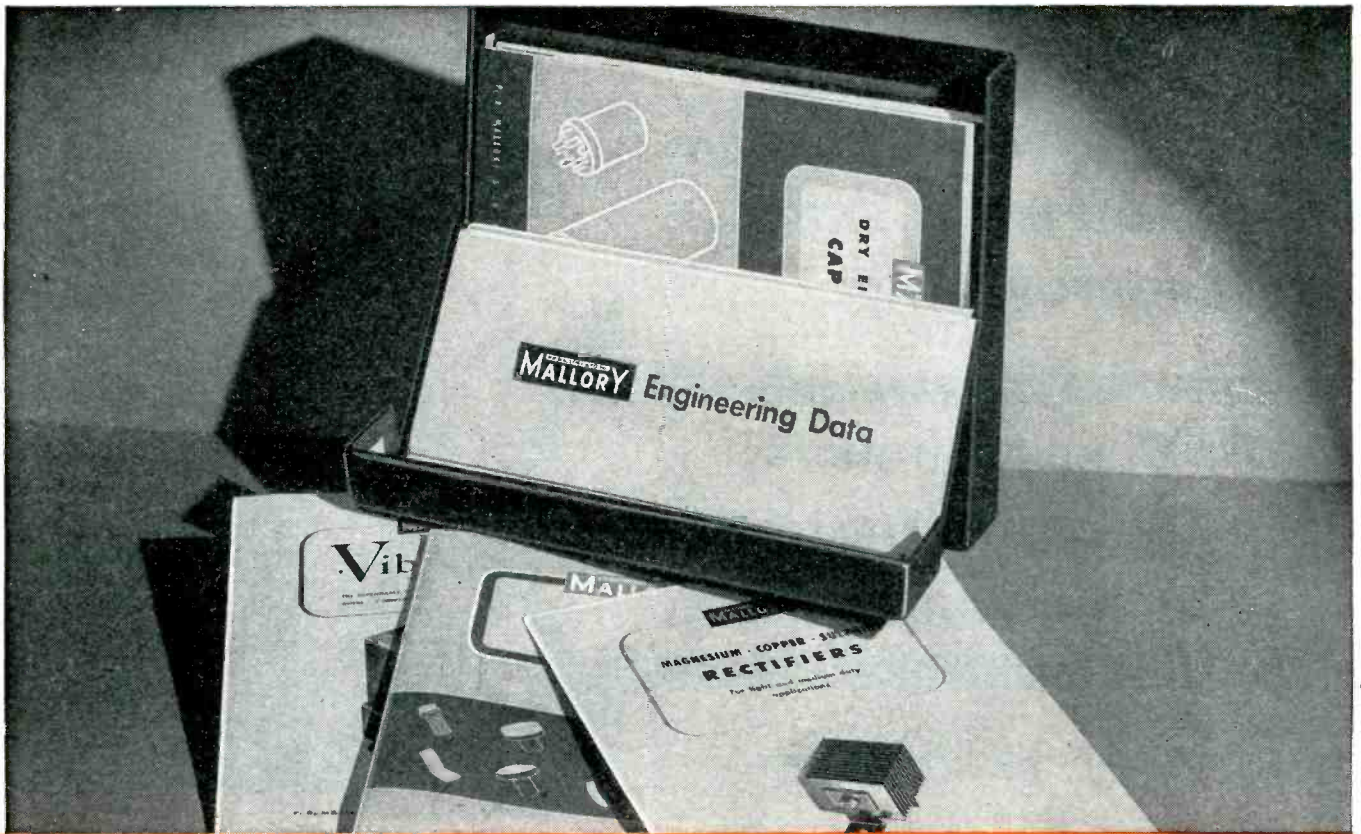

New!

Mallory Publications Portfolio FOR YOUR ENGINEERING LIBRARY

If you're like most Mallory customers, you don't buy just one Mallory product—you buy three, or four or more. And you'd like to have complete, current, factual information about *all* these products for ready reference.

That's why Mallory makes this new publications portfolio available. Complete with folders, bulletins, data books that you particularly need in your work—designed for convenience and accessibility—it represents the kind of extra service you expect and *get* from Mallory.

IN DESK DRAWER
OR FILE

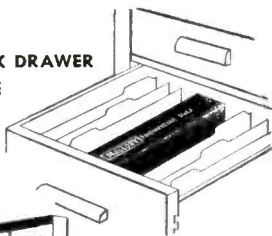

OPEN ON DESK

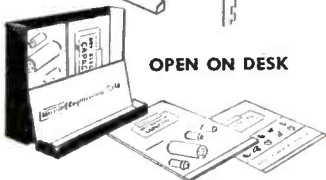

IN BOOKCASE

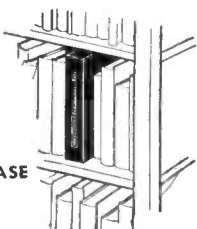

Just check over the list of Mallory printed matter listed below. Then ask your Mallory representative, or write direct for your Mallory publications portfolio.

Among other Mallory publications available to you are the Approved Precision Products Catalog • Electrical Contact Catalog • Electrical Contact Data Book • Capacitor Catalog • AC Capacitor Data Folder • Grid Bias Cells Data Folder • Heavy Duty Rectifier Catalog • RN Resistor Data Folder • Radio Interference Eliminator Folder • Radio Service Encyclopedia • Resistance Welding Catalog • Resistance Welding Data Book • RL and RS Switch Data Folders • Switch Data Book (in preparation) • Technical Manual • Replacement Vibrator Guide • Vibrator Engineering Data Folder • Vibrator Data Book (in preparation).

P. R. MALLORY & CO. Inc.
MALLORY APPROVED
PRECISION PRODUCTS

P. R. MALLORY & CO., Inc., INDIANAPOLIS 6, INDIANA



CROSS TALK

► **LORAN** . . . Arrival in New York Harbor of MS Gripsholm, the well-known Swedish-American luxury liner, with the first commercial installation of loran brightens the hope that this and other wartime developments will soon find their way into peacetime applications. As our readers know, loran is an electronic—and elegant—method of finding one's location on the face of the earth by determining accurately the time required for signals to reach the particular spot from two or more sets of transmitters whose position is accurately known.

This new aid to navigation does not measure the direction of arrival of the signals as do ordinary direction-finding systems. Like radar it does its important job by measuring the small but finite time nature requires for transmitting radio energy through space.

Without doubt passenger ships will carry loran and radar. The latter enables the ship master to see where he is in the dark or in fog, particularly with respect to nearby objects. The combination of loran for long-range and radar for short-range position-finding should prove to be marvelous steps toward complete safety at sea.

Whether cargo vessels will carry loran or radar may turn out to be another story. Insurance rates on ships at sea take into account aids to safety, and if there are no other charges than the purchase and ordinary maintenance of the equipment, the decreased insurance will pay for the new equipment. On the other hand, if an operator is required, then the additional navigation aids represented by loran or radar will add considerable overhead to the cost of running the ship.

In a highly competitive business like cargo shipping, fixed charges must be kept low. Wide adoption of radar or loran by cargo vessels—unless ordered by government—will hinge on the matter of whether extra operating personnel will be required. If the equipment can be operated by deck officers, or by an existing radio operator, and if no additional help is

needed, then these new aids to navigation will find their place in ships at sea as they have in ships of the sky.

► **RESEARCH** . . . Recently a very large American manufacturer found that 10,000 stockholders expressed interest in company research while only 95 wanted to know more about company finances. Such a circumstance can only be a result of the war.

This is all to the good. Only by continuing research can standards of living in peace and success in war be sure. The disturbing factor, however, is the constant stream of researchers who pass through this editorial office who say "my company is cutting down on research—where can I find a job?"

What's the matter with the electronics industry? Is it losing its nerve?

► **FIRE** . . . So far the horizon shows no electronic device, except radio, which can be sold to the average American home. All such gimmicks proposed to date are either too expensive, are not necessary or are just plain silly.

The Christmastime Hartford fire in which aged inmates of a hospital lost their lives, the daily radio and newspaper reports of disastrous fires in which lives and farmer's stock are lost, indicate that some device, electronic or not, which would accurately and cheaply and surely give an alarm within one's own precincts of the approach of fire could be sold in untold millions to American home owners.

► **CROSSROADS** . . . At the request of the Navy Department, Donald G. Fink, Executive Editor of ELECTRONICS, has been granted a leave of absence for the period of the atom bomb tests in the Pacific to be associated with Captain Christian L. Engelman, Electronics Coordinating Officer of the project. Mr. Fink will leave some time around the first of April for Bikini Atoll, returning to his desk early in the Fall.

RADAR ECHOES



Dr. Harold D. Webb (right) adjusts the auxiliary tuning crystal in the lunar receiver while E. K. Stodola looks on. Behind Stodola is the nine-inch type-A indicator which records the echoes



Lt. Colonel John H. DeWitt, Jr., in charge of the project, at the power supply controls of the transmitter, a modified version of the SCR-271 early-warning radar used at Pearl Harbor. DeWitt is former chief engineer of WSM

The author, Jack Mofenson, adjusts the position of the waveform-monitoring stub. Over this transmission line traveled the 3-kw transmitted pulse and the millionth of a billionth of a watt echo



THE RECENT EXPERIMENTS performed by the Signal Corps Engineering Laboratories in receiving radar echoes from the moon have aroused much comment from engineers, astronomers and others engaged in technical pursuits. Although the scientific aspects of sending radio-frequency signals through the ionosphere are certainly of importance, the work done on the project is better classified as an engineering achievement. As yet, no long-term systematic observations have been made. This article is confined, therefore, to a discussion of the technical characteristics and general description of the equipment employed.

Briefly, the experiment consisted of transmitting quarter-second pulses of radio-frequency energy at 111.5 mc every four seconds in the direction of the moon, and detecting echo signals approximately 2.5 seconds after transmission. Display of the detected signals was audible as well as visible. Technically, the experiment utilized well-established radar techniques, but with radically different constants throughout the system. Considerations of pulse width, receiver bandwidth, transmitter power and the precise frequency of the returned signal due to Doppler effect, were such that careful attention had to be given to the design of the overall equipment.

After preliminary calculations were made concerning transmitter power, the reflectivity coefficient of the target, and receiver noise figure, it was apparent that receiving radar echoes from the moon was technically possible. Under the direction of Lt. Col. John H. DeWitt, a project called "project Diana" was set up in September 1945 to develop a radar system capable of transmitting r-f pulses to the moon, and detecting echoes more than 2 seconds later. Prior to entering the Signal Corps, Colonel DeWitt, who

at that time was chief engineer of Radio Station WSM in Nashville, Tenn., designed and constructed transmitting and receiving equipment for the purpose of receiving echoes from the moon. This equipment employed substantially similar transmitter power and frequency to that used by the Signal Corps, but the attempt was a failure due to insufficient sensitivity in the receiver. Colonel DeWitt's appreciation of the problem and personal supervision were the driving forces that made the present experiment successful. Assisting Lt. Colonel DeWitt were: E. K. Stodola, Dr. Harold D. Webb, Herbert P. Kauffman and the writer, all of Evans Signal Laboratory. Credit is also due the members of the Antenna and Mechanical Design Group, Research Section, Theoretical Studies Group and others.

The practical implications of radar contact with the moon are numerous. During the war the Germans used the V2 Rocket which climbed some 70 miles above the earth, and the future holds the unhappy prospect of missiles going far higher than this. The matter of transmission of radio signals to great distances above the earth for detection and control of such weapons becomes a problem of military importance. Further, the use of a reflector far beyond the earth for radio waves makes possible direct measurement of the ability of radio waves to penetrate the ionosphere. A more complete investigation in this direction is indicated. The possibility of using the moon as the reflector for a part-time long-distance point-to-point

electronics
WAR REPORT

By JACK MOFENSON

Evans Signal Laboratory
Belmar, N. J.

FROM THE MOON

Detailed description of the techniques underlying the first recorded radio transmission through outer space. Calculations show that the maximum range of Signal Corps radar on lunar target exceeds one million miles

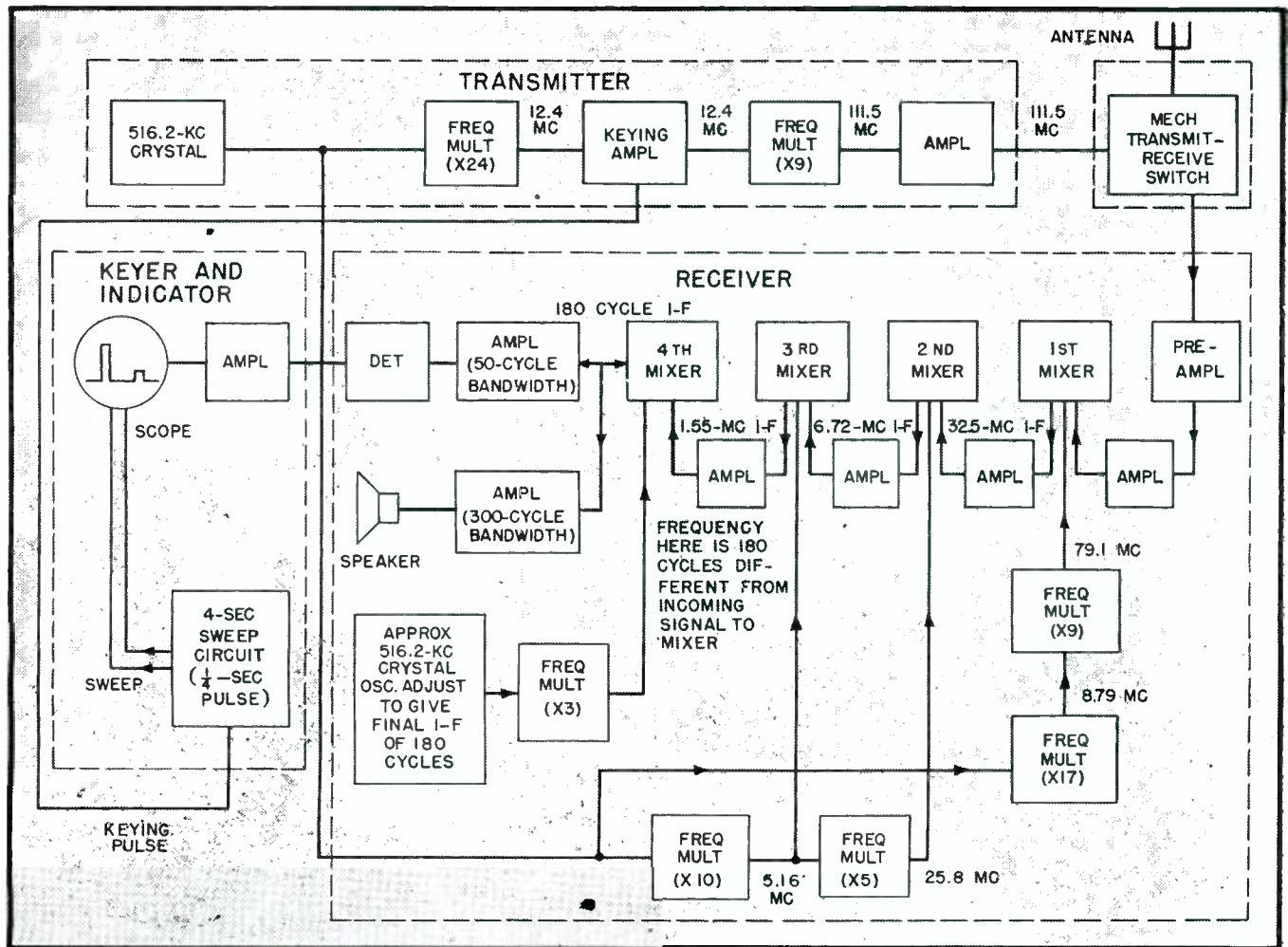

FIG. 1—Block diagram showing the essential elements of the system. Transmitter and receiver are controlled by the same crystal, permitting stable tuning of the narrow-band receiver relative to transmitter frequency

communication system is also being considered, as well as using the moon as a target to measure field-strength patterns.

Determination of Requirements

Several of the constants which determine the maximum distance at

which a radar set can detect targets are peak transmitter power, radio-frequency of the transmitted signal, duration of the signal, receiver noise figure, and target echoing area. These constants, among others, are concisely summarized in what has been called the free-space

radar equation.

$$r = \sqrt[4]{\frac{P_t A_o G_o \sigma}{P_r (4\pi)^2}} \quad (1)$$

This equation has already been derived in ELECTRONICS¹. In this equation, r is the radar range at which a signal may be detected, P_t is the transmitter power during the pulse,



Herbert Kaufman adjusts the bias on the high-level multiplying stages of the transmitter. Kaufman and the four others shown were the personnel of "project Diana"

G , the transmitting antenna power gain, A , the absorption area of the receiving antenna, σ the effective echoing area of the target, and P_r , the power of a barely discernible signal, on the same basis as P_t . The power gain due to ground reflections (not considered in the free-space equation) at maximum effectiveness increases the range of the system by a factor of 2. This is equivalent to a power gain of 12 db.

In the case of a target as large as the moon (2160 miles diameter), calculations showed that in order to receive an echo from the whole hemisphere of the moon at once a pulse width greater than 0.02 seconds was required. This set a lower limit on the transmitter pulse width which corresponds to an optimum bandwidth of 50 cps for the receiver. These requirements eliminate, for the present, the use of the microwave frequencies, because of considerations of pulse length.

Propagation studies indicated that electromagnetic waves at a frequency of 110 mc were capable of penetrating the ionosphere, and because of availability of equipment, a radar set operating at 111.5 mc was chosen for the experiment. The peak power available in this transmitter was equivalent to 3000 watts for P_t , using a 0.25-second pulse. The transmitter had the added advantage of being crystal controlled, deriving its final radio frequency after a series of frequency multiplications from a 516.2-kc crystal oscillator. The receiver associated with the transmitter was of the multi-mixer type (quadruple superheterodyne) capable of beating down radio-frequency signals to a final intermediate frequency of 180 cycles per second. Such an arrangement permitted use of an extremely narrow pass band, 57 cps, thus making the receiver highly selective and limiting the noise to a very low value. The extremely narrow-band receiver was an advantage, also, because it permitted tuning the receiver to the exact radio frequency of the returned echo. The importance of this can best be realized by considering the fact that due to the relative velocities of the earth and the moon, the returned signal may differ from the transmitted signal by as much as 300 cycles, due to the Doppler frequency shift. In using a highly selective receiver whose final mixer is tuned to receive the precalculated frequency of an echo return from the moon, the receiver rejects any signal returned at any other frequency.

To reduce the noise contribution of the receiver, a high-gain, low-noise-

figure pre-amplifier was connected between the antenna and the receiver proper. The minimum perceptible received power was P_r , readily calculated from the formula for noise figure.

$$\overline{NF} = \frac{E^2/4R}{KTB} \quad (2)$$

In this formula $E^2/4R$ is the maximum available signal power at the receiver input terminals in watts, where E is the signal voltage at the antenna terminals, and R is the effective impedance in ohms. KTB is the maximum available noise power at the receiver input, where K is Boltzmann's constant, 1.37×10^{-23} joules per degree Kelvin, T is the temperature in degrees Kelvin, chosen at 300 degrees, and B is the noise bandwidth of the receiver in cycles per second. For this receiver B is 57. For a one-to-one ratio Eq. 3 gives signal-power to noise-power of

$$P_r = \frac{E^2}{4R} = \overline{NF} KTB \quad (3)$$

1.48×10^{-18} watts, taking the effective noise figure of the receiver as 7 db.

The best antenna available at this frequency was a 32-dipole array utilized by the SCR-271 early-warning radar. Two of these arrays were secured side by side and mounted on a 100-foot tower. Calculations show that the array had a power gain of 152 times that of a single halfwave dipole antenna. Since the effective gain of a single dipole is 1.64 times that of an isotropic radiator, the value of G_t is given as 1.64×152 or 250.

The absorption area A_r of the re-

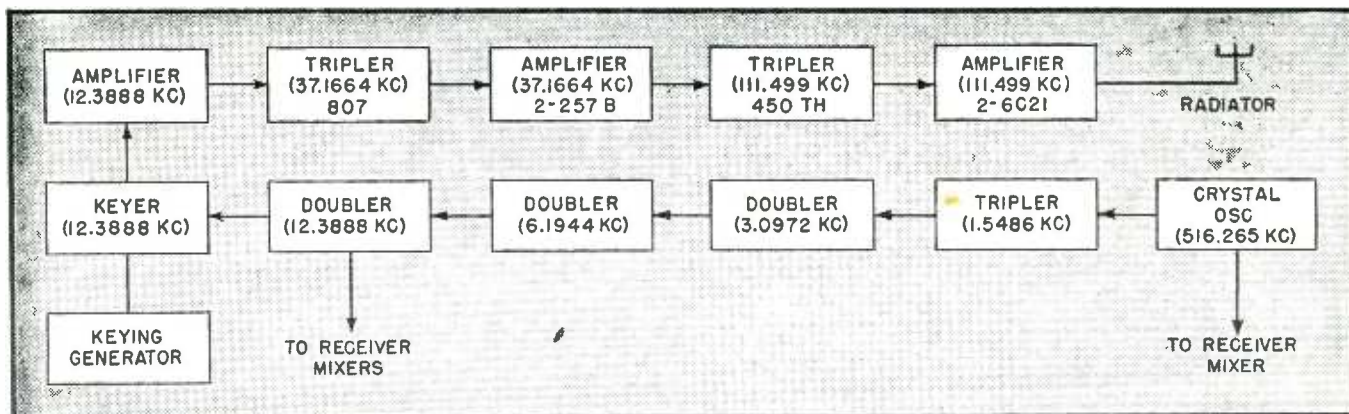

FIG. 2—Block diagram of the transmitter proper. This arrangement is a part of equipment designed for another purpose by E. H. Armstrong, adapted by the Signal Corps for the lunar studies

ceiving antenna is calculated from

$$A_e = \frac{G_o \lambda^2}{4\pi} \quad (4)$$

Substituting the value of G_o previously given, $A_e = 522.1 \times 10^{-7}$ square miles.

The remaining constant to be determined before solving Eq. 1 is σ the effective echoing area of the target. Calculations of the reflectivity coefficient made by Walter McAfee of the Theoretical Studies Group, assuming zero conductivity and a dielectric constant of six for the moon, resulted in the figure 0.1766. The effective echoing area is this figure multiplied by the projected area of the moon, $\pi d^2/4$ where d is the lunar diameter. This gave an effective echoing area of $0.1766 (2160)^2 (3.1416)/4$ or 647,000 square miles.

Substitution of these values in the free-space radar equation gave a maximum range of 573,500 miles and indicated that the effective range of the equipment chosen was more than twice that needed to receive echoes from the moon. By adding the power gain due to ground reflection, a further excess of power of 12 db or a range of 1,140,000 miles was indicated, which meant that according to calculations, the received signal should be about 20 db above thermal noise. This calculation of the signal strength of the returned echo checked closely with observations, and indicated that no appreciable attenuation occurs in free space.

Transmitter

Once the determination of constants was completed, the choice of available radar sets was made. Since no attempt was made to design major components specifically for this experiment, the selection of receiver and transmitter was made from equipment on hand. A crystal-controlled radar transmitter and receiver designed by Major E. H. Armstrong for another purpose were selected since they met the requirements of power and bandwidth. A block diagram of the complete transmitting, receiving and indicating system is shown in Fig. 1.

The transmitter is crystal controlled, deriving its final radio frequency of 111.5 mc after a series of frequency multiplications from a fundamental crystal oscillator frequency

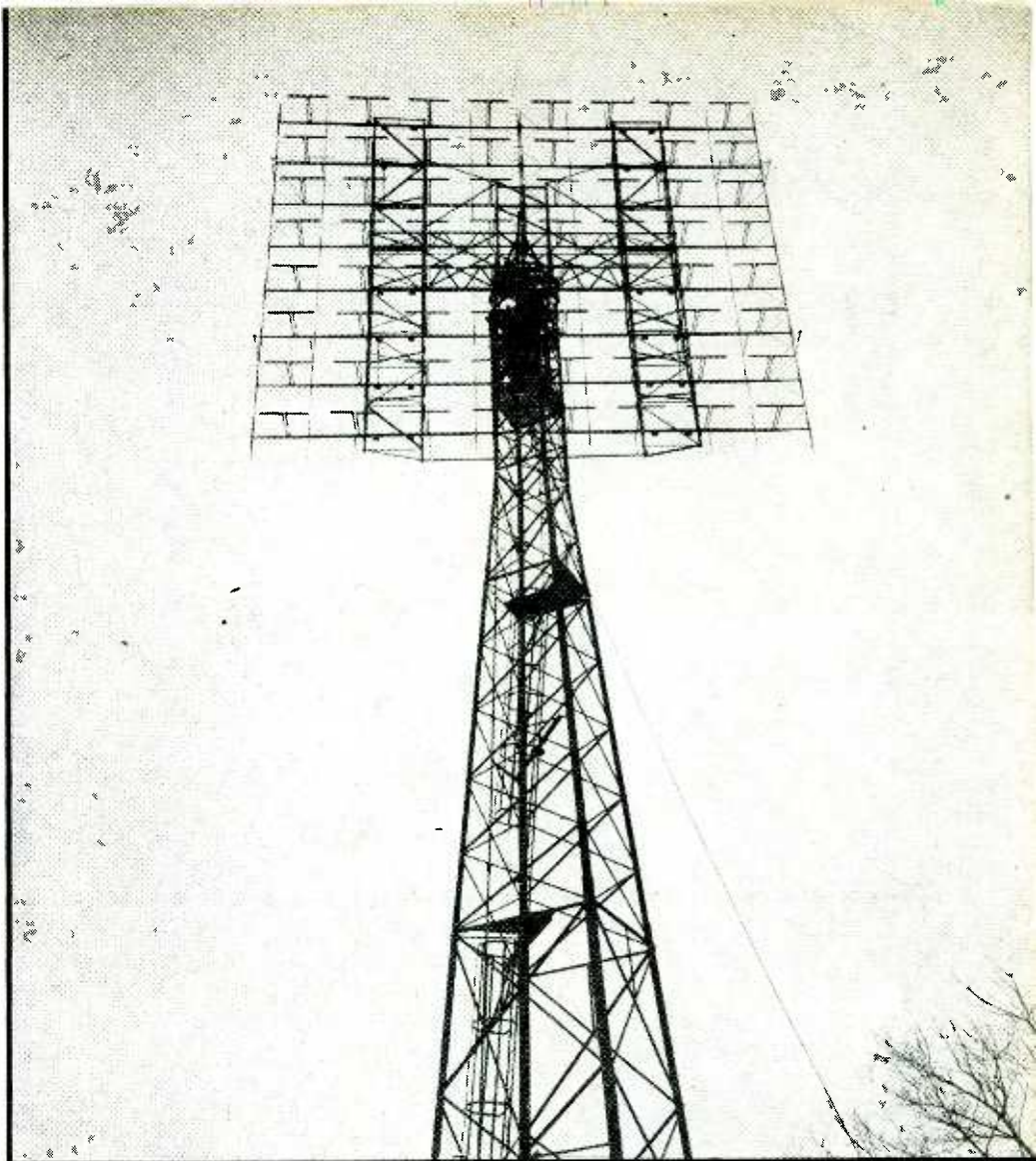

FIG. 3—The radiator consists of two standard SCR-271 "mattresses" mounted side by side, 64 dipoles in all. This 40-foot-square array is supported on a 100-foot tower. can look at the moon only at moonrise and moonset

of 516.2 kc. Keying is accomplished by causing a low-level multiplier stage to conduct by driving its cathode negative for the duration of the transmitted pulse. In the initial set-up, keying was performed mechanically by a relay, but this has since been replaced by an electronic keyer with the pulse width controllable between 0.02 to 0.2 seconds. A block diagram of the transmitter is shown in Fig. 2.

From the diagram it is apparent that the transmitter is of a conventional type. The output is fed over a 250-ohm open-wire transmission line to the antenna array. The antenna contains 64 dipoles horizontally polarized. The effective power gain of the array is 250, or 24 db.

The antenna, shown in Fig. 3, is mounted on a steel tower 100 feet high and is controllable in azimuth only. No provision has been made to incline the antenna in elevation. Because of this restriction, the times

of observation using the present equipment were necessarily limited to moonrise and moonset. That this condition of observation is the worst possible (due to the long path through the atmosphere and the consequent possibility of trapped radiation) has been recognized. But it was impractical to procure an array of the equatorial type. Aside from propagation deficiencies, a far more serious limitation was the fact that observations were limited to two short periods daily.

The beam width of the array is approximately 15 deg at the half-power points, with the first three lobes spaced approximately 3 deg in elevation. Since the diameter of the moon subtends roughly one half degree of arc, most of the power transmitted does not illuminate the target, which constitutes a serious waste of power. The rate of rise of the moon along its ecliptic is 1 degree of arc every

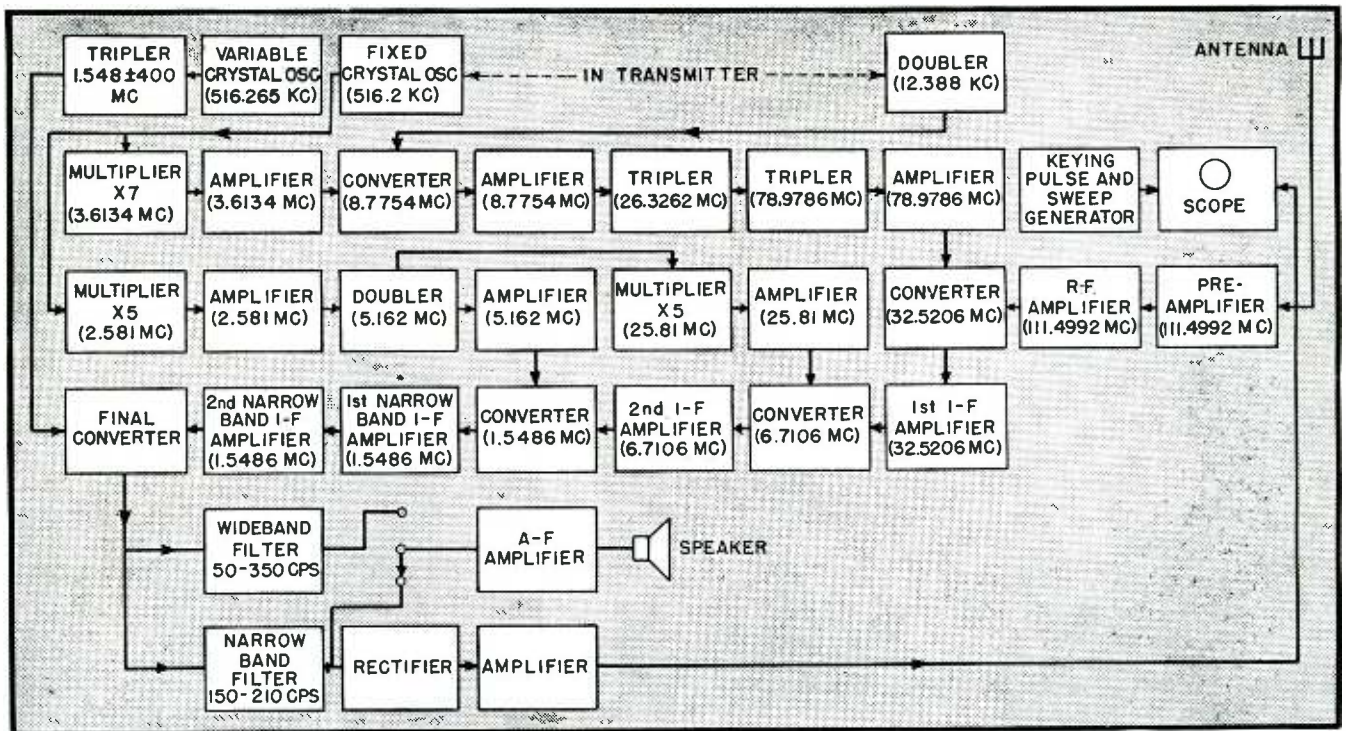

FIG. 4—Block diagram of receiver, a quadruple superheterodyne. Four mixers, controlled from transmitter crystal, keep receiver in tune, beat signal down to 180-cps i-f frequency. Visual as well as aural indications are provided

4 minutes, which allowed roughly 40 minutes of observation as the moon intercepted the first three lobes of the antenna. Bending effects due to long transmission path through the ionosphere undoubtedly exist, but no precise measurement of this effect has yet been made.

Receiving System

The receiving system is sufficiently different from conventional design to warrant a more complete description. A block diagram is shown in Fig. 4. The entire receiver is frequency controlled, and contains four mixer stages which heterodyne the radio-frequency signal to a final intermediate frequency of 180 cps. Since the first three injection frequency voltages as well as the final radio frequency are derived from multiples of a common crystal oscillator, a high degree of frequency stability is achieved in the system. This high degree of stability is essential to permit tuning the highly selective receiver to the frequency of the echo signal. This tuning is accomplished in the final heterodyne stage.

In tuning it is necessary to take account of the change in frequency of the returned signal which results from variations in the relative velocity of the moon with respect to the

earth. The frequency of the returning echo may differ from the transmitted frequency by as much as 300 cycles per second, since the relative velocities of the earth and moon vary from about +900 mph at moonrise to -900 mph at moonset. At the frequency of the transmitter, a relative velocity of 3 miles per hour between antenna and target causes a shift of approximately 1 cycle per second in the received signal. This frequency shift, due to relative velocities of the transmitting antenna and target, is present in all radar echoes from moving targets, but is undetected in conventional receivers because the bandwidth of the normal receiver is many times greater than the frequency shift. In the Diana receiver, a bandwidth of 57 cps is achieved in the final i-f stages. It is therefore necessary to predetermine the Doppler frequency shift for the particular observation being made, and to select the proper crystal for the final heterodyne mixer. To achieve the high degree of accuracy required in the final mixer, provision is made to modify the frequency of the crystal-controlled oscillator by means of a screwdriver control which varies the air gap above the crystal. Final adjustment of the oscillator is made by beating the crystal oscillator output

against a secondary frequency standard source, and observing the output on a monitoring oscilloscope.

The output of the final heterodyne mixer is fed into two channels, one audio, the other video. The audio channel is simply a power amplifier stage with the output connected to a loud speaker. The video output channel is fed into a second detector to recover the envelope of the 180 cps intermediate-frequency signal, and then is amplified by a high-gain video amplifier and connected directly to the vertical deflecting plates of a nine-inch cathode-ray tube. The horizontal deflection is a linear 4-second type-A sweep. The visible output is the characteristic low-frequency noise pattern representing a 57-cycle bandwidth centered at 180 cycles. A sudden upward departure from the base line occurs when an echo signal is received from the moon. This is shown clearly in Fig. 5. The audible signal is random noise of 57-cycle bandwidth, superimposed on a fixed-frequency note, at the intermediate frequency of 180 cycles, when the echo is received.

As stated previously, tuning of the receiver is accomplished in the final mixer. The injection signal frequency must be calculated for each observation to take into account the

mechanically-operated shorting bars on the transmission line, operating from a multivibrator-controlled relay during the transmitted pulse interval of 0.25 sec. One of the shorting bars serves to short out the receiver input during transmission, and the other shorts out the transmitter during reception.

Keyer and Indicator

The visual indicator used is a nine-inch electrostatic cathode-ray tube, 9EP7, with a long-persistence screen. The electron beam is caused to scan the width of the tube, synchronously with the transmitted pulse, in 4 seconds, forming a linear time base. The persistence of the tube is long enough to retain the pattern for at least two sweeps. The circuit employed to generate this sweep is a direct-coupled transitron sawtooth oscillator, described below. A pulse equivalent in time to the keying pulse is also generated by this circuit and is applied to the cathode of a low-level multiplier stage of the transmitter, causing it to conduct for the pulse duration and to drive the subsequent multipliers.

The time-base generator consists essentially of a high-gain pentode amplifier with capacitance coupling between plate and grid. The schematic is shown in Fig. 7. The capacitance coupled path includes a cathode follower stage, the left hand section of V_2 . For the duration of the conduction cycle, the anode voltage of the pentode V_1 drops and capacitor C_1 begins to discharge through the tube. As the voltage on the plate drops the current flow in C_1 drives the grid negative, tending to cut off the plate current. A condition of dynamic equilibrium then exists with the plate voltage dropping at a linear rate determined by R_1 and C_1 , and the grid being maintained at a constant voltage, since each decrement in plate voltage causes a corresponding drop on the grid which keeps the grid signal and hence the output of the tube substantially constant. The time constant of $R_1 C_1$ is chosen to cause C_1 to become fully discharged during the cycle.

When the plate voltage drops to the point where electrons from the cathode can no longer flow to it, an increase in screen current occurs which rapidly decreases the screen

voltage and correspondingly decreases the suppressor voltage. This action, which is cumulative, has the effect of suddenly cutting off the anode current. This causes the cathode current to be retarded by the suppressor grid and made to flow to the screen. A negative pulse appears at the screen, and C_1 begins to charge through the cathode follower until a point is reached where the plate begins to draw current and the oscillator is recycled. The screen returns to its original voltage, and the plate voltage begins to fall. By suitable choice of R_1 and C_1 , a range of from about 0.1 to 3 cps is obtained.

Keying-voltage signals are derived from the differentiated output of the negative pulse appearing on the screen of the oscillator. This is used to trigger a multivibrator whose time constant is controllable by a variable 5 meg resistor, varying the output pulse width from 0.02 to 0.25 seconds.

The addition of the cathode follower stage V_2 was made to shorten the charge time of C_1 by causing it to charge through the grid cathode space of the cathode follower. This reduces the return trace time. Tube V_3 serves as a degenerative phase-inverting amplifier to secure push-pull sweep voltage.

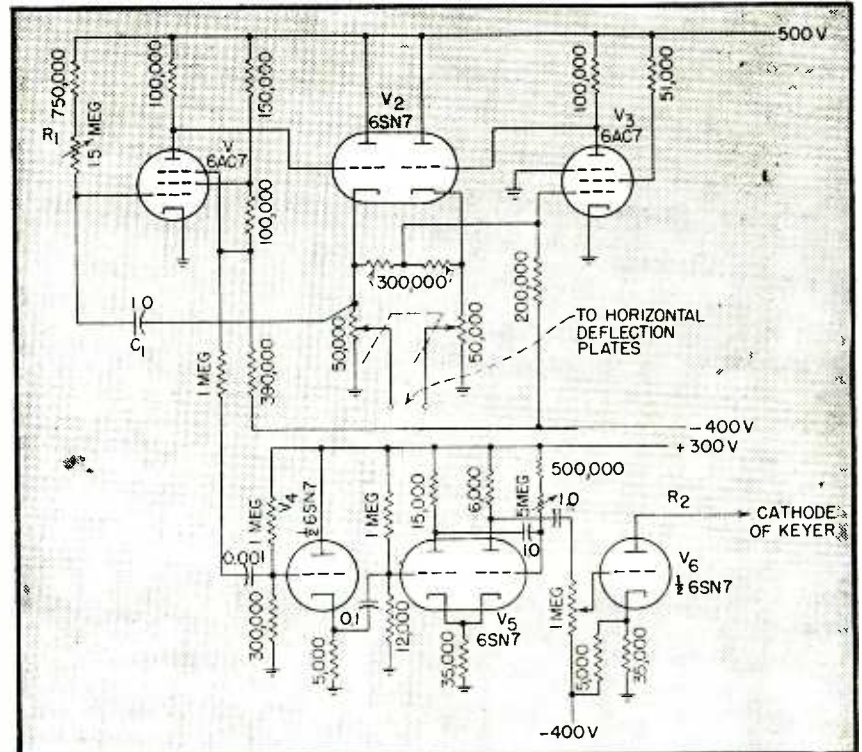

FIG. 7—Linear deflection circuit of type-A indicator, which sweeps spot across screen in up to ten seconds. Basic circuit is transitron oscillator. Sweep and keyer are controlled by the cathode-coupled flip-flop circuit at bottom of diagram

The keyer multivibrator is a conventional cathode-coupled flip-flop circuit with the initiating trigger applied as a positive pulse on the grid of the normally non-conducting section. A positive pulse varying in width from 0.02 to 0.25 seconds is obtained at the plate of the other section. This signal is applied to a normally cut off pentode whose load impedance is the cathode of the 12.388 mc amplifier stage in the transmitter. For the duration of this applied signal, the plate of the amplifier is driven negative, taking the cathode of the keying tube down with it, thus causing it to conduct.

The first echoes from the moon were received at moonrise on January 10, 1946. The indication was of the audible type in the form of a 180-cycle beat note occurring 2.5 seconds after transmission.

Although numerous observations have been made, both at moonrise and moonset, echo returns do not occur after every transmission. Further measurements are needed before precise scientific conclusions can be drawn.

REFERENCE

- (1) The Radar Equation, *ELECTRONICS*, p. 92, April 1945.

USS R-4 submarine, with arrow pointing to JP hydrophone installed topside (U. S. Navy photo)

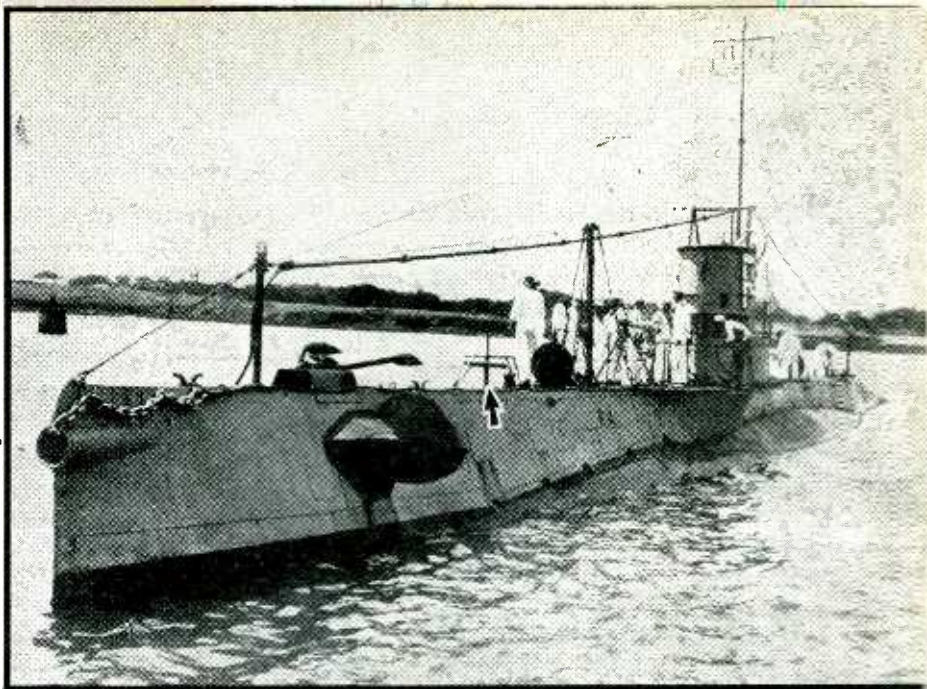

SONAR

FOR SUBMARINES

Technical details of sonar equipment used on submarines for underwater listening, including description of supersonic converter circuit, construction of highly directive line-type magnetostriction hydrophone, and analysis of transmission characteristics of sea water

WITH the declassification by the Navy of JP sonar equipment, it is possible for the first time to describe a complete underwater sound system, including the advanced form of magnetostriction hydrophone that became the standard transducer in submarine listening devices. The JP sonar was developed in cooperation with the Navy by Columbia University, Division of War Research, under NDRC Section 6 at the U. S. Navy Underwater Sound Laboratory at New London, Connecticut.

The success of underwater sound devices became increasingly important to the American war effort with the launching of the German submarine campaign against our coastal shipping in 1942. While playing an important role in the defeat of the U boat, American sonic gear also performed outstandingly against the Japanese. The JP sonar carried a large share of the burden of underwater listening during the war, and constituted a major advance in the development of American underwater sound gear.

Much of the developmental work in the field of underwater sound went into sonic ranging devices which

By **R. S. LANIER**

New York, N. Y.

and

C. R. SAWYER

*Western Electric Co., New York;
formerly Columbia University,
Division of War Research*

project a signal into the water and obtain information of various kinds from the echo. Such ranging devices are of fundamental importance, but a listening device has a complementary importance and a number of advantages as a warning instrument. It gives warning of the presence of a surface vessel at greater ranges than from an echo ranging device, which suffers from the doubled distance the signal must travel and the far from efficient reflection by the target.

The operator of a listening device gets information about the outside world by identification of sounds

which is lacking when echo ranging is employed. Furthermore, the tactical and psychological advantages of actually being able to hear the enemy were found early in the war to be of great importance to the commander of a submerged submarine.

Underwater Listening Problems

The most important sound produced in the water by a moving vessel, either on the surface or submerged, is usually the result of cavitation at the propeller. The resulting underwater sound wave is highly complex and has frequency components throughout the sonic and into the supersonic spectrum. The acoustic pressure produced in the water at 1,000 yards by the propeller of a typical ship moving at medium speed is plotted in Fig. 1 for frequencies between 100 and 10,000 cycles.

Other noises produced in the water by a vessel include the vibration of the engines or other machinery and impact-type noises such as the banging of chains or other gear. Speed-reducing gears and pumps are especially noisy. Some types of bearings may have a periodic squeak, and the hull of the ship may cause cavitation

electronics
WAR REPORT

in the water at high speeds. These types of noises will in general be carried through the water as waves of complex frequency distribution, with both sonic and supersonic components.

Although exact analysis of the transmission characteristics of sea water is difficult, there are two main effects that influence the range of a sound in sea water. The first is the expected inverse-square-law reduction in energy caused by the spreading of the wave; the other is an absorption effect due to the mechanical resistance of the water. The latter effect, for signals below about 5 kc, adds approximately 2 db of attenuation per 1,000 yards to that due to spreading. Above 5 kc, the attenuation from absorption increases rapidly. At 100 kc, the absorption amounts to approximately 20 db per 1,000 yards. This transmission characteristic makes it certain that at relatively long ranges an underwater sound will consist predominantly of low-frequency energy.

Ambient water noise is a never-absent factor that vitally affects the range and effectiveness of underwater listening devices. The noise level varies with different states of sea agitation and with other factors, but under most representative conditions has an energy distribution that falls off rapidly in the higher frequencies. The falling characteristic of the noise with frequency usually gives high signal frequencies a better signal-to-noise ratio at close ranges, but at long ranges the attenuation of the signal at high frequencies tends to cancel this advantage. The frequency at which the signal

first becomes recognizable when closing range may be anywhere in the spectrum, but is most often in the 500 to 2,000-cps range.

Equipment Requirements

It will be seen from the above that a searching device must be capable of responding to signal frequencies anywhere in the sonic and well into the supersonic range. Rugged electro-mechanical transducers for such a range are essential. The transducers must operate under water, at static pressures as high as 250 lb per square inch, and in addition are subject to dynamic pressures arising from depth charges and the motion of the submarine through the water. The problem of matching the transducer impedance to that of the water is of an unfamiliar order of dimensions, as the mechanical impedance of water is many times that of air.

Additional design factors arise from the combination of the listening and tracking functions with searching in the JP sonar. For the listening function it is desirable that the operator be able to hear the signal through a system having controllable characteristics over the audible band. If the aural character of the signal is emphasized by filtering, experienced operators can identify different types of vessels by their sound. Many operators became so experienced in the interpretation of sonic signals that they could in some cases tell whether a ship was loaded or unloaded, when it made a sharp turn in the water, etc.

For the tracking function, the system should, of course, be as directive in its response as possible.

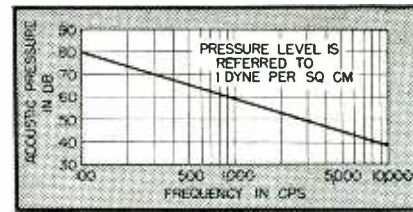

FIG. 1—Acoustic pressure in water due to propeller of freighter 1,000 yards away

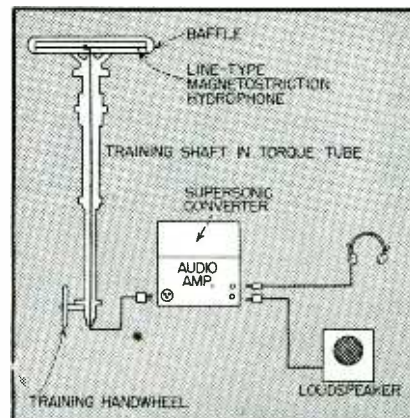

FIG. 2—Drawing of JP sonar listening equipment

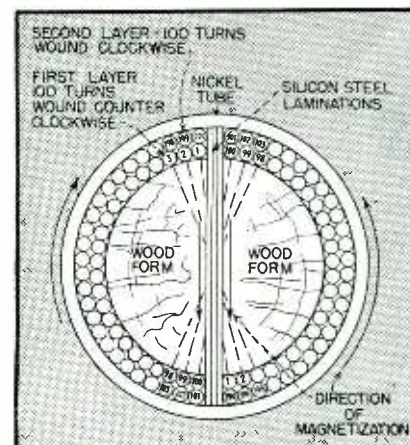

FIG. 3—Cross-section view of line-type magnetostriction hydrophone

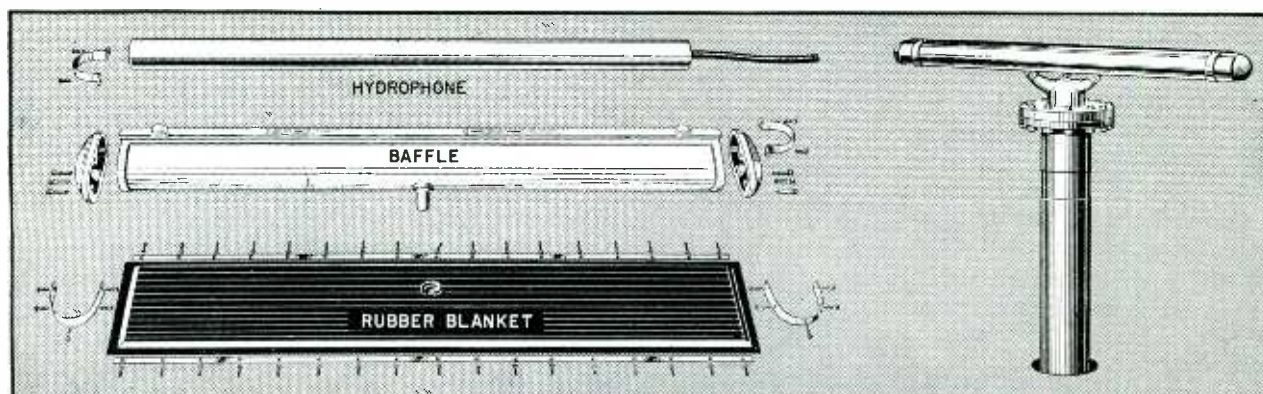

FIG. 4—Magnetostriction hydrophone, disassembled at left and assembled at right for topside mounting on a submarine

The JP equipments met the above requirements through the development of the line type of magnetostriction hydrophone and specialized electronic equipment to function with it. The complete equipment, shown in block form in Fig. 2, consists of the hydrophone mounted at the top of a training shaft which extends through the topside of the submarine, the training gear for revolving the hydrophone and indicating its tracking position to the operator, the listening amplifier for raising the signal level and bringing it under the operator's control, and the supersonic converter for heterodyning signals in the supersonic spectrum down to audibility.

To search or track in the sonic range, or to listen directly to a signal for the aural character, the hydrophone is fed directly into the listening amplifier, with the supersonic converter cut out of the system. When searching for supersonic signals or tracking on the higher components of any signal, the converter is cut into the system between the hydrophone and the listening amplifier.

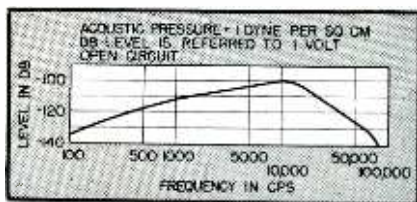

FIG. 5—Frequency response of hydrophone

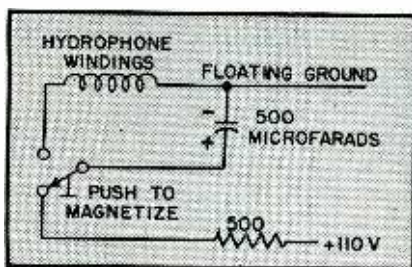

FIG. 6—Circuit for remagnetizing nickel tube of magnetostriction hydrophone

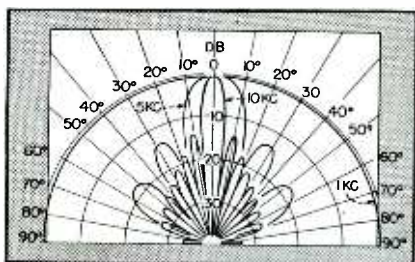

FIG. 7—Directivity pattern of hydrophone at three different frequencies

Earlier types of hydrophones were of piston construction, using a multiplicity of magnetized nickel tubes placed parallel to each other and fastened perpendicularly to a diaphragm in contact with the water. This performs well in certain applications, but when greatly increased directivity is demanded of the system, the physical dimensions of the piston hydrophone make it unwieldy. Interference between successive wave fronts at close bearing angles, which is the basis of the directivity of a typical underwater sound transducer, cannot be achieved in the sonic range with a circular diaphragm of practical dimensions.

Magnetostriction Hydrophone Design

The line type of hydrophone overcame this difficulty by using a single magnetized element, a nickel tube 3 feet long and 2 inches in diameter. The tube itself acts as a diaphragm to receive energy from the water. The coil is wound on a soft wood and silicon steel core and is entirely enclosed in the tube, as shown in the cross-sectional view of Fig. 3. In back of the tube and supporting it in the horizontal position is the baffle, a bronze casting of streamlined cross-section which is covered with a rubber blanket to absorb sound reaching the hydrophone from the rear. The hydrophone tube, the baffle, the rubber blanket, and various fittings disassembled are shown in Fig. 4 along with the complete assembly as mounted at the top of the training shaft.

Hydrophone Characteristics

The nickel tube is magnetized be-

fore use and the instrument operates on the residual magnetism. Deformation of the tube by acoustic energy in the water produces a corresponding variation in the magnetic field, which is carried through the coil by the transverse steel core.

Figure 5 shows the sensitivity and frequency response of the JP hydrophone, in decibels below one volt at the open-circuit terminals, with a constant acoustic pressure of one dyne per square centimeter. The rising character of the response between 100 and 10,000 cycles is desirable to equalize the reverse characteristic of underwater signals at long ranges. The response in the supersonic range is necessary to make the system completely flexible as a tracking and searching device.

The residual magnetism in the tube gradually falls off in use, and may be materially reduced by the shock of depth-charge explosions or other underwater disturbances. The remagnetizing circuit shown in Fig. 6 is therefore provided in the amplifier for remagnetizing the tube. The 500-microfarad capacitor is maintained in a charged condition across the 110-volt d-c power line, and a pushbutton switch allows the capacitor to be discharged through the hydrophone coil.

The directivity pattern of the JP hydrophone is shown in Fig. 7 for single frequencies of 1, 5 and 10 kc. At 1 kc, with a wavelength of nearly five feet, there is no useful directive effect, while at 10 kc the response falls off nearly to zero at about 5 degrees either side of zero bearing. The first secondary lobe in the pattern is about 13 db below the zero-bearing

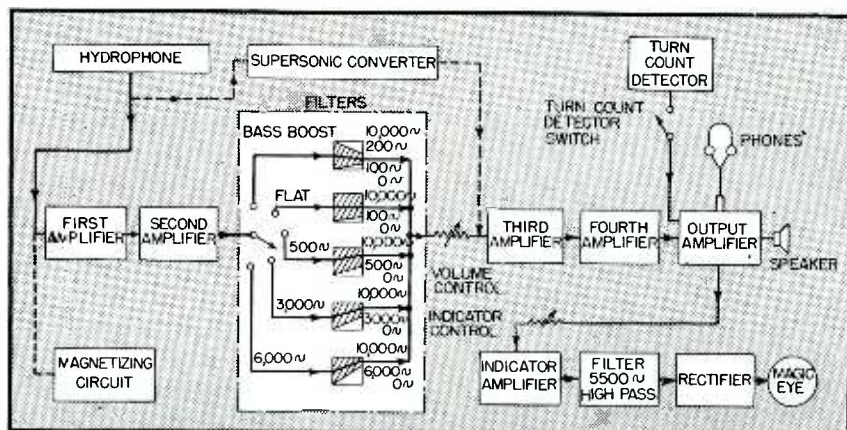

FIG. 8—Block diagram of JP sonic listening gear

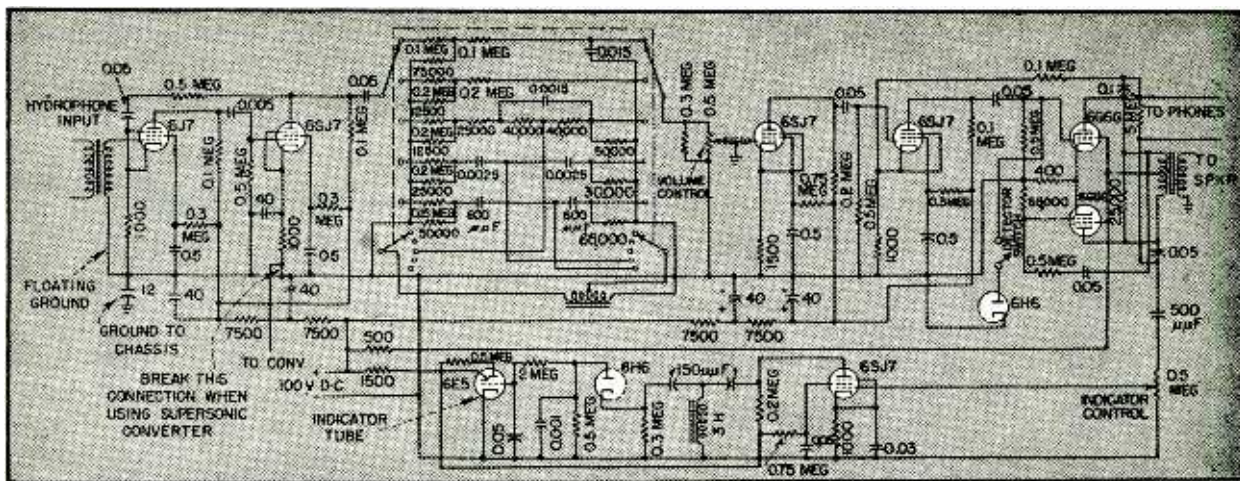

FIG. 9—Circuit diagram of a-f amplifier for models JP-2 and JP-3 sonar equipment

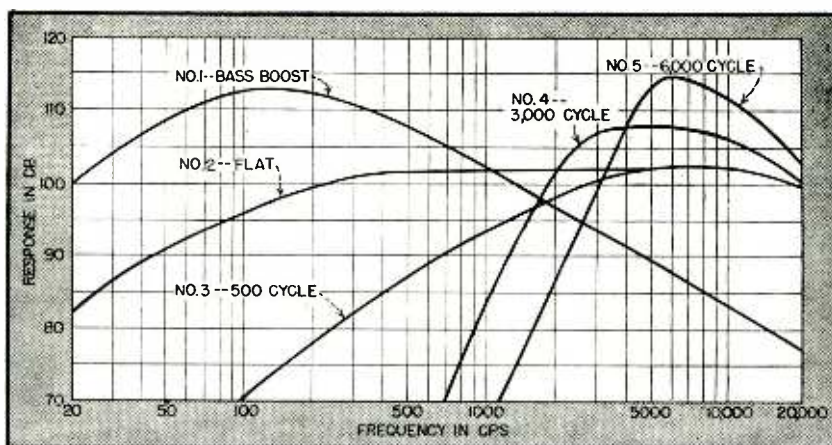

FIG. 10—Response of a-f amplifier at the five filter-switch settings

response. As the signal frequency rises into the supersonic spectrum the directive pattern shows even sharper peaks, which indicates the reason for the emphasis on the high frequencies in the tracking function.

Actual listening employs a band of frequencies which minimizes the prominence of the secondary lobes of the directivity pattern.

The line hydrophone has a solid directive pattern of the pancake type, as opposed to the bowling-pin pattern of the piston hydrophone. The difference can be visualized by revolving the 10-kc pattern of Fig. 7 first around the horizontal reference line as an axis to form the pancake pattern, and then around the vertical center-line to form the bowling-pin pattern. The pancake pattern is considered superior for searching purposes because it gives equal response to signals in a plane normal to the hydrophone axis, no matter what the vertical angle of elevation. This ignores the effect of the baffle, which reduces the response from the rear

and thus allows the operator to place the signal in the forward arc of the pancake pattern.

Amplifier Circuit

The hydrophone output is brought down through the training shaft to the listening amplifier. A block diagram of the amplifier is shown in Fig. 8 and the complete schematic in Fig. 9. It is in the main a resistance-coupled five-stage arrangement of conventional design, using pentodes throughout. Two separate feedback loops are used to stabilize gain and reduce noise, one over the first two stages and one over the last two.

The electrical sensitivity of the system, measured from the output of the hydrophone, is approximately 10^{-8} volt. With a hydrophone of the JP type and overall amplifier sensitivity of the order of 0.01 microvolt, the system has a sensitivity margin of about 20 db over that required to raise the water noise to audibility under average conditions. Further increases in sensitivity have not been

found of value in listening systems of the JP type, as the water noise is at present the limiting factor on the range of the system.

Testing of large groups of operators has shown that for a signal to be recognized through the noise, the signal level must be about equal to the noise level over a band of frequencies somewhere in the audible spectrum. The width of such a band which will just make the signal discernible, known as the critical bandwidth, varies somewhat with the position of the band in the spectrum. With strongly periodic signals, experienced operators can sometimes pick out a signal as much as 10 db below the noise level.

To reduce the noise level and make the system most effective at the point in the spectrum where the signal-to-noise ratio happens to be most favorable, the amplifier incorporates a variable equalizer between the second and third stages. The characteristic response for each of the five filter positions is shown in Fig. 10. The bass-boost or No. 1 position aids in identifying noises with a predominant low-frequency character, such as banging chains, machinery vibration, etc. and is useful at long ranges. The unequalized position is No. 2, and No. 3, 4 and 5 cut in high-pass filters with progressively higher cut-off points. The latter positions are most useful at relatively close ranges, when the falling characteristic of the noise with frequency can be used to advantage.

Limiting the response to the 3,000 or 6,000-cycle-and-up range will often eliminate the major part of the noise energy, which lies in the lower fre-

Printed

By **CLEDO BRUNETTI**

*Principal Physicist
National Bureau of Standards
Washington, D. C.*

and

A. S. KHOURI

*Engineer
Centralab Division, Globe Union Inc.
Milwaukee, Wisconsin*

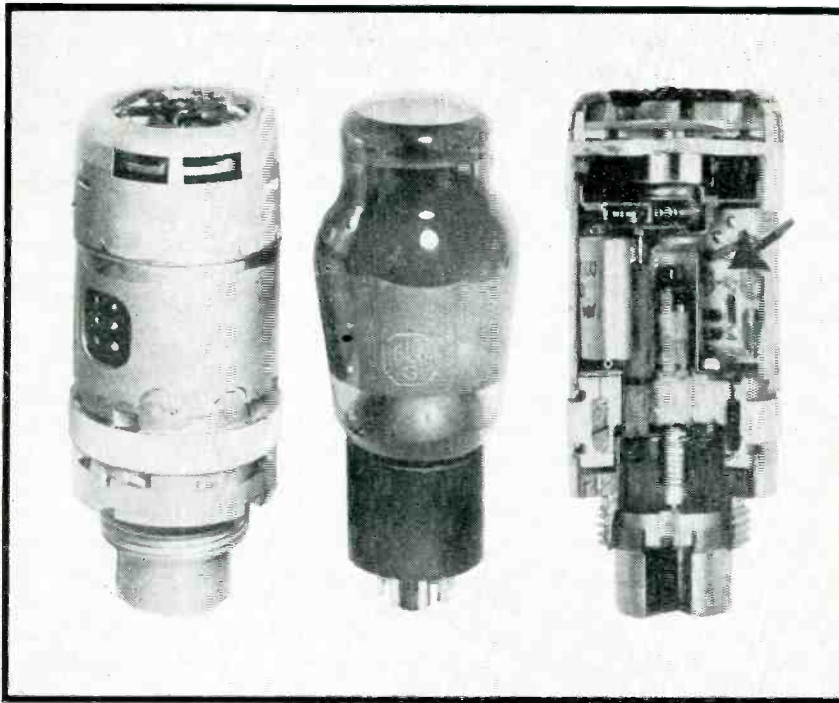

FIG. 1—Comparison of tiniest mortar VT fuze with standard 6L6G radio tube, and cross-section of fuze. Arrow points to printed ceramic electronic control circuit

THE development of the tiny generator-powered radio proximity fuze for the U.S. Army's mortar shells resulted in several new processes and techniques which promise to do much in reducing size and im-

proving efficiency of many types of electronic devices. Outstanding among these is perfection of a method of printing wiring and certain components on a ceramic surface. The diminutive size of the mortar

fuze may be realized from Fig. 1, in which it is shown alongside a 6L6G radio tube. The cross-section view shows a portion of an electronic control circuit constructed according to the new principle. Completely self-contained with radio transmitter-receiver, control circuits, safety devices and a turbo-generator power supply, the fuze was designed to withstand a set-back force of 10,000 times that of gravity. The limited space requirements for the control circuit, coupled with the necessity of rugged-

FIG. 2—Top and bottom views of two-stage amplifier constructed according to present practice and (below) by new printed ceramic technique developed for use with subminiature tubes

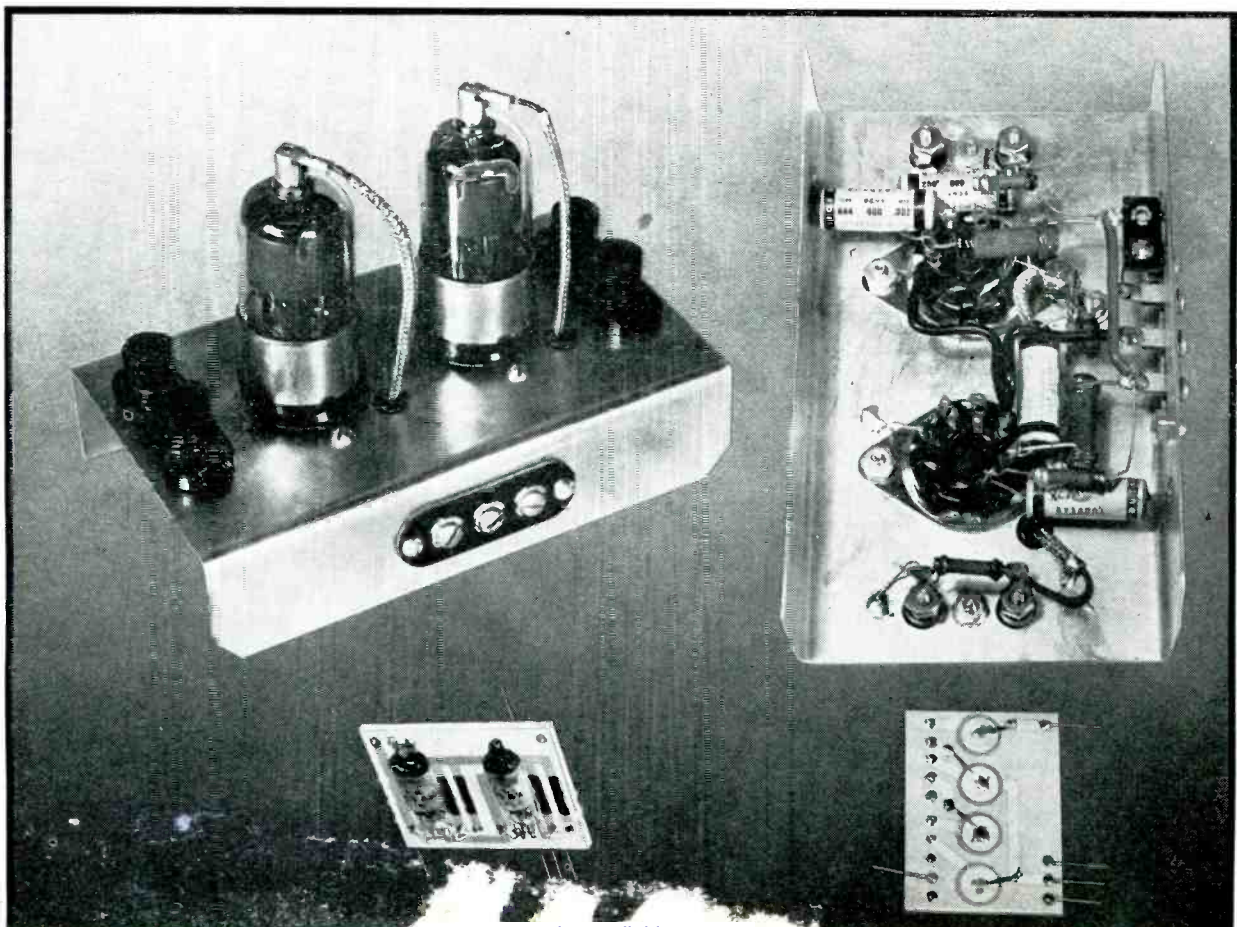

Electronic Circuits

First details of new technique for printing wiring directly on a steatite chassis block with silver solution by a silk screen process, then spraying on resistors through masks. This method makes possible the mass production of ultracompact amplifiers and radio sets

ness in design, led to the adoption of the printed ceramic method.

With the resumption of peacetime activity, the new circuit wiring process promises to have wide use in such applications as pocket radios, personal telephones, miniature hearing aids, meteorological instruments, and miscellaneous electronic control circuits. A typical example of its use is seen in Fig. 2, in which a two-stage audio amplifier constructed on this principle is compared with one made according to present table-model radio practice.

Essentially the process consists of the following four techniques: (1) Printing or stencilling the circuit wiring (using silver paint) onto a suitable chassis or base material,

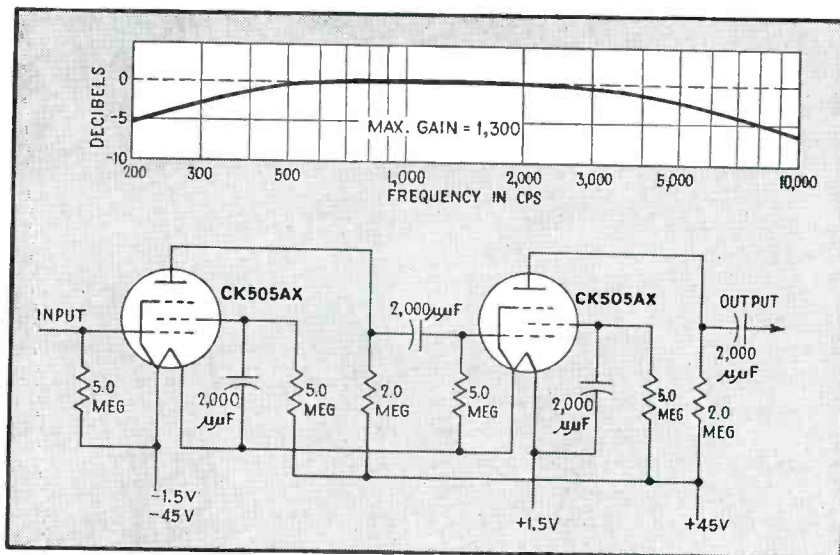
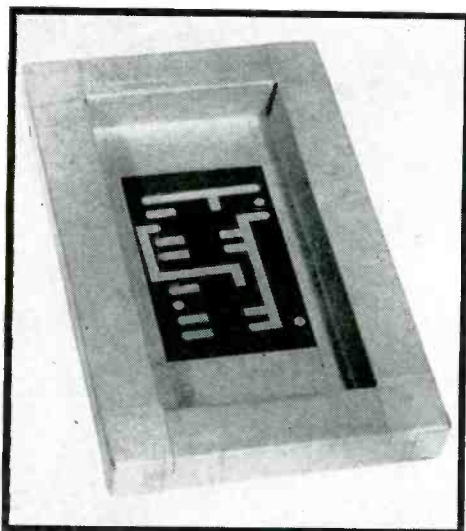

FIG. 3—Circuit and response characteristics of two-stage audio amplifier used as example illustrating the advantages of the printed ceramic technique



Silk screen (above) mounted ready for use, and jig (right) for holding screen and steatite plate during printing. Design has just been printed on the plate by forcing silver solution through the screen with a neoprene bar, and the printed plate has been lowered out of contact with the screen

such as a plate of steatite; (2) Spraying the resistors in the form of a carbon and resin mixture, onto the plate through positioning masks that locate them between appropriate silvered end tabs; (3) Attaching small disc-type capacitors, consisting of a high-dielectric-constant ceramic with both faces silvered, directly to

the silvered wiring on the plate; (4) Soldering other components such as tubes into appropriately located and silvered holes in the ceramic. Used with the newly developed subminiature tubes, the electronic circuit assembly made possible by this process is extremely compact.

Figure 3 shows the circuit and the

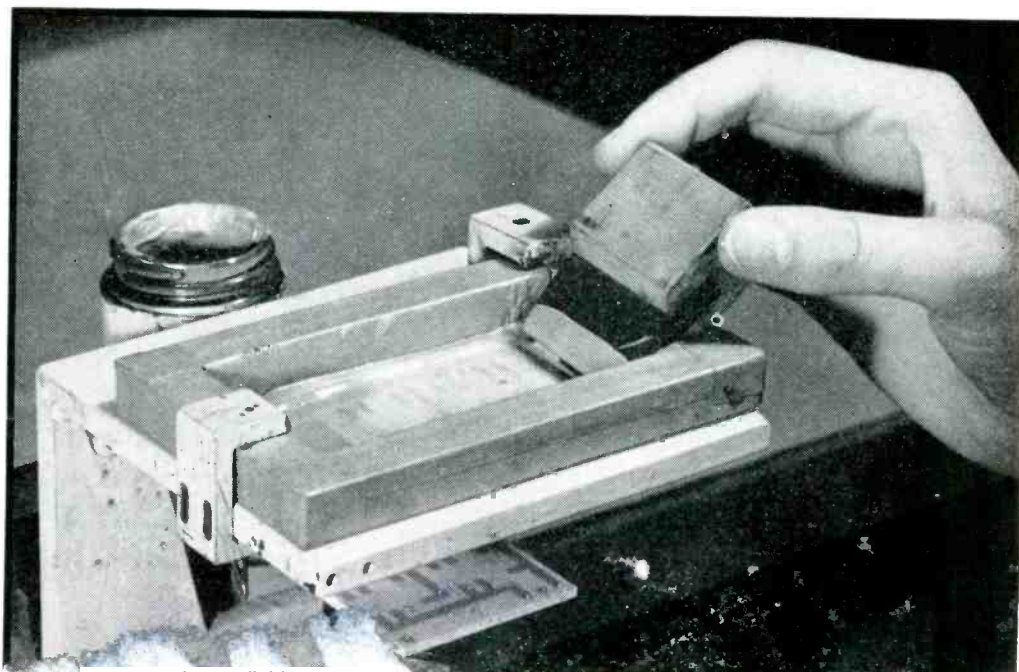

gain-frequency characteristic for the printed amplifier of Fig. 2. The response is identical to that of ordinary circuits. This is to be expected, as basically the components of this circuit are resistors, capacitors, and tubes just as in the standard circuits.

Although an audio circuit is described, the method is adaptable to high as well as low frequencies. In fact, the reduced size of the components and assembly allows very efficient ultrahigh-frequency circuits to be constructed in a limited amount of space. At very high and ultrahigh-frequencies small circular or rectangular spiraled coils may be printed flat on the ceramic surface in the same fashion as the wiring leads, using silver paint. It is possible to obtain Q values of 150 to 200 and even higher if desired.

The method is adaptable also to attenuators, filters, corrective networks and, in general, any low-power electric circuit. In circuits requiring the use of tubes, subminiature tubes now on the market are ideal. These inch-size tubes, which played a principal part in the development of proximity fuzes, are not only small but rugged and efficient. Filament drain is exceedingly low. Typical characteristics of Raytheon submini-



Soldering of subminiature tube leads to a printed ceramic chassis. Ceramic capacitor discs in foreground are also soldered to the steatite

ature tubes as used in printed electronic circuits are shown in Table I.

Although the compactness of the method was the most important factor in its application to the VT fuse, other equally important and desirable

characteristics are the uniformity of finished assemblies both in appearance and performance, high production speed, and ease of circuit checking. Uniformity is obtained since each circuit is an exact reproduction of the master pattern. High production speed is obtained by the screening and spraying operations, which combine in a few fast mechanical operations the former operations of cutting wires to length and soldering wires and resistors into place.

Because of its two-dimensional nature and the open method of construction, circuits constructed by this new process lend themselves to rapid circuit tracing and repair. Faulty components such as resistors and capacitors which are on the chassis can be repaired, if desired, by soldering a conventional component of equivalent value across each faulty part and opening the circuit leading to the fault.

Details of Construction

Six stages in the evolution of the printed ceramic circuit are portrayed in Fig. 4. The base material most commonly used is steatite, a hard, dense, porcelain-like ceramic material. Like porcelain, steatite is

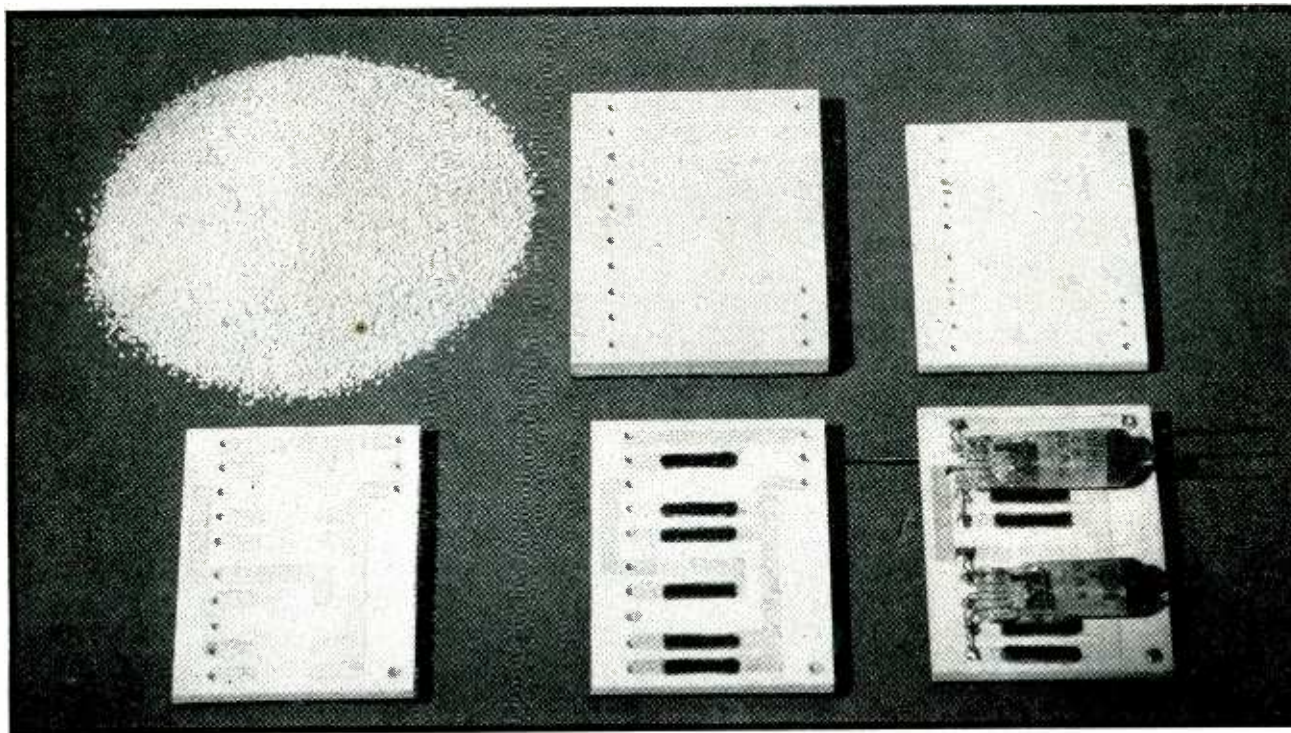

FIG. 4—Evolution of a printed electronic circuit, showing the amount of powder needed to press one steatite plate, the pressed but unfired plate, the fired plate (showing shrinkage), circuit wiring applied through silk screen and fired on, resistors sprayed on, and the final assembled unit

formed by various methods of extruding, pressing, or casting to a predetermined larger size and then dried and fired at almost white-heat temperatures to shrink and vitrify it to its final form.

Preparatory to fabricating to shape, the carefully selected and ground talc is thoroughly mixed with small percentages of clays, fluxes, and organic binders in large muller mixers. Water is added and the batch is worked to a uniformly plastic condition.

The pieces are pressed to the desired form by either a dry or wet press process. The dry press method, which lends itself to more rapid and automatic pressing, is used whenever possible. However, the more complex pieces are of necessity wet-pressed to obtain satisfactory flow of materials to the various parts of the mold. Material is prepared for pressing by disintegrating a wet batch into small granular particles by use of high-speed hammer mills. For wet pressing it is used in this form and pressed in molds at pressures of one-half to two tons per square inch. For dry pressing, the granulated material is dried and screened for use and pressed in molds at pressures between five and ten tons per sq in.

TABLE I. Typical Characteristics of Subminiature Tubes Used in Printed Electronic Circuits

Electrical Characteristics	CK-505AX Pentode Voltage Amplifier Type	CK-503AX Pentode Output Type	2E 31 2E 32 Pentode Shielded R-F Type	2E 41 2E 42 Diode-Pentode	2G 21 [†] 2G 22 [†] Triode-Heptode	CK-509AX Triode Voltage Amplifier Type
Filament voltage in d-c volts	0.625	1.25	1.25	1.25	1.25	0.625
Filament current in ma	30	45	50	30	50	30
Plate voltage in volts	30	45	22.5	22.5	22.5	45
Screen voltage in volts	30	45	22.5	22.5	22.5	—
Control grid voltage* in volts	0	-4.5	0	0	0	0
Peak a-f grid voltage in volts	—	4.5	—	—	—	—
Transconductance in μ hos	175	500	500	400	60 (Gc)	160
Plate resistance in megohms	1	0.12	0.35	0.25	0.5**	0.15
Plate current in ma	0.15	1.25	0.35	0.4	0.2	0.15
Screen current in ma	0.05	0.4	0.3	0.15	0.3	—
Load resistance in megohms	1	0.03	—	—	—	1
Screen resistance in megohms	3	0	—	—	—	—
Power output in milliwatts	—	25	—	—	—	—
Voltage gain	35	—	—	—	—	16
Distortion, percent	—	10	—	—	—	—
Max. grid-plate capacitance in $\mu\mu$ f	—	—	0.018	0.10	0.065***	—
Oscillator plate voltage in volts	—	—	—	—	22.5	—
Oscillator plate current in ma	—	—	—	—	1.0	—

*With 5-meg grid res. connected to F. grid to mixer plate capacitance.

Approx. conversion plate res. *Signal

The pieces thus formed are sprayed or dipped with glass-forming materials on any surface which is to be glazed, and fired through continuous tunnel kilns to temperatures approximating 2400 degrees F. After this treatment they are no longer soft and easily machinable, but have a hardness approaching that of sapphire. In certain instances where more exacting dimensional requirements have to be met than can be held by careful control of the fabrication processes, those dimensions are wet ground to exact size on large carborundum discs or diamond wheels.

Application of Silver Wiring

The leads between components are applied by a process in which the silver is intimately bonded to the ceramic. The silver is in the form of a paint or paste. Very finely divided metallic silver or silver oxide is uniformly dispersed in a suitable vehicle, and the consistency is adjusted with solvents to meet requirements for the specific type of application. The degree of bonding or adherence of the fired silver to the ceramic

surface is largely dependent on the surface condition of the ceramic before application of the silver paint or paste. Therefore, the ceramic surface must be free of dust, dirt, grease, or other contaminants.

The method most commonly used for circuit reproduction is a screening process in which the silver paint is dispersed through the open mesh of a silk or metal screen arranged as a mask to define the circuit. This makes it possible to print circuits of any degree of complexity. Complicated designs can be held to very close tolerances. The deposited or printed film thickness is very uniform and little silver paint is wasted.

For best results a genuine Swiss silk is used for the screen. The mesh size of the silk is dependent on the fineness of design desired and the characteristics of the paint vehicle. The silk is stretched tightly on a wooden frame and coated with a material, such as gelatin or polyvinyl alcohol, which is capable of becoming photosensitive when sensitized with potassium dichromate. A photographic positive is held tightly against the sensitized silk screen and

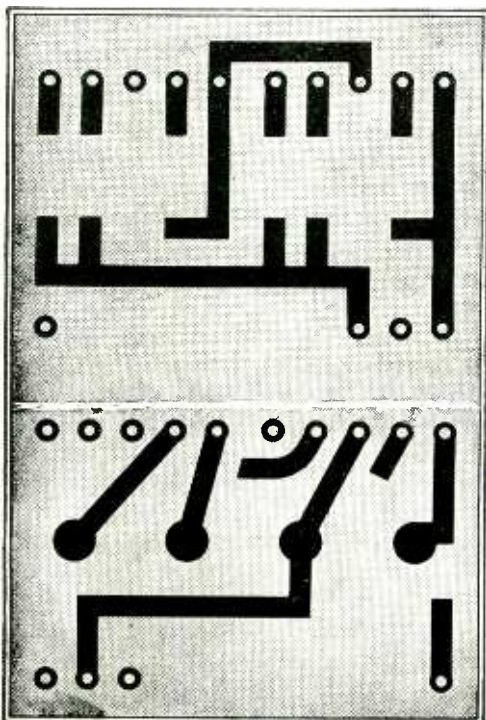

FIG. 5—Front and back patterns for wiring of printed amplifier

exposed to light. The portions of the sensitized coating exposed to light become insoluble in water. Those portions which are not exposed to light are water soluble and wash out. The parts that wash out form the design of the pattern to be printed. Front and back patterns for the wiring of the amplifier of Fig. 2 are shown in Fig. 5.

The next step is to place the paste on one end of the top surface of the screen. The ceramic to be painted is brought into contact with the opposite or bottom surface of the screen. A neoprene bar is moved across the top surface of the silk, forcing the silver paint ahead and through the open mesh of the screen pattern. The paint forced through the open mesh is deposited on the ceramic plate in a design which conforms identically to that of the screen pattern.

After applying the silver to the ceramic, the parts are placed in a furnace and heated to a temperature between 1300 and 1500 F. This temperature removes the vehicle and solvents, and intimately bonds the silver to the ceramic. Properly fired silver has the dull metallic appearance of typical silver color and will adhere to the ceramic surface with a tensile strength of approximately 3000 pounds per square inch.

Resistoring

The process of resistoring involves the application of an accurately controlled amount of resistance paint to the ceramic surface. The paint consists of a conducting material, a filler or inert material, and a vehicle or binder. By varying the quantities of these ingredients, paints covering a resistance range from 3 ohms to 200 megohms may be obtained. Other desired electrical and physical characteristics, including good adhesion to the ceramic surface, are also obtained by the proper formulation of the three components.

The paint is applied by a spray process. The size and position of the resistors are governed by suitable masks which have good adhesion to the ceramic surface. After air drying, the masks are removed and the paint is cured in an oven at 300° F for several hours to produce stable resistors. A special resin coating is applied to the resistors to protect

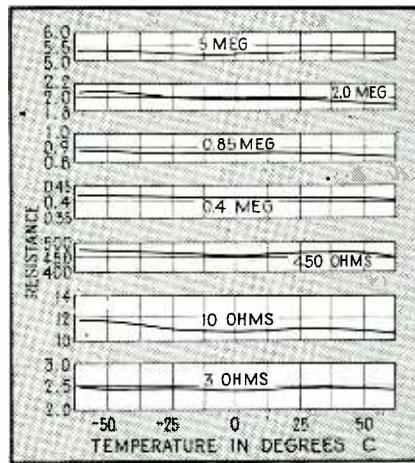

FIG. 6—Effect of temperature on sprayed resistors

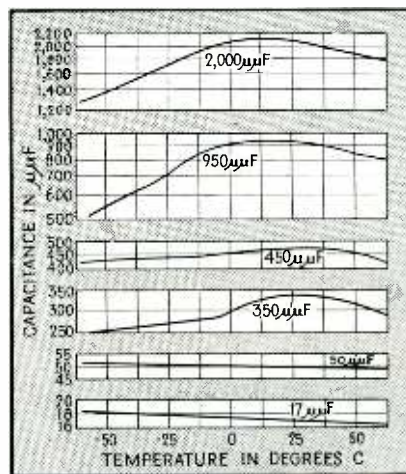

FIG. 7—Effect of temperature on ceramic disc capacitors employing titanates as dielectrics

them against humidity and other effects.

Resistance stability with time, under load or under extreme humidity conditions, is good. When exposed for 100 hours in 95 percent relative humidity at 110 F, the average resistance change was minus 10 percent for values in the range of 5 ohms to 10 megohms. This was not a permanent change, as the original values were obtained on suitable drying.

Ceramic Disc Capacitors

The ceramic disc capacitors are molded from high-dielectric-constant mixtures of titanates. Capacitance is controlled by the mix, the thickness of the disc, and the area of the silvering on the faces. Dielectric constants of 40, 100, 1000, and 2000 are used

for capacitors ranging in value from 6.5 to 2000 μf . These capacitors are from $\frac{1}{8}$ inch to $\frac{3}{8}$ inch in diameter and 20 to 40 mils thick. Higher dielectric constant materials than described have been used, but these are still in the experimental stage.

Soldering to Metallized Ceramic

External leads, such as tube leads or leads from separate resistor or capacitor components, may be soldered to the silver wiring on the plate, providing a solder having about 2 percent silver, to saturate against further absorption of silver, is used. The ceramic disc capacitors are soldered to the plate with a low-temperature bismuth solder. The low-temperature solder minimizes the possibility of fracturing the ceramic during soldering.

Effects of Temperature

Variations in resistance and capacitance values with temperature for several common values of components are shown in Fig. 6 and 7. The performance is comparable to that of standard components. Improvements in techniques to be expected with wide use of the process make probable even superior performance to that obtainable with ordinary type components.

Conclusions

In addition to the advantages delineated above, other features of this method of manufacture are apparent. Amplifier, filter, or other control circuit assemblies may be printed on small ceramic blocks and plugged into a main chassis. Replacements can then be made in the same manner as a tube is now changed. Furthermore, any tampering with a circuit by inexperienced personnel is immediately apparent. Although ordinary resistors or capacitors may be soldered across the printed components, the change is clearly visible.

This article is based on work carried out jointly by the Centralab Division of Globe Union Inc. and the Ordnance Development Division of the National Bureau of Standards under the direction of Harry Diamond. The work was accomplished under development contracts with Division 4, N.D.R.C. under Dr. Alexander Ellett, leading to production contracts by the Army Ordnance Department.

COLOR TELEVISION

On Ultra High Frequencies

Color images broadcast on 490 mc in recent CBS demonstrations show great improvement over 1940 tests. New system uses 10-mc video band to carry 525-line signal, transmits sound by f-m bursts interspersed with the video information

AFTER an interlude of five years occasioned by the war, the Columbia Broadcasting System has resumed development of the color tele-

vision system last demonstrated to the press in September 1940. Several radical departures have been introduced in the latest version of the system, aimed primarily at improving the detail of the images, and secondarily at improving the color quality. The method of introducing the color to the signal remains the same. A mechanically-driven color wheel, composed of trichromatic filter segments, rotates before the camera and a similar wheel rotates synchronously in front of the picture tube in the receiver. This method of transmission was reported^{1, 2} in *ELECTRONICS* and elsewhere in 1940 and 1942.

The color images in the present system are scanned in 525 lines, interlaced 2-to-1, and the interlaced fields are scanned at a rate of 120

per second. Each field is scanned and reproduced in succession through a different primary color in the filter wheel. The three colors are thus presented to the viewer in 1/40th of a second. The persistence of vision extends for a longer period than this, so the three colors fuse in the mind of the observer and a multicolored reproduction results.

The principal shortcomings of the images in 1940 were low definition, 343 lines compared with 525 lines in the standard black-and-white images, and occasional difficulties in the rendition of certain colors, particularly the dark shades. Both definition and color have been considerably improved in the equipment recently demonstrated to the press. Details of the new equipment were described before the IRE Winter convention

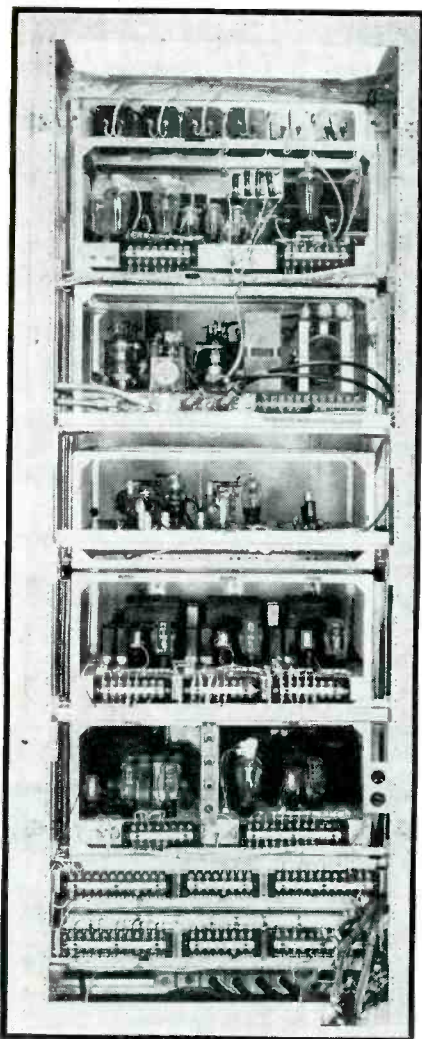

Rear view of the modulator. Video stages occupy second and third racks from top. Remaining racks are power supplies

Front view of transmitter. The large size is required to provide sufficient r-f and video stages to reach 1-kw peak output modulated over 10-mc band



by Messrs. Goldmark, Reeves, Schlesinger, Serrell, and Lyman of the CBS Engineering Staff.

Changes to Improve Definition

To improve the definition of the images, Dr. Goldmark and his staff elected to increase the number of lines to 525, the value now used in black-and-white systems. Since twice as many pictures are transmitted per second in the color system as in the monochrome system, the bandwidth required is twice as great for the same number of lines. The maximum video frequency in the black-and-white system is about 4 mc, so the corresponding figure for color would be 8 mc. The figure adopted for the CBS system is 10 mc, an increase which improves the resolution in the horizontal dimension relative to the standard black-and-white picture.

When 10 mc is adopted as the max-

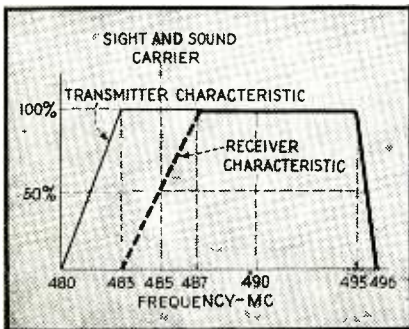

FIG. 1—Proposed uhf channel, employing vestigial sideband transmission over a 16-mc band. Sight and sound signals are transmitted on the same carrier

imum video frequency, space cannot be found for r-f sidebands in the vhf television band (54 to 216 mc). For this reason, among others, CBS decided to enter the uhf experimental television band (480 to 920 mc). The channel proposed for use, shown in Fig. 1, is similar in form to the vhf standard, i.e. vestigial sideband transmission and reception. The transmitter carrier is set at 485 mc, and the sidebands extend from 480 to 496 mc, or 16 mc overall. The receiver i-f bandpass characteristic attenuates the transmitter carrier by 50 percent and thus restores equal amplitude to all video frequencies at the output of the receiver second detector. All this is identical to present black-and-white practice except that the radio frequencies are roughly

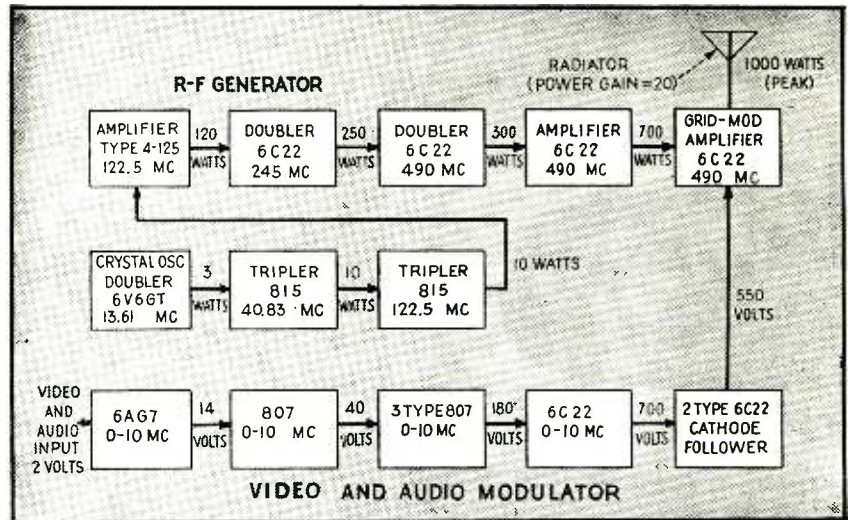

FIG. 2—Block diagram of the transmitter, showing frequency and power transformations and voltage gains in the modulator. The 6C22 r-f tube is a water-cooled disk-seal type

2 to 10 times higher and the bandwidth is 2 to 3 times wider.

The sideband filter required to remove the lower sideband has not yet been completed by CBS, so double sideband operation was used during the demonstrations. To keep within the band, the carrier was set at 490 mc and the sidebands extended 10 mc either side. The additional sideband energy radiated in the lower sideband, relative to the characteristic in Fig. 1, has no effect on the receiver operation which remains as shown, with the 50 percent level shifted to 490 mc.

To design a transmitter capable of radiating substantial power at this frequency, while being modulated over a 10-mc bandwidth was a task of large magnitude. The transmitter was designed and built by the Federal Telephone and Radio Corp., using as its essential component a water-cooled disk-seal triode, type 6C22. The transmitter meets the specifica-

tion with a power output of 1 kilowatt peak or 600 watts average. The block diagram is shown in Fig. 2. The r-f chain consists of eight stages, a crystal tritret, two triplers and two doublers with three linear amplifiers, interspersed as shown. The last four stages, including the final grid modulated amplifier use the new tube. The frequency and power transformations of each stage are shown.

The video modulating chain uses five stages, each conductively coupled so that all frequencies from d-c to 10 mc are passed with constant amplitude and time delay. The voltage gains attainable over this band are not large, ranging from 3 to 7 times depending on the tube type used. The video couplings are of the compensated filter type, both four-terminal and two-terminal networks being used. A 2-volt peak to peak input video signal is capable of modulating the final amplifier to its peak output of one kilowatt.

Synchronization monitor for keeping tabs on complex waveforms throughout video system. Thirty-two pushbuttons permit rapid selection of various signals

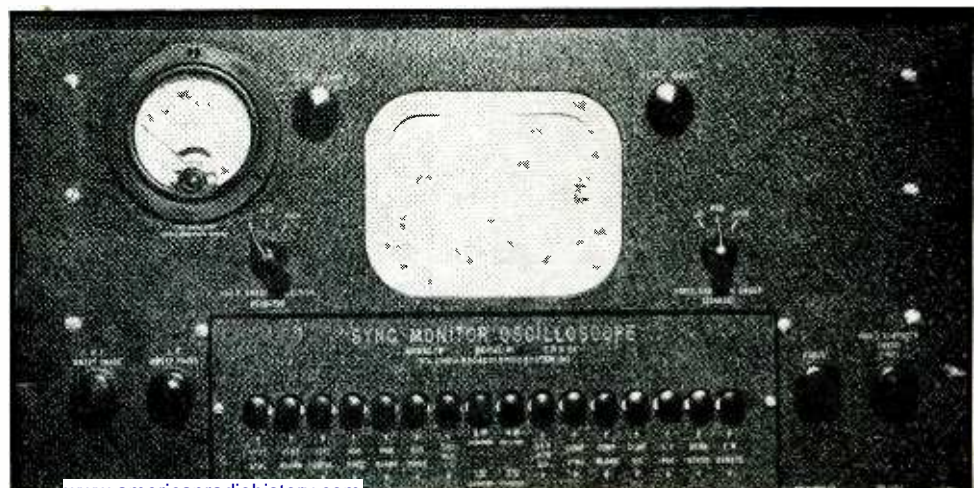

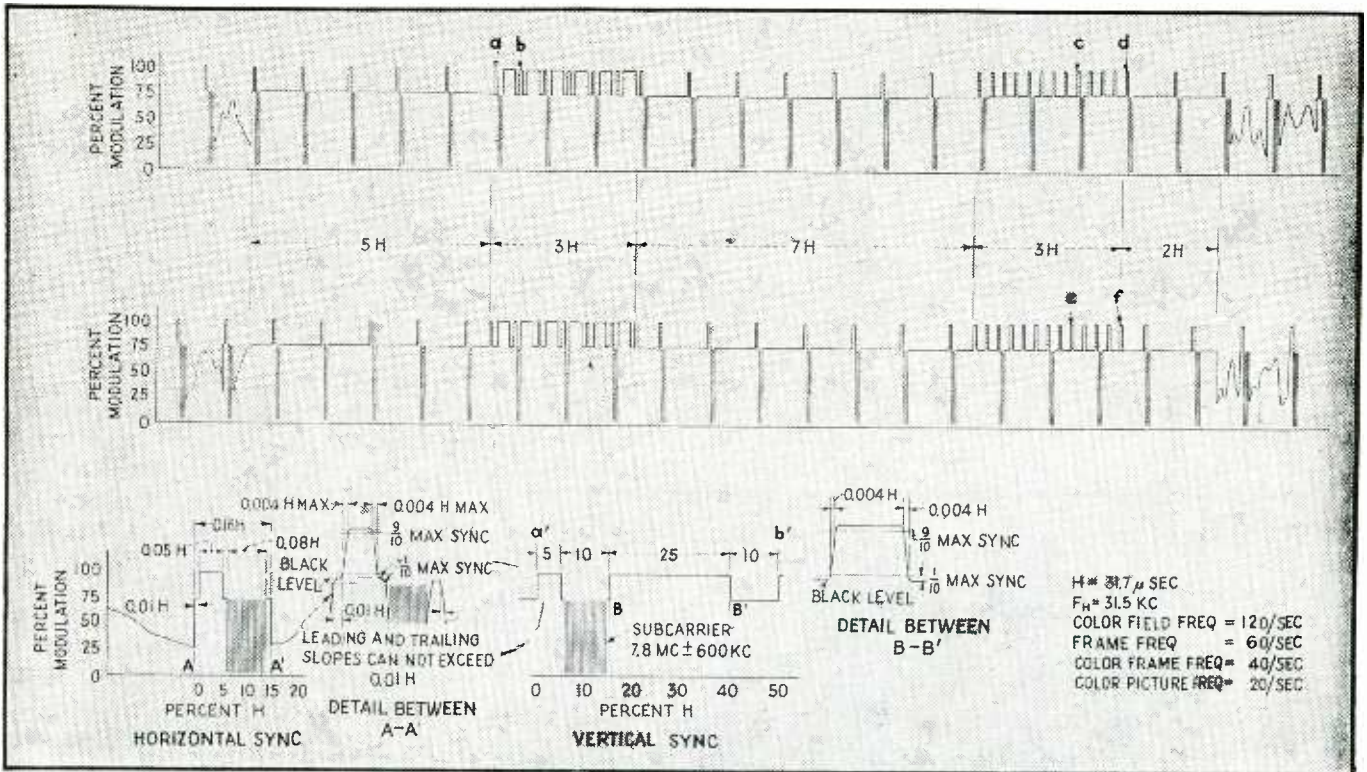

FIG. 3—Video waveform used in the CBS system. The sound is transmitted by an 8-mc subcarrier radiated during the horizontal retrace time. Color pulses are inserted to synchronize the color wheel

The power output of the transmitter is multiplied 20 times by the radiator. The radiation pattern is highly directional in the vertical plane, produced by a slotted waveguide structure which compresses the radiated signal into a vertical angle of 6 degrees, while delivering a signal of substantially constant magnitude over the 360 degrees of the horizon. To compress the beam to 6 degrees requires a radiator surface about 10 wave-lengths long. Fortunately this is not impractical at 490 mc. The antenna consists of two waveguide panels, each 18.5 feet high and 2 feet wide. These panels are mounted on the north and south faces of the Chrysler Building in New York and the beam is so oriented in elevation that the field

strength at ground level is theoretically constant at all points out to the horizon. The horizontal pattern of each antenna panel extends theoretically over 180 degrees. The actual horizontal coverage has not yet been investigated, but it is expected that only a slight loss in gain is experienced in the east and west directions. Each panel has a power gain of 40, the transmitter power being split between the two, resulting in an effective radiated power of 20 kilowatts.

Sight and Sound on Same Carrier

The numerical constants employed in scanning make possible the transmission of the sound signal and the picture signal on the same carrier. Since the 525-line picture is com-

pletely scanned (two fields) in 1/60th of a second, the line scanning frequency is $525 \times 60 = 31,500$ cps. It has been appreciated for some time that the inactive time during the re-



FIG. 4—R-f and video signal components of the receiver. A crystal mixer and six i-f stages (at left of center) are used, and 8-microvolt sensitivity is achieved

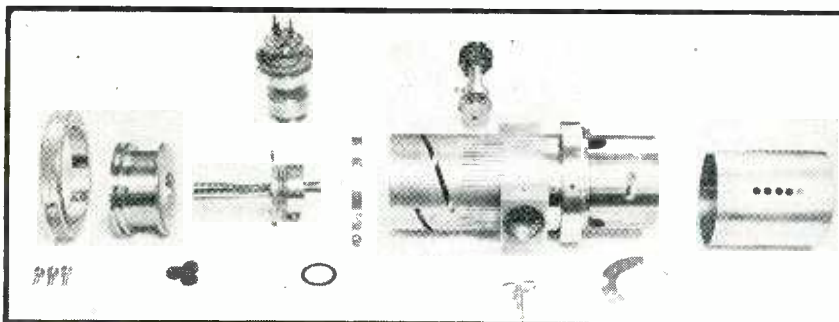

Exploded view of the coaxial final amplifier of the transmitter. Type 6C22 amplifier tube is at top left

trace of the scanning line might be used for transmitting the sound on the picture carrier. But the maximum audio frequency which can be transmitted without serious distortion in such a system is limited to not more than one half the line-scanning frequency. In practice, distortionless transmission can be achieved up to a value of about one-third the scanning frequency, or in this case $31,500/3 = 10,500$ cps. This is high enough to permit faithful sound transmission, but is not as high as

the vertical sync pulse is transmitted. This differs from the black-and-white standard in that no preparatory pulses are used, but the serrated form used in black-and-white (interspersed long pulses and double-frequency line pulses) is retained.

Below the black level, the camera signal is sent in the normal manner. Immediately following each horizontal sync pulse, while the scanning spot is retracing, a burst of 7.8-mc sine-wave signal is inserted, extended over the full amplitude of the black-

all audio signals above 10 kc. The extension of the audio subcarrier into the picture signal region would brighten the cathode-ray beam during the retrace time, unless means are provided to prevent it. Local blanking signals are generated in the receiver to depress the cathode-ray beam during the retrace time.

The two basic advantages of the sound-on-sight system are: (1) one transmitter is required and (2) the receiver tuning is not critical. The receiver also is simpler in that no separate sound i-f amplifier is required, but this advantage is offset by the necessity of providing a low pass audio filter and local blanking circuits to remove the sound bursts from the picture.

The video waveform (Fig. 3) shows the color pulses which are used to synchronize the color wheel of the receiver. These consist of three additional horizontal sync pulses inserted during each of three successive fields (shown as c-d and e-f in the diagram).

The Receivers

Two receivers were demonstrated to the press, a direct-viewing type employing a 10-inch picture tube and magnifier, and a projection set using a Schmitt optical system to produce a 17 by 22-inch picture. The radio and video-frequency components, identical in the two sets, are shown in Fig. 4. The head end of the receiver is a silicon crystal mixer (no preamplification is used), which is continuously tunable over the band from 480 to 920 mc. The tuning element is an extensible transmission line of unusual design. Ganged to the tuning control is a tunable r-f filter which rejects images and reduces the noise spectrum. The local oscillator is a 6F4 acorn triode. The i-f amplifier consists of six stages, type 6AK5, operated at 105 mc and coupled by single-tuned circuits, tuned to three staggered frequencies. The sensitivity is such that the noise level (about 8 microvolts) is reached at full gain. This is an extremely low noise figure, considering that the overall i-f bandwidth is 12 mc. Two video frequency amplifiers are used, terminating in a 6AG7 tetrode.

In the direct-viewing set, Fig. 5, a 22-inch color wheel covers the face of the 10-inch tube. The filter seg-

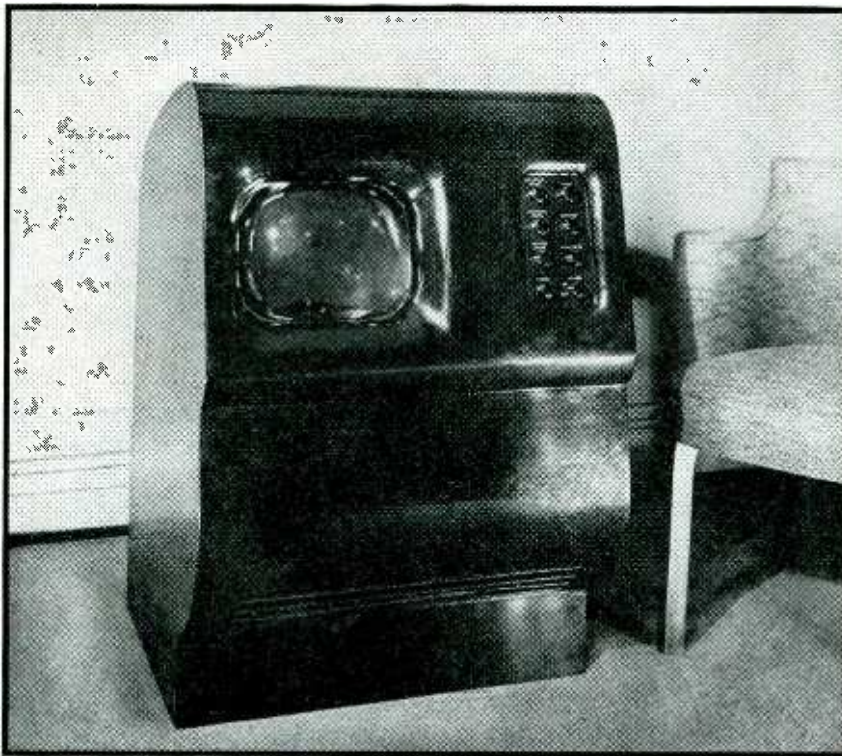

FIG. 5—The direct-viewing receiver demonstrated to the press. The screen of the 10-inch tube is magnified to 12-inch size. The shock-mounted color-wheel drive makes virtually no noise

the 15-kc limit specified for black-and-white sound.

The video waveform, showing the relative position of sound, video and synchronization signals, is shown in Fig. 3. This diagram is not unlike the standard video waveform of the vhf black-and-white system, except for the numerical constants and the insertion of the sound. Negative transmission is employed, that is, upward modulation produces black. In the region above the black level standard horizontal synchronization pulses are sent to synchronize each line. At the conclusion of each field,

to-white region, and lasting for eight percent of the horizontal scanning time. The 7.8-mc bursts constitute a discontinuous subcarrier which is frequency modulated by the sound signal. At the receiver the subcarrier bursts are selected from the video wave in a 7.8-mc tuned circuit and passed through an f-m discriminator which recovers the audio frequencies. The audio signal contains distortion products, due to the discontinuous nature of the carrier, extending from 15,000 cps upward. These are eliminated by a low-pass filter in the receiver which removes

ments have substantially the same shape as those used in 1940,^{1,2} but the filter materials themselves are somewhat different. Standardized color distributions, designated as Wratten numbers 61 (green) 47 (blue) and 26 (red) are used. One form of filter developed by Kodak is produced on an acetate base, coated with the colored gelatine and protected by lacquer. Segments of this material are riveted to a wheel made of transparent plastic. Another filter is a true plastic, developed by Monsanto, the color extending throughout the material. Sheets of this substance are inserted between two transparent discs, in the form of a sandwich.

One cause of occasional flicker in the 1940 images has been eliminated by rigid standardization of the optical transmission of the filter elements. The wheel consists of six segments, two of each color. If the two segments in a given color (particularly green, since this color contributes directly to the luminosity of the image) do not have the same transmission within a few percent, a 20-cycle flicker may be visible in areas having the same color as the filter segment. The manufacturers of the filter materials are able to meet the close tolerances required. The phosphor (of neutral white color) used in the cathode-ray tube has also been standardized by two manufacturers (Sylvania and General Electric). The phosphor is of the aluminum-backed type which increases the brightness and contrast of the image. The direct viewing receiver employs a magnifying lens to increase the apparent size of the image from 10 inches to 12 inches. Since this is a moderate degree of magnification, the angle over which the image is visible extends to about 30 degrees each side of the magnifier axis.

The filter wheel displays an average transmission of about 14 percent. Since 86 percent of the light is absorbed, the phosphor image must be very bright. An accelerating voltage of 8000 is used, obtained from a "flyback" power supply which employs the high voltage generated across the scanning coils during the horizontal retrace periods.

The color-wheel is driven by a 1750-rpm induction motor, synchronized by a type 6SN7 synchronization

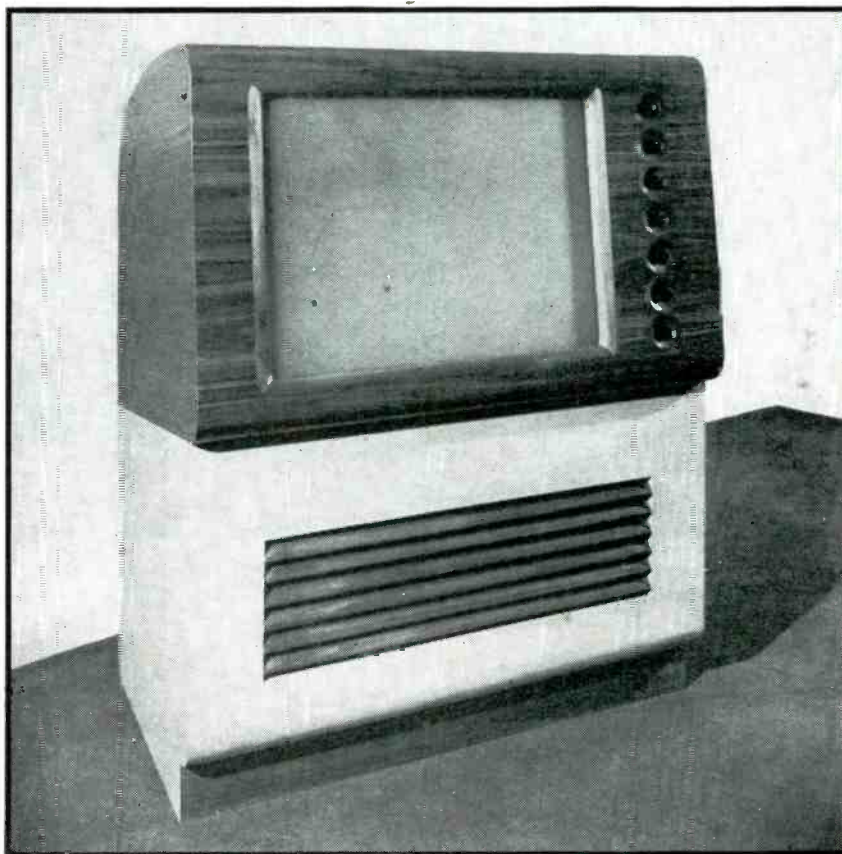
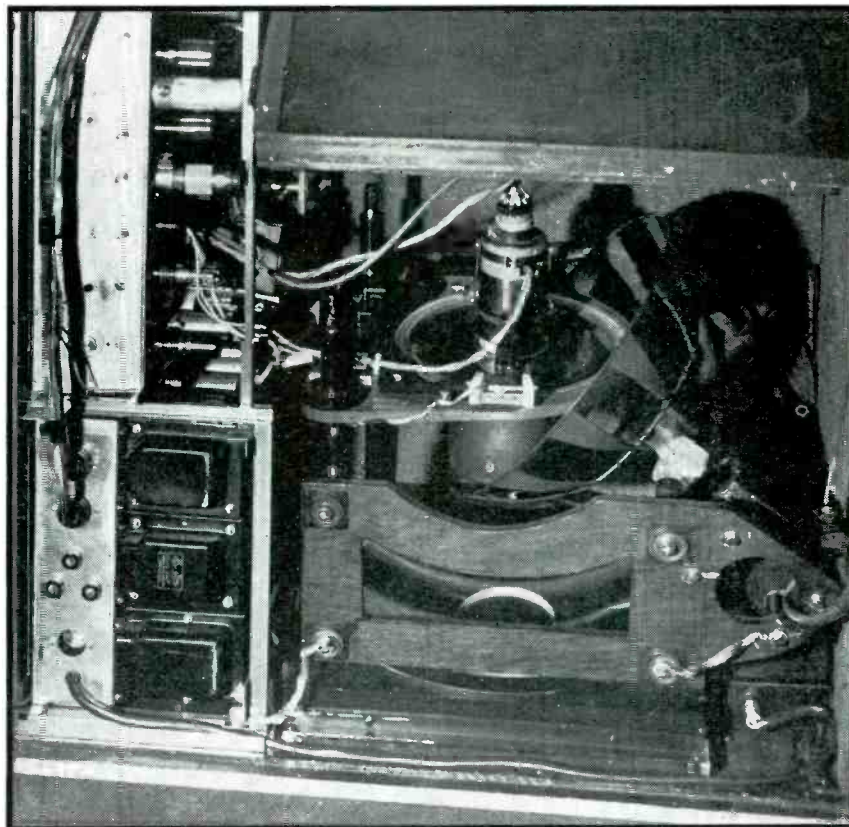

FIG. 8—Front view of projection receiver, which produces a 17 by 22-inch picture through a Schmitt optical system

FIG. 7—Rear view of projection set. The cup-shaped color wheel is shown at right of projection tube, above the spherical mirror



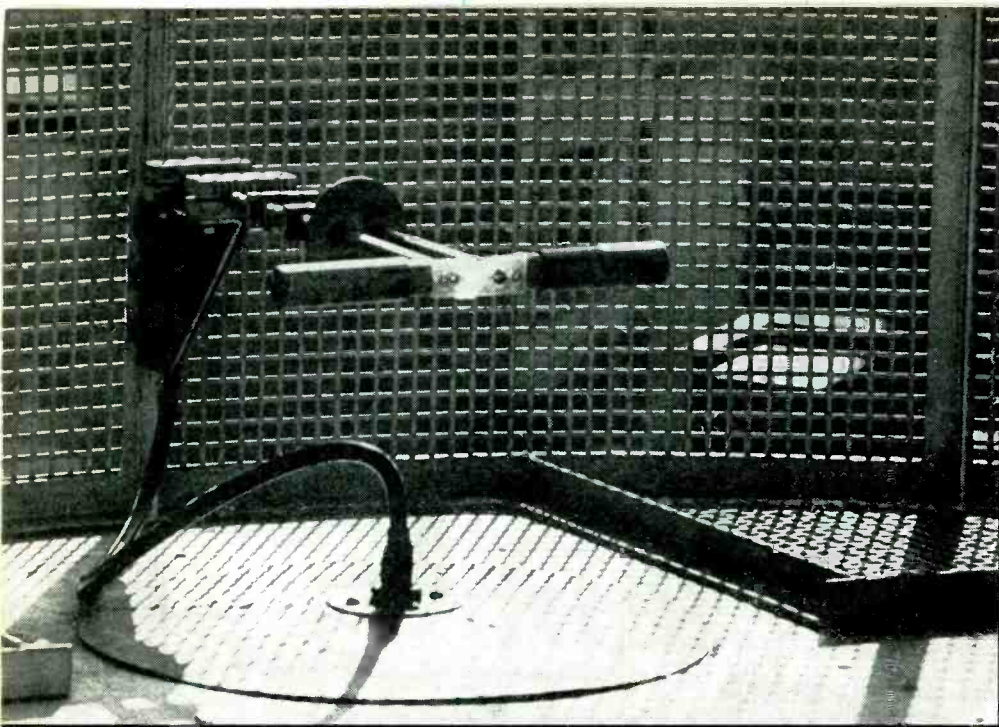

FIG. 8—The receiving antenna consists of a dipole and a 6-by-2 foot parabolic reflector which can be steered by remote control. The fifteen-degree beam width eliminates ghosts from reflected signals

stage which compares the incoming pulses with locally generated ones and thereby controls the speed and phase of the disc. A phase compensation circuit is used to maintain the instantaneous position of the wheel within a few degrees of the correct value as it rotates. This permits full utilization of the area of the filter segments. Since the color wheel synchronization is obtained from the video waveform, the phasing of the color segments is automatically selected (that is, a given color automatically appears before the receiver tube when that color is present before the camera at the transmitter).

Since the fundamental color recurrence rate of the system is 120 per second, which is twice that of the power frequency of 60 cps, precautions must be taken to shield the picture tube from a-c fields, and to avoid power supply ripple in certain critical circuits, particularly the scanning generator output tubes. Such filtering is not required in all scanning tubes, however, and its cost is moderate. The picture tube shield is of the permalloy type.

The projection receiver, Fig. 6 and 7, employs a 5-inch projection tube which faces downward toward the spherical mirror of the Schmitt optical system, where the image is reflected through a molded cast-plastic correction lens. The color sequence is introduced by a modified wheel in the form of a cup, mounted to the side of the picture tube. The filter segments rotate directly under

the face of the projection tube. To conserve light, the blue filter used has twice the optical transmission of the filter used in the direct-viewing receiver, and as a consequence the color gamut is somewhat reduced in the projection set. The projection color wheel rotates at 600 rpm and contains 12 segments, four of each color.

In a high definition picture ghost images must be minimized, and this

is particularly important when color is transmitted. To avoid ghosts from reflected signals (which may also affect the quality of the f-m burst sound transmission) a directive receiver aerial is considered essential for use in built-up city districts.

Receiving Antenna

The antenna used in the demonstrations is a single dipole, Fig. 8, mounted at the focus of a parabolic reflector of perforated metal, 6 feet wide and 2 feet high. The beam width is about 15 degrees in azimuth. The structure is motor driven in azimuth. Direction can be shown on a chart by a remote control through a selsyn indicator system. Excellent ghost-free reception was obtained on direct line to the transmitter as well as by reflected signals from the Empire State building and other tall buildings in the vicinity. No difficulty was experienced in avoiding reflections, although ghosts were visible when the beam was turned so that it faced the wall of the CBS building.

Camera and Pick-up Equipment

At present the CBS equipment is limited to pickup from 16-mm color

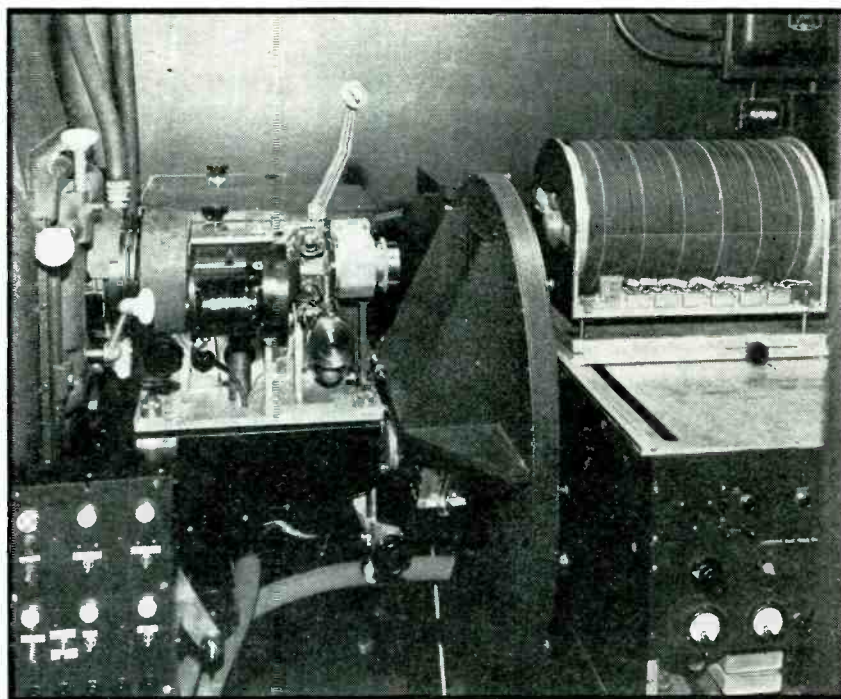

FIG. 9—Camera pick-up equipment for 16-mm film and 35-mm slides. The continuous-motion projector and color wheel are at the left, selector lens disc at center, image dissector in cylindrical housing at right

film and 35-mm color slides. Work is in progress on a direct pickup camera which is expected to be ready for demonstration in May. The film camera tube is an image dissector, a tube ideally suited because it has no storage and hence does not carry over stored charge on the unscanned interlaced lines from one color segment to the next. The tube has low sensitivity, however, and requires correspondingly great illumination—too great to permit direct pickup. The direct equipment will employ an orthicon storage-type tube. The film images are scanned in a continuous-motion projector by passage through five stationary lens elements. A selector disc permitting light to pass through one lens at a time, Fig. 9, introduces a shift in the optical axis to counterbalance the motion of the film.

A block diagram of the pickup and associated sync equipment is shown in Fig. 10. The signal output from the dissector, after passage through the video preamplifier, is passed to a video amplifier and gamma control. The latter is a non-linear amplifier which compensates for the curvature in the dynamic transfer characteristic of the remainder of the system, including the receiver picture tube. After passage through this gamma

control amplifier, the signal has such a form that the light output in the receiver picture tube is a linear function of the light input to the dissector tube, that is, the gamma is unity. This is a new departure which has greatly improved the ability of the system to render dark shades, as well as to maintain color balance over a wide range of illumination. The gamma control has the property of maintaining a fixed output amplitude regardless of changes in the curvature introduced. The gamma control is applied simultaneously to all three colors. A separate gamma characteristic for each color, introduced in sequence, has theoretical advantages but has not proved necessary in practice.

After emerging from the gamma control the camera signal is mixed with the other portions of the video waveform (sync and sound f-m bursts in accordance with Fig. 3. Monitoring facilities are provided at the outputs of the sync generator (waveforms viewed), the gamma control (image viewed in black and white), and the mixer amplifier (image viewed in color). The relative amplitudes of the camera signals produced in the three colors are varied by the color mixer. This is an improved version of the color mix-

ing equipment used in 1940. The 1940 mixer employed 20 tubes and occupied three chassis of equipment. The new mixer is purely mechanical in operation and occupies less space than a 6-inch cube. The image pickup, synchronization and sound-on-sight equipment is now being produced, following CBS designs, by the Westinghouse Electric Corp.

The system just described transmits excellent color pictures. The intrinsic definition of the pictures is better than the 525-line black-and-white pictures by virtue of the more than proportionally wide band used and, of course, the apparent definition is greatly enhanced by the color contrasts present in the image. From this standpoint the images are perhaps the best television pictures yet produced. Further work, to investigate the coverage properties of the uhf signal and to develop direct pickup equipment of equally high quality, has been undertaken by the CBS group and will be reported in these pages as soon as the results are available.—D. G. F.

REFERENCES

- (1) Color Television Demonstrated by CBS Engineers, *ELECTRONICS*, p 32, Oct. 1940.
- (2) Goldmark, Dyer, Piore and Hollywood, Color Television, Part I, Proc. IRE p 162, Apr. 1942.

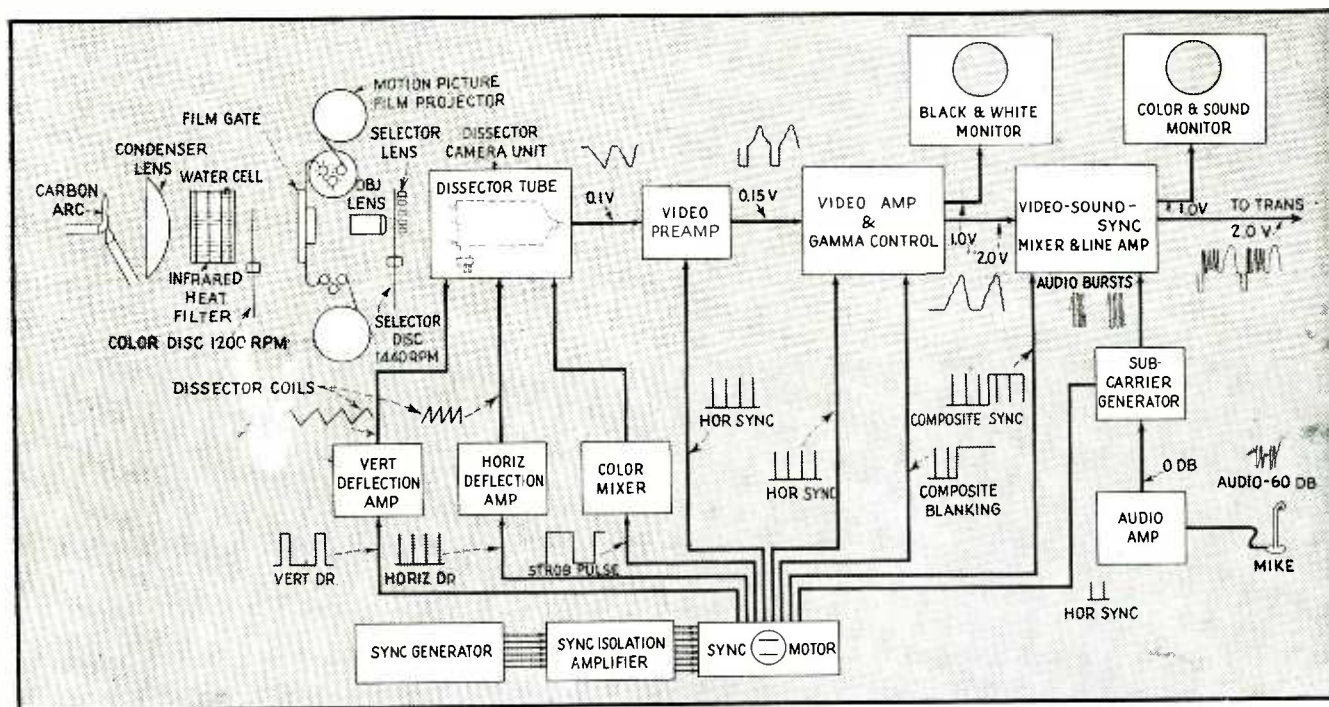

FIG. 10—Block diagram of pickup, sync and sound-on-sight equipment

ULTRASONIC

Design of r-f generator and quartz crystal radiator providing ultrasonic mechanical energy for disintegration of bacterial cells and other unique physical and chemical effects. The frequencies involved range as high as 500 megacycles

By **FREDERICK W. SMITH, Jr.** and **PAUL K. STUMPF**

*Department of Medicine
College of Physicians and Surgeons
Columbia University, New York*

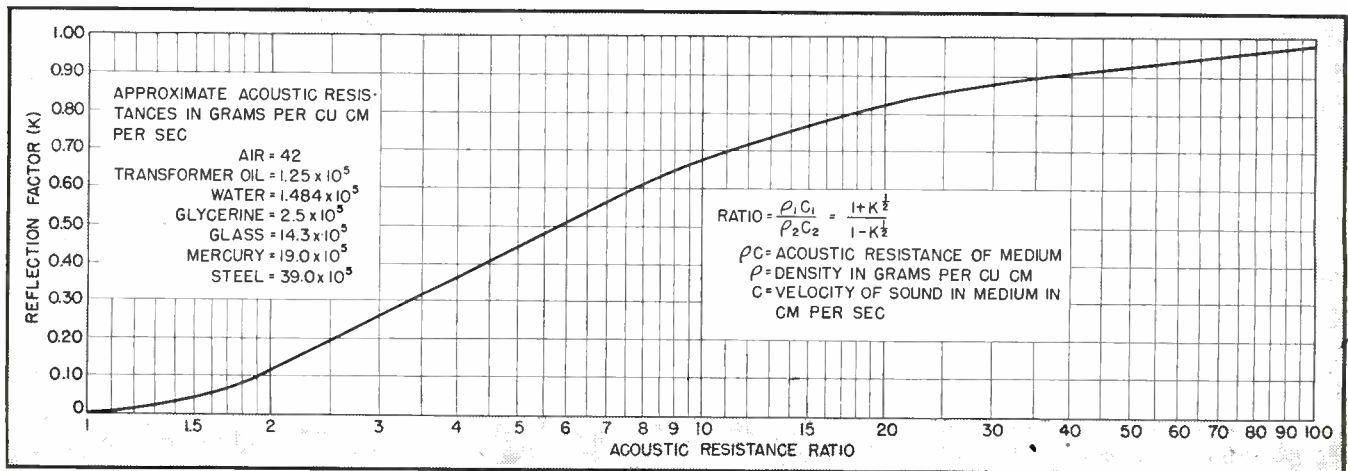

FIG. 1—Chart giving percent reflection ($K \times 100$) at interface of two media having different acoustic resistances

THE term "ultrasonics" is applied to super audible sound waves which can be generated in liquids and solids over a frequency range of 30 kc to as high as 500 mc. The unique physical and chemical effects produced by intense sound fields at these frequencies are finding wide applications in many fields of investigation. As an example, in the field of biochemistry ultrasonic energy has been successfully employed by the authors in the disintegration of bacterial

cells, permitting a detailed study of their enzyme system.^{1, 2} This paper presents a consideration of the problems encountered in the design and construction of ultrasonic laboratory equipment.

The basic element of the piezo type ultrasonic generator consists of an X-cut quartz plate vibrating in the longitudinal or thickness mode, acoustically loaded by immersion in a liquid media and excited at mechanical resonance in order to achieve an appreciable ultrasonic output. The circular plate usually employed has diameters as large as 10 cm, the thickness of course being determined by the resonant frequency desired.

Ultrasonic intensities generated will vary directly with the acoustic resistance of the surrounding medium and with the square of the applied voltage and operating frequency. However, the latter two fac-

tors cannot be increased indefinitely to achieve greater outputs. The maximum voltage that can be applied is determined by the breakdown point of the crystal and its associated supports. Furthermore, vibration does not occur uniformly over the surface of the quartz plate, and if excited too vigorously the elastic limits of certain sections of it may be exceeded even though other areas are relatively motionless. Crystal fragility and liability to voltage breakdown increase at higher frequencies due to diminishing thickness, and hence operation at high intensities is usually confined to frequencies below one megacycle.

Efficiency Criteria

These limitations on the exciting power make it essential that the efficiency of the acoustical system be as high as possible. The four criteria for such a system are as follows:

(1) Damping of the quartz radiator due to its support must be avoided. This is accomplished by securing the crystal at points of low

Height of fountain of liquid thrown up from surface of medium during ultrasonic exposure is criterion of ultrasonic intensity



GENERATOR

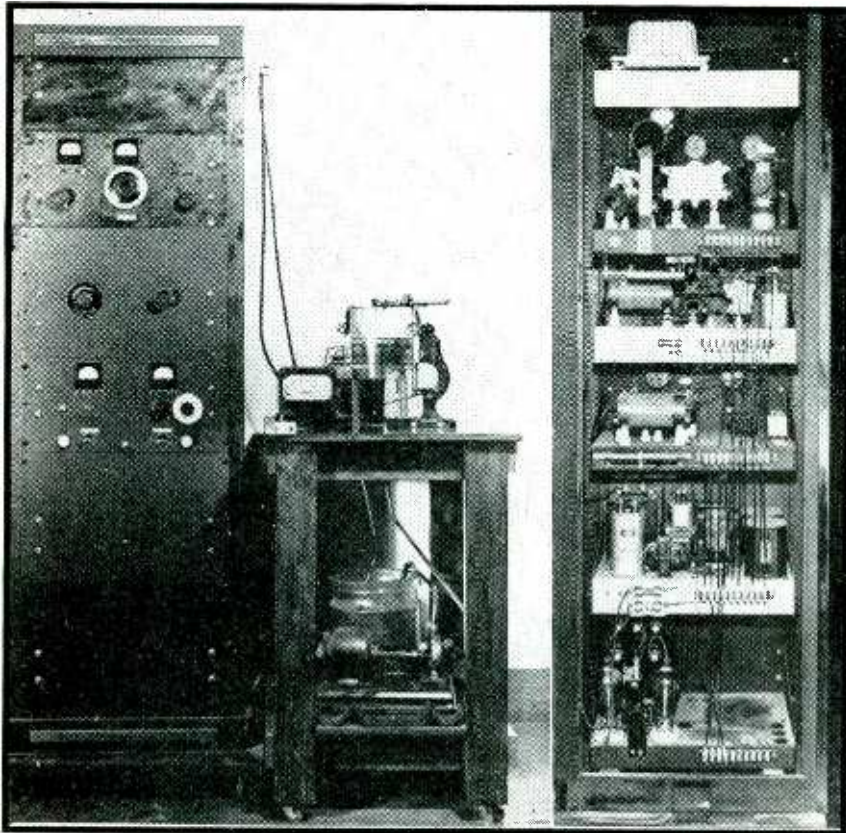

Radio-frequency generator connected to quartz radiator immersed in oil in glass container on table. Cooling system for oil is on shelf under table. Microscope stand is being used as rack and pinion for adjusting height of fluid-filled flask in oil. Output power is over 500 watts in operating range of from 150 to 1000 kc. At right is a rear view of the ultrasonic generator

motion either about its periphery or in the middle of the thickness dimension, the nodal point for an X-cut crystal.

(2) Reflections between objects to be immersed in the sound field and the conducting medium should be minimized. These will occur when the sound crosses a junction of two media having unequal acoustic resistances.³ From the approximate acoustic resistances given on the reflection chart in Fig. 1 it may be seen that the reflection loss for a glass container immersed in an oil medium would be about 70 percent ($K = 0.7$ for an acoustic resistance ratio of 11), and between any medium and air close to 100 percent. Thin sections of material interposed in the sound path will cause a minimum of attenuation if they are an integral number of wavelengths thick.

(3) The acoustic loading on the

radiator should be concentrated on one surface only. This requires that the other be coupled to a medium of very high or low acoustic resistance to provide a maximum of reflection. In practice, one surface is coupled to the liquid medium and the other is exposed to air, concentrating the radiation in one direction.

(4) In order to obtain large intensities coupled with a minimum of re-

lections, a medium having the highest acoustic resistance consistent with good dielectric properties is selected. A transformer oil, such as Wemco C produced by the Westinghouse Electric Corp., has proven to be one of the most suitable.

Fortunately, dispersion of the radiated energy does not introduce much loss since the radiation from a circular plane source is confined to a highly directional beam when the ratio of radiator radius to the wavelength is large. Further concentration may be obtained by using a spherically curved plate of large curvature which develops very high intensities at its focal point. In addition, recent investigation has shown that slightly curved crystals, while not producing a marked focusing effect, provide intensities at all distances from the radiator which are superior to those obtainable from either a flat or focussed radiator.⁴

Design of Crystal Holder

With these requirements in mind, the crystal holder sketched in Fig. 2 was developed. It consists of a quartz crystal sandwiched between two brass rings that are held together by

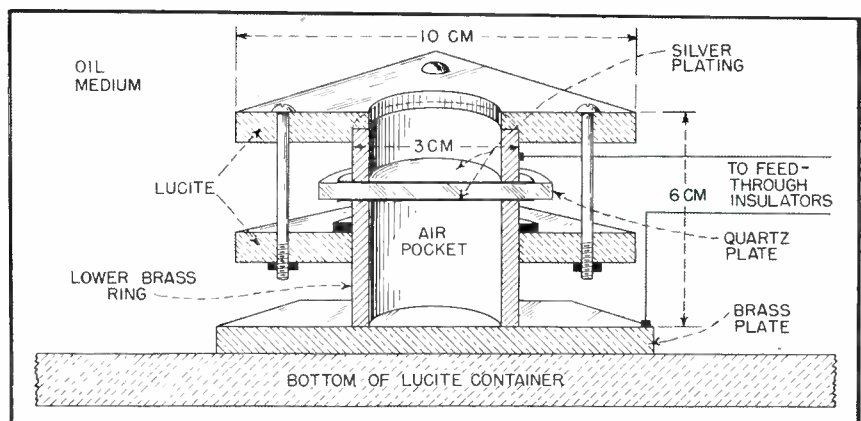

FIG. 2—Construction of quartz radiator designed for immersion in oil

This work was supported by a grant from the John and Mary R. Markle Foundation, administered by Dr. D. E. Green of the Department of Medicine, College of Physicians and Surgeons, Columbia University.

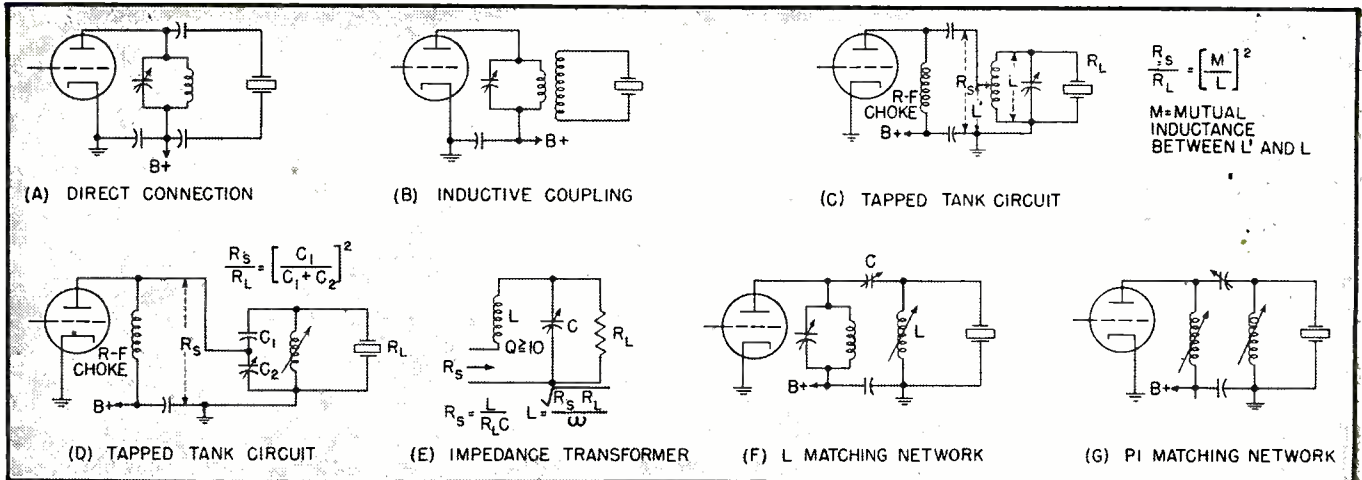

FIG. 3—Coupling circuits suitable for matching the output of an r-f generator to a quartz radiator

a Lucite press device which permits changes in contact pressure of the brass electrodes on the quartz surfaces. Although it leads to some damping, this arrangement has the advantage that breakdown of the insulating medium is eliminated completely. With other types of holders which were constructed and tested, voltage breakdown of the transformer oil resulted in immediate and irreparable damage to the surfaces of the quartz crystal.

The surface of the quartz crystal is silver-plated routinely every six months by Brashear's method. It was found that a silver-plated surface is superior to a surface of aluminum or silver foil cemented or spattered onto the quartz surfaces. To increase the voltage breakdown path, the upper and lower plating is not carried out to the extreme edge of the crystal. Lucite is used exclusively in the mounting and in the oil chamber as insulation against high voltage.

The crystal holder is completely immersed in transformer oil which serves at once as insulation medium, conducting medium for ultrasound, and circulating fluid for the cooling system. The oil is circulated continuously by a centrifugal pump from the ultrasound apparatus through a copper coil surrounded by an ice-water mixture. Much heat is formed during operation and efficient cooling is necessary to prevent the temperature from rising above 30 C in the bacterial suspension.

When the crystal holder is immersed in the oil bath, the lower brass ring electrode automatically forms an air pocket, which almost

completely reflects the sound waves at the lower side of the quartz plate. The reflected waves come automatically into the right phase with those radiated upwards and increase their energy, hence the total damping of the crystal becomes less, owing to the decrease in the radiation decrement.

In the design of the radio-frequency sources used to excite ultrasonic generators, it has heretofore been the trend to increase the power output capabilities of the equipment in order to increase ultrasonic outputs. The futility of this is evident when it is realized that only an increase in applied voltage is necessary to accomplish this. The actual power consumption of any crystal radiator will rarely exceed 250 watts and will usually be much less.

Ultrasonic Power Output

The input impedance at resonance of a quartz radiator is mainly resistive and is the equivalent of a load of 10,000 to 250,000 ohms shunted by a capacitance of as much as 100 $\mu\mu\text{f}$. Developing large voltages across such an impedance is simply a problem in impedance matching. The resistive load which the usual class-C amplifier must see across its tank circuit ranges from 500 to 10,000 ohms depending on its operating conditions, and these values will determine the matching ratios to be used in the network coupling the r-f generator to the crystal.

It is interesting to note that any reflection of sound back to the quartz radiator alters the electrical impedance of the radiator in a manner similar to that in which the imped-

ance of a discontinuous transmission line varies with length. The input impedance is therefore a minimum when the reflection path is an odd number of quarter wavelengths long. Total reflection may also cause a shift in the quartz resonant frequency by as much as 20 percent and consequently is to be avoided.⁵

Coupling Circuits

In Fig. 3 are shown various coupling circuits suitable for matching purposes.

In Fig. 3A the crystal is connected directly across the tank circuit of the r-f generator and the excitation is limited to the peak voltage developed across the tank. In Fig. 3B, an inductive coupling circuit is shown but it has proven to be relatively inefficient and subject to breakdowns.

In Fig. 3C and 3D, a tapped tank circuit is utilized, the final amplifier being connected across only a portion of either branch. A further extension of this idea is the parallel resonant impedance transformer in Fig. 3E, where L is equal to $(R_s R_L)^{1/2} / \omega$. If the circuit Q is greater than 10, a small load R_s will be presented to a generator looking into either branch of the circuit when a large load R_L is shunted across it. This action is identical to that of the L matching network in Fig. 3F.

Probably the best arrangement is the use of a pi network as shown in Fig. 3G, which will provide the most exact impedance match and will obviate the use of a tank circuit.

Voltages developed across matching components will increase as the square root of the impedance level,

and hence special care must be taken in insulating these components. Sharp edges and corners will cause undue concentrations of electrostatic flux which are likely to result in corona and frequent breakdowns. The design of inductive elements should take into consideration not only the potential gradients existing across the windings and forms but also the amount of dissipation the coil forms must accommodate.

R-F Generator Circuit

The requirements of the r-f generator used to excite these radiators are similar to those of the usual radio transmitter, except that provisions for the use of both a crystal-controlled and a stabilized, calibrated variable-frequency exciter should be included. Operating frequencies may cover a wider range than usual but continuous frequency coverage is not absolutely essential. Additional refinements might also include a variable power output control and an automatic timing device to facilitate accurate ultrasonic time exposures.

The circuit of a generator designed and constructed to excite a quartz radiator is shown in Fig. 4. It employs beam-power tetrodes to eliminate neutralization, and the final amplifier consists of type 813 tubes operating in push-pull parallel. The generator has an operating range of from 150 to 1000 kc, obtained by

switching plate circuit inductors. When fully loaded, it will deliver over 500 watts output. In operation, all metallic objects associated with the equipment are grounded to prevent accidental burning of the operator by induced potentials.

Simple oscillator circuits may also be employed as generators. A suitable oscillator circuit for this purpose, similar to those used as high-voltage supplies for cathode-ray tubes, is shown in Fig. 5.⁹ The secondary, L_2 , is tuned to the operating frequency by the distributed capacitance shunting it, and for low power loss is of very high impedance. To obtain a stable tuning characteristic, feedback for the grid circuit is obtained solely from L_2 . To improve the generator regulation, the coupling between L_1 and L_2 is made at least twenty times greater than is critical.

For those tempted to experiment, it should be noted that the high

damping of the quartz plate used as a radiator makes it impossible to employ this plate to establish the frequency of the generator.

Typical Application

One application of the ultrasonic generator to the problems of enzymology will be described briefly. A thin suspension of bacteria is placed in a flask and immersed in the medium by a rack and pinion device. The flask is then adjusted to a critical distance from the radiator determined by the peak in the height of the cone of fluid thrown up within the flask by the radiation pressure of the ultrasound. After a ten-minute exposure to ensure satisfactory disintegration, the material is spun down in the high-speed head of a refrigerated International Centrifuge at 20,000 rpm. In five minutes all cellular debris as well as intact cells will have been centrifuged down, and the supernatant fluid, usually turbid and light amber in appearance, is carefully decanted into a chilled container for analysis.

REFERENCES

- (1) Stumpf, P. K., and Green, D. E., *J. Biol. Chem.*, 153, p. 387, 1944.
- (2) Stumpf, P. K., *J. Biol. Chem.*, 159, p. 529, 1945.
- (3) Bergmann, "Ultrasonics", Ch. 2, J. Wiley & Sons, New York.
- (4) Labaw, L. W., Curved Quartz Crystals as Supersonic Generators, *J. Acous. Soc. Amer.*, 16, p. 231, Apr. 1945.
- (5) Fox and Rock, A Quartz Plate with Coupled Liquid Column as a Variable Resonator, *Proc. IRE*, Jan. 1943.
- (6) Schade, O. H., R. F. Operated High Voltage Supplies, *Proc. IRE*, Apr. 1943.

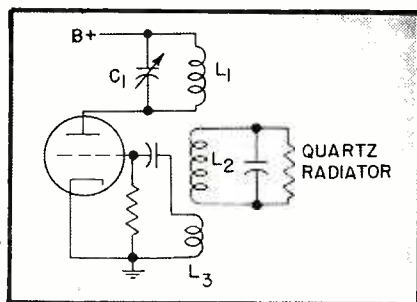

FIG. 5—Self-excited oscillator circuit suitable for driving a quartz radiator

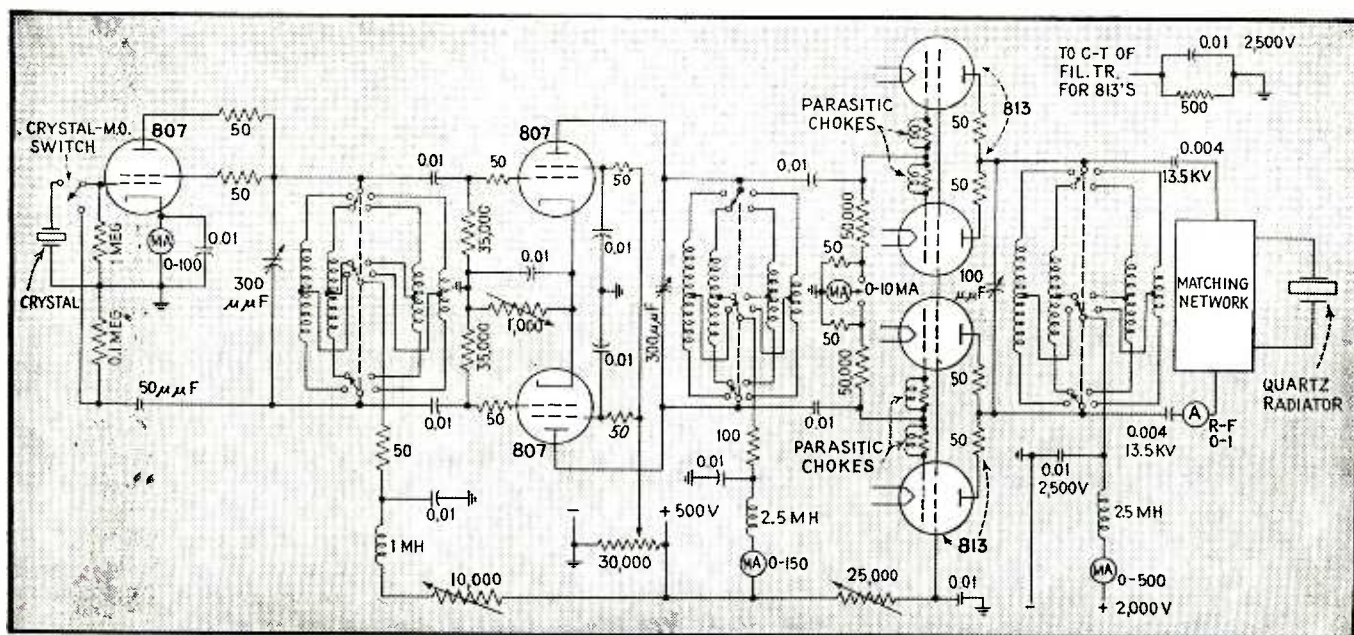

FIG. 4—Circuit of r-f generator used to excite an ultrasonic quartz radiator

AFC for R-F HEATING

Automatic correction of frequency shift under varying load is accomplished by an electric motor that tunes the heating oscillator back to the desired frequency. Discriminator and search circuits actuate relays to control motor rotation

IN PROCESSING MATERIAL by means of radio-frequency energy, it is desirable to accurately control the heating oscillator frequency. Most oscillators used for induction and dielectric heating have poor frequency stability as compared to oscillators used for communication purposes. This is because they are much more heavily loaded, and the characteristics of the load change considerably during the heating cycle.

Some manufacturers have made an attempt to shield their oscillators to eliminate interference to communication services. However, with conditions met in field installations, excessive radiation can easily occur at the work-handling point, even though

By **S. IVAN RAMBO**

*Design Engineer
Industrial Electronics Division
Westinghouse Electric Corporation
Baltimore, Md.*

be practicable to maintain such stability with a self-excited type of generator without some means of frequency correction.

Amplifiers for Low Power

One possible solution to the problem is to employ broadcast transmitter design methods utilizing a crystal or small stabilized oscillator with amplifiers following it until the necessary power required to drive the final amplifier is obtained. In the

frequency-modulation technique in the past few years, many automatic frequency control devices have been developed to maintain accurate oscillator frequency. Extremely accurate frequency control has been obtained by the use of reactance tubes or similar devices connected across the oscillator tank circuit.³ Unfortunately, it is not very practical to utilize such correction means for high-power oscillators because of the large power requirements of the reactance tube and associated circuits. In addition, it is difficult to correct for the large frequency variations encountered in induction and dielectric heating oscillators because of the limited range of reactance variation obtainable with such devices.

It is possible to obtain heating oscillator frequency stability in the order of ± 0.05 percent by mechanical means. If a portion of the oscillator circuit inductance, capacitance, or transmission line length, can be varied by means of a motor, a system such as that shown in block diagram form in Fig. 1 may be used.

Tuning Correction

The output from a crystal oscillator which may operate at a desired heating oscillator frequency⁴ or at some fixed frequency above or below the desired heating oscillator frequency⁵ is fed into a mixer stage along with some voltage picked up from the heating oscillator. The output circuit of the mixer stage is designed to pass the difference frequency between the two oscillators. After suitable amplification, this voltage is applied to a diode discriminator which may be of the Seeley or Crosby type. If the crystal oscillator frequency is made the desired

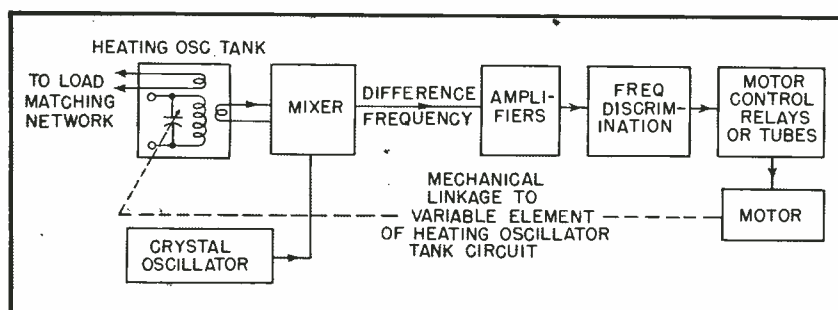

FIG. 1—Essential stages of the afc system for an electronic heating generator. A frequency stability on the order of ± 0.05 percent is obtained

the oscillator itself has been properly shielded, unless extreme precautions are taken in shielding the work circuit as well.¹

The Federal Communications Commission, to reduce interference to other services by industrial electronic equipment, has assigned definite frequency bands for use by industry. The tentative proposed frequency stability requirement is ± 0.05 percent.² Obviously, it will not

case of generators of low output (1 to 10 kw), this method would be relatively inexpensive, although the added size and cost would be considerably greater than that of present heating oscillators. For higher-powered generators (10 to 200 kw), this method would add many complications and increase the cost tremendously over that of a simple oscillator of corresponding power output.

With the rapid development of fre-

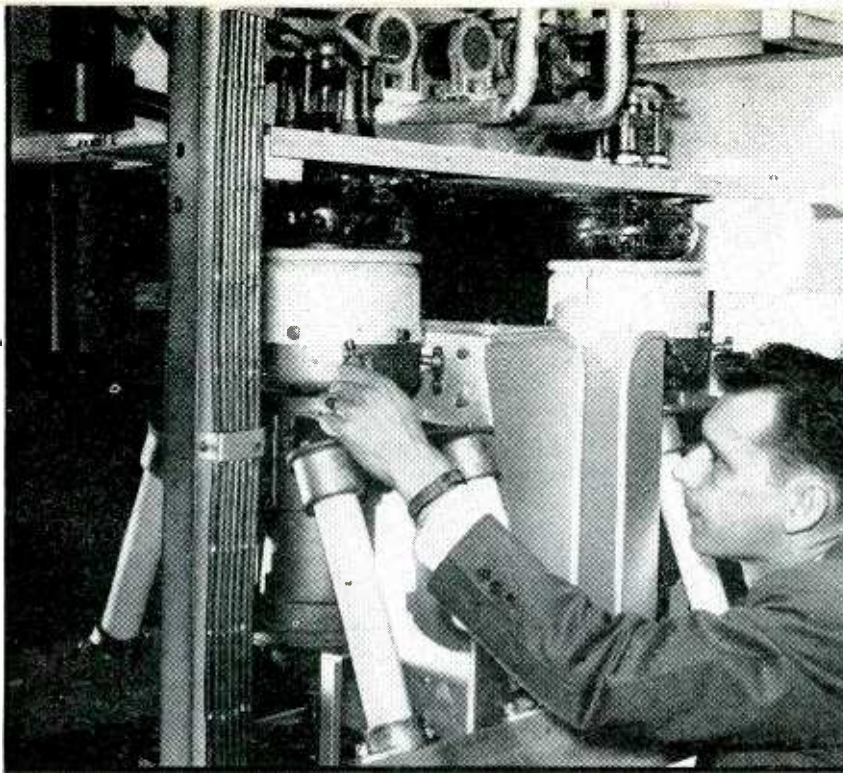

Automatic frequency control is employed on this 100-kw Westinghouse oscillator for electronic heating

heating oscillator frequency, the *RC* or audio-frequency transformer type of frequency discrimination may be used.

The discriminator output is used to control electromagnetic relays, thyratrons or vacuum tubes which in turn control the motor attached to the variable element of the heating oscillator tank circuit.

Motor Tuning Control

If the heating oscillator is on frequency, the resultant discriminator output voltage will be zero so that the control circuit will permit the motor to be at rest. If the heating oscillator frequency drifts higher or lower than mean frequency, the discriminator resultant output will assume a polarity such as to drive the motor in the proper direction to return the oscillator to its proper frequency.

No detailed circuit for the conversion of difference frequency between heating oscillator and desired frequency to direct current is shown because the form which such a circuit takes depends upon the point in the frequency spectrum where the master oscillator operates and the accuracy of correction desired. However, the conversion of the discriminator output to mechanical motion of the variable element of the heating oscillator tank circuit is relatively independent of the oscillator frequency. One possible control system for this purpose is shown.

Figure 2 is a simplified diagram

of a method for motor control which will function properly with certain limitations. The d-c voltage output from the discriminator is connected to the control grids of V_1 and V_2 . In the plate circuits of these tubes polarized relay coils are connected in such a manner that if the plate current of V_1 exceeds that of V_2 by a certain amount, contact K_1A will close. If the plate current of V_2 exceeds that of V_1 , by the same amount, contact K_1A' will close. Then if the discriminator is arranged so that point 1 is negative with respect to ground and point 2 is positive for a heating-oscillator frequency greater than the desired frequency, V_2 will draw more plate current than V_1 , causing relay contact K_1A' to close.

When K_1A' closes, it shorts out the coil of relay coil K_2 so that its contact K_2A opens and K_2B closes. This completes the circuit through the motor armature, causing current to flow from point B to point A .

The motor will rotate to vary the heating-oscillator tank circuit in the proper direction to lower its frequency until the proper frequency is reached when the voltage between points 1 and 2 are equal, at which time K_1A' opens, stopping the motor. Obviously, for a heating-oscillator frequency less than the proper frequency, the tank circuit will be varied in the opposite direction to make the necessary correction. The limitations of the circuit are imposed by the bandwidth of the discriminator employed and the sensitivity of the polarized relay.

Limitations of Discriminator

Figure 3 shows a typical plate current characteristic for V_1 and V_2 . If the discriminator characteristic is so shaped as to cause the polarized relay to operate at points 1 and 2, then it will again center at points 3 and 4 where the difference currents

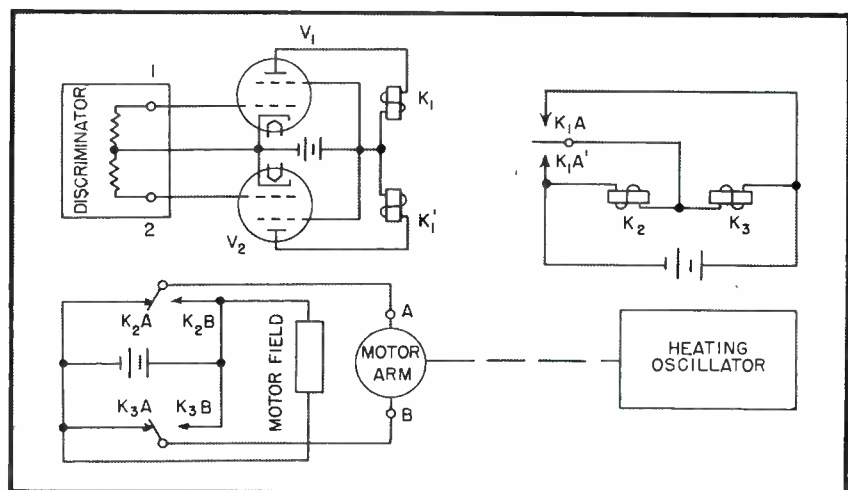

FIG. 2—Control circuit for converting the discriminator output into mechanical motion of the tuning element of the heating oscillator

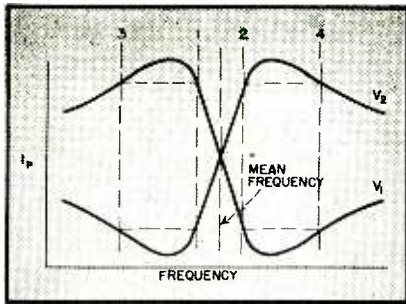

FIG. 3—Plate current characteristics of tubes V_1 and V_2 of Fig. 2. Points 1 and 2 determine the correction accuracy and points 3 and 4 indicate the effective bandwidth of the discriminator

are the same as at points 1 and 2. Unfortunately, the closer the points 1 and 2 are brought together by steepening the slope of the plate current crossover curves to get better accuracy of frequency correction the more rapidly do the plate currents approach one another off resonance.

Search Circuit Operation

With the relatively large frequency change encountered in radio-frequency generators during heat treatment of materials, the oscillator frequency may be outside the limits of points 3 or 4 at the start of a new heating cycle, so that no correction can take place. In order to make certain that this condition cannot occur, a further refinement of the circuit shown in Fig. 2 is usually necessary. A search circuit such as is shown in Fig. 4 can be made to cause the variable element in the heating-oscillator tank circuit to rotate, even though the frequency is outside the limits of points 3 and 4, until it is brought within these limits. The discriminator will then take over to center the frequency.

Some r-f voltage from the heating oscillator is coupled to an LC circuit tuned to the proper oscillator frequency. This circuit is connected to the grid of a pentode used as a detector, with the search relay K , connected in its plate circuit. The Q of this circuit and the bias voltage E are so adjusted that K will close just before point 1 is reached for one direction of frequency connection and just before point 2 is reached in the opposite direction of frequency correction.

The adjustments will also cause K ,

FIG. 4—Search circuit for maintaining the frequency within the desired limits at the start of a new heating cycle

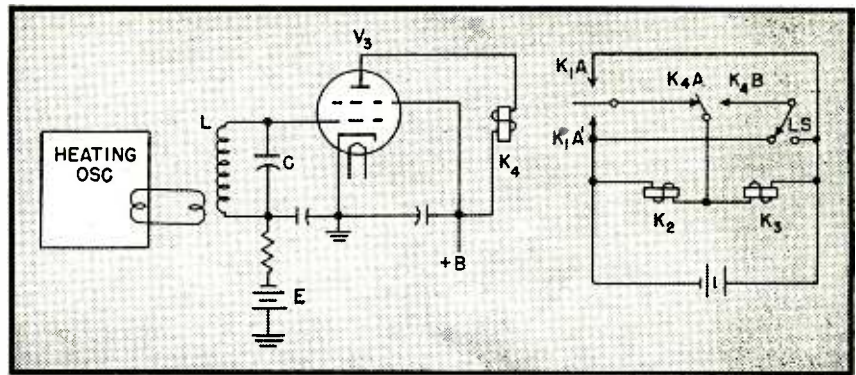

to open just before points 3 and 4 are reached when the frequency departs from the mean frequency. Contacts K_1A and K_1B , along with limit switch LS , will then cause the motor to operate even though the frequency of the heating oscillator is outside the discriminator effective range until the frequency is brought within this range. When that occurs, they will relinquish control to the polarized relay K_1 , which will perform the same function as before.

Other Methods

The frequency of the heating oscillator may be outside the desired limits of correction for an appreciable time at the beginning of a heat cycle. It may therefore be desirable to automatically return the variable portion of the tank circuit to the proper starting point after the completion of a heat cycle for applications where the heating procedure is not a continuous process. This can be done automatically by additional relay contact arrangements.

There are many other possible arrangements of relays, thyratrons and vacuum tubes which have been devised for other applications⁶ and can be used to accomplish motor control for frequency correction. In any of these systems the problem of hunting arises, and may be overcome by the same methods employed for other motor control devices. In general, the higher the sensitivity desired the more difficult it becomes to overcome hunting unless the electrical and mechanical inertia of the system can be kept low.

Unfortunately, for large power oscillators the variable element will

be bulky with inherent high inertia. For such cases, braking or motor-plugging schemes⁷ may be employed to prevent motor overshoot. Such schemes apply reverse current to the motor armature momentarily of such magnitude as to overcome all inertia at the instant when it is desired to stop the motor. Many feedback systems⁸ and motor-braking systems developed for other applications may also be helpful here.

Systems of the type discussed above for frequency correction can be made employing small receiving-type tubes and components whose overall size and cost will be much less than the oscillator-amplifier type of design. For small oscillators from 1 to 10 kw output it may be more economical to employ broadcast transmitter design technique for accurate frequency control. For larger units, the above system is much more economical in both space and cost.

REFERENCES

- (1) Klingaman, G. W., & Williams, G. H., Shielding of Dielectric Heating Installations, *ELECTRONICS*, p 106, May 1945.
- (2) FCC Allocation Plan, *ELECTRONICS*, p 92, Mar. 1945.
- (3) Hund, August, Reactance Tubes in F-M Applications, *ELECTRONICS*, p 68, Oct. 1942.
- (4) Bard, Jr., H. B., Remote Tuning with Reactance Tubes, *ELECTRONICS*, p 100, Aug. 1945.
- (5) Sheaffer, C. F., The Zero-Beat Method of Frequency Discrimination, *Proc. IRE*, Aug. 1942.
- (6) Crosby, M. G., Reactance Tube Frequency Modulators, *RCA Rev.* 5, July 1940.
- (7) Hale, H. Erwin, The K8 Computing Gunsight, *ELECTRONICS*, p 94, Jan. 1945.
- (8) Bond, Donald S., Visual Direction Finders, *ELECTRONICS*, p 144, Jan. 1944.
- (9) Gille, Willis H., & Sparrow, H. T., Electronic Autopilot Circuits, *ELECTRONICS*, p 110, Oct. 1944.
- (10) Moyer, E. E., Electronic Control of D.C. Motors, *ELECTRONICS*, May, June, July, Sept., Oct., 1943.
- (11) Harrell, F. E., & Hough, W. R., D.C. Braking of Induction Motors, *AIEE*, May, 1935.
- (12) Garman, G. W., Thyatron Control of D.C. Motors, *AIEE Transactions*, p 337-342, 57, June, 1938.

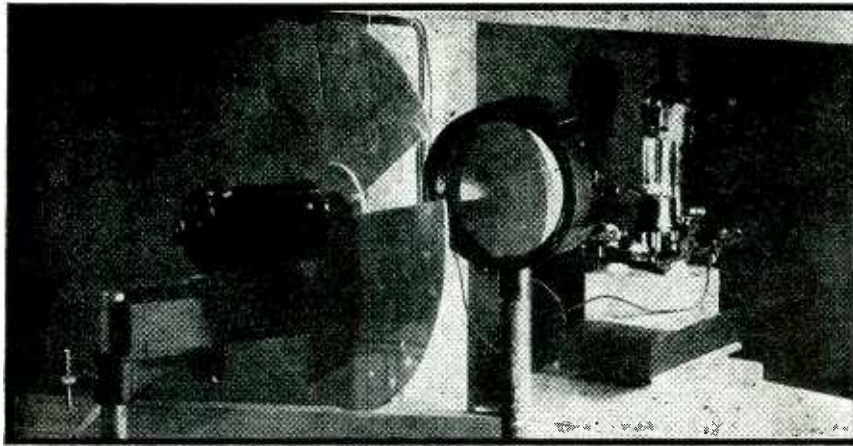

Rotating sector and photo unit arrangement, as used in a grating spectrograph, shown with the electrostatic shield removed

By **J. R. COSBY***
*Department of Physics
 Virginia Polytechnic Institute
 Blacksburg, Va.*

SPECTROGRAPH EXPOSURE CONTROL

Semi-automatic device employing a phototube and a grid-glow tube permits duplicate exposures to be made on photographic plates despite variations in the arc source. Other applications are indicated

IN RECENT YEARS the spectrograph has evolved from a small optical instrument with little dispersive power to a massive structure having dispersive powers of the order of 1.0 angstrom per millimeter or less.

The necessity for some device whereby duplicate exposures on photographic plates may be obtained naturally arises, especially in quantitative spectrographic analysis. A need for such a device is readily grasped when one observes the image of the arc or spark source on the slit of the spectrograph wandering from side to side, changing in intensity and even failing.

The types of spectrographs in use are generally of the grating or quartz-prism types and both can be adapted for use with a semi-automatic integrating exposure control developed by the author. In particular, the grating spectrograph lends itself readily to an integrating method of recording the light energy developed. The apparatus described herein was designed to operate with

a grating spectrograph having a dispersive power of 2.6 angstroms per millimeter, employing a grating of 30,000 lines per inch and having a radius of curvature of 21 feet. Using

a simple photocell, it automatically determines the end point of photographic exposures and further application of such a device to other measurements, such as solar radiation,

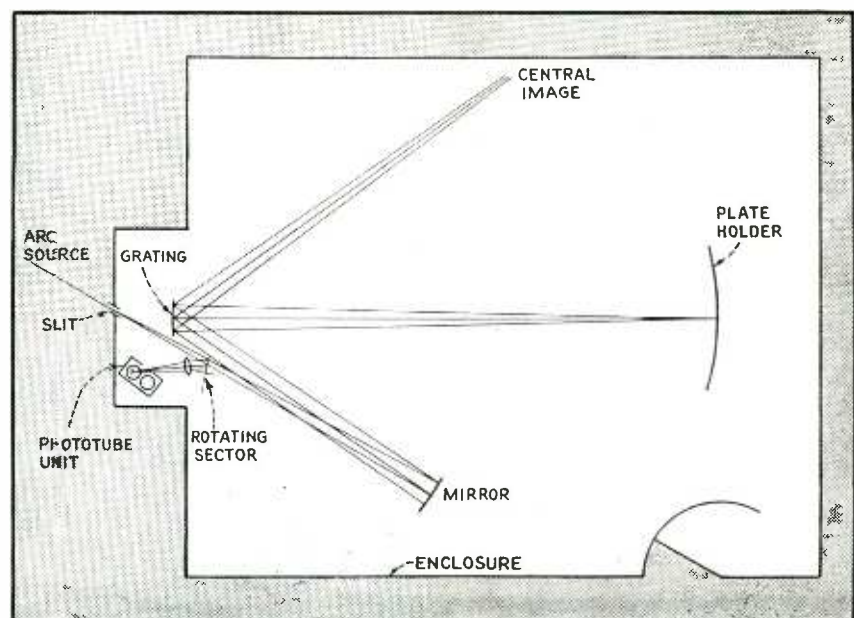

FIG. 1—Simplified diagram of a grating spectrograph equipped with an exposure-control photo unit

* Now with the Friez Instrument Div., Bendix Aviation Corp., Baltimore, Md.

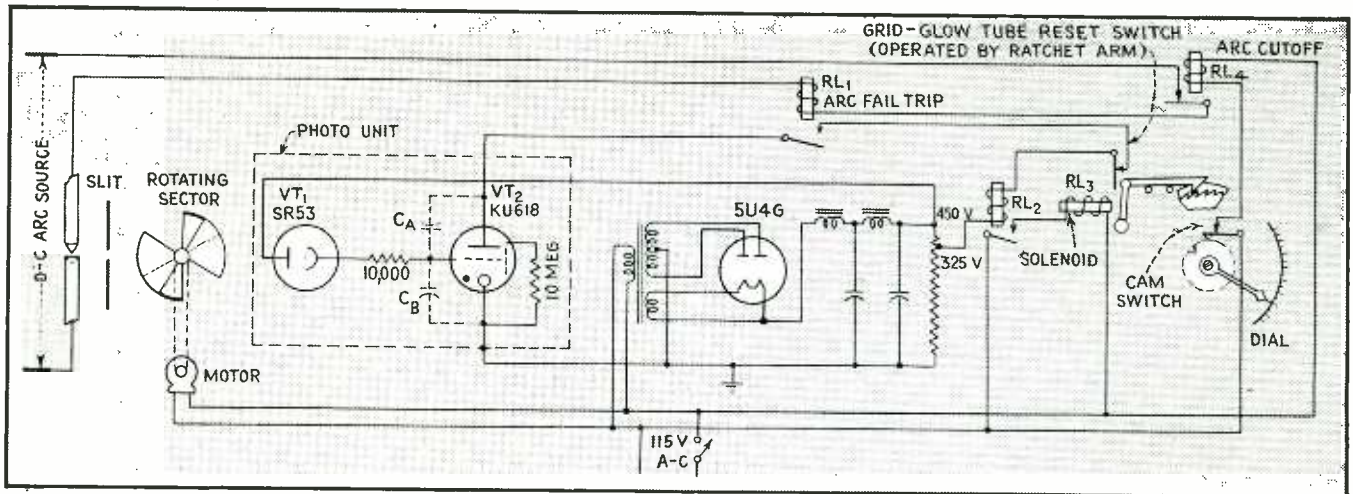

FIG. 2—Complete circuit diagram of the spectrograph exposure control device

visible and invisible, will be apparent. The use of the device to measure the intensity of spectral lines in spectroscopy is also possible.

The Apparatus

Figure 1 shows the relative locations of the various parts of a grating spectrograph. The phototube unit is located near the slit of the spectrograph, within the spectrograph enclosure. Light from the arc source passes through the slit to the mirror and then to the grating, forming spectrum lines on the plate holder and giving a central image.

In this particular application the incident light received by the phototube is reflected from the surface of a polished aluminum rotating sector located between the slit and the mirror within the spectrograph enclosure. The sector is adjustable for long or short exposures, dependent upon the nature of the analysis. Thus the light received by the phototube will be actually only a cross section of that exposing the photographic plate. If the sector is rotated at a reasonable speed (about 900 rpm) the light received by the phototube will be representative of that received by the spectrograph plate.

As shown in Figure 2, the photo unit consists of two tubes VT_1 and VT_2 , a phototube and a cold-cathode grid-glow tube. The grid-glow tube operates as an integrating-device actuator.

Details of Operation

In operation, the phototube converts the incident light into electrical energy and charges a capacitor, C_B ,

at a rate proportional to the intensity of the incident radiation, at the same time discharging C_A . Capacitors C_A and C_B are the partial capacitances of VT_1 and VT_2 . At a particular grid potential predetermined by the voltage on the plate of VT_2 , the grid-glow tube fires, registering one integrated interval, and reestablishes the system to its initial conditions. This process is repeated many times for a complete exposure, thus giving an integrated result. The accuracy is dependent partially upon the size of the increments. The dial setting determines the number of these increments. A ratchet wheel having many teeth is employed to position the dial, sums up the increments and thus becomes the integrator.

The overall unit contains a rectifier to supply the necessary d-c voltages for the phototube and the grid-glow tube. The sample to be analyzed is placed in the cavity of the lower arc electrode (pure carbon) and an arc is established between the two electrodes. This causes relay RL_1 to operate, completing the circuit to the grid-glow tube. Relay RL_1 insures inoperation of the indicator should the arc fail. Reestablishment of the arc restores operation. This provision also permits the exposure to be interrupted if desired without appreciable error due to slight leakages that may exist.

After each successive charge-up of capacitance C_B , VT_2 fires, causing the relay RL_2 to operate, actuating sole-

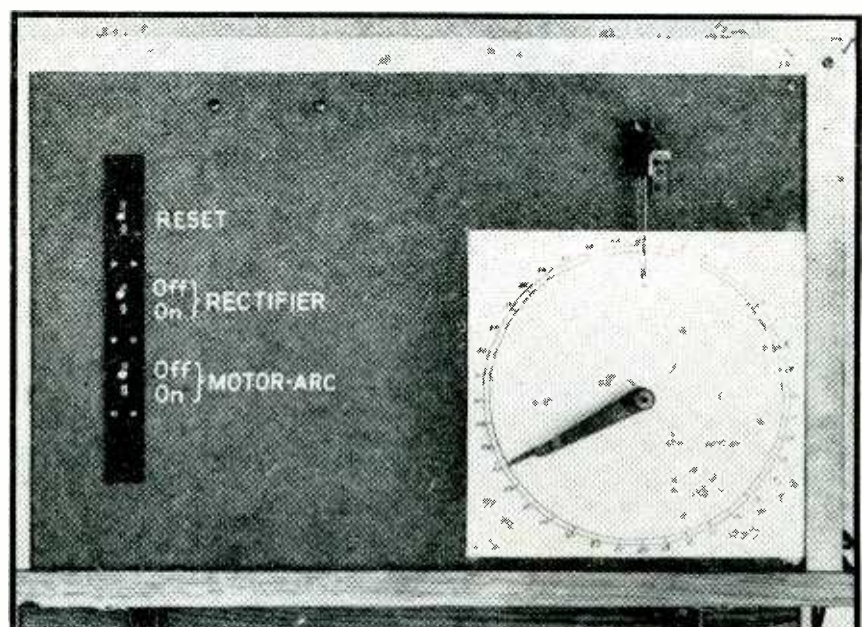

Front panel of power supply, relay and ratchet unit, showing the indicator dial

noid RL , which ratches the dial one increment and resets the grid-glow tube by opening its plate circuit for an instant by means of the switch located near the solenoid arm. After many such cycles of operation are completed a cam-switch opens and releases the arc cutoff relay RL , thus interrupting the arc circuit. This arc cutoff relay extinguishes the arc when the desired exposure or end point is obtained. The desired length of exposure is determined by the position of the cam switch, which is preset by moving the indicator arm about the indicator scale. Once the arc is established for any setting of the dial, the operation is automatic.

Certain precautions must be taken to eliminate as far as possible any leakage paths present across the phototube leads. Removal of the base from the phototube and the grid-glow tube is recommended. The phototube must be mounted on a base of good dielectric material. If mounted compactly, surrounded by some form of electrostatic shielding and properly grounded, a portable arrangement will be obtained with only three interconnecting leads to the recording unit. In humid climates, operation of the phototube unit under a desiccator might be required.

Performance

It is reasonable to expect some variation in the sensitivity of the phototube cathode surface to the wavelength of incident light and to area of surface. However, for any given analysis, especially in samples having the unknown material in percentages of the order $\frac{1}{2}$ to 5 percent, the energy distribution is rather constant. Furthermore the cathode surface exposed for different spectrograms is practically constant. Losses

due to absorption in the air are likewise similar for each sample. These errors, although they represent inaccuracies so far as quantitative measure of the incident light is concerned, do not represent errors in obtaining duplication of results for any complete analysis.

Figure 3 is an exposed spectrograph plate showing five successive copper spectrograms. Each of these exposures was made by the integrating exposure control from unweighed electrodes of copper. There was an actual variation in exposure time of over three to one when taking the five spectrograms. This large variation in exposure time was due to deliberate motion of the arc, causing the image of the arc to wander on and off the slit. Examination of this plate shows the uniformity of results obtained by this equipment.

Further sensitivity can be obtained by employing a C7022B electron-multiplier phototube. Some preliminary data has been obtained using this tube at the central image, thus eliminating lens systems and reflections

from a rotating sector. The results indicate that a sensitivity of at least ten times that obtained with the apparatus described can be obtained. Certain difficulties were encountered, the greatest of these being variation of the sensitivity of the portion of the phototube surface employed.

The author acknowledges the assistance of H. D. Ussery, Dr. F. B. Haynes, and other members of the Physics Department of the Virginia Polytechnic Institute, whose cooperation made possible this development.

BIBLIOGRAPHY

- James, H., and Salzberg, B., *Proc. IRE* 23, Jan., 1935.
- Allen, J. S., *Physical Review*, 55, p 966-971, 1939.
- Allen, J. S., *Proc. IRE*, 27, p 558-566, 1939.
- Zworykin, V. K., *Proc. IRE*, 24, p. 351, 1936.
- Bedell, F., and Reich, H. J., *Rev. of Scient. Inst.*, 2, p 532, 1931.
- Hoag, J. Barton, "Electron and Nuclear Physics," Van Nostrand Co., New York, 1938.
- Hughes, A. L., and DuBridge, L. A., "Photoelectric Phenomena," McGraw-Hill Book Co., New York, 1932.
- Farnsworth, P. T., *Jour. Franklin Institute*, 218, p 411, 1934.
- Radio Corporation of America Application Sheets, 917, p 6, 1939.
- Radio Corporation of America Application Sheets, C7004.
- Westinghouse Electric Company, Bulletin TD81.

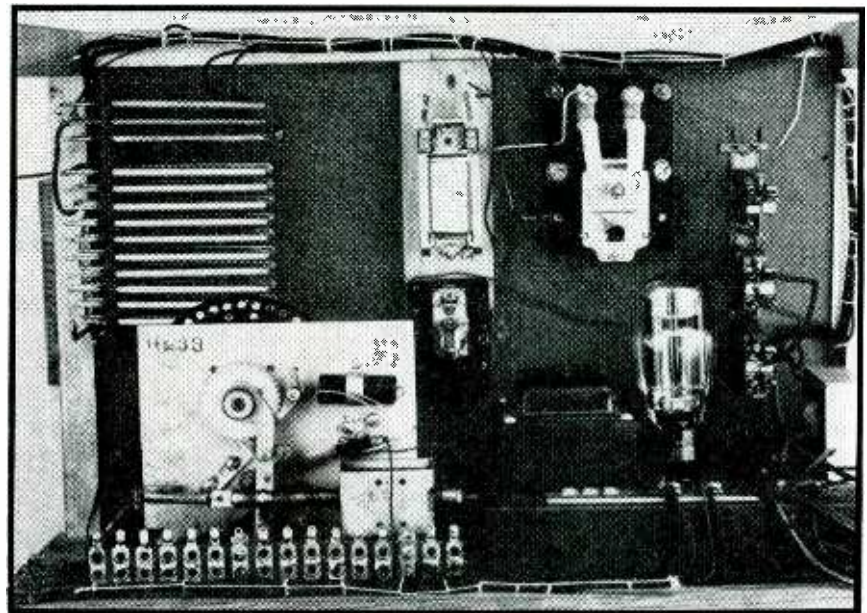

FIG. 3—Spectrograph exposure control power supply, relay and ratchet unit, seen from the back

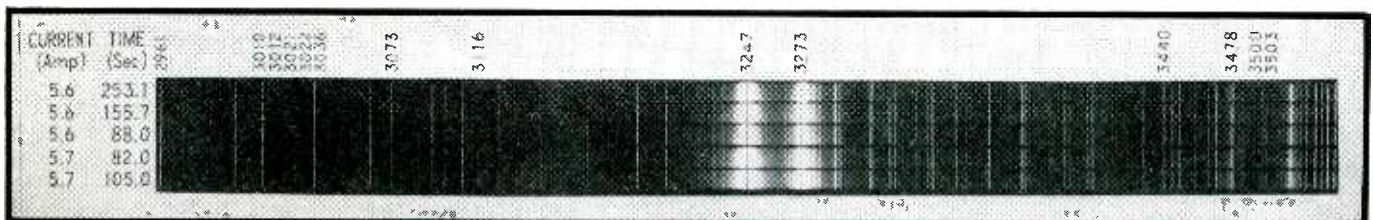

FIG. 3—Exposed plate showing, from top to bottom, five successive exposures under the varying arc and time conditions indicated at the left

Vibration and MOBILE

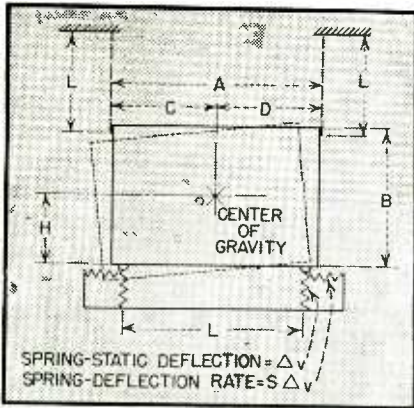
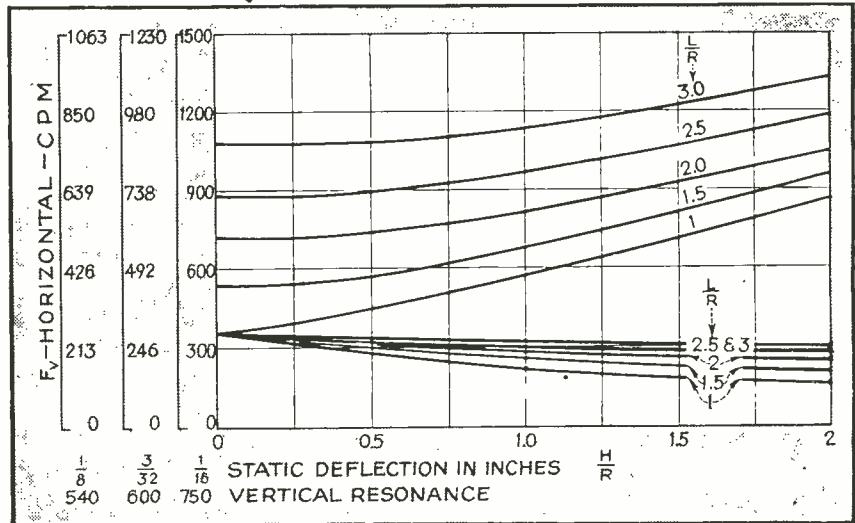

FIG. 1—The solid lines show the usual method of mounting electronic equipment to isolate vibration and reduce shock. The vertical dashed lines show the location of wires used in the experimental determination of radius of gyration

FIG. 2—Resonance diagram for use in applying shock and vibration mounts with horizontal stiffness equal to one-quarter the vertical stiffness. R = radius of gyration $\cong 1/5$ (case height and case width). H = vertical distance-mounts to center of gravity, L = mount spacing



VIBRATION FATIGUE TESTS of commercial and military aircraft radios are standard practice in the industry, and the accepted requirements have been covered by government specifications. However, improved types of vibration isolators¹ are now commercially available for aircraft and new applications of radio equipment are presenting shock and vibration conditions of an entirely different nature. Proper application of the new vibration isolators and tests of equipment² for services other than aircraft require the application of some theory not previously used, as well as a few additional methods of using vibration test equipment.

The tests indicate such things as possible interference due to relative movements of parts under vibration; their points of resonance; the swinging of connecting wires; crystallization of or weakness at soldered terminals; fasteners that loosen; strength of brackets, especially at bends; welded joints subject to shock and vibration; and mount problems.

We use two types of vibration tests in conjunction with design. The first test is a check of the mechanical design of the unit itself. The complete

unshockmounted unit is subjected to vibration over the expected or specified frequency range, and carefully observed with a Strobotac for any resonant vibratory motion of components, panels, etc. The vibration is applied successively in three mutually perpendicular directions by a machine made by L. A. B. Corporation of Summit, N. J.

Vibratory displacements of 0.005 inch are sufficient to produce easily observable motion in any members resonant in the usually specified test range of 600 to 3600 cycles per minute. If there is vibration in service at the resonant frequency of any member, even amplitudes so small that they can barely be felt are sufficient to cause fatigue failure of unmounted equipment resonant at an exciting frequency. If vibration-isolating mounts are used, component resonance must be well above (3 or more times) mount resonance.

Two Tests

The structural strength of radio chassis and brackets is usually empirically determined by the designer, who is normally primarily influenced by such considerations as weight, electrical performance and ease of

servicing. Increased competitive emphasis on these factors requires more highly stressed structural members and increases the probability of resonance at frequencies present in service. No readily usable design data on resonance of structural members is available, and "beefing up" of members found by test to be resonant is the usual procedure. An example of this first test is illustrated by a lightweight receiver designed for use in light personal planes where absolute minimum weight is essential.

Communications equipment designed for services which subject the equipment to shock or vibration is almost invariably shockmounted.

Whether the mounts are primarily intended to absorb shock, or are both to absorb shock and to isolate vibration, there is the same design problem. This is because the usual form of shockmount is essentially a rubber spring and if only its shock-absorbing qualities are considered by the designer the mount in many actual cases will amplify barely noticeable vibration up to destructive amplitudes. Tube failure complaints from the field are a good indication of vibration amplification in service, if

Shock Testing of EQUIPMENT

Proper application of newly developed vibration isolators to mobile communications equipment requires techniques not previously employed. Methods of testing shockmounts in three mutually perpendicular directions are given, along with data on resonant conditions

By JOHN H. BEST

*Engineering Department, Radio Division
Bendix Aviation Corporation
Baltimore, Maryland*

it is known that shock conditions are not the probable cause. The second vibration test is to secure data on the vibration isolation efficiency of the shockmount.

Directions of Resonant Frequencies

In most applications, the greatest shock forces are in a vertical direction, and in the past it was customary to apply the test vibration only in this direction. The current practice, however, is to test in three mutually perpendicular directions, since the direction of vibration in service is dependent on the nature of the equipments support and the structure between the cause of vibration and the equipment. The usual result in field tests is to find some components vibrating in all directions. Since most communications equipment is for general application, it must be assumed for test purposes that all directions of vibration are equally important.

The widely distributed formulas for calculation of isolation efficiency of mounts assume that the equipment will only have a lineal vibratory motion and no tendency to rotate. This is true only so long as the unit is on mounts loaded to equal deflections and located in a plane passing through the center of gravity of the unit. For obvious reasons, however, the most widely used layout places all the mounts between the unit and the

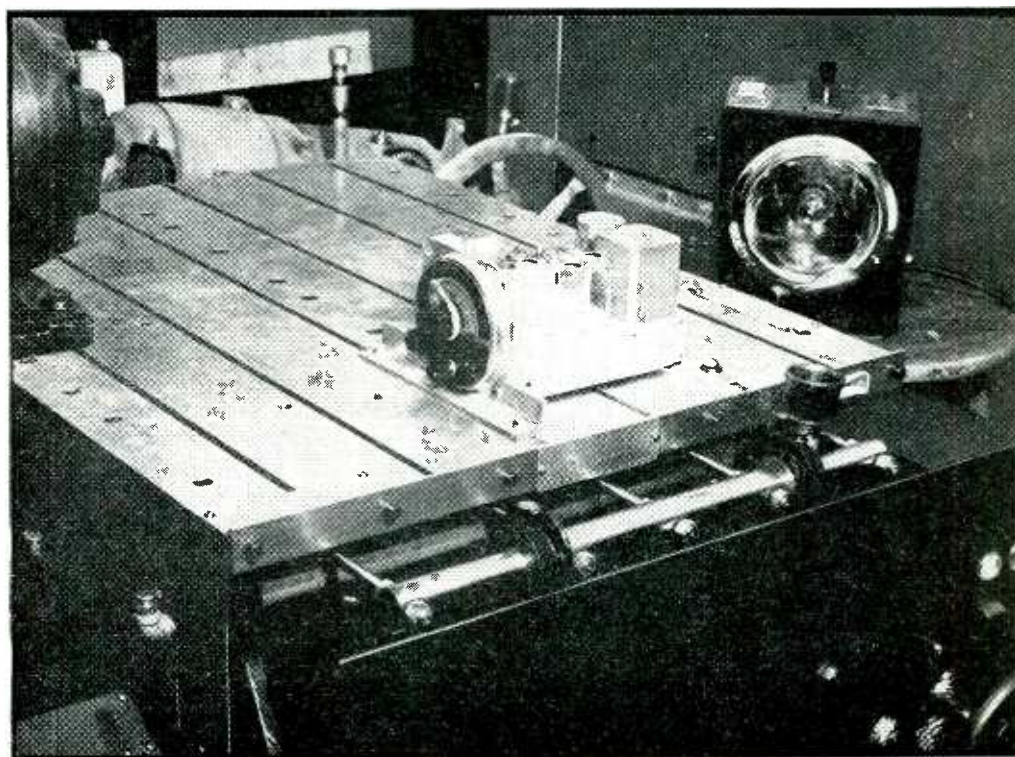

Personal aircraft receiver and radio compass mounted for mechanical resonance test

supporting surface, and the equipment is free to tip as well as to move lineally. In such cases the mounted unit has one vertical resonant frequency, two resonant frequencies about a fore and aft horizontal axis, and two about a sidewise horizontal axis. These occur one above and one below the single horizontal resonant frequency which would be secured if the unit did not tip.

With many of the mount designs applied in the past to usual radio designs this higher resonant frequency is at or near the speed of internal combustion engines, and is very undesirable. There is a sixth resonant

frequency—torsional about a vertical axis—but this has no significance in most applications.

A formula useful for computing these torsional modes of resonance is given below. Its derivation is similar to that of the formula for use without tipping and is based on the classic equation $F = MA$. Equal mounts, equally loaded and symmetrically placed with respect to the center of gravity, are assumed, but for practical purposes negligible error is introduced by using the average of four slightly different static deflections such as are usual in an actual design. The vertical resonant fre-

quency in cps is computed by the usual formula $f_v = 3.1\sqrt{1/\Delta_v}$.

resonant frequencies (cps)

$$= 2.21 \sqrt{B \pm \sqrt{B^2 - 4C}}$$

$$\text{where } B = \frac{S L/2 (2 + H^2 + R^2)}{\Delta_v S R^2}$$

$$\text{and } C = \frac{L^2/2}{\Delta_v^2 S R^2}$$

L = Distance between mounts

H = Height of equipment's center of gravity above plane of mounts

R = Radius of gyration of the equipment

Δ_v = Static deflection of mounts

S = Horizontal to vertical softness ratio of mounts

These relations are illustrated in Fig. 1 which shows a schematic drawing of the usual method of mounting electronic equipment. It also shows the location of supports used in experimentally determining radius of gyration as referred to below.

Radius of Gyration

If any accuracy is to be secured with this formula—or any other formula—the static deflection and softness ratio must be secured under the actual load conditions. Most mount load deflection curves are nonlinear and the slopes at the point of actual loading must be used, rather than total measured deflections. Radius of gyration can be rather laboriously computed by handbook formulas, or can be approximated ($\frac{1}{3}$ of $A + B$ in the sketch is an average value from measurements on a number of aircraft radios), but is best actually measured by use of a bifilar pendulum. For the latter, the formula is as follows (T is the period in seconds; other dimensions show in the sketch and are expressed in inches.)

$$R = 3.14 T \sqrt{CD/L}$$

In applying the resonance formula, the designer usually finds the height and radius of gyration fixed by other considerations. Mounts with suitable static deflection and horizontal softness ratio can be selected, however. Deflection of $\frac{1}{8}$ to $\frac{1}{2}$ inch and softness ratios of 3 to 5 are about the values required for general aircraft application (no resonance above 15 cps) and approximately these values are now commercially available. Graphs similar to that shown in Fig. 2 (for a mount in use by Bendix) can then eliminate the need of successive approximations in finding the greatest spacing which will not exceed the maximum allowable frequency. (The maximum permissible spacing should be used to minimize shock forces on the mounts.)

The improvement in performance which can be secured from use of mounts with suitable horizontal softness is illustrated by the photographs of Fig. 3 and the performance curves of Fig. 4. The unit shown conforms to standard $\frac{1}{2}$ ATR case dimensions. Mounts of the same type and rating were used in both cases, but a simple adapter was added in one case to increase horizontal softness.

Vertical isolation at 1500 and 2100 cpm with the standard mounts is not as great as would theoretically be expected, but is typical of many installations. Unequal loading of the mounts results in slight torsional impulses which have an appreciable effect at the torsional resonance frequency. The performance in the operating range of the horizontally soft mounts under vertical vibration is

improved by the elimination of these slight peaks, even though the load is no more evenly distributed.

Shock Fatigue Tests

The vibration test table may also be used for shock fatigue testing if such a test is warranted by the requirements of the application. For such an application electronic equipment is normally shock-mounted on rubber. The mounts effectively isolate against large impact shock forces caused by rapid small displacements, such as are caused by metal-to-metal contact or by the vibration of structural members induced by impact forces. No effective isolation, however, can be secured from accelerative forces without exceeding reasonable space limitations, and if these forces are large and numerous in service, fatigue failure should be investigated. This requires test forces equal to or greater than those which may be expected in service, at frequencies near the resonant frequency of the mounted equipment. This frequency is dictated by the fact that accelerative forces in service will cause rapidly decaying vibration of the unit at its resonant frequency, regardless of the speed with which the force is applied.

In service, large accelerative shock forces normally will deflect mounts past their lineal range. In test, to secure large forces at low frequencies, the displacements must also be large enough to cause deflection past the lineal range. It is then no longer possible to treat the mount as a simple spring with one resonant frequency, such as is generally assumed for vibration isolation calculations.

FIG. 3—Bendix interphone amplifiers whose geometrical proportions ($\frac{1}{2}$ ATR, CAA designation) present the most difficult vibration isolation problem of the standard equipment cases. The unit on the left is mounted on conventional vertical shear-type mountings and the unit at right is mounted on identical rubber elements with an additional rubber part to produce isolation of horizontal vibration. The test table in both cases is vibrating at a speed of 2100 rpm, with a total excursion of $1/64$ inch in the left-right direction. The photographic definition of the equipment shown at the right illustrates the improvement

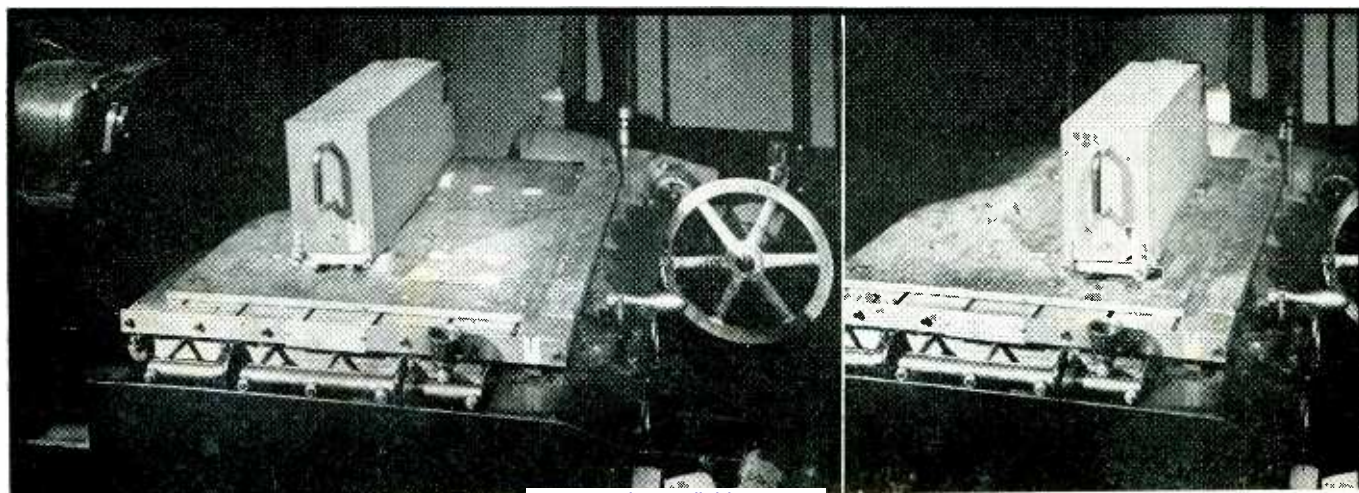

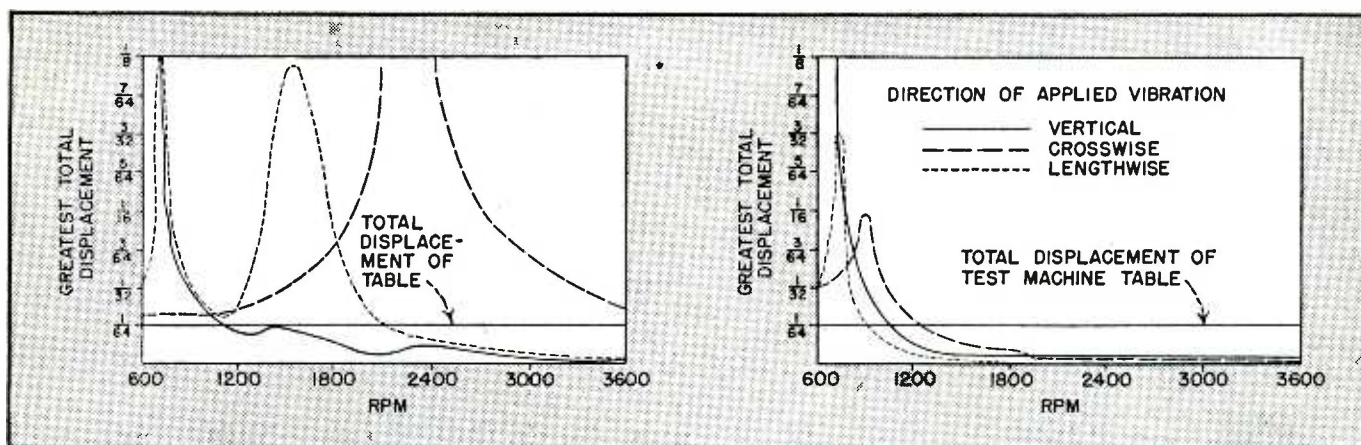

FIG. 4—Overall vibration performance at various engine speeds and in three mutually perpendicular directions is shown on these graphs for the two units of Fig. 3. In the graph on the right, effective isolation is secured in the normal operating range of aircraft engines. The graph on the left shows that conventional mounts actually magnify vibration at these speeds

A load mounted on a spring whose modulus is constant for small deflections but which increases with increasing large deflections has a range of resonant frequencies, rather than a single resonant frequency. If the frequency of an adequate disturbing force is increased past the resonant frequency of the lineal deflection, the spring deflects further into the non-linear range of the spring. The greater force speeds up the motion and resonant motion of the load continues at frequencies above the lineal resonant frequency.

This motion continues as frequency is increased until the friction loss in the mount equals the energy input of the disturbing force, when the motion subsides to movements in the lineal range whose magnitude can be computed by the simple spring formula.

Such resonance carry-over is of course highly undesirable in service, but can easily be—and always is—avoided by making the linear deflection range of the spring materially greater than the vibratory displacements which will be encountered in service. The phenomenon is important, however, when testing at large amplitudes and low frequencies. Knowing the stress-strain relation of the mount, it is possible to compute the approximate deflection for resonance at frequencies above linear resonance. A method for doing this is given in Den Hartog's "Mechanical Vibration," but the method is laborious and the results inaccurate because of the comparatively large effect of internal friction in such

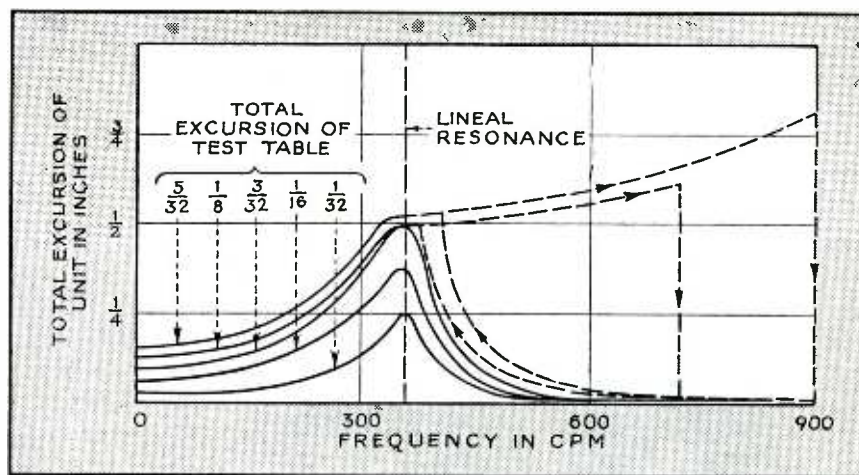

FIG. 5—Vibration isolation and magnification of an effectively lineal vibration isolator and a nonlinear shock absorbing bumper. At amplitudes of vibrations such as would be reasonably encountered in service, there is a single resonant frequency. At larger amplitudes, there is a range of frequencies above this at which resonance continues due to the combined effect of lineal and nonlinear characteristics

cases. For most purposes it is sufficient merely to be familiar with this type of resonance, and frequency displacement curves at various exciting displacements for a case of this type are shown in Fig. 5.

Other Equipment

To use resonance carry-over for test purposes it is also necessary to measure the forces. Since the movement is not simple harmonic motion, the usual G meters reading rms voltage are not suitable. A pressure-sensitive pickup from such a device feeding a recorder of suitable frequency response must be used so that the peak voltage generated by the pickup can be measured rather than the rms value.

With such a device, forces of large

definite magnitudes near linear resonance frequency can be obtained with practically any type of mount. Curves showing the forces generated by the simple harmonic motion of a test table, and the forces in a unit vibrating resonantly with a complex harmonic motion are shown.

The equipment from which the curves were secured is the Bendix railroad model MRT-1 communications transmitter-receiver. The test subjects the unit to forces of the magnitude of those encountered in severe service conditions such as are encountered in switch-engine installations and freight service in mountainous regions.

REFERENCE

(1) Vibration Control for Electronic Products, *ELECTRONICS*, p 134, September 1945.

F-M Radar Altimeter

Frequency-modulated signals from the APN-1 equipment are directed earthward from an aircraft, and the beat note between transmitted and received signals is measured to obtain an indication of altitude, accurate to a few feet above the earth

IN 1938 United Airlines demonstrated to the press a radio altimeter which had been developed by the Bell Telephone Laboratories, and which revealed the height of an aircraft above the terrain by timing a reflected radio wave. The word radar had not then been invented, and the principle employed by the altimeter was different from that of the pulse-type radars which were then being developed in great secrecy. No technical information was revealed at the time, but the general principle of

operation was described in several publications^{1,2}. Shortly thereafter censorship was imposed on further information.

A detailed description of an f-m radar altimeter may now be given, following the recent declassification of the model AN/APN-1 altimeter. This altimeter was installed on over 100,000 Army and Navy aircraft during the war. The APN-1, operating on the same principles as the equipment demonstrated before the war, was designed for production by the

RCA group at Camden. The altimeter is one of two widely used in wartime aviation (the other uses the reflected pulse principle). It is expected to be installed on commercial aircraft following recent type approval by the Civil Aeronautics Authority.

Principle of F-M Radar

Frequency-modulation radar determines the distance to a reflecting surface (in this case the ground beneath the plane) by measuring the frequency shift between transmitted and reflected waves. While the wave is traveling to the surface and back, the transmitter frequency is changing under the influence of the frequency modulation. When the reflected wave arrives back at the transmitter, its frequency is slightly different from that then being transmitted. The transmitted and reflected signals are combined in a detector and the frequency difference between them developed as a beat note. This frequency difference becomes larger as the distance to the reflecting surface becomes greater. The altitude is indicated by converting the beat frequency into a distance indication.

The advantage of this method lies in its ability to measure very short distances, down to a few feet. The minimum detection distance in the pulse method is limited by the length of the pulse. Even if a pulse as short as 0.2 microsecond is used, the minimum range is one hundred feet. Pulse radar thus cannot indicate altitude during landings when the height of the aircraft above ground must be accurately indicated from a few hundred feet down to zero. For indicating higher altitudes, the pulse method is useful and has in fact been employed in a high-altitude instrument.

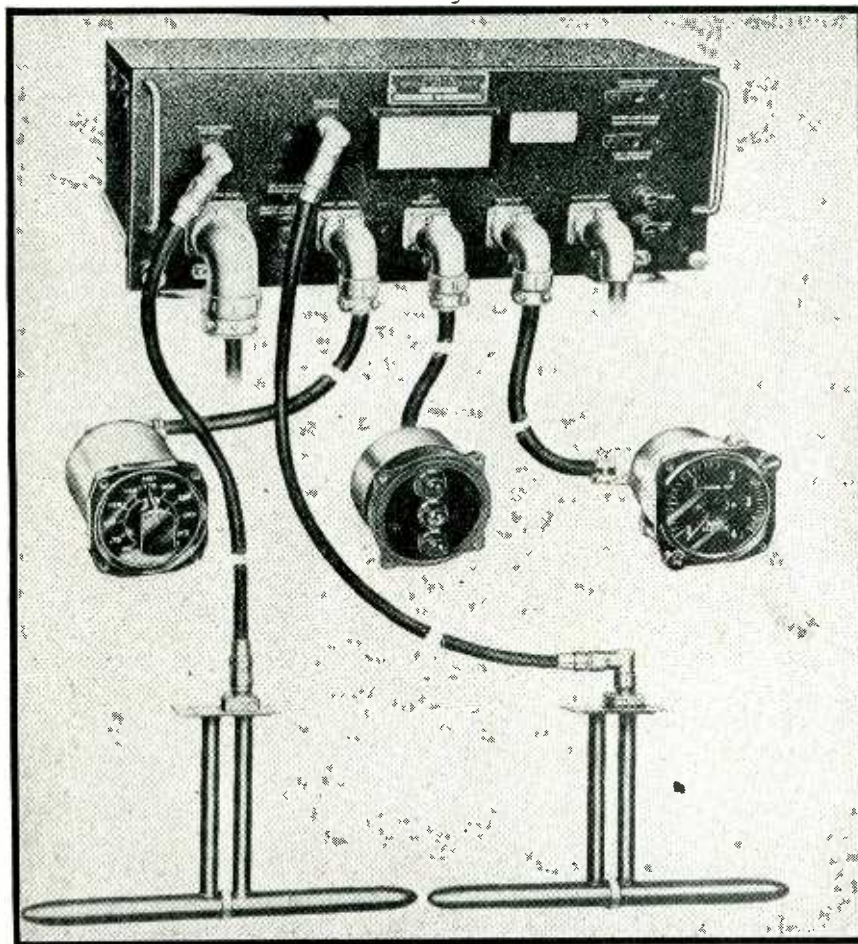

Type AVQ-6 f-m radar altimeter, version of the APN-1 equipment approved by CAA for commercial use

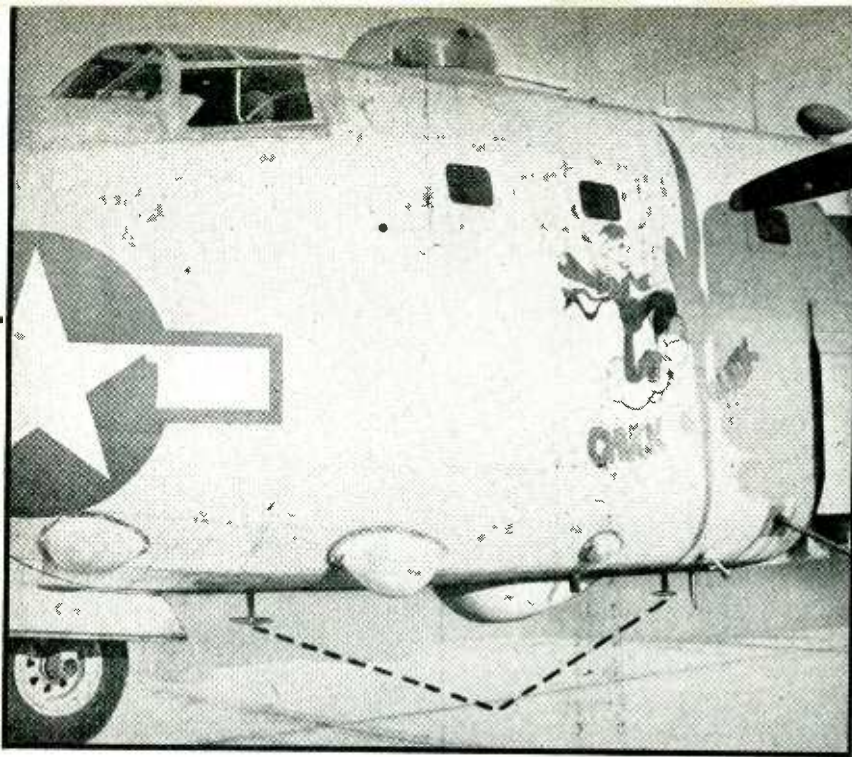

Lubber-line installation of radar altimeter dipoles below the fuselage of a Navy Consolidated Privateer (PB4Y-2). The radomes house antennas for radar countermeasures

One disadvantage of the f-m principle is the fact that an altimeter designed for low-altitude indication cannot indicate very high altitudes without lowering the deviation of the frequency modulation. Hence, two scales are required to cover all operational altitudes and in early equipments there was a chance of human error in reading the correct scale. Later versions of the equipment provided against this type of error.

The quantitative relationships which govern the design of an f-m radar altimeter may be derived from Fig. 1. At the top of the figure, the frequencies of the transmitted and received waves are plotted as functions of time. The solid line represents the transmitted frequency, which is modulated by the linear triangular waveform. The total deviation of the frequency modulation (the peak-to-peak value of the modulation envelope) is indicated as ΔC

megacycles. In the APN-1 equipment, the center frequency is 440 mc, and the deviation is plus or minus 20 mc ($\Delta C = 40$ mc) on the low-altitude range.

The dashed line in Fig. 1 represents the received signal. This signal is, of course, frequency-modulated by the same envelope since the signal preserves its form during reflection, but the received signal is displaced in time by the reflected interval, which is equal to $2h/c$ where h is the height of the aircraft above the terrain in feet and c is the velocity of radio wave propagation in feet per second. As a consequence of this time displacement, a corresponding frequency displacement occurs, indicated by the vertical separation Δf between the solid and dashed lines.

The relationship between the altitude h and the frequency difference Δf , can be found by comparing similar triangles in the figure. The height

of the triangular waveform is ΔC and half its base is $1/(2f_m)$, where f_m is the frequency of the modulation envelope. The ratio of the height to half the base is $2\Delta C f_m$ and this is equal to the frequency difference divided by the time difference:

$$2\Delta C f_m = \frac{\Delta f}{2h/c} \quad (1)$$

where ΔC , f_m , and Δf are all measured in cps. The relationship between frequency difference and height is then found by rearranging Eq. 1

$$\frac{\Delta f}{h} = \frac{4\Delta C f_m}{c} \quad (2)$$

It will be noted that the sensitivity of the indication, in cps frequency difference per foot, can be increased by employing a wide frequency deviation or a high modulation frequency, or both. In the APN-1 equipment, ΔC is 40 mc, f_m is 120 cps, and c is 984×10^4 feet per second, and hence $\Delta f/h$ is 19 cps per foot of altitude.

It thus appears that audio frequencies up to 7,600 cps are developed in the beat note between transmitted and received signals, provided that heights not greater than 400 feet are encountered. For higher altitudes, up to 4,000 feet, a lower frequency deviation $\Delta C = 4$ mc is introduced and the beat frequency is thereby reduced to 1.9 cps per foot. The maximum beat frequency developed is then the same ($4000 \times 1.9 = 7,600$ cps).

A minor aberration occurs during the period between reversal of the

electronics WAR REPORT

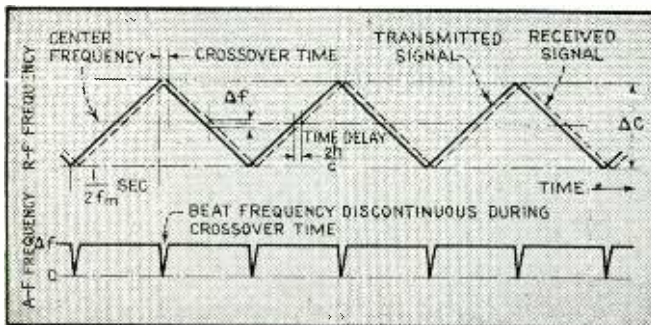

FIG. 1—Time and frequency relationships when a triangular modulation envelope is employed in an f-m radar system. Transmitted and received signals combine to give a-f beat note

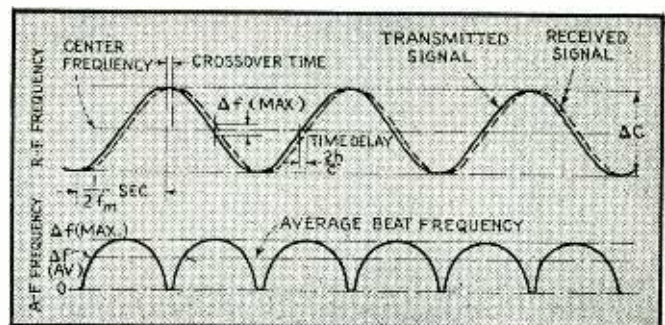

FIG. 2—Time and frequency relationships when the modulation envelope is sinusoidal. The average beat note corresponds to the constant beat of the triangular case (Fig. 1)

transmitted frequency deviation and the corresponding reversal in the received wave, as shown in Fig. 1. The transmitted frequency, at the center of this period, falls to a value equal to the received signal, which is then still increasing. At this instant, therefore, the beat note is zero. During this crossover interval the beat frequency is variable, dropping to zero at the center. However, the duration of the crossover interval is only 20 microseconds, at the maximum altitude of 4,000 feet, compared with 42,500 microseconds, the half period of the modulation envelope. Consequently the crossover effect is negligible.

In practice it is not convenient to modulate the frequency with a triangular envelope, and a sinusoidal envelope is substituted. The situation is then that shown in Fig. 2. The frequency difference is no longer a constant between crossovers, but varies in the manner shown, from

zero at the crossover to a maximum which occurs when the transmitted frequency is passing through its center value. By circuits described later, the average beat frequency is measured and this value corresponds with that produced by triangular modulation. Equation 2 may be used to predict the average beat frequency Δf when sinusoidal modulation is used.

In installing the equipment in an aircraft, care must be taken to equalize residual delays between the transmitting and receiving inputs to the beat-note detector. The distance between the inputs is not zero when the wheels of the aircraft are on the ground, but is equal to the sum of the cable lengths between detector and the two radiators, plus the physical reflection distance (amounting to a few feet) between radiators and the ground midway between them. This residual altitude error is removed in calibrating the instrument.

A final error may appear when the aircraft is flying over very smooth terrain such as a runway or smooth water. Under these conditions, the indicated beat frequency shifts back and forth by an amount equivalent to about six feet when the actual altitude changes by six inches (one quarter wavelength at 440 mc). When the terrain contains a rough surface (projections higher than six inches) the shift is averaged out and the indicated altitude is the correct value. The shifting altitude (known as fixed error) may be quickly recognized, and the correct altitude is the intermediate value between the limits of the shift.

General Layout of APN-1 Equipment

A block diagram of the essential elements of the APN-1 altimeter is shown in Fig. 3. A transformer-coupled audio oscillator operating at 120 cps drives the modulator unit. This is a mechanical modulator resembling the voice-coil assembly of a dynamic loudspeaker. The moving element of the modulator drives one plate of a balanced capacitor in the transmitter tank circuit, thus producing a frequency-modulated output. Two amplitudes of drive are available, one for 40 mc total deviation (low-altitude scale), the other for the reduced deviation of 4 mc (high-altitude scale).

The transmitter itself is a line-controlled push-pull oscillator employing two types 955 acorn triodes. The transmitter produces a power output of about 100 milliwatts at a center frequency of 440 mc. Part of the transmitted signal is passed to a dipole transmitting antenna, mounted under one wing of the aircraft. Another portion of the signal is injected

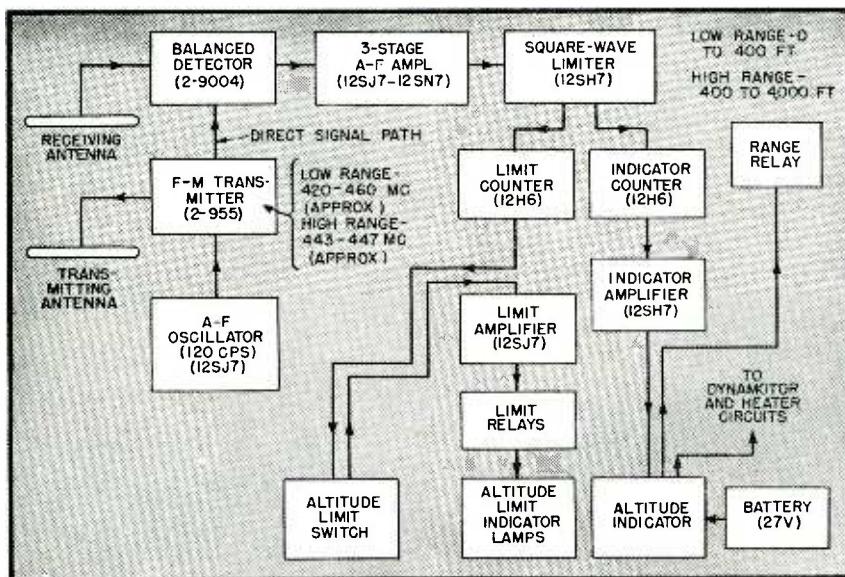
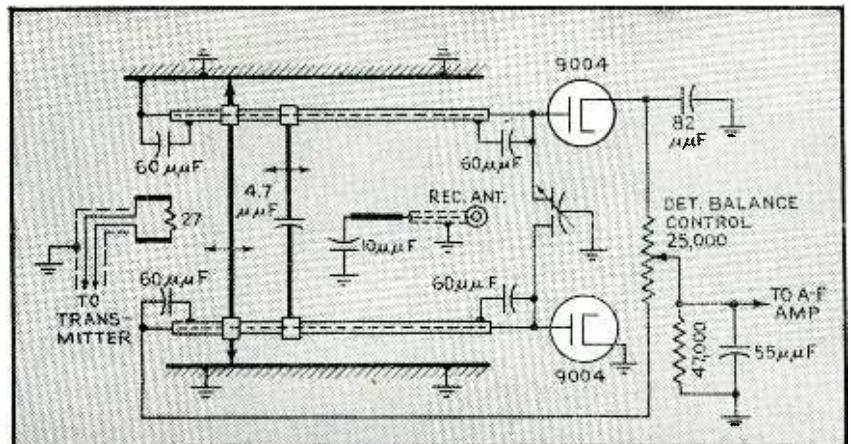

FIG. 3—Block diagram of the APN-1 altimeter. The beat note is clipped and its average frequency measured in the counter circuits

FIG. 4—Balanced diode detector. The circuit arrangement is insensitive to amplitude modulation which may arise due to passage of the f-m signal through the resonances of the circuit elements



directly into the receiver detector.

The head end of the receiver is a balanced push-pull detector employing two type 9004 acorn diodes. The balanced detector mixes the received and transmitted signals. These signals are applied respectively in push-push and push-pull, an arrangement which avoids mutual coupling between the two signals. The push-push connection is a rod centrally located between two conductors of the detector tuned circuit, and the push-pull connection is a coupling loop. The detector circuit is balanced against amplitude-modulated signals and hence discriminates against amplitude variations introduced by the passage of the f-m signals through the resonant regions of the tuned circuits and antennas. The details of the detector are shown in Fig. 4.

The audio-frequency output (beat note) of the detector is passed to a three-stage audio amplifier which has the frequency response characteristic shown in Fig. 5. The low-frequency components are attenuated, since the amplitude modulation due to resonant effects is at a maximum at the modulation frequency (120 cps) and its lower harmonics. The gain characteristic also equalizes the amplitude of the beat note as a function of height, since the received signal is strongest when the aircraft is near the ground and the beat note has its lowest values. The a-f gain continues to increase above 7,600 cps, the maximum beat-note frequency. The high amplifier output drives the altitude indicator off scale when the altitude exceeds 400 and 4,000 feet, respectively, on the low and high altitude scale. The frequency characteristic shown is obtained by the use of degenerative feedback. The amplifier is shock-mounted and is shielded against stray r-f pickup from other equipment.

The audio-frequency output of the amplifier is converted into a corresponding direct-current signal for altitude indication. This signal also actuates limit relays to indicate deviations from an assigned altitude or to control the automatic pilot. The conversion process begins in a limiter stage which converts the sinusoidal beat output (varying in frequency in accordance with Fig. 2) into a rectangular wave of about 135 volts peak-to-peak amplitude. The purpose of this limiter is to remove

FIG. 5—Frequency characteristic of the three-stage audio amplifier which discriminates against low-frequency components

FIG. 6—Double-diode counter circuit, which develops a positive d-c voltage proportional to the beat note frequency

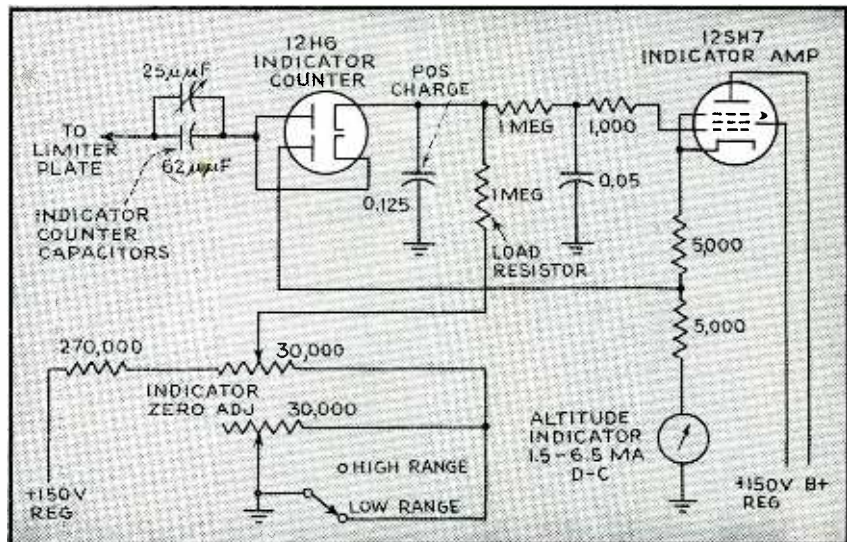
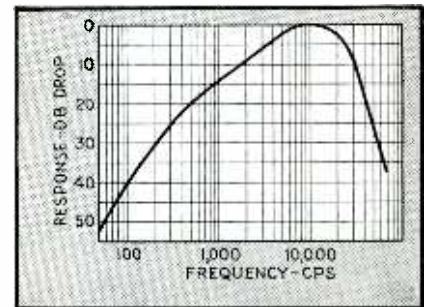

amplitude variations which may persist and to provide sharp leading edges which may be counted in determining the average frequency of the beat note. The limiter stage, an over-driven amplifier, limits the positive peaks by grid current and the negative peaks by grid voltage cutoff.

The output of the limiter stage is passed to two counter stages, which determine the average frequency of the beat note by counting the rectangular waves. The first counter operates the altitude indicator. This circuit, Fig. 6, consists of a double diode. One section of the diode passes the positive half-cycles of the limiter output, charging a capacitor and load resistor in shunt. The resistance and capacitance values are so chosen that the charge on the capacitor leaks off through the resistor at a rate approximating the conduction of charge through the diode. Hence when the positive rectangular waves arrive at a more rapid rate (higher beat note), the direct voltage across the capacitor tends to increase, and vice versa. This voltage is passed through a low-pass RC filter which averages the direct voltage and applies it to the grid of the output am-

plifier tube. A millimeter in the cathode of the latter tube registers, over a range of 5 milliamperes, the average value of the direct voltage on the grid. This meter is calibrated directly in feet, 0 to 400 and 400 to 4,000. The scale shown is switched synchronously with the switch which controls the total deviation of the transmitted signal, so it is not possible to misread the scale.

A part of the voltage across the cathode resistance is fed back to the other section of the diode in the counter circuit. This diode passes the negative halves of the limiter output to ground, and this discharges the coupling capacitor, leaving it ready to receive the ensuing positive half. The feedback from the output amplifier biases the diode and improves the linearity of the indication.

A similar counter circuit is employed to actuate the limit relays. In this case, however, the polarity of the diodes is reversed, and a negative voltage is developed across the load. The amplitude of this voltage is substantially proportional to the frequency of the limiter output and hence to the altitude.

The counter voltage is passed to

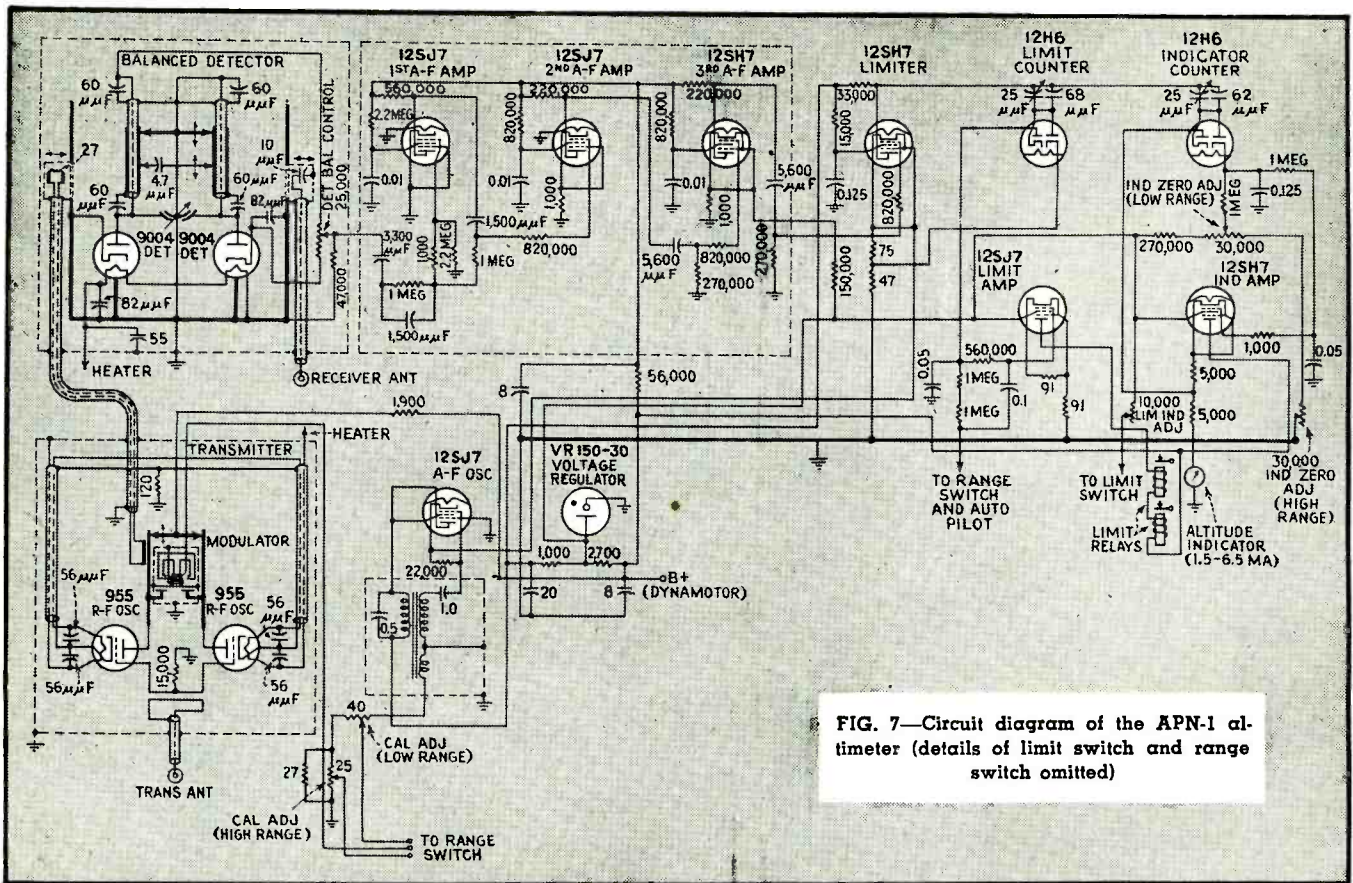

FIG. 7—Circuit diagram of the APN-1 altimeter (details of limit switch and range switch omitted)

the grid of a self-biased pentode stage. Relays in the plate circuit of this tube are actuated when the plate current exceeds certain limits. These limits are set by the operator, who adjusts a potentiometer which applies bias to the amplifier stage. This potentiometer is marked in feet and is set at the altitude at which it is desired to fly. The relays remain in their normal positions if the plane remains within 10 feet of the selected altitude. If the altitude deviates further than this, the counter circuit depresses or elevates the bias by an amount sufficient to operate the corresponding relay. Three lamps are controlled by these relays. One, white in color, lights when the relays are in normal position (altitude within 10 feet of the preset value). A red lamp lights when the altitude falls below the lower limit, and a green lamp when the altitude exceeds the upper limit. Corresponding voltage impulses are available to control the automatic pilot so as to correct altitude changes.

Physical Appearance

Three indicating units appear on the instrument panel of the aircraft,

or at some other convenient point in the pilot's compartment. They are the altitude limit control, the indicating lamps, and the indicator dial. The on-off switch and range switch are provided directly on the face of the indicator. The total weight of the equipment is about 25 pounds, installed, and it consumes about 2.5 amperes at 27.5 volts d-c.

The accuracy is better than plus or minus five percent of the indicated altitude above terrain, plus or minus the six-foot uncertainty previously mentioned. On the high range, the fixed error is plus or minus 60 feet.

The two dipole antennas are installed so that the direct transfer of energy from one to the other is minimized. Usually the antennas are placed under the wings on either side of the metal fuselage. The antenna pattern, when the reflecting surface of the aircraft is taken into account, is a broad cardioid which illuminates the terrain below over a wide area. The f-m altimeter cannot be relied upon to detect obstacles dead ahead, although it will indicate rising ground and thus give advance warning of high ground ahead.

The power supply includes a dyna-

motor for plate and screen voltages, regulated by a gaseous regulator (type VR 150-30). The filaments of the tubes are connected in series parallel across the 27-volt supply. The complete circuit of the APN-1 altimeter is given in Fig. 7.

A model of the APN-1 has been approved by the Civil Aeronautics Authority for use in commercial aircraft. This equipment incorporates an automatic frequency response control in the audio amplifier. At low altitudes when no high frequencies are present except those due to noise, it is advantageous to reduce the high-frequency gain. Conversely, at high altitudes, high-frequency gain is required to amplify the weak beat note.

The editors wish to express thanks to Russell Newhouse of the Bell Telephone Laboratories and H. J. Markley of the RCA Service Company, for information on which this article is based.—D.G.F.

REFERENCES

- (1) Aircraft Radio, 1939, *ELECTRONICS*, Jan. 1939, p. 10.
- (2) Matsuo, Sadahiro, a Direct Reading Radio-Wave-Reflecting-Type Absolute Altimeter for Aeronautics, *Proc. IRE*, p. 848, July 1938.

High Speed Oscillograph

Oscillograph for transient measurements has rapid writing speeds, in excess of 50 centimeters per microsecond. Simultaneous viewing of cathode-ray tube screen by recording camera and operator facilitates positioning and focusing the trace between measurements

By N. ROHATS

General Engineering and Consulting Lab.
General Electric Company
Schenectady, N. Y.

HIGH WRITING SPEED oscillography capable of recording transient voltage or current wave shapes has become an indispensable tool of high-voltage engineering. That section of high-voltage engineering which deals with the behavior of circuits or apparatus under transient conditions requires laboratory equipment capable of producing and recording surge voltages and currents measured in kilovolts and kiloamperes, with time scales measured in microseconds. The transients to be studied are generally produced by the discharge of a number of capacitors in series and the recording is done by some form of cathode-ray oscillograph.

Oscillograph Features

Based on experience gained in operating several types of oscillographs in which the film was inserted in the vacuum chamber of the cold cathode, cathode-ray tube and the compartment vacuum pumped after each loading, an oscillograph was designed around a hot cathode, sealed off, cathode-ray tube (see Kuehni, H. P. and Ramo, Simon, A New High Speed Cathode Ray Oscillograph, *Electrical Engineering*, June 1937, p. 721, disc. 1401). Changes were made in this oscillograph as experience and special requirements suggested.

The features of the resulting oscillograph suit it to rapid recording of high-speed transients. The single, sealed off, cathode-ray tube eliminates delays of releasing and repumping the vacuum and the problems as-

sociated with the pumps. A small camera for photographically recording the transients portrayed on the screen and giving records about 20 to 25 percent of screen size is mounted in front of the tube. New rolls of film can be quickly inserted.

Other oscillographs have been built containing two or three cathode-ray

tubes with rotating or moving film cameras, and with cameras taking full-size pictures. Optical systems can be designed to have separate cameras for the multi-tube types or, by means of mirrors, three tubes may be covered by one camera.

The cathode-ray tube is mounted horizontally in a magnetic shield

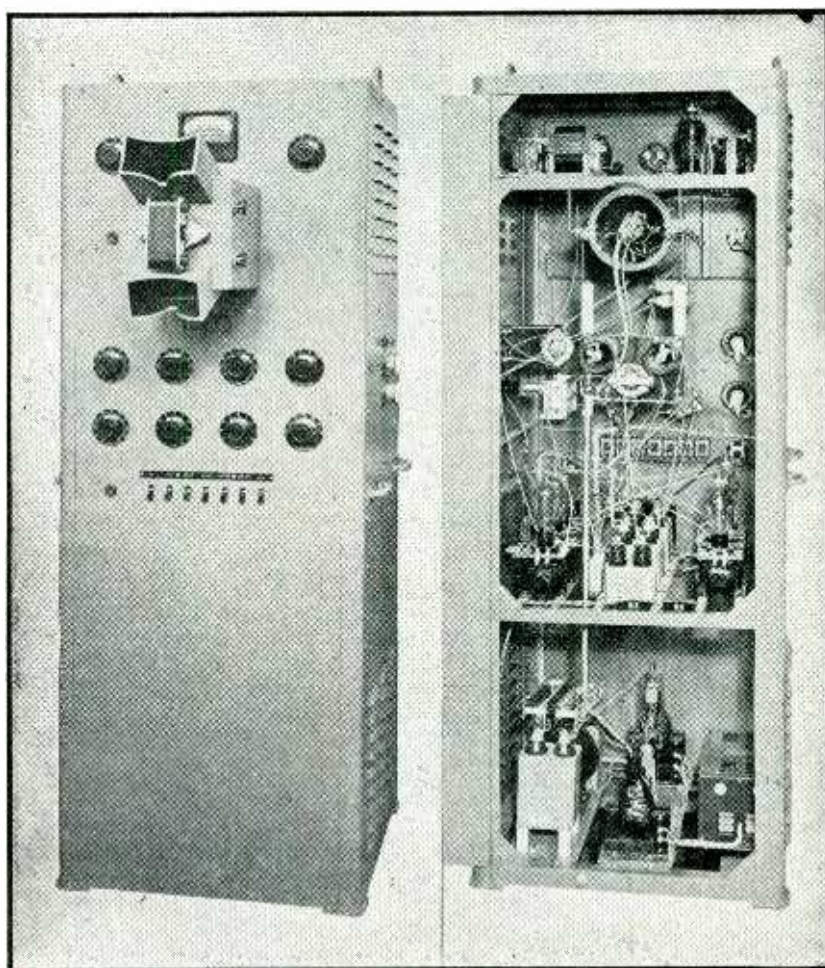

Cabinet houses magnetically shielded cathode-ray tube, sweep generator, and high-voltage power supply. Voltage regulator at bottom prevents interference from power line fluctuation. Operator can view screen during tests from a standing or sitting position

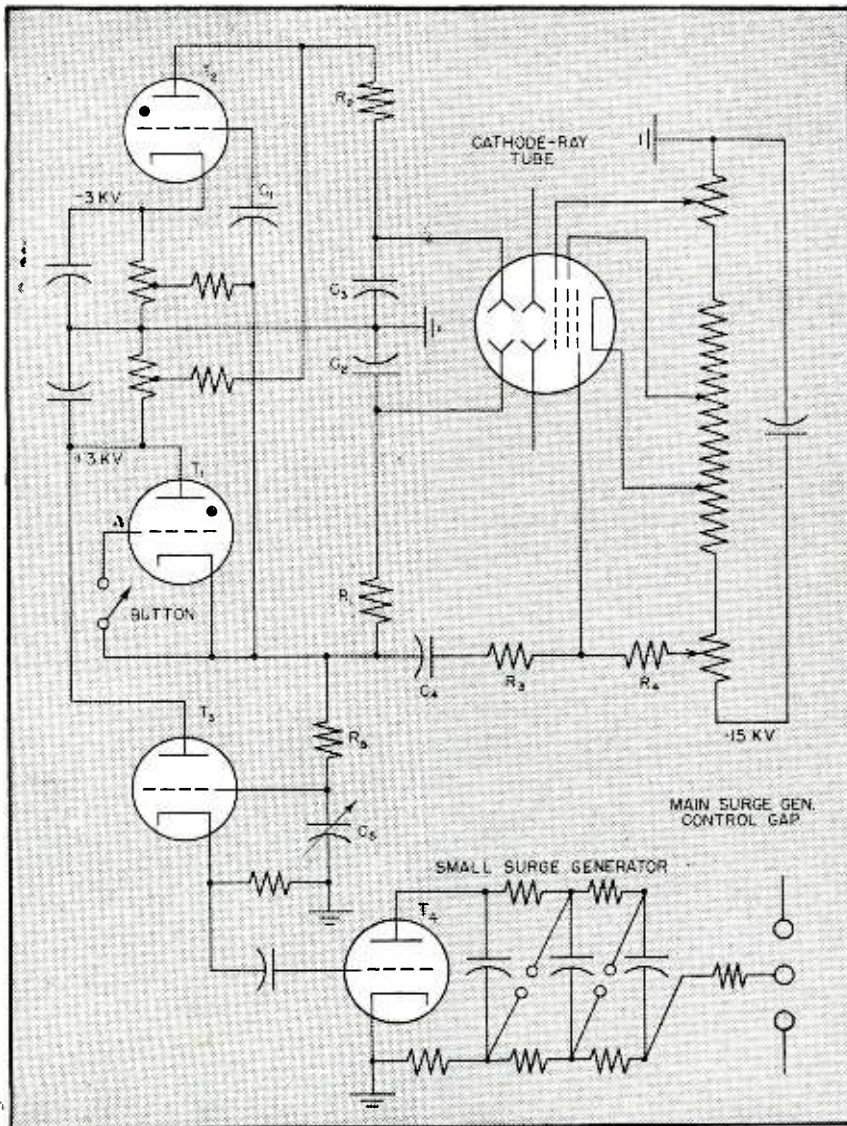

FIG. 1—Sweep generator can either trigger or be triggered by transient under observation

near the top at a level most convenient for visual observation. The camera holder has two eyepieces, one above the camera for observation from a standing position, and one below for operation from a sitting position. Image focusing and continuous visual checking of performance can thus be made without delay or interruption. The size of the steel cabinet, two feet square and five and a third feet high, permits building a desk or table around it for more convenient operation. Power and deflection terminals are on the right side. A door at the back gives easy access to all parts.

At the top right is the timing wave oscillator, giving frequencies

of 10, 50, 500, and 5,000 kc at several hundred volts. At the upper left is the d-c, deflection calibration circuit having a single-wave rectifier and a range of 0-1,000 volts. Below the cathode-ray tube are the sweep and beam control circuits shown in Fig. 1. Rectifier and bias arrangements have been omitted for simplicity. The balanced, thyatron-operated time axis generator gives sweeps ranging from one to 2000 microseconds duration. In the bottom is the 15-kv voltage doubler cathode d-c supply, a resistance divider for obtaining potentials for other tube elements, and a constant voltage transformer to insure accuracy despite fluctuating line voltage.

Figure 2 shows a series of oscillograms taken for plotting the volt-time breakdown curve of a 20-inch rod gap. Time axis and deflection calibrations are also given. This figure illustrates the sort of surge test records which can be obtained. The oscillograms were taken about as fast as the surge generator adjustments were made. The fastest writing speed shown in these records is some 20 centimeters per microsecond. For inclusion in reports these records can be enlarged to suitable size. For tabulating test data and measuring voltage and time values it is most convenient to project the negatives on ruled graph paper.

Oscillograms

Figure 3 shows a record of the flashover of a transformer bushing on the front of the wave. The oscillation after breakdown required a writing speed of about 50 centimeters per microsecond. However, this writing speed is by no means the available maximum. This record was taken with a one to one $f/3$ lens and those in Fig. 2 with an $f/2$ lens. In the course of our laboratory work, writing speeds of several meters per microsecond have been required and easily obtained with an $f/1.5$ lens. Such performance is not unusual and does not require additional skill on the part of the operator.

Sweep Tripping

In the above application the tripping of the surge generator was controlled by the sweep circuit of the oscillograph. Another problem frequently encountered is that of recording a surge whose time of occurrence cannot be controlled. The same sweep circuit used for surge generator work may be used in this connection because it can be tripped and the beam established on the screen with a loss of only 0.2 to 0.3 microseconds. This tripping may be repeated as often as sixty times a second if repeated surges are required. In most cases the loss of 0.2 microsecond is unimportant. Where necessary, this loss can be regained by connecting a delay cable between the surge point and the deflection plates.

The repeating characteristic of the sweep circuit makes possible studies

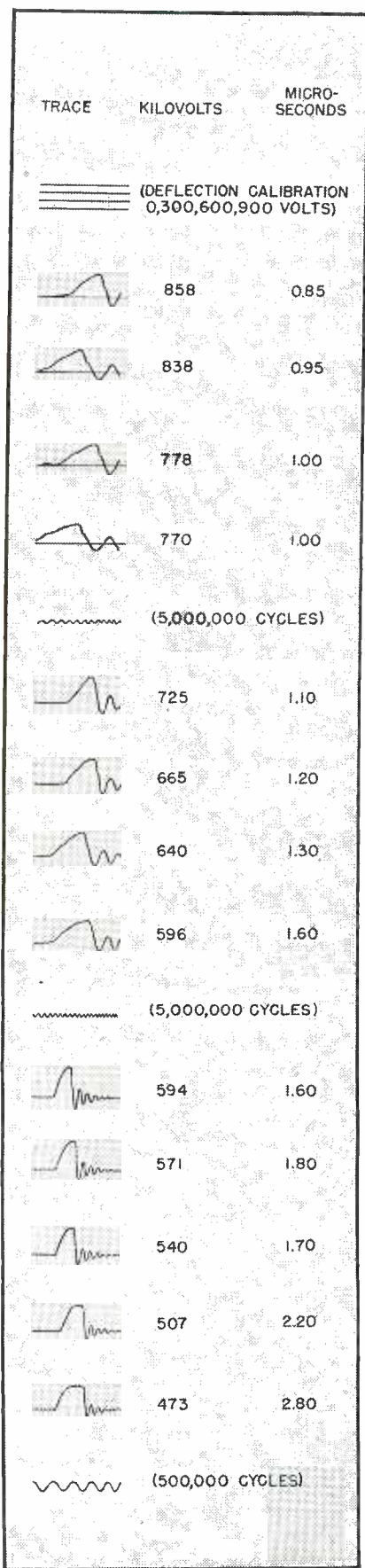

FIG. 2—Series of test oscillograms

of such varied phenomenon as high-frequency vibrations, lightning or switching surges, and ignition circuit transients. In the latter case the deflection plates may be connected to one spark plug and every spark wave shape observed on the screen. Then the effect of various operating conditions can be quickly determined. Records are taken either by snapshot exposure of the stationary film camera or by using a moving film camera.

An application which has lately become important is the measurement of short time intervals either on a single or repeating basis. A deflection voltage of 100 volts is ample for indicating a point along the time axis, and therefore microsecond intervals between phenomenon in one or more circuits can be conveniently measured.

Typical Application

In Fig. 1 is a diagram of the oscillograph as used with a surge generator. The operation is as follows: pushing the button fires the positive sweep thyatron T_1 , raising its cathode from about -1500 volts to $+3000$ volts. This change of voltage has four functions: (1) it immediately trips the negative sweep tube T_2 through coupling capacitor C_1 ; (2) it provides half the sweep voltage by

charging C_2 through R_1 , the other negative half being provided by C_3 charging through R_2 ; (3) it establishes the cathode-ray beam by reducing the negative bias on the cathode-ray tube control grid through the circuit C_4, R_3, R_4 ; (4) it fires the time-delay thyatron T_3 at some time later depending on resistance R_5 and capacitance C_5 .

The firing of thyatron T_3 immediately causes the large thyatron T_4 to fire, thereby tripping the small surge generator. The small surge generator has an output of about 70 kv which is enough for tripping the control gap of the main surge generator. The complete tripping is accomplished with such precision that no variation is visually noticeable in the position of the surge on the screen even on the one-microsecond sweep. For such precision the gaps of both the tripping and the main generator have to be preionized either with ultraviolet light or with corona.

With the sweep already established and in motion, the surge is applied to the vertical plates where it can be observed and simultaneously recorded photographically. Several hundred such records may easily be obtained in an eight-hour day, assuming normal time to prepare each test point.

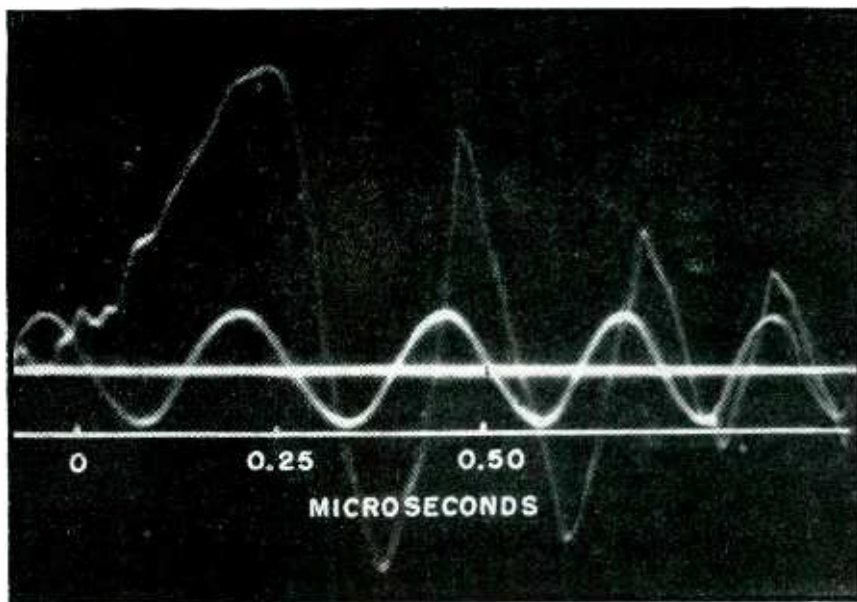

FIG. 3—Record of high-voltage transformer flashover

Grounded-Grid Power

Radio-frequency power amplifiers using grounded-grid circuits operate at higher frequencies and can handle wider bandwidths than capacitance-neutralized grounded-cathode circuits. These advantages suit the grounded-grid circuit to television, f-m, and industrial uses

By E. E. SPITZER

Engineering Department, RCA Victor Division
Radio Corporation of America
Lancaster, Pa.

POWER AMPLIFICATION at high frequencies has always been a difficult technical problem. As the frequency is increased, the problems become more difficult. A number of these problems can be alleviated by a novel circuit which, undoubtedly, is destined to be used widely in the high-frequency field. This circuit is often called the grounded-grid circuit, and while it is not new it has not until recently received the attention it deserves. The purpose of this article is to call attention to this circuit, point out its advantages and characteristics, and show how such a circuit is designed.

There are three practical ways of utilizing a triode as an amplifier. The most common way is to apply the in-

put signal between grid and filament terminals and take output from plate and filament. A second way is to apply input to grid and plate and take output from filament and plate. This type of amplifier is known as a cathode follower. The third way is to apply input to grid and filament and take output from plate and grid. There is no generally accepted name for this type of amplifier. It has been variously called grounded-grid amplifier, inverted amplifier, and common grid circuit because the grid is common to the input and output circuits. According to this terminology, the normal amplifier would be called a common cathode circuit, and the cathode follower would be a common plate circuit. In this article, the

designation grounded-grid will be employed since it has been used fairly widely.

Problems of Tube Design

Consider a normal triode circuit with input applied between grid and filament and a tuned output circuit between plate and filament. The filament is grounded. It is well known that such an amplifier will oscillate by itself at some undesired frequency because of feedback through the grid-plate capacitance of the tube. The cure for this difficulty is neutralization. However, as the frequency is increased, neutralization becomes increasingly difficult to handle. Because feedback is caused by capacitance between grid and plate and because any external neutralizing circuit is isolated from the internal capacitance by the inductances of grid and plate leads, the frequency band over which the tube can be neutralized becomes narrower and narrower with increasing frequency and finally vanishes altogether. Another undesirable effect is that capacitance neutralization serves to increase the input and output capacitances of the amplifier. For example a push-pull cross-neutralized amplifier has an output capacitance per tube equal to the plate-filament capacitance of the tube plus twice the grid-plate capacitance. This resultant high capacitance narrows the r-f bandwidth that can be handled or it may reduce the efficiency of the amplifier because of excessive circulating kilovoltamperes.

Tetrodes and pentodes were developed to overcome the foregoing

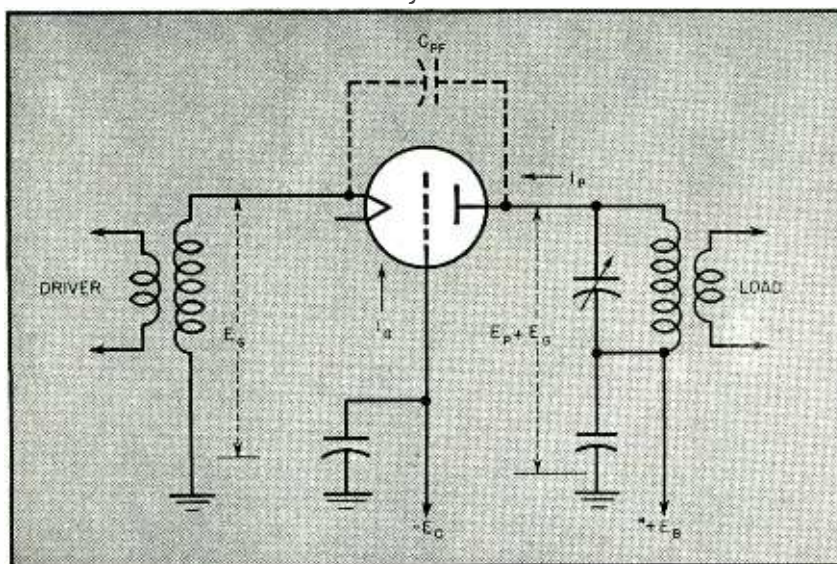
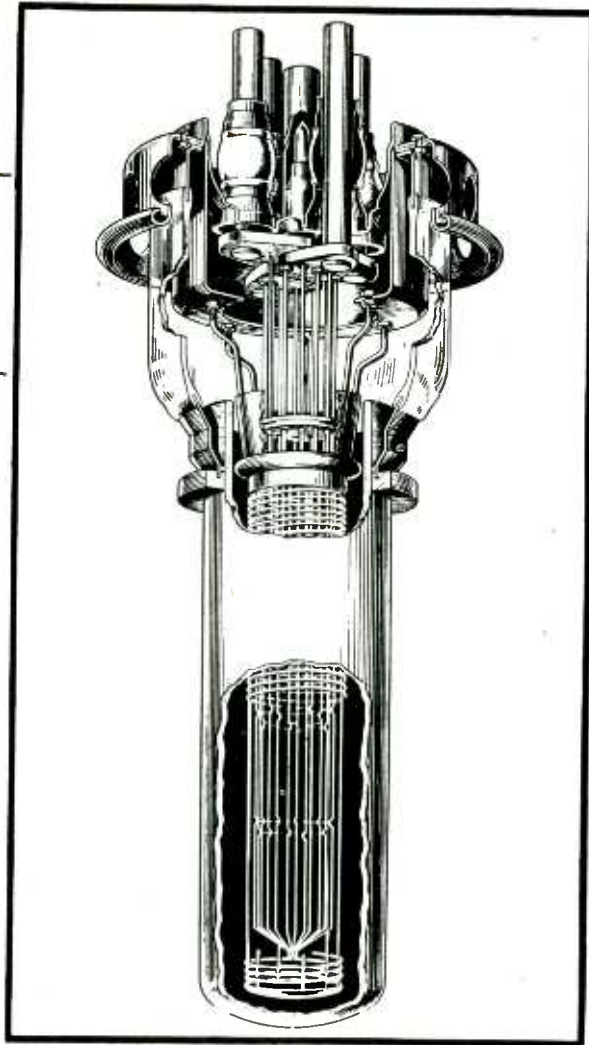

FIG. 1—Circuit and parameters of grounded-grid r-f power amplifier

Amplifiers

FIG. 2—Cut-away view showing method of extending grid cylinder to complete the shielding between filament and plate circuits in a triode especially designed for grounded-grid circuits



difficulties. In these types of tubes, the screen and suppressor shield the control grid from the plate so that the feedback capacitance is low enough to make neutralization unnecessary. However, as the frequency is increased, self-oscillation may occur if the screen and suppressor leads have appreciable inductance. Then, these grids cannot be held effectively at r-f ground potential and, as a result, feed-through may occur. Twin tubes such as the RCA-829B were designed to overcome this difficulty. In a twin tube designed for push-pull operation, screen grids and cathodes can be intimately connected within the tube so that practically no inductance is present between these electrodes. Tubes of this design give excellent performance. The only difficulty is that tube cost for a twin-pentode tends to be high compared to the cost of triodes or triodes for equivalent power output capability.

Circuit Characteristics

The grounded-grid circuit is a way of using a triode which reduces the possibility of self-oscillation without the need for neutralization. Figure 1 shows a grounded-grid amplifier circuit, in which the control grid acts as shield between plate and cathode to reduce feedback capacitance C_{pp} . Thus, the control grid performs one function of a screen grid in a tetrode.

A second characteristic of the grounded-grid circuit is that the driver tube and output tube act in series to supply the load. In Fig. 1, the driver produces an r-f voltage E_o across the input terminals of the

output tube. The latter has an r-f voltage E_p across its plate and cathode. These voltages are 180 degrees out of phase with respect to the cathode so that the r-f voltage from plate to grid and also across the output circuit is $E_p + E_o$. If I_p is the fundamental component of plate current 180 degrees out of phase with E_p , and I_o is the fundamental component of grid current in phase with E_o , the following relations then hold

$$\text{Power delivered to load circuit} = (E_p + E_o)I_p$$

$$\text{Power delivered by output tube} = E_p I_p$$

$$\text{Driver power transferred to load circuit} = E_o I_p$$

$$\text{Power delivered by driver circuit} = E_o (I_p + I_o)$$

$$\text{Power absorbed by output tube} = E_o I_o$$

It is apparent from these relationships that driver tube and output tube act in series to supply the load circuit. Power output, therefore, is

higher than would be expected and the conventional efficiency, based on the input to the output tube, is unusually high.

The foregoing discussion brings out a third characteristic. The driving power of a grounded-grid amplifier is higher than when the same tube is used in a normal triode circuit and may be three to ten times greater. However, this increased power is not lost; it is merely transferred to the plate circuit and appears as output, as explained above.

Tubes for Grounded-Grid Circuits

A fourth characteristic is lower output capacitance. In a grounded-grid circuit, output capacitance is approximately C_{op} , whereas in a normal capacitance-neutralized amplifier the output capacitance is more than twice this value. This fact is most important at high frequencies because lower output capacitance re-

sults in increased r-f bandwidth-handling capabilities and in lower circulating kva in the output circuits.

All of the foregoing characteristics are advantageous with the exception of the increased driving power. The latter is a disadvantage because it may require more or bigger amplifier stages in the transmitter design. Because a pentode or beam tetrode does not have this disadvantage, the field of application of grounded-grid amplifiers is at frequencies at which pentodes are not available for the desired power, or where the cost of pentodes is greater than the cost of additional driving stages required by the grounded-grid circuit. Present indications are that the frequency and power boundaries are about as follows

Power in Kw	Frequency in Mc
0.1	300
25	30
100	10

For the stated power, the grounded-grid circuit becomes desirable at a frequency above that listed.

Most of the characteristics which make a triode desirable in a normal circuit also make it desirable in a grounded-grid circuit. However, there are some additional requirements for a good grounded-grid tube. It has been stated above that the grid and its associated external ground plane should act as a screen between anode and cathode and their respective circuits. Therefore, the tube should be so designed that the anode and cathode connections are on opposite sides of the grid connection. For example, a tube which has an external anode with the grid terminal insulated from one end and the filament terminal insulated from the other end is not at all suited for grounded-grid operation. On the other hand, a tube such as the 9C21 illustrated in Fig. 2 is ideally suited for grounded-grid operation because the grid terminal is a large metal flange which can be connected to a metal shield separating the anode circuit from the cathode circuit. In addition, the grid support of the 9C21 has very low inductance and, therefore, meets the second requirement for a good grounded-grid triode.

Let it be required to design a grounded-grid stage utilizing one 9C21 triode. The tube will be used in

the circuit shown in Fig. 1. The manufacturer's data show the following typical operating conditions for normal grounded-cathode circuits

D-c plate voltage = 17,000 v
 D-c grid voltage = -1,600 v
 Peak r-f grid voltage = 2,200 v
 D-c plate current = 7.9 amp
 D-c grid current = 0.9 amp
 Driving power = 1,800 w
 Power output = 100 kw

Amplifier Design

It is first necessary to obtain the r-f plate voltage swing E_p . This can be estimated from the fact that in a properly excited class-C amplifier, the plate voltage will swing down to the value of the peak positive grid voltage. Because the value of the latter is equal to 2,200 minus 1,600 volts, or 600 volts, E_p is $2 \cdot (17,000 - 600) = 11,600$ volts rms.

Next, the fundamental components of plate current and of grid current must be obtained using the power output and driving power values given above

$$I_p = \frac{100,000}{11,600} = 8.63 \text{ amperes}$$

and

$$I_g = \frac{1,800 \sqrt{2}}{2,200} = 1.16 \text{ amp.}$$

The output power and the driving

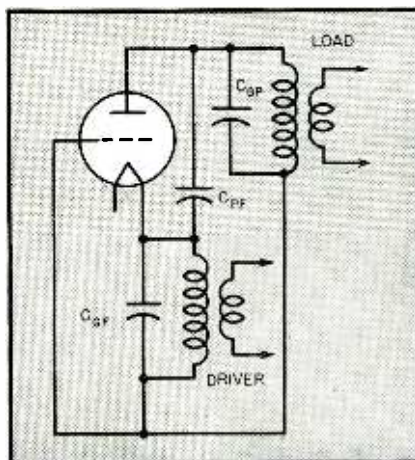

FIG. 3—Rearrangement of circuit of Fig. 1 shows that the grounded-grid amplifier is similar to the Colpitts oscillator

power of the grounded-grid stage can now be calculated from the relations given earlier. We obtain

$$\begin{aligned} \text{Power output} &= (E_p + E_g) I_p \\ &= \left(11,600 + \frac{2200}{\sqrt{2}} \right) 8.63 = 113 \text{ kw.} \end{aligned}$$

Driving power = $E_g(I_p + I_g)$

$$\rightarrow \frac{2200}{\sqrt{2}} (8.63 + 1.16) = 15.2 \text{ kw.}$$

It is possible to change the power output to some extent by varying the grid bias and the grid swing. For example, if the bias should be changed from -1,600 to -2,000 volts and the grid swing by a like amount, i.e., to 2,600 volts, the power output would be 116 kilowatts.

A grounded-grid amplifier stage can go into self-oscillation, particularly at high frequencies, because of feedback from plate to cathode through the plate-filament capacitance. This action is more easily understood if the amplifier stage is redrawn as a Colpitts oscillator circuit, as shown in Fig. 3. Because we are dealing with the worst conditions, inductive tuning only is assumed. The output circuit must be inductive at the oscillation frequency, as the following analysis proves.

Conditions for Oscillation

It is well known that circuit reactance between filament and grid must be capacitive and, furthermore, should be at least one-fifth the reactance between plate and filament. This reactance will produce an excitation ratio, that is, a ratio of plate swing to grid swing, of five. In any good grounded-grid tube, the plate-filament capacitance will be so low that its ratio to the grid-filament capacitance will be much less than one-fifth. Thus, to produce oscillation, the input circuit must be inductive so as to reduce the effective capacitance between grid and filament to a value about five times that of the plate-filament capacitance. With tuned input circuits, this condition can easily be fulfilled. Let it be assumed that this condition is exactly fulfilled.

The total tank circuit capacitance is then

$$C_T = C_{PF} + \frac{5 C_{GP} C_{FP}}{C_{GP} + 5 C_{FP}}$$

In the case of 9C21, this capacitance would be

$$C_T = 1.8 + \frac{48 \times 5 \times 1.8}{48 + 5 \times 1.8} = 9.4 \mu\text{mf}$$

Thus for this 100-kw tube, the tank capacitance for parasitic oscillation is only 9.4 μmf , a value which is quite small. This capacitance will

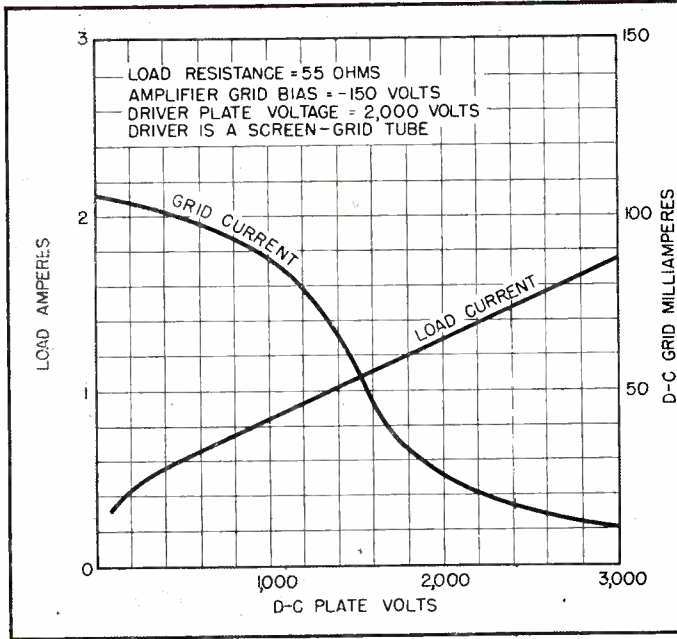

FIG. 4—Plate modulation characteristic of grounded-grid r-f amplifier

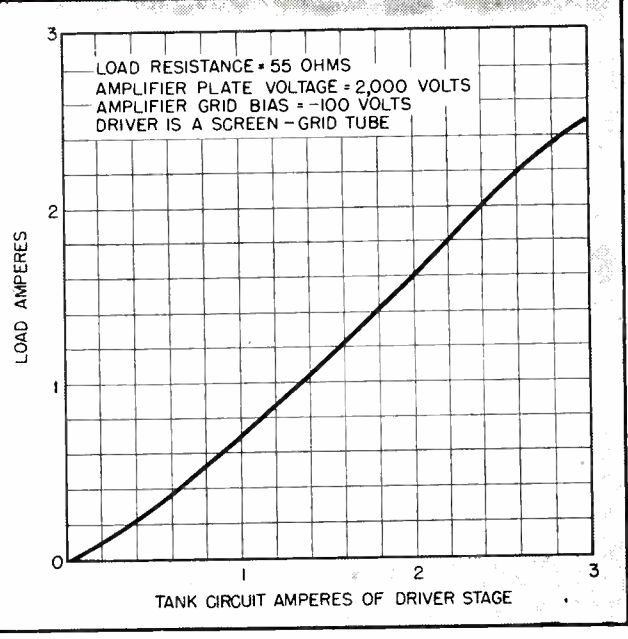

FIG. 5—Class-B power amplification characteristic of grounded-grid circuit

store only appreciable amounts of power at high frequencies. Assume operation at a frequency of 20 mc. The reactance of C_T is then 850 ohms. If the tube is operated at 12 kilovolts with a plate swing of 11.6 kilovolts, the reactive power is $(11,600/2)^2/850 = 80$ kilovoltamperes.

We also know that oscillator stability necessitates an operating Q of at least 12. Therefore, in the above case, the circuit could be loaded to 6.7 kw. If all the circuit losses, including driving power and any power delivered to the load, are less than 6.7 kw, the tube will oscillate with certain adjustments of the input and output circuits. If we assume that the normal output circuit loss is five percent of 100 kw, or 5 kw, this value plus the driving power and the normal load coupled to the tube would be sufficient to make the amplifier stable at the assumed frequency.

Modulation Characteristics

When plate modulation of only a grounded-grid amplifier stage is attempted, a characteristic such as illustrated in Fig. 4 is obtained. It will first be noted that grid current varies widely with plate voltage. As

the plate voltage increases, the plate current also increases and causes an increasing load on the driver stage. Due to the regulation of the latter, driving voltage decreases and with it grid current. This decrease of grid current is quite large and is characteristic of this type of amplifier.

Over quite a range of plate voltage, the output current is linear with plate voltage as in the case of conventional class C amplifiers. However, at low voltages load current departs from linearity and will not be zero until negative values of plate voltage are reached. This phenomenon is due to the fact that r-f driving voltage and d-c plate supply voltage are in series as shown in Fig. 1. As a result the plate not only has a d-c supply voltage but also simultaneously an r-f supply voltage. Therefore, the plate current and the load current do not drop to zero until a value of negative plate voltage equal to the value of the peak driving voltage is reached. Accordingly, the resultant characteristic of modulating only a grounded-grid stage shows distortion unless one is satisfied with partial modulation. To obtain a modulation characteristic which will permit 100-percent modulation,

it would be necessary to modulate simultaneously one or more successive stages.

The above problem is of little practical consequence because amplitude modulation is rarely used at the high frequencies for which the grounded-grid circuit is particularly applicable. The problem does not exist for such services as frequency-modulation, television and industrial power.

When a grounded-grid amplifier is used as a linear, class-B r-f amplifier, quite satisfactory results are obtained, as shown in Fig. 5. Such an amplifier could be used to amplify television signals.

BIBLIOGRAPHY

- (1) Alexanderson, E. F. W., U. S. Patent 1,896,534, filed May 13, 1927, granted Feb. 7, 1933.
- (2) Spitzer, E. E., "Grounded-Grid Operation of Triodes as Class B and C Amplifiers", an unpublished report dated Dec. 22, 1930.
- (3) Lindenblad, N. E., U. S. Patent 2,136,448, filed Apr. 14, 1932, granted Nov. 15, 1938.
- (4) Romander, H., "The Inverted Ultraudion Amplifier" *Q.S.T.*, p 14, Sept. 1933.
- (5) Potter, R. K., U. S. Patent 2,088,722, filed June 12, 1936, granted Aug. 3, 1937.
- (6) Strong, C. E., "The Inverted Amplifier," *ELECTRONICS*, p 14, July 1940.
- (7) Labin, E., "Design of the Output Stage of a High Power Television Transmitter," *Electrical Communication*, 20, No. 3, p 193, 1942.
- (8) Gurewitsch, A. M., "Cavity Oscillator Circuits," *ELECTRONICS*, p 135, Feb. 1946.

Radium-Type Vacuum

Gas molecules are ionized by alpha particles from a pellet of radium, in linear relation to gas pressure, and the resulting ion current is collected and measured with a special high-gain d-c amplifier using an acorn tube and having up to 10^{12} ohms input resistance

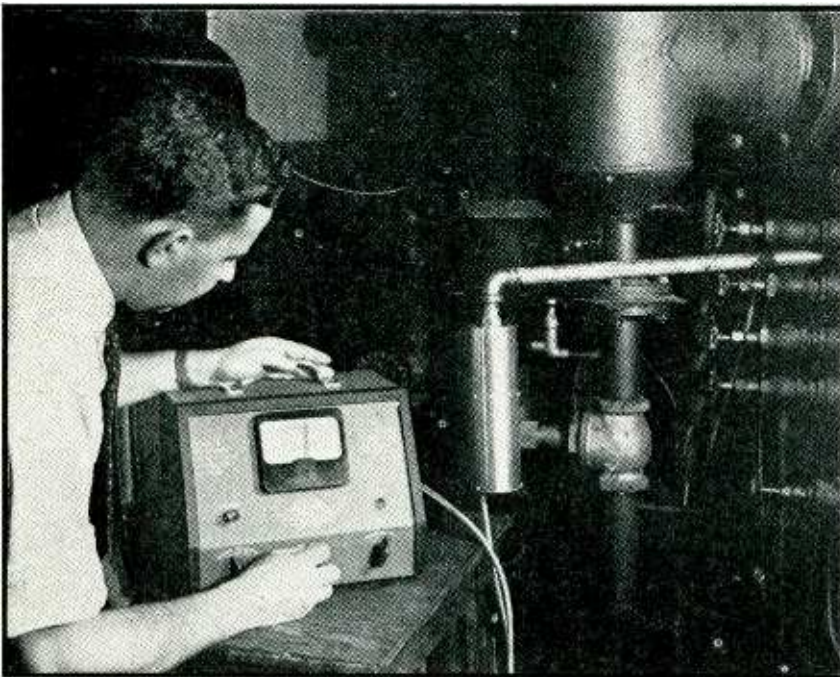

Alphatron radium-type vacuum gage in use on an industrial high-vacuum furnace, registering a gas pressure of 6 mm during pumpdown. The polished metal cylinder attached to the pipe at the right contains the ionization chamber (upper section) and the probe amplifier stage

PRESSURE measurements in the interval between one micron and ten millimeters are required in a number of industrial processes, some of which are indicated on the chart in Fig. 1. The chart also portrays the intervals covered by conventional gages¹ in comparison with the range of a radium-source ion gage described in this article. By utilizing the ionization effect of emanations from a small, permanent radium source, this gage gives indications of gas pressures accurately, directly, and continuously in the in-between range covered only by the unwieldy and fragile McLeod gages.

Since the ionization effect is produced by the constant flow of alpha particles from a sealed radium source, there is no filament to burn

out and no filament current to set and maintain. Furthermore, the gage cannot be damaged by exposure to atmospheric pressure. It is ruggedly constructed of all-metal parts not subject to breakage. There is no degassing to be done when the gage is turned on, and the absence of mercury vapor eliminates one of the common contaminators of vacuum systems.

The use of the ionization effect in the high-pressure range avoids the lag in readings common to gages utilizing the principle of thermal radiation and gives instantaneous response to pressure changes. Within the three standard ranges no complicated calibration curves are required for different gases, there being a linear reaction to pressure.

Gases other than air can be measured merely by applying a multiplying factor to meter readings.

Since air and water vapor give so nearly equal ionization currents, the instrument is ideal for all vacuum applications involving mixtures of these two gases, as in dehydration equipment. If the gage is set to read total pressure of a 50-50 mixture of air and water vapor, it will be accurate within approximately 7.5 percent for all mixture ratios.

At pressures above about 25 mm the recombination of ions produced in the chamber becomes appreciable and linearity is lost, although the gage may be calibrated for pressures up to and beyond atmospheric, as shown in Fig. 2.

Throughout its linear range, when used with the amplifier to be described, the gage measures pressures with three scales of sensitivities: 0-100 microns, 0-1 millimeter, and 0-10 millimeters. Normally the combination of gage and amplifier is calibrated for air pressures, while other gas pressures are determined by the use of conversion factors; however, the scales may be set to read directly for other atmospheres where this is desired. Figure 3 shows the relative response for the ordinary gases encountered. It will be seen that the high relative response to acetone vapor lends itself admirably to the acetone technique of leak detection on kinetic vacuum systems.

Theory of Operation

Alpha particles emitted by a radium source collide with gas molecules in the ion chamber, producing approximately 33 ion pairs per cm of path length per mm air pressure, per alpha particle.^{2,3} By the action of an electric field strong enough to effect saturation currents, these ions

Gage

By **GLENN L. MELLEN**

Physics Department
National Research Corp.
Boston, Mass.

are collected at a rate dependent upon their production, and thus constitute a minute current whose magnitude is a linear function of pressure. Since the alpha activity of a radium source in equilibrium with its immediate decay products is constant for all practical purposes, it only becomes necessary to measure these currents in order to evaluate pressures.

Some 10^7 alpha particles per second are ejected into the ion chamber from the 200-microgram radium source used. With a mean path length of 5.5 cm in the ion chamber, it is predictable that approximately 2×10^{-20} amp of ionization current is to be realized per millimeter of air pressure. Since the recombination of ions is a function of collection field strength and molecular mean free path, an increasing fraction of

the ions produced will be lost in this manner and at some high pressure the deviation from linearity will become detectable for any one set of gage conditions. This point is at 25 mm, for the present design, and no further increase is necessary here for this is well within the operating region of simpler pressure gages.

D-C Amplifier Circuit

The essential features of the radium-type vacuum gage are illustrated in Fig. 4, and include the following: (1) the vacuum chamber,

a brass shell with suitable vacuum-tight insulators and provision for making connection to a vacuum system; (2) the radium source, containing approximately 200 micrograms of radium, sealed to prevent radon loss, and in equilibrium with its immediate decay products; (3) ion collector electrodes, with a plate electrode being used to produce an electric field for ion collection, and a grid essentially at ground potential to minimize the effect of electrical leakage across the input insulator; (4) a suitable means of measuring

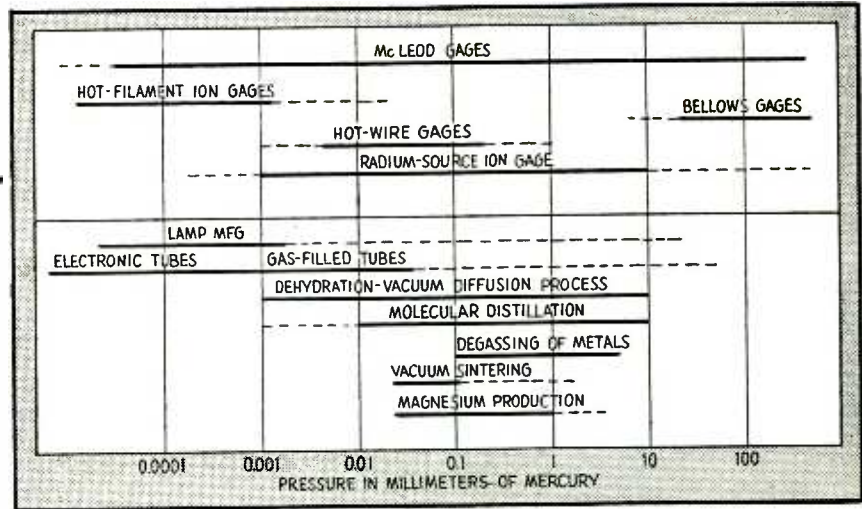

FIG. 1—Pressure ranges of vacuum gages and processes. Solid lines indicate definite regions of operation, while dash-dash lines represent regions that are questionable or to which special gages may extend

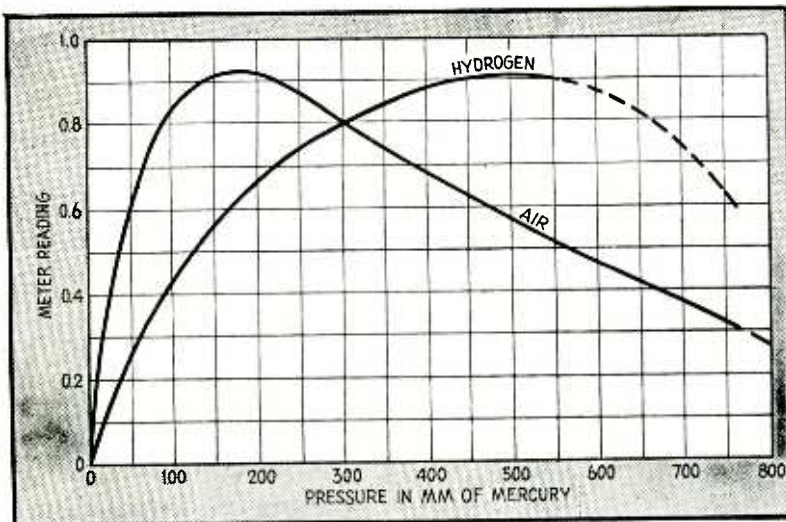

FIG. 2—Calibration curves for extended range of radium-type vacuum gage, indicating possibility of measuring air pressures well over atmospheric if operator knows whether he is above or below the 175-mm peak of the calibration curve. Range setting IV on the instrument is used for these higher-pressure measurements. A separate calibration curve must be prepared for each gas, using a McLeod or bellows gage as a standard

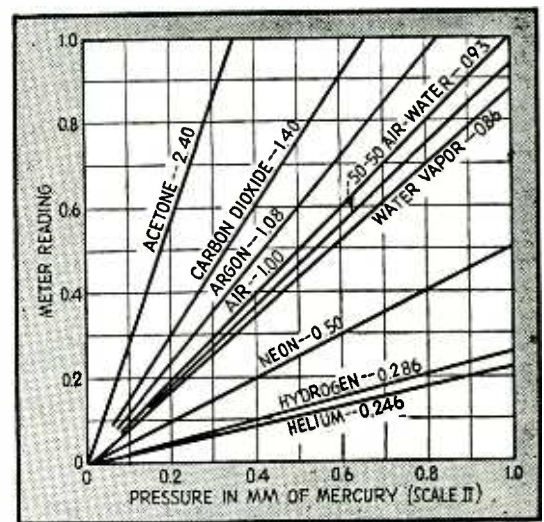

FIG. 3—Calibration curves showing linear performance of gage over its three normal ranges. For scale I, multiply abscissa values by 10; for scale III, multiply abscissa values by 100 and read as microns of mercury. Values on curves give relative response

the minute ion current produced.

The high-gain d-c amplifier devised by Shepard Roberts' lends itself admirably to the job at hand. The basic circuit is given in Fig. 5. Once the cathode bias (E_c) has been adjusted with no input current I_i , so that the battery voltage is equaled by the cathode resistor drop E_2 in the second stage, there will be no output current I_o indicated by the meter. Now, if a minute input current I_i flows through R_1 , a signal voltage E_i is developed. This signal voltage is opposed by the output voltage E_o , so that the net change of bias on VT_1 is $\Delta E_G = E_i - E_o$. If μ is the overall gain of the circuit, $\mu \Delta E_G = E_o = \mu(E_i - E_o)$. From this, $E_i = E_o(1 + 1/\mu)$.

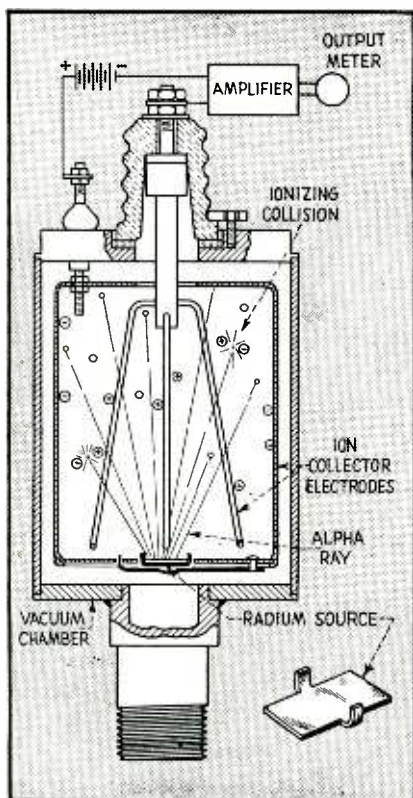

FIG. 4—Cross-section of ion chamber, showing location of radioactive source and collector electrodes

If the gain μ be made large, the factor $1/\mu$ may be neglected without sensibly affecting the relationship. Then $E_i = E_o$, or $I_i R_1 = I_o R_o$. Rearranging gives $I_i = I_o R_o / R_1$; in other words, the calibration (current amplification) is a matter of resistor ratios only and is independent of widely changing tube characteristics

so long as the gain remains high. At the same time the potential of the input grid with respect to ground is changed only by E_i/μ , thus minimizing the effect of electrical leakage across any insulator in the input circuit.

If a 200-microampere meter is used to indicate I_o , it is possible with resistor ratios of 10^7 to measure 2×10^{-11} ampere at full-scale deflections. This is the order of ion currents realized from the gage at 100 microns of air pressure.

Experimental and Production Models

Originally the Roberts circuit was tried with a 6C6-6K5 tube lineup and found satisfactory for gage operation at 0-1 mm and 0-10 mm sensitivities. In this version a single 1,000-megohm input resistor was used in conjunction with switchable 1,000 and 10,000-ohm output resistors. The amplifier then operated on 0.2 and 2.0 volts of signal.

To obtain a third scale by using a 100,000-ohm output resistor would require 20 signal volts on the same basis and since the battery is only $22\frac{1}{2}$ volts, this means of attaining an additional range is not satisfactory.

By the same token one cannot go in the other direction to operate on a 0.02-volt signal. For a 0.2-volt signal and a μ of 100, we obtain $\Delta E_G = E_i/\mu = 0.2/100 = 2$ millivolts for full-scale deflection. Hence for one-percent scale deflection only 20 microvolts of ΔE_G are required. This was found by experience to be the lower limit that gave stable operation, free from zero-setting drift and sporadic fluctuation. Even though the zero setting may drift, the current amplification is unaffected, and I_i is determined by simply resetting and then reading. Zero is reset by disconnecting the input and adjusting E_c for zero I_o .

No attempt was made to measure the inherent grid current of the 6C6 first stage since it was possible to use the amplifier after adjusting the value of heater voltage to approximate the circuit values given in Roberts' article. By using a value of 2×10^{11} ohms for R_1 , the amplifier was pressed to its limit.

In the production model, the first stage of the amplifier was located at

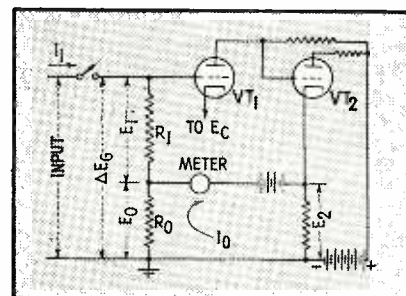

FIG. 5—Basic d-c amplifier circuit

the end of a cable in a probe assembly, since it was considered inadvisable to attempt piping the minute ionization currents from the gage to the amplifier. The need for three ranges of sensitivity (0-100 microns; 0-1 mm; 0-10 mm) dictated that some means of switching the input resistors be provided so that the entire blind spot in the pressure spectrum could be adequately covered. This was first effected by a switch on the probe, but later a relay was added to make all operations remotely controlled.

Acorn Tubes is Used

The production model uses a type 954 acorn tube in place of the 6C6. The simplicity of the amplifier depends upon realizing comparatively high voltage gain in the first stage. The second stage is degenerative about 3 to 1, and the overall gain must be kept up to negate the $1/\mu$ factor.

Acorns have been used before in electrometer circuits,⁵ but the signal has always been applied to the suppressor grid to keep the inherent signal grid current low, and consequently the gain has been approximately unity. Conceivably, two additional stages (to get the proper feedback phase relationship) could be added to attain the required μ , but this becomes somewhat complicated because of the need for batteries between stages.

Screen Grid Voltage

It was discovered that the signal could be applied to the control grid on the 954 and still obtain a low inherent grid current with appreciable gain ($g_m = 90$) if a proper value of screen voltage were chosen. A family of curves is given in Fig. 6 showing

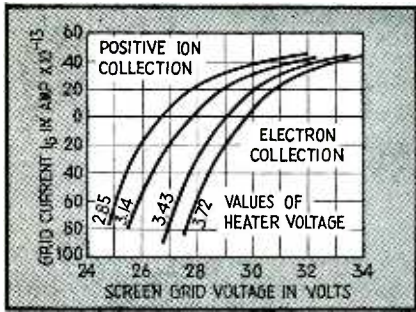

FIG. 6—Operating characteristics of tube

the relation between screen voltage and grid current at various values of heater voltage. At low values the grid current is due to electron collection, while at higher values positive ion collection predominates.

To measure these minute grid currents, the amplifier was adjusted to operate at full-scale deflection with 0.2 volt E_i , so that with a 10^{10} -ohm input resistor each microampere of output current represented 10^{-13} ampere of I_i . By adjusting E_c with a 10^8 -ohm input resistor for zero I_o and then switching to 10^{10} ohms input, any deflection noted will be due to the grid current I_o developing a signal across this higher R_i , and I_o may be evaluated directly. For each value of heater voltage there is a value of screen voltage that will balance positive ion and electron collection, so

that essentially zero grid current exists. This screen voltage is made adjustable to compensate for tube to tube variations, and is set by a searching method so that no deflection is noted when switching between 10^8 and 10^{10} -ohm input values.

Controlling Zero Drift

It is not beyond the realm of possibility to regulate the three variables—cathode bias voltage, screen grid voltage, and heater voltage—to such a degree that zero drift becomes negligible. On the basis of measurements, the arbitrary operating value of 3.7 volts a-c was chosen for the heater voltage. By operating the 954 under the above conditions it was possible to improve the amplifier characteristics over that experienced with the 6C6. At the same time the advantage of a smaller physical dimension was gained so that all the components necessary to complete remote control could be incorporated in a compact probe assembly. Furthermore, I_c was held low by only partially temperature-limiting the emission, and therefore the warm-up time was materially reduced. The 6C6 required operating at full 6.3 volts to start, with later reduction to operating values to run; otherwise, the amplifier would drift for

hours before temperature equilibrium was established. With the 954, the amplifier on highest sensitivity is ready to operate after just one minute of warm-up and will drift only 5 percent of full scale to its final equilibrium in the next five minutes.

Two relays and two high-value resistors complete the major components of the probe assembly. The upper relay mechanism operates to disconnect and ground the ion current input to the tube grid so that the amplifier may be zero balanced. The lower relay serves to connect the low side of the 10^8 -ohm resistor to the 10^{10} -ohm resistor, thus changing the value of R_i . This low end of the 10^8 -ohm resistor must be held above ground by at least 10^{12} ohms when in the open position so that the 10^{10} -ohm resistor will not be appreciably changed in its value by shunting. Therefore, this end is left floating, with no supporting insulator.

Control Panel

A ten-wire cable connects this probe assembly to the control panel, as shown in Fig. 7. In this unit are located the power supply, controls, second stage, battery, and output meter. The four-inch meter is a 200-microampere movement with ap-

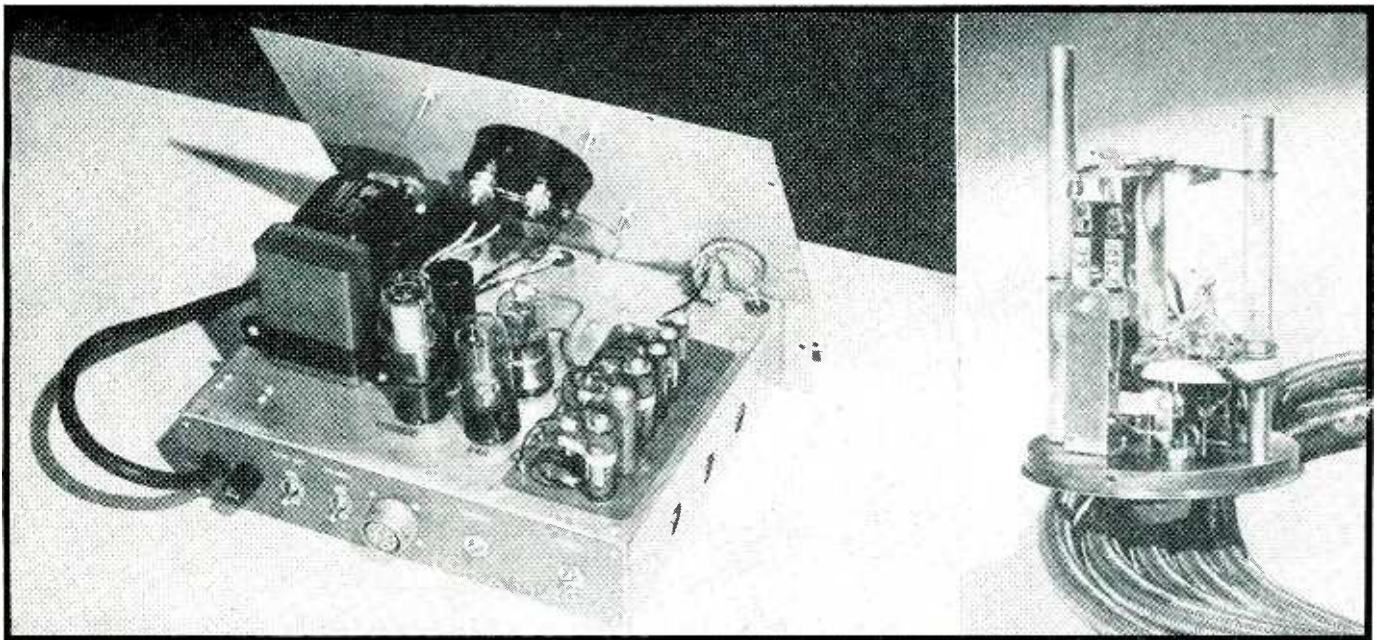

Rear view of chassis of control unit for gage, and closeup of 954 amplifier stage, located in probe head along with two glass-encased high-value resistors (98 and 10.820 megohms here), and two switching relays. This unit fits under the ionization chamber

TRANSIENT Delay Line

Design criteria for a pulse-delay network useful in radar, television, or test oscilloscope work. With highest frequency component of the transient known, a simple, graphical solution is possible for required values of inductance and capacitance

By JOHN M. LESTER

Engineer
Sperry Gyroscope Co., Inc.
Garden City, N. Y.

WHEN designing special electronic equipment, it is often necessary to provide some method of delaying or storing electrical information for a given length of time. If this memory time is in the order of microseconds, an electrical network with special characteristics can be designed and constructed quite easily. Except for a small amount of attenuation, the signals applied to the network input will be

faithfully reproduced at the output after the required time has elapsed.

Effect of m on Phase Shift

By choosing the correct value of m in an m -derived low-pass filter, it is possible to obtain a phase-shift characteristic that is fairly linear with frequency for almost the entire pass band. If a transient signal is passed through this filter, it will be delayed in time by an amount equal

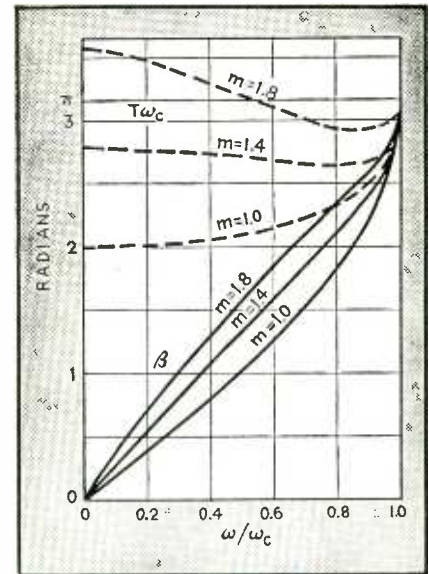

FIG. 1—Phase-shift characteristics for one section are shown by the solid lines. The dashed lines show how the slopes vary as the cutoff frequency is approached, expressed in terms of $T\omega_c$.

to $\beta/2\pi f$ where β is the phase shift in radians at a frequency f . No phase distortion will occur if the phase characteristic of the filter is linear up to the highest frequency included in the transient signal. By placing sections of these filters in cascade any desired delay can be obtained.

The effect of m on the phase-shift characteristic of one section is shown by the solid-line curves in Fig. 1. β is plotted against ω/ω_c for various values of m . The broken-line curves in Fig. 1 show how the slopes of the solid-line curves vary with ω/ω_c . The ordinate is expressed in terms of $T\omega_c$. Because $\beta = \omega T$, this also equals $\beta/(\omega/\omega_c)$. We see that when m equals 1.4, the phase shift is fairly linear up to 95 percent of the cutoff frequency, and the average value for $T\omega_c$ can be taken from the curve as 2.73. $T\omega_c$ will never vary more than ± 2.93 percent from this value for frequencies below 95 percent of cutoff.

Figure 2A shows a T section of an m -derived low-pass filter. Substituting a value of 1.4 for m , we get

$$L'_1 = mL_k/2 = 0.7L_k \quad (1)$$

$$L'_2 = \frac{(1-m^2)}{4m} L_k = -L_k/5.6 \quad (2)$$

$$C' = mC_k = 1.4C_k \quad (3)$$

We can see that L'_2 is negative. This negative value of L'_2 can be obtained by using the network shown in Fig. 2B. The network with mutual inductances is equivalent to the net-

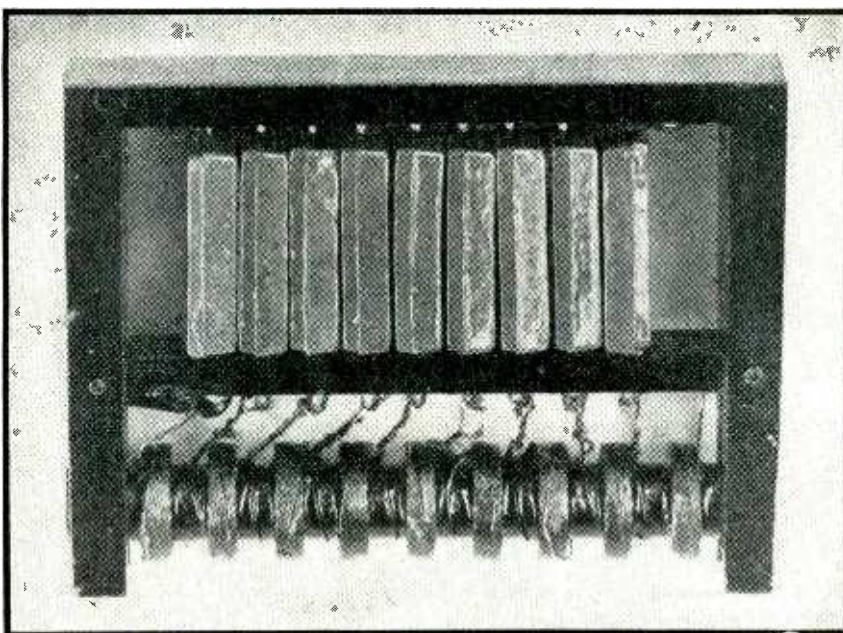

An experimental delay unit of nine sections. Characteristic impedance is 500 ohms. There is a total delay of 1.5 microseconds for a transient having a maximum frequency component of 2.5 mc. The unit is illustrated about twice normal size

work of 2C. Therefore

$$\left(\frac{1-m^2}{4m}\right)L_k = -M \quad (4)$$

$$mL_k/2 = L/2 + M \quad (5)$$

$$mC_k = C \quad (6)$$

Substituting Eq. 4 in Eq. 5 we get

$$L = mL_k + \left(\frac{1-m^2}{2m}\right)L_k = \left(\frac{m^2+1}{2m}\right)L_k \quad (7)$$

Letting $T\omega_c = 2.73$ which is the value we previously determined from Fig. 1, then

$$T = \frac{2.73}{\omega_c} \quad (8)$$

$$\text{or } f_c = \frac{2.73}{2\pi T} = \frac{0.435}{T} \quad (8a)$$

Cutoff Frequency

This derivation shows that T is inversely proportional to the cutoff frequency. Referring to Fig. 2C, the cutoff frequency of an m -derived filter is

$$f_c = \frac{1}{\pi \sqrt{(L+2M)C + 4C(-M)}}$$

Since k (coefficient of coupling) = M/L

$$\text{then } f_c = \frac{1}{\pi \sqrt{(LC + 2kL)C + 4C(-kL)}}$$

$$= \frac{1}{\pi \sqrt{(LC + 2kL)C - 4kLC}}$$

$$= \frac{1}{\pi \sqrt{CL(1-2K)}} \quad (9)$$

$$\text{or } \omega_c = \frac{2}{\sqrt{CL(1-2k)}} \quad (9a)$$

Substituting Eq. 9a in Eq. 8, we get

$$T = 1.36 \sqrt{CL(1-2k)} \text{ when } m = 1.4 \quad (10)$$

With the use of Eq. 10 the time delay of an m -derived filter, when $m = 1.4$, can be calculated.

Terminating the Filter

So that no reflections will occur, it is necessary to terminate the filter correctly. Assuming the filter consists of pure reactances, then the terminating resistance,

$$R_0 = \sqrt{L_k/C_k} \quad (11)$$

Substituting Eq. 6 and 7 in Eq. 11

$$R_0 = \sqrt{L \frac{(2m)}{(m^2+1)} \cdot \frac{C}{m}} = \sqrt{\frac{L(2m^2)}{C(m^2+1)}} \quad (12)$$

Since $k = M/L$, then from Eq. 4 and 7

$$k = \frac{\left(\frac{m^2+1}{4m}\right)L_k}{\left(\frac{m^2+1}{2m}\right)L_k} = \frac{m^2-1}{2(m^2+1)} \quad (13)$$

$$\text{or } 2k(m^2+1) = m^2-1$$

$$2km^2 + 2k = m^2 - 1 \quad (14)$$

and

$$m^2 = \frac{1+2k}{1-2k} \quad (14a)$$

Substituting in Eq. 12, we get

$$R_0 = \sqrt{\frac{L(1+2k)}{C}} \quad (15)$$

Substituting the value of 1.4 for m in Eq. 14a, we see that $k = 1/6$.

The chart shown in Fig. 3 is based on Eq. 10 and 15 which, when reduced to their simplest form, are

$$T = 1.11 \sqrt{LC} \quad (16)$$

$$R_0 = 1.15 \sqrt{L/C} \quad (17)$$

Use of Chart

Knowing the delay time for one T section and the terminating resistance, the correct inductance and capacitance for the filter can be determined from the chart. As many sections as desired may be added in cascade to give any time delay desired. The total delay will be T times the number of sections.

It must be remembered that the chart is fairly accurate only if it is used for frequencies below 95 percent of cutoff.

Using Eq. 8, we see that

$$f_{max} = \frac{0.435 \times 0.95}{T} = \frac{0.41}{T} \quad (18)$$

Suppose we have a transient signal which we want to delay one microsecond. We want the impedance of the network to be 1,000 ohms. Also, the highest frequency contained in the transient signal is one mc. What will be the constants of the network?

Example

Knowing f_{max} , we first determine the maximum delay T per section realizable.

$$f_{max} = \frac{0.41}{T} \text{ or } T = \frac{0.41}{1 \times 10^6} = 0.41 \times 10^{-6} \text{ sec}$$

The number of sections will be the total time divided by T , or $10^{-6}/(0.41 \times 10^{-6}) = 2.44$.

Therefore, three sections are the minimum to be used. With three sections we will have $(10^{-6}/3) = 0.33 \times 10^{-6}$ seconds delay per section. From the chart we can determine L and C . We see that $L = 260 \mu\text{h}$ and $C = 340 \mu\mu\text{f}$. Therefore, the networks will have the constants shown in Fig. 4, when $k = 1/6$.

Design Considerations

The following are practical problems that must be taken into consideration when constructing a delay filter:

- (1) Providing small attenuation.
- (2) Obtaining the correct coefficient of coupling.
- (3) Preventing reflections.

The attenuation of the network depends upon the Q of the capacitors and inductors. Usually the loss due to the capacitors is negligible and can be neglected. The attenuation for frequencies lower than 95 percent of cutoff is approximately equal to $\omega T/2Q_L$ nepers, where T is the delay time in seconds. Q_L can be increased in several different ways. The size of the wire used for winding inductors can be large. However, this will increase the physical size of the filter and hence increase stray capacitance between coils. If the frequencies involved are in the order of 100 kc to 4 mc, the use of litz wire will help to increase Q_L . Also, Q_L can be increased by using powdered-iron cores.

The coefficient of coupling can be controlled by varying the spacing between adjacent coils. The spacing should be adjusted so that the coefficient of coupling is equal to 0.16.

Unless the network is terminated in its characteristic impedance or a

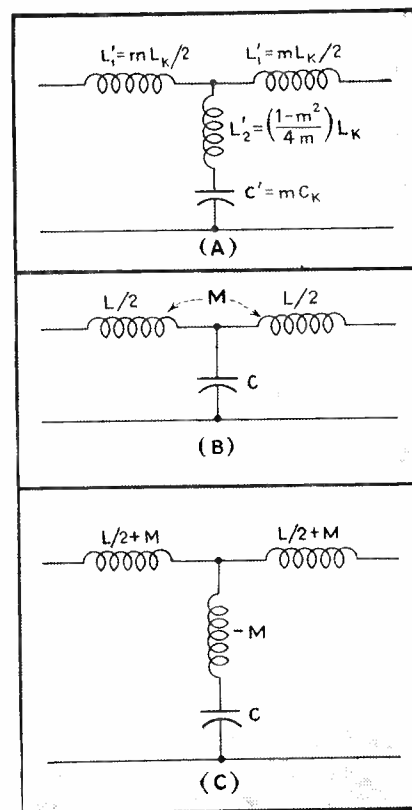

FIG. 2—Development of a T section of an m -derived low-pass filter. (A) The value of L_2' is shown to be negative and is obtained in practice by the circuit of (B). (C) demonstrates the derivation of the cutoff frequency

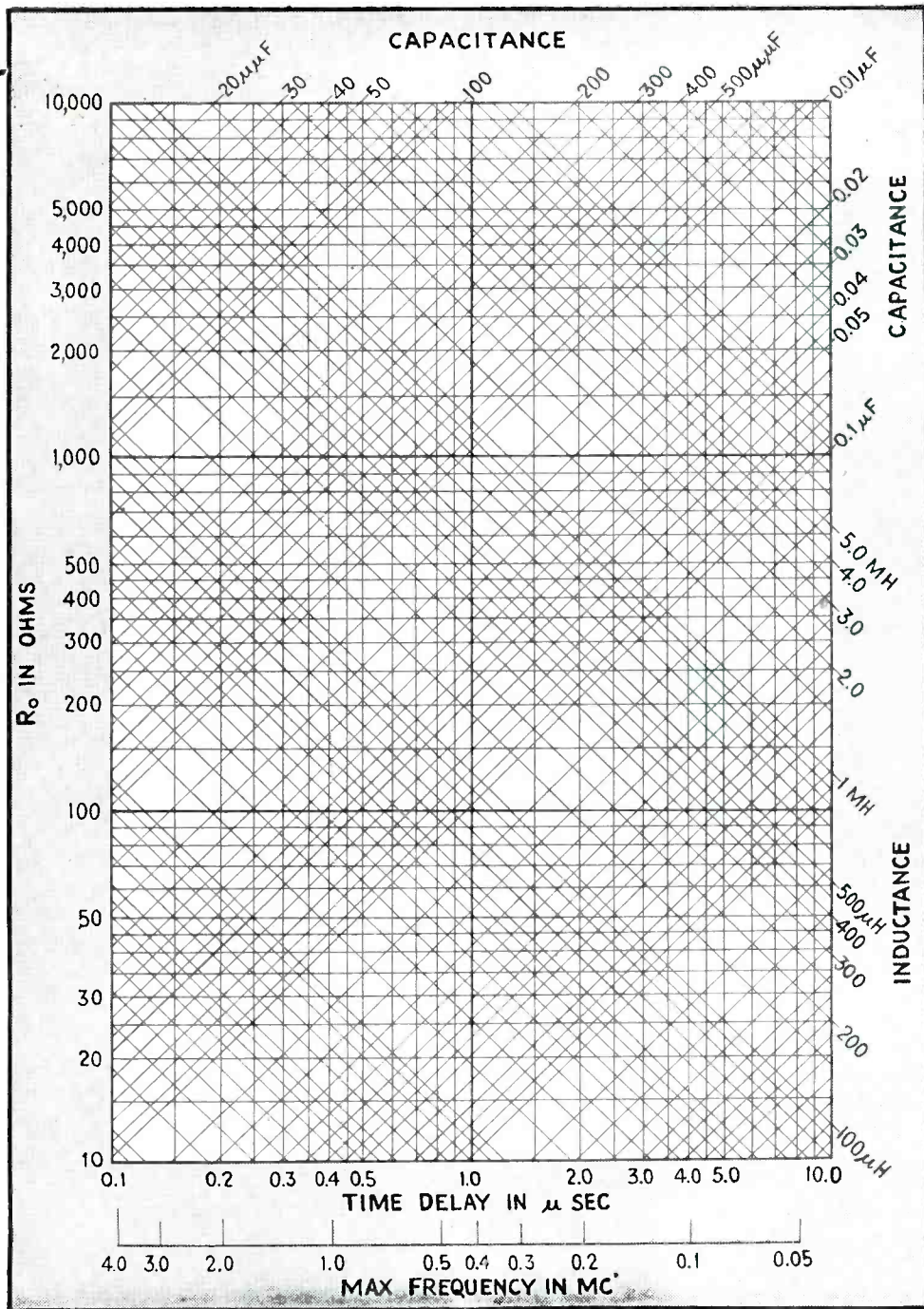

FIG. 3—Chart used in determining the value of inductance and capacitance of the filter when time delay T and terminating resistance R_o are known, accurate only when used for frequency below 90 percent of cutoff

close approximation to it, echoes or reflections will occur when transient signals are inserted. Usually when several sections are used in cascade, a sufficiently good termination will be obtained when both ends of the network are terminated with capacitors equal to $C/2$. However, if a more perfect termination is desired, a half- π section where $m = 0.6$ can be used.

It is good design practice to try to use a network as low in impedance

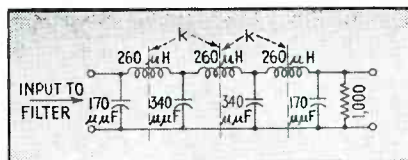

FIG. 4—Three T sections form a filter network to delay a transient signal 10 microseconds. Impedance of the network is 1,000 ohms and the highest frequency contained in the transient is 1 mc

as possible. This reduces the size of the inductors and hence reduces the stray capacitance between coils and permits an increase in the Q of the coil, in turn producing less phase distortion and less attenuation.

BIBLIOGRAPHY

- (1) Guillemin, E. A., "Communication Networks," John Wiley & Sons, Inc., p 324.
- (2) Starr, A. T., "Electric Circuits and Wave Filters," Pitman Publishing Corp., p 242.
- (3) Pierce, G. W., "Electric Oscillations and Electric Waves," McGraw-Hill Book Co., p 321.

FOUR-CHANNEL



Top chassis view of the four-channel electronic switch, showing the ring-counter and gate-amplifier tubes at the right and the crystal-oscillator trigger circuit tubes near the front panel. The wide-band amplifier tubes are type 807

By N. A. MOERMAN

Potter Instrument Company, Flushing, N. Y.

to the input of the cathode-ray oscilloscope by electronic means.

This device, as supplied commercially, is valuable for a number of specific applications, but has several disadvantages for general use:

(1) Only steady-state or recurrent phenomena can be observed since reliance is placed upon persistence of vision or still photography for proper interpretation.

(2) The frequencies of the waveforms under study must be related to each other by some integral multiple.

(3) Transient phenomena can neither be viewed nor recorded satisfactorily because of the low switching frequency normally employed and the use of capacitance-coupled amplifiers.

(4) The number of circuits that may be switched is normally limited to two, although by interconnecting several units this limitation can be overcome.

Requirements of a Four-Channel Recorder

The need for a four-channel recording system imposed a unique

THE cathode-ray oscilloscope has in recent years become an indispensable tool for the research worker and the engineer. The value of this equipment and, concurrently, the reason for its success can be attributed almost wholly to its inherent versatility, a factor that is being constantly enhanced by the development of auxiliary circuits and modified cathode-ray tube types.

One application of considerable importance in research work is multiple-channel cathode-ray oscilloscope recording which has become invaluable for the simultaneous study of several interrelated phenomena of transient character. The most satisfactory method that has been employed for this purpose up to the present time has been photographic recording of the traces of several cathode-ray tubes. The obvious disadvantage of this type of system, however, is the increase in complexity and bulk of the equipment as the number of recording channels is increased.

In an effort to circumvent or minimize this disadvantage, there have been two developments of in-

terest, the multiple-beam cathode-ray tube and the electronic switch.

An electronic switch^{1, 2, 3} is a device that enables simultaneous observation of two separate phenomena with the aid of the cathode-ray oscilloscope. This is accomplished by alternately connecting the respective circuits under study

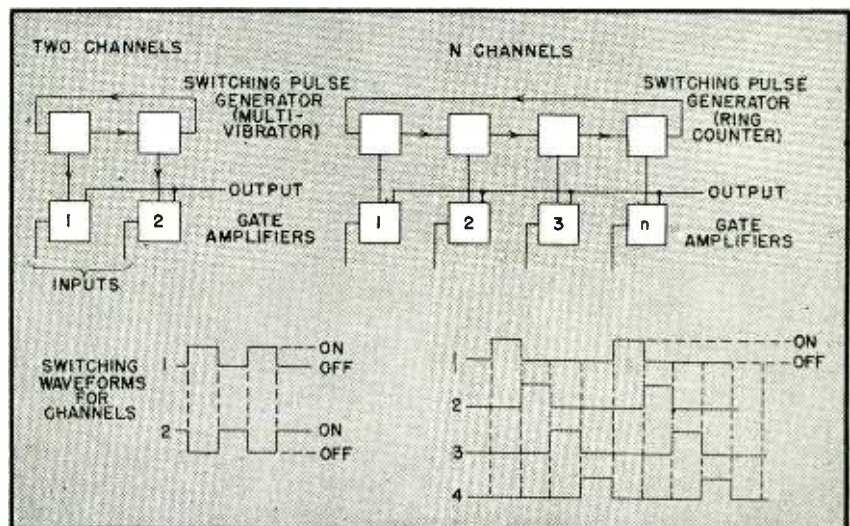

FIG. 1—Block diagram and type of waveform for a standard electronic switch and the four-channel switch described in text. The ring counter circuit can be developed for n channels as indicated

ELECTRONIC SWITCH

An electronic switch permits display of four or more transients at once on a conventional cathode-ray oscilloscope screen. A crystal-controlled ring counter triggers the gate amplifiers which switch and mix signals supplied to a wide-band amplifier in the equipment

requirement on the design of an electronic switch, as indicated in Fig. 1. In a conventional two-channel electronic switch, a multivibrator supplies the required square-wave switching pulses which alternately bias to cut off the respective gate amplifiers. The common plate connection between these amplifiers provides the point at which the composite signal is applied to the oscilloscope. On the other hand, the n -channel electronic switch contains n generators which supply switching pulses consecutively to gate amplifiers 1 to n , this cycle of operation being continuously repeated. The duration of each switching pulse must obviously be $1/n$ times the period for each cycle of operation.

Ring Counter

The requirements for a switching pulse generator have been conveniently satisfied by the use of an electronic ring counter. By means of this system it becomes theoretically possible to devise an electronic switch for an infinite number of channels. Practical considerations have restricted our application to four channels.

An electronic ring counter may be defined as a series of square-wave generating circuits (of the Eccles-Jordan type⁴) so arranged that only one circuit of the series is in the on position at any instant. Trigger pulses applied simultaneously to all the circuits pass this condition consecutively to each square-wave generator, the cycle of operation continuing as long as the trigger pulses are applied.

The on position of a pulse-generating circuit is that state of the circuit from which a positive switching pulse is obtained. A succession of trigger pulses applied to the counter ring results in positive switching pulses being supplied

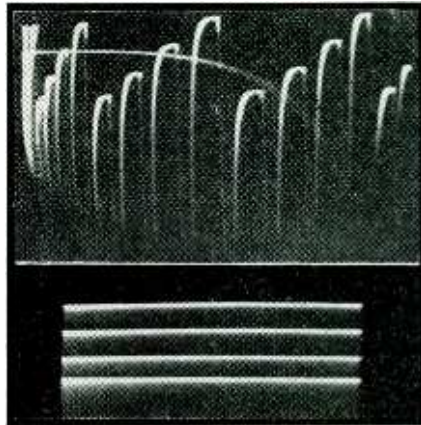

FIG. 2—Composite four-channel waveform on expanded time scale (above). Interval between pulses is $1/100,000$ sec. Below are phase relations among the switching pulses of the four-channel switch, shown with a slower sweep frequency

consecutively by circuits 1 to n . This cycle of operation is continuously repeated. Since all gate amplifiers are normally biased beyond cutoff, the function of these positive switching pulses becomes that of turning on the respective gate amplifiers. Any one of the gate circuits is brought into the conducting state for a period of $1/n$ times the switching cycle and is off during the remaining part of the cycle.

The phase relations between the switching pulses for a four-channel electronic switch are shown in Fig. 1. The composite waveform is again derived from the common plate connection between gate amplifiers. Oscillograms of the actual waveforms obtained are reproduced in Fig. 2.

At this point it may appear that considerable resolution of the waveforms under study will be lost because of the relatively short period during which any channel is active. This would be of some concern if the switching rate were comparable to or less than the frequencies con-

FIG. 3—Oscilloscope traces resulting when three different signals were introduced through the four-channel switch. Top trace presents a 60-cps square wave and the bottom a 60-cps sine wave. No signal was applied to the second-trace input. A 600-cps sine wave of large amplitude superimposes the third trace upon the others. The spacing of the dots is controlled by the crystal oscillator and allows precise determination of the slope of waveforms

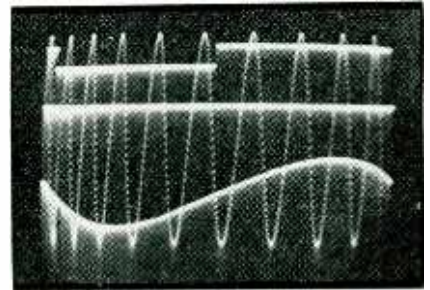

tained in the waveforms under study. This apparent difficulty is largely overcome by making the switching rate as high as possible. In the apparatus described a switching rate of 25,000 cycles is employed.

The degree of resolution actually obtained with the four-channel electronic switch is shown in Figs. 3, 4, and 5.

Design Criteria

The chassis contains all the essential elements for the operation of the four-channel electronic switch with the exception of power supplies and the necessary preamplifiers. These elements are (1) the trigger pulse source, (2) the switching-pulse generator (ring counter), (3) the gate amplifiers, and (4) the output amplifier. They are described in detail below.

For proper operation of the ring counter a source of trigger pulses of the proper frequency and shape is required. A pulse frequency of 100 kc which yields a switching

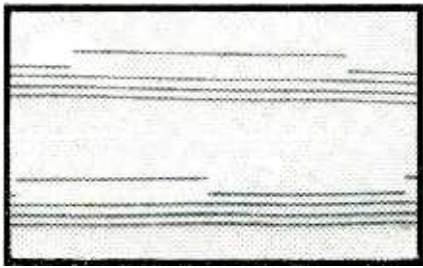

FIG. 4—A 60-cps square wave (top line) recorded with a revolving-drum type camera at a speed of 285 inches per sec (above) and 195 inches per sec (below)

rate of 25,000 cycles was chosen.

In the complete four-channel switch circuit in Fig. 6, one half of tube V_2 (6SN7) is connected with associated components to form a Pierce oscillator. The other half of V_2 serves as a square-wave amplifier.

Circuit Details

Differentiation of the 100-kc square waves is accomplished by the RC combination composed of R_4 and C_2 . Of the positive and negative pulses resulting, only the positive pulses are amplified by tube V_1 , which is biased to cutoff. Negative pulses appearing at the plate of V_1 have the desired characteristics noted above. These are applied to a common bus for injection into the ring-counter and gate-amplifier.

The switching-pulse generator (ring counter) is composed of four 6SN7 tubes connected in standard Eccles-Jordan square-wave circuits with the addition of inductance, L_1 , in each plate circuit. The inductance is placed in that side of the circuit from which the positive switching pulse is derived. A considerable improvement in the squareness of the switching pulse results without adversely affecting normal operation of the circuits.

Square-wave Generator Circuit

An Eccles-Jordan circuit (sometimes called a flip-flop circuit) has two stable states such that for either state one grid is at cutoff and the other at zero, so that one tube is off while the other conducts. Of those grids in the ring counter that are connected to the source of trigger pulses only one grid is zero at any instant. This grid is associated with the circuit that is on. The trigger pulse operates on this grid and flops the circuit to its other stable

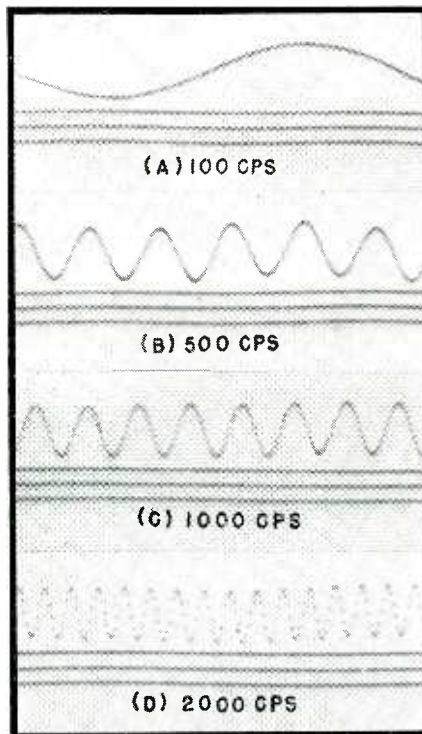

FIG. 5—Photographic recordings of signals fed to a commercial oscilloscope through the four-channel switch, only one channel of which is used here. A high degree of resolution is possible well above commercial power frequencies

state (off). During this transition the positive rise in voltage at the left-hand plate is applied through C_1 to the cutoff-biased grid of the succeeding circuit, which is then turned on. The next trigger pulse operates on this circuit, which is then flopped to the off position as in the case of the preceding circuit. In this way, a positive switching pulse is generated at the right-hand plate of each circuit during the sequence off-on-off.

It will be noted in the schematic diagram that pushbutton switch S_2 has been inserted between the two legs of the square-wave circuits, one of which is connected in reverse order. This provides a front-panel control for initiating the proper sequence of operation for the counting ring after applying power.

Switching the Pulses

The gate amplifiers serve the two-fold purpose of switching and then mixing the signals applied to their respective inputs. For this function the type 6L7 tube was selected.

At the outset, it was felt that the inner control grid of the 6L7 would be the logical point for introducing

the switching pulse since cathode current cutoff could then be assured. This arrangement was tried and found to be unworkable because of the distortion introduced by applying the useful signal to the second control grid. The functions of the two control grids were then reversed and a great improvement in the operation noted. The disadvantage to this mode of operation, however, is the incomplete cathode-current cutoff, requiring isolation of the screen-voltage supplies to insure minimum coupling.

Variable resistor R_1 in the cathode circuit provides a means for orienting the trace on the cathode-ray tube with respect to the other traces. When it is desired to observe less than the four available traces, switch S_1 is thrown. This introduces a large resistor (R_2) into the cathode circuit, which then deflects the respective trace off the screen.

For added flexibility, provisions are made for restoring normal single-trace operation. This may be desired where high-frequency recording and good resolution are required, and is made possible by operating switch S_1 . This shunts the trigger pulses to ground through C_3 and removes the bias on the operating 6L7 tube by connecting its second control grid to cathode.

Wide-Band Amplifier

It was evident early in the development of the apparatus that amplification of the composite signal would present some difficulty. The problem involved is that of amplifying unidirectional square-wave pulses of approximately 75 volts amplitude. These pulses are modulated by as much as 25 per cent. Capacitance coupling could not be used because of the transient d-c amplification requirement. Furthermore, it was found to introduce interchannel coupling.

The output-amplifier circuit finally evolved is shown in the schematic diagram. Triode-connected 807 tubes in push-pull were selected because of their large signal-handling capabilities coupled with low distortion. An excessively large common cathode resistor (R_3) is employed which serves two im-

portant functions: The cathode substantially follows the grid, thereby absorbing the large d-c potential at the 6L7 plates and minimizing undesirable grid loading due to the direct connection. Phase inversion is also conveniently provided.

The grid voltage of the phase-inverter tube is established at a point on a voltage divider from B+ to ground and permits orientation of the composite signal on the cathode-ray screen.

There is linear response over the useful portion (about four-fifths) of the cathode-ray tube screen. Contributing to this is the high value of plate voltage (650 volts) applied to the 807 amplifiers.

Recording

For the recording medium, use is made of a DuMont type 5LP5 cathode-ray tube (blue screen) operating at maximum voltage in order to attain maximum spot inten-

sity. A revolving-drum type camera using a single strip of oscillograph recording paper (Eastman No. 697, 4 x 60 inches) is employed with an f 2.3 (three-inch focal length) lens to provide a one-to-one image.

Records taken with this apparatus are illustrated in Fig. 4 and 5. The cathode-ray tube voltages were, in this case, only three-quarters of the maximum value. These records demonstrate the degree of resolution and recording intensity that may be obtained.

Interpretation of Records

It may appear disadvantageous that the steeply sloping portions of recorded transients are defined by a series of dots. This characteristic, however, may be used to advantage where it is desired to obtain quantitative values for these slopes. For this purpose the oscillator has been crystal-controlled, thereby accurately fixing the time between suc-

cessive dots. The slope measurement then becomes that of simply measuring the vertical distance between successive dots and dividing by $1/25,000$ sec. There is an increase in precision attainable in this way as contrasted to the normal method, by which the horizontal component of steep slopes must be determined.

Acknowledgement

This work was done while the author was employed at the Instrumentation Laboratory, Laboratory Services OR & DC, Aberdeen Proving Ground, Md.

REFERENCES

- (1) Hughes, Harold K., and Koch, Richard F., Combination Vacuum-Tube Switch for Double-Trace Cathode-Ray Oscillograph, Audio Amplifier, and Mixer, *R. S. L.*, p 183, Apr. 1941.
- (2) Cosby, J. R., and Lampson, C. W., Electronic Switch and Square-Wave Oscillator, *R. S. L.*, p 187, Apr. 1941.
- (3) Reich, Herbert J., Electronic Switch for Simultaneous Observation of Two Waves with the Cathode-Ray Oscillograph, *R. S. L.*, p 191, Apr. 1941.
- (4) Phelps, Byron E., Dual-Triode Trigger Circuits, *ELECTRONICS*, p 110, July 1945.

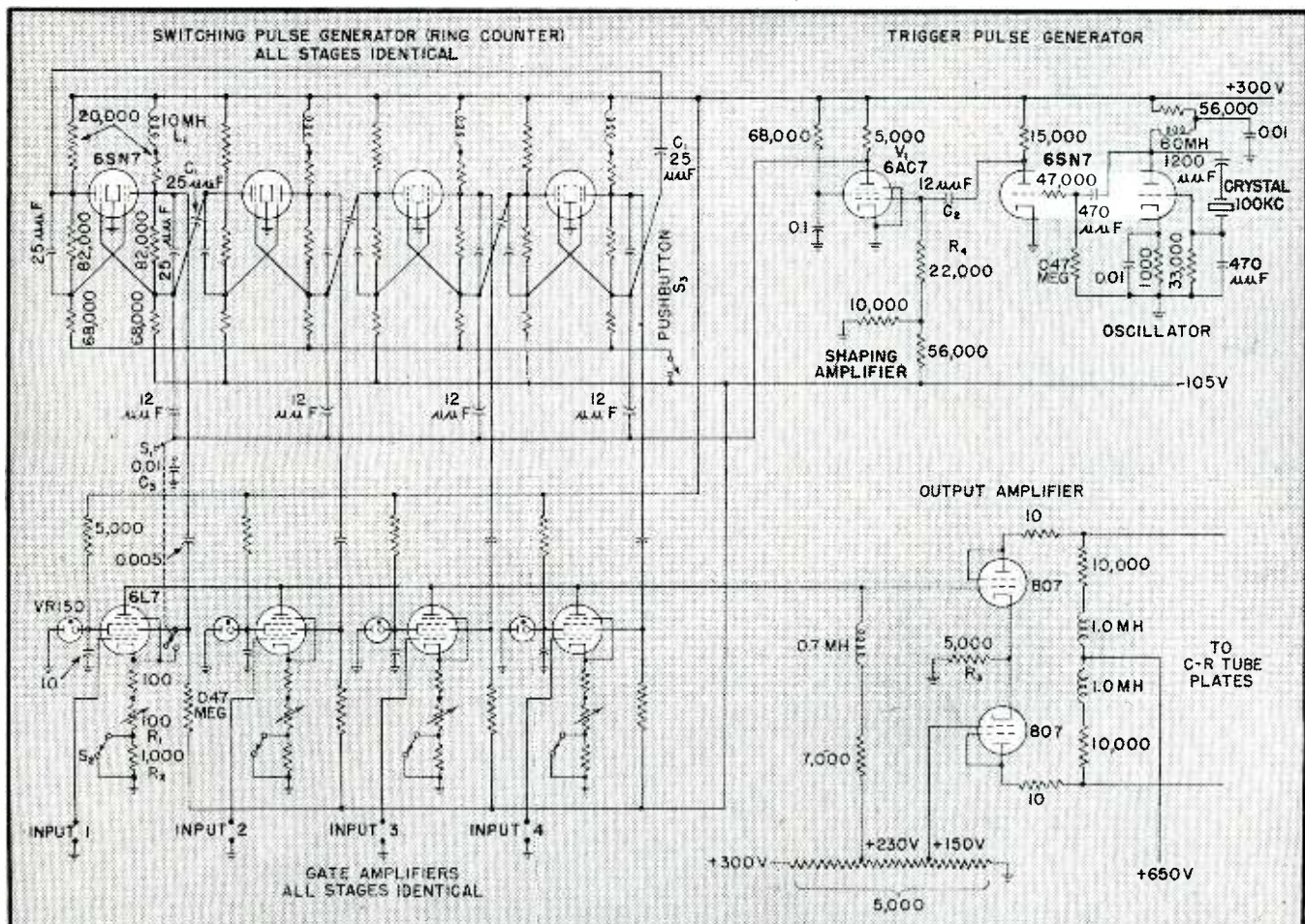

FIG. 6—Schematic circuit diagram of the four-channel electronic switch, showing the crystal-controlled trigger pulse source and output amplifier in detail. Conventional power supplies are not built into the electronic switch unit

THE SONOBUOY

Expendable radio transmitter, modulated by signals from an underwater magnetostriction hydrophone, revealed the presence of submerged submarines to patrol ships and planes

THROUGHOUT THE GREATER PART of the war, the German submarine-menace was great. As is now well known, radar was highly effective in locating U-boats which had surfaced and microwave radar could even detect a submarine's periscope as it just cleared the surface. For underwater detection of enemy submarines, destroyers and DE boats used sonar. However, both radar and sonar required that a signal be sent from the searching plane or ship. Thus the searcher revealed his presence, thereby warning the enemy to take evasive action. The sonobuoy enabled searching planes and ships to locate enemy submarines without revealing their own position.

Tactical Operation

The sonobuoy contains an underwater microphone or hydrophone. This hydrophone picks up underwater

sounds, such as propeller noises, from submarines. The pickup range depends upon the state of the sea, and the speed, depth and type of the submarine. Range varies between several hundred and several thousand yards. After amplification the signal from the hydrophone frequency-modulates a low-powered radio transmitter. The transmitted signal is received by patrol craft. In this ingenious manner a radio operator on or above the sea hears sounds beneath the surface of the water. The sonobuoy thus combines the underwater detecting abilities of sonar and the range of radio.

In locating submarines the radio operator of a patrolling airplane throws out a 13½ pound sonobuoy, first pulling out the 39 inch telescopic antenna, an action which also connects the batteries to the circuits. The navigator records the buoy's sea position. A 24 inch muslin parachute opens to break the buoy's fall and to assure that it strikes the sea in an upright position gently enough not to damage or appreciably detune the radio circuits. The buoy's striking

Radio transmitter inclosed in the buoy is compactly assembled. Rubber grommets provide shock mountings for many of the components. Although the equipment is expendable, it must give dependable operation during its few hours of life

Input transformer and two-stage, resistance-capacitance coupled amplifier provide high voltage gain in audio circuit. By using reactance-tube frequency modulation, negligible modulating power is needed. Reactance tube frequency-modulates the oscillator in its grid tank. Second harmonic from oscillator is coupled into power-amplifier-doubler which feeds the quarter-wave whip antenna

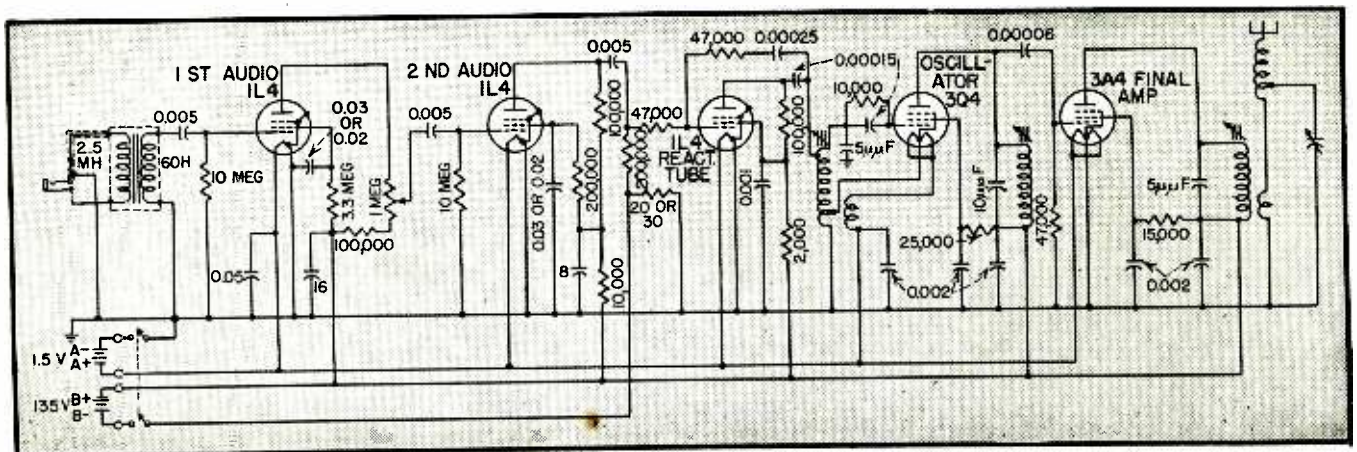
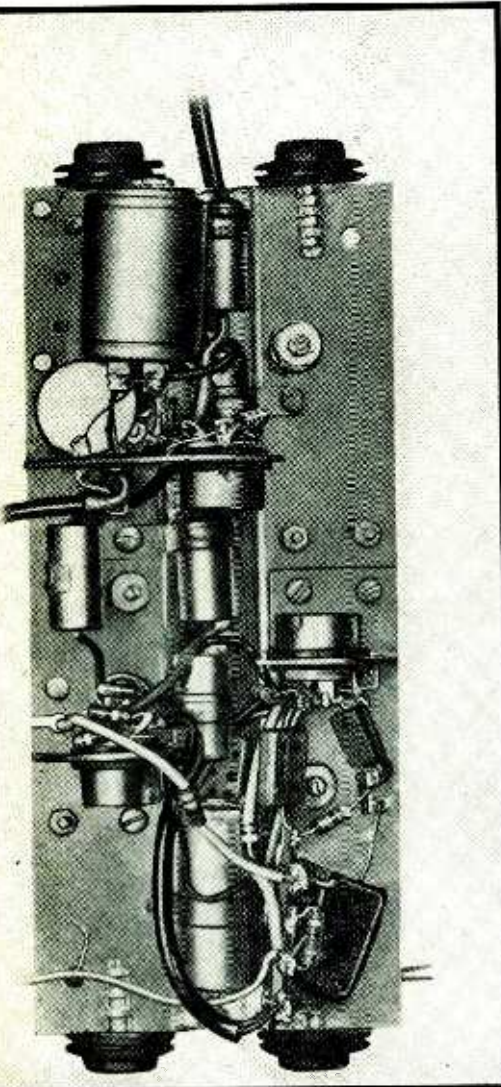

electronics WAR REPORT

the water releases the hydrophone, which unreels itself to a depth of 20 ft. A bag of dye spreads a colored blot on the sea so that the patrol plane can more readily spot the buoy position.

Several sonobuoys may be dropped in a "spread". Frequencies of the buoys in such a spread differ by 0.8 megacycle. Color coding of the buoys and on the dial of the ship's sonobuoy receiver correspond, so that the radio operator can quickly tune in and identify any buoy in the spread.

By listening over the radio the operator can tell, from the relative loudnesses of signals from buoys, near which buoy the submarine is lurking, or in which direction it is moving. While a submarine is under attack the operator hears the explosions and even sounds of the submarine breaking up when the attack is successful. Recordings of these sounds are evidence of a kill.

A soluble carbowax plug in the buoyant, watertight sonobuoy case dissolves in a few hours, and the expendable transmitter sinks, thereby preventing the enemy from recovering it. Power supply batteries were designed to have such a life that they are about exhausted when the buoy floods and sinks.

Circuits

The hydrophone used in the sonobuoy consists of a waterproof-wire winding on a magnetized-nickel cylinder. Sound waves produce electrical voltages by magnetostriction. Approximately three microvolts of audio signal is fed by a high-ratio stepup transformer to a two stage amplifier which is flat from 200 to 10,000 cps and down about 12 db at 200 cps.

A reactance tube frequency-modulates the tank of the electron-coupled Hartley oscillator. The oscillator operates in the vicinity of 18 megacycles, with the plate tuned to the second harmonic. In the r-f amplifier this frequency is again doubled. The transmitter signal is thus in the 70 megacycle range, and has a 75 kilo-

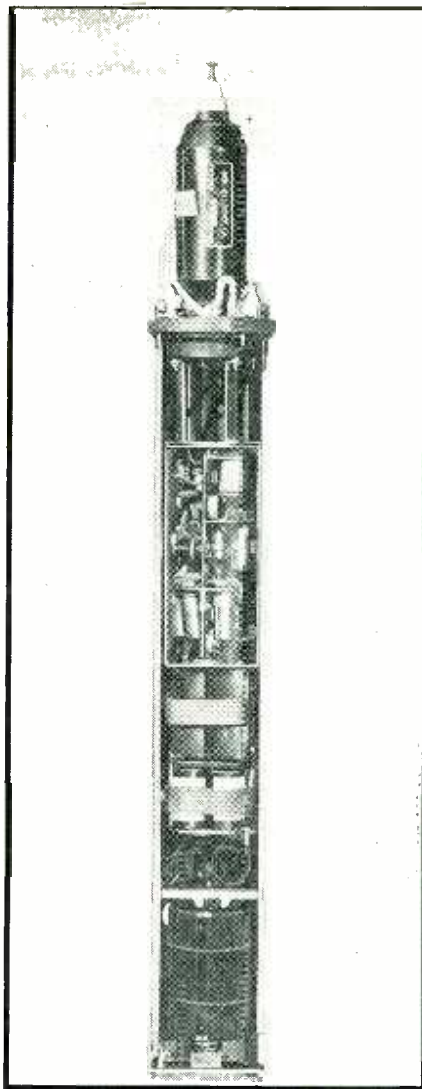

On striking the water a sensitive button in the bottom of the 4 3/4 by 40-inch sonobuoy releases the hydrophone downward on a cable. Batteries, turned on when the buoy is launched, supply power during the four hours of operation

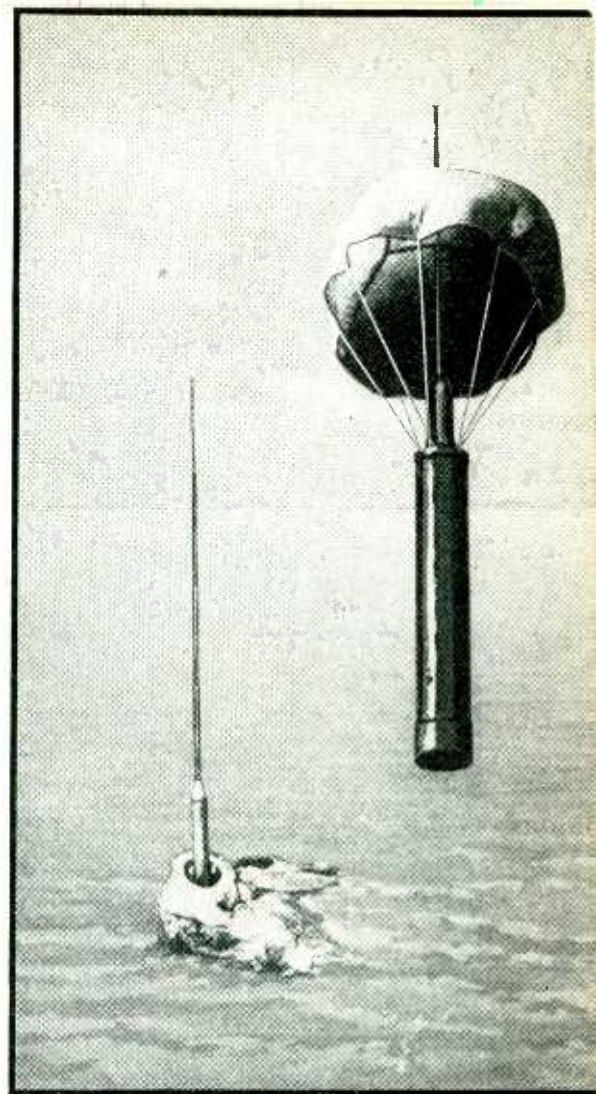

Sonobuoy is thrown from patrol plane. Parachute (right) lowers it into the water (left). Underwater microphone picks up submarine sounds which are relayed by the radio transmitter in the buoy to the patrol plane or a ship

cycle maximum deviation. The antenna is a vertical quarter-wave whip. An insulator holds the antenna base just above the surface of the sea.

The radiated power, about a tenth of a watt, is sufficient for line-of-sight transmission. Depending on how high the receiving antenna is, a ship can receive a sonobuoy signal from about six nautical miles away. An airplane flying at 5,000 feet can receive signals from 40 to 50 nautical miles away. Automatic frequency control in the receiver, working from unbalance in the discriminator output, follows random

drifts of the sonobuoy transmitter center frequency.

Development

Research and development engineering was carried out at the Underwater Sound Laboratory of Columbia University at New London, Conn. under National Defense Research Committee contract. Production engineering and manufacture were done by Emerson Radio and Phonograph Co., and Freed Radio Corp. The navy used hundreds of sonobuoys in both Atlantic and Pacific waters.—K. H.

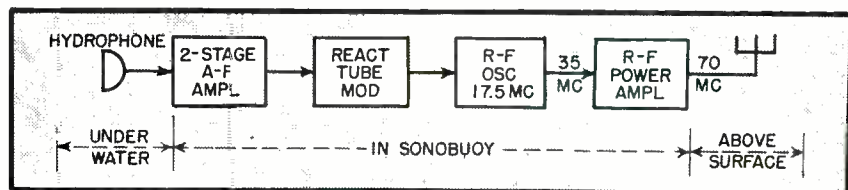

Sonobuoy, shown here in block-diagram form, is a complete, compact f-m transmitter

Coaxial

By **ERVIN E. GROSS, Jr.**

*General Radio Company
Cambridge, Mass.*

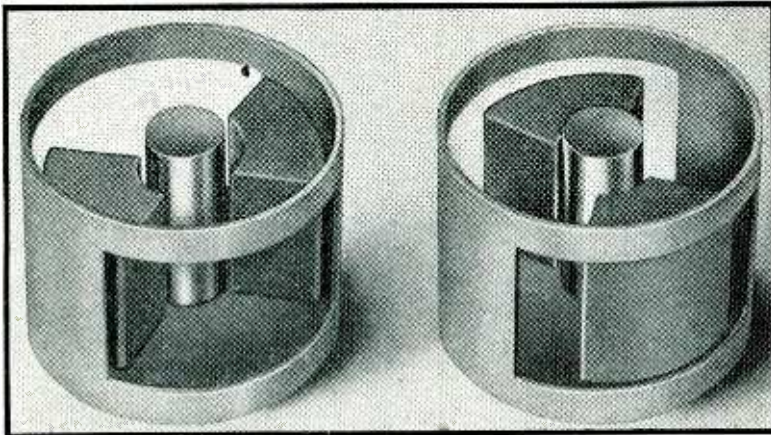

FIG. 1—Basic form of coaxial butterfly circuit. High-frequency setting is shown at left, low-frequency setting at right

IN SPITE of the large increase in production and use of high-frequency equipment during the war, simple and convenient laboratory apparatus such as variable oscillators and standard-signal generators, for frequencies above 500 megacycles, have not progressed commensurably. Much equipment has been built and used at frequencies well above 500 megacycles, but most of it has been for special purposes and is not suitable for general laboratory use.

During the emergency period, when speed was essential, it proved much quicker and easier to build a series of fixed-frequency test oscillators for specified frequencies and uses than to build multiple-purpose wide-range variable oscillators.

While fixed-frequency or limited-range oscillators were being used as an expedient, development work was continued on wide-range variable oscillators. This paper is a report on one such development, using the type 2C43 lighthouse tube. The oscillators developed have a single tuning control, wide tuning ranges, good output, and no sliding contacts.

Original Butterfly Circuit

Simple negative-grid triode oscillators using a single tuned circuit between grid and plate can be made to operate at frequencies approaching the resonant frequency of the tube if the tube has properly proportioned grid-cathode and plate-cathode capacitances. A compact tuning unit such as the butterfly circuit¹ is connected with a minimum of lead inductance between grid and plate, while feedback to sustain oscillation is determined by the effective grid-

cathode and plate-cathode capacitances.

Because of the low ratio of plate-cathode to grid-cathode capacitance of the disc-seal or lighthouse tubes, efforts to use these in simple oscillator circuits were not successful above 700 megacycles. However, of the available high-frequency triodes, the lighthouse tube seems to have power ratings best suited for use in laboratory oscillators, when maximum frequency and good output are required. Although this tube does not work well in the simple oscillators using a single tuned circuit, it will oscillate to higher frequencies than other available tubes, with good efficiency, when used in oscillators employing multiple tuned circuits.

Coaxial Version

To build a tuning unit to fit the lighthouse tube in a convenient manner, a much different mechanical structure from the original butterfly circuit was required. Since the tube was designed for use in coaxial-line

resonators, it seemed desirable to try to build variable oscillators using elements of coaxial lines as resonant circuits. The resulting tuning unit has become known as the coaxial butterfly.

Figure 1 illustrates the basic form of the coaxial butterfly tuning unit, showing the high-frequency position of the rotor at the left and the low-frequency position at the right. This unit consists of a coaxial line shorted at one end and open at the other. The outer conductor is not a full cylinder, but has two 105-degree sections cut away. Rotating between inner and outer conductors are two 75-degree sectors which vary the frequency.

In operation the tube is connected across the open end of the line and acts as a capacitive load foreshortening the line. The length of the line at resonance is much less than a quarter-wavelength because of this loading. As the two rotor sectors are rotated, the characteristic impedance of the line is varied. This means that the amount of foreshortening caused by the tube grid-plate capacitance changes, and hence the resonant frequency is varied.

Figure 2 shows a basic unit equip-

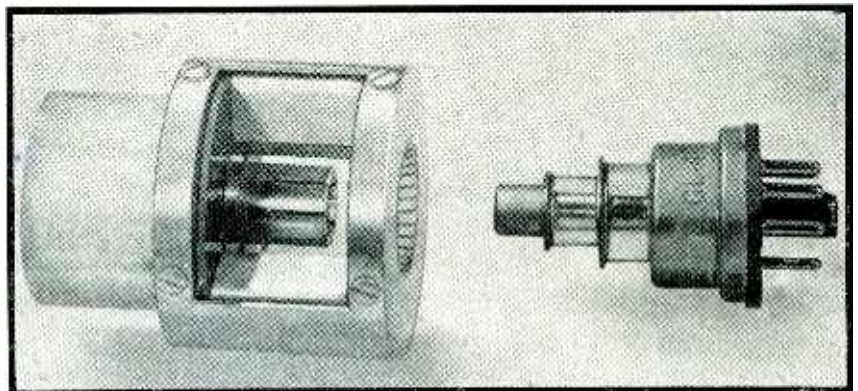

FIG. 2—Coaxial butterfly unit, designed to make plate and grid connections automatically when pushed over the lighthouse tube

Butterfly Circuits

Coaxial versions designed to fit over the type 2C43 lighthouse tube serve as wide-range uhf signal generators suitable for general laboratory use in the range from 500 to 1,600 megacycles. A single control varies feedback and frequency for either c-w or pulsed operation

ped with terminals for connection to the plate and grid of the lighthouse tube. In addition to the loading caused by the tube grid-plate capacitance, there is some capacitance added across the open end of the line by the rotor segments.

Frequency-Capacitance Chart

To get a better understanding of these tuning units, the plot shown in Fig. 3 was made. Values of loading capacitance required for a line of unit cm length are plotted versus frequency for a range of Z_0 from 10 to 500 ohms.

Besides showing that there is not much to be gained in frequency range by making the loading capacitance larger than the tube grid-plate capacitance, the chart can be used as a means of finding the resonant frequency for a line of known impedance Z_0 , known length, and a given loading capacitance, or to obtain the proper loading capacitance for a desired frequency with a line of given Z_0 and length.

The chart has proved very useful in designing some of the coaxial tuning units. For example, with the dimensions and spacings that are considered practical in these tuned circuits, Z_0 can be varied from about 30 ohms to 150 ohms. If we make the tuned circuit 2 cm long, what frequency range should we get if the total effective loading capacitance is $4\mu\text{mf}$. This makes $n = 2$; the chart is adapted for this line length by multiplying capacitance scale values by 2. The original $2\text{-}\mu\text{mf}$ line on the chart now represents $4\mu\text{mf}$, the value at hand, and the frequency values obtained will be divided by 2. For $Z_0 = 150$ ohms the frequency then is $1,600/2$, and is $3,200/2$ at $Z_0 = 30$ ohms, giving a frequency range of 800 to 1,600 megacycles for the unit.

Figure 4 shows the rotor construc-

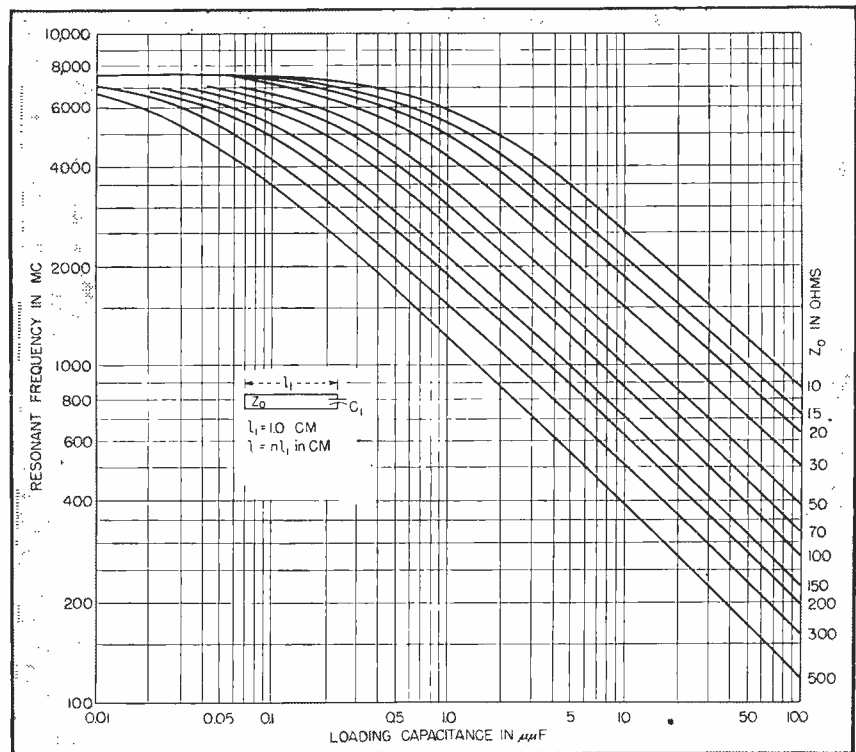

FIG. 3—Calculated curves of resonant frequency as a function of loading capacitance and Z_0 for a line of unit cm length. For a line n cm long, multiply capacitance scale values by n and divide frequency scale values by n before using chart

tion which has given the widest frequency ranges. The two full metal rings at the ends not only make a stronger and more easily supported rotor than is shown in the basic units, but serve to keep the lumped inductance at the ends of the line at a minimum so that it is possible to take advantage of most of the change in Z_0 caused by the rotor segments.

Wide Frequency Ranges

The most effective means for getting wide frequency ranges has been to reduce all spacings between the rotor and the fixed portions of the tuned circuit. This decreases the effective Z_0 when the rotor is meshed with the outer conductor. In addition, the effective loading capacitance is increased. At low frequencies, Z_0

is unchanged, and the resonant frequency is reduced. At high-frequency settings the resonant frequency is increased because the decrease in Z_0 has greater effect than the increase in loading capacitance.

Stator Design

The stator or outer conductor of the line can be altered or shaped to provide a desirable law of frequency variation. While this lowers the top frequency for a given unit, the consequent reduction in the low-frequency limit produces an increased frequency range. Figure 5 illustrates one possibility. Here a 1,000-1,300 megacycle oscillator was designed for beat operation with a fixed 1,000-mc oscillator. A logarithmic variation of beat frequency was desired

between 10 and 300 megacycles. Curve A shows the variation obtained before shaping, with most of the frequency change occurring in the relatively small region where the rotor

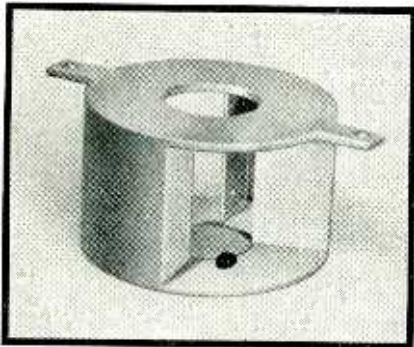

FIG. 4—Coaxial butterfly rotor construction which has given widest frequency ranges in uhf oscillators

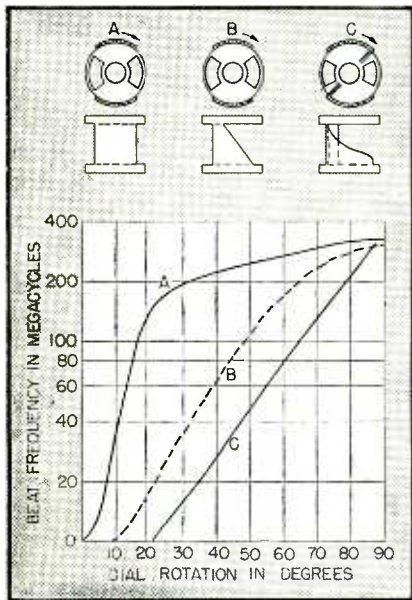

FIG. 5—Example of frequency variation versus dial rotation that is possible with coaxial butterfly units. Curves A, B, and C apply when stator or outer conductor of unit is shaped as in sketches A, B, and C respectively

segments are just beginning to pass under the outer conductor. Curve B shows the results of shaping the stator as indicated in sketch B, and curve C shows the final curve obtained with the outer conductor shaped in the manner shown in sketch C. It will be noted that rotation has been reduced from 90 degrees to slightly less than 70 degrees.

The Q obtained with a coaxial butterfly circuit is low when compared with that obtained in coaxial tuners of optimum dimensions. Measurements on a tuning unit with a range of 620-1,350 megacycles indicate that the Q is about 350 at the low frequency and about 200 at 1,000 megacycles.

Feedback Circuits

The basic feedback circuit used with coaxial butterfly oscillators is shown in Fig. 6. The coaxial butterfly unit supplies a high resonant impedance between grid and plate of the tube. The outer cylinder, with tube and tuned circuit forming part of the inner resonator between grid and cathode of the tube. The fields of the two circuits are linked through the openings of the coaxial butterfly. Proper feedback for oscillation is obtained by adjusting the two disc-shaped plungers within the outer cylinder.

In addition to the frequency-determining rotor, this system requires two adjustable elements which have multiple sliding contacts. This circuit can be simplified if the plungers are properly located for the highest oscillator frequency and feedback for lower frequencies is maintained by adding capacitance C_F between a point on the tuning unit and a point on the outer chamber.

Sliding contacts can be eliminated if this capacitance is added, as shown in Fig. 7, by a series of adjustable metal fingers (a) which mesh successively with a tab on a ring (d) which is carried by the rotor. While multiple tuning elements are required, a variable oscillator with a single tuning control is the result. Oscillators with capacitive feedback adjustments such as this work satisfactorily over frequency ranges of about 1.6 to 1. Coaxial butterfly tuning units can be conveniently built to cover ranges of 2 to 1.

To make use of ranges available for grid-plate tuning units, an additional element to the feedback circuit was found necessary. This addition, shown in Fig. 8, consists of added grid-cathode capacitance produced by a series of adjustable fingers (b) mounted on the cathode stub which mesh successively with the shoe (c) mounted on the feedback ring (d).

As will be demonstrated, the feedback circuits outlined affect the coupling between the grid-plate tuning unit and the grid-cathode resonant circuit as well as keep the grid-cathode circuit properly tuned. Variations in coupling are caused by the relation of the feedback fingers (a) to the openings in the coaxial butterfly unit. For this reason, and because the coupling varies with the rotor position, some amount of experimenting and compromising is required before a continuously variable oscillator with a frequency range of 2 to 1 can be obtained. The final result, however, is an oscillator that has a wide tuning range, good efficiency, a single tuning control, and no sliding contacts.

Steps in the development of oscillators using the coaxial butterfly cir-

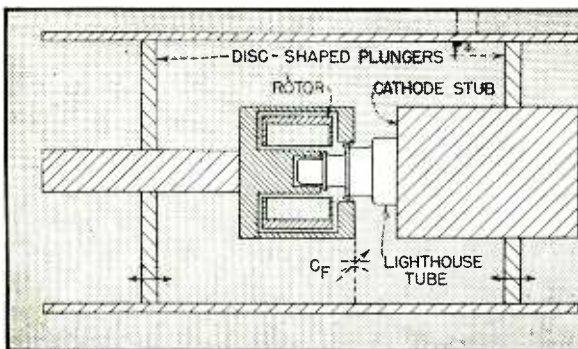

FIG. 6—Basic feedback circuit used with coaxial butterfly oscillators described in this article

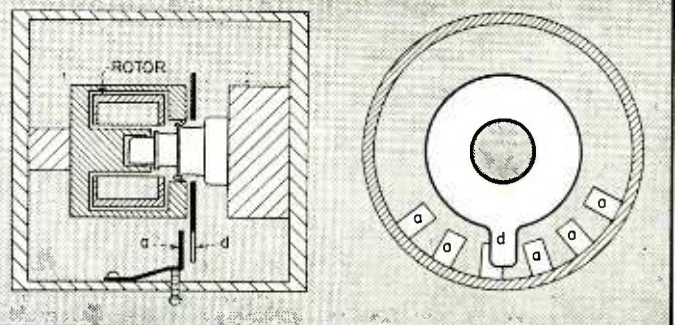

FIG. 7—Cross-section and end views of oscillator, showing C_F of Fig. 6 added to eliminate sliding contacts

cuit have been outlined. Operating characteristics and descriptions of some of these oscillators follow.

The first oscillators developed using the coaxial butterfly unit were for use in a beat-frequency oscillator having a fixed 1,000-mc oscillator beating with a variable 1,000 to 3,000-mc oscillator to produce an output frequency of 10 to 300 mc.

Beat-Frequency Oscillator

The beat-frequency oscillator was suggested as a means for obtaining pulses with extremely short rise time at low frequencies where conventional oscillators do not have sufficiently rapid starting or buildup time. The fixed oscillator was to operate as either a c-w oscillator or a pulsed oscillator.

Pulsing requires more than the usual feedback to obtain the short rise time, and early experiments using the sliding end discs for feedback adjustment showed that a change in feedback was required if the oscillator was to be shifted from c-w operation to pulsed operation. It was noted that the change was accomplished by keeping the length of the outer cylinder constant and moving the tuning unit with respect to the end discs.

It was also found that the results could be duplicated by using the capacitive-type feedback. To reduce drift, the two oscillators were kept as much alike as possible. Outer chamber dimensions were kept the same. Adjustable capacitive-type feedback was retained for the fixed oscillator to obtain the required change in feedback, and the fixed oscillator grid-plate tuning unit was built as a

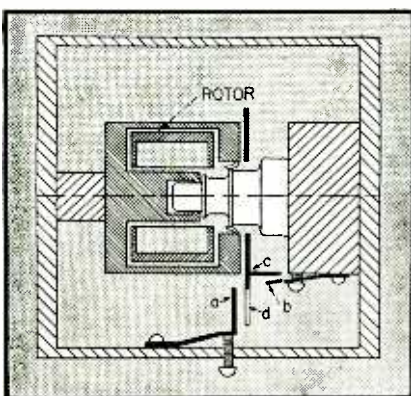

FIG. 8—Feedback circuit for wide-range coaxial butterfly oscillator, with no sliding contacts

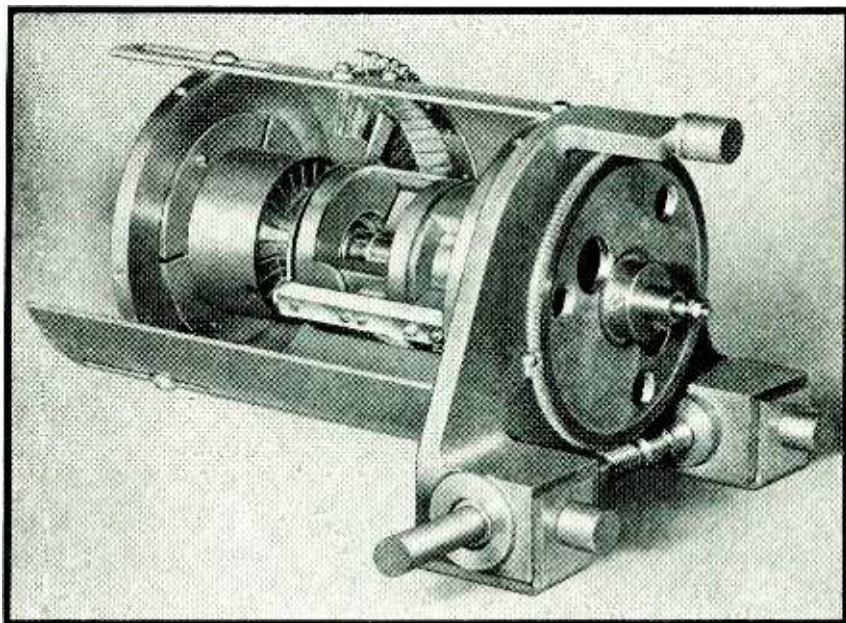

FIG. 10—Coaxial butterfly oscillator for 1,000 to 1,300 megacycles

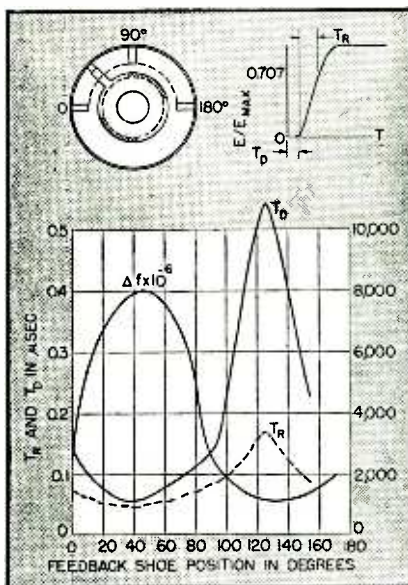

FIG. 9—Variations in oscillator stability and buildup time as a function of feedback capacitance location with respect to openings in the coaxial butterfly unit

coaxial butterfly with the rotor omitted.

Oscillator Buildup Time

Figure 9 demonstrates rather clearly that the capacitive adjustment does more than keep the grid-cathode chamber properly tuned. By shifting the point at which the capacitance is produced, frequency stability and oscillator starting or buildup time are markedly modified. As indicated by the upper right-hand sketch, the oscillator buildup time has been broken up, for convenience, into two components, which have been called T_d and T_r (delay time

and rise time). Good stability required for c-w operation results when the capacitance is produced in line with the solid portion of the tuning unit, while rapid rise time and short delay time required for pulsed operation result when the capacitance is produced in line with the opening of the tuning unit.

As a pulsed oscillator, delay time was reduced to about 0.05 microsecond and the rise time was reduced to less than 0.05 microsecond. Many things was tried in an effort to improve the rise time of the oscillator under pulsed conditions. Loading the oscillator in an effort to reduce the Q of the tuned circuit was one device that was effective. The effect was not noticeable, however, until feedback had been adjusted for optimum pulse shape.

As a means to pulse the oscillator, a relatively low-power negative pulse was produced across the cathode resistor. This method was simple, worked very well, and did not require the high power that would be needed for plate pulsing.

As a c-w oscillator, the stability factor or frequency change in parts per million caused by a 30-percent change in plate voltage was reduced to 1,000. Power output of 1.7 watts with an efficiency of 30 percent was obtained with 250 volts on the plate. While operation is possible for all positions of the feedback capacitance, stability is poor when feedback

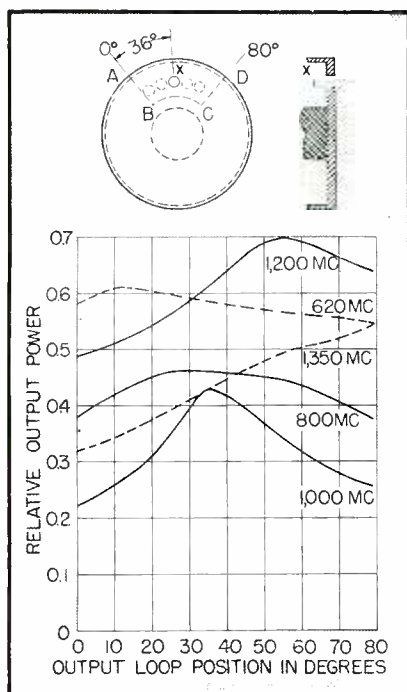

FIG. 11—Oscillator output as a function of output loop location with respect to active feedback fingers

is optimum for pulsing, and oscillator rise time is bad when feedback is optimum for c-w operation.

Variable Oscillator

Power output of an experimental model of the 1,000-1,300 megacycle variable oscillator for use in the beat-frequency oscillator varied from 0.3 watt to 0.7 watt with a plate voltage of 250 volts, while efficiency varied from 6 percent to 15 percent. A sizeable loss of power output and efficiency is the price paid for variable-frequency operation.

Figure 10 is a cutaway view of the variable oscillator which was evolved. This oscillator has a single tuning control and no sliding contacts. The structure which supports and drives the rotor segments also supports and drives the feedback ring past the adjustable fingers. The outer conductor of the coaxial butterfly is shaped to produce the desired frequency distribution, and the contour of one of the sections can be seen in the photograph.

Wide-Range Oscillator

After completing work on the beat-frequency oscillator, it was decided to try to make an oscillator having a wide range that would be suitable for laboratory use. As has already been pointed out, ranges could be

made much wider than were required for the beat-frequency oscillator. Experiments showed that because of the space required by the outboard drive for the rotor, the maximum frequency for which the outer resonant circuit could be adjusted was about 1,350 mc. To get as wide a range as possible for experiments, the lower frequency was reduced. The final frequency range obtained with this oscillator was 620 to 1,340 mc. This range was again obtained with a single tuning control, with no sliding contacts.

Position of Coupling Loop

Location of an output coupling loop for this oscillator was determined experimentally. It was first roughly determined that maximum output could be obtained if the loop were located in the end disc of the outer chamber, opposite the adjustable feedback fingers.

Figure 11 illustrates the method used to locate the optimum position for the loop. At several frequencies throughout the range the oscillator end disc was rotated so that loop X was moved through the arc subtended by the feedback fingers (area ABCD). By this means it was discovered that maximum output for any frequency was obtained when the output loop was opposite the acting feedback finger. The fixed loop position which will give best output over the frequency range is then at 36 degrees, or opposite the 1,000-mc active feedback finger.

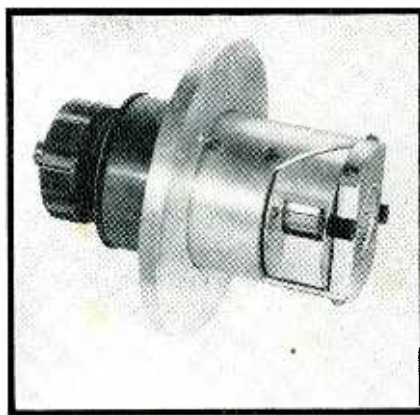

FIG. 12—Coaxial butterfly tuning unit for 800-1,600 megacycles. Tuning knob is at left, and controls the position of the rotor. The lighthouse tube is inserted in the recess at the right end of the unit

Power output obtained over the frequency range varies between 0.15 and 0.30 watt. Here again increased frequency range is gained with a reduction in power output.

Getting Higher Frequencies

To extend the useful range of these oscillators to higher frequencies, a coaxial butterfly tuning unit for a range of 800 to 1,600 mc has been built and is shown in Fig. 12. Its actual frequency range with the type 2C43 tube is 770 to 1,650 mc. This tuning unit features a more compact and simple rotor support and drive than was used on previous models. Portions of the plate end or short-circuited end of the line have been cut away to allow the rotor supports to turn. Also, portions of the grid-end disc have been sliced off to make way for the supports which hold the feedback ring to the rotor. Other mechanical changes have simplified the assembly of the unit appreciably. Oscillations have been obtained over the frequency range of this unit with about the same vigor as are obtained from the lower-frequency unit. Tests have not been completed on this oscillator, but it is hoped that a mechanically simplified feedback circuit can be devised.

Conclusions

The oscillators described in this paper, while not of the more desirable single tuned circuit type depending upon the tube electrode capacitances for feedback, do operate with a single tuning control and are somewhat more efficient. Sliding contacts have been eliminated and wide ranges have been maintained. The oscillators have high enough output to be used as laboratory oscillators or in standard-signal generators.

New tubes may soon make these circuits obsolete, but for the present they are useful and their performance is comparable to that of oscillators operating at much lower frequencies. It is hoped that the information presented here, when added to other bits of information, will make for a better understanding of ultrahigh-frequency triode oscillators.

REFERENCE

- (1) Karplus, Eduard, Wide-Range Tuned Circuits and Oscillators for High Frequencies, *Proc. IRE*, p 426-441, July, 1945.

HERE COMES THE NEW CINCH SOCKET "Mite"

ALONG WITH
THE FIRST OF BELMONT'S
"Better things to come"

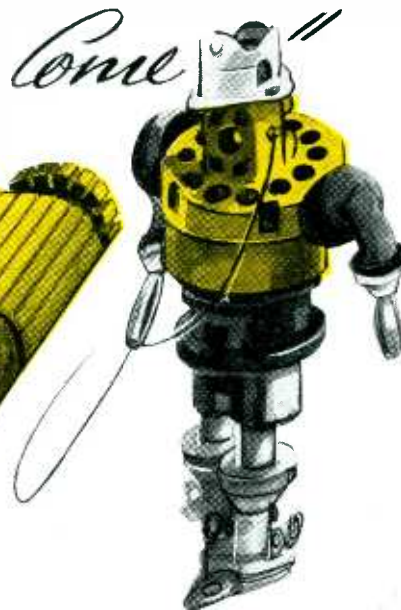
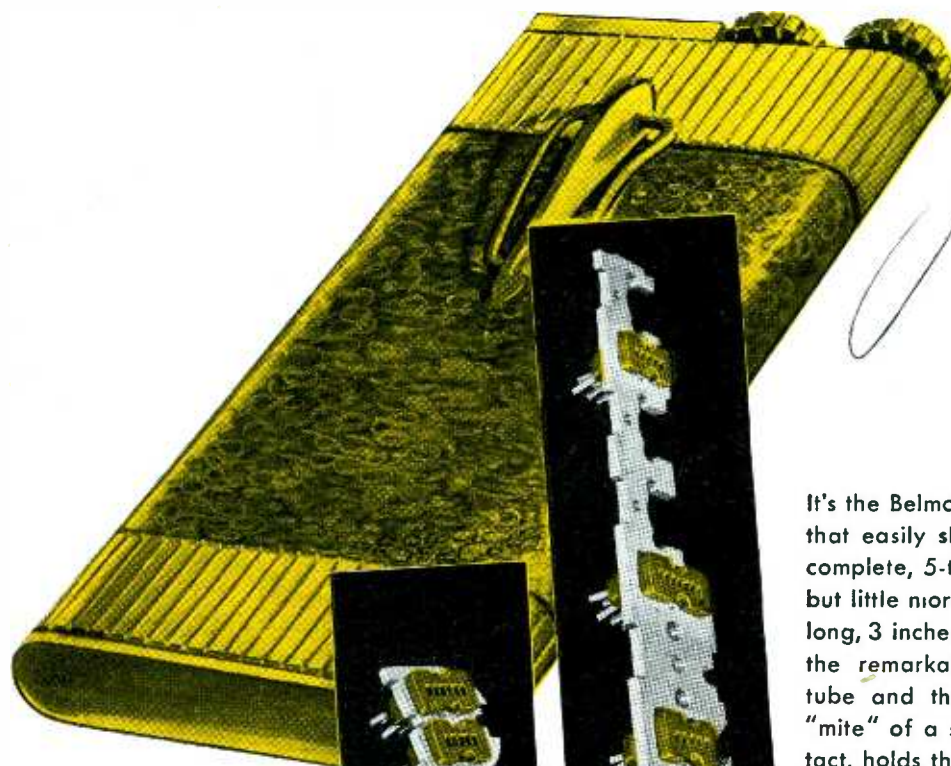

ACTUAL SIZE

No. 54A-11971



No. 54A-11973

It's the Belmont Boulevard—the new radio creation that easily slides into pocket or purse. Yet it is a complete, 5-tube, superheterodyne radio, weighing but little more than half a pound, and just 6 inches long, 3 inches wide and $\frac{3}{8}$ of an inch thick. Employs the remarkable "war-born" miniature Raytheon tube and the new miniature Cinch Socket. This "mite" of a socket insures positive electrical contact, holds the tiny tubes securely in place, permits easy maintenance and replacement, yields maximum insulation resistance and minimum high frequency loss, and provides manufacturers of pocket radio receivers and hearing aids a labor saving chassis installation which serves terminal board functions. The tiny CINCH Socket may be had with five, six, or seven contacts. It is now in production and available on order.

CINCH

MANUFACTURING CORPORATION

2335 West Van Buren Street, Chicago 12, Illinois
Subsidiary of United-Carr Fastener Corp., Cambridge, Mass.

Beat-Frequency

By DON BARTON
New York, N. Y.

INTERFERENCE CHART

INTERFERENCE may be present in the output of superheterodyne radio receivers if their input circuits

are not selective enough to reject all but the desired incoming signal. These spurious responses will be the

result of the combining of the oscillator frequency and/or its harmonics with the fundamental or harmonics of strong stations radiating a frequency differing from that to which the tuned input circuit of the converter is adjusted.

The accompanying chart plots 19 different combinations of signal and oscillator frequencies that can produce interference in a receiver using the RMA standard i-f of 455 kc. The curves are computed from formulas given previously in *ELECTRONICS*.¹

The following examples illustrate several different types of interference. At 660 kc, a vertical line drawn on the chart will intersect all of the curves. Perpendiculars from these points of intersection to the left will give the interfering signal frequency. Thus one objectionable point is determined to be 220 kc from curve 10. A long-wave signal other than that of the i-f may consequently be present in the output of the receiver due to the local oscillator beating with the third harmonic of the interfering signal to produce 455 kc.

The intersection of the 660-kc line with curve 1 indicates an interfering signal of 1115 kc. Although no station operates on this frequency, audible beats would be produced by reaction with either or both the 1110-kc or 1120-kc carriers 5000 cycles away.

Curve number 4 shows that police calls may be received while curves 18 and 19 show that amateur signals can also beat at the same time. By using the formula numbered to correspond to the curve intersected,¹ the exact frequency of the interfering signal can be computed and the audio frequency of the whistle determined, assuming that the station producing the interference is on its assigned wavelength.

REFERENCE

(1) Adams, J. J., Receiver Interference Chart, *ELECTRONICS*, p 43, Feb. 1941.

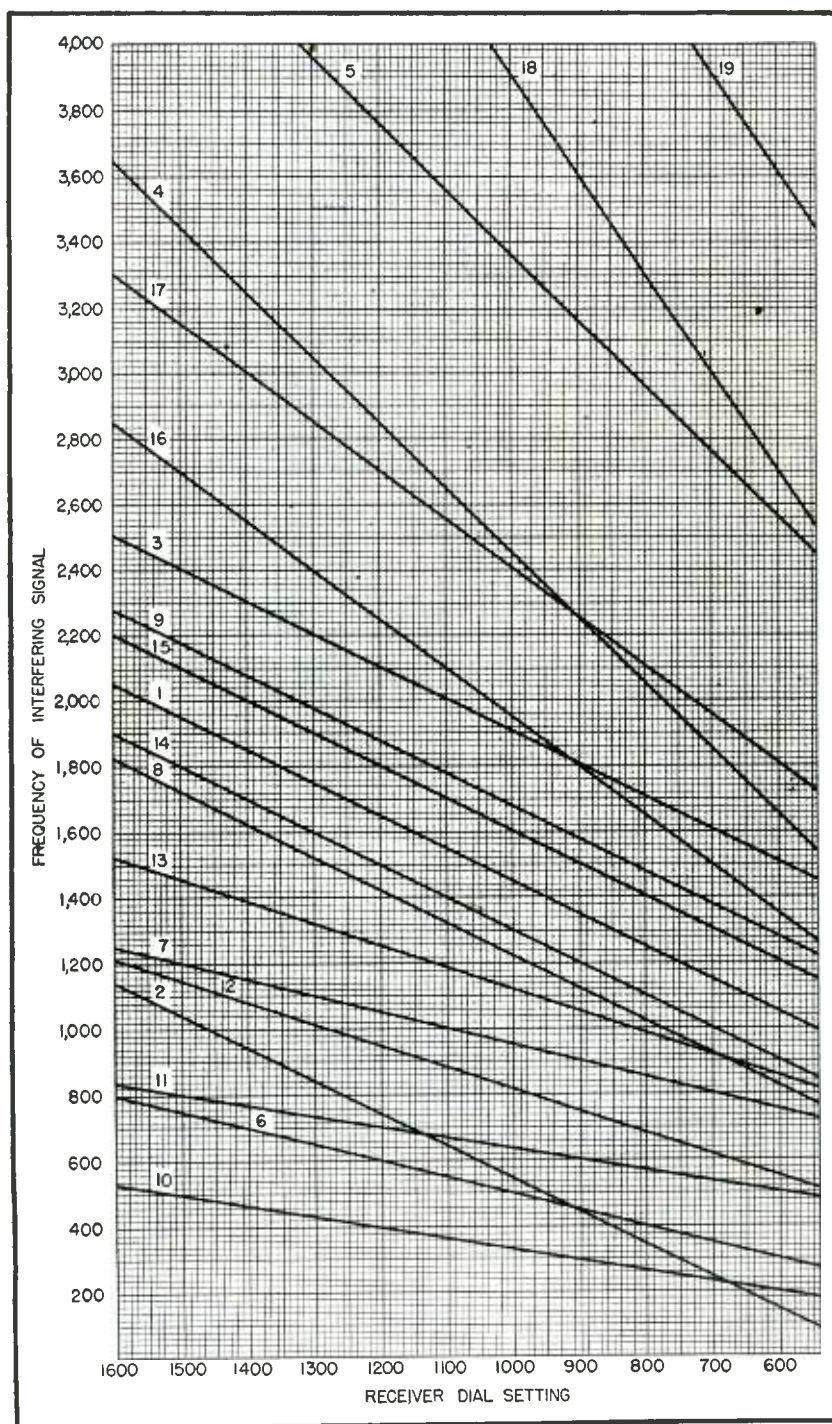

MALLORY RL

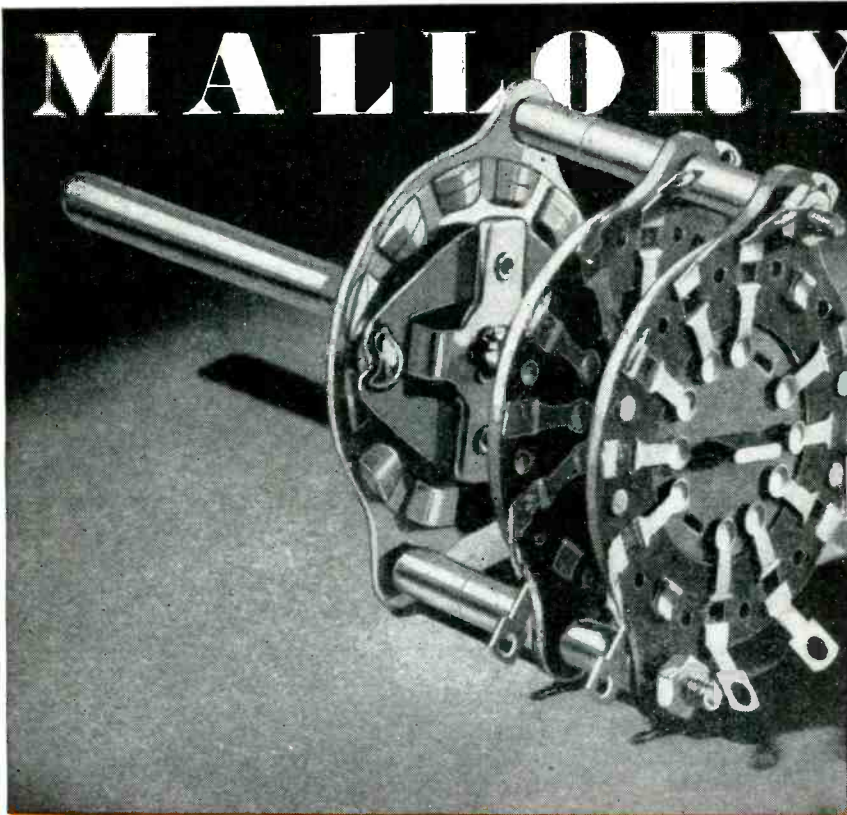

ILLUSTRATION ENLARGED APPROXIMATELY 30X

Top Favorite Switch For Test Equipment

OF all circuit selector switches manufactured by Mallory, this RL unit is the most popular by far for low-power, industrial applications. In a class by itself, the RL switch is the answer for industrial electronic equipment requiring greater durability than provided by the conventional radio circuit selector switch. It offers from 1 to 6 circuits per section with 30 degree indexing—from 1 to 3 circuits per section when 60 degree indexing is used. But that's not the whole story by any means.

The heavy self-supporting terminals of this switch, for instance, are clinched to the stator and held firmly without rivets or staples. Contact ends are ball shaped, formed of high quality spring brass material, and heavily silver plated.

The rotor contact member is made of solid silver, insuring much lower contact resistance. The high lift of the terminals makes possible a self-cleaning

action which further improves electrical contact. High quality Bakelite in the stator provides ample insulation for general applications, yet is sturdy enough to withstand rough usage.

These are only a few of many reasons why this RL switch is found in radio instruments, test equipment, and a wide variety of other applications. For full information about this Mallory "leader", ask for the RL Engineering data folder and specification layout sheets, or see your Mallory representative. Standard Mallory Switches are obtainable from your nearest Mallory Distributor.

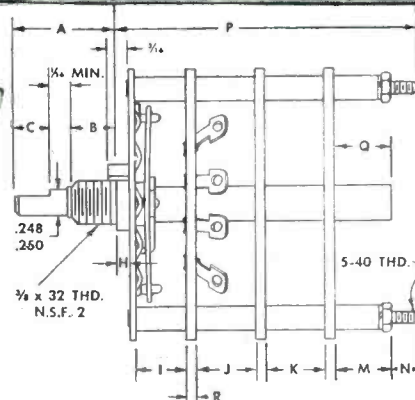

ELEVATION VIEW OF R L SWITCH

Ask for RL

Specification-Layout Sheets

Printed on thin paper to permit blueprinting, these sectional drawings indicate standard and optional dimensions—make it easy for you to order pre-production samples of RL switches built to meet your requirements exactly. Ask your nearest Mallory Field Representative or write direct for a supply.

P. R. MALLORY & CO. Inc
MALLORY SWITCHES
 (INDUSTRIAL AND ELECTRONIC)

P. R. MALLORY & CO., Inc., INDIANAPOLIS 6, INDIANA

INDUSTRIAL CONTROL

Fifty-foot Lightbeam Controls Rotating Mandrel.	164
Radar Increases Safety of Night Boat.....	164
R-F Heating in Bakery Industry.....	166
Electronic Contactors for Control Applications.....	186

Fifty-foot Lightbeam Controls Rotating Mandrel

IN MAKING heavy hose at the Hewitt Rubber Corporation in Buffalo, N. Y., part of the process involves wrapping material on a huge 50-foot rotating mandrel, this being the standard length of finished rubber hose. This is done just prior to vulcanization and is an important step in the making of quality hose.

Until recently, the driven chuck which rotates the mandrel was controlled by the operator stepping on

Recently, photoelectric equipment was installed about 12 inches above the floor. The light beam is thrown the entire 50-foot length and the machine is stopped instantly when the operator kicks either foot forward and so interrupts the beam. This may be done effectively at any point along the machine. A telescopic lens of 32-inch focal length focuses the beam to the phototube.

When first installed, the beam both

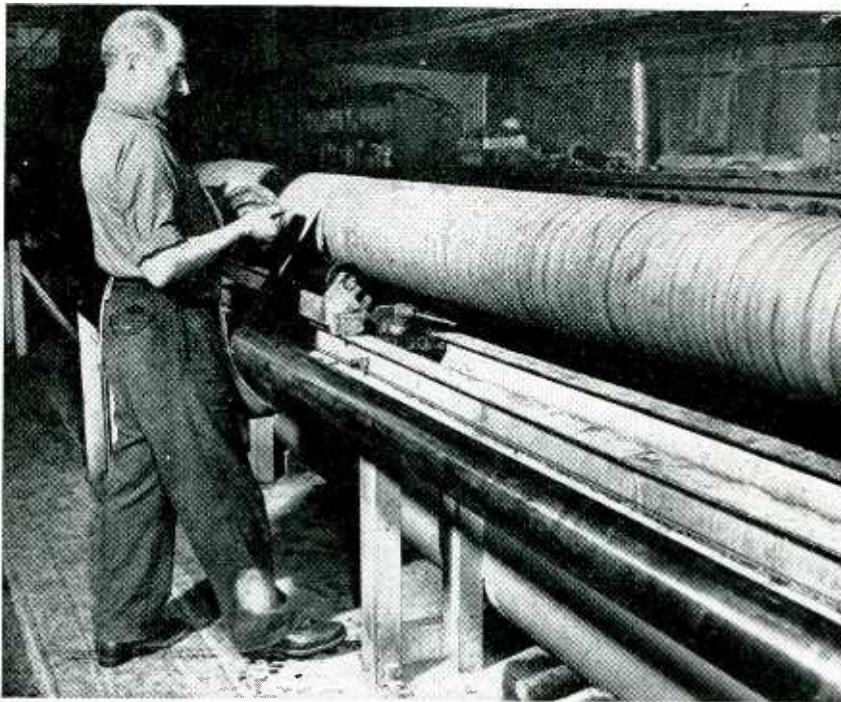

This fifty-foot mandrel on a large hose-wrapping machine is stopped by the operator when he moves his foot forward and interrupts a lightbeam that extends the full length of the machine

a wire cable which was stretched the full 50-foot length or by signaling the operator of the chuck by a nod of his head whenever the machine was to be started or stopped. This signal was sometimes not seen or the response to it was slow, and the wrapper could then be caught in the machine.

started and stopped the machine, but to start the machine a wire cable is now stretched the length of the machine. This is placed close to the wrapping bar and operated by a pull of the finger of either operator.

Besides providing greater safety to the operator, the floor is left clear of any gear that might impair the

travel of the operator, who now controls the machine with a minimum of effort and so may pay full attention to his work.

Radar Increases Safety of Night Boat

REGULAR NIGHT sailings of the commercial passenger-carrying night boat, *City of Richmond*, will benefit from an installation of radar equipment for navigation now being made by Westinghouse. The ship plies between Baltimore and Norfolk for the Old Bay Line, which plans to add more radar units to other ships of its fleet.

The installation is of the continuous plan-position-indicator type that



Westinghouse engineers mount the antenna for laboratory tests of marine radar equipment for the Old Bay Line's Baltimore-Norfolk night boat, *City of Richmond*. The antenna will rotate under a mushroom-like protective cover atop pedestal to be located on the wheelhouse roof

provides a continuous picture of ship traffic and shoreline conditions from 100 yards to 32 miles distant in three ranges 2, 8 and 32 miles radius. The equipment uses a 7-inch cathode-ray tube mounted in a small cabinet convenient to the watch officer's station on the bridge.

The installation is in two major parts: the antenna, mounted under a large mushroom-like plastic dome atop a 5½-foot pedestal on the wheelhouse roof, with the modulator, pre-amplifier and other r-f components in the weatherproof base of the ped-

Free...to Makers of Electronic Equipment

You'd like to have *all* your training films made to order, of course. But if you can't manage to do this, you can still organize an up-to-the-minute training program by supplementing your own films with films made by others.

And that's where this new book, "The Index of Training Films," can help you. It lists—with hundreds of others—a wide selection of films on electronic subjects for training factory workers, salesmen, and

trouble-shooters. Movies and sound-slide films cover electron-tube theory, circuits, electronic motor controls, resistance-welder control, phototube applications, and many other electronic topics.

This informative index describes and classifies outstanding films . . . tells which are free . . . which can be rented or bought, and for how much . . . and where to get them. For your copy, write . . .

Eastman Kodak Company, Rochester 4, New York

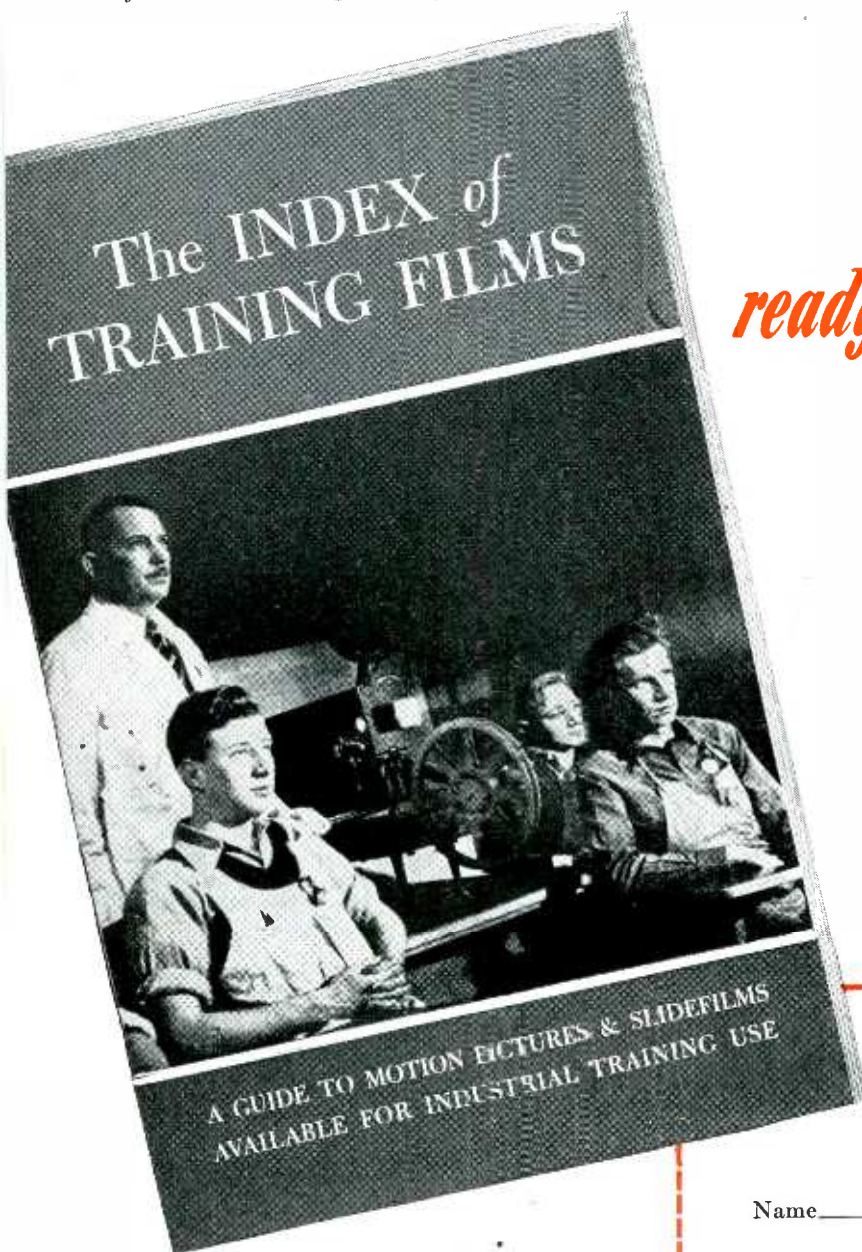

*... a guide to
ready-made Training Films*

**This new book lists 155
films on Electronics and
related subjects which
you can borrow, rent, or
buy very reasonably**

Mail This Coupon for Your Free Copy

Eastman Kodak Company
Rochester 4, New York

Please send me a free copy of the new book,
"The Index of Training Films."

Name _____

Company _____

Street _____

City _____ State _____

Training Films

—another important function of photography

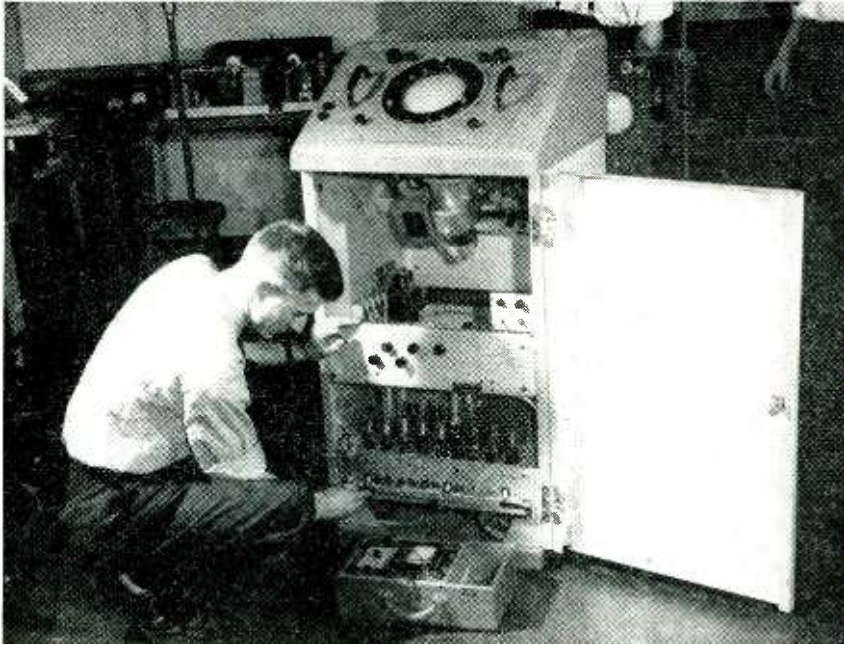

Westinghouse engineer Lynn Ulman checks receiver-indicator of the first major installation for use on long-distance passenger-carrying marine service. The seven-inch ppi scope of this receiver-indicator console will be located on the bridge

estal, and the receiver-indicator console, a cabinet two feet square and 48 inches high located on the bridge. Power is provided by a below-decks rotary converter operating on the ship's d-c line.

Although the antenna is designed to provide a full 360-degree hori-

zontal sweep, because of its location on the wheelhouse roof the stack will obstruct its scan for about nine degrees dead astern. If complete coverage astern is needed, it will be necessary to elevate the antenna. Operation is in the frequency band from 9,320 to 9,430 megacycles.

R-F Heating in Bakery Industry

THAT ELECTRONIC HEATING has been successfully applied to food products for dehydration, cooking, melting, roasting, deinfestation, baking, defrosting, and mold inhibition was announced at an annual meeting of bakers in Chicago by V. W. Sherman, president of Sherman Industrial Electronics Co., who copyrighted the talk. It was stated that certain applications are feasible only under special circumstances and that others are dubious and should not yet be recommended for development. He described some applications that have been repeatedly tested and possess both practicability and economic soundness.

Defrosting

Thirty-pound cartons of perishable fruits like strawberries have been defrosted with electronic heat in a matter of minutes, in contrast to the four hours in warm water or the one to seven days presently required

at room temperature. Smaller two-pound cakes of frozen food were defrosted in less than one minute. Five-

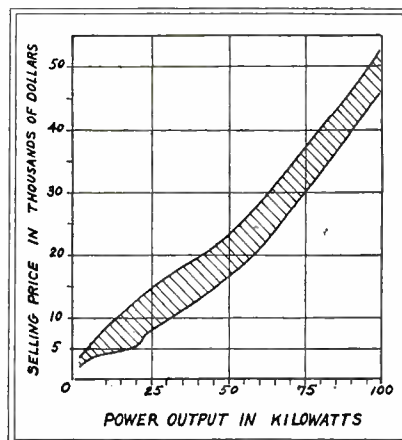

For a given power output, the selling price of an h-f generator increases as the output frequency required by the job becomes higher. Dielectric heaters for bakery and food work require a frequency in the order of 13 to 30 mc. Small units range \$750 to \$1,000 per kw and larger sizes about \$400 to \$500 per kw of output

pound blocks of frozen eggs were defrosted in less than three minutes.

All these jobs were accomplished with only three kw of 13-megacycle electronic heat. Based on this work, a 25-kw electronic defroster was designed to handle barrels of frozen food at the rate of 750 to 1000 lb per hour depending upon initial temperature. To bakers, candy and ice cream makers electronic defrosting means a saving of time, space, and handling and also the reduction of spoilage and the retention of fresh flavor. From the health standpoint, electronic defrosting insures an exceptionally low bacteria count in eggs and similar products due to the speed of the process, which reduced drastically the time food was exposed to the atmosphere.

A large bakery may require the defrosting of 10,000 pounds of product per day. Many ice cream manufacturers use 40 to 50 barrels of frozen fruit a day. Defrosting times ranging from 45 minutes to two hours cover practical requests for equip-

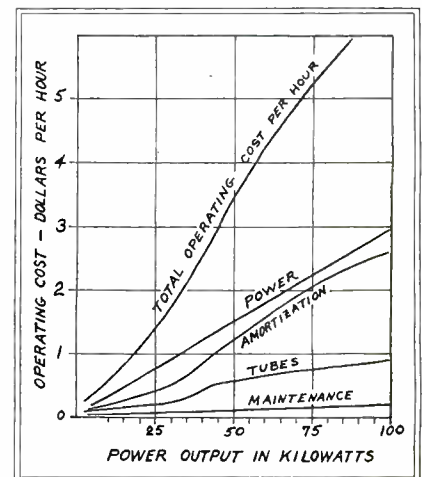

Operating cost for electronic heaters up to 100 kw. The curves are based on one make only and do not necessarily apply to all makes

ment performance at this time and a 30 to 40-minute treatment time is recommended to reduce power and cost, yet insure low bacteria count.

The special defrosting of bread frozen to retain its freshness over a period of two weeks has been successfully done with electronic heat. The appearance and taste of the product were stated by bakery men to be equivalent to that of the fresh product. Other successful defrosting ap-

THE MAN TO KNOW...

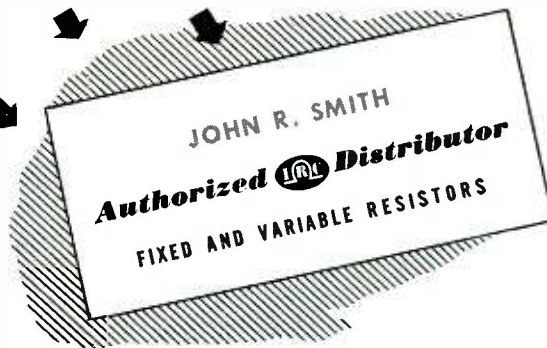

... when you need resistors in a hurry !!!

IRC distributors always have been valuable supplementary sources of supply to manufacturers of electronic and industrial equipment. During the war, they established an unusual record of service to manufacturers. IRC's more than 300 Authorized Distributors have proved themselves to be of the highest caliber, with exceptional organizations and facilities.

Under the newly-announced IRC Industrial Service Plan, these men are better prepared than ever before to give industrial users of resistance units

prompt, intelligent and complete service on all IRC standard products, listed in IRC Catalog #50. They are rapidly gearing to maintain adequate stocks of the most widely-used IRC resistors and their sales forces are conversant with electronic requirements.

When you need resistors in moderate quantities for experimental work, pre-production models, pilot runs, small production runs, and for service and maintenance—it will pay you to call upon your local IRC distributor. We shall be glad to furnish his name upon request.

Write to Dept. 1-D for IRC Catalog #50 and names of local IRC Distributors.



FOR BETTER-THAN-STANDARD QUALITY... *Standardize on IRC*

NEW Versatile Connections

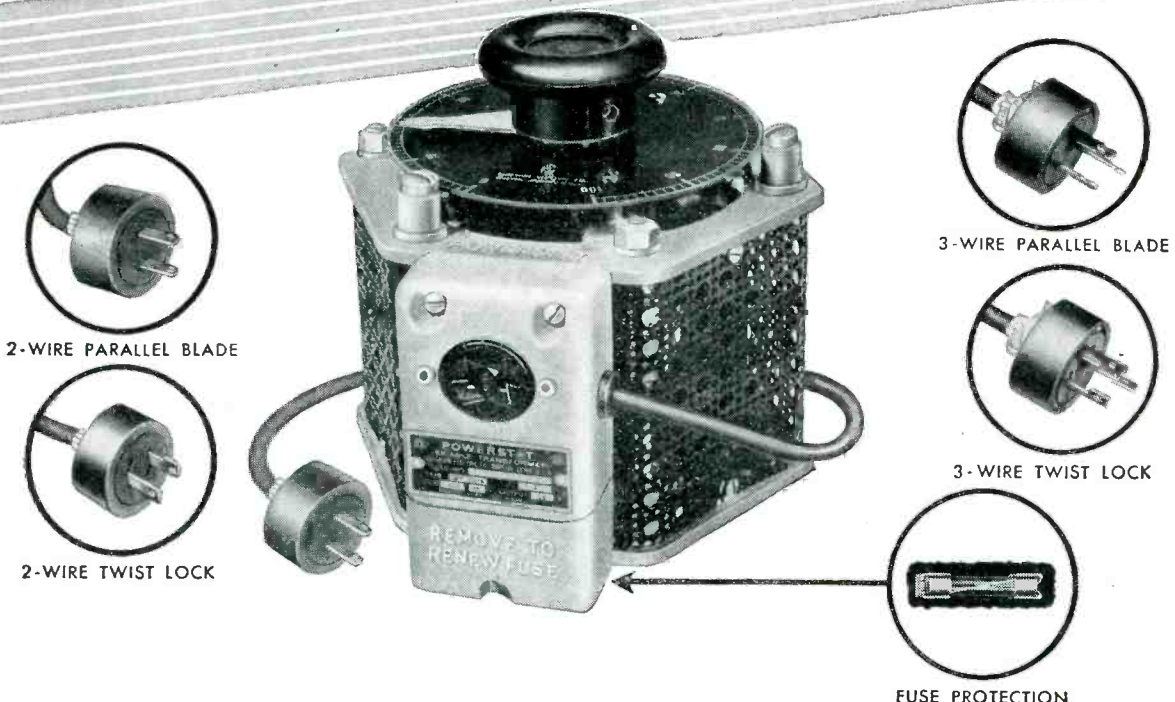

When other than qualified technicians operate electrical apparatus; features of safety, reliability, and convenience must be inherent characteristics. With the ever-increasing use of POWERSTAT variable transformers as the source of continuously adjustable a-c voltage in a multitude of factory operations, it became apparent to the SECO engineers such features should be embodied in units up to 2 KVA capacity.

Heretofore, these decided advantages were available only in 1 KVA ratings. But now, 115 and 230 volt models of twice this capacity can be had with an input cord and plug, output receptacle, and fuse protection. In keeping with the SECO policy of supplying equipment to satisfy individual requirements, these new POWERSTATS are obtainable in either a 2 or 3 wire (3rd wire grounded in 3 wire system) — straight blade or twist-lock type of plug and receptacle.

If you are interested, may we suggest that the factory be consulted regarding the catalog numbers of various units.

Send for Bulletin LE

SUPERIOR ELECTRIC COMPANY
 704 LAUREL STREET, . . . BRISTOL, CONNECTICUT
 STOCKED BY LEADING DISTRIBUTORS IN THE UNITED STATES AND CANADA

turbo

INSULATIONS

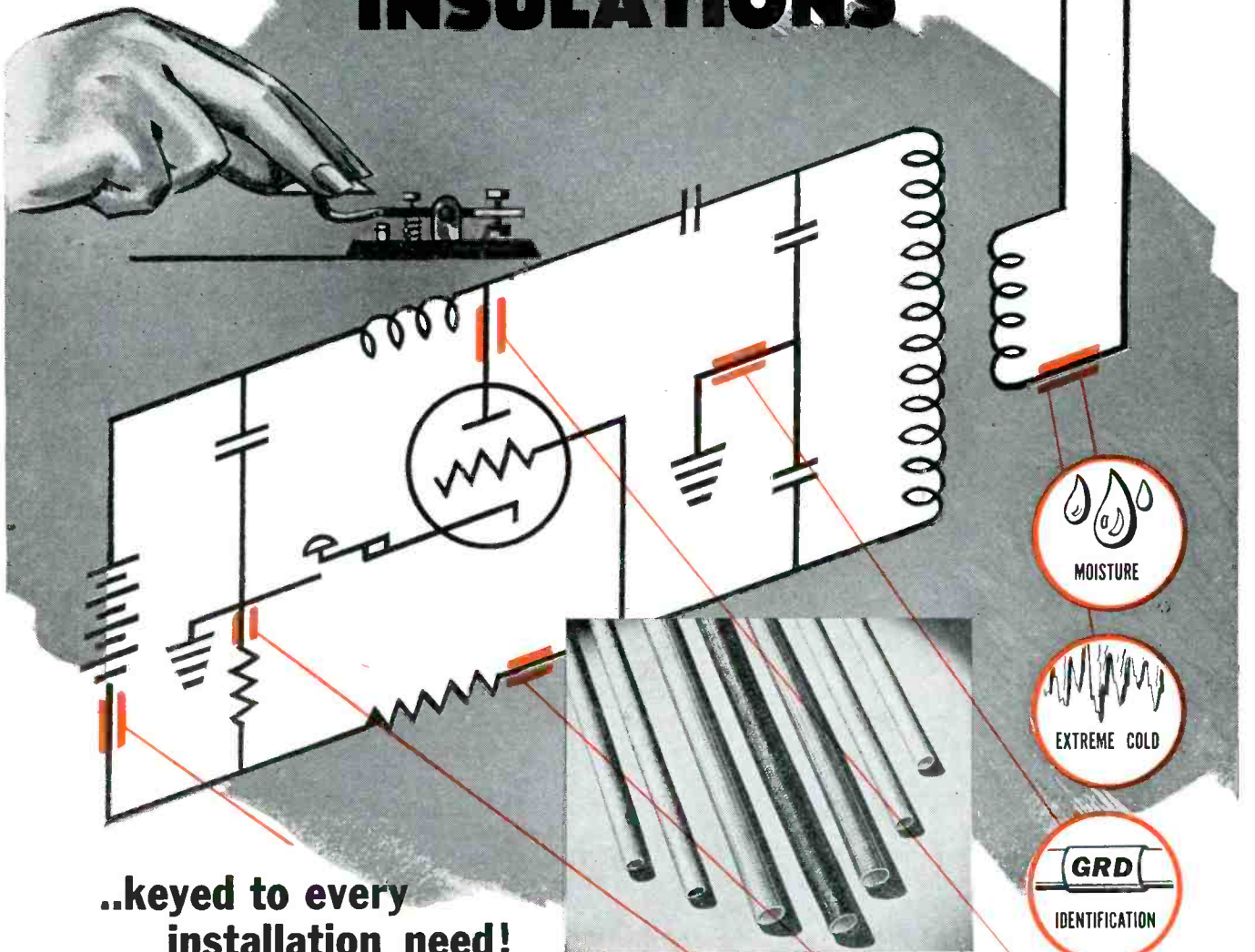

..keyed to every installation need!

Electronic communication circuits are a proving ground for electrical insulation. The varied conditions imposed—high voltage, heat, climatic exposure, battery acid, fumes, etc.—make several insulations, each with specific characteristics, essential. To meet these diversified requirements, TURBO engineers have developed four types of sleeveings that assure unflinching operation under any given operating condition. Each is supplied in a full range of colors and sizes that speed installation and simplify maintenance.

FLEXIBLE VARNISHED OIL TUBING: offers immunity to corrosive fumes, acid, alkalis and most solvents, with enduringly high dielectric values. It is impervious to moisture and non-hygroscopic.

VARNISHED GLASS TUBING: capable of functioning in high ambient temperatures—enclosed motors, unventilated areas, and general heavy duty installations.

WIRE IDENTIFICATION MARKERS: two types—sleeve type that slips directly over pipes, tubes, conductors; and tab type with flexible flag attached to sleeve. Both available in any marking.

Write today for free Specimen Board with samples and sizes of each.

TURBO



WILLIAM BRAND & CO.

276 Fourth Ave., New York 10, N. Y. • 325 W. Huron St., Chicago 10, Ill.



"The whole is equal to the sum of all its parts"—Elementary? Of course—as simple and unchanging as all great principles. This axiom is a fundamental manufacturing creed at Stancor. We know the established excellence of Stancor Transformers is vitally dependent upon the perfection of each successive manufacturing step—from engineering considerations of individual specifications—through coil-winding, laminating, assembling, finishing, testing—and, finally, to careful packing for shipment.

All individual manufacturing operations have one common denominator—QUALITY—uncompromising, changeless QUALITY that continues to prove—"IN TRANSFORMERS, STANCOR GIVES MORE."



STANCOR
STANDARD TRANSFORMER CORPORATION
1500 NORTH HALSTED STREET CHICAGO 22, ILLINOIS

plications have included eggs (40 lb/hr/kw), chickens (30 lb/hr/kw), and a wide variety of packaged frozen foods.

Another application somewhat related to defrosting is the warming through of dough to promote rising. A reduction of shortening required is said to be made possible by the rapid and substantially uniform warming experienced with electronic heating.

Cooking and Baking

With only three kilowatts or less of electronic heat, heavy cookies $\frac{3}{8}$ inch thick by 3 inches in diameter have been baked in 75 seconds. Fruit cake has been baked in glass dishes. Homogeneous foods such as meat loaf, diced vegetables, cored apples and many meal and flour products have been readily cooked. A five-pound leg of lamb was roasted perfectly in 30 minutes, gravy and all. This would have taken 2 to 3 hours in an ordinary oven.

Cooking or baking is an art that requires more than time and temperature. The application of electronic heat to such an art will require cooperative development. For example, the electronically baked cookie had no brown crust, and its surface color was much the same as its interior. Crusting could be readily added as a finishing operation using infrared lamps or electric strip heaters. In either case, the overall baking time would be definitely reduced but such necessary changes in baking technique must be decided by trial.

Melting

Chocolate, cocoa mixtures, sugar in several forms, starches, and other products can be melted with electronic heat. The rapid and substantially uniform heat was of real advantage. In certain cases special fixture design was required because of the product's tendency to foam. This was the case with dextrose and with lump sugar. Sugar syrup does not foam, nor does chocolate, nor starch which rapidly reduced to a jelly-like mass with electronic heat. When the product to be heated has both lumps and powder, the lumps may be expected to heat about twice as fast as the powder.

Mold inhibition is an excellent application and has produced positive

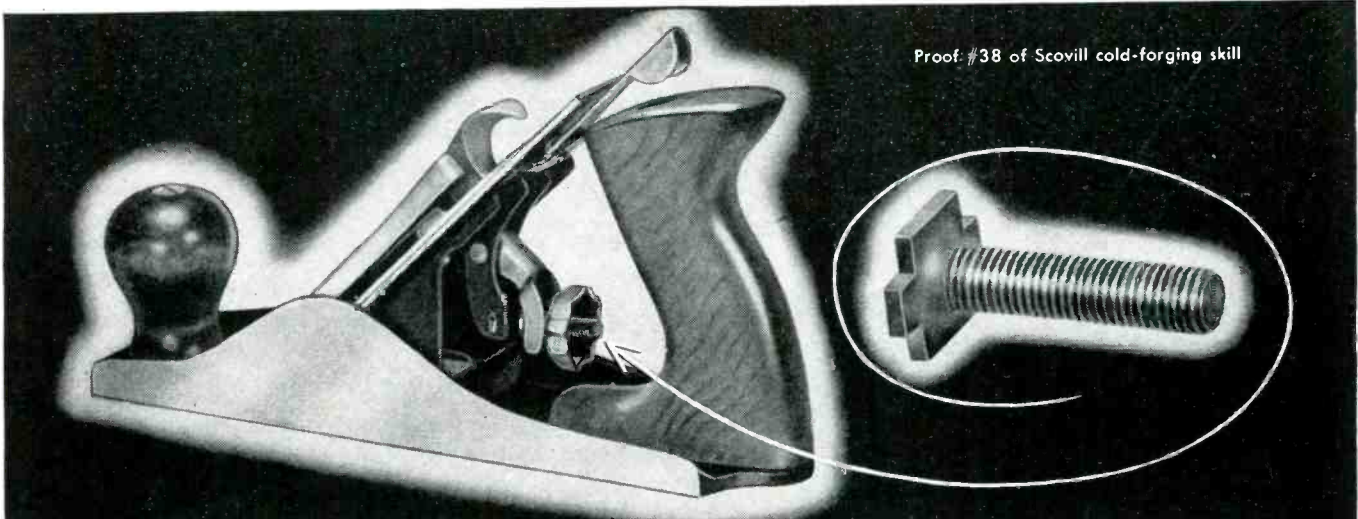
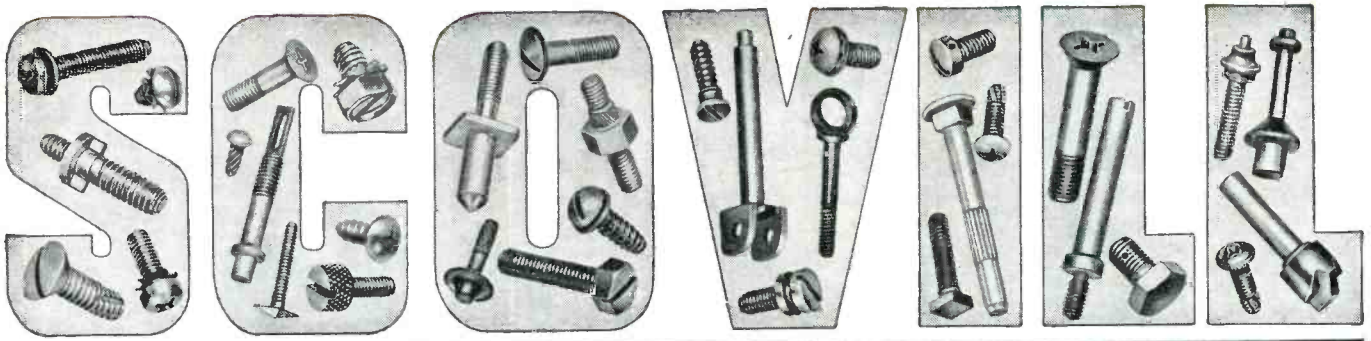

Proof: #38 of Scovill cold-forging skill

ANOTHER CASE WHERE SPECIAL DESIGN CUT ASSEMBLY TIME, AND SCOVILL COLD-FORGING CUT COSTS

The part above is but one of many instances wherein Scovill cold-forging skill and equipment helped customers get better fastenings (frequently at substantial savings over other production methods).

If your product is in the Design stage that is the best place to call in Scovill experts for special, cold-forged fastenings that will reduce assembly time and do a better job on the Job. Scovill cold-forging skill and equipment may not only make such special designs practical but also bring important savings over other production methods.

If your fastenings are already in production Scovill cold-forging may well produce them better for less.

In any event it will pay you to discuss your problem with Scovill. No cost or obligation, of course.

● *Call Scovill on these standard fastenings for production efficiency... Phillips Recessed Head Screws... Type F Self-Tapping Screws... Washer-Screw Assemblies*

SCOVILL MANUFACTURING COMPANY

WATERVILLE SCREW PRODUCTS DIVISION

WATERVILLE 48, CONN.



TEL. WATERBURY 3-3151

NEW YORK, Chrysler Building • DETROIT, 6460 Kercheval Avenue • CHICAGO, 135 South LaSalle Street • PITTSBURGH, 2882 W. Liberty Ave.
 SYRACUSE, Syracuse-Kemper Insurance Building • LOS ANGELES, 2627 South Soto Street • SAN FRANCISCO, 434 Brannan Street

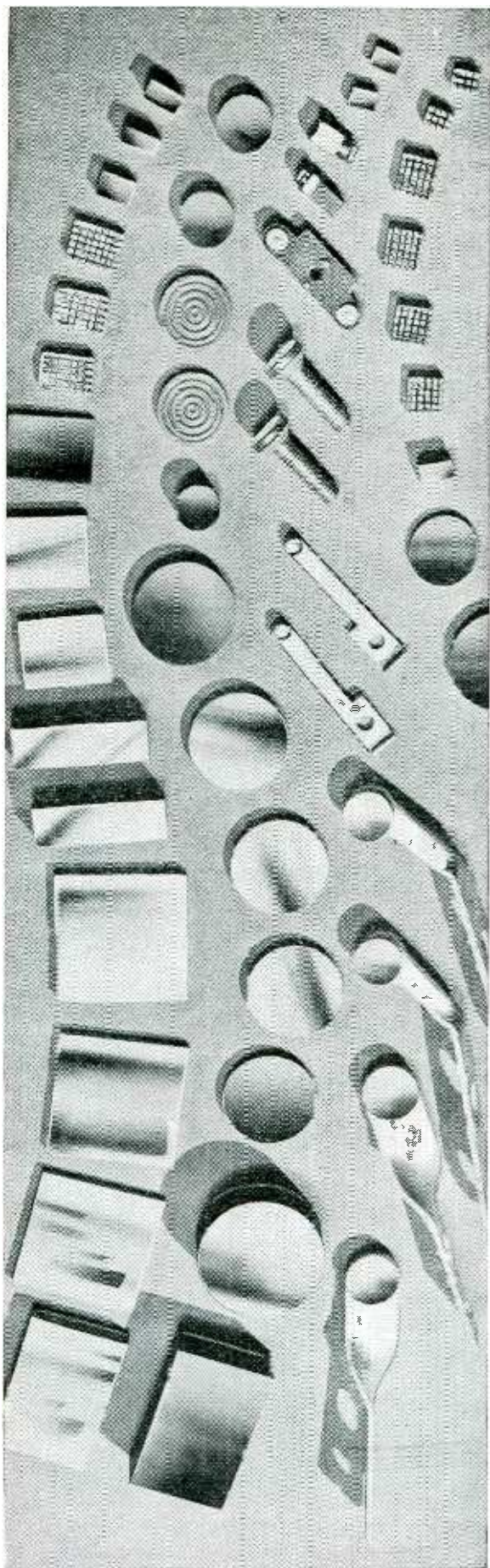

Wilcoloy

(SINTERED POWDER METAL CONTACTS)

WILCOLOY offers Longer Contact Life . . . Greater Resistance to Interrupting Loads, and many other advantages for high current applications.

PROPERTIES AND CHARACTERISTICS—WILCOLOY Silver Tungsten, Copper Tungsten, Silver Graphite, Silver Molybdenum and other WILCOLOY contact materials assure a degree of longevity, and thermal and electrical properties not possible to materials previously used in applications subject to severe current interruptions.

These Sintered Powder Metal Contacts offer a choice of properties including ductility, hardness, density, freedom from sticking, low metal transfer, high conductivity and arc-resistance. They perform uniformly and dependably in heavy duty circuit breakers, both air and oil relays, aircraft units, motor brushes, commutator segments, fuse replacement units and other specialized applications.

CONSULT OUR ENGINEERING DEPARTMENT— Write our Engineering Department for help in developing the proper application of WILCO materials to your products.

SEND FOR WILCO BLUE BOOK—The Blue Book contains descriptions of most WILCOLOY Sintered Powder Metal Contacts and other WILCO products. Send for FREE copy today.

WILCO PRODUCTS INCLUDE:

CONTACTS—

Silver
Platinum
Tungsten
Alloys
Sintered Powder Metal

THERMOSTATIC BIMETAL—

All Temperature ranges,
deflection rates and electrical
resistivities.

**PRECIOUS METAL COLLECTOR
RINGS—**

For rotating controls

SILVER CLAD STEEL—

JACKETED WIRE—
Silver on Steel, Copper,
Invar or other combinations
requested.

ROLLED GOLD PLATE

SPECIAL MATERIALS



THE H. A. WILSON COMPANY

105 Chestnut Street, Newark 5, N. J.

Branch Offices: Chicago • Detroit • Los Angeles

**SPECIALISTS FOR 30 YEARS IN THE MANUFACTURE OF THERMOMETALS
ELECTRICAL CONTACTS • PRECIOUS METAL BIMETALLIC PRODUCTS**

POSITIVE CONTROL

of Varying Power Supply

Raytheon Voltage Stabilizers

DELIVER OUTPUT VOLTAGE CONSTANT TO $\pm 1/2\%$

FLUCTUATION of line voltage need not impair the performance of your electrical equipment. Such variations are easily corrected with magnetic-type, entirely automatic Raytheon Voltage Stabilizers.

Positive control is gained. Power supply is stabilized to $\pm 1/2\%$. Reliability and accuracy of performance are effectively improved, *and at low cost.*

Investigate. Determine how positive control of line voltage can benefit your equipment. Our Bulletin DL-48-537 gives the detailed story. Write for it today.

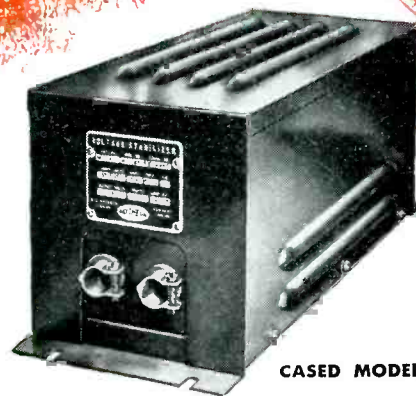

CASED MODEL

Get These Principal
Operating Advantages:

- Control of output voltage to within $\pm 1/2\%$ of 115 or 230 V.
- Stabilization at any load within rated capacities.
- Quick response. Stabilizes varying input voltage within 1/20 second.
- Entirely automatic. No adjustments. No moving parts. No maintenance.

RAYTHEON

Excellence in Electronics

RAYTHEON MANUFACTURING COMPANY
Industrial Electronics Division, Waltham 54, Mass.

ACRO

OPEN BLADE SWITCHES

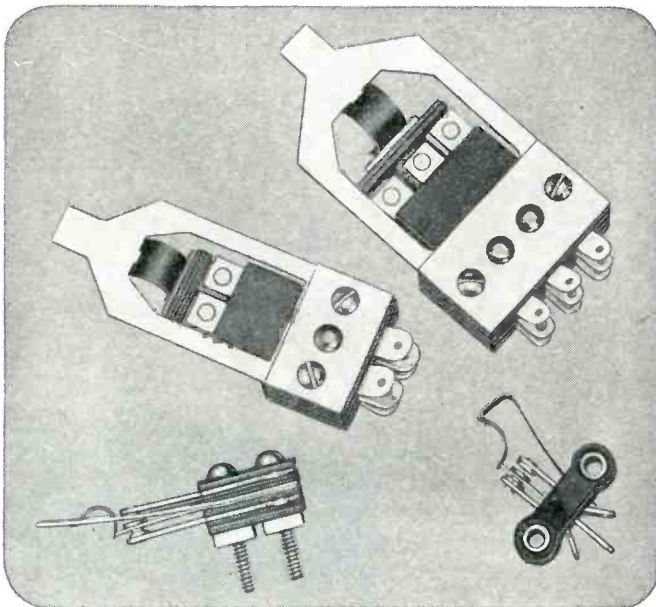

Check these Advantages

- ✓ **LONGER LIFE**—based on ACRO patented beryllium Rolling Spring principle. Some ACRO Switches are guaranteed for ten million operations.
- ✓ **ALL SHAPES AND SIZES**—requiring less space—to fit any conceivable need of your new units. Will perform perfectly, mounted in any position.
- ✓ **OPERATING CHARACTERISTICS TO FIT THE JOB**—1, 2 and 3 poles—single throw or double throw. Return type, set type—wide range of operating pressures. Many applications solved by multiple mountings.
- ✓ **GREATER DEPENDABILITY**—Careful designing and manufacturing, producing positive, fast action and greater contact pressures, make ACRO Snap-Action Switches sturdy and trouble-free.
- ✓ **RATINGS**—15 Amps. at 125 volts A.C.

Send in your engineering details for quick help.

ACRO ELECTRIC COMPANY

1316 Superior Avenue • Cleveland 14, Ohio

results. Whole wheat bread, Boston brown bread, and white bread so treated remained mold-free for over two weeks. An untreated control loaf showed mold before the end of the second day. The protective treatment was given directly after wrapping and sealing the loaf in cellophane. Electronic heat developed the temperature of 140 F uniformly throughout the loaf in a matter of seconds. The small amount of moisture condensed on the inside of the cellophane wrapper during heating was quickly reabsorbed by the loaf during the cooling-off period. The treated product suffered no change of texture or taste.

Other Food Applications

Carmelizing, dehydrating, deinfesting, popping, and sterilizing have been done. Work in the food field has covered a long list of products ranging alphabetically from apples to yeast and including birdseed, candy, cereal, cinnamon, corn, eclairs, gelatin, licorice, malt, meats, muffins, nuts, potatoes, spices, and starch.

Figures 1, 2, and 3 show how white flour, a prepared biscuit mix, and a

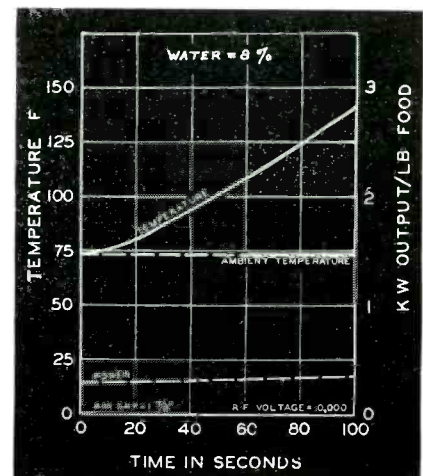
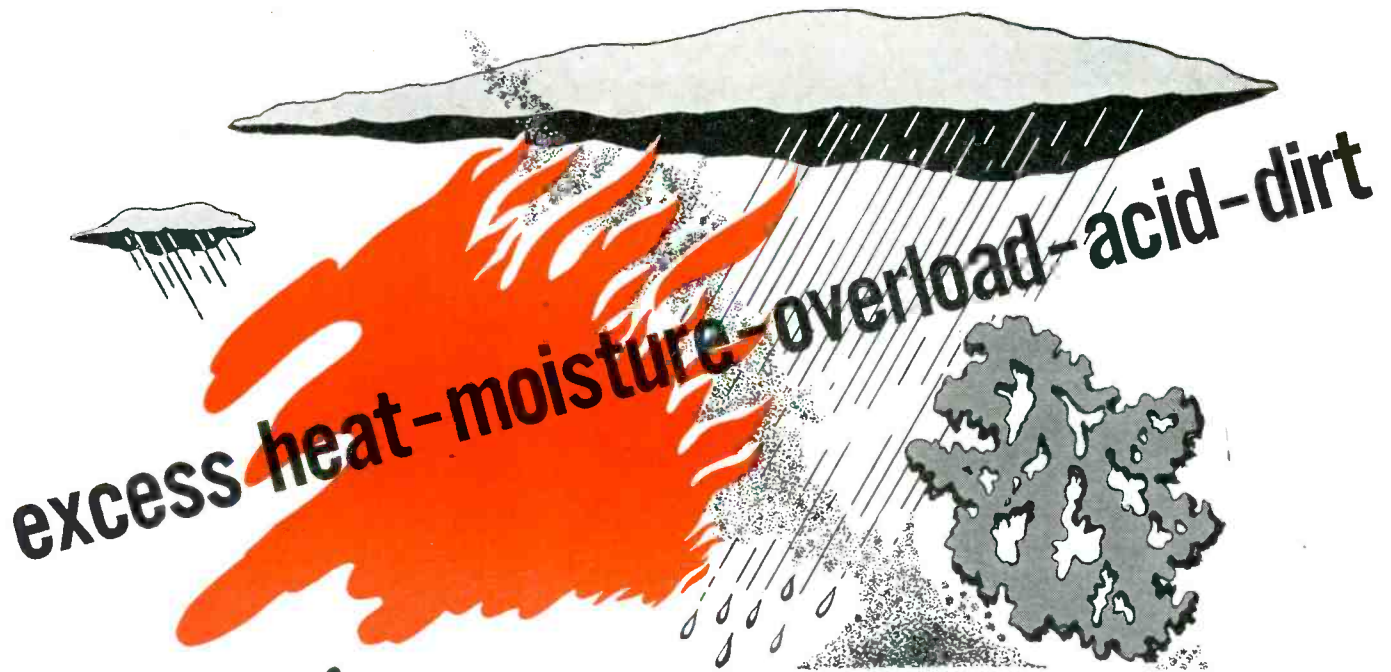
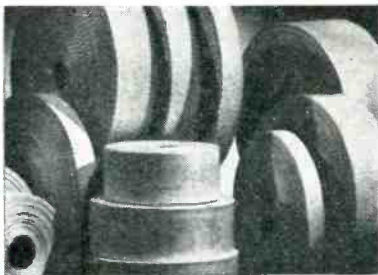

Fig. 1—Electronic heating of white flour

ginger bread mix, respectively, responded to electronic heating which was applied as a protection against infestation. Although each food responded in a somewhat individual manner it may be noted that if the power had been adjusted to exactly one kilowatt in each case, then the 75-degree temperature rise would have been accomplished in substantially the same time (40 to 45 seconds) for each one-pound sample. In



have no effect on these three
Mitchell-Rand fibreglas products



1. M-R FIBERGLAS TAPES . . . available in a wide variety of widths, thicknesses and styles for practically every electrical insulation requirement where high tensile strength and dimensional stability are desired. Continuous filament Fibreglas Tapes, used in over 95% of all applications, are supplied in sizes from .003" to .015" in thickness and from 3/8" to 1 1/2" in width. Medium weave tapes for machine taping are furnished in thicknesses from .005" to .015", while tight weave tapes for manual taping are furnished in thicknesses from .003" to .007" only. Staple fiber tapes in thicknesses from .010" to .025" and widths from 1/2" to 1 1/2" are also available for applications where space is not a primary consideration or where a more resilient wrapper cushion is wanted.



2. M-R FIBERGLAS TYING CORDS . . . three to five times stronger than ordinary electrical twines—provide all the insulation advantages inherent in Fibreglas: heat-moisture-acid resistance and exceptionally high tensile strength. They are used for all kinds of tying purposes: banding field coils, wrapping string bands on armatures, protecting commutator V-rings from flash-overs, banding on V-ring extensions on DC equipment, as filling in winding coils, reset strings and for tying slot insulation in place. They are also used to lash ends of coils in large motors and generators and to hold spacer blocks in place . . . and for many other tying purposes.

Treated cord is used primarily for its exceptional knot strength and resistance to abrasion and is preferred for construction and repair of electrical equipment. Untreated cord is frequently used where space is to be filled, regardless of strength requirements.

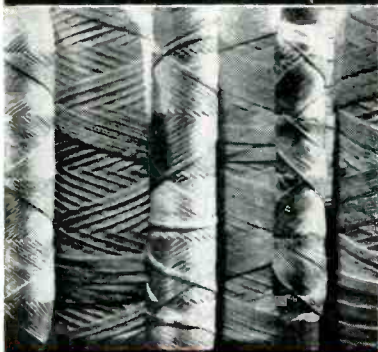

3. M-R FIBERGLAS BRAIDED SLEEVINGS . . . available only in the continuous filament construction, are most efficient for insulation requirements which call for high tensile and dielectric strength, space conservation and flexibility. M-R Fibreglas Sleeveing resists excessive heat, moisture, overload, acid and dirt to make it ideal for use in covering coil leads, transformer leads, coil interconnectors, pigtail brush leads and for other insulation applications.

Fibreglas Braided Sleeveings are furnished in two average wall thicknesses, .008" and .006" with inside diameters from 1/16" to 1/2" in 1/16" increments (there is no 7/16" ID sleeveing). They are available plain (untreated) or impregnated, to prevent ends from fraying, in natural, blue, red, green, black, brown or yellow for circuit or phase identification purposes.

Write to Mitchell-Rand, "the Electrical Insulation Headquarters", for the new Fibreglas Catalog EL 44-7, containing performance and application data of interest to all concerned with electrical insulation . . . as well as description and data covering Fibreglas Tapes, Tying Cords, Sleeveings, Cloths, Mica Combinations, Laminates and other Fibreglas insulation materials.

MITCHELL-RAND INSULATION COMPANY, INC.

51 MURRAY STREET

COrtlandt 7-9264

NEW YORK 7, N. Y.

Fibreglas Varnished Tape and Cloth
 Insulating Papers and Twines
 Cable Filling and Pothead Compounds
 Friction Tape and Splice
 Transformer Compounds

A PARTIAL LIST OF M-R PRODUCTS
 Fibreglas Saturated Sleeveing, Varnished Tubing
 Asbestos Sleeveing and Tape
 Varnished Cambric Cloth and Tape
 Mica Plate, Tape, Paper, Cloth, Tubing

Fibreglas Braided Sleeveing
 Cotton Tapes, Webbing and Sleeveings
 Impregnated Varnish Tubing
 Insulating Varnishes of all types
 Extruded Plastic Tubing





- PRECISION WIRE WOUND RESISTORS
- WHEATSTONE BRIDGES
- RADIO & ELECTRONIC TEST EQUIPMENT
- RADAR ASSEMBLIES

Eastern Electronics Corp.

PHONOGRAPH TURNTABLE UNIT The need at this time for large quantities of phonograph turntable assemblies has prompted us to quickly design and tool up for the immediate production of this item. Engineers will find this compact turntable meeting all of their requirements for performance.

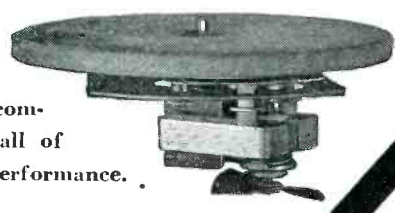

PERFORMANCE:—Correct and uniform speed is secured through the use of a motor of ample capacity, preloaded to operate on the flattest portion of the torque-speed characteristic.

QUIETNESS:—Is assured by full-floating rubber motor mountings and rubber cushioned drive. Permanent freedom from turntable wobble is guaranteed by an extra rigid turntable, an extra long bearing and precision machining of these parts.

RELIABILITY:—The motor is fan-cooled and will operate continuously with an exceptionally low temperature rise. All bearings are of ample size and are provided with self-lubricating features.

We will make special resistors to any value or tolerance.

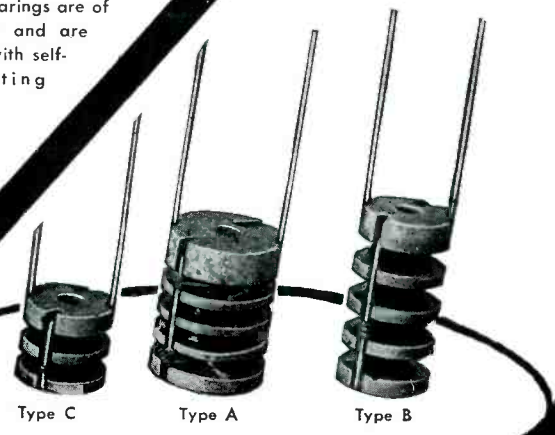

Type C
Maximum resistance 500,000 ohms.

Type A
Maximum resistance 1,000,000 ohms.

Type B
Maximum resistance 1,000,000 ohms.



Type XM
Instrument resistance shunt .1 ohms or lower. 25 watts.

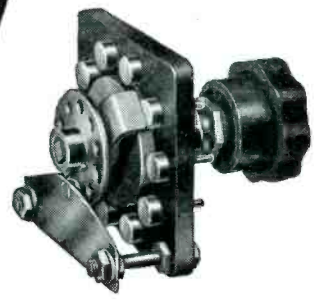

ROTARY SELECTOR SWITCH

Designed for use where low contact resistance and mechanical sturdiness is required. Its construction insures long wear with low contact resistance of less than .001 ohm. May be arranged to have several sections to obtain multi-polar switching.

Well suited for precision test instruments; shunt ammeters, thermo-couple types, Wheatstone Bridges, and similar devices.

Eastern Electronics Corp.

41 CHESTNUT STREET, NEW HAVEN, CONN.

New York Sales Office
Turney & Beale
215-05 27th Ave.
Bayside, Long Island, N.Y.
Tel. BA 9-8958

Chicago Sales Office
Bauman & Bluzat
2753 West North Ave.
Tel. Humboldt 6809

Boston Sales Office
11 Pemberton Square
Tel. Capitol 2425

J. E. Oliphant and Company
505 Uhler Building
Marion, Ohio

Los Angeles Sales Office
Norman B. Neeley
7422 Melrose Ave.
Hollywood, Calif.
Tel. Whitney 1147



High-Safety-Factor Electrical Insulation

... means higher heat resistance

Heat is a limiting factor in design, as designers and manufacturers of electrical equipment know. It's an obstacle to maximum operating efficiency and is a prime source of trouble for the user of the equipment.

As a base for impregnating varnishes of all types, including those specifically developed for high temperature applications, Fiberglas Electrical Insulation Materials provide the fully tested solution to many high-heat problems. Furthermore, it provides a means of overcoming many other conditions which are the major sources of insulation failure—such as moisture, corrosive vapors or acids, and overload.

In addition to unmatched mechanical and electrical advantages, Fiberglas Electrical Insulations can help give your product extremely valuable merchandising features and sales influence.

The full line of Fiberglas Electrical Insulation Materials can help you solve a heat problem—help

increase the operating efficiency of your products—reduce maintenance requirements or provide a potent sales advantage.

Get complete information—write for a copy of "Are your motors a good insurance risk?" The name of the Distributors serving your locality will also be furnished if you desire. Owens-Corning Fiberglas Corp., 1860 Nicholas Bldg., Toledo 1, Ohio. Branch Offices in Principal Cities.

In Canada: Fiberglas Canada Ltd., Oshawa, Ontario

OWENS-CORNING
FIBERGLAS

TM REG US PAT OFF

Electrical Insulation Materials

It is a BETTER Electronic Component, when it is a POTTER CAPACITOR

Metal-Contained — Oil-Filled
with Neoprene Bakelite Seals

VASTLY SUPERIOR TO ORDINARY CARDBOARD TUBULARS

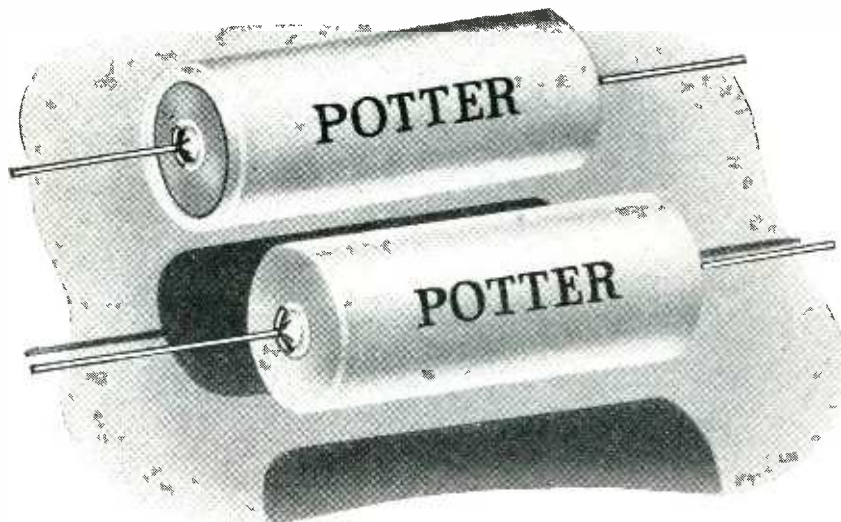

Now—with the increasing multitude of electronic applications, exacting the utmost in dependability, make sure with Potter Quality. Light, durable, space-saving—the highest achievement in capacitor material design and construction, for *today's* precision requirements in electronics. *Aluminum*-contained—oil-filled—neoprene bakelite seals. *Durable*. Space-saving. Far surpassing cardboard tubulars *in every point*.

Here's Evidence! Remarkable Record of Potter Acceptance

Under the most rigid Signal Corps inspection—under conditions of the most intense humidity, acceptance of POTTER CAPACITORS ran 99 9/10 percent. Potter Capacitors have been specified for many types of Army, Navy, and C.A.C. equipment.

Assure your product the constant, high fidelity reproduction of Potter Capacitors to your specifications—performance always faithful to the ideal, under any and every condition of operation.

In ratings up to 2,500 volts

Ask for full details. Get *all* the facts on Potter superiorities—and compare! **PROMPT DELIVERY. Wire or Write**



a commercial installation, where radiation and fixtures losses are negligible compared to energy in the product, almost double this heating rate per pound would be experienced for each kilowatt of applied energy.

For the bakery the following are felt to offer the most immediate value: an electronic baker for baking thick cookies either completely or at least during the early stages so as

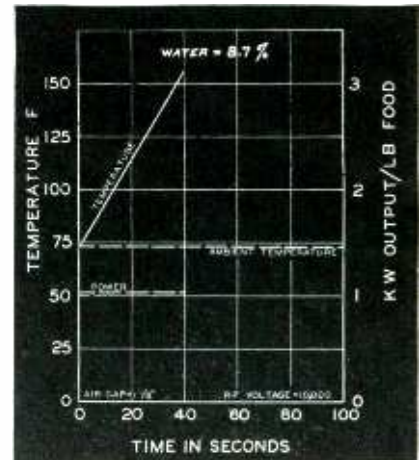

Fig. 2—Electronic heating of prepared biscuit mix

to strike through and initiate heating of the core, an electronic mold inhibitor for packaged goods, and an electronic defroster for frozen fruits and eggs.

Popular Misconceptions

To make use of electronic heat today, the following ideas must be discarded as either downright fanciful or at least of no proven basis.

- (1) That for each material there

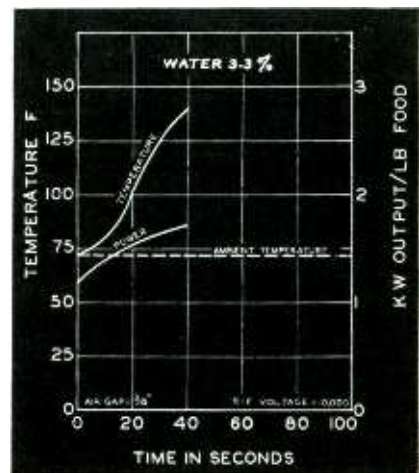

Fig. 3—Electronic heating of gingerbread mix

More output per dollar input!

The highly efficient output network of the Collins 20K AM broadcast transmitter contributes materially to its high operating economy and reliability. Efficient transfer of power from final amplifier to antenna calls for less power input, and therefore less power dissipation in circuit elements. Lower operating cost, greater dependability, and longer component life are the results of ingenious coordination of circuit design, components, and tubes.

Audio frequency distortion, noise level,

and audio frequency response are within FCC high fidelity requirements. Stabilized feedback constantly safeguards these excellent performance characteristics under widely varying operating conditions.

Complete metering and motor tuning provide control over all circuits. Power change-over from 1000 watts to 500 watts is instantaneous. Write for further information. Collins Radio Company, Cedar Rapids, Iowa; 11 West 42nd Street, New York 18, N. Y.

COLLINS
One Kilowatt
20K
Transmitter

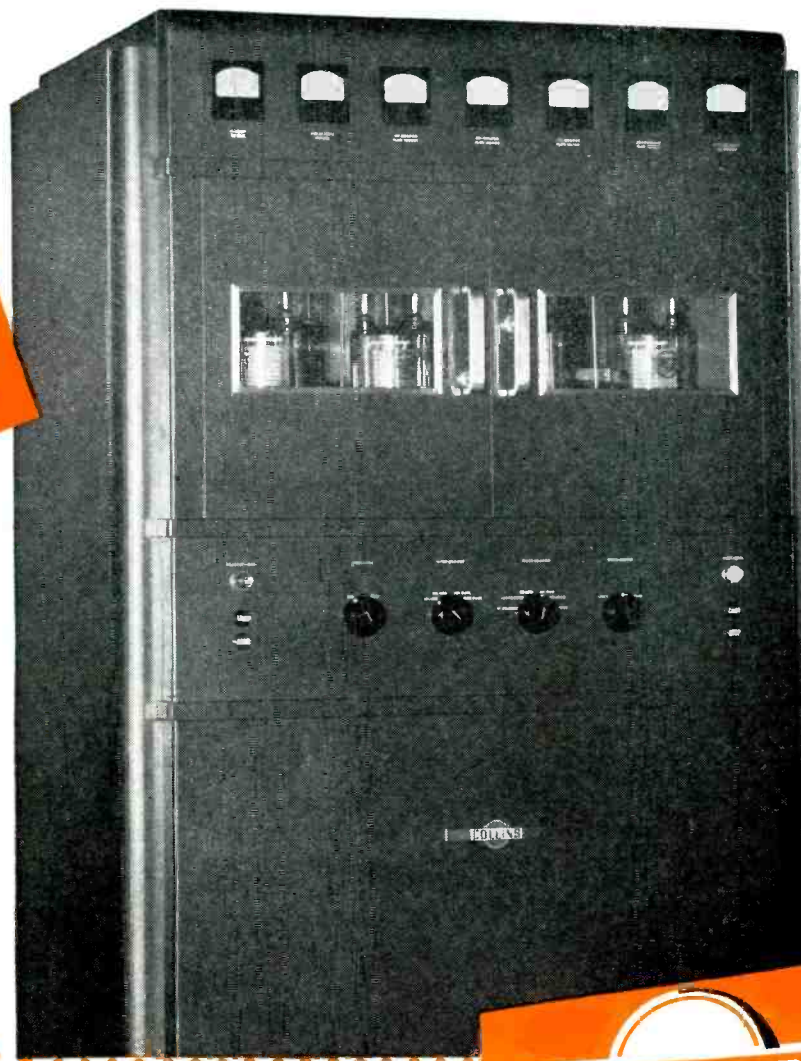

FOR BROADCAST QUALITY, IT'S



Every
AMERTRAN
TRANSFORMER
is
BUILT
WITH
CARE

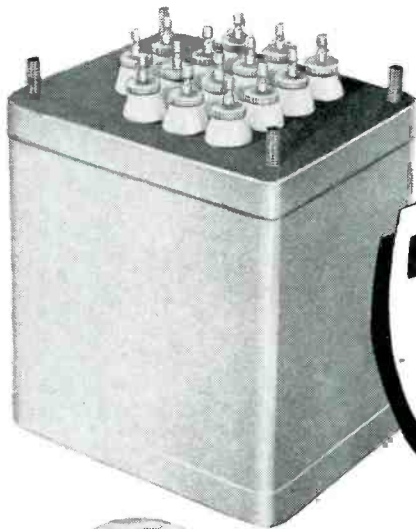

BUILT
WITH
CARE

Advantages *of multiple coil* **winding**

Coil winding is an important phase of AmerTran Transformer construction. Use is made of high speed multiple winding machines (some of AmerTran design) capable of producing many coils at a time with exceptional uniformity. Care enters the picture in the precise control with which such elements as number of turns, tightness of layers and wire tension are maintained. Tight coils have fewer and smaller air pockets, and greater heat-conducting capacity. AmerTran coil winding methods add up to close conformity to specifications, uniformly excellent characteristics, and usually a consumer saving for a specific type and quality of transformer.



Products:

Audio Transformers and Reactors. Modulation Transformers (to 500 KVA). Hermetically sealed Transformers. Plate and Filament Transformers. Filter Reactors. Wave Filters. High Voltage Rectifiers. Microphone and Interstage Transformers. Transtat A. C. Voltage Regulators. Other Electronic and Industrial Transformers.

AMERICAN
TRANSFORMER
COMPANY

178 EMMET STREET
 NEWARK 5, N. J.

AMERTRAN
REG. U. S. PAT. OFF.
MANUFACTURING SINCE 1901 AT NEWARK, N. J.

Pioneer Manufacturers of Transformers, Reactors and Rectifiers for Electronics and Power Transmission



Here's a heart-throbbing story



The Cardiotron is a product of Electro-Physical Laboratories, Inc., 25 West 18th Street, New York 11, N. Y.

THE new Cardiotron, a direct-writing medical instrument, makes an instantaneous tape recording of heart action, permanently visible the instant it occurs. Shown at left, this ultra-sensitive device uses four G-E Neon Glow Lamps, engineered into the product design, to provide these sales-making protection features:

- (1) quick visual indication of proper grounding and current flow,
- (2) correct connection to AC,
- (3) protection against surges, and
- (4) good voltage regulation.

-and it can improve your product

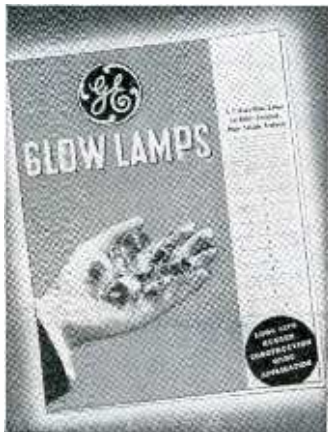
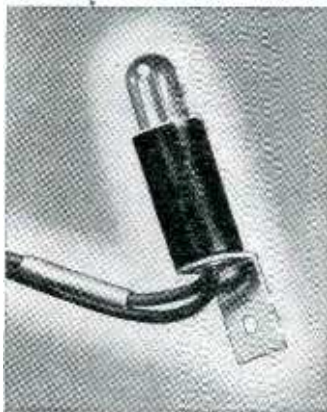

TYPICAL new and practical uses of G-E Glow Lamps are shown at left. They merely hint at hundreds of almost unbelievably low cost applications on home appliances, wiring devices, and many types of industrial equipment. Why not consider these distinctive sales features of G-E Glow Lamps on *your* products:

1. Distinctive orange red glow, needs no cover glass.
2. Dependable long life—rated at 3,000 hours.
3. Very low current consumption.
4. Variety of sizes and wattages.
5. High resistance to vibration and shock.
6. Usable on AC or DC circuits.
7. Work on regular 105-125 volt circuits without the use of step-down transformers.
8. Practically no heat.

FREE NEW FOLDER describes typical uses for G-E Neon Glow Lamps and gives lamp data. Write address below.

G-E LAMPS

GENERAL  ELECTRIC

Nela Specialty Div. Lamp Dept., 1 Newark St., Hoboken, N. J.

Your SHURE *Glider* Pickup Check List

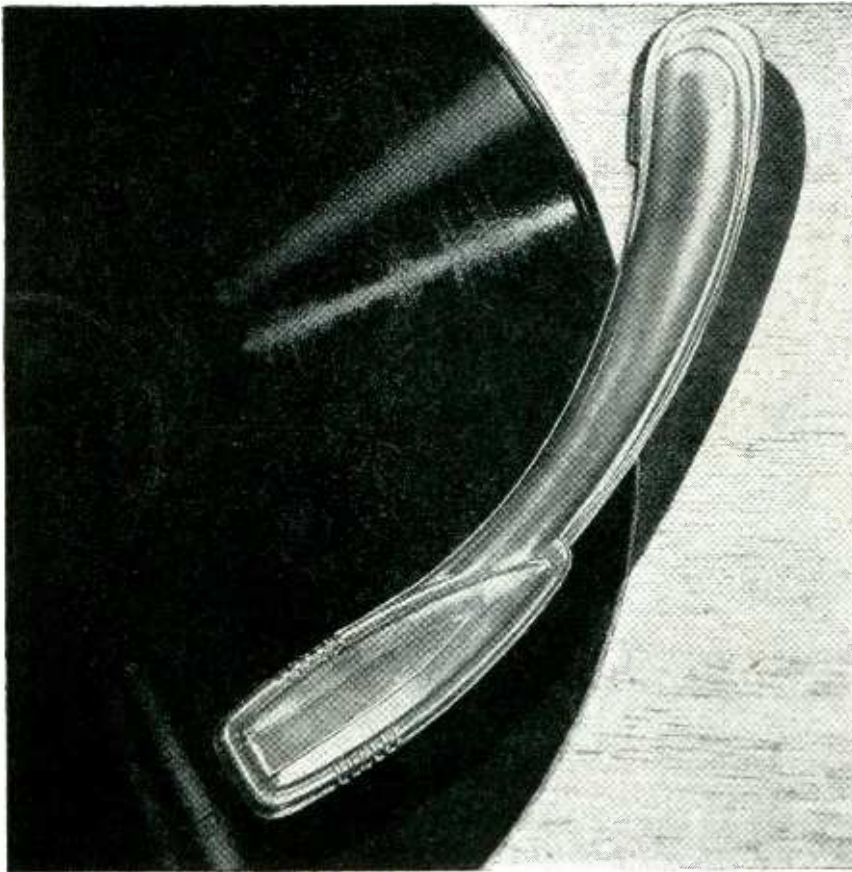

✓ low mass	✓ no springs no counterweights
✓ faithful tracking	✓ absorbs shocks
✓ higher output	✓ longer record life
✓ greater lateral needle point compliance	✓ clearer, fuller tone qualities
✓ 1½ oz. needle force	✓ lever-driven crystal

MODEL 93A—\$5.50 LIST

Immediately Available at Shure Distributors Everywhere
 Patented by Shure Brothers. Licensed under the Patents of the Brush Development Company

SHURE BROTHERS

Designers and Manufacturers of Microphones and Acoustic Devices
 225 West Huron Street, Chicago 10, Illinois
 Cable Address: SHUREMICRO



is one special frequency which produces super results not possible at a frequency slightly different.

(2) That higher frequency will always give better results.

(3) That there is something magic about a Btu of electronic heat.

(4) That electronically heated material escapes the conventional laws of thermo-dynamics, chemistry, etc, and that nothing limits the maximum speed of electronic heat.

(5) That dielectric fields, as such, have germicidal power.

(6) That electronic heaters have some mysterious effect upon persons.

The special-frequency fallacy seems logical until one runs tests on food

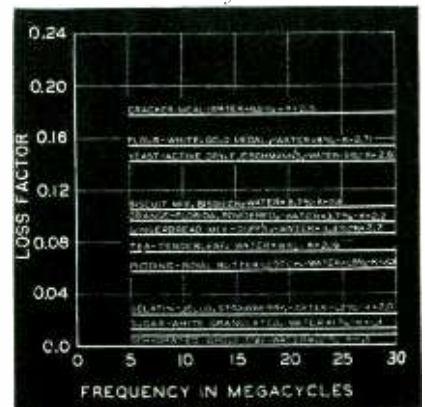

Fig. 4—The electrical loss factor of food is practically constant over a wide frequency range

after food as represented in Fig. 4. Over the usable frequency range, we have no magic frequency and could use almost any practical value as long as it is effective and does not require too high a voltage across the product. In spite of exceptions in the chemical field, it may be stated that thus far no magic frequency has basis for recognition in the heating of food products.

Use of a higher frequency sounds progressive but it gives better results only if lower work voltages are essential or if some unusual circumstance exists.

Electronic heater fields have neither germicidal power nor human sterilization power. They are merely capable of producing heat in a faster and more effective manner. The heat so created may be more advantageously located but it behaves exactly



*for any type
of application*

BLILEY has the crystals

Bliley
CRYSTALS

To name all the engineers who "consult Bliley first" on frequency control problems would make a mighty impressive list

They know from experience that Bliley engineers are always working in advance of the industry's requirements, and that the right crystal for

their particular application will be available without undue delay.

That is why Bliley acid etched* crystals persistently show up wherever important developments are taking place in the communications field—and go with those developments to all parts of the globe.





Your products, too, will benefit if you make it a habit to "consult Bliley first" on frequency control problems. There's over 15 years of quartz crystal engineering experience at your beck and call.

* Acid etching quartz crystals to frequency is a patented Bliley process.

For complete listing of Bliley crystals now available see Bulletin E-27

BLILEY ELECTRIC COMPANY • UNION STATION BUILDING, ERIE, PENNSYLVANIA



STOVE BOLTS	MACHINE SCREWS	WOOD SCREWS	HARDENED, SELF-TAPPING SHEET-METAL SCREWS	
				
			TYPE A	TYPE Z
SCREWS AVAILABLE IN THESE METALS:				
STEEL	COM. BRONZE	MONEL METAL		
BRASS	STAINLESS STEEL	EVERDUR		
	ALUMINUM			

...And Each Screw is Available with all Commonly Used Heads...

**You can get the SPECIAL SAVINGS
of AMERICAN PHILLIPS SCREWS
in any type...with any head...in any metal**

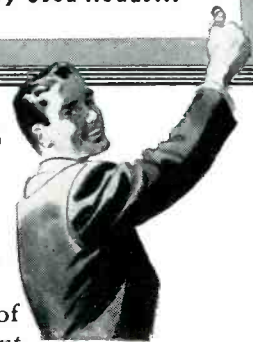

No other screw-driving method can give you the time-savings of American Phillips Screws—*as much as 50% under your present assembly time.* American Phillips Screws give you the self-aligned fit between screw and bit . . . the fumble-proof ease of driving . . . the slash-proof protection for work surfaces . . . and the value-protection for *you* that comes from American's quality-control and 4-phase inspection, assuring higher perfection-percentage in every order marked "*American brand.*"

And nowhere can you find a more complete line, especially in the range of *rust-resistant metals* . . . aluminum, monel, everdur, and particularly stainless steel. American specializes in Phillips Screws of stainless steels in many different analyses, according to specifications dictated by different uses. So make use of American's unrivalled experience and know-how in metallurgical research. Write today for advice on American Phillips Screws of the type and metal that will do the best job on your fastening problem . . . and the best job of cutting your assembly costs to a new low.

AMERICAN SCREW COMPANY, PROVIDENCE 1, RHODE ISLAND
Chicago 11: 59 E. Illinois Street Detroit 2: 502 Stephenson Building

**You've got Thousands to Gain—and Nothing to Lose
WHEN YOU CHANGE TO:**

**AMERICAN
PHILLIPS** *Screws*

More for the Money

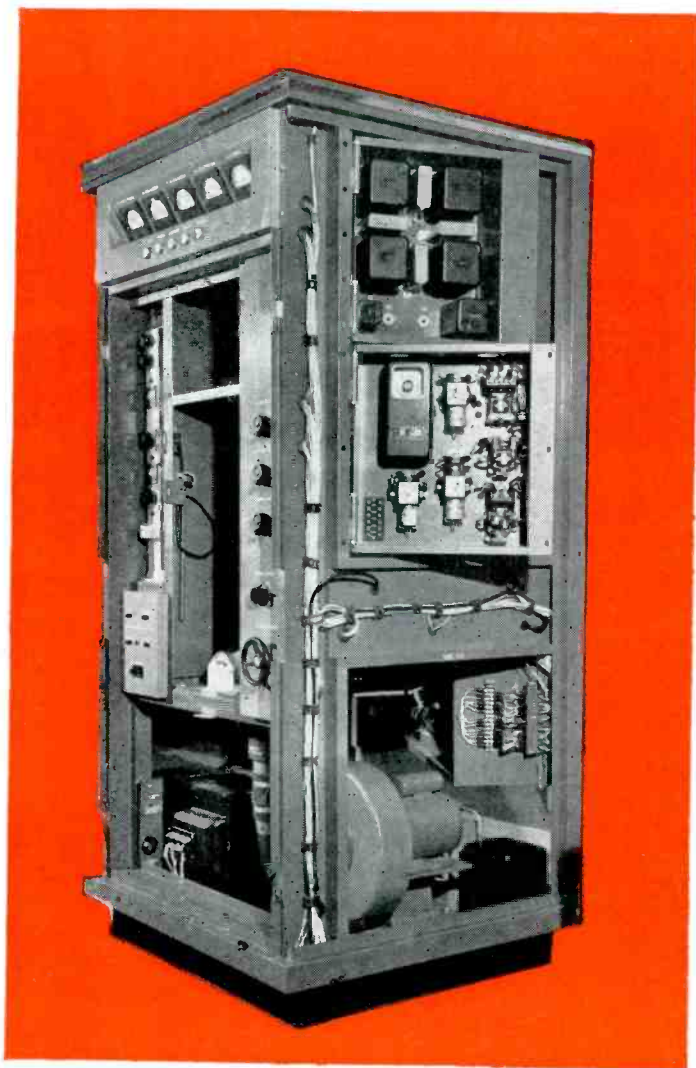

An FM transmitter is not something you buy every day . . . it must serve you a *long time*. It should therefore be purchased with the greatest of care.

REL FM transmitters are built with one basic idea in mind — to incorporate every single feature demanded by the Broadcaster. That is why so much attention has been directed toward providing **maximum performance, reliability, simplicity, accessibility** of all parts—and use of the best components.

It is REL'S constant specialization and concentration on manufacture of FM equipment specially designed to meet the requirements of the Broadcaster that makes it possible to offer such fine equipment at such low prices.

Investigate before you buy! If your location permits, visit our plant and see the REL transmitters in production . . . or consult our nearest sales representative for further details.



Sales Representatives

SOUTHEAST

John F. Bivins
1008 Wellington Road
Highpoint, North Carolina

Electronic Supply Co.
112 North Main Street
Anderson, South Carolina

PACIFIC COAST

Norman B. Neely Enterprises
7422 Melrose Avenue
Hollywood 46, Cal.

MIDWEST

REL Equipment Sales, Inc.
612 N. Michigan Blvd.
Chicago, Ill.

MICHIGAN

M. N. Duffy & Co., Inc.
2040 Grand River Ave. W.
Detroit, Mich.



PIONEER MANUFACTURERS OF FM TRANSMITTERS
EMPLOYING ARMSTRONG PHASE SHIFT MODULATION

RADIO ENGINEERING LABS., INC.

Long Island City, N.Y.

New CANNON PLUG meets radio standardization demands

R-F BAKING

(continued)

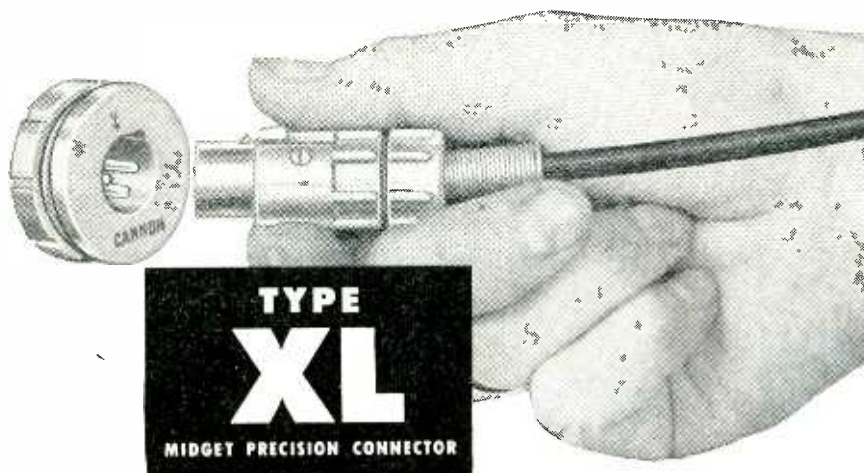

Designed for all low-level sound transmission circuits

... Cannon high quality at a new low price

For 15 years Cannon Plugs have been standard equipment on the best microphones, sound systems and other broadcast equipment. Now, with the trend toward parts standardization and the demand for more compact fittings, Cannon Electric introduces the new "radio universal" Type "XL"—manufactured with the well-known Cannon quality, at a new low price.

Check these SPECIAL ENGINEERING FEATURES:

1. Convenient latchlock to hold connection tight.
2. Extremely light weight (as low as 1½ ounces).
3. Compression gland with cable relief spring.
4. Polarized connection.
5. Smart, modern design.



All the quality features you expect in any Cannon Plug are built into the new "XL"—ample voltage and amperage capacities, specially positioned grounding contact, all screw threads tapped in metal, high quality molded insulation.

Ready now are two plug types and four receptacle types with three contacts of 15-amp capacity for No. 14 B&S wire.

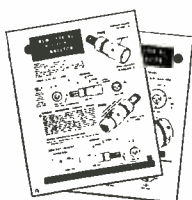
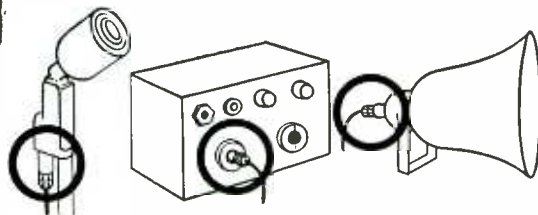

CANNON ELECTRIC

Cannon Electric Development Co., Los Angeles 31, Calif.

Canadian Factory and Engineering Office:
Cannon Electric Co., Ltd., Toronto, Canada

REPRESENTATIVES IN PRINCIPAL CITIES — CONSULT YOUR LOCAL TELEPHONE BOOK



Get this

Special "XL" Bulletin. Write Dept. A-287, Cannon Electric Development Co., 3209 Humboldt St., Los Angeles 31, Calif.

like a Btu from any other heat source.

In other fields we may reasonably expect to see electronic defrosters developed for commercial kitchens and for frozen food stores.

Electronic cookers for special restaurant and domestic use are practical but still expensive and additional development is indicated. The heating fixture and work mechanization requires job engineering in every case and since the job will decide what the electronic heater must be capable of doing, it necessarily follows that the purchase of equipment for an industrial application should be based upon the recommendation of experienced industrial electronic engineers.

Operating Costs

The maintenance problem is confined to routine inspection and the replacement of tubes (average life 2,000 hours). Service cost records, based on several hundred r-f generators ranging in output from three to 75 kw and located throughout the East and Middle West, have indicated an average annual maintenance cost approximately five percent of the purchase price of the generator.

The total of all elements of operating cost rarely exceeds 10 cents per hour per kw of output. A three-kw output unit costs about 30 cents per hour to operate whereas a 25-kw output unit can be operated for only \$1.30 per hour, which is less than six cents per hour per kw of output.

These figures take into consideration an overall electrical efficiency of 50 percent, conservative tube life of 2000 hours, equipment life of ten 2400-hour work-years (300 days × 8 hours), and annual maintenance cost equal to 5 percent of purchase price.

• • •

Electronic Contactors for Control Applications

W. D. MACGEORGE
Technical Consultant
Automatic Temperature Control Co., Inc.
Philadelphia, Pa.

INDUSTRIAL MACHINE and process operations provide a wide field for application of electronic relays and, since their construction presents no appreciable problem, new designs

U. H. F. and other measurements, easily, quickly—at your fingertips

- ★ 25 Millivolts AC Full Scale
- ★ 700 Megacycles Frequency Range
- ★ 7 Micro-Microfarads Input Capacity

**FOR
IMMEDIATE
DELIVERY**

with the new Reiner Model 451

**Vacuum Tube
Voltmeter
and Model 101
Amplifier**

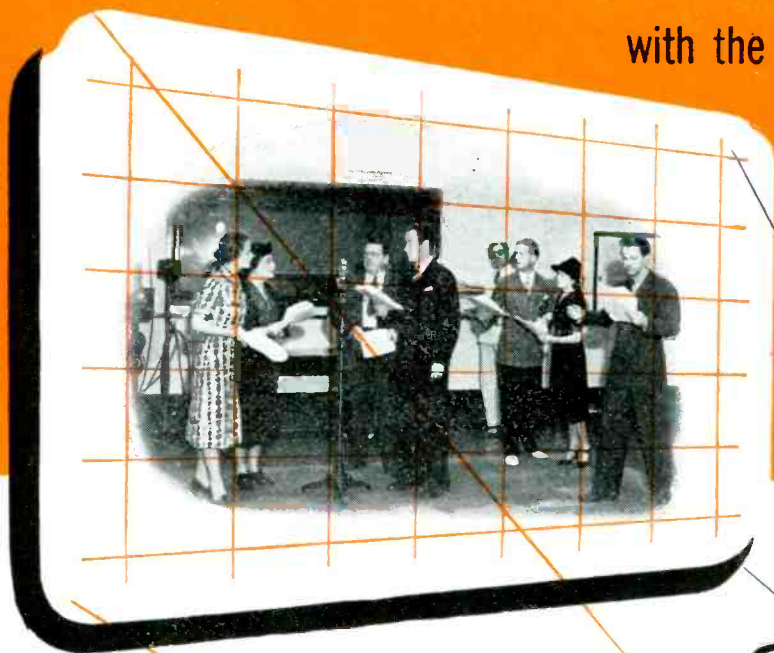

RANGES:

- A. C. VOLTS: 0 — .025 — .1 — .25 (with amplifier) —
2.5 — 10 — 25 — 100 — 250 — 1000
- D. C. VOLTS: 0 — 2.5 — 10 — 25 — 100 — 250 — 1000
- D. C. CURRENT: 0 — 2.5 — 10 — 25 — 100 — 250 — 1000 Ma.
- OHMS: .1 ohm to 1000 megohms
- A. C. FREQUENCY RANGE: 10-5000 cps. (with amplifier) — 50 cps.
to 700 megacycles
- ACCURACY: 2% on full scale — D. C. volt, ohm and current;
2%, 50 cps to 50 megacycles, A. C. volt; 5%
accuracy entire A. C. frequency range

- OTHER FEATURES** Wide Frequency Range • High Input Impedance • One Linear Scale for all Voltage and Current Scales • Wide Voltage Range • Single Zero Adjust for all A. C. and D. C. ranges • Voltage Regulated Supply—Stable Operation • Accuracy 2% of full scale values • Large Overvoltage Capacity • Compartment for Accessories prevents losing or mislaying them; • Many other time-saving, convenience features

MODEL 451, complete with Amplifier Model 101
weighs 20 lbs.; Size: 10 $\frac{3}{4}$ " x 9" x 8".

For more information on this and other Reiner equipment such as square wave generators, oscilloscopes and signal generators, write Reiner Electronics Co., Inc., 152 W. 25th St., New York 1, N. Y.

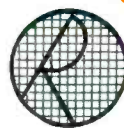

Reiner
ELECTRONICS

LOW FREQUENCIES
ACCURACY TO 1/1,000th of 1%

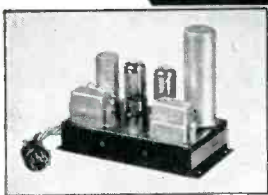
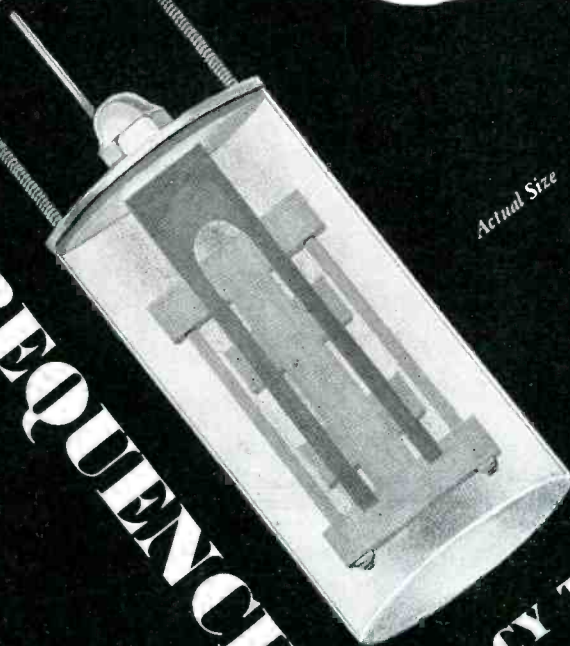

TOP
FREQUENCY STANDARD
(60 cycle) for use with external power supply

CENTER
CHRONOGRAPH
Records time intervals with resolution to .001 second

BOTTOM
FREQUENCY STANDARD
(120 cycles) with self-contained power supply

These tuning forks which include new engineering principles, provide frequencies from 120 to 1,000 cycles directly with an unqualified guarantee of accuracy to 1 part in 100,000 over a wide temperature range. (Better than 1 second in 24 hours). Closer tolerances are obtainable on special order.

These tuning fork assemblies are available only in single or multi-frequency instruments of our own manufacture which are de-

signed to test, measure or control other precision equipment by mechanical, electrical, acoustical or optical means.

The dependability of these frequency standards is being demonstrated for myriad purposes in all climates and under all working conditions.

If you have need for low frequency standards of exceptional accuracy, your inquiries are invited.

American Time Products, Inc.

580 Fifth Ave.

New York, N. Y.

Dist. of Western Electric & **Watch Master** Watch-rate Recorders



.....

Get the **RIGHT ANSWERS**

—when you choose **Black Line Equipment!**

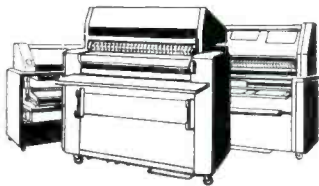

WHAT SIZE MACHINE SHOULD I BUY? Your machine should have ample capacity for peak loads, but you should not pay for excess capacity which you will not use. The Bruning BW System not only provides a careful analysis of your print needs, but also makes available the exact size machine to fit your needs—thanks to the completeness of the BW line. (Illustration shows only a few of the many BW machines available.)

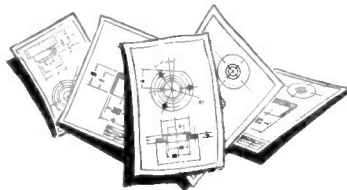

.....

HOW MANY TYPES OF PRINTS WILL I NEED? Your black line equipment should be capable of providing various kinds of prints for departmental differentiation. The Bruning BW System provides black line prints on white paper, black lines on green paper, red line and brown line prints. In addition, there are BW Transparents and BW Film for special purposes.



.....

WHAT ABOUT SERVICE? Bruning representatives sell a complete line of engineering and drafting supplies . . . all the way from tracing paper to drafting machines. Therefore, Bruning has a continuing interest in you as a BW customer . . . and Bruning experience is always available to help you get the most out of your BW machine.

.....

You Get These Six Major Advantages With the **BRUNING BW SYSTEM**

1. A versatile, simple method for making black line prints directly from tracings.
2. 17 years' experience in analyzing printmaking needs.
3. A complete line of materials, including white and green-tinted papers, thin, medium and heavyweight papers, black, red or brown line prints, BW Transparents to supplement original tracings and BW Film for intensifying pencil lines on tracings.
4. A complete line of printing and developing machines to fit every requirement.
5. A continuing service . . . because Bruning sells everything for the engineer and draftsman, not just BW equipment. Buying a BW machine is, therefore, not a "one time sale."
6. Continuing research and development in the customer's interest.

.....

CHARLES BRUNING COMPANY, INC.

Since 1897

NEW YORK

Atlanta
Kansas City
St. Louis

CHICAGO

Boston
Milwaukee
San Francisco

LOS ANGELES

Detroit
Newark
Seattle

Houston
Pittsburgh

.....

CHARLES BRUNING COMPANY, INC.
4712-16 Montrose Avenue, Chicago 41, Illinois
Gentlemen: I want to know more about Bruning BW Prints and equipment. Please send me information.

Name

Company

Street

City

Now available - an
**ELECTRONIC
 VOLTMETER**

BATTERY OPERATED

THIS MODEL 302

Sensitive Electronic Voltmeter is a new battery operated version of the standard Model 300 A.C. operated voltmeter. Operates from light-weight batteries contained within the carrying case.



**MODEL 300
 AC operated**



Incorporating the popular single logarithmic voltage scale and uniform decibel scale, the Model 302 battery operated instrument retains all of the desirable features and performance of the standard Model 300 AC operated voltmeter illustrated at the left.

Voltage Range = .001 to 100 volts
Frequency = 5 to 150,000 cycles
Accuracy = 2% at any point on scale

The Model 302 Voltmeter will be found useful where A.C. supply is not available, as for example in airplanes, boats, automobiles, in the field, etc. Also valuable for making measurements on ungrounded and symmetrical circuits. Batteries meet JAN specifications.

Send for Bulletin for further description



BALLANTINE LABORATORIES, INC.

BOONTON, NEW JERSEY, U. S. A.

are appearing frequently. Basically, however, these electronic relays may be divided into three main groups: the vacuum-tube type, the cold-cathode type, and the hot-cathode type.

Vacuum-tube Type

Figure 1 shows a fundamental circuit for this type of unit. Tube V_1 , usually a medium- μ triode such as the 6J5, is biased to, or near, cutoff by the bias supply B_2 . In this condition, little or no current flows through the plate-cathode circuit.

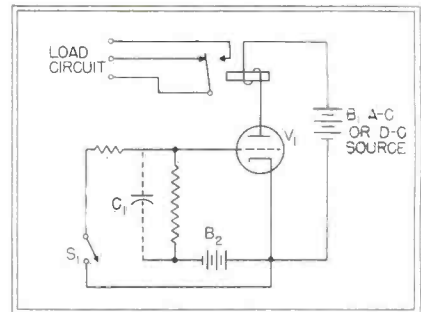

Fig. 1—Circuit of electronic relay using a vacuum tube. Addition of capacitor C_1 provides delayed action

When the control contacts S_1 are closed, the grid of the tube is connected directly to the cathode. This reduces the bias on the tube to zero and a current of between six and ten milliamperes flows through the relay and pulls it in.

The current-multiplying effect of such a circuit is large. With a bias voltage of -10 volts and a grid resistor of two megohms, the maximum current that can flow through the control contacts S_1 will be five microamperes.

The contacts on the relay can be easily designed to handle a single or dual three-ampere inductive circuit. This gives in effect a current amplification of $3,000,000$ or $600,000$. For noninductive circuits, the relay contacts can be rated at a higher current capacity and the amplifying factor may run as high as two or three million.

If the contacts S_1 form a high resistance when they are in the closed position, the bias will be only partially removed from the grid of the tube and the plate current will not rise to its full value. This may cause the relay action to be erratic and prevent snap action.

This type of electronic relay has



**ANOTHER HISTORIC EVENT
— ON audiodescs**

RADAR contact with the moon, broadcast over the nation-wide facilities of the Mutual Broadcasting System on Sunday, January 27th, emphasized once again the essential value of recording in radio broadcasting.

* * * *

From their Belmar, New Jersey laboratories, engineers of the Army Signal Corps made this memorable contact early in the morning of January 27th, while in the studios of WOR-New York, the Special Features Division of MBS were recording the event on an AUDIODISC. A few hours later, at a more appropriate time, the recorded program was broadcast to the nation.

* * * *

In this, as in countless other instances, AUDIODISCS have made it possible for radio listeners to hear a history-making event exactly as it occurred with all the true fidelity of a "live" broadcast.

AUDIO DEVICES, INC.,

**444 Madison Avenue,
New York 22, N. Y.**

*Audiodescs manufactured in
U.S.A. under exclusive license
from La Societe Des Vernis Pyro-
lac—France.*



... they speak for themselves **audiodescs**

PERMANENT MAGNETS MAY DO IT BETTER

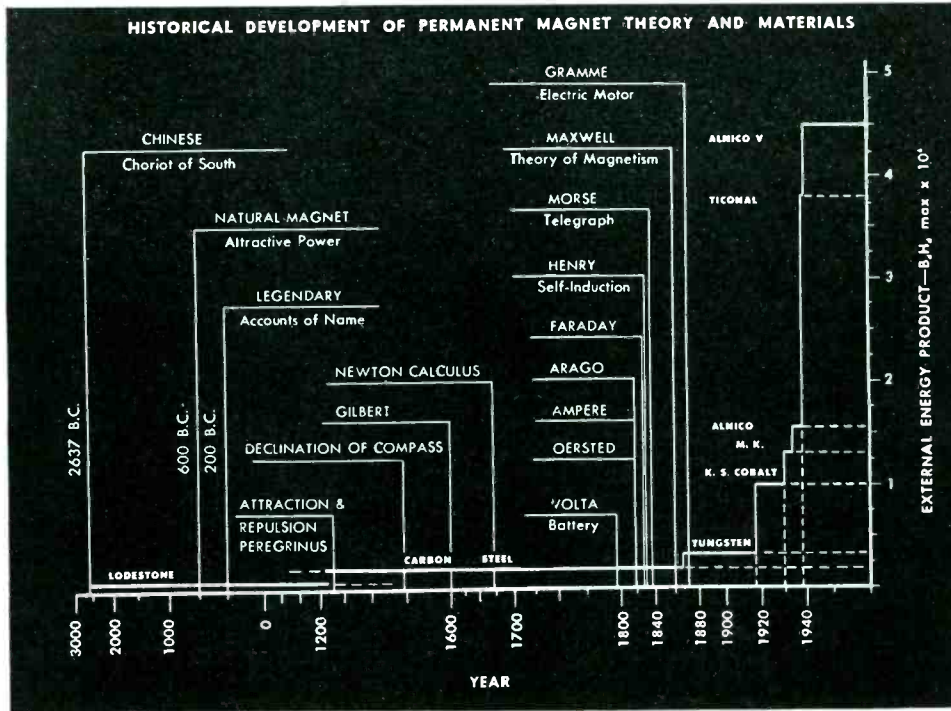

PERMANENT MAGNETS HAVE SERVED MANKIND SINCE 2700 B. C.

The magnet, one of mankind's oldest servants, has contributed much to the advancement of civilization. Primitive compasses utilizing the lodestone, a crude permanent magnet, were used by the Chinese about 2700 B.C. The term "magnet" is said to have derived from *Magnesia*, a city in Asia Minor where many such lodestones were found.

While the compass using the magnet became a valuable aid to navigation and exploration through the centuries, it was not until the 19th Century that important strides were made in discovering other uses; and only in the last two decades that the powerful alloys were developed from which are made the permanent magnets that serve modern communication, transportation, industry and science in their myriad of diversified uses.

Infinitely more power can now be packaged in smaller, more compact magnet designs with the new high-energy alloy materials—such as Alnico V. More than 24,000 permanent magnet applications have been developed by *The Indiana Steel Products Company*, manufacturers of "Packaged Energy" exclusively for over 35 years. "Packaged Energy" may do some job or process better in your industry. We invite you to consult with our engineers. For data on permanent magnet application, write for "Permanent Magnet Manual," prepared by *The Indiana Steel Products Company*.

Producers of "Packaged Energy"

© 1946, The Indiana Steel Products Co.



THE INDIANA STEEL



PRODUCTS COMPANY



6 NORTH MICHIGAN AVENUE, CHICAGO 2, ILLINOIS



SPECIALISTS IN PERMANENT MAGNETS SINCE 1910

For linear variation of light output with current

SYLVANIA GLOW MODULATOR TUBES

The Glow Modulator Tube 1B59/1130B produced by Sylvania Electric is designed to meet the needs of practically any application requiring an essentially linear relationship between current and light output.

In this crater-type tube, a high ionization density is obtained. In addition, the discharge is viewed in depth. These two factors combine to provide a high effective density.

Electrical Ratings:

Operating Voltage	140 volts max.
Operating Current	5–35 ma.
Starting Voltage	225 volts max.
Modulating Frequency	
Range	15–15,000 c.p.s.
Useful Light Range	3500–6500 Angstroms
Filament Voltage	None: Cold Cathode

Applications

The high-intensity light output of Sylvania Glow Modulator Tubes, and their virtually linear relationship between current and light output, suggest many fields of application, such as:

- Facsimile recording
- Sound on film
- Oscillograph timing markers
- Stroboscopic devices
- Seismograph recorders
- Photoelectric counters

Sylvania engineers will be glad to work with you in exploring specific fields of application for Glow Modulator Tubes.



The Sylvania Glow Modulator Tube 1B59/1130B

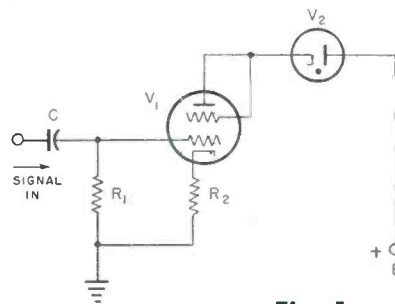

- E +300 volts d-c
- C 0.05 microfarad
- R₁ 0.5 megohm
- R₂ 675 ohms
- V₁ 6L6G
- V₂ 1B59/1130B

Fig. 1

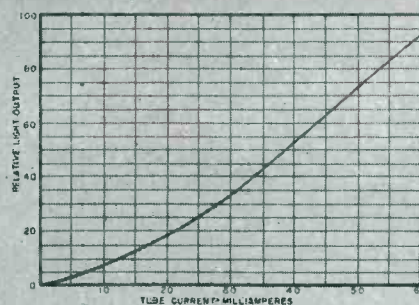

Relationship between light output and current in the 1B59/1130B

Fig. 2

SYLVANIA ELECTRIC

Electronics Division . . . 500 Fifth Avenue, New York 18, N. Y.

MAKERS OF ELECTRONIC DEVICES; RADIO TUBES; CATHODE RAY TUBES; FLUORESCENT LAMPS, FIXTURES, WIRING DEVICES; ELECTRIC LIGHT BULBS

PRODUCT REDESIGN

Problem: Redesign intricate push-button switch parts. Parts must have good insulating properties, permanency of finish and appearance.

Solution: Molded INSUROK—because it can be precision molded into practically any form—makes available many new design and structural possibilities. Threads, holes, trade-marks—can be molded right into INSUROK parts and no further finishing is required after molding.

Whether you are designing a new product or redesigning a present one—let Richardson Plasticians help you. They are highly trained in the proper use of INSUROK Precision Plastics, and will show you new ways to higher profits and greater satisfaction. Write today!

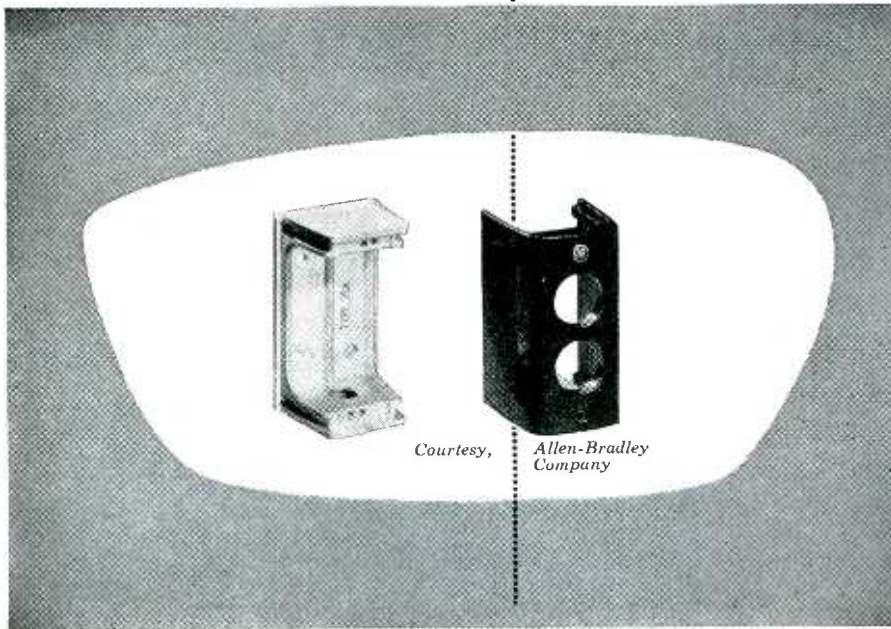

Courtesy, Allen-Bradley Company

INSUROK Precision Plastics

The RICHARDSON COMPANY

LOCKLAND, CINCINNATI 15, OHIO FOUNDED 1858 Sales Headquarters: MELROSE PARK, ILL.

Sales Offices: NEW YORK 6 • CLEVELAND 15 • DETROIT 2

Factories: MELROSE PARK, ILL. NEW BRUNSWICK, N. J. INDIANAPOLIS, IND.

time-delay action. Since the bias circuit of the tube must be direct current to obtain proper operation, resistive and capacitive components can be added to delay the action of the grid and therefore, of the relay. A suitable capacitor connected as C_1 in Fig. 1 will serve this purpose. The relay then will not respond to very rapid changes in contacts S_1 and for this reason, contact chattering can be minimized and suitable time delays for certain applications can be introduced.

Cold-cathode Tube

Figure 2 illustrates the fundamental circuit given in tube manuals for a radio-frequency-controlled relay. Tube V_1 could be an OA4G cold-cathode gas triode, or a similar tube. Resistors R_1 and R_2 are proportioned

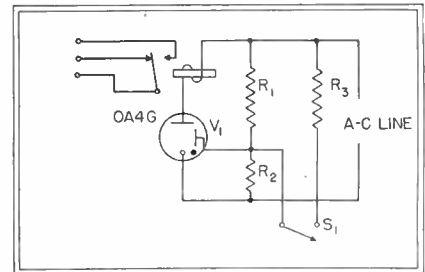

Fig. 2—Conventional relay circuit for a filamentless cold-cathode tube

so that the igniter electrode will normally be maintained below its firing potential. The control contacts S_1 , when closed, raise the igniter potential by means of paralleling resistor R_3 and fire the tube. A relay current of twenty-five milliamperes is usually maximum for this type of tube.

As soon as the control contacts are opened, the igniter is returned to its original potential and the tube will cease firing on the first a-c supply cycle that makes the anode of the tube negative to the cathode. In all relay circuits where a-c is used and the tube acts as a half-wave rectifier, the relay is subjected to half-wave pulses and must either be a fully shaded pole a-c type or must be paralleled with a suitable filter capacitor to smooth out the half-wave pulses and prevent chattering.

Assuming a 115-volt, rms, a-c supply for the circuit shown in Fig. 2, the peak anode-cathode voltage would be 154 peak volts and the igniter

ML889A

Machlett improved design

provides longer life and better performance



The ML889A and ML889RA are outstanding examples of Machlett's ability to apply its time-tested and advanced techniques to tubes of standard design with resulting improvement in construction, performance and life. They incorporate the "know-how" that has made Machlett electron tubes demonstrably superior since 1897. Consider these advanced features that give you better tubes with longer and more uniform performance:

1. Heavy Kovar sections are used instead of the conventional and more fragile feather-edge copper seals. Result—greatly increased mechanical strength, lessening danger of breakage in handling and installation.
2. Filament and grid terminals are solid, continuous and of high conductivity copper. Contact surfaces gold-plated to minimize contact resistance.
3. Special grid and filament assembly reduces lead inductance, permitting safer operation as high as 50 mc. with full input and output.
4. Internal structure greatly strengthened, assuring constant and more uniform grid-filament-plate spacing.
5. One piece copper anode and shield assure uniform internal surface, permit maximum accuracy of assembly, provide complete

shielding of anode seal and reduce difficult-to-outgas inter-faces normally found in tubes of this type.

6. All internal parts completely processed by Machlett's special techniques which prevent contamination and assure complete and permanent out-gassing.

7. Tube "pumped" by unique Machlett straight line, high voltage exhaust process assuring same high standards as characterize the Machlett line of high-voltage X-ray tubes.

These perfected tubes for high frequency heating and communications purposes constitute a further contribution by Machlett of quality, durability and long life to the electron tube art. Now available for initial installation and renewal purposes. For further details, write Machlett Laboratories, Incorporated, Springdale, Connecticut.

General Characteristics — ML889A

Filament Voltage.....	11 volts
Filament Current.....	125 amperes
Amplification Factor.....	21
Maximum Frequency for Full Power	50 mc.
Capacity, Grid to Plate.....	17.8 uuf.
Capacity, Grid to Filament.....	19.5 uuf.
Capacity, Plate to Filament.....	2.5 uuf.
Cooling	Water
Water	3-6 gals./min.
Air (ML889RA)	15 cfm.

At reduced power, may be operated at frequencies as high as 150 megacycles.



ML889RA, Air-cooled version of the ML889A, may be operated at full output at frequencies up to 25 megacycles, at reduced power up to 100 mc.

MACHLETT

APPLIES TO RADIO AND INDUSTRIAL USES
ITS 49 YEARS OF ELECTRON TUBE EXPERIENCE

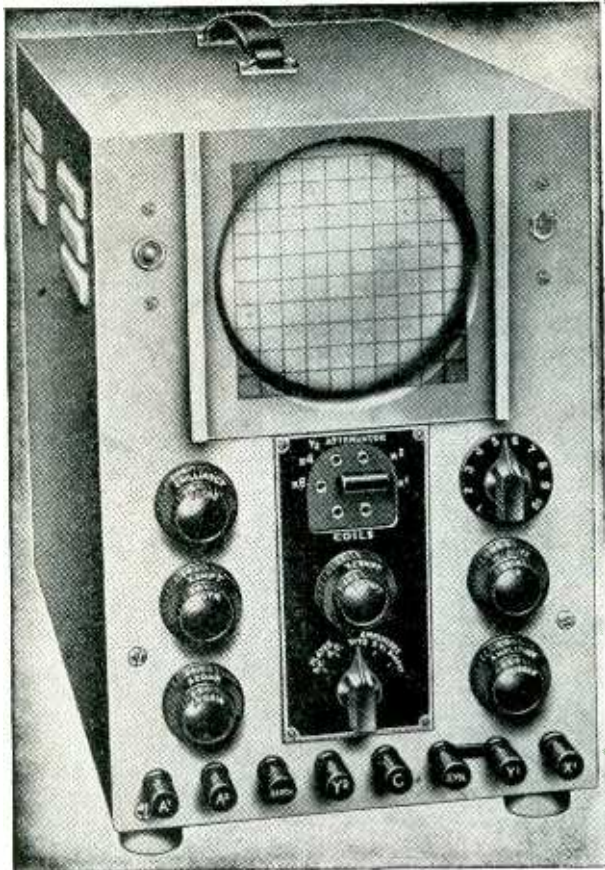

presenting the

DOUBLE

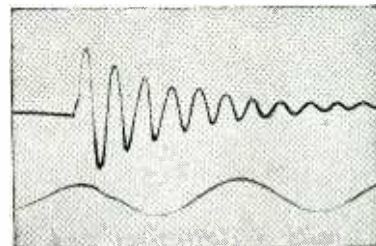

BEAM

OSCILLOGRAPH

Model 339 D. B. OSCILLOGRAPH. PRICE £40 Net F.O.B.

APPROXIMATE PERFORMANCE DATA

TIME BASE . . . 5 — 250,000 c.p.s.

AMPLIFIER	Gain	Frequency Band in c.p.s. — 3db.	Sensitivity mV.RMS/mm
1 stage	28	10 — 100,000	43.0
2 stage High Gain	900	10 — 100,000	1.3
Wide Band	106	10 — 2,000,000	10.0

Seven years after its appearance in 1938, the Cossor Double Beam Oscilloscope is still unique. The intrinsic value of the technique introduced by this instrument, which provides true *simultaneous indication of any two effects* on a common time axis, has long been proved in all fields of research and production testing—both on recurrent and transient work. It is an understatement to say that practice has revealed no sphere of investigation where its use is not at least advantageous. Although of enhanced performance, the instrument is in essence, an oscilloscope of conventional design in which, through the interchangeability of COSSOR single and double beam trapezium-corrected tubes, true double beam technique has been provided without inherent limitations or distortions. These fundamental qualities have been responsible for its selection as the standard Oscilloscope for most of the Allied Nations' Armed Services. Thus precluded earlier from acquainting American users of the "double beamer", we are now able to make good this omission and satisfy also the friendly urging of A.E.F. Technicians who have all wanted "the folks back home" to know about it.

A. C. COSSOR Ltd

INSTRUMENT DIVISION

HIGHBURY

LONDON N.5.

ENGLAND

CABLE ADDRESS: Amplifiers London

CABLE CODES: Bentley's

AGALLOY

SMALL COLD DRAWN
SEAMLESS AND WELDED TUBING



The big advantages of AGALLOY small tubing are:

Proper inside and outside surface conditions . . . Processed to bend and form as required.

Corrosion-resistant, heat resistant, dimensional accuracy:

Stainless (Types 304, 308, 316, 446 and others) . . . Monel metal
317, 321, 329, 347, 410, 430, . . . Nickel . . . Inconel . . . L Nickel.

Available in sizes 5/8-inch outside diameter and smaller

AGALLOY TUBING COMPANY

75 WEST STREET, NEW YORK 6, N. Y.

Chicago Office:
221 North La Salle Street, Chicago 1, Illinois

Mill:
Springfield, Ohio

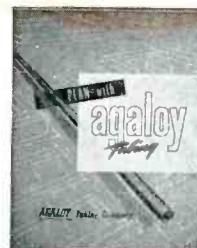

Send for your copy
"Plan with Agalloy
Tubing"

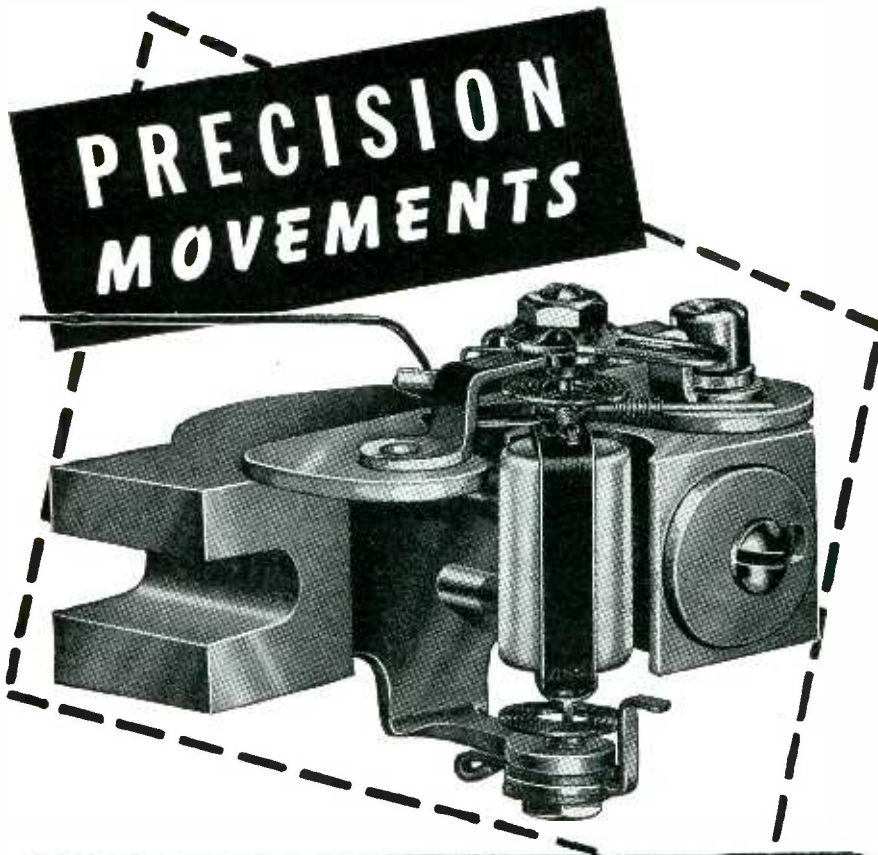

**PRECISION
MOVEMENTS**

Burlington
PANEL INSTRUMENTS



The heart of every Burlington Instrument — and the reason for its high degree of dependability — is the Burlington Precision Movement.

Design, material, and manufacturing processes are selected in such a manner that Burlington gives you a rugged instrument — which may be subjected to rough usage — and

still retain its original calibration characteristics. All DC instruments employ Alnico magnets which are known to be more highly resistant to shock, heat, vibration, and stray fields than any other magnetic material.

All ranges AC & DC are available in 2½", 3½" and 4½" sizes, both square and round, flush mounting.

Engineering Service Furnished for Specialized Applications. No Obligation. Write Today for Further Information.

BURLINGTON INSTRUMENT CO.

108 FOURTH STREET BURLINGTON, IOWA

PANEL INSTRUMENTS • VOLTAGE REGULATORS • AUTOMATIC SYNCHRONIZERS • FREQUENCY REGULATORS

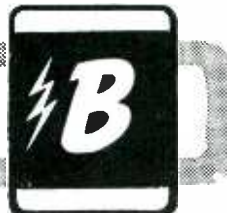

electrode should be maintained at approximately 60 peak volts to prevent firing. To insure ignition for run-of-the-mill tubes, this potential should be raised to 90 peak volts when control contacts S_1 are closed. If R_1 is 150,000 ohms and R_2 is 100,000 ohms, the additional current required through R_2 to raise the igniter to the firing potential of 90 peak volts will be 90 – 60 volts/100,000 ohms, or 0.0003 ampere. This additional current would be obtained through resistor R_2 and would have to pass through control contacts S_1 .

Limitations

Increasing the values of resistors R_1 and R_2 would reduce the control current requirements proportionally, but their values cannot be made too large because the igniter current required to fire the tube is appreciable (approximately 100 microamperes), and an excessive voltage drop through R_1 , when the tube fired, would cause unstable operation. To supply the 0.0003-ampere control current, R_2 would require a value of 413,333 ohms.

The cold-cathode circuit is simple to construct and, if the tubes used are reasonably uniform, will give satisfactory results for most applica-

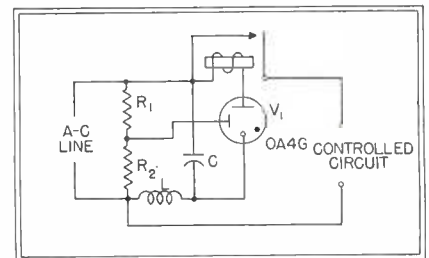

Fig. 3—Actuation by a specific carrier frequency is provided by adding a tuned circuit to Fig. 2

tions. This circuit has certain disadvantages, such as the necessity for handling rather high potentials in the control circuit, and the limitation of the relay current to 25 milliamperes.

The relay circuit shown in Fig. 3, is an interesting application of the cold-cathode tube to r-f carrier relay service. This circuit is similar to Fig. 2 except that a high-Q tuned r-f circuit (LC) is inserted as shown. When no r-f is present, the igniter is maintained below its firing potential by the voltage divider $R_1 - R_2$; if an

UNIVERSAL

Cinémaster II

CAMERA DESIGN

SIMPLIFIED BY

TRUARC

RETAINING RINGS!

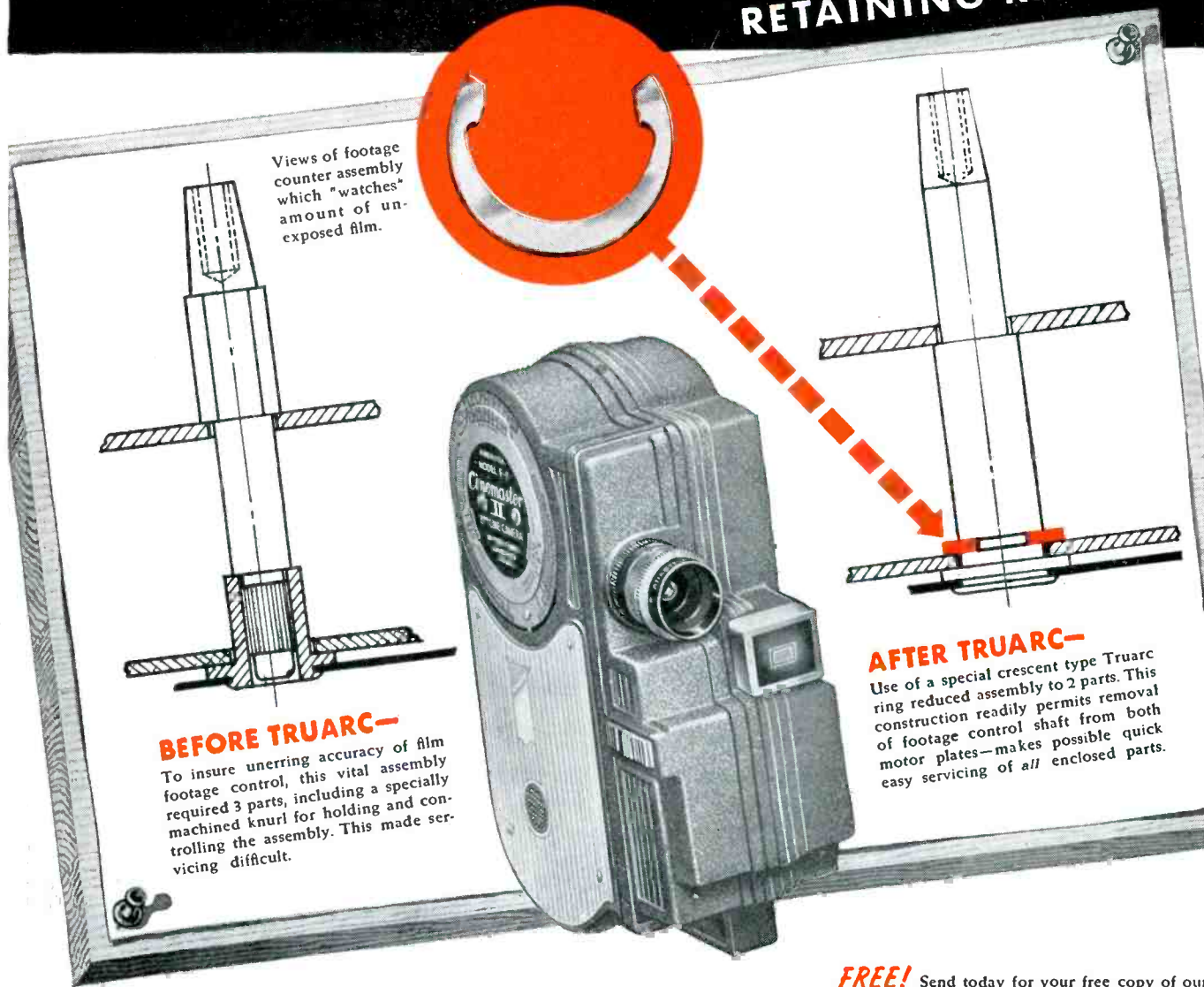

Now your machines can have the DESIGN ECONOMY made possible by Waldes TRUARC Retaining Rings! Truarc allows lighter, more compact units—makes assembly of machine parts quicker, easier. Its perfect circularity gives better, more dependable retention. Truarc rings save weight, space, time and costs in every type of mechanical application. The crescent type is only one of six special Truarc rings. There's a Truarc ring for your machines, too.

FREE! Send today for your free copy of our new booklet—"Outstanding Truarc Applications in American Industry." See how Truarc can improve your product, while reducing production and maintenance costs. Specify booklet 18A.

WALDES TRUARC
TRADE MARK
RETAINING RINGS



WALDES KOHINOOR INC., LONG ISLAND CITY 1, N. Y.
CANADIAN REPRESENTATIVE: PRENCO PROGRESS AND ENGINEERING CORP. LTD., 72-74 STAFFORD STREET, TORONTO

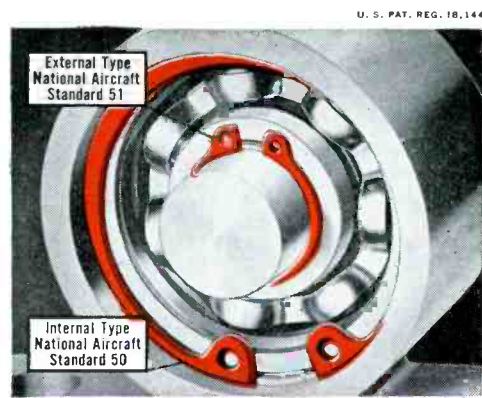

U. S. PAT. REG. 18,144

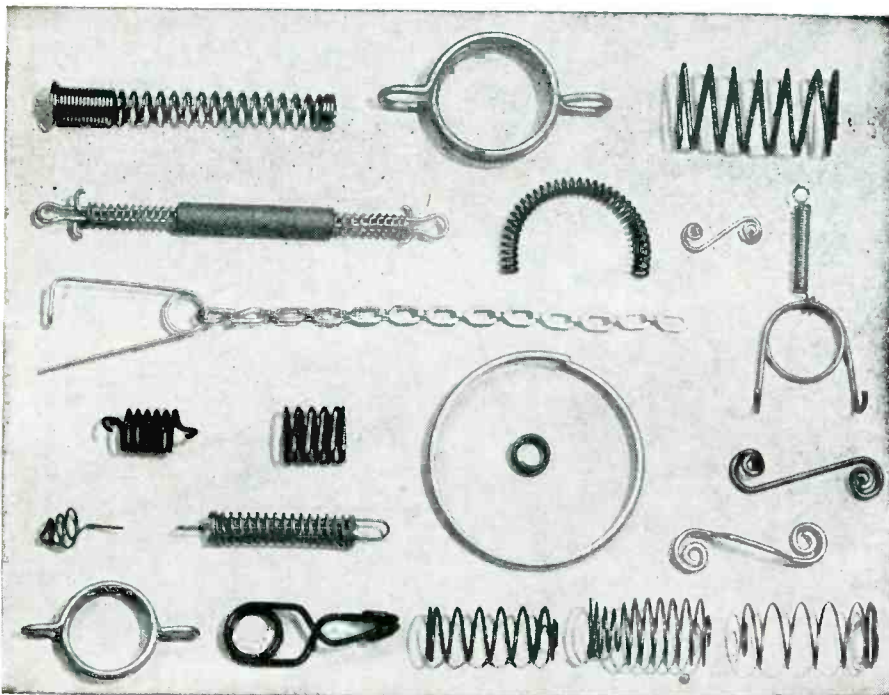

Springs for ELECTRONIC USES



Reliable specializes in the design and production of springs to high precision standards—springs exactly adapted in every detail to the work they must perform. Master craftsmanship is applied to every job in our plant. Spring users whose demands are distinctly above average—who require an uncommon degree of accuracy and uniformity—find Reliable spring service most satisfactory.

We are large volume producers, yet our organization is built so that it is easy for you to bring your individual problem directly to competent executives, and receive their personal attention. In addition to our regular production facilities, we maintain a complete small order department. Carefully designed tools reduce the necessity for time-consuming setups, and large stocks of standard sizes of wire speed up delivery. Reliable engineers are fully qualified to help you work out technical problems in spring design. Reliable Representatives in key cities are always available for preliminary engineering and counsel.

Advise us of your requirements. Catalog sent on request.

THE RELIABLE SPRING & WIRE FORMS CO.

3167 Fulton Rd., Cleveland 9, Ohio

Representatives in Principal Cities

YOU CAN RELY ON

Reliable Springs

ROUND AND FLAT WIRE SPRINGS CLIPS HOOKS BENDS LIGHT STAMPINGS

r-f carrier of the proper frequency appears across the line terminals, an r-f voltage will appear across L and supplement the existing igniter cathode potential sufficiently to fire the tube.

Hot-cathode Type

If the cold-cathode triode is replaced by a hot-cathode thyatron, the control circuit voltage may be reduced to a few volts. This is often important because when it is desired

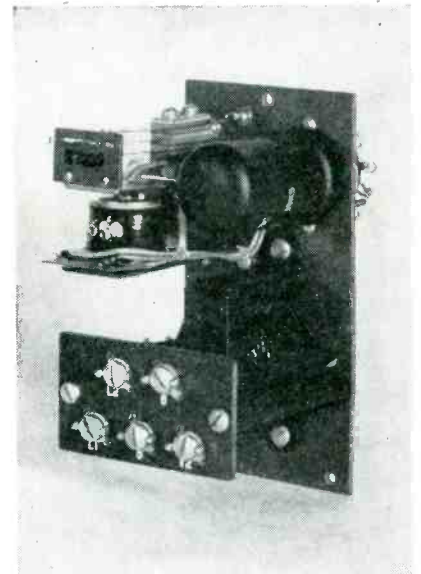

This electronic contactor is employed in a temperature control system that requires snap-acting spdt contacts carrying 12 amperes of noninductive a-c and which are actuated by an impulse of two microamperes

to use very light moving contacts, the contact potential must be kept at a minimum to prevent the electrostatic forces present from causing contact chattering. In addition, the current available for relay operation is practically unlimited, with 100 milliamperes as a normal value for the smaller thyatrons.

Figure 4 shows a typical circuit using a GL502A thyatron. The maximum relay current for this tube is 100 milliamperes. Bias is supplied to the grid by the 6.3-volt filament transformer T_1 , and prevents the tube from firing. When control contacts S_1 are closed, the grid is returned to the cathode, the bias is removed, and the tube will fire.

The rms current flowing through the control contacts is given by the expression $6.3 \text{ volts}/(R_1 + R_2)$. If we assign a value of two megohms to

A NEW ITEM...

An Old Story



For more than twenty-five years, new and unusual electrical appliances of all types—molded in whole or in part of Durez phenolic plastics—have been successfully marketed to the consumer. One of the latest items to come within this category is the "Heet-It" illustrated. This new appliance was designed primarily for heating baby food in the nursery—to save busy mothers many daily trips to distant kitchens. Other applications such as a bedside coffee and broth cooker are obvious.

Why Plastics?

Notice the attractive Durez plastic case and cover. The manufacturer of "Heet-It", Electrical Reactance Corporation, experimented and found that plastics were better suited for these jobs than any other material. Again it's a matter of history repeating itself. Year after year manufacturers in the elec-

trical appliance field have been selecting plastics for specific jobs of this type.

Why Phenolic Plastics?

Because the phenolics are the most versatile of all plastics, alert design-engineers have learned to make them their starting point in solving a materials problem. In this case, the properties called for were dielectric strength, heat resistance, impact strength, attractive finish, and resistance to the acids found in foods. All of these, and more, are inherent characteristics of phenolic plastics.

Why Durez Phenolic Plastics?

For the past quarter century, Durez production has been devoted exclusively to phenolic plastics and resins. As a result, there are now more than 300 multi-proprietary Durez phenolic molding compounds from which to

select the plastic that precisely fits your job. Furthermore, Durez technicians have gained a wealth of experience through active participation in the successful development of many and varied products for manufacturers in practically every field of industry. Naturally, the benefits which this rich background can bring about are very valuable—and they are yours for the asking.

Write for Free Booklet

"Machining Data on Phenolic Plastics" is an informative manual covering all the standard phenolic plastic machining operations encountered in the average plant. Send for your free copy. No obligation, of course. Durez Plastics & Chemicals, Inc., 84 Walck Road, North Tonawanda, New York. *Export Agents:* Omni Products Corporation, 40 East 34th St., New York, N. Y.

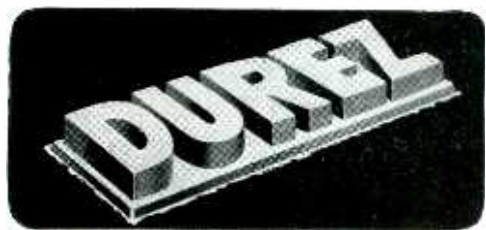

PHENOLIC
RESINS

MOLDING COMPOUNDS

INDUSTRIAL RESINS

OIL SOLUBLE RESINS

PLASTICS THAT FIT THE JOB

TURN TO TURNER



TURNER Model 22 Microphone Gives You All Three

There's more than beauty of styling behind the Turner 22 Microphone. This famous member of the Turner Line is a precision unit — engineered to faithfully reproduce every desired sound without harmonics or distortions — ruggedly built to perform with unflinching dependability under difficult operating conditions. Good reason why so many leading manufacturers of electronic recording and communications equipment specify the Turner 22 as standard for maximum performance . . . why you want the TURNER 22 for your equipment. Available in both rugged crystal and dynamic models. Ask your distributor or write for complete performance characteristics.

★ for Style

★ for Dependability

★ for Performance

You Get These Features in the Turner 22

- ★ Choice of Moisture Proofed Crystal or Rugged Dynamic Cartridge.
- ★ 90° Tilting Head for Semi- or Non-Directional Operation.
- ★ Removable Cable Set.
- ★ Barometric Compensator.
- ★ Mechanical-Shock Proofing.
- ★ No blasting from Close Speaking.
- ★ Low Feedback.
- ★ Certified Performance.

The TURNER Co.

905 17th Street N.E., Cedar Rapids, Iowa
Pioneers in the communications field

TURNER Microphones

Crystals Licensed Under Patents of the Brush Development Co.

Turner Microphones Licensed Under U. S. Patents of the American Telephone and Telegraph Company, and Western Electric Company, Inc.

Free Turner Catalog
Write for your copy



$R_1 + R_2$, the control current will be $6.3/2 \times 10^6$ or 3.15 microamperes. Even lower currents are possible under certain conditions.

Resistor R_1 is placed in series with the grid to prevent any possible damage to this element due to the accidental connecting of a large external voltage source to contacts S_1 . A value of 50,000 ohms is usually adequate.

Capacitor C_1 , shown in dotted lines, may be connected across R_2 to improve the phasing of the circuit and enhance its snap-acting quali-

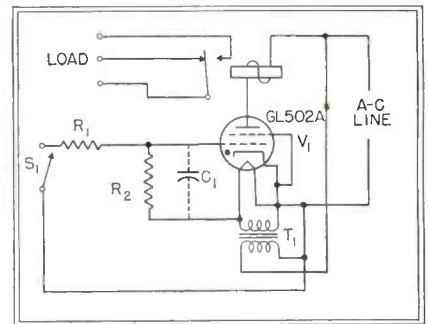

Fig. 4—At low control voltages, a hot-cathode thyatron permits the use of lightweight contacts

ties. The addition of C_1 , although its value is usually quite small, will increase the control current requirements slightly. A capacitance value of $0.001 \mu\text{f}$ in parallel with a two-megohm value of R_2 would permit a control current of 3.9 microamperes to flow if the bias supply has a potential of 6.3 volts.

The circuit shown in Fig. 4 has one disadvantage. If its installation is not properly supervised, a short-circuit or high grid potential may result. This difficulty results from the fact that one of the control contacts is connected directly to the supply line and if the other one becomes grounded, trouble may result. To avoid this difficulty, a transformer-isolated unit, such as that shown in Fig. 5, may be used.

The 100-milliampere relay current capability of the GL502-A is usually sufficient, but it should be kept in mind that larger tubes handling amperes may be used without difficulty. For instance, the RCA 3D22 can be substituted in the circuit given in Fig. 4, without appreciably increasing the control current

BH SPECIAL TREATED FIBERGLAS SLEEVING

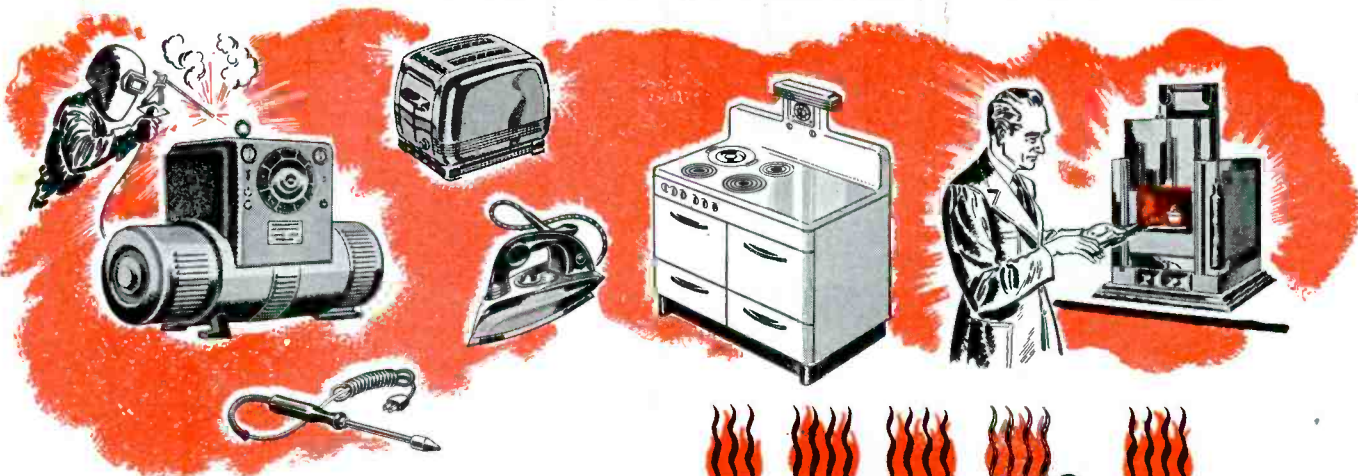

HEAT RESISTANT TO

1200° F!



SNUB TEST

Proves BH Non-Fray Feature

Make this test yourself. Tap a piece of ordinary saturated sleeving on your desk top and see how easily it frays. Then do the same with BH Extra Flexible Fiberglas Sleeving. It only fuzzes a little—doesn't break down—doesn't fray.

THE RESULT



← The BH Way



The Ordinary Way →

BH EXTRA FLEXIBLE FIBERGLAS SLEEVING

2 WAYS BETTER

NON-FRAYING • NON-STIFFENING

IF YOU NEED an electrical insulation that's not affected by temperatures up to 1200°F., yet is unusually flexible, workable and durable, you'll find it in BH Special Treated Fiberglas Sleeving. Even in direct contact with heat units this remarkable sleeving won't burn.

Reason? It's made of inorganic Fiberglas and treated by the exclusive BH process. No saturant is used, yet the sleeving won't fray when cut and it is *permanently* flexible. In addition to many other properties it is moisture, oil and grease resistant . . . works easier, simplifies assembly and lasts longer. Made in natural color only—all standard sizes. Get your free samples today and compare!

HERE'S ANOTHER NON-BURNING SLEEVING

BH *Extra Flexible* Fiberglas Sleeving won't burn because both yarns *and* impregnation are non-inflammable. This high quality sleeving has all the advantages of pure Fiberglas, is toughened against abrasion, is non-fraying and non-stiffening. It lasts indefinitely without rotting or cracking—the ideal all-purpose electrical insulation for all kinds of industrial equipment and home appliances. Available in all standard colors and sizes from No. 20 to 5/8", inclusive. Put it to the toughest tests you know and watch the results!

ALL BH PRODUCTS AVAILABLE IN STANDARD 36" LENGTHS AND 500-FT. COILS



ALSO SLOW-BURNING IMPREGNATED MAGNETO TUBING • SLOW-BURNING FLEXIBLE VARNISHED TUBING • SATURATED SLEEVING • A.S.T.M. SPECIFICATIONS

BENTLEY, HARRIS MANUFACTURING CO.

Dept. E Conshohocken, Penna.

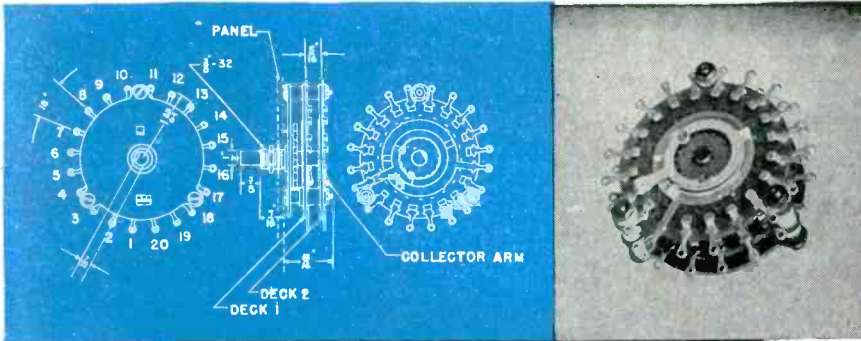

IN LAST PLACE
 ON THE TROUBLESHOOTER'S CHECK LIST
AND PROUD OF IT!

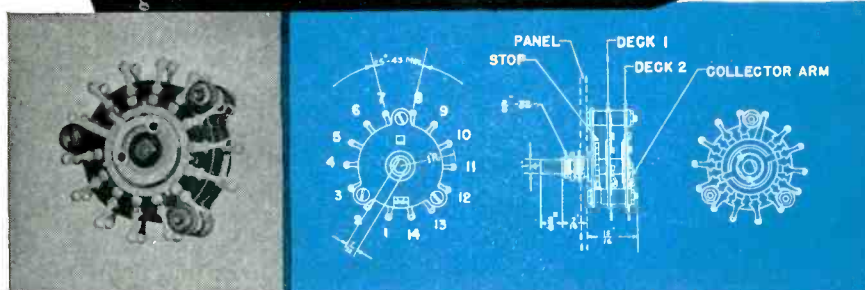

J-B-T Instrument Type Rotary Selector Switches are available in 20 position SS-20 and 14 position SS-14 models, one to six decks, non-shorting standard, and shorting on special order.

... for these are the instrument and tester makers own switches, designed and developed to meet the need for trouble-free, dependable performance in hard service.

They are extensively used in high quality test equipment, portable instruments, in inspection set-ups, and experimental circuits.

Now, because of quantity production, they are in a price range which makes it sensible to consider them for many other electronic applications. And they are available for immediate delivery. Your jobber probably has them in stock by now.

ADVANTAGES:

RUGGED

Rigid, 3-post deck suspension; double-grip contacts, silver to silver; ball bearing indexing with beryllium copper spring; lugs staked for extra strength.

COMPACT

14 or 20 positions in same space generally required for 12 positions. Often eliminates need for other switches or extra decks.

VERSATILE

Many variations, such as multiple circuits per deck; four-pole, double-throw band selectors; unusual contact arrangements; non-standard stops and panel locators are being supplied on substantial quantity runs.

J-B-T INSTRUMENTS, INC.

431 CHAPEL STREET • NEW HAVEN 8, CONNECTICUT

4-JBT-2

and with the ability to deliver 0.75 ampere of relay current.

Motor Control

Another use to which the thyatron circuit is well suited is the direct operation of a motor from contacts carrying microamperes without the use of intermediate electromechanical relays. A direct-current motor can be connected in the anode circuit of tube V_1 in Fig. 4. However, the operation of an a-c two-phase motor requires certain changes. Figure 6 shows a circuit which is adapted to

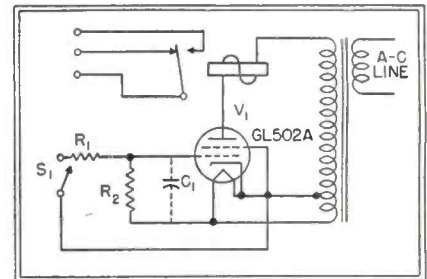

Fig. 5—To prevent grounding one or both control contacts, an isolation transformer can be used

this type of operation. The motor shown is a two-phase, capacitor-type unit and provides reversing operation from a single pair of control contacts, S_1 . The operation is such that when the contacts are open, the motor will rotate in one direction and when they are closed, the motor will rotate in the opposite direction.

Tubes V_1 and V_2 are both biased from the 6.3-volt filament circuit and the grid of V_2 is raised to firing potential by coupling capacitor C_3 , which is supplied with line potential whenever V_1 is dormant. When contacts S_1 are open, V_1 is dormant and V_2 fires; when the control contacts

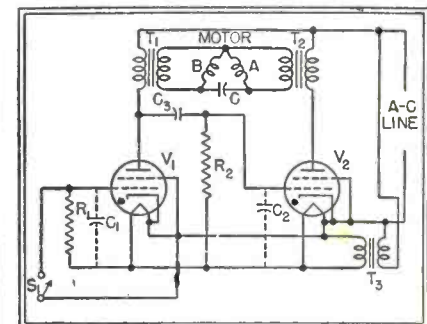

Fig. 6—With this circuit, one pair of control contacts permits reversing a two-phase motor

**Just
ONE
of the large**

VISITRON

family

Rauland Visitron Phototubes are the recognized leaders in the field of light-sensitive devices . . . uniformity, dependability and high sensitivity through the years have earned them that reputation. Whatever the application, sound-on-film, electronic control or television pickup, there is a Rauland Visitron Phototube available to do the job perfectly. Or, we can produce a specially designed tube to meet an entirely new application. Let the experienced Rauland engineers consult with you about your phototube requirements.

To be sure . . . specify VISITRON!



ALSO MANUFACTURERS OF DIRECT-VIEWING AND PROJECTION TYPE CATHODE RAY TUBES

RADIO · RADAR · SOUND

Rauland

COMMUNICATIONS · TELEVISION

Electroneering is our business

THE RAULAND CORPORATION • CHICAGO 41, ILLINOIS

New communications records!

30,000 words per hour!

or 2760 Sq. In. of pictures



THE NEW FINCH "Telefaxer" breaks all records for speed and accuracy in the transmission and reception of words and pictures. 30,000 words per hour or 2760 sq. in. of pictures can be handled by radio. 9600 words per hour or 918 sq. in. of pictures, by ordinary telephone wire. And not one error or deviation from the original manuscript!

Anything that can be printed or written on paper, including drawings and photographs, can be transmitted by this most modern instrument of communications. With Finch Telefaxers, time and money are saved and the mistakes of telegraphic printers are avoided.

- Made by the manufacturers of Finch Facsimile equipment for broadcasting printed news and pictures.
- Write for new illustrated folder giving full particulars.

FINCH TELECOMMUNICATIONS, INC., Passaic, N. J., U.S.A.
Sales Office: 10 East 40th Street • New York 16, N. Y., U.S.A.

finch

First in Facsimile

are closed, V_1 fires and reduces the potential supplying coupling capacitor C_s to a value which is nearly zero. This removes the firing voltages from the grid of V_2 and it becomes dormant.

The motor is supplied by transformers T_1 and T_2 , alternately. When V_2 fires, transformer T_2 feeds an alternating current to motor winding A . Winding B is supplied through phase-shift capacitor C and a rotating field results which drives the motor. Some efficiency is lost due to the shunting effect of transformer T_1 on motor winding B , but the motor operation is satisfactory for most purposes. When V_1 fires, the operation is reversed and transformer T_1 supplies power. Since the input to transformers T_1 and T_2 is half-wave, the addition of some filter capacitance (not shown in the diagram) to the circuit will serve to improve the wave form of the current reaching the motor.

Although any of the three basic relay circuits discussed will be found satisfactory for many operations, the hot-cathode thyatron offers the most promise in the control field since it combines high sensitivity, snap action and large current capacity.

PRIVATE PLANE SPEAKER



A soundproofed cabin and dual engine mufflers in the Stinson Voyager 150 permit use of a loudspeaker mounted in the dome and eliminates being fouled in the headphones if it is necessary to bail out. The radio equipment is mounted on the left of the instrument panel

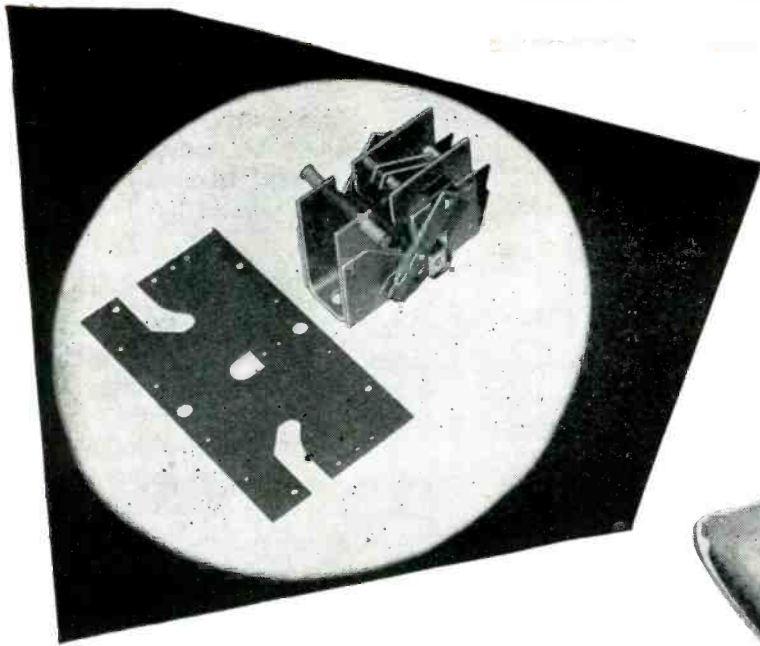

Shapely

Post-Formed Phenolite chassis for high voltage circuit breaker. All holes and cut-outs are punched in the flat blank (*foreground*) before post-forming in channel shape. Use of Phenolite chassis in place of metal eliminates insulation of each separate part of assembly.

POST-FORMED
PHENOLITE*
 shapes profitable production
 and new products

There are opportunities for you in Post-Formed Phenolite—the laminated plastic that simplifies production and offers countless new applications for profitable-selling products!

Economical to produce, Post-Formed Phenolite parts are made in a matter of minutes. Practically any shape or form may be obtained simply by heating the sheet material a few seconds, then forming in low-cost wooden molds with standard press equipment. No sanding or "flash" removal is necessary. Fabrication may be done before or after forming.

Phenolite is extremely light in weight (about 1/2 that of aluminum); yet it has remarkable mechanical and impact strength. It possesses good machinability . . . is an excellent electrical insulator . . . resists heat and moisture . . . is resistant to abrasion . . . and is not affected by solvents and oils.

Find out some of the many ways in which this versatile material can be used. Write for full information and the assistance of one of our trained engineers.

NATIONAL VULCANIZED FIBRE CO.

OFFICES IN
 PRINCIPAL CITIES



WILMINGTON,
 DELAWARE

* FORMABLE THERMOSETTING SHEET MATERIAL

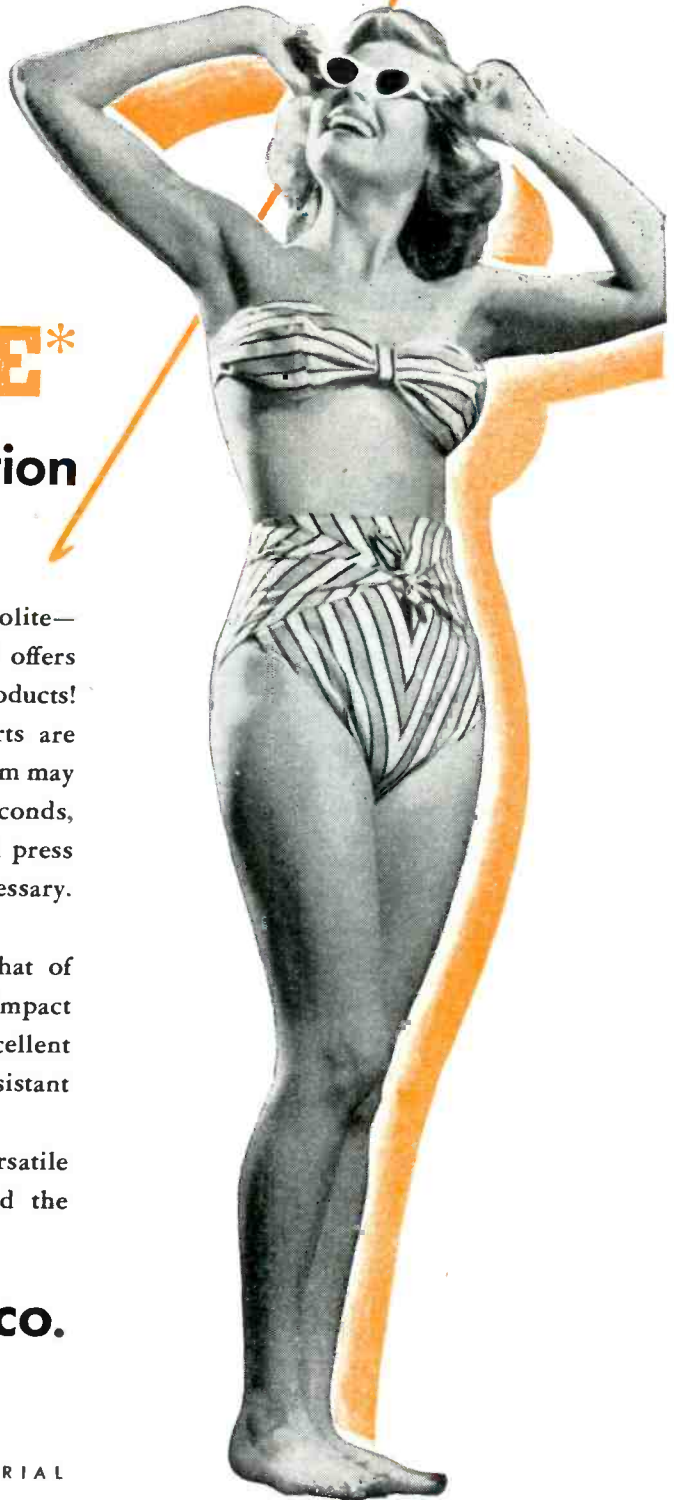

TUBES AT WORK

Video and Audio on One Carrier.....	208
Simple Converter Circuit for New F-M Band.....	212
Frequency Stabilization at 450 Mc.....	214
Radio Design Data Presented in Chicago.....	216
More on Spherics, Storm Detector.....	224

Video and Audio on One Carrier

A NEW television system in which sound and vision can be transmitted from a single transmitter occupying a normal band space has been developed by the British firm of Pye Radio Ltd.

The best method of understanding the new system is to consider the old system used by the BBC before the war, in which the picture was broken up into 405 lines and 25 pictures per second were transmitted. Typical lines are shown as *AB*, *CD*, *EF* in Fig. 1 and the tonal value along the line is expressed as the height of the waveform. During the periods *BC*, *DE*, etc, the electron beam in the camera is returning to start another line.

The time required to scan a line under this arrangement is 90 microseconds and at the end of the line the leading edge of the synchronizing pulse triggers the time-base in the receiver and suppresses the flyback, which occupies 10 microseconds. This obviously means that for 10 percent of the total transmission time the transmitter is idle. Actually it is the flyback which demands the greater part of the 10 microseconds, not the synchronizing pulse.

In the Videosonic system, this idle period is utilized to transmit the sound program and it is done by inserting a pulse into the 10-microsecond period and arranging that the width of the pulse is a measure of the audio modulation. At their maximum, the pulses occupy five microseconds and they narrow down to one microsecond at audio troughs. The mean width is three microseconds. Figure 2 illustrates this point and at the line-scanning frequency of the present system, 10,125 pulses per second are transmitted.

At the receiver end, separation is

easy and depends on the pulse amplitude being greater than the maximum video amplitude. If the former is considered as 100 percent of the r-f carrier, the greatest video amplitude corresponding to a peak "white" is about 75 percent. All that is necessary then is to incorporate

in the receiver simple limiting circuits which will only pass signals whose amplitude is greater than peak "white" signals. In practice the ratio of 75 to 100 percent has been found ample.

Advantages

There is no mutual interference between the sound and vision signals since the pulse corresponding to the former is absent during the scanning period. A new method of blacking out the flyback must be used but no difficulties have arisen in this direction.

The advantages of the new system are:

- (1) The sound transmitter can be dispensed with.
- (2) The received sound signal is more free from noise than under the

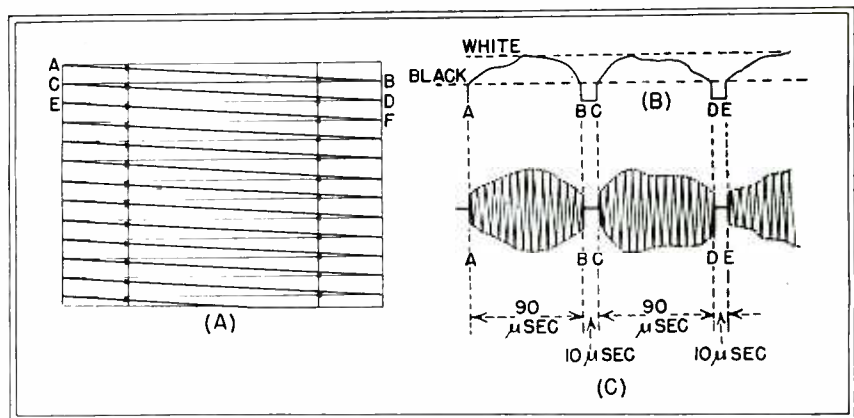

Fig. 1—The method of scanning a television picture is shown at (A). The resulting video waveform is shown at (B) and the radio-frequency waveform at (C)

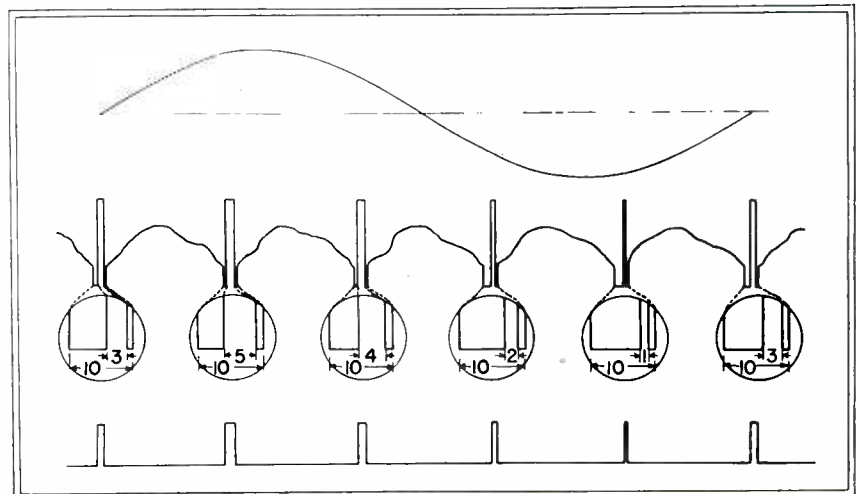
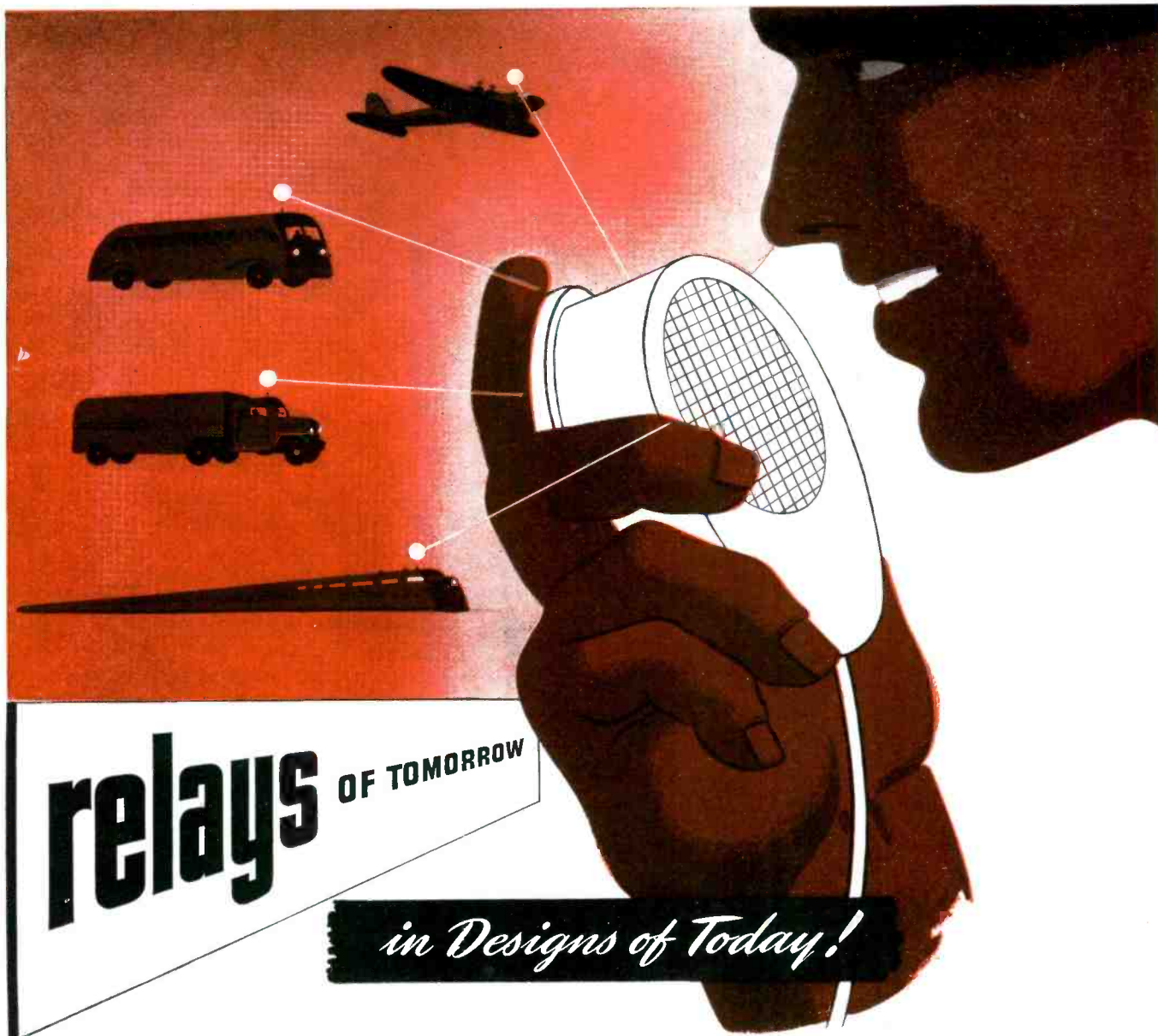

Fig. 2—Method of inserting a sine-wave sound pulse in the flyback periods *BC*, *DE* of Fig. 1 so that the width of the pulse varies with the sound to be transmitted. At the receiver, the pulses at the bottom are separated from the video and passed through a low-pass filter that feeds the loudspeaker



relays OF TOMORROW

in Designs of Today!

FOR COMMUNICATIONS IN TRAINS • TRUCKS • BUSES • PLANES...

Relays BY GUARDIAN— years ahead of today— offer designers of two-way radios definite advancements which contribute to better long-life operation. This is especially evident with Guardian Relays and Switches used in two-way radios for trains, trucks, buses, planes.

For instance, Guardian's series 165-A Relay (A1 Si Mag insulated), for antenna changeover and break-in is small, compact, vibration-resistant. Laboratory tests with 2 normally open contacts prove series 165-A withstands vibration of 16.2 g. + in both energized and de-energized positions. This is achieved by rugged overall construction and precise counterbalancing of the armature assembly. For H.F. and U.H.F. the series 165-A has a contact capacity to handle all required frequencies. Operates at temperatures ranging -65° to +160°F. and at altitudes from sea level to 50,000 ft. Truly, series 165-A merits a trial now! For V.H.F. antenna switching or keying try the war-tested Vacuum Switch Relay by Guardian.

Let us furnish cost-free information about the complete Guardian line of Radio Relays, also all Telephone Type Relays including the small Midget; and a special Switch used on push-to-talk circuits.

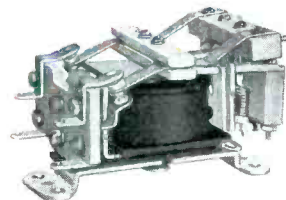

Series 165-A Relay

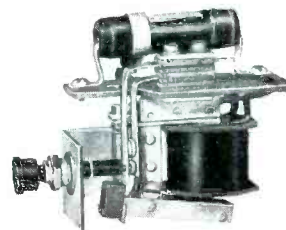

Series X-100 Relay

GUARDIAN  **ELECTRIC**
 1625-D W. WALNUT STREET CHICAGO 12, ILLINOIS
 A COMPLETE LINE OF RELAYS SERVING AMERICAN INDUSTRY

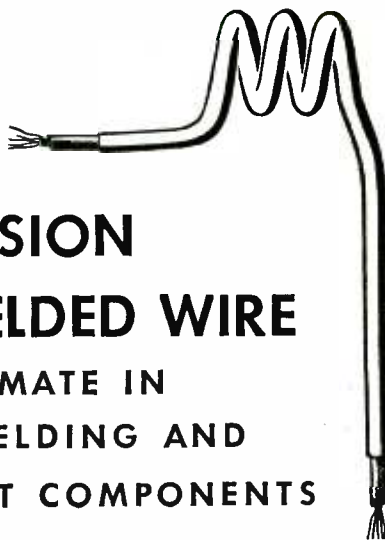

PRECISION METAL SHIELDED WIRE

THE ULTIMATE IN PERFECT SHIELDING AND COAXIAL CIRCUIT COMPONENTS

***Better because it is Shielded with
Seamless Metal Tubing***

QUALITY PERFORMANCE

Precision metal shielded wire is especially suited for closely coupled air core transformers, shielded grid, filament, and antenna leads, and wherever low-loss transmission is required.

VARIETY

A single inner conductor or number of conductors can be shielded with seamless copper, brass, aluminum, or nickel tubing, plated if desired, in random or cut lengths, or formed to customers' specifications. Outside diameters range from 0.018" to 0.375", with any desired wall thickness.

STABILITY

Formed parts are self-supporting. This simplifies assembly and enhances appearance. Rapid changes in barometric pressure, temperature, and humidity do not cause injurious moisture condensation. Dirt is excluded. Since tube is seamless and dielectric is continuous, conductor and shield remain coaxial even when formed into coils or other intricate components.

EASY TO HANDLE

Tubing is easily stripped and formed right on the job, or can be furnished cut to exact length, stripped and formed, ready for instant application.

PRECISION METAL SHIELDED WIRE offers many advantages. It is an absolute method of shielding insulated wire or wires with seamless aluminum, copper, brass, or nickel tubing to provide the most perfect shielding yet devised against electrical interference, noise, moisture, or mechanical damage. As a coaxial line, it provides low loss over a range of frequencies and uniform capacity. Unlimited combinations of desirable electrical characteristics are available to meet your most exacting requirements.

We will be glad to cooperate on engineering problems. Write for further information.

PRECISION TUBE COMPANY

3826 Terrace Street, Philadelphia 28, Pa.

older system. Theoretical investigations have shown that it would be equivalent to increasing the transmitter power 100 times.

(3) The old difficulty of routing the sound and vision signals at the receiver vanishes.

(4) No ether space is occupied by the sound transmitter.

(5) The steady level of the sound pulses makes compensation for fading easier.

(6) The receiving antenna could be made more efficient since it would only have to operate on a single frequency band.

The chief disadvantage of the system is coupled with the existing 405-line transmission. At present, as the line frequency is 10,125, the audio frequency limit would be about 5,000 cycles—an undesirable figure since British listeners have been accustomed to transmitters with a practically flat response between 30 and at least 10,000 cycles. To achieve an upper audio limit of 10,000 cycles the number of lines would have to be increased to 1,000 which would give a line pulse frequency of 25,000.

One advantage of the pulse insertion scheme is that it would be quite easy to incorporate additional pulses corresponding to stereophonic sound, or for color work.

Figure 3 is an oscillogram of the Videosonic waveform during the 10-microsecond period. The sound pulse having a mean duration of three microseconds is shown extending downwards. Figure 4 is a photograph taken on a special receiver to show the variable sound-width pulses occurring during the flyback periods. These pulses build up a white band of variable width reminiscent of the

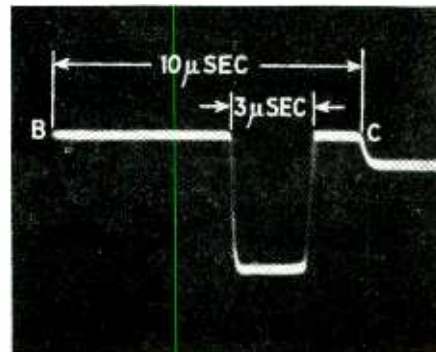

Fig. 3—The waveform during the 10-microsecond period as it appears on an oscilloscope



LEADERS

in internal curing

INSULATING
VARNISHES

For Transformers

IRVINGTON # 100

A clear internal drying varnish noted for long-life at high temperatures. Life test of over 1100 hours at 105°C. Thorough penetration and curing is obtained even in the deepest windings. Provides firm, though flexible, transparent bonding, so clear that coded leads are readily identified. Possesses excellent electrical properties, and is oil, acid and moisture resistant.

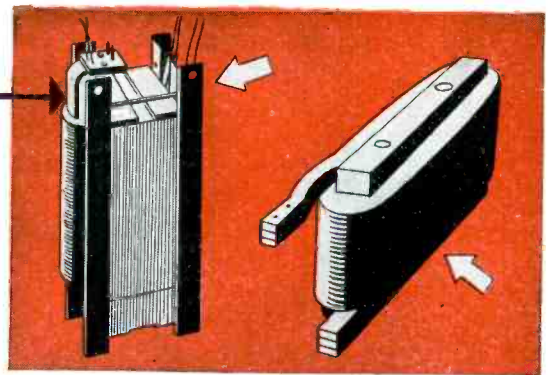

For Motors

HARVEL # 512C and 612C

Phenol-aldehyde type varnishes derived from Cashew Nut Shell Liquid. Set dry throughout by heat induced chemical polymerization, thus cannot leave gummy half-cured interiors. Provide high insulation resistance at all temperatures, and are outstanding in this feature at operating temperatures up to 300°F. Extremely resistant to acids, alkalis, moisture, and oilproof.

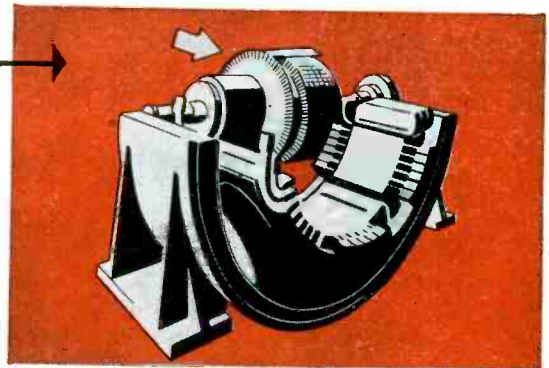

For Fluorescent Transformers and Ballasts

HARVEL # 612C

Now widely used by Fluorescent Ballast manufacturers, because the unique structure of this cashew varnish aids greatly in keeping ballasts hum-free.

All the above varnishes will cure most satisfactorily under conventional convection baking methods, or infra-red. For complete information write Dept. 106, Irvington Varnish & Insulator Company, Irvington 11, New Jersey.

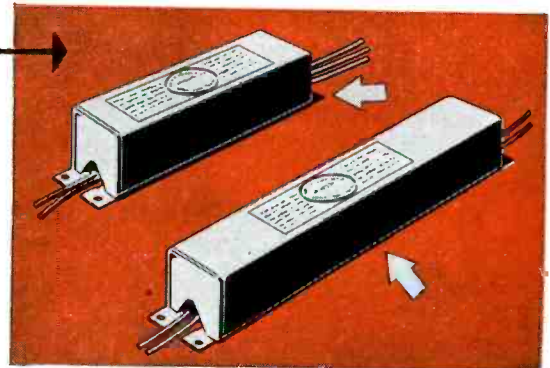

IRVINGTON *Varnish and Insulator Company*

Irvington 11, New Jersey, U.S.A.

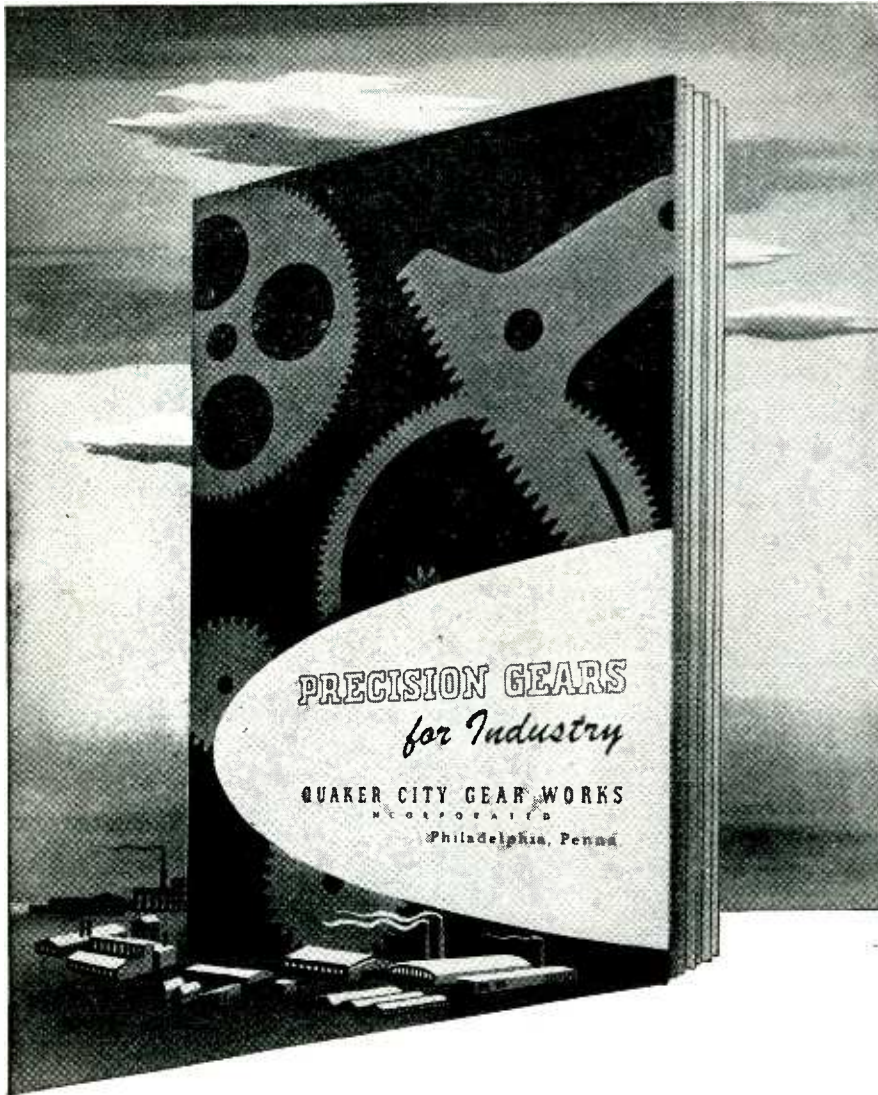

Yours for the asking

A new informative booklet on gears.

It has illustrated sections  on

practically every known form of gearing,

together with  many reference

tables and formulas. Write for your copy

today on your company stationery. 

 **Quaker City Gear Works**
INCORPORATED

1910 N. Front Street, Philadelphia 22, Pa.

7N7 for mixer and oscillator to form a double superheterodyne when connected to a prewar f-m receiver.

When placed on position 1, the four-gang switch permits operation of the receiver on other frequencies by feeding the antenna directly to the receiver antenna terminal. When set to positions 2, 3, and 4, the switch connects trimmer capacitors into the tuned circuits for covering frequency ranges of 84 to 93, 93 to 102, and 102 to 111 megacycles respectively. All tuning over each range is done by means of the regular tuning dial of the receiver.

Power for the converter is obtained from one of the power amplifier sockets in the receiver by an adapter that fits under the tube.

• • •

Frequency Stabilization at 450 Mc

By PETER B. MYERS

*National Bureau of Standards
Washington, D. C.*

DUE TO THE recent FCC allocations and the growing interest in the very high radio frequencies, the matter of constant frequencies at vhf becomes increasingly important. Crystal control is required for greatest constancy but quartz plates above about 30 mc are still impractical and involve delicate hand finishing.

At the present time, higher constant frequencies are generally obtained by electrical harmonic generators working off standard low-frequency crystals. Above about 100 mc, the number of harmonic generators and auxiliary pieces of equipment becomes excessive and other means of frequency control are needed. The mechanical harmonics of a quartz plate may however be utilized; for example, using the fifth mechanical harmonic of a 30-mc plate, the fundamental oscillation would be 150 mc and one stage of electrical harmonic generation (tripling) would produce standard crystal-controlled frequencies of 450 mc.

Used Harmonic Crystal

Mechanical harmonics may be excited in specially prepared AT or BT cut crystals, in which odd harmonics

"ZIRMET CUTS PUMPING TIME 30%"

Says Taylor Tubes, Inc.

Zirmet Benefits Both Tube Manufacturer and Tube User

Interested in reducing pumping time? Then you'll certainly want to look over these excerpts from a letter sent us by Taylor Tubes, Inc., commenting on their use of Zirmet (Foote Ductile Zirconium)...

"The application of the Zirconium Metal to the fins of the T-125 means that we are able to cut our pumping time by about thirty per cent, and the gettering action while the tube is actually in operation, is very good.

"The type T-125 tube is widely used in diathermy at frequencies up to 70 MC, and of course, in Amateur Radio opera-

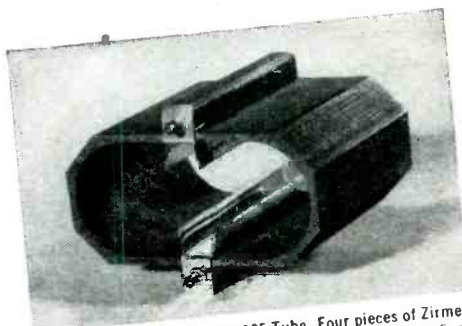

Carbon Anode of Taylor Type 125 Tube. Four pieces of Zirmet 1/16" x 1 1/2" x .005" are welded to the molybdenum fins.

this particular application. It is well worth the small added expense."

Zirmet is literally "what the doctor ordered" and may prove equally effective for you.

Many Advantages for Tube Maker and User

If you are a tube manufacturer, the use of Zirmet as a continuous getter means less pumping time, better vacuum, less shrinkage, clean tubes, and, naturally, satisfied customers. If you are a tube user, you can count on better emission and longer life when you buy a tube containing Zirmet the *continuous getter*.

Investigate Zirmet now. Write or telephone our engineers today for details and prices.



Taylor Type 125 Tube for diathermy and radio applications.

tion at the present time, at 28 to 30 MC. We feel that the Metal is most effective in obtaining a higher order of vacuum in

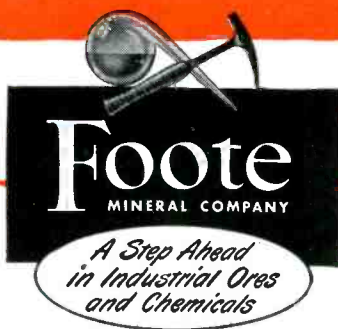

Chemicals • Ores • Metals • Alloys

PHILADELPHIA • ASBESTOS • EXTON, PENNSYLVANIA

Home Office: 517 GERMANTOWN TRUST COMPANY BLDG., PHILA. 44, PA.

West Coast Representative: Griffin Chemical Co., San Francisco, Cal.

FINE MATERIALS . . .
FINE ENGINEERING . . .

Fine Equipment

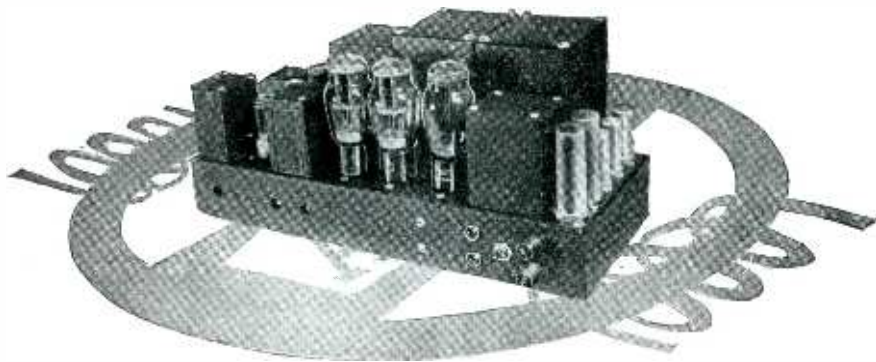

DESIGNED BY SPECIALISTS

THE FACT that we have specialists to properly design custom-built electronic equipment insures the quality you desire. Each device is carefully engineered for your specific job, and constructed in accordance with Audio Development Company's long established high standards; built to give complete and lasting satisfaction.

Among the types of equipment we build are controls, (chemical and positioning), amplifiers for specialized application, audiometers, measuring devices, etc.

Since we design and build the transformers for our electronic apparatus, the highest degree of engineering coordination is available.

Write us or our nearest representative for further information. Descriptive literature is available on standard audiometers, group hearing aids and transformers. Other electronic units—special transformers, filters, etc., are custom built to meet *your* requirements.

Please address all correspondence to our representative nearest your location:

Burlingame Associates, Ltd.
 11 Park Place
 New York 7, New York

Maury E. Bettis & Company
 Room 400, B.M.A. Building
 Kansas City, Missouri

Seattle Radio Supply, Inc.
 2117 Second Avenue
 Seattle, Washington

Walter P. Downs, Ltd.
 702 Dominion Square
 Montreal, P.Q., Canada

Cinema Engineering Company
 1508 West Verdugo Avenue
 Burbank, California

Audio Development Co.
 2833 13th Ave. S., Minneapolis, Minn.
"Audio Develops the Finest"

up to the 23rd have been excited. A limiting factor is the optical flatness of the crystal. Mason and Fair found that the Q of the crystal increases in general with higher mechanical harmonics.¹ Special circuit arrangements are needed for harmonic oscillations above the seventh.

In recent experiments, the fifth mechanical harmonic of a 10-mc crystal was employed, followed by two electrical triplers, to reach 450 mc. Push-pull triplers incorporating midget tubes were used throughout. The oscillator tube was a 6C4 as were the tubes of the first tripler. Since the 6C4 was not found to be suitable for use at 450 mc, two type 6F4 were used in the final stage.

The output proved to be as stable as that obtained at the crystal's fundamental frequency. The generally accepted figure of 0.0025 percent as the maximum deviation in frequency of a crystal in the absence of regulation of any kind would limit the drift to 11 kilocycles at 450 megacycles. A two-hour test of the apparatus with a regulated power supply showed a maximum drift of 1.1 kilocycle at 450 megacycles, amounting to a frequency variation of ± 0.00025 percent or 2.5 parts in a million.

The crystal temperature coefficient was the same for the overtones as for the fundamental. The power output of the crystal oscillator used was less at each higher overtone, but the power was ample at 50 mc to drive a buffer amplifier.

The writer acknowledges his indebtedness to W. D. George and M. C. Selby of the Radio Laboratory of the National Bureau of Standards, where the experimental work was carried out; and his obligation to the Optical Division of the Bureau for the preparation of 10-mc quartz crystals with optically flat and parallel faces.

REFERENCE

(1) Mason, W. P., and Fair, I. E., A New Direct Crystal-controlled Oscillator, Bell Telephone System Monograph B-1363.



Radio Design Data Presented in Chicago

ASPECTS OF f-m receiver design, receiver response trends, and intermodulation effects in audio systems were

Why Not Pay Us a Visit

You Are Always Welcome

If you would permit us to pilot you through the various departments of our modern plant, you would readily understand why Jefferson Electric has earned the reputation for sustained quality in quantity production.

You would agree that it would be difficult to find a plant with all of the many features needed to produce in such quantities with such high standards of quality, accuracy and uniformity.

Engineering, research, experimental departments geared to the latest manufacturing methods and technique are combined with modern equipment and unusual esprit de corps.

When in Chicago, plan to pay us a visit — our suburban location is readily accessible. For your convenience you can call us by local Chicago telephone—Mansfield 7161. JEFFERSON ELECTRIC COMPANY, Bellwood (Chicago Suburb), Illinois. *In Canada:* Canadian Jefferson Electric Co., 384 Pape Avenue, Toronto, Ontario.



TRANSFORMERS



**MILFORD
FASTENING
EQUIPMENT**

**How Much
Could MILFORD
Save for YOU**

**on special, small metal
PARTS and FASTENERS
MADE TO
ORDER?**



Counterbored head, drilled secondary hole to 1/3 of way down through shank.

67% SAVING



Collared and drilled and delivered by the million.

72% SAVING



Two views—to show welding ring, vent hole, under cutting.

69% SAVING



5/8" deep tapped hole features this Milford special part.

37% SAVING

If your product calls for a small, metal part or fastener — it's a job for Milford.

If you use a part or fastener of standard design or size because the cost of a special design or size is too high — it's a job for Milford.

Typical of the endless variety of parts and fasteners which Milford manufactures to order by the millions for American industry — AND AT IMPRESSIVE SAVINGS — are those shown above.

For specific information, send a blueprint or sample.

THE MILFORD RIVET & MACHINE CO.
859 Bridgeport Ave. 1002 West River St.
MILFORD, CONN. **ELYRIA, OHIO**

Inquiries may also be addressed to our subsidiary:

THE PENN RIVET & MACHINE CO., PHILADELPHIA 33, PENNA.

Designers and Manufacturers of: SPECIAL COLD-HEADED PARTS; SPLIT, SEMI-TUBULAR AND DEEP-DRILLED RIVETS; RIVET-SETTING MACHINES; SPECIAL MACHINE SCREWS AND SCREW MACHINE PARTS.

among the subjects covered by ten technical papers delivered at the Chicago Engineering Conference, sponsored by the Chicago Section of IRE. Held early in February, the meeting was attended by more than 500 radio engineers.

Details of f-m receiver design were discussed by Frank C. Gow of RCA Laboratories, who pointed out that series tuning in preselector stages is more effective than parallel tuning and that common coupling can be minimized by efficient design of the r-f circuits and by grounding the stator of the converter tuning capacitor.

Oscillator efficiency and stability can be obtained with four methods of conversion: a pentagrid using inner grid injection, pentagrid using outer grid injection, separate oscillator and mixer, and dual triode oscillator-converters. Greater stability can be obtained by using second harmonic conversion, although conversion transconductance is lower. If oscillation occurs, it can be cured by biasing the converter grid. Outer-grid injection results in more efficient, stable operation. For good operation, a 16- μ v signal in the antenna is sufficient.

High frequency triode mixers are characterized by low input conductance but inductance is sometimes inserted in the plate lead to form a series-resonant circuit to increase grid input resistance. Triode mixers have lower noise level than pentodes.

In the design of the i-f amplifier, stability is the first consideration, with selectivity next. Effects of input loading on the selectivity of avc stages can be reduced by using high-C tuning circuits and adding degeneration by omitting bypass capacitors from bias resistors.

Audio Quality

The new FCC standards on good engineering practices concerning f-m broadcasting specify an a-f bandwidth of from 50 to 15,000 cycles in a manner which includes a minimum of distortion and unpleasant effects. Such specifications make necessary radical changes in audio frequency design, measuring techniques and concepts, according to J. K. Hilliard of Altec Lansing Corp. All elements of distortion must be reduced to a low degree, otherwise results of ex-

HEINEMANN MAGNETIC CIRCUIT BREAKERS

- as simple as -

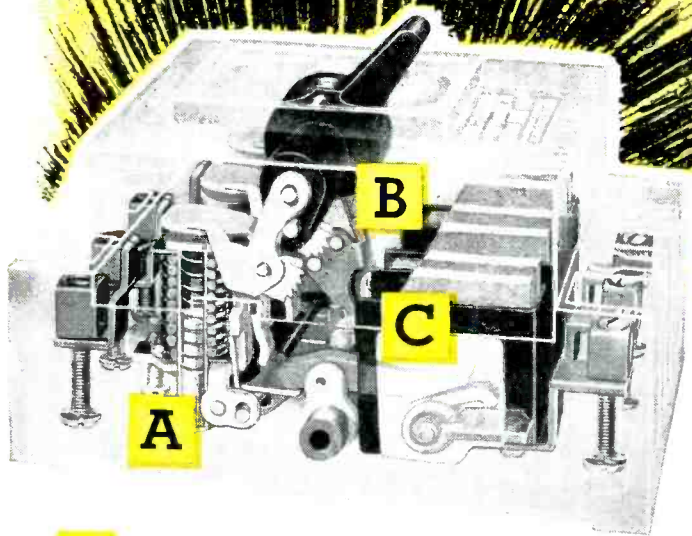
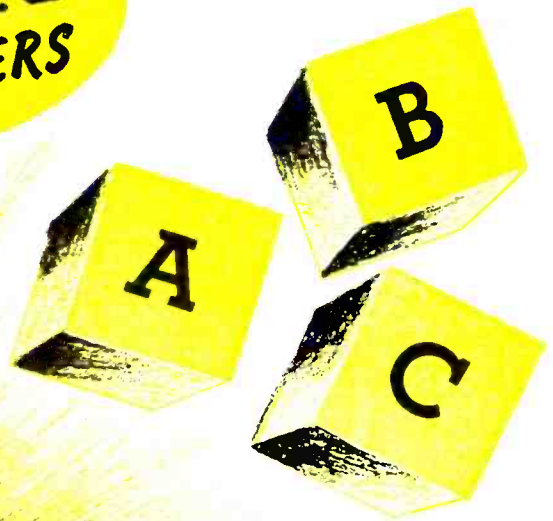

They Are
**ENTIRELY
MAGNETIC**

A MAGNETIC-HYDRAULIC TIME-DELAY

Where specified, HEINEMANN Circuit Breakers have a true inverse time delay in a hermetically sealed unit which allows passage of inrush current. Continued overload, however, opens the breaker in time inverse to the ratio of the current. Breakers are made with time-delays closely matched to customers' specifications.

B HIGH SPEED LATCH

This latch mechanism operates with the least amount of friction and greatest speed of any latch known. It performs two functions, opening the breaker with the least mechanical delay, and opening it independently of handle operation. It functions only under overload or short circuit conditions.

C MAGNETIC HIGH SPEED BLOWOUT

This blowout adds speed to the arc interruption. Individual arcing chambers carefully insulated from each other have magnetic blowout contacts mounted in them. As the value of the current to be interrupted increases, the quenching effect becomes greater, due to the intensified magnetic blow-out field.

Send for **NEW Catalog Showing Complete Line and Engineering Data . . .**

HEINEMANN CIRCUIT BREAKER CO.

Subsidiary of Heinemann Electric Co., Est. 1888

97 PLUM STREET

TRENTON, N. J.

HOW MANY VARIATIONS ARE THERE TO A STANDARD DESIGN

Acme Electric transformers are designed to basic standards to which variations can be adapted to exactly meet the requirements of the application. For example, Mounting Type 100 is for horizontal mounting while type 101 is for vertical mounting, yet both are basically identical. And in either case, one or both mounting legs may be turned down for side mounting to save space. The number of leads or terminals may also be varied to comply to the electrical specifications desired. All things considered, Acme transformers made from standard parts to special specifications are available in hundreds of ratings and to exactly the physical dimensions, design and electrical characteristics you require. Acme Transformer Engineers will be glad to assist you by designing transformers to improve the performance of your product. Bulletin 168 gives more details.

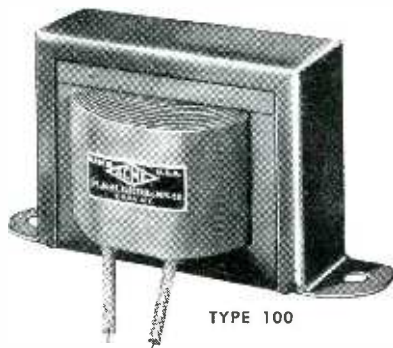

TYPE 100

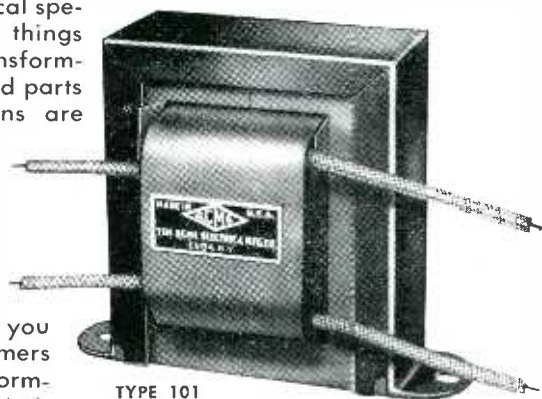

TYPE 101

THE ACME ELECTRIC & MFG. CO.
31 Water St. CUBA, N. Y.

Acme  **Electric**

tending frequency range will produce quality which is less pleasing than that obtained with a limited bandwidth.

Distortions may be in frequency and amplitude, and may be due to hum and noise or caused by interaction of complex frequencies or intermodulation. To meet the FCC requirements, an amplifier should have a total hum and noise at least 66 db below the full modulation or overload point. It should have a reserve sine-wave carrying capacity at least six db beyond full modulation.

There should be no significant difference in frequency response of the amplifier between runs made with oscillator and oscilloscope at maximum operating level, a level of 30 db below that point, and 60 db below maximum level. For direct transmission, six percent intermodulation should not be exceeded in the frequency band, and if the signal is to be recorded and rerecorded or is to be transmitted through a network of amplifiers, it is desirable that intermodulation products be held below four percent.

Test Technique

Intermodulation tests consist of transmitting simultaneously two known frequencies through equipment under test and then measuring the degree of interaction and distortion of the two by determining the amount of new frequencies generated. First and second harmonics of intermodulation and ripple components are usually present.

The test method uses two oscilla-

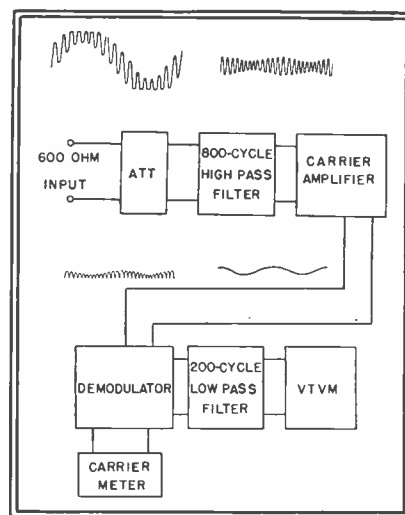

Block diagram of intermodulation analyzer



MN-62A

THE **NEW** NA-1 AIRCRAFT NAVIGATIONAL SYSTEM

*Latest addition to the already famous
Bendix Radio Compass Line*

A new example of Bendix Radio Creative Engineering—The NA-1 System furnishes automatic visual bearings and simultaneous aural reception of cw, mcw or voice signals in the range 100-1750 kc. It also serves as a low frequency range receiver, or manual direction finder, and operates on a straight wire antenna or static reducing loop throughout its frequency range.

The MN-62A Radio Compass Receiver is designed for operation with r.f. transmission lines up to 30 feet in length, for flexibility in location of loop and sense antenna. All receiver and loop control circuits are included in a single case. The receiver operates from a primary power supply of 115 V., 400 cycles a.c. and 28 V. d.c.

The MN-60A Iron Core Loop—Small, streamlined, is ideal for highspeed craft. It increases payload of aircraft by reducing air-drag.

All functions of the NA-1 System are controlled with the type MN-63A Remote Control Unit, or with custom-built controls designed for specific overall systems and types of airplanes. Bendix Radio specializes in the design of such consolidated control assemblies.

Bearing indicators are available in several types and sizes for either a single or dual compass system. All components of the NA-1 System are built to the same rigid specifications that have made Bendix the Greatest Name in Aircraft Radio. They bear CAA type certification for scheduled air-line operation.

For full information, write to Sales Department

BENDIX RADIO DIVISION • BALTIMORE 4, MARYLAND



MN-60A

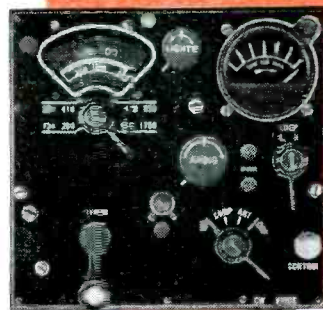

MN-63A



MN-37



STANDARD FOR THE AVIATION INDUSTRY

*Whatever your instrument
rectifier needs, for any
instrument installation
or repair job, you can be sure
you're right, when you . . .*

Choose CONANT Instrument Rectifiers

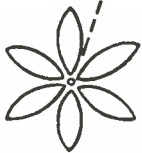

OVER 90 PERCENT of all rectifier requirements are served by 12 types—4 basic assemblies in 3 series. These series are Conant's 500, 160 and 160-C.

Conant special developments include:

BALAC—for applications that involve the balanced bridge principle in AC operation, and **UNI-SCALE**—the rectifier assembly that completely eliminates temperature variations.

YOU NEED THESE BOOKS!

"New Rectifier Replacement Guide" for most test equipment. Know, at a glance, the correct type and size rectifier necessary for any installation. Write for your "Guide" today, it's free.

"Instrument Rectifiers and Rectifier Type Instruments", by H. B. Conant. It's 'must' reading for every user of instrument rectifiers. Send 25¢ to help cover handling and mailing.

Remember: (1) Every order for Conant Rectifiers is shipped to you prepaid, and (2) Substantial quantity discounts apply on large orders.

When you need rectifiers or when you need information, contact your local representative, or write

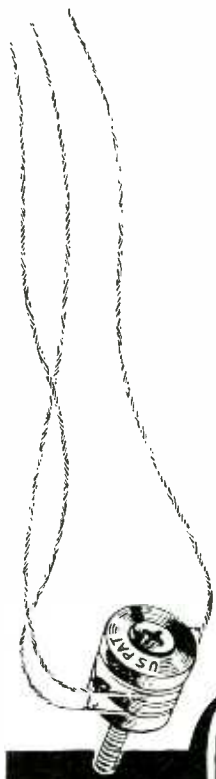

Instrument Rectifiers

ELECTRICAL LABORATORIES

6500 O STREET, LINCOLN 5, NEBRASKA, U. S. A.

20 Vesey St., New York 7, New York
85 E. Gay St., Columbus, Ohio
600 S. Michigan Ave., Chicago 5, Ill.
1215 Harmon Pl., Minneapolis 3, Minn.

2017 Grand Ave., Kansas City 8, Mo.
1212 Camp St., Dallas 2, Texas
378 Boulevard N. E., Atlanta, Ga.
4018 Greer Ave., St. Louis, Mo.

1526 Ivy St., Denver, Colo.
4214 Country Club Dr., Long Beach 7, Cal.
Export Div., 89 Broad St., N. Y. 4, N. Y.
50 Yarmouth Rd., Toronto, Canada

tors, one having low frequency output of 40-60-100 cps and the other with frequencies of 1,000-7,000-12,000 cps combined in a hybrid coil and fed through an attenuator to the equipment under test.

A block diagram of the intermodulation analyzer is shown. The input attenuator can dissipate 50 watts and is adjustable over a 90-db range in one-db steps. The output of the equipment under test consists of a low-frequency signal with a high-frequency signal superimposed plus harmonics of the original tones and intermodulation distortion.

To measure the intermodulation, the original low-frequency component must be removed. This is done in the 800-cycle filter following the attenuator. The filter output, a carrier and its resultant side bands, is then amplified and demodulated. A 200-cycle low-pass filter removes the carrier and transmits only the ripple components up to 200 cycles. The 200-cycle cutoff was set to admit at least second harmonics for all original low frequencies, more being accepted for the 40 and 60-cycle tones.

The ability of an amplifier system to transmit the low frequencies that occur simultaneously with the higher frequencies of speech and music is very important. Without such carrying capacity, extreme distortion may result. Transformers and other devices which change their impedance at low frequencies are a major cause of such distortion. All types of systems show the least distortion near the middle portion of the transmission band. For this reason, test frequencies were chosen near the outer portions of the band.

Practical Aspects of High Fidelity

That too much emphasis is placed on frequency response and not enough on entertainment value of reproduction was stressed by Hugh S. Knowles of Jensen Radio Manufacturing Co. He stated that high-fidelity sets produced in 1935 were capable of reproducing frequencies up to 7,000 cycles, which is far above the average today. Receivers produced in 1937 covered the range from 40 to 4,000 cycles and those produced in 1941, 70 to 3,500 or 4,000 cycles.

Chinn and Eisenberg specify wide-range reproduction as 30 to 10,000

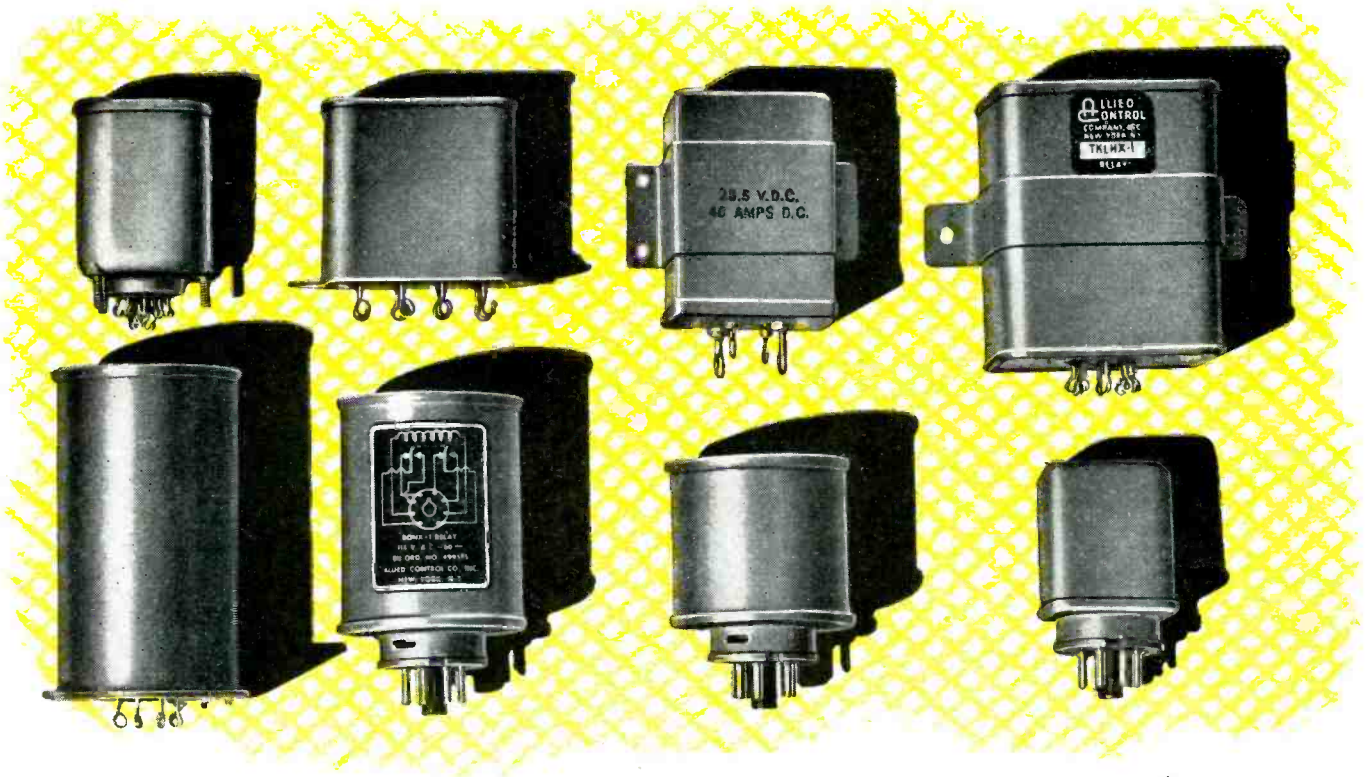

DIVERSITY OF DESIGN *plus* IN **ALLIED'S** HERMETICALLY-SEALED RELAYS

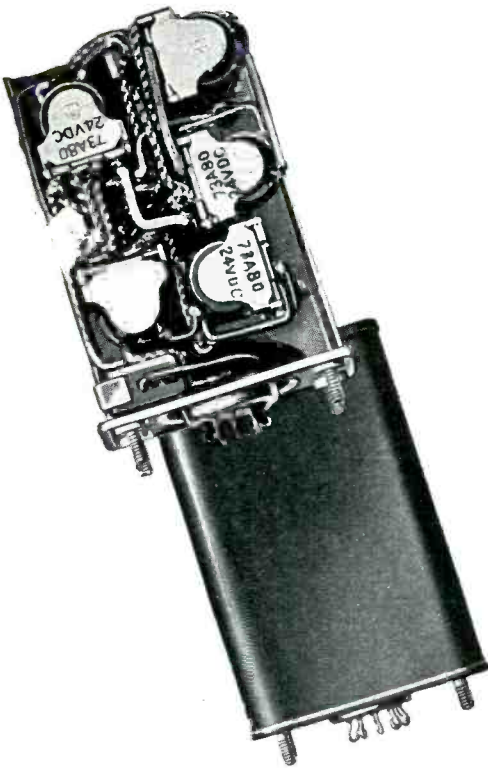

The photo above shows a cut-away view and completed assembly of Allied type TKHX-26 sealed relay with ten soldered terminals individually color marked.

These relays are designed to fit your specific applications and to fill your special requirements completely, but this is not all.

When you specify "Allied" you are sure to get a unit that is completely engineered as a sealed relay — not just equipment built around older types. Moreover these sealed relays are produced completely, from start to finish, in Allied plants, by one organization, under coordinated standards.

These products have back of them a wealth of pioneering experience in the sealing of relays to protect them from dirt, moisture and many foreign substances or to prevent tampering or accidental damage to the working parts. This experience is today expressed in a completely organized sealed-relay division, using the most modern techniques and equipment including a specially designed sealing room where air temperature, humidity and cleanliness are scientifically controlled.

There is wide diversity of design in Allied sealed relays. But of far greater importance are the benefits of experience, complete engineering, and modern manufacturing by one organization. Before you specify be sure to get all the facts about Allied relays.

ALLIED CONTROL COMPANY, INC.

GENERAL OFFICES: 2 East End Ave. (at 79th St.) New York 21, N. Y. Factories: New York City (2 East End Ave.) Plantsville, Conn. Chicago — 4321 N. Knox Avenue, Chicago 41, Illinois. In California: Allied Control Co. of California, Inc. 1633 South Hope St., Los Angeles 15, Calif.



AL-102

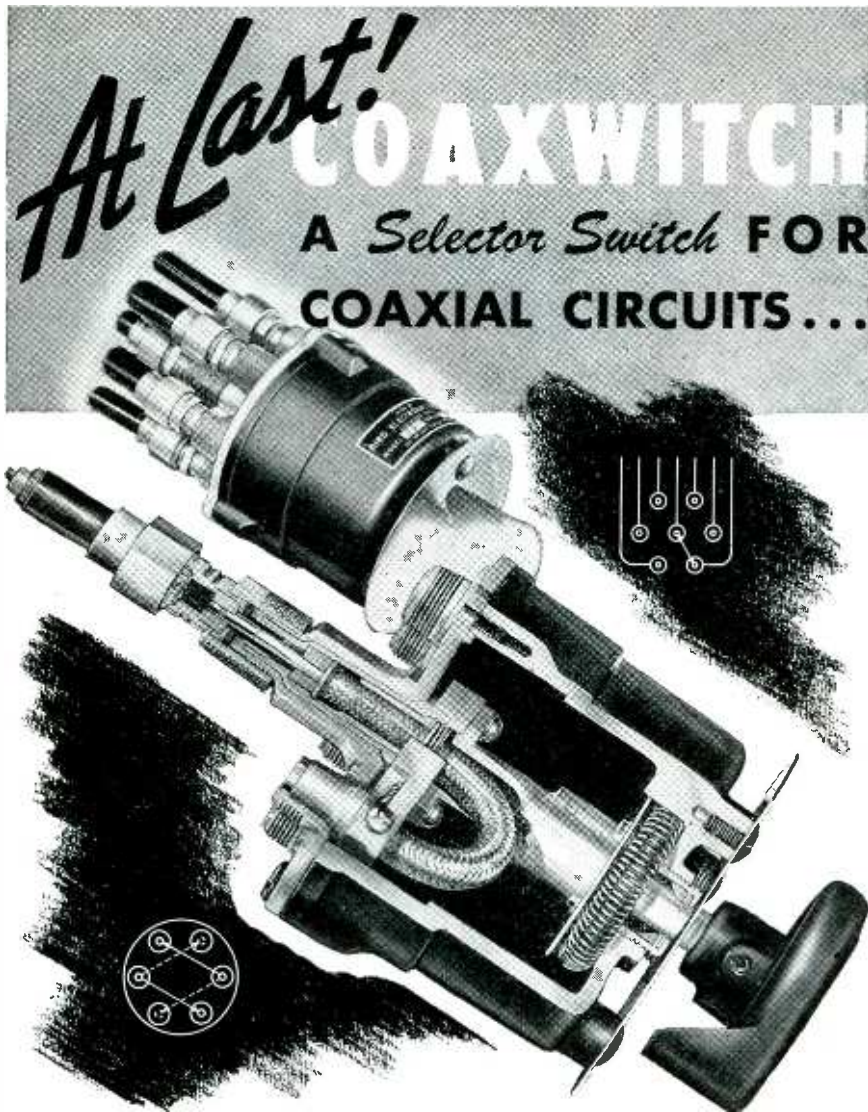

Here's the switch you've been looking for. Now a simple and efficient means of switching coax lines is available in three models. Present Types handle 50-ohm coax at frequencies up to 4000 megacycles. *Characteristic impedance is maintained thru all switch details.*

Application: Selection of antennas, receivers, low power transmitters; Intra-equipment switching in coax links; with phase monitors in directionals; double-ended selection of insertion devices, filters, etc.

Model 74 handles single line with choice of six channels. Model 718 is similar to Model 74 but with 8-channels. Model 72-2 is a double-pole, double-throw type for switching two circuits simultaneously. Other versions of the novel switching action of the COAXWITCH and other impedance levels are under development. If you have a coax switching problem, we can help you. Data sheets are available. Write Bird Electronic Corporation, 1800 East 38th St., Cleveland 14, Ohio, for your copy today.



cycles, medium from 50 to 8,000 cycles and narrow range from 100 to 4,500 cycles. The narrow range is wider than that of most production models of today. Surveys have shown that a band between the narrow and medium ranges is preferred by the public.

Response curves commonly shown as indicative of performance often lead to incorrect conclusions since the curves are dependent on location of the microphone and loudspeaker even in rooms that may be built to a given set of specifications. The loudspeaker output should go up at high frequencies to sound best to the ear. Subharmonic distortion is sometimes introduced to aid reproduction. Distortion from intermodulation varies greatly with frequency and may affect entertainment value of wide-range systems. The speaker felt that the entertainment value of a two-channel system reproducing frequencies up to 3,500 cycles is better than a one-channel system with 15,000 cycle response and that a spread-source effect in reproducing music is desirable even though it cuts articulation efficiency.

• • •

More on Spherics, Storm Detector

FURTHER TECHNICAL details of the spherics detector for locating distant storm centers (ELECTRONICS, Feb. 1946, p 212) have been disclosed by the Office of the Chief Signal Officer. The equipment enables weather forecasters to plot storms across thousands of miles of ocean by detection of static electricity in thunderstorms, cloud masses, or rainfall.

Experience proved that the spherics technique was not as effective in tropical climates as in more temperate regions. It was also found that nocturnal observations were significantly less accurate than those made in the daytime. And due to the comparatively low frequency of the spheric impulses (7 to 10 kilocycles), deflection of the ground wave causes a considerable factor of error, especially in coastal locations. Another element of error is introduced when the direction finders pick up low-frequency communication transmis-

Why do it the hard way ? Just snap on a **SPEED NUT** !

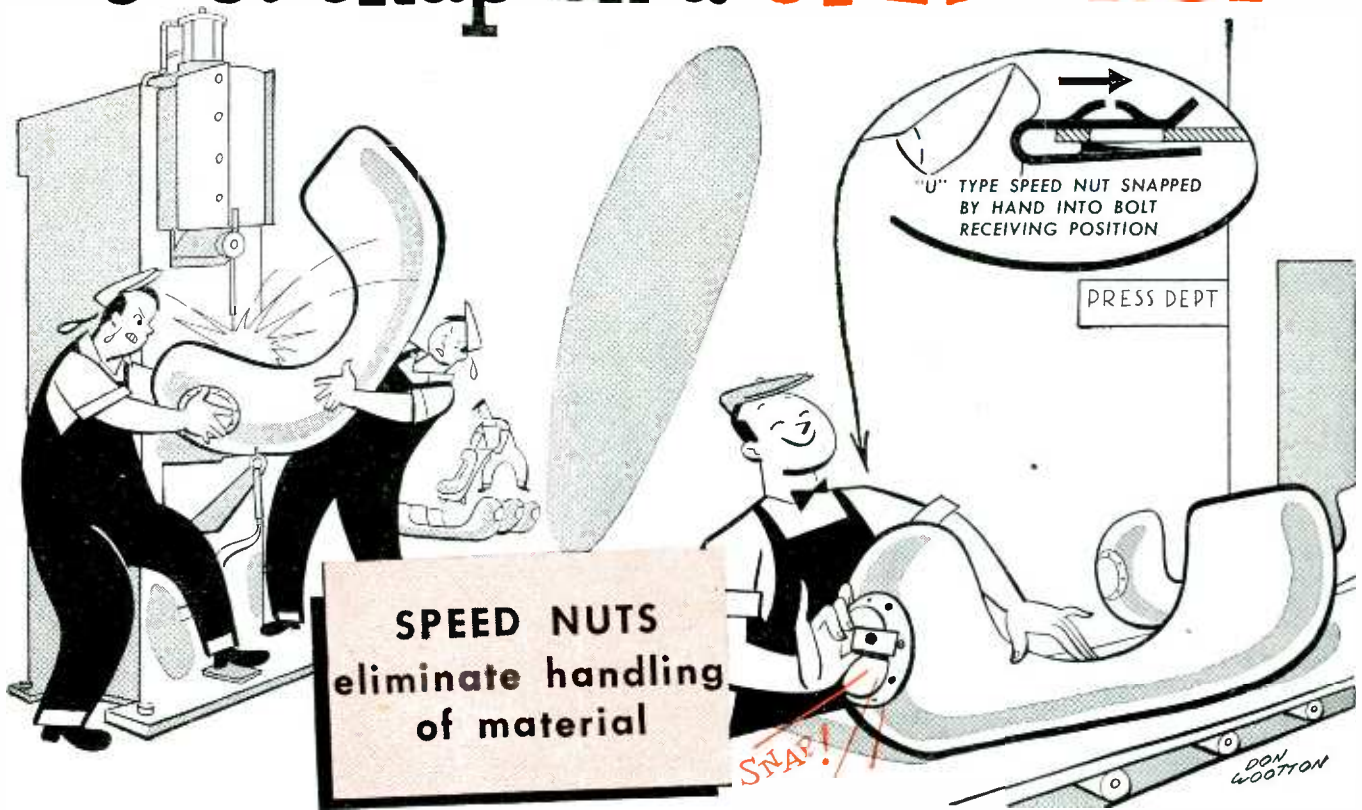

A SPEED NUT CASE HISTORY

One car builder used four welding machines to attach cage nuts on fender stampings for head lamp assembly. Three men were needed for each machine . . . one hauled stampings from the press department and two more wrestled the stampings and located them in fixtures on the welder. Because of all this handling, stampings were frequently damaged. And after painting, threads had to be re-tapped.

Changing to self-retaining Speed Nuts radically reduced the costs of this operation! Two men now do this work on a conveyor and quickly snap the Speed Nuts into place by hand. We will be glad to give you complete details of this case history on request.

In Canada: Wallace Barnes Co., Ltd., Hamilton, Ontario
In England: Simmonds Aerocessories, Ltd., London
In France: Aerocessoires Simmonds, S.A., Paris
In Australia: Simmonds Aerocessories, Pty. Ltd., Melbourne

Time was when the only way to fasten a nut in place for blind location assembly was to weld, rivet or clinch a cage nut over the bolt hole. This anchored the nut . . . but man, what a job it was!

Changing to Speed Nuts really simplifies this type of operation! Effort is reduced to a fraction — hands freed for more productive work. Welding machines eliminated. Less floor space needed. And, there is less handling and easier final assembly. You get all this *plus* a better finished product because the spring tension lock of Tinnerman Speed Nuts *prevents vibration loosening*.

There are many types of self-retaining Speed Nuts . . . all designed to drastically reduce the cost of blind location fastening. Let us show you how they can be used on your product to effect really worth-while savings. Send in your assembly details today!

TINNERMAN PRODUCTS, INC.

2106 FULTON ROAD • CLEVELAND 13, OHIO

Speed

MORE THAN 3000



Nuts

PATENTED

SHAPES AND SIZES

*Trade Mark Reg. U. S. Pat. Off.

F A S T E S T T H I N G I N F A S T E N I N G S

For FM and TV

NEW ANDREW COAXIAL CABLE WITH
51.5 OHMS IMPEDANCE!

Meets Rigid FM-TV Standards

A new coaxial cable, especially designed for FM and TV use, is now a reality at the Andrew Co. Scheduled for mid-June delivery to the first orders received, these new cables, in 4 sizes, introduce the following important engineering features:

1. Characteristic impedance of 51.5 ohms. (The regular Andrew cables for AM applications have a nominal impedance of 70 ohms.)
2. Connectors and associated fittings have been engineered with special care to avoid reflections and discontinuities. Being completely solderless, these fittings simplify installation and eliminate problems of flux corrosion and pressure leaks.
3. Insulators are spaced 12 inches apart in the 3 large size cables, and 6 inches in the 7/8-inch cable.
4. Improved low loss insulation material is used, having a dielectric constant of 6.0 and a maximum loss factor of .004 at 100 mc.
5. Close tolerances have been established on conductor and insulator dimensions, in order to maintain a constant characteristic impedance.
6. Inner and outer conductors are made of copper having a minimum conductivity of 95% IACS at 25° centigrade.

Your order now is the best assurance of early delivery on this new coaxial cable for your FM or TV installation.

Write or wire the Andrew Co., 363 East 75th Street, Chicago 19, Illinois, for complete information or engineering advice on your particular application.

ATTENUATION CURVE

Attenuation is calculated to provide for conductor and insulator loss, including a 10% derating factor to allow for resistance of fittings and for deterioration with time.

- The new 51.5 ohm air insulated coaxial cable for FM and TV comes in 4 sizes, priced tentatively as follows: 7/8", 42c per ft.; 1 1/8", 90c per ft.; 3 1/8", \$2.15 per ft.; 6 1/8", \$5.20 per ft. Andrew Co. also manufactures a complete line of accessories for coaxial cables.

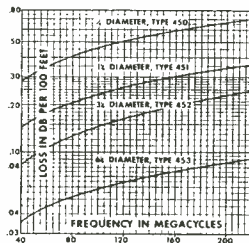

6 1/8" COAXIAL CABLE



3 1/8" COAXIAL CABLE

ANDREW CO.
363 EAST 75th STREET
CHICAGO 19, ILLINOIS

sions simultaneously with spheric impulses.

As used by the Signal Corps, each spherics set weighs about 450 pounds and costs about \$5000. The frequency range of the latest model is 3.6 to 17.5 kilocycles.

Fixed Loop Antennas

Most radio direction finders are designed to detect continuous-wave signals which are sufficiently enduring in time to permit the determination of direction by rotation of an antenna. The detection of spherics obviously poses greater problems, and the static direction finder is engineered with two separate antennas which do not rotate. The two loop antennas are erected at right angles to each other so that the plane of one is perpendicular to the north-south direction and the plane of the other is perpendicular to the east-west direction.

Each antenna consists of 400 turns of wire wound inside a waterproof aluminum shield. The output voltage of each loop is coupled to identical but separate high-gain amplifiers, which are designed to produce identical output voltages in response to equal stimuli. The output voltages of the amplifiers in turn are coupled to the deflection plates of the oscilloscope.

When the loops are mounted at right angles to each other, signals arriving along the ground produce in each loop a voltage whose value is determined by the strength and angle of approach of each received signal. Since the two loops are identical in construction, their output voltages are identical in wave shape

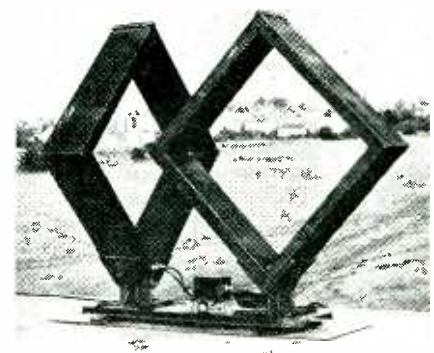

Loop antennas of the direction-finder system for locating distant storms

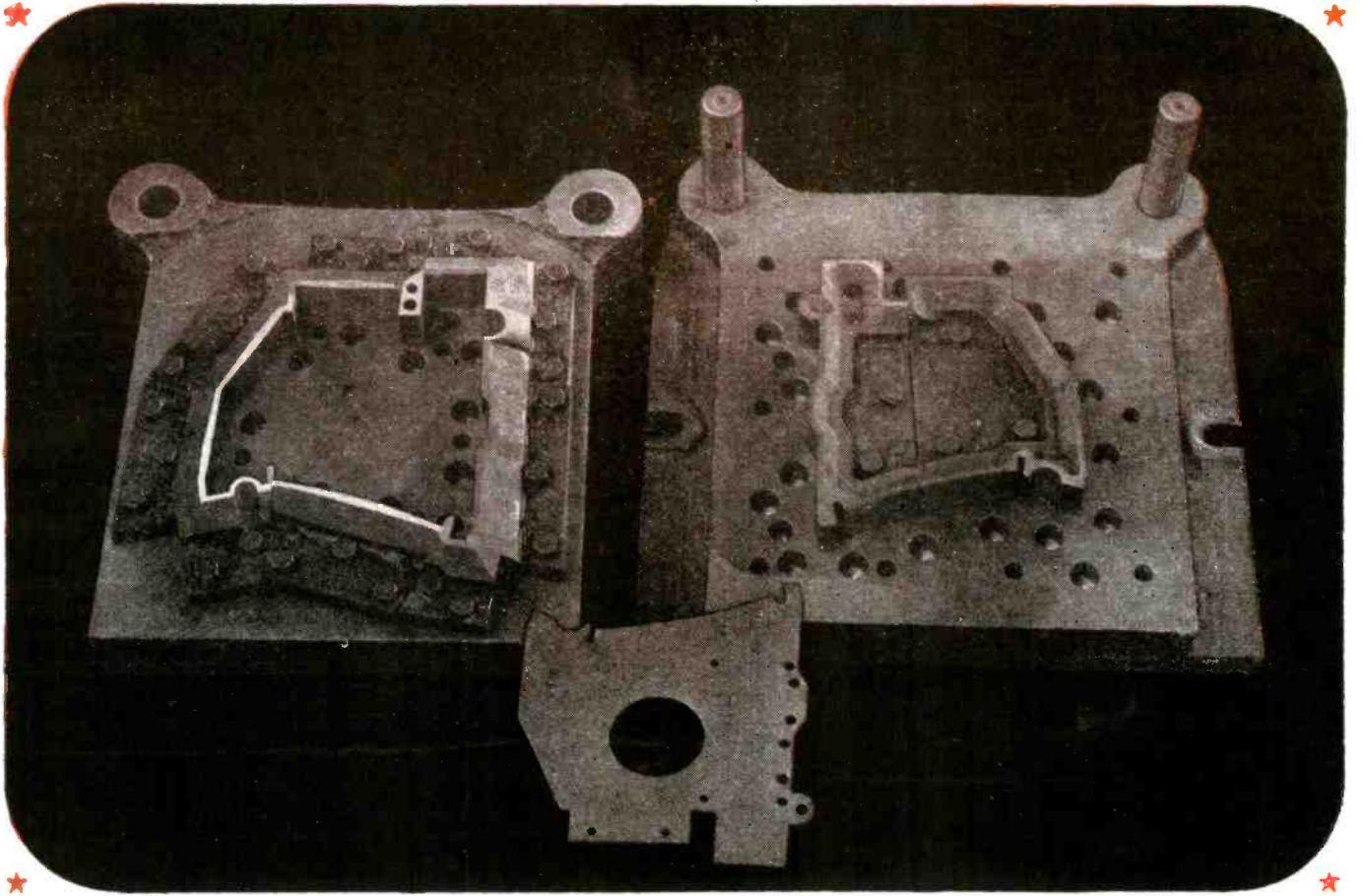

HOW TO *Cut Costs and "Corners"* ON YOUR BLANKING DIES

You can save steel and time in the making of dies for blanking, trimming, beading, or any application involving the cutting of sheet metals to regular or irregular shapes; by assembling them from FCC Composite Steel Die Sections.

These prefabricated die parts consist of fine tool steel cutting edges, in a selection of grades,

electrically welded by a special process to non-hardenable mild steel bases. Thus, screw and dowel holes may be easily drilled after heat treating, and there are numerous other advantages that will be immediately obvious to the die maker.

Thousands of die shapes may be made up from combinations of

thirty-five standard sections. Specially shaped sections are manufactured to customers' specifications in five to ten days.

● Make *your* dies this money-saving way—full data on request.



**ALLEGHENY
LUDLUM
STEEL CORPORATION**

*Forging and Casting Division
Detroit 20, Michigan*

WRITE FOR ENGINEERING DATA

It contains a print showing the various standard shapes available for quick shipment, and explains how to order special shapes, including rib-reinforced extra high sections. It also contains prices. Get your copy—write for it today.

ADDRESS DEPT. E-40

W & D 9477-C

and phase, and are equal in magnitude for signals arriving from angles of 45, 135, 225, and 315 degrees.

The output voltages of the two loops are amplified to the point where they are strong enough to deflect the oscilloscope electron beam. The output voltage of the north-south loop amplifier is applied to the vertical plates and the output voltage of the east-west loop amplifier is applied to the horizontal plates.

In view of the brief duration of the oscilloscope flashes, a certain element of error is inherent in the instantaneous visual reading of the directional bearings. The Signal Corps is attempting to overcome this problem by developing auxiliary photographic equipment which records the oscilloscope indications on 35-mm film. This equipment includes a motion picture camera through which the film is drawn continuously at a speed of one to five inches per second, and a continuous action developer which automatically processes and dries the exposed film received directly from the camera. The film is then projected upon a viewing screen.

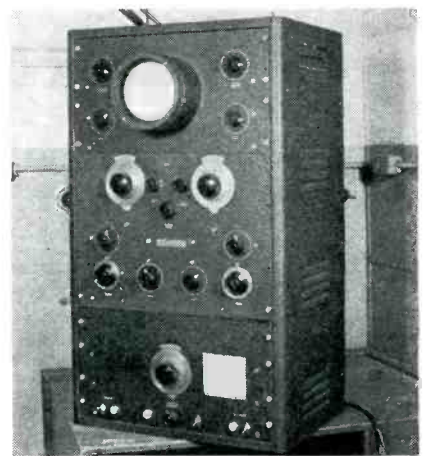

Electronic equipment of the static direction finder. Only half of the cathode-ray tube is calibrated since the individual direction finders provide data with 180-degree ambiguity

The camera action is synchronized at all stations of the spherics network by a radio timing unit which produces timing pulses, accurate to within 1 part in 50,000. This auxiliary photographic equipment is still in the laboratory stage.

Just a few of the thousands of Radio Parts manufactured by INSULINE

Send for complete catalog describing the full line of I.C.A. Antennas. Or, if convenient pick up a copy when you visit our exhibit at the R.P.E.E. Show, Steven's Hotel, Chicago.

Booth #34
(May 13th to 16th inclusive)

insuline
CORPORATION OF AMERICA
INSULINE BUILDING • LONG ISLAND CITY, N. Y.
More than a quarter-century of Quality production.

the IRE Winter Technical Meeting engineers of Westinghouse Electric Corp. described high speed x-ray equipment capable of recording impact pressure waves.)

Measurements

In addition to instruments and measurements largely concerned with testing electrical machinery, three papers pertaining to electronic circuits were presented. In the first, prepared by engineers of the Leeds and Northrup Co., electronically balanced recorders having high input impedances and balancing time in the order of seconds were described. These recorders were developed for use with thermocouples and phototubes. Vacuum tubes within the recorders provide signal amplification, others control the balancing motors.

An automatic oscillograph with a memory was described by A. M. Zarem, California Institute of Technology, Pasadena, Calif. The oscillograph consists essentially of a long-persistence screen, cathode-ray tube. The unit was designed to record randomly occurring transients.

The cathode-ray tube is normally in constant operation. The time base is operating; the signal is applied. When a transient occurs in the system being monitored, the transient is immediately drawn on the tube

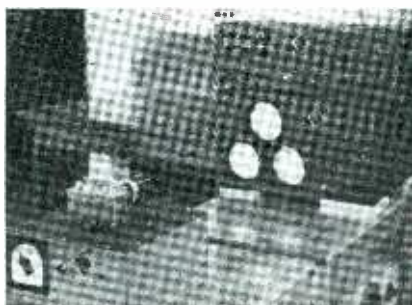

Automatic oscillograph records transients whenever one occurs

screen. The transient also blanks the beam preventing masking of the transient by later steady state signals and trips a camera focused on the screen. The transient trace is photographed before it decays. The system can reset itself in preparation for the next transient once the initial transient trace has been photographed. The beam blanking is removed, the film moved to the next frame, and the camera reset.

Servomechanism problems can be studied by electrical analogy methods described by Westinghouse engineers. The principle of the technique is to represent all mechanical properties such as time lag, inertia, stiffness, and friction by their electrical analogies. The electrical analogies are wired into the servo control circuit. Oscilloscopic observations at essential points in the circuit indi-

cate system behavior. By this method, servomechanisms can be quickly studied and the effects on stability and speed of response of the parameters determined. The paper is specifically concerned with angular position servomechanisms.

Atomic Power

Generation of electric power from atomic fission promises to be the greatest directly constructive social benefit of atomic power. However, engineering difficulties which must be overcome before this application is economically feasible will require years of experience with this new energy source.

In an address before the Institute, J. R. Dunning, Columbia University, New York City, explained that, because of the necessarily thick shielding to confine harmful radiation within the atomic boiler, power plants would be too heavy for all but stationary locations although the reduced bunker requirements might enable atomic prime movers to be carried on the largest battle ships giving them a virtually unlimited range. Reactions within atomic boilers are self regulating; any desired temperature can be produced and maintained.

During his lecture Dr. Dunning demonstrated detection and recording of actual atom splitting, and showed that water acts to decelerate neutrons to their resonant velocity, thereby increasing their effectiveness in splitting atoms.

Addressing a combined meeting of the AIEE with the IRE, L. R. Groves, Maj. Gen. in charge of the Manhattan Project, said that the expense of developing the atomic bomb was only slightly greater than a week of modern warfare. Because of the uncertainty of obtaining usable results, the tactical command proceeded on the assumption that the atomic bomb would not be available. The atomic bomb project used 90,000 electron tubes.

During the AIEE symposium on nuclear energy at which K. K. Darrow, Bell Telephone Labs., Inc., C. G. Suits, General Electric Co., J. A. Hutcheson, Westinghouse Electric Corp., and P. W. Swain, McGraw-Hill Publishing Co., spoke, it was pointed out that present high cost of producing nuclear energy prohibits its im-

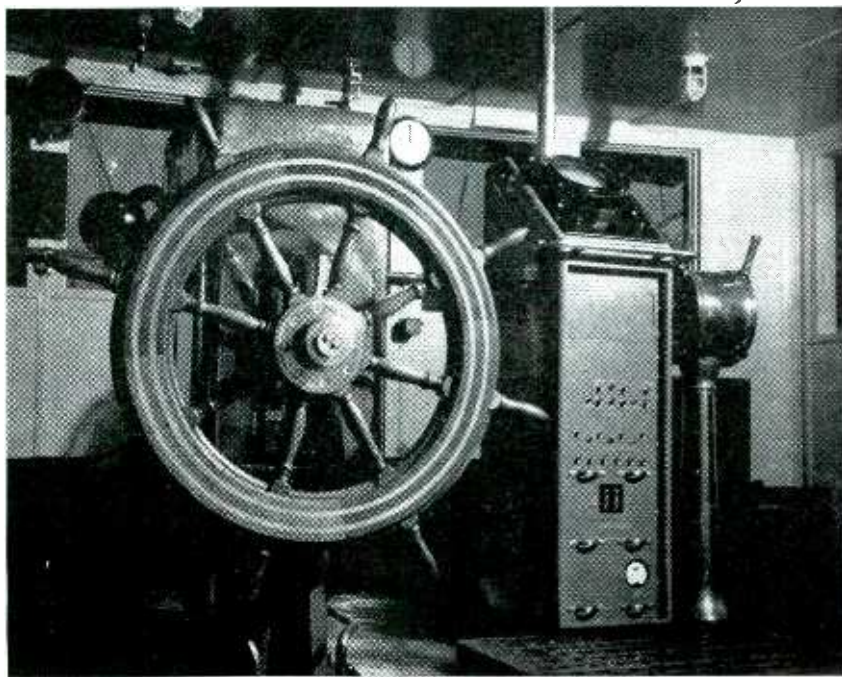

Simplified to the extent that one man in the pilot house can operate it, war developed radar opens new frontiers in maritime safety and independence from weather

Depend on **OHMITE** Experience FOR THE RIGHT RHEOSTAT CONTROL

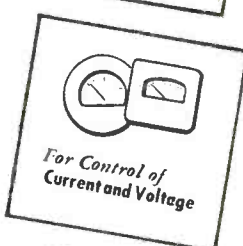
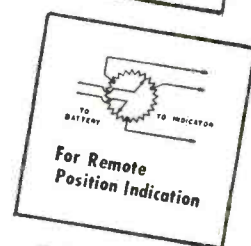
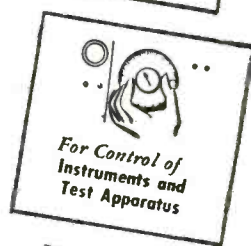
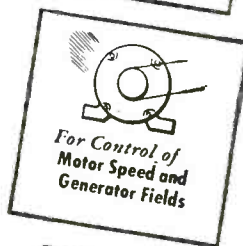
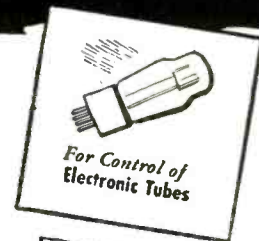
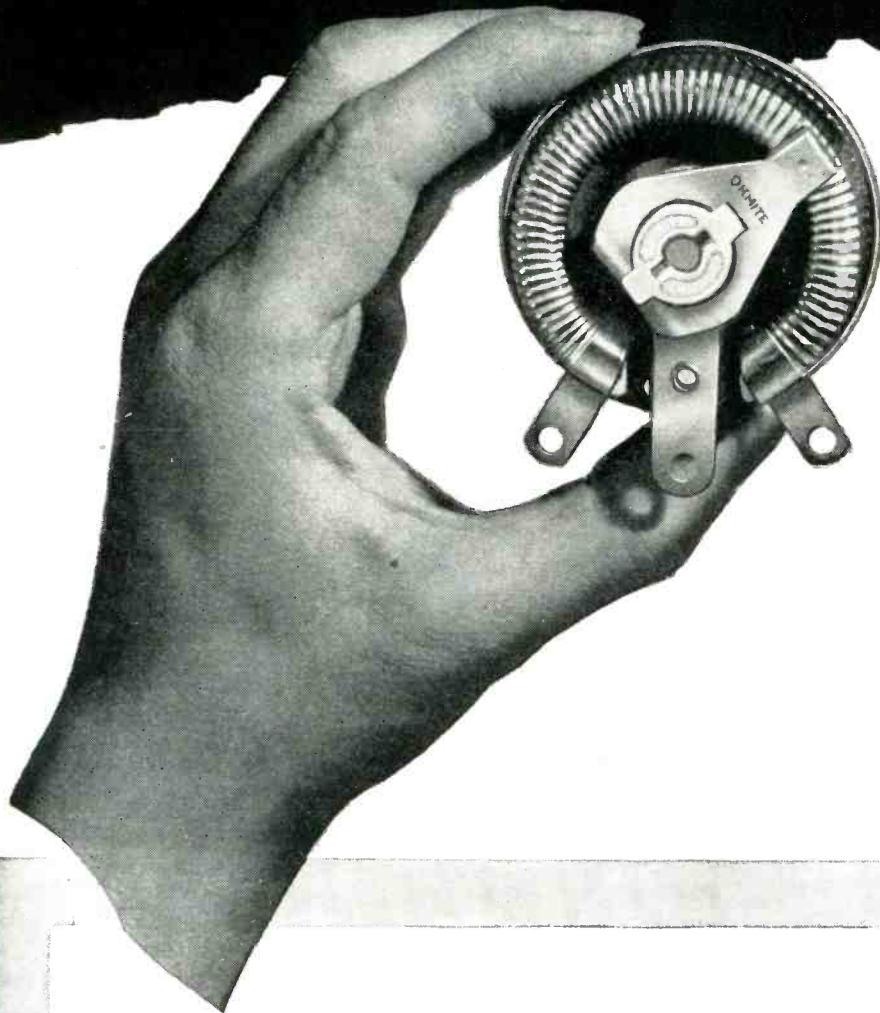

Time-proved Design! Widest Range of Sizes!

You get these advantages: (1) Ohmite experience with countless rheostat applications. (2) Service-proved Ohmite features that assure permanently smooth, close control. (3) Extensive range of sizes and types for easy, economical selection of the best unit for every application.

There are ten wattage sizes ranging from 25 to 1000 watts—from 1 1/16" diameter to 12" diameter—in uniform or tapered winding—in single or tandem units—in regular or special designs. Stock models from 25 to 500 watts, in many resistance values.

Consult Ohmite engineers on your rheostat control problem.

OHMITE MANUFACTURING COMPANY
4816 FLOURNOY STREET, CHICAGO 44, U.S.A.



Send for Catalog
and Engineering
Manual No. 40

Write on company
letterhead for this
helpful guide in the
selection and applica-
tion of rheo-
stats, resistors, tap
switches, chokes
and attenuators.

Be Right with **OHMITE**

RHEOSTATS • RESISTORS • TAP SWITCHES • CHOKES • ATTENUATORS

THE ELECTRON ART

AIEE Winter Convention

SPECIFIC INFORMATION on new frontiers initiated or given impetus by technical advances during the war was presented before approximately 2,000 engineers attending the 1946 AIEE Winter Convention held January 21-25 at the Engineering Societies Building, New York City. Of particular interest to **ELECTRONICS** readers were the sessions on communications, sound recording, industrial tube applications, and radar. Beginning on page 236 abstracts of the more informative papers are presented.

Electronic applications were mentioned in nearly all sessions. Although major portions of these sessions dealt specifically with electrical engineering, such as hydroelectric systems, power transmission and machine tool process drives, electronic techniques were mentioned in the sessions on excitation systems, industrial power applications, and instruments and measurements.

Power Generation

Electronic excitation systems for large a-c generators were described and principles of design and performance characteristics presented by Westinghouse engineers. These exciters provide reliable, continuous service, good generator regulation, and quick generator recovery from load switching and system shorts.

Circuits using thyratrons can be designed so that tubes can be replaced without interrupting service.

Essentially these electronic exciters are rectifiers for supplying the d-c fields of generators. This particular design feature is a means of maintaining d-c excitation despite generator output voltage and current variations, especially during shorts. Besides the obvious method of operating from an auxiliary generator, the output of the exciter can be stabilized over wide ranges of main generator output either by compensating series transformers, firing angle control, or electronic regulation.

Power Applications

Industrial power applications utilizing electronics include induction heating and radiography. During this session, H. F. Storm of Allis-Chalmers Mfg. Co., Milwaukee, Wis., derived a graph of centimeters penetration for long, cylindrical charges heated by induction. The graph covers the frequency range from one cycle to one hundred megacycles and resistivities from one to one-thousand micro-ohms per centimeter.

X-rays produced by electrons magnetically accelerated in the Betatron have higher penetration than those currently produced by direct potential acceleration. Thicker sections of metals can be more quickly radio-

graphed by these x-rays than by lower energy rays.

How the Betatron has been developed from a laboratory instrument into an industrial tool was related in a paper prepared by J. P. Girard of Allis-Chalmers Mfg. Co., Milwaukee, Wis., and G. D. Adams, University of Illinois, Urbana, Ill. Tests indicate that, like steel, most metals have a

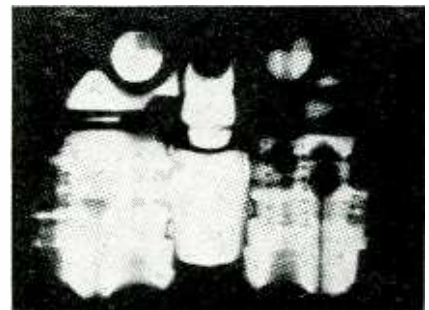

Radiograph of Ford Model T motor made from Betatron produced x-rays

region of minimum absorption in the vicinity of twenty-million electron volt x-rays. Therefore the Betatron is designed to work in this range. Sections having wide variations in thickness can be radiographed. The small spot size of the Betatron x-ray source approximates the ideal point source, making possible enlargement of the specimen on the radiograph by simply increasing the specimen to film distance.

Other projected applications of the Betatron include medical therapy and nuclear research. (News comes from General Electric Co. that engineers of their x-ray laboratory are developing a Betatron x-ray generator. At

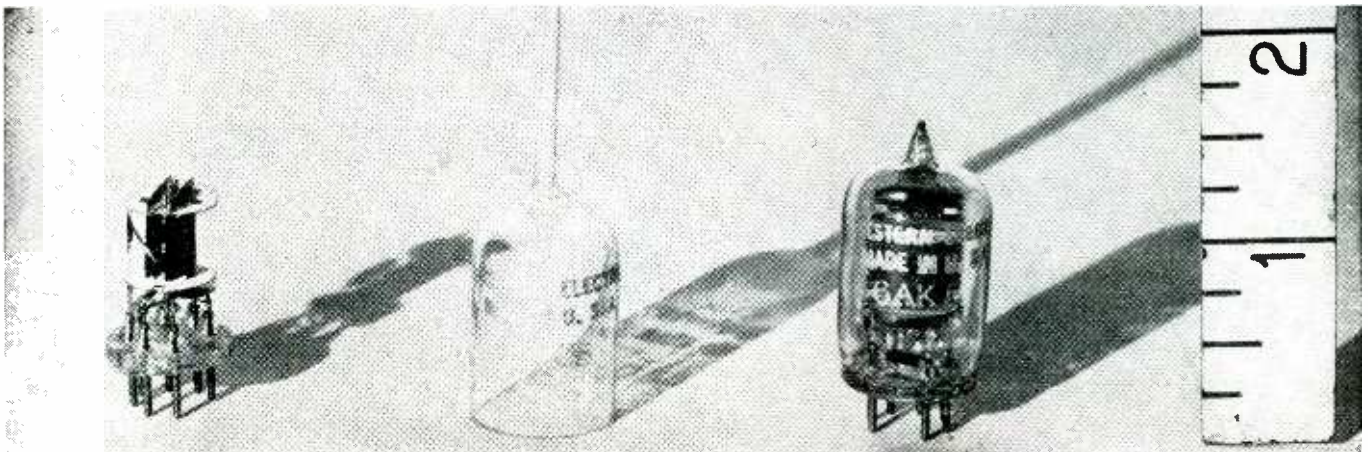

Miniature pentode developed for war time radar and having high figure of merit opens new frontier in such wide band systems as television and pulse modulation

ROSÁN ELECTRICAL TERMINAL STUDS

**Installed . . . Locked in . . . Replaced
from front side of panel!**

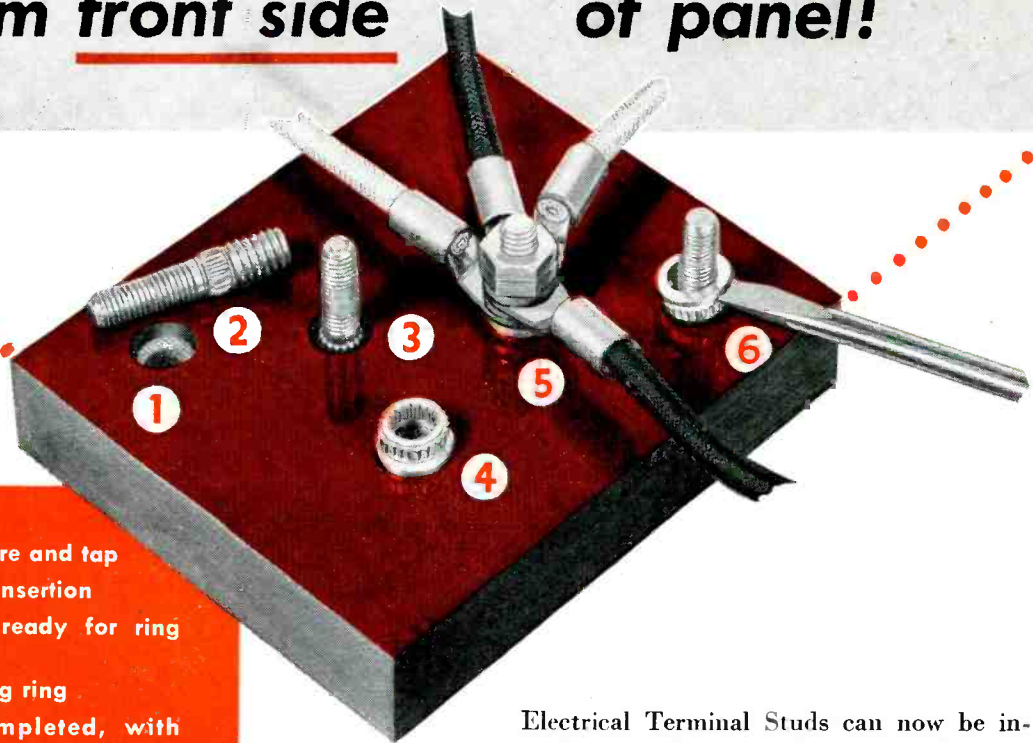

1. Drill, counterbore and tap
2. Stud ready for insertion
3. Stud inserted, ready for ring installation
4. Terminal locking ring
5. Assembly completed, with terminals
6. Terminal locking ring removed

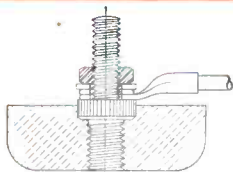

Molded-In Type. Terminal Stud molded solidly in panel, can be removed by simple means and replaced with two-piece type without damage to material or disturbance of other terminals.

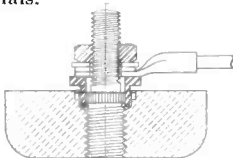

Two-Piece Type. Panel drilled, counter-bored and tapped, terminal stud inserted and locked with ring. Quick and easy removal may be effected as indicated. (No. 6 above)

Electrical Terminal Studs can now be installed, locked-in and replaced from the front side of the panel. This development is possible because of the Rosán Terminal Locking Ring which not only locks the stud firmly in the material, but allows the terminals to be tightly fastened without rotation.

The Rosán Terminal Stud may be molded into the panel, or easily installed after forming. It can be just as easily removed by prying under the flange at the top of the ring, without disturbing other studs or terminals.

Send for samples and full information on this time and moneysaving fastening system.

(Patents issued and pending, U. S. A. and foreign countries)

National
HEADED AND THREADED
PRODUCTS



THE NATIONAL SCREW & MFG. CO., CLEVELAND 4, O.

PACKAGED R. F. RADAR ASSEMBLY ELIMINATES DESIGN HEADACHES

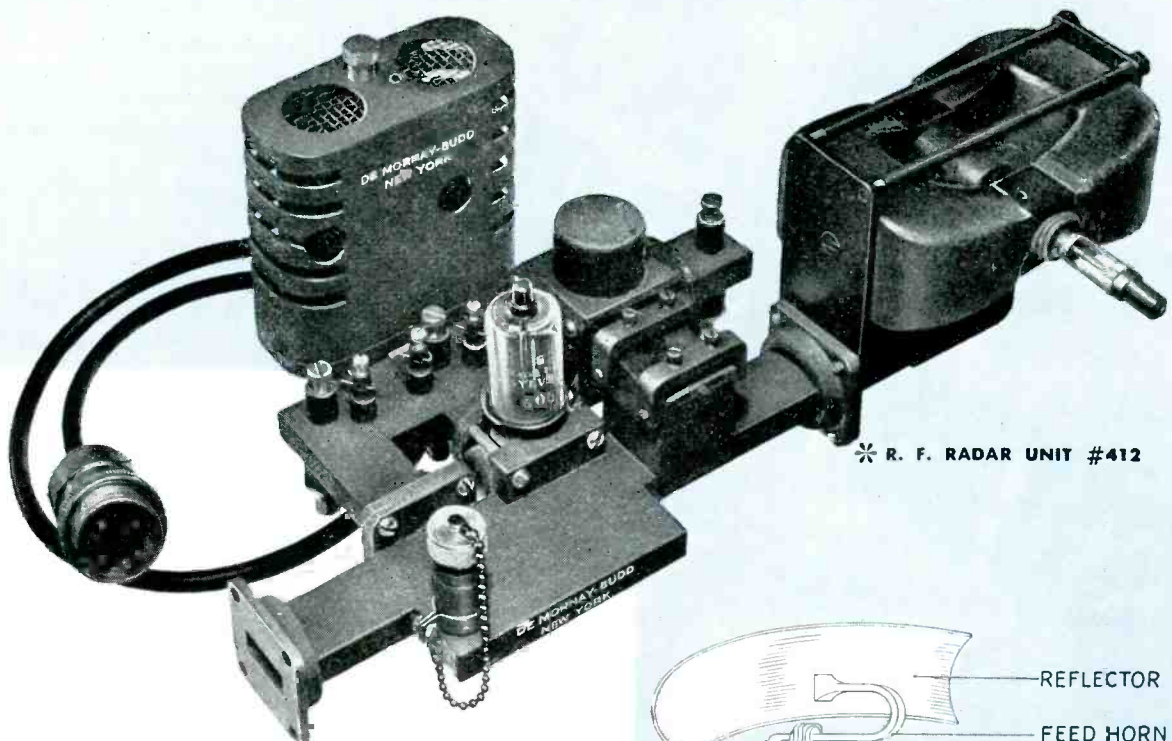

* R. F. RADAR UNIT #412

The DeMornay-Budd packaged R. F. Unit provides a complete R. F. assembly for microwave radar. It is now possible to obtain as standard items all the microwave R. F. components necessary in the fabrication of a complete radar—DeMornay-Budd Standard Transmission Line Components plus packaged R. F. Unit.

The R. F. Radar Unit is delivered complete and ready to operate. It is wired and contains all the necessary tubes and crystals. The unit uses a packaged magnetron capable of delivering 20 kw., peak power, at 9375 mc. Two type 2K25 local oscillator tubes are provided, one for receiver and A.F.C. and the other for beacon operation. A type 1B35 A-T-R tube, a type 1B24 T-R tube and the necessary type 1N21 crystals are included in the assembly. A 20 db. directional coupler permits accurate measurements to be made at any time with a maximum of convenience and safety.

Since the use of radar beacons is contemplated in the near future, the unit has been designed with a beacon cavity and crystal mount. The unit can be supplied without the beacon cavity and crystal mount and beacon local oscillator, and a termination supplied in their place so that it becomes a simple matter to convert to beacon operation when necessary.

We offer complete laboratory research facilities and have available such production test equipment as: Standing Wave Detectors, Calibrated Attenuators, Slug Tuners, Power Supplies, Square Wave Modulators, in addition to transmission line components shown in diagram above. Write for information or catalog.

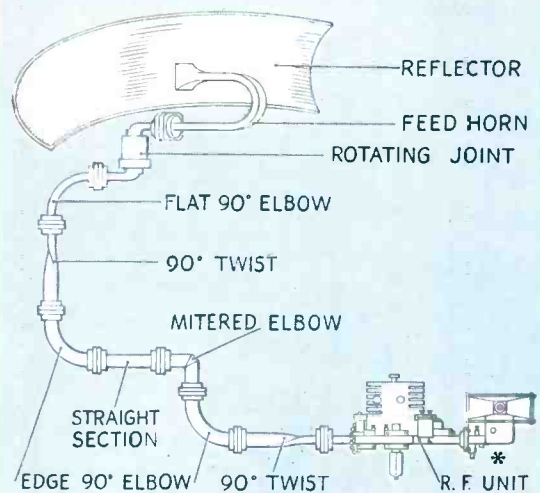

R. F. Radar unit #412 (indicated by asterisk) used in conjunction with standard DeMornay-Budd transmission line components.



DE MORNAY-BUDD, INC.
475 GRAND CONCOURSE, NEW YORK, N. Y.



there
is

NO SUBSTITUTE

for good, honest WIRE, unwinding itself
cross-country, through mighty public buildings and
humble cottages, in and out of America's radio sets and
legion other communications units. You are getting some
CORWICO Wire now . . . and more is on the way . . .

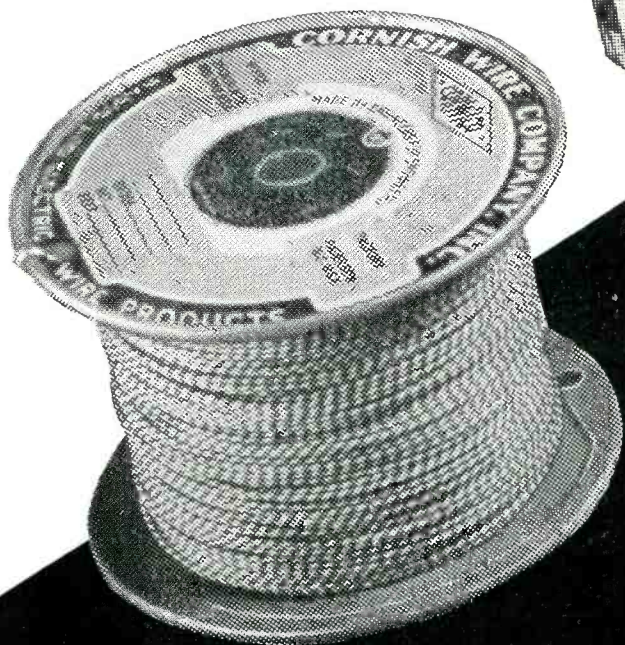

cornish
WIRE COMPANY, INC.

15 Park Row, New York 7, N. Y.

"Made by Engineers for Engineers"

mediate constructive use. In areas where other fuels are scarce, such as Australia, atomic energy will first be harnessed for power generation. Based on present knowledge, small power units for automobiles, homes, and airplanes are not feasible. To support long-range development, much fundamental research in nuclear physics is necessary. The development of the atomic bomb exhausted our surplus of fundamental knowledge. The only new fact learned was the discovery of nuclear fission in 1939. Fission, distinguished from radioactivity, occurs in several relatively abundant elements making nuclear energy marginally economically available.

Most solid fuel consumed in this country produces low pressure, low temperature industrial steam. It is in this field rather than in power generation that atomic energy can best be applied. The limiting economic factor in electric power is transmission. Nuclear energy is most usable in large power generating stations; therefore it is not an immediate competitor for coal because of the technical difficulties and high initial cost of electrical power distribution.

Of particular importance are the applications of nuclear fission in the fields of medicine, chemistry, and for penetrating further into fundamental knowledge of matter from which other sciences can build.

Demonstrations

Displays of wartime developments and field trips to plants indicated new frontiers in a tangible form. Greatest interest was shown in a dial radiophone for automobiles demonstrated by engineers of the Fred M. Link Corp., New York. Operation is on the experimental 152-162-mc band. Dialing on a standard Western Electric dial phone selectively calls other cars or a tie-in station to line subscribers. Communication over the f-m radio link was maintained between engineers at the DuMont Laboratories on Madison Ave. and a moving car.

Awards

The Edison Medal, awarded annually to the individual contributing most significantly to economic and

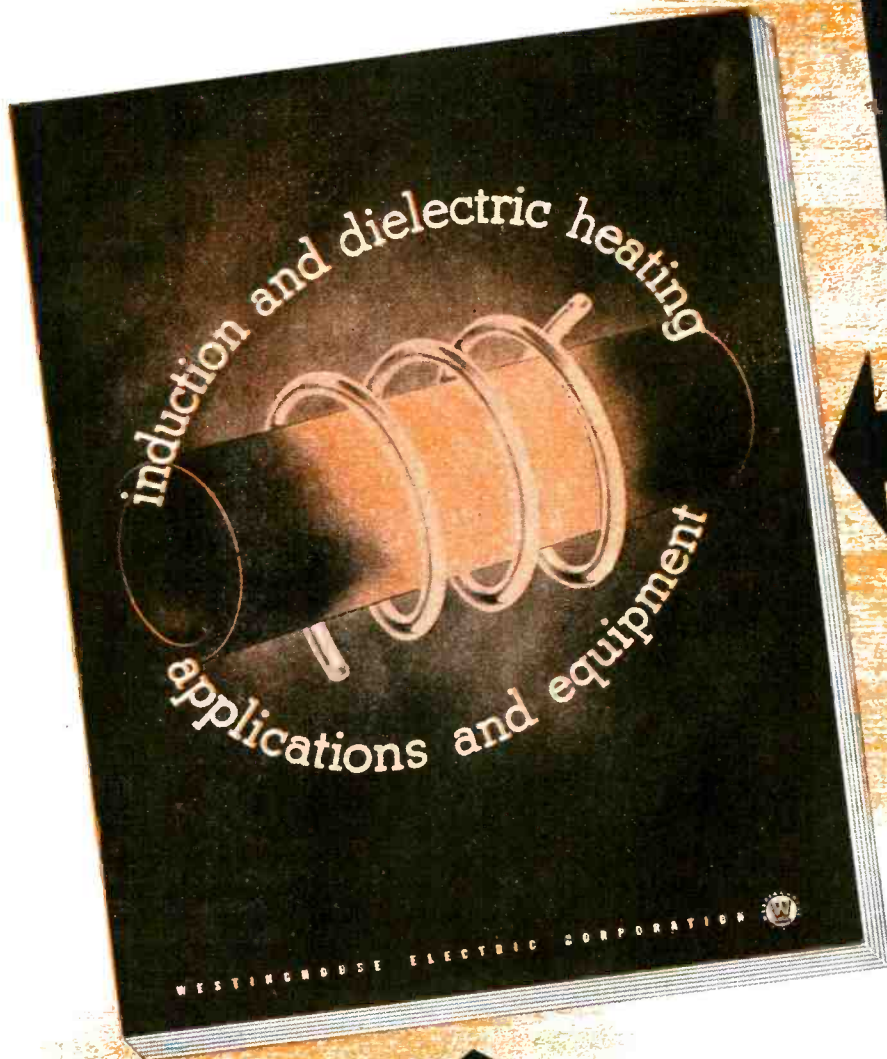

How do induction and dielectric heating work?

What are their advantages and limitations?

Where can you use them?

How do r. f. generators compare with motor-generator and spark gap units?

Now you can get the facts with this new book

The answers are all here in this new fact-packed book by Westinghouse... including full-color illustrations and 14 case histories of induction and dielectric heating... brazing, annealing, hardening, soldering, plastic molding, rubber curing, plywood bonding. Write today for your copy on your business letterhead, please. Ask for B-3620. Westinghouse Electric Corporation, P. O. Box 868, Pittsburgh 30, Penna. J-08161

Westinghouse
PLANTS IN 25 CITIES... OFFICES EVERYWHERE



Electronics at Work

HEADQUARTERS FOR ALL TYPE MOISTURE & MILDEW PROOFING COMPOUNDS

Our wartime experience developing and producing moisture-mildew proofing compounds for all services has equipped INSL-X with the "know-how" to solve any problem in this field.

We have on hand at all times, the materials to render immediate service. Lacquer, wax or varnish with any fungicide alone or in combination with another. Any quantity—put up in any size containers.

When commercial or military requirements call for moisture-mildew proofing, check with INSL-X!

Literature on Request

INSL-X
MEANS MODERN
INSULATION

THE INSL-X COMPANY INC.

857 MEEKER AVE., BROOKLYN 22, N. Y.

CHICAGO • DETROIT • LOS ANGELES • PHILADELPHIA
CLEVELAND • ST. LOUIS

dependable power generation and transmission, was presented for 1945 to Philip Sporn, American Gas & Electric Corp., by W. E. Wickenden, president, on behalf of the AIEE. W. H. Harrison, American Telephone & Telegraph Co., received the Hoover Medal for 1945. This medal, awarded by the national civil, mining, mechanical, and electrical engineering societies, takes its name from its first medalist, and is given to a fellow engineer for distinguished public service. S. F. Voorhees, New York architect, made the award on behalf of the participating societies at a combined meeting of the AIEE with the IRE.

Communication

Electronic Regeneration of Teleprinter Signals

By H. F. WILDER
Western Union Telegraph Co.
New York, N. Y.

DIFFERENCES in transmission velocities over wire lines of the harmonic components of rectangular teleprinter pulses and presence of noise result in deterioration of the signal after transmission over long distances. To restore the sharpness of the impulses and provide a gate to noise, a regeneration repeater is introduced in the line.

To accomplish the function of a signal regenerator electronically, a timing gate is used. The arrival of the start signal in the series of impulses of a teleprinter character trips a relay which sends an impulse down a lumped, timing network. The progression of this timing impulse down the relay line activates a tube at the times there should be polarity reversals of the signal. Thus this tube only accepts signal reversals at the instants they should occur. In this way the signal is restored to its original sharpness, and noise is rejected.

Tunable Rejection Filter

By R. C. TAYLOR
Western Union Telegraph Co.
New York, N. Y.

IN COMMUNICATIONS it is frequently necessary to reject a narrow frequency band. To do this a bridge is used; each arm is resonant at the

**"TO ATTAIN
STILL HIGHER STANDARDS OF SERVICE..."**

"An asset in which the Nickel Plate Road takes great pride is the high standard of service which it renders to the shipping public. With its record for outstanding performance during the war years back of it, the Nickel Plate is looking forward to the utilization of new technological developments, such as radio and teletype, in order to attain still higher standards of service and usefulness."

J.M. Davis
President,

The New York, Chicago & St. Louis R.R. Co.



To fulfill completely its promise of increased rail efficiency, railroad radio equipment must be so designed that individual system units, such as transmitters, receivers, power supplies, and remote control units, will be readily accessible for inspection and quickly removable for service, replacement, or relocation.

Realizing the importance of these requirements, the Farnsworth Mobile Communications Division has engineered its railway communications equipment on the bases of *standardized design* and *unitized construction*.

Practical results from the application of these two engineering principles include the facts that—

(1) The basic components of Farnsworth systems, whether of space-radiating or inductive type, are *separate units*, which can be *quickly disassociated* from a system, either for maintenance or relocation.

(2) The same receiver, transmitter, or remote control unit is usable for wayside, mobile, or relay installations, thus providing *complete interchangeability* of basic equipment throughout any Farnsworth communications system.

(3) *Space-radio and inductive type* Farnsworth units can be *interchanged*, whether a part of mobile or stationary installations, and can be *readily utilized in combination* to meet varying railway operating conditions and requirements.

These are a few of the many engineering features incorporated in Farnsworth railway communications equipments to guarantee *maximum availability and flexibility with simplified, low-cost maintenance*. Farnsworth Television & Radio Corporation, Dept. E-4, Fort Wayne 1, Indiana.

FARNSWORTH

TELEVISION & RADIO CORPORATION

Farnsworth Radio and Television Receivers and Transmitters • Aircraft Radio Equipment • Farnsworth Television Tubes • Halstead Mobile Communications and Traffic Control Systems for Rail and Highway • the Farnsworth Phonograph-Radio • the Capehart • the Panamuse by Capehart

A New BEACON ANTENNA

At the instigation of Link Radio of New York, the Workshop has recently developed a new antenna for their main station police radio transmitting and receiving on the new 152-162 mc band. Essentially, it is a collinear coaxial beacon, vertically polarized, and entirely enclosed in a non-metallic pressurized housing. The pattern has been flattened out to give high gain in comparison to an ordinary dipole. This means much greater coverage with the same power input.

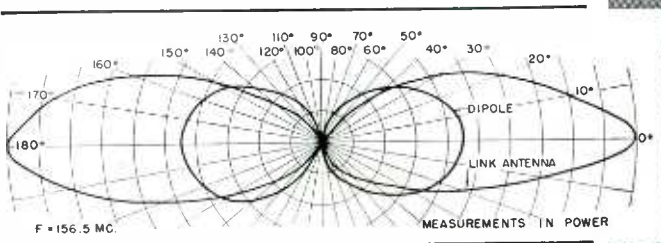

The above graph shows an actual test plot of the vertical patterns of the new Workshop antenna and a conventional half-wave dipole. Note that the power output along the horizon is approximately $2\frac{1}{2}$ times the power output of the dipole. Exhaustive field tests under actual operating conditions even have shown power gains over 4 times that of the dipole.

This new antenna is an example of Workshop specialization in antenna manufacture. If you have an antenna problem in the high-frequency spectrum — from 40 mc up — you will find our exceptional design, measurement and test facilities well adapted to a solution of your problem. Write or phone the details.

THE WORKSHOP ASSOCIATES
INCORPORATED

Specialists in High-Frequency Antennas

66 NEEDHAM STREET, NEWTON HIGHLANDS 61, MASS.

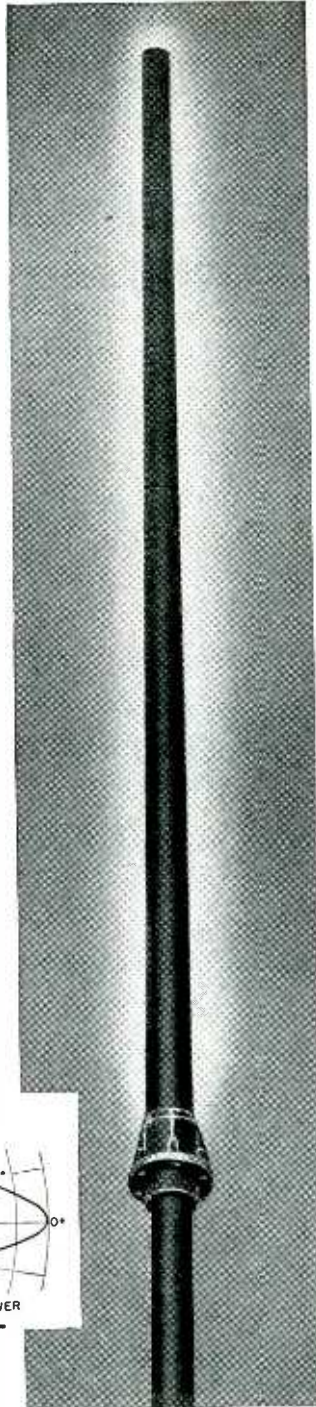

PATENT APPLIED FOR

rejection frequency and the resonant dissipation in the arms are equal, therefore the bridge is balanced and does not pass that frequency.

An analysis made of the filter using circle diagrams shows that the

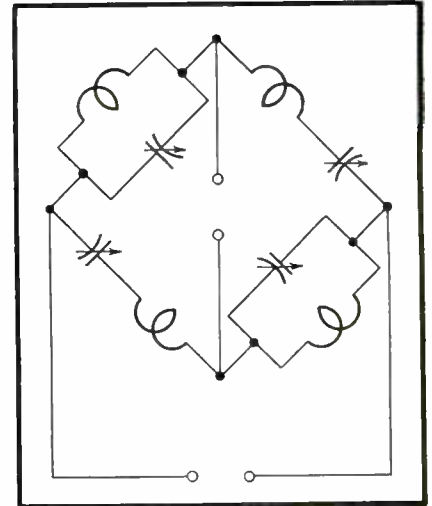

Basic Wheatstone bridge rejection filter eliminates pilot frequencies from carrier communication and telemetering circuits

Q of the inductors determines the narrowness of the rejection band. Two rejection filters in tandem tuned to slightly different frequencies can be used to reject a wider band than one alone. This practice preserves the sharpness of the rejection band.

Inertia Throat Microphones

By L. G. PACENT

Pacent Engineering Corp.
New York, N. Y.

and E. H. GREIBACH

Sonotone Corp.
Elmsford, N. Y.

COMMUNICATION from such noisy locations as airplanes and machine shops can be made using throat microphones. These units pick up the vibrations of the larynx transmitted directly through the throat walls rather than the atmospheric vibrations. Thus they respond to speaking but are relatively insensitive to air-borne noise.

The throat vibrations of speech are weak in overtones. To compensate for this, a rapidly rising response characteristic is required of the magnetic inertia microphone. This requirement necessitates setting the resonant frequency in the



DONUT-SHAPED. The extreme compactness, shape and mounting arrangement of Sprague Type 50P Capacitors offer many unique design possibilities in sealed assemblies where self-contained protection for the capacitor is not needed.

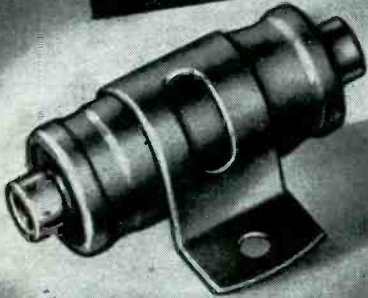

***HYPASS 3-TERMINAL NETWORK.** Sprague Hypass Capacitors are unique in that they do not resonate at frequencies as high as 150 megacycles or more. They are of great advantage where wide frequency bands must be filtered or by-passed. Two terminals are connected in series in the circuit. The third connects to ground.

***VITAMIN Q WITH HERMETIC GLASS-TO-METAL SEAL**
The Sprague achievement of perfecting glass-to-metal seals has resulted in many interesting Capacitor and Resistor developments. These include Capacitors sealed in glass tubes and having maximum flash-over distance between terminals. Impregnated with famous Sprague VITAMIN Q, these units are ideal for operation at extremely high voltages and high ambient temperatures.

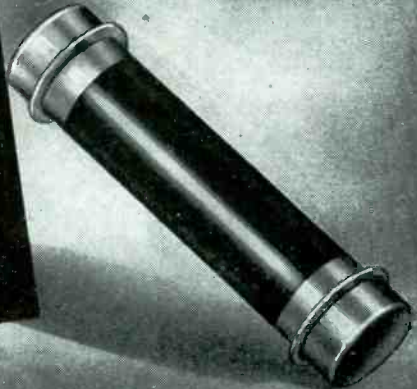

3 RECENT CAPACITOR TYPES *Worth Knowing*

Sprague engineering leadership extends to Mica, Dry Electrolytic and countless Paper Dielectric Capacitor types in addition to those illustrated above. Sprague engineers welcome the opportunity to make recommendations based on your specific requirements.

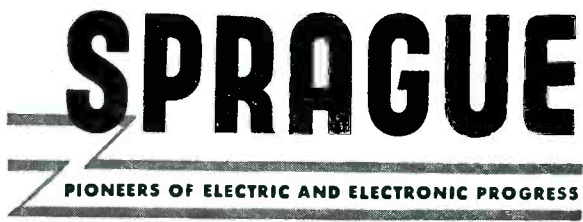

*Trademarks Reg. U. S. Pat. Off.

SPRAGUE ELECTRIC COMPANY, NORTH ADAMS, MASS.

All Engineers and Designers of

MOTORS GENERATORS MAGNETOS REMOTE INDICATORS

should consider

PERMANENT MAGNETS



These Permanent Magnets are representative of some that have been designed for Motors, Generators, and allied equipment. If you have not used Permanent Magnets for these applications . . . consult us for engineering advice.

Write for Technical Bulletin—"Permanent Magnets for Industry," containing valuable data on design, production characteristics and applications of Permanent Magnets.

THE ARNOLD ENGINEERING COMPANY

SUBSIDIARY OF ALLEGHENY LUDLUM STEEL CORPORATION

147 EAST ONTARIO STREET, CHICAGO 11, ILLINOIS

Specialists in the Manufacture of
ALNICO PERMANENT MAGNETS

vicinity of three to four kilocycles. Although so high a resonant frequency improves intelligibility of the microphone signal, it decreases the output. For sound powered com-

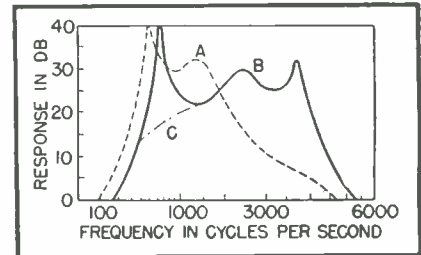

Curves A and B show response for single and double resonant units respectively, curve C shows effect of damping the double resonant microphone to improve quality

munication systems, high output from the microphone is necessary. This requirement can be met by introducing a second resonant frequency in the vicinity of one kilocycle.

Objective Testing of Throat Microphones

By E. H. GREIBACH
*Sonotone Corp.
Elmsford, N. Y.*

LABORATORY TESTING of throat microphones and bone conduction earphones requires a counterpart of the human organ under study. In both cases the transmission characteristic of the skin layer enters into the unit, therefore a single unit can be used in testing either element. The artificial throat is essentially a dynamic loudspeaker, but has masses, springs, and pads to produce the required impedance vs frequency characteristic. Viscoloid pads have given a fair approach to the loss component of the skin, but it is difficult to simulate both skin stiffness and resistance by even a combination of pads.

In operation the driving coil is fed from a resistance-capacitance network to produce uniform velocity of the testing platform over the frequency range. The filter-pad is placed on the platform and then the throat microphone. In this way the microphone sees a simulation of the impedance looking through the skin into the throat. By driving the plat-

CLOTH

is what we make it

filled

Inermesh treatment with various types of plastics, starch, etc., to produce a natural cloth finish with various properties such as—toughness, abrasion, resistance, flex strength, grease and oil impermeability, dimensional stability, etc.

impregnated

Interthread treatment with various newer plastics to give bulk strength, stiffness, transparency, resistance to moisture, mildew, heat, cold, chemical actions, etc., retaining cloth surface appearance.

coated

Surface treatment on a cloth structure to meet a great variety of functional and decorative uses.

HOLLISTON

Special Purpose Fabrics

THE HOLLISTON MILLS, INC., NORWOOD, MASSACHUSETTS

FRANKLIN LAMITEX

(LAMINATED BAKELITE)

is so versatile!

Pictured below just a few of the many thousand various parts we at FRANKLIN FIBRE-LAMITEX have furnished completely machined to exacting specifications for countless uses.

**SHEETS, RODS and TUBES,
FABRICATED OR MOLDED PARTS**

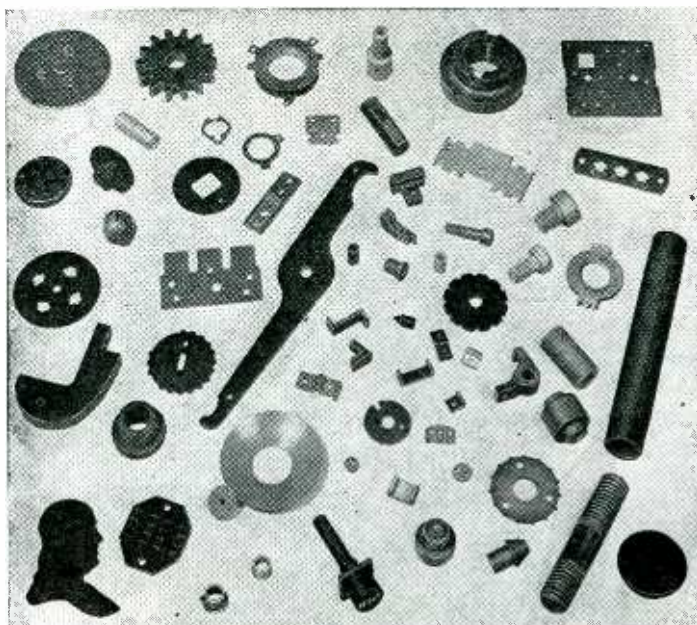

FRANKLIN LAMITEX and VULCANIZED FIBRE are highly machineable. We will machine parts if you lack facilities—or furnish sheets, rods, and tubes. Both LAMITEX and FRANKLIN FIBRE can be drilled, tapped, turned, threaded, punched, shaved, bored, reamed, sawed, milled or completely fabricated into automatic screw machine parts.

Check these FRANKLIN LAMITEX characteristics

- High dielectric strength
- Low power factor
- Low moisture absorption
- Remarkable dimensional stability
- High mechanical strength
- Low co-efficient of thermal expansion
- Low in weight (about half that of aluminum)
- Unaffected by solvents and oils
- Unaffected by most organic acids,
dilute mineral acids or salt solutions

SEND FOR CATALOG CONTAINING COMPLETE DATA.

FRANKLIN FIBRE-LAMITEX CORP.
WILMINGTON, DEL. — 187 LAFAYETTE ST., NEW YORK 13, N. Y.

AIEE CONVENTION

(continued)

form with a receiver and measuring the current generated in the driving coil the unit can be used as an artificial mastoid.

Sound Recording

Wire Recording

By D. W. PUGSLEY
*General Electric Co.
Schenectady, N. Y.*

POSSIBLE USES of wire recording include that for the home, commercial and public announcements at broadcast stations, pocket recorders, and recording in such vibrating locations as cars, trains, and aircraft. The long, continuous records which can be made recommend wire for recording telephone conversations, air and rail traffic messages, and recording for students, the blind, and the sick.

At the present stage of the art, satisfactory frequency response can be obtained at two feet per minute, with a 40-db dynamic range, and three percent total harmonic distortion. Recording, splicing, dubbing, and erasing are easy. Noise is 40 db below signal; there is freedom from interference from external vibration. Records can be played back many times, require small storage space, and are not easily damaged.

However, driving the record and loading the magazine are difficult. The blank is expensive. Because of the difficult and lengthy production of recordings on wire commercially produced recordings in quantity are unlikely.

Wire Recorder Head Design

By T. H. LONG
*C. G. Conn, Ltd.
Elkhart, Ind.*

TESTS ON HEADS through which the magnetic wire runs in a groove showed that the accumulation of magnetic mud in the gap lowered the response to 5,000 cps by 15 db at a wire speed of two feet per second. Low frequencies were less effected. Also lifting of the wire slightly from the bottom of the groove reduced the output 3 db at 5,000 cps, although it did not affect the low frequency output. In addition to these practical defects, there is the theoretical magnetic defect that flux penetration is less for a curved surface than for a flat one.

An improved head design was de-

Announcement

Federated Metals Division, American Smelting and Refining Company, is happy to announce that as of February 1, 1946, it has completed arrangements with the Gardiner Metal Company of Chicago to produce and market the entire line of Gardiner extruded solder.

THESE INCLUDE:

SOLID WIRE
ACID CORE
ROSIN CORE
RIBBON
EXTRUDED BODY SOLDER



As a result of this arrangement, Federated's capacity to produce extruded solders has been broadened. This means a further improvement in service for Federated customers. The combined facilities and experience make available to extruded solder users everywhere, a fund of knowledge and quality of service second to none. These advantages, plus precise metallurgical control, assure buyers of uniform, high quality extruded solders.

Federated Metals Division
American Smelting and Refining Co.
120 Broadway, New York 5, N. Y.
Nation-wide service with offices
in principal cities

END
Federated

ALUMINUM · BRASS · BRONZE · BABBITT · SOLDER · TYPE METAL · DIE CASTING ALLOYS · ZINC DUST

HEARTBEAT

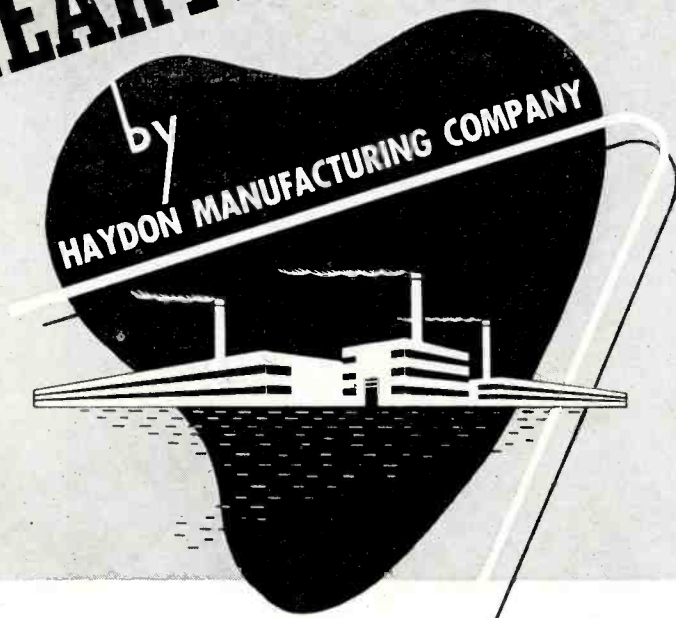

Haydoneered Timing will provide the heartbeat for tomorrow's industry. New timing devices—now measuring and motivating thousands of functions in war plants all over the country—will find even greater scope in the flood of peacetime production to come.

If you are planning a postwar product with movement requiring regulation, let Haydon Engineers lend you a hand. /

AC TIMING MOTOR

Available 450 RPM to 1 REV. per month: manufactured to your specific voltage, frequency, speed and torque requirements.

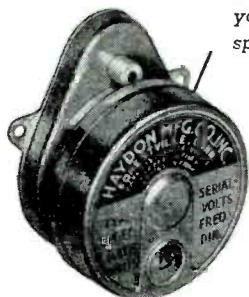

HAYDONEERED TIMING
Haydon

MANUFACTURING COMPANY
INCORPORATED

Forestville, Connecticut

WRITE TODAY FOR CATALOG

veloped after observing that the playback response was 8 db higher when the wire was running across the top of the lamination than when it was at the bottom of the groove. The new head with either open or closed winding duplicates the performance of conventional closed winding types if stainless steel wire having a coercive force of about 175 oersteds and usual retentivity is used.

By lengthening the gap to about

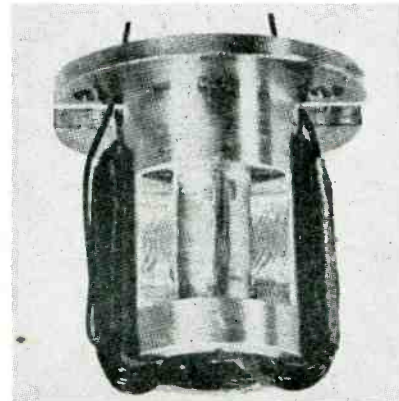

Experimental model of open head. Level winding technique, ease of cleaning, and greater high frequency response are obtained

half an inch, level winding can be used. The record is played back and forth along the gap, distributing wear and helping to keep the surface clean. It was found desirable to fill the gap with hardened beryllium copper to prevent undercutting of the gap material and eventual shunting of the gap by magnetic mud.

B-H Tracer

By T. H. LONG and G. D. McMULLEN
C. G. Conn., Ltd.
Elkhart, Ind.

MAGNETOSCOPE measurements show that variations of coercive force over the length of record wire are sufficient to produce several decibels variation in the low-frequency playback. Changes in wire tension were observed to produce appreciable instantaneous changes in coercive force and retentivity.

The instrument used for these measurements consisted of a magnetizing coil capable of 1,500 ampere turns per inch, although some wires will require more than 2,500 ampere turns per inch for saturation. A balance coil was used to exclude the

No electrical equipment can be any better than its insulation

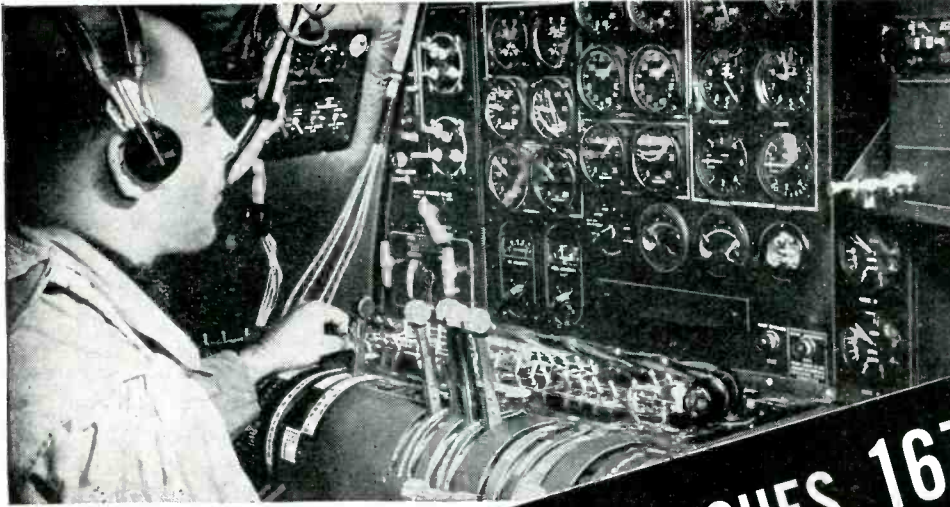

This varnish was chosen to meet the exacting insulation requirements on transformers for aircraft electric power

G-E INSULATING VARNISHES 1673 & 1696

Clear G-E varnishes . . . temperature resistance . . . flexibility . . .
 long life . . . for transformers of all kinds

. . . and the same varnish can protect a fluorescent ballast with long-lived, heat-resisting insulation.

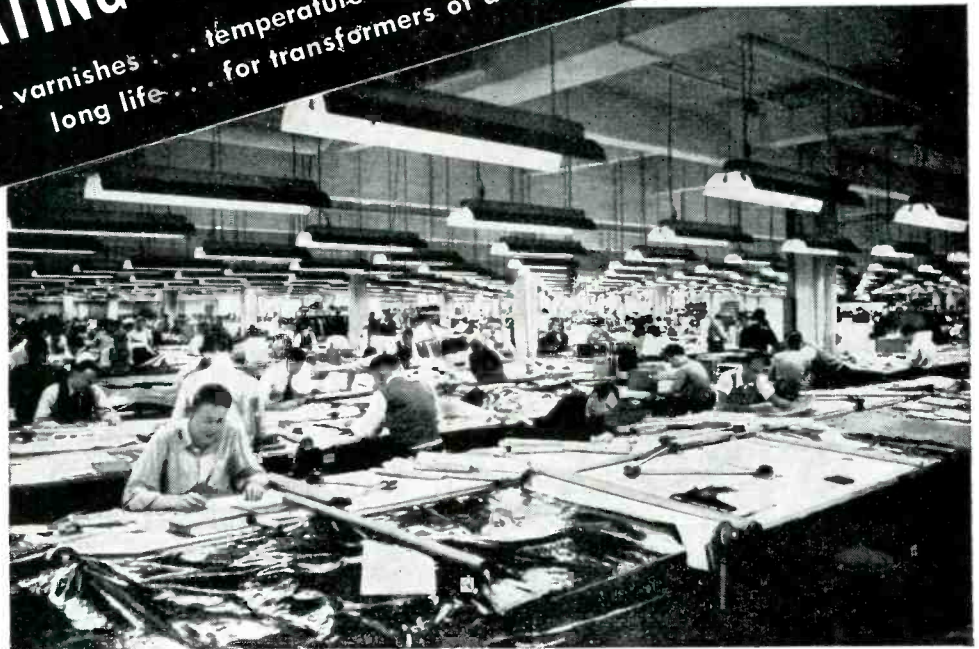

General Electric is one of the world's largest and most experienced manufacturers of insulating varnishes. The capacity to produce millions of gallons for myriad war applications and 45 years of experience in varnish research and manufacture are now available to peace industry. Strict G-E Quality Control assures uniformity of product in every shipment of G-E Insulating Varnishes. For details consult your local General Electric Merchandise Distributor. Or write direct to Section RIMA-4614, Resin and Insulation Materials Division, Chemical Department, General Electric Company, Schenectady 5, New York.



GENERAL  ELECTRIC

CD 46-13

G. E. OFFERS A COMPLETE LINE OF INSULATING MATERIALS

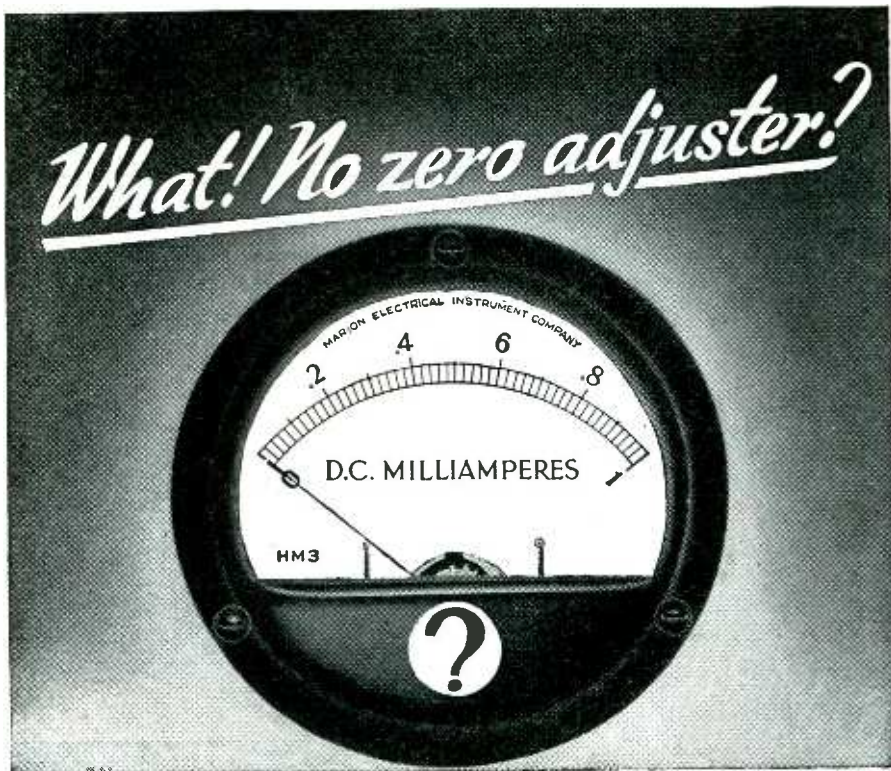

This is the invariable first reaction of engineers and consumers when meeting Marion Glass-to-Metal Truly Hermetically Sealed Instruments face-to-face. Let us begin by saying that zero adjusters correct for mechanical changes in an instrument caused by drift of the hair springs, ageing of the moving system, and are often used to correct (but incorrectly) errors brought about by unbalance of the moving system. Marion "hermetics" eliminate the need for zero adjustment for the following reasons:

Drift-free Springs: Marion "hermetics" use special silvered beryllium copper hair springs which are essentially drift-free. And the instruments as a whole are thoroughly aged at 170° to 180° F for at least 48 hours, assuring permanent "set" to the components of the moving system. These factors permit overloads far in excess of normal specifications, without permanent zero shift of the instrument.

"Apologist for Error": When a panel instrument is overloaded and its pointer is slammed, re-setting with the zero adjuster does not correct the error caused by the unbalance of the moving system. It only apparently corrects this error, and conceals its magnitude. Slammed instruments should be repaired or replaced if stated accuracy is to be maintained, and not just covered up by that apologist for error, the zero adjuster.

Independent Tests . . . by private and governmental laboratories in the United States and Canada prove that Marion "hermetics" sustain zero setting under severe and continuous shock, vibration, temperature and humidity cycling. Maximum permanent zero shift recorded on any "hermetic" by any laboratory has been 1/2 of 1% after completion of any and all combinations of the foregoing tests.

Marion Glass-to-Metal Truly Hermetically Sealed 2 1/2" and 3 1/2" Electrical Indicating Instruments

Write for 12-page brochure



IN CANADA: THE ASTRAL ELECTRIC COMPANY, SCARBORO BLUFFS, ONTARIO

influence of air flux from the measurements. The detector coil was centered in the magnetizing coil where nearly uniform flux can be expected.

A magnetizing frequency of 200 cps was used. The amplifier was designed to have wide frequency response and negligible phase shift because of the necessity of reproducing the irregular B-H curve. The time constant of the integrating circuit was 100 times the half period of the fundamental frequency. Hum bucking as well as complete filtering was necessary in the power supply to eliminate power frequency disturbances in the trace. The B-H curve was reproduced on a conventional oscilloscope.

Magnetic Tape Signal and Noise

By D. E. WOOLDRIDGE
Bell Telephone Labs., Inc.
New York, N. Y.

THEORETICAL ANALYSIS of perpendicular recording on tape, made to determine what properties of tape and associated magnetic elements affect noise and signal output levels, indicate methods of decreasing noise and increasing signal.

Although magnetic theory is still insufficient to correlate tape noise with any measurable magnetic property, it can be said in general that noise is less in demagnetized tape than in saturated tape. High signal to noise level should be produced by tapes having high coercive forces. To meet this requirement, vicalloy tape having a coercive force of 200 to

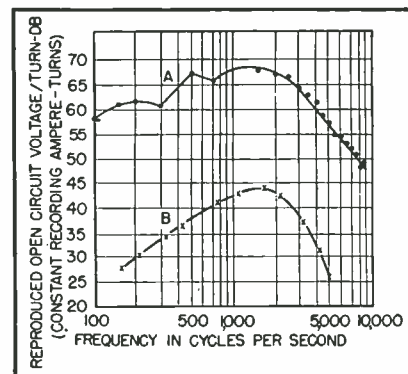

Using vicalloy tape perpendicularly magnetized and offset pole pieces, the characteristic of curve A was obtained. Curve B shows characteristic of old unit for comparison

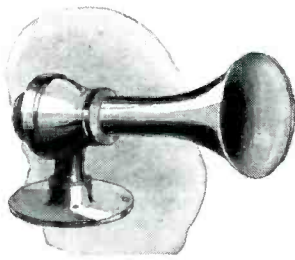
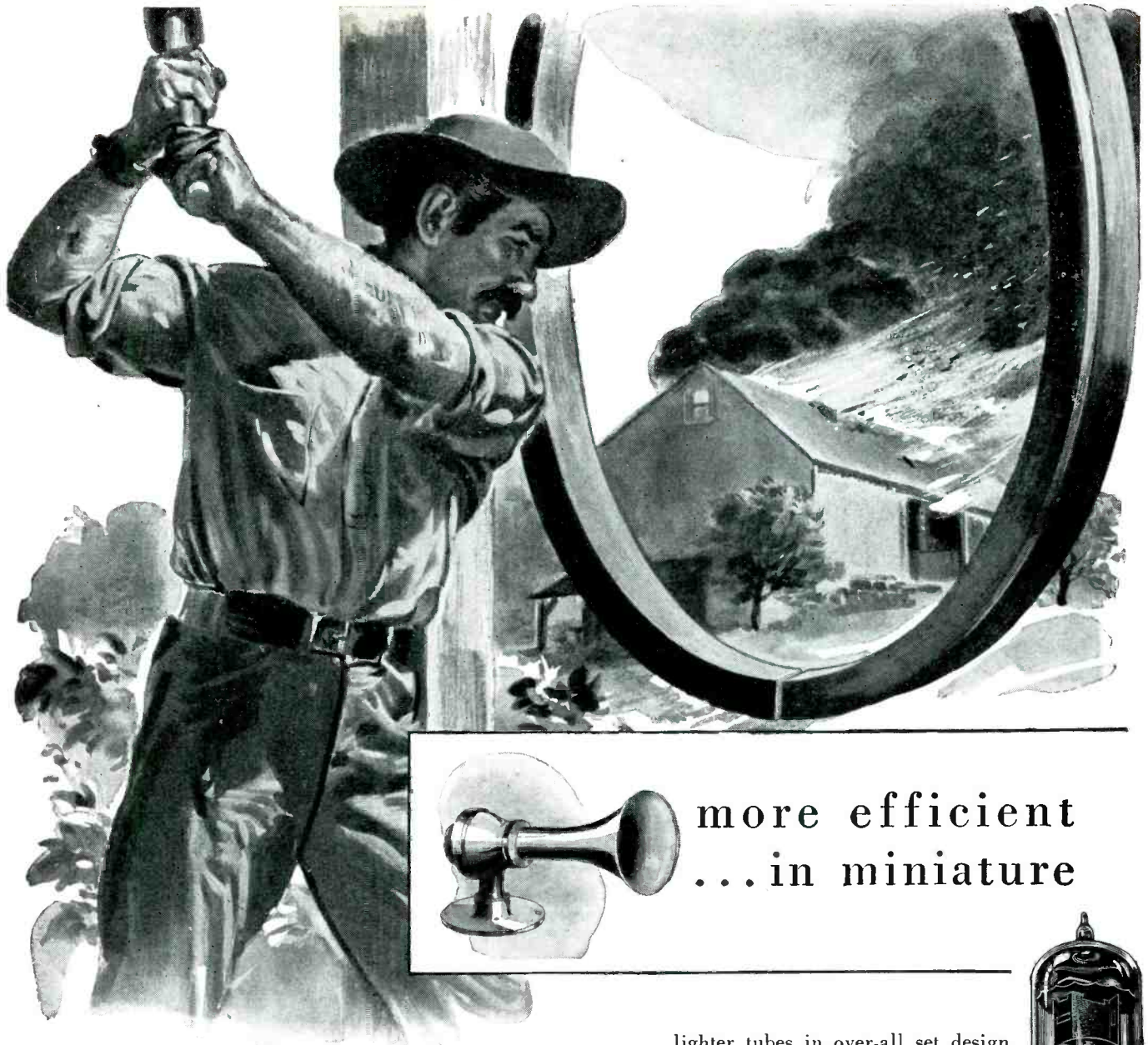

more efficient
...in miniature

At the press of a button, the modern fire siren screams its warning for miles. In contrast, it took a husky man to strike an iron tire hard enough, with a heavy sledge, to sound an alarm even over a comparatively small area. Greater efficiency in miniature is as evident in the fire alarm as it is in the Electronic Tube.

TUNG-SOL Miniature Tubes are more impervious to the effects of shock and vibration as they are constructed with smaller, lighter parts. The glass button base has better dielectric properties than the old style bases. Lower lead inductance, lower inter-element capacities, and higher mutual conductance are characteristics of TUNG-SOL Miniatures that assure superior performance in high frequency currents. The advantages of smaller

lighter tubes in over-all set design needs no amplification.

The TUNG-SOL engineers who developed TUNG-SOL Miniatures are at the service of radio set and other electronic equipment manufacturers. They will be glad to aid in using Miniatures to the best advantage, by advice as to circuits and tube selection. Of course such consultation is held in strictest confidence.



ACTUAL SIZE

TUNG - SOL

vibration-tested

ELECTRONIC TUBES

TUNG-SOL LAMP WORKS, INC., NEWARK 4, NEW JERSEY
Sales Offices: Atlanta • Chicago • Dallas • Denver • Detroit • Los Angeles • New York
Also Manufacturers of Miniature Incandescent Lamps, All-Glass Sealed Beam Headlight Lamps and Current Intermittors

*Watch
Permoflux Speakers!*

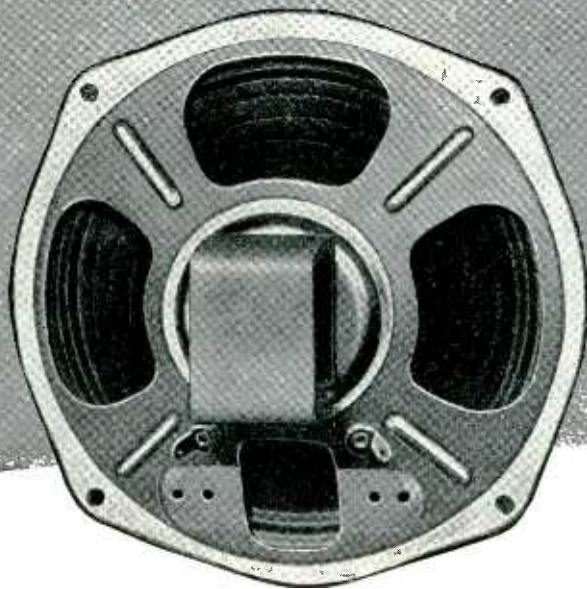

Permoflux Designs Assure Faithful Reproduction!

Because Permoflux Speakers excel in translating the tone capabilities of carefully designed circuits, more and more of the country's outstanding radio manufacturers are specifying them as preferred equipment. Manufactured in a full range of true-dimensioned sizes for every power handling requirement, Permoflux Speakers provide the answer to today's growing demand for better tone quality.

TRADE MARK
PERMOFLUX
PERMOFLUX CORPORATION
4900 WEST GRAND AVE., CHICAGO 39, ILL.



PIONEER MANUFACTURERS OF PERMANENT MAGNET DYNAMIC TRANSDUCERS

250, five times that of earlier tapes, was developed.

Output signal level is limited largely by a region of high reluctance in the pole piece tips. The best material for the pole pieces is already available, molybdenum permalloy. By using wider pole pieces (0.041 inch by 0.040 inch), offset so that the leading edge of one is opposite the following edge of the other, a self-supporting head requiring fewer turns to saturate the tape and giving greater output was obtained. A-c bias is both quieter and capable of giving higher level, high quality recordings than other forms of bias.

Combining these improvements, high quality recordings equalized from 100 to 8,000 cps with a useful volume range of 50 db at a tape speed of 16 ips were obtained.

Phonograph Reproducer Design

By W. S. BACHMAN
General Electric Co.
Bridgeport, Conn.

STRAINED WIRE resistance reproducer design is carried out. The techniques of analyzing the mechanical components are applicable to other reproducer types. Because the output voltage of the polarized strained wire is proportional to its displacement, this type of reproducer is useful in measuring recorded frequency characteristics. A variable reluctance reproducer having low mechanical impedance by virtue of its small moving mass is designed. Both types of reproducer have the supporting arm resonance damped by the suspension compliance.

Studying Disk Performance

By H. E. ROYS
RCA Victor Division
Indianapolis, Ind.

TOOLS AND TESTS for measuring performance, primarily of lacquer recordings and pressings, have been advanced to assure improvements in record fidelity. Cutting force can readily be measured by replacing the permanent magnet field of a cutting head by an a-c field, reorientating the armature assembly to respond to tangential rather than radial forces, and feeding the armature coil output to a meter. Measurements using such a technique indicate the self-regulating effect of a free head



a rigid steel plate is the foundation of a GOOD RHEOSTAT

The first Ward Leonard Rheostats were built with a steel plate foundation. Its rigidity protected the insulating enamels, proved an excellent dissipater of heat and gave a substantial foundation for contacts, terminals and control members. Many of those early Rheostats are in active service today.

While the present day Ward Leonard Plate Type Rheostats have been modernized, made even smoother in action and

offer many more steps of control in smaller diameters, they are still built on a rigid steel plate foundation.

With the wide range of types and sizes of Ward Leonard Rheostats you will find the one to meet your requirements—from the smallest electronic to the largest industrial application. Send for Rheostat Bulletins today.

Visit our booth No. 100 at the
RADIO PARTS AND ELECTRONIC EQUIPMENT SHOW
 STEVENS HOTEL, CHICAGO, MAY 13 to 16

WARD LEONARD

RELAYS • RESISTORS • RHEOSTATS

Electric control  devices since 1892

WARD LEONARD ELECTRIC COMPANY
 32 SOUTH STREET, MOUNT VERNON, N.Y. • OFFICES IN PRINCIPAL CITIES

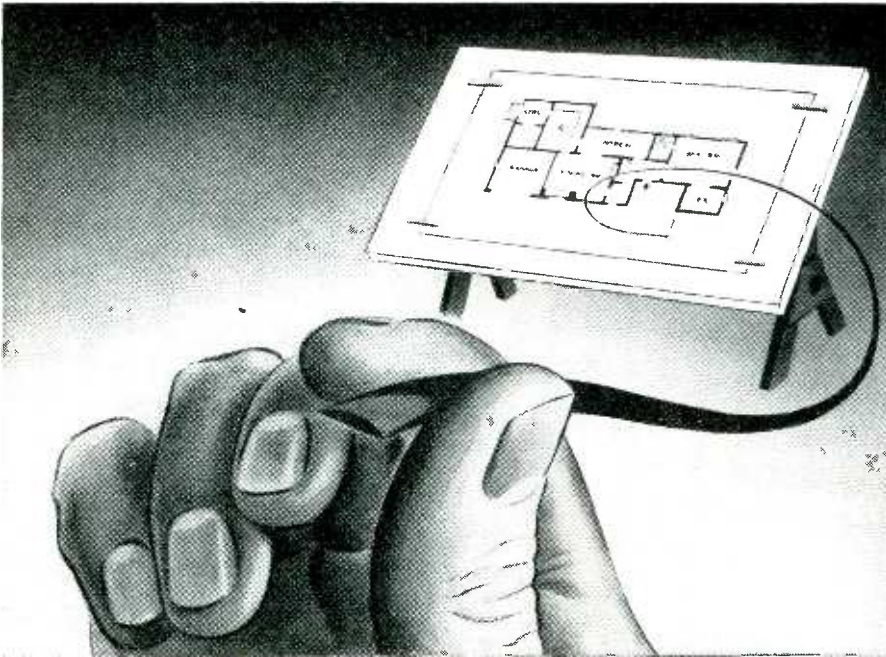

LET'S LOOK AT LINES

that build Tracing Cloth Preference

If you could pick up a line freshly inked on Arkwright Tracing Cloth, you'd see your preference. Your line retains its edge and doesn't go flat or "mushy". It prints like a taut wire, even re-inked over heavy or repeated erasures.

This evenness and crispness of line, coupled with the unusual transparency of Arkwright Cloths, assures contrasty, easy-to-read prints . . . and the transparency is per-

manent. It is obtained by special mechanical processing. Arkwright Cloths do not cloud up nor become brittle with age, because no surface oils at all are used.

Want a treat? Send for working sample. Rule lines. Notice how they flow on evenly. Erase. Hold up to light and see if you can see the markings of a ghost. You'll then have a real preference. Arkwright Finishing Co., Providence, R. I.

★
*Sold by leading
drawing material
dealers everywhere*
★



Arkwright
TRACING CLOTHS

AMERICA'S STANDARD FOR OVER 20 YEARS

against a head controlled by an advance ball. The self-regulating action of the floating head tends to maintain a constant recorded signal level. Effects of lacquer hardness, turntable drive, and cutter bounce can also be determined.

Intermodulation measurements of distortion, which give closer correlation with listener tests than harmonic distortion measurements, show the effects of tip radius and processing of pressings. These tests are easier to apply than harmonic tests because shifting of phase and frequency caused by turntable flutter do not affect the results.

Sound Recording in Business

By L. D. NORTON

*Dictaphone Corp.
Bridgeport, Conn.*

IMPROVEMENTS in electrical recording and reproducing techniques, plus the additional facilities available if dictaphones can be connected to electrical speech channels, make electrical dictaphones feasible. To compete with the acoustic instrument of proven reliability and simplicity, electrical dictaphones must be equally simple and reliable in operation. From a critical examination of requirements for business recorders standards were proposed.

Industrial Electronics

Development of Magnetrons

By W. C. BROWN

*Raytheon Mfg. Co.
Waltham, Mass.*

EARLY LABORATORY magnetrons operated at relatively low frequencies, at low efficiencies, and delivered low

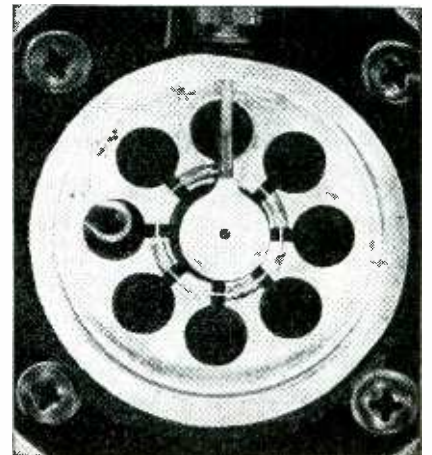

Looking into the cavities of a 300 kw magnetron, cover removed



ONE OF the big advantages of using graphite for anodes is the high thermal emissivity of this remarkable material. Because "National" graphite is almost an ideal black body, it is a nearly perfect heat radiator. In fact, no other anode material even approaches "National" graphite in this respect.

This means that anodes of "National" graphite will operate at lower temperatures for a given amount of energy dissipated. Thus, all tube parts will operate at a lower temperature, resulting in less distortion and more uniform tube characteristics.

In addition to this important property, here are others that, combined, make "National" graphite a most valuable anode material: High electrical and thermal conductivity, low electron emission, extremely low thermal expansion, and no melting point! Furthermore, graphite can be machined into intricate shapes to very close tolerances.

The full story on the possibilities of graphite for your anodes may be had by getting in touch with National Carbon Company, Inc.

This graph shows the total energy radiation from graphite and other anode materials in watts per sq. cm.

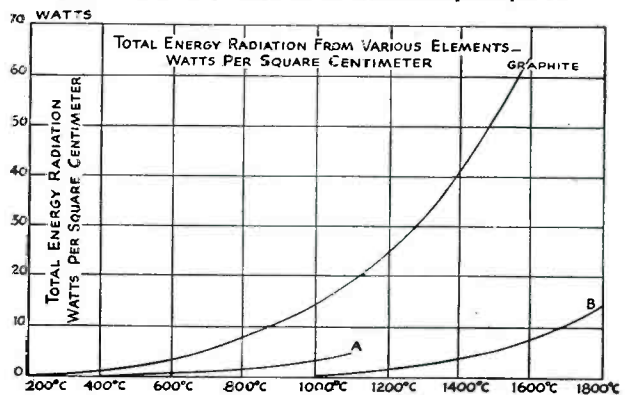

NATIONAL CARBON COMPANY, INC.

Unit of Union Carbide and Carbon Corporation
The word "National" is a registered trade-mark
of National Carbon Company, Inc.



General Offices: 30 E. 42nd St., New York 17, N. Y.
Division Sales Offices: Atlanta, Chicago, Dallas,
Kansas City, New York, Pittsburgh, San Francisco

The advertisement features a central illustration of a man in a striped suit and hat, pointing upwards. To his right are eight different types of Rex-Tubes, each shown in a circular inset. The types are labeled as follows:

- Type RT-20
- Type RT-15
- Type RT-10
- Types RT-6, RT-8, RT-9
- Types RT-12 and RT-14 (heavier)
- Type RT-13
- Types RT-1, RT-2, RT-4, RT-5

There's a REX-TUBE Type to Fit the Most Exacting Application

Rex-Tube isn't a cure-all, of course. But within its capacity this rugged, flexible metal hose will handle efficiently and economically just about anything you give it to do. There are sizes and types, for example, that range from oil can spouts . . . to heavy duty tubing used in steaming out tank cars.

Production men throughout industry know that many of their exacting problems can be solved with Rex-Tube or with the other flexible metal hose products in the complete C.M.H. line, including: Rex-Weld, Rex-Flex S.S., Avioflex and Cellu-lined. We can help you, too! Write today for Booklet E-144.

Flexible Metal Hose for Every Industrial Use



CHICAGO METAL HOSE CORPORATION
MAYWOOD, ILLINOIS

Plants: Maywood and Elgin, Ill.

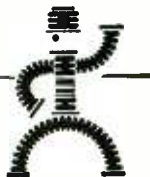

power. Recent, rapid development of magnetrons has resulted in tubes delivering megawatts in the 3,000 megacycle range at efficiencies up to fifty percent. In the 10,000-mc range, up to 300 kw are developed.

Except for the power supply, the magnetron is a complete transmitter within itself. Development of the packaged magnetron, which has an attached permanent magnet, has reduced bulk and weight of the magnetron to the point where it is a simple, reliable tool for electronic engineers.

Hydrogen Thyatron

By H. H. HEINS

Sylvania Electric Products, Inc.
Emporium, Pa.

PULSE TECHNIQUES used in navigational equipment such as radar, loran, and shoran, and in communication systems of the pulse modulation types require rapid, high power pulsing. The hydrogen, cold-cathode thyatron was designed to supply the high peak currents and voltages necessary. Because of the short deionization time of hydrogen, rapid switching rates are possible. Electrical characteristics are little changed by a wide variation of temperature.

The hydrogen thyatron can be used for switching capacitor discharge type welding circuits, and in place of spark gaps in induction-heating equipment.

Dielectric Heating

By I. E. MOUROMTSEFF
Westinghouse Electric Corp.
Bloomfield, N. J.

LABORATORY TESTS indicate that dielectric heating can be used for disinfecting grain in bulk, sterilizing packaged cereals, making safety glass, gluing wood laminations and shoe soles, and curing textile fibers. It has proven useful in drying enamel insulation on wire, and rolls of paper. Medical doctors have found dielectric heating advantageous in treating common colds and some other ailments, although the effects can be duplicated by other forms of heat treatment. Despite the technical possibility of these applications, initial costs of dielectric heating installations are prohibitive at present.

Dielectric heating depends on the presence of permanent molecular di-

RADIO TRANSMITTERS by Press Wireless

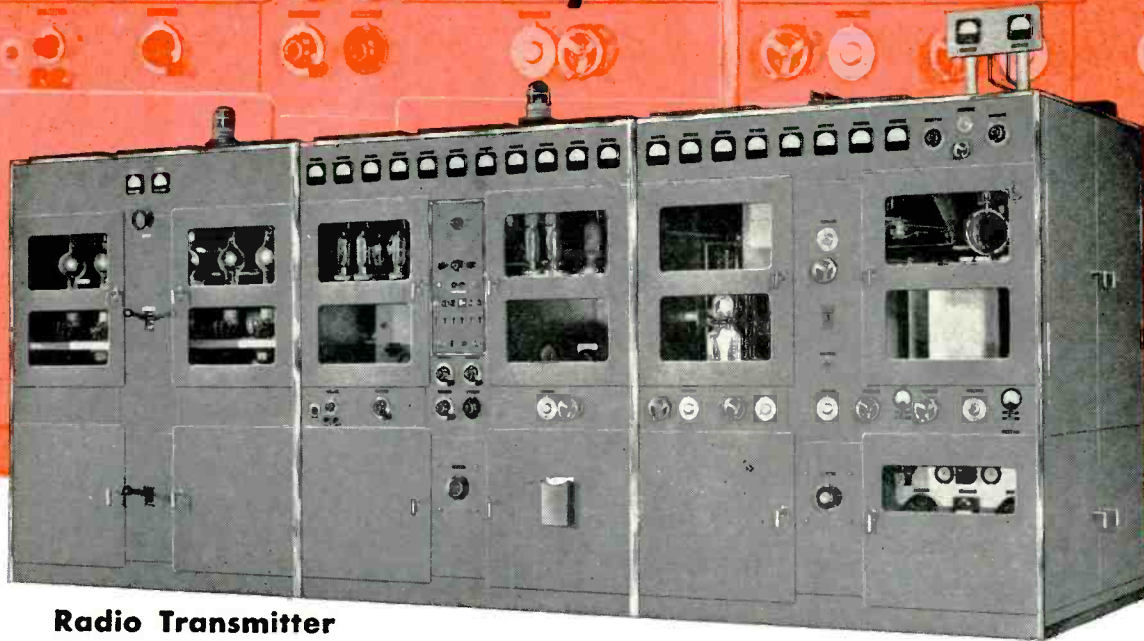

Radio Transmitter Model T50CF-1

This modern, 50-kilowatt, 4 to 21 megacycle radio transmitter is actually two transmitters in one. The entire unit may be used as a 50kw transmitter for on-off CW or frequency-shift keying with an FS keyer and may be modulated by a high-level Class-B modulator. Complete controls and an individual power supply for the exciter and driver stage provide a medium-power r-f carrier of 3-kilowatts on CW or FS—separate and independent of the power amplifier section.

The separate controls and high-voltage power supply for the PA make this section available as an independent Class-C final amplifier unit for use with a suitable double-sideband Class-B modulator-driver. The PA section may be adjusted for operation as a Class-B linear amplifier when used with a suppressed-carrier exciter or other r-f driver source.

DESIGNED for CW or FS operation, this equipment with companion Modulator Model TM 50-1 will transmit MODUPLEX* where AM and FS signal intelligence appear simultaneously on the same carrier.

MODEL T50CF-1 provides protection throughout for personnel and equipment by elaborate interlocking and automatic recycling control circuits. An automatic-shutdown feature cuts off the transmitter after a preset interval if the external (remote) keying line is idle.

Press Wireless will deliver this high quality transmitter and others of 2,500, 5,000, or 20,000 watts with associated equipment within five months from the receipt of your order.

Descriptive literature sent at your request.

*Trade Mark

PRESS WIRELESS MANUFACTURING CORPORATION

Executive and Sales Office, 1475 BROADWAY, NEW YORK CITY 18

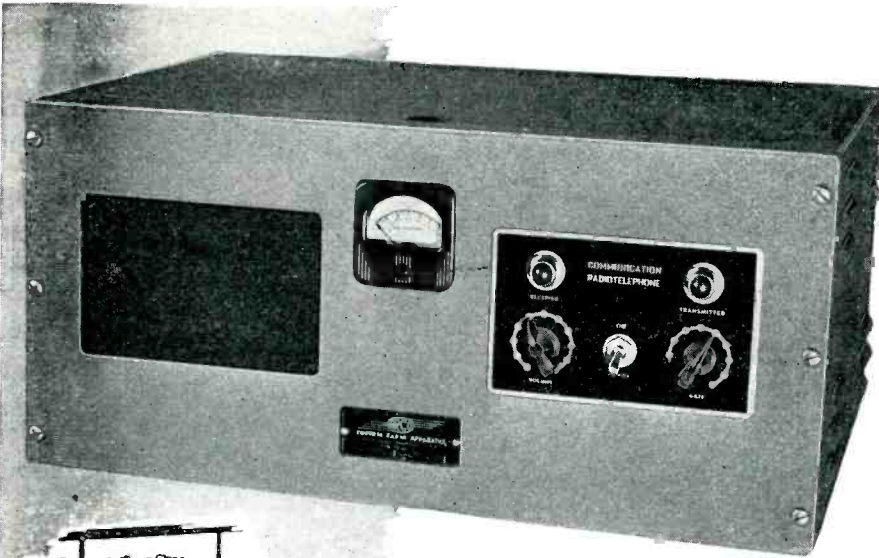

SMALL AIRPORTS



SHIP-TO-SHORE



LUMBER CAMPS



TRADING POSTS



ERCO TYPE 137-TR

"The Itinerant"

RADIO-TELEPHONE

At your service . . . A compact combination transmitter-receiver that is "going places." It's self-contained and has everything. Name your use for low power radio telephone and it will very likely meet your need.

Available for 6, 12 and 32 volt DC or 110 volt 50/60 cycle AC . . . Expected range under average conditions, up to 200 miles or more . . . Power output 18 to 22 watts in the 3 to 6 MC band. The 137-TR is pretuned and fully crystal controlled . . . Push to talk operation with hand microphone or handset . . . Absolutely foolproof; does not require expert knowledge to set up or operate . . . Altho inexpensive, it is built to the high standards of ERCO quality.

Small airports can use it for traffic control . . . and large ones, too, as emergency equipment. Provides ideal ship-to-shore communication and essential contact in forest, mining, oil producing or other remote areas where point-to-point communication is vital . . . Tell us your requirement and we will give you all particulars.



ERCO RADIO LABORATORIES INC

HEMPSTEAD, NEW YORK

Manufacturers of CUSTOM BUILT RADIO APPARATUS

poles in the material to be heated. The choice of frequency depends chiefly upon the ease of load matching and avoidance of standing waves in the work. The wavelength should not exceed one sixteenth the greatest dimension of the work. Dielectric constants of most materials decrease but little with increasing frequency, whereas power factors change variously. Changes of power factor during heating are the greatest load-matching complication.

High powers required for dielectric heating are available. The resatron and magnetron extend these powers into the centimeter range.

Testing with Pulses

By H. W. LORD

Research Laboratory
General Electric Co.
Schenectady, N. Y.

ADVANTAGES of high-potential testing of motors and transformers using surges or pulses are that (1) winding stresses are similar to those due to switching surges during operation, (2) high voltages are obtainable from small equipment, and (3) shock from the pulse voltage is less dangerous than from other high voltage test equipment.

Improved surge testers can be built using techniques originally developed for radar such as hydrogen thyratrons, pulse forming networks, and pulse transformers. By using a shielded pulse transformer balanced to ground, the bulky, motor driven, synchronous switch commonly used in high voltage test sets is eliminated. In addition, fault display on the oscilloscope screen is made simpler and more sensitive, because a bridge circuit giving zero voltage at balance can be used instead of direct comparison of two high voltages.

A laboratory surge tester suitable for testing fractional horsepower motors and radio transformers was demonstrated.

Radar

Radar Systems Considerations

By D. A. QUARLES

Bell Telephone Laboratories, Inc.
New York, N. Y.

RADAR DESIGN has quickly passed into specialists' field. There has been full interchange of technical information

Specify C-D MICABOND

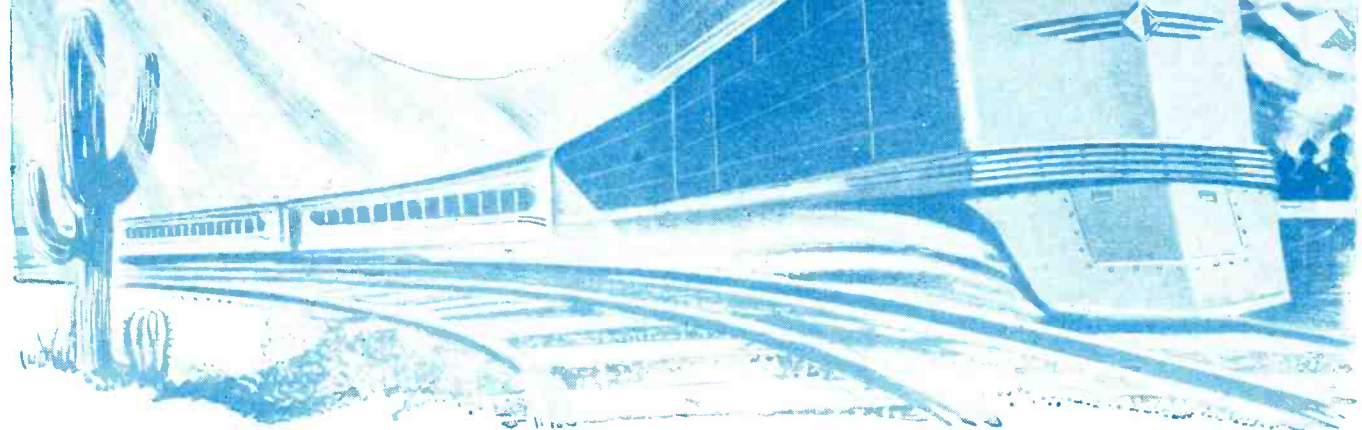
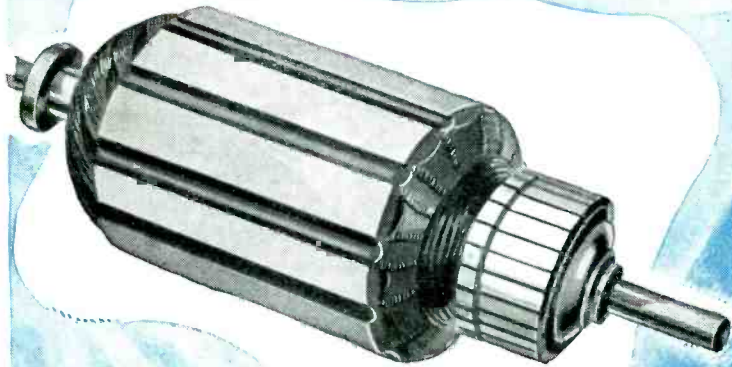

The power that drives a Diesel Locomotive is Electricity! Electricity generated by huge Diesel Driven Generators . . . generators that depend on C-D MICABOND insulation to stand the high heat and vibration of continuous operation. The small armature illustrated separately is used in your automobile generator . . . it too must give long-dependable service . . . furthermore it must also be economical to produce so it is built on a fast moving assembly line. Accuracy in dimensions is essential in both these uses of C-D MICABOND insulating rings and segments . . . first to insure unfailing service; secondly to facilitate fast economical assembly.

C-D MICABOND is Mica in usable forms. MICA splittings bonded together in sheets and tubes from which segments, rings and other shapes are readily and accurately fabricated. Into every shipment of C-D MICABOND goes a half century of C-D "know-how" . . . your assurance that C-D MICABOND is engineered to do the job for which it is specified.



KWC-46

C-D PRODUCTS

The Plastics

DILECTO—Thermosetting Laminates.

CELORON—A Molded Phenolic.

DILECTENE—A Pure Resin Plastic Especially Suited to U-H-F Insulation.

HAVEG—Plastic Chemical Equipment, Pipe, Valves and Fittings.

The NON-Metallics

DIAMOND Vulcanized FIBRE

VULCOID—Resin Impregnated Vulcanized Fibre.

MICABOND—Built-Up Mica Electrical Insulation.

Standard and Special Forms

Available in Standard Sheets, Rods and Tubes; and Parts Fabricated, Formed or Molded to Specifications.

Descriptive Literature

Bulletin GF gives Comprehensive Data on all C-D Products. Individual Catalogs are also Available.

BRANCH OFFICES

NEW YORK 17 • CLEVELAND 14 • CHICAGO 11 • SPARTANBURG, S. C. • SALES OFFICES IN PRINCIPAL CITIES

WEST COAST REPRESENTATIVES: MARWOOD LTD., SAN FRANCISCO 3

IN CANADA: DIAMOND STATE FIBRE CO. OF CANADA, LTD., TORONTO 8



Continental - Diamond FIBRE COMPANY

Established 1895.. Manufacturers of Laminated Plastics since 1911—NEWARK 16 • DELAWARE



AN ASSEMBLY JOB

That Requires Many Parts and Important Operations

The great assembly floor at Astatic's main plant, Conneaut, Ohio, hums with an ever-increasing activity, these days, as every effort is put forth to meet production quotas for radio,

phonograph manufacturer and parts jobber demands. The assembling of Astatic Microphones, Phonograph Pickups, Cartridges and Recording Heads, requires skill obtained from careful training and long experience in handling the many small parts required for these products. That they shall meet Astatic's high standards of operating efficiency, all operations are closely supervised and each product individually tested before released for shipment.



THE
Astatic
ASTATIC CORPORATION
CONNEAUT, OHIO
IN CANADA: CANADIAN ASTATIC LTD., TORONTO, ONTARIO

between workers both here and in England so that each has used the building blocks of the other. In designing radar, the antenna is the essential element. Used both for transmission and reception, it provides the required illumination pattern which can be specially directed into narrow, fan shaped, or other contoured beams depending upon the intended use of the system.

Angular resolution and range discrimination are limited by a volume of confusion, the cross section of which is determined by beam cross section and whose depth is determined by pulse length. To obtain a

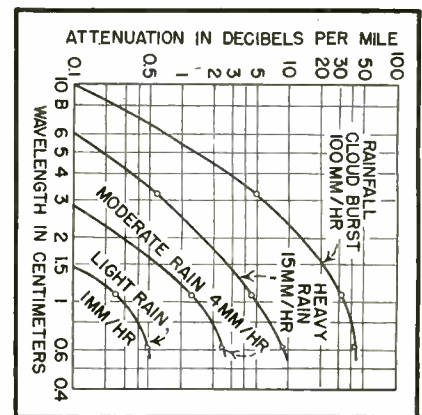

Moisture absorption of radio waves in the centimeter region is appreciable, also absorption bands from molecules (not shown) are encountered at these short wavelengths

narrow beam, high frequencies are necessary in limiting the antenna to physically realizable dimensions. Since the beginning of the war radar has advanced from one meter to one centimeter. Pulses have also become shorter. The figure of confusion has been reduced to about one fifth its earlier volume. However, as shown in the accompanying figure, moisture absorption of these short waves appears to limit the useful radio spectrum at the high frequency end. The spectrum seems to have been explored and is rapidly being conquered and settled.

Production of pulses is done commonly by electronically shorting a storage transmission line by such means as the hydrogen thyatron. The produced pulse is coupled to the r-f tube, usually a magnetron delivering megawatts of instantaneous output to the antenna. Where revolving antennas are used, discontinuities that vary with angular posi-

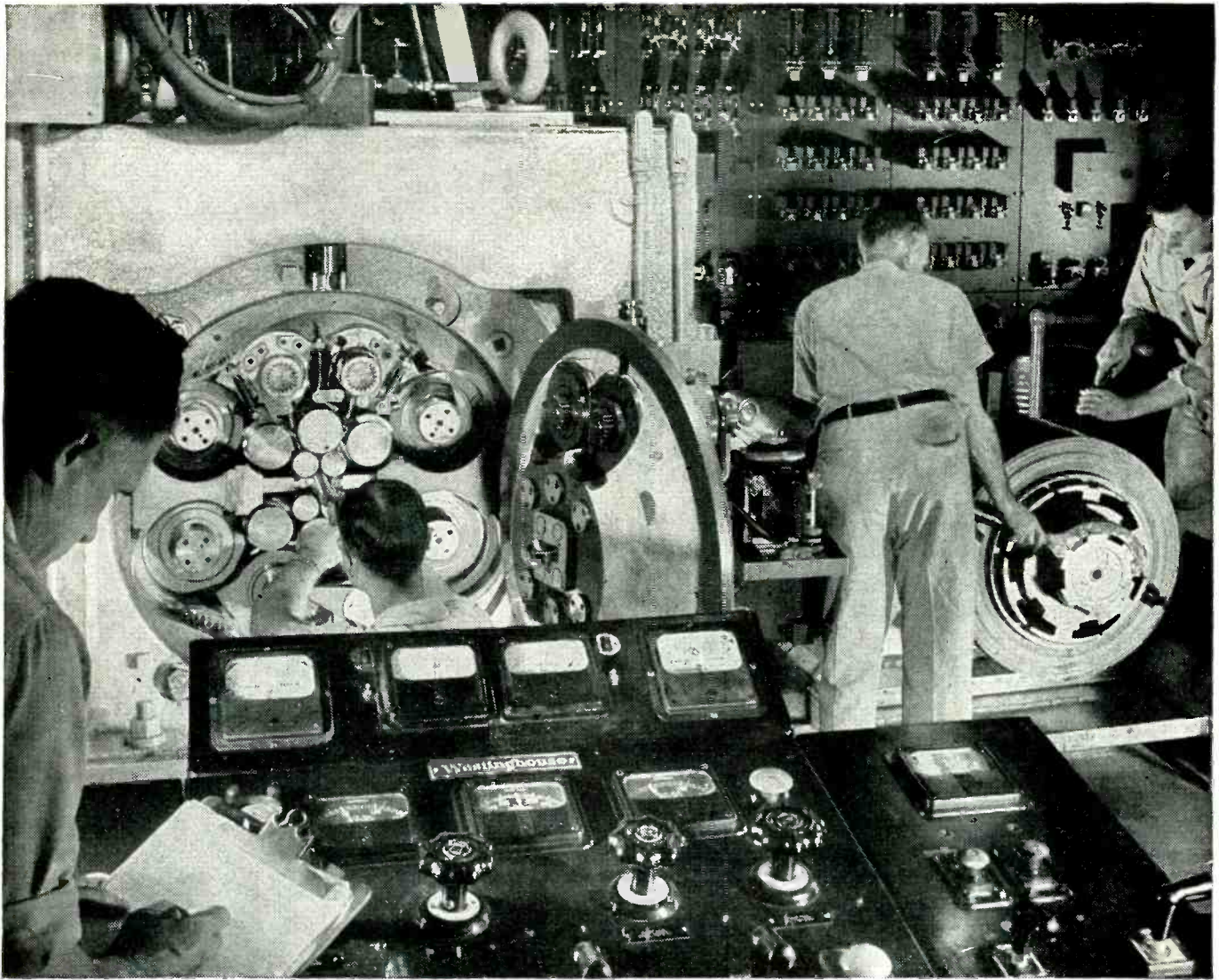

Steel Sheets Thinner Than a Human Hair?

Yes . . . and they'll soon have a lot to do with many electrical products manufactured for home, farm and industry.

These special electrical sheet steels — thinner than this sheet of paper — are being made on the Armco precision cold strip mill pictured above.

During the war they were used in combat walkie-talkies and radar equipment. Now these ultra-thin steels are going into high-quality radio sets, television sets and other electrical devices.

This is one of the latest examples of research by Armco.

Other kinds of Armco Electrical Steel Coils and Sheets are ready for your new products, too. You'll find a correct Armco grade for every need. And you'll get steel that is flat, clean-surfaced and ductile — steel of top magnetic properties and with consistently low core loss and exceptional permeability.

For detailed information about specific applications, just address The American Rolling Mill Company, 1251 Curtis Street, Middletown, Ohio.

* Export: The Armco International Corporation

The American Rolling Mill Company



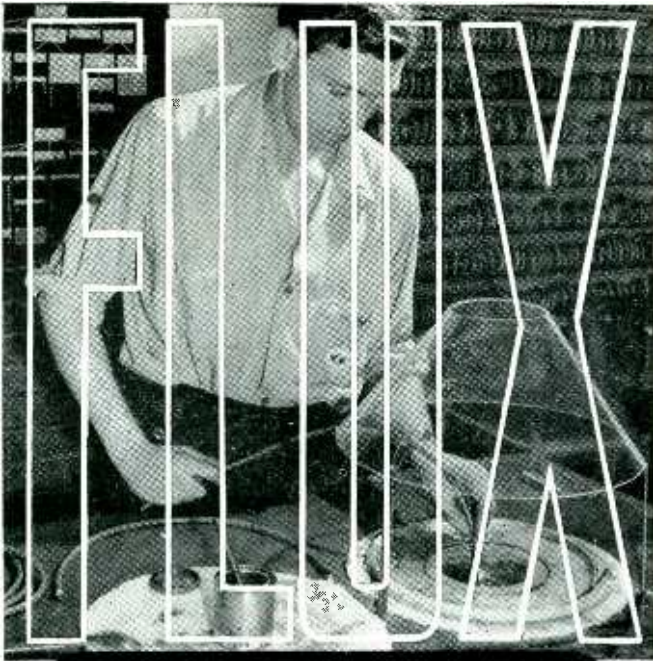

Kester has the RIGHT FLUX for Every Solder Job . . .

- You can always get the right flux, from Kester. . . a flux you *know* will properly clean, prevent oxidation, make way for a tight bond that will resist shock, vibration or bending as desired, and eliminate soldering failures.
- During Kester's 47 years of experience, hundreds of Kester flux formulas have been time-tested in laboratory and industry, to establish exact specifications for every flux need. Among them is the ideal flux formula for you.
- Write us, and Kester engineers will consult with you, without obligation.

KESTER SOLDER COMPANY

4204 Wrightwood Ave., Chicago 39, Illinois
Eastern Plant: Newark, N. J. Canadian Plant: Brantford, Ont.



KESTER
Cored Solders
STANDARD FOR INDUSTRY

tion tend to pull the magnetron frequency. The impedance irregularity is increased by long transmission paths, thus careful design is required.

The receiver, protected during transmitter operation by a gas filled, TR duplexer tube, receives the reflected pulse. The first design problem is to maintain frequency tracking with the transmitter. Beating oscillators are used. In the microwave range, single cavity, reflex, velocity-modulated tubes are common. Their frequencies are



Reflex, velocity modulation, beating oscillator shown full size

stabilized by either controlling the repeller voltage or thermally tuning the cavity. Crystal detectors whose noise closely approximates their theoretical resistance over the spectrum are used as converters in preference to vacuum tubes whose noise factors increase with frequency.

Although early practice was to design the narrowest i-f band consistent with pulse width, experience has indicated that, although noise increases with bandwidth, the increased resolution of the amplified pulse and smaller grain size of the noise from wideband channels gives a clearer picture. Bandwidths up to

DeJUR

BUILDS GREAT LITTLE METERS



The DeJur Model 120
Miniature (1 1/2") Meter

The precision-built DeJur 1 1/2" Meters are doing a man-sized job on many applications where space must be conserved.

DeJur EXTERNAL

PIVOT construction gives maximum accuracy—reduces pointer-rocking, and wear on bearing surfaces—greatly lengthening the life of the instrument.

Compact, Trouble-Free Modern Design

External Pivot
(As Used by DeJUR)

Internal Pivot
(Not Used by DeJUR)

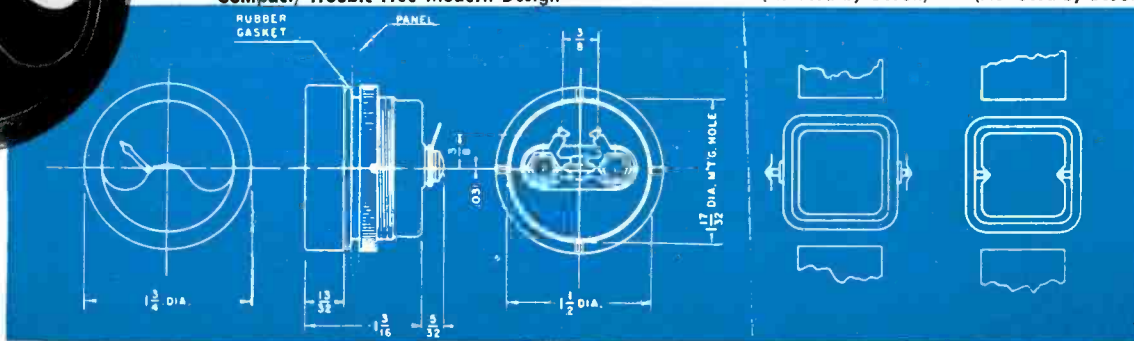

DeJUR RHEOSTAT - POTENTIOMETERS ARE PRECISION BUILT...

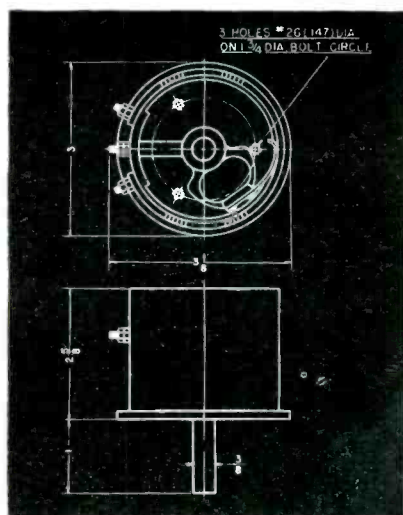

Send details of your requirements to DeJur. Our engineers will gladly advise the correct instrument to meet your needs.

in a wide line of models for many electronic and general electrical applications. They are electrically and mechanically engineered to meet the precise requirements of electrical manufacturers.

The 11 Watt Model 275 (illustrated) is typical of DeJur Potentiometers. Rugged yet light in weight, it is built to give outstanding service under the most severe operating conditions.



WRITE FOR THE LATEST DeJUR CATALOG



DeJUR-AMSCO CORPORATION
LONG ISLAND CITY 1, N. Y.

AMMETERS...VOLTMETERS...POTENTIOMETERS

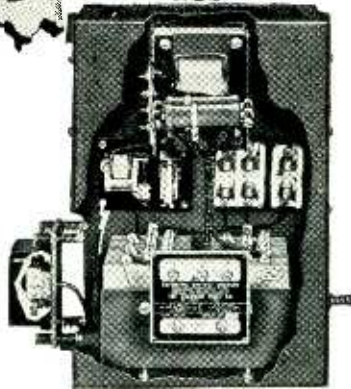
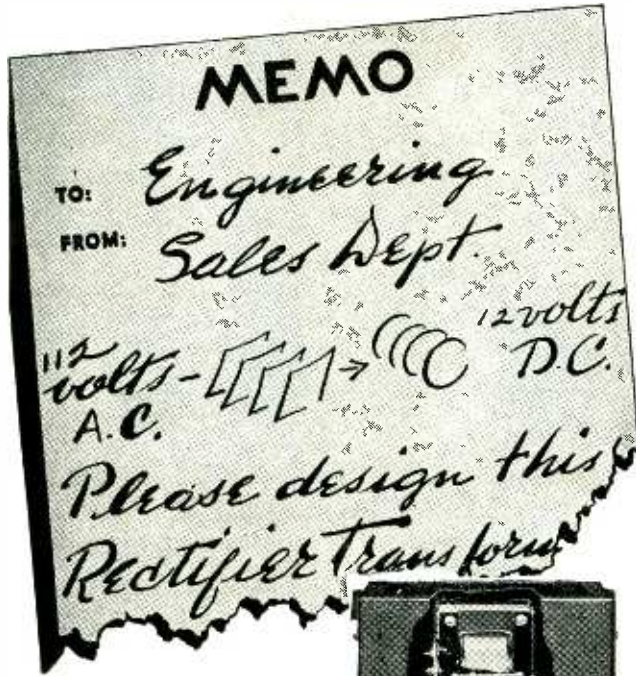

Required:

Battery charger to maintain, fully charged at all times, the 12 volt 6 cell heavy duty battery; to rapidly recharge at 12 ampere rate and to automatically reduce to trickle rate at proper time. . . . Source of power—115 volts AC 60 cycle power line.

We solved this problem by designing the necessary rectifier power pack (to convert the AC to DC)—the heavy duty transformer to step this power down to 12 volts—the automatic charge rate control—and the heavy duty, weather-proof steel housing . . . We had designed and built another rugged, first quality B-L Rectifier Power Pack unit.

Why a metallic rectifier? Because the B-L Rectifier is outstanding in:

1. Durability.
2. Trouble-free long life.
3. The elimination of current reversals during primary power supply failures.
4. Freedom from atmospheric damage.

What is your problem?

SELENIUM  COPPER SULPHIDE

THE BENWOOD-LINZE COMPANY
1815 LOCUST STREET ST. LOUIS 3, MO.

Long Distance Telephone CEntral 5830

Designers and Manufacturers of Selenium and Copper Sulphide Rectifiers, Battery Chargers and DC Power Supplies for practically every requirement.

ten megacycles at either 30 or 60 megacycles are used.

The results are displayed by methods now familiar to all. Cathode-ray focusing by permanent magnets instead of electromagnetic focusing is used, thereby reducing power supply requirements and stabilizing the focus. Techniques are much like those of television with the addition of means to expand portions of the display and to distinguish between fixed and moving objects.

In military applications for precise target location, lobe switching and conical scanning combined with servo tracking are used. Computing systems use the tracking motion to anticipate future target positions. The art has been adequately treated elsewhere.

Marine Radar for Peacetime Use

By L. H. LYNN and O. H. WINN
*General Electric Corp.
Schenectady, N. Y.*

EXPERIMENTS ON A Great Lakes ore boat using a modified military shipborne search radar indicated the increased navigational safety and saving of shipping time especially during periods of low visibility. However, the merchantman can not economically carry the large, highly trained personnel required to operate military radar. Therefore a simpli-

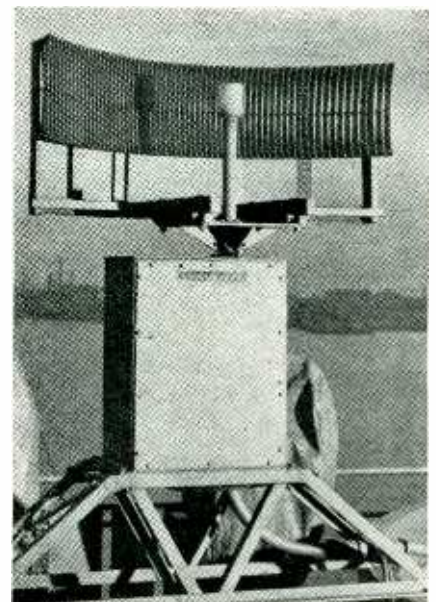

Antenna pedestal houses r-f circuits and scanning mechanism of the simplified maritime radar

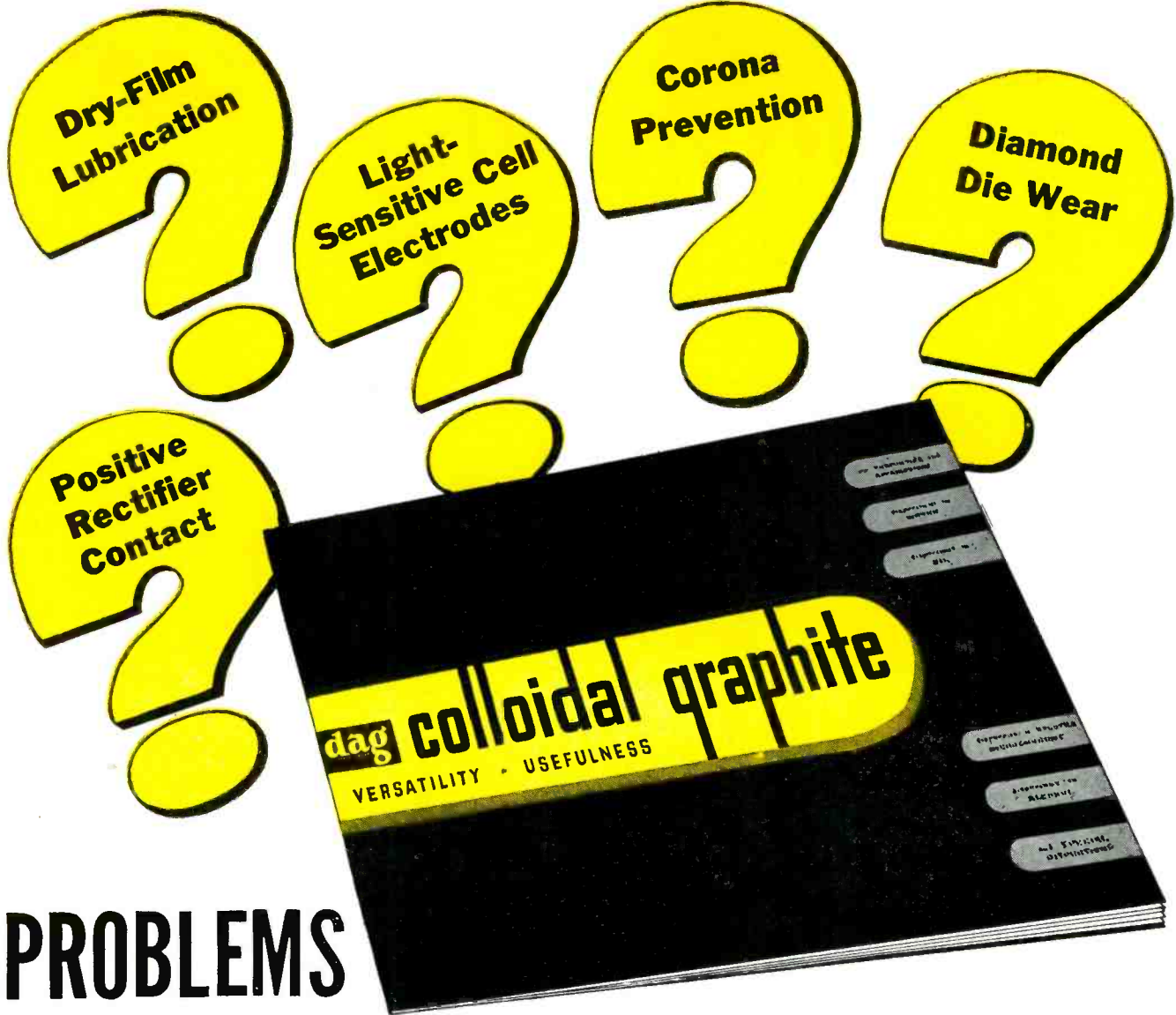

PROBLEMS
(MAYBE YOURS)

HAVE ANSWERS (MAYBE OURS) ■ ■ ■

if you know where to look!

Special problems of lubrication, parting, coating and impregnation are all about us in the electronics field. Those emphasized above are just a few—typical of the “lesser” vexations with “major” consequences.

Our first job is to spot such problems. Our second is to solve them.

To help do both, Acheson Colloids Corporation has just published a new 16-page treatise on the versatility and usefulness of that unique material with so many unique properties—“dag” colloidal graphite. It gives properties and applications. It contains dozens of illustrations and columns of data. It covers dispersions in water, oil, volatile hydro-

carbons, glycerine, alcohol, resins, waxes and other carriers. Send for it. It may open your eyes—both to problems which are costing you money, and to their answers.

JMLco A-D1

ACHESON COLLOIDS CORPORATION, Port Huron, Michigan

<p><i>Write for</i></p> <p>our new bulletin on the Versatility and Usefulness of</p> <p>dag COLLOIDAL GRAPHITE</p>	Dept. DD-5
	Gentlemen: Please send your new Bulletin No. 460
	NAME _____
	POSITION _____
	FIRM _____
	ADDRESS _____
	ZONE No. _____ STATE _____
OUR PRESENT OIL SUPPLIER IS _____	
(Lubricants containing “dag” colloidal graphite are available from major oil companies.)	

1917

1946

MODERN
COIL WINDINGS

We'll Stick to Coil Windings

The pressure of wartime production forced many manufacturers into strange paths . . . we were fortunate that all of our increased facilities could be devoted to coil windings.

Experience has proved to us that superior coil windings result only from continuous attention to their design and production.

We are determined that our reputation for windings of highest quality . . . a reputation earned during 29 years of service to industry . . . shall be maintained.

That's our business and we're going to stick to it.

COTO-COIL CO., INC.

COIL SPECIALTIES SINCE 1917

65 PAVILION AVE.

PROVIDENCE 5, R. I.

fied unit has been developed for merchant marine use.

Because of the simplicity of interpreting the indications, a plan position type indicator is used. Controls are reduced to those necessary to adjust the instrument, select range, and take bearing. Others are available only for installation and service adjustment. The equipment is housed in two units, one in the pilot house, the other at the antenna location. A motor-generator supplies power from the ship's mains.

Airborne Radar for Navigation and Obstacle Detection

By R. C. JENSEN and R. A. ARNETT
*General Electric Co.
Schenectady, N. Y.*

PUBLICITY RECENTLY given radar by newspapers and technical magazines has caught the public imagination. Stimulated by aviation accidents, people have proposed radar for navigation and obstacle detection by aircraft. However limitations to present radar restrict its application.

For observing the ground, as in military applications for bombing, the optimum radiation pattern is one for which the intensity reaching the ground follows the squared cosecant of the angle from the beam axis. However, the display from such a pattern fails to indicate relative heights of objects. Other beams can be used, each with its particular inadequacies.

Sharp beams are necessary to provide adequate resolution of objects. The navigational necessity of scanning a wide area with a narrow beam cannot yet be solved within the carrying capacity of the plane. Before the equivalent three dimensional resolution and range accuracy that is now possible for plan position radar can be achieved with lightweight airborne equipment, many electrical and mechanical engineering problems are to be overcome.

Shoran Precision Radar

By STUART W. SEELEY
*Radio Corp. of America
New York, N. Y.*

FOR NAVIGATION at short range, shoran is more accurate than loran. Used initially to guide bombers and reconnaissance planes over Europe.

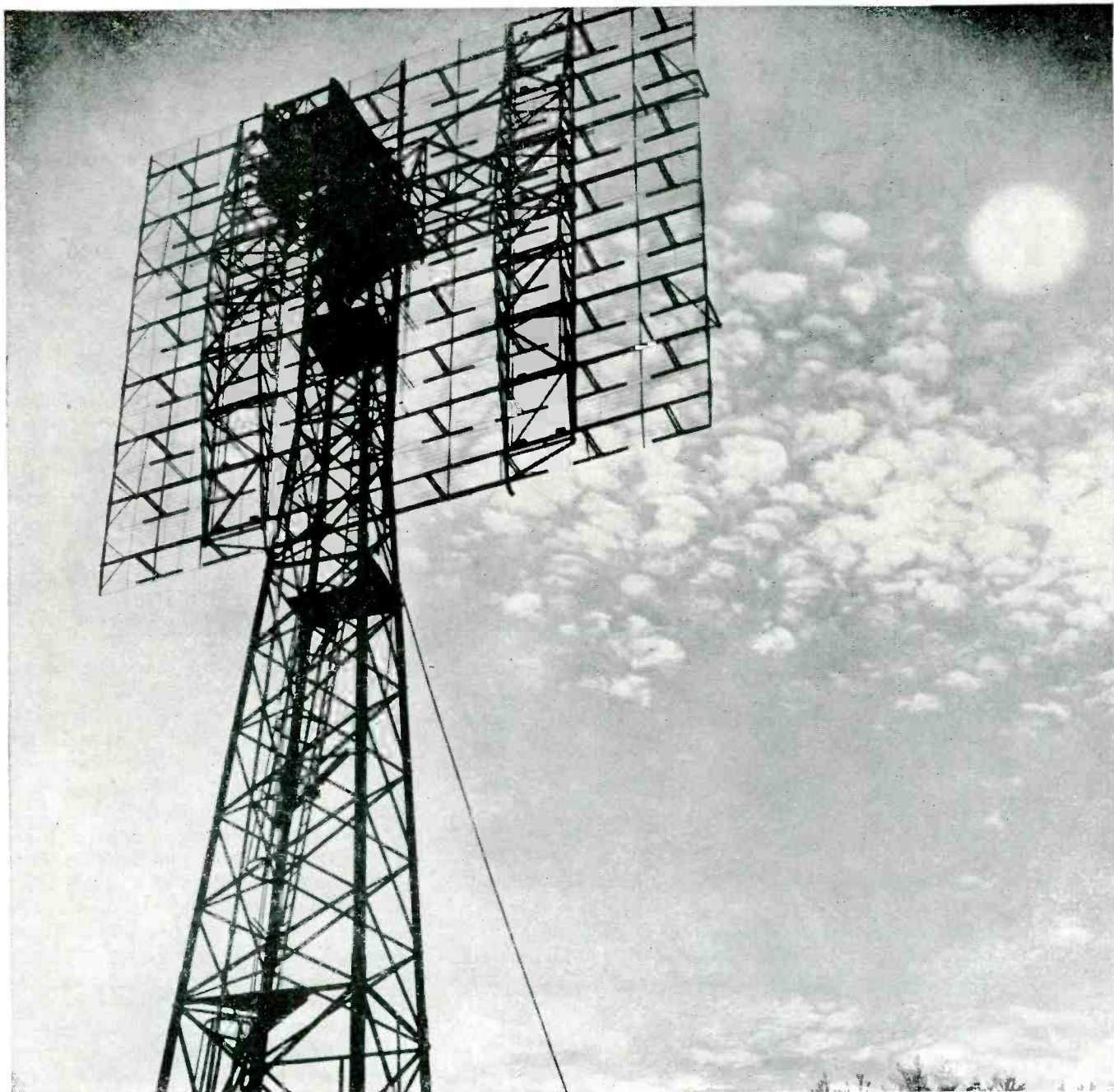

TO THE MOON AND BACK...VIA BLAW-KNOX

Because we have been a confidential advisor to the Army Signal Corps since long before World War II it was only natural that Blaw-Knox should, in a special way, participate in the sensational earth-to-moon contact... The 100 ft. tower, which carries this double 64 dipole antenna, is a Blaw-Knox product.

BLAW-KNOX DIVISION OF BLAW-KNOX COMPANY

2077 Farmers Bank Building, Pittsburgh, Pa.

BLAW-KNOX
VERTICAL RADIATORS
FM & TELEVISION TOWERS



Seven Blaw-Knox plants have been awarded the Army-Navy "E", and have regularly received renewal stars for continued high achievement in the production of war material.

VALPEY

FREQUENCY CONTROL

Valpey Crystals
the Heart of
Modern Communication



DEPT. OF CONSERVATION ...



CIVILIAN AIRCRAFT ...

Finer, longer lasting, lower cost crystals than ever before. We solicit inquiries from "hams" —write for distributor's name in your vicinity.

VALPEY CRYSTAL CORPORATION
HOLLISTON, MASS.



AMATEUR ...



MARINE AND POLICE ...

Valpey
CRYSTALS

CRAFTSMANSHIP IN CRYSTALS SINCE 1931

AIEE CONVENTION

(continued)

shoran can provide precise navigational fixes close to the base stations. The principle of operation is that of measuring the interval between transmission of a pulse by the plane and the return of echoes from fixed reradiation stations. There is no signal coordination between stations. The fixed transmitters are triggered by the pulse radiated from the plane. By determining the roundtrip transmission interval between each of two stations, the navigator locates his position in systems of circular coordinates with the fixed stations as centers. Pulse transmitting equipment, receivers, and timing circuits are similar to those of other pulse signaling equipment.

Microwave Testing

By E. I. GREEN, H. J. FISHER
and J. G. FERGUSON
Bell Telephone Labs., Inc.
New York, N. Y.

TECHNIQUES AND FACILITIES developed for microwave radar testing are applicable in the r-f range from 500 to 25,000 mc, and at intermediate frequencies for communication by pulse, frequency, and amplitude modulation from both audio and video signals. In addition to checking circuit and system operation common to communication and radar, radar testing also includes measuring the accuracy of the indicated target location. Equipment of the types familiar at lower frequencies have been developed.

In the uhf range, coaxial r-f circuits are used; in the shf band, wave guides are used. Standard signal generators have high frequency stability, can be tuned over an appreciable frequency range, incorporate attenuator pads and power measuring circuits (usually calibrated in dbm, that is db from a milliwatt reference level), and f-m sweeps and pulse modulation.

Either coaxial or wave guide wave-meters are common, although a combination of the two called transition wavemeters, are also used. Coaxial resonators are such that only the coaxial mode ($TM_{0,0,n}$) can exist. Cylindrical cavities are excited in their dominant mode ($TE_{1,1,n}$) to avoid spurious resonances from other modes, although for higher selectivity the circular electric mode ($TE_{0,1,n}$) can be used. For variable

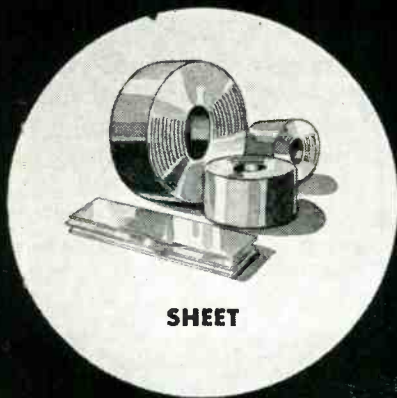

SHEET

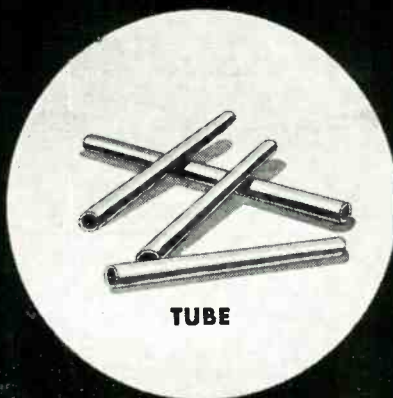

TUBE



WIRE

HERE MAY BE
The Solution
 TO YOUR METAL PROBLEM...



LAMINATED CONTACT BUTTONS

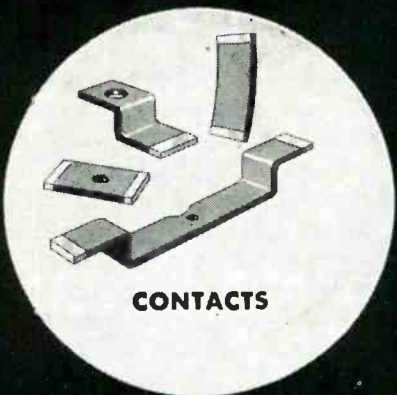

CONTACTS

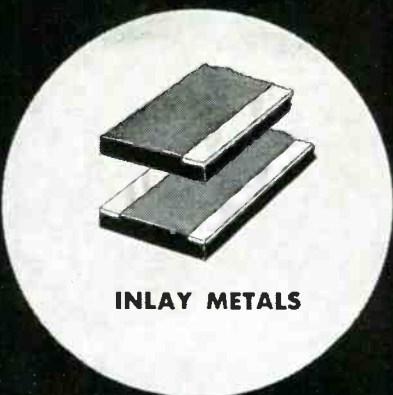

INLAY METALS



THERMOSTAT METALS

General Plate Laminated Metals

General Plate Laminated Metals . . . permanently bonded combinations of precious metals to base metals or base to base metals . . . can provide the solution to your performance or design metal problems whether the product be a peanut radar tube, an electrical contact or a giant turbine.

These versatile laminated metals . . . in sheet, wire, tube — or as fabricated parts . . . give you high electrical performance, corrosion resistance, workability, mechanical and structural properties not found in single solid metals — and best of all, at a fraction of the cost of solid precious metals.

Investigate General Plate Laminated Metals today. Find out how their unusual performance and cost-cutting advantages can help increase production . . . improve your product . . . and save money, too.

Our engineers will gladly help you with your metal problems. Write for their services.

Check these General Plate advantages:

- Corrosion Resistance
- Ease of fabrication
- Ease of soldering
- Workability
- Long life
- Economy
- Electrical Performance

GENERAL PLATE DIVISION
of Metals & Controls Corporation

50 Church St., New York, N. Y.; 205 W. Wacker Drive, Chicago, Ill.; 2635 Page Drive, Altadena, California
 Grant Bldg., Rm. 603, Pittsburgh, Pa.
ATTLEBORO, MASSACHUSETTS



MR. RADIOMAN: CREI
Training Can Equip You To
Step Ahead of Competition
and Gain the Confidence
Born of Knowledge! . . .

Will You Be Ready?
CREI Can Prepare You
Now for a Better Job
and a Secure Career in
RADIO-ELECTRONICS



CREI technical home study training prepares you for the secure radio jobs that pay good money for ability.

You can be ready to enjoy the security of an important engineering position and take advantage of new career opportunities . . . if you prepare yourself now.

Join the ambitious radiomen who are assuring themselves of secure good-paying jobs with a planned program of advancement made possible by CREI home study training in Practical Radio-Electronics Engineering.

You can study at home—in your spare time—develop your technical ability—increase your knowledge to keep pace with important developments now taking place in the industry. CREI courses are constantly being revised and kept up-to-date with the rapid developments.

By adding CREI training to your present radio experience, you can safeguard your future and have a thorough knowledge U.H.F. Circuits, Cavity Resonators, Pulse Generators, Wave Guides, Klystrons, Maguetrons and other tubes. *Are you equipped to handle them?* CREI is equipped to help you, by providing the know-how and the ability that is required.

Act now! Get underway today. It costs nothing but a moment's time to send for complete details—without obligation—and it costs nothing but a moment's time.

CAPITOL RADIO ENGINEERING INSTITUTE

HOME STUDY COURSES IN PRACTICAL RADIO-ELECTRONICS
 ENGINEERING FOR PROFESSIONAL SELF-IMPROVEMENT

Dept. E-4, 3224-16th Street, N. W., Washington 10, D. C.

Contractors to U. S. Navy — U. S. Coast Guard — Canadian Broadcasting Corp.
 Producers of Well-trained Technical Radiomen for Industry

Member: NATIONAL COUNCIL OF TECHNICAL SCHOOLS

Just Off the Press!



WRITE FOR
FREE 36-PAGE
BOOKLET

"Your Opportunity
in the New World
of Electronics"

If you have had professional or amateur radio experience and want to make more money, let us prove to you we have something you need to qualify for a better radio job. To help us intelligently answer your inquiry — PLEASE STATE BRIEFLY YOUR BACKGROUND, EXPERIENCE, EDUCATION AND PRESENT POSITION.

frequency cavities, the TE modes are preferred because of their zero current at the inner walls, thus simplifying design of moving contacts.

Power measurements for signal generator outputs, detecting resonance of wavemeters, and measuring transmitter output, and circuit gains and attenuations are all basically the same. Crystal rectifiers, necessitating protection from overloads and stubbing to provide d-c returns from the indicating instrument, and thermistors, platinum wires or thermocouples, placed directly in the field to be measured, are used. These latter, being sensitive to temperature, require care in use.

Standing wave ratios, indicative of impedance mismatch, can be measured in several ways. A traveling probe in the coaxial line or wave guide can directly detect the standing wave. The standing wave can be made to move past a fixed probe by changing the electrical length of a section of a wave guide by squeezing it, or the reflected energy from a mismatch can be separated from the incident energy by a hybrid T.

Another method of measuring standing wave ratio, also used to separate transmitter and receiver power within a radar antenna feeder, is the directional couple. Because of the quarter-wave spacing of the two pickup probes, energy passing in one direction cancels itself within the directional couple and energy from

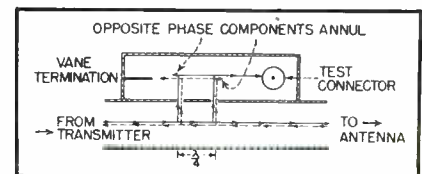

Directional couple for measuring energy passing in only one direction in a wave guide can be used for detecting impedance mismatches

the other direction reinforces itself. In this way energy reflected either from a target or from an impedance discontinuity can be measured.

Wideband amplifiers and high speed, linear sweeps have been developed for oscilloscopes. Accurate timing circuits, triggering circuits, and pulse generators carry accuracies to better than plus or minus two hundredths of a microsecond.

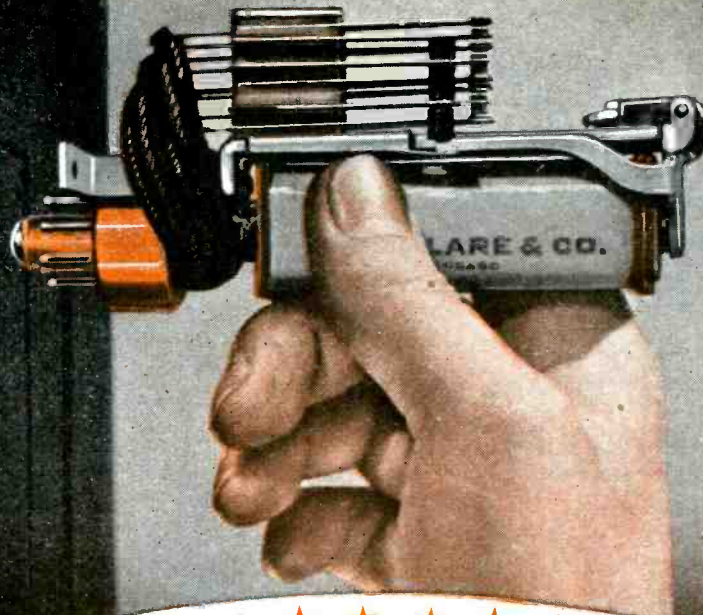

What Do You Want in a Relay?..
CLARE Will "Custom-Build" It
... Exactly

● Clare puts the designer in the driver's seat. Clare Relays permit a flexibility of plan unheard of with ordinary relays.

The secret? There isn't any. It's just that Clare "custom-building" makes it possible for you . . . with the utmost economy . . . to have a relay exactly suited to your specific requirements.

Clare doesn't design and manufacture a new relay for you from the ground up. There would be no economy for you in that. Clare "custom-building" selects the proper combination of Clare features for the job and includes them in a standard basic frame that is ideal for the requirement at hand.

Clare "custom-building" is a method of construction. It permits a wide range of contact ratings . . . five different contact forms or any combination of them . . . either flat or hemispherical contacts which may be of rare metals or special

alloys . . . coil windings to match the circuit and application.

Clare Relays are built for applications where precise performance, long life and dependability are prime requisites. Thousands of users attest to the value of Clare Relays and the Clare "custom-built" principle.

To "custom-build" a relay for you Clare engineers must know all the facts surrounding the requirements. Clare has sales engineers in all principal cities to show you how Clare "Custom-Built" Multiple Contact Relays are the effective answer to modern design problems.

Send for the new Clare Engineering Data Book with its full information on the full line of Clare Relays and allied control apparatus. Address: C. P. Clare & Company, 4719 West Sunnyside Avenue, Chicago 30, Illinois. Cable address: CLARELAY.



Contacts are welded to nickel silver springs by a special process. May be of precious metals or alloys in 12 different standard or special types and sizes.

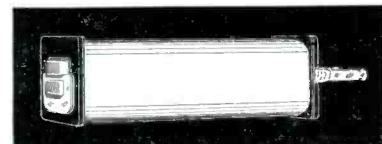

Coil core of a.c. relays is of thin laminations of silicon steel, riveted together. This reduces hysteresis and eddy current losses, gives large amount of power with small heat losses.



High voltage spring pile-up insulators of special heat-treated Bakelite. Have minimum cold flow properties, low moisture absorption content. Permit punching without cracks or checks.

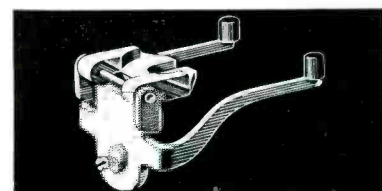

Double arm armature assembly with stainless steel shaft, operating in a marine brass yoke. Heelpiece, core and armature assembly of magnetic metal.

CLARE RELAYS

"Custom-Built" Multiple Contact Relays for Electrical and Industrial Use

NEW PRODUCTS

New materials, new components, new assemblies; new measuring equipment; new technical bulletins, and new catalogs

1

Noise and Field Intensity Meter

STODDARD AIRCRAFT RADIO Co., 6644 Santa Monica Boulevard, Hollywood 38, Calif., is now releasing the Model NMA-4 noise and field intensity meter heretofore available only to the Navy.

It is useful in locating and indicating in microvolts, the amplitude of noise causing disturbance to radio reception in aircraft, and in other receiver locations; in determining the effectiveness of filtering and shielding electrical apparatus which produces radio noise at ultra-high frequencies; for indicating and recording in microvolts per meter the field intensity of a-m, f-m and television transmitters.

The r-f amplifier, mixer and oscillator circuits use butterflies which



vary capacitance and inductance simultaneously, offering noiseless tuning from 100-400 mc.

These circuits maintain a high degree of stability and nearly constant value of resonant impedance which provides for substantially uniform

2

Packaged Magnetron Oscillator for Radar

DE MORNAY BUDD, 475 Grand Concourse, New York 51, N. Y., has available in its line of microwave equipment a packaged r-f radar unit. The magnetron oscillator is capable of delivering 20 kw peak power at

9,375 mc. Two local oscillators, two t-r tubes, crystals, and a narrow-band directional coupler for measurements are included, as well as a beacon cavity and crystal mount for future beacon use.

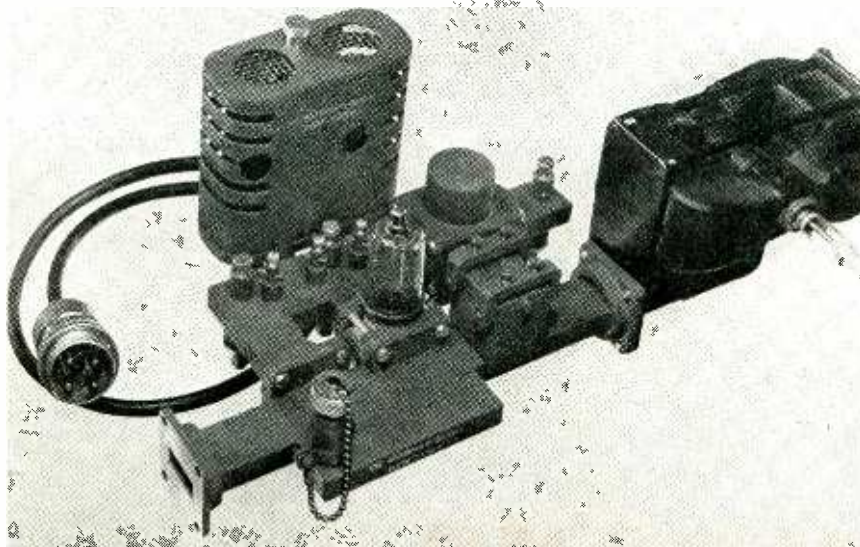

calibration. Stability of calibration is affected by shot noise developed in the plate circuit of the r-f amplifier.

The voltage range is 1 to 100,000 microvolts. The field intensity range is 5 to 100,000 microvolts per meter. Performance and construction specifications are in accordance with acceptable government requirements. Designed for portable or laboratory use at 105-125 v a-c, the unit is 15 $\frac{3}{16}$ in. high, 21 $\frac{1}{2}$ in. wide, 14 $\frac{1}{8}$ in. deep. Weight is 56 lb. Accessories are provided for various types of measurements.

3

Amplifier-Voltmeter

INSTRUMENT ELECTRONICS, 253-21 Northern Boulevard, Little Neck, L. I., N. Y. The Model 45 logarithmic voltmeter has an accuracy of ± 2 percent over its range from 0.0005 to 500 v at frequencies from 7 cps to



1.6 mc. It is useful in vibration studies, audio measurements and in broadcast and carrier frequency communications work. Power consumption is 30 w from a 117-v, 60-cps line. The table model is 7 $\frac{1}{2}$ x 8 $\frac{3}{4}$ x 10 $\frac{1}{2}$ in. and the price is \$185.

4

Vibrating Reed Pickup

FRANK RIEBER, INC., 11916 West Pico Blvd., Los Angeles 34, Calif. The Caltron lateral reproducer is a generator operating by virtue of a vibrating reed moving in a magnetic field. Designed particularly for reproduction of commercial pressings, the pickup is housed and mounted in

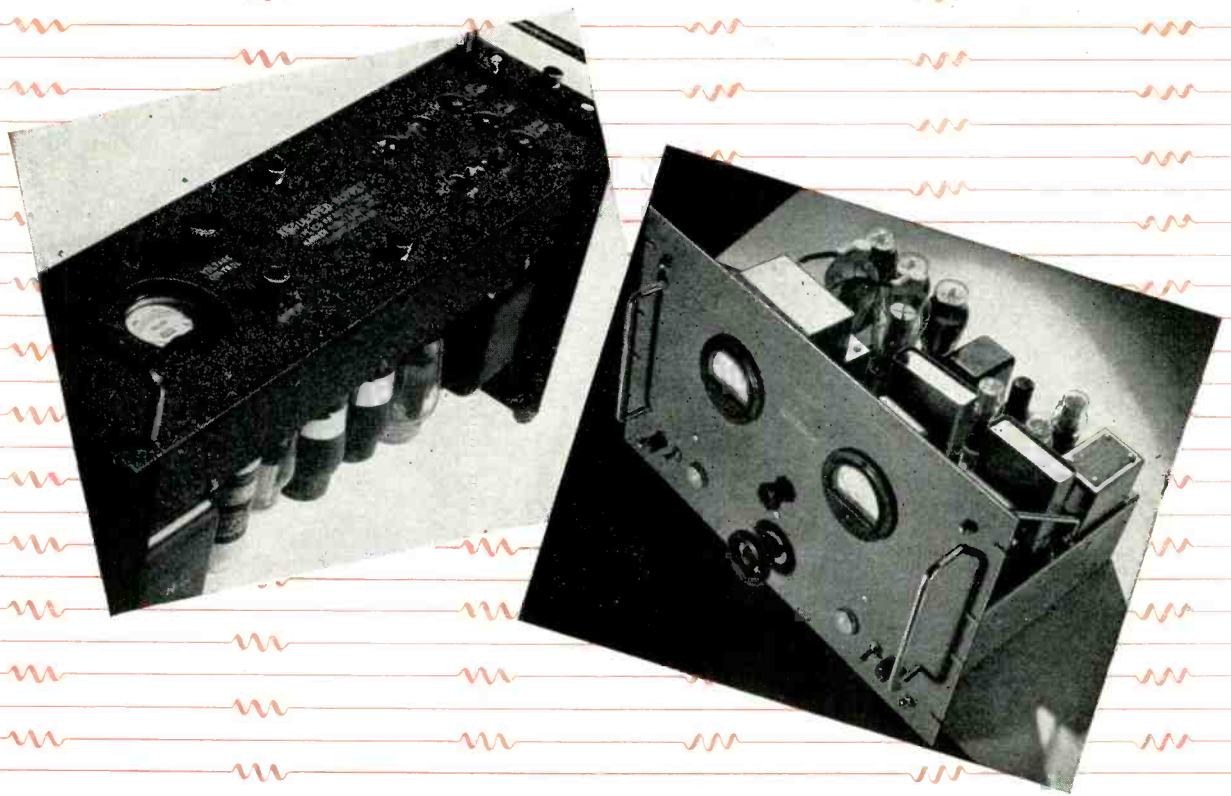

HARVEY OF CAMBRIDGE....YOUR BEST Source of Supply for REGULATED POWER SUPPLIES

If you operate equipment requiring a constant, regulated source of laboratory D.C. power — Amplifiers, Pulse Generators, Constant Frequency Oscillators, Measurement Equipment and the like — you'll find there's a HARVEY Regulated Power Supply that will suit your every requirement to a "T". As the products of pioneers in the development and manufacture of Regulated Power Supplies, HARVEY Units offer the latest and best in design, performance and dependability.

The HARVEY Regulated Power Supply

106-PA meets every need for a controllable, dependable source of laboratory D.C. power between 200-300 volts. Operates from 115 volts A.C. . . . output remains constant even though line voltage varies between 95 and 130 volts. Ripple content is better than 10MV . . . two separate filament voltages available . . . 6.3 volts, 5 amps. each . . . paralleled operation possible making 6.3 volts at 10 amps. available. D.C. voltmeter for measuring output.

The HARVEY Regulated Power Supply 206-PA operates precisely and efficiently

in the 500 to 1000 volt range. It provides a regulated flow of D.C. power in two ranges: 500 to 700 volts at $\frac{1}{4}$ amp; 700 to 1000 volts at $\frac{1}{5}$ amp. Ripple content $\frac{1}{10}$ of 1% or better at any voltage . . . 300MV at 1000 volts or better. Output is constant within 1% from no load to full load in each range; regulation 1% or better.

For complete specifications on the HARVEY 106-PA, write for Bulletin No. 25; on the HARVEY 206-PA, Bulletin No. 26. We'll be pleased to send you either or both. Write:

HARVEY RADIO LABORATORIES, INC.

439 CONCORD AVENUE • CAMBRIDGE 38, MASSACHUSETTS



Typical HARVEY products: Above left: The HAR-CAM Visual Alignment Signal Generator Model 205 TS; center: The HARVEY Marine Radio Telephone Model M-25; right: The HAR-CAM Model MFT-25 FM Transmitter. Write for Bulletins.

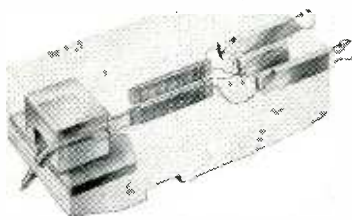

such a way as to be mechanically interchangeable with most crystal pickup cartridges. The hum-bucking coil is seen above the pickup coil in the phantom drawing.

5

Frequency Converter

THE HALLICRAFTERS Co., Chicago 16, Ill., provides a means of converting f-m broadcast receivers now tuning between 42 and 50 mc for reception



of signals on the new band, 88 to 108 mc, in the CN-1 kit. The new circuit components are mounted in a box 6 x 4 x 4 in. which weighs 7 lb. The price is \$15.

6

Heavy Turntable

ROBINSON RECORDING LABORATORIES, 35 South Ninth St., Philadelphia 7, Pa., is now manufacturing a new, heavy, belt-drive turntable equipped with a lever shift from 78 to 33½ rpm. The chassis bed plate is 20 x 24 in. and mounts in an opening 19 x 23 in. It can be supplied without pickup for \$295. Console is \$75 extra.

7

Circuit Breaker

HEINEMANN CIRCUIT BREAKER Co., 97 Plum St., Trenton, N. J., is now manufacturing a three-pole breaker which opens all circuits when an



overload occurs in any one leg. It is designed for 120/230 v a-c or 250 v d-c use at 50 amp maximum. Overall dimensions are 5½ x 2½ x 3 in.

8

Vacuum Relay

MONITOR CONTROLLER Co., Baltimore 2, Md. is manufacturing a spst vacuum relay which operates on 35 ma at 120 v d-c and will make or break a d-c circuit carrying 2 amp at 5,000 v. The Type RC 9972 sells for \$47.

9

Communications Receiver

THE HAMMARLUND MFG. Co., 460 W. 34th St., New York 1, N. Y., is once again manufacturing a Super-Pro



receiver for civilian use. The new Series 400 model operates either between 0.54 and 30 mc or 1.25 and 40 mc with five amateur bands spread substantially over the dial of the latter (SP-400-SX) model. The receiver is equipped with crystal filter, avc, noise limiter, S meter, and has a built-in power supply.

10

Shaded-Pole Motor

ALLIANCE MANUFACTURING Co., Alliance, Ohio, has designed a 1/30 hp shaded-pole motor which will operate

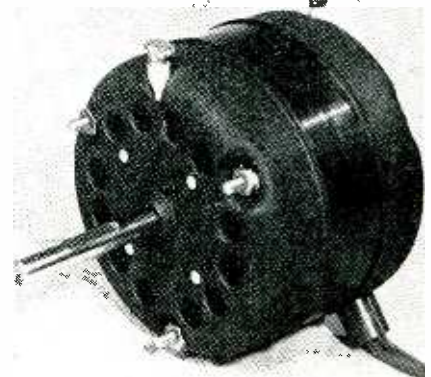

fans or do intermittent duty in other services. It has a 4½ in. outside diameter and operates at 50 or 60 cps on voltages of 220 or less.

11

Industrial Counter

POTTER INSTRUMENT Co., 136-56 Roosevelt Ave., Flushing, N. Y. The dual predetermined electronic counter is proving valuable in such in-

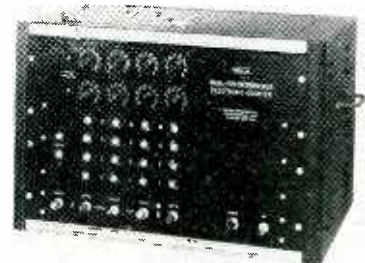

dustrial tasks as the counting and packaging of small items. Employing four-tube counter decade circuits

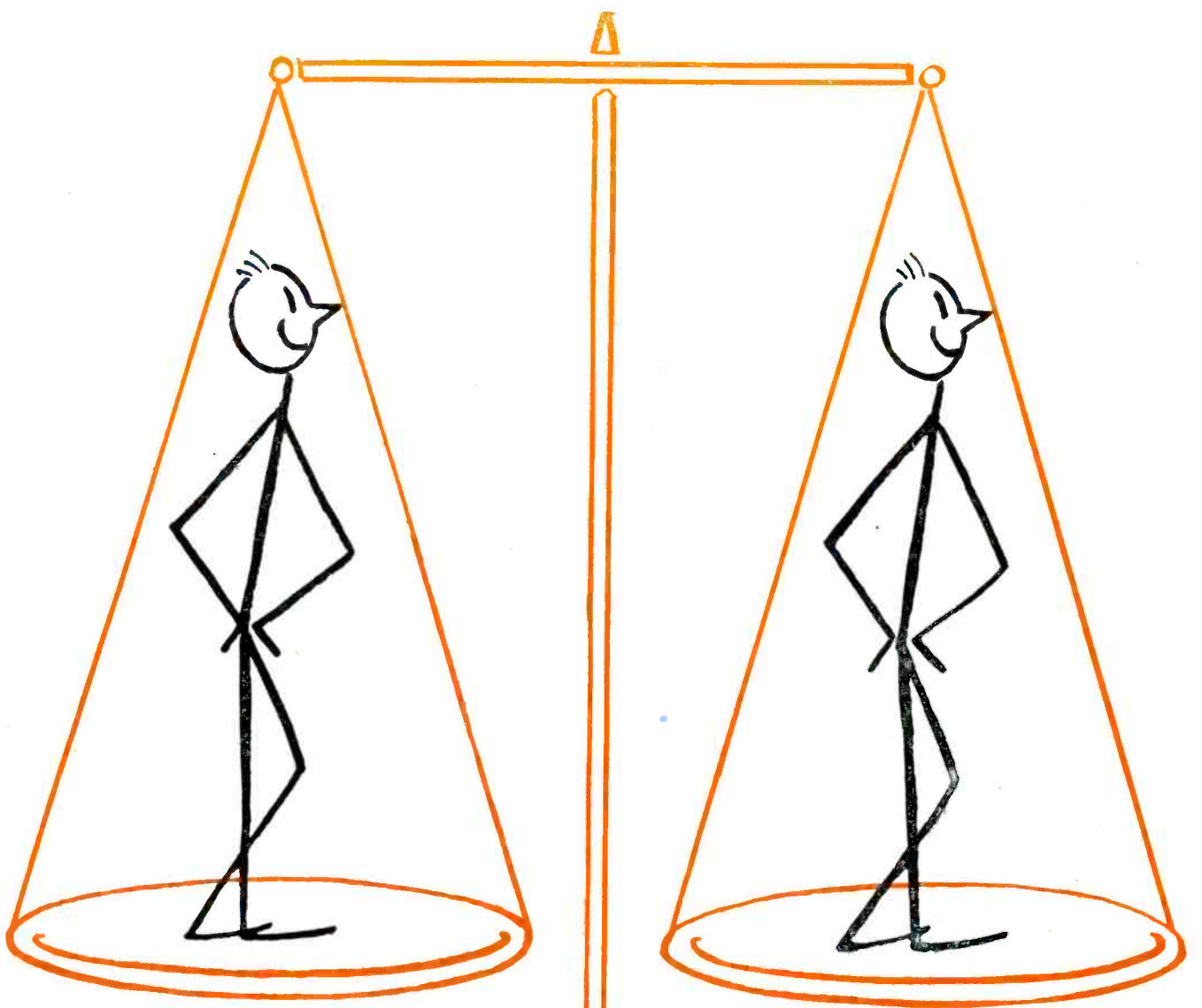

we
believe
in
uniformity

don herrod

Even through the war years, when conditions were difficult, we were able to maintain the uniformity of our thin gauge papers for important military equipment. We continue this ability for you for peace time products, including capacitors, coils, transformers and other insulating purposes, requiring thin gauge papers. Our grades range in thickness from .00025" to .004" with extremely low tolerance limits. Specify Schweitzer for thin gauge paper.

SCHWEITZER PAPER CO.

182 CORNEILSON AVE., JERSEY CITY, N.J.

Plants: Jersey City, Mt. Holly Springs, Pa.

Research Laboratories:

Chrysler Bldg., New York, N. Y.

SPECIALISTS IN THIN GAUGE PAPERS

arranged to give two independent predetermining channels, any number from 0 to 10,000 may be set up by manipulating rotary switches. Operating power is from 110 v 60 cps lines.

12

Sound Projector

ATLAS SOUND CORP., 1449 39th St., Brooklyn 18, N. Y. The Atlas HU-15 weather-proof loudspeaker can be positioned for optimum coverage in



any direction and then locked in place. Voice coil impedance is 8 ohms, input power 12 w. Bell diameter is 8½ in. as is the overall depth. It weighs 6 lb and lists for \$30.

13

Precision Resistors

RESISTANCE PRODUCTS Co., 140 South Second St., Harrisburg, Pa. have begun to market a new line of wire-wound precision resistors designed to meet the requirements of JAN specification R-93, RB10 through RB14. The non-inductive windings



are made on steatite forms, covered with an electrical varnish and baked. Tolerances are normally ± 1 percent but resistors within ± 0.1 percent can be furnished on order. Mounting is by means of a 6-32 machine screw through the center hole. The largest unit with a resistance of 2.75 meg is $\frac{3}{8}$ by 2½ in. exclusive of lugs.

14

Wire Stripping

FAIRCHILD CAMERA & INSTRUMENT CORP., Jamaica, N. Y., is now licensing the use of its chemical solution for quickly and harmlessly stripping all modern types of synthetic covered wires, no matter how small. After nearly two years of use, it has been found non-toxic to the worker and in no way chemically harmful to the product.

15

Alnico II Components

STACKPOLE CARBON Co., St. Marys, Penna., announces a line of sintered

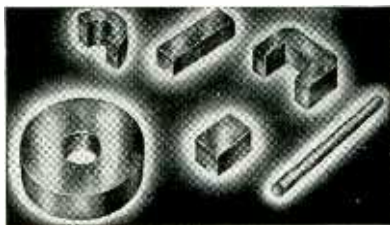

Alnico II parts and an engineering service for production of special components.

16

V-t Volt-Ohmmeter

CLIPPARD INSTRUMENT LABORATORY, 1440 Chase Ave., Cincinnati 23, Ohio, is now producing the Model 406 electronic volt-ohmmeter.

A-c potentials are measured by means of a small-diameter high-impedance pen-type dual-diode probe on a 36-in. detachable shielded cable. A convenient ground terminal near the

end of the probe provides minimum lead length for maximum accuracy of a-c measurements in all frequency ranges.

Full-scale sensitivity of 0-1, 0-3, 0-10, 0-30, 0-100, 0-300 and 0-1,000 a-c and d-c; 0-1,000 megohms in seven ranges with ample overlap to eliminate guess work and a db scale of -20 to +51 is provided on a large square-faced D'Arsonval type meter of 200 microamp sensitivity. The instrument is housed in an oak case with folding leather carrying handle. Detachable 36-in. d-c probe, ground cable, ohms probe and fused power supply cable are also standard equipment.

Input impedance of the meter is less than 7µf, 7 megohms a-c, 28



megohms d-c, assuring accuracy of readings through all ranges with minimum circuit disturbances.

Tube complement consists of one 6X5GT rectifier, and two 6SN7GT dual-purpose tubes chassis-mounted and one 6AL5 dual diode in shielded probe. The instrument is calibrated to 2 percent accuracy in all ranges with 5 percent accuracy guaranteed in the field.

17

Decade Inductors

NEW YORK TRANSFORMER Co., 62 William St., New York 5, N. Y. is manufacturing a series of inductance decades for use in bridge and low-level filter circuits. They range from the Model 211, 0.11 henry in steps

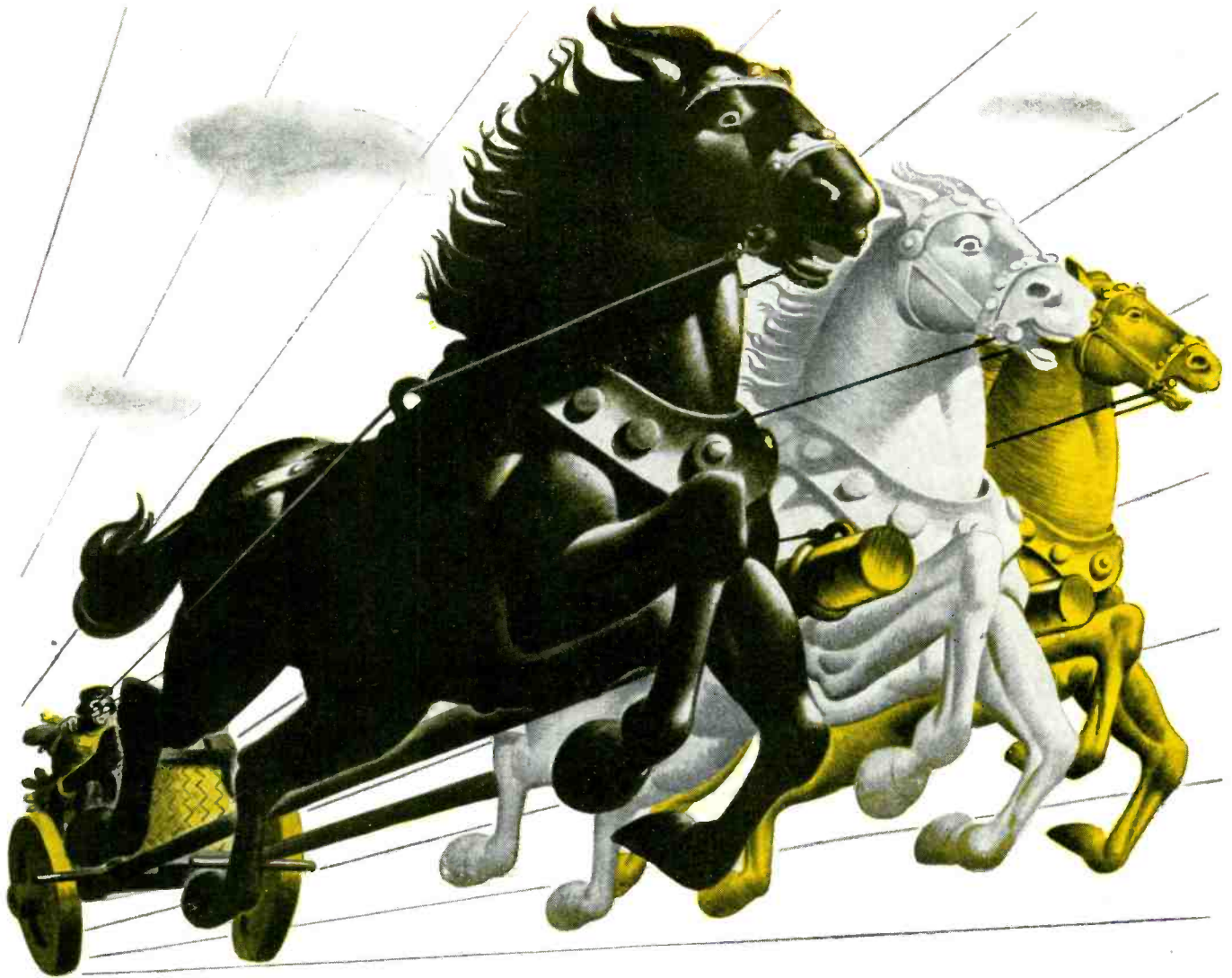

Where There is Horsepower . . .

THERE IS WIRE

Coal . . . Water . . . Oil . . . these are our sources of power. Our early use of each of them was crude and localized and wasteful—before the time of electrical wire.

Now, wire harnesses horsepower. Wire traps it at its birth—even bringing about its generation. Wire packages power and brings it into our homes. Wire transforms power into a thousand different characters. Wire focuses—diffuses—interrupts—intensifies—splits—graduates power; transmuting one energy to many other forms: to heat—to light—to sound—or back again to whirling motion. Wire guides

and controls power and makes it universally useful.

The use of horsepower is a many-sided science, now that wire is here. Each specialized application has its specialized wire counterpart. The development of these wires is in itself a scientific undertaking . . . a challenge . . . an achievement . . . a source of pride for the wiremakers among whom a pioneering leader is Belden Manufacturing Company.

Belden



WIREMAKER
FOR INDUSTRY

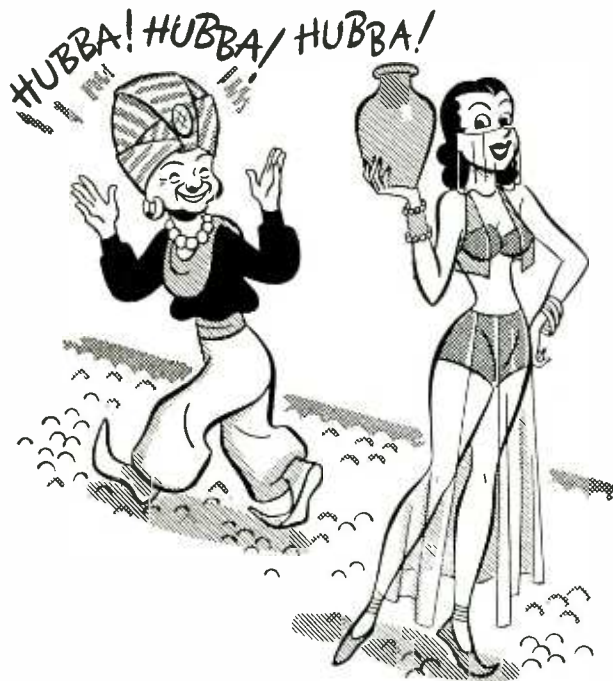

HUBBA, HUBBA, HUBBA!

(East Indian for "there's no substitute"... it's tops)

Of course we've heard the popular expression, "hubba, hubba, hubba!" — and perhaps Micah is only kidding when he tells us it's East Indian for "there's no substitute".

Hubba, hubba, hubba, or not, there is no substitute for mica where mica is needed. Nothing else possesses the high dielectric properties of mica, nothing else lasts so long. And while you're getting mica, there's no reason why you shouldn't get the best — for *Macallen Mica* costs no more.



When you think of MICA think of MACALLEN



of 0.001 h to Model 214 with a total of 110 h in steps of 1.0 h. The former has a Q of about 43 at 4,000 cps, dropping to 15 at 400 and 15,000 cps. The latter has its maximum Q at about 200 cps.

18

Ionization Lamp

AMGLO CORPORATION, 4234 N. Lincoln Ave., Chicago, Ill. produces a lamp which gives light produced by the direct ionization of inert gas when a concentrated electron stream

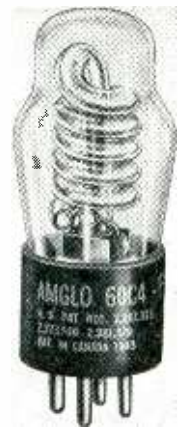

is directed through a closely wound spiral having an open end. When used as a photoflash lamp, it is said to produce a light one hundred times brighter than the sun for 1/10,000 second.

19

Electrocardiograph

ELECTRONIC CORPORATION OF AMERICA, 45 West 18th St., New York 11, N. Y. The Cardiotron makes it possible to record on paper the minutest heart action or variation. Speed of the recording tape can be varied in order to expand or compress the graph. An amplifier magnifies heart



**Thanks to
7 tough
Years...**

... this greatest of test instruments has been tested into top ranking reputation

The Simpson 260 has out-sold and out-performed every other even remotely similar test instrument in the electronic and electrical fields ever since its introduction in 1939. Through the ensuing seven years, covering the War period, circumstances gave it a gruelling test for accuracy never visioned by its makers. It stands today as irrefutable proof that Simpson design and Simpson quality produce accuracy that stays in an instrument year after year.

The demand for the 260 from men who first used it in the Armed Services (in laboratories of 300 government agencies and universities, and on the battlefields the world around) has now been added to its enormous popularity among radio servicemen. The Simpson 260 is easily the world's most popular high-sensitivity set tester for television and radio servicing.

The basic reason for this out-selling and out-performing by the Simpson 260 is this: It out-values every other similar instrument in the field. You cannot touch its precision, its useful ranges, or its sensitivity in any other instrument selling for the same price or even substantially more.

SIMPSON ELECTRIC COMPANY
5200-5218 W. Kinzie St., Chicago 44, Ill.

Simpson

INSTRUMENTS THAT STAY ACCURATE

SIMPSON 260, HIGH SENSITIVITY SET TESTER FOR TELEVISION AND RADIO SERVICING

Ranges to 5000 Volts—Both A.C. and D.C.
20,000 Ohms per Volt D.C.
1000 Ohms per Volt A.C.

At 20,000 ohms per volt, this instrument is far more sensitive than any other instrument even approaching its price and quality. The practically negligible current consumption assures remarkably accurate full scale voltage readings. Current readings as low as 1 microampere and up to 500 milliamperes are available.

Resistance readings are equally dependable. Tests up to 10 megohms and as low as 1/2 ohm can be made. With this super sensitive instrument you can measure automatic frequency control diode balancing circuits, grid currents of oscillator tubes and power tube, bias of power detectors, automatic volume control diode currents, rectified radio frequency current, high-mu triode plate voltage and a wide range of unusual conditions which cannot be checked by ordinary servicing instruments. Ranges of Model 260 are shown below.

Price, complete with test leads.....\$33.25
Carrying case 4.75

Volts D.C. (At 20,000 ohms per volt)	Volts A.C. (At 1,000 ohms per volt)	Output
2.5	2.5	2.5 V.
10	10	10 V.
50	50	50 V.
250	250	250 V.
1000	1000	1000 V.
5000	5000	5000 V.

Milli-ampers	Micro-ampers	Ohms
D.C.		
10	100	0-1000 (12 ohms center)
100		0-100,000 (1200 ohms center)
500		0-10 Megohms (120,000 ohms center)

(5 Decibel ranges: -10 to +52 DB)

ASK YOUR JOBBER

Will you look like this in 1951?



FIVE YEARS FROM TODAY, will you be in the knee-pants era of radio or will you be "up and on to" every new development? The matter is as pointed as that. True, most receivers cannot reproduce the full range of FM broadcasts yet. But soon they will.

MODERNIZE! Start now to monitor your full FM range with the Altec Lansing Loudspeaker System. Make your improvements — your refinements — now. So when tomorrow comes, you will not just be growing up to standards, you will be setting them. See your dealer.



THE ALTEC LANSING DUPLEX LOUSPEAKER SYSTEM

Both high and low frequency units are combined in one horn, reproducing the entire FM range, from 50 to 15,000 cycles, without intermodulation effects or distortion.

ALTEC
LANSING CORPORATION

1161 N. Vine St., Hollywood, Cal.
250 W. 57th St., N. Y. 19, N. Y.

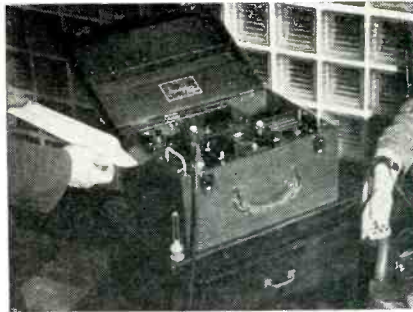

action 14,000 times. The equipment is portable, housed in a case 15½ x 11½ x 9¼. It weighs 34 lb. Built to operate on 115 v a-c, it can be used on d-c., if provided with a converter.

20

Shock Mount

ROBINSON AVIATION INC., Teterboro, N. J. announces a new type of anti-vibration mounting unit which includes a damping system, a snubbing system and electrical bonding. Three



standard sizes are available for loads varying from ½ to 45 lb. The illustration shows the effect of a vibrating test stand on two units, the one to the left mounted on conventional shear-type unit.

21

Production Heater

MARION ELECTRICAL INSTRUMENT CO., Manchester, N. H. The bench-type induction heater now in pro-



SIGMA
Relays

for precision,
sensitivity
and ruggedness

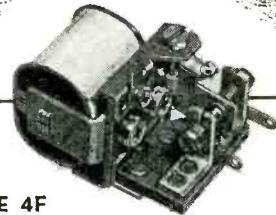

TYPE 4F

Series 4 design characteristics are compactness (1 5/8" x 1 3/8" x 1 5/32"), speed 2 - 3 milliseconds, medium sensitivity (10 milliwatts minimum - - 30 to 50 milliwatts for aircraft performance) and precision. Moderately low cost.

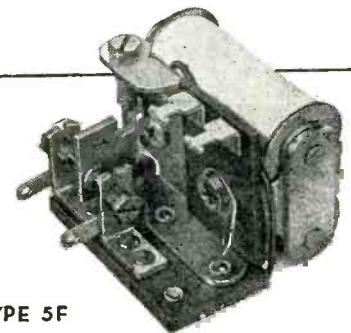

TYPE 5F

Series 5 relays are 1 3/4" x 1 3/8" x 1 7/16", extremely sensitive (.0005 watts minimum - operation on input from thermocouple)—maximum resistance to shock and vibration — precise in operation.

Both Series available with enclosures and plug-in bases, and in hermetically sealed enclosure.

Other Sigma relays in production, and still others under development, include both more specialized and complicated types, as well as simpler and more economical designs for both A. C. and D. C. operation.



Our Sales and Engineering Departments are at your service.

Sigma Instruments, Inc.
Sensitive RELAYS

62 Ceylon St., Boston 21, Mass.

CIRCUIT PRINTING with *Metapaint**

(Metaplast Silver Conductive Paint)

Metaplast Company, pioneers in metal coatings on non-conductive surfaces, announces a great war-time development now available for general peace-time use.

USES FOR *Metapaint*

- To print electrical circuits of low current-carrying capacity, for connecting circuit elements
- To print coils for FM and television circuits
- To print shields
- To spray shields

METHODS OF APPLICATION

- Screen printing
- Spraying
- Painting

Order by the troy ounce. Immediate shipment.

Metaplast COMPANY
205 W. 19 St., N. Y. 11, N. Y.
METAL PLATING ON PLASTICS

California: 1027 N. Seward, Los Angeles 38 — ENGLAND • FRANCE • CANADA • ARGENTINA • BRAZIL • AUSTRALIA

Our 24th year of dependable service to American industries



Use a solder that will contribute to the excellence of your product

No matter what you manufacture, the all-around excellence of your product depends on the quality of the materials you put into it.

Because solder is so extensively used in the manufacture of radio sets, instruments for radar, relays, tubes, transformers etc., it is important to select a brand of known quality and proven dependability.

In every department of the Electronic and Radio fields, Glaser Plastic Rosin Core Solder has given conclusive proof of its outstanding quality — during war and peacetime years.

More and more of the leading manufacturers throughout the country have adopted Glaser Solders as standard. Make Glaser Plastic Rosin Core Solder a contributing factor to the built-in perfection of your product.

Specify "Glaser", the name that means everything you can ask for in Solders and Fluxes.

Glaser Plastic Rosin Core solders exceed Government specifications in purity and are guaranteed to conform with A.S.T.M. Class A specifications.

OTHER GLASER PRODUCTS

Silver Brazing Solder and Flux
Fluxes for every purpose
Lead Products of every description
Lead Lining of acid and plating tanks

Consult our Engineering Department on your Soldering and Flux problems.

GLASER LEAD CO., INC.

31 Wyckoff Avenue,

Brooklyn 27, N. Y.



Glaser
SOLDER PRODUCTS

duction is useful for small-parts industrial soldering. Work coils for the most common types of job can be made up without involved calculations or need for retuning. The equipment is contained in a cabinet 15½ x 21½ x 15 in. and weighs 150 lb. It operates from a 115-v 60-cps line, drawing 775 w. The price is \$360.

22

Recording Turntable

PRESTO RECORDING CORP., 242 W. 55th St., New York 19, N. Y. The new 14-A turntable for commercial use is directly gear-driven at either 78.26 or 33.33 rpm. Mechanical vibration is minimized by the use of mas-

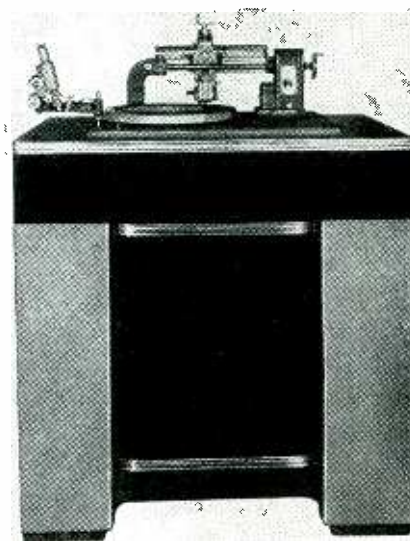

sive parts and care in damping. The motor, gear box and transmission shaft, for example, are mounted on a separate base, the whole assembly weighing 160 lb. The cutting head mounting can be used for either vertical or lateral recording at any one of five pitches.

23

R-f Voltmeter

BALLANTINE LABORATORIES, INC., Boonton, N. J. The Model 300 electronic voltmeter can be used from 30 cps to 5.5 mc with accuracies ranging between 3 and 5 percent. The voltage range is from 0.001 to 1 v in three decade ranges and is extended to 10 and 100 v by multipliers. Input impedance is equal to a resis-

Answers these questions

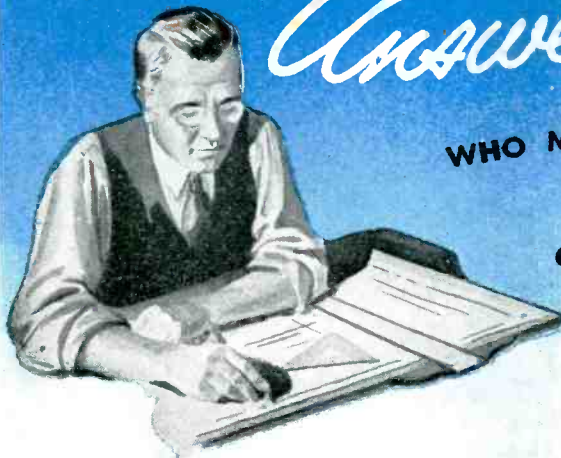

WHO MAKES IT? CAN I USE IT?
WHERE CAN I BUY IT?
ELECTRICAL CHARACTERISTICS?
OPERATIONAL CURVES?
IS IT ECONOMICAL?
WILL IT HOLD UP?



the new electronics BUYERS' GUIDE

Contents were determined by questionnairing a cross-section of the many types of people who will use the Guide. They indicated the information they want, need and use, suggested important listing breakdowns and were enthusiastic about its vital usefulness. That's why we KNOW the Guide will be read . . . it's being "tailored to known needs".

Listings will provide authentic, easy-to-find buying reference. All items will be indexed with classifications broken down where necessary for complete clarification to quickly answer the question, "Who makes it and where can I buy it?" Advertisers' names and page numbers will be flagged in bold type as the source of necessary data on which to base purchases or make direct inquiry.

Advertising space used in the Buyers' Guide should come out of Catalog Budgets. It is the year-round opportunity to promote ALL your products, NOT JUST ONE. Expose them all to the buyers who will use this Guide. Purchases will be based on the data your ads contain, and remember advertisers' names and page numbers will be flagged to secure immediate attention. Use the Guide as your Salesman-In-Print to reach, daily, the buying readership assured this valuable engineers' data book. You can't afford to miss it!

**A SEPARATE ISSUE
COMING JUNE 1946**

A NEW PLAN has been adapted for the 1946 Buyers' Guide. For the Subscriber; it will be an additional, bonus issue of ELECTRONICS containing news and vital information of year-round value, plus the most authentic, comprehensive listing of products ever attempted. For the Advertiser; its twelve-month usefulness assures complete readership by the largest buying audience ever assembled.

CLOSING DATES

Copy to prepare: All details must be in our New York office not later than March 15th. *Copy to set:* April 1st, no proofs April 10th. *Complete Plates:* May 1st. Rates and detailed information can be obtained from the ELECTRONICS representative in your territory, or send for the 12 page descriptive folder illustrated below.

ABC **electronics** ABP

330 West 42nd St. • Established 1930 • New York 18, N. Y.

A MCGRAW-HILL PUBLICATION

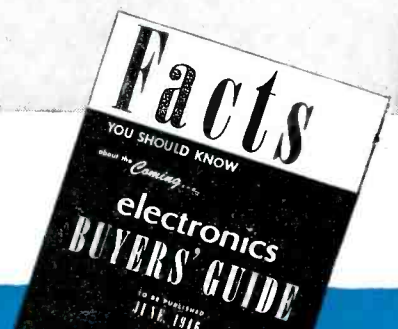

From Design to Delivery

PEERLESS

Does it Better!

A complete transformer service—from engineering design to correctly cased unit. Peerless transformers, windings, reactors, and fluorescent ballasts are available or can be produced in sizes and capacities to meet your needs. Write for new catalog.

Prompt Delivery If You Order Now!

PEERLESS

ELECTRICAL PRODUCTS CO.

6920 MCKINLEY AVENUE
LOS ANGELES 1, CALIFORNIA

Choice territories open for qualified representatives

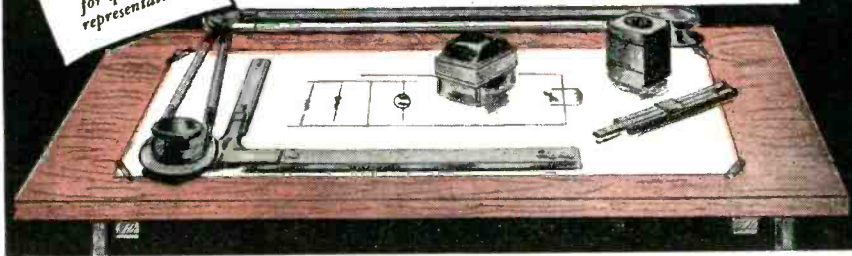

tance of 1 meg shunted by a capacitance of 9 μ f. Seven tubes are used. The self-contained power supply operates on 110-120 v 50-60 cps. The meter is 5 x 6 1/4 x 11 1/2 in and weighs 10 lb.

24

Mike Stand

UNIVERSAL MICROPHONE CO., Inglewood, Cal., is producing a new type A31 microphone desk stand with a die-cast base and wooden handle



which is demountable. The microphone is attached to a threaded brass ferrule at the top of the handle. The stand lists at \$3.

25

R-F Contactors

MONITOR CONTROLLER Co., Baltimore 2, Md. The r-f contactors, Types RC 5710 through RC 5780 operate on 220 v 60 cps and carry up to 2-mc circuits with currents as high as 15 amp and voltages to 10,000. Prices run from about \$42 to \$59 for various contact arrangements. The Type RC

CHASSIS • CABINETS • PANELS • RACKS

Skill in METAL

PAR-METAL . . . a specialized manufacturing plant employing modern high-speed methods. Nevertheless, Par-Metal products have a definite quality of Craftsmanship—a "handmade" quality born of genuine skill and long experience. Write for Catalogue.



Serving the Electronics Field Exclusively

PAR-METAL PRODUCTS CORPORATION

Export Dept.

32-62—49th STREET . . . LONG ISLAND CITY, N. Y. 13 E. 40th St., N. Y. 16, N. Y.

**METAL ASSEMBLIES AND COMPONENTS
FOR
ELECTRONIC AND MECHANICAL DEVICES**

ENGINEERING

DEVELOPING

FABRICATING

ELECTRO-FORMING

PLATING

FINISHING

B **ERNARD** **R** **ICE'S** **S** **ONS**

I N C O R P O R A T E D

MANUFACTURERS OF QUALITY METAL PRODUCTS SINCE 1867

OFFICE: 325 FIFTH AVENUE, NEW YORK 16, N. Y.

WORKS: 139-145 NORTH TENTH STREET, BROOKLYN 11, N. Y.

Crystalab

TRADE MARK REG. U. S. PAT. OFF.

SPECIALISTS IN
SPECIAL CRYSTALS

MYCONS

Q. M.

and Television Components

to your specifications.

Write now!

PRECISE BUTTON MICA CONDENSERS



CRYSTAL RESEARCH
LABORATORIES INC.

29 ALLYN ST., HARTFORD, 3, CONN., PHONE 7-3215

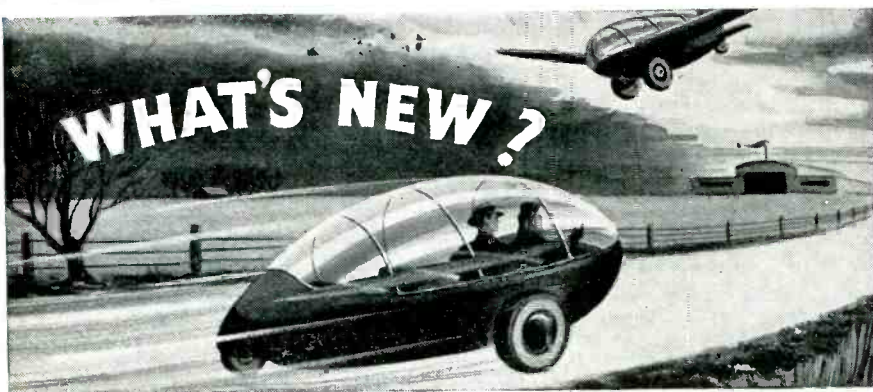

Automobile With Wings

THIS COMFORTABLE 3-wheel sedan is garaged at home ready for everyday use. For flight, its easily and quickly attached wings and tail surfaces are garaged at the airfield.

Delicate instruments, controls and devices that make such conveniences a fact are entirely dependent upon parts of highest precision.

Producing parts for all types of close-

tolerance requirements has been our business here at Ericsson for close on to 35 years. We are glad to consult with manufacturers whose new designs are more effectively marketed with close-tolerance parts produced economically.

(Below) Some of the many thousands of our precision parts that helped "Keep 'em flying and fighting."



ERICSSON

SCREW MACHINE PRODUCTS CO., INC.

25 LAFAYETTE STREET, BROOKLYN 1, N. Y.



7680 transfer switch can be used at 1 mc and carries 75 amp at 15 kv. It measures 12 x 14 x 15 in. The Type RC 5980 can be used at 30 mc, carrying 30 amp and 3,500 v. It is 5 x 8 x 13½ in.

26

A-m Transmitter

RAYTHEON MANUFACTURING Co., 60 E. 42nd St., New York 17, N. Y. The first item of broadcast equipment in a contemplated series is a 250 w a-m transmitter with a flat frequency response from 30 to 10,000 cps. Low-



power stages are tuned by a low-speed, motor-operated clutch mechanism. The final amplifier has a broad frequency response and does not require care in tuning. Air-cooled triodes are used throughout.

27

Aircraft Range Receiver

MAGUIRE INDUSTRIES, INC., 500 5th Ave., New York 18, N. Y. The first item in a line of aircraft radio equipment to be manufactured by this company is the Model ARR-1 range receiver to cover the 190-420 kc frequency band. A filter can be switched in during the reception of voice an-

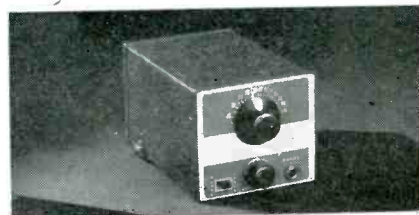

G-E LAMINATED PLASTICS

FABRICATED TO YOUR SPECIFICATIONS

**YOU GET ACCURATELY FINISHED PARTS
MADE OF THE RIGHT MATERIAL
READY FOR THE JOB**



G-E Textolite sheets, tubes and rods are fabricated in an almost unlimited variety of sizes and shapes, and the General Electric Company has the necessary equipment to do this rapidly and economically—lathes, saws, sheafs, punches, hobs and mills . . . even specially designed machinery to speed up and lower the cost on large production runs.

And because there are over 50 grades of G-E Textolite to select from, each having an individual combination of properties—electrical, mechanical, chemical, thermal—you get a grade that fits your needs.

Correctly machined and made of the right material for your application, you can be assured that when G-E Textolite fabricated parts reach you they will do the job.

Let us know your requirements. Write to Section S-2, General Electric Co., Plastics Divisions, One Plastics Ave., Pittsfield, Mass.



G-E Textolite tubing is shown being threaded to exacting mechanical and electrical specifications for radio coil forms.

G-E TEXTOLITE IS SUPPLIED IN THE FOLLOWING FORMS:

Sheets, Tubes, and Rods	Molded Laminated Parts
Fabricated Parts	Post-Formed Laminates
Nameplates	Translucent Laminates
	Low-Pressure Molded Parts

CD-46-E2

"everything in Plastics"

GENERAL ELECTRIC



*Radio Today Is So Technical
An Engineer Welcomes **SIMPLICITY***

SUN RADIO Makes It **EASY**
For You To Buy Parts

And here's how



Our only address! The entire 3rd floor at 122-124 Duane Street, New York City. 6,000 square feet. More room, more parts, more service.

Simpler to Buy



A half million feet of shelves — with radio components of every leading manufacturer.

Simpler to Select

One phone call, one letter, or one visit gets exactly what you need — the **FIRST** time.

Simpler to Order

FREE OFFER

Condensed chart of Graphical Symbols for Electronic Diagrams as standardized by the RMA (includes those until recently kept secret). Just ask for it on your letterhead. Address Dept. R, D.

Call SUN First — It's Simpler

SUN RADIO & ELECTRONICS CO., Inc.
122-124 Duane St. NEW YORK 7, N. Y.
BRa clay 7-1840



PLASTIC KNOBS

for the Electronics Industry

IN the complete line of General Electric phenolic plastic knobs, you will find a wide variety of shapes and sizes to blend in with practically any type of equipment design.

Ruggedly constructed for the hard and constant use that knobs receive, these black phenolic plastic types will not only prove more than satisfactory but will also add a distinctive touch to the appearance of any unit. Write:

*Electronics Department
General Electric Company
Syracuse, N. Y.*

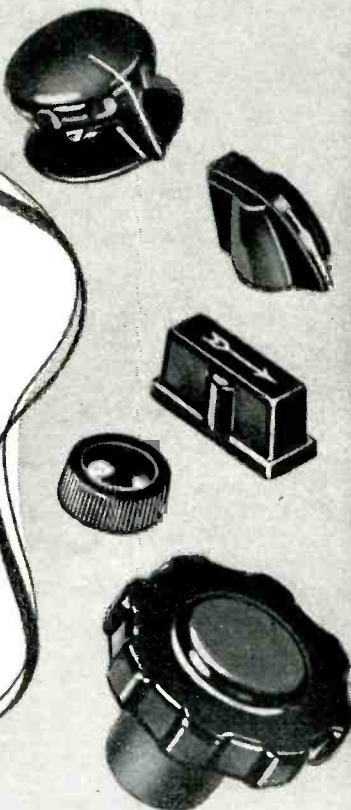

GENERAL ELECTRIC

168-E2

nouncements. Operated entirely by dry batteries, the set weighs a little over 3½ lb and measures 4½ x 4½ x 6½ in. Without batteries or headphones it sells for \$29.

28

Aircraft Radio

BENDIX RADIO, Baltimore 4, Md. The **PATR-10** is a five-channel vhf transmitter combined with a range and broadcast receiver and is designed for the private flier. The transmitter section is crystal controlled,



using only 131.9 and 131.7 mc at this time. The addition of a loop antenna will allow using the receiver unit as an aural-null direction finder. Powered by a 12- or 24-volt battery, the equipment consumes 42 w. It measures 5 x 7 x 7 in. and weighs 7 lb.

29

Flash Capacitor

TOBE DEUTSCHMANN CORP., Canton, Mass. The "N-Erg-Y" capacitor has a storage capacity of 100 watt-seconds at a peak rating of 2,500 v d-c and has been designed for portable flash units. Instantaneous currents



ANSONIA BUILT A GREAT NEW FLEXIBLE CABLE FOR NAVY RADAR



For use on radar and gunfire control, the Navy needed a specialized high frequency cable. It had to feature:

- (1) flexibility
- (2) extreme low dielectric loss factors
- (3) serviceability under extreme weather conditions.

WANTED—High Frequency Transmission Problems, for M-I-29 . . . a new flexible cable featuring extremely low loss and high conductance. For use where coaxial characteristics are required in a flexible cable.



In cooperation with Navy Engineering, Ansonia helped develop a cable answering these requirements—M-I-29—available now, to you!

To the Navy this cable represented high fidelity radar images and dependable service under severe operating conditions. To you, it may mean clearer television, truer FM radio tone or the solution of a problem in

transmitting ultra high frequency power with low loss, since it approaches coaxial cable in dielectric qualities yet is completely flexible.

Insulated with ANKOSEAL thermoplastic insulation, M-I-29 can be engineered and supplied to meet special dielectric characteristics and operating conditions. "Yankee Ingenuity"

displayed in the creation of this cable is ready now to help make it meet your particular needs.

This is one of a complete line of *job-engineered* cables made by Ansonia. For details on this or other cables, write Dept. AL The Ansonia Electrical Company, Ansonia, Conn.

Why ANKOSEAL solves cable problems

Ankoseal, a thermoplastic insulation, can help solve many electrical engineering problems, now and in the future. Polyvinyl Ankoseal possesses notable flame-retarding and oil resisting characteristics; is highly resistant to acids, alkalis, sunlight, moisture, and most solvents. Polyethylene Ankoseal is outstanding

for its low dielectric loss in high-frequency transmission. Both have many uses, particularly in the radio and audio fields. Ankoseal cables are the result of extensive laboratory research at Ansonia—the same laboratories apply engineering technique in the solution of cable problems of all types.

THE ANSONIA ELECTRICAL COMPANY

Specializing in "Ankoseal" a Thermoplastic Insulation

ANSONIA CONNECTICUT



A Wholly-Owned Subsidiary of

NOMA ELECTRIC CORPORATION

GENERAL OFFICES • NEW YORK, N. Y.

Makers of the famous Noma Lights—the greatest name in decorative lighting. Manufacturers of fixed mica dielectric capacitors and other radio, radar and electronic equipment.

..tagged for the big jobs!

**HEXA CON
SOLDERING
ELECTRIC
IRONS**

RCA

**Western
Electric**

Bendix

KAISER

Westinghouse



TYPE P-150
This production iron provides a large reserve of heat at the right temperature for sustained production.

Follow the leaders — and you'll use HEXACON! For rugged, heavy duty work or for light, intricate work . . . for continuous production or hard-to-get at work . . . here's the answer. One reason is "Balanced Heat" — dissipating excessive element-impairing heat—and minimizing element burn-outs and tip replacements. Another, is their light weight, efficiency and dependability.

LITERATURE AVAILABLE — The complete HEXACON line of screw tip and plug tip irons from 40 to 700 watts, and with tip diameters ranging from 1/4" to 1 3/4", is fully illustrated and described. Write today; no obligation.

HEXA CON ELECTRIC CO.
130 W. CLAY AVENUE, ROSELLE PARK, N. J.

HEXA CON

HIGH-QUALITY, LONG-LASTING SOLDERING IRONS

as great as 1,250 amp are possible for more than 10,000 charge-discharge cycles. The steel housing measures 6 1/2 x 4 3/8 x 3 3/4 in. and the unit weighs 6 1/4 lb.

30

Hydrogen Thyratrons

SYLVANIA ELECTRIC PRODUCTS INC., 500 Fifth Ave., New York 18, N. Y. The Type 4C35 and 5C22 hydrogen thyratrons now available for communications and industrial applications are designed to include low de-ionization time, rapid switching



rates, high peak currents, high plate voltages, moderate trigger requirements and operation at zero bias. The tube illustrated has the following characteristics: heater, 6.3 v, 9.6 amp; peak anode, 16 kv, 325 amp; average anode d-c current, 200 ma; bulb size, T-20; overall length, 10 in.

31

Breaker Switch

AIREON MFG. CORP., Kansas City, Kansas, has designed a series of circuit breaker switches for protection of circuits drawing 15 to 35 amp, suitable for a-c or d-c use. The units can be furnished in water-tight and explosion-resisting enclosures.

32

F-m Broadcast Transmitter

RADIO ENGINEERING LABORATORIES, INC., 35-54 Thirty-Sixth St., Long Island 1, N. Y. recently exhibited a 1 kw f-m broadcast transmitter designated the Model 518-DL. The interior of the power amplifier cham-

for Measuring Complex Waveforms

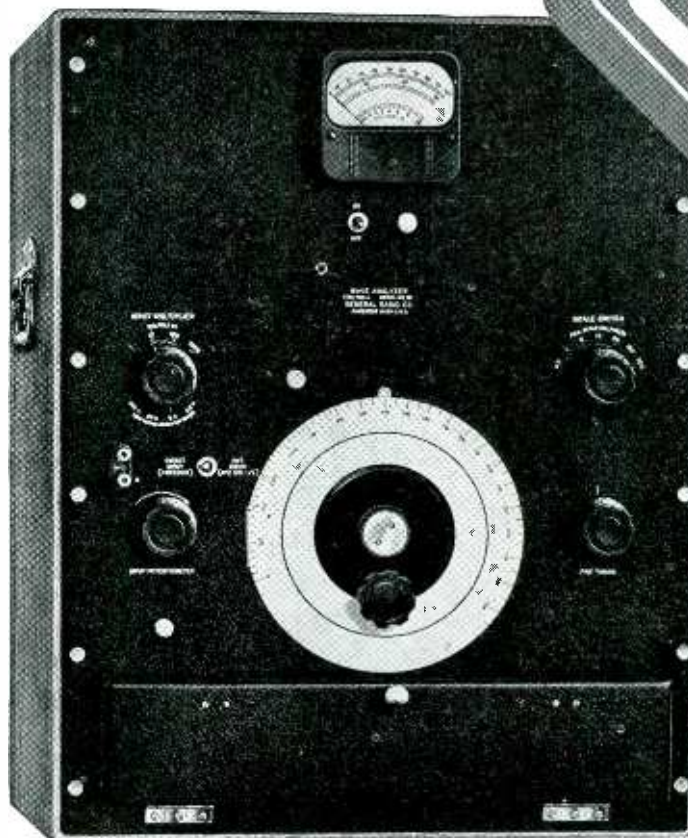

THIS analyzer offers the simplest, most accurate and most direct method of measuring the amplitude and frequency of the components of any complex electrical waveform.

It is ideally suited to hundreds of harmonic-distortion measurements on such equipment as any type of audio apparatus; broadcast receivers and transmitters; telephone and public address systems, oscillators, amplifiers and other vacuum-tube circuits; hum measurements in a-c operated communication equipment; harmonic studies of electric power systems and electric machinery; induction studies on telephone lines.

In its essentials this analyzer consists of a heterodyne-type vacuum-tube voltmeter with a highly selective filter using three quartz crystals. At only 60 cycles from resonance the attenuation is down by 75 decibels, yet tuning is very easy by virtue of the 4-cycle flat top characteristic at resonance. Standards for both voltage and frequency are built into the analyzer and can be used to check its calibration at any time.

The frequency range is 20 to 16,000 cycles and the voltage range 300 microvolts to 300 volts full scale. The instrument is completely a-c operated and has no pickup from external magnetic fields.

TYPE 736-A WAVE ANALYZER . . . \$640.00

WRITE FOR COMPLETE DATA

GENERAL RADIO COMPANY

Cambridge 39, Massachusetts

90 West St., New York 6

920 S. Michigan Ave., Chicago 5

1000 N. Seward St., Los Angeles 38

INSTRUMENT PARTS of *Exceptional Accuracy*

Let us do that difficult job on our PETERMANN automatics, supplemented and supported by the finest Swiss and American machines for maintenance and second operations.

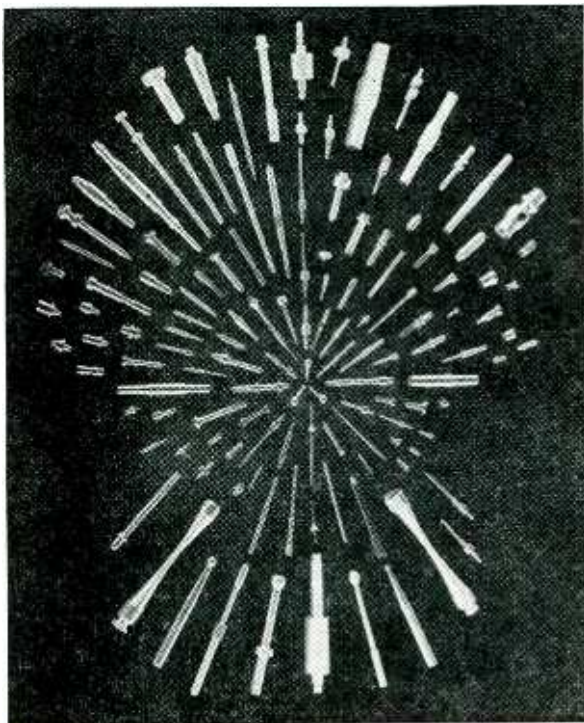

TAKE advantage of our long experience in producing parts of exceptional accuracy and finish, in our fully equipped factory, manned by highly skilled operators.

We will be glad to discuss your requirements or quote from your blueprints

INSTRUMENTS PARTS CORPORATION

TELEPHONE: OSSINING 2220

OSSINING, NEW YORK

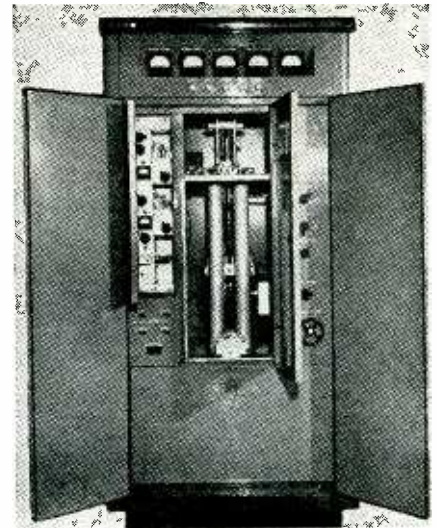

ber is shown in the illustration. The Armstrong dual-channel modulator is at the left and the power and control section to the right. The equipment is designed for operation on the new 88-108 mc band.

33

Miniature Meters

THE MB MANUFACTURING Co., INC., 331 State St., New Haven 11, Conn., has available two series of small meters; the No. 102 mounts through a 1-in. hole and the No. 152 through



a 1½-in. opening. These meters are sealed, have an accuracy of 2 percent of full-scale deflection at any point and embody the features found in larger meters of the same general type.

34

Metal Sorter

CONTROL EQUIPMENT Co., 547 Brush-ton Ave., Pittsburgh 21, Pa. The apparatus used for determining the composition of various metals operates on the principle of a voltage



THE NC-46

The new National NC-46 Receiver is a fine performer at a moderate price. Ten tubes in an advanced superheterodyne circuit provide excellent sensitivity throughout the receiver's range from 550 KC to 30 MC. Circuit features include an amplified and delayed AVC, series valve noise limiter with automatic threshold control, CW oscillator and separate RF and AF gain controls. The push-pull output provides 3 watts power, and the AC-DC power supply is self-contained.



NATIONAL COMPANY, INC., MALDEN, MASS.

Designed for



Application

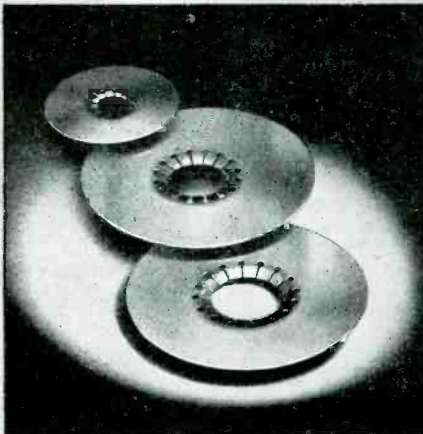

No. 33446 — Cavity Socket Contact Discs

Now that the Secret classification has been lifted from the General Electric type GL496 or "Lighthouse" ultra high frequency tube, we can list the cavity contact discs we have been furnishing to authorized customers during the past few years. This set consists of three different size unhardened beryllium copper multifinger contact discs. Heat treating instructions forwarded with each kil for hardening after spinning or forming to frequency requirements.

JAMES MILLEN MFG. CO., INC.

MAIN OFFICE AND FACTORY
MALDEN
MASSACHUSETTS



being generated when dissimilar metals are rubbed together. Reference standards are compared with unknowns and determinations are made at the rate of 30 a minute in production. There is no destruction of finished parts. The sorter requires less than 100 watts at 115 or 230 v, 25 to 60 cps. It weighs approximately 30 lb.

35

Magnet Charger

RADIO FREQUENCY LABORATORIES, INC., Boonton, N. J. The first commercial version of an instrument magnet charger developed during the war is now coming on the market. Useful on production lines or in repair shops, it operates by the sudden discharge of a capacitor through a

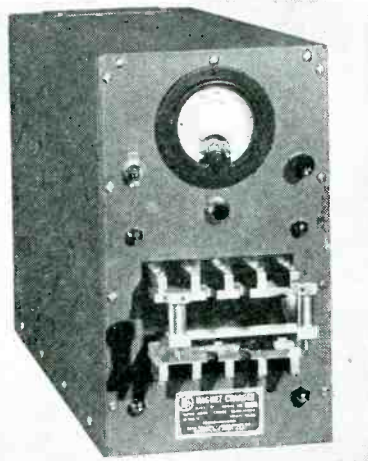

current transformer. A pushbutton control fires an ignitron-type tube to discharge the capacitor. Secondary currents exceed 15,000 peak amp. There are no exposed high-voltage terminals. The unit measures 7 x 13 x 17 in. and weighs 75 lb. It operates from 100-120 v, 50-60 cps lines, consuming 25 w. Price is \$490 f.o.b.

36

Production Counter

THE AUTOTRON Co., Danville, Ill. The Shadowcount will count up to 1,000 items a minute by means of the interruption of a light beam received by a photoelectric tube. Parts drop through a chute past the light beam and need not necessarily be spaced in order to resolve the num-

American Beauty

ELECTRIC SOLDERING IRONS

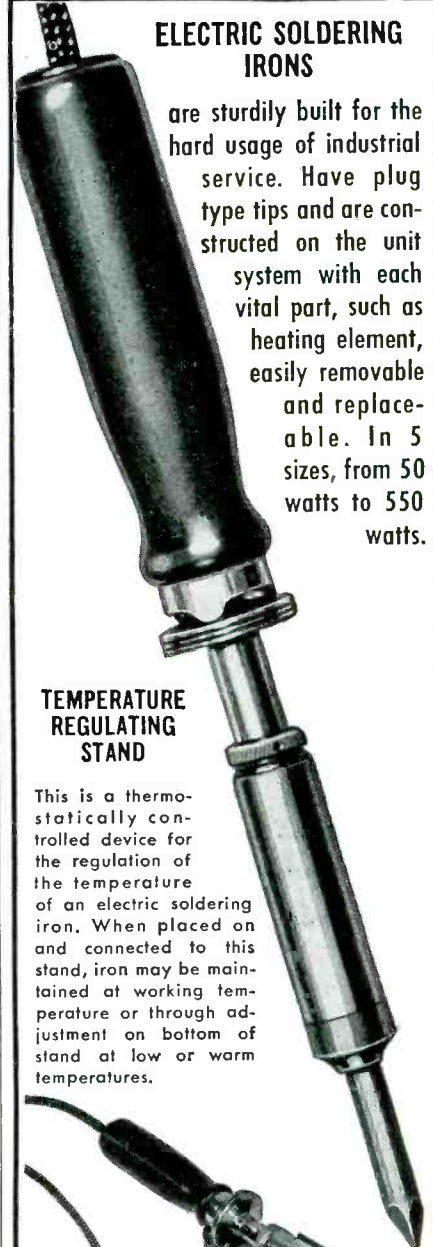

are sturdily built for the hard usage of industrial service. Have plug type tips and are constructed on the unit system with each vital part, such as heating element, easily removable and replaceable. In 5 sizes, from 50 watts to 550 watts.

TEMPERATURE REGULATING STAND

This is a thermostatically controlled device for the regulation of the temperature of an electric soldering iron. When placed on and connected to this stand, iron may be maintained at working temperature or through adjustment on bottom of stand at low or warm temperatures.

Write for Catalog Sheets

110-1

AMERICAN ELECTRICAL HEATER COMPANY
DETROIT 2, MICH., U. S. A.

FINGER TIP CONTROL

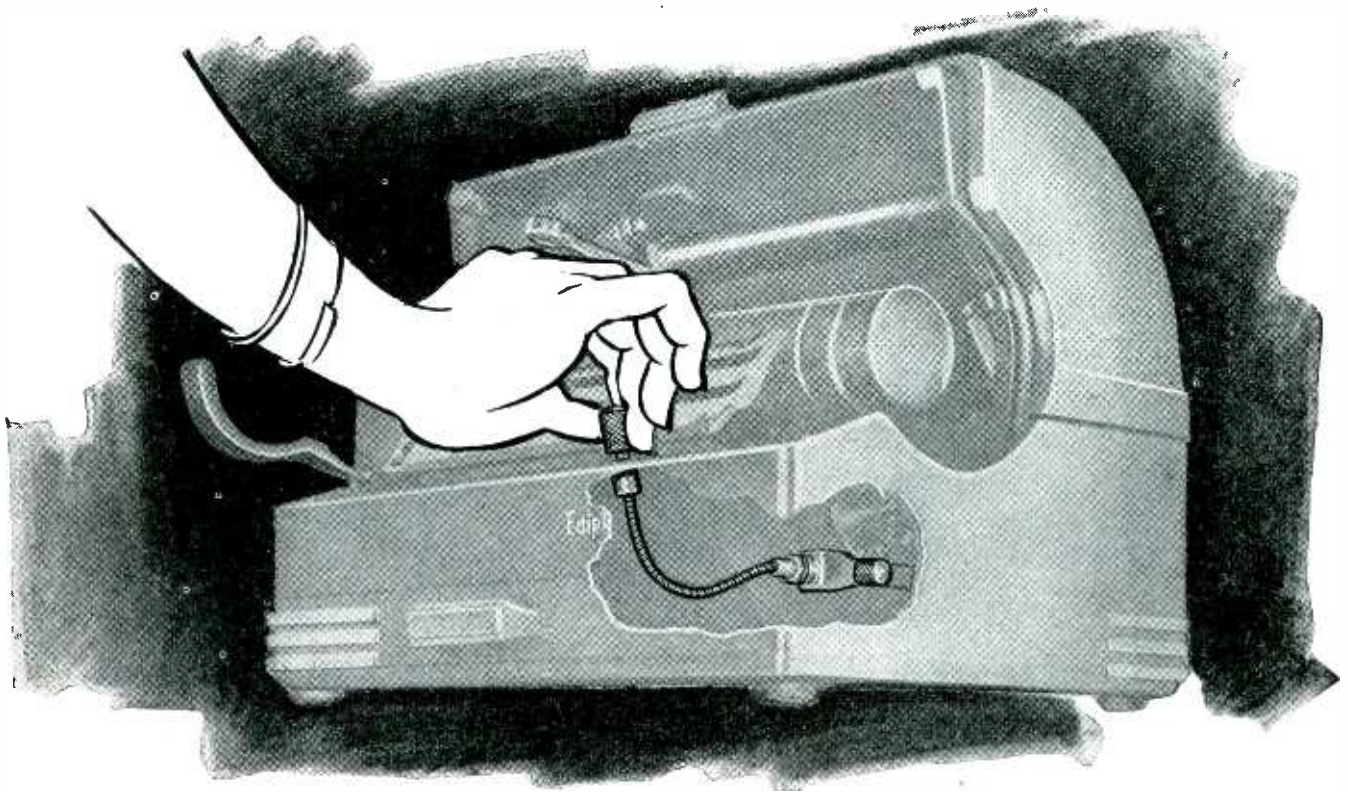

with S.S. WHITE FLEXIBLE SHAFTS

Finger tip control of cylinder speed for regulating voice pitch is provided by means of an S.S. White Remote Control flexible shaft in the Edison Miracle Secretarial Ediphone. Although the shaft makes a 90° bend in a short radius, a quick, sensitive adjustment of the fly-ball governor is made by the typist with a minimum effort of thumb and finger tips on the knurled knob. In the words of the chief engineer, "this application provides a smooth range of speed control with facility of adjustment equal to that of a micrometer."

Where smooth, accurate control is needed in electronic and related equipment, an S.S. White Remote Control flexible shaft is a simple, easily applied way to get it. It will pay every engineer to be familiar with the wide range and scope of S.S. White flexible shaft applications.

FREE HANDBOOK FOR ENGINEERS

Full details of S.S. White Flexible Shafts and their application are contained in the 256-page Flexible Shaft Handbook. A free copy will be sent to any engineer who writes for it on his business letterhead and indicates his position.



S.S. WHITE INDUSTRIAL DIVISION
THE S. S. WHITE DENTAL MFG. CO. DEPT. E, 10 EAST 40th ST., NEW YORK 16, N. Y.



FLEXIBLE SHAFTS • FLEXIBLE SHAFT TOOLS • AIRCRAFT ACCESSORIES
SMALL CUTTING AND GRINDING TOOLS • SPECIAL FORMULA RUBBERS
MOLDED RESISTORS • PLASTIC SPECIALTIES • CONTRACT PLASTICS MOLDING

One of America's AAAA Industrial Enterprises

*It Costs You Less
To Pay a
Little More For*
**SILCOCKS-MILLER
PLASTIC NAME PLATES**



The nameplate that identifies your product should reflect the quality you build into it.

Recognizing this, manufacturers all over the country have made Sillocks-Miller their source for nameplates fabricated of plastic. These companies know that quality is a tradition here at Sillocks-Miller . . . that every job must conform to our rigid standards of accuracy and perfection.

From long experience, our engineers can readily meet your nameplate requirements. There is no lost motion, no delays to you because of "trial and error" production.

That's what we mean when we say it costs you *less* to pay a little more for Sillocks-Miller quality.

Write for complete details
THE SILCOCKS-MILLER CO.
10 West Parker Avenue, Maplewood, N. J.
Mailing Address: South Orange, N. J.

**SPECIALISTS IN HIGH QUALITY, PRECISION-MADE
PLASTICS FABRICATED FOR COMMERCIAL,
TECHNICAL AND INDUSTRIAL REQUIREMENTS.**



ber of objects. Several types and accessories are available to convert the basic counting mechanism to special tasks. The cabinet size, not including hoppers or other external feeding apparatus, is 10 x 12 x 9 in.

37

Mixer Control

CINEMA ENGINEERING Co., 1510 W. Verdugo Ave., Burbank, Calif., has designed a new mixer control which is said to reduce contact noise to a low order. It uses a wedge-shaped

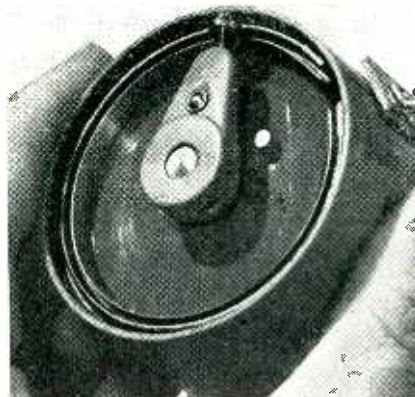

roller riding on a plastic arm to make contact between the resistance wire and a metal track. Models No. 3182 and 1047 ladder-type attenuators are provided with this mechanical improvement.

38

Exposure Control

SIDWARD PRODUCTS Co., 261 Broadway, New York 7, N. Y., produces an integrating light intensity control weighing 6 lb which measures exposures from $\frac{1}{2}$ sec to 45 min. The



Bogen SOUND and COMMUNO- PHONE Equipment

INTER-COMMUNICATION AND PAGING SYSTEMS For Every Requirement

With its reputation for quality earned over the years, and more recently its importance in war, specification of BOGEN inter-communication and paging equipment is your guaranty of functional efficiency and dependability.

The BOGEN line is diversified and complete, with units and systems to meet every particular need; economy features—including installation, maintenance, and service—assure self-amortization in a short time. Investigate BOGEN today; complete details on request.

Address inquiries to Department D

TYPE A COMMUNO-PHONE



Inter-communication system comprises Master Unit and up to 18 remote stations. Two way talk and call. Volume control. Remotes can reply at distance of 20 to 30 feet

from their unit. No need to interrupt routine or work. Other models provide group and all call features.



663 BROADWAY, NEW YORK 12, N. Y.

**BOGEN SOUND SYSTEMS - AMPLIFIERS
COMMUNO-PHONES - ELECTRONIC EQUIPMENT**



They wanted a metal to pull
 an **Electronic Trigger**

In developing the Proximity Fuse, *Problem One* was to design a 5-tube radio transmitter and receiver small enough to fit into a shell nose. *Problem Two* was to engineer the unit to withstand physical shocks and strains never before encountered.

There was the smashing impact of the initial discharge. There was an accelerating force greater than 15,000 times gravity. There was the terrific centrifugal force imparted by barrel rifling.

Yet . . . aside from size, the tiny tubes that formed the "brains" of the fuse did not differ much from those used in home radios.

As in conventional tubes, most had elements of Nickel.

The low gas content of Nickel meant easy evacuation and no impairment of vacuum during use. (*An important feature with so little surface area available for "getter" action.*)

In addition, Nickel could resist deterioration in fabrication and withstand high evacuation temperatures without distortion.

Moreover, Nickel supplied all the required electronic and electrical properties.

Finally, and of very great importance, Nickel could be worked in the extremely small sizes needed.

When you have a metal selection problem, investigate Nickel and high-Nickel alloys. They are workable metals offering a hard-to-find combination of properties for electronic applications. Write for the new "Inco Nickel Alloys for Electronic Uses" which gives you the data you want on the composition and characteristics of 13 Nickel alloys to solve electronic problems.

THE INTERNATIONAL NICKEL COMPANY, INC.
 67 Wall Street, New York 5, N. Y.

Nickel

NICKEL  ALLOYS

MONEL • "N" MONEL • "S" MONEL • "R" MONEL • "KR" MONEL • INCONEL • NICKEL • "L" NICKEL • "Z" NICKEL
 *Reg. U. S. Pat. Off.



After leaving the gun, the Proximity Fuse begins to send out a tulip-like pattern of radio waves.



As target enters wave field, the waves are reflected back to the fuse where they release the electronic detonating trigger.



Here's one of the tiny tubes for the radio in the Proximity Fuse. In most of the tubes used, all elements are made of pure Nickel. Some tubes, depending upon design, use Nickel-molybdenum alloys in addition to Nickel.

MERIT
CVC
Since 1924
FINE
RADIO
PARTS

WE WOULD LIKE TO
SEE YOU AT THE
1946
Radio Parts and
Electronic Equipment
Conference and Show
BOOTH NO. 52
STEVENS HOTEL,
CHICAGO
MAY 13-16

MERIT COIL & TRANSFORMER CORP.
TELEPHONE
4427 North Clark St. Long Beach 6311 CHICAGO 40. ILL.

NEW and Ready for you!

Allied's 1946 CATALOG
of Radio and Electronic Supplies

LARGEST AND MOST COMPLETE STOCKS...Under One Roof

You'll find this new Buying Guide extremely helpful and valuable today! Places over 10,000 items at your finger tips—for research, maintenance and production. Includes parts, tubes, tools, books, test instruments, public address and communications equipment. Concentrates all leading

makes here in one large central stock to give you faster, more efficient, more complete service—saves you time, work and money. Whatever you need... it pays to check with Allied. Write, wire or 'phone Haymarket 6800.

Everything in Radio and Electronics
ALLIED RADIO CORP.
833 W. Jackson Blvd., Dept. 24-D-6, Chicago 7, Illinois

FREE
Send for it
NOW

unit can also be made to actuate a camera shutter. Twenty watts of power at 115 v 60 cps is required to operate the equipment which measures 8 x 8 x 8 in. The phototube housing is 1½ x 1½ x 4 in.

39

Coil Mounting

TINNERMAN PRODUCTS, INC., 2106 Fulton Road, Cleveland 13, Ohio, has just announced a new secure mounting for coil forms in radio chassis

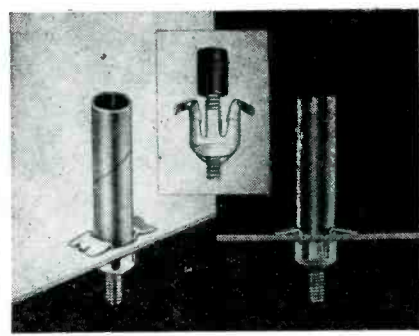

assemblies. The fasteners are available for mounting ½ and ¾ in. forms to panels of various thicknesses. Samples are available.

40

Control Relay

ALLIED CONTROL Co., INC., 2 East End Ave., New York 21, N. Y. The type CR relay is light in weight but has contacts capable of carrying 15

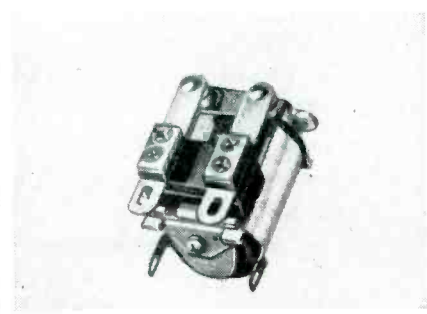

amp at 24 v d-c or 110 v a-c, non-inductive. The single-pole unit is 1½ x 1½ x 1½ in. and weighs 3 oz. A variety of contact combinations is available.

41

Miniature Transformers

UNITED TRANSFORMER CORP., 150 Varick St., New York 13, N. Y. Now

USE STANDARD PARTS—SAVE TIME AND MONEY

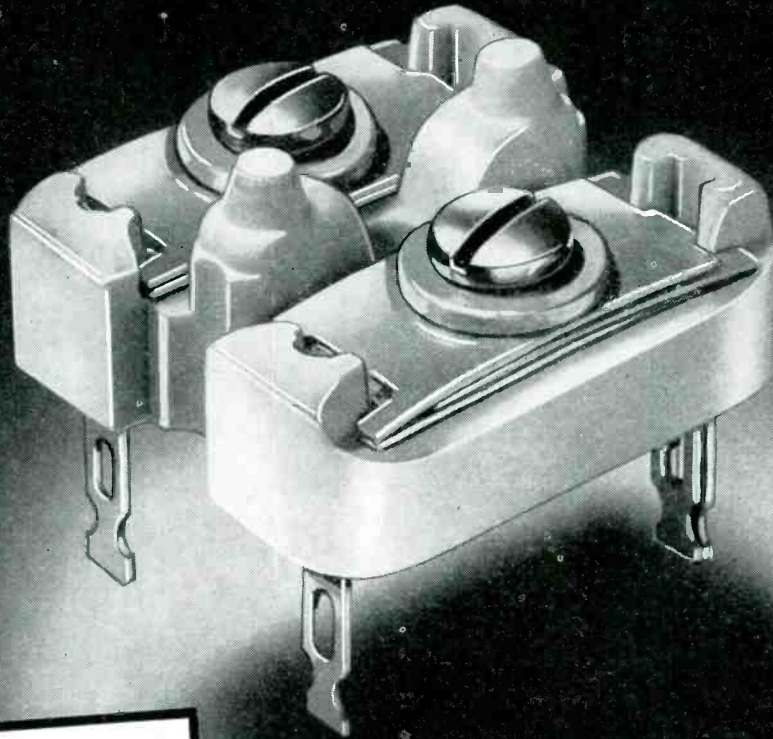

SAVE

*For many years
Automatic has manufactured
Coils and Trimmers for manufacturers.*

*Our mass-production methods
will save you money and headaches.*

*Order your Coils and Trimmers from
people who "know how".*



AUTOMATIC
MANUFACTURING
CORPORATION

MASS PRODUCTION COILS & MICA TRIMMER CONDENSERS

900 PASSAIC AVE.

EAST NEWARK, N. J.

**A major
advancement
in the
recording blank
field . . .**

10 Year
GUARANTEE
GOULD-MOODY
"Black Seal"
**ALUMINUM
RECORDING BLANKS**

**. . . at no increase
in price !**

After prolonged research and experimentation, we have introduced technological improvements into "Black Seal" blanks that not only increase life span, but materially enhance the other finer characteristics of these blanks. And so positive are we of the worth of these perfected "Black Seals" that we're offering them to you on an unconditional ten-year guarantee basis.

**You can't afford to be a
recording isolationist . . .**

"Black Seal" blanks will not rip up, disintegrate or powder after the first playing if kept in storage for any long period of time. You are in no danger of losing valuable recordings in what, up until now, you have considered your safe library of recording blanks. No matter how well you may be satisfied with your present blanks, you can't afford to be a recording isolationist. Try "Black Seals"—if, for any reason whatsoever, you aren't satisfied, return them at our expense.



THE GOULD-MOODY CO.
Recording Blank Division
395 BROADWAY NEW YORK 13, N. Y.

available is a new series of Sub-Ouncer transformers so far used only in military equipment. Coils are uniform layer-wound of Formex wire on a molded nylon bobbin. Re-

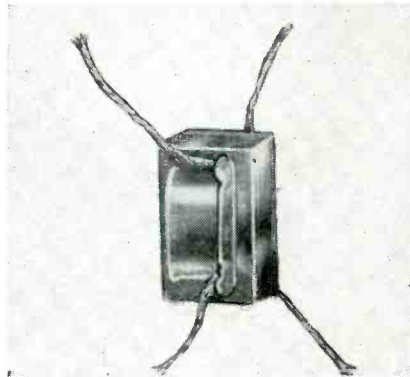

sponse of standard types is within ± 3 db from 200 to 5,000 cps. The five types available immediately measure $\frac{1}{8}$ x $\frac{3}{8}$ x $\frac{1}{2}$ in. and weigh $\frac{1}{8}$ oz.

42

Jewel Bearing

MARION ELECTRICAL INSTRUMENT Co., Manchester, N. H., has developed a new jewel-bearing assembly for D'Arsonval instruments. It con-

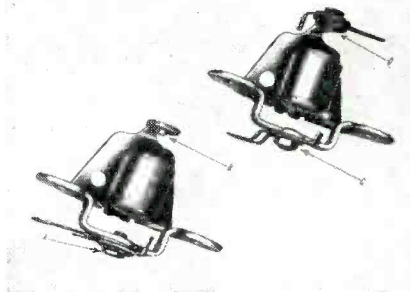

sists of a metalized boro-silicate glass V jewel which is induction-soldered into position to replace the conventional screw setting and jewels. The new, simplified assembly is shown at the left.

43

Conductivity Cell

INDUSTRIAL INSTRUMENTS, INC., 17 Pollock Ave., Jersey City 5, N. J. The type CEL-F wand-type cell can be safely immersed in a vat or tank and withdrawn after the reading is



Model M-151
Improved and Standard Type
Microphone Jacks and Plugs
Solid, silver plated contact coupling can
be unscrewed completely for soldering.

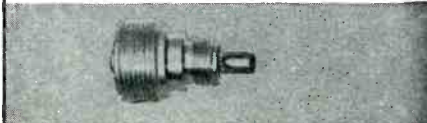

Model M-161
Chassis mounting, solid silver plated
contact. Milled flat prevents turning.



Model M-170
Mates with Model M-151 and M-150
standard solder contact.



Model M-160
Chassis mounting standard. Solder
contact.



Model M-150
Standard solder contact. Mates with
Models M-170, M-161, and M-160.

**PRICE AND DELIVERY
UPON REQUEST
SEND FOR OUR LATEST
BROCHURE.**



KINGS ELECTRONICS CO.
372 CLASSON AVE. BROOKLYN 5, NEW YORK

Always Reliable - All Ways!



SEEBURG RECORD CHANGERS

MINIMUM FRICTION • SILENT • CONSTANT SPEED
LONG LIFE • TROUBLE-FREE OPERATION

RELIABILITY of operation is the prime requisite of a good record changer. New and more efficient features have been added to the complete line of SEEBURG RECORD CHANGERS . . . but only after these features were given exhaustive laboratory and field tests . . . for RELIABILITY is the quality that is built into all SEEBURG RECORD CHANGERS. Years of trouble-free operation in actual use is the best proof that SEEBURG RECORD CHANGERS are Always Reliable—All Ways!

SEEBURG *Wire* RECORDER

An Electronic Engineering Achievement

The SEEBURG WIRE RECORDER is a revolutionary new recording and reproducing instrument. The versatility of the SEEBURG WIRE RECORDER readily lends itself to practical uses in the commercial, legal and entertainment fields. One simple control knob operates the SEEBURG WIRE RECORDER to record and reproduce speeches, plays, meetings, music, radio programs, etc. There are no needles or discs used.

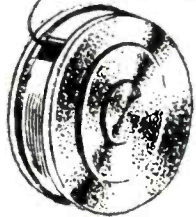

IT WILL BE NECESSARY...

for radio manufacturers to make provisions in their circuits to accommodate the SEEBURG WIRE RECORDER. We therefore invite prompt inquiries from interested radio manufacturers.

Seeburg

DEPENDABLE MECHANISMS

J. P. SEEBURG CORP. • CHICAGO

1946

INDUCTOR HEADQUARTERS

B&W



MINIATURE R-F INDUCTORS

B & W MINIDUCTORS meet the fast-growing need for finely-made miniature coils for modern high-frequency services. Standard diameters range from 1/2" to 1 1/4". AIR-WOUND

Midget Coils for Dozens of High-Frequency Uses

construction assures an amazingly high Q characteristic. Miniductors are supplied in any length and for any type of mounting. Coupling links and other features as required. Write for Bulletin.

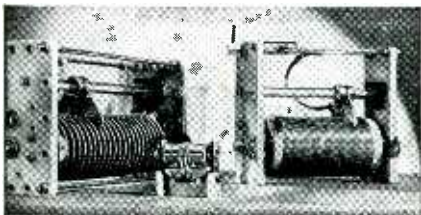

GENERAL PURPOSE ROTARY COILS

From midget sizes only a few inches long with dual opposed windings or other special features to giant units for transmitting, dielectric heating or other uses B & W Rotary Coils providing continuous adjustment throughout the entire length of the winding, are supplied in a wide variety of types. Submit details of your application for recommendation by B & W engineers.

EDGE-WISE WOUND INDUCTORS



Furnished in diameters from 1 1/4" to upward of 10". Minimum size of copper strip 3/16" x .050"; maximum 1" x .250". Inside or outside mountings available, plain or tapped coil styles. Rotary or continuously adjustable units supplied with either inside or outside contacts. Write for details.

WE'LL MATCH ANY INDUCTOR REQUIREMENT



BARKER & WILLIAMSON

Dept. E-46, 235 Fairfield Avenue
Upper Darby, Penna.

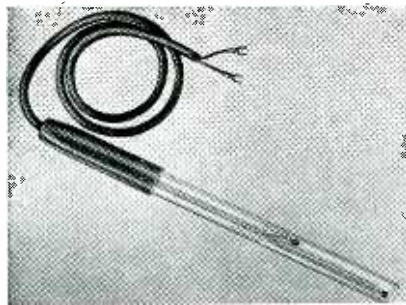

determined from an associated conductivity bridge. It takes the form of a Pyrex wand measuring approximately 1 in. outside diameter by 20 in. long.

44

Cardioid Mike

ELECTRO-VOICE, INC., 1239 South Bend Ave., South Bend 24, Ind. The Model 950 Cardax microphone has a dual frequency-response selector and an on-off switch. Its cardioid re-



sponse allows greater gain to the loudspeakers of a public address system without feedback. Equipped with a built-in connector, 3/8 in.-27 thread and 20-ft cable, the new mike lists at \$37.

Literature

45

Dry Plate Rectifiers. Selenium Corp. of America, 1719 West Pico Blvd., Los Angeles 15, Calif. Catalog B presents a fairly complete sketch of selenium rectifiers from the discovery of the basic metal in 1817 up to a summary of new developments on page 34. The pages between are full of circuits, speci-

What type of
**STAINLESS
FASTENER**
do you need?



Allmetal has it —
or can make it!

Prompt delivery from the
largest stock in the nation!

Screws . . . nuts . . . washers . . . pins . . . Allmetal carries the largest stock in the country of stainless steel fasteners and screw machine parts. We also have facilities for heading, tapping, drilling, reaming, slotting, turning, stamping, broaching and centerless grinding . . . and we work not only with stainless and monel, but also with duralumin, aluminum, brass, bronze, or any other non-corrosive metal. All parts produced to close tolerances. Write for our catalog today. Allmetal Screw Products Co., 33 Greene St., New York.

Send for
FREE CATALOG

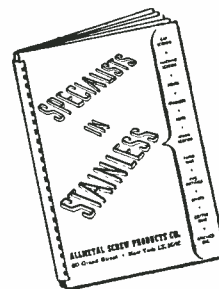

This new, 83-page catalog helps you select the correct size and type of non-corrosive fastening device for any particular job. Includes stock sizes, specials that can be made, engineering data, etc. Make request on company letterhead.

**ALLMETAL
SCREW PRODUCTS CO.**
33 Greene Street, New York 13

**SPECIALISTS in
STAINLESS FASTENERS**

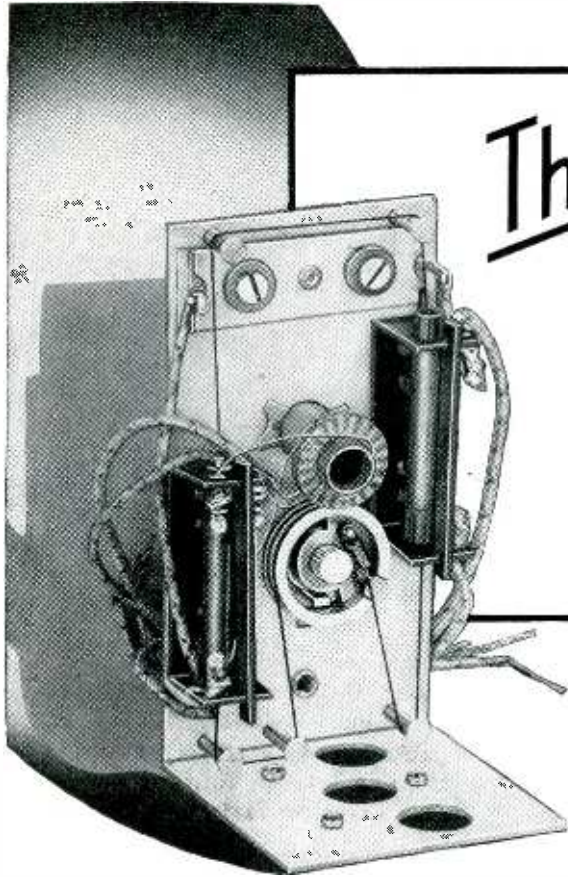

The **RADACOR TUNER**

● Typical example of Micro-Ferrocart's precision-engineering is the Radacor Model T11 Tuner shown here. Sturdily constructed, simply designed, this highly efficient component was evolved to help solve your present-day problems of procurement and engineering.

● If you are interested in this newest of Micro-Ferrocart components, or if you contemplate the manufacture of any product that involves electronic or mechanical powder metallurgy, why not write to us today. The engineering skill that has created for Micro-Ferrocart its reputation for "quality in production" is at your service.

ELECTRONIC & MECHANICAL POWDER METALLURGY

MICRO-FERROCART
PRODUCTS DIVISION

MAGUIRE INDUSTRIES, INC., 375 FAIRFIELD AVE., STAMFORD, CONN.

BIG AND IMPORTANT



The new Gothard Indicator Light Assemblies Catalog is bigger and better than any similar catalog ever published. It offers a wealth of scientific data, which will greatly aid you in selecting the right assembly for your industrial, household appliance, radio or other applications. It also illustrates and describes the largest selection of Underwriters approved assemblies for any voltage and style of miniature lamps and built-in resistor assemblies for neon lamps. Here is the latest data published on Indicator Light Assemblies—ask for your copy immediately.

Gothard MANUFACTURING COMPANY
 2114 CLEAR LAKE AVENUE, SPRINGFIELD, ILLINOIS
 EXPORT DIVISION: 25 WARREN STREET • NEW YORK 7, N. Y.

FIBRE FABRICATION
 TECHNICAL DATA FREE

WRITE FOR
 BULLETIN 120

Baer
 PHENOL AND VULCANIZED
FIBRE
 FABRICATIONS
 FOR
 INDUSTRY

*Design short-cuts—cutting
 engineering and assembling time*

Time saved in preliminary planning is directly proportionate to efficiencies effected in the blueprint stage. By designing-in BAER fibre fabrications—whether your product is instrument, machine, appliance or equipment—the utmost in production stream-lining is assured. Further, the inherent advantages of the material—accurately machined, stamped, punched, drilled, milled or sawed by BAER craftsmen—adds a full measure of dependability under varying service conditions.



N. S. BAER COMPANY, 9-11 MONTGOMERY ST., HILLSIDE, N. J.

cations, and descriptions of uses to which cataloged items can be put.

46

News Digest. General Electric Co., Schenectady, N. Y., publishes a quarterly News Digest reporting activities and developments in the company; not a technical publication.

47

Nickel. International Nickel Co., Inc., 67 Wall St., New York 5, N. Y. List A contains an index of current papers on the uses and properties of metals, including one of interest to the ceramic industry.

48

Components. Aircraft Radio Corporation, Boonton, N. J. In addition to preliminary data on microwave components and aircraft communications equipment, bulletins are available covering fasteners, multi-con-

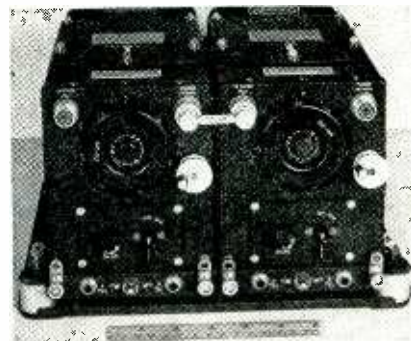

tact plugs and receptacles, switches, d-c relays, sealed capacitors, chokes and transformers and variable air capacitors suitable for transmitting or receiving equipment.

49

Direction Finders. Sperry Gyroscope Co., Inc., Great Neck, N. Y. Publication 15-43 describes an aircraft radio direction finder, listing specifications and tests taken by CAA approved methods.

50

Nomographs. Federal Telephone and Radio Corp., Newark 1, N. J. A folder containing technical data in the form of single sheets will be found useful to engineers interested in determining such information as

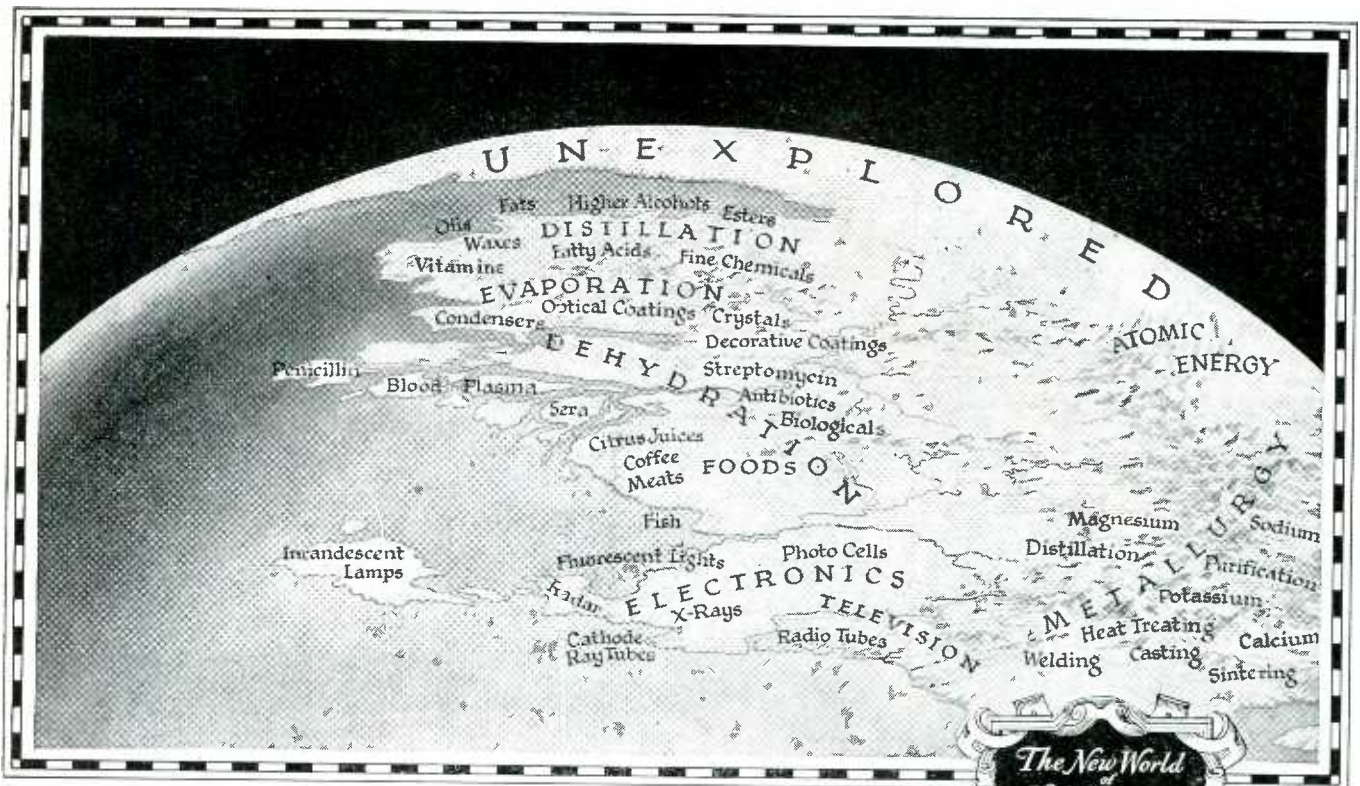

Industry's New World

High Vacuum offers to industry a vast new area, virtually unexplored. No one knows its extent or its resources. No one can say what opportunities are there for your industry. No one can tell you, but National Research Corporation can help you find out as it has helped many others. It can furnish the technology and equipment as it did for the wartime production of Magnesium.

In 1938 the United States produced 2,400 tons of Magnesium while Germany made six times as much. As the war progressed, the demand for aircraft and incendiary bombs increased. Magnesium had become a fighting metal.

As this country became increasingly involved in war, Magnesium became a strategic material that must be produced in quantity — at any cost. There was no time to debate processes. From 1940 to 1942 OPM and WPB built 14 plants using four basic methods never before tried in this country. In 1943, 185,000 tons of Magnesium were produced.

While three of the new processes struggled with problems of large-scale production, WPB turned to the National Academy of Science for further recommendations and was directed to the Canadian National Research Council and the Dolomite-Ferrosilicon process, then developed on a laboratory scale by Dr. Lloyd M. Pigeon.

In this process Magnesium is vaporized from briquettes at temperatures from 1100° to 1150° C. and pressures of about 10⁻² mm. Hg. The vaporized metal is crystallized in cooled cylinders. While the process appeared to be the simplest of all

the methods, it was, in practice, harassed by grave difficulties, not the least of which was the maintenance of high vacuum on an industrial scale, hitherto undreamed of.

At the request of WPB, National Research, under a DPC research contract (Plancor 708), was given the task of solving this vacuum problem, then the largest industrial project involving pressures in the micron range.

Six weeks after receiving the assignment we had a pilot plant in operation. During the following four months we designed large diffusion pumps to improve the yield and shorten the cycle, developed recording gauges for process control and evolved vacuum engineering techniques of value in the design of the larger plants.

Deliveries of equipment were made for a full-scale plant already building in Canaan, Connecticut, for the New England Lime Company. Of all the Magnesium plants begun in wartime, some completed before we were given our assignment, this was the first to be in production. Later equipment was supplied to others, including Ford at River Rouge.

It has been said of the Dolomite-Ferrosilicon process that it was "the most spectacular development of the war" and "the primary candidate for postwar scrapping". Whatever its fate, we are proud of the work that we did in making it quickly practical. This is typical of the sort of engineering that N.R.C. has to offer — the sort of service that you may expect from us when you explore the new world of high vacuum.

NATIONAL RESEARCH CORPORATION, Boston 15, Massachusetts.

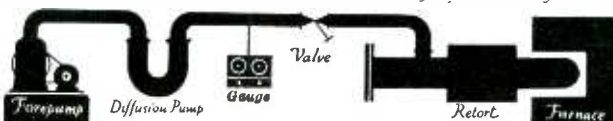

We engineer plant installations and manufacture High Vacuum Gauges, Valves, Seals, Diffusion Pumps, Stills, Furnaces, Coating Equipment and Dehydration Equipment.

HIGH VACUUM FOR INDUSTRY
NATIONAL RESEARCH CORPORATION
Vacuum ENGINEERING DIVISION

HARVEY

is now delivering
reasonable quantities of
ALTEC LANSING
FM MONITORING EQUIPMENT
and
RECORDING AMPLIFIERS

Designed in the famous Altec Lansing Hollywood laboratories for film recording. Takes the guess work out of FM... the only equipment of its kind. HARVEY'S experienced staff can answer technical questions and advise on installation.



604 DUPLEX SPEAKER

... combining high and low frequency units in one horn, eliminating intermodulation effects and distortion through FM range, 50 to 50,000 cycles. With Dividing Network, \$250.00



A-323 AMPLIFIER

... compact, 6-tube, 18-watt linear amplifier, designed for operation with the Duplex speaker from low level phonograph pick-ups, microphones or radio tuners.

Without input transformer; high impedance input \$118.00

With input transformer; 30, 250 and 500 ohms impedance..... \$158.00

Telephone **hrc** Longacre 3-1800

HARVEY
RADIO COMPANY
103 West 43rd St., New York 18, N. Y.

the attenuation in square wave guides, power dissipated in water-cooled devices, and paint requirements for various shaped pieces.

51

Limit Bridge. Freed Transformer Co., 72 Spring St., New York 12, N. Y., has a brochure available for the



new No. 1010 comparison and limit bridge useful in production testing of components. The instrument sells for \$150.

52

Temperature Control. H-B Instrument Co., 2519 N. Broad St., Philadelphia 32, Pa. Catalog No. 14 contains 16 pages of illustrations and details of temperature control for ovens, heating baths and refrigerants.

53

Ceramic Capacitors. Electrical Reactance Corp., Franklinville, N. Y., has just published a bulletin to describe, according to JAN specifications, its line of type CN capacitors with parallel leads.

54

Marine Electronic Equipment. General Electric Co., Schenectady 5, N. Y., will send a non-technical 16-page bulletin about electronic aids to navigation to anyone interested in depth finders, direction finders or radar-type lookout.

55

Antennas. Insuline Corp. of America, 36-02 35th Ave., Long Island City, N. Y., has published its 1946

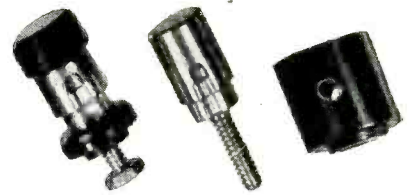

**THERE IS NO
SUBSTITUTE
FOR EBY
SPRING BINDING POSTS**

From the product designer through to final assembly and use in the field, the Eby Spring Binding Post line offers top service based on dependability.

The spring binding post offers unique advantages that can't be duplicated:

1. No screw cap to tighten or come loose with vibration.
2. Constant, even pressure on the wire at all times in all positions.
3. Easy one-hand feeding of wire into the post.
4. Corrosion-resistant, long-life springs.
5. Complete range of sizes, stem lengths, and accessories for every application.

Replace with Eby Spring Binding Posts — Write today.

HUGH H.

E B Y

INCORPORATED
18 W. CHELTEN AVE.
PHILADELPHIA, PA.



MINIMUM SIZE IN METERS

...FOR "VEST-POCKET"
PORTABILITY

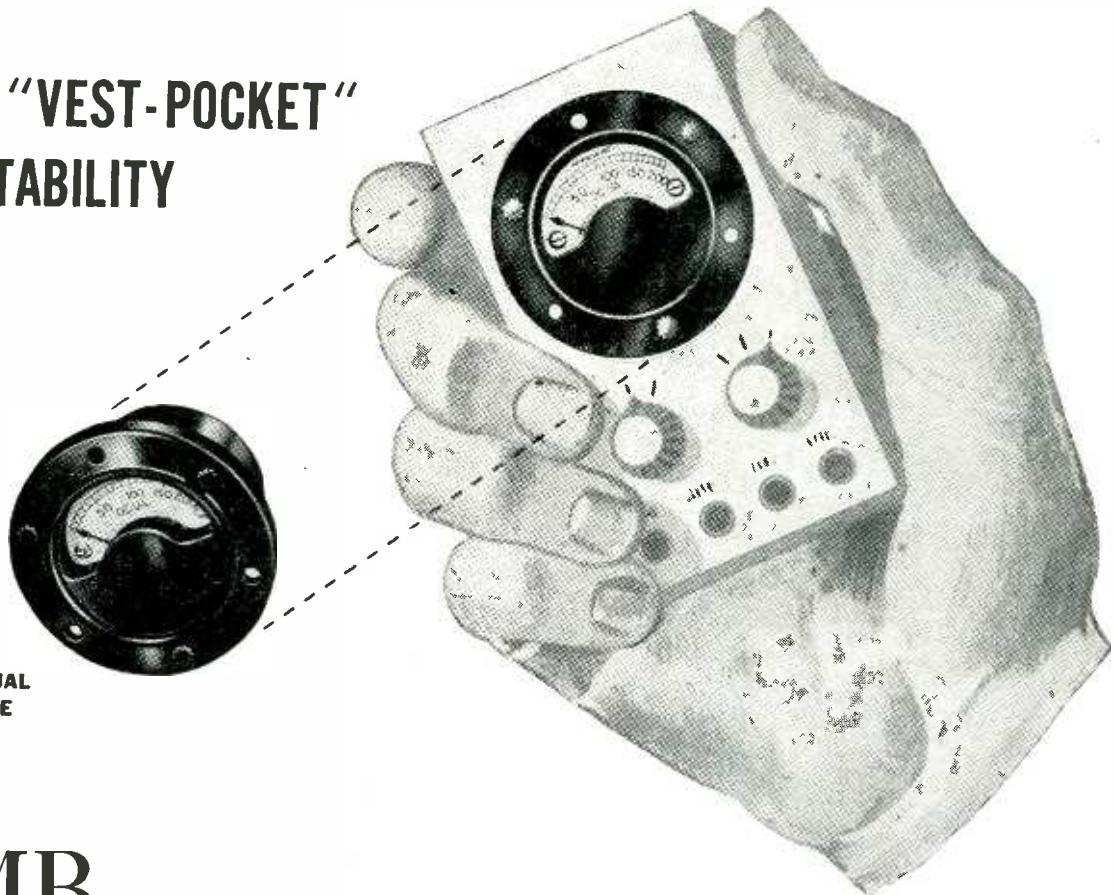

MB MINIATURES HAVE A 1-INCH MOUNTING DIAMETER

A big fact to remember, when designing portable products for compactness, is this: *MB precision meters are the smallest made today.* Their use in many testing devices adds "carrying-convenience"... an influential sales factor.

It's one good reason for putting MB miniatures to work in equipment like photographic exposure meters, electrical tachometers, and other important instruments. In the many unusual applications for which MB meters are now being specified—pocket voltmeters to test hearing aid or flashgun batteries, for example—the equipment takes no more space than a matchbox or watch.

But, in addition to unmatched size, MB instruments offer precision performance. Re-

sponse is fast... and accurate to the $\pm 2\%$ AWS specification, giving reliable readings on the well-defined scales. Damping characteristics are excellent. The lightweight moving element, in anodized aluminum housing, resists damage from shock and vibration... assures long, dependable service life. In short, MB meters can be used in both precision industrial testers and those for consumer use with equal advantage.

Write for information on the complete line of MB 1-inch and 1½-inch meters. These models, available in both round and square shapes, are adaptable to many special purposes. An MB engineer will be glad to work out the details with you.

THE
MB MANUFACTURING COMPANY, INC.
331 East Street, New Haven II, Conn.



MINIATURE ELECTRICAL METERS FOR ANY PURPOSE

**CHECK THE PATENTED
FEATURES AND GREATER
ECONOMY OF DRAKE
LIGHT ASSEMBLIES**

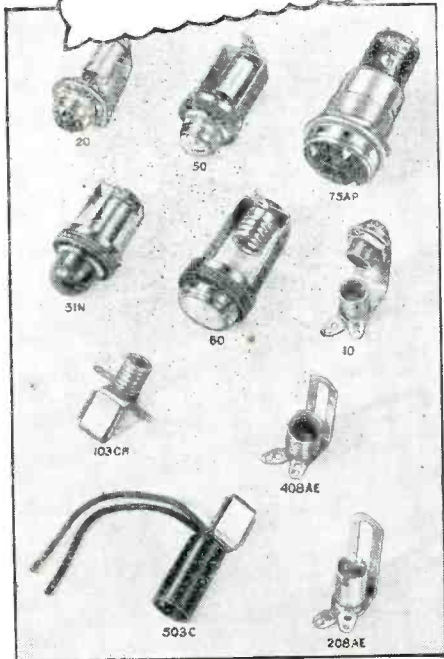

You'll lower production costs yet increase quality and efficiency with DRAKE Socket and Jewel Pilot Light Assemblies. Get the benefit of our patented features . . . of high speed precision methods and machinery developed thru 15 years of specialization. Every conceivable type offered in standard and special designs. Refer to the newest DRAKE catalog for complete information. Do you have a copy?

DRAKE



DRAKE MANUFACTURING CO.

1713 W. HUBBARD ST. CHICAGO 22, ILL.

antenna catalog including information on f-m and television, auto-radio antennas and a complete line of parts.

56

Electronic Education. General Electric Co., Thompson Road Plant, Syracuse, N. Y. is distributing booklet EBR-28 which describes the role of electronics in education. A list of publications bearing on this subject is included.

57

Research Organization. Polytechnic Research & Development Co., Inc., 66 Court St., Brooklyn 2, N. Y., has a brochure describing the services it intends to make available to industry in the field of applied physics. The organization is an outgrowth of P. I. B. Products, Inc.

58

Tubes. Eithel-McCullough, Inc., San Bruno, Cal. has available a non-technical booklet picturing its line of tubes, vacuum pumps and vacuum capacitors together with a price list.

59

Microwave Apparatus. Sperry Gyroscope Co., Inc., Great Neck, N. Y. A new catalog in three parts pictures some of the latest equipment available for civilian use in the

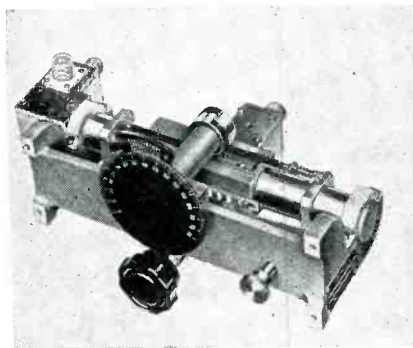

microwave region of the radio spectrum. Microwave measurements, klystrons and wave-guide components are included. The Model 127 30-mc variable attenuator is illustrated.

60

Tube Characteristics. Sylvania Electric Products Inc., Emporium, Pa. Characteristics of radio tubes,

WEILINE POSITIVE PRINT PAPERS



MAKE POSITIVES DIRECT From Drawing

With Weiline you skip many time-consuming steps in print-making. You get perfect work prints in a fraction of the time. True-to-scale prints because dry-developed. No wet chemicals used. No washing. No curling. And a variety of sensitized papers give you the choice of several types of prints.

BLUE • RED • SEPIA

- You can have all-purpose prints with Blue lines, or Red lines, on white background.
- This is useful in distinguishing prints from different depts., or to tell checked from unchecked prints.
- Sepia Transparencized Prints can be made the same rapid way, for use as Intermediate Originals.
- These can replace valuable originals in print making, or can be used to speed up print production.
- Or, to save draftsman's time retracing when making design changes.

**Write for Free Sample
Book and Full Information**

It's easy to adopt Weiline in any Engineering dept. Let us tell you how. Write Dept. D.

J. H. WEIL & CO.

1315 CHERRY STREET
PHILADELPHIA 7, PA.

DRAFTING MATERIALS
SENSITIZED PAPERS
ENGINEERING INSTRUMENTS

FOR TROUBLE-FREE WIRE PERFORMANCE

125 Permanently Insulated ROCKBESTOS Wires, Cables and Cords



From the three basic designs illustrated Rockbestos has developed a complete line of 125 failure resisting wires, cables and cords, a few of which are described. All have the same performance guaranteeing characteristics detailed below. Write for information, samples.

Rockbestos Permanent Insulation Insures Long-Lived Service

- 1 A tough impregnated asbestos braid, resistant to heat, flame, moisture, oil, grease, alkalis and corrosive fumes.
- 2 Felted asbestos insulation impregnated with heat, flame and moisture resistant compounds will not dry out with age, burn, or bake brittle under high temperatures.
- 3 Lubricated varnished cambric for high dielectric strength and added moisture resistance—protected from heat, flame and oxidation by felted asbestos walls.
- 4 Impregnated asbestos insulation that withstands heat of overloads and aging and won't become brittle, crack, rot or burn.
- 5 Conductors are perfectly centered in helically applied non-flowing insulation and will always remain so.



ROCKBESTOS FIREWALL RADIO HOOKUP WIRE

Sizes No. 22 to 4 AWG in 1000 volt rating, and No. 12, 14 and 16 AWG in 3000 volt insulated with high dielectric synthetic tape, impregnated felted asbestos and covered with color coated lacquered glass braid.

Originally designed to meet the demand of airborne radio equipment manufacturers for a flame and heat resistant wire and widely used since in ground, marine and mobile communications systems, electronic devices and apparatus. Operating temperature range 125° C. to minus 50° C. Ideal for wiring harnesses in compact apparatus and small motor, coil, transformer and dynamotor leads. Also available in twisted pair, tripled, or cabled multi-conductor constructions.

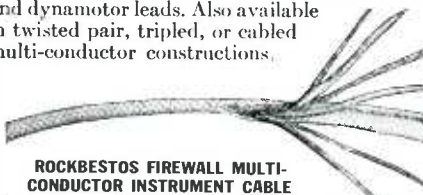

ROCKBESTOS FIREWALL MULTI-CONDUCTOR INSTRUMENT CABLE

This unusually small, light weight, high-dielectric No. 26 AWG three conductor cable, with individuals insulated like our hookup wire, was designed for use where space is at a premium and dependable performance is essential. Made to a nominal diameter of .125" it is smaller than a No. 14 AWG Hookup Wire. Also in 4, 5 and 6 conductor in sizes No. 26 to 20 AWG.

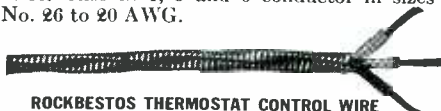

ROCKBESTOS THERMOSTAT CONTROL WIRE

Sizes No. 14, 16 and 18 AWG in two to six conductors with .0125", or .025" or (for 115 volt service) .031" of impregnated felted asbestos insulation and steel armor.

A multi-conductor control wire for low voltage inter-communicating, signal, and temperature control systems. Lifetime heatproof, fireproof insulation and rugged steel armor give trouble-proof circuits.



ROCKBESTOS A.V.C. 600 VOLT SWITCHBOARD WIRE

(National Electrical Code, Type AVB)

Sizes No. 18 to No. 4/0 AWG with varnished cambric and impregnated asbestos insulation and gray, black, white or colored flameproof braid.

Combine fire insurance and fine appearance in your switchboards with Rockbestos Switchboard Wire. It is fireproof and will not dry out under heat. Sharp, clean bends can be made without cracking as the asbestos wall acts as a cushion under the braid. Rockbestos A.V.C. Hinge Cable and Switchboard Bus Cable have same fireproof and heatproof characteristics.



ROCKBESTOS ALL-ASBESTOS LEAD WIRE

Sizes No. 8 to 20 AWG solid or stranded copper, monel or nickel conductors insulated with .031" or .040" of impregnated felted asbestos in black, white or colors.

Resistant to heat, flame, oil and grease this wire won't dry out, crack, flow, swell or rot. For higher dielectric strength and moisture resistance specify Type CA Lead Wire with synthetic tape next to the conductor.



ROCKBESTOS ALL-ASBESTOS 600 VOLT FLEXIBLE CORD

Sizes No. 10 to 18 AWG with two or three conductors insulated with impregnated felted asbestos and covered with asbestos braid.

This heavy duty heat-resisting flexible cord is ideal for leads on instruments and apparatus that develop heat in operation or may be used in hot locations. For moisture resistant type specify Rockbestos A.V.C. construction described below.



ROCKBESTOS A.V.C. 600 VOLT FLEXIBLE CORD

Sizes No. 10 to 18 AWG with two or three conductors insulated with impregnated felted asbestos, varnished cambric, felted asbestos covered with heavy impregnated asbestos braid.

For applications such as mentioned above in which heavy duty, high-dielectric, heat and moisture resistant flexible cord is required we recommend this construction with individual conductors insulated exactly like Rockbestos A.V.C. Motor Lead Cable.



ROCKBESTOS 300 VOLT HEAT RESISTING DUPLEX FLEXIBLE CORD

(Underwriters' Type AFPD)

Sizes No. 10 to 18 AWG stranded plain copper conductors insulated with impregnated felted asbestos, polarized, twisted together and covered with a cotton braid.

This heat-resisting flexible cord made of two Type AF fixture wires covered with braid is approved by the Underwriters' Laboratories for fixture wiring. Also recommended for apparatus leads where moisture resistance is not required.



SHIELDED ROCKBESTOS FIREWALL HOOKUP WIRE

Sizes No. 22 to 4 AWG in 1000 volt rating and 12, 14 and 16 AWG in 3000 volt insulated with synthetic tape and impregnated felted asbestos, covered with color-coded lacquered glass braid, and shielded with a tinned copper braid.

High in dielectric strength and resistance to heat, flame, moisture, oil, grease, gasoline and cleaning fluids like unshielded Rockbestos Firewall Hookup Wire, this construction protects performance in radio equipment and communications systems. 1000 volt type also made in twisted pair, tripled and various multi-conductor constructions.



ROCKBESTOS APPARATUS HEATING CABLE

No. 19 AWG nickel-chromium resistance wire insulated with .040" of impregnated felted asbestos and covered with 4/64" waterproof lead sheath.

Manufacturers of devices requiring the controlled distribution of a mild heat can use this pliable cable to advantage. It can be easily bent and formed to fit in or around irregular shaped objects to put heat where you want it.



ROCKBESTOS A.V.C. 600 VOLT MOTOR LEAD CABLE

(National Electrical Code, Type AVA)

Size No. 18 AWG to 1,000,000 CM insulated with two walls of impregnated asbestos and a high-dielectric varnished cambric insert, with a heavy asbestos braid overall.

Use this apparatus cable for coil connections, motor and transformer leads exposed to overloads or high ambient temperatures. It makes a permanent installation as it is resistant to heat, flame, oil, grease and moisture.



ROCKBESTOS ASBESTOS INSULATED MAGNET WIRE

Round, square and rectangular asbestos insulated conductors finished to meet varying winding conditions and coil treatment requirements. Designed for Class B windings, the insulation is non-checking and not affected by heat or aging.



ROCKBESTOS PRODUCTS CORP.
434 NICOLL STREET, NEW HAVEN 4, CONN.

ROCKBESTOS

The Wire with Permanent Insulation

for precise, light-weight, space-saving thermometers



Specify
H-B
MIDGETS

The trend toward compactness in much of today's industrial construction is well met by this accurate H-B Midget Thermometer. It fits snugly into spaces where clearances must be measured in fractions of an inch. If heavy vibrations or shocks are to be encountered, its sturdy armor gives added strength and longer life. Made in both straight and angle types, weighing but 5 and 7 ozs. respectively; and in standard ranges from minus 30 to plus 750° F., and special ranges can be had in both Fahrenheit and Centigrade scales in almost any desired temperature range level. Straight type, 9 in. overall. Easy to read because of lens-front and yellow back with scale engraved on glass. For details, write to—H-B Instrument Company, 2524 N. Broad Street, Philadelphia 32, Pa.

THERMOMETERS
HYDROMETERS

THERMOSTATS RELAYS
THERMO-REGULATORS

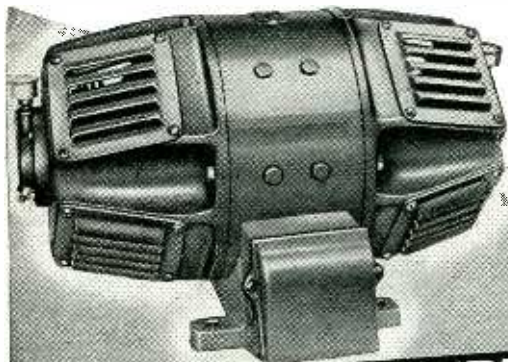

D.C. to A.C.
by **JANETTE**

UP
TO 3.2
K.V.A.

D.C. to A.C. CONVERTERS

Electronic and Gaseous Tube Devices can be operated from direct current power by means of a rugged Janette converter. When used with sound devices, specially designed filters discriminating enough to filter out unwanted noises and to minimize conducted radio noise voltage, can be furnished.

For nearly a quarter of a century Janette converters have given dependable service under varied climatic conditions in all parts of the world.

If you have a D.C. to A.C. requirement and want a reliable, high quality converter you can safely specify a Janette.



Janette

Ask for
Bulletin
13-25

Janette Manufacturing Co. 556 W. Monroe St. Chicago 6, Ill.

cataloged in both numerical and alphabetical order, are given in an 18-page booklet recently published.

61

Mobile Radiophone Service. American Telephone and Telegraph Co., 195 Broadway, New York 7, N. Y., is issuing two booklets describing a proposed mobile service and one type of mobile equipment.

62

Measurement Equipment. Boonton, Radio Corp., Boonton, N. J., has just issued a supplement to its Catalog C covering precision signal generators, a mica tester and a spark coil test set.

63

Mica Ceramic Insulation. Electronic Mechanics, Inc., 70 Clifton Boulevard, Clifton, N. J. Bulletin No. 104 gives suggestions for use of Mykroy insulating material in the fabrication of sockets and terminal supports.

64

Radio Teletype. Globe Wireless Ltd., Chrysler Bldg., New York 17, N. Y., has a non-technical booklet describing applications and operation of the Radiotype system.

65

Induction Heating. Lepel High Frequency Laboratories Inc., 39 W. 60th St., New York 23, N. Y. A 31-page booklet illustrates the manifold uses of induction heating in the industrial field. Soldering, brazing and gear hardening are all possible on the same equipment with a proper choice of work coil for the individual job.

66

Small Switches. Mu-Switch Corp., Inc., Canton, Mass. has evolved an interesting catalog with split pages making it easy to refer to the various switch types and at the same time thumb through a secondary cataloging of their characteristics. There are more than 19 pages of photographs, specifications and prices.

STUDIO AMPLIFIERS

*Engineered for High Quality Performance
and Dependable Service*

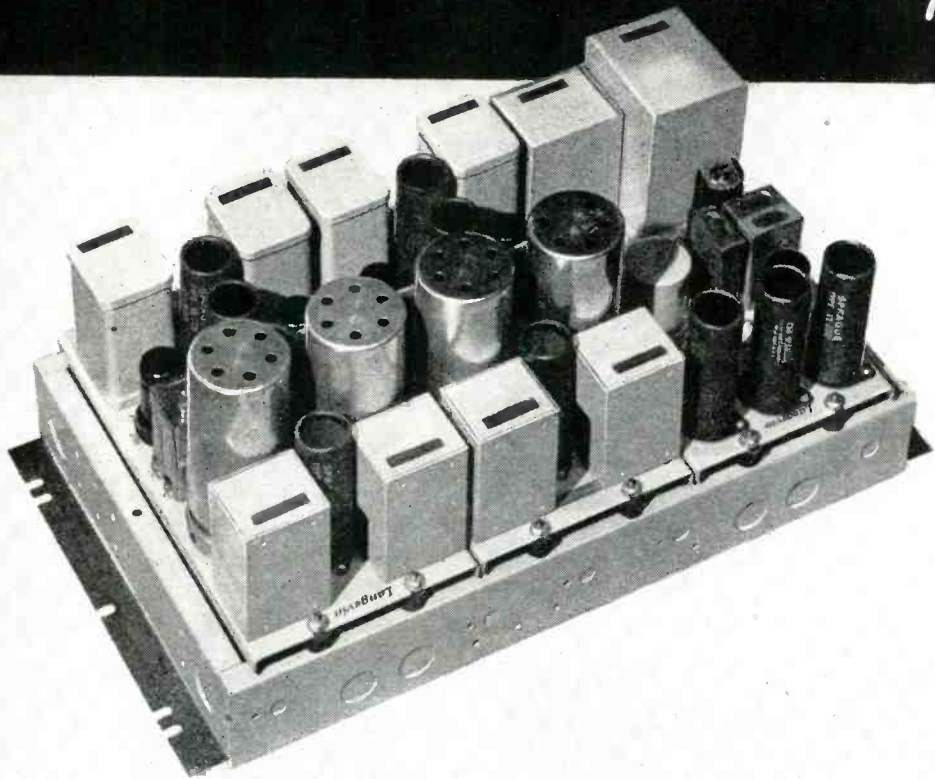

AT LEFT: Two Langevin Type 111-A Dual Pre-Amplifiers and one Langevin Type 102-A Amplifier on a Type 3-A Mounting Frame. This unit provides four pre-amplifiers and one line amplifier, or three pre-amplifiers, one booster amplifier and one line amplifier, all occupying 10½ in. of rack mounting space. An external power supply, the Langevin 201-B Rectifier, as shown below, is required. The Type 3-A Mounting Frame can be housed in a Type 201-A Cabinet, for wall mounting, if desired.

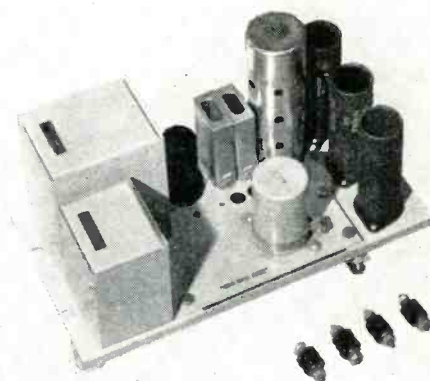

The Type 106-A Amplifier is a two-stage, fixed medium gain, low noise pre-amplifier, or booster amplifier, for use in high-quality speech input systems. The Type 106-A can be mounted on one-third of the space available on a Type 3-A Mounting Frame in combination with two Type 111-A Pre-Amplifiers, or in any similar combination.

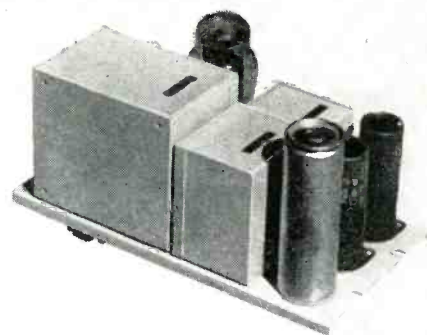

The Type 201-B Rectifier supplies plate and filament power for the Langevin Types 102, 106, 111 and similar amplifiers from a 105-125 volt, 50-60 cycle AC source. The ripple voltage of the 201-B Rectifier is 0.04% at full power output 75MA and 0.02% at a drain of 30 milliamperes.

Langevin Audio Transmission Facilities are designed and built to have the extended frequency response, noise and distortion levels required in the F.C.C. Regulations for FM transmission.

In complying with these regulations too much emphasis cannot be placed on the quality of the transformers that are a part of the audio system. Noise, for instance, is largely associated with the input transformers—distortion, with the output transformers—and frequency response with both. Therefore, the transformers in Langevin equipment are manufactured by us—and are held to a specified tolerance—so that frequency response, noise and distortion levels of the entire system are well within requirements.

"Worthy of an Engineer's Careful Consideration"

The Langevin Company

INCORPORATED

SOUND REINFORCEMENT AND REPRODUCTION ENGINEERING

NEW YORK
37 W. 65 St., 23

SAN FRANCISCO
1050 Howard St., 3

LOS ANGELES
1000 N. Seward St., 38

NEWS OF THE INDUSTRY

Reports on German industry; CAA vhf radio; Lanac; telediffusion in Sweden; guided missile project; wireless television camera; RMA Spring Meeting

War Department Unveils 18,000-tube Robot Calculator

VIRTUAL ELIMINATION of computing time in the solution of mathematical problems is just one of the amazing achievements of the Eniac, an 18,000-tube electronic computer revealed Feb. 15 by the War Department. For problems ranging from prediction of electron paths of nuclear physics to the trajectories of guided missiles and the orbits of planets in cosmic space, this world's largest and most intricate electronic device provides on a printed sheet in a few hours, with up to six carbons, numerical tables that have heretofore required as many as 100 man-years of computed time.

The Eniac (Electronic Numerical Integrator and Computer) was designed and constructed for the Army Ordnance Department at the Moore School of Electrical Engineering, University of Pennsylvania, Philadelphia to break a mathematical bottleneck in computing lengthy and complicated firing and bombing tables for vital ordnance equipment.

Ballistic Applications

For each angle of elevation at which an artillery piece is fired, a different trajectory has to be calculated, embracing such factors as muzzle velocities, powder temperatures, projectile weight, range, time of flight, point of fall, and atmospheric conditions. In addition, such matters as ballistic coefficient and drag function must be taken into account. It takes a skilled computer about three days to compute one such trajectory with the aid of an ordinary desk calculating machine. After the trajectories are calculated, the angles of elevation for many different ranges, using varying conditions of muzzle velocity, density of air, wind, etc. are computed. This part of the work usually takes about three months by a large staff of

trained computers. The Eniac will do both sections of the job in from one to two days.

Industrial Uses

The new robot calculator will solve equally complex peacetime problems in electronics, electrical engineering, aerodynamics and scientific weather prediction. In industry, it is believed that better, more scientific design will now be possible as a result of the new machine's ability to handle hundreds of different factors in one computation. Much lengthy and costly

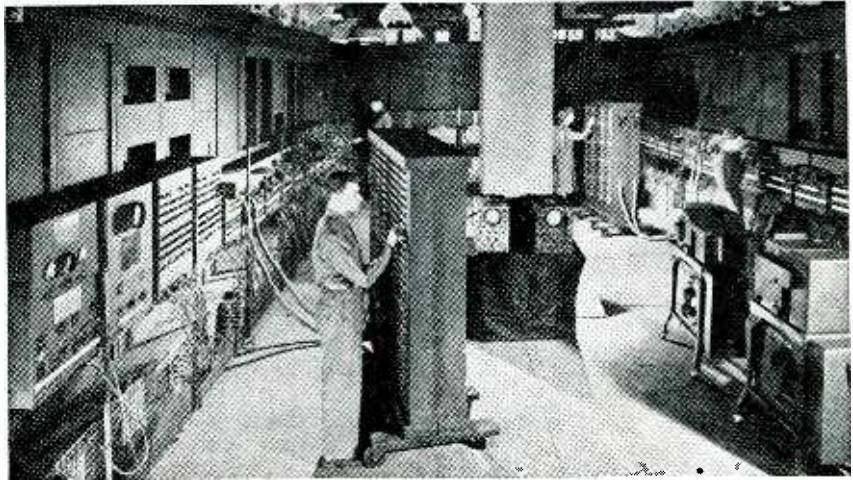

Setting up the Eniac for a problem takes far more time than is required for the machine to punch out the answers on the IBM machines at the right. Power supply panels are across the open end of the U, behind the camera used in taking this photograph

design experimentation, often involving the construction of a series of expensive models, a common practice in airplane design, might also be eliminated. Such trial-and-error methods would not suffice to deal with complex phenomena arising, for instance, from the blast of an atomic bomb.

General Details

The original idea for the Eniac was that of Dr. John W. Mauchly, of the Moore School faculty. Captain

Herman Goldstine, mathematician and ballistic expert for Army Ordnance, enthusiastically promoted development of the Eniac.

Administrative supervision of the project was assumed by Dr. J. G. Brainerd of the Moore School, and J. Presper Eckert, Jr. took charge of the technical and engineering activities.

The Eniac is a digital or discrete variable computing machine, as opposed to continuous variable types such as differential analyzers. If used to complete capacity, the Eniac will carry out in five minutes more than ten million additions or subtractions of ten-figure numbers. The machine performs a single addition in 1/5000th of a second and can do a number of distinct additions simultaneously.

The Eniac occupies a room 30 by 50 feet in size, weighs 30 tons, and has 100 feet of panels arranged in a large U, with 16 of the panels on each leg and 8 panels on the end. Power consumption is 150 kw, of

which 45 kw goes to a bank of 28 power supplies that provides the 88 d-c voltages required.

Operating Procedure

The general method of handling a problem is as follows: First, the scientist must write down mathematical equations that express the phenomena involved. Second, he must break down the mathematical formulation into a sequence of additions, subtractions, multiplications, divisions, square rootings and transfers from

COMPLETE FIXED-FREQUENCY COMMUNICATIONS SYSTEMS AM or FM

TRANSMITTERS — RECEIVERS — ANTENNAS

*Custom-built for ANY FREQUENCY
between 100 and 3000 MC's for...*

- ▷ FIRE and POLICE WORK
- ▷ FORESTRY
- ▷ TELEVISION RELAYS
- ▷ INDUSTRIAL APPLICATIONS

Regardless of the type of communications system you have in mind . . . private, municipal or industrial . . . LAVOIE can supply all necessary equipment to do the job clearly, efficiently and economically. LAVOIE VHF and UHF equipment won widespread acceptance in the U. S. armed

forces during the war, and this same precision manufacture and efficient operation is found in LAVOIE fixed-frequency equipment.

If you will state the general nature of your requirements, we will recommend and quote on a system best suited for your needs.

FREQUENCY METERS
FREQUENCY STANDARDS



TRANSMITTERS
RECEIVERS, ANTENNAS, ETC.

Lavoie Laboratories

RADIO ENGINEERS AND MANUFACTURERS
MORGANVILLE, N. J.

Specialists in the Development and Manufacture of UHF Equipment

PRECISION PARTS

SPINNING THE THREAD OF THE FUTURE

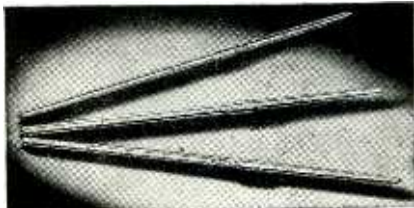

Spinning spindles, whirring bobbins, the shuttling back and forth of warp and wool . . . these are sweet sounds to the ears of a textile-starved America. Spindles that spin so speedily have to be built with fine-spin accuracy, and the incredible accuracy Ace built into parts for guns and engines, radar and radio, is now being built into parts for the machines of peace.

This slender spindle, a very essential part of a textile machine, is a perfect example of the ability of Ace to do fine precision-work on a mass-production basis. Twenty-four different operations were performed to produce its 22 dimensions . . . dimensions that had to be held to a tolerance of .0005" . . . roughing, heat-treating, straightening, finishing. Two finishing-operations were done by centerless grinding, seven by cylindrical grinding, producing tapers and radii where required. Periodic inspections kept overall straightness within .002".

Incredible accuracy on a mass-production basis . . . that's the story of Ace. For small parts and assemblies that require stamping, machining, heat-treating, and grinding . . . all under a single roof, single responsibility . . . it will pay you to have an Ace up your sleeve. Send us a sample, sketch or blueprint for quotation.



This free booklet describes facilities available.



ACE MANUFACTURING CORPORATION
for Precision Parts

1255 E. ERJE AVE., PHILADELPHIA 24, PA.

unit to unit of the Eniac. Finally, program switches must be set, numbers must be put into the function table memory by setting the switches, and connections must be established between units of the Eniac for the communication of programming and numerical information.

There are three basic elements in the Eniac: arithmetic elements, memory elements and control elements. There is also magnitude discrimination, which partakes of both arithmetic and control characteristics and consists of comparing the size of two numbers. On the basis of such comparison, the machine determines which of two computational courses is to be followed.

Arithmetic Elements

The arithmetic elements include 20 accumulators, 1 multiplier and 1 combination divider and square rooter. The accumulators provide means for storing numbers computed in the course of a problem, and also permit addition or subtraction of a second number to or from the stored number. The accumulators

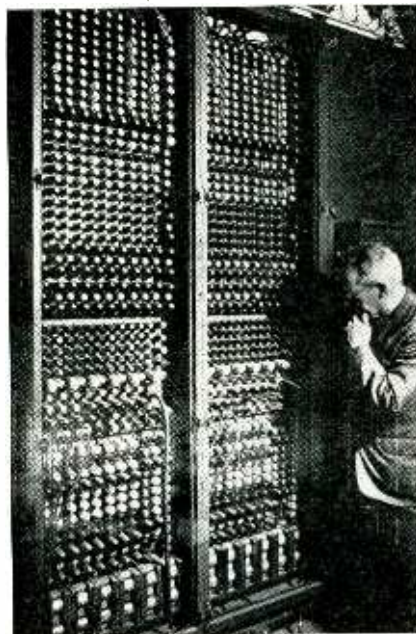

Rear view of two of the accumulator racks of the Eniac. In the upper portion, each vertical row of 28 tubes is mounted on a separate plug-in chassis that can be removed quickly and replaced with a spare unit in case of trouble. In the lower group, banks of 12 tubes are removable. The entire machine is constructed in this manner, and trouble can be isolated to the defective chassis simply by running a selected test problem through and comparing the result with a correct solution kept on file for this purpose

RESISTANCE WIRE

ALLOY "A": Nickel-chromium alloy, resists oxidation at extreme temperatures. Essential for operating temperatures up to 2100° F. Also used for cold resistance. Resists chemical corrosion by many media. Non-magnetic; specific resistance, 650 ohms/C.M.F.

C. O. JELLIFF MFG. CORP.
123 PEQUOT AVE. • SOUTHPORT, CONN.

RESISTANCE WIRE

ALLOY "C": Nominally contains 60% nickel, 15% chromium, and balance iron. High resistance to oxidation and corrosion. Widely used in resistances for radio and electronics, industrial, and domestic equipment. Operating temperature up to 1700° F. Specific resistance 675 ohms/C.M.F.

C. O. JELLIFF MFG. CORP.
123 PEQUOT AVE. • SOUTHPORT, CONN.

RESISTANCE WIRE

ALLOY "180": Nickel-copper alloy with resistivity of 180 ohms/C. M. F. Widely used for resistor elements up to 750° F. (400° C.). For radio controls, magnets, rheostats and voltage control relays.

C. O. JELLIFF MFG. CORP.
123 PEQUOT AVE. • SOUTHPORT, CONN.

RESISTANCE WIRE

ALLOY "45": Alloy of 55% copper, 45% nickel with a constant electrical resistance over wide range of temperatures. Specific resistance 294 ohms/C.M.F.; temperature coefficient 0.00002 ohms per degree F; 32 to 212 degrees range. Used in winding of precision resistors.

C. O. JELLIFF MFG. CORP.
123 PEQUOT AVE. • SOUTHPORT, CONN.

RESISTANCE WIRE

KANTHAL: Exclusive manufacturers of KANTHAL, an outstanding achievement in resistance - wire development. Now available—complete data upon request.

C. O. JELLIFF MFG. CORP.
123 PEQUOT AVE. • SOUTHPORT, CONN.

Note: All alloys are produced in high-frequency type furnaces, and are furnished bright, dull or oxidized finish, also with enamel, silk, or cotton insulation.

*Free—
on request!*

*A Reference Guide
to Magnavox Electrolytic
Capacitors*

QUALITY, PERFORMANCE, LONG LIFE, ECONOMY
DEPENDABILITY, LIGHT WEIGHT, COMPACTNESS,
UNIFORMITY, PRECISION CONSTRUCTION—
ALL ARE DEFINITE FEATURES OF
EVERY MAGNAVOX CAPACITOR



New reference guide for Capacitors

TO assist you in properly meeting your capacitor requirements, Magnavox has prepared this handy reference guide. Specifications, accessory and technical data for the full line of Magnavox Electrolytic Capacitors are given in complete detail.

Magnavox Capacitors, produced expressly for the manufacturing trade, are built to meet severest operating conditions. Containers are standardized into eight sizes to simplify your design and assembly problems.

Economy in size and cost, long life, and efficient

and trouble free operation are features Magnavox Electrolytic Capacitors can promise—and deliver. Mechanically, electrically and chemically they reflect years of research and experience. They have earned and won the confidence of the leading engineers.

Write today for this handy reference guide—and when you need the best in electrolytic capacitors—specify Magnavox. There is no substitute for experience! The Magnavox Company, Components Division, Fort Wayne 4, Indiana.

Magnavox
RADIO PHONOGRAPH.

MAGNAVOX HAS SERVED THE RADIO INDUSTRY FOR OVER 35 YEARS

ELECTRONICS — April 1946

311



**WORKS LIKE A
SCREW DRIVER**
Speeds Production!

Standard
Sizes, Hex,
Square or Knurled,
Chuck Type with many
Tools for many uses
Radio and Electrical Shops
Need them

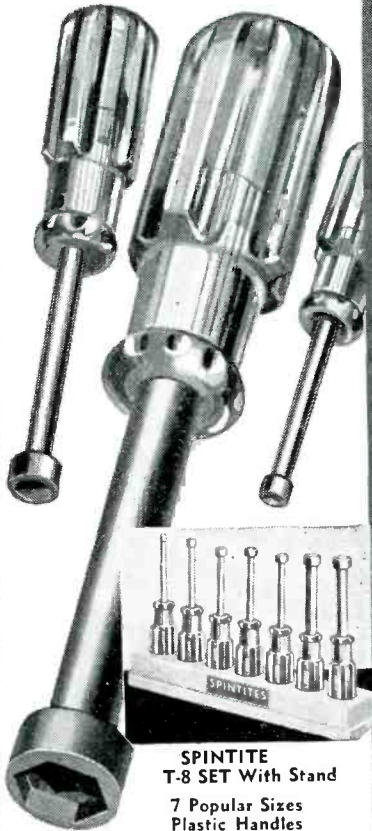

**SPINTITE
T-8 SET With Stand**
7 Popular Sizes
Plastic Handles

Send for Catalog No
141 picturing a full line
of Automobile, Aircraft
and Radio Tools.

**WALDEN
WORCESTER
WRENCHES**

STEVENS WALDEN, INC.
468 SHREWSBURY STREET
WORCESTER, MASSACHUSETTS

are capable of performing these operations on numbers having as many as ten decimal digits, and indicate the associated plus or minus sign. The multiplier can find the product of two decimal numbers, each having as many as ten digits. The combination divider and square rooter can find the quotient of two nine-digit decimal numbers or the square root of a nine-digit decimal number.

Memory Elements

Memory elements of the machine include internal memory devices, of limited capacity, and external memory devices in the form of punched cards having unlimited capacity. Communication between the internal and external memory takes place at speeds which are set by the mechanical punch card devices.

Internal memory can be further subdivided in three ways. First, there are accumulators for numerical data calculated in the course of the computation and which must be available for other portions of the

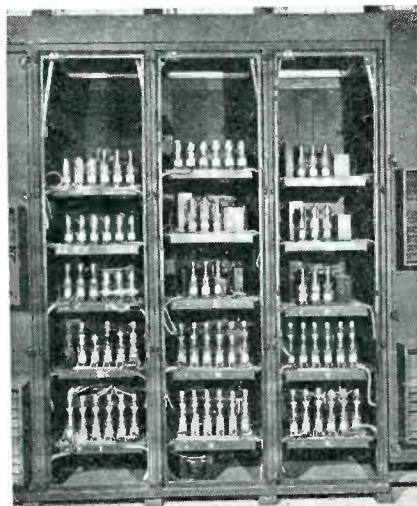

Three of the power supply panels of the Eniac. Xenon-filled 4B24, 4B25 and C6J gaseous rectifier tubes, operating with red-hot plates, provide the 88 d-c voltages required by the robot calculator

computation. Second, empirical data known before the machine is started can be remembered by setting switches on the function tables. Third, there is a memory for instructions. This causes transfer between the various memory and arithmetic units and causes the arithmetic units to perform desired operations on the numbers. Setting of program switches permits program input signals to be received in one or more units, thus causing the unit or units

DRIVE AHEAD WITH

Smooth Power

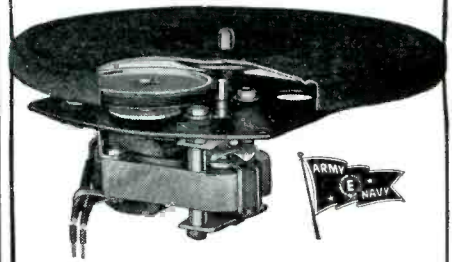

• You'll travel the roads to future markets faster and easier when you standardize on General Industries *Smooth Power* motors. Quick starting, uniform speed and quiet performance have for years made these motors leaders for phonographs, recorders and record-changers. From the GI complete line, select the proper motor for your new design. *For smooth performance, standardize on Smooth Power.*



The General Industries Company
DEPT. M • ELYRIA, OHIO

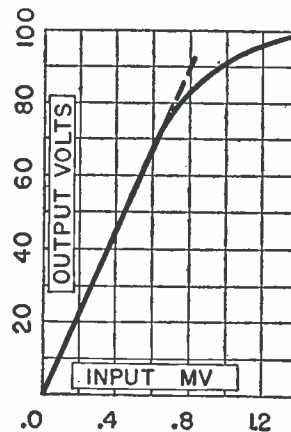
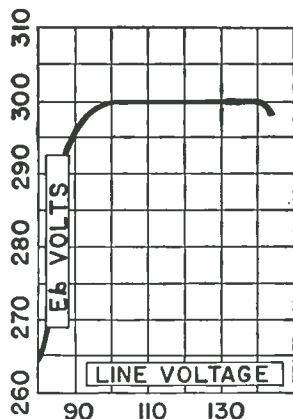
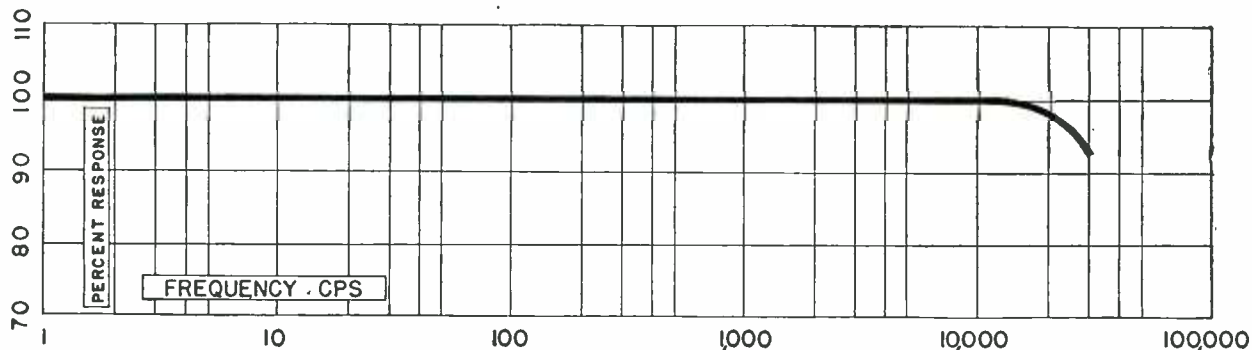

The COX Type 2 AMPLIFIER

... A MULTI-PURPOSE PRECISION INSTRUMENT FOR DEPENDABLE AMPLIFICATION AND MEASUREMENT IN THE FIELD OR LABORATORY

SPECIFICATIONS

Number of Stages.....	3
Overall Gain.....	80,000
Gain (2nd Stage Input).....	1850
Frequency Response (5%).....	1-15000 cps
Input Range (1st Stage).....	.1-250 mv
Input Range (2nd Stage).....	.5-1000 mv
Input Impedance	
1-A (1st Stage).....	.5 meg
1-B (1st Stage).....	100 meg
2 (2nd Stage).....	.5 meg
Output Impedance.....	50,000 ohms
Output Voltage (RMS).....	70
Calibration Voltage.....	0-1000 mv
Harmonic Distortion (At .5 mv Input).....	Max 3%
Power Supply (Regulated) 105-130 Volts.....	50-60 cps
Marker Input.....	4.5 Volts
Weight.....	30 lbs

APPLICATIONS

- ▶ DYNAMIC PRESSURES
- ▶ TORSIONAL VIBRATIONS
- ▶ LINEAR VIBRATIONS
- ▶ SOUND MEASUREMENTS
- ▶ MILLIVOLT MEASUREMENTS
- ▶ ALL PURPOSE VOLTAGE AMPLIFIER

BALANCED ELECTRONIC INSTRUMENTS NOW AVAILABLE FOR MEASURING:

PRESSURES — Pressure-Time or Rate-of-Change-of-Pressure Diagrams
 TORSIONAL OR LINEAR VIBRATIONS — Displacement; Acceleration; Velocity; Frequency

ELECTRONICS DIVISION

COMMERCIAL RESEARCH LABORATORIES, INC.

Master Instrument Craftsmen Since 1912

20 BARTLETT AVENUE

DETROIT 3, MICH.

"DIE-LESS" DUPLICATING

SAVES MAN HOURS AND DELAYS

DIE ACCURACY WITHOUT DIES

Send for CATALOG

BENDER

SHEAR

BRAKE
DI-ACRO is Pronounced "DIE-ACK-RO"

"DIE-LESS" DUPLICATING
The DI-ACRO System of METAL DUPLICATING Without Dies

DI-ACRO
PRECISION MACHINES
DIE-LESS DUPLICATING

O'NEIL-IRWIN MFG. CO.
321 EIGHTH AVENUE SO. • MINNEAPOLIS 15, MINN.

to function within themselves and, on the completion of this internal functioning, to emit program output signals to cause other units to function. The master programmer coordinates this kind of memory function for the entire machine.

Control Elements

The control elements include the initiating unit, concerned mainly with starting and stopping the Eniac, and the cycling unit which generates the fundamental signals. The cycling unit contains an oscillator which generates electrical pulses at the rate of 100,000 per second and can do one basic operation every 20th pulse or a total of 5,000 additions, subtractions, multiplications or divisions per second.

When all controls have been set and cards have been punched for the external memory section, the cards are dropped into the IBM reader section and a starting button is pressed. If the machine is operated at full speed, the numbered neon lights on the panels blink 5,000 times per second and the entire panel appears to give one quick glow before the lights settle down at the final answer. Generally, however, the machine must be slowed down to the rate at which answer cards can be punched mechanically. The punched cards are then run through an IBM machine that prints the answers automatically on a sheet of paper.

Though a calculator can carry out numerous logical operations, it cannot do creative thinking. The mathematician, physicist or engineer is still needed—in fact, more than ever, to analyze the problem mathematically and set up the sequence of operations in the machine. It is expected, however, that machines of this type will bring a greater mathematics consciousness to engineering and production.

Army Seeks Technicians

TO CIVILIANS skilled in the maintenance and repair of radio, radar, telephone, and electric power equipment, and willing to replace enlisted technicians now stationed in the Philippines, Japan, and Korea, the Signal Corps is offering attractive jobs. The appointments, for a minimum of one year with transportation furnished both ways, carry salaries

IN-RES-CO RESISTORS

For super-performance in critical circuits...

Supplying low-cost wire wound resistors to meet critical circuit requirements is our business. Manufacturers of television, radar, radio or other equipment who require fast delivery on resistors of proven superiority are invited to investigate the low cost and diversified types available from IN-RES-CO. A completely illustrated and informative catalog is available on request. Detailed and inductive types for every application need.

Type BLN: 4 watt, moisture proof, non-inductive resistor. Max. res., 20,000 ohms, dia. 7/16", length 1 1/2"

INSTRUMENT RESISTORS CO.
25 AMITY STREET, LITTLE FALLS, NEW JERSEY

Here's How It Works

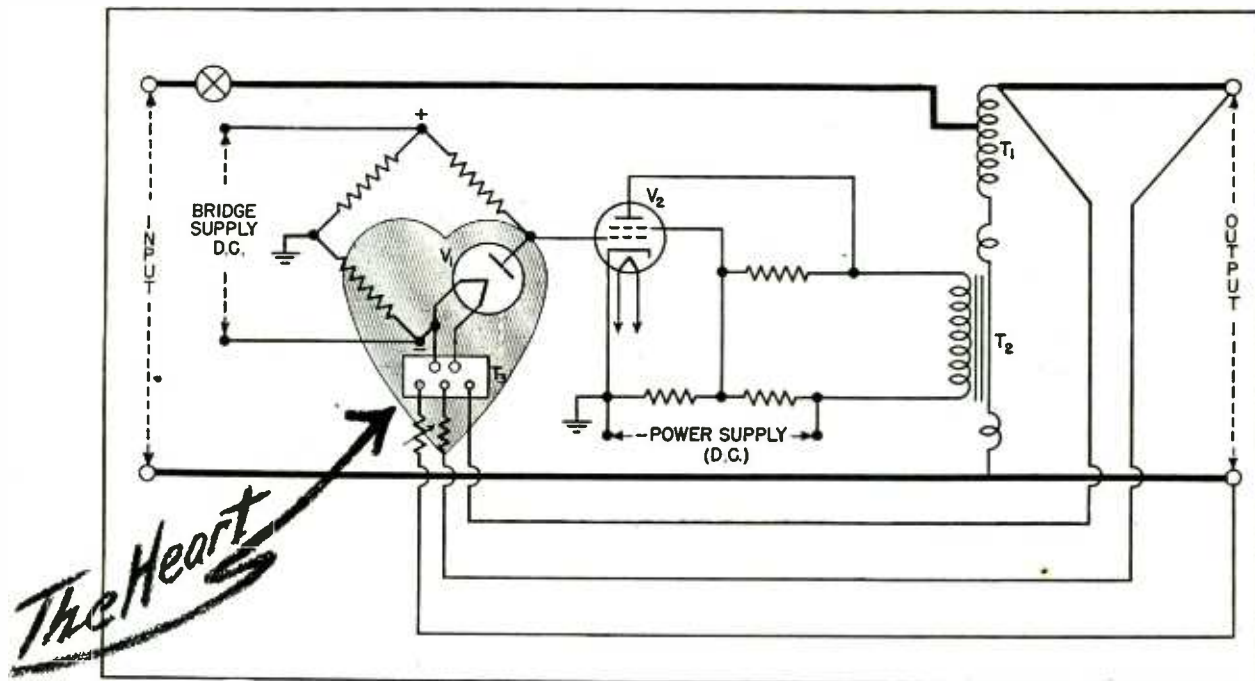

Sorensen A. C. Voltage Regulator

The impedance of saturable core reactor T2 determines what part of the input voltage is impressed across auto-transformer T1.

Impedance of the reactor is varied in accordance with changes in output voltage so as to restore output voltage to within 0.2% of its previous value.

The "heart", T3 and diode V1, control reactor impedance by varying the plate current of V2 thru the saturating winding.

The above extreme accuracy of voltage control is possible because of the almost infinite gain realized from the compensating action obtained from T3 and V1.

General Characteristics of Sorensen Regulators

Constant output voltage to within 0.2% with input variations 95 to 130 volts.
Voltage not affected by variations in LOAD, FREQUENCY or lagging POWER FACTOR.

No hash or interference generated—gas tubes not employed.
Low wave form distortion—average less than 5% (Special models available with less than 2% distortion guaranteed).

Write us about your A. C. Voltage or Current regulation problems. Ask for bulletin giving full schematic and other info. about various models, capacity 25 to 15,000 V. A.

SORENSEN & COMPANY, INC.

AIRBORNE ELECTRONICS

STAMFORD, CONN.

Tracing cloth that defies time

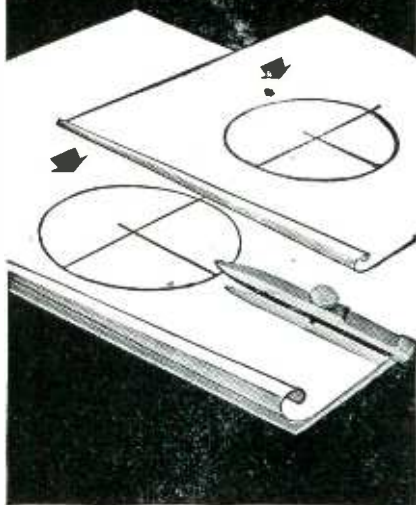

● The renown of Imperial as the finest in Tracing Cloth goes back well over half a century. Draftsmen all over the world prefer it for the uniformity of its high transparency and ink-taking surface and the superb quality of its cloth foundation.

Imperial takes erasures readily, without damage. It gives sharp contrasting prints of even the finest lines. Drawings made on Imperial over fifty years ago are still as good as ever, neither brittle nor opaque.

If you like a duller surface, for clear, hard pencil lines, try Imperial Pencil Tracing Cloth. It is good for ink as well.



IMPERIAL TRACING CLOTH



SOLD BY LEADING STATIONERY AND DRAWING MATERIAL DEALERS EVERYWHERE

ranging from \$1.50 to \$1.70 per hour for a 40-hour week, with provisions for overtime and night work differential. Quarters and subsistence will be provided by the Army at a cost not to exceed \$40 a month. Benefits include annual and sick leave, necessary medical care, hospitalization, and compensation for service-connected injuries. Those interested should apply to their nearest USES office, or to the Office of the Chief Signal Officer, Pentagon, Washington 25, D. C.

German Technical Data

WEEKLY BIBLIOGRAPHIES of both technical and nontechnical reports on scientific and industrial information, mostly obtained in Germany and German-occupied countries, are being made available at the Government Printing Office for a nominal price. The lists also will contain titles of reports on U. S. Government-sponsored research (ORSD, Army and Navy), although only a comparatively few have been released to date.

The reports listed in the weekly bibliographies are grouped according to subject matter, serial number, price and length, with a brief description of report content. Materials, manufacturing processes, products, developmental work, and other scientific and technical matters are discussed in the reports.

Approximately 2,000 reports have been listed previously by the Office of the Publication Board, Department of Commerce. This same listing will be duplicated by the Government Printing Office in its weekly bibliographies until such time as the listing reaches the same point as OPB's lists. Then OPB will devote its full time to checking the various reports, having them photostated or microfilmed and sent to various government repositories in Washington. Complete reports should be ordered from OPB.

The Superintendent of Documents will accept \$10.00 as approximate payment for a yearly subscription to the weekly bibliographies and will notify subscribers if additional remittance is required. Single copies may be purchased at varying prices. The first bibliography is priced at 15¢. Orders for these weekly lists should be accompanied by check,

Attention GI JOE!

Here's Your Opportunity to be First to

Start Your Own RADIO SERVICE SHOP

Complete Startling-In-Business
Package Stocks of

TEST EQUIPMENT
TUBES, PARTS, TOOLS **\$350 up**

Act quickly! Meet the pent up demand for radio service. Turn your special service training into a profitable business of your own. No fuss. No worry. Here's everything you need—\$350 up. Details upon request! Write, wire or phone

RCP 448

"POCKET" VOM
A.C.-D.C. Volts
0-5-50-250-1000
D.C. Mills
0-.5-10-100-1000
Ohms
0-2,000-20,000-200,000-
2 Meg.
Size 3" x 5 1/8" x 2 1/2"



\$24.50 net

RECORD CHANGERS

UTAH-DETROLA # 550C \$18.27
WEBSTER-CHICAGO # 56 27.20

HALLICRAFTERS SX-28A

\$223



SUPER DEFIANT SX25 **\$94.50**
SKY CHAMPION S20R **60.00**
SKYRIDER MARINE S22R **74.50**
S40 NEW MODEL Approximately **79.50**
SKYRIDER JR. S41 **33.50**

HAMMARLUND HQ-129-X \$129

TRIPLETT 625-N

20000 ohms per volt D.C.
10000 ohms per volt A.C.
5" Scale-TOPMOST QUALITY
(12) D.C. Volt Ranges to 5000
(6) A.C. Volt Ranges to 5000
(3) OHM Ranges 0-400-50000-
10 Meg.
(5) D.C. Current Ranges 1 Ma.
to 10 Amp.
PLUS OUTPUT and DB.
RANGES
\$45.00 with test leads.



PHILCO BEAM OF LIGHT

Selenium Cell only, no holder **1.80**

20% deposit required on all C.O.D. orders. 2% transportation allowance on orders of \$26.00 or more accompanied by payment in full.

Write for
FREE CATALOG

**RADIO SUPPLY &
ENGINEERING CO., Inc.**
127 SELDEN AVE. DETROIT 1, MICH.



New

**DEVELOPMENTS BY THE DESIGNERS
OF FAMOUS ROTOBIDGE...**

1

**CML 1800: A-F FREQUENCY METER
AND TACHOMETER**

Measures frequency of a-c voltages 10 cycles to 20,000 cycles in 6 ranges independent of wave form. With "photo-beam converter" Model 1800 serves as an accurate electronic tachometer for measuring speeds of rotating or reciprocal mechanisms. Accuracy better than 1% at full scale. Scores of applications for laboratory and production control operations. Rugged Navy-type construction assures continuous, trouble-free operation.



2

CML 1210: PORTABLE STROBOSCOPE

Employs novel circuit, using self-blocking oscillator. Rotary or vibratory motion can be "stopped" when moving object is examined with stroboscopic light source. Valuable for slow-motion study, observation of stresses and strains under dynamic conditions. Light probe and 4-foot cable housed in handle of cabinet. Extremely compact; weighs only 19½ lbs. complete.

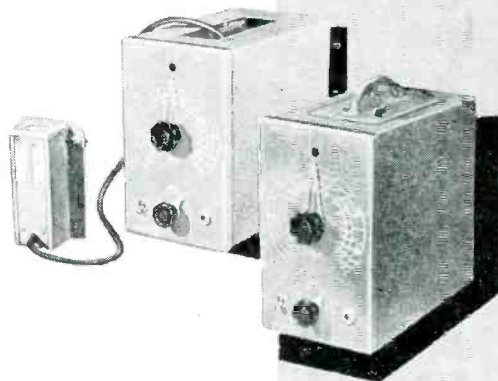

3

CML 1115: DUAL POWER SUPPLY

Provides independent "B" and "C" voltages. "B" supply furnishes continuously variable voltage from 150 to 300 v. d-c at 70 ma with 4 mv ripple. "C" supply furnishes continuously variable voltage from 0 to 65 v. d-c with 1 mv ripple. Panel controls provide for adjustment output through indicated range. Independent insulated panel connectors supplied for high-voltage units.

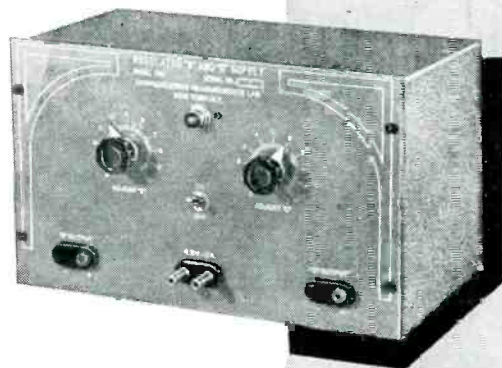

DESCRIPTIVE BULLETINS AVAILABLE—WRITE TODAY

COMMUNICATIONS MEASUREMENTS LABORATORY

120 GREENWICH STREET • NEW YORK 6



CARDWELL ANNOUNCES A NEW ADVANCED HIGH FIDELITY AUDIO AMPLIFIER



MODEL CE-25

- 25 watts undistorted output.
- Three High Impedance Inputs—Two for microphone and one for phonograph.
- Individual bass and treble boosting controls.
- Dynamic audio compensation circuit on phonograph channel.
- Ultra-modern cabinet styling with recessed control panel edge lighted.
- All aluminum construction combines durability with light weight.
- New vane type construction assures good ventilation and low operating temperature.
- Concealed hand holds for easy portability.

SPECIFICATIONS

POWER OUTPUT: 25 watts undistorted.

GAIN: Microphone 135 db. Phonograph 86 db.

FREQUENCY RESPONSE: Response at 50 cycles controllable from -15 to +17 db. Response at 10,000 cycles controllable from -15 to +22 db. In addition, Audio Compensation is used on the phonographic input which boosts bass as the volume level is reduced. This compensation is effective over a 40 db range in volume level and results in exceptional tone balance.

POWER REQUIRED: 115 watts at 105-125 volts 60 cycles AC.

DIMENSIONS: Length 15 1/4 in., Depth 10 1/4 in., Height 8 3/4 in.

CONTROLS: Two microphone volume controls and one phonograph volume control. One bass boost and one treble boost control.

TUBES: (2)—6SJ7, (3)—6SL7GT, (2)—6L6G, (1)—5U4G.

OUTPUT IMPEDANCES: 2, 4, 8, 16, 250, and 500 ohms.

INPUT IMPEDANCES: Microphone channels—10 megohms, Phonograph channel—500,000 ohms.

WEIGHT: 26 lbs. All aluminum case.

**WATCH FOR THE
NEW CARDWELL COMMUNICATIONS
RECEIVER TO BE ANNOUNCED SOON**

*Introducing new and unusual
mechanical and electrical features*

**THE ALLEN D. CARDWELL
MANUFACTURING CORP.**

MAIN OFFICE: 81 PROSPECT ST., BROOKLYN 1, N. Y.

FACTORIES: PLAINVILLE, CONN.—BROOKLYN, N. Y.

money order or Superintendent of Documents coupons and should be addressed to Superintendent of Documents, Government Printing Office, Washington 25, D. C.

Among the mimeographed reports on electronic subjects that can now be ordered from Office of the Publication Board, Department of Commerce, Washington, D. C., are the following:

No. 386—Electronic test instruments; spark and flash discharge photographic equipment, Phillips, Eindhoven—12 pages, \$.50.

No. 421—Manufacture of metallized paper fixed capacitor units by the Robert Bosch Co. (description of manufacturing process and metal vaporizing machine)—9 pages, \$.10.

No. 1027—German magnetic tape recorder, Tonschreiber models b and b1—24 pages, \$.50.

No. 1292—Specialized ceramic products—their use in German communication equipment—37 pages, \$.50.

No. 1571—Enemy tube data (German, Japanese, and Italian)—11 pages, \$.50.

No. 1585—Technical report on UKW PE e 1 direction-finding receiver used for radiosonde—6 pages, \$.50.

No. 1586—German vibration detector—7 pages, \$.50.

No. 1587—Technical report on German infrared (night driving equipment, rifle sighting mechanism, and aircraft experimental model)—20 pages, \$.50.

No. 1588—Technical report on uhf direction-finding receiver FUMB4—11 pages, \$.50.

No. 1589—Technical report on Strassburg-Kehl radio-controlling system for bombs and rockets—23 pages, \$.50.

No. 1591—Technical report on decimeter radio equipment for controlling bombs and rockets—12 pages, \$.50.

No. 1597—Report on Drahtfunk system (wired wireless)—24 pages, \$.50.

CAA Promises Gradual Change to VHF Facilities

THE CHANGE FROM low frequency to very high frequency radio for aircraft communications and signals will be gradual, all existing equipment will continue in use and retain its value, and there will be an interim period in which both vhf and low-frequency equipment will be in use, according to T. P. Wright, Administrator of Civil Aeronautics. Eventually, after a matter of several years, all communications along the airways and all signals for radio navigation will be in the vhf bands, which will be better in all respects than that in use today. In particular, they will be beyond the static belt.

Today, the private flier transmits to CAA ground stations on 3,105 kc and listens to traffic control towers on 278 kc. This equipment represents thousands of dollars investment, and will not be disturbed. The CAA will continue to operate these services on these frequencies. In addition, the existing low-frequency ranges will be available for use by the private flier, since his receiver covers the 200-400 kc band.

Anticipating the crowding of radio



BRADLEY

COPPER OXIDE RECTIFIERS

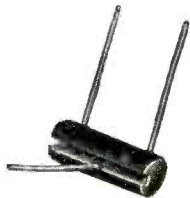

Coprox Model CX-9C2B.

A plastic-sealed rectifier for high frequency applications, conservatively rated $4\frac{1}{2}$ volts A.C., 3 volts D.C., 1 milliamperes D.C.

All Bradley rectifiers have special features that give long life, make easy assembly, and assure accurate performance. Bradley's application experience can be called upon for the development and production of special rectifiers for special jobs.

Illustrated literature, available on request, shows more models of copper oxide rectifiers, plus a line of selenium rectifiers and photocells. Write for "The Bradley Line."

BRADLEY

LABORATORIES, INC.

82 Meadow St. New Haven 10, Conn.

channels by the 400,000 to 500,000 airplanes predicted within the next 10 years, the CAA has made plans for eventual and complete change to vhf equipment. Already, transmitters are installed on the ground which can be used by planes fitted with vhf equipment. This equipment gives better results, and also relieves the 3,105-kc band which, in congested areas, is already crowded.

Radio manufacturers plan to build a five-channel transmitter covering the 131-mc band. Originally, only two frequencies will be covered in this transmitter, 131.9 kc for communication from plane to traffic tower, and 131.7 kc from plane to airways station. Later, as these channels become crowded, three other channels can be made operative by the simple addition to the transmitter of one crystal for each one.

On the ground, vhf transmitters for talking to planes will be in the 118-mc band. Transmitters already are installed at CAA towers, and are being used to communicate with planes in congested areas in order to relieve the low-frequency tower channels. At CAA airway stations, there will be transmitters on 111.1 mc.

An important advantage in the use of vhf is that 90 channels are available for aviation compared to 60 at low frequency, and these channels can be repeated more often within continental United States without interference. As far as the average pilot is concerned, however, vhf will be most welcomed for its freedom from static, a fault of the low-frequency transmission that makes it uncomfortable, uncertain, and sometimes dangerous.

New Range Beacons

The whole airway range system of the country is to be converted to vhf. The two-course aural and visual vhf range has been developed to the point where it is now installed on certain airways in the country, and plans have been completed for putting it in on all airways.

Engineers found that conversion of the aural-visual range to the omni-directional range employed the same equipment and was relatively inexpensive to do. Thus, in the middle of the vhf program, the plan has been modified to include omni-directional ranges. This type of range simplifies flying for the private flier, either on or off the airways, and still

READY NOW

A NEW LINE OF CARDWELL MIDGET CONDENSERS

for
U. H. F.

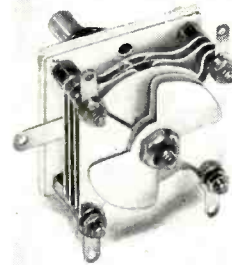

PL-6113
(Type ER-14-BF/SL)
Range: 14-11 mmf. (approx.)
(Minimum capacity loaded by circular rotor plates—for a High "C" circuit.)

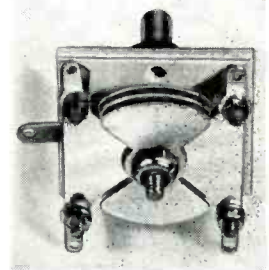

PL-6076
(Type ER-6-BF/S)
Range: 6-2.5 mmf (approx.)

The "Butterfly" rotor plates with 90 degree stators insure:

ELECTRICAL SYMMETRY LOW DISTRIBUTED INDUCTANCE

Features

- Circular plates for low loss fixed minimum permits adjustable band spread.
- No moving contacts.
- Plates easily removed to change capacity range.
- Isolantite Insulation.
- Single Hole Mounting.
- Small size—made to fit standard Cardwell Trim-air hardware.



Other sizes available. Inquiries will be promptly answered.

THE ALLEN D. CARDWELL MFG. CORP.

Main Office: 81 Prospect Street,
Brooklyn 1, N. Y.

Factories: Plainville, Conn.—Brooklyn, N. Y.

**PRECISION
CRYSTALS**

S
I
N
C
E



1
9
3
4

TYPE Z-1

**THE NEW STANDARD CRYSTAL UNIT
FOR ALL HIGH FREQUENCY SERVICE**

FREQUENCY 1.5 TO 10.5 MC.

**TEMPERATURE COEFFICIENT LESS THAN 2 CYCLES
PER MC. PER DEGREE CENTIGRADE**

**CALIBRATION ACCURATE TO WITHIN .005%
OF SPECIFIED FREQUENCY**

MADE BY .

**PETERSEN RADIO COMPANY
COUNCIL BLUFFS, IOWA**

**Now available—
Your guide to precise
usage in working with
ELECTRONICS terms**

**6500
CLEAR-CUT
DEFINITIONS AND
REFERENCE DATA**



HERE is the book that every electronics and radio man has been looking for—an up-to-date, comprehensive dictionary covering all the terms used in electronics and its extensive practical applications, radio, television, communications, and industrial electronics.

For clear, precise definitions, accurate usage, well-illustrated descriptions, and for standardized spelling, abbreviating, and hyphenating policy, this book will be a constant aid to everyone working with electronics and radio engineering—whether student or engineer, editor, or engineering secretary.

Just Published!

**ELECTRONICS
DICTIONARY**

By NELSON M. COOKE, Lt. Com. U.S.N.

*Executive Officer, Radio Materiel School
Naval Research Laboratory, Washington, D. C.*

and JOHN MARKUS
Associate Editor, Electronics

**433 pages, 5 3/4 x 8 3/4
over 600 illustrations, \$5.00**

NOW at last here is an authoritative work to clarify and define the myriad new terms that have come into usage with the vast growth of electronics and electrical engineering. Nowhere else will you find a dictionary comparable to this in scope and timeliness. Nowhere else will you find such a thorough, extensive, generously illustrated compilation.

This glossary fully covers terminology, principles, processes, equipment, abbreviations, and colloquialisms in

- | | |
|---------------------|-------------------------|
| Radio | Photoelectric controls, |
| Television | safety devices, and |
| Foosmile | intrusion detectors |
| Sound recording | Industrial electronics |
| Communications | Electronic motor |
| Medical electronics | control |
| Electronic heating | Long-distance telegraph |
| Electronic welding | and telephone |

This excellent dictionary should be of constant usefulness both to the technician and to the most advanced electronics engineer, for its definitions are exceptionally precise and accurate, and in most cases, each is complete in itself. Invaluable for its consistent abbreviating and hyphenating policy.

Send for a free-examination copy

**McGraw-Hill Book Co.,
330 W. 42 St., N. Y. 18**

Send me Cooke and Markus' **ELECTRONICS DICTIONARY** for 10 days' examination, on approval. In 10 days I will send \$5.00, plus few cents postage, or return book postpaid. (Postage paid on cash orders.)

Name

Address

City and State

Company

Position

In Canada: Mail to Embassy Book Co.,
12 Richmond St. E., Toronto 1

Instant Power for
Your MOBILE TRANSMITTER

Only CARTER gives you instant power when you press your transmitter microphone switch. 600 volt plate power in less than 350 milliseconds!! Actual laboratory tests prove this unequalled starting performance, so important for instant communications. Remember, only the CARTER ORIGINAL GENEMOTOR gives you truly instant power.

Send today for latest free catalog of CARTER Rotary Products.

1606 MILWAUKEE Avenue

Carter Motor Co. Cable Genemotor

gives the airline pilot the kind of guidance he needs. In addition, a grid of ranges similar to the trans-oceanic type eventually will be spotted throughout the country for trans-continental great circle flights at high altitudes. Airliners on such flights will be able to fly the shortest routes without regard to the present irregular airway courses between cities, for they always will be within the sound of these high-powered direction-finding facilities.

Blind Landing Systems

Instrument landing equipment is being installed by the CAA at nearly 100 airports throughout the country. This is the three-element system developed by the CAA, consisting of the localizer, glide path and marker beacon. Although the Army and Navy did remarkable things with radar in instrument landing during the war, the pilots of the airlines, the technical men of the airlines and CAA radio engineers all agree that considerable development work will be required before radar is safely applicable to commercial use.

Of the three elements of the CAA landing system, the marker beacon is considered fully developed. The localizer, heretofore operated on a basis of amplitude comparison, with 90 cycles transmitted on one side and 150 cycles on the other of the line to define the course along the runway, has been improved by using phase comparison instead of amplitude comparison. Now the course is defined by comparing the phase of two 60-cycle signals. This change has resulted in a considerable simplification of the equipment required in the transmitter on the ground, and

COAXIAL CABLE PROGRAM



Status of AT&T coast-to-coast coaxial network. Some sections will be radio relay within the next few years. About 700 miles of coaxial toll cables were placed in 1945, and some 2,100 miles is scheduled for 1946. The recently completed New York-Washington link has already been used successfully for television programs

Complete Facilities-

- Engineering-Design & Development
- Laboratory & Model Shop
- Tool & Die Making
- Coil Winding
- Impregnating
- Blanking & Annealing of Core Steel
- Fabrication of all Mounting Parts
- Complete Assembly
- Compound Filling
- Inspection & Testing

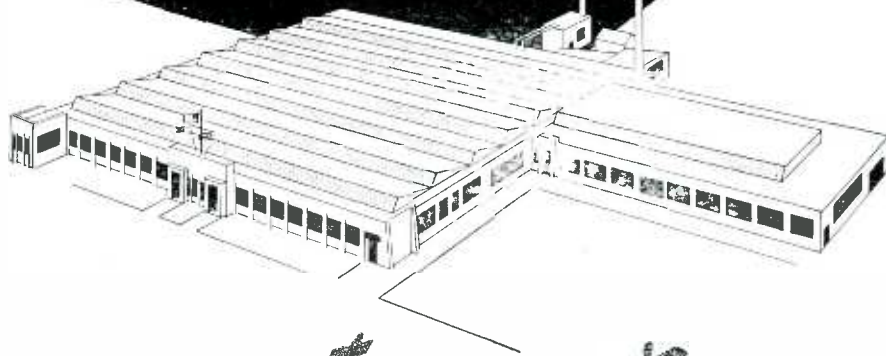

*devoted to
One Primary Purpose*

—the manufacture
of transformers to fit the
specialized requirements
of the Electronic Industry

CHICAGO TRANSFORMER
DIVISION OF ESSEX WIRE CORPORATION
3501 ADDISON STREET · CHICAGO, 18
TRADE MARK REG.

A Name to
Look for on
Electrical
COILS and
Transformers

GRACOIL

"One Good Turn - or a Million"

Famous for
years as
COILS
by
DOYLE



LAYER-WOUND COIL



RELAY COIL

Be sure that the coil you buy bears the trademark name — "GRACOIL", for only then can you know that you have the best in electro-magnetic windings. Every "GRACOIL" is wound to the specified number of uniform turns from precision-gauged wire. Every "GRACOIL" is fully insulated, thoroughly impregnated, and properly laminated when supplied as a complete transformer. The most rigid inspections and tests make sure that each "GRACOIL" is worthy of the name it bears.

If your design calls for a special electro-magnetic application, let competent "GRACOIL" engineers make specific recommendations for you. Write today!



LOW VOLTAGE
TRANSFORMER



GENERATOR
FIELD COIL

THE GRAMER COMPANY

Electrical Coils and Transformers

2736 N. PULASKI RD., CHICAGO 39, ILL., U. S. A.

ZOPHAR

Waxes, Compounds and Emulsions



Materials for potting, dipping or impregnating all types of radio components or all kinds of electrical units. • Tropicalized fungus proofing waxes. • Waterproofing finishes for wire jackets. • Rubber finishes. • Inquiries and problems invited by our engineering and development laboratories.

Zophar Mills, Inc. has been known for its dependable service and uniformity of product since 1846.

ZOPHAR MILLS, Inc.

ESTABLISHED 1846

117 26th STREET, BROOKLYN, 32 N. Y.

PREMAX

For Commercial Installations

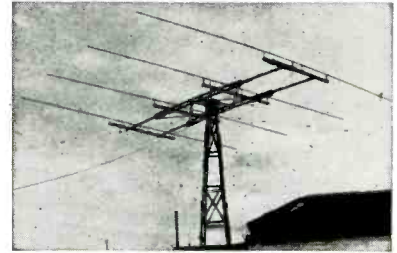

It's Premax

Premax Tubular Steel and Aluminum Vertical Antennas and Mountings are in widespread use on Fire, Police, Public Utility and other emergency vehicles. They give universal satisfaction because they get the signals and can withstand the severe road shocks. Undoubtedly there is a standard Premax design that will fill your needs. Write for Bulletin.

Premax Products

Division Chisholm-Ryder Co., Inc.

4611 Highland Ave., Niagara Falls, N. Y.

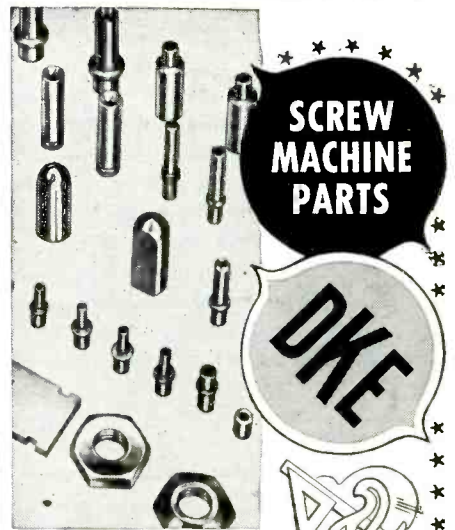

...for exacting needs!

Facilities for rapid production of all screw machine parts. Close tolerance work a specialty. Expanded modern facilities permit fast delivery. All tools, jigs, fixtures produced on premises for precision and economy.

INQUIRIES INVITED

THE ENGINEERING CO.

DANIEL KONDAKJIAN
27 WRIGHT ST., NEWARK, N. J.

a lightening and simplification of the airborne receiver. A straight-line glide path has been developed as an additional improvement of the landing system.

The CAA is cooperating with the Army in service testing of its automatic instrument landing system. In this, the indications of the cross-pointer instrument by which the system is flown are connected to a standard automatic pilot, and the airplane is flown to the point of contact with the ground without human hands on the controls.

Telediffusion in Sweden

By LEONARD SILK
McGraw-Hill World News
Stockholm, Sweden

A FIGHT is in progress here between supporters of telediffusion or wired wireless and technical experts favoring frequency modulation as the solution of Sweden's broadcasting difficulties. Telediffusion is being considered not because mountains make reception in valleys poor, but because of the great distances to the relatively few wireless transmitters which it has been possible to install in Sweden owing to the lack of wavelengths, and perhaps even more important, because of the severe electrical interferences in many areas here.

People living along the railroad tracks in Sweden find it impossible to use their radios at certain hours during the day, since the Swedish railroads are largely electrically-powered. Besides disturbances from high-tension power lines and contact wires for the railways, there are those from electric plants in factories, hospitals, and office buildings. Those listeners are worse off who are resident in certain districts of Värmland, Dalsland, Bohuslän, Smaland and certain communities along the railways. In almost every case, these are not mountainous areas. In the North, however, some interference is experienced from ionospheric disturbances.

According to an over-all estimate made by the Radio Bureau of the Telegraph Administration, even if existing broadcasting stations had been expanded to the fullest possible extent, about 600,000 subscribers to the broadcasting network could not get satisfactory reception. This figure is fantastically large, since the

Announcing 2 NEW CONCORD RADIO CATALOGS

Ready Soon! The presses are roaring now, pouring out the thrill-packed pages of the first great, post-war COMPLETE CONCORD Catalog—featuring

RADIO SETS
AMPLIFIERS
RADIO PARTS
Electronic Equipment

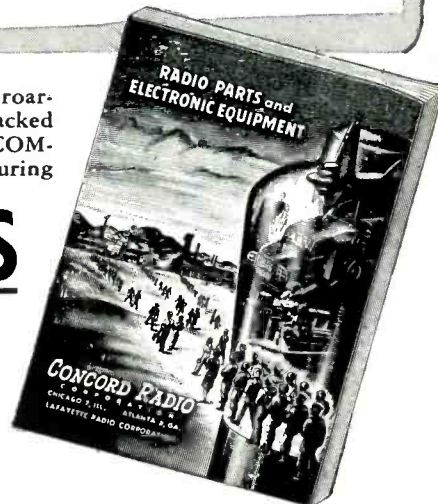

Soon it will be in your hands, presenting the complete line of brand-new postwar-designed CONCORD Radio Receiving Sets and Amplifiers—incorporating a host of new improvements, new developments, modern cabinets, and superb quality throughout—plus page after page of nationally-known standard, top-quality radio and electronic equipment, supplies and amateur equipment. Mail the coupon below NOW—to be sure your FREE copy will be mailed to you as soon as off the press.



Ready Now! New CONCORD Bargain Book of RADIO PARTS SUPPLIES • EQUIPMENT

Just off the press! The newest, latest Concord Bargain Book listing hundreds and hundreds of money-saving bargains on hard-to-get, standard-make radio parts and electronic equipment. Select your needs from the remarkable values offered in Condensers, Resistors, Meters, Transformers, Volume Controls, Relays, Switches, Generators, Microphones, Speakers, Tools, and hundreds of other items. Mail the coupon for your copy now.

CONCORD

RADIO CORPORATION
LAFAYETTE RADIO CORP.

CHICAGO 7 ★ ATLANTA 3
901 JACKSON BLVD 265 PEACHTREE ST.

Concord Radio Corporation Dept. G-46
901 W. Jackson Blvd.
Chicago 7, Illinois

Please mail immediately FREE copy of the New Radio Parts Bargain Supplement—and place my name on the list to be one of the first to receive the new CONCORD COMPLETE CATALOG.

Name.....

Address.....

City..... State.....

The Most Indispensable Reference in Radio-Electronics

Electronic Engineering Master Index

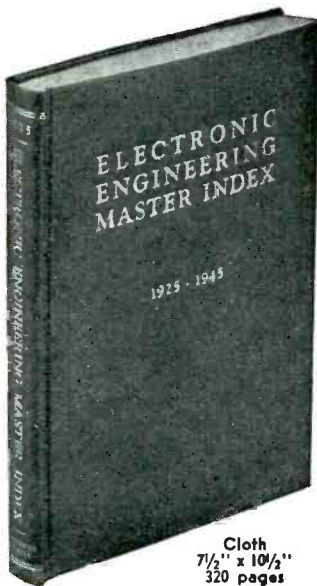

Cloth
7 1/2" x 10 1/2"
320 pages

A master compilation of over 15,000 titles, articles and texts selected for their value to the research engineer, this INDEX covers the years 1925-1945 and enables you to survey twenty years of research literature on any subject in a matter of minutes!

Vitally Needed in Every Laboratory and Library

COMPLETE IN ONE VOLUME

PART I
January 1925 to
December 1934

PART II
January 1935 to
June 1945



PARTIAL LIST OF PERIODICALS INDEXED:

Bell Laboratories Record	Journal of I.E.E.
Bell System Technical Journal	General Electric Review
Communications	Physical Review
Electrical Communication	Proceedings I.R.E.
Electrical Engineering	Transactions of A.I.E.E.
Engineering	Transactions of A.S.M.E.
Electronics	Radio News
Electronic Industries	R.C.A. Review
Jour. of Applied Physics	Wireless Engineer

A \$500 Reference Library in One Volume for \$17.50

Descriptive circular on request.

ELECTRONICS RESEARCH PUBLISHING COMPANY
2 West 46th Street New York 19, N. Y.

CUSTOM  MOLDED
PLASTICS PARTS
FOR THE ELECTRONICS INDUSTRY



Compression Molded... to meet specific requirements... by an experienced organization... tooling for the production of plastics parts for electrical or general applications. Inquiries acknowledged promptly.

Midwest Molding and Manufacturing Co.

335 NORTH WHIPPLE ST., CHICAGO 12, ILL.



APPROVED

Leakproof

ENAMELED MAGNET WIRE

• Much of the success of this Hudson Wire product is due to a new coating method that gives a smooth, permanently-adherent enameling. Mercury-process tests guarantee perfect uniformity; great tensile strength assures perfect laying even at high winding speeds. Especially adaptable for reduction in coil dimensions without sacrificing electrical values.

Our engineering and design facilities are at your disposal—details and quotations on request.

HUDSON WIRE COMPANY
Winsted Division
WINSTED CONNECTICUT



HOW TO BUILD LAMP ANNUNCIATORS

Kirkland Bull-T Units are ideal for this purpose. Just provide the proper size holes in the panel, then insert the Kirkland units and lock into place. Many different units to choose from. Assembly is then ready for installation. Connect incoming wires and place in service. Typical unit illustrated above made with T2 units.

KIRKLAND Pioneer
INDICATING LAMPS

TYPE T2 UNIT



Small and modern, molded of bakelite. For use with slide-base switchboard bulb (24 volts, 0.038 Max. Amp) with resistor on 120-220-440 vol.s. Overall dia. Lens-Cap 3/4".
LIST PRICE (less bulb) 70¢.

Write Today for Catalogue
Where Quality is the Foremost Consideration

The H. R. KIRKLAND CO., Morristown, N. J.

total number of radio licensees in Sweden is 1,840,000.

Another great complaint of Swedish listeners is lack of variety in their radio diet. At present only one program is broadcast simultaneously for all of Sweden. The Broadcasting Committee's ambition is to provide three programs simultaneously.

VHF F-M Broadcasting

In searching for solutions, the Committee discovered that no new wavelengths can be obtained for Sweden in the long-wave, medium-wave and short-wave bands. There are, however, possibilities in the vhf bands, in which f-m is being considered. It would be possible here with about 150 vhf transmitters at an establishment cost of about \$6,800,000 to reach about 75 percent of the present number of license holders. This method permits transmission of two programs at once. Main objection to the solution through f-m is that present radio receiving sets cannot be used for reception of f-m. Capital invested in receiving sets has been estimated at an amount ranging between \$60,000,000 and \$270,000,000.

Carrier Broadcast System

The second solution (which has the support of the Committee) is using high-frequency wired wireless by which radio programs would be distributed along available telephone lines. It would thus be possible to avoid difficulties that arise due to lack of wavelengths in radio transmission, and three or four programs could be transmitted on each line. Broadcasts would be piped from Stockholm to booster stations and thence to private houses (or, in small villages, to one house which would serve as feeder for others).

It is possible to transmit programs by carrier via electric power mains, but the plant then becomes technically complicated and expensive. Something similar was tried in Germany under Hitler but for a different reason—to keep internal propaganda truly internal, and perhaps to avoid broadcast transmissions going off the air in case of air raids.

The Committee considered use of telephone lines to be preferable, especially since transmission can take place without breach of telephone secrecy. Listeners will not have to buy new and expensive receiving sets. Also, special mass-produced wired

AUDIO SIGNAL SYNCHRONIZER— MODEL J for Synchronization of Audio Frequencies



This instrument is essentially a dual input, sensitive vacuum tube voltmeter. In production and laboratory test procedures, typical applications are: synchronizing audio oscillators with radio WWV, calibrating modulation frequencies of transmitters, adjusting filter networks and tuned circuits—or any application where a beat must be observed down to a few cycles per second.

The usual procedure with cathode ray techniques requires considerable time for interpretation of frequency differences. The Model J will synchronize and give direct indication of frequency differences as low as one beat in 24 hours. The gain of each input, for full scale deflection on the meter, exceeds 60 D. B.

Input impedance is 500,000 ohms over the audio spectrum and is constant at any setting of the input attenuators. The inputs are isolated from each other and have no electrical effect on the signal mix. A jack is provided so that the output synchronized signal may be used to drive an oscilloscope.

Dimensions—19" L x 8¾" H x 9½" D
Furnished in oak cabinet if relay rack mounting is not desired.

Write for descriptive literature

Televiso



PRODUCTS CO.
7466 IRVING PARK ROAD
CHICAGO 34, ILLINOIS



Actual *Size*

To utilize the possibilities of new circuits for finer instrumentation.

The VX Series of sub-miniature vacuum tubes.

Measured characteristics of the VX-41 Tetrodes.

Filament current	10 M.A.
Filament voltage	1.25V
Grid current	10 ⁻¹⁴ amp.
Grid resistance	10 ¹⁶ ohms
Plate current	250 microamps.

If these characteristics suggest a solution to a circuit or instrument problem, consult us. A technical bulletin showing circuit applications is yours for the asking.

Available as Pentodes, Triodes, Tetrodes, Diodes.

THE VICTOREEN
3800 PERKINS
CLEVELAND

INSTRUMENT CO.
AVENUE
14, OHIO

The Victoreen Hi-Meg vacuum Sealed Resistor offers a new standard of precision and stability for resistance values in a range of 100 to 10,000,000 megohms. Especially needed where low operating currents require extremely high resistances. The only resistor that covers this range of values with relatively low temperature and voltage coefficients.



Write for technical data on VX Tubes and Resistors.



wireless receiving sets would be a great deal cheaper both to buy and operate than present sets.

Sweden would continue to broadcast one of its three programs on the air and would pipe that program plus two others through the wires. Major criticisms to the scheme are that a nondemocratic government could do terrible things with such a tight internal system and that it would take so long to complete (20 years). Proponents reply that the scheme could be effected immediately to give those with phone lines a variety of programs, that it is essential to get going with some scheme, and that new phone lines which must be laid are important and useful in any case.

The Committee has made additional suggestions and given prices for other means of improving Swedish broadcasting. For extension of the wireless station grid: \$5,000,000. For installation of two short-wave transmitters (to beam programs to Swedes abroad): \$2,400,000. For building of a Broadcasting House (huge studios) in Stockholm, on which construction will probably start this summer: \$12,500,000. For wired wireless to listeners unable to get fully satisfactory reception: \$42,000,000. For wired wireless to all listeners in order to provide several simultaneous programs: \$94,000,000.

Lanac for Aviation

A NEW WARBOURN SYSTEM for protection and navigation of aircraft while in flight has been announced by Hazeltine Electronics Corporation. It is called Lanac, abbreviation for Laminar Air Navigation and Anti-Collision system.

The basic concept of the system, developed by Knox McIlwain of the Hazeltine organization, rests upon the fact that commercial and private aircraft while in flight are restricted to certain laminae or air strata and that it is essential for these planes to know what obstacles are present in their respective strata of operation. The system makes it possible: (1) to prevent collisions between planes in the air or between planes and mountains, high buildings, or other fixed obstacles; (2) to identify individual planes while in flight as to airline and flight number; (3) to furnish direction and other data directly to the pilot without the assis-



From out of the west...
America's
finest
transformers

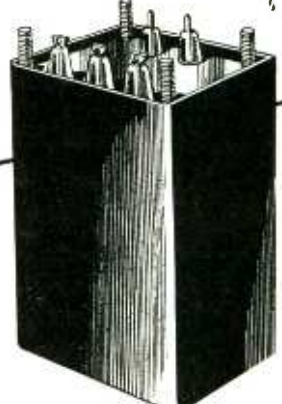

Thermador is a name remembered when the utmost in transformer quality is desired, and when exceptional engineering skill is required.



"Seven Leagues Ahead"

THERMADOR
THERMADOR ELECTRICAL MFG. CO.
5119 District Blvd., Los Angeles 22, California

TERMINAL BOARDS

FOR

Electronic Equipment

MADE TO ORDER
IN ANY QUANTITY

•
IMMEDIATE DELIVERY

•
Send for quotation

FIVE STAR RADIO CO.

416-18 Broadway • Cambridge, Mass.

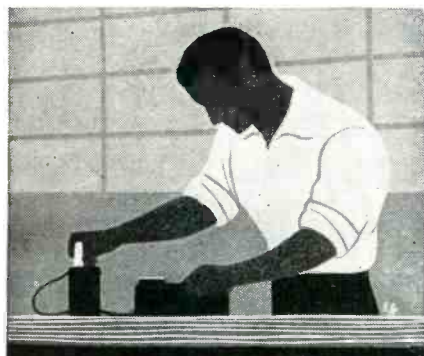

FOR
INDUSTRIAL USES

BURGESS BATTERIES

RECOGNIZED BY THEIR
STRIPES • REMEMBERED
BY THEIR SERVICE

YANATTA



Kwikheat

THERMOSTATIC SOLDERING IRON

A Division of
Sound Equipment Corp. of Calif. • 3903 San Fernando Rd., Glendale 4, Calif.

America's Only Soldering Iron

**WITH BUILT-IN
THERMOSTAT**

225 WATTS POWER in a Mere 14 ozs.



HOT IN 90 SECONDS

Ready for use 90 seconds after plugging in! The Kwikheat Soldering Iron cannot over-heat... adds to life of tips... requires less retinning time, because Kwikheat's built-in patented thermostat maintains proper, even heat for most efficient, economical operation. Powerful—225 watts—yet light weight (14 ozs.). Well balanced with cool, protecting handle. Six interchangeable tip designs adapt the Kwikheat Iron to most any soldering job. Iron with choice of any one tip, \$11.00



◀ **6 Interchangeable tip
styles are available.**



6 TIP STYLES—QUICK-HEATING ELEMENT—BUILT-IN THERMOSTAT—WELL-BALANCED—LIGHT-WEIGHT—COOL, PROTECTING HANDLE

Toroids..

by

DX

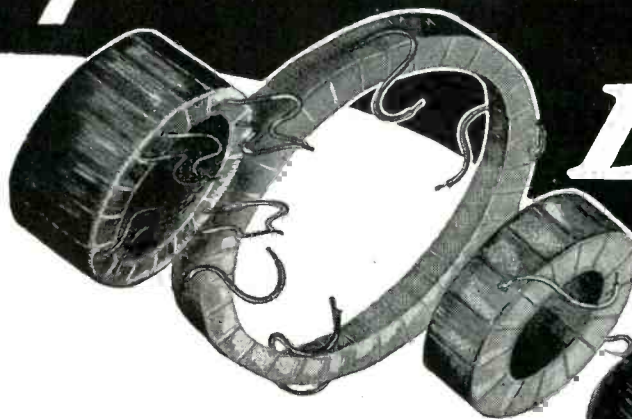

Doughnut Coils for electronic and telephone purposes. High Permeability Cores are hydrogen annealed and heat treated by a special process developed by DX engineers. Send us your "specs" today—ample production facilities for immediate delivery.

DX RADIO PRODUCTS CO.

GENERAL OFFICES 1200 N. CLAREMONT AVE., CHICAGO 22, ILL., U.S.A.



**NEW
MODELS**
Available Now!
of **ATR**
QUALITY PRODUCTS

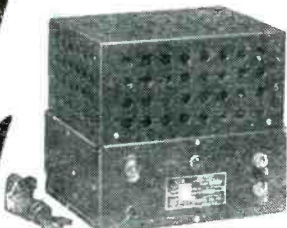

**ATR
"A"**

BATTERY ELIMINATORS

FOR CONVERTING A.C. TO D.C.

New Models . . . designed for testing D.C. electrical apparatus on regular A.C. lines. Equipped with full-wave dry disc type rectifier, assuring noiseless, interference-free operation and extreme long life and reliability.

- Eliminates Storage Batteries and Battery Chargers.
- Operates the Equipment at Maximum Efficiency at All Times.
- Fully Automatic and Fool-Proof.

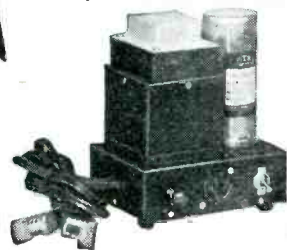

ATR

LOW POWER INVERTERS

FOR INVERTING D.C. TO A.C.

Another New ATR Model . . . designed for operating small A.C. motors, electric razors, and a host of other small A.C. devices from D.C. voltages sources.

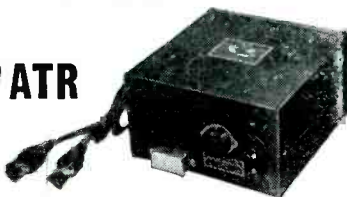

ATR

STANDARD AND HEAVY DUTY INVERTERS

FOR INVERTING D.C. TO A.C.

Specially designed for operating A.C. radios, television sets, amplifiers, address systems, and radio test equipment from D.C. voltages in vehicles, ships, trains, planes, and in D.C. districts.

WRITE FOR NEW CATALOG —
JUST OFF THE PRESS!

AMERICAN TELEVISION & RADIO CO.
Quality Products Since 1931
ST. PAUL 1, MINN. U. S. A.

tance of a ground crew; (4) to increase the traffic-handling capacity of airways and airports; (5) to increase the safety of transoceanic and other flights far distant from ground stations; (6) to give automatic navigational aid to pilots while flying so that the possibility of lost planes is reduced to a minimum; (7) to give airports and ground check stations continuous data on the location as well as the identity of all planes.

If the Lanac system is officially adopted, every airplane will be equipped with a challenger and a replier—radar sending and receiving sets controlled by barometric devices so as to be responsive only at the altitudes for which they are set. The challenger sends out a constant series of challenges which are automatically picked up by the repliers of other planes in the same air stratum. Upon receipt of such signals, the replier automatically transmits a reply so that the presence of another plane in the same stratum is instantly known and collision can be avoided. When ascending or descending, the pilot can temporarily change the barometric range of his challenger to investigate the air layers he is approaching. Through barometric selection, a plane in normal operation is advised only of obstacles in its own stratum of flight and is not confused by a multiplicity of signals from other strata.

Mountains, high buildings, and other fixed obstacles can be equipped with permanent repliers which will be responsive to challenges transmitted by any planes flying at a dangerous altitude.

Plane identification is obtained by varying the characteristics of the reply signals transmitted by the replier of each plane, so as to reproduce in Morse code the letter designation of each individual plane. This information can be picked up by other planes and by ground stations.

For navigational purposes the pilot of a Lanac-equipped plane will be able to challenge navigational beacons on the ground and receive their replies, each so coded as to be readily identifiable. By means of these navigational fixes the pilot can establish his exact position and determine his ground speed. The plan envisages the establishment of these navigational beacons at strategic points.

The Lanac system is already in an

**ELECTRICAL
PAPERS**

*MADE TO
YOUR
SPECIFICATIONS*

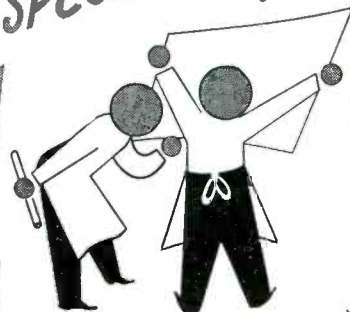

Electrical papers are different! That is why it pays to consult with specialists in determining the most efficient paper for a particular purpose. Our research department, specialists in Electrical Paper applications, will be glad to analyze your requirements and recommend papers of correct properties.

FREE BOOK

Contains data on Electrical Paper properties and a wide variety of samples.

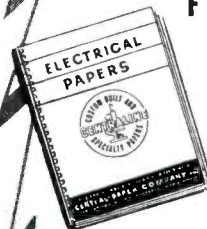

REG. U. S. PAT. OFF.

**CENTRAL PAPER COMPANY
INCORPORATED**

2442 LAKESHORE DRIVE, MUSKEGON, MICH

OFFICES IN:

BOSTON, NEW YORK, BALTIMORE, BUFFALO, CLEVELAND,
CINCINNATI, DETROIT, CHICAGO, ST. LOUIS, SAN FRANCISCO

Radio-Electronic Materials

• Try us for those items you need in a hurry. Our stocks are big—our service, extra-fast!

We've been at it since 1925—and we know how!

Just Try Us

H. L. DALIS, INC.

Wholesale Distributors
RADIO-ELECTRONIC SUPPLIES & PARTS
17 Union Square
NEW YORK 3, N. Y.

Phones: ALgonquin 4-8112-3-4-5-6-7

NEED SMALL BULBS and DEEP DRAWN PARTS to CLOSE TOLERANCES?

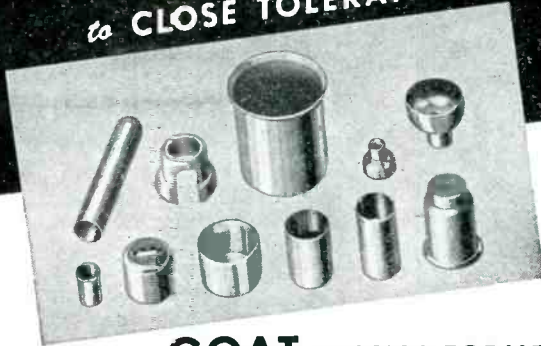

GOAT PRECISE-FORMED DEEP-DRAWN METAL PARTS

Improved Quality at Lower Cost!

Deep drawing, sizing and coining, in conjunction with quality control techniques devised by the Goat Company, make possible the economical production of small parts to tolerances unattainable a few years ago. The new method makes expensive annealing operations unnecessary. The use of these economically produced, precision parts reduces both material costs and assembly costs.



Send us your design prints for engineering recommendations

LET US REDESIGN FOR STAMPING

GOAT METAL STAMPINGS, INC.
Affiliate of The Fred Goat Co., Inc.
314 DEAN STREET BROOKLYN, N. Y.

JONES BARRIER TERMINAL STRIPS



2-142



2-142-3/4W



2-142-Y

Bakelite Barriers placed between Terminals increase the leakage path and prevent direct shorts from frayed wires at Terminals. Terminals and screws are of nickel plated brass. Insulation is of BM 120 molded Bakelite.

Illustrated are three types: Screw Terminals, Screw and solder Terminals and Screw Terminal above panel with solder Terminal below. For every need.

Six series cover every requirement: No. 140 — 5-40

screws, No. 141—6-32 screws, No. 142—8-32 screws, No. 150—10-32 screws, 151—12-32 screws and No. 152—1/4-28 screws.

These sturdy Terminal Strips will not only improve your electrical connections but will add considerably to the appearance of your equipment. A truly modern Terminal.

Write today for catalog No. 14 listing our complete line of Barrier Strips in addition to other Electrical Connecting Devices.

HOWARD B. JONES COMPANY
2460 W. GEORGE ST. CHICAGO 18

For COMMUNICATIONS and INDUSTRIAL Jobs

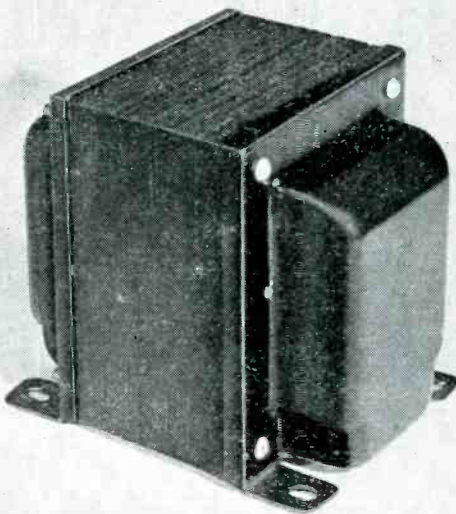

Power Transformers
(Up to 1 kw.)

Audio Transformers

High-Voltage Transformers

Filter Chokes

Coils

DINION COIL COMPANY, Inc.

CALEDONIA, N. Y.

Specialists in Difficult Designs

Electricity

ONAN
ELECTRIC PLANTS

FOR RADIO AND ELECTRONIC APPLICATIONS

ONAN ELECTRIC GENERATING PLANTS supply reliable, economical electrical service for electronics and television applications as well as for scores of general uses.

Driven by Onan 4-cycle gasoline engines, these power units are of single-unit, compact design and sturdy construction. Suitable for mobile, stationary or emergency service.

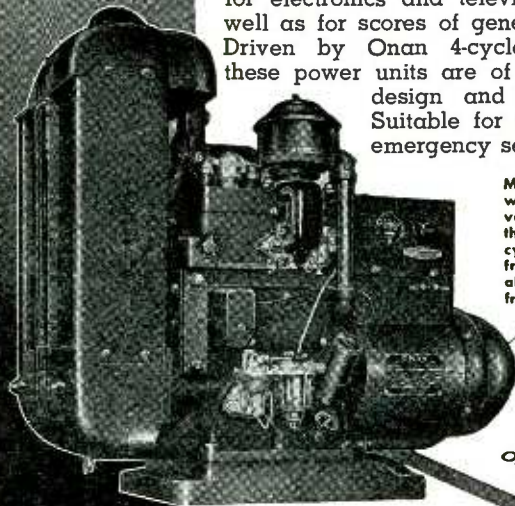

Models range from 350 to 35,000 watts, A. C. types from 115 to 660 volts, 50, 60, 180 cycles, single or three-phase and 400, 500 and 800 cycles, single phase. D. C. types from 6 to 4000 volts. Also available in dual voltage and special frequency types.



Model shown is from #2C series: 2000 to 3500 watts; powered by Onan two-cylinder, water-cooled engine.

D. W. ONAN & SONS

3275 Royalston Ave.

Minneapolis 5, Minn.



MANUFACTURERS OF RADIO, ELECTRICAL AND ELECTRONIC COMPONENTS

VOKAR Corporation

7300 HURON RIVER DRIVE · DEXTER, MICHIGAN

advanced stage of practical development since the whole system is based upon scientific developments worked out during the war. It is estimated that the complete equipment, including challenger, replier, and all accessories for airplane use, will weigh approximately 200 pounds and require a space, exclusive of antenna blisters, of about 4.8 cu ft.

Instrument approach can be governed by an additional position on the control switch by means of which an oscilloscope can be made to show the horizontal and vertical position of the plane with respect to a true glide-path, together with the amount of heading into the wind required to resist any existing cross-wind. The desired glide angle is obtained semi-automatically by the mere setting of a switch, after which the pilot needs only to keep certain pips in alignment on his oscilloscope.

AAF Guided Missiles Group

THE FUNCTIONS OF THE First Experimental Guided Missiles Group, established this year by the Army Air Forces with headquarters at Elgin Field, Florida, and commanded by Colonel H. T. Alness, will be development of tactics and techniques of guided missile operations, training of personnel, development of organizational and equipment requirements of the group, and demonstration of guided missiles in the AAF program.

Personnel for the group, to be composed of 715 enlisted men and 130 officers, will consist almost entirely of highly trained specialists. The men are being selected for their knowledge of radar, television, infrared, aerodynamics, control systems, and other scientific devices connected with guided missiles.

The group will not participate in origination or technical developments of guided missiles, but will develop their tactical use and determine the best methods of employing them in combat.

Guided Missile Projects

Several missiles have already been developed and are now ready for tactical experiments. The Azon bomb, a standard 1,000-pound bomb with a radio-controlled tail that can be steered to the left or right on receipt of radio signals from the plane drop-

“Alnico” permanent magnets

Specializing in the production of highest quality Alnico Magnets in all grades including new triple strength No. 5.

Production material checked to assure highest uniform quality of product.

Castings made to customer's special order on the basis of sketches or blue prints furnished.

Information and suggestions furnished on request.

GENERAL

MANUFACTURERS OF HIGH COERCIVE MAGNETIC ALLOYS



MAGNETIC CORPORATION

2126 E. FORT STREET
DETROIT 7, MICHIGAN

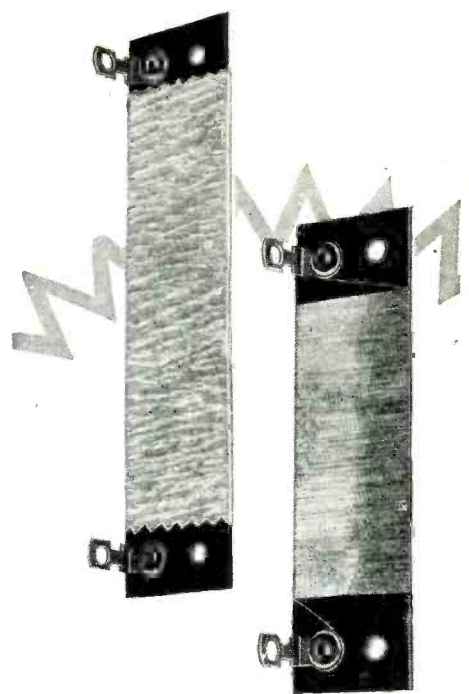

Tight-Tolerance RESISTORS

★ Just turn those tight-tolerance resistor requirements of yours over to CLAROSTAT, just as other instrument-makers have been doing for years past.

Remember, CLAROSTAT specialists offer over two decades of winding experience, outstanding skill, and exclusive winding facilities. They wind all wire sizes even down to .0009" dia. Windings as fine as 600 to 700 turns per inch, on bakelite, ceramic or other material, flat or round. Also string windings in fibre glass and cord.

★ Submit your problem . . .

Solving your resistance and control problems is our business. Call on us for engineering collaboration, specifications, quotations.



CLAROSTAT MFG. CO., Inc. • 285-7 N. 6th St., Brooklyn, N. Y.



**MORE P.A.'s
CONSULT
MacRAE'S**

For advertising and book rates, call your agency or write . . .

**MacRae's
Blue Book**

A DIRECTORY OF AMERICAN INDUSTRY

29 E. HURON ST. CHICAGO 11, ILL.

Radio Headquarters

for 25 years



We ship at once—parts, equipment, whatever you need!

This house began its career almost as early as Broadcasting itself! Today, 25 years later, we're the world's largest radio supply house! **Standard Lines:** National, Hammarlund, R. C. A., Hallicrafters, Bud, Cardwell, Bliley, and all the others!



SUPERSPEED SERVICE Orders shipped out same day received, on most goods.



ENGINEERING SERVICE If your engineering problem requires special equipment, we'll make it

FREE!

Latest bargain flyer includes test instruments, record changers, communication receivers, ham transmitting tubes and a host of electronic items you need today.



Originators and Marketers of The Famous

Lafayette Radio

Radio Wire Television Inc.

NEW YORK 13 BOSTON 10 NEWARK 2

Cut out coupon, paste on penny post card, mail today

R. W. T. Dept. ED-6
100 AVENUE OF THE AMERICAS, NEW YORK 13

Gentlemen: Send me FREE copy of your Latest Bargain Flyer C-36, packed with recent electronic equipment and components.

NAME _____

ADDRESS _____

CITY _____ ZONE _____ STATE _____

ping it, proved highly successful against bridges in India and Burma. One bridge was destroyed for each four sorties, a greatly increased efficiency percentage over ordinary bombs. A further development, completed just before the end of the war, was the Razon bomb, controllable in both azimuth and range.

Other guided missile projects include Felix, a bomb attracted to heat, and the Roc, a standard 1,000-pound bomb equipped with television to scan the target and relay vital information back to the aircraft.

Although the only fully developed American guided missiles at the present time are air-to-ground types dropped from an aircraft, extensive plans have been made for the development of ground-to-air and ground-to-ground missiles. The German V-2 rocket is an example of ground-to-ground missiles.

Further possibilities of guided missile development include retrievable missiles for reconnaissance, automatic photographic sorties, and other similar long-distance missions.

Wireless Television Camera

PEACETIME BENEFITS FROM wartime development of a television-guided bomb were described by Farnsworth Television & Radio Corp. A portable camera-transmitter unit, built originally to help bombardiers steer their missiles directly to the target, has proved adaptable to on-the-spot television news pickups. The camera is light enough to be carried in an ordinary large-sized suitcase and can be operated by battery if a power line is not available.

A main transmitter beams out synchronizing signals to lock in the signals of the portable camera-transmitter, which then sends its composite signal back to the main transmitter for broadcasting. The present range from which this signal can reach the main transmitter is about 15 miles.

The AAF high-angle television bombing technique was in its final stages when the war ended last August. The camera-transmitter unit, an 18-inch diameter cylinder having a depth of 15 inches, was shock-mounted in the nose of a 1000-pound bomb. Also in the bomb was a radio receiving unit which controlled a small gyroscopic mechanism in the tail section. After the bomb fell

SUPREME

TESTING INSTRUMENTS

AFTER A GREAT WAR RECORD

BACK AGAIN!



SUPREME MODEL 504-A TUBE AND SET TESTER

SUPREME regrets that war necessitated an interruption of service to its customers and friends. We are genuinely glad to get back into peacetime production—production for YOU.

MANY SUPREME INSTRUMENTS NOW AVAILABLE

—But not enough to take care of all orders at one time. Demand for accurate, dependable SUPREME equipment is such that we suggest you make arrangements for your needed new SUPREME models without delay.

SEE YOUR NEAREST SUPREME JOBBER NOW!

SUPREME

SUPREME INSTRUMENTS CORP.
GREENWOOD, MISS.
U. S. A.

Export Department:
THE AMERICAN STEEL EXPORT CO., Inc.
374 Madison Ave., New York 17, N. Y.

SAY MODERN METHODS SLASH SCREW COSTS 86%

KEENE, N. H. (Special)—Modern methods applied to screw manufacture were cited today as responsible for the incredible saving of 86% in screw costs for a customer of the New England Screw Company of this city. Figures show that the customer was paying \$3.75 a thousand for screws from another source and that New England Screw furnished the same product for only 53c.

The customer first approached New England Screw when they became dissatisfied with deliveries and service from another manufacturer. Already far behind in production, they had little hope of catching up, much less of saving any money.

"Our delivery schedules had to be set so high," recalled the president of New England Screw, "they didn't dream we could maintain them. But we did! And saved them 86% in the bargain!"

One of the many special screws made by this firm is shown in the illustration at the left. New England Screw has been making standard and special screws and headed shanks for over 59 years, and their modern manufacturing methods are described in an interesting catalog which will be sent to any company requesting it. Engineers of any manufacturer using screws or headed shanks are invited to consult with their Engineering Department which will gladly co-operate.



NEW ENGLAND SCREW CO.
KEENE, NEW HAMPSHIRE

ap
as
8c
Ei
st
th
pr
S
d
t
h
s
h
S
t
h
t
J
e

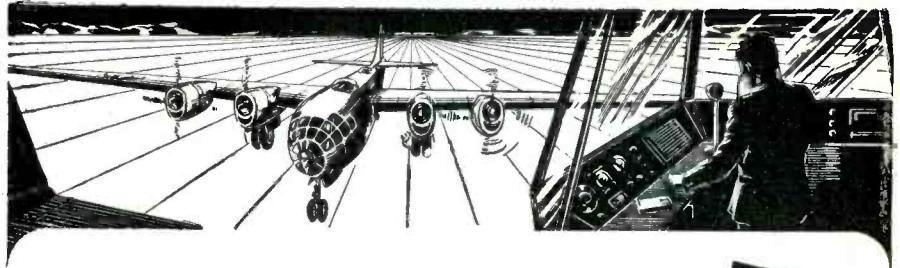

An Invitation to All Electrical Designers to TRY SILVER GRAPHALLOY



FOR BRUSHES

High current density, low contact drop, low electrical noise, and self-lubrication are characteristics of this silver-impregnated molded graphite that may be the answer to your electrical brush problems.

FOR CONTACTS

Low contact resistance and non-welding when breaking surge currents are inherent properties of this unique combination of conductive silver and self-lubricating graphite.

SAMPLES of Silver Graphalloy will be gladly furnished for test on your applications.

Silver Graphalloy is usually silver plated to permit easy soldering to leaf springs or holders. Why not WRITE NOW for your test samples?

GRAPHITE METALLIZING CORPORATION

1055 NEPPERHAN AVE • YONKERS, NEW YORK

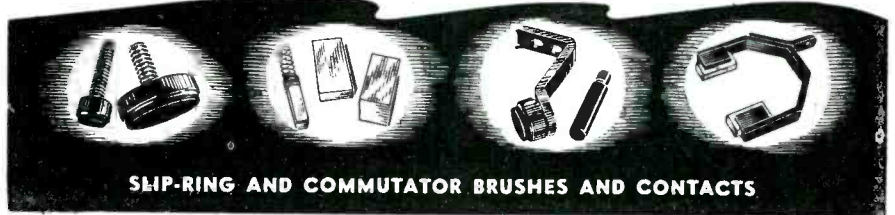

SLIP-RING AND COMMUTATOR BRUSHES AND CONTACTS

HARRIS

DUFLEX SHOCK MOUNTS



TUBULAR MOUNTS
Bonded or Torflex Type



TORFLEX BEARINGS



CONTROL VIBRATION
ELIMINATE SHOCK & NOISE

HARRIS PRODUCTS COMPANY

5106 Cowan Ave. • Cleveland 4, Ohio

NEW SOLDERING GUN

THE SPEED IRON*



Patent Applied For

130 Watts 115 Volts 60 Cycles

Soldering Heat in 5 Seconds

Wherever you have a soldered joint in radio, electrical or electronic repair and service work, the Speed Iron will do the job faster and better.

The transformer principle gives high heat—in 5 seconds—after you press the trigger switch. Convenient to hold with a pistol grip handle, the compact dimensions of this new soldering tool permit you to get close to the

joint. The copper loop soldering tip permits working in tight spots. The heat is produced by the high current flowing through the soldering tip—permitting direct and fast transfer to the soldered connection.

If you want to save time on soldering jobs with a tool that is ready to use in 5 seconds, get a Speed Iron today. See your radio parts distributor or write direct.

*T.M. Reg U. S. Pat. Off.

WELLER MFG. CO.

515 NORTHAMPTON STREET, EASTON, PA.

BRADLEY PHOTO ELECTRIC CELLS



Many Standard Mountings.

In addition to the housed model shown here, with its plug-in contacts, Bradley also offers tube socket, nut-and-bolt types and pig-tail contact mountings.

The shapes of Luxtron photocells vary from circles to squares, with every in-between shape desired. Their sizes range from very small to the largest required.

For direct conversion of light into electric energy, specify Bradley's photocells. They are rugged, lightweight and true-to-rating.

Illustrated literature, available on request, shows more models of Bradley photocells, plus a line of copper oxide and selenium rectifiers. Write for "The Bradley Line."

BRADLEY LABORATORIES, INC.

82 Meadow St. New Haven 10, Conn.

through the bay doors, the eye in its nose began to scan the terrain below, picking out roadways, bridges, buildings and even moving automobiles. The directional transmitting antenna in the rear sprayed this signal back toward the plane in a 90-degree cone.

In the plane, the bombardier picked out the target on a 5-by-7-inch monitoring screen, and guided the bomb in both azimuth and elevation by radio so as to keep the image of the target under the crosshairs.

RMA Changes Resistor Standards

IN RMA STANDARD M4-215, the markings for tolerance of fixed composition resistors have been expanded as follows:

Brown	Plus or minus	1%
Red	Plus or minus	2%
Orange	Plus or minus	3%
Yellow	Plus or minus	4%
Gold	Plus or minus	5%
Silver	Plus or minus	10%
No Color	Plus or minus	20%

The use of green for 5 percent was opposed, so as not to have two different ways of indicating the same tolerance.

In Standard M4-216, the exterior body color of insulated resistors may now be any color other than black. The preferred color is natural tan. The exterior body color of uninsulated resistors shall be black, except that in the case of unisulated resistors with radial leads the exterior body color may be white if the resistors are color-coded in accordance with Standard M4-214B, or may be that of the color code of the first significant figure of the resistance value if resistors are color-coded in accordance with Standard M4-214A.

RMA Spring Meeting

IN TWO TECHNICAL sessions starting at 9:00 a.m. on Monday, April 29 and Tuesday April 30, 1946, eight technical papers will be presented at the Spring Meeting of the Engineering Department of Radio Manufacturers Association, to be held at the Hotel Penn-Harris, Harrisburg, Pa. At a dinner Tuesday evening R. C. Cosgrove, RMA president, will be toastmaster and W. R. G. Baker, director of the RMA Engineering Department, will speak on "The transmitter Engineer and the Electronics Industry."

The following papers are scheduled

SHORTEST
LINE
between
DEMAND
and
SUPPLY

Your need for high quality radio-electronic components is satisfied quickly and on schedule when you deal with firms represented by the Henry P. Segel Co.

Our organization represents leading manufacturers of basic components, concerns with sound reputations for meeting strictest specifications and "delivering on time as promised."

These are dependable sources of supply, geared to fulfill your requirements rapidly and efficiently.

For over 21 years our business has been serving manufacturers and jobbers in New England. Let us prove to you how we can help keep your production going at full speed. For prompt, complete information, contact us now!

HENRY P. SEGEL COMPANY

Manufacturers Representatives
Field Engineers

143 Newbury Street
Boston 16, Mass.

Tel.: KENmore 3012—6333—9755

Branch Office in
Hartford, Connecticut

Serving manufacturers, jobbers, schools
and laboratories in New England

RAWSON TWIN MULTIMETER



Type 5012 Accuracy $\frac{1}{2}$ of 1% DC
Size 12"x8"x6"
A Combination AC, Multimeter and DC
Multimeter

Range of Measurements

DC 1 microampere to 1 Ampere.
20 Microvolts to 1000 volts.
AC (thermocouple type)
2 Milliampere to 3 Amperes.
60 Millivolts to 1000 volts.

Write for bulletin
WE ALSO SUPPLY

REGULAR DC METERS
THERMOCOUPLE AC METERS
MULTIMETERS
FLUXMETERS
ELECTROSTATIC VOLTMETERS

Special apparatus built to order

**RAWSON ELECTRICAL
INSTRUMENT COMPANY**

111 POTTER ST. CAMBRIDGE, MASS.
Representatives
CHICAGO NEW YORK CITY

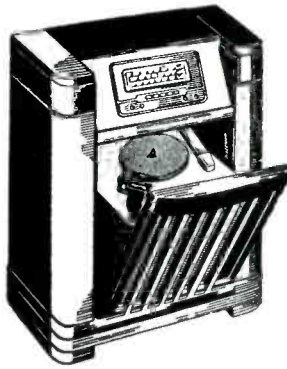

Cellusuede FLOCK

HAS MANY USES
IN RADIO

1. Coating cabinet interiors dissipates reflections and adds acoustical qualities.
2. Coating the edges of adjoining parts before assembly eliminates vibration.
3. Coating wire grills adds a smart finish at low cost.
4. Coating phonograph turntables adds a soft non-scratching cushion for records.
5. Coating cabinet bases lends a soft velvety "feel" and protection to table and desk tops.

Both Cotton and Rayon Flock are available immediately in a variety of colors.

A trial application will show you how easily this versatile material may be handled . . . how practical it is for the above mentioned uses.

Write for Booklet, Color Card, Samples and Prices



Find Out Now About

★ STAR ★ CERAMICS

There are many kinds for special uses, such as applications calling for resistance to electricity, heat, moisture, chemicals or weathering agents. There are more than a score of formulas in actual production at one time in our factory.

Send for "A Brief Survey of Technical Characteristics of Molded Ceramic Products." It is right to the point.

★
The **STAR**
PORCELAIN CO.

Electronics Dept.
Trenton 9, N. J.

PRODUCTION WINDING FACILITIES

For all types of COIL & MOTOR WINDINGS



Wound completely to your specifications:

- 1 Any type of fractional horse power motors or generators, A.C. or D.C.
- 2 Three phase motors from 1/6 horse power to 5 horse power.
- 3 Shaded pole motors such as fans, blowers, etc.
- 4 Dynamotors or small aviation M.G. sets up to 500 watts output.
- 5 Solenoid coils.

**IMMEDIATE
DELIVERIES**

Pilot

ELECTRIC COMPANY
29 S. BROADWAY, LONG BRANCH, N. J.



for Radio Components....

call **NORMAN H. LAWTON**

ENGINEERING • SALES • SERVICE

NEW YORK: 1775 Broadway, 19 INDIANAPOLIS: 635 Pennsylvania St., 4

DIRECT FACTORY REPRESENTATIVE

- A. W. FRANKLIN MFG. CORPORATION—Sockets . . . Terminal Strips . . . Plugs . . . Assemblies.
- ELECTRO-MOTIVE MFG. CORPORATION—Moulded Mica Capacitors . . . Mica Trimmer Capacitors Fused Plugs . . . etc.
- F. W. SICKLES COMPANY (Eastern Representative)—I. F. Transformers . . . Antenna Loops . . . Trimmer . . . Condensers (mica and air dielectric) . . . Tuning Units
- QUAKER CITY GEAR WORKS—Precision Gears for Industry.
- UNITED TRANSFORMER COMPANY—Transformers
- MICA PRODUCTS COMPANY—Mica Sheets and Fabricated Parts

WEAR RESISTANT

NON-CORROSIVE

NON-ABRASIVE

PERMOPIVOTS

NON-MAGNETIC

SUPER-POLISHED

Yes, Extra Value!

Long after the ordinary pivot has worn out you'll find PERMOPIVOTS in the prime of life—faithfully keeping precision instruments precise! It's all due to the special PERMOMETAL up—the ideal osmium alloy. . . . Made to your specifications. Write for information!

PERMO
INCORPORATED

6427 BAYVIEWWOOD AVE., CHICAGO 26
MANUFACTURING METALLURGISTS

for the technical program:

April 29: Broadcast Transmitter Design as Determined by Market Survey, by M. R. Briggs of Westinghouse; A 5-kw Television Tube—Design and Application, by R. B. Ayer and C. D. Kentner of RCA; A Proposed Method of Rating Microphones and Loudspeakers for Systems Use, by F. Rumanow of Bell Labs; Railway Communication, by A. V. Dasburgh of General Railway Signal Co. and E. W. Kenefake of GE.

April 30: The Hydrogen Thyatron, by H. Heins of Sylvania; Mobile Communications Range Tests, by D. E. Noble of Galvin; The Use of Intermodulation Tests in Designing and Selecting High Quality Audio Channels, by J. K. Hilliard of Altec Lansing Corp.; Navar System of Radio Navigation and Air Traffic Control, by H. Busignes and P. Adams of Federal Telephone & Radio Corp.

MEETINGS TO COME

APRIL 1; IRE-AIEE Atomic Engineering Lecture Series (members \$1 per lecture; nonmembers \$1.50); Mass Analysis and Isotope Separation, by J. A. Hipple of Westinghouse; 7 p.m. at Engineering Societies Building, 33 W. 39th St., New York City.

APRIL 8; IRE-AIEE; Measuring Instruments for Atomic Engineering (see April 1 data).

APRIL 10; AIEE; Applications of Servomechanisms, by S. J. Mikina; 7 p.m. at 301 Pupin Hall, Columbia University.

APRIL 15; IRE-AIEE; Medical and Industrial Applications of Atomic Physics, by R. D. Evans of MIT (see April 1 data).

APRIL 25-30; INTERNATIONAL LIGHTING EXPOSITION; Stevens Hotel, Chicago.

APRIL 29-30; RMA SPRING MEETING; Hotel Penn-Harris, Harrisburg, Pa.; chairman V. M. Graham, P.O. Box 750, Williamsport, Pa.; eight technical papers to be presented.

MAY 13-16; RADIO PARTS AND ELECTRONIC EQUIPMENT TRADE SHOW; Stevens Hotel, Chicago; inquiries to 221 N. LaSalle St., Chicago; special train for radio industry personnel leaves Grand Central Station, New York City at 4:15 p.m. May 12—

Optical Glass Specialities



Television Reflectors

Precision-polished optical face plates for cathode ray tubes

Optical lenses, prisms and flats

FS Precision-Bore Glass Tubes with bore exact within .0002"

Contact us for such requirements

FISH-SCHURMAN CORPORATION
230 East 45th St., New York 17, N. Y.

Fish-Schurman 



In future peace-time production, Radex will uphold its war-won reputation by the scope and caliber of its service to the radio and electrical industries.

Radex Corporation

53 W. Jackson Blvd., Chicago 4, Ill.

PLASTICON* CAPACITORS

Can you use a 10,000 VOLT PLASTICON $\frac{1}{8}$ the size of a corresponding paper capacitor?

Because of the 4400 volt per mil breakdown voltage of the Plasticon film dielectric, high voltage Plasticons are smaller, lighter and more economical than paper capacitors.

*Plasticons—plastic film dielectric capacitors

Condenser Products Company
1375 NORTH BRANCH STREET
CHICAGO 22, ILLINOIS

STANDARD CRYSTALS

Send for New Catalog

STANDARD PIEZO COMPANY

Established 1936

Quartz Crystals and Frequency Control Equipment

Office and Development Laboratory

SCRANTON, PA.

CARLISLE, PA., P. O. BOX 164

CARLISLE, PA.

Representatives

COOPER-DIBLASI

259 WEST 14th STREET, NEW YORK 11, N. Y.

HAL F. CORRY

3522 GILLON AVENUE, DALLAS 5, TEXAS

THE FOSTER COMPANY

409 LUMBER BLDG., MINNEAPOLIS, MINN.

GERBER SALES COMPANY

94 PORTLAND STREET, BOSTON 14, MASS.

A. SIDNEY HARDY

650 BOULEVARD N. E., ATLANTA, GA.

HARRY A. LASURE

2216 WEST 11th STREET, LOS ANGELES 6, CALIF.

L. D. LOWERY

1343 ARCH STREET, PHILADELPHIA, PA.

MANUFACTURERS SALES TERMINAL, Inc.

222 COLUMBIA BLDG., SPOKANE, WASHINGTON

HARRY B. SEGAR & COMPANY

ELLCOTT SQUARE BLDG., BUFFALO, N. Y.

E. J. WALL

1836 EUCLID AVENUE, CLEVELAND 15, OHIO

CHECKS - GRADES RESISTORS 100 Ohms to 100 Megohms At A GLANCE



Clippard



AUTOMATIC RESISTANCE COMPARATOR

Type
PR-4

The quality inspection instrument every radio, electrical, electronics, resistor manufacturer and large parts jobber has long been looking for. Makes precision checking of incoming shipments of resistors, factory output, matching or grading to close tolerance limits, a simple production routine!

Easy to Operate

Instrument is readied for operation by snapping power switch, warming up, adjusting zero and connecting standard resistor at left. Operator places resistances to be checked across "unknown" terminals in center. Accuracy can be checked periodically by simple turn of knob at left. To change from one value resistor test to another, merely plug in proper standard. No other adjustment necessary!

Reads Percent Deviation

Face of large, easily-read meter in center illuminates when unknown is inserted, showing percent of variation from standard within limits of -25% to +30%. NO OTHER OPERATION IS REQUIRED, reducing inspection time to absolute minimum!

Laboratory Quality

Rugged laboratory construction and careful calibration assure accuracy of better than $\pm 1\%$ throughout entire range of 100 ohms to 100 megohms. Line variations, 105-125 volts A.C., automatically compensated for by special newly-developed electronic bridge circuits. An instrument that pays for itself quickly and saves you time and labor costs for years thereafter. Write for complete details and specifications, today!

SPECIAL INSTRUMENTS FOR ELECTRICAL AND ELECTRONIC TESTING
ELECTRO MAGNETIC WINDINGS

R. F. COILS

SUB-ASSEMBLIES



make reservations with Perry Saftler, 53 Park Place, New York.

MAY 15-17; NEW ENGLAND ELECTRICAL TRADE SHOW; Exhibition Hall, Boston, Mass.

MAY 20-25; NATIONAL MARITIME EXPOSITION; Grand Central Palace, New York City; inquiries to headquarters at 17 Battery Place.

JUNE 20-23; SOCIETY FOR THE PROMOTION OF ENGINEERING EDUCATION; annual meeting, Jefferson Hotel, St. Louis, Mo.

BUSINESS NEWS

GENERAL ELECTRIC Co. has set up a new industrial engineering division, to be known as the Power Electronics Division and headed by L. W. Morton.

GRIGSBY-ALLISON Co., INC., Arlington Heights, Ill., organized in late 1945 by R. J. Grigsby and K. C. Allison, will produce radio switches, tuners, and other electrical and mechanical devices in a new plant now nearing completion.

L. S. BRACH MFG. Co. celebrates its 40th anniversary by moving into its recently purchased three-story building in Newark, where they will concentrate on development and increased production of a diversified line of antennas while continuing to manufacture private-brand radio and electrical products.

PRECISION SPECIALTIES, Los Angeles, has started operation of a new radio-electronics section. Among the first products will be several models of home radios.

U. S. TELEVISION MFG. CORP. has moved to new quarters at 3 West 61st St., New York City, where they are planning for a production schedule of over 5,000 finished radios per week. Manufacture of television sets is scheduled to begin in the spring. GENERAL INSTRUMENT CORP., Elizabeth, N. J., is installing a $1\frac{1}{2}$ -mile conveyor system and will soon have a total of 3,400 workers as compared to 1,100 on V-J day.

AUDIO PRODUCTS Co., Burbank, Calif., has established an electronic application division to produce various types of electronic controls.

CINCH MFG. CORP., Chicago, wholly owned subsidiary of United Carr Fastener Corp., has purchased the assets of Howard B. Jones Co., and will continue production of Jones

STANDS UP IN HARD SERVICE



IT'S
ENGINEERED WITH
Hi-Q
COMPONENTS

Every engineer knows that failure starts with the little parts. That's why more and more development engineers place their dependence on Hi-Q Ceramic Capacitors, Wire Wound Resistors and Choke Coils. They know through their own actual tests, that Hi-Q Components stand up under every condition of temperature, humidity, vibration and shock. Test these sturdy components in your own applications. Send your specifications for samples and complete data.



CERAMIC CAPACITORS

Made of titanium dioxide (for temperature compensating types). Tested for physical dimension, temperature coefficients, power factor and dielectric strength.



WIRE WOUND RESISTORS

Immediately available in standard ratings or precision built to any tolerance or value.



CHOKE COILS

Sturdy Construction. Insulated or bare types. Quantity production available at once.

**ELECTRICAL REACTANCE
CORPORATION**
FRANKLINVILLE, N. Y.

RADIO HARDWARE
Wires and Cables

Quality since 1923

... also pioneers in the design and manufacture of

Ceramic, Porcelain & Steatite insulators, Antennas, Hook-Up Wires, Shielded Microphone Cable and S. J. Cable.

Specify and use "Birnbach" products. Complete Stock at your jobber.

BIRNBACH RADIO CO., Inc.
145 HUDSON ST. NEW YORK, 13, N. Y.

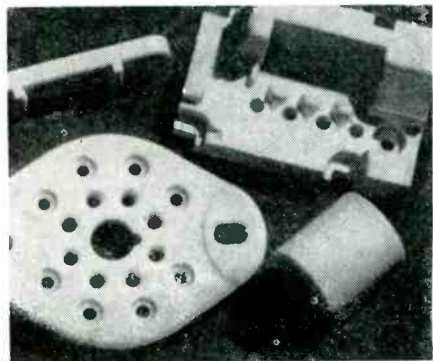

Lavite STEATITE CERAMIC

Properties and Characteristics of Our LAVITE SI-5 Steatite Ceramic Body

Compressive Strength	96,000 lbs. per square inch
Tensile Strength	7,200 lbs. per square inch
Flexural Strength	10,500 lbs. per square inch
Modulus of Rupture	20,000 lbs. per square inch
Dielectric Strength	235 volts per mil
Dielectric Constant	6.42
Loss Factor	2.90
Power Factor	4.46
Bulk Specific Gravity	2.664
Density (from above gravity)	0.096 lbs. per cubic inch
Hardness (Mohr scale)	2.350
Softening Temperature	2,350°F.
Linear Coefficient of Expansion	8.13x10 ⁻⁶
Moisture Absorption (ASTM D-116-42-A)	0.009%

Design engineers and manufacturers in the radio, electrical and electronic fields are finding in LAVITE the precise qualities called for in their specifications . . . high compressive and dielectric strength, low moisture absorption and resistance to rot, fumes, acids, and high heat. The exceedingly low loss-factor of LAVITE plus its excellent workability makes it ideal for all high frequency applications.

We will gladly supply samples for testing.

D. M. STEWARD MFG. COMPANY
Main Office & Works: Chattanooga, Tenn.
Needham, Mass. Chicago Los Angeles

New . . . "DIALCO" PLN-849 Pilot Light

features the
New Neon NE-51 Bulb

with
BUILT-IN RESISTOR

For 110 Volts (and higher)

A RUGGED UNIT. Consumes a small amount of current (under one milliamper) and has dependable long life. Note these important features of the PLN-849 Pilot Light: (1) RESISTOR INTEGRAL with socket assembly. Value to suit supply voltage. (2) Moulded Bakelite Socket. (3) Full-view Jewel Plastic Cap for visibility at all angles. (4) Rugged terminals, binding screw or permanent soldering type. (5) High resistance to vibration or shock. (6) Supplied complete with General Electric Neon NE-51 Bulbs. May also be adapted to accommodate General Electric Radio Panel Bulbs such as 47, 44, etc., for low voltage circuits. Bulbs removable from front of panel.



Patent Pending

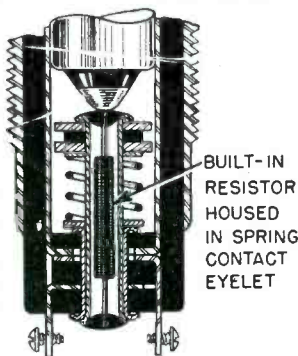

Write today for samples and prices.
There is no obligation.

WRITE FOR NEW ILLUSTRATED BROCHURE

DIAL LIGHT CO. of America, Inc.

900 BROADWAY • NEW YORK 3, N. Y.

Telephone: ALgonquin 4-5180-1-2-3

EISLER EQUIPMENT

..complete and diversified for every phase of electronic* manufacture!

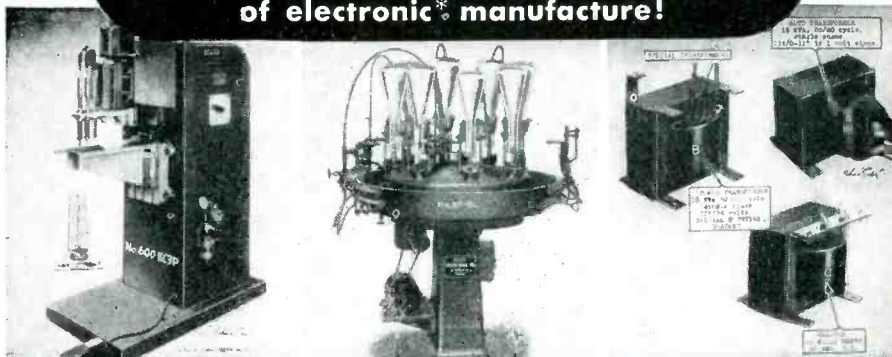

(A) No. 600-KC3P, 50 KVA Press Type Spot Welder, 3 Spots, Air Operated, 18" Throat—a high production unit.

(B) No. 57-8L New Eisler 8 head type Tipless Sealing Machine. Adaptable for all types and sizes of bulbs.

(C) EISLER Special Transformers and Reactors—high or low voltage; air cooled, oil immersed or uncased.

The CHAS. EISLER line of specialized electronic tools, machines and devices is complete and diversified. Included are innumerable types of welders—spot, seam, butt, rocker, arm, pneumatic and special types. Also included are hundreds

of devices for vacuum tube manufacture—glass tube cutters, slicers, stem and sealing machines as well as an all-inclusive line of transformers for every industrial and general need.

* EISLER serves 99% of American vacuum tube producers today. Write for completely illustrated catalog.

CHAS. EISLER EISLER ENGINEERING CO.

751 310 15th STREET (N. Newark Ave.) NEWARK, NEW JERSEY

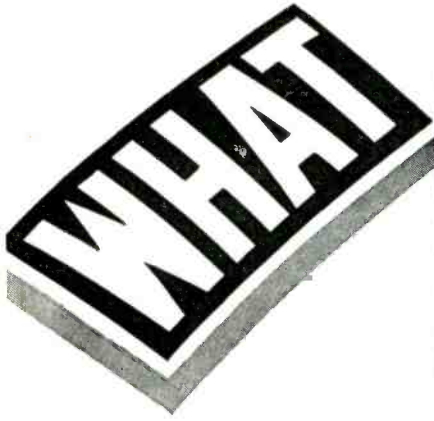

can be done to improve transmitting equipment?

The answer is BUD Products when precision-made coils and condensers are needed. Ruggedness and durability characterize this line.

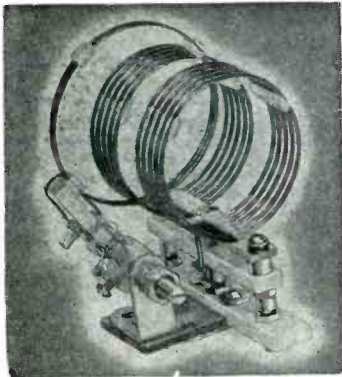

All coils are of the air-wound type to promote efficiency. The use of a variable link to the plate tank as a means of varying the loading of an R.F. stage is effectively utilized.

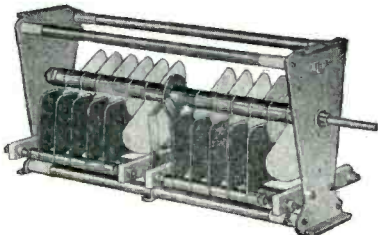

This BUD condenser is the deliberate choice of many engineers for use in broadcast transmitters, high-power transoceanic communications and other types of highly specialized electronic devices.

BUD Can Supply All Your Needs . . .

. . . with the latest types of equipment including: condensers — chokes — coils — insulators — plugs — jacks — switches — dials — test leads — jewel lights and a complete line of ultra-modern cabinets and chassis.



products under a new management, with Howard B. Jones being retained in a consultant capacity.

PAUL GODLEY Co., Upper Montclair, N. J., has moved its radio engineering laboratories to Great Notch, N. J., in a tranquil, close-to-nature setting at The Notch in the Watchung Mountains.

ACME ELECTRIC & MFG. Co. has a new and modern plant nearing completion at Cuba, N. Y. that will more than double its transformer

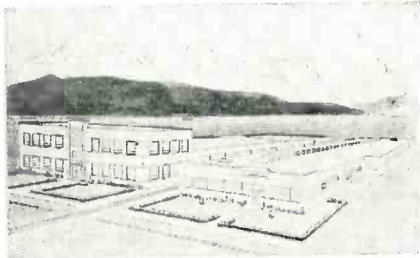

Cuba, N. Y. manufacturing facilities of Acme Electric & Mfg. Co. Noisebreaking walls will separate punch press departments from assembly lines

manufacturing facilities. One entire section will be devoted to research on transformer design and performance.

TECHNOLOGY INSTRUMENT CORP. has been established in Waltham, Mass. by H. H. Scott, R. W. Searle, and L. E. Packard, all formerly with General Radio Co. The new firm will develop and manufacture electronic and laboratory equipment. Mr. Scott, who will serve as president, was responsible for development of General Radio's present line of sound and vibration measuring equipment, f-m and broadcast station monitoring equipment, and other r-f and a-f instruments.

RCA VICTOR DIVISION has leased a plant in Chicago solely for the fabrication and assembly of auto radios, with peak employment of approximately 700 workers scheduled for June 1.

THE ELECTRODYNE Co., Boston, was formed recently to provide research and development service in electromechanics, vacuum-tube applications, and optics, as well as manufacture of electronic equipment. Bertram Wellman is president, Elek J. Ludvigh, II, is director of research, and B. J. Kaplan and Leslie G. Rathbun, Jr., are vice-presidents.

ILLINOIS INSTITUTE OF TECHNOLOGY will make available to sponsoring or-

NEW
MPB

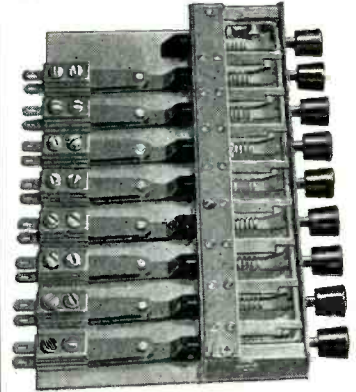

**MASTER PUSH
BUTTON SWITCH**

by

GENERAL CONTROL COMPANY

The new "Master" Model MPB push button switch is new from stem to stern. Its sturdy, modern construction means long trouble-free life — its fine silver contacts, rugged, non-corrosive parts, quality workmanship and only the finest materials throughout, mean customer satisfaction for you.

The new "Master" Model MPB non-locking frame includes nine switch positions — locking type frames have eight switch positions and one reset position. Any switching combination which has been set can be released by one operation of the reset button.

The new "Master" Model MPB is rated at 5 - 10 amperes, 125 volts, 60 cycles A.C. (non-inductive load). If you are a manufacturer or user of electronics and communications equipment, it will pay to investigate the new Model MPB. Further information on request.

Write for
NEW Catalog No. 200
it's just off the press!

General Control Company

1202 Soldiers Field Road
Boston 34, Mass.





HOW TO

Speed up Production

when pouring Potting Compound

Here's a typical installation of Sta-Warm compound melting equipment, employing heated hose for dispensing.

From a rectangular tank built to user's own specifications for capacity and proportions, and equipped with variable thermostat control, melted potting compound is dispensed into transformers through a 10 ft. Sta-Warm flexible metallic hose. The hose itself is electrically heated to maintain proper temperature of the compound until it reaches its destination. A separately controlled

thermostat on the hose line further guarantees that the compound will neither burn (and carbonize) or freeze (and solidify) before leaving the nozzle.

The tank only, the hose only, or both as a complete working unit may be ordered as required to fit into your compound melting and dispensing set-up to speed up production without adding extra man-hours.

Why not inquire for full details and prices today by writing fully to Dept. D?

STA-WARM ELECTRIC CO.

1000 N. CHESTNUT ST. • RAVENNA, OHIO

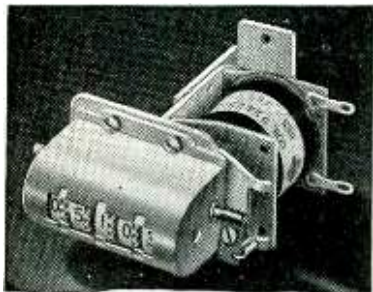

SPECIFICATIONS:

Manual counter type M1. Non-electrical but otherwise exactly as described. Complete with lever. Each: \$1.75. Electric counter, Non-reset, type NR1, exactly as shown and described. \$4.10 each for 115 volts, 60 cycles. Other voltages from 6 to 220 are 75c extra. Convenient mounting bracket, 26c. Reset electric counter, type R1 (not shown), soon available. 5 digits. Heavy duty. Resets with twist of fingers. Torque motor type, suitable also for electronic circuits. Standard voltages 6 to 220. Net each: \$14.50.

40,000 TIMES EVERY HOUR!

A G&G HiSpeed ELECTRO-COUNTER, registers up to 40,000 counts an hour . . . it records with consistent accuracy up to 600 times a minute!

Used for Production Controls, Operational Checks, Functional Actions. Increases accuracy; reduces time of record-taking; permits accumulation of new data.

Compact, sturdy, well-engineered. Mechanism entirely enclosed in cadmium-plated housing. Easy-to-read figures behind plastic window.

Write for counter sheet I-246
facsimile paper sheet "Electrex"

GORRELL & GORRELL

Originators and Makers of Recording Equipment Since 1925
HAWORTH, NEW JERSEY

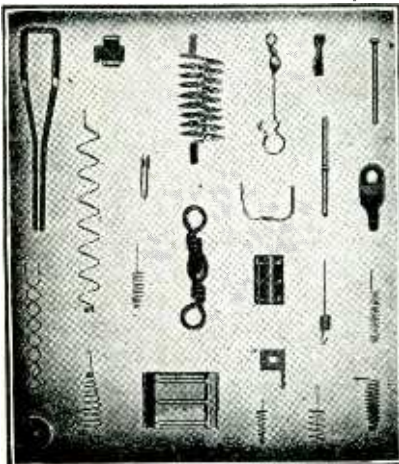

SMALL PARTS

Filaments, anodes, supports, springs, etc. for electronic tubes. Small wire and flat metal formed parts to your prints for your assemblies. LUXON fishing tackle accessories, double pointed pins, fine sizes wire straightened. Inquiries will receive prompt attention.

ART WIRE AND STAMPING CO.

227 High St.

Newark 2, N. J.

ELECTRONICS ENGINEERING

PRODUCT DEVELOPMENT
AND ENGINEERING • RADIO,
TELEVISION, ELECTRONIC
EQUIPMENT DESIGN

Electrical Controls, Motors, Generators, Power and Sub-Station Equipment. FM, Standard and Short Wave Amplifiers, Transformers, Speakers, Station Equipment. Special Induction and Dielectric Heating Machines. Photo-electric Controls, High Frequency Generators, Measuring Equipment, Etc.

action

When You Need It Fast
Entire Project or Any Phase
Work in Your Shop or Ours

BARNES & REINECKE

INDUSTRIAL DESIGNERS & ENGINEERS
230 E. OHIO ST.
CHICAGO 11

STAFF
of 181
12th
YEAR

ANOTHER SPECIAL BY PROGRESSIVE

CATALOG SHOWS DOZENS MORE
 Special heads, threads and finishes on any metal or alloy adapted to cold upset. Weekly output: 25,000,000 pieces. Many specials, suggesting production savings for you, illustrated in latest catalog. Includes weights per 1M standard pieces, dec. equivs. of fractions, other purchasing and engineering helps. Write for Catalog 18.

The PROGRESSIVE MFG. CO.
 50 NORWOOD ST., TORRINGTON, CONN.

ganizations the facilities of its Ohmite Laboratory for making precise measurements of electrical and magnetic quantities, approaching in accuracy those of the National Bureau of Standards.

PERSONNEL

ALEXANDER NORDEN, for many years vice-president of L. S. Brach Mfg. Co., has been elected president of Interstate Mfg. Corp., Newark, N. J.

CHARLES JEFFERS has returned to his post as technical director of WOAI, San Antonio, after three years service with OWI where he served as chief of the Engineering Division, Communications Facilities Overseas Branch.

WILLIAM F. FRANKART, formerly assistant chief engineer of Aireon Mfg. Corp., Kansas City, Kansas, takes over as radio department head at Precision Specialties Co., Los Angeles.

ROGER B. COLTON has retired from the Army after 35 years service and is now associated with the firm of

ENDURANCE

Your profit from the use of any kind of equipment hinges on its quality of performance — and on its *endurance*. Electronic Engineering Company transformers are built ruggedly to give *lasting* service under all conditions. If you have special and difficult transformer problems, feel free to make use of the finest engineering talent and most complete electronic laboratories. Write or call today.

"SPECIALIZED
Transformer
 ENGINEERS"

3223-9 WEST ARMITAGE AVE. CHICAGO 47, ILL.



General Henry H. Arnold (left) presenting Distinguished Service Medal and Legion of Merit to Major General Roger B. Colton in recognition of outstanding wartime services that included developments leading to applications of radar to strategic bombing, fire control, and guided missiles

Colton & Foss, Inc., Washington, D. C., electronic consultants specializing in broadcast, public service communications, radio, and radar development.

ARTHUR H. WULFSBERG has joined the Research Division of Collins Radio Co. Previous work involved design and production of radar and loran equipment at Sylvania Electric Products Inc.

C. R. MADUELL, JR., formerly research physicist for Signal Corps

2 VITAL AIDS

TO THE MANUFACTURER OF
Miniature Tube Radios

★ **STAR**



DOUBLE-CHECK SYSTEM

#JE-10—Miniature socket wiring plug for accurate alignment of miniature socket contacts during wiring. Precision cast of zinc base alloy—Pins of stainless steel.

#JE-12 — (Hardened tool steel insert) or JE-13 (Stainless steel insert) Miniature tube pin straightener to obtain a perfect fit when the tube is placed in the set.



For complete information and prices—write

RADIO ACCESSORY DIVISION
STAR EXPANSION PRODUCTS CO.
147 Cedar St., New York 6, N. Y.

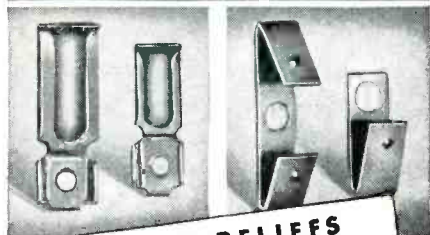
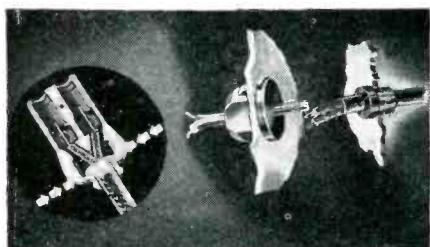

**STRAIN RELIEFS
HEATER PLUG CONTACTS
CUBE TAP CONTACTS**

Complete line for all applications.
Many sizes ready for shipment.
When writing for literature and samples, please state wire size.



HEYMAN MANUFACTURING COMPANY

510 Michigan Ave. Kenilworth, N. J.

HATHAWAY OSCILLOGRAPHS

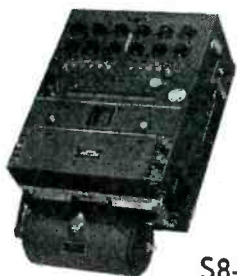

S8-B

*For
Every
Purpose*



S12-A

TYPE S8-B—General purpose, laboratory and field, 12 to 24 elements. Permanent film or paper record, 6" to 10" wide, to 200' long. Record speeds from 1/3" to 40" per second, instantly selected by quick changing transmission. Simultaneous viewing and recording. Time coordinate device. Bulletin SP-165.

TYPE S8-C—Identical to S8-B—with 24 to 36 elements. Bulletin SP-165.

TYPE S8-D—Similar to Type S8-B in quality and accuracy. Low cost; automatic features are not included. Bulletin SP-175.

TYPE S12-A—Portable general purpose laboratory and field, 12 elements. Record speeds quickly selected by change gears from 1/2" to 48" per second. Simultaneous viewing and recording. Bulletin SP-167.

TYPE S14-A—NEW STUDENT OSCILLOGRAPH. Accurate and dependable. General purpose laboratory and field. Ideal for colleges and technical schools. Instant magazine loading. Simultaneous viewing and recording. Bulletin SP-182.

HATHAWAY INSTRUMENT CO., Denver 10, Colo.

A Buy-word for Excellence

40

YEARS

PUR-A-TONE

Reg. Trade Mark

ANTENNAS

DEPENDABILITY

1906

BRACH

1946

ALL TYPES FOR

- AUTOS
- HOMES
- MARINE

A. M. — F. M. — TELEVISION

Make pleased customers and bigger profits . . . ask your distributor for BRACH Puratone ANTENNAS.

Special-purpose transmitting antennas designed for volume production to your own specifications. Collapsible — sectional — direction finding — radar and coaxial type. All sizes, lengths and materials. Consult us on your needs.

L. S. BRACH MFG. CORP.

200 CENTRAL AVENUE NEWARK, N. J.



WORLD'S OLDEST AND LARGEST MANUFACTURERS OF RADIO ANTENNAS AND ACCESSORIES.

CAPACITOR QUESTIONS Answered!



"THE ELECTROLYTIC CAPACITOR"

by Alexander M. Georgiev

Probably no Radio-Electronic component is more important than the Electrolytic Capacitor, and this new book by Alexander M. Georgiev who has devoted more than 15 years to Capacitor research and development answers all the many questions engineers, designers, servicemen and others have been asking about this subject. Abundant data are presented as to Electrolytic Capacitor constructional features, — where, when and how to use them to best advantage in preference to non-electrolytic types — in short, everything you need to know in order to utilize, buy, specify, replace or service Capacitors intelligently and efficiently. A comprehensive bibliography and list of patents will prove of far-reaching value. Contains over 200 pages and eighty illustrations including graphs, photomicrographs, oscillograms, etc. Just out in limited edition—the first modern book to be written on this vital component! Order today while the supply lasts.

WHAT TYPE?

WHY?

WHERE?

~~\$3.00~~
\$3.00

\$3.25 foreign

ALL THE FACTS ON A LITTLE KNOWN SUBJECT

Electrolytic Capacitor Construction Characteristics; Advantages; Applications; Operation at low and high voltages and frequencies; a-c or pulsating d-c; ambient conditions; wet versus dry; electrolytic versus non-electrolytic; behavior of various types; choosing the best type for a given application and operating conditions; servicing; testing; replacement and emergency repairs—and dozens of other subjects of foremost interest to all who design, handle, or service equipment incorporating capacitors.

ORDER NOW!

MURRAY HILL BOOKS, Inc.
Dept. E-46, 232 Madison Ave., New York 16, N. Y.
Enclosed find \$.....for.....copies of Alexander M. Georgiev's "THE ELECTROLYTIC CAPACITOR" (Price \$3 each, \$3.25 foreign) or send C.O.D. (in U.S.A. only) for this amount plus postage.

Name

Address

City & Dist. No.....State.....

Engineering Labs, is now consultant physicist and vice-president of Delta Electronic Equipment Co., New Orleans, La.

ROBERT H. HOLLISTER has been named service department manager at Collins Radio Co.

MATT J. JELEN, after ten years with Sparks-Worthington Co., has joined U. S. Television Mfg. Corp. as senior engineer in the Radio Division.

ALLEN D. PETTEE has been made chief electrical engineer of General Cable Corp., New York, N. Y.

HOMER HOWARD is now chief engineer of Audio Products Co., Burbank, Calif. He was formerly manager of the Pacific Coast radio division of Lear Aircraft.



H. Howard



C. M. Wheeler

CARSON M. WHEELER has joined Amperex Electronic Corp., Brooklyn, N. Y., as chief engineer in charge of tube development. For the last ten years he was with Federal Telephone and Radio Corp., serving during the war as assistant to the director of vacuum tube research.

J. D. SCHANTZ received a promotion to assistant manager of the research department at Farnsworth Television & Radio Corp., Fort Wayne, Indiana, having been with this firm and the predecessor company in Philadelphia since 1936.



J. D. Schantz

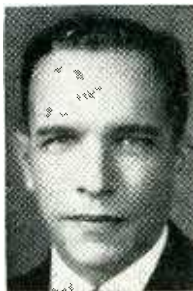

H. C. Florance

HERBERT C. FLORANCE has been made chief engineer of WGHF, new f-m

WOLLASTON Process
Wire... So Fine it
can be seen only
under high
Magnification



We can draw wire as small as

$\frac{1}{100,000}$ of an inch
in diameter

... available in Platinum and some other Metals

.00001" is less than 1/30 the diameter of the smallest wire die commercially available. Yet our Wollaston Process wire (drawn in a silver jacket) closely meets your specifications for diameter, resistance and other characteristics.

This organization specializes in wire and ribbon of smaller than commercial sizes and closer than commercial tolerances. Write for List of Products.

SIGMUND COHN & CO.



44 GOLD STREET NEW YORK 7



ACTUAL SIZE

Commercial Crystals to 35 Megacycles

35 megacycle crystals now mean fewer doublers, less weight, space and cost in your VHF equipment. Immediate delivery of specified frequency crystals.

- Low Temp. Co-efficient
- .01% Tolerance
- 60 ma. Current Capacity
- Nominal Cost

Territory Open for Factory Representation

RADIO SPECIALTY MFG. CO.
PORTLAND, OREGON

PROBLEMS of weight, space, alignment, obstructions, vibration, and cost—solved by WALKER-TURNER Flexible Shafting

• In certain applications of control and power transmission, no other form of drive proves as successful as Walker-Turner Flexible Shafting. For mechanical coupling between components; for control of capacitors, potentiometers, tuning circuits; for flexible power drive around obstructions—use Walker-Turner Flexible Shafting. Our wide experience is at your disposal, without any obligation to you or your company.

WALKER-TURNER COMPANY, INC.
PLAINFIELD, NEW JERSEY

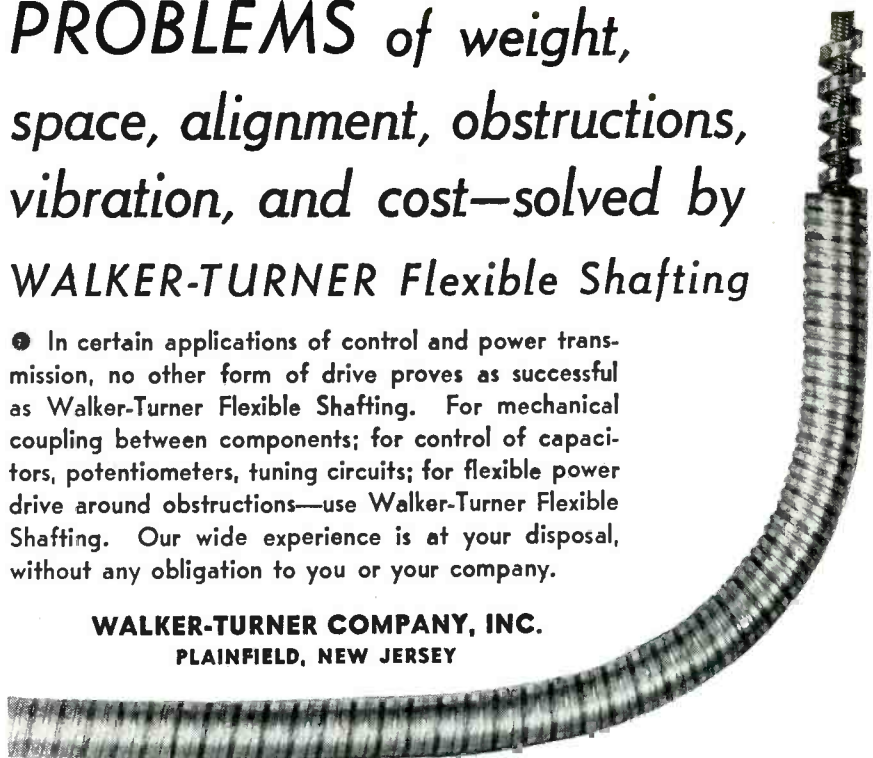

FLEXIBLE SHAFTING

FOR REMOTE CONTROL AND POWER TRANSMISSION

Bagshaw's NEEDLES

FAMOUS SINCE 1892
for Better Record Performance



Maybe the very first "cutting" was done with the grand-daddy of this famous recording needle . . . for BAGSHAW came in with the talking machine itself! Preferred in sound studios where only the BEST will do . . . perfect cutting mate for our great transcription Needle that you know so well!

H. W. ACTON CO., INC.
SOLE DISTRIBUTOR
370 SEVENTH AVENUE NEW YORK 1, N. Y.

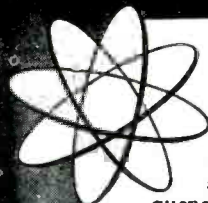

REGULATED POWER SUPPLY

250-450 VOLTS

Wide fields of application have been opened up both in research and industry for this unit. A-C ripple is negligible and extreme care has been taken to eliminate high-frequency noise. Regulated power supply units are invaluable for such applications as amplifiers, television pulse generators, constant frequency oscillators, and measuring equipment.

Other G-E regulated power-supplies are available in the following ranges: 180-300 volts 160-1500 volts Dual Regulated

Write today: Electronics Department, Specialty Division, General Electric, Syracuse, N. Y.

GENERAL ELECTRIC

Electronic Measuring Instruments



PS-1

The **FINEST MICROPHONES**
for P.A. and RECORDING!



AMPERITE VELOCITY
MICROPHONE
WITH
PATENTED ACOUSTIC COMPENSATOR

New P.G. DYNAMIC
WITH NEW
SUPERIOR ELIPSOID PICK UP PATTERN!

AMPERITE KONTAK MIKES
IDEAL FOR AMPLIFYING
STRINGED INSTRUMENTS
USED WITH ANY AMPLIFIER
AND WITH RADIO SETS.

ASK YOUR JOBBER . . . WRITE FOR FOLDER

AMPERITE

361 BROADWAY NEW YORK

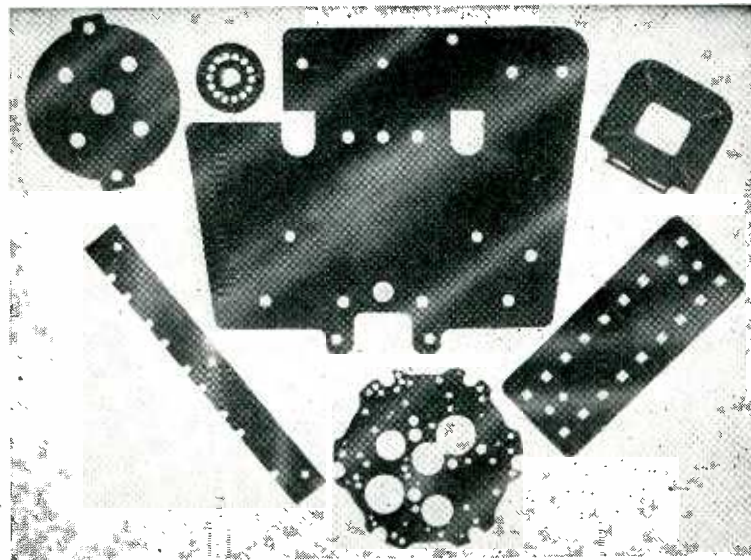
• PLASTIC FABRICATING •

PUNCHED AND FABRICATED PARTS, SPEED AND ACCURACY IN TOOL CONSTRUCTION AND PRODUCTION REQUIREMENTS

• BAKELITE SHEETS, RODS, TUBES •

Over 20 years of fabricating experience

ELECTRICAL INSULATION CO., INC.

12 VESTRY ST.,

NEW YORK 13, N. Y.

and facsimile broadcasting station in New York City.

FRANK H. R. POUNSETT, formerly chief engineer of the radio division of Research Enterprises Limited, is now chief engineer of Stromberg-Carlson Co. Limited, Toronto.

GEORGE L. HALLER has been named assistant dean of the School of Chemistry and Physics at Pennsylvania State College. Colonel Haller's work during the war dealt with radio and radar countermeasure equipment, submarine detection from aircraft, and radio and radar control of guided missiles.

SAMUEL GUBIN becomes vice-president in charge of engineering for Spectrum Engineers, Inc., newly organized engineering and consulting firm in Philadelphia. He was formerly with RCA in Camden, where he supervised the microwave beacon group.

CHARLES J. ALBA is radio research engineer at Air Associates, Inc., Los Angeles. He was formerly with Air Track Mfg. Co., College Park, Md. in the same capacity.

NEAL TURNER is now quality control chief at Hallcrafters Co., Chicago.

JOHN J. LIVINGOOD has left the faculty of Harvard University to become assistant director of research at Collins Radio Co., Cedar Rapids, Iowa. He directed developmental work on high power at ultrahigh frequencies at Harvard RRL and worked on cyclotron design and operation.



J. J. Livingood



W. R. Jones

WALTER R. JONES was made chief engineer of the Radio Tube Division at Sylvania Electric Products Inc. He has been with Sylvania 17 years. THOMAS C. STEPHENS comes to the Research Division of Collins Radio Co. from the University of Iowa where he was an instructor in radio and electrical engineering.

GWILYM A. PRICE becomes president

ANTICIPATE YOUR REQUIREMENTS!

**First Come . . .
First Served!**

Orders for transformers are pouring in so fast that we will soon be booked to capacity for several months to come. If your product requires heavy duty filter reactors, swinging reactors, or plate transformers, anticipate your requirements and place your order NOW!

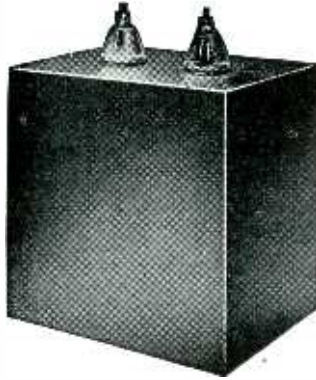

DONGAN ELECTRIC MFG. CO.
2977 Franklin Detroit 7, Mich.

DONGAN

TRANSFORMERS

The Dongan Line Since Nineteen-Nine



**CUP WASHERS
for Binding Screws**



WHITEHEAD STAMPING CO.

1691 W. Lafayette Blvd.

Preferred
as a source of precision-made
WASHERS and STAMPINGS
manufactured to your specifications

Detroit 16, Michigan

GASES

**HYDROGEN
NITROGEN · OXYGEN**

COMPLETE
GAS PRODUCTION
PLANTS INSTALLED
FOR LOWEST COST
OPERATION

FORMING MIXTURES
CARBON DIOXIDE
ACETYLENE

HIGHEST QUALITIES • ANY QUANTITY
DELIVERED ANYWHERE

AMERICAN GAS & CHEMICAL CO.

HARRISON, NEW JERSEY • Contracted Complete Service on All Gases

ARGON · NEON
HELIUM · KRYPTON
XENON

SP&RT



**WE'RE BLUSHING
WITH MODESTY**

*Because of what others are
saying about the new*



NET PRICE CATALOG

"Very interesting, well compiled, and the net prices appealed to us."

— S.L.H. Co., Salt Lake City, Utah

"A masterpiece of its own."

— C.S. Co., St. Louis, Mo.

"Congratulations because you certainly have done a swell job! We were very much surprised to find that your line was as complete as it is."

— L.A.B. Co., Baltimore, Md.

"Truly a work of art."

— J.E. Co., Staunton, Va.

"The best we ever laid eyes on."

— H. Industries, Chicago, Ill.

"It's a humdinger."

— T.R. Co., Chicago, Ill.

"A very valuable asset to our file, and you may feel confident that we will use it to good advantage."

— I.C. Products Corp., South Bend, Ind.

"Certainly unique. Congratulations to you on stepping away from the customary ways of doing things."

— W.F. Mfg. Co., Cincinnati, Ohio

"Wish to compliment you on its skilful arrangement."

— J.B.G. Mfg. Co., St. Louis, Mo.

"Something we have been looking for, some time."

— M. Inc., Savannah, Ga.



FREE

Let our "Net Price Catalog," be your guide to fasteners and prices. An up-to-date encyclopedia and specification chart for every purchasing agent and engineer.

MANUFACTURERS SCREW PRODUCTS

270 W. Hubbard St., Chicago 10, Ill.

It's Faster to Phone — WHitehall 4680
Standardize on STRONGHOLD

PASTE THIS COUPON ON YOUR LETTERHEAD
MANUFACTURERS SCREW PRODUCTS
270 W. Hubbard St., Chicago 10, Ill.
Please send me a copy of the new
STRONGHOLD "Net Price Catalog."

Name

Position

Company

Address

City, Zone, State

Please send a few samples of your products.

Please quote prices as per attached request.

Check here if you would also like a free copy of our "Pocket Library of Engineering Data," a handy, finger-tip reference to technical information every user of fastener products should have.



Lightweight Champion

A compact, lightweight time delay relay. Setscrew timing adjustable from a fraction of a second to several minutes. For alternating current or direct current operation. Information and literature on request. No obligation.

AGASTAT

Electro-Pneumatic *TIME DELAY RELAY*

ELIZABETH **A'G'A** NEW JERSEY
AMERICAN GAS ACCUMULATOR COMPANY

and chief executive officer of Westinghouse Electric Corp., succeeding George H. Bucher who resigned and is now vice chairman of the board of directors.

AWARDS

SOSTHENES BEHN, president of International Telephone and Telegraph Corp., was awarded the Medal for Merit, highest civilian decoration for wartime service, for fostering extensive research and development which produced radio and telephone equipment used to great advantage by the Army.

FRANK M. FOLSOM, executive vice-president in charge of the RCA Victor Division, Camden, was awarded the Medal for Merit in recognition of outstanding services as Chief of the Procurement Branch of the Navy's office of Procurement and Material.

ARTHUR F. VAN DYCK, assistant to Dr. C. B. Jolliffe at RCA, received the Legion of Merit award for his contributions to the development and



Rear Admiral Monroe Kelly presenting Legion of Merit medal and citation to A. F. Van Dyck

establishment of loran systems in the U. S. Navy. Commander Van Dyck was Officer-in-Charge of Navigational Aids in the Office of the Chief of Naval Operations.

JOHN F. RIDER was presented with the Legion of Merit medal for "exceptional administrative service to the Signal Corps Publication Agency," from which he retired in 1945 as Lieutenant Colonel.

MASSIVE WINDING CORE 25% More Capacity

Another exclusive Hardwick-Hindle advantage is this great ceramic core of unusually large cross section for the wattage rating—*more wire, more surface and, less temperature rise.*

And between this ceramic winding core and the rugged die cast base there is ample space for full ventilation to insure low operating temperature for the mounting panel.

This is only one of several exclusive features. Let us tell you of other Hardwick-Hindle advantages in this and in other rheostats, as well as in our resistors.

Our engineering service is always available for specific problems. Write us today.

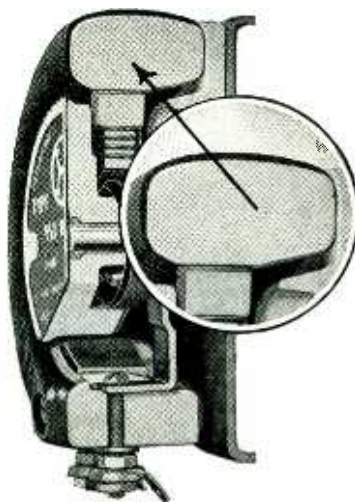

HARDWICK, HINDLE, INC.

RHEOSTATS and RESISTORS

Subsidiary of THE NATIONAL LOCK WASHER COMPANY

NEWARK 5, N. J.

ESTABLISHED 1886

U. S. A.

- SOFT SOLDER RINGS AND PREFORMS
- SILVER SOLDER RINGS
- COPPER BRAZING RINGS

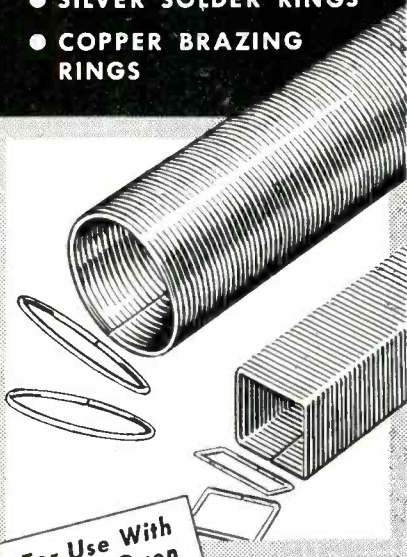

For Use With
Flame, Oven
or Induction
Heating

Large range of wire sizes carried in stock for immediate fabrication into Rings and Preforms.

ELECTRONIC SPECIALTIES MANUFACTURING COMPANY
127 North Main Street, Elkhart, Indiana

DEPENDABLE PORTABLE ELECTRIC POWER

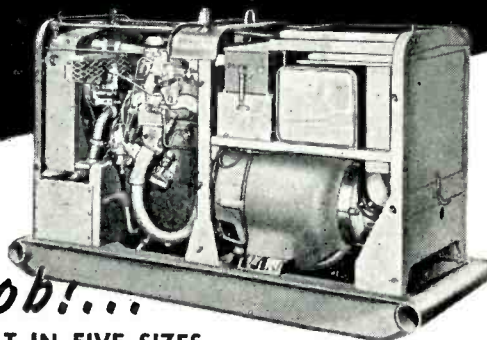

For Your Job!...

... BUILT IN FIVE SIZES, ranging from 3 K. W. to 15 K. W., these portable electric power plants are manufactured to give dependable service under the most rugged conditions. Write today for specifications.

Models Range from 3000 to 15000 Watts, A.C. 120 to 440 Volts, 50 and 60 Cycles, Single or Three Phase.

DEALERS WANTED! Some profitable franchises still available. Write or wire

PIONEER ELECTRIC Co. 3700 East Olympic Boulevard
Los Angeles 23, California

For FM AM CW RECEPTION in the VHF SPECTRUM



HALLICRAFTERS 5-36A

Your requirements for a general-purpose receiver in the v.h.f. spectrum are met by this, the most advanced development in its field. Continuous frequency coverage is provided from 27.8 to 143 mc. in three bands with convenient controls for selecting bands and for switching to FM, AM, or CW reception. The 3-watt audio system is substantially flat from 40 to 15,000 cycles. With hermetically sealed transformers and reactors, oil-impregnated paper capacitors, and moisture proofed wiring, this receiver is suited to mobile or fixed-station service under all climatic conditions. Furnished complete with 15 tubes, speaker, and built-in power supply for 115/230 volt a-c operation. Net price is \$322.00 FOB Boston.

Order today from

Immediate Delivery

The RADIO SHACK
157 WASHINGTON ST.
BOSTON, MASS., U.S.A.

FREE—108-Page Catalog of Electronic Equipment and Components

VULCAN

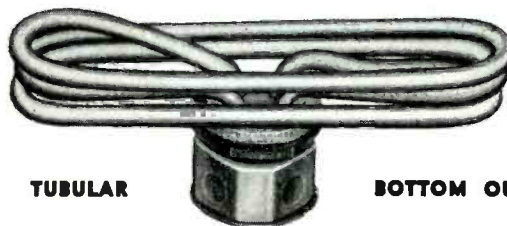

TUBULAR

BOTTOM OUTLET

This VULCAN HEATING ELEMENT

has proved efficient and economical in

COFFEE URNS
STEAM TABLES
STERILIZERS
WATER HEATERS
AND SIMILAR ARTICLES

If you have a problem involving Electrical Heating Units, write us.

VULCAN ELECTRIC COMPANY
DANVERS 10, MASS.

Makers of a wide variety of Heating Elements for assembly line manufacturers' own products and of Heating Specialties that use electricity.



**- IN ALL
RECTIFIER
APPLICATIONS**

● **DC means SC... Selenium Conversion and Selenium Control. Selenium Rectifiers are available in many different ratings and sizes ... each designed to perform an exact and vital function. Selenium Rectifiers are small in size, light weight, efficient, economical and adaptable to all mechanical arrangements. Selenium Rectifiers have no moving parts and require no maintenance. They are simple ... rugged and provide instantaneous and silent operation. A few of the many reasons why DC means SC... Selenium Conversion and Selenium Control. If you use DC... get the facts on SC.**

SEND FOR BULLETINS

**SELENIUM CORPORATION
of AMERICA**

1719 WEST PICO BOULEVARD
LOS ANGELES 15, CALIFORNIA

DEPT. OF SELENIUM INSTRUMENTS
AND POWER RECTIFIERS
AND PHOTO ELECTRIC CELLS

EXPORT DIVISION: FRAZER & HANSEN
301 CLAY STREET, SAN FRANCISCO, CALIFORNIA

IN CANADA: CANADIAN IRE MATERIALS, LTD. TORONTO 13, ONTARIO, CANADA.

NEW BOOKS

Fundamental Theory of Servomechanisms

By **LEROY A. MACCOLL**, *Bell Telephone Laboratories, Inc. D. Van Nostrand Co., Inc., New York, N. Y., 1945, 130 pages, \$2.25.*

GENERAL THEORY OF LINEAR, continuously operating servomechanisms is studied by the technique of feedback amplifier design. That is, the characteristics of servomechanisms are analysed by studying their frequency and phase characteristics in the complex frequency plane. Stability is treated in the manner of Nyquist's criterion for feedback amplifiers. As a consequence of this treatment, the approach is more intelligible to communication engineers than that of the purely mathematical analysis of the differentiating and integrating action of the servomechanism so frequently used in studying its transient behavior.

The material, originally circulated within the limits of wartime secrecy, covers simple systems in their steady state, transient behavior of servomechanisms, stability, and accuracy. Based on the equations for servo characteristics, means of stabilizing and controlling accuracy are discussed. The work concludes with treatments of oscillating control, sampling, and on-off servomechanisms. A chapter is devoted to a comparison of the transient analysis and the steady-state approach to servo operation in which the merits of the steady-state method used in this text are demonstrated.—F.R.

• • •

Electronics For Engineers

By **JOHN MARKUS AND VIN ZELUFF**, *Associate Editors, ELECTRONICS. McGraw-Hill Book Company, New York 18, 1945, 390 pages, \$6.00.*

THIS IS A COLLECTION of articles culled from the pages of **ELECTRONICS** and written by many different engineering authors. According to the preface the editors of the book "... have gone through the complete files of the magazine from the first issue (April, 1930) and from this wealth of technical data have selected 142 articles, reference sheets, charts and graphs that have been in greatest demand for their reference value. All of this material

**ANOTHER NEW
Cramer
MODEL E
INSTRUMENT**



**TYPE
TEC**

**TIME
DELAY
RELAY**

The Type TEC Time Delay Relay allows an adjustable or fixed time delay between operation of a control circuit and subsequent opening or closing of a load circuit.

Its function is to reduce manual supervision and improve quality of the product by automatically controlling industrial processes or electrically operated machinery. It is used extensively in such operations as plastic molding, heat treating, induction heating, mixing, and purging gas fired ovens.

This type of Relay is available with either Automatic or Controlled Reset. Type TEC automatically starts the cycle over again after power interruption. Type TEC-R resumes the cycle at the point of interruption.

Embodying the sturdy construction of the improved Model E design type TEC Time Delay Relay has many specific "use" advantages:

- Large dial for accurate settings.
- Micrometer adjusting knob.
- Progress indicator showing unexpired time cycle.
- Simple screw mounting.
- Clearly marked electrical connections.

If you use "TIME as a factor of CONTROL" in any type of equipment or process, it will pay you to CONSULT CRAMER.

THE R. W. CRAMER COMPANY, Inc.
Box No. 3
Centerbrook, Conn.

Cramer
SPECIALISTS IN TIME
AS A FACTOR OF
CONTROL

INTERVAL - DELAY - CYCLE - IMPULSE - PERCENTAGE

IMMEDIATE DELIVERY!



WRL Multitester

- Sturdy Steel Case
- 30-60 Degree Angle
- Stand it up or Lay it Down

CAT. NO. 16-491

\$18.75

TEST LEADS
CAT. NO. 17-459 **\$6.00**

Ranges: DC Volts—0/5/50/250/500 V, AC Volts—0/10/100/500/1000V, DC Mills—0/10/100 Mills. Ohmmeter—Low Range 0-500 Ohms. High Range—0-100,000—1 Meg. 3" Meter with sturdy D'Aronsva movement. Size 5½ x 8 x 3¼.

Phono Amplifier Kits

Complete with tubes, speaker, stamped chassis, resistors and condensers. Many other kits also available. Cat. No. 7-271. **\$9.50 ea.** Lots of 3, ea... **\$9.15**



WRL LOW PRICED TRANSMITTER KITS
15, 35, 70, and 150 Watt types

WE INVITE INQUIRIES FROM AGENTS, IMPORTERS, BROKERS!

FREE! 52 Page Packed with savings in radio, Catalog electronic, and general merchandise. Send for your copy today.

Handy Tube Base Calculator 25c
Giant Radio Reference Map 15c

Address Dept. E-4 Council Bluffs, Iowa



Formerly Wholesale Radio Laboratories

MOLDED TERMINAL STRIPS

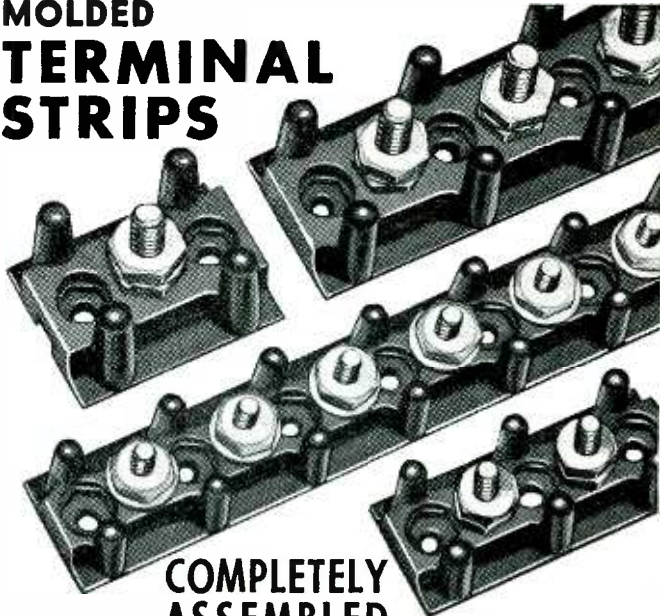

COMPLETELY ASSEMBLED

WITH HARDWARE

Available in lengths from 1 to 20 terminals.

Terminal Sizes: 6-32; 8-32; 10-32

Northern Industrial Chemical Company

7-11 ELKINS ST., SO. BOSTON 27, MASS.
36 YEARS OF PLASTIC MOLDING EXPERIENCE

Solves the Problem of Mailing List Maintenance

Probably no other organization is as well equipped as McGraw-Hill to solve the complicated problem of list maintenance during this period of unparalleled change in industrial personnel.

McGraw-Hill Mailing Lists cover most major industries. They are compiled from exclusive sources, and are based on hundreds of thousands of mail questionnaires and the reports of a nation-wide field staff. All names are guaranteed accurate within 2%.

When planning your direct mail advertising and sales promotion, consider this unique and economical service in relation to your product. Details on request.

for Results



Mc GRAW-HILL
DIRECT MAIL LIST SERVICE

McGraw-Hill Publishing Co., Inc.

DIRECT MAIL DIVISION

330 West 42nd St., New York, 18, N. Y.

THERE'S A **DRAKE** SOLDERING IRON FOR EVERY TYPE OF ELECTRONIC WORK

From that mighty mite



the Drake No. 400 to the high-speed production "honey"



the Drake No. 600-10 there is a high quality Drake Soldering Iron "just right" for the job.

Drake Heat Controls and the Drake "Magic Cup" Stand are important soldering aids.



SEE

YOUR RADIO PARTS JOBBER

DRAKE ELECTRIC WORKS, INC.
3656 LINCOLN AVE. CHICAGO, ILL.

Send for

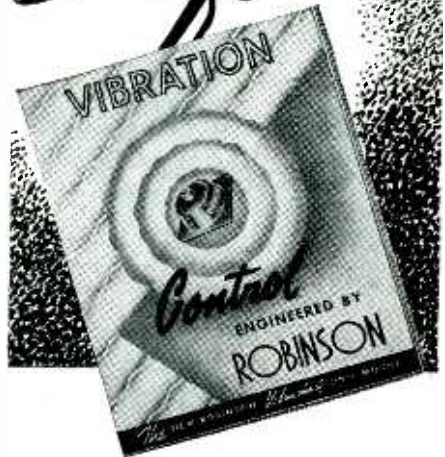

It's new—amazingly effective and surprisingly inexpensive. Vibrashock* triple-action unit mounts really absorb vibration and cushion shock. Compare Vibrashock with any other unit type mount—and see the marked improvement in performance. We believe Vibrashock will solve your vibration problems.

*Trade mark

ROBINSON AVIATION, INC.

Teterboro Air Terminal, Dept. E. 1.

Teterboro, New Jersey

3757 WILSHIRE BLVD., LOS ANGELES 5 CALIFORNIA

ally Designed To Meet Your Needs

For years Westfield has specialized in custom-made nuts for leading manufacturers.

Conforming rigidly to specifications, they are more dependable and frequently more economical. Consult us on present or post-war needs. Write or wire.

WMP WESTFIELD METAL PRODUCTS CO. INC.
WESTFIELD, MASS.

has been carefully checked, edited and condensed where desirable to put it into the best possible form for presentation in a book."

A need for such a book is almost self-evident, for it is the sad but universal experience of subscribers to monthly technical magazines that the material of the new and oncoming issues tends to bury the previously published material. The reader and user, if he makes any attempt, carries on a losing struggle to retain ready access to the articles which he has specially marked for future reference.

The editors have performed a valuable service by bringing together this collection. Theirs is the responsibility for the selections and omissions of material. In the opinion of the reviewer it is a job well done and does credit to their judgment.

The individual papers are grouped into 27 chapters within a self-explanatory alphabetical index. The typography, arrangement and display are excellent. The material is much too rich and varied to make it possible to indicate more than its general scope as given by the chapter headings, as follows: A-F Impedance-Matching Networks, Antennas, Audio Amplifiers, Audio-Circuit Design, Capacitors, Cathode-Ray Tubes, Coaxial Lines, Electronic Heating, Filters, Industrial Control, Iron-Core Transformers and Chokes, Mathematics, Networks, Oscillators, Permanent Magnets, Pulses, Rectifiers, Relays, R-F Coils and Transformers, R-F Impedance-Matching Networks, R-F Power Amplifiers, Sound, Television, Frequency Modulation and Facsimile, Transmission Lines, Tubes, Tuned Circuits, and Wide-Band Amplifiers.

Here is a volume of practical, useful material, the very stuff out of which the practice of electronic engineering is made. Engineers, designers, teachers, and builders of electronic and communication equipment will find in it suggestions and helps which fellow engineers have through the years devised, constructed and passed on out of their own daily practice and experience.—

HENRY E. HARTIG

2,000 HEAVY BOMBERS with 900 fighter escorts carried a total of 27,000 sets of signal equipment.

ATTENUATORS by TECH LABS

"Midget" model is especially designed for crowded apparatus or portable equipment.

MIDGET
TYPE
600



STANDARD
TYPE
700

- Solid silver contacts and stainless silver alloy wiper arms.
- Rotor hub pinned to shaft prevents unauthorized tampering and keeps wiper arms in perfect adjustment.
- Can be furnished in any practical impedance and db. loss per step upon request.
- TECH LABS can furnish a unit for every purpose.
- Write for bulletin No. 431.

TECH
LABORATORIES

Manufacturers of Precision Electrical Resistance Instruments
337 CENTRAL AVE. • JERSEY CITY 7, N. J.

Dimensions

Diameter..... $2\frac{1}{16}$ "
 Housing Length..... $2\frac{1}{32}$ "
 Weight, bare.....21 oz.

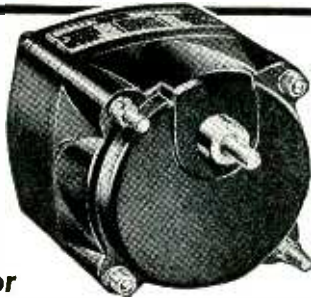

M-31A

**Announcing
 NEW Ostermotors**
 Synchronous and Induction Capacitor
 Type Motors and Gearmotors

New precision Ostermotors designed for timing devices, clock and control mechanisms. Highest quality construction assures unvarying performance. Your choice of bronze or ball bearings in motor. Annealed laminations . . . precision gears . . . compact die cast housings . . . practical mounting arrangements.

These new Ostermotors are built to your order; can be furnished with special shafts, gear ratios, or other mechanical and elec-

Oster No.	Type	Motor	Power Service	Max. H.P. Output	Shaft R.P.M.
LCY LCYR	Motor Gearmotor	Cap. Synch.	115 V 60 C	.0005	1800-3600 30-60
LC LCR	Motor Gearmotor	Cap. Ind.	115 V 60 C	.001	1675-3350 28-57

trical characteristics. They are now in production. Write for further information. . . **John Oster Manufacturing Co., 4 Main Street, Racine, Wisconsin.**

Other Special Ostermotors	H. P. Range at rated load	R. P. M.	Type	Dia.	Length
E. S.	1/50 — 1/30	1725	Induction Split Phase	3 $\frac{2}{64}$ "	4 $\frac{1}{2}$ " to 5 $\frac{1}{4}$ "
E. C.	1/50 — 1/30	1725	Induction Capacitor	3 $\frac{2}{64}$ "	4 $\frac{1}{2}$ " to 5 $\frac{1}{4}$ "
E. U.	1/25 — 1/10	5-10M	Series	3 $\frac{2}{64}$ "	4 $\frac{1}{2}$ " to 5 $\frac{7}{8}$ "
K. S.	1/20 — 1/10	1725	Induction Split Phase	4 $\frac{13}{32}$ "	5 $\frac{1}{2}$ " to 8 $\frac{1}{4}$ "
K. C.	1/20 — 1/10	1725	Capacitor Start & Run	4 $\frac{13}{32}$ "	5 $\frac{1}{2}$ " to 8 $\frac{1}{4}$ "

Oster is now in production or going into production on motors listed here. If you need quality motors in these types or sizes, write us today.

**The COMPLETE STORY
 of ELECTRONICS**
 written so you can
UNDERSTAND it

An accurate, clearly-worded, non-technical account of the seeming miracles that have been accomplished by the modern science of electronics. By electronic means, television, radar, fluorescent lighting, talking pictures, radio, atom - smashing, plastic molding, sound recording, radiography, and other marvels of twentieth-century science are accomplished. This readable and authoritative survey by a member of the staff of the General Electric Research Laboratory is designed to acquaint the interested layman with the fundamental principles, special characteristics, and practical applications of electronics in science, industry and public health.



Just Published

**ELECTRONS
 IN ACTION**

By JAMES STOKLEY

320 pages, 5 1/2x8, 91 Illustrations, \$3.00

In addition to excellent explanations of such developments as frequency modulation, network television, and the electron microscope, the book presents a clear-cut summary of the sensational advances in the field of atomic energy, including a survey of pioneer work in this field and a factual account of the atomic bomb, based on the authentic Smyth report. The significance of radar and loran for peacetime applications is also thoroughly discussed, and a full chapter is devoted to some of the newest knowledge about the effect of the sun and the moon on radio on the earth.

Seventeen fascinating chapters give you an easy-to-understand picture of the whole field of electronics:

1. Modern Miracles
2. They're Called Electrons
3. Electrons Made Free
4. Putting Them to Work
5. Talking Around the World
6. Seeing Beyond the Horizon
7. Cosmic Electronics
8. Light from Electrons
9. Sounds for the Future
10. Electrons in Overalls
11. Measurement
12. Looking Through Matter
13. Smaller and Smaller
14. Electrons in Medicine
15. Faster and Faster
16. Where it Leads
17. Atomic Energy
- Appendix: Radar

What are electrons and where do they come from? How does television work? What is the secret of radar, of loran, of BFO? What is a diode? an ignitron? a klystron? a precipitron? How are pictures and facsimile newspapers transmitted over wires or through the ether? How is sound recorded on motion-picture film and on phonograph records? What is the outlook for postwar developments in electronics?

—These and a great number of related questions are discussed and answered on the basis of current knowledge, for the benefit of the layman interested in electronics—as well as for the specialist in allied fields of engineering, industry, and research.

Send this McGRAW-HILL coupon!

McGraw-Hill Book Co., 330 W. 42 St., New York City 18
 Send me Stokley's **ELECTRONS IN ACTION** for 10 days' examination on approval. In 10 days I will send \$3.00, plus few cents postage, or return book postpaid. (Postage paid on cash orders.)

Name

Address

City and State

Company

PositionL. 4-46

For Canadian Prices Write Embassy Book Co.,
 13 Richmond St. E., Toronto, 1

.....

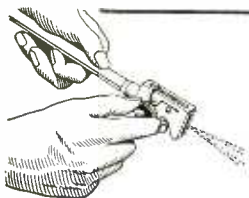

**Would a vibration meter
 locate trouble in your
 WASHER?**

Electrical equipment requires super-precision rigidity—dependability. Make sure with

QUADRIGA Quality Washers

Washers to specifications, of any type, purpose or material; which can be fabricated by punch press, Flat, Special Dimensions, Irregular Contour, Tension and Spring, Formed and Drawn, Cupped and Finishing etc. Wire terminals Send for complete catalog.

Also SMALL METAL STAMPINGS, any design Prompt delivery

THE QUADRIGA MANUFACTURING CO.
 Inc. 1894 "Half a Century" 221-AW, Grand Ave., Chicago 10, Ill.



**for
 ELECTRONIC USE**

FOR YEARS A LEADING SUPPLIER OF PRECIOUS METALS
 TO THE ELECTRIC AND ELECTRONICS INDUSTRIES.

THE AMERICAN PLATINUM WORKS

N. J. R. AVE. AT OLIVER ST.
 NEWARK 5, N. J.

PRECIOUS METALS SINCE 1875

ARITHMIC AC VOLTMETER

WIDE BAND AMPLIFIER



RANGE:

.0005 to 500 volts
-65 VU to +57 VU
Direct Reading
without external
Multipliers

FREQUENCY RESP.

4 C/S to 2 MC/S
±2%

INPUT IMPEDANCE

2 MEGOHMS
15 mmfds.

STABILITY

±1%
105 to 125 volts

INSTRUMENT ELECTRONICS

LITTLE NECK, L. I., N. Y.

253-21 NORTHERN BOULEVARD

BAYSIDE 9-5225

Front or Rear Surface

MIRRORS AND REFLECTORS



FOR TELEVISION,
ELECTRONIC, OPTICAL,
and SCIENTIFIC APPARATUS

Front or Rear Surface Mirrors and Reflectors made to your specifications.
Closest optical and dimensional tolerances observed.

- EXCEPTIONAL REFLECTIVITY
- WILL NOT TARNISH
- OPAQUE OR SEMI-TRANSPARENT
- HEAT RESISTANT
- PROMPT SERVICE

We invite your inquiries. Samples and quotations will be submitted promptly.

Let Zenith help solve your Mirror and Reflector problems!

ZENITH OPTICAL LABORATORY

SPECIALISTS IN
VACUUM DEPOSITION



123 WEST 64th STREET
NEW YORK 23, N. Y.

Backtalk

This department is operated as an open forum where our readers may discuss problems of the electronics industry or comment upon articles which **ELECTRONICS** has published.

Spoof

FOR A NUMBER of years now work has been proceeding in order to bring perfection to the crudely conceived idea of a machine that would not only supply inverse reactive current for use in unilateral phase detractors, but would also be capable of automatically synchronizing cardinal grammeters. Such a machine is the "Turbo-Encabulator." Basically, the only new principle involved is that instead of power being generated by the relative motion of conductors and fluxes, it is produced by the modal interaction of magneto-reluctance and capacitive directance.

The original machine had a baseplate of prefabulated amulite, surmounted by a malleable logarithmic casing in such a way that the two spurving bearings were in a direct line with the pentametric fan. The latter consisted simply of six hydro-optic marzelvanes, so fitted to the ambifacient lunar wan shaft that side fumbling was effectively prevented. The main winding was of the normal lotus-o-delta type placed in panendemic semi-boloid slots in the stator, every seventh conductor being connected by a non-reversible tremie pipe to the differential girdlespring on the "up" end of the grammeters.

Forty-one manestically spaced grouting brushes were arranged to feed into the rotor slip-stream a mixture of high S-value phenylhydrobenzamine and five per cent reminative tetryliodohexamine. Both of these liquids have specific pericosities given by $P = 2.5_n^{0.7}$ where n is the diathetical evolute of retrograde temperature phase disposition and C is Cholmondeley's annular grillage coefficient. Initially, n was measured with the aid of a metapolar refractive pilfrometer (for a description of this ingenious instrument, see L. E. Rum-

CONTACTS

FOR THE FIELD OF ELECTRONICS

Electron Tube Machinery

of every type, — standard, and special design

Specialists in Equipment for the manufacture of Radio Tubes, Cathode Ray Tubes, Fluorescent Lamps, Incandescent Lamps, Neon Tubes, Photo Cells, X-ray Tubes and other glass or electronic products, on production or laboratory basis.

Kable

ENGINEERING COMPANY

1307-1309 Seventh St., North Bergen, N. J.

Strip Insulated Wires

QUICKER... BETTER

with "Speedex"
AUTOMATIC WIRE STRIPPER
 ... Speeds Production
 Strips Insulation from all types of wire — instantly, easily, perfectly. Just press the handles and the job is done. Cuts wire too. Strips 800 to 1000 wires per hour. Available for all size solid or stranded wires — No. 8 to No. 30. List Price \$6.00. Write Dept. E for Full Particulars



GENERAL CEMENT MFG. CO.
 Rockford, Illinois, U.S.A.

FINE RIBBONS OF TUNGSTEN and MOLYBDENUM
 Quality and accuracy in our fabrication of Tungsten & Molybdenum Ribbons have characterized our service to the Electronic industry.
 A development of
H. CROSS Co.
 15 Beekman St., New York 7, N.Y.

MICROMETER FREQUENCY METER

for checking Transmitters from 1.5 to 56 mc., within 0.01 per cent

LAMPKIN LABORATORIES
 Bradenton, Fla., U. S. A.

We manufacture a complete line of equipment

SPOT WELDERS, electric from ¼ to 50 KVA	AC ARC WELDERS from 100 to 400 Amps
TRANSFORMERS, special and standard types	
INCANDESCENT LAMP manufacturing equipment	
FLUORESCENT TUBE MAKING EQUIPMENT	
ELECTRONIC EQUIPMENT, vacuum pumps, etc.	
WET GLASS SLICING and cutting machines for laboratory use	
GENERAL GLASS working machines and burners	
COLLEGE GLASS working units for students and laboratory	

731 So. 13th St. (near Avon Ave.) Newark, New Jersey

REPAIR YOUR ELECTRIC APPLIANCES WITH NEW AMAZING NICHROCITE

Burned or Broken Electric Heating Elements Repaired Instantly ..

Simply overlap ends, apply Nichrocite paste and turn on the current — a perfect

weld results. Used by big utility companies and repair shops. Just the thing for that broken or burned out heating element in your electric iron, stove, toaster or heater. Does the job in a jiffy. Trial order, \$1: 4 ozs. \$2.50; 1 lb. \$8.00.

Armstrong Electric Co., Box 861-EM, Minneapolis

MORE RF KILOWATT HOURS PER DOLLAR WITH

F & O TRANSMITTING TUBES

Inquiries Invited—Let us explain how Savings are effected and the F & O greater guarantee.

FREELAND & OLSCHNER PRODUCTS Inc.
 611 Baronne St., New Orleans 13, La.
 Raymond 4756

High Power Tube Specialists Exclusively
 (5 KW to 100 KW)

HETERODYNE ELIMINATORS

If you are troubled by heterodyne interference consult

J. L. A. McLaughlin
 P. O. Box 529, La Jolla, Calif.

Your Inquiry Will Have Special Value

if you mention that it is in response to advertising in this publication. Advertisers value such acknowledgments highly; so does the publisher. You benefit—as a reader—in the enlarged future service such acknowledgments help to make possible.

REX RHEOSTATS

REX RHEOSTAT COMPANY, BALDWIN, L. I. N. Y.

PROTECTED & UNPROTECTED RHEOSTATS WITH LUBRICATED CONTACTS
 ROTARY DRIVE RHEOSTATS WITHOUT BACK LASH
 PROTECTED & UNPROTECTED ADJUSTABLE RESISTORS UP TO 1000 WATT
 PROMPT SHIPMENTS

18 YEARS IN RADIO

GET THIS *New* CATALOG By This Old Firm

Latest developments in radio and electronic parts and devices, newest ham gear, gadgets for experimenters, bargains in war surplus items.

FREE TO YOU

Mail the coupon below and get this new catalog FREE.

BURSTEIN-APPLEBEE CO., 1012 McGee, Kansas City 6, Mo.
 Send me FREE catalog advertised in Electronics.

I AM _____ STATE CONNECTION IN INDUSTRY
 NAME _____
 ADDRESS _____
 TOWN _____ STATE _____

PROFESSIONAL SERVICES

ASSOCIATED ELECTRONICS COMPANY

INDUSTRIAL ENGINEERING SPECIALISTS
Engineering Research & Development
Product Design
Sales Brochures
Field Surveys
Market Research
Technical Manuals
Laboratory Analysis
Complete Engineering Services For All Industries
133 Nassau Street, New York 7, N. Y.

F. T. FISHER'S SONS LIMITED

Consulting Engineers
Broadcast Transmitters, Antenna Systems, Studio Equipment, Mobile and Fixed Communication Systems.
1425 Dorchester St. West, Montreal

MICHAEL BOZOIAN

Consulting Service In Electronics
Instrumentation & Controls Design—Development—Models Literature & Patent Survey Recommendations For New Laboratories.
Telephone 8521
702 Fifth Street Ann Arbor, Mich.

PAUL E. GERST & CO.

CONSULTING ENGINEERS
Specialists in
Electrical Product Design
El. Machinery, Apparatus & Applications
El. Appliances, Hi-Frequency Apparatus
Electronics, Radio Communication
285 W. Wacker Dr. Chicago 6, Ill.

H. RUSSELL BROWNELL

Consulting Engineer
Specializing in Measurements & Testing Instruments & Techniques - Electrical - Electronic - Magnetic.
188 West 4th St. New York 14, N. Y.

HODGSON & ASSOCIATES

Physics, Mathematics, Research, Development & Patent Consultants.
Satisfaction guaranteed. Submit your problem for a preliminary survey without cost.
Sherman Oaks, California

COOPER & FLEMING

Consulting Electronic Engineers
AM & FM BROADCASTING.
Industrial & Medical Electronics
420 Market St. Sutter 8854 San Francisco, Calif.

J. L. A. McLAUGHLIN

Designer of Communications Receivers
Specializing in the elimination of heterodyne interference.
P. O. Box 529, La Jolla, Calif.

E. STUART DAVIS

Consulting Engineer
Research—Design—Development
Radio - Carrier Current - Supersonics - Radiant Energy - Control and Measurement - Methods and Devices, Communication - Transportation & Industrial applications.
Marine Laboratory facilities aboard the yacht "ELECTRON"
422 N. E. River Drive Ft. Lauderdale, Florida

NATIONAL DESIGN SERVICE

Designers and Developers of
FACTORY TEST EQUIPMENT
TELEVISION R.F. SWEEP GENERATORS
F.M. SIGNAL GENERATORS
COMPLETE CENTRALIZED MODULATED SYSTEMS
95 Liberty St. New York 6, N. Y.

STANLEY D. EILENBERGER

Consulting Engineer
INDUSTRIAL ELECTRONICS
Design—Development—Models
Complete Laboratory and Shop Facilities
6809-13—27th Ave.
Kenosha, Wis. Telephone 2-4213

ALBERT PREISMAN

Consulting Engineer
Specializing in Television and Pulse Techniques, Video Amplifiers, Industrial Applications.
616 St. Andrews Lane, Silver Spring, Md.

ELECTRONIC ENGINEERS

Designers and Consultants
Radio and Electronic Product Design
Radio Equipment to Order
Industrial Electronic Devices to Order
Broadcast Station Allocation
Complete Research and Constructional Facilities
Phone Citrus 1-5884
611 E. Garfield Ave. Glendale 5, California

JOSEPH RAZEK, Ph.D.

Consulting Physicist
Electrical and Mechanical Engineering Problems
Instruments and Control Devices
Specialists in Colorimetry, Spectrophotometry and Industrial Color Control
Laboratory and Shop Facilities
202 Darby Road Llanerch, Pa.
Phone Hilltop 8910

ELECTRONIC RESEARCH ASSOCIATES

ERA will apply progressive, war-proven development in electronic research... counting... timing... measuring... industrial controls... to your manufacturing advantage.
Box 333, 305 Linden Av., San Francisco, Cal.

G. W. RHEIN

Engineering Consultant
Radio Communication Electronics
Complete Development and design for manufacture with engineering models.
St. Paris Pike Springfield, Ohio

ELM LABORATORIES

Research and Design
RADIO TRANSMITTERS AND RECEIVERS
Designs for Home Radios, Electro-Mechanical Devices and Components.
29 South Broadway Dobbs Ferry, New York
Phone—Dobbs Ferry 4058

PAUL D. ZOTTU

Consulting Engineer
INDUSTRIAL ELECTRONICS
High Frequency Dielectric and Induction Heating Applications, Equipment Selection, Equipment and Component Design, Development, Models.
314 Washington St. Newton, Mass.
EQ-9340

pelverstein in "Zeitschrift für Elektrotechnisch-Donnerblitze" vol. vii), but up to the present date nothing has been found to equal the transcendental hopper dadoscope. (See "Proceedings of the Peruvian Academy of Skatological Sciences" June, 1914.)

Electrical engineers will appreciate the difficulty of nubing together a regurgitative purwell and a supramitive wannel-sprocket. Indeed, this proved to be a stumbling block to further development until, in 1942, it was found that the use of anhydrous nangling pins enabled a kryptonastic bolling shim to the tankered.

The early attempts to construct a sufficiently robust spiral decommutator failed largely because of a lack of appreciation of the large quasi-plestic stresses in the gremlin studs; the latter were specially designed to hold the roffit bars to the spamshaft. When, however, it was discovered that wending could be prevented by a simple addition to the living sockets, almost perfect running was secured.

The operating point is maintained as near as possible to the h.f. rem peak by constantly fromaging the bitumogenous spandrels. This is a distinct advance on the standard nivel-sheave in that no dramcock oil is required after the phase detractors have remissed.

Undoubtedly, the turbo-encabulator has now reached a very high level of technical development. It has been successfully used for operating nofer trunnions. In addition, whenever a barescent skor motion is required, it may be employed in conjunction with a drawn reciprocating dingle arm to reduce sinusoidal depletionation.

EDITOR'S NOTE. The above description of the turbo-encabulator is taken from the *Industrial Bulletin* of Arthur D. Little Company, Cambridge, Mass. Unfortunately no photographs of the device are available at the moment. It is hoped that when military restrictions are loosened a bit and Arthur D. Little engineers are not so busy more data will be published on what seems to be a most important industrial instrument. Despite the lucid description quoted above more information is definitely needed.

JOHN AMBROSE FLEMING, discoverer of the diode, wrote more than 90 important scientific treatises between 1892 and 1934. His 1,700 page book on electromagnetic waves is considered one of the classics of radio literature.

MICROWAVE SPECIALISTS DESIRED

Senior Electrical Engineer:

Practical and Theoretical knowledge of subject. Must be capable of individual research and development.

Junior Electrical Engineer:

Thorough knowledge of Laboratory Techniques and equipment.

Laboratory Machinist:

Must produce precision models from sketch or verbal instructions. Imagination and versatility essential.



Address letter containing your qualifications

P-132, Electronics
520 North Michigan Ave., Chicago 11, Ill.

POSITION VACANT

ELECTRONICS: MAJOR oil company, located in New York City, needs a man with training in electronics and some knowledge of chemistry. Work involves routine spectrophotometric analysis, servicing electronic instruments and some development of new electronic apparatus. P-135, Electronics, 330 W. 42nd St., New York 18, N. Y.

RADIO COIL Engineer wanted. Must have experience in design, production methods and necessary test equipment for T. F. and R. F. coil production. Reply in strict confidence stating experience and salary. N. Y. metropolitan area. P-136, Electronics, 330 W. 42nd St., New York 18, N. Y.

SELLING OPPORTUNITY OFFERED

RELAY SALESMAN, should be graduate electrical engineer with mechanical relay experience and background. Headquarters in New York, handle an eastern territory. Good salary. Write giving full information. SW-137, Electronics, 330 W. 42nd St., New York 18, N. Y.

EMPLOYMENT SERVICE

SALARIED POSITIONS \$2,500-\$25,000. This thoroughly organized confidential service of 36 years' recognized standing and reputation carries on preliminary negotiations for supervisory, technical and executive positions of the calibre indicated, through a procedure individualized to each client's requirements. Retaining fee protected by refund provision. Identity covered and present position protected. Send only name and address for details. R. W. Bixby, Inc., 278 Dun Bldg., Buffalo 2, N. Y.

POSITIONS WANTED

ARMY VETERAN to be released from Service the 1st of January 1947 wishes employment in the field of electronics. One year of Army training in radio and electronics. Three months practical experience installation of airborne radar equipment and 21 months practical experience in maintaining and operating navigational radar equipment in the Army overseas. College training: Two years engineering. PW-138, Electronics, 520 N. Michigan Ave., Chicago 11, Ill.

(Continued on page 358)

SEARCHLIGHT SECTION

(Classified Advertising)

EMPLOYMENT : "OPPORTUNITIES" : EQUIPMENT
BUSINESS : (Used or Resale)

UNDISPLAYED RATES
15 CENTS A WORD MINIMUM CHARGE \$3.00.
Positions Wanted (full or part time salaried employment only), 1/2 the above rates payable in advance.
See Numbers—Care of publication New York, Chicago or San Francisco offices count as 10 words.
Discount of 10% if full payment is made in advance for 4 consecutive insertions.

DISPLAYED
Individual Spaces with border rules for prominent display of advertisements.

The advertising rate is \$7.50 per inch for all advertising appearing on other than a contract basis. Contract rates quoted on request.

An advertising inch is measured 1/4" vertically on one column, 3 columns—20 inches—to a page.

NEW ADVERTISEMENTS received by February 7th will appear in the March issue, subject to limitations of space available.

SERVICE SUPERVISOR

WANTED BY

ELECTRONIC ORGAN MANUFACTURER

Unusual opportunity now open for the right man. Must be under 40 years of age and of sound health; have personality which will enable him to meet people of average culture or better, make friends with them quickly, and influence their thinking; sales or other business experience definitely valuable but not absolutely necessary if other qualifications are tops. Position will entail some traveling.

Must be thoroughly familiar with audio circuits and components. Must have proven ability in writing effective service notes and installation instructions. Must be able to set up, train and supervise field force.

Position with old established but progressive firm with highest financial rating. Write immediately giving full particulars and complete history of activities for past ten years, in first letter.

P130 Electronics

520 North Michigan Ave., Chicago 11, Ill.

Sales Engineers

Well established firm in the East desires Sales Engineers in the field of Industrial Electronics as well as sales of other Electronic products. To work out of factory. State fully education, age, and experience.

SW-116, Electronics

320 West 42nd St., New York 18, N. Y.

for CAMERAS and PROJECTORS

Highly rated firm in the East manufacturing established line of amateur photographic equipment is interested in securing executive engineers or designers now commanding good salaries in camera goods or kindred type of work. Consideration given to original letters giving complete necessary details including home phone number, names of present or former employer, etc.

P-963, Electronics

330 West 42nd St., New York 18, N. Y.

ELECTRICAL DESIGNER

fully capable of developing automatic switch gear equipment. Practical experience on electric coin machine, music machine, automatic telephone, step switches, etc., very essential.

If you can qualify, this opportunity will offer future with permanent employment and good salary. When applying for position, please state fully past experience, qualifications, salary expected, and availability.

P-117, Electronics

520 N. Michigan Ave., Chicago 11, Ill.

Additional
Employment ads
on page 358



Available CONSULTING ENGINEER

JUSTICES - microphones,
es, loudspeakers.

ELECTRO-DYNAMICS
INDUSTRIAL ELECTRONICS
RECORDING
MAGNETIC RECORDING

or Full Time CHIEF ENGINEER

If you require responsible
direction of laboratory and
design sections in the above
fields please write

PW-129, ELECTRONICS
520 North Michigan Ave., Chicago 11, Ill.



MISSIONARY WORK WANTED

Do you have something big in Radio or
Television that really needs putting
across.

Available in May Present address:
Lt. Cmdr. R. L. Shoemaker, Box 27 Electronics
Naval Air Station, Banana River, Florida

AVAILABLE PURCHASING DIRECTOR

Presently Manager of Purchases for large radio and
electrical equipment manufacturer.

Seeks position with more executive and managerial
responsibilities.

Specialties: Organization, systems, forms, training,
stores and inventory, production control, cost and
material availability studies.

Engineering education and experience; lifetime
familiarity with circuits, components, radio merch-
andising practices, widespread business contacts.

Experienced buying assemblies, parts, raw mate-
rials, cabinets, and maintenance supplies.

Normal earnings—\$10,000 to \$12,000.

PW-131, Electronics
520 North Michigan Ave., Chicago 11, Ill.

I want to GROW UP with a GOOD MANUFACTURER

Just out of the Army, 25, single.
Plenty of sound FM and VHF re-
pair and maintenance experience.
I know theory, circuits through
practical work and good schooling.
Immediate salary secondary to
tangible opportunity.

Box X340, c/o Harold Marshall Adv. Co.
565 Fifth Avenue NEW YORK 17

POSITIONS WANTED

(Continued from page 357)

TECHNICAL EDITOR: Writing—editing Signal
Corps Instruction books, technical man-
uals, inspection manuals 4 yr. Column (with
by-line) 5 yr. NY Herald-Tribune. 2 yr. fea-
tures NY Telegraph. 10 yr. own adv. agency.
12 summers Ringling adv. dept. Ind. Art Sch.
LL.M. Mature. PW-139, Electronics, 330 W.
42nd St., New York 18, N. Y.

SALES ENGINEER: M.S. in physics with 2
years instructing experience and 5 years ex-
perience in electronic research and design engi-
neering desires position requiring both technical
and public contact abilities. Familiar with
electronic, power, and mechanical equipment.
Single. 30, will go anywhere in states. PW-140,
Electronics, 330 W. 42nd St., New York 18,
N. Y.

CHEMIST-CHEMICAL Engineer. Two degrees.
Five years industrial experience in research,
development, sales-service on materials for
electrical and electronic application—dielec-
trics, resistors, high-K capacitors, ceramics.
Broad electrical experience, proven ability, ex-
cellent references. Desires responsible position
in research and development, production, or
technical sales. PW-141, Electronics, 330 W.
42nd St., New York 18, N. Y.

SECY. NAVY electronics and civilian airline
communications experience, wishes morning
and afternoon, \$1.50 hr. while attending Colum-
bia University. PW-142, Electronics, 330 W.
42nd St., New York 18, N. Y.

LABORATORY ASSISTANT 25, single, televi-
sion laboratory, production, experience.
Army radar training, some college. Connection
with progressive expanding firm desired. PW-
143, Electronics, 330 W. 42nd St., New York 18,
N. Y.

RADIO ENGINEER: age 26, four years expe-
rience design, development, and research
radio receivers in marine, radar, direction find-
ing and VHF. Excellent knowledge field in-
tercity measuring equipment. Desires respon-
sible position development and research. At
present project engineer with large concern.
Location New York City and immediate vicini-
ty. PW-144, Electronics, 330 W. 42nd St., New
York 18, N. Y.

SELLING OPPORTUNITY WANTED

SALESMAN CALLING on principal electronics
mfrs. N. J., Md., Penna., wants additional
line instruments, parts, components. Will
handle on commission basis. RA-145, Elec-
tronics, 330 W. 42nd St., New York 18, N. Y.

SALES ENGINEER: position wanted. Nine
years experience in sales, sales promotion and
sales management with one company. Now
Lieutenant Commander in U. S. Naval Reserve.
Valuable training and experience in electronics
in the Navy. Degree in Chemical Engineering
in 1933. Age 36. Midwest location preferred.
Available for personal interview and employ-
ment upon demobilization from the Naval Re-
serve in May or June. SA-146, Electronics,
520 N. Michigan Ave., Chicago 11, Ill.

BUSINESS OPPORTUNITY

NOT AN Engineer but am considered a good
technician. Hold first telephone and second
telegraph licenses. Years of experience in
aeronautical ground station installations. Will
consider anything with a good future. I have a
small amount of capital which I am willing to
invest in a sound enterprise. Will be available
after July. As I am in a foreign country it
will require considerable time to receive re-
plies. RA-147, Electronics, 330 W. 42nd St.,
New York 18, N. Y.

WANTED

Sales Representation CHICAGO

Prime Materials or Parts for Mechanical,
Electrical, Radio and Radio Parts Manu-
facturing.

RA-113, Electronics
520 N. Michigan Ave., Chicago 11, Ill.

NATIONAL DISTRIBUTION AVAILABLE

For Manufacturers who make products
suitable for sale to radio and electronic
jobbers. We have a complete sales staff
for national and export distribution. Reply
with samples or description of products.

RA-870, Electronics
330 West 42nd St., New York 18, N. Y.

HALLICRAFTERS SIGNAL CORPS

TRANSMITTERS

450 Watt CW—325 Watt Phone
CONTINUOUS DUTY OUTPUT

Used in the SCR-299 mobile station (the
famous "Voice of Victory") these trans-
mitters are outstanding for their depend-
able, efficient service. This war-improved
version of the HT-4, ruggedly constructed
for continuous duty, in modern black con-
sole cabinet, is suitable for the finest com-
mercial or amateur stations. Model BC-610

We make them available for only a
fraction of the original cost!

RECEIVERS

The SCR-299 receivers are one of the
finest, most modern communications type—
excellent for all services.

Two RF stages—crystal filter—two IF
stages—4500 degrees vernier bandspread
—ten metal tubes. Model BC-342

(For mobile, marine, etc. or emergency
service—Model BC-312—operates on 12
Volt Battery)

Operating tables also available

IMMEDIATE DELIVERY

Wire, phone or Special Delivery for
details—Limited quantities.

Since 1925

Distributors of All Standard Lines

WANTED

Your Business

"ANYTHING containing IRON or STEEL"

MORE FOR YOUR DOLLAR
IRON & STEEL PRODUCTS, INC.

40 years' experience
13422-A S. Brainard Ave., Chicago 33, Ill.

MANUFACTURER'S SALES ENGINEER

Former Chief Engineer of
Electronics Plant desires to rep-
resent manufacturer of elec-
tronic components and units as
Sales and Technical represen-
tative in the New York and
New England Area.

RA-134, Electronics
330 West 42nd St., New York 18, N. Y.

CALIFORNIA REPRESENTATION OFFERED

To radio and electronic manufacturers
now looking for firmly established and
thoroughly experienced sales agency.
Correspondence invited.

"IN RADIO SINCE 1911"

RA-133, Electronics
330 West 42nd St., New York 18, N. Y.

Long Established in CALIFORNIA

A Reliable Firm of

MANUFACTURERS REPRESENTATIVES

Seeking New Line

AUTOMOTIVE • AVIATION • HARDWARE
PARTS SUPPLIES EQUIPMENT

RA-995, Electronics
68 Post St., San Francisco 4, Calif.



"Brand New" COMMAND RADIO TRANSMITTER



BC 653A
(Covers Removed)
MADE FOR SIGNAL CORPS

Frequency Range: 2 to 4.5 mc in five quickly selectable frequencies.

Power Output: 90 watts CW, 22½ watts voice.

Power Input: 12 volts DC at 42 amps or 24 volts DC at 30 amps.

Tube Line-Up: Master oscillator type 1613; IPA type 807; PA PP type 814's; modulator type 1613; VR-105's as voltage regulators.

Complete with component antenna relay, dynamotor, less antenna and storage batteries. Immediately available at a remarkably low price. Write for further details.

Sales restricted to communications companies, manufacturers, distributors and dealers.



Central Agents for War Assets Corp.
255 18th Street • Brooklyn 15, N. Y.
702 Bartlett Building • 215 West 7th St.
Los Angeles 14, Calif.

Remler Appointed Agent for WAR ASSETS CORPORATION

(Under Contract No. 59A-3-48)

... to handle and sell a wide variety of **ELECTRONIC EQUIPMENT** released for civilian use

Write for **Bulletin Z-1**
Remler Company Ltd.
2101 Bryant St.
San Francisco 10, Calif.

REMLER

Since 1918

Radio • Communications • Electronics

METERS

NEW WESTON RADIO SERVICE METERS
IMMEDIATE DELIVERY

- Model 772 analyzers \$49.50
- Model 777 Tube checkers \$49.50
- Model 697 analyzers \$24.00
- Model 785 Industrial circuit tester \$93.75
- Model 666 set selector \$15.83
- Model 766 Televerter. 5,000 volt \$18.75
- Model 766 Televerter. 10,000 volt \$22.00

NEW SURPLUS METERS

- WESTON ROUND FLUSH BAKELITE METERS UNLESS SPECIFIED OTHERWISE**
- Model 301, 3½". 0-10, 0-15, 0-50, 0-100, 0-800, 0-1000 Milliampers D.C., \$4.95
 - Model 301, 3½" Sangamo 500-0-500 Microampere Movement 100-0-100 Scale \$3.95
 - Model 506, 2½". 0-15, 0-50, 0-200 Milliampers, D.C. \$3.50
 - Model 643, Surface Mounting. 0-150 volts D.C., \$8.00
 - Model 301, 3½" voltmeters 0-150 volts D.C. \$4.50
 - 0-1½ K.V., D.C. complete with 1000 ohm per volt resistor \$6.95
 - 0-4 K.V., D.C. complete with resistor \$7.95
 - Model 476, 3½". 0-8 volts \$4.00. 0-130 volt \$4.50. 0-150 volts \$5.95
 - Model 517. Round Flush Ring Mounting, 0-15-25-75 volts A.C. \$2.95
 - Model 517, 2½". 0-150 volts A.C. \$2.95
 - Model 476, 3½". 0-4 Ampere Whitescale \$4.50. 0-30 Ampere A.C. Black Scale \$4.00
 - Model 642, 4½ Surface mounting. 0-150 volts A.C. \$9.00. 0-15 Ampere A.C. \$8.00
 - Model 301. 0-25 volts A.C. Rectifier type 2000 ohm per volt \$6.95
 - Model 506, 2½". Decibel Meter —10 to +6 Black Scale \$3.95

WESTINGHOUSE

- Model NA 33, 2½. 0-150 volts A.C. \$1.98
 - Model NX 35, 3½. 0-24 Milliampere movement, with 0-24 MA and 0-1200 volt scale \$2.25
 - Model NH 35, 3½. Total hour meters. 115 volt, 60 cycle \$4.95
 - Model DY-2, 4½. 0-2½, 0-50, 0-60, 0-70, Ampere A.C. surface mounting White Scale \$8.00
 - Model DY-2, 4½. 0-150 volts A.C. surface mounting Black Scale \$9.00
 - Model DY-2, 4½. 115 volt, 50-70 cycle frequency meter White Scale \$35.00
 - GE Type DW44. Radio Frequency ammeter, 2½" Black Scale 0-1 and 0-8 Ampere \$2.95
 - Model DO-40, G.E. 3" Round Surface Mounting Meters, 0-2½", 25 Milliampers, 0-300 Milliampers, 0-300 volts. All D.C. All Zero Center \$2.50
- Add 1% for N.Y.C. Sales Tax when shipped to points within N.Y.C.
Add sufficient postage on P.P. orders. Excess will be refunded.

Maritime Switchboard

336 Canal St. N. Y. 13, N. Y.
Worth 4-8217

BEST QUALITY, USED ELECTRON TUBE MACHINERY

Equipment for the manufacture of all kinds of electron tubes, radio tubes, incandescent lamps, neon tubes, photo electric cells, X-ray tubes, etc.

AMERICAN ELECTRICAL SALES CO., Inc.
65-67 East 8th St. New York, N. Y.

SURPLUS METERS, XMTRS, COMPONENTS

Cathode Ray Tubes, Ham equip, etc.

What can you use? Send your list, any quantity. Get our price first!

ELECTRONIC RESEARCH LABS.
Howell & Hegerman Sts., Phila., Pa.

WRITE FOR 24 P. CATALOG OF

METERS

AND INSTRUMENTS

VOLTMETERS	BRIDGES (Wheatstone)
AMMETERS	MEGOhmmeters
MICRO	RHEOSTATS
AMMETERS	VARIABLE
Ohmmeters	TRANSFORMERS
FREQ. METERS	RELAYS

ELECTRO-TECH Equipment Co.
329 CANAL ST., N. Y. 13, N. Y.

A Windfall! If You Use CAPACITORS

GOVERNMENT SURPLUS
Just about every type and size . . .

Probably includes what you now use . . . at a substantial saving . . . All of highest quality . . . Government inspected. Write for catalog.

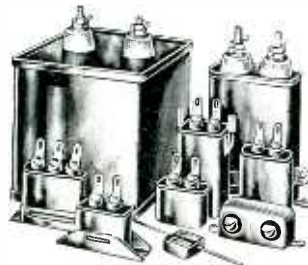

- Oil-filled
- Electrolytic
- Molded paper
- Molded mica
- Ceramic
- Variable
- Transmitting

TOBE DEUTSCHMANN CORPORATION, Canton, Massachusetts
Acting as Agents of War Assets Corporation

magnetic iron powders

The high magnetic performance, exceptional Q and high permeability assured by Mephram magnetic iron powders (hydrogen reduced) is daily advancing them into wider use in high-frequency, tele-communication and magnetic applications.... Strictly controlled production and attractively low prices suggest consultation with the Mephram Technical Staff.... No obligation.... Send for literature.

G. S. MEPHAM CORPORATION
Established 1902 • • East St. Louis, Illinois

PERMANENT MAGNETS

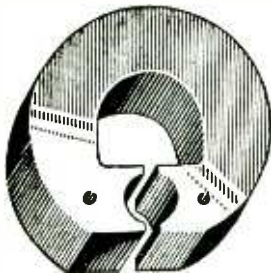

All Shapes—All Sizes—for All Purposes
COBALT—CHROME—TUNGSTEN
Stamped, formed and cast

Alnico (Cast or Sintered)

Also: Laminations for Radio Transformers
TOOLS—DIES—STAMPINGS
Heat Treating of Metals and Alloys

THOMAS & SKINNER STEEL PRODUCTS COMPANY
1116 EAST 23RD STREET • INDIANAPOLIS 5, INDIANA

If You Are Having Difficulty Maintaining Your Mailing Lists...

for Results



Mc GRAW-HILL
DIRECT MAIL LIST SERVICE

Probably no other organization is as well equipped as McGraw-Hill to solve the complicated problem of list maintenance during this period of unparalleled change in industrial personnel.

McGraw-Hill Mailing Lists cover most major industries. They are compiled from exclusive sources, and are based on hundreds of thousands of mail questionnaires and the reports of a nation-wide field staff. All names are guaranteed accurate within 2%.

When planning your direct mail advertising and sales promotion, consider this unique and economical service in relation to your product. Details on request.

McGraw-Hill Publishing Co., Inc.
DIRECT MAIL DIVISION
330 West 42nd Street • New York, 18, New York

You can depend upon CONTROL CORPORATION RELAYS

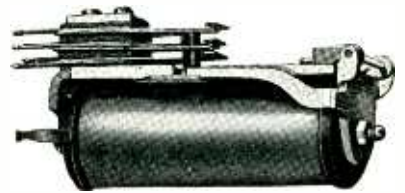

This relay was used to control a million dollar electric utility system. Control Corporation offers dependable relays to fit your needs, including:

Telephone relays
Double coil latching relays
Frequency responsive relays

For details consult

CONTROL CORPORATION

718 CENTRAL AVENUE
Phone GEneva 9361

Minneapolis 14, Minn.

AIRCO ARGON • NEON • HELIUM XENON • KRYPTON Standard and Special Mixtures

Nationwide Distribution through
AIRCO offices

ATLANTA 2, GA.
680 Hamilton Ave., S.E.
(P. O. Box 4176)

BALTIMORE 2, MD.
1310 N. Calvert St.
BIRMINGHAM 3, ALA.
124 So. 16th St.
(P. O. Box 2583)

BOSTON 25, MASS.
122 Mt. Vernon St.
Upham's Corner

BUFFALO 13, N. Y.
730 Grant St.

CHARLOTTE 1, N. C.
Post and McNinch Sts.
(P. O. Box 1147)

CHICAGO 4, ILL.
332 So. Michigan Ave.
Room 604

CINCINNATI 3, OHIO
934 Kenyon Ave.

CLEVELAND 2, OHIO
1112 Williamson Bldg.
DAVENPORT, IA.
2561 State St.
Bethesda, Ia.

DAYTON 1, OHIO
Springboro Pike at
Sellers Road
(P. O. Box 923)

DETROIT 11, MICH.
7991 Hartwick St.

KANSAS CITY 8, MO.
2701 Warwick Trifway

LOS ANGELES 11, CAL.
2423 E. 38th St.

LOUISVILLE 1, KY.
1236 Logan St.

MILWAUKEE 5, WISC.
818 W. Winnebago St.
MINNEAPOLIS 2, MINN.
1111 Nicollet Ave.

NEW ORLEANS 2, LA.
1406 S. Rendon St.
NEW YORK 17, N. Y.
60 East 42nd St.

OKLAHOMA CITY 8,
1521 S. Agnew
(P. O. Box 2457)

PHILADELPHIA 40, PA.
Allegheny Ave. & 17 St.

PITTSBURGH 12, PA.
1116 Ridge Av., N. Side

PORTLAND 10, ORE.
2949 N.W. Front Ave.

RICHMOND 1, VA.
(P. O. Box 1192)

SAN FRANCISCO, CAL.
1280 4th St.

SEATTLE 4, WASH.
3623 E. Marginal Way

SHREVEPORT, LA.
St. Vincent Ave.
Cedar Grove Station
(P. O. Box 763)

ST. LOUIS 2, MO.
430 So. Second St.

WHEELING, W. VA.
94 - 29th St.

Magnolia Airco Offices
EL PASO, TEXAS
Old Fort Bliss Road
(P. O. Box 64)

HOUSTON 1, TEXAS
2405 Collingsworth Av.
(P. O. Box 319)

FORT WORTH 1, TEXAS
801 N. Throckmorton
(P. O. Box 996)

Represented internationally by Airco Export Corp.

AIR REDUCTION

GENERAL OFFICE: 60 E. 42d ST., NEW YORK 17, N. Y.

INDEX TO ADVERTISERS

	Page
Ace Manufacturing Corporation.....	310
Acheson Colloids Corporation.....	261
Acme Electric & Mfg. Co.....	220
Acro Electric Co.....	174
Acton Co., Inc., H. W.....	345
Adams & Westlake Company.....	34
Aerovox Corporation.....	35
Agaloy Tubing Company.....	197
Air Reduction	360
Aircraft-Marine Products, Inc.....	86
Allegheny Ludlum Steel Corp.....	227
Alliance Manufacturing Company.....	41
Allied Control Co., Inc.....	223
Allied Radio Corp.....	294
Allmetal Screw Products Co.....	298
Alpha Metals, Inc.....	72
Altec-Lansing Corp.....	276
American Electrical Heater Co.....	290
American Gas Accumulator Co.....	348
American Gas & Chemical Co.....	347
American Lava Corporation.....	71
American Phenolic Corp.....	76
American Platinum Works.....	353
American Rolling Mill Co.....	257
American Screw Co.....	184
American Television & Radio Co.....	328
American Time Products, Inc.....	188
American Transformer Co.....	180
Amperex Electronic Corporation.....	
Inside Front Cover	
Amperite Co.....	346
Andrew Co.....	226
Ansonia Electrical Company.....	285
Arkwright Finishing Co.....	250
Armstrong Mfg. Co.....	355
Arnold Engineering Co.....	240
Art Wire & Stamping Co.....	341
Astatic Corporation	256
Audak Co.....	363
Audio Development Co.....	216
Audio Devices, Inc.....	191, 216
Automatic Mfg. Corporation.....	295
Baer Company, N. S.....	300
Bakelite Corporation.....	61
Ballantine Laboratories, Inc.....	190
Barker & Williamson.....	298
Barnes & Reinecke	341
Belden Mfg. Co.....	273
Bell Telephone Laboratories.....	18, 19
Bendix Aviation Corp., Radio Div.....	221
Bentley, Harris Mfg. Co.....	203
Benwood-Linze Company	260
Bird Electronic Corporation.....	224
Birnback Radio Co., Inc.....	339
Blaw-Knox Company	263
Biiley Electric Co.....	183
Bogen Co., Inc., David.....	292
Boonton Radio Corp.....	40
Brach Mfg. Corp., L. S.....	343
Bradley Laboratories, Inc.....	319, 334
Brand & Co., William.....	169
Bruning Company, Inc., Charles.....	189
Bud Radio, Inc.....	340
Burgess Battery Co.....	327
Burlington Instrument Co.....	198
Burdny Engineering Co., Inc.....	65
Burstein-Applebee Co.....	355
Callite Tungsten Corp.....	62
Cambridge Thermionic Corporation.....	362
Cannon Electric Development Co.....	186
Capitol Radio Engineering Institute.....	266
Cardwell Mfg. Corp., Allen D.....	318, 319
Carter Motor Co.....	520
Celanese Corporation of America.....	16, 17
Cellusuede Products, Inc.....	355
Central Paper Co.....	328
Centralab, Div. of Globe-Union, Inc.....	54
Chatham Electronics	87
Chicago Metal Hose Corporation.....	252
Chicago Transformer Corp.....	321
Cinch Mfg. Corp.....	161

	Page
Clare & Co., C. P.....	267
Clarostat Mfg. Co., Inc.....	331
Clippard Instrument Laboratory.....	338
Cohn & Co., Sigmund.....	344
Collins Radio Co.....	179
Commercial Research Laboratories, Inc.....	313
Communication Measurements Laboratory.....	317
Conant Electrical Laboratories.....	222
Concord Radio Corporation.....	323
Condenser Products Company.....	337
Continental-Diamond Fibre Co.....	255
Control Corporation	360
Cornell-Dubilier Electric Corp.....	51
Corning Glass Works.....	30, 31
Cornish Wire Company, Inc.....	234
Cosmor, Ltd., A. C.....	196
Coto-Coil Co., Inc.....	262
Cramer Co., Inc., R. W.....	350
Cross, H.....	355
Crystal Research Laboratories, Inc.....	282
Dalis, Inc., H. L.....	329
Daven Company.....	Inside Back Cover
DeJur Amsco Corporation.....	259
De Mornay Budd, Inc.....	233
Deutschmann Corp., Tobe.....	6
Dial Light Co. of America, Inc.....	339
Dinion Coil Co., Inc.....	329
Dongan Electric Mfg. Co.....	347
Drake Electric Works, Inc.....	351
Drake Mfg. Co.....	304
Driver-Harris Co.....	43
Dumont Electric Corp.....	10
DuMont Laboratories, Inc., Allen B.....	36
Durez Plastics & Chemicals, Inc.....	201
DX Radio Products Co.....	327
Dzus Fastener Co., Inc.....	55
Eastern Air Devices, Inc.....	11
Eastern Electronics Corp.....	176
Eastman Kodak Company.....	165
Eby, Inc., Hugh H.....	302
Eisler Engineering Co.....	339, 355
Eitel-McCullough, Inc.....	89
Electrical Insulation Co., Inc.....	346
Electrical Reactance Corp.....	338
Electronic Engineering Co., Inc.....	342
Electronic Products Company.....	24
Electronic Specialties Mfg. Co.....	349
Electronics Research Publishing Co.....	324
Electrons, Inc.....	60
Engineering Company	322
Erco Radio Laboratories, Inc.....	254
Ericason Screw Machine Products Co., Inc.....	282
Erie Resistor Corp.....	74
Essex Electronics.....	361
Farnsworth Television & Radio Corp.....	237
Federal Tel. & Radio Corp.....	28, 29
Federated Metals Div., American Smelting and Refining Co.....	243
Fenwal, Inc.....	211
Ferranti Electric, Inc.....	38
Finch Telecommunications, Inc.....	206
Fish-Schurman Corporation	537
Five Star Radio Co.....	327
Foot Mineral Co.....	215
Formica Insulation Co.....	82
Franklin Fibre-Lamitex Corp.....	242
Freeland & Olschner Products, Inc.....	355
Garrett Co., Inc., George K.....	13
Gear Specialties	25
General Aniline & Film Corporation.....	56, 57
General Cement Mfg. Co.....	355
General Control Co.....	340
General Electric Co.....	73, 79, 181, 245, 283, 284, 345
General Industries Co.....	312
General Magnetic Corp.....	331
General Plate Div. of Metals & Controls Corp.....	269
General Radio Company.....	287
Glaser Lead Co., Inc.....	278
Goat Metal Stampings, Inc.....	329

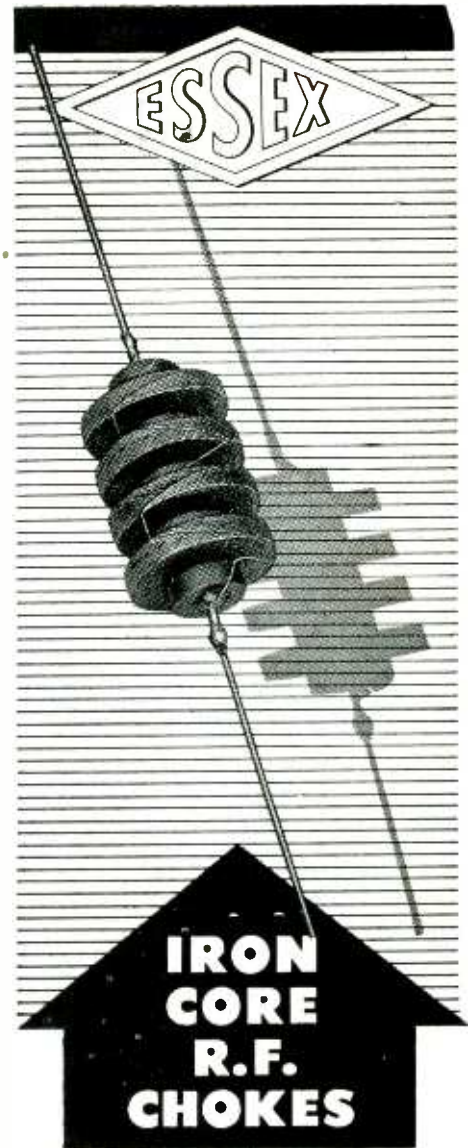

- ◆ Physically compact
- ◆ High Q
- ◆ Available in standard inductances of .5 mh, 1.0 mh, 2.5 mh, 5.0 mh, 10 mh.
- ◆ Inductance tol. $\pm 3\%$

Write for data sheet.

Precision manufacturers of all types of IF and RF coils, chokes, and transformers.

**ESSEX
ELECTRONICS**

1060 Broad St., Newark, N. J.

**Try C.T.C.'s New
SLUG TUNED INDUCTOR COIL**

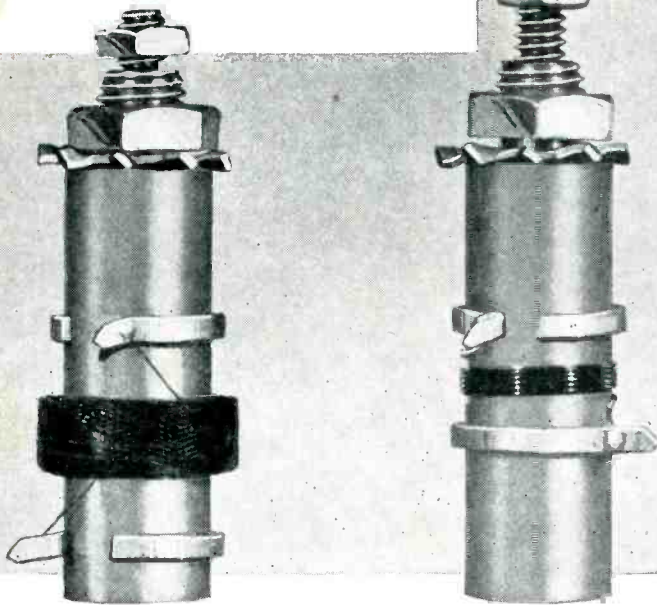

With a frequency range from 1/2 megacycle to 60 megacycles and a slug tuning range from 1.5-1 in frequency, this tiny, compact LS-3 is ideal for many applications.
Be sure to specify the inductance or capacitance and frequency required when ordering the LS-3.
Write for C.T.C. Catalog No. 100.



CAMBRIDGE THERMIONIC CORPORATION
439 Concord Avenue • Cambridge 38, Mass.

WASHERS

STANDARD AND SPECIAL

Every Type
Every Material
Every Purpose
Every Finish

Over 22,000 Sets of Dies

STAMPINGS

OF EVERY DESCRIPTION

Blanking
Forming
Drawing
Extruding

Let us quote on
your requirements.

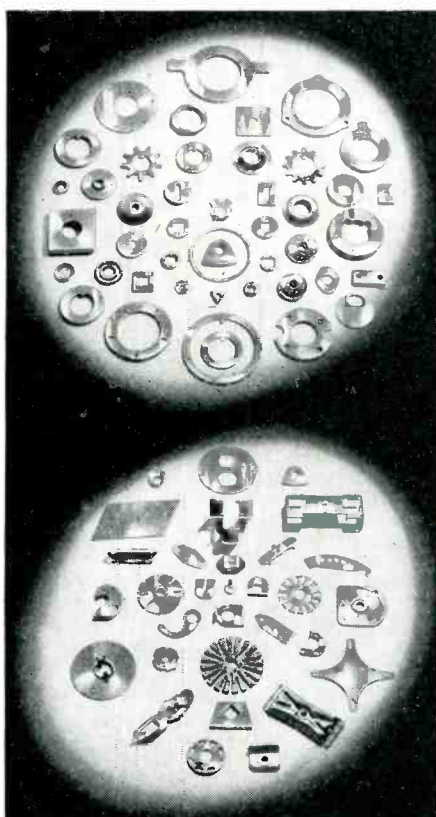

WROUGHT WASHER MFG. CO.
THE WORLD'S LARGEST PRODUCER OF WASHERS

2118 SOUTH BAY STREET • MILWAUKEE 7, WISCONSIN

	Page
Goodrich Chemical Co.	364
Gorrell & Gorrell	341
Gothard Manufacturing Company	300
Gould-Moody Co.	296
Gramer Company	322
Graphite Metallizing Corp.	333
Guardian Electric Mfg. Co.	209
Hallicrafters Co.	33
Hammarlund Mfg. Co., Inc.	8
Hardwick, Hindle, Inc.	348
Harris Products Co.	333
Harvey Radio Company	302
Harvey Radio Laboratories, Inc.	269
Hathaway Instruments Co.	343
Haydon Manufacturing Company, Inc.	244
H-B Instrument Co.	306
Heinemann Circuit Breaker Co.	219
Hewlett-Packard Company	75
Heyman Manufacturing Co.	343
Hexacon Electric Co.	286
Holliston Mills, Inc.	241
Hudson Wire Co.	324
Hytron Radio & Electronics Corp.	12
Imperial Tracing Cloth	316
Indiana Steel Products Co.	192
Insl-X Co., Inc.	236
Instrument Resistors Company	314
Instrument Electronics Co.	354
Instruments Parts Corporation	288
Insuline Corp. of America	228
International Nickel Co., Inc.	293
International Resistance Company	167
Irvington Varnish & Insulator Co.	213
Jack & Heintz, Inc.	58, 59
Janette Mfg. Co.	306
J-B-T Instruments, Inc.	204
Jefferson Electric Co.	217
Jelliff Mfg. Corp., C. O.	310
Jones Co., Howard B.	329
Kahle Engineering Co.	355
Karp Metal Products Co., Inc.	7
Kenyon Transformer Co., Inc.	70
Kester Solder Co.	258
Keuffel & Esser Co.	3
Kings Electronics Co.	296
Kirkland Co., H. R.	324
Kwikheat Division, Sound Equipment Corporation	327
Lampkin Laboratories	355
Langevin Company, Inc.	307
Lapp Insulator Co., Inc.	15
Lavoie Laboratories	309
Lawton, Norman H.	336
Leach Relay Company	14
Lewyt Corporation	80
Lord Manufacturing Co.	44
Macallen Co.	274
Machlett Laboratories, Inc.	195
MacRae's Blue Book	331
Magnavox Co., The	311
Maguire Industries, Inc.	46, 47
Mallory & Co., Inc., P. R.	90, 163
Manufacturers Screw Products	347
Marion Electrical Instrument Co.	246
MB Manufacturing Co., Inc.	81, 303
McGraw-Hill Book Co.	320, 353
McLaughlin, J. L. A.	355
Mepharm Corp., G. S.	360
Merit Coil & Transformer Corp.	294
Metaplast Co.	277
Mica Insulator Co.	66, 67
Micro-Ferrocort Products, Div. of Maguire Industries, Inc.	299
Midwest Molding & Mfg. Co.	324
Milford Rivet & Machine Co.	218
Millen Mfg. Co., Inc., James	290
Mitchell-Rand Insulation Co., Inc.	175
Murray Hill Books, Inc.	344
Mycalex Corporation of America	88
National Carbon Company, Inc.	251
National Co., Inc.	289
National Research Corporation	301
National Screw & Mfg. Co.	229
National Union Radio Corporation	69
National Vulcanized Fibre Company	207
New England Screw Co.	333
Northern Industrial Chemical Co.	351
Ohmite Mfg. Company	231
Onan & Sons, D. W.	330
O'Neil-Irwin Mfg. Co.	314
Oster Manufacturing Co., John	353
Owens-Corning Fiberglass Corporation	177
Par-Metal Products Corporation	280
Peerless Electrical Products Co.	280
Permo, Inc.	336
Permoflux Corporation	248
Petersen Radio Co.	320
Phillips Screw Manufacturers	37
Pilot Electric Co.	335
Pioneer Electric Co.	349
Potter & Brumfield Sales Co.	52
Potter Company, The	178
Precision Tube Co.	210
Premax Products	322
Press Wireless Mfg. Corp.	253
Presto Recording Corp.	45
Price Electric Corporation	85
Printloid, Inc.	50
Progressive Mfg. Co.	342
Quadriga Manufacturing Co.	353
Quaker City Gear Works, Inc.	214
Radex Corp.	337
Radio Condenser Co.	21
Radio Corp. of America, Victor Div.	4, 5, 77, Back Cover
Radio Engineering Lab's, Inc.	185

	Page
Radio Shack	349
Radio Specialty Mfg. Co.	345
Radio Supply & Engineering Co., Inc.	316
Radio Wire Television, Inc.	332
Rauland Corporation	205
Rawson Electrical Instrument Co.	335
Raytheon Mfg. Co.	39, 53, 173
R-B-M Division, Essex Wire Corporation	78
Reiner Electronics Co., Inc.	187
Reliable Spring & Wire Forms Co.	200
Revere Copper & Brass, Inc.	27
Rex Rheostat Co.	355
Rice's Sons, Inc., Bernard	281
Richardson Company	194
Robinson Aviation, Inc.	351
Rockbestos Products Corp.	305
Schweitzer Paper Co.	271
Scientific Electric Div. of "S" Corrugated Quenched Gap Co.	32
Scovill Mfg. Co., Waterville Screw Products Div.	171
Seeburg Corp., J. P.	297
Segel Co., Henry P.	334
Selenium Corporation of America	350
Shure Brothers	182
Sigma Instruments, Inc.	276
Sillcocks-Miller Co.	292
Simpson Electric Co.	275
Sola Electric Co.	49
Sorensen & Company, Inc.	315
Speer Carbon Company	68
Sprague Electric Co.	239
Stackpole Carbon Co.	63
Standard Piezo Company	337
Standard Transformer Corp.	170
Star Expansion Products Co.	343
Star Porcelain Co.	335
Sta-Warm Electric Co.	341
Stevens-Walden, Inc.	312
Steward Mfg. Co., D. M.	339
Struthers-Dunn, Inc.	20
Stupakoff Ceramic & Mfg. Co.	22, 23
Sun Radio & Electronics Co.	284
Superior Electric Co.	168
Superior Tube Co.	84
Supreme Instruments Corp.	332
Sylvania Electric Products, Inc.	193
Tech Laboratories	352
Televiso Products Co.	325
Thermador Electrical Mfg. Co.	326
Thomas & Skinner Steel Products Co.	360
Tinnerman Products, Inc.	225
Triplet Electrical Instrument Co.	64
Tung-Sol Lamp Works, Inc.	247
Turner Company, The	202
Ucinite Company	48
Union Carbide & Carbon Corp.	61, 251
United Transformer Corp.	2
Valpey Crystal Corp.	264
Victoreen Instrument Co.	326
Vokar Corporation	330
Vulcan Electric Co.	349
Waldes Kohinoor, Inc.	190
Walker-Turner Co., Inc.	345
Ward Leonard Electric Co.	249
Webster Electric Co.	212
Weil and Co., J. H.	304
Weller Mfg. Co.	333
Western Electric Co.	18, 19
Westfield Metal Products Co., Inc.	352
Westinghouse Electric Corporation	83, 235
Weston Electrical Instrument Corp.	42
Whistler & Sons, Inc., S. B.	9
White Dental Mfg. Co., S. S.	291
Whitehead Stamping Co.	347
Wilcox Electric Co., Inc.	26
Wilson Company, H. A.	172
Workshop Associates, Inc.	238
World Radio Laboratories, Inc.	351
Wrought Washer Mfg. Co.	362
Zenith Optical Laboratory	354
Zophar Mills, Inc.	322

PROFESSIONAL SERVICES 356

SEARCHLIGHT SECTION
(Classified Advertising)

EMPLOYMENT	357	358
USED EQUIPMENT	358	359
American Electric Sales Co., Inc.	359	
Deutschmann Corp., Tobe	359	
Electro-Tech. Equipment Co.	359	
Harrison Radio Corp.	358	
Iron & Steel Products Inc.	358	
Lectronic Research Labs	359	
Maritime Switchboard	359	
Raytheon Mfg. Co.	359	
Remler Co. Ltd.	359	

5 letter-word for PICK-UP PERFORMANCE

Audax



... the substantially unanimous verdict of experts and music lovers who have put the

RELAYED-FLUX
Microdyne

to the only test that really matters... the **EAR TEST**

*"The Standard
by Which
Others
Are Judged
and
Valued"*

SPECIALIZATION

has made AUDAX a leader in its field. World-wide recognition such as ours could never "just happen". Rather it is the product of KNOW-HOW that comes only through years of specialization.

For twenty years—since pick-ups first became important commercially—the distinguished products of AUDAX have been SELECTED wherever the requirements were exacting.

The leadership which we have won the hard way will never be jeopardized by making pick-ups a side line. Of future MICRODYNE improvements—and of course we are planning them now—we can tell you one thing NOW:—They will uphold and carry forward the AUDAX quality tradition of *fac-simile* performance, regardless of external conditions.

Send for complimentary copy of
"PICK-UP FACTS"

AUDAX COMPANY

500 Fifth Avenue,

New York 18

"Creators of Fine Electronic-Acoustical Apparatus since 1915"

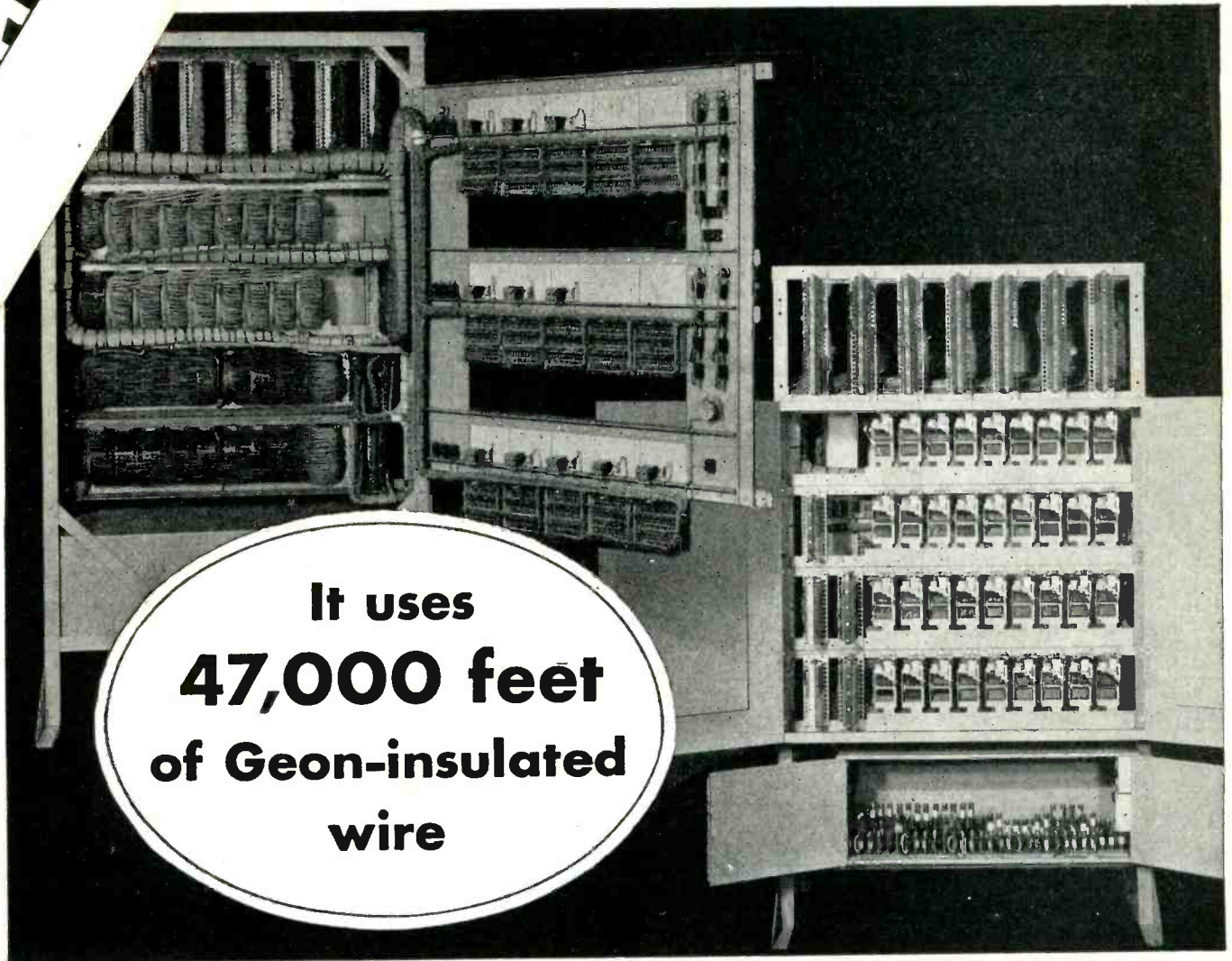

It uses
47,000 feet
of Geon-insulated
wire

Same type insulation is revolutionizing home and industrial wiring

THESE front and rear views of a Rotary Switch and Relay Bank Rack—that's what Western Union calls it—give some idea of where all the wire goes. But they don't tell why so much Geon-insulated wire is used in machines like these as well as other equally complicated instruments designed and built by Western Union engineers.

Most important, of course, are the excellent electrical properties of insulation made from GEON. They permit a thinner coating of insulation. In instrument wiring that means that the assembly engineer has more room for doing his intricate job. In building wiring it means more conductors per conduit or smaller holes to be drilled.

But insulation made from GEON offers more than this. In all types of wiring it's easier to handle because it's

smooth and non-sticky. It's easily identified because of the brilliant, permanent colors. It's highly abrasion resistant—pull it around sharp corners without fear of tearing. It resists water (GEON compounds, of course, are Underwriters approved for TW and other type wires); it resists oil and greases, acids and most other chemicals, sunlight and ozone, flexing, heat and cold, and most other normally destructive factors.

The next time you order wire—for manufacturing, home or industrial wiring—be sure to specify wire insulated with GEON now being made by leading wire and cable manufacturers. Or for more information please write Department F-4, B. F. Goodrich Chemical Company, Rose Building, Cleveland 15, Ohio. In Canada: Kitchener, Ontario.



B. F. Goodrich Chemical Company

A DIVISION OF
THE B. F. GOODRICH COMPANY



SWITCHES

ENGINEERED BY DAVEN

feature **LOW** and **UNIFORM** contact resistance

They are being specified, more and more, wherever precise and dependable operation is required, as in the better power and frequency selection equipment. Daven-engineered switches assure positive control.

PANELS: in bakelite or ceramic, according to requirements, in almost any size and shape.

TROUBLE-FREE operation: heavy duty, laminated switch arms are self wiping; Switch arms and contacts are of special silver alloy for most applications; other metals are available for special needs.

FLEXIBILITY: number of poles and contacts per deck, and number of decks may be had in almost unlimited combinations.

WIRING: in bakelite or ceramic, ac-make-before-break; choice of methods of connection — soldering lugs back of each live contact or soldering lugs mounted on a terminal board.

Consult Daven Engineers With Your Switch Requirements

THE **DAVEN** COMPANY

191 CENTRAL AVENUE
NEWARK 4, NEW JERSEY

RCA-10BP4
Directly Viewed
Kinescope



RCA-7DP4
Directly Viewed
Kinescope



RCA-5TP4
Mirror-Backed
Projection Kinescope



RCA-7GP4
Directly Viewed
Kinescope



ANNOUNCING...
THE NEW RCA
PREFERRED TYPE
KINESCOPES...

For table-model, console and large-screen television receivers

RCA now has available four new and improved Kinescopes of standardized type that meet practically all television receiver design requirements. These RCA-developed Kinescopes feature higher quality, longer operating life and far greater brilliance and definition than the prewar types. The use of high-volume precision equipment in their manufacture, coupled with RCA's extensive wartime experience in the design and mass production of cathode-ray tubes is reflected in the lower pricing of all four types.

RCA-5TP4: The RCA-5TP4 (5" face) metallic film Projection Kinescope more than doubles screen brightness of 16" x 20" projected pictures. The "mirror-backed" screen also improves picture contrast and detail. Combined with the Reflective Optical System, the 5TP4 permits viewing at higher ambient light levels.

RCA-10BP4: The RCA-10BP4 with its 10-inch face is the star performer of the directly viewed line of Kinescopes. It is characterized by high definition and picture contrast 2 to 3 times greater than prewar types. Deflection

and focus are accomplished magnetically. An outside conductive coating, when grounded, serves as a filter capacitor. The new, high-voltage Duodecal 7-pin base is used.

RCA-7DP4: The RCA-7DP4 Directly Viewed Kinescope is a compact tube with a 7" diameter face particularly adaptable to table-model receivers. It incorporates the same features as the RCA-10BP4 but employs electrostatic focusing and a lower anode potential.

RCA-7GP4: Specifically designed for inexpensive table-model receivers, the 7GP4, also having a 7" face, has exceptionally high deflection sensitivity, a high-efficiency screen and operates at a relatively low anode potential. Both deflection and focusing are accomplished electrostatically. The low-price and high-performance characteristics of the 7GP4 make it unusually attractive for

receiver designs aimed at the mass market. RCA Tube Application Engineers are ready to consult with you now on the adaptation of RCA Preferred Type Kinescopes to your television receiver design requirements. If you wish aid in the application of these or other RCA tube types, write RCA, Commercial Engineering Department, Section D-6D, Harrison, N. J.

COMPARATIVE SPECIFICATIONS

	5TP4	10BP4	7DP4	7GP4
Heater Volts	6.3	6.3	6.3	6.3
Heater Amps	0.6	0.6	0.6	0.6
Anode Volts*	27,000	10,000	8,000	4,000
Focus	Electrostatic	Magnetic	Electrostatic	Electrostatic
Deflection	Magnetic	Magnetic	Magnetic	Electrostatic
Deflection Angle	50°	50°	50°	
Raster Size (approx.)	2 3/4" x 3 5/8"	6" x 8"	4" x 5 1/2"	4" x 5 1/2"
Bulb Dia. (max.)	5 1/8"	10 5/8"	7 5/16"	7 1/8"
Length (max.)	12 1/8"	18"	14 7/16"	14 7/8"
Base	Duodecal	Duodecal	Duodecal	Diheptal
Fluorescence	White	White	White	White
Persistence	Medium	Medium	Medium	Medium

*design center maximum value.

The Fountainhead of Modern Tube Development is RCA



TUBE DEPARTMENT

RADIO CORPORATION of AMERICA

HARRISON, N. J.