

SEPTEMBER · 1943

electronics



KEEP EVERYTHING
IN AUTO LOCK IN CA

**UTC
LEADS
THE
FIELD**

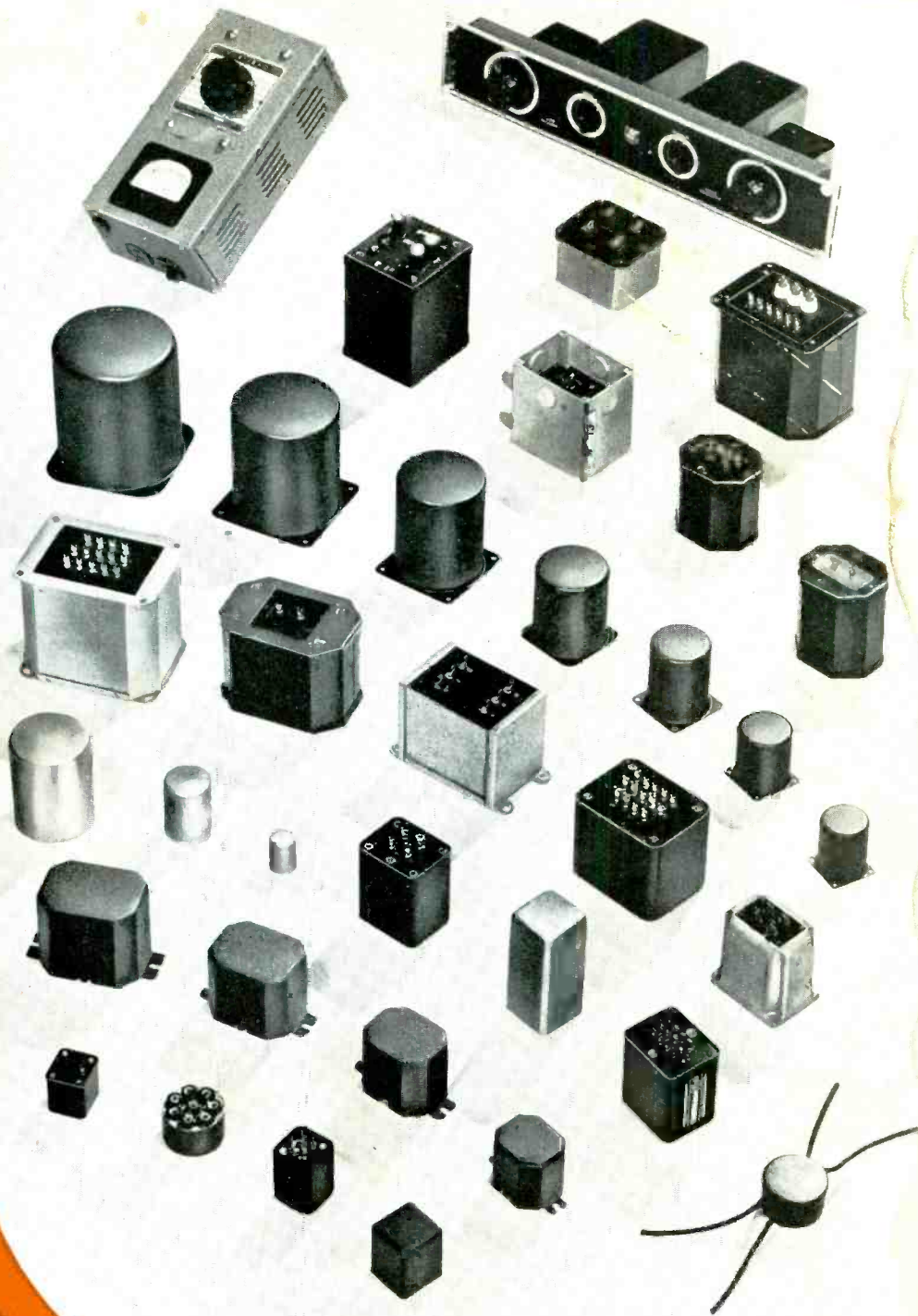

UNITED TRANSFORMER CO.

150 VARICK STREET

NEW YORK 13, N. Y.

EXPORT DIVISION: 13 EAST 40th STREET, NEW YORK 16, N. Y., CABLES: "ARLAB"

electronics

SEPTEMBER • 1943

SEA-RESCUE TRANSMITTER	Cover
Hand-powered unit used by Army airmen to summon help when forced down (<i>Signal Corps</i>)	
RADIO VS. INDUSTRIAL SYMBOLS	94
Lock of uniformity in symbols identifying component parts in circuits causes confusion	
PLANNING A V-H-F COMMUNICATIONS SYSTEM , by J. A. Doremus.....	96
Practical suggestions for police and other services, based on a Massachusetts experience	
R-F HEATING SPEEDS PLASTIC MOLDING , by John P. Taylor.....	102
Preheating of thermosetting preforms by means of a high-frequency field	
MILITARY FACSIMILE	108
Accurately sketched maps are transmitted from sky to earth under battle conditions	
METHODS OF DEPOSITING METALLIC FILMS , by Samuel Wein.....	110
Techniques used in the construction of scientific and electronic instruments and components	
PHOTOELECTRIC CONTACT PRINTER CONTROL , by C. J. Penther and C. Weiske.....	114
Timer insures uniform density of duplicate prints at high printing speeds	
MICROWAVE PLUMBING—PART I , by D. D. King.....	116
Construction of u-h-f transmission lines and wave guides for laboratory instruction	
PRECISION STROBOSCOPIC FREQUENCY METER , by Earle L. Kent.....	120
Whirling discs and a flashing tube measure audio frequencies with high accuracy	
THREE YEARS OF TELEVISION RELAYING , by R. L. Smith.....	122
A record of actual experiences with the New York-Schenectady u-h-f link	
BAND-PASS WAVE FILTER UNITS , by E. S. Purington.....	126
A continuation of the author's analysis of symmetrical wave filters	
A VARIABLE-FREQUENCY ELECTRONIC GENERATOR , by Dana A. Griffin.....	130
Device operated from a-c line delivers 1400 watts at any frequency between 300 and 3500 cps	
ELECTRONIC CONTROL OF D-C MOTORS—PART IV , by E. E. Moyer.....	133
Starting and reversing d-c motors controlled by electronic tubes	
Q OF UNLOADED CONCENTRIC TRANSMISSION LINES , by Robert Miedke.....	139
Sending-end impedance and Q easily determined by means of alignment chart	

KEITH HENNEY, Editor; Beverly Dudley, Managing Editor; Donald G. Fink (on leave); Craig Walsh (on leave); W. W. MacDonald, Associate Editor; John Markus, Assistant Editor; M. L. Matthey, Assistant Editor; J. M. Heron, Assistant Editor; Harry Phillips, Art Director

H. W. MATEER, Publisher; J. E. Blackburn, Jr., Director of Circulation, Electronics; Wallace B. Blood, Manager

DISTRICT MANAGERS, D. H. Miller, New York; R. H. Flynn, New England; F. P. Coyle, Philadelphia; L. P. Canty, Cleveland; C. D. Wardner, Chicago

Contents Copyright, 1943, by McGraw-Hill Publishing Company, Inc.
McGRAW-HILL PUBLISHING COMPANY, INCORPORATED
 JAMES H. McGRAW, Founder and Honorary Chairman
 Publication Office 99-129 North Broadway, Albany, 1, N. Y., U. S. A.

EDITORIAL AND EXECUTIVE OFFICES 330 West 42nd St., New York, 18, N. Y., U. S. A.
 James H. McGraw, Jr., President; Howard Ehrlich, Executive Vice President; Mason Britton, Vice President; Curtis W. McGraw, Vice President and Treasurer; Joseph A. Gerardi, Secretary. Cable address: MCGRAWHILL. New York. Member A. B. P. Member A. B. C.

ELECTRONICS, September, 1943, Vol. 16; No. 9. Published monthly, price 50c a copy. Allow at least ten days for change of address. All communications about subscriptions should be addressed to the Director of Circulation, 330 W. 42nd St., New York, 18, N. Y.

Subscription rates—United States and possessions, Mexico, Central and South American countries, \$5.00 a year, \$8.00 for two years, \$10.00 for three years. Canada (Canadian funds accepted) \$5.50 a year, \$9.00 for two years, \$11.00 for three years. Great Britain and British possessions 36 shillings for one year, 72 shillings for three years. All other countries, \$5.00 for one year, \$12.00 for three years. Entered as Second Class matter, August 29, 1936, at Post Office, Albany, New York, under the Act of March 3, 1879. **BRANCH OFFICES:** 520 North Michigan Avenue, Chicago, Ill.; 68 Post Street, San Francisco, 4; Aldwych House, Aldwych, London, W. C. 2; Washington, D. C., 4; Philadelphia, 2; Cleveland, 18; Detroit, 2; St. Louis, 1; Boston, 16; Atlanta, 3, Ga.; 601 West Fifth Street, Los Angeles, 13.

A McGRAW-HILL PUBLICATION



DEPARTMENTS

Washington Feedback	91
Crosstalk	93
Reference Sheet	139
Tubes at Work	142
Electron Art	182
News of the Industry	212
New Products	256
Book Reviews	284
Index to Advertisers	302
Backtalk	304

CHANGE OF ADDRESS

McGRAW-HILL PUBLISHING COMPANY
 330 West 42nd Street, New York, 18, N. Y.

Director of Circulation:
 Please change my address on Electronics

From

To

Signed

A Long Life

AND A USEFUL ONE

On the job doing their duty all the time—that's the reputation of Tobe Capacitors, earned through an almost complete absence of "returns!"

This record, far from making Tobe engineers complacent, acts as a spur to even higher quality, through constant research in materials and methods. Each Tobe Capacitor continues to be rated with ultra-conservatism.

The Tobe Oil-Mite Capacitor, shown here, is impregnated and filled with mineral oil. It is performing day-in, day-out duty as a filter condenser in war equipment. Inquiries in connection with your condenser problems will receive our prompt attention.



LONG LIFE ASSURED

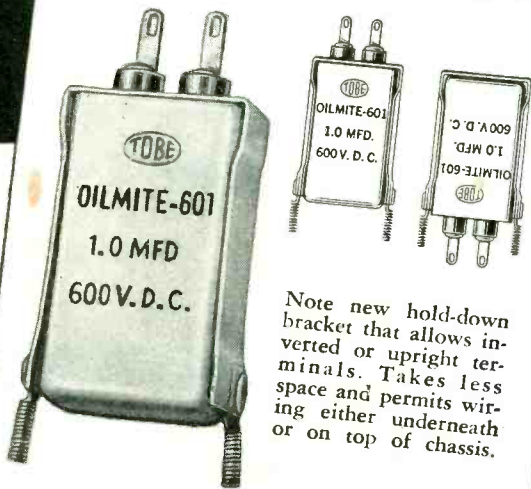

Note new hold-down bracket that allows inverted or upright terminals. Takes less space and permits wiring either underneath or on top of chassis.

CHARACTERISTICS OF TOBE OIL-MITE CAPACITORS

STANDARD CAPACITY TOLERANCE. = 10%
TEST VOLTAGE Twice D.C. rating
SHUNT RESISTANCE .05 to 0.1 mfd. 20,000 megohms. .25 to 0.5 mfd. 12,000 megohms. 1.0 to 2.0 mfd. 12,000 megohms
RATINGS .05 mfd. to 2.0 mfd. 600 V.D.C. .05 mfd. to 1.0 mfd. 1,000 V.D.C.
GROUND TEST 2,500 Volts D.C.
POWER FACTOR At 1,000 cycles—.002 to .005



A SMALL PART IN VICTORY TODAY—A BIG PART IN INDUSTRY TOMORROW



HANDS OFF!

WE PRESERVE OUR ORIGINAL DRAWINGS



PHOTACT prints take the wear and tear of frequent handling — our originals serve only as lasting records

★ ★ ★

Pencil tracings become blurred and smudged with too much handling—or too many runs through the blueprint machine. Even ink tracings can be damaged from frequent use.

Photact *preserves* your originals—whether pencil or ink. By making a Photact of your original you need no longer expose these valuable drawings to the effects of much handling or rough use. Your Photact becomes the “master” for every purpose of reference and reproduction—and your original may be filed away as a permanent record.

Photact *restores* old, worn-out drawings. This method insures maximum pick-up of lines weakened by over-handling and gives you Photact’s clear ink-like lines.

Photact *duplicates* your original drawings. The Photact negative of original tracing

can be used to make any amount of prints on either Photact paper or cloth.

The lines of each Photact have such high opacity, even when made from pencil tracings, that black-line or blueprints made from a Photact “master” are always much more legible than those made from the original.

This high-quality reproduction with sharp contrasts and clearly-defined lines makes Photacts ideal for use in sub-contracting, branch plants—government requirements, etc.

Erasures and changes can be made easily on a Photact.

For complete information about the Photact process and Photact papers and cloths, write: Photact Department, KEUFFEL & ESSER CO., Third & Adams Streets, Hoboken, New Jersey.



EST. 1867

KEUFFEL & ESSER CO.

NEW YORK • HOBOKEN, N. J.

CHICAGO ST. LOUIS • SAN FRANCISCO • LOS ANGELES
DETROIT • MONTREAL



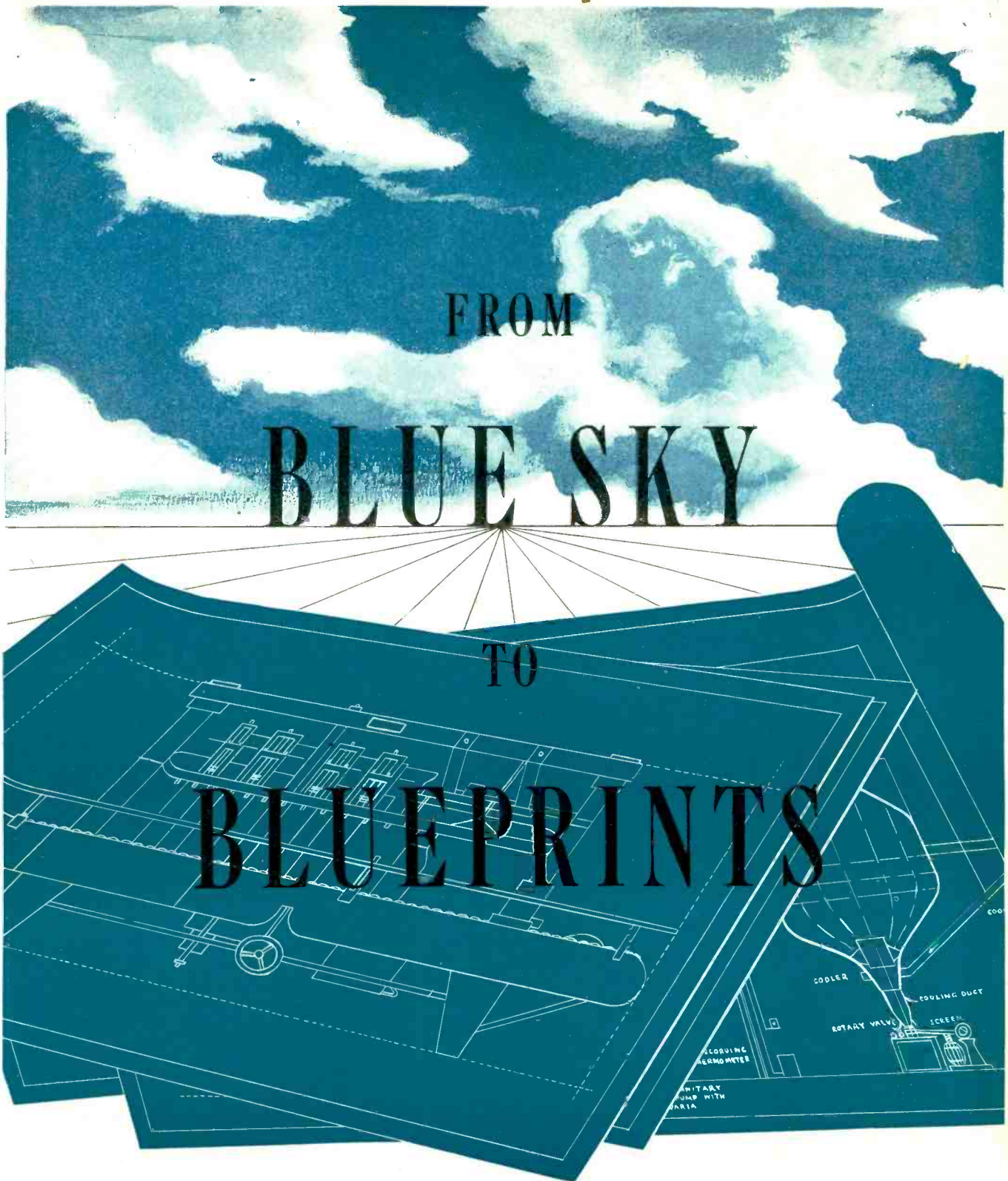

FROM
BLUE SKY
TO
BLUEPRINTS

Westinghouse



Electronic Tubes **AT WORK**

Every blueprint starts from "blue sky." A new device, an improved process, a different method for doing things better, faster, more economically, all start with an idea. From this nebulous beginning, this "blue sky", ideas are translated onto blueprints.

If you are in this stage of your planning, consider the help that electronics and Westinghouse "know-how" can offer you. Today there are Westinghouse Electronic Tubes designed for every purpose. Tubes which can see, hear, feel. Tubes

which clean the air, record brain waves, transform and rectify huge amounts of electrical current, weld metals, dry wood, detect vibrations, measure and control current flow, and perform an endless number of jobs with speed, accuracy, and utmost dependability.

Before carrying "blue sky" ideas too far, investigate electronics thoroughly. Take advantage, too, of the advanced technical assistance that Westinghouse makes available for your use. Westinghouse Electric & Manufacturing Co., Bloomfield, N. J.

A FEW OF THE WESTINGHOUSE TUBES NOW SERVING INDUSTRY

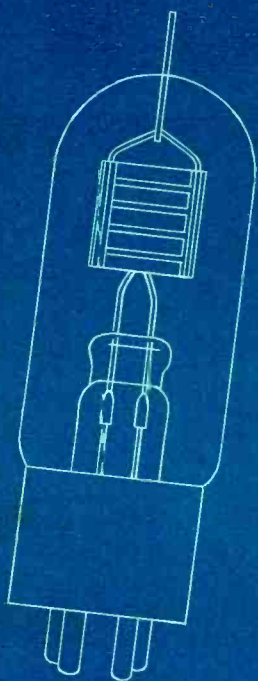

Kenotron

These high vacuum rectifiers supply high voltage low current DC for use in Precipitron, X-ray, high voltage testing and radio.

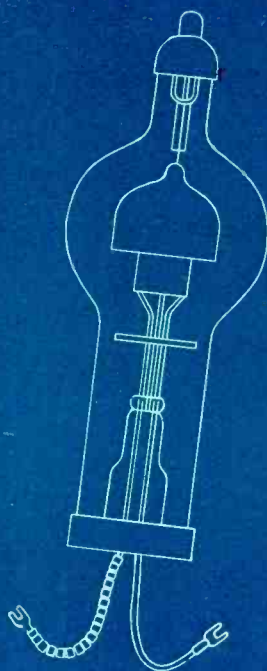

Phanotron

These tubes are used in many induction heating devices to supply high voltage direct current to the oscillators.

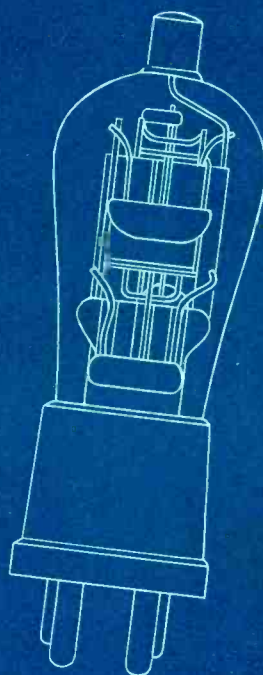

Electrometer Tube

With these tubes it is possible to measure current as low as 10^{-14} ampere and to indicate currents as low as 10^{-16} ampere.

**THE PEACETIME
MEASURES OF RADAR'S
REFLECTION AND
DEFLECTION
WILL BE READ FROM**



TRIPLETT

ELECTRICAL MEASURING INSTRUMENTS

**WITH CONFIDENCE
AND ECONOMY**



THE TRIPLETT ELECTRICAL INSTRUMENT CO., BLUFFTON,

OHIO

BACK UP YOUR BELIEF IN AMERICA...BUY WAR BONDS

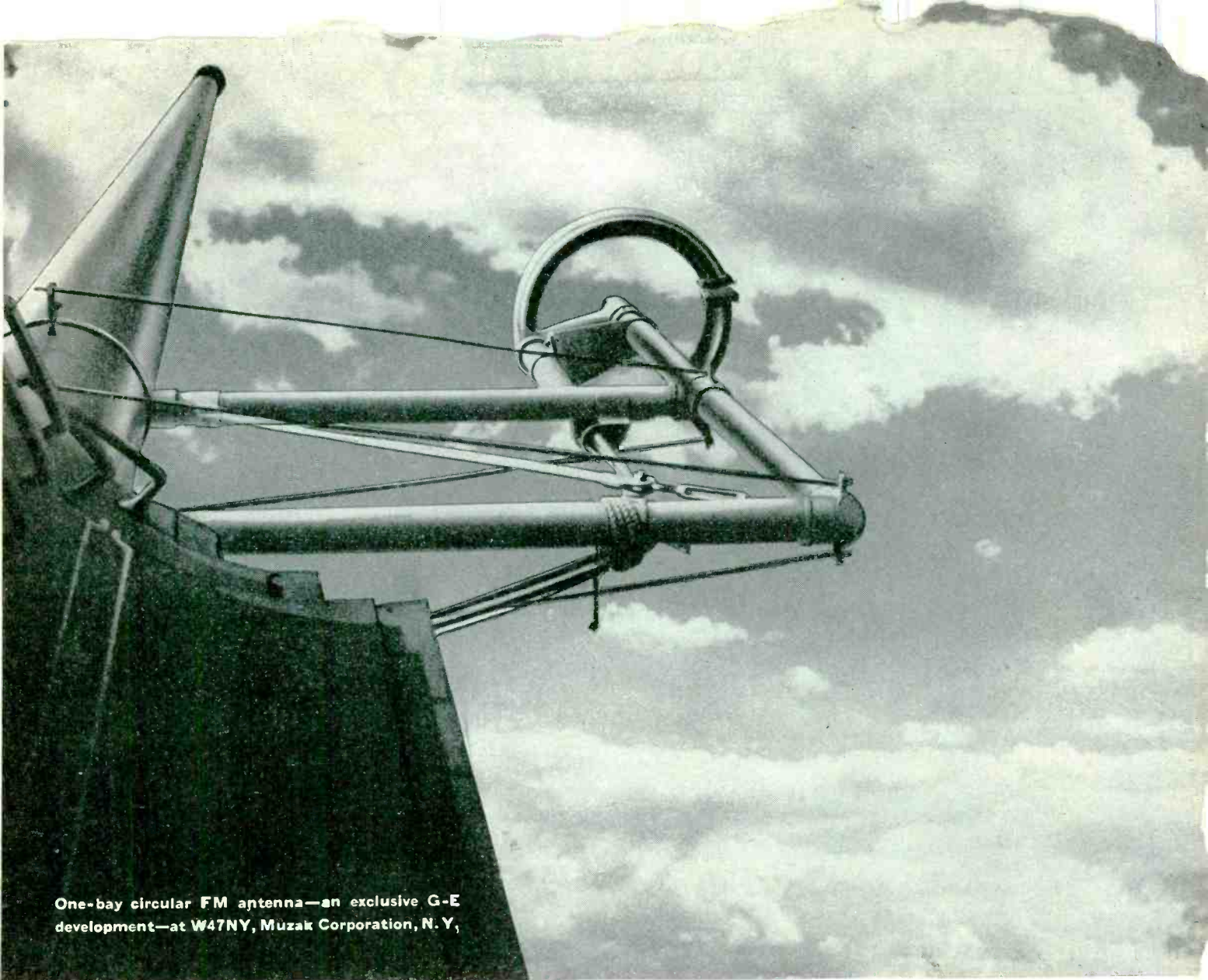

One-bay circular FM antenna—an exclusive G-E development—at W47NY, Muzak Corporation, N. Y.

To 144* broadcasters planning FM stations right after the war

No other manufacturer offers so much FM equipment and experience.

From helping you select the best transmitter site to providing a full line of FM equipment, G. E. offers you complete service.

For instance, G. E. can supply its exclusive S-T relay equipment to bridge the gap between studio and transmitter *without wires*. You locate the station for maximum coverage, the studio for maximum convenience.

General Electric has built more FM broadcast transmitters than any other manufacturer . . . more than a third of existing stations.

General Electric is the only manufacturer that has built both FM transmitters and FM home receivers.

General Electric's line of FM equipment includes: Broadcast apparatus, studio equipment, police radio, military radio, complete S-T FM relay equipment, monitoring equipment, high-gain antennas, home receivers.

General Electric is the only manufacturer who offers a complete promotional plan and local promotional effort on the day your General Electric FM station opens its doors. In newspapers, over local radio, with publicity releases and through every General Electric

dealer in your vicinity, the sale of FM home receivers is pushed in a determined drive to help you establish your station and FM in your area.

It's not too soon now to start detailed plans for the years following Victory. We invite your inquiries. Write to *Electronics Department, General Electric, Schenectady, New York.*

Tune in "THE WORLD TODAY" and hear the news direct from the men who see it happen, every evening except Sunday at 6:45 E.W.T. over CBS. On Sunday evenings listen to the G-E "Hour of Charm" over NBC network.

*According to a recent G-E survey of broadcasters.

GENERAL  **ELECTRIC** FM • TELEVISION • AM

160-B7-6912

DESIGN FLEXIBILITY

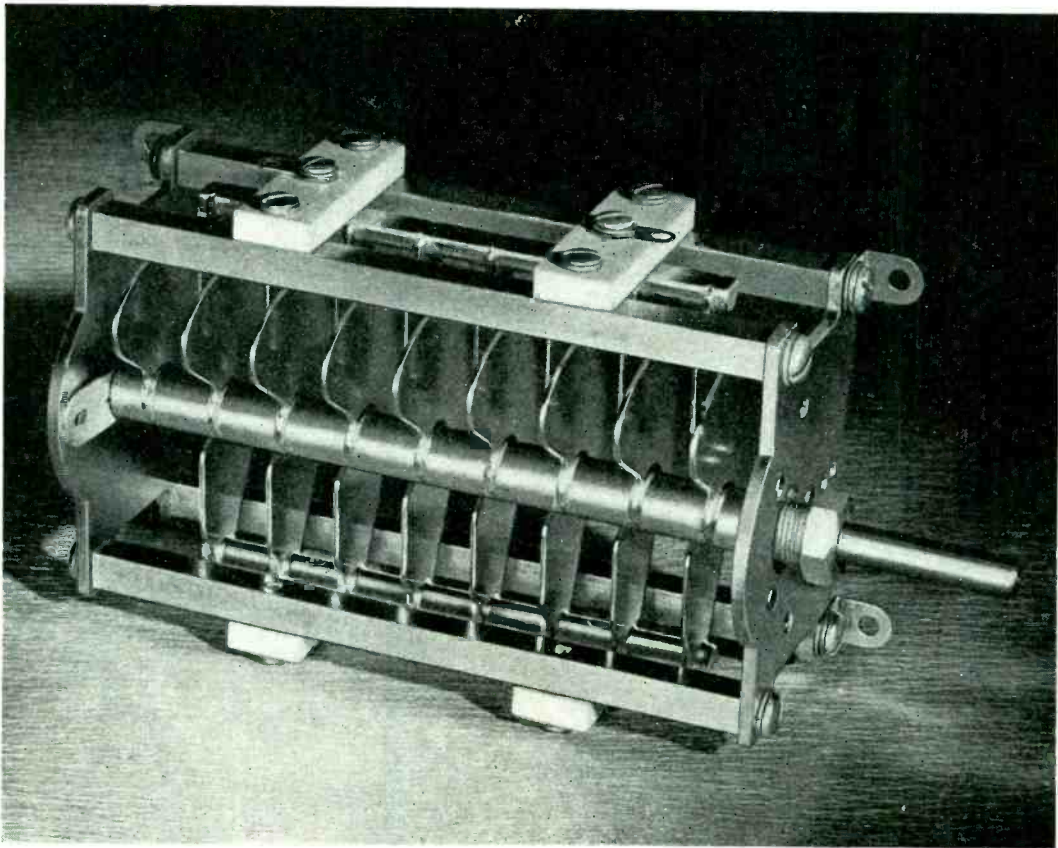

A *special*, built around the "MTC" basic design

WITH our many basic designs we can create highly specialized variable condensers in a much shorter engineering period. Whether you are working on a rush war job or a postwar product, Hammarlund will best serve your needs.

THE HAMMARLUND MANUFACTURING CO., INC.

460 West 34th Street, New York, N. Y.



HAMMARLUND

PLAX POLYSTYRENE CHARACTERISTICS

in sheets, rods and tubes

MECHANICAL

Tensile strength, lbs. per sq. in. (A.S.T.M. D 48-37)
5,500-7,000

Tensile proportional limit, lbs. per sq. in. (.01%
offset)
-38 F=3,700
0 F=2,800
78 F=2,500

Modulus of Elasticity in tension, lbs. per sq. in.
-38 F=554,000
0 F=536,000
78 F=469,000

Modulus of Elasticity in compression, 78 F lbs. per
sq. in. 560,000

Compressive proportional limit, lbs. per sq. in.
(.01% offset) 2,600

Compressive Strength, lbs. per sq. in. 15,200

Rockwell Hardness ($\frac{1}{2}$ " ball, 60 kg. load) R-90-R-97

For design purposes, a maximum normal stress of
750 lbs. per sq. in. is safe, and a stress of 1,200 lbs.
per sq. in. should not be exceeded.

ELECTRICAL

Volume resistivity, ohm. cm. 10^{17}

Arc resistance (A.S.T.M. D 495-42) sec. 120-140

Dielectric strength, volts per mil

.005" thickness=3,500

.010" thickness=2,500

.015" thickness=2,200

.125" thickness= 500-700

Frequency	Dielectric Constant	Power Factor
60	2.5-2.6	.0001-.0002
10^3	2.5-2.6	.0001-.0002
10^6	2.5-2.6	.0001-.0004
10^{10}	2.5-2.6	.0002-.0004

Corona voltage — 85,000

Electrical properties are constant from very low
temperatures up to about 75 C (167 F). At 90 C,
Power Factor is .0009; dielectric constant is 2.6 at
60 cycles.

THERMAL

Distortion temperature (A.S.T.M. D 48-37), F (C)
176-194 (80-90)

Transition temp. F (C) 180 (82)

Softening point, F (C) 220-240 (104-116)

Ignition point, F (C) 1350 (732)

Specific heat, cal. per gr. per degree C. 32

Thermal expansion coefficient per degree C 7.2×10^{-5}

Thermal conductivity — cal. per sec. per cm. per
degree C 3.2×10^{-4}

Burning rate Low

For full details on stock
sizes of Plax Polystyrene
sheets, rods and tubes —
and for a bulletin on how
to machine Polystyrene,
write the Plax Corp., 133
Walnut St., Hartford 5,
Conn. (See page 12 for
machined parts photos.)

CHEMICAL

Effect of:

*Weak and strong acids	none
Weak and strong alkalis	none
Alcohols	none
Esters	soluble
Ketones	swells
Aromatic and chlorinated hydrocarbons	soluble
*Except oxidizers which discolor.	



"BAKELITE" POLY

AS THE SCIENCE of Electronics expands into new industrial fields, so also will BAKELITE Polystyrene Plastics demonstrate increasing usefulness. For these most versatile of all plastics offer the electronics engineer the unusual combination of properties that he demands in an insulating material . . . properties that are obtainable in all the diversified forms in which polystyrene plastics can be produced, including molded parts, tapes, films, filaments, sheets, tubes, and rods — and even resin solutions for insulating coatings.

While the primary consideration in the choice of BAKELITE Polystyrene Plastics is their exceptional electrical insulating qualities, particularly for service at high frequencies, designers should take into account other outstanding characteristics that point the way to improved product styling. The clear and colorless basic forms suggest many uses where transparency is desired. Also, the possibilities for colors—in either transparent, translucent, or opaque effects—are virtually unlimited. The materials have pleasant feel, and are odorless. They can be molded with great facility, and in available forms, can be machined readily.

Mechanical strength characteristics are exceptionally good for a thermoplastic material, and resistance to chemical attack, with few exceptions, places BAKELITE Polystyrene Plastics in the front rank of all plastics.

BAKELITE Polystyrene Plastics are available now for highly essential applications. After Victory these materials will be available in large volume. This fact, coupled with their low specific gravity, indicates that they will provide an extremely low cost insulating medium despite their outstanding properties.

Why not get acquainted now with all of the possibilities offered by BAKELITE Polystyrene Plastics? Write for Booklet 7M, or present your specific problems to Bakelite Plastics Headquarters where they will receive prompt, thorough attention, in strictest confidence.

BAKELITE CORPORATION, 30 E. 42ND ST., NEW YORK 17
Unit of Union Carbide and Carbon Corporation



BAKELITE

The word "Bakelite" and the  Symbol are registered trade-marks of Bakelite Corporation identifying products

Polystyrene Plastics

Outstanding Properties FOR ELECTRONIC USE

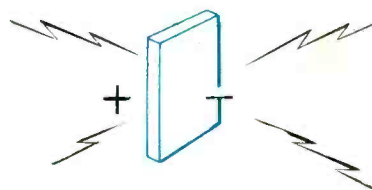

INSULATION—Dielectric strength of BAKELITE Polystyrene, 0.125 inches thick, at 60 cycles is 500 to 700 volts per mil, step by step. At all frequencies, from 60 to 50,000,000 cycles, its dielectric constant remains at 2.50 to 2.60. Power factor, at 60 and 1,000 cycles, is 0.0001 to 0.0002, and at 1,000,000 cycles is 0.0001 to 0.0004. Volume resistivity is over 10^9 megohm centimeters. Arc resistance is 120 to 140 seconds (A.S.T.M. D 495-42).



DIMENSIONAL STABILITY—BAKELITE Polystyrenes are unsurpassed among the thermoplastics for dimensional stability. Even after 318 hours' immersion in water ($2\frac{1}{2}$ " disk) dimensional change is only 0.05 per cent.

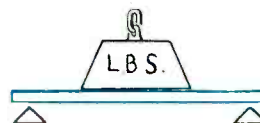

MECHANICAL STRENGTH—Though extremely light in weight (specific gravity 1.07), BAKELITE Polystyrene Plastics have good mechanical strength characteristics. *Flexural strength* (compression-molded) is 6,500 to 7,500 pounds per square inch; (injection-molded) 14,000 to 19,000 pounds per square inch. *Tensile strength* (compression-molded) is 5,500 to 6,500 pounds per square inch; (injection-molded) 6,500 to 7,000 pounds per square inch.

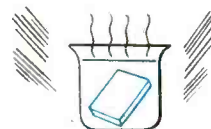

CHEMICAL RESISTANCE—This is an outstanding property of BAKELITE Polystyrenes. They resist alkalis, and non-oxidizing acids to a degree that permits their use, in film form, as separators for sulphuric-electrolyte storage batteries. They have good resistance to hydrofluoric acid. They are dissolved or attacked by benzene, toluene, and similar solvents.

STYRENE-

**Electronics' Most Versatile
Insulating Plastic**

Fabricators Supply

"BAKELITE" POLYSTYRENE IN THESE FORMS

Various plastics fabricators produce prefabricated forms of BAKELITE Polystyrene for further machining into electrical parts. Typical forms are shown below, including sheet, tape, filament, perforated film, unperforated film, tube and rod stock. These forms of BAKELITE Polystyrene are easily punched, sawed, cut or machined into such electrical parts as panels, coil forms, stand-off insulators, and battery separators.

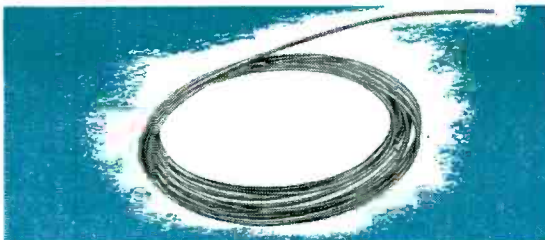
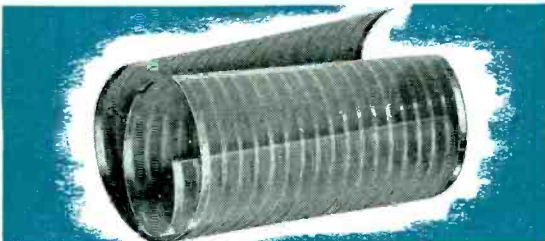
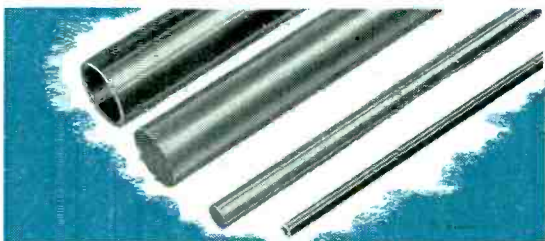

Illustrations by courtesy of Plax Corporation

It may be Readily Molded

BY COMPRESSION OR INJECTION MOLDING

Volume production of parts molded from BAKELITE Polystyrene by injection molding permits great economies. The molding material is heated to fluidity in a compression chamber, forced into the closed mold cavity, chilled, and ejected from the mold. The entire cycle is completed in a few seconds, merely requiring the removal of the molded pieces from the gates. Typical molded forms produced for leading makers of radio and electronic equipment are shown below. BAKELITE Polystyrene Plastics can also be fabricated by compression molding, though, generally, not so readily as by injection molding.

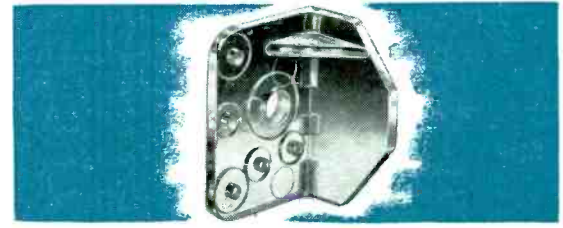
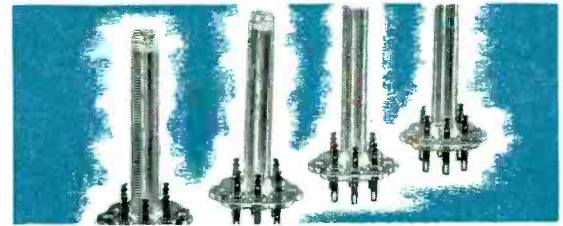
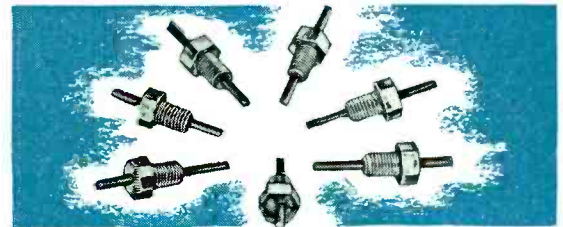

Molded parts by Erie Resistor Corporation, Plastic & Die Cast Corporation, and Plastic Products Company.

PLAX PARTS machined from POLYSTYRENE

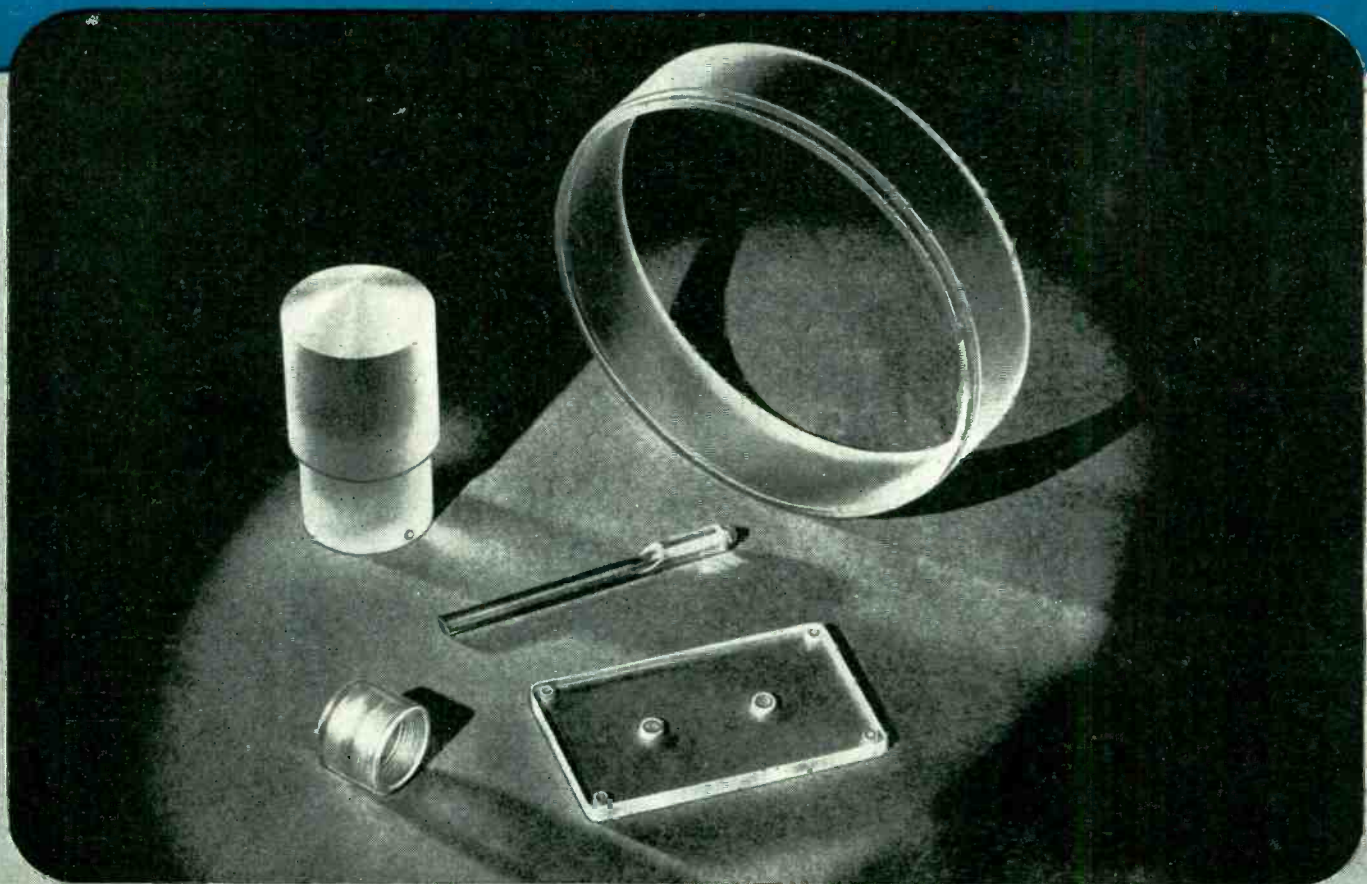

These photographs indicate something of the wide variety of sizes, shapes and applications of Plax-machined Polystyrene parts.

Plax Polystyrene is also available in the famous Polyflex Sheet and Polyflex Fiber, truly tough and flexible extruded forms with wide insulation applications. Full details, and a bulletin on machining Polystyrene, are available from the Plax Corp., 133 Walnut St., Hartford 5, Conn. (See page 9 for Polystyrene characteristics.)

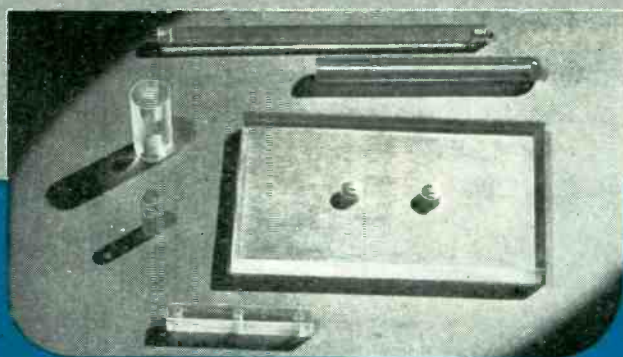
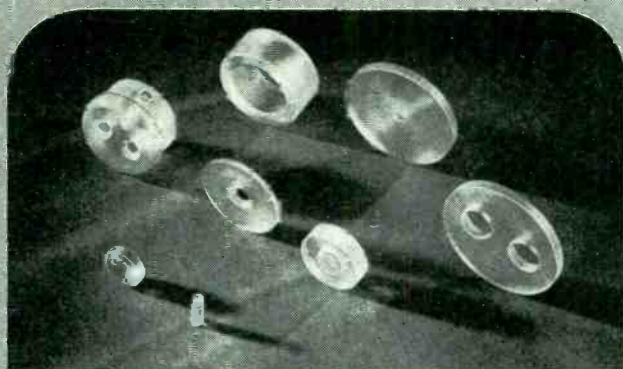

133 WALNUT STREET - HARTFORD 5 - CONN.

In War...

In Peace...

**OUR BUSINESS IS
MAKING LOUD SPEAKERS**

Now being used for military communication, detection and similar war time uses...

built to those high standards of precision, durability and performance born of habitual peace time practice.

Jensen
RADIO MANUFACTURING COMPANY
5601 SOUTH LARAMIE AVENUE, CHICAGO

ELECTRONICS... A MIGHTY WEAPON

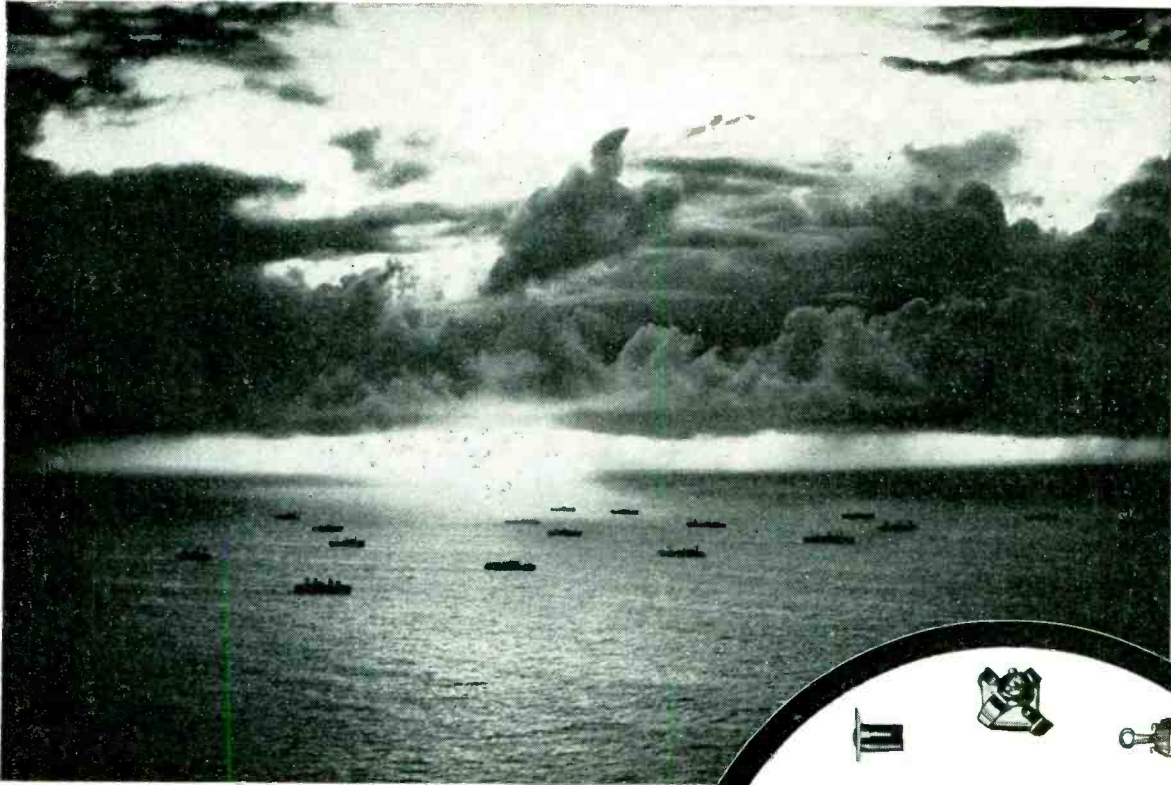

This is **ELECTRONICS** in operation . . . but not until the full facts are released will you be able to see all the technical developments.

ELECTRONIC DEVICES

physically, are assemblies of components, each one contributing its share toward making the instrument function. Among the many activities of American Radio Hardware is the manufacture of over one hundred parts used in **ELECTRONIC** equipment and applications. That our components are used in the production of this mighty weapon is in itself a fine tribute to our skill and our facilities.

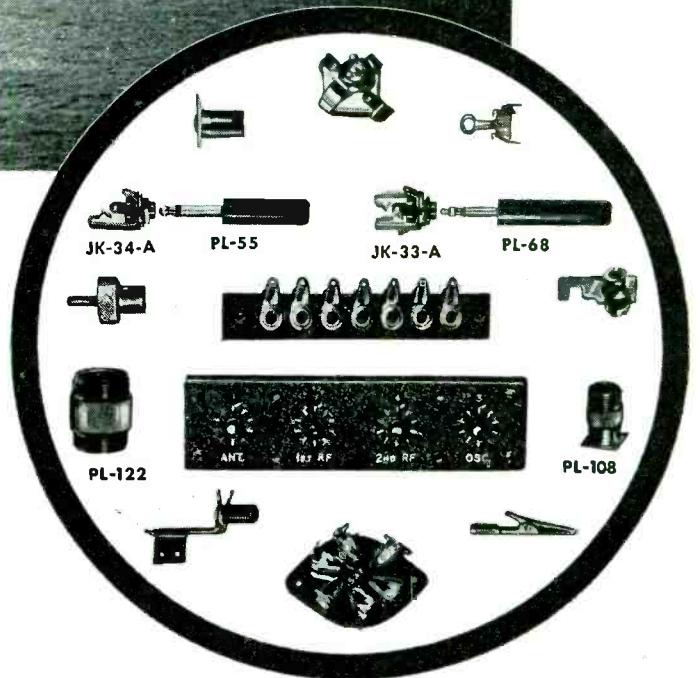

JK-34-A

PL-55

JK-33-A

PL-68

PL-122

PL-108

ELECTRONIC equipment is comprised of many individual components . . . plugs, jacks, insulators, etc.



With electrical and mechanical tolerances as critical as they are nowadays, all of our components have been improved to a commanding degree. When they are released for general use, they will be able to serve you better than ever before. Your inquiries regarding the entire ARHCO line are welcomed:

American Radio Hardware Co., Inc.

476 BROADWAY • NEW YORK 13, N. Y.

MANUFACTURERS OF SHORT WAVE • RADIO • TELEVISION • SOUND EQUIPMENT

FROM HUNDREDS OF MILES AT SEA CAME

THE ALARM THAT SAVED MIDWAY!



Midway was ready when the Jap attempt to capture this strategic U. S. outpost came June 4 to 7, last year. Long before the Jap fleet of battleships, carriers, cruisers, destroyers and transports could bring their big guns into range—vigilant patrol planes with modern radio communications equipment had sounded the alarm. Many miles from Midway's shores American planes blasted their fleet...drove their survivors into a frantic homeward retreat.

REPEATEDLY it has been said—"this war is different". Yes, different because, on land, at sea and in the air, battles are being planned and fought with weapons never before available to our fighting men. Among these is the electronic tube. It is reassuring to know that no nation is making wider or better use of this great weapon of modern warfare than the U. S. A. To help serve the vast requirements of our Army and Navy National Union, for example,

is producing electronic tubes on a scale far exceeding its pre-war peak. Yet, dramatic as are the achievements of electronics in war, there will be even more miraculous peace-time tasks for tubes to perform. National Union will be prepared to aid engineers and production men in applying the power of electronics to their special needs. To producers of war goods, this industrial electronics service of National Union engineers is now available.

NATIONAL UNION RADIO CORPORATION • NEWARK, NEW JERSEY • LANSDALE, PENNSYLVANIA

NATIONAL UNION RADIO AND ELECTRONIC TUBES

Transmitting Tubes • Cathode Ray Tubes • Receiving Tubes • Special Purpose Tubes • Condensers •
Volume Controls • Photo Electric Cells • Exciter Lamps • Panel Lamps • Flashlight Bulbs

"Everything's
OK"

... since they
changed assemblies
over to **AMERICAN
PHILLIPS SCREWS**



IT amounts to rejecting rejection-tags, when you change from slotted screws to American Phillips. For the Phillips Recessed Head automatically aligns with the Phillips bit, forming one straight driving unit which always delivers these 3 operating advantages:

Quick Starting: No fumbling or wobbling, no dropping of screws. One hand aims the Phillips driver, other hand holds the job.

Straight Driving: American Phillips Screw stays straight on the driver. No crooked driving. Power drivers can be safely used.

Each Fastening OK: No screw-heads burred or off plumb. No gouged work surfaces or slashed hands. Screw sets up tighter, looks neater, holds better.

Like scores of other plants, you will find that both men and women can do better work and more of it when using American Phillips Screws. You will further find that American's individual inspection lightens the work of your inspectors.

4-WINGED DRIVER CAN'T SLIP OUT
OF PHILLIPS TAPERED RECESS

AMERICAN SCREW COMPANY

PROVIDENCE, RHODE ISLAND

Chicago: 589 E. Illinois Street Detroit: 5-267 General Motors Building

American Screw Company manufactures a complete line of Phillips Recessed Head Screws, in a full range of sizes, and with all styles of heads.

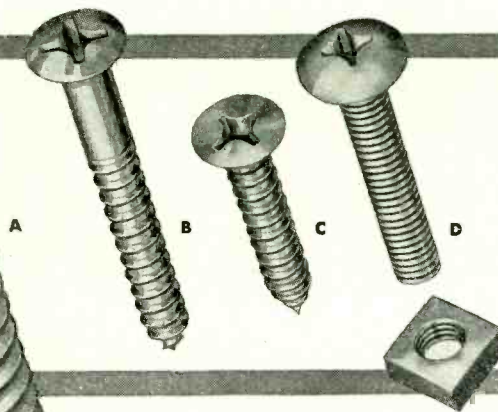

- A. American Phillips Machine Screws.
- B. American Phillips Wood Screws.
- C. American Phillips Hardened Self-Tapping Sheet Metal Screws.
- D. American Phillips Stove Bolts.

"Inside" Dope
on

HEINEMANN MAGNETIC CIRCUIT BREAKERS

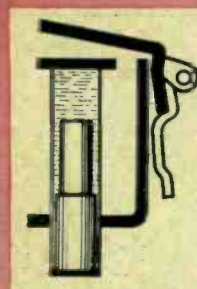
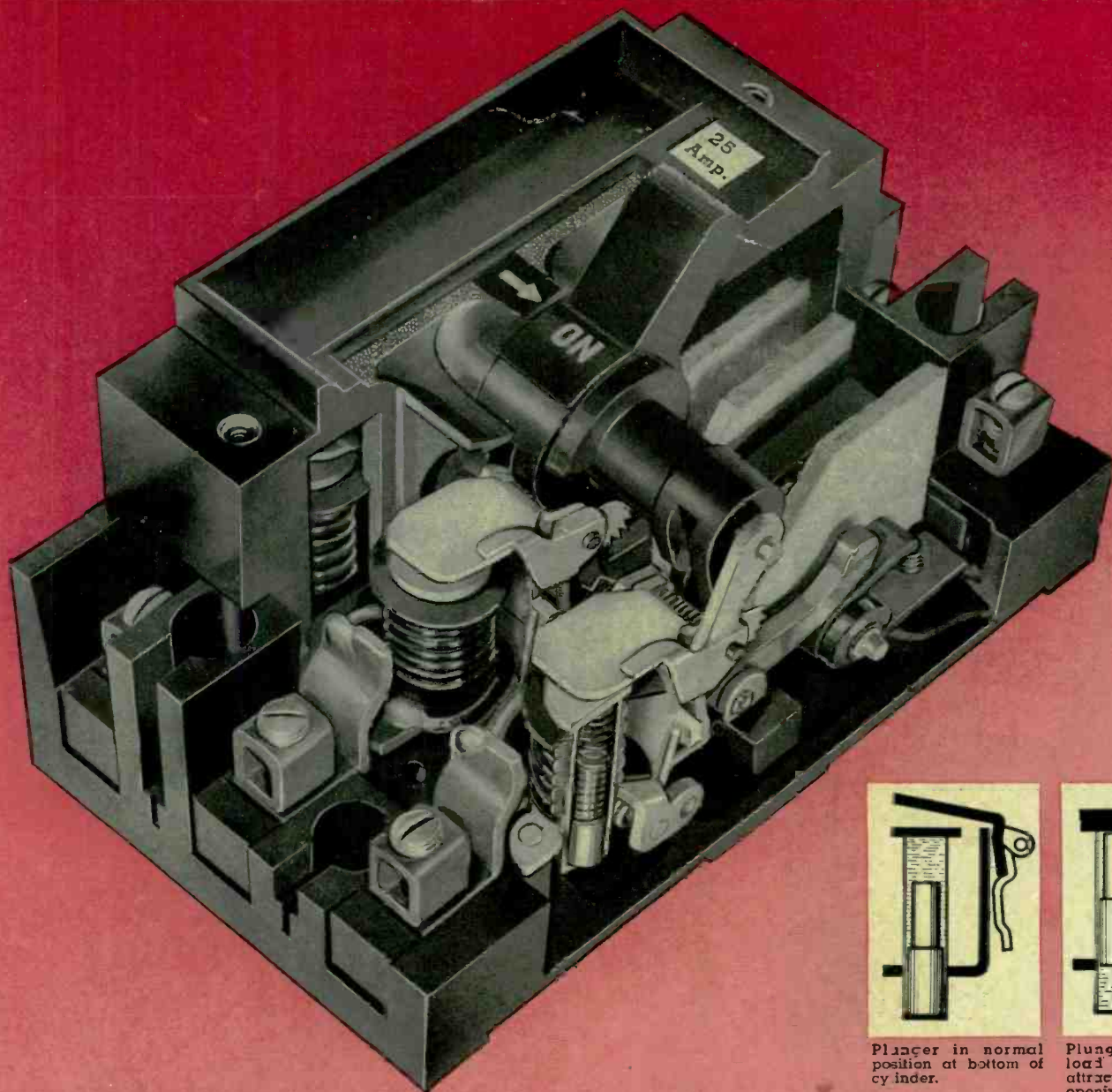

Plunger in normal position at bottom of cylinder.

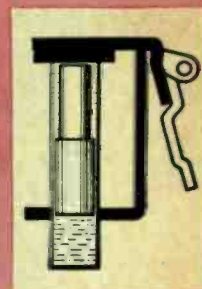

Plunger after overload with armature attracted to pole piece, opening contacts.

TIME DELAY ON OVERLOADS

The magnet coil surrounds a hermetically sealed and liquid filled cylinder which contains an iron plunger. This plunger, while normally not in the magnetic field, moves into the field on overloads with the liquid controlling the speed at which the plunger moves. The magnetic flux increases as the plunger rises, attaining its maximum when the plunger reaches the top of the cylinder. At this point the trip armature is attracted to the pole piece and operates the latch mechanism which opens the contacts. Various time delays can be obtained by the use of liquids of different viscosities.

INSTANTANEOUS ACTION ON SHORT CIRCUITS

Short circuit currents energize the pole piece with sufficient speed to attract the armature before the plunger moves.

BLOWOUT ACTION AT CONTACTS

Magnetic blowout contacts mounted in individual arcing chambers add speed to the arc interruption. As the value of the current to be interrupted increases the quenching effect becomes greater due to the intensified magnetic blowout field.

Send for Catalog 40 Showing complete line

HEINEMANN CIRCUIT BREAKER CO.

Subsidiary of Heinemann Electric Co., Est. 1888

97 PLUM STREET

TRENTON, N. J.

**THE *Squint* THAT PRODUCED
A BETTER RADIO TUBE**



TUNG-SOL
vibration-tested
RADIO TUBES

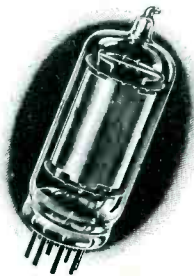

You'd squint too if you tried to worry a hair-like wire through an almost microscopic hole and direct it down through a ladder of cross wires and bring it through the corresponding hole at the bottom. But that was common practice in the entire tube industry in making this tube for "walkie-talkies." The nerve strain was terrific. Girls cracked up under it. Labor turnover on this bottle-neck operation actually jeopardized the production of this vital tube. TUNG-SOL factory men solved the problem with the "lilly-jig" which directs the tiny filament into the top hole from where it is vibrated into place. Production immediately stepped up. Rejects went down. Critical materials were saved. Now every filament is positioned automatically. The result of this tired girl's squint is . . . better TUNG-SOL Radio Tubes.

TUNG-SOL LAMP WORKS INC., NEWARK, N. J., Sales Offices: ATLANTA, CHICAGO, DALLAS, DENVER, DETROIT, LOS ANGELES, NEW YORK
ALSO MANUFACTURERS OF MINIATURE INCANDESCENT LAMPS, ALL-GLASS SEALED BEAM HEADLIGHT LAMPS AND CURRENT INTERMITTERS

WHY TEMCO-BUILT EQUIPMENT STAYS "IN ACTION" LONGER

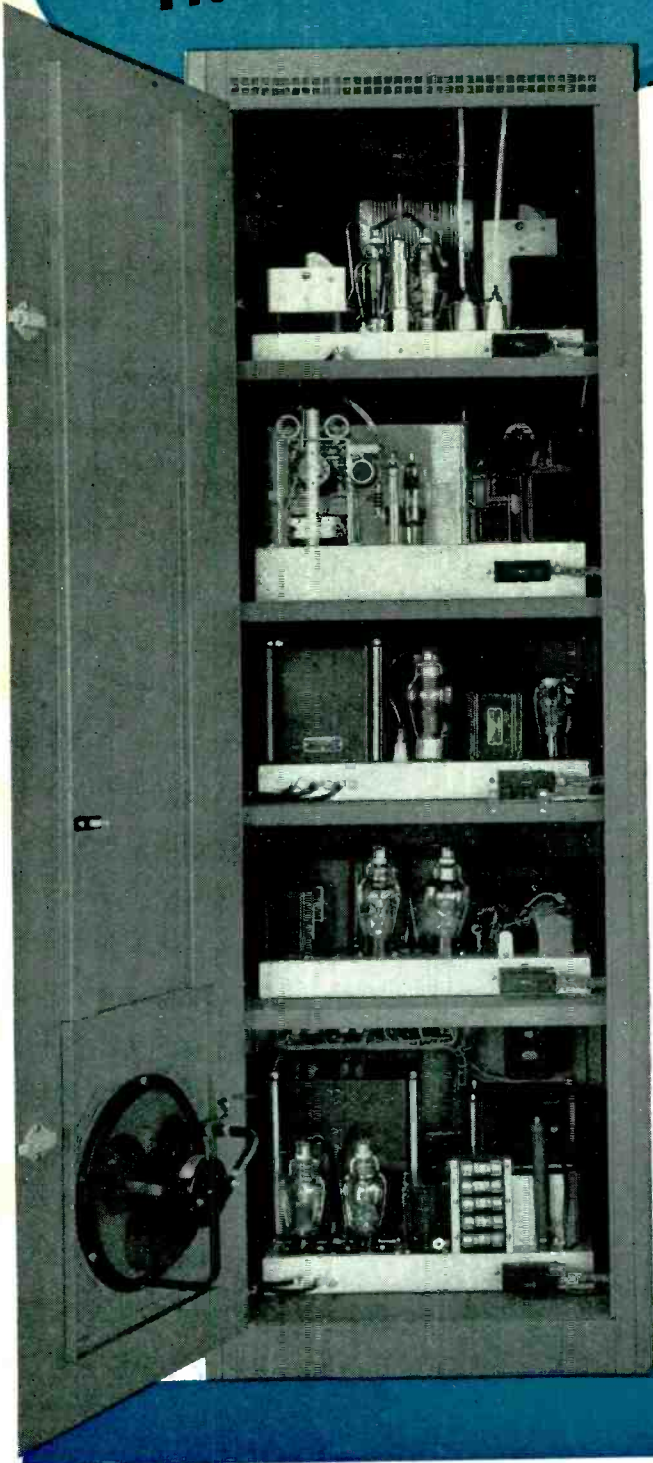

THE acid test of transmitting equipment quality is active service under adverse conditions . . . for long periods.

Temco equipment consistently has been delivering active service—on land, on sea and in the air—for sufficiently long periods to have tested its mettle conclusively.

Its faithful functioning can be attributed to three qualities which are built into Temco units with the insistence of a perfectionist. These qualities are: **Advanced engineering, finest of component parts and painstaking workmanship by craftsmen who are unsurpassed in their specialties.**

TEMCO

RADIO COMMUNICATION EQUIPMENT

TRANSMITTER EQUIPMENT MFG. CO., INC.
345 Hudson Street New York, N. Y.

Model # 250 GSC Radio telephone and telegraph transmitter conservatively rated at 200 watts output from 2 to 16 M. C. with 4 position crystal and electron-coupled master oscillator control.

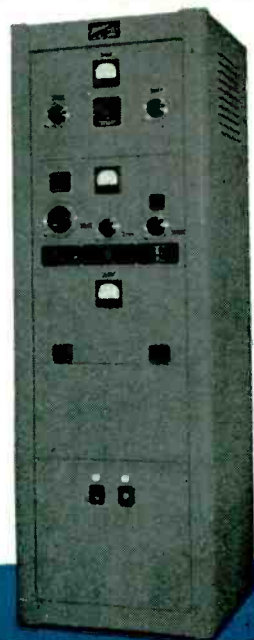

A Great Family

A GREATLY magnified picture of a few Stewart parts—vitaly important although small in size, as practically all assemblies would be useless without them. A "Great" Family in every sense. Great in coverage—meets almost every Terminal requirement in the electrical field. Great because every part is made to highest precision standards—accurately dimensioned and to full standard gauge. Great by reason of the quality of the metals used, assuring maximum strength, durability and long life.

Odd shaped pieces stamped and formed from wire or strip on high speed machines.

Hundreds of items in stock.

Complete Hot Tinning and Plating facilities for handling large orders.

Send for samples and quotations.
Let us have your prints and specifications.

Quick Response to Inquiries

STEWART STAMPING COMPANY

621 East 216th Street, 67, New York

**BUY MORE
WAR BONDS!**

**STEWART
TERMINALS**

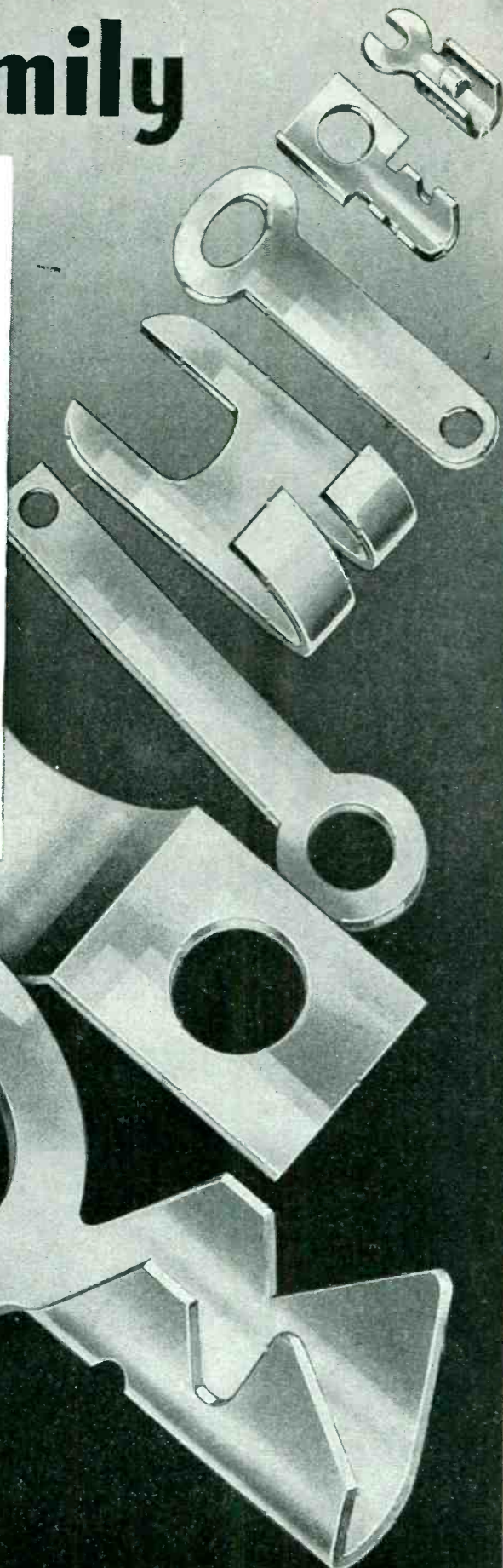

HAVE YOU ANY OF THESE

Capacitor
Application
Problems?

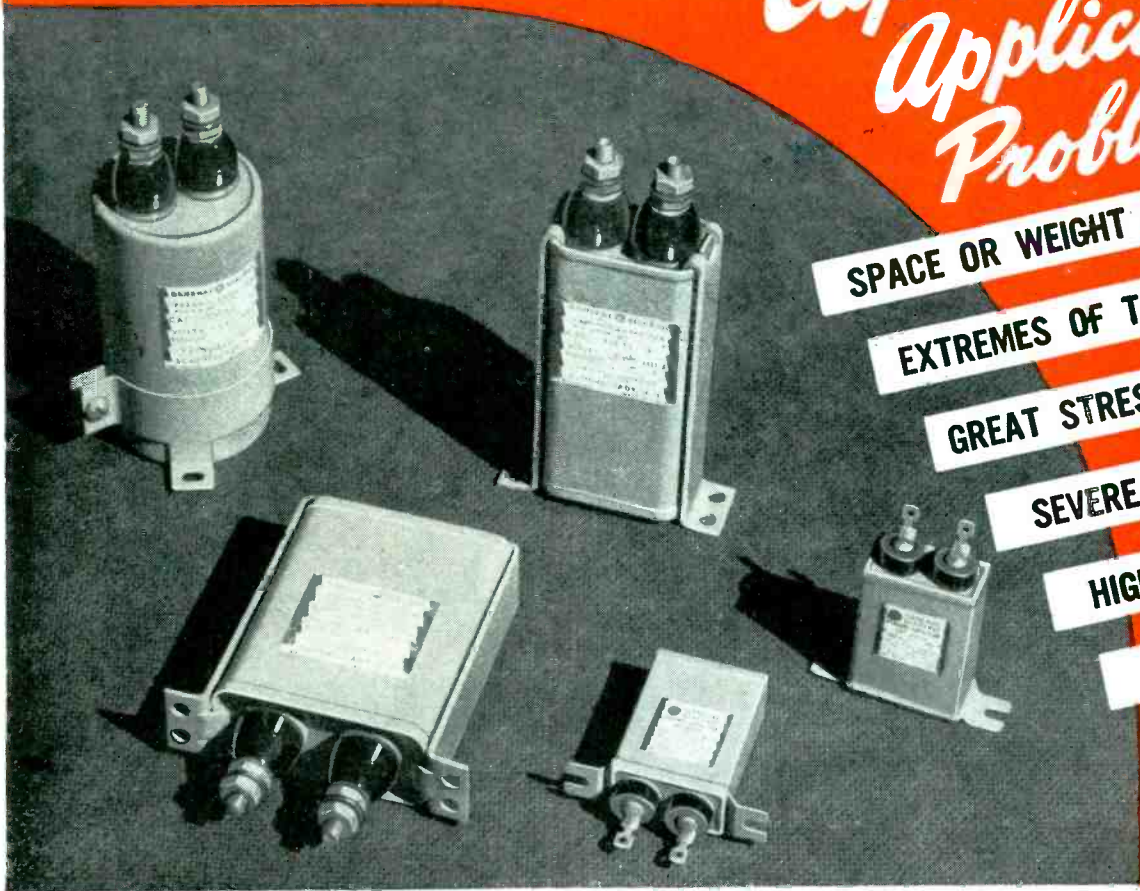

SPACE OR WEIGHT LIMITATIONS

EXTREMES OF TEMPERATURE

GREAT STRESS OR SHOCK

SEVERE VIBRATION

HIGH ALTITUDE

HUMIDITY

Whatever your specifications,
we're likely to have the answer

WE are in an excellent position to provide you with hermetically-sealed capacitors for wartime applications. Our extensive engineering, research, and manufacturing facilities are at your service.

In some cases there will be no need to look further than our standard line of Pyranol* capacitors for built-in applications.

The line includes more than 350 ratings in space-saving shapes and

sizes. Many of the ratings are available in three shapes—oval, cylindrical, rectangular—to make your design problems easier. And they can be mounted in any position.

BE SURE TO GET your copies of our time-saving catalogs on d-c (GEA-2621A) and a-c (GEA-2027B) types. Ask your G-E representative for them by number, or write to General Electric, Schenectady, New York.

*Pyranol is the G-E trade mark for capacitors and for askarel, the synthetic, nonflammable liquid used in treating G-E capacitors.

BUY WAR BONDS



**PYRANOL
CAPACITORS**

GENERAL  ELECTRIC
407-60-5700

ACCURATE

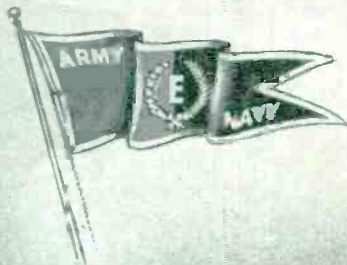

A detailed illustration of a cylindrical Bliley Crystal Unit. The top surface is engraved with the following text: 'TYPE B5', 'BLILEY', 'FREQUENCY CONTROL', 'SERIAL NUMBER', 'R1963E', 'FREQUENCY', '7115 KC', 'MADE IN U.S.A.', and 'ERIE, PA.' The unit has two circular ports on the top and four small feet at the base.

Accuracy and dependability
are built into every Bliley
Crystal Unit. Specify BLILEY
for assured performance.

BLILEY ELECTRIC COMPANY
ERIE, PENNSYLVANIA

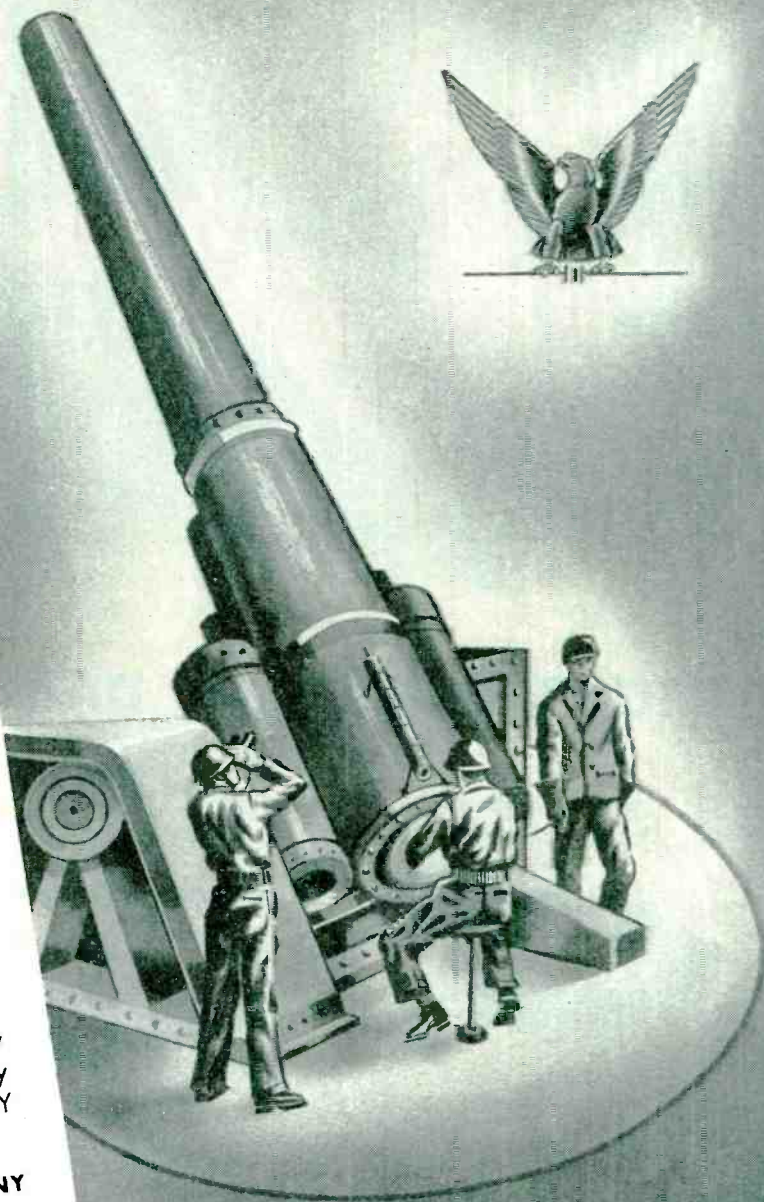

BLILEY ELECTRIC COMPANY · · · ERIE, PA.

Bliley Crystals



MYCALEX
THE INSULATOR

"... is the most nearly perfect electrical insulator known today"

—an opinion subscribed to by leading engineers in radio, television and industry.

U.S. NAVY OFFICIAL PHOTO

THERE IS ONLY ONE MYCALEX

... but, to say that there is only one MYCALEX is not sufficient without the backing of fact. Whatever claims are made have been proved in actual "firing line" application throughout the far corners of the globe. Through intense heat and cold . . . in days before the war, and in these critical times, MYCALEX has emerged predominant in its field and, as leading engineers in industry, radio and television have told us, "is the most nearly perfect electrical insulator known today."

These engineers specify MYCALEX because they prefer MYCALEX. Extremely versatile in its application, it may be cut, drilled, tapped, machined, milled, ground, polished and moulded. It meets re-

quirements for close tolerances. Moreover, MYCALEX is leadless. This, combined with low loss at all frequencies, gives it advantages over any other types of glass bound mica insulation.

MYCALEX is not the name of a class of materials, but the registered trade-name for low-loss insulation manufactured in the Western Hemisphere only by the Mycalex Corporation of America. Be sure to specify MYCALEX if you are looking for low power factor, low loss, negligible moisture absorption and high dielectric strength. Sheets and rods immediately available for fabrication by us or in your own plant.

MYCALEX
THE INSULATOR

Trade Mark Reg. U. S. Pat. Off.

MYCALEX CORPORATION OF AMERICA

Exclusive Licensee under all patents of MYCALEX (PARENT) CO. Ltd.

60 CLIFTON BOULEVARD

CLIFTON, NEW JERSEY

ELECTRONICS — September 1943

23



BETTER BANK ON THE **HUMAN** ELEMENT, TOO

In the excitement of electronic discoveries and predictions, one great and important factor—the *human element*—stands forlorn. Machines and uses are, after all, only the offspring of man's experience and ingenuity. The more capable the man, the more dependable his product.

This is the *human element* upon which the Electronic Corporation of America places a high evaluation. And this, we suggest, is the element you should seek when planning your future program. Find out more about your man and his background. Is he an old-timer or a "war baby"? Does he have the ability and facilities to produce? How high are his standards? These are questions we'll gladly answer. We're 100% in war work now . . . but, occasionally production schedules enable us to accept additional contracts . . . *communicate with us.*

A CALL FOR GREATER EFFORT . . . The WPB reports that war production has fallen off considerably. This is a challenge to industry and labor, and it's up to us to find the reason, whether it be optimism, internal strife, working conditions, discrimination, etc. The roar of battle is thousands of miles away, but, if you listen closely, you can hear the screams of a dying soldier. Can it be because we failed him?

ELECTRONIC CORP. OF AMERICA

45 WEST 18th STREET • NEW YORK 11, N.Y. • WATKINS 9-1870

TRANSTAT VOLTAGE REGULATORS for smooth control of A. C. Voltage

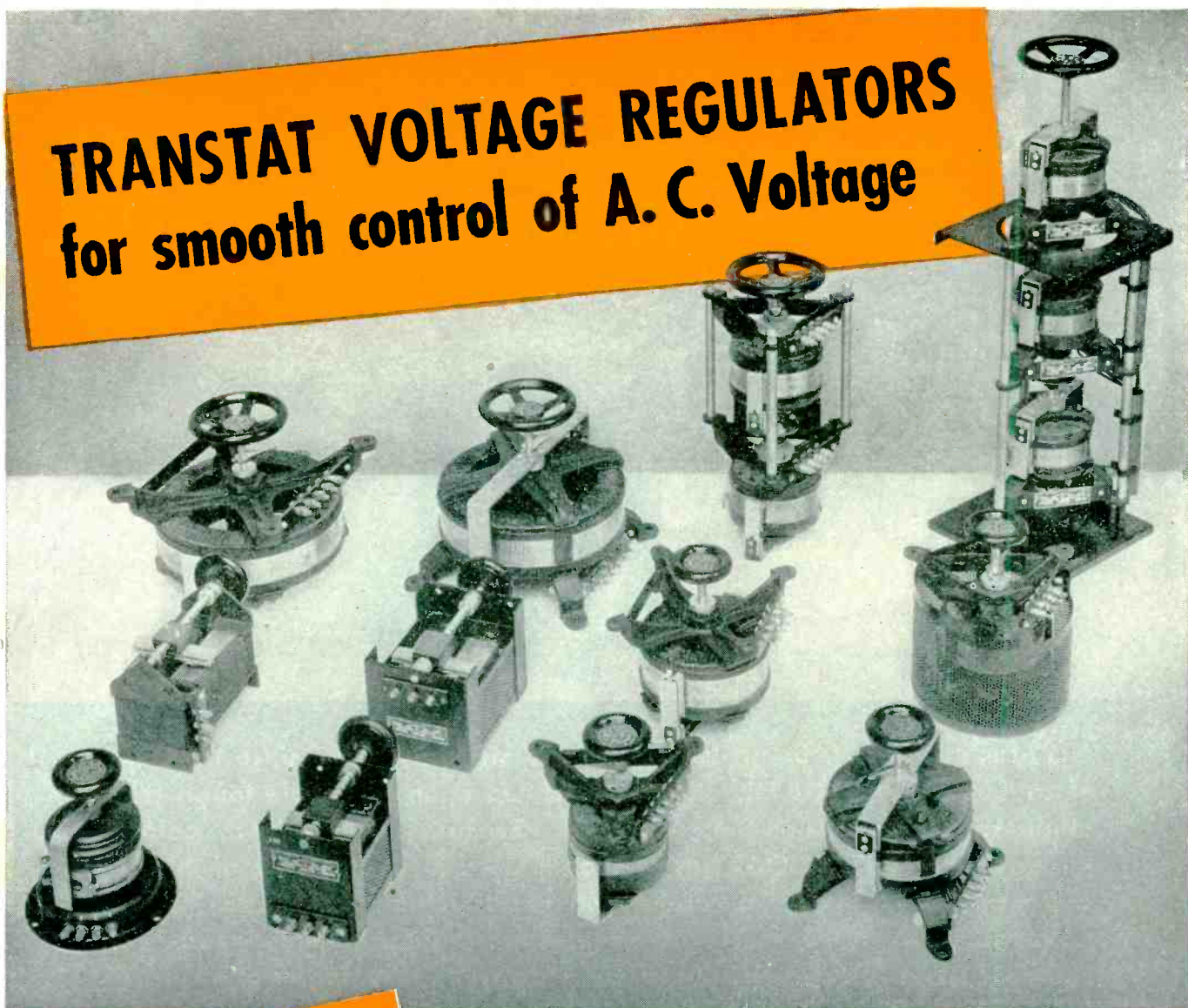

PIONEER MANUFACTURERS
OF
TRANSFORMERS,
REACTORS,
AND RECTIFIERS FOR
ELECTRONICS AND
POWER TRANSMISSION

TRANSTAT Voltage Regulators have unusual features for radio, industrial or laboratory apparatus requiring a special voltage—a continuously adjustable voltage—or a constant voltage from a fluctuating power source. With high electrical efficiency (93-97%), they provide a velvety smooth, practically stepless control through their range of rating in increments of no more than 0.75 volts. In addition, they maintain power factor, cannot distort wave form or

interfere with radio reception.

Standard Type TH Transtat Voltage Regulators operate on 115, 250 and 460 volt single phase or polyphase circuits and handle 20 KVA and smaller loads. They maintain voltages within a narrow range in changing from no load to full load.

The American Transformer Company also manufactures motorized and fully automatic voltage regulators. Full information upon request.

AMERICAN TRANSFORMER COMPANY, 178 Emmet St., Newark, N. J.



AMERTRAN

MANUFACTURING SINCE 1901 AT NEWARK, N. J.

EXPERIENCE?

THIS IS GOAT ELECTRONIC TUBE PART . . .

TYPE G1224



G1224 is just one of the thousands of parts made by GOAT since the days of radio infancy. GOAT is continually called upon to handle tough jobs requiring skill, precision and efficiency. Because of experience gained throughout the years, GOAT has been able to meet the demands of this industry for greater quality, durability and quantity production. Today, GOAT serves almost every electronic tube manufacturer with a tremendous variety of stock and special parts made of any metal to any required degree of accuracy.

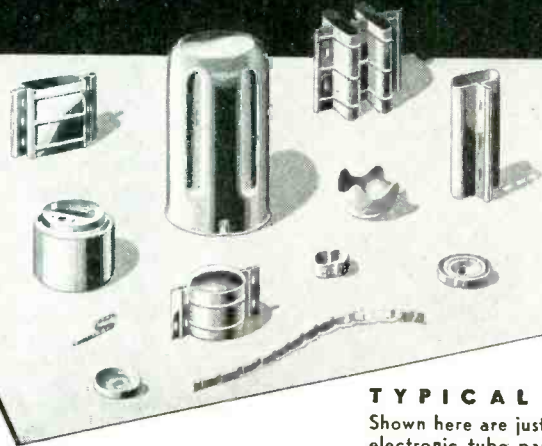
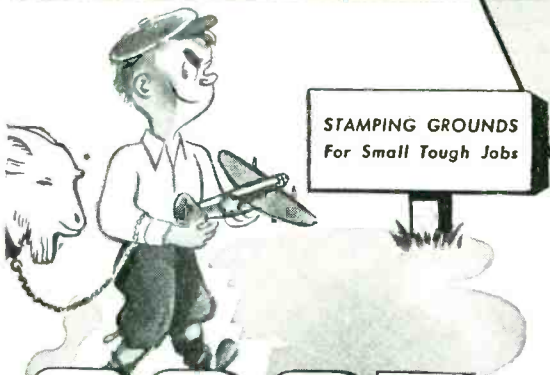

TYPICAL PARTS
Shown here are just a few GOAT electronic tube parts and shields that have been stamped, drawn and formed on GOAT machines, dies and presses.

GOAT

METAL STAMPINGS, INC.

A DIVISION OF THE FRED GOAT CO. INC. EST. 1893

314 DEAN STREET • BROOKLYN, N. Y.



Radio Noise SABOTAGES COMMUNICATIONS unless...

Like so many demons, the crashes and crackles of unwanted radio noise can play havoc with communications. They blot out word-vital words broadcast from plane to plane, from ship to ship, from command car to jeep or tank. They endanger the lives of fighting men—they sabotage communications—unless the proper suppression filter system is installed.

Solar Elim-O-Stats suppress interference *right where it starts*. They absorb interference from generators, motors, contacts and other sources. Thousands of these compact filters protect the lives of our land, sea and air fighters. They prevent the blotting out of vital communications in radio-directed combat.

Pioneers in capacitor manufacture and electronic research, Solar engineers probe the rapidly-expanding future of radio development. In post-victory cars, ships and planes, Solar war-proven Capacitors and Elim-O-Stats will safeguard civilian communications, just as they are safeguarding military operations today. Solar Manufacturing Corporation, Bayonne, New Jersey.

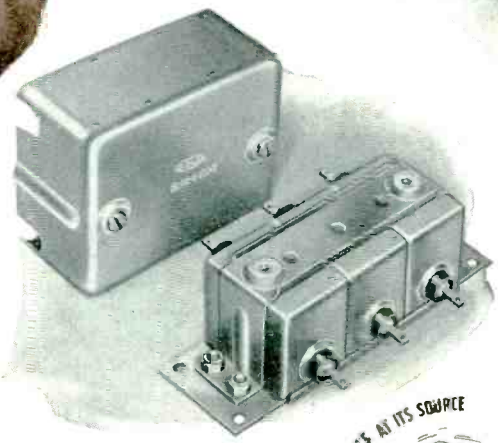

Solar 

ELIM-O-STAT



MAKERS OF RADIO NOISE SUPPRESSION FILTERS AND CAPACITORS



When that day arrives . . .

Let's get together!

If you believe in the future of America as we do, then we're asking for an appointment immediately after the victory has been won . . . when a bright new era awaits us all.

Perhaps we can talk about a coil problem . . . how thoroughly we're organized to help you on such a problem only military censorship forbids telling now. Or it may be that you manufacture your own coils and will be interested in discussing magnet wire—any shape—any insulation that your operations require.

As a matter of fact, perhaps we can get together now, but if it happens we can't, remember we have a date in and for the future. When we both can keep it, you can again take advantage of Anaconda service and the benefits derived from the single product control "from mine to consumer" backed by years of continuous metallurgical experience.

ANACONDA WIRE & CABLE COMPANY
 General Offices: 25 Broadway, New York 4
 Chicago Office: 20 N. Wacker Drive 6
 Subsidiary of Anaconda Copper Mining Co.
 Sales Offices in Principal Cities

48235



Magnet wire and coils

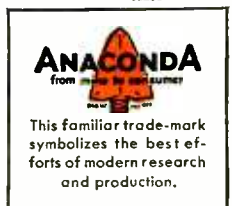

ANACONDA WIRE & CABLE COMPANY

**ANNOUNCING
CML 1400**

**THE NEW, VERSATILE
A-C POWER SOURCE**

ELECTRONIC GENERATOR

**FREQUENCY RANGE — 300 to 3500 cycles
POWER OUTPUT — 1400 watts · REGULATION 1%**

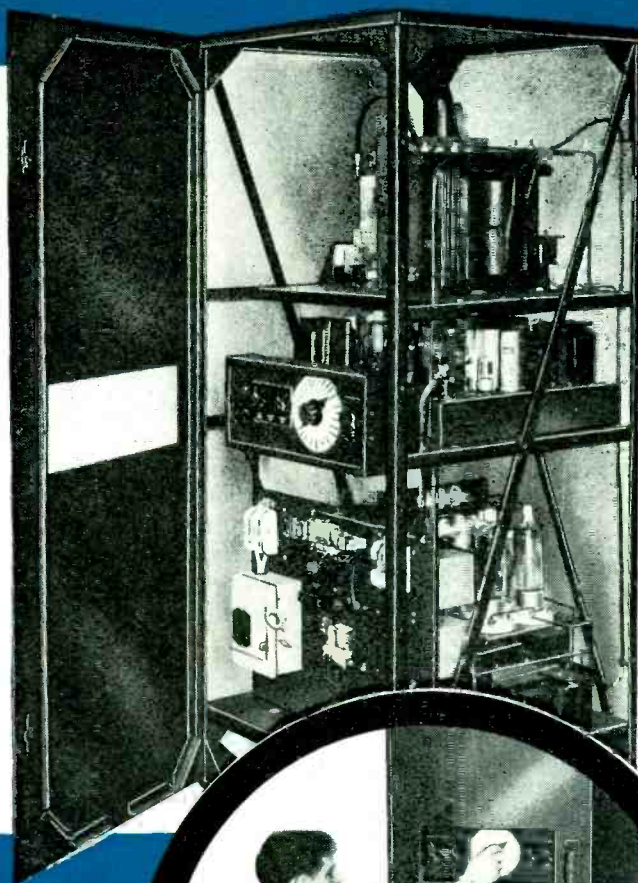

DEVELOPED to fill the need for a versatile source of power, CML 1400 offers unusual advantages to engineers requiring test power at various loads through a wide frequency range.

CML 1400 is proving especially valuable where Government specifications call for complete system tests on the production line, through a wide range of power frequencies. In addition to factory and laboratory applications, maintenance and field service men are enthusiastic about the applications of CML 1400 to their work. Radio installations in aircraft can now be tested in the plane, or serviced in the repair shop without resorting to aircraft power supply ordinarily employed. Also tests transformers and condensers. Extremely simple in operation; completely foolproof controls.

*DESCRIPTIVE BULLETINS
SENT ON REQUEST*

**COMMUNICATION
MEASUREMENTS
LABORATORY**

*Manufacturers of "ROTOBRIDGE"
High Speed Cable and Circuit Tester*

118 GREENWICH STREET

NEW YORK

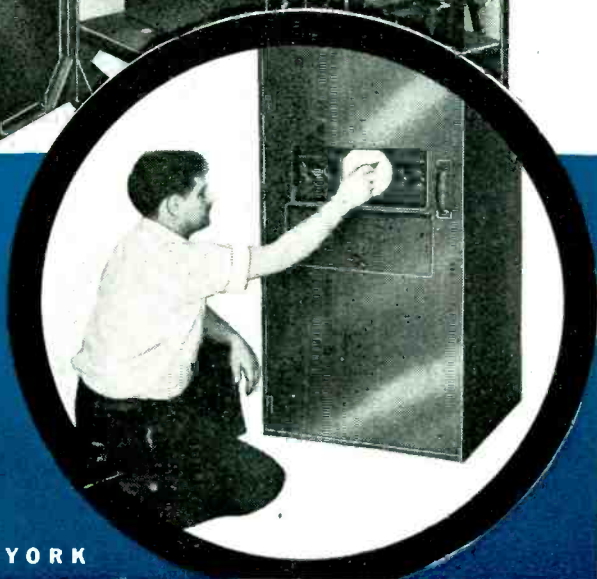

Let's Bury the Tramps—with Bonds and Stamps!



Copyright 1943—Philco Corporation

BEGINNING September 9th, the battle cry of America's home front is, "Back the Attack—with War Bonds." The Third War Loan is on. The goal is fifteen billion dollars. To reach it, Uncle Sam is asking every American, as an individual, to join the offensive and buy an extra War Bond during September.

America is on the move, thanks to the courage and valor of our men on the battle front, the toil and sacrifice of the home front, the might and ingenuity of the industrial front. This is no time to relax . . . it

In cooperation with the U. S. Treasury Department, the Philco cartoon campaign appearing in the national magazines during September will be devoted to the Third War Loan.

is the hour to press the attack!

Our soldiers and sailors are doing it, under the magnificent guidance of their heroic leaders. Industrial America is doing it. The men and women of Philco, today, are producing radio, communications and

electronic equipment, ordnance and storage batteries at an all-time peak. Now we of the home front must do it . . . each one of us . . . during September!

Buy an extra War Bond to back the attack of our boys at the front. It's a personal investment in victory today . . . and the fruits of victory tomorrow.

PHILCO CORPORATION

"BACK THE ATTACK WITH WAR BONDS"

During the Third War Loan in September Buy an EXTRA War Bond . . . for Victory.

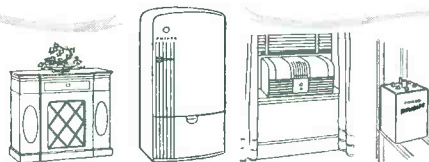

PHILCO—the Quality Name in Millions of American Homes.

LISTEN TO "OUR SECRET WEAPON"

Hear Rex Stout expose Axis lies and propaganda. Every Friday evening, CBS stations.



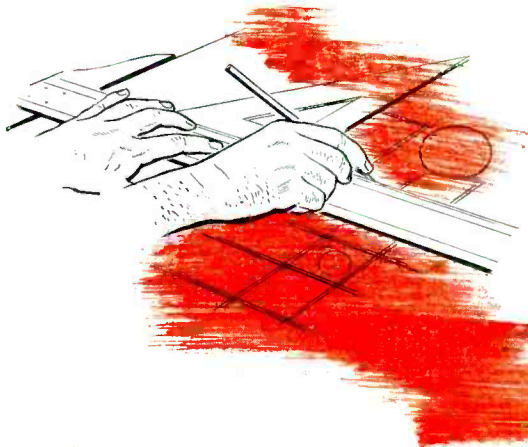

These are products made by our company for war-time aircraft. Because they are typical of American enterprise and engineering they are well-made, precise, and highly useful to the Armed Services.



ASTRO COMPASS

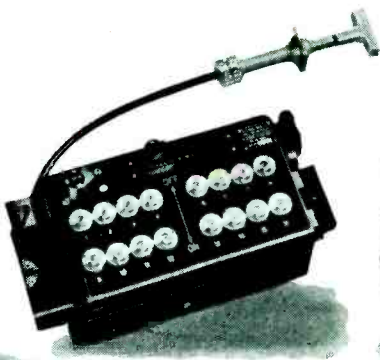

BOMB RELEASE SWITCHES

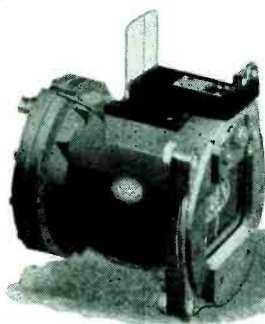

COMPASS SWINGING SIGHT



ELECTRICAL INDICATING INSTRUMENTS



BUT...

Let's take that for granted. Why shouldn't we be able to produce fine weapons in a nation that's filled with good materials, splendid machinery, skilled hands, and fine minds?

The question is—have each of us the spirit that goes a long step beyond mere manufacture—the spirit to build weapons and then *pay for them* with our purchases of war bonds?

That's the measure of our patriotism.

To *build* for Victory is our duty as manufacturers.

To *save* for Victory is our responsibility as *citizens*.



The W.W. **BOES** Company, Dayton, Ohio

MANUFACTURERS OF ELECTRICAL AND NAVIGATIONAL INSTRUMENTS FOR AIRCRAFT

THE INSPECTION OF QUARTZ...

DIAGRAMMED BY CRYSTAL PRODUCTS

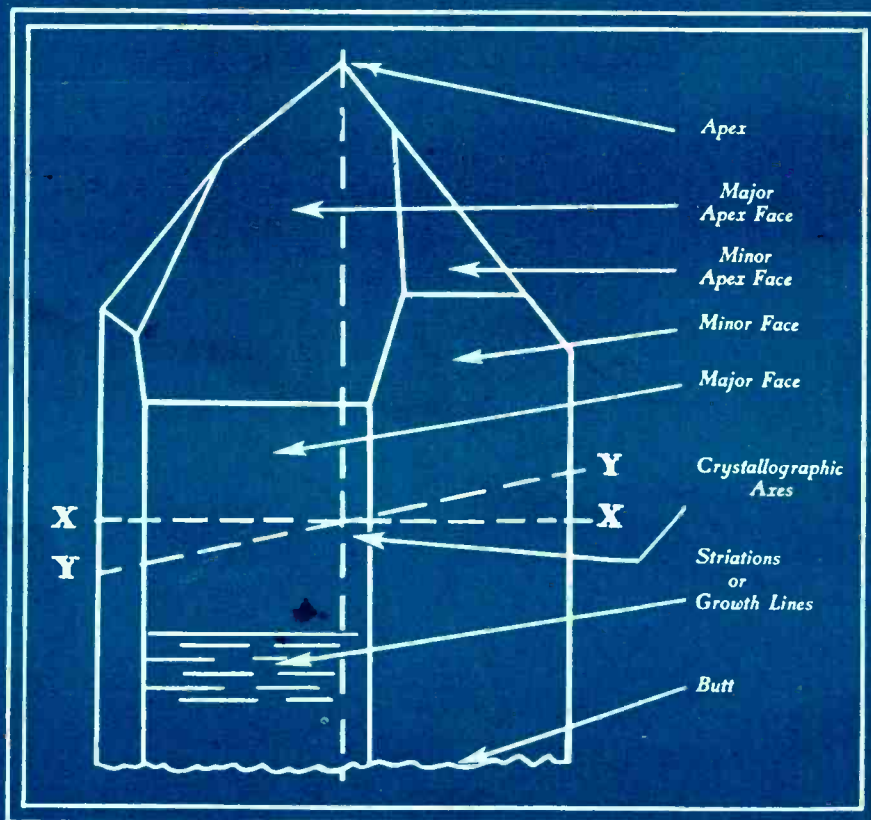

Quartz with the better piezo-electric properties are imported. The mineral is usually classified according to size with pieces ranging from 100 to 300 grams.

A shipment of quartz nearly always represents a cross section of the quartz supply . . . some crystals will have good faces and apexes, others only few faces and no apexes, and still others no faces or apexes at all. It is therefore necessary that they be expertly sorted, usually into three groups, each one to be treated in a different method before cutting.

Next, in order, comes the study of impurities in the

different kinds of crystals. The impurities can be seen with the naked eye, by having a beam of light pass through the crystal. This shows up such impurities as fractures or cracks, foreign particles included within the crystal, bubbles, needles, veils, color and ghosts or phantoms. The latter are cases where the crystal contains internal colored bands or planes parallel to the faces of the crystal. These really represent stages of growth of the crystal and it appears to the eye as if one crystal has grown within another. Crystals with excessive amounts of impurities are, of course, rejected.

 *Crystal*

PRODUCTS COMPANY

1519 MCGEE STREET, KANSAS CITY, MO.

Producers of Approved Precision Crystals for Radio Frequency Control

The Army had a transmitter but no receiver



Have you ever heard the story of the Army's first experiment with short-wave radio?

It begins back in 1925 when Colonel Loughry, stationed at the Presidio in San Francisco, asked Ralph M. Heintz to submit a quotation on a short-wave transmitter. The cost was estimated at \$600, and in spite of the Colonel's eloquence, his senior officers were not persuaded that short-wave was promising enough to merit that amount of money.

But Colonel Loughry was not so easily defeated. There was a \$375 reserve in the Presidio mess fund. The Colonel decided that the military value of short-wave was worth risking the unauthorized transfer of this idle money. Then he and Ralph Heintz combed the Presidio junk pile, salvaging generators and other material from condemned trucks.

Came the day when the transmitter was ready to go on the air, and only then was it realized that the Army lacked a receiver capable of bringing in its new transmitter! So officers in Washington arranged to go to the home of a

local amateur to receive the Army's first short-wave message.

★ ★ ★ ★ ★

The Signal Corps and Heintz and Kaufman, Ltd. have both come a long way since this incident in 1925. The pioneer work of Heintz and Kaufman with high frequency transmission showed the need for specially designed tubes, and Gammatrons were developed to fill this need.

Through continuous research and improvement, Gammatrons have maintained their position of leadership in their field . . . their reputation for high efficiency at very high frequencies, for ease of neutralization, for long life, and for mechanical and electrical stability.

HEINTZ AND KAUFMAN, LTD.

SOUTH SAN FRANCISCO, CALIFORNIA, U. S. A.

Gammatron Tubes



HK-24—The long, capped tantalum plate confines the entire electron stream for useful output, and the grid is closely spaced to the filament for short electron time-flight. The result is high efficiency at very high frequencies. (Plate dissipation 25 watts, maximum power output 90 watts.)





Not Good Enough for Transformers "at War"

"Satisfaction or your money back," "defective parts replaced free," etc., are ample protection for users of civilian goods but with lives and battles depending on Communication Equipment, these peacetime guarantees fail to satisfy. There's no time in a dog-fight to replace a defective transformer, and in battle the only dependable warranty is the assurance that the equipment will *not* fail . . . even under the most abnormal conditions and usage.

Building transformers for aerial communication

is one of Rola's war jobs. *Into* this task goes the knowledge and skill accumulated through years of manufacturing leadership. And *out* of it, certainly, will come new knowledge and new skill for the tasks of Tomorrow.

THE ROLA COMPANY, INC., 2530 Superior Avenue, Cleveland, Ohio.

In addition to transformers of varying types, Rola manufactures headsets and coils of all kinds for aerial communications. If your problem involves Electronics . . . and is important to the war effort . . . why not discuss it with a Rola engineer.

★ ROLA ★

MAKERS OF THE FINEST IN SOUND REPRODUCING AND ELECTRONIC EQUIPMENT

IT MUST BE RIGHT!

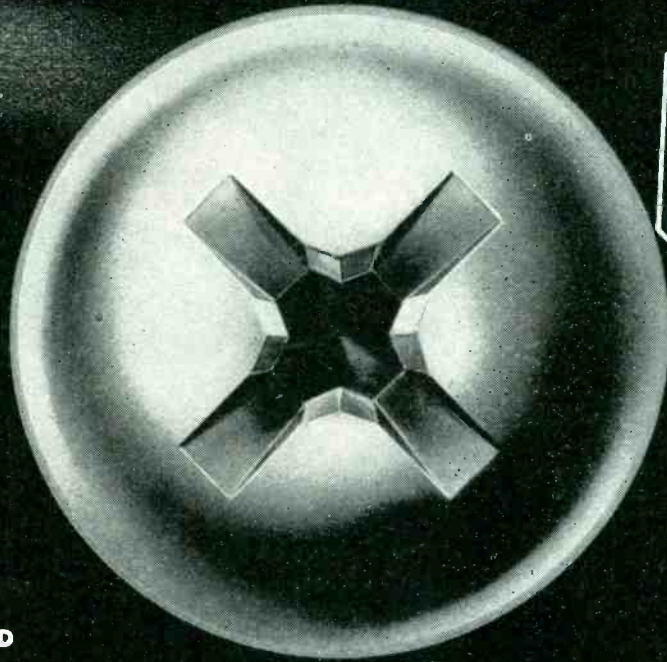

21 Leading Makers of Screws
recommend the
PHILLIPS RECESSED HEAD



WOOD



MACHINE



SELF-TAPPING



STOVE

21 Concerns Offer the Phillips Head

AMERICAN SCREW CO.	Providence, R. I.
THE BRISTOL CO.	Waterbury, Conn.
CENTRAL SCREW CO.	Chicago, Ill.
CHANDLER PRODUCTS CORP.	Cleveland, Ohio
CONTINENTAL SCREW CO.	New Bedford, Mass.
THE CORBIN SCREW CORP.	New Britain, Conn.
THE H. M. HARPER CO.	Chicago, Ill.
INTERNATIONAL SCREW CO.	Detroit, Mich.
THE LAMSON & SESSIONS CO.	Cleveland, Ohio
THE NATIONAL SCREW & MFG. CO.	Cleveland, Ohio
NEW ENGLAND SCREW CO.	Keene, N. H.
THE CHARLES PARKER CO.	Meriden, Conn.
PARKER-KALON CORP.	New York, N. Y.
PAWTUCKET SCREW CO.	Pawtucket, R. I.
PHEOLL MANUFACTURING CO.	Chicago, Ill.
READING SCREW CO.	Norristown, Pa.
RUSSELL BURDSALL & WARD BOLT & NUT CO.	Port Chester, N. Y.
SCOVILL MANUFACTURING CO.	Waterville, Conn.
SHAKEPROOF INC.	Chicago, Ill.
THE SOUTHWINGTON HARDWARE MFG. CO.	Southington, Conn.
WHITNEY SCREW CORP.	Nashua, N. H.

Out of the many screw heads designed through the years to eliminate screw driving troubles, *only ONE* has gained wide approval by the men who should know most about screws...the men who develop and produce fastening devices.

It is highly significant that the leaders

in the screw industry... *21 concerns*... recommend the PHILLIPS RECESSED HEAD as the first recessed head that is *right* in every respect! It assures you that screw driving troubles will be ended when you specify PHILLIPS. Also, it means convenience in buying, and prompt and capable service.

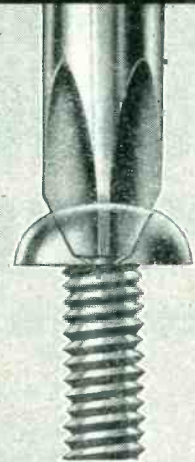

KEY TO FASTENING SPEED AND ECONOMY

The Phillips Recessed Head was scientifically engineered to afford:

Fast Starting - Driver point automatically centers in the recess... fits snugly. Screw and driver "become one unit." Fumbling, wobbly starts are eliminated.

Faster Driving - Spiral and power driving are made practical. Driver won't slip out of recess to injure workers or spoil material. (Average time saving is 50%.)

Easier Driving - Turning power is fully utilized by automatic centering of driver in screw head. Workers maintain speed without tiring.

Better Fastenings - Screws are set-up uniformly tight, without burring or breaking heads. A stronger, neater job results.

PHILLIPS *Recessed Head* SCREWS

WOOD SCREWS • MACHINE SCREWS • SELF-TAPPING SCREWS • STOVE BOLTS

IDEAL CAPACITORS FOR

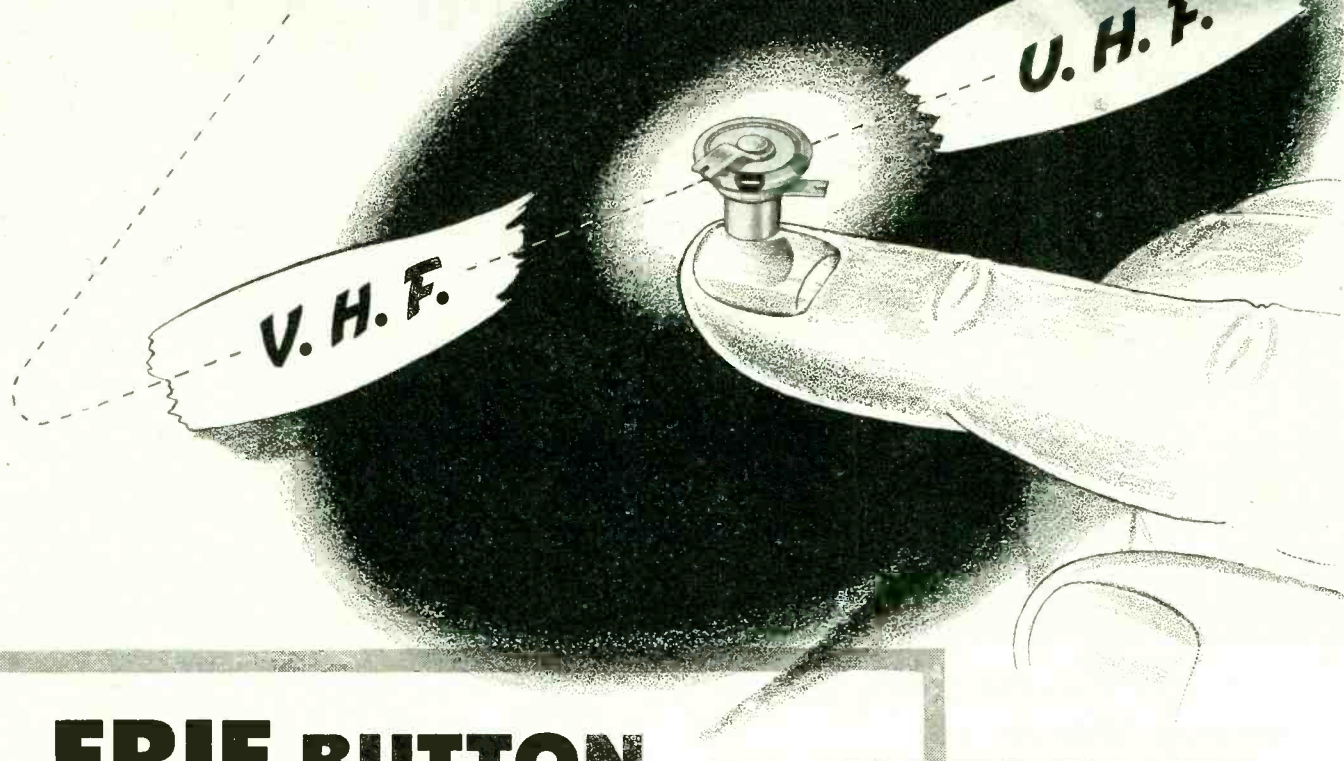

ERIE BUTTON SILVER MICAS

FOR V.H.F. and U.H.F. applications where short ribbon-type leads, low series inductance, and compactness are requisite factors, Type 370 Button Mica Condensers are ideal components.

These small condensers consist essentially of a stack of silvered mica sheets encased in a silver plated housing. The housing forms one terminal, the other terminal being connected at the center of the stack, thus providing the shortest possible electrical path to and from the capacitor.

A wide selection of terminal and mounting designs is available to provide both

CHARACTERISTICS

CAPACITY RANGE:
15 to 500 MMF at 1 mc.

POWER FACTORS:
.08% max. for capacity tolerance $\pm 5\%$ or closer (for resonant circuit applications).
.12% max. for capacity tolerance over $\pm 5\%$ (for by-pass and blocking use).

MAX. WORKING VOLTAGE:
350 Volts A.C., 500 Volts D.C.
Flash Test (2 seconds) 1,000 Volts D.C.
Leakage Resistance, Over 10,000 megohms.

feed-through and by-pass connections. Capacity ranges and electrical characteristics are given above.

The efficiency and quality of Erie Button Silver Micras have been thoroughly proven in large scale production quantities since 1941. Complete technical information will be sent to interested engineers on request.

INVEST TODAY IN BONDS FOR VICTORY

ERIE RESISTOR CORP., ERIE, PA. LONDON, ENGLAND · TORONTO, CANADA.

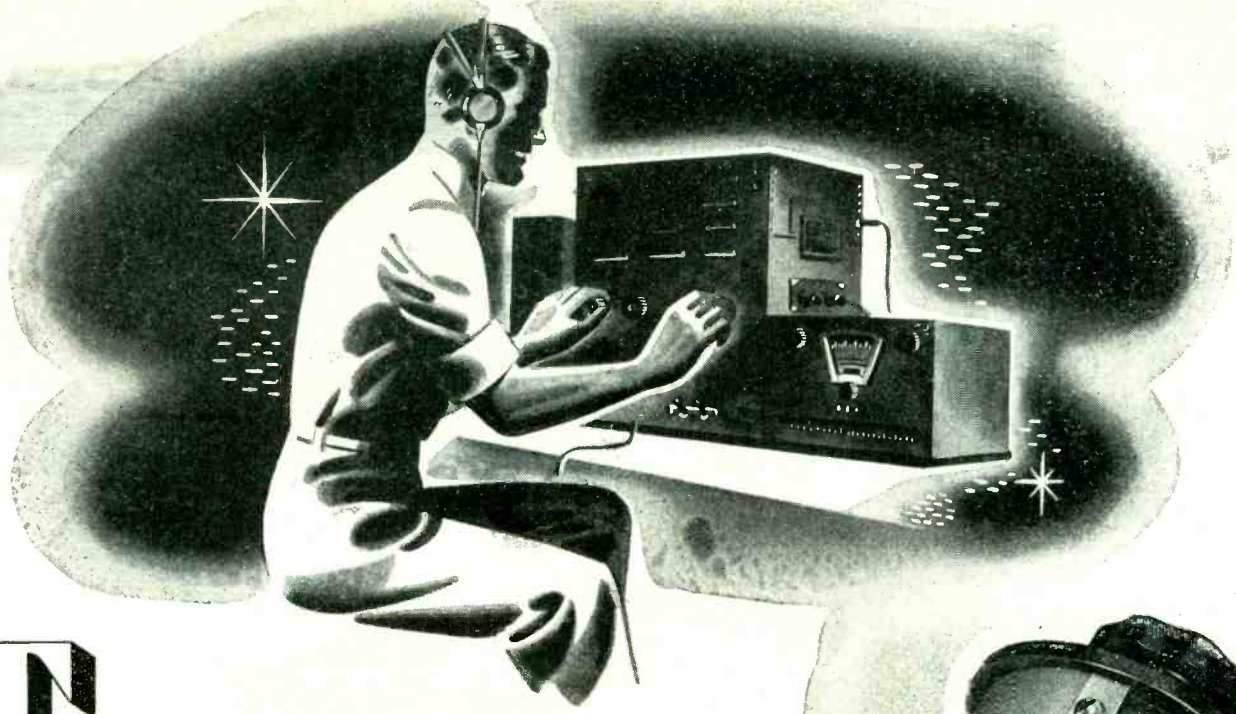

THEY LISTEN...

Around the clock, from Monday to Monday, America's "monitors of the air" sit at their posts—and listen. Serving in a thousand different ways, they check foreign news and propaganda, send and receive weather reports, keep air channels clear, ferret out renegade radio stations. Of prime importance in the apparatus used by monitors are meters and rheostats which assure absolute control and give accurate indications of volume, power, modulation and recording. In many instances the components chosen for dependability are products of DeJur laboratories. Built of the finest materials to exacting precision standards, DeJur instruments are backed by a tradition of twenty-five years of outstanding electrical accomplishment.

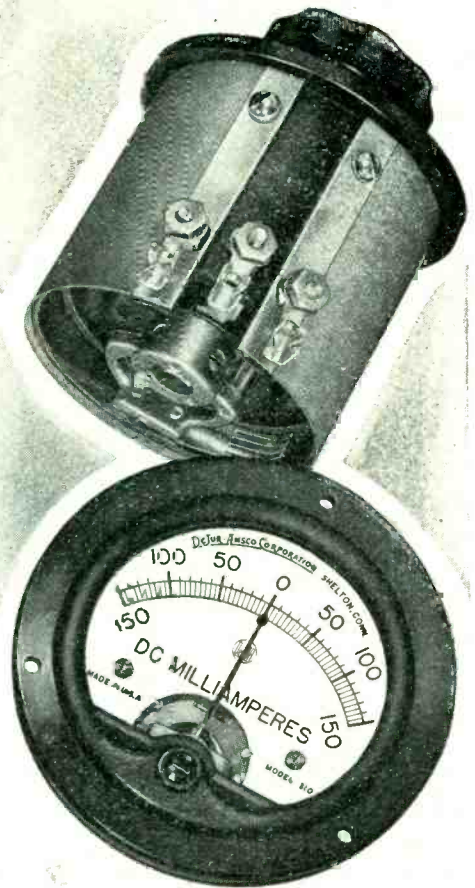

BACK THE ATTACK . . . SUPPORT THE THIRD WAR LOAN DRIVE



DeJur-Amsco Corporation

SHELTON, CONNECTICUT

NEW YORK PLANT: 99 Hudson Street, New York City • **CANADIAN SALES OFFICE:** 560 King Street West, Toronto

LITTLE GIANTS OF DEPENDABILITY

**JAMES
KNIGHTS**

Crystals

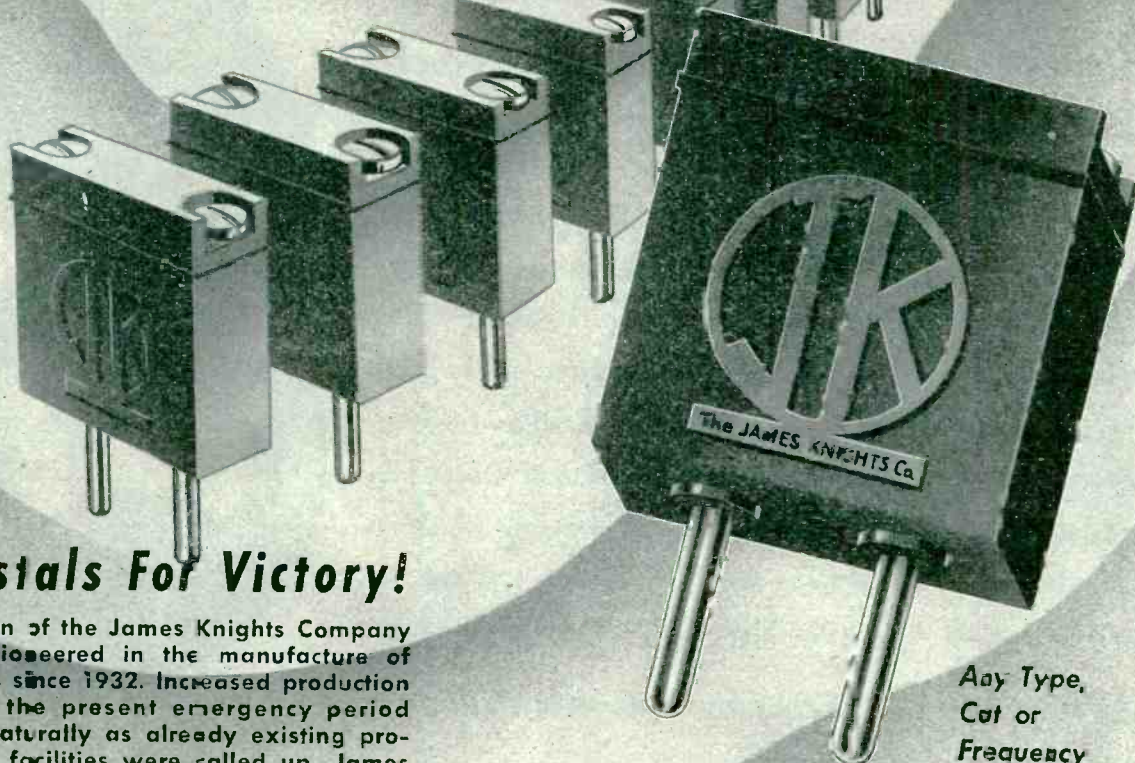

Crystals For Victory!

The men of the James Knights Company have pioneered in the manufacture of Crystals since 1932. Increased production during the present emergency period came naturally as already existing production facilities were called up. James Knights will be making Crystals too when this war is over—supplying them to those who demand the utmost in dependability and efficiency.

Any Type,
Cut or
Frequency

**PRECISION CUTTERS OF QUARTZ
FOR COMMUNICATIONS AND OPTICAL USES**

The JAMES KNIGHTS Company
SANDWICH, ILLINOIS PHONE 65

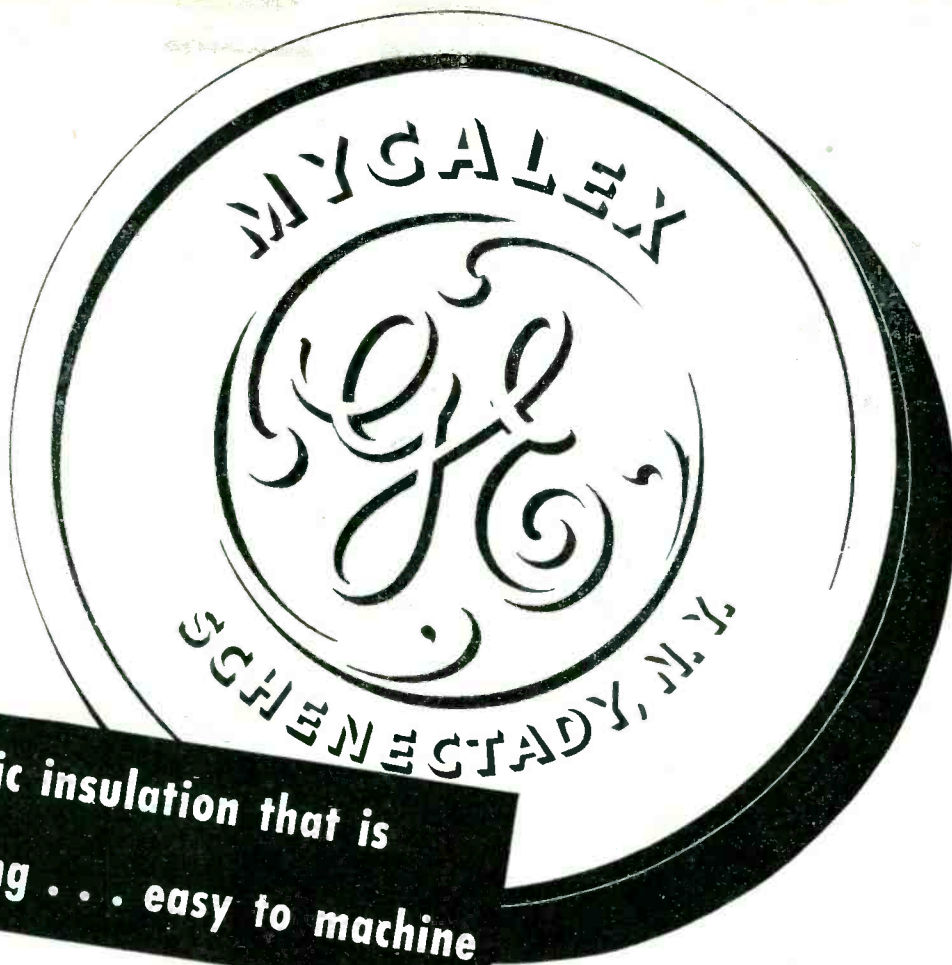

The electronic insulation that is mechanically strong . . . easy to machine

Another example of G-E research

FOR nearly 20 years, radio and industrial-control engineers have been solving stubborn insulation problems with General Electric Mycalex . . . a high-density, stone-like substance ideally suited and extensively used for high-frequency-current insulation.

Because of its excellent dielectric strength, superior refractory qualities, exceptional dimensional stability, and great mechanical strength, G-E Mycalex can handle the toughest insulating jobs.

ESPECIALLY NOTABLE ARE THE FOLLOWING INSULATION CHARACTERISTICS:

ELECTRICAL	
Power factor (1000 kc)	0.002
Dielectric constant (1000 kc)	7.5
Dielectric strength (volts per mil for 0.2 in. thickness)	360
MECHANICAL	
Transverse strength	Modulus of rupture. 14,000-19,000 lb/sq. in.
PHYSICAL	
Water absorption	.003%

For complete details about mycalex, send for booklet, "G-E Compression-Molded Mycalex."

G-E Mycalex rods and plates may be subjected to all machining operations of drilling, filing, sawing, and grinding—making G-E Mycalex ideally flexible for exacting production specifications. . . Write for sample. Address: *Electronics Dept., General Electric, Schenectady, N. Y.*

• Tune in General Electric's "The World Today" and hear the news from the men who see it happen, every evening except Sunday at 6:45 E.W.T. over CBS network. On Sunday listen to "The Hour of Charm" at 10 P.M. E.W.T. over NBC.



Compression-molded and fabricated parts

Outstanding examples of what can be done with compression-molded G-E Mycalex. Note, particularly, the cross-sectioned units. Most of them have brought about elimination of many parts formerly used. For example, the three-piece brush holder (circled) once was made of a score of assembled components. All G-E Mycalex parts have great chemical stability, imperviousness to water, oil, and gas, and resistance to sudden temperature change, plus low thermal expansion, and high dimensional stability.

GENERAL  ELECTRIC

177-M-91-9915

THE E-E DATA BOOK IS READY

...write for your copy!

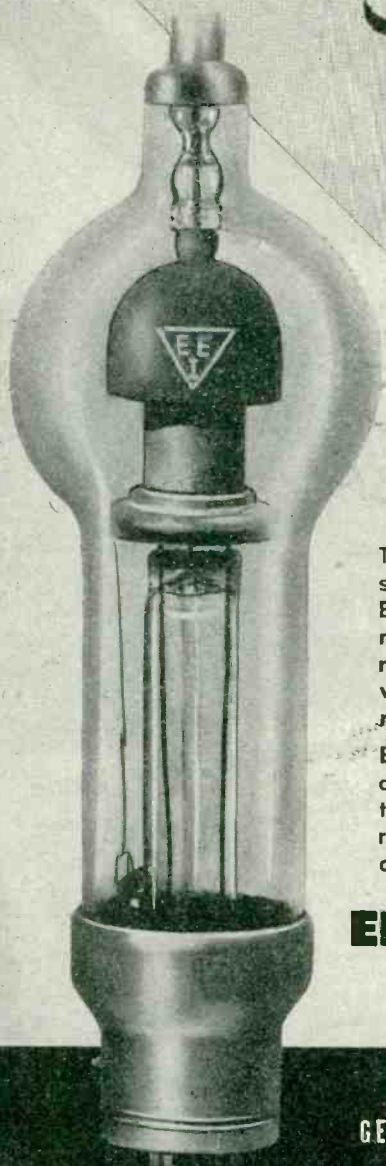

This volume is factual and concise . . . not selling. Its content substantially embodies specifications and technical data pertaining to Electronic Enterprises power and transmitter tubes—mercury vapor rectifier, power amplifier, modulator, half-wave mercury-vapor rectifier, half-wave high-vacume rectifier, transmitter triode, high vacume filament-type diode, etc. Maximum ratings, operating currents and voltages, and typical circuit conditions are given in detail.

Electronic engineers, designers and manufacturers are invited to add this important compilation to their files. The part to be undertaken by E-E electronic tubes in the coming industrial cycle is reflected in present vital military installations for every type application. Write for your E-E data book now; no obligation of course.

ELECTRONIC ENTERPRISES, INC.



GENERAL OFFICES: 65-67 SEVENTH AVE., NEWARK, N. J.

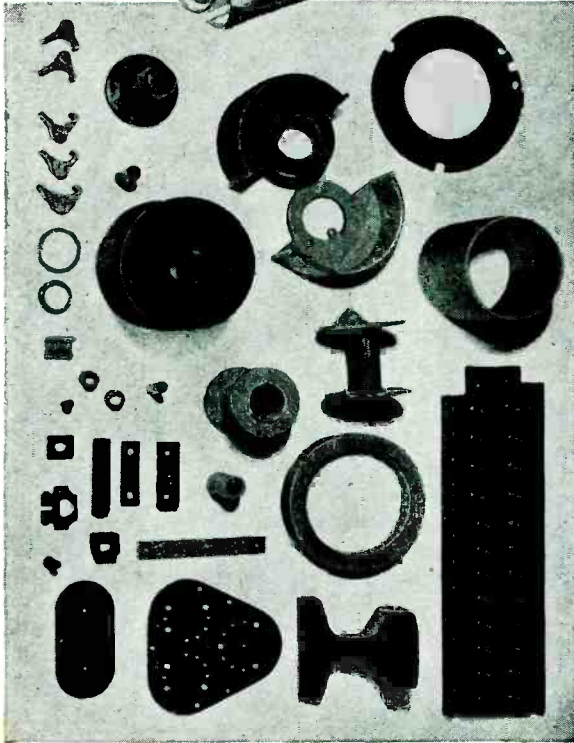
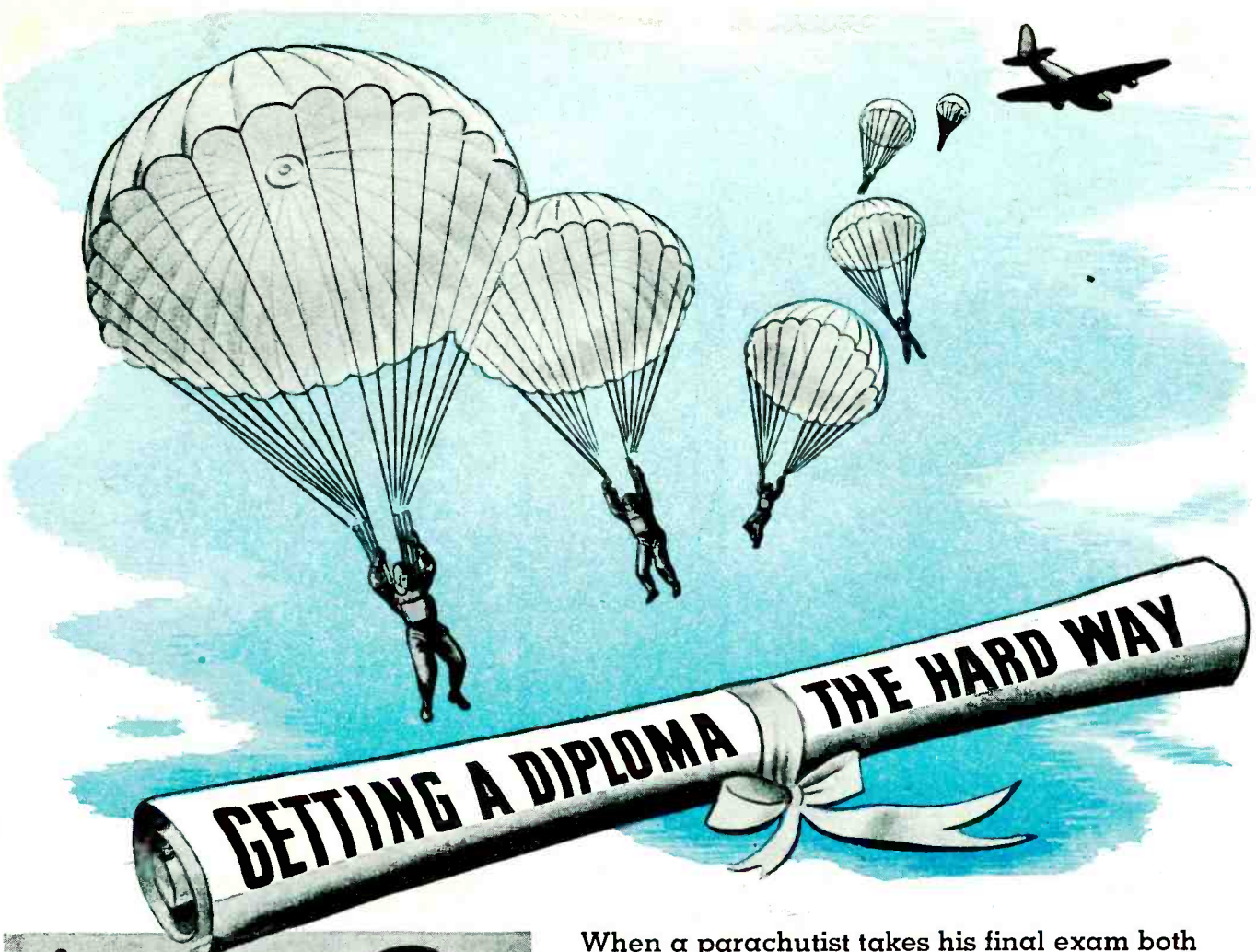

When a parachutist takes his final exam both his diploma and his life depend on the fitness of his rip cord.

Lives also frequently depend upon the fitness of inconspicuous radio and electrical parts of Formica laminated plastic used in war equipment—such parts as insulating spools, insulating spacers, breaker arms, radio tube socket bases, terminal strips, rheostat cores and other insulating parts.

Formica combines lightness with strength, dimensional stability, and resistance to change through chemical action. It has a low power factor, low dielectric loss. There is a wide variety of grades each of which emphasizes some one of the many valuable properties of material for special purposes.



THE FORMICA INSULATION COMPANY

4661 SPRING GROVE AVENUE • CINCINNATI, OHIO

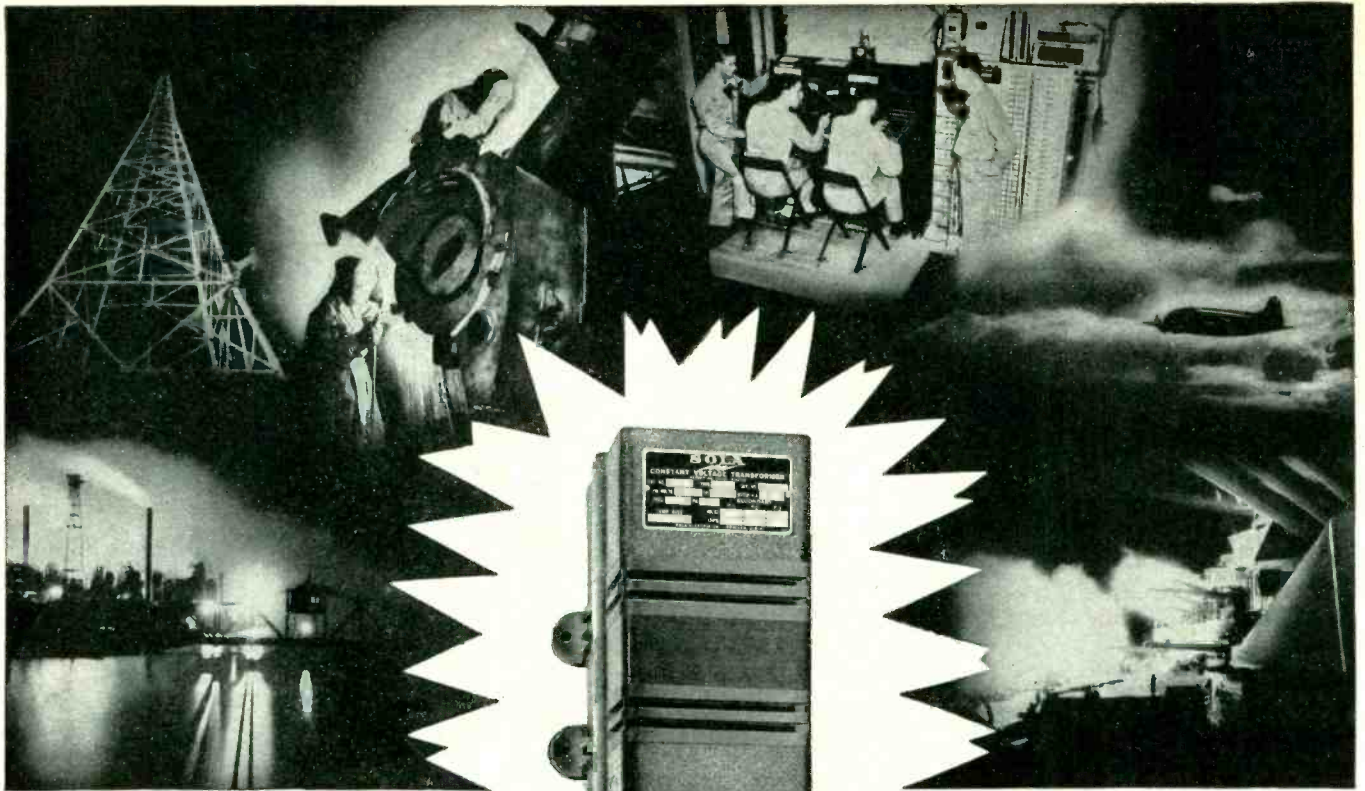

From blast furnace to battle front...

Constant Voltage guides the Tools of War

NEVER before in the history of warfare has precision production been so important as it is today. From the trigger group of an M-1 rifle to the fire control of a 16-inch battery, split-hair tolerances are demanded in millions of intricate munitions parts. Producing to uncompromising standards requires the finest type of machine tools ever designed—operated at a constant level of electric power.

But *constant voltage* is almost non-existent on today's overcrowded power lines. Wartime consumers are busier. Huge volumes of electrical energy are being intermittently used and released. Heavy sags and destructive surges inevitably occur. For that reason, manufacturers in every

field are stabilizing power themselves with SOLA CONSTANT VOLTAGE TRANSFORMERS.

Sola "CVs" equalize voltage sags and surges, absorb variations as great as 30%, feed a controlled flow of power to machines. And they protect the *very life* of sensitive instruments and electronic tubes.

Engineered for long, trouble-free service, Sola "CVs" are instantaneous in action, without moving parts, self-protecting against short circuit. They have a place on *your* production lines—the life lines of American victory.

Note to Industrial Executives: Sola "CV" transformers are available in standard 10VA to 15KVA units. Special units to specification. Ask for bulletin DCV-74

Constant Voltage Transformers

SOLA

Transformers for: Constant Voltage • Cold Cathode Lighting • Mercury Lamps • Series Lighting • Fluorescent Lighting • X-Ray Equipment • Luminous Tube Signs • Oil Burner Ignition • Radio • Power • Controls • Signal Systems • Door Bells and Chimes • etc. **SOLA ELECTRIC CO., 2525 Clybourn Ave., Chicago, Ill.**

SOCKETS



Miniature

Octal

Diheptal

Bayonet Tube

Lockin

Glass Tube

Acorn

Crystal Holder

Battery

Cathode Ray Tube

Consult FRANKLIN on your next Socket problem—be it mounting, contact size or the utility of your socket application.

FRANKLIN SOCKETS are made of either LAMINATED or MOULDED LOW LOSS or CERAMIC construction.

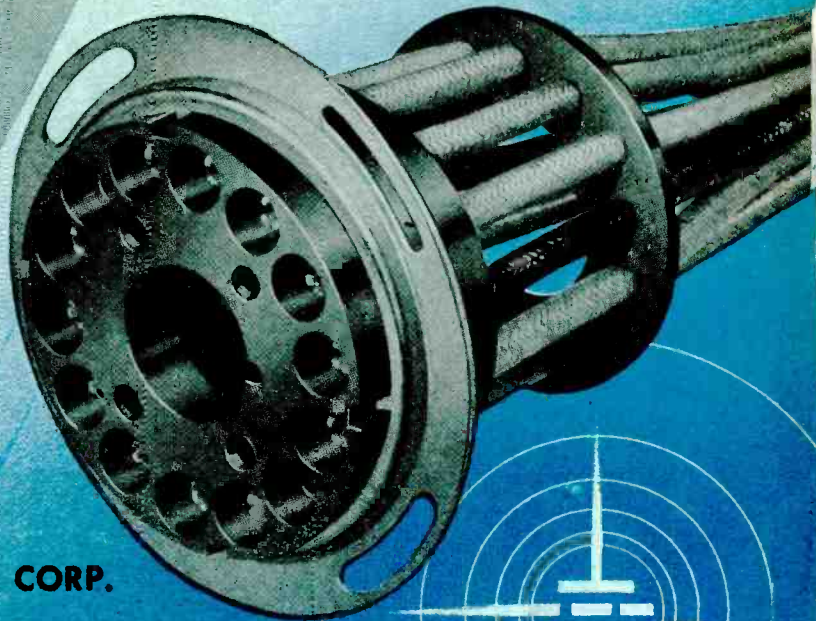

A. W. FRANKLIN MANUFACTURING CORP.

175 VARICK STREET, NEW YORK 14, N. Y.



**For complete, balanced,
fully guaranteed instrumentation . . .**



DUMONT makes both

► DuMont cathode-ray specialists have compiled and published a manual and catalog just off the press. This book is replete with valuable data on cathode-ray principles and practice, as well as descriptions and listings of DuMont tubes and equipment. Write on your business stationery for your registered copy. And do not hesitate to submit your cathode-ray problems for engineering collaboration.

► Yes, DuMont makes both — cathode-ray tubes and instruments. Pioneer of the commercialized cathode-ray art, DuMont has always insisted that such equipment be developed, designed and built as a thoroughly coordinated whole, since basically the equipment is but an extension of the cathode-ray tube itself.

► That is why DuMont tube specialists and instrument makers work side by side. Latest tube developments are immediately available to DuMont instrument makers. Contrariwise, as DuMont instrument makers evolve new circuits or functions, they can count on corresponding tube characteristics. Meanwhile four DuMont plants translate that ideal coordination into up-to-the-minute tubes and instruments.

► Always remember, DuMont makes both — tubes and equipment — for that complete, balanced, fully guaranteed instrumentation.

DUMONT

Precision Electronics & Television

ALLEN B. DUMONT LABORATORIES, INC., PASSAIC, NEW JERSEY - CABLE ADDRESS: WESPEXLIN, NEW YORK



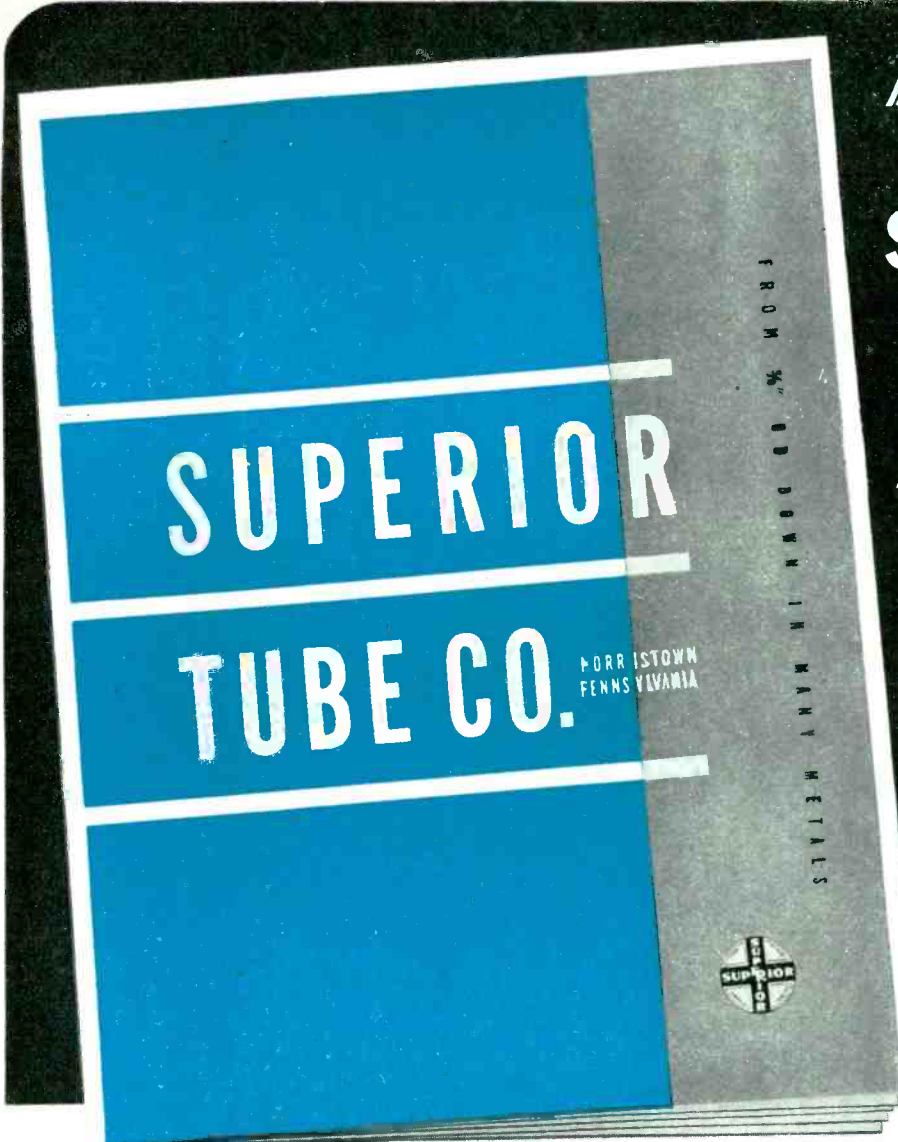

*Brief, Concise Facts
about*

**SUPERIOR
FINE SMALL
TUBING**

(Maximum OD - 5/8")

*Write Today for Your Copy of
SUPERIOR BULLETIN 48*

Whether your use of small tubing extends back over the years, or has been stepped up by the war, we believe this booklet has ready information that will save you time.
WRITE TODAY FOR BULLETIN 48 ON YOUR COMPANY LETTERHEAD.

SUPERIOR

SUPERIOR TUBE COMPANY, NORRISTOWN, PENNSYLVANIA



*The big name in
SMALL TUBING
for Uncle Sam!*

FOR EVERY SMALL TUBING APPLICATION

Tubing from 3/8" OD down... SUPERIOR  *Seamless in various analyses. WELD-DRAWN*  *Welded and drawn Stainless. BRAUN*  *Welded and drawn "Monel" and "Inconel". SEAMLESS and Patented LOCKSEAM Cathode Sleeves.*

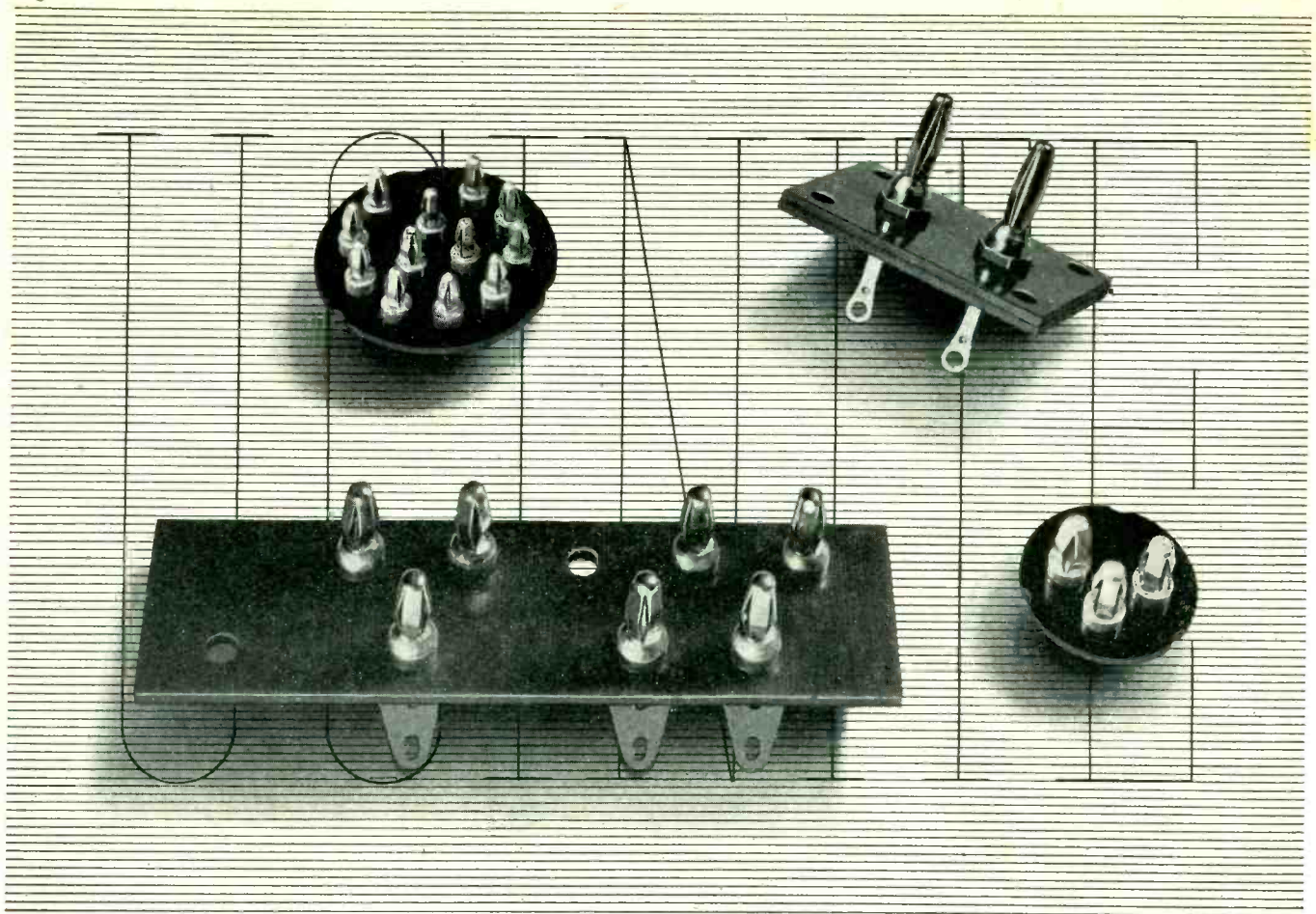

Hard to find

Specific parts for a specific application . . . those are the things that are hardest to find, these days. At Ucinite we specialize in the carrying out of such orders.

Take banana pin assemblies like the ones illustrated above, for instance. We can design them from the start for your particular needs. We make the pins, die-stamp the mounts, assemble them, inspect them and get them out on time.

Small jobs don't bother us. But we have the engineering staff and the production capacity to handle the big jobs, too.

The UCINITE CO.

Newtonville, Mass.

Division of United-Carr Fastener Corp.

Specialists in **RADIO & ELECTRONICS**
LAMINATED BAKELITE ASSEMBLIES
CERAMIC SOCKETS · BANANA PINS &
JACKS · PLUGS · CONNECTORS · ETC.

Another Leader in Radionics

GUTHMAN MOLDED PAPER CONDENSERS for Big Jobs in Small Quarters

Thousands of these important little Guthman condensers perform their necessary duties under most exacting conditions in radio equipment. They are manufactured to meet the rigid specifications of the signal corps. Due to the compactness of these units, they are being widely used for small battery equipment, and are best adapted for use in circuits where the D. C. does not exceed 120 volts.

Guthman Molded Paper Condensers, molded in type CMP 20 case for low voltage use, are available up to .01 mmfd. capacity. In the manufacturing of these condensers the finest Kraft Paper and Aluminum Foil are used. Each condenser is given a transformer oil impregnation, which insures uniformity of quality. These Guthman condensers are then molded in a high grade bakelite case, normalized and heat treated, and then vacuum impregnated at high temperature.



EDWIN I. GUTHMAN & CO. INC.

15 SOUTH THROOP STREET · CHICAGO

PRECISION MANUFACTURERS AND ENGINEERS OF RADIO AND ELECTRICAL EQUIPMENT

A NEW TECHNIQUE *that is* SPEEDING VICTORY

LITERALLY a one man army, the paratrooper strikes fast and hard—almost anywhere. He represents a new and deadly technique of modern warfare, one that America is utilizing to the fullest.

Industry, too, has learned new techniques. New short cuts, new refinements in design, new ways to build faster and better the tools and weapons our fighting men need.

Simpson electrical instruments and testing equipment, for example, offer a basically superior type of movement which required a slow and costly method of construction only a few years ago. Today, in the Simpson plant, this greater accuracy and stamina is a matter of mass production.

Tomorrow the many things industry has learned under the impetus of war will build a brighter, happier world. The harder we work on the job at hand, the sooner that tomorrow will come.

SIMPSON ELECTRIC COMPANY
5200-5218 Kinzie Street, Chicago 44, Illinois



Simpson

INSTRUMENTS THAT STAY ACCURATE

Buy War Bonds and Stamps for Victory

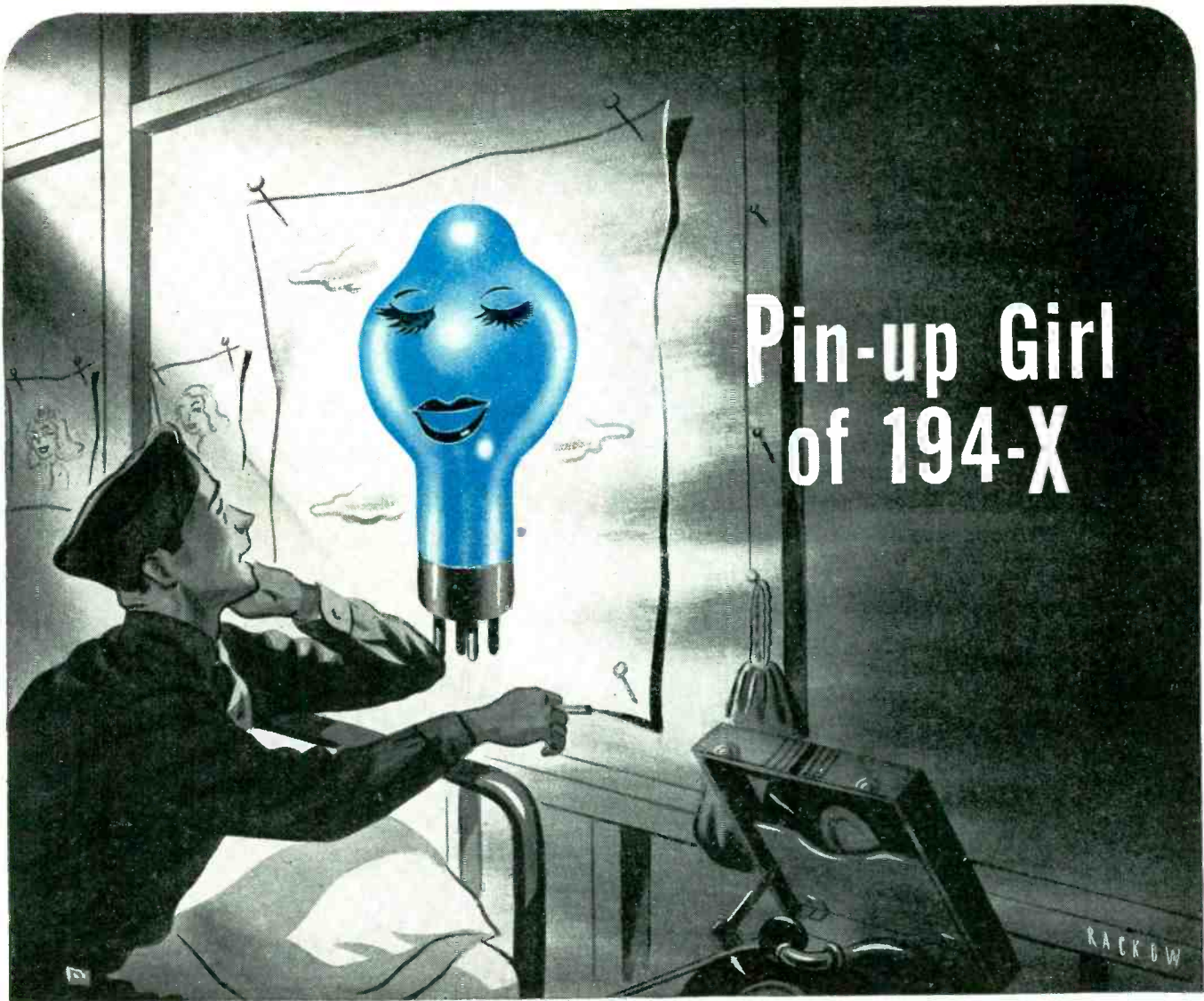

Pin-up Girl of 194-X

SHE ISN'T VERY GLAMOROUS RIGHT NOW—she's much too busy winning the war to take time out for fluff. But fighting men on every front, in every plant will remember her. How she climbed right into coveralls and went to work—testing bullets, sorting cartons, bonding plywood, making steel . . . How she went to work at the front, too—getting messages through, helping to take pictures, saving lives through X-Ray, spotting planes, aiming guns . . .

IN 194-X her popularity will be even greater. She'll have time again for glamorous jobs as well as the dirty work she's not afraid to do. She'll be making possible two-way television,

piloting skyliners for weekends in Europe, producing and controlling power by radio, extending the vision of research . . .

CONCERNS IN THE ELECTRICAL FIELD that intend to go on *with electron tubes* to even newer, more exciting jobs when Victory is won will find that Roebling has been planning along those lines, too. More than planning

—for in meeting war's tough specifications, Roebling is learning new things for peace.

For today's needs and tomorrow's plans rely on Roebling as your source for electrical wires and cables.

JOHN A. ROEBLING'S SONS COMPANY
TRENTON 2, NEW JERSEY
Branches and Warehouses in Principal Cities

ROEBLING ELECTRICAL WIRES AND CABLES



**A LIVE *muscle* OF STEEL
THAT LICKS TOUGH JOBS...**

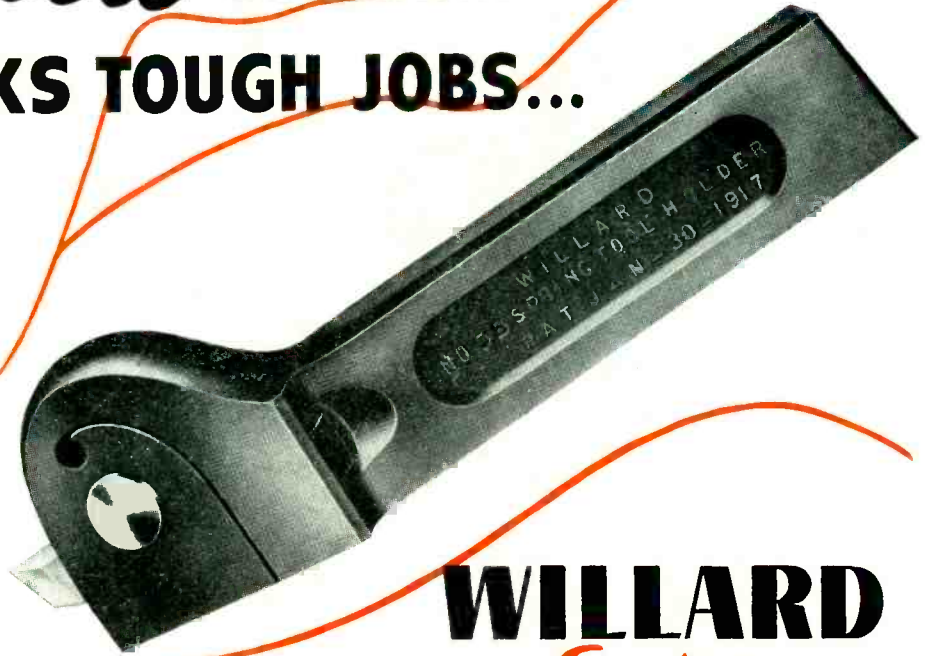

WILLARD
Spring
TOOL HOLDER
For Threading and Forming

Right hand offset. Made in 3 sizes for 1/4", 5/16" and 3/8" square bits. Furnished with hardened wrench and one high speed cutter.

Resilient strength, not rigid inflexibility, is the secret of Willard Spring Tool Holders. It's the reason why these Holders are so successful in preventing cutter breakage and damaged work . . . why they can be used for fine or coarse threading without danger of chatter or tool marks . . . why they can handle faster feeds with a heavier cut . . . why they are so adaptable to a wide variety of work . . . and especially why you should specify Willard Spring Tool Holders for economy, efficiency and accuracy!

Write for descriptive booklet



FORMING TOOL HOLDER

Straight and right hand offset. For cutter 5/8" x 2" diameter. Furnished with hardened wrench and one soft blank cutter.



Awarded to Auto-Ordnance Corporation for excellence in production of "Tommy" Guns

AUTO-ORDNANCE
Corporation

THOMPSON TOOL DIVISION

342 West Putnam Avenue, Greenwich, Conn.

GREENWICH • STAMFORD • BRIDGEPORT • NEW YORK

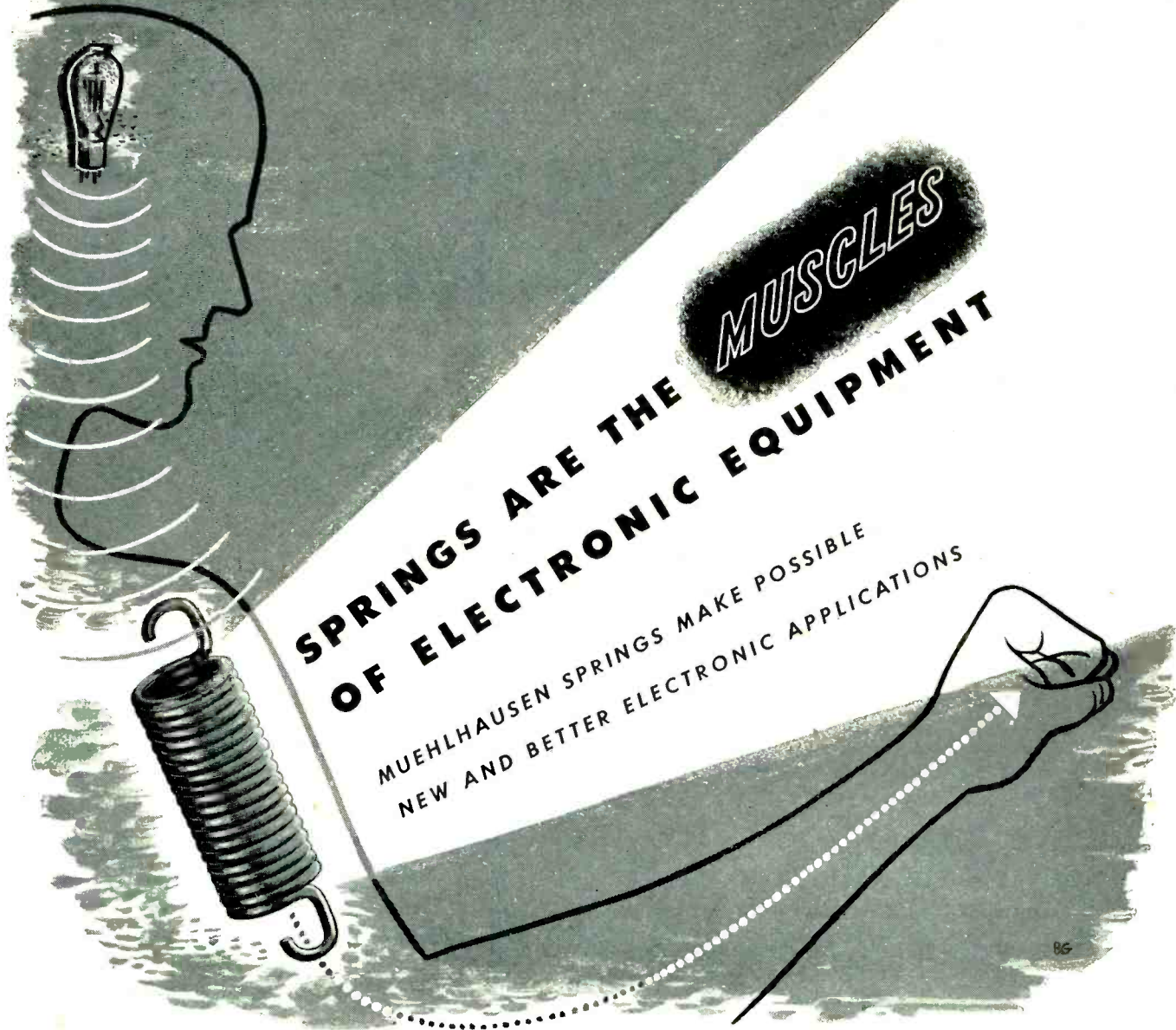

A TINY light flashes. Immediately, a massive machine starts operating. One little tube supplies the impulse. But *springs are the muscles* which accurately control the mechanical motion—tireless muscles, capable of working continuously, without strain.

To give the precise, instantaneous action necessary for gaining full value of electronic control, such springs must be designed for the specific application—and all factors bearing on their use scientifically evaluated.

Muehlhausen engineers have solved thousands of spring problems which arise with unusual applications—by the thorough study they make of all operating conditions, and their many painstaking tests to prove that each design is *right*. An assurance of greater latitude in the design of new and better electronic products.

MUEHLHAUSEN SPRING CORPORATION
Division of Standard Steel Spring Company
 760 Michigan Avenue, Logansport, Indiana

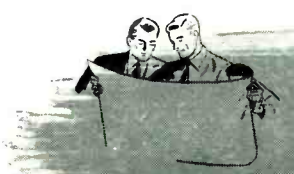

Leading product designers in every industry are consulting Muehlhausen Engineers to secure springs of lasting efficiency.

MUEHLHAUSEN

SPRINGS



EVERY TYPE AND SIZE

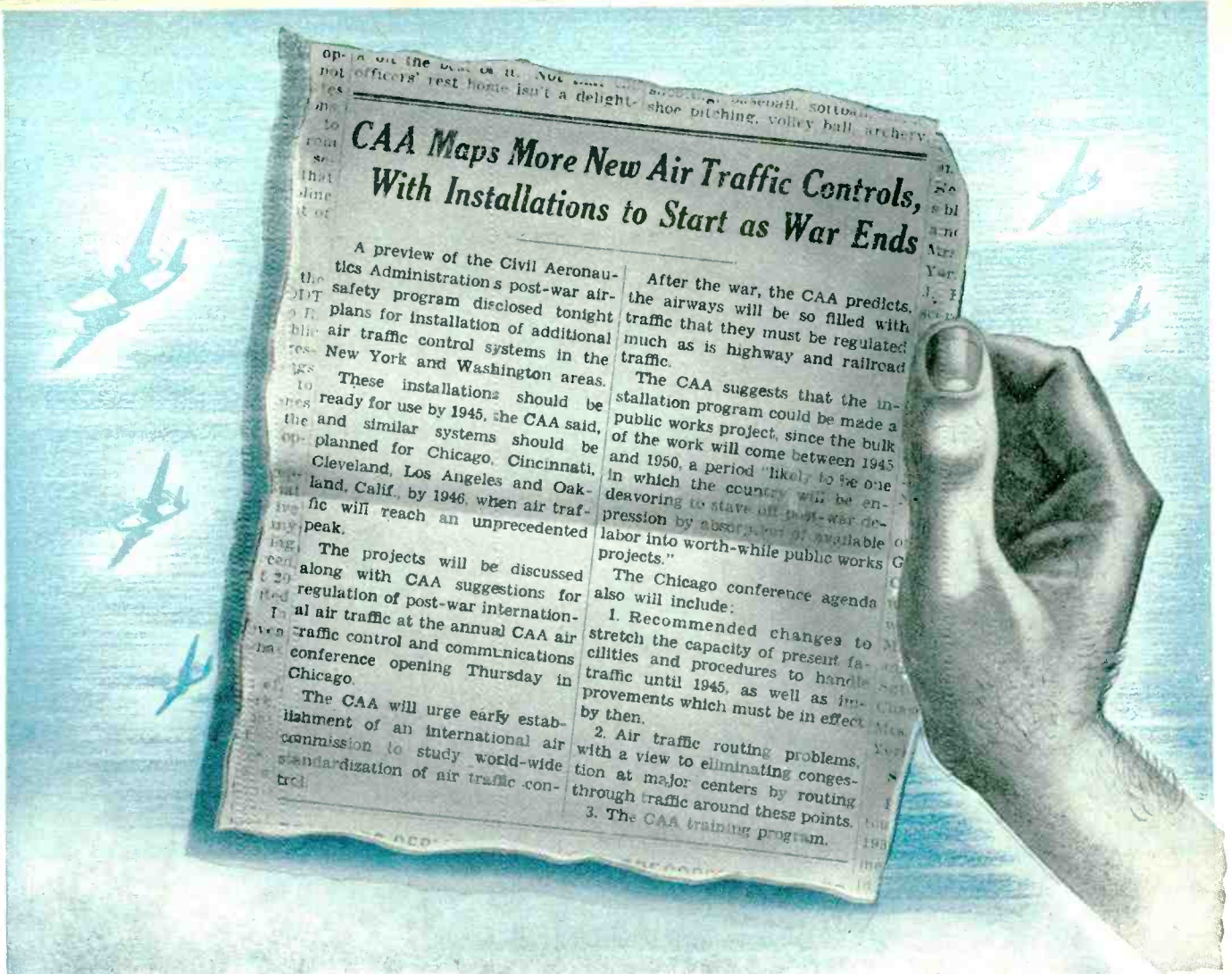

CAA Maps More New Air Traffic Controls, With Installations to Start as War Ends

A preview of the Civil Aeronautics Administration's post-war air-safety program disclosed tonight plans for installation of additional air traffic control systems in the New York and Washington areas.

These installations should be ready for use by 1945, the CAA said, and similar systems should be planned for Chicago, Cincinnati, Cleveland, Los Angeles and Oakland, Calif. by 1946, when air traffic will reach an unprecedented peak.

The projects will be discussed along with CAA suggestions for regulation of post-war international air traffic at the annual CAA air traffic control and communications conference opening Thursday in Chicago.

The CAA will urge early establishment of an international air commission to study world-wide standardization of air traffic control.

After the war, the CAA predicts, the airways will be so filled with traffic that they must be regulated much as is highway and railroad traffic.

The CAA suggests that the installation program could be made a public works project, since the bulk of the work will come between 1945 and 1950, a period "likely to be one in which the country will be endeavoring to stave off post-war depression by absorption of available labor into worth-while public works projects."

The Chicago conference agenda also will include:

1. Recommended changes to stretch the capacity of present facilities and procedures to handle traffic until 1945, as well as improvements which must be in effect by then.
2. Air traffic routing problems, with a view to eliminating congestion at major centers by routing through traffic around these points.
3. The CAA training program.

If the war should end tomorrow . . .

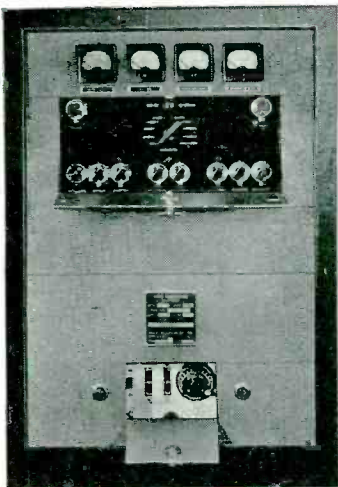

RADIO RECEPTOR, with a wealth of experience encompassing the entire history of radio, would be ready to convert its greatly expanded facilities to the construction and installation of Ground-to-Air Navigation, Communications and Airport Traffic Control Equipment for civilian use.

Now devoted to the war effort, these engineering and production facilities that built the first commercial ultra-high-frequency airport control units, which were installed at Washington National Airport for the Civil Aeronautics Administration, will be in a position to provide all advanced types of airport radio equipment—for municipal and private fields—under a single contract, if desired.

Today, RADIO RECEPTOR installations assure increased safety and efficiency in airports throughout the world. We'll be glad to send a copy of our revised booklet, "HIGHWAYS OF THE AIR", now in preparation. Please write on your business stationery to our Executive Offices, 251 West 19th Street, New York 11, N. Y.

RADIO RECEPTOR CO., INC.



Awarded for Meritorious Service on the Production Front

SINCE 1922 IN RADIO AND ELECTRONICS

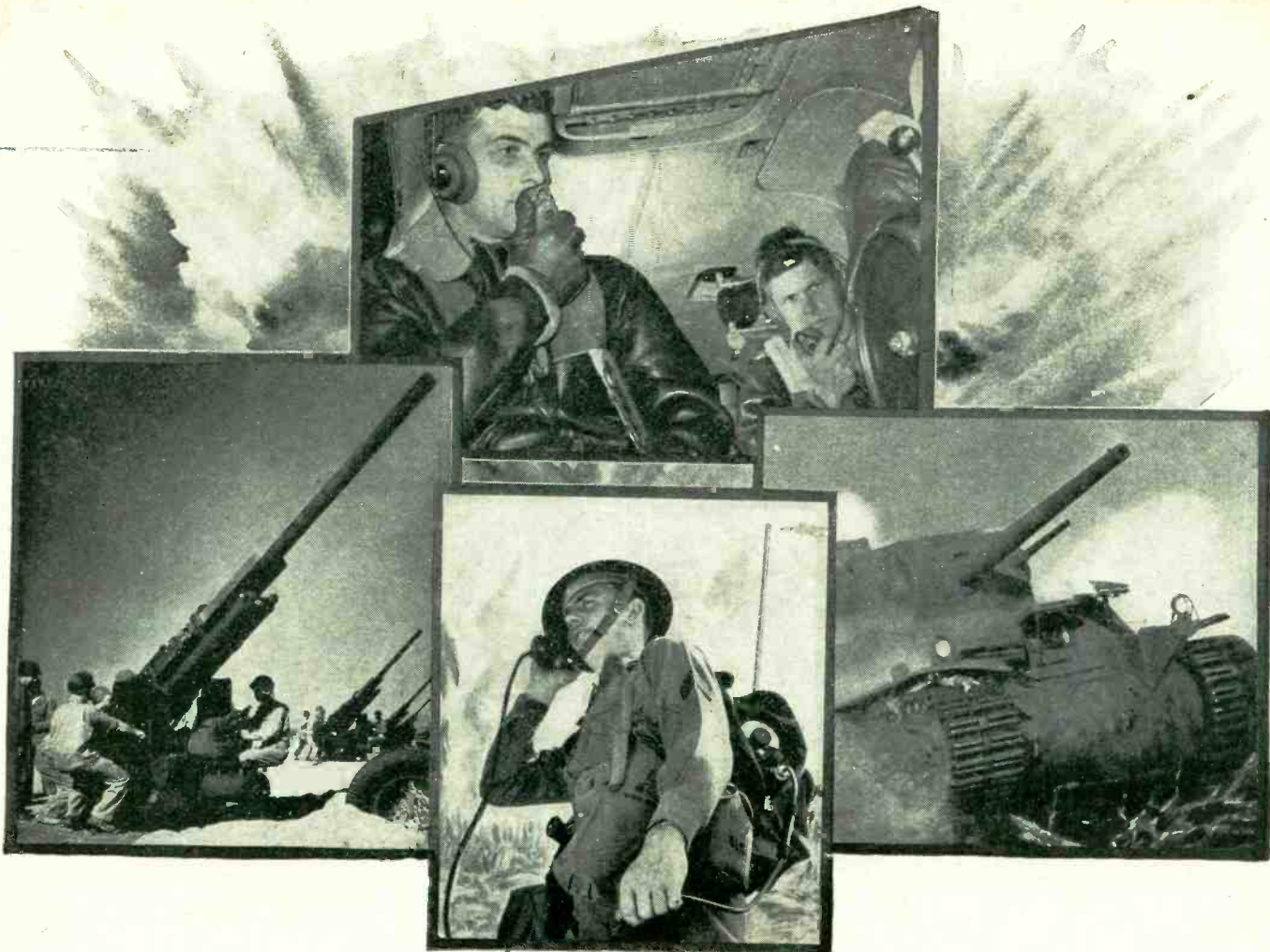

*In the heat of every fight a **CONTINENTAL-DIAMOND** product fights side by side with every soldier, sailor and marine*

70° below zero in the Stratosphere; 130° above zero on the desert; radio sets must function if our fighting forces are going to hold hard won gains. If the electrical insulation fails, the radio fails and the fight may be lost. But DILECTO laminated plastic insulation has been developed by C-D engineers to stand extremes of temperature, humidity and physical abuse, so these vital ears of our armed forces DO NOT FAIL.

Almost fifty years of research, trial, experiment, and application experience with radio and electrical insulating materials are represented by DILECTO laminated plastics. That's why they don't fail when the going is tough.

You can build this same security into your products NOW to help the war effort... TOMORROW to meet peace-time competition. Catalog DO-3 gives complete technical data, electrical and mechanical, on DILECTO. May we send you a copy?

DISTRICT OFFICES:
 New York • Cleveland •
 Chicago • Spartanburg, S.C.
 West Coast Representative:
 Marwood, Ltd., San Francisco
 Sales Offices in principal cities

Continental - Diamond FIBRE COMPANY

Established 1895 . . . Manufacturers of Laminated Plastics since 1911 — NEWARK • DELAWARE

BLUEPRINTS OF SAFETY



TANKS... A MILLION

No slang intended, men, but we're told that's the way it looked . . . when the Shermans started rolling Rommel in reverse. Today . . . headlines emphasize the increasingly effective job that our mechanized units are doing over the entire invasion front . . . And since, in the roar and din of mechanized battle, quartz crystals are the one method for keeping harried Commanders tuned to pre-arranged frequencies, so vital for clear transmission . . . for accurate co-ordination . . . A. A. C. methods of manufacturing are of vital importance. Our "Blueprints of Safety" demand that A. A. C. crystals be matched to guard the invisible tolerance.



ELECTRONICS DIVISION

AIRCRAFT ACCESSORIES CORPORATION

MANUFACTURERS OF
 PRECISION AIRCRAFT EQUIPMENT
 HYDRAULICS ELECTRONICS
 • KANSAS CITY, KANS. • NEW-YORK, N. Y. • CABLE ADDRESS: AACPRO

Roseph E. Walker PRES.

PLASTICS

to *your* specifications

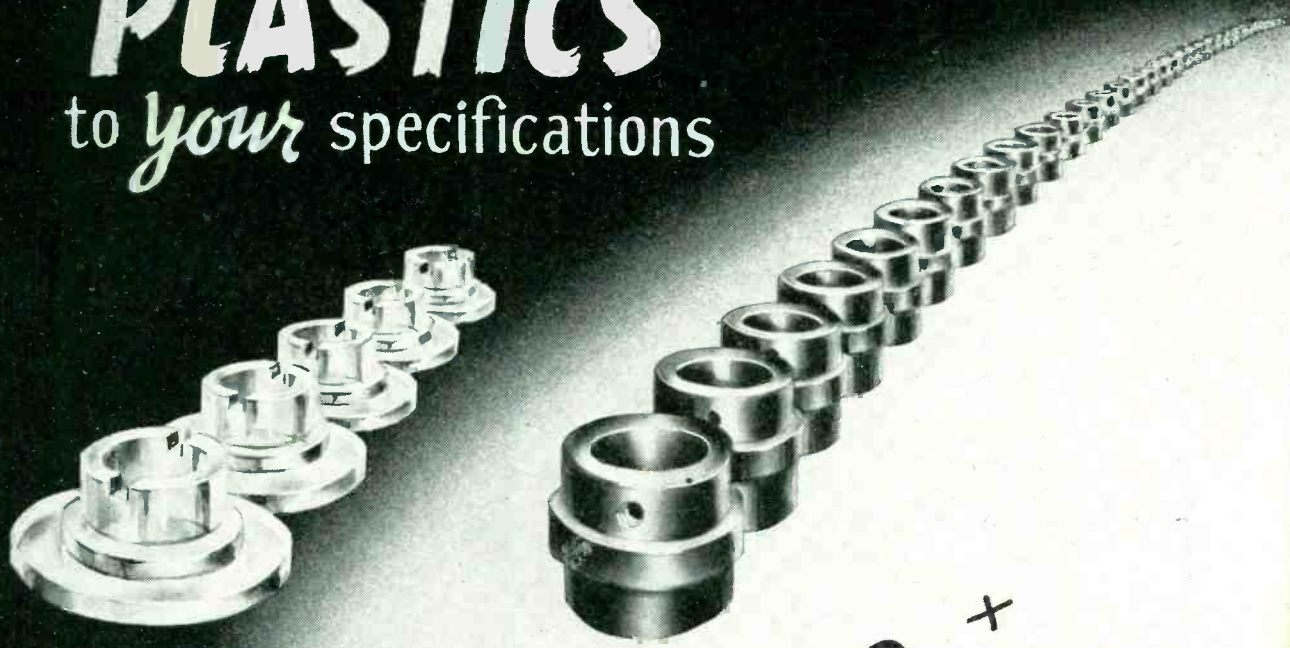

FROM 5 TO 500,000 +

BY **Brilhart**

The BRILHART COMPANY enjoys the unique reputation of being the No.1 "trouble-shooter" in the plastics industry. Through its wide experience in close tolerance work, seemingly impossible problems in plastic production of all types are solved. We realize the importance of helping the little fellow as well as the larger firms and are in a position to handle all types and quantities of production from precision machining to intricate molding.

ARNOLD BRILHART COMPANY
435 MIDDLENECK ROAD · GREAT NECK, N.Y. · Phone GREAT NECK 4054



NOW... PARTY LINE OF THE AIR



WE CAN DELIVER



Complete units or any integral parts can be had promptly. We are tooled up and in production on these and many other inter-communication items. Write for details.

Back home, *listening in* is an indoor sport—but "upstairs" it's a matter of life and death! Ask a fighting bomber crew! Over their "party line"—the bomber's inter-phone system—all the crew, from pilot to tail gunner, simultaneously hear each message. The navigator sings out: "This is it . . . hold her s-t-e-a-d-y . . . on target!" Then the cheering words from the bombardier in the belly, "Bombs away!" and the command to speed home, mission performed.

We at Trav-Ler Karenola are happy to be one of the firms supplying the high quality inter-communication equipment that assures dependable audibility despite shell-shattered air and motor din.



MAUFACTURERS OF QUALITY RADIO AND COMMUNICATION EQUIPMENT

1030 WEST VAN BUREN STREET • CHICAGO 7, ILLINOIS

ONICS — September 1943

57

BURBANK, CALIF.



What is a Gee-whiz-o-stat?

We wouldn't know either!

But General Instrument and their engineers are specialists in reducing these 64 dollar questions to practical production.

There are innumerable "gee-whiz-o-stats"—thingamabobs, ideas now being hatched, nameless today but destined for future fame and profit . . . new products for an era of peace time efficiency.

Perhaps you have such an idea . . . just a doodler's sketch on the back of an envelope. Don't throw it away—or file it. Bring it to General Instrument **NOW**. If it is based on sound principles, our engineers will design it, shape it to precision performance, ready it now for the starting gun of mass-production and post-war distribution.

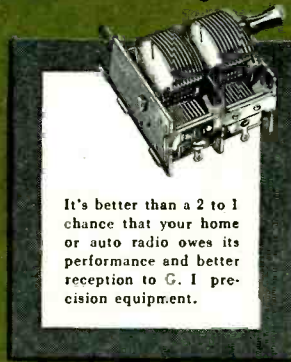

It's better than a 2 to 1 chance that your home or auto radio owes its performance and better reception to G. I. precision equipment.



General

Instrument CORPORATION



EXECUTIVE OFFICES • 829 NEWARK AVENUE • ELIZABETH, N. J.

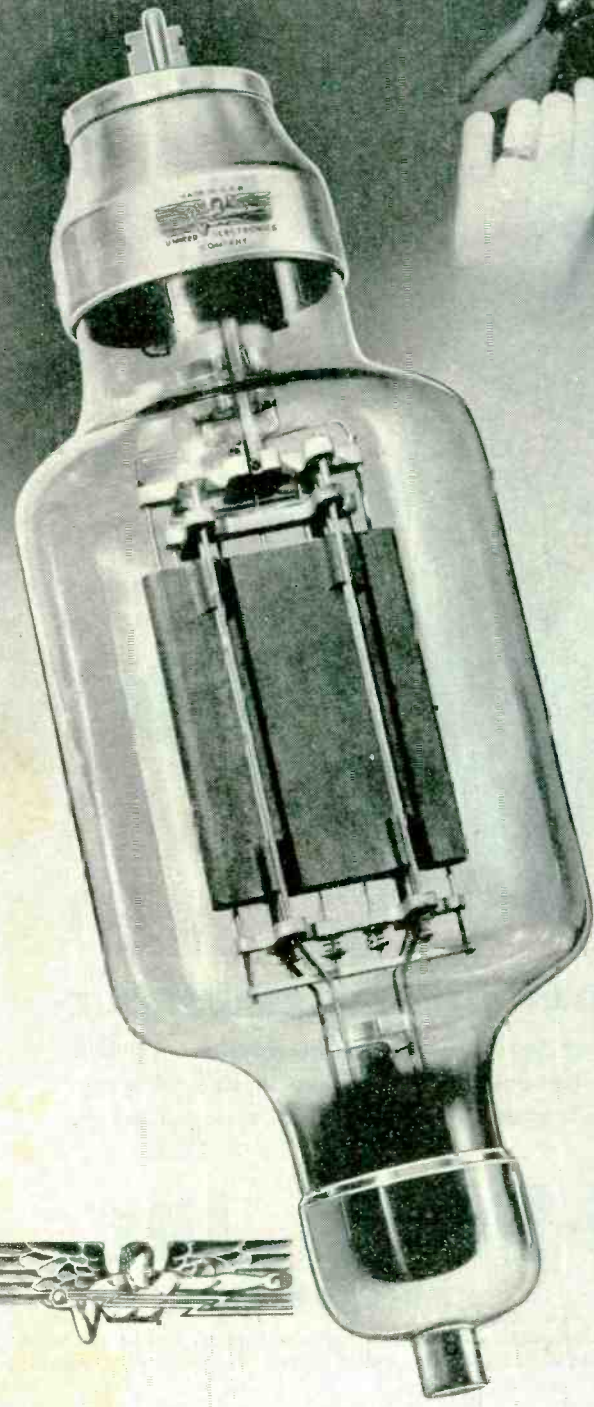
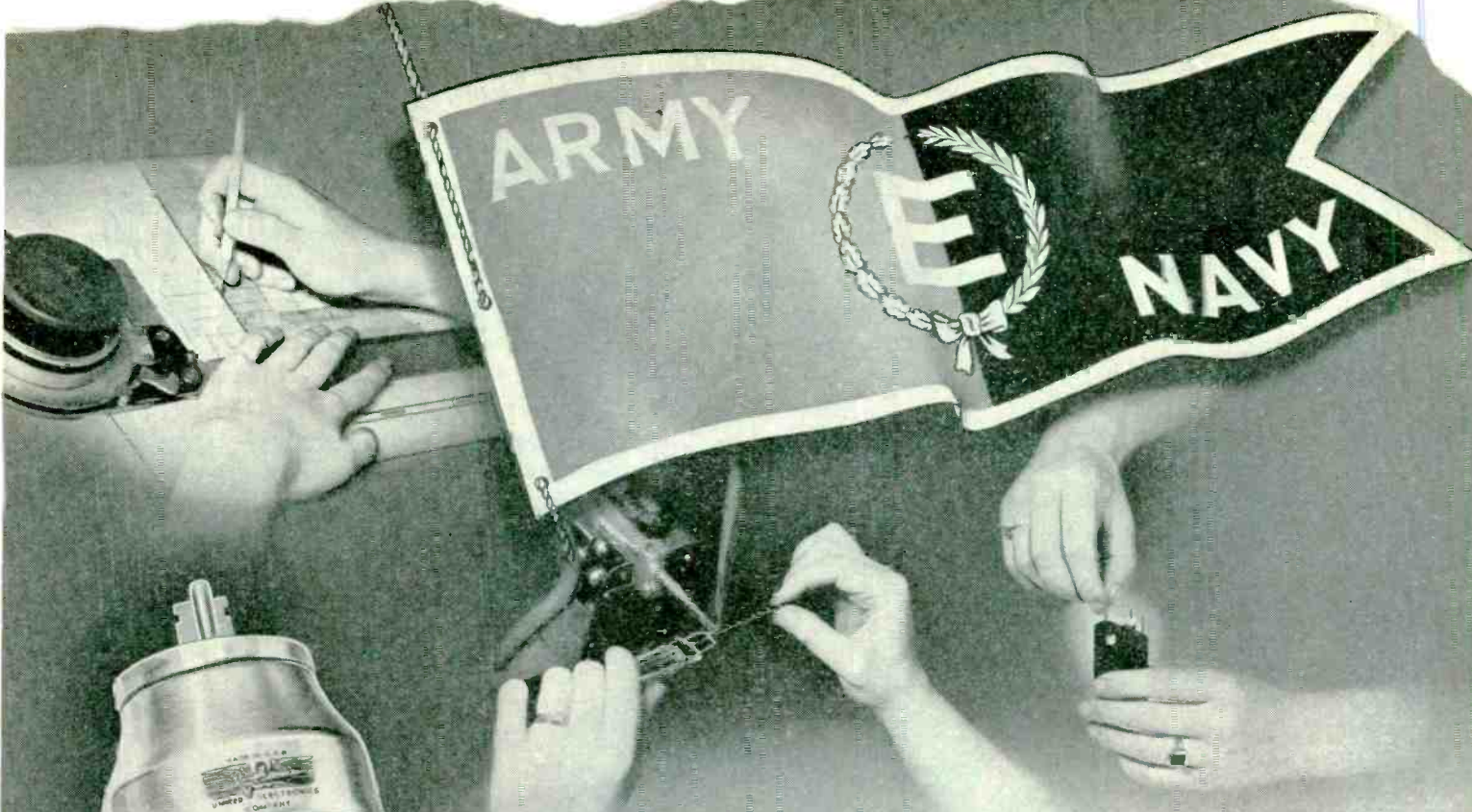

Our Country Honors
SKILLED HANDS
United for Victory

On August 12th, 1943, United Electronics Company received the coveted Army-Navy "E" Award for excellence in production of war materials.

In accepting the honor of flying the "E" burgee over our plant, we extend full and grateful recognition to the skill, the will and the spirit of loyalty which has motivated our personnel ever since Pearl Harbor. To the nation's official tribute we add a hearty "well done" for our family of workers which has achieved an outstanding production record in both quantity and quality of output.

Under the fresh inspiration of our "E" banner, we pledge ourselves to renewed and faithful effort. Our aim continues: more and better electronic tubes . . . for victory today and better living tomorrow.

UNITED

ELECTRONICS COMPANY
NEWARK NEW JERSEY



Dunco Recycling Time-Delay RELAYS FOR CONTROLLING AUTOMATIC OPERATIONS

THERMAL • INERTIA • MAGNETIC • MOTOR-DRIVEN

New developments in Struthers-Dunn motor-driven Type PS Recycling Time-Delay Relays have resulted in units $\frac{1}{3}$ the size of previous compact timers, and having 100% ball-bearing clutch and cam members.

Other Dunco Time-Delay Relays of inertia, thermal, or magnetic construction afford a complete assortment for modern engineering requirements. Based on broad, specialized experience in this field, Struthers-Dunn engineers will gladly make recommendations to meet your needs. Write for your copy of the complete Dunco Catalog and Relay-Timer Data Book.

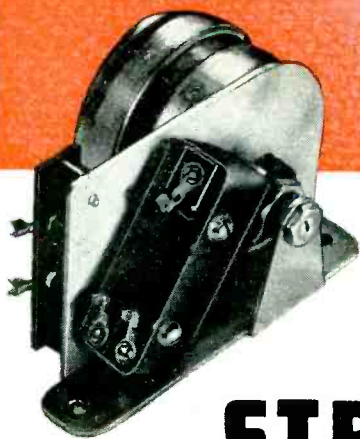
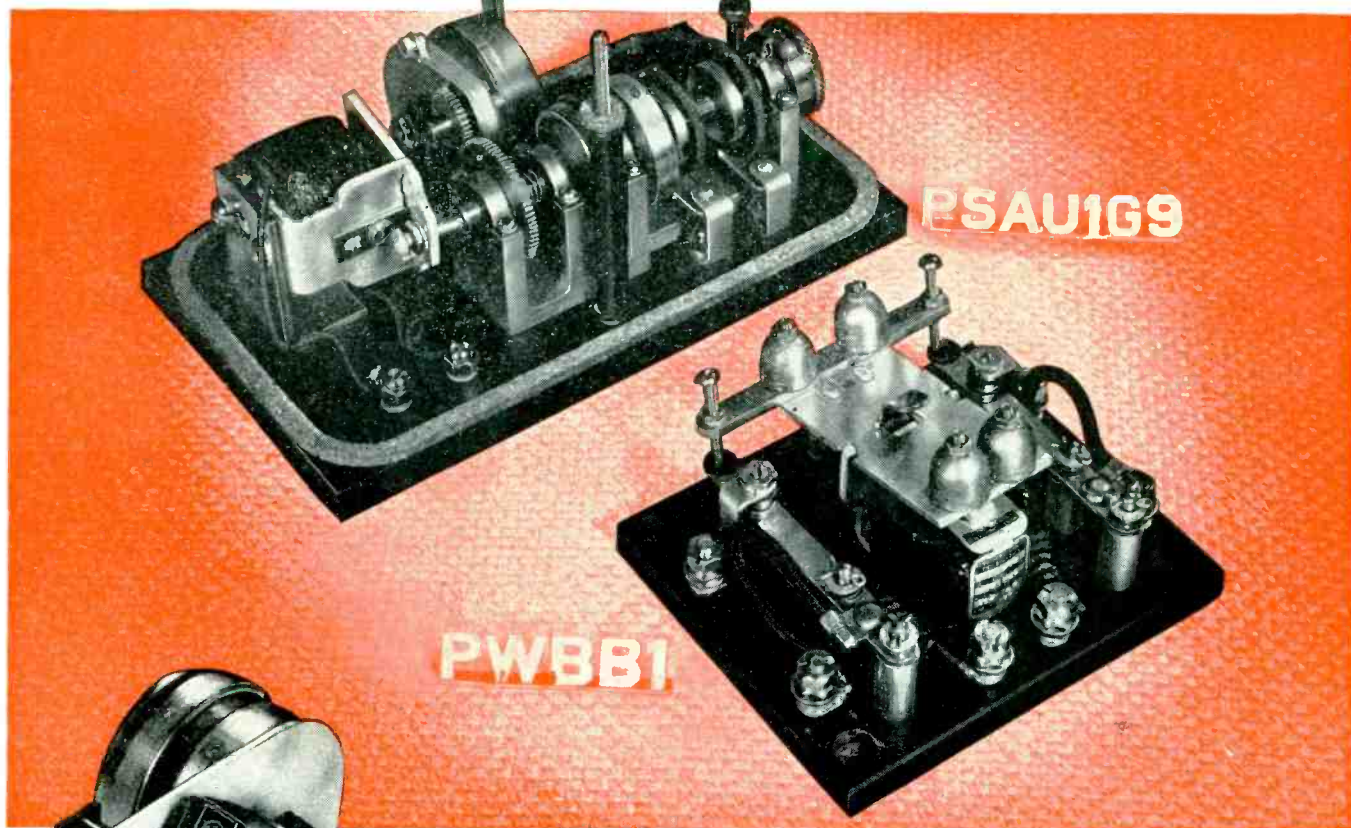

◀ SMALLER — CONTINUOUSLY ADJUSTABLE

Another important Dunco Timer development is the Type PSY1 shown at left. Exceptionally compact, its contact closure time is continuously adjustable from 0 to 100% of the cycle time. It operates continuously at 1 cycle per minute.

STRUTHERS-DUNN, Inc.

1321 ARCH STREET,

PHILADELPHIA, PA.

DISTRICT ENGINEERING OFFICES: ATLANTA • BALTIMORE • BOSTON • BUFFALO • CHICAGO • CINCINNATI • CLEVELAND • DALLAS • DENVER • DETROIT • HARTFORD
INDIANAPOLIS • LOS ANGELES • MINNEAPOLIS • MONTREAL • NEW YORK • PITTSBURGH • ST. LOUIS • SAN FRANCISCO • SEATTLE • SYRACUSE • TORONTO • WASHINGTON

THE CHAIN THAT MUST NOT BE BROKEN

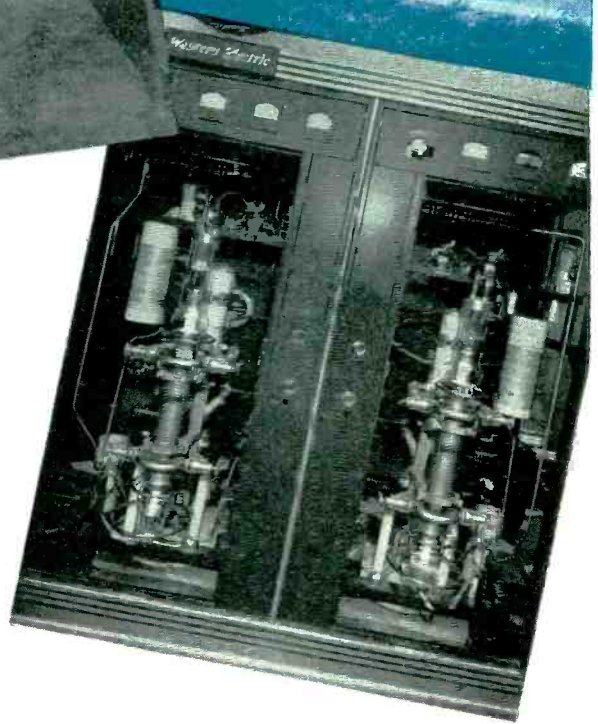
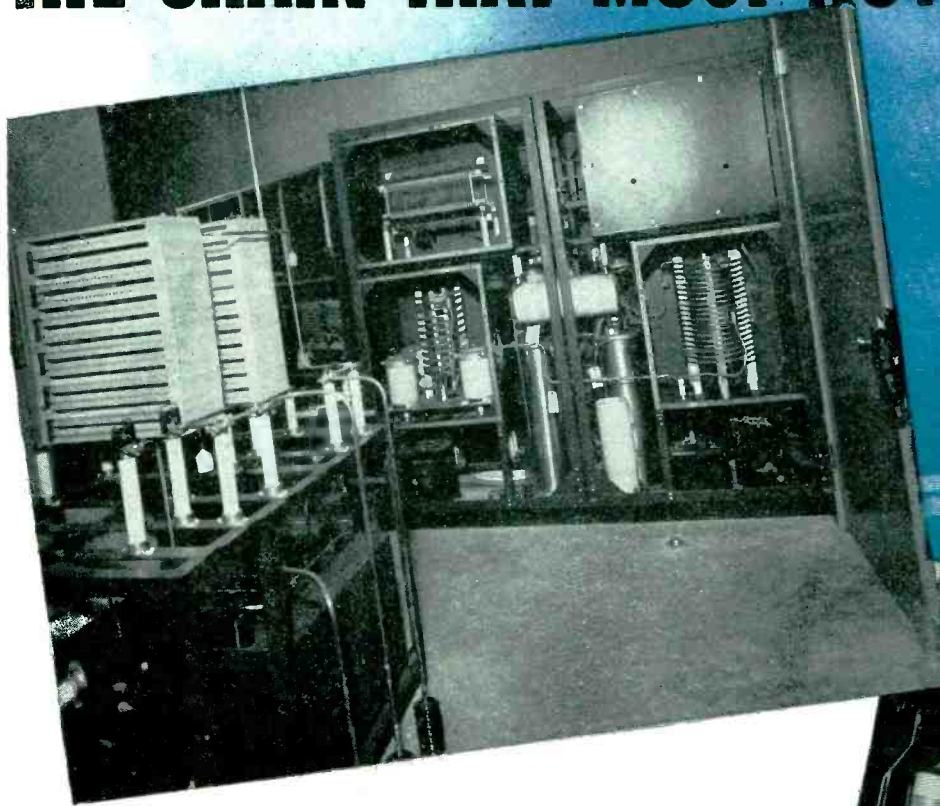

THE continued private operation of America's radio network rests upon the satisfactory performance of individual stations. Forged together, these stations form a mighty chain that secures Freedom of the Air. . . . But each station can remain an organ of Freedom only as long as it discharges all the terms of its license . . . a license that must be underwritten by the assured life and dependability of the many components of a modern transmitter.

Like many of America's great stations, WLAC's transmitter, built by Western Electric Company, uses Cornell-Dubilier capacitors. Today, there are more C-D capacitors in use in broadcast station equipment than those of any other make. This universal acceptance has been won by the *extra* life, *extra* uniformity and *extra* dependability built into every C-D capacitor. Thirty-three years' exclusive specialization in capacitor manufacture is a significant guarantee of fine performance. Cornell-Dubilier Electric Corporation, South Plainfield, N. J.

A complete range of C-D capacitors is available for all transmitting, receiving and electronic applications. Send for catalog No. 160R describing the complete line of C-D CAPACITORS.

Cornell-Dubilier Capacitors



MICA • DYKANOL • PAPER • WET AND DRY ELECTROLYTICS

Check this list against your requirements

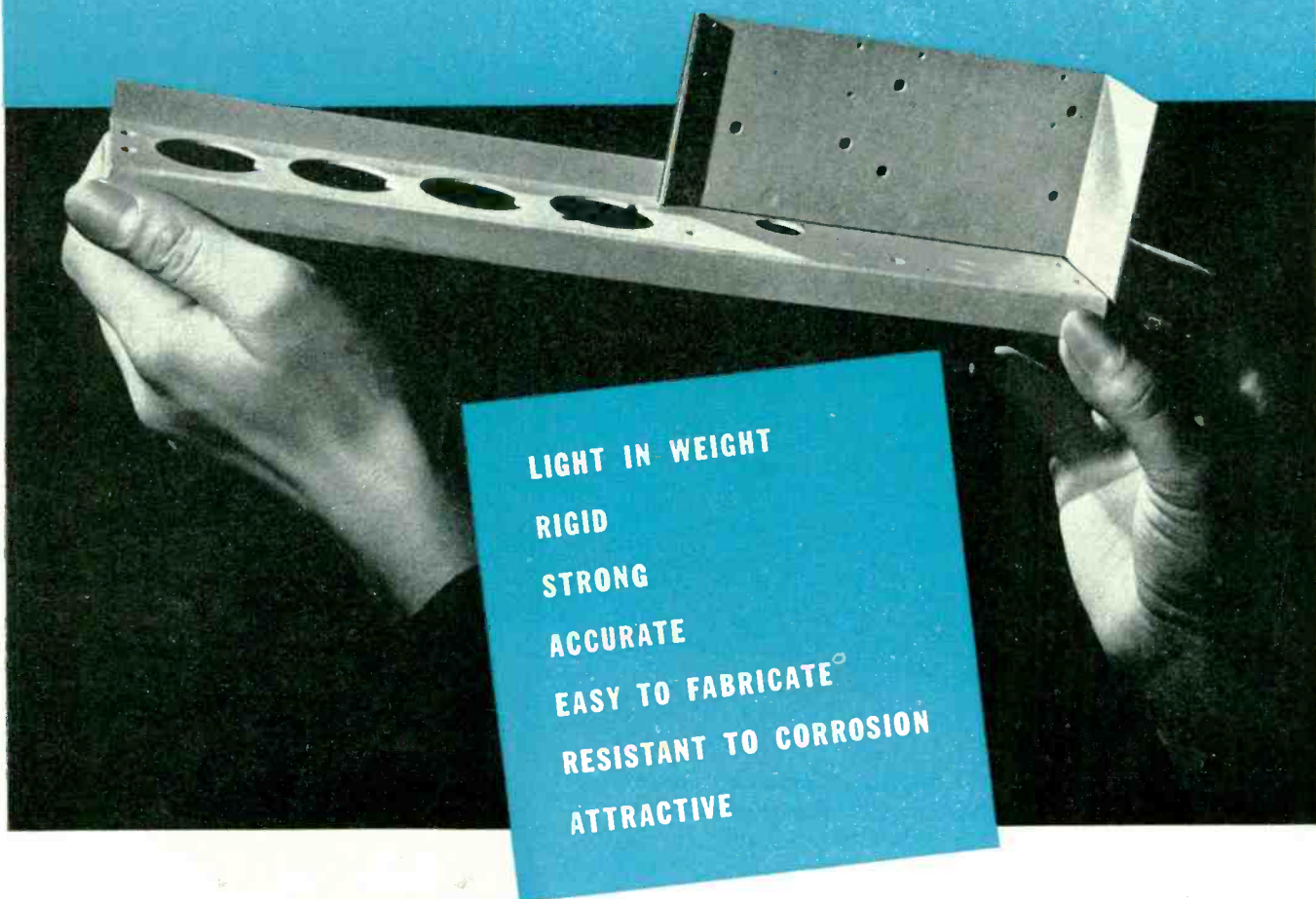

LIGHT IN WEIGHT
RIGID
STRONG
ACCURATE
EASY TO FABRICATE
RESISTANT TO CORROSION
ATTRACTIVE

This warplane radio part has all of these properties, thanks to the use of a heat-treated Alcoa Aluminum Alloy. Aluminum is just naturally light in weight and highly resistant to corrosion. It can be given a variety of attractive, durable finishes.

This particular part is stamped out, formed and quickly assembled by spot-welding while the aluminum is in its annealed condition. Then, locked in a fixture, it is heat-treated and allowed to age harden. Held securely to shape, the finished part is accurate, rigid and high in strength.

Other fabricators often find it possible to heat-treat aluminum and then form it before the metal age hardens. Thus they avoid distortion without having to use a fixture. Ability to do this depends, of course, upon the length of time it takes to complete fabrication of the parts.

Many articles, helpful on war work, have been published on the working and handling of aluminum alloys. These are listed in Alcoa's "Aluminum Service Bulletin No. 4". We'll gladly send you a copy. ALUMINUM COMPANY OF AMERICA, 2136 Gulf Bldg., Pittsburgh, Pa.

ALCOA



ALUMINUM

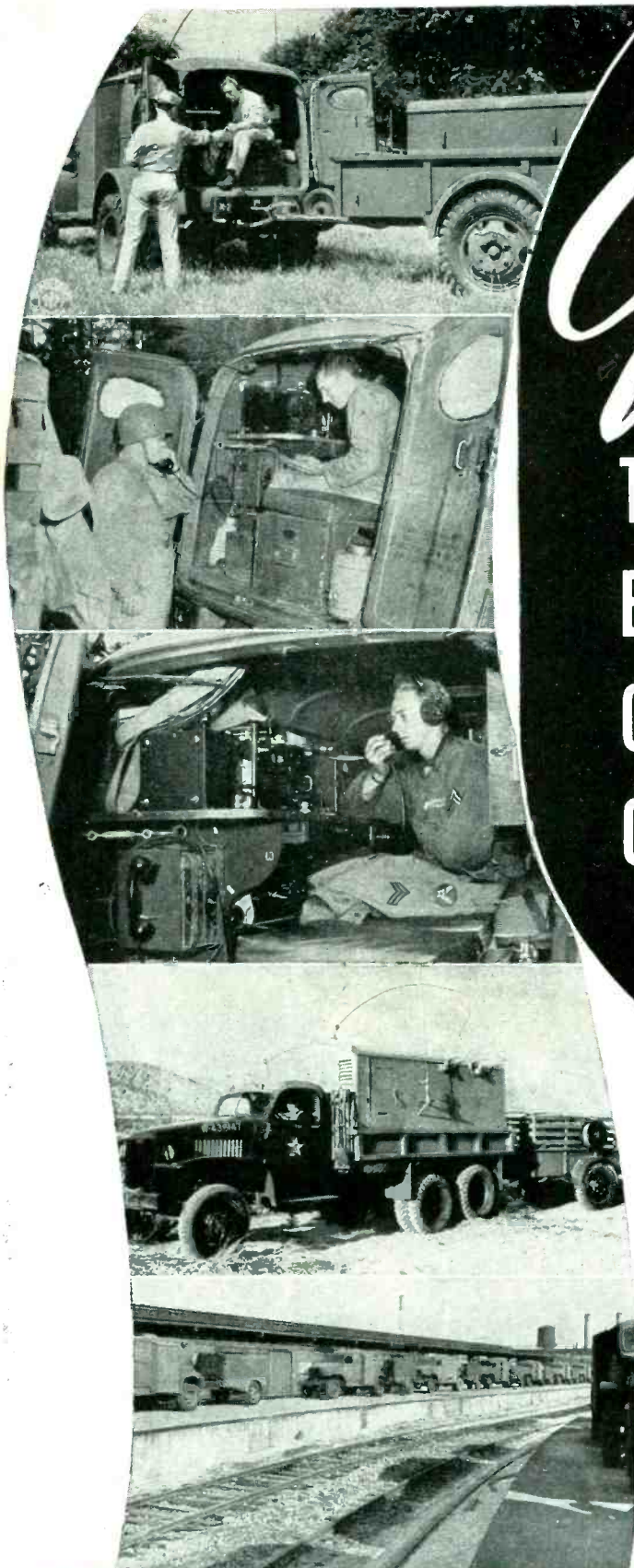

Winning

THE BATTLE OF COMMUNICATIONS

Mobile communications units assembled by Hallcrafters are helping to win the battle of communications on every fighting front. They are built to endure the rigors of modern warfare... The consistent performance of SCR-299 has been highly praised by leading members of our armed forces for its adaptability in meeting all the requirements of combat duty... A phrase best describing the SCR-299 was given when a leading military authority said, "It is to communications what the jeep is to transportation."

hallicrafters

CHICAGO, U. S. A.

THE WORLD'S LARGEST EXCLUSIVE MANUFACTURER OF SHORT WAVE RADIO COMMUNICATIONS EQUIPMENT



BUY MORE BONDS!



THE ROAD



OUT OF TODAY'S RESEARCH • • • TOMORROW IS ENGINEERED

AHEAD

MAN reached for the stars and grasped . . . Electronics.

Devoted now to war, this amazing science promises wondrous adventures for mankind on THE ROAD AHEAD.

As constant research has developed the potentialities of Electronics, so the search for a BETTER WAY, here at American Lava, has perfected steatite insulation best suited to the new requirements.

Pioneers of steatite electrical insulation . . . now in our 41st year of Ceramic Leadership, we are able to say with full confidence that ALSIMAG Steatite Insulators represent the highest quality, precision, dielectric properties and mechanical strength to be found among the Steatites.

There will be no compromise with quality in the production of ALSIMAG Steatite Insulators.

AMERICAN LAVA CORPORATION

CHATTANOOGA, TENNESSEE



AWARDED JULY 27, 1942

ALSIMAG

TRADE MARK REGISTERED U. S. PATENT OFFICE

STEATITE CERAMIC INSULATORS

CHARACTERISTICS TAILORED TO YOUR REQUIREMENTS

Where stability is an important requirement, ALSIMAG Steatite ceramics are unsurpassed for lending rigidity and permanence of alignment to electronic circuits.

to Manufacturers OF ELECTRONIC EQUIPMENT

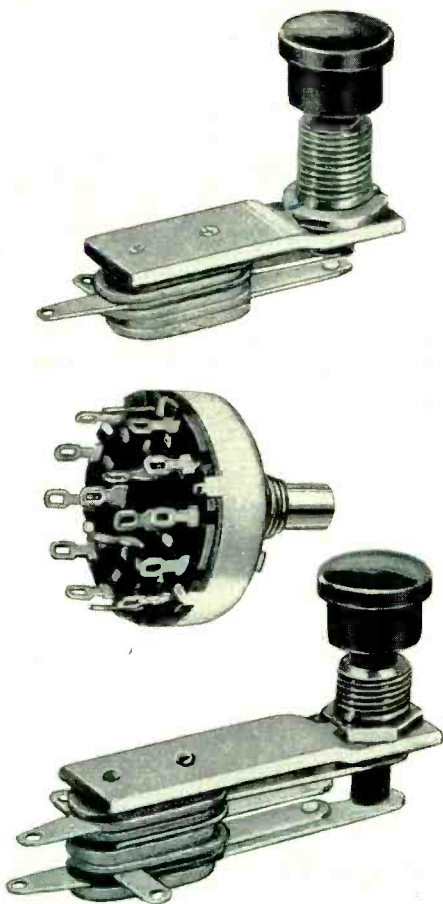

...who use Push and Selector Switches

The electro-mechanical components manufactured by the Chicago Telephone Supply Company have been standard for quality and workmanship since 1896. In spite of wartime demands, manufacturers of electronic equipment may be assured of the same craftsmanship and service to which they have become accustomed throughout the years.

Chicago Telephone Supply Company is also producing plugs, jacks, variable resistors and switches (separate and in combination with variable resistors). Inquiries are invited from manufacturers on these and similar items.

Plugs Jacks Switches
Variable Resistors



Telephone Generators
and Ringers

Representatives
R. W. Farris
127 E. Thirty-first St.
Kansas City, Mo.
Phone: LOfan 0234
Frank A. Emmet Co.
2837 W. Pico Blvd.
Los Angeles, Calif.

Branch Offices
S. J. Hutchinson, Jr.
401 N. Broad St.
Philadelphia, Pa.
Phone: Walnut 5369
In Canada:
C. C. Meredith & Co.
Streetsville, Ontario

CHICAGO TELEPHONE SUPPLY Company

ELKHART ★ INDIANA

Manufacturers of Quality Electro-Mechanical Components Since 1896

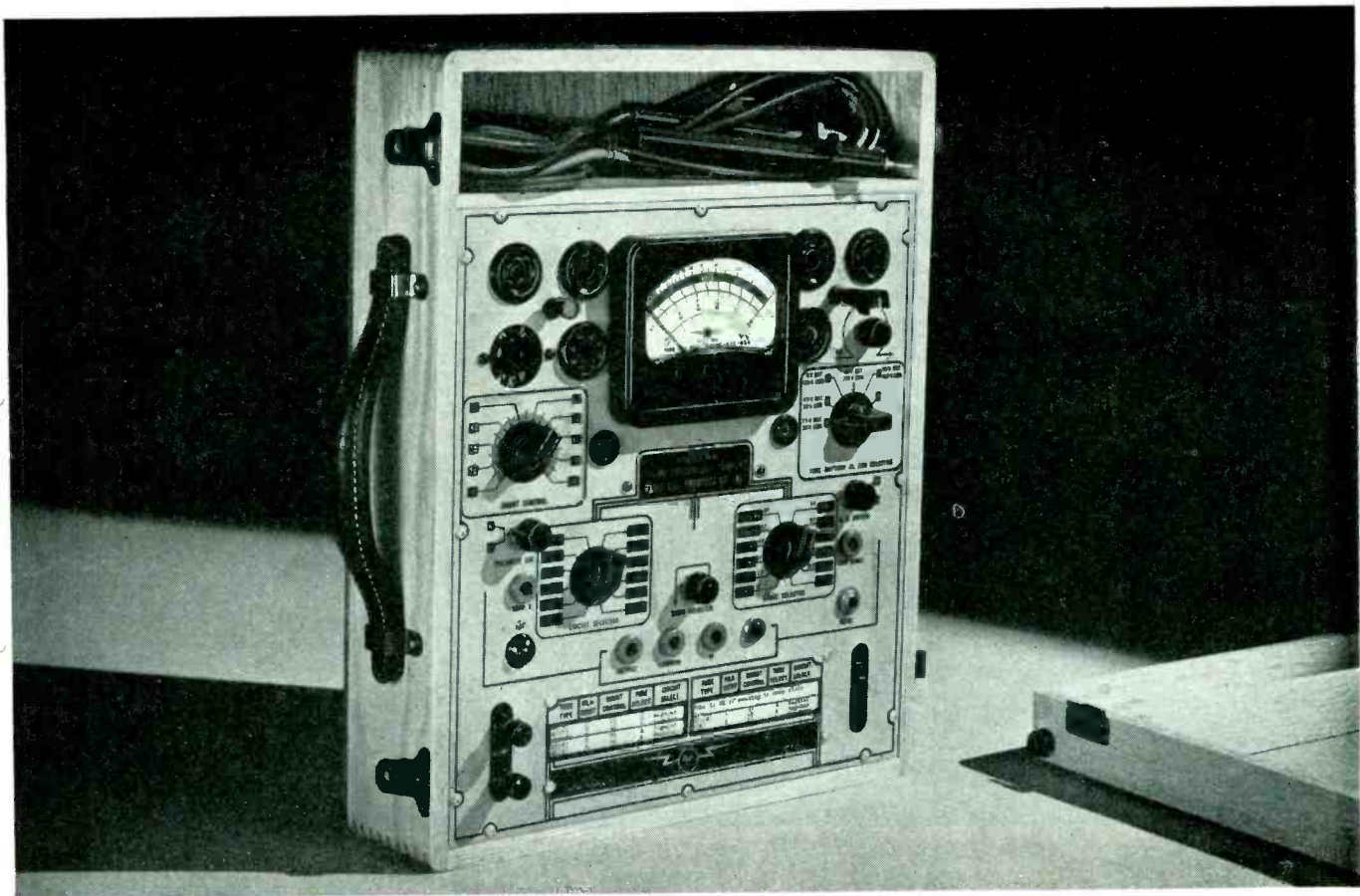

ADVANCED DESIGN DUAL-TESTER

Model 804 is a portable Tube and Set Tester developed by Radio City Products to answer the demand for a modern, efficient instrument. It is equipped for direct testing of all acorn tubes as well as all old and new types of regular receiving tubes, rectifiers, etc. Large quantities of these units, purchased by the U.S. Signal Corps, give evidence of the splendid performance and reliability of this instrument

CHECK THESE FEATURES:

- Famous Dynoptimum tube test circuit.
- Double line Fuses. Meter protected against burn-out by instrument fuse.
- Sensitive leakage, noise and hum tests provided.
- Exclusive RCP method of A.C. measurement eliminates errors inherent in copper oxide rectifier types.
- Ohmmeter reading ratio—500,000,000 to 1
- Current reading ratio—1,000,000 to 1
- Latest type built-in "Rolindex" mechanical roller tube chart.
- Voltage reading ratio—100,000 to 1
- Electrostatic leakage Tester for all mica and paper condensers.
- Electrolytic leakage Tester for all electrolytic capacitor readings on "Good-Bad" Scale.

Battery Tester—actual condition of battery determined by testing under load for various voltage ratings of batteries.

RANGES:

- D.C. Voltmeter :0-25-10-50-250-1000-5000
- A.C. Voltmeter :0-10-50-250-1000-5000
- Output Voltmeter:0-10-50-250-1000-5000
- D.C. Milliammeter :0-.5-2.5-10-50-250-1000
- D.C. Ammeters :0-10 amperes.
- Ohmmeter :0-250-2500-25000-2.5 Meg.-25 Megohms

Model 804 is supplied in a handsome sturdy oak case with removable cover, 14¼" x 13" x 6". . . . Weight 12¼ lbs.

Complete, ready for operation on 105-135 volts, 50-60 cycles \$84.50

RADIO CITY PRODUCTS COMPANY, INC.

127 WEST 26th STREET



NEW YORK CITY

MANUFACTURERS OF PRECISION ELECTRONIC LIMIT BRIDGES—VACUUM TUBE VOLTMETERS—VOLT-OHM-MILLIAMMETERS—SIGNAL GENERATORS—ANALYZER UNITS—TUBE TESTERS—MULTI-TESTERS—OSCILLOSCOPES—AND SPECIAL INSTRUMENTS BUILT TO SPECIFICATIONS

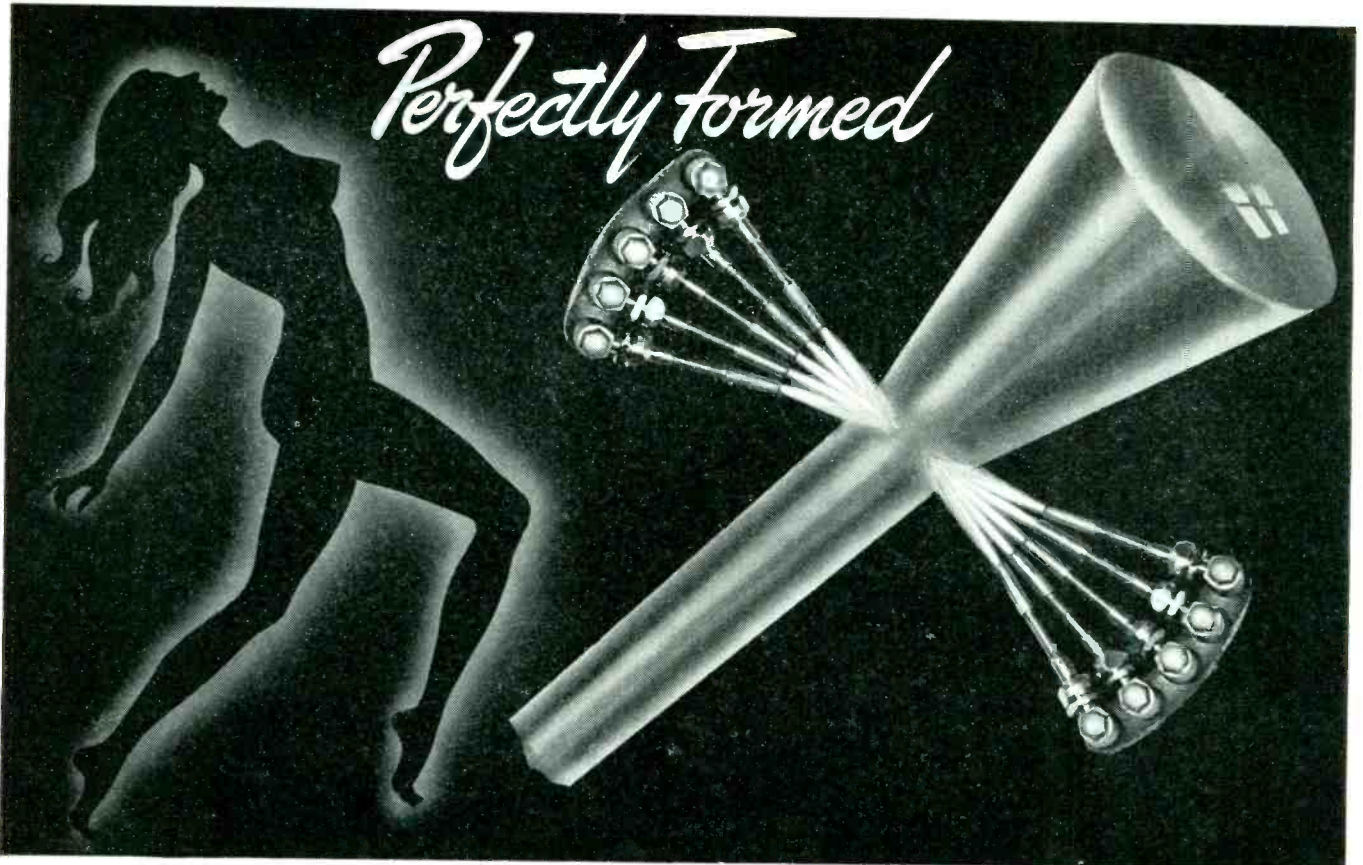

Perfectly Formed

HAYDU BROS
Burner equipment

PERFECT FORM—both in manufacture and performance, is more essential now than ever, if you are driven by war time speed, and the constantly growing need for greater production.

The traditionally dependable performance of Haydu Bros. Burner equipment, has been an assurance of uninterrupted economical production.

Today, thousands of Haydu Bros. Burners, in many styles and sizes, for Gas, Air and Oxygen, are used in plants of the general glass working industry from coast to coast, helping to speed those essential orders.

Specially designed Burners, Torches. Cross-fires and Mixers to meet your requirements.

HAYDU BROTHERS

PLAINFIELD, NEW JERSEY

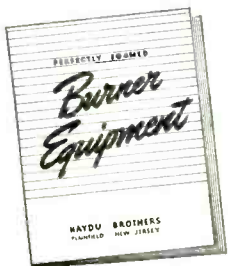
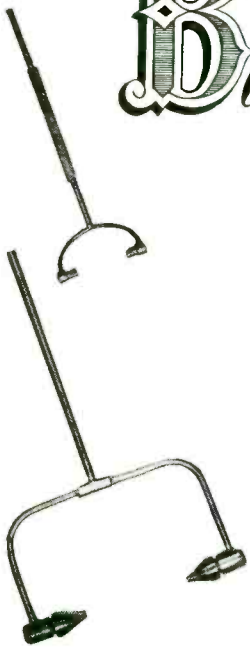

WRITE FOR
 LATEST
 BULLETIN

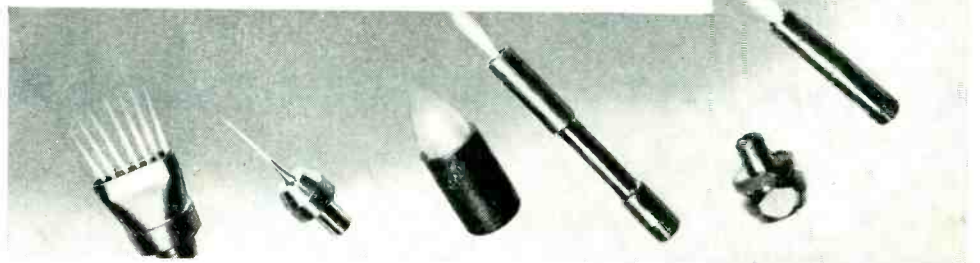

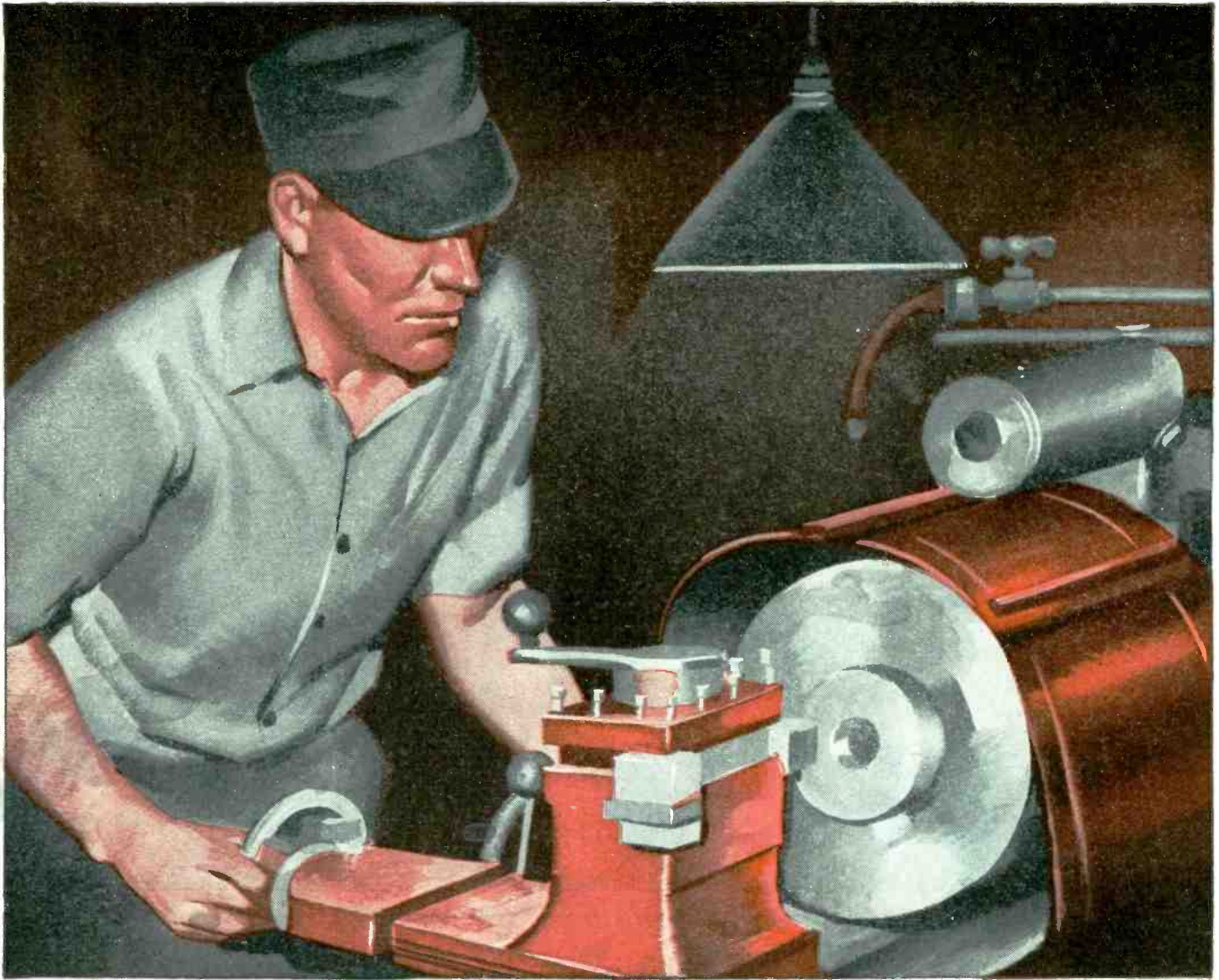

GUNNER BY REMOTE CONTROL

HIS battleground is located far from the fighting fronts. His skill and long experience have been lent to the making of vital parts—parts that are vital to a boy in a bomber over Germany or his neighbor's son in a fighter in the Pacific. Their equipment is dependent on split-hair accuracy of Utah Parts—and he's giving it to them. He's a gunner by remote control.

There are hundreds like him at Utah—soldiers in coveralls. By the skill of their hands and the sweat of their brow, they're making sure that Utah Parts don't fail at the critical moment—as a switch releases a stream of machine gun bullets . . . as a headset receives a command to take a strategic height. These and many other vital electrical and electronic devices are being turned out in quantity and *on time* . . . by this precision task

force at Utah. Important to the success of this task force is the work of the Utah laboratories. Here, new solutions to electrical and electronic problems are being worked out. Here, a great store of knowledge and experience is being accumulated.

Tomorrow that knowledge and experience will be at the service of peacetime America. There will be better Utah products built—more convenience, enjoyment and efficiency for many Americans—because of today's great advancements, necessitated by war.

UTAH RADIO PRODUCTS COMPANY, 837 Orleans Street, Chicago, Illinois. Canadian Office: 560 King Street, West, Toronto. In Argentine: UCOA Radio Products Co., SRL, Buenos Aires. Cable Address: UTARADIO, Chicago.

PARTS FOR RADIO, ELECTRICAL AND ELECTRONIC DEVICES, INCLUDING SPEAKERS, TRANSFORMERS, VIBRATORS, VITREOUS ENAMELED RESISTORS, WIREWOUND CONTROLS, PLUGS, JACKS, SWITCHES, ELECTRIC MOTORS



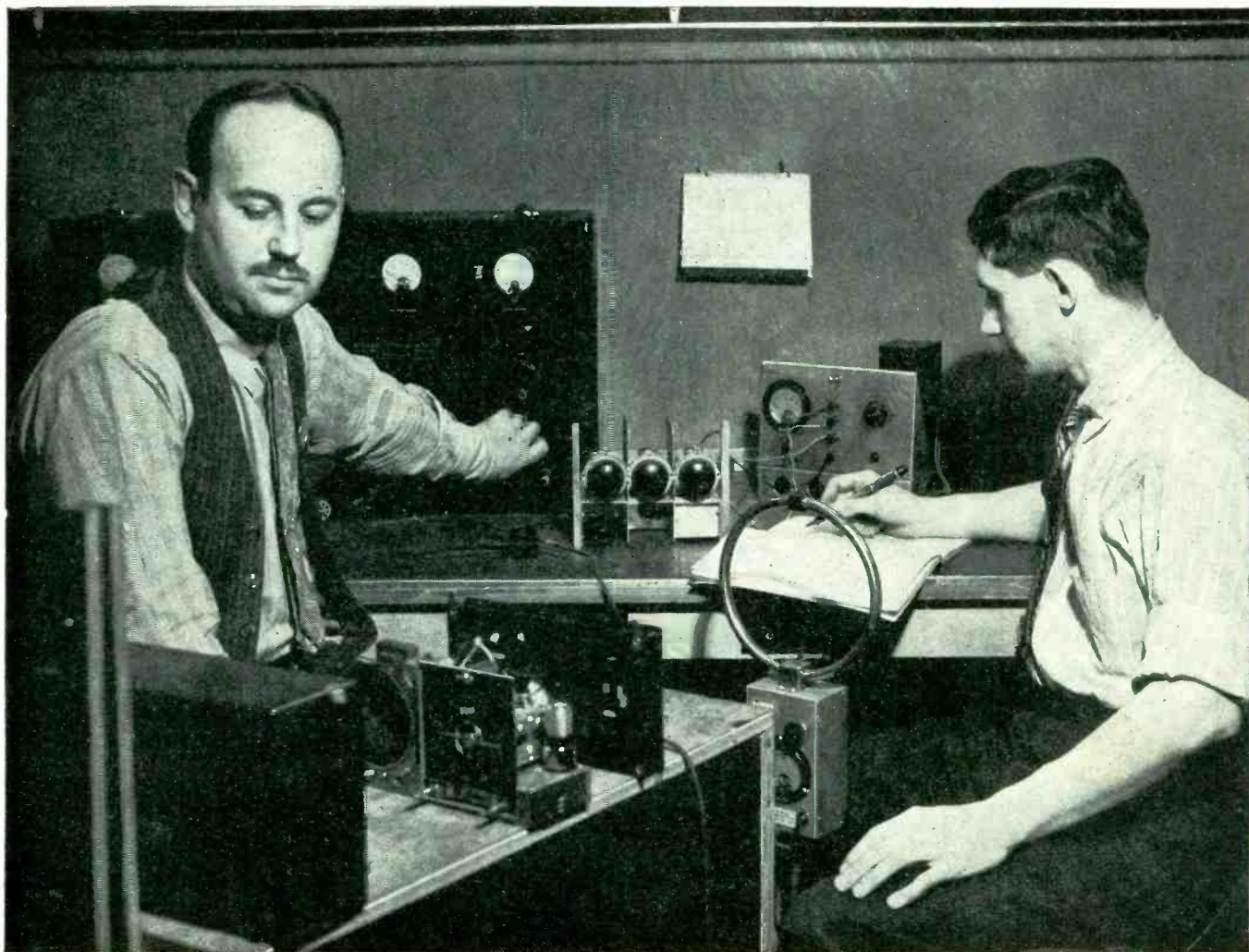

Performance Perfectionists

● Technical progress depends upon tireless experiment to perfect performance.

Sylvania circuit engineers are performance perfectionists. They conduct never-ending tests on new circuit and tube combinations using experimental equipment. They constantly improve radio and electronic tube quality. And they compile data that is the raw

QUALITY THAT SERVES IN WAR



material of invention.

This long-range Sylvania research policy, which maintained our standard of quality in peacetime, has proved invaluable in wartime. It has contributed to the improvement of military communications, to the perfection of Radar, to the volume production of cathode ray tubes, and to the development of timesaving electronic devices for war industry.

And it will prove no less valuable when victory widens the radio-electronics field. It will contribute to the development of FM radio and practical television. It will help to convert electronic military secrets of today into everyday miracles for better life and work tomorrow.



RADIO DIVISION

SYLVANIA ELECTRIC PRODUCTS INC.

Emporium, Pa.

RADIO TUBES, CATHODE RAY TUBES, ELECTRONIC DEVICES, INCANDESCENT LAMPS, FLUORESCENT LAMPS, FIXTURES AND ACCESSORIES

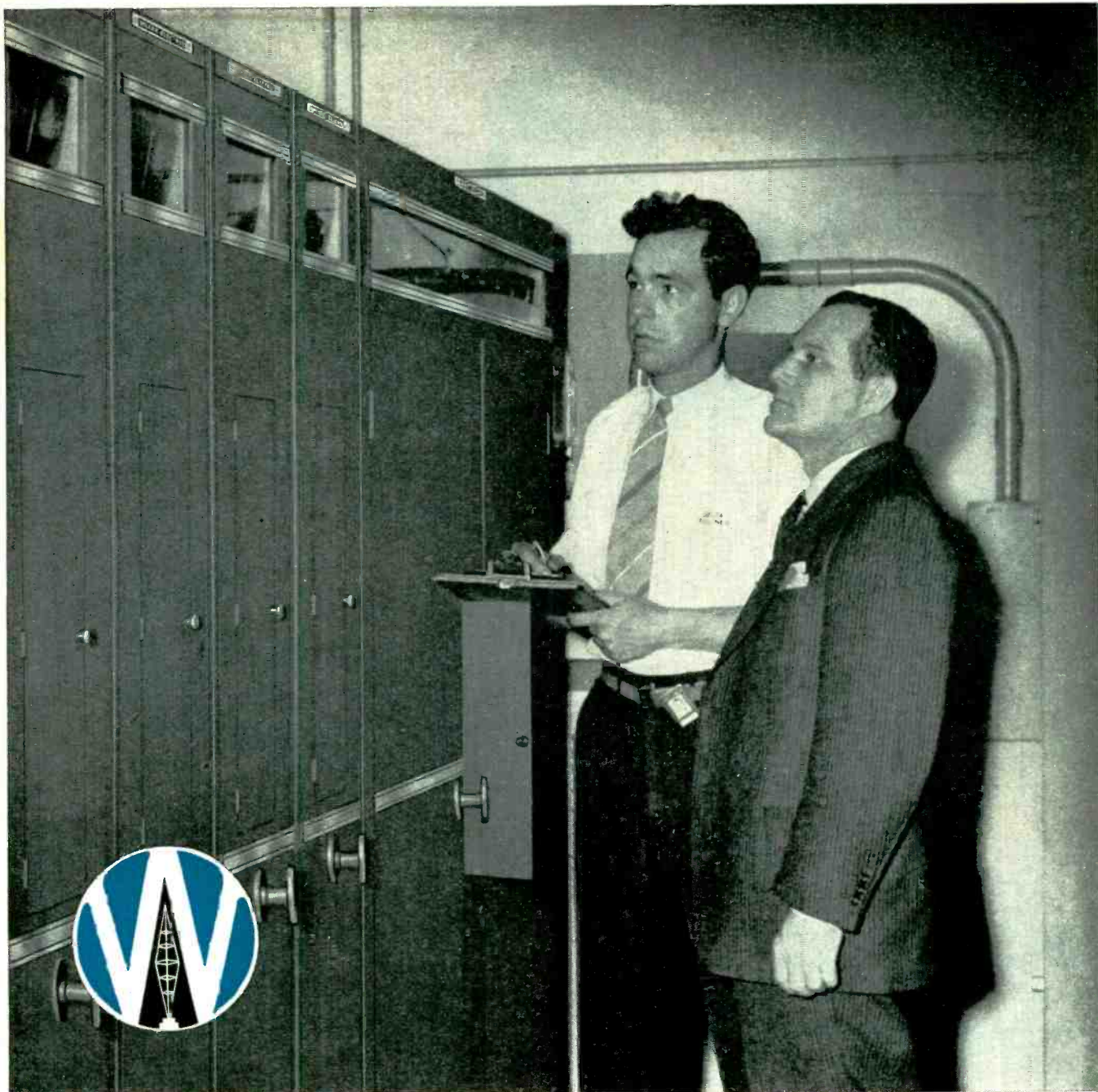

(Right) L. T. Campbell, Supt. Communications, Delta Air Lines, with J. B. Kramer, at Wilcox installation, Atlanta Station.

SERVING THE NATION'S AIRLINES

Wilcox equipment has been used by the major airlines for many years...and while, today, Wilcox facilities are producing largely for military needs, the requirements of the essential airlines also are being handled. Look to Wilcox for leadership in dependable communications!

Communication Receivers
Aircraft Radio
Transmitting Equipment
Airline Radio Equipment

WILCOX ELECTRIC COMPANY

Quality Manufacturing of Radio Equipment

14TH & CHESTNUT

KANSAS CITY, MO.



WANTED:

Orders for Tube Bases!

WHAT is it you need? Tube bases made of BAKELITE, or of the new MICANOL (for low loss at high frequencies)? Bases for receiving, transmitting, or special tubes?

Tell us what you're looking for. See check list below. (If you're a manufacturer of electrical

equipment, perhaps we can supply you with bases for your plug-in connections.)

RCA has a complete line of tube bases to meet a wide range of requirements.

And in most cases, delivery can be started in a reasonably short time.

TUBE PARTS AND MACHINERY

WHAT TO DO:

1. *Write to:* Tube Parts & Machinery Section, Radio Corporation of America, 572 South 5th Street, Harrison, N. J.
2. *Tell us your requirements:*
 - (a) *Type or types of bases needed, including size, number of pins, and material wanted.*
 - (b) *Quantities of each type needed.*
 - (c) *Date when deliveries should start.*



RCA ELECTRON TUBES

RCA Victor Division • RADIO CORPORATION OF AMERICA • Camden, N. J.

PUZZLE... CAN YOU FIND ALL EIGHT ADVANTAGES IN ANY OTHER BUSHING?



SEE WHAT YOU GET WITH NEW PYREX METALLIZED BUSHINGS:

- 1 Permanent hermetic bond** — positive seal against leakage of oil, water, and air—no gaskets, washers, or “dopes” to leak.
- 2 Quicker, less expensive assembly** — fewer parts and fewer operations reduce labor costs and speed up production—several can be soldered at once—no baking required.
- 3 Practically foolproof** — the metallized layer solders easily. You can use any common solder and flux, applied by soldering iron, soft air-gas flame or induction heating.
- 4 Great thermal shock resistance** — will easily meet Army and Navy specifications for rapid temperature change.
- 5 Superior electrical characteristics of glass** — low dielectric constant, low power factor, high dielectric strength, and great electrical resistivity.
- 6 Negligible water absorption** — no glaze to crack or chip.
- 7 Does not carbonize or track** — because it’s inorganic.
- 8 A wide selection in several standard sizes.**

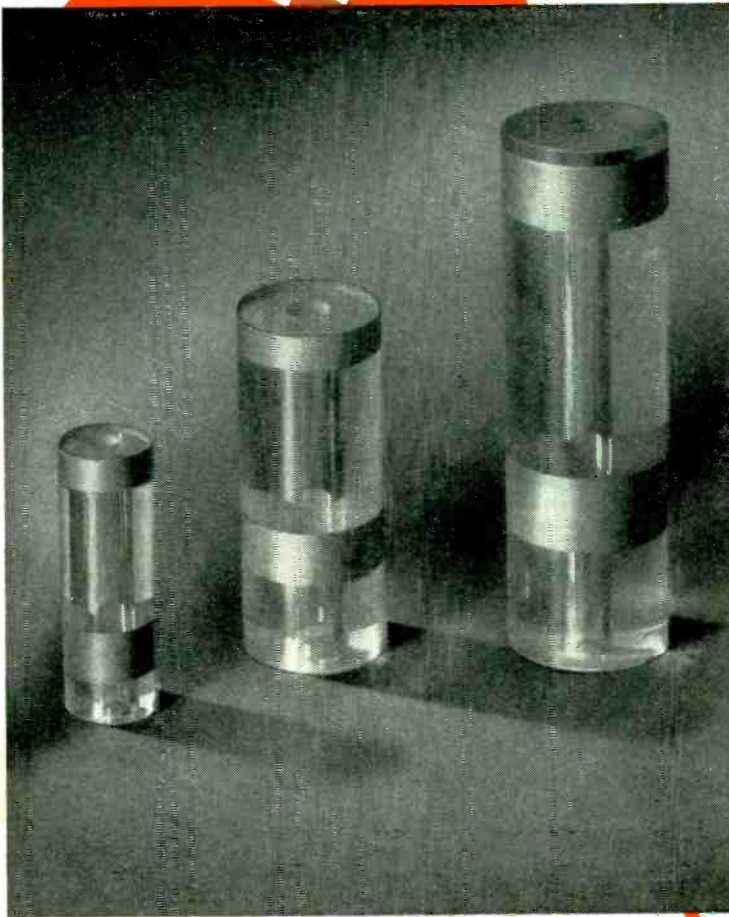

MAIL COUPON for complete story

Pyrex Insulators
BRAND

“PYREX” is a registered trade-mark and indicates manufacture by Corning Glass Works.

Corning Glass Works
Insulation Division, Department, E-92
Corning, N. Y.

Please send me full details of improved method of metallizing on glass.

Name.....

Company.....

Street.....

City.....State.....

Your plane will have a 'phone!



After the war...



... the two-way radiotelephone will be employed by American industry as a convenience, a safeguard and a business requirement. This modern method of communication has many proven applications in the following fields:

Aviation	Railroading
Marine	Mining
Police Patrol	Fire Fighting
Engineering	Trucking
	Public Utilities

If you think you may be able to employ two-way radiotelephone communication in your field, we would be pleased to discuss your problem without cost or obligation. We have nothing to sell since our entire output has been placed at the disposal of the United Nations all over the world!

Requests for information and literature from responsible parties may be addressed to:
 Industrial Engineering Dept.
 Jefferson-Travis Radio Mfg. Corporation,
 245 East 23rd Street
 New York, N. Y.

SOUNDS fantastic, doesn't it? Yet the incredible wartime development of the two-way radiotelephone in military aviation is striking evidence that it will be widely used by the planes, cars and trains of tomorrow. Jefferson-Travis was in the forefront in the development of this unique form of communication long before Pearl Harbor. Today our entire facilities are devoted to producing this type of equipment for the United Nations, thus hastening the day when we will be again building two-way radiotelephones for you and your peacetime purposes in Tomorrow's World!



JEFFERSON-TRAVIS

RADIOTELEPHONE EQUIPMENT

NEW YORK • WASHINGTON • BOSTON

September 1943 — ELECTRONICS



Foiled!
LUMARITH* FOIL
Keeps Out
THE BLACK HAND
of
Electro-Chemical Corrosion

IN Lumarith foil, the electrical and radio industries possess an insulating material unique in its ability to withstand the corrosive effect of copper wire, moisture, and current flow. It has been found that current-carrying copper wire, against Lumarith insulation, is as free of corrosion hazards as it would be if suspended in air.

Lumarith foil is used as an extra covering for coil spools and bobbins made of other insulating materials. It is used for between-layer insulation for multiple wound coils. Molded Lumarith is used for coil spools, connector blocks, fluorescent lamp parts, and for countless other electrical applications.

The possibilities of Lumarith in the electrical field are limitless. Celanese Celluloid Corporation's research department is prepared to offer you suggestions and advice on the subject of Lumarith for insulation.

Celanese Celluloid Corporation, *the First Name in Plastics*, 180 Madison Ave., New York City 16, a division of Celanese Corporation of America sole producer of Lumarith* and Celluloid* plastics. . . *Representatives:* Cleveland, Dayton, Philadelphia, Chicago, St. Louis, Detroit, Los Angeles, Washington, D. C., Leominster, Montreal, Toronto, Ottawa.

LUMARITH* Foil

A CELANESE* PLASTIC

*Trade Marks Reg. U. S. Pat. Off.

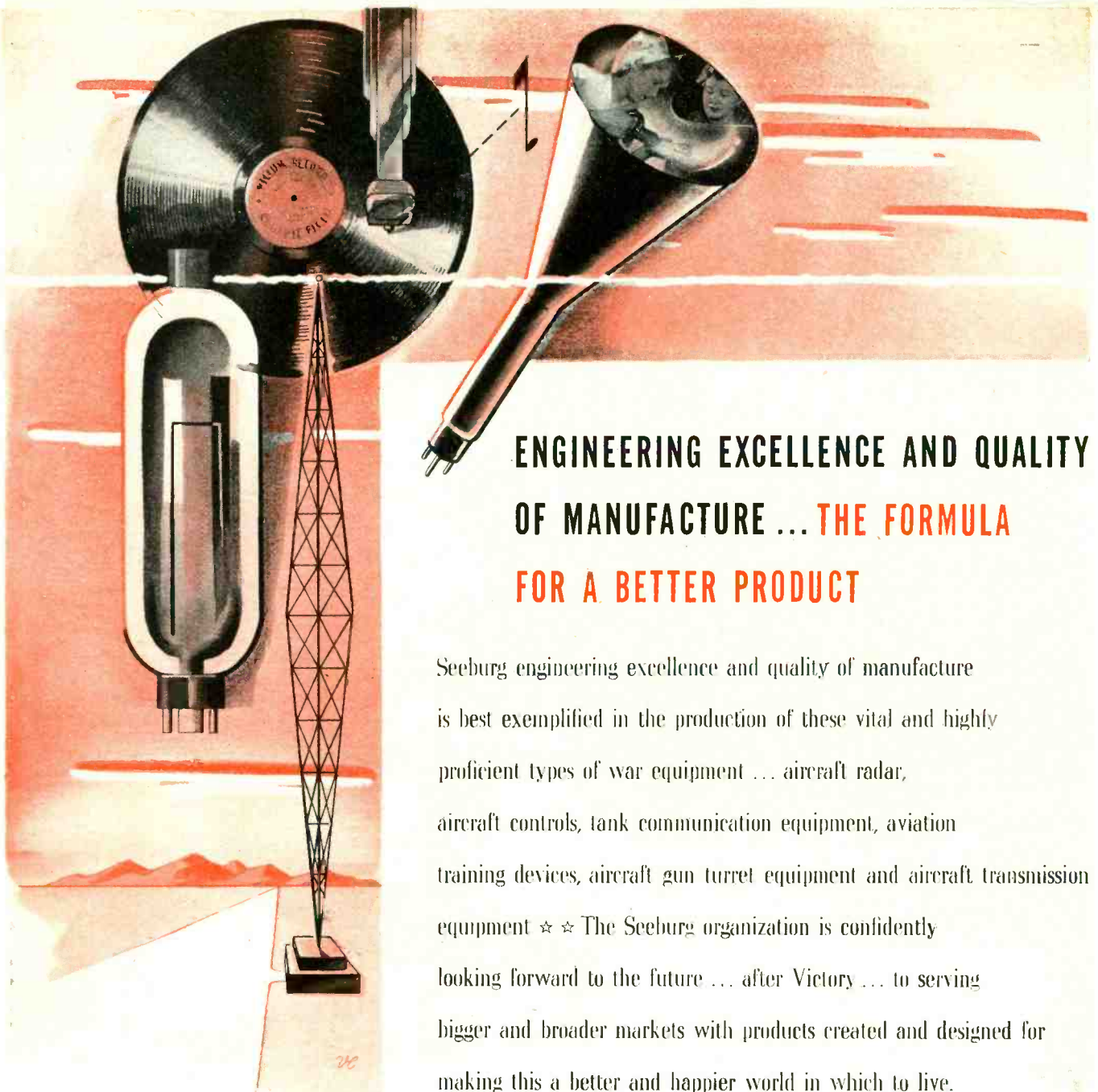

**ENGINEERING EXCELLENCE AND QUALITY
OF MANUFACTURE ... THE FORMULA
FOR A BETTER PRODUCT**

Seeburg engineering excellence and quality of manufacture is best exemplified in the production of these vital and highly proficient types of war equipment ... aircraft radar, aircraft controls, tank communication equipment, aviation training devices, aircraft gun turret equipment and aircraft transmission equipment ☆ ☆ The Seeburg organization is confidently looking forward to the future ... after Victory ... to serving bigger and broader markets with products created and designed for making this a better and happier world in which to live.



* AWARDED TO THE J. P. SEEBURG CORPORATION
FOR OUTSTANDING PRODUCTION OF
AIRCRAFT RADAR • AIRCRAFT CONTROLS • TANK
COMMUNICATION EQUIPMENT • AVIATION
TRAINING DEVICES • AIRCRAFT GUN TURRET
EQUIPMENT • AIRCRAFT TRANSMITTER EQUIPMENT.



MAKERS OF FINE MUSICAL INSTRUMENTS SINCE 1902

Seeburg

J. P. SEEBURG CORPORATION • 1500 DAYTON STREET • CHICAGO, ILL.

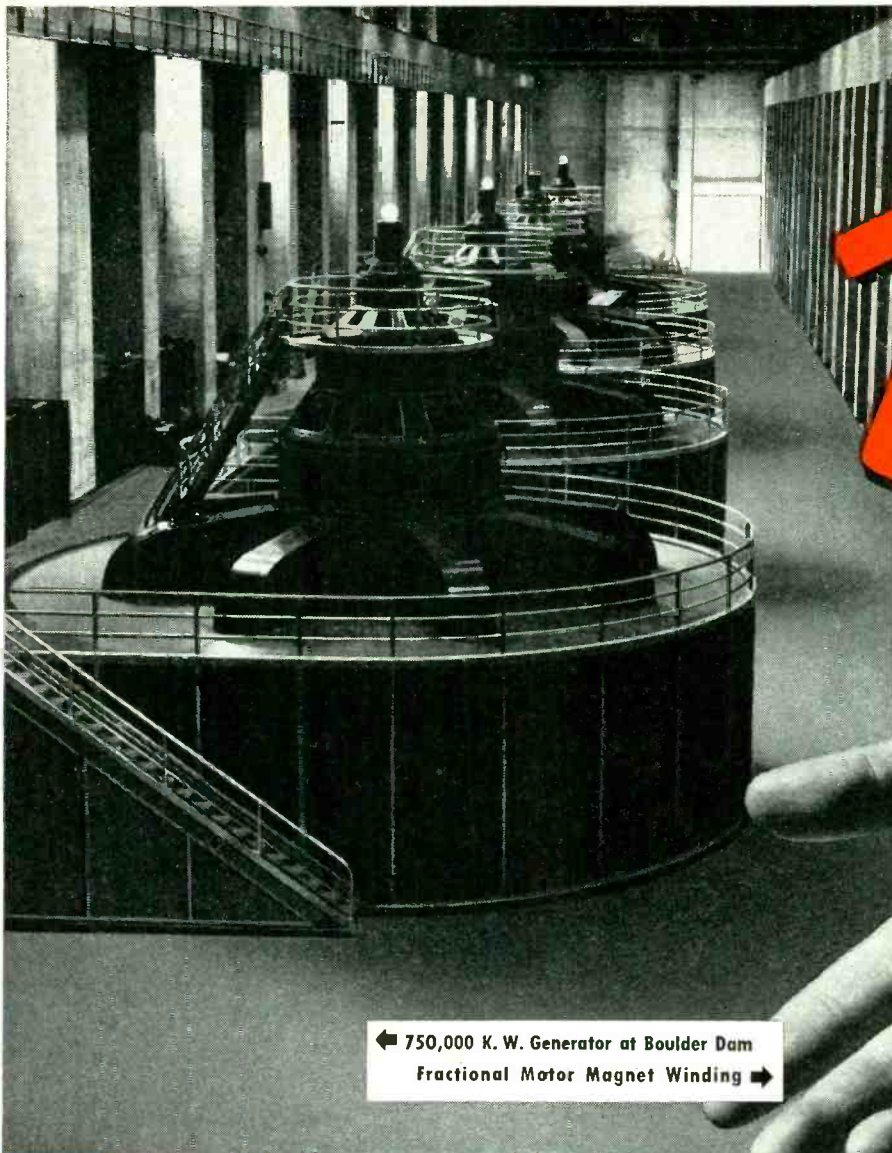

Big
or
Small



← 750,000 K. W. Generator at Boulder Dam
Fractional Motor Magnet Winding →

BACK THE ATTACK WITH WAR BONDS

Auto-Lite Magnet Wire Helps Build Better Products

Back of Auto-Lite Wire Products are research and engineering facilities which are constantly perfecting answers to baffling problems. The range of applications varies from fractional motor field windings to material for Boulder Dam Generators—and the new record-setting turbo-electric units at Chicago.

The controlling factor may be limited space, unusual shape, weight restriction or cost. Keen interest today is focussed on newer wire insulation developments. Butyrate Tape

and Vinylite are two types being used for lighting and low tension circuits in radio production, aircraft construction and other vital war need.

Our business has been built by supplying wire and wire products that solve problems for designing engineers and manufacturers. Whatever your need, unusual shapes, sizes or special insulation requirements . . . feel free to write us for authoritative recommendations.

PORT HURON, MICH.

THE ELECTRIC AUTO-LITE COMPANY

SARNIA, ONT.

Wire Division

AUTO-LITE *ELECTRICAL*
WIRE and CABLE

IN ITS 26 GREAT MANUFACTURING DIVISIONS, AUTO-LITE IS PRODUCING A LONG LIST OF ITEMS FOR AMERICA'S ARMED FORCES ON LAND, SEA AND IN THE AIR

Another **TAYLOR** Triumph!

"Processed Carbon Anodes"

New Metalizing Method... Eliminates Loose Graphite Particles

Taylor's exclusive Processed Carbon Anodes allow higher anode voltages. These amazing new type anodes open new fields for tube design.

Seamless, and without high resistance weld spots, they are accurately machined from solid graphite, then entirely metalized to combine the desirable characteristics of carbon with the advantages of other type anodes. Because they do not warp, they provide insurance against efficiency loss due to changing electrical characteristics. A special method of fusing lead wire to anode assures positive continuity between tube connection and anode. And too, this new Taylor Process allows complete and permanent degassing of the anode.

You will hear more about this far-reaching development as its applications continue to increase Taylor Tube efficiency on a "More Watts Per Dollar" basis.

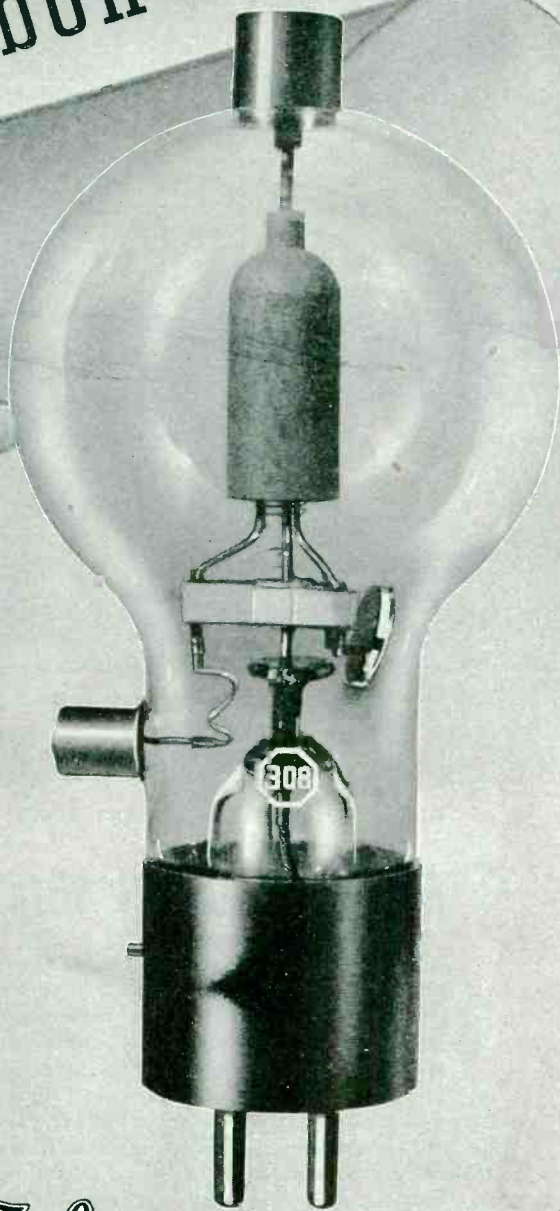

Taylor **HEAVY** **CUSTOM BUILT** **DUTY** **Tubes**

**TAYLOR TUBES, INC.,
2312-18 WABANSIA AVE., CHICAGO, ILL.**

Means
LONGER TUBE LIFE!

Introducing

INTERNAL-PIVOT ELECTRIC INSTRUMENTS

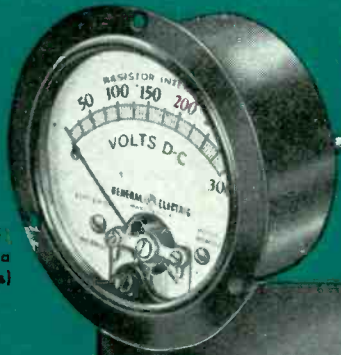

Type DW-51
voltmeter in a
metal (brass)
case

TYPE DW-51 D-c Volt-
meters, Ammeters, Milliam-
meters, and Microammeters

TYPE DW-52 Radio-
frequency Ammeters and
Milliammeters (A-c Ther-
mocouple Types)

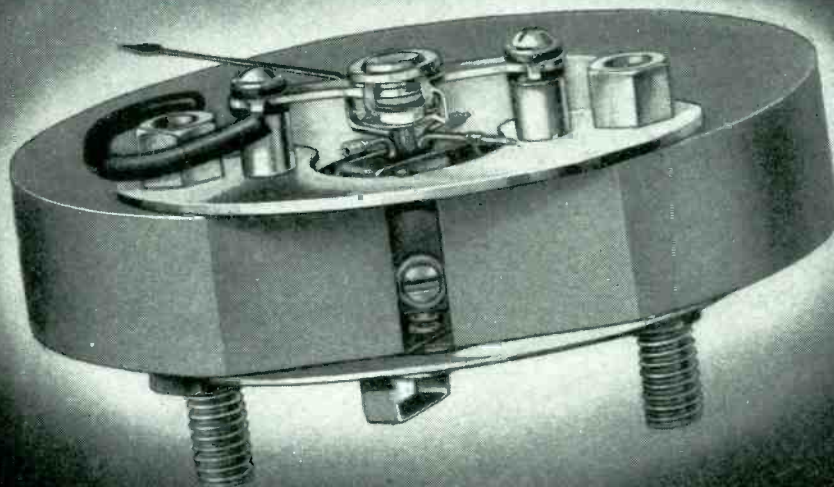

ELEMENT ASSEMBLY

(Approx twice actual size)

Note the clean, simple lines of this compact element,
made possible by the internal-pivot construction and by
securing all parts solidly to the cast-camol magnet.

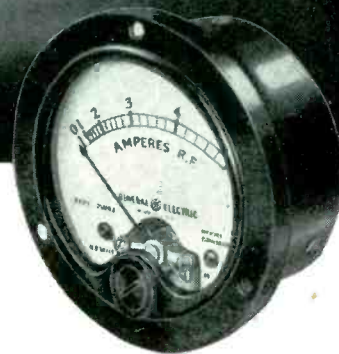

Type DW-52 ammeter in
a molded Textolite case

for **THINNESS** obtained by the use of internal pivots—pivots
solidly mounted on the inside of the armature instead of the outside
with **HIGH FACTOR OF MERIT**—resulting from a feather-
weight moving element and relatively high torque

THESE new instruments are especially well suited
for use in radio and other communications equip-
ment where compactness is essential. In most ratings,
they are approximately *one inch deep*.

Thinness is obtained by the internal-pivot construc-
tion. But this design affords much more than thinness.

The elements, on account of their high torque and
large-radius pivots, are well able to withstand vibra-
tion. High torque combined with a lightweight mov-
ing element results in fast response. Good damp-
ing

makes for ease and accuracy of reading. Large clear-
ances ensure reliable operation.

All these features add up to a high factor of merit
and all-round fine performance.

For complete information on ratings, prices, dimen-
sions, and specifications, ask the nearest G-E office
for Bulletin GEA-4064. Or write to General Electric
Company, Schenectady, N. Y.

GENERAL  ELECTRIC
602-45-6200

STUPAKOFF

FOUNDED IN 1897

Ceramics for the World of Electronics

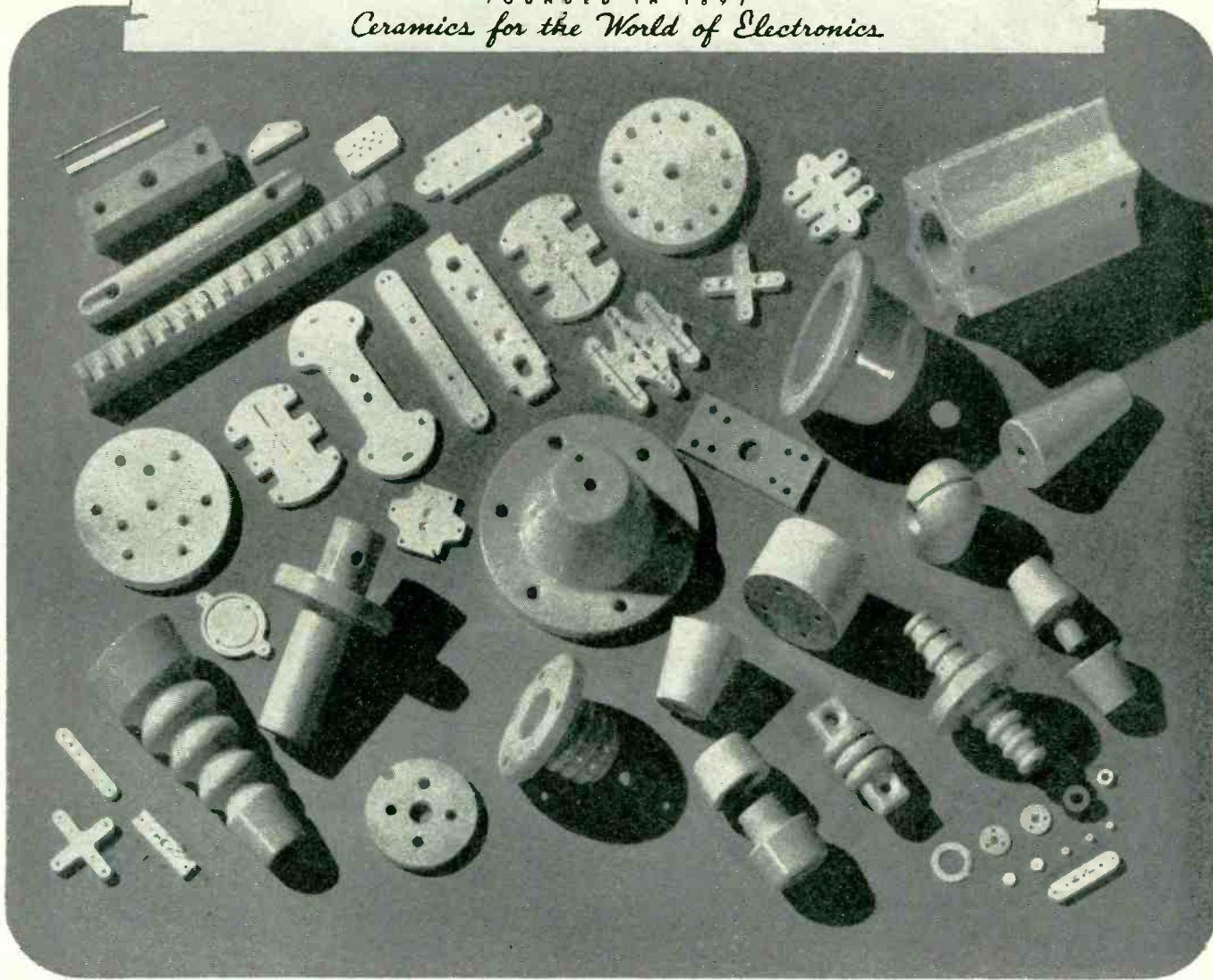

Insulators for Ultra High Frequencies

FOR years we have been closely associated with the rapidly progressing electronic industry and during this time have produced insulators for practically every type of electronic device.

Our knowledge . . . years of experience . . . engineering and manufacturing facilities permit us to meet your most exacting specifications. Every day we produce millions of precision made insulators for the electronic industry.

*For the duration 100 per cent of our attention—
all personnel and equipment—is being
used to hasten Victory.*

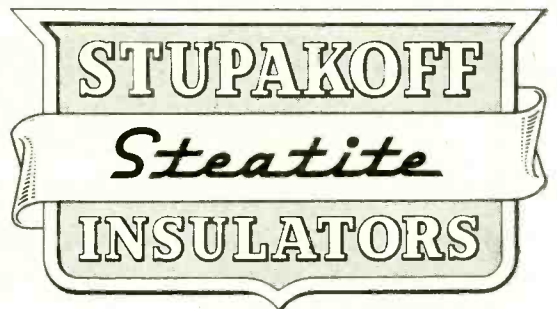

★ INVEST TODAY IN ★
BONDS FOR VICTORY

STUPAKOFF CERAMIC AND MANUFACTURING CO., LATROBE, PA.

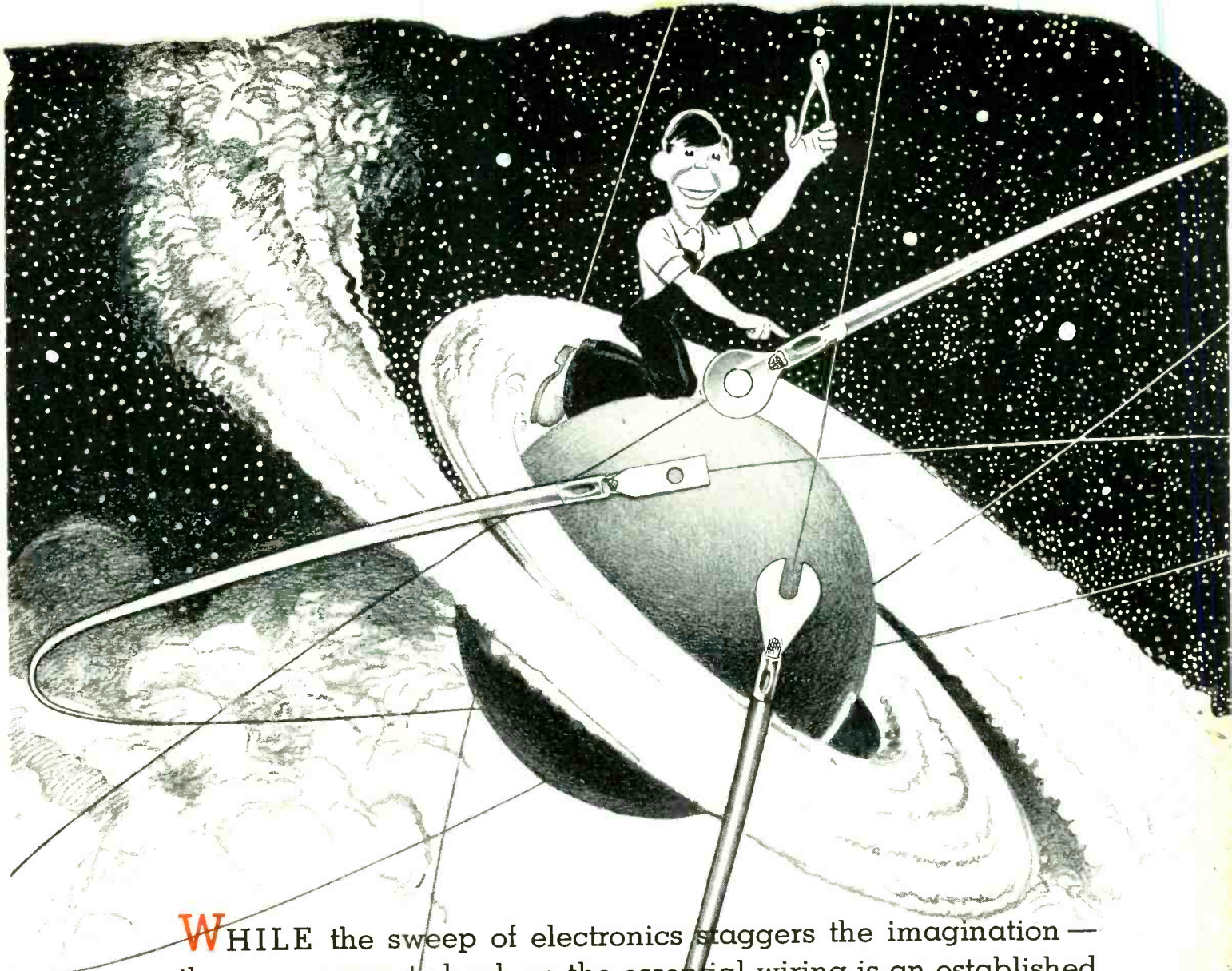

WHILE the sweep of electronics staggers the imagination — the proper way to hook-up the essential wiring is an established engineering procedure. • T&B Sta-Kons — Pressure (Solderless) Wire Terminals — make permanent, metal-to-metal connections. They resist corrosion. They withstand high frequency vibrations. They install fast with any of the various T&B Power Tools. They are made in a great variety of designs and wire capacities. • Approved. Patented. • Send for Sta-Kon Catalog Bulletin No. 500. Write to us on your special problems. • Under the T&B Plan, Sta-Kons, like all other T&B products, are sold only through T&B Distributors who reduce the manufacturer's selling costs, thereby reducing the cost of all electrical equipment to the user.

ORDER SMALL BUT ESSENTIAL PRODUCTION
PARTS AT LEAST FOUR MONTHS IN ADVANCE



THE THOMAS & BETTS CO.
INCORPORATED
MANUFACTURERS OF ELECTRICAL FITTINGS SINCE 1899
ELIZABETH 1, NEW JERSEY
In Canada: Thomas & Betts Ltd. Montreal



FOR Tomorrow's Planning..

PHOTRONIC
PHOTO-CELLS
Matched FOR
output, linearity, spectral response!

Photronic Cells now being made for war purposes only, hold many new possibilities for design engineers searching for better methods or new products for post-war markets.

The improved Type 3 photo-cell has a marked increase in sensitivity and can be produced in various outputs and various linearity factors, to meet specific circuit requirements. They can be matched in spectral sensitivity, too; to give practically the same spectral response curve throughout the color spectrum. And since the fatigue factor has been materially reduced, their response is more uniform, and far more rapid.

The development of the Type 3 is the result of continued research and experience in the processing of photo-cells dating back to 1930 . . . the year in which WESTON introduced the first American-made commercial cell of the barrier-layer type.

Type 3 Photronic Cells can be supplied in various styles and cases, as well as unmounted in a variety of shapes and sizes. Complete technical data, in booklet form, available to design engineers on request. Weston Electrical Instrument Corporation, 618 Frelinghuysen Avenue, Newark, New Jersey.

**PHOTRONIC—A registered trademark designating the photoelectric cells and photoelectric devices manufactured exclusively by the Weston Electrical Instrument Corp.*

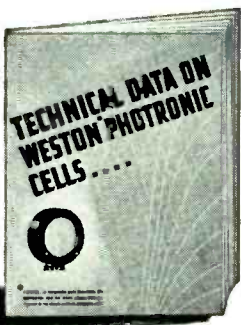

Laboratory Standards . . . Precision DC and AC Portables . . . Instrument Transformers . . . Sensitive Relays . . . DC, AC, and Thermo Switchboard and Panel Instruments.

WESTON

Specialized Test Equipment . . . Light Measurement and Control Devices . . . Exposure Meters . . . Aircraft Instruments . . . Electric Tachometers . . . Dial Thermometers.

FOR OVER 51 YEARS LEADERS IN ELECTRICAL MEASURING INSTRUMENTS

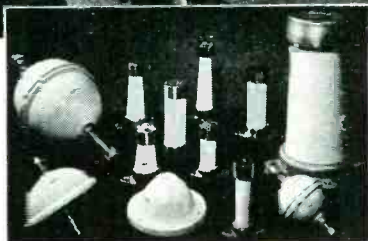
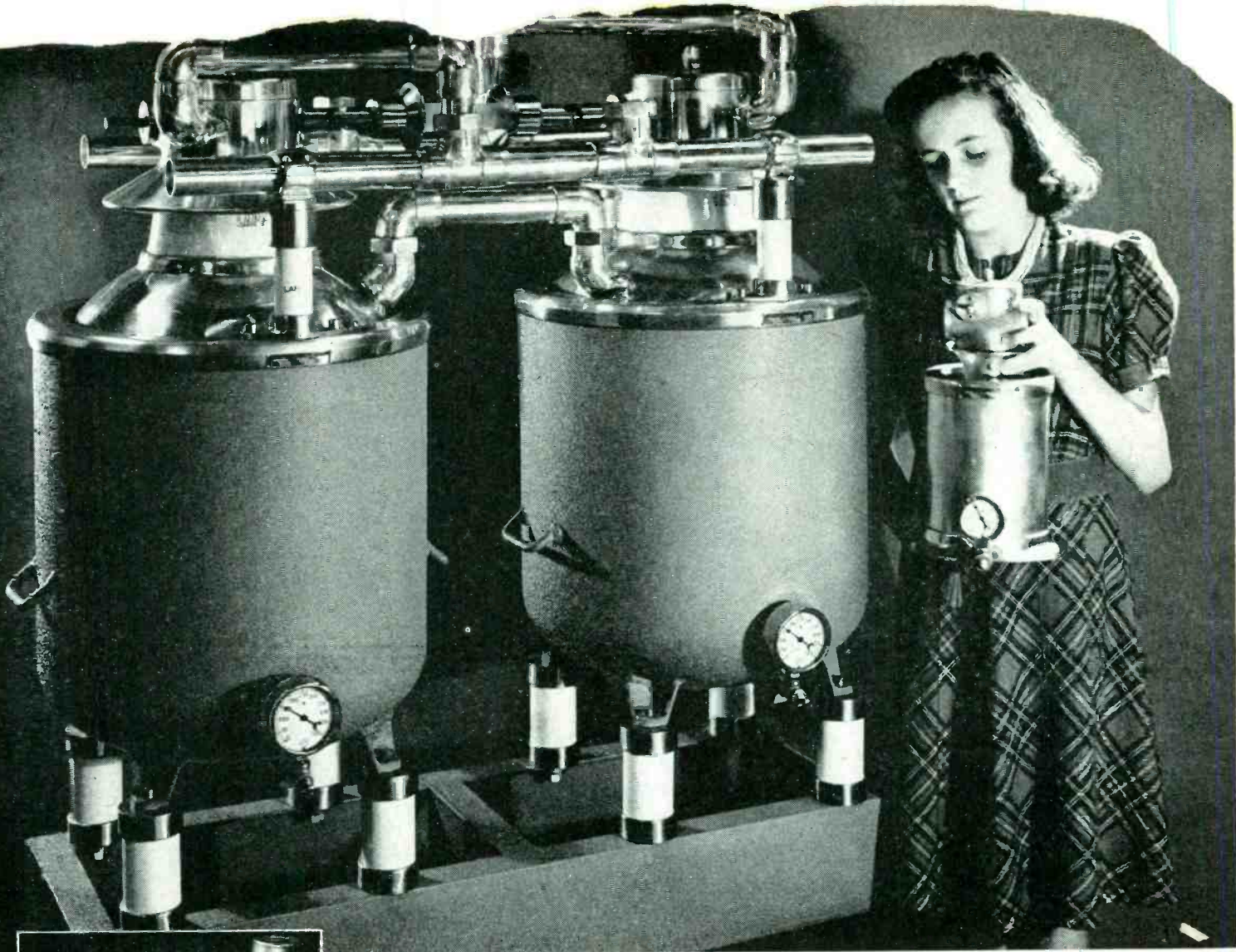

Standoff, bowl, and other special-purpose insulators are available in wide range. Lapp is also equipped for production of many special assemblies, including porcelain or seatite, with all associated metal parts.

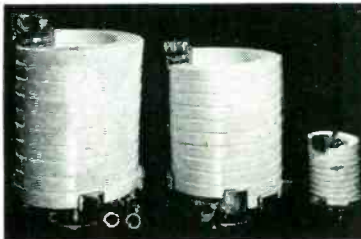

Lapp porcelain water coils, porcelain pipe and fittings provide a means for cooling high-frequency tubes, without sludging, eliminating need for water changing or cleaning.

LAPP *high-capacitance* CONDENSERS FOR INDUSTRIAL

ELECTRONIC CIRCUITS

For lump capacitance in any high-frequency circuit, Lapp gas-filled condensers save space, save power, save trouble—and use no mica. Available for use at any needed voltage rating and capacitance, they operate with practically zero loss, are puncture-proof, fail-proof and constant in capacitance under temperature variation.

Above is Unit No. 26541, consisting of two No. 25934 units. The assembly provides pivoting bus conductors, arranged so that the units may be used singly, in series, or in parallel, providing capacitance continuously variable from .0022 mf. to .022 mf. Each unit is rated at 200 amp., 6500 volts, capacitance variable .0043 mf. to .011 mf.; the combination in series, 200 amp., 13,000 volts, .0022 to .0055 mf.; in parallel, 400 amp., 6500 volts, .0086 to .022 mf. In the girl's hands is Unit No. 23722, rated at 50 amp., 7500 volts, capacitance .000045 mf. to .000075 mf.

Lapp

INSULATOR CO., INC.

LEROY, N. Y.

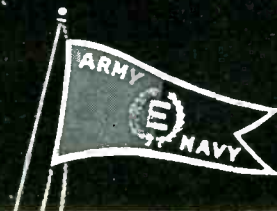

In the Communications Field

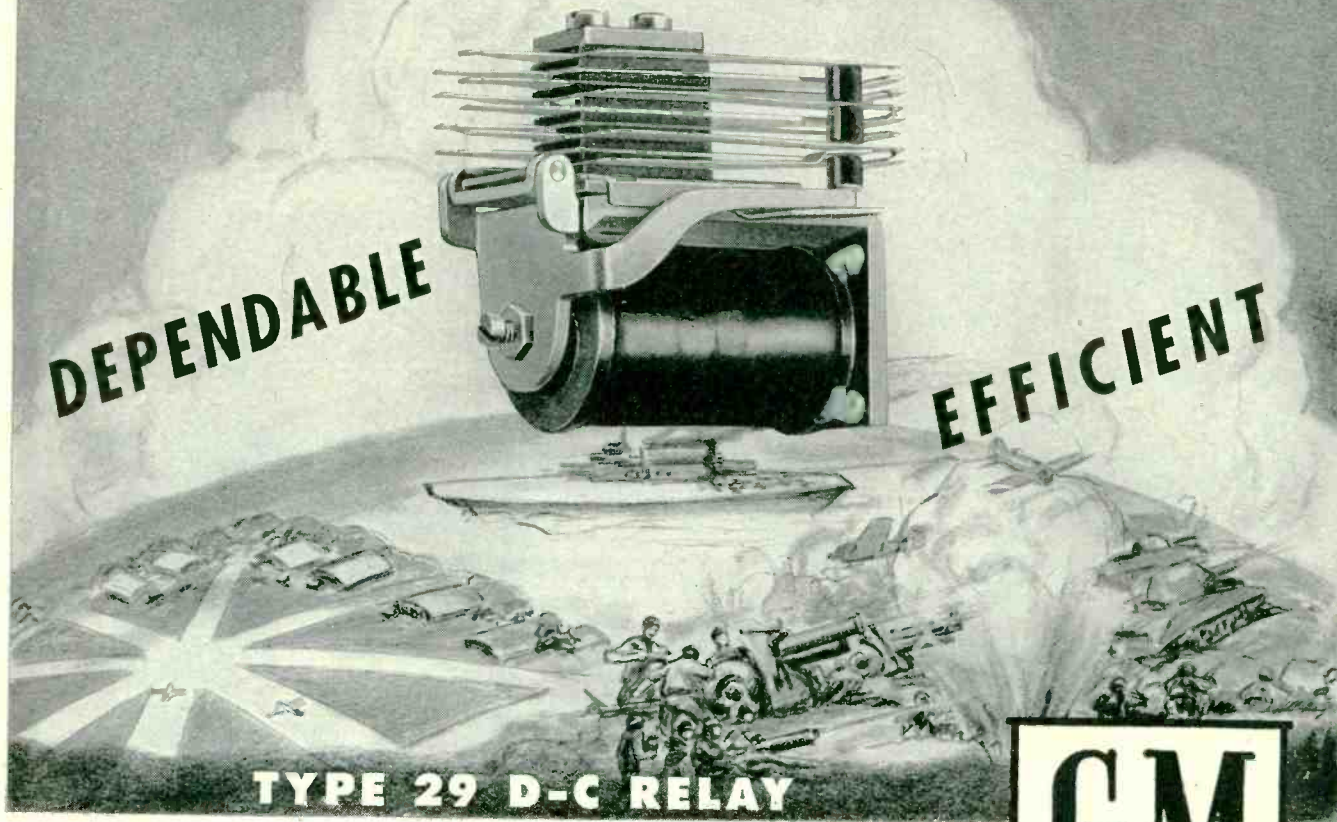

● The G-M Type 29 Relay is designed mechanically and magnetically to give unusual efficiency and dependability in operation. Its small size and light weight combined with rugged construction, characteristic of all G-M relays, make it ideal for a multitude of communications uses. The Type 29 is positive in action and requires an exceptionally low power input.

Numerous circuit combinations are available to meet practically any requirements. The high efficiency of the magnetic circuit insures high contact pressure. Phosphor bronze armature bearings, turning in accurately reamed holes in a brass bracket, insure free operation and long life. The contact springs and anti-vibration springs are of nickel silver. Mycalex insulators are available if specified. All steel parts are heavily cadmium plated and the coil is carefully impregnated so that the entire unit will withstand 200 hour 20% salt spray tests. The illustration above is actual size.

A free standardized sample of the Type 29 relay shown above, specification No. 12899* is available for examination and test to manufacturers who are prospective relay users. Orders for free samples must be accompanied by a priority of AA-4 or better.

*No. 12899 samples have 12 volt D-C coils, two double throw contacts and one single throw normally closed contact.



VISITRON PHOTOTUBES

are available in numerous sizes. Made by G-M, pioneer in development and manufacture of quality phototubes.

G-M LABORATORIES INC.

4313 NORTH KNOX AVENUE, CHICAGO 41, ILLINOIS

Buy WAR BONDS & STAMPS

**PROTECTED
BY VACUUM . . .**



(ACTUAL SIZE PHOTO)

**this condenser
is protected by vacuum from
moisture, dirt, changing
characteristics and mechanical injury . . .**

A permanent capacitance, 50mmf, 5000 volts, which fits any standard fuse mount and performs perfectly under most exacting conditions such as extremely high altitudes. A typical example of the quality vacuum products engineered and manufactured by this young and virile company under experienced heads, which among other things, pioneered the graphite anode and the carburizing of thoriated filaments.

* We invite inquiry. Increased facilities enable us to supply this permanent capacitance to firms with adequate priorities.

**GENERAL
ELECTRONICS
INC.**

101 HAZEL STREET, PATERSON, N. J.

Specialists in Engineering and Manufacturing Vacuum Products for Electronic Applications

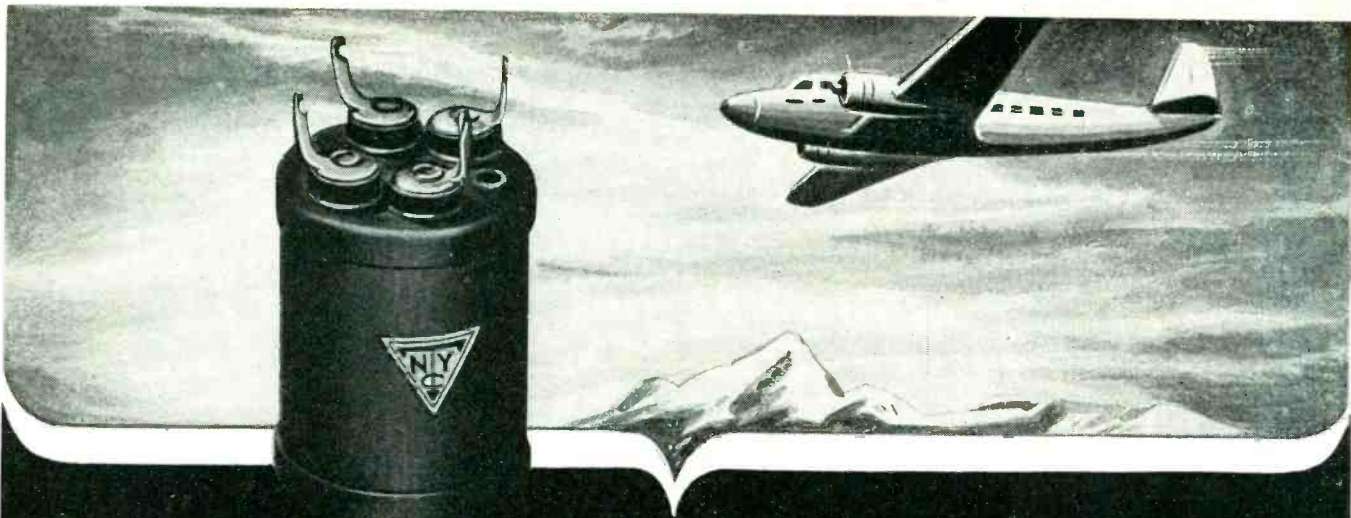

Stratosphere, Troposphere or Aquasphere

N-Y-T engineering can meet transformer needs



The ingenuity of the N-Y-T Sample Department is represented in practically every point above and below the four corners of the earth.

Specializing exclusively in the design and development of audio and power transformers, chokes and filters for highly critical requirements, these custom-built units experience every conceivable electrical and mechanical operating condition.

Abrupt and extreme temperature fluctuations, moisture, acid fumes, concussion, humidity, etc.—yet maximum performance is assured at all times. Too, substantial savings in weight, area and mounting space attest to the resourcefulness of N-Y-T engineering.

The Sample Department, now devoted 100% to problems pertaining to Army, Navy and Air Corps applications, will be available to you later, for peacetime needs.

NEW YORK TRANSFORMER COMPANY
26 WAVERLY PLACE

NEW YORK, 3, N. Y.

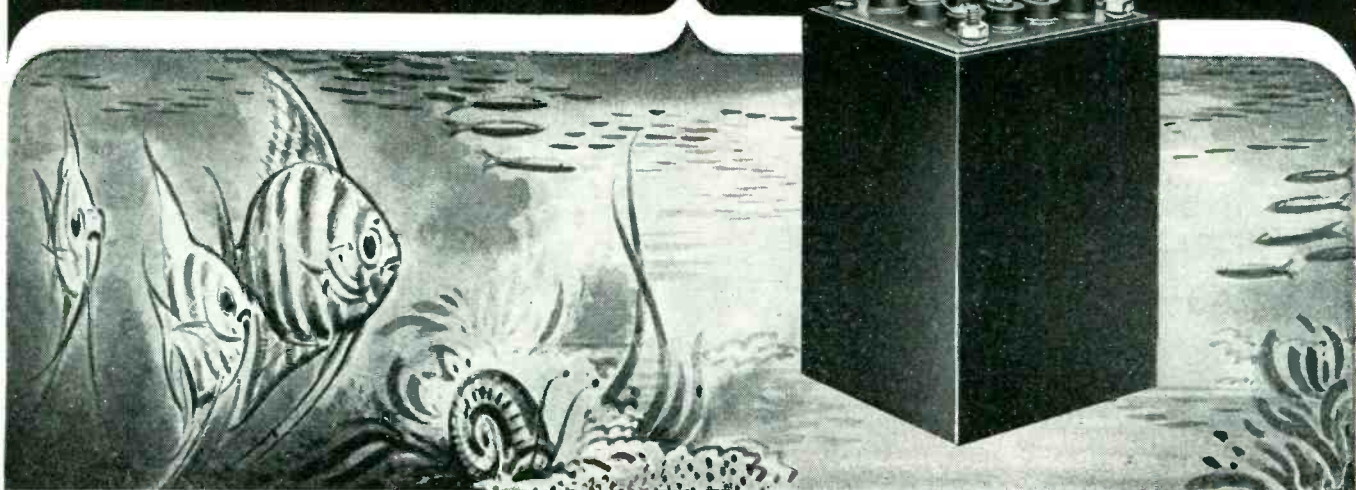

Presenting!

A SOLDERLESS Insulation Support TERMINAL

for
Wire Sizes
26 to 22
Inclusive

"PRECISION ENGINEERING  APPLIED TO THE END OF A WIRE"

Now you can eliminate the inherent difficulties encountered in soldered small wired connections by using the newest addition to the line of Solderless AMP "Diamond Grip" Insulation Support Terminals, designed specifically for electronics use on wire sizes 26 to 22 inclusive.

CHECK THESE ADVANTAGES AGAINST YOUR PRESENT METHODS

1. Eliminates skilled labor by providing self-gauging hand, foot and power installation tools which assure uniform application.
2. Terminal is crimped to both the conductor and the insulation in one single operation — three perfect crimps at one time.
3. Minimum voltage drop through terminal — the result of one-piece construction of current carrying member.
4. Tensile strength of Diamond Grip crimped joint greater than strength of wire itself.
5. Eliminates solder joint failures and speeds up production.
6. Insulation support protects against danger of grounds or shorts.
7. Visual inspection of every connection — wire extends through terminal barrel.
8. Assured uniformity of performance through uniformity of installation.



Take advantage of this new solderless terminal — engineered in every detail by AMP — for use on wire sizes 26 to 22. Write, phone or wire for prices and complete details.

AIRCRAFT-MARINE PRODUCTS, INC.
DEPT. B, 286 NORTH BROAD STREET, ELIZABETH, NEW JERSEY · TEL: ELIZABETH 2-1350

Canadian Representative: A & M ACCESSORIES, LTD., TORONTO, CANADA

OTHER AMP PRODUCTS FOR ELECTRONICS



DIAMOND GRIP INSULATION SUPPORT TERMINALS
A complete line of Diamond Grip Insulation Support Terminals for wire sizes down to #14 (Comm.) in various tongue shapes and stud hole sizes.

Also available are AMP Spade Terminals, Flag-Type Terminals, Hook-Type Terminals, Lighting Contacts, and others for specific electronic usage.



"QUICK DISCONNECT" BONDING JUMPERS
For aircraft radio transmission and receiving equipment. Vibration-proof, yet easy, positive disconnection. Also for use on precipitron equipment.

CRIS CUT DIAMOND SAW BLADES

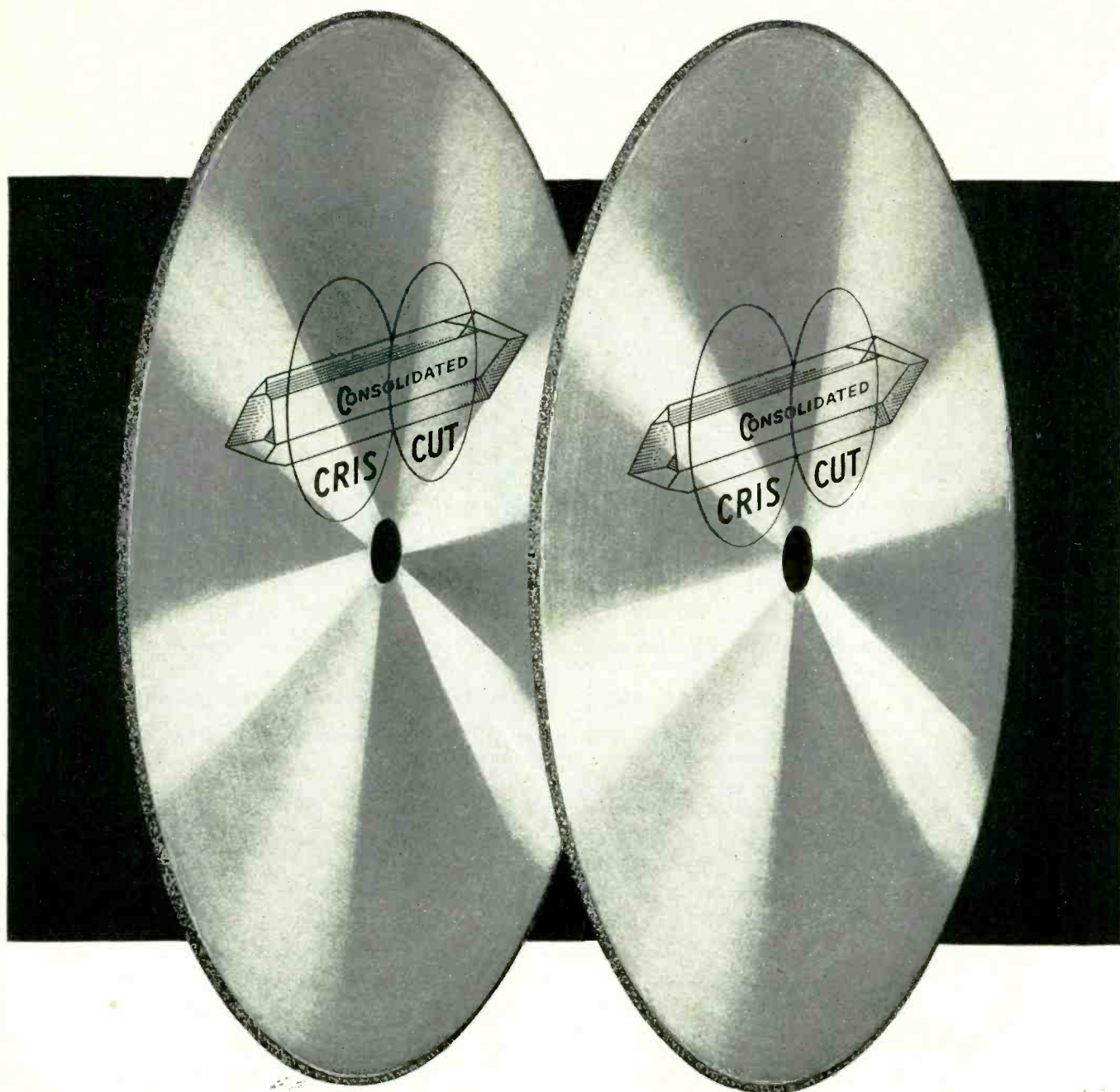

CRIS CUT DIAMOND SAW BLADES have been developed in close cooperation with the quartz processing industry.

CRIS CUT DIAMOND SAW BLADES are metal bonded, manufactured by our own electro charging process. (patents pending)

CRIS CUT DIAMOND SAW BLADES are manufactured to insure:

: parallel cut : smooth surface : fast operation : thin slicing : long life :

CONSOLIDATED DIAMOND SAW BLADE CORP.
320 YONKERS AVENUE **YONKERS 2, N. Y.**

Announcing

'ROUND THE CORNER
EMERGENCY ELECTRONIC
EXPEDITING SERVICE TO
BUSY WAR INDUSTRY



Technically Informed Suppliers of Industrial Electronic Materials



EMERGENCY ELECTRONIC
EXPEDITERS

Experience—yes, experience gained before Pearl Harbor and during the months that followed—marks RCA Tube and Equipment Distributors as eager and qualified to play an important part in America's battle of production. Over three hundred veteran wholesalers and their organizations stand ready to service your wartime requirements—expedite deliveries—keep production rolling!

RCA Tube and Equipment Distributors are technically informed businessmen, familiar with electronic parts and tubes and their applications. And these men are in business today because they get things done!

In cooperation with many RCA Tube and Equipment Distributors who are anxious to put their special talents to work for you, RCA proudly presents a listing of their services on the following pages. You'll find it worth your while to look them over—to call up your local distributor—to get acquainted, and get set for special service!

Meet your local **RCA TUBE** and
EQUIPMENT DISTRIBUTOR!

TO NEW YORK WAR MANUFACTURERS:

Do You NEED ELECTRONIC COMPONENTS?

LINES CARRIED IN STOCK

LABORATORY EQUIPMENT

Testing devices
Temperature devices
Control devices

ELECTRONIC COMPONENTS

Power, industrial and receiving type tubes
Special purpose tubes (cathode ray,
photocell, etc.)
Complete line of component parts,
switches, relays, etc.
Cements, varnishes, solvents and
chemicals

INDUSTRIAL FLUORESCENT LIGHTING

Complete fixtures
Lamps and starters (all sizes)
Ballasts and misc. maintenance parts

TOOLS

Screwdrivers, pliers, and hand tools
Power drills, grinders, sprayers, and
marking tools
Wire strippers, soldering equipment

CONSULTING SERVICE

College trained consultants
Design and development work



STALLMAN OF ITHACA CAN FILL YOUR ORDERS!

Our stock is normally large. And these are days when stock *has* to be large to meet the demands of war manufacturers for specific radio and electronic components, laboratory equipment, industrial lighting, tools and consulting service.

This means we're not only able to fill your orders — but to fill them quickly! Individual attention is given each order — and you'll be pleased with the prompt, efficient service.

Then, if the items you need are not in stock, our consulting service will gladly advise you what is available and where. And to go a step further, if there is any question in your mind as to the material you need, we'll recommend what to use for your specific job, and how to use it.

We're positive you will find our stock and personnel helpful. As always, it is our aim to give

"Just a Little More Service Than You Would Rightfully Expect".

STALLMAN OF ITHACA

128 EAST SENECA ST., ITHACA, N. Y.

Phone WOrth 2-6276



HEADQUARTERS FOR ACCURATE, INFORMED



on your Orders for
**RADIO-ELECTRONIC
MATERIALS**

Need RCA Tubes for any Radio or Electronic application? Need RCA Test Equipment? Need capacitors, resistors, relays, solenoids, rheostats, potentiometers, coils, transformers—or the products of any one of dozens of manufacturers? Then try our service today. We know the Radio-Electronic field. We know who makes the products you need and how they can be obtained. Our personalized service costs nothing extra—and has long since proved its value to busy manufacturers.

**FOX ELECTRIC SUPPLY
COMPANY**
67-69 N. State St.
ELGIN, Illinois
ELGIN 4380
**TUBE AND EQUIPMENT
DISTRIBUTOR**



DAVENPORT

WANTED
YOUR ORDERS FOR
ELECTRONIC MATERIALS

These are days when it pays doubly to send your orders for Radio-Electronic materials to a long-time specialist. We know the field. We know what is available. We know where it can be obtained—faster than you may



have thought possible under existing war-time emergency conditions. RCA Tubes, RCA Test Equipment—or resistors, rheostats, controls, potentiometers, capacitors, relays, transformers, wire—or numerous other products produced by many manufacturers. They're our business. We know how to deliver the goods. Try us on your next order!

**MIDWEST
TIMMERMANN CO.**
114-16 Western Avenue
DAVENPORT, IOWA
Phone 3-1801



TUBES AND EQUIPMENT

Technically informed
SERVICE



PLUS..
**FAST
DELIVERIES**

on needed
**ELECTRONIC
MATERIALS**

Need electronic materials—small quantities or large? Then rush your order to us. See what we mean by Emergency Service to industrial users of Electronic Equipment!

Not only do we carry large stocks. Not only do we deliver the goods faster than you may have thought possible under war-time conditions. We know what is available, where it is available, and how fast it may be obtained. We are in a position to offer valuable recommendations—because Electronics is our business. Our business is one of SERVICE—and that means Service in obtaining materials promptly as well as in using them to best advantage once they've been obtained.

RADIO PARTS CO., Inc.

538 West State St.
MILWAUKEE (3), Wisc.

BRANCH:
326 W. Gorham St.
MADISON, Wisc.



Distributors for RCA Tubes for all Radio and Electronic requirements, RCA Test Equipment, as well as capacitors, resistors, rheostats, controls, potentiometers, coils, transformers, wire, relays, and numerous other components produced by many manufacturers.



CHICAGO

**RADIO AND
ELECTRONIC
COMPONENTS**

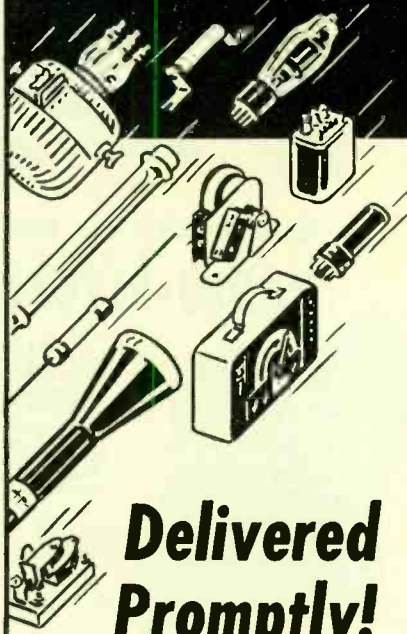

**Delivered
Promptly!**

Tubes, Test Equipment,
Capacitors, Relays, Coils,
Transformers, Resistors, or
What Have You?

Let us stack our "Know How" of the Radio and Electronic industries against your next order for materials. Let us show you what we mean by our slogan "WE DELIVER THE GOODS"—faster, more efficiently than you may have thought possible under present-day emergency conditions!

There's no dark secret about it. It's simply that we've been dealing with Things Electronic for a long time. We know who makes it and where. We know where it can be obtained, and how fast. This PLUS service costs you nothing extra—and it has already proved its value to countless plants which, like your own, are literally "snowed under" with war work.

**THE LUKKO
SALES CORPORATION**

5024 Irving Park Road,
Chicago, Illinois

AVenue 4800



**TUBE AND
EQUIPMENT
HEADQUARTERS**

We are distributors for RCA Tubes and Test Equipment for any Radio or Electronic need, as well as for condensers, resistors, rheostats, controls, potentiometers, coils, relays, transformers, solenoids, wire, and numerous other components produced by many manufacturers.

SERVICE ON RADIO-ELECTRONIC MATERIALS



HARTFORD

TUBES AND  EQUIPMENT



Headquarters for Accurate, Informed Service on
RADIO-ELECTRONIC MATERIAL

- RCA Tubes
- RCA Test Equipment
- Capacitors
- Resistors
- Controls (Potentiometers)
- Relays (Solenoids) and countless other components, produced by many manufacturers

Making war equipment that necessitates frequent calls for Radio-Electronic tubes and other Electronic components? Then get acquainted with our service—today! Chances are, we've got what you need in stock—for immediate delivery upon receipt of suitable priorities. If not, we're well equipped to get it for you faster than you may have thought possible under war conditions—and to render intelligent, personalized expediting service all along the line. Try us on your next order and be convinced!

R. G. SCALI & CO.
227 Asylum Street,
Hartford, Conn.
'Phone: 2-1144

WANTED
YOUR ORDERS FOR
ELECTRONIC MATERIALS

These are days when it pays doubly to send your orders for Radio-Electronic materials to a long-time specialist. We know the field. We know what is available. We know where it can be obtained—faster than you may



have thought possible under existing war-time emergency conditions. RCA Tubes, RCA Test Equipment—or resistors, rheostats, controls, potentiometers, capacitors, relays, transformers, wire—or numerous other products produced by many manufacturers. They're our business. We know how to deliver the goods. Try us on your next order!

AMERICAN RADIO CORP.
510 Central Avenue
DOVER, N. H.
'Phone: Dover 404



LOUISVILLE

**GEARED FOR SERVICE TO
BUSY WAR INDUSTRIES**

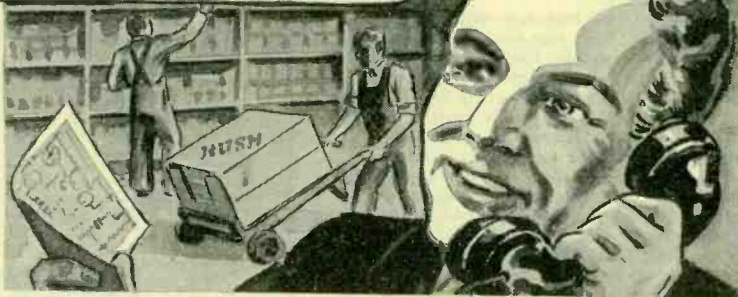

GET YOUR RADIO AND ELECTRONIC
SUPPLIES **ON TIME!**

Here is your "Open Sesame!" to rapid, intelligent expediting on your orders for almost any type of Radio or Radio-Electronic material. Chances are good that we can ship your order from stock upon receipt of proper priorities. If not, we know where the materials can be obtained, how they can be shipped to you far more promptly than you may have thought possible under existing war-time emergency conditions. "Electronics" is nothing new to us. Try our service on your next order—small or large!

SMITH DISTRIBUTING CO.
831 E. Broadway
Louisville, Kentucky
'Phone: Jackson 1155



Remember: The "Magic Brain" of any Electronic Device is a vacuum tube and the fountainhead of modern tube development is RCA. We are headquarters for RCA Tubes for all applications; also RCA Test Equipment, as well as resistors, rheostats, relays, capacitors, transformers, wire, coils, and the products of many different manufacturers.

MIAMI

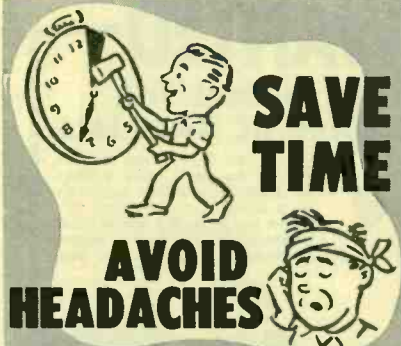

on your Orders for
**RADIO-ELECTRONIC
MATERIALS**

Need RCA Tubes for any Radio or Electronic application? Need RCA Test Equipment? Need capacitors, resistors, relays, solenoids, rheostats, potentiometers, coils, transformers—or the products of any one of dozens of manufacturers? Then try our service today. We know the Radio-Electronic field. We know who makes the products you need and how they can be obtained. Our personalized service costs nothing extra—and has long since proved its value to busy manufacturers.

MAJOR APPLIANCES, Inc.
925 W. Flagler St.,
MIAMI (36), Florida



TUBE AND EQUIPMENT
DISTRIBUTOR



THESE EMERGENCY ELECTRONIC EXPEDITERS

EVERYTHING IN RADIO AND ELECTRONICS

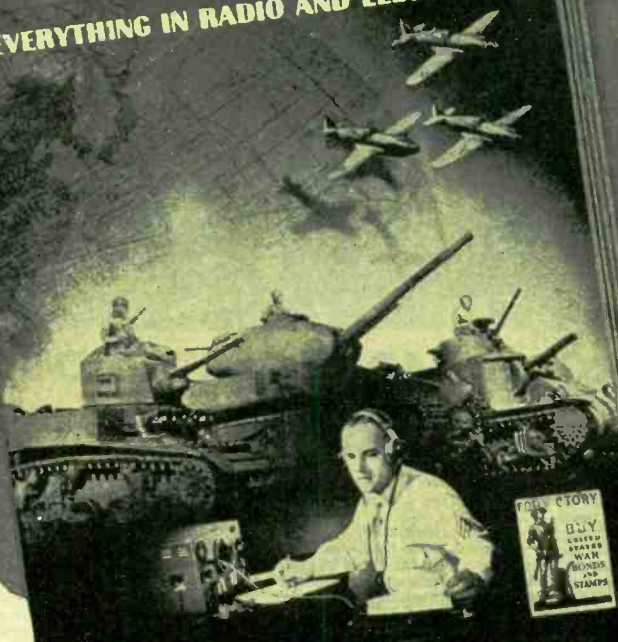

Serving THE ARMED FORCES • WAR INDUSTRY • THE HOME FRONT
1943 CATALOG No. 110
See Index on Page 96

ALLIED RADIO
833 WEST JACKSON BLVD. • CHICAGO, ILLINOIS

COMPLETE CENTRALIZED SERVICE

on *Everything*
in RADIO and
ELECTRONICS

USE YOUR NEW ALLIED CATALOG

Most complete up-to-date Buying Guide. If you do not have yours, send for it today.

It's FREE!

Allied SPEEDS SUPPLIES

for the ARMED FORCES . . . WAR INDUSTRIES . . . the HOME FRONT

Through Allied's centralized service, you can simplify your procurement of RCA tubes and equipment . . . as well as the radio and electronic products of practically all other nationally known manufacturers. Our large stocks speed supplies of over 10,000 items for the Armed Forces, for War Training, for Laboratories, Maintenance and Production. Our special procurement and expediting division is in constant contact with all manufacturing sources. You save time and work — instead of dealing with many sources, you get *everything* you need from this *one* dependable arsenal of supply. Emergency needs are met with speed and efficiency. Let our experienced staff help you as it is helping so many others today.

Write, wire or phone Haymarket 6800

ALLIED RADIO CORP., 833 W. Jackson Blvd., Dept. 24-J-3, Chicago



DISTRIBUTOR

SEND FOR THESE VALUABLE NEW BOOKS

Specially prepared by leading technical experts for radio training and for helpful reference on the job. Priced to cover only the cost of preparation and mailing. Worth much more. *Get all six!*

- RADIO DATA HANDBOOK. Formulas, Tables, Charts. No. 37-754. 25c
- RADIO CIRCUIT HANDBOOK. Schematics and Pictorials. No. 37-753. 10c

- DICTIONARY OF RADIO TERMS. Easy-to-understand definitions. No. 37-751. 10c
- SIMPLIFIED RADIO SERVICING. Short cuts in trouble-shooting. No. 37-755. 10c
- RADIO-FORMULA AND DATA BOOK. Handy pocket-size radio manual. No. 37-752. 10c
- RADIO BUILDERS HANDBOOK. Simplified theory and building projects. No. 37-750. 10c

Write for Quantity Quotations

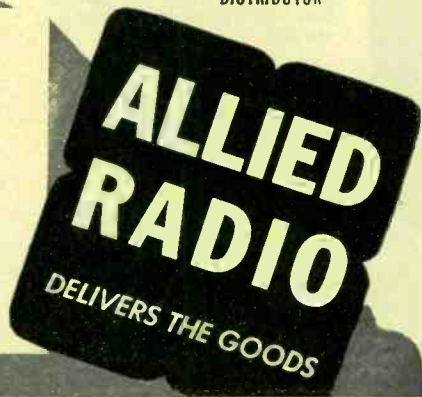

WE CAN GIVE YOU FAST, INTELLIGENT SERVICE



CHICAGO



**Electronic
Component
Specialists**



LARGE STOCKS

FAST DELIVERIES
on all types of Radio-
Electronic Equipment

**TECHNICALLY
INFORMED SERVICE**
on small orders or large

**INTELLIGENT
EXPEDITING**
(we know what is
available and where)

Try our service on your next order for Radio-Electronic materials, large or small. This is *our* business. We know what is available and where. We carry normally large stocks—for immediate delivery upon receipt of suitable priority. We know what to use for a given job and *how to use it*—and will gladly make recommendations if there is any question in your mind. Try our service on your very next order—whether it be for RCA Tubes or resistors, capacitors, transformers, relays, wire or what have you? You be the judge of our service!

THE
RADOLEK CO.

601 W. Randolph St.
Chicago, Ill.

'Phone: Monroe 5434



TUBE AND EQUIPMENT
HEADQUARTERS

COLUMBUS



**GEARED FOR SERVICE TO
BUSY WAR INDUSTRIES**



**"LARGEST RADIO PARTS HOUSE
IN OHIO"**

Here is your "Open Sesame!" to rapid, intelligent expediting on your orders for almost any type of Radio or Radio-Electronic material. Chances are good that we can ship your order from stock upon receipt of proper priorities. If not, we know *where* the materials can be obtained, *how* they can be obtained, and how they can be shipped to you far more promptly than you may have thought possible under existing war-time emergency conditions. "Electronics" is nothing new to us. Try our service on your next order—small or large!



Remember: The "Magic Brain" of any Electronic Device is a vacuum tube and the fountainhead of modern tube development is RCA. We are headquarters for RCA Tubes for all applications; also RCA Test Equipment, as well as resistors, rheostats, relays, capacitors, transformers, wire, coils, and the products of many different manufacturers.

HUGHES-PETERS, Inc.

111-117 E. Long Street

COLUMBUS, OHIO

(Main 4356)

HARTFORD

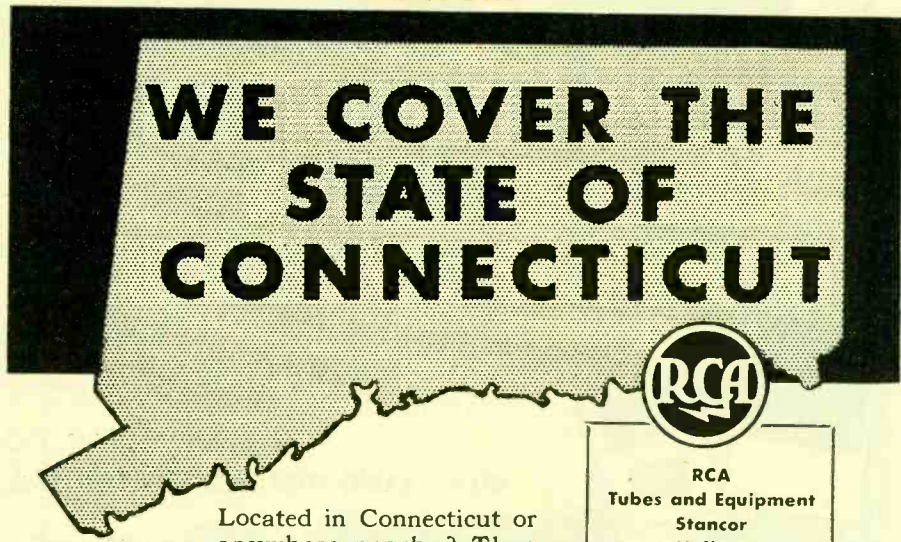

**WE COVER THE
STATE OF
CONNECTICUT**



Located in Connecticut or anywhere nearby? Then call on Hatry & Young for anything from tubes to test equipment, batteries, soldering irons, or what have you? Our stocks are normally large—and if we don't have it in stock we'll get it for you promptly and efficiently. Ask the buyers who know. They'll tell you H & Y is "tops" for service!

- RCA
- Tubes and Equipment
- Stancor
- Mallory
- Stromberg-Carlson
- Utah
- Shure IRC
- National
- Eveready
- Burgess
- Hexacon
- Kwikheat, etc.

HATRY & YOUNG

203 ANN ST.

HARTFORD 3, CONN.



THESE DISTRIBUTORS KNOW WHAT'S

MINNEAPOLIS

PHILADELPHIA • CAMDEN • ALLENTOWN • WILMINGTON



SAVE TIME
AVOID HEADACHES

on your Orders for
RADIO-ELECTRONIC MATERIALS

Need RCA Tubes for any Radio or Electronic application? Need RCA Test Equipment? Need capacitors, resistors, relays, solenoids, rheostats, potentiometers, coils, transformers—or the products of any one of dozens of manufacturers? Then try our service today. We know the Radio-Electronic field. We know who makes the products you need and how they can be obtained. Our personalized service costs nothing extra—and has long since proved its value to busy manufacturers.

NORTHWEST RADIO and ELECTRONIC SUPPLY CO.

204 So. 10th St.
Minneapolis (2), Minn.



TUBE AND EQUIPMENT DISTRIBUTOR

WORCESTER WANTED
YOUR ORDERS FOR ELECTRONIC MATERIALS

These are days when it pays doubly to send your orders for Radio-Electronic materials to a long-time specialist. We know the field. We know what is available. We know where it can be obtained—faster than you may



have thought possible under existing war-time emergency conditions. RCA Tubes, RCA Test Equipment—or resistors, rheostats, controls, potentiometers, capacitors, relays, transformers, wire—or numerous other products produced by many manufacturers. They're our business. We know how to deliver the goods. Try us on your next order!

RADIO MAINTENANCE SUPPLY CO.

17 Central St.
WORCESTER, MASS.

'Phone 4-3123



TUBES AND EQUIPMENT

In... Pennsylvania New Jersey Delaware

FEATURING THESE LINES:
RCA "All the Way"

Sprague
Cornell-Dubilier
IRC Stanco
Aerovox H. B. Jones
Bussman Weston
Bogan Sound
Ohmite Triplett
Thordarson Burgess
Clarostat
Shure
Hallicrafters, etc.



...STORES NEAR YOUR DOOR TO SERVE YOU

Fast service . . . large stocks . . . personalized expediting service through six strategically located stores . . . backed by an exceptionally broad Radio-Electronic experience of long years' standing . . .

These, in brief, are the RADIO ELECTRIC SERVICE COMPANY features that have proved invaluable to war equipment manufacturers throughout a large section of the industrial East.

Try us on your next order—large or small. Write for the big RESCO Catalog. Our representative will gladly call on you if you say the word.

RADIO ELECTRIC SERVICE CO.

Main Store: N. W. Cor. 7th & Arch Sts., Philadelphia, Pa.

Branch Stores

3145 N. Broad St., Philadelphia, Pa. • 5133 Market St., Philadelphia, Pa.
811 Federal St., Camden, N. J. • 1042 Hamilton St., Allentown, Pa.
219 W. 8th St., Wilmington, Del.

TUBES AND EQUIPMENT



AVAILABLE—AND WHERE TO GET IT



3-VITAL ELECTRA

1

SOUND PROJECTION SYSTEMS

WAR has pulled Sound Projection Systems into the midst of battle . . . making them important all along the line. The Eastern Company has complete facilities for the design and manufacture of these Sound Projection Systems of every description . . . ranging from inter-office systems to high-powered units for use in naval, amphibian, and land operations of the armed forces. Today this equipment is being supplied throughout the world by The Eastern Company.



MOBILE SOUND PROJECTION TRAILER

Pictured above is a Trailer equipped with an unusually powerful sound projector. This trailer is attached to military vehicles and is used to direct training, landing, or combat operations. This and similar equipment has been supplied by The Eastern Company to the Armed Forces and is in use throughout the world.

CRASH CONTROL TRUCK

Illustrated below is a Crash Control Truck fully equipped with sound projection devices, short wave radio receiving and sending set, fire fighting and first aid kits. This truck as supplied by The Eastern Company is used at naval and military air bases.



Above are important Electronic Components, used in centrally controlled sound projection systems designed and manufactured by the Eastern Company. They are installed in many Naval and Army Air Bases.



**DESIGN • ENGINEERING
MANUFACTURE • INSTALLATION**
of
**ELECTRONIC APPARATUS
SIGNAL CONTROL DEVICES
INTERCOMMUNICATION SYSTEMS**

RCA
TUBES
AND
EQUIPMENT

THE EASTERN COMPANY

620 MEMORIAL DRIVE - CAMBRIDGE, MASS



HEADQUARTERS FOR ACCURATE, INFORMED

ONIC SERVICES



2

ELECTRONIC PARTS SUPPLY

A highly organized department of The Eastern Company specializes in the procurement of all types of electronic parts and equipment. This department has served radio engineers, war industries, research laboratories, educational institutions, and the Armed Forces throughout the country. A most extensive stock of electronic parts is carried including such nationally known brands as RCA, Mallory, Thordarson, IRC, Centralab, Sprague, Cornell Dubilier, Stancor.

Pictured at left is a section of the Electronic Parts Department.

3

PRIME AND SUBCONTRACT MANUFACTURE OF ELECTRONIC DEVICES

The Eastern Company is active as a prime and subcontractor in the manufacture of important electronic devices for war industry, research laboratories, and the Armed Forces. Ample capacity in plant, equipment, technical, managerial, and financial resources is available to support additional projects of this type. At right are pictured the buildings housing the shops, offices, and warehouse of the Eastern Company.



THE EASTERN COMPANY,
520 Memorial Drive,
Cambridge, Mass.

Please send a copy of your illustrated brochure presenting in detail the facilities and capacities of your company for the manufacture of electronic apparatus.

Name

Address

City State

WASHINGTON DIST. OF COLUMBIA
CHICAGO ILLINOIS
PROVIDENCE RHODE ISLAND
WORCESTER MASSACHUSETTS

SEND FOR BROCHURE

SERVICE ON RADIO-ELECTRONIC MATERIALS



NEW YORK

THE QUICK WAY New York City Gets ELECTRONIC & RADIO SUPPLIES

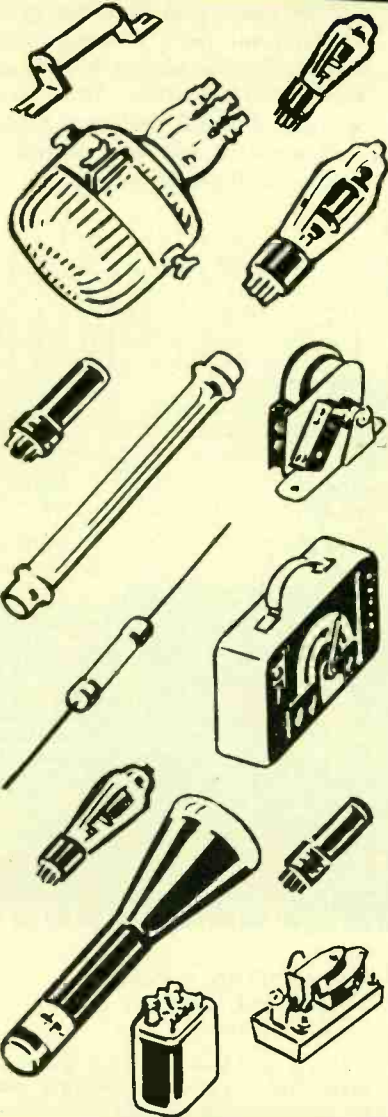

...IS TO ORDER FROM TERMINAL RADIO CORP.!

● Because we have such a long line of supplies . . . and because we are able to fill most orders promptly — we urge you to become acquainted with our headquarters. The best way to prove our value is to let us fill your next order for electronic and radio material.

There's a complete line available, headed by RCA, Ohmite, Thordarson, IRC, National, Hammarlund, Stancor, UTC, Cornell Dubilier, and Aerovox.

Our service is yours. Through years of experience we *know* the Radio-Electronic field. If we happen not to have the product you need, we know who makes it and how it can be obtained.

Of course this service is free, but we offer it gladly because it has helped so many war manufacturers. So—for quick delivery plus our personalized service — try us on your next order! You'll want to repeat!

TUBES AND  EQUIPMENT

TERMINAL RADIO CORP.

85 CORTLANDT ST. NEW YORK 7, N. Y.
'PHONE WORTH 2-4415

FLINT

WANTED YOUR ORDERS FOR ELECTRONIC MATERIALS

✓ These are days when it pays doubly to send your orders for Radio-Electronic materials to a long-time specialist. We know the field. We know what is available. We know where it can be obtained—faster than you may



have thought possible under existing war-time emergency conditions.

RCA Tubes, RCA Test Equipment—or resistors, rheostats, controls, potentiometers, capacitors, relays, transformers, wire—or numerous other products produced by many manufacturers. They're our business. We know how to deliver the goods. Try us on your next order!

SHAND RADIO SPECIALTIES

203 W. Kearsley St.
Flint, Michigan

'Phone 2-9714

TUBES AND  EQUIPMENT

TOPEKA



No Order too Large None too Small

From RCA Tubes and Equipment to all types of well-known Radio-Electronic components — we'll welcome the opportunity to fill your requirements, large or small.

We have normally large stocks *plus* the facilities for obtaining needed equipment, *plus* the all-important "Know How" of its use. Write, wire, or 'phone.

ACME RADIO SUPPLY

634 Quincy St., Topeka, Kansas

TOPEKA, Kansas



'ROUND-THE-CORNER SERVICE FOR BUSY WAR

CHICAGO

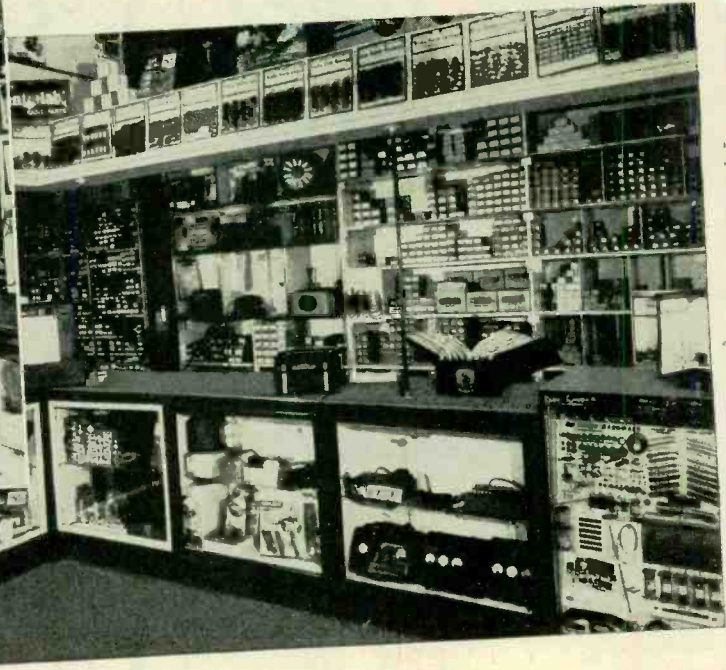

VOLTAGE TRANSFORMER

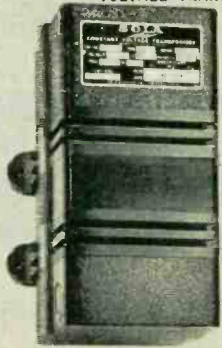

TANDEM TIMER



BIG REFERENCE BOOK *Free!*



Crammed with information on thousands of Radio and Electronic parts and equipment. Free to Purchasing Agents and other officials responsible for buying. Ask for it NOW on company stationery.

TERMINAL BLOCKS



FOOT SWITCH

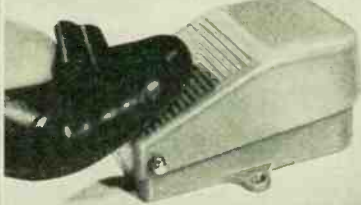

TAP SWITCH

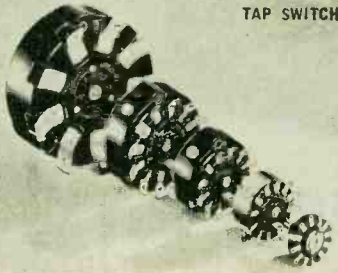

TANDEM SWITCH

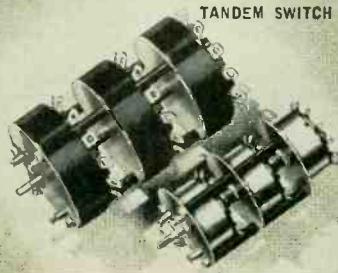

Here are Skilled Technicians and One of the Largest Stocks in the Middle West

SPEED . . . faster deliveries than you ever thought possible under war conditions . . . is the big feature of *W-J Emergency Service!* Three factors are responsible for this unusual speed: 1. A special department has been established for expediting rush priority orders from industrial war plants; 2. One of the largest and most diversified stocks in the middle west is constantly maintained; 3. A highly trained corps of radio and electronic *technicians* . . . men qualified to serve you quickly, efficiently, accurately . . . have been assigned to our Emergency Service Department.

Whether you need 1 item or 100 . . . whether called for, ordered by wire, phone or by mail, the same speedy, expert attention is devoted to your needs.

"START TODAY . . . W-J . . . ALL THE WAY" is a good slogan to act upon! It will save you time and trouble. Only one order to place, one bill to check and pay, one reputable concern to depend upon for speedier deliveries of all your needs.

WALKER-JIMIESON, INC.

311 SOUTH WESTERN AVE., CHICAGO 12, ILL. PHONE: CANAL 2525



INDUSTRIES THROUGHOUT THE COUNTRY



NEW YORK

SAVE TIME!

IN NEW YORK

PHONE

MEDALLION

3-5716

FOR YOUR

RADIO AND

ELECTRONIC

SUPPLIES!

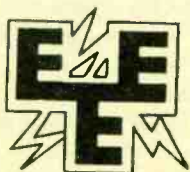

EMERGENCY ELECTRONIC
EXPEDITERS

Engineering Products Division

BRUNO-NEW YORK, INC.

460 West 34th Street, N. Y. C.



Distributors and Manufacturers of
Radio and Electronic Equipment

WASHINGTON

**"Serving our Government
from the Nation's Capitol"**



**RCA SOUND
PRODUCTS**

RCA TUBES

AUDIO DISCS DISTRIBUTORS

In Washington it's American Amplifier!

As specialists in the lines listed above, we are geared to fill war needs accurately and promptly. Try us on your next order—large or small.

Call the Washington representative for personal service on your requirements.

American Amplifier & Television Corp.

1111—19th St., N. W., Washington, D. C. . . Telephone: Republic 7900

MEMPHIS



**MEMPHIS' LARGEST EXCLUSIVE RADIO-
ELECTRONIC PARTS SUPPLY HOUSE**

- ✓ RCA Receiving, Transmitting, and Special-Purpose Tubes
- ✓ Replacement Radio and Electronic supplies and equipment
- ✓ Sound and Inter-communicating equipment
- ✓ RCA Test Equipment

We deliver the goods—rapidly and accurately! Every order receives full benefit of our years of specialized experience in this field.

Large orders or small; 'phone or-

ders or mail—all receive the same care and attention to detail. Whatever your Radio-Electronic requirements, it pays to try Bluff City first!

BLUFF CITY DISTRIBUTING CO.

905 UNION AVE., MEMPHIS 3, TENN.

'Phone 5-5761 and 2

RCA IT PAYS TO BUY ELECTRONIC COMPONENTS

DAYTON

WANTED

YOUR ORDERS FOR ELECTRONIC MATERIALS

These are days when it pays doubly to send your orders for Radio-Electronic materials to a long-time specialist. We know the field. We know what is available. We know where it can be obtained—faster than you may



have thought possible under existing war-time emergency conditions.

RCA Tubes, RCA Test Equipment—or resistors, rheostats, controls, potentiometers, capacitors, relays, transformers, wire—or numerous other products produced by many manufacturers. They're our business. We know how to deliver the goods. Try us on your next order!

KIEFER-STEWART CO.

Georgia & Capitol Aves.
INDIANAPOLIS 9, IND.



SALT LAKE CITY

In the Mountain States It's...



RADIO STUDIOS, Inc.

136 E. Broadway, Salt Lake City 1, Utah

We carry one of the largest stocks in this part of the country—and back it up with personal service and Radio-Electronic knowledge that spells real efficiency for busy war equipment manufacturers and other users.

'Phone 4-7727

TUBES AND  EQUIPMENT



✓ **TECHNICAL KNOWLEDGE**
of things Electronic.

✓ **TRADE KNOWLEDGE** of what electronic materials are available, where they are available, and how they may be obtained as fast as circumstances permit.

✓ **NORMALLY LARGE STOCKS** of RCA Tubes and countless other Radio and Electronic items—for prompt deliveries upon receipt of the necessary priorities.

✓ **AN EFFICIENT ORGANIZATION** that is used to handling small orders—and equally well equipped to handle large ones, too.

Round-the-Corner Supplier to BUSY OHIO WAR INDUSTRIES

If it's Radio-Electronic equipment or components you need, you can get them from Standard—and get them fast!

Supplementing our large stocks, we know what is available and where. From stock room to executive offices, we're geared for the kind of service that busy war industries require.

Whether your order is large or small—give Standard a call!



We feature these lines:

THORDARSON UTAH

MALLORY OHMITE

H & H EVEREADY

CORNELL-DUBILIER

BURGESS BUSSMAN

MUELLER CENTRALAB

GUARDIAN JACKSON

AMPHENOL SYLVANIA

ETC.

Standard Radio and Electronic Products Co.

135 East 2nd St., Dayton, Ohio

Telephone: FU-2174

TUBES AND  EQUIPMENT

AND EQUIPMENT FROM SPECIALISTS



RICHMOND

An Address FOR ALL VIRGINIA TO CONTACT

FOR ELECTRONIC SPECIALS

WYATT-CORNICK
INCORPORATED
RICHMOND,
VIRGINIA



TUBES AND
EQUIPMENT

Need RCA tubes, RCA Victor and Radiola Parts, RCA Commercial Sound and RCA Test Equipment? We have them! And we know that today you need them in double-quick time! So we're geared to fill your order promptly! - to follow through just as soon as we receive your request and priority rating!

And here's an extra service we give you: if you're in doubt as to what item to use for a specific job . . . we'll tell you what to use and even where to get it, if it isn't in our stock! Thus you're assured quick delivery, even if we don't have it available at the moment.

Try our service on your next order!

WYATT-CORNICK, INC. RICHMOND, VIRGINIA
GRACE AT 14th STREET • PHONE 3-1945

WANTED

YOUR ORDERS FOR ELECTRONIC MATERIALS

These are days when it pays doubly to send your orders for Radio-Electronic materials to a long-time specialist. We know the field. We know what is available. We know where it can be obtained—faster than you may



have thought possible under existing war-time emergency conditions.

RCA Tubes, RCA Test Equipment—or resistors, rheostats, controls, potentiometers, capacitors, relays, transformers, wire—or numerous other products produced by many manufacturers. They're our business. We know how to deliver the goods. Try us on your next order!

RADIO ELECTRONIC SUPPLY CO.,
1112 West Warren, Detroit, Mich.
TE 2-5611

TUBES AND EQUIPMENT

CHICAGO — ATLANTA

DELAYS Are Not NECESSARY!



Distributors for RCA tubes and test equipment, as well as capacitors, resistors, rheostats, controls, potentiometers, coils, transformers, wire, relays, and numerous other components produced by many manufacturers.

Get Radio and Electronic Parts — Quickly!

Electronic engineers and research technicians need not delay completion of vital projects for lack of parts or equipment. Lafayette Radio Corp. is headquarters for RCA and every other nationally known manufacturer in the field.

The reputation of Lafayette Radio Corp. for complete stocks and prompt deliveries is well known to thousands of electronic engineers. We can fill your needs quickly!

25 years of radio reliability!

LAFAYETTE RADIO CORP.

910 WEST JACKSON BLVD. CHICAGO 7, ILLINOIS
265 PEACHTREE STREET ATLANTA 3, GEORGIA

SIoux FALLS

We're Ready SOUTH DAKOTA



... Just Send in Your Orders to **Power City Radio Co.**

From stock on hand we are able to fill many orders for sound equipment, office communication equipment, radio repair parts and supplies, hearing aid and Electronic Service.

Just shoot in the orders — along with suitable priorities — and we'll rush the delivery. Our service is fast!

And if the material you want isn't in stock, we're equipped to get it for you in double-quick time. Try us on your next order — small or large — and be convinced!

POWER CITY RADIO CO.

224 So. Main Ave.
SIoux FALLS, SO. DAKOTA

Telephone 1525

TUBES AND EQUIPMENT



HERE IS 'ROUND-THE-CORNER SERVICE FROM

SEATTLE—PORTLAND—SPOKANE

Oldest and Largest *Electronics Distributor*

serving the

PACIFIC NORTHWEST AND ALASKA

ALL LEADING LINES

FAST DELIVERIES

Technically Informed Service

HARPER-MEGGEE, Inc.

Est. 1918

SEATTLE • PORTLAND • SPOKANE



TUBES and EQUIPMENT

TECHNICALLY INFORMED DISTRIBUTORS



PITTSBURGH

IN PITTSBURGH IT'S CAMERADIO



FEATURING THESE LINES

- TECHNICAL "KNOW HOW"
- TRADE KNOWLEDGE of what is available, and where
- LARGE STOCKS
- AN EFFICIENT ORGANIZATION



TUBES AND EQUIPMENT

- | | |
|------------------|----------------|
| AMPHENOL | MAC-KEY |
| ASTATIC | MALLORY-YAXLEY |
| AUDIO DEVICES | MEISSNER |
| B & W COILS | MILLEN |
| BELDEN | MUELLER |
| BLILEY | NATIONAL |
| BOGEN | OHMITE |
| BUD | PAR-METAL |
| BURGESS | PREMAX |
| CARDWELL | PYREX |
| CENTRALAB | RADIART |
| CORNELL-DUBILIER | RADIO CITY |
| CROWE | RAYTHEON |
| DU MONT | RCA |
| DUNCO | READRITE |
| EBY | RIDER |
| EIMAC | R. M. E. |
| FREED | SHURE |
| GAMMATRON | SIGNAL |
| GARRARD | STANCOR |
| GREEN FLYER | SUPREME |
| GUARDIAN | TAYLOR |
| HALLICRAFTER | THORDARSON |
| HAMMARLUND | TRIPLETT |
| HICKOK | UNIVERSAL |
| HYTRON | UNIVERSITY |
| I. R. C. | UTAH |
| JENSEN | U. T. C. |
| JOHNSON | VIBROPLEX |
| KATO | WARD LEONARD |
| KRAEUTER | WESTINGHOUSE |
| LENZ | WESTON |
| LITTLEFUSE | WORNER |

Founded in 1919, Cameradio has been dealing with things Electronic since the "knee pants" days of Radio itself.

Our stocks are large—our lines cover practically any industrial Electronic requirement—and we're geared for the prompt, accurate, technically-informed service that busy war equipment manufacturers, laboratories, and governmental agencies demand.

Next time you need any of the equipment or components produced by manufacturers on the accompanying list—TRY CAMERADIO FIRST.

We deliver the goods!

CAMERADIO

963 LIBERTY AVE.
PITTSBURGH - PA.



CHECK WITH YOUR RCA DISTRIBUTOR FIRST

RADIO AND ELECTRONIC COMPONENTS

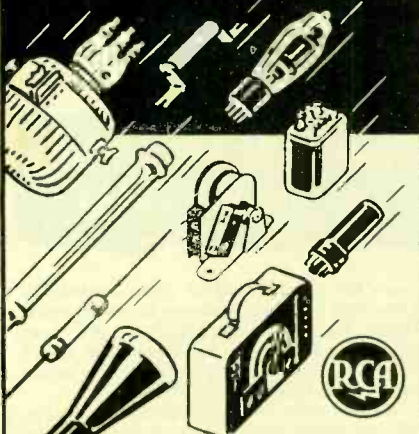

DISTRIBUTORS
RADIO ENGINEERS

M-N DUFFY CO.

DETROIT (26), MICH.
TEL. CHerry 2270

BALTIMORE

WANTED

YOUR ORDERS FOR
ELECTRONIC MATERIALS

✓ These are days when it pays doubly to send your orders for Radio-Electronic materials to a long-time specialist. We know the field. We know what is available. We know where it can be obtained—faster than you may



have thought possible under existing war-time emergency conditions.
RCA Tubes, RCA Test Equipment—or resistors, rheostats, controls, potentiometers, capacitors, relays, transformers, wire—or numerous other products produced by many manufacturers. They're our business. We know how to deliver the goods. Try us on your next order!

RADIO ELECTRIC SERVICE COMPANY

3 N. Howard Street
BALTIMORE, MD.

LEXINGTON

3835-f



TUBES AND

EQUIPMENT

DELIVERING the GOODS

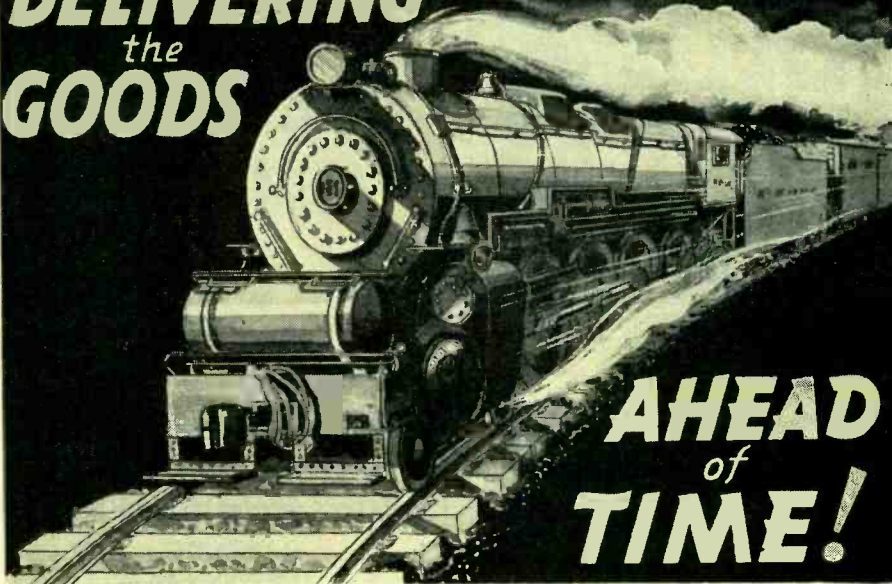

AHEAD of TIME!

That, in addition to buying *more* war bonds, should be the prime wartime aim of every true American. MORE PRODUCTION — AHEAD OF TIME — will see this war through to a glorious Allied victory. At Sun Radio, we are devoting every minute of every day to seeing that deliveries of precious radio — electronic materials are expedited to American Industry with the utmost possible speed.

SUN RADIO OFFERS
**RADIO PARTS, TUBES and
ELECTRONIC EQUIPMENT
FROM STOCK!**

★
*A Complete
Source of Supply*

- for
- INDUSTRIAL MANUFACTURERS
- RESEARCH LABORATORIES
- AIRCRAFT PLANTS
- OIL REFINERIES
- PUBLIC UTILITIES
- TELEPHONE — TELEGRAPH COMPANIES
- BROADCAST STATIONS
- SHIPYARDS
- SCHOOLS • COLLEGES
- POLICE and FIRE DEPARTMENTS
- U. S. ARMY SIGNAL CORPS
- U. S. NAVY
- and many other Government Agencies

★
The process of getting vitally-needed materials to our fighting fronts in a hurry may often appear complex—but getting vital materials for research laboratories and industrial plants is a comparatively simple task if one contacts SUN RADIO. We can save you time, effort and needless expense since we generally can make prompt shipment from our enormous stock, or obtain it in the shortest possible time with required priorities. Radio — electronics has been our business since 1922. Why not let us help, next time?

SEND FOR THIS
FREE BOOK!

If you are actively engaged in the war effort doing purchasing, expediting or specifying radio-electronic parts, our massive 800 page buying guide will be of great assistance in your work. Lists countless thousands of nationally known items — condensers, resistors, transformers, tubes, meters, test equipment, plugs, jacks, switches, relays, connectors, chassis, wire, solder, etc. Write for it today on your company stationery.
Address
Dept. E-9.



800
Page
Buying
Guide

New York's Oldest Radio-Electronic Supply House

SUN RADIO CO.

212 FULTON STREET • NEW YORK 7, N. Y.
Telephone
BArclay 7-1840

TUBES AND



EQUIPMENT

FOR ELECTRONIC EQUIPMENT REQUIREMENTS



RADIO AND ELECTRONIC COMPONENTS

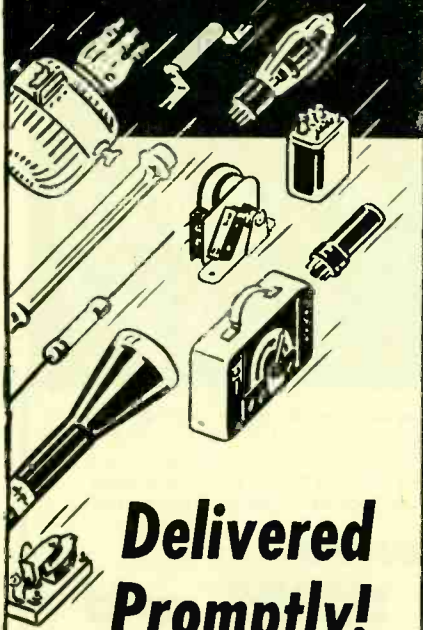

Delivered Promptly!

Tubes, Test Equipment, Capacitors, Relays, Coils, Transformers, Resistors, or What Have You?

Let us stack our "Know How" of the Radio and Electronic industries against your next order for materials. Let us show you what we mean by our slogan "WE DELIVER THE GOODS"—faster, more efficiently than you may have thought possible under present-day emergency conditions!

There's no dark secret about it. It's simply that we've been dealing with Things Electronic for a long time. We know who makes it and where. We know where it can be obtained, and how fast. This PLUS service costs you nothing extra—and it has already proved its value to countless plants which, like your own, are literally "snowed under" with war work.

E. C. WENGER CO.

1450 Harrison St.,

OAKLAND 12, California

Telephone: Glencourt 1020

TUBE AND EQUIPMENT HEADQUARTERS



We are distributors for RCA Tubes and Test Equipment for any Radio or Electronic need, as well as for condensers, resistors, rheostats, controls, potentiometers, coils, relays, transformers, solenoids, wire, and numerous other components produced by many manufacturers.

RADIO AND ELECTRONIC MATERIAL

TUBES
TEST EQUIPMENT
CAPACITORS
RELAYS COILS
TRANSFORMERS AND
RESISTORS
INTERCOMMUNICATING
SYSTEMS
LOUD SPEAKERS



PARTS AND TUBES
OF EVERY DESCRIPTION

TECHNICALLY
INFORMED SERVICE

20 Years of experience
at your command

LARGE STOCKS

Prompt Deliveries!

Write, wire or 'phone for complete information relative to high priority electronic equipment needed in a hurry. Large stocks enable us to dispatch orders promptly. If out of stock, we usually know where materials in this category are available without loss of time and, therefore, can be of real assistance. Vast experience with Governmental orders insures satisfactory service on all orders regardless of size.

DISTRIBUTORS FOR
LEADING MANUFACTURERS

Telephone: Chestnut 2325

INTERSTATE SUPPLY COMPANY

10th AND WALNUT STREETS
SAINT LOUIS, MO.

SERVING THE RADIO TRADE SINCE 1928



NOW NEW YORK FINDS US AT OUR PEAK!

Yes — for 15 years we've done a whale of a business and helped many manufacturers! Today we're well equipped to fill your orders for Electronic equipment and Radio Parts — as soon as you send us the order, along with necessary priorities!

We not only carry a large stock, but can tell you where to get items if they are temporarily low on our list. Chances are, though, we have what you want. Try us on your next order!



TUBES
AND
EQUIPMENT

DYMAC, INC.

27 BARKER ST.

BUFFALO 9, NEW YORK

Phone GA 0252

LITTLE ROCK

ARKANSAS

We Deliver The Goods



Promptly!

In Arkansas, Holcomb Gunn Co. is well equipped to fill your orders for RCA tubes . . . RCA Parts . . . Victor and Blue-Bird Records . . . on short notice!

Our line of these products is ordinarily full. And, if we happen to be out of the items you need, we can tell you *where* and *how* they can be obtained. We go in for this consulting service in a big way, and it will save you time to call us directly! Send us your orders today and we'll give them quick attention!

HOLCOMB GUNN CO.

310-12-14 East Third Street

Little Rock, Arkansas

Telephone 7221

TUBES AND  EQUIPMENT



THESE EMERGENCY ELECTRONIC EXPEDITERS

CHICAGO

RADIO AND ELECTRONIC COMPONENTS



Delivered Promptly!

Tubes, Test Equipment, Capacitors, Relays, Coils, Transformers, Resistors, 500 v. Mica Condensers.

"WE DELIVER THE GOODS" - faster, more efficiently than you may have thought possible under present-day emergency conditions!

We know who makes it and where. We know where it can be obtained, and how fast. This PLUS service costs you nothing extra - and it has already proved its value to countless plants which, like your own, are literally "snowed under" with emergency war work.

NEWARK ELECTRIC COMPANY

323 West Madison Street
CHICAGO, ILLINOIS

Phone Dearborn 0083

TUBE AND EQUIPMENT HEADQUARTERS



We are distributors for RCA Tubes and Test Equipment for any Radio or Electronic need, as well as for condensers, resistors, rheostats, controls, potentiometers, coils, relays, transformers, solenoids, wire, and numerous other components produced by many manufacturers.

NEW YORK

GEARED FOR SERVICE TO BUSY WAR INDUSTRIES



GET YOUR RADIO AND ELECTRONIC SUPPLIES ON TIME!

Here is your "Open Sesame!" to rapid, intelligent expediting on your orders for almost any type of Radio or Radio-Electronic material. Chances are good that we can ship your order from stock upon receipt of proper priorities. If not, we know *where* the materials can be obtained, *how* they can be obtained, and how they can be shipped to you far more promptly than you may have thought possible under existing war-time emergency conditions. "Electronics" is nothing new to us. Try our service on your next order—small or large!



Remember: The "Magic Brain" of any Electronic Device is a vacuum tube and the fountainhead of modern tube development is RCA. We are headquarters for RCA Tubes for all applications; also RCA Test Equipment, as well as resistors, rheostats, relays, capacitors, transformers, wire, coils, and the products of many different manufacturers.

'Phone: WOrth 2-6276

HARRISON

RADIO CORPORATION
12 WEST BROADWAY • NEW YORK 7

HOUSTON

TUBES AND EQUIPMENT



Headquarters for Accurate, Informed Service on RADIO-ELECTRONIC MATERIAL

Making war equipment that necessitates frequent calls for Radio-Electronic tubes and other Electronic components? Then get acquainted with our service - today!

Chances are, we've got what you need in stock - for immediate delivery upon receipt of suitable priorities. If not, we're well equipped to get it for you faster than you may have thought possible under war conditions - and to render intelligent, personalized expediting service all along the line. Try us on your next order and be convinced!

R. C. & L. F. HALL

1015 CAROLINE STREET,

P. O. Box 2434

HOUSTON, TEXAS

'Phone: Capitol 0721

- RCA Tubes
- RCA Test Equipment
- Capacitors
- Resistors
- Controls (Potentiometers)
- Relays (Solenoids)
- and countless other components, produced by many manufacturers

CAN GIVE YOU FAST, INTELLIGENT SERVICE



LOS ANGELES — SAN FRANCISCO

GEARED FOR SERVICE TO
BUSY WAR INDUSTRIES



GET YOUR RADIO AND ELECTRONIC
SUPPLIES **ON TIME!**

Here is your "Open Sesame!" to rapid, intelligent expediting on your orders for almost any type of Radio or Radio-Electronic material. Chances are good that we can ship your order from stock upon receipt of proper priorities. If not, we know where the materials can be obtained, how they can be obtained, and how they can be shipped to you far more promptly than you may have thought possible under existing war-time emergency conditions. "Electronics" is nothing new to us. Try our service on your next order—small or large!



Remember: The "Magic Brain" of any Electronic Device is a vacuum tube and the fountainhead of modern tube development is RCA. We are headquarters for RCA Tubes for all applications; also RCA Test Equipment, as well as resistors, rheostats, relays, capacitors, transformers, wire, coils, and the products of many different manufacturers.

LEO. J. MEYBERG CO., Inc.

2027 S. Figueroa St.,
Los Angeles, Cal.

70 Tenth St.,
San Francisco, Cal.

ANN ARBOR — BATTLE CREEK

TUBES AND  EQUIPMENT



RCA Tubes
Relays
Resistors
Coils

Rheostats
Transformers
Meters
Switches

Potentiometers
Wire & Cable
Photo Cells
Sockets

**WEDEMEYER
ELECTRONIC SUPPLY CO.**

OF

MICHIGAN

ANN ARBOR

BATTLE CREEK

ATLANTA-SAVANNAH



for
**FAST Delivery
OF
ELECTRONIC
SUPPLIES
IN
GEORGIA**

**TRY SPECIALTY
FIRST!**

We're geared, ready and waiting to fill your orders—orders from busy war industries needing materials from the RCA line, also Solar, Stancor, Thordarson, P. R. Mallory Co., and others.

Most likely we have what you need right in stock, because our line is very complete. If not, we're able to service at any time. This EXTRA service has helped manufacturers in many instances. We know you will find it helpful. Send us your next order!

**SPECIALTY
DISTRIBUTING CO., Inc.**

425 Peachtree Street, N.E.
ATLANTA 3, GA.

223 E. Broughton St.
SAVANNAH, GA.

TUBES AND  EQUIPMENT



CHECK WITH YOUR RCA DISTRIBUTOR FIRST

NEW YORK

IF IT'S TUBES YOU NEED *Chances are We Have Them!*

Yes!

Right from stock on hand we may be able to make delivery of the Radio Tubes you need — Power Tubes, Special Purpose and Receiving Types.

For years we have kept our supplies well stocked — and today, while they have necessarily been reduced due to war demands, we have many of the critical types on hand or can possibly get them for you, **QUICKER!** Just send us your order — with the necessary priority — and we'll take fast action to see that it gets filled promptly!



TUBE AND
EQUIPMENT
DISTRIBUTOR

SANFORD ELECTRONICS CORPORATION

(Formerly Sanford Samuel Corporation)

136 LIBERTY STREET, NEW YORK 6, N. Y.

TELEPHONE: BARCLAY 7-2242

FOR ELECTRONIC EQUIPMENT REQUIREMENTS



Sometimes you can
Get Ahead **FASTER** going
BACKWARD



If you haven't seen the pages immediately in front of this page we suggest you read this magazine backward!

Here's the reason . . . The pages preceding this one list many of the RCA Tube and Equipment Distributors who are anxious to use their specialized knowledge of things electronic to give you real service on the items they have in their stock or can expedite for you while you're busy with other problems.

If you're not already acquainted with the RCA Tube and Equipment Distributor in your city, we suggest you look him up—and put him to work on the material you need in a hurry! That's right. He is in business to serve you, and to help expedite material needed to win this war!



RADIO CORPORATION OF AMERICA

RCA Victor Division

Camden, N. J.

Aviation—A Progress Report

The Lessons of War Become the Key to a Richer Peace

TUNISIA, PANTELLERIA, SICILY — stepping stones to momentous events! But that is not all. For they spell out across the blue waters of the Mediterranean a pattern of invasion that has progressed far since last summer's first major Commando operation against the French coast.

From Dieppe, you remember, too many of the raiders never got back. But in Tunisia, and on through Sicily, the Allied might plowed inexorably forward, winning objective after objective at a surprisingly low cost in casualties. Air supremacy over the battlefield? Yes. But we have learned, too, how to save lives and shorten the war by strategic air bombardment as a prelude to invasion.

Thus the bombardment plane—rarely seen by the doughboys on the fighting fronts—is destined to save their lives by hundreds of thousands in the decisive attacks that are to come. This fact is confirmed by the cold calculations of the responsible strategists. It will give renewed courage and confidence to every member of the armed forces and of the home fronts throughout the United Nations.

For instance: thorough strategic bombardment of an objective reduces by nearly fifty per cent the surface forces required for invasion. Anticipated losses are reduced from more than fifty per cent of the original ground force to about twenty per cent. Precision bombardment—as used on railroad objectives in Rome—reduces this percentage of loss still further when it is followed by offensive action on the ground.

The inference is clear. Effective prosecution of the war will require smaller ground combat forces and much larger air forces than some of our strategists once thought.

Our most urgent need, then, is for ever-mounting fleets of aircraft. And, fortunately, this is just what we are getting. The American aircraft industry now is producing as many airplanes as all the rest of the world combined. In 1938 we made 100 planes a month. Now we make three times that many in a single working day. By the end of 1943, our production rate will be about 10,000 a month.

But at this stage of the war, types of planes are more important than mere numbers. In the early months the program was heavy, and properly so, with single-engine trainers. Then, as training planes accumulated, the emphasis shifted to heavier types. Now we are turning out multi-engined bombers at a rate that is the envy of

the entire world. Some months ago the President revealed that we were manufacturing 500 long-range bombers every month. The figure was conservative even then. And soon we shall be producing planes of this one type at a rate adequate to replace the normal losses of a fleet of at least 1000 American heavy bombers operating as continuously as the weather will permit.

A glimpse of the poundage production may help us still further to evaluate the miraculous achievements of the aviation industry as a whole. It was 89,000,000 in 1941 . . . 291,000,000 in 1942 . . . 911,000,000 in 1943 . . . and 1,417,000,000 in 1944

This is the fifteenth of a series of editorials appearing monthly in all McGraw-Hill publications, reaching more than one and one-half million readers. They are dedicated to the purpose of telling the part that each industry is playing in the war effort and of informing the public on the magnificent war-production accomplishments of America's industries.

— if we need it. There you have the magnificent record of the American aircraft manufacturing industry — a monument to the cooperation of industry, labor, government, and to all-out teamwork between the aviation industry and those other industries which have converted their facilities to the manufacture of airplanes.

What of our enemies and our Allies?

German production probably has flattened out at 2500 a month — with downward revision in immediate prospect. Japan may be able to produce as many as 1000 planes a month — until we get our new long-range super-bombers in sufficient numbers to whittle down that figure. Italy may be able to turn out her 500 a month — for a little longer. At best the maximum Axis monthly total is 4000.

Add to our monthly score of nearly 8000, a total of approximately 4000 for Britain, Canada and Russia, and the United Nations score comes to 12,000 monthly. There we have a three to one advantage for our side. And between our own rising production and the brilliant operations of our bomber commands we should soon boost the ratio well above that figure. Therein lies the certainty of continued and growing air superiority over all the far-flung battlefields.

The critics of American airplane quality have been silenced ever since the ratio of enemy combat losses to our own on bombardment missions surpassed four to one. In the Pacific where our heavily armed and armored planes are knocking off the desperately stripped racing craft of the Nipponese, enemy losses often run as high as eight to one or more. In the Mediterranean theater, where the Italians were abandoned by their Allies, the story is much the same. Only in the well-defended homeland of the Nazis do we sometimes drop below the average, but even in those rare instances the ratio is still well in our favor and the effectiveness of our bombardment is adding constantly to our margin.

* * *

Behind the production lines the battle of research and design still rages. In many a laboratory night-shift, on many a secret test field, new and terrible surprises for the enemy are in the making. Super-bombers, destined for Tokyo, have long since passed

out of the design stage and the Japanese may learn about them almost any day. New discoveries, designed to sow swift and silent devastation, are farther along than our enemies believe. No longer will fog or storm or night be permitted to fight on the side of our foes.

The men of science who are toiling to broaden the horizon of our knowledge stand today on the threshold of discoveries that have been sought for centuries. New reservoirs of power may soon exert a profound influence in many fields of technology and through them on our way of life.

Once the war is won these new discoveries will be translated into better living. No longer will countless thousands spend their lives within their own communities or countries. New efficiencies in transportation will bring world travel within the reach of many who once had to stay at home. New family vehicles will navigate the skyways as easily and safely as the highways. Already more than a dozen manufacturers of airplanes, ships, automobiles, and electrical equipment are designing, building, or flying rotary-winged aircraft such as the helicopter or autogyro to meet the needs of tomorrow's families. New and safer aircraft of the fixed-wing type are ready for production as soon as materials become available.

The quality that now makes each of our war planes worth so many of those built by our enemies will be translated into the sturdy reliability demanded by peacetime operation. The devices that seek out and find our enemies behind the veil of fog or darkness will, after the war, reduce weather hazards to the point where they will be no greater in the air than on the ground.

Science and industry will continue to do their jobs and do them well. But if the world is to be made a better place for men to live in, statesmanship must not fail to do its part.

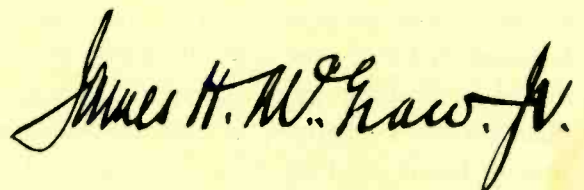

President, McGraw-Hill Publishing Company, Inc.

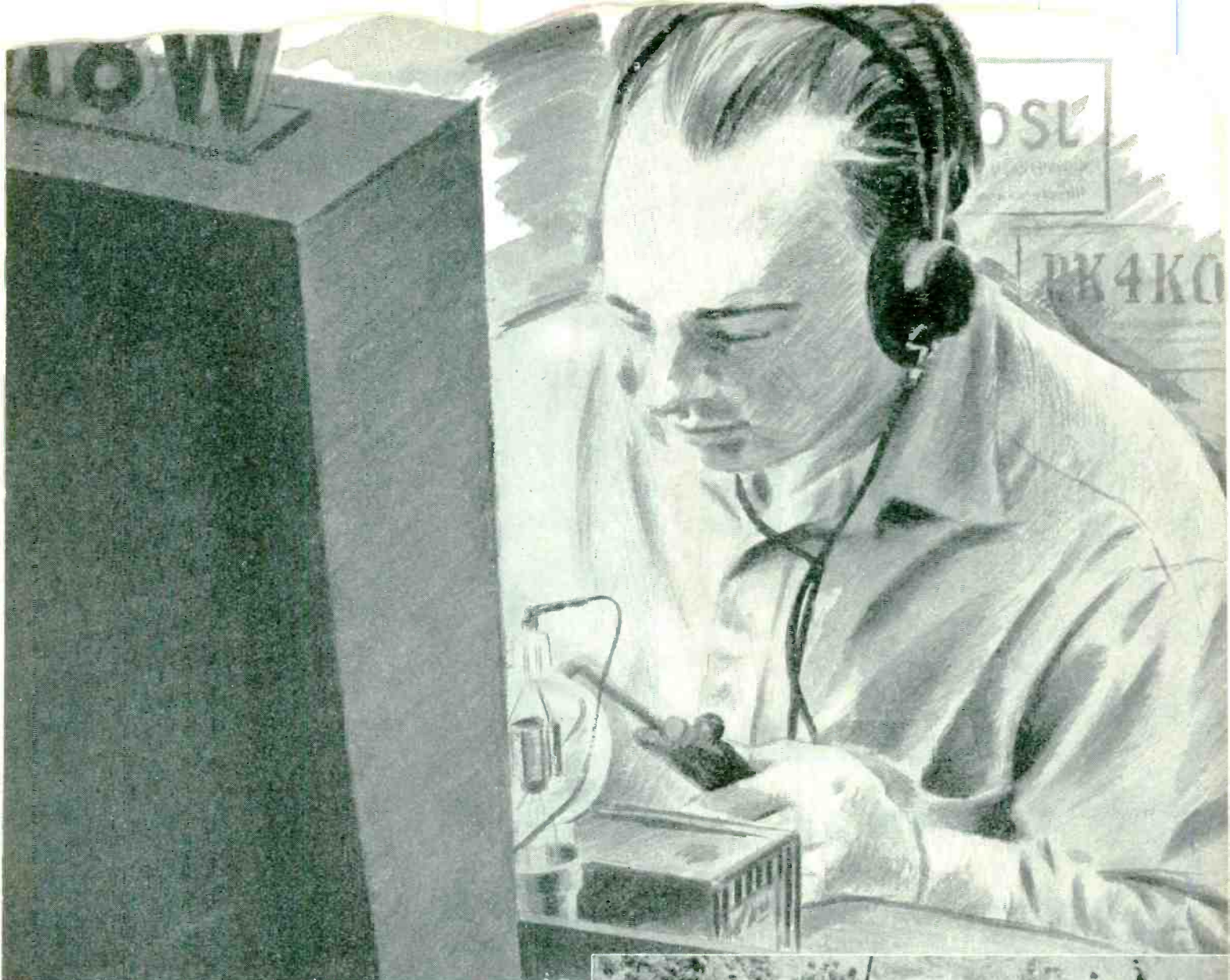

the amateur is still in radio

He's not at his haywire rig in the attic...he's holding down key engineering spots in the laboratories, the factories, the army, navy and marine corps. Today the radio amateur is the top electronic engineer who is doing the impossible for his country and for the world. And why not?...the radio amateur has always done the impossible. He's the one who refused to obey the rules...demanded more and ever more from his "ham" rig. The equipment that he used...especially the tubes...had to have greater stamina and vastly superior performance capabilities. Thus the radio amateur literally forced electronics forward. For the products created to stand up under his gruelling treatment represented real advancement. Eimac tubes are a good example, for Eimac tubes were created and developed in the great amateur testing grounds. That's one reason why Eimac tubes have proved so vastly superior for commercial and war uses. Yesterday the leading radio amateurs throughout the world preferred Eimac tubes. Today these radio amateurs are off the air as amateurs but wherever they are, as the leaders in electronics, they're still using Eimac tubes.



Follow the leaders to

Eimac
REG. U. S. PAT. OFF.
TUBES



EITEL-McCULLOUGH, INC. • SAN BRUNO, CALIFORNIA
Export Agents: *Frazar & Hansen, 301 Clay St., San Francisco, Calif., U. S. A.*



SIX YEARS OLD

— but still
the whopper
of them all!

HERE you see the first commercial 250 KW power amplifier tube being put through its paces in 1937. It was the world's biggest sealed off vacuum tube then—and it still is today.

While its giant proportions and power are striking, the really significant thing is not the tube itself—but *what's back of it!* And that is the unique "know how" of Bell Telephone Laboratories and Western Electric, which made possible this tube—and which has brought forth so many other developments that have speeded the growth of electronics.

Today Bell Labs and Western Electric are adding steadily to their specialized knowledge—are applying all they know to devices to help win this war. In the years of peace to come this pair of pioneers will continue their leadership.

★Buy War Bonds regularly—all you can—from now till Victory!

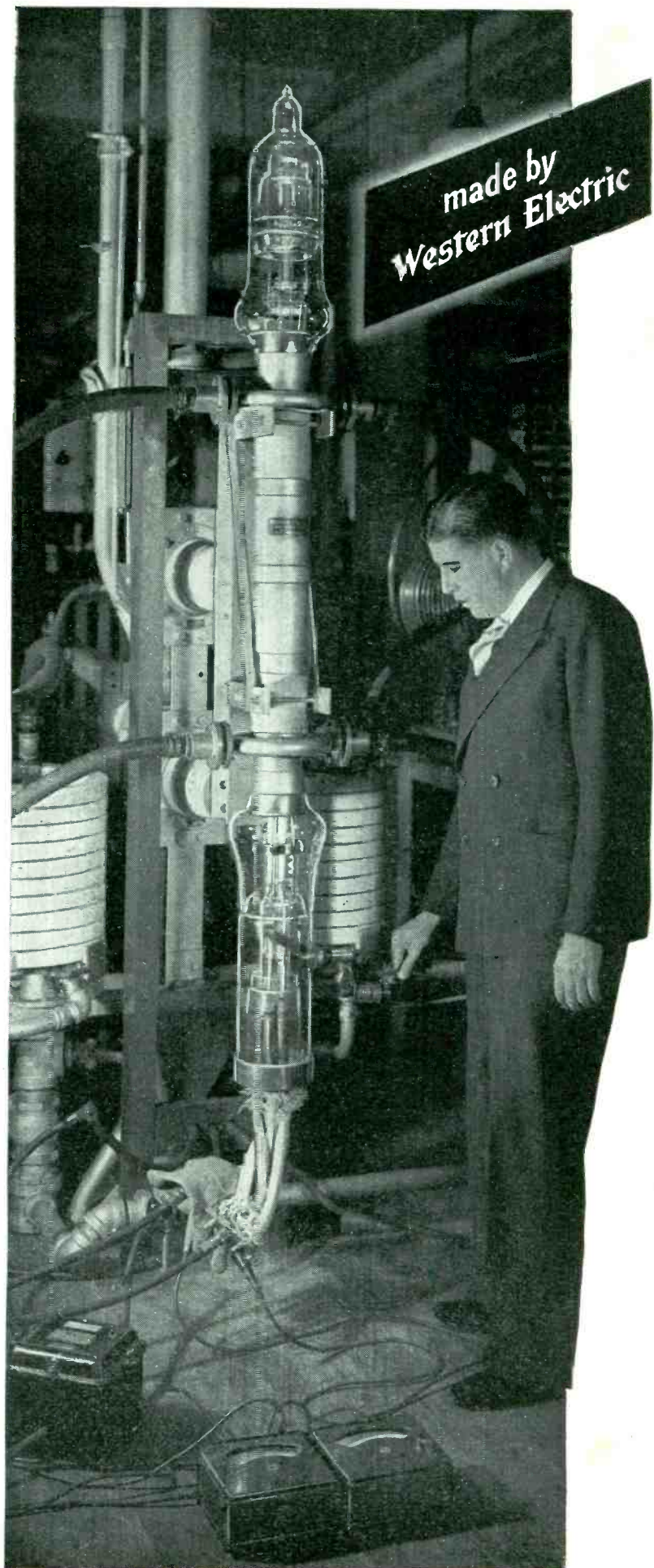

WASHINGTON FEEDBACK

Of vital importance to the electronic industry is the list of "critical" occupations about to be issued by the War Manpower Commission. This list has long been in the making and is primarily designed to protect industry's dwindling supply of highly skilled technicians.

Experience has amply demonstrated that while the declaration of certain industries as "essential" lessened pirating and labor-shifting from plant to plant, it did not afford enough protection by way of deferment from military service. The War Production Board's radio officials have long felt that the drain of the military services on the reservoir of young engineers, technicians and researchers had created a particularly difficult problem for the greatly expanded and comparatively young electronic industry.

The critical list will certainly include skilled employees now engaged in manufacture of radio and radar equipment.

WPB REORGANIZATION — The Radio and Radar Division of WPB, which was reorganized last winter, is undergoing a few more changes.

Frederick S. Boland, formerly chief of the Scheduling and Distribution Section, has become chief of the Program branch. Gerald E. Miller, former chief of the Program branch, left WPB several months ago.

Arthur Wilson has been given the top job in the Distribution and Scheduling branch. Working under him are Robert Lovelace, in charge of the Distribution Section, and Oscar McDaniels, in charge of the Scheduling Section.

The Domestic and Foreign branch is unchanged under Frank M. McIntosh, except for the fact that Peter J. Faber, assistant manager and buyer for the radio department of

Montgomery Ward, has come in as an advisor.

WPB also plans to bring in as labor consultant a representative of the unions.

DIAMOND DIES—The bottleneck in the production of critical small-sized diamond dies has been broken, according to Charles E. Wilson, executive vice chairman of WPB.

Indispensable in the radio equipment program, Mr. Wilson explained, is wire so fine that it is invisible to the eye (one pound will span 100 miles). Such wire must be drawn through precisely-drilled diamond dies. Our small pre-war requirements had been filled through imports from France and the Low Countries, where die craftsmen had been trained for generations.

At the beginning of this year, it was estimated that the U. S. would need between 25,000 and 30,000 small-sized diamond dies, which seemed a hopeless goal. A half-dozen craftsmen were located and set to work in this country. Then, as a result of experiments conducted in Britain and later in the U. S., we perfected a machine that drilled from 8 to 10 dies at one time. Methods of greatly lengthening the life of each die have since been developed.

It now seems assured that quotas will be met this year.

ENEMY PATENTS—Large firms are availing themselves of enemy patents held by the Alien Property Custodian. This is evidenced by a recent application of a single company for 3700 patents. The fee for obtaining a license is now \$15 for each patent, instead of \$50 for a single patent plus \$5 for each related patent included in the same license. (See this month's *Electron Art* for data on electronic patents.)

SALVAGE—Producers or suppliers to consumers of electronic equipment, if unable to dispose of used, defective, exhausted or condemned parts for salvage, were advised by the WPB to destroy the useless parts within 60 days, thus assuring that the parts will not find their way back into trade channels. Action was taken through an amendment to Order L-265, effective July 23.

CMP-5 REVISED—WPB has revised CMP-5, governing maintenance and repair, to include radio communications companies under the highest priority rating. AA-1 places such companies on a par with the armed forces. The action was taken because international carriers are handling an increasingly heavy load of wartime military traffic. Radio communications companies formerly had AA-2 rating.

RESISTORS—Elmer Crane, chief of the Components Division of WPB's Radio Division, urges manufacturers to continue the use of the lowest grade of resistors and capacitors that satisfactorily meet circuit performance requirements. There has been a great deal of discussion on what grade of resistor should be used in spare part kits.

MINIATURE TUBES — Dr. L. Grant Hector has been appointed production consultant on miniature tubes for the Radio Division of the WPB. He will seek to increase production and improve quality of these receiving tubes through coordinated efforts of manufacturers. Dr. Hector is chief engineer of the National Union Radio Corporation.

PATENTS—At a recent meeting in Washington, the American Patent Law Association, through its Board of Managers, endorsed the principles of the report of the National Patent Planning Commission, transmitted to Congress by the President on June 18, 1943, but reserved consideration of the individual recommendations until legislative bills are framed.—G.T.M.

The Thirty-First Time Was Also the First!

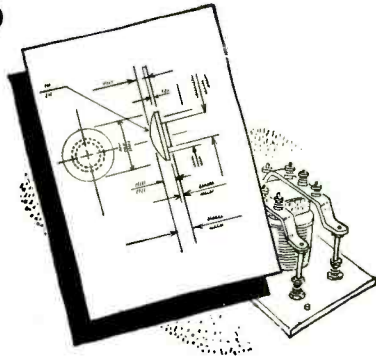

Not all contact problems yield the answer on the first try. In this case, thirty different combinations of materials were tested; the thirty-first experiment brought the desired solution. And—it was the first time the problem had been licked.

War demands have uncovered marvelous design ingenuity on the part of manufacturers. But new designs breed new material problems and this case was no exception. Indeed, it was plenty tough.

The part was a regulating relay for automotive equipment. The electrical contact specification was the knotty question. In test operation, alloys used produced excessive material transfer, indicating eventual contact failure. But Mallory engineers delved into experience and "know how" to come up, on the thirty-first try, with a Mallory Elkonium that measured up to the job.

Without that experience to draw on, tests might easily have run to a hundred and thirty-one tries!

Mallory aids many a manufacturer to get maximum life from contacts and complete contact assemblies. Specifically, Mallory services, in this connection, can:

1. Suggest contact alloy for any application.
2. Suggest backing materials and methods of assembly.
3. Suggest most suitable operating conditions for the contacts.

Mallory will be glad to cooperate with you.

P. R. MALLORY & CO., Inc., INDIANAPOLIS, INDIANA

Cable Address — PELMALLO



P. R. MALLORY & CO. Inc.
MALLORY

**ELECTRICAL CONTACTS AND CONTACT ASSEMBLIES . . . NON FERROUS ALLOYS
POWDERED METAL ALLOYS**

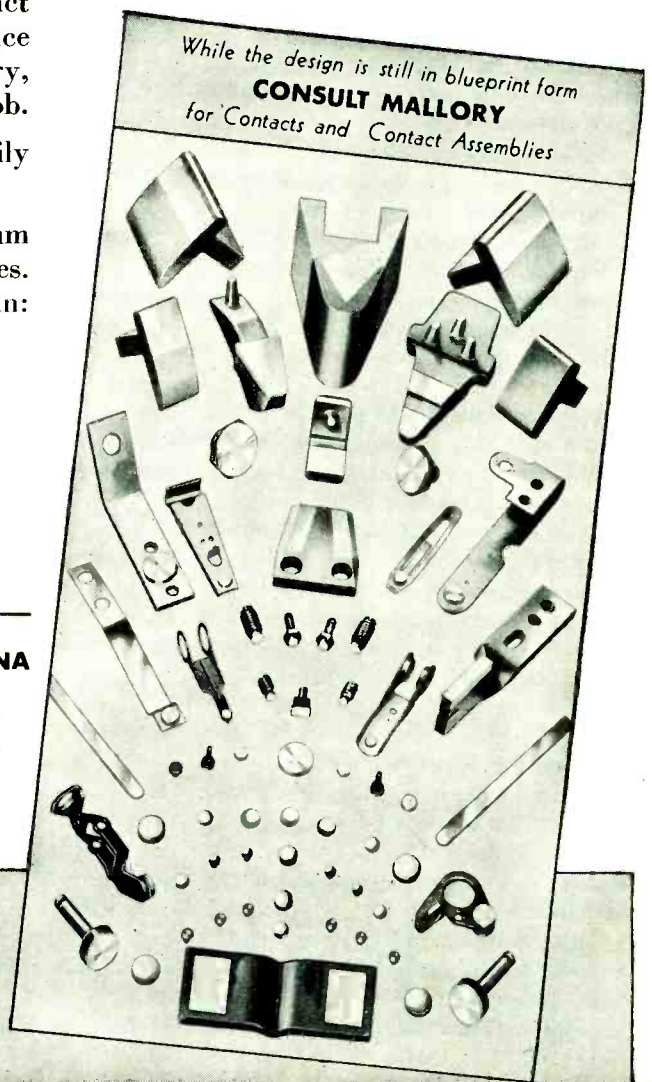

While the design is still in blueprint form
CONSULT MALLORY
for Contacts and Contact Assemblies



CROSS TALK

► **COST** . . . In all the present whoopla about electronics being the great new industry after the war, no one says much about the cost of the new things. You can't sell electronics on glamor; and in spite of the fact that there seems to be very little that cannot be accomplished by electron tubes, there is a very serious doubt that anybody can sell much electronics that is not economic.

For example, many housewives are going to preserve fruits and vegetables this year. Home canning is hard work over a hot stove. Suppose we could get a simple induction heating rig into which a standard-size Mason fruit jar would fit. Undoubtedly this could be worked out. But what would it cost? H-f heating is economic when the material heated has a high economic value per unit volume. Fruits and vegetables, however, are mostly water and not worth much. The amount of power required to raise the material to the boiling point can easily be calculated; and any radio man can figure what the apparatus would cost.

Having made the calculations, it is our guess that thousands of housewives will still be laboring over a hot stove this summer—and will continue to do so. Home canning by electronics is still uneconomic.

► **POST-WAR EDUCATION** . . . After the last war, thousands of men whose educations had been interrupted returned to college, were given

simplified courses, and secured war degrees. Many of these men are now leaders in industry and in high military positions.

Thousands of men are leaving colleges now; and many of them will want to return. They will want degrees; but they will not want the kind of thing they were taking as boys in college. They will want some streamlining; they will want to make themselves electronic men, aviation experts; proficient in the new techniques to which they have been exposed by their wartime jobs.

It is not too soon for engineering schools to be thinking of this problem; to arrange courses in these new subjects which men who have been out of touch with the classroom can take and benefit by. It would have a most welcome ray of hope if colleges could publicly announce, soon, just what they are going to do to help the returning men (and women) to quickly equip themselves to find their place in the new world after the war.

► **WORK** . . . A McGraw-Hill editor returning from a trip to England reports that men there are working 60 to 65 hours per week, women 50 to 55 hours per week. Men are paid an average of about 8 pounds for their work week with 1 pound deducted for taxes. In addition men and women put in about 12 hours a week on home guard duty. The pound is now worth about 4 dollars. Think it over.

► **A-N** . . . At the American Foundation for the Blind, a weighing machine has been devised which permits blind operators to operate scales accurately. (See "Tubes at Work," page 104, Jan. 1943, *ELECTRONICS*.) The most important point about this machine is the use of the A-N concept so familiar to airplane pilots and aircraft radio men. Except for use in aircraft navigation the A-N idea has lain idle until the Foundation put it to a new use. It is quite conceivable that this ingenious idea could be applied to many another balancing system.

► **FREEDOM** . . . In the popular interest in radar and the share in it played by Sir Robert Watson Watt, the fact that Sir Robert has broader interests is overlooked. At the British Association conference on "Science and the Citizens" Sir Robert said that the radio listener of post-war days had a right to expect his own four freedoms: (1) freedom from interference, (2) freedom from distortion, (3) freedom of choice, (4) freedom from distraction. The first three are technical problems only; they can be solved by putting broadcasting on the higher frequencies and by using FM. The meaning of the fourth freedom was not indicated in *Wireless World's* report; but Americans would wish for freedom from offensive commercials. Broadcasting has everything now—except good taste.

Radio vs. Industrial

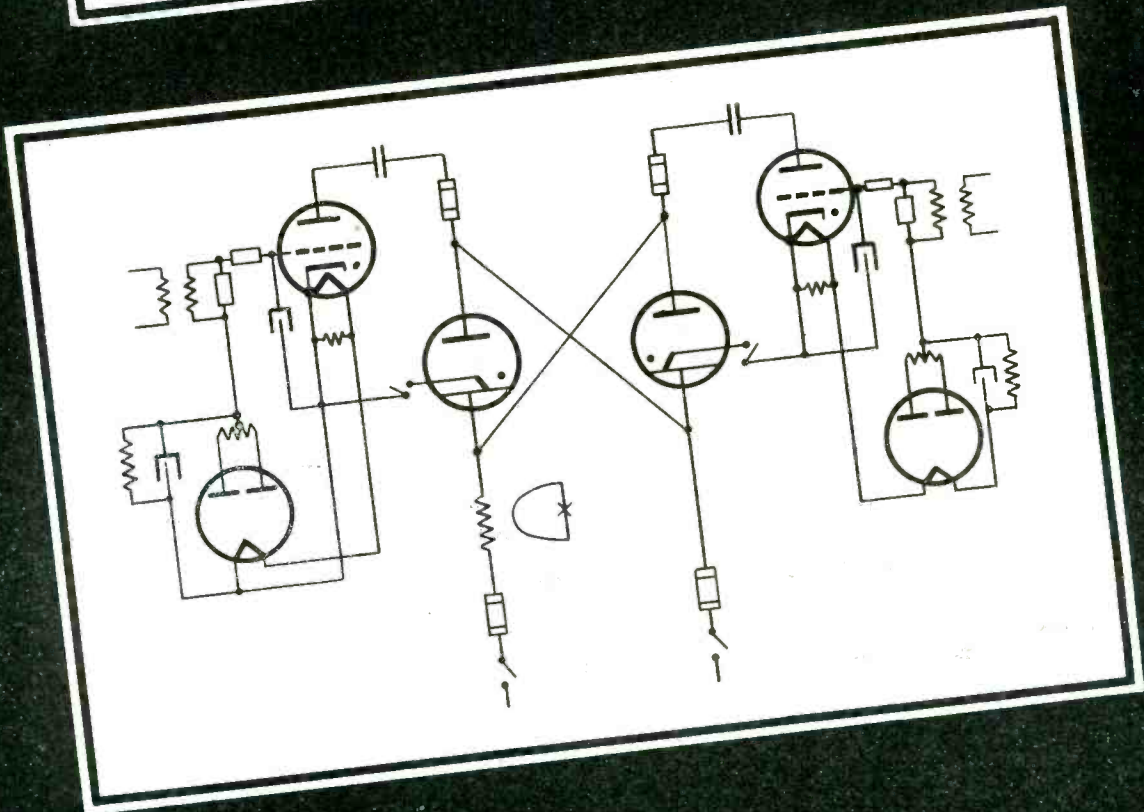
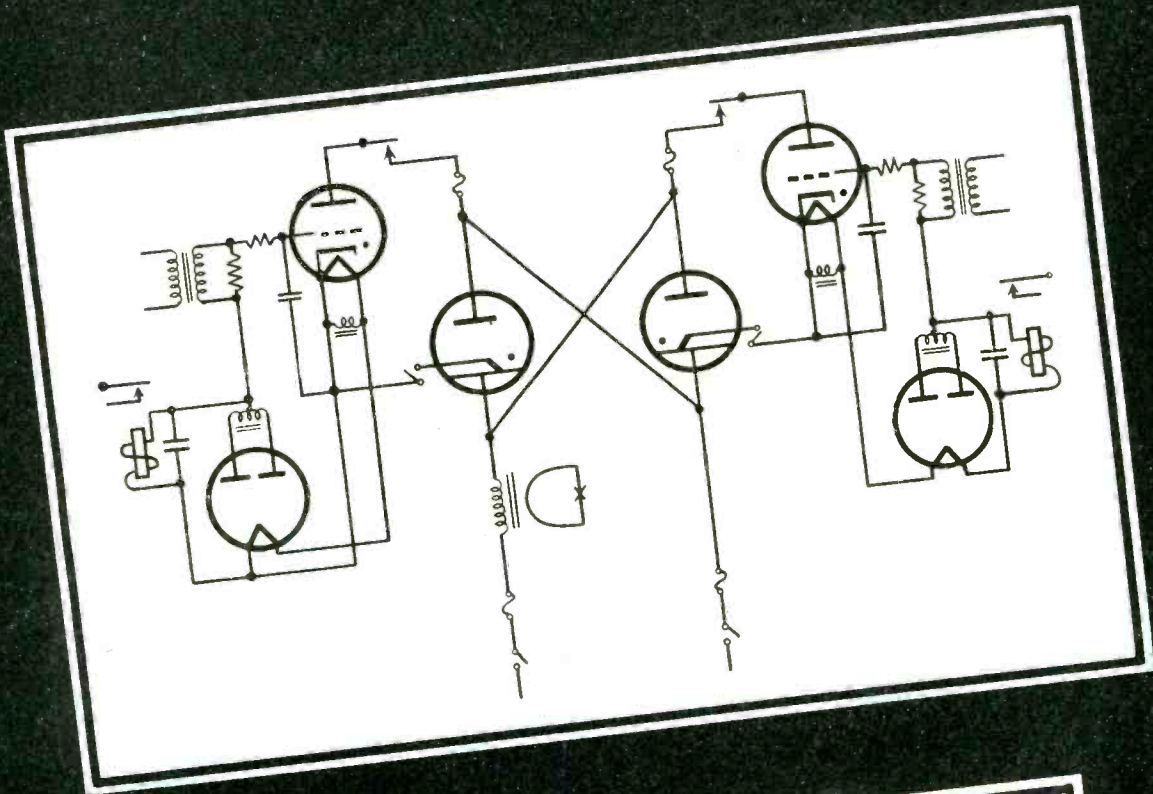

Same **CIRCUIT** . . . different **SYMBOLS**

SYMBOLS

Lack of uniformity in symbols identifying the component parts in electronic equipment circuit diagrams causes confusion which is inimical to the war effort. Failure to standardize on one set of symbols for both communications and industrial gear will also multiply the possibilities of error when commercial activity is resumed

PRESENTED herewith are two diagrams representing exactly the same circuit. Component parts in one are drawn in symbols used by telephone, telegraph and radio engineers; the other employs symbols used by power, control and measurement engineers. Both sets of symbols represent approved ASA standards.

Even a casual glance will show that certain elements in the circuit are not only represented differently when drawn for communications use than when drawn for power use, but that a given symbol often represents two entirely different concepts to these two groups of people. What looks like a capacitor to a radio man is a normally-open contact to a power man; the symbol used by a communications engineer to represent a resistor indicates a magnetic-core inductor to a power engineer. The main difficulties occur in representing in symbolic form such important components as resistors, capacitors, inductors (including relay windings and transformers), relay and switch contacts, and fuses.

Says the American Standards Association:

"Much thought has been given to the coordination of symbols for communication, power, control and measurement. Many copies of tentative standards have been distributed, including copies to electrical manufacturers and others not represented directly on committees, for such comments and suggestions as might be helpful in attaining the best symbols possible.

"It has been found that all but four of the basic symbols could be harmonized. Of these, the different purposes for which the symbols are required, and the established usage of most of these symbols for upwards















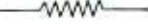

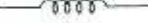
of forty years in each field, makes it practically impossible to evolve single symbols which meet the requirements and uses of all groups."

ELECTRONICS believes that it is possible to devise a uniform set of symbols which will be acceptable to both communications and industrial engineers; it believes that this should be done now in the interest of war-time efficiency and to avoid perpetuating a ridiculous difference in symbols after the war; it believes that the ASA is the logical place for the present dual set of symbols to be fused into one.

Until recently, the difficulties created by discrepancies in our symbolic language were not serious, since the communications people and the power people rarely utilized the same circuit diagrams. Now, however, the

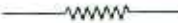
picture is rapidly changing. Industry is awakening to the vast possibilities of electronic apparatus and circuits which come directly from communication engineering are being used for "power, control and measurement" applications. The situation is further complicated by the fact that hundreds of thousands of men are being trained by the military services to recognize the communications symbols. To most of these men, many of whom will have much to do with industrial as well as communications gear after the war, power symbols will be strange.

Neither the communications nor the industrial symbols used at present are perfect. ELECTRONICS will be glad to help in any way it can in the proposed development and adoption of a single set of symbols.—K.H.

COMMUNICATION		POWER	
	Resistor		
	Capacitor		
	Inductor (magnetic core)		
	Inductor (nonmagnetic core)		
	Fuse		
	Rheostat		
	Relay		
	Contact (open)		
	Contact (closed)		

Planning a V - H - F

By **JOHN A. DOREMUS**

*Instructor,
Massachusetts Institute of Technology,
Radio Engineer,
Commonwealth of Massachusetts*

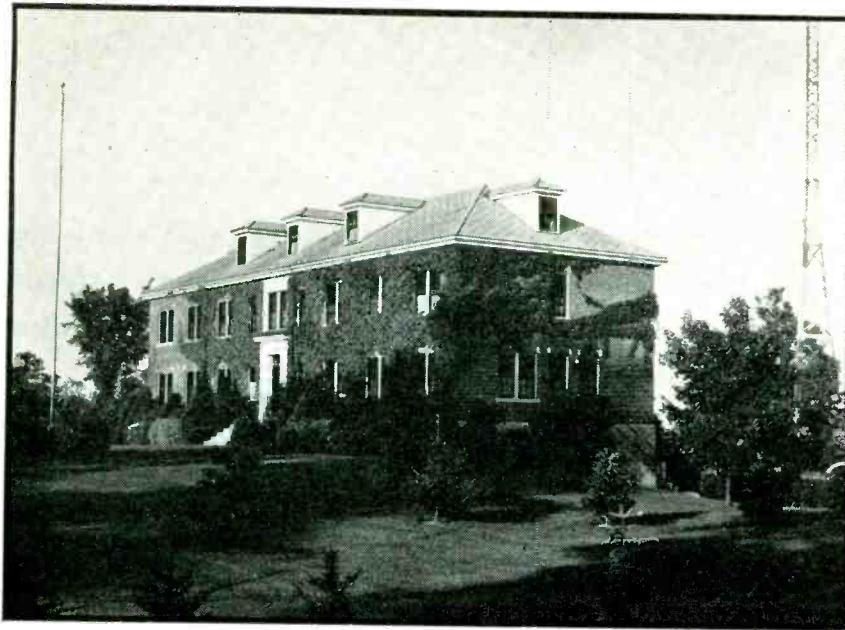

Northampton troop headquarters, typical of the four points from which remotely operated transmitters are controlled

at the scene of a fire or accident, or chasing a fugitive at high speed along a highway. They may tunnel through mountains and under rivers, or peacefully patrol the roads of a rural countryside.

A few years ago, any venture into the realms of radio to accomplish the vitally needed communication was looked upon as a questionable experiment. Today, a properly-designed radio system can make instantaneous contact with all parts of an organization as commonplace as a telephone conversation. Installations such as those for the Pennsylvania Turnpike, *ELECTRONICS*, May 1943, the Connecticut State Police, *ELECTRONICS*, November and December 1940, and the system just installed for the Massachusetts State Police are practical examples of the possible services that can be rendered by radio.

EVERY Police and Fire Commissioner looks forward to the time when he can have instant communication between all important units of his force, whether they be Troop Commanders located at a fixed headquarters, patrol units which might be temporarily located at any point throughout the area served, or a single man sent on an important assignment where he may need instant contact with his headquarters. In such service, mobile units may be

Typical control desk. The control for a new frequency-modulated station is on the left.

The unit on the right controls a now out-moded medium-frequency transmitter

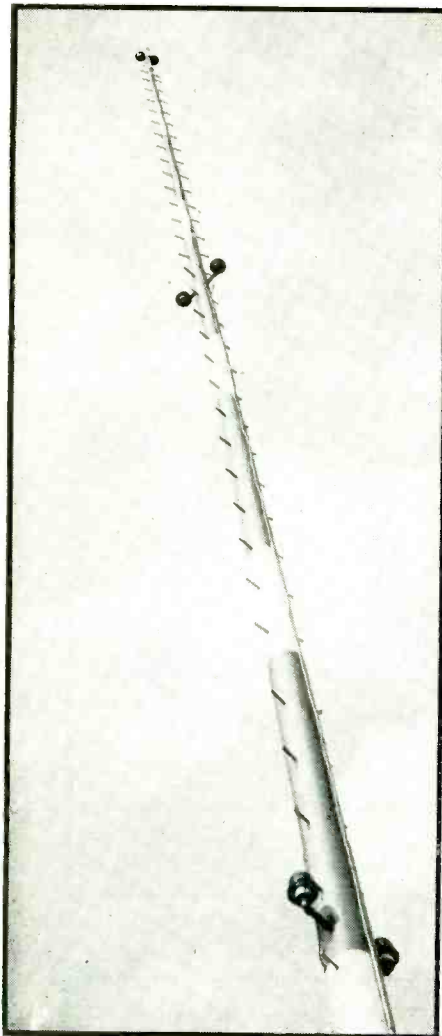

Closeup of a 125-ft unguyed tower, one of those used in the eastern part of the state



COMMUNICATIONS SYSTEM

Design, installation and maintenance of radio equipment. Operation and administration suggestions. Details concerning the Massachusetts State Police system, employing frequency-modulated equipment, are included as practical examples of successful V-H-F systems

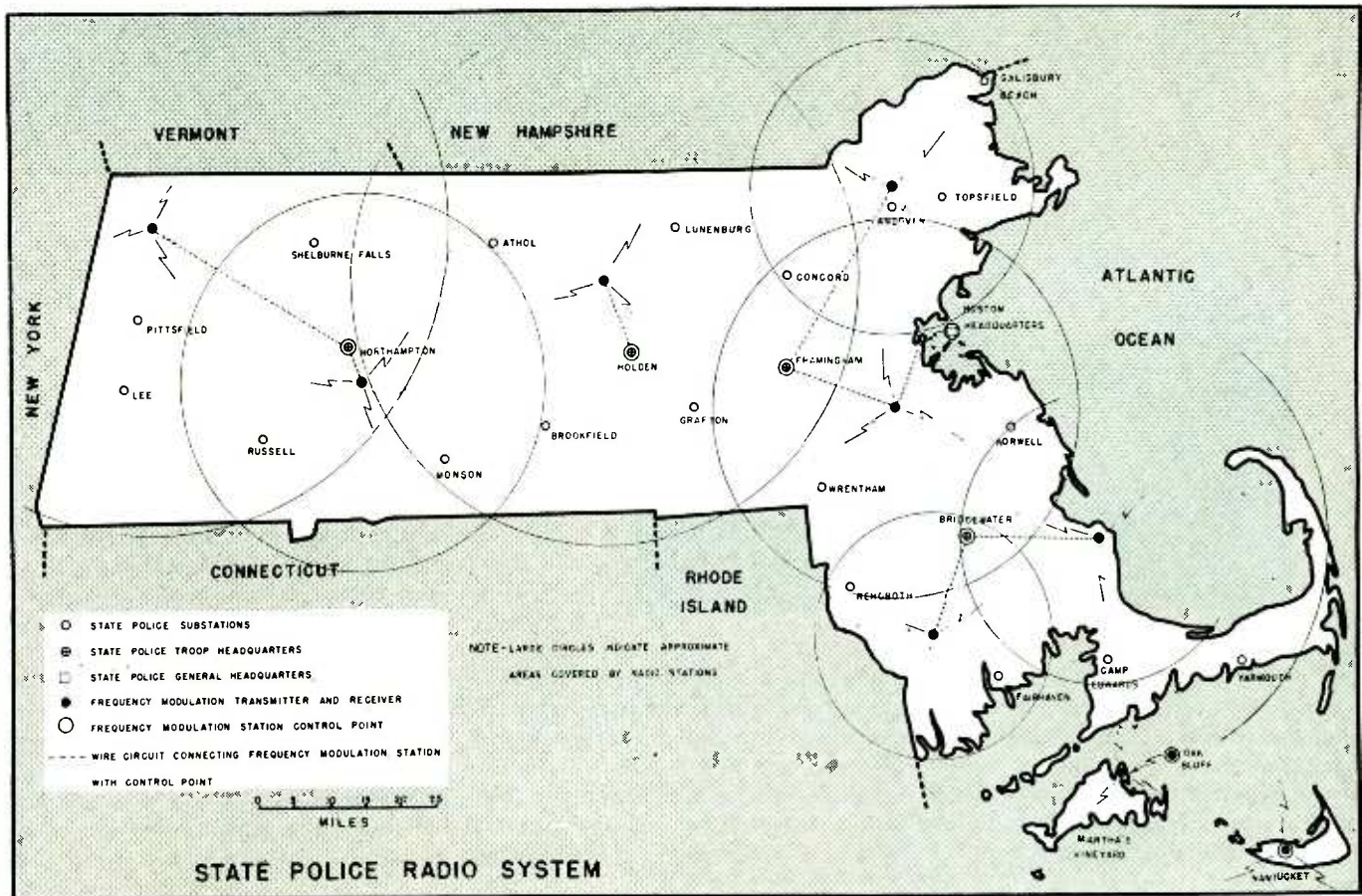

Map of the entire Massachusetts system. Circles indicate approximate areas covered by various stations. In most instances at least two stations can be heard in all locations

Dependable radio communication for the Emergency Services has evolved through tireless experimentation and careful manufacture. The recent development of frequency-modulated equipment for this service promises to simplify and standardize system design. The increase in service range and dependability make FM equipment a welcome substitute for both medium frequency and HF amplitude-modulated units.

Experience has led to the formulation of certain design fundamentals that can now be used to tailor-make a system to the exacting needs of any

particular department. These were vividly brought to the fore during the design of a system which has recently been installed for the Massachusetts State Police.

Budget—The first fundamental requirement for a successful system is not technical, but administrative. The success of a communications system depends greatly upon its place in the organizational chart of the department it serves. In almost every case, communication is the most important factor in the effectiveness of a police or fire department, and should be treated as such.

Equipment used in communication should be chosen carefully and should be maintained in an accurate state of adjustment. The communications department should be provided with a budget that will permit proper maintenance of the equipment in order to provide the unflinching service required by the organization.

Basic System—Every radio system design must be carefully drawn up to include all features required by the agency it must serve. This can best be accomplished by bringing into the picture a quali-

Typical mountain-top concrete station house. This one is located at Blue Hill

Mt. Greylock station. In this instance, gear is located in the basement of a summit house. The mast is guyed to withstand high winds and heavy ice-loads

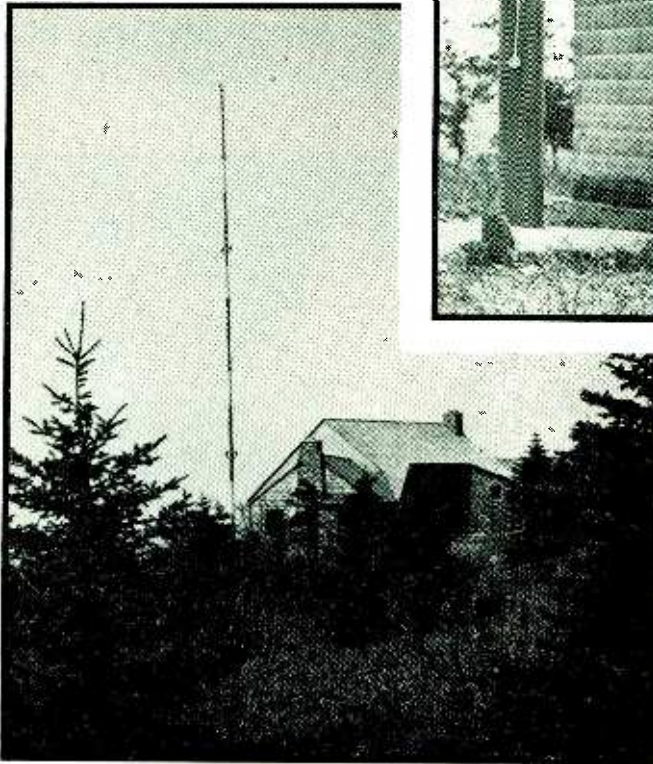
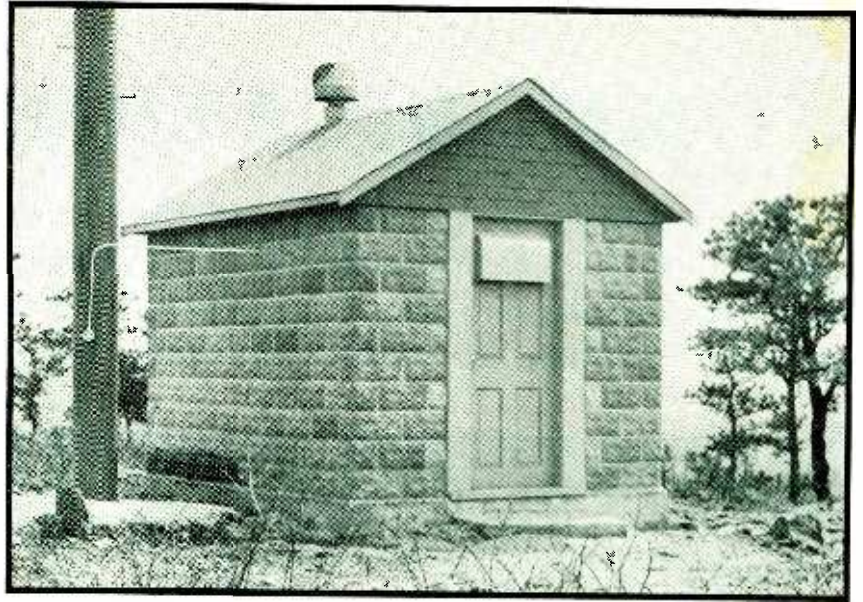

quarters building to make the system as simple as possible. On the other hand, when a large area is to be served, it becomes necessary to locate the fixed station transmitter at some vantage point and provide control circuits to the headquarters.

Antenna—The most important single factor in the choice of a transmitter site is the height of the transmitting antenna above the average ground level of the area to be covered. The antenna should be located on a tower that projects well above any objects in its immediate vicinity. When the antenna is located on a peak with abrupt slopes, operation will be more satisfactory than when the location is on a gentle rolling hill. This effect is quite marked and will make desirable the choice of a steep hill located in one corner of the service area in preference to a gentle hill of the same altitude located near the center of the area. When it is necessary to locate a station in a region where only low hills exist, a considerable increase in the height of the antenna tower will produce results that will justify the corresponding increase in antenna-tower cost. A hill located at the junction of several valleys would be a highly desirable location for a station to serve that area.

Antenna towers should be designed to withstand all possible wind and ice conditions encountered where the station is located. In general, the steel tube masts are preferred to support antennas and should be guyed when winds and ice loads make it necessary.

fied communications engineer who should be required to make a thorough study of the department's communication needs before he attempts even a basic design. It may well be that certain communication functions can be carried out better and more economically by the use of wire lines rather than radio. On the other hand, radio can provide channels to points that cannot be dependably served by wire circuits. Certain requirements will determine the choice of FM, AM or medium-frequency equipment. After the engineer has completed his study, he should draw up his basic plan in close collaboration with the Commissioner and other administrators who will be responsible for the operation of the system.

Specifications—When the basic plan has been established, the engineer must prepare specifications for the equipment. These must be written so that they will invite competition between manufacturers but at the same time be accurate and

complete so that the equipment furnished will fulfill the basic plan. A most important consideration should be that of maintenance. Similar units should be used wherever possible. Mountings should permit quick replacement of defective equipment with spare units. Experience has dictated that a system should incorporate one spare unit for each ten in service. Equipment should be specified to contain components that are operated well within the ratings placed on the parts by the manufacturers.

The preparation of the basic plan will require considerable time and expense. Field tests will be required with experimental equipment. However, time and money spent in this way will be reflected directly in the performance of the system.

Fixed Station Problems—Almost every system incorporates communication between a general headquarters and a number of mobile units. Whenever possible, the fixed station should be located at the head-

Radio stations should be located at points that have dependable electric and telephone facilities and should be easily accessible for maintenance and repair. However, it is often necessary to sacrifice accessibility to attain the antenna height afforded by some of the more remote mountain tops. Gasoline-driven power-generating equipment should be installed with automatic facilities for putting it on the line should the normal supply fail.

Station Housing — When the transmitter is located in the headquarters building, a suitable room can usually be made available. Adequate ventilation is important and should be provided. When a transmitting station is to be located on an isolated mountain peak, a serious housing problem exists. Because of the desirability of high, exposed locations, the building must withstand all the weather conditions experienced. Brick, concrete or concrete block afford more insulation than most other types that can be built economically, yet will afford adequate protection against fire of either internal or external origin. However, careful waterproofing must be undertaken to protect equipment from moisture and controlled ventilation should be provided.

Electric power and telephone facilities should be well protected from the elements. Underground cable is most satisfactory and insures maximum station dependability. A simple voltage-regulating transformer will protect the equipment against large line-voltage fluctuations encountered in remote areas.

Control—When the station location is accessible and reasonably close to the control point, telephone wire control links are quite satisfactory. When long distances must be covered, radio relay equipment can provide a very satisfactory control link. In addition, considerable saving in telephone-line rental is possible and the radio link will be the most economical installation.

Control functions should provide all operations required by the basic plan. It is usually possible to accomplish control on the same circuit that handles the speech signals by the use of direct current or by a high- or low-frequency alternating carrier. Provision should be included for operating the transmitter in the event of control line failure.

Mobile Station Problems—Mobile equipment must be constructed to withstand the severe vibration encountered in the rear of a police cruiser. Careful design and rigorous maintenance are the only effective cures for the gremlins that crawl into the units to loosen bolts and soldered connections.

The choice of equipment should be made with due consideration of battery drain. Frequency-modulated equipment has considerably lower drain than AM equipment for the same power output.

Again, the antenna height is a prime factor in determining the effective range of the mobile transmitter. An antenna mounted on the rear of the car has a directional radiating pattern that sends a signal in a direction from the antenna towards the front of the car that is three to four times as great as the signal in the opposite direction. An antenna mounted in the center of the top of the car emits a greater signal in all directions than the rear-mounted antenna in its maxi-

imum direction. Wherever practical, roof-top antennas will produce better radio performance but sometimes their appearance is objectionable.

Because mobile equipment will often be operated by untrained personnel, control of the equipment should be as simple as possible. A common telephone handset is preferable and there need be no more switches to put the unit in operation than a single press-to-talk button on the handset. Pilot lights, a master switch which can also be used to turn on the receiver, and a volume control are the only other controls needed.

Hand-carried equipment is needed to provide communication on forest-fire patrols and many other types of missions that cannot be performed in automobiles. Equipment for this type of service must be carefully designed and built to be dependable and simple to operate. Low drain tubes should be used to give maximum battery life. Any arrangement for increasing antenna

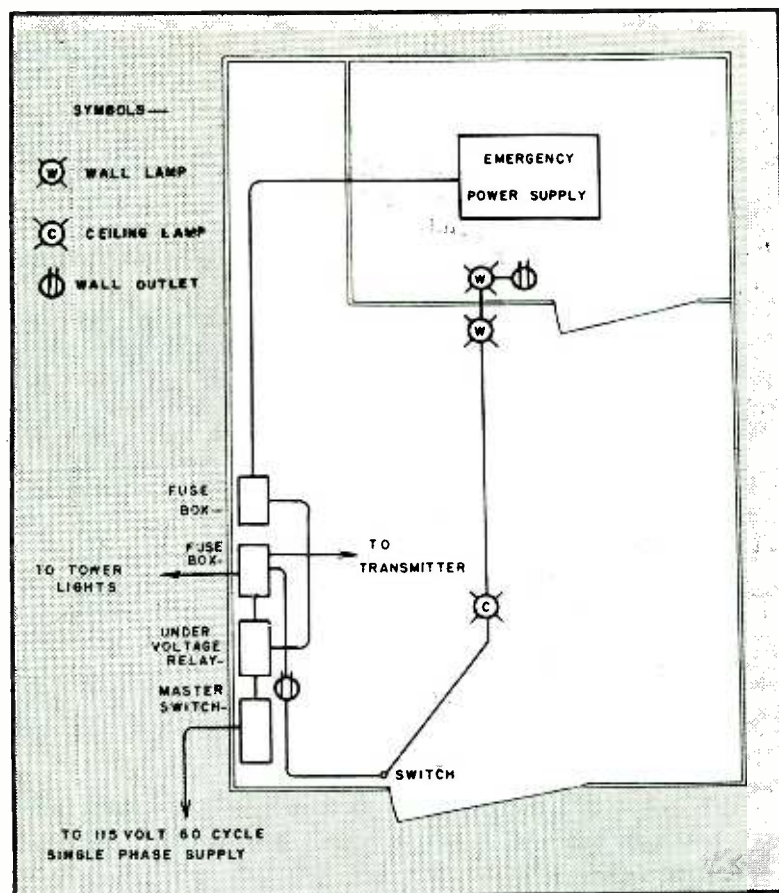

Floor-plan of typical mountain-top 250 watt station building. The transmitter is placed in the approximate center of the building, permitting access from both front and rear for speedy repair work

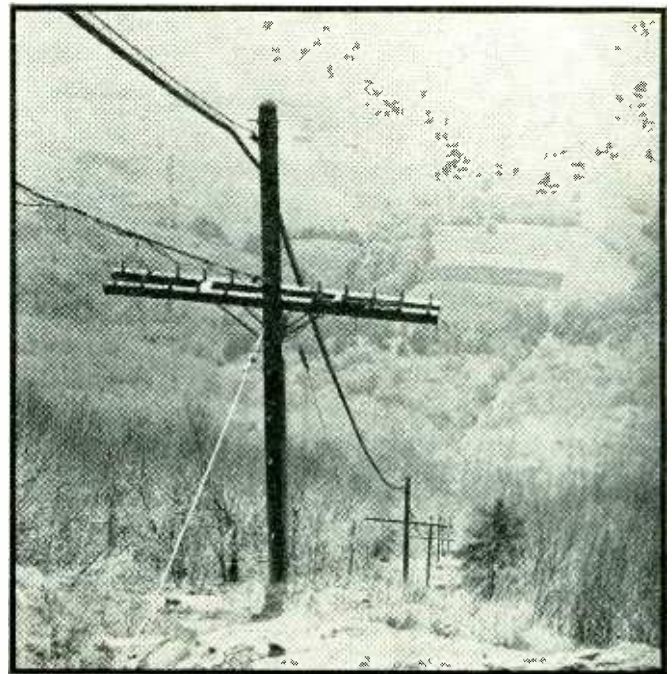
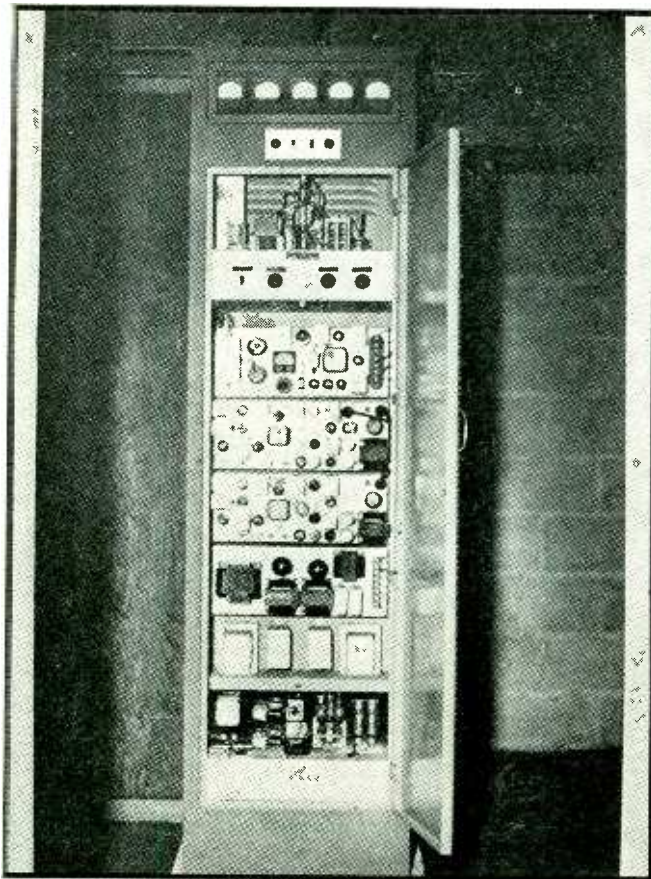

Long telephone and power lines control the mountain-top stations. View shows distant farms and the town of Adams, approximately 2,000 ft below the Mt. Greylock station

View through door of typical transmitter house, showing a unit containing a transmitter, two receivers and control equipment

height will greatly increase the range of the units.

Maintenance—When radio equipment is new, its performance is determined by the quality of manufacture. However, after a period of service, the performance is dependent entirely upon the man who keeps the circuits in adjustment. As soon as possible after new equipment is installed, complete maintenance facilities should be provided. Each mobile unit should be inspected and checked at least every 30 days. It is common practice to inspect fixed stations weekly. A card file of unit numbers and equipment on hand will help keep inspection schedules in order. Rigid inspections of this type should almost eliminate breakdowns in service.

A close estimate of the annual maintenance cost of all equipment, including buildings and towers, but not including salaries, is approximately ten percent of the system valuation. This will permit the purchase of supplementary units to replace those wearing out over a long period of time.

Instruments essential to the operation of a maintenance shop include a frequency monitor and sig-

nal generator, alignment oscillator, cathode-ray oscilloscope, tuning meter for transmitters and receivers, condenser checker, vacuum-tube voltmeter and ohmmeter and r-f power-output meter. Power drills and screwdrivers and a small rolling table aid greatly in making car installations.

Radio maintenance can be successfully accomplished if the radio men are on duty during the normal business hours. However, the radio men should be on 24-hour call to handle emergency situations.

Whether a radio system designed along the lines described here is intended for a police department, fire department, or public works department, the fundamental principles are the same. After the basic requirements have been determined, the major problem will be that of careful installation and maintenance.

Massachusetts State Police System

Massachusetts, the largest of the New England states, has four and one-half million inhabitants who live in an area of 8257 square miles. The State is approximately 180 miles long and 46 miles wide except

near the eastern coast where it broadens to a width of approximately 100 miles. The terrain varies from the sands of Cape Cod to 3500-ft. Mt. Greylock which is inaccessible, except on snowshoes, five months of the year.

In 1941, the State Legislature authorized the installation of a state-wide radio system to fulfill the particular needs of the Massachusetts State Police. A complete communication survey of all state departments had just been undertaken by the Massachusetts Institute of Technology and the author, who was a member of the survey committee, was retained as State Radio Engineer.

The State Police organization is made up of 425 officers and men who operate approximately 125 vehicles in the accomplishment of their normal duties. Plans are now being made to enlarge this force by the addition of Auxiliaries to aid in the present emergency. The organization, which is directed from the Boston Headquarters, is subdivided into four troops with headquarters at Framingham, Northampton, Holden and Bridgewater. Although the officers are based in

twenty-one substations in addition to the Troop Headquarters, all police activity is directed by the Troop Commander. All headquarters and substations are interconnected by a private-line teletypewriter system which is normally used for all inter-station business. This teletypewriter system is inter-connected with similar systems in many eastern states allowing a quick inter-change of all urgent traffic.

The new radio system replaces a medium-frequency (1666 kc) system which was made up of obsolete, inefficient equipment that was capable of dependable one-way communication with cruisers in less than half the State. Two-way operation was possible with a few selected cruisers equipped with composite high-frequency transmitters constructed by the members of the Radio Department.

The basic plan of the new system, which evolved from the communications survey, was drawn to closely follow the organization plan of the State Police and included the following features:

1. Two-way communication should be possible between Troop Headquarters and mobile units in every part of the State.

2. Car-to-car transmission should be possible over limited ranges. This should be accomplished with a minimum amount of extra equipment in the mobile units.

3. Communication should be possible between all police headquarters and substations in the event of failure of the teletypewriter facilities.

4. The state-wide coverage should be accomplished with the use of a minimum number of fixed stations of not more than 250 watts each, yet incorporate a generous safety factor that will permit reasonable service from adjacent stations should one station be temporarily inoperative.

5. The entire system should be able to operate through any emergency that would interrupt normal power circuit facilities.

6. All buildings and antenna structures should be able to withstand the extreme climate that is sometimes experienced in New England.

7. Standard units should be used throughout the system to facilitate maintenance and replacement.

Specifications were drawn up for the equipment and submitted to manufacturers. The contract was

awarded to Fred M. Link of New York whose bid was 20 percent lower than the next competitor's. The successful installation of this elaborate system during these times of material shortages was made possible by Mr. Link, who was able to supply much of the equipment from stock without waiting for material allocations.

The fulfillment of the basic plan required seven 250-watt and two 25-watt fixed stations located at strategic points throughout the State. Frequency-modulated equipment was used throughout the system. The main stations of the system operate on 35.9 Mc while all mobile

units normally operate on 35.78 Mc. For car-to-car operation, a small relay changes crystals in the mobile transmitter so that it can operate on the frequency of the main station. With frequencies as close as those chosen, no retuning of the transmitter circuits is necessary. Each fixed station has a receiver on both frequencies.

Coaxial antennas are mounted on 90-ft and 125-ft tubular-steel towers that are designed to withstand over 150 mile-an-hour wind velocities. Two towers on the highest mountains are guyed while others are self-supporting. Special antennas had to

(Continued on page 178)

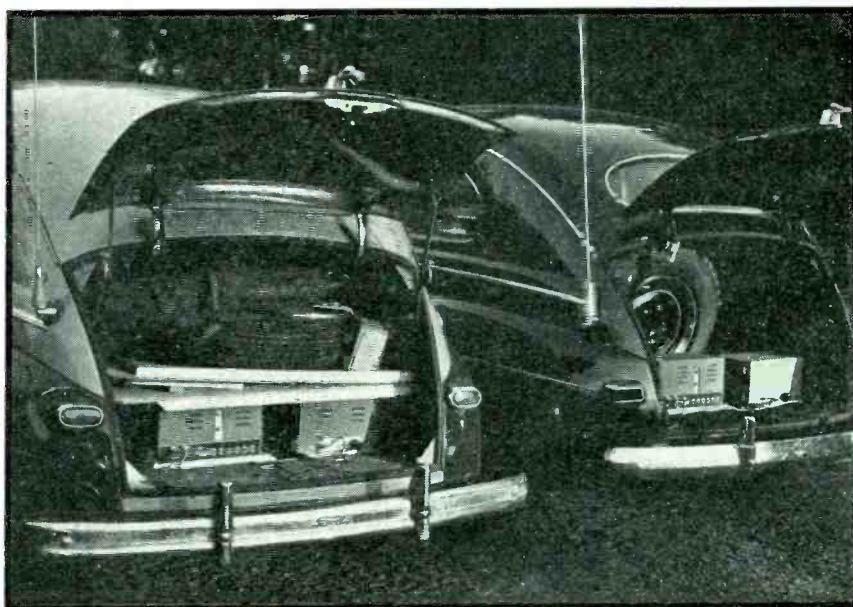

Installations in Ford cruisers. The car on the left carries a portable stretcher for emergency first-aid work, on a shelf above the radio gear

Radio control unit and handset in a typical cruiser



R-F HEATING

Speeds PLASTIC

Preheating of thermosetting plastic preforms by means of a high-frequency field doubles press production by reducing curing time, eliminates breakage of inserts and pins, minimizes gassing problems, reduces the amount of pressure required

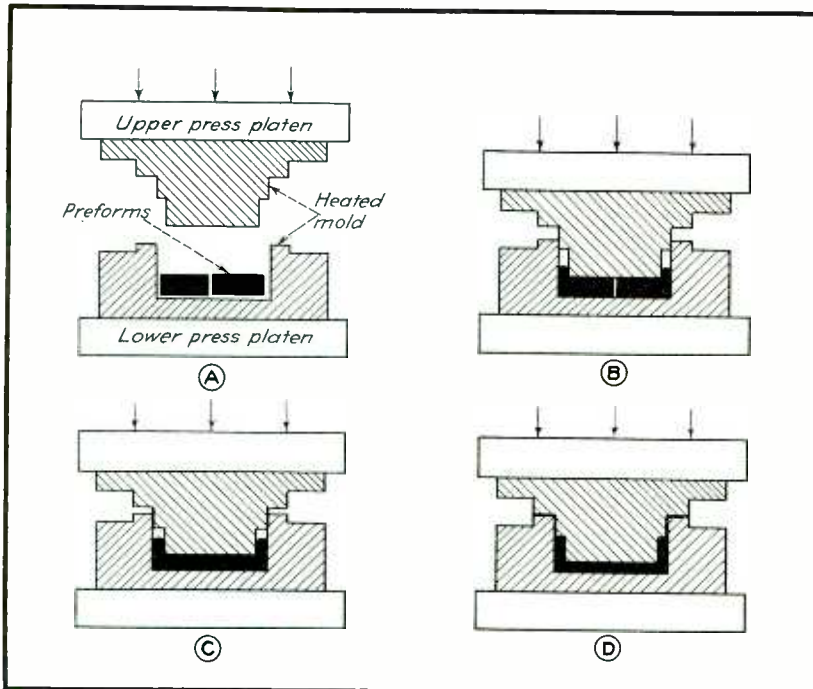
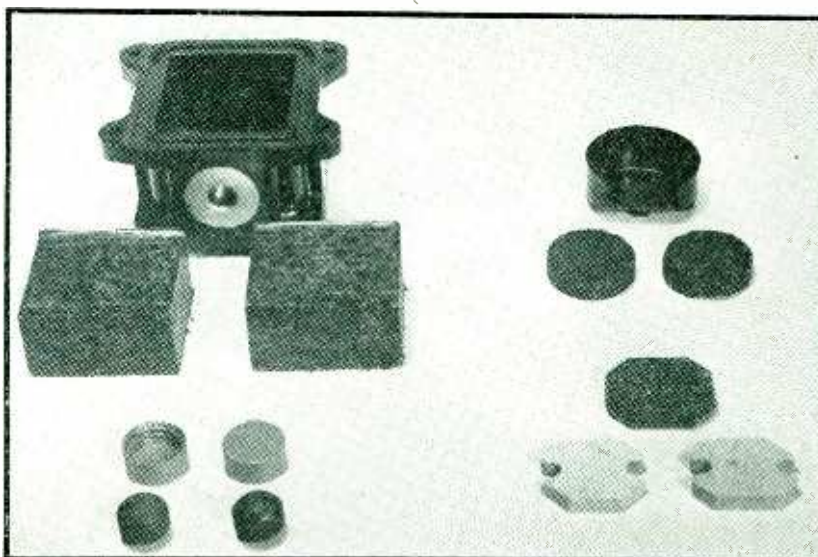

FIG. 1—Simplified diagrams illustrating successful stages in the closing of a positive type mold, as used in compression molding



THE NEWEST large-scale use of r-f heating is in the plastics molding industry. In one of the most promising applications so far developed, radio-frequency current is used to preheat plastic molding materials just before these materials are placed in the press.

By eliminating the appreciable time otherwise required to bring the molding material to the softening temperature, such heating enables the output of the press to be greatly increased. Under favorable conditions, production of a given press may be doubled or even tripled. Since the material is softened before it goes into the press, lower pressures can be used. Gassing and flow problems are alleviated, rejects are fewer and stoppages due to pin-breakage are much less frequent.

Installations to date have been limited to operations using materials in the shape of preforms. The method shows promise for many other molding operations.

The Heat Problem

The advantages of radio-frequency preheating are the tangible results of applying the simplest form of dielectric heating^{1,2,3} to standardized molding procedures.

The conventional process of molding thermosetting materials is illustrated in the simplified sketches of Fig. 1. The molding material, which is frequently a mixture made

FIG. 2—Typical preforms of thermosetting molding material (front) together with the finished pieces (rear) molded from these preforms. The unit at the upper left is a small jackbox

MOLDING

By J. P. TAYLOR

RCA Victor Division,
Radio Corporation of America
Camden, N. J.

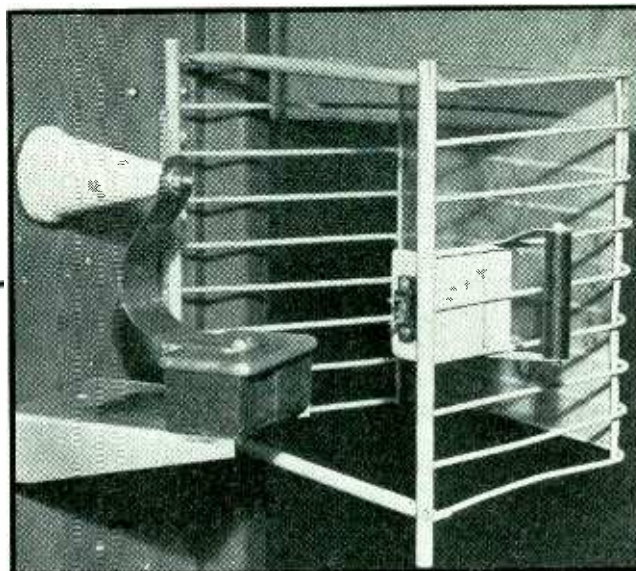

Close-up of the electrodes, with plastic preform in position, and the interlocked protective cage on side of r-f unit

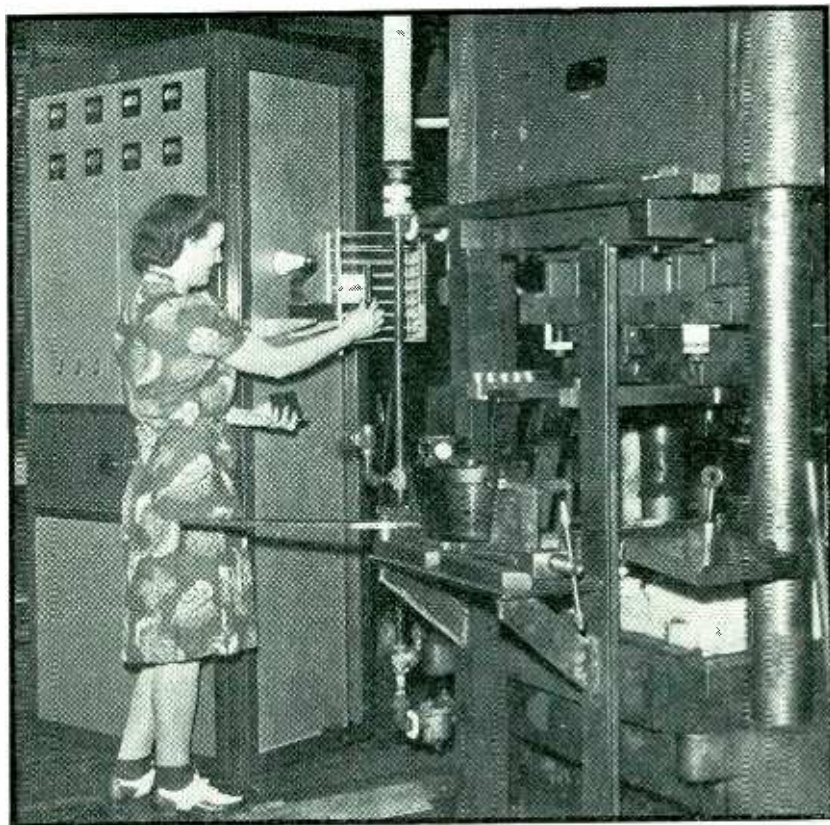

Shop setup for production molding with the aid of radio-frequency preheating equipment. A girl operating the r-f unit places preforms on a metal shelf constituting one output electrode, settles another electrode into place on top of the preform, closes a protective cage and subjects the preforms to a high-intensity field for about 40 seconds. She then feeds the preheated preforms to the operators of two presses

up of a resin binder and a filler such as wood-flour, rags, or paper, is placed in the cavity of a mold which is mounted on the lower platen of the press. The male part of the mold, which is attached to the upper platen, descends into the mold cavity, forcing the material to take the desired shape.

Both parts of the mold are heated by steam or electricity. The heat is required for two reasons; first, to

bring the material up to the softening or flow temperature (without which it would be impossible to press the material into anything but the simplest shapes) and second, to raise the material to a temperature which will cause it to cure or set and hold it there a reasonable length of time.

Since most of the resins used will cure in a minute or two at temperatures just above the softening

points, it is apparent that the time required to bring the material up to temperature is the major determining item in the cycle. This time is considerable for all except the smallest pieces and, in most cases, represents the major part of the press cycle. The reasons will be apparent from a study of Fig. 1. It is obvious, for instance, that while the layer of material next to the hot mold will come up to temperature rapidly, the part of the material near the center will, because of the low thermal conductivity of these materials, come up rather slowly. Moreover, since the material will not flow until it reaches a fairly high temperature (usually 250 deg. to 300 deg. F), and since the mold does not make contact over the full area until then, the heat transfer is bound to be a relatively slow process. This heating problem has been the bottleneck in all attempts to speed up molding processes.

The sketches in Fig. 1 are intended to illustrate the process generally referred to as compression molding. Compression molding and transfer molding are the two methods ordinarily used for molding of thermosetting materials.

Transfer molding differs from compression molding only in that the material is first placed in a chamber separate from the mold cavity proper. A ram which descends into this chamber forces the material, as it is softened, through a small opening called the gate,

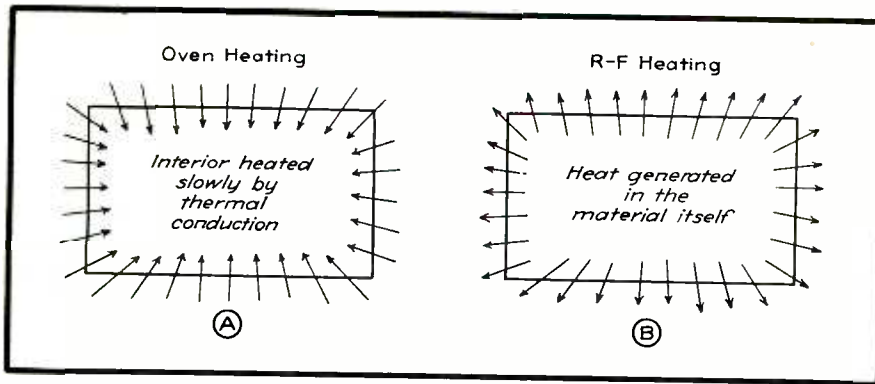

FIG. 3—Diagrammatic illustration of the heat-flow in a plastic preform when using oven heating (A) and when using r-f heating (B)

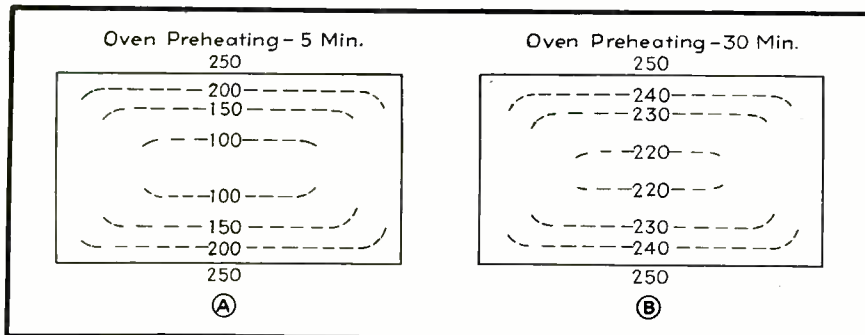

FIG. 4—Isotherms for the preform from which the jackbox in Fig. 2 was made, showing conditions of preheating in an oven at 250 deg. F for 5 minutes (A) and preheating in an oven at 250 deg. F for 30 minutes. In practice, the first-mentioned method gives insufficient heating of the center to be useful while the second causes the outside to be "pre cured" so that it cannot be molded

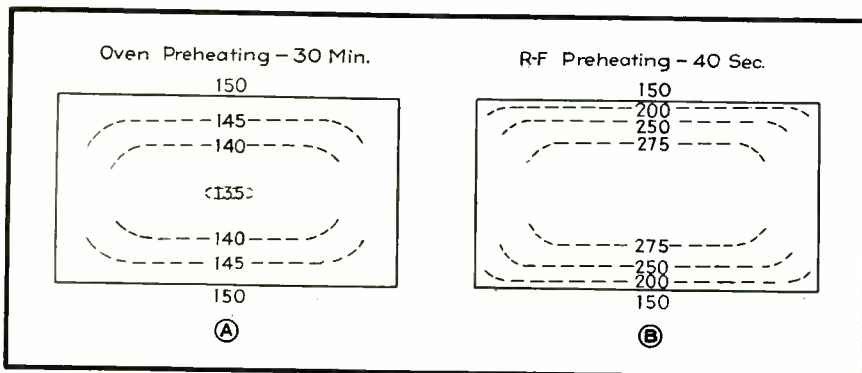

FIG. 5—Isotherms for the preform from which the jackbox in Fig. 2 was made, after preheating in an oven at 150 deg. F for 30 minutes (A), and after preheating for 40 seconds with r-f power (B)

into the mold cavity. The same problems of heat transfer and conductance are present. Transfer molding is of advantage and is ordinarily used when the mold is of intricate shape, since by softening the material before it comes in contact with the pins and inserts, less likelihood of breakage is involved. Even so, r-f preheating should be of advantage in reducing the heating cycle. It is also likely that many parts now necessarily made by transfer molding will, with the availability of r-f preheating, be

made by the relatively simpler method of compression molding.

The Use of Preforms

In compression and in transfer molding, the molding material may be in the form of loose powder, small granules, or preforms. Preforms may be regular shapes, such as pellets, cubes, discs, or the like, which are convenient to handle, or they may be of more intricate shapes having some relation to the shape of the final molded piece (Fig. 2). In either case, they are

usually formed from carefully determined amounts of material, by cold-pressing.

The use of preforms offers several advantages from the point of view of handling and convenience. In using a so-called positive mold such as shown in Fig. 1, it is necessary to use exactly the right amount of molding material in order to maintain constant density. Preforms avoid the necessity of having to weigh out the correct amount of powder for each piece. Again, many molding materials have high bulk factors, meaning that they compress greatly on molding. This makes them difficult to handle unless some means of "predensification," such as preforming, is utilized. In the case of specially shaped preforms, there is an added advantage in that the shaping facilities flow into the recesses of the mold cavity.

The trend in the molding industry is very definitely toward the use of preforms for nearly all operations involving the use of thermosetting materials.

Shortcomings of Oven-Heating

An advantage often claimed for preforms is that they are adaptable to preheating. As applied to the older method of preheating, in an oven, this advantage is nebulous, at least insofar as all but the smallest preforms are concerned.

Consider, for example, a preform such as is shown at the upper left in Fig. 2, two of which are used in molding the adjacent jackbox. This preform is roughly $2\frac{1}{4} \times 2\frac{1}{4} \times 1\frac{1}{4}$ in size. From well-known formulas for heat flow⁴ it can be shown that if this preform is placed in an oven at a temperature of 250 deg. F, it will require approximately a half-hour for the center to reach 225 deg. F (90 percent of the surface temperature). But this preheating cycle is out of the question since the curing of this kind of material is a time-temperature function and even five to ten minutes at 250 deg. F would completely set the surface and thereby make molding impossible.

At lower temperatures longer preheating periods are, of course, permissible. Before the advent of r-f heating, the jackbox preforms shown were preheated for a half-hour in an oven at about 150 deg. F.

This was nowhere near the softening temperature and, moreover, the center never reached this figure. Even so, the preheating operation was considered worthwhile, which is an indication of the importance attached to preheating.

Radio Frequency Heating

Radio-frequency heating is the ideal method of preheating preforms. Moreover, this statement is almost equally true in reverse, for preheating of preforms is certainly a very good, if not an ideal example of radio-frequency heating. The truth of these statements is immediately apparent when the essential difference between r-f heating and other methods of heating is considered. The diagrams of Fig. 3 illustrate this difference.

In all other methods of heating (except chemical reaction) the source of heat is outside the material. No matter how produced, such heat must start at the outside of the preform and travel inward by thermal conduction (Fig. 3A). Radio-frequency heat, on the other hand, is produced in the material itself. The heat is produced simultaneously throughout the preform and, except for the effect of radiation and conduction losses, is uniform throughout. The only flow of heat is the slight outward flow due to these losses (Fig. 3B).

Figures 4 and 5 show the isothermal lines for the jackbox preform

shown in Fig. 2 for four different conditions of heating. In Fig. 4 the preform is assumed to have been placed in an oven at 250 deg. F. The isotherms calculated by approximate methods for times of five minutes and thirty minutes are shown. It is obvious that in the shorter time (Fig. 4A) not enough heating of the interior has been accomplished to be of value. In the longer time (Fig. 4B) the interior has started to heat, but by this time the outside has been set hard. Thus neither of these time-cycles is practical. In order to prevent curing of the exterior and still obtain some heating of the interior the actual procedure (prior to use of r-f heating) was to place the preforms in an oven at 150 deg. F for thirty minutes. As can be seen from Fig. 5A, this oven-heating cycle produced only a relatively small temperature increase.

The result of heating the preforms by r-f energy is indicated in Fig. 5B. The two preforms are fed about 2 kw of r-f for a period of forty seconds, at which time the

temperature of the inside reaches 280 deg. F. (The isotherms shown for this case are estimates based on a relatively small amount of data, but they are considered representative.) The temperature of the preform is fairly high all over, with the exception of small areas at the edges. Even this slight differential is no great disadvantage in that when the preforms are placed in the mold the outer edges immediately take up some heat from the hot mold, thereby tending to equalize the temperature all over the block.

Method of Applying R-F Heating

The method of applying r-f heating to regularly shaped preforms is simplicity itself. The only critical part of the operation lies in the fact that the heated preforms must be transferred to the mold cavity without appreciable delay, since if they are allowed to stand long after being brought to curing temperature they will set.

The heating cycle must be coordinated with the press operation. To

FIG. 6 — Curves showing relative curing times for non-preheated (A), oven preheated (B) and r-f preheated (C) preforms of various thicknesses, reproduced by courtesy of V. E. Meharg of the Bakelite Corporation

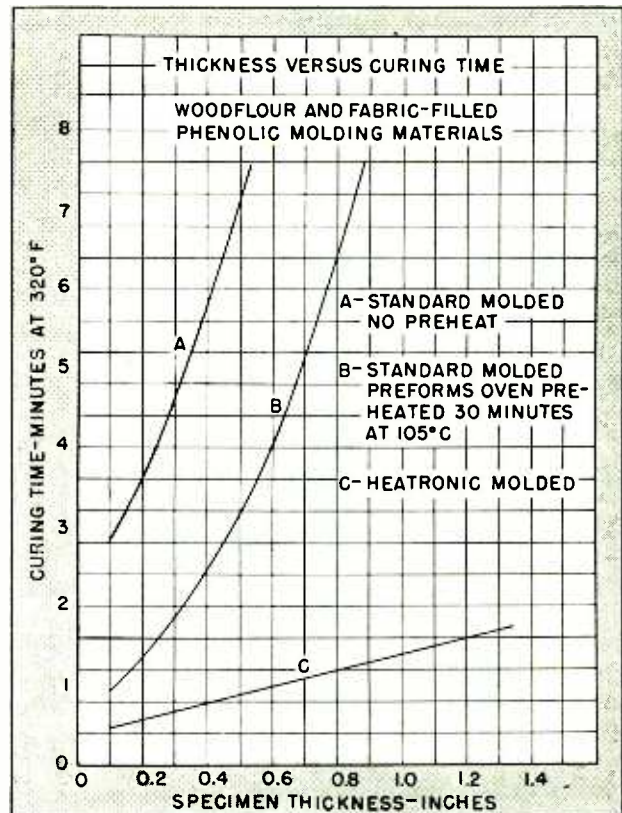
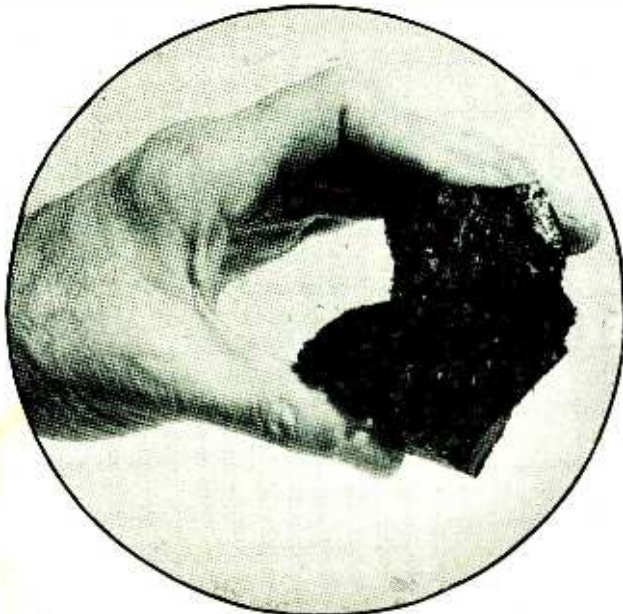

FIG. 7—After r-f preheating, typical thermosetting plastic preforms are soft and can be crushed between the fingers as shown



accomplish this the r-f generator is ordinarily located near the press. The r-f equipment may be operated by the press operator, or, in cases where some assembly time (placing of inserts, etc.) is involved, it may be advantageous to have a separate operator. In the operation shown in a photograph accompanying this paper, a girl operates the r-f generator and feeds heated preforms to the operators of two presses.

The heating box for the preforms, which is also pictured here, is usually mounted on the r-f unit, an arrangement which simplifies installation and allows the unit to be moved about without too much difficulty. The box actually is a screened cage, hinged at the back for easy opening and interlocked so that power is automatically removed on opening.

To heat the preforms the operator places them on a metal shelf and rests a small brass plate on top of them. This plate, which may be made larger or smaller as required, forms the top electrode, while the shelf forms the bottom or grounded electrode. After the preforms have been placed in position and the cage closed, the operator pushes an "On" button and allows the heating to proceed until a small amount of gas is given off by the material, at which point the current is turned off and the preforms are ready to go in the mold. An automatic timer may be used.

Production Advantages of R-F Heating

The most obvious advantage of r-f heating is, of course, the very considerable reduction in curing time in the press. Actually, what is usually spoken of as curing time includes not only the time at curing temperature but also whatever time is required for all parts of the material to reach this temperature.

In thick preforms not preheated, or only slightly preheated by oven methods, the time required to reach cure temperature is considerable. When using r-f preheated preforms the curing time is a very short period indeed since the material is put in the press near cure temperature. Thus in thicker preforms the reduction in so-called curing time is spectacular. The curves given in Fig. 6 by V. E. Meharg illustrate this particularly well.⁵ Curing time reductions are seen to be considerable when r-f preheating is used.

One note of caution must be sounded here. The curves of Fig. 6 do not give the true picture of overall time reduction. To the cure time must be added the time for unloading and loading the mold. This will necessarily be fixed and in the case of molds having a number of inserts, it may be as much as several minutes. The jackbox shown in Fig. 2 is a good example. According to W. M. Witty⁶, the cure time for making this box could be reduced from seven minutes with oven preheating to one and one-half minutes with r-f preheating. Actually, a cure time of two and one-half minutes was adopted. When to this were added the three to four minutes necessary for disassembling and then reassembling a complicated mold, the actual saving of overall time was only about 40 percent. Nevertheless, this made it possible to obtain with two presses the production previously obtained with three. The cost of the r-f equipment, in this instance, was approximately 25 percent of that of the third press and mold which it replaced. In fact, the third mold alone would have cost approximately the same as the r-f unit and, unlike the r-f unit, its usefulness would have been limited to the production of this one item.

Other R-F Heating Advantages

Spectacular as time-saving feature may be, it is likely that other advantages of r-f preheating will soon be recognized as being of equal or greater importance. Of these, the most outstanding is the fact that r-f preheated material is in a soft state when it is injected into the mold.

When a preform is heated by r-f, it tends to swell up slightly and to soften as the resin approaches the flow stage. When such preforms are removed from the heating box ready for the press, they are quite soft and can be crushed between the fingers as shown in Fig. 7. This fact, namely, that the material as it goes into the press is soft and plastic, is of considerable importance in that it means that the material will begin to flow as soon as pressure is applied. Moreover, it will flow uniformly throughout and will not have hard lumps in the center which, when forced against inserts or pins, may break off the inserts or pins. If the mold diagrammed in Fig. 1 is imagined with all of the inserts, pins and projections necessary to produce the jack-

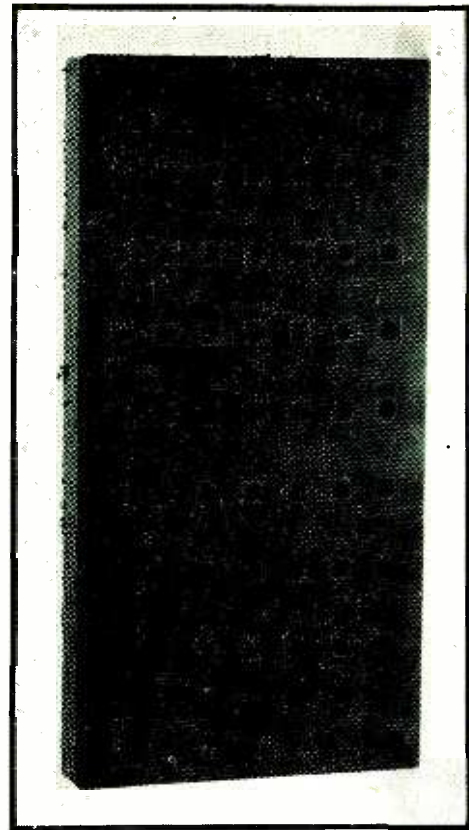

FIG. 8—Molded terminal strip, pressed from a preform which has preheated by r-f power. Because of the large number of pins in the die used to press this piece it was difficult to mold by older methods

box shown in Fig. 2, the importance of preform softening will be evident.

Going a step further, it may be predicted that the use of r-f will make possible some moldings which otherwise could not be made at all. The terminal strip shown in Fig. 8 has a large number of holes which must be formed by pins inserted in the mold. Attempts to make this unit without preheating resulted in a high breakage of pins. Preheating with r-f completely eliminated this trouble.

Another similar possibility is in the simplification of preforms. It has been found that intricately shaped preforms are usually not necessary when the softening action of r-f preheating is utilized.

The use of r-f preheating may be of considerable advantage in eliminating, or at least reducing, gassing problems. In some molding materials, particularly phenols, heating releases volatile materials in the form of gases. Previously it has been necessary to provide some means for

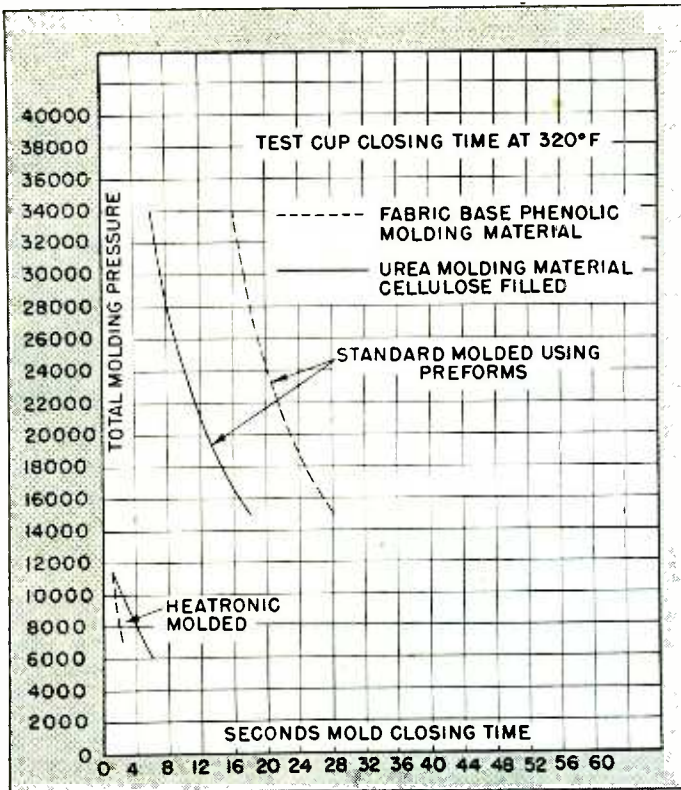

FIG. 9—Curves showing the reduction in molding pressure which is permitted when r-f preheating is employed, reproduced by courtesy of V. E. Meharg

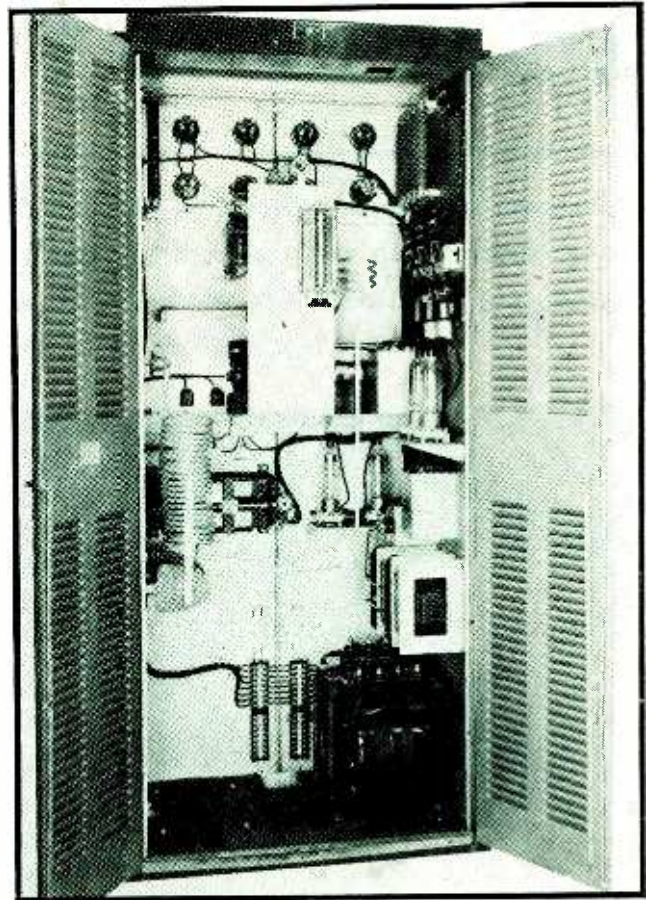

FIG. 10—Rear interior view of 2-kw. r-f generator shown in use elsewhere in these pages. The 833-A oscillator tubes are behind the panel at the top center. Rectifier and control components are on the wall at the right. Load tuning inductances may be seen at the left. General design follows radio transmitter practice

the escape of these gases from the mold cavity. In some cases this was accomplished by design and shaping of the mold. However, in other cases it was necessary to "breathe" the press (open it momentarily) in order to allow the gases to escape.

In r-f preheating the gases are mostly driven off before the material is placed in the mold. Breathing will rarely be necessary and molds can be designed without concern as to how gases will escape. This is of particular advantage in the molding of pieces with long vertical sides (deep draws), such as radio cabinets.

Still another advantage of the softening caused by r-f preheating is that lower pressures may be used to obtain the necessary compression and cause the mold to close. Curves given by Meharg (Fig. 9) illustrate this point. The reduction in required pressure can be turned to advantage in either of two ways. As applied to presses presently operating, it allows the press (with the same pressure applied) to be closed much more

quickly. In the pressing of the jack-box shown in Fig. 2 it was found that the press closing time was reduced from one and one-half minutes with oven preheating to less than twenty seconds with r-f preheating. In the future it will allow

cheaper presses of lighter construction to be used, or, conversely, bigger pieces to be molded in existing presses. Similarly, there is at least a good chance that less expensive dies can be used. Such a development (Continued on page 204)

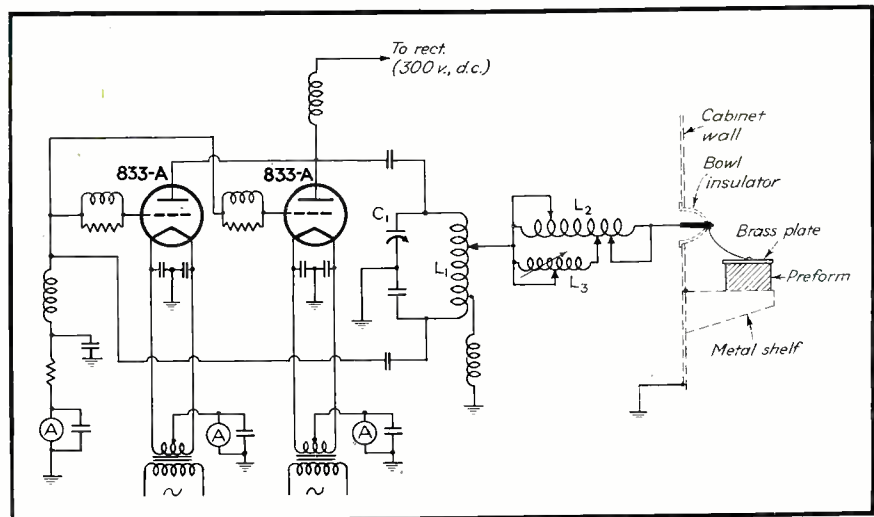
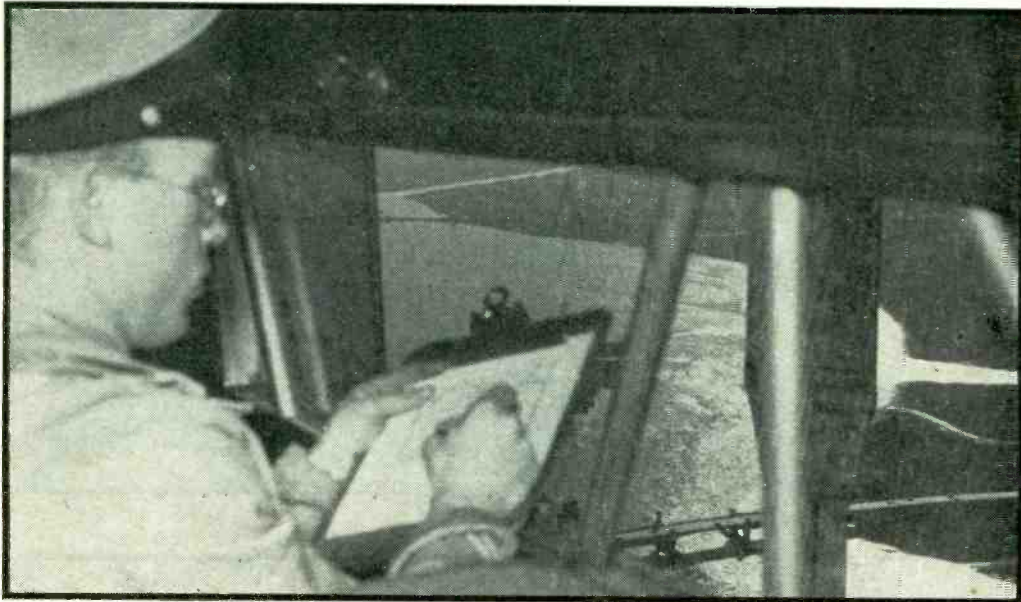

FIG. 11—Simplified circuit of the 2-kw r-f generator shown in Fig. 10

MILITARY FACSIMILE

Facsimile transmitters in scout planes permit sketching military data with black pencil on a red outline map and transmitting the black portions to headquarters during flight. The signals are meaningless to the enemy if intercepted unless they also possess the exact outline map tracing used at headquarters to complete the received copy



SKETCHING — Over enemy territory, the observer sketches on an accurate scale map vital data on the disposition of enemy troops and equipment. Since the map is in red and the facsimile transmitter is insensitive to this color, only the added markings are transmitted. These would be meaningless to anyone intercepting the radiated signal

TRANSMISSION—The completed map is clamped on the sending drum, and transmission begins as soon as go-ahead orders are received by radio from the receiving officer in the mobile field headquarters. During scanning, the observer can receive new instructions from headquarters and discuss them by radio, since multiplex equipment permits simultaneous two-way radio communication in the wave band used for facsimile transmission. Either the transmitter or the receiver, or both, can be used in tanks, armored cars, scout cars, ships, planes or any other mobile equipment having the necessary source of power. The useful working range is hundreds of miles

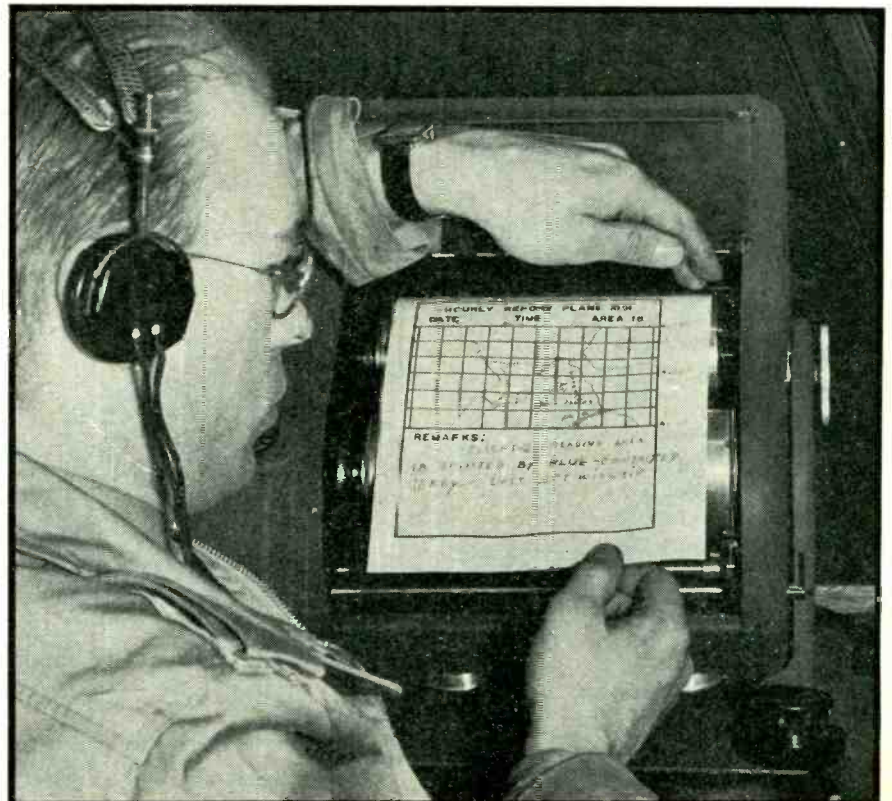



RECEPTION—About half of the map has been reproduced here at the facsimile receiver. The complete transmission requires only a few minutes, as the stylus burns in the image at the rate of 8 sq. in. per min. on a 6½ x 8 inch copy sheet. The stylus has a linear velocity of 1850 in. per min. and the scanning spot has a diameter of 0.01 in.

INTERPRETATION—The commanding officer places his map transparency over the received copy, adjusting the position so the squares coincide, and thereby secures a complete map. The facsimile equipment shown here, providing near-perfect synchronization between transmitting and receiving scanners, was developed by William G. H. Finch

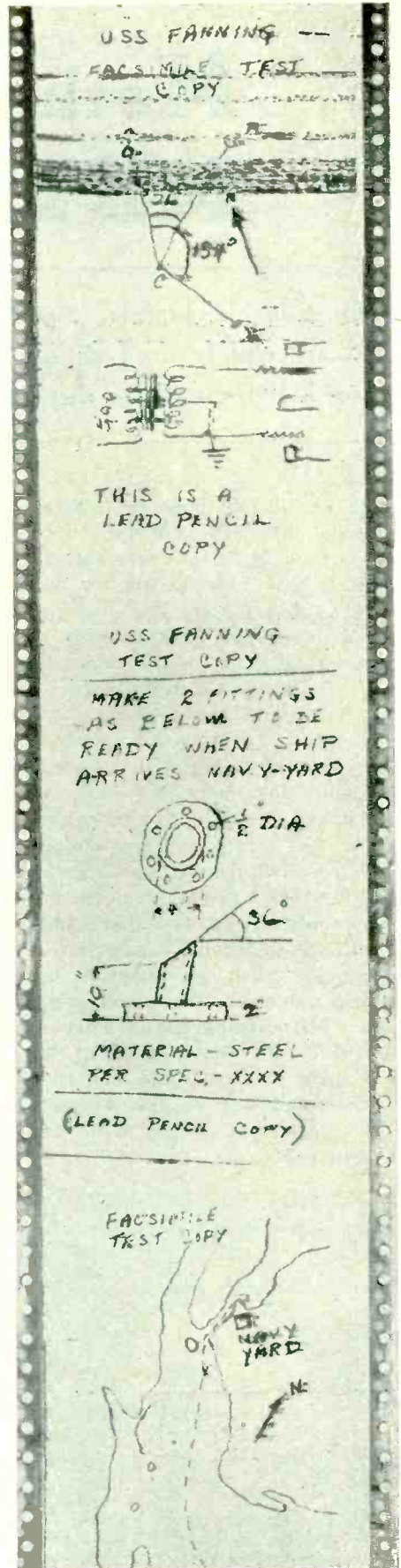
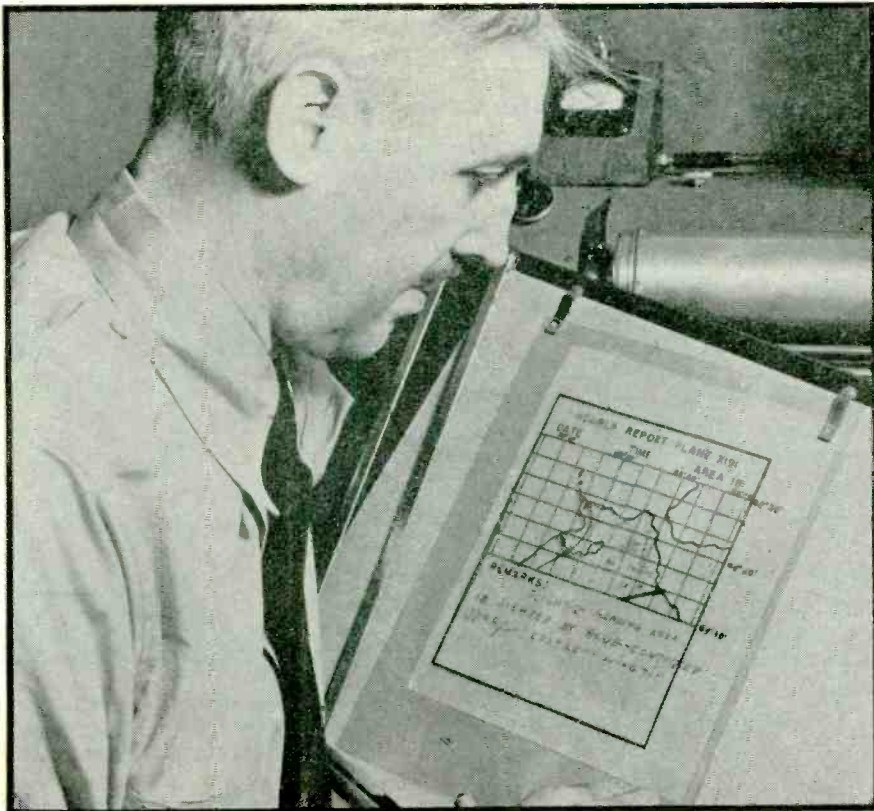

SAMPLE—Reproduction of facsimile test copy received on board a battleship (about 1/3 actual size)

Methods of Depositing METALLIC FILMS

Thin films of metals, "sputtered" or otherwise deposited on glass, ceramics, plastics etc., are widely used in apparatus employed by electronic engineers. Methods of deposition are discussed in this comprehensive survey of old and new deposition techniques

ALTHOUGH methods of depositing thin films of metals on surfaces such as glass, ceramics and plastics have been known for more than 50 years, they have not been widely employed until recently except by physical and chemical laboratories studying atomic structure and electron theory.

Today, however, metal film-depositing techniques are being used commercially for many purposes. Thin films provide highly reflective surfaces for mirrors. They simplify the manufacture of spectrometers and interferometers. They increase the conductivity of fine quartz fibers used as suspensions in sensitive instruments such as quadrant and string galvanometers, electrometers and electrocardiographs. They are useful in the construction of barrier layer photocells and lend themselves admirably to the design of other electronic equipment component parts.

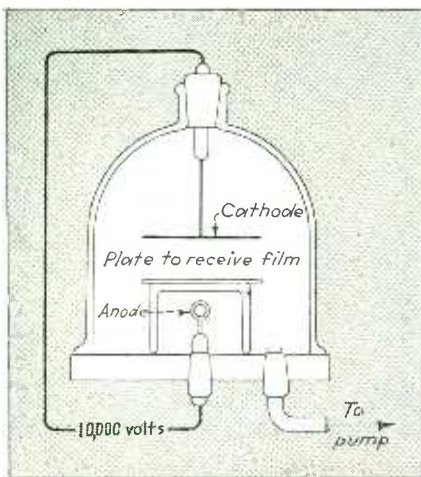

Apparatus for production of mirrors, etc., by cathode sputtering. (From Gardner and Case)

By SAMUEL WEIN

This article presents a brief survey of known metal film depositing methods. These methods have certain advantages. For example:

Extremely thin films may be formed; so thin in fact that they may be used as optical filters and at the same time serve as electrical conductors as, for example, in the barrier layer types of photocells.

Metals that ordinarily cannot be precipitated out of solution can be deposited on surfaces.

Metals can be applied to nonconductors without resorting to special chemical or physical treatments.

Materials can be coated with metals by this method which could not be coated if high temperatures or chemically destructive compounds were required, as in some other processes.

Alloys and elements such as tellurium, silicon and selenium can be deposited on any given surface in very thin layers.

One metal can be deposited on another that is far removed from it in the electrochemical series, whereas this is impossible by electroplating. For example, gold or platinum can be deposited on aluminum or magnesium.

There are also disadvantages. For example:

The processes are comparatively slow and tedious.

The deposits are not made conveniently.

Cathode Sputtering

The technical literature indicates that Grove was the first to deposit

metallic films by means of a high voltage across an anode and a cathode operating in a vacuum. When this method is used, the cathode disintegrates and the metal of which the cathode is made is deposited upon the anode as an extremely thin and homogeneous film. The method is commonly known as cathode sputtering, and is gradually being superseded by others.

Sputtering Methods

There are two commonly employed methods of sputtering. Both are carried out in a partial vacuum or in the presence of an inert gas at low pressures.

Arc—Pencils of the metal, or metals, to be coated on a given surface are brought together, with a suitable source of emf applied between them. Sometimes a voltage is also applied between the cathode of the arc and the work in order to "pull" the metal ions over to the surface to be coated.

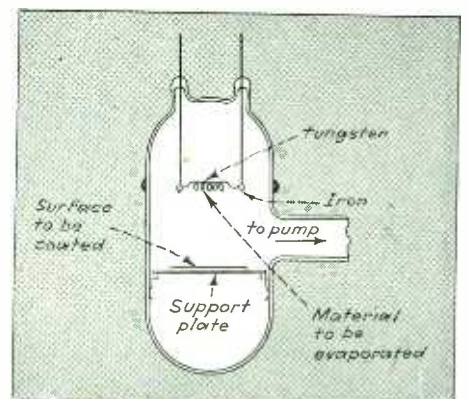

Apparatus for deposition of metals by the evaporation method. The metal is heated by placing it in a crucible inside the tungsten coil or by placing the metal itself in the coil (Gardner and Case)

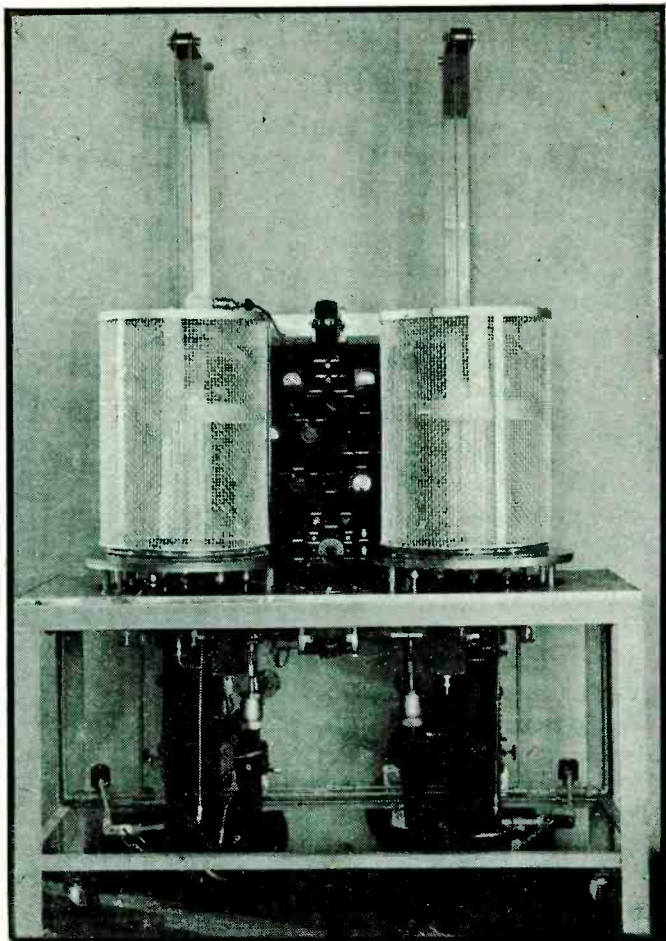
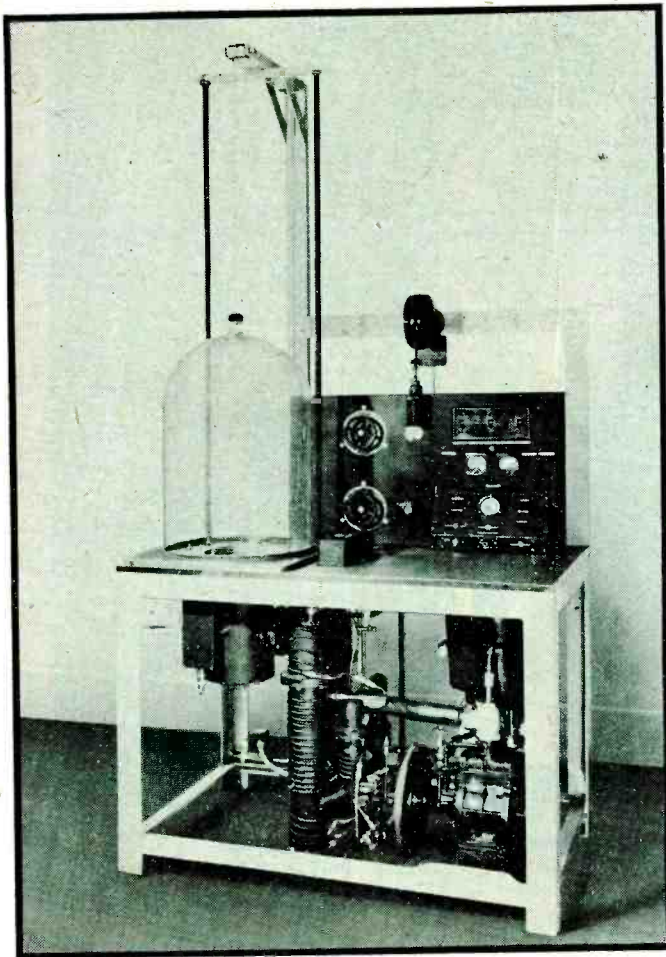

Single and two-bell evaporation units made by Distillation Products, Inc.

High Voltage—Gardner and Case give a description of one layout of a high-voltage method. A base plate of metal or glass is covered by a glass bell jar with the joints made tight by wax or rubber cement. "If an aluminum base plate is used, it may serve as the anode. The connection for evacuating is brought out through the base plate and the pressure is reduced to approximately 0.001 mm Hg. The cathode, a thin sheet or wire grid of the metal to be deposited, and the surface to be coated are placed parallel, approximately 25 mm apart. A 10,000-volt transformer ($\frac{1}{2}$ kw is satisfactory) furnishes the current. It is advisable to rectify the current, either by means of a vacuum tube or by means of a mechanical rectifier driven by a synchronous motor. If no rectifier is used, the anode should preferably be of aluminum".

Evaporation Methods

Distillation—Here we have a small crucible of ceramic or other material whose melting point is much higher

than that of the metal to be distilled. The metal is placed in the crucible in the form of particles of irregular shape, wires of different sizes, coarse granules, or powder or salt (organic or inorganic). The crucible is heated by means of a heating coil to a sufficiently high temperature to bring about a vapor condition of the metal, which will condense on a cold glass plate. Suitable means for accomplishing this in a vacuum chamber have been covered by Sommer, O'Brien, Sukumuly, Berghaus and Burkhardt.

Thermal Evaporation—This method was first suggested by Edison and thereafter developed in detail by Zworykin, Trautman, Saeger, Edwards, Williams, Williams and Ruedy, Alexander, Gardner, Biggs, Walker, Burkhardt and Reinecke, Siebertz, and Lenz. It is commonly used today because of its simplicity and because the required equipment is inexpensive.

In the early days, Edison used filaments of carbon, molybdenum or tungsten. Nichols at the Bureau of

Standards makes a coil of tungsten about $\frac{1}{4}$ mm in diameter, clamped by strips of iron to heavy (1 mm) tungsten wires. The material to be coated is placed on a glass plate and supported on a clamp which can be raised or lowered. If the surface to be coated is too close to the material used as the coating, the film will not be uniform, being thickest in the center. Also, the heat from the filament may break the glass if it is thick and too close to the filament.

One can watch the progress of evaporation by looking up toward the filament from the bottom of the tube. This is especially convenient when semitransparent deposits are required. When the filament is heated the metal to be evaporated will assume a vapor or gaseous condition, which soon condenses on the glass and the inner wall of the bell jar.

Henderson evaporated nickel which had been electroplated onto a tungsten wire in a technique designed to secure especially uniform films. Pfund evaporated bismuth from a tungsten spiral by a similar method.

Eddy Current Technique

The use of eddy currents for "exploding" magnesium within vacuum tubes is common practice. This method forms a mirror-like deposit on the inner wall of the evacuated bulb. The method is fast, but in some cases the investment for equipment to produce the eddy current is prohibitive. "Getter pills" using alloys of different proportions between magnesium and aluminum, with a small percentage of barium, are commonly used in the vacuum tube art and are also employed for making front-surface mirrors. This idea is covered by the patents of Case and Macksoud.

Getter pills are usually made up to individual requirements with regard to whether the aluminum or the magnesium is in preponderance. Some typical getter pill alloys formulated by the King Laboratories, Inc., are shown in the table below.

The lower of the two temperature values in the column at the right gives the temperature at which the evaporation of the magnesium is practically complete and at least a trace of barium is detectable in the deposit. The higher figure gives the temperature of practically complete barium deposition. In the case of alloys containing no magnesium, the lower figure gives the approximate temperature at which the barium begins to deposit and the higher value is the value required for complete evaporation.

The magnesium will usually begin to distill at least 50 deg lower than the lower value given in the table. It is recommended that where the "flashing rate" be fast, the getter be raised to a temperature at least 50 deg higher than the upper figure given in the chart.

GETTER-PILL COMPOSITION

BARIUM	MAGNESIUM	ALUMINUM	FLASH TEMP. (DEG. C)
42 $\frac{3}{4}$	5	52 $\frac{1}{4}$	1025-1075
37 $\frac{1}{2}$	25	37 $\frac{1}{2}$	850-900
43 $\frac{3}{4}$	12 $\frac{1}{2}$	43 $\frac{3}{4}$	900-950
25	55	20	700-750
42	9	49	925-1000
35	50	15	900-950
37 $\frac{1}{2}$	37 $\frac{1}{2}$	25	750-800
43	20	37	850-900
45	..	55	1125-1175
50	..	50	1125-1175
60	..	40	1000-1075
70	..	30	950-1025
75	..	25	925-1000
40	..	35	875-925

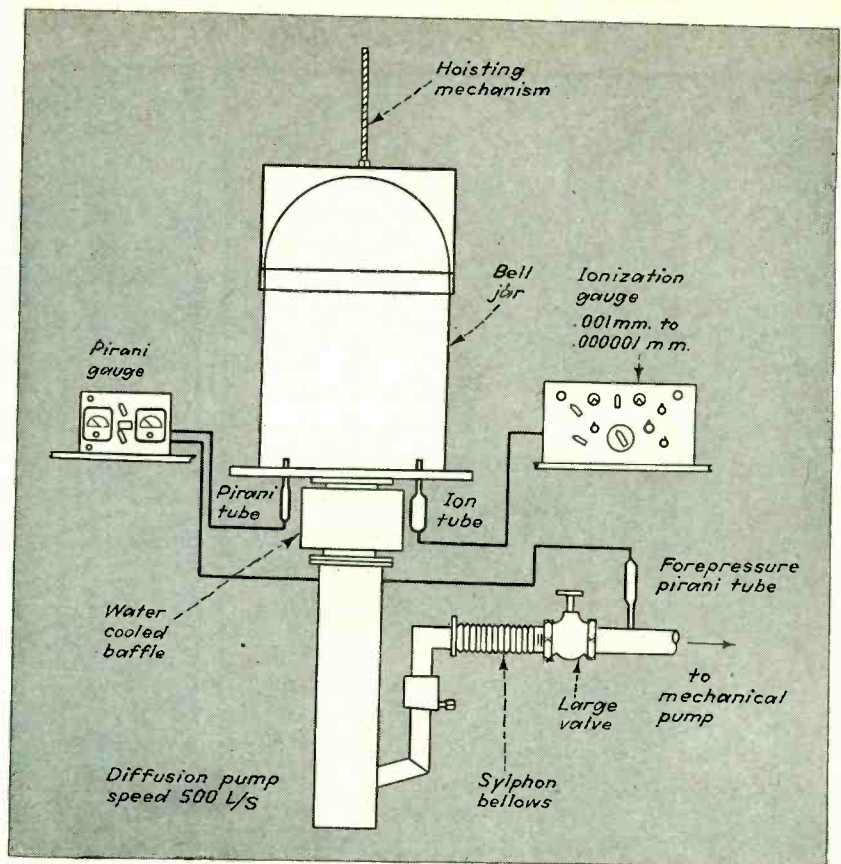

Layout of a modern high-speed high vacuum evaporation unit made by Distillation Products, Inc.

Thin metallic films find numerous applications in mirrors, optical filters, microscopes and other optical instruments. Some of these applications are now described.

Optical Applications

Front-Surface Mirrors—Deposited metal films are particularly useful for telescope mirrors, optical comparators, etc., in which there is no glass between the reflecting surface and the air or other medium through which the light rays approach the mirror. This type of mirror eliminates distortion effects introduced by

the optical properties of glass and effectively increases reflection (due to absence of absorbing material). Metals not generally used in the formation of reflecting surfaces prove useful when properly deposited. For instance, chromium has been found to provide a very satisfactory surface when it is properly coated on glass. Chromium gives to the surface two especially valuable properties: (1) It reflects light over a wide range of wavelengths, having a reflectivity of 85 percent in the ultraviolet region, where silver drops off to 4 percent reflectivity; (2) such a surface does not tarnish quickly, if at all, as compared with silver.

The following notes on aluminum surfaces will be useful to those interested in front-surface mirrors:

The reflectivity of aluminum is very nearly as high as silver for green light and is much higher for the ultraviolet, according to Coblenz and Starr, making possible the use of mirrors for ultraviolet optics where the lack of achromatism in a lens system is often objectionable. Edwards finds that aluminum reflects 89.5 percent of light and aluminum-magnesium alloys reflect 94 percent.

Aluminized mirrors exposed for more than 6 months show no tarnish. The permanence of the high reflectivity definitely exceeds that of silver protected by an evaporated quartz layer, according to Cartwright and Strong. The aluminum is inert to corrosive agents because of the layer of oxide which forms on the surface when removed from the evacuating chamber.

The aluminum adheres more tenaciously to glass than does silver, so that dust, etc., may be washed off with soap containing no caustic soda. Soda with water may be used as a cleansing agent.

Aluminum mirrors have a greater uniformity than silver in reflectivity and transmission throughout the visible wavelengths and find wide application for interferometer plates for this reason.

Optical Filters—Semi-transparent films of metals are used as optical filters having unique transmission characteristics dependent on the metal deposited, and are also used as optical filters which must simultaneously serve as electrical conductors, as in the case of a conducting medium for the barrier type of photocell.

Such filters may be formed of a single metal or an alloy. Alloys are used where transmission of a specific color is required and where the required characteristics can not be obtained with a single metal. The following table shows the colors transmitted by certain metals:

METAL	COLOR
Silver	Blue-violet
Chromium	Brown
Aluminum	Blue
Gold	Green
Copper	Green
Selenium	Orange

Any two or more of these metals applied to a glass surface as successive films will produce a transmission equal to the product of the transmission of the component metals.

It is well known that a coating of a metallic fluoride on an optical lens will reduce or eliminate reflection at the glass-air interface if the coating has the proper thickness. This is a most important application of coating technique.

In spectrophotometers semi-transparent films which transmit all colors to an equal degree are employed to attenuate one source of light with-

out affecting the color response. An alloy of chromium and platinum has such a characteristic. Another use of semi-transparent films is in interferometers employed to examine minute contractions and expansions in industrial machines.

Beam-splitting, as in binocular microscopes or in color cameras, is another use of thin metallic layers. For example, a film of an alloy of aluminum and copper will reflect red and blue light but will transmit green light, the aluminum reflecting the blue and the copper reflecting the red.

Electronic Applications

Thin metallic films, such as those which may be deposited by any of the methods described, have a number of applications in the electronic field. Typical examples follow:

Microphone diaphragms made of duralumin coated with gold are located between two small chambers containing granular carbon. The carbon granules are in electrical contact with the sputtered gold film on the duralumin diaphragm (Western Electric Co.).

Piezo-electric crystals are coated with metals to make better or more intimate electrical contact, according to Hulburt, Kingsley and Vigoureux.

Resistor units, according to Richtmeyer, Zworykin and Hobruck, are coated with metals for electrical contact purposes.

Shielding for high-frequency oscillators is made by sputtering metals on plastic and other materials.

Phonograph master records made in wax, insoluble metallic soaps or other similar materials must, of necessity, be electroplated with a suitable hard metal and then backed up to a desired thickness for use as a "stamper." To accomplish this electroplating process, Edison sputtered gold on the master record, then backed the thin shell with copper by electroplating. Russell used palladium because it is harder than gold and is not affected by chemical action between the palladium surface and the resinous material with which it is in contact during the molding process.

Other Uses of Metallic Films

Window glass has been coated with semi-transparent films so that those inside a building can see out but those on the outside cannot see in.

Advertising displays have been made by placing text and illustrations in a suitable box containing a light that flashes on and off periodically. When the light is on, the copy can be seen. When the light is off the display acts like a mirror because of the material coated on a glass plate within the box.

Tin cans have been coated so that contamination of the material by the tin is eliminated. Alloys of silver have been used for this purpose.

Materials such as vegetable and animal matter in the form of fabric or textile (cotton, wool, silk, paper, wood, linen, jute, hemp, leather, gelatin, mica, etc.) have been coated by

(Continued on page 248)

ORGANIC FLUIDS FOR VACUUM PUMPS

Name	Formula	Mol. Wt.	S.G. at 25° C	N _D ¹	Z ²
Butyl Phthalate	C ₈ H ₄ (COOC ₄ H ₉) ₂	278.1	1.0465	1.491	39
Butyl Sebacate					
Amoil	C ₈ H ₄ (COOC ₅ H ₁₁) ₂	306.2	1.0190	1.485	44
Amoil-S	C ₈ H ₁₆ (COOC ₅ H ₁₁) ₂	343.3	0.9251	1.449	53
Octoil	C ₈ H ₄ (COOC ₈ H ₁₇) ₂	390.3	0.9796	1.488	39
Octoil-S	C ₈ H ₁₆ (COOC ₈ H ₁₇) ₂	426.3	0.9103	1.443	53

Name	Vacuum Ultimate at 25° C	B.P. °C ³	K ⁴	Viscosity 80	100	150
Butyl Phthalate	10 ⁻⁴	85	1.7 x 10 ⁻¹⁰	79	58	45
Butyl Sebacate						
Amoil	2.5 x 10 ⁻⁵	100	1.7 x 10 ⁻¹¹	100	81	52
Amoil-S	3.1 x 10 ⁻⁶	111	2.9 x 10 ⁻¹³	71	65	50
Octoil	2.5 x 10 ⁻⁷	122.5	2.6 x 10 ⁻¹⁰	178	171	75
Octoil-S	5 x 10 ⁻⁸	143.4	6.7 x 10 ⁻¹²	83	81	57

1. Refractive index for sodium D line

2. Dispersion ratio, i.e., $\frac{N_D - N_e}{N_D - 1}$

3. Boiling point at 10⁻² mm

4. Conductivity in mhos at 27° C

5. Viscosity in seconds—Saybolt viscosimeter

Photoelectric Contact Printer CONTROL



Once the correct printing time has been determined for a given negative, a phototube-thyratron-guillotine shutter arrangement insures that all contact prints made from that negative will have uniform density regardless of variations in lamp intensity due to changes in filament temperature

To make large numbers of contact prints economically from a single negative requires the minimum printing time consistent with exact density duplication between prints. High printing speeds, in turn, demand high light intensity and automatic exposure.

A number of electronic timing devices were used before the development of the unit described here, but in every case print densities varied. The earlier timing units used solenoid

contactors or mercury relays for controlling the current to the lamps. It was found that the release time of these relays was inconsistent and consequently the time cycle varied even though the electronic circuit provided absolutely accurate timing.

The relays were replaced with thyratron tubes whose action was instantaneous, but severe density variations were still experienced. These were traced to variations in light intensity between cold and hot lamps.

Using six number 2 photoflood lamps and printing times of one-half second and less, the time for the lamps to reach maximum temperature (maximum light intensity) depended on the starting temperature of the filament. A series of prints made from a cold start and continuing as rapidly as the operator normally worked would show increasing densities until a temperature equilibrium had been established. Any appreciable interruption in printing would result in less dense prints until the temperature was again equilibrated.

Variations in density due to thermal inertia in the lamp filaments can be overcome by exposure through a shutter rather than by increasing and decreasing the brilliancy of the lamps. If the exposure is actually measured by using a phototube to discharge a timing capacitor, the device will be self-compensating for line voltage changes, darkening of the lamp envelopes or any other change that varies the light intensity. An Eastman No. 12 studio printer is easily modified to incorporate such a timing device. Figure 1 shows the complete installation, comprising the "guillotine" shutter, the thyratron relay circuit, the phototube and step-wedge, and the mechanical system for varying the exposure by placing different steps of the step-wedge in front of the phototube mask opening.

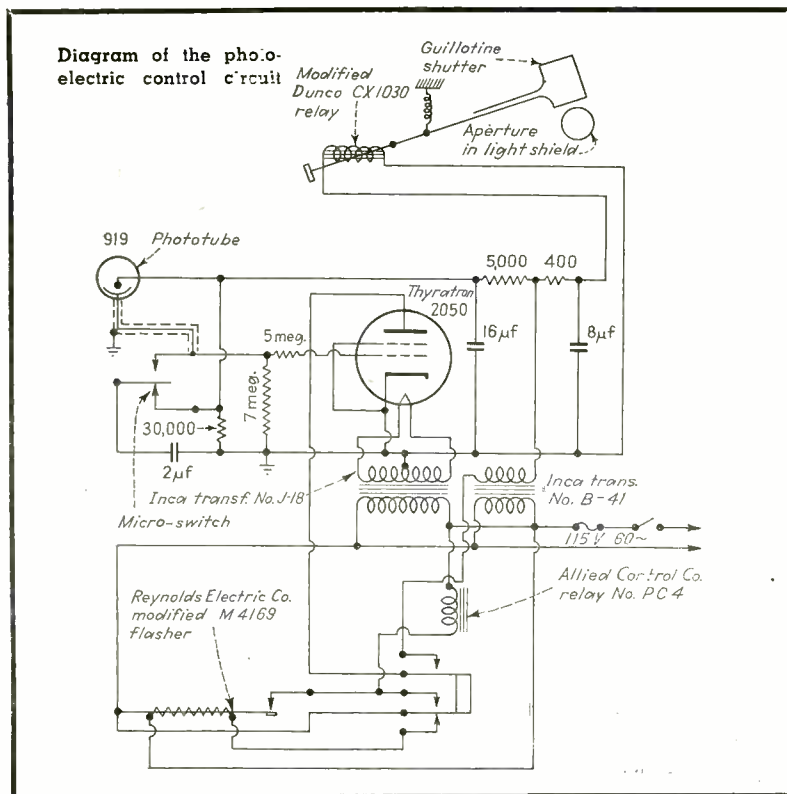

Operating Principle

The light path in this printer starts out horizontally. A concave mirror

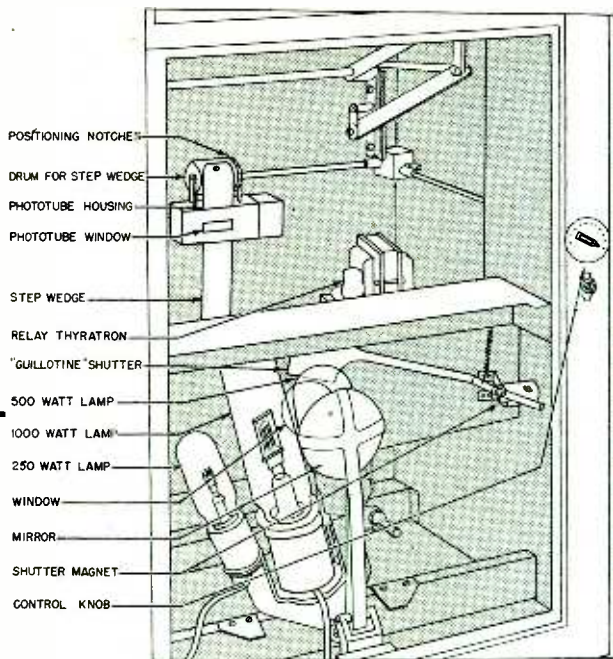

(shown in Fig. 1) concentrates the light from the printing lamp into a horizontal beam that is directed through an aperture in the vertical light shield to a plane mirror (not shown) positioned behind the shield at an angle of 45 deg, so it reflects the beam vertically upward to the film and paper on top of the table. The mirror is mechanically coupled to the platen and is turned to a vertical position when the platen is lifted so as to expose the "safe" light (also behind the white shield in Fig. 1).

A thin aluminum vane shutter is placed between the light and the shield. It is operated electromagnetically by a coil in the anode circuit of a miniature thyatron (type 2050).

The time cycle is determined by the time required to discharge a capacitor in the grid circuit of the thyatron from one fixed voltage to another. A phototube is used to discharge the capacitor, and the rate of discharge is determined by the intensity of the light falling on the tube.

The phototube, placed so as to receive light directly from the lamp when the shutter is opened, is housed in a light-tight box with a small window which is covered with a photographic film "step-wedge". The wedge, which varies the time of exposure, can be moved one step at a time in front of the window by means of a drum having a "detent" device which accurately locates each

FIG. 2—(Right)—Nominal exposure time for each timing dial setting and each lamp. Actual time is automatically varied to compensate for lamp intensity changes

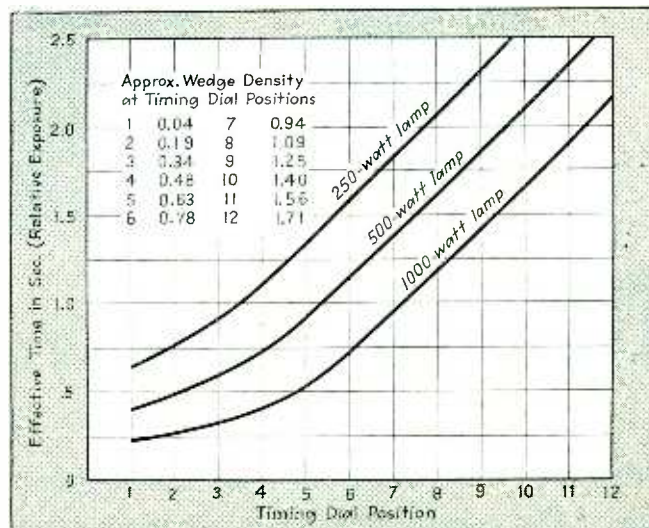

step in front of the window. The control knob is mounted on the front of the printer, where it is readily accessible to the operator.

Figure 2 shows the calibration curves for the timer, plotted for each lamp. These curves were made with a "Shutter Speedometer" that indicates "effective time", a measure of light quantity (intensity \times time), taking into account the shutter efficiency. The curvature at the lower end, which increases with the power of the lamp, is due to the finite time required for the shutter to operate. The minimum effective time is approximately 0.2 sec. for the 1000-watt lamp, 0.4 sec. for the 500-watt lamp and 0.65 sec. for the 250-watt lamp.

By effective time is meant the time the shutter would be fully open if it opened and closed with infinite speed. Since the shutter requires time to open and close, the elapsed time for a shutter cycle is longer than the effective time. The overall variation in effective time is less than ± 10 percent for line voltages from 100 to 120 volts. By marking each negative with the lamp

By C. J. PENTHER and C. WEISKE

Shell Development Co., Emeryville, California

FIG. 1—Photograph (on opposite page) and diagram (at left) of Eastman No. 12 studio printer as modified to incorporate a photoelectric timing device that automatically compensates for changes in light intensity as the printing lamp warms up during production runs. This printer gives a choice of three different lamps

size and the wedge position number, prints can be exactly duplicated at any time.

Circuit Details

The photoelectric circuit, shown on the opposite page, is an adaptation of the timing circuit described by Goldberg², modified to incorporate the phototube timing feature and shutter mechanism. The resistor required as a grid return for the thyatron determines the maximum time of operation. Its resistance is made as high as possible (consistent with stable operation) in order that the dark-time be so long that it has a negligible influence on the actual operating time. That this is the case is indicated by calibration curves showing no tendency to curve downward at the upper end.

The microswitch actuating the timer is set to close just after the mercury switch which turns the light on. They are both automatically operated by closing the platen. When the microswitch disconnects the timing capacitor from the charging source and connects it

(Continued on page 274)

FIG. 1—Parallel wire transmission line with accessories as follows: (a) variable air capacitor, (b) telescoping tandem bridge, (c) current detector, (d) voltage indicator, (e) sine-wave oscillator with detuning stub at (f), and (g) tandem bridge

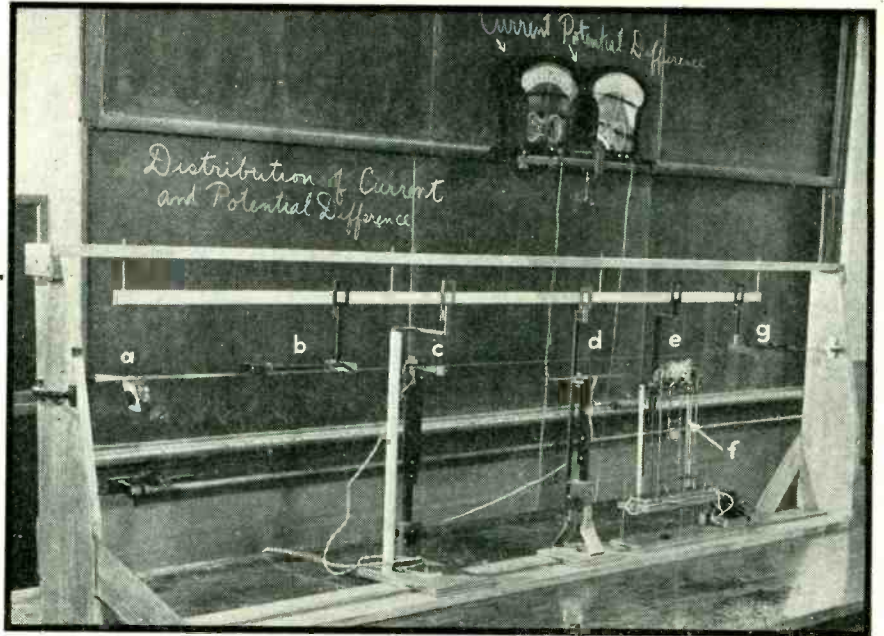

MICROWAVE PLUMBING

Laboratory instruction in u-h-f transmission requires new equipment not previously available. The construction of transmission lines and wave guides used at Harvard is described. Concluding installment to discuss u-h-f antenna systems and oscillators

A straightforward circuit setup in a clear and orderly fashion is generally the core of a good electrical laboratory experiment or lecture table demonstration. The design of u-h-f laboratory equipment follows this principle, but other considerations apply in addition. To keep a piece of apparatus from misbehaving at ten centimeters or two meters may require careful attention to the geometrical as well as electrical design, in spite of the apparent simplicity of both. Furthermore, use in laboratory instruction demands that the equipment be rugged and versatile.

Suitable combinations of the various pieces of apparatus to be described give a fairly complete coverage of u-h-f transmission phenomena and have been used with success both in the laboratory and for lecture demonstrations. The work may be divided conveniently into three

By D. D. KING,

*Cruft Laboratory,
Harvard University,
Cambridge, Mass.*

sections: (1) transmission lines, (2) wave guides, (3) antennas. The description to follow will be in that order.

Transmission Lines

A typical transmission line set-up is shown in Fig. 1. A rigid wooden frame with guide track and meter scale supports the line, which is hung on polystyrene blocks. In order to prevent spurious resonance effects it is best not to make the line an integral number of half wavelengths long.

From left to right along the line are:

(a) A variable air capacitor across the open end. Inductive and capacitive (close wound) coils, resistors,

and bars are hung on the line to give any desired termination.

(b) A telescoping tandem bridge with grooves for various line spacings.

(c) A current detector consisting of two brass rods mounting a postage stamp blocking capacitor at one end and a small crystal at the other. A microammeter (supported from the blackboard) is connected across the crystal. Coupling is varied by raising or lowering the whole unit or by moving it laterally along the track. The brass rods may be telescoped in and out from the line as well.

(d) A voltage indicator comprising two parallel rods acting as an antenna to feed a crystal connected near their center. The whole unit again may be moved laterally or raised and lowered with a rack and pinion. The voltmeter is supported from the blackboard.

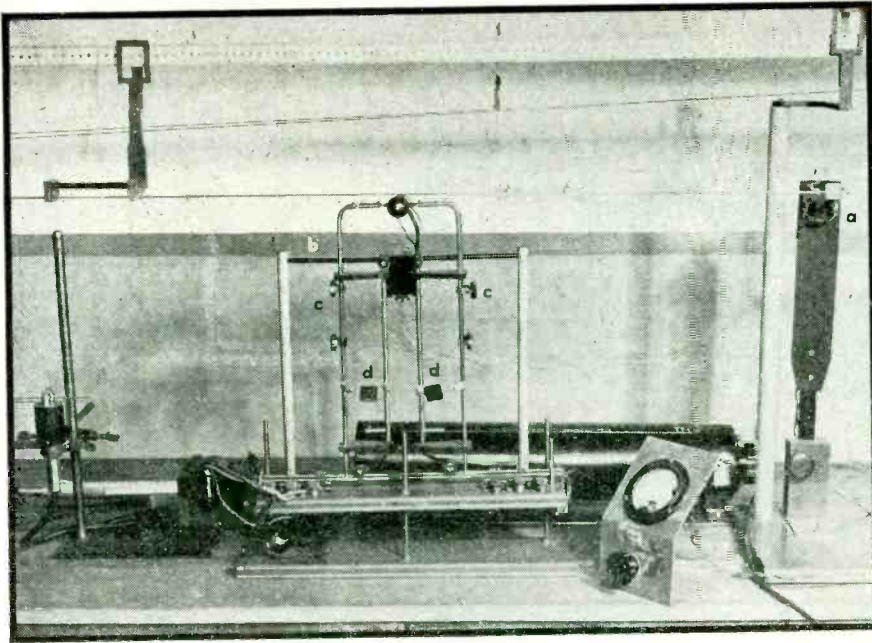

FIG. 2—Transmission line type of coupled circuits operated at one meter with equipment as follows: (a) detector, (b) oscillator, (c) tuning capacitors, and (d) shorting capacitors

(e) A sine-wave symmetrical oscillator¹ using two W. E. 316A tubes in a modified Hartley circuit. Grid and plate (tank) rods are bridged by tandem postage stamp capacitors for tuning.

(f) A detuning stub on the central tubes containing the filament leads.

(g) Another telescoping tandem bridge.

Measuring equipment for a line experiment for the study of coupled-circuit phenomena is shown in Fig. 2. The measuring line with current detector at (a) is loosely coupled by a polystyrene frame to the secondary.

The oscillator (b), feeding the primary of the coupled circuits, uses an RCA 8012 and is similar to the one mentioned above. Tandem tuning bridge capacitors (c) and below them, shorting capacitors to the supports (d), keep the r-f currents in the tank. The General Radio 757A oscillator in the background, with matching section and antenna, is used for calibration.

Compared with crystals, vacuum tube voltmeters have the advantage of requiring a less sensitive meter. At wavelengths below 50 cm their sensitivity declines. Nevertheless, acorn tubes at 10 cm are as sensitive as a crystal. Close spacing between tubes and line as well as standing waves on the tube supports complicate the operation at very short wavelengths.

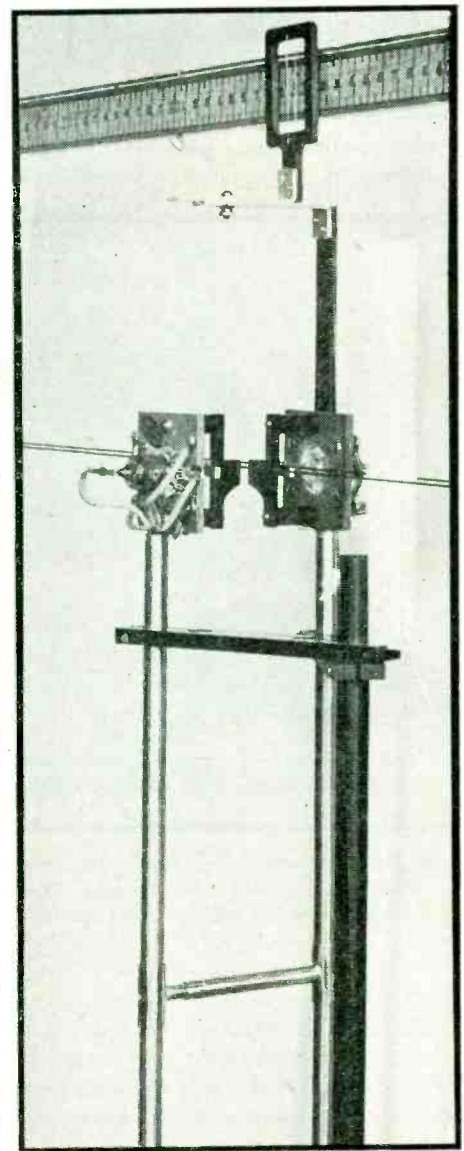
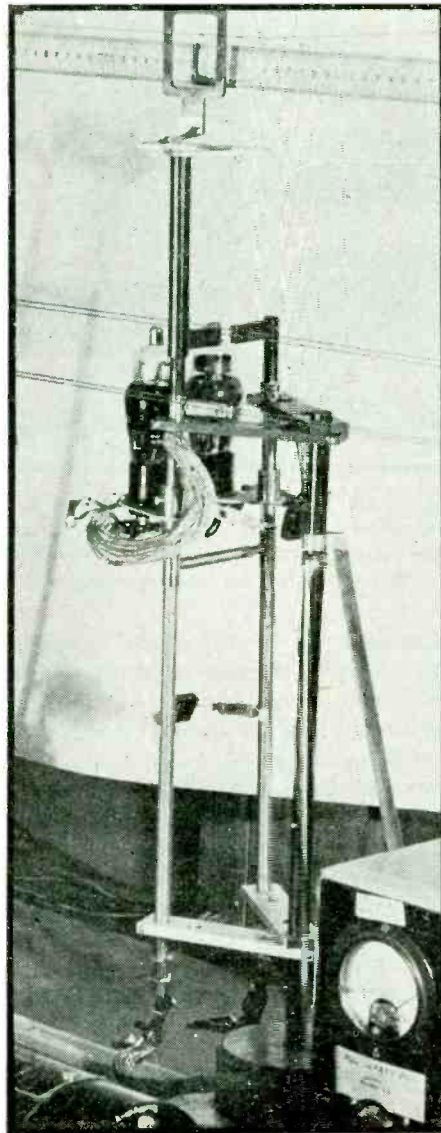

FIG. 4—Transmission line voltmeter using a pair of acorn tubes

FIG. 3—Vacuum tube voltmeter for parallel line measurements, using ordinary r-f pentodes

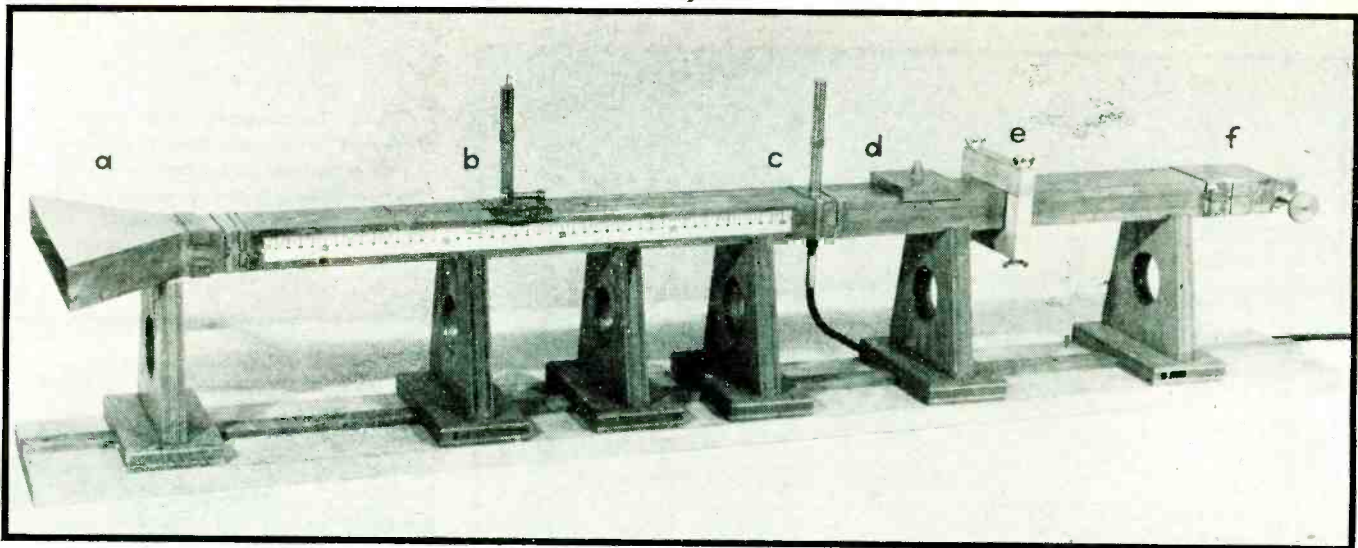

FIG. 5—Rectangular wave guide. From left to right are: (a) radiating horn, (b) measuring section with scale and movable detector, (c) fixed driving unit, (d) movable driving unit, (e) wooden frame for compression yoke, and (f) piston assembly

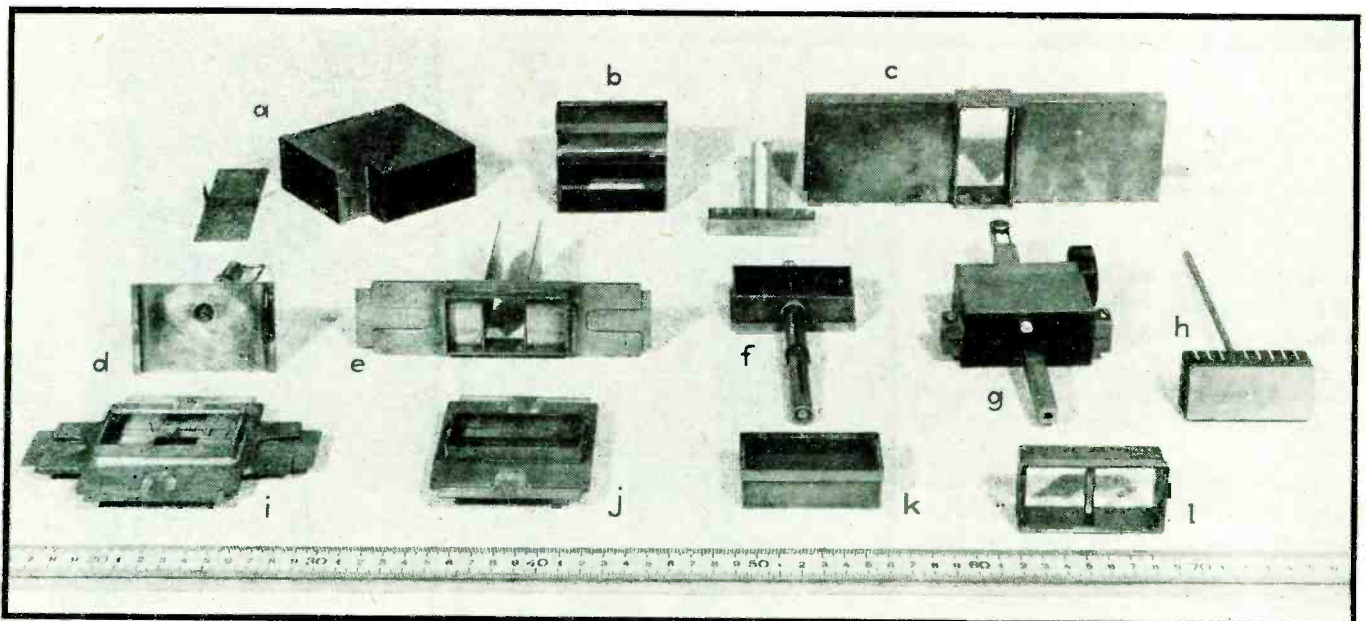

FIG. 6—Accessories for rectangular wave guide: (a) horizontal elbow with reflector plate removed, (b) vertical elbow, (c) double T-section with one plunger removed, (d) bottom view of detector, (e) double L-section, (f) fixed driving unit, (g) piston assembly, (h) piston for assembly at (g), (i) parallel resonant section, (j) capacitive section, (k) insertion section with bakelite slab, and (l) insertion section with dielectric rod

Two vacuum tube voltmeters using 6D6 (or any r-f other pentode) and 956 tubes respectively are shown in Fig. 3 and 4.² Movable low-value resistors or capacitors connected across likely points of voltage maximum, with detuning stubs placed on the support and lead-in tubing, are precautions necessary to prevent self-resonance.

Wave Guides

A rectangular guide for use at 3000 megacycles with the H_{10} mode is set up in Fig. 5. The sections are built up from stiff brass, silver soldered together at the edges. Pins in

the joints give additional strength to the shorter sections. Short collars soldered on the female ends readily snap on the male ends. Once the desired assembly has been completed, wooden frames, one of which is shown, may be secured to the outermost sections. Steel rods (not shown) forming a yoke at each end are slipped on, and set screws place the whole assembly under compression. The rigid unit thus obtained is well adapted for use where large numbers of students handle the apparatus.

The special types of sections and the associated equipment used with

this wave guide are shown in Fig. 6 and will be considered individually.

The detector unit (d) of Fig. 6 consists of a flat plate with heavy strips along the edges to make it slide smoothly on the section with the mounted scale. Constructional details of the detector are shown in Fig. 7. A pickup rod of adjustable length protrudes from this base into the guide, through a longitudinal slit in the measuring section. A pickup loop may also be used. Sensitivity may be adjusted by altering the probe length or by moving the slider of the tuning stub up and down. The crystal cartridge is easily replaced.

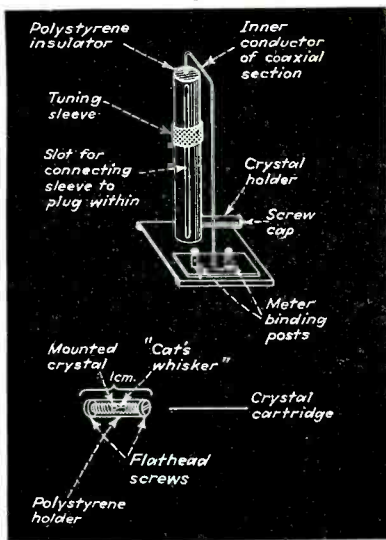

FIG. 7—Constructional details of detector unit

A driving unit is shown at (f) of Fig. 6. A movable probe antenna extending a very short distance into the guide, as in the detector, is the best type for experiments with the guide resonant; here loose coupling and a movable antenna are required. A short section of guide with coaxial adapter at the bottom and a matching stub at the top is a more efficient unit for power transfer. The inner coaxial conductor is simply extended through the guide into the coaxial stub above, thus forming a fixed antenna to excite the vertical E field in the same fashion as the probe.

Tuning piston assembly and tuning piston are shown at (g) and (h) of Fig. 6. A rack and pinion with scale is mounted in a frame to clamp

on the outside of the male section. The removable piston with springy phosphor-bronze edges fits snugly into the guide.

Horizontal and vertical elbows (a) and (b) respectively and T sections (c) of Fig. 6 are of straightforward construction. Flat reflector plates to cover the corners of the elbows may be slipped in to change their behaviour. A reflector plate, removed from its angle piece, is shown at (a).

Plates or rods of various materials and metal grids, called insertion sections, may be inserted in sections fitted with guide pins or ridges and a small spring to keep them in place.

Insertion sections with a bakelite slab and with a dielectric rod are shown in Fig. 6 at (k) and (l) respectively.

Various sections have been developed to give reactive effects with the H_{10} mode. Inductive effects are given either by a vertical double T section with adjustable plungers (c) or by inserting plates into the guide from the narrow sides (e). Capacitive effects are obtained by inserting plates from the top and bottom (j); insertion from all four sides (i) gives the possibility of obtaining parallel resonance. Finally, the whole width of the guide may be effectively re-

(Continued on page 276)

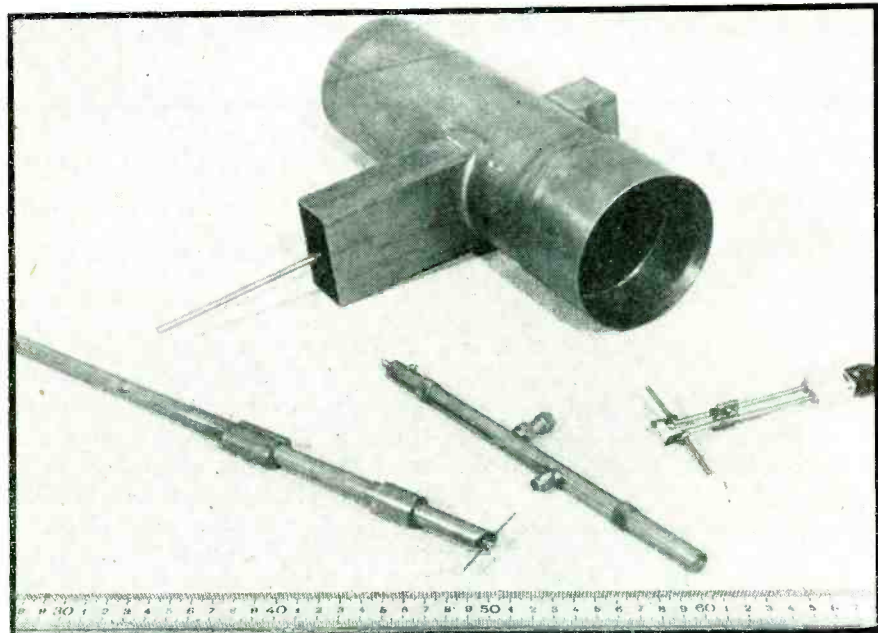

FIG. 8—Cylindrical wave guide with detector and driving unit mounted for measurement. In the foreground, from left to right, are: a piston, six different insertion grids and disks, and insertion holder. The cylindrical wave guide permits studies of modes of oscillation which cannot be demonstrated by the rectangular guide

FIG. 9—Accessories for cylindrical wave guide. Cylindrical section with rectangular attachment enables mode of oscillation to be changed. In foreground, from left to right are: antenna mounted on coaxial section, double stub for matching coaxial line to generator or load, and probe antenna with crystal detector

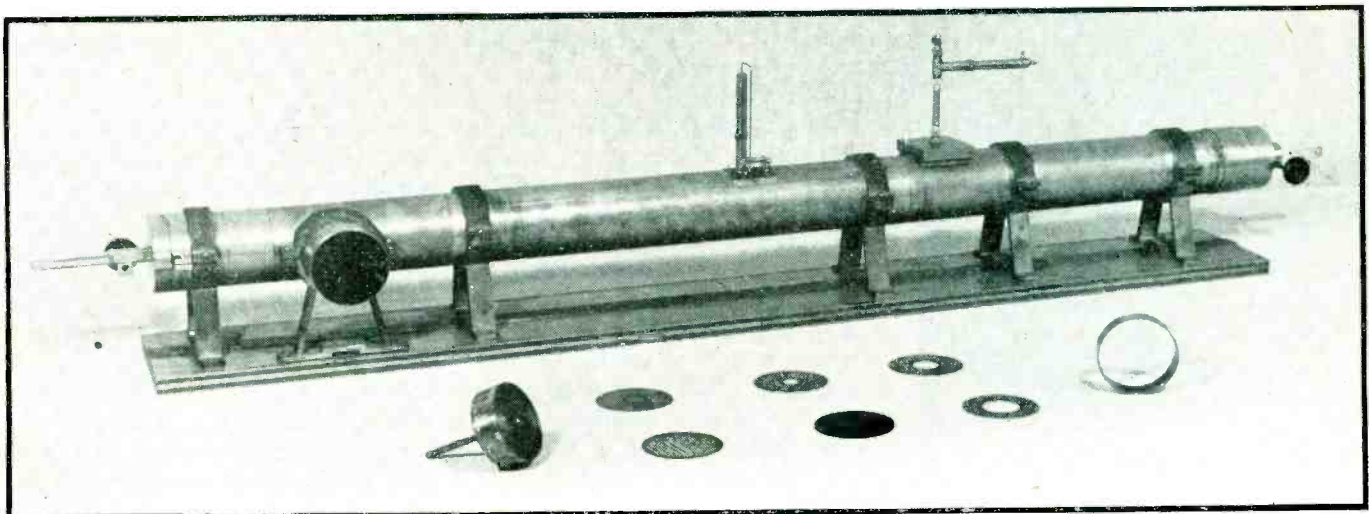
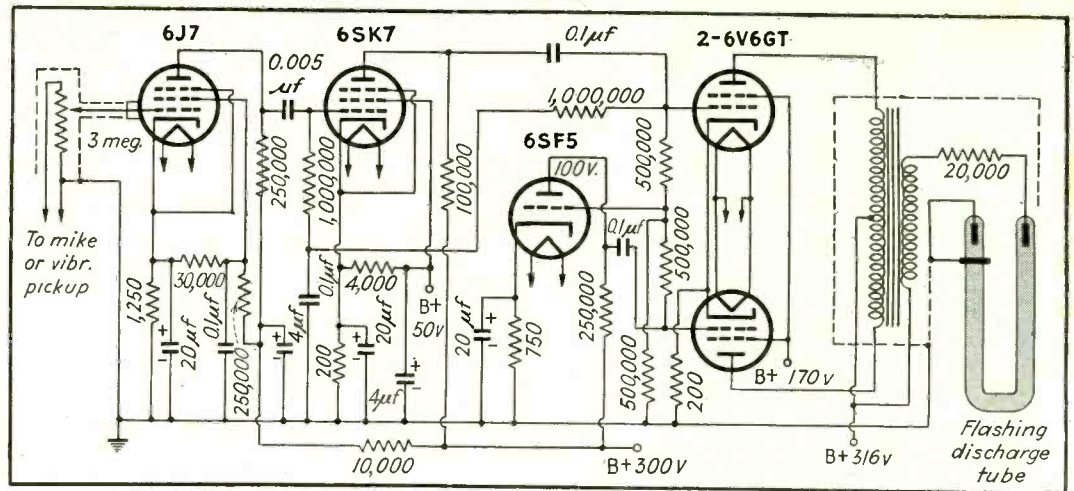

FIG. 1—Circuit used to produce intense flashes of light at an audio rate corresponding to that of the frequency being measured



Precision Stroboscopic

A fork-controlled electronic generator is adjusted until one of 84 rotating patterns appears stationary when illuminated by a discharge tube fed with the signal to be measured. The direct-reading range covers 32 to 4000 cycles with 0.05 percent accuracy

By **EARLE L. KENT**

Director of Instrument Research
C. G. Conn, Ltd.
Elkhart, Indiana



Conn stroboscope for sound analysis

ALTHOUGH originally developed to test the intonation of wind instruments, the chromatic stroboscope to be described has been successfully used in piano and organ tuning (where it can provide specific data permitting duplication of tuning), in investigations of pitch, and in giving musical instructions or demonstrations to students.

More recent uses in war industries and in laboratories involve checking the speed of rotating objects, calibrating or checking tachometers, measuring natural frequencies of moving parts of engines, measuring stack frequencies, and calibrating oscillators, impulse generators and similar equipment.

The instrument as made by C. G. Conn, Ltd. is essentially a logarithmic frequency meter of the stroboscopic type, capable of measuring the frequency of any sound, vibration or a-f voltage directly in the logarithmic unit known as the semitone. Results may also be expressed in cycles per second by referring to a suitable table. The logarithmic scale is particularly advantageous in measuring ratios of two frequencies, with or without regard to the actual frequencies involved.

In use, the alternating quantity to

be measured is converted into an audio signal, amplified, and fed to a discharge tube that produces flashes of light at the audio rate involved. This light illuminates a series of 12 identical pattern discs, each rotating at a different determinable speed that is proportional to the frequency of a calibrated tuning fork in an electronic generator circuit that feeds a synchronous motor geared to the pattern discs. Each disc is imprinted with a pattern consisting of seven rings of alternate light and dark segments, with the inner ring having two segments and each other ring having twice as many as the preceding ring. The fork frequency is adjusted until one of the patterns on one of the wheels appears stationary due to stroboscopic effects. The frequency of the input signal can then be read on the dial.

The pickup device may be a crystal microphone, vibration pickup, rotating contactor or any other device capable of delivering a signal of at least 1.5 millivolts to the input of the amplifier circuit shown in Fig. 1. This amplifies the input signal sufficiently to actuate a U-shaped discharge tube that produces flashes of light at a rate corresponding to the frequency being measured.

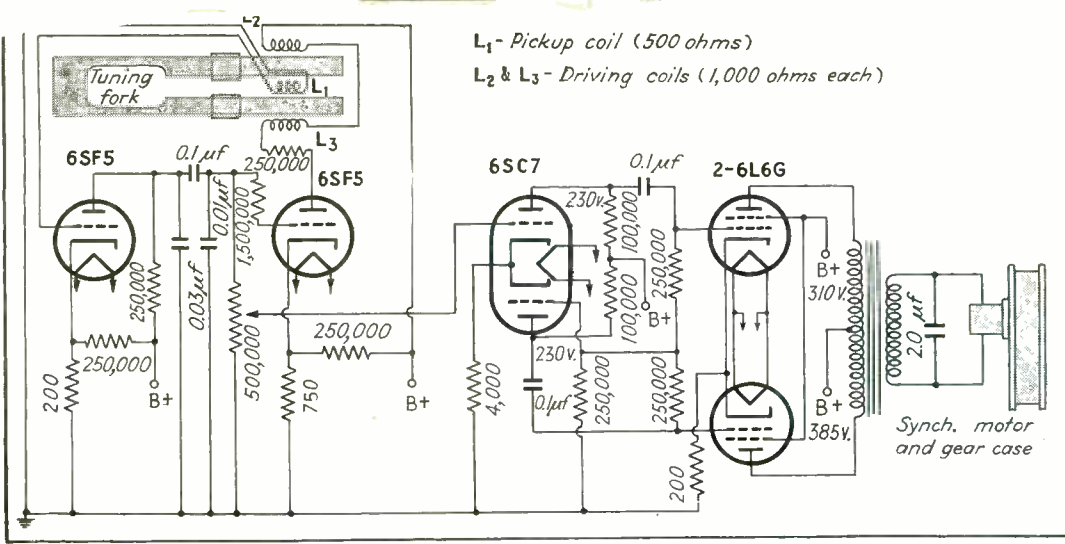

FIG. 2—Circuit arrangement of the tuning fork and amplifier for driving the synchronous motor

BELOW: One of the pattern wheels. The rings have 2, 4, 8, 16, 32, 64 and 128 segments respectively, thus taking care of seven octaves

Frequency Meter

The discharge tube is positioned behind 12 translucent pattern discs that are geared together in such a way that the speed ratio between adjacent discs is that of an equally tempered semitone (a ratio equal to the twelfth root of 2, which is about 6 percent). This ratio is obtained with sufficient accuracy by successive use of the two gear ratios 89/84 and 107/101 in alternation.

The circuit of the electronic generator that feeds the synchronous motor is shown in Fig. 2. The temperature-compensated tuning fork that controls the frequency is driven by coils L_2 and L_3 in a regenerative circuit whose pickup coil is L_1 . The succeeding a-f amplifier stages that step up the power to meet the input requirements of the motor are of conventional design.

Sliding weights on the tuning fork are calibrated in 100 steps covering a frequency range of 3 percent above and below 55 cycles (the fork frequency). This range in combination with the 84 patterns (7 on each of the 12 discs) is sufficient to give a stationary pattern for any frequency in the range from 31.772 cycles to 4066.8 cycles.

The frequency range can be extended considerably upward by using

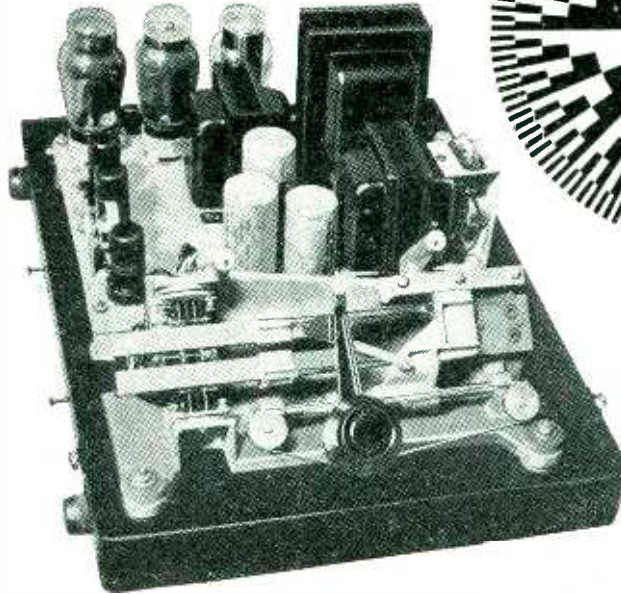

Above: Tuning fork and amplifier. The knob controls the positions of sliding weights on the tuning fork arms, providing changes of up to 3 percent in frequency. The pickup and driving coils are near the ends of the fork

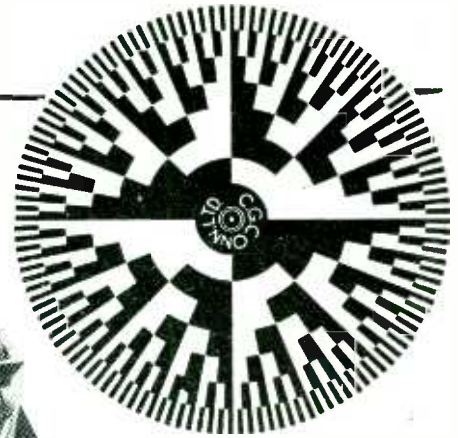

Below: U-shaped discharge tube, gear train and motor are behind the 12 pattern discs

an external frequency divider. Frequencies up to 50 kc have been measured with the same degree of accuracy as the fundamental range, namely 0.05 percent.

The 440-cycle tone broadcast regularly on 5000 kc by the National Bureau of Standards is adequate for checking the calibration, because an adjustment of the fork at any one frequency makes it correct for all other frequencies.

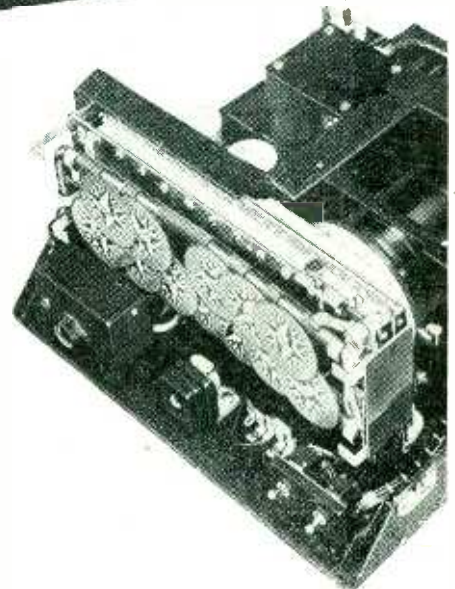

DURING the winter of 1938-39, while the television transmitter of W2XB, now WRGB, was under construction, considerable thought and study were given to the possibility of establishing a program link with television transmitters in New York City. In the spring of 1939, a television receiver and an experimental 160-Mc receiver were taken to the top of Mt. Beacon, on the Hudson River, opposite Newburgh, and a 160-Mc transmitter was installed at the present transmitter site of WRGB, where power was available. While a very strong 44-50 Mc signal was received on Mt. Beacon from New York, no trace of the 160-Mc signal was received from the capitol district. Even though it was realized that the 160-Mc path was below the line of sight, it was hoped that some diffraction effect would permit a signal transmission which would give a basis for calculation. The complete absence of this signal caused a revision of plan. The circuit was reversed, with the receivers installed in a truck with a gas-engine power

supply. Transmissions were made from Mt. Beacon on schedule while the truck was parked at various selected locations in the Helderbergs, near Schenectady. At none of these locations was any trace of the 160-Mc link signal observed; but checks on NBC's video channel using only a simple dipole antenna disclosed a fair, although weak, signal. The low noise level in the area gave promise of a relayable signal if a large enough factor of antenna gain could be obtained.

Accordingly, the next step in this developmental project was undertaken. A temporary—and portable—small metal building, large enough to house a receiver and three or four people, was obtained. A rhombic antenna was erected on four 45-foot collapsible metal-tube masts, and observations of NBC's signal were begun. A number of sites were tried as locations for the receiver, although the first one tried was preferred because of its accessibility to the road, to power, and to phone lines. For these reasons, as well as because of

Valuable experience gained in extended tests during the relaying of New York programs to the Schenectady area gives a picture of what post-war television problems will be and how to solve them

THREE

signal intensity, this site was chosen for final adoption. During negotiations for the site and the period of planning and construction, observations were continued with satisfactory results. This site is about 1½ miles (airline distance) from the main WRGB transmitter, and slightly west of south of it. This physical separation necessitated a relay transmitter to provide a link for the video portion of the signal. A wire-line link could be economically provided for the audio signal.

A profile of the transmission path between New York City and the Helderberg relay station shows that the relay station site is well over a mile below a clear line of sight from the top of the Empire State Building. In fact, a straight line run from the top of the New York antenna to the relay station passes 1500 feet or more below the surface of the earth, neglecting prominences.

Establishment of Relay

As finally erected, in the fall of 1939, the relay station was housed in a permanent structure having a floor area of about 16 by 16 feet. The antenna, suspended between 128-foot towers, consisted of two similar rhombics located end to end along a common principal axis. The length per side was nine wave-lengths. The input impedance of the remote rhombic supplied the ter-

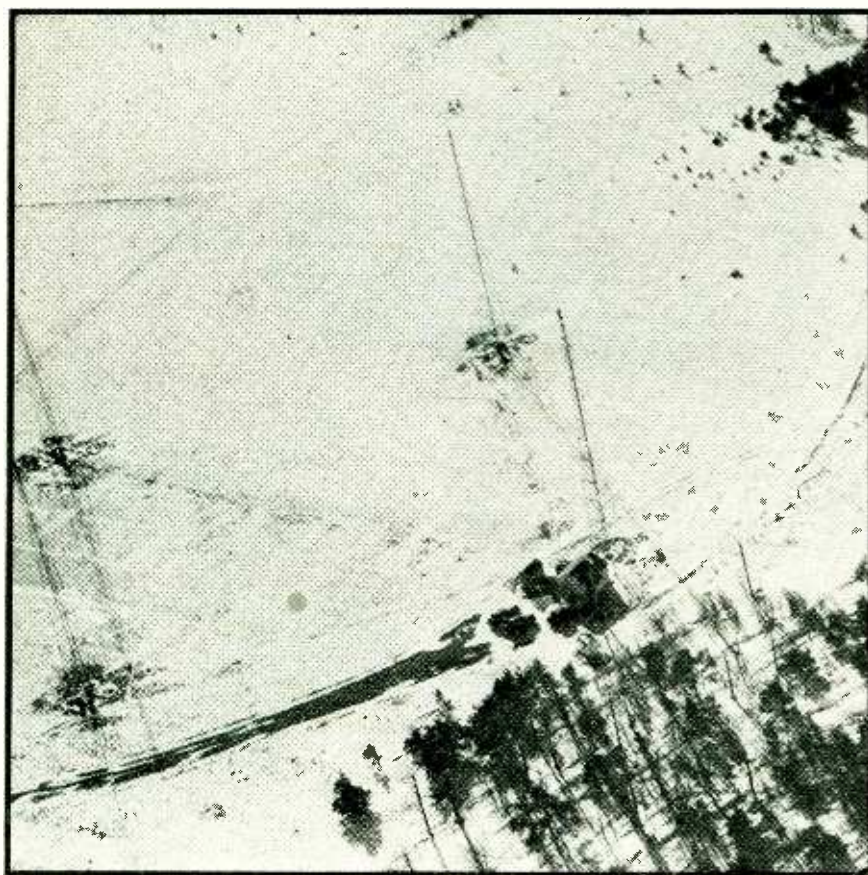

Aerial view of relay station. A double rhombic antennae is suspended between the two sets of masts

N.B.C. TRANSMITTER
EMPIRE STATE
BLDG.
ELEV. 1300 FT.

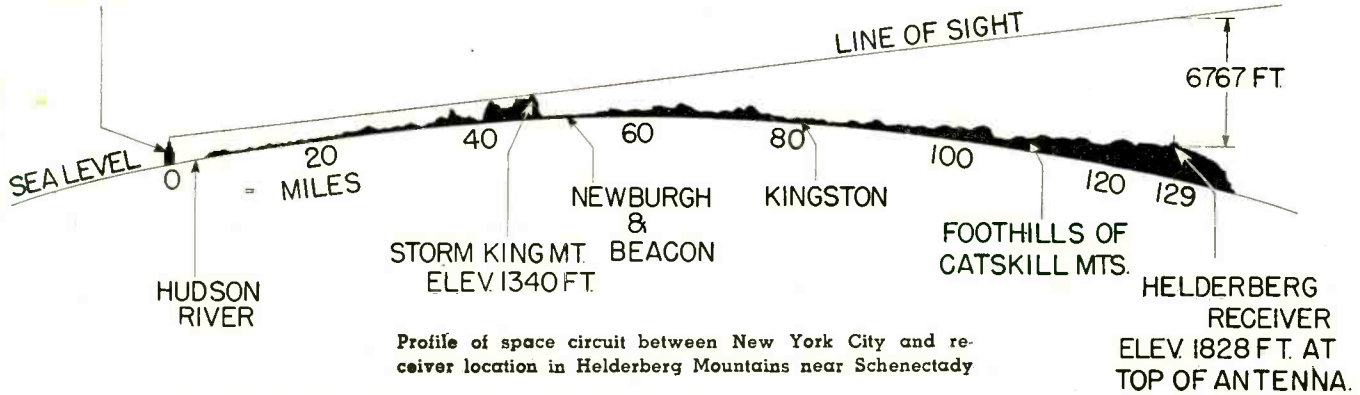

YEARS of Television Relaying

By R. L. SMITH,

Supervisor, Technical Operations
Television Station, WRGB
General Electric Company
Schenectady, New York

mination of the nearer rhombic. The remote rhombic was itself terminated by a resistor whose value was adjusted for optimum front-to-rear response of the system. A wide-band single-stage amplifier covering 44 to 56 Mc (Channels 1 and 2) was installed at the top of the tower near the building to provide a better signal-to-noise ratio at the lower end of the transmission line.

Reception was first accomplished by means of standard GM275 General Electric television receivers, the video signal output being taken off the kinescope grid. The relay transmitter consisted of a crystal controlled oscillator, multipliers, and a grid modulated pair of 834 tubes delivering 40 watts peak signal at 157.25 Mc carrier. The video signal was amplified and fed to the modulator stage, which consisted of two 807 tubes. The usual type of d-c insertion circuit was incorporated to effect d-c controlled output. The output was fed through a transmission line and an elevator section to provide impedance matching, to a small rhombic antenna directed toward the WRGB transmitter station. Over the short distance of 1½ miles of line of sight, this provided extremely good signal-to-noise ratio. The audio signal was taken from the television receiver audio channel, through a program amplifier and over a wire line to the transmitter.

A diode coupled to the video transmitter antenna circuit was connected to the video amplifier and synchronizing circuits of a second television receiver for output monitoring. Comparison of the two pictures gave an accurate indication of relay-transmitter fidelity.

Early Operations

During operation in 1940 interference was encountered from transatlantic telephone, telegraph, and broadcast stations in the i-f amplifier band of the receivers (8-12 Mc). The exceptionally good receiving location, plus the great gain in these amplifiers, resulted in the presence in the output stage of the i-f amplifier of extremely strong signals from some of these transmitters. Shielding the receiver chassis and the inclusion of filters in the power leads, antenna lead, etc., had no appreciable effect. A well-shielded communications receiver having negligible pickup without an antenna, would pick up very strong signals with a 6-inch antenna in this band with the television receiver turned on, and practically none when it was shut off. These signals resulted in spurious modulation of the video signal

and were audible in the television receivers throughout the area when the audio channel was tuned over the video band.

Operation of this installation was continued through July, 1940. During this period, 148½ hours of program were transmitted in addition to 140 hours of test pattern. This program of relaying transmissions was curtailed at the end of July by the shutdown of the WNBT transmitter to permit frequency change from the old No. 1 channel (44-50 Mc) to the new No. 1 channel (50-56 Mc).

During the period of no relaying, following the WNBT shutdown, a program of reconstruction was undertaken. Relaying was resumed and carried on for several months in 1941. Operation of the relay system during this period was not as satisfactory as that of the previous year. This was due in part to a slight reduction of the WNBT output power (necessitated by operation of the tubes on the higher frequency of 50-56 Mc) and in part to the changes of propagation efficiency on the higher frequency band.

Description of Redesigned Station

After this time the actual relay of programs was discontinued for a time while the stations were being converted to the newly adopted standards. During the negotiations

preceding the adoption of these standards, so many different possibilities for future transmission systems were opened up that it was immediately realized that a successful relay link must be able to accept, and pass on without modification, any possible type of signal which might in the future become standard. This requirement included not only all the various arrangements of amplitude-modulated signals, by the combination of FM synchronizing pulses with the amplitude-modulated picture signal, or even FM transmission of the entire signal. Consideration of these possible requirements quickly led to the conclusion that the only simple method of accomplishing

level. Since variation of grid bias results in a change of grid input impedance, and a consequent variation of band-pass characteristics, the control of gain is effected by variation of screen potential. To avoid reflections due to feed back around any or all stages, heavy shielding and cascade decoupling had to be provided. The output of this receiver chassis is fed by means of a triple-tuned circuit to the converter grids. Here conversion to Channel No. 8, (162-168 Mc) is effected. Further amplification at this frequency in two successive stages provides a peak output of 50 watts.

The requirement that the output frequency be locally controlled and

the following test: With a 1-microvolt signal from a signal generator impressed on the receiver input and the AFC control voltage lead open, the master oscillator was tuned so that the output frequency deviation was 10 kc. The control circuit was then closed. The deviation dropped to about 1000 cycles, and became negligible when the input was raised to 10 microvolts. Since a receiver input signal of 50 microvolts is required to give normal relay transmitter output with at least a fair signal-to-noise ratio, this results in an extremely good factor of safety.

Automatic gain control voltage is derived from a peak diode rectifier coupled to the output antenna circuit. The well filtered output of this rectifier drives the grids of two 6AC7 tubes. One of these tubes is used to actuate a meter to give a reading proportional to peak output. The other 6AC7 tube is a d-c amplifier whose plate current controls the screen voltage of a number of the r-f amplifier tubes in the receiver chassis. A switch is provided for selecting either automatic or manual control. The latter control is a necessary feature in conducting tests on the system.

Additional diodes for monitoring purposes are provided in the following circuits: receiver-output stage, converter grid, intermediate power-amplifier grid, power-amplifier grid and antenna.

These diodes are used for checking the line-up of the various stages by means of a hand-sweep oscillator and oscilloscope. They are made available by a rotary tap switch mounted on the rear of the racks. In addition, the antenna and converter grid diodes are wired to a front panel switch controlling the input to the picture and also to the wave-form monitor.

The aural receiver is a GE JFM-90 translator which has been modified by removal of the multisection variable tuning condenser and the substitution of trimmers across the circuits. A front-panel vernier on the oscillator condenser permits slight adjustments of its frequency to compensate for circuit drift. Attempts to couple this receiver directly to the antenna input line showed that the low impedance of the visual receiver input resulted in too low a value of signal to drive the high impedance aural receiver reliably. Sufficient

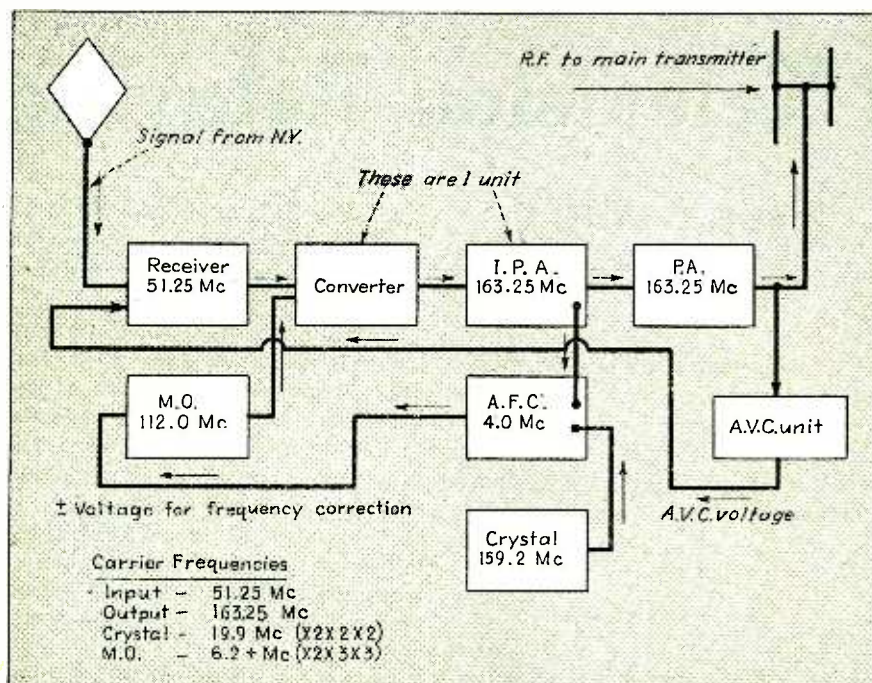

Block diagram of relay system, showing signal path and frequencies used

this was to amplify and convert the signal without demodulation or in any way changing the signal envelope.

Previous experience with the pick-up of r-f interference in the i-f band made it appear inadvisable to use any system involving the use of such low-frequency bands; so development of a high-frequency (50-56 Mc) high-gain r-f amplifier was started. The requirements included high-gain (approximately 250,000 times) and 4.75-Mc-wide band pass with little variation over the pass band. This amplifier also had to be arranged for automatic gain control to compensate changes in the signal

maintained within 0.01 percent was met by the inclusion of AFC circuits. A portion of the output energy is picked up and heterodyned with the output of a crystal oscillator which has been multiplied and amplified. The resulting i-f frequency (4 Mc) beat is amplified in a narrow-band stage and, by means of a standard discriminator circuit, produces a d-c potential proportionate to frequency drift. Application of this voltage to the grid of a reactance tube permits shifting the frequency of the local oscillator so as to restore the carrier frequency.

The efficiency of operation of this circuit has been demonstrated with

gain was present in the visual receiver chassis at the aural carrier frequency, however, to permit coupling the aural receiver anywhere within six inches of the output stage of the visual receiver. The best coupling point has been found to be the 1-inch extension of the grounded shaft of the output circuit tuning capacitor! The existence of this field even at the attenuated aural channel frequency indicates the stringent requirements for shielding, decoupling, etc., found necessary in the development of the visual receiver.

Station Arrangement

All equipment is built on standard rack-mounted panels, resulting in ease of maintenance and a high degree of accessibility. The left rack houses (from top to bottom) a receiver for relaying standard FM programs, a three-band FM-AM receiver, and a rack-mounted standard television receiver. The second rack houses the television-channel aural FM receiver, the visual-receiver master oscillator-multiplier unit, and a group of power supplies. The third rack contains a standard FM receiver, the transmitter power-amplifier unit, converter-amplifier unit, AFC unit, crystal oscillator-multiplier unit, and power supplies. The fourth rack is devoted to monitoring equipment and contains the frequency monitor, visual picture and wave-form monitors, and switching and power-supply units. The right rack contains all audio equipment. A second room, 8 by 16 feet, has been added to the building to provide emergency living quarters for personnel when inclement weather prevents their return to town at night.

Antennas Employed

During the previous operational period it was observed that the band-pass characteristics and gain of the two-section rhombic antenna were not satisfactory over the 50-56 Mc band. Responsibility for this was found to lie in the necessary insulator connected across the junction point. This caused phase shift so that one unit did not properly terminate the other. For that reason, the antenna was changed to a single-section rhombic of the same over-all length. The gain of this antenna is about 25 times over a simple dipole antenna. For similar reasons the small rhombic transmitting antenna

was eliminated and a new type of wide-band directional antenna was erected. This antenna consists of a dipole and driven director of large diameter, and having lengths of less than one-half wave, so that, when transferred back through the feed lines, their impedance is practically constant and purely resistive over the band.

Results of Relay Operation

This new installation was completed early in 1942 and went into scheduled program operation on February 9th, 1942. Operation over a continuous period of 15 months indicates that a reasonably reliable relay schedule can be maintained.

sequence. The most serious sources of interference with good relaying have been precipitation static and lightning static. The former, caused generally by flying snow or ice particles releasing their charges on the antenna, is, of course, mainly present in cold weather. Very little multiple-path transmission and resultant reflections or ghosts have been noticed.

The first 100 hours of operation disclosed that 4½ percent of operating time was of unsatisfactory quality, as a result of precipitation static. An additional 2½ percent was marred by fading. In the summer months, fading increases in intensity and duration, and precipitation static gives away to lightning disturb-

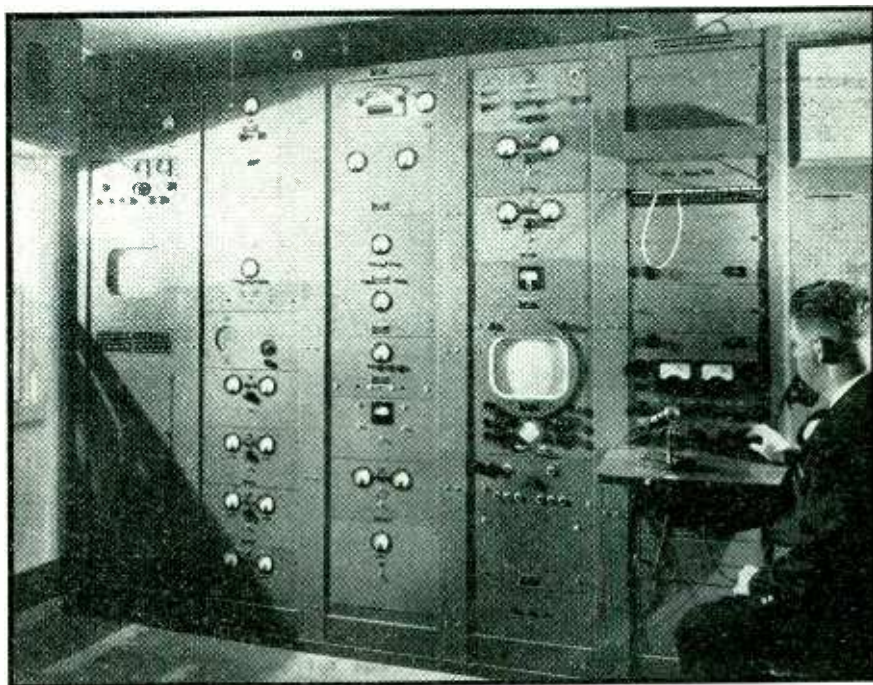

Equipment for relaying WNBT New York television programs through WRGB, Schenectady

The variations of signal intensity are not too prevalent or too great, in most cases. Few, if any, fast fades are noted, most variations being slow and of long duration. It is interesting to observe the fact that seldom do both audio and video carriers fade at the same time. The WNBT signal, on an average operating day, has been found to vary from a low of 100-150 microvolts to a high of 400 microvolts, measured at the receiver input.

Interferences (r-f) with the incoming signal has been negligible since this system was adopted. Some occasional interference from diathermic sources has been noticed at times, but has been of little con-

ances. A year's average figure of unsatisfactory transmission conditions due to these causes would be:

Lost by fading 5 percent

Lost by static causes 10 percent

On the average, the relaying of the signal from WNBT has been more successful than at any time in the previous two periods of relaying. The improved transient characteristics of the system have been responsible for this great improvement. Automobile ignition interference, which was formerly severe, has little effect, unless the pulse happens to fall near the leading edge of a synchronizing pulse and causes a loss of speed for a horizontal line.

(Continued on page 277)

Band-pass Wave Filter

Analysis of wave filters of the band-pass type on the basis of bisectable symmetrical

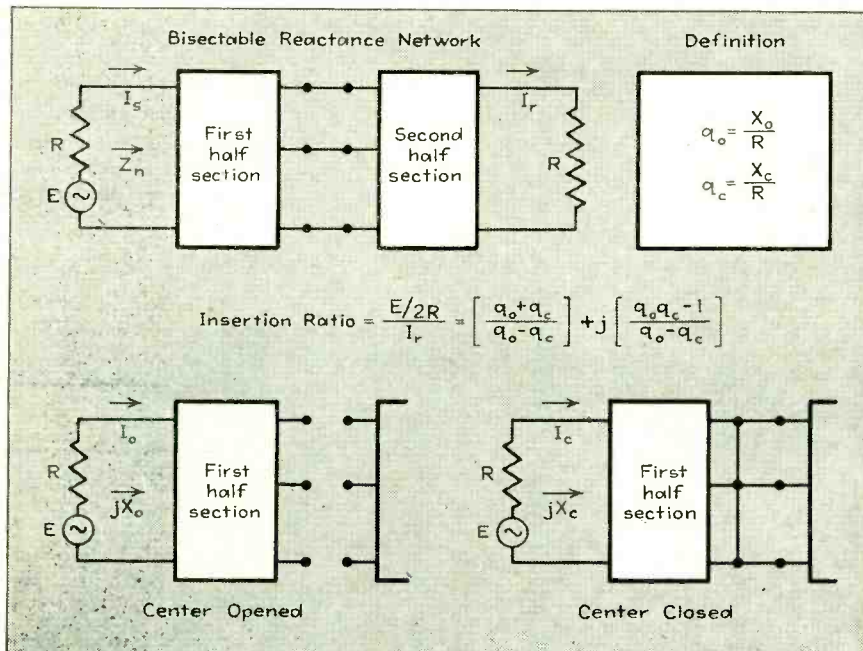

FIG. 1—Bisectable reactance networks with equal resistance terminations

By E. S. PURINGTON

Hammond Research Corporation
Gloucester, Mass.

IN a previous discussion it has been shown that the insertion loss and lag for bisectable reactance networks with respect to equal resistance terminations are derivable from q functions as defined in Fig. 1. The function q is determined by the circuit involving the sending termination R and the first portion of the network with the connectors to the second portion opened, and q_c is similarly determined by the same arrangement but with the connectors closed together. These q 's are the tangents of the phase angles by which the driving voltages E lead the circuit currents I_o and I_c respectively for the opened and closed conditions. To provide for coverage of the performance with varying ratio of the impedances of all the network elements with respect to the terminations, an impedance level parameter

h^* was introduced to which the reactances X_o and X_c of the figure, and consequently the q 's are proportional. Q_o and Q_c may now be defined as the values of the q functions at unity impedance level; that is $Q_o = q_o/h$, and $Q_c = q_c/h$. Further it is convenient to abbreviate for the product, sum and difference of the Q 's; $P = Q_o Q_c$, $S = (Q_o + Q_c)$ and $D = (Q_o - Q_c)$. With these additional nomenclatures, the circuit loss and lag equations are:—

$$\text{Loss} = 10 \log_{10} \left[1 + F_{1, \dots}^2 \right], \quad F_{1, \dots} = \left[\frac{h^2 P + 1}{h D} \right] \quad (1)$$

$$\text{Lag} = \tan^{-1} \left[F_{1, \dots} \right], \quad F_{1, \dots} = \left[\frac{h^2 P - 1}{h S} \right] \quad (2)$$

In addition the lag angle is to be placed in the second or third quad-

* $h = R_1/R$ where R_1 = impedance level of network and R = filter termination.

rant provided $(Q_c/Q_o)^2$ is greater than unity. Therefore the performance is entirely expressible for any network combination when the four simple arithmetical combinations of the Q 's and the impedance level are known.

Occasionally it is required to know the impedance Z_n of Fig. 1 relating to the impedance load upon the sending arm R which includes the driving force E , due to the network with the receiving arm R attached. This is given by the readily derived equation:—

$$Z_n = \left[\frac{E}{I_s} - R \right] = R \left[\frac{h^2 D^2 + j 2h S (1 + h^2 P)}{4 + h^2 S^2} \right] \quad (3)$$

This is a pure resistance of value R when $P = -h^{-2}$ corresponding to a zero loss condition; it is also a pure resistance but of value $R h^2 D^2 / 4$ when $S = 0$ corresponding to a 90 deg phase shift condition, and can be a pure reactance only when $D = 0$ corresponding to an infinite insertion loss condition.

The general theory of which the above summary is the simplest equational expression has been illustrated by a detailed study of low- and high-pass wave filter units. The performance was expressed in terms of the ratio x of any frequency f to a reference frequency F_o , which preferably has some physical significance. For the low-pass and high-pass units, types A to D of Fig. 2, F_o corresponded to theoretical cutoff. Simplicity of equations resulted by properly setting up the circuit elements to make the product function $P = Q_o Q_c$ a simple algebraic function, such as $(x^2 - 1)$ for the type B unit. The functions Q_o and Q_c involved x and also a parameter k^{**} relating to a value of x corresponding to infinite

** Thus $k = F_{\infty} / F_o$ where F_{∞} is the frequency of which the insertion loss is infinite and F_o is the geometric mean of the two cut-off frequencies.

Units

circuit arrangements

insertion loss. For all types, one of the Q 's corresponded to an inductor and a condenser in series or in parallel and resonating at $x = 1$, and the other Q corresponded to an inductor or a condenser only. Low- and high-pass filters are two-band filters, with the cutoff frequency F_0 , the transition point between low- and high-loss values.

Three-band Filter Units

Next in the order of complexity are the three-band filter units of which the band-pass units are the more important. Band-pass filters are desired to produce high insertion loss for both low and high frequencies, but to produce low loss in the range between a lower cut-off frequency F_1 and a higher cut-off frequency F_2 . The present discussion is limited to the elementary units useful for this purpose. One simple method of approach is to consider the minimum structural change in low- and high-pass units necessary to make them yield high loss at both low and high frequencies, leaving the possibility of low loss in the mean frequency range. The four resulting structures are shown in Fig. 2, where elements identified by multiplicative or divisive factors m , n and p applied to basic inductance value L and capacitance value C correspond to similarly designated elements for

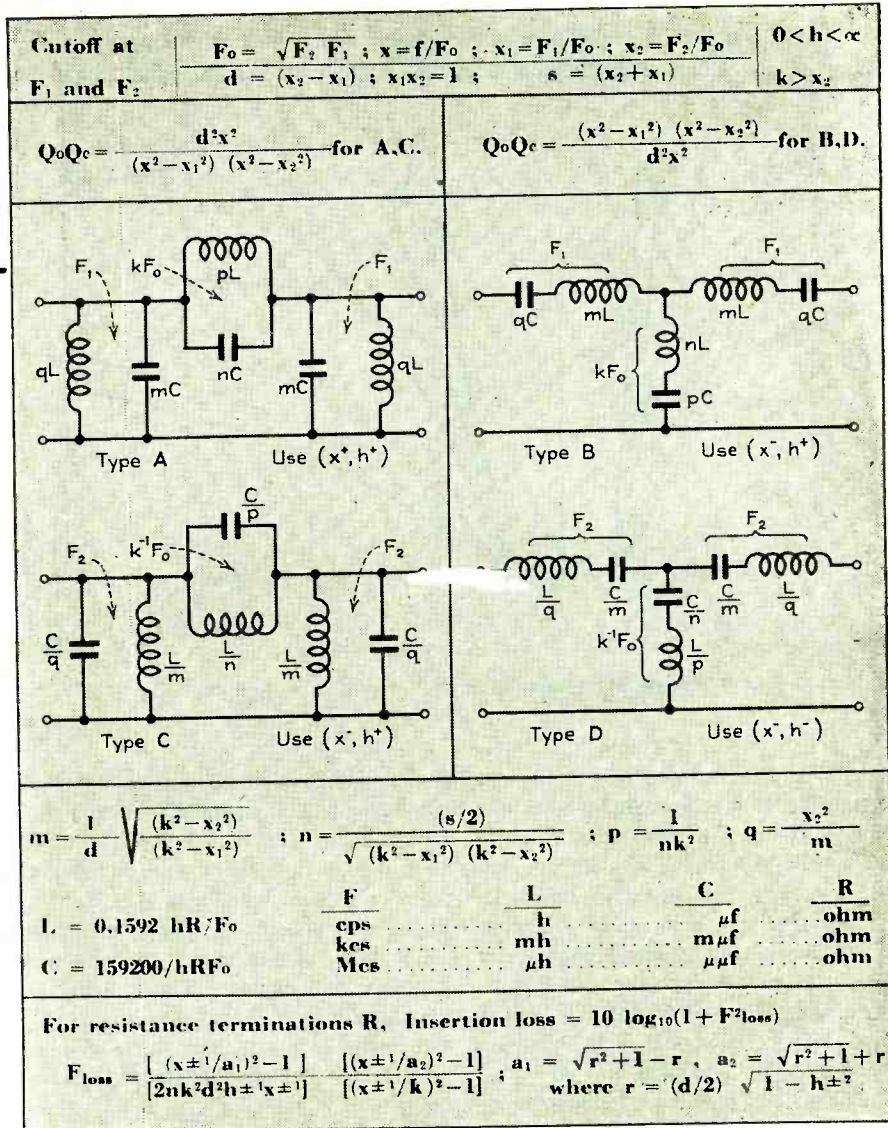

FIG. 2—Circuits and parameters of fundamental band-pass filters built up from low- and high-pass structures

low- and high-pass purposes. Elements involving the next alphabetical letter q operate to provide the loss band not provided by the other elements.

The chart provides full information for determining the possible insertion loss characteristics when any unit is terminated by equal resistances, and for evaluating the network elements required to yield a loss characteristic specified by values of parameters h , k and d , for a specified choice of R and F_0 . It will be noted the newly introduced parameter d relates to the relative difference of the two cut-off frequencies. This is a band-width parameter, and is determinable from the cut-off frequency ratio value x_1 and/or x_2 , or from either. Choice of reference fre-

quency F_0 , as the geometric mean of the two cut-off frequencies is in the interest of equational simplicity, and further, results in the product function $P = Q_0 Q_c$, being the same for any unit as for its frequency complementary. These product functions are set up to be in conformity with the structural arrangements, and also to make them negative in the range x_1 to x_2 , and negative unity at the geometric center of the range at $x = 1$. Some of the threefold infinitude of possible insertion loss curve shapes are shown in Fig. 3, for a choice of band-width parameter $d = 0.409$ making F_2 fifty percent greater than F_1 . The impedance level parameter in each case is chosen to make the insertion loss nearly as uniformly low as possible in the pass

Previous Analyses

Symmetrical Electrical Systems
(November 1942, page 54)

Reactance Networks with Resistance Terminations
(January 1943, page 69)

Low- and High-pass Filter Units
(June 1943, page 106)

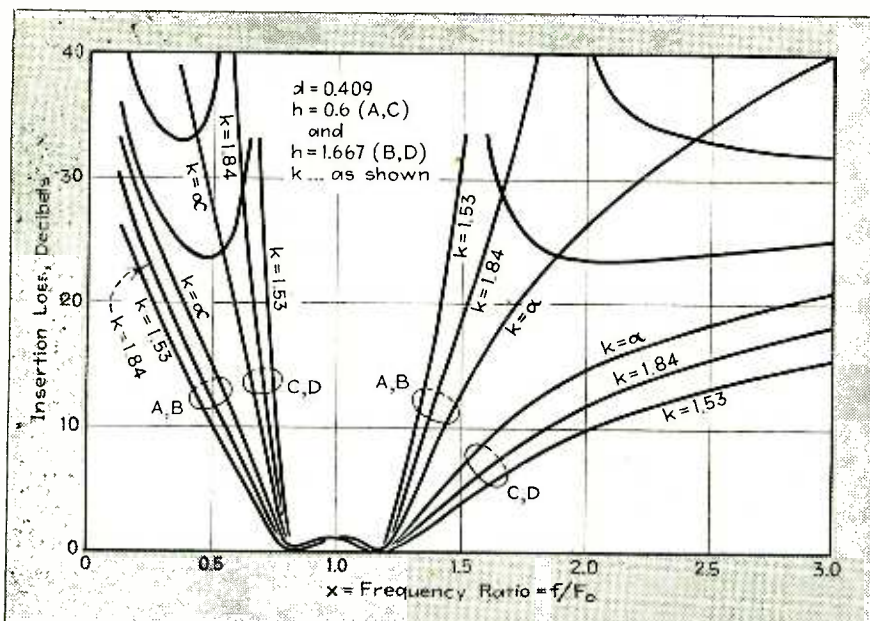

FIG. 3—Loss curves for band-pass filter units for band-width parameter $d = 0.409$

band, and the infinite insertion loss parameter is given values to make infinite loss occur for A and B units at F_2 , multiplied by 1.25, 1.5 and infinity respectively. A rough comparison is therefore possible between the performance of band pass units A and B and the corresponding performance of low-pass units A and B previously considered. The shunting effect of qL and blocking effect of qC in these two units are mainly operative at low frequencies to modify the characteristics below F_2 , providing an additional frequency for zero loss, and providing for infinite loss at zero frequency. From inspection of the curves, it is evident A and B units will be used whenever the emphasis is to be upon sharpness of cutoff above F_2 , and C and D units whenever the emphasis is to be upon cutoff below F_1 .

These band-pass units may be replaced by a wide variety of structural equivalents due to the number of ways that T and delta arrangements of inductors and condensers occur, but these will not be covered here. In general these basic band-pass filter arrangements are characterized by both of the Q 's corresponding to similarly tuned circuits, one resonant at F_1 , and the other at F_2 . For A and C units these are parallel resonant circuits, and for B and D they are series resonant circuits. The end circuits involving m and q represent one of the tuned circuits,

and regardless of the nature or complexity of the coupling circuit between them these end circuits are of themselves sufficient to make the loss infinite at both zero and infinite frequencies. Consequently band-pass units are readily possible with any number of reactor elements in the coupling arms, here involving only two elements in an arrangement similar to the end circuits which they couple.

Coupled Circuit Application

The information recorded here covers the simpler case in which the coupling element is a single reactor. For the special case of the infinite

loss parameter becoming infinity, the four factors become $m = 1/d$, $n = 0$, $p = 2/s$ and $q = dx_2^2$, so that elements involving n are not required. Types A and D then become simple inductively coupled types, and B and C become simple capacitively coupled. When the three inductors of such a type A unit are replaced by two inductors with mutual inductance between them, the unit takes on the important form of Fig. 4, with which loss, lag, and design information is included. This is the familiar coupled circuit system with each circuit mC and wL tuned very closely at the geometric center of the transmission band, and connected in parallel with the terminations, with mutual inductance gL between the inductors wL .

Because of its extensive use it is important to record here Fig. 5 a brief method of treatment when each tuned circuit is dissipative with Q designating the combined quality factor of the elements mC and wL . This will hold sufficiently well for practical purposes when the band-width parameter is a small quantity, making $mw = 1$ very closely. Under these conditions the reactances of both mC and wL are numerically hdR at F_0 . It is irrelevant for practical purposes whether the dissipative effect is represented by a resistance hdR divided by Q in series with mC or wL , or by a resistance hdR multiplied by Q in parallel with these elements. By making the latter choice, the middle circuit of Fig. 5 indicates the performance is the same as if the two terminations R were shunted by resistances $R_0 =$

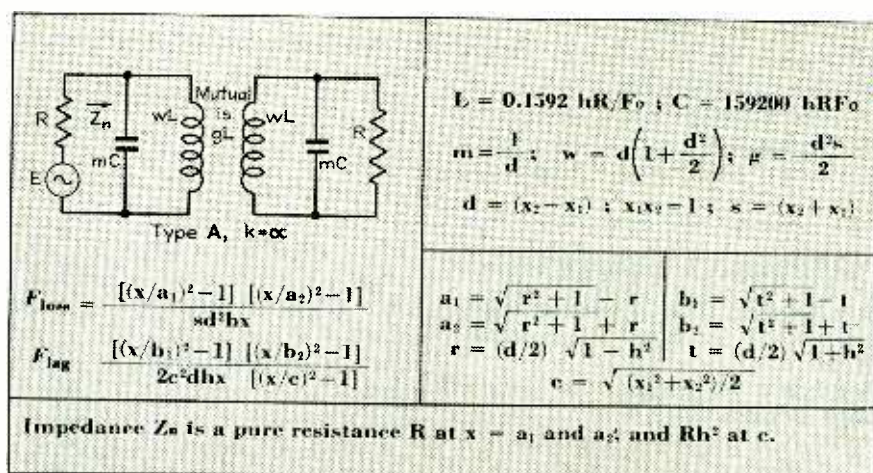

FIG. 4—Type A ($k = \infty$) inductively coupled band-pass filter

$hdRQ$. By the application of Thévenin's theorem, the performance of this dissipative circuit is precisely the same as if the network were non-dissipative, but with E and R replaced by lower values E' and R' for which the formulas are given. As a result, for narrow-band dissipative cases the performance of the dissipative circuit as to loss and lag is to a close approximation determinable from the non-dissipative equations. Due to the lowered effective terminations, it is required that the actual impedance level parameter h be replaced in the performance equations by a greater value $h' = h(1 + 1/hdQ)$. Due to the lowered effective driving voltage E' , it is required that the loss computed using h' be increased by $20 \log_{10} (1 + 1/hdQ)$ decibels at all frequencies. In both cases the modification of the performance due to the dissipative effect is determined by the product of the three parameters h , d and Q . Obviously the practical need for low loss coils and condensers is not so great for wide-band units of this type as for narrow-band units.

A 5-Mc Interstage Transformer

As a practical example, consider the design and performance of an intertube intermediate frequency transformer, specified to have a nominal band-width of 200,000 cycles centered at $F_o = 5$ Mc, for use with 1-megohm terminations. The band-width parameter is therefore $d = 0.04$, and if an impedance level parameter $h = 0.60$ were chosen to yield a good approach to uniform transmission in the pass band, the value of the input and output condensers mC would be the impossibly low value of $1.33 \mu\mu\text{f}$. If these condensers are assigned a lowest practical value say $25 \mu\mu\text{f}$, the coil wL must be correspondingly $40 \mu h$ making both elements of reactance 1260 ohms at 5 Mc. On this basis the impedance level is $h = 0.031$, and dissipative loss is necessary in order that the transmission curve may be satisfactory. For $h = 0.031$, $d = 0.04$, a value of circuit quality factor $Q = 44$ will make $h' = 0.6$. As far as performance is concerned it is irrelevant as to whether this quality factor is obtained by smallness of coils, closeness of shield, or by resistance artificially introduced. In any event the effective termination is cut from $R = 1$ megohm to about 50,000 ohms, and the effective voltage in the ter-

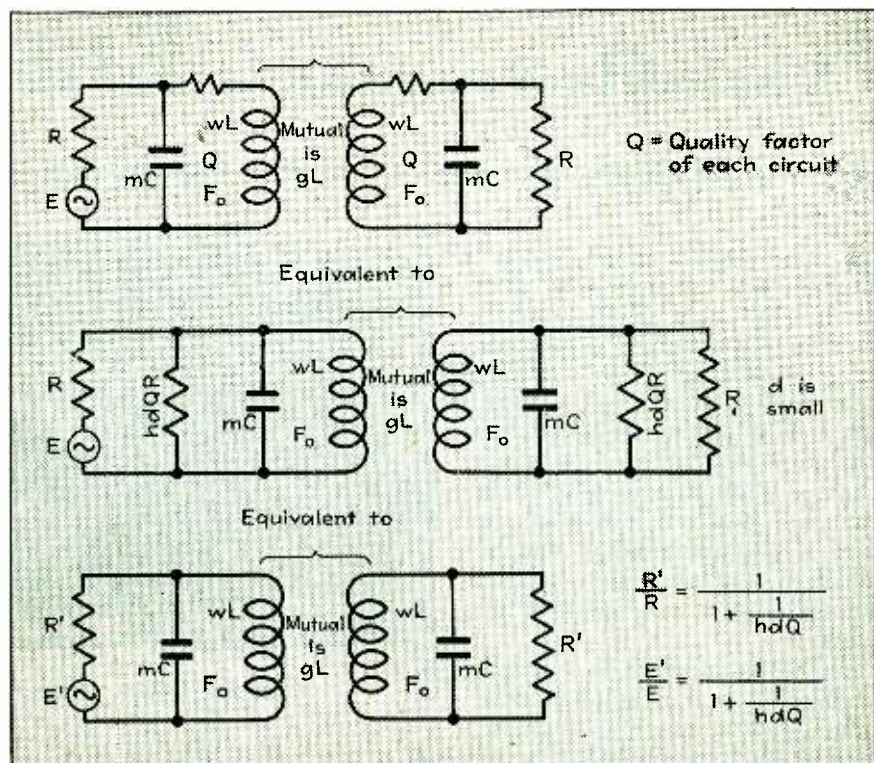

FIG. 5—Treatment of narrow band dissipative symmetrical coupled circuits

mination is cut to $E' = E/19.4$ corresponding to 25.7 decibels added insertion loss. Since the dissipative effect is representable by resistors of 55,000 ohms across each condenser mC , the actual load Z_n upon the sending termination of impedance 1 megohm is about 27,000 ohms at the frequencies of minimum loss.

Correlation Between Loss and Lag

Computed curves for loss and lag corresponding to the example given are shown in Fig. 6, illustrating the correlation between loss and lag performance that occurs in conventional intermediate frequency transform-

ers. In the transmission band, the loss is uniform to within about 0.5 db between the cut-off frequencies. For frequencies equally above and below the center of the band, and differing by twice the nominal band-width, the loss is about 9 db greater than in the transmission band. The lag is an increasing function of frequency, changing by 360 deg throughout the entire frequency range, and by approximately 180 deg in the transmission band. For the central frequency the phase shift here shown as a 90 deg lag can be made a 90 deg advance by changing the sense of the coupling. If the driving voltage E represents an amplitude modulated wave form, side frequencies are shifted differently than the central frequency so that shifts of the phase of modulation occur amounting to 90 deg for the highest frequency of modulation.

It will be understood the present discussion is limited to the symmetrical units directly related to the previously discussed low-and high-pass units. Other band-pass units may in turn be related to the basic band-pass units here considered. Especially complete information is given for symmetrical coupled-circuit units as a special case of the more general type A band-pass unit.

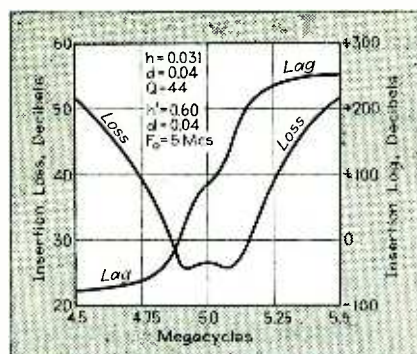

FIG. 6—Loss and lag curves of typical intermediate frequency (5 Mc) transformer described in text

A Variable-Frequency ELECTRONIC

THE ELECTRONIC GENERATOR to be described was developed to fill the growing need for a versatile source of a-c power. Several branches of the electronic industry require a device capable of delivering a reasonable amount of power to various loads, over a wide frequency range. Good waveform and good regulation under various load conditions are also essential requirements. The variable-frequency electronic generator was designed to take care of this problem.

The power output of the generator is 1400 watts over a frequency range of 300 to 3500 cps. The frequency stability is better than 2 percent after the initial warm-up period. Output voltage is adjustable between 85 and 125 v rms. The regulation is better than 1 percent from no load to full load. The waveform is substantially sinusoidal under operating conditions ordinarily encountered.

Typical Applications

Operating requirements of much airborne radio and radar equipment are such that the equipment must function properly even though the frequency of the power source varies through a wide frequency range. It follows, therefore, that a power supply that can quickly be shifted from one frequency to another is a practical necessity in a number of applications.

The design engineer requires such a power supply for development work. Transformer, capacitor and cable manufacturers also need a power source of this type in order to meet test requirements. Government specifications frequently call for complete systems tests on the production lines, over a wide range of power frequencies. The creation of high audio frequency vibrations for test purposes, employing magnetostriction devices actuated by the electronic generator, is another interesting application.

In addition to factory and laboratory applications there are others applying to maintenance and service.



Close-up of variable-frequency electronic generator control panel

For example, radio installations in aircraft can be tested in the plane or serviced in the repair shop without resorting to the gasoline-driven aircraft power supplies ordinarily employed.

The basic approach to the problem of designing a variable-frequency electronic power source is well known to those familiar with the design of radio telephone transmitters. The generator employs a tunable audio oscillator and several stages of audio amplification in cascade, the final stage using a pair of power tubes operating as a Class B amplifier. Similar amplifier arrangements are used in many modulator systems in radio transmitters.

General Circuit Arrangement

The electronic generator differs from a transmitter modulator system in that a variable-frequency audio oscillator is connected to the input

stage in place of a microphone. The frequency can then be adjusted by turning the frequency control knob of the oscillator. The only serious problem in design is the problem of regulation. Inasmuch as the impedance of the final amplifier stage is several thousand ohms, the regulation of such systems is ordinarily poor. Unless special provision is made to insure good regulation, output voltage may vary considerably from no load to full load.

An electronic control circuit employed in the electronic generator changes this picture completely. Through the operating range of the control circuit, the regulation is better than 1 percent, and the recovery time when the load condition is drastically altered is less than a second.

The block diagram across the top of the accompanying drawing shows the overall electronic generator circuit. Two of the three schematic diagrams appearing below within dotted lines constitute "blow-ups" of circuits within individual blocks to which they are appended. The other schematic, at the bottom, shows details of a regulated power supply unit to be discussed later. Blocks for which schematics are not shown are conventional and need no elaboration here.

The oscillator employs two tubes in a conventional *RC* circuit. Two frequency ranges are provided, 300 to

WARTIME Special

NOT, of course, limited to wartime applications, equipment of the type described here is particularly useful at a time when rotating machines are difficult to obtain

MOREOVER, it provides extreme flexibility needed to test certain radio and radar apparatus during design and production and facilitates maintenance of such gear

GENERATOR

Device operated from 220 v a-c line turns out 1400 watts of power at any selected frequency between 300 and 3500 cps. Novel automatic control circuit keeps regulation within 1 per cent for output voltages between 85 and 125 v

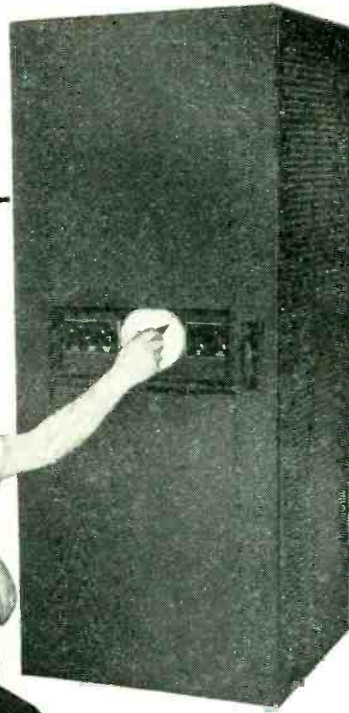

By
DANA A. GRIFFIN
*Communications Measurements Laboratory
New York, N. Y.*

The complete unit, shown with sides and back removed

Arrangement of final Class B amplifier stage components

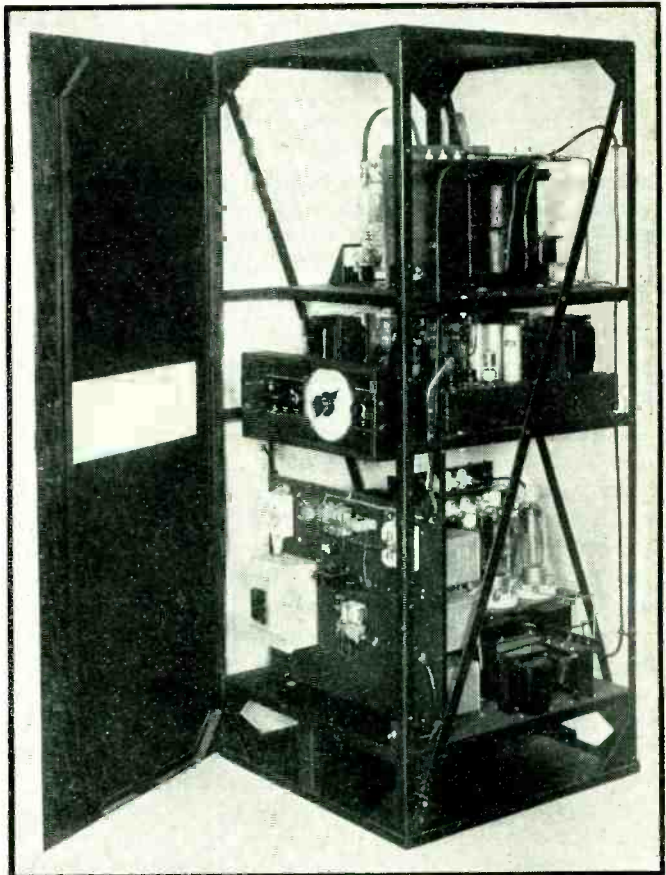
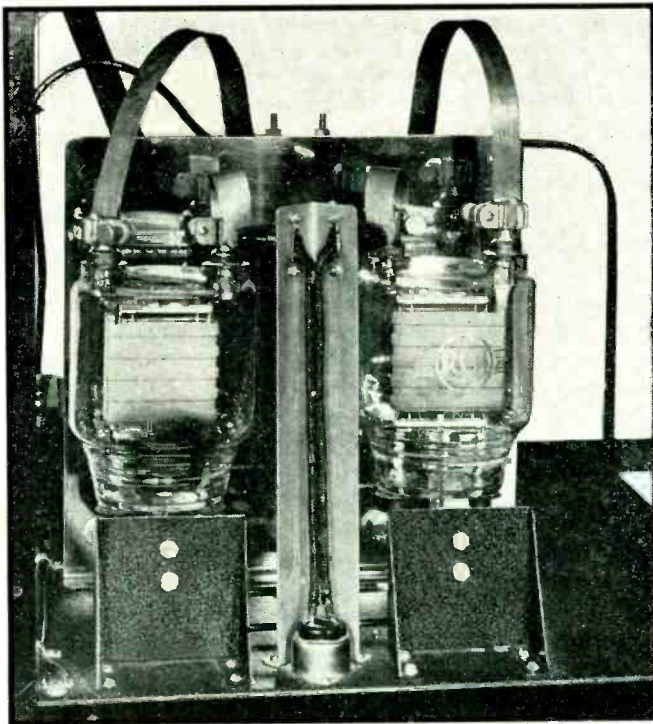

1000 cps and 1000 to 3500 cps. A switch is provided to select the range. The tuning dial is supplied with a double-ended pointer so that the calibration scale for each range may occupy approximately 180 deg.

The oscillator drives the 6L7 tube in the control circuit (shown schematically). Output of the 6L7 drives

the phase-inverter 6SN7. The 6SN7 is followed by push-pull 6A3's in Class A, which drive 812's in Class B. The 812's drive the final stage, using 833-A's in Class B.

Automatic Regulation Control

With a given amount of drive to the final amplifier, the output voltage

at the secondary of T , will ordinarily vary through wide limits when control is not provided, being dependent upon the load. The solution is simple, if we approach the problem from the correct angle.

The maximum load to be used is connected to the output transformer. Then the drive to the final amplifier

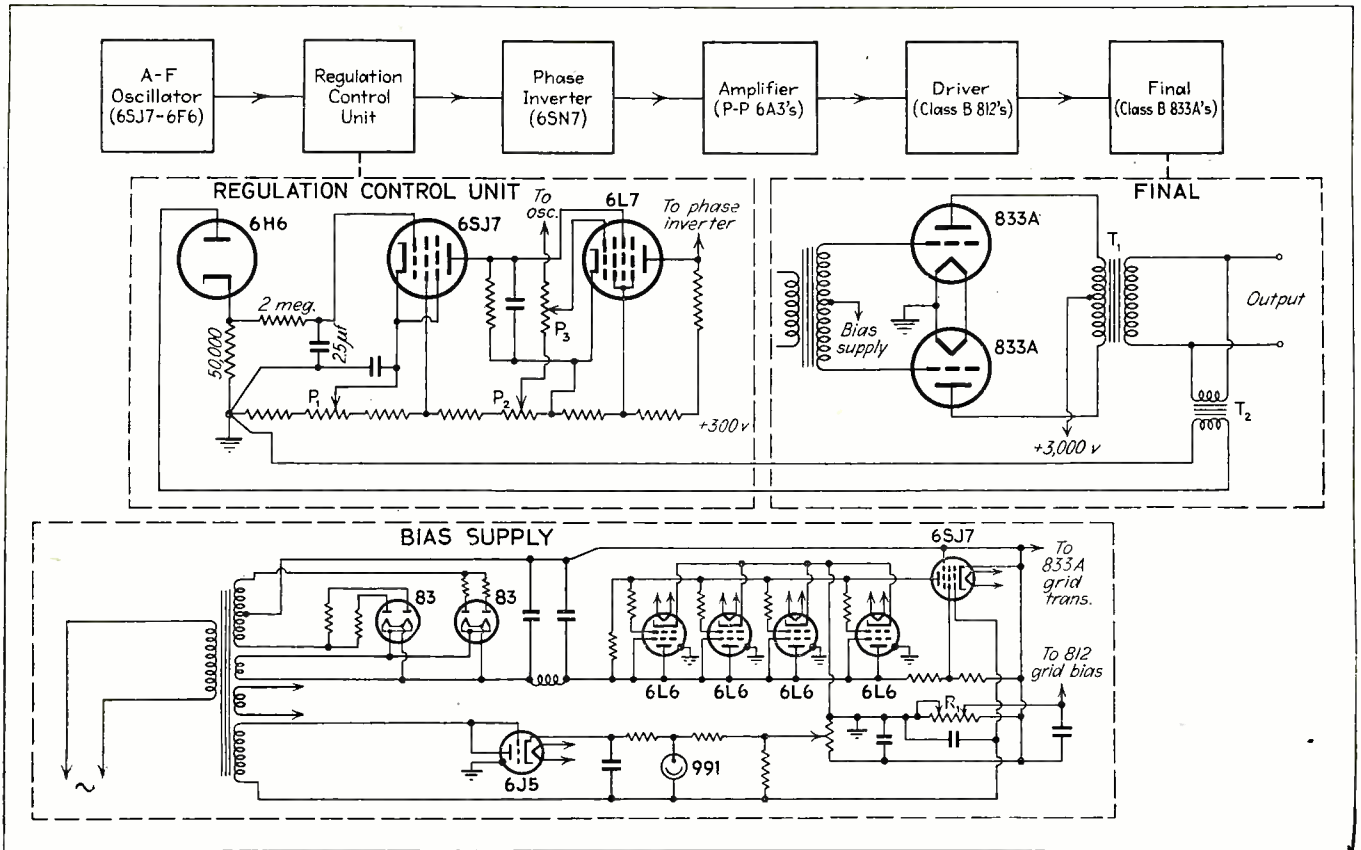

Combination block and schematic diagram of variable-frequency electronic generator. Blocks across top show overall circuit arrangement. The two schematics appearing immediately below, within dotted lines, show circuit details of the units to which

they are appended, namely within the regulation control unit and within the final Class B amplifier unit. The schematic at the bottom shows details of a regulated power supply unit which provides bias for the driver and final amplifier

is adjusted to deliver the proper voltage to this load. This is accomplished by control of potentiometer P_3 , in the grid of the 6L7 control tube. If the load is removed, the output voltage will rise quickly under ordinary circumstances. The function of the control circuit is to prevent this by reducing the drive to the final amplifier whenever the output voltage exceeds the predetermined level.

An isolation transformer T_2 feeds output voltage to the 6H6 diode in the control circuit. This transformer is used so that the output circuit may be kept independent of the ground system of the generator. The normal 120-v output at the secondary of T_1 is reduced to 40 volts at the diode by T_2 . Potentiometer P_1 , in the cathode circuit of the 6SJ7 d-c amplifier, is adjusted so that the positive bias normally generated by the diode is cancelled and the 6SJ7 is operating at a point close to plate current cut-off. A slight negative bias on the injector grid of the 6L7 results because of the small plate current of the 6SJ7. The control grid bias on the 6L7 control tube is adjusted by

means of P_2 . The latter is adjusted so that the output of the 6L7 is linear through the control range.

When adjusted as described, the control circuit operates as follows: The output of the diode increases when the load on the generator is reduced. The 6SJ7 grid bias becomes less negative and 6SJ7 plate current increases, which puts increased negative bias on the 6L7 injector grid. This reduces the drive to the final amplifier so that the output voltage is held to a value extremely close to that obtained under the full load condition.

Because the control circuit is connected from the input of the system to the output, the arrangement is one conducive to oscillation. For this reason the constants in the diode circuit must be such that the system will not "take off" in a low frequency oscillation. With the values given, tendency to oscillate is eliminated.

Naturally, the output voltage can be changed from zero to maximum (150 v) under load by the adjustment of P_3 . Complete functioning of the control circuit, is, however,

limited to the range between 85 and 140 volts at the secondary of T_1 . This range of control is sufficient to cover most applications. Where additional voltage is needed with good regulation, the use of appropriate step-up or step-down transformers is indicated.

Bias Supply Details

One other design problem was the construction of a suitable grid bias power supply for the final amplifier. As the 833A tubes require a negative bias of 70 v and the peak grid current under full load is around 300 ma, it was necessary to consider the problem of securing a bias supply of good regulation. In ordinary times a small d-c generator might be considered for this application as such a generator satisfies the requirement of low impedance. The output voltage is not independent of line voltage, however, and the procurement situation at the moment is extremely difficult. For these reasons the electronic approach was again resorted to with excellent results.

(Continued on page 278)

ELECTRONIC CONTROL of D-C Motors . . . Part IV

Methods of starting tube-controlled d-c motors, filtering and stabilization, reversing, and obtaining regeneration by inverter action are treated in this series of articles outlining the application of electron tubes to industrial control of rotating machinery

By E. E. MOYER

*Electronic Section
Industrial Control Engineering Department
General Electric Co., Schenectady, N. Y.*

THE CONTROL CIRCUITS thus far described have limited excessively high armature current by means of a signal voltage proportional to current. This voltage regulated the grid phase retard of the thyatron tubes so as to maintain their rectified output voltage at the correct value to sustain only this limited amount of current.

Before the armature circuit is closed to start the motor from standstill, there is no armature current with which to produce a current-limit signal voltage. And, at this time, the speed control potentiometer may have been preset to call for any speed within the range of the drive. It may be preset to give either partial armature voltage and full field, or full armature voltage and partial field. Consequently, if the armature circuit is closed at a time when the rectifier voltage is greater than the IR drop corresponding to the armature current at which it is desired to current-limit, then the initial armature current is proportionately greater than the current-limit value.

The current continues to be excessively high until either the current-limit signal voltage builds up to the extent of taking over its control function of regulating the rectifier voltage to the correct value, or, until the speed of the motor increases sufficiently to develop a counter emf by which to oppose the rectifier voltage and reduce the armature current.

Under these undesirable condi-

tions, an unloaded motor would probably start off with a jolt and, in order to reduce the armature current, the motor counter emf would build up faster than the current-limit signal volts. On the other hand, a motor coupled to a high inertia load such that the speed could not change rapidly, would be subject to this excessively high armature current until the current-limit signal could take over to reduce the current.

Even more serious is the fact that if the speed control potentiometer had been preset for a speed in the weak-field range, the initial acceleration would begin under weak field

conditions with corresponding reduction in torque and commutating ability. Then, even though a very few half cycles of armature current would be sufficient to build up the current-limit signal voltage to the extent of actuating tube EE of Fig. 1 and thereby produce full field voltage, the accelerating period might be extended under weak field conditions because the inductance of the field circuit retards the build-up of field current.

Pre-Conditioned Starting Current

For initial starting, one form of pre-conditioning control was devised which produced a false signal of d-c volts - proportional - to - armature-current, acting on tubes E and EE to

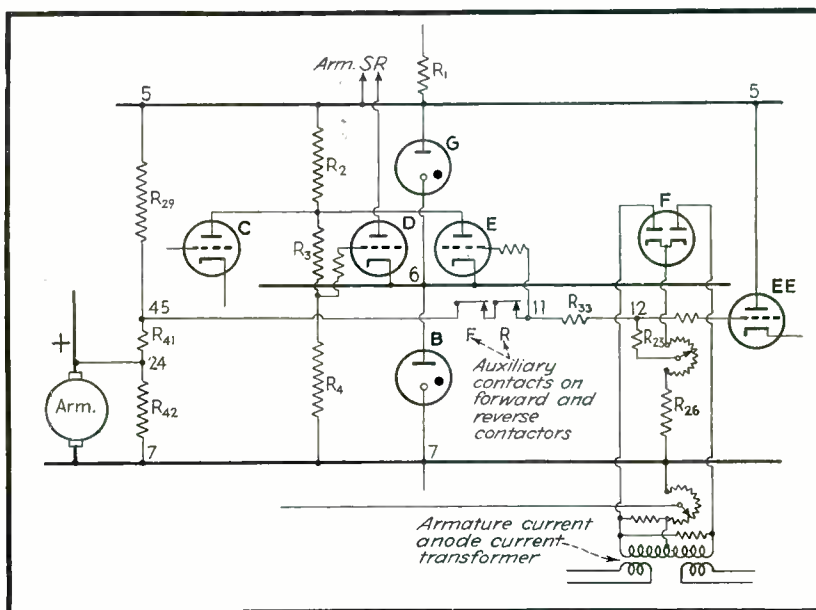

FIG. 1—Armature current limit preconditioning circuit as applied to armature voltage control

Editor's Note. For purpose of consistency, the symbols employed in this article are those commonly used in communication circuits.

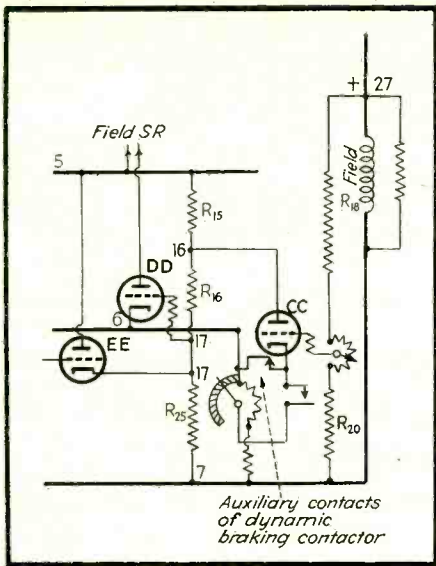

FIG. 2—Preconditioning added to electronic voltage control of d-c motors

reduce the initial armature voltage and to produce full field excitation irrespective of the setting of the speed control potentiometer. This proved inadequate for controls which necessitated reversing from a high-speed, weak-field condition, where it is important to have the pre-conditioning act on the armature and field circuits in such a manner that the armature circuit can be pre-conditioned for a definite current limit at the same time that the weak-field condition remains unchanged.

Another scheme, which satisfies both starting and reversing requirements, pre-conditions the armature circuit by operating on the grid of tube E and pre-conditions the field circuit by operating on the cathode connections of tube CC.

Armature circuit pre-conditioning is established through normally-closed contacts on the initiating contactor—in this instance, auxiliary contacts of the forward and reverse contactors. These contacts set up a control circuit by which the armature thyatrons are pre-phased to, and regulated at, a definite firing point. This degree of phase control produces an average rectified output voltage which has been pre-selected to be approximately equal to the IR drop of the armature circuit, corresponding to the current-limit value of the armature current which it is desired to maintain, say 150 percent of rated current.

This control circuit, in effect, compares a pre-selected portion of armature voltage with the standard

reference voltage of tube B and applies the voltage difference to the grid of tube E which, in turn, controls the armature circuit saturable reactor. A study of Fig. 1 indicates that the method of comparing this portion of armature voltage against the voltage of tube B is somewhat roundabout in that actually a portion of the difference between the total armature voltage and the sum of the voltages of tubes B and G is compared with the voltage of tube B and then impressed on the grid of tube E. The control sense is correct to regulate armature voltage because an increase in armature voltage tends to reduce the voltage difference appearing across resistors R_{20} and R_{25} . This, in turn, tends to make grid-point 11 become less negative, and thus tube E passes more current to limit the increase in armature voltage. This control has very little effect on tube EE because the voltage drop across resistor R_{25} (due to the current flow through R_{25} , R_{20} and down through the control potentiometer and R_{25}) makes the grid of tube EE more negative than that of E.

Field circuit pre-conditioning is established through a combination of normally-closed and normally-open contacts on the dynamic braking contactor. These contacts serve to transfer the cathode of tube CC from its normal connection on the slider of the field-voltage control potentiometer to a temporary connection on the middle control bus, point 6. This transfer is the electrical equivalent of moving the slider onto its conductor segment, thus setting the field for full excitation. This control

circuit is shown in Fig. 2. In this instance, the dynamic braking contactor is energized (picked-up) during normal running of the motor in either direction of rotation. Hence the cathode of tube CC is normally connected to the slider of the speed-control potentiometer.

During the brief interval between contact operation—i.e., when the auxiliary contacts are opening and the main contacts closing—these pre-conditioning signals are maintained at their false values by the time constants of the saturable reactor circuits and by the circuit-stabilizing capacitor-resistor networks (see Fig. 5) associated with tubes E and CC. So, when the armature circuit is closed, the armature voltage is at just the correct value to produce only a current-limit value of armature current in the circuit of the stalled armature; also, full field has been established so that full starting torque is available. The net result is a smooth start from standstill to a condition of constant current acceleration.

Armature Voltage Limit

Let us assume that we have a 590/2300-rpm, 230 volt motor running at 2300 rpm under field-weakened conditions. If the operator of this electronic control were to suddenly turn the speed-control potentiometer back to a position calling for, say, 10 percent speed by armature voltage control (or, if an automatic limit-switch transfers from one speed control potentiometer to another which has been pre-set for a low-speed condition), tubes C and

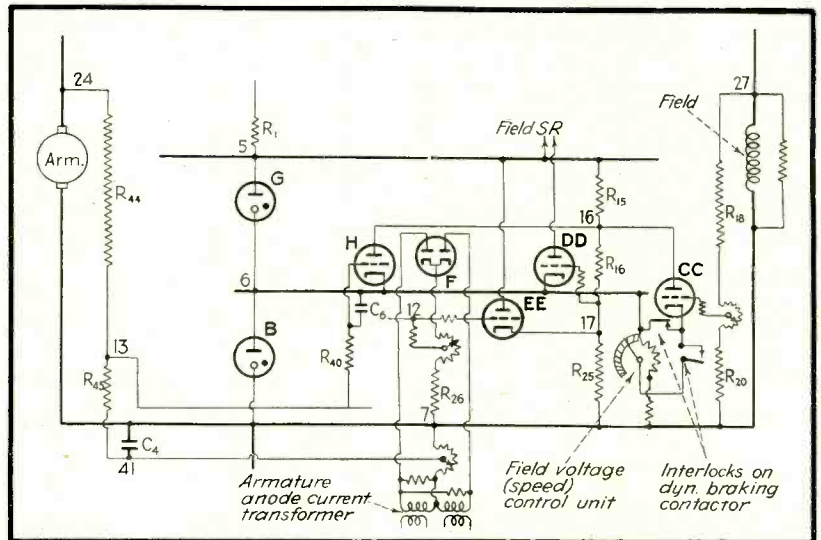

FIG. 3—Armature voltage limit control added to field voltage control

D would retard the grid phase on the armature thyratrons so as to reduce their output voltage to the value required for 10 percent speed. This would reduce the average rectifier voltage below the counter emf of the motor so that the armature current would tend to reverse. As a result, the current would be cut off by the electrical free-wheeling action of the armature trying to pump back through tubes, which will not conduct current in a reverse direction.

At the same time, tubes CC and DD would fully advance the grid phase on the field thyratrons so as to produce full field voltage. In the relatively short time determined by the time constant of the field circuit, the field current would reach full rated value. Then, if the motor load had had sufficient inertia to maintain the motor speed during this interval, the armature voltage would have risen to about four times rated value. That is, the armature voltage would reach about 920 volts in this instance where a 230 volt motor is running at four times basic speed (because the generated voltage is a measure of the speed at which the armature conductors cut field flux and the 590-rpm basic speed alone is sufficient to produce 230 volts).

Such excessively high voltage is objectionable because it might hi-pot some part of the armature circuit or cause the commutator to arc over. The occurrence of high voltage under these conditions is not peculiar to electronic control alone—it may occur with magnetic control using certain relay sequences in combination with contacts which open the armature circuit—but the speed of response of the electronic circuits may aggravate the condition.

This high open-circuit voltage can be snubbed, or limited, by the simple expedient of taking a signal from the armature voltage, comparing this signal against a standard voltage, determining the sense of the resultant voltage, and then using this resultant voltage to actuate another triode, tube H of Fig. 3, which prevents the field saturable reactor from increasing the field excitation to any value greater than that which would produce a pre-selected maximum armature voltage. This ceiling voltage should be sufficiently greater than the rated 230 volts to render tube H inoperative (cut-off) during normal operation. A 300 volt ceiling

is usually sufficient to accomplish this result. Tube H will be operative so long as the control tube (CC) tends to strengthen the field from a weak-field condition at a time when the armature is rotating at such speed that the generated voltage tends to be in excess of the ceiling voltage limit which tube H is preset to limit.

Voltage Filter Circuits

The voltage wave which appears across the armature of the motor is composed of positive and negative portions of a sine wave, superimposed on the d-c counter emf of the armature as shown in Fig. 4. The positive-voltage portion of the vol-

age voltage which a d'Arsonval meter (permanent magnet type d-c meter) reads when connected across the armature.

The filtering action is accomplished by a combination of grid resistance and a grid-to-cathode capacitor at the grid of tube C. The resistor absorbs some of the peaks of voltage and yet lets enough current through to build up the capacitor voltage to a little-higher-than-average level so that when the capacitor voltage leaks off during the idle period between peaks, the over-all average voltage is equivalent to the av-

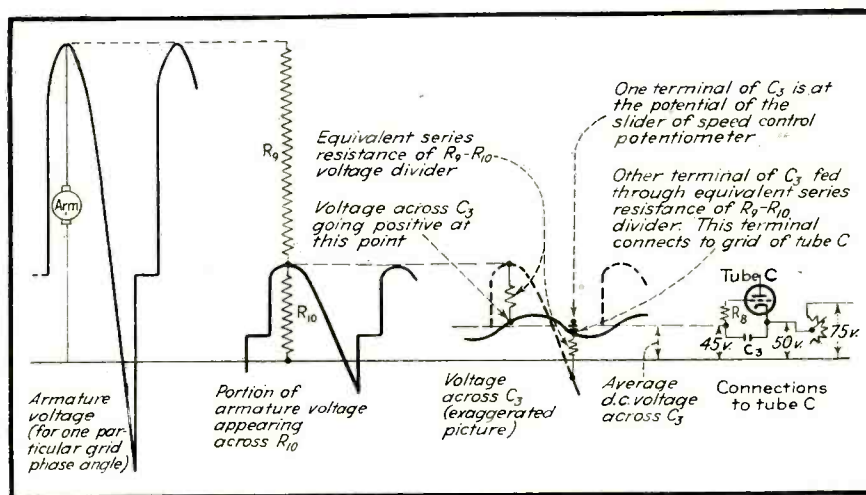

FIG. 4—Filtering action of capacitor, C_3 , in armature voltage-signal circuit

tage wave may have a peak height equal to the peak value of the anode-to-neutral voltage of the anode transformer. The negative portion may reach a negative peak of equal value under certain circumstances dependent upon the inductance of the armature circuit and the load on the motor.

Tube C, which receives the armature voltage signal, operates over its full range with only a few volts change in grid voltage. Hence, it is desirable to smooth out the armature voltage wave before these very high voltages are applied to the grid of tube C. Otherwise, tube C would be paralyzed in response to all but a small portion of the voltage wave near the counter emf level and would not transmit a true picture of the average signal voltage.

This filtering process consists of clipping off the tops of the wave and filling in the depressions so as to give

an equivalent value of average height or average voltage—much as a road is built over a hill and across a valley by taking off only as much of the hill as is necessary to fill the valley and grading the road at the resultant level.

erage voltage which a d'Arsonval meter (permanent magnet type d-c meter) reads when connected across the armature. The better this filtering action, the slower the capacitor voltage level responds to changes in the average value of the armature voltage wave, with the result that the armature voltage could change widely before the capacitor would change enough to transmit this knowledge to the control circuit so that when the control did respond it might be too little and too late. Hence, only so much filtering of this type can be tolerated at this point—just enough to take off the rough spots, so to speak.

Anti-hunting Circuits

Another type of filtering which takes advantage of the amplification factor of the triode to effect a reduction in the size of the filter elements is a resistor in series with

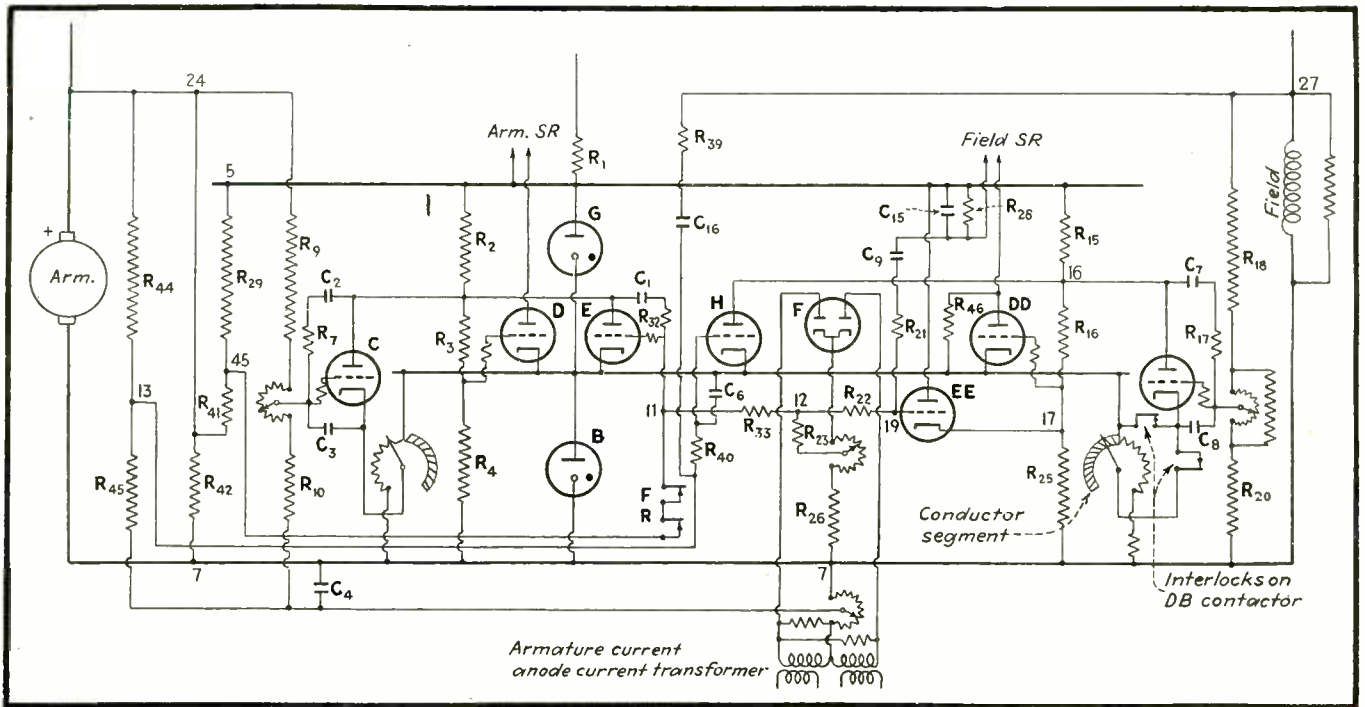
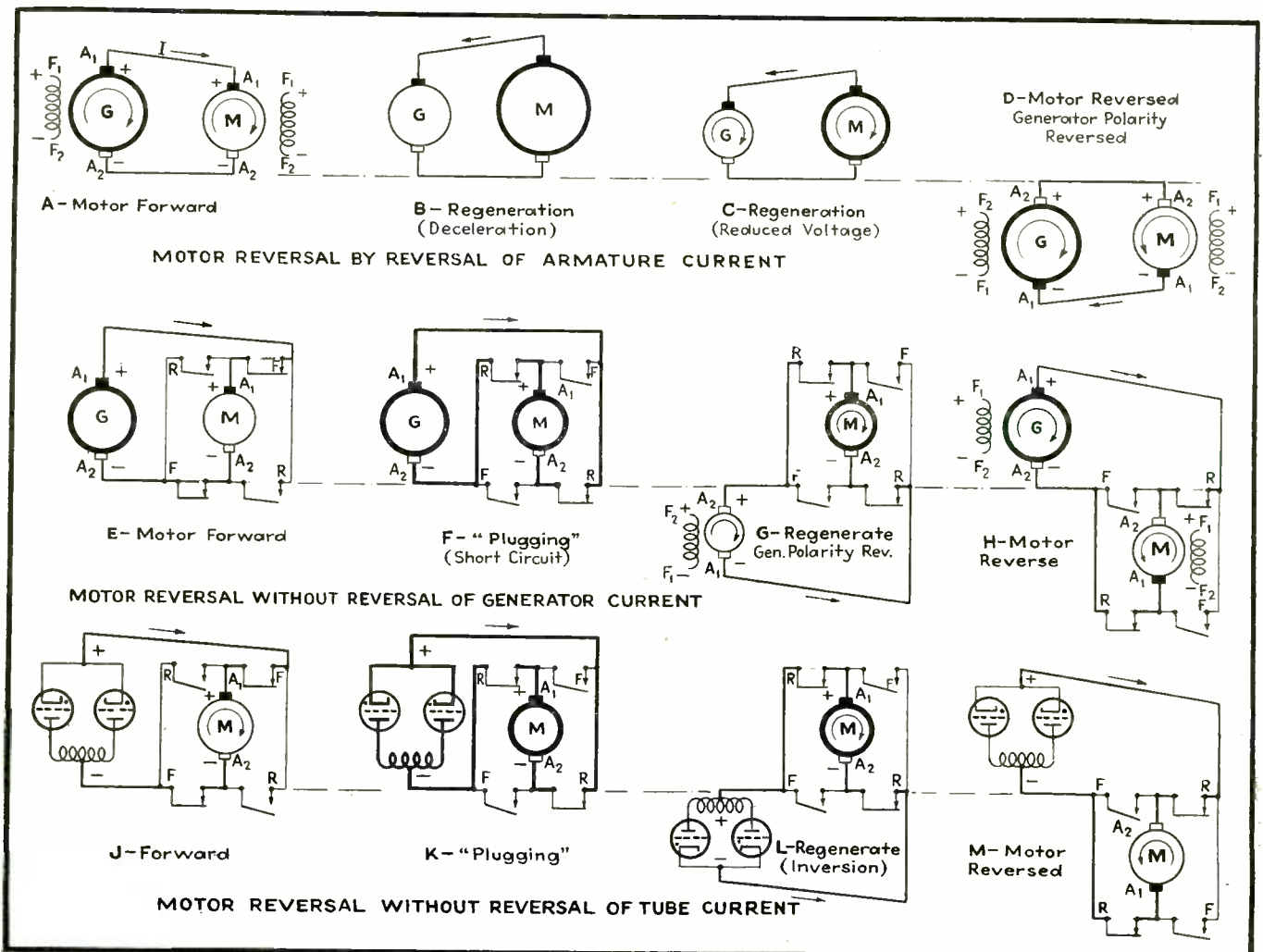

FIG. 5—Filters and RC stabilizing circuits added to armature and field control circuits

FIG. 7—Comparison of wave forms of rectification and inversion

FIG. 6—Comparison of motor-generator drive and electronic drive during motor reversal



a capacitor connected between grid and plate of the tube.

If one remembers that the voltage drop across a resistor can be changed instantly whereas the voltage drop across a capacitor can only be changed slowly, then the behavior of this particular RC combination may be explained briefly and simply as follows: If the voltage signal applied to the grid is such as to make the grid less negative so that the triode tends to pass more plate current, the plate voltage across the triode tends to decrease and the

with the capacitor is increased, the snubbing effect of the capacitor is lessened because a greater portion of the grid-to-plate voltage can appear instantaneously across the resistor. The combinations of resistance and capacitance which will work best are not too critical, and once decided upon, seem to work for a wide range of motor sizes and load conditions.

Sometimes, it is sufficient to connect the series combination of resistance and capacitance between plate and cathode instead of plate

forms of the a-c windings. This signal of current through the d-c winding of the saturable reactor is derived from the voltage drop across resistor R_{28} , filtered by capacitor C_{12} .

These RC circuits are much more important than is indicated merely by the number and size of the components. Without such stabilizing influences the high amplification of the basic control circuits would make the regulatory action very erratic and impractical. The high amplification, or sensitivity to small signal changes, is necessary if the control functions are to be regulated within close limits, as, for example, in maintaining practically constant speed from no-load to full-load on the motor. And, the damping or stabilizing or anti-hunting influence is necessary to temporarily and partially nullify this high amplification in proportion to the rate at which the ever changing nature of a dynamic load demands automatic and compensating adjustments from the control.

Reversing

If a generator were driving the motor as in A, B, C, D of Fig. 6, instead of a grid-controlled rectifier, the direction of rotation of the motor could be changed by reversing the polarity of the generator field excitation, which in turn reverses the polarity of the generator terminals. Motor reversal would be accompanied by a reversed direction of current flow out of the generator and into the motor (compare Fig. 6A and 6D). In these figures, it is assumed that to drive the motor forward, the current is leaving the A_1 terminal of the generator and entering the A_1 terminal of the motor, and that to drive the motor in the reverse direction the current would then have to leave at the A_2 terminal of the generator and enter at the A_2 terminal of the motor.

In the process of reversing from a high speed (weak field) in one direction to a different speed in the opposite direction, the motor field could first be strengthened to increase the motor emf and, temporarily, to cause the motor to act as a generator. Current would flow out of the A_1 terminal of the motor into the A_1 terminal of the generator because the motor voltage would be greater than the generator voltage.

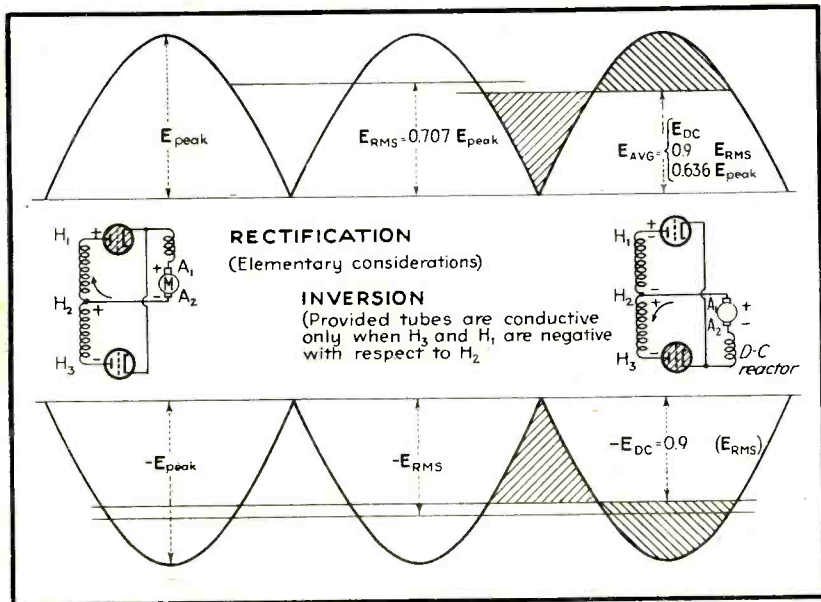

voltage across the resistor in series with the plate tends to increase. In other words, the plate tends to move electrically towards the grid. Suppose, now, that there is very little resistance in series with the capacitor between plate and grid. Then, if the plate tends to move quickly towards the grid while at the same time the grid signal causes the grid to move towards the plate, the capacitor counters this dual action because the initial voltage of the capacitor cannot change quickly and so tends to tie grid to plate and temporarily blocks any action. Then, as the capacitor voltage gradually changes, the blocking is just as gradually released.

A very slowly changing grid signal and its corresponding very slowly changing plate voltage are blocked only very slightly because the change in voltage between grid and plate is slow enough for the capacitor voltage to keep pace with events. If the resistor in series

to grid and in this way snub the plate circuit alone without directly involving the grid circuit.

Resistor-capacitor anti-hunting circuits are found throughout the control network, as shown in Fig. 5. Usually, at least one such RC circuit will be associated with each control function. Much the same anti-hunting circuits, in similar circuit locations, are used in the armature-voltage control as in the field-voltage control, except that the respective values of R and C may be different. Also, in the case of field-voltage control, an RC combination for the grid-to-plate circuit of tube DD, which saturates the field saturable reactor, is caused to respond to a signal of current through the reactor winding rather than to a signal of voltage across the tube. This is because the plate voltage of the triode contains a peculiar voltage-ripple which is induced in the d-c winding of the saturable reactor by the non-sinusoidal wave

Then, the motor would be pumping its energy into the generator and back into the a-c system via the a-c motor which drives the generator.

This transfer of energy from motor to generator quickly causes the motor speed to decrease (decelerate). Soon, even full field on the motor would not generate sufficient voltage to maintain the motor voltage at a level greater than the generator voltage; then the generator field could be reduced as the motor speed decreased so as to keep the generator voltage below the motor voltage, and thereby maintain a definite armature current or rate of deceleration (see Fig. 6C).

Theoretically, (but not practically because of hysteresis or permanent-magnet-like retentivity of the field structure), when the generator voltage had been reduced to zero, the motor speed would be zero. Then, the generator field excitation could

be reversed (+ on F_2 and - on F_1 instead of the previous + on F_1 and - on F_2) and could be gradually increased so as to build up the generator voltage in the opposite polarity and cause the motor to rotate in the opposite direction in order to develop a counter emf opposing the generator voltage and limiting the armature current now flowing in the opposite direction.

Reversing Contactors

If a thyatron tube rectifier were substituted for a generator, the customary method of reversing could not be used since the output voltage of tubes acting as rectifiers cannot be reversed, nor can the current flow through the tubes be reversed. Whenever the load on the motor became of such an overhauling nature that the emf of the motor tended to exceed the output voltage of the rectifier, the direction of current

flow would tend to be reversed but would actually only become zero because the tubes will not conduct current in the reverse direction.

Reversal of motor rotation must be accomplished without a change in the direction of flow of armature current. This is possible if the connections of motor terminals to rectifier terminals are reversed as by means of a magnetic reversing switch (contactor) in the d-c line between motor and rectifier. Then, with the motor running so as to be generating an emf, its armature terminals would be connected to the rectifier in such a manner that what constitutes a reversed flow of current in the armature becomes a normal direction of current flow through the tubes so that there is a circuit path through the tubes for the flow of reversed armature current.

This same scheme could be used
(Continued on page 281)

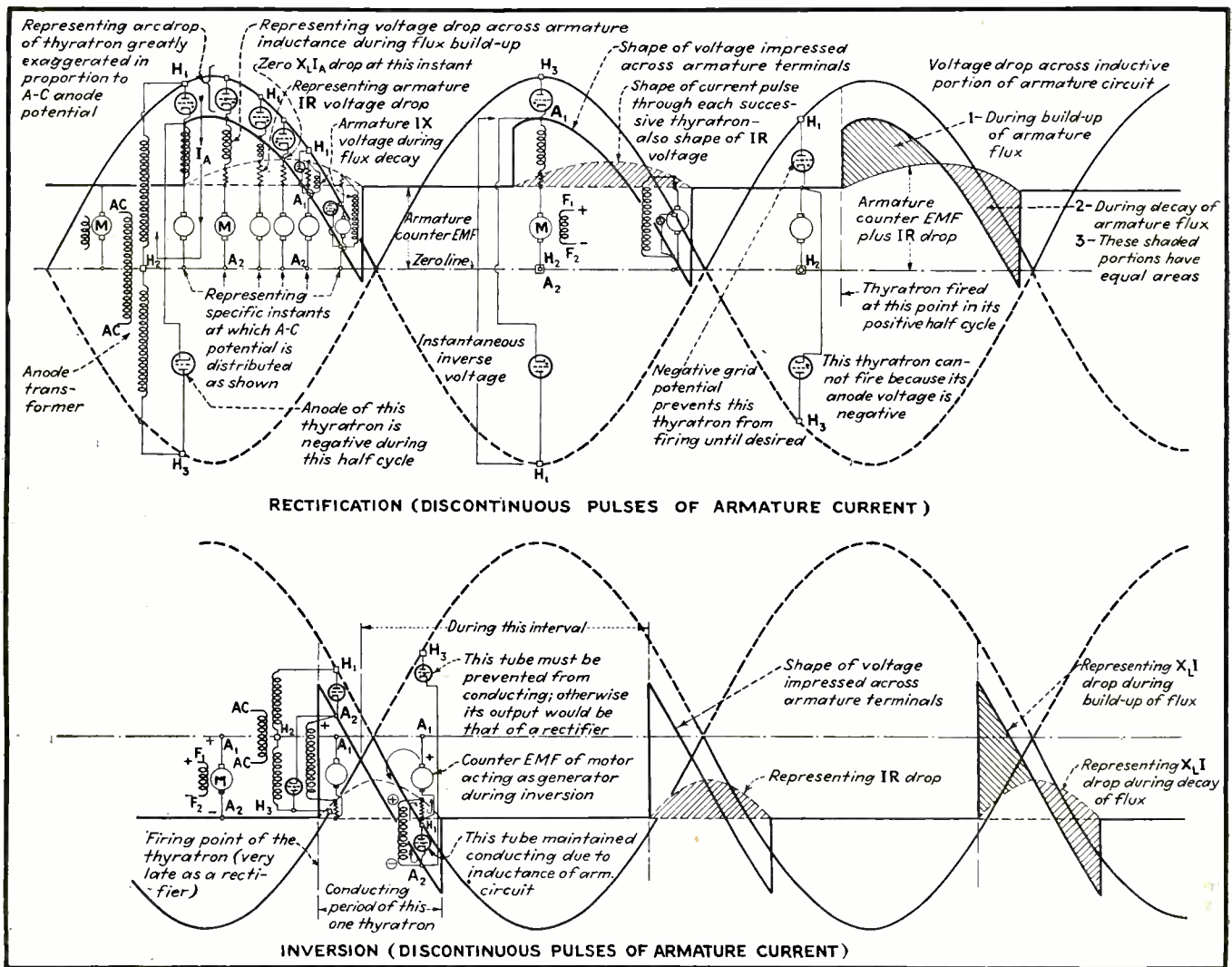

FIG. 8—Comparison of voltage distribution for rectification and inversion

Q for Unloaded Concentric Transmission Lines

Alignment chart makes possible rapid determination of Q and sending-end impedance for copper concentric cables of optimum conductor ratios. Supplementary chart extends results for use with concentric transmission lines having any ratio of conductor diameters

By R. C. MIEDKE, Washington, D. C.

THE nomogram on the following page and the supplementary curves below are designed to permit easy determination of the sending-end impedance Z_s , as well as the value of Q for unloaded concentric conductor transmission lines, in terms of the resonant frequency and the conductor sizes. The charts may be applied to the usual concentric transmission lines used as transformers, filters, or transmission networks, which are either an odd number of wavelengths long and short-

circuited at the receiving end, or an even number of wavelengths long and open at the receiving end.

The alignment chart of this Reference Sheet has been drawn to apply to a concentric line of copper conductors of such dimensions ($b/a = 3.6$) as to produce maximum Q. The value of Q is independent of the number of quarter wavelengths of line length. To use the alignment chart for a line of optimum dimensions, it is necessary to know the inner radius of the outer conductor, b , in inches

or centimeters, and either the frequency in megacycles, f , or the wavelength in meters, λ , at which the line is operated. A straight line connecting either f or λ (on the scales at the right) with the appropriate value of b (center scale) and extended to the scales at the left, will indicate the values of Q and Z_s for the line.

The value of Z_s given in the alignment chart applies only to a line for which $b/a = 3.6$ and for a line only one quarter wavelength long.

To extend the use of the chart to lines for which b/a may have any value from 1 to 100, it will first be necessary to determine Q or Z_s for a line for which $b/a = 3.6$, as indicated above. The values of Q and Z_s , thus determined must then be multiplied by the factors K_Q or K_{Z_s} , respectively, determined from the graph on this page, for the desired value of b/a . Maximum value of Z_s occurs for $b/a = 9.2$.

An example will help to illustrate the use of these charts. Assume we have a transmission line whose inner conductor has a radius of $\frac{1}{4}$ " and whose outer conductor has a radius of $\frac{1}{2}$ ", and that the line is operated at a frequency of 100 Mc. From this data we have $a = \frac{1}{4}$ ", $b = \frac{1}{2}$ ", $b/a = 2$, and $f = 100$ Mc. Connect the points, $f = 100$ Mc and $b = 0.5$ in., and read $Q = 1,080$ and $Z_s = 105,000$ from the alignment chart.

From the chart relating K with b/a , for $b/a = 2.0$ we find that $K_Q = 0.83$ and $K_{Z_s} = 0.44$. The correct line constants are then

$$Q' = K_Q Q = 0.83 \times 1,080 = 896$$

$$Z'_s = K_{Z_s} Z_s = 0.44 \times 105,000 = 46,200 \text{ ohms}$$

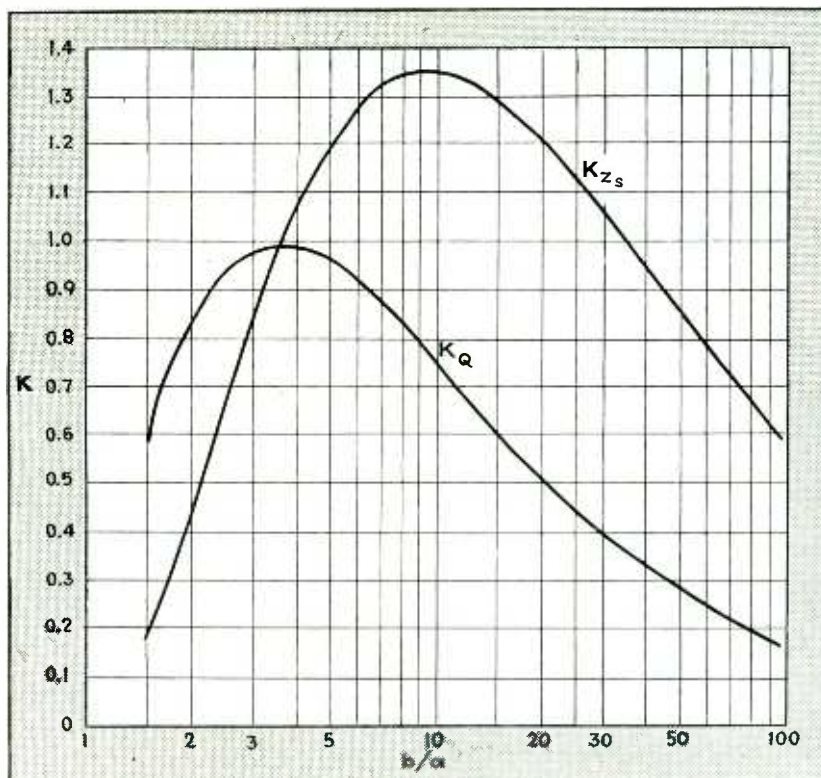

Plot of multiplying factor, K, for concentric transmission lines having various values of inner and outer conductor diameters

Q for Unloaded Concentric Resonant Lines for Optimum Ratio of Conductor Dimensions, $b/a=3.6$

By R. C. MIEDKE

Washington, D. C.

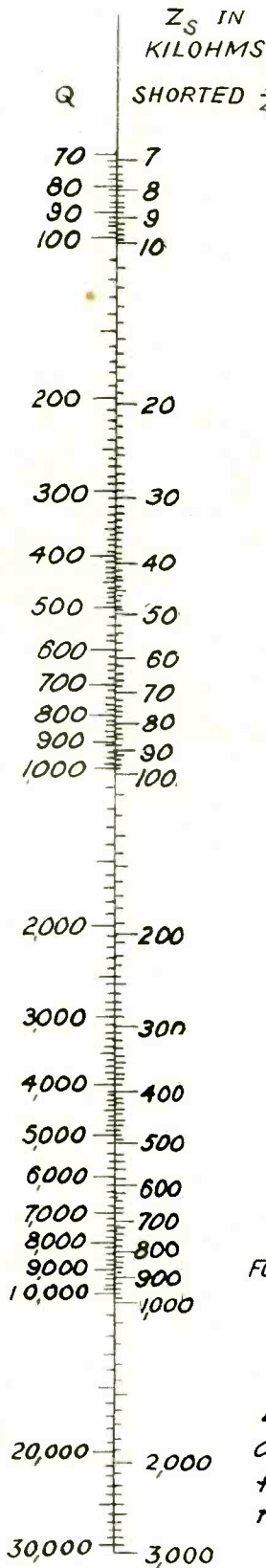

CONCENTRIC
CONDUCTORS

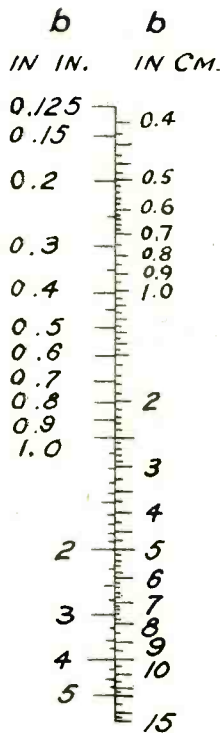
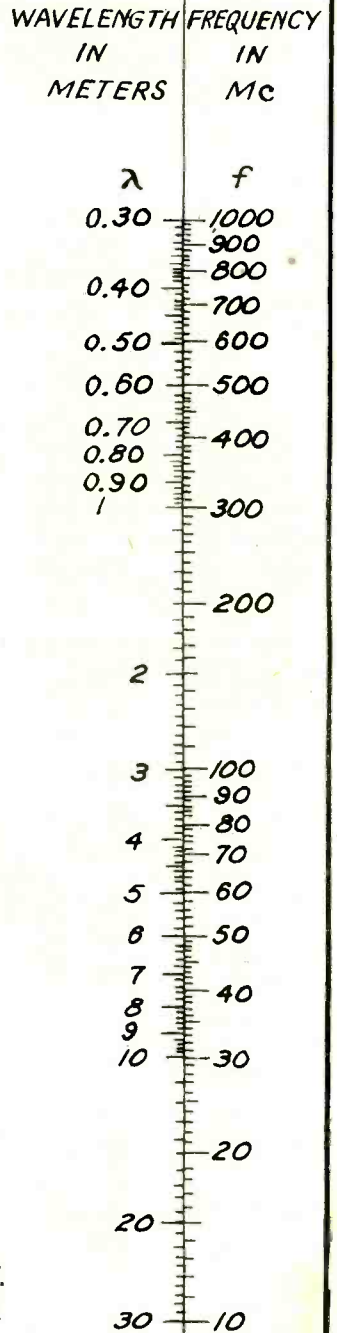
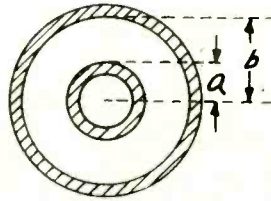

FOR CONCENTRIC COPPER CONDUCTORS IN WHICH $b/a=3.6$

$$Q = 8.39 b \sqrt{f} \times 10^{-2}$$

$$Z_s = \frac{8.23 b \sqrt{f}}{n}$$

b = INSIDE RADIUS OF OUTER CONDUCTOR IN CM.

a = OUTSIDE RADIUS OF INNER CONDUCTOR IN CM.

f = FREQUENCY IN MEGACYCLES

n = NUMBER OF QUARTERWAVELENGTHS OF LINE

The "KING PIN"
in any set...



COORDINATION—every little part helps



ACTUAL SIZE

CINCH CONTACT

The contact between tube and socket is the focal point for positive authentic transmission of sound. "Cinch Sockets" are specified for those communicating systems that are "delivering" because the contact, the King Pin positively assures electrical connection. Constant research by our Engineers, proper selection of alloys, temper, individual tension tests, sizing, plating, are factors insuring reliable performance of each CINCH CONTACT.



CINCH MANUFACTURING CORPORATION • 2335 West Van Buren St., Chicago, Ill.

SUBSIDIARY: UNITED-CARR FASTENER CORPORATION, CAMBRIDGE, MASS.

TUBES AT WORK

Mass Spectrometer for Butadiene Analysis.....	142
Welding Monitor.....	142
Temperature-Compensated Wavemeter Coil.....	148
Sending Train Orders by Facsimile Telegraphy.....	148
Improvised Memorizing Machine.....	156
Remote Adjustment of Synchronous Clocks.....	158
Voltage-Stabilized Bias Supply for Power Tubes.....	160
Hearing Aid Circuits.....	165
Program Quality Analyzer.....	168
Diving Amplifier.....	170
Electronic Dehydration of Food.....	176

Mass Spectrometer for Butadiene Analysis

BUTADIENE MOLECULES are built according to definite chemical patterns from carbon and hydrogen atoms. During this molecular assembly process the composition must be checked at intervals but present methods are so slow that the batch of butadiene is often finished incorrectly before the analysis is completed. A mass spectrometer that permits speedy analysis of the gases used to form butadiene has been developed by Dr. John A. Hipple, physicist at Westinghouse Research Laboratories.

The heart of the new spectrometer is a glass tube a yard long that is

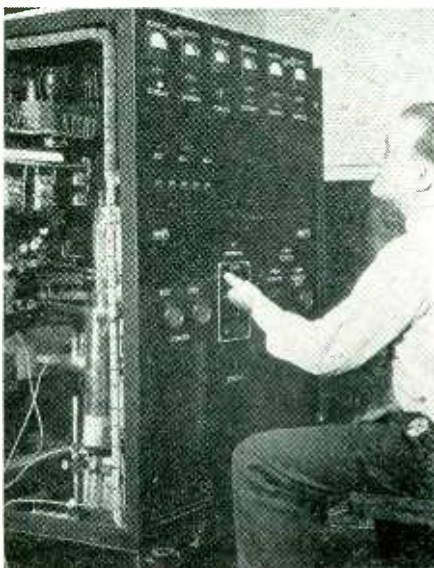

Control panel of the electronic mass spectrometer used for analyzing gases formed in making butadiene, principal ingredient of several synthetic rubbers. The instrument analyzes a complex gas molecule in fifteen minutes

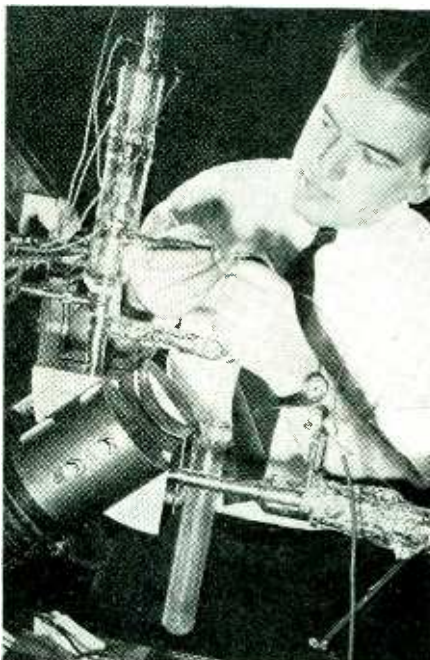

Gas molecules, traveling at high speed through the tube shown above, are sorted by electromagnets and their charges measured for chemical analysis

lined with metal and shaped in a quarter-circle. Gas molecules are given an electrical charge at one end of the tube and forced by high potentials toward the other end at a speed of a million feet per second. An electromagnetic field is arranged to pull at the speeding molecules so that only those having a certain mass or weight travel down the center of the tube and around the curved portion to pass through a slot in a metal target at the end.

Molecules of less weight are attracted to the metal lining of the tube before they reach the bend, while heavier molecules, that offer more resistance to the pull of the

electromagnet, strike the walls of the tube when they try to negotiate the bend.

The molecules that get through the target are collected by a metal plate and give up their charges. The charges are amplified and counted by meters that indicate how many molecules of a certain weight comprise the gas mixture.

At the present time certain analyses of this type require from fifteen hours to three days of laboratory work by from five to ten chemists. The mass spectrometer can analyze a complex gas molecule in fifteen minutes and is said to be more accurate than other methods.

Welding Monitor

ONE OF THE REQUIREMENTS of arc welding is that the length of the arc be maintained at a definite value. Adjustment of the proper arc length can be made by measuring the voltage developed across the arc. In this respect the amount of voltage is not as important to a good weld as the deviation from a predetermined value. This deviation can be indicated by electronic means by the circuit shown in Fig. 1.

For training welding students in judging the correct arc length, two small bulbs are mounted at the side of the window in the student's shield and connected by cable to the monitor. When the arc is too long, the voltage increases across the arc and the bulb at the right of the window begins to glow. Its brilliance increases with the length of the arc. When the arc is short the voltage is low and causes the bulb at the left of the window to glow. The correct arc length is obtained when both bulbs remain dark. A duplicate set of bulbs on the panel of the monitor permits the instructors to follow the student's work, as shown in the photograph.

For convenience the circuit is reduced to essential components in Fig. 2. The secondary winding of the output transformer forms a bridge circuit with winding T_2 of the power transformer and the bulbs in the welder's helmet. The current from winding T_2 is adjusted by resistor R_2 to a value just below that necessary for the indicator bulbs to



**MEASURING STRESS
AT 60 M.P.H.**

CALLS FOR IRC RESISTORS

A locomotive driving-rod packs plenty of power as it hurtles its heavy load over the rails. To detect and accurately measure stress changes in driving rods, under actual running conditions, presented an exciting challenge to engineering ingenuity. Heretofore such data was approximated through polaroid means or empirical formulas, based on scale models.

ANOTHER **IRC DEVELOPMENT**

Research on the intricate device finally evolved, indicated the need for a very thin resistance ele-

ment of uniform characteristics . . . sensitive enough to accept every stress modification yet sufficiently stable so that readings made from time to time would be comparable. I R C engineers solved the problem by a unique application of I R C's exclusive Metallized coating to a non-conductive plastic strip.

If you are confronted with a question involving resistances, why not consult I R C, the company that makes resistors of more types, in more shapes, for more uses than any other manufacturer in the world?



INTERNATIONAL RESISTANCE COMPANY

403 N. BROAD STREET • PHILADELPHIA



STEATITE

by Centralab

No Shortage • Ample Capacity
Custom - Made to Your
Requirements

Centralab

Division of GLOBE-UNION INC., Milwaukee



PARTS

by Centralab

Steatite Insulators • Ceramic Trimmers
High Frequency Circuit Switches
Sound Projection Controls
Wire Wound Controls
Ceramic Capacitors

Centralab

Division of GLOBE-UNION INC., Milwaukee

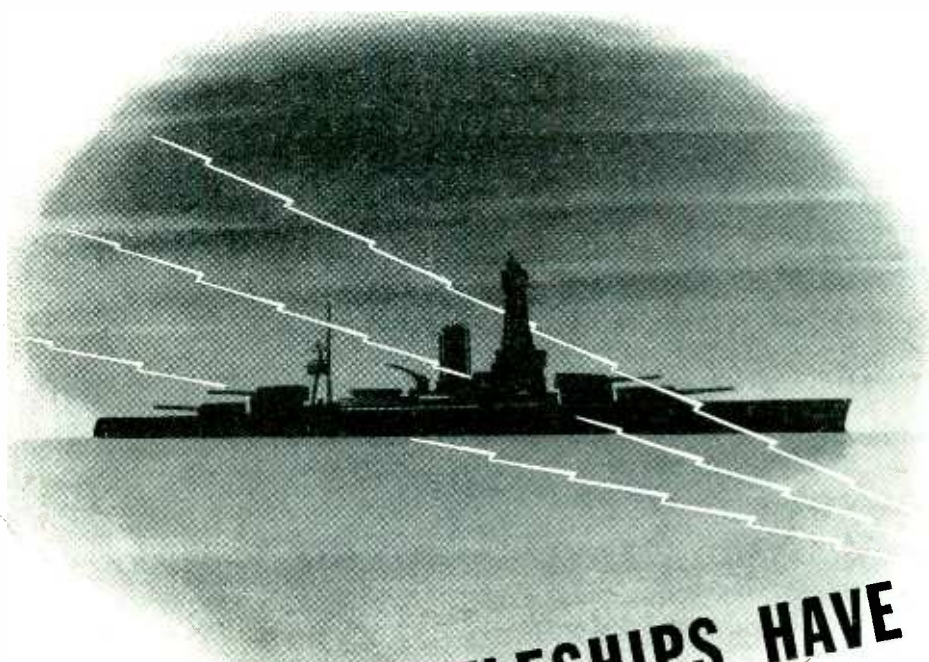

THICKSKINNED BATTLESHIPS HAVE NERVES!

Beneath their many inches of armor-plate, Uncle Sam's battlewagons are as finely co-ordinated as champion boxers . . . instantly responsive to commands. A network of nerves . . . the lines of electric communication . . . runs through the ship. The command, "Battle Stations!" is electric . . . *literally*.

To keep these nerves alive with energy is one of the war jobs now being done by Stancor Transformers. When peace is won, American industry will enter a new age of electronics . . . the transformation of electric power to build and serve a happier world. Stancor engineers are preparing, by foresighted research, to serve the needs of peace after victory.

S T A N C O R



STANDARD TRANSFORMER CORPORATION - 1500 NORTH HALSTED STREET - CHICAGO

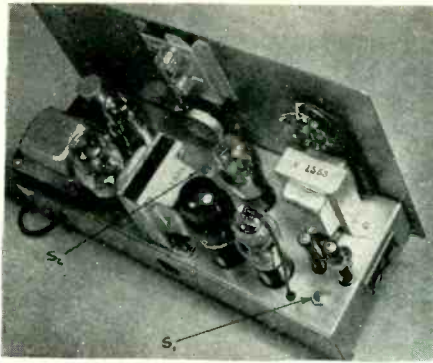

Rear view showing chassis of welding monitor. Arrows indicate screwdriver adjustments of potentiometers

and controls the degree of amplification of the tube.

The monitor includes a switching circuit, detailed in Fig. 1, that permits reversing the polarity of the terminals without changing the leads to the electrodes. One position on this switch permits the instrument to be used on a-c welding circuits by connecting the primary of a transformer to the arc electrodes. The transformer secondary winding feeds a 6ZY5G connected as a full-wave rectifier, to obtain the d-c voltage required by the bucking circuit.

Temperature-Compensated Wavemeter Coil

By E. O. THOMPSON

Engineering Dept.
Philco Radio & Television Corp.
Philadelphia, Pa.

WAVEMETERS used by the Army and Navy to adjust transmitters are required to maintain their accuracy in spite of temperature and humidity changes. This is accomplished in the device to be described by employing a thermostatic control to compensate for changes of inductance in the coil of the resonant circuit of the wavemeter.

The device comprises a conducting ring which is placed in the magnetic field of an inductance coil. The ring is thermostatically controlled to change its angular relation with respect to the axis of the coil in response to temperature changes. Such changes in angularity vary the degree of coupling be-

Editor's Note: Mr. Thompson and David Sunstein of the Philco factory, his collaborator in developing this device, were officially cited for their work by the Board for Individual Awards of the War Production Board.

tween the ring and the coil, and thereby effect variation in the inductance of the coil as a whole.

The assembly essentially comprises a tuning coil unit 1 and a closed conductor 2 supported at one end of the coil unit for rotation on a shaft 3, but held at an angle of about 45° with respect to the axis of the coil unit at normal temperature by means of a bimetallic thermosensitive spiral 4 having its inner end connected to the shaft 3 and its outer end affixed to the closed conductor 2.

The ring, bimetallic spiral and shaft assembly are carried in a bracket 5 which straddles the edge 6 of the coil unit and is connected to the coil form. This bracket is adjustable in relation to the edge 6 and thus provides for ready adjustment of the ring 2 axially in relation to the coil, to vary the amount of compensation required as the temperature changes.

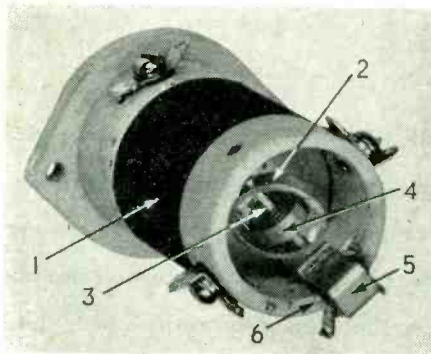

The compensated coil assembly utilizes a thermostatic spiral to rotate a metal ring and vary inductance. Numbers indicate the parts described in the text

Once the device is adjusted to obtain the desired effective inductance of the coil at normal ambient temperature, a rise in the normal temperature, tending to increase the coil inductance, affects the bimetallic spiral which, in turn, rotates the conducting ring 2 toward a position more nearly parallel with the turns of the winding. This increases the coupling between the ring and the coil and maintains the effective coil inductance constant. On the other hand, a decrease in the normal temperature acts on the bimetallic spiral to rotate the conducting ring in the opposite direction and decreases the degree of coupling. In this manner the effective inductance may be caused to remain

substantially constant over a wide variation of temperature. By proper design of the unit, it may also be used to effect controlled variation of the effective coil inductance in response to increments of temperature change.

Sending Train Orders by Facsimile Telegraphy

"The bulk of overhead wires crisscrossing the continent are destined to come down and be replaced by radio and light beams," in the opinion of F. D. D'Humy, Western Union vice president, at a recent hearing before the FCC. He referred to the possible postwar use of radio and light beams for telegraphy and Telefax, the automatic transmitter and recorder system recently placed in operation by Western Union to handle train orders for American railroads.

The facsimile transmitter of the new system is described in a recent issue of *Electrical Communication*, and is pictured in the accompanying illustration. The transmitter oper-



Automatic transmitter for facsimile telegraphy. The square, black block on the message blank synchronizes the scanning drums

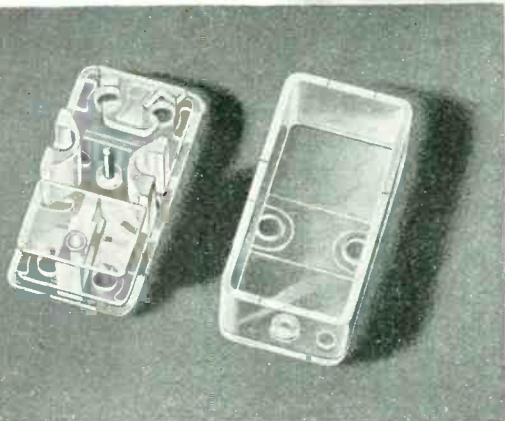
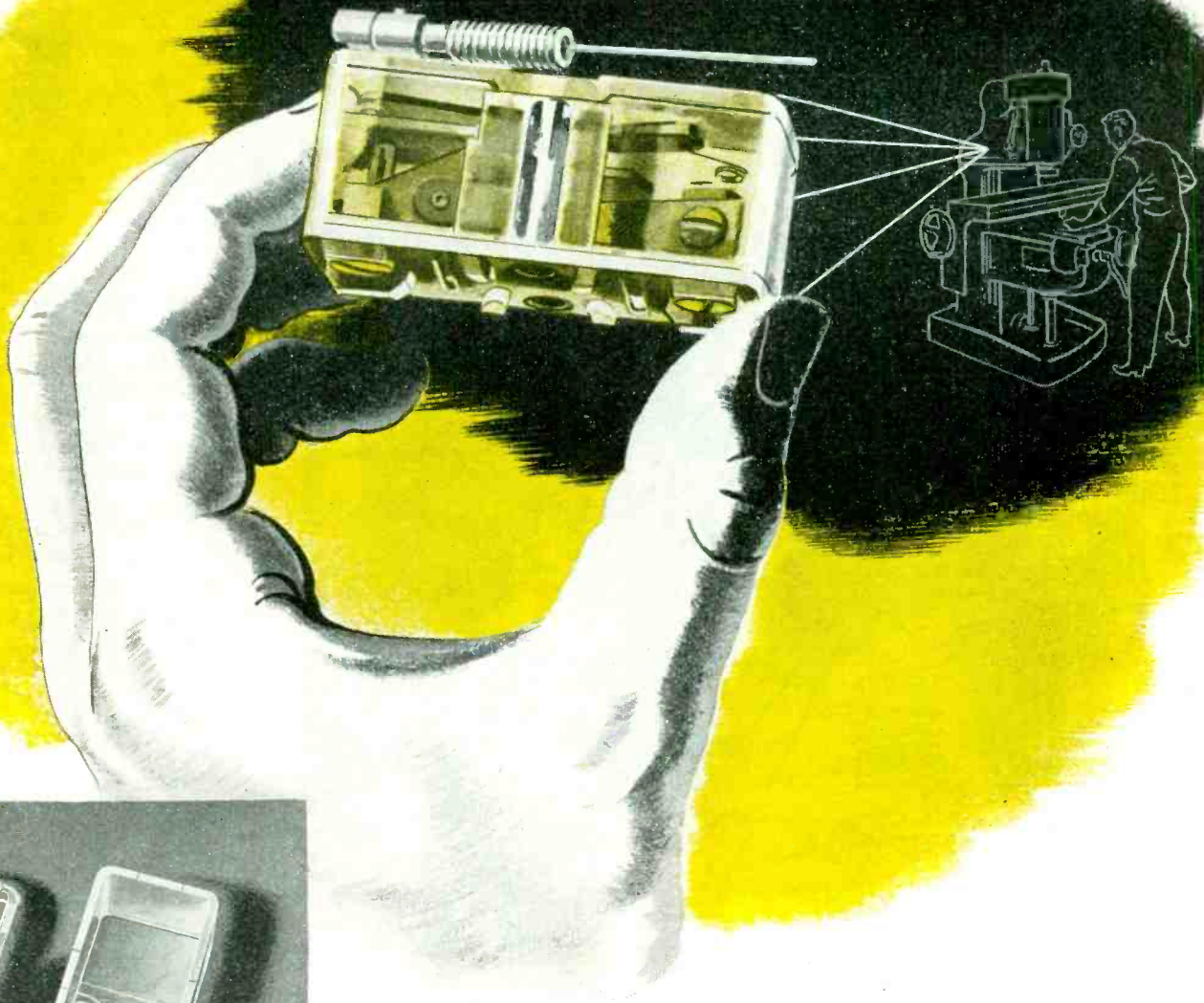

STYRON SIMPLIFIES MOLDING OF TRANSPARENT CASE

Ease of fabrication ranks high on the list of outstanding Styron characteristics. By using this thermoplastic injection molding material, one cavity for each part is sufficient for producing the housing illustrated above. Faster molding cycles are also possible. Thus, through Styron, the cost of fabricating equipment is reduced, and production volume increased.

Precision in Plastics

Limit switches, specifically designed for modern machine tools, call for complete precision in both design and fabrication. To the limit switch manufacturers, the Square D Company, and to the molders, the Kampa Manufacturing Company of Milwaukee, this demand for accuracy pointed to Styron—Dow's transparent plastic used for the molded case.

Styron was selected because it possesses the electrical properties, heat resistance and dimensional stability required for precision performance. Its outstanding insulating qualities eliminate any tendency toward carbonization or carbon tracking from the small arc produced at the contacts. In addition, Styron's complete transparency permits visual inspection of the mechanism and, at the same time, permanently seals the unit against tampering.

THE DOW CHEMICAL COMPANY, MIDLAND, MICHIGAN
 New York • St. Louis • Chicago • Houston • San Francisco • Los Angeles • Seattle

STYRON

DOW PLASTICS

ETHOCEL • SARAN



CHEMICALS INDISPENSABLE TO INDUSTRY AND VICTORY



for
"listening
posts"
on the
home
front....

A **SONOTONE**
ACHIEVEMENT
TO WHICH **CALLITE**
CONTRIBUTED



Designed for the 3-tube amplifier of the Sonotone hearing aid, these miniature tubes enable thousands of handicapped people to serve the nation's war effort. Not much bigger than thumb-nail size, these tubes have a man-sized job to perform. That's why Sonotone specifies C-T molybdenum wire for the grids of these tiny tubes.

The uniformly excellent working properties and complete freedom from oxidation makes C-T fine molybdenum wire a "must" in such critical applications as the Sonotone miniature tubes. Molybdenum wire is but one of a large family of specialized Callite products for electronic tubes and incandescent lamps. Other Callite products — all the result of years of specialization and incessant research — are listed below. Our engineers will be glad to cooperate with you on your specific requirements.

Specialists in the manufacture of Hard Glass Leads, Tungsten and Molybdenum Wire, Rod and Sheet, Formed Parts, and other components for electronic tubes and incandescent lamps.

CALLITE TUNGSTEN CORPORATION

544 39th STREET



UNION CITY, N. J.

CABLE: "CALLITES" • BRANCH OFFICES: CHICAGO • CLEVELAND

ates on a carrier frequency of 2500 cycles and uses a drum speed of 180 rpm and a line advance of 1/100 inch per revolution, adopted as standard constants for facsimile equipment by Western Union to permit scanning the entire message blank in two minutes. It requires for operation a two-wire line, a ground connection, and a 50 to 60 cycle, 115-volt supply. The associated recorder requires, in addition to the line pair and ground connection, a similar power source whose frequency is synchronous with that of the transmitter.

Over the line circuit flows the facsimile tone signal as well as the d-c control currents. The ground return also functions for the control circuits. The facsimile tone signals are applied to and taken from the line pair through capacitors to separate the a-c and d-c circuits.

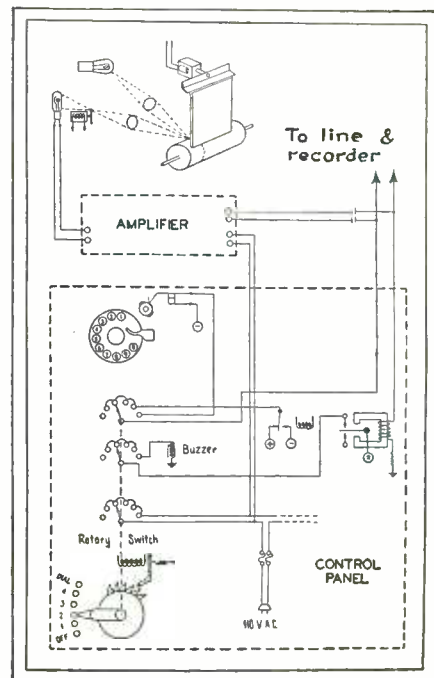

Essential components of transmitter for railroad facsimile telegraphy

The circuit of the transmitter is shown in simplified form in the diagram. A relay in one connecting line wire permits certain functions of the transmitter to be controlled by the receiving recorder. A similar relay in the other line wire permits certain functions of the recorder to be controlled by the transmitter. These line relays are three-position polar relays, the position being determined by the polarity of the d-c potential

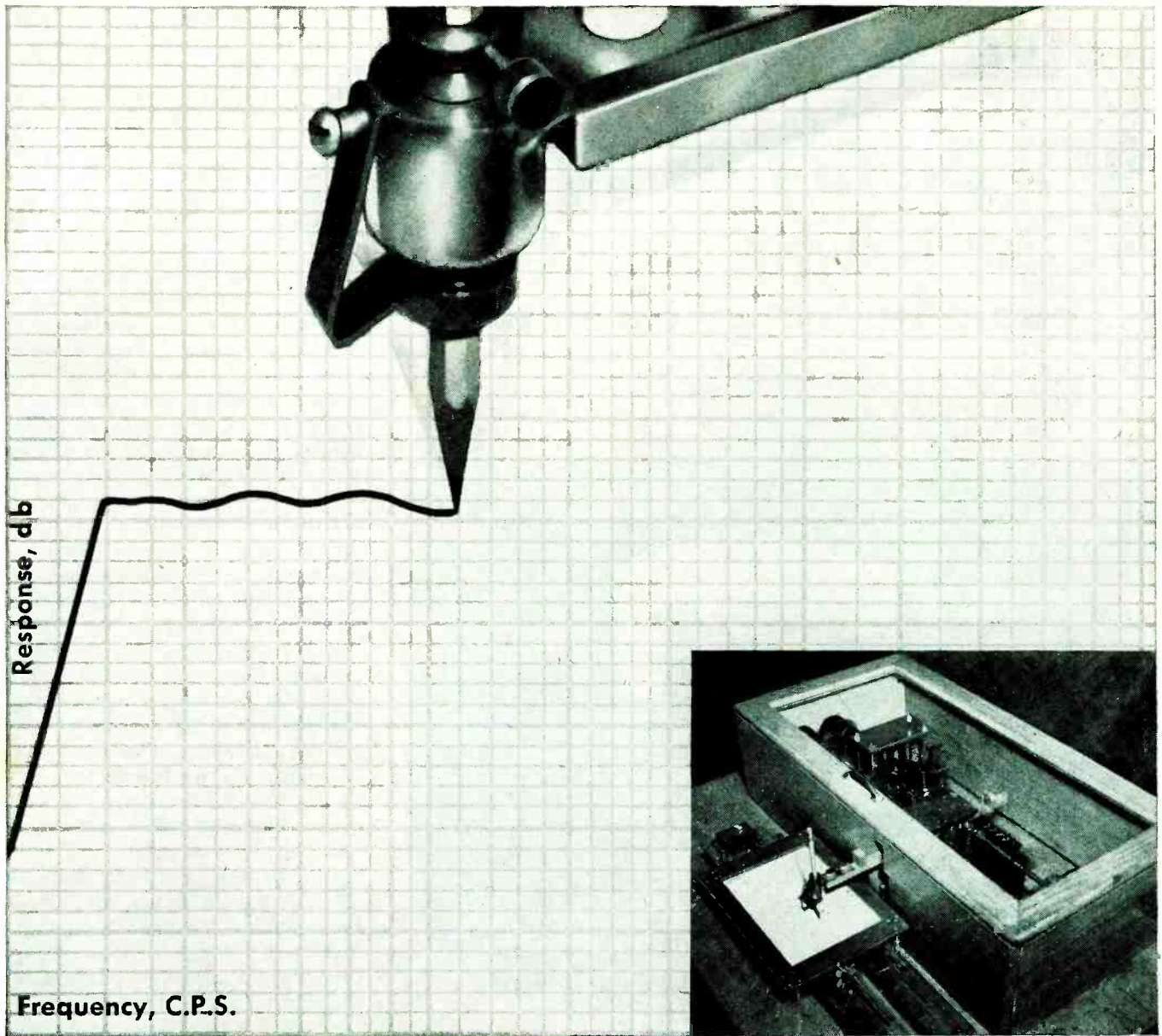

It writes by ear...

For years, Shure Engineers have relied upon accurate and scientific measurement in determining microphone performance. They do not rely, alone, upon listening or point by point measurement.

Shure Engineers designed this Automatic Curve Recorder to plot the operating characteristics of our microphones. It writes by ear.

This and other advanced testing techniques have enabled Shure to meet and often exceed the rigid requirements of microphone design demanded by the Army and Navy. You will have every right to expect new standards in microphone performance after the war is won.

SHURE BROTHERS, 225 West Huron Street, Chicago
Designers and Manufacturers of Microphones and Acoustic Devices



No RF Circuits and plenty of output

in this stable, accurate
audio frequency oscillator

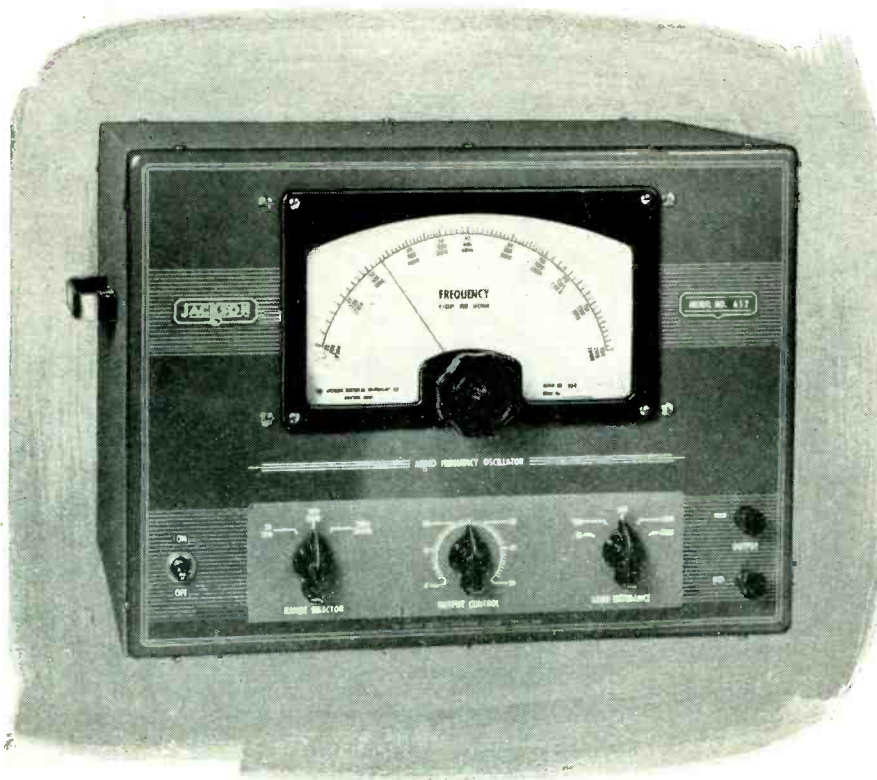

Here's an A.F. oscillator that gets down to fundamentals: sound in electrical and mechanical design—convenient to use—reliable in service. Entirely different from beat frequency oscillators, it develops output voltage directly at the desired fundamental frequency, free of any spurious signals or beats. There's no zero adjustment. Original calibration is permanently "locked."

Range: from 20 to 20,000 cycles. **Waveform:** excellent through entire frequency range, even with large changes in line

voltage. **Accuracy:** within 3% or 1 cycle. **Output impedance:** five convenient values—10,250,500,5000 ohms and high (controlled by selector switch). **Output control:** continuously variable from zero to maximum. **Output power:** approximately .5 watts, ample for all ordinary purposes.

This truly fine instrument may be the answer to many of your problems in audio frequency measurements. It, and many others from the Jackson line, are "in the service" now. They'll again be widely available when victory has been won.

All Jackson employees—a full 100%—are buying War Bonds on a payroll deduction plan. Let's ALL go all-out for Victory.



JACKSON

Fine Electrical Testing Instruments

THE JACKSON ELECTRICAL INSTRUMENT COMPANY, DAYTON, OHIO

applied at the other end of the line. If the potential is removed from the line the relay armature stands in the center position, touching neither contact. The line circuit should be a reasonably quiet pair with a loss not exceeding 25 db at the carrier frequency.

Sequence of Operations

When the starting button is depressed, power is applied to the transmitter and a tone is sent over the line to the recorder. This tone energizes a relay in the output of the recorder amplifier and connects the power line to other units in the recorder. When these circuits are completed at the recorder a d-c potential is applied to one line of the pair, operating the line relay at the transmitter. This in turn illuminates a panel reading "deposit telegram" and opens a chute into which the message blank may be dropped. The possibility of lost messages due to line or equipment failure is practically eliminated by this return impulse from the recorder to the transmitter.

When the message is dropped into the chute at the transmitter it is guided between an idler roller and a drum. The idler roller "spikes" the blank on a row of projections on the drum. In passing to the drum the blank operates contacts that actuate the scanning mechanism and also apply a d-c potential to one wire of the line to operate a relay at the recorder. This relay sets up a circuit which acts to place a recording blank on the receiving drum.

Synchronizing the Blanks

Above the writing space on the special transmitting blank is printed a solid black "phasing" square, and this is the only mark scanned during the first few revolutions of the blank. When the phasing square is scanned the tone interruption causes a relay at the recorder to lock up and energize a solenoid that moves an idler roller against the recorder drum. The idler roller spikes the receiving blank to the drum in much the same manner as was done at the transmitter.

In passing onto the drum the blank operates contacts that start the scanning drum revolving and position the recording stylus on the blank. After the blank is phased on the drum, and while the message is being recorded, a light bulb and pho-

DI-MET QUARTZ CUTTING MACHINES

INCREASE QUARTZ CUTTING EFFICIENCY!

*Quickly pay
for themselves
in*
time saved
quartz saved
increased production

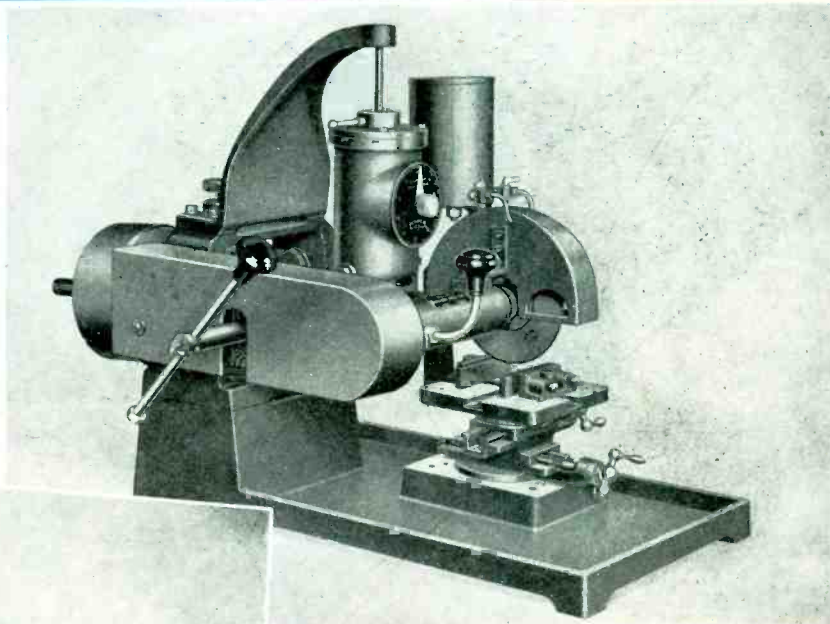

DI-MET Model 80 Basic Unit.

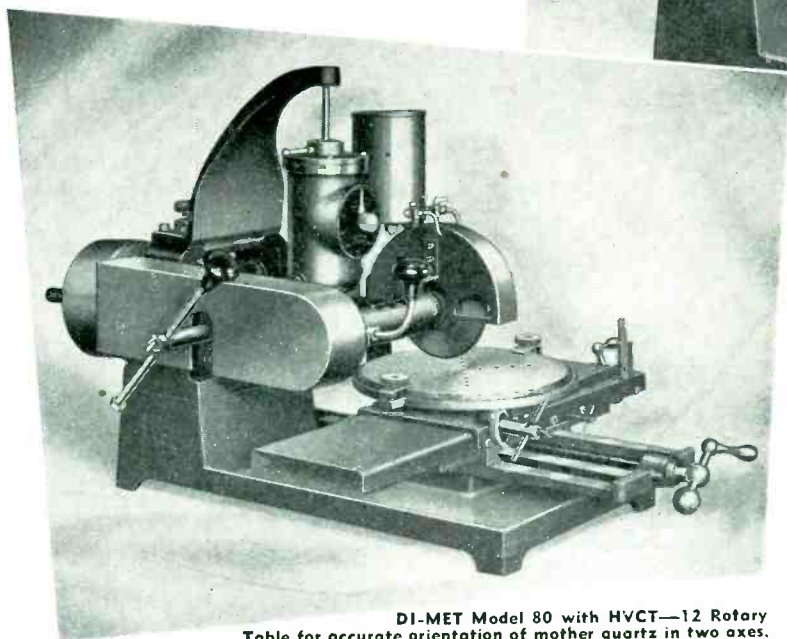

DI-MET Model 80 with HVCT-12 Rotary Table for accurate orientation of mother quartz in two axes.

HERE ARE TWO variations of the versatile DI-MET Model 80 machine, not just adapted to quartz cutting but especially designed for quartz cutting and its attendant problems! Both models incorporate the Felker hydraulic retardant, which provides many operating benefits of more importance today than ever before because of limited quartz supplies.

Tests prove that diamond abrasive wheels cut more efficiently and accurately when only sufficient pressure is employed to maintain a light, firm contact with the work. Excessive pressure does not increase rate of cut but causes buckling, deviation from a true cut, wafer breakage and shortened blade life.

The Felker hydraulic retardant overcomes these difficulties. It controls down-feed to any desirable rate, maintains a UNIFORM cutting speed from start to finish, limits cutting pressure, and prevents crowding and buckling of blades with their accompanying faults. Furthermore, by using the retard-

ant, blades slide smoothly into and out of the quartz, eliminating frequent wafer breakage upon completion of the cut and greatly increase the cutting life of blade!

If you want smoother cutting, minimized vibration, **MORE PRODUCTION, MORE ECONOMY**, get complete information on the DI-MET Model 80* quartz cutting machine! Fully described and illustrated in our catalog—write for your copy!

*Model 120 is comparable to Model 80 in design and characteristics but has increased capacity for extremely large quartz and for special work. Both Models 80 and 120 are available (1) as basic units, (2) with Rolling Tables for fast through-feed operations, (3) with Rolling Tables and HVC-12 Rotary Tables, (4) with HVCT-12 Rotary Tables.

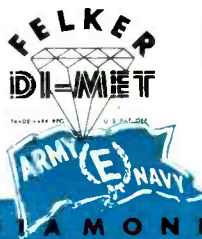

FELKER MANUFACTURING CO.
1116 BORDER AVENUE TORRANCE, CALIF.

MANUFACTURERS OF DIAMOND ABRASIVE WHEELS

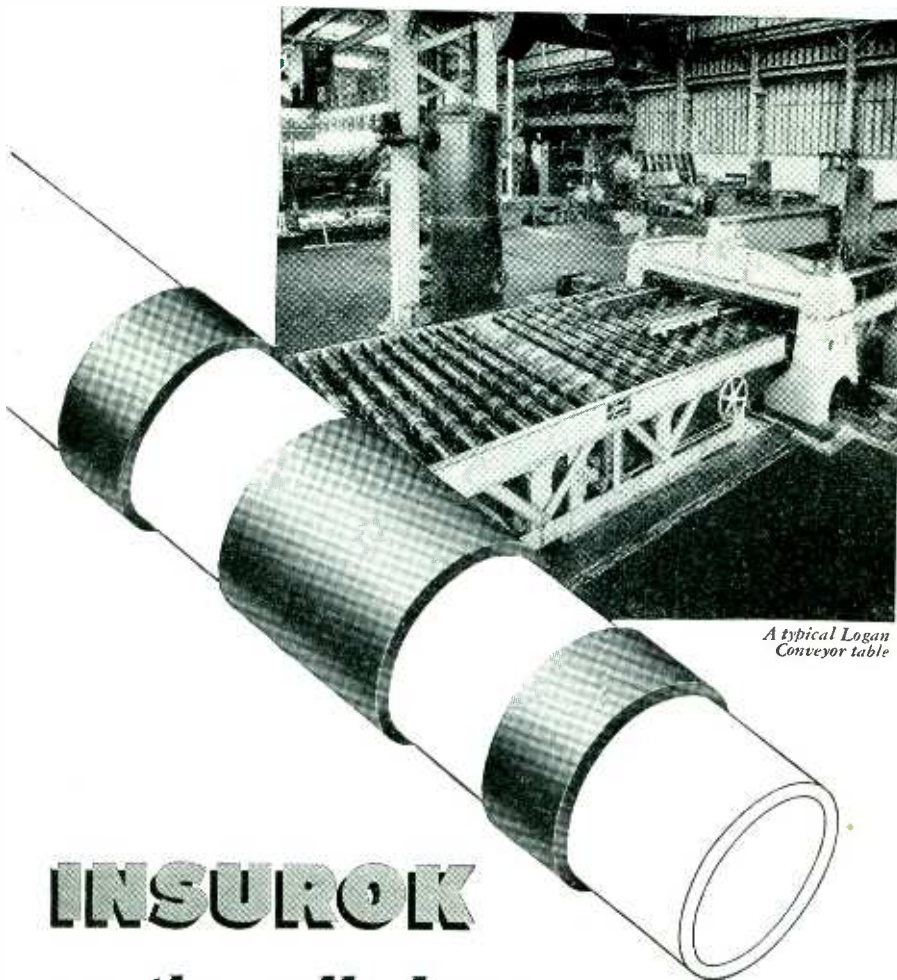

*A typical Logan
Conveyor table*

INSUROK

on the rolls keeps scratches off the sheets

Stainless steel and aluminum sheets, which are today almost worth their weight in gold, start their trip to fabricators over roller conveyors like this. Protecting the sheets from mars or scratches are sections of INSUROK affixed to the rolls. This is but one of the many ways in which Laminated INSUROK was used to solve problems before the war—is helping to solve them now.

In addition to the many spectacular wartime uses to which INSUROK, molded and laminated, has been put by the armed forces, it is widely used for many commonplace articles—things that you see and use every day. For scores of products for the home, the office, the factory, INSUROK can

effect numerous manufacturing economies, can do things which could not heretofore be done, can solve many a postwar problem effectively and economically.

Richardson Plastics can help you select the grade of Molded or Laminated INSUROK best suited for any mechanical, electrical or chemical applications. They will be glad to suggest the commercial or special grade to meet all the conditions under which your present or postwar product will perform. Write for complete information.

INSUROK

Precision Plastics

The RICHARDSON COMPANY

MELROSE PARK, CHICAGO, ILL. NEW BRUNSWICK, N. J. FOUNDED 1884 INDIANAPOLIS, IND. LOCKLAND, CINCINNATI, OHIO
DETROIT OFFICE: 402 G. M. BUILDING, PHONE MADISON 9386 NEW YORK OFFICE: 35 WEST STREET, PHONE WHITENALL 4-887

totube act to cause a motor to draw another blank from a roll and into position for the next message.

Recording of the message proceeds until the writing space is scanned, at which time a contact is made by movement of the transmitter carriage which removes the d-c potential from the line and releases the line relay at the recorder. Releasing this relay energizes a magnet that has a projection attached to its armature. This projection slips under the leading edge of the receiving blank and peels it from the spikes holding it to the drum. As the blank leaves the recording drum and drops into a receptacle, it opens contacts that permit the recorder carriage to return to the starting position and also reverse the polarity of the line potential. This reversal of the line potential at the recorder causes the line relay at the transmitter to operate a similar peeling mechanism at the transmitter to remove its blank, after which the transmitter shuts down. Since the tone is removed from the line, after two or three seconds the recorder also shuts off.

Handling Train Orders

In the distribution of train orders a transmitter and several recorders are connected by a single line pair. The desired recorder is selected by operating a telephone-type dial at the transmitter. A selector circuit in each recorder unit then turns on the line amplifier. When the tubes are heated sufficiently the recording mechanism is turned on by the tone signal. A motor-driven code wheel is also actuated by the selector circuit, to operate a buzzer in the transmitter and assure the operator that the desired recorder is selected. This answer-back to the transmitter will not be given unless there is a blank in the phase position of the recorder and provides assurance not only of having selected the proper recorder, but also that the recorder is ready to operate.



A MILES-PER-WATT record of 0.82 is claimed by FM station W75C of Chicago as a long-distance record for FM thousand-watters, based upon a report of fairly regular reception by a listener in Greenville, R. I.

**HERE'S ANOTHER EXAMPLE
OF SCOVILL COLD-FORGING
SKILL THAT MAY SOLVE
YOUR PROBLEM**



3 TIMES ACTUAL SIZE

**"Know how" proof #13
... more each month**

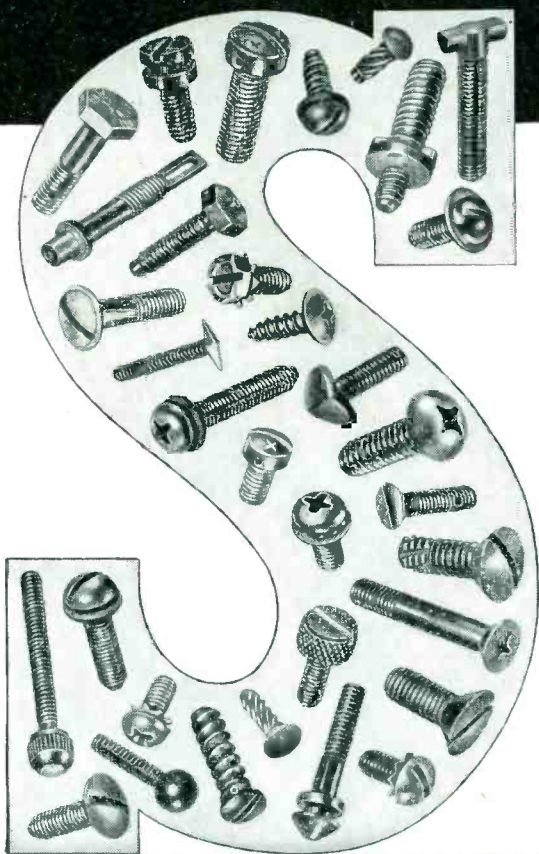

The contact point illustrated is one of many important war jobs here at Scovill. Like all war work (and post-war, as well) savings in materials—money—motions are vitally important. Scovill's cold-forging "know how" delivers them.

These contact points are made with but two cold-forging operations, plus threading. The product shows the ingenuity required. This contact point itself will not solve your problem—but it proves a cold-forging "know how" that probably can do so.

We are going to continue to keep Scovill standards of production on the same high level after the present war crisis. However, if your needs for "special" or "standard" fastenings are immediate, consult our nearest office listed below. Even if our current war commitments should not permit us to meet your immediate requirements, our Fastenings Expert may still be able to assist you with your problems—he will also welcome the opportunity to serve you on your post-war needs.

Also: It may be of service to others in your organization if you route this on. Thank you.

SCOVILL MANUFACTURING COMPANY

WATERVILLE SCREW PRODUCTS DIVISION

WATERVILLE 48, CONN.



TEL. WATERBURY 3-3151

NEW YORK, Chrysler Building • DETROIT, 6432 Cass Avenue • CHICAGO, 1229 W. Washington Boulevard • PHILADELPHIA, 18 W. Chelton Avenue Building
PITTSBURGH, 2882 W. Liberty Ave. • SYRACUSE, Syracuse - Kemper Insurance Bldg. • LOS ANGELES, 2627 S. Soto St. • SAN FRANCISCO, 434 Brannan St.

FOR YOUR RADIO, WALKIE-TALKIE AND COMMUNICATION SYSTEMS EQUIPMENT



"Photo U. S. Army Signal Corps"

Save Time with **JEFFERSON TRANSFORMERS**

● In the manufacture and assembly of your equipment, you save time with Jefferson Electric Transformers—because correct basic engineering insures your getting exactly the transformers to fit the job—and skilled experienced craftsmanship assures uniformity, whether you need one hundred or one hundred thousand.

Of still greater importance, time is saved on the job,—and on the battle fronts, where reliability and performance of Jefferson Electric Transformers have resulted in a clean record with time saved again because of reduced amount of servicing or replacing.

To the men in the fighting forces, Jefferson Electric's production of Transformers means better communication system and radio equipment. To those manufacturers whom our modern facilities make it possible to serve,—the suggestions and cooperation of our specialized transformer engineers will aid in arriving at appropriate designs to accomplish desired results reliably. JEFFERSON ELECTRIC COMPANY, Bellwood (Suburb of Chicago), Illinois. Canadian Factory: 60-64 Osler Ave., W. Toronto, Ont.



Improvised Memorizing Machine

REPLACEMENT OF ARMATURE WINDINGS in a d-c motor with paper capacitors connected to the commutator bars gave Westinghouse engineers a memorizing machine capable of remembering electrical details of arc backs in ignitrons long enough for an oscillograph to get up to operating speed.

There is as yet no way to forecast the exact time when an ignitron will arc back (pass current in the reverse direction, so electrons flow from anode to cathode and there is no rectifying action). It is impractical to keep the oscillograph running and expose hundreds or even thousands of feet of film while waiting for the trouble to occur, and it is impossible to utilize the arc back itself to start the oscillograph since the action lasts for only one-sixtieth of a second and film cannot be brought up to operating speed fast enough to catch even a portion of the desired picture.

A memorizing time of one-thirtieth of a second is long enough for the oscillograph to get up to speed after receiving a "go-ahead" signal. This time was obtained by driving the memorizing machine at 1800 rpm or 30 rps with an electric motor.

Two graphite brushes rub against



Battery of memorizing machines driven by a single electric motor, used to store electrical records of voltages existing in various parts of an ignitron tube during an arc back. Capacitors replace conductors in the armature slots of these machines

BOY-IT'S GOT TO BE GOOD



The Hytron 807—peacetime all-purpose favorite—is now a veteran. Before it joins its battle-scarred brothers, however, like all Hytron tubes it must pass Hytron factory specifications which weed out the 4-F's as efficiently as Army doctors at an induction center. Unless a Hytron 807 is in top fighting condition, it never leaves the factory. Let's look at a few of the many test hurdles it must surmount.

BUMP TEST



Ever stop to think of what a leaping, bouncing jeep or peep can do to a tube's "innards"? One answer to the question of a tube's ability to withstand such punishment, is the Bump Test. Several resounding smacks by a heavy, swinging hammer loosens up the weak sisters pronto!



IMMERSION TEST

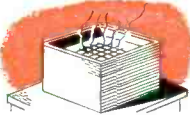

A "PT" boat leaning back on its stern, and plowing a foaming furrow through steaming tropical waters would spell disaster to poorly-cemented bases and top caps. That is why Hytron 807's are thoroughly soaked in a hot bath, before they are O.K.'d.



LIFE TEST



Day and night, Hytron 807's on life-test racks are proving that they can give long, dependable service. Soaring skyward in our big bombers, these tubes have a big investment in men and matériel to protect. Long after the big fellows have been patched for the last time, these tubes are still doing their jobs.



VIBRATION TEST



Link-trainer for 807's aspiring to tank service is a motor-driven eccentric arm which shakes the tube like an angry terrier while a v.t. voltmeter in the plate circuit records the ability of the elements to take it like the iron men who ride those clanking, thundering monsters.



HYTRON TOLERANCES

tighter than

CUSTOMER TOLERANCES

No manufacturer makes all tubes of a given type exactly alike. Hytron does manufacture its tubes to tight specifications which insure against slight inaccuracies due to meters and the human element. Engineered to these narrower limits, Hytron tubes fit exactly the circuit constants with which they must operate.



OLDEST EXCLUSIVE MANUFACTURER OF RADIO RECEIVING TUBES



HYTRON
ELECTRONIC AND RADIO TUBES CORPORATION

SALEM AND NEWBURYPORT, MASS.

If You've Been Thinking About D. C. Power Supply-

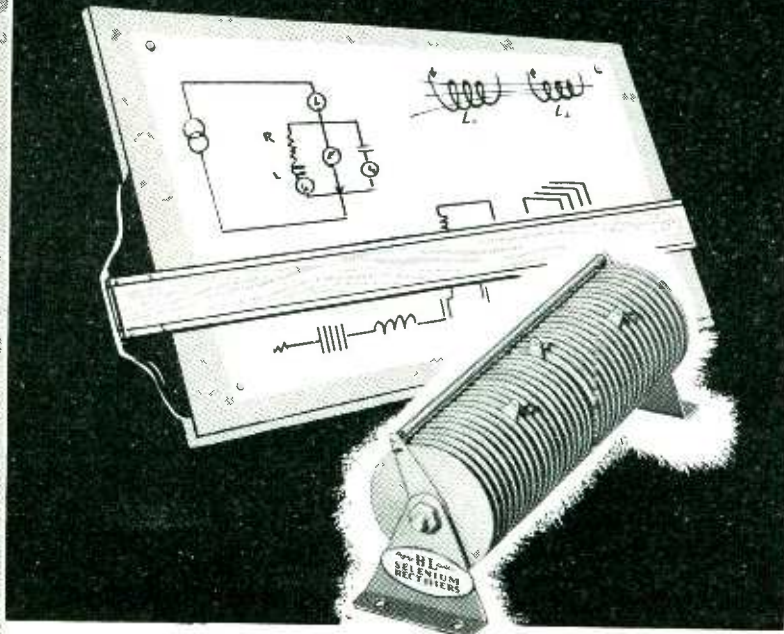

You Should Be Thinking About



Looking ahead for better ways to do an old job—or proper ways to do a new job—Engineers are finding more and more important uses for Metallic Rectifiers. Applications once thought impractical or impossible have been proved completely suitable of Rectifier use.

B-L Engineers are eager to help you develop modern applications which combine simplicity, economy, and efficiency. Tell us your problems involving Metallic Rectifiers, D. C. power supplies, and conversion assemblies. We shall be glad to help you solve them.

Write today to your business letterhead for Bulletin R-59 giving full details on B-L Metallic Rectifiers

THE BENWOOD LINZE CO. ST. LOUIS, MISSOURI
Designers and manufacturers of Copper Sulphide and Selenium Rectifiers, Battery Chargers and D. C. Power Supplies for practically every requirement.

the commutator; one receives voltage from the ignitron and feeds it to each of the armature capacitors in turn, and the other discharges these capacitors through the oscillograph after their respective commutator bars have completed one revolution. The oscillograph is set in motion by an electronic switch which is closed by the arc back, so that the film is in motion whenever the capacitors on the rotating armature have an interesting voltage pattern to feed to the oscillograph.

The faster the armature is rotated, the shorter becomes the memorizing time and the more details there are of the surges existing in various parts of the ignitron tube during arc back. Any number of capacitor-filled armatures can be driven by a single motor and used to feed stored-up voltage patterns to several oscillographs or to different galvanometers of a multi-element oscillograph.



Remote Adjustment of Synchronous Clocks

BY ALVIN LEEMAN
Chief Engineer, Station WKBH
La Crosse, Wisconsin

WHERE FREQUENT ADJUSTMENT of self-starting synchronous clocks is necessary to keep them in close step with a standard, the process can be simplified without affecting accuracy by use of the circuit shown.

A standard automobile radio vibrator is used to develop 140 volts at 115 cycles from a 6-volt d-c supply having good regulation.

If the clock is fast, pressing the pushbutton halfway in will remove

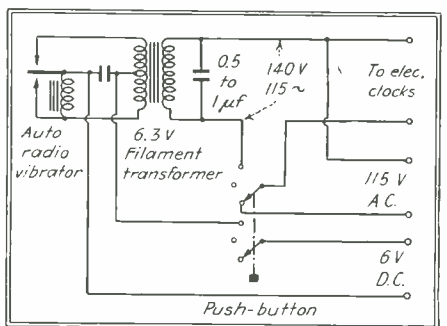

WKBH uses this circuit with car radio vibrator to supply high frequency for remote adjustment of synchronous clocks

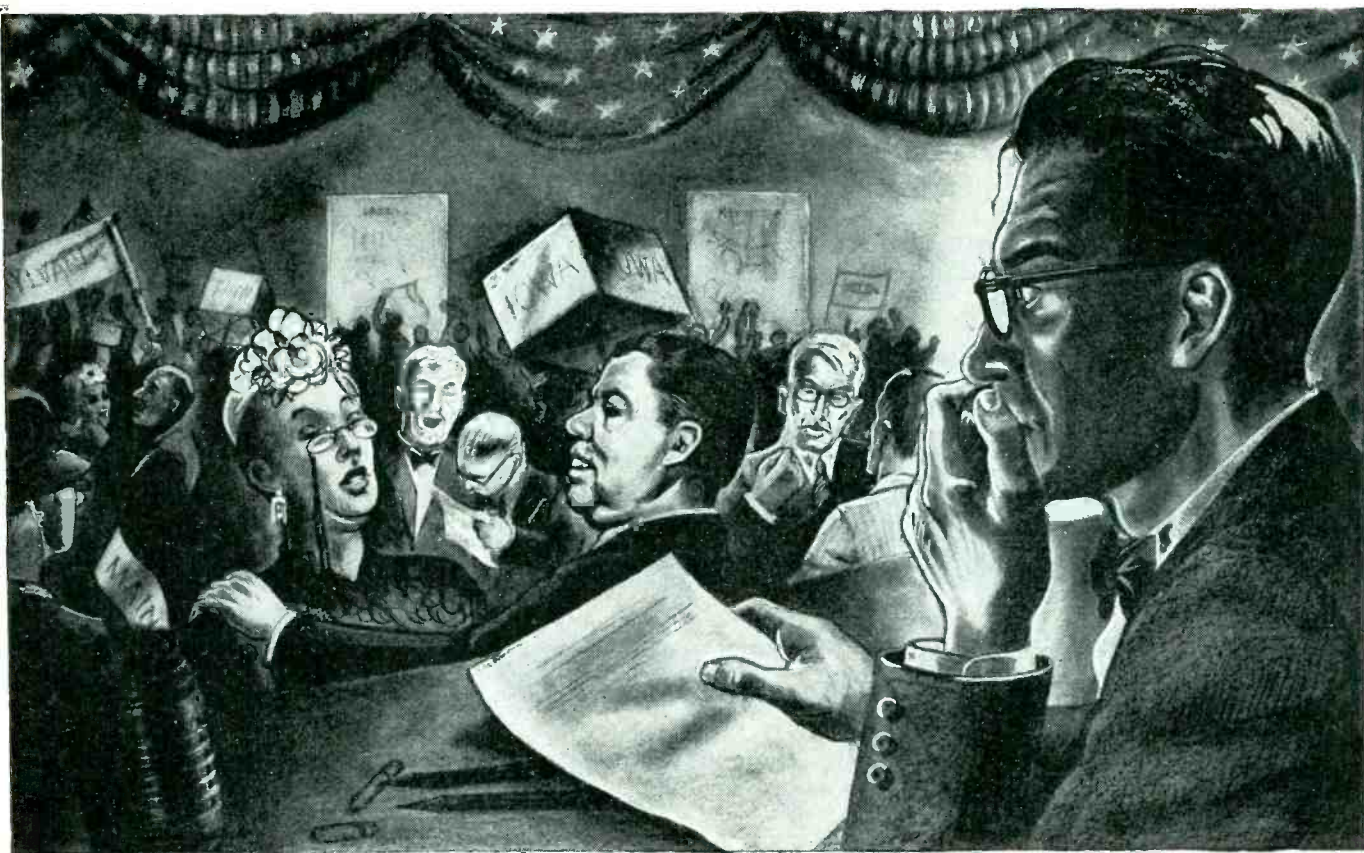

Worthington For President!

Favorite Son Worthington's name has just been introduced. Around and around the convention floor go the delegates, a'whooping and a'hollering, hell-bent for putting Worthington across.

TO BRING the dramatics and color of America's biggest show—a presidential convention—to the folks back home will be another peacetime assignment for Electro-Voice Microphones. Announcers' broadcasts will be heard clearly and distinctly above an adjustable volume of background noise that may be retained, if desired.

Fitting easily into the hand or attached snugly to the face, weighing barely more than a whisper, these new Electro-Voice Microphones are incomparable from the standpoint of stability, articulation and reduction of background noise. We'd like to tell you more about this radically different microphone design . . . show it to you. Manufacturers of war equipment may receive full particulars.

Make your present equipment last. Submit your Electro-Voice Microphone to your local distributor for TEST and REPAIR at the factory.



BACK THE ATTACK — SUPPORT THE THIRD WAR LOAN DRIVE

Electro-Voice MICROPHONES

ELECTRO-VOICE MANUFACTURING CO., INC. • 1239 SOUTH BEND AVENUE • SOUTH BEND, INDIANA
Export Division: 13 East 40th Street, New York 16, N. Y. — U. S. A. Cables: ARLAB

How to SAVE STEEL, BRASS, TIME, LABOR
 ... yet give your Product *Greater Security!*

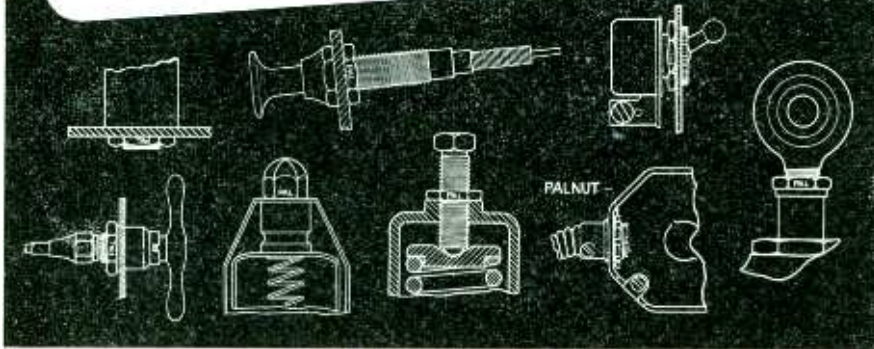

Use DOUBLE-LOCKING PALNUTS!

Look over your designs! Wherever you now use a jam nut—lockwasher and nut—or plain washer, lockwasher and nut . . . more than likely you can replace with a single Self-Locking PALNUT. This saves from 60 to 80% in weight, reduces space, cuts assembly time and labor up to 50% . . . while giving your product un failing, double-locked security under vibration, stresses and shrinkage of parts.

IMMEDIATE DELIVERY

can be made on PALNUTS, in a wide range of sizes, finishes and materials. Send details of your assembly for specific suggestions and samples of PALNUTS.

SEND FOR PALNUT MANUAL NO. 2 giving full details of Self-Locking PALNUT principle, advantages, application, types, sizes and materials.

THE PALNUT COMPANY

77 Cordier St. Irvington, N. J.

Self-Locking PALNUTS are single thread, spring tempered locknuts, accurately formed to fit standard screw threads. PALNUTS are light in weight, require small space, apply easily and speedily with hand or power drivers, withstand high temperatures and are very low in cost. They have been used for over 15 years on all types of radio, electrical and mechanical assemblies.

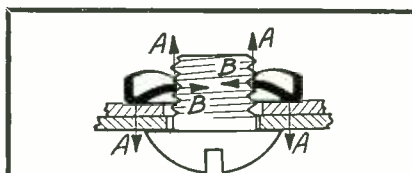

DOUBLE LOCKING ACTION

When the PALNUT is tightened, its arched slotted jaws grip the bolt like a chuck (B-B), while spring tension is exerted upward on the bolt thread and downward on the part (A-A), securely locking both.



Self-Locking PALNUTS

the regular 115-volt, 60-cycle power from the clock, causing it to stop. The button should be released after a lapse of time equal to the amount the clock is fast.

If the clock is slow the pushbutton is depressed completely. This removes the regular 115-volt, 60-cycle power from the clock and applies 6 volts to the vibrator power pack which supplies 140 volts at 115 cycles to the clock. The higher frequency causes the clock to run almost twice as fast as at 60 cycles. The button should be depressed slightly more than twice the time the clock was slow. For instance, if the clock is 3 seconds slow the button should be pressed until the clock's second hand has moved 7 seconds.

Although 120 cycles would be more desirable for this purpose and can be obtained through adjustment of the reed, the usual factory adjustment is 115 cycles and operation at this frequency is sufficiently accurate.

If a rugged vibrator and a 6-volt d-c power supply having good regulation is used, several identical self-starting synchronous clocks can be corrected at once. This is of particular advantage in radio stations that use this type of clock in studios and control rooms. All clocks are then wired to operate from one a-c outlet.

An advantage of this device over an oscillator is that it requires no warm-up period and consumes no power until needed.

Voltage-Stabilized Bias Supply for Power Tubes

WHEN VOLTAGE-STABILIZED power supplies are employed for bias on power tubes the flow of grid current of the power tube is in the reverse direction to current flow in the bleeder resistor of the bias supply and tends to remove the load from the supply. The diagram shows the circuit of a degenerative, shunt-type, voltage-stabilized bias supply that maintains a 65-volt output within very close limits on reverse current swings up to 200 milliamperes. This circuit was developed by George E. Pihl, and is described by him in



*Do Things Faster,
More Accurately,
More Economically*
THE ELECTRONIC WAY!

Communicating • Measuring • Checking
Analyzing • Actuating • Protecting
Testing • Detecting • Matching • Sorting
Controlling • Magnifying • Heating
Rectifying • Counting • Transforming
"Seeing" • "Feeling"

The following RCA Tube publications are available from Radio Corporation of America, Commercial Engineering Section, Harrison, N. J.

- RCA PHOTOTUBES (booklet on request)
- RCA POWER AND SPECIAL PURPOSE TUBES (catalog on request)
- RCA TRANSMITTING TUBE GUIDE (Guide 35c net)

Modern Measurements . . .

without mechanical movement or its limitations

Perhaps no single type better illustrates the indispensable nature of the Electronic Vacuum Tube throughout science and industry than RCA Cathode-Ray Tubes.

Used in Oscillographs, these tubes are pacing the way to new, higher standards of measuring anything or any phenomena that can be transformed into electrical impulses—and doing it without mechanical movement and the limitations inherent in such movement. Every day, RCA Cathode-Ray Tubes are proving unexcelled in the development and production of war materiel. They are being used in such widely diverse fields as acoustics and vibration studies . . . studies of magnetic phenomena . . . water-leak tests . . . geological and geophysical investigations . . . manufacturing operation tests . . . ignition timing and adjustment work . . . medical and

biological research . . . engine-pressure indications . . . power plant maintenance . . . aeronautical engine synchronization . . . and a host of others, including their better-known applications in communications, radio and servicing.

Other RCA Tube types, from Phototubes to Power Tubes, are doing equally important jobs contributing to the war effort along entirely different lines—and doing them so well that today's "Do It the Electronic Way" becomes far more than a slogan. It stands as a challenge to every civilian and war industry to handle countless tasks faster, more accurately, or more economically than they have ever been handled before!

RADIO CORPORATION OF AMERICA
RCA Victor Division, Camden, N. J.



RCA TUBES FOR INDUSTRIAL EFFICIENCY

High-vacuum, gas, and vapor tubes . . . voltage amplifiers . . . low-power and medium-power tubes . . . cathode-ray tubes . . . phototubes . . . rectifiers . . . voltage regulators . . . relay tubes



*Unchallenged
Performance!*

... the Heritage of
Permoflux
DYNAMIC HEADPHONES

When the need came for a better performing headphone, Permoflux applied advanced sound reproduction principles it had developed years before.

The same efficient designs which had established Permoflux Acoustical Products as leaders in many fields, provided in Permoflux Dynamic Headphones an increased measure of sensitivity and improved signal audibility under every operating condition.

While Permoflux Dynamic Headphones are today completely in the service of our fighting forces, the coming of Victory will make them available to all.



TRADE MARK
PERM-O-FLUX

CORPORATION

4916-22 W. Grand Ave., Chicago, Ill.

PIONEER MANUFACTURERS OF PERMANENT MAGNET DYNAMIC TRANSDUCERS

Bulletin No. 10 published by the College of Engineering, Northeastern University, Boston.

In the conventional shunt type of voltage stabilizer circuit, two 2A3 tubes can produce an output of about 60 volts when handling a grid current swing of 100 milliamperes. With such a current swing an output voltage deviation of about 8 volts takes place. Using the same tubes in the amplified shunt stabilizer circuit shown in the diagram the change in output voltage becomes 0.2 volt with the same current swing.

Operation of the Circuit

When the circuit is used to supply bias to a modulator or other power tube the periodic increase of grid current causes a small change in the output voltage of the stabilized supply. This change in output voltage in turn is applied through the voltage regulator tubes, VR-150 and VR-105, in series with resistor P_3 , to produce increased bias on the grid of T_1 , a 6J7 tube. This action decreases the plate current of the tube, the plate becoming more positive. The positive voltage change is applied to the grid of T_2 and effectively lowers the plate-to-cathode resistance of the tube. The lowered resistance permits additional grid current of the power tube to flow through T_2 and stabilize the circuit.

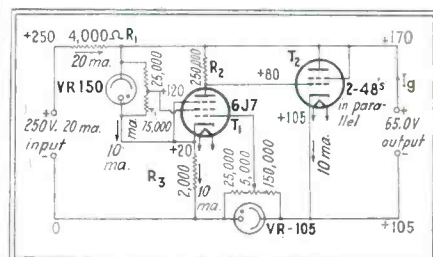

Changes in bias voltage caused by reverse grid current flow of the controlled tube are minimized by the voltage stabilizer shown here

To minimize the deviation of output voltage necessary for operation of the system the change of resistance of T_2 is made large for a small change of grid voltage of T_1 . Tube T_2 must be capable of a total current variation of from 10 to 210 ma at a plate voltage of 65 volts without having its grid go positive. A pair of type 48 tubes operated in parallel as triodes can pass 210 milliamperes at 65

MICRO SWITCH

*the "Heart" of
Cook Bellows Switch*



Micro Switch precision and rugged dependability has never shown to better advantage than in the uses to which it has been put in the Cook Bellows Switch, manufactured by the Cook Electric Company of Chicago. This bellows switch has been found valuable in such applications as industrial processing, water and oil pumping systems, gas filled cable alarms, etc. Operated with air, gases or fluids, the Cook Bellows Switch is a custom engineered unit of rugged dependability for operation on pressure differentials ranging from as low as an ounce to over 100 pounds.

Micro Switch with its small size, precise action and absolute dependability is a "natural" for difficult switching problems, operating at the same point through millions of operations . . . actuated by minute changes of movement or energy. Micro Switch is helping to solve hundreds of other difficult design problems.

Micro Switch is thumb size—measures only $11/16'' \times 27/32'' \times 1 \ 15/16''$, weighs only an ounce, operates on force as low as $1/4$ ounces and movements as low as $.0002''$. Listed by Underwriters' Laboratories with ratings of 1200 V.A. loads, from 125 to 600 volts A.C.

Supplied in a wide range of types and housings, Micro Switch can be adapted to meet a variety of operating conditions and requirements. The experience and skill of Micro Switch engineers is available to help you find the best possible answer to your precision switching problems.

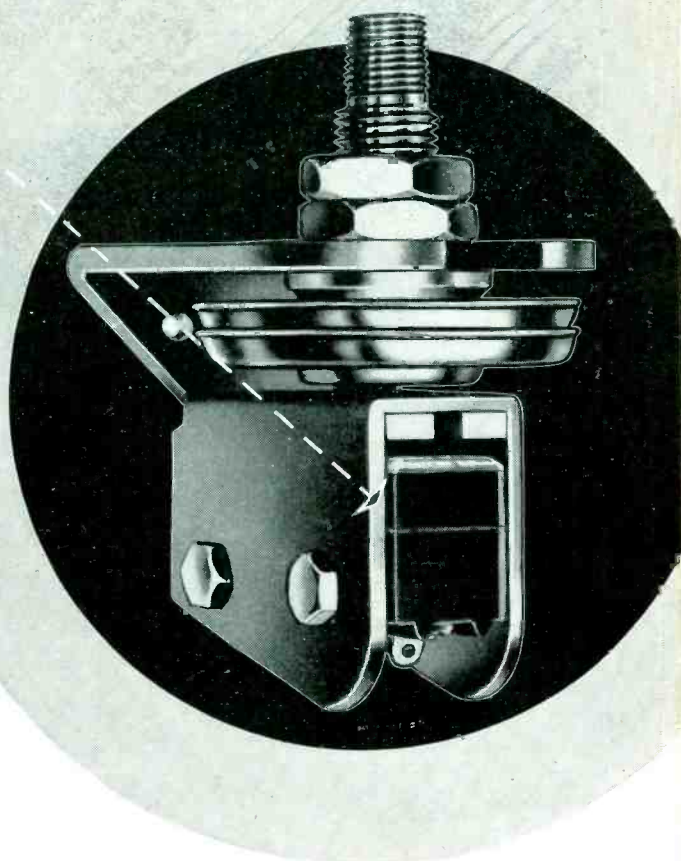

SEND FOR THESE CATALOGS



The two catalogs illustrated here will give you the complete details—Number 60 which covers Micro Switch in general and Number 70 which deals with Micro Switches for aircraft.

Micro Switch Corporation, Freeport, Illinois
Branches: 43 E. Ohio St., Chicago • 11 Park Place, New York City
Sales and Engineering Offices: Boston • Hartford • Los Angeles

The trademark MICRO SWITCH is our property and identifies switches made by Micro Switch Corporation

MICRO SWITCH

Made Only By Micro Switch Corporation . . . Freeport, Illinois

© 1943



Radio after the
WAR

what price Star-Gazing?

To dream and plan realistically for the future is both good and necessary. However, to indulge in Star-Gazing through the wrong end of the telescope is an extravagance which no industry can afford. RADIO can point with pride to its achievements and its miraculous progress made under the impetus and emergency of war. But to promise that the miracles of Radar and other Electronic development will be ready for delivery on V-Day . . . is to damage an otherwise glorious record.

THE FUTURE IS BRIGHT . . .

BUT LET'S KEEP OUR EYE ON THE BALL!

Our number one job right now is the production of Radio Communications Equipment and Radar for the armed services. These are weapons which will help win the war. The application of new Electronic knowledge to peacetime radio production will, of necessity, be a gradual and evolutionary process. We know too that Electronic research and development now entirely serving our war effort can and will elevate every phase of human living.



For the development and production of Radio Communications Equipment for our armed forces, the Motorola organization was awarded the Army-Navy "E" with added Star for continued excellence of performance. Motorola is proud of the part it has been privileged to play in the speeding of Victory.

You May Expect Big Things from Motorola. We can't say when but we can say . . . no one will be ready sooner!

Motorola

RADIO

FOR CAR & HOME

GALVIN

MANUFACTURING CORPORATION • CHICAGO

volts and zero bias, and were therefore used.

Operating potentials at various points in the circuit are indicated in the diagram and are referred to the negative side of the input voltage source. An initial current of 10 ma through the 48 tubes is permitted to stabilize the VR-105 tube. To maintain this current, a negative bias of 25 volts is necessary on the grids of the 48 tubes. Another 10 ma is allowed to flow through the VR-150 for stabilization.

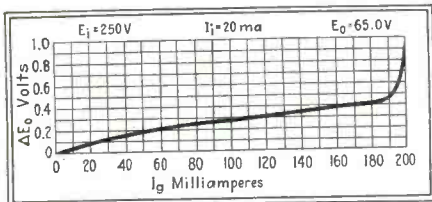

Curve of deviation in output voltage vs. grid current, plotted under operating conditions

The graph shows the change of output voltage plotted against grid current of the power tube. The rate of change of output voltage is approximately 0.002 volts per ma of current flow, according to the slope of this curve. This is the same result that a perfectly regulated source of voltage in series with two ohms would produce.

An unstabilized power supply would require a two-ohm bleeder resistor to obtain this result and the bleeder would be obliged to dissipate more than two kw of power.

• • •

Hearing Aid Circuits

TWO METHODS OF connecting a Brush bimorph Rochelle salt earphone unit to the output stage of a hearing aid amplifier are shown in the diagram. One circuit contains a choke as the plate load on the vacuum tube and is preferable unless a transformer with high-inductance windings is available. A choke inductance of 100 henrys is advisable but values as low as 50 henrys may be employed. Only one blocking capacitor is usually necessary, but an additional 0.02 μ f capacitor is shown in the diagram and may be incorporated when it is desirable to isolate the receiver from the high side of the plate battery.

In the transformer coupling cir-

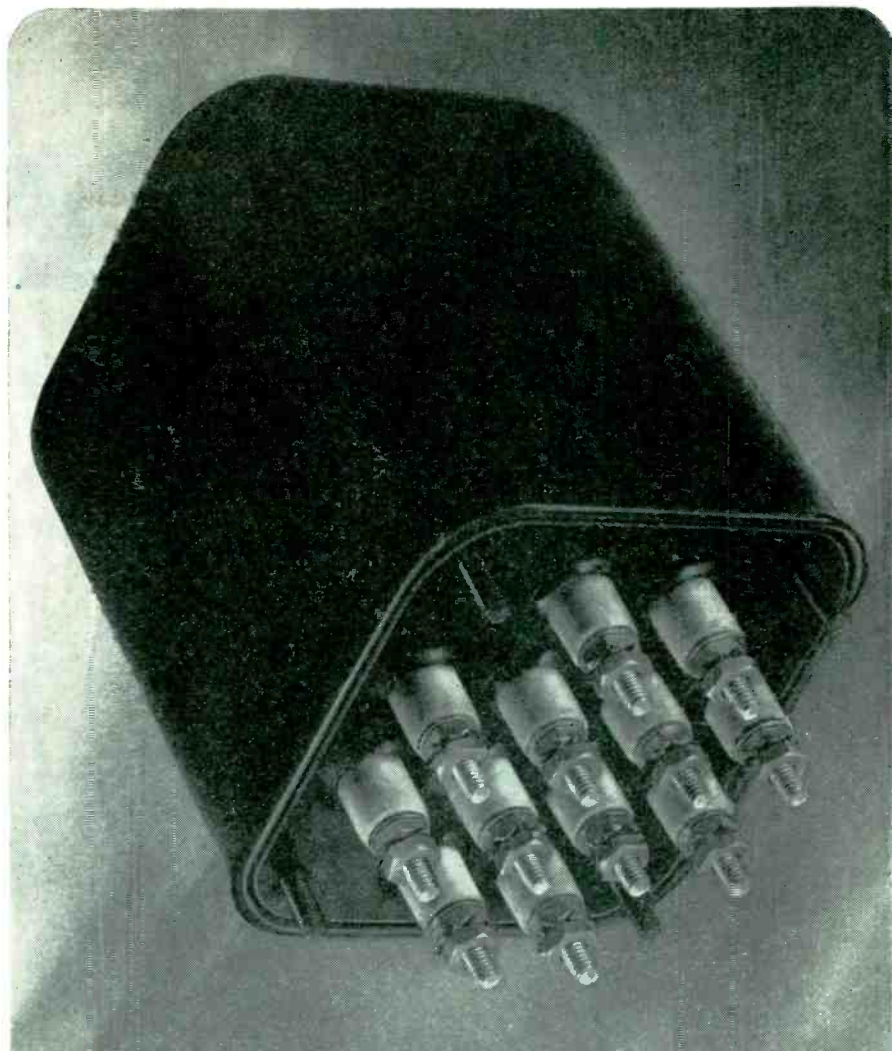

Use **DRAWN STEEL CASES**
with **DRAWN STEEL BASES**
For Better Sealing and Shielding

A recently developed type of base for drawn steel case transformers has greatly improved sealing and shielding.

The new drawn steel base has a deep lip that is stamped to close tolerance with the case interior and press fitted to position.

The results are a deeper internal seal, stronger and more uniform, due to solder seepage into the fitted seams, and better shielding because true metal to metal—case to base contact has been established.

If your problem is one of finding transformers that will withstand unusual conditions—Write Today.



CHICAGO TRANSFORMER
CORPORATION

3501 WEST ADDISON STREET • CHICAGO

The Famous SCR-299 built by Hallicrafters



... equipped with **ANDREW Coaxial Cables**

The SCR-299 high-powered mobile transmitter, built by the Hallicrafter Co. and equipped with ANDREW coaxial cables, received high praise from Generals Montgomery and Eisenhower and their men as they drove Rommel out of North Africa. Designed to meet specific high standards of the U. S. Signal Corps, the performance of the SCR-299 has surpassed the greatest expectations of military radio men. It is highly significant that ANDREW coaxial cables were chosen as a component of this superb unit: one more proof that the name ANDREW is synonymous with quality in the field of antenna equipment.



The ANDREW Company is a pioneer in the manufacture of coaxial cables and accessories. The entire facilities of the Engineering Department are at the service of users of radio transmission equipment. Catalog of complete line free on request.

**COAXIAL CABLES
ANTENNA EQUIPMENT**

363 EAST 75th STREET • CHICAGO 19, ILLINOIS

cuit the secondary of the output transformer must have high inductance (50 to 100 henrys) to match the crystal earphone unit. Unless the coupling impedance is high, considerable bass response will be lost. The transformer primary input impedance should match the tube impedance at 1,000 cycles.

Plate current and plate voltage of the amplifier should be adjusted by varying the grid bias until the neces-

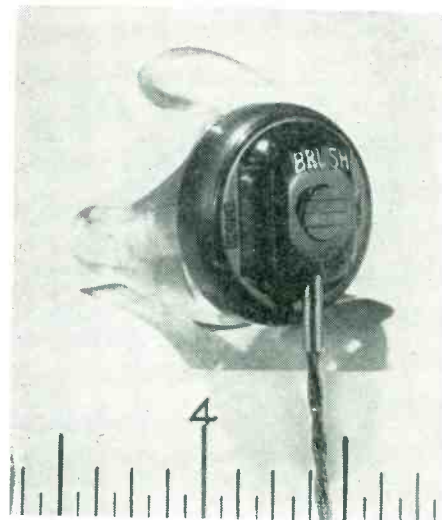

Brush model DJ Rochelle salt crystal receiver attached to plastic insert that fits into ear. The unit has a diameter of $\frac{3}{4}$ inch and weighs 0.08 oz.

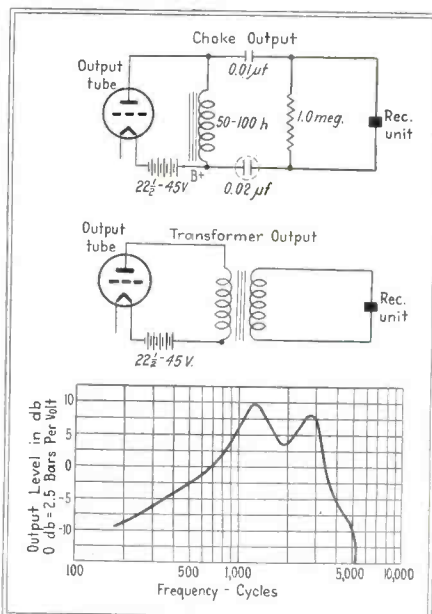

Two circuits for coupling a vacuum-tube hearing aid amplifier to a crystal receiver unit. A typical response curve for a Brush model DJ crystal hearing aid receiver, obtained with a molded ear-piece fitting into a Brush artificial ear with constant voltage applied to the unit, is shown below

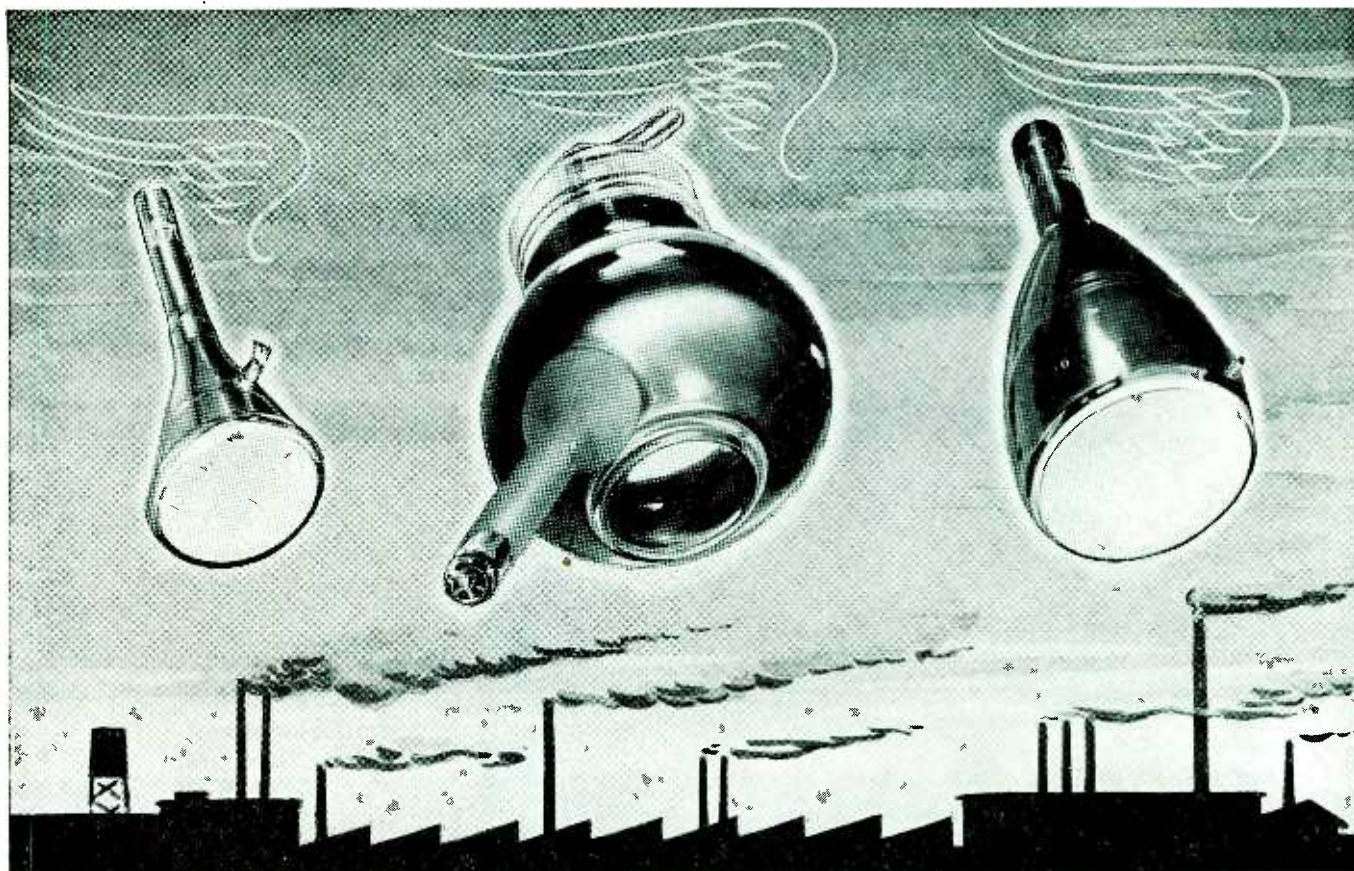

Every tube has its mission

No single tube can serve the many and diversified applications of electronics in war and industry. Because their purposes vary widely, so must size, shape and power. Every tube has its mission . . . every purpose its specially designed and engineered tube. RAULAND engineers have dedicated their time and combined skill to the development of electronic tubes for the unending uses of this new science . . . with an impressive record of achievements ranging from the large cathode ray television tube which made possible televised projection on 15 foot x 20 foot screens . . . to the tiny tube with power out of all ratio to its size. Forward looking research is ceaselessly going on in RAULAND laboratories today to help clear the way for industrial progress tomorrow.

RADIO... SOUND...

Rauland

... COMMUNICATIONS

Electroneering is our business

THE RAULAND CORPORATION . . . CHICAGO, ILLINOIS

Buy War Bonds and Stamps! Rauland employees are still investing 10% of their salaries in War Bonds

INGGO
INDUSTRIAL CONDENSER
CORP.

.5 MFD. 50,000 VOLTS D.C. WORKING
CONTINUOUS OPERATION

.5 MFD. 50,000 Volts DC Working
28 inches high, weight 175 pounds,
extra heavy duty unit built by Industrial
Condenser Corporation to meet navy spec-
ification; oil impregnated, oil filled. Built for
24 hour continuous operation, and total
submersion in salt water!

PAPER, OIL AND ELECTROLYTIC CAPACITORS
INDUSTRIAL
CONDENSER
CORPORATION
1725 W. NORTH AVE., CHICAGO 22, U. S. A.

DISTRICT OFFICES IN PRINCIPAL CITIES
QUICK DELIVERY FROM DISTRIBUTOR'S STOCKS

sary value of 15 volts rms undistorted output is obtained. When this amount of signal is maintained during operation of the hearing aid, the drop of output with temperature changes can be compensated by adjustment of the amplifier sensitivity control.

The response characteristic of the Brush DJ earphone, shown in the diagram, represents a pass band of about 200 to 5,000 cycles, entirely adequate for hearing aids, hence amplifier components need not handle anything beyond this band. The positions of the peaks are of importance because human response curves vary greatly. Over most of the useful frequency range the receiver may be considered as purely voltage operated. Another Brush unit, the model DK, has a peak extending up to 3,500 cycles, for use where hearing drops off rapidly above 3,000 cycles.

• • •

Program Quality Analyzer

BY DETERMINING the listener's reaction to each moment of a broadcast program, CBS has been testing program quality. Ten typical listeners, selected from the broadcast audience of WABC, are placed in a small studio to listen to a recorded program. Each person is given two pushbuttons and instructed to press the green button when the program seems good, and the red button when poor. If indifferent to any portion of the program, no buttons are pressed during that portion.

Individual reactions are recorded on a tape marked with vertical lines indicating seconds of program time. The tape moves while the recorded program is played, and red and green styli record the various reactions of listeners on the tape. During the test a trained psychologist watches the tape and makes notes of the reactions so that he may question the listeners in a discussion period held after the test. A stenographic record of this later discussion is made.

Each program is tested by six or more groups and the sixty odd reaction curves that result are analyzed by three psychologists. A complete report requires about a month to compile, and is submitted to program producers and writers as guides for planning future programs.



THE DAWN OF A NEW ERA

WITH electrons . . . revolving around their nuclei . . . has come the dawn of a new era. In this development . . . a broad experience in the specialized knowledge and building of vacuum tubes was a natural forerunner of Slater's electron tube progress. And Slater research continues in capturing and controlling the minute electronic currents to do their miraculous tasks in the war effort . . . and for the peace-time applications when victory is won.



SLATER ELECTRIC & MFG. Co.

BROOKLYN, NEW YORK

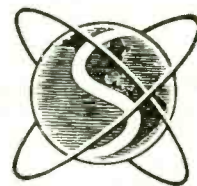

MANUFACTURERS OF PRECISION ELECTRONIC TUBES AND INCANDESCENT STREET LIGHTING LAMPS

ELECTRONICS — September 1943

HAIRLINE PRECISION for Air-Line Duty!



★ Though they occupy only a fraction of airplane space, WILCO Contacts and Thermometals mean much to precision flight.

★ Either paired with the correct WILCO THERMOMETAL, or used alone, WILCO Aeralloy Aircraft Magneto Contacts are doing their part to assure smooth airplane performance through their own unfaltering performance under grueling conditions in aircraft magnetos.

★ WILCO THERMOMETALS (thermostatic bimetals) are used for engine oil controls, compensation in voltage regulators, and dependable action in other precision instruments.

★ WILCO THERMOMETALS are also used in various instruments for the Army and Navy—and WILCO Electrical Contacts in tank, gun and ship applications.

★ A SINGLE SOURCE OF SUPPLY—WILCO facilities permit manufacturing customers to secure both electrical contacts and thermostatic bimetal from a single source. This is important, for materials from these two groups are frequently used in conjunction, as parts in the same device. The most effective use of one necessitates a knowledge of the other.

WILCO PRODUCTS ARE: *Contacts*—Silver, Platinum, Tungsten, Alloys, Powder Metal. *Thermostatic Metal*—High and Low Temperature with Electrical Resistance from 24 to 530 ohms per sq. mil.-ft. *Precious Metal Collector Rings* for rotating controls. *Jacketed Wire*—Silver on Steel, Copper, Invar, or other combinations requested.

★ WILCO sales and engineering representatives are familiar with both Electrical Contact and THERMOMETAL application. Send us your problems for analysis.

THE H. A. WILSON COMPANY
105 Chestnut St., Newark, N. J.
Branches: Chicago ★ Detroit



Diving Amplifier

By D. W. GELLERUP
Technical Supervisor, Station WTMJ,
Milwaukee

THE DIVING AMPLIFIER EQUIPMENT to be described provides two-way communication between a diver's tender station on the surface and one to two divers. The equipment was designed and built by members of the staff of WTMJ-W55M, the Milwaukee Journal stations, at the request of the local Navy diving school. Most of the construction work was done in the basement workshop of Herman Lasche, an operator at the station. Twenty-seven portable units have been accepted by the Navy at a price of \$200 each.

Loudspeakers serve both in their normal capacity and as microphones. The system is normally set up for transmission of speech from all connected divers to the tender. Switching facilities are provided on the control panel to select and talk to any one diver from the surface station. Volume control is also provided to make more intelligible the speech as picked up under varying pressure conditions.

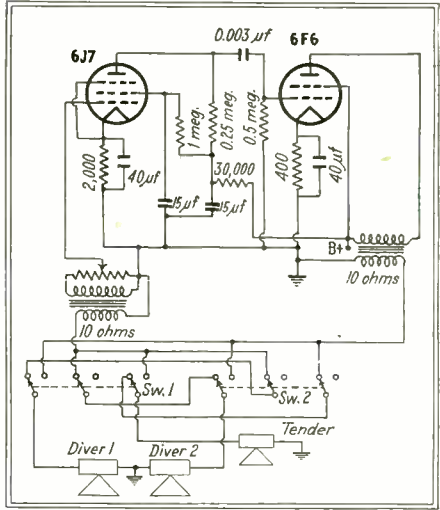

Circuit of the amplifier and speaker switching arrangement for communicating with divers

The amplifier is housed in a heavy formed steel case plated and painted to resist corrosion. Connection to the two divers' cables is made through two receptacles at the rear of the amplifier cabinet. These receptacles are of special design to accommodate the standard Navy diving equipment plug. The

FOR HIGHEST DEGREE OF VIBRATION ISOLATION EFFICIENCY

Specify

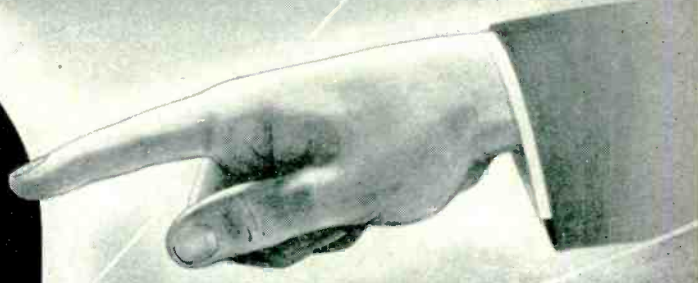

Photographs proving strength of Lord Shear Type Mountings

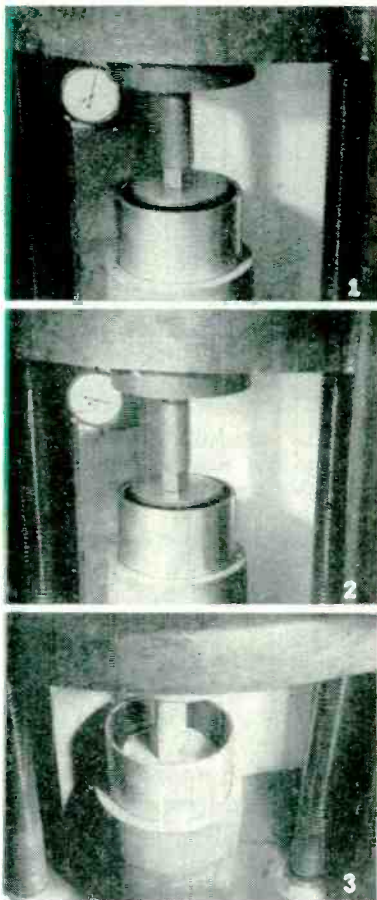

The above tests were made using a Lord Tube Form Mounting 5½" O. D. x 4½". Figure one shows mounting under no load. Figure two shows mounting stressed in shear under its rated load of 2,200 lbs. Center sleeve is depressed ¼". Figure three shows same mounting under 50,000 lbs. load (press capacity). Center sleeve is depressed 1-13/16" and shows no failure of rubber-to-metal bond, even with more than 2000% overload.

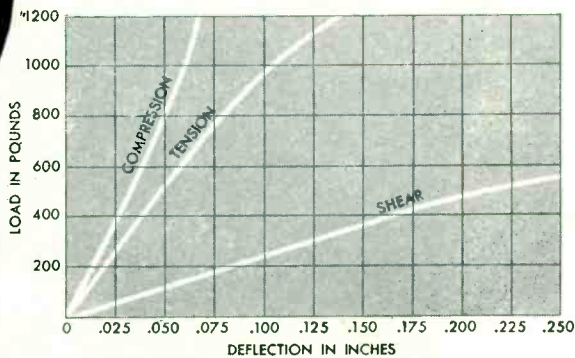

The curves in above chart indicate deflections obtained from test specimen in tension, compression, and shear, under identical loading. Note the much greater deflection of the shear stressed system, resulting in a softer suspension and consequent higher degree of vibration isolation efficiency.

To obtain the highest degree of vibration control or isolation efficiency, a flexible suspension must be employed which is soft in the direction or directions of the disturbing forces, thereby providing adequate axial deflection, and maintaining ample stability in directions normal to the major thrusts.

The only mounting design which incorporates these features is one in which the rubber is stressed in shear. Rubber in shear is much softer, yields more readily than in tension or compression, and consequently greater deflections can be obtained from a given size rubber element. (See chart)

Lord, by developing and perfecting a process for forming a strong and uniform bond between rubber and metal, has been able to apply this principle of shear stressed rubber to two basic designs of vibration isolation mountings, plate form and tube form, and other bonded rubber products including flexible couplings, torsion bushings, radius rod joints, turnbuckles, and diaphragms.

This process, which produces a bond as strong or stronger than the rubber:

1. Facilitates the manufacture of a simple, rugged, compact, lightweight mounting, allowing full shear freedom to the rubber element.

2. Will bond firmly and directly to various metals—Low and High Carbon Steels . . . Alloy Steels, Brass, Aluminum, and Monel Metal.
3. Produces a high ratio of bond strength to working stress providing an ample factor of safety under all loading conditions.

Lord Mountings, in plate form and tube form, with snubbing or non-snubbing features are made in various shapes and many sizes, with load ratings ranging from a few ounces to several thousand pounds. Millions of Lord Mountings and other Bonded Rubber Products are being used in almost every type of military and naval equipment, as well as in practically every field of industry, providing protection against the harmful effects of shock, vibration, and noise translation. Investigate the possibility of including them in your new equipment designs.

Complete information covering all Lord Mountings, as well as an engineering discussion on vibration control, is contained in Bulletins 103 and 104. Lord Vibration Engineers are available for consultation on your design problems. Write today. There is no obligation.

INVEST TODAY IN BONDS FOR VICTORY

IT TAKES RUBBER *In Shear* TO ABSORB VIBRATION

LORD MANUFACTURING COMPANY
ERIE, PENNSYLVANIA

SALES REPRESENTATIVES
NEW YORK - 280 MADISON AVE.
CHICAGO - 520 N. MICHIGAN AVE.
DETROIT - 7310 WOODWARD AVE.
BURBANK, CAL. - 245 E. OLIVE AVE.

Originators of Shear Type Bonded Rubber Mountings



A LEADER
can't rest
on his laurels!

For real leadership requires constant vigilance
... constant research... constant unwillingness
to admit that perfection is ever attained!

That explains why Thordarson engineers...
in good times or in bad... in peace-time, or in
the midst of war, are forever experimenting,
investigating, striving in every way to develop
transformers that are ready to fill every
need... not only AS the need arises, but even
BEFORE the need arises.

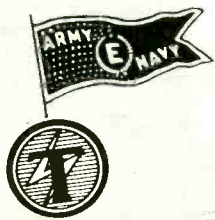

THORDARSON

ELECTRIC MFG. COMPANY
500 WEST HURON STREET, CHICAGO, ILL.

Transformer Specialists Since 1895
.. ORIGINATORS OF TRU-FIDELITY AMPLIFIERS

plugs are so polarized and connected as to prevent the insertion of any plug in the wrong receptacle. The tender's speaker unit, of the direct radiator type, is mounted on the front panel.

The divers' reproducers, which mount in the diving helmets, consist of small permanent magnet driver units with a suitable mounting bracket and protective grille. These speakers have an impregnated fibre cone.

Amplifier Circuit

The amplifier is essentially a resistance-capacitance coupled circuit using a 6J7 vacuum tube functioning as a voltage amplifier. This stage is coupled to a 6F6 vacuum tube in the output stage. The input is coupled to the voice circuits through an input transformer. The output is coupled to the voice circuits by means of a suitable output transformer.

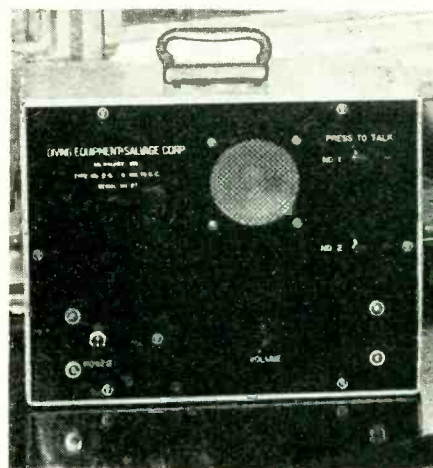

One of the completed amplifiers, with which continuous monitoring of all divers is possible from the diving tender

The power supply from which the amplifier is designed to operate is a 6-volt d-c source. For this condition, a vibrator-type voltage converter is used to secure the necessary plate voltage. This converter is supplied as a unit mounted on the chassis. Incorporated in this unit is a self-driven vibrator, one 0Z4 or 6X5 rectifier, a transformer, and the necessary filter chokes and capacitors to remove the high transient voltages developed by the rapid switching of battery current by the vibrator.

Control Circuits

Manually adjusted controls for

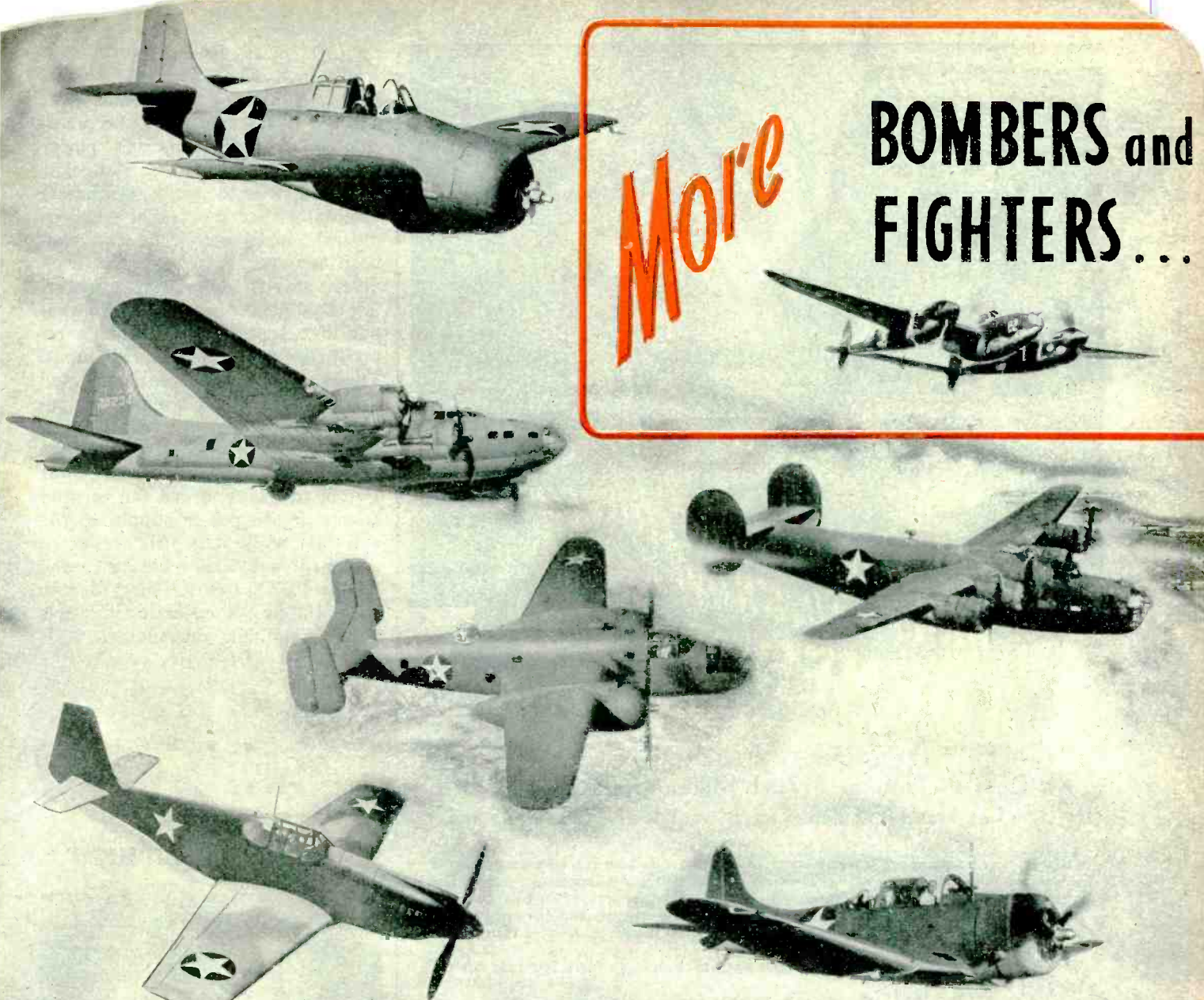

More

**BOMBERS and
FIGHTERS...**

are on their way with NEW

Speed Nuts

Every day bombers and fighters are assembled with more and more SPEED NUTS. The increased use of SPEED NUTS rolls them off the line faster and lightens them for added useful load. These approved self-locking aircraft nuts grip the screws with a DOUBLE SPRING-TENSION LOCK that resists vibration for the life of the plane.

The tons of metal conserved with the use of

SPEED NUTS is almost impossible to calculate. And the man-hours assembly time saved runs into millions. Over 1500 shapes and sizes including many new ones just released. Approved for most all non-structural attachments by U. S. Army Air Forces and Navy Department Bureau of Aeronautics. Also used on trucks, jeeps and tanks. Write for our new book No. 185, illustrating some of our very latest developments.

TINNERMAN PRODUCTS INC., 2106 Fulton Road, Cleveland, Ohio

IN CANADA: Wallace Barnes Co., Ltd., Hamilton, Ontario

IN ENGLAND: Simmonds Aerocessories, Ltd., London



FASTEST THING IN FASTENINGS!

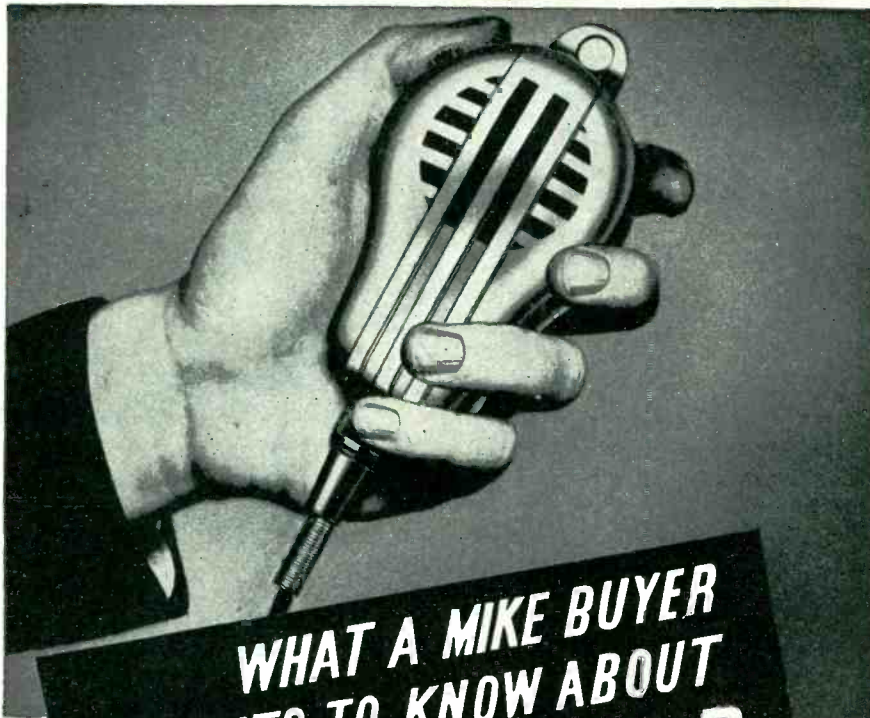

**WHAT A MIKE BUYER
WANTS TO KNOW ABOUT
TURNER HAN-D**

- It Does the Job of Several Mikes • You Can Hold It
- You Can Hang It • You Can Mount It on Standard Stands

A truly multi-purpose microphone, which can do the job of two or more units. It fits the hand snugly; is equipped with a suspension hook for hanging mike applications, stage work and call systems; it can be mounted on any standard floor or desk stand. Especially engineered for maximum voice response and smooth, natural response to music pick-ups. Gunmetal or chrome type finish.

The Turner Han-D is equipped with a contact slide switch, for easy on-off operation.

9X Crystal has level of -48 DB, range of 60-7,000 cycles.

9D Dynamic, especially recommended for use under bad climatic conditions, intense heat and rough handling. Level -50 DB. Range 60-7,000 cycles. With 7 ft. removable cable set, available in 200-250 ohms, 500 ohms or hi-impedance.

TURNER THIRD HAND WITH L-40 MIKE

Leaves Both Hands Free for Other Jobs

For every spot where both hands are needed on the job, Turner 3-H-L40 is the lightweight unit to use. Defense plants use it for call systems. Police cars need it for better communications. The "Third Hand" holds the mike close to the mouth, giving tremendous volume without feedback.

Equipped with Turner L-40 microphone which has exceptionally high signal level. Gives more intelligible speech reproduction and minimizes feedback. Chest sounds are damped out. Gunmetal or chrome type finish. Level -48 DB.

The Turner Third Hand, 3-H, slips over the neck in a jiffy. Goose neck adjusts mike to any position. Can be used with long lines as traveling mike. Window demonstrators find 3-H indispensable. Can be ordered with mike switch at extra cost.

All Crystals Licensed Under Patents of the Brush Development Co.



Free New Turner Microphone Catalog, showing all available models. Write for yours today.

THE TURNER CO.
CEDAR RAPIDS, IOWA



this system are located on the control panel. These consist of one volume control, two switches SW1 and SW2 for controlling the direction of transmission, and power switch SW3. The volume control is provided so as to obtain the correct level at either the tender's or the divers' reproducers. The two two-position switches, one for each diver, provide means for transferring the divers' reproducers from input to output and the tender's reproducer from output to input. These switches are so connected that the normal, or unoperated, position provides speech transmission from all connected divers to the tender's reproducer. The power switch provides means for turning on or off the power supply to the amplifier while it is still connected ready for use. This must be turned to the "ON" position in order to apply the proper operating voltages to the amplifier components.

• • •

SUB-ZERO EQUIPMENT



Lt. Col. John H. Talbott, commanding officer of the Army Climatic Lab, is shown checking the thermo-coupled harness worn by Pvt. Donald W. Peterson. This harness has eighteen thermo-coupled junctions recording skin temperatures of the soldier from finger-tips to toes, plus another harness between his clothing, all connected to recording machines by multi-wired cables.

INSULATED IRON CORES

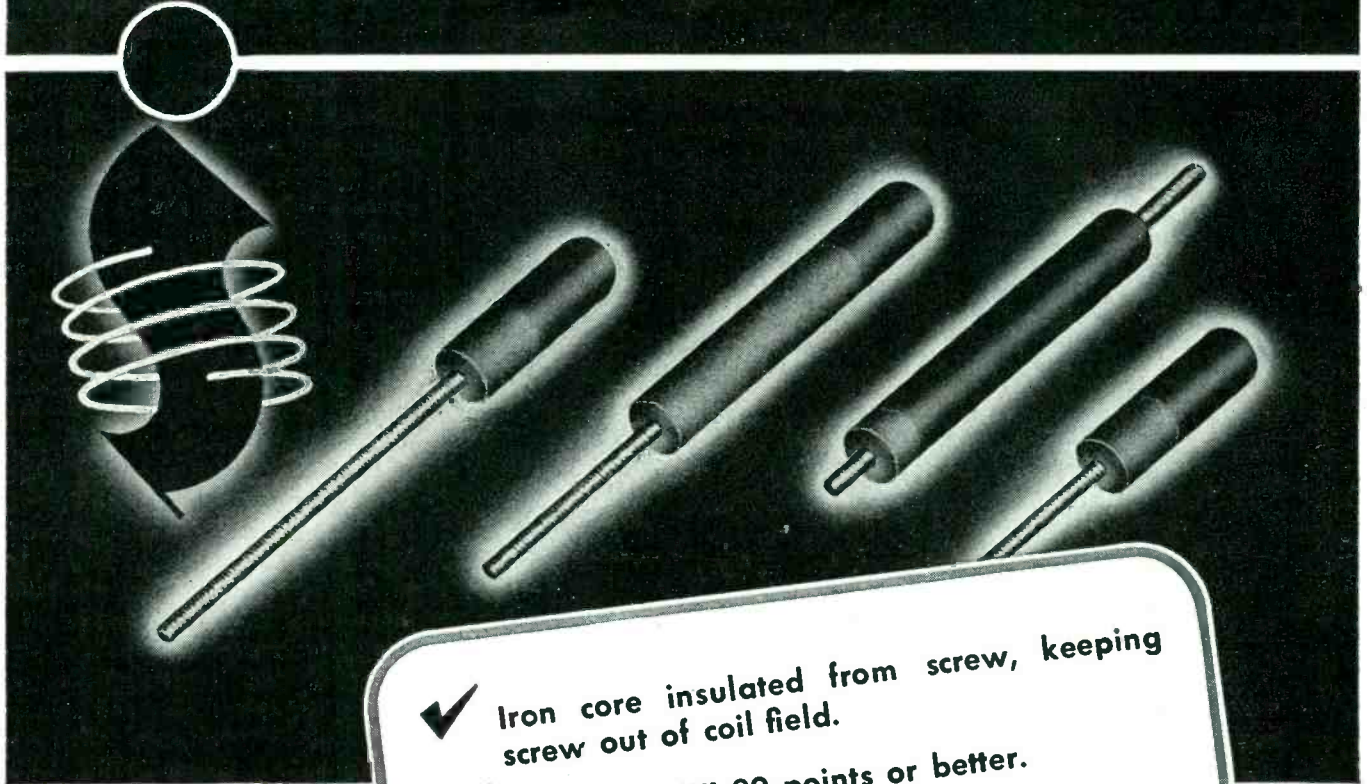

- ✓ Iron core insulated from screw, keeping screw out of coil field.
- ✓ Increases "Q" 30 points or better.
- ✓ Reduces distributed capacity of coil.
- ✓ Reduces hand capacity effect where screw is not grounded.

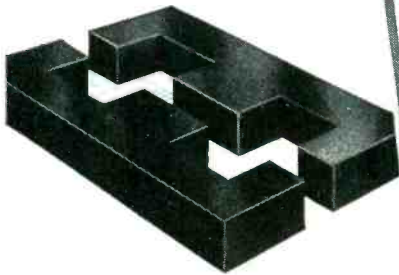

MOLDED IRON TRANSFORMER CORES

... another Stackpole development in powder metallurgy. Designed for transformers and chokes where constant inductance is required over a given frequency range—also where constant inductance, limited only by the saturation point of the core, is needed for various currents. This saturation point can be predetermined to meet specific conditions

Stackpole Insulated Iron Cores mean new standards of efficiency for applications such as antenna or oscillator coils; I-F transformers of either top and bottom-tuned or top-tuned types; permeability tuning (either audio modulation or frequency modulation): transmitting tuning and others. The insulation is bonded to the core to form an integral unit, and may be any length from $\frac{1}{4}$ " up to 1". Core diameters of .198", .250", and .365" are produced as "standard", although other diameters are available.

STACKPOLE CARBON COMPANY, ST. MARYS, PENNA.

STACKPOLE

EVERYTHING IN CARBON BUT DIAMONDS — BRUSHES (all types for all rotating machines) — CONTACTS (all carbon, graphite and composition types — also molded rare metal contacts) — ANODES — ELECTRODES — BRAZING BLOCKS — BEARINGS — WELDING RODS, ELECTRODES AND PLATES — PIPE — PACKING, PISTON AND SEAL RINGS — RHEOSTAT PLATES AND DISCS — BRAKE LINING, etc.



"MAGIC!"

is their word for it

We damn well know it won't win the war . . . *but* if your boy is in there pitching it's encouraging to know the Hits of Broadway and Main Street are delivered right to his foxhole.

How? With Presto Recordings and Playbacks. Whether he's with MacArthur, Eisenhower, Spaatz, or training on home grounds, Presto Equipment is bringing him the latest from Home—music, news, songs, entertainment . . . recorded while "live" and rebroadcast to him between battles. That goes for the Navy, too!

And when Presto Recordings and Playbacks are not dishing out the "jive" they're drilling in the facts of fighting—training troops, broadcasting orders, recording operational data, and a lot of other things we won't talk about.

"Magic!" is the word the boys have for it. But to you it's just plain Presto! . . . trade name of all that's finest and best in Sound Recording.

PRESTO
RECORDING CORP.
242 WEST 55th ST. N.Y.

In Other Cities, Phone . . . ATLANTA, Jack. 4372 • BOSTON, Bel. 4510
CHICAGO, Har. 4240 • CLEVELAND, Me. 1565 • DALLAS, 37093 • DENVER,
Ch. 4277 • DETROIT, Univ. 1-0180 • HOLLYWOOD, Hil. 9133 • KANSAS
CITY, Vic. 4631 • MINNEAPOLIS, Atlantic 4216 • MONTREAL, Mar. 6368
TORONTO, Hud. 0333 • PHILADELPHIA, Penny. 0542 • ROCHESTER,
Cul. 5548 • SAN FRANCISCO, Su. 8854 • SEATTLE, Sen. 2560
WASHINGTON, D. C., Shep. 4003—Dist. 1640

World's Largest Manufacturers of Instantaneous Sound Recording Equipment and Discs

Electronic Dehydration Removes 99 Percent of Moisture in Food

REMOVAL OF 99 PERCENT of the moisture content from vegetables has been made possible for the first time by a high-frequency dehydrating process developed by Federal Telephone and Radio Corp. in cooperation with the Office of the Quartermaster General of the U. S. Army. Evidence indicates that vegetables dehydrated to this extent will not deteriorate over a period of one to two years even in hot, humid climates. Soaking in water restores the original color and consistency, after which the vegetables may be cooked and served the same as fresh vegetables, with normal taste and aroma.

The new process involves removing about 80 percent of the moisture initially by conventional forced hot air drying, leaving the vegetables pliable but without formation of a tough, blackened skin known as case hardening. The vegetables are then compressed into bricks and remaining moisture is removed electronically down to 1 percent, after which the bricks are wrapped in paper, wax coated, packed and shipped. Laboratory results show that one pound of water may be removed electronically with less than one kwh of energy.

Dried whole milk has had its moisture content reduced electronically from 2 percent to 1 percent, making it possible to ship this product without danger of its butter fat content becoming rancid. When reconditioned by addition of water, this product becomes as palatable and nutritious as fresh milk.

• • •

ELECTRON GUNS FOR WAR

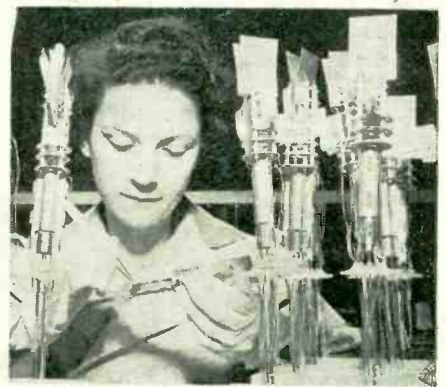

Checking electron gun assemblies for cathode ray tubes in an air-conditioned room at a Canadian plant

**AVAILABLE IN ALL STANDARD SIZES, ANY
 QUANTITY * FLEXIBLE, NON-FRAYING AND NON-
 BURNING * ACID, MOISTURE AND OIL
 RESISTANT * HIGH DIELECTRIC VALUES**

**..all these
 general
 features**

TURBO

SATURATED SLEEVING-VARNISHED TUBING
will do your job tomorrow!

Here's the insulation for your present essential needs, and post-war plannings! Smooth bore, non-deteriorating and non-absorbent characteristics, and resistance to wear, abrasion and impact assure higher operating efficiencies under most severe conditions. Moreover, because many applications today require insulation embodying specific properties in varying degrees to meet great divergence in electrical

and mechanical requisites, a range of TURBO products are available for particular needs — Flexible Varnished Oil Tubing, Varnished Glass Tubing, and Extruded Tubing. Also, to safeguard circuits, TURBO Wire Identification Markers are offered.

☆ ☆ ☆
 Check the advantages of each TURBO product below. Sample board, with specimen of each and list of standard sizes will be sent on request.

WILLIAM BRAND & COMPANY
 276 FOURTH AVE.
 NEW YORK, N. Y.

**325 W. HURON STREET
 CHICAGO, ILL.**

**..and these
 individual
 features!**

FLEXIBLE VARNISHED OIL TUBING:

resistant to deteriorating influences
 ● This TURBO insulation meets the diversity of requirements necessary to stand up against general break-downs, impairment through moisture absorption, and the general deteriorating influences caused by acids, alkalis, etc.

EXTRUDED TUBING:

resistant to sub-zero temperatures
 ● Where the effects of extreme low temperatures are apt to induce insulation embrittlement, TURBO Extruded Tubing is especially suited. Sudden climatic changes, wide fluctuations in temperature, or refrigerant operating conditions will not effect the dependability.

VARNISHED GLASS TUBING:

resistant to extremely high heat
 ● The extensive use of this TURBO product is directly attributable to its excellent characteristics under high heat conditions. Heavy duty operating conditions, confined areas where ventilation is minimized and other similar problems are solved.

WIRE IDENTIFICATION MARKERS:

to meet rigid ordnance specifications
 ● The facilitating of production and assembling operations, with corresponding increases in functional efficiency, are effected with this TURBO insulation product. Available in any size, length or color, these TURBO markers are strictly in accord with Army, Navy and Air Corps



Under Fire!

When the Signal Corps moves its equipment up to advanced posts both men and equipment take terrific punishment. Signal Corps communications equipment rides in the rumbling tanks . . . crouches in foxholes and behind shell-blasted tree-trunks . . . marches into the thick of battle with the infantry. *It's got to be good!*

CONSOLIDATED RADIO headphones are withstanding all the unprecedented rigors of modern warfare. CONSOLIDATED RADIO is proud to be manufacturing headphones that are fighting side by side with the invincible infantry.

Consolidated Radio's Modern Mass Production Methods Can Supply Signal Corps and Other Headphone Units in Quantities to Contractors



Electronic and Magnetic Devices

CONSOLIDATED RADIO

Products Company

350 W. ERIE ST., CHICAGO, ILL.

V-H-F Systems

(Continued from page 101)

be constructed to withstand the severe atmospheric conditions in some locations. In all locations lightning is an ever-present problem. Lightning gaps are included on the antennas and each tower is well grounded at the base. The antenna leads are of $\frac{3}{4}$ -inch coaxial cable filled with dry nitrogen which is kept above atmospheric pressure to exclude moisture.

At certain locations the transmitters and receivers were installed in existing buildings while in the majority of the locations, a 12-ft x 8-ft x 7-ft high concrete-block building was constructed. A small room was built within the building to house a gasoline-driven power generator.

These buildings were waterproofed satisfactorily with a preparation that is "painted" on the surface and allowed to soak into the pores of the block. To prevent condensation under the moist air conditions experienced in New England, circulating ventilation is provided through the buildings. Air enters through louvres in the door, passes into the generator room through an appropriate opening in the partition and leaves the building through a rotating-vane ventilator which encourages air flow over this path. When the generator is running, an electric fan greatly increases the air flow to adequately cool the unit.

The operation of the 3-kw gasoline-driven generator is controlled by an under-voltage relay which starts the unit when the line voltage drops below a pre-determined value. When the unit starts, it automatically takes over the load and continues to run until the normal power supply is again restored. All power and telephone circuits are led to the station houses through underground cables.

The remotely-located stations are controlled from the Troop Headquarters over telephone circuits leased from the New England Telephone Company. A second control circuit is provided from one of the stations to the General Headquarters in Boston. Some difficulty has been experienced maintaining these lines through the severe winter weather and radio control circuits are being considered as

ACTUAL-SIZE
ILLUSTRATIONS

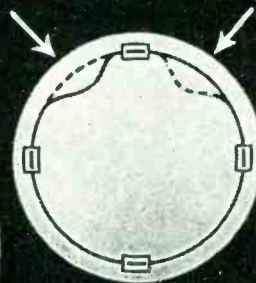

INDENTS
FACILITATE
TAPPING
OF ANY
TURN!

No. 1590

Single winding with indents. Weight complete, only $2\frac{1}{4}$ ounces. Coil 2" diam. x 4" long. $3\frac{1}{4}$ " overall height.

No. 1591

Double winding (tapped outer coil with inner winding for coupling to a low-impedance load). Weight complete, $2\frac{3}{4}$ ounces. Coil 2" diam. x 3" long. $3\frac{1}{4}$ " overall height.

**MADE "SPECIAL"—MADE FAST—
and MADE RIGHT!**

These two Air-Wound units, designed for ship-to-shore radio telephone transmitters, are typical of B & W small coils now being produced to meet exacting specifications by modern production methods *at the rate of 1200 a day!*

Many outstanding advantages accrue to these coils as a result of the famous B & W Air-Wound construction: Exceptionally light weight; mechanical ruggedness (they are not

likely to be put out of commission by dropping or rough handling); adaptability to design or engineering changes in laboratory or field use; and the ease with which *ANY* of the closely-wound turns may be tapped, thanks to the special indent feature.

B & W Air Inductors of this general type are available for all normal frequency ranges. Literature on request.

BIG COILS, TOO! →

Here you see the small No. 1591 Air Inductor shown in comparison to a B & W high-power unit for 10 KW. service. Details on any type gladly sent.

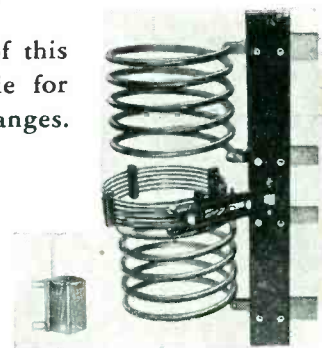

AIR INDUCTORS

Air-Wound and Ceramic and Phenolic Form Types

BARKER & WILLIAMSON, 235 Fairfield Ave., Upper Darby, Pa.

Designed for

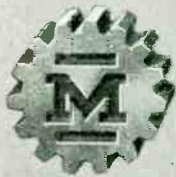

Application



Another exclusive Milken "Designed for Application" product. Combination high voltage terminal and thru-bushing. Tapered contact pin fits firmly into conical socket providing large area, low resistance connection. Pin is swivel mounted in cap to prevent twisting of lead wire. Easy to use. 1/4" o.d. insulation high voltage cable fits into opening in cap. Bared conductor passes thru pin for easy soldering to pre-finned tip of contact plug.

Standard 37001 available in either black or red bakelite. No. 37501 is low loss mica filled yellow bakelite for R.F. applications.

**JAMES MILLEN
MFG. CO., INC.**

MAIN OFFICE AND FACTORY
**MALDEN
MASSACHUSETTS**



supplements to the wire circuits in certain locations.

Control functions provide for operating the transmitter by a push-to-talk button on the handset at the control point. In addition, when the handset is lifted from its hanger, a relay mutes the station-frequency receiver and opens wide the "squelch" control on the car-frequency receiver. This allows discrimination in favor of a car signal if another main station in the system should be transmitting at the same time.

At the control point, the operation of the transmitter is supervised by a small receiver whose output is connected to a carrier-indicating meter located on the control box. A second meter indicates the speech levels on the control line coming from the receivers or the level of the operator's voice when transmitting. An intermittent audio signal is imposed on the line when the gasoline-driven generator is in operation to give an indication of power line failure. Tower light control is also possible if required during a blackout. All these control functions are carried out over a single-pair telephone line.

The transmitter modulator employs E. H. Armstrong's original circuit. The oscillator employs a low-drift crystal operated at 1/32 of the transmitting frequency. The output of the oscillator is phase-modulated, quadrupled twice, doubled, and then amplified in a stage having an output of 50 watts. This drives a 250TH tube and is coupled to the coaxial line by a simple two-condenser tank circuit which permits ready variation of the load on the transmitter.

The receivers are double super-heterodynes in which both local oscillators are crystal controlled. Amplification is sufficient to permit satisfactory results from signals as low as 0.1 microvolt. Audio amplification provides a level of approximately + 6 db which is satisfactory for feeding to the telephone line.

A most important feature of both transmitting and receiving equipment is that provision is made for tuning all circuits using a simple indicating milliammeter. This makes it easy to check alignment frequently and keep the units at peak performance.

One hundred mobile units are equipped with 25-watt transmitters and associated receivers. The mobile

transmitter is fundamentally the same as the main station unit but has only one amplifier after the doubler stage. Plate power is obtained from a generator mounted directly on the chassis. The mobile receiver is exactly like the fixed-station receiver but obtains its power from a small vibropack. The mobile station requires 23 amps from the 6-volt car battery when transmitting and 8.5 amps when receiving.

Rear-mounted whip antennas with springs are used on most cars. However, in the western areas where valleys are deep and narrow, improved operation has been accomplished by the use of roof-top antennas because of the added height and decreased directivity.

Two or three radio maintenance men are employed in each of the four troops. A completely equipped repair depot is located at each Troop Headquarters where all repairs are made. Spare parts include three spare mobile transmitters and receivers for each troop and a complete set of spare tubes for all equipment in service. The radio men arrange to inspect each mobile unit at intervals not longer than four weeks to ensure peak performance. The convenient tuning indicating meter makes this procedure quite simple. Careful records are kept of these inspections and of any work done on the units. Fixed stations are inspected weekly to test the emergency generators and make adjustments.

Installation of the system began September 1942 and proceeded slowly during the winter months due to the weather conditions and the difficulties in obtaining certain materials needed for wire lines and building construction. The last of the fixed stations is now being installed. The service area of each station has proved to be considerably greater than that indicated on the map and except in the extreme western areas, there is no area that is not served by at least two stations. If a station loses its control line, secondary communication can be accomplished using a mobile unit at the remote location which is in constant contact with another unit at the control point. The officer in the remote car can re-transmit the messages on his own transmitter or operate the main station with a local control in the station building.

September 1943 — ELECTRONICS

Dieflex

VARNISHED TUBING PRODUCTS AND IGNITION MARKERS

including . . .

FIBERGLAS
T.M. Reg. U.S. Pat. Office

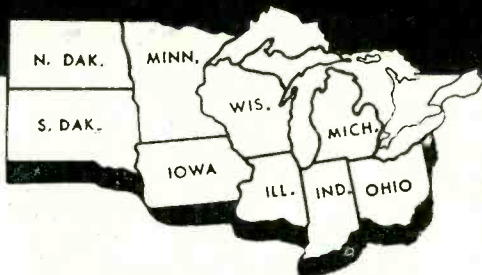
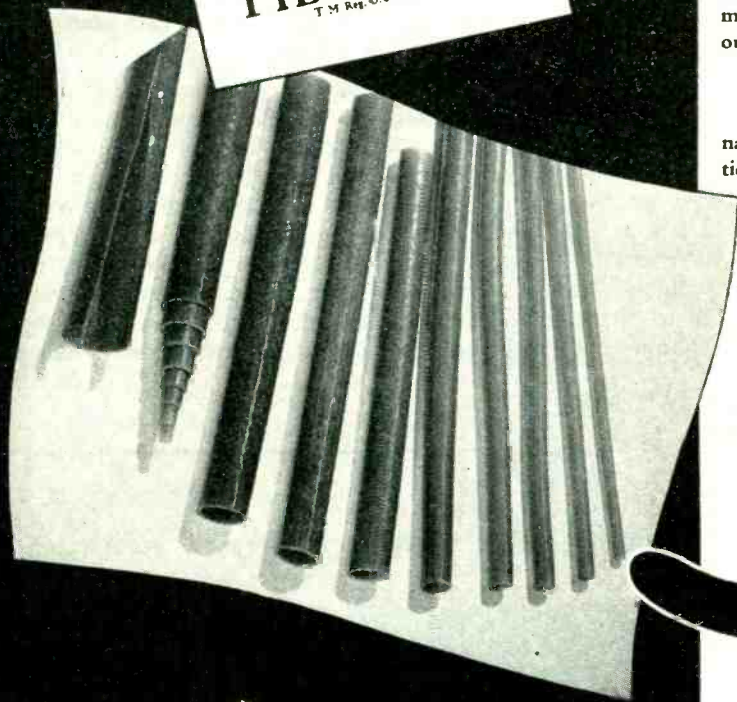

**SERVICE FOR MANUFACTURERS
IN THIS MIDWEST TERRITORY**

Dieflex Varnished Tubing products offer you these advantages:

SPEED PRODUCTION

Smooth inside treated bore. Prevents snagging or interference. Facilitates telescoping. Complete roundness — uniformity of size — extreme flexibility — non-fraying — resumes complete roundness immediately after cutting — will not pinch.

SAVE SPACE

Excellent bending qualities. Good workability. Due to complete varnish impregnation throughout — maximum results with space saving wall — maximum protection in a minimum space. The Fibreglas grades provide permanent protection with a thinner wall.

INSURE PROTECTION

High dielectric strength. Excellent aging qualities. Meets or surpasses the V. T. A., A. S. T. M., and similar specifications. Complete varnish impregnation protects against moisture, oils, and chemicals. Long life without stiffening or cracking.

SPECIFY "DIEFLEX"

Specify "DIEFLEX." Be sure that the name "Dieflex" is written in your specifications and on your shop requisitions.



INSULATION MANUFACTURERS CORPORATION

- ★ CHICAGO 6 • 565 West Washington Blvd.
- ★ CLEVELAND 14 • 1005 Leader Building

Representatives in {
MILWAUKEE 2—312 East Wisconsin Ave.
DETROIT 2—11341 Woodward Ave.
MINNEAPOLIS—316 Fourth Ave. So.
PEORIA—101 Heinz Court

THE ELECTRON ART

Enemy-Owned Patents	182
Bibliography of Dropping Mercury Electrode	188
A Versatile Q Meter	190
Machine for Calculating Polar Diagrams	196
Protective Metal Finishes	201
New Mathematical Tables	202
Emissive Plates for Pentodes	202

Enemy-Owned Patents

The following foreign-owned electronic patents, available to American industry on a licensing basis of \$15 per patent, are representative examples of nearly 50,000 patents now controlled by the Alien Property Custodian, Washington, D. C.

Land Mine Locator

To detect underground mines or unexploded shells, the apparatus shown in the diagram is suggested by Henri Chireix of Paris, France in a patent application having Serial No. 419,545. A search coil or loop is employed to induce eddy currents in the metallic object, and the resulting counter-field modifies the characteristics of an oscillator circuit. These changes cause a variation of phase of the current in the circuit with reference to the oscillator voltage. A phasemeter circuit controls a lamp for a visual signal or a buzzer and earphone for aural indication.

In order to reduce electrostatic effects the search coil has one low-resistance winding. For the same reason the inventor suggests that the frequency of the oscillator be chosen in the range from 210 kc to 2.1 Mc. Within these limits the effects of currents induced in the ground itself are negligible.

As indicated in the diagram, the light metal loop is mounted at the end of an insulating rod. Main tuning of the loop is accomplished by the 0.02 μ f mica capacitor. Vernier adjustment is provided by a small variable capacitor mounted at the normal position for the operator's hand. To permit simultaneous observation of the indicator lamp and the location of the search coil, the lamp may

be mounted at the end of the rod. Tubes and batteries are contained in a separate carrying case slung from the operator's shoulder.

The output of the oscillator tube is coupled by transformer *M* to two dry-disc rectifiers whose loads are 200,000-ohm resistors. This portion of the circuit appears to form a Wheatstone bridge with one diagonal fed by the search circuit and the other by the secondary of transformer *M*. Capacitor *C* permits the voltage between terminals *A* and *B* to be adjusted so that it equals the voltage developed across one half

of the secondary of transformer *M*. At resonance the dry-disc rectifiers receive equal voltage. Because of the series connection of the rectifier load resistors, the voltage from the grid of the indicator tube to ground is zero.

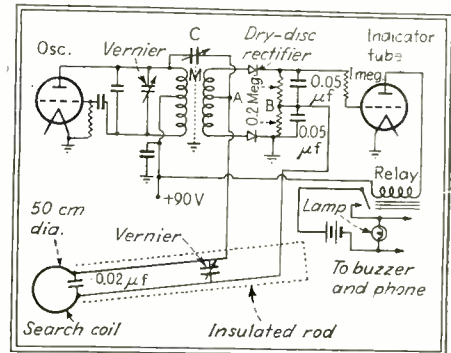

Circuit of portable metal locator for detection of land mines and unexploded shells

When a metallic body is present it reduces the apparent self-induction of the search coil, and the voltage between terminals *A* and *B* begins to lead the transformer secondary voltage by a definite amount. Since the two voltages are no longer in exact quadrature the voltage produced by the upper rectifier in the diagram becomes less than the voltage pro-

RADIO MEN ARE TRAINED IN PLANE MOCK-UPS

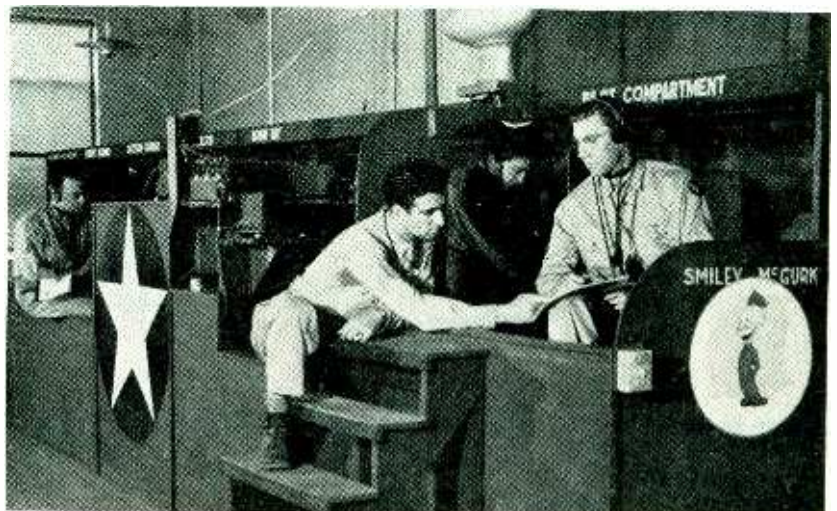

Semi-mock-ups constructed of plywood, with one side open to facilitate study and classroom demonstration, are equipped with all the radio equipment the corresponding plane would carry, and are used in the Army Air Forces radio school at Scott Field to give the men actual on-location experience with aircraft communication equipment without tying up planes for training purposes

OHMITE RESISTORS

A Type and Size for Every Electronic Need

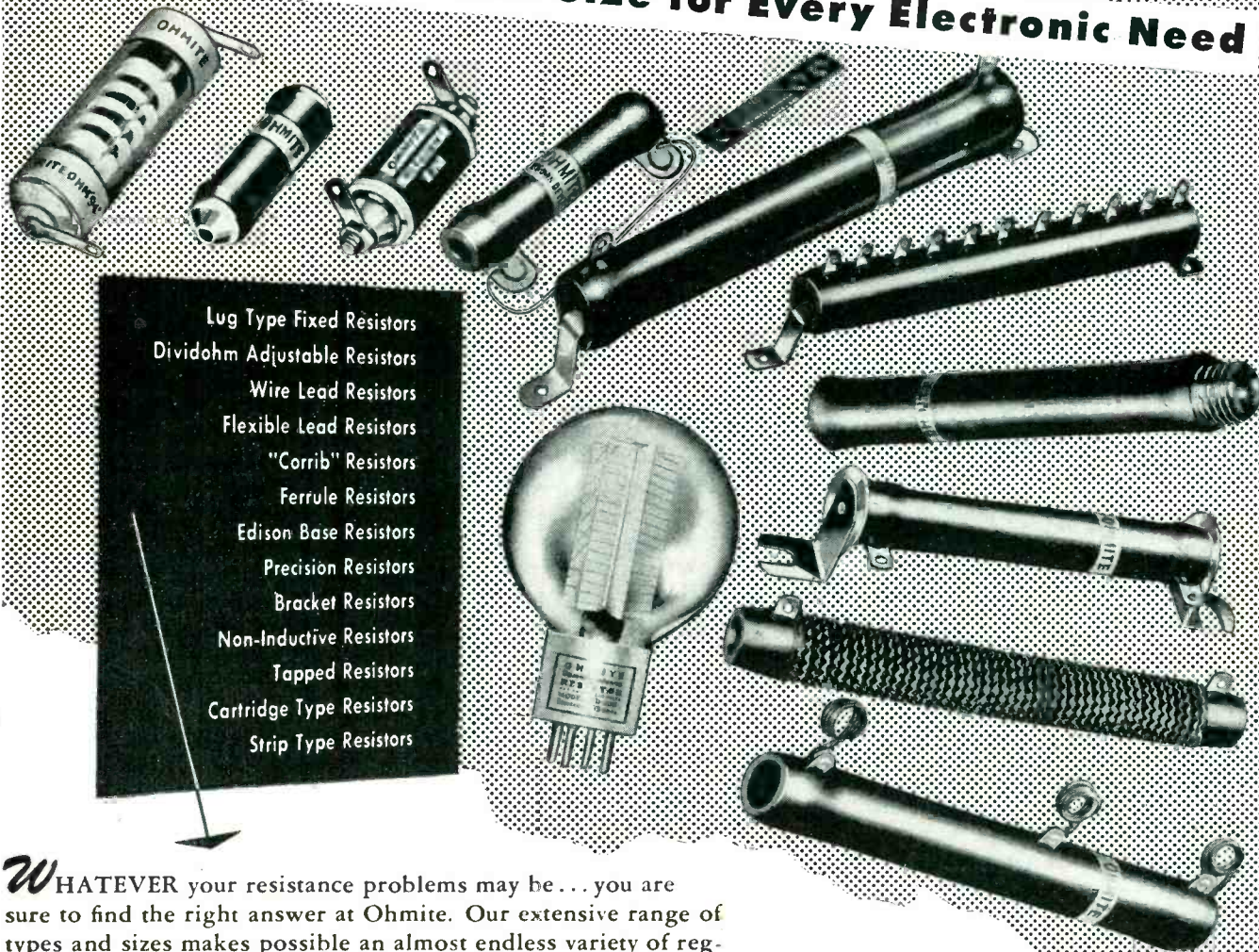

- Lug Type Fixed Resistors
- Dividohm Adjustable Resistors
- Wire Lead Resistors
- Flexible Lead Resistors
- "Corrib" Resistors
- Ferrule Resistors
- Edison Base Resistors
- Precision Resistors
- Bracket Resistors
- Non-Inductive Resistors
- Tapped Resistors
- Cartridge Type Resistors
- Strip Type Resistors

WHATEVER your resistance problems may be . . . you are sure to find the right answer at Ohmite. Our extensive range of types and sizes makes possible an almost endless variety of regular or special resistors to meet every requirement. Core sizes range from 2½" diameter by 20" long to ⅝" diameter by 1" long . . . and are produced with standard or special windings, terminals and other features. Many are stock units.

Because of their extra dependability under the most critical operating conditions, Ohmite Resistors are used today in all types of electronic and electrical applications . . . in planes, tanks, ships, in laboratory research and development, in scientific instruments and in the production tools of war.

Send for Catalog and Engineering Manual #40

Write on company letterhead for complete helpful 96-page guide in the selection and application of resistors, rheostats, tap switches, chokes and attenuators.

OHMITE MANUFACTURING COMPANY
4818 Flournoy Street • Chicago 44, U.S.A.



Cut-away view of Ohmite Vitreous Enamelled Resistor

The resistance wire is evenly wound on porcelain core, rigidly held in place, insulated and protected by Ohmite vitreous enamel. Dissipates heat rapidly—prevents hot spots and failures. Core sizes range from 2½" diameter by 20" long to ⅝" diameter by 1" long.

duced by the other rectifier. A negative voltage then results at the grid of the indicator tube, and plate current of the tube decreases. A relay in the plate circuit permits contacts to close the battery line to an indicator lamp. A buzzer and earphone in this battery circuit may be actuated at the same time.

VHF Coupling Device

Radio direction finders that operate on ultra-short waves usually contain one-turn stators and a one-turn rotor. At lower frequencies suitable distribution of the turns permits the current induced in the rotor to be proportional to the sine of the angle formed by the mean plane of the rotor with a reference plane. To obtain a similar purpose with a single-turn rotor is the object of patent application having Serial No. 440,417, by Rene Hardy and Pierre de Maertelaere of Lyon, France.

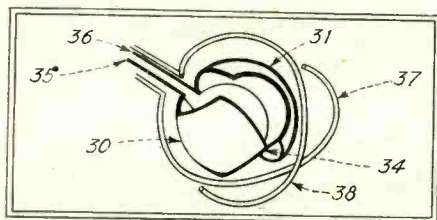

Special rotor employed in VHF direction finder to give a sinusoidal output current

From the illustration it would appear that there are two stators, 37 and 38, each consisting of a single turn. The rotor consists of two hemispherical shells (30 and 31 in the illustration). In each of these the two opposite half-domes are cut away perpendicular to the plane of their base. The half-shells are mounted with their segments staggered by 90 deg, and a metallic connection between them is made at the point marked 34. Wire leads at 35 and 36 are soldered to the shells diametrically opposite this connection.

The inventors claim that a rotor of this type is traversed during its rotation by an induced current having substantially a sinusoidal shape. The device is not limited to direction finders, but may also be used for input and output current attenuators for oscillators and amplifiers.

Secret Communication System

A method of arranging a transmitter and a receiving system to provide secrecy is suggested by Berko Tenen-

baum of Lyons, France, in a patent application having Serial No. 417,800. He suggests that the transmitter contain a number of quartz crystals of different frequencies, and that they be connected in sequence in the transmitter by a special switch. Continuous variation of the switch contacts permits only a small fraction of the message to be transmitted on any one frequency.

For receiving and combining the signals a receiver is required for each frequency transmitted. Each receiver is stabilized at one frequency by quartz crystal control in the local oscillator. The audio outputs of each receiver are combined in one pair of earphones to obtain the composite signal and form the complete message.

The applicant also proposes a method of tuning superheterodyne receivers in which the local oscillator is tuned to one frequency at all times by quartz crystal control. For station selection the intermediate frequency stages are tuned by ganged capacitors that replace the conventional trimmer capacitors. Auxiliary tuning of the mixer stage to the signal frequency is also provided.

The inventor claims the scheme is particularly suitable for wavelengths less than one meter. The application includes descriptions of mechanical arrangements of a double Lecher system used with the circuit. In these, one of the conductors of the Lecher circuit from the oscillator branches into two conductors. These two conductors form a second Lecher circuit for the incoming signal. Methods of forming the Lecher elements concentrically are also described by the inventor.

Preventing Radiation from Superheterodynes

A method of coupling the oscillator to the mixer tube in a superheterodyne receiver to minimize radiation from the antenna is described in patent application Serial No. 380,368 filed by Walter Dallenbach, Alfred Allerding and Erich Huttmann of Berlin, Germany. The schematic diagram of the proposed circuit is shown in the illustration.

A two-wire line, marked 5 and 5' in the diagram, conducts energy from the antenna to the resonant circuit formed at point 6. From the resonant circuit the conductors lead through blocking capacitors 7 and 7'

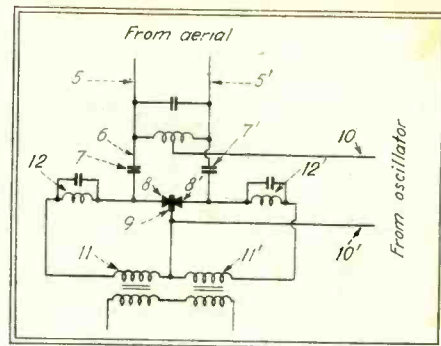

Balanced circuit of superheterodyne mixer for wavelengths less than one meter

to the plates, marked 8 and 8', of a duo-diode employed as the mixer. To the common cathode (9 in the diagram) of the diodes and to the center of the tuned inductance are connected wires of a Lecher system coming from the oscillator, 10 and 10'.

The plate circuits of the diodes contain the primary winding of a push-pull intermediate frequency transformer. This is composed of two windings, 11 and 11', that are wound opposing one another. To prevent high-frequency current from flowing in the transformer primary, resonant circuits at 12 and 12' are connected between the diode plates and the windings 11 and 11'.

The bridge circuit formed by the diodes receives energy from the oscillator and permits both diode plates to be fed in phase. Current to each plate flows from the center connection through the opposed windings of the transformer and the effective cancellation produces no potential difference at the secondary windings.

High-frequency voltage from the antenna line, 5 and 5', is conducted to the diode plates in a push-pull arrangement. Because of the opposed primary windings the two currents are in the same direction and produce voltage in the secondary windings.

Methods of Projecting Television Images

Optical storage of picture elements, to create large screen television images from a small cathode ray tube, is described in the patent application having Serial No. 358,511 by Heinrich Strubig of Teltow, Germany. A drawing of the apparatus is shown.

The alkaline earth halides have the property of changing their color under the influence of an electron beam. This coloring can be com-

from RAILWAY SIGNAL SYSTEMS

to AIRPORT TRAFFIC CONTROL

RELAYS BY GUARDIAN...

★ The smooth operation of rail and airlines depends largely upon efficient traffic control systems. Split-second response, unfailing operation, and a minimum of maintenance are characteristics of these systems.

The Series 5 D.C. and the Series 10 A.C. relays are adaptable to numerous signal system applications. Both A.C. and D.C. types are sensitive and require but a minimum of power. Contacts are adjustable; switch capacity ranges up to double pole double throw. Series 5 D.C. relay consumes a minimum of .01 watts, maximum 5.5 watts. Delayed attract or release is available on this unit. Series 10 A.C. requires an average of 5 VA; minimum .3 VA with single pole single throw contacts of 1.5 amp. capacity.

Write for Series 10 bulletin for A.C., or Series 5 bulletin for D.C. applications.

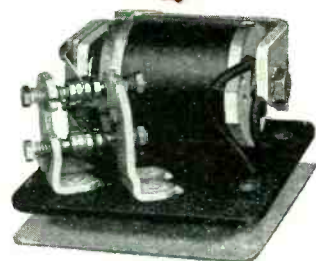

Series 10 A.C. Relay

Special base. (Round base is standard.) Dimensions: Length 3-9/32"; Width: 2-3/8"; Height 2-7/32". Weight: Approx. 11 ounces with cover.

GUARDIAN  **ELECTRIC**

1625-K WEST WALNUT STREET

CHICAGO, ILLINOIS

A COMPLETE LINE OF RELAYS SERVING AMERICAN WAR INDUSTRY



PROVING GROUND

After a motor or dynamotor has been properly designed, built, and inspected — what then? At *Eicor* it is installed on one of these run-in lines for a series of tests extending over many hours, to subject the unit to conditions more severe than those encountered in its operating life.

Each unit is individually connected and fused, and then supplied with input voltage considerably higher than that specified. Output, too, is increased markedly to provide an overloaded condition for observing the electrical and mechanical characteristics before final inspection is made.

Naturally the details and duration of these "proving ground" tests vary with the design and duty of each motor or dynamotor. But every unit must at this point prove itself under adverse operating conditions. The efficiency and regulation are calculated — ripple measured — noise level checked — and above all, output stability established beyond question.

These operations characterize the thoroughness and care used in building all Eicor products.



EICOR INC. 1501 W. Congress St., Chicago, U. S. A.
DYNAMOTORS • D. C. MOTORS • POWER PLANTS • CONVERTERS
Export: Ad Auriema, 89 Broad St., New York, U. S. A. Cable: Auriema, New York

pletely removed by heating the material for a short time or by exposing to infra-red light. Examples of such materials are the chlorides, bromides and iodides of sodium and potassium. The material may be a single flat crystal, although a layer of small crystals is usually preferable.

In the proposed projector a thin layer of finely divided crystals of potassium bromide is deposited on film and held in position by transparent lacquer. To activate the chemical layer a cathode ray tube is mounted so that its rays strike the film as it passes beneath the tube.

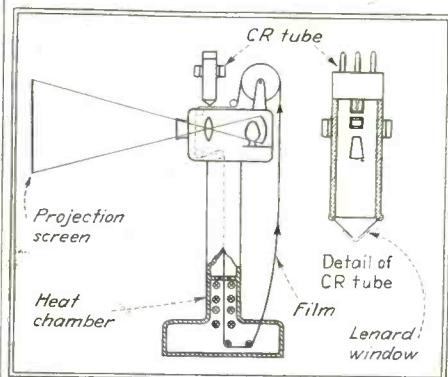

Apparatus for producing a large television picture from a small cathode ray tube. Image is first created on film, then projected to screen

The cathode ray tube contains a Lenard window having the form of a slot covered with aluminum foil or other similar material. When a sprocket assembly moves the film with uniform speed past the Lenard window the potassium bromide layer changes color line by line in accordance with the intensity of the electron stream. Images formed on the film are framed in the optical system of the projector to produce moving pictures.

Potassium bromide has an absorption in the yellow part of the spectrum and the inventor suggests that a sodium vapor lamp be used as the light source in the projector. An alternative with other sources is a yellow projection screen or a yellow light filter.

It is also possible to obtain a black-and-white image with white light. If thin layers of a substance absorbing blue rays and another substance that absorbs yellow rays, potassium bromide and rock salt for example, are placed upon one another the image

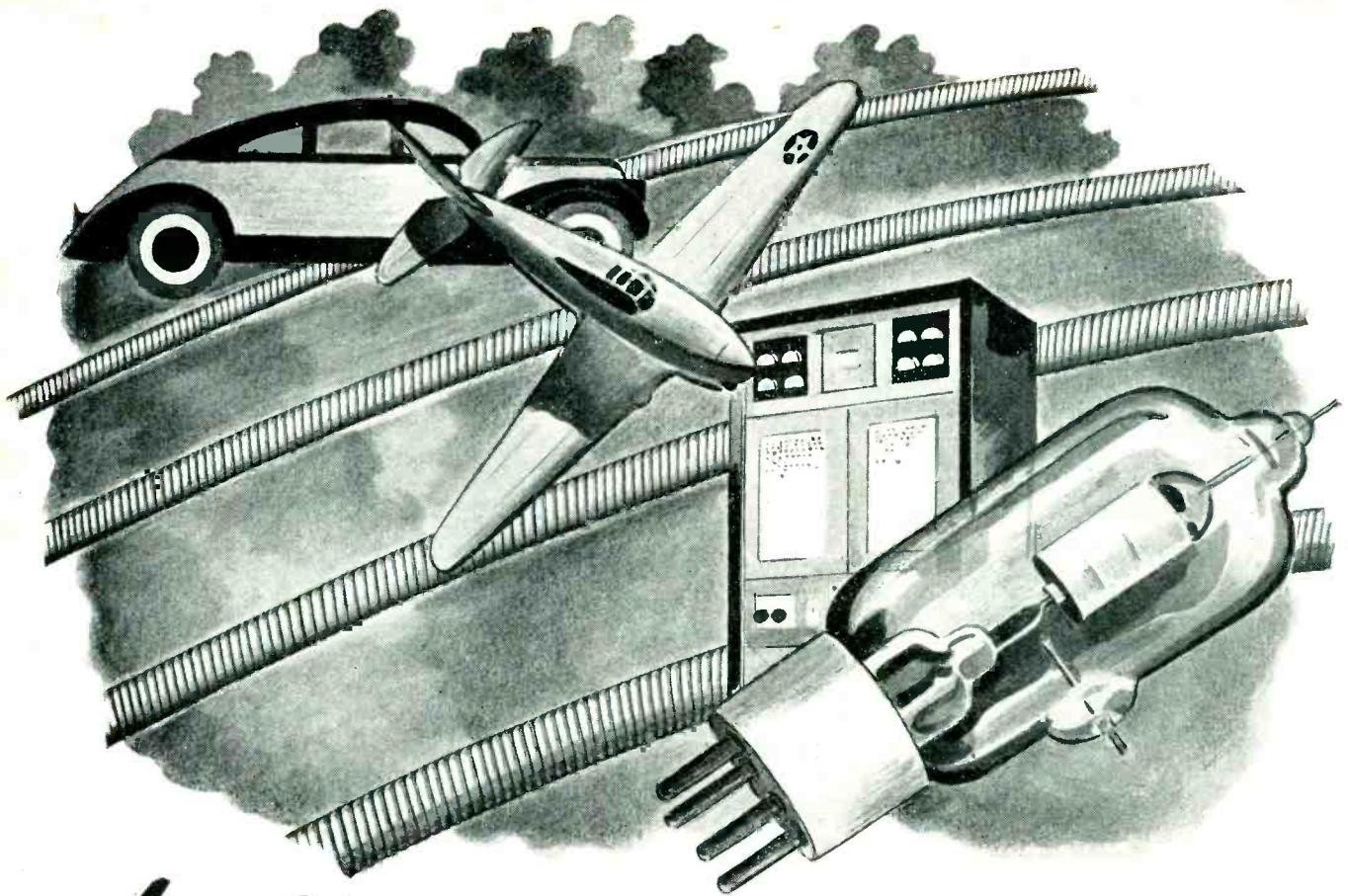

In Electronics too— S. S. WHITE FLEXIBLE SHAFTS — have their place

In the vast new field of electronics, S. S. White Flexible Shafts are certain to serve a wide variety of uses, just as they are doing in aircraft, in motor vehicles, in radio and in many other fields.

For in electronics, as in these other fields, there are many cases where it is necessary to **transmit power** to instruments and other auxiliaries or from one driven part to another—or to **control** from remote positions, parts and equipment requiring operational adjustments.

S. S. White Flexible Shafts are the answer in a large percentage of such cases. Regardless of the relative locations of the connected members, S. S. White Shafts make it possible to carry the drive or control from one to the other, around turns, past obstructions, through congested areas, over long or short distances—with **but a single, easily applied mechanical element**. This means fewer

parts, simplified assembly, faster production, lower costs.

It will pay to keep S. S. White Shafts in mind when designing equipment,* because their use makes it possible to place driving and driven or controlled members in positions which best satisfy the important requirements of space, electric circuit efficiency, ease of assembly, convenience of operation and servicing.

ASK FOR OUR BULLETINS

The following bulletins will be mailed on request.

BULLETIN 1238

Power Drive Flexible Shafts.

BULLETIN 38-42

Remote Control Flexible Shafts.



* The need of our shafts in war equipment confines our production and service to war work until Victory is won.

S. S. WHITE

The S. S. White Dental Mfg. Co.

INDUSTRIAL DIVISION

Dept. E, 10 East 40th Street, New York, 16, N. Y.

FLEXIBLE SHAFTS • AIRCRAFT ACCESSORIES • MOLDED RESISTORS • CONTRACT PLASTICS MOLDING

Flight-similitude Cold Testing

Only *Mobile* units offer program controlled or manually set flight-similitude conditions. These units provide completely coordinated altitude-temperature curves to a maximum of 80,000 feet altitude at a temperature minimum of -120°F .

Reheat and humidity testing is standard also in these *Mobile* units, up to $+185^{\circ}\text{F}$ with fully controlled humidity conditions according to your requirements.

Our production time has recently been cut almost 40%. We invite your inquiry.

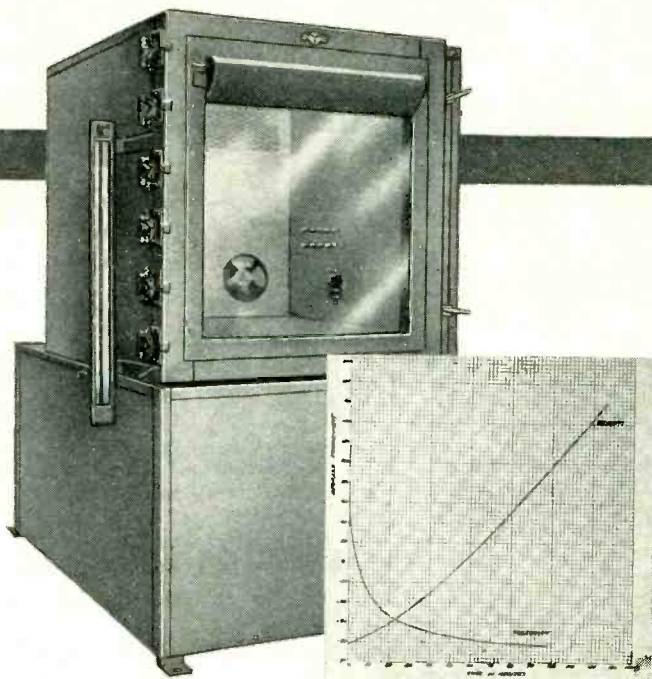

May we work with you?

MOBILE REFRIGERATION

38-32 54TH STREET



WOODSIDE, L. I., NEW YORK

will have black and white contrasts.

After projection the film is permitted to run through a heat chamber containing resistance units or incandescent lamps. The heat removes the color produced in the chemical layer and the film is ready to be used over again. Heat from the optical system can be prevented from harming the image by means of a water filter through which the light rays are permitted to pass.

Another portion of the same patent application deals with the construction of a cathode ray tube in which a layer of potassium bromide is arranged within the tube envelope. The electron gun is mounted in the neck of the tube so that the bromide screen is in the path of light rays from the optical system. Rays of light from an arc lamp pass through the bromide screen and focus the image on a projection screen. Removal of the image is accomplished by passing an infra-red ray over the bromide screen. A similar arrangement using a tube called a Skiatron was shown on page 75 of Nov. 1940 *ELECTRONICS* and in May, 1940 *Proc. IRE*.

• • •

Bibliography of Dropping Mercury Electrode

SINCE THE FIRST APPLICATION of the polarized dropping mercury electrode to the analysis of metal ions in aqueous solutions there have been extensive advances in the development of methods of use and applications. The progress of these advances is outlined in a comprehensive bibliography on the subject that has been brought out by Leeds & Northrup Co., Philadelphia 44, Pa.

The book contains over 800 references arranged chronologically from 1903 through 1940. It is in two sections, the first section containing a complete bibliography and the second a subdivision arranged according to the more extensive applications. The soap, petroleum, sugar, and fermentation industries are listed separately in the second section. The subjects in this section also include colloid, organic, and analytical chemistry, metal alloys, alkaline earth metals, and cancer, blood, and biological applications.

Titles of references in other languages have been translated into English and the language of origin indicated after the references.



“how quickly can we get
Radio Parts?”

Lafayette Radio Corp. is strategically located to give you quick deliveries on radio and electronic parts and equipment, especially on priority, to industrials, training schools and all branches of the armed services. Lafayette's procurement and expediting service has helped to prevent work stoppages on many vital war production lines.

Many instances are on record wherein Lafayette has made immediate delivery on hard-to-find key items, eliminating costly delays in giant armament programs. This is because Lafayette handles the products of every known manufacturer in the radio and electronic field. A single order to Lafayette Radio Corp., no matter how large or how small, will bring prompt delivery of *your* requirements.

Lafayette Radio Register—Free to responsible executives. This 400 page technical and buying aid describes practically every known make of radio parts and electronic equipment. Address Dept. 963



LAFAYETTE RADIO CORP.
901 W. JACKSON BLVD. CHICAGO 7, ILLINOIS
265 PEACHTREE ST. ATLANTA 3, GEORGIA

A Versatile Q Meter

By F. E. PLANER

Western Electric Co. Ltd.
London, England

THE VOLTAGE GAIN that is developed in a series resonant circuit varies with the Q of the circuit. This voltage (across the capacitor) is employed in the instrument to be described as a convenient measure by which the quality of a circuit component may be judged. The instrument is direct reading in terms of Q , and may be applied to other measurements of inductors, capacitors, and resistors over a wide frequency range.

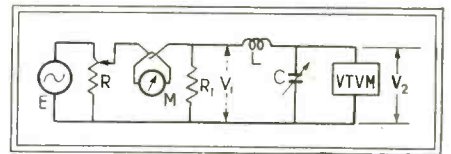

Fig. 1—Circuit illustrating the principle of operation of the Q meter

The basic circuit arrangement is shown in Fig. 1. In operation the voltage output of the oscillator is adjusted to a predetermined value by varying potential divider R until thermocouple microammeter M registers a specified current. The voltage V_1 produced across resistor R_1 is fed to a tuned circuit formed by the inductor L under test and a low-loss variable capacitor C . At resonance, as indicated by the vacuum tube voltmeter, it can be shown that $V_2 = QV_1$.

The actual circuit, shown in Fig. 2, avoids the use of the thermojunction and microammeter, and employs only the vacuum tube voltmeter. This has the advantage of economy, less tendency to accidental overloads, ease of initial and check calibration, and a wider scope of applications. Measurements of Q at different test voltages and extension of the frequency range beyond the calibration of the vacuum tube voltmeter are also possible.

The coil under test, or a standard inductance in the case of tests on capacitors and dielectrics, is connected at L . With selector switch S_2 set to C , resonance is established by adjusting capacitor C_2 to obtain maximum deflection on the milliammeter. Next, the voltage across the variable arm of potentiometer P is adjusted to give the same reading

...It's no trick at all

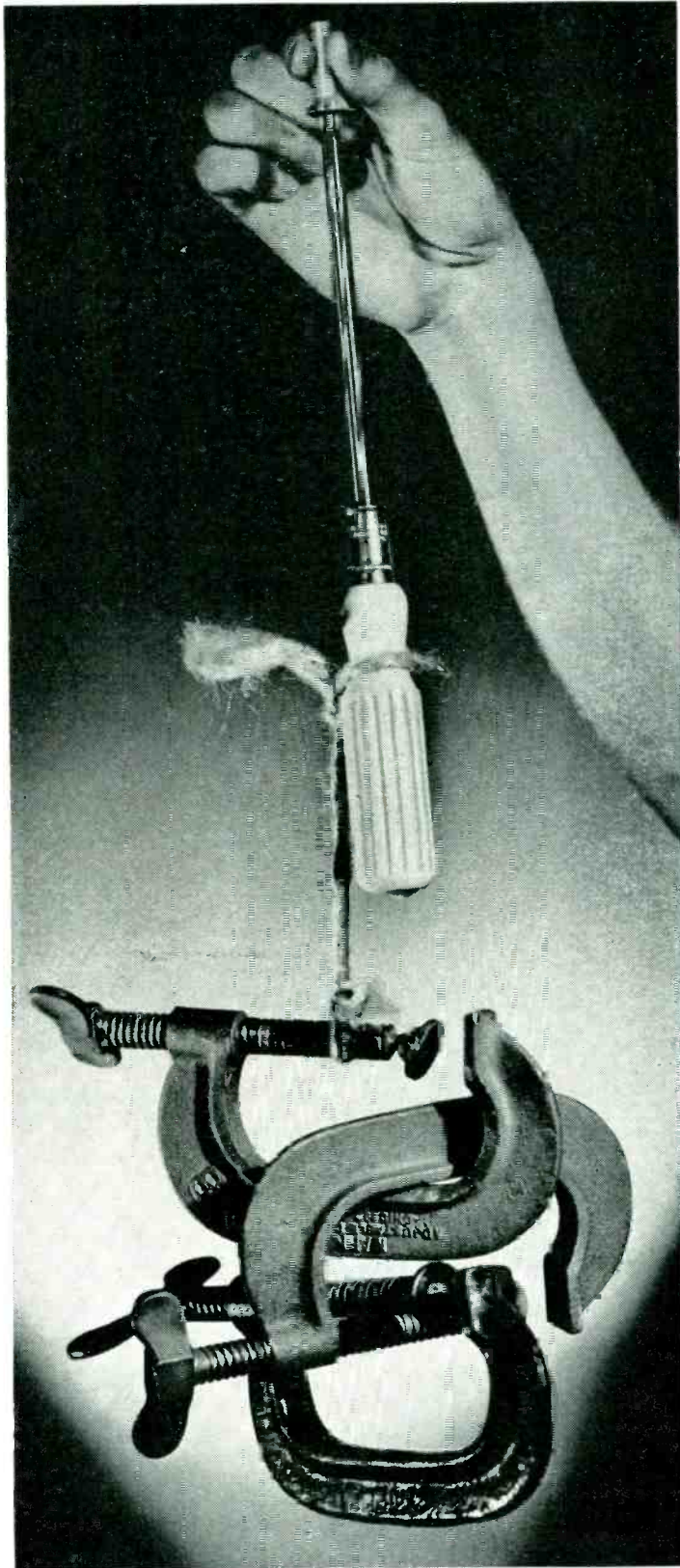

with this powerful CLUTCH HEAD "lock-on" feature to liquidate the problem of hard-to-get-at spots . . . to free slowed-down assembly from fumbling with human or "mechanical" fingers and dropping screws. A simple reverse turn of the driver in the Clutch locks screw to bit as a unit for fast and certain one-handed driving from any angle. Frankly, the iron clamps were added to emphasize the tenacity of the hold . . . yet, the lock is instantly released by the normal turning of the screw for the drive home with hand or power driver.

Many assembly lines operating in the war effort have found that this is just one of several factors contributed by CLUTCH HEAD SCREWS *alone* towards better and lower cost production. They have found that the combination of deep Clutch and self-centering bit smooths out hesitation, eases the fatigue load, and establishes confidence against slippage. They have found time and money economy also in the sturdy construction of the Center Pivot Assembly Bit with its longer uninterrupted "spell" in operation . . . plus its longer total life through briefly grinding the end surface to restore maximum efficiency as needed. Add to these, the fact that CLUTCH HEAD SCREWS *operate with an ordinary type screwdriver* . . . so important when it comes to emergency service in the field.

CLUTCH HEAD SCREWS are available in Standard and Thread-forming types for every purpose. Their unusual advantages have won recognition in many phases of wartime service.

United invites your inquiries.

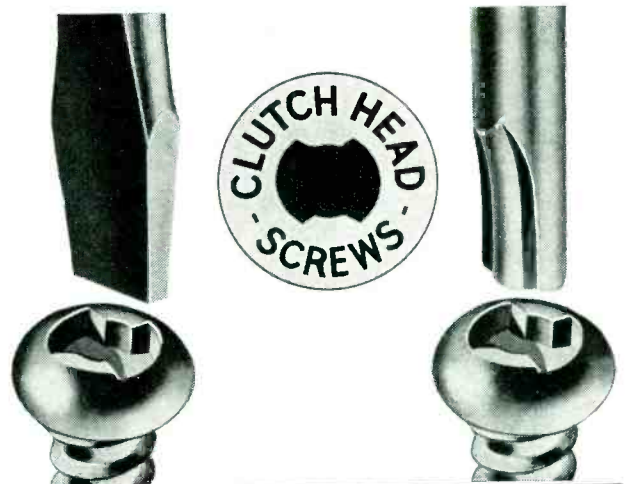

UNITED SCREW AND BOLT CORPORATION
CHICAGO CLEVELAND NEW YORK

THE LONG-RANGE VIEW



"The long-range view" is a fixed policy of the makers of BELL Sound Systems. That's why BELL was ready to step up to the production "firing line" in a hurry when war brought urgent demands for new types of electronic sound equipment. Bell had aimed years of study, research and experiment at the day when electronics would come of age. Now, with the production of electronic sound devices that are proving to be master weapons in wartime roles, BELL Engineers are gaining still further knowledge of this science. They will again have a head start—in applying electronics to new peacetime needs.

BELfone

INTERCOMMUNICATION SYSTEMS—one of many types of BELL sound equipment—provide instant speaking contact between all executives in any firm—or between individual executives and any number of subordinate stations. Write at once for complete details.

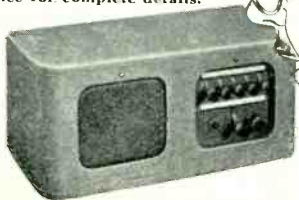

BELL SOUND SYSTEMS
Incorporated
1108 ESSEX AVE., COLUMBUS 3, OHIO
Export Off., 4909 Euclid Ave., Cleveland 3, Ohio.

on the meter with S_2 set to position Q . The voltage gain across the coil is read off the calibrated dial of P .

Owing to the low impedances used, the error due to shunt capacitance will be negligible, and the calibration of the potentiometer may be carried out at low frequencies or based on the d-c resistance values: $Q = (A + R_1)/R_1$. The dial is calibrated from 1 to 10, and a multiplier switch S_1 extends the measuring range up to 50 times. The total measuring range thus covers values of Q from 1 to 500. At the same time, the multiplier arrangement serves to lower the effective source resistance for high- Q inductors.

Circuit of Instrument

The vacuum tube voltmeter consists of a cathode follower tube VT_1 , amplifier VT_2 , rectifier VT_3 , and a balancing tube VT_4 . The same type of tube may be employed throughout. The English type EF50 was used in the original model, and is believed to be similar to the American type 58. The sensitivity with a 0-1 ma milliammeter for the arrangement given is one volt rms for

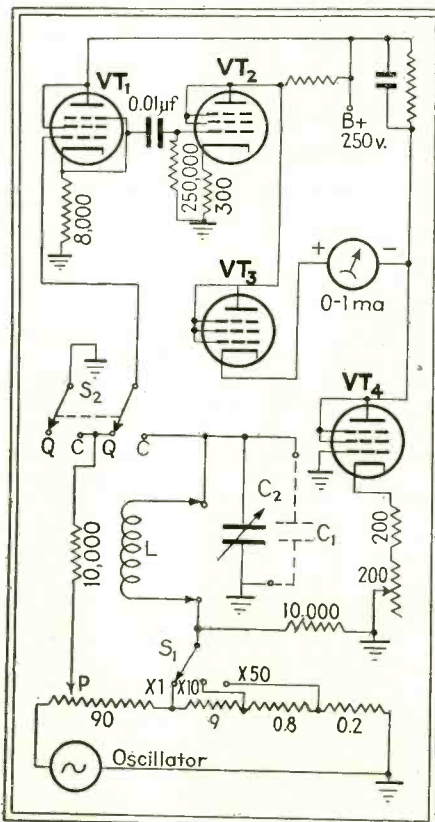

Fig. 2—Complete diagram of the instrument. Tube VT_1 is employed as a cathode follower to maintain high input resistance

HUNTER HEATER ADAPTABLE FOR LAND AND AIR SERVICE UNITS

High or Low Test Gasoline Burner Solves Problems in Heating Field Equipment; Trucks, Trailers and Aircraft

UTILIZES "SEALED IN STEEL" FLAME

CLEVELAND, OHIO—The problem of efficiently using all types of gasoline in one simple device for heating, has been solved by a group of Cleveland engineers. As a result, equipment made for use of the armed forces now can be fitted with heating units utilizing whatever gasoline is at hand, ordinary truck gasoline or 100 octane aircraft fuel.



Hunter Universal Gasoline Heaters are serving the armed forces in many ways which cannot be described, but it is an uncensored fact that they can be successfully used for heating and ventilating

trailers, busses, trucks, mobile photo laboratories, field hospitals, truck or trailer-mounted field repair shops, shelters for radar and radio equipment. Also for heating and ventilating tents, portable houses, field or permanent barracks for officers, and similar housing. Certain models can be used for standby heating of truck or plane engines to assure starting in severe weather, and for cabin heating in busses and aircraft.

Wherever personnel or equipment goes, the same type of gasoline that takes them there can be used for fuel in Hunter Universal Gasoline Heaters. The simple gasoline burner also is available in an automatic water heating tank, ideal for trailers or mobile service units.

To make this handy heating available to everyone manufacturing service equipment, as well as to procurement officials in various branches, Hunter and Company have an engineering group whose job is to search out new applications of their basic heating and ventilating units, and to work out adaptations for any specific heating and ventilating problem. A bulletin is available which briefly describes the standard models, the basic principal of the burner and the general purposes for which they are suitable. It is called "Bulletin HA-2".

Full information, or a consultation with a representative, may be had by writing or wiring Hunter and Company, 1558 East 17th Street, Cleveland 14, Ohio.

(Advertisement)

full-scale deflection. The input impedance of the voltmeter is very high owing to the use of the cathode follower tube, so that loading of the tuned circuit is negligible. The meter scale is practically linear. The meter scale is practically linear.

Negative feedback is used to stabilize the circuit with regard to changes of circuit components and variations in the supply voltages. The bridge arrangement serves as a safeguard for the meter, a pre-set zero control being provided in the cathode circuit of balancing tube *VT*.

The vacuum tube voltmeter, apart from its function as an indicator, registers the voltage applied across the coil. Its calibration, as well as that of the variable capacitor, may conveniently be carried out by the use of the internal voltage divider.

Applications of Tester

For rapid routine tests the meter reading itself may be employed as the indication of the value of *Q*. In this case the voltage injected into the resonant circuit is adjusted at the source to produce a deflection of one volt with *S*, set to *Q* and *P* set to maximum output. With *S*, moved to *C*, measurements are then limited to the calibrated frequency range of the vacuum tube voltmeter, as well as to the specified signal voltage.

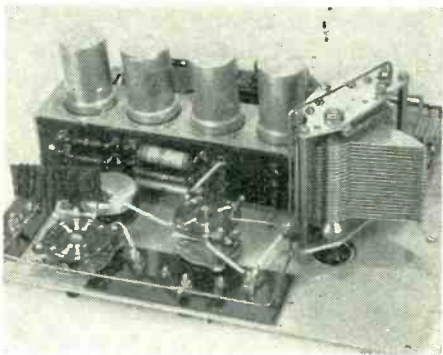

Use of standard circuit components in the completed *Q* meter permits the assembly shown above. Four shielded tubes are employed

Calibration of the meter in volts enables use of the instrument for variation methods. Measurements of this type may be of advantage in certain cases where it is required to determine the series loss resistance or the selectivity of a tuned circuit directly. Reactance variation methods may be carried out merely by observing the meter reading and detun-

"SEALED IN STEEL"

Flame

**Burns ANY
Type of GASOLINE**

HUNTER UNIVERSAL GASOLINE HEATERS

have a hundred handy uses—heating, ventilating and providing automatic hot water supply in trailers, busses, trucks, field service shops, hospital stations, photo laboratories, mapping stations; for portable or permanent installation in barracks, storage buildings, radio and radar shelters. • Many other special applications that may include one of YOUR problems. • Write or wire for bulletin No. HB-3 or for a test under your specifications.

Typical Hunter unit at right has capacity of 20,000 to 40,000 B.t.u. per hour, with 400 C.f.m. air circulation. Others from 10,000 to 60,000 B.t.u. capacity. Also assemblies for duct installation . . . Automatic water heating units.



HUNTER AND COMPANY

Aircraft Equipment

1558 E. 17th St.

CLEVELAND • OHIO

The DP-B has a total of 10 contacts. Six 15 amp contacts, two 30 amp contacts, two coaxials for radio antenna. The coaxials can be removed for soldering without disturbing other contacts.

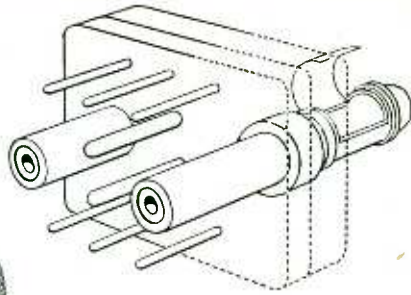

CANNON CONNECTORS help set new production "highs"

In new secret applications, electronics have become the nerve center of our armed forces . . . and electronic devices are helping almost every war industry roll back the old limits on productive capacity.

After Victory's won, the peacetime possibilities of electronic products are limitless . . . and since electrical circuits are involved, Cannon connectors will naturally play an important part in their operation.

In either war or peace, Cannon connectors are the finest development in electrical plugs. They assure absolute dependability of

operation under all conditions . . . they are easy to service . . . adapted to quick assembly...and applicable to any industry.

Send for your copy of the new 24 page bulletin on Cannon DP Connectors. Gives general information and description of parts, applications, dimensional sketches and tabular matter. Write Department A-120, Cannon Electric Development Company, Los Angeles 31, California.



CANNON ELECTRIC

Cannon Electric Development Co., Los Angeles 31, Cal.
Canadian Factory and Engineering Office: Cannon Electric Co., Ltd., Toronto



REPRESENTATIVES IN PRINCIPAL CITIES — CONSULT YOUR LOCAL TELEPHONE BOOK

ing capacitor C_2 or changing the frequency at the source.

Resistance variation measurements are carried out by connecting a standard resistance box in series with the inductor at terminals L .

If at resonance the resistance is increased from zero to a value R , such that the voltage reading is reduced to half its original value, then $R = R_s$, where R_s is the total effective series resistance in the tuned circuit.

The equivalent impedance R_p of the tuned circuit may be found in a similar manner, provided the stray capacitances are not unduly large. For this purpose the coil is connected to terminals available for an auxiliary capacitor C_1 , the resistance box remaining at L . The use of S_1 with P at minimum facilitates this measurement. For inductors having Q values greater than about 10, the following approximations relating Q to R_s and R_p may be used: $Q = \omega L/R_s = R_p/\omega L$ where ω is 2π times the frequency.

In the above measurements the inductance of the coil under test is evaluated from the capacitor setting required for resonance: $L = 1/\omega^2 C$. The tuning range may be extended by connecting external capacitors at C_1 .

Distributed Capacitance

The instrument further lends itself to the determination of the distributed capacitance and the natural period of inductors. A convenient method is to note the capacitance readings C_1 and C_2 required to tune the coil to resonance at two frequencies f_1 and f_2 , having a ratio of $1:\sqrt{2}$. The self-capacitance of the coil is then given by $C_s = C_1 - 2C_2$. The resonant frequency of the coil by itself is

$$f_r = f_1 \sqrt{(C_1 - C_2)/(\frac{1}{2}C_1 - C_2)}.$$

Resistor & Capacitor Measurements

Measurements on capacitors are carried out with a previously calibrated inductance connected at L . Neglecting the losses in C_2 , the reciprocals of the Q values of the coil (Q_L) and of the capacitor (Q_C) are additive, and thus $1/Q = 1/Q_L + 1/Q_C$. From this, the power factor, the phase difference, etc., may be evaluated.

The capacitance of capacitors may be determined directly by substituting

Norelco

**Creates new aids to Victory
—and to American industry**

BACK of the Norelco name and trademark is a deep heritage of technical research in the electrical field, and a reputation for electronics development which has earned the respect of engineers the world over.

Today, Norelco products are dedicated exclusively to Victory. This is the biggest job in the world today, and one to which all our efforts and resources are directed.

Tomorrow, Norelco products will make today's aids to Victory profitably available to the peacetime pursuits of American industry. Tomorrow, Norelco precision and craftsmanship will help American industry achieve new standards of perfection wherever electronic devices are used.

Be sure you share in these new developments by asking us to put your name on the Norelco mailing list today. Your inquiries and problems will be welcomed by Norelco engineers.

Products for Victory include: Cathode Ray Tubes; Amplifier Tubes; Rectifier Tubes; Transmitting Tubes; Oscillator Plates; Tungsten and Molybdenum in powder, rod, wire and sheet form; Tungsten Alloys; Fine Wire of all drawable metals; bare, plated and enameled; Diamond Dies, Searchray (X-Ray) Apparatus for industrial and research applications; X-Ray Diffraction Apparatus; Electronic Temperature Indicators; Direct Reading Frequency Meters.

**Norelco ELECTRONIC PRODUCTS
NORTH AMERICAN PHILIPS COMPANY, INC.**

Main factory and offices in Dobbs Ferry, N. Y.; other factories at Lewiston, Maine (Elmet Division); Mount Vernon, N. Y. (Philips Metalix Corp.) Industrial Electronics Division, 419 Fourth Avenue, New York 16, N. Y.

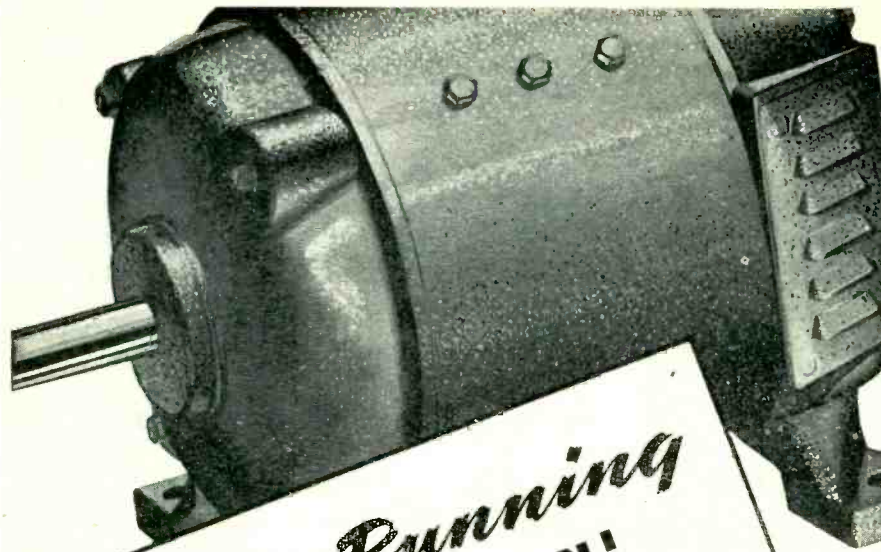

Keep 'Em Running FOR THE DURATION!

It is difficult to secure new Generating Sets or new Rotary Converters . . . Pioneer is devoting all of its resources toward winning the war . . . but we can, and will, help you keep your present equipment running for the duration. Send your service problems, by letter, to Pioneer's Customer Service Department.

DYNAMOTORS · CONVERTERS · GENERATORS · DC MOTORS · POWER PLANTS
GEN-E-MOTORS

PINCOR Products

PIONEER GEN-E-MOTOR
CHICAGO, ILLINOIS · EXPORT ADDRESS: 25 WARREN STREET, NEW YORK CITY
CABLE ADDRESS: SIMONTRICE, NEW YORK CITY

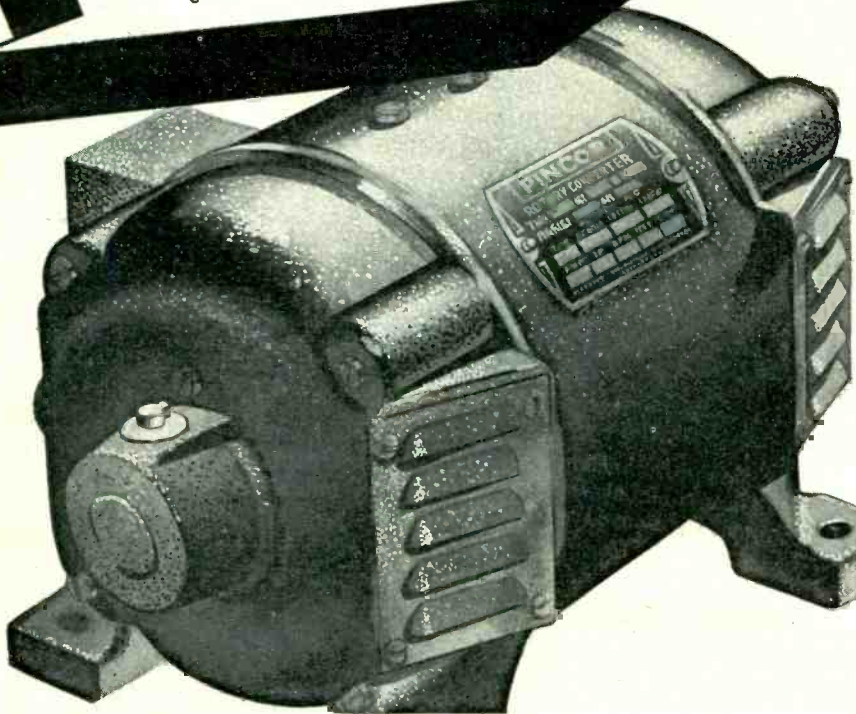

tion of the unknown capacitor at C_1 , observing the change in the setting of C_2 required to establish balance with and without the unknown capacitor. Another application of the instrument is measurements of high-frequency resistance, residual reactance, and phase angles of resistors. In the case of low resistance the resistor is connected in series with a previously calibrated inductor at L . High resistances are more suitably applied across the tuned circuit, at terminals C_1 . The results are obtained from observation of the drop in voltage gain and the magnitude and sign of the change in the tuning capacitance C_2 , using the expressions given above.

The examples given by no means exhaust the possibilities of the instrument. The use of special test jigs enables the adaption of the apparatus for measurements of the dielectric losses and permittivity of solid dielectrics, the permeability of core materials, characteristics of liquid dielectrics, etc.

• • •

Machine for Calculating Polar Diagrams

A MACHINE THAT PLOTS the polar radiation pattern of any directional array of vertical antennas in a few minutes is described by H. Paul Williams in a recent issue of *Electrical Communication*.

The machine contains selsyn motors having a three-phase stator and a single-phase rotor. They are used as transformers rather than motors, to take advantage of the fact that their windings are such that the phase of the emf in the rotor is exactly proportional to the angular position of the rotor. When a number of such motors are connected with their three-phase primaries in parallel, the phases of the voltages in the rotors used as secondaries will be determined by the angular positions of the individual rotors.

The rotors do not revolve in the usual manner, but are restrained in certain angular positions to represent the phases of the received voltage components. The magnitude of each voltage vector can be adjusted to correspond to a given antenna current by a potentiometer across each secondary. The vector sum of all the



PLUGS

are Vital

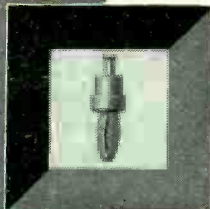

Where connections must be made and broken quickly and where these connections occur thousands of times in the life of the apparatus, only

plugs are practical. In most cases, proper functioning of the apparatus demands a perfect connection, combining qualities of low resistance, mechanical stability and long life.

Now, the lives of our fighting men depend on such small things as plugs. There can be no compromise in engineering design, in the quality of materials, in the honesty of manufacture. A few cents per thousand in the cost of plugs can cost the lives of hundreds of men in Europe or the Pacific.

Let Johnson, one of the pioneers in the manufacture of plugs and jacks, suggest a plug and jack combination for YOUR requirements in YOUR apparatus. Johnson has production capacity and a type for every requirement. Samples are available. Inquire today.

Free on Request
CATALOG 967D



JOHNSON

a famous name in Radio

FINDING COLD FACTS

ABOUT WAR-NEEDED INSTRUMENTS

LOT TESTING of frequency meters at the plant of Allen D. Cardwell Mfg. Corp., Braoklyn, N. Y. Note the panel of twelve meters. This method permits temperature testing of a large number of meters at one time. During testing at sub-zero temperatures, operators work in comfort at room temperature.

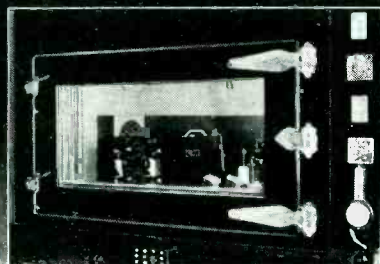

HOW'S YOUR ARCTIC BEHAVIOR? That question is answered in advance as far as these condensers, transformers and other instruments are concerned. The effects of cold and sudden drops in temperature can be observed during test through the hermetically sealed multiple panes of glass, in this AMCOIL RTC-1XX Testing Chamber.

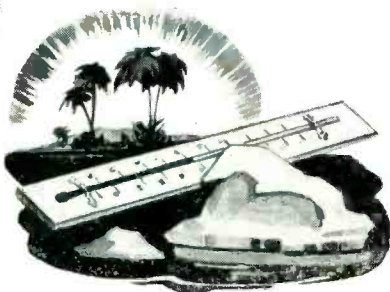

AMERICAN COILS CO.

25-27 LEXINGTON STREET • NEWARK, N. J.

HER FINGER TIPS HAVE AN ICY TOUCH. Plunging her arm into a protective sleeve, this operator makes hand adjustments on radia parts being tested in this AMCOIL humidity and temperature test chamber. As used at the Cardwell plant, this way of making adjustments has proved its advantage over shaft tests, because of direct finger tip contact with units tested.



THESE TESTS HELP THEM. Members of the U. S. Army Signal Corps will use instruments which pass the tests shown in the foregoing series of photographs. Such equipment is vital to keeping communication channels open. Radio parts as well as troops must be seasoned.

The Amcoil Testing Chambers used at the Allen D. Cardwell Mfg. Corp. are regular models containing special testing accessories developed by that company's engineers working closely with Amcoil technical men. The temperature range of these chambers is from -56.7° C. (-70° F.) to $+70^{\circ}$ C. ($+160^{\circ}$ F.). Inside dimensions of chamber—52 in. long, 30 in. deep, 27.5 in. high. Amcoil consultation and advisory engineering service is at your disposal on test chambers for essential war purposes now—or testing operations for post-war activity.

secondary voltages is obtained by connecting the secondaries in series and by measuring the total voltage with a high-impedance voltmeter.

The angle of phase of the voltage depends upon the rotor position and is obtained mechanically by an arm and pinion arrangement. The magnitude of the a-c voltage in each rotor is adjusted to be proportional to the antenna current. Each antenna is represented by a motor and its corresponding mechanical linkage, and the complete assembly of linkages is driven off one main shaft. The exploring angle is read from a dial marked in degrees and the corresponding relative amplitude is shown on the voltmeter.

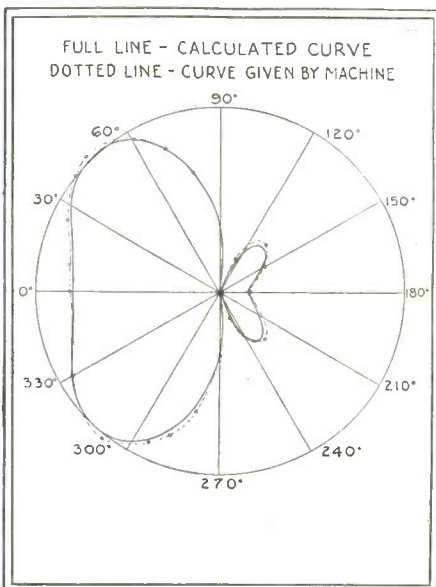

Comparison of calculated curve of polar diagram of typical antenna system and the curve obtained from the machine

A polar diagram for a typical antenna system is shown in the illustration. In this the solid line is the curve plotted by the usual calculations and the dotted line is the curve obtained from the machine. The accuracy varies at different degrees of rotation from zero to five percent. Since the accuracy of the seisin motors is two percent the differences are due to mechanical linkage in the machine.

The author states that the device has also been useful in determining the current and phase relationships which must exist in an antenna system when a certain polar pattern is measured in the field. In one case

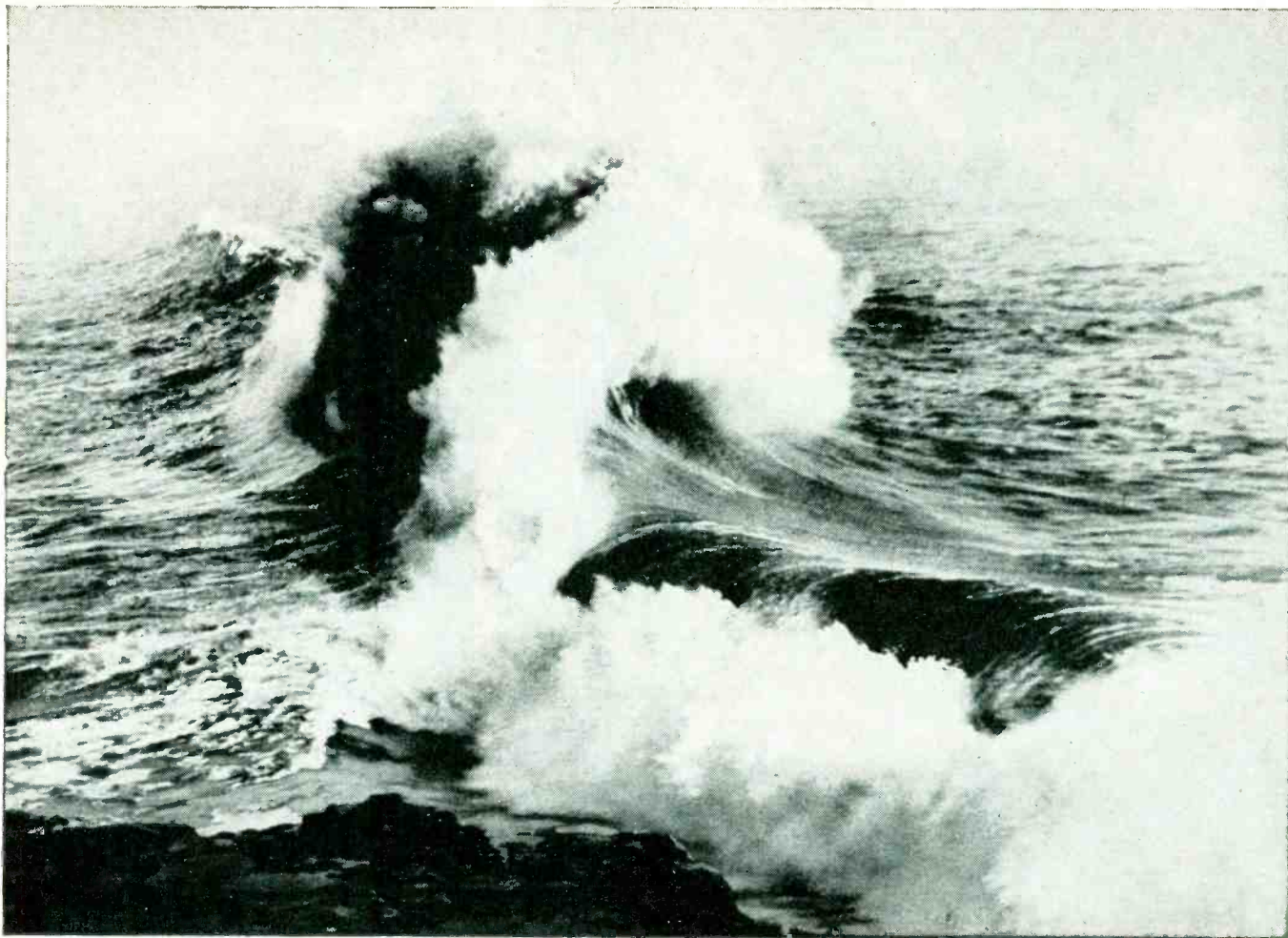

This is the reason they called the tube **KLYSTRON***

Does it seem far-fetched to you?

Can there be any possible similarity between an ocean wave and an ultra-high frequency tube?

As a matter of fact, there's a very definite similarity.

A breaking wave is the best way we know to picture what happens to electrons in the KLYSTRON tube invented by the Varian brothers—Russell and Sigurd—and Dr. William W. Hansen.

Inside this tube, the inventors were able to direct a stream of electrons which concentrated their power and released it much as waves do when they mount into crests and crash on the shore.

That's why the tube is called KLYSTRON. The name comes from a Greek word that denotes the breaking of waves on a beach.

Initial research on the KLYSTRON was done in California at Stanford University. The Sperry Gyroscope Company was quick to see the tube's possibilities. So they helped the inventors carry on further development of the KLYSTRON as a valuable tool of war and aeronautics.

When the tube got beyond the early experimental stages, the Varian brothers and Dr. Hansen joined Sperry's staff of inventors, engineers, and research men.

With the close co-operation of the

Army and Navy, the development and perfection of the KLYSTRON continued, and is still continuing.

Applications of the KLYSTRON include the generation, amplification, and reception of ultra-high frequency waves. Naturally, they are being devoted exclusively to war uses at present.

When the war is won, Sperry research will explore the fascinating field of KLYSTRONICS** in relation to the comfort and security of a world at peace.

SPERRY
GYROSCOPE COMPANY, Inc.
BROOKLYN, N. Y.
Division of the Sperry Corporation



*KLYSTRON is a registered trademark of the Sperry Gyroscope Company—Registration No. 371650.

**Trademark

M-R Extruded

PLASTIC TUBINGS

MIRAFLEX
MIRATEN
MIRALON
MIRAGLAS
MIRADIE

MITCHELL-RAND
for
54 YEARS
THE ELECTRICAL
INSULATION
HEADQUARTERS

non-combustible
extremely high dielectric
great tensile strength
solders successfully
ages very well
flexible and elastic
resists solvents
resists high and low temperatures
resists abrasion
won't brittle
thin or thick walls
moisture proof
made in transparent and six colors

	MIRAFLEX	MIRATEN	MIRALON	MIRAGLAS MIRADIE
Dielectric Strength 020 Wall Dry Wet	750 VPM 350	1000 VPM 1000	1000 VPM 1000	850 VPM 815
Water Absorption after 34 hours	1.5%	0.5%	0.6%	0.4%
Tensile Strength lbs. per sq. in.	2,150	4,000	4,000	3,000
Life at 105° C.	400 hrs.	1,000 hrs.	1,000 hrs. (plus)	
Resistance to Brittleness	Does not become brittle or shatter at —40° F. —58° F. —50° C.			
Wemco Oil Test 48 hours.—100° C.	All grades passed satisfactorily			



FREE FOR YOUR ASKING.—A Sample Card of Varnished Tubings; samples to fit sizes from B&S wire #20 (.032") to #0 (.325")... a Wall Chart with quick easy to read reference tables of electrical symbols, capacity of conductors, dielectric averages of insulating materials, mathematical tables, tap drill sizes, standards of varnished tubing sizes... Wax and Compound Guide Book and the M-R Book of Electrical Insulations.

ALL ARE FREE FOR YOUR ASKING . . . WRITE FOR THEM ON YOUR LETTERHEAD

MITCHELL-RAND INSULATION COMPANY, INC.
51 MURRAY STREET **Cortlandt 7-9264** **NEW YORK 7, N. Y.**

Fibreglas Varnished Tape and Cloth
 Insulating Papers and Twines
 Cable Filling and Pothead Compounds
 Friction Tape and Splice
 Transformer Compounds

A PARTIAL LIST OF M-R PRODUCTS
 Fibreglas Braided Sleeving
 Cotton Tapes, Webbing and Sleeveings
 Impregnated Varnish Tubing
 Insulating Varnishes of all types

Fibreglas Saturated Sleeving and Varnished Tubing
 Asbestos Sleeving and Tape
 Extruded Plastic Tubing
 Varnished Cambric Cloth and Tape
 Mica Plate, Tape, Paper, Cloth and Tubing

the field patterns were not as expected from theory, the departure being outside the bounds of normal measuring errors. In order to discover the actual phase relationships and phase magnitudes of the currents in the antenna, a series of polar diagrams were made on the machine. The true phases and currents in the antenna were found by taking the polar diagram which most closely corresponded to the actual field pattern.

• • •

Protective Metal Finishes

THE EXTENSIVE USE OF various metals, widely differing in chemical and physical properties, for scientific instruments and apparatus brings many problems in providing satisfactory protective coatings and finishes for metal surfaces. A comprehensive symposium on this subject appears in the June 1943 issue of the *Journal of Scientific Instruments*, a British publication.

Of the sources of corrosion, solution potential differences are probably the greatest problem. The solution potentials of metals and alloys depend upon the solutions to which they are exposed, and potentials approaching two volts are not uncommon. The potential difference is a measure of the force tending to cause corrosion currents but the rate of corrosion due to contact of dissimilar metals depends on the magnitude of the corrosion currents and these are much affected by the surface film formation and polarization effects. To obtain improved resistance to corrosion the use of chemical treatment of metals and alloys to provide a protective finish is often resorted to. Methods of treatment are reviewed at length in one article of the symposium.

Aluminum possesses a natural resistance to corrosion since it forms a thin layer of oxide on its surface. This resistance is generally reduced, however, when its mechanical strength is increased by alloying and is particularly decreased in alloys of aluminum that contain heavy metals. The anodic oxidation of aluminum and its alloys to minimize this condition is also treated in the symposium. A third article deals with the problem of obtaining a uniform, protective surface on metals by applying paints and varnishes.

An Important Message to Technical Men

The war has carried the manufacturing age to a new peak! Production demands have created technical problems the like of which the world has never seen before! The services of engineers are at a premium. Especially the services of one particular class—executive engineers—*engineers with business training*; engineers who can "run the show."

In these critical times, the nation needs engineers of executive ability *now, today*—not five, or ten years from now! The shortage of such men is acute—even more acute than that of skilled production workers. And company heads, aware of this situation, are offering high rewards to engineers who have the necessary training in industrial management.

Golden Opportunity for Engineers

In this new era, the engineer with vision and foresight has a golden opportunity. He will realize that out of today's tremendous production battles will emerge technical men who not only will play a major role in winning the war, but who also will be firmly entrenched in key executive positions when peace comes.

However, before the engineer can take over executive responsibilities, he must acquire knowledge of the other divisions of business—of marketing, accounting and finance. He has of necessity a vast amount of technical training and experience. But in order to grasp the opportunities that present themselves today—to assume leadership on the production front—he must *also* have an understanding of practical business principles and methods.

The Alexander Hamilton Institute's intensive executive training can give you this essential business training to supplement your technical skill.

FREE help for engineers

Ever since the war began, there has been an unusually heavy demand on the part of our technically-trained subscribers for the Institute's special guide on "How to Prepare an Engineering Report". Extra copies of this practical, helpful 72-page Guide are now available and, for a limited time only, will be sent free to all technical men who use the coupon at the right.



134,000 men on the operating side of business have enrolled for this training. More than 37,500 are technical men—engineers, chemists, metallurgists—many of whom are today heads of our huge war industries.

This training appeals to engineers because it gives them access to the thinking and experience of the country's great business minds. It is especially valuable to such men because it is basic, not specialized—broad in scope, providing a thorough groundwork in the fundamentals underlying *all* business. It covers the principles that every top executive must understand. It applies to all types of industrial organizations, because all types of organizations are based on these same fundamentals.

Business and Industrial Leaders Contribute

The Institute's training plan has the endorsement of leading industrialists and business men. And it is only because these high-ranking executives recognize its value and give their cooperation that such a plan is possible. Among those who contribute to the Course are such men as Frederick W. Pickard, Vice President and Director, E. I. DuPont de Nemours & Co.; Thomas J. Watson, President, International Business Machines Corp.; James D. Mooney, President, General Motors Overseas Corp.; Clifton Slusser, Vice President, Goodyear Tire and Rubber Co. and Colby M. Chester, Chairman of the Board, General Foods Corp.

Send for

"FORGING AHEAD IN BUSINESS"

The facts about the Institute's plan and what it can do for you are printed in the 64-page book, "Forging Ahead in Business". This book in its own right is well worth your reading. It might almost be called a handbook of business training. It is a book you will be glad to have in your library, and it will be sent to you without cost. Simply fill in and mail the attached coupon *today*.

Alexander Hamilton Institute, Inc.
Dept. 57, 73 West 23rd Street, New York, N. Y.
In Canada, 54 Wellington St., West, Toronto Ont.
Please mail me a copy of the 64-page book—"FORGING AHEAD IN BUSINESS" and also a copy of "HOW TO PREPARE AN ENGINEERING REPORT," both without cost.

Name.....
Business Address.....
.....
Position.....
Home Address.....



This Portable Electric Megaphone was used at Pearl Harbor and is now in use in various branches of our Armed Forces from the Tropics to the Arctic.

GUIDED RADIO CORPORATION

161 Sixth Ave.

New York 13, N. Y.



New Mathematical Tables

THREE TABLES THAT may save a great deal of laborious computation have been made available by the National Bureau of Standards, Washington, D. C.

Mathematical Table MT 17 is in two parts. The first deals with Planck's radiation functions and evaluates four functions of λT relative to their maximum values. The second part of this table consists of 28 pages and gives in five columns the values for the velocity of an electron relative to the velocity of light, the energy in electron kilovolts, and the curvature of the electron path in a magnetic field times the field. Copies are priced at \$1.50.

The zeros of the Legendre polynomials of order 1-16 and the weight coefficients for Gauss' mechanical quadrature formula are tabulated in Mathematical Table MT18, obtainable from the Bureau at 25 cents.

A table of confluent hypergeometric functions, Mathematical Table MT19, is also priced at 25 cents.

• • •

Emissive Plates for Pentodes

ALTHOUGH THE PRIMARY function of a suppressor grid in a pentode is elimination of secondary emission, the purpose is somewhat defeated when the suppressor grid is wound as an open, pitched spiral. An invention described in *Wireless World* (British) and assigned to Philips Lamps, Ltd., proposes to overcome this condition by coating the plate and screen grid with an emissive material.

The inventors suggest that a material such as caesium oxide, which is highly emissive, be used. Although the total secondary emission is increased over that from ordinary nickel or molybdenum elements, the content of fast-moving secondary electrons is smaller. Braking action of the open pitched suppressor is sufficient to prevent the passage of the comparatively slow electrons, though it fails to stop those traveling at high speed.

—❖—

WITHIN EARSHOT today of the nine FM stations in the New York area are more than 80,000 FM receivers, according to an FMBI report.

A UNIQUE ENGINEERING GROUP IS READY TO ROLL UP ITS SLEEVES FOR YOU!

FOR wartime production or postwar planning...in the application of existing devices or the development of new designs...we are ready to help you harness the miracle of electronics to your specific needs. We have the background: 65 years of constant cooperation with the communications industry in all its phases. We have the facilities: military and government agencies may tell you some of the story. And we are neither too big to bother with small problems . . . nor too small to



succeed with big ones. Can we get together?

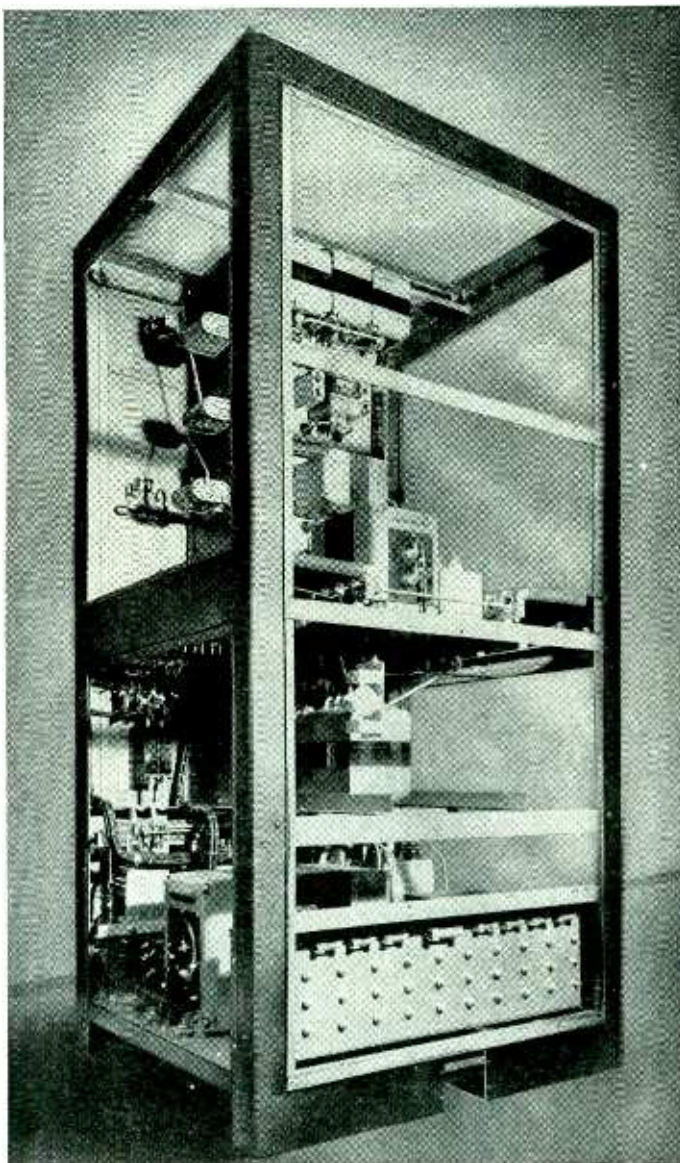

J. H. BUNNELL & Co.

GENERAL OFFICES: 215 Fulton St., New York City · FACTORIES at Brooklyn, N. Y.

Designing Engineers and Manufacturers of:

ELECTRONIC INDUSTRIAL DEVICES ★ INDUSTRIAL RECTIFIERS
HIGH POWER RADIO FREQUENCY GENERATORS ★ TRANSMITTERS
RECEIVERS ★ AUTOMATIC TELEGRAPH EQUIPMENT

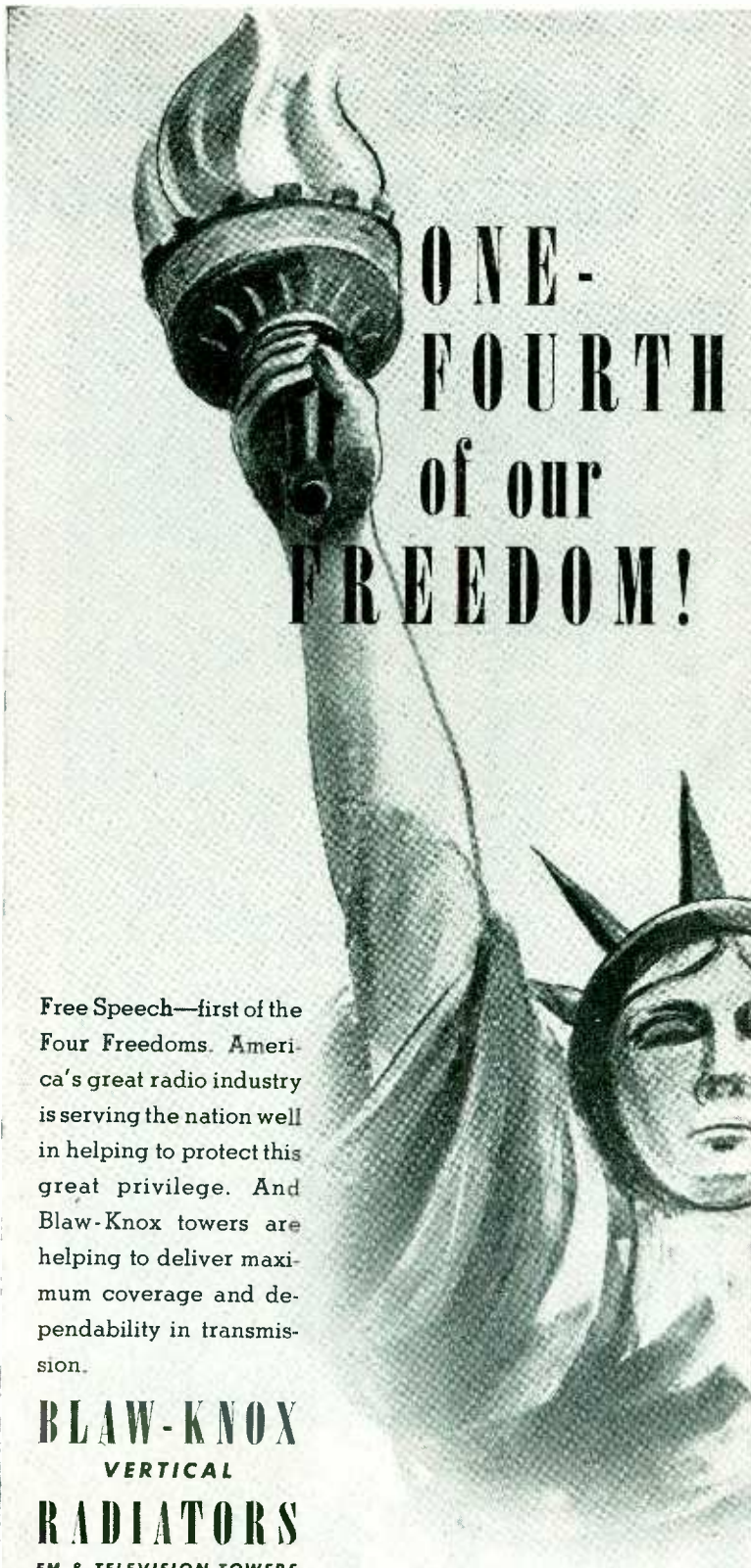

Free Speech—first of the Four Freedoms. America's great radio industry is serving the nation well in helping to protect this great privilege. And Blaw-Knox towers are helping to deliver maximum coverage and dependability in transmission.

BLAW-KNOX
VERTICAL
RADIATORS
FM & TELEVISION TOWERS



DISTRIBUTOR
Graybar
ELECTRIC COMPANY

BLAW-KNOX DIVISION of Blaw-Knox Company
Farmers Bank Building . . . Pittsburgh, Pa.

R-F Heating

(Continued from page 107)

would be of great value in reducing the cost of molded parts on small-run orders, since for small quantities the cost of the necessary molds is a major item.

Elements of the R-F Circuit

The radio-frequency equipment for r-f preheating obviously can be any unit capable of supplying sufficient energy at the required frequency. Although most of the units used for this particular purpose are oscillators, they are usually called r-f generators. This seems good practice since the term is more or less generic and can be assumed to cover oscillator-amplifiers and other types of controlled circuits which may come into use later.

Several companies are presently manufacturing r-f generators for preheating of plastics, with indications that there will be more. These generators vary in size and in various minor details, although in major respects they are much alike. Consideration of equipment will be confined at this time to a brief description of the unit shown in Fig. 10, which is more or less representative.

The unit pictured is a 2-kw generator (output rating) adapted from a radio transmitter design. A simplified schematic of the circuit is shown in Fig. 11. The circuit is that of a simple Colpitts-type oscillator. A pair of 833-A's connected in parallel are used as oscillators. The rectifier (not shown in schematic) employs four 872-A's in a single-phase, bridge-type circuit. Fairly extensive control, metering, and protective circuits are provided.

The load impedance presented by a preform between metal plates (the electrodes) is, of course, capacitive. It is usual to series-resonate such a load. In the unit shown, the series-tuned output circuit is tapped across the tank coil of the oscillator. Tuning of the load circuit is accomplished by means of inductances L_1 and L_2 . The main tuning inductance, L_3 , is made large so that a wide variation in preform sizes (from small in cross-section and tall in height to large in cross-section and small in height) can be tuned. In order to obtain close control of tuning, a much smaller inductance of the "trolley-rider" type is connected across part

BOMBS AWAY OVER TARGETS FARTHER AWAY

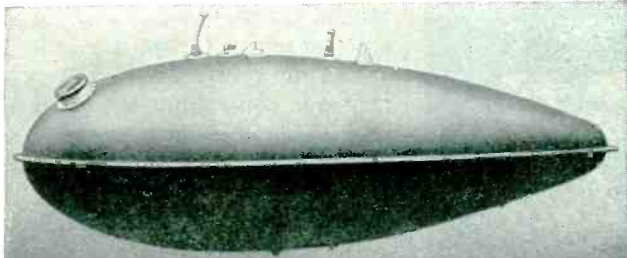

A **JETTISON GAS TANK*** made of National Vulcanized Fibre by U. S. Rubber Co. These auxiliary gas tanks are hooked beneath the wings or fuselage of a plane. When empty they may be dropped to reduce "air friction." Produced in sizes, 50 to 250 gallons capacity.

Thanks to the development of jettison gas tanks made of lightweight, strong National Vulcanized Fibre, our army planes get increased gas loads, providing wider flying range . . . our aviators are able to carry the fight farther away . . . are able to ferry planes longer distances. This use of National Vulcanized Fibre is typical of the war work of our company . . . supplying materials for everything that "flies, floats or shoots."

NATIONAL VULCANIZED FIBRE CO.

WILMINGTON

Offices in



DELAWARE

Principal Cities

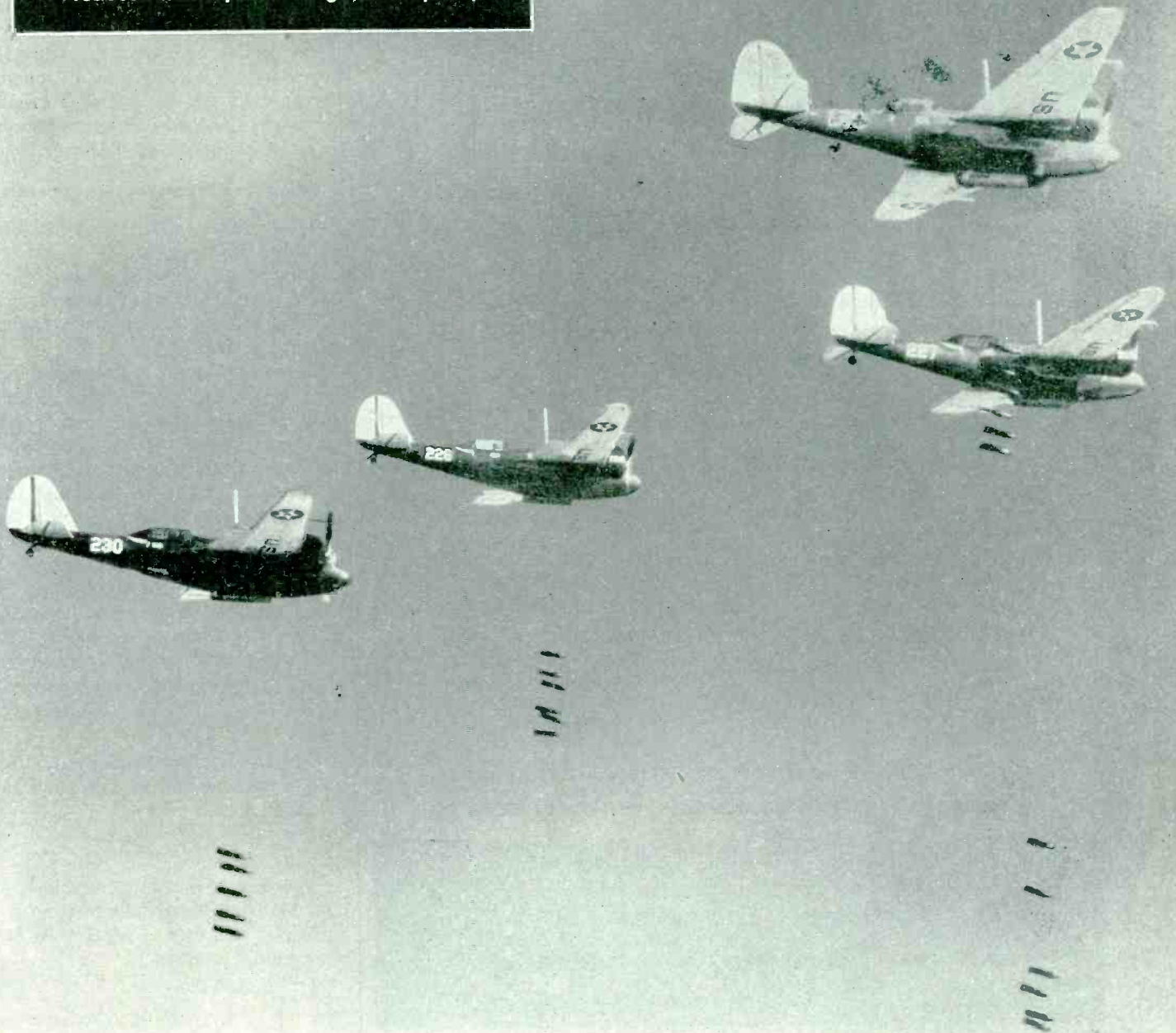

★ In a Hurry . . .

REMLER Plugs and Connectors

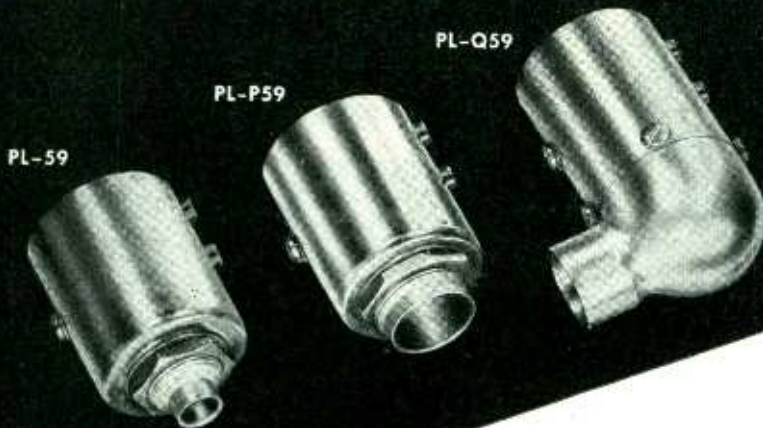

Made to
**ARMY SIGNAL
CORPS SPECIFICATIONS**

Remler made plugs and connectors of the following types are used by more than fifty concerns engaged in manufacturing communications equipment for the U. S. Army Signal Corps:

Types:	PL				PLP		PLQ		PLS	
50-A	61	74	114	150	56	65	56	65	56	64
54	62	76	119	159	59	67	59	67	59	65
55	63	77	120	160	60	74	60	74	60	74
56	64	104	124	354	61	76	61	76	61	76
58	65	108	125		62	77	62	77	62	77
59	67	109	127		63	104	63	104	63	104
60	68	112	149		64		64			

Special Designs to Order

Remler is equipped to manufacture other plugs and connectors of special design—in large quantities. Submit specifications.

Prompt Delivery • Inspection

Signal Corps inspectors in attendance. Uniformity assured—no rejects. Write, wire or telephone if we can be of assistance.

Remler facilities and production techniques frequently permit quotations at lower prices

*Manufacturers of Communication Equipment
SINCE 1918*

REMLER COMPANY, Ltd. • 2101 Bryant St., • San Francisco, Calif.

of the larger inductance. Motor-drive is provided, the motor being controlled by pushbuttons on the front panel. This is the only tuning control on the front panel. A variable capacitor, *C*, which can be seen at the top center in Fig. 10, is used only for controlling the grid feedback. This need be varied only when changing to preforms of markedly different size.

The lead to the high-voltage or so-called hot electrode is brought out of the cabinet through a bowl-insulator. In the simplest case, the top electrode is a brass plate which rests directly on the preform. A spring arrangement allows for the swelling which occurs when heating some preforms. In the case of specially shaped preforms, it is sometimes necessary to use shaped electrodes, and in some cases it is necessary to allow a small spacing between electrode and preform (which requires supporting the top electrode). The use of spacing is generally undesirable as it greatly increases the load voltage, with consequent likelihood of flashover.

Power and Frequency Requirements

There has been much wishful thinking in regard to radio-frequency power, some of which has, in effect, attributed to r-f the ability to cause heating out of all proportion to the power used.

Obviously, there is nothing magical about r-f energy in this respect, at least. The same number of Btu are required to heat a given weight of material to a required temperature, regardless of whether the heating agent is steam or radio frequency. The cost of providing this power, the efficiency with which it may be delivered into the load or the time required may vary, but the power which must be delivered to the load is the same and is given by a very simple physical law, namely

$$H = Sw\Delta T \quad (1)$$

where

H is the total heat delivered in Btu
S is specific heat of substance being heated

w is weight of substance in lb

ΔT is temp. change in deg. F

This gives the total amount of heat required, regardless of time (or method). The rate of heating in Btu per minute is given by

$$H/t = Sw\Delta T/t \quad (2)$$

where *t* is the heating time in min-



Type PM
(NAF-1131)
Circuit Breaker

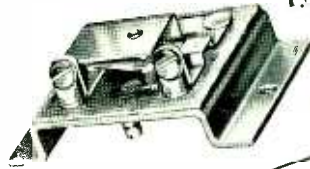

Type C-4351 Series.
Used for
Tube Warming,
Tube Cooling,
and High
Limit Controls



Type C-6363
Switch Circuit
Breaker



Type RT Adjustable
Crystal Temp.
Oven Control



Type B-3120
Crystal Dew Point
Control



Type C-2851 Series.
Used as Roughing
Controls on Outer
Crystal Ovens



Type ER Series
Ambient Compensated
Time
Delayed Relays

They come up from
the School of

HARD KNOCKS

LIFE in a tank, or a plane, or an Army truck is no bed of roses . . . but Klixon Controls seem to thrive on it. And there's a mighty good reason.

All Klixon Controls are snap-acting. They are actuated by a simple, scientifically calibrated thermostatic disc which is not effected by vibration, shock, motion, altitude or position of mounting. And that is why you can always use Klixon Controls on jobs associated with hard knocks.

Small, simple, and fool proof in operation, Klixon Controls are available for many uses . . . motor and transformer overheat protection, electrical circuit overload protection, circuit breakers, temperature control, as well as many uses in radio equipment.





MICAH* Goes "G. I."

Yes, Sahib, I've gone G.I. several times through the years, but never in so big a way.

I'm on the job with ignition systems in planes, tanks, jeeps, PT's and submarines; — with range finders, fire controls and all sorts of detectors. Macallen-made mica sheets, shapes and sizes are in tremendous demand to insulate current-controlling, heat-confining devices that are helping to win this war.

But, I still keep an eye on industry, especially on this absorbing science of electronics. It reminds me of the days in which a bright young man named Thomas A. Edison first challenged my ingenuity. Somehow, I managed to keep pace with him; and I'm keeping pace with *Macallen-made mica specialties* in the amazing development of your new science.

**MICAH represents the high-grade mica products processed by Macallen. He would like to send you his 50th anniversary book — Macallen and Mica. Your name and address, please?*

PRODUCTS

Compressed Sheets — Mica Paper, Cloth, Tape. Heater Plate, Compressed Sheet Tubing — Commutator Insulation — Compressed Sheet Washers — Insulating Joints and Canopy Insulators — Railway Specialties — Domestic and Imported Raw Mica. *Always specify MACALLEN MICA.*



THE MACALLEN COMPANY

16 MACALLEN ST., BOSTON

CHICAGO: 565 W. Washington Blvd.

CLEVELAND: 1005 Leader Bldg.

utes and the other symbols have the same meaning as above. Converted into watts, this gives the power requirement P in watts where a given amount of material is to be heated in a specified time, namely

$$P = 17.6 Sw\Delta T/t \quad (3)$$

In the heating of preforms the time dare not be too long or pre-curing (curing before pressure is applied) will take place. The maximum allowable time (which will, obviously, determine the minimum power which can be used) varies with the type of material. Information available so far is not sufficient to justify setting definite limits. It would, however, appear that for materials such as those shown in Fig. 2 something like a minute and a half is the maximum. The minimum heating time will be determined by the economics and, possibly, by the point of voltage flashover across the load. As a practical working compromise a time cycle of one minute is generally used in making preliminary calculations. For purposes of illustration an example is useful.

Most plastics have specific heats of the order of 0.3 to 0.5 or less. If we assume 0.5 for the specific heat, one pound as the amount of material to be heated in 1 minute, an ambient temperature of 80 deg. F, and a desired final temperature of 280 deg. F (all of which are typical values), the necessary power from (3) above is $17.6 \times 0.5 \times 1 \times 200/1$, which is 1760 watts. It should be noted that this is the actual power required in the load. The power lost in the load circuit must also be supplied. If we assume a power factor of 0.03 (average for most molding materials) and a Q of 200 for the inductance used to tune the load, these losses will be about 15 percent of the power in the load. From this it will be seen that about 2-kilowatts of power is required to heat a pound of material in one minute under average conditions. This is the ratio usually used in quick computations. Obviously if the material has a lower specific heat, the power requirement will be somewhat less. If, on the other hand, the material has a much lower power factor, the circuit losses will be greater and the power requirement correspondingly higher.

The reasons for the choice of a particular frequency for dielectric heating are often misunderstood. It is not unusual to see statements like:



1. The Gibson Girl outfit is dropped from plane.

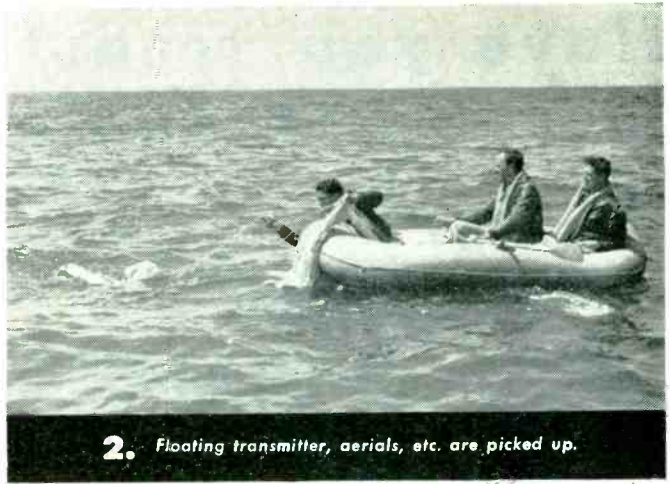

2. Floating transmitter, aerals, etc. are picked up.



A Voice in the Sky

FOR MEN ADrift



NOW flyers down at sea can radio their position and be almost certain of rescue. The new automatic emergency transmitter, the *Gibson Girl*, sounds a clear, far-ranging SOS... can be heard over an effective range of one hundred thousand square miles. It is saving lives!

THE GIBSON GIRL, during its development by Bendix Aviation, Ltd., North Hollywood, California, in collaboration with the Signal Corps Aircraft Laboratories at Wright Field, was nicknamed the *Gibson Girl* because of its hour glass contour. The name has stuck.

THE ADVANCE MICRO RELAY is a *vital* component of this remarkable life-saver. It regulates the voltage output of the hand-cranked generator. Without this control, wide variations in cranking speed produce such fluctuations of power that the signals are not effective.



Actual Size: 1 1/2" x 1" x 1 1/8"

The Advance Micro Relay which performs this vital function of control is the same compact time-tested relay that is giving distinguished service in communication equipment on all war fronts and throughout industry. It is available for *your* use, on proper authority. Write for new Advance Relay Catalogue, just off the press. Please address Department 000.

 **Advance Relays**

ADVANCE ELECTRIC COMPANY
1260-1262 West Second Street • Los Angeles 26, California

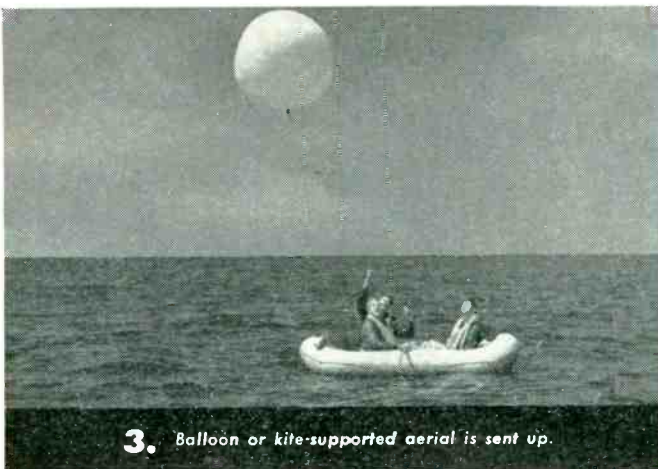

3. Balloon or kite-supported aerial is sent up.

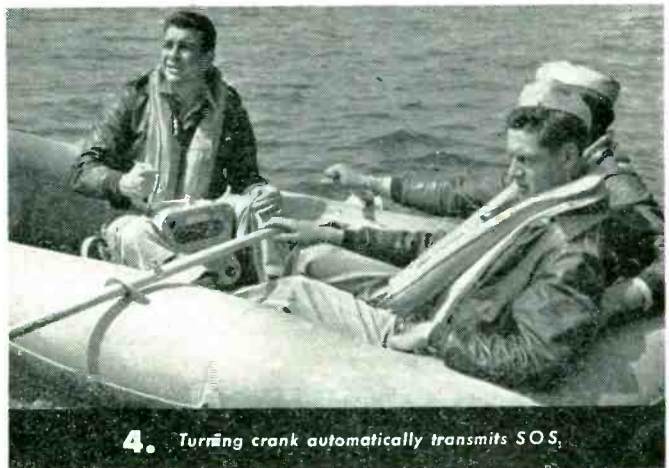

4. Turning crank automatically transmits SOS.

Have you transformer troubles?

TRY

Newark TRANSFORMERS

Standard or Special



Oil Cooled Transformer
for Plate Supply Furnace,
Welding, etc.



For Electronic
Applications

If your difficulties involve transformer performance, why not use our twenty years of experience to iron them out. If the job calls for a standard dry type transformer, you will find just what you need in the NEWARK line. If it is a special transformer job, you will find in the NEWARK staff the brains and experience to design the transformer you need, and in the NEWARK shops the components required to assemble it, and the skilled workmanship to do it right.

Are your difficulties based on delayed deliveries? Well, the reputation of NEWARK for unusual delivery always has been good, and still is. Let us confirm this, on your job.

Full details on Newark Transformers, Dry Type or Oil Cooled Distribution Type, in descriptive bulletins on request.

Newark

TRANSFORMER CO.
17 FRELINGHUYSEN AVE.
NEWARK, NEW JERSEY

OUR SUBCONTRACT FACILITIES may be just what you need to meet delivery needs on war production. We established this department long before Pearl Harbor, and it is skilled in handling all kinds of work, not only electrical in character.

Phone: BIGELOW 3-5600

NEWARK TRANSFORMER CO.

17 Frelinghuysen Ave.

Newark, N. J.

"The heating effect increases with frequency." Such a statement is true, of course, only if the voltage across the load is held constant, which means that the power is increased accordingly. But this is entirely the wrong viewpoint since ordinarily it is the power to the load which is held constant, and the reason the frequency is increased is to reduce the voltage.

The almost invariable approach to an r-f heating problem is first, to calculate the required power (from the constants of the material and the desired heating rate, as demonstrated above) and second, from this power and the estimated capacity of the load, to determine an operating frequency at which the voltage across the load will not cause flashover.

A method of calculating the load voltage has been previously described in connection with the heating of woods.³ Actually, such calculations are made only for loads presenting new problems. For most others the choice of frequency is based on experience. In the case of preforms of the general type shown in Fig. 2, it has been found that frequencies in the range of 10 to 15 megacycles are satisfactory. If the material has a low power factor, higher frequencies will be required.

REFERENCES

- (1) Radio Frequency Heating Speeds Plywood Bonding. *ELECTRONICS*, p. 79, 15, Nov. 1942.
- (2) Zottu, Paul D., Electrostatic High-Frequency Heating Makes Possible Many New Designs. *Product Engineering*, Jan. 1943.
- (3) Taylor, J. P., Heating Wood with Radio Frequency Power. *Trans. ASME*, p. 201, April 1943.
- (4) Brown, Aubrey I., and Marco, S. M., "Introduction to Heat Transfer", McGraw-Hill Book Co., Inc., New York, 1942.
- (5) Meharg, V. E., Heatronic Molding. *Modern Plastics*, March 1943.
- (6) Witty, W. M., Molding with Radio Frequency. *Modern Plastics*, May 1943.

LATEST MILITARY HEADSETS have a small, soft neoprene plug which fits inside the ear, providing a more effective seal against outside noises than older large rubber caps. A new pair of plug inserts is issued to each new wearer. The new headsets resemble hearing aids, and can be used interchangeably with all ground Signal Corps equipment.

MAGNAVOX TRAINED

32 YEARS FOR THIS WAR

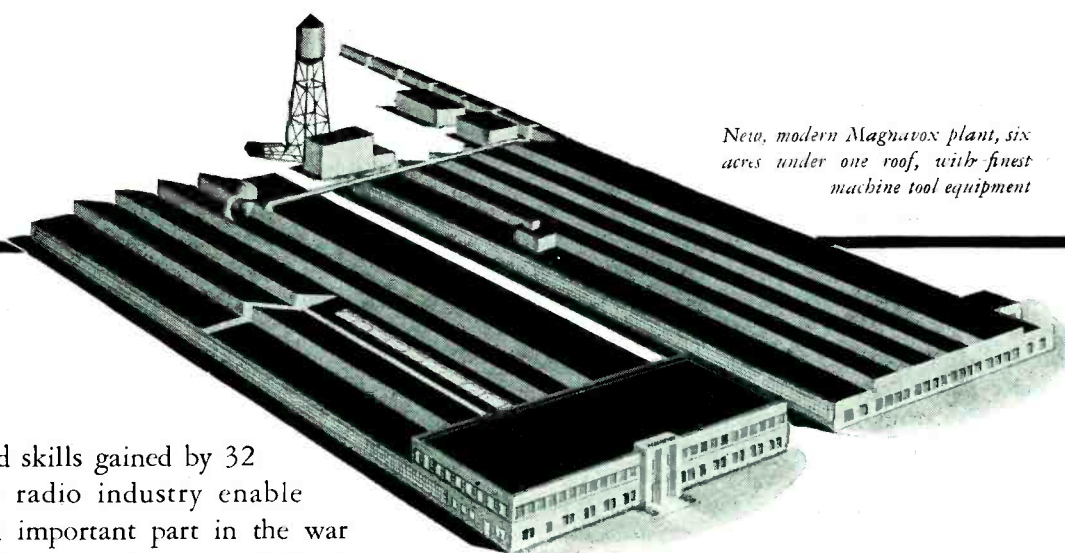

New, modern Magnavox plant, six acres under one roof, with finest machine tool equipment

THE EXPERIENCE and skills gained by 32 years' service to the radio industry enable Magnavox to take an important part in the war effort, producing equipment such as the following for all branches of the Armed Forces:

Communication Receivers for the Army and Navy. Radio Direction Finders. Radio Control Receivers. Interphone Systems . . . for Aircraft . . . for Tanks. Warship Announcing & Music Distribution Equipment. Carbon Microphones. Electric Gunfiring Solenoids. Bomb Arming Solenoids. Powered Antenna Reels. Dynamic Microphones. Dynamic Head Sets. Loud Speakers for various Military Applications. Electrolytic Condensers for Military Applications. Radio Phonographs for Military Applications. Sound Slide Film Military Training Equipment.

This wide variety of military products reflects, besides experience and diversified skills, the splendid facilities of Magnavox . . . the new, modern six acre plant, the excellent machine tool equipment and the production economies of efficient management. The Magnavox Company, Fort Wayne, Indiana.



Magnavox skill and craftsmanship won the Navy "E" in 1941, among the first awarded . . . now with 3 White Star Renewal Citations.

Magnavox

LOUD SPEAKERS • CAPACITORS • SOLENOIDS • COMMUNICATION & ELECTRONIC EQUIPMENT
ELECTRONICS — September 1943

NEWS OF THE INDUSTRY

Signal Corps setup in Sicily; post-war electronic thinking; London Lady engineers; new WWV standard-frequency broadcast schedules; new contracts offset production cutbacks, personnel items

How Electronic Equipment Aids Invasion Forces

THE FIRST extended report of the role played by communications under actual battle conditions was given recently in a statement by the Signal Corps. The operations are allegedly imaginary but they are believed to accord closely with what has recently transpired in the Mediterranean theatre of operations.

Every type of communications has its definite assignment from the Handie-Talkies and Walkie-Talkies to the short-range radio sets, vehicular radio sets, cavalry guidon sets, then regular combat operational communication sets with a range of several hundred miles, and finally the powerful telephone and radio communications systems reaching all United Nations headquarters.

Here is the Signal Corps' account of what Signal troops are accomplishing during a water-borne invasion:

"The Allied landings on Sicily highlight the importance of proper communications in modern amphibious warfare. How crucial this element of invasion is may be more fully gauged when it is recalled that United Nations troops swarmed ashore at three widely separated points: Yanks at Gela, Canadians at Pachino, and British at Augusta. In order to coordinate these three major landings, proper communications were vital. The exact part played by the Signal Corps in the Sicilian operations cannot, as yet, be detailed. But an over-all picture of its activities in the assault upon the Italian island can be given, and we may assume that Signal Corps units oper-

ated generally, in the manner outlined.

Sicily is Studied

"Before the start of the attack, the terrain, of course, is closely studied, and participating troops are assigned definite sectors to attack and defend. X Division, for example, part of the Task Force, is assigned the establishment of a beachhead in one particular sector.

"X Division includes, in addition to the usual complement of infantry, artillery and other special troops, a Division Signal Company. In that company are a radio section, a tele-

phone and telegraph section, an intercept section, a direction-finding section, and construction, service, repair, and maintenance sections. It is their job to insure proper communications for the troops ashore.

"As the amphibious Task Force approaches its objective, Naval Forces bombard the beach. Air Force bombers and strafing fighters concentrate on the same spot. As the cannonading lifts, the assault troops make an initial landing.

Portable Radio Sets Used First

"During this first phase, communications are short and direct. The Handie-Talkie and Walkie-Talkie radio sets enable shock troops to keep in contact with each other and with divisional headquarters aboard a ship.

"The Handie-Talkie is a small, compact radio sending and receiving instrument which can be carried by a single soldier in one hand. It has a range of several miles. The Walkie-Talkie is similarly a small compact radio sending and receiving instrument that is carried on the back of a single soldier just as a haversack is. Its range is somewhat greater.

"Visual signaling, such as flag hoists, lamps, and pyrotechnics are used by the Navy during the early phases to control landing traffic and gunfire.

"Short-range radio is also used to



At least two radio direction finder stations like this are set up by the Signal Corps as soon as possible after capture of a beach-head during invasion, to determine positions of enemy radio stations by triangulation.—Signal Corps photo

WAR WORK

Housed within four daylit floors is a modernly equipped tool and die shop, and every facility for fabrication from raw stock to shining finished product of such items as:

METAL STAMPINGS . . .

Chassis, radio parts, cans, and special stampings to specifications

MACHINE WORK . . .

Turret lathe, automatic screw machine parts and products from bar stock to castings

LAMINATIONS . . .

Scrapless E & I type ranging from 1/2" to 1 3/4" core size. Many other types and sizes. Laminations made to your specifications

PANEL BOARDS . . .

Bakelite items from dial faces to 24" panels machined and engraved to specifications

PLASTIC PARTS . . .

From sheets and rods to any specification

MECHANICAL INSTRUMENTS . .

Line production checking equipment, jigs and tools

ELECTRICAL INSTRUMENTS . .

Switch boxes, lighting fixtures, etc.

●
OUR ENGINEERING DEPARTMENT WILL COOPERATE IN THE DEVELOPMENT OF ANY SPECIAL ITEM TO MEET YOUR REQUIREMENTS.

We Invite Inquiries and Blueprints

WILOR MANUFACTURING CORP.

794 East 140th Street, New York 54, N. Y.

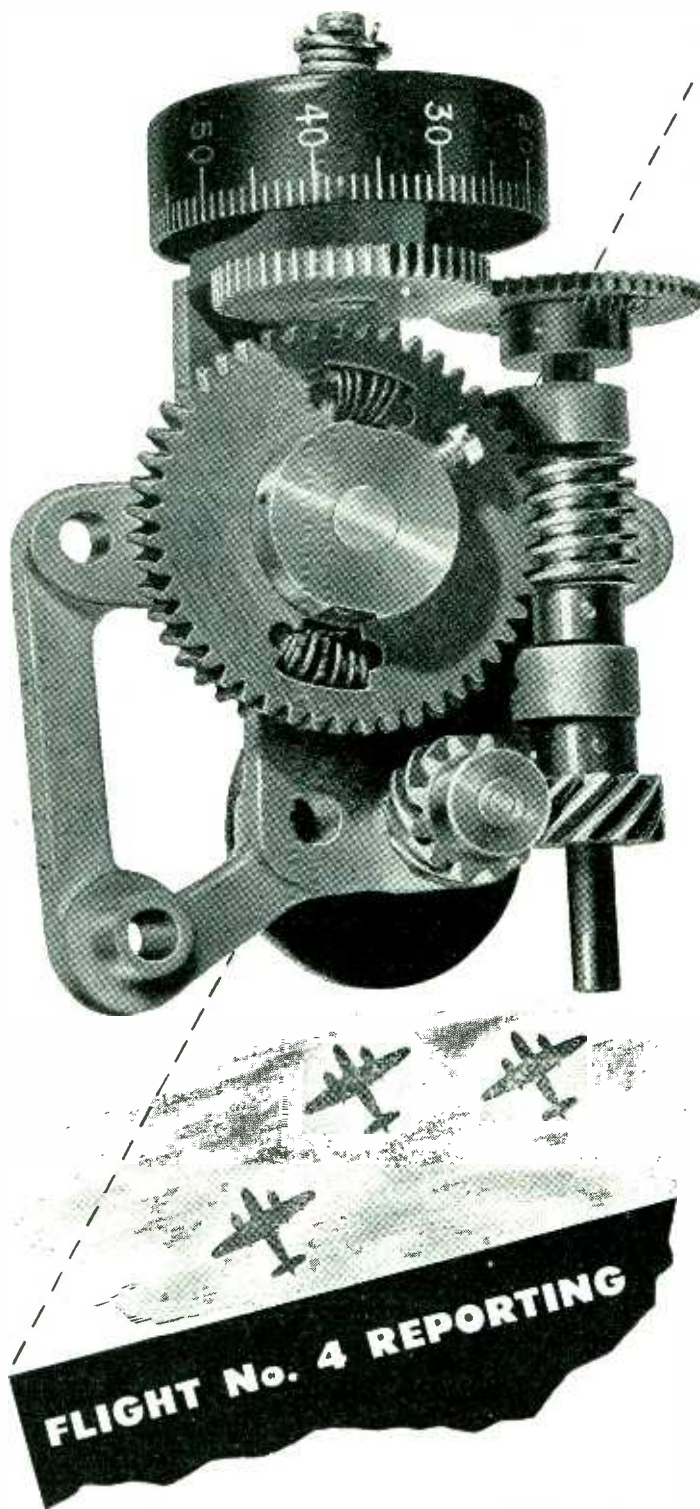

In base to plane communication one of the vital contributing factors toward the accuracy of pin point tuning is precision gears, and we are proud to say that **QUAKER CITY GEARS** are playing their part in assuring this accuracy.

Quaker City Gear Works
INCORPORATED

1910-32 NORTH FRONT STREET, PHILADELPHIA, PENNSYLVANIA

maintain communications for air support. Air-support units are in constant contact with Air Force headquarters and enable ground troops to call for and receive tactical air support.

Assault Wire is Laid

"Depending on the tactical situation, it may be several hours or even several days before the battle enters the second phase. However, when this does occur, signal communications begin to expand. Assault wire, which is a thin light line, is laid to connect up the command posts of the various assault battalions.

"Also, as depth is gained, use is made of the more powerful radios. One sample of this type is the vehicular radio set, which can be mounted in reconnaissance cars, half-tracks, and so forth. For use in conjunction with jeeps and other vehicles, the cavalry guidon radio set, originally made to fit into a guidon boot, is used. By this time, tanks, each of which has a radio, are ashore and operating.

Long-Range Gear Comes Next

"At the end of the second phase, with success, sufficient depth has been gained to allow regular combat operational communications to be established. The long-range mobile headquarters set is now operating for divisional and corps headquarters communications. This set has a range of several hundred miles. The light, fragile assault wire is superseded by regular field wire. A message center is established, as are radio and wire systems.

"Assuming, as the invasion continues, that the mission in addition to establishing a beachhead, is to take a town some miles inland, Signal Corps special troops have their part to play. Special combat teams race for the nerve center of the town as soon as it is entered by our troops. Included among them are two groups of Signal Corps soldiers; a telephone team and a radio team.

Radio and Telephone Teams

"The telephone team has as its job the taking of the local telephone plant, its rehabilitation if necessary, and its operation for our own use if possible. The Signal Corps telephone men have the job of utilizing existing telephone and telegraph communications, and should they not find such

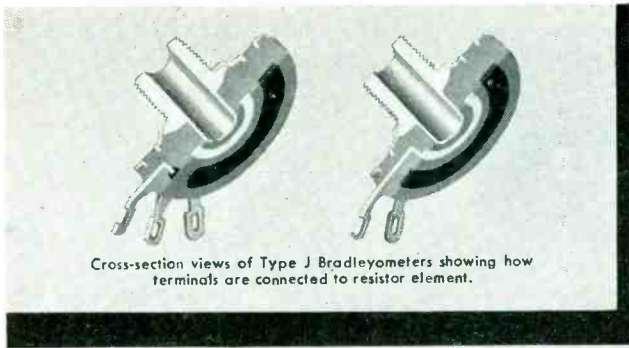

Cross-section views of Type J Bradleyometers showing how terminals are connected to resistor element.

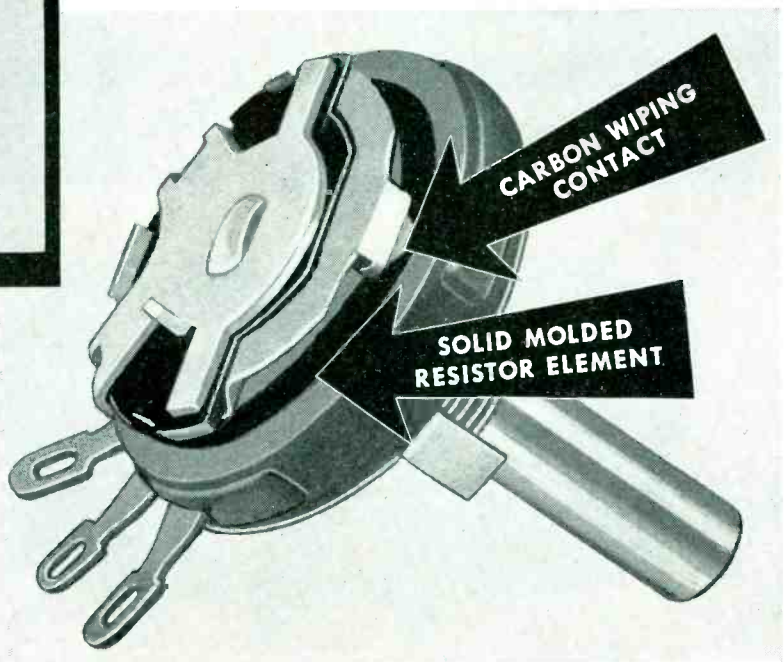

Type J Bradleyometer showing how low-resistance carbon brush makes a smooth contact with the resistor element.

Cold • Heat • Moisture cannot affect this **SOLID MOLDED** Resistor

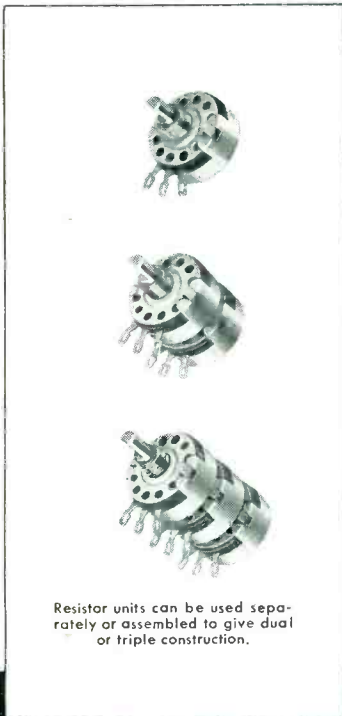

Resistor units can be used separately or assembled to give dual or triple construction.

The Type J Bradleyometer is the only variable resistor in which the resistor material, insulating material, terminals, face plate, and bushing are all molded into a single unit. The resistor material has substantial thickness and in this respect differs from the thin film types which consist of resistor material painted or sprayed on an insulation base. Once the A-B unit has been molded, the toughest war use cannot alter its performance. It remains quiet after hundreds of thousands of operations.

Actual experience in war service and laboratory tests has proved that Type J Bradleyometers function perfectly through a temperature range from -60° to $+70^{\circ}$ C. The resistor material is relatively inert, so changes due to moisture are negligible. The entire unit is corrosion-resistant and will easily pass the 200 hour salt spray test.

The simple construction of Bradleyometers means fewer parts and greater reliability. There are no rivets, no soldered or welded connections, and no conducting paints. Can be supplied for rheostat or potentiometer applications, with or without a switch.

Write today for complete specifications.

Allen-Bradley Co., 110 W. Greenfield Ave., Milwaukee, Wis.



Type EB $\frac{1}{2}$ -watt insulated Bradley unit molded fixed resistor. Actual length of element $\frac{3}{8}$ inch.



ALLEN-BRADLEY

FIXED & VARIABLE RADIO RESISTORS

QUALITY

USING LIGHT FOR NEW MEASUREMENT ACCURACY AND SPEED



Two Ingenious Coleman Instruments Use Luxtron* Photocells

No airman's blood is drawn when the Coleman Anoxia Photometer is used to determine oxygen content at different altitudes . . . Gravimetric and volumetric methods of analysis are made obsolete by Coleman's Model 11 Spectrophotometer . . . Both unique instruments use Bradley's Luxtron* photocells.

Some Photocell Advantages:

- No amplification required
- Long life at original calibration
- Unaffected by shock and vibration
- Light weight . . . less bulk

Some Photocell Applications:

- Measurements
- Analysis
- Metering
- Control
- Sound reproduction

Luxtron* photocells have been *proven* under all conditions. They are available in all sizes, shapes, types and capacities.

Write Bradley for Literature



Coleman Universal Spectrophotometer Model 11 selects a monochromatic light band 35 mu wide, anywhere from 300-800 mu, with better than 2 mu precision. It passes light bands of any line, including invisible bands at end of the spectrum, through any translucent product. Operation is simple.

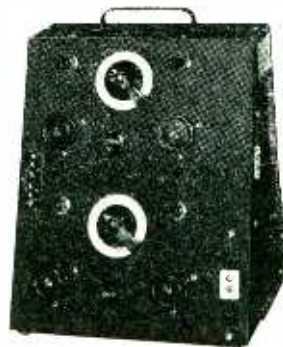

Coleman Anoxia Photometers, used in aviation, oxygen therapy, and anesthesia, employ Luxtron* cells in a diminutive photometer which clamps on subject's ear, projects light through membrane, then measures spectral characteristics of emergent beam, directly indicating degree of anoxemia. Models A (above) and 17, for aviation and clinical uses.

For complete literature on Coleman instruments, write: Coleman Electric Co., 415 Lexington Ave., New York City, or 310 Madison St., Maywood, Illinois.

"When you use light, use Luxtron!"

* Reg. U. S. Pat. Off.

BRADLEY

LABORATORIES, INC.
82 Meadow Street, New Haven 10, Conn.

facilities, of putting up rapid pole-line construction for overhead wire, or of laying the special spiral 4 field cable. In most cases, these wire men find it necessary to 'bridge', for some of the telephone lines run out into enemy territory. In that case, special wire crews go out and tap the line within the farthest boundaries of our own advance and connect the two taps with field wire.



From communication centers like this, established close to the front lines of invasion forces, go commands insuring coordination of all units participating in an advance.—Official U. S. Navy Photograph

"The radio team has as its objective the local station or stations. Its job is to take over the radio station, repair it if it is damaged, and put it back on the air for the use of American forces. The radio station is used for long-distance military communications and announcements to the local populace. The establishment of powerful radio broadcasting and receiving stations for military purposes is also part of the Signal Corps' responsibility. Ultimately our forces would have a broadcasting and receiving station for military communications powerful enough to reach the U. S., London, or any of the headquarters of the United Nations.

Radio Intercept Teams

"Special mention is given by the Signal Corps to radio interception and direction-finding men. Signal Corps Radio Intercept teams, during the first phase, normally operate



This is Synthetic Rubber

Synthetic rubber is a new basic raw material which is processed, treated and formed in much the same way as natural rubber. And...like natural rubber...it is of different types, is capable of many variations.

Synthetic rubber is manufactured from gasoline, alcohol, coal and gases kept liquid under pressure and is now being made in five basic commercial types. Each type has distinct properties and characteristics that fit it for specific tasks. For some, synthetic rubber is superior to natural rubber. For others it is equally as good.

To determine which synthetic rubber is right for the job, however, requires a really thorough knowledge of rubber chemistry. The manufacturer must be familiar with the properties of all five commercial types

... Buna-S, Buna-N, Neoprene, Thiokol and Butyl.

United States Rubber Company uses all five basic types of synthetic rubber and is thoroughly familiar with the characteristics, properties and suitability of each type to the task for which it is intended. As the nation's largest user of synthetic rubber, "U.S." has built up a tremendous backlog of knowledge of this new basic raw material and experience in processing synthetic rubber to handle a certain definite job. Today, this knowledge and experience are being drawn upon to the fullest in supplying the Armed Forces and war industries with the synthetic rubber and synthetic rubber products they need.

A copy of "The Five Commercial Types of Synthetic Rubber" will be a valuable addition to your files.

Listen to the Philharmonic Symphony program over the CBS network Sunday afternoon, 3:00 to

1230 Sixth Ave., Rockefeller Center, New York 20 • 4:30 E. W. T. Carl Van Doren and a guest star present an interlude of historical significance.



UNITED STATES RUBBER COMPANY

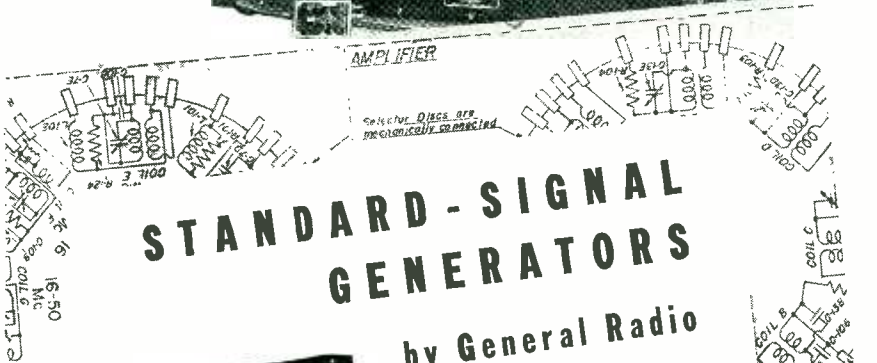
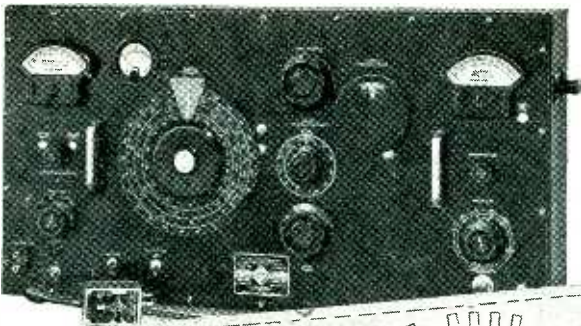

STANDARD-SIGNAL GENERATORS

by General Radio



SINCE General Radio pioneered the first commercial standard-signal generator in 1928, it has been the aim of our design engineers to make available signal generators for testing all types of home, commercial and military receivers.

In addition to standard catalog models, many specialized instruments have been designed and built for the armed services, in peace time as well as in war. Present designs collectively cover a frequency range of 300,000:1. While many of these are not at present available for general use, because of wartime secrecy requirements, they contribute to the stock of engineering design experience that will be applied to the production of commercial models after the war.

The country's leading radio receiver laboratories are equipped with General Radio signal generators, backed by 28 years' experience in building high-quality instruments.

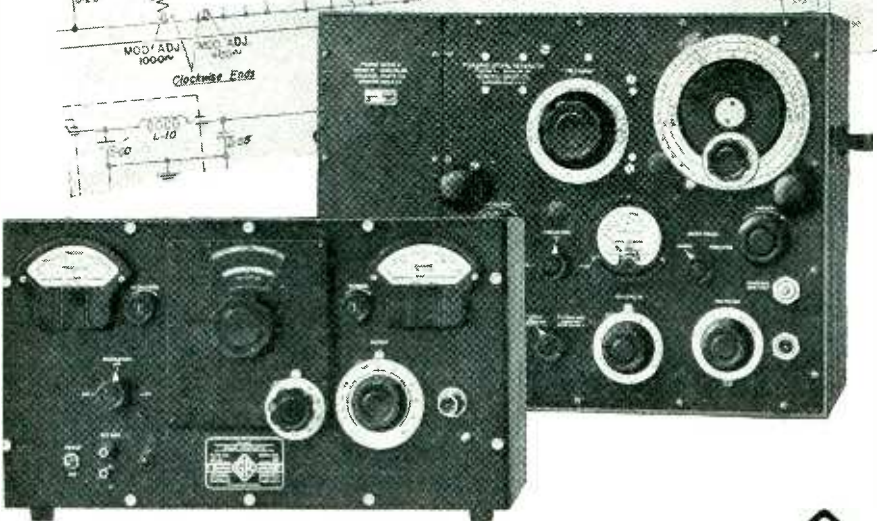

GENERAL RADIO COMPANY

CAMBRIDGE 39, MASSACHUSETTS
NEW YORK 6 • LOS ANGELES 38



from one of the vessels of the invading fleet. Their job is to listen in on enemy traffic and turn over the information they receive to the G-2 of the force. If the messages intercepted are in enemy code, they are turned over to the cryptographic section for decoding. Last but not least, radio interceptor units monitor our own radio communications to keep radio traffic under control and to see that military security is not compromised by our own people.

Radio Direction-Finding Men

"Direction-finding equipment, operated by Signal Corps personnel, goes ashore as soon as possible after the beachhead is established. Direction-finding is done by two radios, set as far apart as possible. By tuning in on enemy stations the Signal Corps operators are enabled to compute, through triangulation, the position of an enemy station. Direction-finding signal men relay their information to artillery, which lays down a barrage at that point. The information also might be used to send out an air mission to bomb and strafe the enemy location.

Radio for Paratroops

"Paratroops overrun enemy air fields after they have been bombed and strafed by American aircraft. Their means of communication is the Handie-Talkie. Among the air troops are signal troops who have the responsibility of establishing the same kind of communications as their ground force comrades—a message center, a radio net, and, where necessary, telephone and telegraph communications.

Photos Reach Washington in 7 Min.

"Signal Corps photographers also deserve special mention. They accompany each assault battalion and their mission is to take pictures from the moment of landing for military intelligence, historical and training purposes. Each combat unit is accompanied by two photographers, one who takes still pictures and the other motion pictures. These men are equipped with the best of American photographic instruments. The still picture photographer has two cameras, a speed job that uses a 4x5 cut film pack, and a small candid camera loaded with 35-mm film. The motion picture man uses a hand-held 35-mm camera. Supplementing this

Voice communications on every front...

Whether by radio or land wire telephone, a voice command gets the job done with clarity and speed.



KEITH THOMAS



Available from stock, 1700U series microphone. Single button carbon type, push-to-talk switch, etc. For trainers, inter-communication and general transmitter service.

UNIVERSAL microphones are playing a vital part in voice communications of all the Armed Forces . . . being the first instrument through which a command is given. Care must be taken that the electronic patterns of the voice are held true for the many electrical circuits through which they must later pass. UNIVERSAL microphones with their precise workmanship are carrying the message through in all forms of voice communication whether from a tank, ship or aeroplane. UNIVERSAL products meet all U. S. Army Signal Corps Laboratory tests. Standardization of parts, inspection, and workmanship of high order combined with the best of material, make UNIVERSAL'S microphones and accessories outstanding in every application.

U. S. Army Signal Corps and U. S. Navy plugs and jacks are offered as voice communication components to manufacturers of transmitters and sound equipment for the Armed Forces. Catalog No. 830 contains complete details.



UNIVERSAL MICROPHONE CO. LTD.
INGLEWOOD, CALIFORNIA

FOREIGN DIVISION, 301 CLAY ST., SAN FRANCISCO 11, CALIF. • CANADIAN DIVISION, 560 KING ST. W., TORONTO 2, ONTARIO

KINNEY

COMPOUND DRY VACUUM PUMP

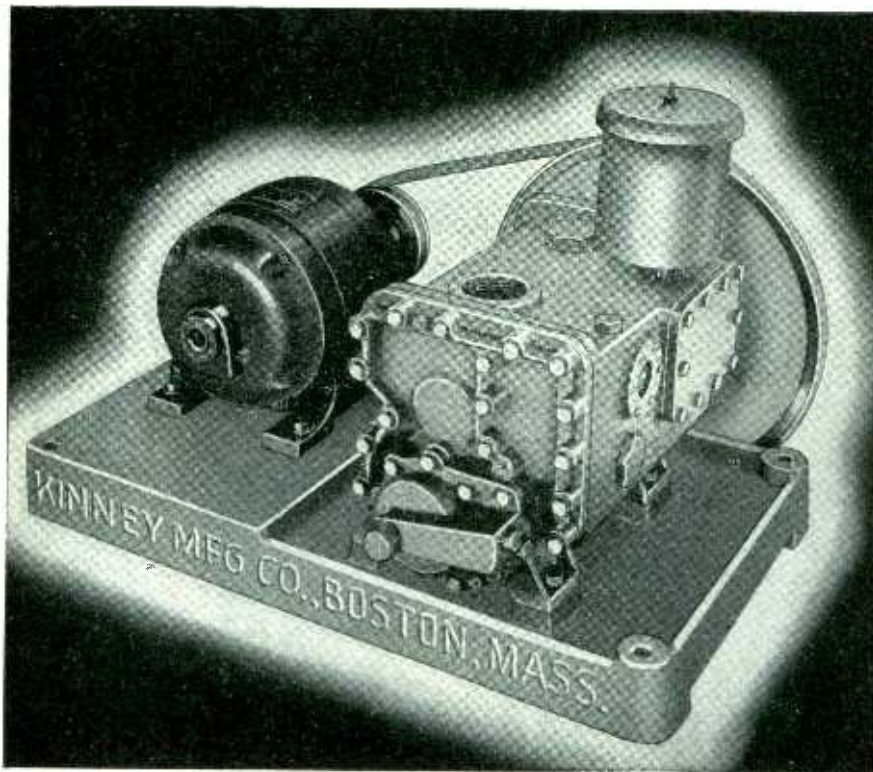

for Unusually High Vacuums

The Kinney Model CVD Compound Vacuum Pump is not a new pump! It was brought out several years ago after extended experimentation and utilizes the working mechanism of the well known Kinney VSD and DVD Vacuum Pumps. To those experienced in the task of creating and maintaining high vacuums with mechanical pumps, the results claimed for this Kinney compound pump were astonishing. Laboratory readings, on an ionization gauge, of 0.5 microns (0.0005 mm.) are regularly obtained and tests have shown readings on the McLeod gauge of better than 0.1 micron. For next higher range of absolute pressures, Kinney Single Stage Pumps are available in sizes from 12 to 680 cu. ft.

Users report splendid results

Since first announced, the CVD pumps have been widely used and results in actual service in a wide variety of uses, especially in the lamp and tube field, have been excellent. For many services, the final vacuum produced by these pumps is so high that they have replaced mercury vapor pumps with gratifying results both as to production times

and operating expense since cold traps are eliminated and the pumping system simplified.

Write for this real "tell-all" bulletin

Bulletin 18 contains complete descriptions, capacity and dimension tables, and efficiency curves covering all Kinney High Vacuum Pumps . . . includes a valuable section giving formulas for determining correct pump sizes—address any office listed.

KINNEY MANUFACTURING CO.

3565 WASHINGTON ST., JAMAICA PLAIN, BOSTON, MASS.
New York • Chicago • Los Angeles • Philadelphia • San Francisco

he has a hand-held 16-mm camera, and for detail and fast action shots, a pocket-size 16-mm camera.

"On the mainland of North Africa is a still photographic "desk". As soon as pictures are received back across the 90-mile Sicilian strait, for example, photographic technicians develop and print the film. After being checked through censorship, these pictures are rushed to the Signal Corps radio-telephoto transmitter and within 7 minutes copies of these pictures come off the Signal Center's telephoto receiver in Washington.

"In this war of speed and distance, communications are of the essence. Today more than ever, the nerve center of the American Army is its Signal Corps."

Older Workers Succeed at Jobs

TEN MONTHS AGO the Lamp Division of the Westinghouse Co. formed a "middle-aged corps" of workers to help solve the war manpower problem. The group includes a retired lawyer, actor, auto salesman, banker, housewives and other older workers with no previous mechanical experience. They work under the same conditions as regular employees of the company, and have the same hours



Helping make radio tubes for communications equipment, Herbert W. Royal, 54, a retired lawyer, is a member of the middle-aged group working for Westinghouse. He served in the Air Corps in 1918

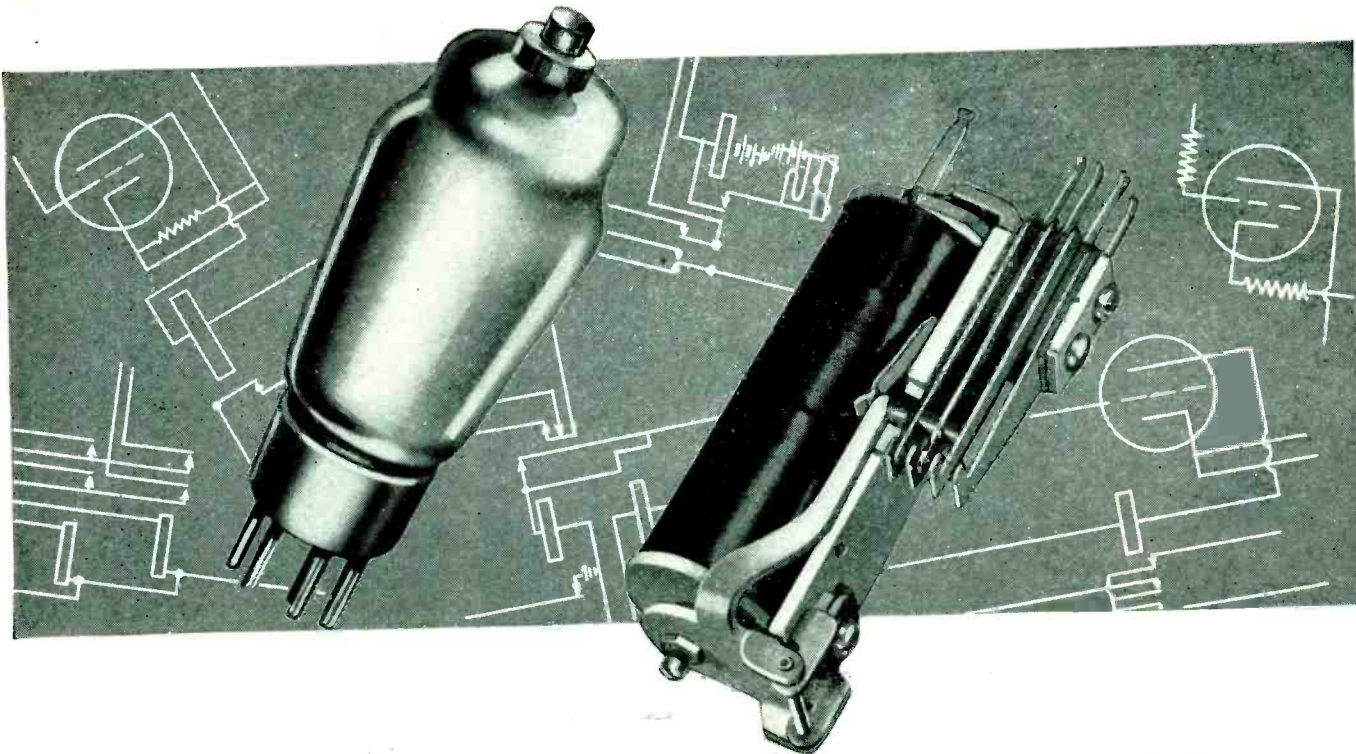

THE TEAM THAT IS MAKING MIRACLES COME TRUE

All along the fighting fronts where the tools of war are being used—and in industrial plants where they are being made—electronic science is working miracles to hasten the day of victory.

Team-mates in this new world of magic are the electronic tube, in its infinite variety of types and applications, and the Automatic Electric relays, stepping switches and other control devices that are so often needed to make electronic developments take practical and useful form.

Electrical control has been Automatic Electric's sole business for over fifty years. That is why electronic designers in scores of industries are finding it both helpful and profitable to work with Automatic Electric field engineers in determining the right control apparatus for each job. Together, they speed new electronic developments through the laboratory and into the production line.

If you have a control problem—whether electronic or just electrical—it will pay you to take these two steps: First, be sure you have the Automatic Electric catalog of control devices. Then, if you would like competent help in selecting the exact combination to meet your need, call in our field engineer. He will be glad to place his experience at your disposal.

AUTOMATIC ELECTRIC SALES CORPORATION

1033 West Van Buren Street, Chicago, Illinois

In Canada: Automatic Electric (Canada) Limited, Toronto

Relays
AND OTHER CONTROL DEVICES
by **AUTOMATIC ELECTRIC**

Automatic Electric control devices are working with electronic tubes in these typical applications:

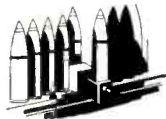

Quality control—automatic inspection and sorting operations



Detecting and indicating—checking operations and revealing unstandard conditions

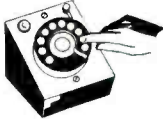

Automatic or directed selection of mechanical or electrical operations



Selection and switching of signaling and communication channels



Counting and totalizing of mechanical or electrical operations



Time, temperature and sequence control of industrial processes.

The Automatic Electric catalog of control apparatus is the most complete reference book on the subject ever published. Write for your copy.



MUSCLES  FOR THE MIRACLES OF ELECTRONICS
ELECTRONICS — September 1943

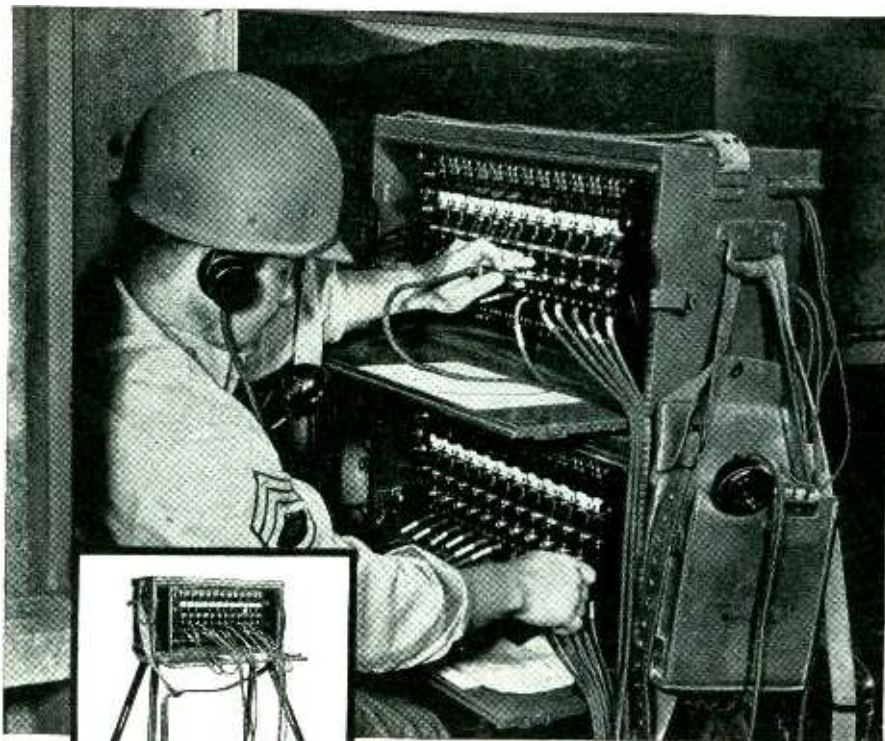

BD-72

● Military authorities doubt that the war will be won by any secret super weapon. They count on fighting efficiency developed out of many small things—advantages gained from foresight and painstaking attention to detail.

For example, take the BD-72 portable military switchboard developed at *Connecticut*, in cooperation with Signal Corps engineers. It has many features we can't tell you about, but we can say that the BD-72 was designed to save space, to get into operation faster, to stand a lot of rough usage under fighting conditions. Small things? Not if its small size permitted getting one more machine gun aboard the truck. Not if it helps "get the message thru" even *seconds* sooner. Small things sometimes loom large when the job is to get the jump on the enemy.

All over America, the doom of the Axis is being made more and more certain by giving the fighting men of the United Nations better fighting tools. The birth of better ways of doing things *after* the war, is an all-important by-product of this effort. *Connecticut Telephone & Electric* is an excellent source of ideas for developing your postwar product or manufacturing methods, if they involve communications, or the engineering and manufacture of precision electrical devices.

CONNECTICUT TELEPHONE & ELECTRIC DIVISION



MERIDEN, CONNECTICUT



For the second time within a year, the honor of the Army-Navy Production Award has been conferred upon the men and women of this Division.

© 1943 Great American Industries, Inc., Meriden, Conn.



Former auto dealer John Schott, 57 (left) and British Army veteran Fred Smith, 48, dropped their former jobs to join the "middle-aged corps" at the Westinghouse Lamp Division in Bloomfield, N. J., and are here discussing a transmitting tube

and jobs in building tubes for communications equipment.

Some of the older men operate glass lathes used to seal tube envelopes, where a steady hand and experienced judgment are required. A number of older women work alongside young girls in assembling tube parts and welding tube elements.

Records reveal that older workers are absent only one-fourth as often as other employees, and their lateness rate is correspondingly low.

Army Will Salvage Its Tubes

AS PART OF its conservation campaign, the Signal Corps has made arrangements to have broken radio tubes shipped back to the U. S. from the fields of battle. Radio tubes, some of which cost as high as \$35 per unit, contain in the aggregate great amounts of critical materials like tungsten, nickel, tantalum, platinum and molybdenum. These materials can be refabricated, and some of them can be re-used as many as twenty times.

UHF RELAY stations for network television broadcasting are being given major consideration by RCA in plans for post-war television.

Certainly, POWERSTAT

variable voltage transformers

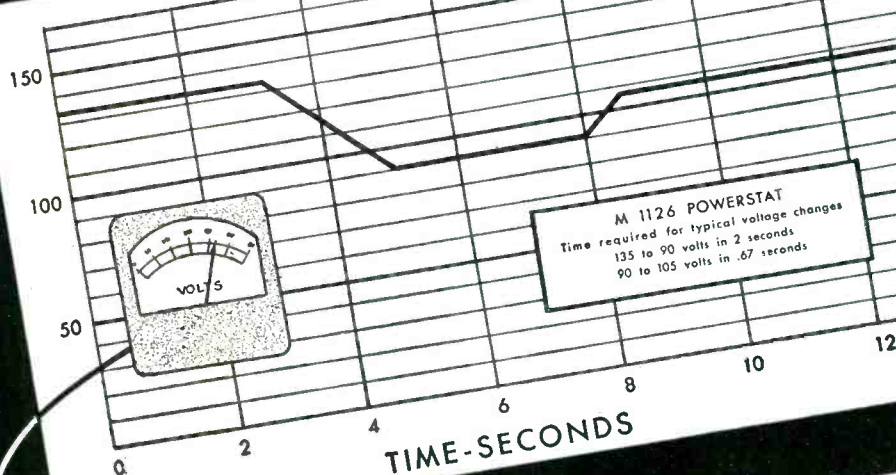

for REMOTE CONTROL

SECO'S Motor-Driven POWERSTAT Variable Transformers offer a highly efficient and accurate method of controlling AC power. It is unnecessary to bring heavy cable to cumbersome tap changers on switch boards or control desks. Simple wiring from your automatic control device or push button station to the pilot terminals of a Motor-Driven POWERSTAT Variable Transformer will enable the operator to control kilowatts of power safely and smoothly.

Where a self-contained piece of apparatus is required for rapidly controlling voltage to any desired value — investigate Motor-Driven POWERSTAT Variable Transformers. This equipment is used in radio transmitters, vacuum tube manufacture, electrical testing, induction heating, electric furnace temperature control, automatic voltage regulators and other applications where an efficient high quality control is required.

Standard types are available in sizes up to 75 KVA for 115, 230 or 440 volt operation on single or polyphase circuits.

FOR FURTHER INFORMATION
SEND FOR THESE BULLETINS
POWERSTAT Variable Voltage Transformers 149 LE
SECO Automatic Voltage Regulators 163 LE

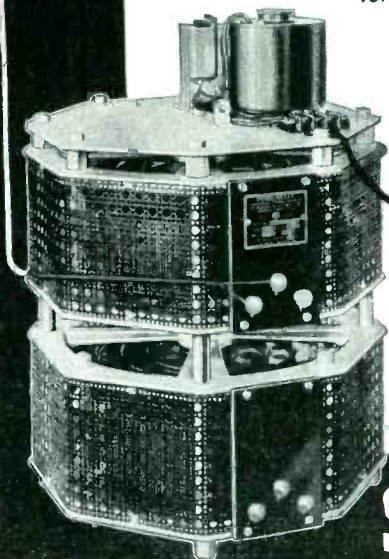

SUPERIOR ELECTRIC COMPANY
31 LAUREL STREET, BRISTOL, CONNECTICUT

SUPERIOR *Electric Company*

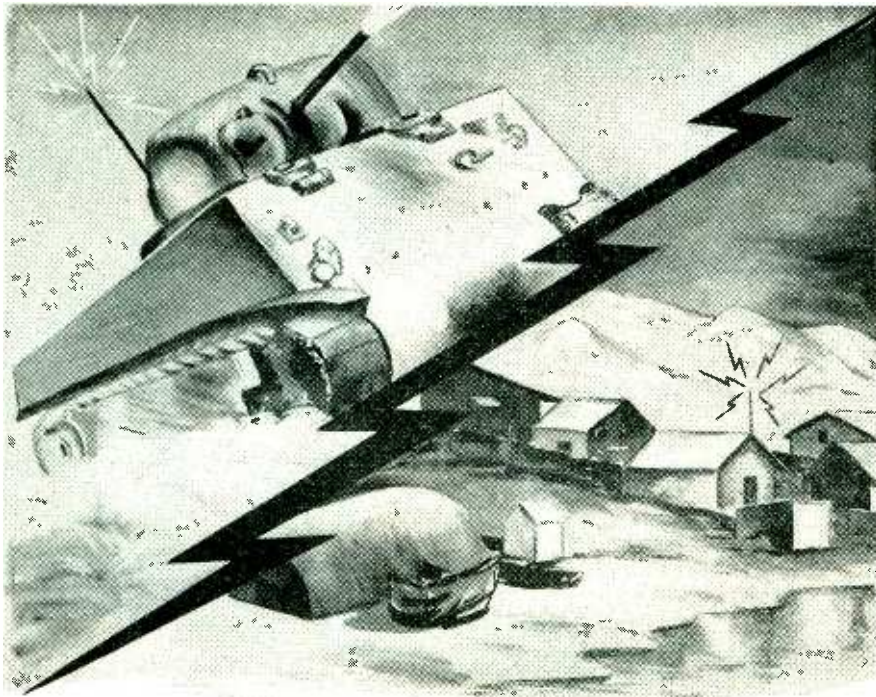

In DESERT TANK and ATTU SHACK...

Crystals guard men's lives!

 It's a far cry from the sweltering oven-interior of a jolting tank doing desert patrol duty to the comfortless shack on the bleak windswept tundra of an Aleutian outpost...

Yet, in both, men's lives may depend on the exacting skill of a girl they never saw!

For, by her painstaking work is made the tiny crystals without which they could have no communication with the outside world. Crystals which, if not unflinching perfect, might leave them un-forewarned of danger... and death.

At Scientific Radio Products Co., that need for perfection is never forgotten for a moment. The big share of those perfect crystals go to Uncle Sam. But our facilities are such that we can take care of your important needs, too. Write us, if we can help.

Scientific **RADIO PRODUCTS CO.**

738 W. Bdwy.

LEO MEYERSON W9GFQ
E. M. SHIDELER W9IFI

Council Bluffs, Iowa

MANUFACTURERS OF PIEZO ELECTRIC CRYSTALS AND ASSOCIATED EQUIPMENT

Electronic Production Ideas Win WPB Awards

MAINTENANCE FOREMAN Lawrence Handler of the Westinghouse Lamp Division recently received a War Production Board merit award, a \$50 war bond, and a \$541.50 check for development of a transmitting tube holder that has resulted in an average daily saving of nine production hours and considerable critical materials by preventing tube breakage.



Lawrence Handler and the machine tool fixture he redesigned to eliminate breakage of vacuum tubes during assembly. The new fixture saves critical materials as well as nine production hours daily

The fixture is essentially a collar that fits over the end of a vacuum tube assembly to hold it in position while the glass bulb is sealed around it. To release the collar after sealing, it was necessary to hammer it back to its original position, with the possibility of breaking the tube or damaging the fixture. The new holder has three metal jaws to retract the collar and eliminate hammering and consequent damage.

A certificate of individual production merit has been awarded to Charles Chudoba, machinist at RCA Victor Division, who suggested a way of preventing burnout of coils on induction heating equipment. He proposed enclosing the coils in fiber glass sleeves to prevent moisture, oxide and scales from short-circuiting the turns. The sleeves have been in use for three months without a burnout



PRODUCING PRECISION EQUIPMENT IN EVER GREATER QUANTITIES

Even before Pearl Harbor, Webster-built apparatus was serving faithfully with America's armed forces. Since our nation actively entered the war, a steady stream of Webster equipment has poured out to the services. So that we may continue to supply these vital war supplies . . . with the highest standards of quality and service . . . we have expanded the facilities purchased from the Webster-Chicago Corporation. New engineers have been added to our personnel —new machinery and equipment supplement the previous facilities. Webster Products is now better than ever able to serve you with *proved-quality* electrical apparatus.

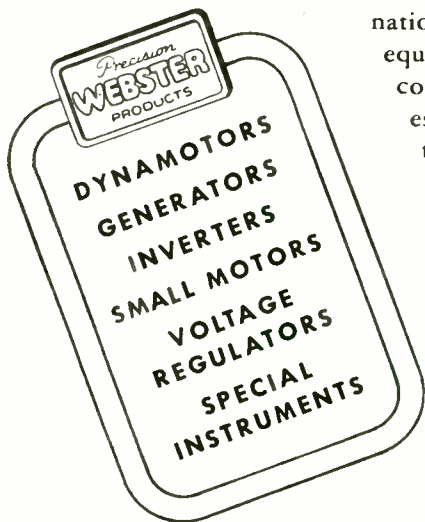

We invite your inquiries and will welcome your detailed investigation of our facilities.



WEBSTER PRODUCTS

3825 ARMITAGE AVENUE · CHICAGO

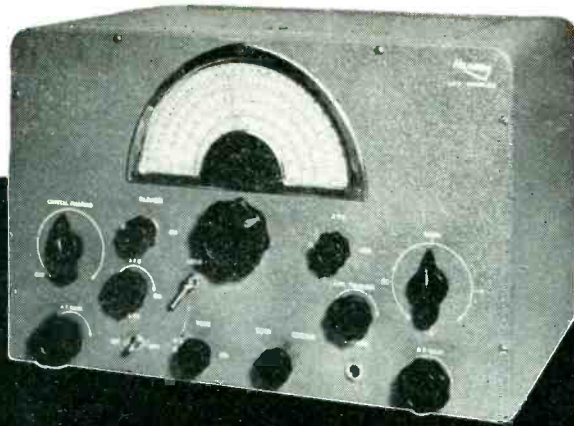

The HARVEY

Model HM-10

GROUND STATION and SHIPBOARD COMMUNICATION RECEIVER

Features

- ✓ Turret-type RF Coils
- ✓ Two Stages of Pre-selection
- ✓ "Unitized" Construction
- ✓ Inter-channel Noise Suppression
- ✓ Automatic Noise Limiter
- ✓ AC or DC Optional
- ✓ Manual Antenna Trimmer Control
- ✓ Crystal Filter
- ✓ BF Oscillator with Manual Pitch Control
- ✓ Spot Frequency Lock
- ✓ Four Frequency Bands
- ✓ Voltage Regulated Oscillator
- ✓ Two IF Stages
- ✓ Universal Output Impedance

Combining features that insure dependable, stable operation under the most adverse conditions, Harvey-Machine Model HM-10 Receivers are equally suitable for use on land or sea. Such developments as rotary turret coils for band changing, which improve L/C ratios of the RF circuit and cut minimum circuit capacitance by 40% in comparison with conventional RF amplifiers, are typical Harvey features.

Inherently short leads minimize mutual inductance and stray capacitance between critical portions of the circuit . . . and materially contribute to the high over-all performance of Harvey-Machine Receivers.

"UNITIZED" Cellular Construction is an Exclusive HARVEY FEATURE

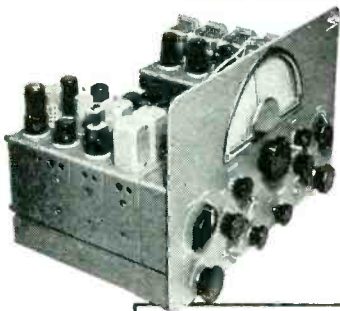

Standardized Harvey cells for R.F., I.F., and Audio sections are the backbone of the Model HM-10 Receiver . . . each cell is quickly removable for service and interchangeable with other cells of the same circuit element. Servicing is thus simplified and made practical in the field, since replacement cells can be maintained and installed without special tools, circuit diagrams or skill.

Write for complete specifications of *Harvey Machine* MODEL HM-10 Communication Receivers . . . or for data on Harvey Cells for use with electronic devices of other firms. We also manufacture ultra-high frequency trans-receivers and inquiries are invited.

Electronics Division!
HARVEY
MACHINE CO., INC.

6200 Avalon Blvd.
 Los Angeles 3, California
 PLANT ALSO IN LONG BEACH, CALIFORNIA

Other Harvey Divisions
 • AIRCRAFT
 • SPECIAL MACHINERY

For over a quarter of a century geared to flying production.



and will save 350 pounds of copper and 450 man hours per year.

Another certificate of individual production merit went to Gerald Thinner, working group leader at RCA Victor, who suggested a new procedure for lapping electrodes. The work was formerly done by hand with a production cycle of two minutes per electrode. His suggestion, that twelve electrodes be lapped simultaneously on a plate similar to that used for crystals, produces twelve electrodes in ten minutes.

The WPB Awards Branch has received suggestions from several other RCA employees. These include one from Thomas H. Schelling and Victoria Kocher of the Work Simplification Department, in which a complicated procedure involving five operations in welding a tungsten filament to a tungsten wire lead has been reduced to two operations. The new method permits a saving of \$84 per thousand assemblies and an annual direct labor saving of 3,000 hours.

George W. Pratt of RCA suggested a change in procedure for handling, assembly and welding of parts for cathodes and cathode-grid units of cathode-ray tubes. Re-routing parts and operations has resulted in a saving of \$500 in shrinkage and 930 hours of labor per year.

Production engineer William J. Carlin of RCA redesigned the filament position in the cathodes of two receiving tubes so that the filament apexes were above the end of the cathode, thereby reducing bare heater to cathode shorts about one percent. On a yearly production of 355,000 tubes with a standard factory cost of \$0.31 per tube, the annual saving will be \$1,100.

New Contracts Offset Cutbacks In Radio Industry

PLACING OF military production contracts with radio and electronic manufacturers to meet Army and lend-lease requirements for 1944 is to be completed by Jan. 1, 1944, according to Signal Corps plans. One objective of the new Signal Corps Procurement and Distribution Service under Major General William H. Harrison is leveling of contract requirements to minimize peaks and valleys in the production of communications equipment and component parts.

The award of \$638,000,000 for com-

PAN AMERICAN USES THEM

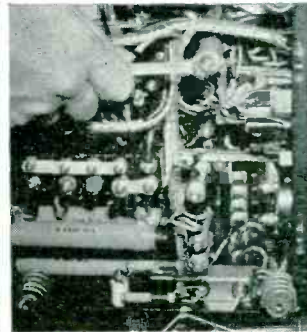
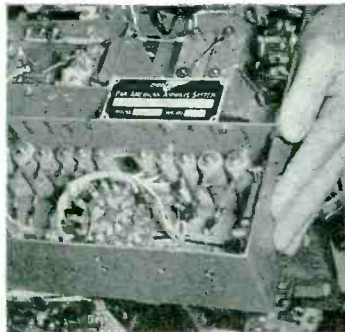
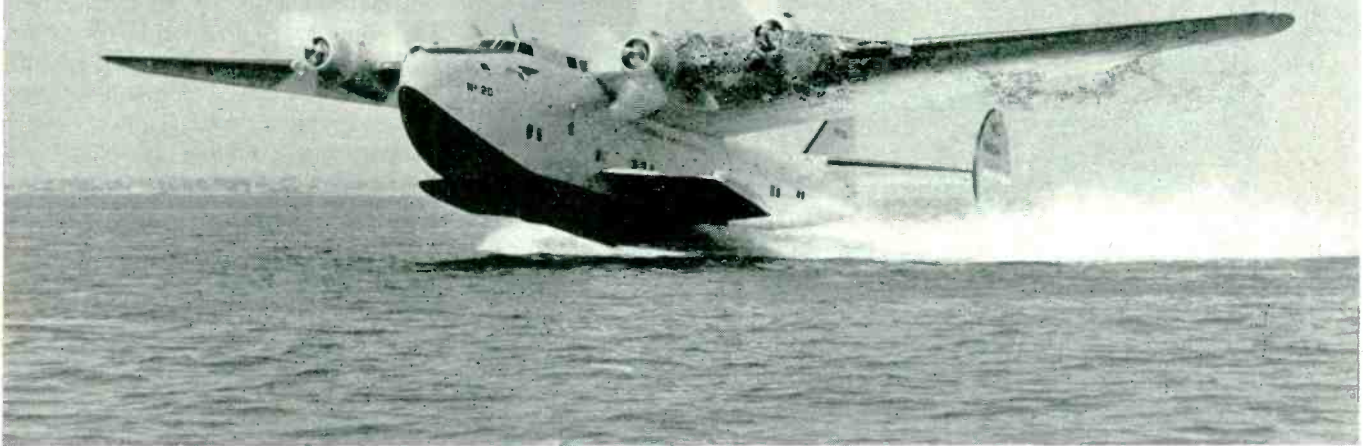

The Ward Leonard Vitreous Enamel, Wire Wound Resistors shown are used on maintenance and operation equipment at the Miami Clipper base of Pan American World Airways.

WARD LEONARD

RELAYS • RESISTORS • RHEOSTATS

Electric control  devices since 1892.

WARD LEONARD ELECTRIC COMPANY, 32 SOUTH ST., MOUNT VERNON, NEW YORK

BOMBS AWAY!



Communication Equipment
Made by Kellogg for
Military Use Includes

The Big Moment Made Possible by DEPENDABLE COMMUNICATIONS

Months of intensive training at air bases here at home . . . followed by further training on foreign shores . . . then the take-off . . . and finally, flights over hostile areas sometimes harassed by enemy fighters and flak . . . that's just part of what it takes to put a man in position to release a block-buster at the right place at the right time. To make that moment possible demands co-ordination of the highest types—co-ordination facilitated by modern, reliable communication equipment.

Here at Kellogg communication parts and products are flowing to our Armed Forces in a steady stream. The fine engineering and precision manufacturing methods which produce these war-time items will be reflected in the post-war period, when this 46-year old manufacturer will again utilize its facilities for the production of fine quality communication and industrial electrical equipment for peacetime purposes.

KELLOGG SWITCHBOARD & SUPPLY CO.

6638 South Cicero Avenue, Chicago, Ill.

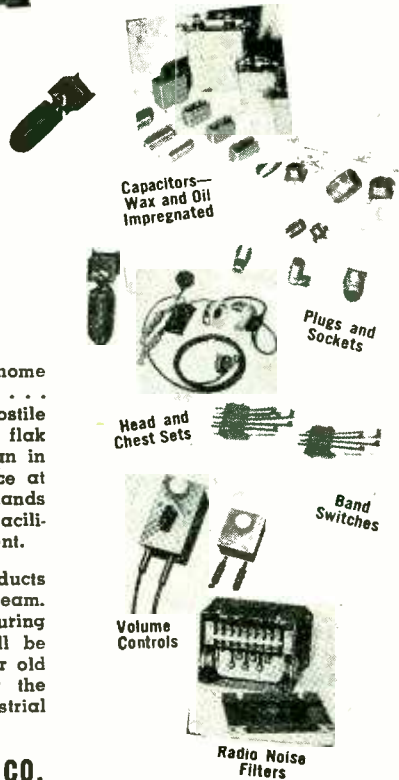

Other Kellogg-made communication equipment: telephone and radio ear-phones; hand, palm, desk and throat microphones; crash alarms; cord assemblies; and many others from single parts to complete systems.

munications equipment contracts in June 1943 made this month break all procurement records in the history of the Signal Corps.

A WPB survey of all manufacturing and production facilities for quartz crystal production is now under way, according to WPB Radio and Radar Division Head Ray C. Ellis. It is hoped that the survey will reveal methods of securing increased production of vital quartz crystals for military communications equipment.

A feature article by Donald M. Nelson in the July 1943 issue of *Factory Management and Maintenance* contains his personal, unofficial opinion that about 30 percent of the present total war production program will be affected in some way by cut-backs or changes. These changes are due to such situations as the fact that in the Tunisian campaign we lost only half of the planes we thought we would lose. The overall production is still going up, but individual companies will in many cases have to make secondary conversions. Subcontractors will often have to scramble the hardest for new lines of production, but there will simultaneously be prime contractors looking for subcontractors. Mr. Nelson does not deny that a few companies may find reconversion completely impossible, but states that we are in a much better position today than a year ago to see that all practicable facilities are used.

Standard Frequency Broadcasts of National Bureau of Standards

THE NATIONAL BUREAU of Standards broadcasts standard frequencies and related services from its radio station WWV at Beltsville, Md., near Washington, D. C. The service has been improved and extended, a new transmitting station has been built, 10-kilowatt radio transmitters installed, and additional frequencies and voice announcements added. The services include: (1) standard radio frequencies, (2) standard time intervals accurately synchronized with basic time signals, (3) standard audio frequencies, (4) standard musical pitch, 440 cps, corresponding to A above middle C.

The standard-frequency broadcast

KELLOGG



*Finer Communication
Equipment* FOR WAR AND PEACE

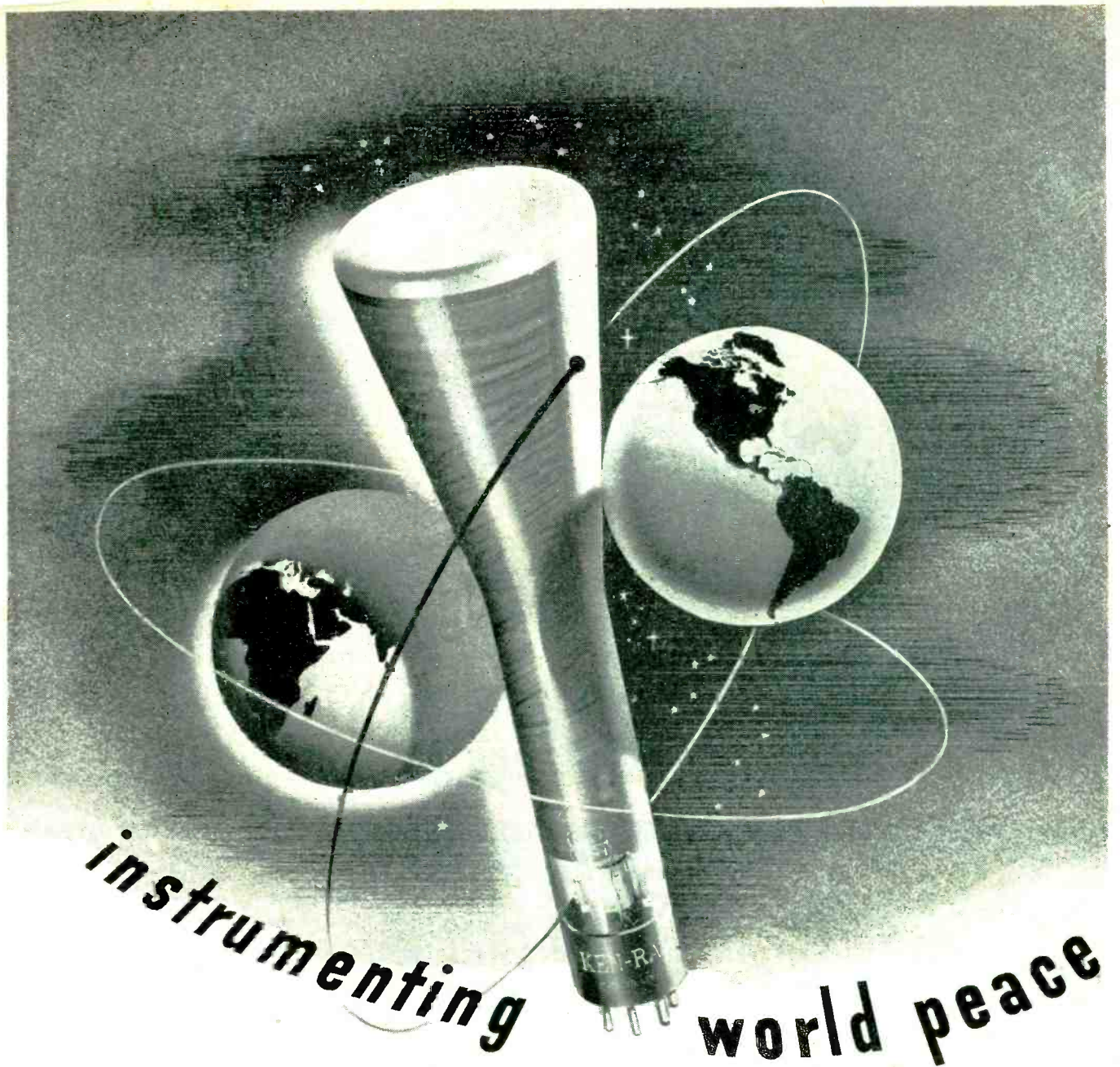

Ken-Rad completely converted to the mightiest of all war tasks looks to the day when it can place at the command of peaceful progression the techniques developed for war. New miracles will then be performed with Ken-Rad electronic tubes.

KEN-RAD

TRANSMITTING TUBES
CATHODE RAY TUBES

INCANDESCENT LAMPS
FLUORESCENT LAMPS

SPECIAL PURPOSE TUBES
METAL AND VHF TUBES

OWENSBORO KENTUCKY U S A

ELECTRONICS — September 1943

229

PERMANENT MAGNETS

THE Arnold Engineering Company is thoroughly experienced in the production of all ALNICO types of permanent magnets including ALNICO V. All magnets are completely manufactured in our own plant under close metallurgical, mechanical and magnetic control.

Engineering assistance by consultation or correspondence is freely offered.

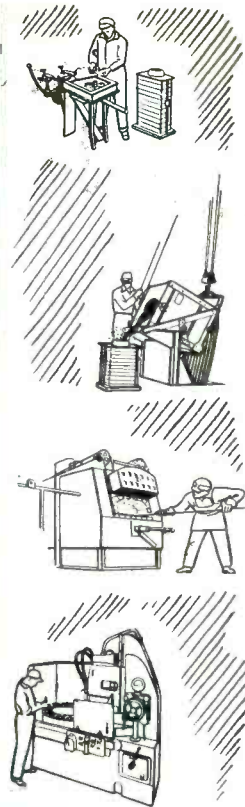

THE ARNOLD ENGINEERING COMPANY

147 EAST ONTARIO STREET, CHICAGO 11, ILLINOIS

CARTER *Magmotor* The Invisible Member of the Crew

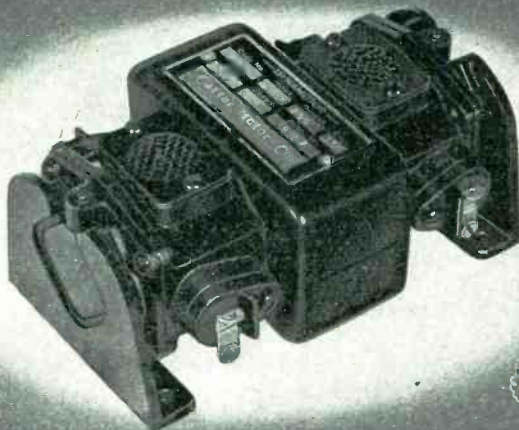

Only
4 3/4 lbs.
Up to
100 watt
output

THE Carter Magmotor, the unique and only Dynamotor with Permanent Magnet fields, has set new performance records for stamina, efficiency, light weight, and reliability. The 100 watt output models weigh only 4 3/4 lbs., nearly half the weight of other ordinary conventional type Dynamotors of equal output.

Without question it is the finest Dynamotor for Aircraft receiver and small transmitter requirements, as well as numerous other applications.

The latest catalogue containing Magmotors, Genmotors, Converters, Dynamotors, and Permanent Magnet Hand Generators will be sent upon request.

Carter Motor Co.
Chicago, Illinois

1606 Milwaukee Ave. Carter, a well known name in radio for over twenty years. Cable: Genemotor

service makes widely available the national standard of frequency, which is of value in scientific and other measurements requiring an accurate frequency. Any desired frequency may be measured in terms of any one of the standard frequencies, either audio or radio. This may be done by the aid of harmonics and beats, with one or more auxiliary oscillators.

The service is continuous at all times, day and night. The standard radio frequencies are:

5 Mc (5000 kc or 5,000,000 cps) broadcast continuously.

10 Mc (10,000 kc or 10,000,000 cps) broadcast continuously.

15 Mc (15,000 kc or 15,000,000 cps) broadcast continuously in the daytime only (i.e., day at Washington, D. C.).

All the radio frequencies carry two audio frequencies at the same time, 440 cps and 4000 cps; the former is the standard musical pitch and the latter is a useful standard audio frequency. In addition there is a pulse every second, heard as a faint tick each second when listening to the broadcast. The pulses last 0.005 second; they may be used for accurate time signals, and their one-second spacing provides an accurate time interval for purposes of physical measurements.

The audio frequencies are interrupted precisely on the hour and each five minutes thereafter; after an interval of precisely one minute they are resumed. This one minute interval is provided in order to give the station announcement and to afford an interval for the checking of radio-frequency measurements free from the presence of the audio frequencies. The announcement is the station call letters (WWV in telegraphic code (dots and dashes) except at the hour and half hour when the announcement is given by voice.

The accuracy of all the frequencies, radio and audio, as transmitted, is better than one part in 10,000,000. Transmission effects in the medium (Doppler effect, etc.) may result in slight fluctuations in the audio frequencies as received at a particular place; the average frequency received is however as accurate as that transmitted. The time interval marked by the pulse every second is accurate to 0.00001 second. The 1 minute, 4 minute and 5 minute



Stepping up to
TEN MILLION VOLTS
 X-Ray and Impulse
 Generator Capacitors

AEROVOX TYPE '26

Applications :

- X-ray filter capacitors
- Impulse test generators
- Carrier-current coupling capacitors
- High-voltage laboratory equipment
- Many other high-voltage applications

Ratings :

- 50,000 v. D.C. — .005 to .1 mfd.
- 75,000 v. D.C. — .001 to .05 mfd.
- 100,000 v. D.C. — .001 to .05 mfd.
- 150,000 v. D.C. — .001 to .03 mfd.

● Charged in parallel, discharged in series, these capacitors provide for voltages up to ten million and over for certain deep-penetration X-ray and impulse generator applications. For usual X-ray work, single units operate up to 150,000 volts.

Aerovox Type '26 capacitors are designed for just such service. Multi-layer paper sections, oil-impregnated, oil-filled, housed in sturdy tubular bakelite cases. Choice of metal cap terminals facilitates stack mounting and connections. Sections of matched

capacitance insuring uniform voltage gradient throughout length of capacitor.

Behind these capacitors stand those giant Aerovox winding machines handling dozens of "papers" at a time for highest-voltage paper sections. Likewise batteries of Aerovox vacuum tanks insuring thorough impregnation even to the last paper fibre. Such facilities spell Aerovox—the last word in oil capacitors—safeguarded by thorough inspection and testing from raw materials to finished units.

● New catalog, listing an outstanding line of heavy-duty capacitors for radio, electronic and industrial functions, sent on request to individuals engaged actively in professional engineering or production. Submit your capacitance problems and requirements.



Capacitors

INDIVIDUALLY TESTED

AEROVOX CORPORATION, NEW BEDFORD, MASS., U. S. A. • SALES OFFICES IN ALL PRINCIPAL CITIES
 Export: 100 VARICK ST., N. Y. C. • Cable: 'AR-AB' • In Canada: AEROVOX CANADA LTD., HAMILTON, ONT.

Can An ENGINEER Be A Businessman?

Let's talk sense.

We're not going to insult your intelligence or kid ourselves with a lot of meaningless words . . .

But . . .

If you are businessman enough to realize, and want to capitalize on, the opportunities that are now available to every engineer who wants to take advantage of them . . .

Then, by investing a few hours of your spare time a week, and a small portion of your present income, you can start gaining the advantages of CREI home study. This is the advanced technical study that will bring your knowledge up-to-date . . . help you in your daily work, and develop your ability to cope with any technical radio problem.

In an industry that is expanding as rapidly as radio . . . CREI courses take on new importance. CREI offers a proven program for personal advancement for the high calibre men that radio looks to for its efficient operation and progressive development.

One CREI student, a broadcast engineer, recently wrote: "I found your course sufficiently advanced for a college graduate, and of an engineering nature."

Now . . . if you're interested—

WRITE FOR OUR FREE BOOKLET

If you are a professional radio engineer, let us prove the value of CREI study. To help us intelligently answer your inquiry, PLEASE STATE BRIEFLY YOUR BACKGROUND OF EXPERIENCE, EDUCATION AND PRESENT POSITION.



CAPITOL RADIO ENGINEERING INSTITUTE

Home Study Courses in Practical Radio
Engineering for Professional Self-Improvement

Dept. E-9 3224—16th Street, N. W.
WASHINGTON, D. C.

Contractors to the U.S. Signal Corps—U.S. Coast Guard
Producers of Well-trained Technical Radlomen for Industry

intervals, synchronized with the seconds pulses and marked by the beginning and ending of the periods when the audio frequencies are off, are accurate to a part in 10,000,000. The beginnings of the periods when the audio frequencies are off are so synchronized with the basic time service of the U. S. Naval Observatory that they mark accurately the hour and the successive 5 minute periods.

Of the radio frequencies on the air at a given time, the lowest provides service to short distances and the highest to great distances. For example, during a winter day good service is given on 5 Mc at distances from 0 to about 1000 miles, 10 Mc from about 600 to 3000 miles and 15 Mc from about 1000 to 6000 miles. Except for a certain period at night, within a few hundred miles of the station, reliable reception is in general possible at all times throughout the United States and the North Atlantic Ocean and fair reception over most of the world.

Information on how to receive and utilize the service is given in the Bureau's Letter Circular, "Methods of using standard frequencies broadcast by radio", obtainable on request. The Bureau welcomes reports of difficulties, methods of use or special applications of the service. Correspondence should be addressed National Bureau of Standards, Washington, D. C.

Post-War Possibilities Demonstrated by RCA

ELECTRONIC APPLICATIONS that ranged from toasting marshmallows in three seconds to the drying of rayon threads were recently demonstrated to newspapermen and magazine writers at the RCA Laboratories in Princeton. The demonstrations primarily concerned peacetime applications of electronic devices for home and industry and included new and improved tubes for television. One of these, a screen grid type, contains a water-cooled anode and is designed for operation on five meters. Although normal research on television apparatus is not possible at this time at the laboratories, B. J. Thompson, associate director of General Research, pointed out that this phase of activity is not being entirely neglected.

JONES BARRIER STRIPS SOLVE MOST TERMINAL PROBLEMS

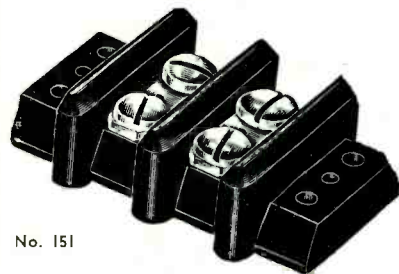

No. 151

A compact, sturdy terminal strip with Bakelite Barriers that provide maximum metal to metal spacing and prevent direct shorts from frayed wires at terminals.

6 SIZES

cover every requirement. From 3/4" wide and 13/32" high with 5-40 screws to 2 1/2" wide and 1 1/8" high with 1/4"-28 screws.

Jones Barrier Strips will improve as well as simplify your electrical intra-connecting problems. Write today for catalog and prices.

HOWARD B. JONES
2460 West George Street
CHICAGO 18 ILLINOIS



In the Nation's Service

PREMAX TUBULAR METAL ANTENNAS

If your problem is a satisfactory Antenna for communications, you will probably find the answer in Premax Bulletin of Standard Antennas and Mountings or Premax Special Service.

Premax Products

Division Chisholm-Ryder Co., Inc.
4302 Highland Ave., Niagara Falls, N. Y.

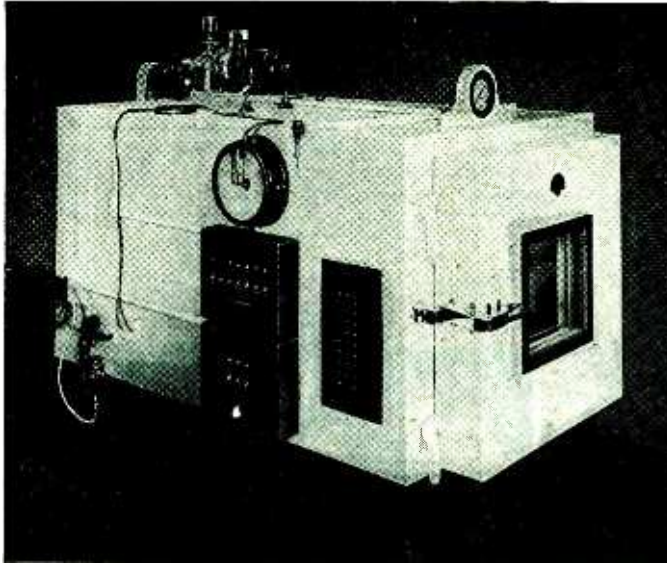

PERFORMANCE

Satisfactory

Radio and Electrical equipment is being tested in Tenney units by leaders throughout the country.

Uncle Sam's Inspectors are passing it after exacting tests with words of highest praise to the Electrical Engineers—

“PERFORMANCE SATISFACTORY”

Tenney units reproduce any atmospheric condition from the ground to Stratosphere.

Tenney Engineering, Inc. equipment is used by the Aviation Industry and the United States Government for all types of test.

*Stratosphere Chambers and Rooms to 60,000 feet. Humidity Chambers to 95%.
Constant and Variable Temperature Baths to $\pm 0.1^\circ$ F. Temperature Cabinets to -100° F.
Accurately controlled by exterior instruments.*

Our Engineering staff is at your service

Illustrated and descriptive booklet on request. For Precision Control, write—

TENNEY ENGINEERING COMPANY, INC.

Dept. E-9, 8 Elm Street

Montclair, N. J.

Telephone: Montclair 2-5535



SCIENTIFIC CONTROL OF HUMIDITY, SUB-ZERO TEMPERATURE and VACUUM

ELECTRONICS — September 1943

233

ALL THREE DANIEL KONDAKJIAN PLANTS

... now at capacity for Victory!

NOW — all on full schedules, all producing the tungsten leads, bases and caps so vital to the war effort. Daniel Kondakjian electronic components are represented in every type of military application — Radar, communication, navigation, control mechanism, x-ray equipment, etc.

LATER — the complete engineering and research facilities of the Daniel Kondakjian organization will be available for tomorrow's business strategies, comforts, conveniences, benefits and welfares. Inquiries, pertaining to post-war intent, and applicable to our capabilities, are invited.

THE ENGINEERING CO., 27 WRIGHT ST., NEWARK, N. J.



TUNGSTEN LEADS DANIEL KONDAKJIAN BASES AND CAPS



MICA

FOR EVERY RADIO, ELECTRICAL AND ELECTRONIC USE

Fabricated parts for electronic tube and condenser manufacturers — including discs, bridges, supports, stampings in any shape or form, condenser films, etc.

Serving hundreds of leading companies since our company was established under its present management in 1917. Special attention has been paid to radio tube and component manufacturers since the early days of the radio industry.

Our complete manufacturing facilities, experience and the quick understanding of our customers' problems, blend to make our services invaluable to an increasing number of new clients.

May we quote on your requirements or discuss your mica problems with you?

FORD RADIO & MICA CORPORATION

JOSEPH J. LONG, *President*

538 63rd Street

Brooklyn, N. Y.

Established 1917 • Telephone: WIndsor 9-8300

Post-War FM Problems

AT A RECENT MEETING of the directors of Frequency Modulation Broadcasters, Inc., post-war problems of frequency-modulation stations received major attention. The president, Walter J. Damm, was elected to represent the association in the Radio Technical Planning Agency, now in process of formation by engineering societies.

The meeting was addressed by Major E. H. Armstrong, who suggested that standards and wavelength allocations for FM be made sufficiently flexible to permit correction of any errors of judgment of future conditions that will probably be made. In this connection he said, "The classic example of this was in the radio allocation which gave all the wavelengths below two hundred meters to the amateur!

"A second blunder was the assumption that a five-thousand cycle modulation band was all that would ever be required for good broadcasting, and this assumption resulted in a permanent impairment of the quality of transmission on the standard broadcast band.

"A more recent illustration was the allocation of television to wave bands where it had no business to be, that is, where the modulation frequency was a large percentage of the carrier frequency."

London News Letter

By JOHN H. JUPE
London Correspondent

Talking About Electronics. I was somewhat annoyed the other day to see that a British Member of Parliament had asked a question in the House of Commons regarding the relative advances and developments of electronics in this country and the U.S.A. He tried to compare RCA, Bell Labs, etc., with such British concerns as the British Broadcasting Corp., Cables and Wireless Ltd., The British Post Office Engineering Department, etc. Of course, comparison is impossible and he was told so by a Government speaker.

Discussing this later with some engineering colleagues, we came to

This ROCKBESTOS FIREWALL Hookup Cord

REG U S PAT OFF

may answer your wiring problem

Actual size No. 14 AWG, 2-Conductor
Rockbestos Firewall Hookup Cord



Construction Detail—Enlarged 3 Times

First, a color-coded braid of glass yarn (or cotton or rayon) lacquer-finished to a hard, smooth surface that never becomes gummy or tacky and is resistant to heat, cold, moisture, oil, grease and gasoline. Next, a firewall of resilient felted asbestos, impregnated with heat, flame and moisture resisting compounds, that acts as a heat barrier against high am-

bient temperatures and won't burn even under copper-melting arcs. Then a thin, tough, mechanically strong synthetic tape for uniform high dielectric strength and high moisture resistance. And finally, a stranded tinned copper conductor perfectly and permanently centered in helically applied insulation that will not migrate or flow under heat.

Or These Permanently Insulated Wires

ROCKBESTOS FIREWALL RADIO HOOKUP WIRE

The first light weight, small diameter, flame resistant hookup wire, designed in 1937 and widely used since in radio equipment for aircraft and ground installations, instruments and apparatus. Operating temperature range from 125°C to minus 50°C. Sizes No. 18 to 4 AWG in 1000 volt rating, and No. 12, 14 and 16 AWG in 3000 volt, constructed as in cut-back illustration to the right.

SHIELDED ROCKBESTOS FIREWALL RADIO HOOKUP WIRE

Made in the same sizes and construction as above, in single or multi-conductor, and covered with a tinned copper shielding braid.

ROCKBESTOS TYPE CA LEAD WIRE

Has high dielectric strength plus high moisture resistance for use where heat and humidity is encountered. Sizes No. 20 to 8 AWG solid or stranded copper, monel or nickel conductors with synthetic tape and various thicknesses of felted asbestos in black, white or colors.

ROCKBESTOS ASBESTOS INSULATED MAGNET WIRE

Designed for Class B windings, it is suitable for use as bus wire where high dielectric strength is not required. The insulation is non-checking and is unaffected by heat or aging.



If you are manufacturing or developing electronic equipment that develops heat in operation or may be used in hot, damp locations, the Rockbestos Firewall Hookup Cord, illustrated, may answer your wiring problem.

Especially designed for severe operating conditions, this small diameter, light weight polarized cord has a *permanent insulation* that is unaffected by temperatures ranging up to 125°C and down to minus 50°C. The resilient asbestos firewall, applied between the outer braid and primary dielectric, acts as a heat barrier against high ambient temperatures and won't burn under copper-melting arcs. It also "gives" like a cushion to reduce the possibility of damage caused by abrasion and vibration. Rockbestos Firewall Hookup Cord resists heat, flame, cold, moisture, oil, grease and gasoline. The *permanent insulation* won't bake brittle, rot, flow or de-center.

For long-lived wire performance in your electronic devices, specify Rockbestos *permanently insulated* wires, cables and cords. 122 standard constructions are available to meet practically every requirement. Rockbestos Research will develop wires for applications requiring special performance characteristics. Write, specifying your problems, to nearest branch or:

Rockbestos Products Corp., 404 Nicoll St., New Haven 4, Conn.

ROCKBESTOS RESEARCH

Solves Difficult Wiring Problems

NEW YORK, BUFFALO, CLEVELAND, CHICAGO, PITTSBURGH, ST. LOUIS, LOS ANGELES, SAN FRANCISCO, SEATTLE, PORTLAND, ORE.

★ FOR VICTORY INVEST IN U. S. WAR BONDS ★

GOULD MOODY

**CAN GIVE YOU THE
RECORDING BLANKS
YOU REQUIRE**

*"Black
Seal"*

**GLASS BASE
INSTANTANEOUS
RECORDING
BLANKS**

*Immediately
Available*

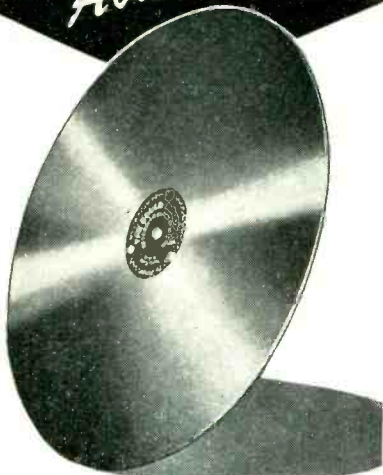

Don't delay ordering your "Black Seal" Recording Blanks because of priorities. An AA-2X rating is automatically available to all broadcasting stations, recording studios and schools.

"No better instantaneous recording blank was ever made," say engineers in major broadcasting stations from coast-to-coast of the new Gould-Moody "Black Seal" Glass Base Instantaneous Recording Blanks.

Enclosing your priority rating when ordering will expedite deliveries.



**THE GOULD-MOODY
COMPANY**

RECORDING BLANK DIVISION
395 BROADWAY · NEW YORK 13, N. Y.

the conclusion that such talk ought to be killed at once. The people who spout it generally go to one extreme or the other. They either say, "Oh, the Yanks are far ahead of us," or else they say, "Nothing in the world can touch the British product."

Each country has its own specialties and leanings, but the real spirit of electronics and radio is international and should always be viewed as such.

Lady Engineers. When war broke out it was quickly realized that the radio transmitting stations would lose some of their engineers. The British Broadcasting Corp. decided that the only permanent solution was to train women very thoroughly. To start with, a technical training manual of really high standard was prepared. There was no insistence on previous engineering experience, but a fairly good general education was required.



This member of the BBC Recorded Programs Department is listening to playback of one of President Roosevelt's speeches, marking portions of the record with white crayon pencil for use on British broadcasts

Each woman passed through the long training course and sat for the examination at the end. She was then allotted to program controlling, transmitter operation or program recording, in each case under the guidance and supervision of men engineers.

These women totaling 700, not only had to work under "blitz" con-

University
LABORATORIES



**REFLEX
SPEAKERS**
are now the
**ACCEPTED
STANDARD**
for all
WAR USE



EVERY REFLEX
in the
UNIVERSITY LINE
is the result of
YEARS of
RESEARCH



EVERY REFLEX
in the
UNIVERSITY LINE
has a vital part
to play in the
WAR PROGRAM

There are
OVER 50 SPEAKERS
in the
UNIVERSITY LINE

Submit your special
problems direct to our
engineering depart-
ment.



UNIVERSITY
225 VARICK STREET N. Y. C.

TELEGRAPH and RADIO KEYS

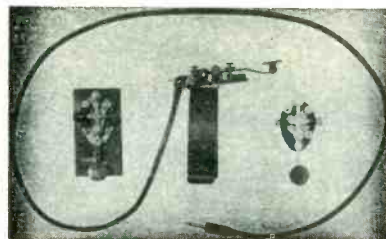

Telegraph Keys to Signal
Corps Specifications

Types now in production include

J-12, J-18, J-28, J-29, J-30

J-31, J-37, J-38, J-40, J-41-A

J-44, J-45, J-46, J-47, J-48

Quotations upon request

THE WINSLOW COMPANY
INCORPORATED
9 Liberty Street, Newark, N. J.

ATTENTION: DESIGN ENGINEERS!

Do any of these new miniature motors
fit into your design plans?

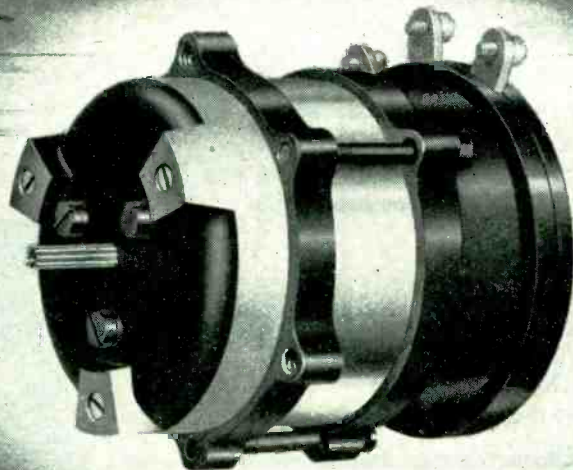

TYPICAL KOLLSMAN DRAG CUP MOTOR

Model 776-01

(Illustrated above actual size)

Frequency—400 cycles

Voltage Phase 1—24 volts
Phase 2—35 volts

Speed, no load—5700 RPM

Torque, stalled—.70 in./oz.

Weight—Complete Motor—12 oz.
Shaft Assembly—.53 oz.

Of interest to design engineers of many electrical and electronic manufacturers will be the new line of miniature motors with special remote indication and control applications, just released by Kollsman Instrument Division of Square D Company.

Typical of these new units is the Drag Cup Motor illustrated actual size above. It is specially designed for installations requiring quick-starting, stopping and reversal characteristics. This is obtained by an extremely lightweight rotor having correspondingly low inertia. Extensive tests have shown it to have definite performance advantages over other motors of this type.

Similar design and operational advantages are to be found in the other Kollsman Motors described in the catalog pictured at right.

★ ★ ★
Complete information and performance data on Kollsman remote indicators and motors with electronic applications now available in catalog form. Please write for copy on your letterhead. Address: Kollsman Instrument Division, Square D Company, 80-10 45th Ave., Elmhurst, New York.

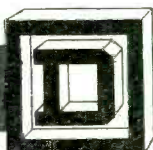
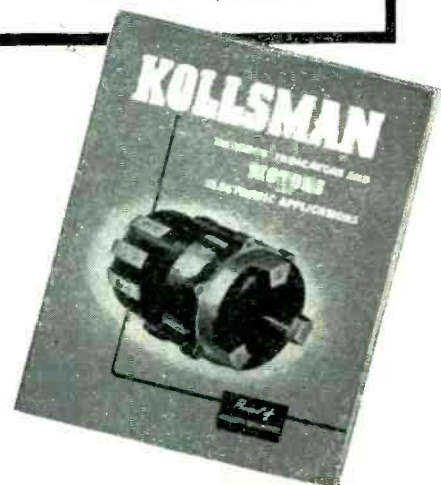

ELECTRICAL EQUIPMENT

KOLLSMAN AIRCRAFT INSTRUMENTS

SQUARE D COMPANY

ELMHURST, NEW YORK

GLENDALE, CALIFORNIA

**ANOTHER
NEW**

Gothard

**PILOT
LIGHT**



for GROUNDED PANELS

- Mounts 1" on centers.
- Body length approximately 2".
- Hexbody permits socket wrench installation.
- Bulbs change from the front without disturbing wiring.
- Well ventilated.
- Takes Bayonet socket lamp (long or round)
- Faceted Jewel Model 900
Plain Jewel Model 901

Gothard

Request complete information.

MANUFACTURING COMPANY
1310 North Ninth Street, Springfield, Illinois



**WHEN THE UNIFORMS
ARE PUT
AWAY...**

... will you be ready to return to the ways of peacetime production?

It's time to start thinking of what the future means for you. And think, too, of ERWOOD—its two decades of engineering experience will solve many of those problems that lie ahead.

THE ERWOOD COMPANY

225 WEST ERIE STREET

CHICAGO, ILLINOIS



Starting up a Presto disc recording machine in the BBC Engineering Division in preparation for cutting one of the 4000 discs per week used by the British Broadcasting Corp. for radio programs. These photos are unposed, and represent fair samples of what women are doing in England



Women at work in a BBC wartime control room at which both incoming and outgoing radio programs are routed to their proper destinations. Telephone communication is maintained from here to all distant control rooms and transmitters

ditions but had to adapt themselves to ever-expanding program hours. Soon, twenty-four hours a day, every day was reached. Owing to the care with which they were chosen and trained, the plan has proved very successful, perhaps even amongst the most successful employment of women in our war effort.

Television Patent. A very important factor in the post-war development of television is the question of obsolescence of receivers. J. L. Baird has been granted a British patent (No. 545078) which deals

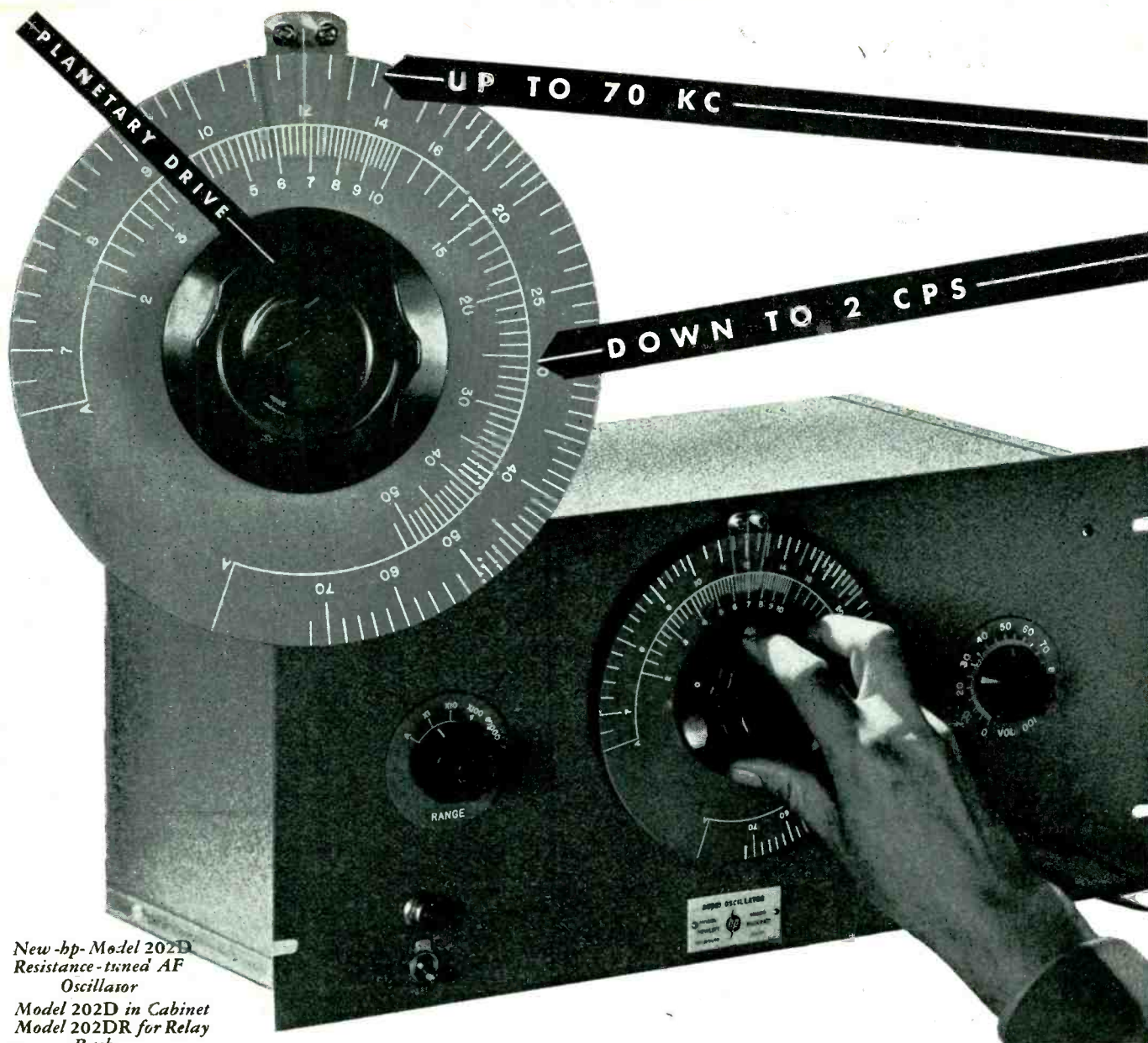

New -hp- Model 202D
Resistance-tuned AF
Oscillator
Model 202D in Cabinet
Model 202DR for Relay
Rack

Interested in LOW FREQUENCIES?

This newest addition to the -hp- line of Resistance-tuned Audio Oscillators provides you with all the excellent features found in its predecessors plus a range of available frequencies heretofore not provided. Large, easy to read dial has two scales extending over 270° rotation. Smooth planetary drive with a 5 to 1 reduction makes it easy to control. The outside scale is calibrated for frequencies from 7 cps to 70 kc. The inside scale is calibrated for frequencies from 2 cps to 50 cps. All calibrations are for direct reading. A resistance-coupled power amplifier provides

uniform output over the entire range. The instrument is extremely stable, having a frequency drift of less than $\pm 2\%$ even during the initial warm-up period. Line variations of as much as 20% will change the frequency less than $\pm 0.2\%$ at 1 kc. As with all -hp- AF oscillators *no zero setting is required*. Write today for more complete data. Give us details of your problem so that we can be of utmost assistance. Ask for your copy of the 24 page -hp- catalog which gives much valuable information about electronic instruments. There's no cost or obligation.



HEWLETT-PACKARD COMPANY

P.O. Box 1135 "S", Station A, Palo Alto, California

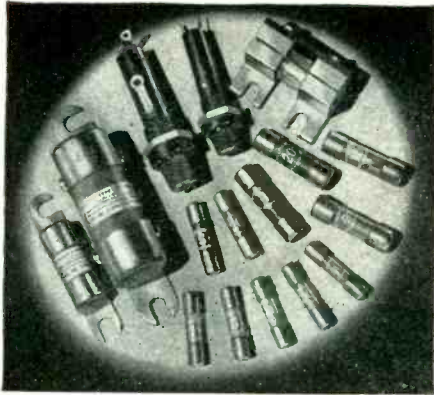

American Fighting Machines Require Littelfuses

Millions of Littelfuses are guarding countless electrical circuits of our fighting equipment in the air, on land, on sea, and undersea.

On Guard Where Protection is Vital

Every circuit built into a plane, tank, boat, or submarine must withstand unprecedented shock, surges and vibration.

Precision instruments, dials, indicators, radio, all delicate electrical mechanisms of aircraft are subjected to shocks of dives from 60° below zero to 120° above—in seconds. Fuses must not fail.

Littelfuses are engineered to meet all conditions: By mechanical depolarization, new protection against severest vibration; by spring-and-link elements protecting smaller fuses; by reinforcement counteracting expansion and contraction; by patented locked cap assembly sealing fuse element against moisture and preventing caps from loosening.

The Show-Down Sets the Pace

Besides supplying Army and Navy requirements, over 4000 manufacturers depend on Littelfuse products for sure and uninterrupted performance of their equipment for war use.



Mechanical Depolarization

New protection from severest vibration by twisting elements at 90°.



Spring-and-Link Element

(For 5 amp. rating or less)
Fusing section protected from vibration and crystallization by copper spring at middle of tube.



Non-Crystallizing Elements

Spring forming takes up contraction and expansion.



Locked Cap Assembly

(Patented)
Caps locked not cemented on tubes. Seals from moisture. Prevents cap loss.

Fuse Every Instrument and Electrical Circuit for Safety—With Littelfuses

LITTELFUSE, INC.

4755 Ravenswood Ave., Chicago, Illinois
225 Ong Street, El Monte, California

particularly with this problem. He proposes to transmit a 600-line scan made up of three 200-line interlaced scans. Existing British receivers would then reproduce the 200-line picture, while later models fitted with suitable interlacing means would benefit to the full extent of the 600-line service.

Alternatively, the transmission could be made by scanning a succession of 200-line blue, red and blue pictures so that the blue lines of the first picture are covered by the red lines of the second picture and so on.

Suitably equipped receivers would then reproduce pictures in color, whilst older models would still give satisfactory reproduction in monochrome.

Radio Business News

NORTH AMERICAN PHILIPS CO. INC. announces a new trademark, Norelco, to be applied to products handled by its Industrial Electronics Division. Some of these products are: electronic temperature indicators, direct-reading frequency meters, X-ray apparatus, vacuum tubes, quartz plates, fine wire of drawable metals, and diamond dies, all handled at the Dobbs Ferry, N. Y. plant of the company. The Elmet trademark will continue to be used in connection with tungsten and molybdenum, products of the factory at Lewiston, Maine.

AIRCRAFT ACCESSORIES CORP. has acquired a controlling interest in the Phonette Co. of America, former maker of a music-vending device whose facilities have been converted to war production of radio components.

GODFREY L. CABOT, INC. has completed a million-pound dry cell carbon plant at Pampa, Texas. An application has been filed with the War Production Board for permission to build a second plant of two million pounds capacity. American dry battery manufacturers have previously been dependent on sources outside the U. S.

STATION WJW, new Blue Network outlet in Cleveland, opened August 29 with 5,000 watts power. The station has been transferred from Akron, and is one of the few stations to open since the war began.

• NUMBERALL • NUMBERING and LETTERING PRESS

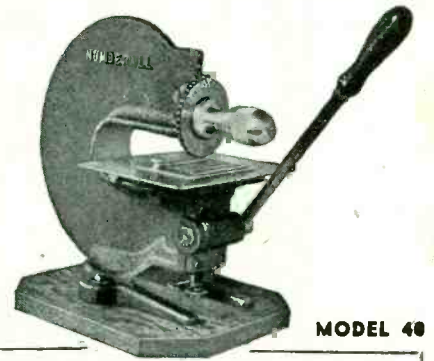

Quickly stamps serial numbers and other details on name plates, names and numbers on tags, etc. Can also be furnished for HOT stamping. Write for catalog.

**NUMBERALL
STAMP & TOOL CO.**
Huguenot Park Staten Island, N.Y.

For Tomorrow's
Broadcasting—

LOOK TO ★LINGO

For advanced design and
superior performance in

**VERTICAL TUBULAR
STEEL RADIATORS**

**PATENTED FM
TURNSTILE RADIATORS**

We're "all out" for Victory, but our engineers are ready to work with you on post-war plans.

JOHN E. LINGO & SON, Inc.
CAMDEN, NEW JERSEY

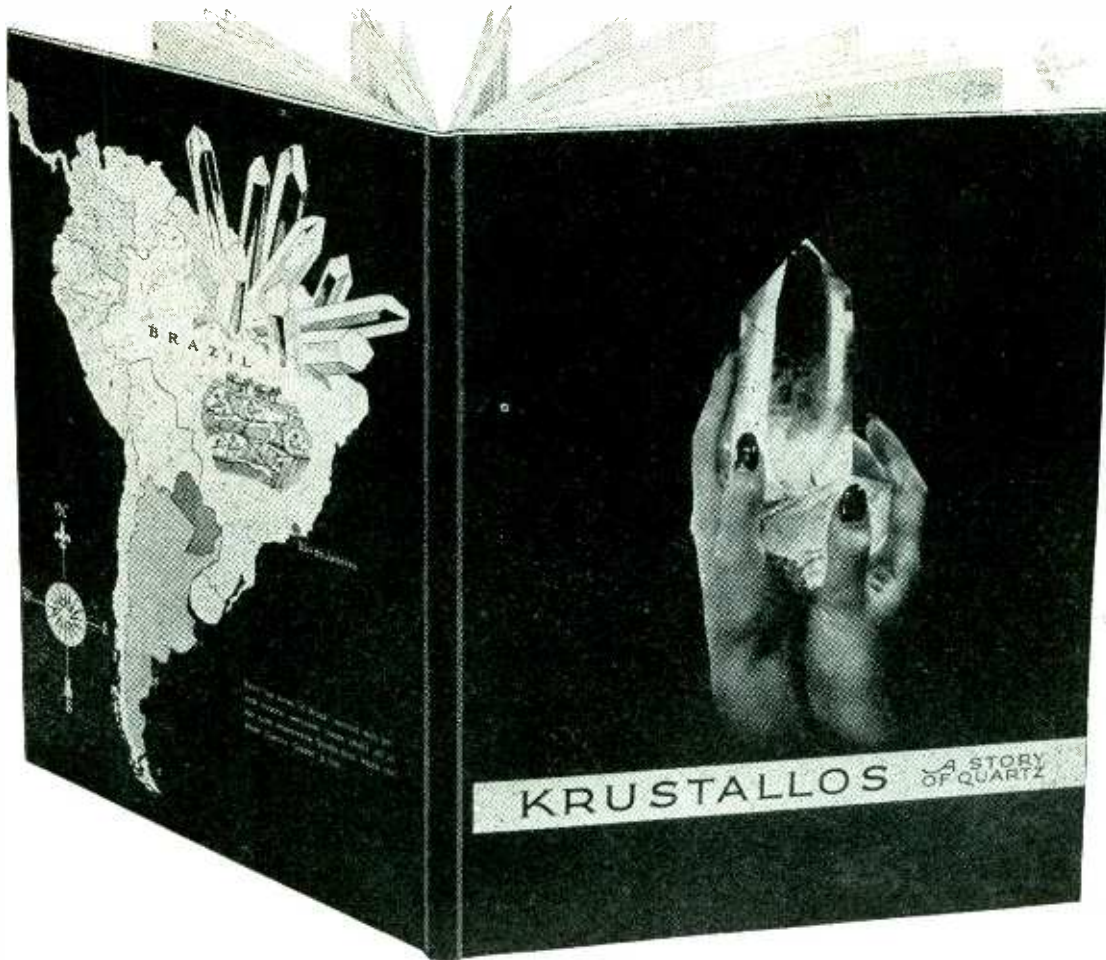

A STORY OF QUARTZ

is yours for the asking

After months of Research, the August E. Miller Laboratories have produced this challenging "STORY OF QUARTZ" depicting

Its Romance in the Past • Its Realities in the Present • Its Promise for the Future

We will gladly forward a copy of this Brochure to any Electronics Reader who gives his official title when signing request on business stationery.

Three requirements are necessary for producing the perfect OSCILLATING QUARTZ CRYSTAL

- 1—Knowledge** The August E. Miller Laboratories have a background of more than a quarter century in Quartz Research.
- 2—Organization** The August E. Miller Laboratories is staffed by experts in every department—no problem is too difficult for them to attempt to solve.
- 3—Equipment** The August E. Miller Laboratories are equipped with the most modern instruments and machines known for the production of the Oscillating Quartz Crystal.

AUGUST E. MILLER LABORATORIES, 9226 Hudson Blvd., North Bergen, N. J.

WAR PRODUCTION BY
*Northern Industrial
 Chemical Company*
 7-11 ELKINS STREET SO. BOSTON, MASS.
**35 YEARS OF PLASTIC
 MOLDING EXPERIENCE**

Distributed by
Graybar
 ELECTRIC COMPANY

NATIONAL UNION RADIO CORP. has purchased a modern plant in Robeson, Pa. and will begin manufacturing there in the near future. Selected women workers from the surrounding area will take a three-week training course in the Lansdale plant of the company, then return to Robeson to instruct other employees in radio tube manufacturing.

DUMONT TELEVISION STATION W2XWV will be used once a week to televise programs from WOR. Artists and announcers of WOR will have an opportunity to experiment with delivery, makeup and other problems while technicians under J. R. Poppele, Chief Engineer of WOR, will observe technical details of the broadcasts.

SYLVANIA ELECTRIC PRODUCTS, INC. has announced purchase of manufacturing facilities of Electro Metals, Inc. of Cleveland, makers of lead-in wires for radio tubes and incandescent and fluorescent lamps. Operations will continue at the present site to supply customers of Electro Metals.

The company has also acquired its fifteenth manufacturing plant. Located in Warren, Pa., the building will be devoted to production of assembly parts for radio tube, lighting, and electronic products.

Sylvania has formed an International Division that will provide engineering counsel and personal contact with the market in other countries.

• • •

ELECTRONIC SOLDERING



G-E high-frequency heating unit being used to provide heat for simultaneous soldering of six crystal units at a time

CRYSTALS

BY

Ample production facilities available for lots or individual crystal orders—Priorities, of course.

Buy More Bonds!

DX CRYSTAL CO.
 GENERAL OFFICES: 1841 W. CARROLL AVE., CHICAGO, ILL., U.S.A.

DX XTALS
 the heart of a good transmitter
 TRADE MARK

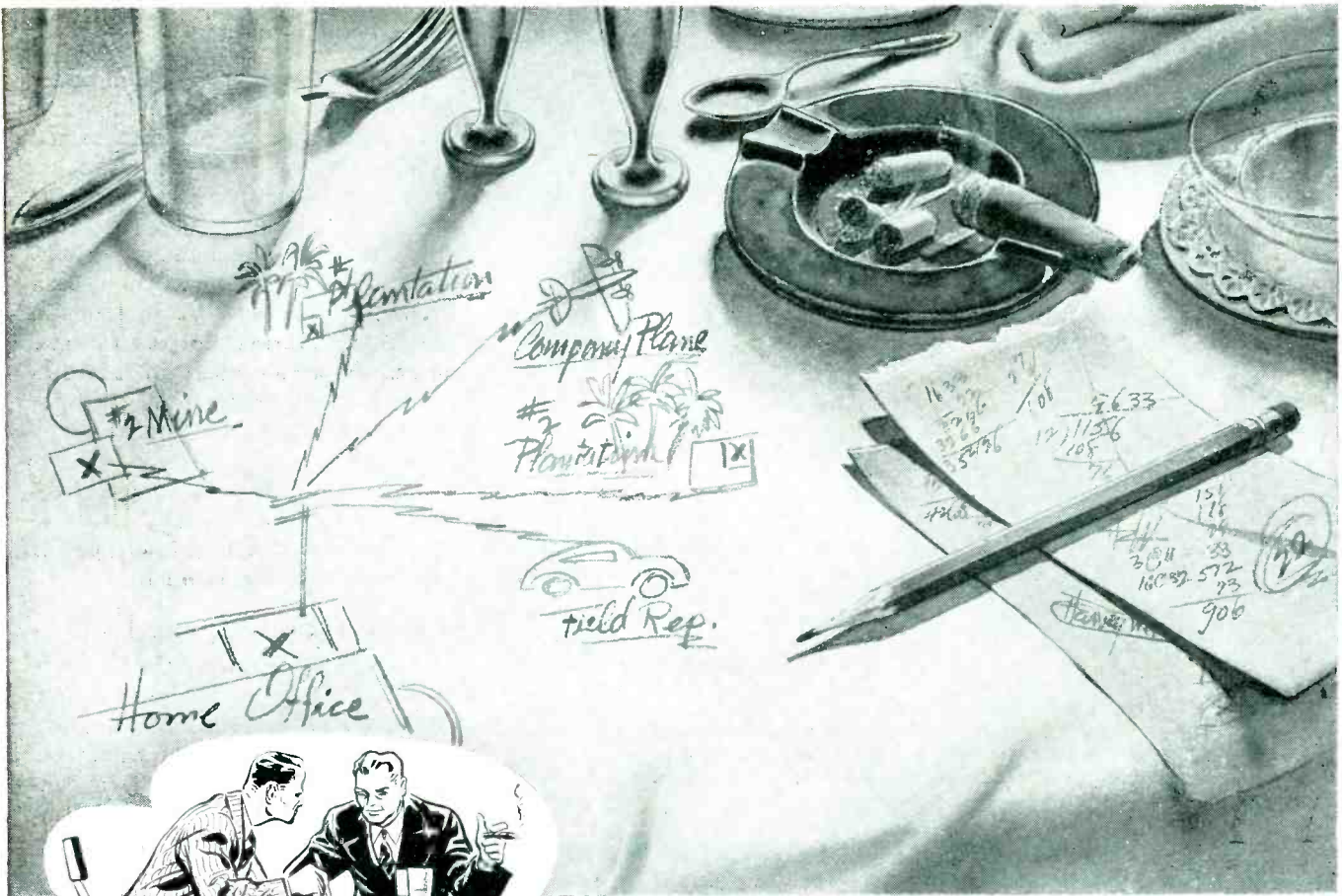

"AS A MINE AND PLANTATION OPERATOR, HAVE YOU THOUGHT OF USING COMMUNICATIONS AFTER THE WAR?"

"Tablecloth" Communications

...or just plain pencil doodlin'—perhaps—and no doubt you've been doing some yourself, planning for post-war operations in your own business.

Our job right now is making specialized communications equipment for our government; and what we're learning now will be of utmost value to communications in YOUR business, post-war and after.

Since infinite peacetime applications come from the stimulation of war—YOUR communications equipment will be BETTER than ever. Better in design, lighter in weight and more compact through skilled manufacturing.

Here we have done a bit of doodlin' for applications in a mine and plantation set-up. Future "Tablecloth Communications" will dramatize possible uses of Harvey-Wells equipment in industries, transportation, lumbering and other allied fields.

HARVEY-WELLS
Communications inc.
★
HEADQUARTERS
For Specialized Radio Communications Equipment
SOUTHBRIDGE, MASS.

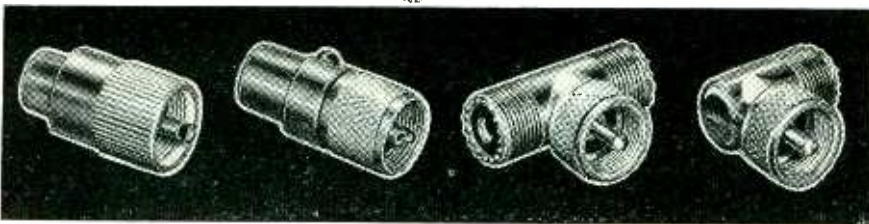

Building Railroad Tracks for ELECTRONS



BEFORE being shot out into space to perform their amazing tasks, radio's tiny electrons must travel tortuous circuit paths or tracks laid down for them when radio equipment installations are made. These "tracks," or cables, are held together at intersections, curves and terminals by what is known, in the language of electronics, as Constant Impedance High Frequency Connectors, Co-axial Cable Connectors, Multi-contact

Plugs and Sockets and other similar parts familiar to the industry. Astatic's manufacturing facilities are today devoted chiefly to the volume production of these important parts. Approved by Army and Navy engineers, and highly praised by many leading electronic equipment manufacturers, Astatic Connectors are rendering the highest degree of operating efficiency in wartime service.

ASTATIC

IN CANADA
CANADIAN ASTATIC, LTD.
TORONTO, ONTARIO

THE ASTATIC CORPORATION
YOUNGSTOWN, OHIO

BUD PRECISION CONDENSERS

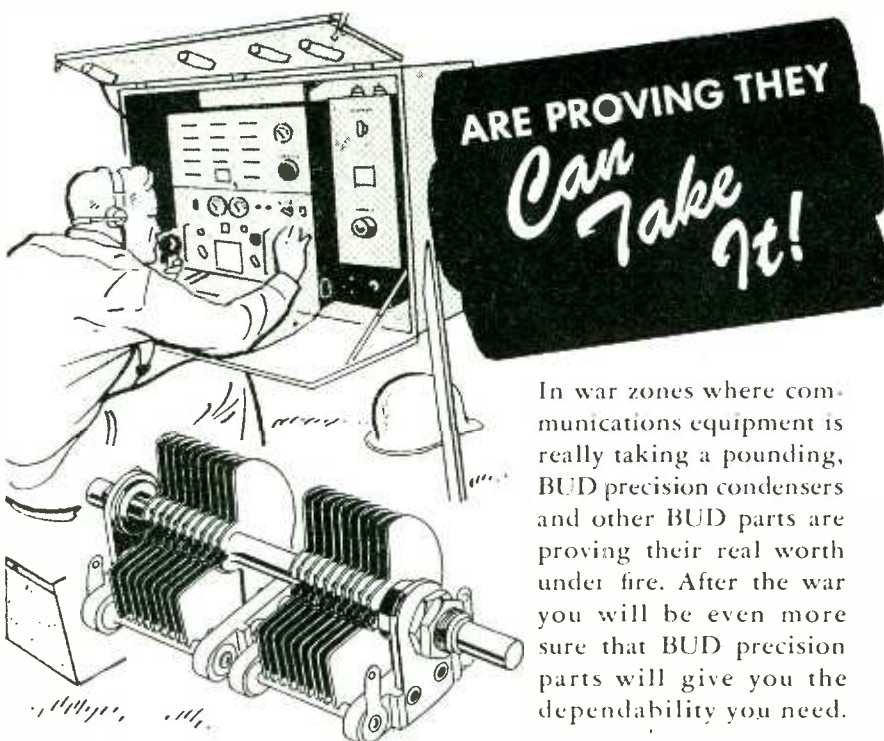

In war zones where communications equipment is really taking a pounding, BUD precision condensers and other BUD parts are proving their real worth under fire. After the war you will be even more sure that BUD precision parts will give you the dependability you need.



BUD RADIO, INC.
CLEVELAND, OHIO

Personnel

Palmer M. Craig, chief engineer in charge of radar and radio equipment development, has been named chief engineer of the Radio Division of Philco Corp.

Noran E. Kersta, manager of NBC Television Department, has been commissioned First Lieutenant in the U. S. Marine Corps. He pioneered in development of business methods and commercial policies for television for NBC.

John T. Williams, formerly of NBC Radio-Recording Division, has been appointed acting manager of the Television Department.

Roy C. Corderman, assistant chief of the OWI Bureau of Communications Facilities, has resigned to join the Radio Division of Western Electric Co. He will also resign from the International Broadcasting Co-ordination Committee, on which he represented both OWI and CIAA.

Lt. Commanders Rawson Bennett, II and William S. Parsons, of the Navy's Bureau of Ships, have been promoted to the rank of full Commander. Commander Bennett is in charge of underwater sound design, while Commander Parsons handles ship communications equipment.

Fred E. Harrell, assistant chief engineer of Reliance Electric & Engineering Co. of Cleveland since 1934, has been appointed chief engineer of the company.

Daniel W. Gellerup, technical supervisor of radio for WTMJ and W55M, Milwaukee Journal radio stations, has been granted an indefinite leave of absence to serve as civilian consulting engineer with the U. S. Navy, under the National Defense Research Committee. He was engineer for Milwaukee's first broadcast station WAAK in 1921, and became connected with the Journal Co. in 1925 as chief engineer for WHAD, fore-runner of the present stations.

Lieutenant Henry E. J. Smith, recent managing director of the Bolivian subsidiary of IT&T, is now serving with the U. S. Army in North Africa.

Designing Molded Plastics Parts: G-E MYCALEX

From the engineering files of One Plastics Avenue



G-E mycalex is an inorganic compound composed of ground mica and a special glass, having unique heat and electrical properties, and ranking above all other insulators for certain applications because of a combination of features possessed by no other material. Because it is singularly different from other molding compounds, special consideration must be given in designing parts to be made from G-E mycalex. This material is particularly valuable for use in ignition, radio and electronics equipment.

Desired Design Characteristics of G-E mycalex Parts

1. Well rounded corners and fillets.
2. Three to five degree taper on mold walls is desirable.
3. Minimum wall thickness of parts $\frac{1}{16}$ inch.
4. Minimum hole diameter $\frac{1}{16}$ inch.

Advantages of G-E mycalex

1. Ready anchorage of metallic inserts in material during molding.
2. Molding of holes in part.
3. Close tolerances in molding.
4. Ability to produce intricate shapes.
5. Reduction or elimination of finishing and machining operations.

Properties

1. High dielectric strength.
2. Low power factor.
3. Prolonged resistance to electric arcs.
4. Chemical stability; negligible deterioration with age.
5. Dimensional stability; freedom from warpage, shrinkage, etc.
6. Imperviousness to water, oil, and gas.
7. Resistance to sudden temperature changes.
8. Low coefficient of thermal expansion.
9. Exceptional heat resistance.
10. Insulating properties compare favorably with porcelain.

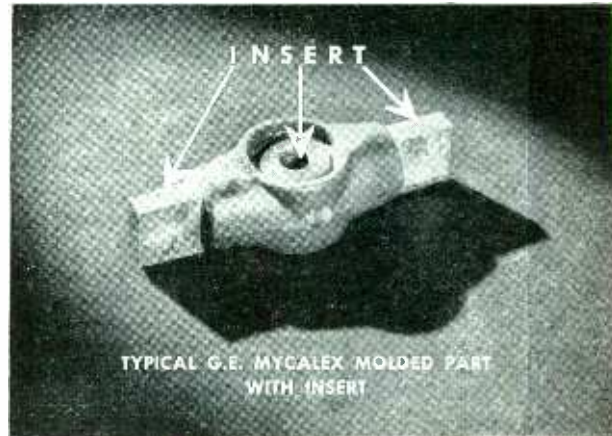

Types of G-E mycalex

#2801—General purpose grade for all molded parts. Used where mechanical strength is of primary importance.

#2800—Lower loss factor, lighter weight and smoother finish. Unaffected by changing atmospheric conditions; has superior stability of power factor after prolonged immersion in water.

GENERAL ELECTRIC is the nation's largest molder of plastics. The combined experience and plastics "know-how" of its chemists, designers, product engineers, toolmakers and molders is available to all interested. Write for G-E mycalex booklet, Section M-5, General Electric Co., Plastics Divisions, Pittsfield, Mass.

Hear the General Electric radio programs: The "Hour of Charm" Sunday 10 P.M., EWT, NBC—"The World Today" news every weekday 6:45 P.M., EWT, CBS

BUY WAR BONDS

17-55

PLASTICS DIVISIONS
GENERAL ELECTRIC



PORTABLE POWER PROBLEMS

No. 1—Balloon-borne Weather Spy

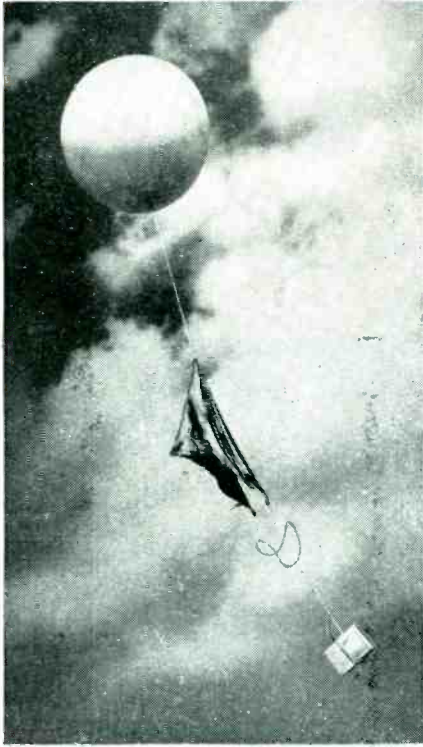

NO ORDINARY BATTERY could power the vital voice of the radiometeorograph. High voltage in light-weight, compact form was required, and Burgess engineers "delivered the goods!"



BURGESS-BUILT POWER-HEART of Uncle Sam's mechanical weather observer is shown here . . . Why not bring your portable power problems on electronic equipment to Burgess engineers?

FREE..ENGINEERING HANDBOOK

80-page manual of basic data and characteristics of dry batteries for all electronic applications. Tabbed for ready reference. Write Dept. 9 for free copy. *Burgess Battery Company, Freeport, Illinois.*

BURGESS BATTERIES

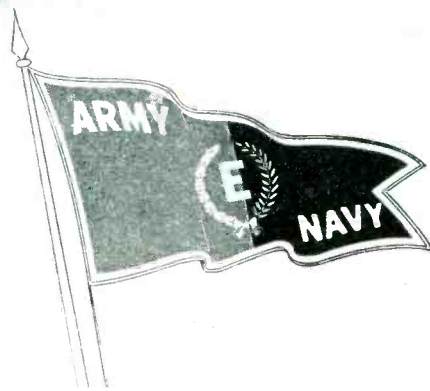

BENDIX AVIATION CORP.,
Julien P. Friez & Sons Div.,
Towson, Md.

CANNON ELECTRIC DEVELOPMENT
Co.
Los Angeles, Cal.

CORNING GLASS WORKS
Charleroi, Pa.

GREAT WESTERN DIV., of
The Dow Chemical Co.,
Pittsburgh, Cal.

UNITED ELECTRONICS CO.
Newark, N. J.

The Award of the Maritime "M" and Victory Flag, for outstanding production achievement was extended to Air Reduction Company, Bethlehem, Pa., and to its seven subsidiary companies located throughout the United States.

BOOBY TRAPS

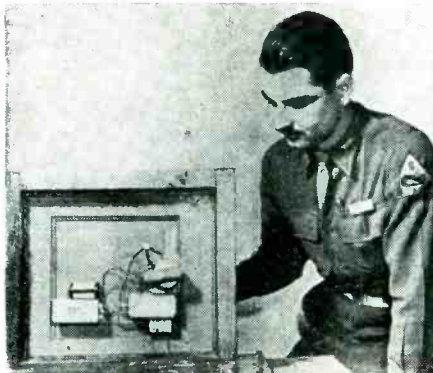

Capt. Francis T. Snyder is teaching soldiers at the Fort Knox Armored Force School to be wary of booby traps. A veteran of Rommel's pushes through Libya, he demonstrates how a movement of a door handle completes the electrical circuit leading to a can of TNT. Other kinds of booby traps, which are attached to windows, light switches, desk drawers, chairs, are also explained to trainees



NEW Test Lead

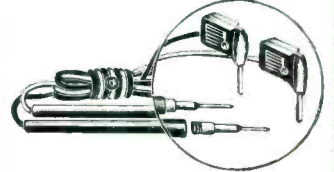

This new ICA Test Lead (No. 373) is approved by the Signal Corps. Preferred by leading test equipment manufacturers

Mfrs. and Contractors, write for this 12-page Industrial Catalog.



INSULINE

CORPORATION OF AMERICA
INSULINE BUILDING
(36-02 35th AVENUE)
LONG ISLAND CITY, N.Y.

Wartime Service



• The country's largest exclusive wholesale distributor of radio and electronic parts offers you the benefit of its well-trained organization, long experience and exceptional factory connections, in filling your **PRIORITY** requirements.

• Try Dalis — write, wire or 'phone . . .

H. L. DALIS, Inc.

Distributors of
RADIO & ELECTRONIC SUPPLIES
17 Union Square o New York, N.Y.

Phones: ALgonquin 4-8112-3-4-5-6-7



SERVICE



His chances are
better — with

WALKER-TURNER FLEXIBLE SHAFTING

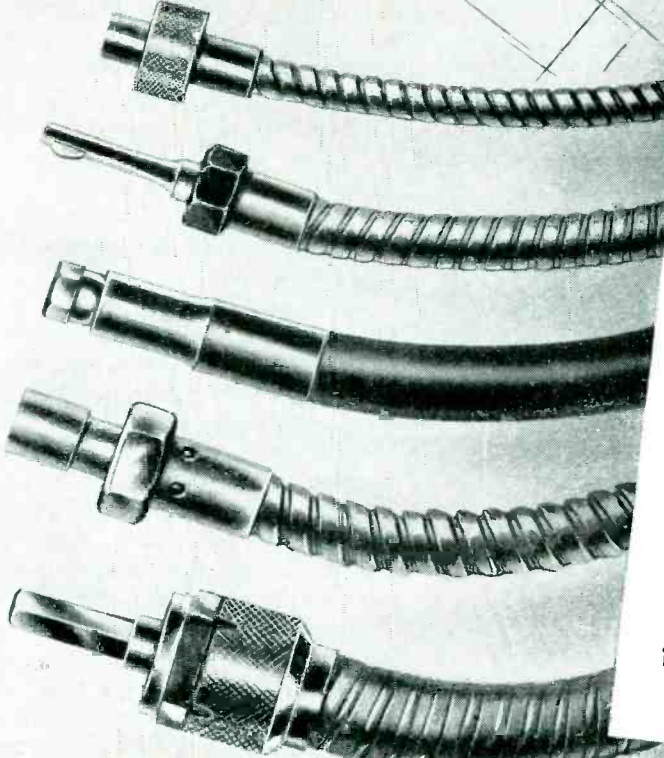

WALKER-TURNER Flexible Shafting has met the hardest tests of war, because previously it had been thoroughly proven in thousands of rigorous applications in industry. For years, this Company has been making the finest quality of flexible shafting for its own flexible shaft machines and for other manufacturers whose products required this form of power transmission or remote control.

Perhaps we can help you work out the solution to a problem of this nature, calling for unusual compactness, lightness and positive action. We'd be glad to try.

WALKER-TURNER COMPANY, INC.
1493 Berckman St., Plainfield, N. J.



FLEXIBLE SHAFTING

FOR REMOTE CONTROL AND POWER TRANSMISSION

★ ★ ★ ★ ★

LECTROHM SOLDER POTS for continuous operation



★ ★ **AVAILABLE
from STOCK**

1 3/4 and 2 Pound Capacity Solder Pots

—designed for tinning small wires and leads with maximum efficiency and minimum cost in radio, motor and other electrical equipment plants where individual solder pots are desired for each operator. A single-heat, porcelain nickel-chrome heating element, which can be quickly and inexpensively replaced when necessary, heats the pot. Operates on 110 v., a.c. or d.c.—or 220 v. if requested. Ruggedly constructed for long, dependable service.

Complete information furnished on request

LECTROHM
INCORPORATED
5127 W. 25th Street, Cicero, Illinois

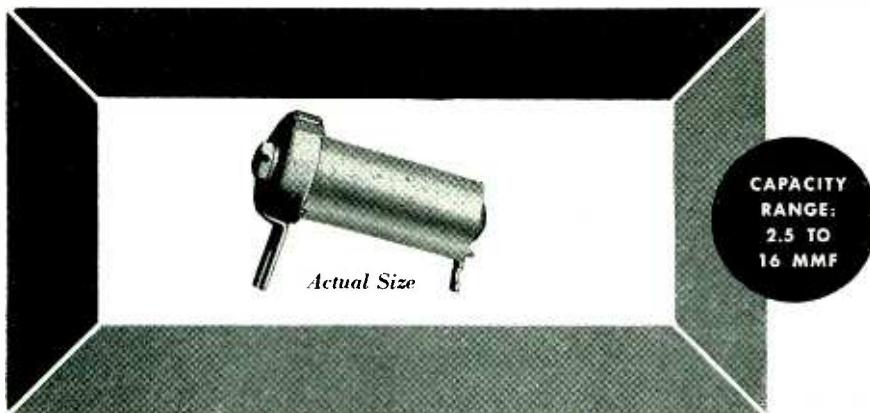

IMPROVED Low Loss ALIGN-AIRE TRIMMER!

Meissner improved, low loss, low drift, Align-Aire Trimmers are ideally suited for operation under high humidity...and in critical R.F. circuits...3200 degrees rotation...less than 1 mmf per 180 degrees!

Dissipation factor at 1000 kc: .064%... Q-1570...dissipation factor at 40 mc:

3.7%...insulation resistance: greater than 1500 megohms...breakdown over 350 volts, 60 cycles...700 volt AC breakdown available on special order. Meissner Align-Aires are encased in the newly developed Type 16444 Bakelite...compact in size: 7/16" in diameter by 1 1/8" long.

Samples sent upon request.

Meissner
MT. CARMEL, ILLINOIS

"PRECISION-BUILT ELECTRONIC PRODUCTS"



Metallic Films

(Continued from page 113)

von Boose, Pfanhauser and Sommer and others. One manufacturer is producing thousands of yards of tinsel daily by coating metals on cellulose acetate and cellophane.

Coating Technique

The prime requisite for the successful deposition of metals on any given surface is *cleanliness*. Unless the surface is chemically clean, the deposited film of metal will not adhere and may not deposit at all. The idea is to free the given surface from dust, dirt, grease, finger marks and any other foreign matter.

When depositing metal on glass the first step is generally to wash the surface with running water, hot or cold. Some workers prefer to wash the surface with alcohol. Rubbing alcohol will suffice. Other workers prefer to wash the surface with a dilute caustic soda or caustic potash solution. The surface is then rinsed with running water, treated with a concentrated solution of nitric acid and subsequently washed again with running water. Chemical compounds such as "Alphasol" have been used by Macksoud and others for cleaning the glass. A solution of sodium dichromate, 4 grams to 100 cc of sulphuric acid, makes another good washing compound when followed with running water.

Great care must be exercised not to touch the surface of the glass with the fingers, or it will again be contaminated with grease or oils and recleaning will be necessary. The glass plate or other surface can be handled at the edges.

After the washing process has been carried out, the surface is so positioned that the water will drain off and the object will dry.

Almost all common metals and alloys have been employed for one purpose or another. Among these may be mentioned aluminum, copper, chromium, gold, iridium, iron, magnesium, molybdenum, nickel, palladium, platinum, rhodium, silver, tin, and tungsten, along with alloys of these metals.

Vacuum Technique

Although sputtering may be effected at inert gas pressures up to 1 mm Hg, a high vacuum is necessary

0.00002 to 10,000 VOLTS!

BALLANTINE ELECTRONIC AC VOLTMETER AND ACCESSORIES



MODEL 300
ELECTRONIC
VOLTMETER



MODEL 505
ARTIFICIAL EAR



MODEL 402
MULTIPLIER



MODEL 220
DECADE AMPLIFIER

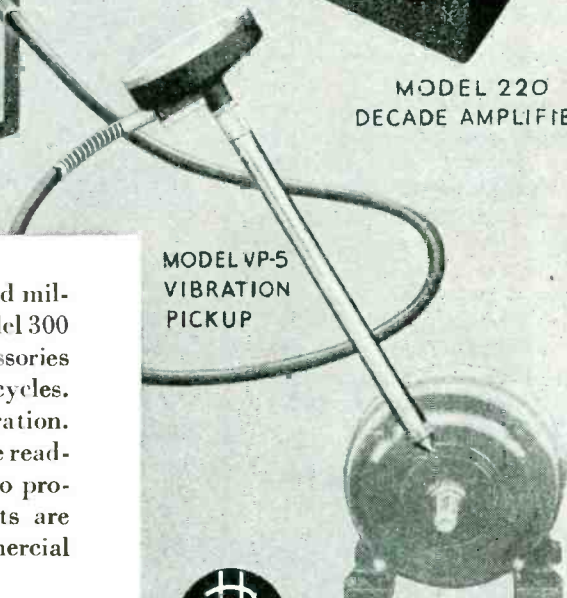

MODEL VP-5
VIBRATION
PICKUP

This enormous range of voltages—five hundred million to one—is accurately covered by our Model 300 Electronic Voltmeter and some of the accessories shown above. Frequency range 10 to 150,000 cycles. Accuracy 2% over most of the range. AC operation. Five decade ranges with logarithmic scale make readings especially easy. Uniform decibel scale also provided. Over a thousand of these instruments are giving excellent service in Government, commercial and university laboratories and factories.

Send for Bulletin 8



BALLANTINE LABORATORIES, INC.

BOONTON, NEW JERSEY, U.S.A.



SLOW DELIVERIES ROB YOU OF PRECIOUS TIME?

☆
Get this Emergency Service on
Your Electronic & Radio Supplies

MAINTAIN production schedules! Refuse to be robbed of time you can never replace . . . time stolen by slow deliveries of Electronic and Radio Supplies. This unique **EMERGENCY SERVICE** was established to *speed up* war production in research laboratories, industrial plants, and *wherever rush electronic war work won't wait!*

Now you can phone, wire, or mail us your orders, for one or one hundred items, made by many different manufacturers. We're equipped with a special technical staff, over-size, over-diversified stocks, and emergency handling technique all geared to function with a degree of speed and efficiency heretofore considered impossible in the history of electronic supply distribution. **TEST** this super service on the next batch of materials you need. See what we mean by **EMERGENCY SERVICE**.

SEND FOR FREE CATALOG

WALKER-JIMIESON, INC.
311 S. Western Ave., Chicago, Ill.
Phone: Canal 2525



for most thermal evaporation processes. The following description of the several vacuum systems now in use will serve as an introduction to the subject:

The procedure in many cases is to first evacuate roughly with a mechanical pump and then follow with a diffusion pump, the latter being in series with another mechanical pump. The mechanical and diffusion pumps are well known to vacuum tube engineers and will not be described here.

Burch suggested the use of low vapor-pressure fractions of hydrocarbon oils as a substitute for mercury. These fluids are commercially known as "apiezon oils," permitting the attainment of relatively low pressures, less than 10^{-6} mm, without a cold trap of any kind.

In 1930 Hickman and Sanford suggested replacing hydrocarbon oils with highly purified synthetic organic compounds such as esters of phthalic acid and in particular butyl phthalate.

More recently the developments of compounds of much lower vapor pressures have rendered n-butyl phthalate obsolete, except in cases where the lowest pressures are not of primary importance. By employing some of the newest esters such as Octoil and Octoil S, it is possible to obtain pressures at room temperatures which are as low or lower than those made possible with the best mercury pumps employing liquid air traps.

A table in this article lists different types of organic compounds suggested by Dr. Hickman and his co-workers and used in the pumps manufactured by Distillation Products, Inc. These pumps are made of glass or metal and can be had in simple or fractionating models, the latter with as many as three stages.

The United States Patent Office classifies the subject matter of metal coating in Subclasses 192 and 298 of Class 204 of the Patent Office Classification System. The number of patents in these classes is in the neighborhood of 100.

The writer wishes to acknowledge the help of Dr. Holger C. Andersen in the preparation of this manuscript and, particularly, for the illustrative material incorporated within it.

BIBLIOGRAPHY

Alexander, P., U. S. Pat. No. 2,100,045. Nov. 23, 1937.
Becker, J. A. & Jaycox, B. K., A New High

"IN-RES-CO resistors for high accuracy"



☆ The increasing importance of IN-RES-CO resistors in critical ordnance applications, substantiates the great responsibility placed on their proper functioning at all times. Leading engineers emphasize the fact that "a job is being done by IN-RES-CO units where a high degree of accuracy must be maintained.

Write today for illustrated literature describing the complete IN-RES-CO line of specialized resistors — each application designed for a specific requirement.

TYPE DB (at top), 1 Watt, Non-inductive, Standard tolerance $1/2\%$, Maximum resistance 1 meg-ohm, Size $11/16''$ diam. x $13/16''$ high.

TYPE DL (bottom), 1 Watt, Non-inductive, Standard tolerance $1/2\%$, Maximum resistance 1 Meg-ohm, Size $3/4''$ diam. x $3/4''$ high.



INSTRUMENT RESISTORS COMPANY

25 AMITY ST., LITTLE FALLS, N. J.



CASED MODEL

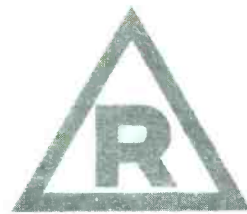

RAYTHEON

Voltage Stabilizers

Accurately Control Fluctuating

Voltage to $\pm \frac{1}{2}\%$

Raytheon Voltage Stabilizers are available for incorporation in your product or equipment for almost any type of service. There are three designs —cased, uncased and endbell models—to meet

your installation requirements. All Raytheon Stabilizers deliver controlled output voltage to $\pm \frac{1}{2}\%$ over their full rating. Write, outlining your needs —Raytheon Engineers will make recommendations.

Raytheon Voltage Stabilizers Give You These Outstanding Advantages . . .

- Hold constant varying A. C. input voltage to $\pm \frac{1}{2}\%$.
- Stabilize at any load within their ratings.
- Quick action . . . stabilizes within 2 cycles . . . variations cannot be observed on an ordinary volt meter.

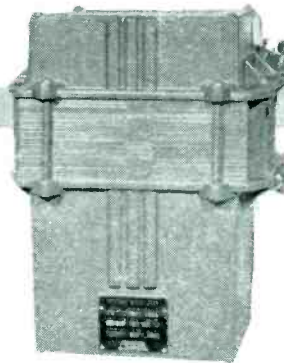

Endbell Model

- Wide A. C. input voltage limits . . . 95 to 135 volts.
- Entirely automatic . . . no moving parts . . . requires no maintenance . . . connect it and forget it.

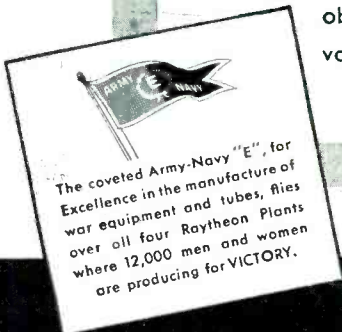

RAYTHEON MANUFACTURING
Company

190 WILLOW ST WALTHAM, MASS.

VICTORY...in the Making

Here, at Doolittle, we are coordinating every effort and skill to help provide the communications equipment so essential for Victory. This will mean better peace-time communications after our battles are won.



To Assure Victory
Buy More U. S. War
Bonds and Stamps

Doolittle

RADIO, INC.

Builders of Precision Radio Communications Equipment
7421 S. Loomis Blvd., Chicago, U. S. A.

The Sun Never Sets on a CINAUDAGRAPH SPEAKER



..... In every climate, in all temperatures Cinaudagraph Speakers keep pushing our vital messages clearly, perfectly and with a minimum of maintenance. Watch Cinaudagraph Speakers after Victory!



Cinaudagraph Speakers, Inc.

3911 S. Michigan Ave., Chicago

"No Finer Speaker Made in all the World"

Vacuum System, *Rev. Sci. Inst.*, p. 773, 2, Dec. 1931.

Biggs, O. H., U. S. Pat. No. 2,123,706, July 12, 1938.

Bodgett, K. B., Use of Interference to Extinguish Reflection of Light from Glass, *Phys. Rev.*, p. 391, 55, Feb. 1939.

Burch, C. R., Oils, Greases and High Vacua, *Nature*, p. 729, 122, Nov. 1928. Some Experiments on Vacuum Distillation, *Proc. Roy Soc. Lond.*, p. 271, 123, Mar. 1929.

Burkhardt, W. & Reinecke, R., U. S. Pat. No. 2,148,045, No. 2,148,046, Feb. 21, 1939.

Cartwright, C. H. & Strong, J., An Apparatus for the Evaporation of Various Materials in High Vacua, *Rev. Sci. Inst.*, p. 189, 2, Mar. 1931.

Case, F. A. & Gardner, I. C., *Bur. Std. Cir.* No. 389, 1931.

Case, T. W., U. S. Pat. No. 1,584,728, May 18, 1926.

Coblentz, W. W. & Stair, R., Ultraviolet Reflecting Power of Aluminum and Several Other Metals, *U. S. Bur. St. Jour. Res.*, p. 189, 4, Feb. 1930.

Crawford, W. W., The Parallel Jet High Vacuum Pump, *Phys. Rev.*, p. 557, 10, Nov. 1917.

Dushman, S., Recent Advances in the Production and Measurement of High Vacua, *Jour. Frank. Inst.*, p. 689, 211, June 1931.

Edison, T. A., U. S. Pat. No. 484,582, Oct. 18, 1892. U. S. Pat. No. 526,147, Sept. 18, 1894.

Edwards, H. W., Aluminum-Magnesium Mirrors, *Phys. Rev.*, p. 205, 43, Feb. 1933. U. S. Pat. No. 2,067,997, Jan. 19, 1937.

Gaede, von W., Die Diffusion der Gase durch Quecksilberdampf bei niederen Drucken und die Diffusionsluftpumpe, *Ann. der Phys.*, p. 357, 46, 1915. Die Entwicklung der Diffusionsluftpumpe, *Zeit. fur Tech. Phys.*, p. 837, 4, Oct. 1923.

Gardner, B. C., U. S. Pat. No. 2,107,784, Feb. 8, 1938.

Gardner, I. C. & Case, F. A., *Bur. Std. Cir.* No. 389, 1931.

Gaviola, E. & Strong, J., On the Figuring and Correcting of Mirrors by Controlled Deposition of Aluminum, *Jour. Opt. Soc. America*, p. 153, 26, Apr. 1936.

Grove, W. R., On the Heating Effects of Electricity and Magnetism, *Phil. Mag.*, p. 311, 1, 1852.

Henderson, J. E. & Laird, E. R., Reflection of Soft X-rays, *Proc. Natl. Acad. Sci.*, p. 773, 14, Oct. 1928.

Hickman, K. C. D., Trends in Design of Fractionating Pumps, *Jour. App. Phys.*, p. 302, 11, May, 1940.

Hickman, J. C. D. & Sanford, C. R., A Study in Condensation Pumps, *Rev. Sci. Inst.*, p. 140, 2, Mar. 1930. U. S. Pat. No. 1,857,508

Hobrock, R. H., U. S. Pat. No. 2,057,431 Oct. 31, 1936.

Hulbert, E. O., U. S. Pat. No. 1,848,630, Mar. 3, 1932.

Jaycox, E. K. & Becker, J. A., A New High Vacuum System, *Rev. Sci. Inst.*, p. 773, 2, Dec. 1931.

Kingsley, T. G., U. S. Pat. No. 2,097,488, Nov. 2, 1937.

Laird, E. R. & Henderson, J. E., Reflection of Soft X-rays, *Proc. Natl. Acad. Sci.*, p. 773, 14, Oct. 1928.

Langmuir, J., The Condensation Pump: An Improved Form of High Vacuum Pump, *Gen. Elect. Rev.*, p. 1060, Dec. 1916 also *Jour. Frank. Inst.*, p. 719, 182, Dec. 1916.

Lenz, C., U. S. Pat. No. 2,304,834, Dec. 15, 1942.

Mackoud, M. E., U. S. Pat. No. 2,164,332, July 4, 1939.

Molthan, von W., Die Ausbreitung eines Dampfstromes im Vakuum und deren Bedeutung fur die Wirkung der Diffusionsluftpumpe, *Zeit. fur Tech. Phys.*, Pt. 1, p. 337, 7, Aug. 1926. Pt. 2, p. 452, 7, Oct. 1926.

Morse, R. S., Modern Vacuum Practice in Electronics, *ELECTRONICS*, p. 33, 12, Nov. 1939. Baffles for Oil Diffusion Pumps, *Rev. Sci. Inst.*, p. 277, 11, Sept. 1940.

Morse, R. S. & Bowie, R. M., A New Style Ionization Gauge, *Rev. Sci. Inst.*, p. 91, 11, Mar. 1940.

Nutting, P. G., Some Quantitative Data on Cathode Deposited Metals, *Jour. Frank. Inst.*, p. 115, 182, July 1916.

O'Brien, B., U. S. Pat. No. 2,160,981, June 6, 1939.

Pfanhauser, W. A. F., U. S. Pat. No. 1,758,531, May 13, 1930.

Quinn, J. H., Bismuth Black and its Applications, *Phys. Rev.*, p. 1434, paper 76 Wash. Meeting Amer. Phys. Soc., 35, June 1, 1930.

Reinecke, R. & Burkhardt, W., U. S. Pat. No.

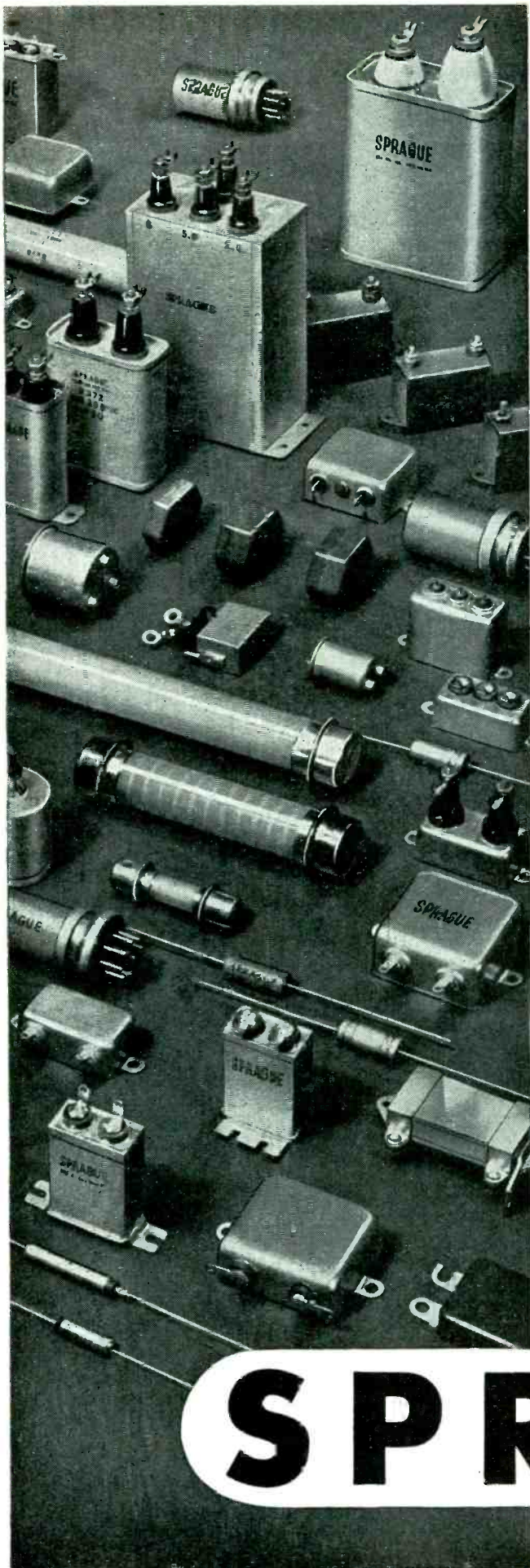

**“Plus ça change
plus c’est la
même chose”***

***(THE MORE IT CHANGES,
THE MORE IT IS THE
SAME THING)**

Over 95% of Sprague capacitors being produced today are different from those of pre-war days—and a lot of hard, painstaking and fast work has gone into making the necessary changes to meet wartime conditions. The primary insulation, the basic dielectric, the fundamental processes—these did not spring full fledged over night, but are “the long result of time.” These processes produced good condensers before the war, are producing good condensers now to meet war specifications—and will produce good post-war condensers. Specifications change, the condensers change to meet them, but always Sprague condensers are good condensers. ‘Plus ça change—’”

SPRAGUE SPECIALTIES COMPANY, NORTH ADAMS, MASS.



NOTE TO SUPPLIERS

Just as we do our best to make Sprague a good place from which to buy, so do we aim to make it a good place to which to sell. We are always open to suggestions, new ideas, and all the other helps that suppliers are often so well equipped to give. Although we buy carefully—just as we manufacture carefully—we aim to back this buying with the same courtesy, consideration, and loyalty we ourselves like to receive.

SPRAGUE
CAPACITORS KOOLOHM RESISTORS

CURRENT and VOLTAGE FLUCTUATION REDUCED

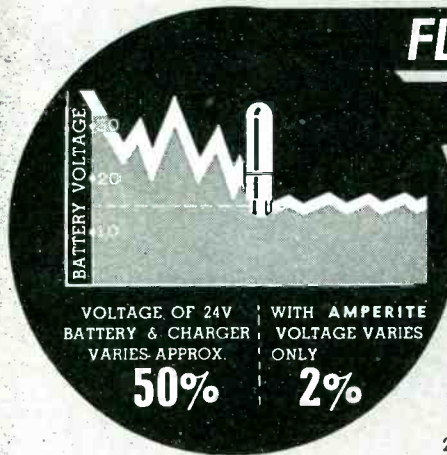

VOLTAGE OF 24V
BATTERY & CHARGER
VARIES APPROX.

50%

WITH AMPERITE
VOLTAGE VARIES
ONLY

2%

WITH AMPERITE REGULATORS

Features:

1. Amperites cut battery voltage fluctuation from approximately 50% to 2%.
2. Hermetically sealed — not affected by altitude, ambient temperature, humidity.
3. Compact, light, and inexpensive.

Used by U.S. Army, Navy, and Air Corps.

DELAY RELAYS: For delays from 1 to 100 seconds.
Hermetically sealed. Unaffected by altitude. . . . Send for catalogue sheet.

ENGINEERS: This 4-page folder will help you solve Current and Voltage Problems; contains much valuable data in practical form — Write for your copy now.

AMPERITE CO., 561 Broadway, New York (12), N. Y.
In Canada: Atlas Radio Corp., Ltd., 560 King St., W. Toronto



2, 148,045, No. 2,148,046, Feb. 21, 1939.
Richtmyer, F. K., U. S. Pat. No. 1,388,373,
Aug. 23, 1921.
Russell, A. G., U. S. Pat. No. 1,986,536, Jan
1, 1935. No. 1,994,668, Mar. 19, 1935.

Saeger, C. M., U. S. Pat. No. 1,940,814, Dec.
26, 1933.

Sanford, C. R. & Hickman, J. C. D., A Study
in Condensation Pumps, *Rev. Sci. Inst.*, p.
140, 2, Mar. 1930. U. S. Pat. No. 1,857,508.

Siebertz, K., U. S. Pat. No. 2,164,595, July
4, 1939.

Sommer, L. A., U. S. Pat. No. 2,074,281, Mar.
16, 1937.

Stair, R. & Coblenz, W. W., Ultraviolet Re-
flecting Power of Aluminum and Several
Other Metals, *U. S. Bur. St. Jour. Res.*, p.
189, 4, Feb. 1930.

Strong, J., On a Method of Decreasing Re-
flection from Nonmetallic Substances, *Jour.
Opt. Soc. America*, p. 73, 26, Jan. 1936. E-
vaporation Technique for Aluminum, *Phys. Rev.*
p. 498, 43, Mar. 1933.

Strong, J. & Cartwright, C. H., An Appara-
tus for the Evaporation of Various Materials
in High Vacua, *Rev. Sci. Inst.*, p. 189, 2,
Mar. 1931.

Strong, J. & Gaviola, E., On the Figuring and
Correcting of Mirrors by Controlled Deposi-
tion of Aluminum, *Jour. Opt. Soc. America*,
p. 153, 26, Apr. 1936.

Sukumlyn, T. W., U. S. Pat. No. 2,218,638
May 5, 1942.

Timperley, & Walker, C. H., U. S. Pat. No.
2,143,723, Jan. 10, 1939.

Trautman, O. C., U. S. Pat. No. 1,700,002
Jan. 22, 1929.

Von Boose, J., U. S. Pat. No. 1,661,517, Mar
6, 1928.

Walker, C. H. & Timperley, U. S. Pat. No.
2,143,723, Jan. 10, 1939.

Williams, H. B., A New Mercury Vapor
Pump, *Phys. Rev.*, p. 588, 7, May 1916.

Williams, R. C., U. S. Pat. No. 2,079,784
May 11, 1937. U. S. Pat. No. 2,151,457, Mar.
21, 1939. U. S. Pat. No. 2,239,452, Apr. 22,
1941.

Webster, D. L., K-electron Ionization by Di-
rect Impact of Cathode Rays, *Phys. Rev.*,
p. 1118, paper 39 Wash. Meeting Amer. Phys.
Soc. 31, Apr. 1928.

Zworykin, V. K., U. S. Pat. No. 1,682,457,
Aug. 28, 1928.

LIGHTNING CHARTS



Gilbert D. McCann, analyzes filmed mea-
surements of lightning and Charles F.
Wagner, right, uses this data to plot prob-
ability curves indicating low many times
thunderbolts may be expected to strike
in a certain area. By such studies, the
two Westinghouse engineers are able to
prescribe adequate defenses for power
lines. The filmed records of the duration
and amount of current in thunderbolts are
obtained from cathode-ray oscillographs,
which are connected to transmission lines
throughout the country

110-VOLTS A.C. ANYTIME, ANYWHERE!

On the Fighting Front On the Home Front

With KATOLIGHT GENERATORS supply-
ing electricity, same as you obtain from
power lines, right out in the field which
permits our fighting forces to be equipped
with the most modern electrical appliances.

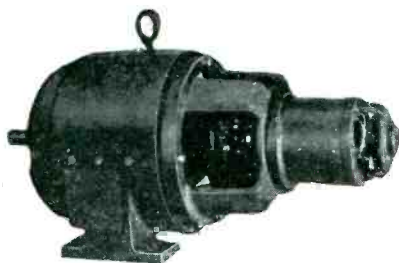

5 K.W. 3 Phase, Separately Excited, Katolight
Generator

Good deliveries on A.C. and D.C. gen-
erators, 350 watts through 25 K.W. Avail-
able in all standard voltages, 110, 220, or
440 volts single phase or 115/230 or
220/440, four ring, single phase. Also
available for straight 110, 220 or 440,
three wire, three phase or 120/208 four
wire, three phase. Inherent voltage regula-
tion approximately 10% between no load
and full load with 3% speed change. Fur-
nished for independent or direct connect
design.

Kato's entire production at present must
be confined to orders with high priorities.
Write us if you need this kind of equip-
ment for war orders.

Also manufacturers of High Frequency
Generators, Rotary Converters, Frequency
Changers and Motor Generator Sets.

KATOLIGHT COMPANY
61 Elm St., Mankato, Minn., U. S. A.

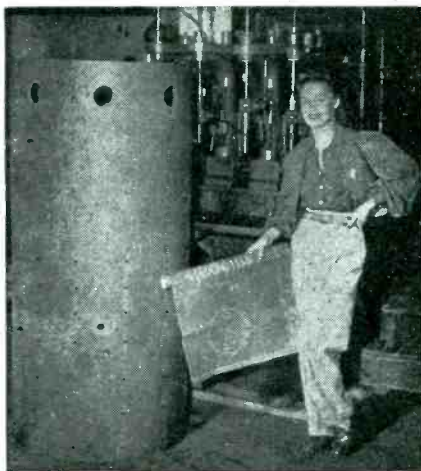

BAKELITE FABRICATION BASED ON EXPERIENCE

There are no handbooks in the
fabricating business. Only years of
experience can give that added touch
—sharpening a cutter—designing a
tool—for the type of work you expect.

All parts that can be fabricated from
laminated sheets, rods, or tubes, are
available. Twenty years of experience
at your service.

Write us, or phone us, and we will
have an engineer call on you for
consultation.

ELECTRICAL INSULATION CO., INC.

12 VESTRY ST., NEW YORK CITY
Sheets, Rods, and Tubes Fabricated Parts



More Power to War Plants...

... from Federal Heavy Duty
Power Units powered by
I. T. & T. Selenium Rectifiers

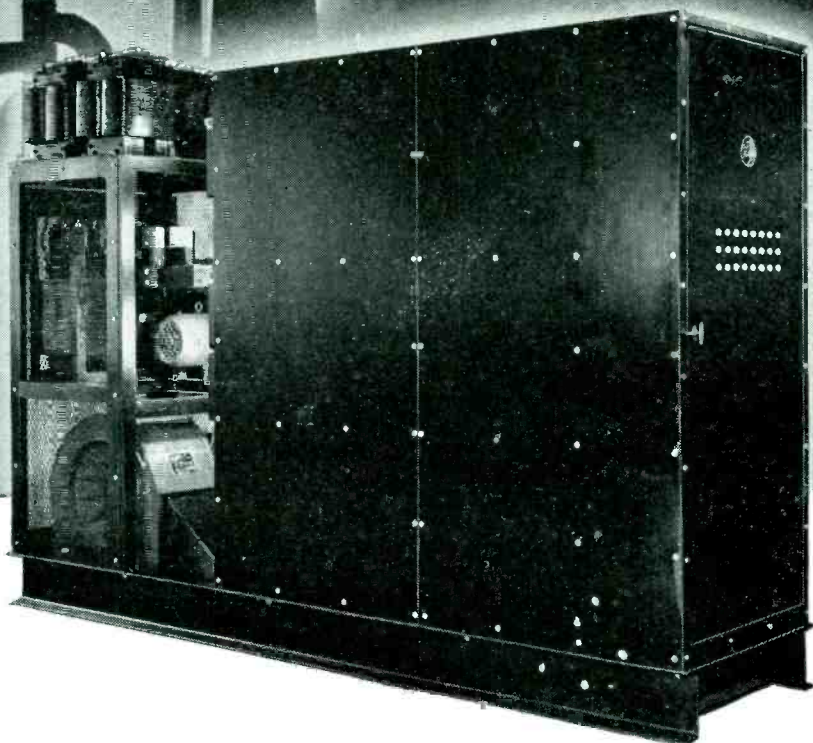

If plant expansion has overloaded your source of D.C. power, add Federal Power Supply Units as needed — in any capacity up to 100 kilowatts each.

Whatever your use for rectifier equipment — as part of military devices, in the production and processing of war materiel, or in your postwar products — Federal Power Supplies include the features you require.

Rugged, calling for a minimum of critical material, readily adaptable to most demands for conversion of A.C. to D.C., these power equipments assure long life and efficient maintenance-free operation.

All units are powered by I. T. & T. Selenium Rectifiers — introduced and manufactured by Federal Telephone and Radio Corporation and accepted as standard by industry. *Consulting engineering services available on application to Department H.*

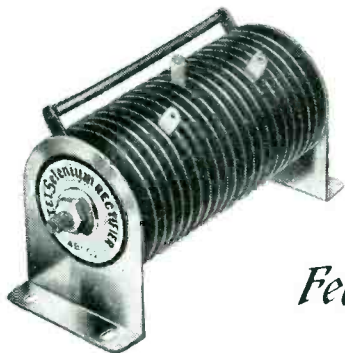

SELENIUM RECTIFIER DIVISION

Federal Telephone and Radio Corporation



1000 Passaic Ave.
East Newark, New Jersey

NEW PRODUCTS

Month after month, manufacturers develop new materials, new components, new measuring equipment; issue new technical bulletins, new catalogs. Each month descriptions of these new items will be found here

High Speed Circuit Tester

ROTOBRIDGE IS AN AUTOMATIC mass production tester which can be used by unskilled labor for factory circuit checking of all types of communication, electronic and electrical equipment for errors in resistance, reactance, and in circuit wiring. The manufacturer states that the unit is capable of checking one circuit per second, and that only one set-up of the instrument is required.

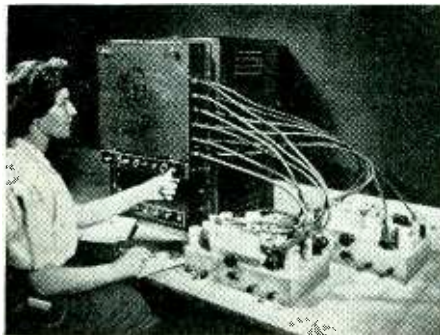

Also available is a new model Rotobridge tester of interest to aircraft, tank and switchboard manufacturers. The manufacturer says that multi-wire cable harnesses may be rapidly checked and that up to 120 circuits (including several hundred wires) may be tested at once, in four minutes operating time.

Bulletins giving complete details of the Rotobridge are available from the manufacturer, Communication Measurements Laboratory, 120 Greenwich St., New York, N. Y.

Balanced Relay Test Panel

MODEL 81 IS AN INSTRUMENT used for testing of aircraft and industrial relays in production. No wire or external connection clips are

needed. Relays to be tested are inserted on a carriage which moves up and down. This carriage can be arranged to take almost any type of commercial relays, and when fitted the motion of the lever is directed upward into the contact box to shield the operator from connection with high voltage. The electrical circuit is arranged to duplicate actual field conditions. The instrument is especially useful for balanced relays where the current through each coil must be identical. By means of a balanced control it is possible to upset or create a balanced condition. Meters furnished with the instrument include one current meter and two individual current meters. Standard type 301 Weston meters are used.

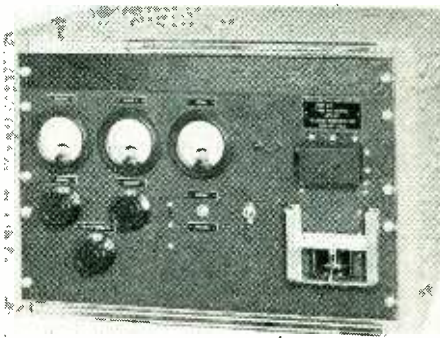

The instrument comes complete and ready to operate. It is mounted on a standard all metal relay rack panel. A spare panel is supplied at the top of the cabinet for additional switching or indicating accessories. External power supplies used may be either 400 cps direct current or 105-120-volt, 60 cps. The instrument measures 20 x 15 x 14 inches and weighs 16 lbs.

Televiso Products Inc., 6533 N. Olmstead Ave., Chicago, Ill.

X-Ray Apparatus

A COMPACT X-RAY UNIT, called Search-ray, gives an instantaneous fluoroscopic and radiographic examination of parts and finished products of rubber, plastics, ceramics, light alloys, food, drug and allied products, and package and luggage inspection at war plants. The unit is operated by simply plugging it into a standard 110-volt power line, placing the object to be inspected in the compartment, closing the door and then pressing the button. The object can then be instantly seen fluoroscopically through an eye-piece. The hous-

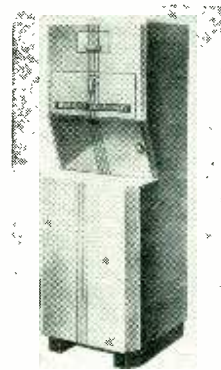

ing is ray-proof as well as shock-proof, and has full automatic electric interlocks which will interrupt the circuit while the compartment door is open. The article compartment measures 21 x 18 x 9 inches. The fluoroscopic screen's observable area measures 8½ x 11½ inches. The unit itself is portable and measures approximately 69 x 26½ x 24 inches and weighs approximately 425 pounds. The machine is supplied with accessories which permit radiographic examination covering a maximum area of 11 x 14 inches (using standard 12x14-inch x-ray film or paper).

North American Philips Co., Inc., Dobbs Ferry, N. Y.

Plastic Blower

ILLUSTRATED IS MODEL NO. 1½ blower which is housed in a one-piece, molded high-impact plastic. The output of the blower is rated as 15 c.f.m. at 3000 rpm. The wheel is a turbo type, 1½ inches in diameter and made of steel, cadmium plated. The wheel and housing weigh 2 ounces. The blower uses a back plate to facilitate

SANBORN *Neering*

IN

ELECTRONIC DEVELOPMENT AND PRODUCTION

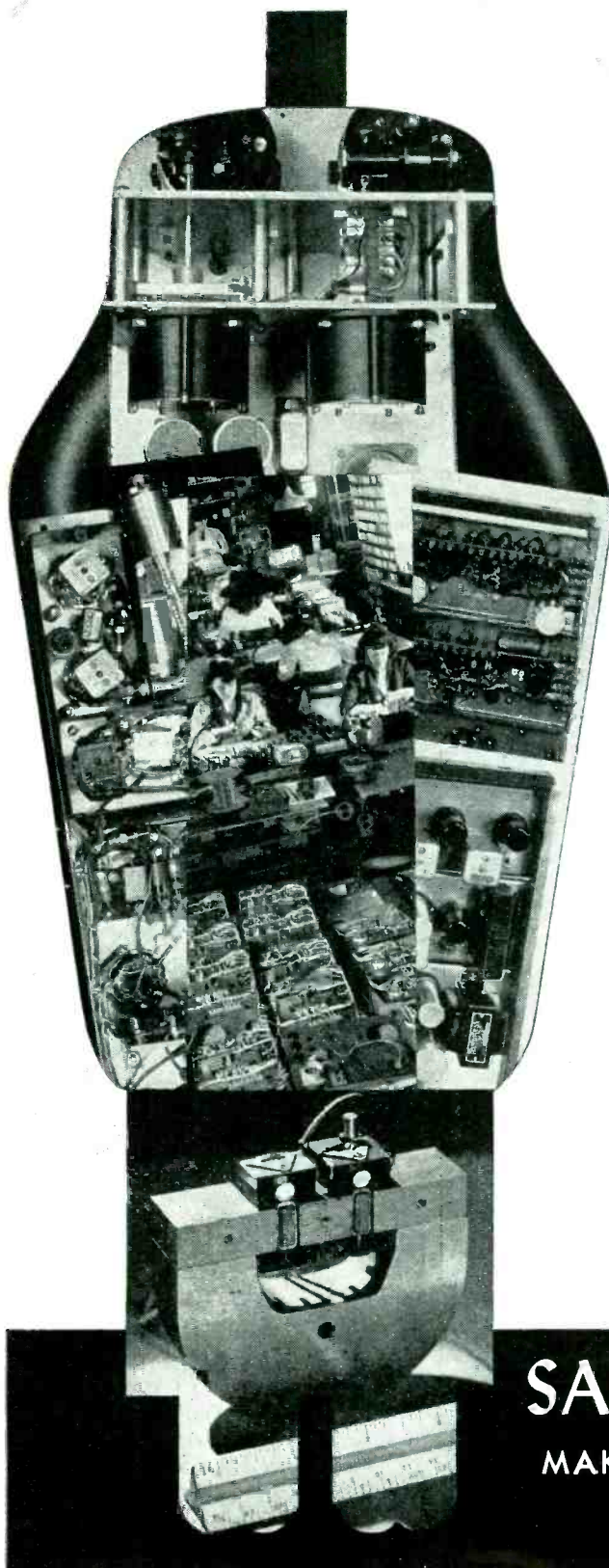

Sanborneering is a combination of factors that together are producing results here at the Sanborn plant. Unusually complete manufacturing facilities, an engineering staff with a background of electronic and electro-mechanical accomplishments, and an experience-trained personnel of co-partners—that is what we like to call Sanborneering.

Prior to the war, we were recognized leaders in the design and manufacture of high grade medical diagnostic instruments, including several types of vacuum-tube electrocardiographs. So that, when our first war assignment of integral RADAR equipment came in, we were prepared for the strict standards set by the armed forces. Engineering staff and production lines were already geared to the requirements of precision, perfection and performance. And other sub-contracts, and prime contracts, were handled equally "in stride" by an up-to-date machine shop, complete assembly facilities, and electrical testing laboratories.

We are proud of the esprit de corps of our workers, 56% of whom are stockholders. All employees share in the company profits, and in all its 25-year history the company has never had a labor dispute.

If it is a problem of electronic development or production, it can be solved by Sanborneering. If you have such a problem now, a portion of our design and manufacturing facilities is available for your use. Address inquiries to Radar Department.

SANBORN COMPANY

MAKERS OF ELECTRONIC INSTRUMENTS

CAMBRIDGE 39, MASS.

Soldering 'Em to STAY Soldered

with
KESTER

The vital function of solder in the radio equipment of war machines is to *stay put*, come what may—and that's exactly what Kester Cored Solders are scientifically compounded to do. They're in action, night and day, on every battlefield from the Arctic to the Tropics.

Kester Cored Solders are *right* for every soldering job. They're available in a wide range of core and strand sizes, fluxes and alloys, one combination of which is exactly suited to every requirement, however special.

Electrical circuits installed with Kester Rosin-Core Solder are free from terminal resistance; service difficulties of every sort are minimized. Kester Acid-Core Solder for general application makes a tight, clean, permanent union.

Kester's 44 years of highly specialized solder experience is at your command. Consult Kester engineers freely on any soldering question.



KESTER SOLDER COMPANY
4204 Wrightwood Avenue, Chicago, Illinois
Eastern Plant: Newark, N. J.
Canadian Plant: Brantford, Ont.



SILVER-LEAD ALLOY—Kester is prepared to offer for test on your work, a wartime solder of silver and lead, in cored and wired form.

KESTER
Cored Solders
STANDARD FOR INDUSTRY



mounting on any type of motor. The advantage claimed for the motor by the manufacturer is that air circulation problems are minimized by the type of construction utilized in this model.

L-R Mfg. Co., Torrington, Conn.

General Purpose Relays

A SMALL, COMPACT GENERAL-PURPOSE relay which will withstand shocks and vibration has been designated by the manufacturer as the SP series. It has a balanced armature which operates in any position. Screws and rivets have been eliminated from the relay's construction by the use of a bakelite molded base and a stationary contact support which also pro-

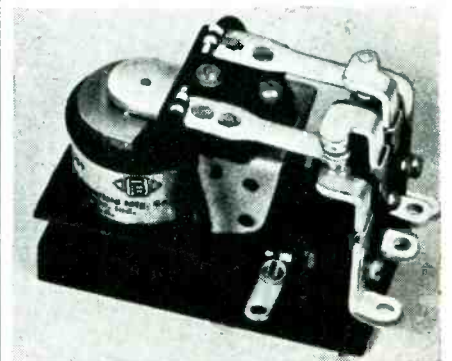

vides insulation. The armature frame and core are made of steel and are heat treated after fabrication. All steel parts are cadmium plated. The relay will carry a noninductive load of 5 amp at 110 volts, 60 cps. A-C or d-c types are available. Special voltages are available on request. The average size of the relay is 2 3/8 x 1 1/2 x 1 1/2 inches.

Potter and Brumfield Mfg. Co., Princeton, Ind.

CABINETS
PANELS

CHASSIS
RACKS



Serving the
Electronics
Field
Exclusively

Write for
Catalogue
No. 41-A

Though manufactured by modern high-speed methods, Par-Metal products have a definite quality of craftsmanship—that "hand-made" quality which is born of years of specialization.

PAR-METAL PRODUCTS CORPORATION

32-62—49th STREET . . . LONG ISLAND CITY, N. Y.
Export Dept. 100 Varick St., N. Y. C.

We make AN Connector Plugs from tool design to finished products

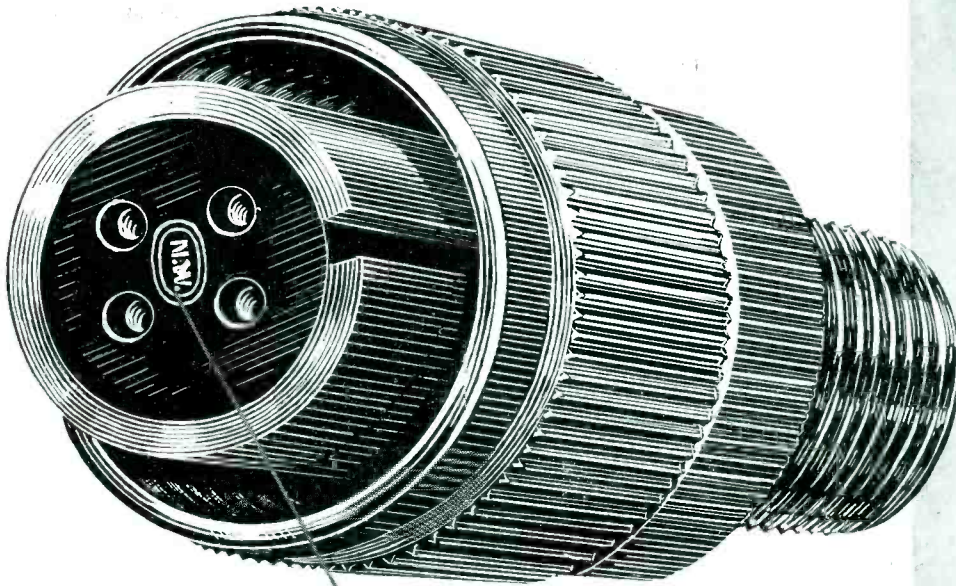

If deliveries are slowing your production perhaps we can help. For there is much less chance of a bottleneck when you order plugs from a manufacturer who makes (with the exception of one tiny part) the entire plug.

Being the only completely, self-contained plant in the country, when we make a promise we are in a better-than-usual position to keep it because we do the engineering, designing, tool-making, die-casting, insulator-molding, machining and assembling.

If desired, we are equipped to give each aluminum die-cast part the diachromatic finish. Our production now runs to many thousands

of AN Connector and Signal Corps Plugs per day. Our manufacturing technique has been developed to a degree where product perfection is virtually assured.

Our production of connector plugs is not purely a wartime effort. We are building for the peace, too. That's why we have a large engineering staff working constantly on the further improvement and development of electrical connectors.

We urge you to visit our factory and examine our facilities with an eye to their being utilized for the purpose of increasing your production and thus stepping up the flow of completed equipment to our armed forces.

Write, wire or telephone . . .

NORTHAM WARREN CORPORATION

War Works Division

STAMFORD, CONNECTICUT



With the
exception of
this tiny part
WE MAKE THE
ENTIRE PLUG

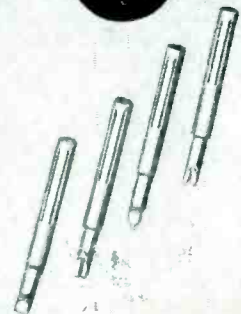
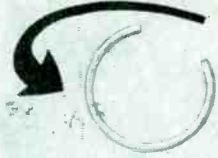



We never laugh at String Savers

The man who saves string knows what he is doing . . . some day those treasured pieces may come in handy. So, rather than laugh, we encourage, for we, ourselves, know something about the value of putting away for a rainy day.

For example, the nuggets of knowledge stored up in yesterday's manufacture of ultra-high frequency transmitters and receivers have a definite bearing on the important war work that we are doing. And the ideas that we're "banking" today will be mirrored in ABBOTT equipment for tomorrow.



We illustrate an ABBOTT Model TR-4 . . . a standard, compact and efficient ultra-high frequency transmitter and receiver.

Invest every dollar
you can in the Third
War Loan Drive

**ABBOTT
INSTRUMENT, INC.**

8 West 18th St., New York 3, N. Y.

Ceramic Capacitors

THESE CAPACITORS ARE PART of the manufacturer's products known as Disc Ceramicons, and are designed as basic Type 160 and basic Type 170. A silver-plated metal housing is utilized to allow latitude in mounting and terminal designs. The manufacturer states that their construction gives a higher resonant frequency, thereby making them more useful at ultrahigh frequencies, especially for by-pass applications. They are hermetically sealed to provide protection from humidity. Basic Type 160 measures $\frac{3}{8}$ inch in diameter, and basic Type 170 measures $\frac{1}{2}$ inch in diameter. Each is available with several different mounting and terminal designs, designated by the letters from A to H inclusive. The maximum height is $\frac{3}{8}$ inch, not including mounting stud and terminal. Basic Type 160 is rated at 500 volts, d-c working, and is available in any desired temperature coefficient from +100 (P100) to -750 (N750) parts per million per degree C, in capacitances up to 4000 $\mu\mu\text{f}$. Basic Type 170 is available in 500 volts (tentative) up to 7500 $\mu\mu\text{f}$; 1000 volts, up to 4000 $\mu\mu\text{f}$; and 1500 volts, up to 1500 $\mu\mu\text{f}$, d-c ratings. Ten standard temperature coefficients are available. Standard tolerance on temperature coefficient for both types is ± 60 parts per million, or ± 15 percent, whichever is greater. Closer tolerances are also available on specification. Capacitance tolerances not smaller than $\pm 3 \mu\mu\text{f}$, or ± 1 percent (whichever is greater) may also be specified.

Erie Resistor Corp., Erie, Pa.

Latching Wire Harness Clamps

WIRING HARNESS CLAMPS with a latching finger are available for use in aircraft or other applications. These clamps work independently of the attaching screw in the assembly of wire harnesses. Any or all of the wires may be removed or replaced without loosening the screw that holds the clamp in position. These clamps are used in place of boggles. They remain snapped over the wires during transportation to the final assembly location and then

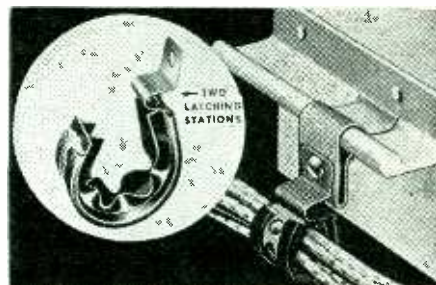

serve as the mounting means for attaching the harness to the structure. Made of parkarized spring steel, they are given two coats of lacquer, and then are cushioned with extruded synthetic rubber channels (which have integral resilient ribs to absorb variations in thickness of harnesses). Each clamp is provided with two different latching stations. Six different sizes of clamps are available to accommodate wire bundles ranging in sizes of from $\frac{1}{8}$ inch to $1\frac{3}{8}$ inches.

Tinnerman Products Inc., 2106
Fulton Road, Cleveland, Ohio.

PERMANENT MAGNETS

ALL SHAPES — ALL SIZES
FOR ALL PURPOSES

Stamped, Formed, and Cast; Chrome, Tungsten Cobalt and ALNICO** (cast or sintered) under G. E. license.

THOMAS & SKINNER
STEEL PRODUCTS COMPANY
1116 E. 23rd STREET INDIANAPOLIS, INDIANA

Laminations for Radio Transformers — Tools
Dies — Heat Treating — Stampings

42 YEARS EXPERIENCE

We've An Open Door For Open Minds

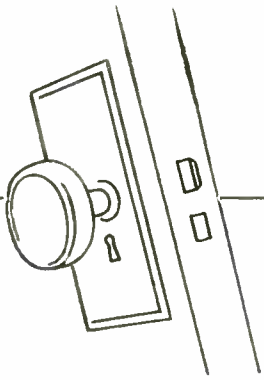

Manufacturers... Designers... Technicians... Sales Executives and others now giving thought to economical production of Tomorrow's new and better products, are invited to investigate the unique facilities of the Magna Manufacturing Company for the practical disintegration of materials heretofore unavailable in powder form.



TRACER BULLETS, parachute flares, illuminating signals require powdered magnesium...and plenty of it! To reduce this difficult and extremely hazardous metal to a uniform dust in compliance with rigid U. S. Army and Navy standards, Magna developed special machinery and precision processes.

Today in three great Magna Plants...the largest and most modern facilities of their kind...we are carrying on this vital wartime job. But Tomorrow...

The facilities that Magna perfected have a far-reaching importance... opening vast new

possibilities for the utilization not only of magnesium but also all other types of disintegration-resisting metals and other materials such as ceramics, plastics and pigments.

AN INVITATION...

Magna capacities today are entirely occupied with production for Victory. However, Magna engineers are prepared to consult with forward-looking industries on ways and means to utilize powdered metals and other materials in postwar product developments.

MAGNA

MANUFACTURING COMPANY, INC.
MANUFACTURERS OF *Magnaflake* METAL POWDERS
444 MADISON AVE. NEW YORK 22, N. Y.



Makers of Precision
Engineered
**ELECTRONIC
PRODUCTS**

Radell
CORPORATION

6327 GUILFORD AVENUE, INDIANAPOLIS, INDIANA

METAL
Stampings **DUPLICATED
WITHOUT
DIES**

If you desire to save time and critical materials on production of metal stampings or other small parts, then the DI-ACRO System of "Metal Duplicating Without Dies" merits your consideration. It is based on the rapid and accurate production of formed parts with DI-ACRO Shears, Brakes and Benders. All duplicated work is accurate to .001". These precision machines are adaptable to an endless variety of work, and ideally suited for use by girl operators. For short runs your parts are processed in a matter of hours instead of waiting weeks for dies.



SHEARS

BRAKES

BENDERS

Send for this Catalog
"METAL DUPLICATING
WITHOUT DIES"

It illustrates many stampings or parts made without dies, gives full details on DI-ACRO machines and shows how they may readily be adapted for various applications. Request your copy now.



O'NEIL-IRWIN  **MFG. CO.** 321 Eighth Ave. So. Minneapolis 15, Minn.

**High-Frequency
Heating Equipment**

BOTH STATIONARY AND PORTABLE high-frequency generators are available in capacitances up to 300 kw per hour, for electrostatic heating of plastics, cellulose, paper, textiles, powders, felts, woolens and cottons, ceramics, clays, oxides, tobaccos, cork, glue and other non-metallic substances. The smaller units contain a one-knob control, one meter and are semi-automatic. Machines may be operated by unskilled work-

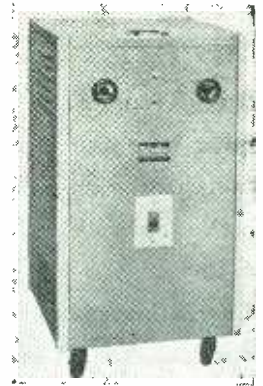

ers. The model illustrated is a small portable type (various sizes are available) which is used in pre-heating and molding of plastics. All coils, tubes, controls, etc., are housed in a safety cabinet. The high-frequency voltage is applied to flat electrodes which cover the opposite sides or the top and bottom of the mass to be heated.

The Girdler Corp., Thermex Div., Louisville 1, Ky.

Slide-Wire Rheostat

THIS CIRCULAR SLIDE-WIRE rheostat is designed especially for low-resistance, low-wattage applications. A length of resistance wire, stretched tightly around the outside of a cylindrical core, is bonded to a ceramic base. The wire is anchored to two terminals. Contact to the wire is made by a phosphor-bronze spring arm connected to a third terminal which allows the unit to be used as a potentiometer or voltage divider. The maximum resistance which can be supplied on this unit is approximately 1 ohm, while the minimum total resistance can be made approximately 0.1 ohm. The resistance varia-

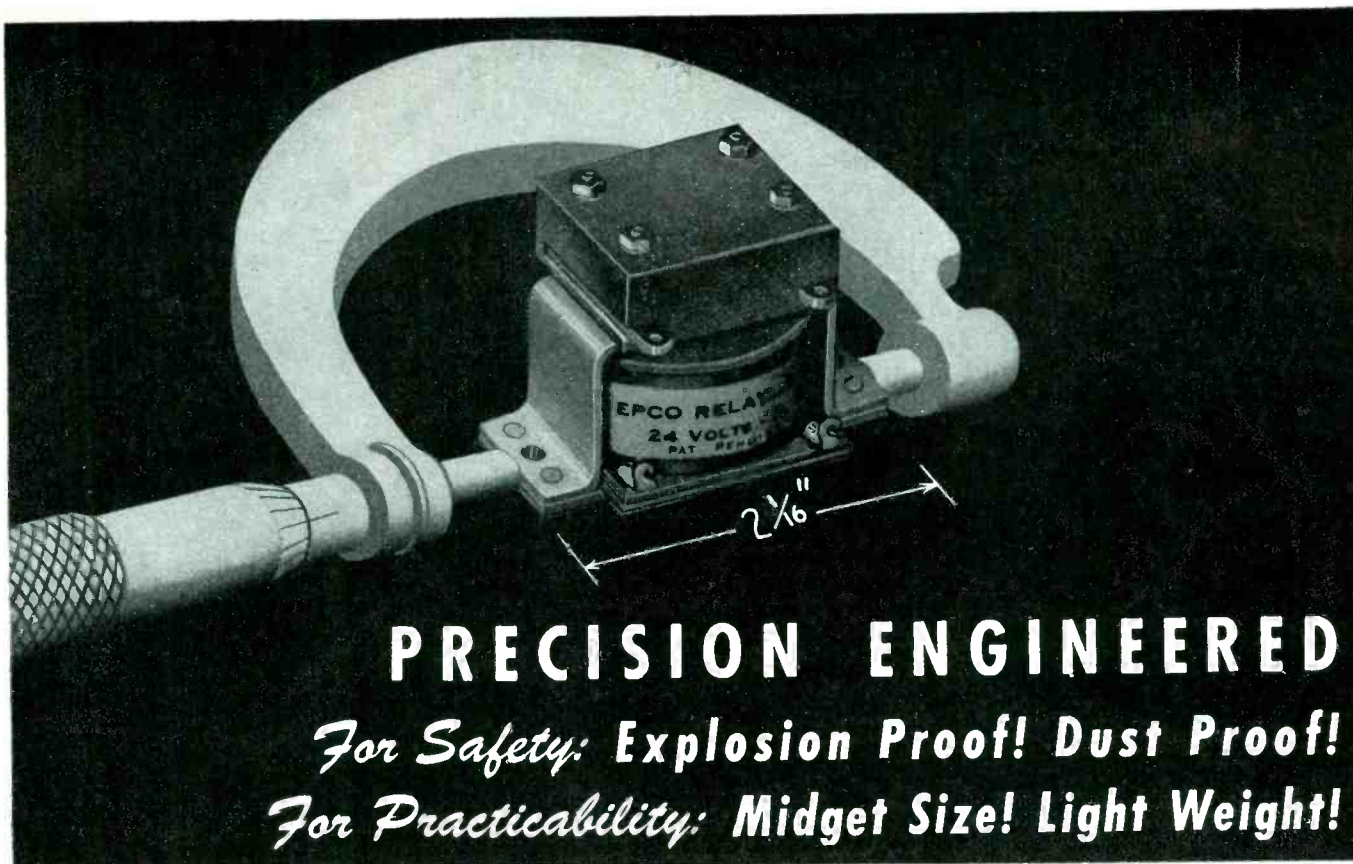

PRECISION ENGINEERED
For Safety: Explosion Proof! Dust Proof!
For Practicability: Midget Size! Light Weight!

(Photograph Actual Size)

NEW "Sealed" MIDGET RELAY

Sealed Chamber—Makes Relay Explosion Proof and Dust Proof; serves as effective arc quench.

Excess Capacity—Rated at 25 amperes; operates satisfactorily at 50 amperes; tested without failure at 120 amperes high inductive load.

Light and Compact—Standard model above (S47D) weight only 4.7 ounces; overall dimensions as follows: Height, 1 9/16"; Width, 1 21/64"; Length (less base), 1 7/16"; Overall of base, 2 1/16"; Mounting holes, center to center, 1 3/4".

Positive Action—Overtravel spring insures positive contact pressure and instant "break" release.

Tamper Proof—Factory adjusted and sealed; protection against unauthorized re-adjustments.

Reversible Contacts—If worn from excessive use contacts may be reversed in the field, thus providing new surfaces without disturbing adjustment.

Specifications:

Normal Coil Rating, 24 volt - 150 m. a. - 3.6 watts.

Contact Rating, 25 amps. inductive load at 30 volts.

Unit has withstood Army tests, including overload; vibration 55 cycles per second with .06" excursion; acceleration of 10 gravity units; salt spray tests of 240 hours duration.

These Improved Features

Tell the Story—

Electrical
PRODUCTS SUPPLY CO.

Affiliated with Electrical Products Corp.

1140 Venice Blvd. Los Angeles 15, Calif.

NEW



THE new General Electric line of ELECTRONIC MEASURING INSTRUMENTS is designed in the famous G-E Electronic Laboratory. It provides an extensive choice of compact apparatus for service, maintenance, or research.

For measuring electronic circuits and component parts, these modern G-E unimeters, capacitometers, audio oscillators, wide band oscilloscopes, square wave generators, signal generators, power supply units, and other utility measuring instruments assure accurate, dependable service.

Planned for easy, error-free reading, the units are sturdy, stable, shock-resistant, and compact.

G-E testing equipment is now in production primarily for the Armed Forces; it may be purchased on a priority if you are engaged in war work. After the war, the full line will again be available to everybody. . . . *Electronics Dept., General Electric, Schenectady, N. Y.*

• We will welcome your inquiry for G-E electronic measuring equipment made to your specific requirements.



**ELECTRONICS DEPARTMENT
GENERAL ELECTRIC CO.
Schenectady, N. Y.**

Please send, without obligation to me, the General Electric Measuring Instrument Catalog, F-1 (loose-leaf), for my information and files.

Name _____
Company _____
Address _____

GENERAL ELECTRIC
ELECTRONIC MEASURING INSTRUMENTS 177-B1

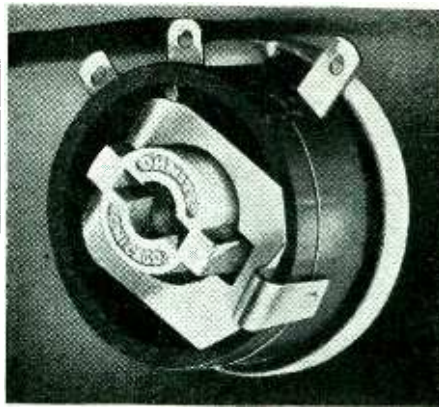

tion is stepless because the contact arm travels along the wire from end to end. Shafts for knob control can be supplied. These units are made to order to suit particular applications.

Ohmite Mfg. Co., 4835 West Flournoy St., Chicago 44, Ill.

Record-Marking Device

A NEW RECORD-MARKING device called the Spot-O-Graph facilitates the individual timing of sound effects and music. It is designed in the form of an ordinary record, but with a cone-shaped partition down the center, on each side of which there is a minutely graded scale, so that the needle can fit exactly in the desired spot. All notations and markings are made on



the Spot-O-Graph instead of the record itself. The device can be used by broadcasting stations and recording studios, radio schools, stage and screen sound engineers, or where a phonograph is used to learn a foreign language. The device is available in 10, 12 and 16-inch sizes and is a product of Heroservice, 45 West 45th St., New York 19, N. Y.



THESE FOLDERS Give You The Dope . . .

These folders are especially designed to help engineers, electricians, etc., in insulating electrical units with varnish. A section is devoted to the proper method of insulating units as determined by the DOLPH Laboratories. This section also gives information on pre-heating of units and dipping.

Another section will aid those who vacuum impregnate their units. The method described has generally been accepted as standard for impregnating all types of electrical units with both the conventional and synthetic insulating varnishes.

These folders are yours for the asking together with any other information you may desire regarding insulating varnishes.

JOHN C. DOLPH COMPANY
Insulating Varnish Specialists
169-A Emmet St., Newark, New Jersey

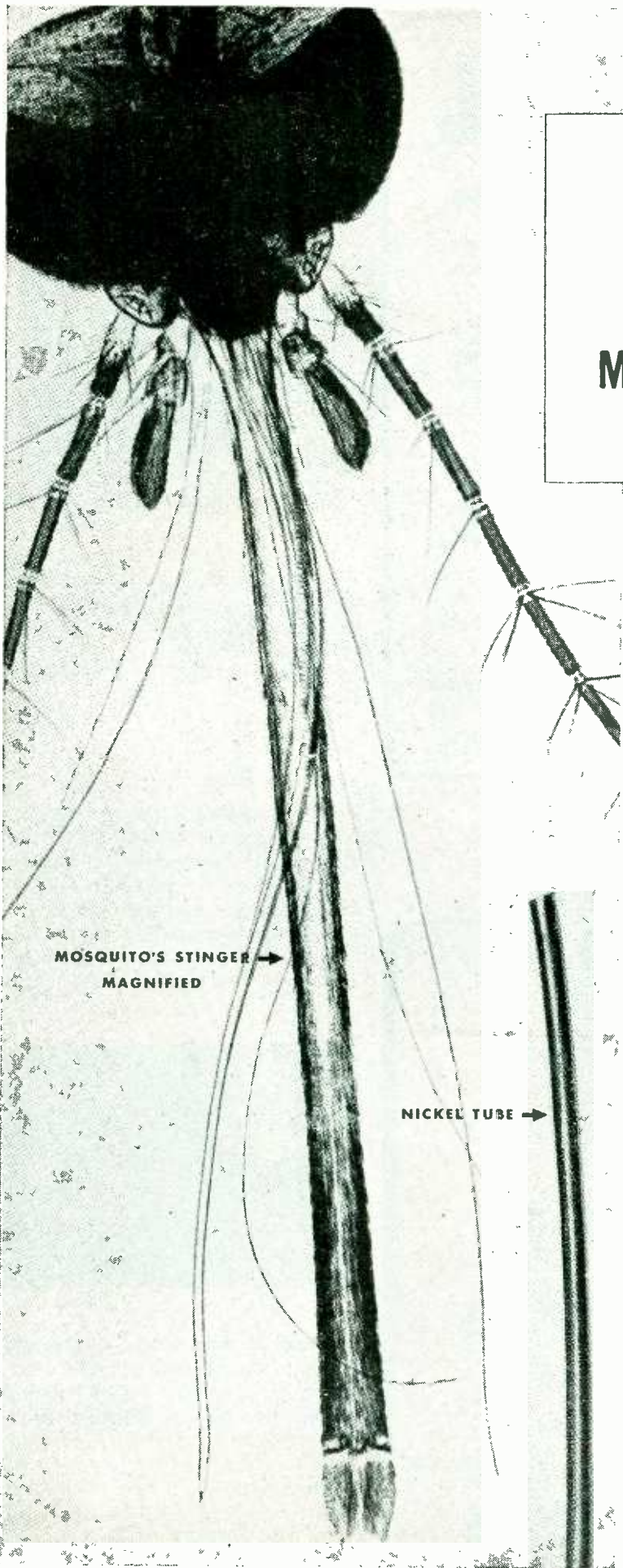

They wanted a
METAL TUBE
FINER than a
MOSQUITO'S STINGER

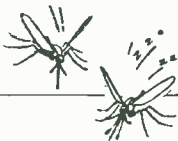

... and Superior Tube Co. found the metal to make this microscopic tubing... the smallest ever drawn... among the INCO Nickel Alloys

An example of the remarkable workability of INCO Nickel Alloys is given by the magnified photograph at the left.

It shows one extreme of the forms and sizes obtainable in these strong, tough, corrosion-resistant metals . . . that range from the giant forged gate stems at Boulder Dam down to wire drawn to split-hair diameter, and tubing finer than a mosquito's stinger.

Pure nickel was found best for producing this minute tube, by the Superior Tube Co., Norristown, Pa.

The outside diameter is 19/10,000, the wall is approximately 75/100,000, and the inside diameter is 4/10,000 of an inch. One pound would stretch more than 18 miles. 27 tubes together equal the thickness of a dime

All of the 8 INCO Nickel Alloys are immune to rust. All have high strength and toughness. In addition, each alloy has individual properties that make it uniquely fitted for special applications.

A booklet, "Tremendous Trifles", which discusses the properties of each alloy, together with sizes and forms, will be sent you on request.

THE INTERNATIONAL NICKEL COMPANY, INC.
 67 Wall Street, New York 5, N. Y.

INCO NICKEL ALLOYS

**MONEL • "K" MONEL • "S" MONEL • "R" MONEL
 "KR" MONEL • INCONEL • "Z" NICKEL • NICKEL
 Sheet . . . Strip . . . Rod . . . Tubing . . . Wire . . . Castings**



ONAN ELECTRIC PLANTS

Electricity for Any Job—Anywhere

ONAN GASOLINE DRIVEN ELECTRIC PLANTS provide electricity in locations where it is not otherwise available, and for emergency and standby service.

Thousands of these reliable, sturdy Plants are doing a winning job on all the fighting fronts by providing electricity for many vital war tasks. Ratings from 350 to 35,000 watts. A.C. 50 to 800 cycles, 110 to 660 volts. D.C. 6 to 4000 volts. Also dual A.C. and D.C. output models. Air or water cooled.

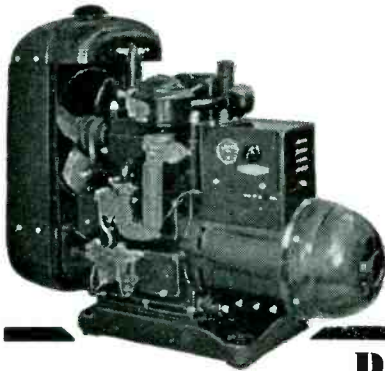

Details gladly furnished on your present or post-war need for Electric Plants.

D. W. ONAN & SONS

1923 Royalston Ave.

Minneapolis, Minn.

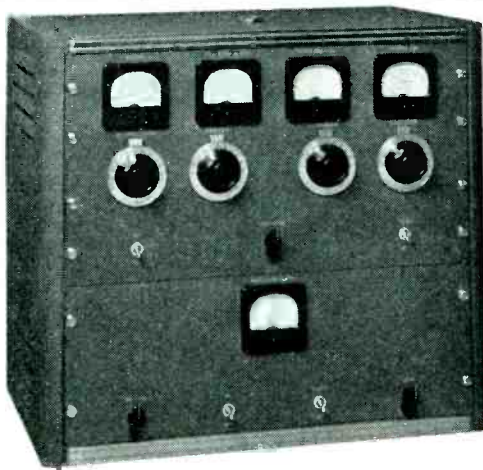

HARVEY 100-T TRANSMITTER

Compact . . . High Efficiency

100 Watt Transmitter . . . Telephone and Telegraph

HARVEY Radio Laboratories, Inc.
445 CONCORD AVENUE · CAMBRIDGE · MASS.

Rotary Switch

TYPE MR ROTARY switches have one to six positions with many contact arrangements and sequences which are accomplished by means of adding

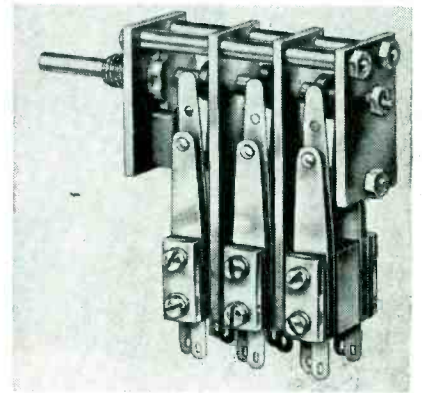

cams and contact build-ups. They are of single-pole mounting. The width and depth depend on the cams and contacts required.

General Control Co., Cambridge, Mass.

Locking Ring

THESE LOCKING RINGS were developed to speed up the process of locking sockets and components to chassis and bases, and to assure a positive lock. Another feature claimed for these rings is that they may be unlocked without damaging the component or the chassis. The rings

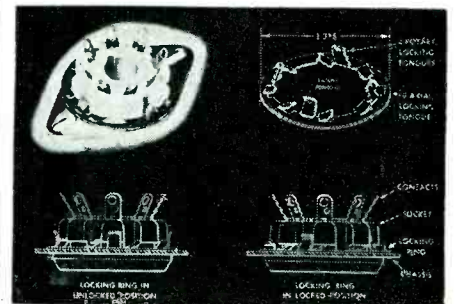

are easy to work with. A ring fits between the chassis and the component to be locked; a simple tool is placed over the component and a slight turn to the right securely locks to component to the chassis. A further slight turn does the unlocking.

A. W. Franklin Mfg. Co., 175 Varick St., New York, N. Y.

These Facts We Know

to be True . . .

Brush Spring for Aircraft Radio Dynamotor

"Micro-Processed" for best combination of strength, electrical conductivity, and resistance to heat.

Design stress, 68,000 lb. per sq. in. for service at 270 deg. F.

Produced by the hundred thousand to tolerances of:

± .002 in. on outside or inside diameter
± 4% on brush pressure at specified compressed length.

Calibrated Spring for Aircraft Instrument

"Micro-processed" for minimum drift and maximum proportional limit.

Design stress, 65,000 lb. per sq. in.

Produced by the thousand to tolerances of:

± .004 in. on free length
± .001 in. on outside diameter
1 deg. on squareness of ends.
± 0.6% deviation from standard deflection curve.
0.2% maximum drift, full load for 24 hours

Flexible Centering Ring

Punched and formed while soft and ductile, then hardened to a tensile strength of 200,000 lb. per sq. in.

"Micro-processed" by the thousands to hold center in plane of rim to within .005 in.

THESE three beryllium copper springs may well be considered "fussy"—yet they were produced in the quantities noted—by the same production control routine used by Instrument Specialties Company on hundreds of less rigid but nonetheless important spring jobs.

These springs owe their success to "Micro-processing"—a precise technique by which the extraordinary spring qualities of beryllium copper are consistently predicted and controlled by I-S through every step of production, beginning with the spring wire itself.

Spring users are rapidly learning that they can expect more of their springs. As a result, many manufacturers are designing more service life into springs; are setting up and are obtaining closer tolerances and improved electrical qualities; are making steady use of our ability to control drift performance when necessary.

These are statements of fact which we can back up to the hilt. There is no better test of micro-processing than on your own springs—those now in use or on your drawing boards. Whether your requirements are as rigid as those illustrated or not, you can expect and will obtain, improved performance and greater freedom of design when you use "Micro-processed" beryllium copper springs. You can prove these statements to your own satisfaction without obligation by sending samples or drawings to our engineering department.

INSTRUMENT SPECIALTIES CO., INC.

DEPT. D, LITTLE FALLS, NEW JERSEY



Illustrations Approximately Twice Size

A completely new
PEERLESS
DESIGN
for vacuum-tight,
moisture-proof transformers

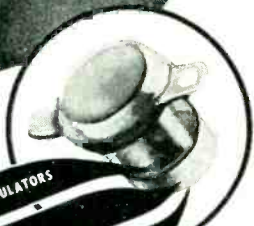
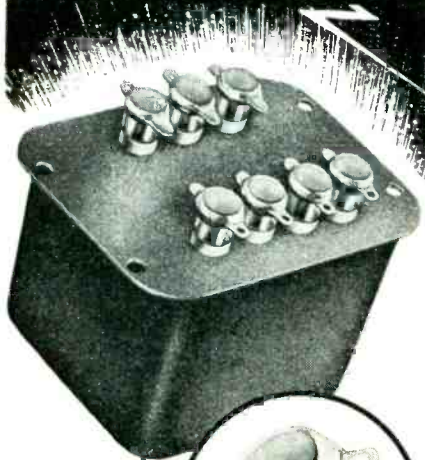

Can be quickly produced
in any desired size
or capacity to
customer's specifications!



Write for
complete
specifications
and
catalog



"There is a Peerless
Quality Transformer
for Every Purpose"

PEERLESS
Electrical Products Co.

6920 McKinley Avenue
Los Angeles 1, California

**High-Altitude Generator
Brushes**

To GIVE THEM INCREASED LIFE these brushes have been treated with a special process developed by Westinghouse Elec. & Mfg. Co. They

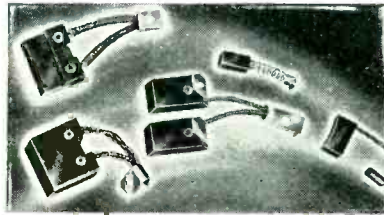

may be used at altitudes above 30,000 feet and the manufacturer states that thin air and high humidity does not affect them. They are available "tailor-made" for specific generators from Stackpole Carbon Co., St. Marys, Pa.

**Two-Terminal Oil
Capacitors**

TYPE 10 OIL CAPACITORS (which utilize inverted screw mounting) have been improved by the manufacturer so that both terminal lugs are insulated from the "floating" can and no insulating washer is required. The capacitors are hermetically sealed by the use of a one-piece molded bake-

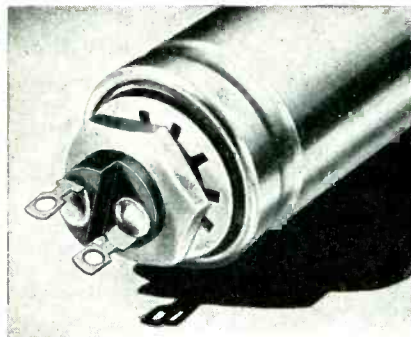

lite terminal assembly which prevents penetration of moisture and leakage of oil. The manufacturer states that these capacitors will pass all immersion tests required by Governmental agencies. The capacitors (available with either Hyvol vegetable oil or with mineral oil) are rated up to 4.0 μ f at 600 volts d.c. and up to 0.5 μ f at 1500 volts d.c.
Aerovex Corp., New Bedford, Mass.

WAR EARS

FOR



BUILDING "war ears" for the U. S. Army Air and Signal Corps is our job in this war. We're proud of the famous sensitivity and clear reception of our Radio Phones—proud that Uncle Sam is using so many of them. We're proud, too, that we're beating our war production schedules!

Murdock Radio Phones have solved many civilian communication problems, too. May we help you?

Write to Dept. 64 for Catalogue.



THE
EARS OF
A
NATION

Murdock
RADIO
PHONES

WM. J. MURDOCK CO.
CHELSEA 50, MASSACHUSETTS



Are You, Too, Planning For "The Age of Electronics?"

WITH many electronic developments proving successful on the battlefronts, it's only natural for America's scientists and engineers—busy as they are—to sense the importance of peacetime applications from the miracles they have wrought. And the postwar results of their thinking will create "The Age of Electronics."

Whether you are manufacturing war matériel or planning peacetime products, have you considered incorporating the principle of the *permanent magnet*? Permanent magnets of our design and manufacture are used in many of the war's outstanding elec-

tronic developments and in countless other important devices—increasing their uses and improving their functions. 33 years of specializing in this one field has enabled us to make valuable engineering contributions. Very likely we can help you, too.

Though our plant (the nation's largest specializing in the making of permanent magnets) is devoted to war orders, our engineers will be glad to consult with you and give your problems the benefit of their unusual experience. Write for the address of our office nearest you and a copy of our 30-page "Permanent Magnet Manual."

Back the attack with an EXTRA Bond—and help increase production!

The
INDIANA STEEL PRODUCTS
Company

★ SPECIALISTS IN PERMANENT MAGNETS SINCE 1910 ★
 6 NORTH MICHIGAN AVENUE • CHICAGO, ILLINOIS

The BOOK EVERY ENGINEER SHOULD HAVE!



The NEW DIALCO CATALOG OF WARNING & SIGNAL PILOT LIGHT ASSEMBLIES



24 pages of valuable data on the most extensive line of Warning & Signal Pilot Light Assemblies — completely covering all Electrical, Electronic, Radio, Marine and Industrial applications.

An indispensable guide for Engineers, Technicians, and Purchasing Agents.

Write for your copy, on company letterhead, today!

DIAL LIGHT CO. OF AMERICA, Inc.
90 WEST STREET • NEW YORK (6), N. Y.

Adhesive for Bonding

A NEW ADHESIVE PROCESS called the Reanite Bonding Process is available for bonding metals to rubber, plastics, synthetics, leather or wood to metal or to each other. The process does away with the necessity of brass plating and develops a bond rated by the manufacturer as being from three to five times as strong. The

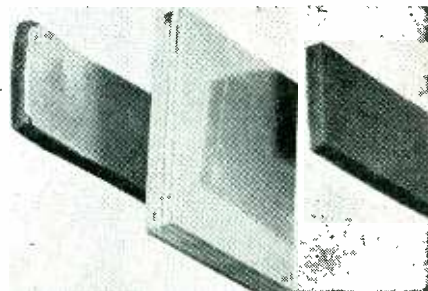

illustration shows a test sample of aluminum bonded to tire tread rubber which the manufacturer states passed separation tests under pulls well above 300 lb. Joints made by this process are unaffected by fresh or salt water, are noncorrosive to metals, possess corrosion-resistance, and have high dielectric strength.

The U. S. Stonware Co., Akron, Ohio.

Metal-Coating Process

THIS PROCESS WAS DEVELOPED to expedite application of the heavier silver coatings for bus bars, lugs and other parts of electrical equipment, as well as for plating, replating or touching up rust and corrosion resistant coatings of other metals. It is available in silver, cadmium, tin, copper, zinc, nickel and gold. Further information about this process may be obtained from Rapid Electroplating Process, Inc., 1414 S. Wabash Ave., Chicago 5, Ill.



LONGSHOREMEN in San Francisco get report-for-work instructions twice a day now from radio station KYA, eliminating thousands of phone calls to hiring calls while waiting for assignments. Relaxing of a cherished FCC ban on use of point-to-point communication by broadcasters permitted the new radio service.

FUSED QUARTZ INSULATORS AS USED IN ELECTRONIC TUBES

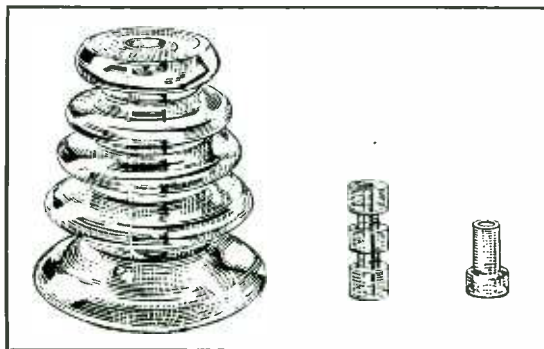

HIGH SURFACE RESISTANCE
AT ELEVATED TEMPERATURES
NON-HYGROSCOPIC
NOT SUBJECT TO THERMAL SHOCK
FABRICATED TO REQUIRED SHAPE

QUARTZ MERCURY ARC LAMPS
BLACK LIGHT EQUIPMENT

HANOVIA CHEM. & MFG. **CO., NEWARK, N. J.** DEPT. E-2

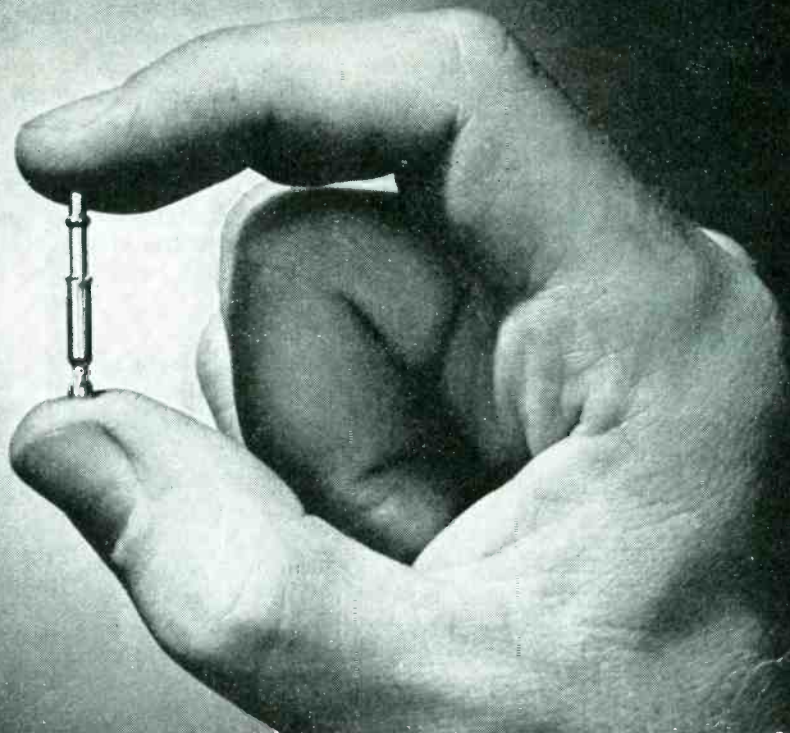

A TYPICAL 'MULTI-SWAGE' JOB

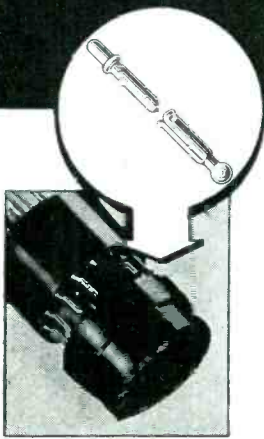

Most of the radio tube contacts used today are made by the BEAD CHAIN MULTI-SWAGE PROCESS.

The radio tube contacts shown above typify the precise, high-speed, volume production of small metal parts possible by the BEAD CHAIN MULTI-SWAGE PROCESS. These parts are formed from flat stock, practically without waste . . . a feature of all MULTI-SWAGE jobs which results in substantial economy in the cost of the finished product.

A great variety of similar parts, solid or hollow, can be produced advantageously by

MULTI-SWAGE. Large quantities can be turned out quickly. Most metals can be processed by MULTI-SWAGE.

Right now, our MULTI-SWAGE facilities are running full-time on war work. But, if you are planning post-war products using hollow, or solid round, cylindrical or angular parts, our Research and Development Division will gladly show you the advantages of making them by MULTI-SWAGE.

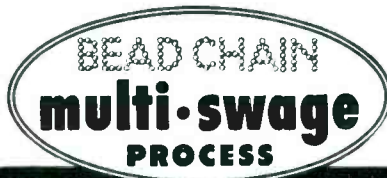

THE MOST ECONOMICAL METHOD OF PRODUCING SMALL METAL PARTS TO CLOSE TOLERANCES WITHOUT WASTE
THE BEAD CHAIN MANUFACTURING COMPANY
MOUNTAIN GROVE AND STATE STS., BRIDGEPORT 5, CONN.

PRECISION PARTS

"STAMPINGS" ON THE TOES OF THE AXIS

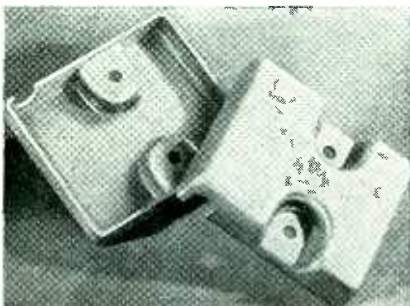

... "ten times faster" ...

Armed jeeps that race around the battlefields are the toughest little bits of dynamite that it is possible for the world's greatest automobile manufacturers to produce.

These small parts illustrated are one of the contributions of ACE to their fast, sturdy construction. Originally designed as a casting, the metal stamping department of ACE is now turning them out ten times faster, and conserving a lot of valuable metal in the bargain. The problem was to compensate for the different draws in the blank development so that the bottom of the piece comes flat.

How to hold a piece to closer tolerances, how to deliver it in large quantities on a mass production basis—that's typical of the problems that the ingenuity and modern machinery of ACE are constantly solving.

If you are looking for a source of supply for small parts or assemblies which call for stamping, machining, heat-treating, or grinding, ACE still has some capacity available from time to time. Send us a sample, sketch, or blueprint for quotation.



A copy of this folder, describing the modern heat-treating facilities at Ace, will be sent on request.



ACE MANUFACTURING CORPORATION
for Precision Parts



1255 E. ERIE AVE., PHILADELPHIA 24, PA.

Literature

Resistor Charts. Two graphical charts, one for resistors in parallel and the other for Ohm's Law and power problems, are available in 26" x 36" size for wall hanging to aid teachers and engineers in war training programs and in industry. Use official or company letterhead when requesting them from Ohmite Mfg. Co., 4835 Flournoy St., Chicago 44, Ill.

Electronic Applications. Illustrated and described in a three-color 44-page booklet (B-3264) obtainable on request from Dept. 7-N-20, Westinghouse Electric & Mfg. Co., East Pittsburgh, Pa.

Connectors. Rectangular rack and panel type connectors for radio and instrument applications in aircraft, tanks, etc., some with coaxial radio antenna contacts, are described in a new 30-page type DP connector catalog put out by Cannon Electric Development Co., Los Angeles, Cal.

Automatic Timing. Condensed 24-page Catalog No. 1 describes Cramer synchronous motor driven automatic timers, presenting in reference form the function, uses, features and specifications of such basic types as interval timers, automatic reset timers, time delay relays, cycle timers, impulse timers, double cycle timers, multi-contact timers, running time meters, signal control switches and contact making clocks. Catalog available from R. W. Cramer Co., Inc., Centerbrook, Conn.

Plugs and Jacks. A four-page catalog supplement called "Universal U. S. Army and Navy Specification Plugs and Jacks" is available from Universal Microphone Co., Inglewood, Cal.

Snap Switches. Specifications on nine types of Acro rolling-spring snap switches, some with operating pressures as low as 1 oz, are given in a 10-page file-size catalog just issued by Acro Electric Co., 1305 Superior Ave., Cleveland, Ohio.

Self-Locking Nuts. Fifty time-saving applications for Speed Nuts and Speed Clips of various forms for nonstructural assembly operations in aircraft are pictured and described in 24-page catalog No. 185 of Tinnerman Products Inc., 2106 Fulton Road, Cleveland 13, Ohio.

Recorder. The July 1943 issue of "Sound Advances" describes a simplified graphic level recorder and tells how it can be used to obtain frequency response characteristics in the range from 40 to 40,000 cycles for loudspeakers, microphones, underwater transmitters and receivers, and other transducers. A complimentary subscription to this house organ is available to engineers on request from Sound Apparatus Co., 150 W. 46th St., New York 19, N. Y.

Radar. A 24-page, two-color booklet explaining radar in elementary terms and outlining the part played by RCA in its development has been published by the Department of Information, Radio Corporation of America, RCA Bldg., New York 20, N. Y.

Test Insulation the Modern Way
with a **MODEL B-5**
MEGOHMER

NEW BATTERY-VIBRATOR TYPE

No more tiresome cranking of a hand-driven generator . . . Entirely self-contained, steady test potential of 500 volts DC, available at the touch of a switch. Direct reading in insulation resistance.

HERMAN H. STICHT CO., INC.
27 PARK PLACE NEW YORK, N. Y.



VARIOUS NEW MODELS
AND RANGES

WRITE FOR BULLETIN No. 430 8

RADIO RECEIVER AND TRANSMITTER CHASSIS FOR *Your* APPLICATION

SMALL:—Various types of Receivers and Transmitters require a space only 7" wide, 10½" deep and 7½" high.

PERFORMANCE:—*Receivers* with 1 microvolt sensitivity, high selectivity with a band width of only 16 KC at 30 DB down. Tunable, multi-channel crystal controlled or combination models available.

Transmitters with up to four crystal controlled channels, built-in antenna matching network, 20-25 Watts power output with 100% modulation capability on phone. 10 watt model with power supply on same small chassis also available.

VERSATILE:—Operation on 6, 12, 32, 110 volts DC; 117 volts AC or various DC-AC combinations. Dynamotor or Vibrator power supplies available for operation of transmitters and receivers.

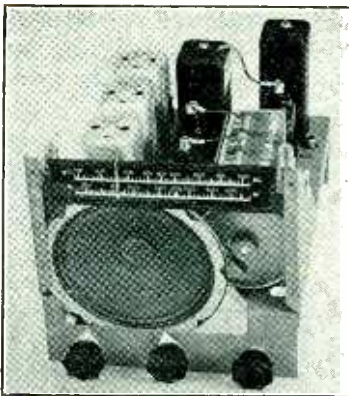

Series 6 tunable receiver. 2 band model illustrated, range 550-4000 K.C.

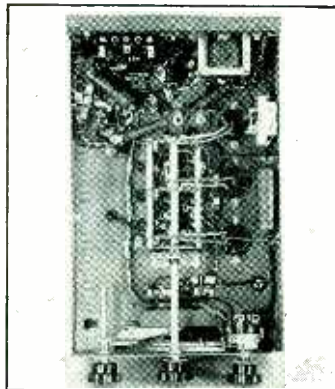

Under chassis view Series 6 tunable receiver.

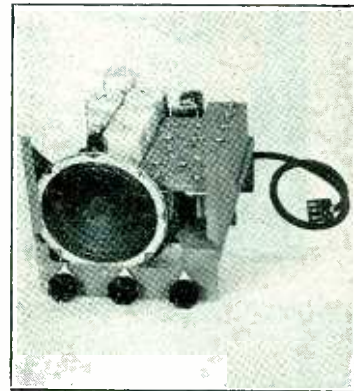

Series 6, five channel fixed tuned receiver. Model illustrated not crystal controlled.

★ ★ ★ ★ ★



Series 20, 4 channel 1600-6000 KC, 20 watt transmitter.

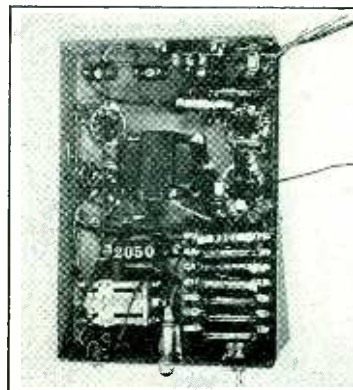

Under chassis view Series 20 transmitter.

★ ★ ★ ★ ★

KAAR ENGINEERING CO.

PALO ALTO, CALIFORNIA

Manufacturers of High Grade Mobile and Central Station Radiotelephone Equipment

New and Exclusive!
**VINYLITE PLASTIC
 HAIRLINE INDICATOR**
 More accurate than human hair.
 Moisture-proof, won't shrink or warp.

ACETATE SPACING WASHER
 POLYSTYRENE LEAD-THRU BUSHING
 POLYSTYRENE COIL FORM
 POLYSTYRENE LEAD-THRU BUSHING
 POLYSTYRENE COIL FORM

PLASTIC PARTS
 Supplied Immediately! No Molds! Close Tolerance!
 What's your urgent problem? Send specifications—blue-
 print, if possible—we'll get to work within 24 hours.
 Printloid experience and research facilities are your guar-
 antee of satisfaction. Literature on Request. Dept. EL-9

PRINTLOID Inc.
 93 Mercer Street New York, N. Y.

Printer Control

(Continued from page 115)

to the cathode of the phototube and grid of the thyatron, the thyatron is extinguished. This de-energizes the solenoid and allows the shutter to expose the aperture. The current flow caused by the light thus allowed to fall on the phototube discharges the capacitor at a rate dependent on the light intensity. When the capacitor has discharged to a definite voltage established by the other electrode potentials, the thyatron again fires and closes the shutter. The light is extinguished and the capacitor is recharged for the next timing cycle when the platen is lifted.

The grid lead of the thyatron and the cathode lead of the phototube must be well insulated and well shielded. The 2- μ f timing capacitor must be a high-quality paper-insulated type.

A time delay relay is essential to protect the cathode of the thyatron from ion bombardment by delaying application of anode potential until the cathode has heated. The delay system, which resets itself after operating, is improvised from an inexpensive thermostatic sign-flasher and an a-c relay. Other components are standard radio parts.

REFERENCES

- (1) Penther, C. J., Timing Device and Method, U. S. Patent 2,274,158 (Feb. 24, 1942).
- (2) Goldberg, H., An Electronic Timer, Photo Technique, Feb. 1941.

• • •

TINY COMMUTATORS

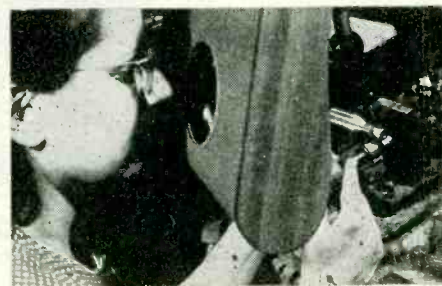

Cutting slots in commutators for small dynamotors that provide plate supply voltages for radio sets in planes, tanks and other mobile military equipment. Morene Hennon watches her work through a magnifying glass at the Westinghouse plant in Lima, Ohio

ESPEY MANUFACTURING COMPANY, INC.

SIGNAL GENERATORS - AUDIO OSCILLATORS - TEST EQUIPMENT
 RADIO RECEIVERS - TRANSMITTERS - ELECTRONIC DEVICES
 Licensed by - RCA - HAZELTINE - ARMSTRONG

DOING A WAR JOB!

305 EAST 63rd STREET
 NEW YORK CITY, N. Y.
 Telephone: REgent 7-3090

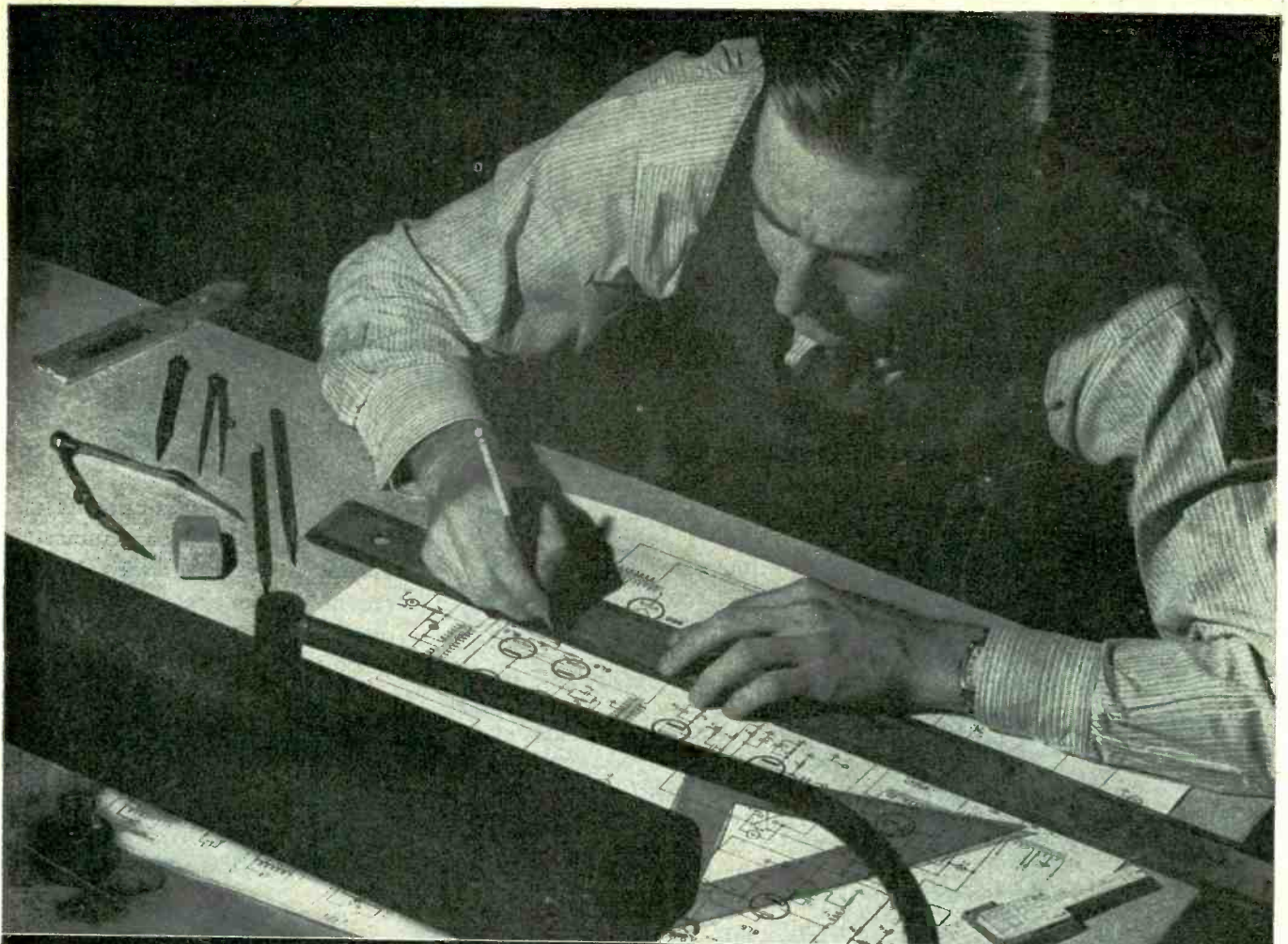

this man is wasting his time . . .

. . . unless the component parts specified in electronic engineering are equal to the task the design requires of them. The man-hours spent in new developments deserve the best components. The performance of the most intricately conceived circuit is no more dependable than the tubes contained in it.

The complete dependability of Raytheon Tubes is a long-established fact in both civilian and military experience. Whether the need be for standard tubes, or for tubes of special design, Raytheon meets the most exacting requirements.

Since Pearl Harbor the Raytheon laboratories have hung up a remarkable record of achievement in new — and in some cases, unprecedented — tube designs, and the Raytheon Manufacturing Company is producing them in heretofore undreamed-of quantities!



Four "E" Awards for Excellence
Each Division of Raytheon
 has been Awarded the Army & Navy "E"



DEVOTED TO RESEARCH AND THE MANUFACTURE OF TUBES AND EQUIPMENT FOR THE NEW ERA OF ELECTRONICS

"dag" COLLOIDAL GRAPHITE

ITS PROPERTIES

- An electrical conductor
- Low in photoelectric sensitivity
- Diamagnetic
- A black body
- Low coefficient of expansion
- Gas absorbent
- Opaque
- Chemically inert
- A conductor of heat

ITS USES IN ELECTRONICS

- Vacuum tubes
- Ray focusing anodes in cathode ray tubes
- Shields
- Grids, radio
- Plates, radio
- Electron guns
- Nonmetallic electrodes
- Glow discharge tubes
- Luminous gaseous discharge lamps
- Experimental cells
- Converter and output tubes
- Electron multipliers
- Half wave rectifiers
- Three element discharge devices
- Photoelectric cells
- Counter electrodes
- Resistances
- Thermopiles

ACHESON
COLLOIDS CORPORATION
PORT HURON  MICHIGAN
COLLOIDAL PRODUCTS

Microwave Plumbing

(Continued from page 119)

duced to cut-off and beyond by inserting double *L* section plates in the sides, as shown at (e) of Fig. 6.

Constructional details of the fixed detector unit are shown in Fig. 7. The upper diagram shows the construction of the moving detector and probe with tuning sleeve. The lower diagram shows the crystal detector mounted between two flat-head machine screws tapped into a polystyrene tube.

The cylindrical guide Fig. 8, is of very similar construction, but with the connecting flanges machined into the brass pipe itself. The cylindrical type is inherently more rigid and no compression yoke is required. The H_{11} mode is used and antennas of the same type as in the rectangular model may be used to excite the *E* field or loops in the plane of the cross-section to excite the *H* field. Of course, all sections can be rotated in their supports or joints. The diameter 7.3 cm permits only the H_{11} mode to exist. A section 15 cm in diameter, with piston and measuring slit, is used to observe the first few higher *E* and *H* modes. Axial and radial driving antennas are provided to excite the different modes.

A few miscellaneous wave guide accessories are shown in Fig. 9. The large cylinder with rectangular attachment protruding permits conversion from the H_{10} rectangular mode to the E_{11} cylindrical mode. The antenna at left is mounted on a coaxial section with detuning sleeve and adjustable mounting sleeve. The section in the center is a double stub for matching a coaxial line to generator or load. Input and output terminals are $\frac{1}{2}$ wavelength apart. Finally, at right is a probe antenna on which crystal cartridge and capacitor tuning stub are clearly shown.

The second part of this article, dealing with u-h-f antennas, is scheduled for publication in the next issue of **ELECTRONICS**.

REFERENCES

- (1) King, R., A Variable Oscillator for U-H-F Measurements. *R.S.I.*, 10, Nov. 1939.
- (2) King, R., A Screen-grid Voltmeter Without External Leak. *Proc. I. R. E.*, 22, No. 6, June 1954.

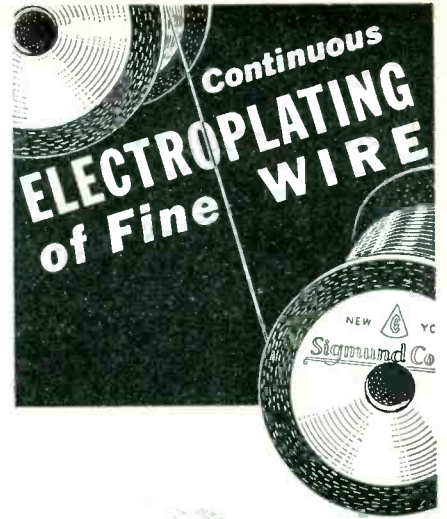

Complete equipment and staff of specialists for the continuous electroplating of fine wire. We can now plate a wide range of metals either on your own wire or on wire supplied by us . . .

Your inquiry is invited

SIGMUND COHN & CO.
44 GOLD ST. NEW YORK
SINCE 1901



Monarch's special calibrating equipment, testing and measuring instruments are performing vital services for manufacturers of radio and electronic devices.

Monarch testing instruments have been chosen by many manufacturers for shipment with other equipment, as required by government contracts.

If your problem has to do with testing equipment, special coils, or almost any type of small machine parts, we will welcome an opportunity to consult with you.

MONARCH MFG. CO.
2014 N. Major Ave. Chicago, Ill.

Television Relaying

(Continued from page 125)

During 1942 a total of 255 hours of program and test pattern transmission was relayed. At present, and for some time past, the schedule has consisted of relaying the NBC Monday evening Air Raid Warden Refresher course and the two hour entertainment which follows.

It is recognized that, while this television relay system is reasonably successful, and delivers pictures of good quality to receivers in the surrounding area, it represents only a portion of a complete program of investigation in this field. As is the case with many fields of civilian enterprise, development decreased materially with Pearl Harbor. It is planned to resume the full investigation of all factors involved when engineering time and equipment again becomes available.

The progress of development of all reception and relaying of television signals here recorded has dealt with NBC transmission. It should be noted that observations have periodically been made on Channel No. 2, occupied by WCBW (Columbia Broadcasting System). During the earlier transmissions of WCBW on the old No. 2 channel, (50-56 Mc) and before WCBW's shift to the present No. 2 channel (60-66 Mc), its test transmissions were frequently observed. However, before full-power, regular programming by them permitted a regular series of observations, the changes in frequency were effected. Nevertheless, the development of apparatus for a second channel was completed, and means for switching have been installed to permit its use when sufficiently strong signals are again available.



TELEVISION receivers containing many improvements resulting from wartime discoveries will be available shortly after the war with screen sizes ranging from 6 to 24 inches, according to Dr. Ralph R. Beal, RCA research director.



• You may have wondered — how could any *one* organization make so many significant contributions in the fields of electronics, irradiation, fluorescent lighting, and medicine?

There is an inspiring reason — perhaps one unparalleled in American industrial history.

For beyond Sperti, Inc., are laboratories, dedicated to pure scientific research . . . headed by world-famous scientists, devoted to the single, unswerving ideal of human betterment.

Sperti, Inc., was created for the purpose of making the practical discoveries of these research laboratories available.

Beyond Sperti are laboratories devoted to pure scientific research

That's why it is not surprising that manufacturers, seeking vision beyond their own engineering and research departments, are turning to Sperti, Inc., as they get deeper into postwar planning.

Today—even when you, and we, are almost totally occupied with war production —it is not too soon to begin discussions of your problems in research, development, and manufacture. Out of it may come an advantage to you over competition which may have an important bearing on your postwar success. Write, today.

Look ahead . . . look to

Sperti INCORPORATED

RESEARCH, DEVELOPMENT, MANUFACTURING • CINCINNATI, OHIO

POWERS ELECTRONIC & COMMUNICATION COMPANY

Engineering and Manufacturing

OF

Communicating, Control, and

Allied Systems

FOR THE

UNITED STATES GOVERNMENT SERVICES

A SUBSIDIARY OF POWERS PHOTO ENGRAVING CO.

GLEN COVE

NEW YORK

Electronic Generator

(Continued from page 132)

Conventional regulator circuits did not appear to work well here as complete control was required at the low output voltage of 70 v. The 6J5 and the 991 tubes shown schematically at the bottom of the schematic provide a stabilized bias for the 6SJ7 bias supply unit control tube that operates above ground potential in a negative direction. The high voltage supply using a pair of 83 rectifiers, also shown schematically, delivers 250 v to the four 6L6 regulator tubes, so that a voltage of 70 volts at 350 ma is developed across R_1 .

Of course, regulation is not a serious problem until the 833A tubes begin to draw grid current. Under such conditions increasing grid current tries to increase the voltage appearing across R_1 . The control tube then increases the bias on the 6L6 regulator tubes so that the bias voltage is maintained at a constant value. As the system is independent of reasonable line voltage changes, and as the impedance is substantially zero insofar as variations in voltage caused by grid current are concerned, the supply affords an excellent answer to the bias problem.

Mechanical Design

The mechanical design of the generator was undertaken while keeping in mind the different requirements occasioned by different types of use. In a laboratory, complete control should be available for the engineer. In some shop applications where a fixed critical frequency is needed the controls should be made inaccessible to unskilled operators. For this reason the front door of the cabinet is provided with locks and the small door covering the control panel can also be locked if desired. The sides, back, and top of the cabinet are made of expanded metal to insure adequate ventilation. Openings are provided in the rear of the back panel so that a-c line input and power output cables can easily be brought in to fuse blocks on the lower deck.

The lower deck is given over to a 3000-v plate supply for the 833A tubes and a 1500-v plate supply for the 812 tubes. Control equipment includes a time-delay relay which delays the application of high vol-



PyroFerric

IRON CORES

Pyroferric research and development proved the practicability of producing specification powder metal components for high or low frequency, high "Q", high resistance, great physical strength and to fit any circuit. Pyroferric with its background of research and experience will gladly consult with you in your Powder Metallurgy requirements.

PYROFERRIC Co.
175 VARICK STREET NEW YORK, 14, N. Y.

tages until the rectifier tubes have had an opportunity to warm up. An adjustable overload relay is also included. A safety interlock switch is operated when the front door is opened.

The chassis on the second deck includes a 300-v regulated supply for the low-level audio stages and the output voltage regulation control circuit. The audio oscillator and the C bias supply for the 833A and 812 tubes are also located on this chassis.

The top deck is devoted to the high level Class B output stage. As the heat dissipation from the tubes is quite large a polished baffle plate is located between the tubes and the output transformer to prevent the latter from overheating. Sufficient room is available on this deck to install corrective elements where the load is highly inductive.

The control panel includes all of the controls essential to operation once the switch from the power line has been closed. The plate switch on the left controls the high voltage to the two Class B stages. This enables the operator to cut off the power output, without shutting off the whole unit, to conserve the life of the 833A's. The power could, of course, be cut off by means of a line-switch in the output circuit but the method used is desirable from a tube conservation standpoint. If an overload occurs the overload relay operates, removing the high voltage. When the trouble is cleared, operation of the overload-relay push-button switch will again apply plate voltage to the power tubes. The third control from the left is the audio oscillator frequency range switch and the next, of course, is the frequency control dial. The audio gain control, at the right of the frequency control dial, is adjusted to give required output under full load. The last control, for diode threshold adjustment, permits the circuit to be externally adjusted for best regulation.

Electronic Generator Efficiency

The power requirements are 3.5 kw from a single-phase 60-cycle line. An auto-transformer is included in the unit so that voltages from 208 to 260 v can be used. Taps are provided on the transformer at 10-v intervals within this range. The overall efficiency of the system is better than 40 percent. This of course does not



only as effective as the equipment used

AT THE GRUMMAN AIR FIELD . . . hundreds of test flights daily . . . aeroplanes coming and going . . . all dispatched from the Control Tower . . . all placing a great responsibility on the communications equipment. For maintaining contact with a large number of planes . . . giving each the "O.K." to taxi in or leave . . . what runway to use . . . telephoning vital instructions to pilots . . . all depend on the reliability and effectiveness of the radio equipment.

It was not by chance that ERCO Radio Communications Equipment was selected by the Grumman Aircraft Engineering Corporation. Grumman engineers knew that the sound and unique engineering built into ERCO equipment could be fully depended upon to meet the exacting requirements demanded by radio control tower operations.

ERCO engineering, backed by many years' experience, has long been recognized for outstanding achievements in the field of radio communications. And, today, the name ERCO takes on a new significance in providing quality apparatus that assures complete dependability for the U. S. Coast Guard, U. S. Signal Corps, Pan American Airways System, and other prominent users of radio equipment.

ERCO Radio Communications Equipment installed in Grumman Radio Control Tower.

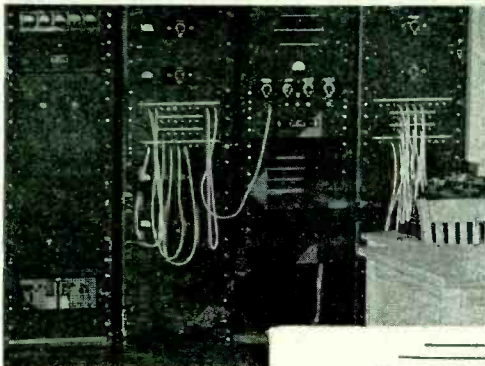

ERCO

ERCO RADIO LABORATORIES

HEMPSTEAD, NEW YORK

Manufacturers of CUSTOM BUILT RADIO APPARATUS



PLASTIC BRANDING } by ROGAN
PLASTIC MOLDING }

While molding and branding plastics that serve on all battle fronts, Rogan is also preparing for the peace that will follow. Preparing to meet the demand from peacetime industry for the many NEW applications of plastics. And, when Peace does come, get Rogan facts on how you can get faster production of plastic parts at less cost. Write now about your present War plastics and future Peace products.



ROGAN BROTHERS
 2003 South Michigan Avenue Chicago, Illinois

compare favorably with rotary machines but on the other hand the wide frequency range and excellent regulation cannot be secured by mechanical means.

In closing, it is well to point out that the design described was intended to cover as many industrial applications as possible consistent with reasonable cost. Different frequency ranges and power outputs are design variables that may be changed to meet special cases. The first is quite easy to shift within reasonable limits by changing the constants of the audio oscillator. Good performance can be expected through a frequency range limited in extent only by the performance of the Class B transformers.

Considering the second design variable, it is obvious that the number of watts per dollar will decrease at lower power outputs and increase with higher power outputs. This is true because the chief changes are related to the type of tubes used in the final amplifier and the size of the final amplifier voltage plate supply.

• • •

TUBES FOR TINNING



I. E. Mourmtseff, Westinghouse electronics engineer, holds one of the high-power oscillator tubes used in the recently-developed high-frequency process of reflowing tin after electroplating. Alongside are broadcast transmitter tubes that may also play important roles in industrial electronics

Quality
AND LOTS OF IT

★ **Transformers for Combat**

In Active Service Over the Entire Globe

DINION COIL COMPANY
 CALEDONIA, N. Y.

Motor Control

(Continued from page 138)

with a generator drive and is diagrammed in E, F, G and H of Fig. 6 for purposes of comparison with the equivalent electronic drive of J, K, L and M of Fig. 6. Note: It should not be inferred from the inclusion of F and K of Fig. 6 that "plugging" is one of the steps in the reversing sequence. These are included merely to show that plugging would result if the motor terminals were reversed without reversing the generator polarity. Actually, both generator polarity and motor connections are reversed to avoid plugging.

There is one important difference in the behavior of these two drives insofar as the contactors are concerned. In the case of the electronic drive, the grid-controlled rectifier-action of the thyratrons assists in interrupting the armature current so that the contacts have a minimum of circuit-interrupting duty. And, upon reclosure, the pre-conditioned current-limit control minimizes the circuit-making duty of the contacts. Thus, the function of these contacts is merely that of mechanical switches, so that a-c rated contactors can be used in these d-c circuits. It should be emphasized here that the contactors operate only once during a reversal.

Regeneration

During regenerative deceleration when the motor must electrically pump back its mechanical rotational energy through the tube circuit into the a-c system, the power circuit must act as an inverter. That is, it must be capable of inverting the d-c potential of the motor into the a-c potentials of the anode transformer. Then, after deceleration to zero speed, the tube operation should continue smoothly into rectification so as to supply energy to the motor to accelerate it to the desired speed in the opposite direction.

Figures 6G and 6L compare the polarities of generator and electronic control during the inversion period. Note that the generator polarity in Fig. 6G has been reversed by reversing its field excitation in order that the generator voltage will be counter to the motor voltage during the regenerating period of deceleration,

"One - Two - Three - Four - Testing!"

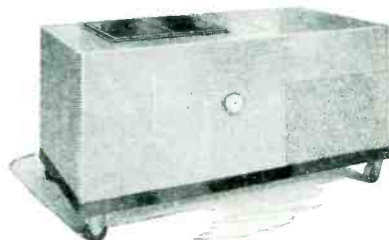

5.4 Cu. Ft. 32" x 34 1/2" x 63 1/2"

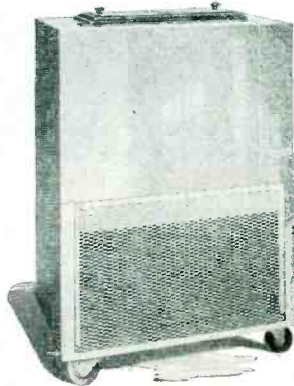

2.0 Cu. Ft. 48" x 24 1/2" x 31 1/2"

The chant of the Army or Navy radio operator preparing for action, is definitely allied with Kold-Hold thoroughness and accuracy in developing testing equipment for radio and airplane parts.

Kold-Hold Sub-Zero units provide accurate temperature control conveniently located for the operator at one spot.

The applications of Sub-Zero machines include the testing of airplane instruments, radio receivers and transmitters, conductor wire, crystals, insulators, plastics, glass, lubricating oils, paints, chemicals and others too numerous to list. What are your requirements?

New York Chicago Philadelphia
Los Angeles

KOLD-HOLD MANUFACTURING CO.
446 N. Grand Avenue LANSING, MICHIGAN



THIS picture might have been taken almost anywhere. All over the world small groups of soldiers are guarding our outposts against attack. Vigilant, lonely and unafraid, these men rely on their skill . . . and on radio. Radio for warnings. Radio for help when needed. Radio for coordination. Radio for entertainment. Radio for Victory.



PHOTO BY
U. S. ARMY SIGNAL CORPS



NATIONAL COMPANY
MALDEN, MASS., U. S. A.

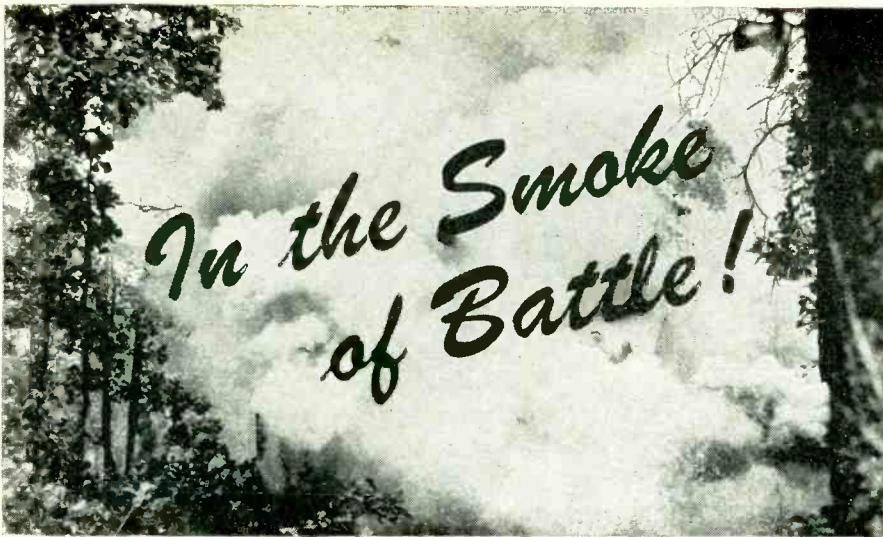

... the radio of the future is being tested today—unerringly carrying out the strategy and guiding the action of our armed forces.

When the battle smoke has cleared away, Sentinel, now producing war equipment exclusively will be ready with up-to-the-minute radios and electronic devices that will thrill a product-hungry market... Equipment which has stood the acid test of war... Merchandise that promises volume sales for Sentinel dealers.

SENTINEL RADIO CORPORATION
2020 Ridge Avenue, Evanston, Ill.

Quality
Since 1920

Sentinel RADIO

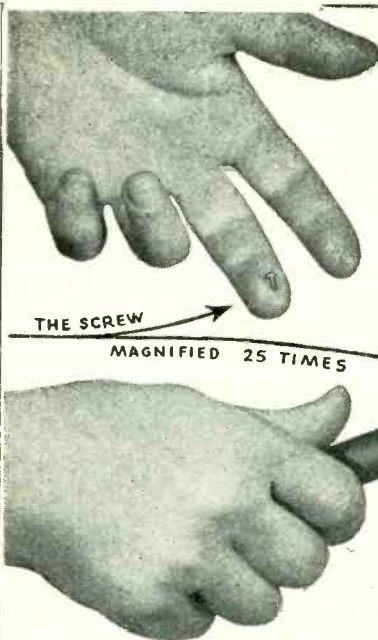

PERFECTION IN MINIATURE

**So Small That It Might Have
Been Designed for Your Watch**

YET millions of these tiny 1-72 screws (.072 diameter) are going into vitally important precision equipment such as head phones, microphones and delicate instruments. **STRONGHOLD** is one of the very few manufacturers who make them.

Like the equipment of which they are a part, these fasteners, too, are precision made, so nearly perfect that they may be magnified many times without disclosing a single flaw in heads, threads or points. They are typical of the whole range of "Stronghold" screws.



96-Page Catalog On Request

MANUFACTURERS SCREW PRODUCTS

270 West Hubbard St., Chicago 10, Ill.

whereas in Fig. 6L the thyratrons are fired as inverters to produce a negative and counter voltage which oppose the motor voltage and thereby limit the armature current.

Inversion

Ordinarily, connecting the positive terminal of a running motor (+ potential as a generator) to a normally-negative rectifier terminal (- of a source of emf) results in a plugging action (see Fig. 6F and 6K) and the armature current tends to be abnormally great because the two potentials are added together in a closed loop with a small circuit resistance to limit short-circuit current.

This condition exists only if the output voltage of the thyratrons is of a polarity conventional to rectifier operation, that is, a positive polarity at the cathode terminal of the tubes and a negative polarity at the center-tap of the anode transformer winding. But, the circuit polarity may be reversed to receive energy from the d-c source when the tubes are caused to act as inverters. That is, the mid-tap of the transformer becomes a positive terminal (current flowing into the receiver) and the cathode of the tubes becomes a negative terminal (current flowing out of the receiver).

Figure 7 is intended to show how a rectifier circuit, which normally changes alternating potentials into a direct potential, may also utilize its negative half cycles of alternating potentials to produce a negative counter voltage during inversion, provided some means is available to control the starting (grid control to initiate firing) and stopping (power circuit action to stop conduction through the tube plus a negative grid potential to prevent re-conduction until the desired point) of the anode current.

The circuit will become an inverter instead of a rectifier if:

(1) A direct potential (the armature generated emf of the motor, in this instance) is available to maintain a current flow through the thyratrons *against* the turn-off effect of the negative transformer voltage.

(2) The thyratrons are fired too late to furnish appreciable output as rectifiers (too late because the terminal of the anode transformer, which is connected to the anode of the thyatron is rapidly making the anode-voltage negative).



Global

REG. U. S. PAT. OFF.

CERAMIC RESISTORS

RESISTORS are, in the final analysis, energy dissipators and as such they should be rugged. Since the demands of electronic circuits are quantitatively exacting, a resistor should be electrically and mechanically stable. Ruggedness and stability in a resistor gives assurance that it will retain indefinitely its established resistance value under normal loading.

A good resistor should withstand, without suffering a permanent change in resistance, the maximum accidental over-voltage to which it might be subjected in service. Moreover a resistor should be relatively free from microphonic effects, inductance and capacitance and it should not be affected by humid atmospheres.

"Global" Brand Ceramic Resistors meet these specifications. Right now deliveries must be scheduled according to priority ratings and date of order. Nevertheless we invite you to tell us about your needs; we pledge our best efforts to assist you.

The condensed table below gives you at a quick glance the physical and electrical characteristics of the more commonly used industrial type "Global" Resistors.

TYPE		A	B	CX
LENGTH	Min.	1/4"	1/4"	1/4"
	Max.	18"	18"	18"
DIAMETER	Min.	1/16"	1/16"	1/16"
	Max.	1"	1"	1"
RESISTANCE Per Inch of Length	Min.	25 ohms	5 ohms	1 ohm
	Max.	15 megohms	15 megohms	100 ohms
OVERALL WATT RATING	Max.	54 watts	54 watts	150 watts
NORMAL RATING W. Sq. In. of Radiating Surface		1 watt	1 watt	2 1/2 watts
MAXIMUM VOLTAGE Per Inch of Length		400 v.	400 v.	** Note

*These ratings may be substantially increased by artificial cooling.

CHARACTERISTIC COEFFICIENTS:

TYPE A: Comparatively Straight Line Temperature and Voltage.

TYPE B: Negative Temperature and Voltage.

TYPE CX: Slightly Positive Temperature.

Other resistor types are available for specialized applications.

TERMINALS: Metalized ends for clip mounting or wire leads.

** Type CX resistors have a low specific resistance and cannot be subjected to voltage stresses permissible with Types A and B. Maximum allowable voltage is that required to yield maximum watt rating.

Global Division

THE CARBORUNDUM COMPANY

REG. U. S. PAT. OFF.

NIAGARA FALLS, N. Y.

(Carborundum and Global are registered trade-marks of and indicate manufacture by The Carborundum Company)

(3) If the current through each thyatron is interrupted and held off before its conduction continues into the succeeding positive half-cycle of alternating anode voltage (when, if conduction were to continue, each tube would be a rectifier, and plugging action would result).

During rectification, the current flows in the direction dictated by the polarity of the anode transformer and against the polarity of the d-c system voltage, hence power flow is out of the a-c system into the d-c system. During inversion, the current flows in the direction dictated by the polarity of the d-c system and against the then-negative (or, counter sense) of the anode transformer, hence power flow is out of the d-c system and into the a-c system. Since the negative alternating potential of any one tube exists for only the negative half cycle and then becomes positive for the succeeding half cycle, it is imperative that the current in each tube cease before conduction is carried over into the rectifying half cycle.

The greater the portion of each negative half cycle during which current flow can be maintained, successively, through each thyatron against its then-negative half cycle of alternating potential, the greater becomes the portion of that half cycle interval when energy is being transferred from the d-c source into the a-c system. Likewise, the greater becomes the average negative counter voltage of the thyatron circuit because this negative voltage is useful only when current flows.

The theoretical value of negative d-c counter voltage equal to 0.9 of the a-c (rms) voltage is not realized in practice because of the necessity of firing the thyatrons late in their rectifier half-cycles in order to commutate current from one to the other, which reduces the counter voltage.

In Fig. 8 the wave forms and conditions of rectification are compared with those of inversion and the diagram shows how the various circuit components absorb the instantaneous difference in potential between the ever-changing alternating potential and the constant d-c counter emf. Arrows indicate the direction of current flow through the local circuit which comprises a transformer, winding, thyatron, armature inductance, armature resistance, and armature counter emf.



RADIO AND ELECTRONIC COMPONENTS



ALL YOU WANT!

Immediate Delivery!

TUBES • CAPACITORS •
RELAYS • COILS • RESISTORS
• TRANSFORMERS • TEST
EQUIPMENT • 1001 OTHERS

We've been around for 17 years . . . so we know where to look, what to look for, and what to buy! We know materials, qualities, workmanship, prices! We can take that big burden off your shoulders and replace it with the components and equipment that you need to help speed your production.

Write, Wire or Phone HARVEY

If we haven't what you want in stock, we'll find it for you as fast as wartime conditions permit.

Telephone Orders to **BRyant 9-1946**

HARVEY

RADIO COMPANY

103 WEST 43 ST. NEW YORK, N. Y.

Speed Working Tools for Precision Operations

New and Old Workers find SPINTITE the fastest wrench for speedy assembly of small parts.

Standard sizes with hex sockets from 1/16" to 5/8". Rounded Round and Square Sockets available on special order. SPINTITE works like a screw driver.

T51 Set in Leatherette Roll includes 7 SPINTITES 3 screw drivers and chuck type handle

STEVENS WALDEN, INC.
453 SHREWSBURY STREET
WORCESTER, MASSACHUSETTS, U. S. A.

NEW BOOKS

Applied Electronics

By MEMBERS OF THE STAFF OF THE DEPARTMENT OF ELECTRICAL ENGINEERING, MASSACHUSETTS INSTITUTE OF TECHNOLOGY. John Wiley & Sons, New York, 772 pages, price \$6.50.

THE THIRD VOLUME of the M.I.T. series of texts dealing with the principles of electrical engineering is covered by the present volume which is designated as "a first course in electronics, electron tubes and associated circuits." It is similar to the previous two volumes in general format, scope, and rigor of treatment. The volume may be regarded as "a first course in electronics" in the sense that the completeness of treatment of the volume will provide the reader with adequate text for problems encountered in the ordinary and customary applications of electron tubes. Since the text is designed for the use of upper class students in electrical engineering, the volume can, by no means, be regarded as an elementary treatment for those lacking a good basic foundation in electrical engineering.

Although the volume is treated from the point of view of the electrical engineer, more than the usual proportion of this text is likewise suitable for the student of physics. This is especially true with regard to the first few chapters which are primarily devoted to the liberation of electrons and the forces existing between the charged particles which may be encountered in electronic devices.

The general scope of the volume is laid out along the lines of most well-known texts on the subject. The chapter heading, accordingly, will give the reader an indication of the topics treated. Such headings are: Electron Ballistics; Electron Emission from Metals; Electrical Conduction Through Vacuum Gases and Vapors; High Vacuum Electron Tubes; Gas Tubes; Single Phase Rectifier Circuits; Polyphase Rectifiers; Vacuum Tubes as Linear Circuit Elements (Single Phase Class A Amplifiers); Class A₁ Amplifiers; Amplifiers with Operation Extending Beyond a Linear Range of the Tube Characteristics Curves; Vac-

Here's news for men in radio and electronics—

Just out

One of the most complete works of its kind ever published, this outstanding reference work presents a wealth of essential theory and up-to-date standards, practice, and data, especially selected and organized to meet the needs of the engineer dealing with practical radio and electronic problems.



RADIO ENGINEERS' HANDBOOK

By Frederick E. Terman

Professor of Electrical Engineering and Executive Head, Electrical Engineering Department, Stanford University (absent on leave), Director, Radio Research Laboratory, Harvard University

1,019 pages, 6 x 9,
profusely illustrated, \$6.00

13 big sections, covering

1. Tables, Mathematical Relations, and Units
2. Circuit Elements
3. Circuit Theory
4. Vacuum Tubes and Electronics
5. Vacuum-tube Amplifiers
6. Oscillators
7. Modulation and Demodulation
8. Power-supply Systems
9. Radio Transmitters and Receivers
10. Propagation of Radio Waves
11. Antennas
12. Radio Aids to Navigation
13. Measurements

Terman's Handbook concentrates on those topics which the radio man thinks of as constituting radio engineering—presented in concise descriptions, fundamentals, formulas, procedures useful in actual design, tables, diagrams, etc. Consult it for data needed in routine problems of design and practice, or in investigation of special problems or branches of work. Check your methods against best accepted practice. Save time, trouble, and error—get quick, dependable answers to your questions, when you need them, from Terman's Radio Engineers' Handbook.

See one of the first copies off press. Just mail the coupon; pay for or return the book after examination. This authoritative and convenient summary of radio engineering knowledge can be of constant and valuable aid to you. Send the coupon today.

10 DAYS' FREE EXAMINATION

McGraw-Hill Book Co., 330 W. 42nd St., New York, 18, N. Y.

Send me Terman's Radio Engineers' Handbook for 10 days' examination on approval. In 10 days I will send you \$6.00 plus few cents postage or return book postpaid. (We pay postage on cash orders.)

Name

Address

City and State

Position

CompanyL. 9-43

uum Tube Oscillators; and Modulation and Demodulation or Detection. The treatments which have been accorded to many of the topics are more or less standard. In many cases, however, alternative methods of analyses (or two or more ways of looking at the same problem) are presented. This approach is undoubtedly of considerable value to the student and, it might be remarked, to the engineer using this volume as a reference work.

Several important features characterize "Applied Electronics." First and foremost is the comprehensiveness of scope which has been made possible within the confines of 772 pages. No important principle of electronics and no important application of electron tubes has been omitted, even though it is manifestly impossible to show (or even hint at) the manifold variety of tube circuits currently in use. The aim of the book is that of teaching fundamentals rather than of presenting a collection of tube and circuit applications. A second important characteristic of this volume is the painstaking thoroughness with which it has been documented. This thoroughness is not only extended to the documentation of the various footnotes throughout the volume and the bibliography at the end of the text, but also applies to tabular and graphical material when these have been taken from other sources. The bibliography and footnote references alone provide the engineer with an appreciable source of reference material in the field of electronics. A third feature worth mentioning is the fact that the book is well balanced as regards the needs of the power and communication engineer. The text is likewise well suited to the needs of the industrial electronic engineer.

Indeed, Professor T. S. Gray, who probably had more to do with the organization, writing, and editing of the present volume than any of the other members of the Electrical Engineering Department, has used preprints of the present volume in courses of instruction for students taking the option in electronic engineering.

In general the volume is mechanically well done. The illustrations and typography are good, as is also the paper. Most texts of this type may be expected to sell at about 1

GRAY



Makers of telephone
pay stations
since 1891

Now serving the
war effort in such
vital fields as

✓ An Opportunity for
a forward-looking
MANUFACTURER or
INVENTOR

If you have any ideas on electronics and electro-mechanical products which you think will further the war effort, or which have post-war application, we would like to hear from you.

As part of our post-war program, we are planning to add to our line 5 or 6 electro-mechanical products obtained from outside sources. These may already be on the market or in the idea stage . . . If you feel that you have something on which we might work together on a mutually profitable basis, we suggest that you write our President, Mr. W. E. Ditmars, in complete detail.

ELECTRONICS

We have designed and produced large quantities of electronic equipment for the Army and Navy

RADAR · RADIO

and wire communication

AVIATION

SOUND RECORDING

METAL SPINNING

in aluminum, brass, steel,
copper and magnesium

THE GRAY MANUFACTURING COMPANY

HARTFORD, CONNECTICUT

230 PARK AVE., NEW YORK

Electrodes for Crystals

BUTTON TYPE. FLAT OR STEPPED TYPE

SQUARE, OBLONG AND ROUND

CLOSEST TOLERANCES

EXCELLENT FINISH

MINIMUM LAPPING
GREAT SAVINGS IN MAN HOURS
AND COSTS

PROMPT DELIVERIES

Send for full information

Genex Company

UNION, NEW JERSEY

Hand Molded STEATITE by STAR

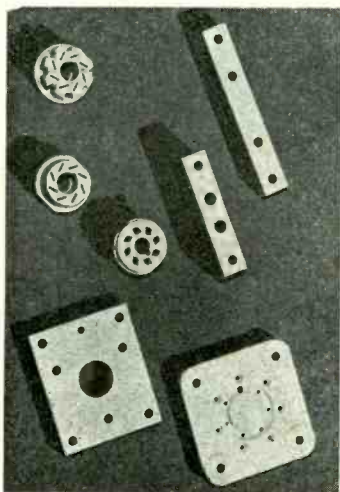

The pieces here illustrated were carefully molded on manually operated presses to assure perfect shapes without distortion.

This is only one of several ways by which STEATITE pieces are produced at the STAR plant. Automatic Molding, and Extrusion and Machining are other methods. Write for further information.

The STAR
PORCELAIN COMPANY
 ELECTRONICS DEPT. TRENTON, NEW JERSEY

cent per page so that the price is reasonable. The volume is a heavy one which the student will undoubtedly give hard use. It would not appear that a very large "safety factor" had been applied in the selection of the cover and binding.

As a general text on electronics or a reference work for the practicing engineer, "Applied Electronics" should be adequate in every respect.—B.D.

• • •

Fundamentals of Electric Waves

By HUGH H. SKILLING, *Professor of Electrical Engineering, Stanford University. John Wiley and Sons, Inc., New York. 186 pages, price \$2.75.*

THIS SMALL VOLUME has for its primary purpose the presentation of the classical Maxwellian theory of electricity and magnetism in a form suitable for communication engineers. The point of view is essentially that in the treatise of Abraham, but an attempt is made to make the material more readable by using frequent practical illustrations. The objective physical picture of each new concept is stressed.

A brief treatment of the Gibbs vector notation is followed by a thoughtfully worked out explanation of the special Maxwellian operators. The author wisely avoids difficult topics of limited interest to the radio engineer, such as the complex Poynting vector, and the detail study of the interaction phenomena at optical interfaces. Instead, emphasis is placed on the newer developments, such as the application of cylindrical waves to wave guides. The concept of vector potential is developed at some length to serve as an introduction to the theory of radiation from doublets and simple antennas.

The book, while admittedly not comprehensive enough to function as a reference treatise, will fill a need currently felt by many communication engineers for an introduction to the more difficult concepts required to understand the theory of operation of the special radio equipment being developed now primarily for wartime military use, but with extensive and important post-war applications in civil aeronautics and other fields—W.J.C.

THERE'S MORE TO KNURLING THAN MEETS THE EYE



UNBRAKO

... far more. In "UNBRAKO" SELF-LOCKING HOLLOW SET SCREWS, for example, knurling of the points means positively that they won't shake loose come what may and that is equivalent to a real saving in maintenance cost, time, labor; and an increase in industrial safety. The Knurled Points dig in and absolutely prevent the "Unbrako" from unwinding and so eliminate a great many of the repairs necessary on machinery where ordinary set screws are used.

"Unbrako" Screws range in size from No. 4 to 1½" diameter. Send for the "Unbrako" Catalog today.

In "UNBRAKO" SOCKET HEAD CAP SCREWS, the knurled feature serves a double purpose—it speeds up production by providing a firm grip for mechanics' fingers even when greasy—and provides a simple and effective means of locking after countersinking. Naturally both these advantages also result in labor and monetary savings too.

Knurling of Socket Screws originated with "Unbrako" years ago.

Pat'd
and
Pats. Pend.

STANDARD PRESSED STEEL CO.
 HENKINTOWN, PENNA., BOX 886 • BRANCHES: BOSTON • DETROIT • INDIANAPOLIS • CHICAGO • ST. LOUIS • SAN FRANCISCO

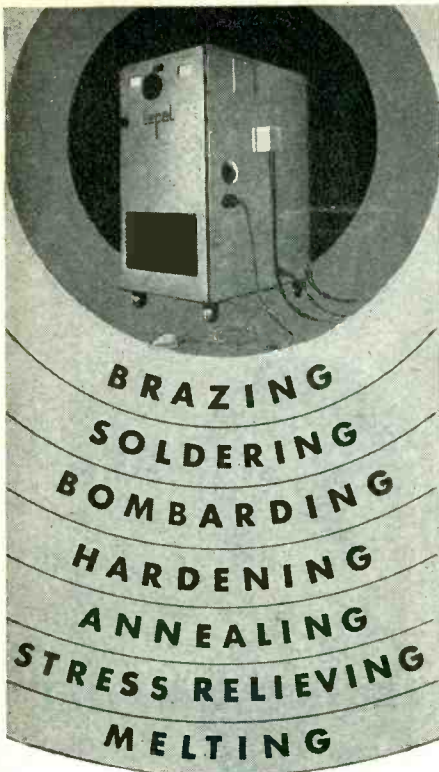

One Compact LEPEL UNIT does them all

— so fast that production is multiplied while maintaining a degree of precision and uniformity rarely attainable through other methods.

Yet it is so simple, dependable and clean in operation that many installations are operated entirely by women.

It's easily movable, relatively inexpensive and readily convertible from war production to peacetime applications without any conversion whatever. Manual or automatic control.

Send samples and specifications for complete engineering data and recommendations on your work. Ask for Catalog E.

LEPEL HIGH FREQUENCY LABORATORIES, INC
39 West 60th Street, New York 23, N. Y.

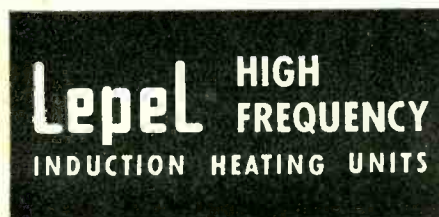

Dictionary of Science and Technology

By MAXIM NEWMARK, PH. D., *Department of Modern Languages, Brooklyn Technical Inst. Philosophical Library, New York. 386 pages. Price \$6.00.*

A GUIDE FOR FOREIGN LANGUAGE reading in technical fields. The main section consists of approximately 10,000 English terms arranged alphabetically and numbered, with French, German and Spanish equivalents and synonyms for each term but no definitions. This is followed by three indexes, listing alphabetically in turn the French, German and Spanish terms and the position number of the equivalent English term in the main section. Six pages of technical abbreviations in the four languages add greatly to the value of the book, particularly for those doing research requiring study of foreign language sources.—J.M.

. . .

Vector and Tensor Analysis

By HOMER V. CRAIG. *McGraw-Hill Book Co., Inc., New York, 1943, 434 pages, price \$3.50.*

WITH THE CONTINUOUS DEVELOPMENT of microwave technique—"it looks as if the engineer will at last really have to learn electrical field theory"—Dr. Condon writes in a recent article. We may add also that many engineers will have to consider Maxwell's equations at the beginning instead of the end of their study. For this reason a more complete knowledge of vector analysis will become very important, even for the most elementary exposition of wave guides and cavity resonators. To this, of course, the use of tensors in the study of rotating electric machinery must be added, to explain the desirability of a widespread knowledge of these two important branches of mathematics.

This new book by Professor Craig has been written without any reference to electrical applications. It is divided into four parts which can be considered, to a certain extent, separately. In the first part elementary concepts of calculus and algebra are briefly reviewed as a mathematical background. In the second part, the most important concepts of vector analysis are introduced together with some concepts of analytic and differential geometry considered from the

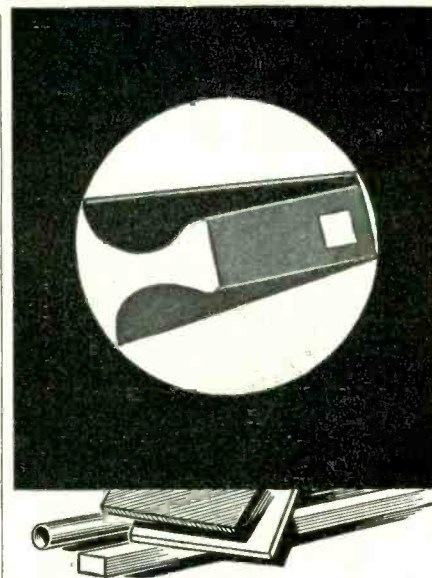

Where Time is precious and Service imperative—

use Wilmington Fibre.

That it is uniform in density in dielectric resistance, in the qualities and characteristics that make for accurate machining and lasting service—is the important point. These attributes are the fruit of adequate and controlled curing and processing.

That it is made in the standard shapes—sheets, rods and tubes—and standard sizes, you may take for granted.

The point to remember—now when priorities or directives govern shipments, or later when you will have free choice and prompt deliveries—is that consistent high quality is inherent to the processing, curing and control of genuine vulcanized FIBRE.

WILMINGTON FIBRE SPECIALTY CO.
NEW CASTLE, DEL.

Miller

RADIO

INTERFERENCE FILTERS



INDUSTRIAL FILTERS

Miller industrial filters are designed for all types of radio interference producing devices and are highly effective at broadcast and short wave frequencies. They have highest attenuation characteristics at all frequencies used in radio communication. Each filter is completely sealed for complete protection under all climatic conditions.



AIRCRAFT INTERFERENCE FILTER

The No. 7884 Radio Interference Filter, developed expressly for aircraft use, will effectively suppress noise present in the ship's electrical system. Insure noise-free radio reception by installing a Miller Duo-Lateral Wound Radio Interference Filter. Dimension 2½" diameter by 3" long. Weight 1.25 lbs. Write for specification sheet.



APPLIANCE FILTER

Designed for use with larger household appliances and commutator type motors, as well as communication type receivers and recording equipment, this Miller Filter, No. 7515, uses larger capacitors and heavier capacitor inductors to handle load requirements up to 550 watts. Size 2½" square x 4" long. 115 volts, 550 watts.



See your Wholesaler or write us for literature

J. W. MILLER COMPANY
5917 S. Main St., Los Angeles, Calif.

• BUILDERS OF QUALITY RADIO INDUCTANCES SINCE 1924

point of view of vector theory. In the third part, the theory of tensors and extensors is explained from a somewhat new point of view and with some results found by the author. The fourth part contains applications to mechanics and to special and general relativity.

It is difficult to agree with the author about the simplicity of his exposition which is often very formal and involved. He has considered that in explaining a result the emphasis should be put on the correct formulation of the conditions for its validity. For this reason a reader who is already well acquainted with the subject will find in this book the answer to many doubts that other simpler but less complete demonstrations have left in his mind, but a reader for whom each result is new will look in vain for a clear explanation of the essence of each result before going into the important details introduced by the necessity of mathematical rigor. Furthermore it is the definite intention of the author to make as little appeal as possible to the geometrical or physical intuition of the reader. While this may contribute to the generality of the proofs, it can hardly be said that it makes the book easy to read.

It is really unfortunate that the author has chosen a formal approach that most engineers will find difficult to follow because he has given to the concept of invariant the very important place which belongs to it in all branches of mathematics, and especially in vector analysis. By introducing this concept and emphasizing it in the early pages of the book, he prepares the reader to extend it to more complicated cases, thus obtaining a very coherent and elegant construction.

In conclusion, this book cannot be recommended to an electrical engineer mainly interested in the direct application of the principles of vector analysis but it can be considered as a book to which very diligent readers will refer to find a rigorous formulation of definitions and results.

—E.F.



SNARL-PROOF tipless plastic-covered cord developed by IT&T for subscribers' telephone sets can be cut to length and connected to a new screwdown adapter without stripping or soldering.

Defeats



HEAT



COLD



HUMIDITY



THERMATITE TREATED THERMADOR TRANSFORMERS

Thermador Transformers are Thermatite treated to withstand extreme temperatures and humidity—arid or moist heat—dry or damp cold do not hamper their efficiency. Thermatite is the name of a process of accurate heat controlled vacuum impregnation developed and improved over a period of ten years.

Thermador also manufactures built-in Electric Heaters, Electric Ranges, Electric Water Heaters.

THERMADOR
Electrical Manufacturing Co.
5119 S. Riverside, Los Angeles
Seven Leagues Ahead



High Frequency Thermionic Tubes

By A. F. HARVEY, *John Wiley & Sons, New York, 235 pages, price \$3.00.*

TO THIS REVIEWER'S KNOWLEDGE, "High Frequency Thermionic Tubes" is the first volume of book size available in English, which deals exclusively with the characteristic behavior of ordinary negative grid tubes at high frequencies and which also discusses the newer types of tube structures specifically intended for operation at frequencies of 100 megacycles or more. The extensive and increasing use of tubes at very high frequencies at the present time is a guarantee that this little volume will receive its fair share of attention.

A foreword by E. B. Moullin summarizes Dr. Harvey's present contribution so well that it is deemed worthy to quote from it: "The recent developments in television have called for the use of ultrahigh radio frequency, and the results have produced revolutionary changes in tube and circuit technique. Up to a point the new requirements have been met by improved construction of the familiar multi-electrode thermionic tube. Dr. Harvey devotes the first two chapters of his book to describing such new tubes, and the effect of their residual parameters. It will be welcomed by all as a gathering together of new results and values not otherwise readily accessible.

"The need for the use of short wavelengths has stimulated interest in methods of producing them which do not depend on the conventional use of a three-electrode tube. A study which has been in progress for many years, in physical laboratories at universities. . . . About half of Dr. Harvey's book is devoted to the magnetron, and a collective account of the work on this puzzling piece of apparatus is most welcome. . . . The last chapter gives an outline of velocity modulation tubes, klystrons, etc., and of wave guides and horn radiators. It forms a very useful introduction and survey of a subject which is in its infancy and about which comparatively little is known at present."

The volume is a comparatively small one somewhat reminiscent of the monographs which are frequently published in England. Like many of these monographs, Dr. Har-

Potter & Brumfield
have made 7,000 types of
RELAYS
in the last ten years!



Send your relay specifications
for prompt production estimate

Potter & Brumfield
Princeton, Indiana

"THE POSITIVE ACTION RELAY"



MATERIAL does not matter
—when it comes to **MARKING**

WOOD PLASTIC GLASS METALS

Putting your name or trade mark on articles of post war production may, because of material changes, bring to you new problems. They are not problems to us because our equipment is now being used to mark, identify or number, plain or in multiple colors — war production items of plastics, metals, fabrics, paper, and many other materials.

Assembly is facilitated by small part marking, sources are identified by code or other marking, step processing keyed, and in many other ways Markem equipment, synchronized to automatic speed handling, is serving on the war production line.

Markem equipment is versatile and adaptable to frequent and quick changes. Material, surface or contour present no insurmountable difficulties. Markem equipment is engineered to special needs and Markem service includes the laboratory development of inks to meet every requirement.

If, for present or future use, you have a marking problem, put it up to MARKEM. Ask for Bulletin L9.

TEXTILES PAPER BOXES

MARKEM
MACHINE COMPANY
KEENE N. H.

PRECISION BUILT PRODUCTION MACHINES FOR INDUSTRIAL MARKING

Now!

Vibration Fatigue Testing with Automatic Acceleration Change

NEW Model 10 MA All American Vibration Fatigue Testing Machine meets the long felt need for a machine that would provide automatic acceleration change.

Any part or assembly up to 10 lbs. in weight can be secured, by means of tapped holes, to the 7" x 7" table and subjected to vibration fatigue test with acceleration automatically changing from 10 to 55 cycles per second and back to 10 cycles per second in one minute, continuously and uniformly. Soundly engineered, mechanical frequency changing device is ruggedly constructed for service over extended periods. Meets government specifications. Has a capacity of 28 g's. Displacement variable from 0 to .250". Frequency may also be controlled manually and is accurately recorded on electric tachometer. Table operates vertically with simple harmonic motion. Construction is more substantial than on our standard Model 10, to accommodate the more severe use resulting from rapid and continuous acceleration changes.

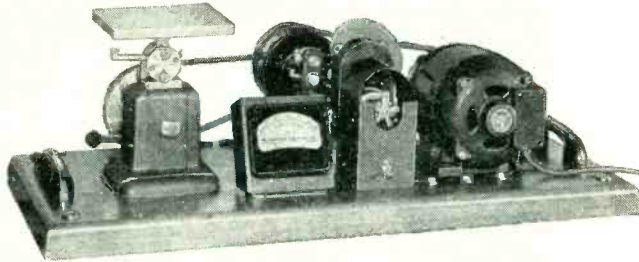

ALL AMERICAN
Tool & Manufacturing Co.
1014 Fullerton Ave., Chicago

Send for
complete
information

**WHEN THE FULL STORY
IS TOLD...**

**about
the Famous SCR-299 built by Hallicrafters**



Since
1924



MERIT will take justifiable pride in its manufacture of precision parts for this miracle mobile unit which has contributed so much to the victories of our armed forces, and gives but a glimpse now of the limitless post-war future.

Now manufacturing for every branch of the Armed Services. enlarged facilities enable us to offer prompt shipment on priority orders.

Transformers—Coils—Reactors—Electrical Windings of All Types for the Radio Trade & other Electronic Applications.

MERIT COIL & TRANSFORMER CORP.
311 North Desplaines St. CHICAGO 6, U.S.A.

vey's volume comprises a wealth of data (in this case largely experimental) adequately presented in compact, concise form without the detours which are required when detailed mathematical developments are offered. In the main, the book deals with conclusions which may be arrived at by an examination of the present stage of the art. The author has gone to considerable pains in classifying and evaluating book and periodical references which are available. The book is flooded with references to the works of others. In itself, this is a valuable contribution, but Dr. Harvey has also managed to include a wealth of experimental data which, if not entirely new, certainly has not received widespread publication.

Chapter headings include: General Properties of Thermionic Tubes; Influence of Frequency of Operation; Retarding Field Generators; The Magnetron (in two chapters); and Miscellaneous Tubes and Circuits at Very High Frequencies. The material in Chapter I should be familiar to anyone dealing with electronics. There is no new material presented here, but the 21 pages of this chapter are used for a concise summary of tube behavior where the effects of frequency are not yet too disturbing. The second chapter is designed to point out the changes in the propagation of thermionic tubes at very high frequencies. While the chapter is devoted to negative grids in vacuum thermionic devices, the illustrative photographs and examples shown bring well to the fore the changes which are required when tubes are operated at high frequencies. The third chapter deals with electronic generators in which the oscillations are produced by virtue of electron inertia in thermionic tubes rather than by feedback effects. Theoretical, practical, and experimental considerations are treated. Approximately 100 pages are devoted to the magnetron. Chapter IV deals with the cutoff characteristics and the negative resistance properties of magnetrons, whereas Chapter V is devoted to a consideration of operation in which the wavelengths of oscillation depends only partly on the constants of the external circuit and to the production of electronic oscillation. The final chapter deals with the comparatively newer types of tubes whose operation depends upon

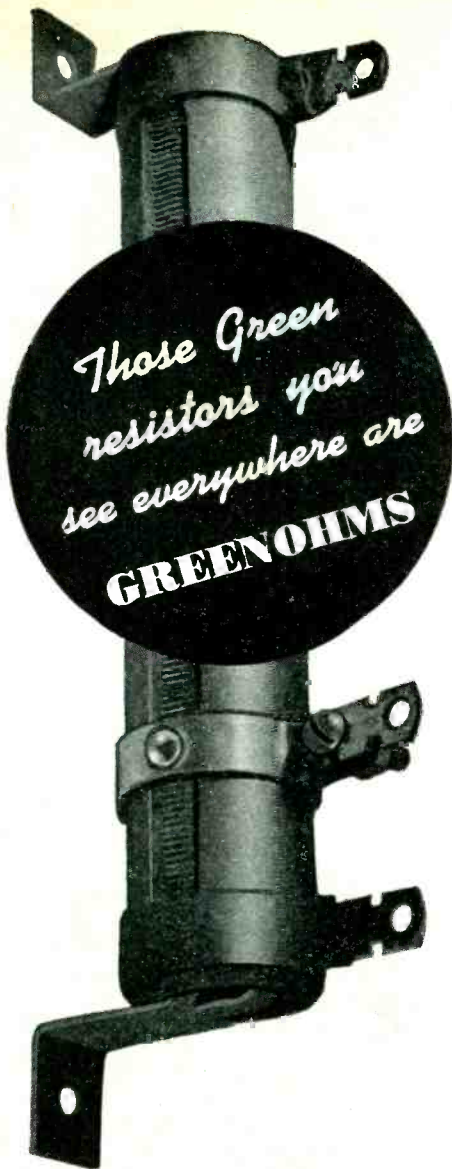

★ Yes sir, you see them everywhere—those green-colored special-inorganic-cement-coated power resistors. But more particularly in aircraft electrical, electronic and radio assemblies that must stand up, regardless.

Greenohms can take an awful beating. Even when seriously overloaded—red hot—they won't burn-out, flake, peel, crack. Standard units: 10 and 20 watts fixed; adjustable, up to 200 watts. Also special types with choice of windings, taps, terminals, mountings. Remember, only Clarostat makes Greenohms.

★ Consult us . . .



CLAROSTAT MFG. CO., Inc. • 285-7 N. 6th St., Brooklyn, N. Y.

the modification of a beam of electron. The concluding part of the last chapter is devoted to wave guides and horn radiators, particularly with reference to their use as coupling elements between the ultrahigh frequency generator and free space in which the radio waves are to be propagated.

Each chapter has at least four or five dozen references and certainly there are several hundred references given throughout the volume. This is not the sort of a volume which will appeal to those who are currently attracted by the present "glamour" and "newness" of electronics. But for those who have a good basic foundation in electron tube technology and who wish to be brought up to date in the quickest possible manner on the more recent developments which have transpired during the past few years, Dr. Harvey's book has no equal.—B.D.

. . .

Transients in Linear Systems

By F. MURRAY GARDNER and JOHN L. BARNES. *John Wiley and Sons, Inc., New York, 1942, Vol. I, 389 pages, \$5.00.*

THE TITLE OF THIS VOLUME is given more fully on the title-page as "Transients in Linear Systems Studied by the Laplace Transformation; Lumped-Constant Systems." Problems in electric circuits and networks, and several in mechanical vibrations, form the illustrations from engineering. Mathematically they are problems in systems of linear ordinary differential equations, integrodifferential equations, or difference equations with constant coefficients.

The essential properties of the Laplace transformation are developed and used in all these problems, giving the direct and satisfying procedure that is the modern form of operational calculus. The Laplace transformation of a function $f(t)$ of the positive variable t is the operation

$$\int_0^{\infty} f(t) e^{-st} dt,$$

which produces a function $F(s)$ of the parameter s ; $F(s)$ is the transform of the function $f(t)$. The correspondence thus established between pairs of functions $f(t)$ and $F(s)$ is such that differentiation of $f(t)$ corresponds to the multiplication of

An APOLOGY and a PROMISE!

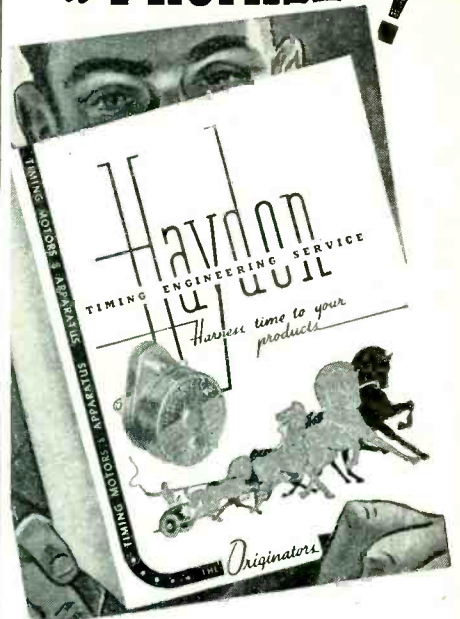

Through Uncontrollable Circumstances . . . Our Catalog was Delayed

Our sincere apologies . . . we've tried to be patient, and hope you have too, but it is now really ready for mailing, after several months' delay in preparation. It's NEWER, more VALUABLE, and more INTERESTING.

We promise you a BETTER book, however, because the interim has allowed us to include many new items. The catalog is packed full of helpful, up-to-the-minute information on timing motors for use in Automatic Reset Timers—Time Delay Relays—Vacuum Tube Circuit Controls, etc.

{ Complete information on Timing Motors by The Originators of The Timing Motor }

Send TODAY for Your Copy!



SPLIT-CYCLE ACCURACY IN EVERY UNIT

When you design or build crystal-controlled equipment, you stake your reputation on the mounted crystal, made by someone else.

When you specify a CRL unit, made by a well-equipped organization which gives precedence to long life and accuracy in your equipment, you can stake your reputation on the results. Speed is a plus, precision the must at CRL.

Write for illustrated literature which shows why CRL can meet your demands and which contains a chart of crystal application data.



CRYSTAL
RESEARCH
LABORATORIES
INCORPORATED
29 ALLYN STREET
HARTFORD 3, CONN.

$F(s)$ by s , except for the addition of a polynomial in s . Consequently certain types of differential equations in $f(t)$ correspond to algebraic equations in $F(s)$. Other properties of the correspondence make possible the simplification of certain types of integrodifferential and difference equations.

The chapter following the introduction gives a detailed discussion of the mathematical formulation of one-dimensional problems in electrical and mechanical systems. This chapter, over seventy pages in length, can be read independently of the rest of the book. The six chapters that follow take up the properties of the Laplace transformation and its inverse, and their applications. In addition to the more common circuit problems the illustrative applications include, for example, problems in vacuum-tube amplifiers, one on automatic controls, and one on a mechanical filter. The final chapter deals with difference equations and their applications.

The appendix contains a table of transforms and a table of corresponding operations; also a historical sketch and an extensive bibliography both worthy of the attention of everyone writing on the subject. A list of problems, mostly without answers, appears at the end of each chapter.

The book is carefully written. The reader may find the subject-matter difficult at times, but he has a good chance of understanding it if he reads carefully. The method can be understood by the reader who is not familiar with some of the more modern mathematical terms used here. The book presents an interesting set of problems and an interesting method for solving them. The method is to be applied to problems in partial differential equations in the second volume.—R.V.C.



PLATING of plastics, glass or any other nonconducting material by means of a new process comparable in quality to electroplating of metals is announced by Precision Paper Tube Co., 2023 W. Charleston St., Chicago 47, Ill. The metal plating is permanent and does not crack, chip or peel.

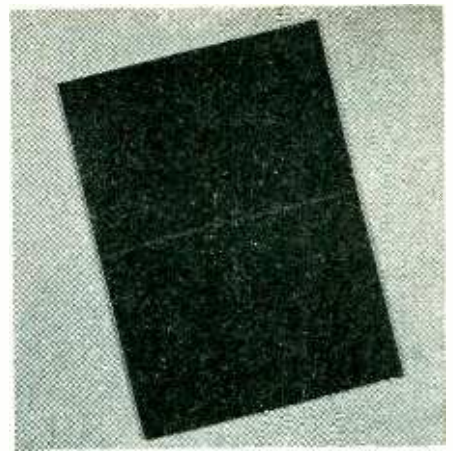

A cut of JELLIFF .0008. ALLOY "C" WIRE was laid upon the above square . . . it is so fine, the camera almost missed it.

Below is a microphoto of the same wire, enlarged 420 diameters . . . a sturdy uniform wire.



X-rays in Research and Industry

By H. HIRST, *University of Melbourne, Chemical Publishing Co., Inc., Brooklyn, N. Y., 1943. 127 pages. Price \$2.50.*

A WELL-ORGANIZED SURVEY of industrial radiography, starting with the theory of x-ray production and ending with a specific application to manufacturing problems, that of inspecting the spiral resistance element inside the steel tube of a hotplate radiant element. Properties of x-radiation and the structures of crystals are briefly covered to provide essential fundamental knowledge for an understanding of the two

. . .

BIG CAPACITOR

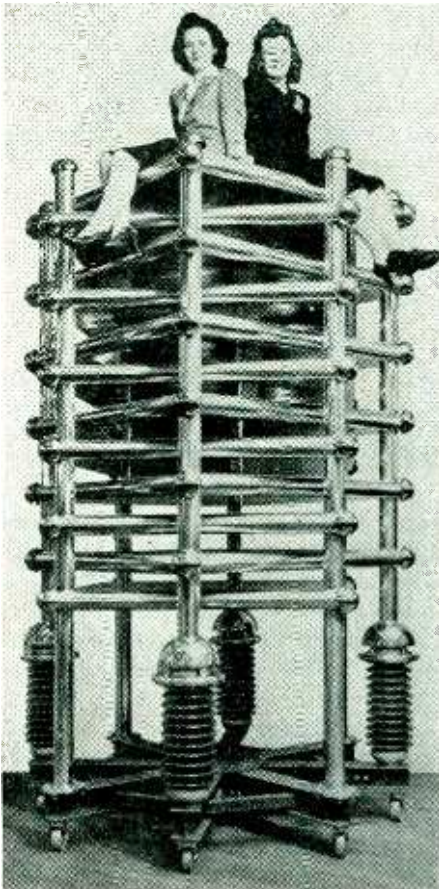

This air capacitor, weighing over a ton and rated at 2500 $\mu\mu\text{f}$ and 200,000 volts, was constructed at a Newark plant of Federal Telephone and Radio Corp. for use as a phantom antenna capacitor in the company's high-power transmitter laboratory. The hollow tubes that serve as plates were nickel plated to improve conduction and efficiency, while the polished balls at the ends of the "plates" prevent dissipation of electricity into the air

GET THE COMPLETE TECHNICAL RADIO BACKGROUND

most in demand today under this attractive offer

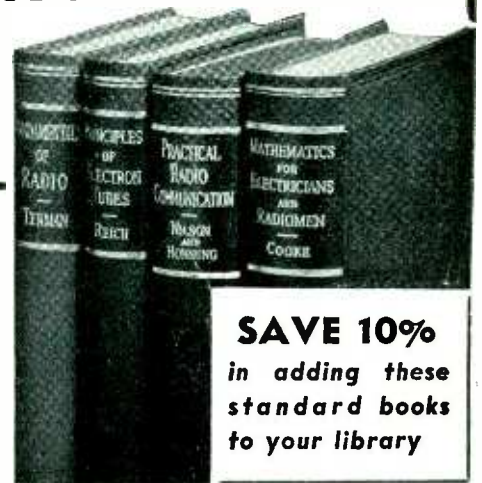

SAVE 10%
in adding these standard books to your library

Here is a library of books that brings you advanced radio engineering knowledge in the form in which you can most readily assimilate it and put it to use. The books were carefully selected from among standard McGraw-Hill works to give the most complete, fundamental coverage possible, in a small number of concise, compact, reasonably priced volumes. Use these books to bridge the gap between your own radio training or experience and more advanced, engineering command of the subject—the genuinely technical knowledge that best meets today's practical needs.

RADIO TECHNICIANS' LIBRARY

comprised of these 4 volumes:

Terman's **FUNDAMENTALS OF RADIO**
Reich's **PRINCIPLES OF ELECTRON TUBES**
Nilson and Hornung's **PRACTICAL RADIO COMMUNICATION**
Cooke's **MATHEMATICS FOR ELECTRICIANS AND RADIOMEN**

2363 pages, 1432 illustrations

In two of these books widely-used advanced engineering texts have been abridged, to cover the most fundamental aspects of tubes and circuits and their applications, but in the simplified form suited to introduce the man of limited radio and electrical training to these subjects. Another volume further applies these fundamentals to practical communication apparatus, completing a view of radio with which you can solve the technical problems met in a wide variety of situations. The fourth book gives you, at the same time, a progressive command of the radio and electrical mathematics, from arithmetic to advanced principles necessary in using the formulas and computations of advanced technical work.

SPECIAL LOW PRICE EASY INSTALLMENTS

Bought separately, these books would total \$17.25 in price. Under this special Library Offer you save \$1.75 of this amount, get all four books at once, and pay for them over an extended period. Get these advantages by deciding now to add these volumes to your radio library. Mail coupon today for 10 days' free examination.

10 DAYS' FREE EXAMINATION

McGraw-Hill Book Co., 330 W. 42nd St., New York 18, N.Y.
Send me Radio Technicians' Library for 10 days' examination on approval. In 10 days I will send \$3.50 plus few cents postage, and \$3.00 monthly until \$15.50 is paid, or return books postpaid. (We pay postage if you remit with first installment.)

Name

Address

City and State.....

Position

Company

L. 9-43

WANTED!

FOR POST-WAR MARKETS

New ideas or patents relating to equipment, apparatus, or instruments applicable to research and control laboratory work, embracing—

ELECTRONIC INSTRUMENTS
PETROLEUM TECHNOLOGY
GAS TESTING
CLINICAL, BACTERIOLOGICAL
BIOLOGY
PLASTICS, CERAMICS, CEMENT
MATERIALS TESTING
SOILS
FOOD PROCESSING, CEREAL CHEMISTRY
WATER AND SEWAGE TESTING
RUBBER TECHNOLOGY
METALLURGY
OPTICAL DEVICES

Our client is an old, reputable manufacturer with a record of successful management and excellent financial standing—recognized design and engineering skill—skilled workman—modern well-equipped shops—research and development laboratories—a technically trained staff—and complete sales representation throughout the world. All replies will be kept confidential. Address by mail only:—Earl C. Carlson & Associates, Dept. 26, 1 N. LaSalle Street, Chicago 2, Ill.

major sections, on methods of crystallographic examination and on applications of x-ray methods.

Three methods of x-ray examination of crystals are taken up—the Laue method, the rotating crystal method and the powder method—with instructions for interpreting the pattern in each method.

In connection with x-ray examination of alloys, attention is given to techniques for securing x-ray photographs of powdered alloys, determination of the effect of atomic distribution on the properties of alloys, identification of phases in alloys during age-hardening, estimation of grain size, deformation of crystals and preferred orientations of crystals for particular characteristics.

The subject matter is substantially that of a series of lectures given under the same title by the author before the Melbourne University Metallurgical Society. The book is recommended for those desiring a quick picture of this promising and relatively new branch of electronics, providing they have sufficiently good eyesight to withstand the small type and poor printing of this American version.—J.M.

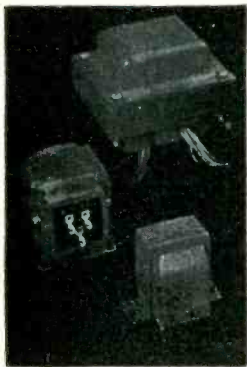

"DONGAN"

FOR YOUR NEW ELECTRONIC DEVICES

Specially Designed DONGAN TRANSFORMERS

If you are contemplating the building of a post-war product involving electronics, post yourself on the latest developments in transformers for this particular purpose. With 34 years of experience in transformer engineering and manufacturing, we are confident that we can assist you in reaching a satisfactory solution to your transformer problems.

WRITE US

as to your particular transformer requirements
DONGAN ELECTRIC MANUFACTURING CO.

2977 Franklin Detroit, Mich.

"The Dongan Line Since 1909"

STOP OVERHEATING

Cool with #1½ BLOWER

Reduces space requirements for heat dissipation.

Unexcelled for applications in ELECTRONIC Equipment.

Output—15 C.F.M. at 8000 R.P.M.

Housing—High Impact Plastic

Wheel—Turbo type 1½" diam.

Weight—Housing and wheel—2 oz.

Bulletin including complete performance specifications available upon request.

L-R MANUFACTURING COMPANY • TORRINGTON, CONN.

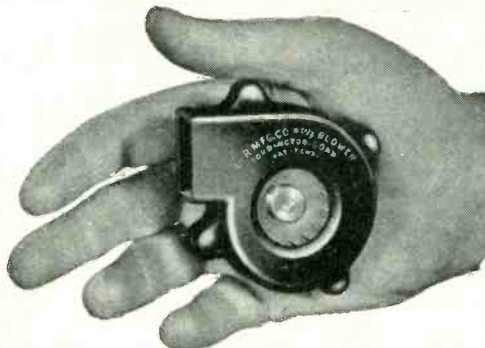

Electromagnetic Waves

By S. A. SCHELKUNOFF, Member of the Technical Staff, Bell Telephone Laboratories. 530 pages. Price, \$7.50. D. Van Nostrand Co., New York.

AS A RESULT of the numerous technical papers and lectures on antennas and radiation which he has given—and which have attracted much commendable attention Dr. Schelkunoff has long been established as a mathematician making outstanding contributions to the theory and practical utilization of electromagnetic waves. The present volume is thus assured of a solidness and comprehensiveness of treatment since it is an outgrowth of Dr. Schelkunoff's mathematical work extending over nearly a score of years.

"Electromagnetic Waves" is an advanced book requiring a good knowledge of electrical principles, and mathematical ability in the manipulation of vectors and functions of the complex variable. It is definitely a volume for the advanced student, the research worker, or the mature engineer, and will have little

PERMANENT MAGNETS



LITTLE Changes

**Can Make A
BIG Difference**

But the important thing is—where and how changes in the design of permanent magnets should be made. That takes knowledge of the subject of magnetism.

Perhaps our long experience in this field would be helpful, if you are not entirely satisfied with the performance of your present magnets. And once the improved design is worked out, we can supply your requirements in ALNICO or NIPERMAG.



8-CC-1

**CINAUDAGRAPH
CORPORATION**

STAMFORD, CONNECTICUT

appeal for those seeking a popularized account on "how radio waves act." The author has intended that the book serve as a text and as a reference work, for the preface states, "In it a practicing engineer will find basic theoretical information on radiation, wave propagation, and wave guides and resonators. Those engaged in theoretical research will find a stock of equations which may serve as a starting point for further investigation."

The book divides itself into two approximately equal sections. The first half presents introductory material which lays the foundation for much of the mathematics required; it also presents a mathematical theory of electromagnetic oscillations. The second portion of the volume is devoted to applications and deals with electromagnetic waves in wave guides, in resonators, and in free space. The first three chapters are largely used to build up the mathematical groundwork required in subsequent chapters, and to introduce the reader to the author's methods and nomenclature. In general, they present the mathematician's point of view and are largely

• • •

LAFAYETTE RAISED

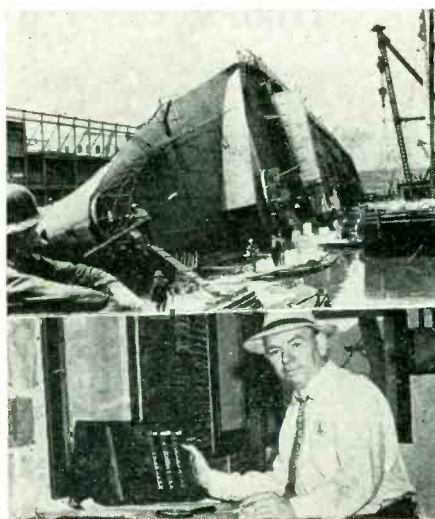

Captain J. I. Tooker, Salvage Master for the former Normandie, relied upon a 30-channel Executone two-way intercommunication system for contact with divers and workers in strategic positions during the recent floating of the huge vessel in New York harbor

Guessing

WON'T DO!

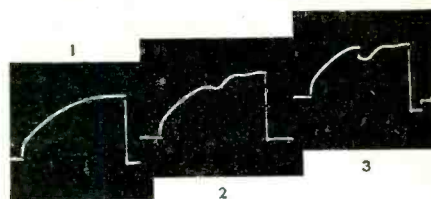

Oscillograms demonstrating (1) current rise in relay coil, armature not moving, (2) current rise with dip caused by increasing reactance when armature moves to close contacts, (3) current rise curve displaced by introduction of a voltage through contact circuit when contacts are not closed. Indicates time of operation, and whether or not bounce is present.

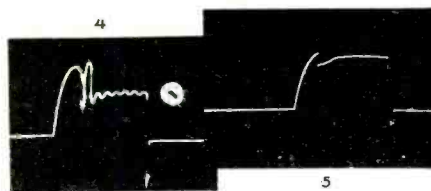

Curve (4) shows an average amount of bounce attendant on the closing of relay contacts. Curve (5) was obtained from a similar relay operating under conditions wherein the bounce has been eliminated.

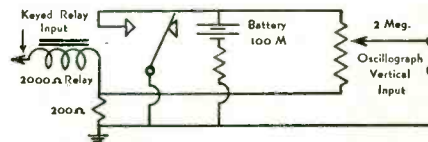

Circuit used for obtaining above oscillograms. Battery voltage appears on oscillograph input except when shorted by closed contacts. Voltage developed across 200 Ohms resistor used to indicate relay coil current. All oscillograms unretouched photographs. 30 cycle sweep.

This Type of investigation is routine in our engineering department when your problem involves timing, or exceptionally fast and clean contact.

**SIGMA
Type 4R**

1 1/2" x 1 1/2"
2 5/8" high
above
socket

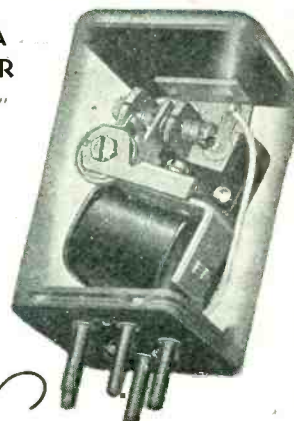

Sigma Instruments, Inc.

Sensitive RELAYS

40 FREEPORT ST., BOSTON 22, MASS.



"O BRAVE NEW WORLD..."

Tomorrow's new world lies in the palms of the draftsmen of today. They are linking country to country, continent to continent. And in this tremendous project, as in every other important blueprinting work, Typhonite ELDORADOS lead all other drawing pencils with their decisive clarity, uniform degrees, opacity and speed.

Pencil Sales Dept. 59-J9
Joseph Dixon Crucible Company
Jersey City, N. J.

TYPHONITE
ELDORADO

Lavite **STEATITE**
CERAMIC



CHARACTERISTICS

Specific gravity of only 2.5 to 2.6.
Water absorption 5. 1.5-0.001 per cent. Per cent power factor.
S. 1.5 to 60 cycles was only 0.0165.
Dielectric constant at 60 cycles was 5.9-1000 KC 5.4.

Makers of electrical and radio apparatus destined for war service are finding in LAVITE the precise qualities called for in their specifications . . . high compressive and dielectric strength, low moisture absorption and resistance to rot fumes, acids, and high heat. The exceedingly low loss-factor of LAVITE plus its excellent workability makes it ideal for all high frequency applications.

We will gladly supply samples for testing.

D. M. STEWARD MFG. COMPANY
Main Office & Works: Chattanooga, Tenn.
New York Needham, Mass. Chicago Los Angeles

divorced from physical interpretation. Chapter IV deals with the fundamental electromagnetic equations and, since the mathematics is combined with physical interpretations, perhaps this represents the point of view of the physicist more than that of the engineer.

To communication engineers who have not particularly specialized in electromagnetic wave theory, Chapter V on "Impedors, Transducers, and Networks" and Chapter VII on "Transmission Theory" will undoubtedly deal with the most familiar ground. The sections on wave guides is undoubtedly the most detailed which is available at the present time—and it is here collected in one place. Throughout the volume a generalized point of view has prevailed so that important practical applications may be treated as special cases of the general theory.

In writing "Electromagnetic Waves" Dr. Schelkunoff has made an important contribution to the technical literature of electrical communication. The volume should fill an important need in current research activity and can be well recommended as an advanced text or reference volume for those who have preparation in electromagnetic theory.—B. D.

• • •

RADIO MULE



This mule provided mobility for a combination radio transmitter and receiver used by British Signal Corps men in North Africa. The Arab is an essential part of the unit, because of his knowledge of the mule

CONTACTS

For the Field of Electronics



BIRTCHEER
AIRCRAFT
RELAYS

TYPE B5-A



Meets Army Air Corps Specifications
94-32351-A
and other applicable specifications
PROMPT DELIVERY!

THE BIRTCHEER CORPORATION
Manufacturers AIRCRAFT, RADIO
and RADAR PARTS
5087 HUNTINGTON DR. LOS ANGELES 32

HARVEY RADIOLAB'S, Inc.
Manufacturers of
Radio Transmitters
ELECTRONIC APPARATUS
447 Concord Ave. Cambridge, Mass.

Professional Services

STANLEY D. EILENBERGER

Consulting Engineer

Complete Laboratory and Shop Facilities
General Electronics Communications Electro Biology Patent Development
6309 27th Ave. Kenosha, Wis.
Telephone 2-4213

JOSEPH RAZEK, Ph.D.

Consulting Physicist

Electrical and Mechanical Engineering Problems
Instruments and Control Devices Electronics
Specialists in Colorimetry, Spectrophotometry and
Industrial Color Control
Laboratory and Shop Facilities
202 Darby Road Llanerch, Pa.
Phone Hilltop 6910

J. L. A. McLAUGHLIN

Designer of

Communications Receivers

P. O. Box 529, LaJolla, Calif.

CONTACTS

FOR THE FIELD OF ELECTRONICS



We manufacture a complete line of equipment

SPOT WELDERS, electric, from ¼ to 50 KVA
 TRANSFORMERS, special and standard types
 INCANDESCENT LAMP manufacturing equipment
 FLUORESCENT TUBE MAKING EQUIPMENT
 ELECTRONIC EQUIPMENT, vacuum pumps, etc.
 WET GLASS slicing and cutting machines for laboratory use
 GENERAL GLASS working machines and burners
 COLLEGE GLASS working units for students and laboratory

EISLER ENGINEERING CO.

731 So. 13th St. (near Avon Ave.)

Newark, New Jersey



TUBES CAN'T
**SHAKE
 OUT**

WHEN LOCKED-IN
 with BIRTCHER
 TUBE CLAMPS

BIRTCHER Stainless Steel locking-type Tube Clamps have been adopted by leading builders of Radio and Radar equipment. Made in a variety of sizes to fit any size tube base. Precision Workmanship.

PROMPT DELIVERY
 SAMPLES AND PRICES UPON REQUEST



THE BIRTCHER CORPORATION

Manufacturers AIRCRAFT, RADIO
 and RADAR PARTS

5087 HUNTINGTON DR. LOS ANGELES 32

FINE RIBBONS

of
TUNGSTEN and MOLYBDENUM

Making a modest but effective contribution in Electronics' War accomplishments.
H. CROSS

15 Beekman St. New York

A STEADY SOURCE OF ALL
 ELECTRONIC
 EQUIPMENT

TERMINAL RADIO CORP.
 Telephone: WOrk 2-4416
 85 CORSLANDT ST., NEW YORK, N.Y.

Your Plant

FOR ACTION!
 PHONE! WIRE! WRITE!
 BULLETINS AND CATALOGS ON REQUEST

FADA

FACTORY
 SERVICE DEPT.

has a large stock of Record
 Changer Parts. Also replacement
 parts for all FADA
 MODELS as well as a completely
 equipped SERVICE
 DEPARTMENT.

FADA OF NEW YORK
 928 Broadway, New York, N. Y.
 Tel: GRamercy 7-0951-2

? Find what you are looking for?
 ? If this or other advertising in
 this issue does not supply the
 information of products wanted
 write

Electronics
 330 West 42nd St., New York City

**MICROMETER
 FREQUENCY
 METER**

for
 checking
 transmitters
 from 1.5 to 56 mc.,
 within 0.01 per cent

LAMPKIN LABORATORIES
 Bradenton, Fla., U. S. A.

**CRYSTALS by
 HIPOWER**

Thousands of vital transmitting installations rely on the accuracy and dependability of Hipower Precision Crystal units. With recently enlarged facilities, Hipower is maintaining greatly increased production for all important services. When essential demand begins to return to normal, Hipower will be glad to help with your crystal needs.

HIPOWER CRYSTAL CO.
 Sales Division—205 W. Wacker Drive, Chicago
 Factory—2035 Charleston Street, Chicago, Ill.

**RADIO
 AND
 ELECTRONIC
 DEVICES**

BURSTEIN-APPLEBEE CO.
 1012-14 McGee St. Kansas City, Mo.

**Strip Insulated Wires
 QUICKER... BETTER**

with "Speedex"
AUTOMATIC WIRE STRIPPER
 ...Speeds Production

Strips insulation from all types of wire—instantly, easily, perfectly. Just press the handles and the job is done. Cuts wire too. Strips 800 to 1000 wires per hour. Available for all size solid or stranded wires—No. 8 to No. 30. List Price \$6.00.

Write Dept. E For Full Particulars

GENERAL CEMENT MFG. CO.
 Rockford, Illinois, U.S.A.

Electron Tube Machinery

of every type,—standard, and special design

Specialists in Equipment for the Manufacture of Radio Tubes, Cathode Ray Tubes, Fluorescent Lamps, Incandescent Lamps, Neon Tubes, Photo Cells, X-ray Tubes and other glass or electronic products, on production or laboratory basis.

**Kahle
 ENGINEERING COMPANY**
 1307-1309 Seventh St., North Bergen, N. J.

JUST OFF THE PRESS!
 THE MOST COMPLETE
 CATALOG
 OF ITS KIND

Chas. Eisler

CHAS. EISLER'S NEW
 94 PAGE CATALOG
 INCLUDES

- GAS AIR-OXYGEN
- BURNERS
- ECONOMIZERS
- MIXERS
- GLASS ROLLERS
- GENERAL GLASS WORKING EQUIPMENT

EISLER ENGINEERING CO.
 730 SO. 13th ST. NEWARK, N. J. U.S.A.

Ask for CATALOG No. 43-B

**WRITE FOR
 YOUR COPY
 TODAY!**

**CHAS. EISLER
 EISLER ENGINEERING CO.**
 730 SO. 13th ST. NEWARK, N. J.



IF YOU HAVE A VIBRATION PROBLEM . . .

You can easily eliminate loose connections, troublesome vibration noise, and resistance caused by bad contacts through the use of Boots Self-Locking Nuts. Boots Nuts can't work loose . . . they successfully withstand the effects of heat, and corrosion by oil, water

or chemicals. They have great re-usability. They simplify maintenance and assembly and they do away with the need for lock-washers. If you have a vibration problem, Boots engineering department can help you solve it. Write today.

There's a BOOTS NUT for every application

ROL-TOP



BOOTS

BOOTS AIRCRAFT NUT CORPORATION
GENERAL OFFICES, NEW CANAAN, CONNECTICUT

ANCHOR



CRYSTALS EXCLUSIVELY



**EXCLUSIVELY
FOR WAR. . . .**

Split second communications are vital to offensive action. Valpey crystals insure reliable transmission of tactical orders at all battle fronts.

**THE VALPEY CRYSTALS
HOLLISTON, MASS.**
Since 1931

VALPEY

Tables of Functions with Formulae and Curves

By EUGENE JAHNKE and FRITZ EMDE.
380 pages. Price \$3.60. 1943. Dover
Publications, New York City.

THIS NEW EDITION of the well-known work of Jahnke and Emde is published and distributed by an American firm under the authority of the Alien Property Custodian. The current, 1943, edition is essentially a photographic reproduction of the third edition of April, 1938, with the addition of a 76-page section on tables of elementary functions which, while appearing in earlier editions, was omitted from the third edition. The inclusion of the elementary functions as an addenda makes possible the inclusion, within two covers, of virtually all the mathematical functions which the electronic engineer will have occasion to employ.

As has been customary in former editions of this reference work, corresponding text is available in the original German as well as in English. The German notation of a comma for the decimal point, and the use of type of German script for some of the functions are minor annoyances with which American users could well dispense.

In this edition, as in previous editions, the mathematical tables themselves are supplemented with many two-dimensional graphs and three-dimensional relief drawings which give the reader a clear idea of the contours and gradients of the functions so plotted. These graphs and relief drawings are exceedingly well done. Another feature of this work which is useful to those who may require more accurate or more complete tables of mathematical functions is the list of books on mathematical tables by other authors, printed in German.

The main body of the work is divided into the following broad divisions: (1) logarithmic sines and cosines, (2) factorial functions, (3) error integrals and related functions, (4) theta functions, (5) elliptic integrals, (6) elliptic functions, (7) Legendre functions, (8) Bessel functions, (9) Reimann theta functions, (10) contour and hypergeometric functions, (11) Mathieu functions, (12) some often used constants, and (13) useful books for the computer. The 76-page addenda of elementary functions include: (1) table of

PROTECTION for Electrical Equipment WITH THE HYPOT

Prevent serious delay and breakdown in electrical equipment . . . test for insulation quality with the HYPOT! In quick time you can locate and repair insulation faults that would burn out in operation. The HYPOT has ample capacity for all testing . . . quick easy control from zero to maximum voltage . . . exclusive "Burn and Test" feature . . . meets all AIEE specifications . . . self-contained, sturdy, compact, portable . . . complete safety to operator and equipment. Write today for full information.



ASSOCIATED RESEARCH, Incorporated
225 SO. GREEN ST. CHICAGO 7, U.S.A.

powers, (2) auxiliary tables for computation with complex numbers, (3) cubic equations, (4) elementary transcendental equations, (5) the functions $x \tan x$, $(\tan x)/x$ and $(\sin x)/x$ (6) the exponential function, (7) Planck's radiation function, (8) source function of heat conduction, (9) hyperbolic functions, and (10) circular and hyperbolic functions of a complex variable. Most are four or five place tables and many are provided with difference columns for aiding interpolation.

The 1943 edition of Jahnke and Emde will fill a real need for engineers, research workers, and physicists. The exceedingly modest price of this volume, especially when compared with prices of the original German copy, should make it possible for the American edition to have widespread acceptance. The publication of this volume under the Alien Property Custodian makes possible the availability of this useful reference work as a means of expediting current research and engineering activities in the United States.—B.D.

Driver-Harris

ALLOYS

for

ELECTRONIC APPLICATIONS

40 Years Experience

Over 40 years experience in making special alloys for special requirements is at your service. For information regarding special radio alloys write



DRIVER-HARRIS Company
HARRISON, NEW JERSEY

*TRADE MARK REG. U. S. PAT. OFF.

SEARCHLIGHT SECTION

POSITION VACANT

ELECTRONIC ENGINEERS — Research — Manufacturing — Teaching. A fine selection of positions open in this field for well qualified men. The Engineering Agency, Inc., 53 W. Jackson Blvd., Chicago, 4, Ill.

POSITIONS WANTED

RADIO ENGINEER: Employed two years by large manufacturer of Radar Equipment. Present job is non-engineering shop supervision of inspection and testing on all types of Radar and communications equipment. Have B.S. degree in Electrical Engineering, ten years radio service and amateur experience and also hold a commercial 1st Class Radio-telephone license. Have a 2B draft classification. PW-550, Electronics, 520 N. Michigan Ave., Chicago, 11, Ill.

ATTENTION RADIO OR ELECTRONIC Manufacturer: Thirty-eight year old sales executive, draft ex-mpt, with technical background, desires administrative or sales connection, or a connection as manufacturer's agent or distributor. PW-551, Electronics, 520 N. Michigan Ave., Chicago, 11, Ill.

MAN familiar with crystal quartz and basic knowledge of oscillator crystal production available nights or part-time—metropolitan area preferred. PW-555, Electronics, 330 W. 42nd St., New York 18, N. Y.

WANTED

WANTED metal finder complete Community Radio Electric Service, 745 Penn Ave., Wilk-insburg, Pa.

"Searchlight" Employment and Business Opportunity ads continued on following pages

AVAILABLE

ELECTRONIC ENGINEER

DETROIT—Industrial Area

Available for essential war work as field engineering representative or contractor on electronic equipment installation or maintenance. Fifteen years continuous experience in radio and sound fields. Local industrial contacts. Complete and modern laboratory, machine shop, drafting and office facilities. Address

M-549, Electronics
520 North Michigan Ave., Chicago 11, Ill.

Permanent Employment ELECTRONIC DEVELOP- MENT ENGINEERS

Well-established Eastern Massachusetts concern desires graduate electronic engineers with flair for research and eye to future. Permanent position concerned at present with important development work for government, with increased opportunities after the war. Unusual openings for men with capacity and initiative. Must be U. S. Citizens.

P-510, Electronics
330 West 42nd St., New York City

ELECTRICAL ENGINEER FOR PRODUCT RESEARCH AND DEVELOPMENT

• We need a competent Electrical Engineer—one who has followed the technical phases of business since leaving college.

For this permanent and continuing activity we need a man with experience in the field of research and product development, a pleasant personality and of calibre adequate to meet with and discuss electrical insulation problems with our customers and their engineers. This is a well-known company in the electrical insulating materials business. Salary open. Please submit resume of schooling, business experience, draft status, etc. Address

P-554, Electronics
330 W. 42nd St., New York 18, N. Y.

Electrical Public Relations Advertising Executive Available

Now Public Relations and Promotion Counsel to two important electrical associations. For ten years Advertising Promotion Manager electrical manufacturer. Creates plans that sell now or for the post-war period. Good organizer. Initiated war-time advertising and war plant conservation, employee training incentive production plans for employer. Familiar all markets as sales manager. Effective placing publicity. Good post-war ideas. Salary substantial. Employed. 44.

PW-538, Electronics
330 West 42 St., New York 18, N. Y.

ENGINEER and PHYSICIST

to become permanent members of project development staff of a nationally-known industry in New York metropolitan area now engaged in the production and development of aircraft instruments and other aircraft equipment vital to the war effort.

Those selected for these positions will be retained after the war to develop commercial instruments, if they prove themselves capable.

The work requires several years' experience in the development and design of small electro-mechanical devices, a broad knowledge of physics and electricity, also ability to handle contacts with outside suppliers and governmental agencies.

Persons in war work or essential activity not considered without a Statement of Availability. Reply, giving full record of experience, personal qualifications and date of availability.

P-546, Electronics
330 West 42nd St., New York 18, N. Y.



WANTED

1. RADIO, ELECTRONIC ENGINEERS — preferably with experience in radio, ultra high frequencies, general electronics.
2. RECENT GRADUATES in electronics or physics.
3. TECHNICIANS — experienced in radio and electronics.
4. MECHANICAL ENGINEERS — experienced in the design of high production items and familiar with manufacturing practices and requirements.
5. DRAFTSMEN — experienced in product layout and/or detailing.

This increase in staff is required to take care of war work of high military urgency and for definite post-war plans.

If you are employed in essential war work to the full extent of your skill, do not apply.

Write to:

**PERSONNEL OFFICE
DELCO RADIO DIVISION
GENERAL MOTORS CORPORATION
KOKOMO, INDIANA**

WANTED ELECTRO-ACOUSTIC ENGINEERS

Experienced in laboratory development, research, etc., for development of war production items. Offers excellent post war opportunities. Write.

Personnel Manager

**Universal Microphone Co., Ltd.
Box 299 Inglewood, Calif., U.S.A.**

WANTED Electrical or Chemical Engineer

thoroughly versed in the theory of liquid and solid dielectrics for the position of chief engineer. To direct the research, development and general laboratory on capacitors and capacitor applications. This is an unusual opportunity for a capable engineer interested in his present and postwar future.

**Industrial Condenser Corp.
1725 W. North Ave., Chicago, Ill.**

TWO IMPORTANT, PERMANENT ENGINEERING POSITIONS ARE OPEN

Connecticut Telephone & Electric Division of Great American Industries, Inc. needs two experienced men in its Meriden, Connecticut plant.

The first man should have a thorough knowledge of acoustics and experience with magnetic circuits and acoustical measurements.

The other man must be familiar with the application and molding technique of plastics. He should have several years of design experience on small electrical apparatus, and an understanding of magnetic and electrical circuits.

"Connecticut Telephone" is a prime war contractor with an assured peacetime future. The two engineers described above will work on both wartime and postwar projects. Write, phone or wire Mr. William R. Curtiss, Chief Engineer, Connecticut Telephone & Electric Division, Great American Industries, Inc., Meriden, Connecticut.

Men now employed at their highest skill in war industry need not apply.

**GREAT AMERICAN INDUSTRIES INC.
70 Britannia St., Meriden, Conn.**

MANAGER FOR ELECTRONIC ENGINEERING DEPARTMENT

Experienced man needed to take charge of new department just being installed with latest electronic equipment. Important post war work including experimental work on improving materials and processes. The employee will have the entire support of our technical staff in order to assist him with his development problem. His personality should be such that he can direct activities of others and contact other executives throughout our organization. Splendid opportunity to join large Mid-western rubber company. In reply state fully training and experience in field of electronics, age, and salary demand.

P-552, Electronics
520 N. Michigan Ave., Chicago 11, Ill.

WANTED
Your Surplus Radio Parts and Equipment
Specification changes may cause accumulation of undesired space-consuming material. Any quantity purchased for cash. Mail us your descriptive list and prices desired.

W-539, Electronics
330 W. 42nd St., New York 18, N. Y.

FREELAND & OLSCHNER, INC. REBUILDERS OF RADIO TRANSMITTING TUBES

Let Us Help You
Solve Your Tube Problems

250 W up

611 Baronne St. New Orleans, La.

Opportunities For POST-WAR European Markets

Well known manufacturing company, with able French engineering and management staff, and with substantial interests here and abroad, is interested in preparing for the exploitation of post-war European markets. Large manufacturing companies in the mechanical or electrical field are invited to communicate with us concerning our plan for the establishment of assembly plants or representation abroad.

Our wide technical and commercial experience in both European and American industry enables us to handle any management problems involved, as conversion of specifications to European standards, etc. Only direct communications from first rate companies will be considered.

BO-548, Electronics
330 W. 42nd Street, New York 18, N. Y.

BEST QUALITY, USED ELECTRON TUBE MACHINERY

Equipment for the manufacture of all kinds of electron tubes, radio tubes, incandescent lamps, neon tubes, photo electric cells, X-ray tubes, etc.

AMERICAN ELECTRICAL SALES CO., INC.
65-67 East 8th St. New York, N. Y.

FOR SALE

D.C. Generator, 5KW complete with exciter and motor geared for 50 and 60 cycle operation with rheostat; also Weston Model #432 KW meter, two 10 Amp. Watt-hour meters, 12 Triplett Model #331 meters, one Dumont Cathode Ray Oscilloscope with electronic switch. No Priorities.

NATIONAL TRANSFORMER CORP.
50 State Street Paterson, New Jersey

FOR SALE or TRADE Westinghouse Portable Oscilloscope

Type 492509 Serial #1059872 Six String with positions for three additional Strings. Complete with photographic attachments Operating Spares.

THE DAVEN COMPANY
191 Central Avenue, Newark 4, New Jersey



Basic electrical and radio theory in the simplest possible language, written especially for those without mathematical or technical training.

Dozens of complete how-to-build-it descriptions of many types of receiver, transmitter, and test equipment show practical applications. Hundreds of diagrams and large photographs.

Enlarged war-training chapters include: expanded basic principles, more test equipment which can be field-built and mathematics for solving simple radio problems.

Over 600 pages, durably clothbound, gold-stamped. From your favorite dealer, or from us, postpaid; please add any applicable taxes.

\$2.00 in Continental U.S.A. Elsewhere, \$2.25

EDITORS AND ENGINEERS
1418 North Highland Avenue, Los Angeles

WANTED TECHNICAL SPECIALISTS

MEN and WOMEN

The COLONIAL RADIO CORPORATION needs immediately, for WAR RADIO WORK, the following technically trained personnel:

RADIO ENGINEERS

AERONAUTICAL
COMMERCIAL
RESEARCH

PHYSICISTS—RADIO

VACUUM TUBE ENGINEER

PRODUCTION CONTROL

These are NOT temporary positions. Satisfactory employees may expect PERMANENT employment. Qualified applicants, NOT NOW IN WAR WORK, should write, giving full history of education, experience, and salary desired.

COLONIAL

RADIO
CORPORATION

254 RANO ST.

BUFFALO, N. Y.



WANTED

Engineers and Technicians

A well established Tulsa, Oklahoma, concern is in urgent need for:

Engineers who have had experience in design and development of electronic equipment;

Engineers who are experienced in the mechanical design of small precision equipment, and are familiar with shop practice and tools;

Engineers who are experienced in laboratory development of both electrical and mechanical equipment and their components;

Technicians for assembly and construction of electrical and mechanical instruments.

If your abilities are not being fully utilized in War Industries, write us today giving full details of past experience, education, age, draft status and salary expected. Recent graduates and female applicants will be given full consideration. All applicants must be Citizens of the United States, and must have W. M. C. certificate of availability.

P-553, Electronics
520 No. Michigan Ave., Chicago 11, Ill.

CANADIAN MANUFACTURER SEEKS U. S. CONNECTION

Advertiser has facilities for manufacturing small or medium sized articles of an electrical or mechanical line.

Factory well equipped and has competent and experienced management. Located in Montreal, the largest city in Canada, the Company is well organized, has ample financial resources and a successful record.

Is prepared to manufacture in Canada on a contract basis a line sold direct to users by means of special sales staff or through hardware, automobile accessory, electric accessory or general stores. Particularly interested in line now sold but not manufactured in Canada.

**DOMINION ELECTRIC
PROTECTION COMPANY**
92 Adelaide St. W.,
Toronto, Canada

WANTED

S-C-R-E-W B-A-L-L INVENTOR

Who Gets Occasional
Sparks of Sanity

Inventors are crazy people who save the world untold drudgery thru creation of new labor-saving, time-saving devices which might never occur to so-called normal people used to doing things in the accepted, conventional way.

A large, amply-financed corporation interested in the development now of salable new products for home and industry to be marketed immediately after Victory, is looking for just the right "screw ball," an inventive mind on the shoulders of a person who, tho not necessarily an engineer, can work with engineers in our research and experimental department and inspire them to greater creative effort; one who by not knowing a thing can't be done might succeed in doing it where others fail.

To such a man we offer an almost unlimited future. Send snapshot (which will be returned) and complete application information plus specific data concerning past achievements and your ambitions for the future to

P-547, Electronics
68 Post St., San Francisco 4, Calif.

IN SELECTIVE SERVICE



“RELAYED-FLUX” Microdyne

*“The Standard by Which Others
Are Judged and Valued”*

EQUIPMENT for the war effort,—

- (1.) MUST perform up to highest standards.
- (2.) MUST continue to perform ir-
respective of climatic variations.

That is why AUDAX magnetically powered pickups are selected for war contracts. In building pickups under such contracts, we do not have to change our peacetime specifications because such MUSTS have *always* been a basic requirement in AUDAX Instruments.

The sharp clean-cut facsimile reproduction of MICRODYNE — regardless of climatic conditions—is a marvel to all who have put it to the only test that really counts . . . the EAR TEST.

WITH OUR COMPLIMENTS

A copy of “PICKUP FACTS” is yours for the asking. It answers many questions concerning record reproduction.

BUY WAR BONDS

AUDAK COMPANY

500 Fifth Ave. New York City

*“Creators of High Grade Electrical
and Acoustical Apparatus since 1915.”*

INDEX TO ADVERTISERS

	Page		Page
Abbott Instrument, Inc.	260	Consolidated Diamond Saw Blade Co.	88
Ace Manufacturing Corp.	272	Consolidated Radio Products Com- pany	178
Acheson Colloids Corporation.....	276	Continental Diamond Fibre Co., Inc.	54
Advance Electric Company.....	209	Continental Screw Company.....	35
Aerovox Corporation.....	231	Corbin Screw Company.....	35
Aircraft Accessories Corporation....	55	Cornell-Dubilier Electric Corp.....	61
Aircraft Marine Products, Inc.	87	Corning Glass Works, Insulation Div.	73
All American Tool & Mfg. Co.....	290	Cross, H.	297
Allen-Bradley Co.	215	Crystal Products Company.....	32
Allied Control Company.....	20	Crystal Research Laboratories, Inc....	292
Aluminum Company of America....	62		
American Coils Co.	198	Dalis, Inc., H. L.	246
American Lava Corp.	64, 65	Daven Co.	Inside Back Cover
American Radio Hardware Co., Inc.	14	DeJur-Amsco Corp.	37
American Screw Company	16, 35	Deutschman Corp., Tobe.....	2
American Transformer Company... ..	25	Dial Light Co. of America, Inc.....	270
Amperite Company	254	Dinion Coil Company.....	280
Anaconda Wire & Cable Company... ..	28	Dixon's Typhonite Eldorado Pencils.	296
Andrew Co., Victor J.	166	Dolph Co., John C.	264
Arnold Engineering Company.....	230	Dongan Electric Manufacturing Com- pany	294
Associated Research, Inc.	299	Doolittle Radio, Inc.....	252
Astatic Corporation, The.....	244	Dow Chemical Company	149
Audak Company	302	Driver-Harris Company	299
Auto-Ordinance Corporation, Thompson Tool Division.....	51	Dumont Electric Company.....	50
Automatic Electric Sales Corpora- tion	221	DuMont Labs., Inc., Allen B.....	44
		Dunn, Inc., Struthers.....	60
Bakelite Corporation.....	10, 11	DX Crystal Co.	242
Ballantine Laboratories.....	249		
Barker and Williamson.....	179	Eicor, Inc.	186
Bead Chain Manufacturing Co.....	271	Eisler Engineering Co.	297
Belden Manufacturing Company....	21	Eitel-McCullough, Inc.	89
Bell Sound Systems, Inc.	192	Electric Auto-Lite Co., The.....	77
Benwood-Linze Co.	158	Electrical Insulation Co., Inc.....	254
Bircher Corp., The	296, 297	Electrical Products Supply Company	263
Blaw-Knox Co.	204	Electronic Corporation of America..	24
Bliley Electric Co.	22	Electronic Enterprises, Inc.....	40
Boes Company, W. W.	31	Electro-Voice Manufacturing Co., Inc.	159
Boots Aircraft Nut Corporation....	298	Engineering Co., The.....	234
Bradey Laboratories, Inc.	216	Erco Radio Laboratories, Inc.....	279
Brand & Company, William.....	177	Erie Resistor Corp.	36
Brilhart Co., Arnold.....	56	Erwood Co., The.....	238
Bristol Co.	35	Espey Manufacturing Co., Inc.....	274
Bud Radio, Inc.	244	Essex Specialty Co., Inc.....	304
Bunnell & Co., J. H.....	203		
Burgess Battery Company.....	246	Fada of New York.....	297
Burstein-Applebee Company	297	Federal Tel. & Radio Corp.....	255
		Felker Mfg. Co.	153
Callite Tungsten Corporation.....	150	Ford Radio & Mica Corporation....	234
Cannon Electric Development Com- pany	194	Formica Insulation Company.....	41
Capitol Radio Engineering Institute.	232	Franklin Manufacturing Corporation	43
Carborundum Co., The.....	283		
Carlson & Associates, Earl C.....	294	Galvin Manufacturing Corporation..	164
Carter Motor Company.....	230	Gemex Company	285
Celanese Celluloid Corporation....	75	General Cement Manufacturing Com- pany	297
Centralab Div., Globe Union, Inc.	144, 145	General Electric Company, 7, 19, 39, 79, 245, 264	264
Central Screw Company.....	35	General Electronics, Inc.	85
Chandler Products Corporation....	35	General Instrument Corporation....	58
Chicago Telephone Supply Company	66	General Radio Co.	218
Chicago Transformer Corporation... ..	165	G-M Laboratories, Inc.....	84
Cinaudagraph Corporation	295	Goat Metal Stampings, Inc.....	26
Cinaudagraph Speakers, Inc.....	252	Gothard Manufacturing Company....	238
Cinch Manufacturing Corporation... ..	141	Gould-Moody Company	236
Clarostat Manufacturing Co., Inc....	291	Gray Manufacturing Company.....	285
Cohn & Co., Sigmund.....	276	Guardian Electric Manufacturing Company	185
Communication Measurements Lab- oratory	29	Guided Radio Corporation.....	202
Connecticut Telephone & Electric Division of G. A. I.....	222	Guthman & Company, Inc., Edwin I.	47

	Page
Hallcrafters Company	63
Hamilton Institute, Inc., Alexander	201
Hammarlund Manufacturing Co., Inc.	8
Hanovia Chem. & Mfg. Company	270
Harvey Machine Company, Inc.	226
Harvey Radio Company	283
Harvey Radio Lab's, Inc.	266, 296
Harvey-Wells Communications, Inc.	243
Haydon Manufacturing Co., Inc.	291
Haydu Brothers	68
Heinemann Circuit Breaker Company	16A
Heintz & Kaufman, Ltd.	33
Hewlett-Packard Co.	239
Hipower Crystal Company	297
Hunter & Co.	192, 193
Hytron Corp.	157
Indiana Steel Products Company	269
Industrial Condenser Corp.	168
Instrument Resistors Co.	250
Instrument Specialties Co., Inc.	267
Insulation Manufacturers Corporation	181
Insuline Corp. of America	246
International Nickel Co., Inc.	265
International Resistance Co.	143
International Screw Company	35
International Tel. & Tel. Corp.	255
Jackson Electrical Instrument Co.	152
Jefferson Electric Company	156
Jefferson-Travis Radio Manufacturing Co.	74
Jelliff Manufacturing Corp., C. O.	292
Jensen Radio Mfg. Co.	13
Johnson Co., E. F.	197
Jones, Howard B.	232
Kaar Engineering Co.	273
Kahle Engineering Co.	297
Katolight Company	254
Kellogg Switchboard & Supply Co.	228
Ken-Rad Tube & Lamp Corp.	229
Kester Solder Co.	258
Keuffel & Esser Company	3
Kinney Manufacturing Co.	220
Knights Co., James	38
Kold-Hold Manufacturing Co.	281
Koolsman Instrument Division, Square D Company	237
Lafayette Radio Corp.	190
Lampkin Laboratories	297
Lamson & Sessions Co.	35
Lapp Insulator Co.	83
Lectrohm, Inc.	248
Lepel High Frequency Lab's	287
Lingo & Son, John E.	240
Littelfuse, Inc.	240
Lord Manufacturing Company	171
L-R Manufacturing Company	294
Macallen Company, The	208
Magna Manufacturing Company	261
Magnavox Company	211
Mallory & Company, Inc., P. R.	92
Manufacturers Screw Products	282
Markem Machine Company	289
McGraw-Hill Book Co., Inc.	284, 293
Meissner Manufacturing Co.	248
Merit Coil & Transformer Corporation	290
Micro Switch Corporation	163
Millen Manufacturing Company, Inc. James	180
Miller Company, J. W.	288
Miller Laboratories, August E.	241
Mitchell Rand Insulation Co.	200

	Page
Mobile Refrigeration, Inc.	188
Monarch Mfg. Co.	276
Muehlhausen Spring Corporation	52
Murdock Co., Wm. J.	268
Mycalex Corp. of America	23
National Company, Inc.	281
National Screw & Mfg. Co.	35
National Union Radio Corporation	15
National Vulcanized Fibre Co.	205
Newark Transformer Company	210
New England Screw Co.	35
New York Transformer Co.	86
North American Philips Company, Inc.	195
Northam Warren Corporation	259
Northern Industrial Chemical Co.	242
Numberall Stamp & Tool Company	240
Ohmite Manufacturing Company	183
Onan & Sons, D. W.	266
O'Neil-Irwin Manufacturing Company	262
Palnut Company, The	160
Parker Co., Charles	35
Parker-Kalon Corp.	35
Par-Metal Products Corp.	258
Pawtucket Screw Co.	35
Peerless Electrical Products Co.	268
Permoflux Corporation	162
Pheoll Manufacturing Company	35
Philco Corporation	30
Phillips Screw Manufacturers	35
Pioneer Gen-E-Motor Corp.	196
Plax Corporation	9, 12
Potter & Brumfield	289
Powers Electronic & Communication Company	278
Premax Products	232
Press Wireless, Inc.	189
Presto Recording Corporation	176
Printloid, Inc.	274
Pyroferic Co.	278
Quaker City Gear Works, Inc.	214
Radell Corporation	262
Radio City Products Co., Inc.	67
Radio Corp. of America, Victor Div. 72, 161, Back cover	
Radio Corp. of America, Victor Div. & Distributors 88A to 88Z	
Radio Receptor Co., Inc.	53
Rauland Corp., The	167
Raytheon Mfg. Co.	251, 275
Remler Co., Ltd.	206
Richardson Co., The	154
Rockbestos Products Corp.	235
Roebing's Sons Co., John A.	49
Rogan Brothers	280
Rola Company, Inc., The	34
Russell, Burdsall & Ward Bolt & Nut Co.	35
Sanborn Co.	257
Scientific Radio Products Co.	224
Scoville Mfg. Co.	35
Scoville Mfg. Co., Waterville Screw Products Div.	155
Seeburg Corporation, J. P.	76
Sentinel Radio Corporation	282
Shakeproof Lock Washer Co.	35
Shure Brothers	151
Sigma Instruments, Inc.	295
Simpson Electric Co.	48
Slater Electric & Mfg. Co.	169
Sola Electric Co.	42
Solar Manufacturing Corp.	27

	Page
Southington Hardware Mfg. Co.	35
Spencer Thermostat Co.	207
Sperry Gyroscope Co., Inc.	199
Sperti, Inc.	277
Sprague Specialties Co.	253
Stackpole Carbon Co.	175
Standard Pressed Steel Co.	286
Standard Transformer Corp.	147
Star Porcelain Co.	286
Stevens Walden, Inc.	284
Steward Mfg. Company, D. M.	296
Stewart Stamping Corporation	18
Sticht Co., Inc., Herman H.	272
Stupakoff Ceramic & Mfg. Co.	80
Superior Electric Company	223
Superior Tube Co.	45
Sylvania Electric Products, Inc.	70
Taylor Tubes, Inc.	78
Tenney Engineering Co., Inc.	233
Terminal Radio Corp.	297
Thermador Electrical Mfg. Co.	288
Thomas & Betts Co.	81
Thomas & Skinner Steel Products Co.	260
Thordarson Electric Mfg. Co.	172
Tinnerman Products, Inc.	173
Transmitter Equipment Mfg. Co., Inc.	17
Trav-Ler Karenola Radio & Television Corp.	57
Triplet Electrical Instrument Co.	6
Tung-Sol Lamp Works, Inc.	16B
Turner Co., The	174
Ucinite Co., The	46
Union Carbide & Carbon Corp.	10, 11
United Electronics Co.	59
United Screw and Bolt Corporation	191
United States Rubber Company	217
United Transformer Co.	
Inside Front Cover	
Universal Microphone Co., Ltd.	219
University Laboratories	236
Utah Radio Products Company	69
Valpey Crystals, The	298
Walker-Jimieson, Inc.	250
Walker-Turner Co., Inc.	247
Ward Leonard Electric Corp.	227
Webster Products	225
Western Electric Co.	90
Westinghouse Elec. & Mfg. Co.	4, 5
Weston Electrical Instrument Corp.	82
White Dental Mfg. Co., S. S.	187
Whitney Screw Corp.	35
Wilcox Electric Co.	71
Willor Manufacturing Corp.	213
Wilmington Fibre Specialty Company	287
Wilson Co., H. A.	170
Winslow Company	236
■	
PROFESSIONAL SERVICES	296
■	
SEARCHLIGHT SECTION	
(Classified Advertising)	
BOOKS	300
Editors & Engineers	300
EMPLOYMENT	299
WANTED TO PURCHASE	300-301
REBUILDING	
Freeland & Olschner	300
USED EQUIPMENT FOR SALE	
American Electric Sales Co., Inc.	300
Daven Co., The	300
National Transformer Corp.	300

BACK TALK

This department is operated as an open forum where our readers may discuss problems of the electronics industry or comment on articles which have been published in *Electronics*

Philharmonic

I WAS MOST GRATIFIED to read your brief Crosstalk in last issue of *ELECTRONICS*, in regard to the New York Philharmonic Symphony broadcasts under the sponsorship of the U. S. Rubber Company. For some time, I and many of my friends have been quite puzzled and regretful that these broadcasts are not going out on Columbia's FM transmitter.

The latter sends out occasional musical programs in the form of records, but if one wants that sort of thing, there are several stations which offer an even larger variety of recorded broadcasts, and we don't need to tune in FM to get them.

Especially during the summer, reception of WABC, even here where its signal strength is excellent, is usually marred by static, making wide-range reception unpleasant. Thus, the only musical program that we can actually enjoy fully is NBC's Summer Symphony, which we get over W2XWG, i.e. NBC's FM transmitter.

The same comment applies, of course, to WNYC's broadcasts of the Stadium Concerts, which should be put on FM also.

Broadcasters don't realize how many people would appreciate such outstanding programs if they were on FM, as we can't see any other explanation of their failure to add that channel for diffusing programs ideally suited to FM, while they waste their FM stations on routine programs.

MIRKO PANEYKO
Fairfield, Conn.

Patent Situation

I WOULD LIKE to call your attention to the present patent situation. At present it is almost impossible to dispose of a patent on account of priorities of materials, also because of hardship in tool-making. For this

reason, patents which were issued prior to the present emergency are bound to expire without exploitation. The present emergency might continue for several years and after said emergency will come the usual post-war readjustment, which always follows war. In view of the fact that this is a world war, it will take a considerable time of post-war readjustment before business will become normal and there will be requirement for patents. All in all, it will deprive a patent of approximately about ten useful years. Patents which are issued even now will have no value for the reason that no manufacturer will start to promote a patent which has only seven or eight years to run after the post-war period. Many patents which were issued before this emergency are entirely valueless as they will expire during the post-war period. The only remedy is up to Congress to prolong the life of all non-expired patents which were issued before this emergency; also patents issued during the present emergency, otherwise they are facing complete destruction. There is no reason why an owner of a patent, while carrying all the obligations and taxes as a citizen, shall be deprived of his property rights.

Congress will do a great justice to the American inventors by allowing a seventeen year period to all non-expired patents issued before this emergency; patents that have had no chance of exploitation. American inventors are entitled to the same consideration as the alien-enemy patents that were recently issued by the Government in competition with our own American inventors. These alien patents will have seventeen years to run, while the patents of the American inventors, if not extended, will expire and will be replaced by said alien patents.

JOHN HOLTZMAN
New York, N. Y.

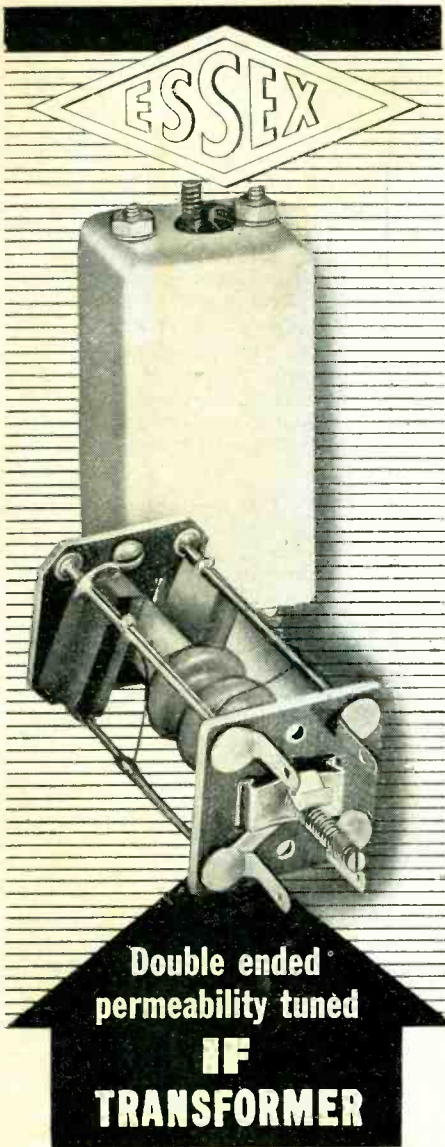

Double ended
permeability tuned
IF
TRANSFORMER

Manufactured in standard dimensions $1\frac{1}{8}$ " square x $2\frac{1}{4}$ " seated height . . . for all frequencies in the range from 175 kc to 15 Mc . . . silver-mica fixed condensers . . . wide band application . . . sturdy mechanical construction . . . compact size, in shielded can with mounting screws attached.

Write for data sheet.

Precision manufacturers of all types of IF and RF coils, chokes, and transformers.

Electronics Division
ESSEX
SPECIALTY CO., INC.
1060 Broad St., Newark, N. J.

YOUR DOLLARS ARE NEEDED NOW . . . BUY MORE WAR BONDS AND STAMPS



Earned Prestige

One effective way of judging a product is by the quality of equipment in which it is incorporated. If it's a companion piece to the finest in the field, you can be sure that it, too, has earned its prestige.

In top-ranking motion picture sound recording studios, where standards are highest, DAVEN products are preferred. They are the original components in major fixed installations, and are also specified by studio engineers whenever special apparatus is developed.

DAVEN produces the most complete line of precision attenuators in the world, plus more than 80 models of laboratory test equipment for the broadcast, sound picture, television and electrical fields. May we send you a catalog?

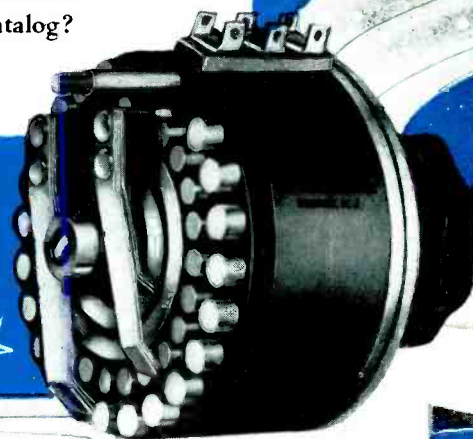

THE DAVEN COMPANY

191 CENTRAL AVENUE

NEWARK 4, NEW JERSEY

Prepared For Action!

One day, nearly two years before Pearl Harbor, RCA called its peace-time army of tubes to order.

"Fall in—right dress—count off!"

"One-two-three-four-five" . . . and on up to many hundreds! Tall tubes, short tubes, squat tubes, skinny tubes.

But of that number, RCA had promoted from the ranks by inspection time that night exactly 36 receiving tubes for special duty. Each was picked, for some fundamental characteristic, as an RCA Preferred Type Tube.

Why did RCA do this? To develop larger manufacturing runs on fewer types, resulting in better tubes of greater uniformity at lower cost.

That this was a sound, forward-looking program is evidenced by the similar Army-Navy Preferred Type Tube program—to release for other uses materials formerly tied up in many styles of tubes, and to insure ready replacement of *standard* types on the fighting fronts. If you'd like a copy of the latest revised (March 1, 1943) "Army-Navy Preferred List of Tube Types", we will gladly send it to you.

Since this "Preferred Type" idea has such definite peace-time advantages, our application engineers invite inquiries now from equipment manufacturers as to tubes most likely to be on the post-war preferred types list.



RCA ELECTRON TUBES

RCA Victor Division • RADIO CORPORATION OF AMERICA • Camden, N. J.