

electronics

JULY • 1943



BUY WAR BONDS
AND STAMPS
FOR VICTORY

DRAWN
DIE CAST
FORMED
MOLDED
EXTRUDED

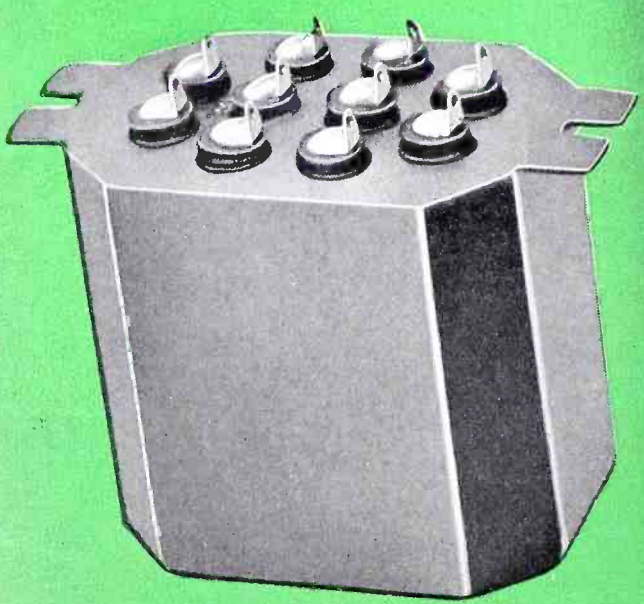
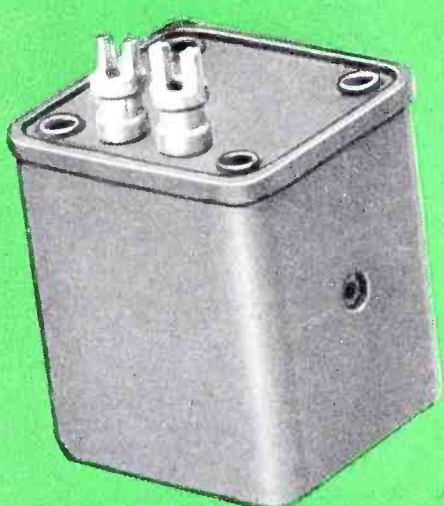
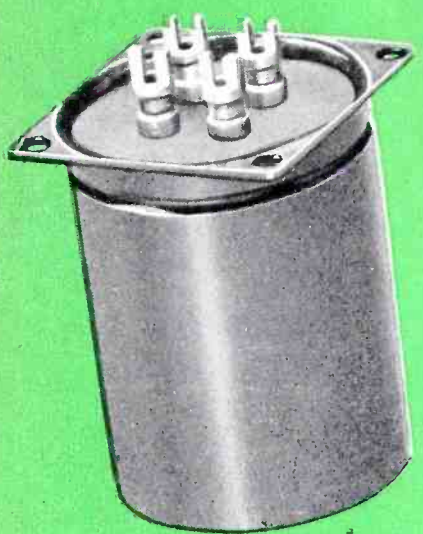
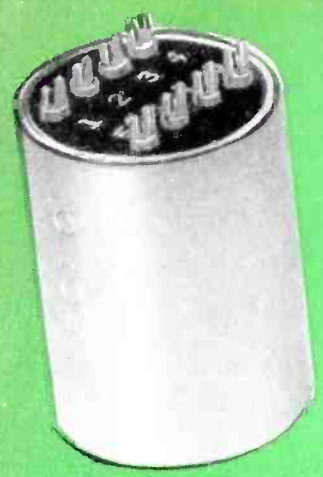

No one type of housing structure is suitable for all transformer applications. UTC units are housed in structures ranging from heavy sand castings to bakelite cases made in 30 cavity molds. A few structures, with their relative advantages for specific functions, are illustrated below.

This unit is a tunable inductor in a die cast housing. The casting itself incorporates facilities for the internal mounting of the unit, mounting of the terminal board, tapped mounting facilities, and tapped set screw hole. The only screw used in this entire item is that for setting the inductance.

Drawn round cans are ideal for many applications. The type illustrated effects small base dimensions with screw mounting. The cylindrical shape lends itself ideally to hermetic sealed units.

Drawn octagonal cans are simple in construction, and effect a minimum of volume. The two hole flange type mounting permits the construction of a unit poured with compound, having the same overall and mounting dimensions as an equivalent open channel mounting unit. Four hole mounting octagonal cases are used where additional mounting strength is required.

The extruded can used on the now famous UTC Ouncer unit affords submersion test construction a minimum of weight, and sufficient metal thickness in the base opposite the terminal board for tapped mounting holes. Pioneered by UTC, the Ouncer unit is probably the most popular item in aircraft communication equipment.

May we design a unit to your war application?

UNITED TRANSFORMER CO.

150 VARICK STREET



NEW YORK, N. Y.

EXPORT DIVISION: 100 VARICK STREET NEW YORK, N. Y. CABLES: "ARLAB"

electronics

JULY • 1943

THE ENGINEER'S PLACE IN THE POST-WAR PICTURE , by S. S. Egert.....	86
How "the boys in the laboratories" can help develop the industrial electronic market	
BUOY RADIOBEACONS FOR INSHORE NAVIGATION	88
Automatic Coast Guard transmitters guide ships having radio direction-finders through difficult waters	
TRANSMISSION LINE CHARTS , by R. F. Baum.....	92
Two graphical charts enable impedance distribution of transmission lines to be determined	
FLUORESCENT INSPECTION OF TUNGSTEN , by S. A. Kulin.....	95
Large quantities of tungsten rods inspected for cracks by treating with fluorescent penetrant	
V-H-F RECEIVER OSCILLATOR DESIGN , by S. Y. White.....	96
Problems confronting engineers developing highly stable gear for the future are outlined	
MOVIES AND SLIDEFILMS SPEED WARTIME TRAINING OF TECHNICIANS , by L. S. Metcalfe.....	98
Movies and slidefilms help engineers train war workers, present new teaching techniques to engineers	
RECORDING AUDIO ANALYZER	100
Recording audio analyzer which provides quick, permanent record of the level at each audio frequency	
DETECTING SMALL MECHANICAL MOVEMENTS , by J. C. Frommer.....	104
Electronic measuring instrument detects movements as small as a millionth of an inch	
CALIBRATION OF CAMERA SHUTTERS WITH THE CATHODE-RAY OSCILLOGRAPH , by T. H. Bullock....	106
Cathode-ray tube used to determine all essential characteristics of interlens or focal plane shutters	
QUARTZ CRYSTAL CUTS , by L. A. Elbl.....	110
A discussion of the various angular relationships between oscillator plates	
ELECTRON TUBES FOR INDUSTRY AND COMMUNICATION	(Between pages 112 and 113)
Sixty years of electronics, graphically portrayed	
ELECTRONICS APPLIED TO HEAT TRANSFER TESTS , by R. V. Brown.....	113
Electronic circuits maintain constant temperature and measure amount of power used in heating	
ELECTRONIC LOAD REGULATOR FOR METER TESTING , by B. E. Lenehan.....	116
Saving of manpower and increased precision of calibration made possible by electronic load regulator	
ELECTRONIC CONTROL OF D-C MOTORS—PART III , by E. E. Moyer.....	118
Discussion of extension of speed range by electronic methods of field weakening	
DESIGN FOR DISSYMMETRICAL T PADS , by E. Y. Webb.....	123
Design data for determining resistances of dissymmetrical pads for attenuation of from 5 to 25 db	

KEITH HENNEY, Editor; Beverly Dudley, Managing Editor; Donald G. Fink (on leave); Craig Walsh (on leave); W. W. MacDonald, Associate Editor; John Markus, Assistant Editor; M. L. Matthey, Assistant Editor; J. M. Heron, Assistant Editor; Harry Phillips, Art Director

H. W. MATEER, Publisher; J. E. Blackburn, Jr., Director of Circulation, Electronics; Wallace B. Blood, Sales Manager

DISTRICT MANAGERS, D. H. Miller, New York; R. H. Flynn, New England; F. P. Coyle, Philadelphia; L. P. Canty, Cleveland; C. D. Wardner, Chicago

Contents Copyright, 1943, by McGraw-Hill Publishing Company, Inc.

McGRAW-HILL PUBLISHING COMPANY, INCORPORATED
JAMES H. McGRAW, Founder and Honorary Chairman

Publication Office 99-129 North Broadway, Albany, 1, N. Y., U. S. A.

EDITORIAL AND EXECUTIVE OFFICES 330 West 42nd St., New York, 18, N. Y., U. S. A.
James H. McGraw, Jr., President; Howard Ehrlich, Executive Vice President; Mason Britton, Vice President; B. R. Putnam, Treasurer; Joseph A. Gerardi, Secretary. Cable address: MCGRAWHILL, New York. Member A. B. P. Member A. B. C.

ELECTRONICS, July, 1943. Vol. 16; No. 7. Published monthly, price 50c a copy. Allow at least ten days for change of address. All communications about subscriptions should be addressed to the Director of Circulation, 330 W. 42nd St., New York, 18, N. Y.

Subscription rates—United States and possessions, Mexico, Central and South American countries, \$5.00 a year, \$8.00 for two years, \$10.00 for three years. Canada (Canadian funds accepted) \$5.50 a year, \$9.00 for two years, \$11.00 for three years. Great Britain and British possessions 36 shillings for one year, 72 shillings for three years. All other countries, \$6.00 for one year, \$12.00 for three years. Entered as Second Class matter, August 29, 1936, at Post Office, Albany, New York, under the Act of March 3, 1879. **BRANCH OFFICES:** 520 North Michigan Avenue, Chicago, 11; 68 Post Street, San Francisco, 4; Aldwych House, Aldwych, London, W. C. 2; Washington, D. C., 4; Philadelphia, 2; Cleveland, 15; Detroit, 2; St. Louis, 1; Boston, 16; Atlanta, 3, Ga.; 601 West Fifth Street, Los Angeles, 13.

A McGRAW-HILL

PUBLICATION



DEPARTMENTS

Washington Feedback	83
Crosstalk	85
Reference Sheet.....	123
Tubes at Work.....	126
Electron Art	164
News of the Industry.....	212
New Products	234
Index to Advertisers.....	258

CHANGE OF ADDRESS

McGRAW-HILL PUBLISHING COMPANY
330 West 42nd Street, New York, 18, N. Y.

Director of Circulation:
Please change my address on Electronics

From

To

Signed

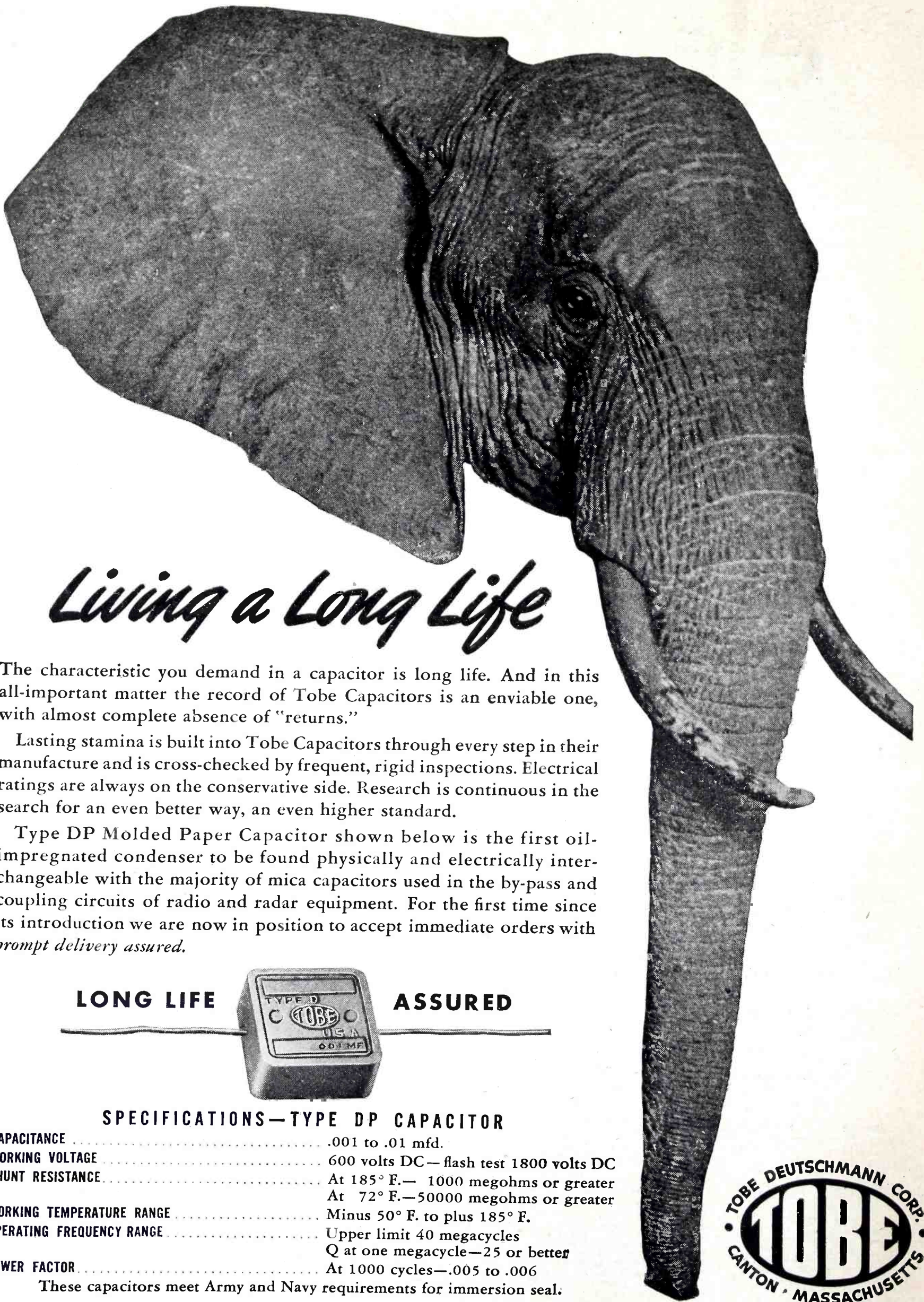

Living a Long Life

The characteristic you demand in a capacitor is long life. And in this all-important matter the record of Tobe Capacitors is an enviable one, with almost complete absence of "returns."

Lasting stamina is built into Tobe Capacitors through every step in their manufacture and is cross-checked by frequent, rigid inspections. Electrical ratings are always on the conservative side. Research is continuous in the search for an even better way, an even higher standard.

Type DP Molded Paper Capacitor shown below is the first oil-impregnated condenser to be found physically and electrically interchangeable with the majority of mica capacitors used in the by-pass and coupling circuits of radio and radar equipment. For the first time since its introduction we are now in position to accept immediate orders with *prompt delivery assured.*

LONG LIFE

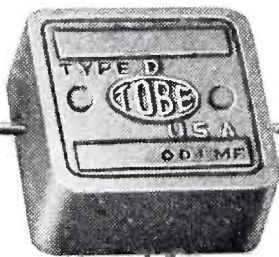

ASSURED

SPECIFICATIONS—TYPE DP CAPACITOR

CAPACITANCE001 to .01 mfd.
WORKING VOLTAGE	600 volts DC—flash test 1800 volts DC
SHUNT RESISTANCE	At 185° F.—1000 megohms or greater At 72° F.—50000 megohms or greater
WORKING TEMPERATURE RANGE	Minus 50° F. to plus 185° F.
OPERATING FREQUENCY RANGE	Upper limit 40 megacycles Q at one megacycle—25 or better
POWER FACTOR	At 1000 cycles—.005 to .006

These capacitors meet Army and Navy requirements for immersion seal.



A SMALL PART IN VICTORY TODAY—A BIG PART IN INDUSTRY TOMORROW



HANDS OFF!

Our valuable original drawings are carefully *preserved*—filed away for record purposes. Our duplicates are made from **PHOTACT** prints. They do the heavy work — take the wear



Every smudged drawing means time lost on the production line.

You *can't* replace that loss. But you can take this step to prevent it, quickly and surely—use Photact, because . . .

Photact *preserves* originals. Make a Photact of your costly original and in a matter of minutes you have a reproduction down to the finest line—sharp, clear, opaque. Your Photact is now the “master” for every purpose, and your original can be filed away for safekeeping.

Photact also *restores* old, worn-out drawings—points up blurred lines to their original clarity—gives you a fresh workable drawing. Put the old “veteran” drawings through the Photact process and

come out with a new “master.”

Photact *duplicates* originals. From your negative you can make as many prints as may be needed on either Photact paper or cloth. And Photact duplicates, even when made from pencil drawings, will be sharper and clearer with ink-like lines. There are no “absentee” lines in a Photact duplicate. That's why sub-contractors and branch managers welcome Photact prints. They can make an unlimited number of sharp black-line or blueprints from Photact “masters.”

For complete information about Photact papers and cloths and the Photact process, write: KEUFFEL & ESSER CO., Photact Department, Hoboken, N. J.

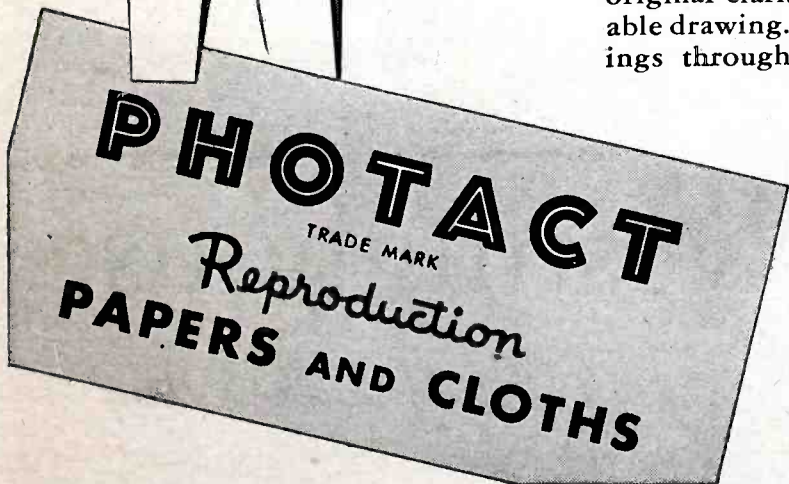

EST. 1867

KEUFFEL & ESSER CO.

NEW YORK • HOBOKEN, N. J.

CHICAGO • ST. LOUIS • SAN FRANCISCO • LOS ANGELES

DETROIT • MONTREAL



5 reasons why you need X-Ray for War Production

Why consider it? X-ray provides the only means of non-destructive and foolproof internal inspection of parts and assemblies to control and improve quality.

War products demand it today; keen postwar competition between products and processes will demand it tomorrow.

Is it complicated? Contrary to popular conception—no! Simplified controls, developed by Westinghouse, facilitate both training and operation.

In fact, X-ray greatly simplifies many production, design, inspection, analysis jobs.

Is it costly? Like any other modern production tool, industrial X-ray justifies its purchase price by reducing production costs and waste . . . insuring uniform quality and satisfied customers.

Consider these five “down-to-earth” reasons why you should consider X-ray as a necessary war production tool in your plant.

REASON ONE



SAVES MACHINE AND MAN HOURS

- Eliminates machining and assembly of faulty parts.
- Determines exact location and extent of faults in products or assemblies.

REASON TWO

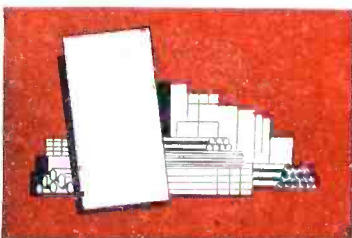

CONSERVES CRITICAL MATERIALS

- Eliminates rejects. Weeds out bad units.
- Replaces “destructive” tests.

REASON THREE



SPEEDS PRODUCTION

- Easily quick-checks hidden assemblies.
- Permits use of high speed manufacturing processes . . . welding, die casting.

REASON FOUR

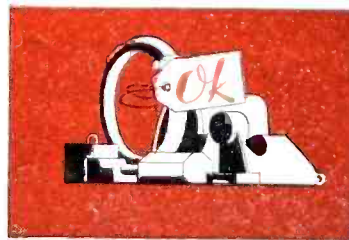

CONTROLS QUALITY

- Perfects techniques quickly for quantity production.
- Keeps quality consistent by pictorial comparison or check of all completed units.

REASON FIVE



HELPS TRAIN WORKERS

- Arouses worker interest by giving him exact picture of work he is doing.
- Provides accurate test of worker's qualifications. Serves as basis for visual education in training.

Westinghouse

PLANTS IN 25 CITIES OFFICES EVERYWHERE

look inside with X-ray

Typical Applications



Problem: A New England war plant, purchasing steel castings from an outside source, was experiencing a reject rate of 75% after machining. Three man-hours were lost on each rejected unit.

Solution: X-ray inspection.

Result: Defective castings detected before machining. Production accelerated. Tremendous saving effected in time, labor and materials.



Problem: Weight of bomber landing gear was excessive. Could weight be reduced without sacrifice of safety factor?

Solution: Analysis of stressed part with X-ray.

Result: Deadweight in casting safely reduced by 50%. Tons of critical material saved . . . load carrying capacity of plane increased.



Problem: Solenoid plunger in communications equipment wouldn't function properly. Engineers certified design as okay; factory said manufacture was okay; part appeared perfect.

Solution: Examination with X-ray.

Result: Picture disclosed that when machined, chromium plating on one side of plunger was heavier than on other—reducing its magnetic properties.

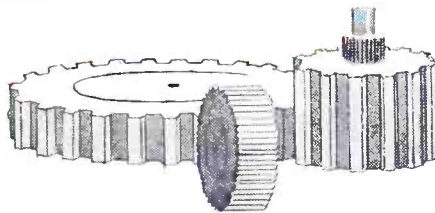

Problem: Inspectors questioned mesh and clearance between gears and housings in tab gear boxes for fighter planes. Only proof of accuracy was check of production drawings.

Solution: A look inside gear housing with X-ray.

Result: Inspectors given X-ray proof that each completed gear unit was constructed properly . . . or rejected before shipment.

Two Proposals

PROPOSAL NO. 1 Send for our new book on Industrial X-ray Inspection. The most complete book of its kind, it is packed with practical, understandable, question-answering information on how and where to use industrial X-ray inspection — how to set up an X-ray department — how to select the right equipment — range of equipment available. Ask for B-3159.

PROPOSAL NO. 2 If you want fast action on your problem just tell us to send a Westinghouse X-ray Specialist. He'll respond promptly—and competently.

Either way, mark the coupon and mail it to Westinghouse Electric & Manufacturing Co. East Pittsburgh, Pa., Dept. 7-N.



J-02015

Mail this Coupon

Westinghouse Electric & Mfg. Co.,
Dept. 7-N, East Pittsburgh, Pa.

..... Send new Industrial X-ray Book B-3159

..... Send a Westinghouse X-ray Specialist

Name.....

Company.....

Address.....

City..... State.....

X-Ray

a new versatile production tool

Specify

STEATITE

and stop worrying

*There is
NO
Shortage!*

Centralab

Division of Globe-Union Inc., Milwaukee, Wis.

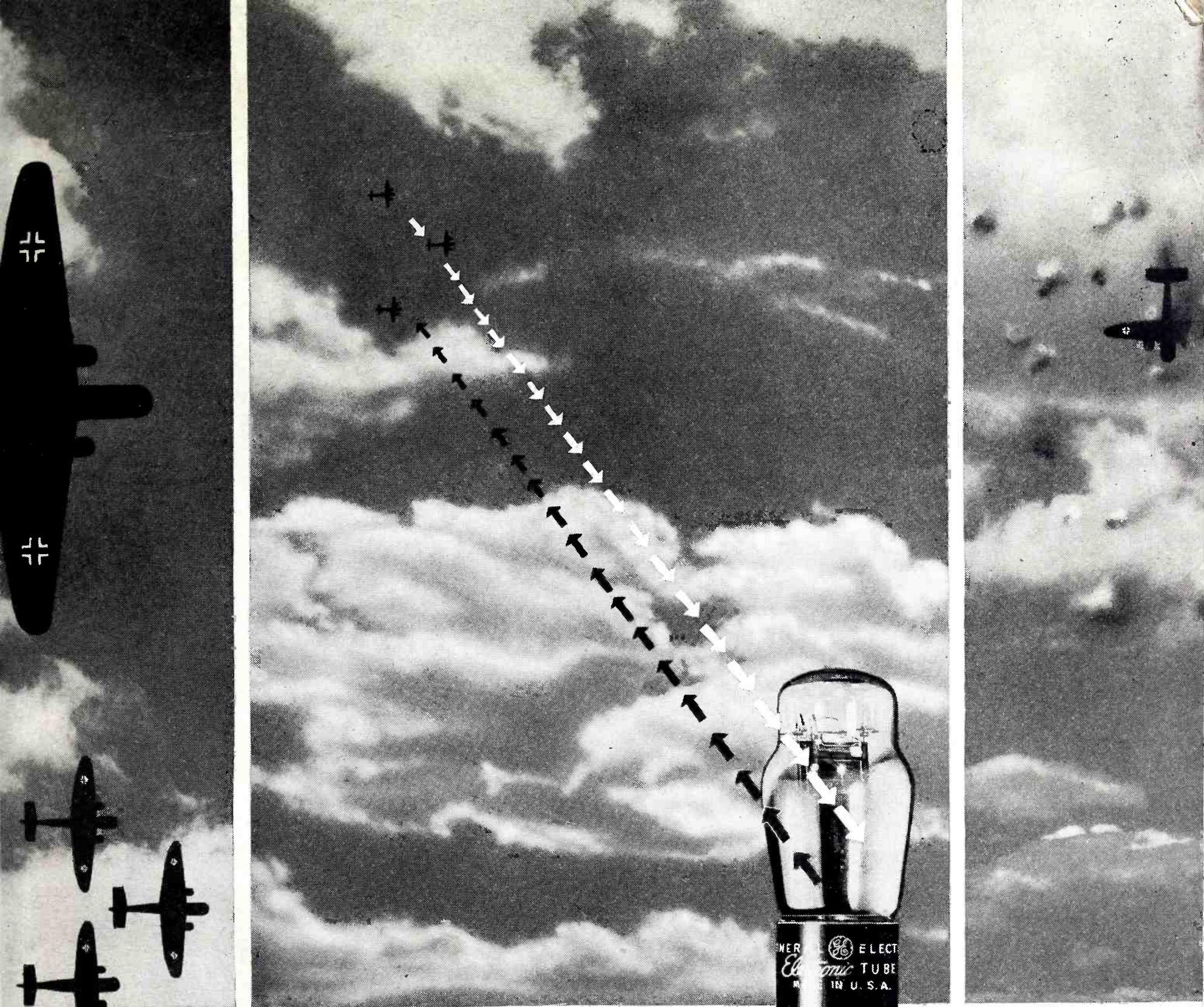

1. Enemy planes rise from distant airfields.

2. Radar sends out beam of ultra-high-frequency waves, reflected back to instruments which determine planes' location, speed, and direction.

3. Interceptor planes then surprise and destroy the advancing enemy.

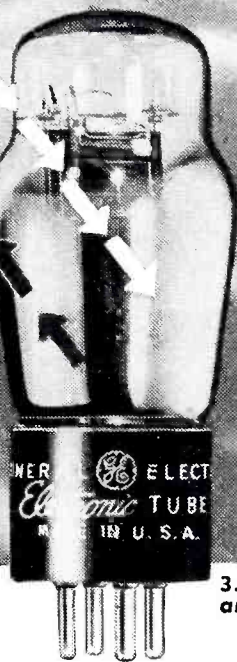

The facts about RADAR

"The whole history of Radar has been an example of successful collaboration between Allies on an international scale."

THE NEW YORK TIMES, MAY 16

THIS amazing electronic invention that locates distant planes and ships despite darkness and fog is a great co-operative achievement of Science and Industry.

In this country and in the British Isles, over 2000 scientists and engineers, some

working alone, some in the Army and the Navy, many in research laboratories of colleges and industrial firms, joined eagerly in the search for Radar knowledge.

Team-work that succeeded. Once this electronic device had been perfected, industry after industry rallied to the nation's call to manufacture Radar. General Electric is proud to have played a large part, with other manufacturers, in supplying to the Army and Navy this key weapon whose peacetime applications hold so high a promise.

As early as the Twenties, G-E engineers and scientists were developing the kind of high-frequency tubes, circuits and apparatus that make Radar possible. Thus long before Pearl Harbor, G.E. was able to build Radar equipment.

Post-war applications will be many. Radar will guard and guide the flight of great commercial transports. Planes will land blind. Transoceanic liners will slip safely into fog-bound harbors — all with Radar detection equipment.

In addition to Radar, General Electric is supplying to the Army, Navy, and Marines radio transmitters, antennae and receivers, carrier-current equipment, all kinds of electronic measurement equipment, and monitors. *Electronics Department, General Electric, Schenectady, N.Y.*

Tune in General Electric's **WORLD TODAY** and hear the news from the men who see it happen, every evening except Sunday at 6:45 E.W.T. over C.B.S. . . . On Sunday evening listen to the G-E Mazda Lamp program over N.B.C. network.

GENERAL  ELECTRIC

G-E employees are now purchasing over \$1,000,000 in War Bonds weekly

160-B5

*Head in
the clouds...*



... but "FEET" on the ground

Patrolling high above the battle area, the voices of our observers still echo clearly in the earphones at Headquarters, reporting enemy strength and movement. This highly sensitive radio equipment must not fail, for information often decides the tide of battle.

Auto-Lite is in quantity production on various types of wire used in equipment for

our armed forces. Today, in addition to Magnet Wire, hook-up and lead-in wire of conventional types, Auto-Lite also produces Formvar Magnet Wire, Butyrate Tape and Plastic insulated hook-up and lead-in wires adaptable for all types of electrical equipment.

Feel free to write us, whatever your problem. It will have our prompt attention.

PORT HURON, MICH.

THE ELECTRIC AUTO-LITE COMPANY
Wire Division

SARNIA, ONTARIO

AUTO-LITE *ELECTRICAL*
WIRE and CABLE

IN ITS 26 GREAT MANUFACTURING DIVISIONS, AUTO-LITE IS PRODUCING A LONG LIST OF ITEMS FOR AMERICA'S ARMED FORCES ON LAND, SEA AND IN THE AIR

FOR HIGH-FREQUENCY POWER SOURCES

LAPP GAS-FILLED CONDENSERS

In any electronic circuit, wherever lump capacitance is needed, Lapp condensers will save space, save power and save trouble. Available for duty at almost any conceivably-useable voltage rating and capacitance, they bring to any application notable mechanical and electrical advantages: practically zero loss, smallest space requirement, non-failing, puncture-proof design, constant capacitance under temperature variations. *Shown, at left, Unit No. 25934, rated at 200 amp., 6500 volts, capacitance variable 4300 mmf. to 11000 mmf.; right, Unit No. 23722, rated at 50 amp., 7500 volts, capacitance 45 mmf. to 75 mmf.*

STANDOFF, BOWL, ENTRANCE INSULATORS

Standoff, bowl, entrance and other special-purpose insulators are available in wide range as standard Lapp catalog items. Other insulators of special design are easily produced by Lapp methods, either in porcelain or steatite. The wide choice of such insulators available from Lapp simplifies the design of high-frequency equipment. Also, Lapp is equipped for production of many special assemblies, of porcelain or steatite, and the associated metal parts.

LAPP PORCELAIN WATER COILS

For cooling of high-frequency tubes in radio transmitters and other electronic power sources, Lapp porcelain water coils have been widely used. With nothing about the porcelain to deteriorate, sludging is eliminated, and with it the need for cleaning and water changes. Porcelain pipe and fittings in any needed size are also available as catalog items. We welcome inquiry on any Lapp equipment for experimental or industrial electronic application.

Lapp

INSULATOR CO., INC.

LEROY, N. Y.



MAGNAVOX SAVED

YOUR GOVERNMENT

EIGHT MILLION DOLLARS

EXCERPTS from Ford Motor Company's broadcast, "Watch the World Go By," April 5, 1943, in which Earl Godwin paid respects to American free enterprise.

"Take the folks at the Magnavox Company of Fort Wayne, Indiana . . . that before the war made superbly-toned radio-phonograph combinations. Today they're building Solenoid firing controls for aircraft-mounted machine guns for Ford-built Liberator bombers and Army and Navy planes . . . Within fifteen days of the time Uncle Sam asked Magnavox for these controls, working models were completed and firing tests furnished. Thirty more days and the controls were being turned out . . . Increased firing pressure 180%, decreased weight 18% and reduced battery drain 50%, and the mass production techniques developed by

Magnavox have saved the government approximately eight million dollars in manufacturing costs."

We are making equipment for Army, Navy, Coast Guard, Marine Corps and Maritime Commission, in our new six acre factory, on prime and sub-contracts. Facilities for additional contracts become available from time to time. Write, wire or phone The Magnavox Company, Fort Wayne, Indiana.



The skill and craftsmanship which won for Magnavox the first Navy "E" award (and two White Star Renewal Citations) among radio receiver manufacturers, have served the radio industry capably for a span of thirty-two years.

Magnavox

THE GREAT VOICE OF RADIO

COMMUNICATION AND ELECTRONIC EQUIPMENT

SUPERIORity in TUBING

is the Result of

Intensive Specialization

(IN SIZES $\frac{5}{8}$ " AND UNDER IN MANY METALS)

SUPERIOR

SUPERIOR TUBE COMPANY, NORRISTOWN, PENNSYLVANIA



The big name in

SMALL TUBING

for Uncle Sam!

FOR EVERY SMALL TUBING APPLICATION

Tubing from $\frac{5}{8}$ " OD down...SUPERIOR  Seamless in various analyses. WELD-DRAWN  Welded and drawn Stainless.

BRAUN  Welded and drawn "Monel" and "Inconel". SEAMLESS and Patented LOCKSEAM Cathode Sleeves.

*The Peacetime Habit
that Went to WAR... will Serve Again on
a Grander Scale!*

*RADAR-RADIO-ELECTRONICS PIONEERING



*will Serve Again on
a Grander Scale!*



Emerson AT WAR

RADAR • RADIO • ELECTRONICS

In RADIO, in RADAR, in many phases of ELECTRONICS—in Detecting, Transmitting and Receiving Apparatus for land, sea and air—Emerson is designing, developing and manufacturing in the QUALITY tradition, measuring up to the highest Army and Navy standards—ENOUGH and ON TIME.

★ ★ ★ ★ ★ ★ ★ ★ ★ ★ ★ ★ ★ ★ ★ ★

THE "HABIT" of PIONEERING—the imagination and skill and drive that made Emerson the LEADER in Home Radio—is in there now, pitching for the inevitable VICTORY.

Engineers, specialists, expeditors—trained workers with vastly increased manufacturing facilities—are beating schedules, piling up new delivery records every month.

It is generally accepted that "if it's EMERSON made, it will serve, and serve you well." Experience has proved it!

New techniques, new discoveries, new methods learned in wartime production will add even greater lustre to Emerson Radar-Radio-Electronics of the future.

Shifts from wartime to civilian manufacture will be rapid, orderly—and REALISTIC. We are "telling the

Emerson OF TOMORROW

RADAR • RADIO • ELECTRONICS

Small Radio, Television, F. M. and other Sound Recording and Electronic instruments are included in Emerson's constructive plans for the future. Each of those products will be in keeping with the needs and opportunities of the times. Incalculable possibilities for Emerson distributors and dealers lie ahead.

★ ★ ★ ★ ★ ★ ★ ★ ★ ★ ★ ★ ★ ★ ★ ★

world", ahead of time, what to expect from this war-matured organization.

In the great days ahead the Emerson Distributor and Dealer franchise will be an increasingly valuable asset. *Preserve it—with confidence.*



Emerson
RADAR • RADIO • ELECTRONICS
EMERSON RADIO AND PHONOGRAPH CORPORATION • NEW YORK, N. Y.

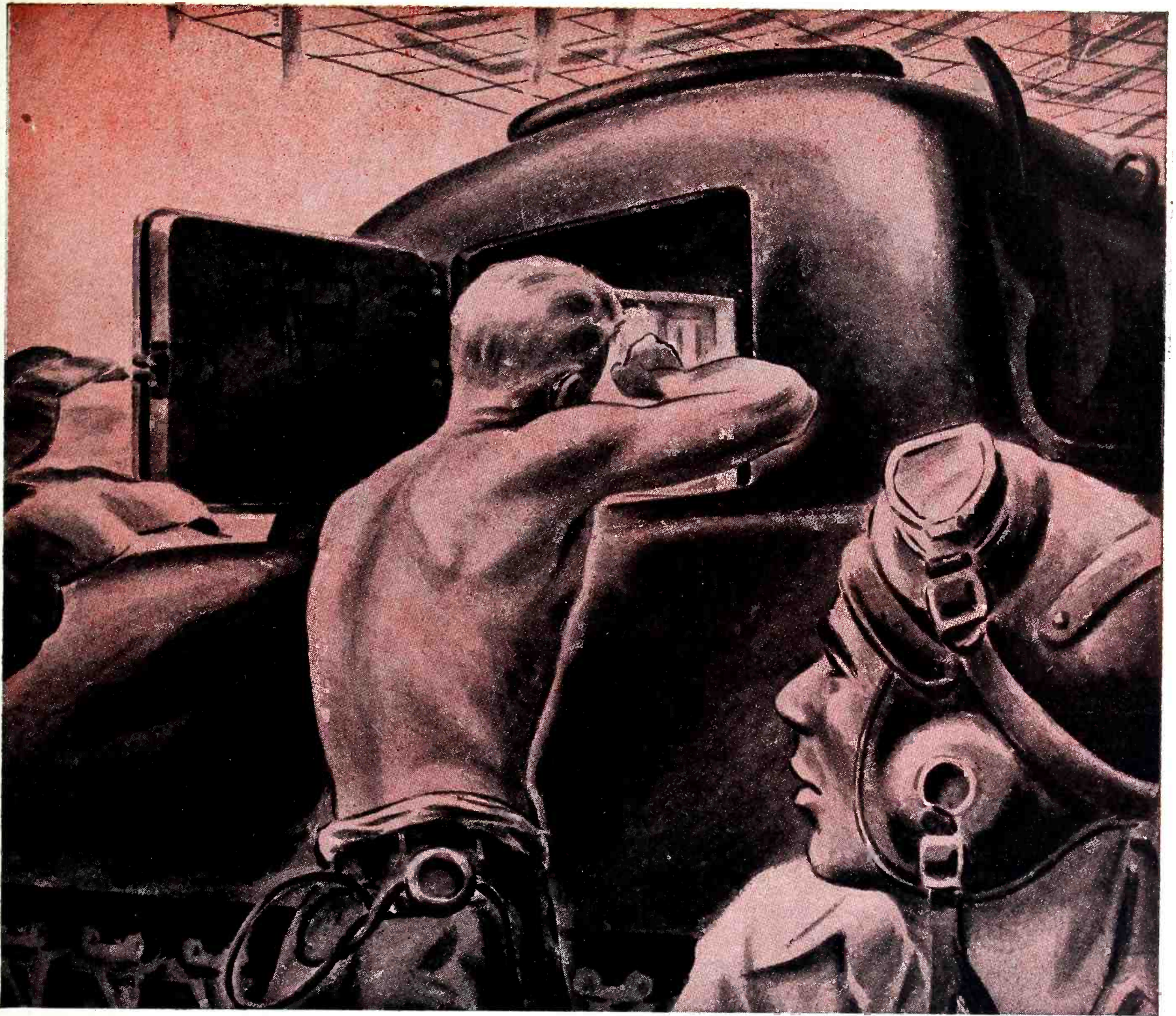

"Hmm! Nothing wrong with the Capacitors anyhow"

In steaming swamps, icebound wastelands and arid desert—the fighting fronts of global war—Cornell-Dubilier capacitors are revealing the stout-hearted stamina that's in them. Today, as in peacetime, there are more C-D capacitors in use than any other make.

You can give your product this same measure of dependability by using C-Ds whenever the design calls for capacitors. Engineered by specialists and backed by 33 years of manufacturing experience, the C-D capacitor—as a *fighting tool* of World War II—is more reliable than ever. Cornell Dubilier Electric Corporation, South Plainfield, New Jersey.



MICA CAPACITORS
for low power transmitter applications
The Type 9 Moulded Mica Capacitor series is designed for r.f. bypass, grid and plate blocking purposes in low power transmitters and amplifiers.

CHECK THESE FEATURES:

Moulded in Bakelite—strong mechanically, well insulated, moisture resistant.

Short, heavy terminals—minimum r. f. and contact resistance.

No magnetic materials used—reduces losses at all frequencies.

Special impregnation—assures stable capacity characteristics and high insulation resistance.

The Type 9 capacitors, as well as others in the complete C-D line, are described in Catalog No. 160T free on request.

Cornell Dubilier

capacitors

MICA • DYKANOL • PAPER
WET & DRY ELECTROLYTIC



M O R E I N U S E T O D A Y T H A N A N Y O T H E R M A

ELECTRONICS — July 1943

THE *Ability* TO GO TO WAR!

In 1929, fourteen years ago, the first JENSEN Auditorium speaker was introduced. The first of its kind, it has during all the succeeding years faithfully served the public and professional need for a heavy duty, high quality loud speaker. We think it is undeniably the world's best known and respected loud speaker product. Now, this fourteen year old JENSEN product goes to war. Naturally it incorporates the refinements and improvements which have been steadily added, but the basic design and function remains the same. Many other JENSEN products are thus endowed with the ability to go straight to war.



Jensen
RADIO MFG. CO.

6601 SOUTH LARAMIE AVENUE
CHICAGO, U. S. A.



(Photo Courtesy Pan American Airways System)

They cover the water-front

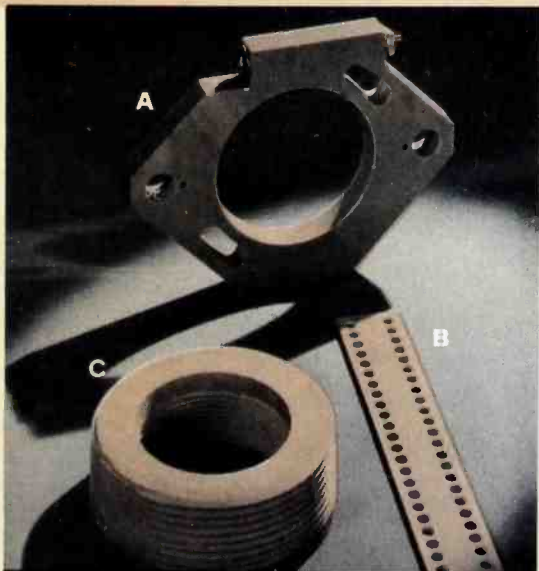

A—Sawed, milled, drilled and bored Brush Ring. **B**—Sawed, sanded and drilled Insulating Plate. **C**—Threaded and tapped Reducing Bushing.

OVER the Atlantic, the Pacific . . . over all the vast reaches of America's water-front, the Clippers are winging on errands of war, mercy and business. Of many parts made from Synthane for the Clippers, probably the most important are those for radio and electrical instruments.

Synthane is valued in the air service for its many combined properties—light

weight, for instance (half the weight of aluminum), excellent insulating characteristics, hardness, ease of machining, resistance to corrosion from aviation oils and gasoline, and mechanical strength.

Synthane now is confined to essential work, but new materials and applications are in the making. Keep up-to-date with information such as you will find on the back of this and future sheets.

SYNTHANE CORPORATION, OAKS, PENNSYLVANIA

Plan your present and future products with Synthane Technical Plastics

SHEETS • RODS • TUBES • FABRICATED PARTS

SYNTHANE
Bakelite — laminated

MOLDED-LAMINATED • MOLDED-MACERATED

KEEP POSTED WITH THIS NEW PAGE OF INFORMATION ON

SYNTHANE Molded-Laminated and Molded-Macerated Products

Many of you are already familiar with the manufacture, uses and properties of SYNTHANE Bakelite-laminated. You perhaps know that it is made from paper or fabric impregnated with a plastic resin and transformed under heat and pressure into a hard, dense material of many combined properties.

Laminated materials are produced in the form of sheets, rods and tubes, usually requiring some machining to finished form.

There are two associated forms of SYNTHANE which reduce or eliminate the necessity for machining—known as molded-laminated and molded-macerated SYNTHANE.

Molded-Laminated

Frequently it is economical to produce finished products by a combination of molding and laminating techniques. Laminations of the impregnated paper or fabric are cut to the rough outline of the desired piece and molded under heat and pressure to finished form. The result is a product with approximately the strength of SYNTHANE Bakelite-laminated without machining time or expense. Obviously, the quantity of pieces required must be sufficient to justify the costs of molding, including the cost of the mold itself, as compared with the costs of regular laminated material and machining. Obviously, too, there are certain limitations to the application of the molded-laminated process. If shapes are intricate, it may not be practical to cut the laminations to fit the mold. Molded-macerated construction may then be the answer.

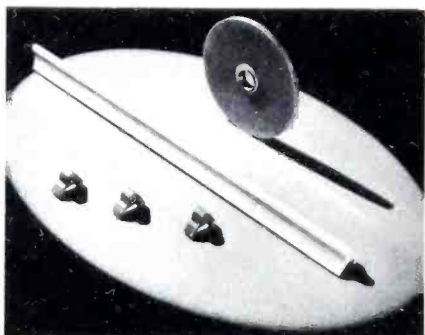

Combination molded-laminated-macerated wheel. Molded-laminated distributor arms.

Molded-Macerated

The molded-macerated procedure is similar to molded-laminated except that the impregnated paper or fabric is chopped into small flakes or chips before the mold is charged. The flakes, being comparatively small, allow considerably more latitude in the shape and complexity of the mold than is possible with the molded-laminated process.

Naturally, impregnated flakes do not have the flow characteristics of molding powder. Therefore, it is wise to avoid undercuts or pins which are perpendicular to the direction of the molding pressure (generally vertical). Side holes and undercuts may be more satisfactorily machined.

Properties

Both the processes described bear some resemblance to powder molding

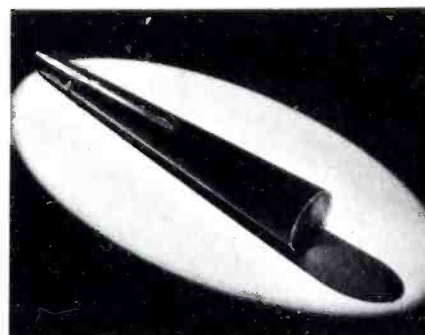

Molded-laminated horn for carbon dioxide fire extinguishers.

except that molded-laminated or molded-macerated articles have far greater mechanical strength than powder moldings. Molded-laminated material approaches laminated material in strength; molded-macerated has about 50 to 75% of the mechanical strength of corresponding laminated grades. The mechanical, electrical, physical and chemical properties can be varied over a wide range or adjusted one against the other to meet specific needs just as is the case with laminated materials.

Combination Molded-Laminated-Macerated

It is possible to combine the benefits of molded-laminated and molded-macerated into one molding where maximum strength in one section and maximum resin flow in another are necessary.

Methods Used for Testing Synthane

- (1) Tests were made on $\frac{1}{8}$ " thickness, at room temperature, approximately 25 deg. C., following the American Society for Testing Materials Method D-229-42.
- (2) Tests were made on tension test specimen, at room temperature, approximately 25 deg. C., following the American Society for Testing Materials Method D-48-42T.
- (3) Tests were made under oil on $\frac{1}{16}$ " thickness, according to American Society for Testing Materials Method D-149-40T.
- (4) Tests were made under oil on disc 4" diameter and $\frac{1}{8}$ " thick, according to American Society for Testing Materials Method D-48-42T.
- (5) Tests were made on pieces 3" x 1" x $\frac{1}{8}$ " thick according to the American Society for Testing Materials Method D-229-42 after immersion in water for 24 hours at approximately 25 deg. C. plus or minus 2 deg. C.
- (6) Tests were made on molded discs 2" diam. x $\frac{1}{8}$ " thick according to the American Society for Testing Materials Method D-48-42T.
- (7) Tests were made on notched specimens $2\frac{1}{2}$ " x $\frac{1}{2}$ " x $\frac{1}{2}$ " thick according to the American Society for Testing Materials Method D-256-41T.
- (8) Tests were made on specimens used for water absorption tests according to the American Society for Testing Materials Method D-634-41T.
- (9) Tests were made on specimens 1" x 1" x $\frac{1}{2}$ " thick according to the American Society for Testing Materials D-229-42.

Comparison of Synthane Molded-Laminated and Molded-Macerated with Synthane Standard Grade C Laminated

	GRADE C LAMINATED	GRADE C MOLDED-LAMINATED	GRADE C MOLDED-MACERATED
TENSILE STRENGTH Lbs./Sq. In.	(1) 9,500	(1) 8,200	(2) 7,800
FLEXURAL (TRANSVERSE) STRENGTH Lbs./Sq. In.	(1) 20,000	(1) 17,000	(2) 12,000
COMPRESSIVE STRENGTH Lbs./Sq. In.	(1) 38,000	(1) 32,000	(2) 27,000
DIELECTRIC STRENGTH Volts per Mil (.001") Short-Time Test	(3) 200	(3) 180	(4) 180
Step-by-Step Test	120	110	110
% MOISTURE ABSORPTION	(5) 1.7	(5) 1.9	(6) 1.0
IZOD IMPACT STRENGTH (Flatwise) Ft.-Lbs./In. of notch (Edgewise)	(7) 3.2 2.0	(7) 2.7 1.7	(7) 2.2 1.7
SPECIFIC GRAVITY	(8) 1.36	(8) 1.36	(8) 1.36
ROCKWELL HARDNESS	(1) M110	(1) M110	(1) M110
BONDING STRENGTH—Lbs.	(9) 2400	(9) 2000	(9) 2000

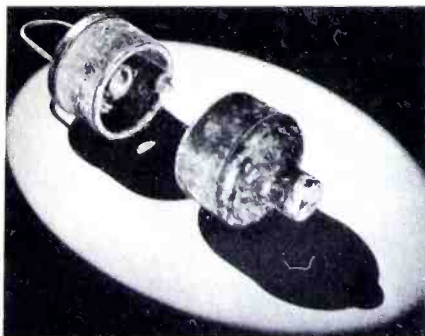

Molded-macerated cap and base for explosives container.

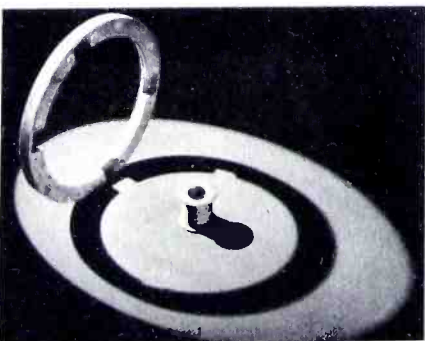

Molded-macerated gasket and spool.



Molded-macerated collar and spool.

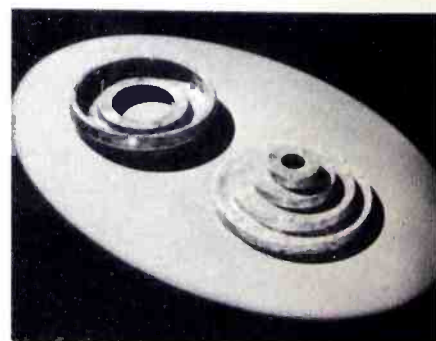

Molded-macerated handwheel and form for V-belt pulley.

PLAN YOUR PRESENT AND FUTURE PRODUCTS WITH SYNTHANE TECHNICAL PLASTICS

SYNTHANE
Bakelite — laminated

SHEETS•RODS•TUBES•FABRICATED PARTS•MOLDED-LAMINATED•MOLDED-MACERATED

SYNTHANE CORPORATION, OAKS, PENNA.

REPRESENTATIVES IN ALL PRINCIPAL CITIES

LETHAL WEAPON

IN THE WAR ON U-BOATS



THE NEW SCIENCE OF ELECTRONICS has profoundly changed the art of war. On land, in the air, above and below the surface of the sea, our forces fight today with electronic weapons of incredible power, speed, precision. It is satisfying to the men of Radio to know that these weapons have proved so successful on every battlefield where our boys, planes, tanks and ships have come to grips with the enemy.

The revelations concerning RADAR and its part in the war came as no surprise to those whose job is to supply our fighting forces with modern electronic equipment. Since before Pearl Harbor these Americans have been working shoulder to shoulder with our armed forces in applying the power of electronics to the art of war. Out of this united effort have come fighting weapons never before known—on land, at sea or in the air. In this pioneering work it has been National Union's privilege to play a progressively

increasing part. A greater National Union has been built to cope with vastly larger responsibilities. Today, National Union is ready to consult with and assist other manufacturers in the use of electronic tubes. Tomorrow, when peace comes—when the industrial usage of electronics gets the green light—engineers and production men will find at National Union unexcelled service and cooperation in perfecting new electronic applications for the production, testing and packaging of their products.

NATIONAL UNION RADIO CORPORATION • NEWARK, N. J. • LANSDALE, PA.

NATIONAL UNION RADIO AND ELECTRONIC TUBES

Transmitting Tubes • Cathode Ray Tubes • Receiving Tubes • Special Purpose Tubes • Condensers •
Volume Controls • Photo Electric Cells • Exciter Lamps • Panel Lamps • Flashlight Bulbs

Out of the test tubes RESEARCH EXPERIENCE AND SERVICE...

... was developed
the Mitchell-Rand line
of electrical insulations

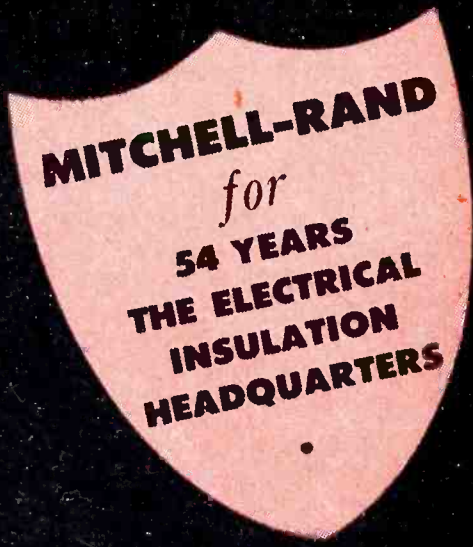

VARNISHES

**MICA, PAPER
and TWINES**

**MORE THAN 3500
WAX and COMPOUND
FORMULAS**

**5 GRADES OF
VARNISHED TUBING
and SLEEVING**

**TAPES, WEBBINGS
and CLOTHS**

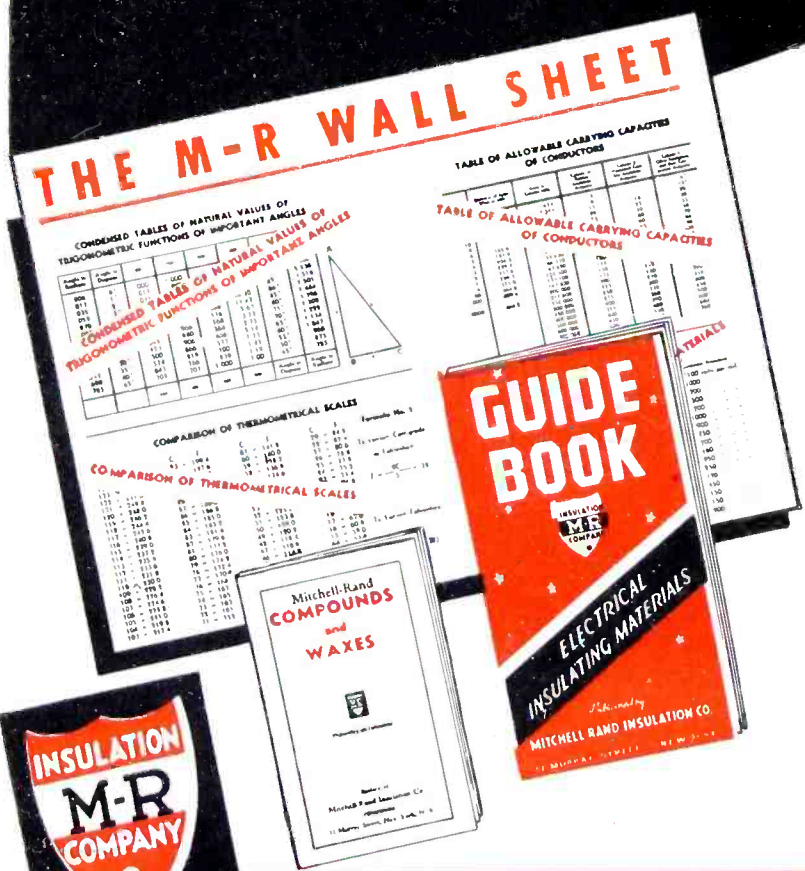
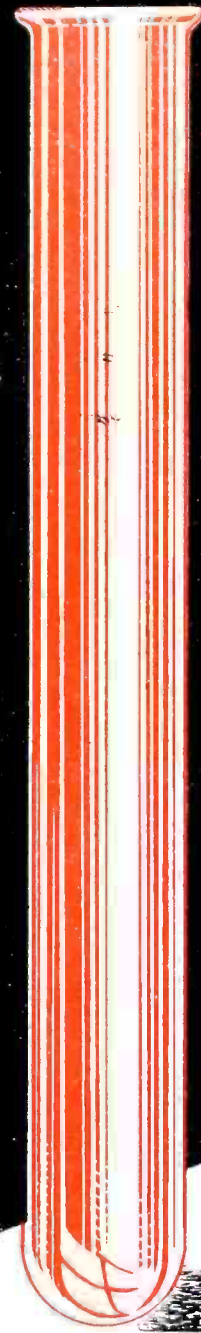

54 years of specialized service to the Electrical and Electronic Industries brought us countless electrical insulation problems.

The experience and research necessary to solve the progressively difficult electrical insulation problems was of inestimable value in the development of the complete line of Mitchell-Rand Electrical Insulations.

Today as yesterday our experience and research is at your service . . . send us your electrical insulation problems . . . or your requirements for any of our extensive and proven line of electrical insulations.

FREE FOR THE ASKING!

Write today for your Free Card of Varnished Tubing with samples ranging from size 0 to 20 to fit wires from .032 to .325 inches . . . other valuable aids, are the M-R Guide Book of Electrical Insulation . . . the Wall Chart with reference tables, electrical symbols, allowable capacities of conductors, dielectric averages, thicknesses of insulating materials and tap drill sizes . . . and the M-R Wax and Compound Guide Book . . . they are full of valuable information . . .

WRITE TODAY ON YOUR COMPANY LETTERHEAD!

MITCHELL-RAND INSULATION COMPANY, INC.
EST. 1889
51-A MURRAY STREET **Cortlandt 7-9264** **NEW YORK, N. Y.**

- A PARTIAL LIST OF M-R PRODUCTS**
- Fiberglass Varnished Tape and Cloth
 - Insulating Papers and Twines
 - Cable Filling and Pothead Compounds
 - Friction Tape and Splice
 - Transformer Compounds
 - Fiberglass Braided Sleeving
 - Cotton Tapes, Webbings and Sleeveings
 - Impregnated Varnish Tubing
 - Insulating Varnishes of all types
 - Fiberglass Saturated Sleeving and Varnished Tubing
 - Asbestos Sleeving and Tape
 - Extruded Plastic Tubing
 - Varnished Cambric Cloth and Tape
 - Mica Plate, Tape, Paper, Cloth and Tubing

ELECTRONEER IT

WITH ALSIMAG STEATITE

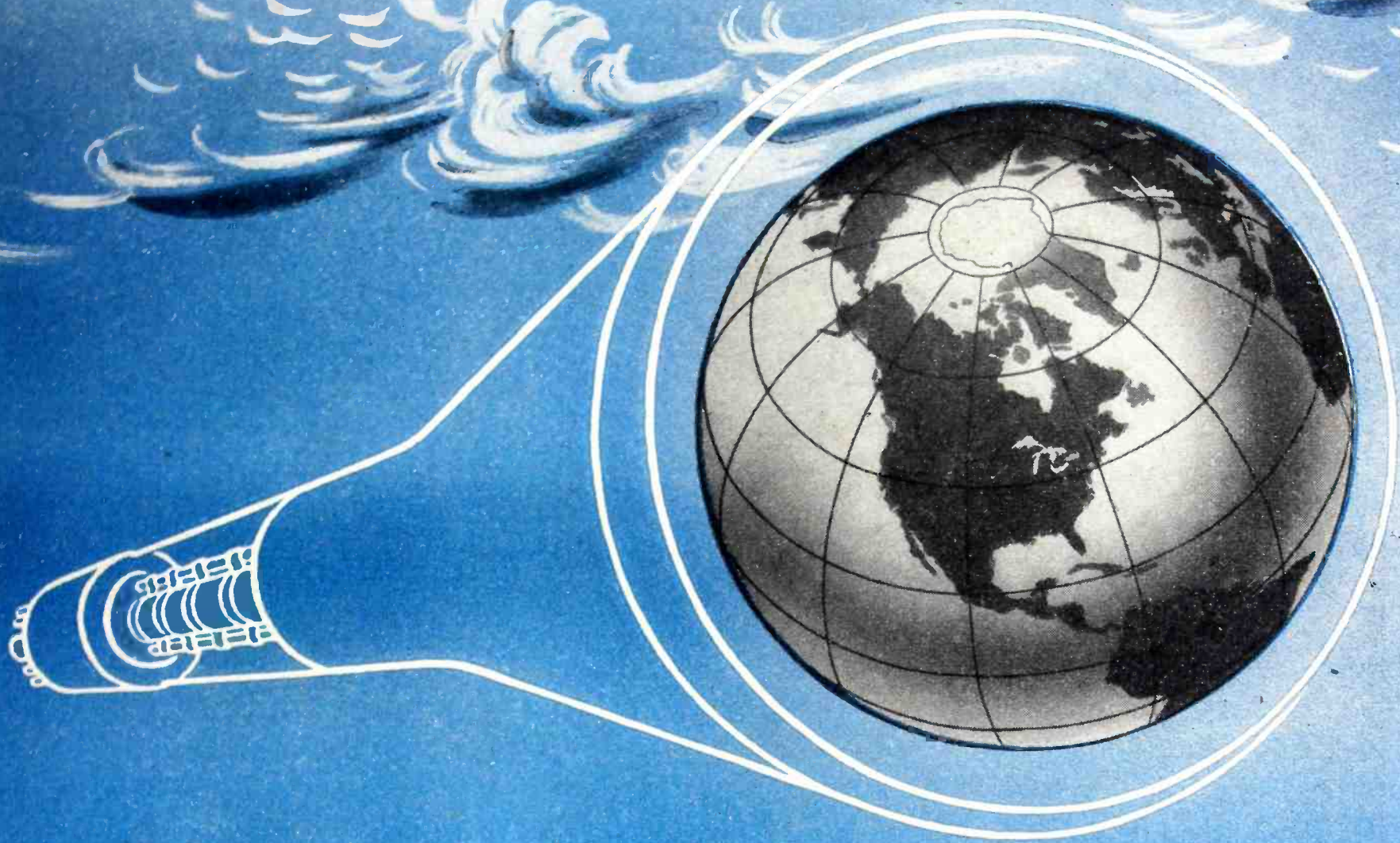

OUT OF TODAY'S RESEARCH . . . TOMORROW IS ENGINEERED

IN that *Better World* which you are Electroneering, substitute materials of lesser performance have no place.

It is a well known fact that the properties of steatite for high frequency insulation are not duplicated.

ALSiMAG lifts the properties of steatite to highest levels of dielectric and mechani-

cal strength. ALSiMAG Steatite Ceramic insulators are custom made to your design.

Do your Electroneering . . . your planning, thinking and designing with ALSiMAG steatite in mind. Our research people will gladly cooperate in today's blueprint or tomorrow's production.



41st YEAR OF CERAMIC LEADERSHIP

ALSiMAG

TRADE MARK REGISTERED U. S. PATENT OFFICE

AMERICAN LAVA CORPORATION
CHATTANOOGA, TENNESSEE

ARHCO

Varieties of 1943

2008 Wartime Essentials

We do stamping, screw machine work, moulding, and general Radio and Radar communications assemblies. Illustrated are but a mere handful of the 2008 wartime essentials which we are now manufacturing. Your inquiries will receive prompt attention.

Now, more than ever, it is important that you keep on buying War Bonds and Stamps.



*American
Radio
Hardware* CO., INC.

476 BROADWAY, NEW YORK, N. Y.

MANUFACTURERS OF SHORT WAVE • TELEVISION • RADIO • SOUND EQUIPMENT.

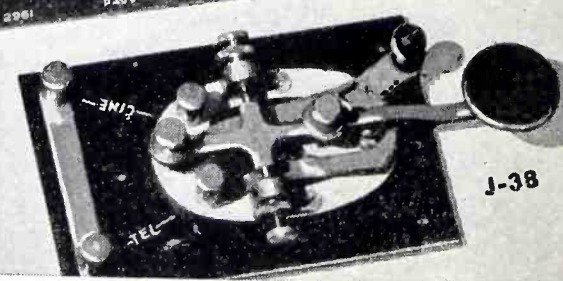
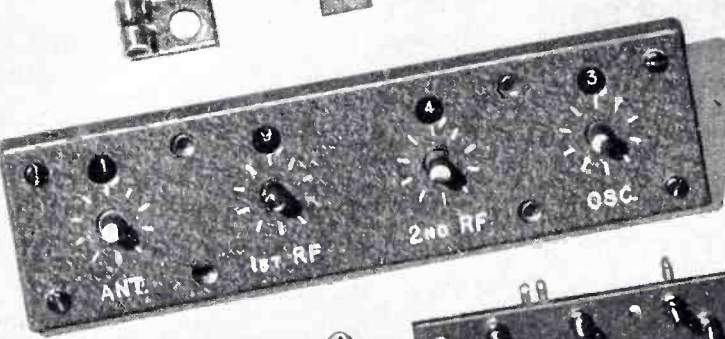
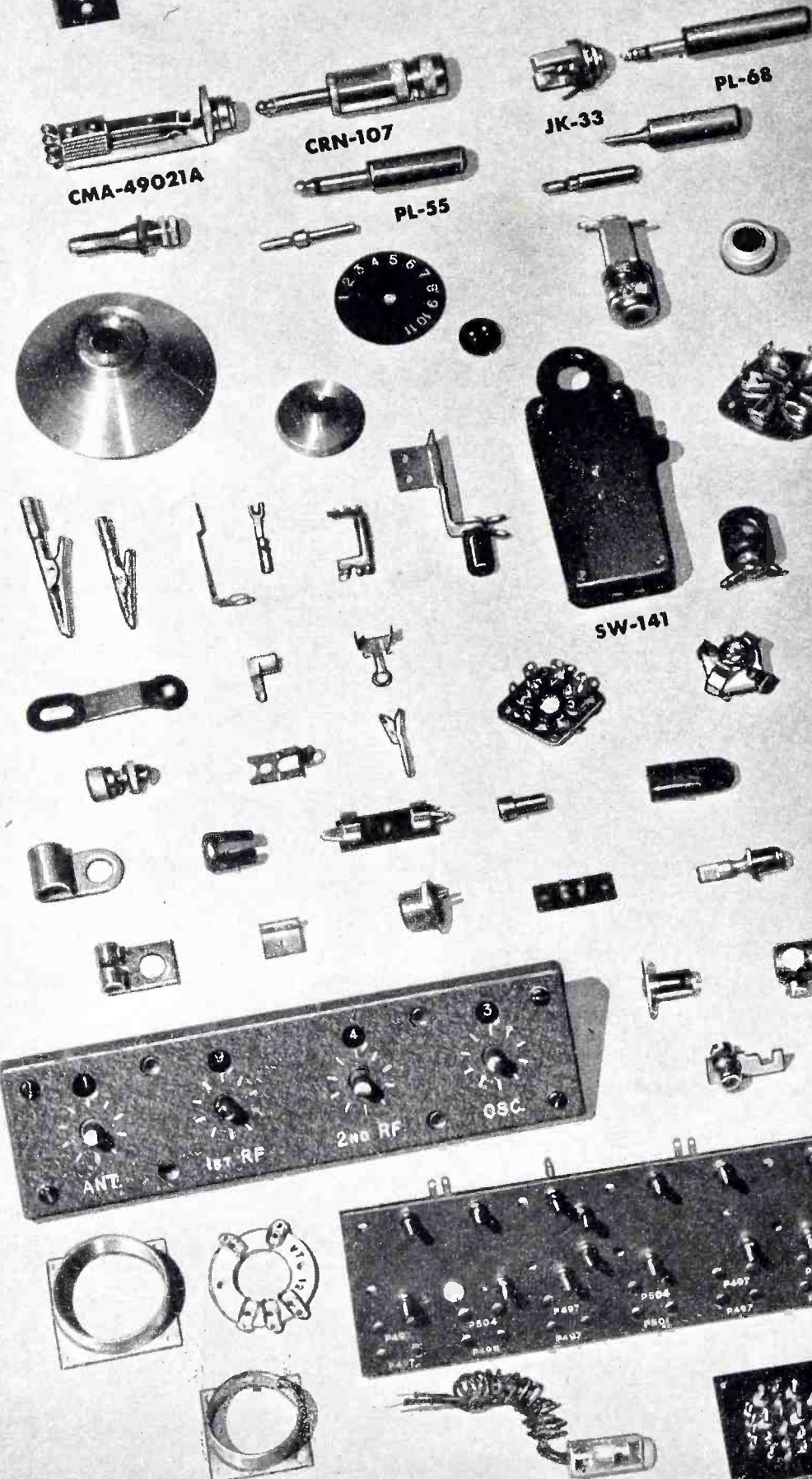

"mind your baby,
ma'am?"

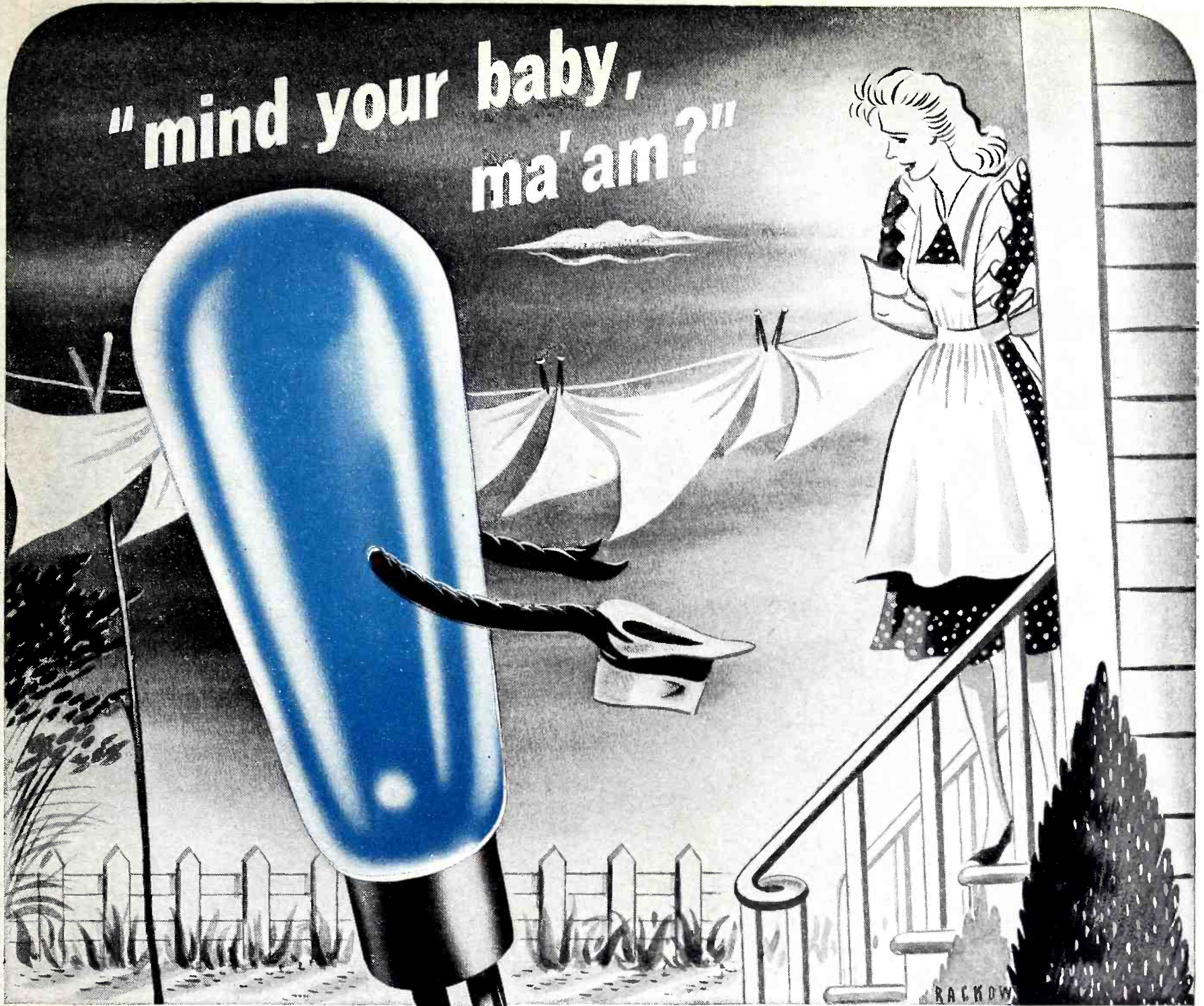

SOME DAY not too far away, electron tubes in hundreds of sizes and kinds are coming home from war. And it's no tall tale to anyone who's seen what tubes are doing for Victory today—this picture story of minding the baby tomorrow. You can bet electron tubes will mind our babies—and cook our meals and heat our homes and regulate our lighting and ventilation and . . . what more do you want? Name it—and electron tubes can and will do it for you!

Here at Roebing we're laying great store by what electron tubes hold for the future of America. Not just in the services they'll perform in the home, the office, the factory—though these are *primary* benefits. We're thinking of electronics today as a maker of *jobs* for *millions* tomorrow! And we're thinking of electronics, too, as a minder of "babies" that are going to

grow into great new industries! And, here at Roebing, we're making our plans for the future accordingly . . .

Right now those plans are simply to produce every *extra ounce* of vital material we can to win this war *quicker*—more Paper-Insulated Power Cable, Armored Parkway Cable, Roevar Magnet Wire . . . And even as we win that battle to raise production to higher and higher levels, we're learning lots of ways we never knew

before of how to make electrical wires and cables better, stronger, longer-lasting . . . Those are the babies we're minding today—and they'll be right on hand tomorrow, full grown, to help you meet America's new demands for tubes and power and new appliances to use them both.

JOHN A. ROEBLING'S SONS COMPANY
TRENTON, NEW JERSEY
Branches and Warehouses in Principal Cities

ROEBLING

ELECTRICAL WIRES AND CABLES

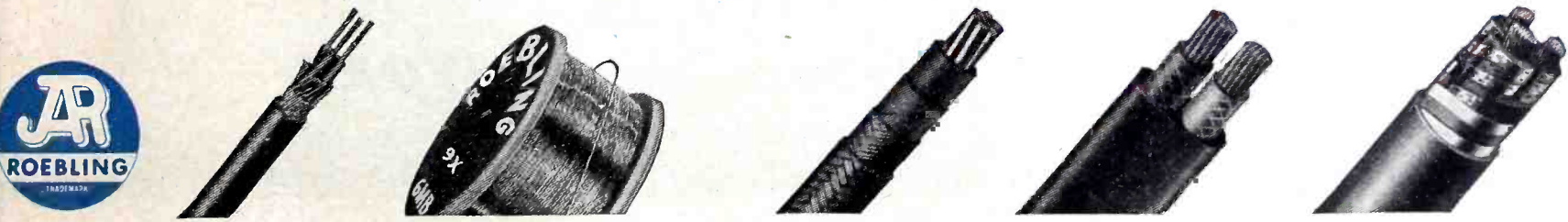

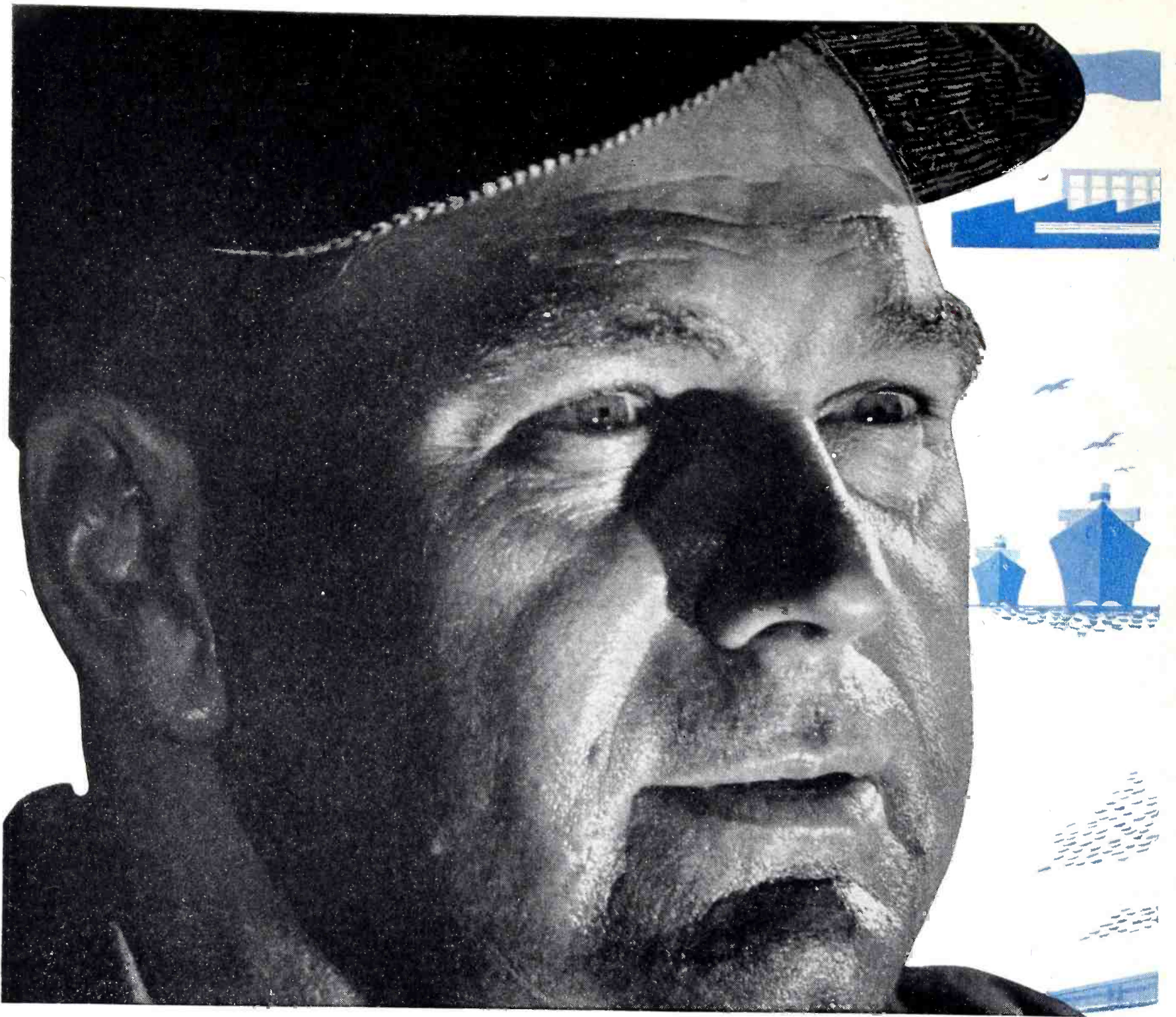

Everyday, electronics and manpower become closer allies.

Today, Westinghouse Electronic Tubes are hard at work on hundreds of industrial and military fronts, adding their own power to manpower. By helping to perform many tasks better, they are speeding up production, improving quality and extending man's control into the realms of the impossible.

For example, you will find Westinghouse tubes saving time and work on jobs such as these: vibration detectors for rotors, heat treating, welding and dust precipitation. You'll also find them as part and

parcel of amazing developments which enable men to "see" in darkness, land planes at "ceiling zero," keep ships off rocks in fog-bound harbors and detect planes at great distances.

All of these are today's developments, jobs in which Westinghouse tubes are building a reputation for perfection of design and construction.

In your thinking and planning for today and tomorrow, include the use of electronic tubes. Westinghouse . . . pioneers in electronic "know how" are at your service. Westinghouse Electric and Manufacturing Company, Bloomfield, N. J.

Westinghouse



Electronic Tubes *AT WORK*

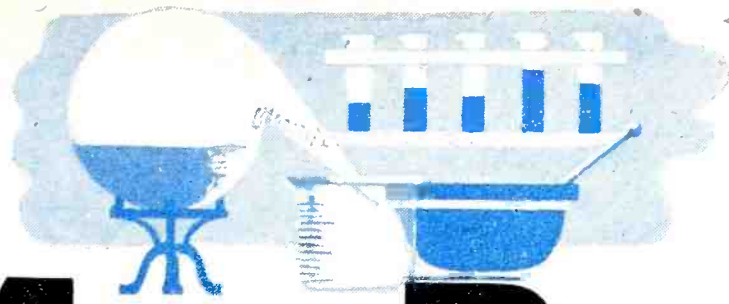

More Power for Manpower

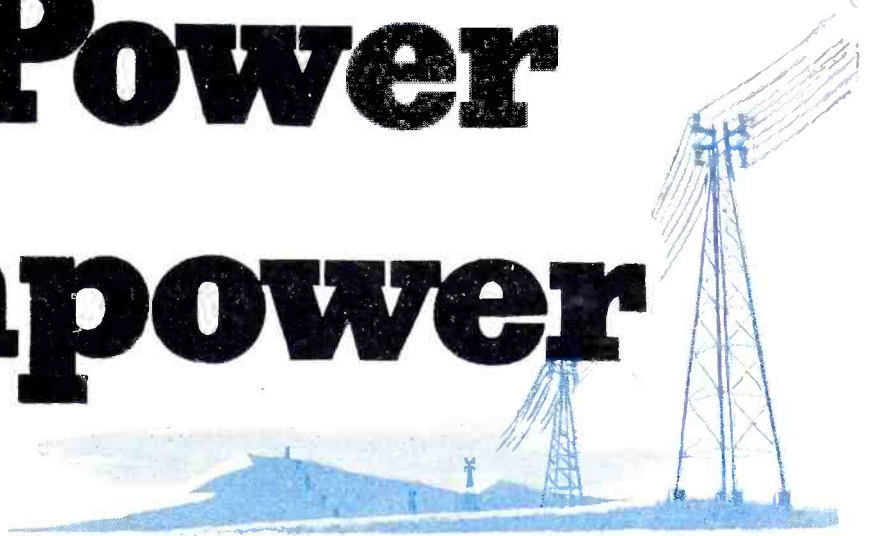

A FEW OF THE WESTINGHOUSE TUBES NOW SERVING INDUSTRY

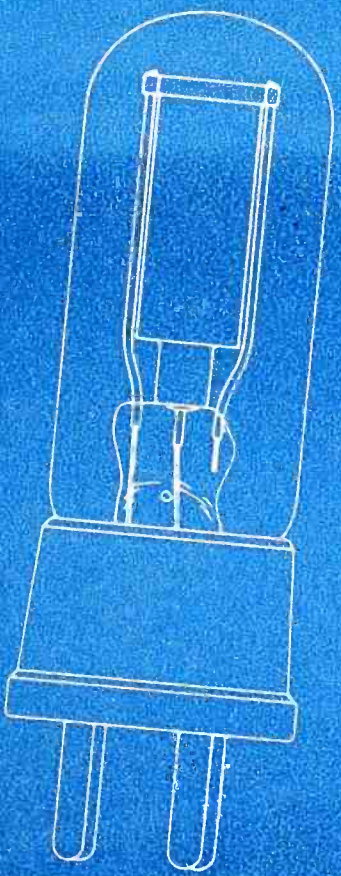

Phototube

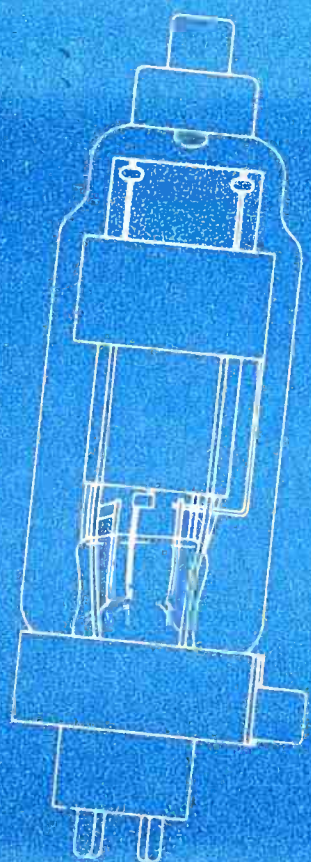

Thyatron

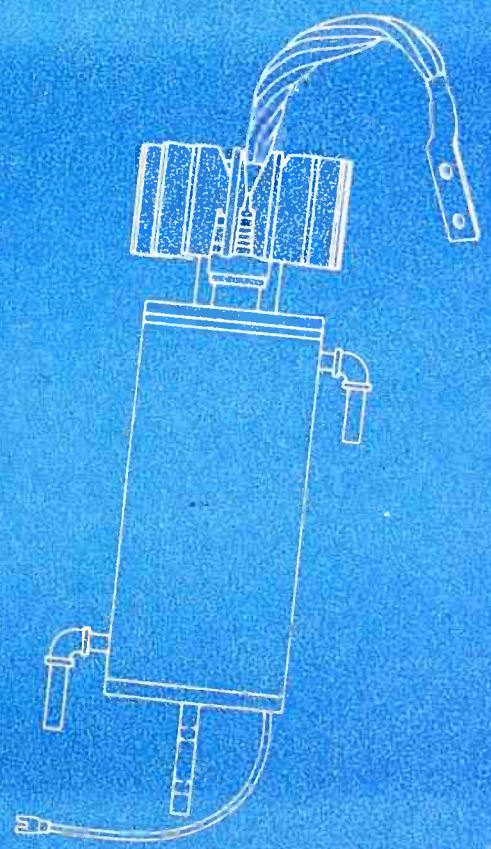

Ignitron

SPLIT CYCLE CONTROL
Microamperes to Kiloamperes

Facts about **STEATITE** **LOW LOSS** **INSULATORS**

NO SHORTAGE EXISTS

in STEATITE parts so necessary in Radio and Radar Equipment for the war effort—the demand is being met.

EXPERIENCED ENGINEERING STAFF

—with years of training in research and the development of methods and processes—so necessary to produce precision made STEATITE parts of rigid and exacting specifications.

AMPLE FACILITIES

—are available for producing precision made extruded, pressed and machined STEATITE parts
—NO SHORTAGE exists of production facilities.

SUBSTITUTES

—for STEATITE are no longer necessary—STEATITE parts are available for prompt delivery in all sizes, shapes and quantities.

*For the duration 100 per cent of our attention—
all personnel and equipment—is being
used to hasten Victory.*

**BUY WAR
BONDS**

STUPAKOFF

Steatite

INSULATORS



STUPAKOFF CERAMIC AND MANUFACTURING CO., LATROBE, PA.

Ceramics for the World of Electronics

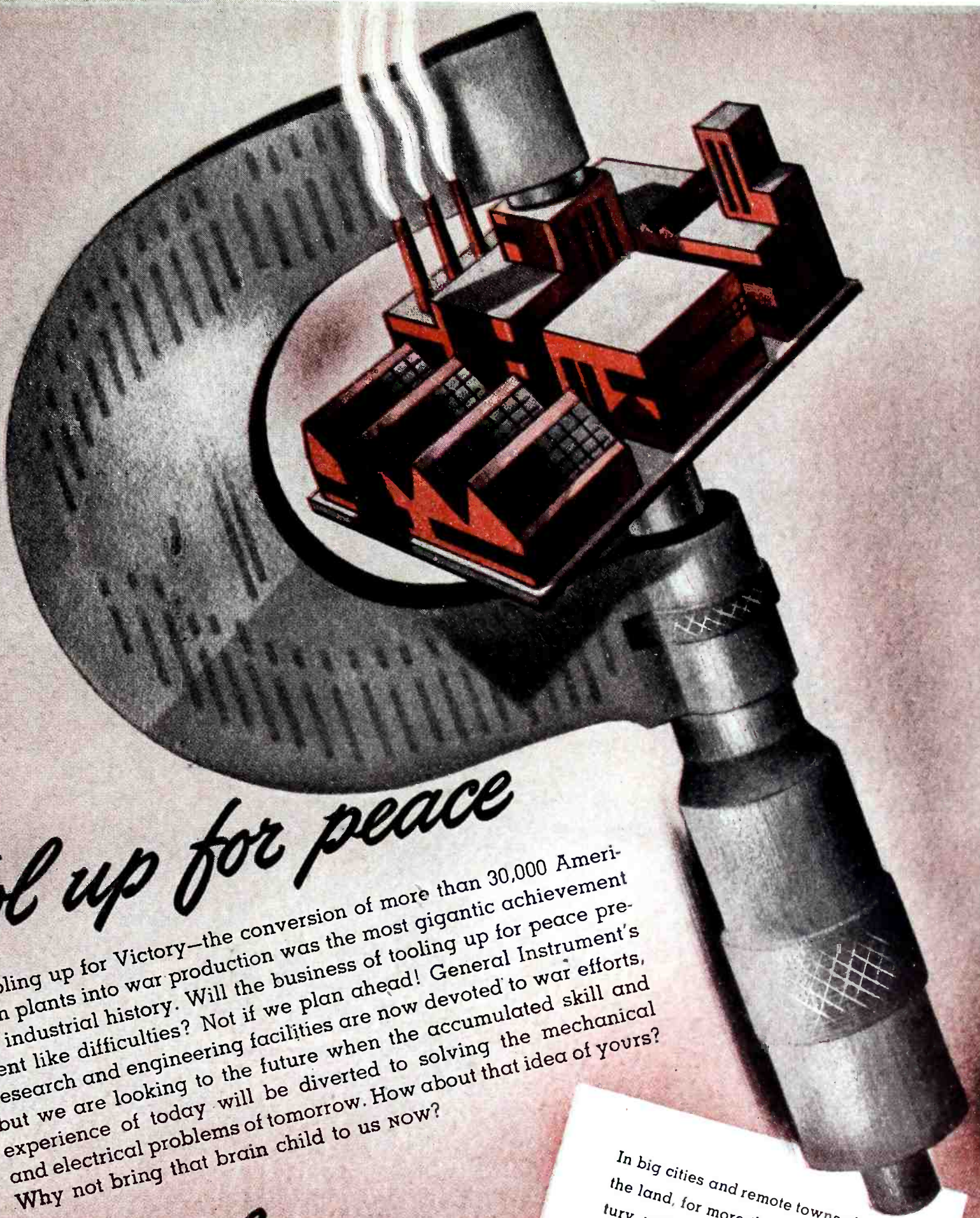

Tool up for peace

Tooling up for Victory—the conversion of more than 30,000 American plants into war production was the most gigantic achievement in industrial history. Will the business of tooling up for peace present like difficulties? Not if we plan ahead! General Instrument's research and engineering facilities are now devoted to war efforts, but we are looking to the future when the accumulated skill and experience of today will be diverted to solving the mechanical and electrical problems of tomorrow. How about that idea of yours? Why not bring that brain child to us now?

**General
Instrument**
CORPORATION

Executive Offices: 829 Newark Avenue, Elizabeth, New Jersey

In big cities and remote towns all over the land, for more than a quarter century, millions of owners of home radio sets have enjoyed better reception because of General Instrument precision equipment.

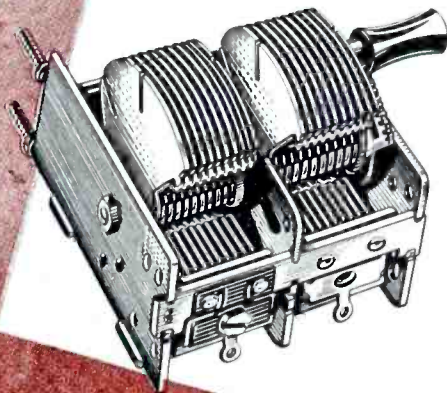

CHECKING THE EXACTNESS OF THE ANGLES OF THE SLICE, OR WAFER, OF A CRYSTAL

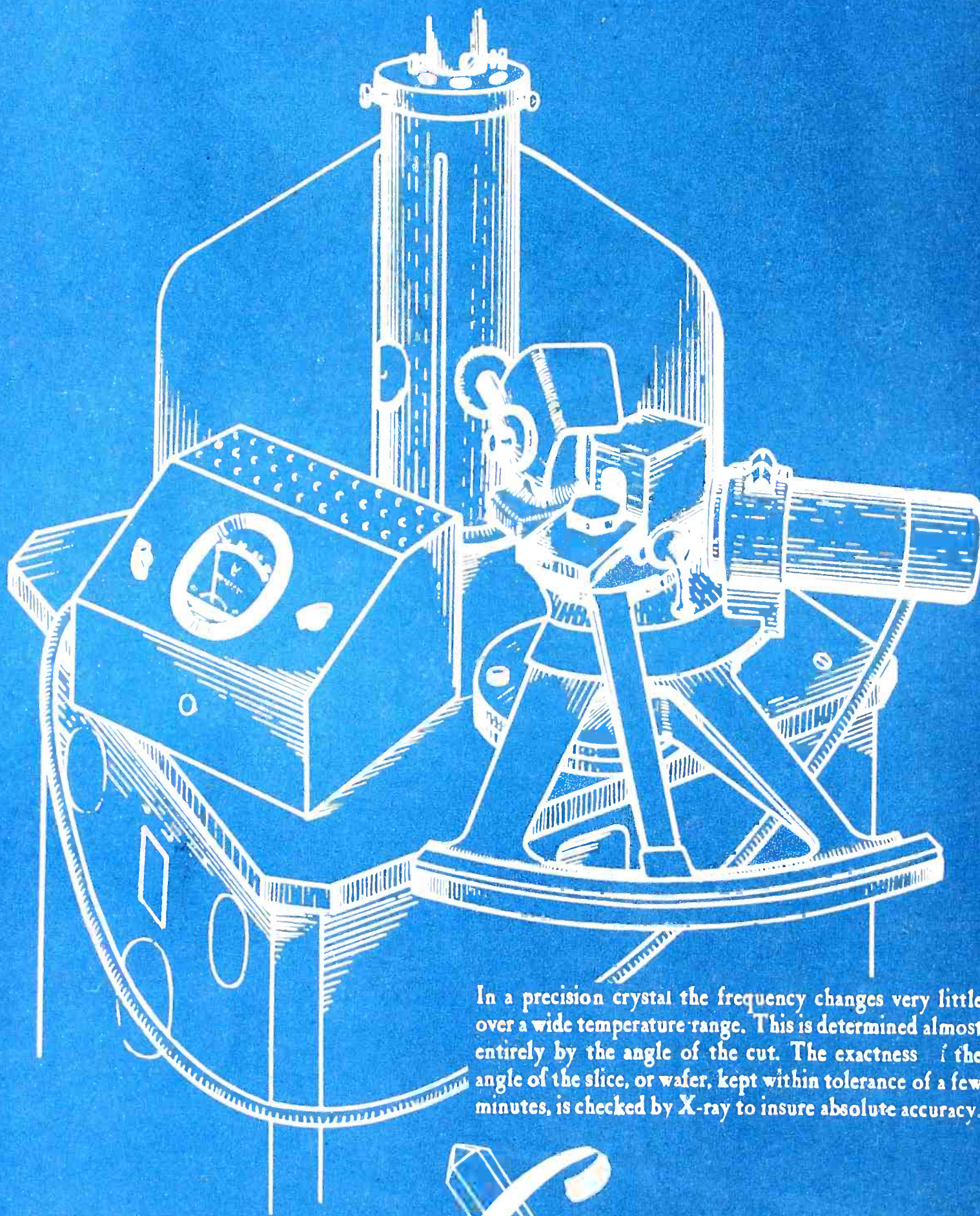

In a precision crystal the frequency changes very little over a wide temperature range. This is determined almost entirely by the angle of the cut. The exactness of the angle of the slice, or wafer, kept within tolerance of a few minutes, is checked by X-ray to insure absolute accuracy.

Crystal

PRODUCTS COMPANY
1519 MCGEE STREET, KANSAS CITY, MO.

Producers of Approved Precision Crystals for Radio Frequency Control



TO PRESERVE THE

Four Freedoms!

... freedoms that are uppermost in the heart of every American. Workers in industry have toiled unceasingly to build peak production to enable their country to be the world's best equipped fighting forces to protect these freedoms.

The Hallicrafters employees have

twice been cited by their country for excellence in production ... once with the Army-Navy "E" Burgee ... and now the addition of a star to this Burgee for continued excellence in producing communications equipment so vitally needed by our boys on all fronts.

This new honor will serve as an additional incentive to greater production.



**BUY
MORE
BONDS!**



hallicrafters

CHICAGO, U. S. A.

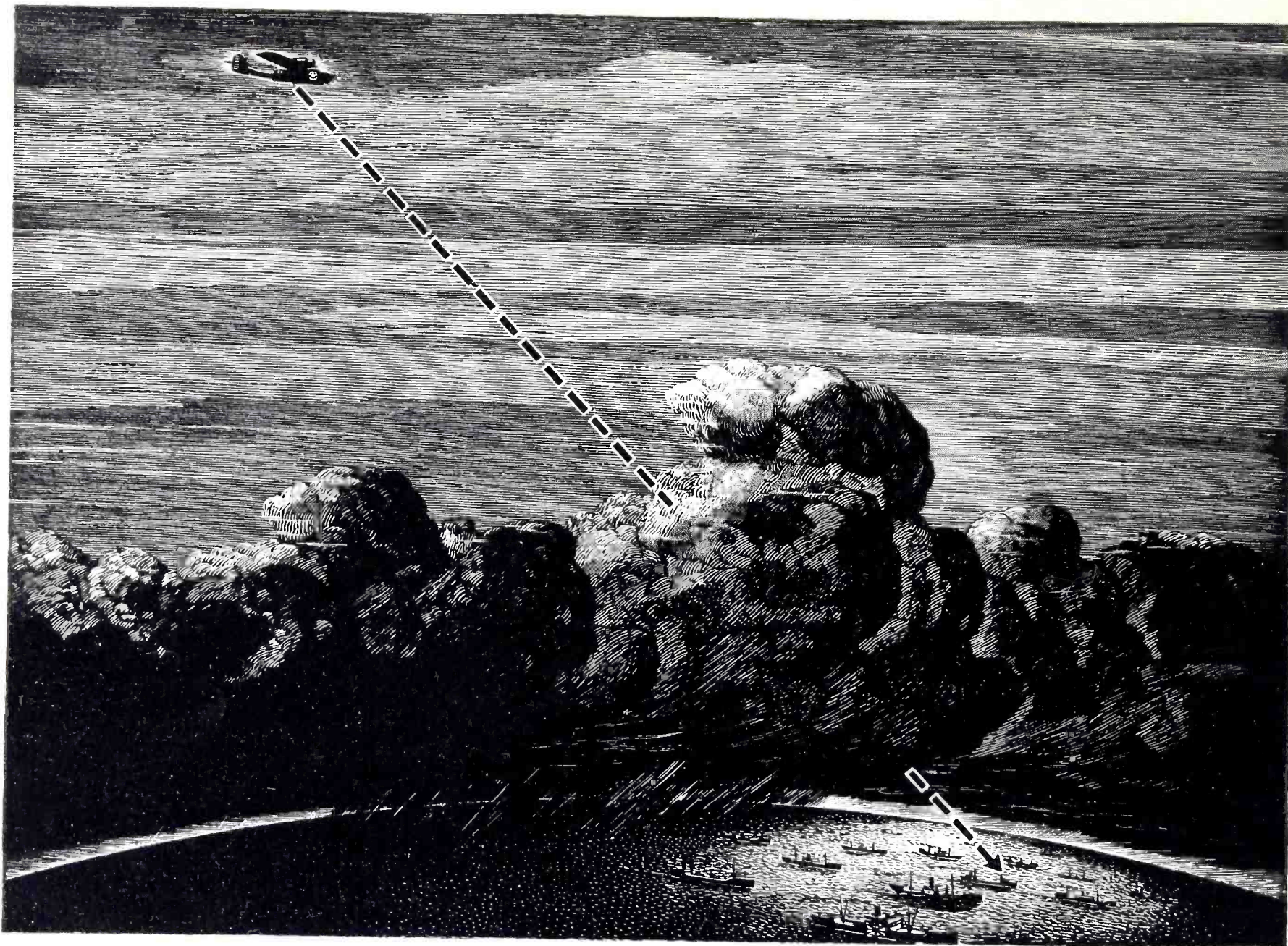

RADAR, the secret weapon, tells the story of PHILCO at war!

When the Army and Navy released the secret of *Radar*, the sensational story of Philco's vital contribution to victory was officially revealed. Radar, the fabulous weapon that pierces fog, storms and darkness and seeks out the enemy beyond the range of human eyes and ears, is one of Philco's major war assignments.

Throughout its overwhelming leadership in radio, Philco laboratories *pioneered* in the science of ultra-high frequency radio waves, upon which Radar is based. When the Jap struck, Philco was ready to answer the

call of our fighting forces for "impossible" deeds of Radar development and production. Today, theirs is the most dramatic story that has yet been told from the annals of war production.

Even more important will be the peacetime sequel to these Radar achievements. Wherever Radar and electronic principles may be applied, Philco research and experience will be ready, again, to serve the field of industry. And in home appliances, only the future can reveal the untold progress that will appear under the famous Philco name.

PHILCO CORPORATION



OUR WAR PRODUCTION PLEDGE: MORE • BETTER • SOONER

MEN OF ELECTRONICS CAN PICK THEIR OWN INDUSTRY IN POSTWAR!

Aviation? When the war is over, giant transport planes will fly almost with the speed of sound, and, through electronics, fly more safely. Radio? To FM will be added the wonders of seeing what is happening miles away, by means of electronic television. Agriculture—steel-making—medical science... Tomorrow the doors to all of these may be open to the electronic engineer.

Almost every day new uses and potentialities for the science of the future unfold, many in the ultra-high frequency ranges where, a few years ago, it was thought electronics could serve no practical purpose. Within the "narrow" 100 to 1000 megacycle range of the spectrum, particularly the former *No Man's Land* beyond 300 MC, a host of applications has been discovered for this new science—for example, in the aircraft industry—itself limitless in peacetime possibilities.

With the opening up of new portions of the frequency spectrum for practical use, men wise in the ways of electronics, or familiar with the theory of harnessing the electron, will be in demand everywhere.

For the practical application of the electronic principle is going to require a new engineering of products, as well as the development of special devices and machines that speed up production...increase accuracy, or measure, control, record and perform the countless other things envisioned in the coming Era of Electronics. And each of these represents opportunity—careers for the men in laboratory and field today hastening this stupendous new age.

Spurred by war's demand for electronic devices, Isolantite is busy preparing for the vastly accelerated application of the electron tube at war's end. For it has been demonstrated in the crucible of war how important is insulation—*high-grade* insulation—to the performance of this equipment designed to accomplish things which man cannot.

ISOLANTITE

CERAMIC INSULATORS
ISOLANTITE INC., BELLEVILLE, N. J.

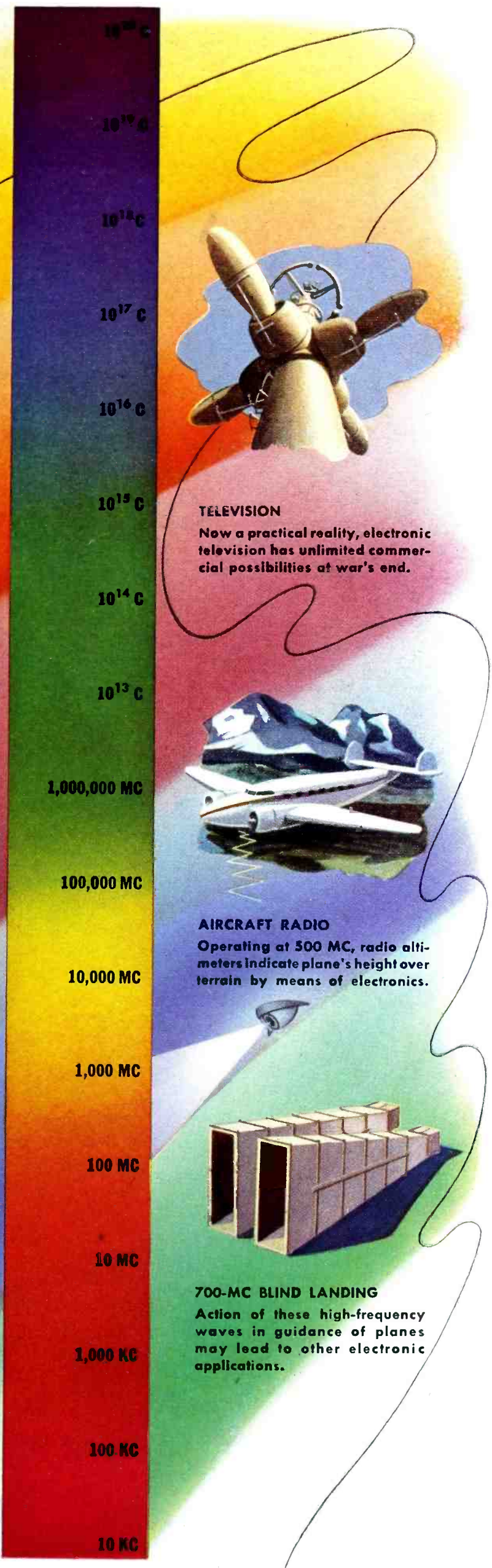



Engineering begins here...

FOR THE SOLUTION OF YOUR TRANSFORMER PROBLEMS



Grey matter—as measured in terms of Victory in war, or progress in peacetime—is a decisive, tangible factor. Strategies, techniques and analyses—whether for military or commerce—are its by-products. Success is directly proportionate to the quality involved.

The calibre of N-Y-T engineering is proved by the thousands* of new transformer designs evolved to individual requirements over the past few years. These audio and power components are now assuming a vitally important role in World War II, in Army, Navy and Air Corps applications.

When the world crisis is over, and our present 100% Victory effort terminates, N-Y-T engineers and technicians will be available for collaboration in the solution of your transformer problems. The vast experience gained now, should be of tremendous value then.

NEW YORK TRANSFORMER CO

26 WAVERLY PLACE NEW YORK, N. Y.

*The exact number is confidential information for the duration.





If you believe in the future of America as we do, then we're asking for an appointment immediately after the victory has been won . . . when a bright new era awaits us all.

Perhaps we can talk about a coil problem . . . how thoroughly we're organized to help you on such a problem only military censorship forbids telling now. Or it may be that you manufacture your own coils and will be interested in discussing magnet wire—any shape—any insulation that your operations require.

As a matter of fact, perhaps we can get together now, but if it happens we can't, remember we have a date in and for the future. When we both can keep it, you can again take advantage of Anaconda service and the benefits derived from the single product control "from mine to consumer" backed by years of continuous metallurgical experience.

43231
 ANACONDA WIRE & CABLE COMPANY
 General Offices: 25 Broadway, New York
 Chicago Office: 20 North Wacker Drive
 Subsidiary of Anaconda Copper Mining Co.
 Sales Offices in Principal Cities

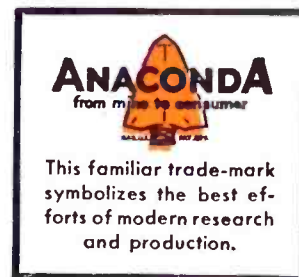

 *Magnet wire and coils*

ANACONDA WIRE & CABLE COMPANY

RESETABILITY

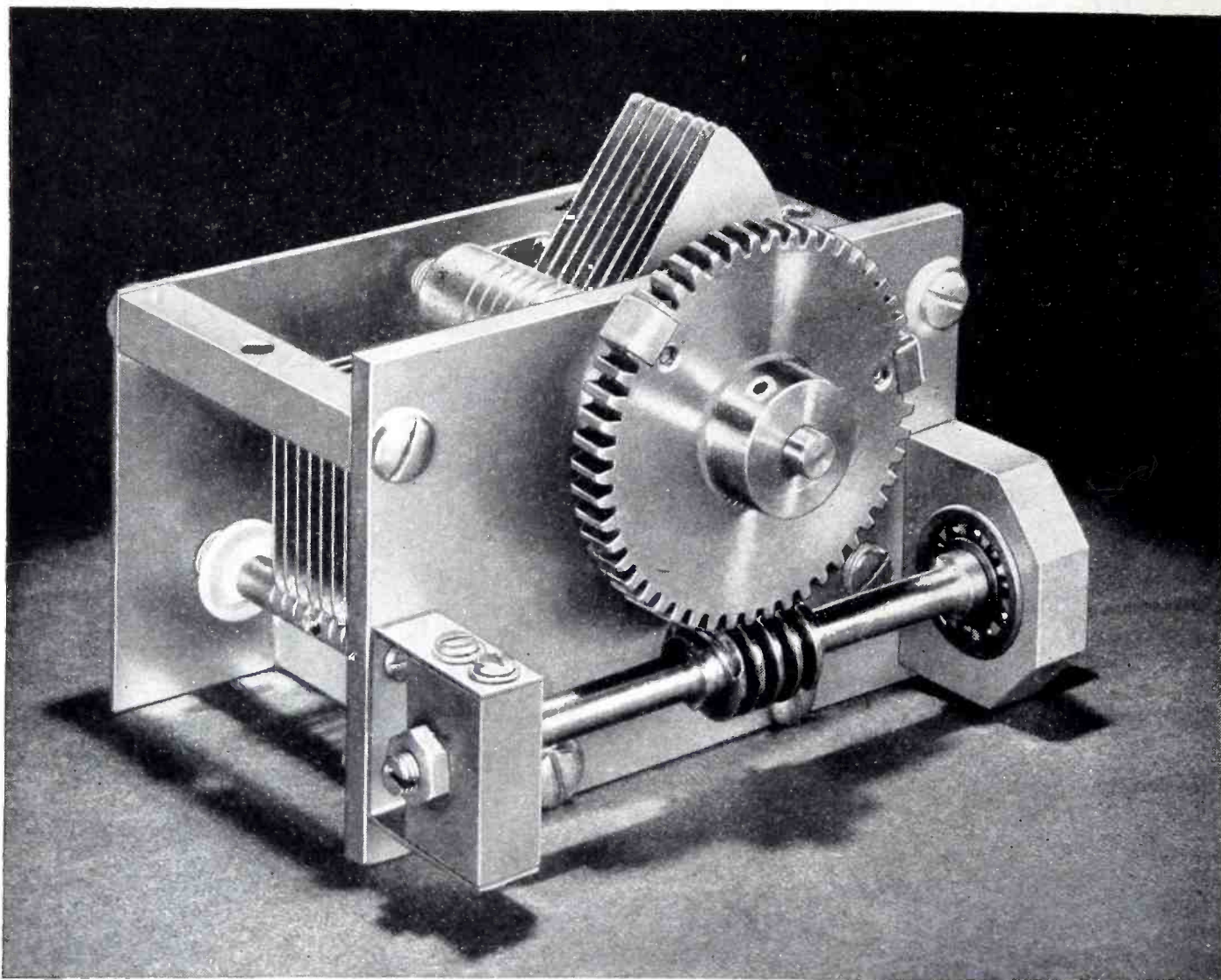

High-stability Variable Condensers

DAY AFTER DAY intricate military radio equipment responds to the layman's touch . . . a transmission frequency is chosen on a moment's notice — a crank is turned — hairlines blend into one—a command is given, and victory is one step nearer. "Resetability" is an important feature of all Hammarlund variable condensers.

THE HAMMARLUND MANUFACTURING CO., INC.
460 West 34th Street, New York, N. Y.



HAMMARLUND

BLUEPRINTS OF SAFETY



BRINGING 'EM BACK... ALIVE!

Smash the objectives—then high-tail for home—that's the job of our Bomber Command . . . And because the use of quartz crystals, in radio transmitting equipment is the only way to insure the stability of prearranged frequencies, so vital in guiding pilots there and back, the A. A. C. method of manufacturing them is of particular importance. . . Among other rigid specifications, our "Blueprints of Safety" demand, that A. A. C. Crystals be ground to—.0001 of an inch tolerance. P. S.: Check our interesting story on deliveries!

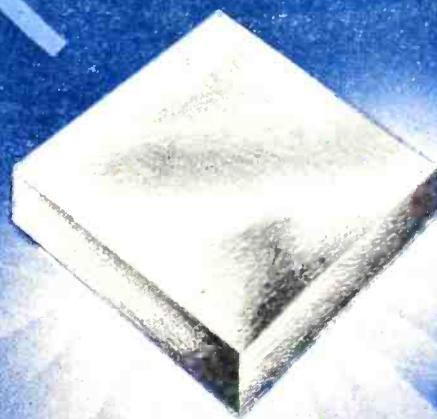

ELECTRONICS DIVISION



AIRCRAFT ACCESSORIES CORPORATION

MANUFACTURERS OF
PRECISION AIRCRAFT EQUIPMENT
HYDRAULICS ELECTRONICS

BURBANK, CALIF. • KANSAS CITY, KANS. • NEW YORK, N. Y. • CABLE ADDRESS: AACPRO

Ralph E. Walker PRES.

Drilling Diamonds for Victory

DRAWING of fine wire for delicate precision instruments depends on the accuracy with which the diamond dies are made. Philips manufacture these dies down to .0008 of an inch with diamond drilling machines developed by Philips engineers.

This operation—as well as the actual drawing of the wire—calls for extreme precision and exemplifies the wide technical knowledge and skill behind all Philips products.

Today, the research and experience of the North American Philips Company in electronics are devoted to the single aim of aiding the United Nations war effort. Tomorrow, this knowledge will aid industry in creating a new world for free men.

Products For Victory include Cathode Ray Tubes; Amplifier Tubes; Rectifier Tubes; Transmitting Tubes; Electronic Test Equipment; Oscillator Plates; Tungsten and Molybdenum in powder, rod, wire and sheet form; Tungsten Alloys; Fine Wire of all drawable metals: bare, plated and enameled; Diamond Dies; X-Ray Apparatus for industrial, research and medical applications.



NORTH AMERICAN PHILIPS COMPANY, INC.

Electronic Research and Development

Factories in Dobbs Ferry, N. Y.; Mount Vernon, N. Y. (Philips Metalix Corp.); Lewiston, Maine (Elmet Division)

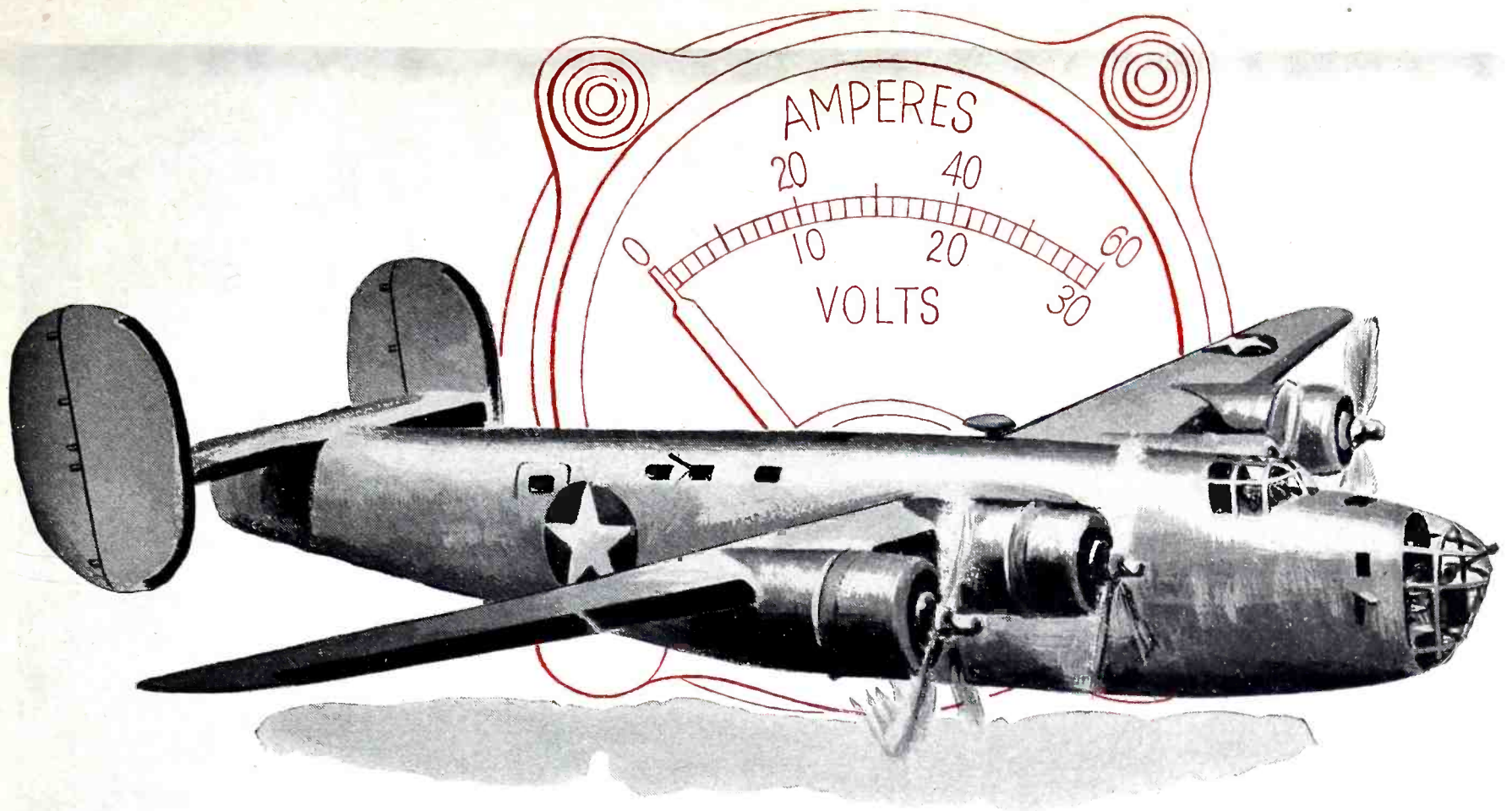

HELPING "DEALERS IN DEATH" *save lives*

When the accuracy of instruments means Victory . . . or death . . . instruments must be precision-built for battle duty. Today, in ships . . . planes . . . tanks, the accurate, positive calibration of Westinghouse instruments is guiding our warriors into battle . . . and out . . . in spite of searing heat, congealing cold or shock of bursting shells.

THE PIVOT PROTECTS THE ACCURACY

One reason for this dependable accuracy is the tough hard pivots used in all Westinghouse instruments. Made by a special process, they resist blunting . . . protect careful calibrations. Every manufacturing step is carefully controlled.

Honing pressure is precisely regulated . . . pivots are tumbled to relieve stress and set grain structure . . . a 500-to-1 contour enlargement of each point is carefully inspected . . . photomicroscopic studies and hardness tests check uniformity.

Casting "shadows" of Victories to come . . . these details are of prime importance today. For, on them, human lives depend. The skills and abilities we are now directing to war work, will, in peacetime, enable us to supply you with electrical instruments finer than ever before. Westinghouse Electric & Manufacturing Company, East Pittsburgh, Pennsylvania, Department 7-N. J-40339

THIS IS A WAR OF INSTRUMENTS

Westinghouse INSTRUMENTS

PLANTS IN 25 CITIES... OFFICES EVERYWHERE

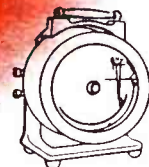
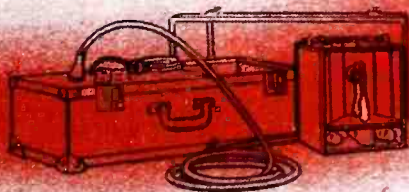

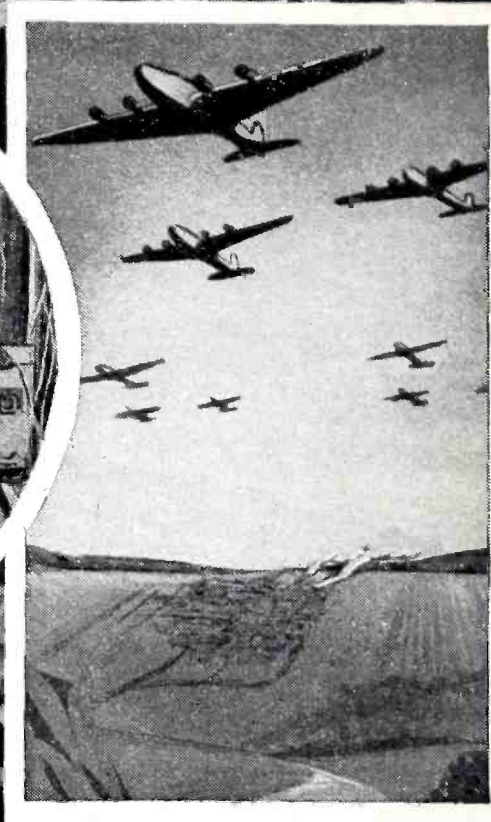
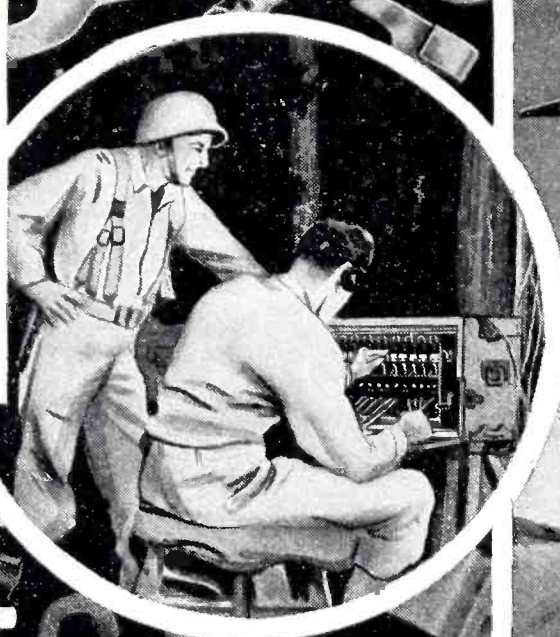
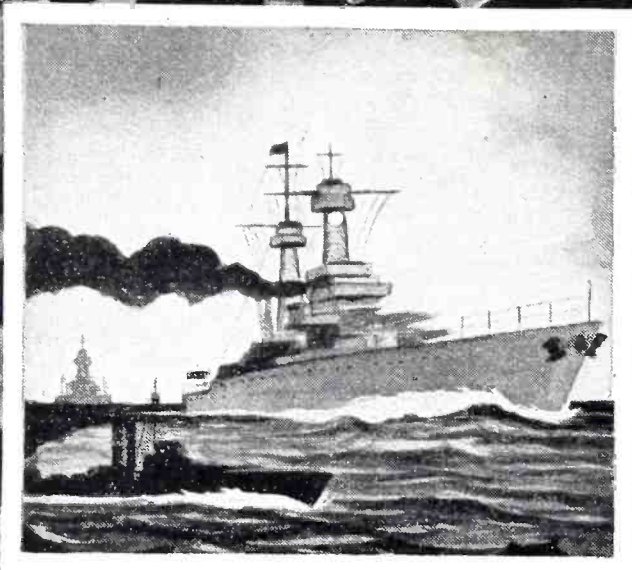

**On Sea -
Land -
and Air -**

**Stewart
is "there"**

**TERMINALS, LUGS,
BRACKETS, CLIPS**

**AUTOMATIC WIRE FORMING
AND METAL STAMPING**

Odd Shaped Pieces Stamped
and Formed from Wire
or Strip on High Speed
Machines.

Hundreds of items in stock
to meet practically every
installation requirement.

Complete Hot Tinning and
Plating facilities for handling
large orders.

Send for samples and quo-
tations. Let us have your
prints and specifications.

QUICK RESPONSE TO INQUIRIES!

**STEWART STAMPING
COMPANY**

621 East 216th Street
New York

TERMINALS
by **STEWART**

Built to Highest Precision Standards

Reliability ★ **BUILT IN** ★ for The Nerve Centers of Air Lines

The dependability of Wilcox equipment has been proved in use by leading air lines. Today, the entire output of Wilcox factories goes to military needs. Wilcox was chosen to help win the war by "building in" reliability for vital communications. When the war is over, Wilcox facilities will be ready to keep pace with a greater air-borne world.



Wilcox Installations. Photo, courtesy American Airlines

There **MUST** Be Dependable Communications

Communication Receivers
Aircraft Radio
Airline Radio Equipment
Transmitting Equipment



**WILCOX ELECTRIC
COMPANY**

Quality Manufacturing of Radio Equipment

14th & Chestnut

Kansas City, Missouri

"LET'S TRY IT *Electronically*"

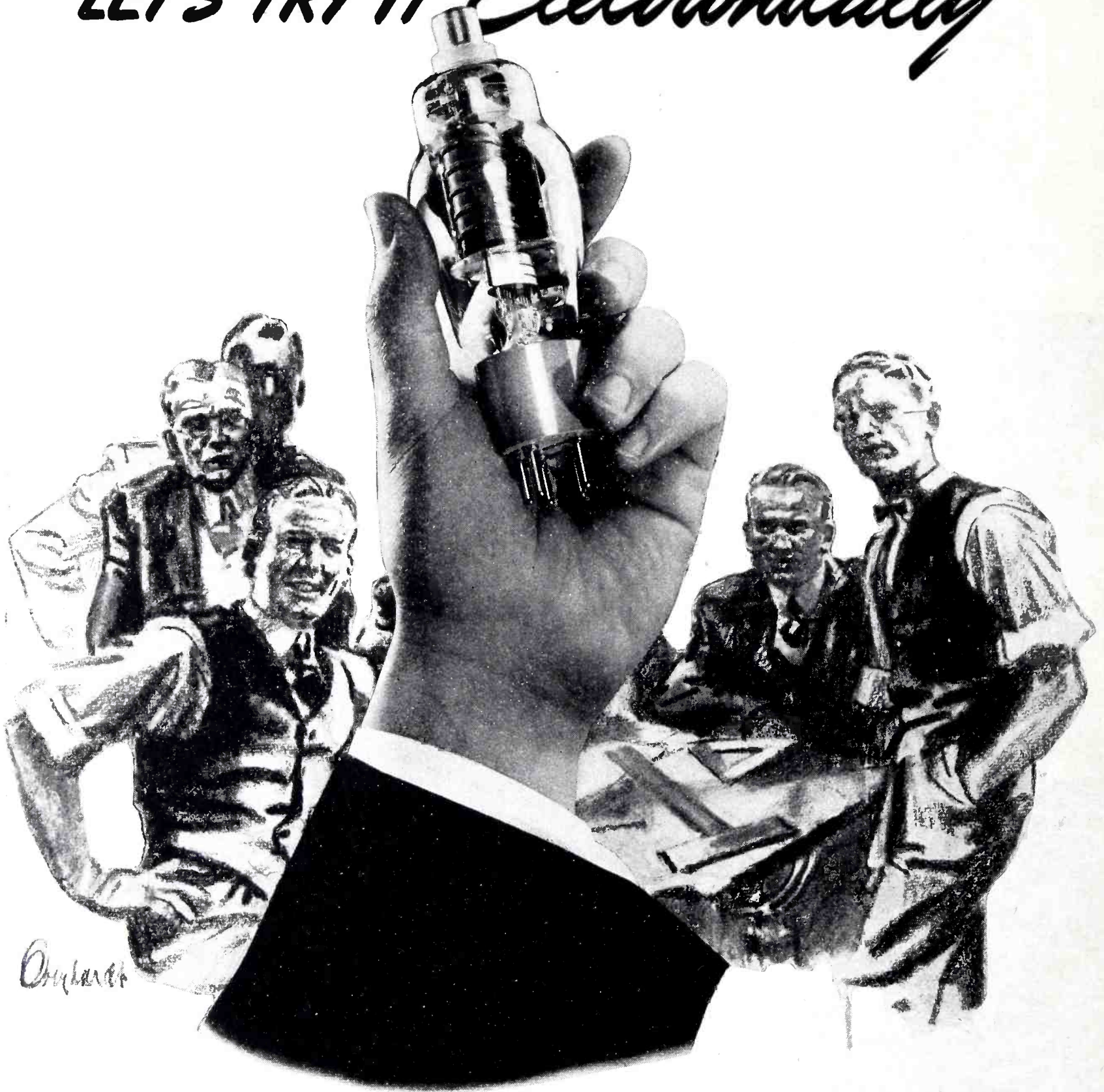

It is surprising how frequently electronics are mentioned when new products are being planned.

Those who are in a position to see the accomplishments of electronics in the war, can appreciate how this science is bound to affect our post-war world. The added flexibility and scope that electronics impart to many products gives them new and wider horizons. Today no product planning is complete without consideration of electronics.

Here at TUNG-SOL we see our post-war job as adapting to peacetime uses the many transmitting, receiving and amplifying tubes developed for war.

The services of our staff of research engineers are at the disposal of manufacturers who intend to employ electronics. When you want to "Try it electronically" TUNG-SOL is ready to help you.

TUNG-SOL
vibration-tested
RADIO TUBES

TUNG-SOL LAMP WORKS INC., NEWARK, N. J., Sales Offices: ATLANTA, CHICAGO, DALLAS, DENVER, DETROIT, LOS ANGELES, NEW YORK
ALSO MANUFACTURERS OF MINIATURE INCANDESCENT LAMPS, ALL-GLASS SEALED BEAM HEADLIGHT LAMPS AND THERMAL SWITCHES

**HERE IS THE INSULATION
TO MEET ALL YOUR NEEDS**

TURBO

... offering specifically-designed types with the flexibility and qualities to meet dielectric and physical requirements for present and post-war applications. Whether you design or manufacture machines, apparatus, equipment or accessories, the new advantages now available in TURBO will effect even greater efficiencies. The complete TURBO line includes Mica Plate and Products, Varnished Cambric, Tapes, Cloths and Composites.

Varnished Glass Tubing

Resistant to extremely high heat, is perfectly suited for heavy duty operating conditions, confined areas where ventilation is at a minimum, and other similar applications.



Flexible Varnished Oil Tubing

Resistant to deteriorating influences and meeting the diversity of requirements essential to withstand general breakdowns, moisture absorption, acids, alkalis, etc.



Extruded Plastic Tubing

Incorporating the most advanced developments of the plastic art as applied to electrical insulation. Especially applicable to conditions wherein embrittlement from the effects of sub-zero temperatures must be met.



Wire Identification Markers

To meet rigid ordnance specifications, are available in any size, length or color, with any marking. Made of standard TURBO tubing, thereby conserving the use of critical materials such as rubber, metal, vinylite, etc. Non-projecting, snug-fitting.



Specimen boards, with representative samples of Varnished Tubing, and a list of standard sizes, will be sent promptly on request; write today.

WILLIAM BRAND & CO.



276 FOURTH AVENUE, NEW YORK, N. Y. • 325 W. HURON STREET, CHICAGO, ILL.

TAYLOR TUBES



Efficiency in Action...

As always, Taylor is building the finest tubes possible to produce. Every Taylor Tube is designed and engineered to deliver maximum service under strenuous battle conditions. Unfailing, "on the air" performance is their keynote—extra power for vital communications is their heritage. You can rely on Taylor Tubes "More Watts Per Dollar" service in any situation.

Taylor HEAVY **CUSTOM BUILT** DUTY *Tubes*

TAYLOR TUBES INC., 2312-18 WABANSIA AVE., CHICAGO, ILLINOIS

**AMERICAN MEN and AMERICAN SHIPS
are equal to any occasion...**

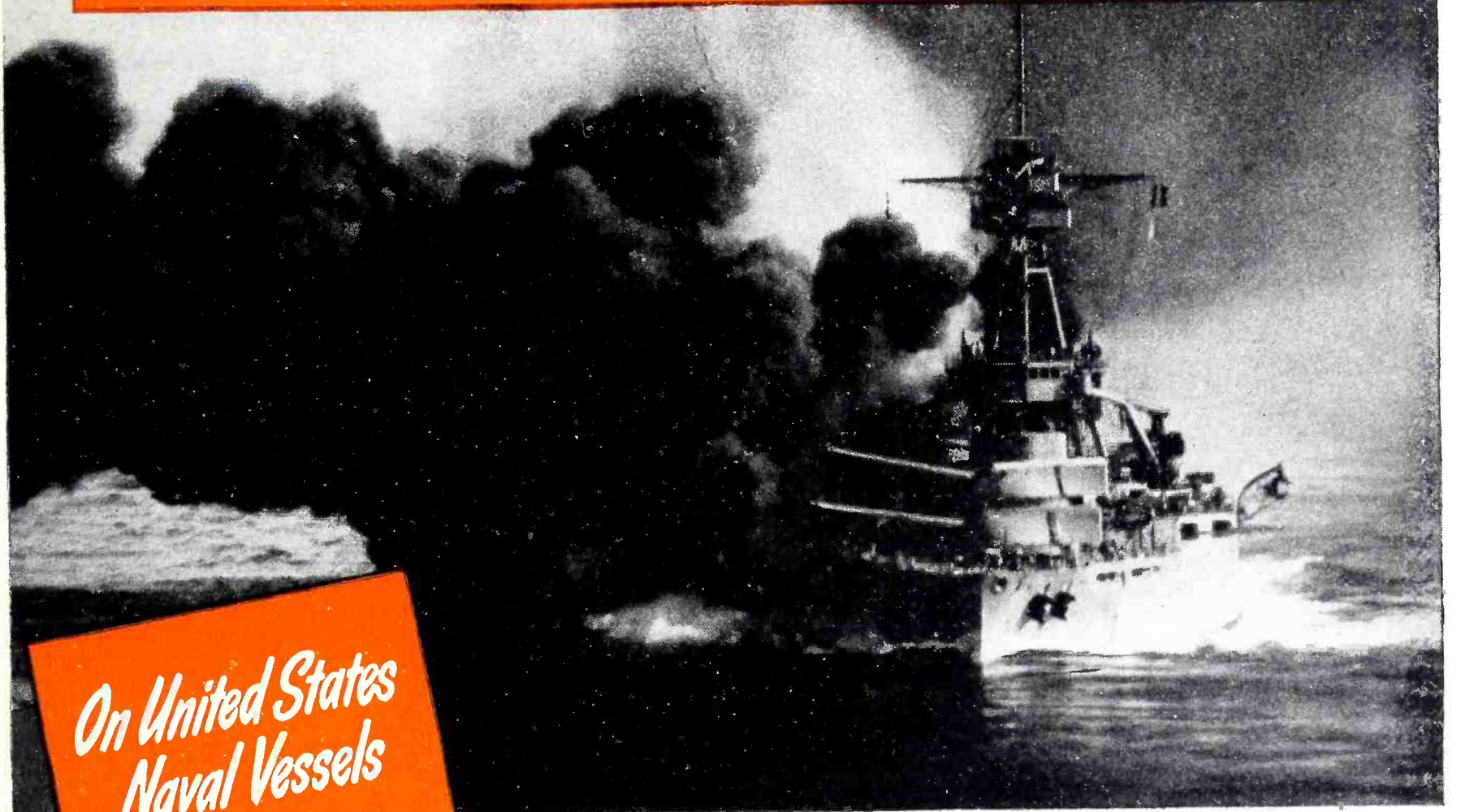

OFFICIAL U. S. NAVY PHOTO

*On United States
Naval Vessels*

AmerTran Transform-
ers, Reactors and
Rectifiers are used
in Radar, fire control,
searchlight control,
communications and
other applications.

IN THE beginning the enemy had a field day. But it's the end of a war that determines the victor.

Already, the United States Navy has proven that it is master of the best the Axis can produce. That goes for personnel, for ships and for equipment.

Take Radar, for example. Only a nation of the greatest inventiveness and highest technical development could

have produced the quality of Radar equipment that helped to smash the Jap at Midway, Coral Sea and elsewhere.

We contemplate the future of the war and of our Country with complete confidence. Our Armed Forces, assisted by American technical knowledge and industry, will win in the end.

AMERICAN
TRANSFORMER COMPANY
178 EMMET STREET, NEWARK, N. J.



**PIONEER MANUFACTURER OF
TRANSFORMERS, REACTORS AND RECTIFIERS
FOR ELECTRONICS AND POWER TRANSMISSION**

ELECTRONICS — July 1943

AMERTRAN

MANUFACTURING SINCE 1901 AT NEWARK, N. J.

MADE IN U.S.A.
ELECTRONICS
UNITED COMPANY

SO MUCH... FOR SO MANY.

**THEY PUT
THEMSELVES
IN THEIR WORK**

Look at a United Tube! Where you see a filament, we see faces... faces of United employees. Men and women of United are putting not only their skilled hands, but their very selves into their product.

BY SO FEW

UNITED Tubes for the United Nations are pouring out in a ceaseless stream touching every shore of this warring world. So *much* material of victory for so *many* . . . from the hands of so *few*!

Almost before the echoes of Pearl Harbor died away, United had swung 100% of its labor and facilities into production of transmitting tubes of Army and Navy specifications. And tubes of some

of the first Radar and other devices used to protect our ships and shores came from the hurrying hands of United employees.

United men and women number hundreds, not thousands. Yet in terms of production per employee, as well as overall company output, United has achieved a record which we believe is unique in the nation.

HERE IS THAT RECORD:

Relative production, May 1943, compared with average monthly output in 1941 & 1942

Production per employee, May 1943, compared with average month, 1941 & 1942

Production per sq. ft. of space, May 1943, compared with average month in 1941 & 1942

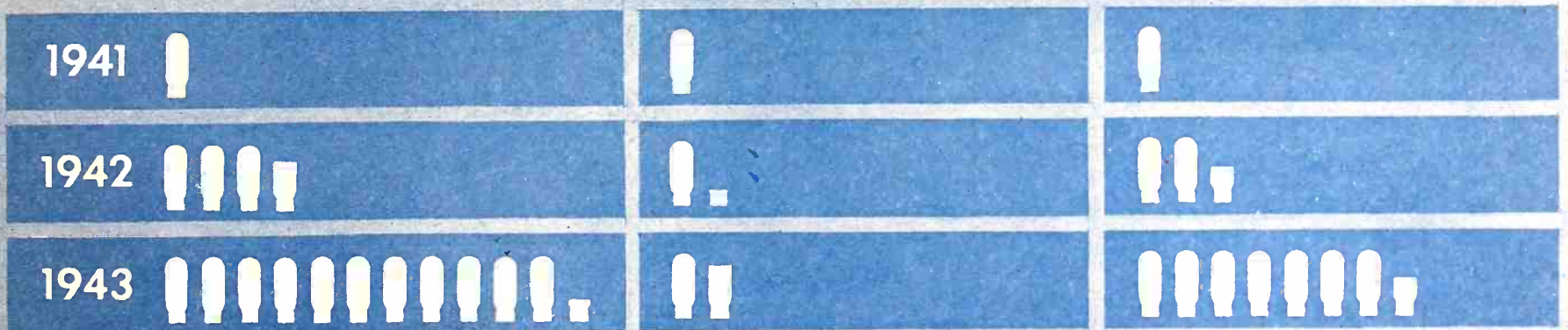

Significantly, this achievement has added meaning because it is superimposed on an already established, high normal output. Moreover, United production volume has been accompanied by parallel progress in the development of new, improved and special types of electronic tubes. At the same time, United ingenuity has made important contributions to efficiency by effecting

substitutes for many scarce, critical materials.

In grateful acknowledgment of a job well done, the management of this company salutes its heroes and heroines of the production front. These men and women are rendering truly distinguished service in the defense and freedom of our country. We know our country will share this glow of pardonable pride.

UNITED

ELECTRONICS
NEWARK



COMPANY
NEW JERSEY

ERIE *Insulated* CERAMICONS

REG. U.S. PAT. OFF.

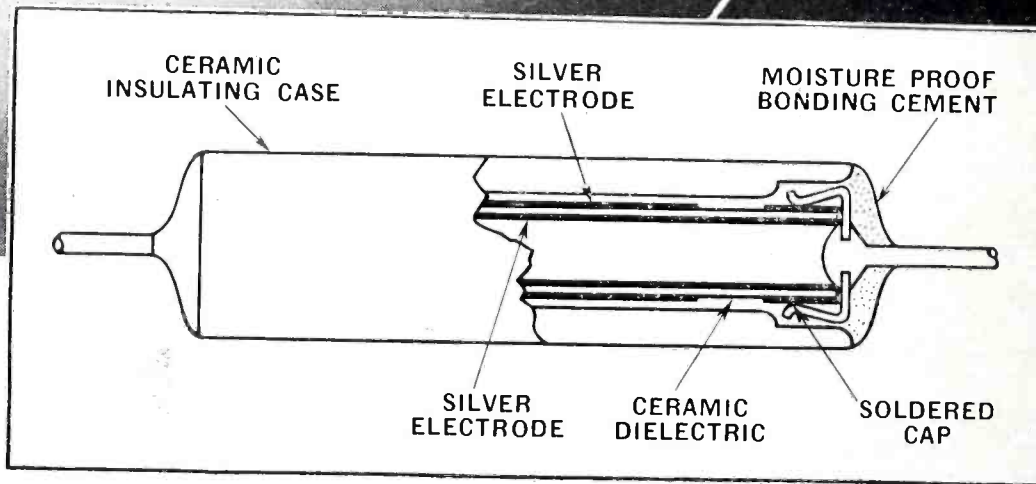
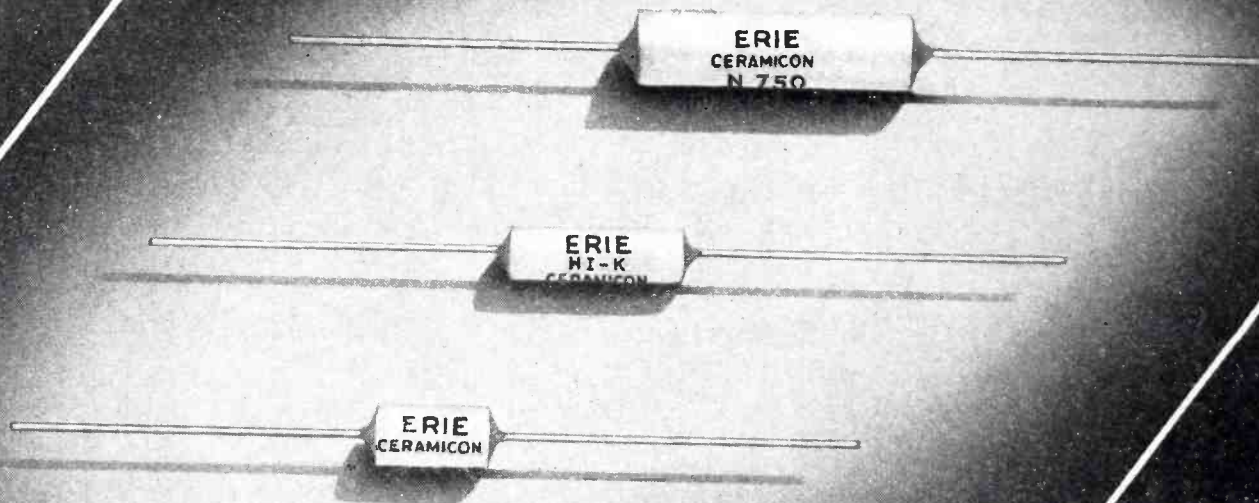

for

MODERN ELECTRONIC DESIGNS . . .

THE modern trend toward more compact electronic assemblies necessitates the use of *insulated* components. Fully appreciating the inherent advantages of insulated components, we have concentrated on the production of Insulated Ceramicons, since we first introduced ceramic condensers in this country nearly seven years ago.

Details of construction are shown in cross sectional drawing above. The ceramic case is sealed with a resin-bonded cement and unit is vacuum-impregnated with a specially developed wax. These units possess greater mechanical strength, provide better protection against humidity, a more direct and uniform electrical path, and can be located anywhere in the chassis regardless of proximity of other components.

Erie Insulated Ceramicons are made in nine temperature coefficients ranging from +100 parts per million per °C to -750 parts per million per °C, and in capacities up to 375 mmf in the latter temperature coefficient. Erie "Hi-K" Ceramicons are made in insulated styles up to 5,000 mmf. Where choice of capacitors lies within these ranges, the use of Insulated Ceramicons is advantageous.

For greater protection and better design, specify Erie Insulated Ceramicons when available capacities meet your requirements.

For complete information covering operating characteristics of Erie Insulated Ceramicons write for data sheet.

ERIE RESISTOR CORP., ERIE, PA. LONDON, ENGLAND · TORONTO, CANADA.

FLEXIBLE but UNFAILING CIRCUIT PROTECTION

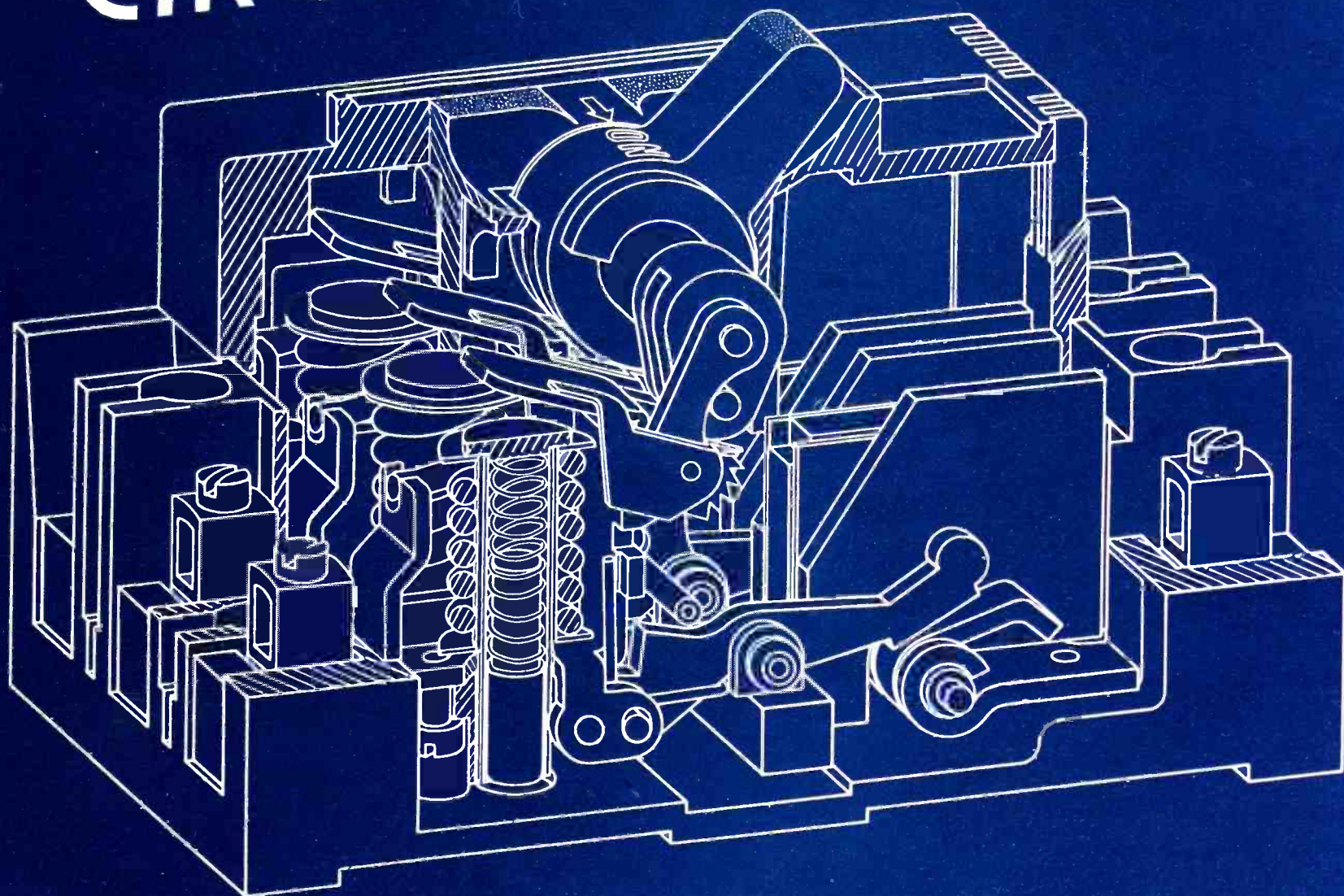

HEINEMANN

MAGNETIC CIRCUIT BREAKERS

Drawing shows cross section of time delay type breaker, designed to prevent nuisance trips on transient overloads and starting surges, while opening rapidly on sustaining and heavy overloads and instantaneously on short circuits. Same breaker can be made without the time delay arrangement as straight instantaneous trip type. Magnetic blowout provides high and fast interrupting capacity.

HEINEMANN CIRCUIT BREAKER CO.

Subsidiary of Heinemann Electric Co., Est. 1888

TRENTON

•

NEW JERSEY

DESIGNERS — here is a **NEW CHART** that gives you at a glance data on four essential **NON-metallics**.



USE CONTINENTAL-DIAMOND

LABORATORY RESEARCH and MANUFACTURING EXPERIENCE

To Help You Adapt C-D Non-Metallics to Your Design and Production Problems

- to **STRENGTHEN**
- LIGHTEN WEIGHT**
- ABSORB VIBRATION**
- PREVENT CORROSION**
- INCREASE EFFICIENCY**
- SPEED UP PRODUCTION**
- INSULATE ELECTRICALLY**

C-D laboratory research is not a product of the present emergency — this service was established and used extensively by our customers as early as 1914—today it offers you a wealth of experience gained in solving thousands of material problems. Use it as though it were a division of your own company.

HOW TO USE THIS CHART

C-D products are indicated

D for Dilecto . . . **M** for Micabond
F for Vulcanized Fibre . . . **V** for Vulcoid
THEY ARE ARRANGED FROM UPPER LEFT TO LOWER RIGHT in order of their suitability for problems involving two known requirements . . .

PRIMARY REQUIREMENT ↓	SECONDARY REQUIREMENT →	DIELECTRIC STRENGTH	POWER FACTOR	DIELECTRIC LOSS FACTOR	DIELECTRIC CONSTANT	ARC RESISTANCE	FLEXURAL STRENGTH	TENSILE STRENGTH	COM-PRESSIVE STRENGTH	HEAT RESISTANCE	DIMEN-SIONAL STABILITY	MOISTURE RESISTANCE	OIL RESISTANCE	CHEMICAL RESISTANCE
DIELECTRIC STRENGTH		D M V F	M D V F	M D V F	M D V F	F V M D	D V F M	D F V M	D V F M	M D V F	D V M F	D V M F	D V M F	D V M F
POWER FACTOR		M D V F	M D V F	M D V F	M D V F	M V D F	M F V D	M F V D	M V D F	M D V F	M V D F	M D V F	M D V F	M D V F
DIELECTRIC LOSS FACTOR		M D V F	M D V F	M D V F	M D V F	F V M D	F V M D	F V M D	F V M D	M D V F	M D V F	M D V F	M D V F	M D V F
DIELECTRIC CONSTANT		M D V F	M D V F	M D V F	M D V F	M V D F	M V D F	M V D F	M V D F	M D V F	M D V F	M D V F	M D V F	M D V F
ARC RESISTANCE		F V M D	F V M D	F V M D	F V M D	F V M D	F V M D	F V M D	F V M D	M D V F	M D V F	M D V F	M D V F	M D V F
FLEXURAL STRENGTH		V F M D	V F M D	V F M D	V F M D	V F M D	V F M D	V F M D	V F M D	M D V F	M D V F	M D V F	M D V F	M D V F
TENSILE STRENGTH		V F M D	V F M D	V F M D	V F M D	V F M D	V F M D	V F M D	V F M D	M D V F	M D V F	M D V F	M D V F	M D V F

Continental = Diamond FIBRE COMPANY

"Manufacturers of Laminated Plastics Since 1911" — NEWARK • DELAWARE

ANCE		F	F		V D F M
DIMEN-SIONAL STABILITY		D V M F	D V M F	D V M F	D V M F
MOISTURE RESISTANCE		D V M F	D V M F	D V M F	D V M F
OIL RESISTANCE		D V M F	D V M F	D V M F	D V M F
CHEMICAL		D V M F	D V M F	D V M F	D V M F

C-D, No. 12 Chapel Street, Newark, Delaware
Send me the 20" x 26" wall chart on C-D non-metallic materials and the booklet "What Material?"

NAME

COMPANY

ADDRESS



REMEMBER THE "SOUTHERN CROSS"?

CAPTAIN Charles J. Kingsford-Smith on the morning of May 31, 1928, lifted the *Southern Cross* off the runway of the Oakland Airport and headed home for Australia. Eight days later his tri-motored Fokker monoplane landed at Brisbane after a three-legged trans-Pacific hop of 7362 miles.

"This trip," according to the *New International Year Book*, "was notable for the accuracy of the navigation and the fact that the radio operator was constantly in communication with either shore stations or ships throughout the flight."

The transmitter then aboard the *Southern Cross*, and now on display in the Smithsonian Institute, was designed by Ralph M. Heintz, co-founder of Heintz and Kaufman, Ltd. Its signal on 33.1 to 33.5 meters never faltered during the 83 hours and 19 minutes of flying.

The experience gained by Heintz and Kaufman, Ltd. while pioneering memorable events in radio history is reflected in the Gammatron tubes today serving the military, naval and air arms of the United Nations. The efficiency of modern Gammatrons at high frequencies, their long operating life and high stability, spring from 17 years of continuous and often brilliant research and development by Heintz and Kaufman engineers.

HEINTZ AND KAUFMAN, LTD.

SOUTH SAN FRANCISCO • CALIFORNIA, U. S. A.



HK-454

GAMMATRON TUBES . . . The grids and plates in Gammatron tubes are made of tantalum, a unique metal which eliminates the need for unstable getters, and protects Gammatrons from the release of gas even when heavily overloaded. Other Gammatron advantages: low driving power, easy neutralization, freedom from parasitics, and high efficiency at radio and very high frequencies.

LEADERS IN ELECTRONICS YESTERDAY, TODAY AND TOMORROW

Like a phone in your car?



After the war..



... the two-way radiotelephone will be employed by American industry as a convenience, a safeguard and a business requirement. This modern method of communication has many proven applications in the following fields:

Aviation	Railroading
Marine	Public Utilities
Police Patrol	Fire Fighting
Trucking	Engineering
	Mining

If you think you may be able to employ two-way radiotelephone communication in your field, we would be pleased to discuss your problem without cost or obligation. We have nothing to sell since our entire output has been placed at the disposal of the United Nations all over the world!

Requests for information and literature from responsible parties may be addressed to Jefferson-Travis Radio Manufacturing Corporation, 380 Second Avenue, New York.

THE development and production of two-way radiotelephone equipment for military purposes is convincing evidence that you will employ this unique form of communication in many undreamed-of ways after the war. Long before Pearl Harbor, Jefferson-Travis was making superior two-way radiotelephone equipment for ship-to-shore and plane-to-ground communication. With Victory, it will again be used for these and a great many other peacetime purposes by all nations in Tomorrow's World!



JEFFERSON-TRAVIS

RADIOTELEPHONE EQUIPMENT

NEW YORK • WASHINGTON • BOSTON

July 1943 — ELECTRONICS



FORMICA

FLYING THEM HOME THROUGH THE WORLD'S WORST WEATHER



BOMBER crews and fighter pilots' chances of "flying them home" are limited if pulleys fail and jam the controls.

Formica control pulleys and cable fairleads are preferred parts because of their high strength to weight ratio, and ability to reduce cable wear.

Formica control pulleys are the result of good engineering and progressive production methods.

Other aircraft parts made of Formica are instrument panels, ignition breaker arms, radio coil forms, sub panels and tube bases, antenna insulators, propeller blades, guide blocks and vibration frequency change collars.

THE FORMICA INSULATION CO., 4661 SPRING GROVE AVE., CINCINNATI, O.

the *unusual* in Springs is *not unusual* at Muehlhausen

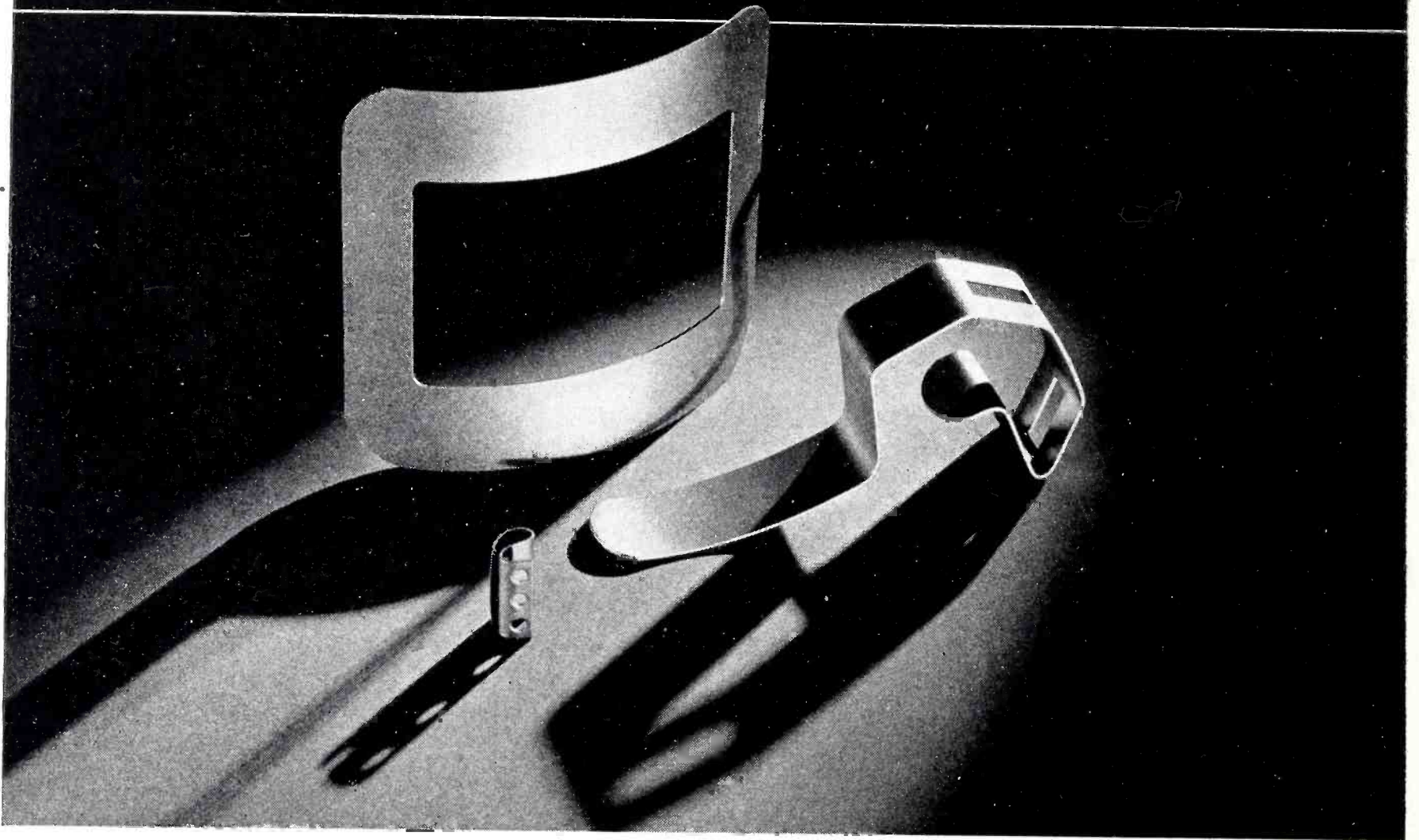

★ Muehlhausen has provided the answers to many challenging spring problems—provided them at a speed in keeping with war-time demands. Unusual spring requirements have been successfully met with unusual spring designs—made possible by this company's widely varied experience, plus engineer-

ing skill and extensive production facilities.

Springs of every shape and size, in quantities large and small, are part of everyday production. Muehlhausen craftsmen are able to produce the correct spring for every requirement—whether a tiny compression spring that will be flexed a hundred times

a minute; or a large, hot-formed spring that must withstand extreme operating temperatures.

This ability of Muehlhausen to design and fabricate unusual springs has permitted greater latitude in designing war products now, and will enable engineers to plan, with greater freedom, the products of tomorrow.

MUEHLHAUSEN SPRING CORPORATION
Division of Standard Steel Spring Company
760 Michigan Avenue, Logansport, Indiana



SEND FOR TWO NEW FOLDERS—FREE

New Die Spring Bulletin illustrates, describes 206 sizes and types of die springs.

New Armament Bulletin shows importance of springs for many types of war equipment.

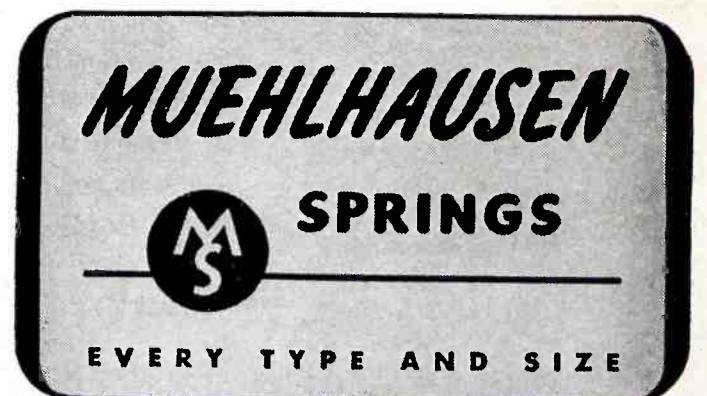

Dependable

DUNCO MERCURY RELAYS

NON-WELDING, DIRT-FREE CONTACTS

Dunco Mercury-Contact Relays have established enviable standards of performance on applications where high inrush loads, such as on lamps and motors, must be controlled, or for use where dust and fumes might foul ordinary contacts.

Rugged, heat-proof glass tubes keep the mercury in perfect condition, guarding it against fouling from contact with metal parts. On the Dunco Lami-

nated Clapper Type Relays (Series 91), these tubes tilt over a wide angle, assuring positive contact without the need for any unusual mounting precautions. Dunco Mercury Swing Types (Series 22) require level mountings. These units have the advantage of making noiseless contact, and being lower in price.

Other Dunco Relay-Timer Types

30 ampere—Sensitive—Instrument Controlled—Low Voltage, Heavy Current, D.C.—Mechanical Latch-in (Electrical Reset)—Telephone Auxiliary—Lamp Controlling—Polarized—Overload—Timing—Industrial Control and Power Transfer—Sequence, Ratchet Type—Motor Reversing, and many others.

Write for the New Dunco Catalog and Relay Data Book.

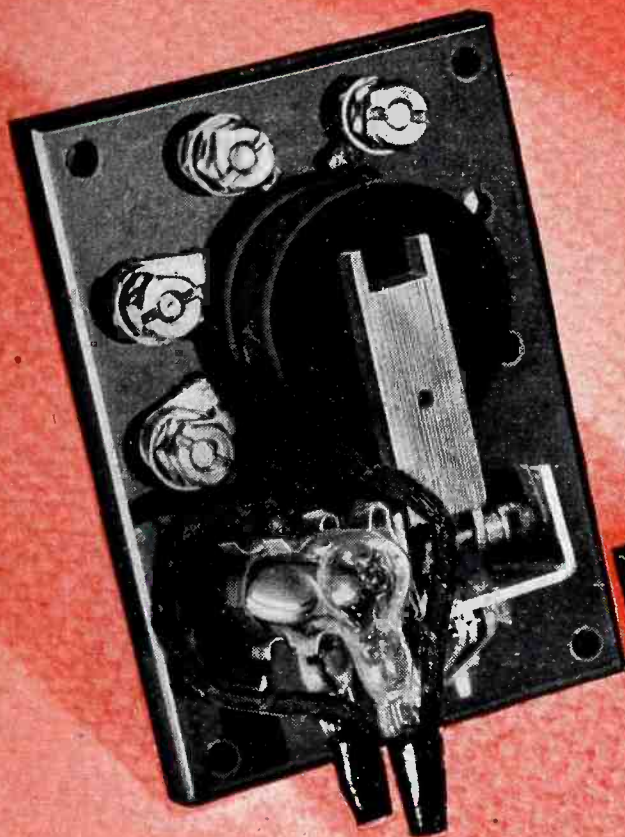

91AXX39

91BXX39

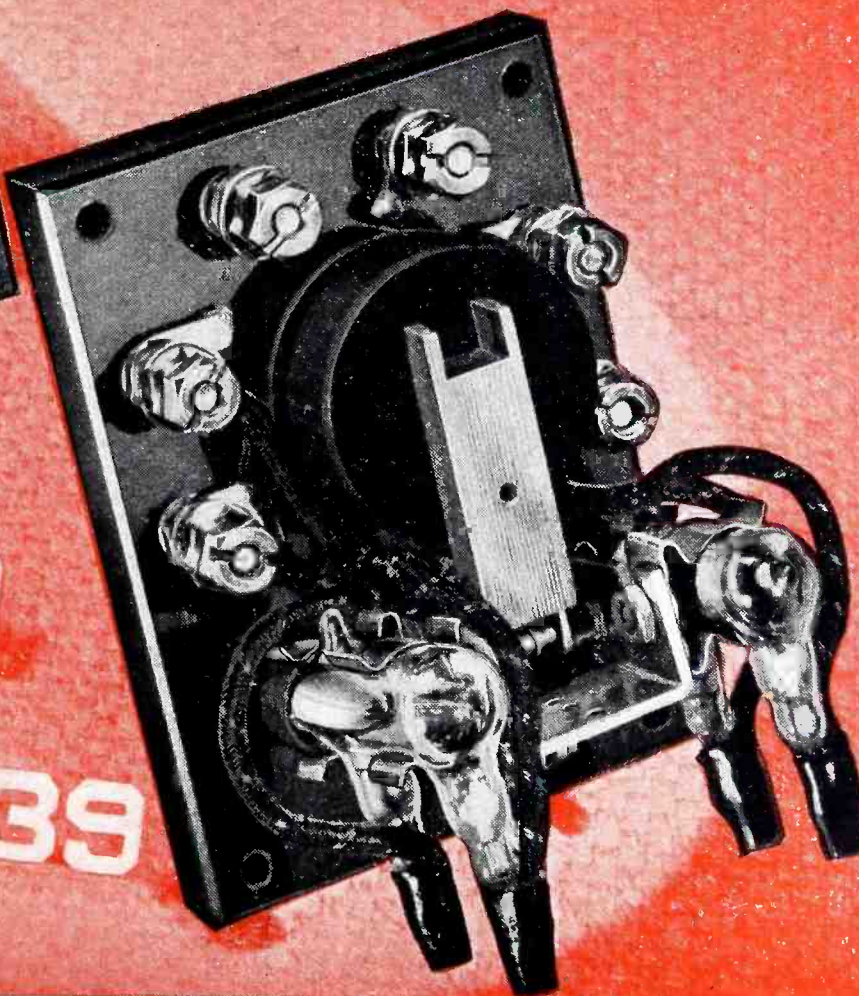

STRUTHERS DUNN, Inc.

1321 ARCH STREET

PHILADELPHIA, PA.

LET DUNCO DISTRICT ENGINEERS IN 28 STRATEGICALLY LOCATED CENTERS HELP SOLVE YOUR RELAY PROBLEMS

ELECTRONICS — July 1943

JAMES

Crystals

KNIGHTS

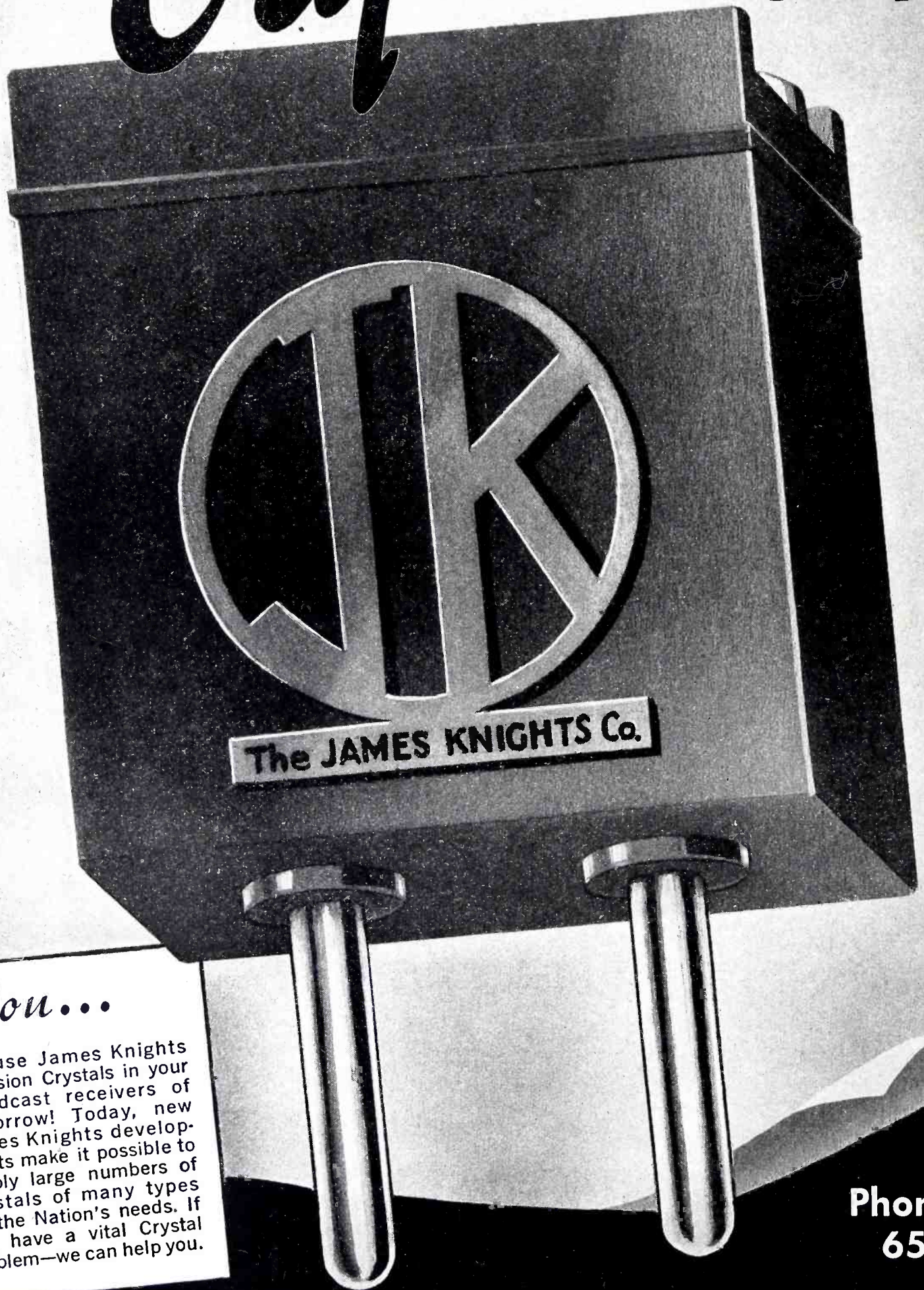

You...

will use James Knights Precision Crystals in your broadcast receivers of tomorrow! Today, new James Knights developments make it possible to supply large numbers of Crystals of many types for the Nation's needs. If you have a vital Crystal problem—we can help you.

**Phone
65**

**PRECISION CUTTERS OF QUARTZ
FOR RADIO AND OPTICAL USES**

**The JAMES KNIGHTS Co.
SANDWICH, ILLINOIS**



**960 CONTACTS PER SECOND
PERFECTLY SYNCHRONIZED**

**1/4 WATT OR 1,000 WATTS  VIBRATOR CONVERTERS
give higher efficiency . . . require no service**

The vibrator is the most efficient means yet developed for changing DC current to AC.

This is an inherent characteristic of the vibrator, because electrical and mechanical losses as well as wear are negligible. Building on this fundamental, Electronic Laboratories have extended the vibrator's field of usefulness by developing vibrator type power supplies which provide extraordinary adaptability, for all types of current conversion, together with unusual efficiency and service life.

Ingenuity of design and precision of manufacture make possible load capacities up to 1,000 watts in *E·L* Vibrator Power Supplies. The 450-watt capacity, 120-cycle vibrator, illustrated above, for instance, has eight sets of contact points. Each of them must make 120 contacts per second, and each synchronized perfectly with every other contact. Adjusted and locked, that is exactly what they do—for life!

Growing use of *E·L* Vibrator Power Supplies in war equipment—land, sea and air—is evidence of their efficiency and reliability under the most severe operating conditions. Wherever you have a problem of current conversion, *E·L* engineers will be glad to work with you to meet it most effectively, and most economically.

**Only *E·L* VIBRATOR POWER SUPPLIES
Offer All These Advantages:**

1. **CONVERSION**—DC to AC; DC to DC; AC to DC; AC to AC.
2. **CAPACITIES**—Up to 1,000 Watts.
3. **VARIABLE FREQUENCIES**—A power supply may be designed to furnish any frequency from 20 to 280 cycles, or a controlled variable output within a 5% range of the output frequency.
4. **MULTIPLE INPUTS**—For example, one *E·L* Power Supply, in quantity production today, operates from 6, 12, 24, 110 volts DC or 110 volts AC, and 220 volts AC, with a single stable output of 6 volts DC.
5. **MULTIPLE OUTPUTS**—Any number of output voltages may be secured from one power supply to suit individual needs.
6. **WAVE FORMS**—A vibrator power supply can be designed to provide any wave form needed for the equipment to be operated.
7. **FLEXIBLE IN SHAPE, SIZE AND WEIGHT**—The component parts of a vibrator power supply lend themselves to a variety of assembly arrangements which makes them most flexible in meeting space and weight limitations.
8. **HIGHEST EFFICIENCY**—*E·L* Vibrator Power Supplies provide the highest degree of efficiency available in any type power supply.
9. **COMPLETELY RELIABLE**—Use on aircraft, tanks, PT boats, "Walkie-Talkies," jeeps, peeps and other military equipment, under toughest operating conditions has demonstrated that *E·L* units have what it takes!
10. **MINIMUM MAINTENANCE**—There are no brushes, armatures or bearings requiring lubrication or replacement because of wear. The entire unit may be sealed against dust or moisture.

Electronic

LABORATORIES, INC.

***E·L* ELECTRICAL PRODUCTS**—Vibrator Power Supplies for Communications . . . Lighting . . . Electric Motor Operation . . . Electric and Electronic Equipment on Land, Sea or in the Air.

INDIANAPOLIS



ON GUARD AGAINST SABOTAGE!

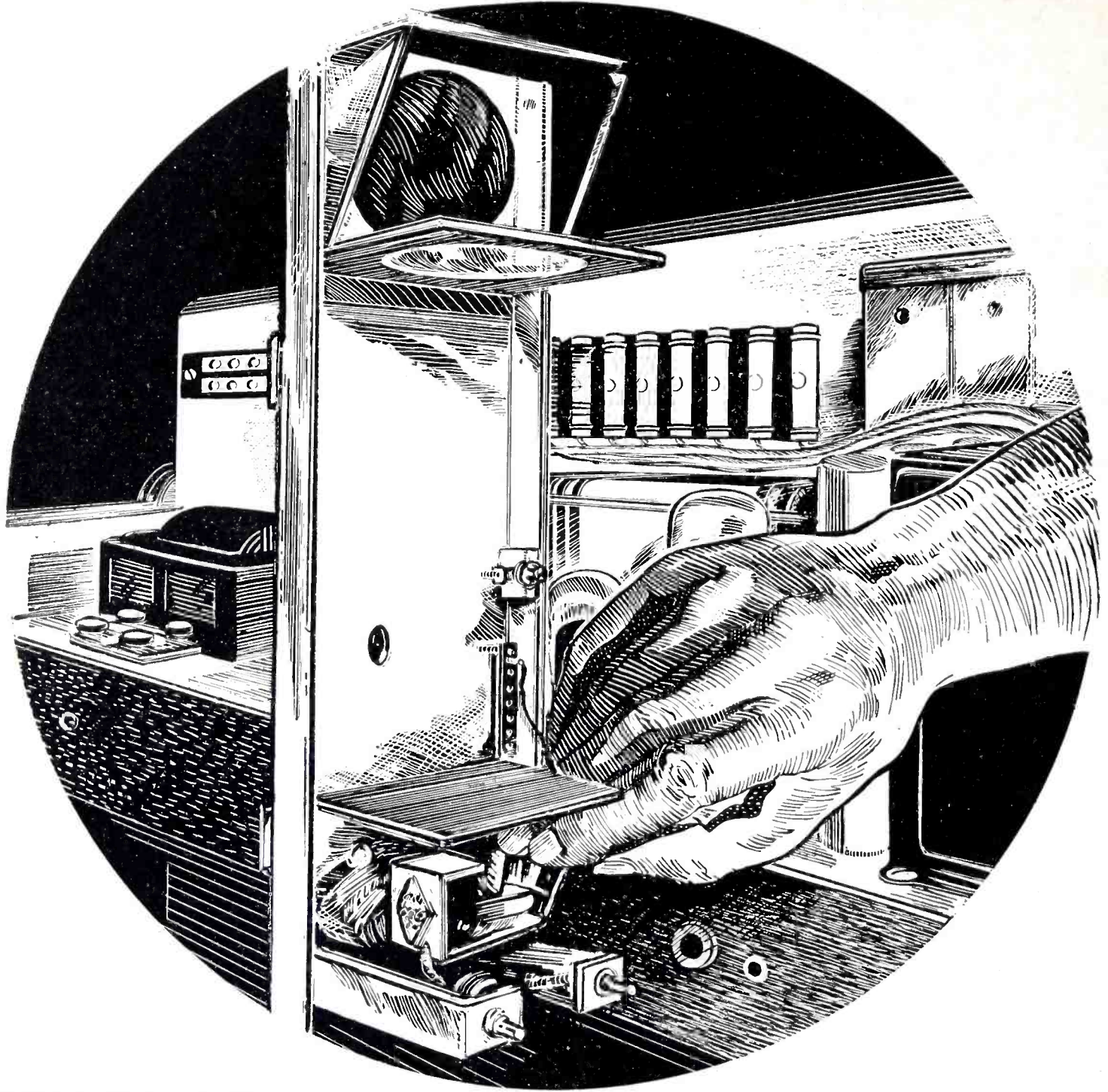

ELECTRONIC TUBES AID PLANT PROTECTION

America's war production plants are carefully guarded . . . night and day electronic tubes guard against intrusion. Units that transmit a virtually invisible light beam are powered by tubes that are constantly on the job . . .

guarding against sabotage! . . . Raytheon's experience during its war time production of tubes for our armed forces will prove an invaluable factor when these new developments can be released for general domestic uses.



Raytheon Manufacturing Company

Waltham and Newton, Massachusetts

DEVOTED TO RESEARCH AND THE MANUFACTURE OF TUBES AND EQUIPMENT FOR THE NEW ERA OF ELECTRONICS

WHAT UTAH PARTS ARE USED HERE?

(ANSWERS AT BOTTOM OF PAGE)

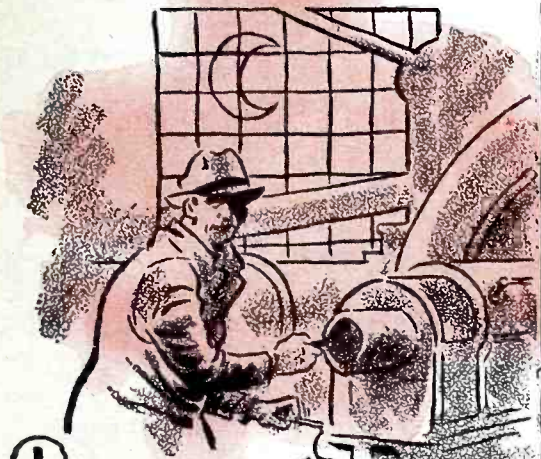

① **ALARM SYSTEMS**
SABOTEURS AND OTHER MARAUDERS ARE STOPPED IN THEIR TRACKS BY INCORRUPTIBLE MECHANICAL GUARDIANS THAT NEVER SLEEP. A UTAH PART HELPS MAKE THEIR NON-FAILING PERFORMANCE POSSIBLE.

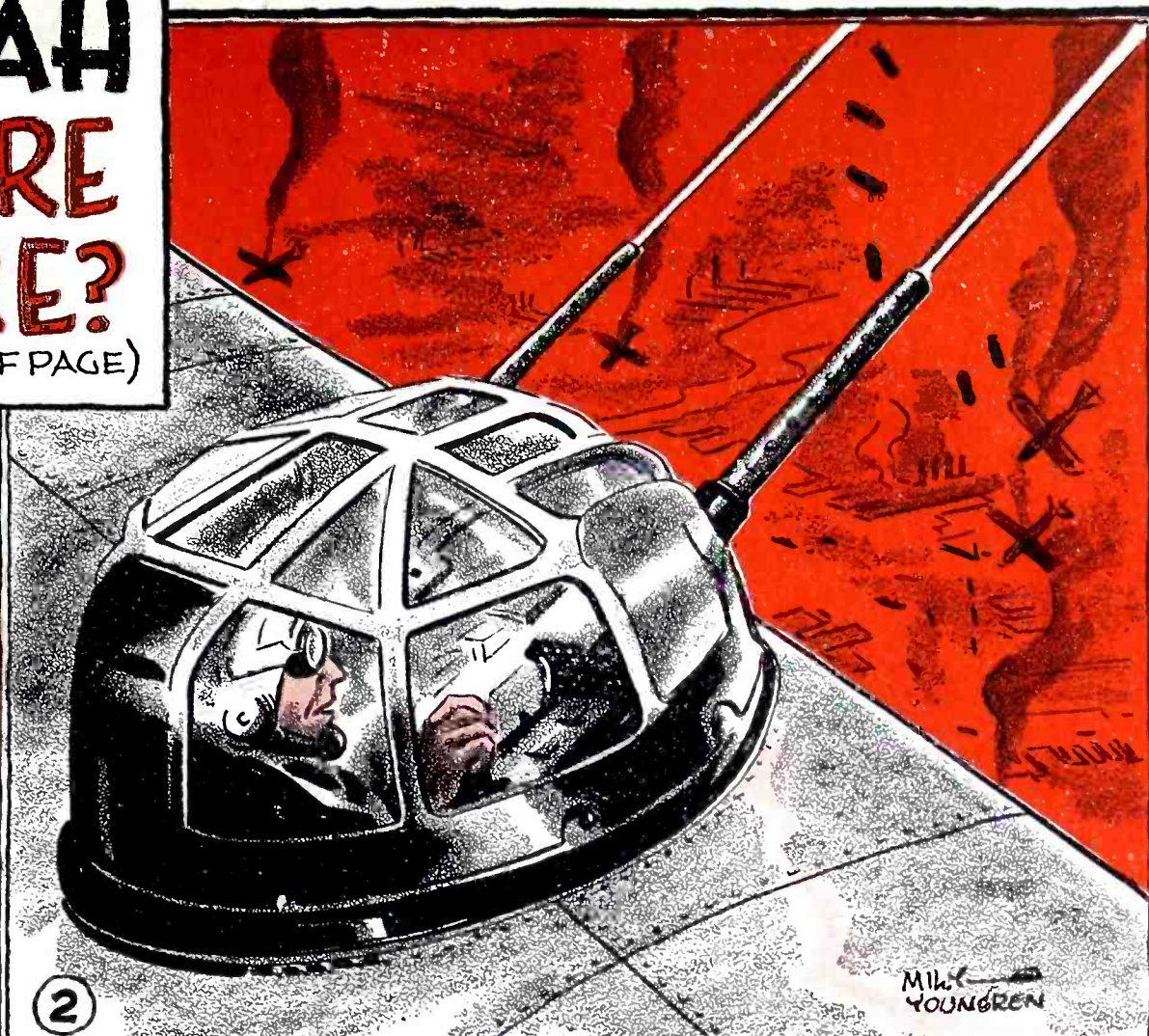

② **POWER-DRIVEN MACHINE GUN AIRCRAFT TURRET**
LIKE THE TWO-GUN MAN OF FRONTIER DAYS, THIS GUNNER HAS HIS WEAPONS READY TO SPIT FIRE IN A SPLIT-SECOND...NO MATTER FROM WHICH DIRECTION THE ENEMY MAY ATTACK. A UTAH PART PLAYS A VITAL ROLE.

Mik Youngren

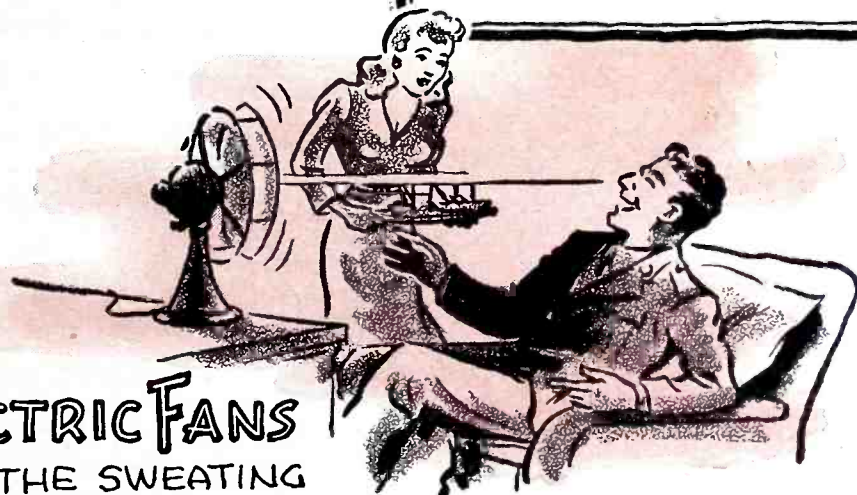

③ **ELECTRIC FANS**
COOL THE SWEATING BROW OF THE WAR WORKER IN HIS HOME... INVIGORATE THE WEARY SOLDIER OFF DUTY. UTAH PARTS PROVIDE DEPENDABILITY AND LONG LIFE.

THESE ARE ONLY A FEW OF THE MANY PRODUCTS NOW USING PARTS MADE BY UTAH. YOUR PRODUCT, TOO, CAN PROBABLY BENEFIT FROM UTAH'S EXTENSIVE EXPERIENCE IN SOLVING WARTIME ELECTRICAL PROBLEMS. UTAH MAKES A WIDE LINE OF PRODUCTS FOR ELECTRICAL AND ELECTRONIC DEVICES. WRITE US TODAY FOR FULL INFORMATION — GET THE FACTS BEHIND UTAH'S PRECISION MANUFACTURING AND ADVANCED ENGINEERING AND SEE HOW THEY CAN BENEFIT YOUR PRODUCT.



UTAH RADIO PRODUCTS COMPANY, 837 Orleans Street, Chicago, Illinois • Canadian Office: 560 King Street, West, Toronto
In Argentine: UCQA RADIO PRODUCTS CO., S. R. L., Buenos Aires • Cable Address: UTARADIO, Chicago

RESISTORS ③ POTENTIOMETERS, RESISTORS, HEADSETS ② RESISTORS, RHEOSTATS ①

AT LAST!

A New Sleeving— Flexible as String and Non-Fraying

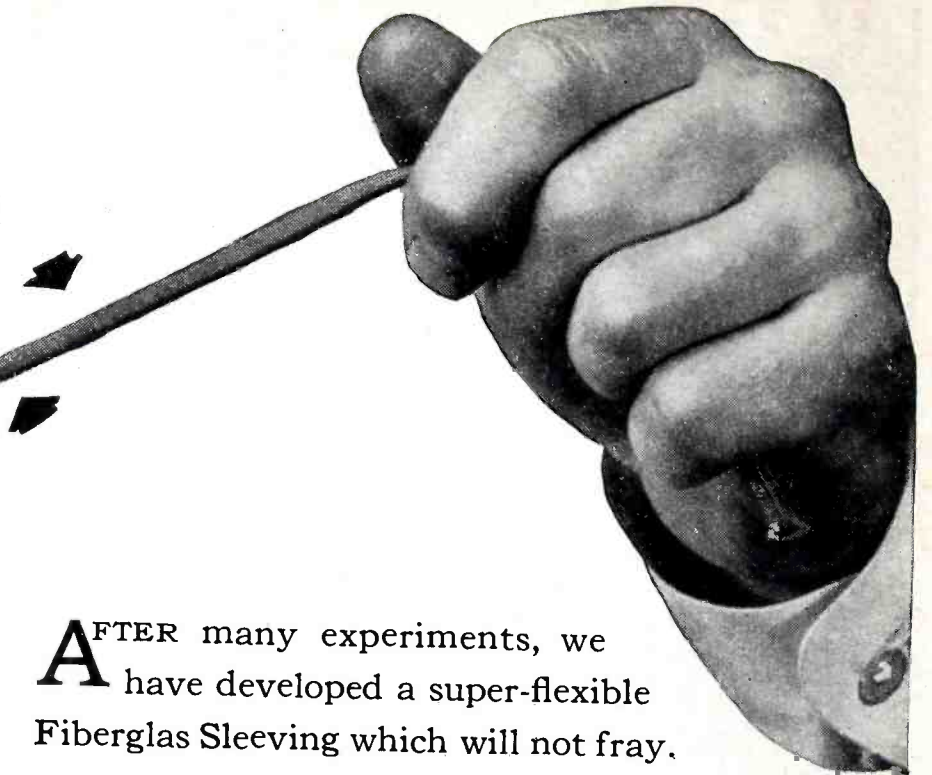

AFTER many experiments, we have developed a super-flexible Fiberglas Sleeving which will not fray.

This sleeving is made by an entirely new, recently-discovered process. Formerly, to prevent excessive fraying, it was necessary to saturate the sleeving, sometimes to a degree where stiffness became objectionable. The new BH Fiberglas Sleeving is as limp and flexible as string—you could tie any kind of a knot with it—yet the severest handling will produce only the merest fuzz at the end.

**NON-FRAYING • FLEXIBLE • HEAT-RESISTANT
NON-INFLAMMABLE • WATER-RESISTANT
NON-CRYSTALLIZING at LOW TEMPERATURES**

The new BH Fiberglas Sleeving is woven from the choicest continuous-filament Fiberglas yarns. It possesses extremely high dielectric strength, is water-resistant and, like all BH Sleeving and Tubing—is non-inflammable.

All sizes, from No. 20 to $\frac{5}{8}$ "', inclusive, are available. Write for samples of this radically new and different sleeving today—in the sizes you desire. Seeing is believing! Bentley, Harris Manufacturing Co., Dept. E, Conshohocken, Pa.

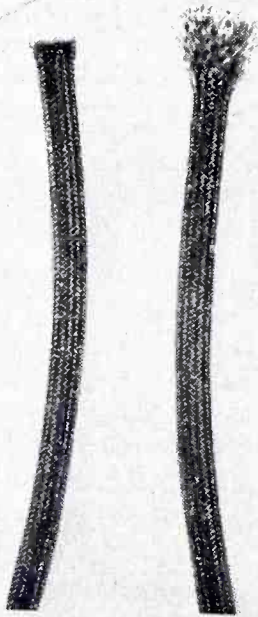

THIS — NOT THIS



**NON-BURNING IMPREGNATED MAGNETO TUBING • NON-BURNING FLEXIBLE
VARNISHED TUBING • SATURATED AND NON-SATURATED SLEEVING**

BENTLEY, HARRIS MANUFACTURING CO.

Conshohocken, Penna.

We're... **"ALL WORK TO WIN THE WAR!"** ENLISTED BEFORE PEARL HARBOR... EVERY DIVISION IN THE "GUTHMAN ARMY"



IN THIS BOMBER IS MORE THAN ONE VITAL GUTHMAN PRODUCT

We can not tell what these important units are, but we are working hard so that these products can keep up essential communications. The pride of being selected for such war time tasks is reflected in the skilled efforts of our 700 employees. Guthman-made radio units are being supplied for tank, plane, and command car transmitters and receivers, and other army and navy signal corps equipment. Housed in our 60,000 square foot building is one of the most modern radio, electrical and chemical laboratories. Our plant is 100% concrete and brick, completely sprinkler-equipped.

Edwin I. Guthman & Co. and our affiliated Lincoln Machine and Tool Corporation were converted to 100% war production prior to Pearl Harbor:
 Tool & Die Division... Machine Division (Production Milling Machines, Lathes, etc.)... Punch Press Division (Presses up to 150 tons)... Automatic Screw Machine Division (OOG-2G B. & S. Machines)... Zinc Shield Can Fabrication and Choke Coil Division... Hegeler Zinc Co.)... RF, IF (Special Molded Paper and Mica) Condenser Division... Trimmer Condensers... Wire Insulation Division (Litzendraht and Textile Covered Magnet Wire)... Electro-Plating and Finishing Division (with completely Modern Mechanical Conveyors and Barrels)... General Assembly Division of Complete Units incorporating the above items such as complete RF Tuning Assemblies, Intercommunication Units, etc.

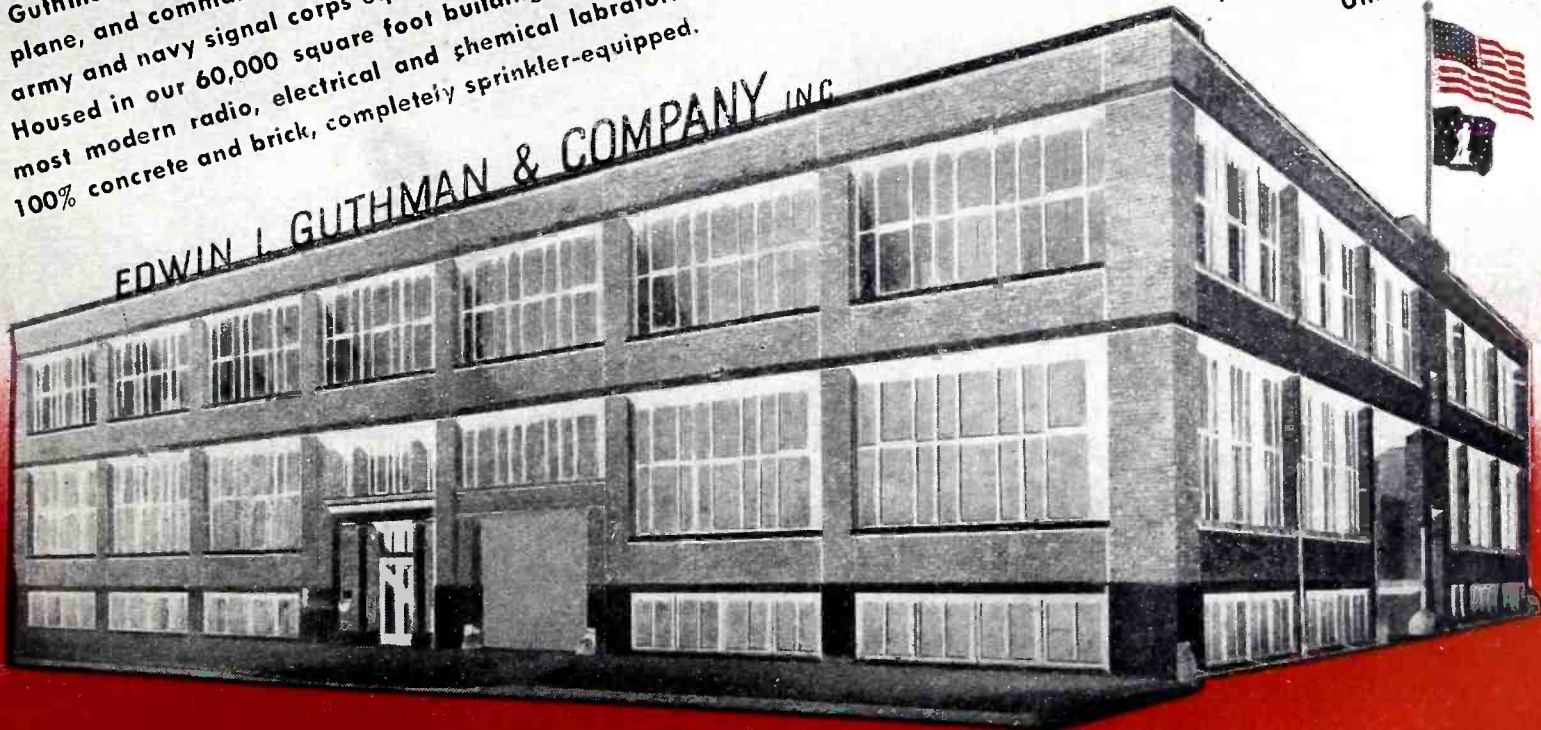

EDWIN I. GUTHMAN & CO., INC.

15 SOUTH THROOP STREET ★ CHICAGO

PRECISION MANUFACTURERS AND ENGINEERS OF RADIO AND ELECTRICAL EQUIPMENT

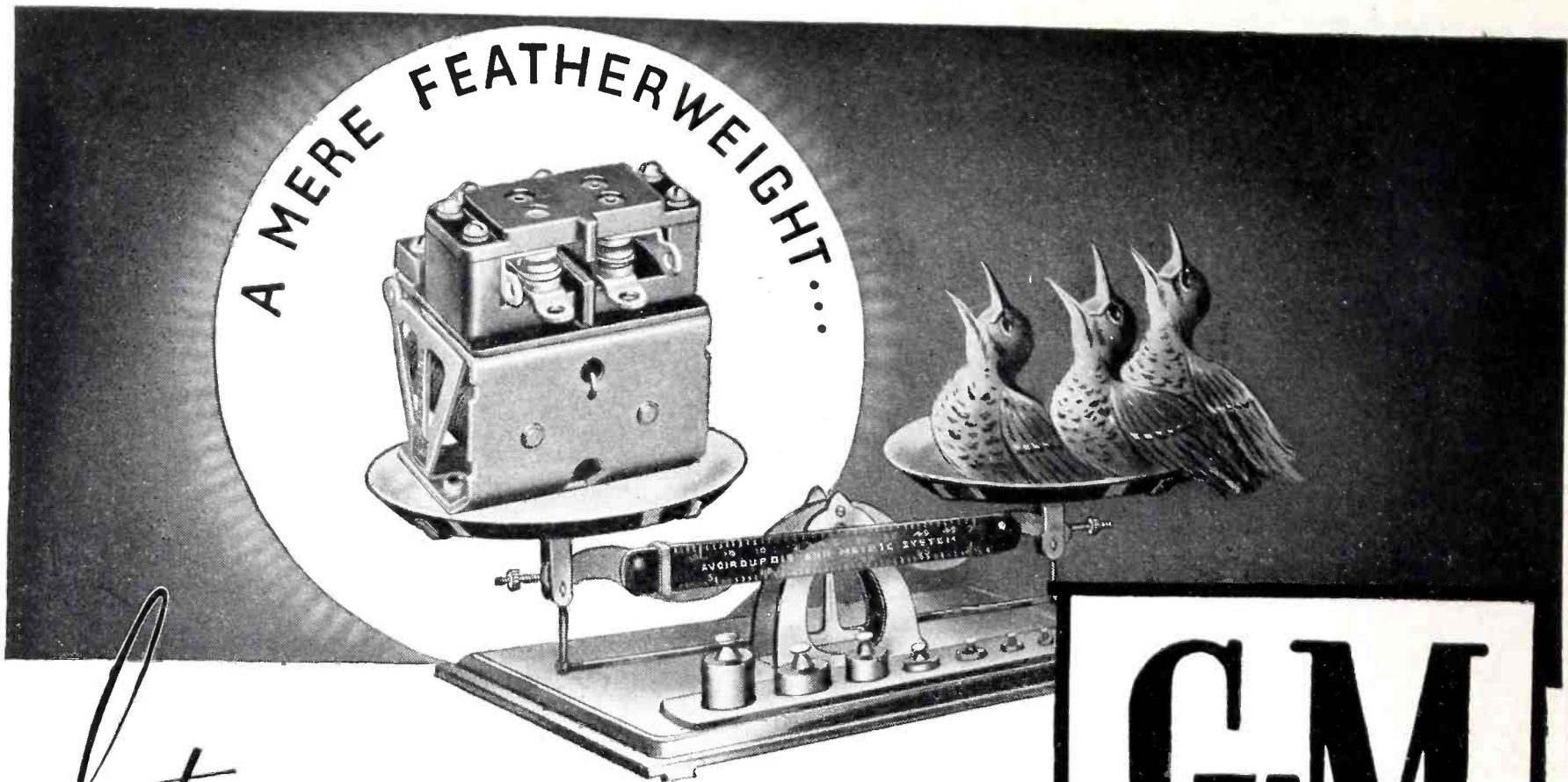

but BUILT TO DO A HERCULEAN JOB

The Type 27 SUPER AIRCRAFT RELAY



Expert design . . . Small size . . . Light Weight . . . yet a powerful Aircraft Relay possessing a number of noteworthy characteristics, which can be varied over a wide range to suit the requirements of different applications.

The box frame construction gives the Type 27 Relay superior strength and sturdiness . . . yet it weighs only 5 ounces. The above illustrated relay is capable of withstanding 15g or more without a tremor . . . has a contact pressure of 60 grams (double make-double break) and a contact capacity of 20 amperes at 30 volts d.c. (100 ampere inrush). The pickup is 6.5 volts (.61 watt) at 20° C. The nominal coil voltage is 12 volts d.c. Coil wattage at 12 volts d.c. is 2.1 watts at 20° C. Temperature range is from -40 to 90° C. Size 1½ x 1⅝ x 1⅞".

Free samples of the above Type 27 Relay (SPDT double make-double break in 2 pole construction) are available to relay users if request is accompanied by a priority of AA-4 or better. Write or wire today requesting relay No. 12723.



VISITRON PHOTOTUBES

are available in quantity in numerous sizes. Made by G-M, pioneer in development and manufacture of quality phototubes.

G-M LABORATORIES INC.

4313 NORTH KNOX AVENUE, CHICAGO, ILLINOIS

Buy WAR BONDS & STAMPS

STARTING TODAY

PAY ^{UP} _{TO} 47% LESS

FOR ELECTRICAL COIL FORMS

1. DO THIS... DESIGN YOUR FORMS WITHIN THESE 7 MONEY- SAVING SPECIFICATIONS

- *1 **OUTSIDE DIAMETERS** between 1 inch and 3 inches.
 - *2 **WALL THICKNESSES** between 5/32 in. and 9/32 in.
 - *3 **LENGTHS** up to 9 inches (with better prices for shorter lengths).
 - *4 **MAXIMUM** of 20 holes for coil forms 1/4 inch and 9/32 inch thick with maximum of 4 holes tapped.
 - *5 **MAXIMUM** of 10 holes for coil forms 5/32 inch to 7/32 inch thick with maximum of 2 holes tapped.
 - *6 **MAXIMUM** of 14 grooves to the inch.
 - *7 **TOLERANCES** on general dimensions $\pm 2.0\%$, but not less than ± 0.010 inches.
- * Proposed A.S.A. Standards.

2. DO THIS... CLIP COUPON TO YOUR BLUEPRINT AND MAIL!



Corning Glass Works
Insulation Division, Dept. E-72, Corning, N. Y.

Please send us estimate on coil forms as per attached blueprint and data below:

Quantity.....

When Needed (date).....

Electrical Characteristics.....

.....

Acceptable Revisions.....

.....

Name.....

Company.....

Street.....

City.....State.....:

Pyrex Insulators

BRAND

"PYREX" is a registered trade-mark and indicates manufacture by Corning Glass Works.

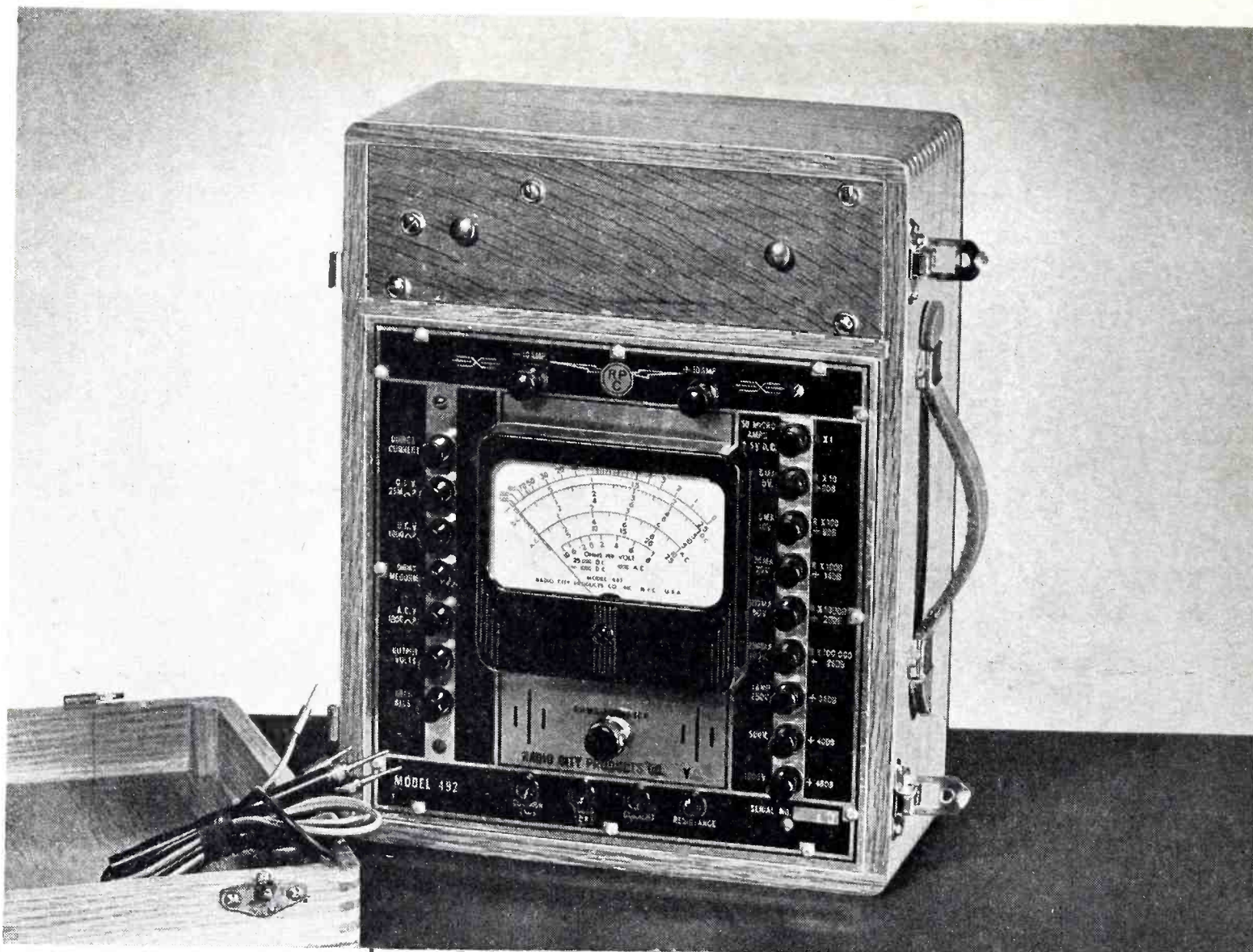

ULTRA-SENSITIVE MULTITESTER

25,000 Ohms per volt • Push-button operated

Designed for the needs of Today, this R. C. P. Model 492 Multitester provides the wide range of measurements and features required for general laboratory use. Its rugged construction and sturdy carrying case also make it an ideal unit for field and shop measurements on military, naval and radar equipment.

OUTSTANDING FEATURES

Dual D. C. sensitivity of 25,000 ohms per volt and 1,000 ohms per volt.

A. C. sensitivity of 1,000 ohms per volt.

All shunts and multipliers are matched and 1% accurate.

Wide-scale 4½" rectangular meter with a movement of 40 microamperes.

Readings as low as 1 microampere can be made.

Push-button operated. Meter circuit automatically opened if two or more buttons are actuated inadvertently.

Over-all dimensions of Model 492: 12½" x 10" x 6¼". Supplied ready to operate, complete with self-contained battery, test leads and a convenient carrying case with removable cover.

RANGES

- D. C. Voltmeter:
0-2.5-5-10-25-50-100-250-500-1,000 volts.
- A. C. Voltmeter:
0-2.5-5-10-25-50-100-250-500-1,000 volts.
- Output Voltmeter:
0-2.5-5-10-25-50-100-250-500-1,000 volts.
- D. C. Microammeter:
0-50-500 microamperes.
- D. C. Milliammeter:
0-5-25-100-250-1,000 milliamperes.
- D. C. Ammeter:
0-10 amperes.
- Ohmmeter:
0-500-5,000-50,000-500,000 ohms, 5-50 megohms.
- Decibel meter:
minus 10 db. to plus 54 db.

RADIO CITY PRODUCTS COMPANY, INC.

127 WEST 26th STREET



NEW YORK CITY

MANUFACTURERS OF PRECISION ELECTRONIC LIMIT BRIDGES—VACUUM TUBE VOLTMETERS—VOLT-OHM-MILLIAMMETERS—SIGNAL GENERATORS—ANALYZER UNITS—TUBE TESTERS—MULTI-TESTERS—OSCILLOSCOPES—AND SPECIAL INSTRUMENTS BUILT TO SPECIFICATIONS

Tools for Machining Aluminum

FOR GENERAL MACHINE SHOP PRACTICE

TOOLS for machining aluminum should generally have more top and side rake than is common for machining steel; the cutting edges should be keen and the tool surfaces should have a smooth, bright finish.

In the following illustrations, a wide range of rake angles is indicated. In general, the larger rake angles are employed for finishing tools and for the aluminum alloys that are not free-cutting; this includes the softer materials which require tools with exceptionally acute and keen cutting edges. On the other hand, rake angles

in the lower range are used for roughing cuts and for machining the alloys that have free-cutting characteristics. Tools similar to those used for machining steel may often be employed successfully.

TOOL MATERIALS—High-carbon steels are good for many jobs where the cutting speed is low. High-speed tool steels are better for quantity production. Cemented-carbide-tipped tools are superior to high-speed tool steels, especially for aluminum alloys with a high silicon content.

CUTTING SPEEDS AND FEEDS—Generally, aluminum can be machined to best advantage by using the highest speed at which the equipment is capable of operating, with moderate feeds and cuts.

CUTTING COMPOUNDS—Use a copious amount of cutting compound. Soda water or soluble oil may be used for milling, drilling, and sawing operations. Mineral oil with the addition of 5 to 10 per cent fatty oil, such as lard oil, is an excellent lubricant. A 50-50 mixture of kerosene and lard oil gives excellent results.

HANG ONE OF THESE CARDS IN YOUR SHOP

LATHE TOOLS



TYPICAL LATHE TOOL AND HOLE

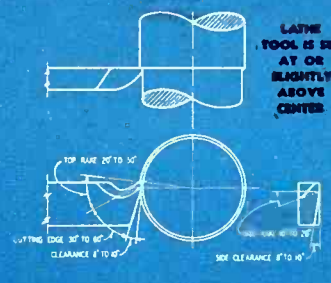

LATHE TOOL IS SET AT OR SLIGHTLY ABOVE CENTER

TOP RAKE 15° TO 30°
CUTTING EDGE 15° TO 30°
SIDE CLEARANCE 8° TO 10°

MILLING CUTTERS

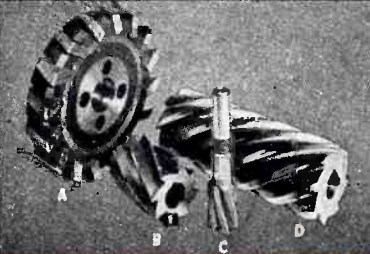

A. Inserted-tooth face milling cutter. B. Spiral nicked-tooth plain milling cutter. C. End mill for milling aluminum. D. Helical milling cutter.

E. The endcut teeth provide "hook." Spiral provides side rake. Coarse teeth provide chip clearance.

DRILLS AND REAMERS

TWIST DRILLS

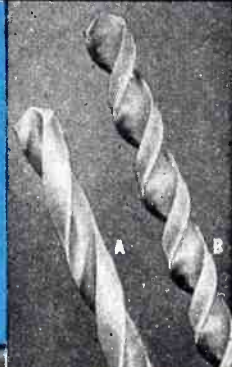

A. Double-fluted standard twist drill, 14° spiral angle.
B. Special double-fluted twist drill, 47° spiral angle.

Either drill may be used, but "B" is better when drilling soft materials.

Large, deep, polished flutes allow cuttings to escape, and ease the strain on the drill.

PLANER TOOLS

PLANNER TOOL FOR ROUGHING CUTS

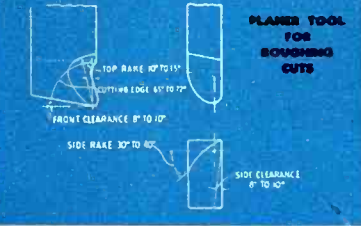

TOP RAKE 40° TO 55°
CUTTING EDGE 45° TO 75°
FRONT CLEARANCE 8° TO 10°
SIDE RAKE 30° TO 40°
SIDE CLEARANCE 8° TO 10°

PLANNER TOOL FOR FINISHING CUTS

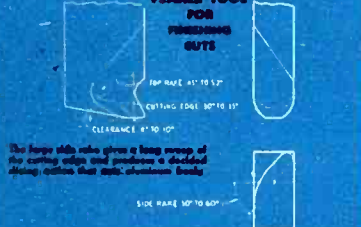

TOP RAKE 45° TO 55°
CUTTING EDGE 50° TO 55°
CLEARANCE 8° TO 10°
SIDE RAKE 30° TO 40°

The large side rake gives a long sweep of the cutting edge and produces a decided chip-curling action that aids aluminum finish.

THREADING TOOLS

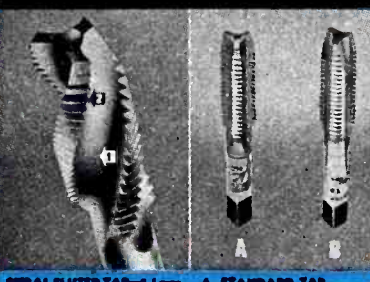

SPIRAL FLUTED TAP—A. Large polished flutes provide easy cut for cutting. B. Undercut flutes provide "hook" to cutting edges.

A. STANDARD TAP. B. SPIRAL-POINTED SCREW THREAD TAP. Note deep flutes.

REAMERS

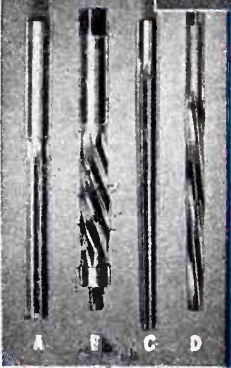

A. Plain, straight-fluted reamer.
B. Spiral-fluted reamer.
C. Straight-fluted taper reamer.
D. Spiral-fluted taper reamer.

FILES

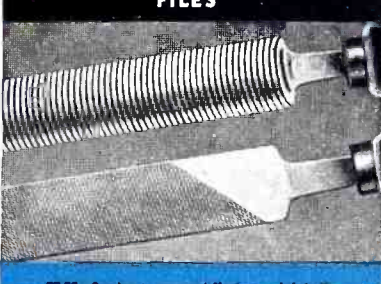

FILES—Double-cut, coarse-tooth file, long-angle file, etc.

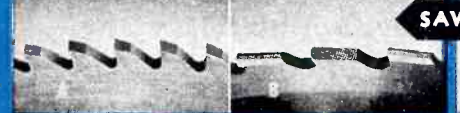

SAWS



A. BROAD-TOOTH TYPE CIRCULAR SAW. B. CHIP-BREAKER TYPE SAW. Either type of saw may be used, but the chip-breaker type cuts better. The top rake or "hook" should be small for hand feeding, but may be quite large, up to about 45°, for positive feed work.

BAND SAWS—Band saws have relatively coarse teeth and should operate at speeds of 2,000 to 3,000 feet per minute. For heavy work, the flexible back type saw blade with hard teeth is preferred.

HACK SAWS—Hack-saw blades with wavy or group-cut teeth are excellent for hand sawing.

ALUMINUM COMPANY OF AMERICA

PITTSBURGH, PENNSYLVANIA

The information printed on this large card (14" x 20") will answer many questions for machine operators, to whom the machining of aluminum is new. Use this coupon to send for a copy or write us on your company letterhead—

ALUMINUM COMPANY OF AMERICA
2136 Gulf Building, Pittsburgh, Pa.

Please send me your wall card on "Tools for Machining Aluminum."

NAME _____ TITLE _____

COMPANY _____

ADDRESS _____

TOWN _____ STATE _____

WEIGHT 2 LBS., CHRISTENED RADIOSONDE

... talks fluently from birth!

This tiny brainchild of meteorologists renders an invaluable service for all its short-lived existence!

Upper air soundings—to determine the pressure, temperature and relative humidity at various altitudes—are obtained by the use of the Radiosonde. It is carried aloft by a free balloon, and radio signals are transmitted to a ground receiving station where the signals are converted into respective readings.

When the balloon bursts—usually in the 20,000 feet vicinity—the instrument is carried down by means of a small parachute. Some thirty-odd stations throughout the U. S. make observations by this method.

This is only one of the innumerable peacetime applications of electronic tubes. With the advent of new advancements in the field of electronics, **ELECTRONIC ENTERPRISES** can be expected to achieve an important position—equal to that now assimilated in war work—in the development and production of these vital units. Inquiries are invited.



ELECTRONIC ENTERPRISES, INC.

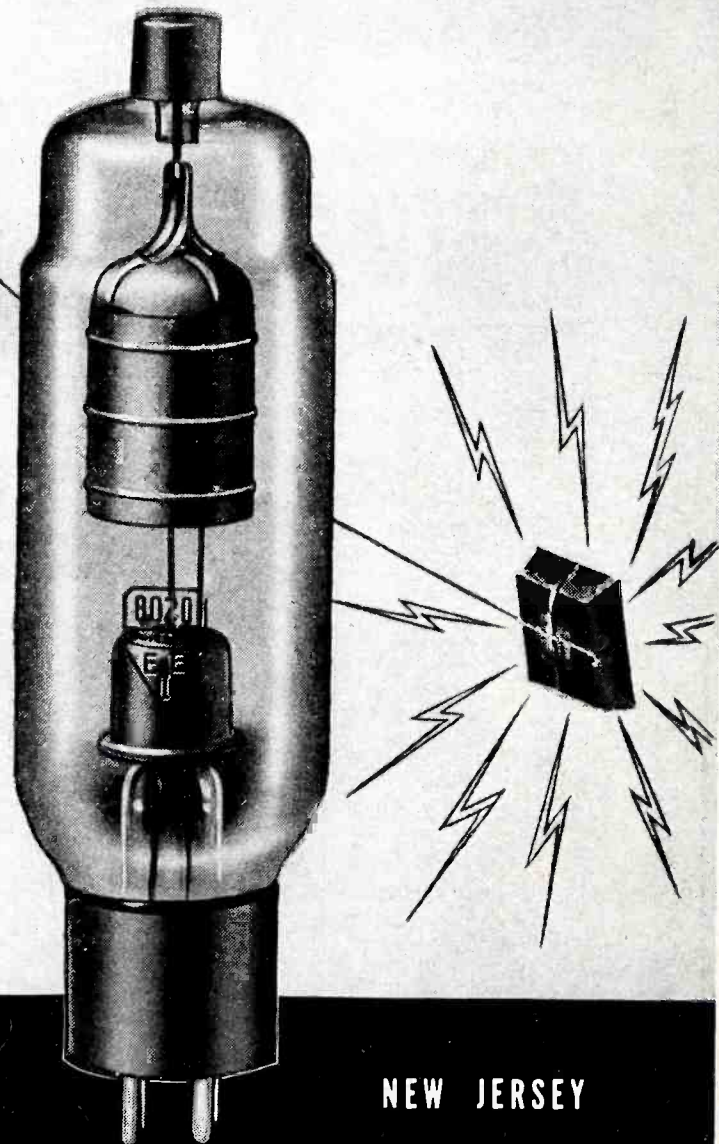

GENERAL OFFICES: 65-67 SEVENTH AVENUE, NEWARK

NEW JERSEY

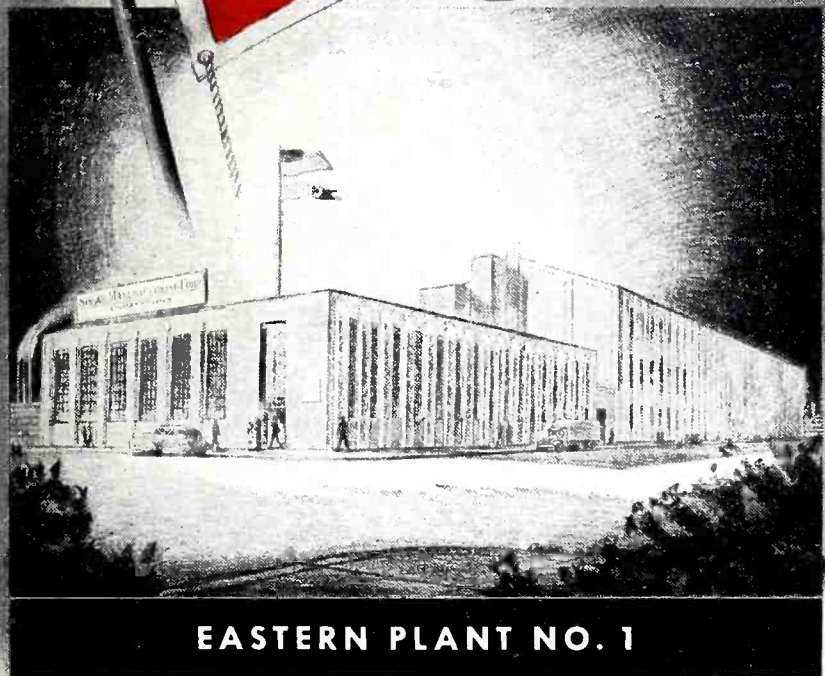

EASTERN PLANT NO. 1

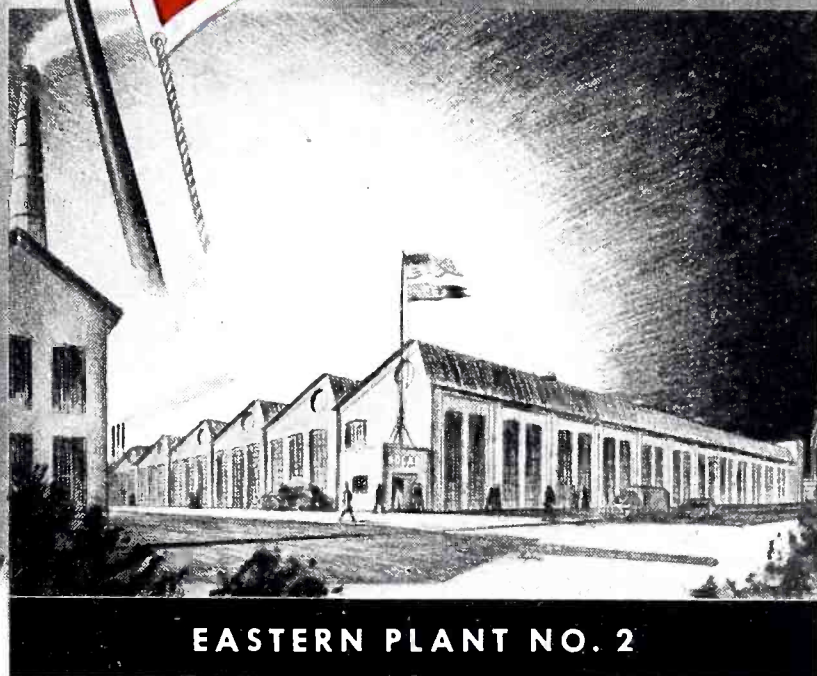

EASTERN PLANT NO. 2



MIDWESTERN PLANT NO. 3

3 Plants ... 2 Flags ... ONE PURPOSE

To beat the band of Axis bandits, three Solar factories are now operating "round the clock". The men and women of Eastern Plants 1 and 2 were told "Well Done" by the Army and Navy; they proudly wear the Army-Navy "E".

The Midwestern Plant has just started production;

the men and women of this modern air-conditioned factory are ready to help you speed the day of Victory.

If your capacitor or filter problem is made ours, you can be certain of "Quality Above All".

Solar Manufacturing Corporation, General Offices: Bayonne, New Jersey.

Ⓢ 3762

Solar **SOLAR** — **CAPACITORS** —

CAPACITORS and RADIO NOISE-SUPPRESSION FILTERS

Security posted

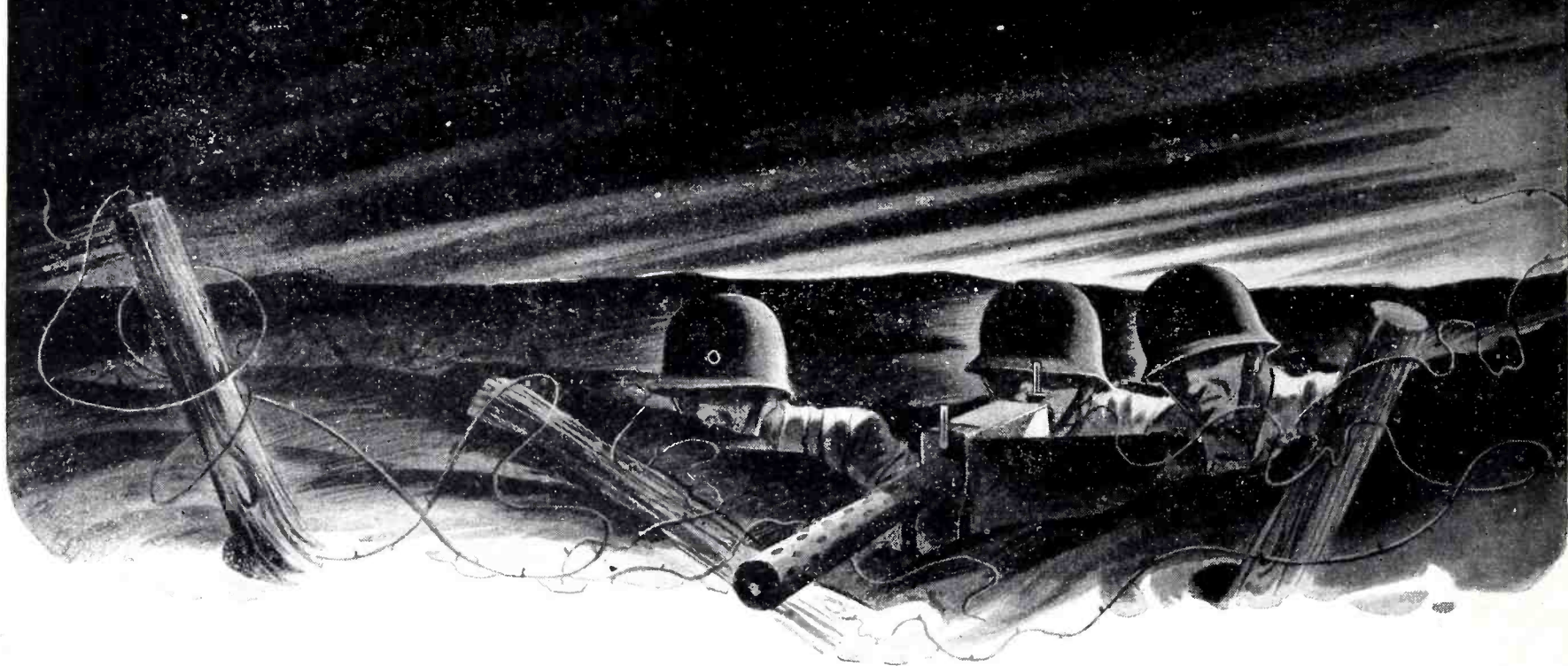

MANY TIMES every day "surprise attacks" occur along your power line. Some heavy user momentarily stops operation. A sudden over voltage slams like lightning into delicate machines, precision tools or precious vacuum tubes. You can't see these blitz attacks but you can't escape seeing the results—higher percentage of rejections, damage to sensitive instruments, premature failure of expensive electronic tubes.

Every unit, however small, is responsible for its own security. This cardinal rule of combat applies in production too. That is why, everywhere in industry, you will find SOLA CONSTANT VOLTAGE TRANSFORMERS on duty at important "out-guard" posts.

Sola "CVs" are especially designed to protect against surprise overload assaults. They will ab-

sorb voltage sags and surges as great as 30%—and still feed constant, rated voltage to your machines. Sturdy Sola sentinels ask no relief. Day and night, without care or supervision, they stick to their posts—instantaneous in action, without moving parts, self-protecting against short circuit.

Many vital points in your production system are vulnerable to attack. Secure them with Sola "CVs". SOLA CONSTANT VOLTAGE TRANSFORMERS are built in standard units from 10VA to 15KVA capacity, or in special units to your specifications.

Note to Industrial Executives: *The problems solved by Sola "CV" transformers in other plants and products may have an exact counterpart in your own. Find out. Ask for bulletin DCV-74.*

Constant Voltage Transformers

SOLA

Transformers for: Constant Voltage • Cold Cathode Lighting • Mercury Lamps • Series Lighting • Fluorescent Lighting • X-Ray Equipment • Luminous Tube Signs • Oil Burner Ignition • Radio • Power • Controls • Signal Systems • Door Bells and Chimes • etc. **SOLA ELECTRIC CO., 2525 Clybourn Ave., Chicago, Ill.**

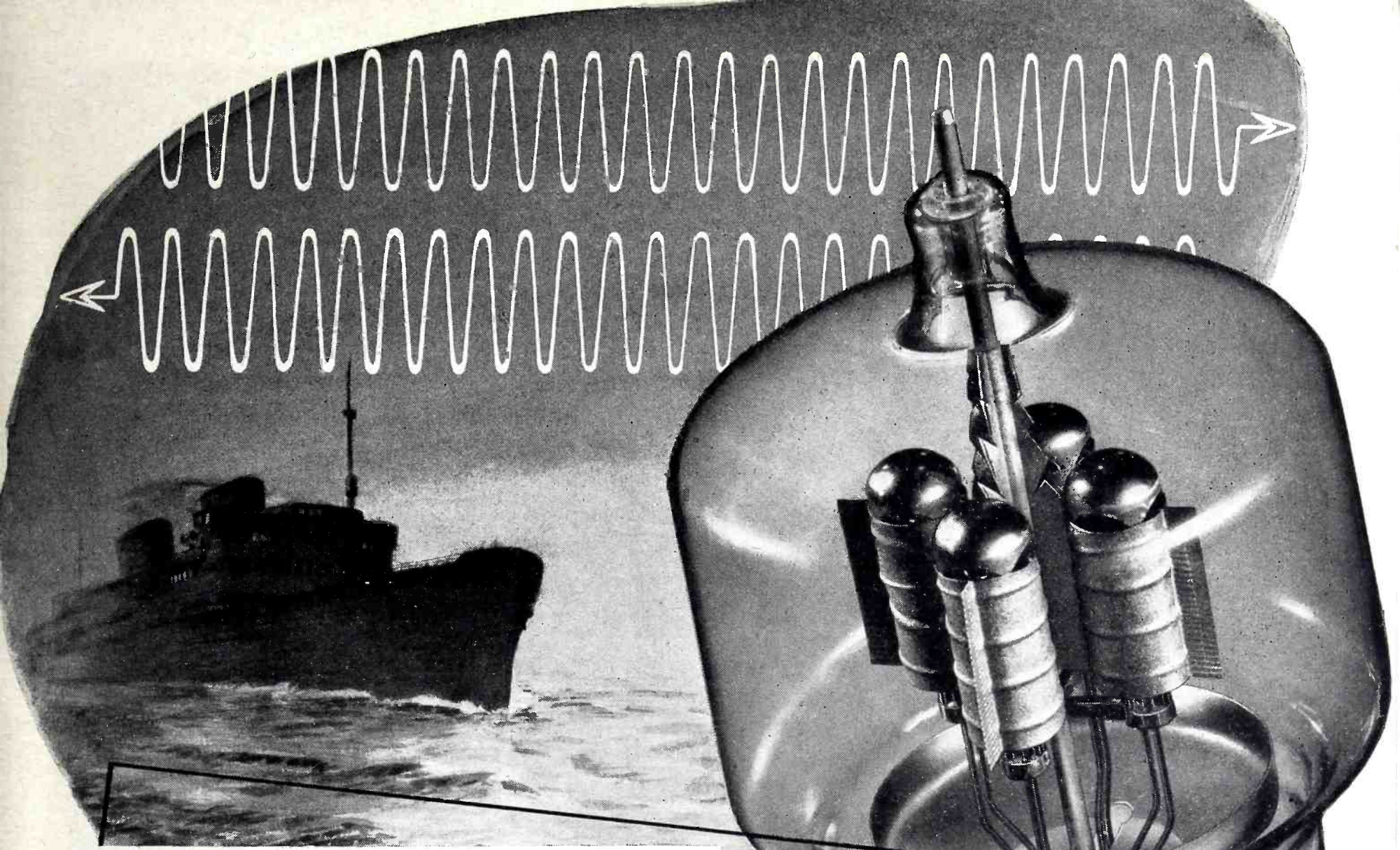

electronic briefs: **radar**

Radar is a method of transmitting ultra-high-frequency radio waves to an object which reflects the wave back to its source. The time required for the round trip from the transmitter to the object and back to the receiver is the measure of the distance to the object. The direction is established through the use of directional wave transmission.

High transmitter power is essential in radar for the amount of energy which is reflected is extremely small. Plate voltages are in the order of tens of thousands of volts and plate currents are measured in tens of amperes. The vacuum tubes used in such equipment must be capable of operating efficiently and dependably over long periods under extremely heavy loads.

High voltage, high frequency, operation at absolute peak emission...ability to stand momentary overloads of as much as 400%...unconditional guarantee against emission failure due to gas released internally...are the features which marked Eimac tubes as ideal for this important application. These are some of the reasons why Eimac has been "Standard" in Radar transmitters for the past number of years. Just one more proof that Eimac tubes are first in the important new developments in electronics.

**EIMAC
304T**

EITEL-McCULLOUGH, Inc.
SAN BRUNO, CALIFORNIA

Export Agents: Frazar & Hansen
301 Clay Street, San Francisco, California, U. S. A.

Follow the leaders to



Awarded for high achievement in the production of war materials.

Eimac REG. U.S. PAT. OFF.
TUBES

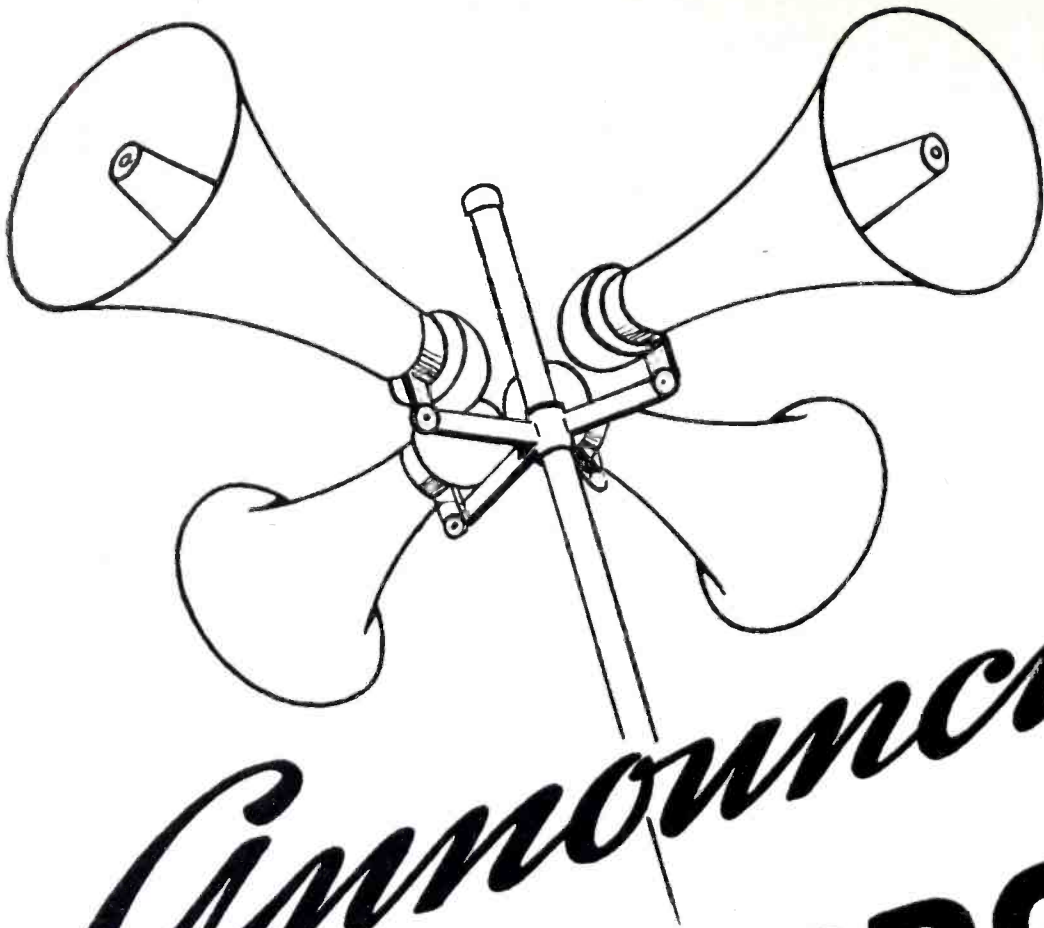

Announcing **WEBSTER PRODUCTS**

ELECTRICAL, RADIO, PHONOGRAPH,
AIRCRAFT APPARATUS

EFFECTIVE APRIL 1st, 1943

Webster Products has purchased and will continue operation of the business of the Armitage Avenue Plant of Webster-Chicago Corporation.

With *all* of the personnel and facilities previously used in operation of the Armitage Avenue Plant, additional engineers, *plus* newly acquired machinery and equipment . . . Webster Products is fully qualified to continue the business on the highest standards of quality and service.

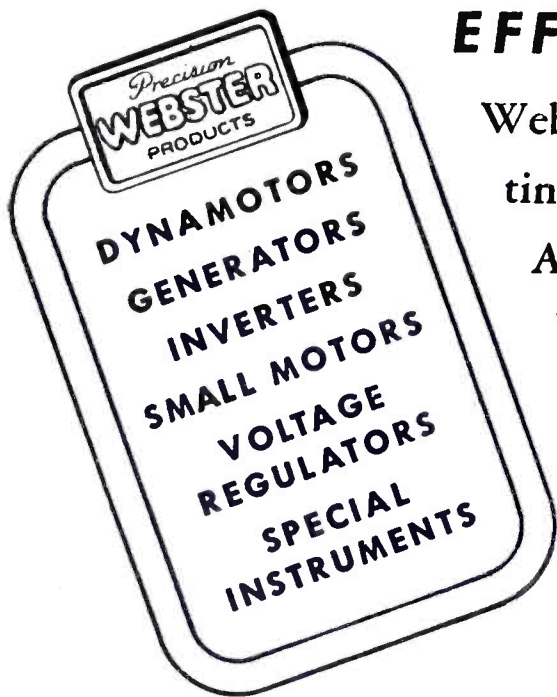

We invite your inquiries and will welcome your detailed investigation of our facilities.

**WEBSTER
PRODUCTS**
3825 ARMITAGE AVENUE • CHICAGO

PARTS by Centralab

● Since 1922 Centralab has been synonymous with Quality. Parts by Centralab include:

STEATITE INSULATORS

CERAMIC TRIMMERS

HIGH FREQUENCY

CIRCUIT SWITCHES

CERAMIC CAPACITORS

WIRE WOUND CONTROLS

SOUND PROJECTION CONTROLS

Centralab

Division of Globe-Union Inc., Milwaukee, Wis.

Meeting the mica-capacitor shortage . . .

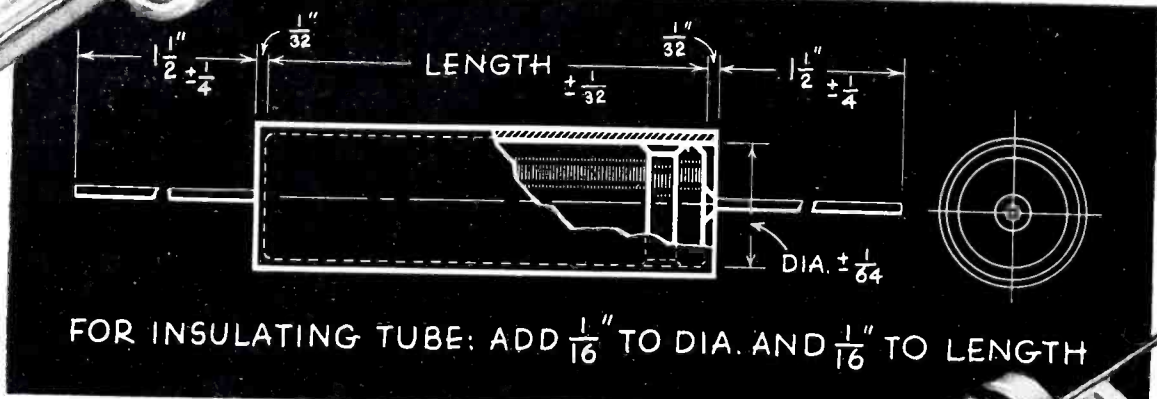
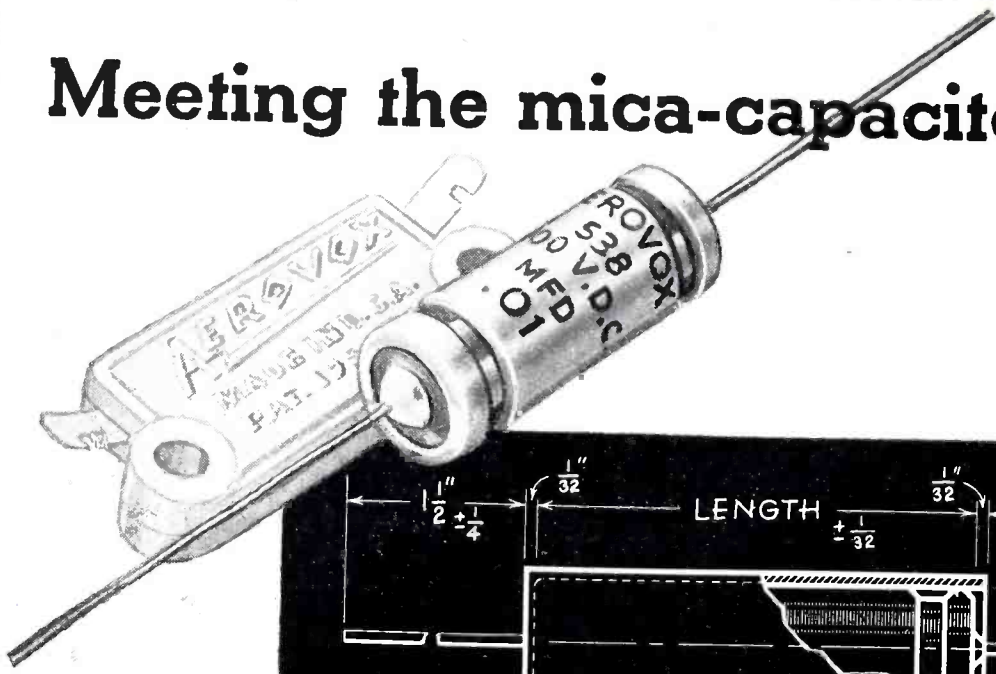

In three sizes:
 5/16" dia. x 1 3/16" long
 7/16" dia. x 1 3/16" long
 7/16" dia. x 1" long

MICA-CAPACITOR

Alternates

• An alternate choice for those hard-to-get mica capacitors in most applications—that was the problem put up to Aerovox engineers.

Various applications were studied. Voltages, capacitances, frequencies, power factor—these and other factors were considered along with dimensional limitations, after the manner of A.A.E.* Out of it all evolved this new Aerovox Type 38 mica-capacitor alternate now in production.

Here is a miniature oil-filled metal-case tubular. Ideal for assemblies where both space and

*Aerovox Application Engineering.

weight are at absolute minimum. Requires no more space than mica capacitor it replaces. Conservatively rated. No skimping of insulation or oil-fill despite minute dimensions (see drawing). Meets all standard specifications for paper-dielectric capacitors used as mica alternates. (See brief specifications)

Type 38 mica-capacitor alternate is but one of several new wartime capacitors described and listed in our latest Capacitor Catalog. Write on business letterhead for your registered copy.

FEATURES

Metal case. Double-rubber-bakelite terminal-insulator assembly.

Both terminals insulated or with one terminal grounded to case. Pigtail terminals.

Normally without outer sleeve. Can be had with insulated sleeve, adding 1/16" to diameter and length. Note dimensional drawing.

Vegetable (Hyvol) or mineral oil impregnated and fill.

300 to 800 v. D.C.W. Capacities of .001 to .01 mfd.

DIMENSIONS

Capacitance tolerances up to but not including .01 mfd. -20% +50%; .01 mfd. -10% +40%.

OUR WAR EFFORT

From January 1941 to December 1942, Aerovox . . .

- Stepped up production output 500% for our armed forces.
- Increased production floor space 300%.
- Sought, hired, trained and put to work additional workers—a 300% increase in productive personnel.
- Opened second plant in Taunton, bringing work to available workers there.
- And—doing more and more; growing week by week!



Capacitors

INDIVIDUALLY TESTED

AEROVOX CORPORATION, NEW BEDFORD, MASS., U. S. A. • SALES OFFICES IN ALL PRINCIPAL CITIES
 Export: 100 VARICK ST., N. Y. C. • Cable: 'ARLAB' • In Canada: AEROVOX CANADA LTD., HAMILTON, ONT.

LUMARITH* Foil

KEEPS OUT

The Black Hand of Corrosion



LUMARITH, because it is resistant to electrochemical oxidation, does not promote corrosion—the Black Hand that cuts short the life of coils and transformers, crippling vital military and industrial equipment.

Corrosion of copper wire induced by many insulating materials represents a “built-in” hazard.

Copper wire wound in a coil insulated with LUMARITH foil has been found to be as free of the hazard of corrosion as if it were suspended in free air.

Major manufacturers are finding LUMARITH the answer to an increasing number of insulation problems. LUMARITH is non-corrosive. It has high dielec-

tric strength and high resistivity.

Celanese Celluloid Corporation, *The First Name in Plastics*, a division of Celanese Corporation of America, 180 Madison Ave., New York City. *Representatives:* Cleveland, Dayton, Philadelphia, Chicago, St. Louis, Detroit, Los Angeles, Washington, D. C., Leominster, Montreal, Toronto, Ottawa.

A Celanese Plastic*

*Trade Marks Reg. U. S. Pat. Office

PIONEERS IN RADIO

PRESS

- ★ **COMMUNICATIONS**
- ★ **RESEARCH**
- ★ **DEVELOPMENT ENGINEERING**
- ★ **MANUFACTURING**

Executive Offices
435 N. MICHIGAN AVE., CHICAGO

NEW YORK • CHICAGO • LOS ANGELES • LONDON • HAVANA

WIRELESS INC.

Developers and Manufacturers of

- HIGH POWER TRANSMITTERS
- DIVERSITY RECEIVERS
- AIRCRAFT AND AIRFIELD RADIO EQUIPMENT
- RADIO PRINTER SYSTEMS
- MODUPLEX UNITS
- CHANNELING DEVICES
- RADIO PHOTO TERMINALS
- FACSIMILE MACHINES

AND OTHER TYPES OF RADIO AND COMMUNICATION EQUIPMENT.



Awarded to our Hicksville, Long Island plant for outstanding achievement in war production.

Sales Offices, Manufacturing Division
1475 BROADWAY, NEW YORK CITY

• RIO DE JANEIRO • MONTEVIDEO • SANTIAGO DE CHILE

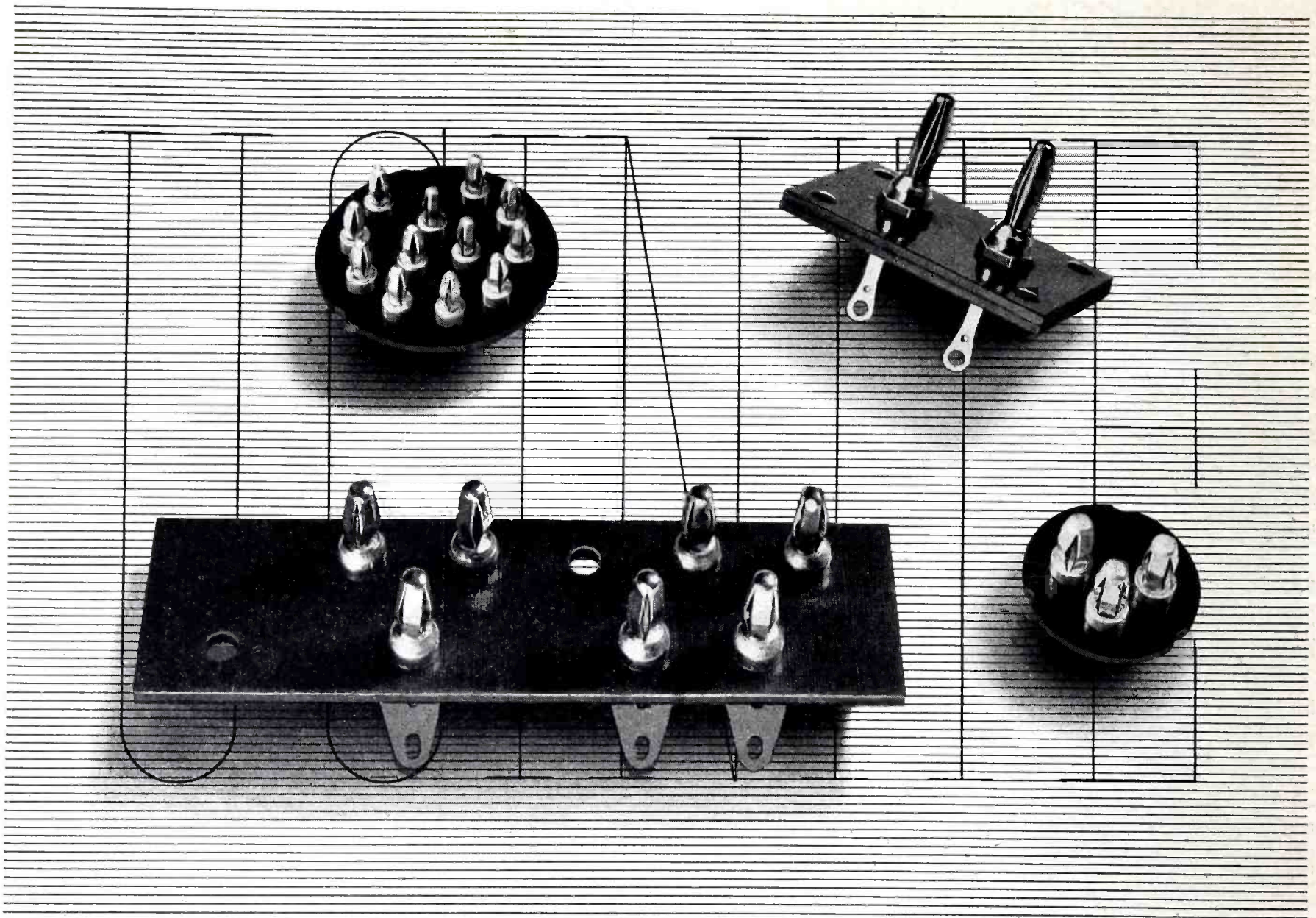

Hard to find

Specific parts for a specific application . . . those are the things that are hardest to find, these days. At Ucinite we specialize in the carrying out of such orders.

Take banana pin assemblies like the ones illustrated above, for instance. We can design them from the start for your particular needs. We make the pins, die-stamp the mounts, assemble them, inspect them and get them out on time.

Small jobs don't bother us. But we have the engineering staff and the production capacity to handle the big jobs, too.

The UCINITE CO.

Newtonville, Mass.

Division of United-Carr Fastener Corp.

**Specialists in RADIO & ELECTRONICS
LAMINATED BAKELITE ASSEMBLIES
CERAMIC SOCKETS · BANANA PINS &
JACKS · PLUGS · CONNECTORS · ETC.**

**SCHEDULED FOR DELIVERY
SOME TIME IN 194?**

Motorola
FM
PHONOGRAPH - RADIO
COMBINATION

A GREAT NEW
Motorola
FM
PHONOGRAPH-RADIO
COMBINATION

A new and distinctly better type of home radio combination was about ready to make its bow to the American public when war drafted the complete Motorola facilities. Had this static and noise-free F-M receiver been seen and heard by the general public, it would have aroused unqualified enthusiasm . . . whetted an appetite that will have to be satisfied when Peace once again releases electronic talents and

skills war-sharpened for radio's greatest progress and achievement. In the interests of national defense, Motorola is now delivering the finest in F-M emergency broadcast and receiving equipment. You may look for notable scientific developments in F-M radios from Motorola engineers. We can't say *when* . . . but we *can* say that no one will be ready sooner.

Expect big things from Motorola!



THE ARMY-NAVY "E"—Awarded for excellence in the production of Communications Equipment for America's Armed Forces

Motorola Radio Communications Systems
Designed and Engineered to Fit Special Needs

GALVIN MFG. CORPORATION • CHICAGO

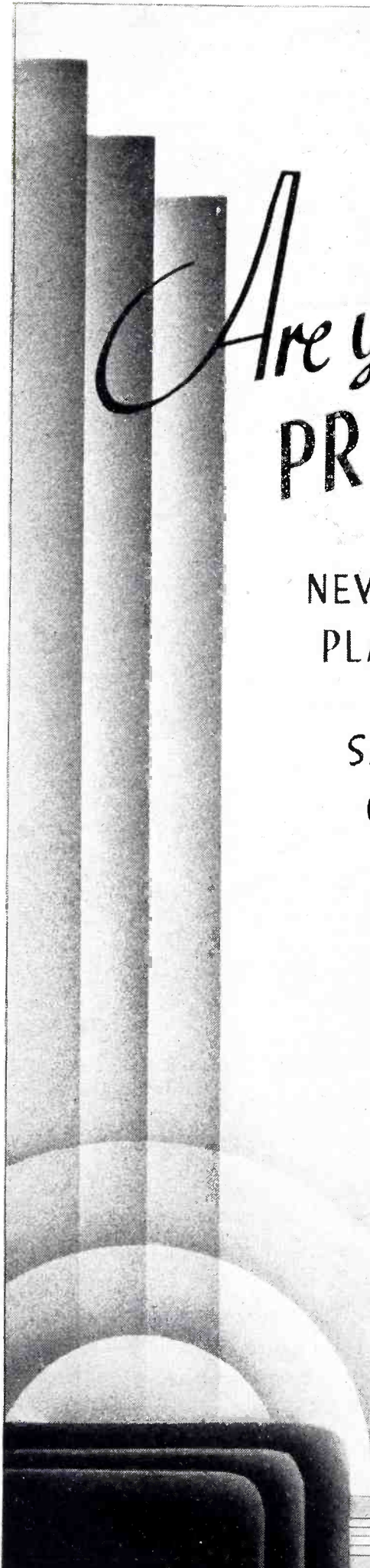

Are you having trouble obtaining
PRECISION PLASTIC PARTS?

NEW METHODS ENABLE US TO MACHINE
PLASTICS TO TOLERANCES AS CLOSE AS .0005

SMALL QUANTITY EXPERIMENTAL PIECES
OR LARGE PRODUCTION RUNS

ALL FIXTURES, TOOLS, JIGS and DIES
MADE IN OUR MODERN TOOL ROOM

LET *us* WORK OUT *your* PROBLEMS

ALSO SPECIALIZED INJECTION
MOLDING OF SMALL PARTS, INTRICATE
INSULATING and INSERT WORK

*Quotations submitted upon
receipt of print (Include priority ratings)*

ARNOLD BRILHART Co. 435 MIDDLENECK RD. GREAT NECK, N.Y.

It's easy for you to design with
PYRANOL CAPACITORS

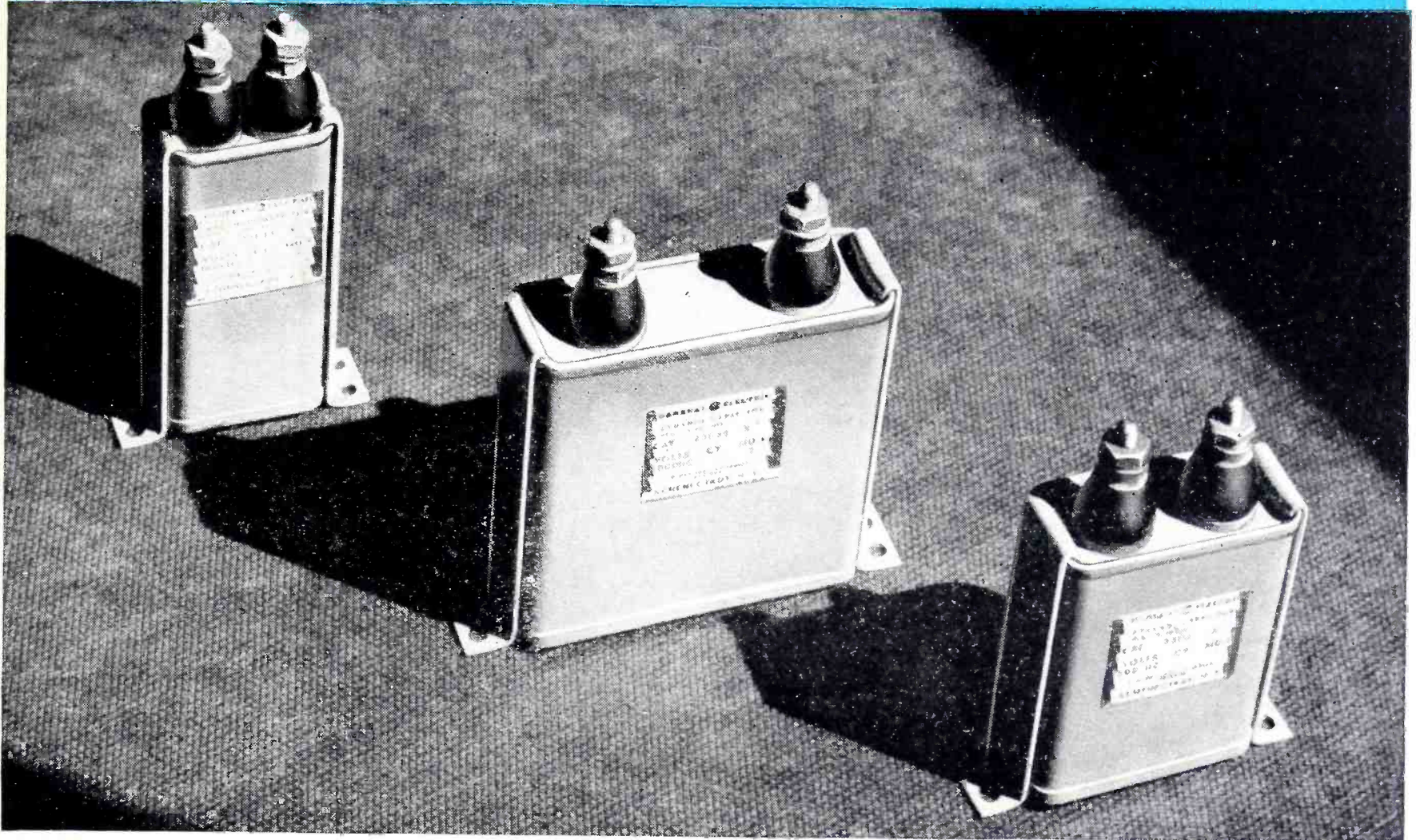

**More than 350 standard ratings to choose from,
 in sizes and shapes to meet your requirements best**

COMPACTNESS — High capacitance per cubic inch, because of Pyranol's unusual dielectric properties.

SPACE-SAVING SHAPES — Many of the ratings are available in oval, cylindrical, or rectangular cases to make your design problems easier.

CONVENIENCE — They will work equally well mounted in any position.

DEPENDABILITY — Hermetically sealed for permanence and uniformity of characteristics.

LONG LIFE — Ensured by superior materials, supervised manufacture, individual testing.

Pyranol is the G-E trade name for askarel, a synthetic, nonflammable liquid used in treating G-E capacitors.



BE SURE TO GET these time-saving catalogs (GEA-2621A and GEA-2027B). They cover our complete line for a-c and d-c applications. General Electric, Schenectady, N.Y.

GENERAL  ELECTRIC

407-58-5700

LOOK

to TINNEMAN

for newer and faster fastenings



Many New Types Just Released

• Turn your beam on the steady stream of new SPEED NUT shapes and sizes. High-precision production is turning them out at machine gun speed. Demand is spreading to more and more applications. Why? Because Speed Nuts drastically reduce weight and cost. Because they lock on screws with a firm spring tension grip that prevents vibration loosening. And because they can be applied with a speed that breaks all previous records.

Many self-retaining Speed Nuts are snapped into position for blind location assembly requiring no riveting or staking. They need not even be touched or seen while making the attachment. Approved, too, by the U. S. Army Air Forces and the Navy Dept. Bureau of Aeronautics for most non-structural attachments.

Write for our new 20-page book No. 185 for complete description of our latest developments.

TINNEMAN PRODUCTS INCORPORATED
2106 FULTON ROAD, CLEVELAND, OHIO

IN CANADA:
Wallace Barnes Co., Ltd., Hamilton, Ontario

IN ENGLAND:
Simmonds Aerocessories, Ltd., London



Speed Nut System

THE FASTEST THING IN FASTENINGS!

Engineering Design

—Creator of America's Mechanized Might

In war, as well as in peace, the design engineer is the vital link between the inventive mind and the mass-production reality

IT is gratifying and interesting to note that reports of new "secret weapons" not only have reversed their course during the past few months . . . they also have increased in frequency. Once they filled us with dread and misgiving. Today the enemy does the worrying.

Word about the latest new Army weapon reached us as this was being written . . . a 2½ ton truck that performs on water as well as on land with equal efficiency. "The Duck", resembling an overgrown amphibious jeep, is particularly suited to landing operations where docks are lacking. Loaded with 20 fully equipped soldiers or their equivalent in supplies, its propeller runs it ashore. It climbs the beach on its six-wheel drive and continues the trip on land.

This important addition to our "second-front" fighting equipment, coming so closely on the heels of the now famous tank-killing "Bazooka", is one of many history making contributions of American design engineers — the men who transform nebulous ideas into practical realities — the men who make our war machines superior to those of our enemies.

Invasion and eventual victory became a certainty as soon as America's design engineers threw their full effort into the war against aggression. Adapting intricate ordnance designs to mass production, these men developed weapons such as the M-10 destroyer of Rommel's tanks and brought out the new fighting planes and bombers that have won the air superiority that has turned the tide against the Axis. Taking ideas and giving them form, selecting the materials of construction, deciding upon the method of fabrication, adapting the electrical and mechanical parts that power the product, specifying the finish that protects and beautifies it . . . these men are the focal point of American production. Their ingenuity has no parallel. Once they put automobiles on a mass production basis and within the reach of all. Today, after less than three years and with little previous experience in armament design,

they have brought America's war weapons to the highest efficiency . . . surpassing Hitler's weapons despite all the vaunted scientific wizardry of the Germans and their ten year start.

At this point it is well to remember that while Germany's military might is traceable to its superiority in armament, many of the basic technological discoveries (including the airplane and the submarine) are the products of American genius. The Germans always have been aware of the military advantages of technological superiority and have forced its expansion with all their might. They knew that mobility and surprise play a decisive role in modern warfare and their design engineers were kept

busy, with unique intensity, to achieve unprecedented results in fast-moving, hard-hitting fighting equipment. Our own military and industrial engineers did not go into action until it became certain that we would be involved in the conflict. But even before our country actually embarked on its Preparedness Program they were busily engaged in developing the designs of our war equipment. Tanks, planes, guns, ships and hundreds of other apparatus and machines of war were studied. Carefully selected committees of our national engineering societies

were organized under the leadership of the Army Ordnance Department to serve as advisors and consultants in the development of advanced designs of tanks and other motorized equipment of war. The above mentioned "Duck" and the now famous Sherman tank are just two of the many results of these efforts.

After the Preparedness Program had officially been launched and Congress had made its initial appropriation, it was necessary to create the manufacturing blueprints from which the engines of war could be built. Because the designs of the machines of production, as well as the designs of the products themselves, determine the speed and economy with which anything can be manufactured,

This is the thirteenth of a series of editorials appearing monthly in all McGraw-Hill publications, reaching more than one and one-half million readers. They are dedicated to the purpose of telling the part that each industry is playing in the war effort and of informing the public on the magnificent war-production accomplishments of America's industries.

the capacity of our industrial system is dependent, to a considerable extent, upon the ability and ingenuity of American design engineers. Germany's military might was successfully mechanized because Germany, for more than 10 years preceding the war, was riding the wave of a world-wide technological revolution. This revolution was as far-reaching as the advent of the electric motor and the internal combustion engine. It was born of the profusion of inventions and discoveries since the last war. German design engineers took advantage of every one of these.

If we are to defeat our enemies and if we are to continue to play the leading role in the post-war world we must make better use of the new technology than do our enemies. The job is up to American product engineers who already have made tremendous strides in designing the intricate machinery of production and of war equipment. Much remains to be done however.

It has been said that the Germans have not developed one single item that can be classified as basically original, nor are there indications that any so-called "secret weapon" will henceforth be developed by them. Today the Nazis are completely outclassed by the tremendous manpower of engineering brains that is at the disposal of American industry. Although we were faced by the same fundamental problems of shortages in materials, manpower and time, our engineers not only solved these problems quickly and effectively, but they outstripped the enemy by the preponderant weight of talent which we were able to bring to bear upon our problems. As is evidenced by studies of the designs of captured German war equipment, our airplanes are faster, carry heavier loads, have superior protective armor and heavier armament. Our tanks, especially the Shermans, stand unmatched. Our tractor-mounted artillery excels theirs in fighting power. Our automotive vehicles are the envy of the world. Our battleships are supreme. Our signal and detection devices are frustrating all of our enemies' attempts to dominate the seas.

And as we approach the end of the conflict, the pattern of which already has been set, the forces that converted American industry from peace to war-production will again be brought into play, and the product engineer will continue to be the fulcrum. Our post-war industry will grow from his blueprint. Nor will his job be any less urgent, any less responsible, any less sweeping in its effects than were his efforts during the war-preparedness program.

Since the cessation of the manufacture of peace-time goods, many new materials and production techniques have been developed. Plastics, synthetic rubber and magnesium in the field of materials were relatively new and restricted in their uses when war came. So were powder metallurgy, induction heating, electrostatic heating, adhesives for joining metals and compressed resin-impregnated wood. The new possibilities in product design created by the electronic devices and applications developed during the war period virtually stun the imagination and the "atomic revolution"

promises to change the entire pattern of manufacturing operations.

Never before has there been so much speculation about the future as there is today. Looking forward, who can doubt our limitless capacity to continue our industrial world leadership?

While no one can predict developments in product design in the post-war period, certain it is that they will be so vastly different and so far superior to existing designs that they will obsolete most products as we know them today. With engines of vastly superior metals, designed to burn 100 octane gasoline and built to a precision ten times greater than that of pre-war engines, our post-war automobiles will give from 40 to 60 miles to the gallon. Tires will last from forty to fifty thousand miles. The comfort and smoothness with which these cars of tomorrow will glide along are undreamed of today. Polaroid windshields will eliminate the glare of oncoming headlights and the driver will need to give but scant attention to the manipulation of his simplified gear shifts.

According to no less an authority than Igor Sikorsky, we stand on the threshold of a new air age in which the helicopter will contribute to the greatest prosperity we have ever known.

Prophecies are hard to make at a time like this but speedy house building seems to be a certainty in the world of tomorrow. Air conditioning, new methods of heating, humidifying and drying, promise to be necessities in the post-war home. Vacuum sweepers will be much lighter, less noisy and easier to manipulate. Washing-machines will be fully automatic and practically free of noise and vibration. Not only will our homes and most of the furnishings be of radically new design, but so will the factories and machines that produce them.

Only one factor can prevent the fulfillment of the dream of the product designer. His job is not accomplished over night. To convert sound ideas into production blueprints involves a great deal of time and money. The building of test models is an expensive and tedious procedure. An abundance of seed money is required to perfect the product, to develop mass-production methods and to bring it to fruition as a finished saleable product.

It is the patriotic duty of every industrial leader to hasten these developments so that the material benefits created by them may speed our progress along the road of abundance.



President, McGraw-Hill Publishing Company, Inc.



Save



30 TO 50% WEIGHT

IN RADIO TRANSFORMERS AND OTHER ELECTROMAGNETIC APPARATUS WITH

HIPERSIL* CORES

On a soldier's back or in a plane, ounces quickly become pounds. That's why a new material that can cut weight *and* increase efficiency is important news.

Hipersil, the new magnetic steel, does just this. It increases flux-carrying capacity $\frac{1}{3}$... saves 30 to 50% weight.

At present, Hipersil cores are used in a steadily increasing variety of communication applications... in radio transformers, chokes, relays, reactors and loading coils. They should be used wherever high permeability is wanted at both high and low densities, and where high fidelity and light weight are of greatest interest.

Hipersil makes possible these design improvements:

SMALLER SIZE of core cross sections and coils... ideal for airplanes, tanks, submarines, "walkie-talkie" sets...

WIDER RANGE OF LINEAR RESPONSE. Knee of the saturation curve for Hipersil is higher than for ordinary silicon steel. It gives approximately $\frac{1}{3}$ greater straight-line response for winding and core cross section.

SIMPLIFIED CONSTRUCTION. Split-core design makes coil and core easy to assemble, saves man-hours. No laminations—just two or four pieces to handle.

Ask your Westinghouse representative about standard Hipersil core sizes now available.

*Registered trade-mark, Westinghouse Electric & Mfg. Co., for High PERmeability SILicon Steel.

J-70407



GET THE FACTS ABOUT HIPERSIL

Write for B-3223, a data book crammed with application and performance facts about Hipersil. Address: Westinghouse Electric & Mfg. Co., East Pittsburgh, Pa., Dept. 7-N.

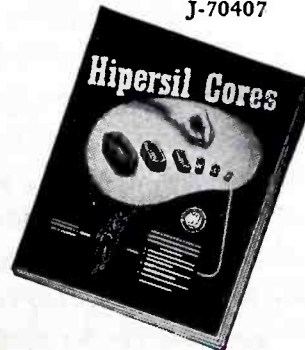

Westinghouse
PLANTS IN 25 CITIES... OFFICES EVERYWHERE

HIPERSIL

Even the Most Minute Part Has Its Big Moments



The contact points in a fighter plane's "turn and bank" indicators are not much for size, but they must be brutes for action. Like all component parts in a plane's electrical apparatus, they must function perfectly or spell trouble for the pilot. Always, he must be sure of his maneuver.

Under war need's pressure, a new type "turn and bank" indicator—an instrument in which the pointer remains stationary to show the degree of deviation from normal flight—called for contacts capable of operating 75 times a second, but extremely sensitive. Tiny contacts they are, less than a tenth of an inch in diameter, but they make and break the circuit that controls the speed of the gyroscopic motor.

Early in the designing, Mallory contact experience was sought. Standard contact materials set up excess arcing, creating unwanted radio interference. Then Mallory metallurgists, working against time, developed a combination of metals—standard tungsten for one point, Elkonium-34 for the other—that licked the problem in jig time. Just one contribution to the development of accurate combat maneuvers, to be sure, but an excellent example of how concentrated cooperation is functioning to insure that even the most minute part does its bit at the critical moment.

Mallory's years of contact experience and "know how," stimulated by war production demands, are furnishing innumerable solutions to perplexing problems of contacts and contact assemblies. Many of the applications developed in the Victory effort have significance for the future.

When you have contact problems, bring them to Mallory.

P. R. MALLORY & CO., Inc.
INDIANAPOLIS, INDIANA

Cable Address—PELMALLO



*While the design is
still in blueprint form*



CONSULT MALLORY
*for Contacts and
Contact Assemblies*

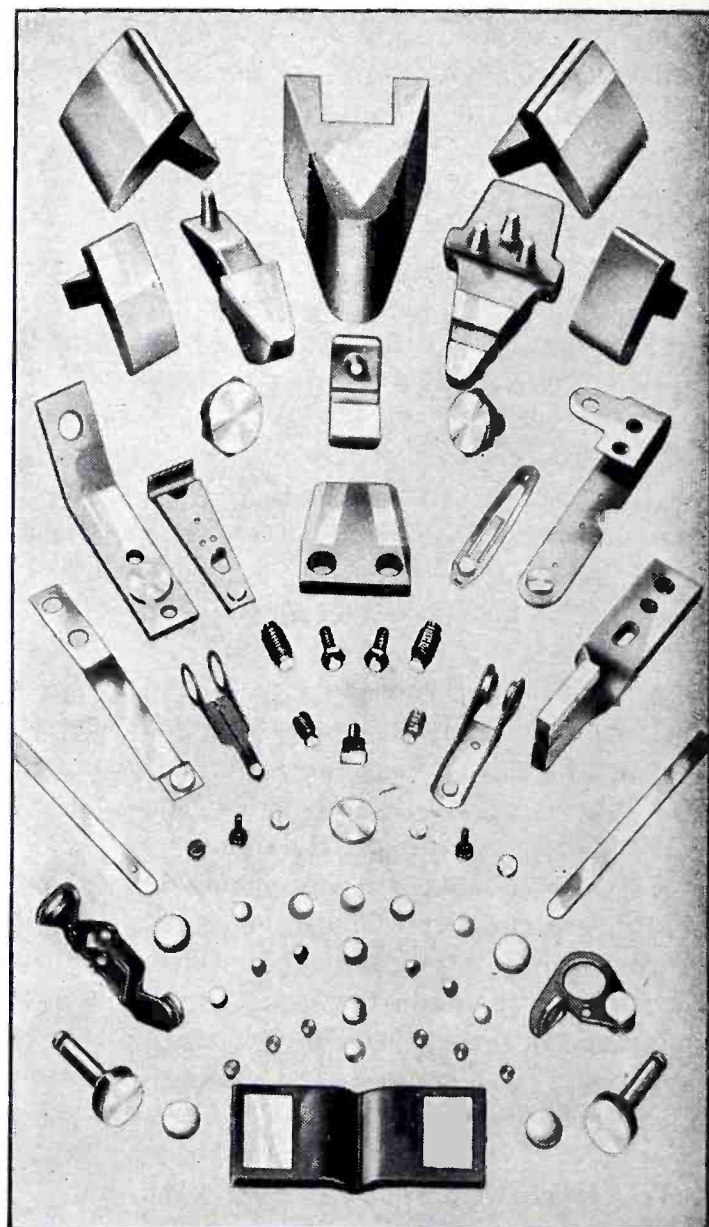

P. R. MALLORY & CO., Inc.
MALLORY

**ELECTRICAL CONTACTS AND
CONTACT ASSEMBLIES
NON FERROUS ALLOYS
POWDERED METAL ALLOYS**



CROSS TALK

► **TRIVIA** . . . Outfit in Connecticut industrial city is having great trouble holding labor. It seems that this company does its government work on straight contract basis. Other outfits in same city, however, work on cost plus basis and are quite willing to pay fancy prices for labor. First company trains the men; second outfit hires them away.

In one of the high-powered laboratories working for the Government, bright engineers have been requested to keep their new ideas to themselves; not to tell armed forces about them. It seems that the boys can think up swell ideas faster than they can be put into production with the result that government men are always ecstatic about some new device which would win the war if they could get it. In meantime war goes on and men in field must fight with what we can produce right now. A thousand units today, no matter how much better they could be made later, are worth far more than the promise of a thousand deluxe units six months from now.

From a New York City plant making communication equipment for Signal Corps and Bureau of Ships, local draft boards take trained men so fast the owner of the place is about to give up and quit. Unable to get men and train them as fast as they are required to fill local quotas he is falling down on contracts. In spite of representations by both service branches stating how important to the war is the material being manufactured, men are being taken away steadily.

► **CAMPAIGN** . . . Now that the United States Rubber Company has bought the rights to broadcast the

New York Philharmonic-Symphony orchestra over CBS, an opportunity exists for both sponsor and broadcaster to cultivate the vigorous and enthusiastic market residing in thousands of FM receiver owners. This No. 1 high-quality program should be put on FM stations; and somebody has done a bum selling job if this celebrated orchestra with its many years of CBS broadcast history is not on FM stations.

► **EXPEDITING** . . . There is no substitute for brains when it comes to breaking production bottlenecks and getting out gear needed for the war effort. But a fresh viewpoint helps too. Some of the expediting boys who are not hampered by too intimate a knowledge of how things have always been done before are proving it.

A good example of what can be accomplished is the case of the assembler who ordered a hundred ten-foot lengths of coaxial from a cablemaker. He waited five months for delivery and then became impatient. A man was sent over to the busy plant. He didn't find any cable ready to ship but he did spot, over in a corner, miles of the stuff that had apparently been discarded.

"What's that cable?" he asked. "Oh," he was told, "that stuff was rejected because the outside diameter is not uniform." Momentary silence on the part of the expeditor, and then: "It may not have uniform o.d. in long lengths, but how about checking it to see if you can't get a hundred ten-foot pieces out of it?"

Result: 85 cables were shipped in the next two weeks!

The ENGINEER'S PLACE in

New industrial electronic applications will make it necessary for designers to maintain closer contact with prospective customers. Equipment manufacturers will, of necessity, lean more heavily upon their top technicians for administrative and marketing help

By S. S. EGERT

NEW APPLICATIONS of tubes will undoubtedly bring about radical changes in the responsibilities of electronic engineers after the war. They will simultaneously create new administrative opportunities for such engineers.

In the past, much of our industry's business consisted of radio receivers designed for the man in the street. Most of the ultimate customers for industrial electronic equipment will be technicians of one kind or another, instead of laymen having little technical background. This difference in the character of an important new group of customers, and the varied nature of industrial jobs they want done, will make it desirable for the electronic engineer to maintain much closer contact with the field. It will be necessary for electronic equipment sales organizations aiming at this group to lean more heavily upon their engineers for marketing help.

New responsibilities will involve additional work, not directly associated with the laboratory. Let us examine some of these extra functions and speculate concerning their probable influence upon the development of the industrial electronics field and, particularly, upon the future of electronic engineers.

Designing Products for Industry

The electronic engineer will find it necessary to assume more of the responsibility for the physical appearance and mechanical design of equipment. In industry, physical design cannot be dictated by mere saleability of appearance. This contrasts sharply with recent practice in the radio receiver field.

Obviously, the answers to physical

and mechanical design problems involving functional effectiveness, ability to "take it" and safety in operation are not in the laboratory. They are out in the field. It would be well for the engineer designing industrial electronic equipment to take this point seriously as it is of great importance. The future may otherwise see many excellent circuits fail because they are improperly housed and protected for industrial requirements. Two identical devices may have to be housed differently, depending upon the industry they are to go into.

Assisting the Sales Department

Advertising managers and agencies will lean more heavily on the electronic engineer in the future. Industrial literature, to be effective, must give facts and only the engineer can supply these facts.

Engineers who are in administrative positions should study literature of other established industries as well as that of their own. Great savings in correspondence about a company's industrial electronic products

can be made if questions are anticipated and answered in printed data sheets. The engineer will not only aid his sales department by cooperating in the preparation of printed matter of all kinds but will also conserve much of his own time thereafter.

Five suggestions which may prove helpful are listed below:

(1) Make descriptions short and to the point. A set of specifications with short summations is often more helpful to the industrial prospect than a lengthy description.

(2) Graphs and curves are highly descriptive. They tell more about the performance of certain types of equipment than any number of words. Use them freely and whenever possible.

(3) Large and clear illustrations should be used. Good photographs are much more than just advertising. They can effectively and usefully illustrate constructional details and physical layouts.

(4) Use the language of the industry you are particularly interested in influencing. Realize that terms and definitions may vary widely from one industry to another.

(5) Dimensional line-drawings of components and complete units are of the utmost importance. They tell the industrial engineer immediately if a component or unit can be readily fitted into an available space.

Training of Service Specialists

The problem of servicing industrial electronic equipment is entirely different from that in the radio receiver field.

In industry, and particularly in connection with production machinery, a slight delay in making electronic apparatus repairs might involve tremendous cost to the customer if he has to shut down while the machine is idle. Therefore, highly-trained service specialists must be

From the FIRING LINE

THE AUTHOR is a salesman of electronic apparatus, with a technical background and considerable experience among both communications and industrial accounts

He passes along a few suggestions to the "boys back in the laboratories" concerning development of the industrial market as contrasted with the radio receiver market, based on personal observation of important differences between the two

the POST-WAR PICTURE

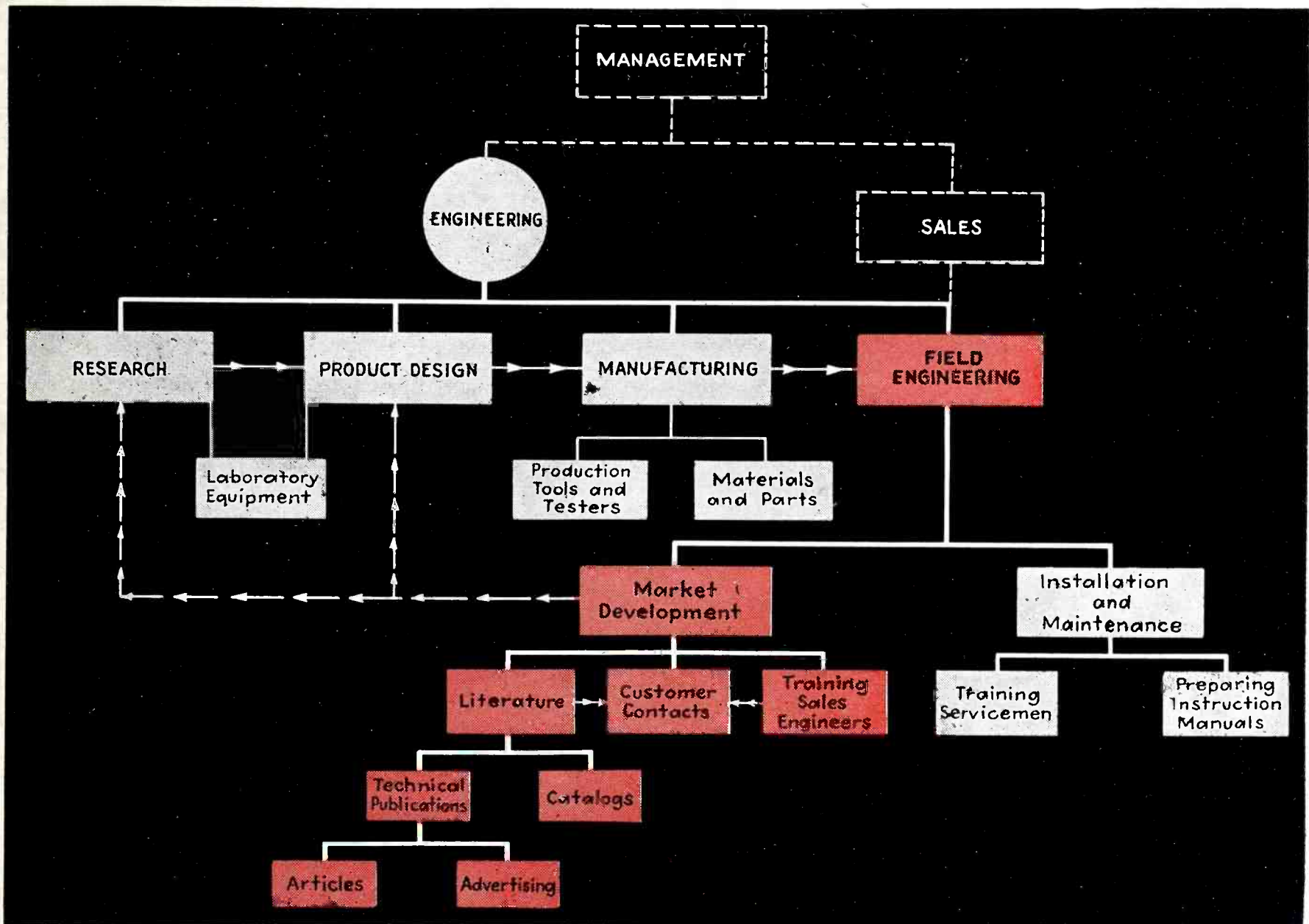

Functions shown in red are particularly important factors in the development of the industrial market

created to perform this duty quickly and properly. It will be the responsibility of the industrial electronic engineer to select, train and supervise these men.

The background of servicemen will vary from that afforded by a trade school to the preparatory education obtained in an engineering college, depending upon the service to be rendered in the field and the nature of the equipment. The reservoir of suitable men is at present so dry as to be almost non-existent. So the training of servicemen will have to be started from scratch in many instances, after the war. Field maintenance work will be excellent basic training for younger men starting in the industrial electronics field and aiming at eventual engineering and administrative jobs.

A word is desirable here about

the writing of instruction manuals. All engineers, and particularly those in administrative posts, must realize the value and importance of clear, concise and accurate instruction booklets. To a large extent the suggestions for sales literature preparation listed above also apply to the writing of manuals. Engineers will, of course, have to cooperate in their preparation, or handle the entire job.

Developing New Applications

The industrial electronic engineer of the future will of necessity be more concerned with marketing problems than he has wanted to be, or has been permitted to be, in the radio receiver business.

Problems which only the engineer can solve will arise frequently in the coming search for industrial markets and in the later efforts to capture

these markets. It is well-known that the potential market for industrial electronic equipment is very extensive. Many applications, however, are so deeply hidden in a labyrinth of complex mechanisms that only the trained engineer will be able to uncover them.

Constant reading of industrial publications can lead the engineer to added markets. Preparation of papers concerning new developments by the engineer himself can also be of great value in the search for new applications. For example, publication in *ELECTRONICS* of a paper describing new methods for the high-frequency-heating of wood adhesives would carry the message broadly to all industry. This would not only reach prospects in the wood product manufacturing field but would also,

(Continued on page 156)

BUOY RADIOBEACONS

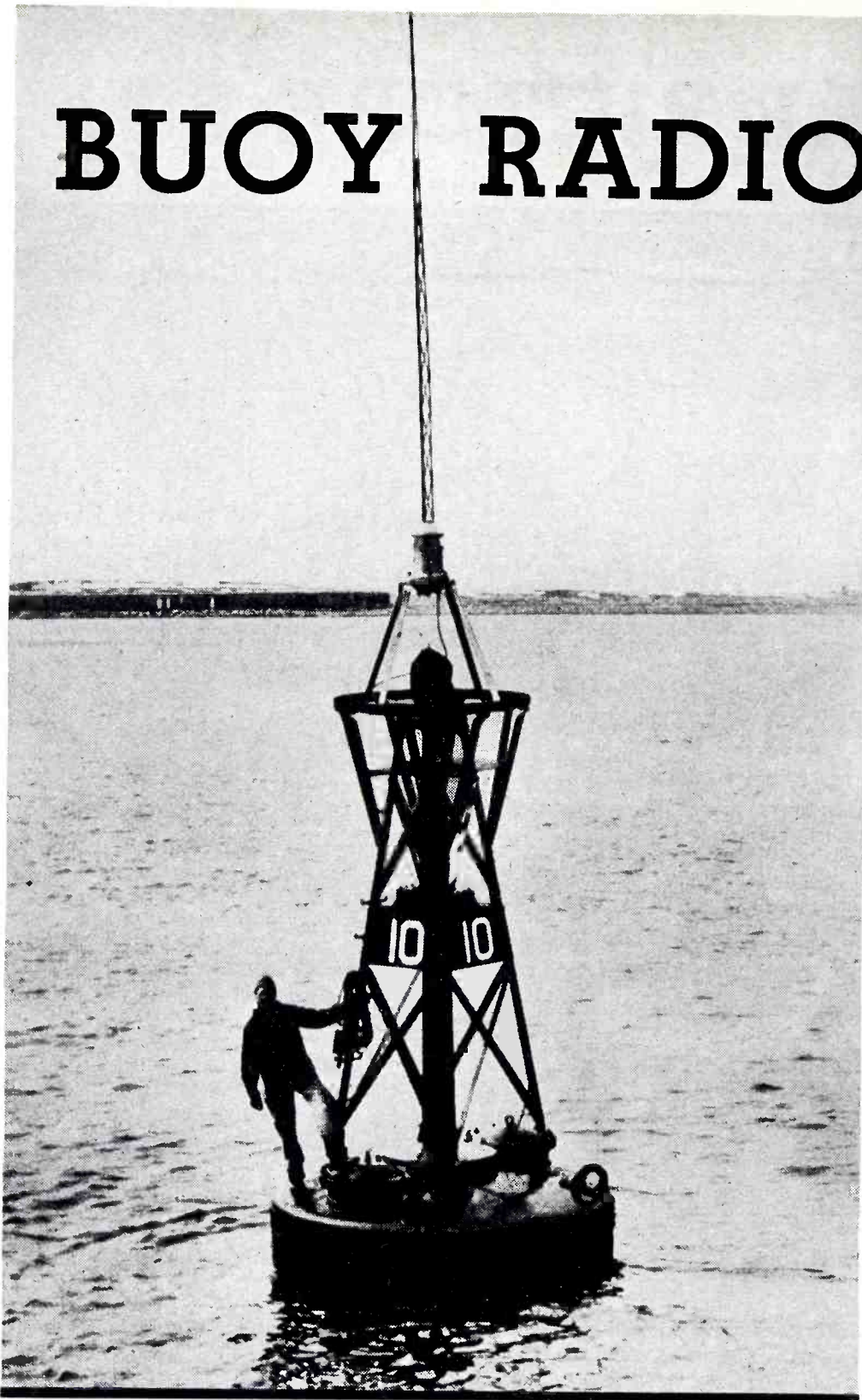

A radio-equipped buoy "on station." The storage-battery-operated transmitters stow away below waterline in a sealed "pocket" within the hull. A flexible coaxial cable carries r-f output up to an antenna coupling unit at the top of the superstructure. The 15 ft. monel-metal radiator mounts directly on a ceramic insulator included in the antenna coupling unit protective case design

SHIPS navigating in open waters offshore, near populated coasts, have long been able to get a good position "fix" by radio.

Originally, they turned on their transmitters, called land stations having direction-finding equipment and held their keys down while these stations manipulated loop receiving antennas. When the shore stations had determined the compass bearings of the ships with respect to their own positions in this manner they passed the information along by radio. Navigators then plotted bearings received from two or more

widely-separated land stations on their charts and placed their vessels where these lines intersected.

Later, many ships were equipped with their own radio direction-finders and the process was exactly reversed, rendering unnecessary special transmissions between ships and shore. The ships merely tuned in identifiable radiobeacon shore stations, determined the bearings of such stations and plotted their positions from this data. Certain selected shore stations and lightships transmitted continuously for this purpose during fog or thick weather,

Unattended transmitters, housed in buoys anchored near channel and harbor approaches before the war, aided ships through difficult waters when abnormal conditions reduced the effectiveness of lights, bells and horns. Pilots identified buoys by their emitted characteristic codes. Radio direction finders were then used to "run them down"

constituting radio "lighthouses" or radiobeacons. During clear weather these radiobeacon signals were broadcast every half hour on scheduled operation to permit navigators to obtain position fixes frequently, thus minimizing chances of observational error by reason of lack of practice and familiarity with radio direction finders.

Ships operating in confined waters inshore, and particularly those attempting in abnormal weather to locate the entrances to narrow channels, could theoretically use their radio direction-finders in this same manner. Location of position by the intersecting line method is, however, often too slow where distances to be sailed are short and land is near at hand, or in restricted channels. Obviously, the inshore piloting problem would be very much simplified if radiobeacon transmitters could be installed in buoys anchored at or near channel entrances. Ships equipped with direction-finders might then tune in such radiobeacon buoys and use the signals emanating from them to "home" on, riding down the radio waves to their source, using caution

for Inshore Navigation

to set course to pass safely clear of the buoys and avoid collision with them.

This is precisely what was planned just before the war. The type TB-113 buoy radiobeacon units described here were designed by Coast Guard radio engineers, developed by the U. S. Coast Guard Radio Laboratory, built by the Transmitter Equipment Mfg. Co., Inc., of New York and Erco Radio Laboratories, Inc., of Hempstead, N. Y., and installed in

buoys marking the entrances to harbors.

General Description

The radiobeacon signalling equipment for one buoy consists of the following interconnected units:

(1) A 14 v bank of low-discharge type storage batteries supplying all necessary operating power and capable of running the apparatus for three to four months without removal for recharging. Radio equipment

battery drain, exclusive of power required for the operation of the buoy light and of a "flasher" or automatic switching and keying device, is nominally six amps while keying. The overall power drain is about 900 amp-hours per month.

(2) A "flasher" mechanism consisting of motor-driven cams, connected in series with the storage-battery-bank positive output leads and performing two distinctly separate functions, namely (a) the keying of

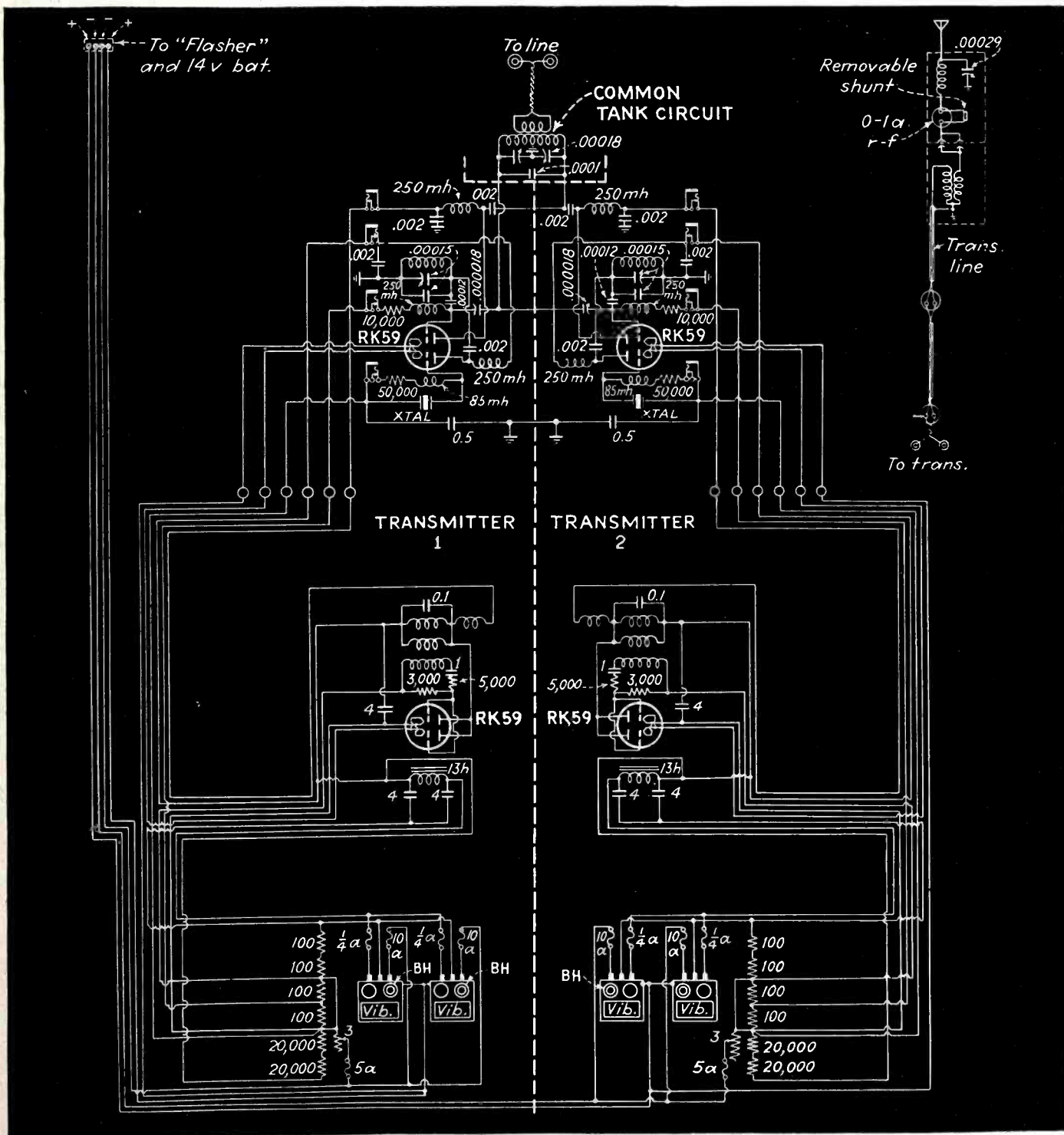

Schematic of the "twin" transmitter and, at the upper right, of the common antenna tuning unit. High voltage Vibrapacks are diagrammed in simplified form at the bottom, with modulator circuits appearing immediately above and oscillator-amplifier circuits at the top. Power required to operate the equipment, alternately switched from transmitter to transmitter by a motor-driven cam mechanism not shown here, is connected to the receptacle at the upper left. In the design diagrammed motor-driven cams also keyed the transmitters, simultaneously interrupting both filament and plate voltages. Recently modified units key by means of cam-operated relays in Vibrapack positive leads. Filament voltages are not interrupted

each transmitter, automatically and alternately at intervals, and (b) the control of the buoy light characteristic. Automatic keying of the transmitters is accomplished as follows: When a flasher cam closes the circuit to one of the transmitters this sets up the proper relay sequence, lights the tubes and closes all circuits for keying in the positive lead of the Vibrapacks. This operation is repeated alternately for each transmitter. A normal schedule consists of groups of quarter-second dashes for seven or more seconds, followed by a silent period of about the same length of time. The tube filaments are heated continuously during the keying period. Use of transmitting tubes having directly-heated cathodes with suitable thermal characteristics, and cold-cathode high voltage pack rectifier tubes, aided design.

(3) The TB-113 transmitter unit proper consists of two identical transmitters. Each transmitter is complete in itself, comprising high-voltage power packs, audio tone-generating modulator, crystal-controlled oscillator and single-ended r-f amplifier—complete except for the use of a common final amplifier tank circuit. Only one transmitter operates at a time, due to the functioning of the automatic switch gear already mentioned. Thus failure of either transmitter would not put the buoy off the air and such failure would be apparent when listening only if it was noted that there were longer-than-normal periods of silence between transmissions. This is true since both transmitters are tuned to the same frequency somewhere between 286 and 315 kc, use class A2 emission having a 1000 cps modulation tone and each turns out five watts of radio frequency power. The r-f power is picked up by a coil mounted in fixed inductive relationship to the final amplifier tank coil and fed into a 25 ft. length of coaxial transmission line having a characteristic surge impedance of 73.5 ohms.

(4) The MR-118 antenna coupling unit consists of a combination impedance-matching transformer and antenna base-loading coil. When properly adjusted by means of a variable capacitor included in the assembly (as indicated by maximum reading on a 0-1 amp r-f ammeter, also included), this unit tunes the antenna to resonance and simulta-

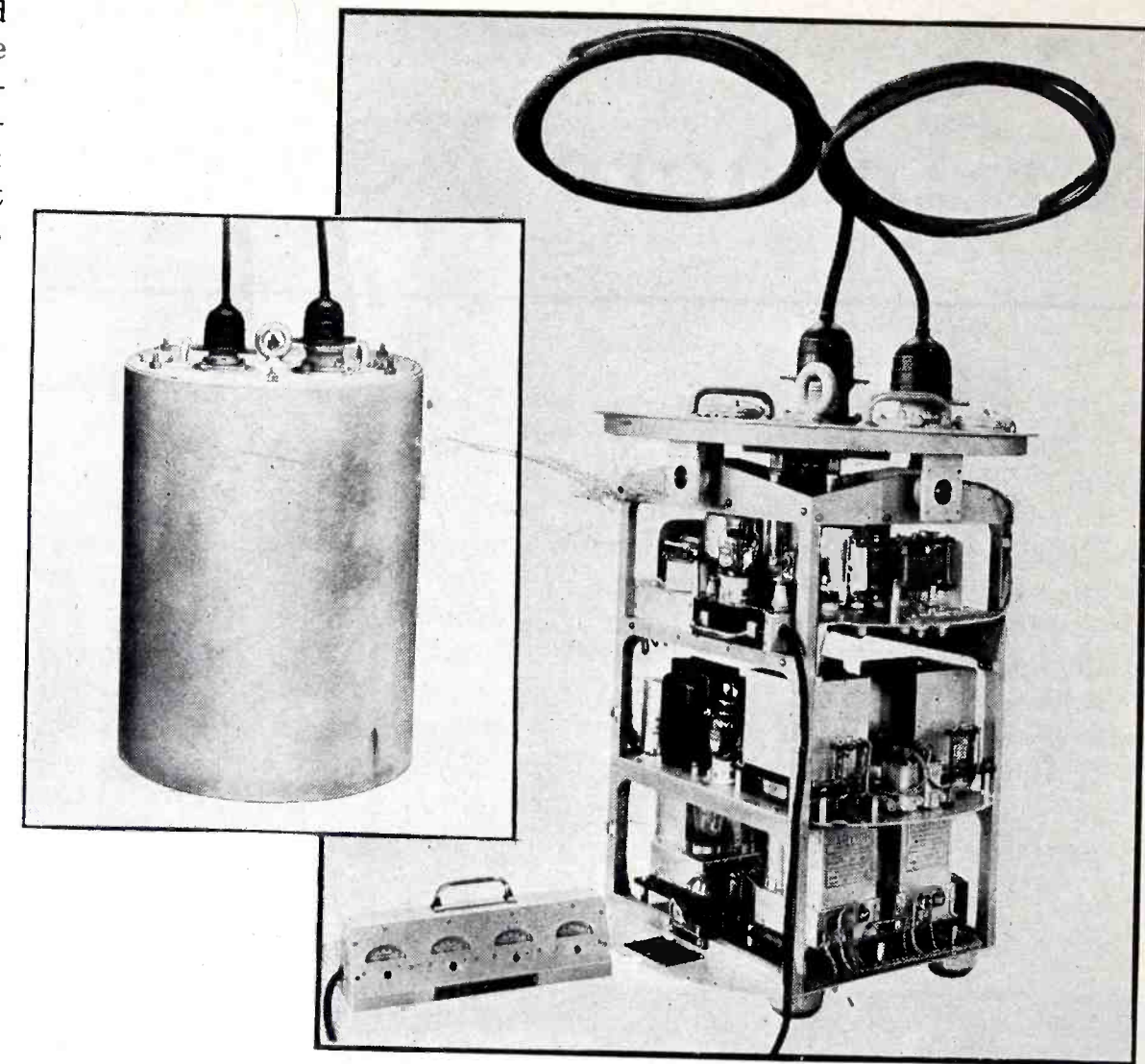

Open and sealed views of the twin transmitter, less antenna tuning unit, batteries and automatic switching and keying mechanism. Note use of vibration mountings to "float" the apparatus within its protective can. Adjustments are made before the equipment is sealed and stowed away. The special circuit-analyzer shown connected and ready for use in the open view was supplied as an accessory

neously eliminates the possibility of standing waves on the transmission line by terminating the line in a value equivalent to its own surge impedance.

(5) The antenna itself, consisting of a 15 ft. monel-metal tripod mounted on ceramic bowl type insulators forming the top of the antenna coupling unit.

Circuit Details

Except for the use of a common final r-f amplifier tank circuit which facilitates their operation into one antenna, both transmitters within a single buoy radiobeacon unit are identical and are mounted on the same chassis. A description of one transmitter therefore suffices for both.

In the r-f section, one triode of a type RK59 twin-triode tube serves as a shunt-fed crystal-controlled oscillator. Oscillator bias is a combination of voltage obtained from a grid leak and voltage obtained from a power-supply bleeder-resistor tap,

insuring stable operation. Crystals having high activity are used.

The plate circuit of the oscillator is capacitively tuned and coupled by means of a fixed capacitor to the grid of the other triode within the same RK59 envelope. This triode operates as a class-C r-f amplifier.

The class-C r-f amplifier uses a combination of grid leak and fixed bias, the latter being obtained from a power supply bleeder resistor tap. The plate is shunt-fed. The stage is plate-circuit neutralized. At the low operating frequency involved no complications developed with respect to either neutralization or final amplifier tuning despite the use of a common tank circuit for two final amplifiers and the resulting equivalent connection of operative and non-operative tube output circuits in parallel.

It should be noted that no metallic connection exists between d-c plate and grid circuits and the transmitter frame, capacitive r-f grounding being used throughout. The outer con-

ductor of the r-f transmission line between transmitters and antenna coupling unit is, on the other hand, directly grounded to the transmitter frame.

The class-C r-f amplifier is plate-circuit modulated. The modulator consists of another RK59 tube with its plates and grids connected in parallel and operating as a single triode. Special air-core coils connected in this circuit introduce feedback, causing the modulator stage to oscillate and generate a 1000 cps audio tone. Thus one tube serves as a combination modulator and audio tone generator.

High voltage d-c required for oscillator, r-f amplifier and modulator plates and grids is supplied by two Vibrapacks connected in parallel. Each of these uses a type BH full-wave cold-cathode gaseous rectifier tube.

The entire transmitter unit uses a total of eight tubes, four in each transmitter.

Operating Data

The buoy radiobeacon transmitter units were tuned ashore, placed in

their protective cans and later lowered into buoy pockets. Tuning adjustments made with protective cans removed were not appreciably affected by installation of the units in the cans and installation of the cans within buoys. Typical operating conditions, with a 14.2 volt primary battery supply, were as follows:

Circuit	286 kc	314 kc
Cryst. Osc. grid current	1.5 ma	1.4 ma
Cryst. Osc. plate current	21.0 ma	18.0 ma
R-F Amp. grid current (no load)		
R-F Amp. grid current (loaded)	45.0 ma	44.0 ma

All of these readings were conveniently taken by inserting the connector-cable plug of a special test-analyzer accessory containing four panel instruments into closed-circuit jacks provided in the transmitter unit for this purpose.

Antenna tank circuit r-f currents normally measured 450 ma at 286 kc and 445 ma at 314 kc, with the antenna connected and tuned to resonance, as indicated by the 0-1 r-f ammeter permanently included in the antenna coupling unit. Antenna tank r-f current readings, unlike transmitter unit readings given in tabular form above, could be taken either in the shop or while the buoys were on station. Antenna tuning adjustments were, however, invariably made with the antenna itself "out in the clear" and with no metal objects other than the buoy itself in the immediate field. When tuned on station,

for example, a man "marooned" on a buoy would make such adjustments while the cutter conveying him to the station stood off 100 ft. or more. Performance of the equipment modulators was in this case noted aboard the distant cutter by listening in on a suitable receiver.

Where r-f transmission line performance checks seemed desirable this was done in the shop ashore by connecting a 0-1 r-f ammeter temporarily in series with one leg of the line. Normal readings, with the antenna connected and tuned to resonance, were 320 ma at 286 kc and 300 ma at 314 kc.

Overall outside dimensions of the type TB-113 buoy radiobeacon transmitter unit are: 23 inches in diameter and 36 inches high to the top of the r-f transmission line and battery power connector plugs. The total weight of the transmitter unit, in its protective can, is 257 lbs. The transmitter unit chassis alone, without the protective can, weighs 132 lbs.

Laboratory investigation is now under way to improve certain features of the buoy radiobeacon equipment, based on experience gained thus far. It is intended to improve the present 5 to 8 mile effective range by the use of a longer antenna. Two experimental antennas 25 ft. long have been prepared and are now awaiting test.—W. MACD.

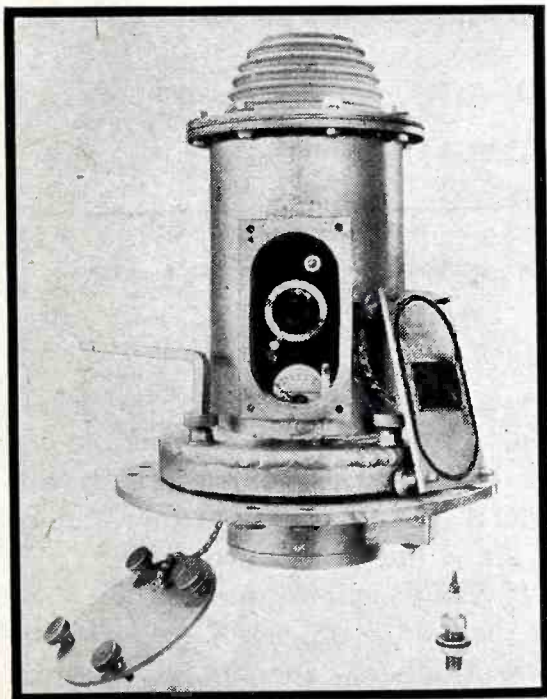

Antenna coupling unit, with gasketed inspection-port cover removed. This part of the gear is conveniently adjusted while the buoy radiobeacon is on station

Top view of r-f chassis. Tuning capacitors are wrench-adjusted and locked. Crystals and tubes are clamped in their sockets. Labelled jacks at top and bottom edges permit the two separate oscillator-amplifiers to be independently metered. Note careful labelling of parts to facilitate maintenance

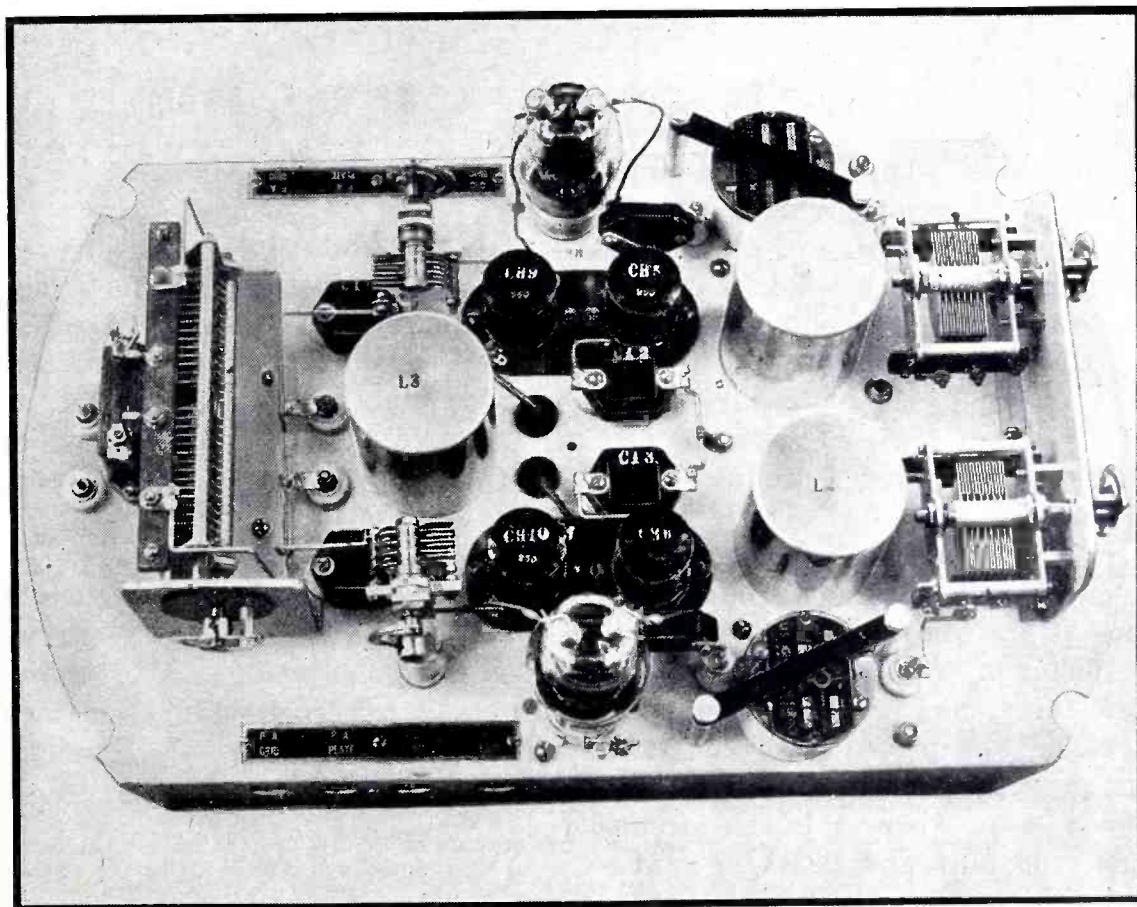

Transmission Line Charts

Graphs enable simple computation of voltage, current, and impedance distribution for any point on a long transmission line, and for any termination producing standing waves

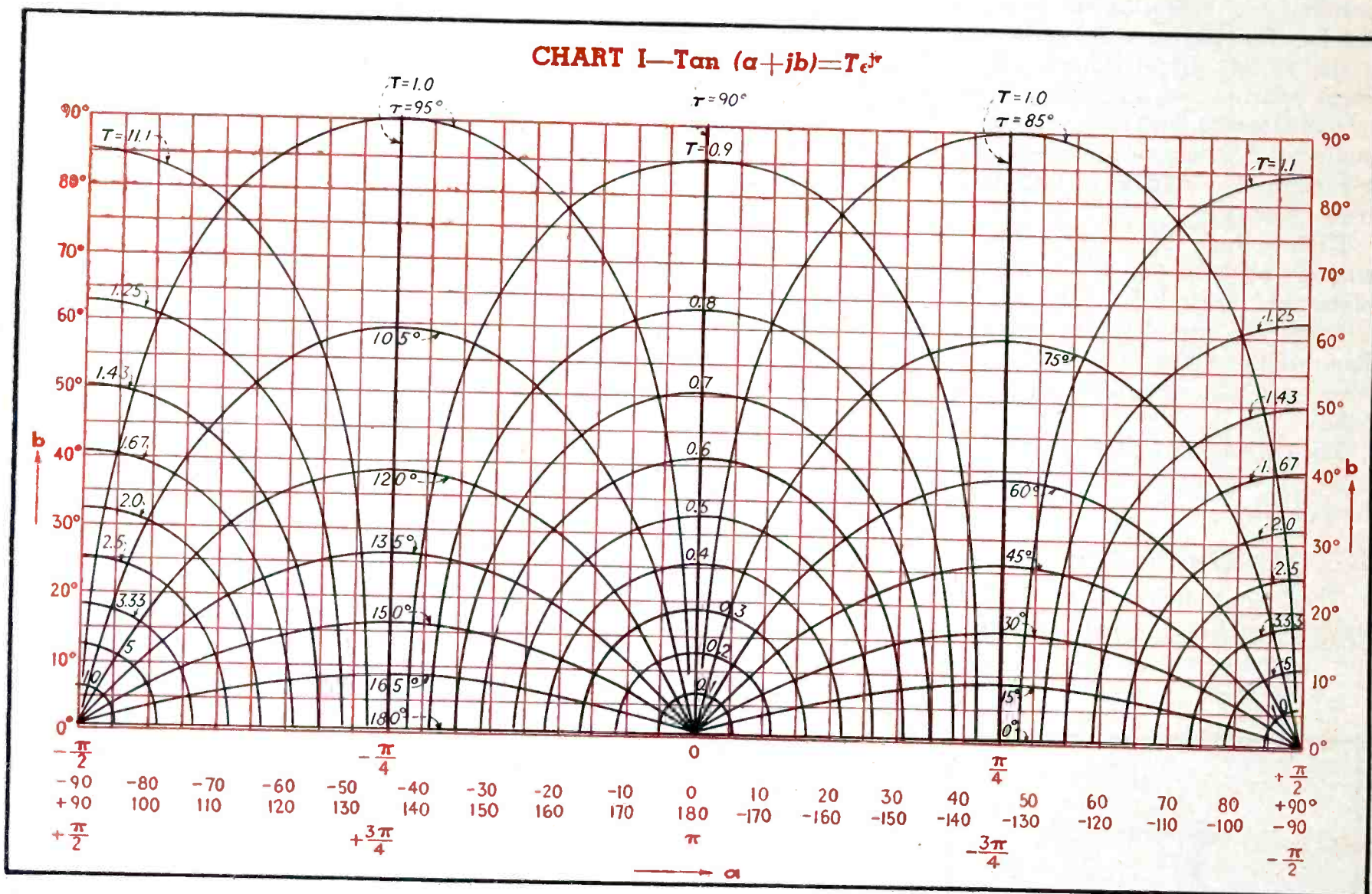

FIG. 1—This chart enables transferring tangent of complex quantity from rectangular to polar form and vice versa

TWO charts are given for a quick determination of the value of $\sin Z$ and $\tan Z$ where Z is a complex number. The same charts can be used for the valuation of other trigonometric or hyperbolic functions. The charts are useful in determining the voltage, current and impedance distributions on electric lines of any load with the exception of that equal to the characteristic impedance of the line.

The equations of electric lines represent current, voltage, and impedance at any point on an electric line by means of trigonometric or hyperbolic functions of a complex number γ , called the propagation constant. The propagation constant is given by $\gamma = \alpha + j\beta$ where α is the attenuation constant and β is the wave-

By R. F. BAUM

*Industrial Instruments
Jersey City, N. J.*

length constant. It is desirable to have a clear picture of the values these functions can possibly take and to have at hand charts to avoid complicated numerical computations.

There is a close relationship between the trigonometric and hyperbolic functions

$$\sin jZ = j \sinh Z \text{ or } \sinh jZ = j \sin Z \quad (1)$$

$$\cos jZ = \cosh Z \text{ or } \cosh jZ = \cos Z \quad (2)$$

$$\tan jZ = j \tanh Z \text{ or } \tanh jZ = j \tan Z \quad (3)$$

These formulas enable us to transform any hyperbolic functions into trigonometric functions. Furthermore,

$$\cos Z = \sin (Z + \frac{1}{2} \pi)$$

$$\cot Z = 1/\tan Z$$

reducing the number of necessary charts for all trigonometric and hyperbolic functions of a complex variable, Z , to two. In this paper a chart of $\sin Z$ and $\tan Z$ are given.

If Z is a complex number, $Z = a + jb$, then $\sin Z$ and $\tan Z$ are also complex numbers, and may be represented by their absolute magnitudes, S and T , respectively, and their phase angles, σ and τ , respectively. Thus,

$$\sin (a + jb) = S e^{j\sigma}$$

$$\tan (a + jb) = T e^{j\tau}$$

In the coordinate system used on the attached charts, the point Z is found by going a distance a from the origin in the direction of the horizontal (real) x -axis and then a distance b in the direction of the vertical

CHART II— $\text{Sin}(\alpha + jb) = S e^{j\sigma}$

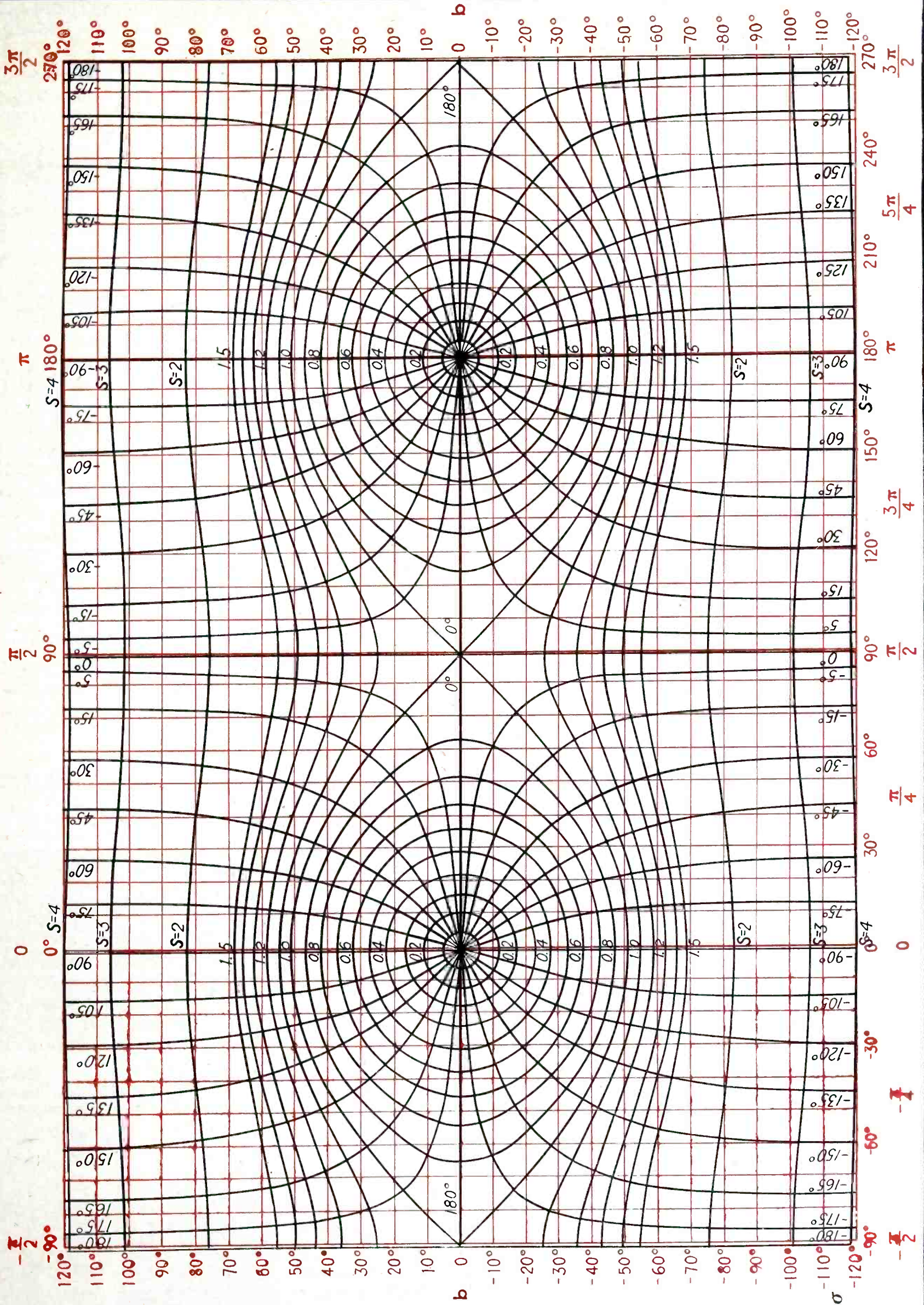

FIG. 2—Graphical chart for transforming sine of complex quantity from rectangular to polar form and vice versa

(imaginary) y -axis. The values of S and σ or T and τ respectively can be taken immediately or after interpolation between adjacent values. Both coordinates are counted in degrees (90 deg. = $\frac{1}{2} \pi$ radians).

If a voltage is applied to a line of length, l , then the voltage, V_y , the current I_y , and the impedance Z_y , at a point a distance y from the load end of the line is given by

$$V_y = C_v \sin(Z + \gamma'y + \frac{1}{2}\pi) \quad (4)$$

$$I_y = C_i \sin(Z + \gamma'y) \quad (5)$$

$$Z_y = V_y/I_y = C_z \tan(Z + \gamma'y + \frac{1}{2}\pi) \quad (6)$$

where

C_v , C_i , and C_z are complex constants,

Z_l is the load impedance

Z_0 is the characteristic impedance of the line,

$\gamma = \alpha + j\beta$ where α is the attenuation constant and β is the phase constant

$\gamma' = j\gamma = -\beta + j\alpha$, and

Z is determined by $\tan Z = jZ_0/Z_l$ or

$$Z = \tan^{-1} jZ_0/Z_l \quad (7)$$

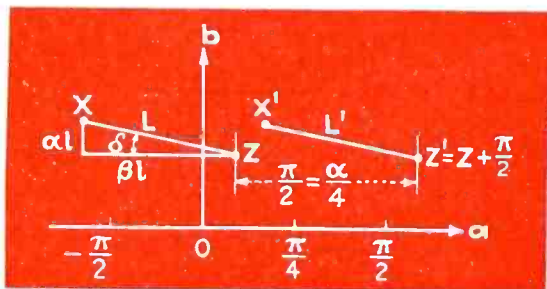

FIG. 3—Lines L and L' , constructed as indicated in text, enable determination of voltage, current and impedance for any position on the line

In general, Z and γ' are complex and we may therefore use the charts.

The expression $(Z + \gamma'y)$ appearing on the right side of Eq. (5) represents a straight line, L , in our coordinate system originating at point Z (in Fig. 3) where $y = 0$ (load end) and extending up to point X where $y = l$ (feeder end of the line).

As $\gamma' = -\beta + j\alpha$ the line $(Z + \gamma'y)$ points to the left at an angle of inclination, $\delta = \tan^{-1} \alpha/\beta$. A half wave on the line is given by $\beta y = \pi$ which means that the projection of the line $X-Z$ upon the axis is π for a half wavelength line. A longer (or shorter) line will have a proportionally longer (or shorter) projection, and any point between feeder and load end of the electric line can easily be identified on the straight line, L by dividing its length proportionally.

The expression $(Z + \gamma'y + \frac{1}{2}\pi)$ in Eqs. (4) and (6) represents a straight line, L' , parallel to line L and originating in point $Z' = Z + \frac{1}{2}\pi$

which lies 90 deg. or $\frac{1}{2} \pi$ radians to the right of point Z , in Fig. 3.

The first step in the application will be to find the point Z by means of Eq. (7). The position of this point depends only upon the load Z_l , or more exactly upon the ratio of the characteristic impedance to the load:

$$\tan Z = jZ_0/Z_l = T e^{j\tau}$$

Chart I gives Z immediately for any value of T and τ .

In Charts I and II draw the lines L and L' . According to Eqs. (4), (5), and (6). They furnish current, voltage, and impedance distribution along the line.

The constant C_v is easy to find from Chart II.

$$C_v = V_0 / [\cos(Z + \gamma'l)]$$

Then $C_i = C_v / jZ_0$

$$C_z = -jZ_0$$

where V_0 is the voltage applied to the line.

The location of point Z for different loads, Z_l , and for characteristic impedance, Z_0 , a pure resistance is shown in Fig. 4.

Examples indicating the use of these charts will help indicate their application.

Example 1. To calculate the value of $\sin(2.3 + j1.5)$ where the values are given in radians, it is first necessary to convert radians to degrees. Thus,

$$\sin(2.3 + j1.5) = \sin(132^\circ + j86^\circ)$$

Enter Chart II 132 deg. to the right of the origin, and project up 86 deg., and find a point between lines $S = 2$ and $S = 3$ and between lines $\sigma = -45$ deg. = 315 deg. and $\sigma = -30$ deg. = 330 deg. Interpolating gives this point as $S = 2.3$ and $\sigma = 320$ deg. and hence

$$\sin(2.3 + j1.5) = 2.3 / 320^\circ$$

Example 2. Find $\tan(2.3 + j1.5) = \tan(132^\circ + j86^\circ)$. Entering Chart I at a point 132 deg. to right of origin and 86 deg. upward, it is found by interpolation that $T = 1.05$ and $\tau = 100$ deg. Therefore

$$\tan(2.3 + j1.5) = 1.05 / 100^\circ$$

An exact calculation, which is quite laborious, given $1.06/96^\circ$, illustrating that the error is no more than may be expected from any graphical computation.

Example 3. A cable 75 meters long is fed with 10 volts applied at 1.5 Mc. The characteristic impedance is $Z_0 = 75$ ohms. The attenuation and phase constants per 100

meters of line are, $\alpha = 0.013$ and $\beta = 3.5$ so that $\alpha l = 0.013 \times 0.75 = 0.0098$ radian or 0.6 deg. while $\beta l = 3.5 \times 0.75 = 2.63$ radians or 151 deg. The load is given as $Z = R + j\omega L = 55 + j125 = 136.5/66^\circ$. From this data we find that

$$\begin{aligned} \tan Z &= jZ_0/Z_l = j75/(136.5/66^\circ) \\ &= 0.55/24^\circ = T e^{j\tau} \end{aligned}$$

Now, looking up in the Chart I the intersections $T = 0.55$ and $\tau = 24$ deg. we find $Z = 28 + j10$ deg. The point X is given by:

$$\begin{aligned} X &= Z + \gamma'l = Z + j\alpha l - \beta l \\ &= 28 + j10 - 151 + j0.6 \\ &= -123 + j10.6 \text{ deg.} \end{aligned}$$

A line connecting X with Z gives the current distribution on Chart II. A parallel line displaced 90 deg. to the right gives the voltage and impedance distribution. This line connects the point $X' = -33 + j10.6$ with $Z' = 118 + j10$. These lines are substantially horizontal at the inclination, $\delta = \tan^{-1} \alpha/\beta$ is only 0.004.

Point X' in Chart II reads $S = 0.58$ and $\sigma = 165$ deg. corresponding to an input voltage $V_0 = 10/0^\circ$ volts. Therefore,

$$\begin{aligned} C_v &= V_0 / (S/\sigma) = 10 / (0.58/165^\circ) \\ &= 17.25 / -165^\circ \end{aligned}$$

Point Z in Chart II reads $S = 0.95$, and $\sigma = -3$ deg. and therefore the output voltage is

$$\begin{aligned} V_l &= C_v S / \sigma \\ &= [(17.25) / -165^\circ] [(0.95) / -3^\circ] \\ &= 16.4 / -168^\circ \end{aligned}$$

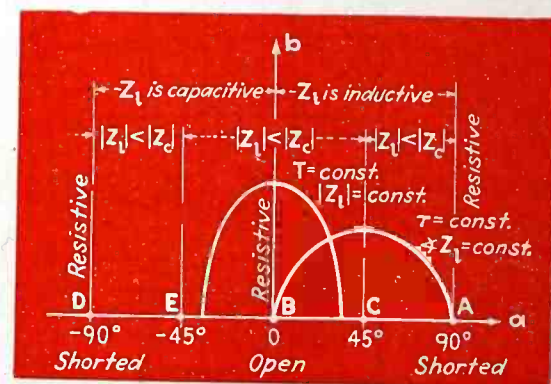

FIG. 4—Diagram showing reactance of line for various loads and for line whose characteristic is a pure resistance

Going along the line $X'Z'$ the point of minimum voltage is obtained at $0 + j10$ with $S = 0.17$ and $\sigma = 90$ and the point of maximum voltage at the point $90 + j10$, with $S = 0.99$ and $\sigma = 0$. Therefore

$$\begin{aligned} V_{min} &= 0.17 \times 17.25 / 90^\circ - 165^\circ \\ &= 2.95 / -75^\circ \text{ volts} \end{aligned}$$

$$\begin{aligned} V_{max} &= 0.99 \times 17.25 / 0^\circ - 165^\circ \\ &= 17 / -165^\circ \text{ volts} \end{aligned}$$

(Continued on page 158)

Fluorescent Inspection of Tungsten

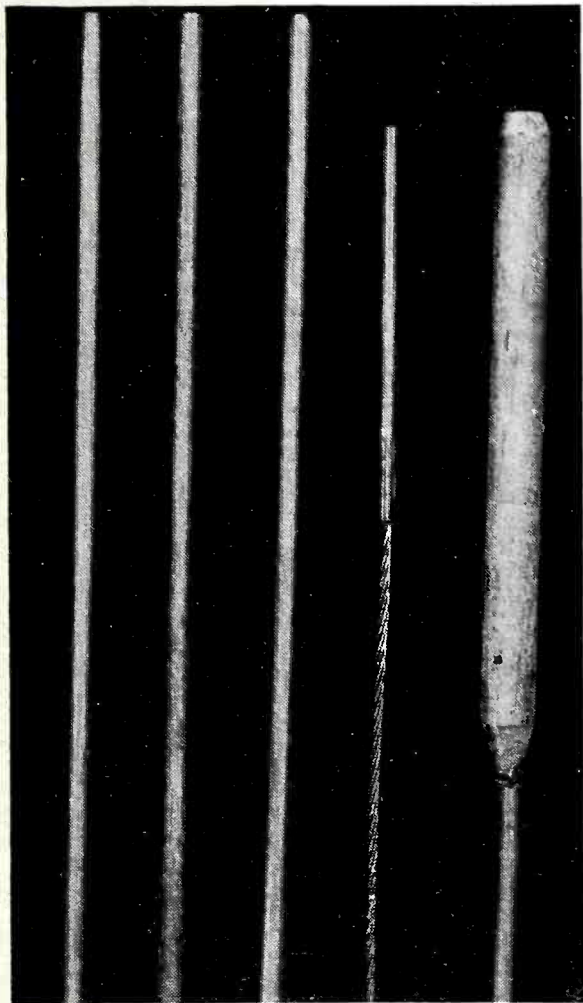

FIG. 1—Typical tungsten leads photographed under white light. These leads are for glass envelopes of power tubes

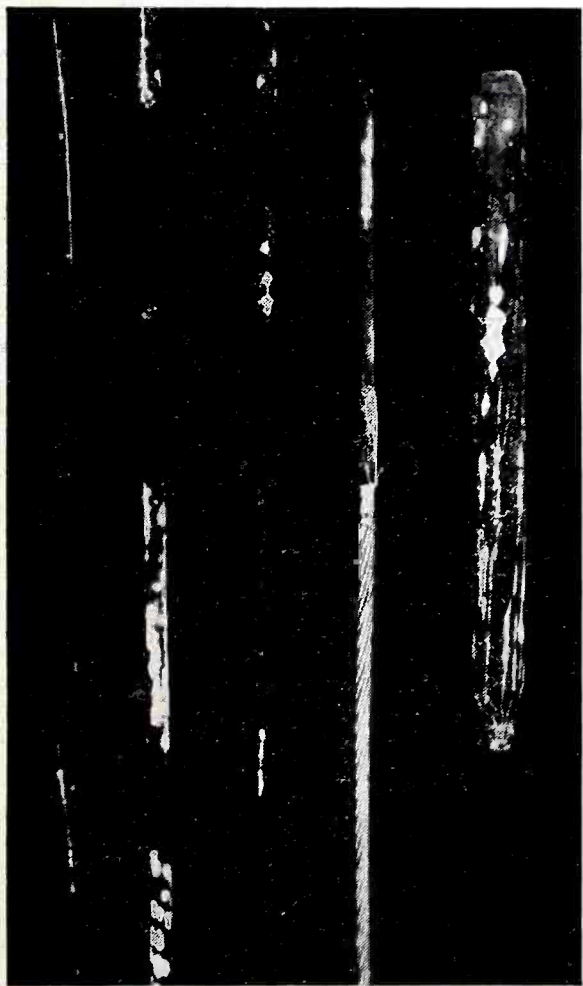

FIG. 2—Same tungsten leads after treatment with fluorescent penetrant, photographed under ultraviolet light

Minute longitudinal cracks in tungsten leads passing through glass are a major cause of gassy electronic tubes. A fluorescent penetrant method applicable to large quantities of tungsten parts is described. It makes cracks glow under ultraviolet illumination

By S. ANDREW KULIN

*Metallurgist, Power Tube Division
Rathenow Mfg. Co., Waltham, Mass.*

A LARGE percentage of unexplained leaks in vacuum tubes have undoubtedly been caused by longitudinal cracks in tungsten leads sealed into the glass envelopes. Many of these cracks can be detected by visual inspection with binocular microscopes, but this method is tedious and is quite slow since the field of vision is small. Furthermore, microscopic inspection does not permit differentiation between cracks and harmless scratches.

The fluorescent penetrant method of inspection known commercially as "Zyglo*" has been successfully applied to the problem of inspecting large quantities of tungsten leads. The tungsten to be inspected may be in either ground or ground and etched condition, may vary over a wide range of lengths and diameters, and may be plain tungsten, tungsten welded to nickel and stranded copper or tungsten welded directly to stranded copper.

In the new method, the tungsten parts are first cleaned to remove oil and grease which might cover surface discontinuities and prevent the penetrant from entering small crevices. The cleaned parts, in fine mesh baskets, are then immersed in the special fluorescent penetrant. The parts are allowed to stand for two hours or more, during which time the low-viscosity water-emulsifiable penetrating oil flows by capillary action into all cracks and pores and surplus oil drips into a recovery pan.

* Available through the Magnaflex Corp., Chicago; a patented method.

When tungsten rods are welded to stranded wire, the parts are bundled together in such a way that only the tungsten is immersed. Immersion of stranded wire would present a difficult cleaning problem.

The next step is washing with a spray of warm water (120 to 140 deg. F) under ultraviolet light so the operator can see when excess penetrant on the surface has been removed. The parts are agitated during washing. A higher water temperature is to be avoided because it would remove the penetrant from the shallower surface cracks.

After all penetrant except that in the cracks has been washed off, the parts are dried in a recirculating air drier in which the temperature is carefully controlled. Excess heat here would allow the penetrant to escape from the cracks in the tungsten, and flaw indications would lose their sharpness or disappear.

The thoroughly dried tungsten rods are arranged in tiers and completely covered with an absorbent yellow powder for one hour. This powder draws the penetrating oil out of the cracks and spreads it out from the cracks to give magnification of the defects. The fluorescent indication will be proportionately wider than the actual defect.

Surplus powder is removed by shaking, sifting or compressed air, and the rods are inspected under ultraviolet light (approximately 3600 Angstroms). The defective parts in Fig. 1 would appear as in Fig. 2

(Continued on page 160)

V-H-F

Receiver Oscillator Design

Secular stability — Unitary construction — Choice of materials — Tuned circuit types — Circuit Q — Series resistance — Voltage stability — Selectivity — Tube characteristics — Interelectrode variations — Transit time and inverse feedback loading

By S. YOUNG WHITE

IT IS SAFE to predict that great activity in further opening up the frequency range from 50 to 250 Mc will be a feature of the radio art after the war.

This range contains 20,000 of our familiar 10 kc broadcast channels. If wide-band frequency modulation is used there will be substantially fewer channels available but for a number of commercial services a swing of 25 kc may be sufficient and this still provides a lot of channels.

After the war it will be desirable to have as many channels as possible in this region. Obviously, many ideas concerning the precision-tuning of receivers will have to be revised. The problem of designing a dial readily set to five figures by unskilled users will, alone, tax our ingenuity. The apparatus behind the dial will have to perform with astronomical accuracy.

The purpose of this paper is to discuss some of the major problems associated with accurate tuning and the maintenance of calibration at very high frequencies. Since the calibration of receivers of the super-heterodyne type, which will undoubtedly be used, largely involves oscillator design, oscillator circuits only will be considered in the following discussion.

General Considerations

There is apparently no royal road to stability. Each component of the high frequency oscillator of the future will have to be completely stable, or will have to cooperate with some other element to cancel out overall

circuit instability. Warm-up drifts and those caused by line voltage changes will have to be held within assigned channels and, if we design for mobile, aircraft or equivalent use then temperature, humidity and vibration effects will have to be similarly limited.

Such results can most readily be expected of simple, rugged and compact designs where, in effect, every part "flows" mechanically and electrically into another part and we tend to have a homogenous unit rather than an inter-connected aggregation of conventional components. It will be a mark of good design to have some "imaginary" components, i.e., certain details of construction performing circuit functions without the specific inclusion of

parts recognizable as such. Any wiring at all in r-f circuits is unthinkable.

When we begin to consider maintained accuracies of the order of 0.01 percent to 0.02 percent we must place first on the list of requirements that of "secular" stability. This is a phrase the writer recently came across in an article on coils, written by a British engineer. "Secular" has to do with the ages, or long periods of time. If you build a pyramid well of the right materials and come back in a few thousand years it will still be the same old pyramid. The word seems to express our primary need better than the usual term, "aging." This requirement allows us to consider the use of no constructional material subject to appreciable cold-flow or change in cubic volume with age.

Circuit Resistances

Since this paper has to do with tunable equipment and so many of the tuning means we shall have to consider involve sliding or switching contacts, let us consider the order of circuit resistances involved.

Round figures for the Q values of oscillator tuned circuits would be as follows: A two-inch coaxial line would have a Q of about 1700. "Cups", depending upon size, would be about 1200. A parallel line would average 1000. A concentrated coil, capacitor-tuned, 650. A coil and fixed ceramic capacitor, ready for insertion of a movable core, 700 (from which must be subtracted the core-losses, giving resultant Q's from 28

PRESENT and FUTURE

THE AUTHOR, in this timely paper, sets out primarily to stimulate thinking on the part of engineers concerning tomorrow's equipment designed to operate between 50 and 250 Mc

He includes, however, considerable data which not only supports his predictions but should also prove immediately useful in the design of very-high-frequency gear for the war effort

to 400, depending upon core material). A sliding-contact coil, 300, lowered to some extent by the tuning mechanism contact resistance.

These Q values, by simple calculation, show an r-f resistance range from a little over 20 milliohms (0.020 ohm) to 50 milliohms. Any external resistance we place in series with such circuits must therefore be negligible in relation to these values. This introduces a number of design problems. For example, a band-change switch that is consistently lower than one milliohm resistance is a pretty large object and if we use concentrated circuits we cannot readily use units of large dimensions. The sliding-contact to the rotor of most variable capacitors must, similarly, be viewed with suspicion as to its ability to maintain low resistance under service conditions.

Q of Tuned Circuits

Further speculating regarding future design, let us compare the Q values and dynamic impedances of two typical lumped circuits, one designed to operate at 1 Mc and the other at 150 Mc.

The designer is thoroughly at home at 1 Mc and, when called upon to design a stable oscillator for that frequency, might readily choose a tuning capacitor value of 300 $\mu\mu\text{f}$. The oscillator tube inter-electrode capacitance would be, say, 10 $\mu\mu\text{f}$, or only one-thirtieth of the total. The reactance of the selected capacitor is approximately 530 ohms and, when multiplied by a Q of 100, gives a dynamic impedance for the circuit of 53,000 ohms. This is indeed a nice load for the tube to work into.

To have the same capacitive reactance at 150 Mc, the tuning capacitor would have to be about 2 $\mu\mu\text{f}$, or less than the inter-electrode capacitance of an "acorn" type tube. Since the tube would therefore be virtually the whole tuned circuit insofar as capacitance is concerned, we can only shudder at the effects of any variations in tube characteristics. These might include varying glass losses, mica losses, input resistance losses. They might also include variations in electrode geometry with changes in wattage dissipation. Such changes would be the very reverse of secular stability.

Now, suppose we try to "swamp" the tube capacity by increasing the tuning capacitor size thirty times,

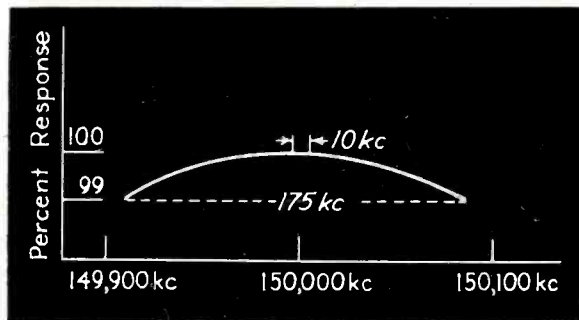

FIG. 1—Resonance curve of typical v-h-f receiver circuit having a Q of 100, showing relatively poor frequency discrimination. Note that the curve is nearly flat insofar as 10-kc selectivity is concerned even at the peak and that acceptance is 175 kc wide only one percent down

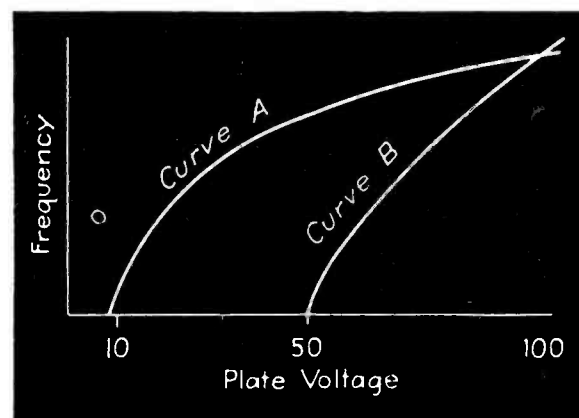

FIG. 2—Curves showing striking-voltage characteristics of two oscillators, one (A) having a 15 $\mu\mu\text{f}$ tuning capacitor and the other (B) a 60- $\mu\mu\text{f}$ tuning capacitor. The oscillator of curve A starts at 8 volts and will obviously be much more stable with changes in plate voltage above 100 volts

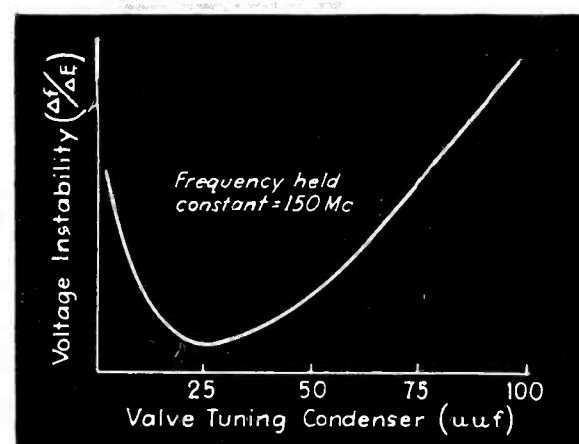

FIG. 3—Voltage stability curve of a typical oscillator. Note that maximum stability occurred with the tuning capacitor around mid-range. At capacity settings under 25 $\mu\mu\text{f}$ the tube constituted an appreciable part of the circuit capacity and so tube variations reduced stability. At capacity settings over 25 $\mu\mu\text{f}$ dynamic impedance of the circuit was lowered sufficiently to cause a poor match between tube and load, again reducing stability

as we can so readily do at 1 Mc. The resultant capacitance would be 60 $\mu\mu\text{f}$, with a reactance of only 18 ohms at 150 Mc. It would take a Q of about 3,000 to produce a dynamic impedance equal to the 53,000 ohms we obtained with the low coil Q value of 100 at 1 Mc.

To further complicate matters at high frequencies, the tube is apt to be working under difficulties due to transit-time loading and inverse-feedback loading caused by the inductance of the cathode lead.

Tube Characteristics

The importance of Q in maintaining oscillator frequency despite change in supply voltages is generally appreciated. There are, however, several separate effects involved and all of them must be considered at very high frequencies.

One effect is the change in tube element dimensions and the physical relationships between elements with changes in wattage dissipation. Such changes occur when the heater and plate voltages are, for any reason, altered. This results in changes in inter-electrode capacity.

Another consideration is the change in tube impedance and the change in phase-angle due to varying electron transit-time as heater and plate voltage vary.

There is also a change in reflected impedance when the G_m of the tube is changed. This occurs, for example, where a tickler coil having large leakage-inductance is used. Tube charging-current passing through such a tickler is phased, amplified by the tube and reintroduced into the tank circuit, where it appears as a reactance. The amount of reactance generated in the tank circuit is proportional to the amplification of the tube. This effect is always troublesome and can best be avoided by designing the circuit so that the tube generates no phase-angle, which almost entirely precludes the use of a tickler-type oscillator.

Resonance Curves

Still another problem is involved. We usually think of the peak of a resonance curve as being the point of highest circuit impedance, and zero phase-angle. Consequently, the critical frequency of oscillation is normally defined by the peak. But,

(Continued on page 206)

MOVIES and SLIDEFILMS Speed

By LYNE S. METCALFE

An analysis of sound movies and slidefilms available to engineers newly confronted with the problem of teaching electronic manufacturing techniques to war workers. Some films show how to teach effectively, while others supplement standard instruction methods

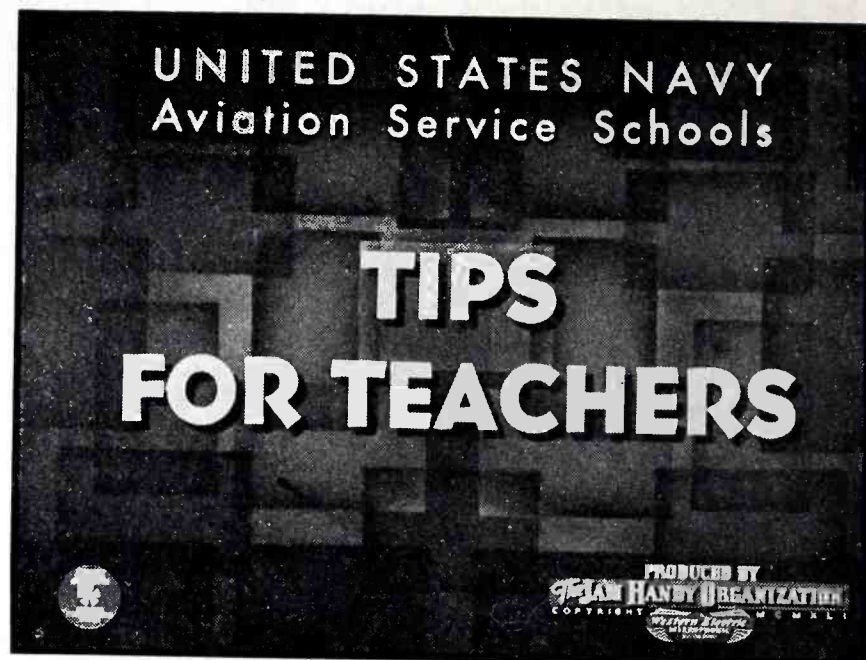

Title slide for slidefilms prepared for U. S. Navy

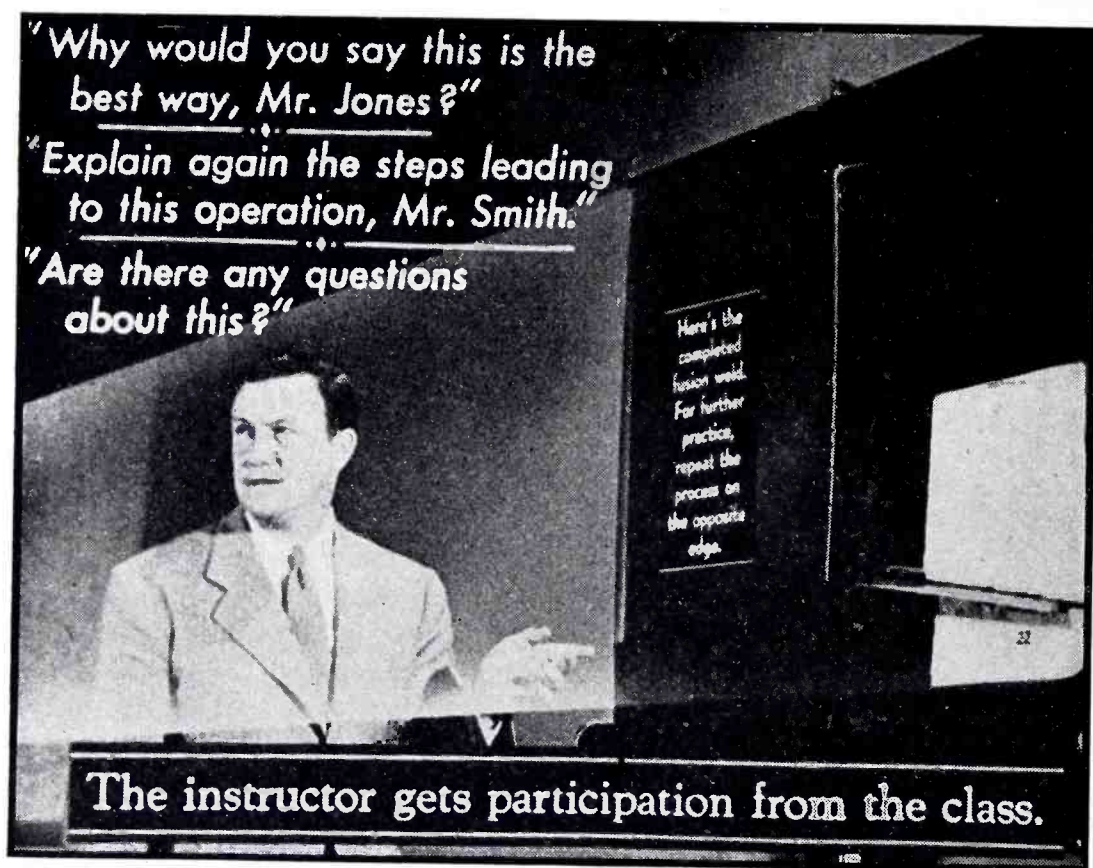

Scene from "Tips on Slidefilms", which shows instructors how to use visual teaching aids with maximum effectiveness

TO train new war workers in skills and vocations essential to war production in the shortest possible time, something more than routine factory instruction is necessary. This is particularly true in the fields of electricity and electronics, where the training usually involves complicated and technical information.

The training-within-industry program, necessitated and expanded by the Government early in the war production effort, has taken a definite place in our war economy. As a result, heavier and sometimes new burdens are thrown on the personnel

training department, on foremen and particularly on electronic engineers.

In an industrial training class which includes a large percentage of untrained or partly trained beginners, the technique or quality of the instruction has a great deal to do with the speed and effectiveness with which the classes are conducted and the facility with which apprentices are moved into actual work at the bench or machine.

Movies Teach Engineers to Teach

To supply a measure of teaching

technique to these groups, the picture screen, already a powerful force in the war production training program, has been tried out with considerable success. Motion picture films and slidefilms show the instructors how to teach what they know—by grounding them in the basic principles of educational techniques. This program is particularly aimed at the skilled mechanic or workman, fully competent in his specialization, but too often without experience or knowledge in how best to pass it along to others.

One recent film designed to help the experienced worker break in a new worker is titled "Passing the Know-How Along." It is a 16-mm sound motion picture approximately 15 minutes long, based upon material in Bulletin 2-C of the Training-Within-Industry Section of the WPB. This motion picture demonstrates seven tested and logical steps that help in passing along how-to-do-it information in terms so simple that anyone may improve his or her performance after seeing it. It applies to any kind of manufacturing because it deals with basic procedures and with the psychology of the process of transmitting information at the workbench.

Another 16-mm sound motion picture is titled "Giving a Shop Demonstration." It is a two-reel subject with a screen time of about 20 minutes. The objective of this picture is

Wartime Training of Technicians

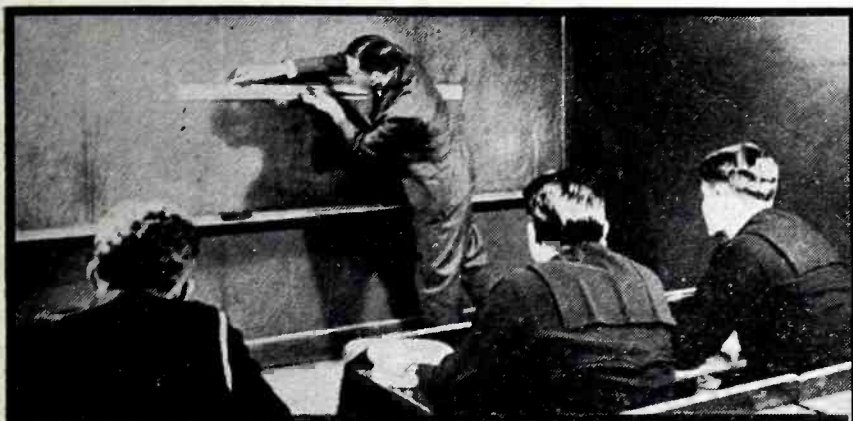

For one thing, it helps you hold the interest of the class. ACTION is an attention-holding element of showmanship, and MOVEMENT is a necessary part of work at the blackboard.

3

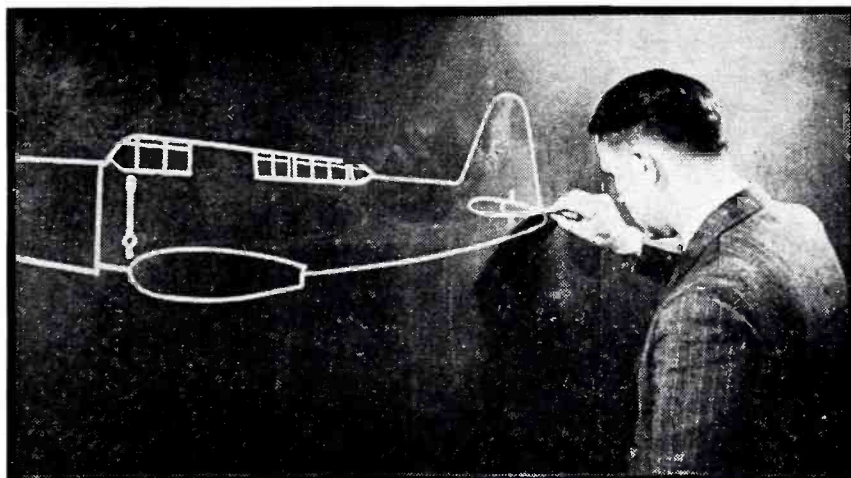

— they see the relation of each part to the others, and they understand it more clearly and retain it longer. Pictures help shorten the learning process.

5

Scenes from "Tips for Teachers", a visual training kit for engineers who are training war workers. It consists of nine slidefilms and a series of 33 $\frac{1}{3}$ rpm phonograph records containing accompanying sound

to show the best basic procedures in demonstrating a shop job by actual before-the-eye demonstration. The material covers the shop demonstration by the instructor which must precede practical work on the part of the class. This picture was planned and produced in cooperation with the Aviation Service Schools of the Bureau of Aeronautics of the United States Navy.

Slidefilms Give Tips for Teachers

Recently, a series of nine sound slidefilms (or filmstrips) has been made available under the title "Tips for Teachers." These nine films comprise a total of 701 individual pictures, photos, graphs, charts, drawings and exhibits. (The two motion pictures reviewed above may be used along with these slidefilms if desired, inasmuch as they are supplementary.) The nine subjects in the slidefilms are:

- (1) The Teacher
- (2) Some Principles of Teaching
- (3) I Want to Learn
- (4) The Lesson Plan
- (5) Make Your Chalk Talk
- (6) Teaching—a Vocation
- (7) Shop Teaching
- (8) Designing Examinations—Part I
- (9) Designing Examinations—Part II

The slidefilm (or filmstrip) is a strip of 35-mm safety motion picture film, on each segment or frame of which is a picture. These individual pictures are arranged in logical sequence in order to show a given procedure pattern, while the accompanying disc record provides the ver-

bal commentary, lecture or miscellaneous sounds. Slidefilms are more economical and more convenient than movies when each scene is to be studied for some time by the audience.

When the picture screen is used, certain factors not present in the ordinary blackboard talk or study session appeal may nullify the best efforts of the most skilled instructor. Modern projection equipment is simplicity itself, yet there are certain precautions that can be taken which will avoid interruptions, digressions and failure.

A discussional type slidefilm which points out to instructors how seemingly simple hazards to a smooth running session may be circumvented has been made available to war production plants. This subject is called "Tips on Slidefilms" and comprises a total of 80 individual pictures with text superimposed on the films.

Picture-Screen Training is New Tool

The purpose of picture-screen war production training is not to substitute for or supplant any form of instruction which has proved its value over the years. The screen is not used as a substitute for textbook study, lectures, demonstration or shop-work. Rather, it is intended to provide the instructor with a new tool which has the power to save his or her time and labor by more rap-

idly conveying the fundamentals of a skill, its purpose, tools, equipment and basic techniques, leaving more time for the instructor to carry on actual demonstration. In achieving this purpose it has been signally successful.

List of Films Available

Some of the training slidefilms and motion pictures now available to the electronic field as supplements to standard training methods are:

Basic Electricity: A series of 12 discussional-type slidefilms, comprising 888 individual pictures, drawings, photos, charts, graphs and exhibits. The Jam Handy Organization, 2900 E. Grand Blvd., Detroit, Mich.

Excursions in Science No. 3: A single-reel sound motion picture covering the fundamentals of magnetism. The General Electric Co., Schenectady, N. Y.

Electrochemistry: A single-reel sound motion picture. Erpi Classroom Films Inc., New York, N. Y.

Elementary Science (Physics): A series of eleven reading-type slidefilms. The Society for Visual Education, Chicago, Ill.

Introduction to Machining: A series of sixteen discussional-type slidefilms with a total of 701 individual pictures. The Jam Handy Organization, Detroit, Mich.

Fundamentals of Bench Work: Ten discussional slidefilms. The Jam Handy Organization, Detroit, Mich.

Electricity at Work: A single slidefilm subject. The Society for Visual Education, 100 E. Ohio St., Chicago, Ill.

The following have been prepared to present effective modern teaching techniques to engineers themselves:

Passing the Know-How Along: A 16-mm sound film 1 $\frac{1}{2}$ reels long. The Jam Handy Organization, Detroit, Mich.

Giving a Shop Demonstration: A 16-mm sound film 2 reels long. The Jam Handy Organization, Detroit, Mich.

Tips for Teachers: A series of 9 slidefilms totalling 701 frames, with accompanying sound film 2 reels long. The Jam Handy Organization, Detroit, Mich.

Tips on Slidefilms: A slidefilm with 80 frames. The Jam Handy Organization, Detroit, Mich.

Recording Audio Analyzer

A heterodyne audio frequency analyzer and a high-speed graphic level recorder together trace on a chart the level of each frequency in the audio spectrum from 10 to 9500 cycles, permitting accurate determination of predominant frequencies causing noise or vibration

IN general, the sound produced by any mechanical device includes the fundamental frequency at which the device is operating and the various harmonics thereof, along with the natural resonant frequencies and harmonics of parts which are set into vibration by shock excitation. The operating frequencies are readily calculated, and many of the resonant frequencies can likewise be calculated by various methods. Once the chief frequency components of noise have been found for a device, the problem of reducing or eliminating the noise is already half solved.

A sound-level meter measures the over-all level of a sound without telling which frequencies are responsible for that sound. A sound analyzer, on the other hand, gives the level or amplitude of each individual frequency component in a sound, permitting a determination of the frequencies chiefly responsible for the noise.

The audio analyzers in common use today can be classified according to their selectivity characteristics. The degenerative type is an example of those having a constant-percentage characteristic, wherein the band width being analyzed widens proportionally as frequency is increased.

The heterodyne analyzer described in this article is an example of the other type, in which the band width being analyzed remains the same for all frequencies and hence gives almost razor-sharp selectivity at higher audio frequencies.

Recording-Type Analyzer

In many sound problems it is highly desirable to be able to secure a complete graphic record, in a few minutes, of the sound level at each frequency in the audio range being studied. This eliminates tedious plotting of graphs after test runs, and gives an instantaneous picture of how a change in design affects all frequency components.

A recording audio analyzer of the heterodyne type was developed by Western Electric Co. to meet this industrial demand for a recording instrument.

The complete unit, known as the Western Electric Model RA-281 recording sound frequency analyzer, consists of a pickup device, a heterodyne analyzer with associated a-f amplifier, and a special graphic level recorder which automatically plots the response at each frequency over the range being studied. The complete record is produced on wax-coated paper in two minutes or less,

with no processing being required either before or after the test run.

Heterodyne Analyzer

A quick understanding of the operation of the audio analyzer circuit can be obtained with the aid of the block diagram in Fig. 1. For simplicity, assume that the microphone is picking up only a 1000-cycle (1-kc) sound. After amplification, this 1-kc a-f signal is combined with the 49-kc signal from a local r-f oscillator to produce sum and difference frequencies of 48 and 50 kc along with the 49-kc signal. The crystal filter passes a band a few cycles wide centered on 50 kc, hence only the 50-kc component (the upper side frequency) gets through. This is amplified and combined with the 49-kc local oscillator signal in the demodulator to produce the original 1000-cycle signal again.

Essentially the same picture holds true if the microphone is picking up a complete audio spectrum. All of the audio components beat with the 49-kc oscillator signal to produce sum and difference frequencies, but only the 50-kc component due to the 1000-cycle input frequency will get through the crystal filter.

Now suppose that the local r-f oscillator is slowly varied from about

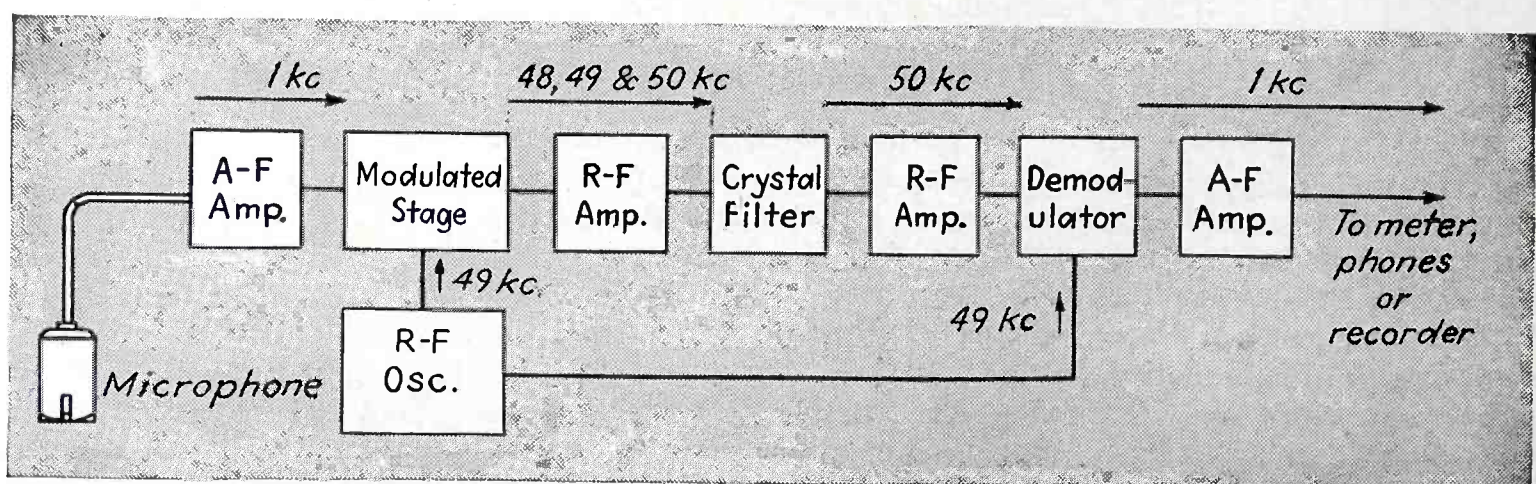

FIG. 1—Block diagram of the audio analyzer, with frequencies present in each section during analysis of a 1000-cycle sound



ABOVE

Complete audio analyzer system, consisting of the analyzer unit (at the left, with driving motor being lowered over tuning knob) and the graphic level recorder (at right)

RIGHT

Exposed view of the graphic recorder chassis. The discs on each side of the paper roll are the Permalloy magnetic clutches. They rotate continuously in opposite directions. The scribe is attached to an endless wire cable which goes around these discs, but moves only when one of the clutches is engaged

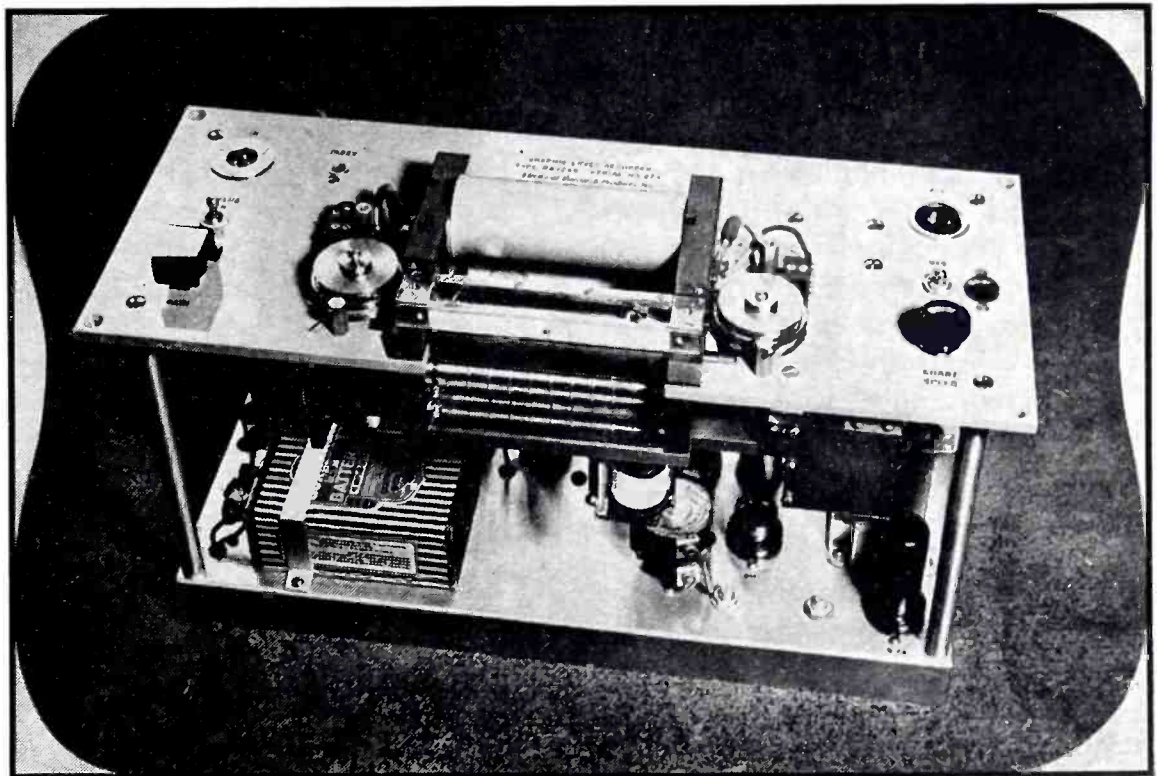

40 kc to 50 kc while the microphone is picking up all audio frequencies. At 40 kc, the 10,000-cycle component will give a 50-kc beat which can get through the filter, while at 49.99 kc the 10-cycle component will produce the required 50-kc beat. Thus, as the sweep is made from 40 to 50 kc, each audio component in turn will produce its own frequency in the output of the analyzer.

The complete schematic circuit diagram of the analyzer is given in Fig. 2. The audio input signal to

be analyzed, obtained either from a dynamic microphone or a moving-coil type vibration pickup, is applied to tube V_1 in the first a-f amplifier stage through matching transformer T_1 . This stage is highly stabilized, with R_6 and C_1 providing feedback from plate to grid for this purpose.

With key K_1 in the position shown, the output of the first a-f stage is fed to the control grids of tubes V_6 and V_7 in the balanced modulated stage through the triode sections of V_6 , which provide a-f amplification and phase inversion respectively. The 40-50 kc signal, produced in the self-excited oscillator stage containing triode-pentode tube V_0 , is fed to the parallel-connected third grids of the modulated tubes to give electronic mixing of r-f and audio signals. The r-f carrier component cancels out in plate load resistors R_{01} and R_{02} because it is fed to the two modulated tubes in phase, but sideband components produce voltages across these resistors for application to the crystal filter because the a-f signal is fed to the two modulated tubes 180 degrees out of phase.

The Quartz Crystal Filter

The filter unit passes only the desired narrow band of frequencies centering on 50 kc. The standard filter unit supplied with the instrument has a band width of 5 cycles, and suppresses frequencies outside

this range at the rate of approximately 45 db in the first 55 cycles. Additional filters with 20, 50 and 200-cycle band width are available, and up to three can be built into the unit and connected to a suitable selector switch. Filters with widths of 2 or 10 cycles are available on special order.

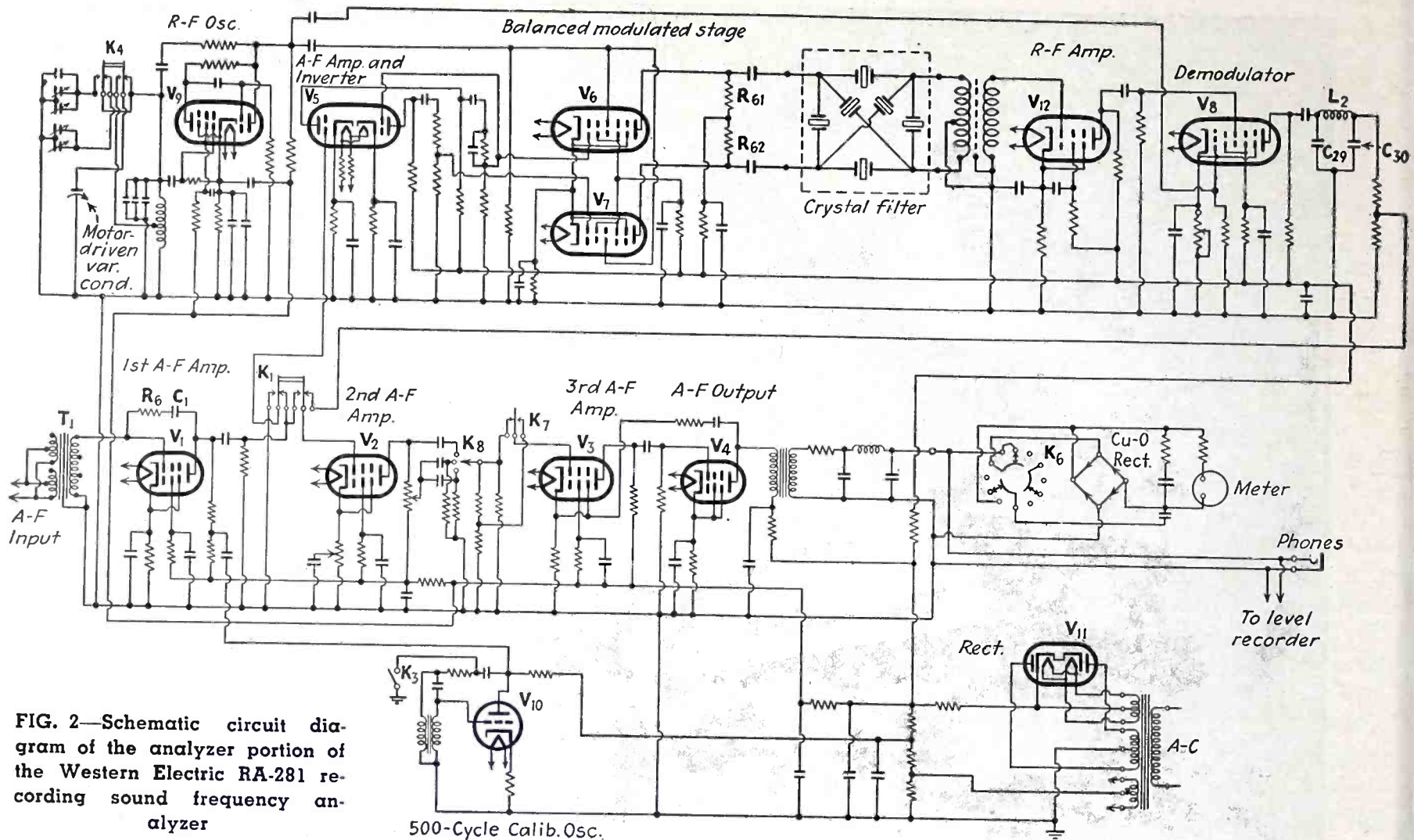

FIG. 2—Schematic circuit diagram of the analyzer portion of the Western Electric RA-281 recording sound frequency analyzer

The crystal filter used in the audio analyzer contains a lattice network of quartz crystals. The pass band determines the exact type of lattice circuit and the number of crystals to be used. The wider the band, the more crystals are needed.^{1,2,3}

Each crystal must be ground accurate to a fraction of a cycle so as to build up the desired band width. The crystals collectively must provide a flat-top response centered on 50 kc, with almost straight sides outside the desired band. All crystals in a given filter are ordinarily ground from the same mother crystal so as to have identical characteristics.

The crystals are usually mounted in individual hermetically sealed containers. In some applications, however, it has been found desirable to mount each crystal individually in a vacuum tube, to eliminate air damping and further improve the crystal as a filter element.

Demodulator and A-F Amplifier

The output of the crystal filter is amplified in r-f amplifier stage V_{12} , then combined with the r-f oscillator signal in the demodulator stage by

means of electronic mixing. This gives in the output circuit of demodulator tube V_8 a difference frequency corresponding to the audio frequency being analyzed. Pi filter $L_2C_{20}C_{30}$ passes only frequencies below 15 kc, hence suppresses the original r-f components in the demodulator.

From the demodulator, the single audio frequency component being analyzed at the moment is fed through the other section of key K_1 to the second a-f amplifier stage, and thence through the third a-f and output stages to headphones and the graphic level recorder. Aural monitoring simplifies the selection and identification of peak components during manual tuning.

In the position shown, key K_6 connects the copper-oxide rectifier and meter across the output. In another position it places a condenser across the meter circuit for additional damping when dealing with fluctuating noise components, and in the third position it disconnects the meter and rectifier.

Key K_1 permits feeding V_1 directly to the remainder of the a-f amplifier, giving a conventional type of sound

level meter which is responsive to all frequencies. Either the graphic level recorder or the meter can be used for output indications. When the analyzing section is switched out of the circuit in this manner, key K_8 provides a choice of flat, ear-40 and ear-70 frequency responses as called for in ASA specifications for sound-level meters.

Key K_7 in the a-f amplifier permits inserting a 20-db pad when it is desirable to reduce output signal level a definite known amount.

A 500-cycle calibrating signal is fed into the output of the first a-f amplifier stage from triode V_{10} , for checking the frequency and gain calibration of the analyzer before making a series of tests. When not desired, it can be removed by closing key K_3 , which in effect grounds the a-f output of V_{10} .

Key K_4 provides a choice of two different r-f ranges in the local oscillator, thereby giving audio frequency ranges of 10–1000 cycles and 100–9500 cycles for analysis. For special requirements the analyzer can be modified to operate up to 25,000 cycles.

The synchronous motor which is

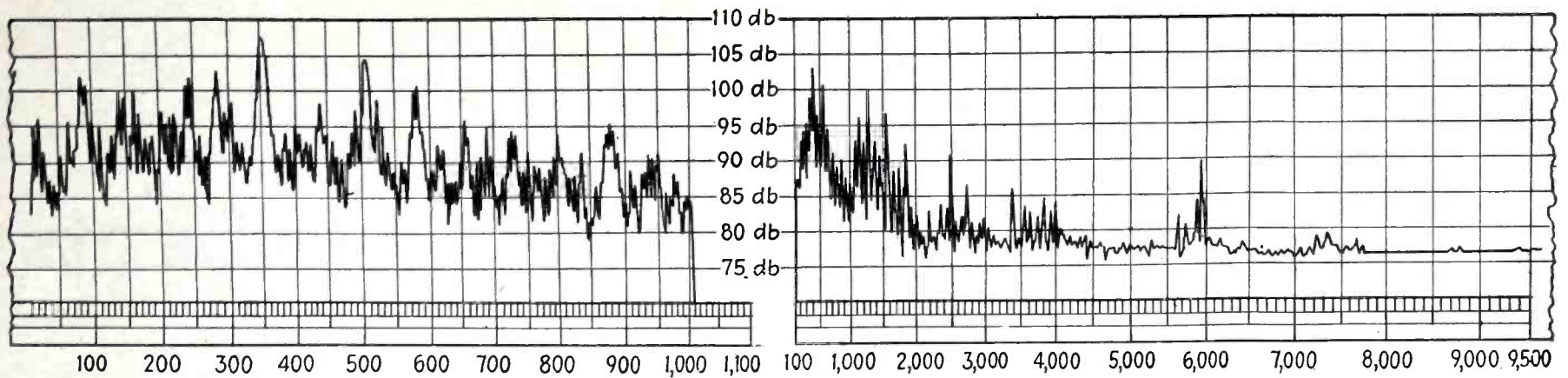

Example of a frequency analysis record of the gear noise in a marine engine. The frequency scales are separate; they are placed on the tape and the vertical lines drawn up from the scales for convenience in studying the results

supplied to drive the tuning dial of the analyzer requires approximately two minutes to cover one of the ranges. The motor speed was selected to give a complete analysis as quickly as possible without missing important audio components. In use, it plugs into an outlet on the analyzer panel and engages the dial knob through prong coupling, so that the motor can readily be removed when manual tuning is to be used.

The graphic recorder was de-

veloped simultaneously with the

Recorder Plots Level vs. Frequency

processing after test runs are made. The recorder utilizes a special bridge circuit developed by Swartzell and Bedell⁴ for the clutch mechanism driving the marking scriber. The final circuit arrangement is shown in Fig. 3.

The a-f signal from the a-f output stage of the analyzer is applied to a five-stage a-f amplifier in the recorder (V_1 , V_2 , V_3 , V_4 and V_5),

clutch only when motion is required.

Initially, P_1 is adjusted so that equal currents will flow through both clutch coils for a particular desired scriber position and corresponding setting of P_2 . Now, if the a-f input level increases above this initial value, more current will flow through the left clutch, for instance, causing this clutch to attract a rotating Permalloy disc which clamps on the endless wire belt which moves the scriber. The action of the clutch thus moves the scriber in the direction selected for higher signal level. The movement stops when P_2 has been moved sufficiently to balance the clutch currents again, under which condition both Permalloy discs just clear the wire. If the a-f level drops, the right-hand clutch engages and the scriber is pulled in the opposite direction.

The action of this particular clutch circuit is so fast and so sensitive that it is possible to make the scriber move completely across the recording paper in less than one second, and respond to changes as great as 58 db per second. The electric motor which drives the scriber through the clutch mechanism also moves the paper. A gear shift on the panel gives a choice of three different paper speeds.

The paper used is ordinary colored paper 4½ inches wide, with a coating of wax. A white wax coating on red paper has proved highly satisfactory and provides clear photostats. Scraping away of the wax by the scriber allows the red paper to show. The paper moves between ridged cylinders which impress longitudinal decibel level lines automatically on the strip chart, thereby permitting the use of inexpensive unprinted paper.

(Continued on page 210)

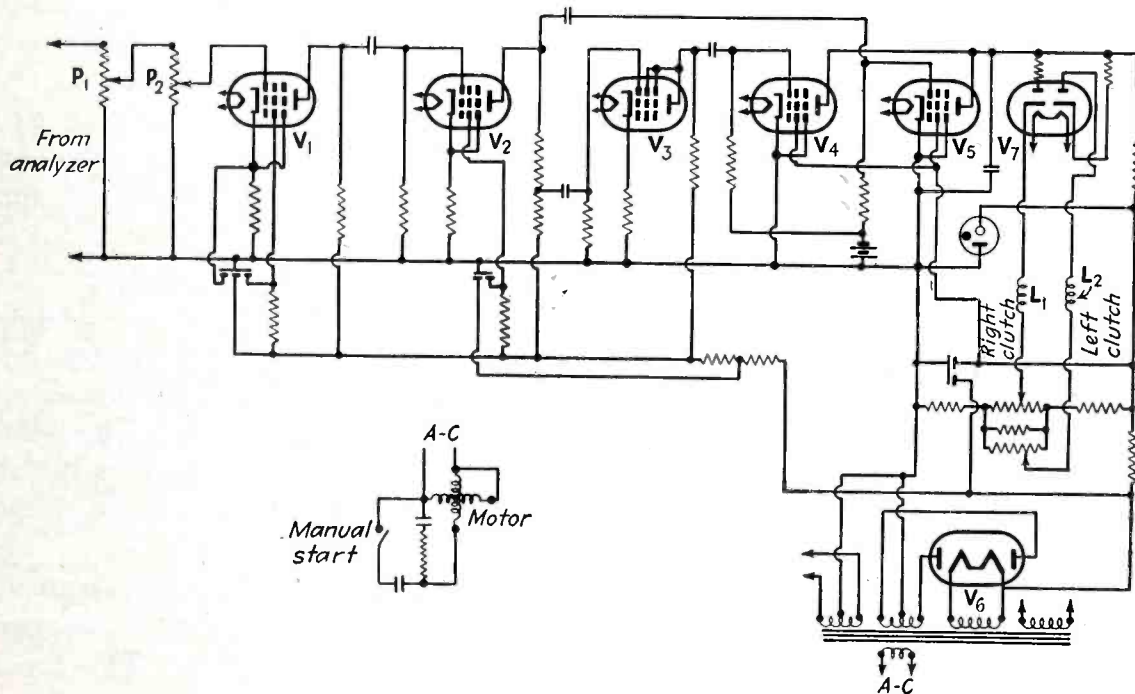

FIG. 3—Schematic circuit diagram of the graphic level recorder

veloped simultaneously with the sound frequency analyzer because no existing recorder could be found which would meet the special requirements of this application. The recorder had to be rugged to permit use in a moving automobile or any other location subject to severe vibration. It had to have a linear decibel scale, had to respond accurately to sudden changes in level, and had to produce an economical permanent record requiring no

through potentiometers P_1 and P_2 . The resulting a-f signal is applied to a bridge circuit arrangement employing full-wave rectifier V_7 in two legs and clutch coils L_1 and L_2 in the other two legs.

The movable contact arm of potentiometer P_2 is mechanically linked with the scriber arm, with the combination being driven by a small electric motor. The scriber or stylus is engaged to the constantly moving drive system through a magnetic

Detecting

Small Mechanical Movements

An improved vacuum tube circuit for detecting mechanical movements as small as a millionth of an inch, by converting them into capacitance changes of the order of $0.01 \mu\mu\text{f}$. Accuracy is high because variations in oscillator and cable characteristics are nullified

OSCILLATOR circuits have been used for some time in the measurement of extremely small mechanical movements, by transforming the movements into changes in electrical capacitance between a fixed and a moving plate. This varying capacitance is connected into the tuned circuit of the oscillator, causing a corresponding change in output which can be measured, recorded, or made to actuate a relay. The chief drawback of these systems, however, has been the fact that any changes in the circuits themselves are equivalent to changes in the capacitance being measured and hence constitute a source of error.

The seriousness of this problem is readily understood if we consider that the maximum variation in capacitance between movable and fixed plates is often less than $0.1 \mu\mu\text{f}$, and the normal variations in capacitance are of the order of $0.01 \mu\mu\text{f}$, whereas the tuning capacity of a tuned circuit is usually $50 \mu\mu\text{f}$ or more. A change of 0.2 percent in the tuning capacitance would thus simulate the full movement of the movable plate. Another source of error is introduced when the displacement unit, i.e. the condenser consisting of the movable and fixed plates, has to be connected to the amplifier by a flexible cable. This cable has to be shielded. The capacitance between shield and lead will vary somewhat when the cable is moved, even if highest grade concentric cable is used, and this variation will simulate an equal variation of capacitance in the displacement unit.

The circuit to be described, on

By Joseph C. Frommer

Rolling & Engraving Mills, Inc.
Chicago, Ill.

which patent application has been made, is essentially free from these drawbacks. It is based on insertion of the displacement unit between an r-f oscillator and an r-f amplifier, as shown in Fig. 1(a). If the capacitance decreases, the input will decrease. The resulting arrangement is highly independent of variations in circuit constants.

For practical reasons, it is in most cases desirable to connect one plate of the displacement unit to ground. If this is done, the other oscillator terminal and both amplifier input terminals must be removed from ground, as indicated in Fig. 1(b).

The circuit diagram of the entire system is given in Fig. 2. Oscillator tube V_2 holds its plate and line H at an r-f potential with respect to ground. The first tube of the amplifier, V_3 , derives its plate supply from these lines. Displacement unit

D is connected between ground and a tap on the coil of tuned input circuit T_2 . Radio frequency current will flow from ground to line H through the capacitance of D and the tapped part of tuned circuit T_2 .

The impedance of D is high compared to the impedance of the tapped center section of tuned circuit T_2 , and therefore the r-f current flowing through these impedances is essentially proportional to the capacitance of D . This current causes an r-f voltage difference between the grid and cathode of V_3 , and a corresponding r-f plate current flows through T_3 . The resulting induced r-f voltage in the secondary of T_3 is rectified in full-wave detector V_4 . The d-c potential thus obtained across 0.5 -megohm resistor R is filtered and applied to the grid of V_5 . The plate current of V_5 can be fed to a meter, recording galvanometer, oscilloscope, relay, etc.

The lead between displacement unit D and tuned circuit T_2 is surrounded by two shields. The inner shield is connected to the cathode of V_3 because a grounded shield around that lead would form an undesirable capacity in parallel with the displacement unit. The inner shielding is surrounded by an outer, grounded shield to eliminate radiation and to diminish changes in capacitance between inner shielding and ground when the flexible cable is moved.

The at-rest capacitance of the displacement unit can be compensated by variable capacitor C , which is connected between H and ground through a coil coupled to T_2 in the proper direction. The gain of the

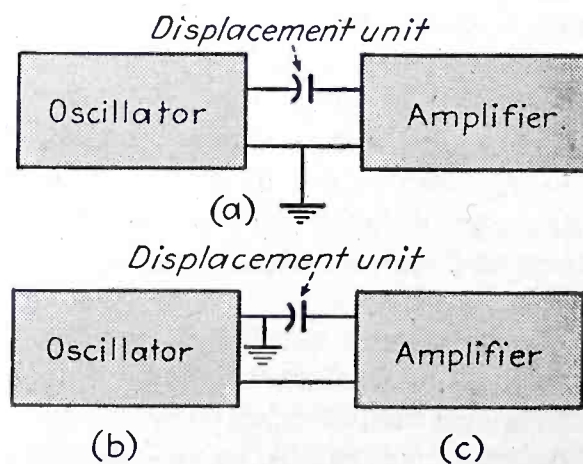

FIG. 1—Block diagram showing position of displacement unit and two possible grounding arrangements

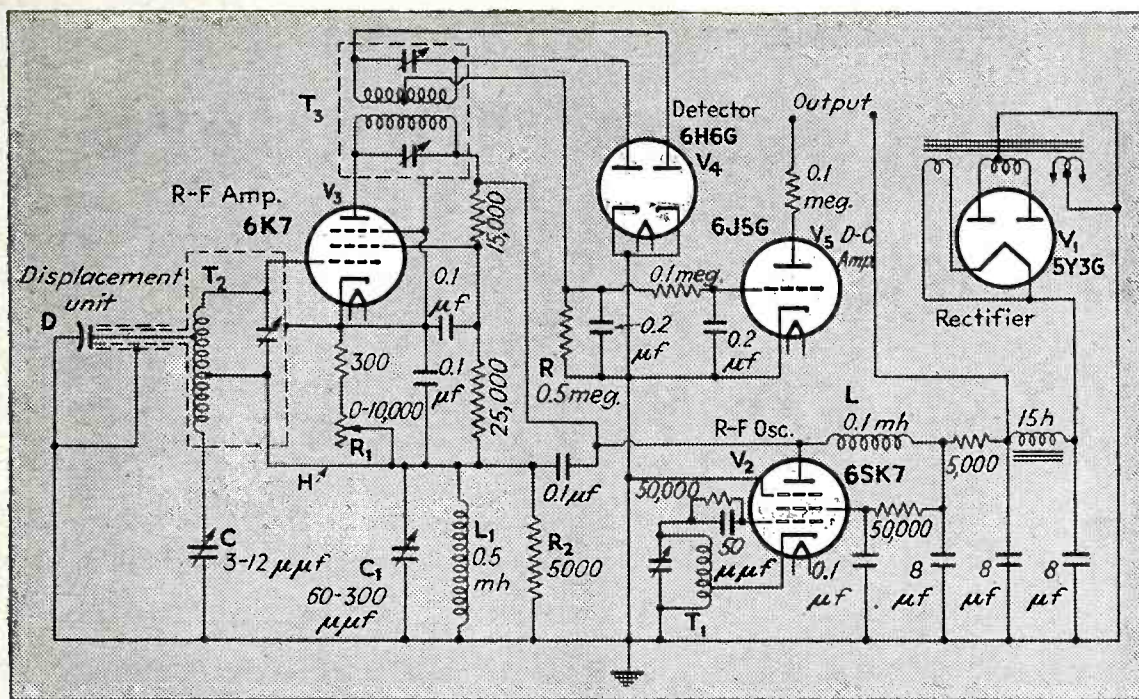
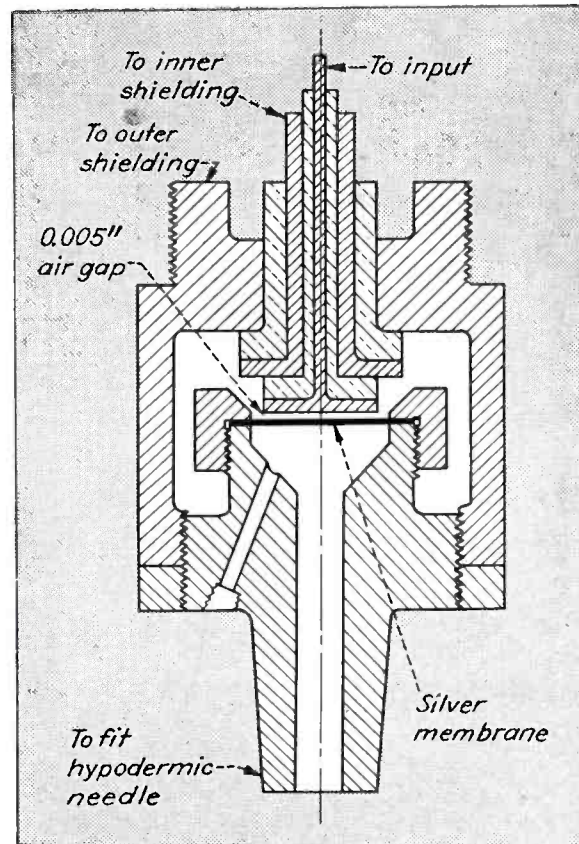

Fig. 2—Complete circuit diagram of oscillator and amplifier used to detect small capacity changes in the displacement unit independently of circuit variations

Fig. 3—Cross-section of displacement unit used for converting arterial blood pressure variations into corresponding changes in capacity



amplifier can be controlled by R_1 .

The circuit was designed to be insensitive to changes in capacitance between lead and inside shielding (of the order of $1 \mu\mu\text{f}$ for an unusually severe punishment) and to changes between inside shield and outside shield (of the order of $10 \mu\mu\text{f}$ for an unusually severe punishment). The oscillator is of the electron-coupled type, so that detuning of the plate circuit does not affect the frequency of oscillation. The r-f voltage obtained at the plate is proportional to the plate load impedance, however. To make this voltage independent of the capacitance between inner and outer shielding (which forms part of the plate-to-ground capacitance), r-f chokes L and L_1 and adjustable capacitor C_1 are tuned to the frequency of oscillation, and the resonant impedance of this tuned circuit is artificially decreased by resistor R_2 .

The oscillator signal is fed to a tap rather than to the top of tuned circuit T_2 because any changes in capacitance between lead and inner shielding are reflected to the top of the tuned circuit in proportion to the square of the ratio of turns. In addition, if we slightly detune a tuned circuit, its impedance varies in proportion to the square of the detuning capacitance. Accordingly, the effect of changes in the capacitance between lead and inner shield will decrease with the fourth power of the ratio of turns. At the same time the input sensitivity will decrease in proportion to the ratio of turns (the impedance of D being higher than the resonant resistance of T_2).

If a substantial power output is

necessary, the output tube can be fed from a separate power pack, or a class A push-pull arrangement can be used in which the plate current of one tube increases by the same amount as the plate current of the other tube decreases.

The construction of a displacement unit responsive to arterial blood pressure is shown in Fig. 3. It is designed to fit a hypodermic needle which can be inserted in an artery. A silver membrane 0.0015 inch thick and $\frac{1}{4}$ inch in diameter serves as the diaphragm, and can be moved to its extreme limit by the pressure of a 100-inch water column, corresponding to the peak pressure in the artery of a dog. The actual movement of the membrane under this pressure is less than a thousandth of an inch, too small to be detected with an ordinary indicator.

Calculations and experimental results both indicate that diaphragm movements as small as a millionth of an inch can be reliably detected. With an additional stage of amplification, there is a good possibility that the sensitivity can be still further increased. The response time of the system is limited only by the inert mass of fluid between the diaphragm and the pressure source (in the needle and on the needle side of the diaphragm in the displacement unit).

The selectivity of the whole amplifier can be kept as low as desired to exclude errors due to shifting of the resonant frequency of either the oscillator or amplifier circuit. Practically the only remaining source of error is the fluctuation of line volt-

age, which can be eliminated by the use of a voltage-regulating transformer.

The amplifier described here has already been used successfully in connection with the recording of blood pressure curves. In addition to this and similar medical applications, the system lends itself to the detection of other mechanical movements, particularly in industry. It can be applied where the displacement is made accessible only by a flexible cord or where response to rapid changes is essential. Possible applications are checking the eccentricity of rotating shafts, detecting small pressure variations in internal combustion engines, and detecting deformation due to stresses in machine or structural parts.

BIBLIOGRAPHY

- Wiggers, C. J., "The Pressure Pulses in the Cardiovascular System," Longman, Green & Co., New York, 1928.
 Lilly, John C., The Electrical Capacitance Diaphragm Manometer, *Rev. Sci. Instr.* 13, p. 34, Jan. 1942.
 Roess, L. C., Condenser-Type High-Speed Engine Indicator, *Rev. Sci. Instr.*, 11, p. 183, 1940 (with extended bibliography).
 Gilson, W. E., Applications of Electronics to Physiology, *ELECTRONICS*, p. 86, Jan. 1943.
 Gilson, W. E., Photoelectric Manometer (improved design), *ELECTRONICS*, p. 112 April 1943.

Calibration of Camera Shutters with the Cathode-ray Oscillograph

Simple photographic methods, using stock apparatus, are outlined for testing individual shutters of the focal-plane and inter-lens type. All essential shutter characteristics can be determined. Methods for production testing and control are suggested

By **THEODORE H. BULLOCK**

*Section of Neuro-Anatomy, School of Medicine
Yale University, New Haven, Conn.*

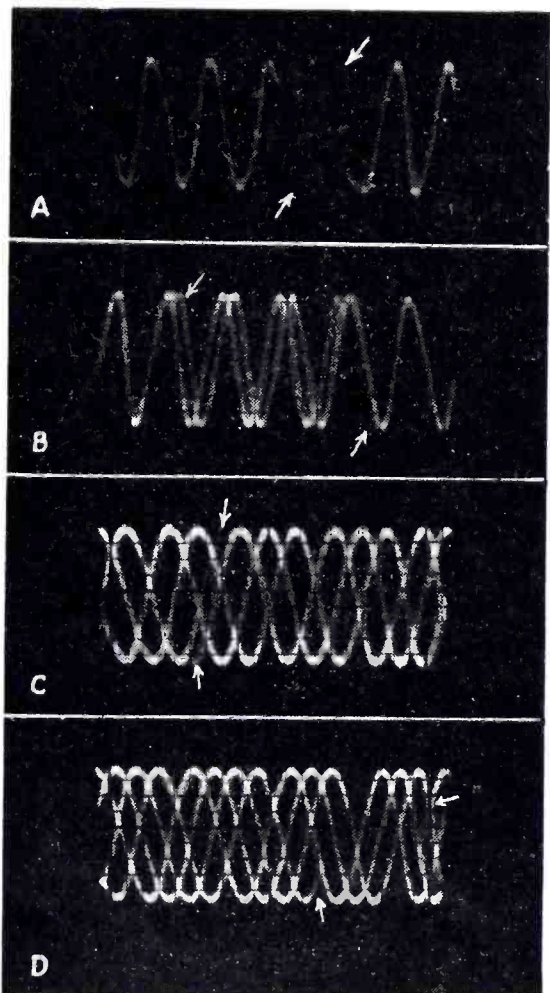

FIG. 1—Sample tests on inter-lens shutters. Arrows indicate beginning and end of photographic traces and hence determine shutter opening and closing. (A) 720 cps vertically with sweep slightly differing from 120 cps. Nominal exposure, 1/200 sec.; actual exposure, 1/125 sec. (B) Same as (A) except shutter set between 1/100 and 1/50 sec. Actual exposure, 1/72 sec. (C) 240 cps vertically with sweep just above 60 cps. Nominal exposure 1/25 sec.; actual exposure 1/20.5 sec. (D) 120 cps vertically with sweep just above 30 cps. Nominal exposure 1/10 sec.; actual exposure, 1/8.4 sec.

MANY methods have been devised for checking the accuracy of shutter speed settings and with them evidence has been obtained that significant errors are common, even in new and high priced cameras.¹ The extensive use of color film has greatly increased the importance of testing shutter speeds, since this factor in exposure seems more likely to be in error than either diaphragm setting or film speed. The two methods whose description occupies most of this article are adapted to the testing of inter-lens and focal plane shutters, respectively, wherever the reading of the result can wait upon the development of a negative, as in the calibration of individual or occasional cameras. It is felt, however, that an even more important application of testing procedure is in large scale testing in factory and service shop. Here direct reading apparatus, designed for the job, is necessary. Electronic methods offer perhaps the best possibilities of solution of this problem and since the problem is chiefly an engineering one, this article will attempt only to call attention to the opportunity for such application and point out a few of the available principles on which a method might be based.

The calibration of inter-lens shutters by measuring the arc described on a film by an image of a point moving in a circle at a predetermined

rate is well known. This method has been used with the cathode-ray oscillograph as the source of the moving image,² taking advantage of the flexibility of control of the rate of rotation and the ease of measuring that rate precisely with this instrument.

But a still simpler method is possible with the same equipment, namely, a source of audio-frequency sine wave voltage such as a beat frequency oscillator, and the cathode-ray oscillograph. An ordinary oscilloscope is satisfactory except that the usual green fluorescent screen is much less photoactive with ordinary fast films than the blue screen and the persistence of image in the green screen is sufficient to introduce an uncertainty in the reading of the records.

Employing the same principle of measuring the length of the line described on the film by a spot of light moving at a known rate in the interval during which the shutter is open, one may use other than circular motion. Much simpler than to obtain a perfect circle at various frequencies of rotation with stock apparatus, is the tracing of a sine-wave (or other regularly recurring wave form) against time on the screen of the cathode-ray tube oscilloscope. The usual sweep circuit suffices for providing the time axis since accurate linearity of sweep is unimportant. It is set at a conveni-

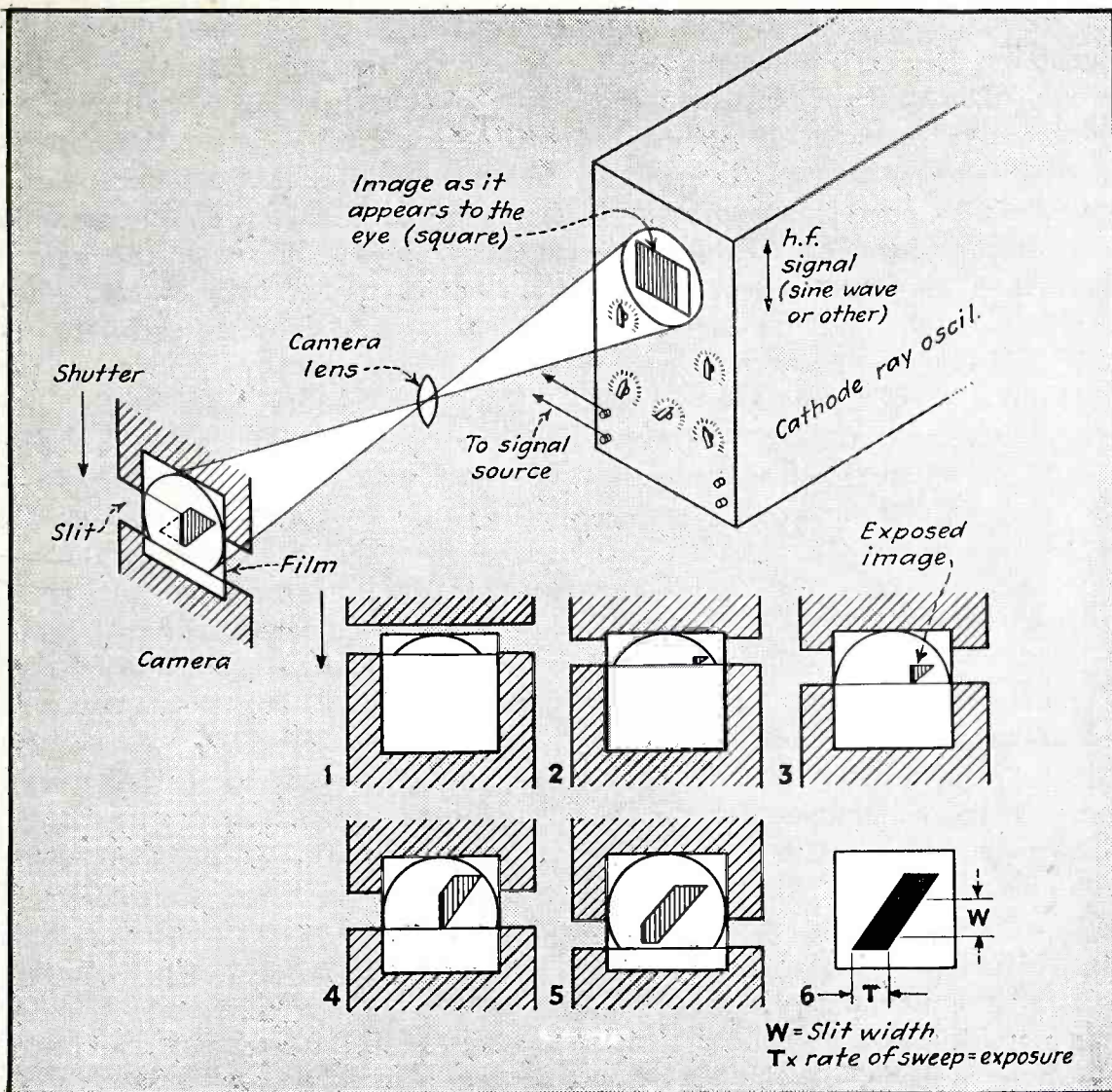

FIG. 2—Diagram (above) illustrating development of rhomboidal figures during exposure and (below) six steps in generation of the parallelogram

distance travelled by the spot in this method than in the method of circular motion, its available accuracy is greater. A saw tooth signal or one of some other shape producing an image of uniform density would be preferable to the sine wave but the latter is quite adequate.

While this method is satisfactory* for shutters which expose the whole picture area at once, it is applied only with difficulty to the focal plane shutter. Here the exposure is effected by the slow movement of a slit across the picture area. At low shutter speeds the slit is often as wide as, or wider than, the entire picture area, the leading and trailing edges of the slit each occupying the entire nominal period of the exposure in their movement or less than that period. In this case each edge of the slit is motionless while the other edge is in motion. They

ent sweep rate, for example, about twice that of the shutter speed under test. The source of alternating voltage is set at a carefully calibrated frequency (the line frequency is a sufficiently accurate standard) of some convenient value, for example, about six times the sweep frequency. Thus for 1/10 sec. shutter speed a sweep frequency of 20 cps and a frequency on the vertical deflection plates of 120 cps is convenient; for 1/200 sec. shutter speed a sweep of 240 cps and vertical signal of 1440 cps is adequate and easy to calibrate from a 60 cps standard. The vertical deflections will be used as the standard and should be accurately known. The horizontal need not be maintained at the figures suggested, indeed, it is preferably altered just enough that the standing image used for calibrating the oscillator is set in rapid motion. An exposure is then made on fast film, with the camera under test mounted fairly close to the screen. The screen need not fill the negative but should be large enough to permit ready resolution of the individual waves. The shutter is snapped at a random moment without regard to the phase of the sweep, since the pattern re-

FIG. 3—Bar of light (720 cps) moving downward 20 divisions (2 in.) every 1/60 sec. with 60 cps sweep. Slit moving right to left in camera. Effective exposure in center of frame is 1/100 sec. since 12 divisions are shown. Slope of upper edge is less steep than that of lower edge

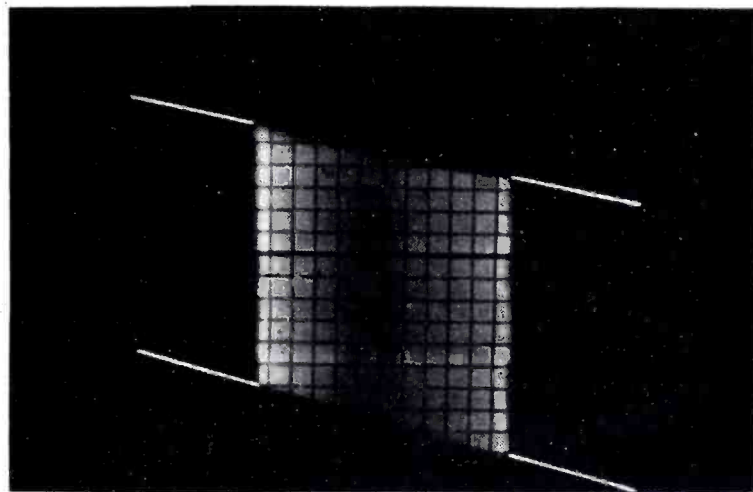

fers without appreciable loss of time.

By this procedure there will result on the negative a pattern of about two sweeps with six vertical waves each, as shown in Fig. 1. Due to setting the standing image in motion they will not be superimposed but will easily be counted. Such sine waves can be estimated to $\frac{1}{2}$ cycle so that counting approximately 12 cycles an overall accuracy of 1 percent is obtained. This is more than necessary for shutter calibration and at high speeds other errors, such as the uncertainty of the beginning and end of the trace due to the closing and opening time of the shutter, become much larger than this. Because of the much greater

do not necessarily move at the same rate, in some cameras and it is possible to obtain uneven exposure of the negative from this cause. At high shutter speeds the slit is narrower than the picture area, the time of traverse is longer than the nominal period of exposure and the two edges have to move at the same rate, but may accelerate and pro-

* The difference between motion stopping capacity and light passing capacity in non-focal plane shutters makes it difficult to say that any simple method is entirely satisfactory. This method, like most usually used, is primarily designed to measure motion stopping capacity. Light passing capacity can only be estimated roughly. The interrelation between these properties, which is different at different shutter speeds makes it necessary for practical purposes to adopt a more or less arbitrary definition of effective motion stopping exposure. Because of the efficiency of focal plane shutters both properties are easily measured at once in these shutters as by the method described here.

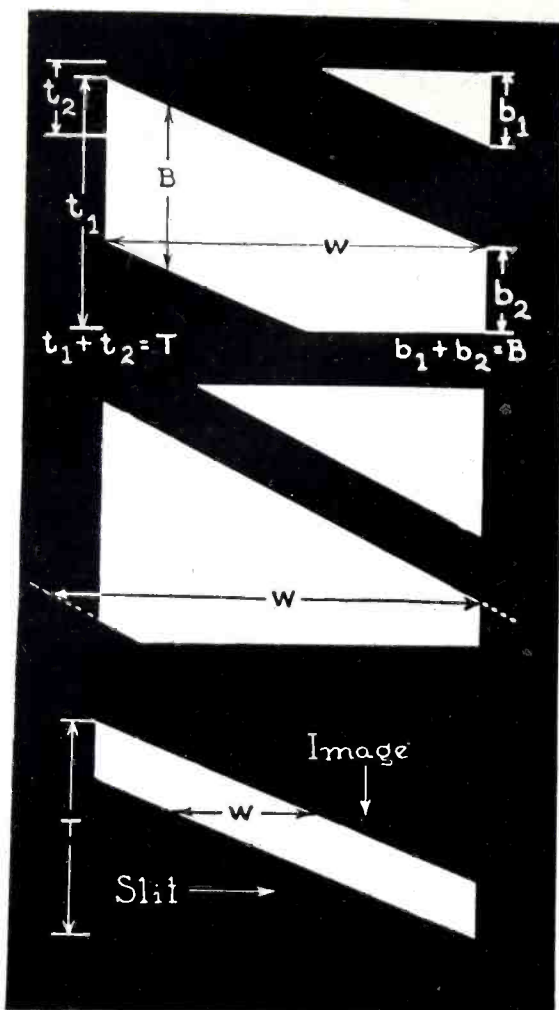

FIG. 4—Diagrams of three possible types of records. (A) Slit width equal to width of negative. (B) Slit width greater than width of negative. (C) Slit width less than width of negative, and elapsed time of exposure time = B/ni where B is width time of each spot. Actual exposure at that point on the film is calculated by exposure time = B/ni where B is width of figure in axis of image motion, n is distance traversed per sweep, and i is sweep frequency

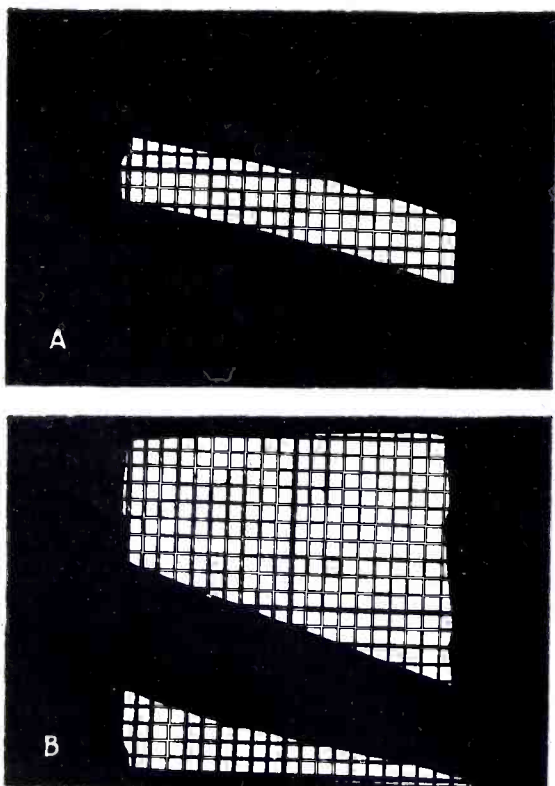

FIG. 5—Tracings of actual records made as in Fig. 3. Bar of light moving 20 divisions vertically in 1/15 sec. (above) and 1/20 sec. (below). (A) Nominal exposure, 1/100 sec.; actual exposure 1/75 sec. (B) Nominal exposure, 1/30 sec.; actual exposure, 1/29 sec. Wavy edges are due to 60 cps pick-up. Wedge shape distortion at (B) due to oscillograph characteristics

duce uneven exposure in this way. A good method of calibrating such shutters should, then, measure the effective exposure at all points in the picture area, that is at each point along the axis of slit movement.

The usual methods of calibrating focal plane shutters either accomplish this result only with great difficulty or by repeating the whole test for each region of the negative. They further involve, in most instances, removal of the back of the camera, sometimes an awkward or impossible procedure.

All Shutter Characteristics Easily Determined

Perhaps the simplest method of measuring all the significant properties of such shutters at once would be to expose a negative during the uniform linear motion, at right angles to the axis of shutter movement, of a bar of light the length of the field of view. The rate of movement of the bar must be precisely known and linear and should be variable over a considerable range in order to be adapted to the entire range of shutter speeds to be tested.

These requirements are easily met by the cathode-ray oscillograph. The only additional piece of equipment necessary is some source of alternating current at a frequency anywhere between 1000 and 20,000 cps, such as the a-f signal generator mentioned in the first described method. This signal is applied to the input of the vertical deflection plate amplifier and provides the bar of light. The saw tooth time base oscillator built into the oscilloscope is used to move this bar at a known, linear, variable rate across the screen. Since the direction of this movement will be horizontal, the camera should be held so that the shutter moves vertically—either up or down (it is not necessary to know which). Any deviation from 90 deg. in the angle between axis of image movement and axis of shutter movement will create an error in the measurement. The camera is fitted with any necessary close-up attachment to make it possible to fill the whole negative area with the image of the screen. The distances chosen, the focal lengths, the degree of reduction, are uncritical as all measurements are made in terms of the ruled celluloid facing provided on the screen of the oscilloscope. If there is a sig-

nificant distance between the shutter and the focal plane, as there is in some cameras, the speed calibration will be accurate only for the object distance and diaphragm setting used in the test. Greater distances and smaller stops will make the same shutter speed effectively faster. The present method gives an estimate of whether this effect is serious.

The exposure is made with the shutter speed under test, the diaphragm wide open, the sweep frequency of the oscilloscope adjusted to some value conveniently calibrated against a-c mains (or other available frequency standard) and a little lower than the value of the shutter speed. Thus, when testing a shutter speed of 1/25 sec. a 20 cps sweep would be satisfactory. Finally, the amplitude of the sweep is carefully adjusted to some convenient value and recorded in terms of the celluloid ruling. The exposure is made without regard to the phase of the recurring cycles of motion of the bar of light, but if several exposures are made, one negative is likely to contain all of one cycle. This will be more likely the slower the sweep, but it is not necessary for accurate measurement, since the cycles recur without appreciable loss of time.

Analyzing the Diagrams

A rhomboidal figure is obtained. Two of its sides are horizontal (parallel to some edge of the negative) and are defined by the amplitude of the vertical deflecting signal. The other two edges are diagonal and may be parallel or not quite parallel. These are the edges that matter. They are identified as the edges that are not parallel to any edge of the negative. They were defined by the two motions, at right angles to each other, of the sweep and of the shutter slit. One of them represents the resultant of the sweep of the bar of light and the opening or leading edge of the slit, the other represents the resultant of the sweep of the bar of light and the closing or trailing edge of the shutter. Their slant is a function of the rates of these two motions. The schematic Fig. 2 will show how the rhomboid is formed in the ideal case where the sweep happens to begin just as the shutter reaches the margin of the image. A little experimenting with a pencil will show the effects of

varying the parameters involved. Some of the possible figures are reproduced here (Figs. 3 to 6). To obtain the actual exposure at any point in the negative it is only necessary to count the number of rulings exposed between the diagonals in the axis of motion of the bar of light passing through this point. Knowing the rate of motion of the bar of light the calculation of exposure time is:

$$E.T. = B/nf$$

where t is exposure time in seconds

B is number of rulings counted

n is number of rulings per sweep

f is sweep frequency in cps.

Thus in Fig. 3 the camera shutter was set at 1/100 sec. the sweep at exactly 60 per second and 20 divisions of the ruling. It will be seen that the shutter allowed 12.5 divisions to be exposed at the right edge of the image and the exposure at this position was therefore $t = 12.5 / (20 \times 60) = 0.0104 = 1/96$ sec.

It was found in practice that a stock Model 164 Dumont oscillograph with a short-persistence blue screen** gave usable density on Eastman Super XX film at high shutter speeds, an aperture of $f/3.5$. The linearity of the sweep was satisfactory. A model with higher intensity, still better linearity, and larger screen area would increase precision and usefulness. A sawtooth signal on the vertical plates would be, of course, the best but a sine wave proved satisfactory even though it gives less density of the negative in the center than at the ends of the figure.

By this method it will be noted that the exact effective exposure at every point in the picture area can be obtained. Thus, inequalities in the rate of movement of the leading and trailing edges of the slit are recorded as lack of parallelism of the diagonals and can easily be measured as a difference in the number of rulings exposed at the two ends of the negative.

From the figure obtained it is also possible to determine: (1) the direction of movement of the slit, (2) its width at each setting, and (3) the total elapsed time during an ex-

** A medium persistence screen would give graded rather than sharp margins on the diagonals reducing the accuracy of measurement, and is not sufficiently photoactive for adequate density of the negative.

posure. The first is easily derived from the direction of slope of the diagonal on the film, knowing the direction of movement of the bar of light on the screen. The second is measured directly on the negative as the width of the diagonal band in the axis of shutter movement. If an insufficient fraction of the whole parallelogram appears on the negative, due to a very wide slit or an image that does not fill the picture area, projections of the slopes are drawn as in Fig. 4. The total elapsed time (for exposure of the whole negative) is the distance T (Fig. 4) calculated as seconds from the known rate of movement of the image.

Shutter Efficiency

Still another characteristic of the camera is revealed in the same record. The efficiency of the focal plane shutter, that is the degree to which agreement exists between the total time of exposure of any point of the film and the time during which that point is receiving all the light admitted by the lens, depends on the distance between the shutter and the actual focal plane. A good focal plane shutter is built close to the plane of the film, casts a sharp shadow on that plane and approaches 100 percent in efficiency. But many cameras are constructed with an appreciable distance between the plane of the curtain and that of the film, reducing the efficiency markedly. Any significant loss of efficiency will show itself in the negative of the moving bar of light as a graded rather than a sharp margin on the diagonals. If the zones of graded intensity at both margins amount to less than 5 to 10 percent of the total width of the rhomboidal figure, the inefficiency is negligible, and the shutter must be close to the focal plane. Of course, this estimation presupposes that the spot on the cathode-ray tube is sharply focused both on its screen and on the film. If the margins are sharp nothing further need be done, but if there is a significant fuzziness it should be validated by comparison with the vertical margins of the figure and with the diagonals of figures of very slow shutter speeds.

This method is usable not only for focal plane shutters but for inter-lens shutters. In this case the resulting figures will not be rhomboidal

(Continued on page 250)

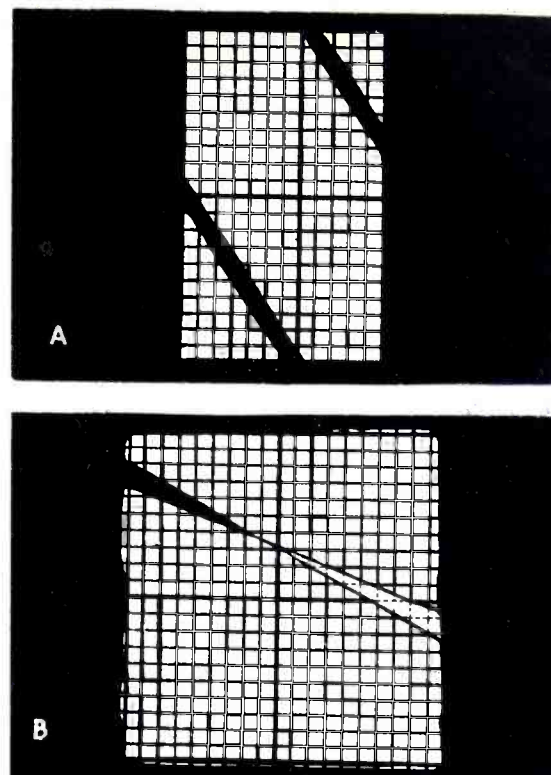

FIG. 6—Same as Fig. 5 (A) Shutter set for 1/200 sec. Sweep, 120 cps. Actual exposure 1/130 sec. (B) Shutter set for 1/30 sec. Sweep, 30 cps. Actual exposure 1/30 sec. in center of picture, but 13 percent less at left edge and 13 percent greater at right edge since leading edge of focal plane shutter moves faster than trailing edge of focal plane shutter. Triangle at right (B) represents region of double exposure, shown as area of greater density on original film

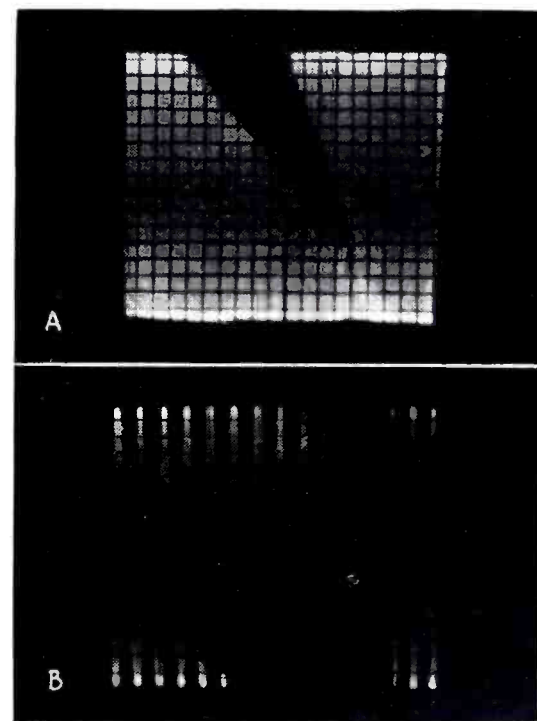
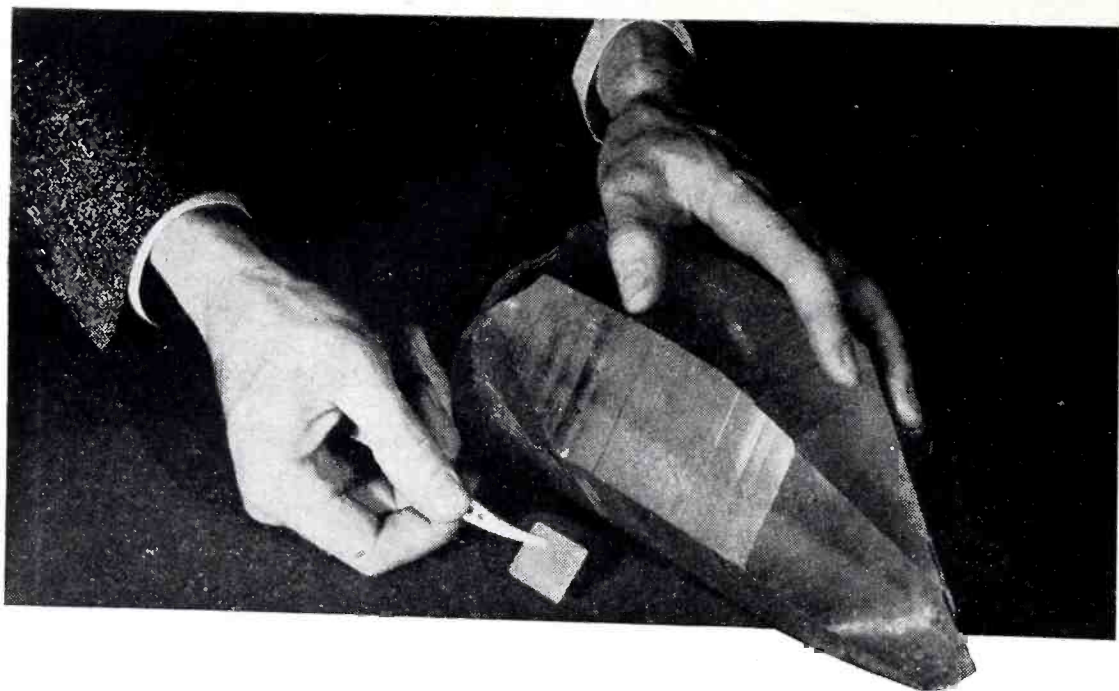

FIG. 7—Records made with 35-mm focal plane camera. (A) Bar of light moving left to right 20 times per sec., shutter slit moving from top to bottom. Nominal exposure, 1/25 sec. Actual exposure 1/25 sec. in center, but varies considerably above and below center due to leading edge of slit moving faster than trailing edge. (B) Sweep, 120 cps, left to right, illustrating use of slower vertical signal to give separate waves instead of bar of light. Vertical signal is 1.920 cps. Shutter set for 1/200 sec. Actual exposure varies from 1/160 to 1/215 sec.

QUARTZ



By L. A. ELBL

*Engineering Dept.,
Crystal Products Co.,
Kansas City, Mo.*

QUARTZ CRYSTALS or, more correctly, "quartz oscillator plates," have numerous peacetime as well as wartime uses.

Today quartz oscillator plates fix the frequency of transmitters and receivers used by the Army and Navy on land, at sea and in the air, playing a vital part in the performance of military communications equipment. They are used in the recently publicized radar devices. They also perform important functions in connection with artillery range-finding and submarine-detecting gear and permit the internal pressures within gun-barrels and combustion engines to be readily measured and indicated.

Military uses cannot be detailed at this time. It is desirable, however, to call attention to the expanding scope of quartz oscillator plate applications for the peacetime world to come.

Expanding Uses

Quartz oscillator plates serve many useful purposes on the home front. Broadcasting, police and other radio stations make use of them for frequency control. Through their use it is also possible to send hundreds of telephone calls over one wire line with no interference. Perhaps in the not too distant future, all telephone systems will make use of such plates.

Our most accurate timepieces or chronometers, as well as seismographs for locating earthquake disturbances, contain vibrating plates. By the use of such oscillating plates man has bettered the constancy of the earth's rotation. A quartz plate

may vary less than one part in 10,000,000 in frequency, which figures less than 1/100 of a second per day.

Other rapidly developing applications of quartz plates are in the field generally known as "ultrasonics." Plates are now used in the dairy industry to homogenize milk. Milk is passed over a vibrating quartz plate and, under the action of pressure-waves, cream droplets are broken up and dispersed, making a uniform liquid. There is no cream separation and a smoother, more consistent, and more easily digested product results. A similar application is being tried in the petroleum industry. Gasoline is being produced from crude oil by splitting the large hydrocarbon molecules by means of vibrating plates. This process is termed "cracking."

The dispersing ability of ultrasonic waves is finding numerous other uses. New alloys are being prepared from metals, such as aluminum and lead, which ordinarily do not mix when melted together. Another metallurgical application of ultrasonic waves is the detection of flaws and blowholes in castings, by means of wave-patterns. Because a solid conducts the wave in unbroken fashion, breaks or flaws in the interior can be detected by variations in the wave-pattern.

In the field of chemistry, research engineers have found that starch can be converted into dextrine, and cane sugar into glucose, by ultrasonic vibrations. Photographic chemists are now turning out better film because homogenization of the emulsion has made possible greater con-

centration of silver compounds. Not only can particles be broken up and dispersed, but a reverse action enables ultrasonics to condense vapors, smokes, and fumes. This principle has been used to eliminate the smoke hazard in some of our cities.

Ultrasonic waves are even being used in medicine. When these vibrations are sent through an arm or leg, the flesh and bone-marrow get warm while the bone stays cool. This is due to the fact that flesh and marrow are poor vibration conductors, while bones readily conduct the vibrations. Flesh and marrow absorb ultrasonic energy and convert the vibrations into heat. Thus, we have a method of treating certain internal diseases. Experiments of this type are now in progress in many clinics throughout the country.

It has also been found that ultrasonic waves act as a "death-ray" on certain microscopic plants and animals. Tiny organisms are literally shaken to death. Thus we can make from quartz plates practical devices for killing disease-producing bacteria.

Piezo-electricity Principle

The above uses of quartz plates come about because such plates possess "piezo-electric" characteristics. This phenomenon was discovered by Pierre Curie about 1881.

Piezo-electricity may be briefly explained as follows: When properly cut quartz plates are distorted by compression or elongation along certain axes, electric charges are produced on opposite faces. The reverse effect is the production of a mechanical distortion by the appli-

CRYSTAL CUTS

By preserving certain angular relationships with respect to the various axes of a mother crystal, oscillator plates may be given characteristics most suitable for specific jobs. Modes of vibration in basic cuts and recent modifications are discussed. Present-day and future applications of quartz oscillator plates are broadly outlined.

cation of an electric charge to the plate.

By applying an alternating voltage to the surface of the plate, it may be made to expand and contract very slightly in time or in tune with the alternations. In other words, by stimulating the plate with alternating voltage of approximately the same frequency as its natural vibration period the plate may be made to vibrate mechanically at a frequency determined by its size and shape.

By very accurate cutting and grinding, a quartz plate can be made to oscillate at a frequency which is very constant.

Modes of Vibration

Quartz plates may vibrate in several different ways. Vibration patterns are frequently studied by placing lycopodium powder on the vibrating plate. Patterns are sometimes quite complicated but, in general, may be classified into three simple types: (1) flexure, (2) longitudinal, and (3) shear. A fourth classification, which may be a modification of any of these three, is the "harmonic" type.

In the flexure type of motion (Fig.

Quartz oscillator plate cuts, showing their angular relationship with respect to the X (electrical) and the Y (mechanical) and the Z (optical) axes of a mother crystal

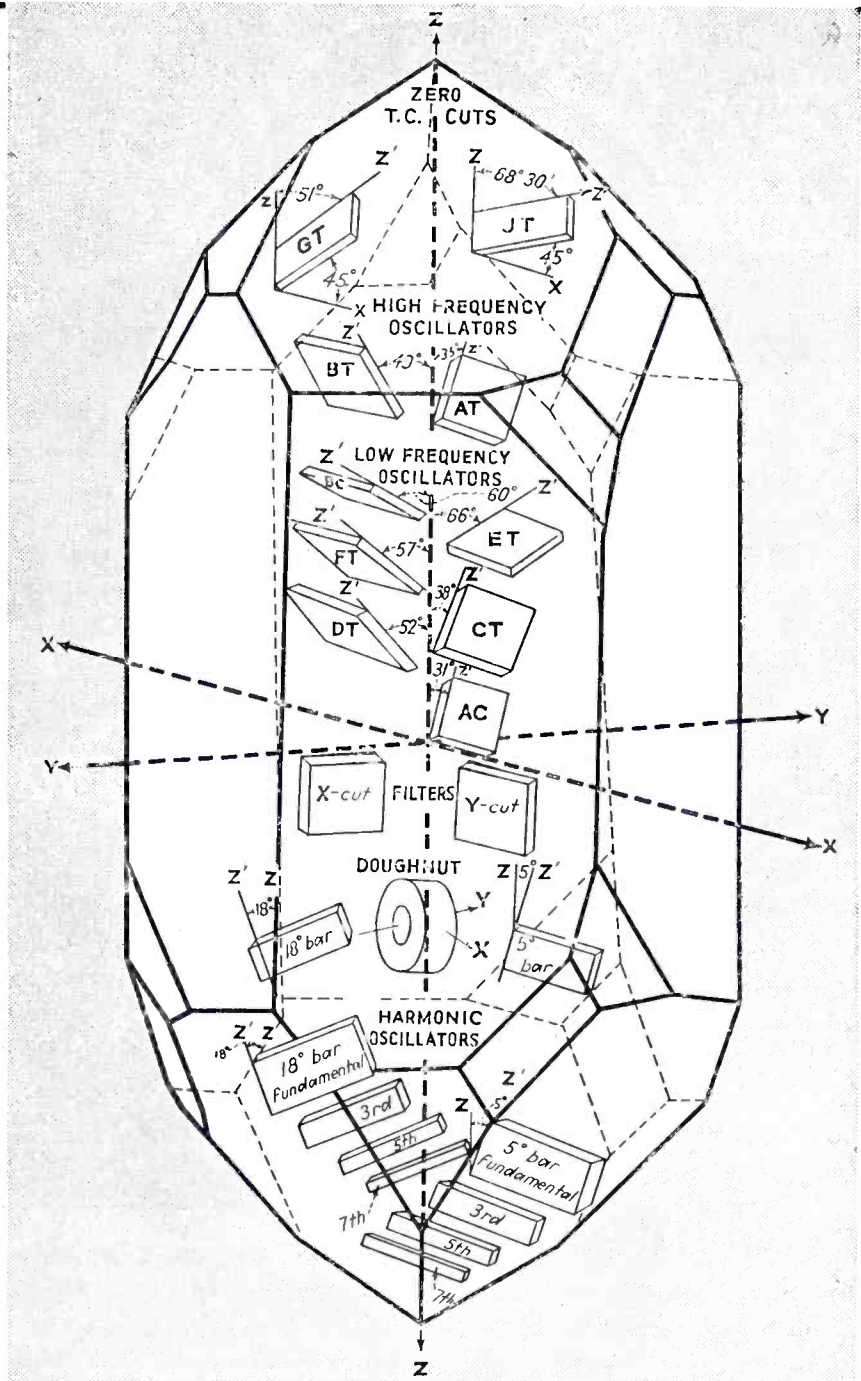
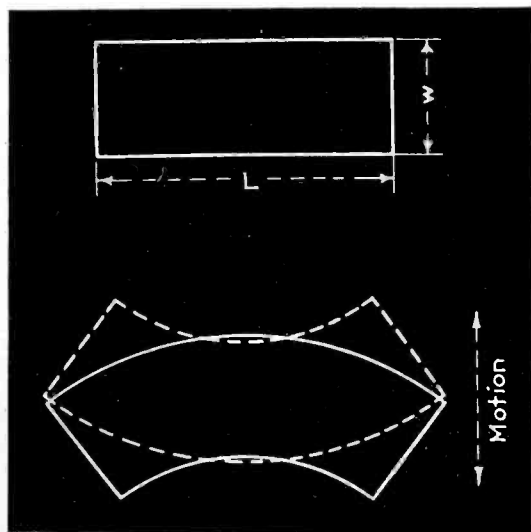

FIG. 1 — Plate vibrating "in flexure"



1) we have the plate vibrating on the width, with the displacement upon the width and the wave propa-

gated along the length. The plate is distorted first in one direction and then in the other.

In the longitudinal type (Fig. 2) the displacement is on the length and the wave is propagated along the length.

The shear type of motion is more complicated (Fig. 3) and consists of an expansion and contraction in opposite phase along two diagonals of either the face or the thickness.

Just as a string can be made to vibrate as a whole, giving a fundamental tone, or in higher frequency "segments", so we may have quartz plates vibrating on harmonics. Such plates (Fig. 4) are the same general types as those used for fundamental frequency vibrations but, by utiliz-

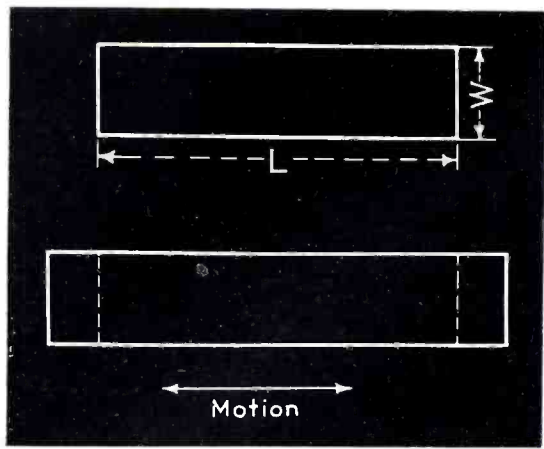

FIG. 2—Plate vibrating longitudinally

ing a different grinding and mounting technique and different circuits, are caused to vibrate on a harmonic. Odd harmonics are much more commonly used than even ones. The working frequency is usually but not always three times the fundamental. It may vary as much as 50 kc from a calculated frequency, depending upon the manner of vibration.

Quartz plates may have two, or even three, modes of vibration. It is the task of the manufacturer to determine what mode of vibration is to be used for a particular frequency and eliminate all others. This is accomplished by correct dimensioning of the plate and precise grinding technique. Generally speaking, in the low frequency range from 15 to 400 kc, bar-types vibrating on the length, or plates vibrating in flexure on the width are used. In the range from 400 to 11,000 kc, plates vibrating on a thickness shear are commonly used. From 11,000 to 30,000 kc harmonic crystals are employed. At present there are several modifications of these classes being used for special military purposes.

Early Cuts

In manufacturing a quartz oscillator plate, one must first consider the purpose for which it is to be used. In plates used to control the frequencies of radio transmitters and receivers, the most important single property is the temperature coefficient. In plates used for ultrasonic applications, the temperature coefficient is not as important as the activity of oscillation and mechanical output efficiency. In plates used as tuned filters, for the most part, the activity is not as important as in the service mentioned above. Activity can always be low. In some cases a low temperature coefficient is required.

First of all, let us consider the temperature coefficient. This is defined as the fractional change in frequency per unit change in temperature. If quartz plates are to be used in radio transmitters and receivers in any part of the world—at the poles or at the equator—there must be very little change in their frequency with change of temperature if the equipment is to be efficient. In our recent African Campaign, ground troops in a torrid region had to be in constant communication with bombers and observation planes up in the stratosphere at sub-zero temperatures. Obviously, if the frequency of the quartz plates used in communications gear changed excessively with temperature, the different units of the army would have been unable to communicate.

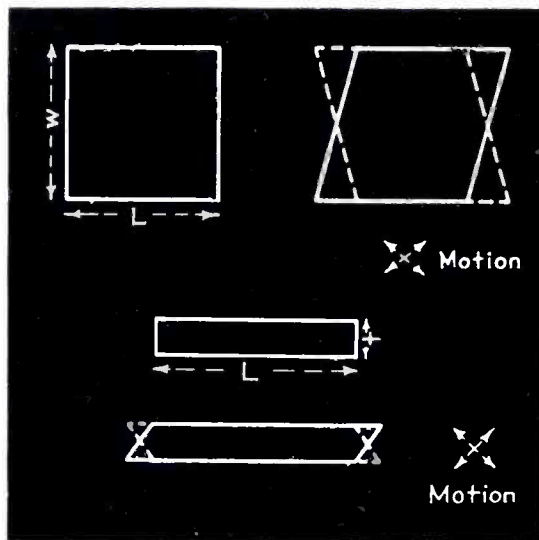

FIG. 3—Quartz plate vibrating "in shear" on face and "in shear" on thickness

To calculate the t.c., we divide the change of frequency in cycles by the product of the frequency of the plate in cycles and the Centigrade change in temperature in degrees. If the change is in the same direction as the temperature (i.e. an increase in frequency with rising temperature or vice-versa) the t.c. is positive. If the frequency and temperature go in opposite directions, the t.c. is negative.

To be a good radio frequency control device, the temperature coefficient should not exceed 2×10^{-6} per degree. Thus, a 4 Mc plate operating from -30 to $+70^\circ$ C with a change of 800 cycles would have a temperature coefficient

$$t.c. = \frac{\text{frequency change in cycles.}}{\text{frequency of plate in cycles times temperature change in degrees centigrade.}}$$

$$t.c. = \frac{800}{4 \times 10^6 \times 100} = 2 \times 10^{-6}$$

In general, the temperature coefficient is determined by the angle of cut, the size and shape of the plate, and the precision of grinding and mounting. Most emphasis is placed on the angle of cut.

To produce piezo-electric charges, one must exert stress either in the direction of the X (electric) axes, or the Y (mechanical) axes. This knowledge was used in cutting the first quartz oscillator plates, which were X-cut plates cut perpendicular to the X-axis, and Y-cut plates cut perpendicular to the Y-axis.

The first plates produced were longitudinal oscillators, but it was not long before thickness oscillators were used for the high frequencies. The X and Y cuts had very poor t.c.'s, the X-cut running as high as 50 parts and the Y-cut as high as 100 parts. Both types did have good activity and are still used for certain types of crystal calibrators and filters and are useful in ultrasonic applications.

Two other cuts similar to the X and Y cuts are the AC cut (-31° to the Z), and the BC cut ($+60^\circ$ to the Z). The AC type has a temperature coefficient of $+20$ and the BC a temperature coefficient of -20 . They are used for the same general purposes as X and Y cuts.

Newer Cuts

Numerous attempts have since been made to improve the performance of quartz oscillator plates. It was soon found, for example, that crystals cut at $+35^\circ 15'$ to the Z axis, or -49° to the Z axis, with one side kept along the X-axis, had the very low temperature coefficient of $\pm 3 \times 10^{-6}$. The first of these is known as an AT and the latter as a BT cut. Both are used as high-frequency radio oscillators, vibrating on a shear of the thickness. The AT is commonly used in the range from 400 to 4000 kc and the BT from 4000
(Continued on page 252)

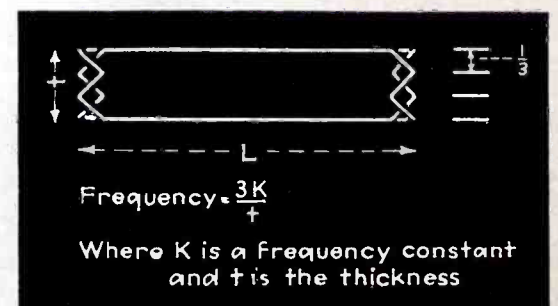
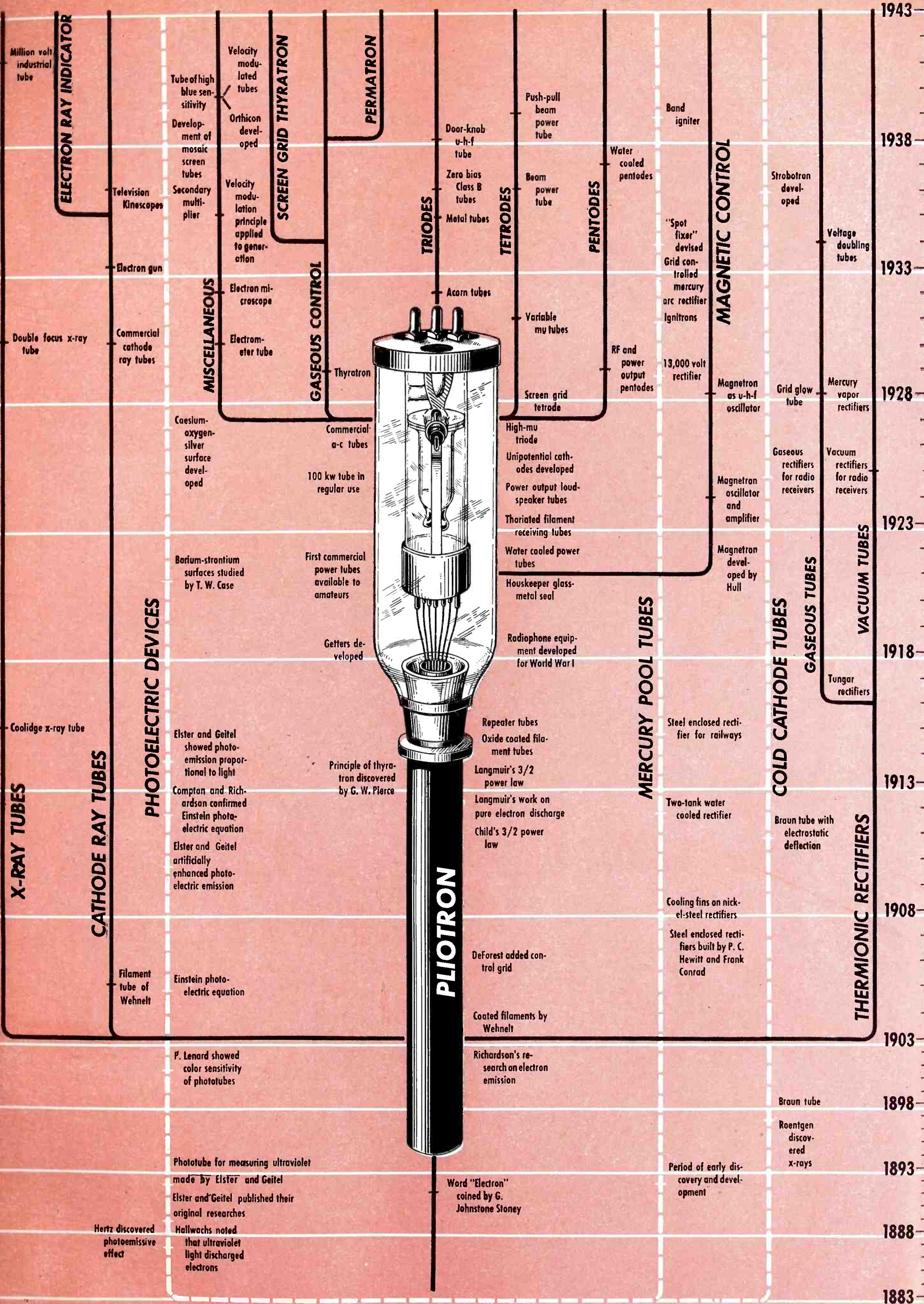



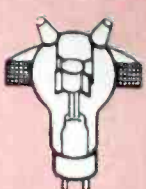





















FIG. 4—Quartz plate vibrating "in shear" on thickness, at third harmonic

SIXTY YEARS OF ELECTRONICS 1883-1943



		 TUNGAR OR RECTIGON			 KENOTRON		 PLIOTRON		 MAGNETRON	
TYPICAL APPLICATIONS		1. Battery charging installations. 2. Low voltage, high current rectifiers. 3. Relaxation oscillators. 4. Voltage rectifiers for a-c generator sets.			1. High voltage, low current rectifiers for radio receivers. 2. Vacuum tube voltmeters. 3. Power supplies for broadcast and television stations and apparatus.		1. Amplifiers and oscillators for communication. 2. Induction heating. 3. Industrial control applications. 4. Frequency multipliers and dividers. 5. Diathermy uses.		1. Magnetically operated switch. 2. Generator of very high frequency oscillations whose frequency depends on external circuit or on transit time of electrons.	
CLASSIFICATION										
INPUT		ELECTRICAL ENERGY								
OUTPUT		ELECTRICAL ENERGY								
SOURCE OF ELECTRONS		Thermionic Cathode								
METHOD OF CONTROL		None			Electrostatic		Electromagnetic		None	
CHARACTER OF CONTROLLED REGION OR SPACE		High Pressure Gas	Low Pressure Gas	Vacuum	Gas or Vapor	Vacuum	Gas or Vapor	Vacuum	Vapor	Vapor
TUBE NAME		Tungar or Rectigon	Phanotron	Kenotron	Thyratron	Pliotron	Permatron	Magnetron	Pool Tube	
FUNCTION	RECTIFIER OR SWITCH									
	CONTROLLED RECTIFIER									
	AMPLIFIER									
	OSCILLATOR, GENERATOR OR INVERTER									
	VOLTAGE REGULATOR									
	WAVE FORM ANALYSIS									
	LIGHT DETECTION AND MEASUREMENT									
PRODUCTION OF RADIANT ENERGY (Usually Light)										
TYPICAL APPLICATIONS		1. Voltage limiting or breakdown devices. 2. Pulse generators. 3. Trigger devices. 4. Relaxation oscillators. 5. Visual indicators. 6. Rectifiers.			1. Voltage or phase controlled rectifier. 2. DC to AC inverter. 3. Electronic welding. 4. Commutation and switching. 5. Motor speed control. 6. Electrical timing.		1. Magnetically operated switch. 2. Control of large currents by external magnetic field.		1. High voltage, high current rectifier. 2. Commutation and switching. 3. Power supply for railway and street car systems. 4. Current and power control.	
		 PHANOTRON			 THYRATRON		 PERMATRON		 POOL TUBE	

INDUSTRY AND COMMUNICATION

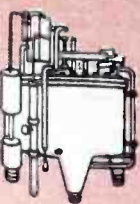

GRID POOL TUBE



GLOW TUBE



X-RAY TUBE



CATHODE RAY TUBE



STROBOTRON



VACUUM PHOTOTUBE

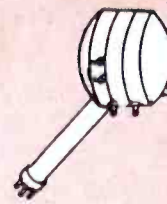

MOSAIC SCREEN TUBE

High voltage, high current controlled rectifier for large power applications. 2. Railway power supply. 3. Rectification and commutation. 4. Current and power control.

1. Voltage regulator and stabilizer. 2. Visual indicator. 3. Relaxation oscillator. 4. Production of light. 5. Rectification. 6. Protection of circuits.

1. Medical examinations. 2. Industrial examinations of products. 3. Crystal examination. 4. Detection of forged or altered paintings. 5. Diffraction studies.

1. Television receiving tube. 2. Visual indicator for electrical measurements of all kinds. 3. Application to industrial measurements. 4. Brain wave studies.

1. Control tube for photographic uses. 2. Source of intermittent light flashes. 3. Stroboscopic measurements. 4. "Slowing action" of recurrent moving mechanisms.

1. Measurement of light and color. 2. Picture transmission. 3. Spectro-photometers. 4. Measurement and control of high temperature. 5. Measurement of glare.

1. Television camera and pick-up tubes. 2. Transmission of pictures over wires or radio circuits. 3. Picture monitoring and remote control over radio or wire circuits.

CLASSIFICATION OF ELECTRON TUBES

ELECTRICAL ENERGY									RADIANT ENERGY (Light)					
Cathode		Cold Cathode		Thermionic Cathode				Cold Cathode	Photoelectric Cathode					
Electrostatic	Igniter Electrode	None	Electrostatic	None	Electrostatic	Electrostatic	Electromagnetic	Electrostatic	Radiant Energy (Light)					
Vapor	Vapor	Gas	Gas	Vacuum	Vacuum	Vacuum	Vacuum	Gas	Gas	Vacuum	Vacuum	Vacuum	Vacuum	Metallic Contact
Grid Pool Tube	Ignitron	Glow Tube	Grid Glow Tube	X-Ray Tube	Electron Ray Tube	Cathode Ray Tube	Cathode Ray Tube	Strobotron	Phototube	Phototube	Secondary Multiplier	Mosaic Screen Tube	Barrier Layer Cell	

Spot welding control. 2. Illumination control. 3. Motor commutation. 4. Frequency transformation. 5. High voltage, high current rectifier. 6. DC to AC inversion.

1. Controlled voltage regulator and stabilizer. 2. Relaxation oscillator. 3. Remote control applications. 4. Production of light. 5. Current or power control.

1. Visual indicator of voltage. 2. Bridge balancing indicator. 3. Tuning indicator on radio receivers. 4. Measurement of voltage, current or power.

1. Television tube. 2. Measurement of e/m of electron. 3. Visualizing electrical phenomena. 4. Industrial and electrical measurements. 5. Medical applications.

1. Industrial counting, sorting, weighing. 2. Light control element. 3. Industrial protection and control. 4. Intrusion detector. 5. Sound-on-film uses.

1. Measurement and control of light and color. 2. Measurement of density, transmission, opacity, glare. 3. Light control device of high sensitivity.

1. Photographic exposure meter. 2. Portable light meter. 3. Industrial protection. 4. Measurement of high temperature. 5. Conversion of light into electricity.

IGNITRON

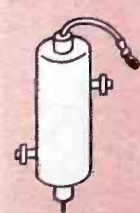

GRID GLOW TUBE



ELECTRON RAY TUBE



CATHODE RAY TUBE



GAS PHOTOTUBE

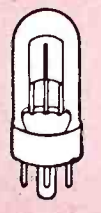

SECONDARY MULTIPLIER



BARRIER LAYER CELL

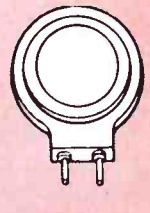



ELECTRONICS

Applied to Heat Transfer Tests

By **ROBERT V. BROWN**

*Case School of Applied Science
Cleveland*

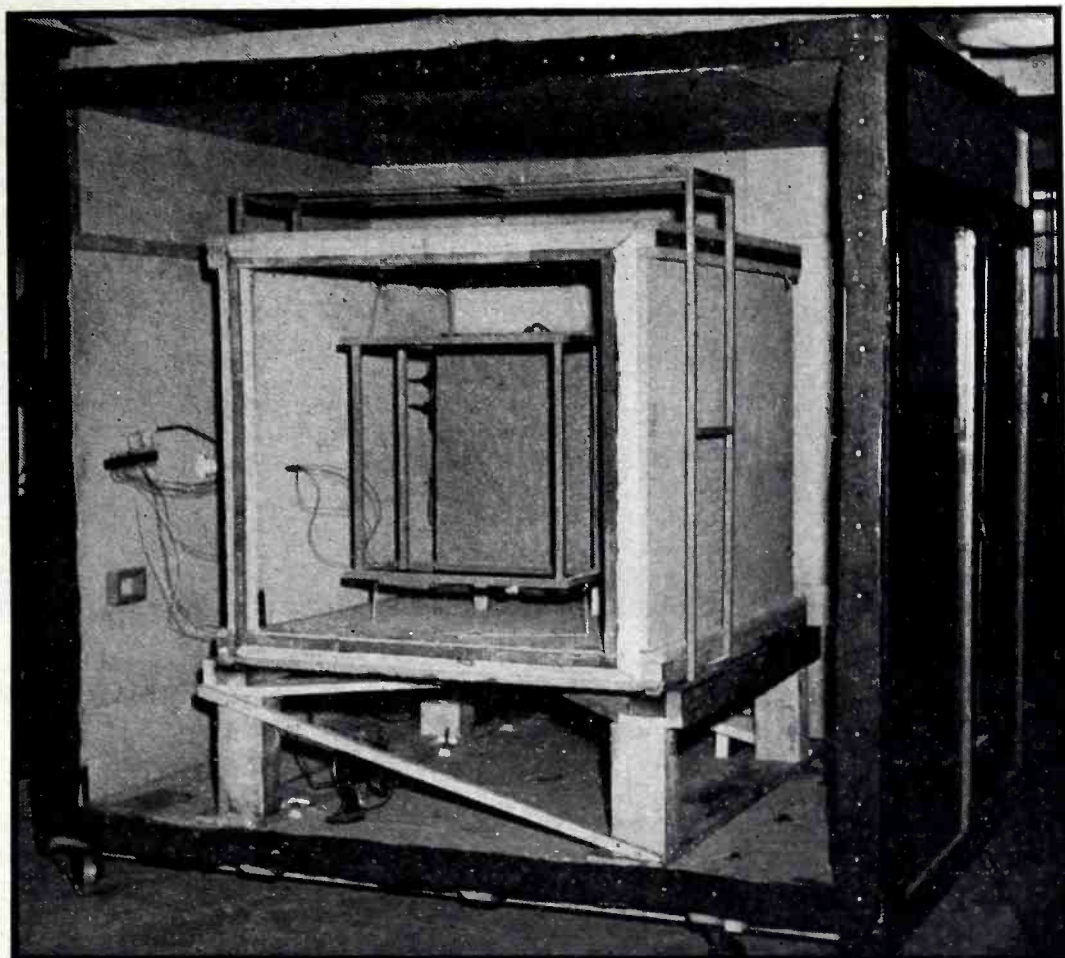

FIG. 1—Guarded hot box test unit. The outer and inner boxes are made flush with section of wall under test. The wooden frame carrying bridge wires in the inner box and between inner and outer boxes are evident. Fans are used to provide air circulation and prevent stratification

ONE of the most important properties of materials affecting their use as heat conducting or heat insulating elements in building or equipment construction is their coefficient of heat transfer. This coefficient expresses the time rate of heat transfer of the particular material or assembly in terms of a unit area and a unit temperature difference and, for certain types of materials, in terms of a unit thickness. To determine these coefficients, two types of test equipment are used and are specified in Codes set up by the American Society of Heating and Ventilating Engineers and others.*

* The two types of equipment are described in the *Jour. Am. Soc. Heat. and Vent. Engrs.*, Vol. 26, No. 7, Oct. 1920 and Vol. 32, No. 5, May 1926. The former reference describes the guarded hot plate used for determining the heat transfer coefficients for homogeneous materials such as asbestos or plywood sheets. The latter reference describes the guarded hot box unit which is used to determine the overall heat transfer coefficients or characteristics of samples of wall construction such as typical brick or frame construction.

Electronic circuits for maintaining temperature of heat box constant employ Wheatstone bridge and photoelectric relay circuits. Accurate temperature control provided. Power for heating is measured by phototube operated trigger circuit which actuates electric counter. Two units described applicable to other measurement and control problems

Since it is the primary purpose of this article to describe two instruments developed in the Heat-Transfer Laboratories of Case School of Applied Science for use on these units, a brief description of only one of these units, the guarded hot box, will be included. For further information on either method of test, the above references may be consulted. While the heat transfer tests for which the instruments were primarily designed may appear to have limited application, the principles they embody are applicable to a wide variety of different uses.

The guarded hot box unit, shown in Fig. 1, consists of an inner box open on one face and about 3 feet in

all dimensions with walls of heat insulating material. This box is placed centrally in a similarly open faced guard box with insulated walls and with its open face in the same plane as the open face of the guard box. The wall whose heat transfer characteristics are to be determined is constructed according to specifications and is used as one wall of a cold room which is well insulated on its other walls and is kept cool by refrigeration. In use the double box unit is clamped to the wall under test with the test wall thus forming the sixth wall of the two boxes. The test is carried out by lowering the temperature of the cold room while maintaining the temperature in the

guard and inner boxes at or above room temperature by means of electrical heating elements placed in the two boxes. With these conditions maintained, a flow of heat from the boxes to the cold room is set up through the wall.

Description of Guarded Hot Box Equipment

The need for the guard box surrounding the inner box may be understood if it is noted that without the guard box all of the heat (electrical energy) entering the inner box will flow through the wall to the cold room only if the inner box is at the same temperature as the room in which the box is used. If this is not true and the room is at some lower temperature, for instance, some of the energy supplied to the inner box would flow to the room and not through the wall under test. Since it is sometimes desirable to maintain the inner box at temperatures other than room temperature, a guard box whose temperature can be maintained at the temperature of the inner box is necessary. The guard box, if held at this same temperature, thus serves as a perfect insulator between the inner box and the room in which the equipment is used.

From the above it is evident that such a test can be conducted accurately only if the guard box is maintained at the same temperature as the inner box. In addition to maintaining the above condition, it will be necessary in conducting such a test to measure accurately the energy supplied to the inner box, to measure the temperature of the air and test wall surfaces in the inner box and cold room and to know the area of the wall covered by the inner box. Thermocouples are used for the temperature measurements. The two instruments to be described were designed to hold the guard box temperature the same as the inner box temperature and to permit the accurate measurement of the energy to the inner box.

Control of Guard Box Temperature

The inner box contains an electrical heating element with taps from 5 to 125 watts, in steps of 5 watts each, while the outer box contains two fixed heaters of 400 and 80 watts maximum respectively. Both of the

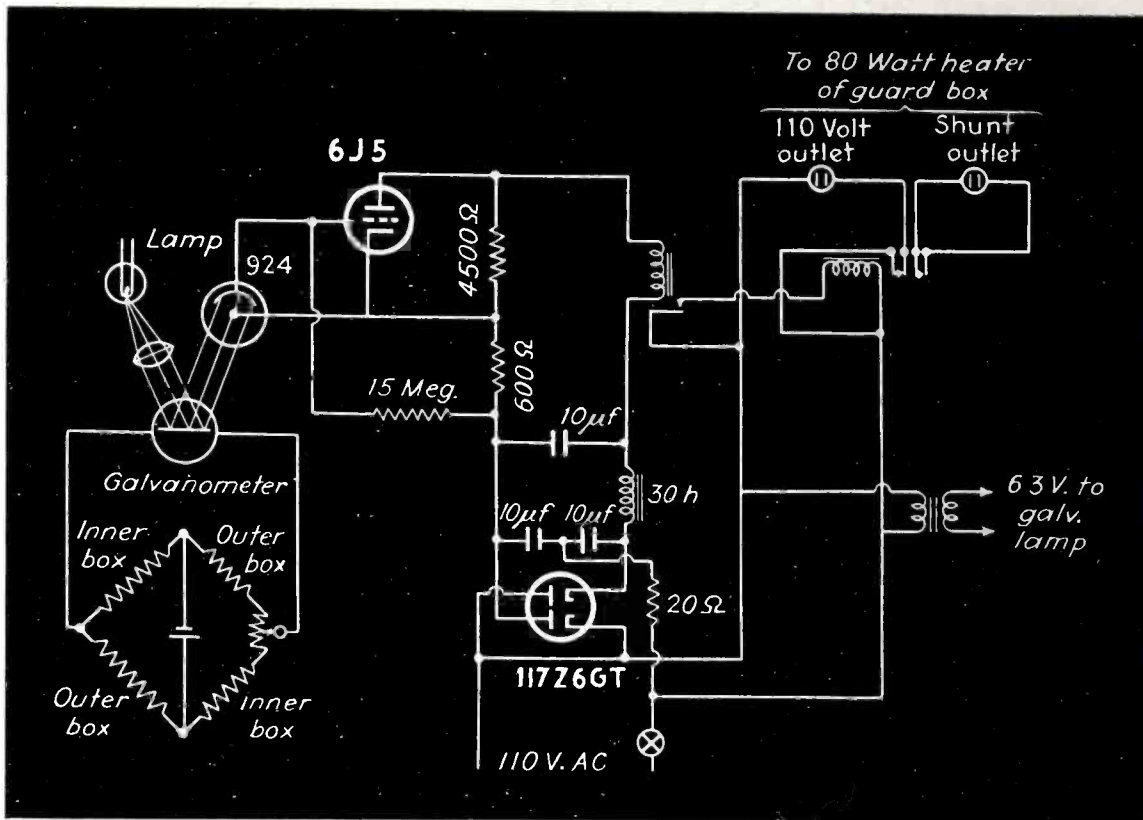

FIG. 2—Phototube relay circuit for maintaining constant temperature. Any unbalance of temperature unbalances the bridge, cutting off light from phototube and actuating plate circuit relays

outer box heaters are supplied through variable auto-transformers or Variacs, while the tapped inner box heater uses the full 110 volts a.c. for all settings. The inner heater is set to maintain any desired temperature in the inner box while the 400 watt heater transformer is set to hold the outer box temperature slightly below the temperature of the inner box. The 80 watt heater in the guard box temperature has, as its maintain the temperature in both boxes the same.

The instrument which controls the guard box temperature has, as its detecting element, a Wheatstone bridge of four equal arms of approximately 100 ohms each made up of enamel covered iron thermocouple wire. Two of the opposite elements or arms, as shown in Fig. 2, are wound on a light wooden frame and hung in the inner box while the other two arms are similarly placed in the guard or outer box. A balancing resistor is also placed in the circuit to correct for slight inequalities in the resistance of the four arms of the bridge. This type of detecting element has a particular advantage in its low heat capacity making it ideal for rapid and sensitive response to slight temperature changes. In addition, since the four arms may be wound with comparatively wide spacings, the elements fill a reasonably large volume of the boxes assuring a good average tem-

perature for each of the boxes.

The bridge is supplied from a single dry cell while the unbalance across the bridge is detected by a Leeds and Northrup Type 2420 lamp and scale galvanometer. For control purposes this galvanometer has been fitted with an RCA 924 phototube which has been mounted inside the galvanometer box in such a manner that it intercepts the light beam when the galvanometer deflects in one direction. A six-prong socket has been provided on the side of the galvanometer box and carries the six wires of the lamp, galvanometer and phototube circuits. This arrangement and also the fact that the phototube is removable permit plugging the operating control circuit into the galvanometer box with the least difficulty and still leaves the galvanometer free for other uses.

The operating control circuit shown in Fig. 2 consists simply of an electronic phototube relay which, under control of the galvanometer light beam, operates or releases a sensitive relay. This relay in turn controls another heavier duty relay with two poles. One of the poles is used to supply or disconnect 110-v power to a suitable outlet on the control box which in use is connected to the 80-watt heater of the guard box. The other pole is used as a shunting or short-circuiting device across a similar outlet on the box. This shunting arrangement is used when work-

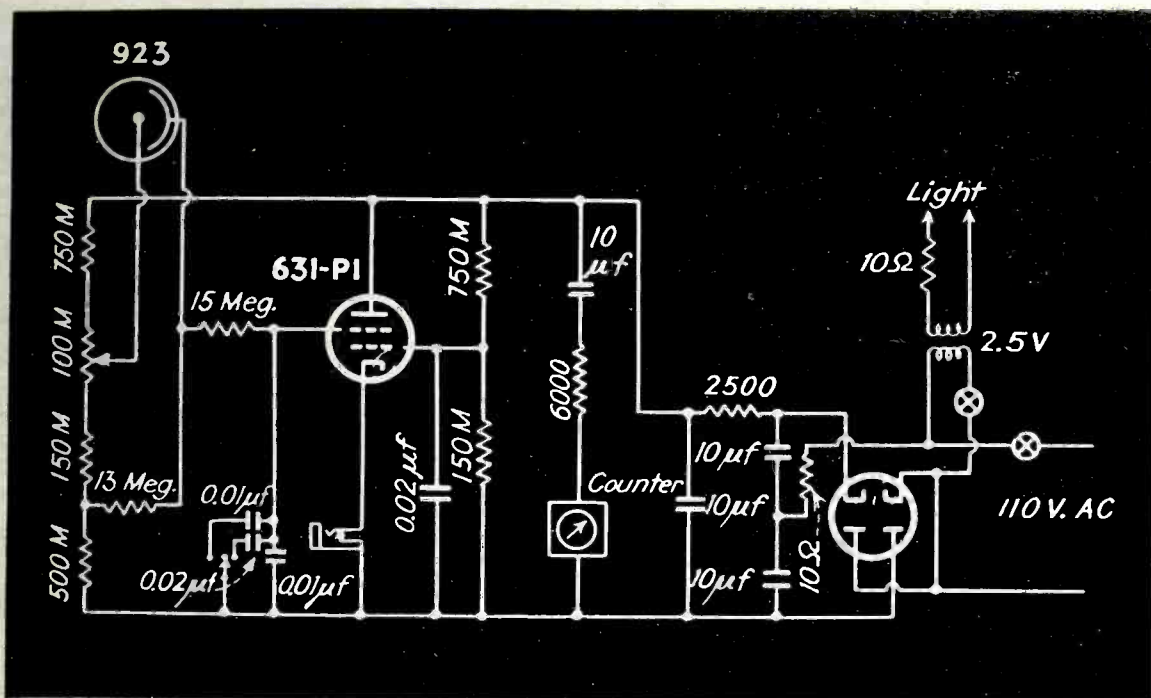

FIG. 3—Schematic diagram of light actuated impulse counter, used with small wattmeter to record total amount of energy for heating the test boxes

FIG. 4—Photograph of power measuring instrument. Phototube and light source are mounted within glass case of meter which is painted black

which was painted on its inner surface with black paint. The phototube is connected to a suitable electronic amplifier and counting circuit, Fig. 3, which counts the revolutions of the watt-hour meter as detected by the rotating mirror. The main features of the counting circuit include a General Radio Type 631-PI Strobotron tube which is of the cold cathode trigger type and a Cenco No. 73511 high speed high resistance counter. The operation of the circuit is such that for every revolution of the meter disc and mirror, the phototube initiates an impulse which triggers the Strobotron and registers on the counter. An adjustment is neces-



ing with the guarded hot plate unit whose heater circuits differ slightly from those of the guarded hot box unit. The operating control circuit includes a voltage-doubler rectifier and power supply for the phototube and vacuum tubes, a 6-v transformer power supply for the galvanometer lamp, a battery and switch for the bridge circuit (not shown in the figure) and a rheostat for varying the galvanometer sensitivity (also not shown). In operation the control system is so connected to the hot box bridge that if the guard box is warmer than the inner box, the power to the 80-watt heater in the guard box is cut off. If the reverse, heat is added to the guard box.

In addition to the above arrangement which applies to the hot box unit, the control box also has a set of binding posts connecting directly with the galvanometer which permits the unit to be used with a thermocouple. This makes the unit rather general in its applications and not limited to use with the above equipment since either a d-c bridge or a thermocouple may be used as a detecting element.

Measurement of Power

It may be seen that in the use of the guarded hot box it is necessary to measure the power to the inner box accurately since this power represents the energy passing through the test wall in the form of

heat. In addition, since such tests usually take a comparatively long time to run, it is also most convenient if the power can be measured continuously and cumulatively. It is unnecessary to measure the power to the guard box although all the heater circuits have been wired through 4-prong sockets into which wattmeters may be plugged to read and adjust the power to the different heaters.

The other instrument to be described was developed to measure the power to the inner box continuously and accurately. It consists essentially of a General Electric Type I-30-A watt-hour meter. This meter is of the type normally used with current transformers and has a 2.5 ampere current coil which is used directly in this case giving the low watt-hour meter constant of 0.3 watt-hour per revolution. As used in this application, the register dials were removed and a small plane mirror glued to the rotating shaft of the meter. In the place occupied by the register dials, a small light source and phototube were mounted. The light source is a 2.2-v "Penlite" or "Lenslite" flashlight bulb which has a fairly concentrated beam. The phototube used was an RCA 923 with the base removed although the 924 type might be preferable due to its smaller size. Both the light source and the phototube are mounted within the glass case of the meter

sary and is provided in the circuit to adapt the counting circuit for measurements of small powers (25 watts or less) where the disc rotates very slowly and of larger powers (300 watts) where the meter rotates much more rapidly.

In use on the guarded hot box test, the meter measures the power to the inner box only and it does so continuously and automatically. The adjustment of the inner box heater by taps rather than by transformer control was to permit the meter to measure at its rated voltage of 110 volts at all setting of the heater.

This equipment, watt-hour meter, counter, power supply and tube circuit all mounted as a single unit as shown in Fig. 4 may be used for any other power measurements within its range. As such it is a relatively inexpensive and rugged power measuring instrument which may be easily calibrated against the more expensive rotating watt-hour meter standard which would be necessary in its place.

By
B. E. LENAHAN

*Westinghouse Electric and Manufacturing
Co., Newark, N. J.*

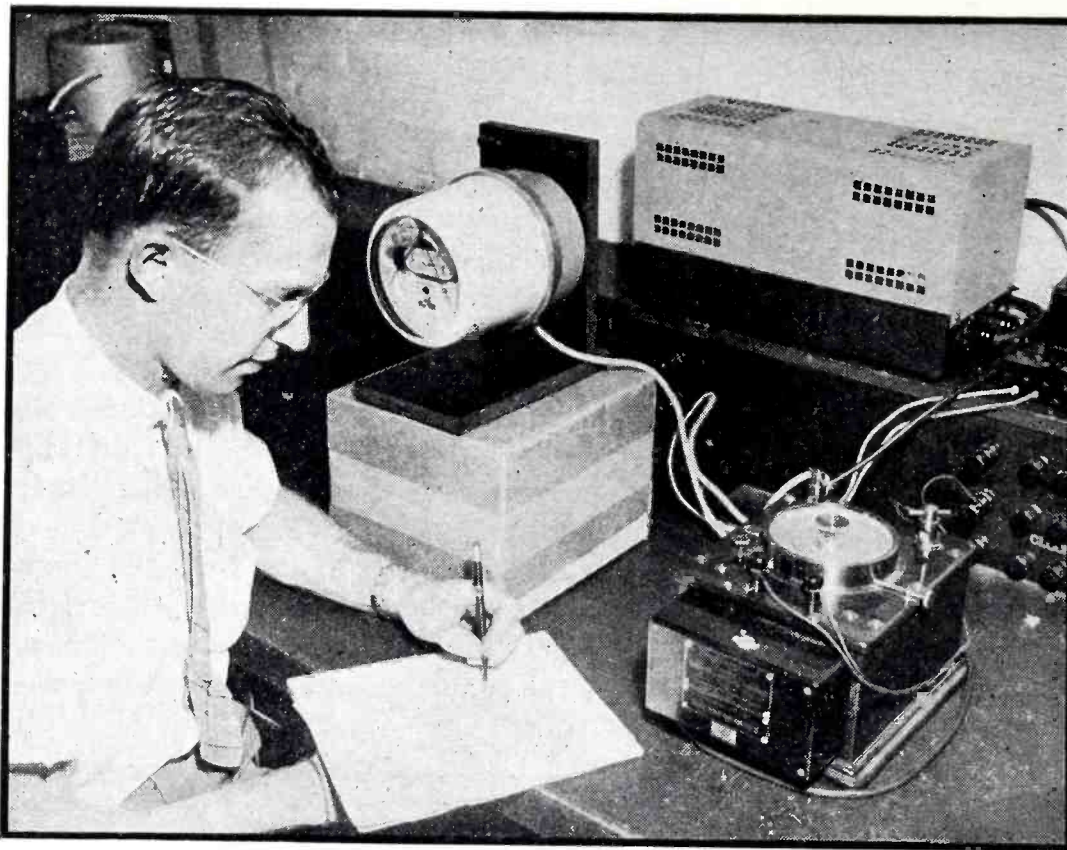

FIG. 1—Using electronic method, one operator replaces two previously needed for testing demand meters

ELECTRICITY meters, commonly used for measuring electrical energy sold to users, measure the product of power and time. To test such a meter for basic accuracy requires measuring two quantities. Since time is easily measured to high accuracy, it is common practice to hold power constant and measure time. This practice is also justified by the fact that errors are a function of the power measured rather than time.

Some types of demand meters may require test periods up to fifteen minutes, other types to one hour. When such tests are performed manually, an operator observes the motion of the pointer on a standard wattmeter and by adjusting a rheostat controls a portion of the total test load to correct for the small variations arising from voltage fluctuations, resistor heating, and other causes.

The operator learns by experience that in order to keep the average of the load constant he must try to compensate for the transient variations by briefly applying a greater correction than the deviation, the operator thus mentally averaging the peaks and dips. This is a somewhat tedious operation involving both judgment and eye-strain. The result is that the accuracy of the test is somewhat lower than the accuracy of the standard used.

The device to be described performs the required operations automatically by electronic means.

Basic System

The apparatus illustrated in Fig. 1 is applied to a standard wattmeter of the null deflection type and may be said to contain three functional parts, corresponding to an operator's eye, brain, and hand. The same principle is readily applied with structural variations to other forms of a-c wattmeters or to direct

current calibration problems. A diagram showing the complete circuit is shown in Fig. 2.

The "eye" part consists of a mirror which receives a beam of light from a lamp, two phototubes and a shutter vane which is carried on the meter mechanism. This vane swings in front of the mirror close to the lamp, forming an optical lever to magnify the motion of the moving coil, and controls the light on the phototubes. The distance between the lamp and phototube is made small in order to give good illumination with a small, long-life lamp. The shutter width, and spacings, are chosen so that each tube is just half-illuminated when the load is normal.

The phototubes are connected in series and the lamp position is adjusted until no current flows from

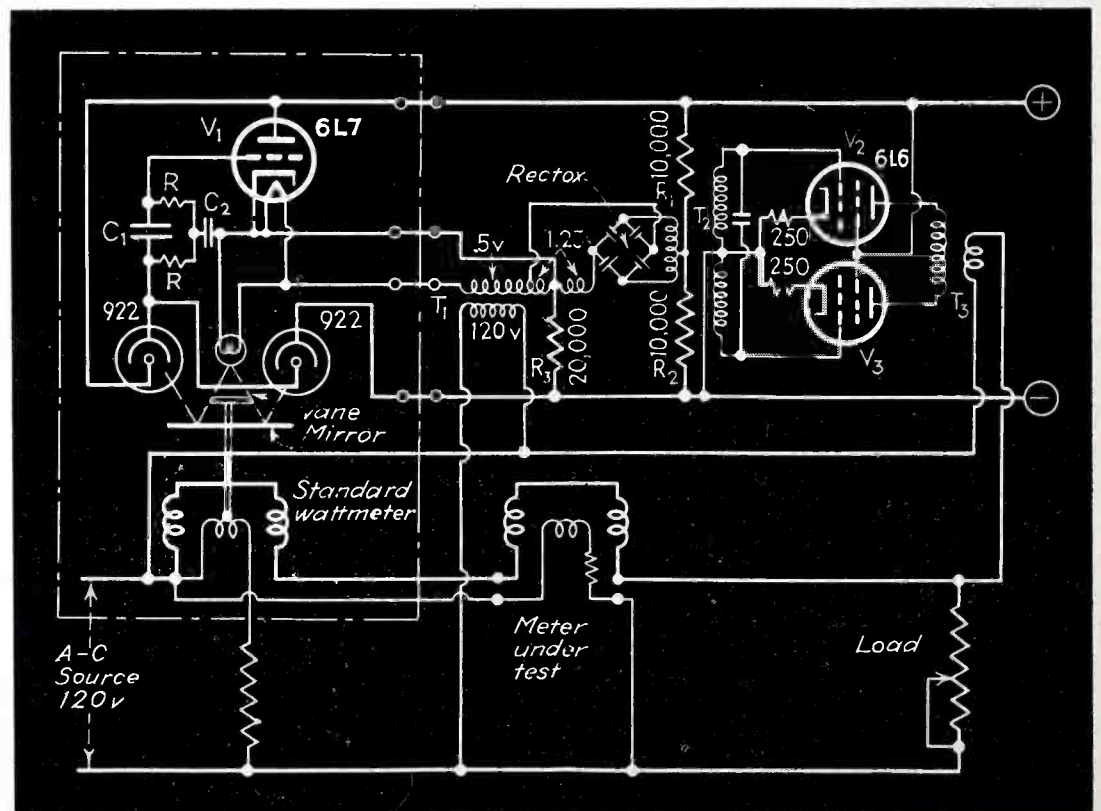

FIG. 2—Schematic wiring diagram of the electronic circuit for testing and calibrating meters

Load Regulator for METER TESTING

Electronic method of calibrating watt-hour meters saves manpower and increases precision of calibration. Method employs phototube and amplifying circuit for making comparisons between meter under test and precision instrument

the junction of the phototubes when the wattmeter is in the normal position for the load desired. With this arrangement, the current output of the phototubes is proportional to the displacement of the wattmeter element from the normal position. Thus the electric eye converts a mechanical deviation into a current.

The "brain" of the device is a network of resistors and capacitors, connected between the junction of the phototubes and the grid of the tube V_1 as shown in Fig. 2. The current flowing through this circuit sets up a potential difference which operates the remainder of the device.

Circuit Details

The tube V_1 and the parts following it in the circuit produces a correction component for the variation in the load on the meters, the correction being proportional to the change in grid voltage of the tube from its normal value.

Since the meter illustrated is a wattmeter the correction can be applied either to the voltage or the current circuit. In practical use the voltage is kept relatively constant while the current is the variable element. By applying the correction in the current circuit, the correcting torque on the moving element can be made proportional to the correction. This means that the torque resulting from a correcting current will be dependent upon the product of the correcting current and the voltage and thus will be proportional to correcting current but independent of load current value. This simplifies the operation considerably as the gain of the amplifier does not need to be re-adjusted for every load change.

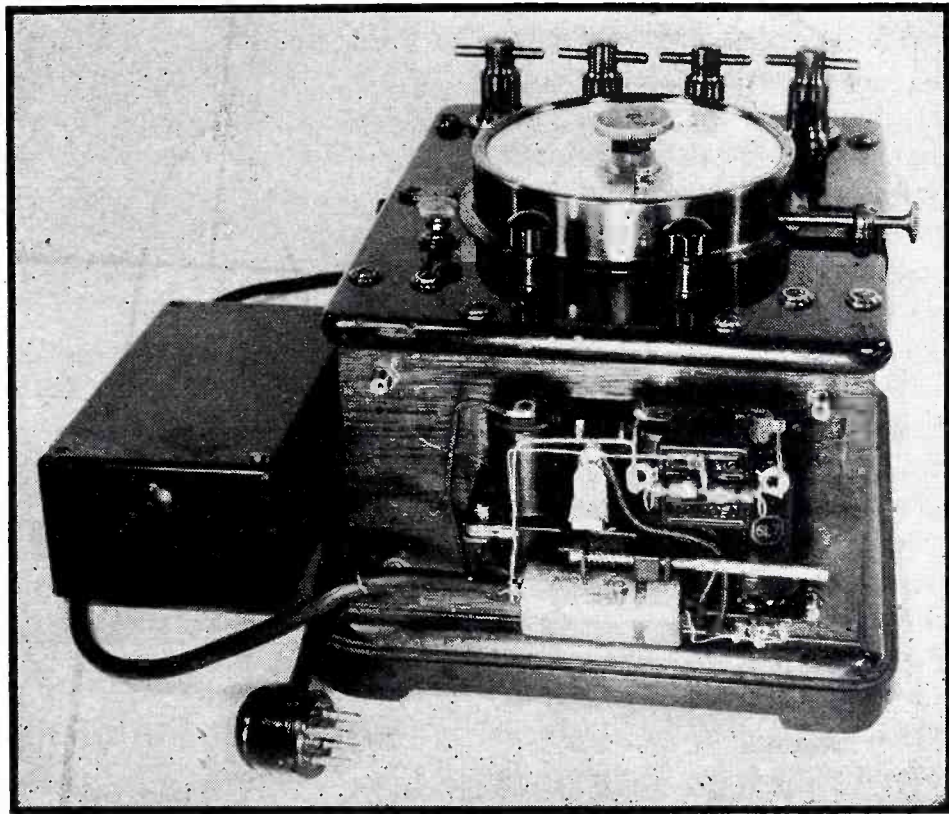

FIG. 3—Detail view of the electronic calibrating device

The tube V_1 is part of a bridge circuit made up of its cathode resistor R_3 and the resistors R_1 and R_2 . Normally the cathode is at about the same potential as the junction of R_1 and R_2 and the grid bias is at a value corresponding to a plate resistance of 20,000 ohms.

Any change in grid bias causes a direct current to flow from the center tap of the 2.5 volt winding of the transformer T_1 to the center tap primary of T_2 . This current unbalances the Rectox bridge through which it flows, and the a-c voltage is applied to T_2 primary. When the direct current input on the Rectox bridge reverses, this bridge which has non-linear resistance characteristics becomes unbalanced in the opposite direction. The output of the amplifying tubes V_2 and V_3 is made proportional to the grid voltage of

V_1 by a choice of operating conditions and the output transformer T_3 steps up the alternating voltage to a value suitable to apply to the meter coils. The secondary side of this transformer is connected across the current coils of both the standard and the test meters, where an electromotive force of only a few volts is required. With this connection most of the correction current component flows through the meter coils and but little through the load impedance.

The condenser shown across the secondary winding of T_2 is to correct the phase angle error and improve the wave form. It will be noted that the cathode resistors for tubes V_2 and V_3 are not by-passed. This is to provide current feed-back to insure a good wave form in their

(Continued on page 254)

By E. E. MOYER

Electronic Section
Industrial Control Engineering Department
General Electric Co., Schenectady, N. Y.

WHEN a shunt motor is designed to be operated at higher than base speed by reduced field current, the field may be supplied with variable excitation from a grid controlled thyatron rectifier similar to that of the armature circuit and independently adjustable.

If the field voltage be accepted as an indication of field flux (which is not an exact relation because of the non-linearity between flux and current due to saturation, because of field distortion due to armature flux, and because of field resistance change with temperature) then the means for controlling the reduction in field excitation may be patterned after the armature voltage control circuit which is shown in Fig. 1. Grid phase control of the output voltage of the field thyatrons, and hence field excitation, may be varied by using another saturable reactor-resistor bridge circuit and exciting the d-c winding of the saturable reactor through a vacuum tube from the 150/75 volt control bus. This field control circuit is shown in Fig. 2. Electrical feed-back of the field voltage signal will serve to maintain a preset level of field excitation independent of a-c line voltage variations. For more precise control, field current instead of field voltage should be used as the signal; this could be done by an anode current transformer and rectifier connected to read anode current in the field thyatrons.

When the field excitation is reduced, the ratio between speed and armature counter electromotive force is changed in such a way that the armature must rotate at a higher speed in the weaker field in order to generate the same counter emf. It is the reduction in counter emf accompanying a reduction in field strength which allows an excess of current to flow in the armature conductors and produces the extra torque necessary to increase the motor speed to the new level at which speed the counter emf is again sufficient to limit the armature current to the value re-

For purposes of consistency, the symbols employed in this article are those commonly used in communication circuits.—Editor.

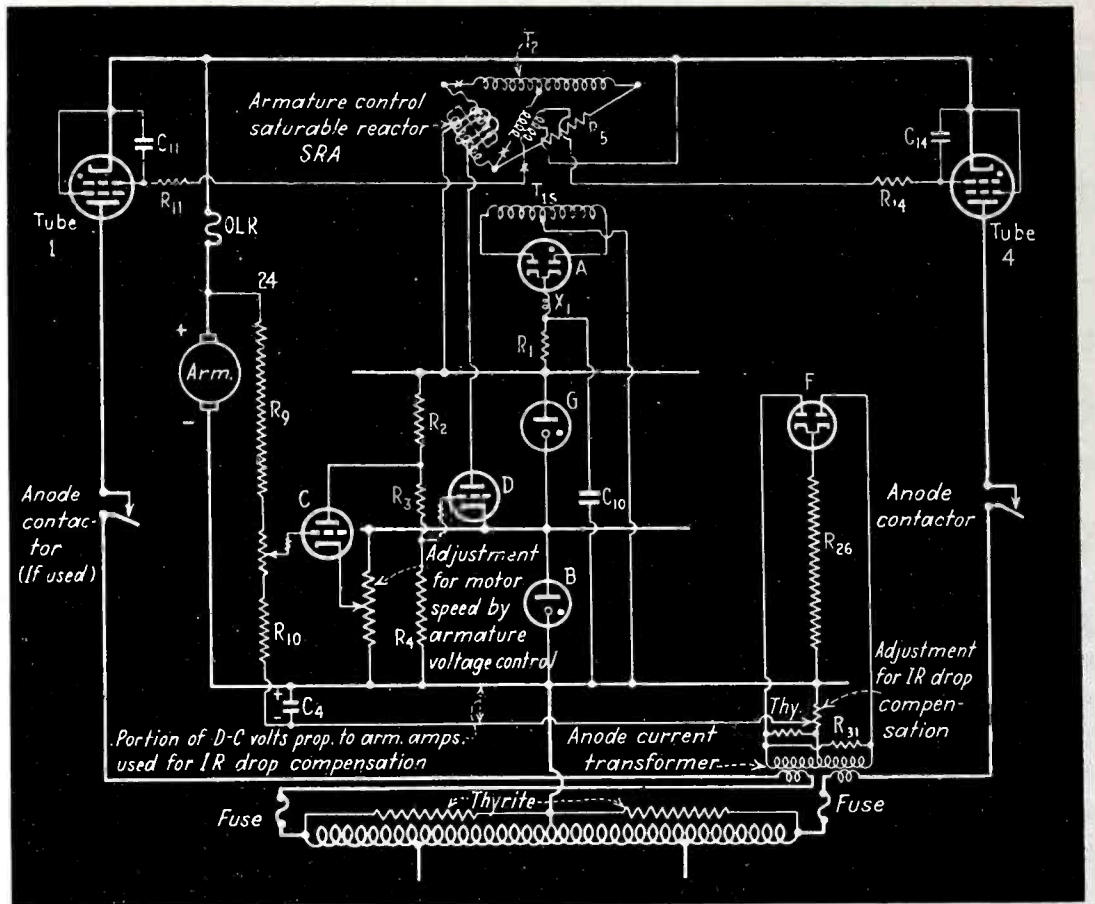

FIG. 1—Armature and excitation control circuits with voltage drop compensation
FIG. 2—Field excitation and control circuits

Electronic Control of

The third installment of this series on industrial electronics deals with methods of extending the speed range of d-c

excitation should be maintained at required to maintain this speed. A given preset speed level is maintained relatively constant by grid phase control of the armature thyatrons as they automatically phase advance to compensate for voltage drop accompanying changes in armature current. Speed is not regulated by changes in field excitation; speed is only preset to new levels at which it is regulated by armature voltage control. Hence, when the armature thyatrons are phased full on and the armature voltage has been increased to the limit determined by the a-c anode voltage there can be no further speed regulating action.

Single Dial Control of Over-all Speed Range

When the speed of the motor is controlled by variations in armature voltage only, as determined by the setting of the armature voltage control potentiometer, the motor field

excitation should be maintained at rated value if the motor is to develop rated torque. Then, when the speed range is extended by field weakening as determined by the setting of the field voltage control potentiometer the armature counter emf should remain at rated value if the motor is to develop constant rated horsepower. Except for special control characteristics there is no occasion to have these two controls overlapping so that, for example, the field is weakened long before the armature counter emf is brought up to rated value. Therefore, the two control potentiometers can be ganged on one shaft if the armature voltage control potentiometer is so constructed that its entire variable resistance range is compressed within the first 150 deg of shaft rotation and the slider connects to a conducting segment over the remaining 150 deg of shaft rotation, and if the field-voltage con-

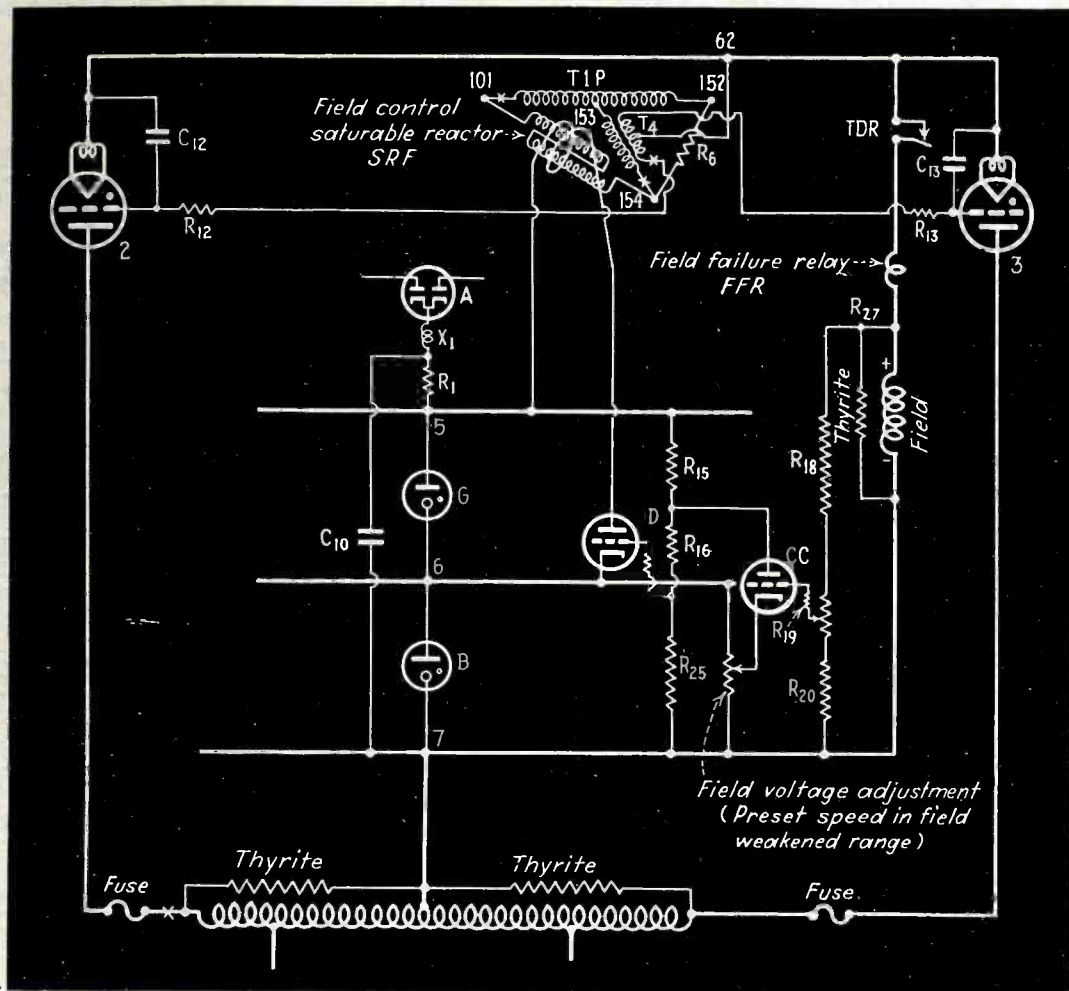

D-C Motors—Part III

motors through the use of automatic electronic devices for field weakening

trol potentiometer is so constructed that its slider rides on a conducting segment during the first 150 deg of shaft rotation and rides on the resistance portion during the remaining 150 deg. These dual potentiometer circuits are diagrammed in Fig. 3.

One objection to the dual speed control arrangement, if used without supplementary control devices, is that if the speed control were preset for a speed in the weak-field range, the field excitation would be maintained at this reduced value, so that to develop rated torque while accelerating a load the armature current would have to be excessively, if not prohibitively, high. Also, full voltage would be applied to the armature at standstill which would result in abnormally high starting current.

Armature Current Limit

An armature current-limit control is provided so that the speed control

potentiometer can be preset to any desired speed, the starting sequence initiated, and the motor brought up to that speed level smoothly without exceeding a predetermined armature current. In other words, the motor is accelerated uniformly from standstill to preset speed under conditions of constant armature current in the quickest possible time consistent with that value of armature current and the load on the motor. This same current limit functions on overload to prevent the armature current from exceeding this maximum value even under stalled conditions. (The overload relay or fuses open the armature circuit before damage to the motor if the stalled or overload condition is maintained.)

If a d-c shunt motor is to be used to accelerate a high-inertia load as quickly as possible, from standstill to maximum motor speed, the field should initially be at full excitation

and the armature voltage should be initially at that reduced value which will permit the flow of only the maximum armature current for which the motor is rated. Assuming that this value of armature current will be sufficient to break-away the load, the armature will begin to rotate and the armature current will tend to be reduced due to the increasing counter emf generated by the rotation of the armature conductors. To maintain this maximum permissible current level, the armature voltage should be increased in proportion as the armature counter emf tends to reduce the current; in other words, as the speed increases the armature voltage should be increased in proportion. This process should continue until rated counter emf is reached, at which point the armature current tends to decrease to the level demanded by the load at this "basic" speed. If the field current is now weakened, which reduces the counter emf at that speed, the armature current will increase and will tend to cause the motor speed to increase until the armature counter emf is again sufficient to limit the armature current to the value necessary to drive the load at this increased speed level. Hence, to increase the motor speed by field weakening and yet maintain that maximum permissible armature current for which the machine is rated, the field should be weakened only in proportion as the increase in speed builds up the counter emf which tends to reduce the armature current. When the field weakening process is halted, the motor will operate at that speed level which corresponds to the reduced value of field current. These optimum accelerating conditions are fulfilled: (1) When an armature-current signal is used to force and maintain full-field excitation, regardless of any weak-field setting of the field-voltage speed-control potentiometer. (2) At the same time, the armature current is maintained at the constant current-limit value throughout the armature voltage control range. (3) When this same armature current signal is used to govern the decrease

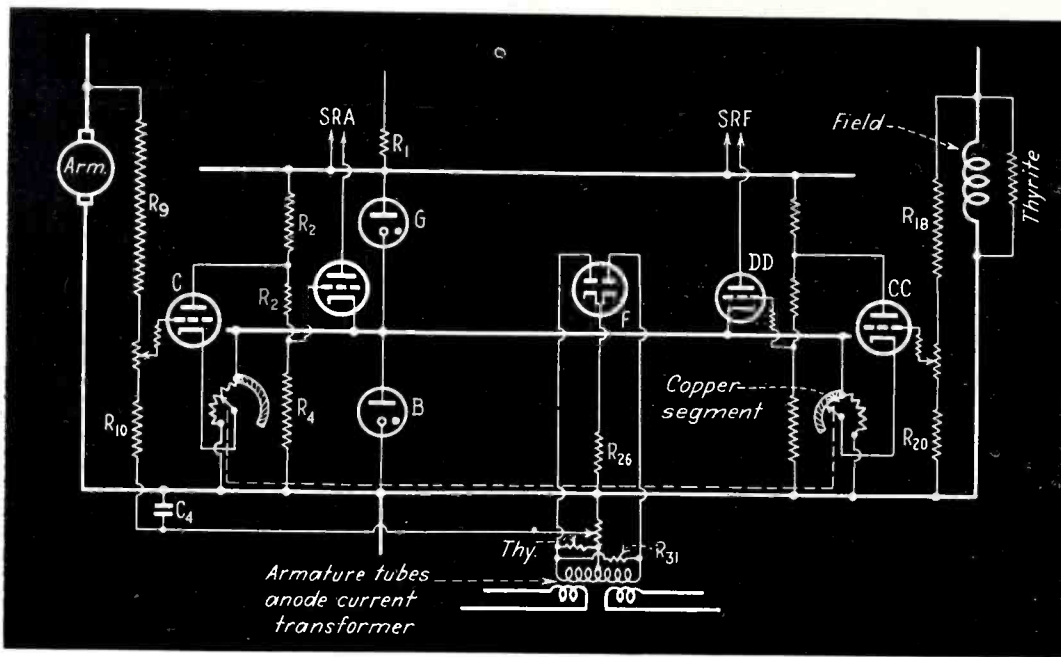

FIG. 3—Single dial, dual unit speed control potentiometers for armature and field circuits

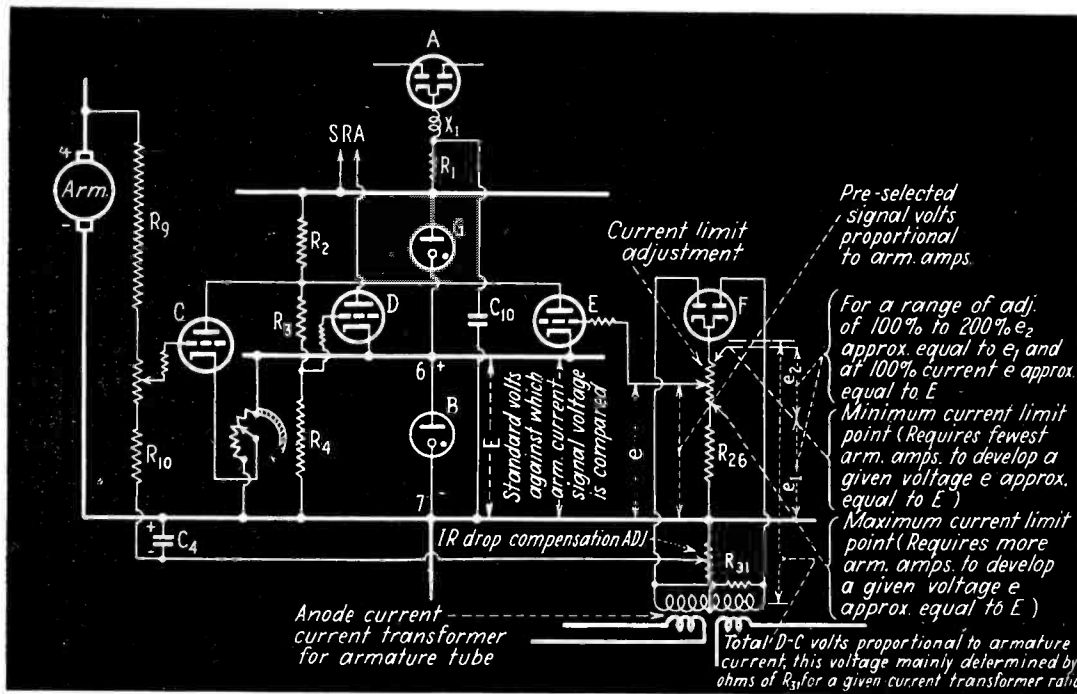

FIG. 4—Current limiter added to armature voltage control

in field current as the acceleration continues into the field-weakened range.

This current-limit control is one which is inoperative from zero current up to the preselected current at which current limit is to become effective; otherwise, the amount of current would be continually tapering the constant-speed control. When it comes into play the current-limit action takes over sharply, that is, as near the preselected value of current as possible, and exercises its control function from top speed to stall with only a small increase in armature current above the preselected level. The value of current at which current limit becomes effective is usually adjustable over a band of, say 100 percent to 200 percent rated armature current so as to provide for different motor applications.

Since a signal of d-c voltage proportional-to-armature-current has been made available for IR drop

compensation, this same voltage source can be used for armature current-limit control. In Fig. 4 is shown the method by which current limit is added to the armature control circuit. To make the current limit inoperative until a certain value of armature current is reached, a preselected portion, e , of the d-c volts - proportional - to - armature - current signal is compared against the voltage standard, E , of tube B . Then, the voltage difference between the signal voltage and the standard voltage is "sensed" (signal less than standard, equal to standard, or greater than standard) by the grid action of tube E and amplified by this same triode. Finally, the amplified signal is superimposed on the armature voltage control triode, tube C , by connecting the anode of tube E to the anode of tube C . Whichever of tubes C or E "works the hardest" controls the shutting-off action on tube D which controls the armature

voltage (and hence the current).

In the circuit of Fig. 4, the cathode of tube E is connected to the positive end of voltage standard tube B , and the negative terminal of tube B is common to the negative end of the d-c voltage signal of volts - proportional - to - armature - current, and the positive end of this d-c signal voltage is connected to the grid of tube E . Whenever the d-c volts-proportional-to-armature-current is less than the voltage of tube B , the grid of tube E will be very much negative relative to its cathode and tube E will be non-conducting and inoperative. Limitation of current to 150 percent rated armature current requires that, at 150 percent armature current, the signal voltage e , of d-c volts-proportional-to-armature-current, must be preselected to be approximately equal to the 75 volts drop, E , across regulator tube B . As this chosen value of armature current is reached, and hence as the d-c signal voltage, e , approaches 75 volts, a point will be reached when the grid of tube E will be sufficiently less negative that tube E begins to conduct current through resistor R_2 . This is the same resistor through which the armature voltage control triode, tube C , conducts current to control tube D , so that additional current through R_2 via tube E has the same effect as though tube C conducted more current, i.e., it makes tube D less conducting, which desaturates the saturable reactor of the armature thyatron and retards grid phase so as to reduce the armature voltage and current. Thus, the tube (C or E) which determines the controlling current through R_2 also governs the degree of saturation of the armature saturable reactor, SRA . The two controls, armature voltage vs armature current limit, are only additive in the sense that, in a very small region of overlapping functions, tube C gradually gives up what tube E takes over; this because tube C is operative most of the time and tube E takes over only after the armature current has increased to the preselected value. Of the two control signals, voltage vs current, only that which is dominant does the controlling. Also, the armature voltage control triode, tube C , cannot take control away from the current limit triode, tube E , until the armature current has dropped below cur-

rent limit value and has thus rendered tube *E* inoperative.

The circuit of Fig. 5 shows how armature current limit is applied to the field-voltage-control. The general scheme is similar to the armature current limit control of Fig. 4 in that the d-c voltage-proportional-to-armature-current is compared against a reference voltage and the difference voltage is applied to tube *EE* which acts on the saturating circuit of the saturable reactor of the field thyatron. However, in this instance of field weakening control there are two distinct differences in the action of tube *EE* compared to tube *E*: (1) an increase in armature current beyond a predetermined amount must increase the field strength by saturating the saturable reactor of the field thyatron (whereas with armature voltage control an increase in armature current necessitated a decrease in saturation of the reactor of the armature thyatron); and (2) the reference voltage against which the signal of d-c volts-proportional-to-armature-current is compared is not the constant voltage, *E*, of regulator tube *B* but rather is the slightly variable voltage, *e*, between the grid of tube *DD* and the negative bus, which voltage is in itself referred to the standard voltage, *E*, of tube *B*. In Fig. 6 are compared the current limit controls as applied to armature voltage and field voltage control circuits.

Referring again to Fig. 5, the field-forcing triode, tube *EE* (which is associated with armature current control of field weakening), has its plate connected to the positive con-

trol bus and its cathode connected to the grid of tube *DD* and the voltage divider composed of R_{16} and R_{26} . Turning on field forcing tube *EE* will cause point 17 to become more positive with respect to point 6 so as to make tube *DD* and the field thyatrons more conducting to increase the saturation of the field reactor and strengthen the field.

During normal operation and prior to current limit the grid of tube *DD* is a few volts negative with respect to its cathode, which cathode is at the potential of the neutral control bus, point 6. How much or how little negative this is depends on the extent to which tube *DD* is rendered conductive as determined by the setting of the field voltage control potentiometer. Hence, the grid of tube *DD* is positive with respect to the negative control bus, point 7, by a voltage which is almost, but not quite, equal to the voltage drop *E* across tube *B*. Since the cathode of tube *EE* is connected to the same point (17) as the grid of tube *DD*, the cathode of tube *EE* is maintained positive with respect to common point 7 by a voltage almost equal to *E*. The grid of field forcing tube *EE* is connected to the armature current signal voltage, *e*, so that whenever *e* is less than the reference voltage, across R_{26} , the grid of tube *EE* is highly negative with respect to its cathode and tube *EE* is rendered sufficiently non-conducting to be inoperative. Only when the signal voltage *e*, has increased to within a few volts of the reference voltage across R_{26} will tube *EE* commence to operate. As the signal voltage, *e*,

continues to increase, the field forcing tube *EE* is made more conducting which tends to make the grid of tube *DD*, more positive and thereby cause an increase in saturating current in *SRF*. Thus, an increase in armature current beyond a preselected limit will cause the field excitation to be increased regardless of the setting of the field-voltage control potentiometer.

Overload

Figure 6 is constructed to exaggerate the fact that the cathode, (point 17) of field forcing tube *EE* is normally at a less positive potential than the cathode (point 6) of armature current limit tube *E*. By this means, field-forcing tube *EE* is caused to act slightly ahead of armature current-limit tube *E*. That is, as the signal portion, *e*, of the d-c voltage-proportional-to-armature-current increases in a positive direction with respect to the negative control bus (point 7) the grid of the triode whose cathode voltage is nearest to that of point 7 (triode *EE* in this instance) will first become less negative. The triode with the greater cathode-to-negative-bus voltage will become less negative later and hence will become operative later in the sequence of events.

Assume the motor to be operating in the weak-field region due to the setting of the speed-control potentiometer, and also that the armature current-limit is set at 150 percent rated armature current, but that the nature of the load is such as to require less than 100 percent rated armature current. Then, as the load

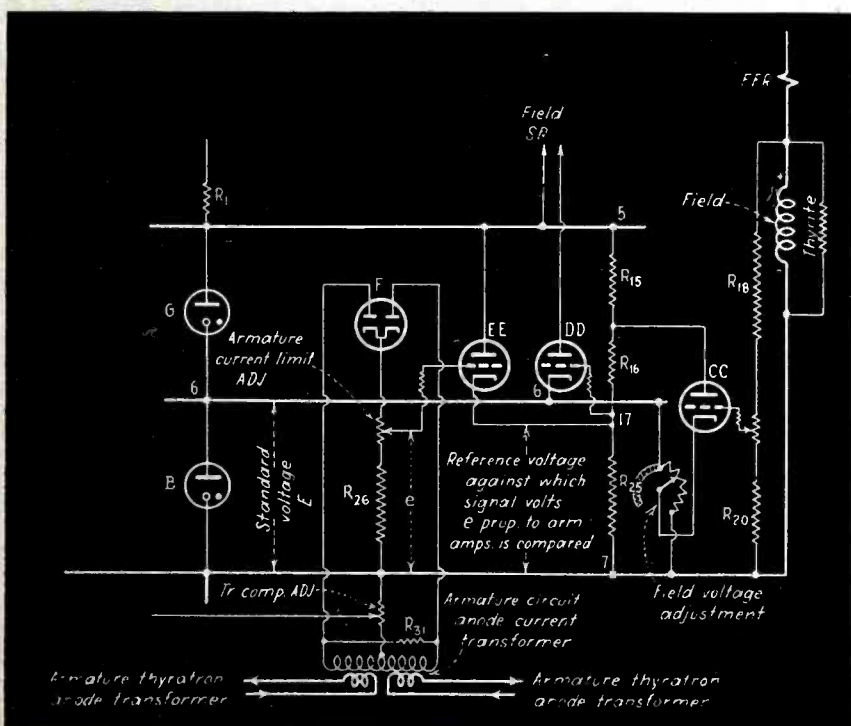
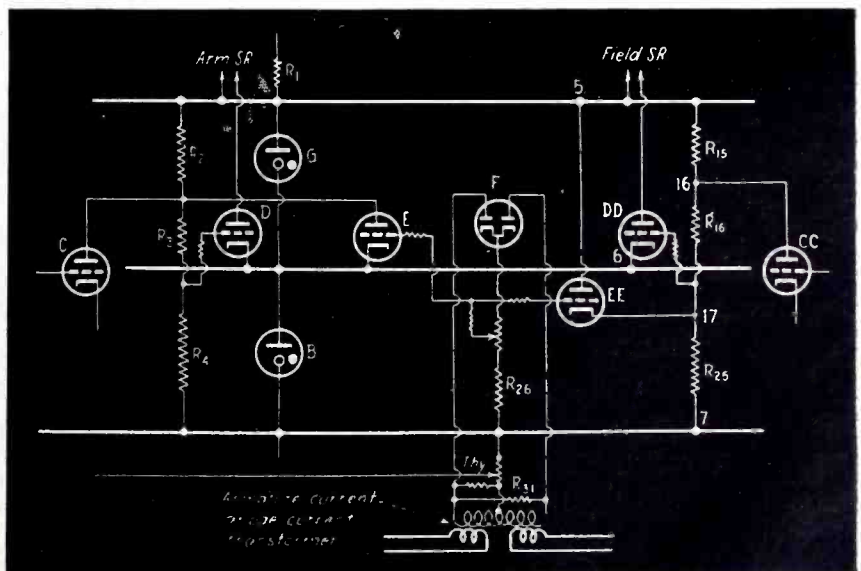

FIG. 5—Armature current limit added to field voltage control

FIG. 6—Comparison of armature current limit as applied to armature and field circuits



is gradually increased toward the 150 percent armature current limit, the field-forcing tube *EE* will first begin to take effect a few percent ahead of the 150 percent point. A continued slight increase in armature current will bring the field up to full excitation, meanwhile causing the motor speed to decrease to basic value. A continued increase in armature current of a few more percent will cause the armature current-limit tube *E* to take effect and reduce the armature voltage, and consequently the motor speed, to whatever extent is necessary to prevent the armature current from exceeding the preset 150 percent limit. This current-limit process is continuous down to zero speed (stalled armature) where the armature voltage is the IR drop of the armature circuit at this 150 percent value of armature current. If the nature of the load allows, the motor will operate at constant current and will run current limited at any speed in the current-limit region. As the excess load is removed, the speed will increase towards the preset speed at which it will be maintained if the current drops below limit value.

On a quickly applied load, the commutating ability of the motor might be overstressed if the armature current-limit tube *E* had to await prior action of field-forcing tube *EE*. However, this control acts on both tubes *E* and *EE* independently; it merely acts on tube *EE* at a current-limit value which is a few percent less than that of tube *E*. On a quickly applied load the tendency for the armature current to exceed a preselected current-limit value gives a signal to the field to increase, and, almost simultaneously, without awaiting results from the field, gives a signal to the armature voltage to decrease to whatever value necessary, to maintain no more than current-limit value of armature current.

Acceleration

Assume that the speed-control potentiometer has been preset to call for a speed of four times basic speed. The motor is assumed to be current-limit accelerated at 150 percent rated armature current in that portion of the speed-control range where the speed is determined by variable-armature voltage. Also the field is forced to full-field excitation irrespective of the weak-field setting of

the speed-control potentiometer.

The motor speed will increase at a rate which is determined by the inertia of the load and by the respective values of armature current and field current. This increase in speed will continue until the armature counter emf reaches rated value corresponding to the maximum speed setting of the armature voltage-control potentiometer. As this point, the armature-voltage control would begin operating to prevent the counter emf from increasing any further so that the tendency is for the speed to remain at this value and the armature current to decrease to the amount necessary to furnish the required torque at this speed.

A slight decrease in armature current below the preset 150 percent current-limit value causes tube *EE* to ease up, in a magnified sense, on its field-forcing action. This allows the field excitation to decrease just enough to require an increase in speed to restore the armature counter emf to its former rated value.

At rated counter emf, the armature-voltage control once again tends to prevent the counter emf from rising further so that the armature current again tends to decrease, whereupon the field-forcing tube *EE* eases up a bit more, allows the field current to decrease another small increment, and requires an increase in speed to restore approximately rated counter emf. This process continues until tube *EE* has completely eased up on its field-forcing effect, at which point the field voltage is determined by the setting of the field-voltage control potentiometer, acting through tubes *CC* and *DD*.

The sensitivity of the control action on tube *E* and *EE*, (whereby these tubes take over sharply at the current-limit value and exercise their control with very little change in armature current) assists in obtaining the maximum output from the motor consistent with the nature of the load at the preset current limit value of armature current. The current-limit feature of a circuit such as that of Fig. 6 is such that when set for a stalled armature current limit of 5.8 amperes (average current) the field-forcing tube *EE* first begins to ease up at 5.2 amperes and has almost fully strengthened the field when a current of 5.35 amperes is reached. Then, these particular circuit constants are such that the

current has to increase from 5.35 to 5.75 amperes before the armature current-limit tube *E* takes appreciably control over the armature voltage. Thereafter, an increase of armature current from 5.75 to 5.8 amperes is sufficient to reduce the armature voltage to the stalled level of IR drop at 5.8 amperes. The break between 5.35 and 5.75 amperes is probably due to the difference in potential between point 17 and point 7. So that the operation of tube *E* will follow more closely upon the completion of operation of tube *EE* and narrow the break in the current limit characteristic, it would be necessary to adjust the cathode connection of tube *EE* closer to point 16 along resistor *R₁₆*. That is, tube *EE* will alter the bias of tube *DD* such that full field is established when tube *E* becomes operative to reduce the armature voltage via tube *D*.

Many modifications of armature-current limit will undoubtedly be made as the applications suggest themselves. One interesting variation is a constant horsepower drive for wire-reeling and similar constant tension, variable-speed loads wherein the armature circuit is operated at constant-armature current and the speed is varied by armature current-limit control of the field excitation.

The use of dual speed-control potentiometers also necessitates some means of limiting the armature current upon starting and some means of limiting the high armature voltage which can result when changing quickly from a high speed to a low speed adjustment. Then, there is the matter of filtering and stabilizing components of the various circuits, the stopping sequences, and inverter action associated with a reversing drive. These will be discussed in the next and final article of this series.

REFERENCES

- Emelus, K. G., "The Conduction of Electricity Through Gases," E. P. Dutton & Co., Inc., New York.
- Marti, O. K., and Winograd, H., "Mercury Arc Power Rectifiers," McGraw Hill Book Co., New York.
- Gulliksen, F. H., and Vedder, E. H., "Industrial Electronics," John Wiley & Sons, Inc., N. Y.
- Reich, H. J., "Theory and Application of Electron Tubes," McGraw Hill Book Co., New York.
- Millman and Seely, "Electronics," McGraw Hill Book Co., New York.
- Cobine, J. D., "Gaseous Conductors," McGraw Hill Book Co., New York.
- Everitt, W. L., and Assoc., "Fundamentals of Radio," Prentice-Hall Inc., New York.
- Muller, R. H., Garman, R. L., Droz, M. E., "Experimental Electronics," Prentice-Hall Inc., N. Y.
- Alexanderson, E. F. W., and Mittag, R. H., "The 'Thyratron' Motor," *Electrical Engineering*, Nov., 1934.
- Chambers, D. E., "Application of Electron Tubes in Industry," *Electrical Engineering*, Jan. 1935.

Design for DISSYMMETRICAL T PADS

Graphs for determining the resistance of the three elements of T-pad networks facilitates the design of pads having attenuation of as much as 25 db, and impedance mismatch ratios up to 5 to 1. Graphs are also adaptable to design of symmetrical pads with matched loads

IN radio and communications work the necessity for "pads" or attenuators of definite electrical loss and definite terminal impedance often arises. It is the purpose of this article, and attached curves, to facilitate the design and construction of such pads of symmetrical or dissymmetrical *T* configuration, through simple, rapid, graphical methods, without making necessary recourse to the usual mathematical design equations.

In the following discussion *a* and *b* will refer to the series impedances and *c* the shunt impedance of the three-element *T* network. As pads with elements other than pure resistances are seldom encountered, only the case of a pure resistance network will be discussed, although the symbol *Z* will be used. If a balanced pad is desired, it is necessary merely to place half of the value of *a* and half of the value of *b* in the two lower branches of the pad.

Three individual graphs are given, one for each of the impedance element in a *T* network. Each graph contains a family of curves, one for each of several different values of attenuation or loss in decibels. The family of curves is plotted to show the normalized resistance (for the element *a*, *b*, or *c* of the *T* for which the curve applies) as ordinates, against the ratio of impedance transformation as abscissa. Since the curves are plotted for the normalized impedance of 1 ohm, the resistances found from the curves must be multiplied by the actual impedance value of the input circuit to obtain the true values of resistance for the elements

By **EDWIN Y. WEBB, Jr.**,

*American Telephone and Telegraph Co.
Atlanta, Ga.*

of the desired *T* network. By plotting normalized impedances, only one set of curves is required no matter what the impedance value may be. It should be noted that while the curves are plotted for a dissymmetrical *T* network, which is useful in matching unequal impedance, the curves are equally useful for the symmetrical *T* network for matching equal impedances since in the latter case the impedance transformation is 1/1, and *a* and *b* are equal.

The graphs can be used for any impedance ratio normally encountered in practice. If an impedance ratio less than 1 is encountered, the *T* network can be reversed, for purposes of analysis, to obtain a transformation ratio greater than 1. The curves can of course be used for uneven ratios, such as 2.5/1 or 3.7/1. The curves can likewise be used for symmetrical *T* pads, for in this case the terminal impedances, *Z*₁ and *Z*₂ will be alike. The network impedances *a* and *b* will also be alike, and hence we need only use the curves for determining two separate constants, *a* and *c*. The curves are plotted more accurately than the accuracy of commercial resistors, and consequently errors involved from the graphical design method will be negligible for ordinary purposes. Care should be exercised in reading the curves, however, to ascertain that the scales are not misinterpreted.

It is to be particularly noted that the actual values of *Z*₁ and *Z*₂ (the

terminal impedances) do not affect in any way whatever the values used in plotting the curves as only their ratios were used. Therefore, for a 10-db pad of terminal impedances 5 and 10 ohms the identical points on the curves will be used as if the terminal impedances were 300 and 600 ohms, as in both cases the ratio of *Z*₂ to *Z*₁ is 2 to 1.

The loss of the pad is obtained by calculating the ratio of the power transferred from *Z*₁ to *Z*₂ with the pad in the circuit and again with the pad removed from the circuit. Assuming 1 volt applied, and impedances of 100 and 200 ohms, the power transferred when the pad is out of the circuit is

$$P_0 = I^2 R = \left(\frac{1}{300}\right)^2 \times 200$$

With the pad in the circuit, the power absorbed by *Z*₂ is

$$P_1 = I^2 R = \left[\left(\frac{1}{200}\right)\left(\frac{99.2}{200 + 145 + 99.2}\right)\right]^2 \times 200$$

$$= \left[\left(\frac{1}{200}\right)\left(\frac{99.2}{444.2}\right)\right]^2 \times 200$$

The loss in decibels is then

$$db = 10 \log_{10} (P_0/P_1)$$

$$= 10 \log_{10} \frac{\left(\frac{1}{300}\right)^2 \times 200}{\left[\left(\frac{1}{200}\right)\left(\frac{99.2}{444.2}\right)\right]^2 \times 200}$$

$$= 10 \log_{10} \left[\left(\frac{200}{300}\right)\left(\frac{444.2}{99.2}\right)\right]^2 = 9.5 \text{ db.}$$

Hence, the terminal impedances as calculated from the graphs are correct. The loss of the network is actually 9.5 db instead of the 10 db for which it is designed, but the error is sufficiently small to be neglected for nearly all practical purposes.

Design for Dissymmetrical T Pads

To use the graphs it is necessary to know: (1) the attenuation or loss, in decibels, which the network is to provide; (2) the impedance, Z_1 , from which power is fed to the T attenuator, and (3) the impedance, Z_2 , into which the T network feeds. The first condition specifies the network loss, and hence indicates which curve of the three families is to be selected for any particular problem. The second and third conditions determine the impedance transformation ratio, and hence determine at what point on the abscissa the graph is entered. From this point of entry, project vertically upward until the desired curve is reached; then project to the left and read the normalized resistance for the specified conditions for the element for which the chart applies. Multiply this reading by Z_1 to obtain the true resistance of the element for the specified conditions.

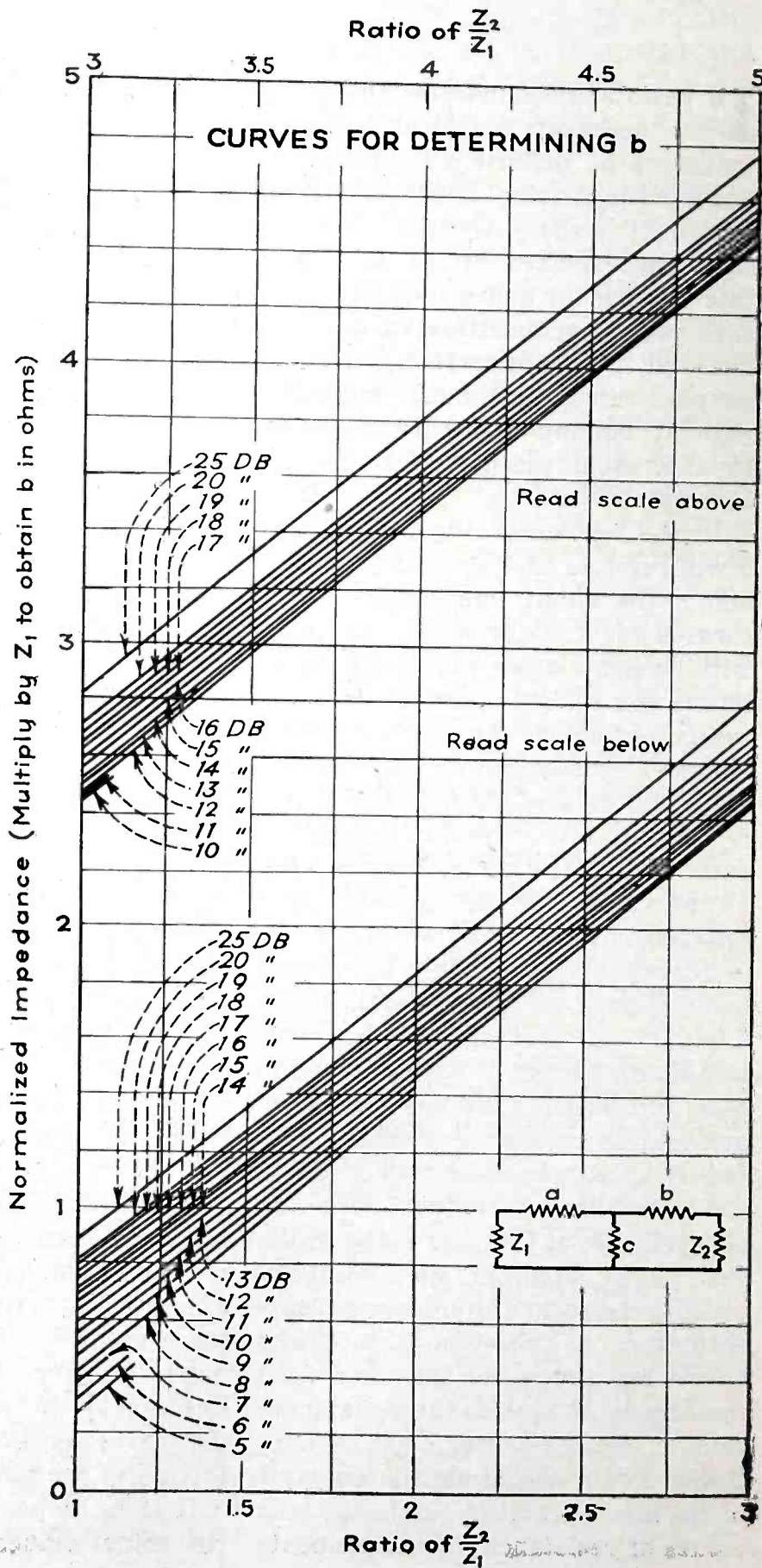
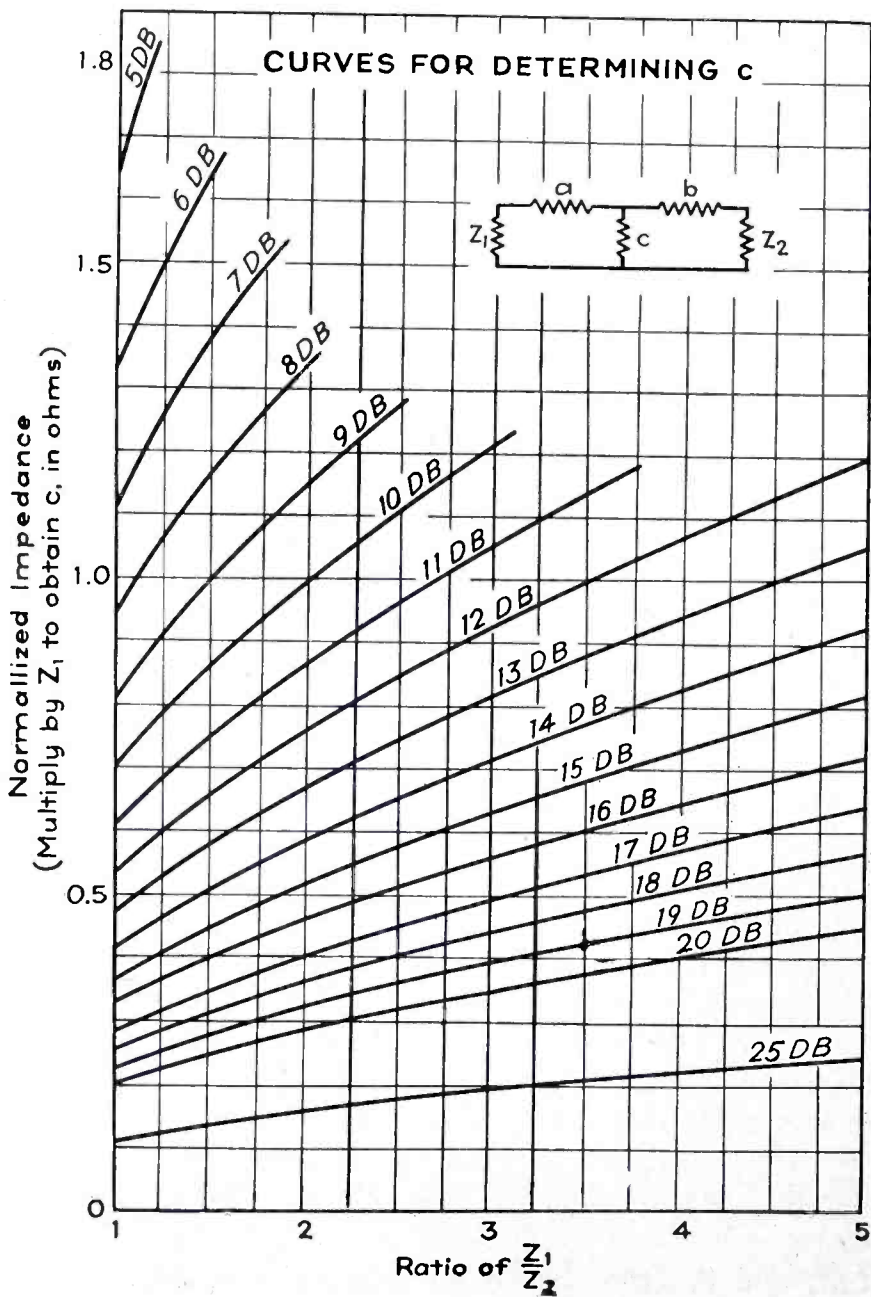
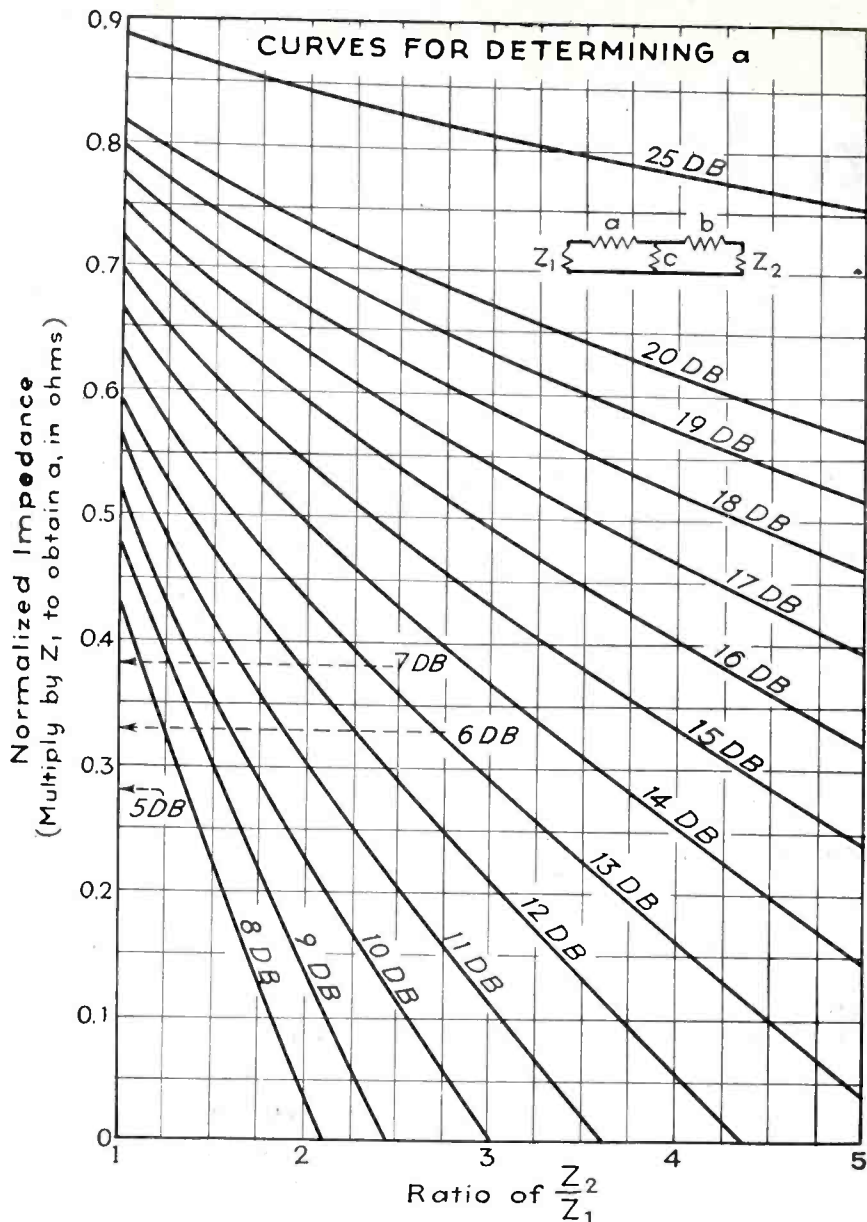

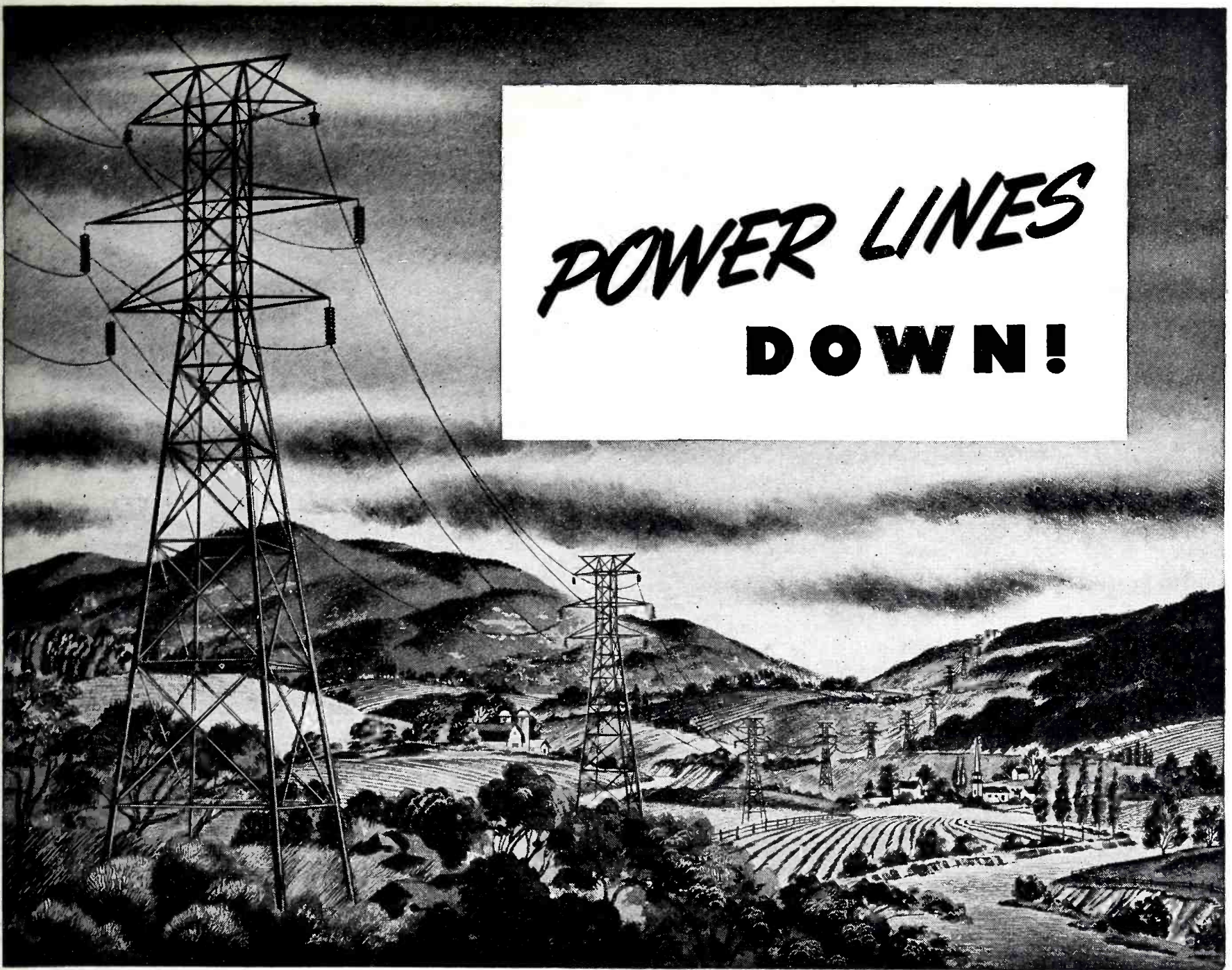

**POWER LINES
DOWN!**

IRC RESISTORS Send the Signal

When trouble develops on a high voltage power line, time is of greatest essence. For in our fast-moving electro-mechanical age, minutes quickly translate themselves into countless man-hours. Communications go "dead" . . . lights snuff out . . . vital production grinds to a sudden halt . . . and it's "taps" for a busy world.

Another IRC Contribution

Until comparatively few years ago, when power transmission interruptions occurred, it often required hours to locate the trouble. Today, thanks in part to the contribution of IRC research engineers, the point of disruption in any electrical circuit—whether power or communications—can readily be spotted in a matter of moments.

Specially designed, IRC high voltage power resistors dependably dissipate the heavy loads and deliver the voltage required to operate trouble-signalling mechanisms. On receipt of signal, other instruments in which resistors play an important role accurately locate the point of disturbance within a few feet.

Here at IRC we welcome—and usually solve—unusual problems in the field of resistance devices.

And because IRC makes more types of resistance units, in more shapes, for more applications than any other manufacturer in the world, many leading engineers make it a point to seek our unbiased counsel. There is no obligation, of course.



INTERNATIONAL RESISTANCE COMPANY

403 N. BROAD STREET • PHILADELPHIA

TUBES AT WORK

Spark Gap Circuits Used in Induction Heating Units.....	126
Thyratron Tube Tester.....	128
Balancing 30-ton Marine Gears.....	132
Measuring Transformer Noise Level.....	134
Trouble-Shooting in Electronic Equipment.....	134
Hundred Million Volt X-rays.....	141
Electrostatic Precipitators Remove Oil Mist in Shops.....	141
Using Phone Line for Remote Indication of Overmodulation...	144
Converting Capacity Changes to Current or Voltage Changes	150



Method of checking spark gap with a feeler gauge and adjusting gap thickness with a wrench. The loops of copper tubing carry cooling water between holes drilled transversely through the brass cylinders which support the tungsten electrodes

Spark Gap Circuits Used in Induction Heating Units

SPARK-TYPE high-frequency oscillator circuits as well as vacuum tube units are today generating high-frequency power for industrial induction heating purposes.

One basic spark circuit is shown in the accompanying diagram. It resembles in many ways the old Tesla coil and the spark gap transmitters of the first world war. This circuit has been found highly effective and reliable for generating frequencies in the range from 100 to 300 kc, and is used by Lepel High Frequency Laboratories of New York City in units having power inputs ranging from 3½ kw to 30 kw.

Rugged, adjustable water-cooled spark gaps with pure tungsten discs about an inch in diameter are used, with as many as 30 gaps connected in series in higher-power units so as to distribute the heat over a greater area. Ordinarily the gaps are checked with a feeler gage and readjusted to a spacing of 0.004 inch about every 50 working hours, as shown in the accompanying photograph, to maintain peak efficiency and keep the heating time uniform on production runs.

Each unit will generally have a few air-cooled gaps in series with water-cooled gaps, to insure starting of the spark even though condensation on the water-cooled gaps shorts them out for a time after cooling water is turned on. A few minutes of operation will heat the gaps enough to drive off this external condensation of moisture.

The work coil and tank condenser form a parallel resonant tank circuit which is in turn connected into a

series resonant circuit across the spark gap. Tuning involves adjusting the series tuning coils for maximum output current in the work coil as determined by an r-f ammeter loosely coupled to the output circuit.

Circuit Details

Maximum output current is obtained when the series resonant circuit is tuned to the same frequency as the output tank circuit. This frequency will be somewhere between 100 and 300 kc, but its value is ordinarily not important. If a particular frequency is required, the series tuning coils can be set for this frequency rather than for resonance if there is sufficient reserve of power to permit operating the tank circuit off its resonant frequency.

Work coils are made from flattened copper tubing shaped to provide the necessary number of turns either around or inside the object to be heated. The majority of coils have from one to ten turns. Cooling water

is forced through the work coil and its connecting leads to prevent overheating during operation, since a coil may carry up to 1000 amperes of r-f current. Rubber hose connections to an ordinary city water supply provide adequate cooling water for both the coil and the gap electrodes.

In spark gap units made by Lepel the radio frequency output power can be adjusted by means of a capacitive-type input control. The entire unit can be switched on and off by a remote-control magnetic switch operated by an automatic timer, automatic temperature control unit, foot switch or small pilot switch. The work coil has only a few turns and the high-frequency circuits are balanced to give zero potential to ground at the center of the coil, hence the work coil can be safely handled by the operator while power is on. Mica blocking capacitors prevent the high

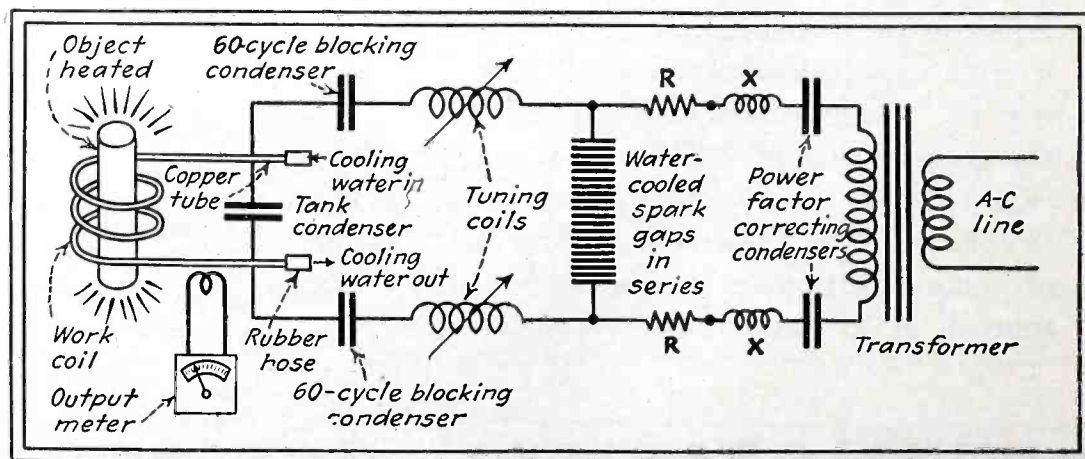

Basic spark-type circuit used for generating large amounts of high-frequency energy for induction heating purposes

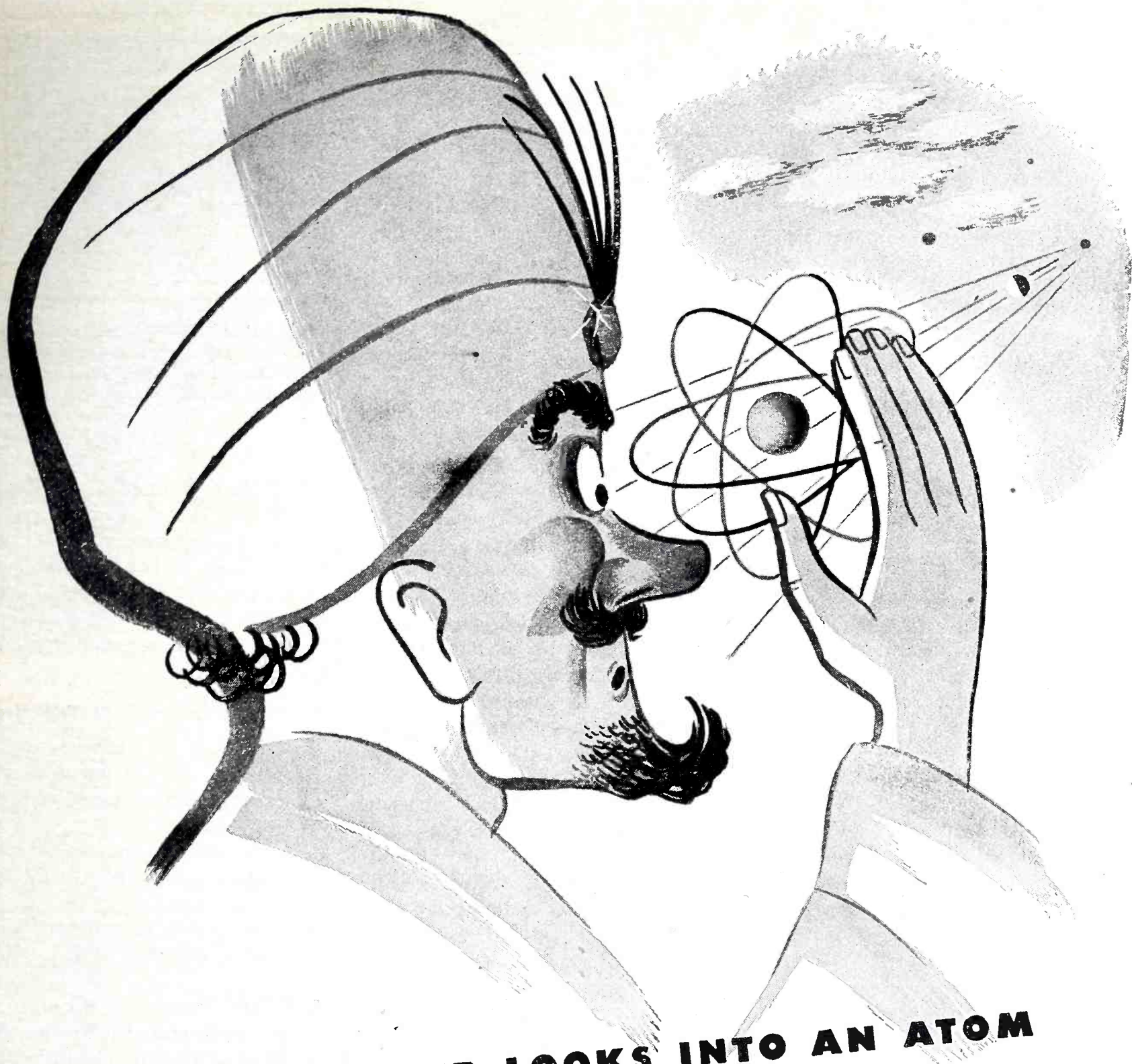

THE CRYSTAL-GAZER LOOKS INTO AN ATOM

Hocus-pocus with a crystal ball has been replaced by the electron microscope . . . and a host of other devices . . . that really give us a vision of the future. Today's unpublished observations . . . censored by war secrecy . . . will be the basis for tomorrow's industry.

Stancor Transformers are now fighting the war with armies of electrons . . . speeding the energies of military communications. But Stancor engineers are looking ahead . . . through the clearer-than-crystal glass of scientific research . . . to the practical problems of the coming age of electronics.



STANCOR

STANDARD TRANSFORMER CORPORATION
1500 NORTH HALSTED STREET • CHICAGO

60-cycle voltage across the spark gaps from reaching the work coil.

There is no appreciable r-f radiation from the work coil and its leads, and the radiation from the spark gap is spread over such a wide portion of the frequency spectrum that the radiated energy at any particular frequency travels only a short distance. In one instance where interference was observed at 35 Mc due to a peculiar combination of circumstances, the radiation was readily eliminated by placing a metal screen around the unit.

Thyratron Tube Tester

By V. P. MCKINNEY
Douglas Aircraft Co., Inc.
Santa Monica, Calif.

THE ACCOMPANYING CIRCUIT has proved highly satisfactory for checking FG57 and FG95 thyratrons, FG32 phanotrons and 872-A rectifier tubes for shorts, low ionizing potential, erratic operation and low emission.

The tester operates from a 440-volt, single-phase, 60-cycle a-c line. This voltage was used because it happened to be available and was more economical than stepping up a lower voltage in view of the heavy load current demand for testing these tubes.

Assuming switch S_2 to be in the position which disconnects the anode, grid and cathode from their respective circuits, and assuming

switch S_1 is closed, the filament of the tube under test is being heated by the secondary of transformer T_3 , which in turn is supplied by the secondary of transformer T_1 .

With S_1 and S_2 in the above positions, switch S_3 is rotated to apply 110 volts in series with the neon tube between grid and cathode, grid and plate and cathode and plate in turn of the tube being tested, as a shorted-electrode test.

Throwing switch S_2 to its other position applies all voltages to the tube under test and permits regular tests on the tube. The grid potential at the instant the tube becomes conductive is read on the voltmeter. The plate current is then read on the 10-amp d-c ammeter in series with the load resistor, which is of such value as to allow the passage of rated load current for the tube. The tap and switch S_6 are provided because some of the tubes tested have a different plate current rating.

Under the foregoing conditions transformer T_2 is also energized. It applies a rectified voltage between the grid and cathode of the tube under test, through the type 80 rectifier tube and the brute-force filter consisting of condensers C_1 and C_2 and choke L_1 . The grid is negative with respect to the cathode here, and the value of the grid-cathode voltage is determined by the setting of the potentiometer in series with the 3000-ohm resistor, which together serve as voltage divider and bleeder. The value of this voltage is indicated by

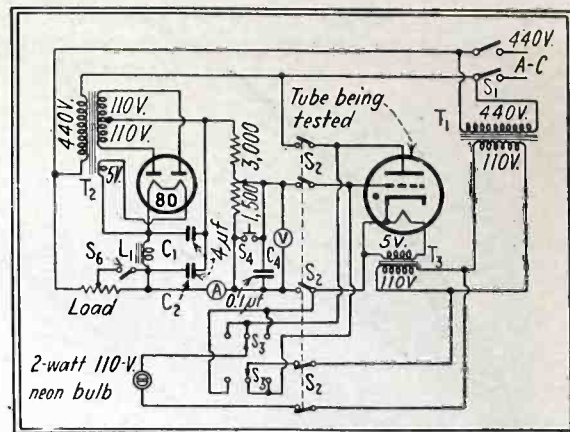

Circuit for testing thyratron and similar tubes. Two types of sockets are required for the tubes being tested, with their corresponding terminals connected in parallel

a 25-volt d-c voltmeter. Condenser C_4 maintains the grid at a constant potential, independent of ripple voltage or surges. S_4 is a normally open push-button switch, serving to bring the grid to zero potential as a check for intermittent operation of the tube.

Test Procedure for FG57 Thyratron

1. Make sure all switches are in off positions, and the potentiometer is in its minimum-voltage (counterclockwise) position.

2. Insert FG57 tube in left-hand socket, and connect red (grid) lead to cap on top of tube.

3. Close switch S_1 and wait until condensation has cleared from sides of tube.

4. Rotate switch S_3 through its three positions and observe the neon tube. If both sides of tube light simultaneously, a short circuit is indicated, and the tube should be discarded without further test.

5. Close switch S_2 , and rotate the potentiometer slowly in the clockwise direction while watching the grid voltage meter. The tube should ionize when the grid meter reads 5 volts. If the reading is appreciably lower, a weak tube is indicated, and the tube should be discarded or marked weak. After the tube has ionized, advance the potentiometer to its extreme clockwise position, and observe the reading of the plate current meter. This reading should be 2.4 amperes. A lower reading indicates low emission, and consequently a weak tube.

6. Press push-button switch S_4 to short-circuit the grid to the cathode. The tube should ionize each time this switch is depressed, regardless of the setting of the potentiometer. This switch is incorporated to facili-

Plywood Cases Protect Emergency Gear

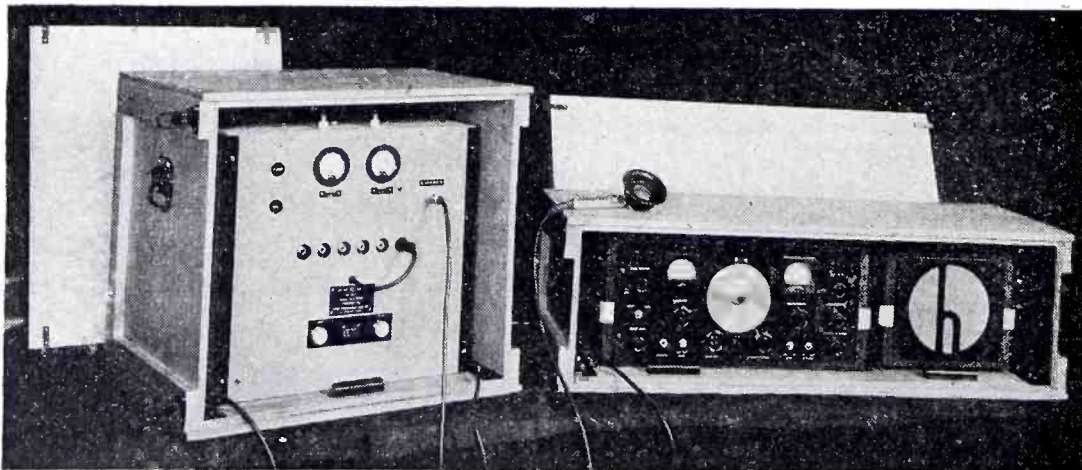

By enclosing transmitters and receivers in plywood cases of rugged, weather-proof design, such as those illustrated here, gear intended for use in the field may be more readily transported. In this instance one case houses a REL 50-watt radiphone while the other contains a Hallicrafters communication receiver and speaker



STOUT HEARTS

are carrying it through

Guardians of the sea—out across the North Atlantic, Coast Guard cutters help guard our life-lines



STURDY PARTS

are in it, too

Sturdy CINCH hammered lug strips are made to take punishment in the severest use

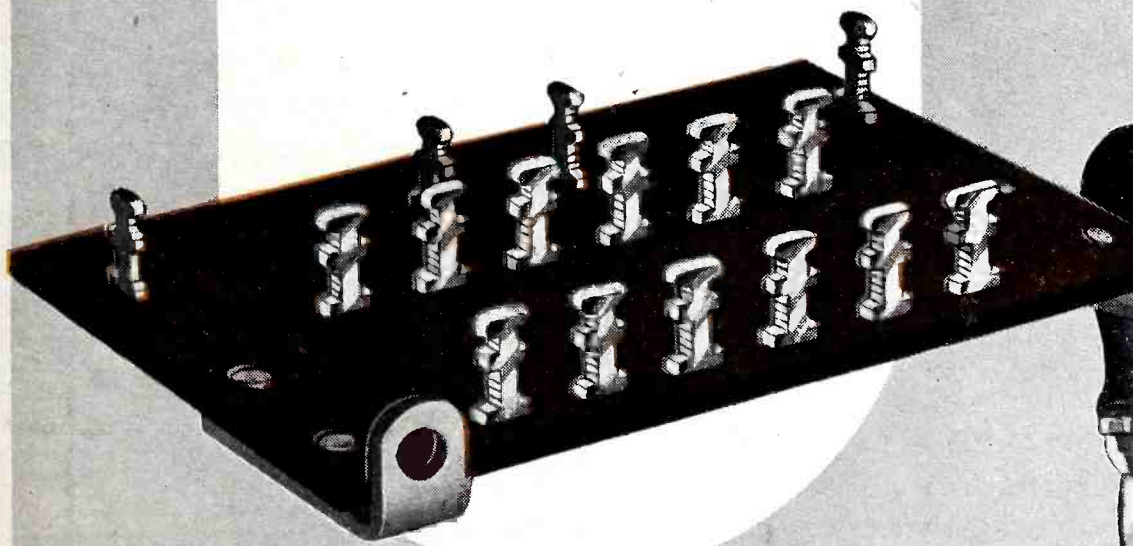

★ The lugs stamped from copper are ruggedly set by automatic hammer in fabricated UCINITE, Cinch's own laminated material, and will not loosen in soldering. Serrated edges hold wires firmly in place. Hot tin dipped for quick and easy soldering. There are many different types.

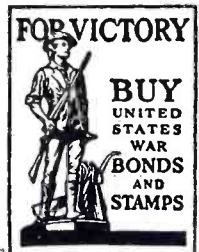
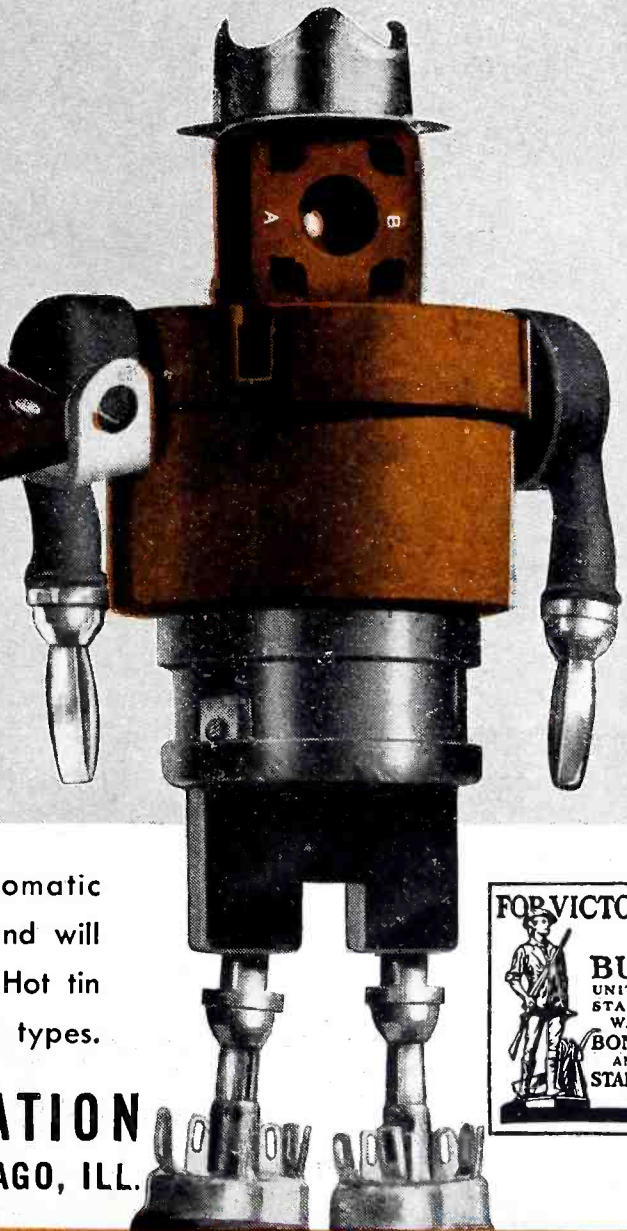

CINCH MANUFACTURING CORPORATION
2335 WEST VAN BUREN STREET • CHICAGO, ILL.

SUBSIDIARY: UNITED-CARR FASTENER CORP., CAMBRIDGE, MASS.



a *Federal* achievement
to which *Callite* contributed

In many transmitters today, two Federal F-124-A tubes are supplanting the work of four ordinary tubes. With a power rating not available heretofore, this new tube designed by the Federal Telephone & Radio Corporation is successfully increasing the efficiency and providing reserve power in broadcast and high frequency transmitters everywhere.

Because dependability is essential in the performance of this outstanding tube, it is only natural that Federal should turn to Callite for the tungsten rods required for internal leads and supports. You may not be a manufacturer of transmitting tubes, but if you do manufacture an electronic or electrical product calling for precision metallurgical components, our Engineering Department will be glad to cooperate with you.

Specialists in the manufacture of lead-in wires, filaments, formed parts and components for all electronic tube and incandescent bulb applications

CALLITE TUNGSTEN CORPORATION

544 39th STREET



UNION CITY, N. J.

CABLE: "CALLITES" • BRANCHES: CHICAGO • CLEVELAND

tate locating tubes which may be erratic in operation.

Test Procedure for FG95 Thyatron

1. Make sure all switches are in off positions, and potentiometer is in minimum-voltage position.

2. Insert FG95 tube in right-hand socket, connect red lead to cap on top of tube, and connect black lead to cap on side of tube.

Remainder of procedure is identical to that given above.

Test Procedure for FG32 Phanotron

1. Make sure all switches are in off positions, and S_0 is in open position.

2. Insert FG32 tube in left-hand socket and connect red lead to cap on top of tube.

3. Close switch S_1 and wait until condensation has cleared from sides of tube.

4. Make leakage test as outlined in step 4 for FG57.

5. Close switch S_2 and observe reading on plate current ammeter, which should be 2.4 amperes.

Test Procedure for 872-A Rectifier

The procedure for testing this tube is exactly the same as for the FG32 thyatron except that switch S_0 must be in its closed position, and the plate current should read 1.4 amperes.

• • •

SELECTOR SWITCH TESTER

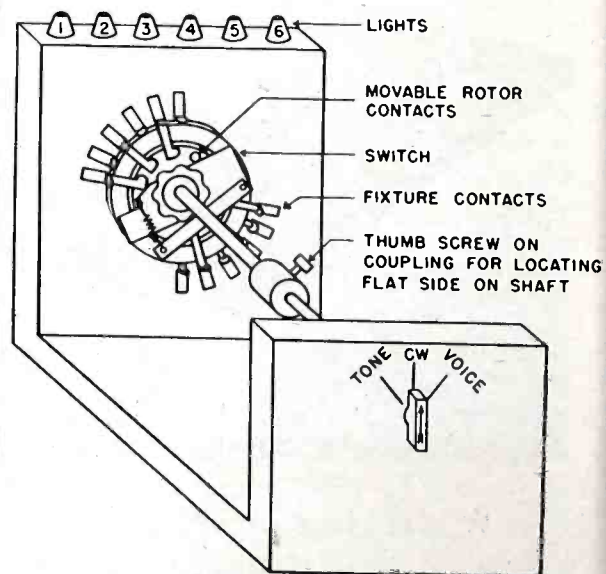

Testing jig developed by Mrs. Catherine Marchewka of G-E for making simultaneous electrical and mechanical tests of selector switches used in radio transmitters. For good switches, lamps 2, 3, 4 and 6 light in the TONE position; lamps 3 and 5 in the CW position; lamps 1, 4 and 6 in the VOICE position. If any deviation from these combinations is obtained, the switch is rejected

ANOTHER PROBLEM SOLVED BY SCOVILL

COLD-FORGING SKILL WITH IMPORTANT SAVINGS IN MATERIALS—MONEY—MOTIONS



"Know how" proof #11... more each month

Scovill produced the above part in quantity from alloy steel wire with but four operations—head, re-head, trim and turn. No matter how different your fastenings problem from this important war production job, it will benefit from the cold-forging "know how" that solved it.

This wide range of Scovill standard fastening devices also benefit from this same engineering ingenuity. Customers find that the skill that licks the tough ones insures extra uniformity and satis-

faction no matter how simple the fastening or large the quantity.

Today Scovill is largely engaged in war work. However, realizing the vital importance of better postwar products and production, Scovill welcomes any opportunity to help with postwar planning problems (or current needs) to the limits its present commitments permit. Call in the Fastenings Expert in the nearest office listed below for a prompt, frank answer as to where and when we can serve you.



To the Reader: Kindly pass this advertisement on to any of your associates whom we may be able to serve. Thank you!

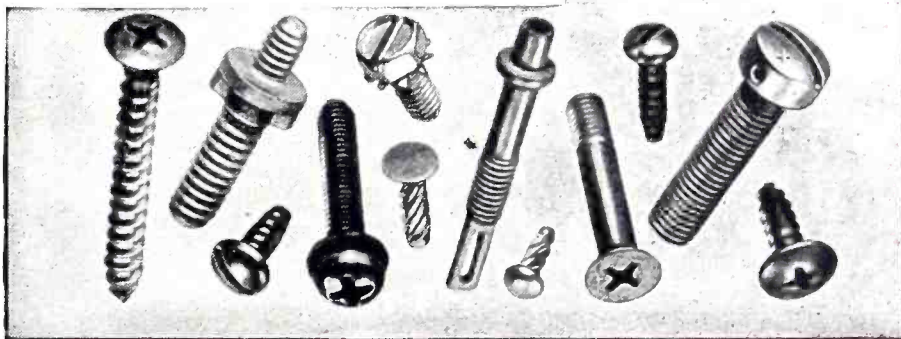

SCOVILL MANUFACTURING COMPANY

WATERVILLE SCREW PRODUCTS DIVISION

WATERVILLE, CONN.



TEL. WATERBURY 3-3151

NEW YORK, Chrysler Building • DETROIT, 6432 Cass Avenue • CHICAGO, 1229 W. Washington Boulevard • PHILADELPHIA, 18 W. Chelton Avenue Building
PITTSBURGH, 2882 W. Liberty Ave. • SYRACUSE, Syracuse-Kemper Insurance Bldg. • LOS ANGELES, 2627 S. Soto St. • SAN FRANCISCO, 434 Brannan St.



**JACKSON INSTRUMENTS are found
NOT FAR BEHIND THE FRONT!**

"Handie talkies"—miniature transmitter-receivers, each not much larger than a carton of cigarettes—are in constant use by our fighting men over-seas.

These important little instruments are aiding the airplane spotters, the reconnaissance squads, and even the commanders who are directing attacks.

But occasionally, of course, severe usage may put these little "talkies"

out of order . . . and then the Signal Corps experts—quite possibly aided by Jackson testing equipment—will soon have the "talkie" back in operation.

Jackson production is now entirely war work. We are happy in doing our best toward helping to keep vital war communication lines open.

1 1 1

All Jackson employees—a full 100%—are buying War Bonds on a payroll deduction plan. Let's ALL go all-out for Victory.

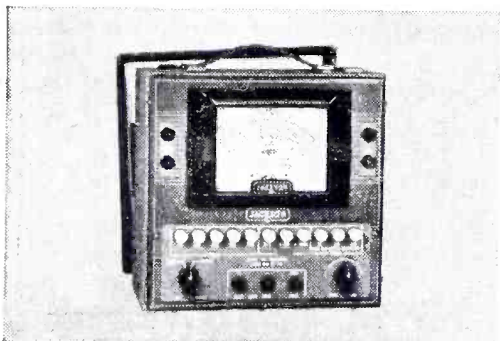

Model 642 Multimeter

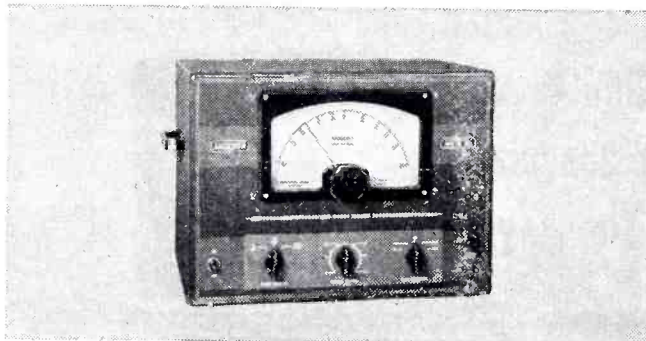

Model 652 Audio Oscillator

JACKSON

Fine Electrical Testing Instruments

JACKSON ELECTRICAL INSTRUMENT COMPANY, DAYTON, OHIO

Balancing 50-ton Marine Gears

AUTOMATIC CONTROL of the accelerating rate in bringing 17-ft. diameter marine propulsion gears up to full speed of 200 rpm for dynamic balancing is obtained with G-E Thyro-trol type electronic control for the 200-hp driving motor. The 50-ton gear to be tested is mounted on a 24-inch diameter shaft supported by bearings which permit the gear to vibrate freely in a horizontal direction. Conventional pick-up coils convert this movement into electrical impulses which energize a wattmeter in a conventional dynamic balancing circuit which indicates the points at which correction of unbalance is required.

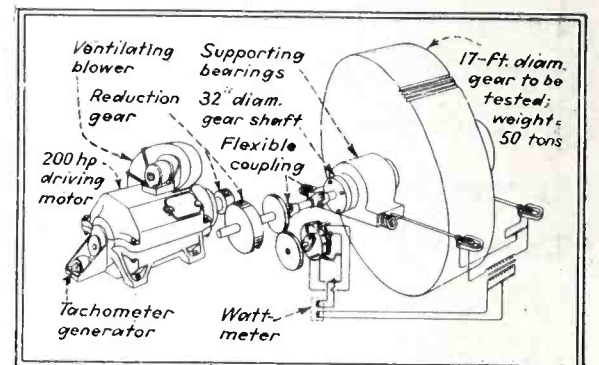
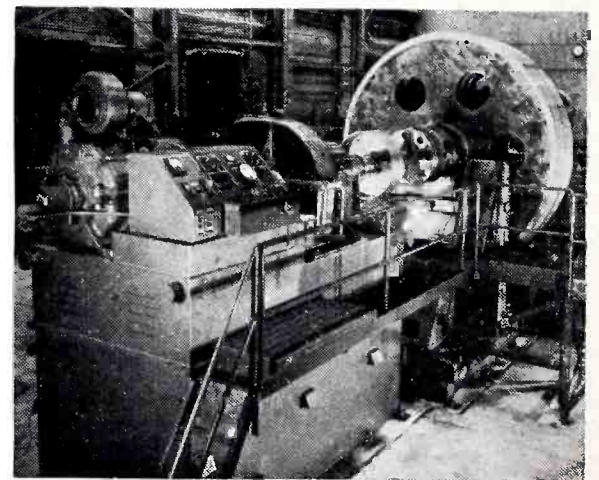

Diagram and photo of dynamic gear-balancing machine using electronic motor control



Electronic control equipment was chosen because both squirrel-cage and wound-rotor induction motors heated excessively during the required long acceleration time of 10 minutes. The arrangement finally selected consists of a 200-hp, 650/1300 rpm shunt-wound d-c motor and a motor-generator set for the motor field current, with electronic control for both the motor and generator to provide high breakaway torque for starting, smooth, constant-torque acceleration and deceleration, and simple, accurate setting of the operating speed.

ONE *Expert* TO SEND THE MESSAGE



Miss Gertrude Theberge records results of 955 ultra-high-frequency performance tests.

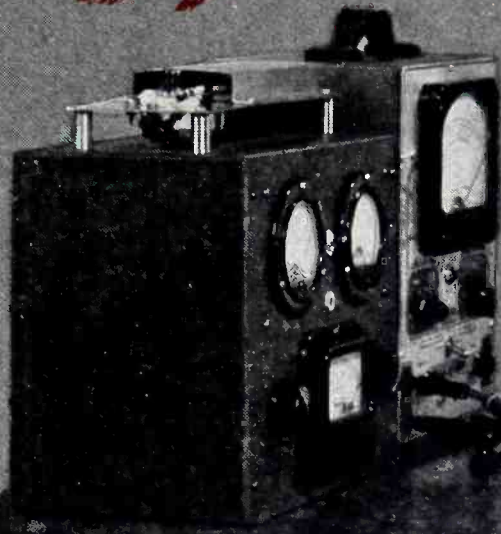

ONE *Expert* TO PROVIDE THE EQUIPMENT



VR105-30 and VR150-30
Gaseous voltage-regulator tubes

Specialists on the Factory Front must back up those on the Fighting Front. As an American, you would be proud to see at Hytron carefully trained girls holding down important supervisory and technical jobs, and displaying manual dexterity on fine work which a watchmaker would admire.

Here at Hytron we realize fully our responsibility for fashioning well the radar, radio, and electronic tubes upon whose performance the lives of our fighting men depend. To fulfill this trust, we have gone all out to train hundreds of new specialists capable of building to exacting standards countless dependable War tubes. That their skills may help bring closer the day when our boys come marching home, is the sole purpose of all Hytron employees.

Oldest Exclusive Manufacturer of Radio Receiving Tubes

Hytron

ELECTRONIC AND
RADIO TUBES

Corporation

SALEM AND NEWBURYPORT, MASS.



PERFECTION
from a
HUNDRED PAIRS
OF HANDS

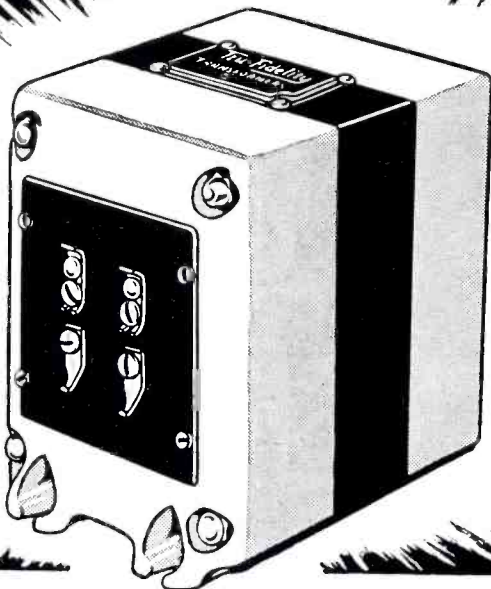

The "human element" so consistently mentioned as a necessary part of every great accomplishment, is exemplified in the high quality of Thordarson transformers. From engineering laboratory to final inspection, countless pairs of hands and minds work in harmony to bring about in each complete transformer a coordination of effort that makes for superb performance.



THORDARSON

ELECTRIC MFG. COMPANY
 300 WEST HURON ST., CHICAGO, ILL.

Transformer Specialists Since 1895

... ORIGINATORS OF TRU-FIDELITY AMPLIFIERS

Measuring Transformer Noise Level

TRANSFORMER NOISE LEVELS are scientifically measured and compared in a special acoustically treated noise level room built into the Sharon transformer works of Westinghouse. For comparison tests, two trucks, each carrying a transformer, are wheeled into position in the room. Flexible clip-leads on the truck are readily attached to the transformer terminals. These leads go to contact blades on the truck which fit into corresponding jacks inside the room, so that power connections are made automatically when the trucks are pushed into position.

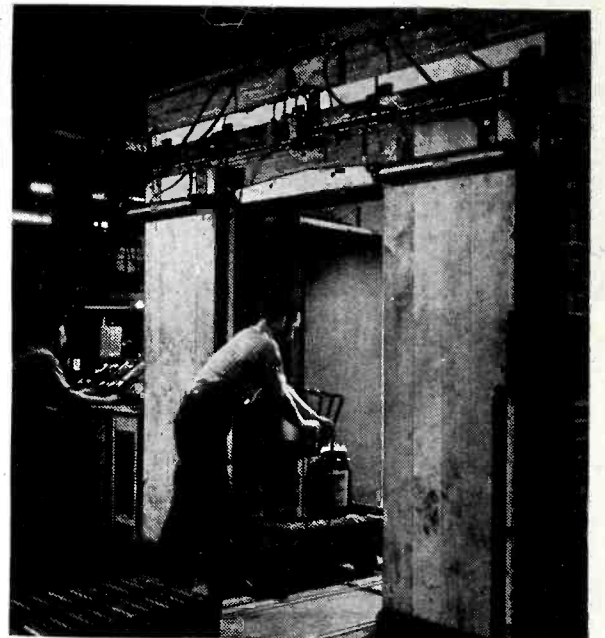

Pushing a power transformer into the Westinghouse noise-level room. The control panel is at the left, outside the room

A microphone mounted on an adjustable stand inside the room picks up the sound. Outside the room is a control panel at which the exact value of the sound can be read, or the relative values of sounds produced by two transformers can be determined.

• • •

Trouble-Shooting in Electronic Equipment

ALTHOUGH MAINTENANCE is minimized in electronic equipment because there are few or no moving parts, faults can occur as in any other electrical device. The following suggestions taken from G-E bulletin GEH-1173 on photoelectric relays will permit quick location of the trouble in the majority of cases.

First isolate the electronic equipment and observe its output when



—so we brought the jungle to Chicago

Sweltering jungle heat and ever-dripping moisture is a real test of endurance for our fighting men. But how about the *Communications* equipment upon which their very lives often depend? To find the answer, RAULAND engineers brought the jungle right into our laboratories! They built a large, glass-enclosed, air-tight cabinet . . . provided it with the dripping wetness of saturated, super-heated air and

tropical plants and lush vegetation, deep rooted in mossy loam. Into this "torture chamber" went RAULAND Communications equipment . . . to finally emerge with the correct answers to some very vital questions. A typical example of RAULAND engineering thoroughness in making certain that its precision instruments serve dependably under even the most trying conditions.

RADIO . . . SOUND . . .

Rauland

. . . COMMUNICATIONS

Electroneering is our business

THE RAULAND CORPORATION . . . CHICAGO, ILLINOIS

Buy War Bonds and Stamps! Rauland employees are still investing 10% of their salaries in War Bonds

Look **INSIDE** with X-ray

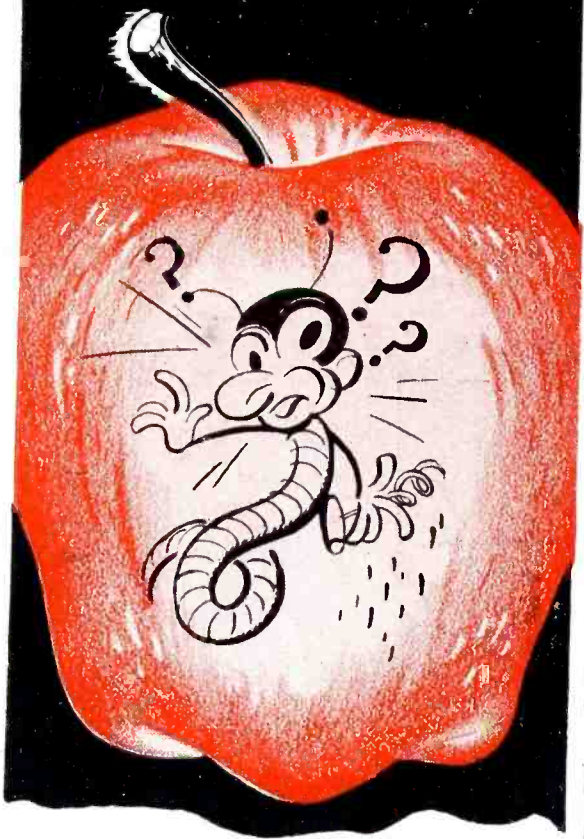

... the modern way
to spot "foreign agents"
in parts ... packages ...
mechanical assemblies

X-ray takes the guess-
work out of quality control
... lets you look inside parts
of rubber, plastic, porcelain
... inside metal assemblies
and packaged goods, to de-
tect impurities and foreign
substances. Quality control
is just another of hundreds
of unusual jobs in industry
that can be done better,
faster and cheaper with
Westinghouse X-ray.

J-08056

More dope?

See Pages 4, 5.

Westinghouse
PLANTS IN 25 CITIES; OFFICES EVERYWHERE
X-RAY
BALTIMORE • MARYLAND

the usual input signal is artificially applied. If the correct output signal is obtained, the trouble is not in the electronic equipment.

If the trouble is electronic and is not obvious on careful inspection after the housing is removed, turn on the power and adjust the equipment for proper operation as outlined in the instructions. Observe tubes and light sources to see if filaments are heated. See if metal tubes are warm. If ignitrons with metal tubes are used, however, turn off power before touching them, because the envelopes may be at line potential.

If there is a contactor on the panel, close it manually to check proper operation of its contacts.

If spare tubes are available, they may be inserted to check tube operation. Receiving type tubes may be checked with an ordinary tube tester, while thyratrons and phototubes are tested according to procedures described in bulletins in the tube cartons.

Inspect wiring near terminals, as vibration will often cause breaks which are not readily visible. Look for blown fuses, burned-out resistors and damaged parts.

Before proceeding any further, study the wiring diagram and instruction book for the equipment, then check circuit voltages with an ordinary multimeter or 1000-ohm-per-volt voltmeter, with particular attention to d-c electrode voltages of tubes. Other measurements can also be made, in much the same manner as for servicing radio receivers and transmitters. As a rule, electronic equipment is far easier to service than radio equipment, once the circuit is understood.

ARBOR FOR CERAMIC COIL FORMS

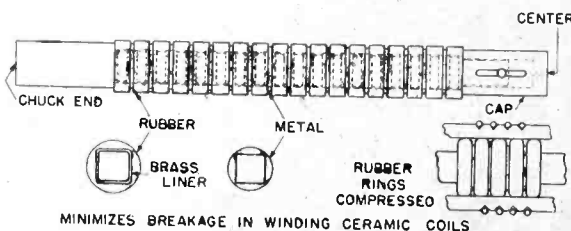

Alternating metal and rubber washers on a square shaft form an arbor which minimizes breakage of ceramic coil forms during winding. Pressure is applied longitudinally by moving the tailstock center against a sliding cap which fits over one end of the arbor. The arbor was devised by A. C. Schlansker, G-E Electronics Dept. foreman

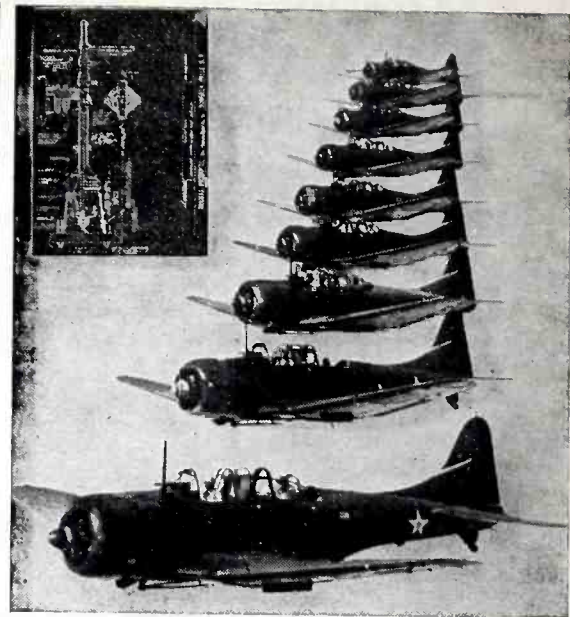

In the Allied Service

PREMAX TUBULAR METAL ANTENNAS

If your problem is a satisfactory Antenna for communications, you will probably find the answer in Premax Bulletin of Standard Antennas and Mountings or Premax Special Service.

Premax Products

Division Chisholm-Ryder Co., Inc.
4302 Highland Ave., Niagara Falls, N. Y.

Lavite STEATITE CERAMIC

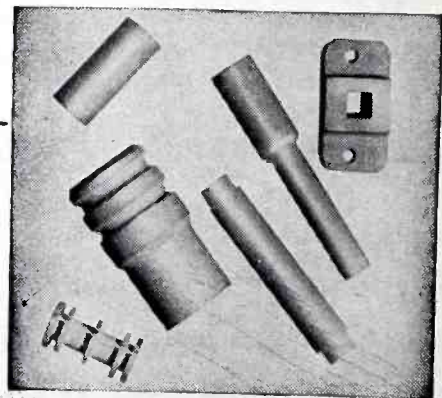

CHARACTERISTICS

Specific gravity of only 2.5 to 2.6.
Water absorption S. 1.5-0.001 per cent. Per cent power factor.
S. 1.5 to 60 cycles was only 0.0165.
Dielectric constant at 60 cycles was 5.9-1000 KC 5.4.

Makers of electrical and radio apparatus destined for war service are finding in LAVITE the precise qualities called for in their specifications . . . high compressive and dielectric strength, low moisture absorption and resistance to rot fumes, acids, and high heat. The exceedingly low loss-factor of LAVITE plus its excellent workability makes it ideal for all high frequency applications.

We will gladly supply samples for testing.

D. M. STEWARD MFG. COMPANY

Main Office & Works: Chattanooga, Tenn.
New York Needham, Mass. Chicago Los Angeles

Where was RCA on the night of January 2, 1940?

- January 2, 1940 — 23 months and 5 days before Pearl Harbor — where was RCA on that night?
 - It was at the point of launching a peace-time program that was to be recognized eventually as an important military measure. For that program was one of *simplification*.
 - It was called the *RCA Preferred Type Tube Program* and was inaugurated because the several hundred different tube types then in existence resulted in short, uneconomical manufacturing runs, complex problems of warehousing and replacements, and other inefficiencies which made it impossible to give the ultimate customer the maximum of dependable service and the greatest value for his money.
 - With the advent of war, the government recognized the advantages of such a program and issued an "Army-Navy Preferred List of Tube Types." The latest revision of this list is dated March 1, 1943. We will be glad to send you a copy on request.
 - The urgent requirements of war are proving the worth of this program in releasing for other purposes the large quantities of materials ordinarily tied up in many types and styles of tubes. Also, the principle of Preferred Type Tubes is proving a blessing on the fighting fronts—where vital replacements can be expedited for equipment designed to use standard types of tubes.
- ★ Buy United States War Bonds and Stamps ★



RCA ELECTRON TUBES

RCA VICTOR DIVISION • RADIO CORPORATION OF AMERICA
CAMDEN, N. J.

TUBE RECOMMENDATIONS FOR POST-WAR DEVELOPMENTS

The advantages of the Preferred Type Tube Program are so far-reaching that it is only logical to assume that we will continue the program after the war. Our applications engineers will be glad to consult with equipment manufacturers concerning the tube types most likely to be on our list of post-war preferred types.

Today this



flag flies over

From this world headquarters for radio-electronic research flow new weapons, new discoveries and inventions vital to the winning of an Allied victory!

TODAY, over RCA Laboratories, flies a new distinguished battleflag—the coveted Army-Navy “E” Award.

One of the few laboratories in America to receive this award, RCA is at once proud of this distinction, and humbly aware of the responsibilities that it imposes. For much of the progress of the entire radio-electronic industry stems from the work done in these laboratories.

It was perhaps with this thought in mind that—at the dedication of the RCA Laboratories in Princeton—the Chief Signal Officer of the Army called them “The Hidden Battlefront of Research.”

HIDDEN—because, for the duration of the war, this magnificent building of 150 separate laboratories must be closed to all but the scientists and research technicians who are working on radio-electronic instruments important to our military effort.

BATTLEFRONT—because in the waging of modern warfare, radio-electronics is of first importance. It follows the flag and the fleet—locates the enemy—flashes urgent orders—safeguards the convoy—guides the bombers—directs the artillery—maneuvers the tank. This science fights on every front.

And when that certain day of Victory comes, RCA Laboratories will be devoted to the happier task of making our peacetime world richer, safer, more enjoyable and more productive—through new and finer products of radio, television and electronic research.

OTHER SERVICES OF RCA WHICH HAVE EARNED OUR COUNTRY'S HIGHEST WARTIME AWARDS



The Army-Navy “E” flag, with two stars, flies over the RCA Victor Division plant at Camden, New Jersey.



The Army-Navy “E” flag, with one star, has been presented to the RCA Victor Division at Harrison, New Jersey.



The Army-Navy “E” flag, with one star; also the U.S. Maritime Commission “M” Pennant and Victory Fleet Flag have been awarded to the Radiomarine Corporation of America in New York City.

*A Service of
Radio Corporation of America*



RCA

WORLD HEADQUARTERS

America's Secret Battlefield
RCA Laboratories



Laboratories

FOR RADIO-ELECTRONIC RESEARCH



FROM BUSINESS MACHINES



TO BOMB RELEASES



RELAYS

by

GUARDIAN

★ Instantly responsive . . . accurate far beyond the limitations of human eyes and hands . . . "Relays by Guardian" served in peacetime as "nerve centers" for intricate business machines. Today, in wartime, they help guide the plane to the target and release the bombs in a predetermined pattern.

The Series R Stepping Relay is typical of units used in aircraft and automatic business machines. It is a versatile relay affording innumerable circuit control combinations. The contact finger will rotate clockwise, counter-clockwise, or in both directions, and may be electrically reset. Four fingers may be used on a single disc relay or two fingers per disc if two discs are required. Standard power requirements are 29 volt-amperes on AC and 14 watts on DC. A request on your business letter-head for Series R Bulletin will bring you further information.

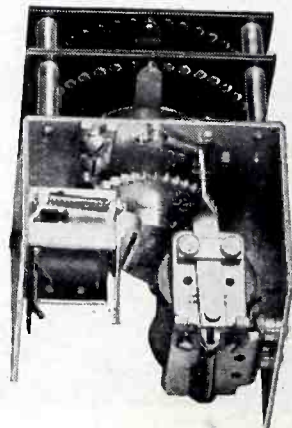

Series R Stepping Relay

GUARDIAN  **ELECTRIC**

1625-H WEST WALNUT STREET

CHICAGO, ILLINOIS

A COMPLETE LINE OF RELAYS SERVING AMERICAN WAR INDUSTRY

Hundred Million Volt X-rays

WITH AN INDUCTION ELECTRON accelerator now nearing completion in the G-E Research Lab. in Schenectady, voltages up to a hundred million volts will be available for the production of x-rays and cathode-rays. One purpose of the project is to determine what radiographic and other useful results can be accomplished with such high-voltage radiation.

The high-voltage cathode-rays offer promise in the treatment of deep-seated tumors, since these rays will have sufficient penetration and have maximum effect only near the end of their range. This property may facilitate destruction of a tumor without damage to overlying tissues, according to Dr. William D. Coolidge, G-E vice-president in charge of research.

• • •

Electrostatic Precipitators Remove Oil Mist in Machine Shops

HIGHER OPERATING SPEEDS of modern machine tools and resultant increased breaking up of coolant oil into mist, coupled with increased machine-hours per day and increased numbers of machines in a given space, create a serious oil smoke and mist problem in many machine shops today. Efficiency of lighting equipment is lowered, visibility is reduced,

• • •

MOBILE MOUNTING



Two metal brackets bolted within the trunk compartment, plus a metal plate forming a shelf, accommodate REL emergency radio gear in rigid, workmanlike style and still leave room for the spare tire

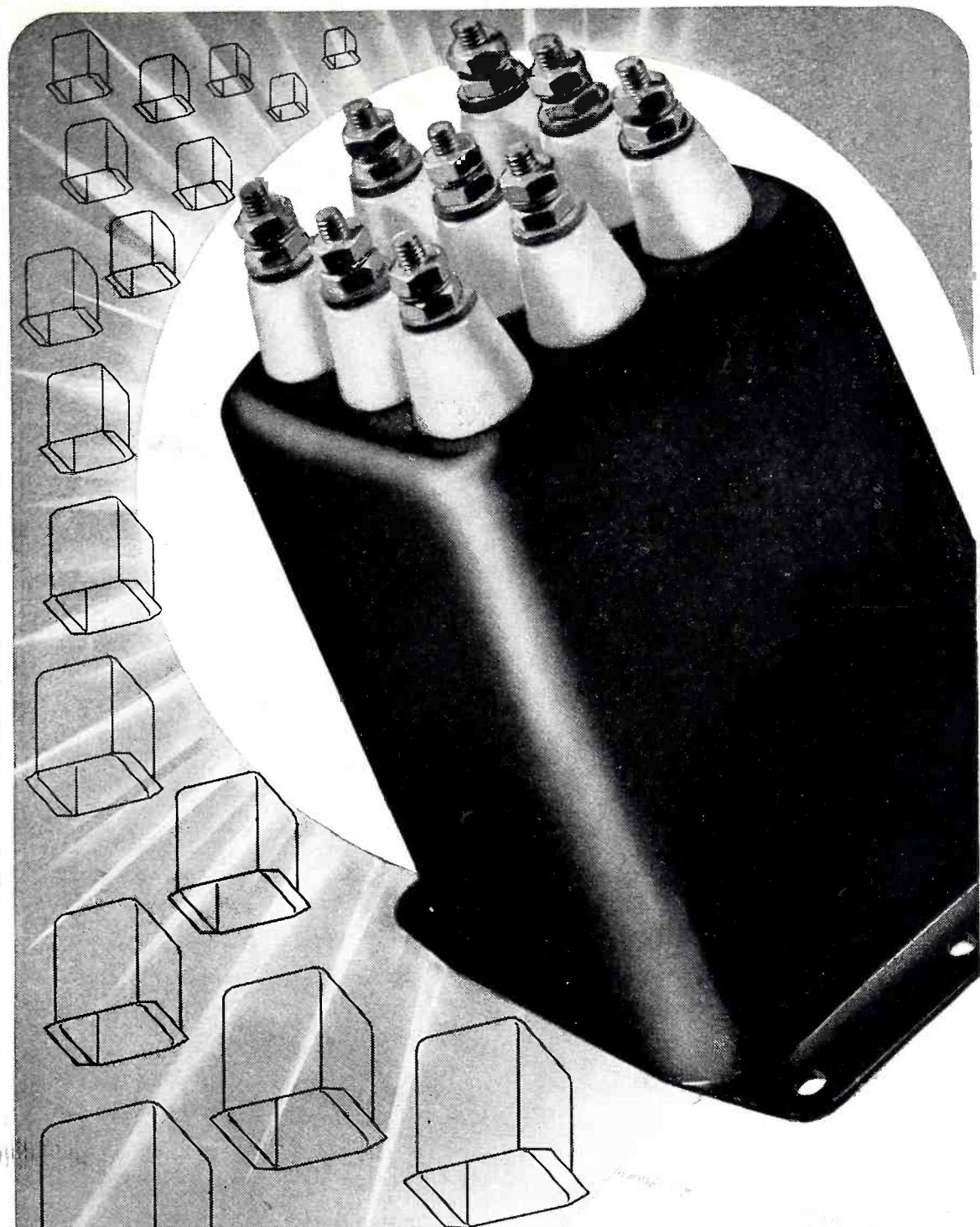

The TOUGHEST TRANSFORMERS

have Drawn Steel Cases

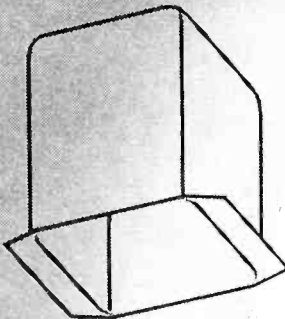

A one-piece Drawn Steel Transformer Case without seams or spot welds is, because of its simplicity, the strongest type of mechanical construction. Then, too, the one-piece construction provides a continuous electrical and magnetic path resulting in better shielding from outside electrical and magnetic disturbances. Absence of seams also assures maximum protection against atmospheric conditions—guarantees longer transformer life. If your transformers have to pass the most rigid tests, Potted Transformers in Drawn Steel Cases are probably your answer. Write for information on this Drawn Steel Case line!

Pioneers of the Compound Filled Drawn Steel Transformer Case



**CHICAGO TRANSFORMER
CORPORATION**

3501 WEST ADDISON STREET • CHICAGO

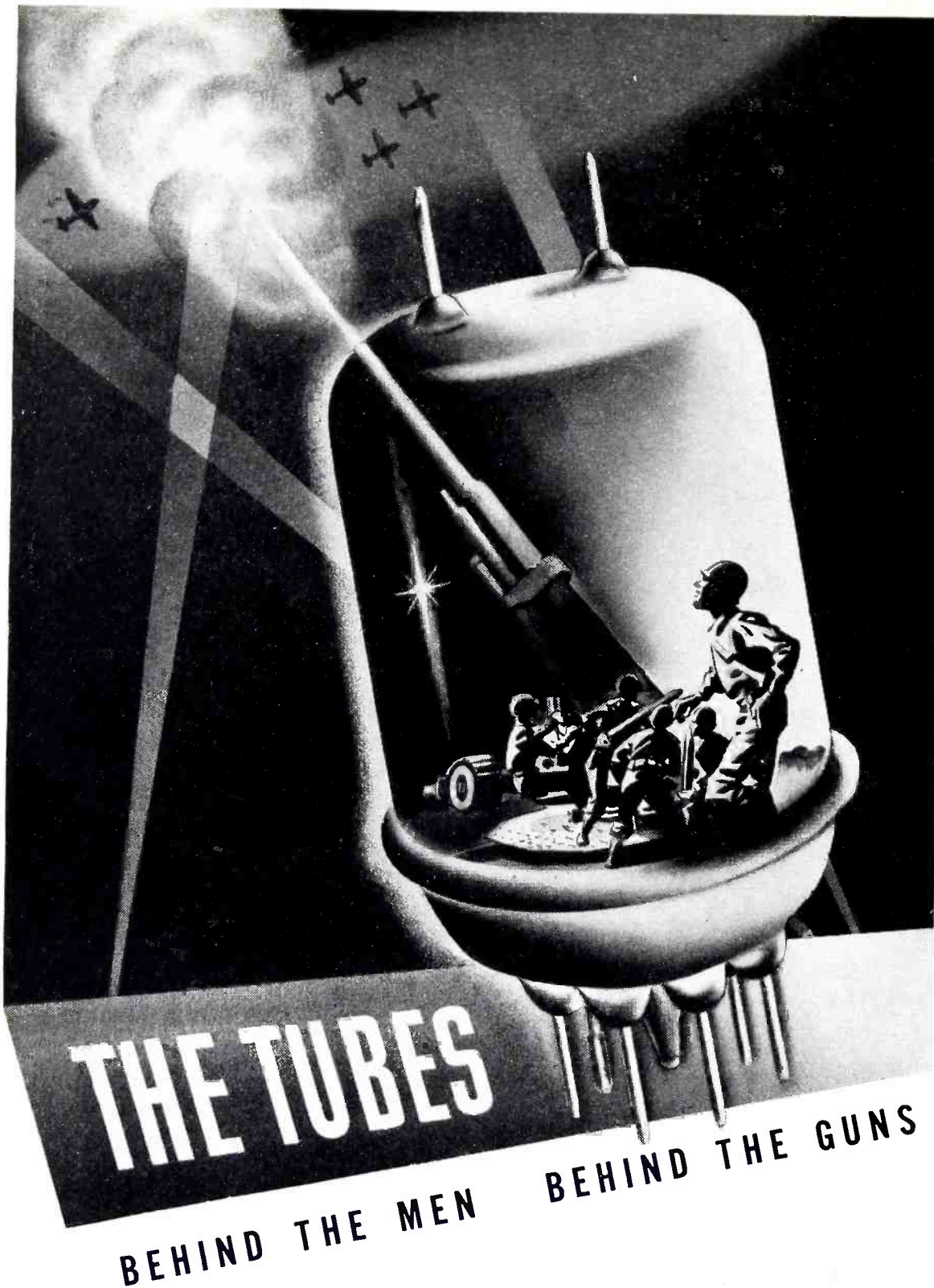

THE TUBES

BEHIND THE MEN BEHIND THE GUNS

All honor to the men behind the guns Ken-Rad salutes them heroes they Not only salutes with words but with electronic tubes that sight time and fire the guns that detect enemy nearness *in advance of sight or sound*

Electronic engineers knew before anyone else that the blitz on Britain was thwarted by the locators which gave the ground defenses time for repulsing action And we know that Electronics will be the servant of men of good will for whom Ken-Rad now is working at war!

TRANSMITTING TUBES
CATHODE RAY TUBES
SPECIAL PURPOSE TUBES
METAL AND UHF TUBES

KEN-RAD

OWENSBORO KENTUCKY U S A

and a fire hazard is created due to condensation of oil on electrical insulation and inflammable materials.

Although simple ventilation can overcome the problem to some extent, it is prohibitively expensive in many cases because the required large volumes of air cause excessive heat loss in winter and excessive refrigeration loss in summer.

Electrostatic precipitation of oil mist offers a more satisfactory solution in many respects. Modern precipitators have greatly increased efficiency, and now produce so little ozone and oxides of nitrogen that cleaned air can be recirculated for ventilation. Furthermore, the coolant removed from the air is recovered as a liquid and can be used again. The average amount of oil recovered per machine is about two gallons per 24 hours, or 100 gallons per day for a 50-machine plant.

When machines are already in use, sheet metal hoods and ducts should be used at each machine to collect the mist before it has a chance to circulate throughout the room. In some cases, however, it would be possible to design machines to incorporate the ventilating ducts and electrostatic air cleaner within the housing of the machine.

In a comparison test of a Westinghouse Precipitron and a standard mechanical air cleaner, both operating at a volume rating of 600 cfm, photographs were made of a light beam directed inside a dark space at the exhaust end of each unit. The

• • •

BALL BEARING DISPENSER

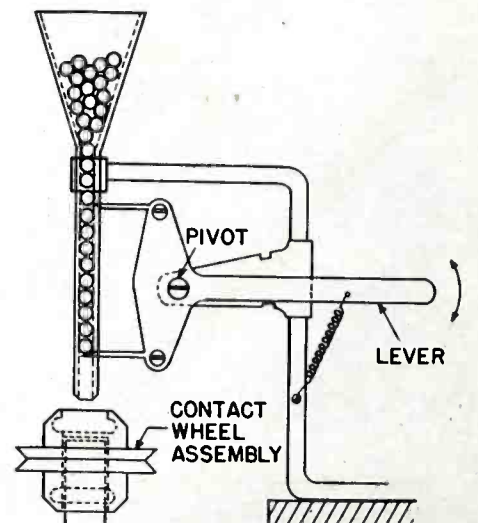

This simple lever and funnel arrangement for feeding exactly nine ball bearings to the contact wheel assembly of a radio transmitter was devised by W. D. Simpson, an assistant general foreman in the G-E Electronics Dept.



QUARTZ SHORTAGES are effecting important improvements in cutting methods and equipment. DI-MET's contribution in this direction is **DYNAMIC FLATNESS**, a method for keeping diamond abrasive wheels flat under high speed rotation. This new perfection aids in obtaining a greater number of usable quartz blocks per pound of raw material by reducing runouts, chipping, wafer breakage, and other defects caused by rim wobble.

Experiments prove that all blades which test flat do not always operate flat. This variation is due to unequalized strains within the blade which are released during operation and reassert themselves to cause blade warpage and rim wobble.

DI-MET engineers have overcome rim wobble by a new process for obtaining dynamic flatness! Strains are first equalized throughout the blade — and the rim then placed under a balanced, radial tension. The tension is uniform throughout the circumference and prevents run-out due to normal temperature rise and nominal pressure variation during cutting.

With proper care, DI-MET dynamically flattened blades stay flat for the life of the blade — not only reduce the number of blades required — but produce more crystals per pound of quartz! Try dynamically flattened DI-MET Rimlocks. You pay no premium for this **BETTER** cutting tool!

**UNDER
TENSION**
*for
Dynamic Flatness*

New catalog illustrating DI-MET Quartz Cutting Machines is now available. Have you received your copy? Write for it!

Look for this symbol  of dynamic flatness

FELKER MANUFACTURING COMPANY
1116 BORDER AVENUE • TORRANCE, CALIFORNIA

MANUFACTURERS OF DIAMOND ABRASIVE TOOLS



MAINTENANCE

helps to keep them in service

Your impedance bridge, like your automobile, needs occasional cleaning and lubrication.

Moving contacts wear out faster when dry and when dust gets into them. Neglect may result in failure when equipment is needed most.

Periodic maintenance will go a long way toward keeping your electrical test equipment in trouble-free operation. Increased life and reliability will more than repay you for the effort. Set up a definite maintenance program for your test equipment.



★ Thousands of users of General Radio instruments find our SERVICE AND MAINTENANCE NOTES useful in keeping their instruments in service. If you do not already have these notes for your GR instruments, send us the type numbers and serial numbers of the equipment you have. Your service notes will be forwarded promptly.



GENERAL RADIO COMPANY
Cambridge, Massachusetts

NEW YORK

LOS ANGELES

light beam was visible in proportion to the number of foreign particles reflecting light in the air. The light beam was not visible on the film exposed while the Precipitron was operating, and densitometer measurements on the negatives indicated that the electrostatic filter was 7.3 times as efficient as the mechanical filter.

In an electrostatic precipitator, a d-c voltage of the order of 12,000 volts is produced by a power pack using high-voltage rectifier tubes. This voltage is applied to a fine wire mesh through which the dust particles first pass, thereby charging the particles. The dust-laden air then passes through a system of parallel plates, alternate plates being grounded and the remaining plates connected to a 6000-volt d-c terminal of the power pack. The charged particles are pulled to plates of opposite polarity and thus removed from the air.

• • •

Using Phone Line for Remote Indication of Overmodulation

By ALVIN LEEMAN
Chief Engineer, Station WKBH

THE SIMPLE CIRCUIT arrangement in Fig. 1 permits one modulation monitor unit to provide indications at both transmitter and studio of a radio station.

The output of the modulation monitor at the transmitter location is fed to a d-c relay arranged to close its contacts on overmodulation. The studio-transmitter order line and ground provide a complete circuit for these relay contacts to the grid

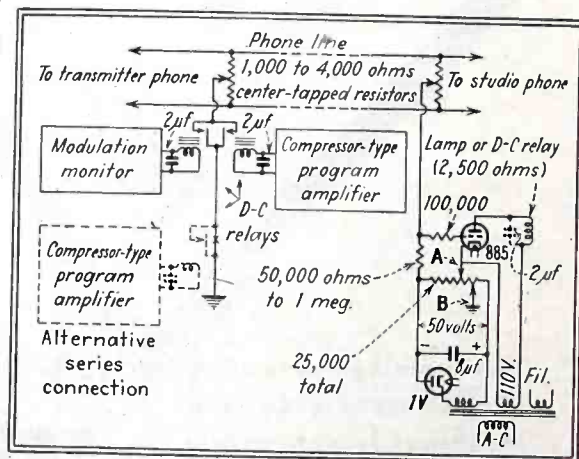

Fig. 1—Overmodulation indicator circuit and phone line connections. Ordinarily only the modulation monitor will be connected to the transmitter end of the line

Arm Your Screw Driving Army for SPEED TACTICS



SPEED-UP WITH PHILLIPS SCREWS!

Give your assembly line Phillips Recessed Head Screws and you'll give them the ammunition to clean up lagging assembly jobs on the double-quick!

In most cases, change-overs to Phillips Screws have cut driving time in half! All of the screw driving troubles that slow-up work are eliminated by the Phillips Recessed Head. The scientific recess, by automatically centering the driving force, prevents fumbling, wobbly starts . . . prevents slant-driven screws . . . burred and

broken screw heads . . . dangerous screw driver skids.

The Phillips Recess lends "old-hand" skill to the newest newcomer . . . makes fast, faultless driving automatic. It permits power or spiral driving on almost any job.

They cost less to use! Compare the cost of driving Phillips with that of slotted head screws. You'll realize that the price of screws is a minor item in your total fastening expense . . . that it actually costs less to have the many advantages of the Phillips Recess!

KEY TO FASTENING SPEED AND ECONOMY

The Phillips Recessed Head was scientifically engineered to afford:

Fast Starting - Driver point automatically centers in the recess . . . fits snugly. Screw and driver "become one unit." Fumbling, wobbly starts are eliminated.

Faster Driving - Spiral and power driving are made practical. Driver won't slip out of recess to injure workers or spoil material. (Average time saving is 50%.)

Easier Driving - Turning power is fully utilized by automatic centering of driver in screw head. Workers maintain speed without tiring.

Better Fastenings - Screws are set-up uniformly tight, without burring or breaking heads. A stronger, neater job results.

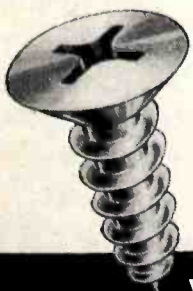

PHILLIPS *Recessed Head* SCREWS

WOOD SCREWS • MACHINE SCREWS • SELF-TAPPING SCREWS • STOVE BOLTS

21 SOURCES

American Screw Co., Providence, R. I.
The Bristol Co., Waterbury, Conn.
Central Screw Co., Chicago, Ill.
Chandler Products Corp., Cleveland, Ohio
Continental Screw Co., New Bedford, Mass.
The Corbin Screw Corp., New Britain, Conn.
The H. M. Harper Co., Chicago, Ill.

International Screw Co., Detroit, Mich.
The Lamson & Sessions Co., Cleveland, Ohio
The National Screw & Mfg. Co., Cleveland, Ohio
New England Screw Co., Keene, N. H.
The Charles Parker Co., Meriden, Conn.
Parker-Kalon Corp., New York, N. Y.
Pawtucket Screw Co., Pawtucket, R. I.

Pheoll Manufacturing Co., Chicago, Ill.
Reading Screw Co., Norristown, Pa.
Russell Burdall & Ward Bolt & Nut Co., Port Chester, N. Y.
Scovill Manufacturing Co., Waterville, Conn.
Shakeproof Inc., Chicago, Ill.
The Southington Hardware Mfg. Co., Southington, Conn.
Whitney Screw Corp., Nashua, N. H.



DON'T PEEK OVER MICAH'S* *Shoulder*

Sure! If you are interested in mica, what he's reading will be absorbingly interesting to you. But there's no need to glance furtively over Micah's shoulder.

We'll gladly send you a copy of this Macallen Mica Book, if you'll just tell us you'd like one. You'll find it a valuable reference work.

It tells how Macallen developments with mica have kept pace with achievements in the electrical field since Thomas A. Edison found it so superior. It tells about sheets, sizes and forms; about combinations with cloth and paper; about grades and colors; what each is good for.

Also, it indicates the special co-operation you can get from both the engineering and production departments of The Macallen Company, now so largely engaged with electronic problems. Do send for a copy today.

**Micah represents the high-grade mica products processed by Macallen.*

PRODUCTS

Compressed Sheets — Mica Paper, Cloth, Tape. Heater Plate, Compressed Sheet Tubing — Commutator Insulation — Compressed Sheet Washers — Insulating Joints and Canopy Insulators — Railway Specialties — Domestic and Imported Raw Mica. *Always specify MACALLEN MICA.*



THE MACALLEN COMPANY

16 MACALLEN ST., BOSTON

CHICAGO: 565 W. Washington Blvd.

CLEVELAND: 1005 Leader Bldg.

circuit of a gas triode at the studio. Closing of the contacts lowers the bias on the tube enough to energize the relay or lamp in the plate circuit and give the desired indication.

The center-tapped resistor across the phone line at each end should be made high enough in resistance to prevent it from affecting normal use of the telephone line. Satisfactory operation can be obtained with less than 1 ma of relay current in the line circuit.

As some of the compressor types of program amplifiers also have facilities for operating relays at some predetermined level, they can be used in place of the modulation monitor, or the contacts of the relays of each unit can be connected either in parallel or in series to indicate a predetermined program condition. In parallel, either the modulation monitor or the program amplifier can produce an indication at the studio. In series, the relays of both monitor and amplifier must operate to give a studio indication.

In adjusting the device for operation, first see that the relay contacts at the transmitter end of the order wire stay open. Decrease the bias voltage at movable contact A until the relay or lamp in the plate circuit of the 885 tube is energized, then increase the bias voltage until the relay or lamp is no longer energized. Increase the bias slightly more so that induced voltage on the telephone line will not operate the indicator.

For the adjustment of B, close the relay contacts at the transmitter end of the order wire and move sliding contact B toward the negative side of the voltage divider until the relay or indicating lamp is deenergized, then move this contact toward the positive side until the relay or lamp is again energized. Slide the contact a little further in the same direction so that positive operation of the device is assured.

In the circuit as shown in Fig. 1, the relay in the plate circuit of the 885 tube will operate as a buzzer-type indicator. A 2- μ f capacitor across the relay coil will cause this relay to operate as a straight relay, however, and its contacts can then be used to make or break other circuits as desired.

For those desiring to use a neon bulb as a peak indicator and a lamp or buzzer as an overmodulation indicator, the arrangement shown in Fig.

On Pan American's "LITTLE SISTER TO THE CLIPPER"

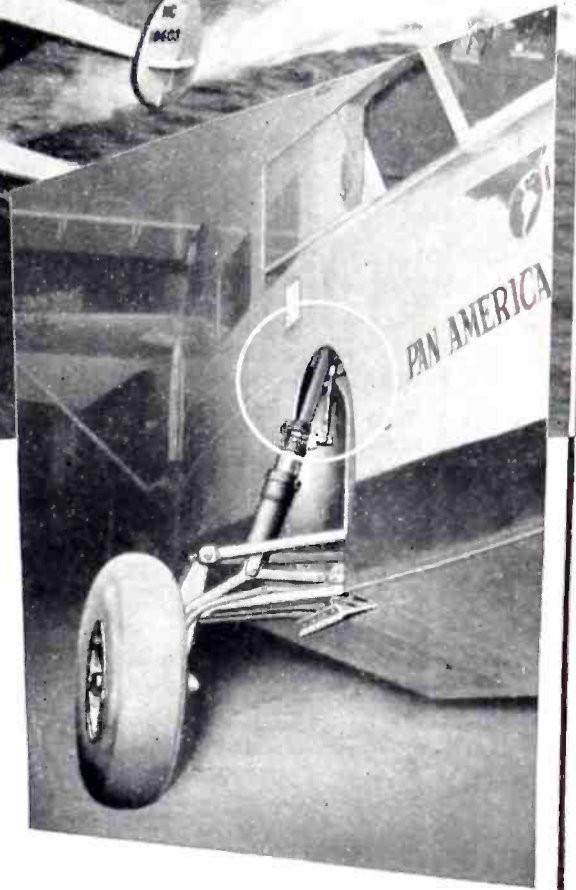
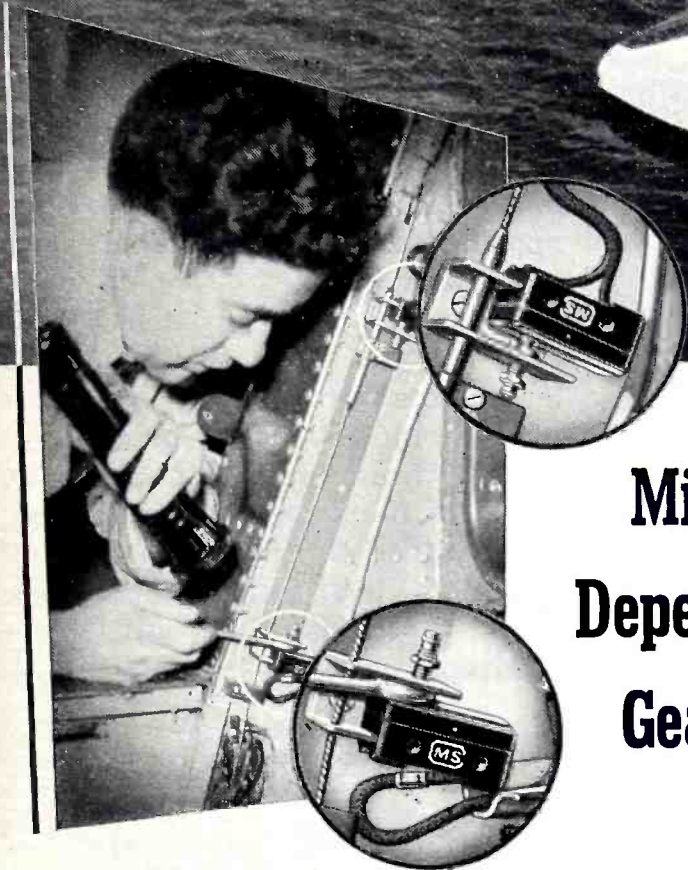

Micro Switches Act Dependably as Landing Gear Limit Switches

Illustrated here is one of the Pan American Airways' huge 42½ ton Transocean Clippers. In the inserts are shown the landing gear and the Micro Switches which are used as limit switches on Pan American's Grumman Widgeon trainers. This plane is often referred to as the "Little Sister to the Clipper."

These trainers are used for training the intrepid pilots who fly the giant Clippers over the seven seas. Because of the nature of the work performed, it is obvious that every precaution must be taken, every contingency provided for. That is why Pan American depends on the rugged dependability of Micro Switch.

Thumb-size and feather-light, Micro Switch is amazingly rugged, resists vibration, and requires no leveling. It operates precisely at the same point for millions of operations with lightning-fast contact action. It is accurately built to exact standards from precisely made parts. Its performance characteristics can be changed to meet functional requirements.

Micro Switches are used to perform many different

functions in aircraft. Special brackets, actuators, and aluminum housings are available for this purpose. For heavy duty service such as machine tools, there are Micro Switches enclosed in steel which can be sealed against dirt, dust, water, oil, metal chips and other foreign particles.

All Micro Switches can be supplied with a variety of actuators to meet all needs. Micro Switches operate on pressures as low as one ounce and movements as low as .0002". Micro Switch is listed by Underwriters' Laboratories with ratings of 1200 V.A. loads, from 125 to 600 volts A.C.

Every engineer should have a copy of Micro Switch Handbook Catalogs which tell and illustrate the principles and applications. Handbook Catalog Number 60 deals with Micro Switch in general, and Number 70 is written specifically for aircraft applications.

Micro Switch Corporation, Freeport, Illinois
Branches: 43 E. Ohio St., Chicago • 11 Park Place, New York City
Sales and Engineering Offices: Boston • Hartford • Los Angeles

The trademark MICRO SWITCH is our property and identifies switches made by Micro Switch Corporation

© 1943

M I C R O S W I T C H

Made Only By Micro Switch Corporation... Freeport, Illinois

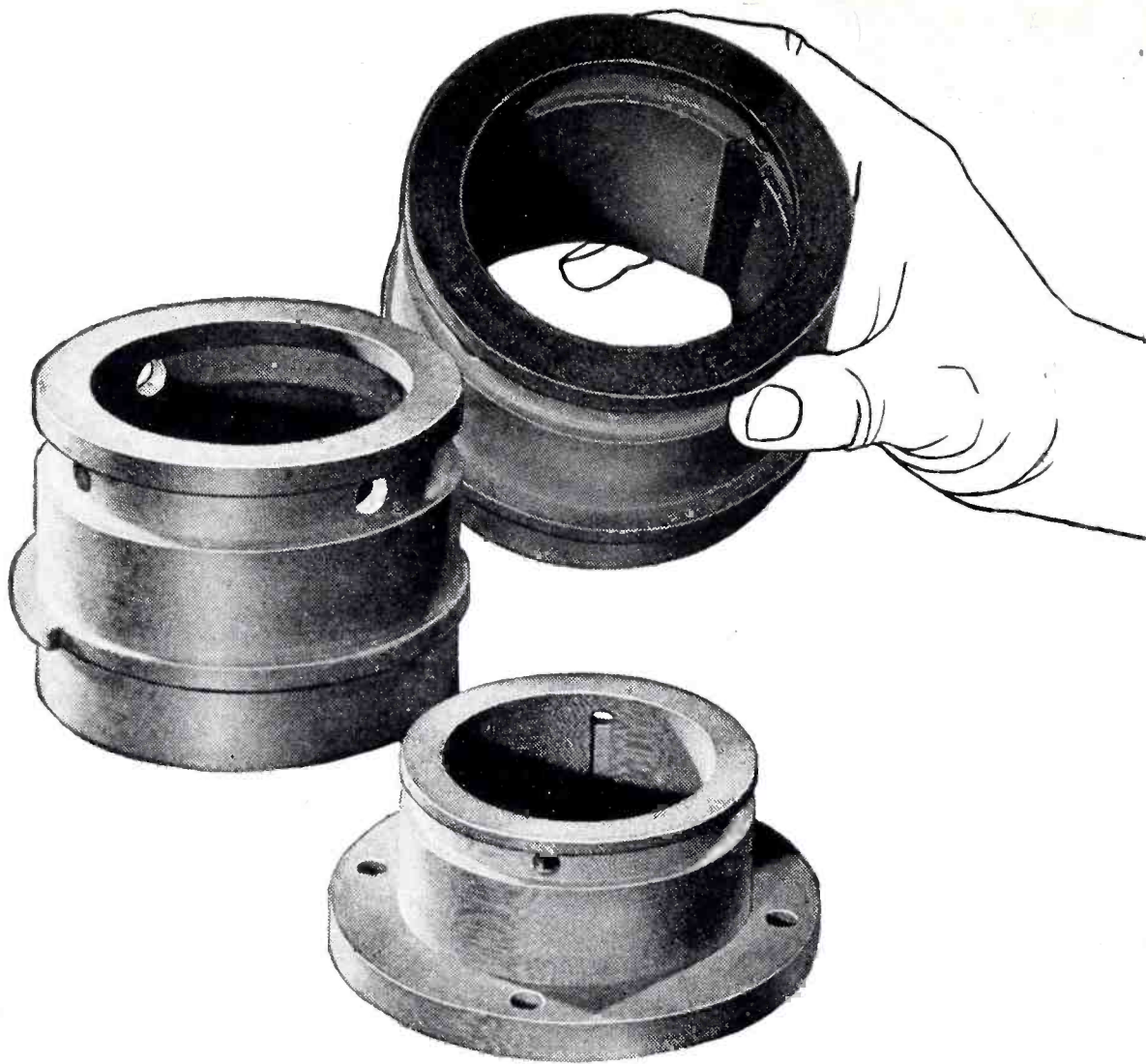

Salt water doesn't freeze BEARINGS OF INSUROK

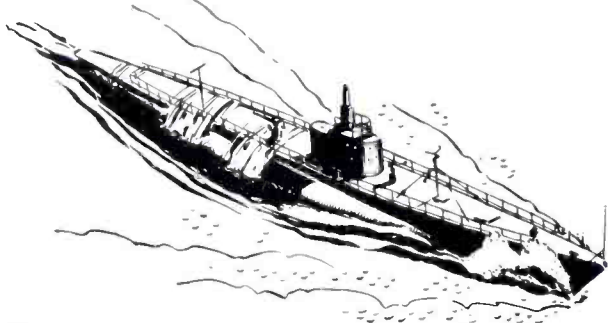

Cargo ships, escort vessels and submerging submarines, bound for the fighting fronts face many hazards in addition to those of enemy craft. Pump bearings that have become frozen by electrolytic action, for instance, can cause dangerous delays and require costly, difficult repair.

That is one of the reasons why Laminated INSUROK is being used on many of the centrifugals that pump in ballast for submersion, that circulate water through important cooling systems, or that are just installed as stand-by equipment. In the development of this part, Richardson Plastics suggested the grade of

INSUROK best suited for this particular use—suggested it because of its high strength, wearability and dielectric qualities—recommended it because it has been so successfully used where self-lubricated as well as water, oil or grease lubricated bearings were required.

In meeting the needs of today and in helping to plan for "tomorrow," Richardson Plastics are continually recommending the grade of Molded or Laminated INSUROK to meet various combinations of specifications. They will be glad to suggest the commercial or special grade to meet *all* the conditions under which your present or plan-stage product will perform. Write for complete information.

INSUROK
Precision Plastics

The RICHARDSON COMPANY

MELROSE PARK, ILL. LOCKLAND, OHIO FOUNDED 1858 NEW BRUNSWICK, N. J. INDIANAPOLIS, IND.
SALES OFFICES: 75 WEST ST., NEW YORK CITY, G. M. BUILDING, DETROIT

Converting Capacity Changes Into Current or Voltage Changes

A DUAL-OSCILLATOR CIRCUIT for converting small changes in capacity into corresponding electrical changes is described by E. V. Potter in the May 1943 *Review of Scientific Instruments*. It has low background noise, high sensitivity, and is relatively free from interference by local electrostatic and magnetic fields. The circuit can be used to study vibrations or capacity changes having frequencies ranging from 0 to over 200 kc, and has been found particularly useful by the U. S. Bureau of Mines in connection with seismometers for recording earth vibrations, in studies of the motion of large vibrating surfaces, in measurement and recording of the elongation of test specimens being stretched, and in a host of other machines used in metallurgical research.

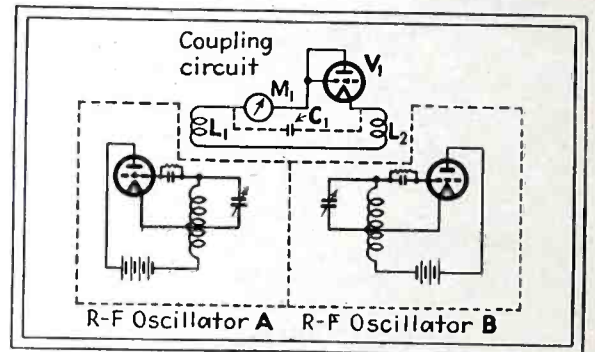
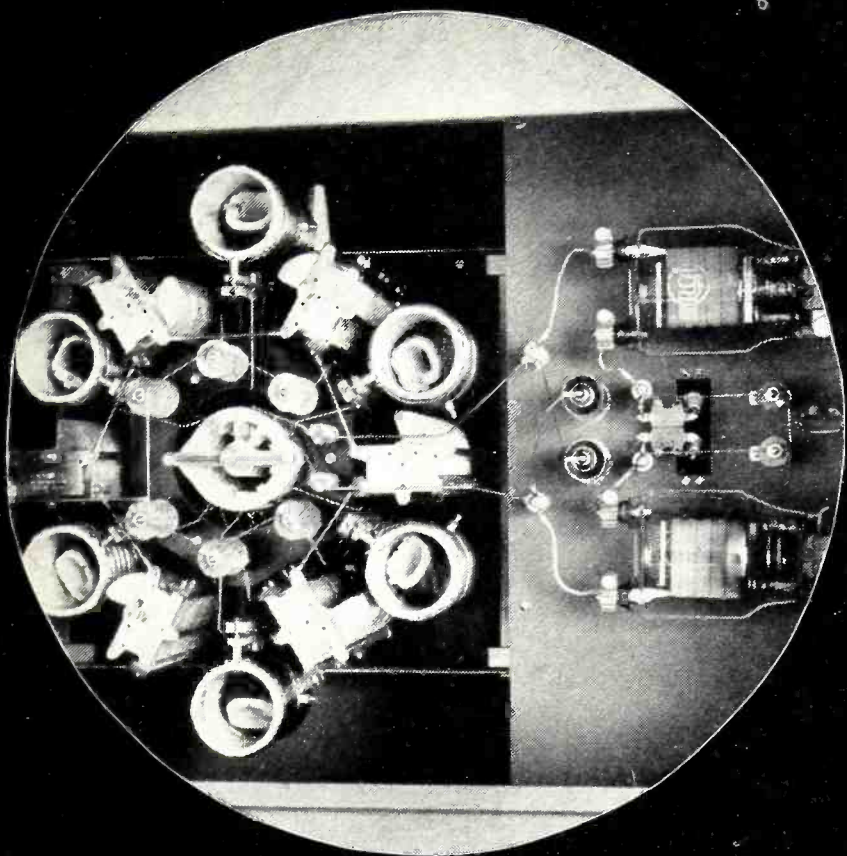

Fig. 1—Essential parts of a circuit for changing capacity variations into current variations. It is often referred to as a transducer circuit

The basic circuit arrangement is shown in Fig. 1. The two r-f oscillator circuits are isolated from each other as much as possible, so that the only path for interchange of signals is through the coupling circuit consisting of rectifier V_1 , d-c milliammeter M_1 and coils L_1 and L_2 which are closely coupled to the tuning circuits of r-f oscillators A and B respectively. These oscillators are as nearly alike as possible, and are normally operated so they would oscillate at virtually the same frequency if the coupling circuit were removed.

The coupling provided through the coupling circuit is adequate to make the oscillators synchronize, even when the frequency of one oscillator is changed within certain limits. R-F current in the coupling circuit is a minimum when both oscillators are tuned to the same frequency, and



Detail view of final amplifier tube circuit construction.

Product of

**UNEXCELLED
CRAFTSMANSHIP**

Radio communications equipment is a highly specialized and technical product. Its successful performance is largely dependent upon the qualifications and ability of the men responsible for its design and construction. TEMCO engineers, designers and technicians never lose sight of their individual responsibility. This is one reason why TEMCO continues to enjoy an unexcelled reputation in radio communications engineering.

TEMCO

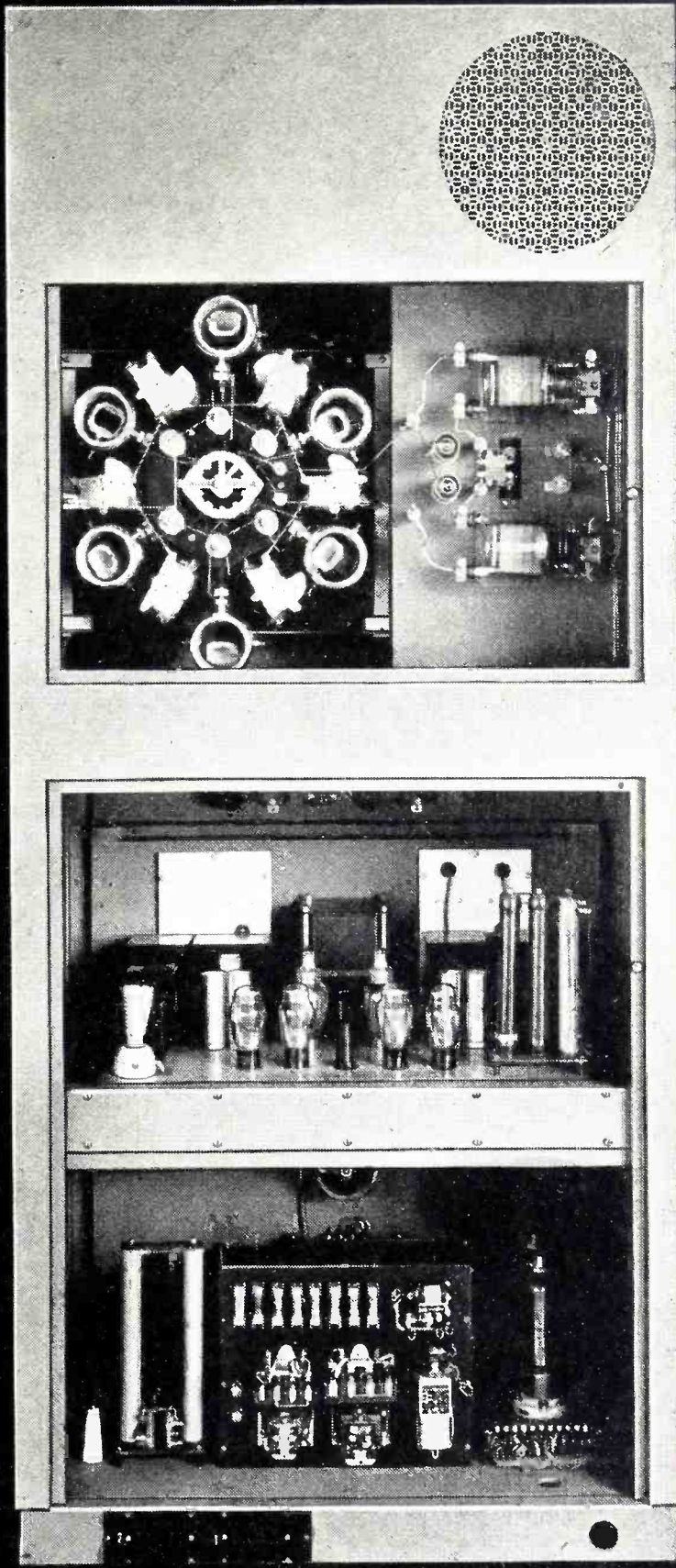

Model # 1000 AG-CW 1000 Watt telegraph transmitter with motor drive frequency selector.

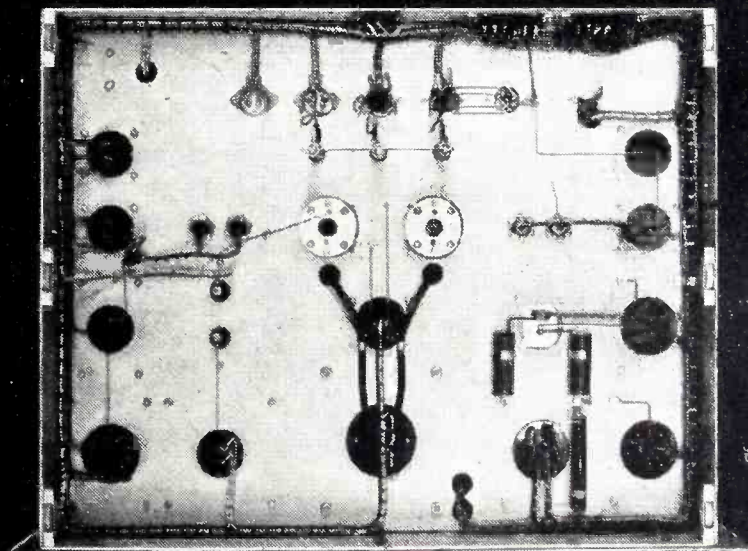

Underside view of low voltage and relay control chassis, Model # 1000 AG-CW transmitter.

STANDARD AND CUSTOM-BUILT RADIO COMMUNICATION-EQUIPMENT

TRANSMITTER EQUIPMENT MANUFACTURING CO., INC.

345 Hudson Street, New York, N. Y.

SERVICE AND REPLACEMENTS for your PRESTO TURNTABLES

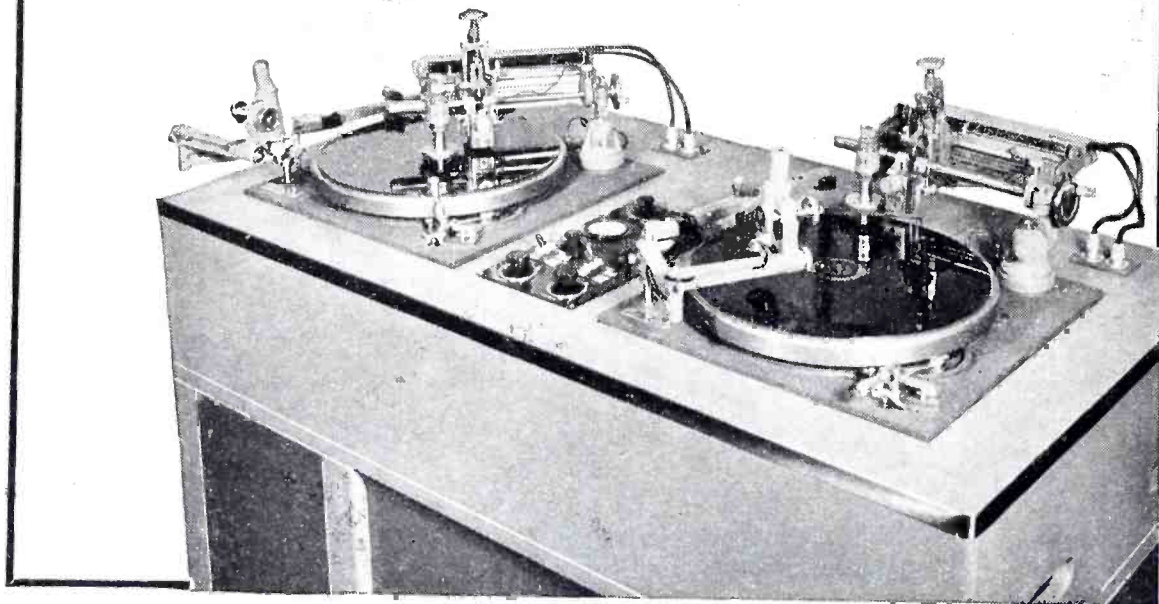

Although 90% of our plant is now making war equipment other than recorders, we still maintain a service department and a complete stock of replacement parts for the convenience of Presto owners.

You can add years to the life of your turntables by giving them a periodic factory reconditioning.

These are the parts of your Presto tables that should be checked at least once a year.

1. Cutting heads and pickups.
2. Rubber tires, idler wheels and motor mounting grommets.
3. Bronze gears and bearings.
4. Cutting mechanism feed finger.
5. Cutting mechanism and turntable alignment.
6. Motor bearings and pulleys.

If your equipment has not been serviced recently, arrange to send your tables to us one at a time. Reconditioning will be handled promptly and at moderate cost.

Apply your AA-2 or AA-1 priority to your order to cover critical materials.

PRESTO
RECORDING CORP.
242 WEST 55th ST. N.Y.

In Other Cities, Phone . . . ATLANTA, Jack. 4372 • BOSTON, Bel. 4510
CHICAGO, Har. 4240 • CLEVELAND, Me. 1565 • DALLAS, 3709S • DENVER,
Ch. 4277 • DETROIT, Univ. 1-0180 • HOLLYWOOD, Hil. 9133 • KANSAS
CITY, Vic. 4631 • MINNEAPOLIS, Atlantic 4216 • MONTREAL, Mar. 6368
TORONTO, Hud. Q333 • PHILADELPHIA, Penny. 0542 • ROCHESTER,
Cul. 5548 • SAN FRANCISCO, Su. 8854 • SEATTLE, Sen. 2560
WASHINGTON, D. C., Shep. 4003—Dist. 1640

World's Largest Manufacturers of Instantaneous Sound Recording Equipment and Discs

increases with detuning of either oscillator as power is transferred between oscillators to keep them in synchronism. The coupling current is a maximum near the point where further detuning will cause the oscillators to drop out of synchronism.

The actual current values will depend on the amount of power being transferred, the resistance of the coupling circuit, rectifier tube and meter, and the amount of coupling between the tuning coils and the coupling coils. The shape of the current-capacity curve can be controlled by changing the arrangement of coils.

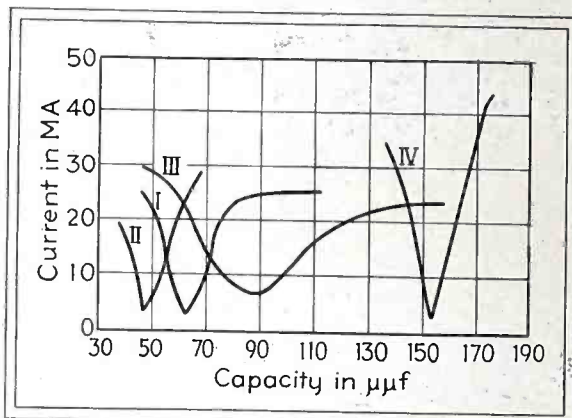

Fig. 2—Typical curves showing variation of synchronizing current in coupling circuit with tuning capacity for various coupling coil arrangements. These curves were obtained with the circuit in Fig. 3

Examples of curves for various coupling coil arrangements are shown in Fig. 2. These were obtained by plotting coupling circuit current against change in capacity of one of the oscillator tuning condensers. Curve IV is best for general use because it has a high sensitivity (about 2 ma/ $\mu\mu\text{f}$) and a large region in which current is a straight-line function of capacity. The coil arrangement giving this curve is shown in Fig. 3 along with the actual transducer circuit now being used by the Bureau of Mines.

Circuit Data

The circuit in Fig. 3 is essentially the basic circuit of Fig. 1 arranged for operation from a single 60-cycle a-c power pack, with a 4-pole double-throw switch in the coupling circuit to provide a more flexible output. The input terminals are arranged so the capacity pick-up device can be connected in parallel with the tuning capacitor of either oscillator or, when the pick-up provides two capacities one of which decreases as the other increases, one can be con-

SPRAGUE ARMY — NAVY "E" AWARD
at BROWN ST. PLANT WORKING TOGETHER FOR VICTORY FRI. APRIL 2nd.



THIS IS WHAT COUNTS!

There's a difference between working on "gadgets" and being an integral part in the manufacture of quality products that are a matter of intense pride throughout the community in which you live. That difference represents the extra "plus" factor of goodness you find in Sprague Capacitors.

North Adams is not a large city. It doesn't produce a great deal by big-city standards—but what it does produce it believes in producing right. And Sprague Capacitors and Koolohm Resistors by the hundreds of thousands are among its chief products.



SPRAGUE SPECIALTIES COMPANY, North Adams, Mass.

WORKING TOGETHER FOR VICTORY

Sprague Army-Navy "E" presentation day was a holiday in North Adams—but a holiday on which everyone still worked. At right is one of many congratulatory window displays made by North Adams merchants. At left is the day's North Adams Transcript with a 16-page section devoted to the event.

**SPRAGUE
 CAPACITORS
 & KOOLOHM RESISTORS**
*Quality Products — Expertly
 Engineered — Competently Produced*

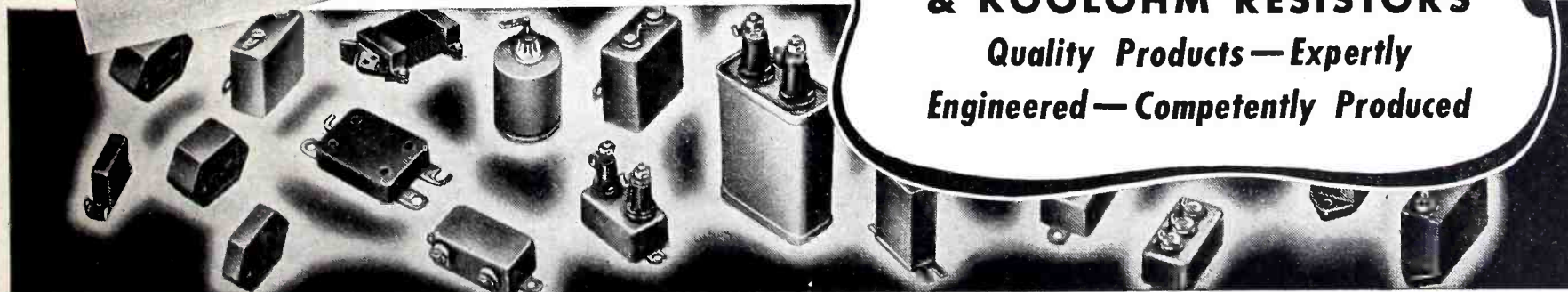

KINNEY

COMPOUND
DRY VACUUM
PUMP

for Unusually High Vacuums

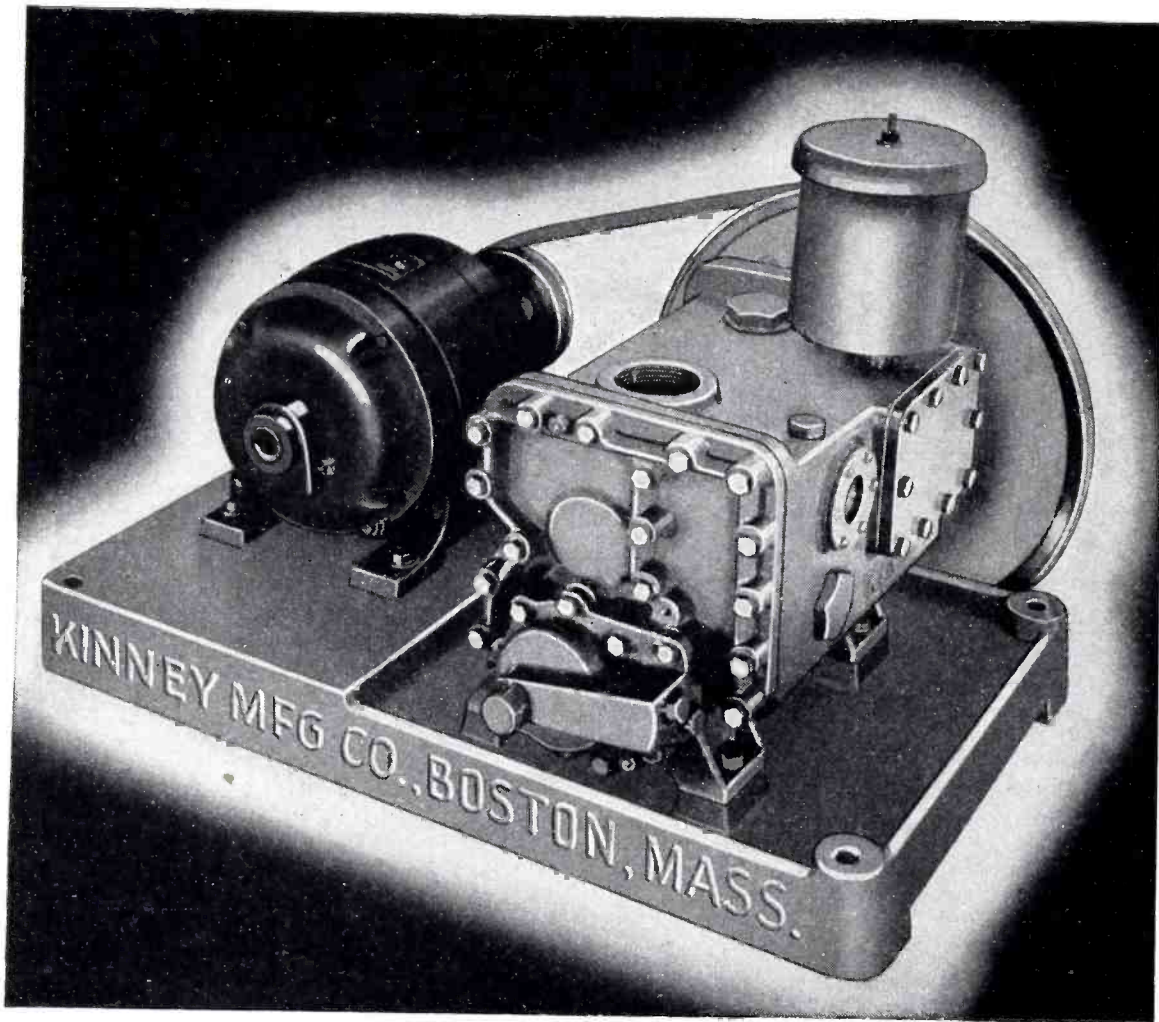

The Kinney Model CVD Compound Vacuum Pump is not a new pump! It was brought out several years ago after extended experimentation and utilizes the working mechanism of the well known Kinney VSD and DVD Vacuum Pumps. To those experienced in the task of creating and maintaining high vacuums with mechanical pumps, the results claimed for this Kinney compound pump were astonishing. Laboratory readings, on an ionization gauge, of 0.5 microns (0.0005 mm.) are regularly obtained and tests have shown readings on the McLeod gauge of better than 0.1 micron. For next higher range of absolute pressures, Kinney Single Stage Pumps are available in sizes from 12 to 680 cu. ft.

Users report splendid results

Since first announced, the CVD pumps have been widely used and results in actual service in a wide variety of uses, especially in the lamp and tube field, have been excellent. For many services, the final vacuum produced by these pumps is so high that they have replaced mercury vapor pumps with gratifying results both as to production times

and operating expense since cold traps are eliminated and the pumping system simplified.

Write for this real "tell-all" bulletin

Bulletin 18 contains complete descriptions, capacity and dimension tables, and efficiency curves covering all Kinney High Vacuum Pumps . . . includes a valuable section giving formulas for determining correct pump sizes—address any office listed.

KINNEY MANUFACTURING CO.

3565 WASHINGTON ST., JAMAICA PLAIN, BOSTON, MASS.
New York • Chicago • Los Angeles • Philadelphia • San Francisco

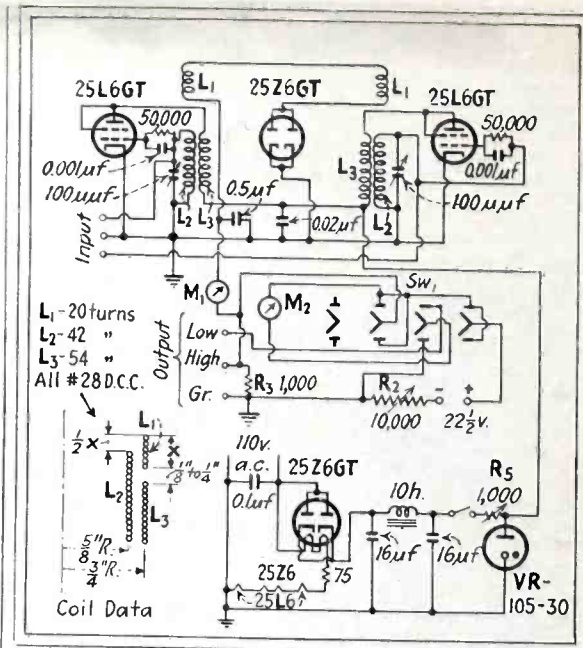

Fig. 3—Complete transducer circuit, with coil construction data

nected to each oscillator for doubled sensitivity.

The circuit fundamentally provides a low-impedance output, making it adaptable for use with a low-impedance, current-operated measuring or recording instrument. This is connected between the LOW and GR. output terminals, with switch SW_1 in the upper position. The minimum current value (or the normal value if the operating point is chosen somewhere near the middle of the linear region of the curve) may not be desirable in some applications because of its effect on sensitivity and range. For this reason, a battery and rheostat R_2 are provided in a bucking circuit to permit reducing to zero the initial current in the external circuit. Meter M_1 (0-50 ma.) then reads the total d-c synchronizing current, and meter M_2 (3-0-3 and 30-0-30 ma.) reads the actual current in the external circuit.

It is sometimes desirable to use a high-impedance voltage-operated device such as a cathode-ray oscilloscope, or to amplify the output signal before it is measured or recorded. To obtain the required voltage output for this purpose, switch SW_1 is thrown to its lower position, which inserts 1000-ohm resistor R_3 in the coupling circuit. The HIGH and GR. output terminals are used.

A well-regulated power supply is required to eliminate effects of line voltage variations. Satisfactory results were obtained with the universal half-wave rectifier shown in Fig. 3, with a voltage regulator tube across the output.

0.00002 to 10,000 VOLTS!

BALLANTINE ELECTRONIC AC VOLTMETER AND ACCESSORIES



MODEL 300
ELECTRONIC
VOLTMETER

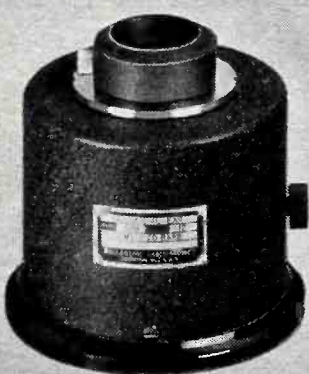

MODEL 505
ARTIFICIAL EAR



MODEL 402
MULTIPLIER



MODEL 220
DECADE AMPLIFIER

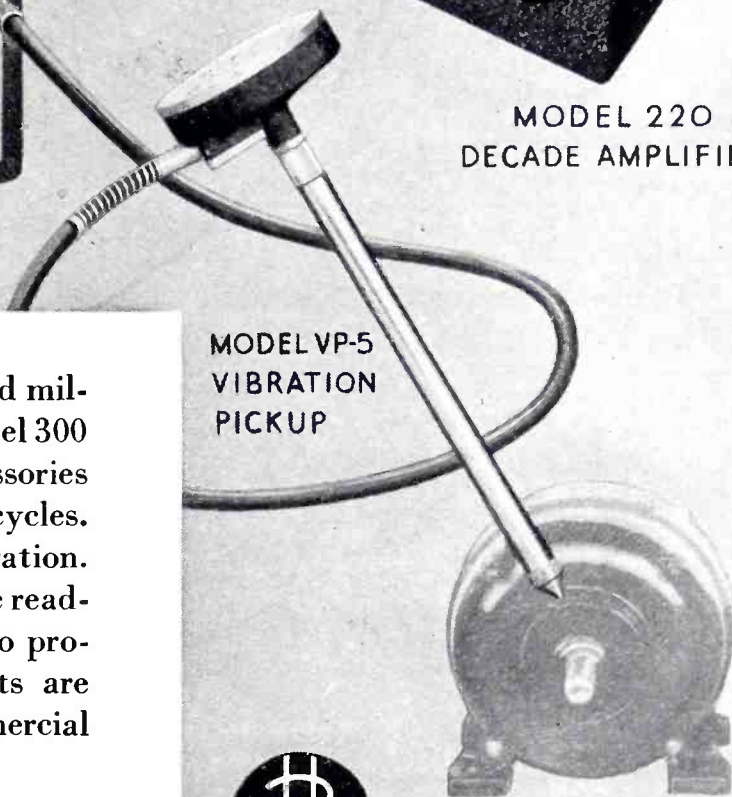

MODEL VP-5
VIBRATION
PICKUP

This enormous range of voltages—five hundred million to one—is accurately covered by our Model 300 Electronic Voltmeter and some of the accessories shown above. Frequency range 10 to 150,000 cycles. Accuracy 2% over most of the range. AC operation. Five decade ranges with logarithmic scale make readings especially easy. Uniform decibel scale also provided. Over a thousand of these instruments are giving excellent service in Government, commercial and university laboratories and factories.

Send for Bulletin 8

BALLANTINE LABORATORIES, INC.
BOONTON, NEW JERSEY, U.S.A.

CANNON

Visual Aids

TO HELP YOU LICK THE MANPOWER SHORTAGE
BY MAKING YOUR WORKERS MORE EFFICIENT

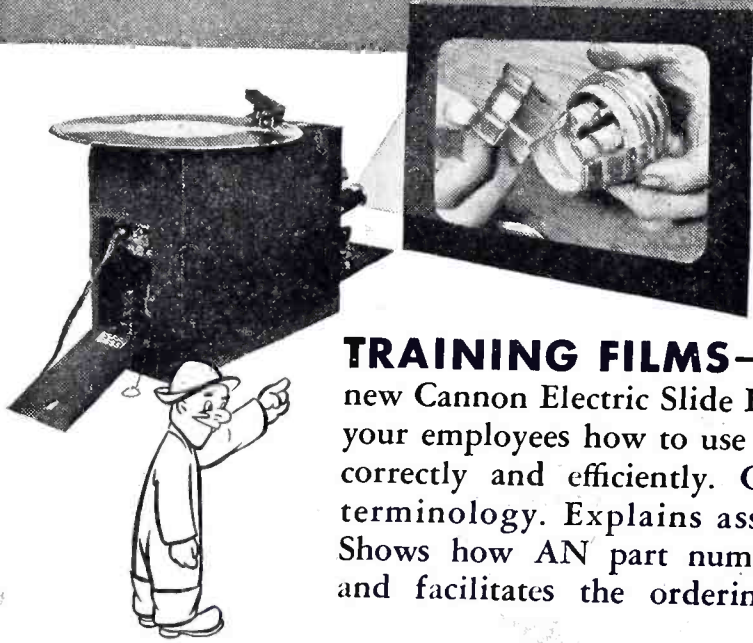

TRAINING FILMS—Ready now! The new Cannon Electric Slide Film with sound tells your employees how to use electrical connectors correctly and efficiently. Clears up confusing terminology. Explains assembly techniques. Shows how AN part numbers are established and facilitates the ordering of replacements.

CATALOGS—Engineers, production executives, service men need the basic information clearly presented in the new catalogs covering many types of Cannon Connectors.

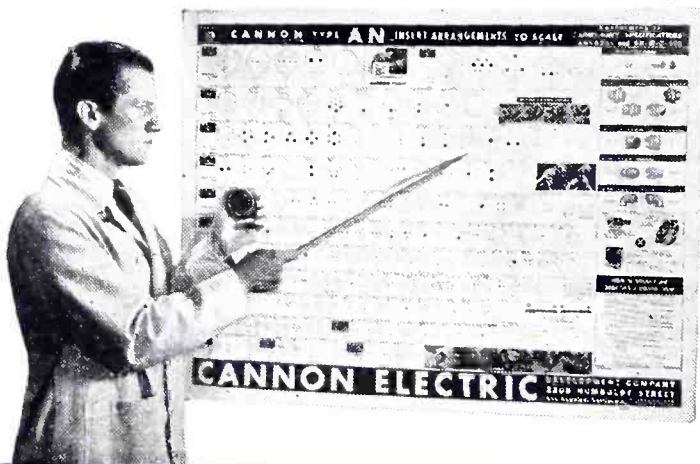
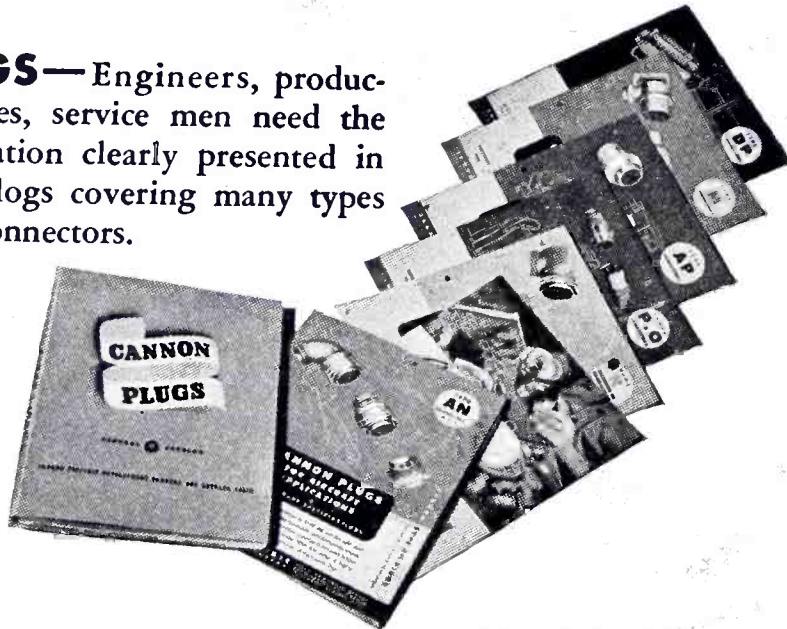

WALL CHART
Gives the insert arrangement and shell sizes on AN specification connectors at a glance, thereby facilitating designing, wiring and servicing operation in factories as well as in the field.

TEAR OUT THIS COUPON AND ATTACH TO YOUR BUSINESS LETTERHEAD



CANNON ELECTRIC

Cannon Electric Development Company, Department A-120
3209 Humboldt Street, Los Angeles, California

Please send us more information on the visual aids checked below:

TRAINING FILM

CATALOGS

WALL CHART

Post-War Picture

(Continued from page 87)

inevitably, help unearth other industrial applications for the same or similar gear.

Importance of Field Work

The best possible method by which the engineer may obtain accurate information regarding required industrial electronic equipment design features, perhaps the only one, is to go where the problems exist. The electronic engineer of the future will spend more time in the field since in many cases the machines he will have to control electronically cannot be brought to the laboratory.

A desire on the part of the engineer to go out into the field for the practical answers to his problems can bring surprising results. It not only provides practical answers to industrial design problems but also stimulates the creative talents in other profitable directions.

Training of Sales Engineers

The problem of educating sales engineers and sales representatives to properly present specialized components and equipment to engineers of other industries will be a most difficult task and one which must be shouldered by the electronic engineer.

The future educational program to be worked out requires a high order of engineering knowledge as well as creative sales talents, an executive combination which is difficult to find. Engineers of this calibre will be in greatest demand.

The need for sales engineers and sales representatives who have been trained as specialists in certain industrial fields will also be very great since only men thoroughly conversant with the relatively complicated equipment they are selling and the problems of their prospects will be accepted by engineers in other industries.

Sales engineering as well as design engineering will be a highly important field of endeavor in the industrial electronic market of the future. It has long been a lucrative field for engineers in other industries, but it is only now that the real need for capable sales engineers in the electronic field is being born.

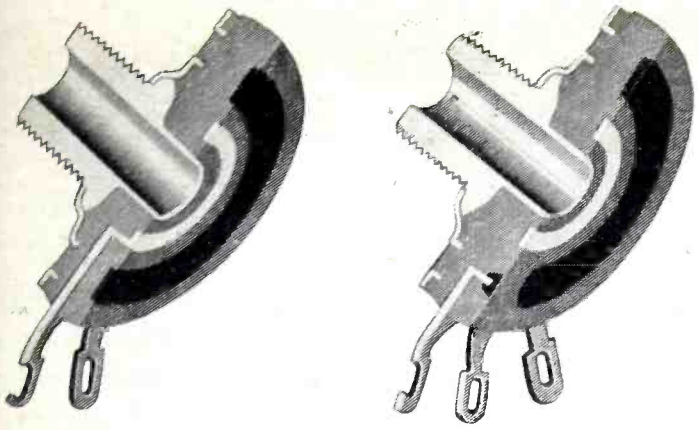

Cross-section views of Type J Bradleyometers showing how terminals are connected to the solid, molded resistor element.

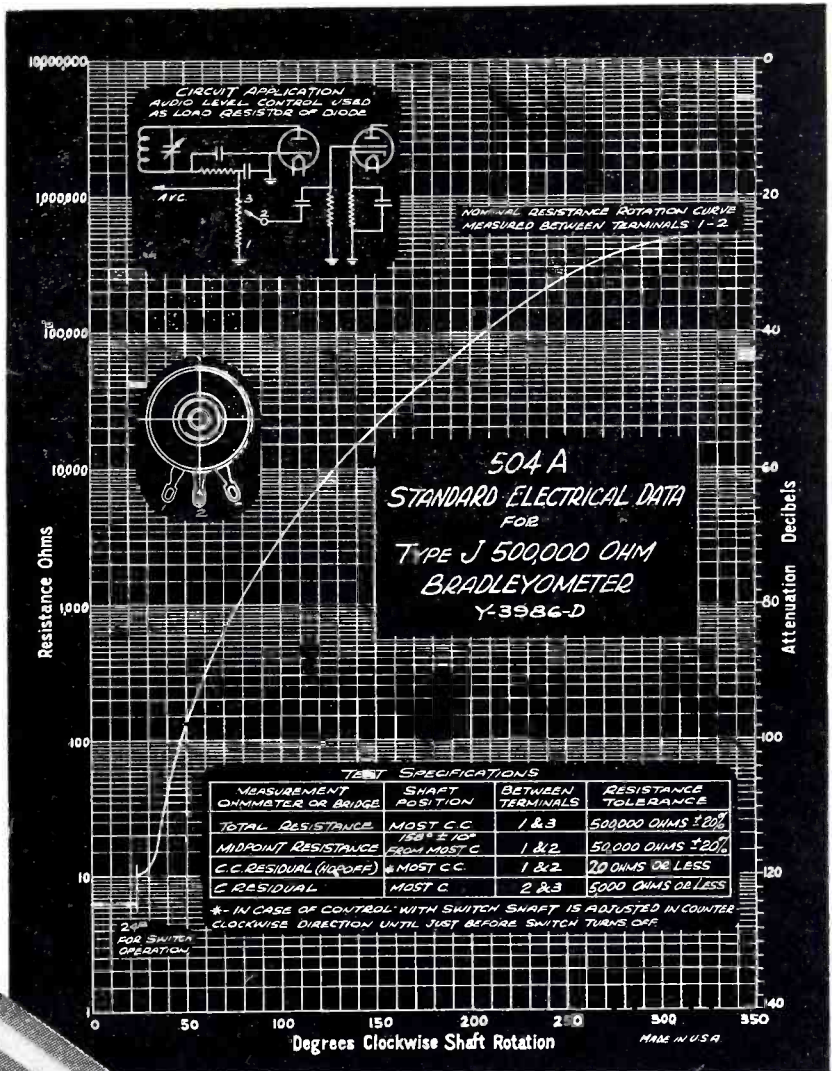
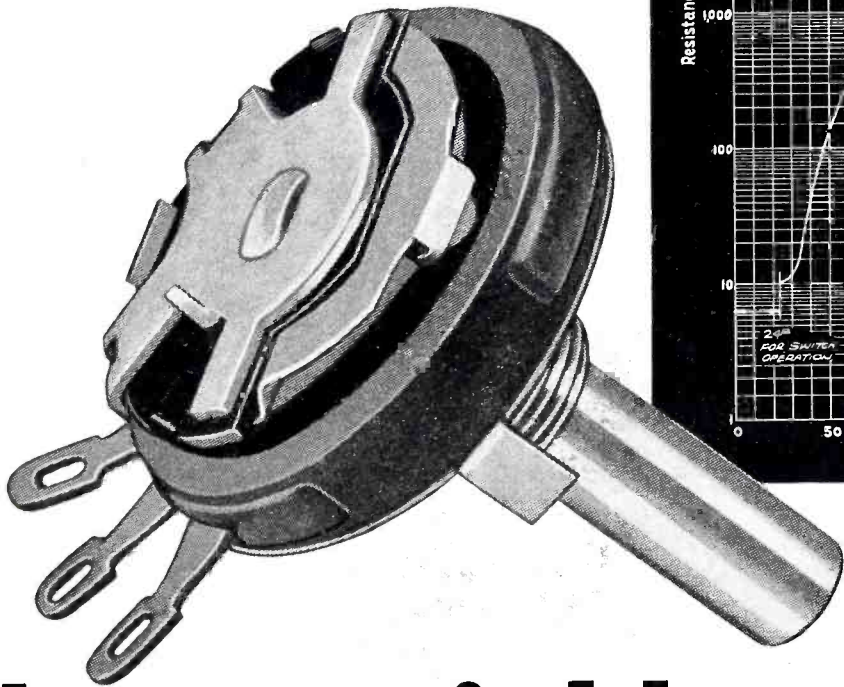

Here's a variable resistor with the highest safety factor for war service

There's a big margin of safety in the conservative two-watt rating of the Type J Bradleyometer. No other variable resistor of comparable size can meet it. The resistor element is solid and has substantial thickness. It is molded with the insulation, terminals, face plate, and bushing as a single unit, making an exceptionally simple, rugged, and reliable resistor... with no rivets, soldered or welded connections, or painted resistor elements.

During manufacture, the resistor material can be varied throughout the length of the element to provide practically any resistance-rotation curve. Once the unit has been molded, its performance is not affected by heat, cold, moisture, or hard use.



Type JS Bradleyometer with switch.

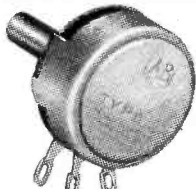

Type J Bradleyometer without line switch.

The low-resistance carbon brush, which makes a smooth contact with the surface of the molded resistor, assures long life and permanently quiet operation. All these factors make Bradleyometers especially suited for the war conditions, where space is limited and absolute reliability is needed.

Bradleyometers can be used separately or assembled to give dual or triple construction to fit any particular control need. They can be supplied for rheostat or potentiometer applications, with or without a switch. Write for specifications today.



Type E 1/2-watt non-insulated Bradleyunit molded fixed resistor.

Allen-Bradley Co., 110 W. Greenfield Ave., Milwaukee, Wis.

ALLEN-BRADLEY
FIXED & VARIABLE RADIO RESISTORS
QUALITY

DEPENDABLE

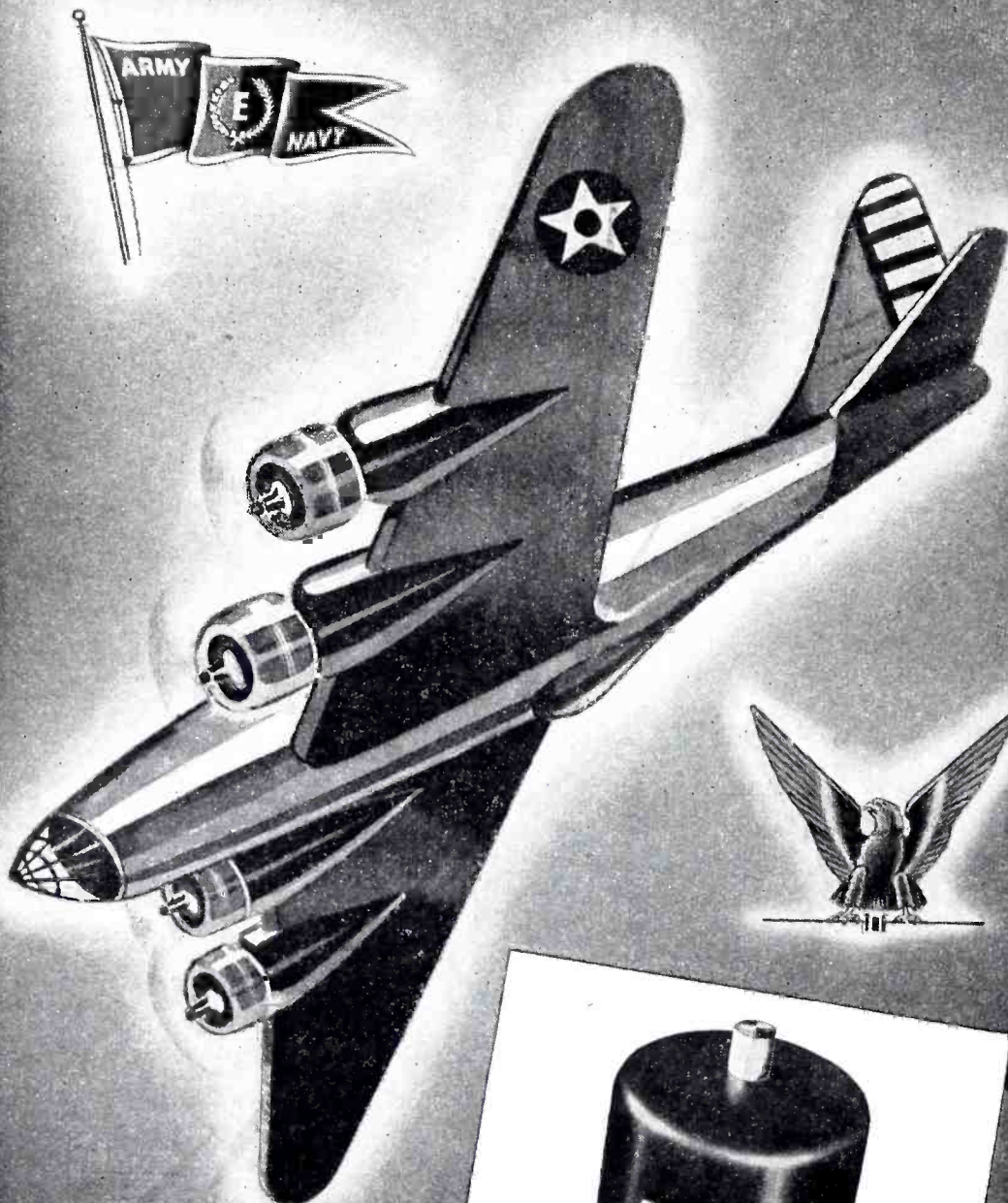

Accuracy and dependability
are built into every Bliley
Crystal Unit. Specify BLILEY
for assured performance.

BLILEY ELECTRIC COMPANY
ERIE, PENNSYLVANIA

BLILEY ELECTRIC COMPANY . . . ERIE, PA.

Bliley Crystals

Inspection of Tungsten

(Continued from page 95)

during this "black light" inspection, with each crack showing as a brilliant green indication against a purple background. Figure 3 shows how one of these cracks appears in cross-section when enlarged 200 times.

Rejections range from rods having only one short and very fine indication to rods almost completely covered with cracks. Even when the only crack is not in the area to be beaded, the rod is rejected because experience has shown that these cracks often spread to the glass seal upon heating during subsequent glass work.

Defects which are not revealed by fluorescent inspection are chiefly of the irregular type shown in Fig. 4, which produce one or more bubbles in the glass when the tungsten is beaded over the defect. It is believed that cracks like this are filled with oxide which prevents entrance of the penetrant. The number of tubes found with bubbles in the beads is now only a small fraction

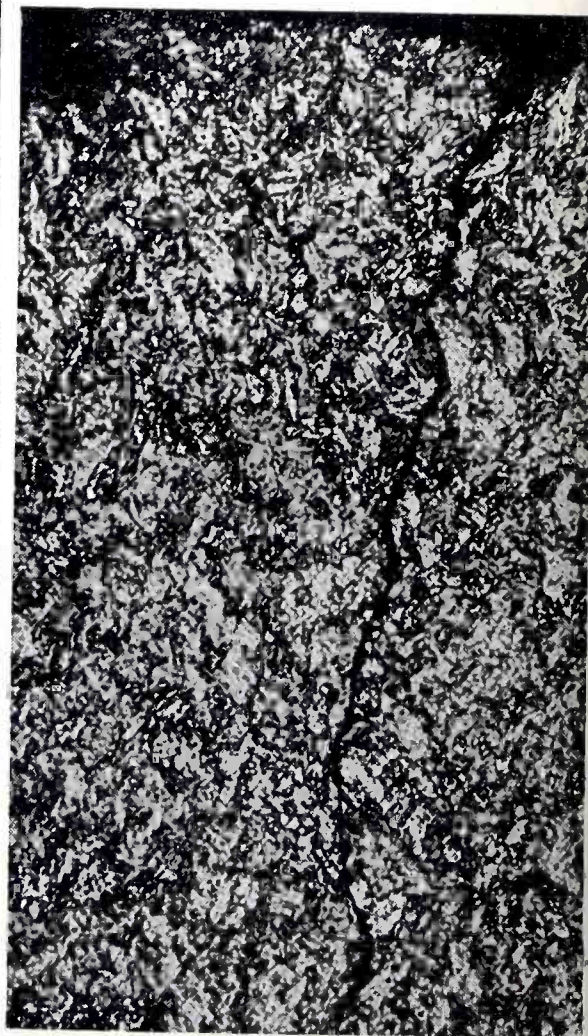

FIG. 3—Etched cross-section of tungsten lead, magnified 200 times, showing crack revealed by fluorescent method

NEW DATA ON IMPROVED PLAX POLYSTYRENE

Plax is one of the biggest producers of commercial polystyrene products in this country — and, so far as we know, uses more polystyrene for experimental purposes than any other company.

Out of this experience Plax presents these new data, suggesting how much better Plax Polystyrene can meet your own high-frequency insulation problems.

Compare its electrical characteristics with those of high-grade mica and fused quartz, add features unusual in any plastic, and you'll agree with other leaders in your field that Plax Polystyrene is one of the best high-frequency insulations ever known.

In addition to offering polystyrene sheets, rods and tubes themselves, Plax machines them into a wide variety of standard and special electronic parts.

From polystyrene, Plax now makes Polyflex Sheet. Tough and flexible, it is easily punched and has obvious uses for condensers, cable, storage batteries, etc.

Also new is Polyflex Fiber, proved in production and in the field as a cable wrapping and in other high-frequency applications.

Ask Plax for more data on these products, for engineering help in applying polystyrene to your products, and for a bulletin on machining polystyrene. In other words, "When it comes to polystyrene, come to Plax."

PROPERTIES OF PLAX POLYSTYRENE

MECHANICAL

Tensile strength, lbs. per sq. in. (A.S.T.M. D 48-37) 5,500-7,000
Tensile proportional limit, lbs. per sq. in. (.01% offset)
-38 F=3,700
0 F=2,800
78 F=2,500
Modulus of Elasticity in tension, lbs. per sq. in.
-38 F=554,000
0 F=536,000
78 F=469,000
Compressive proportional limit, lbs. per sq. in. (.01% offset)
2,600

ELECTRICAL

Volume resistivity, ohm. cm. 10^{17}
Arc resistance (A.S.T.M. D 495-38T) sec. 240-250
Dielectric strength, volts per mil
.005" thickness=3,500
.010" thickness=2,500
.015" thickness=2,200
.125" thickness= 500-700
Frequency Dielectric Power
Cycles Constant Factor
60 2.5-2.6 .0001-.0002
10³ 2.5-2.6 .0001-.0002
10⁶ 2.5-2.6 .0001-.0004
10¹⁰ 2.5-2.6 .0002-.0004

THERMAL

Distortion temperature (A.S.T.M. D48-37), F (C) 176-194 (80-90)
Transition temp. F (C) 180 (82)
Softening point, F (C) 220-240 (104-116)
Ignition point, F (C) 1350 (732)
Specific heat, cal. per gr. per degree C. .32
Thermal expansion coefficient per degree C. 7.2×10^{-5}
Thermal conductivity — cal. per sec. per cm. per degree C. 3.2×10^{-4}

CHEMICAL

Effect of:
*Weak and strong acids none
Weak and strong alkalis none
Alcohols soluble
Esters swells
Ketones
Aromatic and chlorinated hydrocarbons soluble
*Except oxidizers which discolor.

PLAX CORPORATION

133 WALNUT ST.
HARTFORD, CONN.

DO YOU HAVE A PRODUCTION PROBLEM?

Ward

CAN HANDLE CONTRACTS THAT REQUIRE:

	See Page
Radio, Electronic or Mechanical Engineering	2
Completely Equipped Tool Room	3
Automatic Screw Machines	4
Hand Screw Machines	5
Swaging Operations	6
Punch Presses	7
Foot Presses	7
Drill Presses	8
Treading Operations	9
Lathe Operations	10
Milling Operations	10
Light Section Spot Welding	11
Intricate Soft and Silver Soldering	12
Plating	13
Buffing and Sanding	13
Wire Braiding	14
Parkerizing	14
Painting or Spraying	15
Infra-red Baking or Air Dried Finishing	15
Intricate Mechanical and Electronic Assemblies	16
Careful Inspection	16

All these facilities are available from one convenient source.

THE WARD PRODUCTS CORPORATION
1523 East 45th Street
Cleveland, Ohio

Write for your copy of this illustrated brochure

The Ward Products Corporation offers the services of its two fully equipped plants to help you solve your manufacturing problems. The brochure illustrated above describes in detail our production facilities and other qualifications for handling contract work for present or post-war needs. Send for your copy on your business letterhead.

The
WARD **PRODUCTS**
CORPORATION

1523 EAST 45TH STREET
CLEVELAND, OHIO

Transmission Line Chart

(Continued from page 94)

Going along the line $X'Z'$ in Chart I, we have for point X' , the values $T = 0.58$ and $\tau = 157$ deg. which must be multiplied by $-jZ_0$ to obtain the input impedance. Thus

$$Z_i = jZ_0 T / \tau = (75 / -90^\circ) (0.58 / 157^\circ) = 43.5 / 67^\circ \text{ ohms}$$

Now point Z' must correspond to the load impedance, and at this point we find, $T = 1.75$ and $\tau = 158$ deg. The load impedance is therefore,

$$Z_l = (75 / -90^\circ) (1.75 / 158^\circ) = 131 / 66^\circ \text{ ohms}$$

which differs slightly from the true value of $136.5 / 66^\circ$ ohms.

Knowing the input impedance and the voltage, the input current will be

$$I_i = \frac{V_i}{Z_i} = \frac{10}{43.5 / 67^\circ} = 0.23 / -67^\circ \text{ amp.}$$

The current distribution can be followed on line XZ in Chart II.

The author is indebted to Prof. C. Breitfeld, University of Prague, for the principles of this method which were outlined in lectures on electric power lines in 1933.

• • •

FIRST WOMAN RADIO ENGINEER AT G.E.

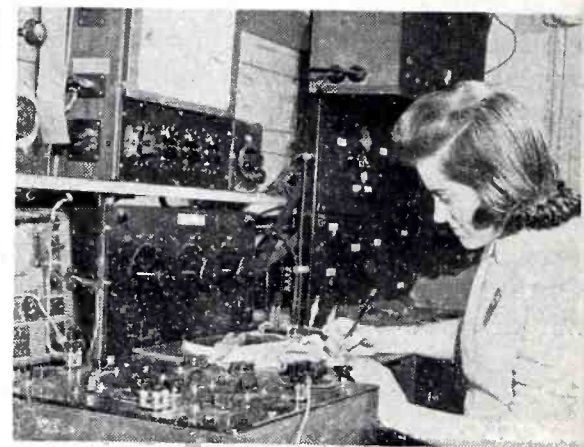

The first woman to work in General Electric's radio receiver engineering section at Bridgeport, Conn., is 21 year old Margaret Allen. Miss Allen joined G. E. when the company started a special training program for women college graduates similar to the company's training course for graduate men engineers. She is one of the graduates who are replacing men in the testing of some war equipment and giving skilled assistance to engineers in laboratories and factories



GENERAL ELECTRIC MYCALEX

is an electrical insulator possessing a combination of features not found in any other single material. G-E mycalex, because of its high dielectric strength and low power factor, is ideally suited for use as a high frequency insulator in radio equipment and for ignition assemblies in high altitude aircraft. Arcs occurring at high altitudes do not cause permanent conductive tracks.

Because intricate shapes may be molded with G-E mycalex with "molded-in inserts", because these parts are made to extremely close tolerances and because their dimensional stability is high, G-E mycalex is a superior material for assemblies which must stand up under severe operating conditions. Although G-E mycalex can be drilled, milled, and ground, these operations are seldom necessary due to the fact that parts can be molded to shape.

For further information write section M-4, One Plastics Ave., Pittsfield, Mass.

PLASTICS DIVISIONS
GENERAL ELECTRIC



PD-34



DEPENDABLE

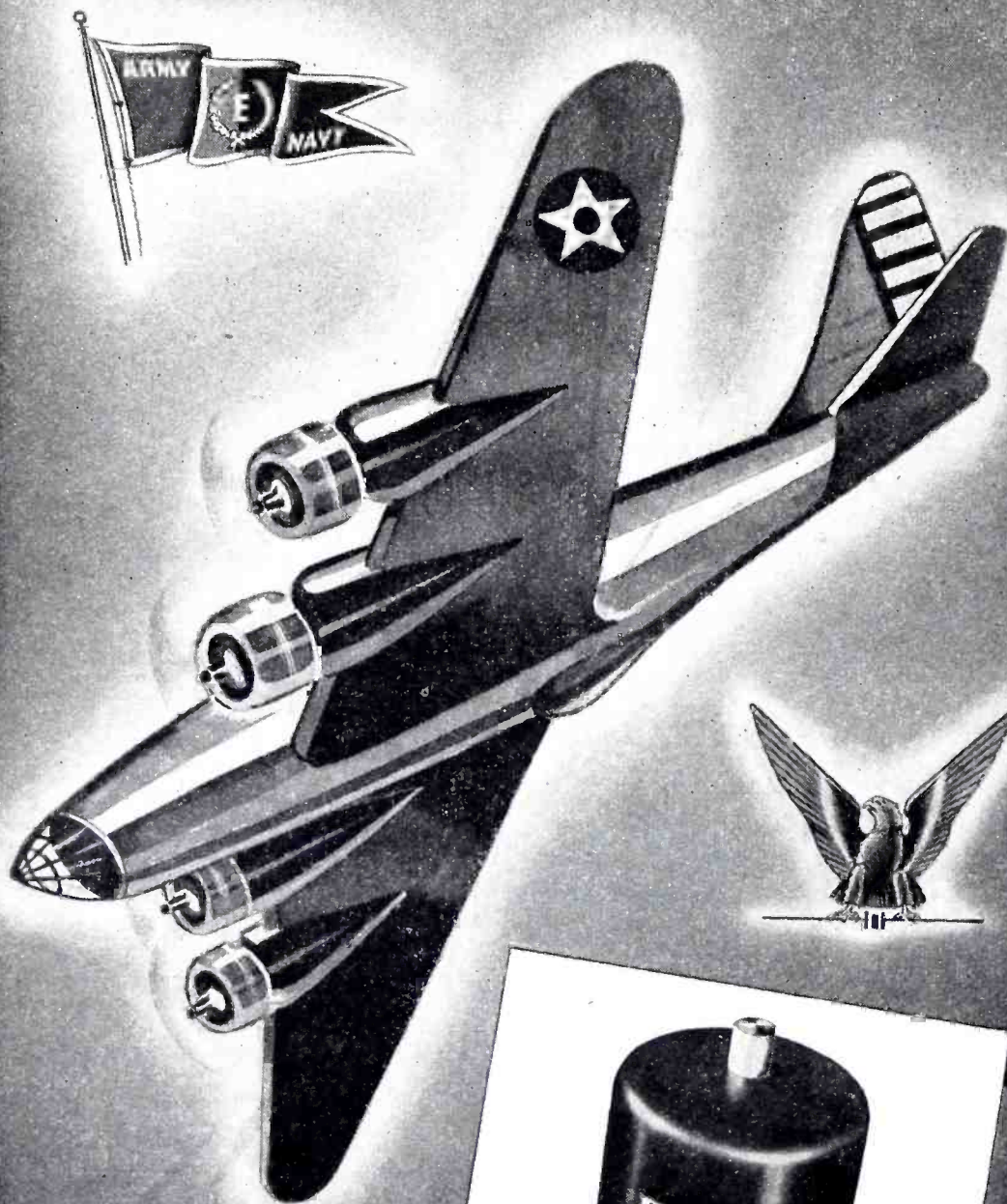

Accuracy and dependability
are built into every Bliley
Crystal Unit. Specify BLILEY
for assured performance.

BLILEY ELECTRIC COMPANY
ERIE, PENNSYLVANIA

BLILEY ELECTRIC COMPANY . . . ERIE, PA.

Bliley Crystals

Inspection of Tungsten

(Continued from page 95)

during this "black light" inspection, with each crack showing as a brilliant green indication against a purple background. Figure 3 shows how one of these cracks appears in cross-section when enlarged 200 times.

Rejections range from rods having only one short and very fine indication to rods almost completely covered with cracks. Even when the only crack is not in the area to be beaded, the rod is rejected because experience has shown that these cracks often spread to the glass seal upon heating during subsequent glass work.

Defects which are not revealed by fluorescent inspection are chiefly of the irregular type shown in Fig. 4, which produce one or more bubbles in the glass when the tungsten is beaded over the defect. It is believed that cracks like this are filled with oxide which prevents entrance of the penetrant. The number of tubes found with bubbles in the beads is now only a small fraction

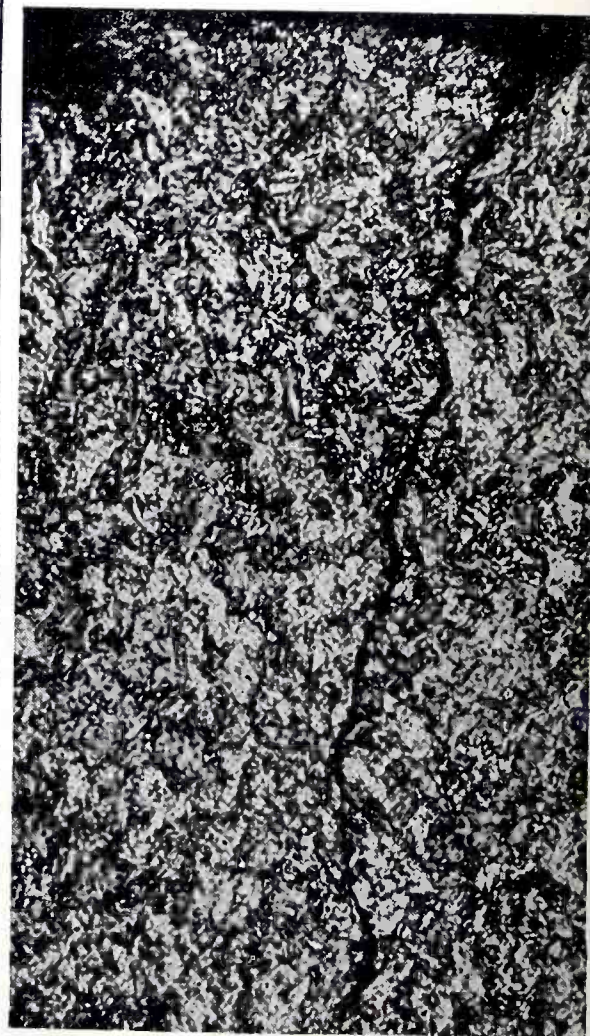
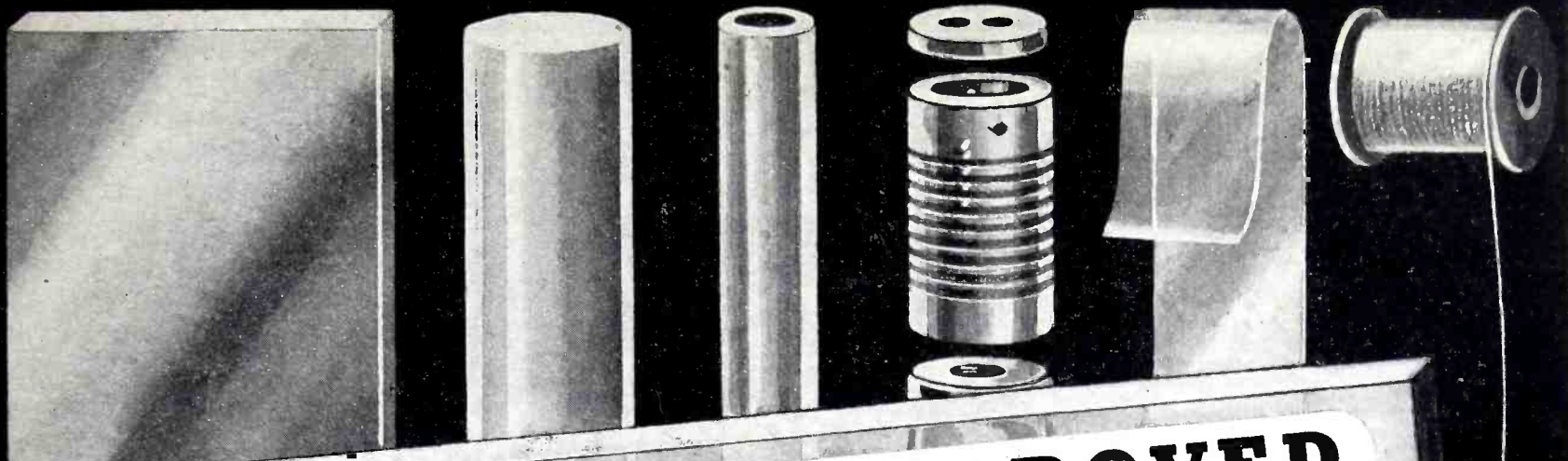

FIG. 3—Etched cross-section of tungsten lead, magnified 200 times, showing crack revealed by fluorescent method



NEW DATA ON IMPROVED PLAX POLYSTYRENE

Plax is one of the biggest producers of commercial polystyrene products in this country — and, so far as we know, uses more polystyrene for experimental purposes than any other company.

Out of this experience Plax presents these new data, suggesting how much better Plax Polystyrene can meet your own high-frequency insulation problems.

Compare its electrical characteristics with those of high-grade mica and fused quartz, add features unusual in any plastic, and you'll agree with other leaders in your field that Plax Polystyrene is one of the best high-frequency insulations ever known.

In addition to offering polystyrene sheets, rods and tubes themselves, Plax machines them into a wide variety of standard and special electronic parts.

From polystyrene, Plax now makes Polyflex Sheet. Tough and flexible, it is easily punched and has obvious uses for condensers, cable, storage batteries, etc.

Also new is Polyflex Fiber, proved in production and in the field as a cable wrapping and in other high-frequency applications.

Ask Plax for more data on these products, for engineering help in applying polystyrene to your products, and for a bulletin on machining polystyrene. In other words, "When it comes to polystyrene, come to Plax."

PROPERTIES OF PLAX POLYSTYRENE

MECHANICAL

Tensile strength, lbs. per sq. in. (A.S.T.M. D 48-37) 5,500-7,000
Tensile proportional limit, lbs. per sq. in. (.01% offset)
-38 F=3,700
0 F=2,800
78 F=2,500
Modulus of Elasticity in tension, lbs. per sq. in.
-38 F=554,000
0 F=536,000
78 F=469,000
Compressive proportional limit, lbs. per sq. in. (.01% offset)
2,600

ELECTRICAL

Volume resistivity, ohm. cm. 10^{17}
Arc resistance (A.S.T.M. D 495-38T) sec. 240-250
Dielectric strength, volts per mil
.005" thickness=3,500
.010" thickness=2,500
.015" thickness=2,200
.125" thickness= 500-700
Frequency Dielectric Power
Cycles Constant Factor
60 2.5-2.6 .0001-.0002
10³ 2.5-2.6 .0001-.0002
10⁶ 2.5-2.6 .0001-.0004
10¹⁰ 2.5-2.6 .0002-.0004

THERMAL

Distortion temperature (A.S.T.M. D48-37), F (C) 176-194 (80-90)
Transition temp. F (C) 180 (82)
Softening point, F (C) 220-240 (104-116)
Ignition point, F (C) 1350 (732)
Specific heat, cal. per gr. per degree C. .32
Thermal expansion coefficient per degree C 7.2×10^{-5}
Thermal conductivity — cal. per sec. per cm. per degree C 3.2×10^{-4}

CHEMICAL

Effect of:
*Weak and strong acids none
Weak and strong alkalis none
Alcohols soluble
Esters swells
Ketones
Aromatic and chlorinated hydrocarbons soluble
*Except oxidizers which discolor.

PLAX CORPORATION

133 WALNUT ST.
HARTFORD, CONN.

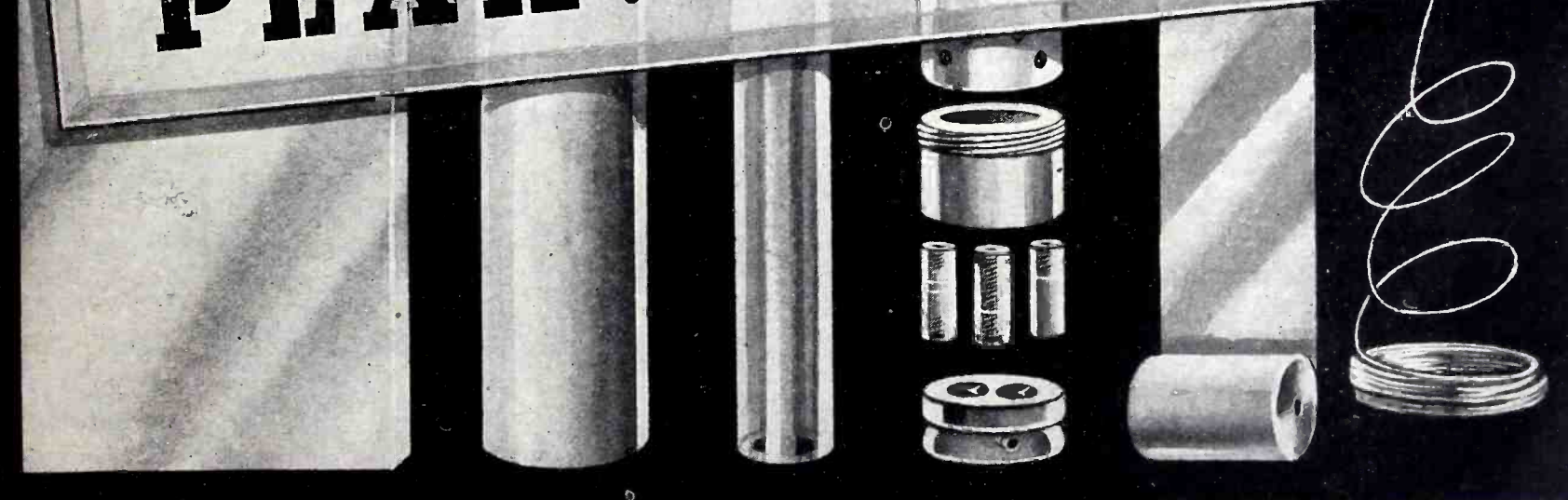

**PRODUCTION
Must not SLOW DOWN!**



**GET NEEDED RADIO PARTS
Quickly!**

Don't allow your production lines to slow down for lack of essential parts. Lafayette Radio Corp. is headquarters for all radio and electronic parts and equipment of every nationally known manufacturer in the field. Let Lafayette help you keep your production humming and save your time — one single order to Lafayette will insure prompt delivery on all hard-to-get parts and equipment your program may require.

Thousands of manufacturers, electronic engineers and private and military training program directors know Lafayette's reputation for complete stocks and extensive procurement facilities. We can fill your needs too — quickly!

Write today for Free 130 page Radio and Electronic Parts and Equipment Catalog —
Address Dept. 7G3



LAFAYETTE RADIO CORP.

★ 901 W. JACKSON BLVD.

CHICAGO, ILLINOIS

★ 265 PEACHTREE STREET

ATLANTA, GEORGIA

of that encountered prior to use of the new inspection method, however.

The penetrating oil used in the inspection process caused dermatitis on the hands and face of the worker who first processed large quantities of parts. This has been eliminated by having workers wear rubber gloves to avoid skin contact with the penetrant. Some of the inspectors at first complained of eyestrain and

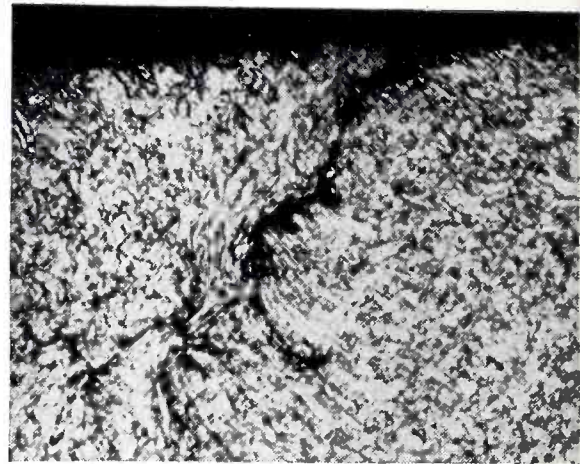
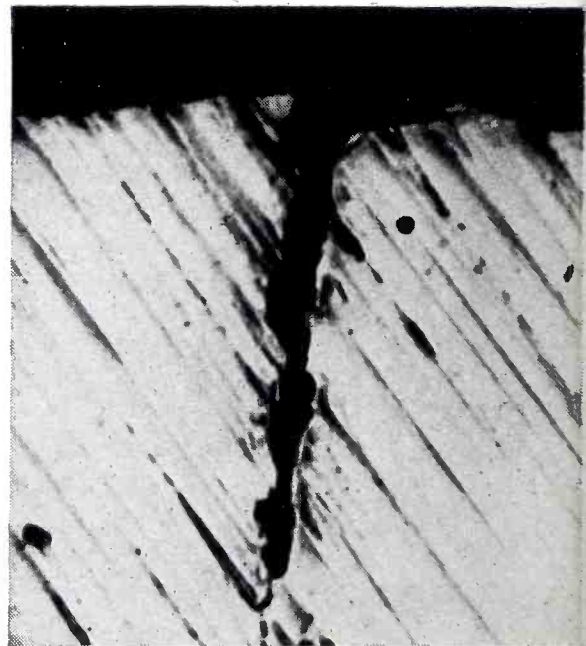

FIG. 4—Irregular cracks like this (etched cross-section magnified 200 times) may not be revealed because oxide prevents entrance of fluorescent penetrant

headaches; these were given two Vitamin A capsules daily, each containing 25,000 U.S.P. units, clearing up the trouble.

The fluorescent penetrant method of tungsten inspection should prove of great value during war time when materials and manpower are so critical. The sooner a defect is located during production of a tube, the less material and time is wasted.



Rough polished section of 0.06-inch diam. tungsten rod, magnified 693 times to show longitudinal crack which can allow air to enter a tube through its tungsten lead

SALUTE TO THE WOMEN OF TOMORROW!

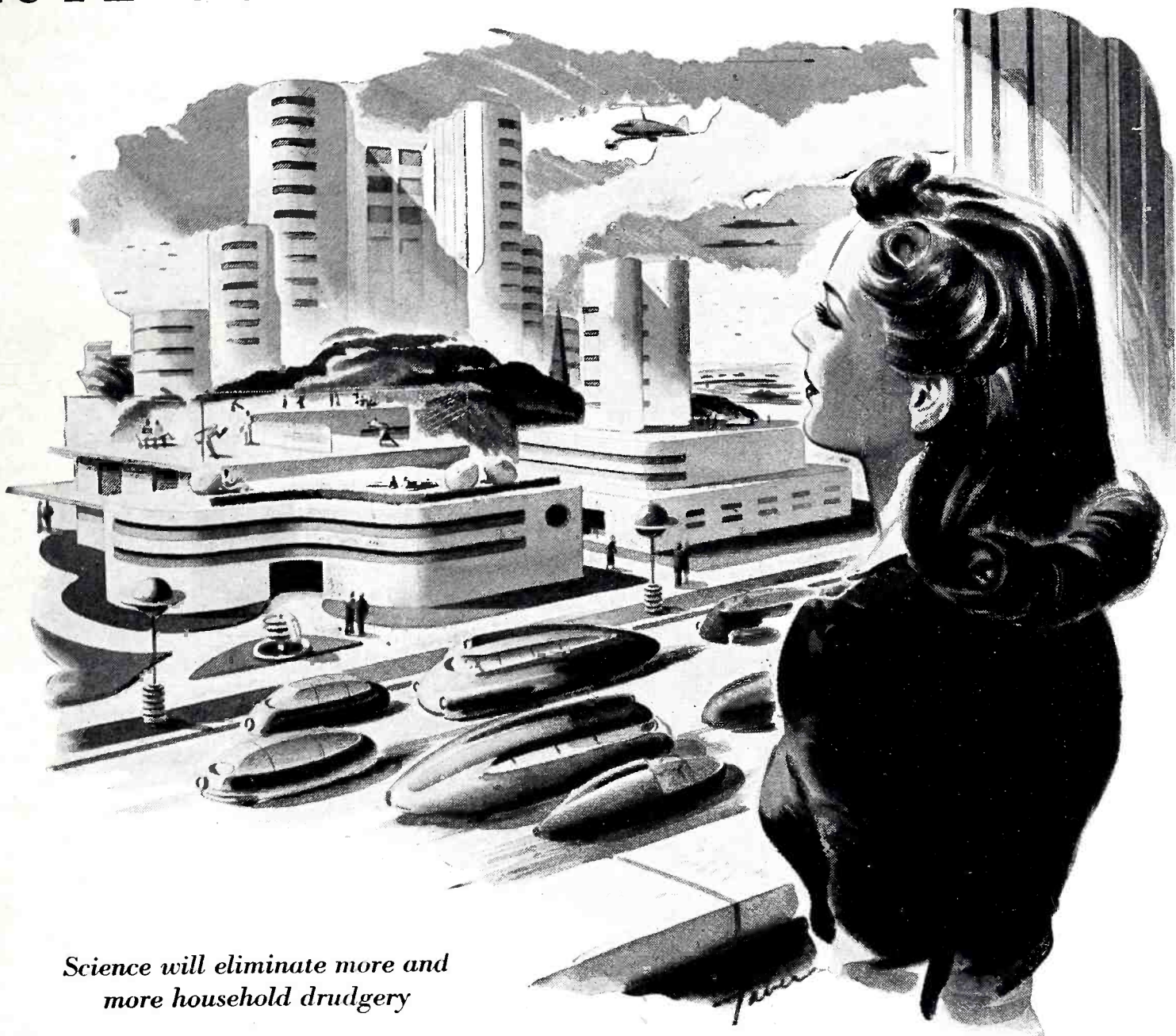

Science will eliminate more and more household drudgery

RESearch AND INVENTION have been speeded up by the war — the tragedies of today will, in the not-too-far-distant future, be transformed into the blessings of peace.

The women of tomorrow will step out of the bondage of household chores into more zestful, more creative living. More and more, they will share with men in the re-making of this world.

Typical of the forward-looking companies which will translate the visions of today into the actualities of tomorrow is Small Electric Motors (Canada) Limited.

This virile, rapidly-expanding industrial organization, now engaged solely in war work, is planning an important post-war future. From its large, modern plant will come electrical equipment of revolutionary design — for ships and planes — for factories and homes!

DESIGNERS AND MANUFACTURERS

of all types of precision electrical apparatus including

*D.C. & A.C. Motors for specialized purposes
Aircraft Generators
Aircraft Engine Starters
Alternators
Motor Generators
Electric Pumps
Motors with Governors
Gyros, etc.*

Small Electric Motors (Canada) Limited

and its subsidiary

Semco Instruments Limited

2-43

LEASIDE • TORONTO 12 • CANADA

THE ELECTRON ART

Generation of Short Waves	164
Photoelectric Timer Controls X-ray Film Exposure	178
Calibrating Stop Values of Lenses	186
Protecting Meters with Fuses	188
Recording Blood Flow in Stomach with Couples and Phototube	190
Momentary Contact for Time Clock	194
Magnetic Control Switch	196
Eating Marked Atoms	200
Precision Temperature Control for Electric Furnaces	202

Generation of Short Waves

Behind any engineering development and practical application lies a vast storehouse of past experience, trial and error, and theory. As science progresses and becomes more organized—and more complicated—theory forms a larger and larger portion of the background of engineering.

Back of many modern tubes used for the generation of very short waves lies the theory of the utilization of velocity modulated and directed streams of electrons, for which the background was laid by A. Arsenjewa-Heil and O. Heil in *Zeitschrift für Physik*, Vol. 95, p. 762, 1935. Considerable interest has been expressed in this article, notwithstanding its comparative age. The translation of this article, from the German, has been prepared by Theodore J. Wang, and is presented to meet the many expressions of the need for having this material readily available in English.—Ed.

THE PRODUCTION of undamped electromagnetic waves of high intensity in the wavelength region from 1 meter down to a few centimeters* still offers difficulties today. That we cannot produce in this wavelength region the intensities common with longer waves depends, in general, upon two kinds of difficulties: (1) The electrons move too slowly. The transit time of the electrons between the electrodes is comparable with a period of oscillation or even greater than this. (2) For short waves the electrodes of the tube must be as small as possible as they form the capacity of the oscillatory circuit. For the generation of large energy, on the other hand, the electrodes must be as large as possible so that they can radiate the heat produced by the electron bombardment. Thus both demands, short waves and high energy, cannot be fulfilled simultaneously; they are incompatible.

In the generator principle herein described these difficulties are circumvented in the following ways: (1) The finite transit time of the electrons, which formerly caused trouble, is actually made use of now, in order to control the electron stream. (2) The electrons do not strike the oscillating electrodes at all. An electron stream flows through these electrodes, and the

* Collected papers: K. Kohl, *Ergebn. d. exakt. Naturwiss.* 9, 1930; H. E. Hollmann, *Hochfrequenztechnik und Elektroakustik* 44, 37, 1934.

oscillation energy is taken out of the electron stream. In this way the heating of the small oscillating electrodes is entirely avoided.

The Generator Principle

The generator principle is illustrated in the schematic diagrams of Fig. 1. Figures 1(a) and (b) show the electrode arrangement, and Fig. 1(c) shows the corresponding potential variation. The negative potential is drawn upward so that we can represent the electrons as balls which roll along the potential curve. Electrons are emitted from the cathode A and accelerated to electrode B, which is maintained at a constant positive potential. The electrons are then retarded as they enter electrode C, which forms a Faraday cage. After the flight through the cage the electrons are again accelerated by means of electrode D, which is directly connected to electrode B and thus has the same potential as B. Electrons passing beyond electrode D can again be retarded and collected.

The mechanism of oscillation generation takes place in the space between electrodes B and D. C is the electrically oscillating electrode, which is

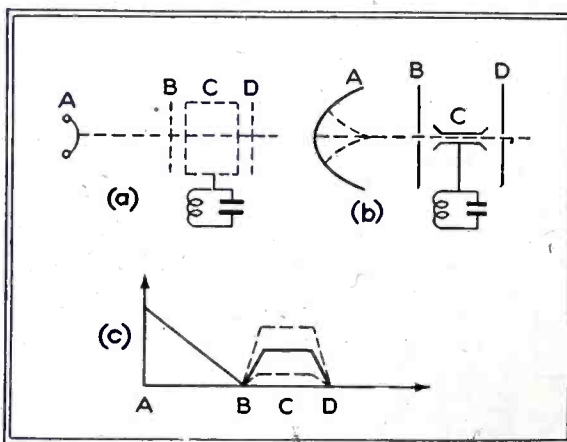

Fig. 1—Electrode arrangements of generators utilizing beams are shown at (a) and (b). Potential variations of electrodes are shown at (c). Mechanism of oscillation takes place between electrodes B and D

illustrated in the figure by the schematically drawn oscillatory circuit. Electrons flowing from B to C form an influx of negative charge into the cage, while electrons flowing from C to D form an outflow of negative charge from the cage. Electrons in the interior of the cage act, toward the outside, as though they reside in the metal wall of the cage. The time of stay of electrons in the interior of the cage is important, for through this the current is controlled. The time of stay depends upon the velocity of the electrons, i.e., it is dependent upon the potential of the cage at the moment of the electrons' entrance.

Let us consider that the circuit is oscillating and that the potential of the cage is varying sinusoidally in time. The potential of the cage then varies back and forth as between the dotted lines shown in Fig. 1(c). With a properly chosen cage length we can obtain the condition that the slow electrons, which enter the cage during the negative half cycle, leave the cage for the most part in the following positive half cycle; while the fast electrons, which enter the cage during the positive half cycle, leave the cage for the most part in the same positive half cycle. Accordingly, during the positive half cycle there is a net electron current out of the cage, and during the negative half cycle there is a net electron current into the cage. This means a building up and damping down of the existing oscillations. Or in other words: as a consequence of the different time of stay of the electrons, there is a pulsating space charge in the inside of the cage, and this pulsating space charge adds to and detracts from the oscillations. One can figure how much energy is supplied to the oscillatory circuit in this manner by calculating the energy loss of an individual electron and summing over the course of a period.

The theory shows that a maximum of 35 percent of the energy of the electron stream is converted into energy of oscillations. The efficiency can conceivably approach 100 percent, since the electron stream can be slowed down to a halt with the opposition field. The theory shows that the generator is self-oscillating and stable.

The theory of the generator is given herewith. The following nomenclature is employed:

- Let e = charge on the electron
- m = mass of the electron
- v = velocity of the electron
- p = potential of the Faraday cylinder
- p_1 = potential at the electron entrance
- p_2 = potential at the electron exit
- V = average potential of the Faraday cylinder (applied voltage)
- A = amplitude of the oscillations (potential)
- $\omega = 2\pi\nu$ = angular frequency
- T = time of stay of electrons in the Faraday cylinder
- l = path length of the electrons in the Faraday cylinder
- C = capacity of the oscillatory circuit
- J = magnitude of the electron current
- N = energy conversion efficiency
- E = reinforcement

OHMITE

RESISTANCE UNITS

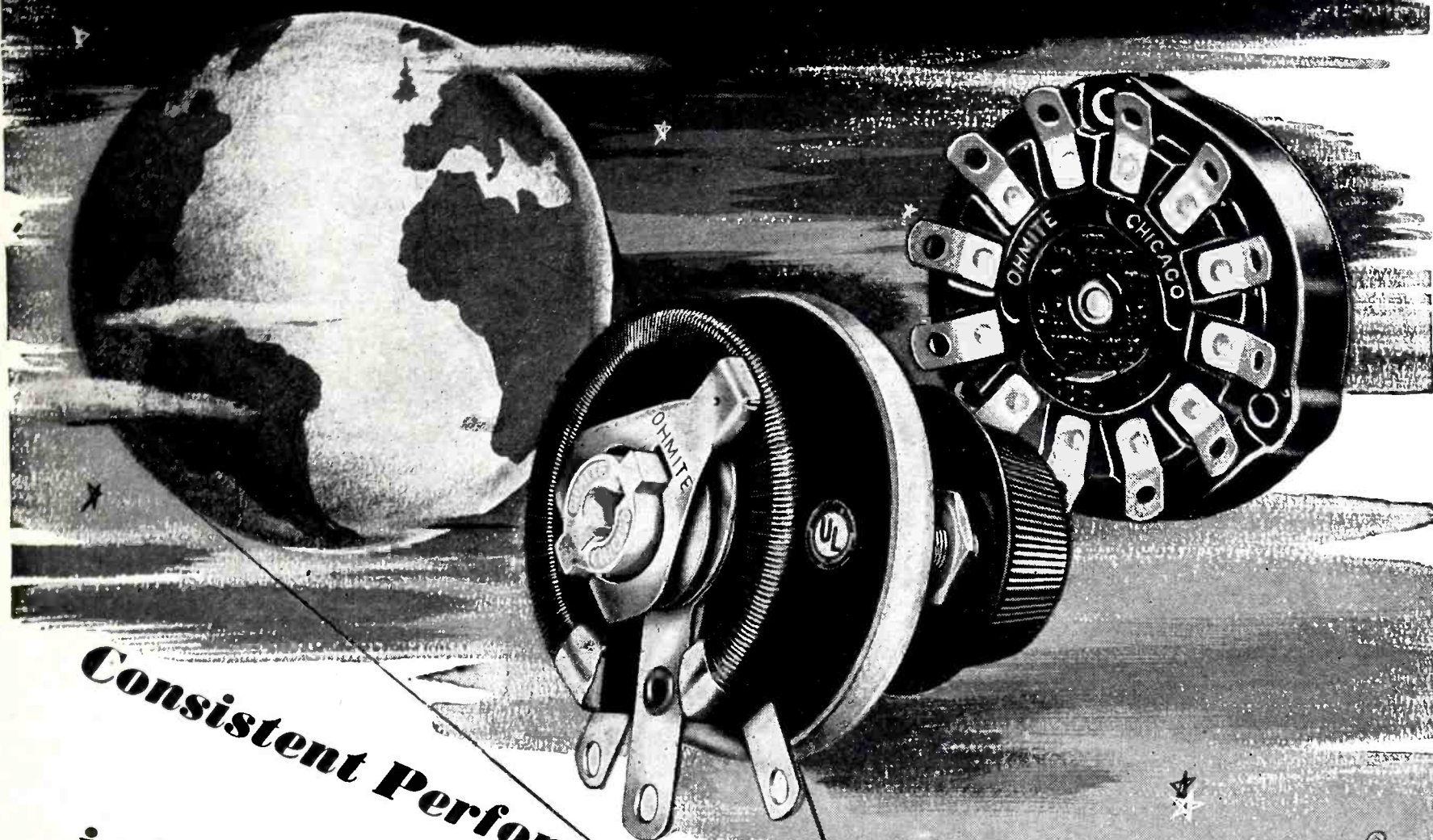

*Consistent Performance
in Every Part of the World*

Years of world-wide service in all types of applications, under all kinds of operating conditions, have proved the sterling qualities of Ohmite Products. During this time, we have helped pioneer many applications of resistance units in electronic and electrical devices. As a result, we have developed and produced the widest range of types and sizes in power rheostats, resistors, and tap switches to meet every need.

**Send for Catalog and
Engineering Manual No. 40**

Write on company letterhead for helpful 96-page guide in the selection and application of rheostats, resistors, chokes, tap switches and attenuators.



Today, Ohmite Units serve in plant and laboratory—and on every battle front, from below the sea to the stratosphere, and from "down under" to the top of the world. Tomorrow, they will be ready and eager to meet new postwar requirements.

**OHMITE MANUFACTURING COMPANY
4816 Flournoy Street, Chicago, U. S. A.**



Extended Range!



Permoflux Dynamic Headphones Mean Extra Striking Power!

Carrier planes cannot safely extend operations beyond their effective communication range. A few extra miles may sometimes mean the accomplishment of otherwise impossible objectives. The high sensitivity and wide, uniform frequency response of Permoflux Dynamic Headphones at all altitudes, provide improved intelligibility under adverse noise level conditions — assure reception of vital messages at maximum distance from home base.

BUY WAR BONDS FOR VICTORY!

TRADE MARK
PERM-FLUX

CORPORATION

4916-22 W. Grand Ave., Chicago, Ill.

PIONEER MANUFACTURERS OF PERMANENT MAGNET DYNAMIC TRANSDUCERS.

The problems involved are:
 (1) To find the optimum values of V , A , and l , and to obtain a numerical value for the energy conversion efficiency N (hereinafter designated e.c.e.), defined as the ratio

$$N = \text{e.c.e.} = \frac{\text{oscillation energy gained}}{\text{average electron stream energy } (J,V)}$$

(2) To determine if the generator self-oscillates and if it is stable at the operating point. Toward this end we introduce the concept of reinforcement, E , and we seek to obtain E as a function of V and A . We define E as the ratio.

$$E = \frac{\text{energy fed to oscillatory circuit per period}}{\text{existent energy in oscillatory circuit}}$$

Theory

The instantaneous potential of the Faraday cylinder (see Fig. 2) is

$$p = V + A \sin \omega t$$

The electron velocity v , as a function of the time of the electron's entrance into the Faraday cylinder, may be obtained from

$$\frac{mv^2}{2} = e(V + A \sin \omega t)$$

$$v = \sqrt{2e(V + A \sin \omega t)/m}$$

The time of stay, T , of the electron in the Faraday cylinder is

$$T = \frac{l}{v} = \frac{l}{\sqrt{2e(V + A \sin \omega t)/m}}$$

The electron exit potential, p_2 , as a function of the entrance time, is

$$p_2 = V + A \sin \omega(t + T) = V + A \sin \omega \left(t + \frac{l}{\sqrt{2e(V + A \sin \omega t)/m}} \right)$$

The energy loss of the electron is equal to the energy gain of the oscillatory circuit

$$e(p_2 - p_1) = eA[\sin \omega(t + T) - \sin \omega t]$$

A constant stream of electrons flows into the Faraday cylinder (n electrons per second). The total energy gain of the oscillatory circuit during a period is then

$$\begin{aligned} neA \int_0^{2\pi/\omega} [\sin \omega(t + T) - \sin \omega t] dt \\ = JA \int_0^{2\pi/\omega} \sin \omega(t + T) dt \\ = JA \int_0^{2\pi/\omega} \sin \omega \left(t + \frac{l}{\sqrt{2e(V + A \sin \omega t)/m}} \right) dt \end{aligned}$$

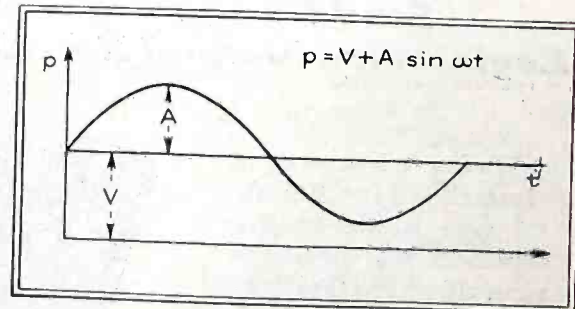

Fig. 2—Instantaneous potential in Faraday cylinder



When There's No Time For Fumbling

When orders must get through quickly, **FREQ-KC** crystal units select the right channel, instantly and reliably. Absolute frequency specifications and protection from heat, cold or shock guard against communication failure or miscarriage of vital messages. This war-proved accuracy and dependability one day will be available to manufacturers of peace-time products. In the meantime, our electronic engineers are at your service to help design and specify crystal-controlled applications for essential products or ahead-of-competition models.



Gentleman Products Division of
HENNEY MOTOR COMPANY

Home Office at FREEPORT, ILLINOIS — Factory at Omaha, Nebraska

★ In a Hurry . . .

REMLER Plugs and Connectors

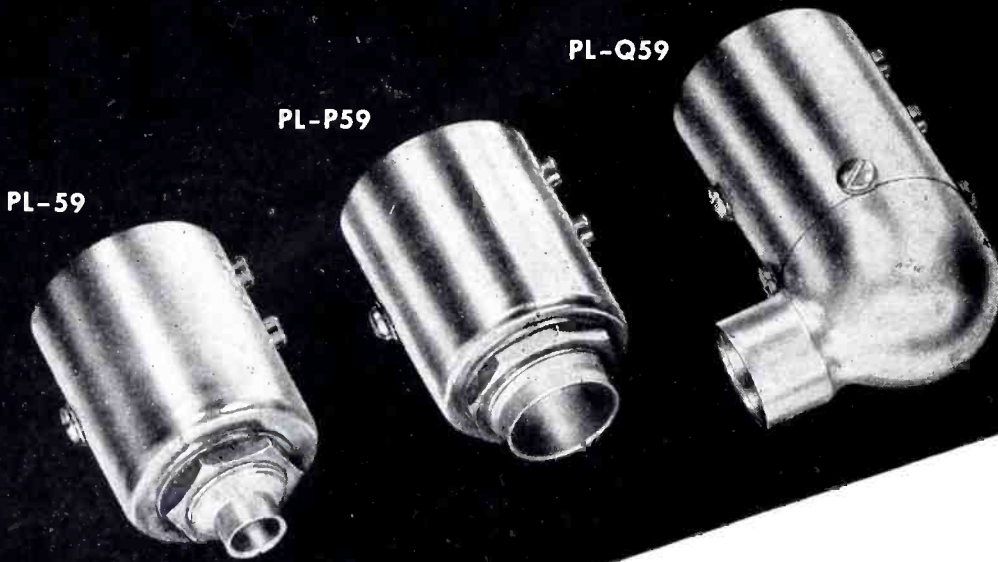

Made to
ARMY SIGNAL
CORPS SPECIFICATIONS

Remler made plugs and connectors of the following types are used by more than fifty concerns engaged in manufacturing communications equipment for the U. S. Army Signal Corps:

Types:	PL	PLP	PLQ	PLS
50-A 61 74 114 150	56 65	56 65	56 64	
54 62 76 119 159	59 67	59 67	59 65	
55 63 77 120 160	60 74	60 74	60 74	
56 64 104 124 354	61 76	61 76	61 76	
58 65 108 125	62 77	62 77	62 77	
59 67 109 127	63 104	63 104	63 104	
60 68 112 149	64	64		

Special Designs to Order

Remler is equipped to manufacture other plugs and connectors of special design—in large quantities. Submit specifications.

Prompt Delivery • Inspection

Signal Corps inspectors in attendance. Uniformity assured—no rejects. Write, wire or telephone if we can be of assistance.

Remler facilities and production techniques frequently permit quotations at lower prices

Manufacturers of Communication Equipment
SINCE 1918

REMLER COMPANY, Ltd. • 2101 Bryant St., • San Francisco, Calif.

The energy flow into the oscillatory circuit per second is

$$\frac{\omega}{2\pi} JA \int_0^{2\pi/\omega} \sin \omega \left[t + \frac{l}{\sqrt{2e(V + A \sin \omega t)/m}} \right] dt$$

We are interested in the e.c.e., N , which now is the ratio of the energy of the electron stream which is absorbed by the oscillatory circuit, to the total energy brought in by the electron stream:

$$N = \left\{ \frac{\omega}{2\pi} A \int_0^{2\pi/\omega} \sin \omega \left[t + \frac{l}{\sqrt{2e(V + A \sin \omega t)/m}} \right] dt \right\} / V$$

and we are also interested in the reinforcement, E , which is the ratio of the energy introduced into the oscillatory circuit per period, to the existent energy in the oscillatory circuit:

$$E = \left\{ J \int_0^{2\pi/\omega} \sin \omega \left(t + \frac{l}{\sqrt{2e(V + A \sin \omega t)/m}} \right) dt \right\} / \frac{1}{2} CA$$

wherein C denotes the effective capacitance of the oscillatory circuit.

Results of the Calculations

In Fig. 3 are shown some curves which portray the energy loss of the electrons over the course of a period. This energy loss of the electrons is equal to the gain of the oscillatory circuit. Averaged over a period it is positive and equal to the difference of the positive and negative portions of the cross-hatched areas under the curves. The different curves in Fig. 3(a), (b),

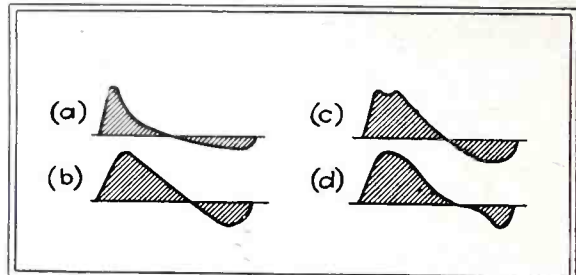

Fig. 3—Typical curves showing energy loss for a cycle of operation, for electrons in the region between B and D of Fig. 1. The various curves are for different amplitudes and cylinder voltages

(c), and (d) are for different values of amplitude A and of average cylinder potential V . Curve c represents the case of the maximum e.c.e. of 35 per cent. Curve d represents a special case in which the slowest electron remains three half periods within the cylinder, and the fastest remains one period.

We can build up a working diagram of the generator if we know the e.c.e. and reinforcement for all values of A and V . The e.c.e. and reinforcement have been calculated and are shown in Figs. 4, 5, 6, and 7.

In Fig. 4 the e.c.e. is shown in percentage as a function of A and V . In

10 KW!

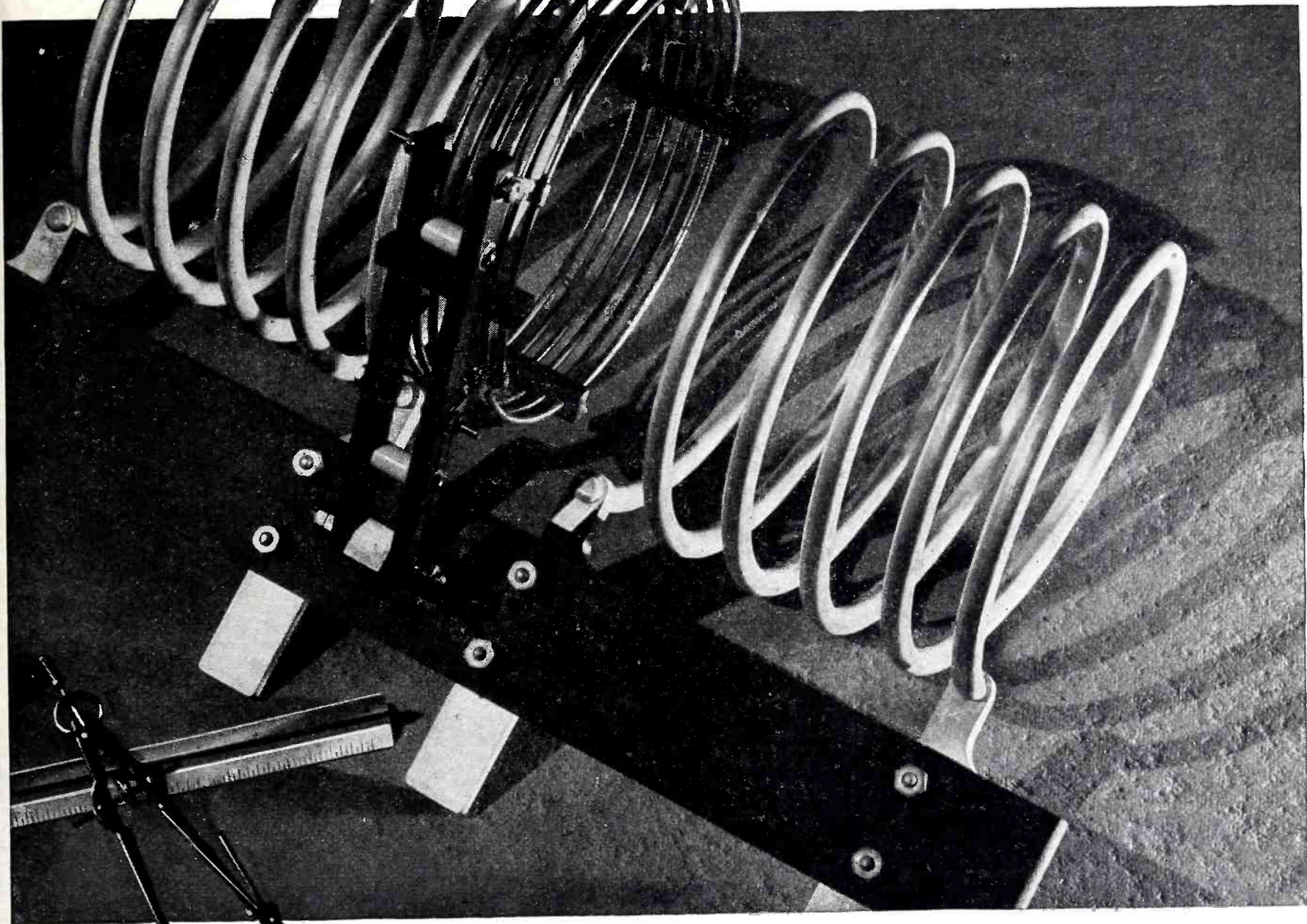

... a typical B & W high-power coil

Over 10" in diameter by 20" long, and designed for 10 KW. service, this variable-link final amplifier, plate coil, is a good example of B & W engineering at work on the job of matching modern inductor requirements. B & W Inductors of this general type are available in all standard frequency ranges. Coils are bolted in place, and may be switched for band-changing with a minimum of time and effort. Connections are silver-soldered,

and all metal parts, including coils, are heavily silver-plated. Coils in the unit illustrated are of $\frac{5}{8}$ copper tubing. Other B & W Air Inductors of this type utilize tubing as large as 1".

FAST DELIVERIES on all B & W Air Inductor types are assured by our greatly expanded facilities, and straight-line production on most smaller types. Engineering data on any type upon request.

BARKER & WILLIAMSON, 235 Fairfield Ave., Upper Darby, Pa.

Air Inductors

"BABIES AND JUNIORS" (25 to 75 watts)

STANDARD TYPES (100 watts to 1 KW.)

SPECIAL HIGH-POWER TYPES
(to 10 KW. and above)

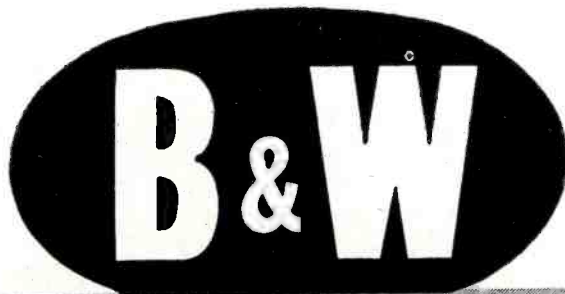

TURRETS — BAND HOPPERS —
SWINGING LINK ASSEMBLIES, ETC.
SPECIAL RADIO AND ELECTRONIC
EQUIPMENT ASSEMBLIES

Variable Air Condensers
(Integral neutralizing types)

MANUFACTURERS OF QUALITY ELECTRONIC COMPONENTS FOR OVER A DECADE

*Now—A Tiny Power Supply
Unit Weighing Only 34 Ounces*

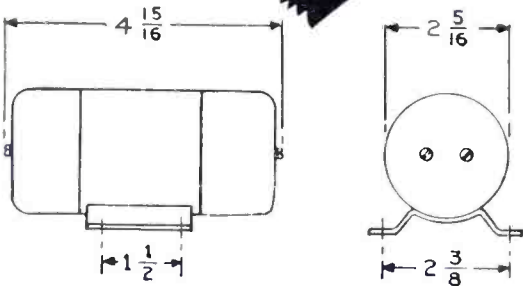

OUTPUT		INPUT		EICOR PART NO.
VOLTS	AMPS	VOLTS	AMPS	
200	.050	28	1.0	2316-21
		14	2.0	2316-22
150	.067	28	1.0	2316-23
		14	2.0	2316-24
100	.100	28	1.0	2316-25
		14	2.0	2316-26

Continuous duty. 50°C temperature rise.
Regulation 20% from no load to full load.

Here is Eicor's answer to your need for a power supply that is much smaller, much lighter, and completely dependable. This tiny Dynamotor is now available to manufacturers of electronic equipment for critical applications where space and weight requirements are of utmost importance.

SAMPLES AVAILABLE

Our specialized experience can be of help to you. Samples of this exclusive Eicor product in the types listed at left furnished quickly for development purposes on priority order.

Write, wire or phone

EICOR INC. 1501 W. Congress St., Chicago, U.S.A.
DYNAMOTORS • D. C. MOTORS • POWER PLANTS • CONVERTERS
Export: Ad Auriema, 89 Broad St., New York, U. S. A. Cable: Auriema, New York

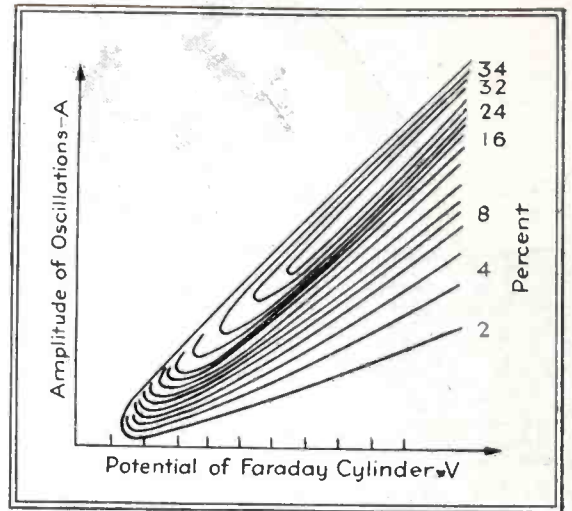

Fig. 4—Family of curves of amplitude of oscillation plotted against potential of Faraday cylinder, with various values of energy conversion efficiency as parameter

this representation the lines of equal e.c.e are shown as contours. A cross section through this mound for different values of V is shown in Fig. 5. The points through which the cuts were made are shown marked on the V -axis in Fig. 4. For the maximum values of the e.c.e.

$$e. c. e. e_{max} = \frac{v l}{\sqrt{2e V/m}} = 0.173$$

In Fig. 6 the reinforcement is represented by contours as a function of A and V . Figure 7 shows cross-sections through this surface for different values of V . The points through which the cuts were made are marked on the V -axis in Fig. 6. The reinforcement is here given only relatively. The actual value of the reinforcement for any particular condition may be obtained from

$$E = 4 \pi N V J / A^2 \omega C$$

Discussion of the Results

The course of the reinforcement determines the behavior of the generator. The condition for equilibrium is that for which the reinforcement is equal to the damping, wherein the damping includes both the useful, energy-conversion damping of the electron stream and the wasteful, inherent damping of the circuit elements. The useful damping is large compared with the inherent damping.

The requirement for stability is that $dE/dA < 0$. Oscillations cease whenever dE/dA becomes positive and the equilibrium

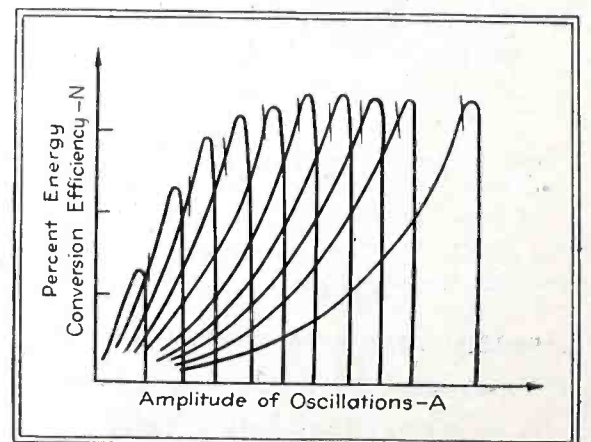

Fig. 5—Energy conversion efficiency, N , plotted against amplitude of oscillation for various values of voltage

FOUND: A NEEDLE IN A HAYSTACK IN 3 SECONDS FLAT!

Acres of ground and 5,000 men to cover... yet a key man is found as fast as you can say his name!

One man... a group... the entire plant... Straight-Line Communication reaches them **QUICKER** and **BETTER** than any other means.

Think of the manpower saved every day! Think of the increased efficiency... the increased production.

Then remember... in man-hours alone this system saves enough to pay for itself in an amazingly short time.

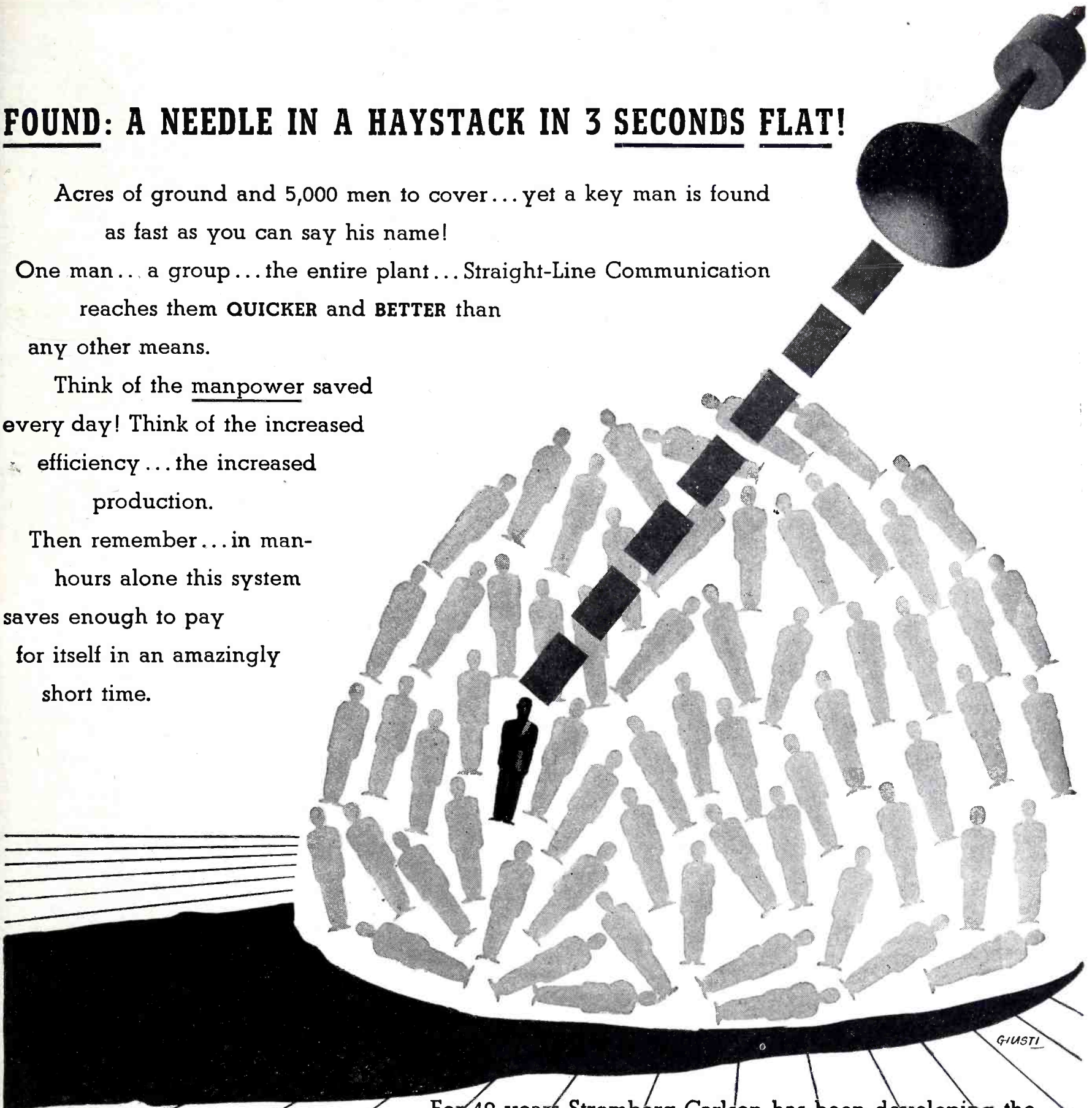

For 49 years Stromberg-Carlson has been developing the finest type of sound reproducing equipment. Today this equipment is playing a vital role in speeding plant production all over the country.

If you have any communication problem that needs solving... why not get in touch with the

Sound Systems Division of the Stromberg-Carlson Company,
100 Carlson Road, Rochester, New York. Write for free Booklet No. 1935.

STROMBERG-CARLSON



STRAIGHT-LINE COMMUNICATION SAVES MANPOWER • SPEEDS THE WORK TO VICTORY

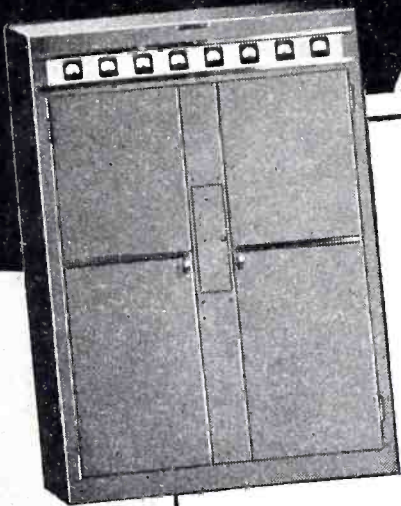
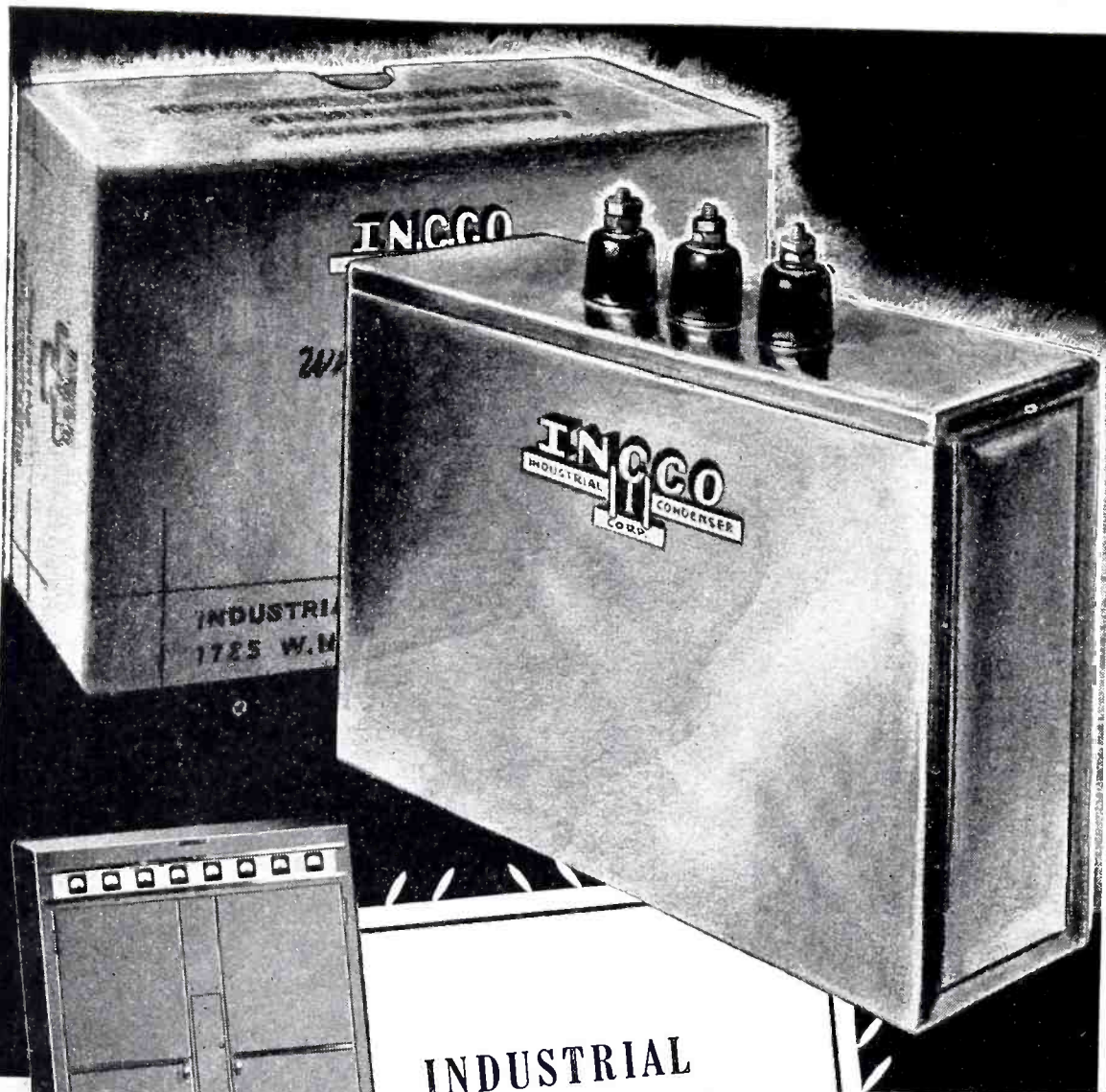

INDUSTRIAL
CONDENSERS
ARE IN
SERVICE THE
WORLD OVER
WITH —



WILCOX ELECTRIC
COMPANY

COMMUNICATIONS
EQUIPMENT

PAPER, OIL AND ELECTROLYTIC CAPACITORS

**INDUSTRIAL
CONDENSER
CORPORATION**

1725 W. NORTH AVE., CHICAGO, U. S. A.

DISTRICT OFFICES IN PRINCIPAL CITIES
QUICK DELIVERY FROM DISTRIBUTOR'S STOCKS

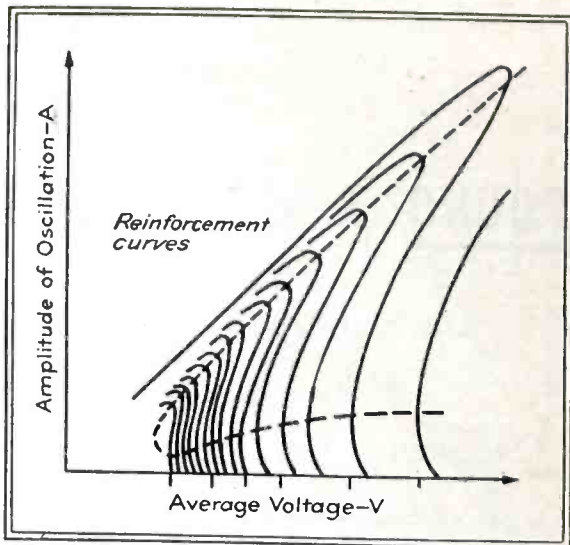

Fig. 6—Reinforcement, represented by contours as function of amplitude of oscillation, A , and voltage, V

condition is satisfied. The behavior of the generator may be deduced completely from these conditions and from the diagrams of Fig. 6 and Fig. 4.

With a particular arrangement it is possible to make V dependent on A through the use of the retarded electron stream. However, in general, V will be independent of A . For the latter case we get two regions of stable equilibrium in the A - V diagram, one for small amplitudes, which does not interest us, and one for large amplitudes. Both regions overlap in the range of small amplitudes and small voltages. The dotted line of Fig. 6 represents the boundary of these regions. In the middle region of the A - V diagram stable oscillations are possible. In this region the amplitude can increase in case the reinforcement exceeds the damping, or the amplitude can decrease in case the damping is equal to, or greater than, the reinforcement. The upper stable region contains the maximum of the e.c.e. The boundary of the stable domain is marked with strokes on the curves of Fig. 5. These markings correspond to the maxima of the associated curves in Fig. 7.

By way of example the behavior of the generator for constant V and variable load can be shown with the aid of Fig. 8. The two curves correspond to reinforcement and e.c.e. At small loads the generator action corresponds to the points a and a' respectively. With an increase of load the output climbs to the maximum of e.c.e. at points b' and b respectively, and falls again to the maximum of reinforcement at points c' and c respectively. At these last points the oscillations cease.

We can see also from Fig. 6 how the generator oscillates when it is first turned on. We first apply the operating voltages to all the electrodes except the cylinder. When the cylinder potential V is applied, it rises slowly because of the self-induction of the supply leads. The generator is in equilibrium at each moment of this potential rise. Since the damping remains always constant, the generator

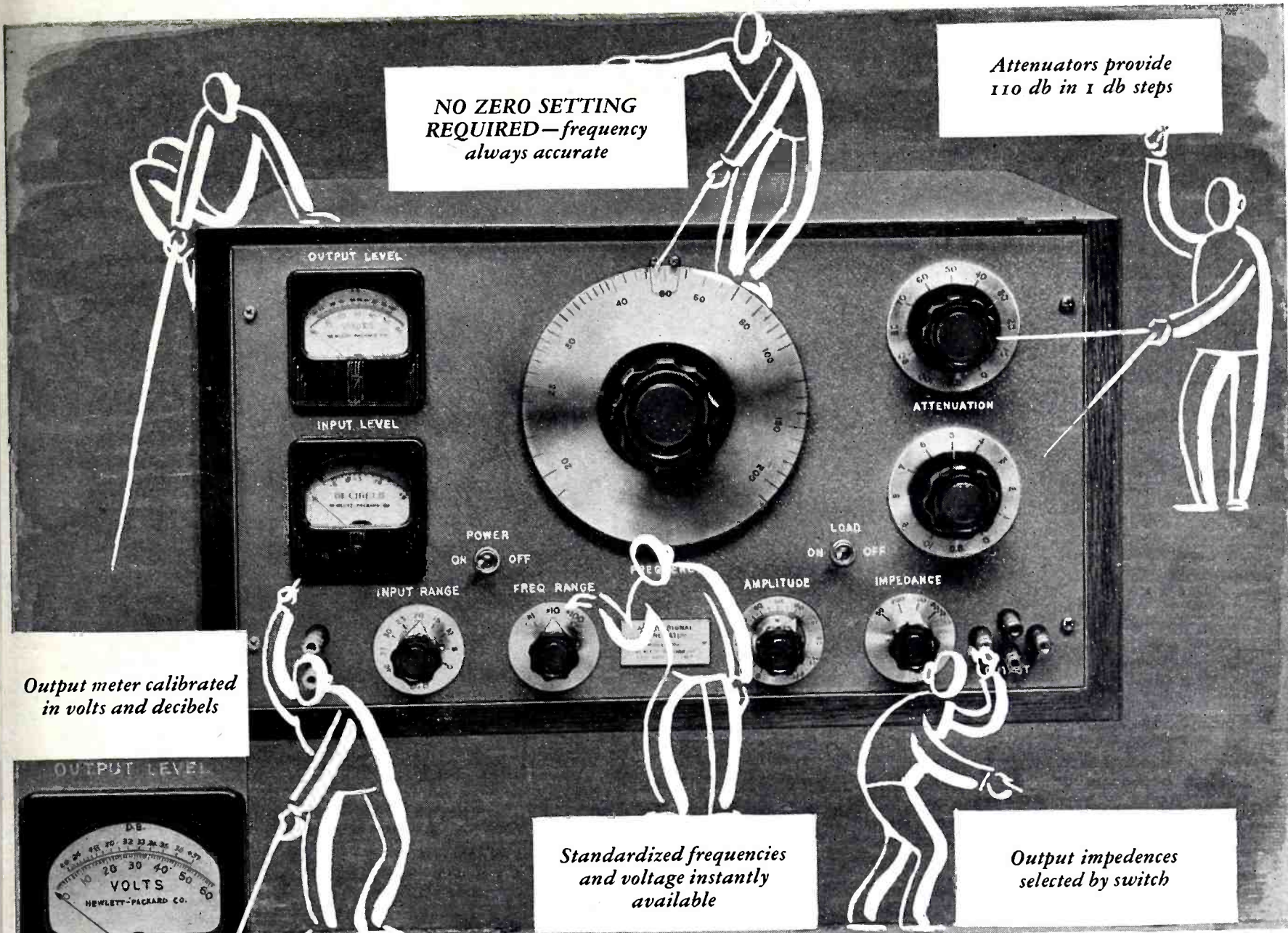

**NO ZERO SETTING
REQUIRED—frequency
always accurate**

**Attenuators provide
110 db in 1 db steps**

**Output meter calibrated
in volts and decibels**

**Standardized frequencies
and voltage instantly
available**

**Output impedances
selected by switch**

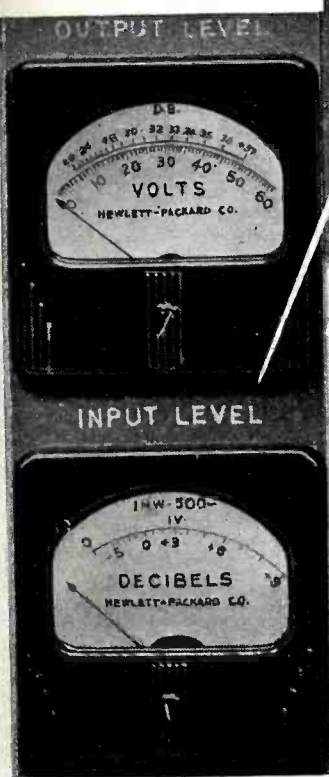

**Separate input meter
for making gain
measurements**



Six reasons why this AUDIO SIGNAL GENERATOR saves your time and insures better accuracy

This all-in-one combination of instruments insures the utmost of speed without sacrifice of accuracy in making certain laboratory and production measurements. The model 205AG consists of an *-hp-* Resistance Tuned Audio Oscillator, an output meter, attenuator and an impedance matching system. In addition a separate input meter is provided. Thus no auxiliary equipment is required in making gain measurements. It is ideal for general laboratory applications because it supplies a known voltage and a known frequency at the commonly used impedance levels.

Of outstanding importance is the fact that the Resistance Tuned Oscillator requires no zero setting. The frequency drift is negligible even during the first few

minutes of operation. The constant output of this oscillator makes it ideal for checking frequency response of apparatus. Waveform distortion is very small, hence this instrument provides an excellent source of voltage for distortion measurements.

Below is a block diagram showing the arrangement of the components in the Model 205AG Audio Signal Generator. Get full information about this and other *-hp-* laboratory instruments. Ask for your copy of the 26-page fully illustrated catalog which gives valuable data on making tests and measurements as well as details of the *-hp-* line of instruments.

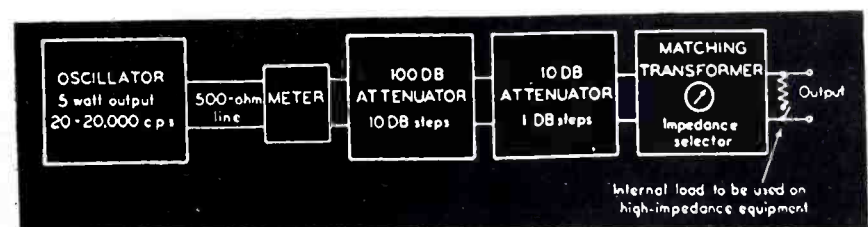

hp HEWLETT-PACKARD COMPANY

Box 1135 K Station A, Palo Alto, California

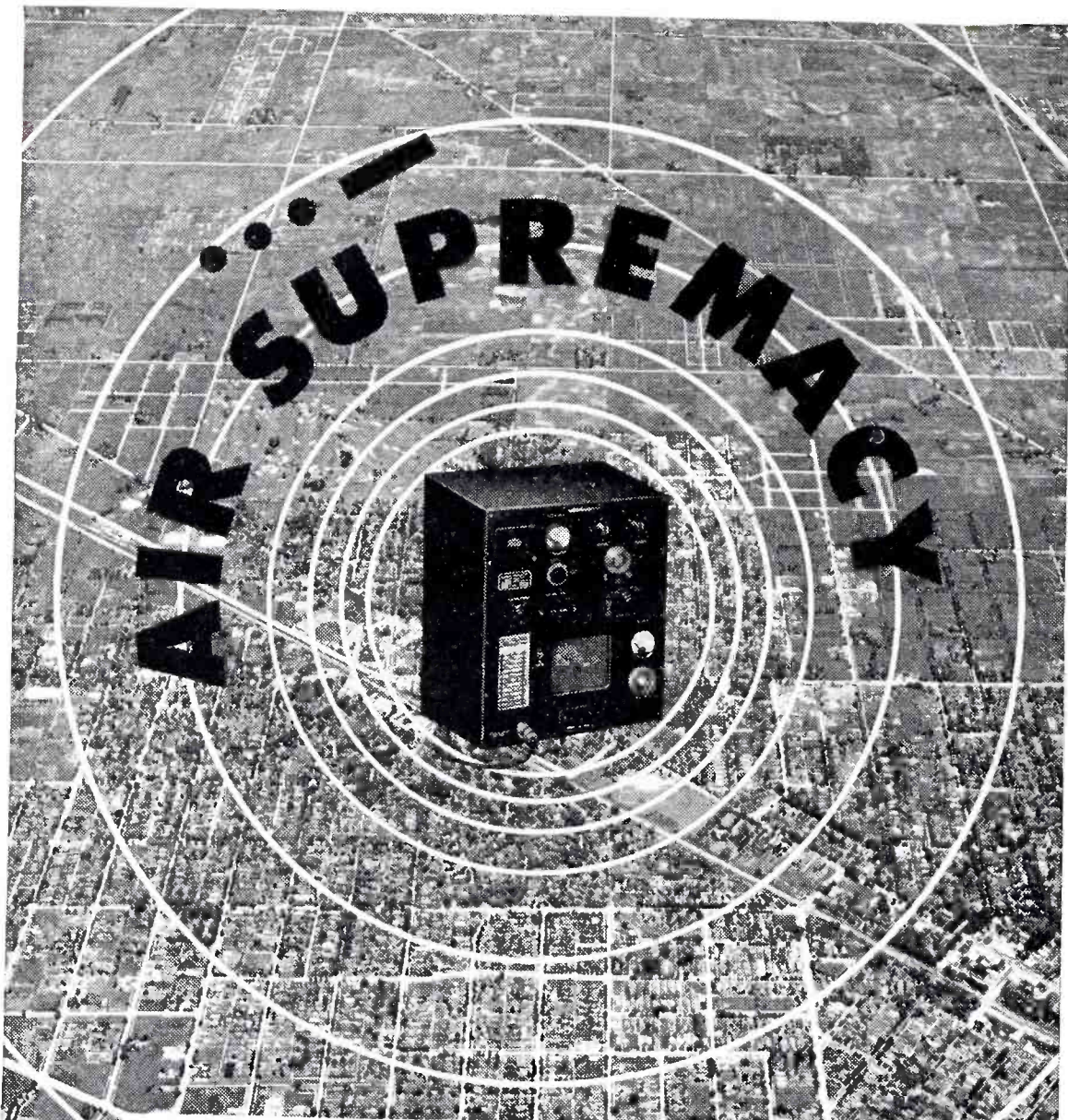

War's Test of Sentinel Radio Promises Superior New Merchandise

● America's domination of the air over many battle fronts is not only an aircraft achievement. Radio has played an outstanding part in flying successes—and to this Sentinel has contributed a tremendous volume of important equipment.

The new radios, radar, and electronic equipment to bear the Sentinel name after the war will reflect the extreme precision built into today's battle front models.

SENTINEL RADIO CORPORATION
2020 Ridge Ave., Evanston, Ill.

Sentinel RADIO

Quality Since 1920

FUTURE FEATURES:

are still a laboratory secret but we pledge, improved Performance, increased Value and Traditional Sentinel Quality

works along a curve of constant reinforcement, and actually upon the upper, almost straight, branch of the curve (Fig. 6). The oscillations begin to fall off only after V is raised up to the reversal point of this curve.

As a consequence of the linearity of the above mentioned curve branch one can, through variations of V , modulate the amplitude almost proportionately to V , i.e., almost without distortion.

The above described method of oscillation production has its limitations with respect to the shortness of the waves and with respect to the power output. The limitations are apparent:

(1) From the equation for the reinforcement, we have

$$E = \frac{\pi NVJ}{A^2 \omega C}$$

From the equation one observes the following: The reinforcement remains constant as the wavelength is reduced, only if at the same time the capacity is proportionally reduced and the magnitude of the electron current remains uniform. This means an increase of the electron current density which is proportional to the decrease in wavelength. Other conditions fixed, the capacity increases approximately in proportion to the electron stream cross-section. Thus we can produce shorter waves insofar as we are able to produce high electron current densities. We apply the usual methods of electron optics to achieve concentration of the beam.†

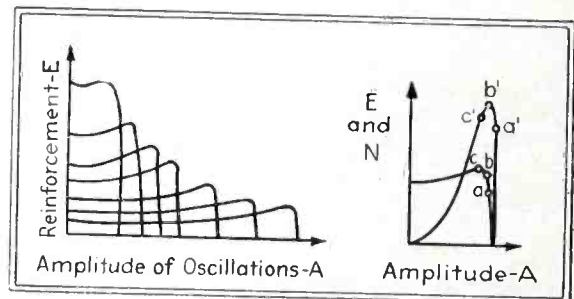

Fig. 7 (left)—Cross section through Fig. 6 for various values of voltage, V

Fig. 8 (right)—Energy conversion efficiency and reinforcement for two different conditions of load

(2) Another limitation is the condition that the reinforcement must be as large as possible compared with the inherent damping of the oscillatory circuit. The reinforcement must be as large as possible, the damping as small as possible. The inherent damping of the oscillatory circuit is composed of both ohmic damping and dielectric loss. The beam damping includes only the useful, energy-conversion damping. The ohmic resistance is minimized through the use of broad metal hoops or tubular metal hoops for self-induction. The dielectric loss is avoided by enclosing the oscillatory circuit entirely within the tube. Only experiment can show to what extent one can raise the electric density and reduce the inherent damping.

† See, for example, B. E. Brüche and O. Scherzer, *Geometrische Elektronenoptik*. Berlin, Julius Springer, 1934.

Announcing

A NEW LINE

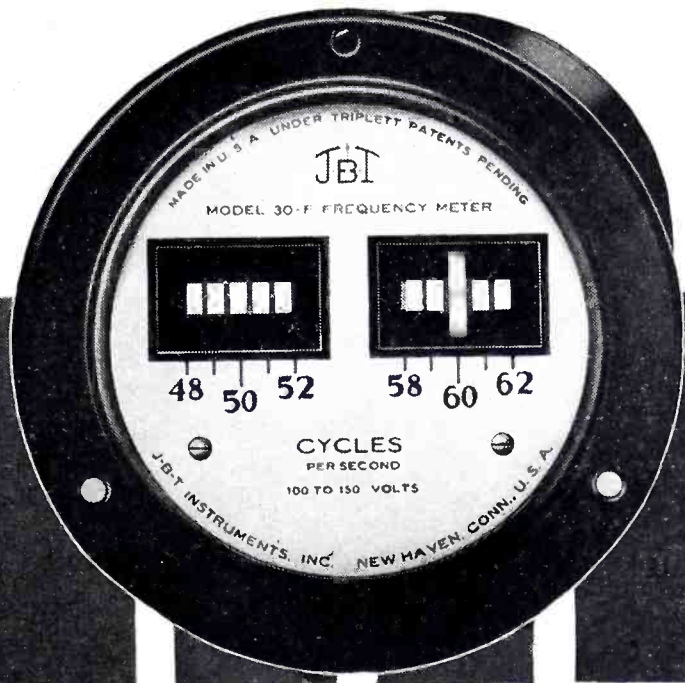

VIBRATING REED FREQUENCY METERS

Sturdy and Simple in Design, Permanently Accurate

Important new features of this line are—simplified construction, with fewer parts—individual reed activation so that the whole bank does not vibrate—great variety of cases and sizes. Vibrating reed type of frequency meter offers these advantages:

- easy to read
- needs no adjustment in service
- low in power consumption
- exceptionally accurate

- not affected by wave form
- not affected by normal temperature change or external magnetic fields

Available in full range of frequencies—full range of types and sizes—full or half-cycle increments—sharp or broad response—wide voltage range.



{Manufactured under Triplet Patents and/or Patents Pending}

Bulletin VF-43 just off the press. Write for your copy now.

JBI

INSTRUMENTS, INC.

441-H CHAPEL STREET • NEW HAVEN, CONNECTICUT

7-JBT-1

Standard or special, it's right

if it's a **Newark**
TRANSFORMER



Type P
Two to three phase insulating transformer, 1.0 to 10 kva. Also auto transformer, 1.0 to 25 kva.

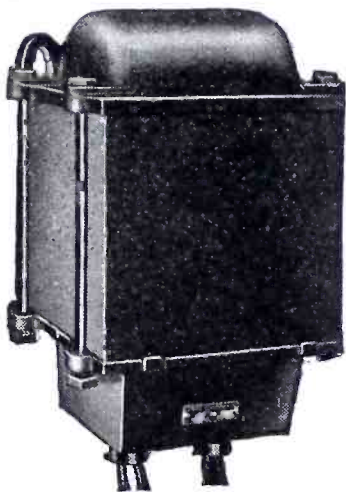

Type N
Single phase insulating transformer, 0.050 to 7.5 kva. Auto transformer, 0.250 to 15 kva.

Twenty successful years at designing and building transformers, are represented in every transformer you order from "Newark". They've got to be good.

A fair stock of components enables us to produce standard dry type transformers for reasonable delivery dates—perhaps sooner than you may expect. Check on this.

A broad knowledge of manufacturing expedients aids us in getting out special transformers to your specifications. "Newark" has made a real reputation along this line. We tame tough transformer troubles.

Dry type transformers in standard or special types, using components of proven correctness and quality, in capacities from 1 to 150 kva. 'Phone, wire or write. Bulletins on request.

Newark

TRANSFORMER CO.
17 FRELINGHUYSEN AVE.
NEWARK, NEW JERSEY

*Our Subcontract Division
can help your production*

Experienced engineers, skilled operators, machines and floor space—ready to jump in on your subcontract work. Established long before Pearl Harbor, this division has hung up new production records on general manufacturing as well as electrical work. 'Phone us—**BIGELOW 3-5600.**

NEWARK TRANSFORMER CO., 17 Frelinghuysen Ave., Newark, N. J.

The time of approach and of recession of the electrons to and from the Faraday cylinder was not considered in the theory. Likewise the force of the exterior field of the Faraday cylinder was neglected. An investigation leads to the following: The effect of the exterior field is as though the distances of approach and of recession of the electrons were greater. The approach and recession times cause:

1. An apparent increase in l . This apparent increase in l is greater for slow electrons than for fast electrons. The time of flight of the slow electrons is consequently increased more than that of the fast ones. This can be made to aid the e.c.e. by proper dimensioning.

2. A "washing out" of the electron velocities. The electrons do not have the velocities which correspond to the existing entrance potential. The velocities correspond more nearly to an unsymmetrically flattened sine curve. With correct dimensioning this too makes for an enhanced e.c.e., since a larger part of those electrons which enter the Faraday cage in the negative half period leave it during the positive voltage maximum. The diagrams of Fig. 4 to 7 are somewhat in error because these factors have been neglected; however, the essential features of the diagrams are correct.

Design Considerations

To reduce energy losses in the connections one should use two systems working in reciprocal fashion within a single chamber. A section through such an arrangement is shown in Fig. 9. Both electrodes C are joined to one another through a self-induction loop. The voltage connection must tie into the midpoint of this loop. The passage from electrode B to C and from C to D acts as a convergent lens on the electron stream and increases the electron concentration. Toward this end one can apply the usual Braun tube technique of gas concentration.‡

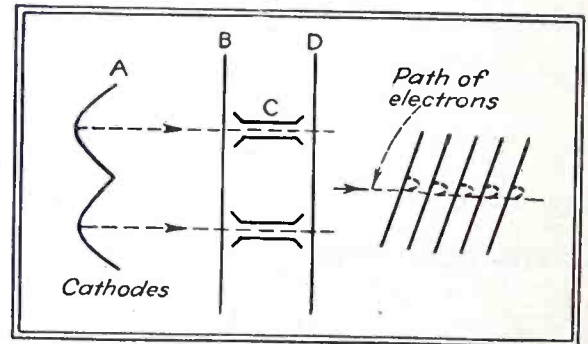

Fig. 9 (left)—Double system of electrodes in parallel to reduce losses

Fig. 10 (right)—Path of electrons (dotted) between inclined metal plates for slowing and collecting electrons

The electron stream on leaving electrode D includes electrons of various velocities. With an arrangement as shown in Fig. 10 one can slow the electrons down in steps and collect them.

‡ See previously cited references to K. Kohl and H. E. Hollman.



and women
MEN AT WORK

WINNING a war is not an easy job. Victory goes to the side that *fights* harder, and *works* harder. ★ From all reports our fighting men will stand up to anybody, anywhere. It is our job, here at home, to prove that we can work as hard as they can fight. ★ The way the women of America have accepted this responsibility is worthy of tribute. Here at Simpson much of our *manpower* has changed to *womanpower*—good soldiers all, taking the place of husbands, brothers and sweethearts. ★ Like all men and women in American industry, we know but one resolution—to make *all* the electrical instruments and testing equipment we can, the *best* we can, as *fast* as we can.

SIMPSON ELECTRIC CO.
 5200-5218 Kinzie Street, Chicago, Illinois

Simpson

INSTRUMENTS THAT STAY ACCURATE

Buy War Bonds and Stamps for Victory

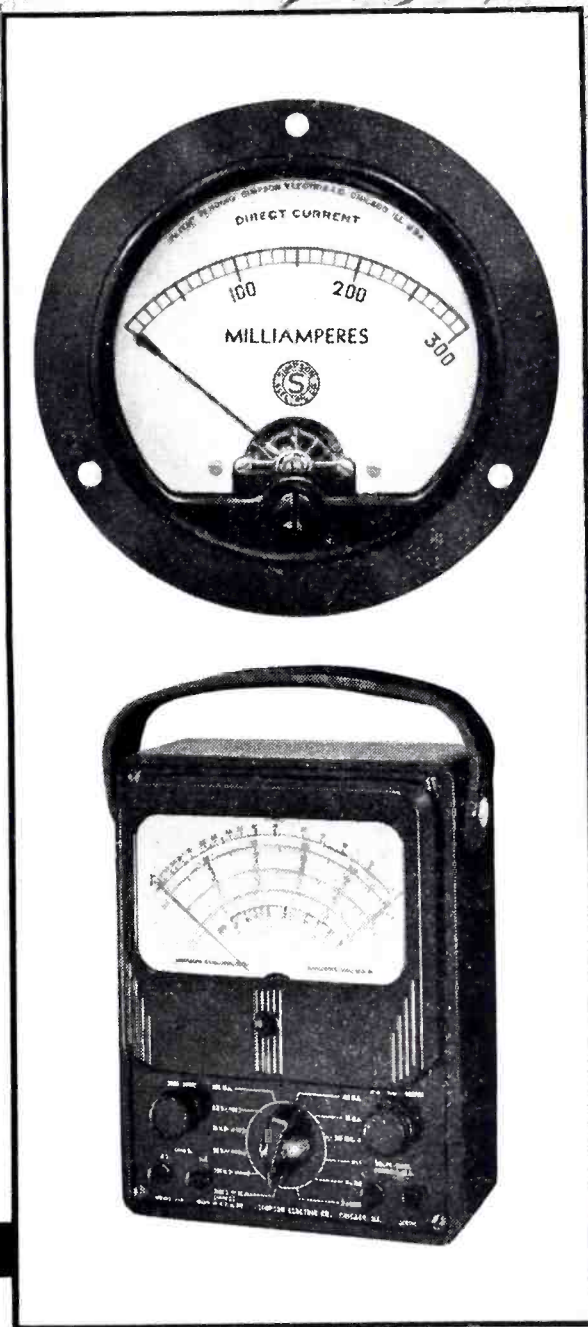

She Doesn't Wear
a Uniform . . . but,



She's a Soldier, too!

. . . . helping win the war!

She and several hundred others here at Scientific Radio Products Co.

They're turning out the perfect crystals that put life into the radio equipment of our armed forces,—and keep alive the vital communications on which depend the very lives of our armies.



Temperature co-efficient testing is an important job! Crystals must perform perfectly in all degrees. Fighting men depend on our accuracy!

With two ingredients . . . loyalty plus skill . . . they're forming crystals that are dependable.

Although we're busy with Uncle Sam's needs right now, our facilities are such that we can take care of your requirements, too!

Write us.



E. M. SHIDELER—W9IFI



LEO MEYERSON—W9GFQ

Scientific **RADIO PRODUCTS CO.**

738 W. Bdwy.

LEO MEYERSON W9GFQ
E. M. SHIDELER W9IFI

Council Bluffs, Iowa

MANUFACTURERS OF PIEZO ELECTRIC CRYSTALS AND ASSOCIATED EQUIPMENT

A system of parallel metallic plates is mounted somewhat inclined to the direction of the electron stream. From left to right the plates are maintained increasingly negative in steps. The dotted lines show the tracks of the electrons of different velocities. One could also permit the electrons to fall with full velocity onto a water-cooled electrode. The principal concern is, however, that the development of heat from the electron bombardment takes place sufficiently far from the small oscillating electrodes.

Let us give just one example in conclusion. Suppose that within one tube we maintain two concentrated electron streams of 50 milliamps each. The potential of the accelerating electrodes is 10,000 volts, that of the two oscillating electrodes, 4000 volts. The electron stream has an operating energy of 100 milliamperes \times 4000 volts, or 400 watts. With an e.c.e. of 35 percent we would get 140 watts oscillatory power output. One can count on 25 percent e.c.e. in practice. This means an output of 100 watts. Length of the Faraday cylinder figures about 5 mm for a 20-cm wave.

. . . .

Photoelectric Timer Controls X-ray Film Exposure

AN ELECTRON MULTIPLIER phototube, a thyratron and several ignitrons in a simple electronic circuit make correct exposure of x-ray film an entirely automatic process. Calculations, technical factors, critical adjustments of x-ray tube voltage and adjustments of mechanical or motor-driven timing mechanisms are entirely eliminated.

The photoelectric timing mechanism utilizing this arrangement was developed by Dr. Russell H. Morgan of the Division of Roentgenology of the University of Chicago, and is described by him in the *American Journal of Roentgenology and Radium Therapy*, Vol. 48, No. 2. It is essentially a modification of the x-ray exposure meter which he previously developed^{1, 2}, providing automatic control features rather than a meter indication.

It is highly essential in the production of diagnostically excellent radiographs that the method by which exposure is determined be consistently reliable. The principal guides are measurements of the thickness of the anatomical structure under examination and occasionally the age and weight of the patient.

X-ray Exposure Meter

The first step in mechanization of this important process was the de-

REA

MAGNET WIRE HEADQUARTERS

BARE AND ALL INSULATIONS

SILK COTTON
PAPER FORMVAR
ENAMELED

REA MAGNET WIRE COMPANY
FORT WAYNE, INDIANA

WITH VICTORY AT STAKE THE BEST IS NONE TOO GOOD!



Available in sizes up to 75 KVA

Large amounts of POWER can now be controlled by a push button or automatic device

Choose POWERSTAT MOTOR DRIVEN VARIABLE TRANSFORMERS for control. When regulation of voltage, current or power is necessary in your design, POWERSTATS are the answer to your most rigid specifications. This equipment is an engineered combination of a POWERSTAT VARIABLE TRANSFORMER and a highly damped low speed motor of advanced design.

for

- SMOOTH STEPLESS CONTROL
- EXACTING CORRECTION
- FREEDOM FROM OVERSHOOTING
- ZERO WAVE FORM DISTORTION
- CONNECTION TO AUTOMATIC OR PUSH
BUTTON CONTROL STATIONS
- GOOD REGULATION WHERE OUTPUT IS TO BE
INDEPENDENT OF LOAD AND POWER FACTOR

SELECT

POWERSTAT MOTOR DRIVEN VARIABLE TRANSFORMERS

Send for POWERSTAT Bulletin No. 149 LE and
Automatic Voltage Regulator Bulletin No. 163 LE.

SUPERIOR ELECTRIC CO.
39 LAUREL ST. BRISTOL, CONN.

velopment of the exposure meter. This is similar in basic design to photographic exposure meters of the photoelectric type. The glass envelope of a phototube is coated with a fluorescent material, and its output is fed through an amplifier to a microammeter. The phototube assembly is placed underneath the structure to be studied, an x-ray beam is projected through the structure, and the meter deflection is observed. The meter scale can be calibrated directly in terms of exposure time.

One objection to the meter is the need for two exposures, one for taking the reading and the other for exposing the film. The newly developed phototimer completely eliminates this objection by checking exposure time concurrently with exposure of the film, and shutting off the machine automatically when the proper quantity of radiation has been delivered to the film.

Basic Arrangement of Timer

The basic components of the phototimer are designated in Fig. 1. When the x-ray machine switch is closed, a roentgen beam passes through the patient, exposes the film, and excites the fluorescent screen. The resulting light, proportional to the intensity of the radiation passing through the film, is picked up by the phototube and converted into a voltage which charges a capacitor.

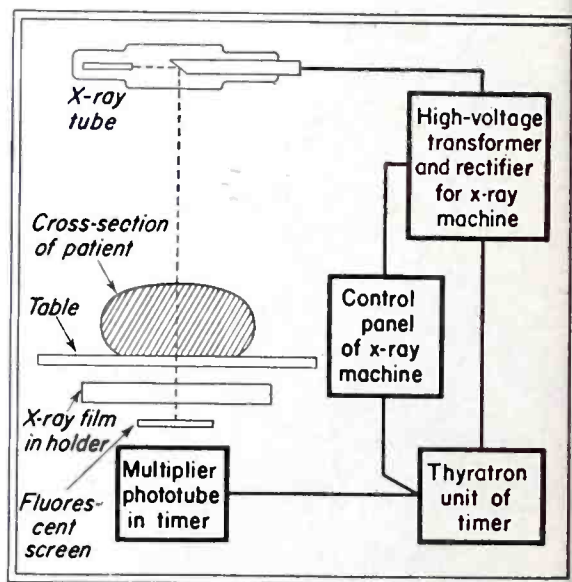
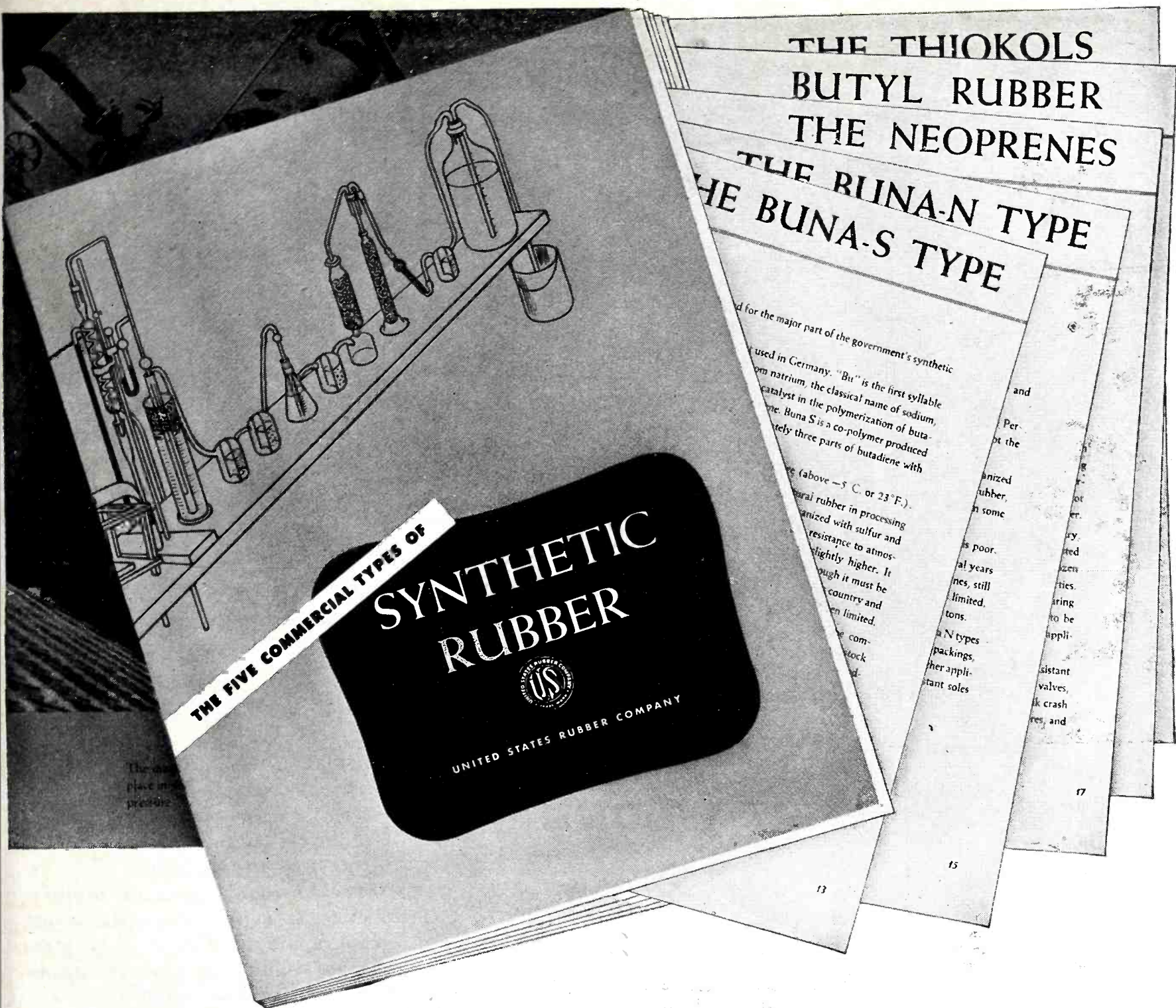

Fig. 1—Block diagram of electronic method for securing correct exposure of x-ray film automatically

When the capacitor voltage reaches a predetermined level, it triggers off a thyatron, which in turn energizes relays which turn off the x-ray machine, terminating the exposure.



WHAT IS SYNTHETIC RUBBER? HOW IS IT MADE? WHERE IS IT USED? HOW DOES IT COMPARE WITH NATURAL RUBBER? *You'll find the answers in this new book*

As the supply of natural rubber diminishes, undoubtedly more and more mechanical goods will be made of synthetic rubber... hose, belts, packings, molded goods, tank linings, and other rubber products used by industry.

Having worked in the field of synthetic rubber for more than twenty years, we know what each of the five types will do; what chemicals such as sulfur, carbon-black, or ultra-accelerators must be added,

and how to compound them. We work with all five types; use the type available that is best suited for the purpose.

You can get an over-all picture of the properties and characteristics of synthetic rubber in the new book recently published by United States Rubber Company. A request for "The Five Commercial Types of Synthetic Rubber" made on your company letterhead will be filled promptly. Address your letter to Dept. 5.

UNITED STATES RUBBER COMPANY

Listen to the Philharmonic Symphony program over the CBS network, Sunday afternoon 3:00 to 4:30 E. W. T. Carl Van Doren and a guest star present an interlude of historical significance.

1230 SIXTH AVENUE • ROCKEFELLER CENTER • NEW YORK
IN CANADA: DOMINION RUBBER COMPANY, LTD.



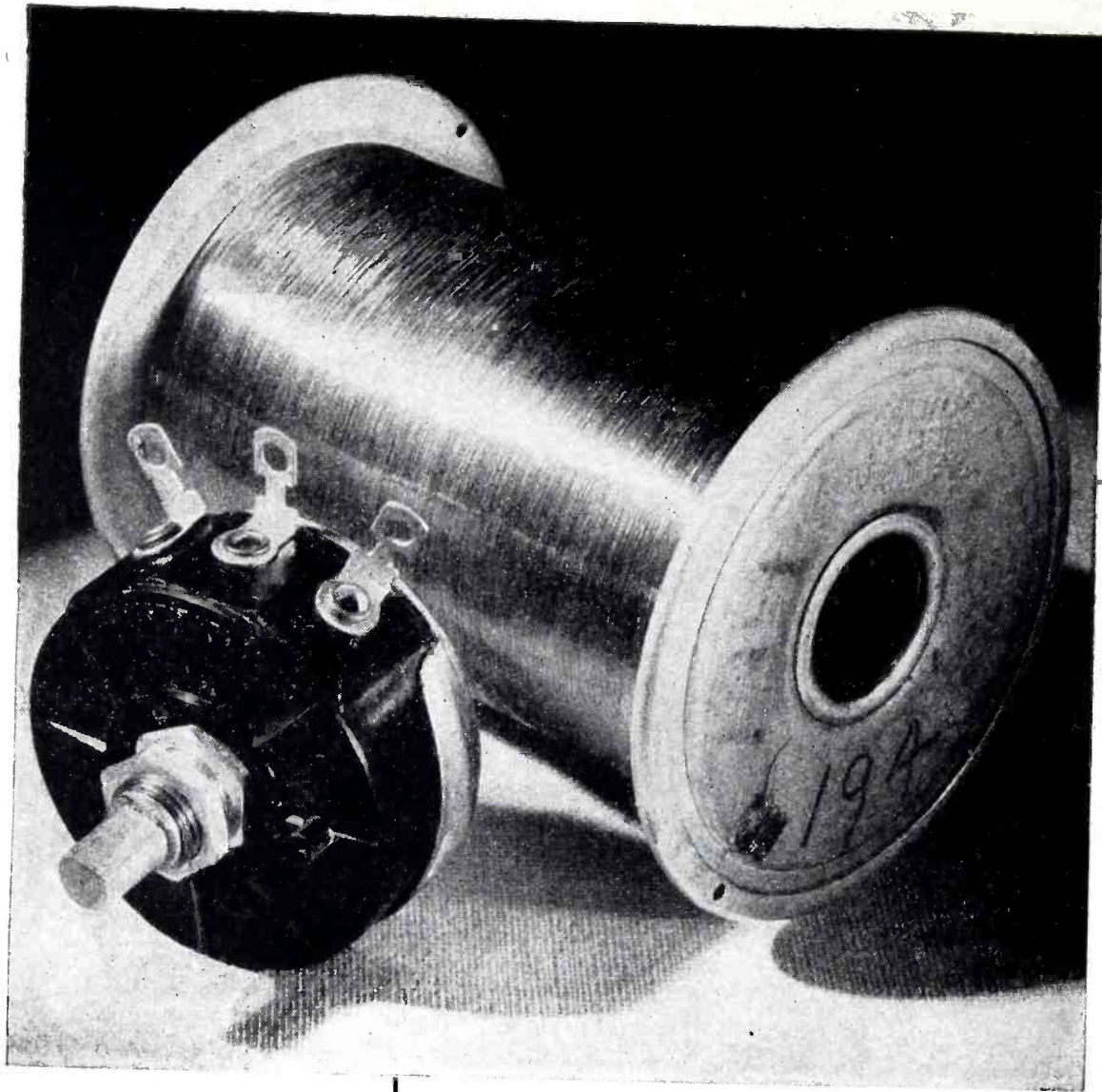

Wire-wound rheostats and potentiometers Type 58 shown above. 1 to 100,000 ohms. Choice of tapers. Linear, rated at 3 watts; tapered, 1.5 and 2 watts.

★

Multiple controls up to 20 units in tandem. Single shaft locks with rotor of each control. Interlocking resistance ratios provide any desired voltage or current at given degree of rotation, for each circuit.

★

Power rheostats in 25- and 50-watt ratings. 0.5 to 10,000 ohms. Exceptionally rugged. Normal current may be exceeded by 50% at any setting up to 1/3 rotation. Also available in tandem combinations. Special units made in strict accordance with Army and Navy Air Force specifications. Enclosed or armored units.

★

Also other types of wire-wound controls, standard and special, to meet all needs.

WIRE-WOUND

Controls

★ A 300% increase in winding capacity! This feature of Clarostat's recent production expansion climaxed by the opening of a second plant, is a vital contribution to the war effort. Please bear this wire-winding capacity in mind in connection with your high-priority requirements.

And remember also that for the past two decades Clarostat engineers have designed, built and steadily refined their *exclusive* winding machines. Marvels of mechanical ingenuity, these machines produce those precise windings of uniform or variable pitch; those round, square or flat windings; those tricky multiple-tapped windings; those high-ohmage windings requiring wire even as fine as .0009" (nine ten-thousandths—finer than human hair). All of which explains why most *really tough* control jobs usually come to Clarostat.

★ *Send Your Problem . . .*

If it deals with adjustable or fixed resistance send it to us for engineering collaboration, specifications, quotations. Literature on request.

CLAROSTAT



Controls and Resistors

CLAROSTAT MFG. CO., Inc. · 285-7 N. 6th St., Brooklyn, N. Y.

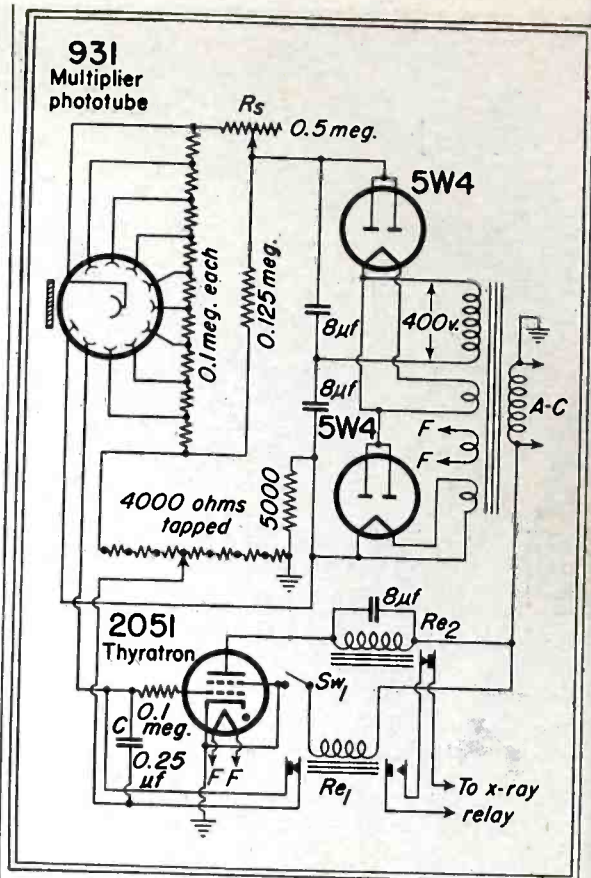

Fig. 2—Complete phototimer circuit

The original article develops the equation for proper exposure of the film. This is $CV/k = a_c$, where k is a constant depending upon phototube sensitivity, a_c is a constant depending on the speed of the film emulsion, C is the capacitance and V is the voltage across the capacitor.

The current output of ordinary phototubes is so small under roentgenographic conditions that stray charges collected through the insulation of the phototube and wiring system and from the control grid of the thyatron can become an appreciable portion of the total charge reaching the capacitor and can hence make the phototimer act prematurely. The multiplier phototube eliminates this difficulty, giving a current output of several microamperes when activated by the radiation intensities employed^{3,4}.

Analysis of Complete Circuit

The schematic diagram of the complete phototimer circuit is given in Fig. 2. The type 931 multiplier phototube contains nine dynodes in addition to the conventional photocathode and anode. The number 9 dynode is employed as the control electrode of the circuit in place of the anode, because the charge delivered to capacitor C by the anode would be of the wrong polarity to activate the thyatron. Although the potential of this dynode with respect to the photocathode increases as the capaci-



HORN- TOOTING

We have never boasted of our accomplishments. We knew we were doing a good job . . . our customers knew it, too.

The smaller, but paradoxically more publicized division of our organization, was devoted to the manufacture of **FEDERAL ENLARGERS** . . . precision optical and mechanical instruments for the photographic market. The major portion of Federal facilities has been serving the Signal Corps and leading radio equipment manufacturers for more than fifteen years.

Came Pearl Harbor . . . and our **entire** productive capacity immediately was placed at the disposal of the Armed Forces. With justifiable pride we can say that we were among the first to receive the coveted Army-Navy "E".

With production efficiently geared, we are now sufficiently far ahead of all current schedules to permit us to solicit additional contracts. We invite orders for the manufacture of large and small assemblies to precise tolerances . . . electrical and mechanical.

At this time, would an occasional "horn toot" be excusable?

FEDERAL

Electronics

Division of

FEDERAL MANUFACTURING AND ENGINEERING CORPORATION

Manufacturers of FEDERAL ENLARGERS

209 Steuben Street

Brooklyn 5, New York

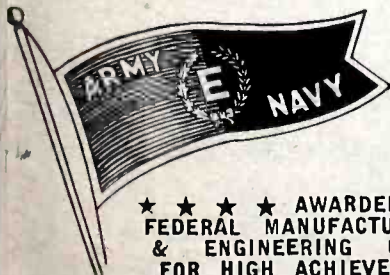

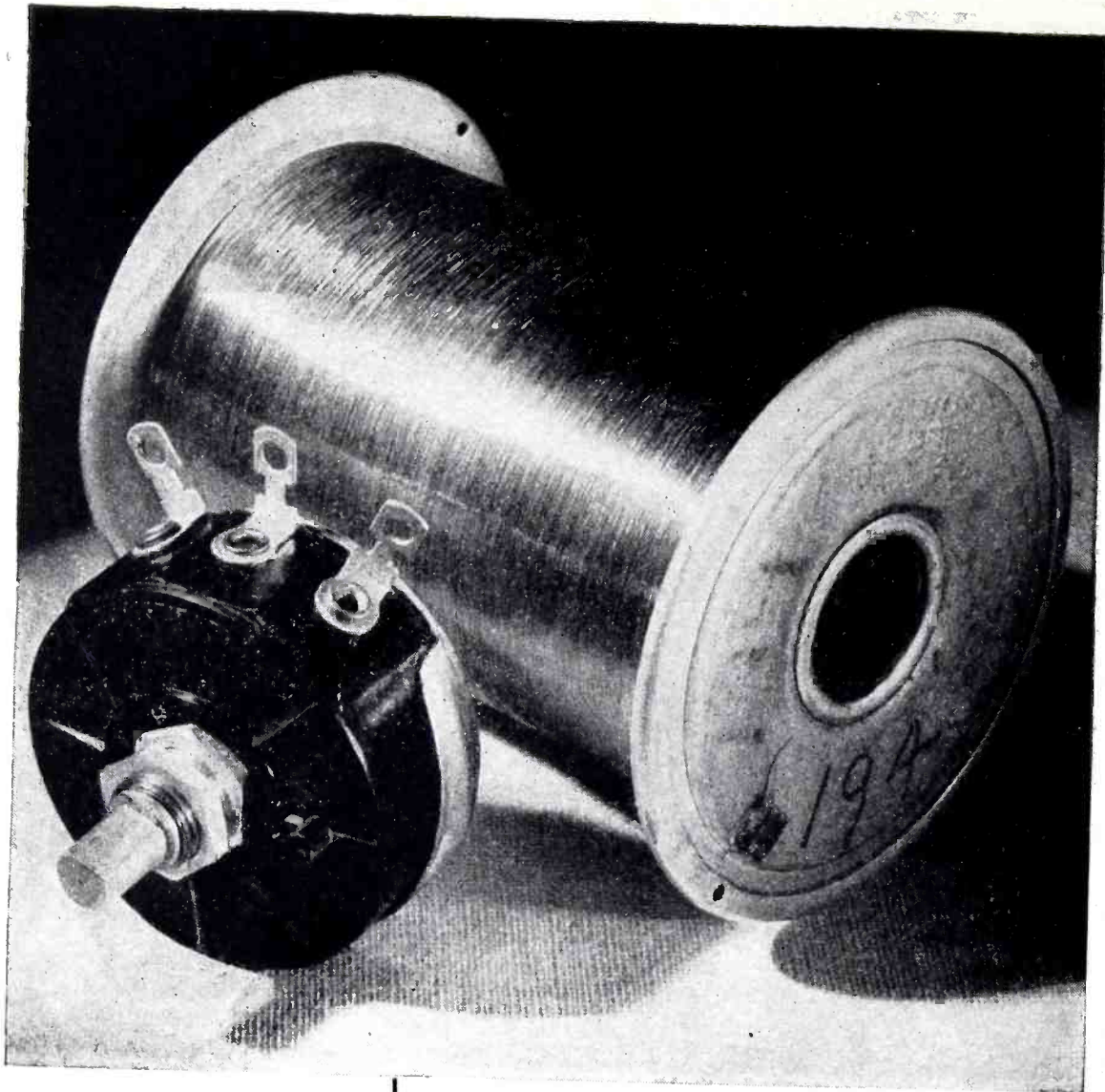

Wire-wound rheostats and potentiometers Type 58 shown above. 1 to 100,000 ohms. Choice of tapers. Linear, rated at 3 watts; tapered, 1.5 and 2 watts.

★

Multiple controls up to 20 units in tandem. Single shaft locks with rotor of each control. Interlocking resistance ratios provide any desired voltage or current at given degree of rotation, for each circuit.

★

Power rheostats in 25- and 50-watt ratings. 0.5 to 10,000 ohms. Exceptionally rugged. Normal current may be exceeded by 50% at any setting up to 1/3 rotation. Also available in tandem combinations. Special units made in strict accordance with Army and Navy Air Force specifications. Enclosed or armored units.

★

Also other types of wire-wound controls, standard and special, to meet all needs.

WIRE-WOUND

Controls

★ A 300% increase in winding capacity! This feature of Clarostat's recent production expansion climaxed by the opening of a second plant, is a vital contribution to the war effort. Please bear this wire-winding capacity in mind in connection with your high-priority requirements.

And remember also that for the past two decades Clarostat engineers have designed, built and steadily refined their *exclusive* winding machines. Marvels of mechanical ingenuity, these machines produce those precise windings of uniform or variable pitch; those round, square or flat windings; those tricky multiple-tapped windings; those high-ohmage windings requiring wire even as fine as .0009" (nine ten-thousandths—finer than human hair). All of which explains why most *really tough* control jobs usually come to Clarostat.

★ *Send Your Problem . . .*

If it deals with adjustable or fixed resistance send it to us for engineering collaboration, specifications, quotations. Literature on request.

CLAROSTAT



Controls and Resistors

CLAROSTAT MFG. CO., Inc. • 285-7 N. 6th St., Brooklyn, N. Y.

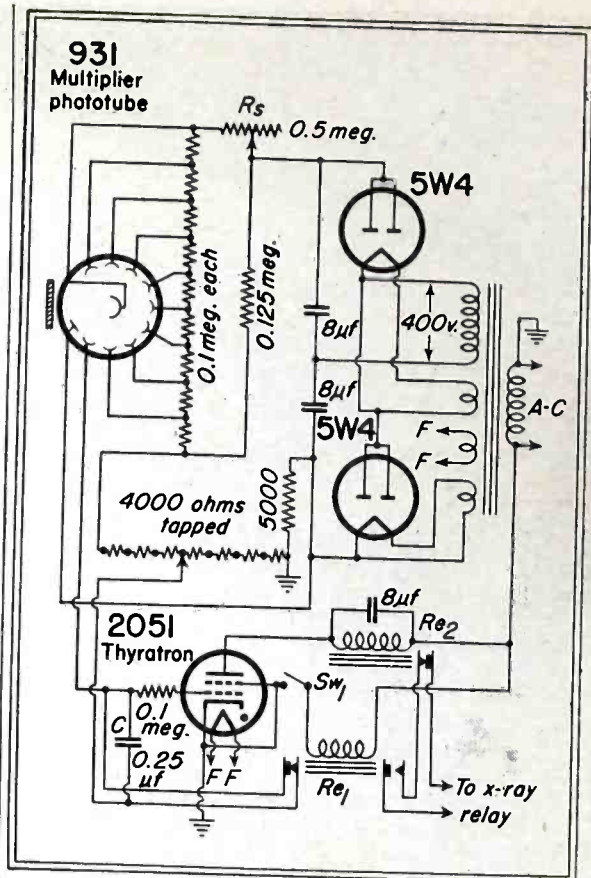

Fig. 2—Complete phototimer circuit

The original article develops the equation for proper exposure of the film. This is $CV/k = a_c$, where k is a constant depending upon phototube sensitivity, a_c is a constant depending on the speed of the film emulsion, C is the capacitance and V is the voltage across the capacitor.

The current output of ordinary phototubes is so small under roentgenographic conditions that stray charges collected through the insulation of the phototube and wiring system and from the control grid of the thyratron can become an appreciable portion of the total charge reaching the capacitor and can hence make the phototimer act prematurely. The multiplier phototube eliminates this difficulty, giving a current output of several microamperes when activated by the radiation intensities employed^{3,4}.

Analysis of Complete Circuit

The schematic diagram of the complete phototimer circuit is given in Fig. 2. The type 931 multiplier phototube contains nine dynodes in addition to the conventional photocathode and anode. The number 9 dynode is employed as the control electrode of the circuit in place of the anode, because the charge delivered to capacitor C by the anode would be of the wrong polarity to activate the thyratron. Although the potential of this dynode with respect to the photocathode increases as the capaci-



HORN- TOOTING

We have never boasted of our accomplishments. We knew we were doing a good job . . . our customers knew it, too.

The smaller, but paradoxically more publicized division of our organization, was devoted to the manufacture of **FEDERAL ENLARGERS** . . . precision optical and mechanical instruments for the photographic market. The major portion of Federal facilities has been serving the Signal Corps and leading radio equipment manufacturers for more than fifteen years.

Came Pearl Harbor . . . and our **entire** productive capacity immediately was placed at the disposal of the Armed Forces. With justifiable pride we can say that we were among the first to receive the coveted Army-Navy "E".

With production efficiently geared, we are now sufficiently far ahead of all current schedules to permit us to solicit additional contracts. We invite orders for the manufacture of large and small assemblies to precise tolerances . . . electrical and mechanical.

At this time, would an occasional "horn toot" be excusable?

FEDERAL

Electronics

Division of

FEDERAL MANUFACTURING AND ENGINEERING CORPORATION

Manufacturers of FEDERAL ENLARGERS

209 Steuben Street

Brooklyn 5, New York





Keep 'Em Running FOR THE DURATION!

It is difficult to secure new Generating Sets or new Rotary Converters... Pioneer is devoting all of its resources toward winning the war... but we can, and will, help you keep your present equipment running for the duration. Send your service problems, by letter, to Pioneer's Customer Service Department.

DYNAMOTORS · CONVERTERS · GENERATORS · DC MOTORS · POWER PLANTS
GEN-E-MOTORS

PINCOR Products

CHICAGO, ILLINOIS · EXPORT ADDRESS: 25 WARREN STREET, NEW YORK CITY
CABLE ADDRESS: SIMONTRICE, NEW YORK CITY

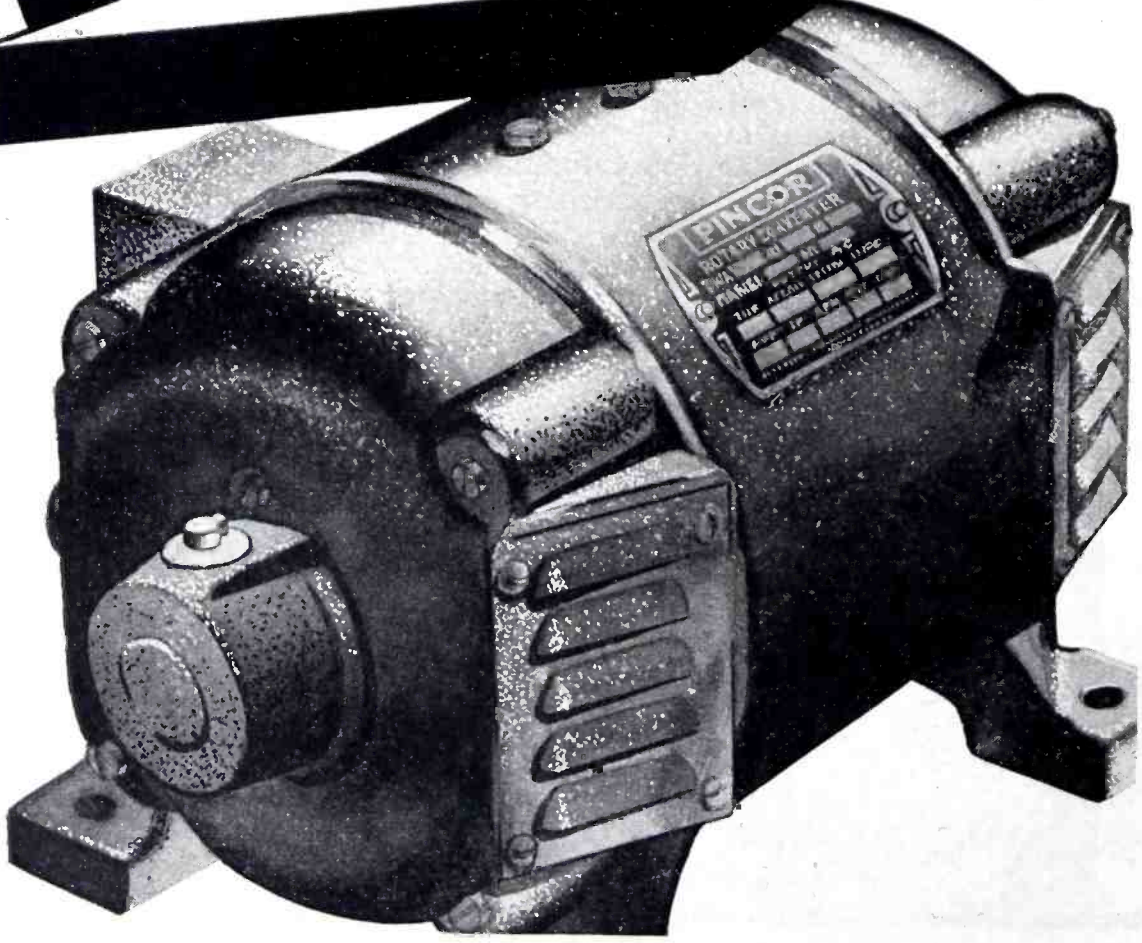

tor becomes charged, this does not appreciably change the sensitivity of the phototube over the normal operating range.

Operating potentials for the phototube and for the grid of the thyatron are provided by a voltage-doubling circuit using two 5W4 tubes fed by the 400-volt secondary of the power transformer. It is desirable to connect the primary of this transformer to a stabilized 115-volt a-c source, such as the primary filament circuit of the x-ray machine. The same source may also provide plate voltage for the thyatron, which is self-rectifying.

The timing mechanism controls the x-ray machine through the two relays, Re_1 and Re_2 . After a film has been inserted in the film tray and the patient has been properly positioned, the machine is adjusted to any reasonable voltage for the anatomical structure under examination, potentiometer R_s is set to the speed number of the film to be exposed, and starting switch Sw_1 is closed. This energizes the main relays or ignitrons of the x-ray machine, beginning the exposure. When exposure is completed, as determined by charging of C to the value required for triggering the thyatron, the resulting thyatron plate current energizes relay Re_2 , opening its contacts and thereby breaking the circuit to the x-ray machine. At any convenient time thereafter, switch Sw_1 is opened manually, de-energizing relay Re_1 . Condenser C then discharges through the closed contacts of this relay and the thyatron deionizes, preparing the timing mechanism automatically for the next exposure.

The initial voltage on the control grid of the thyatron is governed by the setting of the tapped voltage divider. This adjustment permits compensation for changes in the response k of the phototube and its fluorescent screen when the voltage of the x-ray tube is altered and a Potter-Bucky grid or an intensifying screen is used. Only the basic divider circuit is shown in the diagram; in the actual unit two dividers and a switch are used, with the dividers mechanically coupled to the voltage control of the x-ray machine to make this adjustment entirely automatic. When films are exposed without screens or grids, no compensation for changes in x-ray tube voltage is needed.⁵

The phototube, its fluorescent

RADIO RECEIVER AND TRANSMITTER CHASSIS FOR Your APPLICATION

SMALL:— Various types of Receivers and Transmitters require a space only 7" wide, 10½" deep and 7½" high.

PERFORMANCE:— *Receivers* with 1 microvolt sensitivity, high selectivity with a band width of only 16 KC at 30 DB down. Tunable, multi-channel crystal controlled or combination models available.

Transmitters with up to four crystal controlled channels, built-in antenna matching network, 20-25 Watts power output with 100% modulation capability on phone. 10 watt model with power supply on same small chassis also available.

VERSATILE:— Operation on 6, 12, 32, 110 volts DC; 117 volts AC or various DC-AC combinations. Dynamotor or Vibrator power supplies available for operation of transmitters and receivers.

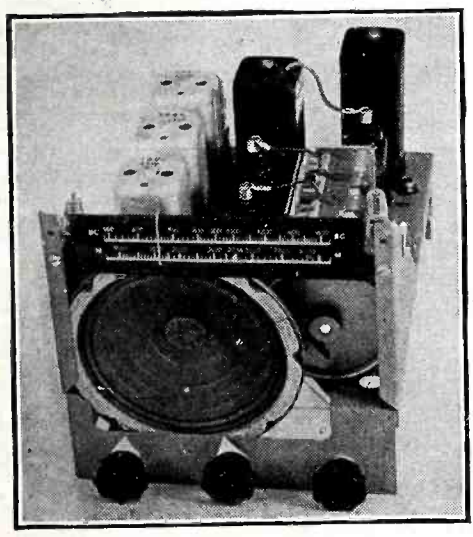

Series 6 tunable receiver. 2 band model illustrated, range 550-4000 K.C.

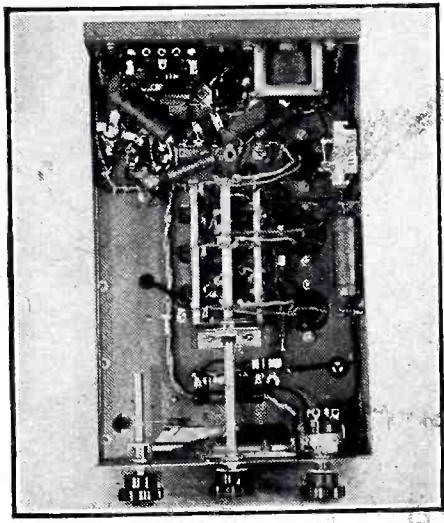

Under chassis view Series 6 tunable receiver.

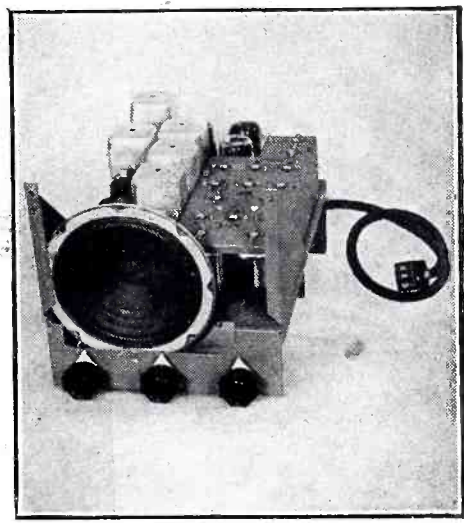

Series 6, five channel fixed tuned receiver. Model illustrated not crystal controlled.

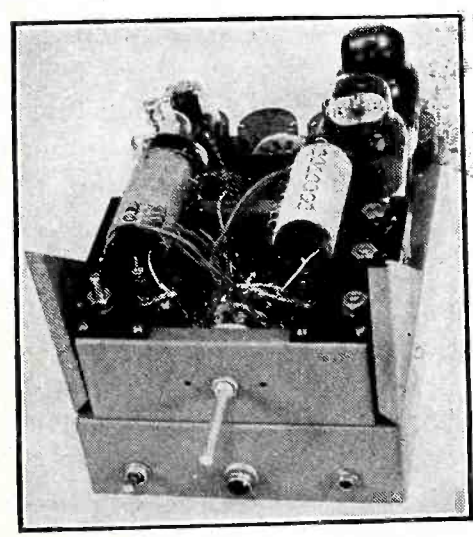

Series 20, 4 channel 1600-6000 KC, 20 watt transmitter.

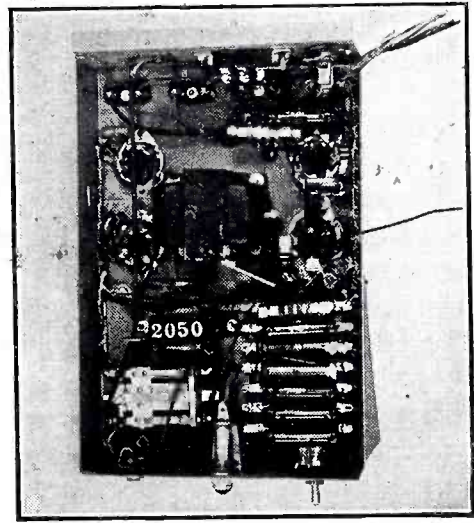

Under chassis view Series 20 transmitter.



KAAR ENGINEERING CO.

PALO ALTO, CALIFORNIA

Manufacturers of High Grade Mobile and Central Station Radiotelephone Equipment

A DRAMATIC DROP BY MEN AND MACHINES



Parachuting from stratosphere altitudes of over 30,000 feet and sub-zero temperatures often as low as minus 92° F., the pilot drops earthward at an amazingly rapid rate to lower altitudes and higher temperatures.

MODEL RTC-1H
Temp. Range: -55° C. to +70° C. Humidity Range: ambient to 140° C.; ambient to 95% relative. Usable Interior: 25.9 cu. ft.

There are other "fast drops", just as dramatic. For instance, the exceptionally quick pull-down in temperature, distinctive to Amcoil Testing Chambers. Their fast rate of temperature change means more tests per hour and more tests per dollar. As one user so aptly put it, "she goes up and down like an elevator".

Have you the problem of simulating conditions of the upper altitudes and observing their effect upon the behavior of your instruments prior to their use? In addition to temperature test chambers with either mechanical or dry ice refrigeration, Amcoil units are available for humidity testing and altitude testing. Ask an Amcoil Engineer to help you by recommending the correct equipment for wartime pre-testing of your instruments.

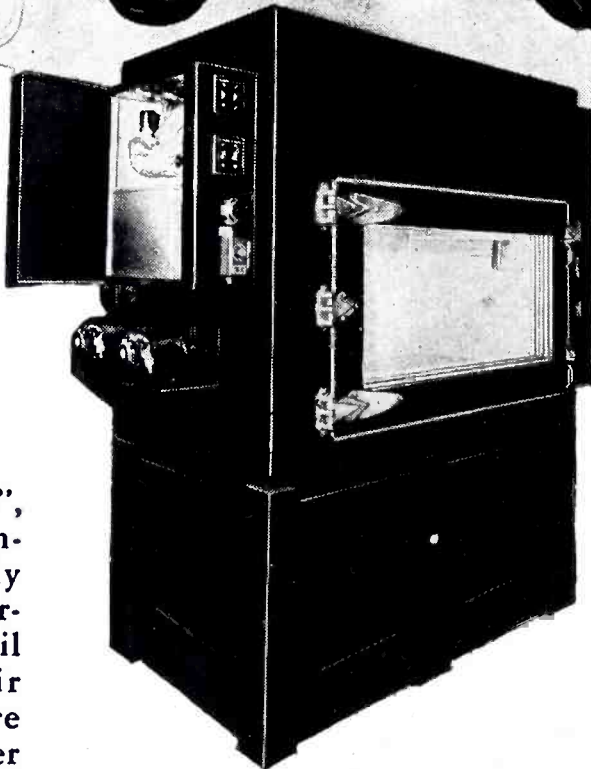

AMERICAN COILS CO.

25-27 LEXINGTON STREET • NEWARK, N. J.

screen and the dynode resistor network were mounted in a light-proof case 6x1.5x1.5 inches for one typical application, and positioned directly beneath the center of the film tray. An opening several inches in diameter was drilled through the tray to permit free passage of the radiation to the phototube assembly. The rest of the timer was built into the control stand of the x-ray machine.

In chest radiography two phototubes, each scanning separate lung fields, are used in the phototimer circuit.

The main switches of the x-ray machine should be of the ignitron type, to insure beginning and ending of an exposure at a zero point in a cycle.

REFERENCES

- (1) Morgan, R. H., An Exposure Meter for Roentgenography, *Am. J. Roentgenol. & Rad. Therapy*, 47, p. 777-784, May 1942.
- (2) Morgan, R. H., Studies in Roentgenographic Exposure Meter Design, *Am. J. Roentgenol. & Rad. Therapy*, 48, p. 88-89, July 1942.
- (3) Rajchman, J. A., An Electrically Focused Multiplier Phototube, *ELECTRONICS*, 13, p. 20-24, Dec. 1940.
- (4) Zworykin, V. K., and Rajchman, J. A., Electrostatic Electron Multiplier, *Proc. I. R. E.*, 27, p. 558-566, 1939.
- (5) Wilsey, R. B., Photographic Photometry of Roentgen Rays, *Am. J. Roentgenol. & Rad. Therapy*, 32, p. 789-804, 1934.

Calibrating Stop Values Of Lenses

WRITING IN THE APRIL 1943 issue of *American Cinematographer*, Daniel B. Clark points out that the transmission of lenses may be as much as a full stop in error when diaphragm openings are calibrated by the conventional formula $f = F/D$, in which f is the numerical value of the f -stop in question, F is the focal length of the lens and D is the diameter of the aperture at the stop indicated by f . The reason for this error is failure of the formula to take into account the type of glass used in constructing each element of the lens, the number of elements and their respective transmission factors, the number of glass-air surfaces and the presence of a coating on the lens.

The solution offered is photoelectric measurement of actual transmitted light through the lens itself, using a known standard light source. The equipment is arranged as shown in the diagram, and a calibrated master lens is screwed into one end of a light-tight tube having at its opposite end a phototube. The image

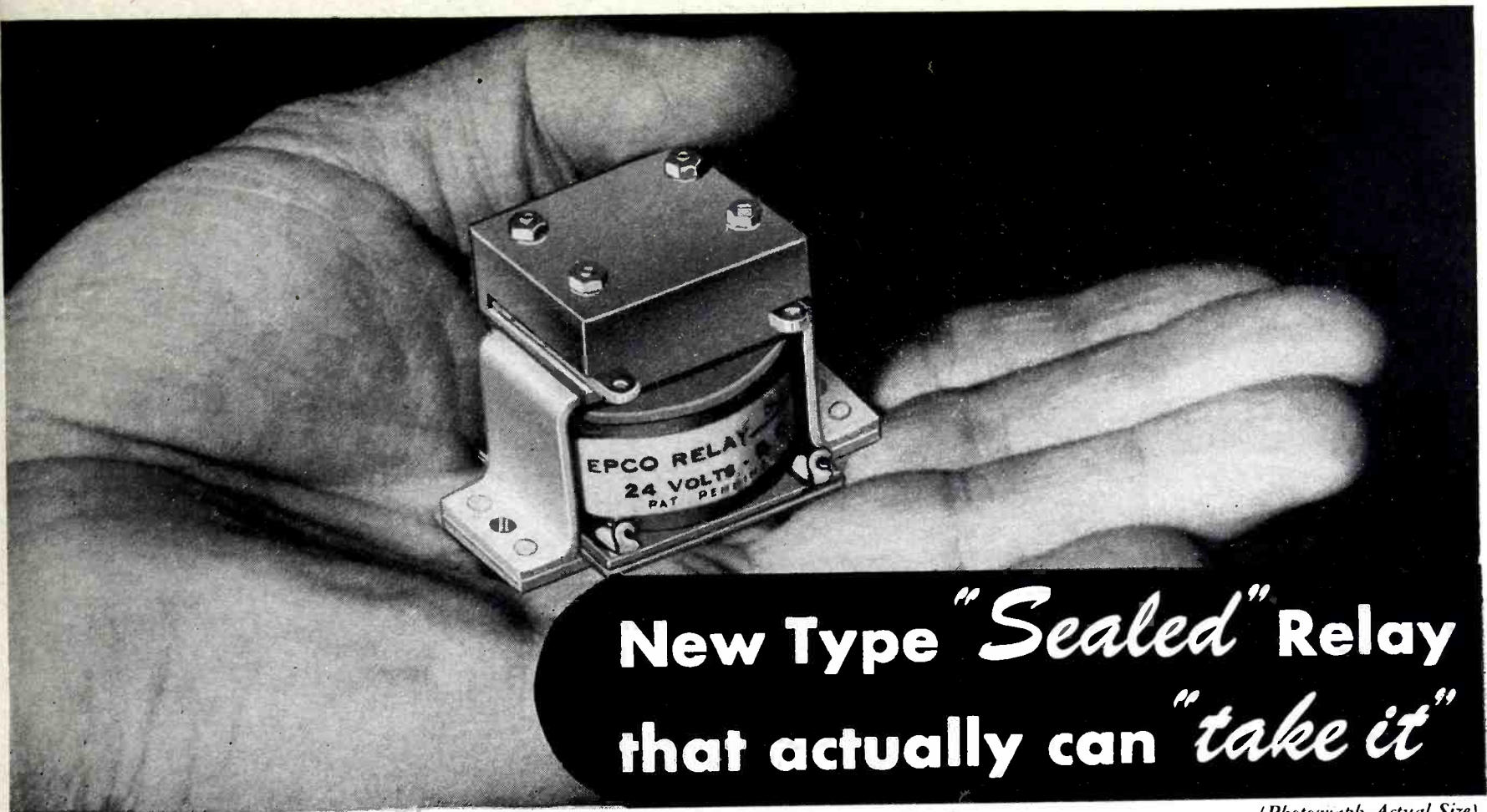

New Type "Sealed" Relay that actually can "take it"

(Photograph Actual Size)

Engineered on a New Principle with the Precision of a Fine Watch, this Sturdy Little Midget Really Stands Up Under the Punishment of Hard War Use For Which It Was Specifically Designed.

Improved Features:

Sealed Chamber. Serves as effective arc quench and also reduces the fire and explosion hazards of exposed contacts.

Excess Capacity. Rated at 25 amperes; operates satisfactorily at 50 amperes; tested without failure at 120 amperes high inductive load.

Light and Compact. Standard model above (S47D) weighs only 4.6 ounces; overall dimensions as follows:

Height, 1 9/16"
Width, 1 21/64"
Length (less base), 1 7/16"
Overall of base, 2 1/16"
Mounting holes, center to center, 1 3/4"

Positive Action. Overtravel spring insures positive contact pressure and instant "break" release.

Tamper Proof. Factory adjusted and sealed; protection against unauthorized re-adjustments.

Reversible Contacts. If worn from excessive use contacts may be reversed in the field, thus providing new surfaces without disturbing adjustment.

**Electrical
PRODUCTS CORPORATION**

General Office:
1128 Venice Blvd. Los Angeles, Calif.

Specifications:

Normal Coil Rating. 24 volt - 150 m. a. - 3.6 watts.

Contact Rating. 25 amps. inductive load at 30 volts.

Unit has withstood Army tests, including overload; vibration 55 cycles per second with .06" excursion; acceleration of 10 gravity units; salt spray tests of 240 hours duration.

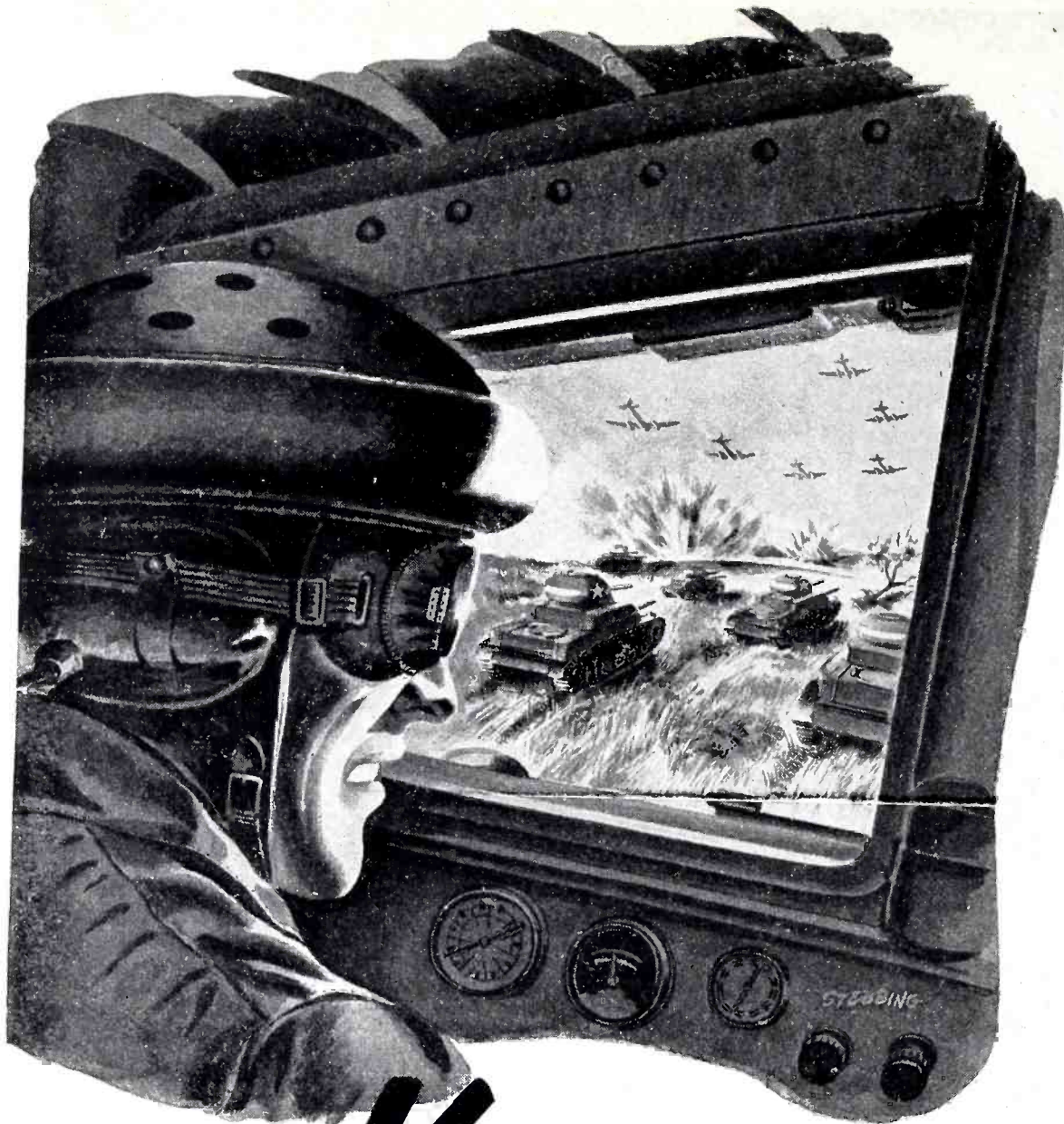

ON TO VICTORY!

IT TAKES stout, rugged men to fight a tank. The speed, the bucking and swaying, the paralyzing roar and shudder of gunfire continuously test stamina of both men and equipment.

Consolidated Radio is justly proud to be making headphones that are slugging it out with our fighting tank men...and coming through...the roughest, toughest battle conditions.



Consolidated Radio's Modern Mass Production Methods Can Supply Signal Corps And Other Headphone Units In Quantities To Contractors.

**CONSOLIDATED
RADIO PRODUCTS CO.**

SPECIALISTS IN MAGNETIC AND ELECTRONIC DEVICES

350 WEST ERIE STREET • CHICAGO, ILLINOIS

of the lens is accurately focused on the cathode of the phototube. In front of the lens is a suitable light source, mounted behind a ground glass diffusing panel and connected to the power line through an accurate voltage control and meter. The phototube is connected to feed an ultrasensitive microammeter.

With the diaphragm of the master lens set at $f/3.2$ (or some other opening in the middle range), the voltage of the light source is adjusted until a convenient reading near mid-scale is obtained on the microammeter. Use of the master lens in this manner eliminates errors due to variations in the light source, phototube or meter.

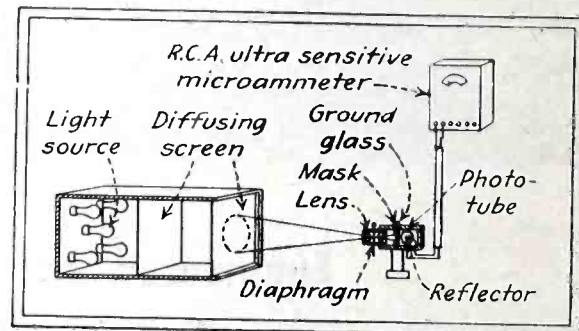

Photoelectric set-up for calibrating stop values of a lens

The lens to be calibrated is now substituted for the master lens and its diaphragm is manipulated to give the same meter reading. This diaphragm setting is calibrated as $f/3.2$. Mathematically correct transmission values are then computed for each stop above and below this median value and are converted into microammeter readings based on the reading for $f:3.2$, after which other stops are calibrated by their actually measured transmission. The resulting calibration is correct, stop for stop, regardless of the design and construction of the lens. Steps are under way to establish this procedure as a national standard for calibrating lenses.

• • •

Protecting Meters with Fuses

METER SHORTAGES and greatly increased use of meters by relatively untrained personnel in industrial plants and the military training program make protection of meters highly advisable today whenever possible. For this reason, portions of an

It's a **WAR** of **WIRE NERVES**

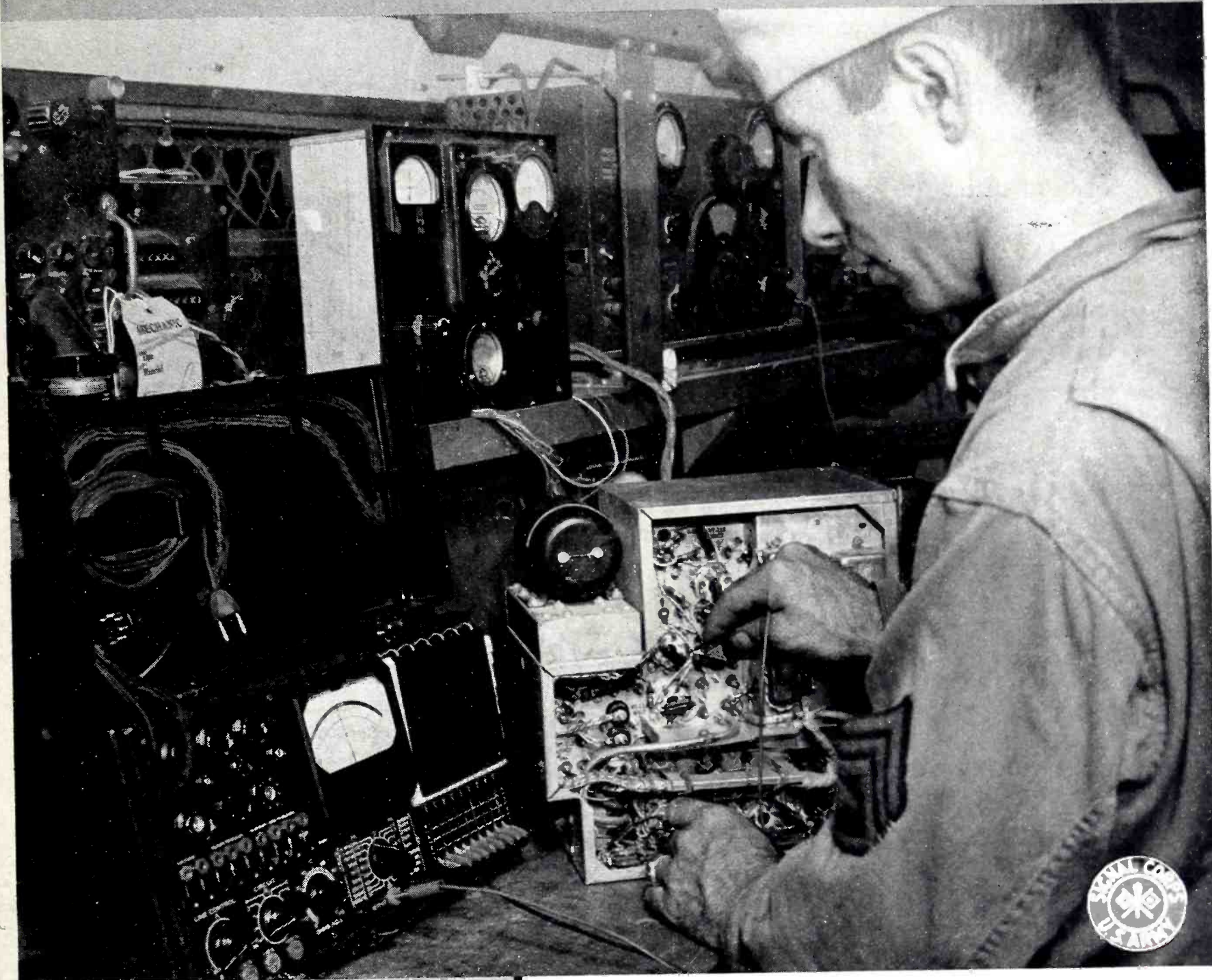

These **SPECIALIZED Belden Wires and Cables** see service on many fronts . . .

Belden all-rubber electrical cords with Belden unbreakable soft rubber plugs • radio hook-up wire • microphone cable • test prod lead wire • high frequency cables • aircraft spark plug wires and primary cables • automotive wires and cables • Beldenamtel magnet wire • and many others.

★ In this electro-mechanical war, wire is on constant duty on many fronts in planes, tanks, ships, and submarines. It is on duty, too, in the machines that produce vital war equipment and on still others that test it. Wherever it is used, good wire and good wire connections are necessary to help insure success.

For forty years Belden engineers have devoted their efforts to building not just wire—but *plus-performance* wire. World-wide war service is demonstrating the value of this experience. Make sure of your wiring—specify Belden.

Belden Manufacturing Company
4625 W. Van Buren St.
Chicago, Illinois

Belden WIRE

Awarded the U. S. Treasury Special Citation of



Merit for initiating the War Bond-or-Cash Dividend Plan

Flight-similitude Cold Testing

Only *Mobile* units offer program controlled or manually set flight-similitude conditions. These units provide completely coordinated altitude-temperature curves to a maximum of 80,000 feet altitude at a temperature minimum of -120°F .

Reheat and humidity testing is standard also in these *Mobile* units, up to $+185^{\circ}\text{F}$ with fully controlled humidity conditions according to your requirements.

Our production time has recently been cut almost 40%. We invite your inquiry.

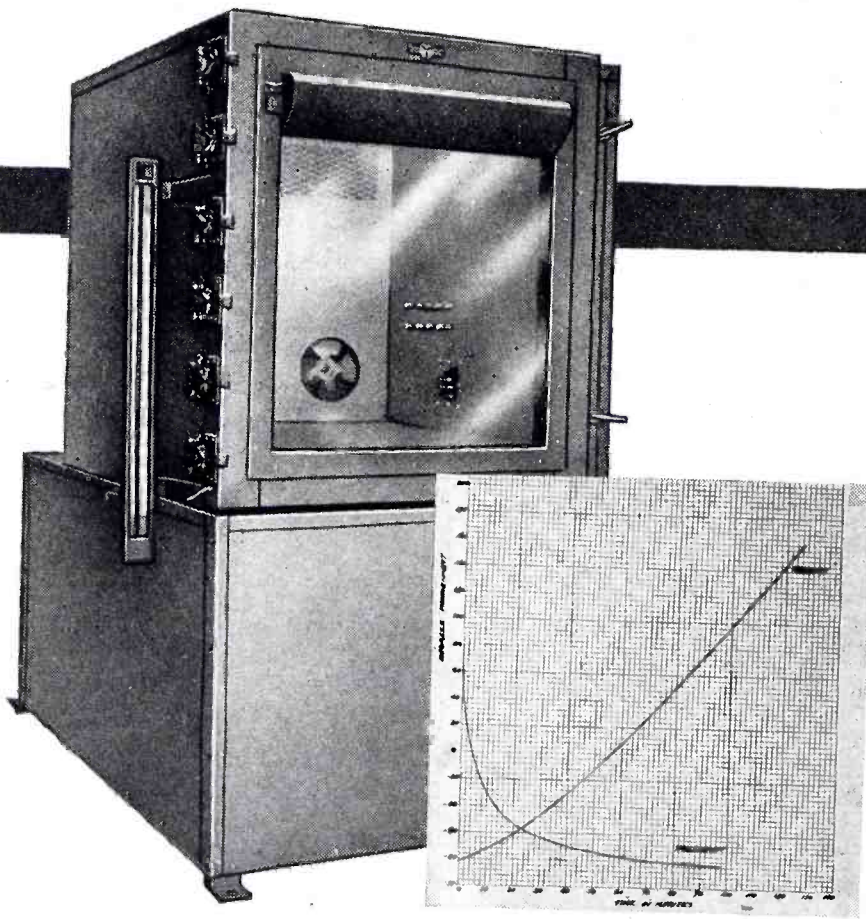

May we work with you?

MOBILE REFRIGERATION

630 FIFTH AVENUE



NEW YORK 20, N. Y.

article "When Meters Blow" by Louis J. Fohr, Jr., of Littelfuse Inc. are abstracted here from the Jan. 1937 issue of *ELECTRONICS*, with additions to include the latest developments along instrument protection lines.

Fusing of the meter circuit can provide simple, fast and effective protection against overload. Standard sizes of fuses are available and are quite low in cost. Whereas a 1/100 amp fuse was the smallest available in 1937, today vacuum-enclosed meter fuses are available in sizes down to 1/1000 amp.

Whenever possible, the fuse should be inserted before the meter shunt or multiplier. In most cases, the added resistance of the fuse will add negligible error to the meter reading. If the error is greater than the permissible tolerance, however, a push-button switch may be shunted across the fuse to short it out for final readings only.

The time required for an instrument fuse to blow is an inverse function of the degree of overload. An overload of 0.02 amp will blow a 1/100 amp fuse in 0.1 sec, an overload of 0.1 amp will blow the fuse and interrupt the circuit in 0.0002 sec, and an extreme overload will make the blowing time practically instantaneous. This is an important and desirable characteristic when protecting the calibration and balance of a delicate instrument.

• • •

Recording Blood Flow in Stomach with Thermocouples and Phototube

THE MEASUREMENT of blood flow in the intact human stomach and intestine presents an interesting and important problem, applicable among other things to an investigation of the mechanism underlying the development of peptic ulcers.

In the past many studies of intestinal blood flow have been made, all of which involved rather extensive surgical procedures and cannulation of the arteries and veins. The results of these studies have been variable and at times contradictory, possibly because of the different amounts of trauma (injury) produced by different operators. In any case, these methods could not be applied to man.

In *The Journal of Clinical Investi-*

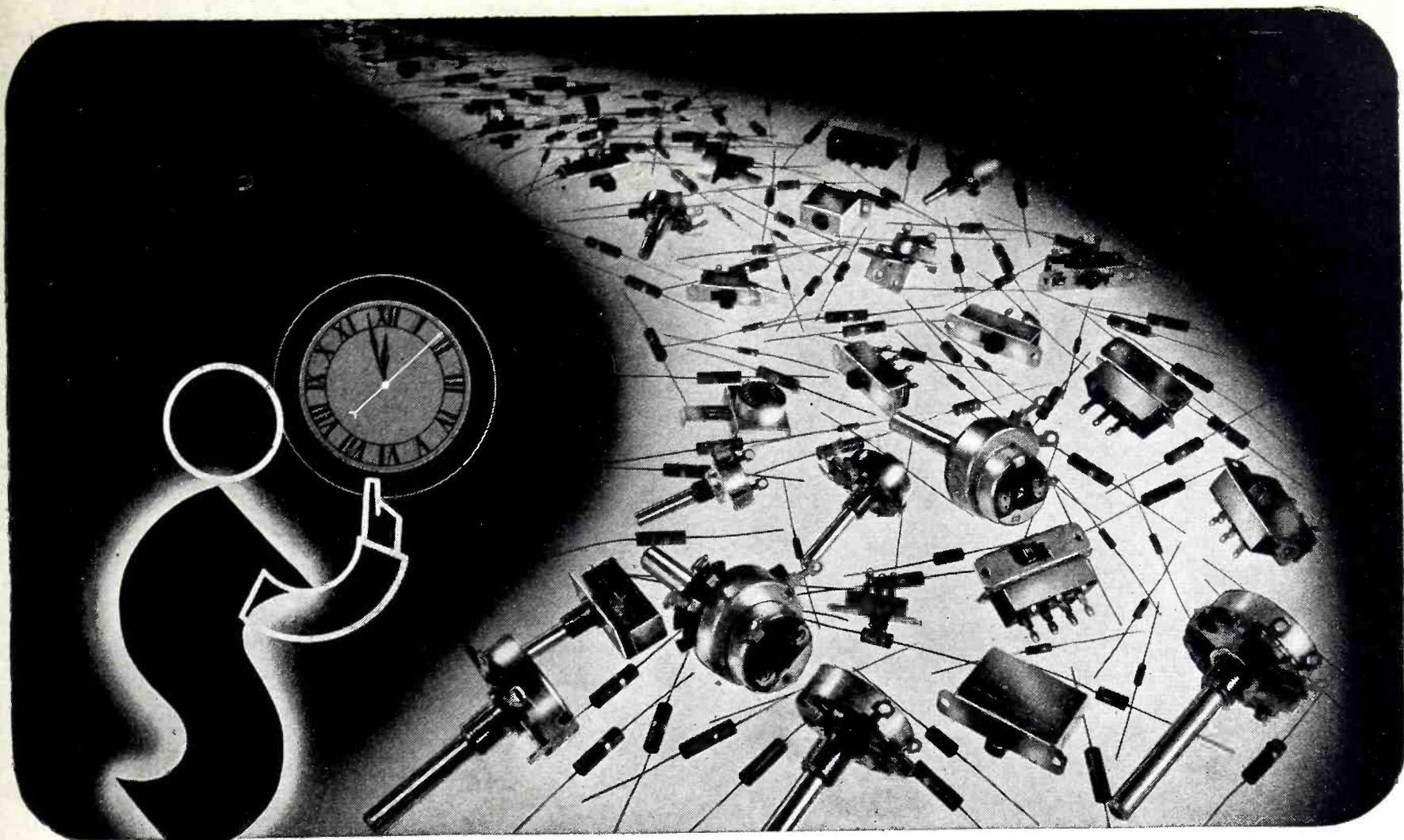

HUNDREDS OF COMPONENTS A MINUTE

... EVERY MINUTE—EVERY DAY!

Every minute, every day, Stackpole electronic components to the tune of hundreds of units are being completed—each one ear-marked for an inconspicuous but highly important part in the war effort.

These Stackpole items include iron cores, line switches, slide-action switches, fixed resistors, and standard variable resistors as well as those designed for dusty, extremely humid, or salt spray conditions.

Stackpole facilities—long among the very largest—have been greatly expanded. Stackpole engineers have the all-essential “know how” to help solve your resistance problems. Stackpole service assures personalized attention to your requirements.

STACKPOLE CARBON COMPANY

Electronic Components Division • St. Marys, Penna.

STACKPOLE MAKES THESE PRODUCTS

Brushes for all rotating equipment • Carbon, Graphite, Molded Metal, and Composition Contacts • Powder Metallurgy Components • Bearings • Anodes • Electrodes • Power Tube Anodes • Brazing Blocks • Welding Rods, Electrodes and Plates • Packing, Piston, and Seal Rings • Flashlight Battery Carbons • and numerous others.

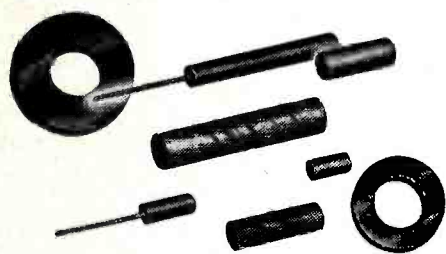

IRON CORE PROBLEMS ANSWERED

Stackpole *knows* iron cores—*knows* their applications—and *knows* how to make units of the proper characteristics and shapes to match today's requirements. High among more recent developments in this line are Stackpole Iron Cores for modern high frequency equipment. When you need cores, it pays to try Stackpole first!

STACKPOLE

MOLDED METAL POWDER AND CARBON PRODUCTS

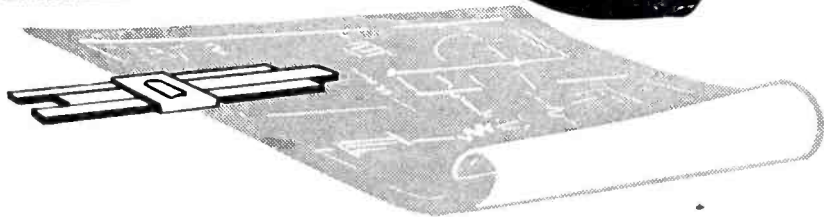

Are You the Man Who's Interested In **RECTIFIERS?**

—Then We'd Like to Tell You About

Copper
Sulphide



Selenium

ENGINEERS who are now busy with Post-War Planning are uncovering many new applications for metallic rectifiers—applications once thought impractical. Are YOU one of these Planners-for-the-Future?

If so, B-L Engineers are eager to help you develop the ideal modern application for simplicity, economy, and efficiency. In wartime use, B-L Metallic Rectifiers have proved their value over and over—and pointed the way to new peacetime developments.

Let B-L engineers help solve your problems of metallic rectifiers, D. C. power supplies and conversion assemblies.

Write Today
on your business
letterhead for
Bulletin R-51
giving full
details on
B-L Metallic
Rectifiers

THE BENWOOD LINZE CO. ST. LOUIS, MISSOURI

Designers and manufacturers of Copper Sulphide and Selenium Rectifiers, Battery Chargers and D. C. Power Supplies for practically every requirement.

gation, 21, p. 551/557, 1942, Charles H. Richards, Steward Wolf, and Harold Wolff of the Cornell University Medical College describe a thermal gradientometer which they have constructed with the assistance of William A. Geohegan. This method, which is conveniently applicable to man, depends on the cooling effect of the flowing blood on a group of heated thermocouples.

Balloon Device is Swallowed

The apparatus consists of a balloon, about 8 cm long and 2.5 cm wide at its greatest diameter, through which passes a duodenal tube. Six constantan-copper thermocouples are moulded into the wall of the balloon at its greatest diameter. The duodenal tube at the center of the balloon has wound around it a heating coil with the reference thermocouples beneath it. The heater temperature is about 10 deg. C above that of the body, and heat is radiated to the whole surface of the balloon. The tissue in contact with the balloon is consequently warmed slightly above body temperature. Small contact variations are of little importance, as the indicated temperature is the average obtained from six points.

The device measures the flow of blood through the tissues, not the amount of blood in the tissues. Thus a decreased flow would be indicated from a congested area, as the relatively motionless mass of blood would be unable to carry away as much heat as a normal flow.

Photoelectric Recording Is Used

The apparatus was arranged to record on a kymograph recorder drum with a moving pen both the temperature gradient, indicating the relative flow, and the contractions of the stomach. In both cases the phenomena were photoelectrically recorded. A sensitive galvanometer was used with the thermocouples, its light beam so arranged that a larger deflection would cause a greater illumination of a phototube. The phototube anode voltage is a.c., regulated on the effective half cycle by a 4005CL neon lamp. Thus an increased temperature gradient causes an increased illumination of the phototube which produces a half-wave 60-cycle voltage which is amplified by a

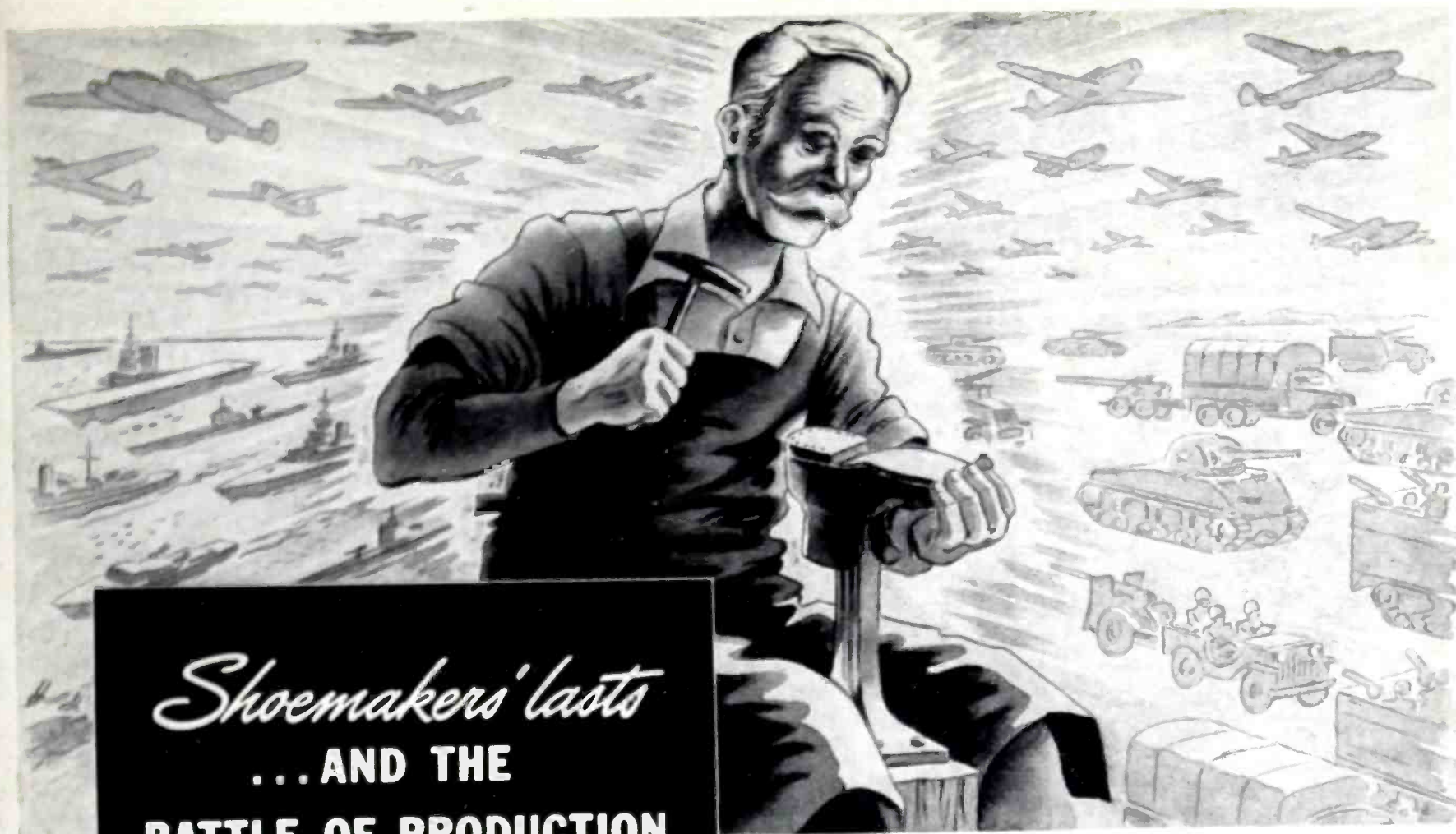

Shoemakers' lasts
 ... AND THE
BATTLE OF PRODUCTION

"SHOEMAKER stick to thy last" may have been good advice once... but it doesn't apply in the Battle of Production, where the ability of American industry to enter new fields and make new things has amazed the world.

Take Rola, for example. Recognized for years as a leading maker of Sound Reproducing Equipment, Rola's principal war assignment became the manufacture of various types of transformers for the intricate communications systems of our Army and Navy Air Forces.

The specifications were unusually "tough" but Rola was equipped to do the unusual. Calling upon the skill and ingenuity of its people and upon an experience that dates from the very beginning of Radio Communications, Rola "tooled up". New machines

were designed, new methods and processes devised, new tests and inspections employed, so that today the name "Rola" on a transformer is as much a hall-mark of quality as it is on the 25,000,000 radio loud-speakers that Rola has produced.

If transformers are a part of any product you are making, Rola solicits an opportunity to discuss your requirements with you. Many of the country's foremost prime producers of communications equipment have found our product and our performance eminently satisfactory. We are sure you would, too. The Rola Company, Inc., 2530 Superior Ave., Cleveland, Ohio.

RECEIVER OUTPUT • MODULATION • MICROPHONE
 FILAMENT • AUDIO INPUT • RADIO STAGE • POWER • CHOKE COILS
 HEAD SETS • RELATED ELECTRONIC ITEMS

★ **ROLA** ★

MAKERS OF THE FINEST IN SOUND REPRODUCING AND ELECTRONIC EQUIPMENT

SAVE TIME—CUT COSTS

FASTENING RADIO and ELECTRONIC PARTS!

- Eliminate Lockwashers
- Save Assembly Time
by using
Self-Locking PALNUTS

Wherever you now use a regular nut, jam nut or nut and lockwasher to keep parts tight . . . *one* Self-locking PALNUT will do the job with unfailing security, in less space—at less cost—with less assembly time.

Self-locking PALNUTS are single thread, tempered spring steel locknuts formed to fit standard screw threads. Easily applied with an ordinary wrench—or, on fast moving assembly lines, with Yankee and Power Drivers. PALNUTS weigh 70% less than jam nuts, 80% less than regular nuts—90% less than nut and lockwasher. Cost less than half as much as nut and lockwasher combined. Used for over 10 years on radio, electrical and all types of mechanical assemblies. Several types available, in a full range of sizes.

Send details of your assembly for data and samples. Write for Palnut Manual No. 2, giving full information.

THE PALNUT COMPANY
77 CORDIER ST., IRVINGTON, N. J.



Self-Locking PALNUTS



Shown above is the Self-Locking PALNUT used to fasten Electrolytic Condensers to the chassis. This replaces regular nut and lockwasher, saving weight, cost and assembly time. Use on Electrolytic Condensers approved by U. S. Signal Corps.

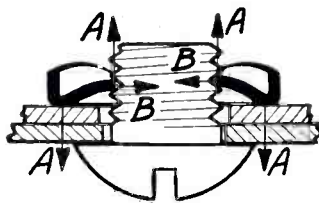

DOUBLE-LOCKING ACTION

When the PALNUT is wrench-tightened, its arched, slotted jaws grip the bolt like a chuck (B-B) while spring tension is exerted upward on the bolt thread and downward on the part (A-A), securely locking both.

condenser-coupled amplifier and rectified. The rectified voltage is applied to the grids of parallel 6L6G tubes which have in their plate circuit a solenoid which actuates the recording pen.

To record contraction the balloon in the stomach is inflated and the tube leading to it attached to a U-tube mercury manometer. A beam of light is passed across the surface of the mercury onto a phototube connected as described above. Gastric contractions cause an increase of pressure in the balloon, elevating the mercury and, somewhat indirectly, the recording pen.

Discussion of Results

As would be expected, it was found that with the onset of each strong contraction of the stomach there was a sudden increase in blood flow, followed by a decrease during the continued contraction. With the thermal gradientometer in the duodenum, it was found that showing the subject appetizing foods or even discussing them produced strong contractions within thirty seconds and an increased blood flow within ninety seconds. When distasteful foods were shown there was no effect, or an actual decrease in blood flow would occur.

An interesting finding was that anxiety, tension, and resentment were associated with an increased blood flow. It has long been known that these emotions produce increased contractions, while fear and mental shock lessen the contractions. Probably further use of the device will bring out the response of the blood flow to the latter emotions as well.

This apparatus shows again that almost any physiological phenomenon which is not already electrical can be transformed by a phototube into electricity and then handled and recorded easily.—W.E.G.

• • •

Momentary Contact for Time Clock

MOMENTARY CLOSING of a circuit with the hour hand of an electric clock for a time interval as short as one second is readily obtained with a roller and contact arrangement described by Max L. Yeater on page

PERMANENT MAGNETS MAY DO IT BETTER,

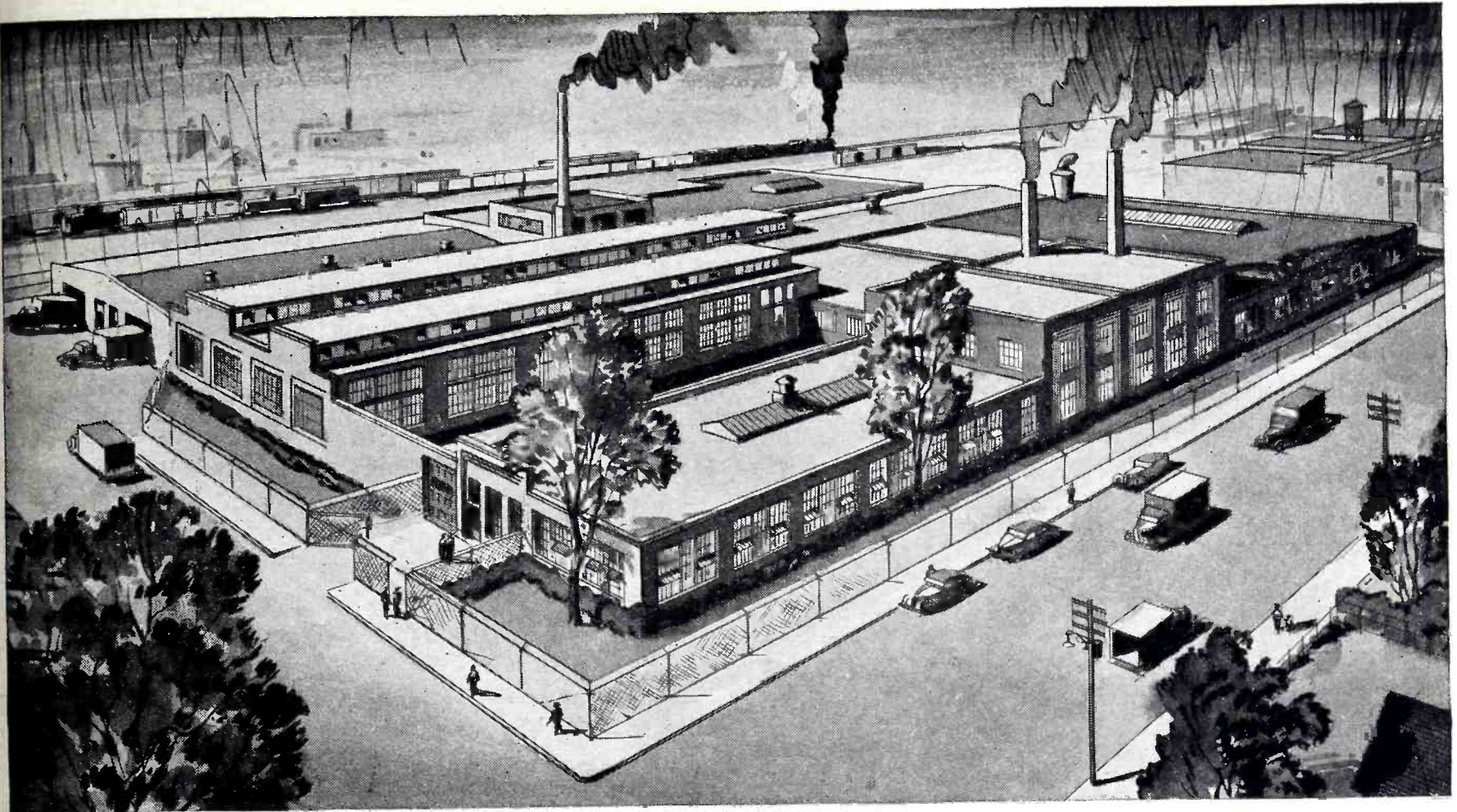

THE LARGEST PLANT IN AMERICA for Making Permanent Magnets!

IF YOU USE permanent magnets in your products, chances are that you've either dealt with us or heard about us sometime during the past 33 years. But if you haven't, we'd like to tell you how and why we can help you if there's a possibility of your using them in your *war or post-war* products.

Since we started in business in 1910, we've specialized in doing one thing especially well—designing and producing *better* permanent magnets, and applying them intelligently to hundreds of different types of products. As a result, we have had a wealth of experience in all of the

highly technical considerations involved—from the selection of the proper type and grade of materials to the quality of the finished magnets. Our plant is the nation's largest devoted to the exclusive production of permanent magnets. It is completely equipped and staffed with engineers and workers of the highest calibre.

Our production capacity is now devoted entirely to war orders. But our engineers will be glad to show you how and why countless products function better with permanent magnets. Write for the address of our office nearest you and a copy of our 30-page "Permanent Magnet Manual."

The
INDIANA STEEL PRODUCTS
Company

★ SPECIALISTS IN PERMANENT MAGNETS SINCE 1910 ★
6 NORTH MICHIGAN AVENUE • CHICAGO, ILLINOIS

SPECIFY RELAYS* WITH...

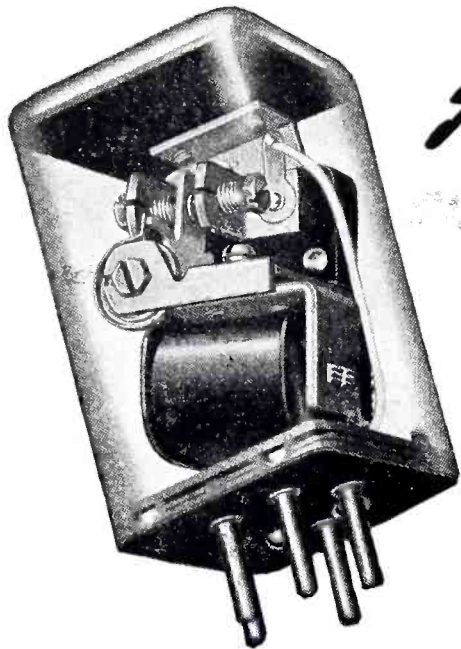

Assurance!

It is now possible to predetermine with relative exactness the performance of a Sigma Sensitive Relay in a proposed circuit; to design the circuit for desired relay performance; and to avoid costly trial and error research.

*SIGMA SENSITIVE RELAYS OF COURSE

NEW TYPE 4 R

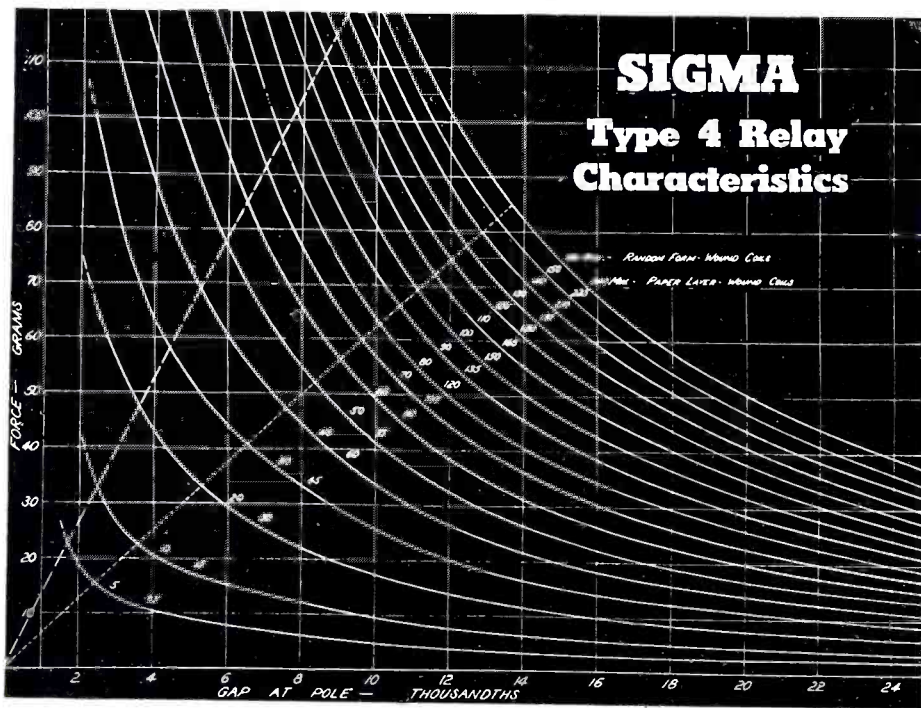

Operating characteristics of the Sigma Type 4 Relay have been reduced to a family of curves comparable to those used to describe performance of a vacuum tube. These curves are reproduced in a bulletin which besides describing the method of their use, gives data on basic requirements which must be satisfied under different operating conditions.

Careful consideration of this bulletin should preclude "mismatch" of relay to circuit which has all too often lurked like gremlins to upset the proper operation of an otherwise soundly engineered piece of equipment.

Your copy is ready for mailing.

SIGMA
Sigma Instruments, Inc.
Sensitive **RELAYS**
60 FREEPORT ST., BOSTON 22, MASS.

146 of the May 1943 *Review of Scientific Instruments*.

A spring brass arm is mounted on the hour shaft of an electric clock, with the end of the arm machined longitudinally to serve as a shaft for a small metal wheel which rolls over one or more pairs of closely spaced contacts set into the face of the clock. The roller describes a circular path and passes over each pair of contacts once each hour, shorting them.

The time interval during which a pair of contacts will be shorted and its circuit closed can be predicted (assuming ideal mechanical construction) from the equation $t = ks/\omega_r r u$, in which r is the length of the roller arm, s is the radius of the roller, ω_r is the angular velocity of the roller arm, u is the spacing between the contacts and k is the gap required to break the arc between two contacts at the voltage and current involved.

This method makes it possible to control both the duration of contact and the interval between successive contacts in a revolution with a high degree of accuracy.

• • •

Magnetic Control Switch

ONE PURPOSE of electronic control is to open or close a circuit without the actuating element coming into physical contact with the switching element. Capacity control circuits accomplish this by using a metal vane as an actuating element and causing it to change the capacity in a vacuum tube oscillator circuit. In applications where there is ample actuating power, however, a magnetic control switch developed by Harry Fuchs of New York City offers a simpler solution which still meets the requirement that there be no physical contact.

The principle is essentially that which causes the pointer of a magnetic compass to follow a piece of iron which is moved around the outside of the compass case. A slender iron armature pivoted between the poles of a horseshoe permanent magnet is magnetized by induction (or may be hard steel previously magnetized), and assumes a position according to the law that unlike poles attract. One end of the armature projects slightly beyond the horse-

NEW...

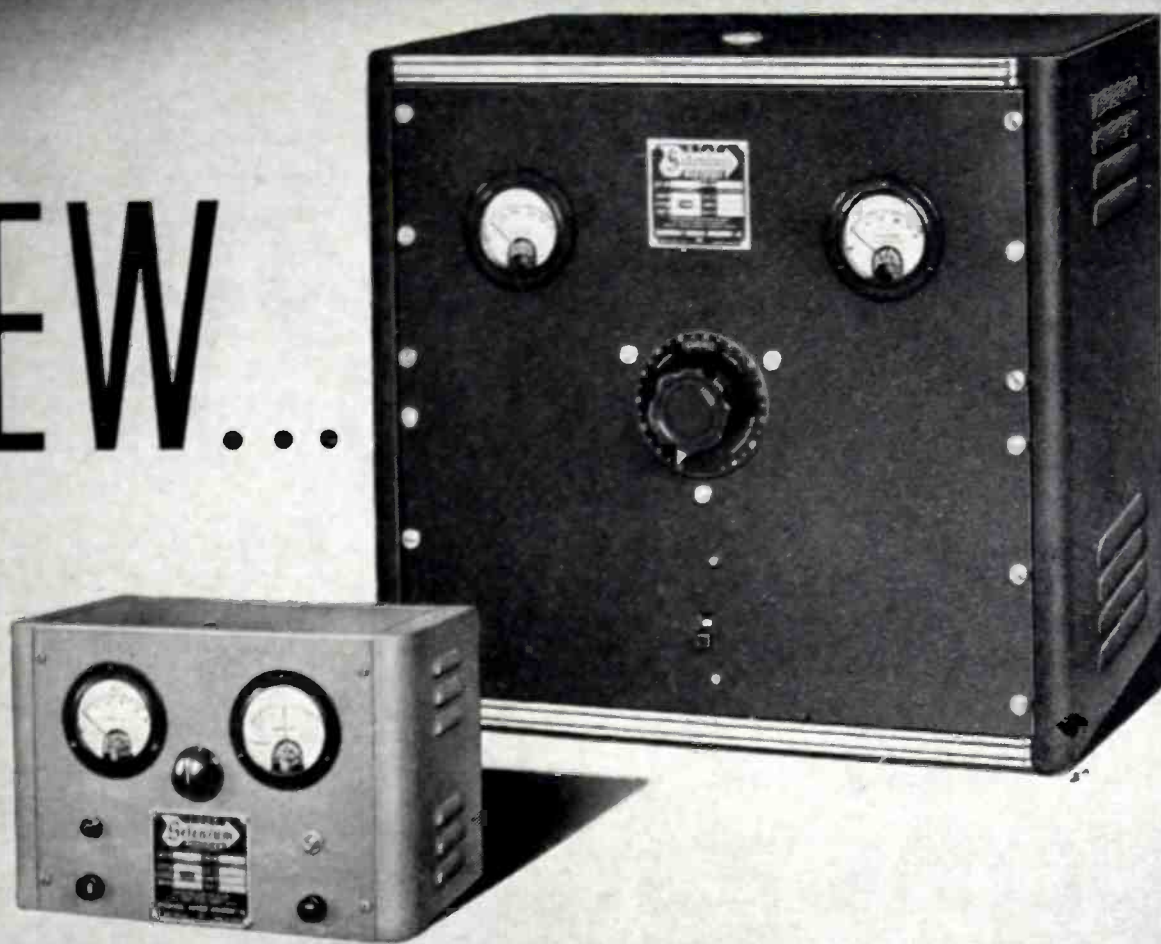

A complete line of Federal Battery Chargers Powered by I. T. & T. Selenium Rectifiers

Now – to users of battery charging equipment – we present a complete line of Federal battery chargers, of wide voltage and practically unlimited current range, covering every need and purpose.

And – to the manufacturer requiring battery chargers of special design – we offer our complete Federal design and manufacture service, geared to handle your requirements promptly.

All Federal battery charging equipment is powered by long-life, trouble-free I. T. & T. Selenium Rectifiers – accepted as standard by the electrical industry.

For powering production lines and for use in military devices, Federal also manufactures a complete series of general purpose power supply equipment. Consulting Engineering service available. For descriptive bulletins write *Department H*.

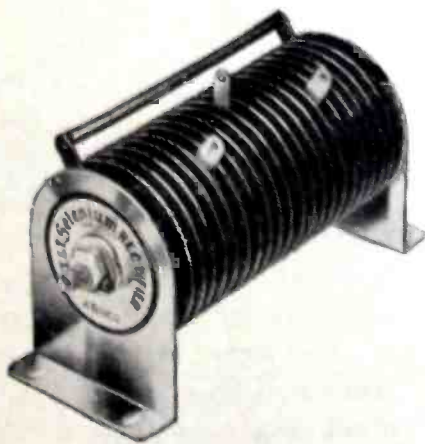

SELENIUM RECTIFIER DIVISION

Federal Telephone and Radio Corporation

AN IT&T
ASSOCIATE

1000 Passaic Ave.
East Newark, New Jersey

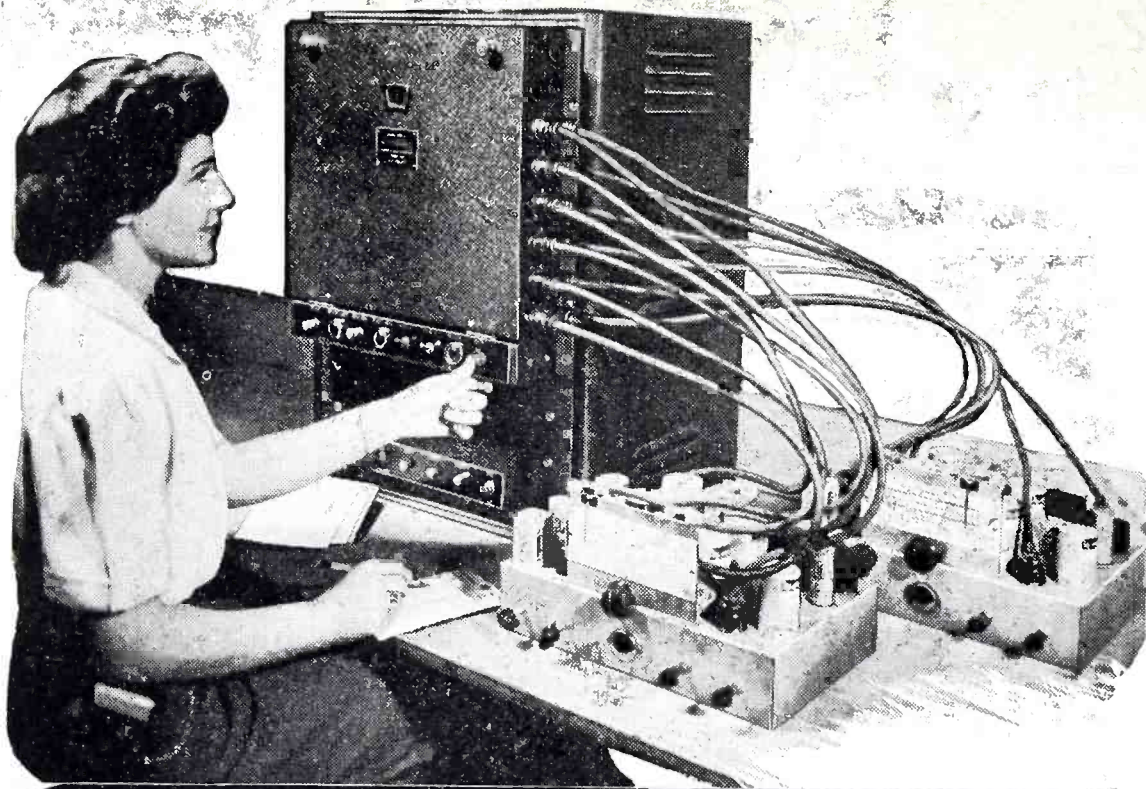

SPEED UP PRODUCTION TESTING

with no sacrifice in ACCURACY
— even with unskilled labor!

ROTOBRIDGE

— the automatic high speed mass production tester gives Wheatstone bridge precision to factory circuit testing — at the amazing rate of one circuit per second. Yet Rotobridge measurements are made by unskilled operators within limits set up by the engineer.



All tests made are on a "pass" or "reject" basis, completely eliminating the human element. All types of electronic equipment may be checked for errors in resistance, reactance, and in circuit wiring. Equipment that passes Rotobridge is all set to pass a dynamic test — with flying colors.

**WRITE TODAY FOR
ILLUSTRATED BULLETINS**

**NEW! MODEL 1001
ESPECIALLY DEVELOPED
for CABLE TESTING**

Now in use for rapid checking of multi-wire cable harnesses in aircraft, tanks, switchboards, etc.

COMMUNICATION MEASUREMENTS LABORATORY

120 GREENWICH STREET

NEW YORK

shoe magnet, and the other end has a contact which will line up with a fixed contact when the armature is rotated, as shown in the diagram.

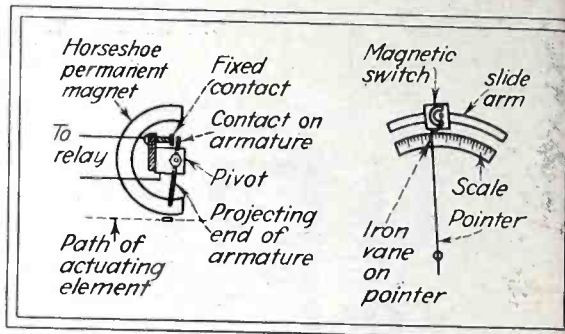

Construction of magnetic control switch, and use for automatic weighing

When an iron object or small permanent magnet is brought near the projecting end of the armature, the armature tends to follow the object, just as a compass needle follows an iron object. Motion of the actuating element in the proper direction will thus close the contacts, which in turn can close a relay circuit or perform any other desired electrical function.

Possible Applications

By mounting the magnetic switch on a curved slide arm above the pointer of a scale and placing a suitable piece of iron on the end of the pointer, automatic weighing action can be obtained for filling containers one after another. The switch is positioned so the projecting armature

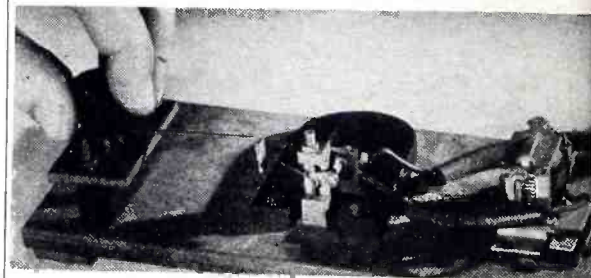

Experimental model of magnetic control switch. The knob rotates a wire rod having at its end a piece of iron simulating the actuating element in a practical application

is at the desired weight value. When the scale pointer reaches this value, it will actuate the switch and close the relay circuit, initiating a mechanism which stops the flow of material.

Other applications might include counting of freshly painted iron or steel objects on a belt conveyor, detection of iron slugs in coin-operated machines, automatic levelling of ele-

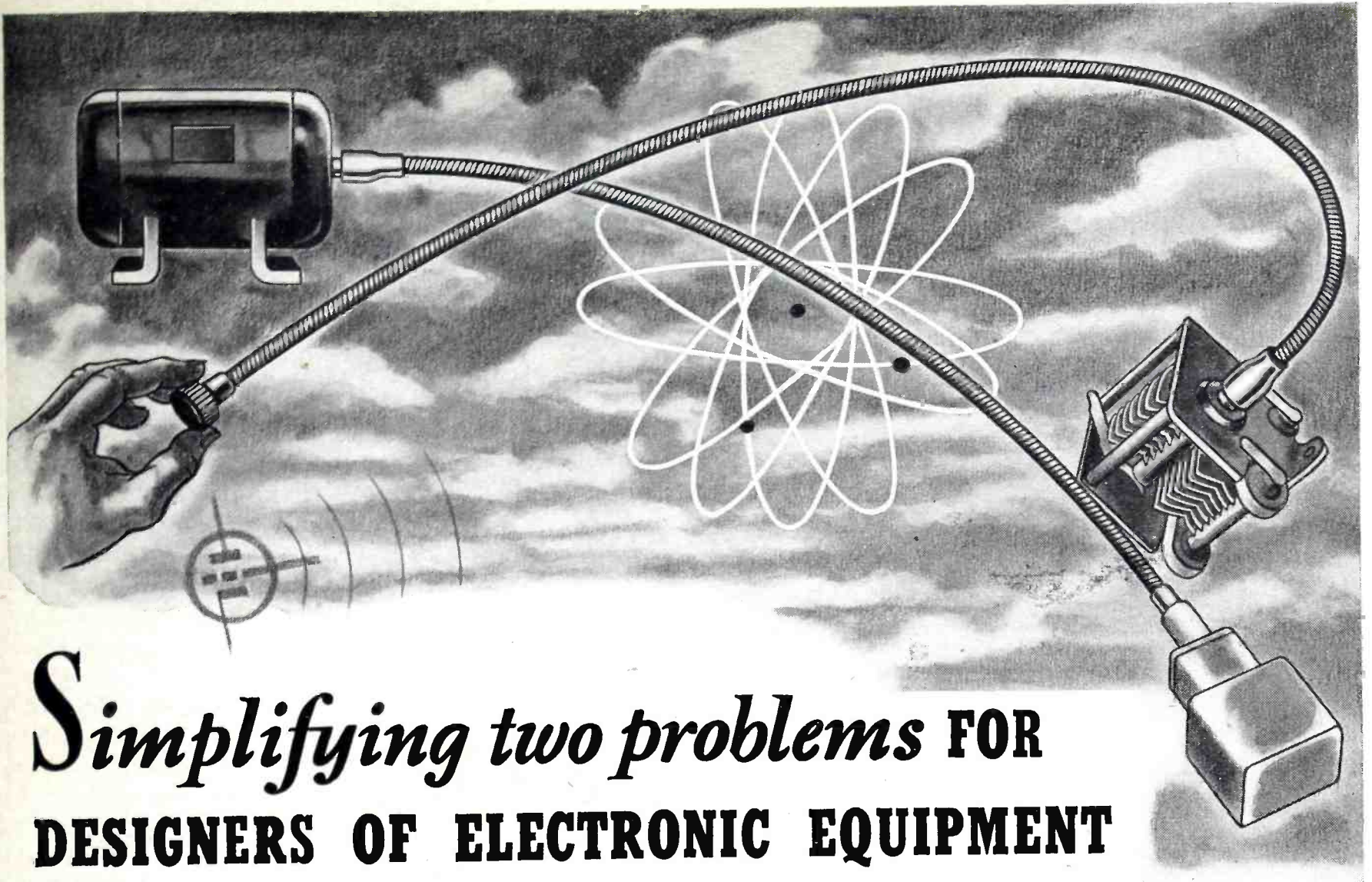

Simplifying two problems FOR DESIGNERS OF ELECTRONIC EQUIPMENT

Imagination and ingenuity in the highest degree are needed to solve many of the new and complex problems confronting the electronic equipment designer.

But there is a thoroughly tried and proved answer always at hand to two mechanical problems which often arise. These problems are:

- (1) **Power Transmission** from small motors to driven parts, or from one driven part to another.
- (2) **Remote Control** of electrical circuit or other elements requiring adjustments or manipulation.

And the answer to these two problems, in many cases, is found in S. S. White Flexible Shafts. It is a highly satisfactory answer because it offers these important advantages.

SIMPLICITY—It takes only a single, easily applied unit to carry power or remote control between any two points, regardless of the relative positions of the two points. This means fewer parts, simplified assembly, faster production, lower costs.

BETTER DESIGNS—Because a flexible shaft removes all limitations on the placing of driving and driven or controlled elements. They may be located wherever desirable to satisfy the require-

ments of electrical circuit efficiency, space conditions, easy assembly, convenient operation and servicing.

ECONOMY—In addition to the economy of simplicity, the fact that a flexible shaft makes accurate alignment of connected elements unnecessary, adds further to the saving in manufacturing costs.

S. S. White Flexible Shafts come in a wide range of diameters and physical characteristics—a range that will meet the operating requirements of practically any application in the electronic field.

CONSULT S. S. WHITE when you have a power drive or remote control problem.* The cooperation of our engineers may mean a quicker, and possibly a more effective, solution.

Flexible Shaft Data For Engineers BULLETIN 1238

Flexible Shafts for Power Drives

BULLETIN 38-42

Flexible Shafts for Remote Controls

BULLETIN 43

End Fittings for Shafts and Casings
Copies of these bulletins will be mailed on request. Write for yours today.



* The need of our shafts in war equipment confines our production and service to war work until Victory is won.

S. S. WHITE

The S. S. White Dental Mfg. Co.

INDUSTRIAL DIVISION

Dept. E, 10 East 40th Street, New York 16, N. Y.

FLEXIBLE SHAFTS • AIRCRAFT ACCESSORIES • MOLDED RESISTORS • CONTRACT PLASTICS MOLDING

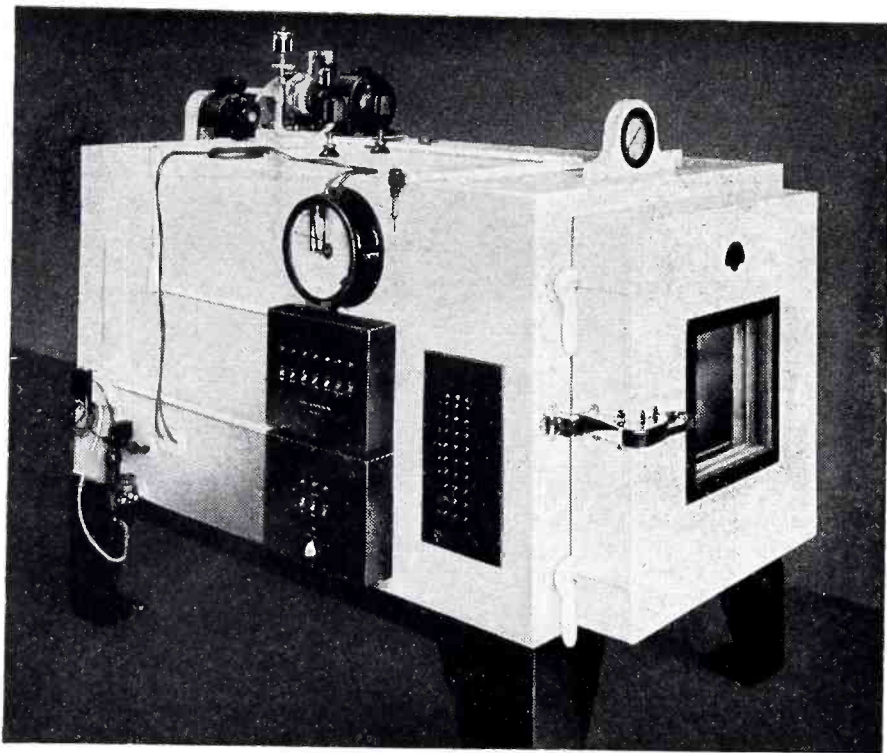

PERFORMANCE

Satisfactory

Radio and Electrical equipment is being tested in Tenney units by leaders throughout the country.

Uncle Sam's Inspectors are passing it after exacting tests with words of highest praise to the Electrical Engineers—

"PERFORMANCE SATISFACTORY"

Tenney units reproduce any atmospheric condition from the ground to Stratosphere.

Tenney Engineering, Inc. equipment is used by the Aviation Industry and the United States Government for all types of test.

Stratosphere Chambers and Rooms to 60,000 feet.

Humidity Chambers to 95%.

Constant and Variable Temperature Baths to $\pm 0.1^\circ$ F.

Temperature Cabinets to -100° F.

Accurately controlled by exterior instruments.

Our Engineering staff is at your service

Illustrated and descriptive booklet on request

For Precision Control, write—

TENNEY ENGINEERING, INC.

Dept. E-7, 8 Elm Street Montclair, N. J.

Telephone: Montclair 2-5535

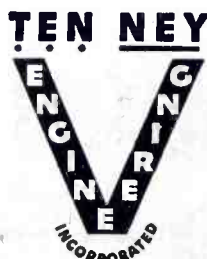

vators and other moving objects, monitoring of fuel or liquid level from the outside of an aluminum or plastic tank or container, and initiation of any other action which is dependent upon motion of an iron object near the projecting end of the armature.

Eating Marked Atoms

AN UNUSUAL and interesting application of the Geiger-Muller counter is reported by W. T. Pommerenke and P. F. Hahn in *The Proceedings of the Society for Experimental Biology and medicine*, 52, p. 223-224, 1943. Within recent years there has been considerable use of substances artificially made radioactive to trace labeled particles through the body. The influence on the breast-fed child of substances imbibed by the lactating mother has been of considerable interest to physiologists and clinicians, as well as providing a certain amount of discussion for bridge club clinical symposia. It has been shown that nicotine is excreted in the milk of cigarette-smoking mothers.

By the use of radioactive sodium

AMATEURS DO THEIR PART



Many of the 50,000 radio "hams" in this country have offered their services as radio operators for the Armed Forces, hundreds of them are on the air as volunteer members of the War Emergency Radio Service. Under this service a system of short-wave radio communication has been made available for civilian defense use. Mrs. Joyce Bonar, is shown tuning a WERS transmitter-receiver in a civilian defense control center to pick up reports of walkie-talkie sets operating at the scene of an incident

TOUGH BABIES

Klixon Controls
are small, sensitive and Rugged



The big advantages of Klixon Control can be traced right down to their actuating element . . . the Spencer Thermostatic Disc. This disc . . . scientifically calibrated . . . does the work of far more complicated elements, toggles, relays, magnets and other fussy and space consuming parts. And being snap-acting in performance provides a solid make or quick, complete break which cannot be affected by vibration or shock.

Whether you want motor and transformer overheat protection, or electrical circuit overload protection, or temperature control, or controls for radio equipment, specify Klixon Controls. They are the smallest, simplest, surest, and sturdiest controls you can find.

KLIXON
TRADE MARK REG. U.S. PAT. OFF.
Spencer Thermostat Company
ATTLEBORO, MASS.

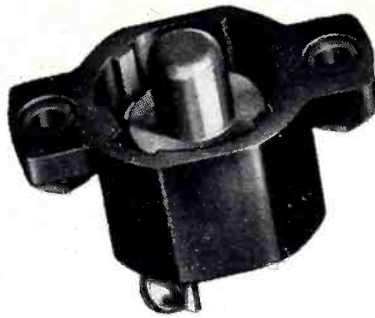

*Type PM
(NAF-1131) Circuit Breaker*

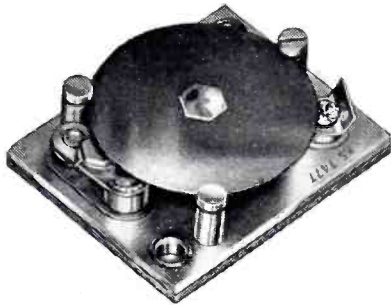

*Type B-3120
Crystal Dew Point Control*



*Type C-6363
Switch Circuit Breaker*

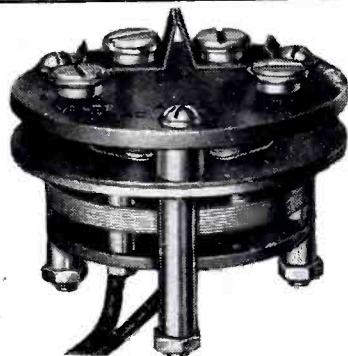

*Type ER Series
Ambient Compensated Time
Delayed Relays*

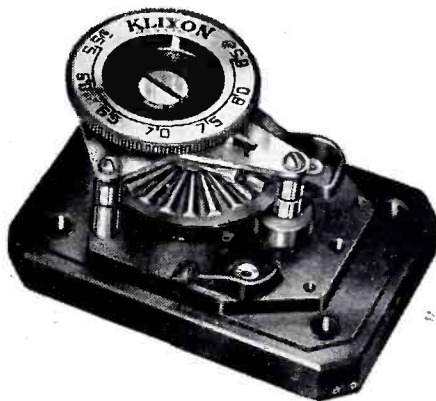

*Type RT Adjustable
Crystal Temp. Oven Control*

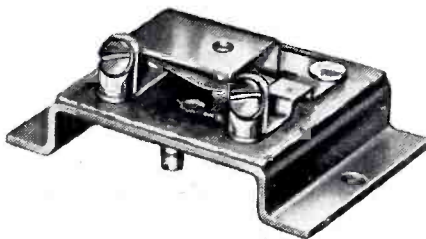

*Type C-4351 Series
Used for Tube Warming,
Tube Cooling, and
High Limit Controls*



*Type C-2851 Series, Used as
Roughing Controls on Outer
Crystal Ovens*



Marbles . . . AND COMMUNICATIONS

What's the connection? . . . Just this.

. . . playing marbles, goin' fishin', sand-lot ball games, free enterprise, backyard talks with the neighbors, Sunday rides . . . are ALL a part of the American way of living.

We, at Harvey-Wells, now producing military communications equipment, firmly believe in the American way of living, and we want it that way—ALWAYS.

We've sent our brothers, fathers and sons out to fight the barbarians. They have put on uniforms and gone into the dangers of war to defend us.

That's THEIR sacrifice . . . and WE must sacrifice also . . . to help them achieve the Victory that will ultimately mean man's right to human decency.

It's our call to arms . . . and we'll answer by buying MORE and MORE War Bonds and Stamps . . . to put all spare dollars straight into the very heart of this tremendous undertaking . . . yes, to transform those crisp greenbacks into ammunition.

It's your fight . . . and ours—morally and financially, and we MUST get the goods out . . . and ON TIME!

★
Watch for The New Series
by HARVEY-WELLS . . .
"Tablecloth Communications"

HARVEY-WELLS
Communications inc.

★
HEADQUARTERS
For Specialized Radio Communications Equipment
SOUTHBRIDGE, MASS.

the authors have determined quantitatively the rate of excretion in the milk of substances taken orally by lactating women. At the beginning of each experiment the selected breast was emptied with an electric pump. Sixty-five milligrams of radioactive sodium, such as the chloride, were then dissolved in orange juice and given to the subject. Samples were pumped from the breast at frequent intervals and the radioactivity of the milk determined by means of the Geiger-Muller counter. It was found that the radioactive sodium could be detected in the milk within twenty minutes, and that the peak concentration was reached in about two hours. The amount then slowly decreased, in some cases being detectable after ninety-six hours.—W.E.G.

Precision Temperature Control for Electric Furnaces

IMPORTANT EXPERIMENTAL details involved in successful application of A. W. Hull's photocell-thyratron circuit (*Gen. Elec. Rev.* 32, p. 394, 1933) to precise automatic control of temperature in electric furnaces are given by C. E. Waring and G. Robison in the May 1943 *Review of Scientific Instruments*.

In the Hull circuit, a platinum resistance thermometer is placed in the furnace to be controlled and used as one arm of a Wheatstone bridge having a mirror galvanometer as the indicating instrument. The bridge is balanced for the desired

SPECTROPHOTOMETER

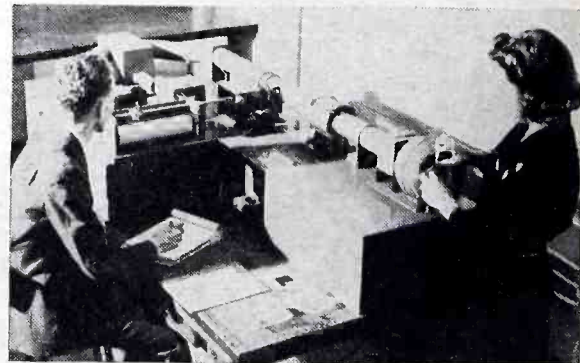

Photoelectric recording spectrophotometer being used to measure color of sample of yellow paper. The spectrophotometric curve is being drawn automatically on drum at left. Originated by Dr. A. C. Hardy and built by General Electric, this photoelectric device permanently and accurately records and specifies all colors the human eye can see

SLATER ELECTRONIC TUBES

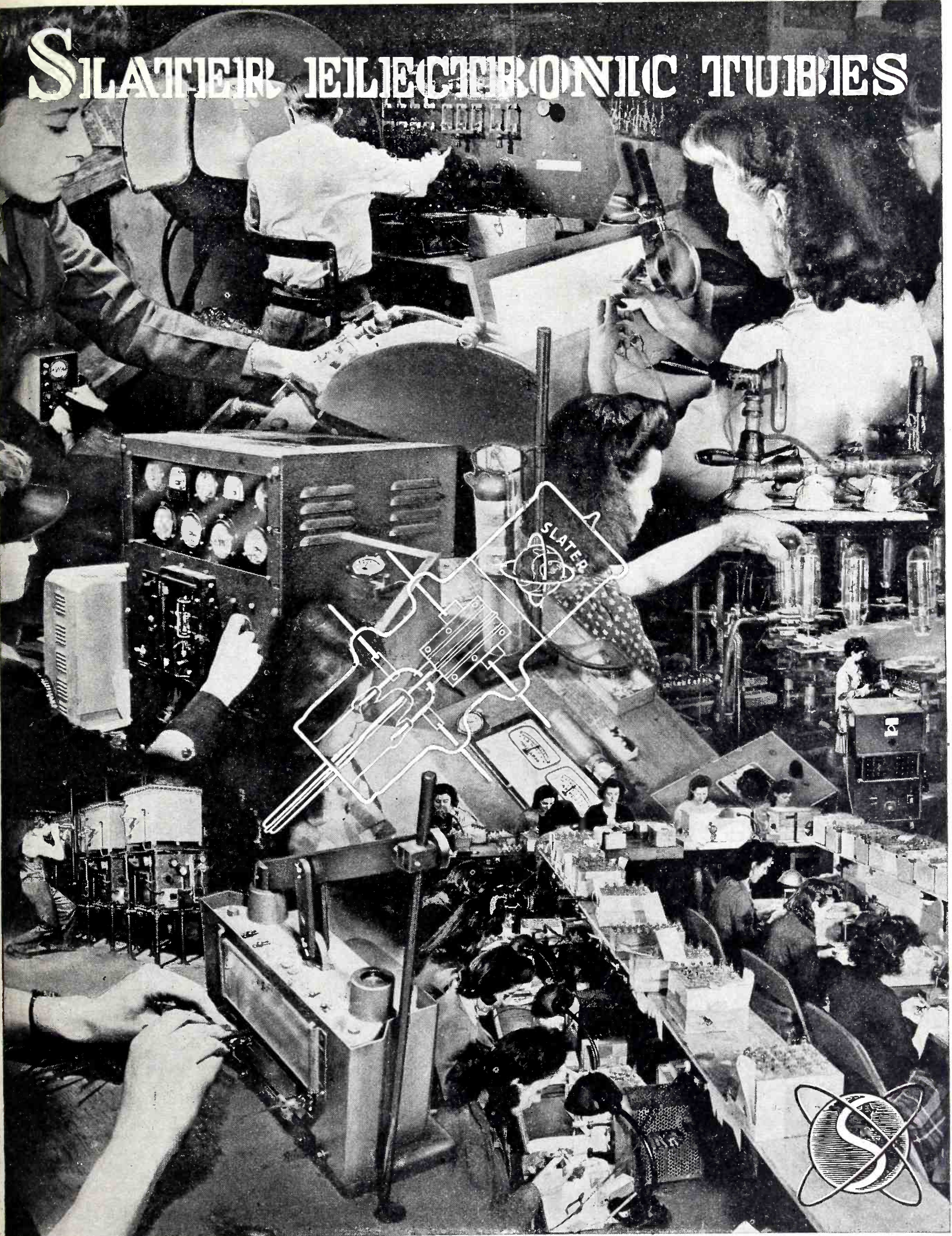

WHERE SKILLED HANDS REFLECT THE HIGH STANDARDS OF EXCELLENCE OF SLATER PRODUCTS

SLATER ELECTRIC & MFG. CO. BROOKLYN, NEW YORK
MANUFACTURERS OF PRECISION ELECTRONIC TUBES AND INCANDESCENT STREET LIGHTING LAMPS

ELECTRONICS — July 1943

Designed for

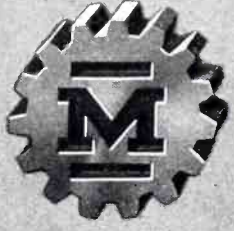

Application



THE 33087 TUBE CLAMP

Still another exclusive Millen "Designed for Application" product. Easy to use, easy to install, effective in function. Available in special sizes for all types of tubes. Single hole mounting. Spring steel, cadmium plated.

**JAMES MILLEN
MFG. CO., INC.**

MAIN OFFICE AND FACTORY
**MALDEN
MASSACHUSETTS**



temperature and the light beam reflected from the galvanometer mirror is permitted to fall on a phototube whose internal resistance controls the phase of the grid voltage of an FG-57 thyatron with respect to its plate voltage. When balanced, the beam covers most of the active surface of the phototube. When the temperature drifts, the bridge goes off balance, and either more or less light falls on the phototube. This causes continuous regulation of the power passing through the thyatron to part or all of the furnace winding, thereby giving constant temperature.

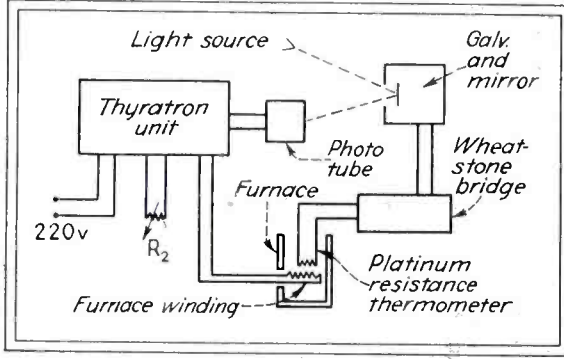

Block diagram of original circuit developed by A. W. Hull for controlling high-temperature furnaces

The paper bridges the gap between presentation of an electronic circuit and actual application of the circuit by the average scientist or engineer, by describing in detail the various precautions required to insure satisfactory operation. It tells which photocell gave best results, gives construction data for the platinum resistance thermometer, specifies batteries which give sufficiently stable voltages for the purpose, and indicates exactly where Isolantite insulation is required. A step-by-step procedure for making initial tests and adjustments is followed by operating instructions such as would be found in a factory manual of a commercial product. Important factors affecting precision over long operating periods are given.

By following the procedure outlined, it was possible to hold an electric furnace at a temperature of 600 deg. C automatically for a one-hour period with maximum deviation of only 0.05 deg. from this value. One unit maintained this temperature constant to within 3 deg. without adjustment for a period of eight weeks.

110-VOLTS A. C.
ANYTIME, ANYWHERE WITH
KATOLIGHT
GENERATORS AND POWER PLANTS

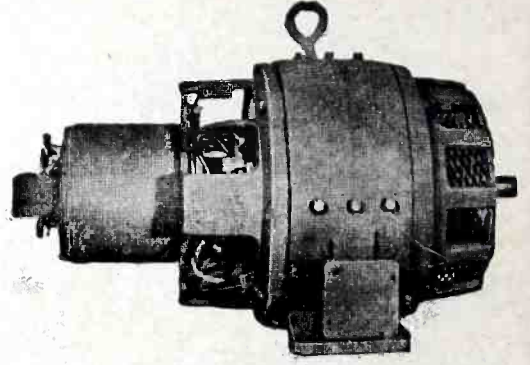

Furnish same kind of current as City power lines permitting emergency hook-ups right out in the field for operating repair equipment such as drills, grinders, saws, etc., for making on the spot repairs; transmitters & receivers; portable X-Ray equipment.

Good deliveries on A.C. generators 300 through 15,000 watts. Available all standard voltages. Good voltage regulation.

Kato's entire production at present must be confined to orders with high priorities.

Also manufacturers of a complete line of rotary converters and complete power plants.

KATO ENGINEERING CO.

530 Front St. Mankato, Minn.

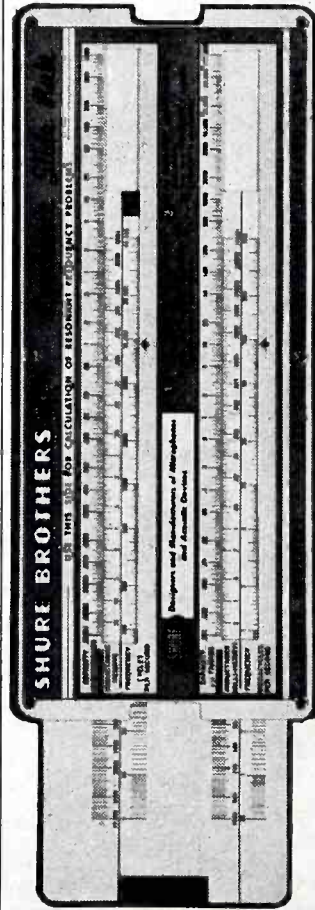

have you
sent for
your **SHURE
REACTANCE
SLIDE RULE?**

Thousands of engineers and technicians find the Shure Reactance Slide Rule helpful in radio computations. Simplifies problems in resonant frequencies, circuits, inductances, condensers. Range 5 cycles per sec. to 10,000 megacycles. Complete with instructions. Send 10c in coin to cover handling.

SHURE BROTHERS
225 W. Huron St., Chicago
Dept. 174 M

Designers and Manufacturers of Microphones and Acoustic Devices



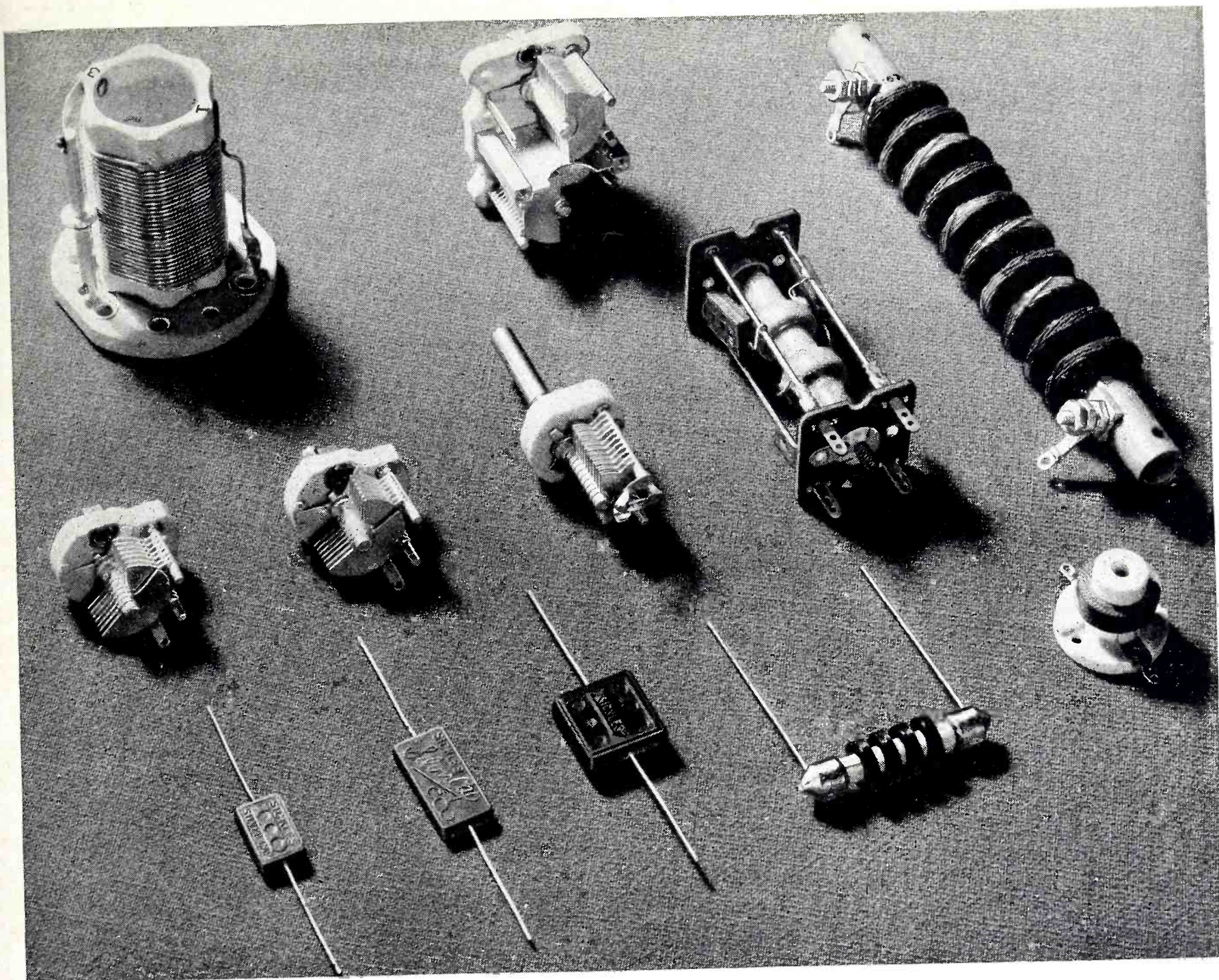

Jewelry? *In a way, yes . . .*

These are Sickles products — coils and condensers —
 as precise and clean-cut as a Swiss watch, as handsome as Florentine silver,
 and as scarce, for non-military purposes, as rubies . . . though our production is up
 in several departments some 400% over that of pre-war days. They're jewels as performers, too . . .

as you might well judge by our recently-won Army-Navy "E."

Superior Sickles specialties of this same high quality will be available
 for general use as soon as Victory is won. Meanwhile, please bear us in mind.

The F. W. Sickles Company, Chicopee, Massachusetts.



SICKLES

Electronic Specialties

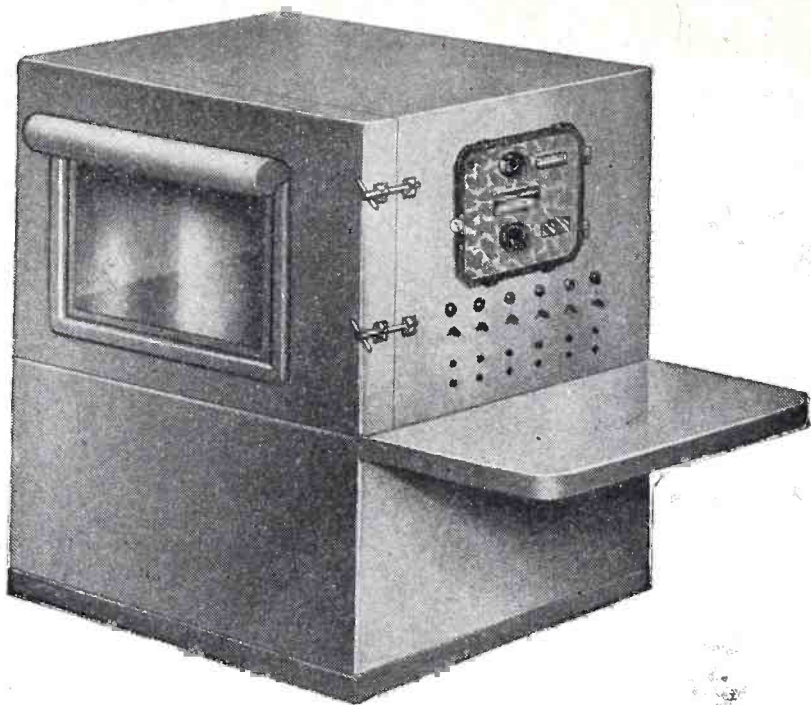

Operational Condition Test Equipment

Army, navy, air corps, and C. A. A. specifications for Electronic products as well as instruments and their component parts require operational condition testing—cold, heat, dust, humidity, salt spray.

Whether for development work or for production testing calibration, Northern Engineering Laboratories can supply you quickly with standard or custom built test chambers which will provide all of the atmospheric conditions your specifications require.

Model NEL135-43 is typical in performance -100°F to $+160^{\circ}\text{F}$; 20% to 95% R.H. in the physical range; altitude simulation from sea level to 80,000 feet. ($\frac{1}{2}$ " Hg. absolute). The graphs below show actual flight simulation curves of performance of the unit pictured above.

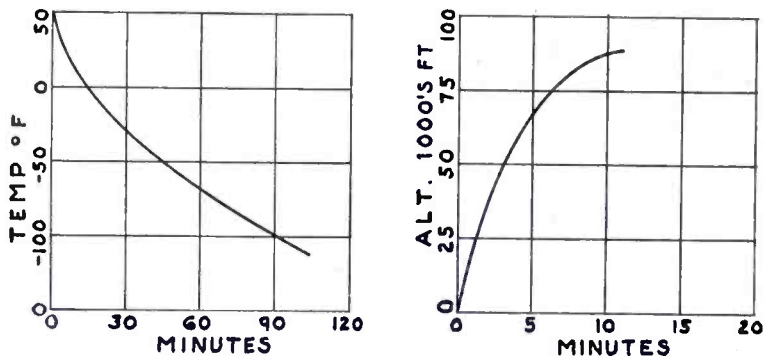

Rugged construction—complete shock and vibration isolation—Electronic indicator controller—full view observation window—fully automatic operation—high and low frequency electric connections from instrument panel to chamber interior—temperature controlled to plus or minus 0.2°F of selected temperature—fully mechanical refrigeration with complete refrigeration control—Freon 22 refrigerant—feature this laboratory instrument.

For full information and details send for Bulletin #22.

PRESSURE

HEAT

COLD

HUMIDITY

NORTHERN ENGINEERING LABORATORIES

50 CHURCH ST., N. Y. C.

V-H-F Receiver

(Continued from page 97)

when we plot the shape of a high-frequency oscillator curve, and examine the peak, we find that in terms of the 10 kc unit of drift we may want to establish as a desirable maximum the peak is practically flat at the top.

Figure 1 shows the poor frequency discrimination afforded by a 100-Q circuit at 150 Mc. The curve is 175 kc wide only 1 percent down.

Voltage Stability

In the past it has been assumed that the higher the Q the higher the voltage stability of the oscillator. After full investigation of this point the writer is convinced that there is no such direct relationship. It is true, merely, that the higher the Q the larger tuning capacitor you can use to swamp out tube capacitance with its host of variables. This is not quite the same thing. Also, in a distributed type of circuit such as a parallel line you can slide the tube down the circuit so that it is across just a small portion of the line and still obtain enough impedance at this point to load the tube up nicely.

Striking Voltage

Figure 2 brings out one practical aspect of this effect. It may be said of any oscillator that if the phase-angles, impedances and Q are all good the oscillator will "strike", or start to oscillate, at a very low plate voltage if the tube has very small G_m . Curve A is that of an average type 955 acorn triode in a 400-Q circuit, using a tuning capacitor of $15\ \mu\text{f}$ in a concentrated tank circuit. It strikes at 8 v on the plate and the frequency changes rapidly as the voltage increases. At 100 v it is nicely flattened off. Curve B is the same type circuit with the $60\text{-}\mu\text{f}$ tuning capacitor, with a similar coil reduced in inductance to allow oscillation at the same frequency as that of the oscillator in curve A. In this case it will be seen that the plate voltage must increase to 50 v to cause the oscillator to strike.

It will be noted that at 100 v curve B is still quite steep and shows little tendency to flatten off.

IN-CURVE *or* **OUT-CURVE**

- it's all the same to

WALKER-TURNER FLEXIBLE SHAFTING

In plane, tank, ship and many other weapons of war, Walker-Turner Flexible Shafting is in there pitching. And it never goes to pieces in the pinches, either. For transmission of power in small amounts and for remote control between two points in line or out of line, this flexible shafting has shown itself to be the logical answer to many difficult problems.

The design of Walker-Turner Flexible Shafting is based on the construction and use of thousands of Walker-Turner Flexible Shaft Machines in a wide variety of industries throughout the country. In addition, we have worked out special problems in power transmission and remote control for many products made by other manufacturers. Perhaps we can help you, too. Ask us.

WALKER-TURNER COMPANY, INC. 1473 BERCKMAN STREET, PLAINFIELD, N. J.



FLEXIBLE SHAFTING

FOR REMOTE CONTROL AND POWER TRANSMISSION

EDITORIAL REPRINTS

NEW WORLD OF ELECTRONICS. . . . Reprints of this symposium from the March 1943 issue contain articles on the application of electronics to telephone, telegraph, radio and military communications; applications of electronics to welding control, induction heating, facsimile and photograph transmission, television, motor control, geophysical prospecting, industrial control problems, research, medicine etc., etc.

This 100-page book is useful for executives and engineers wishing to know what electronics offers American industry in speeding up war production and as a profitable post-war business. Each article is by an expert.

Prices, 1 to 50 copies, \$1.00 each; 50 to 100 copies, 85 cents each; 100 copies and more, 75 cents each.

UHF TECHNIQUES . . . Last call for this 64-page book on the new science of ultrahigh frequencies. Widely used by Signal Corps, U. S. Air Corps, U. S. Navy and pre-service schools. Individual articles are "Electrical Concepts at Extremely High Frequencies," "Radiating Systems and Wave Propagation," "Generators for U-H-F Waves," "U-H-F Reception and Receivers," "Wide Band Amplifiers and Frequency Multiplication," "Measurements in the U-H-F Spectrum," "Applications of Cathode-Ray Tubes," "Wave Form Circuits for Cathode-Ray Tubes."

This is a final reprinting; paper scarcity makes impossible any further restocking. Price 50 cents each for single copies or 35 cents each for 26 or more.

ABBREVIATED EDITION . . . A shortened edition of the UHF Technique symposium containing the articles "Electrical Concepts at Extremely High Frequencies," "Applications of Cathode-Ray Tubes," and "Wave Form Circuits for Cathode-Ray Tubes" is available at 25 cents each.

ELECTRONICS EDITORIAL DEPARTMENT
330 West 42 St., New York, N. Y.

Please send me..... copies New World of Electronics
..... copies UHF Techniques
..... copies UHF Technique Abbreviated Edition

I enclose \$.....(this saves time and accounting)

Please bill me for \$.....

Name.....

Address.....

At zero plate voltage an oscillator tube has zero G_m and almost infinite plate impedance. As we gradually apply plate voltage the mutual conductance increases and at the same time the plate impedance decreases. At 8 v the G_m is very small and the plate impedance very high. Yet the tube in curve A strikes. As we continue to increase the plate voltage we change both these parameters by a large factor. We bring the tube plate impedance down to a value which is a very good match to the dynamic impedance of the tuned circuit and increase the G_m to a much higher value than at 8 v. Thus at 100 v the tube is working under the best possible conditions. Beyond 100 v the plate impedance and G_m change very little.

Other Effects

An interesting variation in voltage stability will be noted in variable capacitor-tuned oscillators. At low frequencies we normally expect that the oscillator will be most stable with the tuning capacitor set at maximum capacitance value. In the very high frequency region under discussion the maximum voltage stability will usually occur somewhere around the mid-capacitance value, since at low capacitance values the tube will be the larger part of the tuned circuit and will contribute its variable parameters, while at the maximum value of the tuning capacitor the tube capacity will be swamped but the dynamic impedance will be so low that the striking voltage will be excessive, with resultant instability.

This effect frequently limits the tuning range in a "disciplined" receiver designed for very high frequency operation and is brought out in Fig. 3, wherein the ordinate represents the voltage instability in terms of kc change in frequency for a given change in supply voltage and the abscissa represents the L/C ratio expressed in terms of the tuning capacitor value. That is, the oscillator frequency in this case was held constant at 150 Mc by reducing the inductance as the tuning capacitor value was increased and vice-versa. It will be noted that the maximum stability occurred in the neighborhood of 25 μf .

The designer can, by taking advantage of the above mentioned points, go far toward maintenance of secular stability.

THE AMERICAN WAY IS FOR ALL TO SAY... "TAKE MORE THAN 10% EVERY PAYDAY"



The Army-Navy "E" Award
conferred upon the J. P. Seeburg
Corporation for outstanding production
of War Materials in each of
its Four Plants

*This honor is sincerely appreciated by each and every
one of us, and is accepted with sober consideration
of the greater responsibilities it demands.*

J. P. SEEBURG CORPORATION

N. Marshall Seeburg
PRESIDENT

Makers of Fine
Musical Instruments
Since 1902.....

Seeburg

J. P. SEEBURG CORPORATION * CHICAGO, ILLINOIS

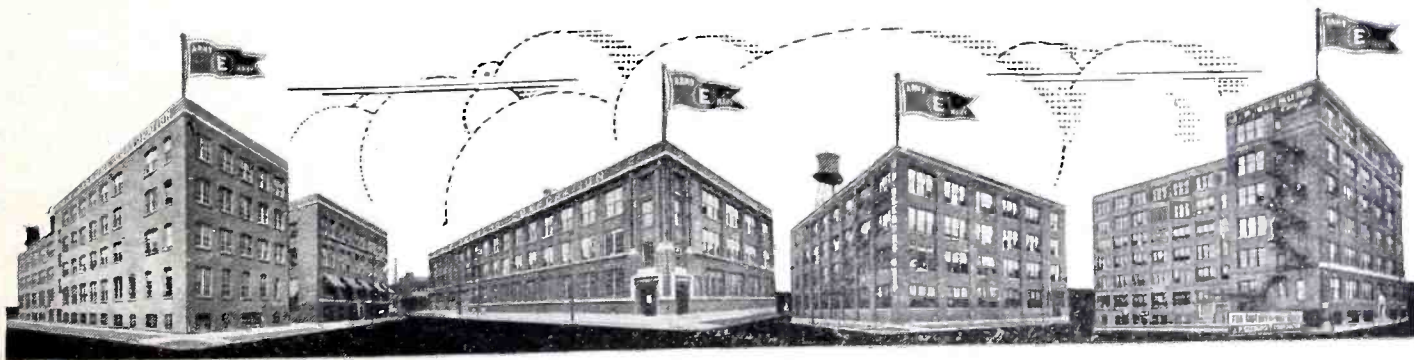

AIR CRAFT RADAR * AIR CRAFT CONTROLS * TANK COMMUNICATION EQUIPMENT * AVIATION TRAINING DEVICES * AIR CRAFT GUN TURRET EQUIPMENT * AIR CRAFT TRANSMITTER EQUIPMENT

Talk to any Point in your Plant ... IN A SPLIT-SECOND!

SAVE MAN HOURS ... SAVE STEPS ... SAVE MONEY

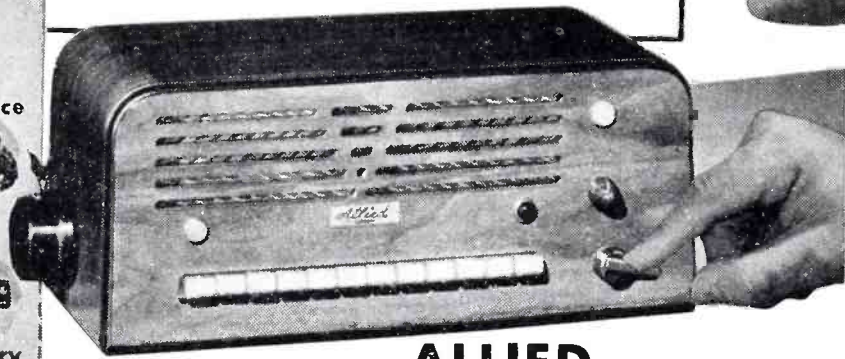
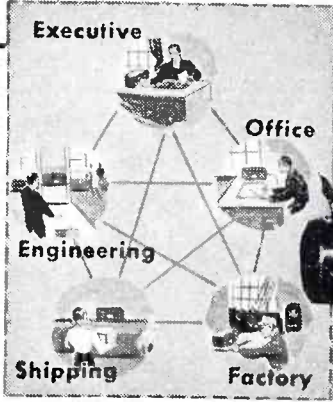

ALLIED INTERCOMMUNICATION SYSTEMS

Speed communication between departments ... remove traffic from your switchboard! *The new 10-Station "SUPER-CHIEF" illustrated* handles up to 5 separate 2-way conversations. New features include: Private Multi-Station Conference—Call Waiting and Busy Signal Lights—No Eavesdropping—Privacy Earphone—High Power. Available with any number of stations.

★ Other versatile low-cost Allied Intercom Systems for War and Industry. Easily installed and operated. Our veteran staff can help you. Send for literature and full details.

Write, wire or phone Haymarket 6800.

ALLIED RADIO CORP.

833 W. Jackson Blvd., Dept. 24-G-3, Chicago

ALLIED RADIO ★
EVERYTHING IN ELECTRONICS AND RADIO

COMPLETE CENTRALIZED SERVICE On Electronic and Radio Needs

Simplify your procurement ... speed delivery ... get *everything* in Electronics and Radio from this *one* dependable, central source. Over 10,000 electronic parts ... all famous brands ... for the Armed Forces and for Industry.

FREE!
NEW
Most Complete
Up-to-Date 1943
BUYING
GUIDE

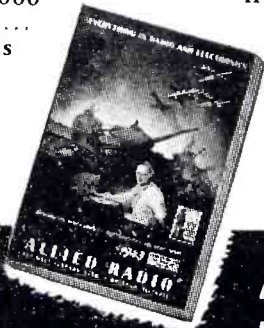

Audio Analyzer

(Continued from page 103)

The chief value of this recording-type analyzer in the field of sound and vibration analysis lies in the fact that a complete chart showing the intensity at each frequency can be obtained in only two minutes. This chart shows at a glance the predominant frequencies, and knowing these, an engineer can generally make quick calculations to determine which parts could have such resonant values. Adjustments can then be made and new charts run off until a combination of conditions is found which gives minimum peak amplitudes and hence minimum noise. If the nature of the test permits, the analyzer can be set to each peak frequency in turn while the meter is connected in place of the recorder, and adjustments made on the noise-producing equipment to eliminate individual peaks.

Industrial Applications

In one instance, engineers were using the analyzer to check the noise produced by a vacuum cleaner. The resulting chart indicated a predominant noise frequency which was almost instantly identified as being produced by the fan blade.

When used on the French liner Normandie some time ago, the analyzer pointed to the propellers as a major cause of the severe vibration experienced during early runs. A change of propellers materially reduced the vibration, confirming the results obtained with the instrument.

Many recording audio analyzers have been ordered by governmental agencies for military purposes. Reduction of noise in marine engines of surface vessels to minimize chances for detection by submarines, and in submarines to prevent detection by enemy ships with listening apparatus, are just a few important military applications.—J.M.

REFERENCES

- (1) Mason, W. P., Electrical Wave Filters Employing Quartz Crystals as Elements, *Bell System Tech. Jrl.*, p. 405, 13, July 1934.
- (2) Mason, W. P., Resistance-Compensated Band-Pass Crystal Filters for Use in Unbalanced Circuits, *Bell System Tech. Jrl.*, p. 423, 16, Oct. 1937.
- (3) Mason, W. P., and Sykes, R. A., Electrical Wave Filters Employing Crystals with Normal and Divided Electrodes, *Bell System Tech. Jrl.*, p. 221, 19, Apr. 1940.
- (4) Wentz, E. C., Bedell, E. H., and Swartzell, K. D., A High Speed Level Recorder for Acoustic Measurements, *Bell System Tech. Jrl.*, p. 121, 14, Jan. 1935.

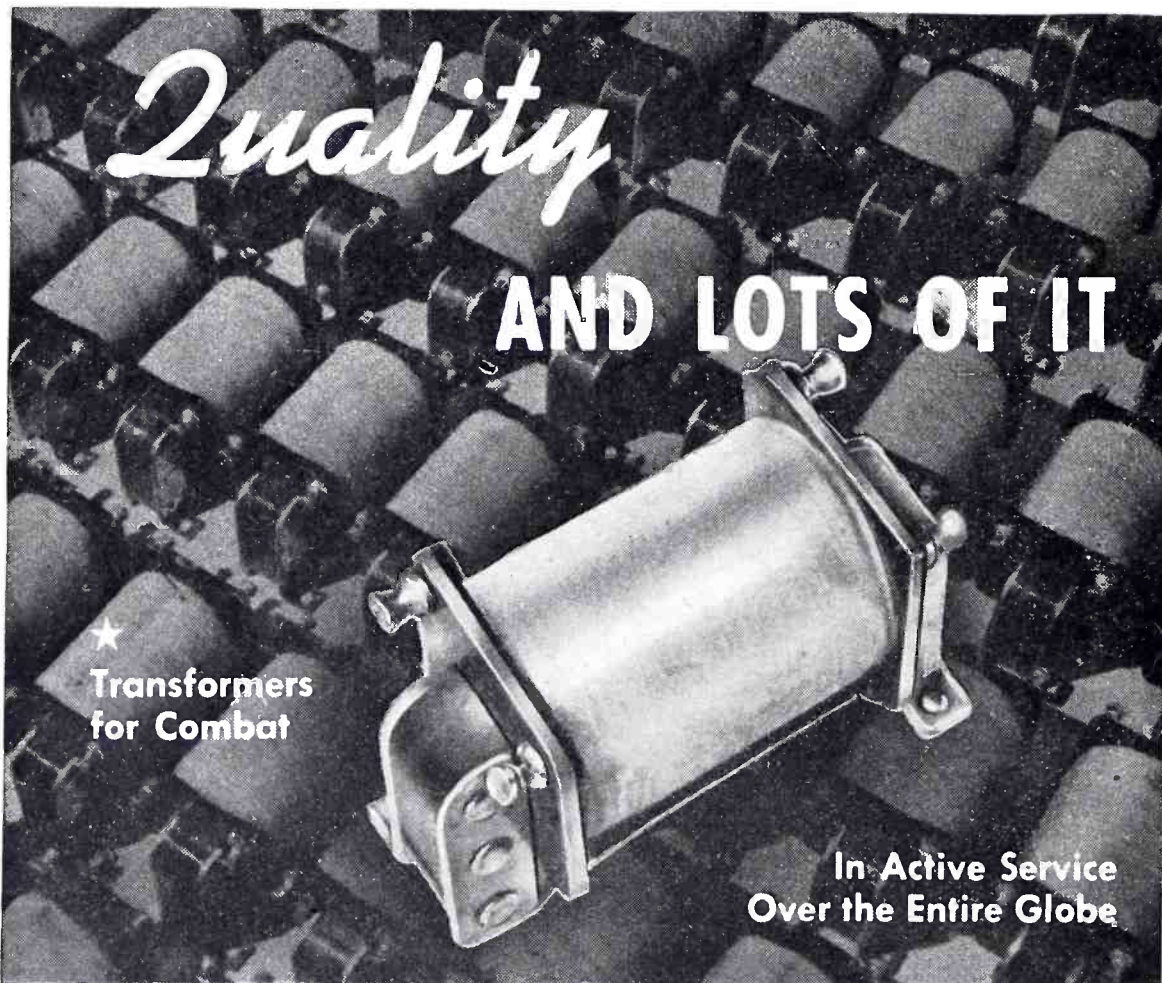

Quality

AND LOTS OF IT

★
Transformers
for Combat

In Active Service
Over the Entire Globe

DINION COIL COMPANY

CALEDONIA, N. Y.

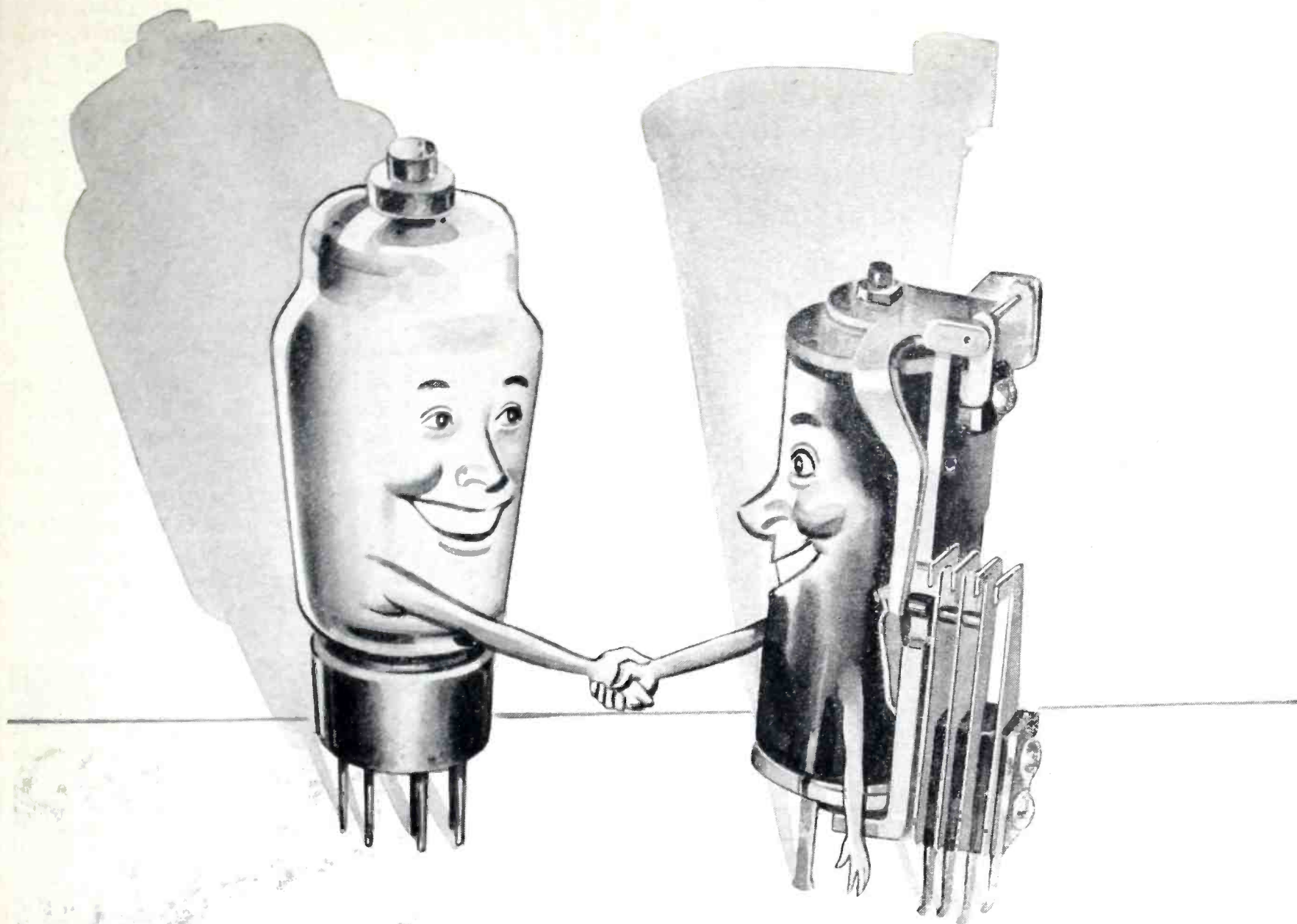

LET'S POOL OUR KNOWLEDGE

WORKING with electronic engineers in scores of industries has taught us a lot about electronic science—what it is doing to increase the effectiveness of our tools of war—how it is speeding up war production—about the miracles it promises for our postwar world.

We have learned, for example, how much this "new-old" science depends on the right electrical controls—the important part that relays, stepping switches, solenoids and other control devices play in putting electrons to work.

And that's *our* strong point. We know electrical control because that has been our sole business for over fifty years. So why not pool our resources? Let's apply *our* experience in electrical control to *your* problems in making electronic developments do a better job at lower cost.

First step in this direction is to make sure you have the Automatic Electric catalog of control apparatus. Then, if you need help on any specific electronic problem, call in our field engineer. Behind him are Automatic Electric's fifty years of experience in control engineering. His recommendations may save you time and money.



AUTOMATIC ELECTRIC SALES CORPORATION
1033 W. Van Buren St. Chicago
In Canada: Canadian Telephones & Supplies Limited, Toronto

Relays
AND OTHER CONTROL DEVICES
by **AUTOMATIC
ELECTRIC**

MUSCLES FOR  THE MIRACLES OF ELECTRONICS

NEWS OF THE INDUSTRY

Early history of radar; future of electronics; IRE news; new commercial communications agency; Wall St. looks at electronics; college courses in electronics; WPB news; radio business news; personnel changes; E awards

Recent Developments in Military Radio Communication

ONE POTENT WEAPON in the continuous propaganda battle raging over the air waves is "blind broadcasting" of news photographs by short-wave stations, for reception by anyone with the necessary receiving equipment. The OWI now leases 2½ hours of short-wave radio time daily for four news picture broadcasts, to Northern Europe from Sweden to Bombay, to Central Europe from London to Cairo, to North Africa, and to Central and South America. Previously, photographs moved only over controlled circuits of established commercial radio channels, and transmission did not begin until code contact had been made with the receiving operator.

Six super-power radio stations operated by the Civil Aeronautics Administration provide direct communication with a plane in flight anywhere on the globe, according to William Burden, Special Aviation Assistant to the Secretary of Commerce. This means that passengers in post-war airliners can talk to the folks back home even though flying over China, the North Pole or any other remote portion of the globe.

Units of the Army Air Forces, maintaining 24-hour vigil atop mountain peaks of India, are using radio and undoubtedly also radar to notify American air bases of the approach of Jap planes.

Kite string made from continuous filaments of glass wound with fine copper wire is used with a box kite to carry aloft the antenna of the emergency radio transmitter developed by the Army Air Forces for its life rafts. The yarn has great strength in proportion to its weight, and is not weakened by salt water, tropic sunlight, rain or dampness.

The transmitter automatically grinds out the SOS signal on the international distress frequency of 500 kc when the power-generating crank is operated.

Wavemeters built by Philco for calibration of Army and Navy radio transmitters contain a self-compensating device, thermostatically operated, which automatically changes the effective length of the wire in the tuning coil as temperature varies. E. O. Thompson and David Sunstein, of the Philco Engineering Dept. and Factory Organization respectively, were officially cited by WPB for this wavemeter improvement.

Navy's History of Radar

Editor's Note: The second Navy press release on radar, issued May 23, 1943, is a testimonial to the perseverance of the men and manufacturers who successfully bridged the gap between observance of a phenomenon and practical development into the outstanding scientific contribution to the war effort. The release is given here just as released by the Navy, because of its reference value.

Reflection of Signals is Noticed

In mid-September 1922 two research scientists Dr. A. Hoyt Taylor and Mr. Leo C. Young working in the Naval Aircraft Radio Laboratory Anacostia, D. C., observed that certain radio signals were reflected from steel buildings and metal objects. They also observed that ships passing by a transmitter and receiver at such frequencies gave a definite interference pattern. These observations gave rise to the suggestion that:

"Possibly an arrangement could be worked out whereby destroyers located on a line a number of miles apart could be immediately aware of the passage of an enemy vessel between any two destroyers in the line, irrespective of fog, darkness or smoke screen."

The discovery by Dr. Taylor and Mr. Young, more than 20 years ago,

was the birth of radar. Their imaginative, searching preliminary suggestion marked its first possible military application.

As announced in the joint Army-Navy press release of April 25, 1943 (given on p. 274, June 1943 *ELECTRONICS*), the term "radar" means radio-detecting-and-ranging.

Research Begins

Dr. Taylor and Mr. Young have been connected intimately with the development of radar ever since those fateful days in September, 1922. For like most discoveries which shape the path of mankind, as has radar in the present war, the chronological development of radar is mainly the story of unceasing human endeavor. Their early equip-



Dr. A. Hoyt Taylor



Mr. Leo C. Young



Revere
Distenoff

THE SKILL *and* **THE WILL**
... today and tomorrow

Only one American in many thousands is privileged to wear the "E" pin, symbolic of high achievement on the production front. It symbolizes skill and determination above and beyond the high average standard set by American Industry. . . . The men and women of Connecticut Telephone & Electric Division have been honored by the Army-Navy Production Award twice in a period of six months. This symbol

of a job being well done in the cause of Victory is evidence, too, of what may be expected when the war is won. . . . The manufacturer seeking cooperation in product engineering and improvement, the development of production control, or any problem involving the application of advanced electrical or electronic knowledge, is cordially invited to discuss the matter with our engineering staff.



CONNECTICUT TELEPHONE & ELECTRIC DIVISION

MERIDEN



CONN.

© 1943 G.A.I., Inc., Meriden, Conn.

**DESIGN, ENGINEERING & PRODUCTION
OF PRECISION ELECTRICAL EQUIPMENT**

Speed Working Tools for Precision Operations

New and Old Workers find SPINTITE the fastest wrench for speedy assembly of small parts.

Standard sizes with hex sockets from 3/16" to 5/8". Knurled Round and Square Sockets available on special order. SPINTITE works like a screw driver.

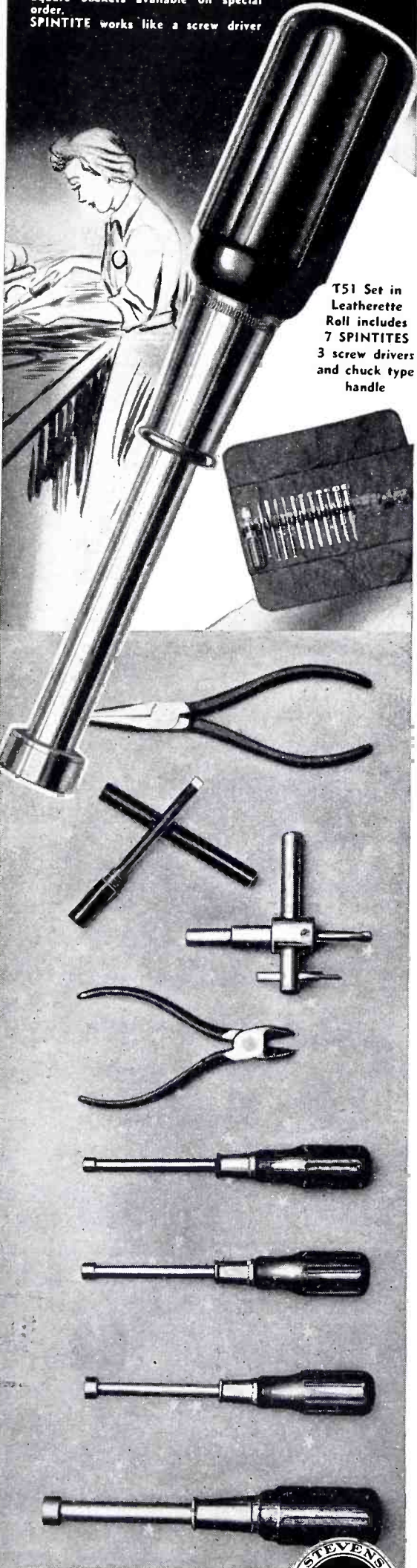

T51 Set in Leatherette Roll includes 7 SPINTITES 3 screw drivers and chuck type handle

STEVENS WALDEN, INC.
459 SHREWSBURY STREET
WORCESTER, MASSACHUSETTS, U. S. A.



ment difficulties were almost unbelievable, but the continuing faith of Dr. Taylor and Mr. Young enabled them to drive forward their development to a degree whereby radar has changed markedly the tactical science of modern warfare.

Dr. Taylor is now Superintendent of the Radio Division of the Naval Research Laboratory. Mr. Young is now Assistant Superintendent of the same Division.

On September 27, 1922, a report on Dr. Taylor and Mr. Young's initial findings and their suggested implications was forwarded to the Bureau of Engineering, Navy Department, Washington, D. C.

Despite the pressure of their other work and the discouraging factors which face the pursual of most research work, Dr. Taylor and Mr. Young continued their trail. Between 1925 and 1930 the reflection phenomena observed in 1922 was used to measure the height of the Kennelly-Heaviside layer, an atmospheric formation which acts as a reflector for certain beams. Dr. Taylor and Mr. Young did this work in conjunction with Dr. Gregory Breit and Dr. Merle A. Tuve, of the Carnegie Institute. Their associates during this period included Mr. L. A. Gebhard and Mr. M. H. Schrenck.

During this period, Dr. Taylor and Mr. Young also measured the time required for radio signals to go around the world by reflection from the Kennelly-Heaviside layer. For this purpose extremely brief radio signals were employed, and apparatus was designed to both transmit and receive such brief signals. Mr. L. A. Hyland, now with the Bendix Corporation, was one of Dr. Taylor's associates during this early work.

On June 24, 1930, Mr. Hyland, working under Dr. Taylor, observed that aircraft crossing a line between a transmitter and receiver operating directionally gave an interference pattern clearly indicating the presence of such aircraft.

Dr. Taylor Makes Detailed Report

On November 5, 1930, the Director of the Naval Research Laboratory submitted to the Chief of the Bureau of Engineering, Navy Department, a detailed report, prepared by Dr. Taylor, on "radio-echo signals from moving objects." This report summarized all observations made prior to that date, presented the theory

"...IN-RES-CO resistors for hard-to-get-in applications"



★ Electronic designers are solving intricate installation problems by specifying IN-RES-CO resistors wherever mounting presents unusual obstacles. The wide range of IN-RES-CO resistors, multipliers, meter shunts, chokes, etc., permit extreme latitude in the selection of a special application-designed product to efficiently meet your requirements. Check the electrical and mechanical features of IN-RES-CO units today; literature on request.

TYPE ALN (at left), 2 Watt, Non-inductive, Standard tolerance 3%, Maximum resistance 25,000 ohms, Size 7/16" diam. x 1" long.

TYPE BL (center), 6 Watt, Inductively wound, Standard tolerance 3%, Maximum resistance 150,000 ohms, Size 7/16" diam. x 1 1/2" long.

TYPE BC (at right), 10 Watt, Inductively wound, Standard tolerance 3%, Maximum resistance 60,000 ohms, Size 7/16" x 1 1/2" long.

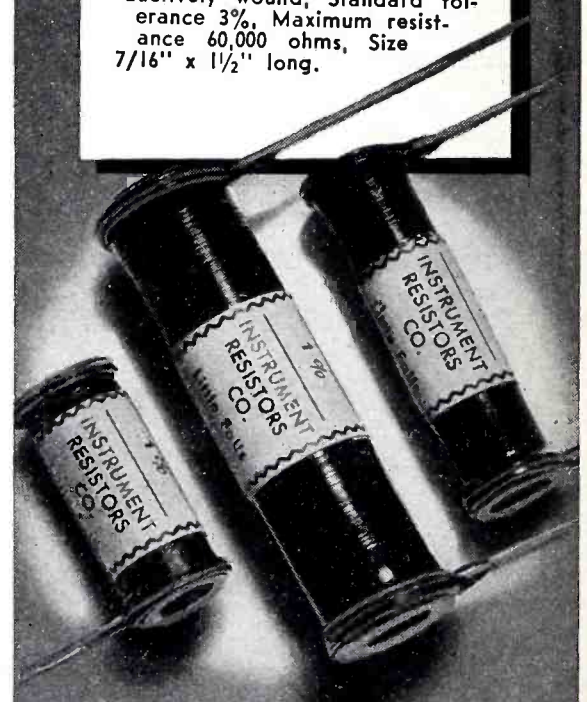

INSTRUMENT RESISTORS COMPANY

25 AMITY ST., LITTLE FALLS, N. J.

underlying the observed phenomena and concluded with the recommendation that the investigation be continued and intensified.

Dr. Taylor's report having been thoroughly studied, the Radio Division of the Bureau of Engineering on January 19, 1931, assigned the Naval Research Laboratory the following problem:

"Investigate use of radio to detect the presence of enemy vessels and aircraft. Special emphasis is placed on the confidential nature of this problem."

On October 21, 1931, Captain Harold G. Brown, U.S.N., then Assistant to the Chief of the Bureau of Engineering, (now Rear Admiral, Special Assistant to the Under Secretary of the Navy), forwarded for comment and consideration to the Naval Research Laboratory certain radio proposals of Lieutenant (now Commander) Joseph N. Wenger, U.S.N. Two weeks later, on December 20, 1931, Dr. Taylor replied that all of Lieutenant Wenger's proposals had already been demonstrated in previous work at the Naval Research Laboratory to have practical possibilities, and again Dr. Taylor recommended that this research be given a high priority.

Meanwhile the theory of reflection from moving objects had been confirmed by experiments conducted in cooperation with the dirigible Akron.

War Department Gets First Report

At this stage in radar's development the Navy's findings were brought to the attention of the War Department. On January 9, 1932, the Secretary of the Navy wrote the Secretary of War describing the work carried on at the Naval Research Laboratory. This letter contained the following suggestion:

"Certain phases of the problem appear to be of more concern to the Army than to the Navy. For example a system of transmitters and associated receivers might be set up about a defense area to test its effectiveness in detecting the passage of hostile aircraft into the area. Such a development might be carried forward more appropriately and expeditiously by the Army than by the Navy."

A copy of Dr. Taylor's report of November 5, 1930, was enclosed with the Secretary's letter, and the War Department was offered the assis-

The advantage of A Single Source of Supply

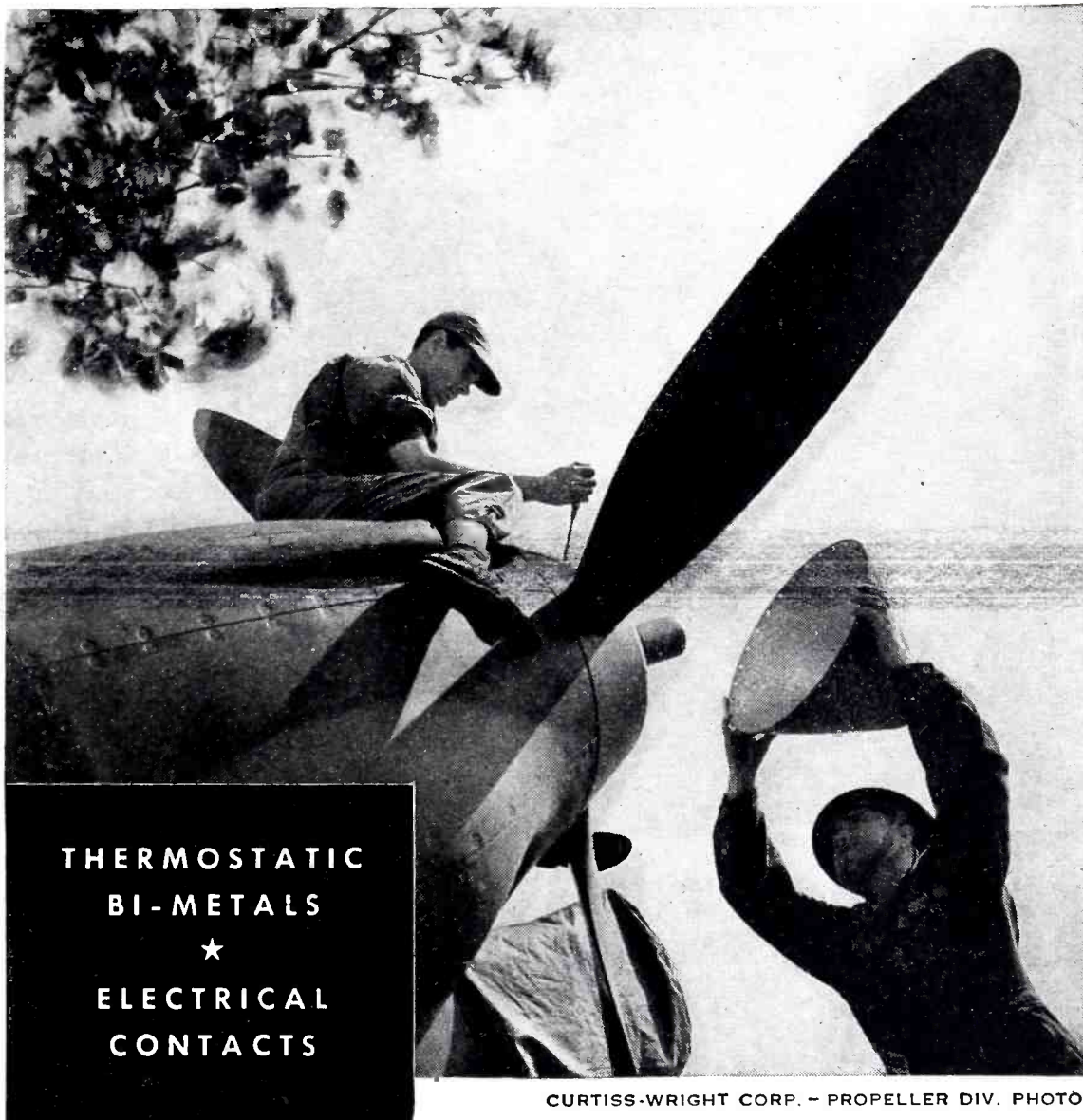

THERMOSTATIC
BI-METALS
★
ELECTRICAL
CONTACTS

CURTISS-WRIGHT CORP. - PROPELLER DIV. PHOTO

★ The facilities of THE H. A. WILSON COMPANY enable manufacturing customers to secure both electrical contacts and thermostatic bimetals from a single and dependable source. This is important, for materials from these two groups are frequently used in conjunction, as parts in the same device.

★ WAR stresses the vital importance of perfected team play; and WILCO Electrical Contacts and THERMOMETALS (hermostatic bimetals) are now functioning with flawless coordination in various plane, tank, gun and ship applications. They also function separately or together in various instruments of the Army and Navy.

WILCO PRODUCTS ARE: *Contacts*—Silver, Platinum, Tungsten, Alloys, Powder Metal. *Thermostatic Metal*—High and Low Temperature with Electrical Resistance from 24 to 530 ohms per sq. mil.-ft. *Precious Metal Collector Rings*—For rotating controls. *Jacketed Wire*—Silver on Steel, Copper, Invar, or other combinations requested.

★ WILCO sales and engineering representatives are familiar with both Electrical Contact and THERMOMETAL application. Send us your problems for analysis or write for a copy of the new WILCO Blue Book of Thermometals and Electrical Contacts.

THE H. A. WILSON COMPANY
105 Chestnut Street, Newark, N. J.
Branches: Chicago ★ Detroit





A 1 lb. BILLET OF ALLOY
makes

106 MILES of
JELLIFF ALLOY "C" WIRE
(.0008)



*Drawn
entirely
in the*

**JELLIFF
MILL**



THE C. O. JELLIFF MFG. CORP.

SOUTHPORT — CONN.
SPECIALISTS IN
FINE WIRES

tance of the Naval Research Laboratory and the Bureau of Engineering in any investigations that Department might desire to make.

*Airplanes Detected 50 Miles Away in
1932*

By this time airplanes in motion nearly 50 miles from the transmitter had been detected under certain conditions. On July 1, 1932, in one of Dr. Taylor's reports of progress made on the problem assigned January 19, 1931, he described certain tests of aircraft detection at such distances and added that the object of the investigation now was to develop instruments for the collection, automatic recording and correlating of data to show position, angle and speed of the approach of objects in the air. The first instruments of this nature were developed by Mr. Robert M. Page, of the Naval Research Laboratory, assisted by Mr. Robert C. Guthrie.

Mr. Page and Mr. Guthrie, since this time, have been constantly engaged in radar research, and many of the radar developments now in use in the Naval service are credited by the Navy Department to the efforts of these scientists.

By March 28, 1933, various types of apparatus and systems for detecting enemy aircraft and vessels had been developed to a degree which enabled the Naval Research Laboratory to outline in detail the theoretical military applications.

In 1935 the Naval Appropriations Committee of the House of Representatives on its own initiative allotted \$100,000 for research purposes to the Naval Research Laboratory. This Committee has been intensely interested in the development of radar. The Committee repeatedly has made inspections at the Naval Research Laboratory and has given special financial support to its work. During most of this period Representative James E. Scrugham, of Nevada, a former engineer, was Chairman of the Committee. Mr. Scrugham is now a member of the U. S. Senate.

By this time the Bureau of Standards had been advised of the radar work of the Naval Research Laboratory, and the Bureau of Standards and the Naval Research Laboratory were cooperating with representatives of the Army regarding methods

of detecting aircraft by utilizing ultra-high-frequency radio waves. The War Department had emphasized the importance of this project, and constant liaison has been maintained between the Services.

In June, 1936, representatives of the Bureau of Engineering witnessed a demonstration of aircraft detection equipment at the Naval Research Laboratory, and Rear Admiral Bowen, then Chief of the Bureau, directed that plans be made for the installation of a complete set of radar equipment, as then existed, aboard ship.

First Ship Installation is Ordered

As result of studies made during the tactical maneuvers of the U. S. Fleet in the Pacific during the Fall of 1936, Admiral A. J. Hepburn, U.S.N., Commander in Chief of the U. S. Fleet (now Chairman, General Board, Navy Department), advised Rear Admiral Bowen of the importance of having radar equipment tested with the Fleet.

On February 17, 1937, visiting the Naval Research Laboratory, Assistant Secretary of the Navy Charles Edison (now Governor of the State of New Jersey) and Admiral William D. Leahy, U.S.N., Chief of Naval Operations (now Chief of Staff to the Commander in Chief of the Army and Navy) witnessed a demonstration of the detection of aircraft by the first radar set developed in this country.

The next two years were spent in designing and manufacturing a practical shipboard model. After continual trials, a set of radar, manufactured by the Naval Research Laboratory, was installed on the USS New York late in 1938. During January, February, and March, 1939, this equipment was given exhaustive tests at sea during the winter cruise and the battle maneuvers carried on at that time. The Commanding Officer of the USS New York was most enthusiastic and recommended that the work be continued. Vice Admiral Alfred F. Johnson, U.S.N., commanding the Battleship Division, stated, "The equipment is one of the most important radio developments since the advent of the radio itself."

Decision was made to develop additional radar sets, while, at the same time, it was emphasized that the im-

mediate procurement of this material must not interfere with the progress of the development.

Bell Labs and RCA Cooperate in Research

In October, 1939, contracts, on a bid basis, were awarded the Radio Corporation of America for manufacture of six sets of aircraft detection equipment patterned after the original model which had been built at the Naval Research Laboratory and installed in the USS New York.

Two of the major electronic laboratories of the Country, Bell Laboratories and RCA, by this time were working in cooperation with the Naval Research Laboratory on radar research and development.

General Electric Converts to Radar

In August, 1940, realizing that this Nation was faced with limited radar production facilities in the event of war, Rear Admiral Bowen persuaded Mr. Charles E. Wilson, president of the General Electric Company (now executive vice chairman of the War Production Board) to institute radar manufacturing at the General Electric plants. Within two weeks Mr. Wilson sent 20 scientists from Schenectady to inspect the Navy's radar equipment at the Research Laboratory. The company's representatives were most enthusiastic.

Two weeks later Mr. Wilson, himself, headed another inspection party and was so impressed that he directed Dr. Walter R. Baker, head of the Radio Division of the General Electric Company, to take the necessary actions to enable General Electric to catch up with the Naval Research Laboratory's radar program. Mr. Wilson additionally reorganized General Electric's Radio Division. Dr. Baker was made vice president of General Electric, and General Electric became the first radio company to transfer all of its radio engineers to radar work. Additional radar manufacturing facilities were started immediately.

The General Electric Company subsequently was awarded a large contract for radar equipment for Naval vessels.

Westinghouse Enters Picture

On October 16 1940, Admiral Bowen appealed to Mr. A. W. Robert-

KELVIN- WHEATSTONE BRIDGE NO. 637

A SHALLCROSS Development

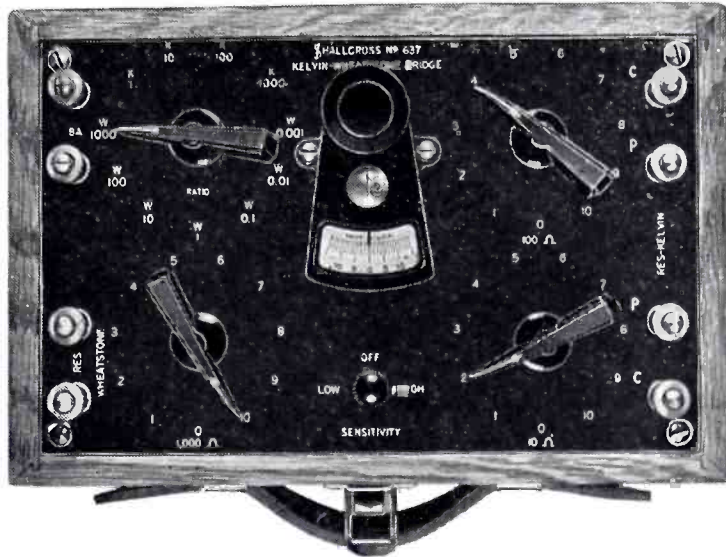

A wide range resistance-measuring instrument — combining the features of the Kelvin and the Wheatstone Bridge.

IT MEASURES . . .

Low resistances between 0.001 and 1 ohm on the Kelvin range.

Normal resistances between 10 ohms and 11,000,000 ohms on the Wheatstone range.

A portable instrument of moderate accuracy for practical resistance measurements for factory, service shop and field use.

Address Dept. 3.

Creators and Makers of

Accurate Resistors—Switches—Special Equipment and Special Measuring Apparatus for Production and Routine Testing of Electrical Equipment on Military Aircraft . . . Ships . . . Vehicles . . . Armament . . . and Weapons



SHALLCROSS MFG. CO.

COLLINGDALE, PENNA.

They stay on the Job!



UNBRAKO SELF-LOCKING HOLLOW SET SCREWS WITH THE KNURLED POINTS

Use "Unbrako" Self-Lockers that won't work loose. Just tighten in the usual way and the knurled points dig in and positively prevent the "Unbrako" from shaking loose. Yet they are easily removed and can be used again and again. Sizes: No. 4 to 1 1/2" diameter.

Pat'd.
and
Pats. Pend.

Knurling of Socket Screws originated with "UNBRAKO" years ago.

KNURLED SOCKET HEAD CAP SCREW

Saves time—because the knurling provides a better grip and allows the fingers, handiest of wrenches, to turn the screws faster and farther before a wrench is needed. Sizes: No. 4 to 1 1/2" diameter.

Write for
"Unbrako"
Catalog now!



STANDARD PRESSED STEEL CO.

JENKINTOWN, PENNA. BOX 596

BRANCHES

BOSTON • DETROIT • INDIANAPOLIS • CHICAGO • ST. LOUIS • SAN FRANCISCO

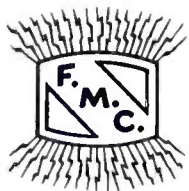

MICA

FOR EVERY RADIO, ELECTRICAL AND ELECTRONIC USE

Fabricated parts for electronic tube and condenser manufacturers — including discs, bridges, supports, stampings in any shape or form, condenser films, etc.

Serving hundreds of leading companies since our company was established under its present management in 1917. Special attention has been paid to radio tube and component manufacturers since the early days of the radio industry.

Our complete manufacturing facilities, experience and the quick understanding of our customers' problems, blend to make our services invaluable to an increasing number of new clients.

*May we quote on your requirements or
discuss your mica problems with you?*

FORD RADIO & MICA CORPORATION

JOSEPH J. LONG, *President*

538 63rd Street

Brooklyn, N. Y.

Established 1917 • Telephone: WIndsor 9-8300

son, Chairman of the Board, and Mr. George Bucher, president of the Westinghouse Electric Company, to participate in the Navy's radar program. Westinghouse representatives visited the Naval Research Laboratory and subsequently immediately reorganized their own radio division and were awarded a large Navy contract for radar manufacture.

Radar Data Exchanged With British

In September 1940, representatives of the British Technical Mission held a series of conference with representatives of the Navy Department and the Naval Research Laboratory at which time much technical information relating to radar was exchanged. Previously it had been known that Great Britain was in possession of a system for detecting aircraft but most of the details of the British system were unknown here. During this conference with the British Technical Mission, it was found that the British equipment was similar in many respects to the equipment developed by the Naval Research Laboratory, and members of the British Mission stated that the British development had resulted from articles reporting the preliminary work between 1926 and 1930 of Dr. Taylor and Mr. Young, of the Naval Research Laboratory, and Dr. Breit and Dr. Tuve, of the Carnegie Institute, studying the height of the Kennelly-Heaviside layer. With this preliminary study as a base, the British independently had developed their radar system and independently had arrived at frequencies and circuits very similar to those developed in this country.

In October, 1940, Rear Admiral Bowen, then head of the Navy Research Laboratory, was designated coordinator of all phases of the Navy's radar program.

Commercial Production Under Way in 1941

By the beginning of 1941, the General Electric, Westinghouse, RCA, and Bell Telephone laboratories were carrying on research and undertaking commercial production.

Lieutenant Commander (now Commander) David R. Hull, U.S.N., Assistant to Admiral Bowen, was put in immediate charge of Naval contacts with all private, commercial, and governmental activities engaged

PRECISION PARTS

THEIR END-USE IS A SECRET

A story of amazing accuracy of American instruments will come out of this war. It can't be told yet because there are still a lot of surprises in store for Herr Hitler and his gang of bandits. There is no secret, though, back of the amazing precision work that has made this accuracy possible.

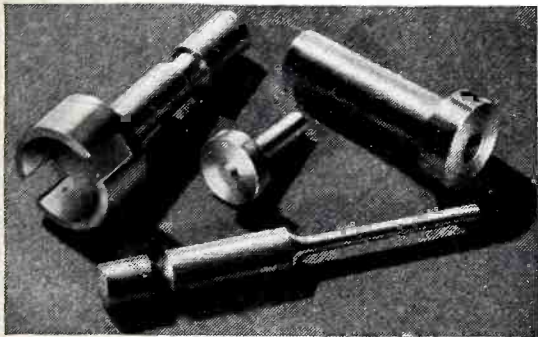

"... ten times as fast ..."

These small, army, instrument parts are typical. Each is centerless ground to within tolerances of .0002". Concentricity between diameters is held to limits of ten thousandths. Some of them call for definite radius requirements where the shank meets the head. Others must have no radius at all. And there is another very important requirement—they must be turned out by the thousands.

Ace is a pioneer in this ever-increasing accuracy which World War II has taught to mass production. Management "know-how" and modern equipment are turning out tolerances as close as .0001", and finishes which a speck of dust or a warm hand distorts—and doing it ten times as fast as ever before. Ace is a dependable source for volume production of Bar Stock, Shafts, Studs, Pins, Punches, Taper Pins and parts. Diameters may be as small as .020" or as large as 6". Capacity is available for your Centerless Grinding requirements. If you have any grinding problems send us a sample, sketch, or blueprint for quotation.



This new booklet describes the facilities available at Ace for the machining, assembling and heat treating of small parts. A copy will be gladly sent upon request.



**ACE
MANUFACTURING
CORPORATION**

for Precision Parts

1255 E. ERIE AVE., PHILADELPHIA 24, PA.

in radar research and development, and in this capacity he supervised the development of models which resulted in the first quantity production of many types of radar equipment.

Commander (now Captain) Jennings B. Dow, U.S.N., spent the greater part of 1941 in England obtaining information on British radar methods. Upon his return to the United States, Commander Dow organized the Radar Branch in the Radio Division, Bureau of Ships. Radar procurement and design work in the Bureau of Ships prior to that time had been conducted by Lieutenant Commander (now Commander) Samuel M. Tucker, U.S.N. Major contributions in the radar field also have been made by Lieutenant Commander (now Captain) M. E. Curts, U.S.N., Lieutenant (now Commander) William S. Parsons, U.S.N., and Lieutenant Commander John F. Mullen, Jr., U.S.N.

Radar research is continuing and new developments are constantly being made—by the Government and by private industry. Every manufacturer of any size in the electronic industry is participating. Radar procurement is one of the Navy's prime projects.

Jap Battleship Sunk at Night By Radar-Aimed Salvos

SPEAKING in Spartanburg, S. C. on Memorial Day, James F. Byrnes, Director of War Mobilization, cited the following example of the effectiveness of radar:

"History will some day record the part radio and radar have played in giving us fighting superiority over the Axis. But let me give you one instance. On the night of Nov. 14, off Guadalcanal there lay a Japanese battleship. It was a stormy night. Eight miles away was a ship of our own fleet. With the use of radar our ship, with its second salvo, sank the Jap battleship in the blackness of the night, eight miles away."

No Limitations to Electronics

SPEAKING ON THE SUBJECT "Rediscover the Rainbow" at Columbia University on May 20, Dr. Willard H. Dow made reference to the great fu-



TIME'S A-WASTIN'

Try the watch pocket, Buddy!

The little woman is sizzling.

If that little ring were some hard-to-locate radio component, we'd say, "Try HARVEY".

Harvey Radio Company can eliminate many of the production delays caused by missing components. Our staff is specially trained in locating, purchasing, and expediting deliveries of any such parts that you may demand. This almost instinctive ability to find what you need has been developed by many years of association with radio manufacturers and sources of supply. Or we may have a few of the materials you are seeking on our shelves.

Next time your time's a-wasting call Harvey.



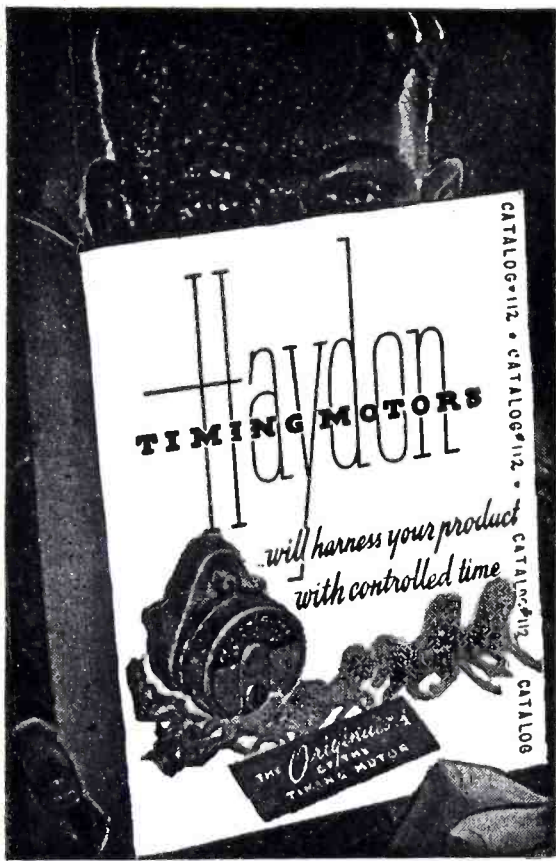

Just off the Press!

**IT'S VALUABLE
IT'S INDISPENSABLE
IT'S TIMELY**

So Send TODAY for Your Copy!

*Complete Information
on Timing Motors*

FOR USE IN:

Automatic Reset Timers
—Time Delay Relays—
Vacuum Tube Circuit—
Controls, etc.

Extensively used in Plate
Circuit Time Delays for
Communication Equip-
ment.

BY

*"The Originators of
the Timing Motor"*

Haydon

MANUFACTURING COMPANY
★ INCORPORATED ★

Forestville, Connecticut

ture of electronics in his theme that recognition of immutable, natural scientific laws in relation to world-wide ways of living is the one way out for erring, squabbling, dreaming humanity.

The following is an excerpt from the talk he gave upon receipt of the Chandler Medal for distinguished service in science as president and general manager of The Dow Chemical Co.:

"The idea of one scientific development being a tool which helps in another development is clearly understood and appreciated by those with scientific experience, and but slightly understood by others.

The radio is probably considered by the public as one of the most necessary means of entertainment and communication, but the whole physical science of radio-development is one of the most vitally necessary tools in all sorts of commercial operation. It permits automatic control where human hands cannot reach. The electron microscope in turn permits magnification that lenses cannot produce. It would be an unwise prophet who would attempt to define the probable limitation of electronics, or what it will do in aiding all science to further understanding and benefit."

Philco Will Train 60 "Radarettes"

A 50-WEEK COURSE including mathematics, elementary electricity, radio, television, radio laboratory technique, electrical drafting, industrial orientation and production processes is being given at Temple University to a selected group of sixty young women, all recent high school graduates selected from the Philadelphia area by Philco Corp. The training plan, involving full scholarships with pay, was initiated to meet the needs of the war emergency and help qualified girls to obtain the needed technical training for research work at Philco.

Upon completion of the course, the girls will be known as "Radarettes", and will serve as assistants to Philco engineers engaged in radar and other military radio work. According to Philco engineering vice-president David Grimes, women are more important today in the radio industry than ever before.

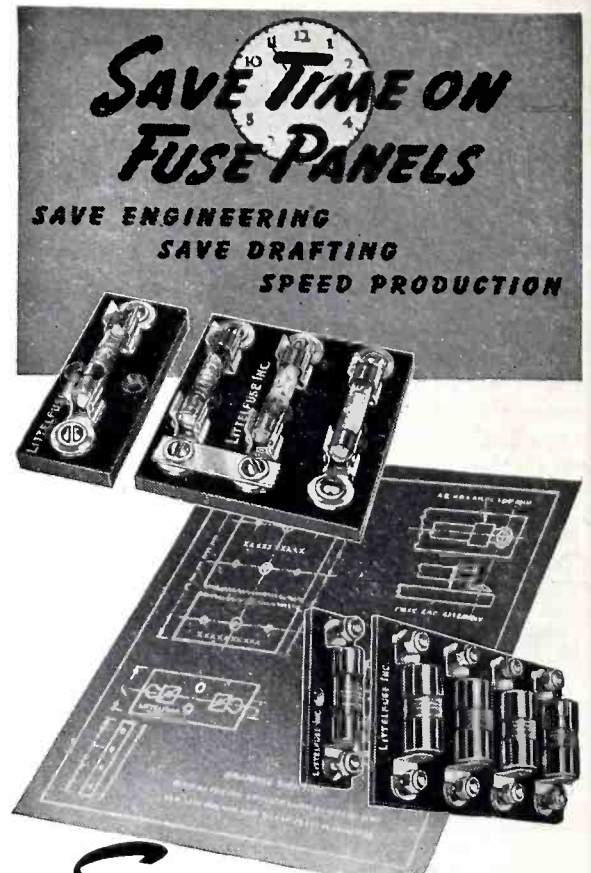

*Send NOW for
New Blueprint of*
LITTELFUSE
Universal FUSE PANEL No. 1505

Blueprint comes to you without charge. With it you can quickly designate the Fuse Panel for your requirements — exactly to your specifications. One number covers your mounting. #1505 specifies Standard Panel Mounting; first dash number, size of fuse required; second dash number, the number of poles required. If bus bars are required, specify separately, and specify poles to be bussed.

READY TO MOUNT

These strong light panels are equipped with terminals and Beryllium Copper Fuse Clips, or terminal studs. They meet all Air Corps requirements. They insure the utmost in durability.

**MANUFACTURERS, ENGINEERS, DRAFTSMEN,
PRIME CONTRACTORS, PURCHASING AGENTS:**

Here is important aid in saving hours of time and labor, speeding production. Send for as many copies as you need of new B/P for Littelfuse Universal Fuse Panel No. 1505. Special panels to your specifications made promptly.

**LITTELFUSE
INCORPORATED**

4755 Ravenswood Avenue
Chicago, Illinois

225 Ong Street
El Monte, (Los Angeles suburb)
California

IRE Opposes Kilgore-Patman Bills

IN THE FOLLOWING RESOLUTION adopted on June 2, 1943, by the IRE Board of Directors, this engineering society took a firm position against socialization of engineering research:

"Whereas, The Board of Directors of The Institute of Radio Engineers is of the opinion that the scientific and technical resources of the Nation and in particular the radio personnel and facilities of the country are mobilized to a high degree and are working efficiently in the war effort; and

"Whereas, It appears that enactment of The Kilgore-Patman Bills S-702, HR-2100 to mobilize the scientific and technical resources of the Nation, to establish an Office of Scientific and Technical Mobilization, and for other purposes, would actually endanger the war effort by a reorganization of these resources along totally untried lines, and

"Whereas, It is the opinion of the Board of Directors that the premises given in the declaration of policy of S-702 are unsound and not representative of the facts; and

"Whereas, The enactment of these bills would establish a post-war bureaucracy inimical to the best interests of scientific and technical progress and thus also to the best interests of these United States; therefore, be it

"Resolved, That the Board of Directors of The Institute of Radio Engineers finds no valid reason for enactment of Senate Bill S-702 and House Bill HR-2100 and strongly opposes such enactment because these bills if enacted will result in confusing the war effort; and furthermore be it

"Resolved, That the Board of Directors of The Institute of Radio Engineers expresses its general opposition to any proposals which would have the effect of placing the scientific and technical personnel and facilities of the Nation under government supervision and control."

Status of Telegraph Merger

THE FIRST AND MOST IMPORTANT step toward merging of telegraph facilities in this country came on May 13 when heads of Western Union Tele-

SOLVE YOUR "SHORT RUN" DIE PROBLEMS

with

DI-ACRO

PRECISION MACHINES
(DIE - A C K - R O W)

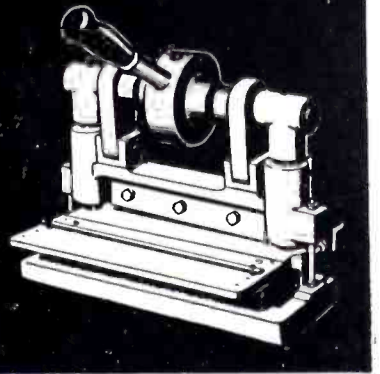

SEND FOR CATALOG "Metal Duplicating without Dies"

It's an eye-opener on what you can do without dies, shows typical parts, and gives sizes and capacities of all models of Di-Acro Shears, Brakes, Benders.

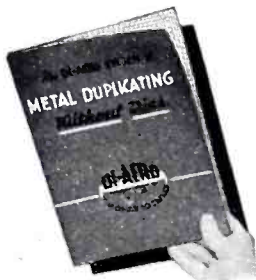

"Extra Special Rush! Speed it up! When can you deliver?" Maybe you don't have to wait — Wait — WAIT — for dies! Try "DIE-LESS DUPLICATING" with Di-Acro Shears, Brakes, Benders. These are *precision* machines — all duplicated work is accurate to .001". You'll get a new slant on "short-run" production problems from the great variety of parts which can be produced by Di-Acro Machines. Thousands of them are in use saving Man Hours and Critical Materials.

BENDERS

Di-Acro Bender bends angle, channel, rod, tubing, wire, moulding, strip stock, etc. Capacity — Bender No. 1 — 3/4" round cold rolled steel bar. Bender No. 2 — 1/2" cold rolled steel bar.

BRAKES

Di-Acro Brake forms non-stock angles, channels or "Vees". Right or left hand operation. Folding width — Brake No. 1 — 6". Brake No. 2 — 12". Brake No. 3 — 18".

SHEARS

(Illustrated)

Di-Acro Shear squares and sizes material, cuts strips, makes slits or notches, trims duplicated stampings. Shearing width — Shear No. 1 — 6". Shear No. 2 — 9". Shear No. 3 — 12".

O'NEIL-IRWIN  MFG. CO. 321 8th Avenue So., Minneapolis, 15 Minn.

TRIPLITT

Combat Line TESTERS



TRIPLITT MODEL 1200 G TEST METER

Portable multi-range metal case test meter provided with removable cover and carrying pocket.

RANGES—D.C. or A.C. VOLTS
0-10-50-250-500-2,500 at 1000 ohms per volt.
DIRECT CURRENT 0-500 microamps 0-1-5-50-500 Ma.
0-1 amp.

ALTERNATING CURRENT
0-1 Ma.

RESISTANCE 0-30-10,000 ohms
0-1-10 megohms
OUTPUT—Jacks and condenser in series with A.C. voltage ranges.

TRIPLITT

Although some older designs are no longer obtainable several alternate models are available to you under Government requirements.

TRIPLITT ELECTRICAL INSTRUMENT CO. • BLUFFTON, OHIO

VICTORY...in the Making

Here, at Doolittle, we are coordinating every effort and skill to help provide the communications equipment so essential for Victory. This will mean better peace-time communications after our battles are won.



To Assure Victory
Buy More U. S. War
Bonds and Stamps

Doolittle
RADIO, INC.

Builders of Precision Radio Communications Equipment
7421 S. Loomis Blvd., Chicago, U. S. A.

S. S. White **MOLDED RESISTORS** The "All-Weather" Resistors

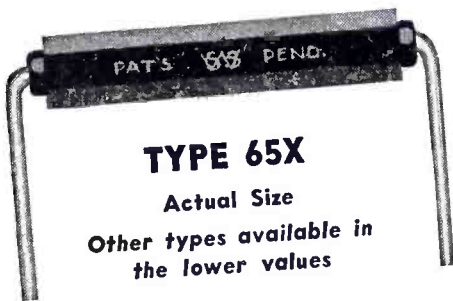

TYPE 65X

Actual Size
Other types available in
the lower values

**RESISTOR BULLETIN 37
GIVES FULL DETAILS...**

It shows illustrations of the different types of S. S. White Molded Resistors and gives details about construction, dimensions, etc. A copy, with Price List will be mailed on request. Write for it—today.



S. S. WHITE

The S. S. White Dental Mfg. Co.

INDUSTRIAL DIVISION

Department R, 10 East 40th St., New York 16, N. Y.

THESE widely used Resistors are favored because of their noiseless operation and durability and because they retain their values and characteristics under extremes of temperature, humidity and climatic changes.

STANDARD RANGE
1000 ohms to 10 megohms.

NOISE TESTED

At slight additional cost, resistors in the Standard Range are supplied with each resistor noise tested to the following standard: "For the complete audio frequency range, resistors shall have less noise than corresponds to a change of resistance of 1 part in 1,000,000."

HIGH VALUES

15 megohms to 1,000,000 megohms.

graph Co. and Postal Telegraph Inc. signed a purchase agreement. The purchase is subject to approval of the FCC, stockholders of the two firms, and various other governmental groups. The purchase is to be effective at the earliest possible date, but in no event later than Oct. 1, 1943. Under its terms, Western Union will acquire all the assets and business of Postal, and assume its liabilities.

FCC Chairman James Lawrence Fly promised speedy consideration by the Commission in the following statement: "I am confident that a genuine public benefit, in terms of improved service during the war period, will result from a sound plan of merger between Western Union and Postal Telegraph. Our own Committee, composed of Commissioners Payne, Wakefield and Durr, I am sure, will continue to devote themselves assiduously to the task of studying the merger problem and of cooperating on the necessary procedures with all interested parties and agencies."

Supreme Court Strengthens FCC

A FAR-REACHING COURT decision which turns over to the Federal Communications Commission almost limitless control of all phases of broadcasting came when the Supreme Court, on May 10, upheld the restrictions which the FCC had ordered for chain broadcasting. The court opinion was 5 to 2, with Justices Frankfurter and Roberts dissenting. Networks are resigned to operation under the new rules, though some still refer to the rules as "a death blow to nation-wide broadcasting".

Signal Corps Establishes New Commercial Communications Agency

ALL RELATIONS between commercial communications services and the Army, with the exception of functions procured and administered by service commands, will be handled from now on by the Army Communications Commercial Agency, with offices at 50 Broadway, New York City. It will function as a field installation under the control of Col. I. W. Treest, Director of the Army Communications Division.

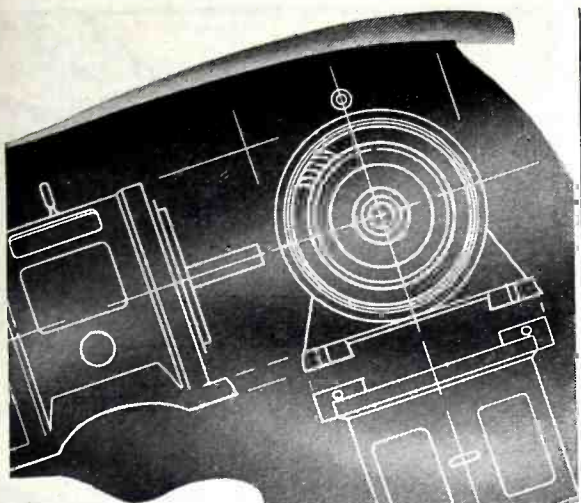

**FOLLOW THROUGH
IT COUNTS!**

Laboring under terrific strain, engineers are constantly striving to improve electrical units so that they will perform more efficiently and meet diversified needs. Minute details in the blueprints are thoroughly checked and carried out in production.

As units must comply with specifications, and pass rigid inspections, why not follow through by specifying DOLPH's Insulating Varnishes? After all, your electrical units are no better than the varnish which protects them.

The DOLPH Laboratories are constantly developing new insulating varnishes to meet the exacting needs of improved electrical units. The answer to your insulating problem may be found in the DOLPH Laboratories. There are no obligations, so why not inquire?

**MANUFACTURERS OF
SYNTHITE and CHINALAK
Insulating Varnishes
DOLCOTE Cable Enamels
Impregnating Compounds**

Dolph's

JOHN C. DOLPH COMPANY

Insulating Varnish Specialists

169-A Emmet St., Newark, New Jersey

Wall St. Watches Electronics

REPORTS BY FINANCIAL FIRMS, articles in financial magazines and presentation of a lecture series on electronic subjects in the Governing Room of the New York Stock Exchange indicate serious interest in the post-war possibilities of the electronic industry from a financial standpoint.

A 42-page analysis of recent developments and post-war possibilities of electronics, prepared for its customers by Kidder, Peabody & Co. of New York City, is by far the most complete financial survey seen to date. It divides electronics into six fields primarily for convenience of analysis. Concrete facts and statistics are presented on pre-war, present and post-war activities in (a) radio fields, (b) radio frontiers of FM, facsimile and television, (c) communication fields, (d) lighting and related fields, (e) industrial fields, and (f) the electrical manufacturing industry. Products and applications are cited in each group, with yearly production figures where available. Leading manufacturers are named. Ten pages are devoted to financial descriptions of selected leading companies, and investment recommendations are made. Summarizing statements: (1) Investors should give little weight to war-time developments since present earning power is inflated; (2) The next important development will be widespread use of FM, with radio facsimile and television coming later; (3) Don't expect too much too quickly after the war since the electronic industry in general is concentrating now on winning the war; (4) Probably no other section of our industrial economy presents broader horizons during the next decade, (5) A substantial drop in earnings is to be expected after the war, followed by resumption of pre-war growth but probably at an accelerated rate; (6) Current publicity over-emphasizes the immediate potentialities in the field of electronics.

No. 2 in the series of "Industries of Tomorrow" bulletins by C. B. Richard & Co. of New York City is a four-page leaflet on the electronic industry, describing a few electronic developments and giving data on the shares and the capitalization of radio, television and of electronic concerns.

Weekly lectures under the auspices



NO BRASS KNUCKLES NEEDED

**to Get War Emergency Service
on Radio and Electronic Supplies**

DO away with the cussing and cajoling . . . the seemingly endless **WAITING** for delivery of **Electronic and Radio Supplies**. *Rush war work won't wait!* That's why we have developed an emergency service tuned to the tempo of **WAR**. We are answering the call for *speed* with over-size, over-diversified stocks, with specially trained, experienced technicians and elimination of red tape . . . every facility streamlined to give vital industrial users of **Electronic and Radio** products an **EMERGENCY SERVICE** incredibly fast and efficient in the face of increasing shortages. Write, wire or phone. Tell us how we can best serve you, **NOW!**

Free BOOK

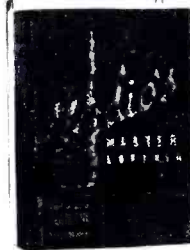

A big reference book & buyer's guide crammed with information on thousands of Radio and Electronic parts and equipment. Free to Purchasing Agents and other officials responsible for buying and specifying in industries using this

equipment. Ask for it **NOW** on company stationery, please.

WALKER-JIMIESON, INC.

311 S. Western Ave., Chicago, Ill.
Phone: Canal 2525





Globar

REG. U. S. PAT. OFF.

CERAMIC RESISTORS

RESISTORS are, in the final analysis, energy dissipators and as such they should be rugged. Since the demands of electronic circuits are quantitatively exacting, a resistor should be electrically and mechanically stable. Ruggedness and stability in a resistor gives assurance that it will retain indefinitely its established resistance value under normal loading.

A good resistor should withstand, without suffering a permanent change in resistance, the maximum accidental over-voltage to which it might be subjected in service. Moreover a resistor should be relatively free from microphonic effects, inductance and capacitance and it should not be affected by humid atmospheres.

"Globar" Brand Ceramic Resistors meet these specifications. Right now deliveries must be scheduled according to priority ratings and date of order. Nevertheless we invite you to tell us about your needs; we pledge our best efforts to assist you.

The condensed table below gives you at a quick glance the physical and electrical characteristics of the more commonly used industrial type "Globar" Resistors.

TYPE		A	B	CX
LENGTH	Min.	1/4"	1/4"	1/4"
	Max.	18"	18"	18"
DIAMETER	Min.	1/16"	1/16"	1/16"
	Max.	1"	1"	1"
RESISTANCE Per Inch of Length	Min.	25 ohms	5 ohms	1 ohm
	Max.	15 megohms	15 megohms	100 ohms
*OVERALL WATT RATING	Max.	54 watts	54 watts	150 watts
*NORMAL RATING W. Sq. In. of Radiating Surface		1 watt	1 watt	2 1/2 watts
MAXIMUM VOLTAGE Per Inch of Length		400 v.	400 v.	**Note

*These ratings may be substantially increased by artificial cooling.

CHARACTERISTIC COEFFICIENTS:

TYPE A: Comparatively Straight Line Temperature and Voltage.

TYPE B: Negative Temperature and Voltage.

TYPE CX: Slightly Positive Temperature.

Other resistor types are available for specialized applications.

TERMINALS: Metalized ends for clip mounting or wire leads.

** Type CX resistors have a low specific resistance and cannot be subjected to voltage stresses permissible with Types A and B. Maximum allowable voltage is that required to yield maximum watt rating.

Globar Division

THE CARBORUNDUM COMPANY

REG. U. S. PAT. OFF.

NIAGARA FALLS, N.Y.

(Carborundum and Globar are registered trade-marks of and indicate manufacture by The Carborundum Company)

of the New York Institute of Finance have been given at 11 Wall St. in New York for members of the Stock Exchange and officials of investment concerns, with outstanding engineers and scientists as speakers.

How a Bat Flies

John Mills of Bell Telephone Laboratories discussed "The Scientific Method", describing as examples the procedure used by scientists in determining how bats avoid obstacles when flying at night, how Bell developed the telephone, and how Bell Labs improved the DeForest audion through painstaking research. Quotes are: "Pin your faith to companies that have good research departments and are really doing research and not merely testing"; "If you know how a bat flies you will know all you need to about the radio locators or radar".

Dr. K. K. Darrow, also of Bell Labs, covered "Transmutation and Radioactivity", starting with the structure of the atom and the use of neutron projectiles for changing atoms. He stated that it is now possible to change every atom into at least one other, and every element can be produced by directing neutrons at some other atom. Radioactivity produced artificially with a cyclotron makes it possible to mark certain atoms and trace them through the human system or through plants. Thus, water containing radioactive sodium can be detected at the tip of your finger 20 minutes after drinking it. Radioactive methods of exploring oil wells have recently been developed.

Dr. Willard F. Libby of the Univ. of Calif., speaking on "Chemistry and Electronics", continued the subject of nuclear physics with an explanation of how isotopes like heavy hydrogen are produced, and how an atomic isotope with almost any desired radioactive life can be obtained. He cited practical applications of the newly-gained knowledge, and prophesied that important advances would be made in the fields of biochemistry and medicine in the next few years through use of natural or radioactive isotopes. He pointed out that no business or industrial concerns are as yet producing radioactive substances for sale, and this factor is holding up industrial applications of radioactive techniques.

Ralph S. Beal, RCA Research Director, reviewed "Radio-Electronic



"DALIS has it"

●Try Dalis with those priority requirements. You'll be surprised.

Ample stocks provide prompt shipment on many items, particularly resistors, condensers, controls, wire, transformers, cable, headphones, relays, batteries, tubes, tools, etc.

And if required items are not in stock, DALIS go-gets 'em for you in shortest possible time.

Try DALIS — a dependable source of supply since 1925 — and an indispensable source today in getting things in a hurry.

●Write, wire or 'phone ..

H. L. DALIS, Inc.

Distributors of

RADIO & ELECTRONIC SUPPLIES

17 Union Square · New York, N.Y.

Phones: ALgonquin 4-8112-3-4-5-6-7

"or go-gets it"



DALIS



SERVICE

Research", predicting that electronic television would become a vast post-war industry giving employment to many people, and reporting on latest RCA developments such as high frequency heating and the electron microscope. Reviewing the part played by RCA Laboratories in radar development, he stated that basic research on apparatus and techniques had been started by RCA as early as 1932, and that RCA had installed collision-prevention equipment in its own airplane in 1937. Production of experimental radar units for the Navy and Signal Corps began shortly afterward.

Dr. David Grimes, Philco vice-president in charge of Engineering, addressed the group on "Electronics, FM and Television", pointing out first that electronics covers just as wide a field of endeavor as does sound vibrations. He explained basic principles by analogy: If we could see at a frequency corresponding to that of radio waves, each transmitting antenna would be like a huge lighthouse having a definite color. Everything radio waves pass through would be transparent, so that buildings would be invisible except for their metal frameworks. Suppose a particular transmitter produced green light; with AM modulation, this green light would flicker with modulation without changing color, but with FM modulation the color would vary while the brilliance would stay constant. Introducing television, he pointed out that we must transmit pictures as a series of impulses in much the same way that we transmit thoughts vocally as a sequence of syllables. Today, he said, television is equivalent in quality to 16-mm movies.

The remaining two scheduled lectures in the series, by A. C. Monteith of Westinghouse on "Electronics as Applied to Industry" and by Dr. W. R. G. Baker of General Electric on "Advance and Future Thinking", will be reported later.

The May 19, 1943 issue of *Financial World* contains a two-page feature article, "Electronics in the War—and Afterward", briefly describing some routine and spectacular applications of electronics, including a new healing ray that increases the speed of nature in repairing wounds by inducing erythema (reddening) of exposed flesh.

CRYSTALS EXCLUSIVELY



EXCLUSIVELY
FOR WAR. . . .

Split second communications are vital to offensive action. Valpey crystals insure reliable transmission of tactical orders at all battle fronts.

THE VALPEY CRYSTALS
HOLLISTON, MASS.
Since 1931

VALPEY



Photo Courtesy Vega Aircraft Corporation

For Faster, More Permanent Soldering—

Put KESTER on

Your PRODUCTION LINE

Kester Cored Solders meet squarely both wartime essentials in the field of electronics—first, precision in manufacturing that will insure faultless operation; second, ease of application that safely expedites production.

Kester Cored Solders hold tight. Available in a range of sizes, alloys and fluxes that exactly fits every production requirement, they stand up under vibration, bending, shock, contraction and expansion. Alloy and flux in right kind

and amount are applied in one simple operation.

The patented plastic rosin flux in Kester Rosin-Core Solder prevents terminal resistance in electrical circuits; it won't cause corrosion or injure insulating material.

Kester's 44 years of highly-specialized solder experience is at your command. Consult Kester engineers freely, without obligation.

KESTER SOLDER COMPANY
4222 Wrightwood Avenue, Chicago, Illinois
Eastern Plant: Newark, N.J. Canadian Plant: Brantford Ont.



KESTER

Cored Solders

STANDARD FOR INDUSTRY

Gothard

DETACHABLE SNAP-SOCKET PILOT LIGHT

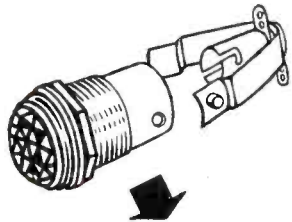

WITH NEW
STYLE RIGID
TERMINALS

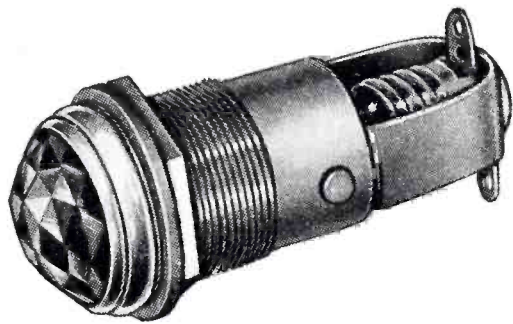

Gothard Series 800 Pilot Lights are very popular for switch-board and similar mounting. Socket and new style rigid terminals that cannot work loose or twist are integral parts of the spring member, which locks firmly into Jewel housing. Socket is easily removed with spring member for replacement of lamp bulb. Bulb may also be inserted from front of panel by removing slip-ring mounted Jewel. Range of Jewel colors—plain or faceted—miniature or candelabra screw sockets, or miniature bayonet sockets.

Request the *Gothard Pilot Light Assemblies Catalog* for complete information.

Gothard

MANUFACTURING COMPANY, 1310 North Ninth Street, Springfield, Illinois

GONE ARE THE DOODABS!
TODAY THE *Accent's ON*

RUGGED CONSTRUCTION

of

- CABINETS
- CHASSIS
- PANELS
- RACKS

for ELECTRONIC APPARATUS

Send specifications; or write for
our Catalog No. 41A.

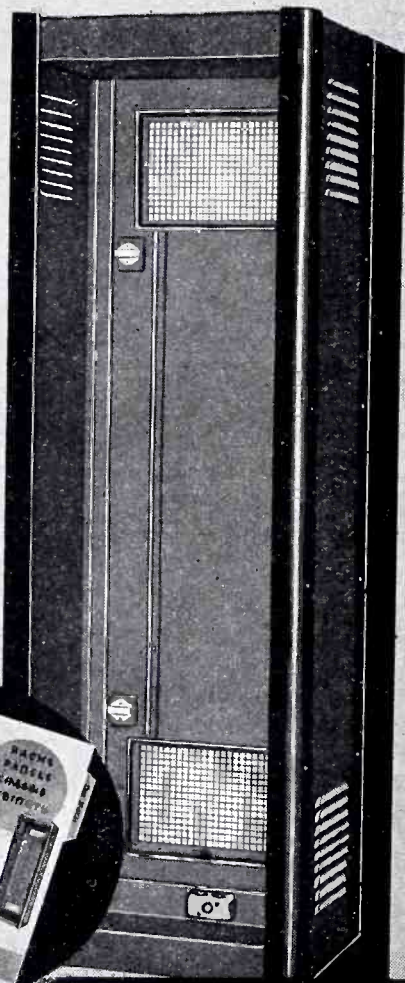

PAR-METAL PRODUCTS CORPORATION

32-62—49th STREET . . . LONG ISLAND CITY, N. Y.

Export Dept. 100 Varick St., N. Y. C.

Manpower

THE INDUSTRY according to Ray C. Ellis, is faced by some currently acute problems. One of the most critical is the difficulty of securing and holding skilled employees.

The production of military radio and radar, although based on pre-war radio industry manufacturing facilities, is virtually a new field—one employing a large number of young technicians who are now being called into the armed services in great numbers. The colleges to which the industry must look for skilled recruits to put new developments and discoveries into practical application—physicists, chemists and engineers—are subject to the same drain.

Use of still more women in the industry is one solution seen by Mr. Ellis, who points out that in some phases of manufacture women are more adept than men, as in the handling of delicate tube elements.

Already some 50 percent of the inspectors employed by the Signal Corps are women.

College Courses in Electronics

WRITING IN THE May 1943 issue of *The Journal of Engineering Education*, S. G. Lutz of Naval Research Laboratory analyzes college training in electronics thusly:

"Electronics still seems to constitute one of the weak links in most curricula. Much of the trouble students experience may be attributed to the way we must crowd a host of new and seemingly unrelated concepts into a single three or four semester-hour course. Practically all other electrical courses are based upon a very few fundamental principles which are developed in a sufficiently leisurely manner for the student to correlate them.

"In electronics, we may start with an orgy of modern physics associated with electron emission and space charge flow, introduce a host of new symbols for our discussion of the characteristics of diodes, triodes, etc., rush through an inadequate treatment of the application of these tubes in amplifiers, oscillators, etc., jump to phototubes with new concepts of electron emission, then to cathode-ray tubes and a smattering of electron optics, give passing mention to microwaves and end by spend-

**"NAZI TANKS BEHIND
NEXT HILL ON LEFT—
WATCH OUT!"**

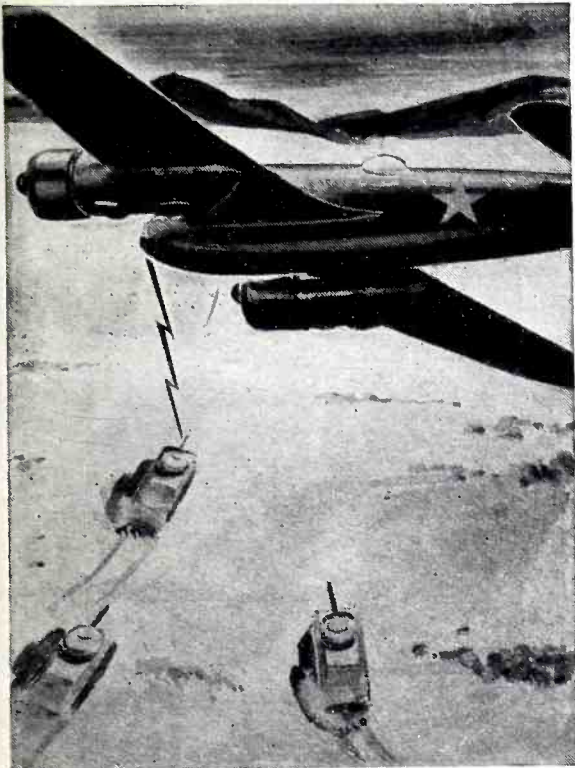

RADIO STOPS A FLANK ATTACK!

Out of the sky by radio flashes quick warning of an ambush. Our tanks wheel to meet it — and turn disaster into victory!

It's this kind of instant, sure communication that saves the day in war. With split-second timing must go clear, undistorted radio reception — never-failing dependability.

Because it knows these qualities distinguish MURDOCK Radio Phones, the U. S. Signal Corps uses these time-tested receivers.

Take a tip from the leaders — use MURDOCK Radio Phones! Write Dept. 62 for catalogue.



Wm. J. Murdock Co.
Chelsea, Mass.

ing most of the time on the industrial applications of hot and cold cathode gas tubes!

"Another factor which must be considered is that many of our concepts of electronics are changing and expanding very rapidly, just as they did during the last war, and many topics which we now pass over lightly soon will assume unusual importance. Many of our graduates now entering wartime communication work are coming in contact with electronic equipment which involve principles they have never heard of. This condition may continue after the war unless we are prepared to reorganize our treatment of electronics.

"In view of these deficiencies, eight semester hours seems the minimum time which communication men should be required to devote to electronics if they are to obtain a sufficient knowledge of this subject to begin to follow its progress in the literature."

New List of American Standards

MORE THAN 600 STANDARDS, 94 of which represent new and revised standards approved since the August 1942 issue, are listed with prices in the new list of American Standards published by the American Standards Association. The 20-page list for 1943 can be obtained free of charge by writing to the American Standards Association, 29 West 39th St., New York City.

A special section of the list is devoted to American War Standards, including those on fixed mica capacitors, meters, and radio receiver replacement parts.

IRE Post-War Planning Committee

A SPECIAL COMMITTEE under the Chairmanship of Haraden Pratt, Vice-President of Mackay Radio and past president of IRE, was delegated by the IRE Board of Directors with drafting of a plan for setting up a technical body to provide for post-war development of radio, television and electronic applications. The association is to be representative of a broad cross-section of the entire radio industry, and one of its objectives is to recommend methods of introducing new radio developments.

LONGER LIFE

with

Photo-Electric Cells

Vibration, shock and other mechanical violence show no effect for a very long time on calibration accuracy, or the sensitivity, of photo-electric cells. This useful longevity, plus light weight and the fact that no amplification is required for measurement problems, makes photo-electric cells the logical choice for many critical instrument applications.

LUXTRON
BRADLEY PHOTOELECTRIC CELLS
PHOTO ELECTRIC CELLS

Here at Bradley Laboratories, we have had continuous proof of the exceptional performance of our Luxtron* cells. In demanding military service applications, Luxtron* cells have made records for lasting. When photocells are the logical choice, Luxtron* cells are the first choice.

BRADLEY
LABORATORIES, INC.
82 MEADOW STREET, NEW HAVEN, CONN.

* Reg. U.S. Pat. Off.

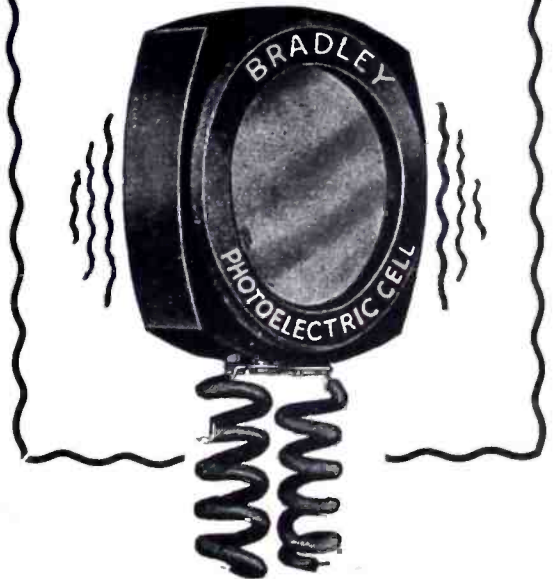

Miller

RADIO INTERFERENCE FILTERS

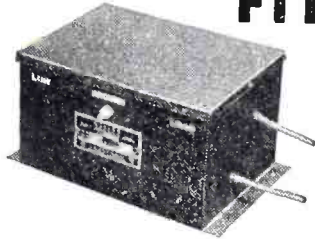

INDUSTRIAL FILTERS

Miller industrial filters are designed for all types of radio interference producing devices and are highly effective at broadcast and short wave frequencies. They have highest attenuation characteristics at all frequencies used in radio communication. Each filter is completely sealed for complete protection under all climatic conditions.



AIRCRAFT INTERFERENCE FILTER

The No. 7884 Radio Interference Filter, developed expressly for aircraft use, will effectively suppress noise present in the ship's electrical system. Insure noise-free radio reception by installing a Miller Duo-lateral Wound Radio Interference Filter. Dimension 2½" diameter by 3" long. Weight 1.25 lbs. Write for specification sheet.

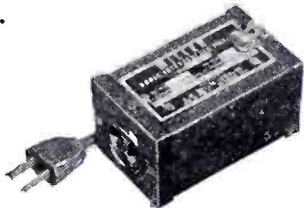

APPLIANCE FILTER

Designed for use with larger household appliances and commutator type motors, as well as communication type receivers and recording equipment, this Miller Filter, No. 7515, uses larger capacitors and heavier capacitor inductors to handle load requirements up to 550 watts. Size 2½" square x 4" long. 115 volts, 550 watts.



See your Wholesaler or
write us for literature

J. W. MILLER COMPANY
5917 S. Main St., Los Angeles, Calif.

• BUILDERS OF QUALITY RADIO INDUCTANCES SINCE 1924

FM Oddities

A MUNITIONS PLANT in Detroit picks up the programs of FM station W45D daily and relays them via loudspeakers to about 6000 workers in its three plants. The station provides a special show at certain hours for stimulating worker's morale, consisting of appropriate melodies with no vocals and infrequent announcements. Other local war plants are showing interest also. Each war worker hearing FM is a good prospect for an FM receiver after the war.

During a luncheon in Philadelphia at which Lowell Thomas was awarded a medal by the Poor Richard Club, soft music came from the public address system. It persisted after the speeches started, giving a certain poetic grandeur to some of the duller phrases. Listeners thought the music a nice touch until an announcer broke in and gave the call letters of a local FM station. By some hard-to-explain circuit peculiarity, the public address system was acting like an FM receiver and picking up the signal.

Police Radio Convention

THE 1943 NATIONAL CONFERENCE of the Associated Police Communication Officers will be held at Madison, Wisc., Aug. 31 to Sept. 2. Discussions on war-time police radio operations, WERS, OCD, priority problems and similar war topics will occupy most of the time. Ray Groenier, Chief Radio Engineer of the Madison Police Dept., is Chairman of the conference.

WPB News About Quartz Crystals, Batteries, Steatite and Radio Sets

QUARTZ CRYSTALS are needed. Citizens who own property on which the crystals may be found, or know where any can be found, are requested to get in touch with the Miscellaneous Minerals Division, War Production Board, Temporary "R" Bldg., Washington, D. C. Only separate individual crystals weighing at least half a pound, at least three inches long and an inch thick are desired. They must be clear and color-

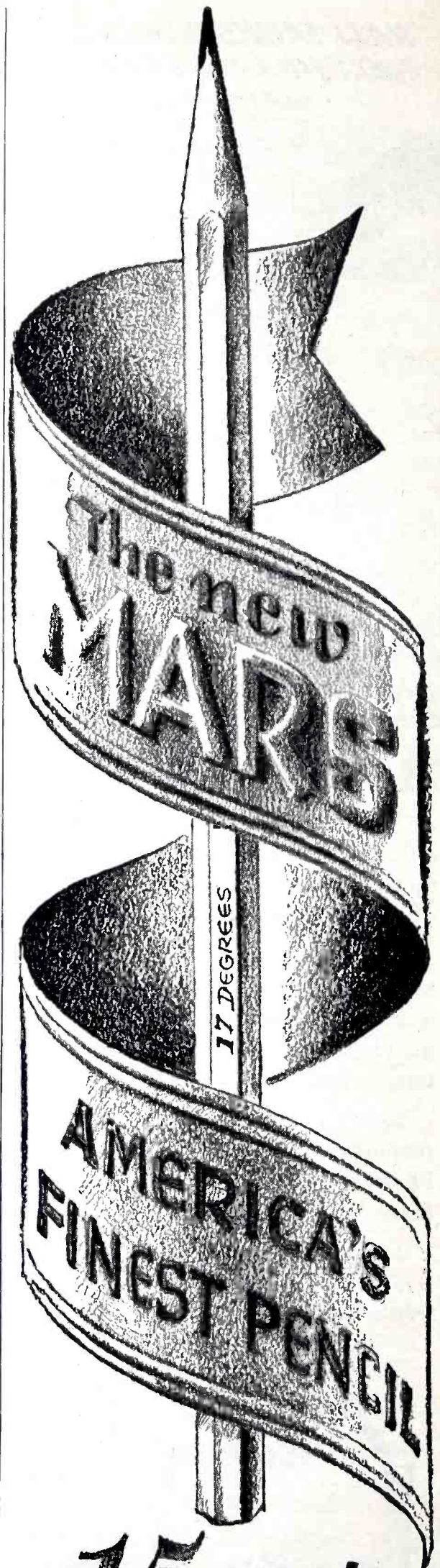

15 cents

"Demand the Best!"

J. S. STAEDTLER, INC.
33-55 WORTH STREET
NEW YORK, N.Y.

less or have a light smoky color. Milky quartz, rose quartz and purple quartz (amethyst) are useless.

BATTERY PRODUCTION has been boosted to 425,000 per month to bring relief to rural dwellers who depend upon battery radio sets for daily war and food program news and for entertainment. This exceeds pre-war production, but the existing backlog of requirements means it will take quite some time to balance supply and demand. Furthermore, batteries require critical materials, facilities and manpower all subject to prior claimants, including the Army and Navy, hence the present rate may have to be cut back again.

STEATITE is plentiful now, along with a new product called multiform glass, hence the WPB Radio and Radar Division is encouraging their use by manufacturers for moulded insulators in electronic equipment. Phenolic plastics will probably be available for new uses later this year. Producers are urged to watch for changes in supplies and use their own initiative in switching quickly from materials becoming scarcer to those becoming less critical.

HOME RADIO SETS will soon be repaired with component parts standardized by WPB Limitation Order L-293. Production of dry electrolytic and paper capacitors, power and audio transformers and choke coils according to the new standards will start July 1. The new parts require minimum use of critical materials. According to latest information, they will carry brand names of manufacturers.

RADIO TUBES not on the preferred list will henceforth require a minimum rating of AA-1 instead of A-1-J. This applies chiefly to obsolete types.

Radio Business News

DETROIT ELECTRONIC LABORATORY, a new firm with headquarters at 10345 Linwood Ave., Detroit, Mich., announces a "Victory Repair Service" for hard-to-get ignition tubes, including the General Electric GL and GF series and the Westinghouse WL series. The new company is directed by John D. Gordon as General Manager, and will also develop and manu-

Solve Voltage Variation
PROBLEMS IN AIRCRAFT, TANKS, ETC.
 WITH

AMPERITE

BATTERY CURRENT & VOLTAGE REGULATORS

Features:—

1. Amperites cut battery voltage fluctuation from approx. 50% to 2%.
2. Hermetically sealed — not affected by altitude, ambient temperature, or humidity.
3. Compact, light, and inexpensive.

Now used by U. S. Army, Navy, and Air Corps.
 Send us your problem.

VOLTAGE OF 24V BATTERY & CHARGER VARIES APPROX. **50%** WITH AMPERITE VOLTAGE VARIES ONLY **2%**

AMPERITE COMPANY • 561 Broadway, New York, N. Y.
 In Canada: Atlas Radio Corp., Ltd., 560 King St. W., Toronto

Cable: Alkem, New York

...YES,

"I'M GLAD WE HAVE THOSE **MONARCH INSTRUMENTS**" ...IN THE PLANT FOR FASTER PRODUCTION

Our calibrating equipment, and special testing-measuring instruments are doing important "war jobs" everywhere for manufacturers in the radio-electronic field. May we help YOU?

MONARCH MFG. CO., 2014 N. Major Ave., Chicago, Ill.

Test Insulation the Modern Way
 with a MODEL B-5

MEGOHMER

NEW BATTERY-VIBRATOR TYPE
 No more tiresome cranking of a hand-driven generator . . . Entirely self-contained, steady test potential of 500 volts DC, available at the touch of a switch. Direct reading in insulation resistance.

VARIOUS NEW MODELS AND RANGES

HERMAN H. STICHT CO., INC.
 27 PARK PLACE NEW YORK, N. Y.

WRITE FOR BULLETIN No. 430 E



NO ARGUMENT ABOUT IT

BRANDING
on *Plastics* is the
order of the day!



★ War time demands for the swift, accurate production of plastic parts have made Rogan's deep-relief branding method the order of the day.

Many essential plastic war parts, of every conceivable size and shape, are now being marked to specifications by Rogan's exclusive method of branding in deep-relief. Accurate graduations, lettering, designs and other markings are fused into the material for permanence. Note Rogan branding on curved surfaces of Bakelite housing illustrated at right.

We urge you . . . write for complete details on this faster, less costly, approved method for marking plastics . . . Rogan deep-relief branding.

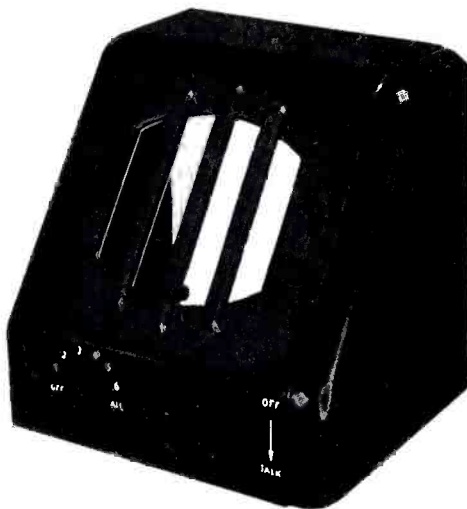

ROGAN BROTHERS

Compression Molders and Branders of Plastics

2003 S. Michigan Ave.

Chicago, Illinois



ONAN
ELECTRIC PLANTS

Doing a Winning Job in the War

ONAN GASOLINE DRIVEN ELECTRIC PLANTS provide electricity in locations where it is not otherwise available, and for emergency and standby service.

Thousands of these reliable, sturdy Plants are doing a winning job on all the fighting fronts by providing elec-

tricity for many vital war tasks. Ratings from 350 to 35,000 watts. A.C. 50 to 800 cycles, 110 to 660 volts. D.C. 6 to 4000 volts. Also dual A.C. and D.C. output models. Air or water cooled.

Details gladly furnished on your present or post-war need for Electric Plants.

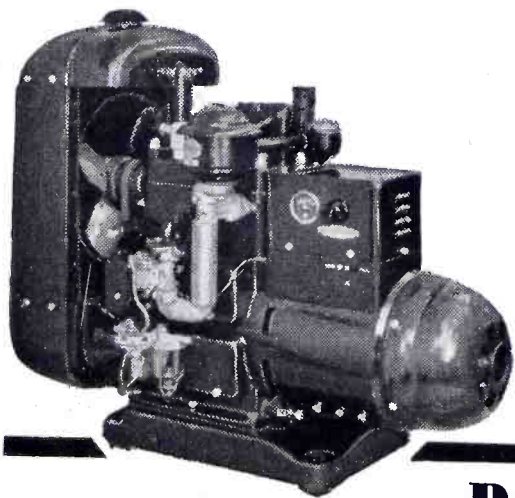

D. W. ONAN & SONS

1921 Royalston Ave.

Minneapolis, Minn.

facture special-purpose electronic tubes such as those used for control equipment for resistance welding.

WEBSTER PRODUCTS has purchased the Armitage Ave. plant of Webster-Chicago Corp. in Chicago, and will continue the manufacture there of dynamotors, generators, inverters, voltage regulators, small motors and special instruments.

COOK ELECTRIC Co. has opened a new plant for its Bellows Division at 909 Diversey Parkway, Chicago, containing a modern testing laboratory with newest facilities for altitude tests on aircraft equipment.

EIMER AND AMEND have moved to new headquarters at Greenwich and Morton Sts. in New York, with manufacturing shops, laboratories, stock rooms and offices all in a single building.

WESTINGHOUSE has opened a new four-acre blackout plant on the East Coast for production of special Army radio equipment. Illumination is provided by nearly two miles of fluorescent lamps simulating daylight conditions, and huge electric fans provide ventilation in the windowless structure. Interior traffic flows along the side walls, leaving central areas available for machinery.

RADAR EQUIPMENT for a single large airplane costs about \$30,000, and radio communication equipment for large planes costs about \$20,000, according to testimony presented before the House Appropriations Committee.

PERMO, INCORPORATED is the new name adopted by Permo Products Corp. of Chicago, manufacturers of pivots for precision instruments.

London News Letter

By JOHN H. JUPE,
London Correspondent

Rediffusion. The British Post Office Engineering Department has carried out some advanced experiments in the transmission of broadcast programs over the usual telephone lines, using radio frequency methods. Plans have more or less been completed whereby it will be possible to give a choice of six programs. Like many more things, however, it seems highly probable

that no general offer will be made to telephone subscribers until after the war.

The cost of the audio frequency rediffusion service which is so common in this country is about 30 to 50 cents per week depending on whether a loudspeaker is hired from the company or supplied by the subscriber. There is no standard charge, as all the present systems are in private hands.

Electrical Brain Writing. Some weeks ago, considerable interest was aroused in this country by the introduction of "brain writing" in a murder trial. A young man who committed a murder seemed definitely abnormal, so tests were made on him by means of a direct ink-writing electroencephalograph. The case was featured in the daily press as it was the first time in British legal history that such an instrument had been used as a means of obtaining evidence.

Industrial Uses for X-Rays. An x-ray machine designed by the British Post Office is being used to find pins and paper clips in waste paper. Bundles of paper are taken in five at a time, and the presence of any metal is shown at once on a screen. Good bundles are thrown into a basket; bad ones are laid aside for hand sorting. The pulping plant is no longer damaged by pieces of metal, and the time taken to sort the scrap has been reduced by one tenth.

Personnel

John K. Hilliard has joined Altec Lansing Corp. of Los Angeles as chief engineer of their Radar and Motion Picture Division. He was formerly chief transmission engineer of the M-G-M sound department, and recently served as consultant to the Radiation Laboratories at MIT.

Frederick S. Rowe will be responsible for scheduling and coordinating production of electronic tubes in all plants of the Westinghouse Lamp Division, in his new position as manager of electronic tube production and stocks. He joined Westinghouse in 1913 as a production clerk, at the age of 16.

Lectrohm FERRULE TERMINAL

Resistors



GIVE YOU THIS ASSURANCE

- a cool operating unit
- a resistor that is integrally one-piece and trouble-free.
- silver soldered connections that cannot become loose.
- exclusive ferrule design assuring positive contact.
- a complete range of sizes to suit all applications.

Request Bulletin No. 98 for complete information.

LECTROHM
INCORPORATED

5127 W. 25th Street

Cicero, Illinois

TURNER 101 CARDIOID Stops

**BACKGROUND
NOISES**



*Offers best features of
both Velocity and Dynamic*



Free

Write for your copy of Turner's new catalog.

Utilizing a 2-element generator, 101 offers true cardioid characteristics; extremely sensitive to sounds originating in front of the microphone, the rear may be considered dead. Where the going is tough and acoustic conditions practically impossible, Turner 101 assures complete intelligibility. Equipped with tilting head, balanced line output connection and heavy duty cable. Available in Standard, DeLuxe and Broadcast models.

The TURNER Co. . . Cedar Rapids, Iowa

Throwing Rocks at the Axis

In cutting quartz down into wafer-thin fighting Xtals the DX Crystal Company is pacing the industry. Speed, precision and dependability are prime watch-words of those who help make these vital parts.

BUY MORE BONDS!

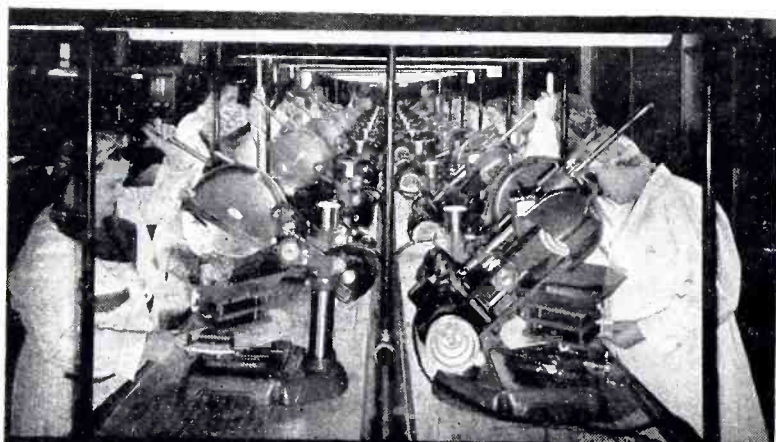

DX CRYSTAL CO.

GENERAL OFFICES: 1841 W. CARROLL AVE., CHICAGO, ILL., U.S.A.



Mr. H. B. Crouse, president of the Crouse-Hinds Co., Syracuse, N. Y. manufacturers of electrical equipment since 1897, died of a heart ailment on June 12, at the age of 70. The firm is one of the largest manufacturers of electrical appliances in the country, was among the first to manufacture electric traffic signals, and is now engaged in war production.

Mr. Crouse was a graduate of Phillips Andover Academy, from which he was graduated in 1891. After spending several years in industry, Mr. Crouse organized the Crouse-Hinds Co. with J. L. Hinds in 1897, and has always been extremely active in that organization.

The J. H. McGraw Medal "for signal contributions to the advancement of the manufacturing branch of the electrical industry" was awarded to Mr. Crouse in 1940. Long a member of the National Electrical Manufacturer's Association, Mr. Crouse was also a director of the New York Telephone and Telegraph Co. and also of the Massachusetts Mutual Life Insurance Co. In February he was named a member of the War Department's Advisory Committee on Procurement and Policy. In addition he was an active participant in many civic organizations in Syracuse, N. Y.

Thaddeus Niemiec becomes chief engineer of General Control Co. His previous experience includes electrical and electromechanical work at Westinghouse, along with electronic engineering.

Leslie G. Thomas steps up from works manager to vice-president in charge of production at International Resistance Co. His pioneer production activities in radio manufacturing date back to 1920.

David E. Chapman, formerly vice-president of Airadio in Stamford, Conn., is now chief engineer of United Cinephone Corp. of Torrington, Conn.

Col. William O. Reeder and Col. John H. Gardner of the Signal Corps were among 52 colonels recently elevated to the rank of Brigadier General. Both have long records of achievement in military communication. Officers in the field received more promotions than those in Washington.

- ★ SOLDERING
- ★ BRAZING
- ★ BOMBARDING
- ★ HARDENING
- ★ ANNEALING
- ★ MELTING

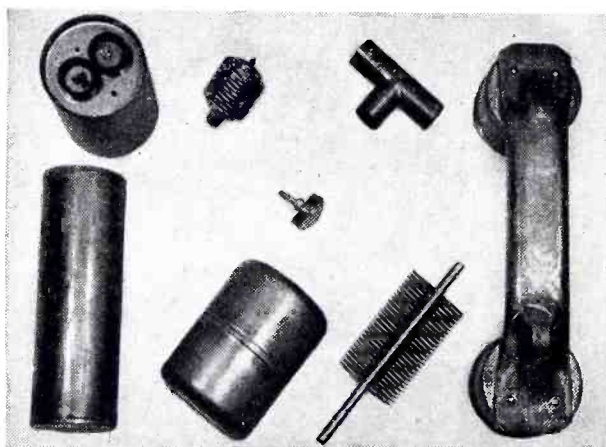

A COMPACT LEPEL

HIGH FREQUENCY

INDUCTION HEATING UNIT

... performs all these operations quicker, simpler, more efficiently and at a fraction of the cost. Complete engineering data on your work is freely offered. Send samples, or write for catalog E today.

Lepel

HIGH FREQUENCY LABORATORIES, INC.
39 West 60th Street, New York, N. Y.
PIONEERS IN INDUCTION HEATING

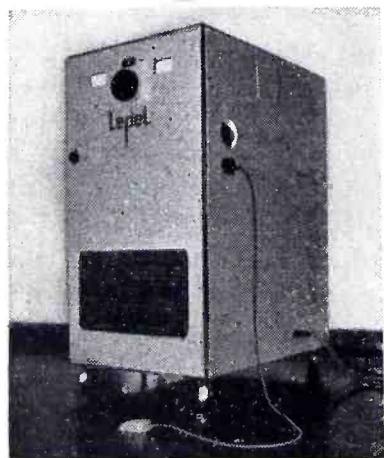

Carl A. Frische has been named chief research director of the Sperry Gyroscope Co., and assumes charge of the company's Garden City, Long Island laboratory, which designs, develops and tests military, marine and aircraft precision instruments. He has made notable contributions to the development of automatic pilots and bombsights and to the soundproofing of airplanes since joining the Sperry organization in 1933.

Comdr. D. F. Shea and Lieut. Comdr. Ralph T. Brengle have been appointed assistants to the Head of the Radio Division of the Bureau of Ships. Comdr. Shea has had communications engineering experience, and was in charge of procurement before his present duty. Comdr. Brengle is widely known in the radio industry as head of the Ralph T. Brengle Sales Co. of Chicago.

Thomas A. Morgan, president of the Sperry Corp., received an honorary Doctor of Science degree from Duke University in recognition of his leadership in building up the Sperry Gyroscope Co. and two associated firms. His firm developed the highly important Klystron velocity-modulated tube following initial research at Stanford University.

Meredith L. Koerner, formerly with the Radio Intelligence Division of the FCC, has joined the OWI Wire and Overseas Communications Facilities Division as associate engineer, and will have charge of the purchasing and inspection of communications equipment. He had previously served for six years as assistant chief engineer of station WSBT in South Bend, Ind.

FM Broadcasters, Inc., reelected Walter J. Damm of W55M in Milwaukee as president, T. C. Streibert of W71NY in New York City as vice-president, Robert T. Bartley as secretary-treasurer, and F. M. Doolittle of W65H in Hartford, Conn., as a director. Newly elected directors are George Lang of W59C in Chicago, Walter Evans of W57PH in Philadelphia and Arthur B. Church of W9XER in Kansas City, replacing Carl J. Meyers (now in the Navy), John Shepard, 3rd, and Paul Morency. Remaining directors (not up for election this year) are J. H. DeWitt, Jr., of W47NV in Nashville, John V. L. Hogan of W2QXR in New York City and Ray H. Manson of W51R in Rochester, N. Y.

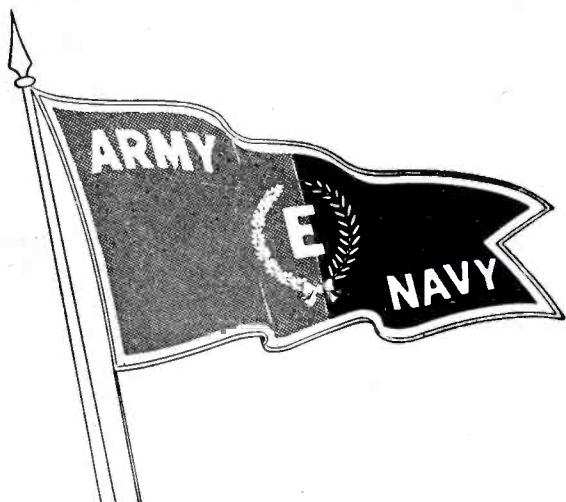

ARMY-NAVY AWARDS

- AMERICAN CYANAMID & CHEMICAL CORP., SELDEN DIV. Bridgeville, Pa.
- D. W. ONAN & SONS Minneapolis, Minn.
- RADIO SPEAKERS, INC. Chicago, Ill.
- RAYTHEON MFG. Co. Newton and Waltham, Mass.
- R. C. A. LABS Princeton, N. J.
- WORCESTER MOULDED PLASTICS Co. Worcester, Mass.



PERMANENT MAGNETS

ALL SHAPES — ALL SIZES
FOR ALL PURPOSES

Stamped, Formed, and Cast; Chrome, Tungsten Cobalt and **ALNICO**** (cast or sintered) under G. E. license.

THOMAS & SKINNER
STEEL PRODUCTS COMPANY
1116 E. 23rd STREET INDIANAPOLIS, INDIANA

Laminations for Radio Transformers — Tools
Dies — Heat Treating — Stampings

42 YEARS EXPERIENCE

DEFEATS

HEAT

COLD

HUMIDITY



**THERMATITE TREATED
THERMADOR
TRANSFORMERS**

Thermador Transformers are Thermatite treated to withstand extreme temperatures and humidity—arid or moist heat—dry or damp cold do not hamper their efficiency. Thermatite is the name of a process of accurate heat controlled vacuum impregnation developed and improved over a period of ten years.

Thermador also manufactures built-in Electric Heaters, Electric Ranges, Electric Water Heaters.

THERMADOR
Electrical Manufacturing Co.
5119 S. Riverside, Los Angeles
"Seven Leagues Ahead"



NEW PRODUCTS

Month after month, manufacturers develop new materials, new components, new measuring equipment; issue new technical bulletins, new catalogs. Each month descriptions of these new items will be found here

Hipersil Cores for Communication Components

DESIGNED FOR use in radio transformers, chokes, relays, reactors and loading coils, a new line of Type "C" Hipersil cores are available in a wide range of sizes. The manufacturer states these steel cores have one-third more flux-carrying capacity than conventional cores of the same size and weight, and that assembling and replacement are simplified because only 2 to 4 pieces are involved. Construction of cores consists of winding a Hipersil strip continuously on a mandrel of desired dimensions. It is annealed at high temperature and vacuum-impregnated with a plastic compound to make it a solid unit. It is then cut into two segments, the ends of which

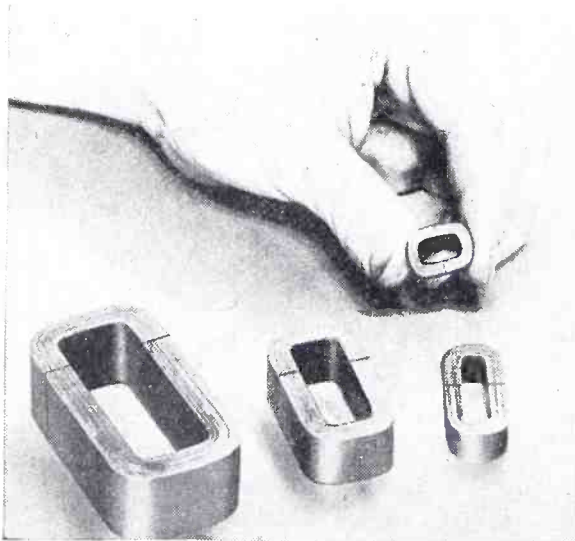

are machined and worked to produce coinciding surfaces when reassembled. A check test for fidelity of performance is made. Cores are assembled on coils by means of metal bands tightened to insure correct tension. The butt joint eliminates cross-fluxes or masking effect and does not increase core loss. Each joint is equivalent magnetically to a 0.0005 air gap. Hipersil steel cores of nominal gauge are used for frequencies up to

400 cps; thinner Hipersil steel is available for frequencies higher than 400-cps; and a still thinner gauge is available for very high frequencies and exceptional fidelity.

Department 7-N-20, Westinghouse Elec. & Mfg. Co., East Pittsburgh, Pa., or any Westinghouse office will supply further information.

Regulator Tube

THIS REGULATOR TUBE (for use in industrial applications and railroad signals) decreases the 40 percent voltage variations on railway signal systems to 5 percent. It is not affected

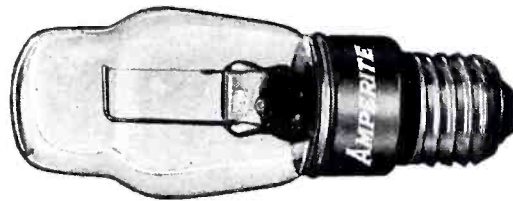

by temperature or humidity and has no moving parts. Standard screw or standard radio octal bases can be supplied by the manufacturer, Amperite Co., 561 Broadway, New York, N. Y.

Coaxial Antenna

SUITABLE FOR FIXED station use, and pre-tuned at the factory to the desired operating frequency, Type 899 vertical coaxial antenna is easy to install, and provides an inexpensive half-wave radiator in the frequency range of from 30 to 200 Mc. The upper half of the antenna is a whip of conventional design. The lower half, or skirt, is a 2½ inch tube. The entire assembly is supported by a 1½ inch support pipe 12 ft. long, which is attached to a mast with a clamp. Overall length, including support pipe, is about 20 ft. and the weight is 48 lb. No impedance matching devices are required. The whip

and skirt are cut to length at the factory for the exact operating frequency. The unit is designed to be fed from a 70 ohm coaxial transmission line. Fourteen feet of 7/8 inch coaxial cable are provided with the antenna.

Victor J. Andrew Company, 363 East 75th St., Chicago, Ill.

Tube Type Quartz Crystals

ADDED TO THE LINE of the manufacturer's piezoelectric quartz crystals is a new special-purpose type which comes housed in a conventional metal tube case. By means of this mounting, freedom from moisture and atmospheric changes are secured.

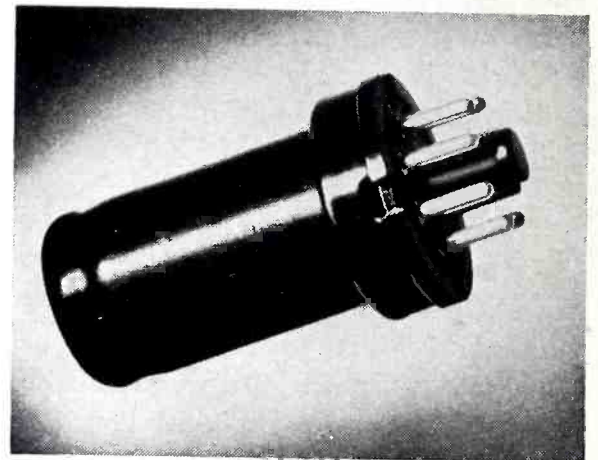

Another service the manufacturer offers is their facilities to fabricate all crystal oscillators and resonators completely from the raw quartz.

John Meck Industries, Plymouth, Ind.

Vibration Fatigue Testing Machine

MODEL 100 VIBRATION fatigue testing machine is similar in appearance and operation to Model 25, which was described in April ELECTRONICS. The main difference between the two models is the greater capacity of Model 100. Its specifications are: Horizontal table movement; table area of 15x18 ins; table load capacity, 100 lbs; table mounting holes (115) 3/8 inch-16 thread; total displacement, 0 to 0.125 ins. (adjustable); maximum capacity is approximately 23 G; frequency is rated at 10 to 60 cps (adjustable); base measures 24x42 ins; base mounting hole dimension measures 20x38 ins; total height is 12 3/8 ins; net weight is 550 lbs; the motor is rated as 1½ hp, 220 volts, 60 cps, a.c., 3-phase.

All American Tool & Machine Co., 1014 Fullerton Ave., Chicago, Ill.

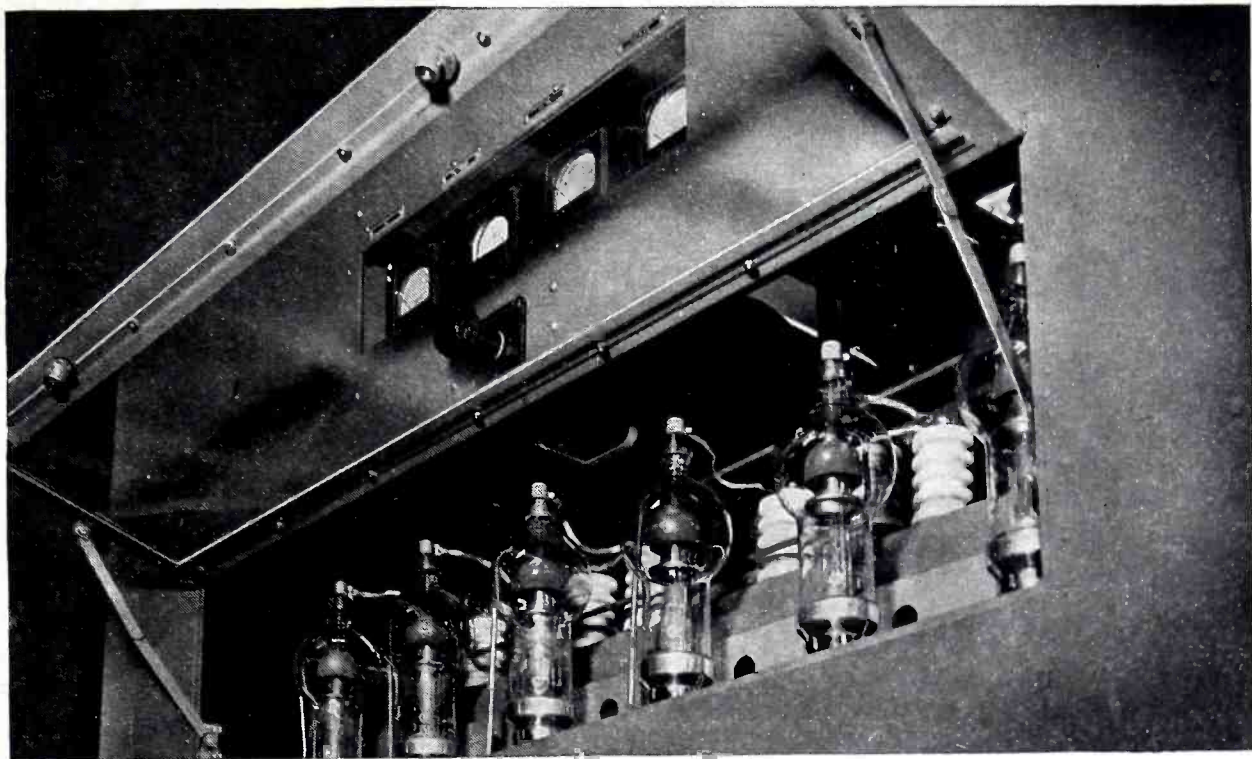

Since **1878**

*T*HROUGH the growth of years of the communications industry in all its phases, the pioneers have depended upon equipment of Bunnell design and manufacture. Today the industry broadens its horizons; its developments will revolutionize untold hundreds of industrial processes. Again the pioneers will look to the technical assistance of the Bunnell Engineering Group. Their experience is at your disposal.



J. H. **BUNNELL** *& Co.*
GENERAL OFFICES: 215 Fulton St., New York City • FACTORIES at Brooklyn, N. Y.

Designing Engineers and Manufacturers of:

ELECTRONIC INDUSTRIAL DEVICES ★ INDUSTRIAL RECTIFIERS
HIGH POWER RADIO FREQUENCY GENERATORS ★ TRANSMITTERS
RECEIVERS ★ AUTOMATIC TELEGRAPH EQUIPMENT

STAR STEATITE

Is Produced By
THREE MODERN METHODS

(1) Hand Molding

For complicated shapes, or parts where most careful handling is needed.

(2) Automatic Molding

For speed and accuracy. Many automatic machines made in our own shops.

(3) Extruding and Machining

High pressure hydraulic presses insure uniform density and dimensions.

**STAR STEATITE Meets U. S.
Specifications for Grade G Ceramics**

The
STAR
PORCELAIN COMPANY
ELECTRONICS DEPT. TRENTON, N. J.

Photoelectric Protection System

THIS PHOTOELECTRIC protection system projects a fence of invisible light over distances of 1500 ft. and gives instant local or central-station alarm if an intruder enters the protected area. The instrument may be used to protect harbors, docks, industrial properties, airports, and similar large areas. It consists of a light source, Type L60M, which is aligned with a receiver, Type A30M, to which it focuses a modulated beam of infrared light. The receiver is not affected by other artificial light or by day-light. In applications where infrared light is not required, the system exceeds a protection area of 2000 ft. A fan in the light source serves as a light chopper to produce rapidly fluctuating light of the desired frequency, and also cools the heavy-duty lamp. Once the invisible beam of light projected to the receiver is momentarily broken, the alarm circuit latches in operation. Either power or tube failure will cause the alarm circuit to operate as though the light beam had been broken. Supplied with the receiver and the light source is an auxiliary latching relay with a reset button. The equipment is designed for operation on 105 to 125 v., a.c.

Photoswitch Inc., 77 Broadway, Cambridge, Mass.

Raytheon VOLTAGE STABILIZERS

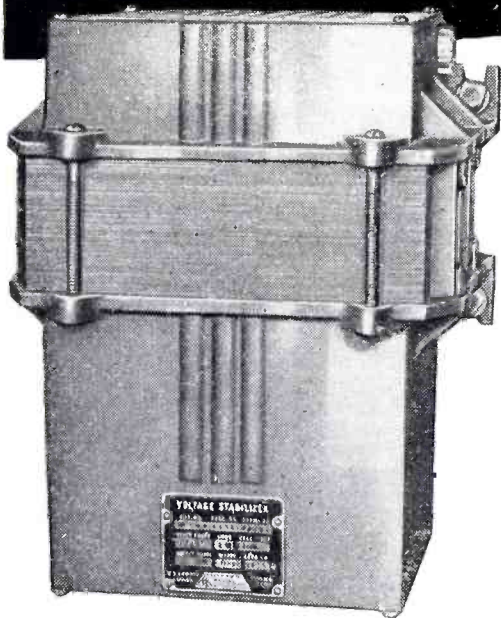

ENDBELL
MODEL

Control Unreliable Input Voltage

By controlling varying input voltage to $\pm 1\frac{1}{2}\%$, Raytheon Voltage Stabilizers improve the performance and accuracy of the following equipment . . .

Television . . . Colorimeters . . . Radar & Radio . . . Signal Systems . . . X-Ray Machines . . . Sound Recording . . . Electronic Devices . . . Testing Equipment . . . Photo-Cell Devices . . . Production Machinery . . . Constant Speed Motors . . . Motion Picture Equipment . . . Communications Apparatus . . . Precision Laboratory Apparatus . . . Other Applications Requiring Regulated Voltages.

How Raytheon Improves Performance

Holds Constant A. C. output voltage to $\pm \frac{1}{2}\%$.
Stabilizes at any load within its rating.
Quick action—variations stabilized instantly,—can't be observed on ordinary volt meter.
Wide A. C. input voltage limits—95 to 135 volts.
Entirely automatic . . . No moving parts . . . Connect it and forget it.



The coveted Army-Navy "E", for Excellence in the manufacture of war equipment, flies over all four Raytheon plants where 12,000 men and women are producing for VICTORY.



RAYTHEON MANUFACTURING
Company

190 WILLOW ST. WALTHAM, MASS.

Choke Coils

CHOKER COILS rated at an inductance up to 22 henries, maximum, may be had wound and adjusted to suit individual requirements.

Union Electric Products Co., 7 Liberty St., Newark, N. J.

Jacks for Mobile Field Units

TYPE JK-37 JACKS are U. S. Army Signal Corps approved, and are available for prime and sub-government contractors. The jacks (of a telephone switchboard extension type) have coin silver contacts, and are actually a three-way, heavy duty, three-prong type with high impact phenolic body and steel bracket attachments.

Universal Microphone Co., Inglewood, Cal.

READY TO ATTACK NEW PROBLEMS

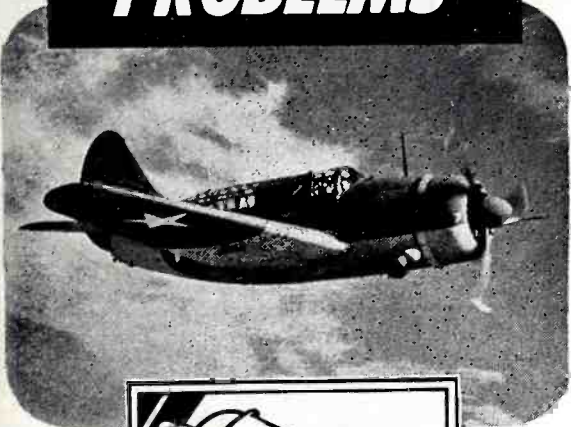

Official
U. S.
Navy
Photo

BELL was ready for action when war brought sudden needs for new types of electronic sound equipment. Years of research, experiment and experience were at the fingertips of BELL engineers, ready to be applied.

Looking ahead to new possibilities in sound amplification, transmission and recording is an old policy at BELL. It explains why BELL SOUND SYSTEMS are widely recognized as the most advanced in their field.

And while details regarding the war-vital electronic devices now being produced at BELL cannot yet be revealed, you can be sure they include many developments that will make news in peace-times to come. For today, as yesterday, BELL is prepared for tomorrow.



BELfone INTER COMMUNICATION SYSTEMS

With BELfone, you touch a key and START TALKING INSTANTLY with your party. You save time, steps, energy. No numbers to dial, no switch-board delays. Requirements of any type or extent can be met with standard BELfone units. Write at once for complete details.

BELL SOUND SYSTEMS,
Incorporated
1189 ESSEX AVE. COLUMBUS, OHIO
Export Office:
5761 EUCLID AVE. CLEVELAND, OHIO

Cathode-ray Tube Socket

THESE ONE-PIECE MOULDED construction cathode-ray tube sockets were designed to completely enclose and seal the contacts against temperature and humidity conditions, and to provide high voltage flashover at high altitudes, and high resistance between adjacent pins. Another fea-

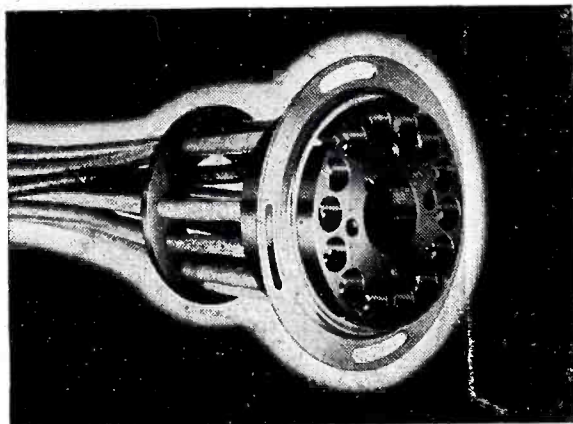

ture is a strain relief ring which protects the soldered joints against vibration pull, or twist of the wires. The sockets are supplied in either assembled units complete with cable, or ready for assembly.

Franklin Mfg. Co., 175 Varick St., New York, N. Y.

Tandem Power Rheostats

COMPACT, TANDEM POWER rheostat assemblies, of two or more sections, are made up of two 25-watt or two 50-watt rheostats coupled together and held in a metal cradle. One-hole mounting and locking-projection are

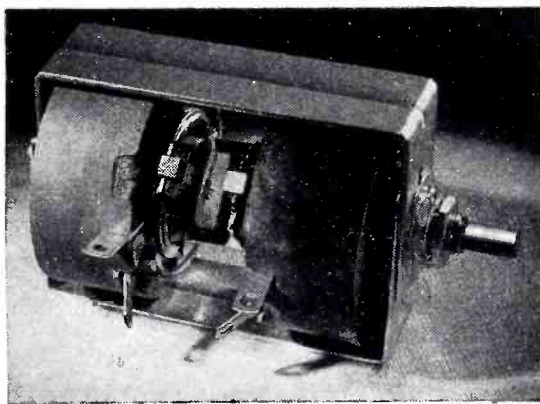

used. The individual rheostats can be of any standard resistance value, taper, tap and hop-off, and all units go through the same degree of rotation as the single shaft is turned. The units are fully insulated from each other and from the ground. These assemblies are made only on special order.

Clarostat Mfg. Co., Inc., 285 North 6th St., Brooklyn, N. Y.

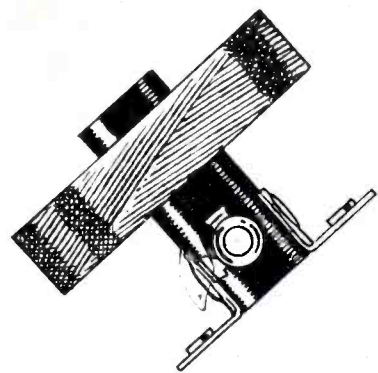

RADIO COILS ON TIME!

WE ARE EQUIPPED
TO GIVE PROMPT
DELIVERY ON
ALL TYPES OF
I.F. AND R.F. COILS

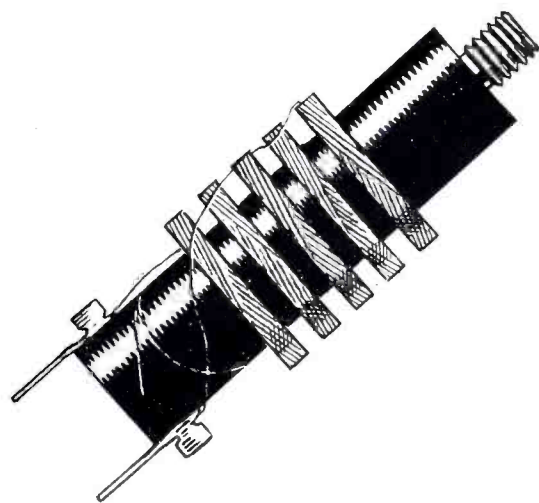

COILS

Electronics Division
ESSEX SPECIALTY CO., INC.
1060 BROAD ST.
NEWARK, N. J.

MIRACULOUS MINUTENESS in EMBY Selenium Instrument Rectifiers Engineered for Engineers

EMBY Instrument Rectifiers have specially treated metal electrodes and use the uni-polar conductivity of metal to selenium junction. Rectification is instantaneous—no warm-up period required. No moving parts. Shock proof. Permanent characteristics. Unlimited life. Increased efficiency with increased temperature. Temperature range, -70 to $+70^{\circ}$. Unaffected by severe atmospheric conditions. Sealed-off units supplied for aircraft service. Series "N" and "S" have satisfactory frequency characteristics and can be used in the frequency range up to 100 kc.



Input 5 volts. Half wave. Continuous dc current 1 ma. Used with meters, detector circuits, bias voltage.



Input 5 volts. Half wave. Continuous direct current 8 ma. Numerous field applications.



Input and output same as H-SM, but has two rectifying elements connected in series.



Input 10 volts. Full wave Bridge. Continuous dc 10 ma. Unbreakable plastic case with mounting extension.



Input 10 volts. Full wave Bridge. Continuous dc rating 35 ma. Mounted in aluminum case with mounting extension.

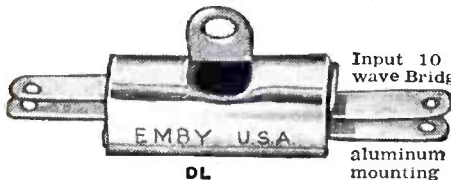

Input 10 volts. Full wave Bridge. Continuous dc rating 50 ma. Mounting extension available if specified.



Input 10 volts. Continuous output rating 80 ma. Designed for



Input 10 volts. Continuous output rating 80 ma. Designed for

ALL ILLUSTRATIONS ACTUAL SIZE
Send for Bulletin with complete specifications.
(Bulletin No. 10 on Self-generating Photo-Electric Cells is also available.)

SELENIUM CORP. OF AMERICA



Manufacturers of EMBY Rectifiers,
Photo-Electric Cells and allied
scientific products

1800-1804 West Pico Blvd.
Los Angeles, California

Eastern Sales Division, 29-57 214th St., Bayside, L. I.

Half-Wave Type Rectifier

A HALF-WAVE RECTIFIER of the selenium type, designated as N type, is given a special forming process to assure long life. It has a working temperature range which extends from -70 deg. C to $+75$ deg. C, and a negative temperature coefficient. All associated equipment, such as meters, relays, etc., have positive temperature coefficients with resulting compensation when used with selenium rectifiers.

Type N-2 consists of two rectifying elements $\frac{5}{8}$ ins. in diameter assembled in a tubular plastic case $\frac{3}{4}$ ins. and is rated 10 volts a-c. The rated voltage is 5 volts a-c. per rectifying element. The d-c rating for continuous load is 1 ma; for instantaneous load, 3 ma. Impedance in the forward direction is 1000 ohms. Impedance in reverse direction is 1 megohm per plate. All units are hermetically sealed with special sealing compound so that the assembly is independent of atmospheric changes and impervious to moisture. Two soldering terminals are provided.

Selenium Corp. of America, 1800 W. Pico, Los Angeles, Cal.

Kettles for Melting Electrical Compounds

CALLED "HEET-MASTER", these kettles are insulated on the outside, and heated from the inside by any gas line. They are designed to heat quickly with minimum fuel. A removable immersion tube heating unit makes cleaning easy. Accurate temperature control is achieved by the use of an electric magnetic valve and thermostat with a range of 150 deg. to 550 deg. F. The draw-off valve which is used for filling transformers, batteries, condensers and other electrical equipment is controlled by lever action outside and on top of the unit. It is a non-drip type, and opens inside the kettle. A hand control rod or foot pedal can be attached for convenient operation. Four valve reducers are furnished with the unit to reduce the stream of melted compound to $\frac{3}{4}$, $\frac{1}{2}$, $\frac{3}{8}$ and $\frac{1}{4}$ inch, as desired. The kettles are compact, and come in sizes of 5, 10 and 25 gallons.

Aeroil Burner Co., Inc., West New York, N. J.

• NUMBERALL • NUMBERING and LETTERING PRESS

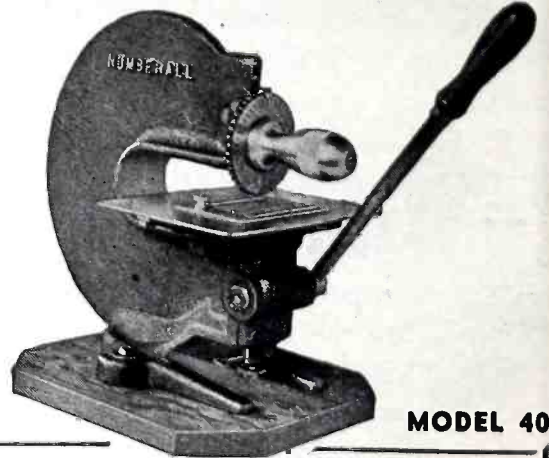

Quickly stamps serial numbers and other details on name plates, names and numbers on tags, etc. Can also be furnished for HOT stamping. Write for catalog.

NUMBERALL STAMP & TOOL CO.

Huguenot Park Staten Island, N.Y.

ELECTRONIC ENGINEER

Wanted at Once!

A client of ours—one of the most progressive and alert manufacturers in the electronic field, has an immediate need for a thoroughly trained and experienced engineer. This Company has been well established for more than 10 years, and is currently engaged in war work, but has already outlined a definite program for post-war production.

This position is permanent, and offers unlimited opportunity to a man with ability, vision and a desire to make real progress. Located in a medium size midwest city, with pleasant living conditions. Preference will be given a graduate engineer with a proven record—but not essential. Write Today, stating age, draft classification, family status, training, experience, present salary and other pertinent information.

W. D. LYON CO.

Bever Bldg., Cedar Rapids, Iowa

Att: Mr. Evans

Plug Receptacle Assembly

A PLUG-RECEPTABLE ASSEMBLY, for use with panel-rack type of radio equipment, features mechanical precision; rugged construction to withstand mistreatment in the field; full-floating contacts; and steatite insulation which resists flashover and surface tracking. Each plug and receptacle is constructed of a zinc die-casting on which are mounted

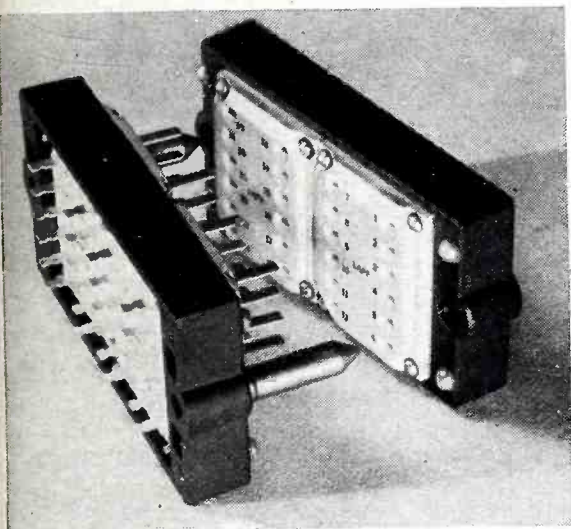

four ceramic plates, which hold the metal contacts in full floating position. At the ends of the male plug are machined steel pins, which engage corresponding holes in the female receptacle, to provide positive and accurate alignment. The standard design of these plugs provides 24 contacts, but units carrying contacts in any multiple of 12 can be produced.

Lapp Insulator Co., LeRoy, N. Y.

Humidity Test Chambers

STANDARD LOW AND HIGH temperature test chambers are available with automatic humidity control. The units have standard refrigeration equipment and a new attachment for humidity control. The standard relative humidity range is at temperatures from ambient to 140 deg. F. Special adaptations can be made for humidities below ambient if the requirements are known. The exterior overall measurements are 95 x 91 x 42 inches. Usable space measures 52 x 27½ x 30 inches. The interior cubical content is 25.9 cu. ft.

Model RTCI-H embodies, as an integral part, equipment for mechanical refrigeration and electric heat-

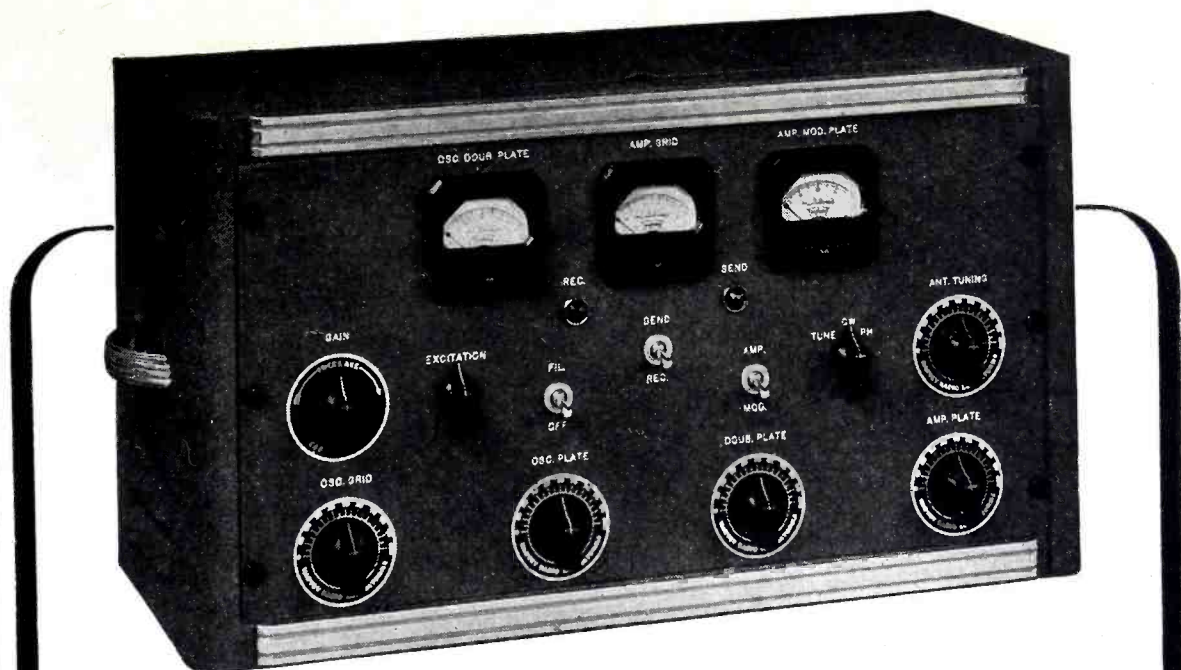

Harvey UHX-25

25-watt General Purpose Radio Telephone Transmitter available for operation between 1.5 M. C. and 30 M. C.

HARVEY Radio Laboratories, Inc.

★ 447 CONCORD AVENUE · CAMBRIDGE · MASSACHUSETTS ★

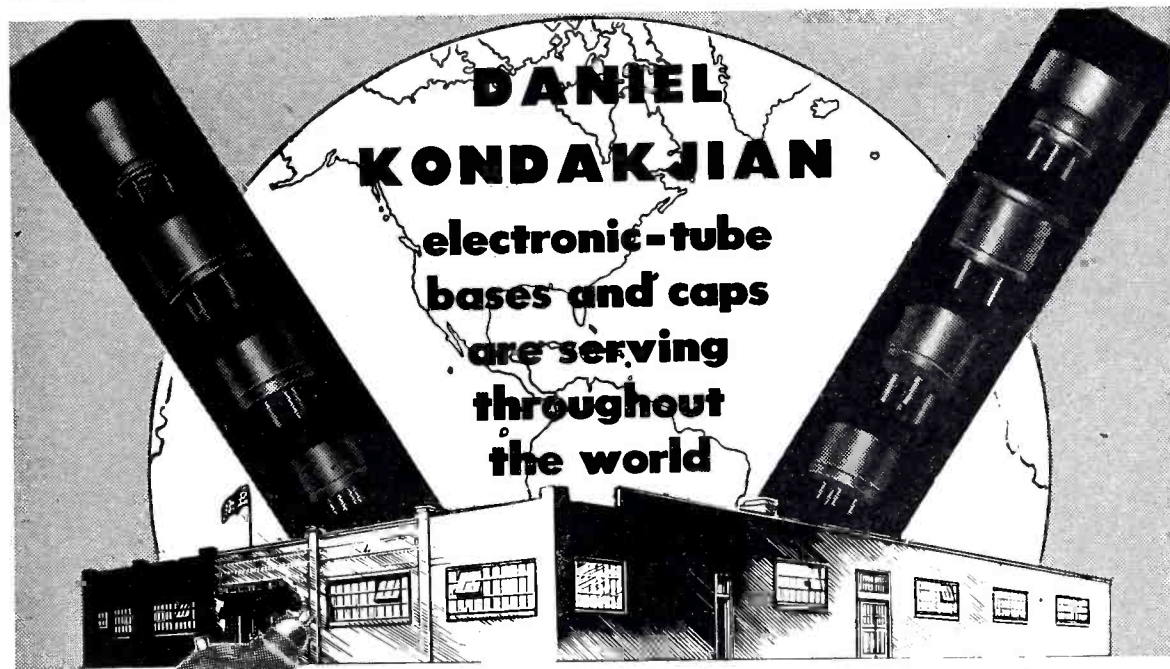

...designed to bring Victory closer now.. and better, more healthful living tomorrow!

The wonders of electronics are slowly being unfolded—guns accurately aimed through cloud banks and darkness of night, continuous indication of aircraft's position relative to the earth's surface, making visible U-boats far down in the ocean's depths—these are a few of the strides as applicable to a military world. But tomorrow . . . even the most hopeful guess will probably be surpassed in the

progress to come in the post-war era. The field is limitless.

DANIEL KONDAKJIAN electronic components will assume an important role in tomorrow's world, too. Engineers and manufacturers with projects or problems pertinent to future plans, and suitable to our capabilities, are invited to send inquiries. Our complete collaboration, in strictest confidence, is assured; write today.

THE ENGINEERING CO., 27 WRIGHT ST., NEWARK, N. J.

TUNGSTEN LEADS DANIEL KONDAKJIAN BASES AND CAPS

Communications are helping

WIN THE VICTORY



Lightning war maneuvers are made possible by radio communications. Were it not for the swift transmission of vital messages, victory would be delayed. Today on many far-flung battle fronts, Bud Radio products, so dependable in peace, are showing their real worth under fire.

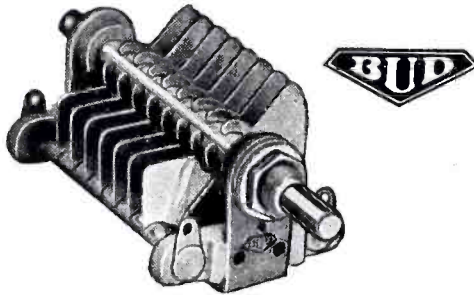

BUD RADIO, INC. ★ *Cleveland, Ohio*

MICROWAVE TRANSMISSION

By **J. C. SLATER**

Professor of Physics, Massachusetts Institute of Technology. 310 pages, illustrated, \$3.50.

Deals with such problems as:

- attenuation in rectangular wave guides
- composite wave guides and the avoidance of reflection
- radiation and absorption of energy by a simple antenna
- effect of reflectors and other devices for producing directed beams, with problems of diffraction
- coupling of coaxial lines and wave guides

►For all who are interested in the problems of transmission through hollow pipes and coaxial lines—this book brings together the developments in the field and presents them in a sound, understandable explanation of the distinctive characteristics of microwaves and a discussion of the use of Maxwell's equations as a means of handling the problems of transmission line design. Problems are treated both from the standpoint of conventional transmission lines and of Maxwell's equations.



10 DAYS' FREE EXAMINATION

McGraw-Hill Book Co., 330 W. 42nd St., N. Y. C.

Send me Slater's Microwave Transmission for 10 days' examination on approval. In 10 days I will send \$3.50, plus few cents postage, or return book postpaid. (Postage paid on cash orders.)

Name

Address

City and State

Position

Company

L-7-43

ing. Its temperature range is minus 55 deg. C. to plus 70 deg. C. Other features include the use of a two-stage Freon condensing unit and special refrigeration accessories that make possible flexible operation at various loads and temperatures. Positive forced air circulation, that can be varied in volume, and temperatures with thermostatic control are used for tests on delicate mechanisms and precision equipment. Observation of products under test is provided by a door having five sealed and dehydrated panels of glass measuring 46 x 21½ inches. The steel frame door has a clear opening which measures 51½ x 26½ inches.

American Coils Co., 25 Lexington St., Newark, N. J.

Optical Comparator

THIS COMPARATOR is an instrument for quickly and accurately measuring and comparing intricate shapes for inspection purposes. It checks such items as screw threads, parts for instruments, dies, gears, etc., for height, width, thickness and radius. It may also be used in industrial applications as a surface illuminator, strain finder, opaque projector, or stereo projector. The instrument is particularly useful for inspection of mass production parts which are not easily checked with ordinary gauges. After a preliminary adjustment, the instrument will check an unlimited number of similar objects in rapid succession. The comparator operates by the use of a 32-candle power incandescent lamp which is focused into a powerful beam by an aspheric condenser lens system which operates in conjunction with a projection lens. A clear image of the part under examination appears on a ground glass screen which measures 9x15 ins. On the same screen is placed a sketch of a perfect model which has been drawn in the same scale of magnification on a transparent sheet. A centering device aligns the drawing with the contour of the projected object and permits a detailed comparative examination. The instrument operates on 110-115 v., a.c., and may be used in any room under normal lighting conditions. Overall dimensions are 16½x17½x40 ins.

Fish-Schurman Corp., 230 East 45 St., New York, N. Y.

NOW

a really high-powered

RADIO ENGINEERING LIBRARY

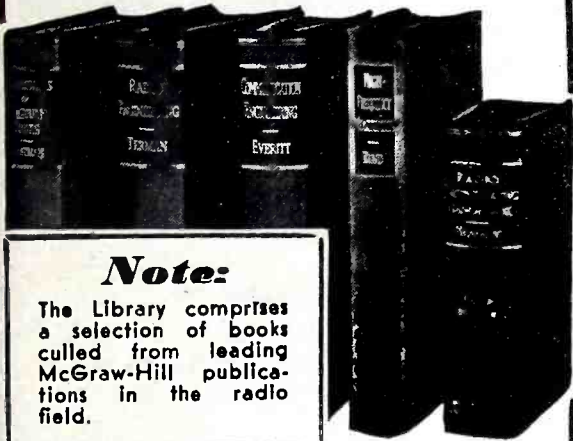

Note:

The Library comprises a selection of books culled from leading McGraw-Hill publications in the radio field.

- ↳ especially selected by radio specialists of McGraw-Hill publications
- ↳ to give most complete, dependable coverage of facts needed by all whose fields are grounded on radio fundamentals
- ↳ available at a special price and terms

These books cover circuit phenomena, tube theory, networks, measurements, and other subjects—give specialized treatments of all fields of practical design and application. They are books of recognized position in the literature—books you will refer to and be referred to often. If you are a practical designer, researcher or engineer in any field based on radio, you want these books for the help they give in hundreds of problems throughout the whole field of radio engineering.

- 5 volumes, 3559 pages, 2558 illustrations
- Eastman's **FUNDAMENTALS OF VACUUM TUBES**, 2nd edition
- Terman's **RADIO ENGINEERING**, 2nd edition
- Everitt's **COMMUNICATION ENGINEERING**, 2nd edition
- Hund's **HIGH FREQUENCY MEASUREMENTS**
- Henney's **RADIO ENGINEERING HANDBOOK**, 3rd edition

SPECIAL LOW PRICE • EASY TERMS

Special price under this offer less than cost of books bought separately. In addition, you have the privilege of paying in easy installments beginning with \$3.00 in 10 days after receipt of books, and \$3.00 monthly thereafter. Already these books are recognized as standard works that you are bound to require sooner or later. Take advantage of these convenient terms to add them to your library now.

FOR 10 DAYS' EXAMINATION SEND THIS

.....ON-APPROVAL COUPON.....

McGraw-Hill Book Co., 330 W. 42nd St., N. Y. C.

Send me Radio Engineering Library for 10 days examination on approval. In 10 days I will send \$3.00 plus few cents postage, and \$3.00 monthly till \$24 is paid, or return books postpaid. (We pay postage on orders accompanied by remittance of first installment.)

Name

Address

City and State

Position

Company F.L. 7-43

Electric Motors for Remote Control Devices

THESE LIGHTWEIGHT MOTORS incorporate the manufacturer's "Fastop Clutch" which stops the driven member in 1/50th of a second from 8000 rpm. These are for use in aircraft. The controls are flexible and operate efficiently at low temperatures. The

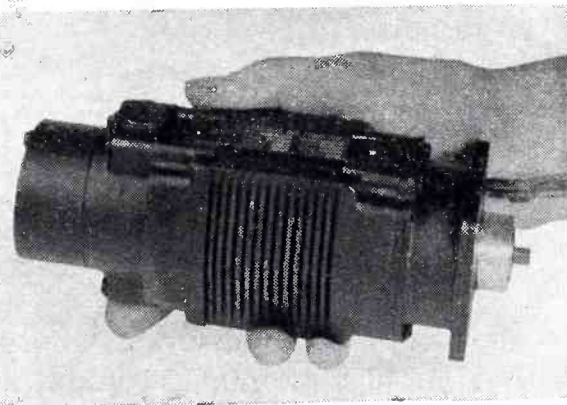

manufacturer recommends the use of this patented clutch in applications where instantaneous braking is desired. Illustrated is DD-20 electric motor with a Fastop clutch and burn out protection. It has a peak power output of 1/8 hp and weighs 5.56 lbs. It is patented by the manufacturer, Lear Avia, Inc., Piqua, Ohio.

Aircraft Autosyn Voltage Calibrator and Polarity Indicator

MODEL No. 7 is an instrument used in the production-testing of aircraft autosyn indicating motors. It may also be used by military inspection stations and repair depots. The autosyn, being the heart of the instrument panel on aircraft, requires a quick method of checking its calibration and polarity against a known standard.

To operate the unit it is necessary to insert the autosyn motor in the frame. No clamps are required; all fits are held to 0.001 in. The positioning arm is then slipped over the rotor shaft which ordinarily receives the indicating pointer. To check calibration, the positioning arm is set at 90 deg. or center scale by letting a spring arm snap into position. The unit is then connected to a vacuum tube voltmeter and a power source of 400-cycle. A standard autosyn, an integral part of the instrument, is then rotated by means of a knurled

PERMANENT MAGNETS



LITTLE Changes

**Can Make A
BIG Difference**

But the important thing is—where and how changes in the design of permanent magnets should be made. That takes knowledge of the subject of magnetism.

Perhaps our long experience in this field would be helpful, if you are not entirely satisfied with the performance of your present magnets. And once the improved design is worked out, we can supply your requirements in ALNICO or NIPERMAG.



CC-1

CINAUDAGRAPH CORPORATION

STAMFORD, CONNECTICUT

**Hit...HARD!
HARD! HARD!**



The news from the fighting fronts is good . . . and by the time you read this it may even be better. The power to shorten the war lies as much in your hands and ours as it does with the boys over there. Now . . . right now . . . is when we're needed the most. Let's hit hard — hard — hard! Surely it's worth the try to cut the life of the war by at least six months.



Over there punching, day in and day out, are ABBOTT Transmitters and Receivers . . . faithful products of hands born and bred in the best traditions of American mechanical and electrical skill. Illustrated is an ABBOTT TR-4 . . . a standard, compact and efficient ultra-high frequency transmitter and receiver.

ABBOTT
INSTRUMENT, INC.
8 WEST 18 STREET • NEW YORK, N. Y.

thumb screw until the vacuum tube voltmeter reads zero. To check calibration the positioning arm from the

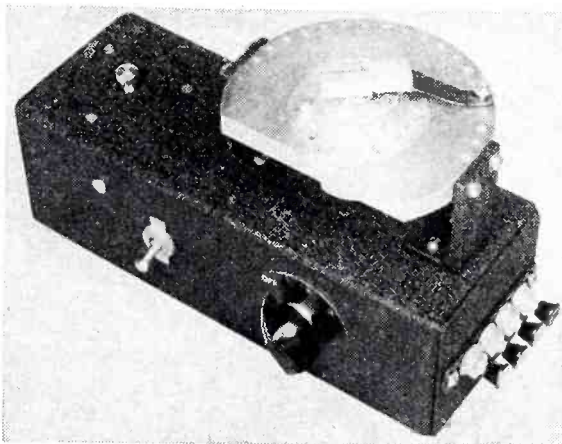

center scale position is lifted and moved clockwise or counter-clockwise one position. Each position from center is equal to 10 deg. with an accuracy of plus or minus 3 minutes. The vacuum tube voltmeter will then read voltage deviation from standard and can be checked progressively every 10 deg. after balance to zero is made. The price of the instrument is approximately \$319.00. It measures 10x6x3 ins., and weighs 6 lbs. All pin positioning tolerances are held to plus or minus 0.0002 in.

Televiso Products Co., 6533 Olmsted Ave., Chicago, Ill.

Removable Terminal Stud

AN ADDITION TO THE LINE OF the Rosan Locking System, used in airplane manufacturing and in the electrical field, are Rosan Terminal Studs which are stud-locked in material but are removable because the locking ring is furnished with a flange by which it may be pried out, the stud replaced, and the ring reinserted in its original position. This may be accomplished without disconnecting wires or removing a panel from a ship when repairs are necessary.

The Rosan Locking System itself consists of a steel stud which is locked in the softer material by means of a steel locking ring, serrated inside and out. When the ring is driven into place, its inner teeth engage the teeth of a serrated collar on the stud. The outer teeth broach their way into the material. Pressure of surrounding material causes the ring to close in on the serrated collar, making a solid unit of the whole.

Bardwell & McAlister, Inc., Hollywood, Cal.

JONES BARRIER STRIPS

SOLVE MOST TERMINAL PROBLEMS



No. 151

A compact, sturdy terminal strip with Bakelite Barriers that provide maximum metal to metal spacing and prevent direct shorts from frayed wires at terminals.

6 SIZES

cover every requirement. From 3/4" wide and 13/32" high with 5-40 screws to 2 1/2" wide and 1 1/8" high with 1/4"-28 screws.

Jones Barrier Strips will improve as well as simplify your electrical intra-connecting problems. Write today for catalog and prices.

HOWARD B. JONES
2300 WABANSIA AVENUE,
CHICAGO ILLINOIS

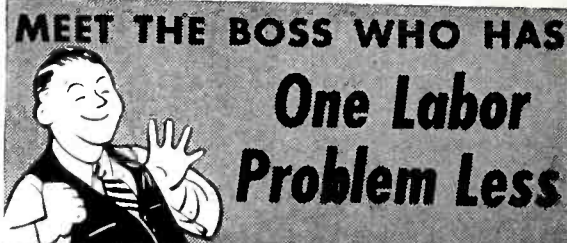

MEET THE BOSS WHO HAS
**One Labor
Problem Less**

**P.S. he owns an APeCO
PHOTOCOPY MACHINE**

APeCO Eases Man-Power Shortage. It saves valuable time now spent on tracing, typing, and copying—releasing Men, Women and their Equipment for other work.

APeCO makes photocopies up to 18x22"—*1st copy in 3 minutes—120 copies an hour.* No chance for error! Used by leaders throughout industry, law, government, engineering. Foolproof operation! Sturdy construction!

Anyone · Any Time Can Make Photo-Exact Copies of Anything Written, Printed, Drawn or Photographed

Any inexperienced girl or boy can produce permanent, photoexact copies at any desk or table. No darkroom needed.

Write for FREE folder now! Without obligation, ask to have an APeCO Consultant call — located in all principal cities and Canada.

\$55
F.O.B. CHICAGO



AMERICAN PHOTOCOPY EQUIPMENT CO.
2849 N. Clark Street, Dept. AG-6 Chicago, Ill.

SAVE TIME WITH PHOTOCOPIES OF
LETTERS
BLUEPRINTS
DRAWINGS
WORK ORDERS
PHOTOGRAPHS



General Purpose Radio Relay

A GENERAL PURPOSE RADIO relay, Series 345, for aircraft, is available in contact combinations from SP, ST, up to three PDT. It has a large coil winding area and measures $2\frac{3}{8} \times 2\frac{1}{2} \times 1\frac{1}{8}$ ins. Contacts, rated 12 amps at 24 v. d.c., are arranged to withstand 10 g acceleration and vibration in all positions. Coil resistances range from 0.01 ohm to 15,000 ohms. Standard voltages are 16 to 32. Other values are also available. The bearing is a pin type of hardened, non-magnetic, stainless steel and is staked to the armature hinge. The armature return spring is a torsion type and maintains an even spring pressure. Relay parts are plated to resist deterioration under conditions of high humidity.

Circular No. 345 describes these relays which are available from Guardian Electric Mfg. Co., Dept. 345, 1625 W. Walnut St., Chicago, Ill.

Tiny Relays

CLASS "S" DESIGNATES a line of tiny, sensitive and rugged new relays which provide twin contacts, built-in vibration resistance, and a range of operating and release speeds.

Typical assemblies, having a maximum of six contact springs, measure $\frac{3}{4} \times 1\frac{1}{2} \times 1\frac{3}{8}$ ins. in size, and weigh $1\frac{3}{8}$ oz. Assemblies with maximum capacity of 12 springs are

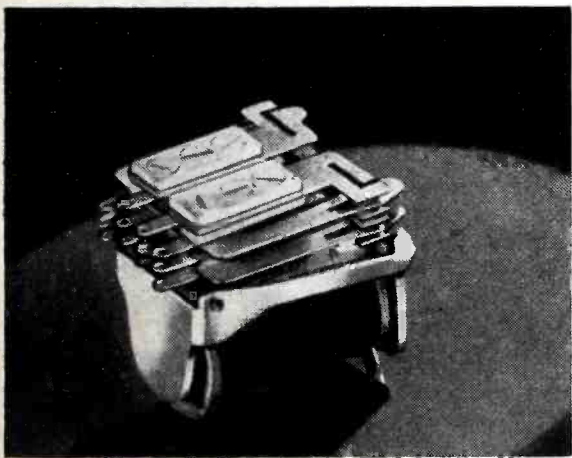

slightly larger, and weigh about 2 oz. Relays can be supplied with any number of springs up to the maximum and with any combination of make, break and break-make contact arrangements. Vibration resistance (provided by torsion) insures against false operation or release of contacts at up to 10.5 g's ($\frac{1}{8}$ in. excursion at 60 cps), as determined by

Coming thru the fog!

★ Men, machines and military missions depend every minute of every day upon the operating efficiency of radio communications. Astatic Co-Axial Cable Connectors, Multi-Contact Plugs and Sockets, Dynamic Microphones and other radio parts equipment are manufactured with utmost precision and skill to insure the highest and most dependable operating efficiency under the most trying conditions.

ASTATIC

THE ASTATIC CORPORATION

YOUNGSTOWN, OHIO

In Canada:
Canadian Astatic, Ltd.
Toronto, Ont.

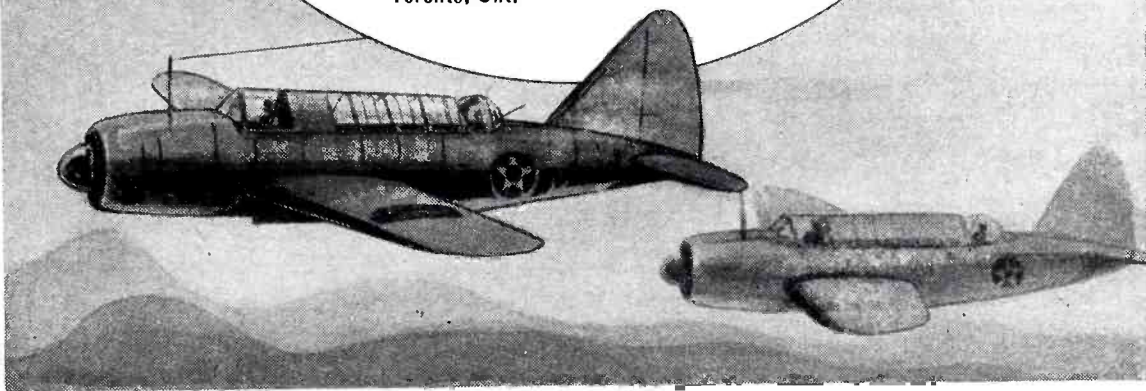

Mr. Engineer:

Where will you fit in Radio After the war?

If you are wise, you will realize that the secure future that every man desires must be gained by preparing now. You will not wait for a "lucky break." You will analyze your present capabilities—decide where you will fit into the postwar world of radio and industrial electronics. You won't wait very long. For you will realize that time is short—that your future is now!

CREI home study can prepare you for the opportunities that are available to every engineer. Our program of technical study will bring your knowledge up-to-date . . . help you in your daily work, and develop your ability to cope with any technical radio problem.

CREI courses are prepared to fit into busy schedules. You can study a few hours a week without interfering with your present work. So, "follow-through" now—for this is the time to make sure your preparation for postwar success shall not be "too little, too late"!

WRITE FOR DETAILS IN BOOKLET about CREI Home Study Courses

If you are a professional radio-man and want to make more money—let us prove to you we have something you need to qualify for the BETTER career-job opportunities that can be yours.



TO HELP US INTELLIGENTLY ANSWER YOUR INQUIRY—PLEASE STATE BRIEFLY YOUR EDUCATION, RADIO EXPERIENCE AND PRESENT POSITION.

CAPITOL RADIO ENGINEERING INSTITUTE

Dept. E-7, 3224-16th., N.W.
Washington 10, D. C.



MANY OF THESE ICA PRODUCTS CAN HELP YOU NOW!

Yes, ICA can help you meet schedules by manufacturing any number of a wide range of high quality Radio-Electronic products, such as:—

- Metal Cabinets, Chassis, Panels
- Metal Stampings ● Plugs and Jacks ● Completely Assembled Screw Machine Products ● Hardware and essentials
- Antennas for "Walkies Talkies", etc.

Mfrs. and Contractors: Send specifications for estimates.

Write for this 12-page Industrial Catalog now!

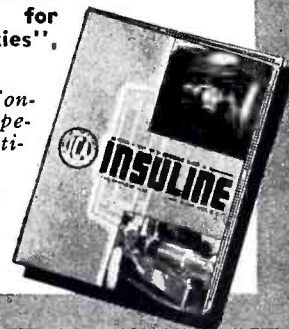

INSULINE

CORPORATION OF AMERICA

INSULINE BUILDING

(36-02 35th AVENUE)

LONG ISLAND CITY, N.Y.

For Assembly or Tracer Marking on Wire and Plastic Tubing

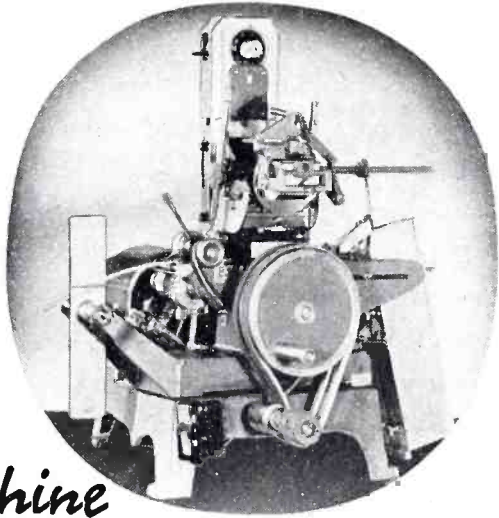

WIRE

PLASTIC SLEEVE

This machine

imprints tubing or wire on one side with clear, durable King Markwell marking compounds which penetrate into plastic or plastic insulation. Will not wear or wash off. Handles wire from No. 4 to No. 22 size automatically from reel; lets wire fall loose or rewinds same; plastic sleeve up to 5/8" tube diameter printed, rewound, notched or cut off as desired. Speeds up to 4500 lineal feet per hour. Marking changes easily made — automatic reset stop at desired intervals. Write for Bulletin 125 for full information.

NOTE: Machine for two side wire marking will be announced soon.

Put your marking problem up to Markem as did Grumman Aircraft Engineering Corporation and other leading aviation firms now using Model 125.

MARKEM MACHINE COMPANY, KEENE, N. H.
PRECISION BUILT PRODUCTION MACHINES FOR INDUSTRIAL MARKING

a cathode-ray oscillograph and stroboscopic examination. Twin contacts assure positive contact operation, and will make or break 1 amp non-inductive, or 1/2 amp inductive load, and carry 2 amps.

Operating speeds range from 2 to 16 milliseconds, release speeds from 5 to 85 milliseconds; coils are available from 150 to 3500 ohms, for d-c operation up to 48 volts. Other features include resistance to humidity, to temperatures from -40 to +130 deg. F, and to insulation test voltages up to 500 volts (a-c test current).

Automatic Electric Co., 1033 Van Buren St., Chicago, Ill.

Sealed Relays

A SEALED CHAMBER is one of the safety features of a new midget relay which is a light, compact and sturdy instrument designed to withstand hard usage. The sealed chamber serves as an effective arc quench and reduces fire and explosion hazards. While rated at 25 amps, the manufacturer states the new relay operates satisfactorily at 50 amps and has been tested without failure at 120 amps, inductive load. An over-travel spring insures positive con-



and Antenna Equipment

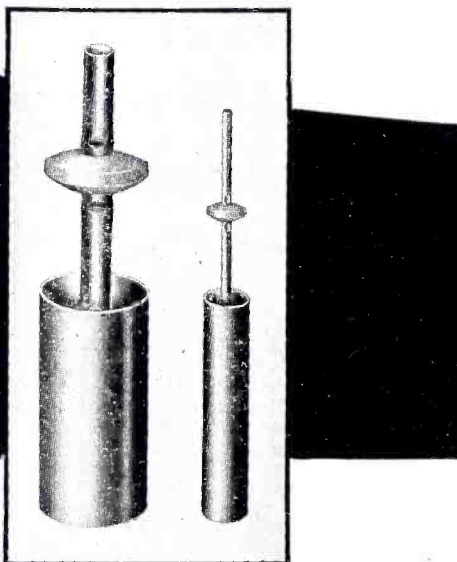

If you need ceramic insulated coaxial cables, you are invited to consult the engineering staff of the Victor J. Andrew Company for recommendations to meet *your* requirements. The Andrew Company, pioneer specialists in the manufacture of antenna equipment, is now in a position to take additional orders, in quantity, for all sizes of ceramic insulated coaxial cables and equipment for all applications.

If coaxial cables are your problem . . . write for new catalog showing complete line of coaxial cables and accessories.

VICTOR J. ANDREW CO.

363 East 75th Street, CHICAGO, ILLINOIS

ANTENNA EQUIPMENT

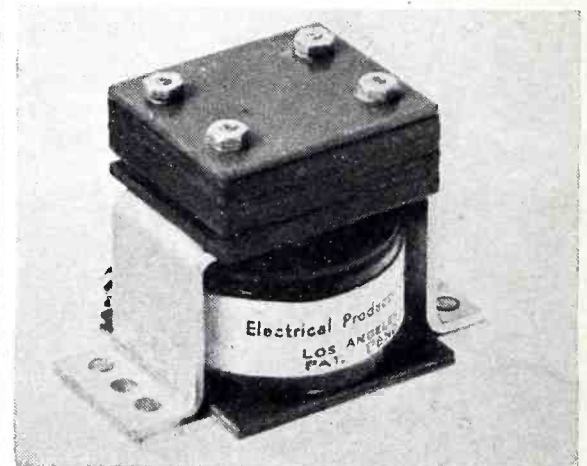

tact pressure and instant break release. The relay is factory adjusted and sealed. Army tests which the relay has withstood include overload; vibration at 55 cps with 0.06 inch excursion; acceleration of 10; and salt spray tests of 240 hours duration. Another feature of these relays are reversible contacts. If worn with excessive use, the contacts may be reversed in the field to provide new surfaces without disturbing adjustment.

Electrical Products Corp., Los Angeles, Cal.

KOLD-HOLD

Stratosphere Testing
Equipment That Insures
Performance

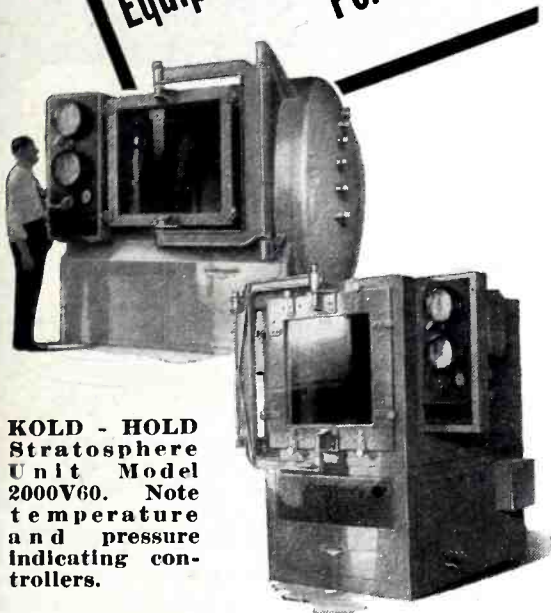

KOLD - HOLD Stratosphere Unit Model 2000V60. Note temperature and pressure indicating controllers.

Instrument manufacturers today are faced with a triple problem — achieving perfection, at increased speed and on a quantity production basis. This applies particularly to aircraft instruments and aircraft parts' testing, but it is also applicable to many other fields and processes that are vitally important in wartime production. KOLD - HOLD testing equipment meets this triple challenge for performance under the severest working conditions.

● KOLD-HOLD Stratosphere Unit affords adjustable temperatures and pressures over a wide range to meet specific altitude conditions. Waiting for "favorable" climatic changes is no longer necessary, for within a few hours, hundreds of aircraft instruments can be tested on these variations and thus speed vital aircraft production.

● Write for information.

NEW YORK — 254 West 31st Street

CHICAGO — 201 N. Wells

LOS ANGELES — 1015 West Second St.

PHILADELPHIA — 2414 Clover Lane,
Upper Darby

KOLD-HOLD MANUFACTURING CO.
446 N. Grand Ave., LANSING, MICH., U.S.A.

Relays for Aircraft Power Circuits

BULLETIN No. 103 describes relays which are designed particularly for aircraft power circuits. The armature and contact assembly of the relays retain either position under conditions of vibration and shock and at high values of acceleration of gravity. The normally-open, SP contacts are rated 25 amps at 24 v., d.c.,

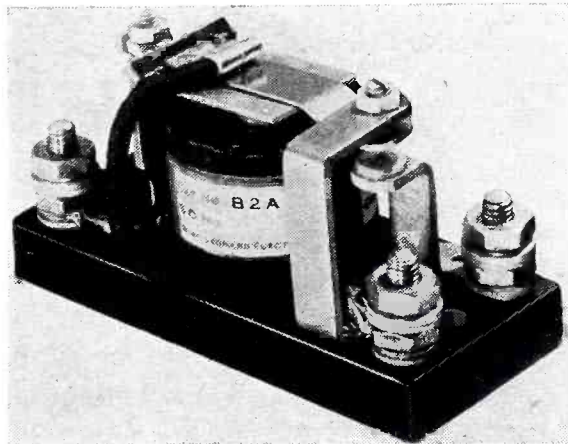

non-inductive load. The contact gap and tail spring tension are adjustable. Molded bakelite, nearly $\frac{3}{8}$ inch thick, forms the base which measures $1\frac{3}{8} \times 3\frac{1}{8}$ ins. Two holes are provided in the base for mounting.

Ward Leonard Electric Co., Mount Vernon, N. Y.

Plastic Battery Retainer

A PLASTIC STORAGE BATTERY, for use in certain types of Exide batteries, is now being manufactured from slotted polystyrene. The manufacturer states that the retainer has, in addition to technical advantages, more permanence than former types of retainers.

The Electric Storage Battery Co., Philadelphia, Pa.

Emergency Radio Transmitter and Glass Kite String

A PRECISION EMERGENCY radio transmitter which automatically sends out SOS signals is called the Gibson Girl and was developed by Bendix Aviation Ltd., of North Hollywood, Cal., in collaboration with the Signal Corps' Aircraft Radio Laboratory. The equipment is for use of fliers forced to make crash landing at sea. The transmitter is waterproof. It weighs 33 lbs. with its accessories, and is capable of sending the distress signal over thousands of square

Meissner "Align-Aire"

Condensers Meet
Exacting Performance
Requirements!



Meissner "Align-Aire" (midget) units are now encased in the newly developed, low loss, bakelite (number 16444) and occupy extremely small space . . . only $\frac{7}{16}$ " in diameter and $1\frac{1}{8}$ " long . . . they are an ideal trimmer for high frequency coils. Midget "Align-Aire" Condensers are exceptionally stable. Capacity range 1 to 12 mmfd.

Many years of engineering research developed the Meissner "Align-Aire" Condensers to meet the exacting performance requirements of high frequency circuits.

Samples sent upon request.

AVAILABLE ONLY ON PRIORITIES

"PRECISION-BUILT
ELECTRONIC PRODUCTS"

Meissner
MT. CARMEL, ILLINOIS

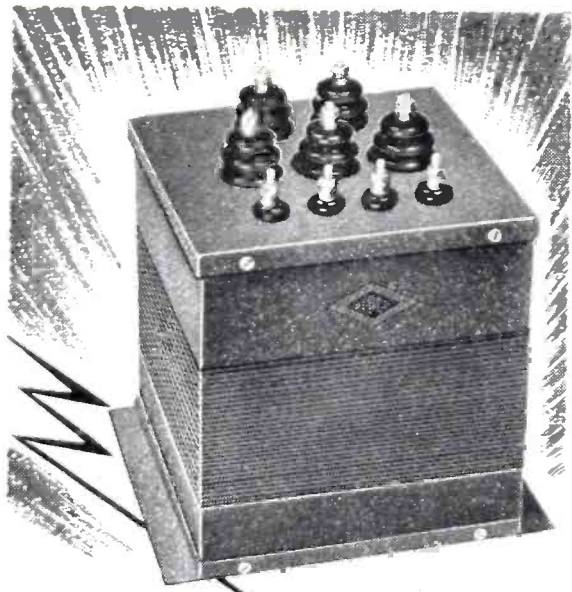

PEERLESS STOCK TRANSFORMERS

for Radio, Sound, Public Address
and Television Equipment

Outstanding quality is maintained through Peerless design, the development of special winding and impregnation equipment and rigid adherence to difficult specifications. Peerless Stock Transformers are available in a broad range of designs and capacities.

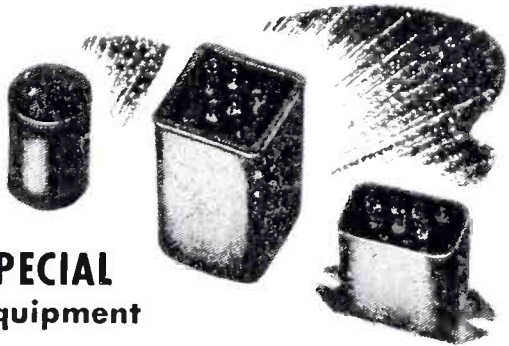

SPECIAL Equipment

Peerless is now building special transformers for Aircraft and other military equipment. These transformers are designed for light weight, small size and protection against moisture or exposure to any climate. Special transformers will be built to your specifications, for similar military services.

Write for
complete
specifications
and
catalog

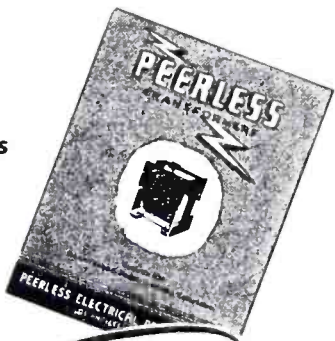

"There is a Peerless
Quality Transformer
for Every Purpose"

PEERLESS Electrical Products Co.

6920 McKinley Avenue
Los Angeles 1, California

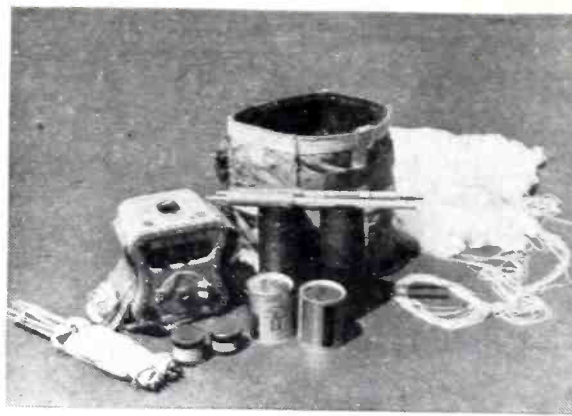

miles. Rotation of a hand crank operates a keying device which automatically spells out the SOS and also produces the necessary power through a generator. The voltage output of the generator remains constant. The device is pre-tuned to the International distress frequency of 500 kcs and is capable of tripping tuned automatic shore alarm stations. Controls on the front panel enable the user to operate the set manually for sending messages in code. The transmitter kit, colored a vivid yellow so that it may be easily discernible in water, consists of the transmitter, kite, two deflated balloons in sealed cans, two hydrogen generators, two spare reels of antenna wire, and a signal light.

Glass yarn, used as the kite string, is manufactured by Owens Corning Fiberglas Corp., Toledo, Ohio. The yarn has great strength in proportion to its weight, and does not rot or deteriorate from the effects of salt water, tropical sunlight, rain or dampness. The yarn is twisted and plied from continuous filament glass fibers which can be drawn to indefinite lengths.

General Electric Products

A NEW LINE OF electronic heaters for h-f induction heating and radio-noise filters for aircraft have been announced by the General Electric Co., Schenectady, N. Y.

THE HEATERS are for induction heating of metal parts for brazing, soldering, and selective heat treating, and are essentially power oscillators which convert 60-cycle power to high-frequency power at approximately 500,000-cycles. Two standard sizes are available; the first has an output of 5 kw and the other an output of 15 kw. Simple circuits are employed and the electronic tubes, controls and other equipment are ar-

MICRO-DIMENSIONAL WIRE & RIBBON FOR VACUUM TUBES

• Complete range of sizes and alloys for Transmitting, Receiving, Battery and Miniature Tubes . .

• Melted and worked to assured maximum uniformity and strength

WIRES drawn to .0005" diameter
RIBBON rolled to .0001" thick

• SPECIAL ALLOYS made to meet individual specifications. Inquiries invited.

Write for list of stock alloys

SIGMUND COHN & CO.
44 GOLD ST. NEW YORK
SINCE 1901

Lingo

—a name to remember when
the war is forgotten

★
VERTICAL TUBULAR
STEEL RADIATORS

★
PATENTED FM
TURNSTILE RADIATORS

★
We're "all out" for Victory,
but our engineers are ready
to work with you on
post-war plans

★
JOHN E. LINGO & SON, Inc.
CAMDEN, NEW JERSEY

ranged in compact, completely enclosed cabinets. The manufacturer states that the use of conservatively rated elements reduces maintenance to the periodical replacement of tubes, which when properly applied have an average life expectancy of 5000 to 10,000 hours or more. Attached to the electronic heater is a work table with water-cooled coil, or coils, connected to the heater terminals. Among the advantages given for the heaters are: Heating is rapid

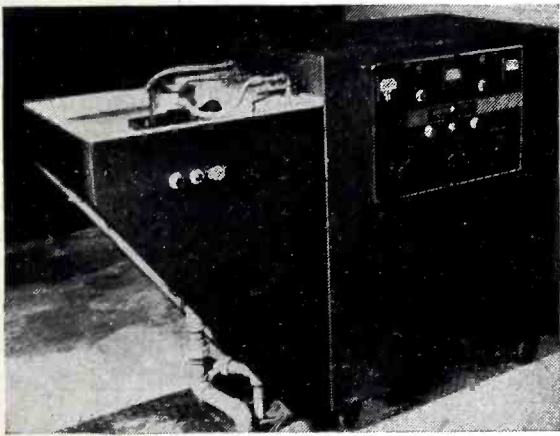

and can be confined to the area desired; operation can be carried on by unskilled operators after preliminary adjustments have been made; and the amount of heat and its distribution is controlled accurately and automatically.

THE RADIO NOISE filters have high attenuation characteristics and are

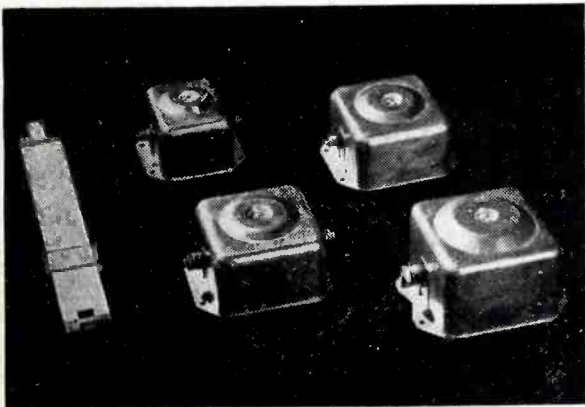

for use in suppressing noise, especially from 200 to 20,000 kc, in aircraft electric systems (circuits with such equipment as generators, amplidyne, inverters, and dynamotors). The filters are compact and lightweight—for example, in the 100 amp rating the unit weighs 2½ lbs, and measures 5 x 4 x 2½ ins. They can be mounted in any position, and will operate over a temperature range of ±50 deg. C. Available in ratings of 20, 50, 100 and 200 amps, d-c at 50 v, the filters comply with U. S. Army Air Forces specifications, including the requirements of vibration and acceleration. Complete information is contained in bulletin GEA-4098.

New and Exclusive!
VINYLINE PLASTIC HAIRLINE INDICATOR
 More accurate than human hair. Moisture-proof, won't shrink or warp.

ACETATE SPACING WASHER
 POLYSTYRENE LEAD-THRU BUSHING
 POLYSTYRENE LEAD-THRU BUSHING
 POLYSTYRENE COIL FORM
 POLYSTYRENE COIL FORM

PLASTIC PARTS
 Supplied Immediately! No Molds! Close Tolerance!

What's your urgent problem? Send specifications—blue-print, if possible—we'll get to work within 24 hours. Printloid experience and research facilities are your guarantee of satisfaction. Literature on Request. Dept. EL-7

PRINTLOID Inc.
 93 Mercer Street
 New York, N. Y.

PERMANENT MAGNETS

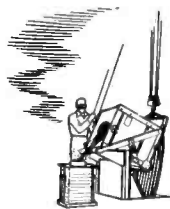

THE Arnold Engineering Company produces all ALNICO types including ALNICO V. All magnets are completely manufactured in our own plant under close metallurgical, mechanical and magnetic control.

Engineering assistance by consultation or correspondence is freely offered in solution of your magnetic design problems. All inquiries will receive prompt attention.



THE ARNOLD ENGINEERING COMPANY

147 EAST ONTARIO ST. • CHICAGO, ILLINOIS



When WILL THE WAR END?

No one knows. Victory may come with startling suddenness... let us hope so.

When the war does end, you will find the ERWOOD engineering talent available for your problems.

THE ERWOOD COMPANY

225 WEST ERIE STREET

CHICAGO, ILLINOIS



PRACTICE MAKES PERFECT

How many sacks of flour does an Attack Bomber drop on friendly tanks? How often does a Tank Commander draw a bead on a friendly plane? How long must Air and Armored Forces flex their muscles together in practice before they become welded in a coordinated striking force?



Know-how takes time to acquire. We are thankful that National had years of radio communications know-how all ready.

NATIONAL COMPANY, INC. MALDEN, MASS.

Literature

Tube Substitution Chart. War time tube substitution chart giving approved government types for 288 types available prior to the government limitation order. Preferred substitutions are shown and types are coded to indicate necessity of changes such as changing sockets, changing bias, using external shield, using filament shunt and rewiring sockets. A functional cross index shows the replacement with regard to functional considerations vs. heater considerations. Available from National Union Radio Corp., Newark, N. J.

End Fittings. Bulletin 43 deals with end fittings for shafts and casings. These fittings cover a wide range of application requirements and are grouped according to the size of shaft or casing with which they can be used and should be selected accordingly. This bulletin also includes flexible shaft data and flexible casing data. Bulletin 43 available from S. S. White Industrial Division, 10 E. 40th St., New York, N. Y.

Spot Welders. Electric welding equipment and transformers are described in Bulletin 42-W. Spot welders for aircraft production, air operated projection spot welder, butt welders, push and gun welders are among the several welders illustrated in this booklet. Also illustrated are several manual operated, motorized, air operated and variable speed welders. Bulletin 42-W available from Eisler Engineering Co., Inc., 750 S. 13th St., Newark, N. J.

Communication Receivers. "Unitized" communication receivers are explained and illustrated in this 4 page folder. In this system there are three basic cells; r-f, i-f, and audio, each is assembled in a standardized protective metal case. Cell components are arranged so that 75 percent less hook-up wire is required. Available from Harvey Machine Co., Inc., 6200 Avalon Blvd., Los Angeles, Calif.

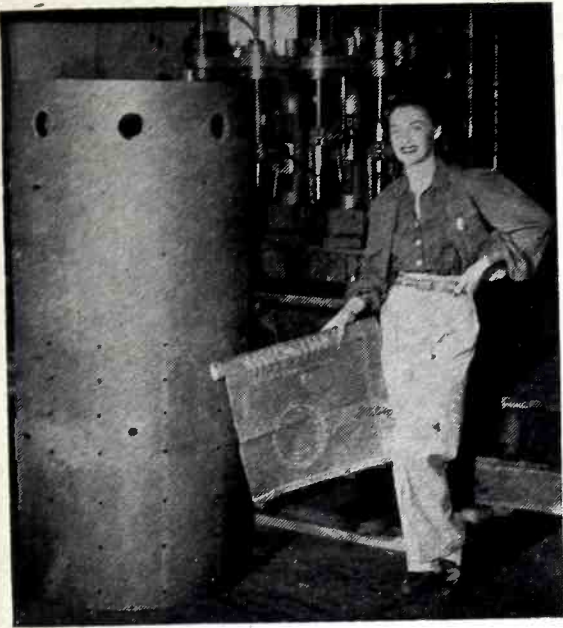

PHENOLIC COIL FORMS JUMBO SIZE

This coil form, one of a production lot, presented an unusual fabricating problem, because of its size and close tolerances.

Encountering difficult problems in the field of laminated phenolics is an old story to our engineers.

Regardless of whether your requirements are fabricated from sheets, rods, or tubes, a consultation with one of our organization may help you to meet a delivery date.

ELECTRICAL INSULATION CO., INC.
12 VESTRY ST., NEW YORK CITY
Sheets, Rods, and Tubes Fabricated Phenolic Parts

Transformers. Bulletin 160 describes air-cooled transformer applications in war production industry. The types of air-cooled transformers manufactured are described and illustrated. The range of 55 deg. ratings of auto, two winding, three winding and four winding type transformers up to 50 kva are listed. "Power Where You Need It" available from Acme Electric and Mfg. Co., Cuba, N. Y.

Relays. Bulletin 800 describes relay type TD1C and type TD3C. These relays provide an adjustable or fixed time delay between the closing of a control circuit and later closing or opening of a load circuit. The uses, features, housings, construction, time scale and price list are included. Bulletin 800 available from R. W. Cramer Co., Inc., Centerbrook, Conn.

Home Study Courses. Home study courses in practical radio engineering and television engineering are covered in this 32 page booklet. A detailed description of the various courses presented to the student are given, the various lessons are outlined and a schedule of courses, tuitions and terms are given. Booklet available from Capitol Radio Engineering Institute, 3224 16th St., N. W., Washington, D. C.

Industrial Music. "Music and Manpower" tells how music has made mahours more effective. This booklet describes music as the mental vitamin, tells what music does as far as morale and fatigue are concerned, the various types of music to use and the results that have been obtained from the use of it. Available from Operadio Mfg. Co., St. Charles, Ill.

Production Facilities. A 24 page booklet outlining the production facilities and equipment available in two plants of the Ward Products Corp. This company is active in the field of radio and electronics but will consider any kind of manufacturing which requires the production equipment and assembly qualifications described in this booklet. Available from Ward Products Corp., 1523 E. 45th St., Cleveland, Ohio.

Basic Facts on Electricity Needed to UNDERSTAND ELECTRONICS!

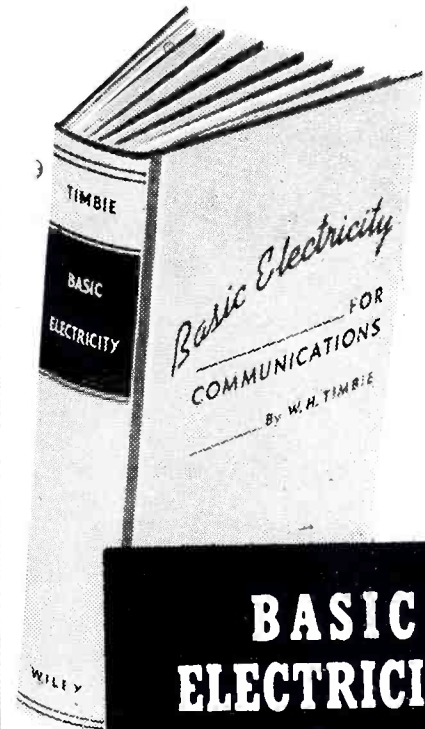

BASIC ELECTRICITY for COMMUNICATIONS by W. H. TIMBIE

A clear, concise, practical book for those who want to prepare themselves now for the rapidly growing fields of Communications and Industrial Electronics.

Only those facts and principles every communications or electronics worker needs to know—and know well, are presented. Actual job problems are used throughout to show, step by step, how to solve electrical and communications problems that arise in practice.

This book gives you a comprehensive picture of the fundamental laws and principles governing communications practice. You will know the instruments and apparatus used—what they look like—how they work. You will know the symbols and language of the trade, and learn to figure quickly daily problems. This book will give you a foundation that will serve you well at all times and prepare you for advanced work in the field.

603 pages \$3.50

.....ON APPROVAL COUPON.....

JOHN WILEY & SONS, INC.
440 Fourth Avenue, New York 16, N. Y.

Please send me a copy of Timbie's BASIC ELECTRICITY FOR COMMUNICATIONS on ten days' approval. At the end of that time, if I decide to keep the book, I will remit \$3.50 plus postage; otherwise I will return the book postpaid.

Name

Address

City and State

Employed by E-7-43

University
LABORATORIES



**REFLEX
SPEAKERS**
are now the
**ACCEPTED
STANDARD**
for all
WAR USE



EVERY REFLEX
in the
UNIVERSITY LINE
is the result of
YEARS of
RESEARCH



EVERY REFLEX
in the
UNIVERSITY LINE
has a vital part
to play in the
WAR PROGRAM

There are
OVER 50 SPEAKERS
in the
UNIVERSITY LINE

Submit your special problems direct to our engineering department.



UNIVERSITY
225 VARICK STREET N. Y. C.

Potter & Brumfield
 have made 7,000 types of
RELAYS
 in the last ten years!

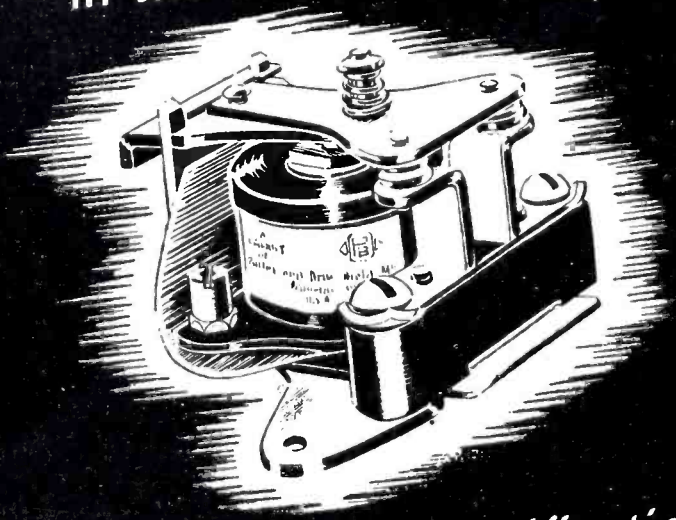

Send your relay specifications
 for prompt production estimate

Potter & Brumfield
 Princeton, Indiana

"THE POSITIVE ACTION RELAY"

IT ASSURES VIBRATION-PROOF CONNECTIONS

BEFORE

bolt engages locking section of the nut

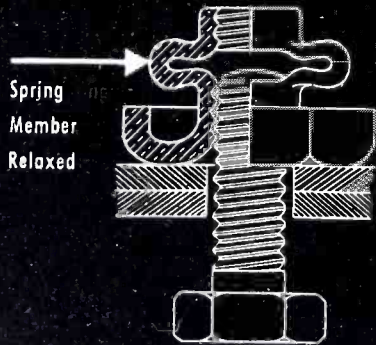

Spring
 Member
 Relaxed

AFTER

bolt engages locking section of the nut

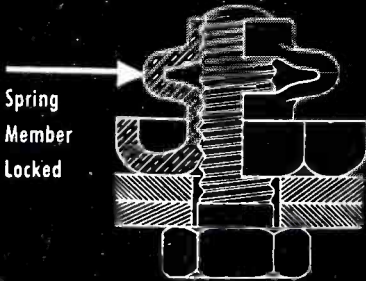

Spring
 Member
 Locked

ELIMINATES AXIAL PLAY

The Boots Self-Locking Nut is one piece, all-metal—withstands severest vibration. The top (locking) section is displaced in a downward direction . . . locking threads are out of lead with load carrying threads of lower section.

Upon insertion of bolt, top section of nut is extended to engage with threads of bolt. A constant force is thus established which locks nut firmly into position. Axial thread play is eliminated.

IDEAL RADIO FASTENINGS

Boots all-metal, self-locking nuts have several distinct advantages: they

1. Prevent resistance through bad contacts.
2. Prevent any loosening of connections.
3. Eliminate noise due to vibration.
4. Simplify assembly and cut maintenance time.
5. Have great re-usability.
6. Eliminate lock-washers.

Our engineering department can help you with your fastening problems.

There's a **BOOTS NUT** for every application

ROL-TOP



BOOTS

ANCHOR



BOOTS AIRCRAFT NUT CORPORATION

GENERAL OFFICES, NEW CANAAN, CONNECTICUT

Calibration of Camera Shutters

(Continued from page 109)

but rectangular; the margins will not be shadows of the shutter, but the width of the figure in the axis of movement of the bar will measure the effective exposure and the fuzziness of those margins at high speeds will roughly indicate the opening and closing times and hence the inefficiency of the shutter. The method will not be as accurate as that first described for inter-lens shutters since less total linear movement of the spot is measured. Many variations of these methods to emphasize one or another factor are possible but cannot be elaborated here.

Some Suggested Production Methods

While the methods described above lend themselves to small scale testing since they require no special construction, assembly or capital expenditure,† they are not suitable for production control in factory or service shop. Here a direct reading rather than a photographic method is desirable. The requirements are well within the possibilities of modern electronics.* A few of the workable methods can be mentioned, the engineering and the relative practicabilities of which are out of the scope of this article.

If we begin with a phototube which receives from a suitable source, light passed by the shutter under test, the single, approximately square pulse put out by the phototube can be used in various ways, to determine either light-admitting capacity or motion-stopping capacity of the shutter. Thus if the total charge (milliampere-milliseconds, or area under the curve of amplitude against time) is measured, as by a ballistic galvanometer or an electronic integrator, the light admitting capacity is measured. For example, a device with a pre-set tolerance, and indicating simply by the glow of one or both or neither (passing, too high, too low, respectively) of a pair of thyratrons, could be used. The phototube output, suitably amplified,

† Arrangements could doubtless be made with many of the better equipped radio service shops to perform the simple manipulations of oscillator and cathode-ray oscillograph called for, thus making such tests possible for the photographer to whom electrical equipment is unfamiliar or unavailable.

would charge up a large condenser with a high resistance leak, converting the round cornered or tapering square wave into peak voltage. The voltage across the condenser would control the grids of two thyratrons biased below the firing threshold but above the extinction point and adjusted so that the two limits of tolerance will each just fire one of them. A cathode-ray stop watch can be adapted to measure either of the two properties of the shutter. If a signal of a known frequency is swept across the screen (or in a circular path for greater accuracy), and triggered on and off by the unknown pulse, either through control of the deflection amplifiers or of the cathode-ray grid, the operator needs only to count the number of waves (of known frequency) which are allowed to appear, in a single sweep on a long persistence screen. The controlling pulse may be the effective motion stopping exposure—the duration of the photocell output above a chosen threshold amplitude, or some function of the integrated output to measure total exposure.

The cathode-ray may also be used to visualize further the actual form of the light intensity time curve described by the shutter, either with a long persistence screen or with the aid of one of the endless magnetic tape devices which repeat the phenomenon over and over, permitting unhurried study of a standing wave. This may be compared in each of its dimensions with a standard curve drawn on the face of the tube or otherwise utilized.

Any circuit developed for measurements on the basis of the photocell and a light source would include switching and zero setting arrangements to compensate for different light intensities, lens speeds (shutter calibrations at various diaphragm settings are instructive in inter-lens shutters), and mechanical and electrical fluctuations. Calibration of these devices is easily effected with rotating discs or similar standards. Inter-lens shutters would be set up simply with light source on one side, phototube on the other, using all or any part of the light passed. Focal plane shutters would be set up with a narrow slit at right angles to the axis of shutter movement and just behind the shutter—in the position of the film. Light would pass to the phototube only while the

Over 300 Types
OF DIALCO UNITS
Serving the War!

Because you need PILOT LIGHT ASSEMBLIES precision-made in a *terrific hurry*, your surest course is to call on **DIALCO NOW!**

Request **NEW CATALOGUE**

DIAL LIGHT CO.
of America, Inc.
90 WEST STREET • NEW YORK, N. Y.

MANUFACTURERS OF THE MOST EXTENSIVE LINE OF WARNING & SIGNAL PILOT LIGHT ASSEMBLIES

ELECTRICAL TRAINING

COMBINE BRITISH THEORY WITH AMERICAN PRACTICE

World War II shows that both British and American engineering methods are vitally necessary for victory! The following home study courses in all branches of electrical engineering,

and other branches of engineering, fit you for responsible work anywhere. They are of the highest technical standards but if necessary begin with elementary work.

Endorsed by leading engineers for over fifteen years. Full investigation invited.

ELECTRICAL

A.M.I.E.E.; General Electrical Engineering; Alternating Current Engineering; Electrical Installations; Power House Design; Electric Traction; Electricity Supply; Electrical Meters and Measuring In-

struments; Design and Manufacture of Electrical Machinery and Apparatus; Telegraph; Telephony.

RADIO

A.M.Brit.I.R.E., General Wireless; Advanced Wireless and High Frequency; Radio Servicing and Maintenance; Short Wave Radio; Practical Television; Sound Picture Engineering.

AVIATION

A.F.R.Ae.S. Examination; Air Ministry Exams for Ground Engineers; Advanced Aeronautical Engineering and Aeroplane Design; General Aeronautical Engineering; Aero Engine Course; Aircraft Apprentices' Course; Pilots' "B" License; Air Navigators' Certificates; Matriculation (London); B.Sc. (London) Pure Science.

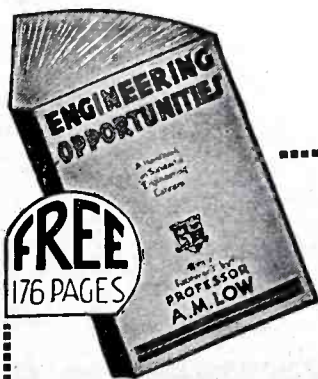

Canadian Institute of Science & Technology, Limited
45 Chester Bldg., 219 Bay Street, Toronto, Ont.

Please forward free of cost or obligation of any kind your 176-page Handbook, "ENGINEERING OPPORTUNITIES".

Name

Address Age.....

Course interested in

WE MANUFACTURE
ALL TYPES OF MOLDED
FITTINGS FOR NAVY and MARITIME SHIPS

Northern Industrial Chemical Company

7-11 ELKINS ST., SO. BOSTON, MASS.

35 YEARS
OF PLASTIC MOLDING
EXPERIENCE



No. 9-S-5013-L
No. 9-S-5012-L JACK BOX
JACK BOX

CARTER *Magmotor* The Invisible Member of the Crew

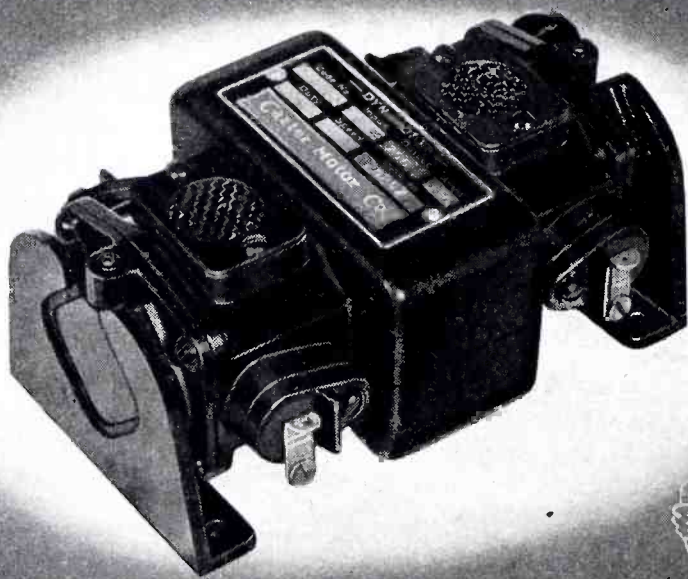

Only
4 3/4 lbs.
Up to
100 watt
output

THE Carter Magmotor, the unique and only Dynamotor with Permanent Magnet fields, has set new performance records for stamina, efficiency, light weight, and reliability. The 100 watt output models weigh only 4 3/4 lbs., nearly half the weight of other ordinary conventional type Dynamotors of equal output.

Without question it is the finest Dynamotor for Aircraft receiver and small transmitter requirements, as well as numerous other applications.

The latest catalogue containing Magmotors, Genemotors, Converters, Dynamotors, and Permanent Magnet Hand Generators will be sent upon request.

Carter Motor Co.
Chicago, Illinois

1606 Milwaukee Ave. Carter, a well known name in radio for over twenty years. Cable: Genemotor

moving and the stationary slits coincide. The latter may be moved to various parts of the negative area to measure the inequalities in exposure across the field. This stationary slit must be narrow for the calibration will be in error by the ratio of its width to that of the shutter slit. In the case of focal plane shutters which are not significantly "inefficient," i.e., are close to the focal plane, the pulse of phototube output will be virtually a square wave and the problem of calibration is much simpler than for the inter-lens shutter. No integration of sloping ends is necessary and a simple electronic stop watch, such as the cathode-ray device mentioned, is adequate.

With these and other possibilities open to makers of cameras for rapid, unskilled, inexpensive testing of shutters it may be hoped that, even though expense prohibits accurate setting of every shutter, an individual calibration may be furnished with each camera, for use in critical work. At the same time, if service shops in many localities are equipped to perform shutter tests in a few minutes, at nominal expense, it may be expected that a wider realization of inherent shutter inaccuracies will result and a significant factor in badly exposed color photographs will be brought under anyone's control.

REFERENCE

1. English, F. L. *Amer. Photog.*, Dec. 1939; Jan. 1940.
2. Brailsford, H. D. *Du Mont Oscillographer*, June-July, 1940.
3. Bradford, C. I. *ELECTRONICS*, Nov. 1940.
4. Marsal, P. A., *ELECTRONICS*, Jan. 1942.

• • •

Quartz Crystals

(Continued from page 112)

to 11,000 kc. For low frequencies modifications of these two cuts are often used. The *CT* type, cut at -38° to the *Z*, and the *DT* type, cut at -52° to the *Z* are in this category. They vibrate in a shear on the plane of the plate. Two other similar low frequency oscillator plates are the *ET* type cut at $+66^\circ$ to the *Z* and the *FT* type cut at -57° to the *Z*.

A still newer cut is the *GT*, which has a zero temperature coefficient over a large temperature range. When properly cut the t.c. of this plate is less than one part over a 100° temperature range. The plate

Radell

Makers
of
Crystals

Radell

CORPORATION

6327 Guilford Avenue
INDIANAPOLIS, IND.

Professional Services

STANLEY D. EILENBERGER
Consulting Engineer

Complete Laboratory and Shop Facilities
General Electronics Communications Electro Biology Patent Development
6309 27th Ave. Kenosha, Wis.
Telephone 2-4213

JOSEPH RAZEK, Ph.D.
Consulting Physicist

Electrical and Mechanical Engineering Problems
Instruments and Control Devices Electronics
Specialist in Colorimetry, Spectrophotometry and
Industrial Color Control
Laboratory and Shop Facilities
202 Darby Road Llanerch, Pa.
Phone Hilltop 6910

J. L. A. McLAUGHLIN
Designer of

Communications Receivers
P. O. Box 529, LaJolla, Calif.

Professional Assistance . . .
in solving your most difficult problems in the specialized field of electronic devices is offered by consultants whose cards appear on this page.

is cut at -51° to the Z-axis and at 45° to the X-axis. It vibrates in a face shear which is really two strongly coupled longitudinal modes and is used primarily in the low frequencies. It has been extensively used in frequency and time standards devices. Another cut similar to the *GT* is the *JT*, cut at $68^\circ 30'$ to the Z and 45° to the X axis.

As has been stated previously, X and Y cuts are used for non-critical filters. When low temperature coefficient filter plates are required the two most common ones are the -18° filter plate, tipped -18° to the Z, and the $+5^\circ$ filter plate, cut at $+5^\circ$ to the Z axis. The former has a longitudinal motion and the latter both a flexure and longitudinal vibration which are coupled together to obtain a low t.c. Both types are commonly used as filters for pilot channel work.

Low temperature coefficients obviously can be attained by coupling two modes of vibration as in the case of the last mentioned plate. This scheme is used in the so-called "doughnut" type of oscillator. Here, a shear motion is coupled to a flexure in the quartz ring. Due to the fact that the t.c.'s of the two modes are opposite in sign, a zero temperature coefficient is obtained. Coupled types of plates have not, in the main, found wide use outside of frequency standards because of the relative difficulty of mounting and adjusting, and the frequent presence of spurious responses near the desired frequency.

As already stated, harmonic oscillator plates can be made from fundamental type plates. They can be made from -18° plates and 5° plates, or from *AT*, *BT*, and other types suitable for extremely high frequencies.

Many of the cuts mentioned above were developed by the Bell Telephone Laboratories.

Finishing and Mounting

After quartz oscillator plates have been properly cut, they are still a long way from precision devices.

They have to be very delicately and precisely finished to specified frequencies. In addition to worrying about frequency, one must also watch the activity, or oscillating strength during manufacture. This is largely determined by geometrical dimensions and absence of impurities. Charts are usually followed to arrive at the correct dimensions and

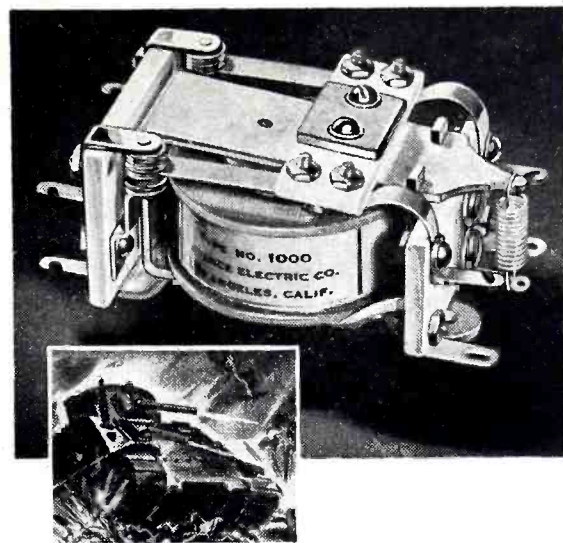

WHEN THE ORDER COMES TO ADVANCE

. . . It comes with the assurance of experience. Thousands of Advance Relays have proved their rugged reliability on the battlefronts.

ADVANCE MIDGET TYPE CERAMIC INSULATED R. F. RELAY

This unit is a sturdy, compact double pole double throw relay available for either A. C. or D. C. operation. Especially designed and widely used for aircraft, marine and other mobile communication equipment, it is only $2\frac{3}{4}$ " x $1\frac{1}{2}$ " in base dimensions, and $1\frac{1}{4}$ " in height (minimum space required for mounting).

• To safely handle R. F. power, high dielectric ceramic Steatite insulation is used throughout and all control terminals are adequately spaced. A third contact assembly may be added to this unit, either single pole, single throw or single pole double throw. Pure silver contacts afford ample carrying capacity for all types of portable rigs. Coils are continuous duty type. The unit may be mounted and operated in any position. There is complete absence of "hum" or "chatter" on A. C. operated units.

OTHER ADVANCE RELAYS

are made for general circuit control applications. Each receives individual adjustment and inspection. Orders given prompt attention, and deliveries are on schedule. Write for details.

 **Advance Relays**

ADVANCE ELECTRIC COMPANY
1260-1262 West Second Street, Los Angeles, California

The Mighty Pencil

The man behind the ELDORADO is a threat to the Axis. His lead is proving as deadly as the kind used by the man behind the gun. His job is that of creating the blueprints of destruction to destroy said Axis.

Never underestimate the value of Typhonite ELDORADO pencils in America's drafting rooms. They're doing magnificent work! Drawings made with Typhonite ELDORADO leads insure clean, easy-to-read blueprints... in less time. There's no time out for inking in... the density and accuracy of ELDORADO'S leads guarantee blueprinted whites sharp—readable.

Pencil Sales Dept. 59-J7
Joseph Dixon Crucible Co.
Jersey City, N. J.

TYPHONITE ELDORADO



PLUGS JACKS

U. S. ARMY
SIGNAL CORPS
U. S. NAVY
APPROVED



NAF-1136-1
PL-68, PL-54
PL-55, JK-26
JK-48, PL-291
NAF-212938-1

Prompt Deliveries

UNIVERSAL MICROPHONE CO., LTD.
424 WARREN LANE
INGLEWOOD, CALIFORNIA

before plates reach the finishing department they are put through a very rigid examination during which all with impurities are removed.

After the plate is correctly finished it must be properly mounted in a holder. Mounting is an art in itself and beyond the scope of this paper. The type and construction of the holder is determined by the mode of oscillation and intended use. In its final mounting, the quartz oscillator plate must be held firmly in place and be absolutely free from dust, dirt and moisture since any of these will adversely affect and may completely prevent its performance.

Fabricating quartz oscillator plates is a scientific job which is still in its infancy. New discoveries are being made every day. Methods which were considered satisfactory yesterday may be completely out of date a week hence.

Meter Testing

(Continued from page 117)

current output, under all conditions.

In any device of this kind it is absolutely essential to prevent hunting or oscillation. Any mechanism such as a wattmeter movement which has inertia and spring torque, must be controlled for stable equilibrium by damping or anti-hunting means in order to avoid oscillation.

The motion of the meter is reproduced in currents by the phototubes, and the "brain network" must produce a voltage to stop the motion at normal pointer position and keep it there. The means provided for doing this is really the brain of the outfit, the action being as follows:

A change of current acts through C_1 to cause an over-correction to be applied, and this is reduced as the condenser C_1 becomes charged. The condenser C_2 has comparatively high capacitance and accumulates the photoelectric current, building up a voltage which will correct for any slow drift of load current, and also provides the response characteristics of holding the average value constant while correcting the instantaneous swings in values as well. These values of C_1 , C_2 and R_1 are critical and dependent upon the

JUST OUT

ELECTRONIC CONTROL OF RESISTANCE WELDING

By GEORGE M. CHUTE
Application Engineer,
General Electric Company, at Detroit

389 pages, 6 x 9,
173 illustrations, \$4.00

COVERS

- ignitron contractor
- time-delay relay
- automatic Weld timer
- pulsation welding sequence controls
- synchronous spot-weld timer
- weld heat control
- seam-welding control
- all-tube control for seam, spot and pulsation welding
- welder controls used with series capacitors
- capacitor stored-energy control
- reactor stored-energy control

- Exactly how the electron tubes and other elements of these controls work—
- What circuits are used and why—
- What happens at every point in the circuit, at each moment of operation—
- How to install the equipment—
- How to maintain it for long life and efficient service—

—that's the sort of information you can get from this new book—by means of some of the most practical, clear, and easy-to-understand explanations you ever have seen applied to a technical subject.

Here is an unusually simple and practical manual, fully explaining the tubes and circuits used to control resistance welders in industrial plants, for the aid of men who work with and maintain these controls. From it, the man with no previous training in electronics can gain a sound knowledge of tubes and circuits and their application in all varieties of control devices, including synchronous timers and stored energy controls. How the tubes work, power requirements, the factors for good welding involved, installation and maintenance of the devices—everything is covered to give the reader the ability to get the most in long life and efficient service from these equipments.

10 DAYS' FREE EXAMINATION—SEND THIS COUPON

McGraw-Hill Book Co., 330 W. 42nd St., N.Y.C.

Send me Chute's Electronic Control of Resistance Welding for 10 days' examination on approval. In 10 days I will send \$4.00, plus few cents postage, or return book postpaid (Postage paid on cash orders.)

Name

Address Position

City and State..... Company L. 7-43

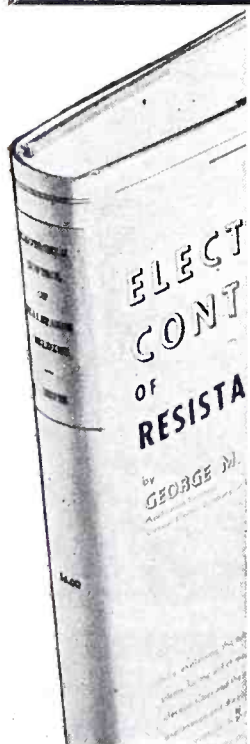

CONTACTS

FOR THE FIELD OF ELECTRONICS

CRYSTALS by HIPOWER

Thousands of vital transmitting installations rely on the accuracy and dependability of Hipower Precision Crystal units. With recently enlarged facilities, Hipower is maintaining greatly increased production for all important services. When essential demand begins to return to normal, Hipower will be glad to help with your crystal needs.

HIPOWER CRYSTAL CO.

Sales Division—205 W. Wacker Drive, Chicago
Factory—2035 Charleston Street, Chicago, Ill.

FADA

FACTORY SERVICE DEPT.
has a large stock of Record Changer Parts. Also replacement parts for all FADA MODELS as well as a completely equipped SERVICE DEPARTMENT.

FADA OF NEW YORK

928 Broadway, New York, N. Y.
Tel.: GRamercy 7-0951-2

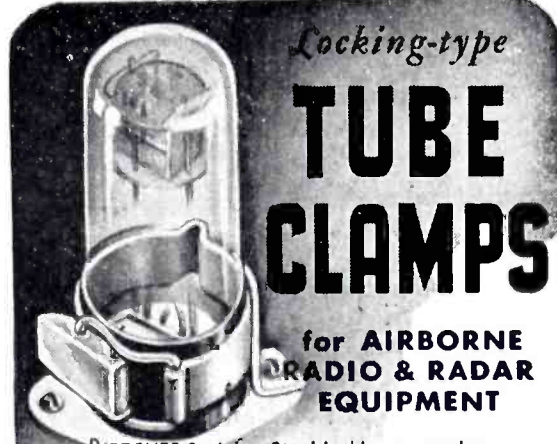

Locking-type TUBE CLAMPS

for AIRBORNE RADIO & RADAR EQUIPMENT

BIRTCHER Stainless Steel, locking-type tube clamps are flying with Allied Aircraft all over the world. Made in a variety of sizes to fit any size tube base. Precision workmanship.

"You can't pull a tube out of a BIRTCHER clamp!"

PROMPT DELIVERY
SAMPLES AND PRICES UPON REQUEST



The Birtcher Corporation
RADIO & AIRCRAFT SPECIALTIES
PLASTIC FABRICATION & MOULDING
5087 HUNTINGTON DR. • LOS ANGELES, CALIF.

ELECTRON TUBE MACHINERY

of every type,—standard, and special design

KAHLE ENGINEERING COMPANY
Specialists in Equipment for the Manufacture of Radio Tubes, Cathode Ray Tubes, Fluorescent Lamps, Incandescent Lamps, Neon Tubes, Photo Cells, X-ray Tubes and other glass or electronic products, on production or laboratory basis.
1307-1309 Seventh St., North Bergen, N. J.

RADIO AND ELECTRONIC DEVICES



BURSTEIN-APPLEBEE CO.

1012-14 McGee St. Kansas City, Mo.

JUST OFF THE PRESS!

THE MOST COMPLETE CATALOG OF ITS KIND

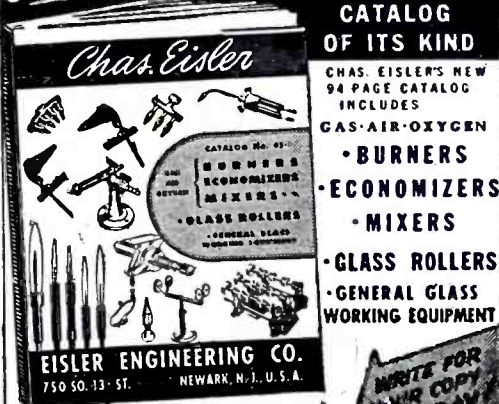

CHAS. EISLER'S NEW 94 PAGE CATALOG INCLUDES
GAS-AIR-OXYGEN
• BURNERS
• ECONOMIZERS
• MIXERS
• GLASS ROLLERS
• GENERAL GLASS WORKING EQUIPMENT

EISLER ENGINEERING CO.
750 SO. 13th ST. NEWARK, N. J., U. S. A.

Ask for CATALOG No. 43-B

CHAS. EISLER
EISLER ENGINEERING CO.
751 SO. 13th ST. NEAR AVON AVE. NEWARK, N. J.

WRITE FOR YOUR COPY TODAY!

MICROMETER

FREQUENCY METER

for checking transmitters, from 1.5 to 56 mc., within 0.01 per cent

LAMPKIN LABORATORIES

Eradenton, Fla., U. S. A.

FINE RIBBONS of Tungsten and Molybdenum

Molybdenum in widths .006" to 1" in thickness to .0005"

Tungsten Ribbon to specification

H. CROSS

15 Beekman St. New York

HARVEY RADIOLAB'S, Inc.

Manufacturers of Radio Transmitters
ELECTRONIC APPARATUS
447 Concord Ave. Cambridge, Mass.

A STEADY SOURCE OF ALL ELECTRONIC EQUIPMENT

TERMINAL RADIO CORP.
Telephone: WOrth 2-4416
85 CORTLANDT ST., NEW YORK, N. Y.

FOR ACTION: PHONE! WIRE! WRITE!
BULLETINS AND CATALOGS ON REQUEST

... Your Plant

MICA CONDENSERS—

Harrison has 203,520

FILTER CAPACITORS—

Harrison has 37,460

TRANSFORMERS—

Harrison has 2,170

TUBES—

Harrison has 26,540

RESISTORS—

Harrison has 59,271

OTHER ELECTRONIC SUPPLIES—

Harrison has plenty!

FOR IMMEDIATE DELIVERY

HARRISON RADIO CORP.

12 West Broadway • New York City
Phone WOrth 2-6276

We manufacture a complete line of equipment

SPOT WELDERS, electric, from ¼ to 500 KVA
TRANSFORMERS, special and standard types
INCANDESCENT LAMP manufacturing equipment
FLUORESCENT TUBE MAKING EQUIPMENT
ELECTRONIC EQUIPMENT, vacuum pumps, etc.
WET GLASS slicing and cutting machines for laboratory use
GENERAL GLASS working machines and burners
COLLEGE GLASS working units for students and laboratory

AC ARC WELDERS
From 100 to 400 Amps.

EISLER ENGINEERING CO.

731 So. 13th St. (near Avon Ave.) Newark, New Jersey



Find what you are looking for? If this or other advertising in this issue does not supply the information wanted, of products or services write

Electronics

330 W. 42d St., New York, N. Y.



FOUR-RANGE RHEOSTATS

Lubricated Contacts



Rex Rheostat Co.
BALDWIN, L. I., N. Y.

WRITE FOR CATALOG

SEARCHLIGHT SECTION

EMPLOYMENT • BUSINESS • OPPORTUNITIES • EQUIPMENT—USED or RESALE

UNDISPLAYED RATE:

10 cents a word, minimum charge \$2.00.
(See ¶ on Box Numbers.)

POSITIONS WANTED (full or part-time salaried individual employment only), 1/2 above rates.

PROPOSALS, 50 cents a line an insertion.

INFORMATION:

BOX NUMBERS in care of any of our New York, Chicago or San Francisco offices count 10 words additional in undisplayed ads.

DISCOUNT of 10% if full payment is made in advance for four consecutive insertions of undisplayed ads (not including proposals).

DISPLAYED—RATE PER INCH:

The advertising rate is \$6.50 per inch for all advertising appearing on other than a contract basis. Contract rates quoted on request.

AN ADVERTISING INCH is measured 7/8 inch vertically on one column, 3 columns—30 inches—to a page. E.

NEW ADVERTISEMENTS received by 10 A. M. July 14th will appear in the August issue, subject to limitation of space available.

FORWARD-LOOKING COMPANY NEEDS ENGINEERS

A progressive company with an expanding engineering department is seeking several good men—but of course cannot take men now employed at their highest skills in war industry.

One should have a good theoretical knowledge of acoustics and experience with magnetic circuits and acoustical measurements.

Another is needed for laboratory measurements on a-f communications apparatus. He will design and supervise equipment for production testing, maintaining laboratory standards, and he should be familiar with government specifications and inspections procedure.

A third man must be familiar with the application and molding techniques of plastics. He should have several years of design experience on small electrical apparatus and an understanding of magnetic and electrical circuits.

These men will be concerned now with war contracts and planning post-war developments in a technically expert organization that's going places. Write, phone or wire the Chief Engineer, giving background and salary requirements.

GREAT AMERICAN INDUSTRIES INC.
70 Britannia St., Meriden, Conn.

WANTED ELECTRO-ACOUSTIC ENGINEER

Experienced in laboratory development, research, etc., for development of war production items. Offers excellent post war opportunities. Write,

Personnel Manager

UNIVERSAL MICROPHONE CO., Ltd.
Box 299 Inglewood, Calif., U.S.A.

BEST QUALITY, USED ELECTRON TUBE MACHINERY

Equipment for the manufacture of all kinds of electron tubes, radio tubes, incandescent lamps, neon tubes, photo electric cells, X-ray tubes, etc.

AMERICAN ELECTRICAL SALES CO., INC.
65-67 East 8th St. New York, N. Y.

FOR SALE

HAVE QUANTITY of used Weston meters and relays, also test equipment. No priority. FS-537, Electronics, 330 W. 42nd St., New York, N. Y.

FOR SALE OR TRADE—6 Jensen all-weather horns less speakers. 2 professional full-frequency cutting-heads, Universal 15-ohm. New RCA 167 R-F Oscillator. Shure Transcription pick-up. 12-inch Audak pick-up. 4 new 807 tubes. Need condenser-analyzer, what have you? Damon Transcription Lab., Midland Bldg., Kansas City, Missouri.

WANTED Electrical or Electrochemical Engineer

thoroughly versed in the theory of liquid and solid dielectrics. To direct a research and development program in the development and application of dielectrics to capacitors. This is an unusual opportunity for a capable engineer interested in his present and post-war future.

Industrial Condenser Corp.
1725 W. North Ave., Chicago, Ill.

Permanent Employment ELECTRONIC DEVELOPMENT ENGINEERS

Well-established Eastern Massachusetts concern desires graduate electronic engineers with flair for research and eye to future. Permanent position concerned at present with important development work for government, with increased opportunities after the war. Unusual openings for men with capacity and initiative. Must be U. S. Citizens.

P-510, Electronics
330 West 42nd St., New York City

POSITION VACANT

HAM'S PARADISE

With \$3000-\$5000 Per Year Pay

If you have at least a Class A ham license, good electrical background, know how to build your own transmitter, receivers and test equipment—and are not now employed at your fullest capacity or can get a release:—

We can use you in our lab or in test or design work!

Send full data, including a small photo (which will not be returned), also draft status, salary required, etc. We are located in the Middle West and are engaged 100% in war work.

P-535, Electronics
520 No. Michigan Ave., Chicago, Ill.

For Every Business Want
Think "Searchlight" First!



The "RADIO" HANDBOOK

Basic electrical and radio theory in the simplest possible language, written especially for those without mathematical or technical training.

Dozens of complete how-to-build-it descriptions of many types of receiving, transmitting, and test equipment show practical applications. Hundreds of diagrams and large photographs.

Enlarged war-training chapters include: expanded basic principles, more test equipment which can be field-built, and mathematics for solving simple radio problems.

Over 600 pages, durably clothbound, gold-stamped. From your favorite dealer, or from us, postpaid; please add any applicable taxes.

\$2.00 in Continental U.S.A. Elsewhere, \$2.25

EDITORS AND ENGINEERS
1418 North Highland Avenue, Los Angeles

INSTRUCTION MANUALS

Technical manuscripts prepared, checked, printed. Experienced in government TM manual work. Former S.C. engineer, extensive technical radio background, author of many radio books and articles.

M. N. Beitman

Supreme Publications

328 S. Jefferson St. Chicago, Ill.

FREELAND & OLSCHNER, INC.

REBUILDERS OF RADIO TRANSMITTING TUBES

Let Us Help You
Solve Your Tube Problems

250 W up

611 Baronne St. New Orleans, La.

WANTED FOR CASH

New or used radio equipment, meters, oscillographs, oscillators, galvanometers, laboratory equipment, etc. Also radio receivers, parts, tubes, etc.

Wire, Write or Phone

UNITED RADIO CO.

Dept. T Newark, 1, N. J.

Have quantity used Weston
Meters and Relays also Test
Equipment. No priority.

FS-536, Electronics
330 West 42nd St., New York, N. Y.



RADIO and ELECTRONIC ENGINEERS

Wanted at Once by one of the most progressive radio receiver and transmitter manufacturer organizations in the U. S. A., now engaged in the manufacture of all forms of Aircraft and Ground Station Radio Receiving and Transmitting equipment for military purposes only, but with a definite program for all types of civilian radio receiving and transmitting equipment AFTER VICTORY.

Radio Receiver Design Engineers

Engineering Specification Writers

Tool Designers—Model Makers

Test Equipment Engineers

Mechanical Engineers

Transmitter Design Engineers

Electro-Mechanical Engineers

Laboratory Technician—
Radio Calibration
Technicians

Mechanical Draftsmen

Physicists—Radio

This Unusual Company occupies two large modern plants in Stamford, Conn., amid clean, pleasant New England surroundings. Ideally located for both suburban and metropolitan life, only 35 miles from Times Square, New York. Housing accommodations are available at reasonable rates, in and around Stamford, that will amaze the most critical home-minded person.

WRITE AT ONCE

Giving complete details of past experience

Interview will be arranged

Those now employed to full skill in war work will not be considered.

AIRADIO
INCORPORATED

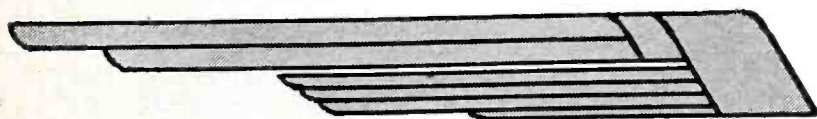

STAMFORD, CONNECTICUT



Wanted

Electronic and Electrical ENGINEERS and PHYSICISTS

100% WAR WORK FOR DURATION

All persons replying will be considered, although men and women with practical experience are preferred. Reply should state whether applicant is a citizen and should include complete information as to education and experience.

Salaries will be commensurate with work performed. Adequate housing facilities available at plant site for single employees and for families. Good living conditions; school, church and recreational facilities.

Transportation for interviews will be provided under special arrangement.

Work is to be performed near Knoxville, Tennessee.

Address

CLINTON ENGINEER WORKS
Tennessee Eastman Corporation
P.O. Box 590, Knoxville, Tenn.



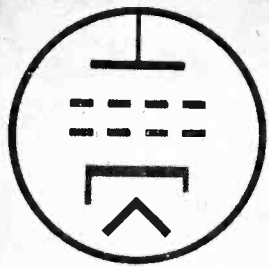

UHF *Electronic* ENGINEERING

*Our primary concern
is not how much we
can make from your
problem . . . but how
successfully we can
solve it.*

LAWTON

PRODUCTS COMPANY INC.
624 MADISON AVE.
N. Y. C.

Protection and Safety with VIBROGROUND

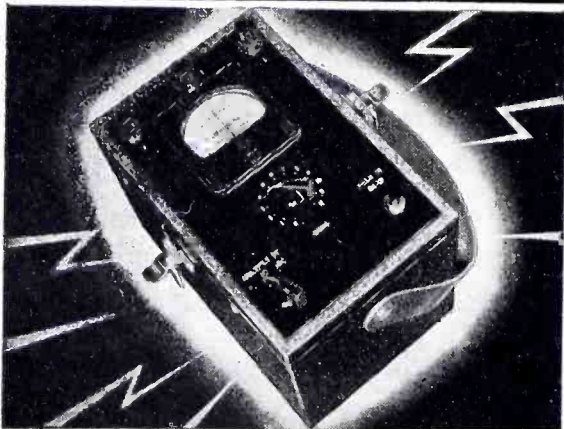

For protection and safety to life and equipment—test your grounds regularly with the dependable VIBROGROUND! No calculations . . . no hand cranking . . . merely press the button to get direct readings in ohms on an evenly divided scale. Accuracy is not affected by stray ground currents. Write for the Engineering Bulletin No. 251-1 today.

ASSOCIATED RESEARCH
231 SO. GREEN ST. CHICAGO

INDEX TO ADVERTISERS

	Page		Page
Abbott Instrument, Inc.	242	DuMont Labs., Inc., Allen B.	42
Ace Manufacturing Corp.	219	Dunn, Inc., Struthers	53
Advance Electric Co.	253	DX Crystal Co.	232
Aerovox Corp.	70	Eicor, Inc.	170
Aircraft Accessories Corporation	35	Eisler Engineering Co.	255
Allen-Bradley Co.	157	Eitel-McCullough, Inc.	67
Allied Radio Corp.	210	Electric Auto-Lite Co., The	8
Aluminum Company of America	63	Electrical Insulation Co., Inc.	249
American Coils Co.	186	Electrical Products Corporation	187
American Lava Corp.	21	Electronic Corp. of America	18
American Phenolic Corporation	27	Electronic Enterprises, Inc.	64
American Photocopy Equipment Co.	242	Electronic Laboratories, Inc.	55
American Radio Hardware Co., Inc.	22	Electro-Voice Mfg. Co., Inc.	14
American Screw Co.	145	Emerson Radio & Phonograph Corp.	12
American Transformer Co.	45	Engineering Co., The	239
Amperite Co.	229	Erie Resistor Corp.	48
Anaconda Wire & Cable Company	33	Erwood Co., The	248
Andrew Co., Victor J.	244	Essex Specialty Co., Inc.	237
Arnold Engineering Co.	247	Fada of New York	255
Associated Research, Inc.	258	Federal Manufacturing & Engineer Corp.	183
Astatic Corporation, The	243	Federal Tel. & Radio Corp.	197
Audak Co.	260	Felker Mfg. Co.	143
Automatic Electric Co.	211	Ford Radio & Mica Corp.	218
Ballantine Laboratories	155	Formica Insulation Co.	51
Barker and Williamson	169	Galvin Mfg. Corporation	77
Belden Manufacturing Co.	189	General Electric Co.	7, 43, 79, 159
Bell Sound Systems, Inc.	237	General Instrument Corp.	29
Bentley, Harris Mfg. Co.	58	General Radio Co.	144
Benwood-Linze Co.	192	Gentlemen Products Div. of Henney Motor Co.	167
Birtcher Corp., The	255	G-M Laboratories, Inc.	60
Bliley Electric Co.	160	Goat Metal Stampings, Inc.	259
Boots Aircraft Nut Corporation	250	Gothard Mfg. Co.	226
Bradley Laboratories, Inc.	227	Guardian Electric Mfg. Co.	140
Brand & Co., William	41	Guthman & Co., Inc., Edwin I.	59
Brilhart Co., Arnold	78	Hallcrafters Co.	31
Bristol Co.	145	Hammarlund Mfg. Co., Inc.	34
Bud Radio, Inc.	240	Harrison Radio Corp.	255
Bunnell & Co., J. H.	235	Harvey Machine Co., Inc.	148
Burstein-Applebee Co.	255	Harvey Radio Co.	219
Callite Tungsten Corp.	130	Harvey Radio Lab's., Inc.	239, 255
Canadian Institute of Science & Technology, Ltd.	251	Harvey-Wells Communications, Inc.	202
Cannon Electric Development Co.	156	Haydon Mfg. Co., Inc.	220
Capitol Radio Engineering Institute	243	Heinemann Circuit Breaker Co.	48a
Carborundum Co., The	224	Heintz & Kaufman, Ltd.	49
Carter Motor Co.	252	Hewlett-Packard Co.	173
Celanese Celluloid Corp.	71	Hipower Crystal Co.	255
Centralab Div., Globe Union, Inc.	6, 69	Hytron Corp.	133
Central Screw Co.	145	Indiana Steel Products Company	195
Chandler Products Corp.	145	Industrial Condenser Corp.	172
Chicago Telephone Supply Co.	15	Instrument Resistors Co.	214
Chicago Transformer Corp.	141	Insuline Corp. of America	243
Cinaudagraph Corporation	241	International Resistance Co.	125
Cinch Manufacturing Corp.	129	International Screw Co.	145
Clarostat Mfg. Co., Inc.	182	International Tel. & Tel. Corp.	197
Cohn & Co., Sigmund	246	Irvington Varnish & Insulator Co.	19
Communication Measurements Lab- oratory	198	Isolantite, Inc.	32a
Connecticut Telephone & Electric, Division of G. A. I.	213	Jackson Electrical Instrument Co.	132
Consolidated Radio Products Co.	188	J-B-T Instruments, Inc.	175
Continental-Diamond Fibre Co., Inc.	48b	Jefferson-Travis Radio Mfg. Co.	50
Continental Screw Co.	145	Jelliff Mfg. Corp., C. O.	216
Corbin Screw Co.	145	Jensen Radio Mfg. Co.	16
Cornell-Dubilier Electric Corp.	13	Johnson Co., E. F.	75
Corning Glass Works, Insulation Div.	61	Jones, Howard B.	242
Cross, H.	255	Kaar Engineering Co.	185
Crystal Products Company	30	Kahle Engineering Co.	255
Dalis, Inc., H. L.	224	Kato Engineering Co.	204
Daven Co.	Inside Back Cover	Ken-Rad Tube & Lamp Corp.	142
Deutschman Corp., Tope	2	Kester Solder Co.	225
Dial Light Co. of America, Inc.	251	Keuffel & Esser Co.	3
Dinion Coil Co.	210	Kinney Manufacturing Co.	154
Dixon's Typhonite ELDORADO Pencils	254	Knights Co., James	54
Dolph Co., John C.	223	Kold-Hold Mfg. Co.	245
Doolittle Radio, Inc.	222		

	Page
Lafayette Radio Corp.....	162
Lampkin Laboratories	255
Lamson & Sessions Co.....	145
Lapp Insulator Co.....	9
Lawton Products Company, Inc.....	258
Lectrohm, Inc.	231
Lepel High Frequency Lab's.....	232
Lingo & Son, John E.....	246
Littelfuse, Inc.	220
Lyon Co., W. D.....	238
Macallen Company, The.....	146
Magnavox Company	10
Mallory & Co., Inc., P. R.....	84
Markem Machine Company.....	244
McGraw-Hill Book Co., Inc.....	240, 254
Meissner Mfg. Co.....	245
Micro Switch Corporation.....	147
Millen Mfg. Co., Inc., James.....	204
Miller Company, J. W.....	228
Mitchell-Rand Insulation Co.....	20
Mobile Refrigeration, Inc.....	190
Monarch Mfg. Co.....	229
Muehlhausen Spring Corp.....	52
Murdock Co., Wm. J.....	227
National Company, Inc.....	248
National Screw & Mfg. Co.....	145
National Union Radio Corp.....	17
Newark Transformer Co.....	176
New England Screw Co.....	145
New York Transformer Co.....	32b
North American Philips Company, Inc.	36
Northern Engineering Laboratories.....	206
Northern Industrial Chemical Co.....	252
Numberall Stamp & Tool Co.....	238
Ohmite Mfg. Co.....	165
Onan & Sons, D. W.....	230
O'Neil-Irwin Mfg. Co.....	221
Palnut Company, The.....	194
Parker Co., Charles.....	145
Parker-Kalon Corp.	145
Par-Metal Products Corp.....	226
Pawtucket Screw Co.....	145
Peerless Electrical Products Co.....	246
Permoflux Corporation	166
Pheoll Mfg. Co.....	145
Philco Corporation	32
Phillips Screw Manufacturers.....	145
Pioneer Gen-E-Motor Corp.....	184
Plax Corporation	161
Potter & Brumfield.....	250
Premax Products	136
Press Wireless, Inc.....	72, 73
Presto Recording Corporation.....	152
Printloid, Inc.	247
Radell Corporation	253
Radio City Products Co., Inc.....	62
Radio Corp. of America.....	138, 139
Radio Corp. of America, Victor Div.....	137
Rauland Corp., The.....	135
Raytheon Mfg. Co.....	56, 236
RCA Mfg. Co., Inc.....	Back Cover
Rea Magnet Wire Co.....	179
Remler Co., Ltd.....	168
Rex Rheostat Co.....	255
Richardson Co., The.....	150
Rockbestos Products Corp.....	149
Roebing's Sons Co., John A.....	23
Rogan Brothers	230
Rola Company, Inc., The.....	193
Russell, Burdsall & Ward Bolt & Nut Co.	145
Scientific Radio Products Co.....	178
Scovill Mfg. Co.....	145
Scovill Mfg. Co., Waterville Screw Products Div.	131
Seeburg Corporation, J. P.....	209
Selenium Corp. of America.....	238
Sentinel Radio Corporation.....	174
Shakeproof Lock Washer Co.....	145
Shallcross Mfg. Co.....	217
Shure Brothers	204

	Page
Sickles Co., F. W.....	205
Sigma Instruments, Inc.....	196
Simpson Electric Co.....	177
Slater Electric & Mfg. Co.....	203
Small Electric Motors (Canada) Ltd.....	163
Sola Electric Co.....	66
Solar Manufacturing Corp.....	65
Southington Hardware Mfg. Co.....	145
Spencer Thermostat Co.....	201
Sprague Specialties Co.....	153
Stackpole Carbon Co.....	191
Staedtler, Inc., J. S.....	228
Standard Pressed Steel Co.....	218
Standard Transformer Corp.....	127
Star Porcelain Co.....	236
Steward Mfg. Company, D. M.....	136
Stewart Stamping Corporation.....	38
Sticht Co., Inc., Herman H.....	229
Stromberg-Carlson Company	171
Stupakoff Ceramic & Mfg. Co.....	28
Superior Electric Company.....	180
Superior Tube Co.....	11
Sylvania Electric Products, Inc.....	26
Synthane Corporation	16a, 16b
Taylor Tubes, Inc.....	44
Tenney Engineering Co., Inc.....	200
Terminal Radio Corp.....	255
Thermador Electrical Mfg. Co.....	233
Thomas & Skinner Steel Products Co.....	233
Thordarson Electric Mfg. Co.....	134
Tinnerman Products, Inc.....	80
Transmitter Equipment Mfg. Co., Inc.....	151
Triplett Electrical Instrument Co.....	221
Tung-Sol Lamp Works, Inc.....	40
Turner Co., The.....	231
Ucinite Co., The.....	76
United Electronics Co.....	46, 47
United Screw and Bolt Corporation	74
United States Rubber Company	181
United Transformer Co.....	Inside Front Cover
Universal Microphone Co., Ltd.....	254
University Laboratories	249
Utah Radio Products Company.....	57
Valpey Crystals, The.....	225
Walden, Inc., Stevens.....	214
Walker-Jimieson, Inc.	223
Walker-Turner Co., Inc.	207
Ward Products Corp.....	158
Webster Products	68
Western Electric Co.....	82
Westinghouse Elec. & Mfg. Co. 4, 5, 24, 25, 37, 81, 136	
White Dental Mfg. Co., S. S.....	199, 222
Whitney Screw Corp.....	145
Wilcox Electric Co.....	39
Wiley & Sons, Inc., John.....	249
Wilson Co., H. A.....	215
Winslow Company	260
PROFESSIONAL SERVICES	253
SEARCHLIGHT SECTION (Classified Advertising)	
BOOKS	256
Editors & Engineers.....	256
EMPLOYMENT	256-257
WANTED TO PURCHASE	256
REBUILDING	256
Freeland & Olschner.....	256
SPECIAL SERVICES	256
Beltman, M. N.....	256
USED EQUIPMENT FOR SALE	256
American Electric Sales Co., Inc.....	256
United Radio Co.....	256

Stamping Grounds

for
**ELECTRONIC
TUBE PARTS
and SHIELDS**

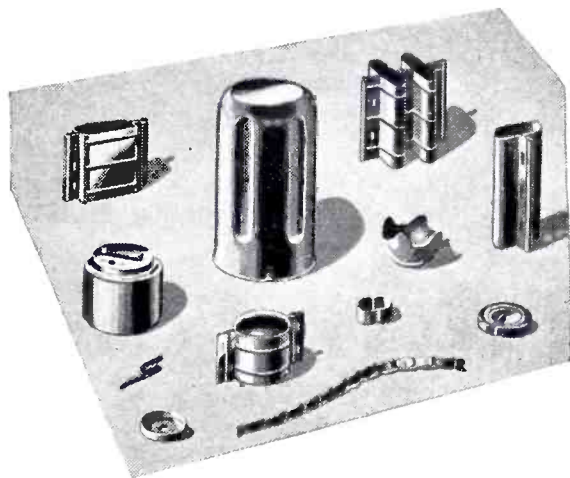

Shown here are just a few typical samples of GOAT Electronic Tube Parts and Shields that have been stamped, drawn and formed on GOAT machines, dies and presses.



**SMALL TOUGH
JOBS . . .** handled with skill, precision and efficiency, are a regular part of GOAT Service. GOAT'S position today, as largest independent manu-

facturer of electronic tube parts, is due to GOAT'S experience and growth. From the days of radio infancy, GOAT has been able to design and improve the parts needed by this industry as it demanded greater sensitivity and durability as well as quantity production.

Today, GOAT serves almost every electronic tube manufacturer with a tremendous variety of stock parts. Facilities are so complete that GOAT actually can supply any kind of small metal stamping, made in any metal, to any required degree of accuracy.



GOAT

METAL STAMPINGS, Inc.

Division of THE FRED GOAT CO., INC.
Machinery Specialists since 1893
314 DEAN STREET, BROOKLYN, N. Y.

IN SELECTIVE SERVICE

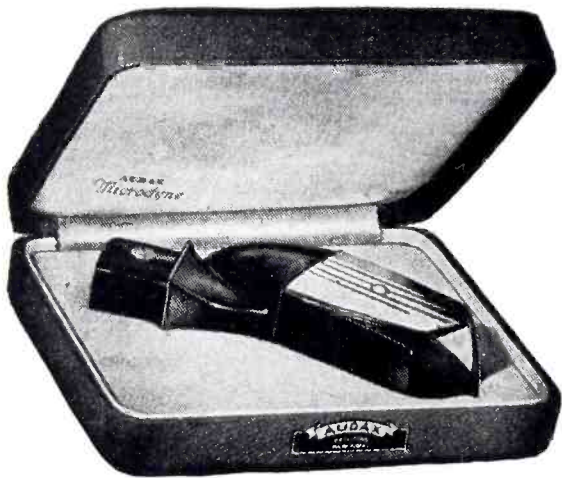

"RELAYED-FLUX" Microdyne

*"The Standard by Which Others
Are Judged and Valued"*

EQUIPMENT for the war effort,—

- (1.) **MUST** perform up to highest standards.
- (2.) **MUST** continue to perform irrespective of climatic variations.

That is why AUDAX magnetically powered pickups are selected for war contracts. In building pickups under such contracts, we do not have to change our peacetime specifications because such **MUSTS** have *always* been a basic requirement in AUDAX Instruments.

The sharp clean-cut facsimile reproduction of MICRODYNE — regardless of climatic conditions—is a marvel to all who have put it to the only test that really counts . . . the EAR TEST.

WITH OUR COMPLIMENTS

A copy of "PICKUP FACTS" is yours for the asking. It answers many questions concerning record reproduction.

BUY WAR BONDS

AUDAK COMPANY

500 Fifth Ave. New York City

"Creators of High Grade Electrical and Acoustical Apparatus since 1915."

mechanical constants, spring strength, damping and moment of inertia and the amplifier gain.

The requirements for non-oscillation may be mathematically expressed by the stability conditions for the fourth degree differential equation of motion for the mechanical system, including forces produced by the amplifier output current.

The system may also be considered as a form of feed-back amplifier, for which the requirement of non-oscillation has been stated by Nyquist to the effect that the gain versus phase angle polar curve, as frequency is varied, must not encircle the point (1, 0).

These two versions of the requirements are identical. The frequency region near the mechanical resonant frequency of the meter element is the only one where gain is large around the circuit but here the phase angle also changes very rapidly. The gain must be large in the negative or restoring direction and be less than 1 at any frequency in the positive or oscillating direction.

The time of response may be greatly reduced over that of the meter element alone as the amplifier output forces act to reduce the periodic time and increase the damping.

It is not possible to obtain any greater degree of load holding accuracy than that represented by the mechanical pivot friction of the standard meter, since the unbalanced force must move the meter element before a correction can follow, although the amount of motion may not be observable to the eye.

Several devices of the type are in use in the Development Laboratories of the Westinghouse Electric and Manufacturing Company's Meter Works at Newark, New Jersey. As constructed they form an attachment applied to the "precision type" standard wattmeters, and allow full advantage to be taken of the inherent accuracies of these instruments. Furthermore errors of observation, and inconvenience of use under unsteady supply conditions, are entirely eliminated. After an instrument is set to maintain a required load the observer may concentrate his attention upon the test instrument. The use of two observers (one to read each meter) is eliminated.

TELEGRAPH and RADIO KEYS

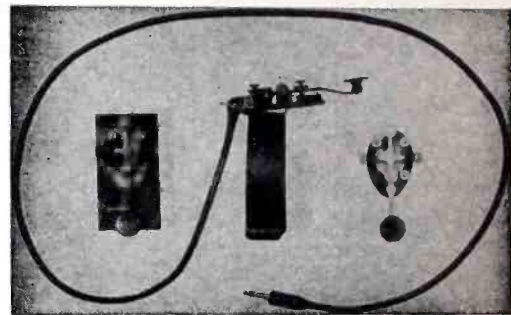

Telegraph Keys to Signal Corps Specifications

Types now in production include

J-12, J-18, J-28, J-29, J-30

J-31, J-37, J-38, J-40, J-41-A

J-44, J-45, J-46, J-47, J-48

Quotations upon request

THE WINSLOW COMPANY

INCORPORATED

9 Liberty Street, Newark, N. J.

Solves the Problem of Mailing List Maintenance!

Probably no other organization is as well equipped as McGraw-Hill to solve the complicated problem of list maintenance during this period of unparalleled change in industrial personnel.

McGraw-Hill Mailing Lists cover most major industries. They are compiled from exclusive sources, and are based on hundreds of thousands of mail questionnaires and the reports of a nation-wide field staff. All names are guaranteed accurate within 2%.

When planning your direct mail advertising and sales promotion, consider this unique and economical service in relation to your product. Details on request.



WE
Mc GRAW-HILL
DIRECT MAIL LIST SERVICE

McGraw-Hill Publishing Co., Inc.

DIRECT MAIL DIVISION

330 West 42nd Street New York, N. Y.

So that it won't happen again...

Now, more than ever, let us draw inspiration from our fighting men. Let us work even harder . . . make every required sacrifice . . . give even more of our minds and muscles and means. To pin casualty lists down to minimum, to hasten victory, to perpetuate the peace should be our one and only consideration. Remember—once before we said, "never again"—this time, let's make it stick.

To boost efficiency and secure victory has been, and still is, the job of every DAVEN component. On the battlefront, DAVEN products furnish precise and dependable control for America's fighting might. In the electrical, television, broadcast and sound picture fields, DAVEN meets all critical standards for accurate and consistent service.

We provide American industry with more than eighty models of laboratory test equipment, and the most complete line of precision attenuators in the world. A copy of our comprehensive catalog should be in your reference files. Ordering standard components from this catalog may expedite deliveries.

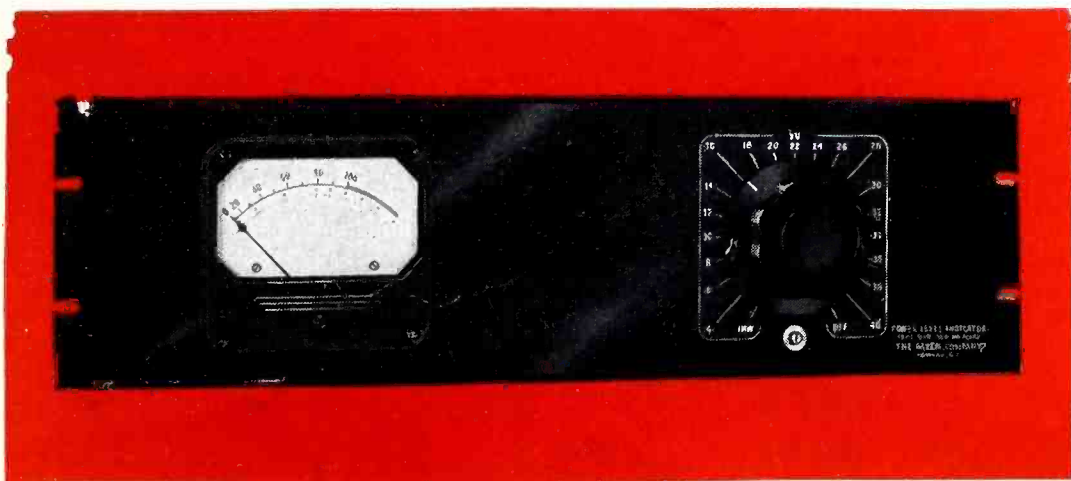

THE DAVEN COMPANY

158 SUMMIT STREET

NEWARK, N. J.

HELP SUPPORT THE WAR EFFORT . . . BUY MORE WAR BONDS AND STAMPS

THE "MAGIC BRAIN" OF Any Electronic Equipment IS A TUBE...

and the fountainhead of
modern tube production
is

RCA

LET'S LOOK AT THE RECORD!

To a greater degree than any other manufacturer, RCA has solved the problem of turning out in quantity, high quality Tubes expertly engineered to the requirements of the practical user.

In the field of "Receiving" Tubes, RCA is looked to by the government as well as many other critical customers as producing an eminently satisfactory product—and doing it in tremendous quantities.

In Cathode-Ray Tubes, RCA was the first to produce well-engineered units at low cost, thus making them available to industry generally.

RCA has long led in Phototube development, meeting one newer and more exacting application after another. Included here as RCA "firsts" are such outstanding developments as the RCA-931 Multiplier Tube, and other Phototubes utilizing the famous S4 surface which is highly responsive to daylight and blue light.

RCA first developed the Beam Power Tube in

the "Receiving" field, subsequently carrying this important development into the field of Transmitting Tubes.

In the field of Ultra-High-Frequency Tubes, RCA was the first to bring out Acorn Tubes—and, later, many others, among them such important Tubes as the RCA-1628 (and its successor, -8012), -825, -827 and RCA-832.

In Power and Transmitting Tubes, RCA was the first to design a successful air-radiator for cooling heavy-duty units.

Time and again, RCA has anticipated the need for new or improved Tube types, often pioneering them far ahead of any commercial demand.

And always RCA has led the way with Application Engineers in the field. These practical men apply their specialized talents to the dual objective of developing better tubes for the job at hand, and finding ways to use tubes already available to better advantage.



BUY U. S. WAR BONDS AND STAMPS

RCA RADIO-ELECTRONIC TUBES

RCA Victor Division, RADIO CORPORATION OF AMERICA, Camden, N. J.