

electronics

radio, communication, industrial applications of electron tubes ... engineering and manufacture

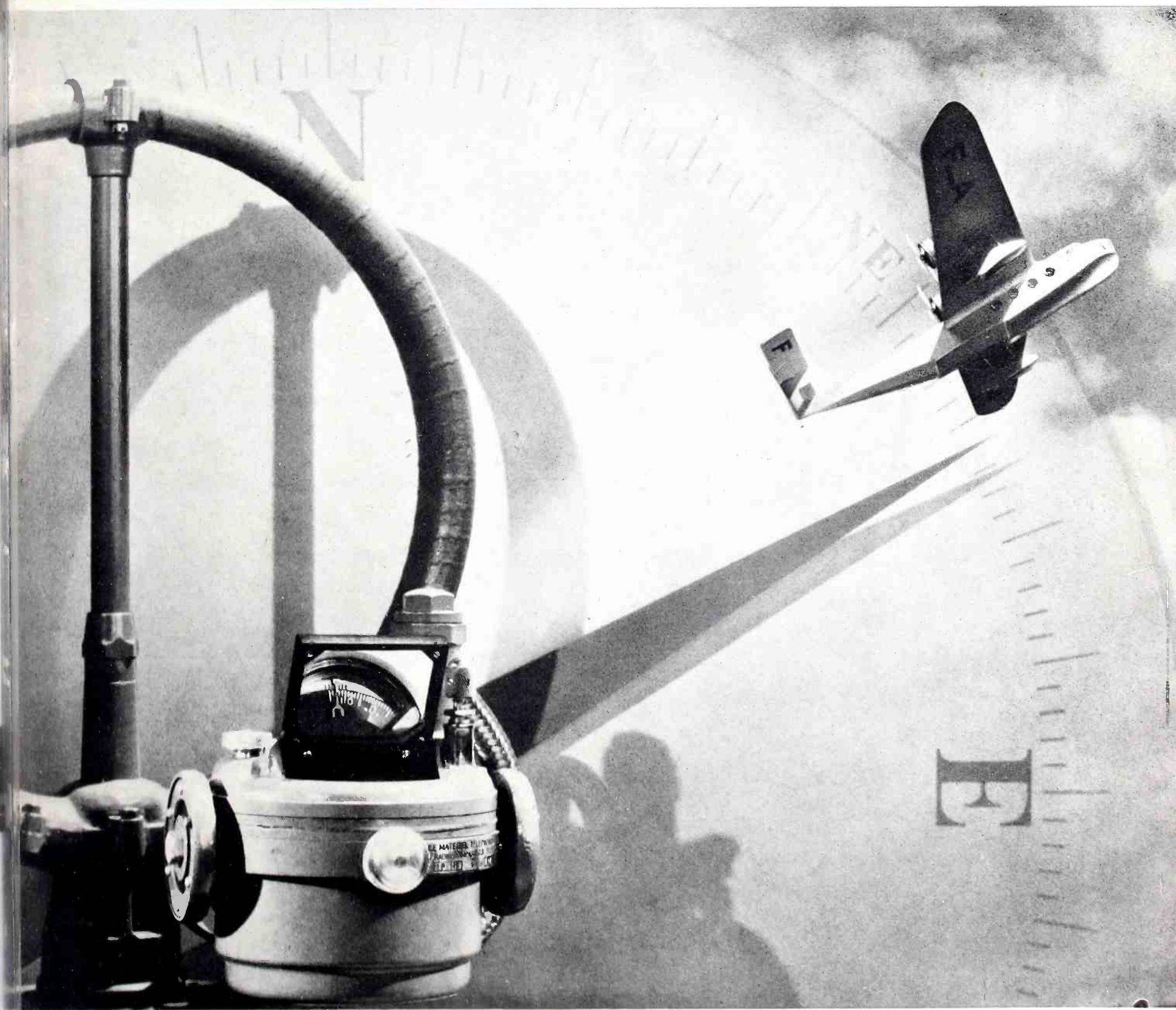

McGRAW-HILL
PUBLISHING COMPANY, INC.

JANUARY
1938

Price 50 Cents

www.americanradiohistory.com



Efficiency

Though each Amperex tube embodies exclusive features of structural design and processing which enhance their desirability, longevity and uniformity, their average electrical operating characteristics and overall dimensions are identical with tubes of the same type of other manufacture. These tubes may be interchanged or used to replace tubes of other manufacture without need for circuit re-adjustment and with the certainty of greater operating efficiency.

Extensive knowledge and irreplaceable craftsmanship is built into all Amperex Water and Air Cooled tubes . . . every step in production is checked to insure greater efficiency and lower operating costs.

Transmitting tube catalog available on request.

AMPEREX ELECTRONIC PRODUCTS, Inc.
79 WASHINGTON STREET
BROOKLYN, NEW YORK

electronics

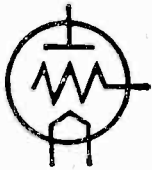

RADIO . . . COMMUNICATION AND
INDUSTRIAL APPLICATIONS OF
ELECTRON TUBES . . . DESIGN . . .
ENGINEERING . . . MANUFACTURE

HOWARD EHRLICH
Executive Vice-President

H. W. MATEER
Manager

KEITH HENNEY
Editor

DONALD G. FINK
Managing Editor

BEVERLY DUDLEY
Associate Editor

HARRY PHILLIPS
Art Director

ELECTRONICS, January, 1938, Vol. 11, No. 1.
Published monthly, price 50c a copy. Subscription
rates—United States and possessions, Canada,
Mexico and Central American countries, \$5.00 a
year. All other countries, \$6.00 a year or 24
shillings. Entered as Second Class matter, August
29, 1936, at Post Office, Albany, N. Y., under
the Act of March 3, 1879.

Branch Offices: 520 North Michigan Ave., Chicago;
883 Mission St., San Francisco; Aldwych House,
Aldwych, London, W. C. 2; Washington; Phila-
delphia; Cleveland; Detroit; St. Louis; Boston;
Atlanta, Ga.

Contents Copyright, 1938, by
McGraw-Hill Publishing Company, Inc.

McGRAW-HILL
PUBLISHING COMPANY, INC.

Publication Office
99-129 North Broadway, Albany, N. Y.
Editorial and Executive Offices
330 West 42nd Street, New York, N. Y.

James H. McGraw, Jr., President
Howard Ehrlich, Executive Vice President
James H. McGraw, Honorary Chairman
B. R. Putnam, Treasurer
D. C. McGraw, Secretary
A. W. Morrison, Circulation Manager

Cable Address:
MCGRAWHILL, New York
Member A.B.P. Member A.B.C.

CONTENTS, JANUARY, 1938

PHOTOGRAPHIC COMPOSITE, PREPARED AT THE LE MA- TÉRIEL TÉLÉPHONIQUE LABORATORIES IN PARIS	Cover
Loop and indicator, lower left, are essential elements of the new L.M.T. rotating-loop radio compass	
REVIEWING THE VIDEO ART	8
A report of the Rochester meeting of the RMA Committee of Television	
BATTERY RADIO DESIGN, By Paul Marsal	12
Getting the most from A, B, and C battery power	
REVERBERATION CONTROL, By John K. Hilliard	15
How to add echo, without distortion, to movie sound tracks	
WIDE-BAND TELEVISION AMPLIFIERS, By F. A. Everest	16
Design for high-frequency response; filter-coupled stages	
NEW INDUSTRIAL X-RAY TUBES, By Herbert R. Isenberger	20
Portable, including protection against exposure and shock, improved anode structure	
MAKING THE SUPER-PRO RECEIVER	22
Photographs of interesting manufacturing operations in the Hammarlund plant	
A CATHODE-RAY PHASEMETER, By S. Bagno and A. Barnett	24
An ingenious Lissajou-figure method of measuring phase difference of very small magnitude	
RADIO BROADCAST FACSIMILE	26
The broadcast stations, newly licensed for facsimile, prepare for a new home service	
THE TRIOGRAPH, By H. E. Hollman	28
A three-phase cathode-ray tube for indicating the distribution of heart potentials, in medical diagnoses	
A MAGNETIC RECORDER, By T. J. Malloy	30
A shielded magnet permits recording of high frequencies, as well as low, on steel wire without excessive wire speeds	
A RADIAL GROUND SYSTEM CHART, By George H. Brown	33
Effect of length and number of ground wires on signal strength	
ULTRASONICS AND SUPERSONICS, By Harry Schecter	34
A bibliography of references in the field of super-audible sound waves and their uses	

DEPARTMENTS

CROSSTALK	7
REFERENCE SHEETS	33, 34
TUBES AT WORK	38
BOOK REVIEWS	50
BACK-TALK	51
ELECTRON ART	54
MANUFACTURING REVIEW	61
PATENTS REVIEW	73
INDEX TO ADVERTISERS	76

MEMO

*for
Designing
Engineers*

CONCERNING REMOTE CONTROL

Push-Pull and Rotary motion can both be imparted with a single Flexible Shaft

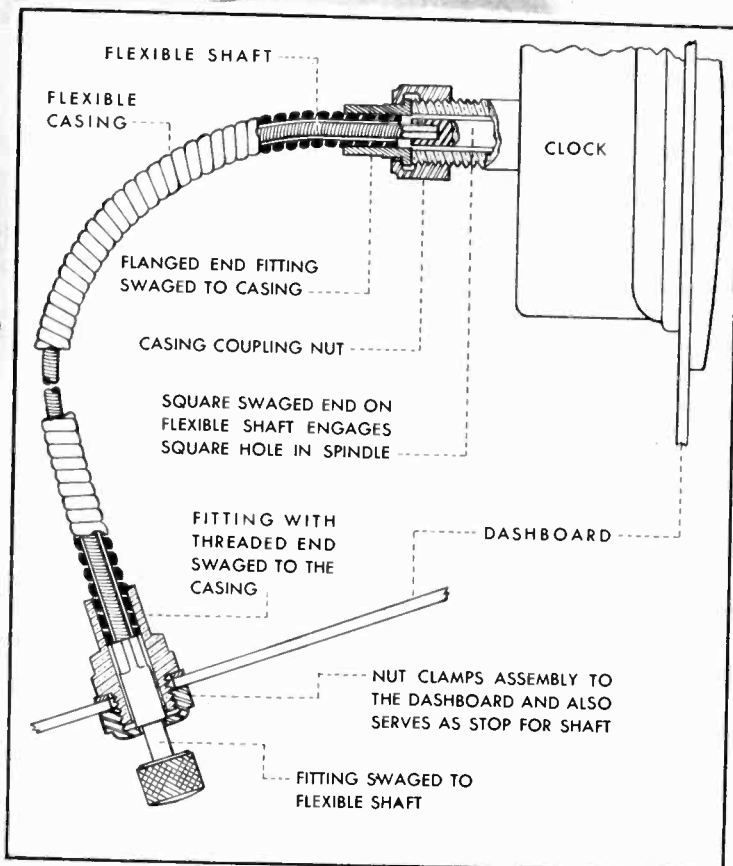
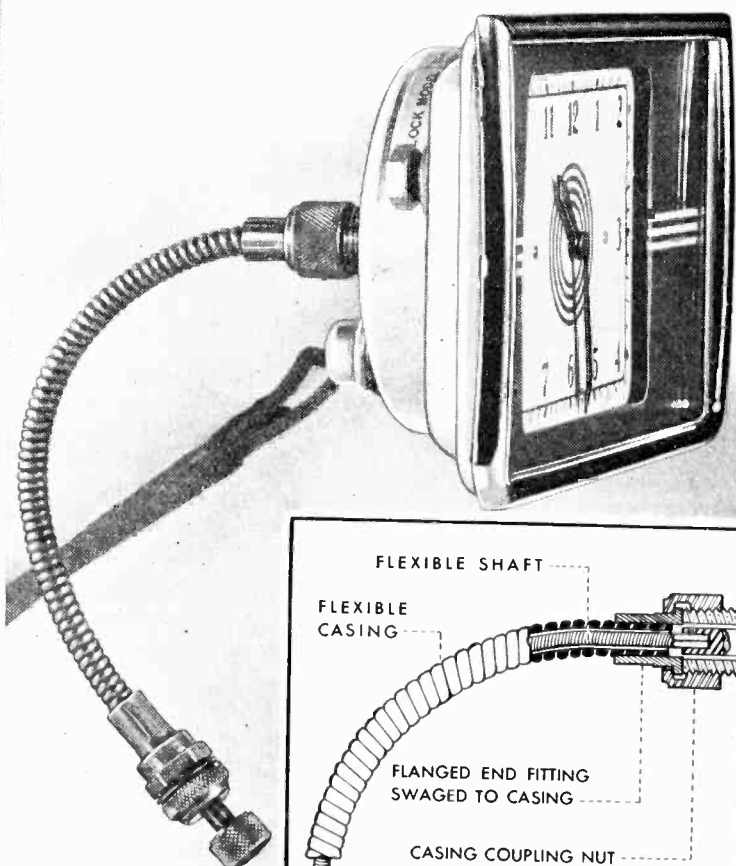

In designing mechanical remote controls the problem sometimes arises where the element to be controlled requires *both lateral and rotary motion*.

A typical example is the arrangement for setting the hands of the automobile clock illustrated. The spindle on which the hands are mounted is first pushed in against the pressure of a spring, to engage it, and the hands are then turned. The drawing shows how both the pushing and the turning are accomplished with a single flexible shaft.

The same arrangement is also used for resetting the trip mileage on speedometers. Combined choke and needle valve control on carburetors has also been provided with a single shaft.

If you have a dual control problem of this kind, a flexible shaft may be the answer. Put it up to us—we'll be glad to help you work it out. No obligation. Send details.

**The S. S. WHITE Dental Mfg. Co.
INDUSTRIAL DIVISION**

10 East 40th St., Room 2310E, New York, N. Y.

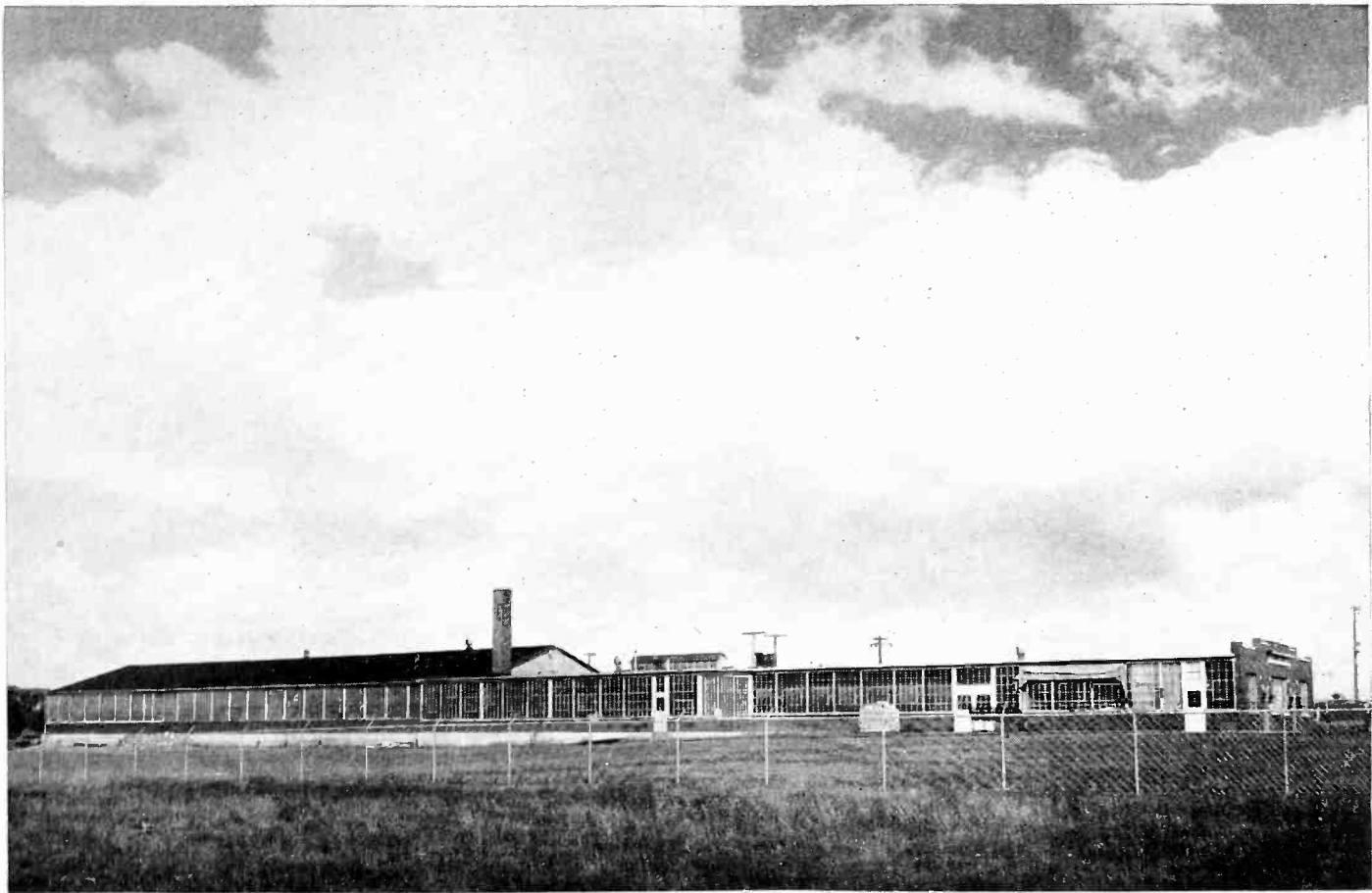

This Year . . . Look to "Superior"

That little "rest period" during the last few months of 1937 put us in a position to get ready for 1938.

With 21 million feet of specialty small tubing to show for our three years existence, it is natural that we have learned much from the intricate processes involved—experience we propose to benefit by.

New operating policies in keeping with modern scientific control are being adopted and these will shortly be announced. As usual, we work in small things only but in many metals.

●
MANUFACTURERS OF SEAMLESS
AND LOCK SEAM CATHODE SLEEVES
AND SMALL SEAMLESS TUBING IN
VARIOUS METALS AND ALLOYS.

SUPERIOR TUBE COMPANY, Norristown, Penna.

25 miles from Philadelphia

100 miles from New York

SUPERIOR TUBING

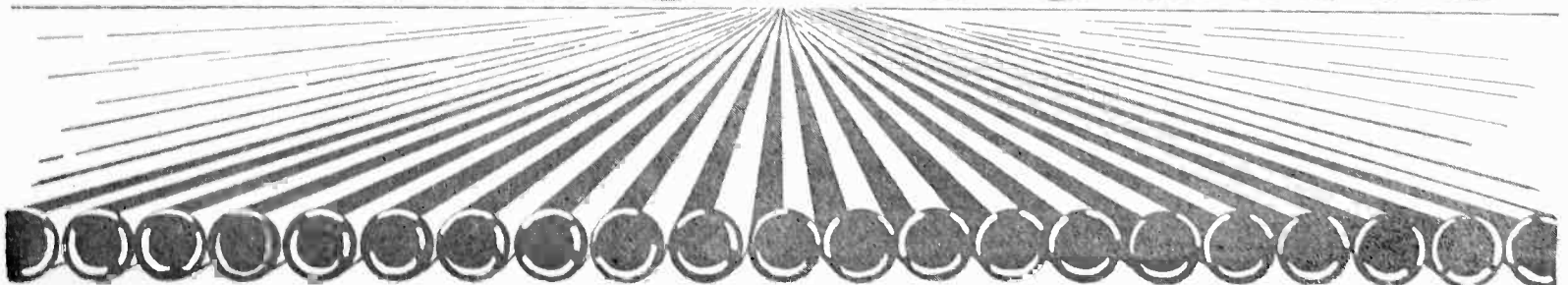



NICKEL...

the metal that put TUBES in RADIO

Its ever increasing variety of Radio applications proves Nickel as amazing as the industry itself

WHEN the Wright Brothers first flew at Kitty Hawk—and broadcasting stations were yet undreamed—radio pioneers were casting about for a metal that would make it possible to produce tubes on a commercial scale. *And from all the metals available*, they chose Nickel. For this reason: Nickel had the combination of properties they needed: Strong, rugged, easy to form and weld, rust-proof, highly resistant to both corrosion and oxidation.—Nickel proved the most suitable and economical metal for the job.

And as the amazing young industry grew, it found in Nickel an equally amazing ability to meet increasingly diversified demands.

Today, Nickel's use extends far beyond tubes. In the form of alloys it provides: Better magnetic properties for speakers and audio transformers; better electrical properties for rheostats and fixed resistors; better resistance to fatigue and corrosion in contact springs, etc.

Study Nickel's properties in connection with your requirements. Write for the bulletin, "Nickel in the Radio Industry". Address:

In producing radio tubes NICKEL delivers:

1. Forming and welding qualities adapted to mass production of precision parts.
2. Ruggedness to keep that precision during assembly and in service.
3. Immunity to rusting from handling and cleaning parts during assembly.
4. Low gas content to simplify evacuation of tubes, and also freedom from distortion at the high temperatures used in the process.
5. Compatibility with the electron emissive coatings required for cathodes.

6. Adherent carbon coatings, which dissipate excessive heat from the plate, can be deposited uniformly on the Nickel without embrittling it.
7. High stiffness and damping capacity to minimize vibration of parts and resulting microphonic noise.
8. Special Nickel alloys provide vacuum tight metal to glass seals, and meet other special requirements.
9. Available in a wide range of forms, sizes and tempers.
10. Uniformity from lot to lot, which increases the yield and lowers production costs.

THE INTERNATIONAL NICKEL COMPANY, INC., 67 WALL ST., NEW YORK, N. Y.

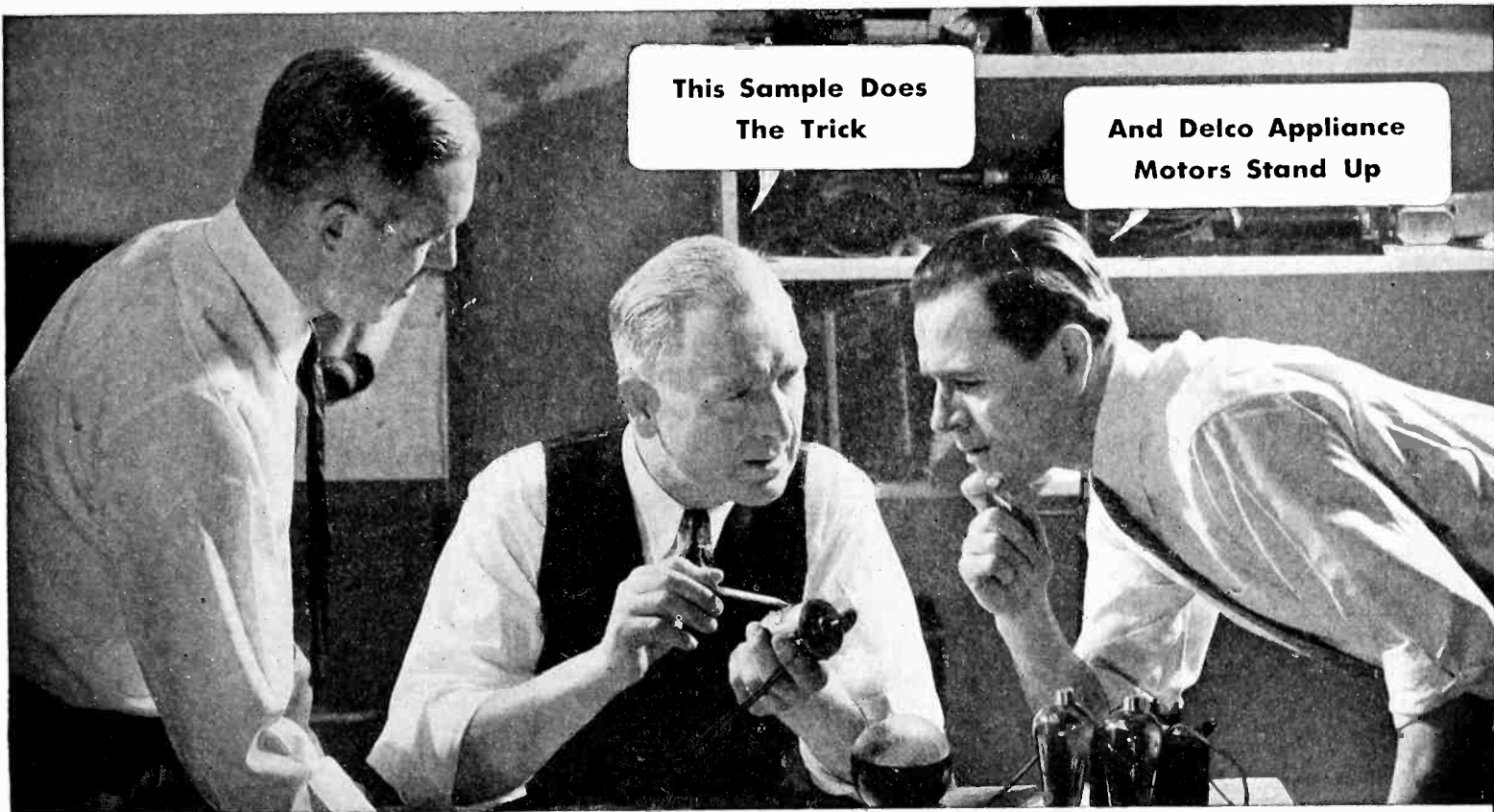

This Sample Does
The Trick

And Delco Appliance
Motors Stand Up

OVER 90,000 **DELCO APPLIANCE** MOTORS WERE USED

FOR ELECTRIC TUNING BY A SINGLE
RADIO MANUFACTURER IN 1937!

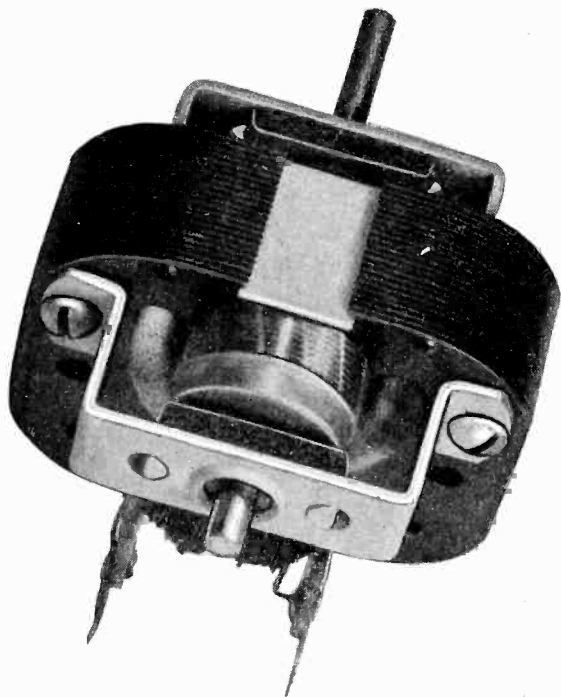

This one statement tells the significant story of Delco Appliance Radio Tuning Motors...proves that they must be quiet, smooth, sensitive, uniform in operation, have ample power and rugged durability.

These proven factors, plus their wide variety of mountings and drives and the fact that they are suitable for single pole, double throw switch operation, make Delco Appliance Radio Tuning Motors worthy of investigation by radio manufacturers everywhere.

It will pay you to find out about these small, inexpensive Motors with the die cast rotor and other important features. If you will send data showing your requirements, our engineers will be glad to make recommendations covering your application.

DELCO APPLIANCE MOTORS



PRODUCT OF GENERAL MOTORS

DELCO APPLIANCE DIVISION

GENERAL MOTORS SALES CORPORATION

ROCHESTER, N. Y.

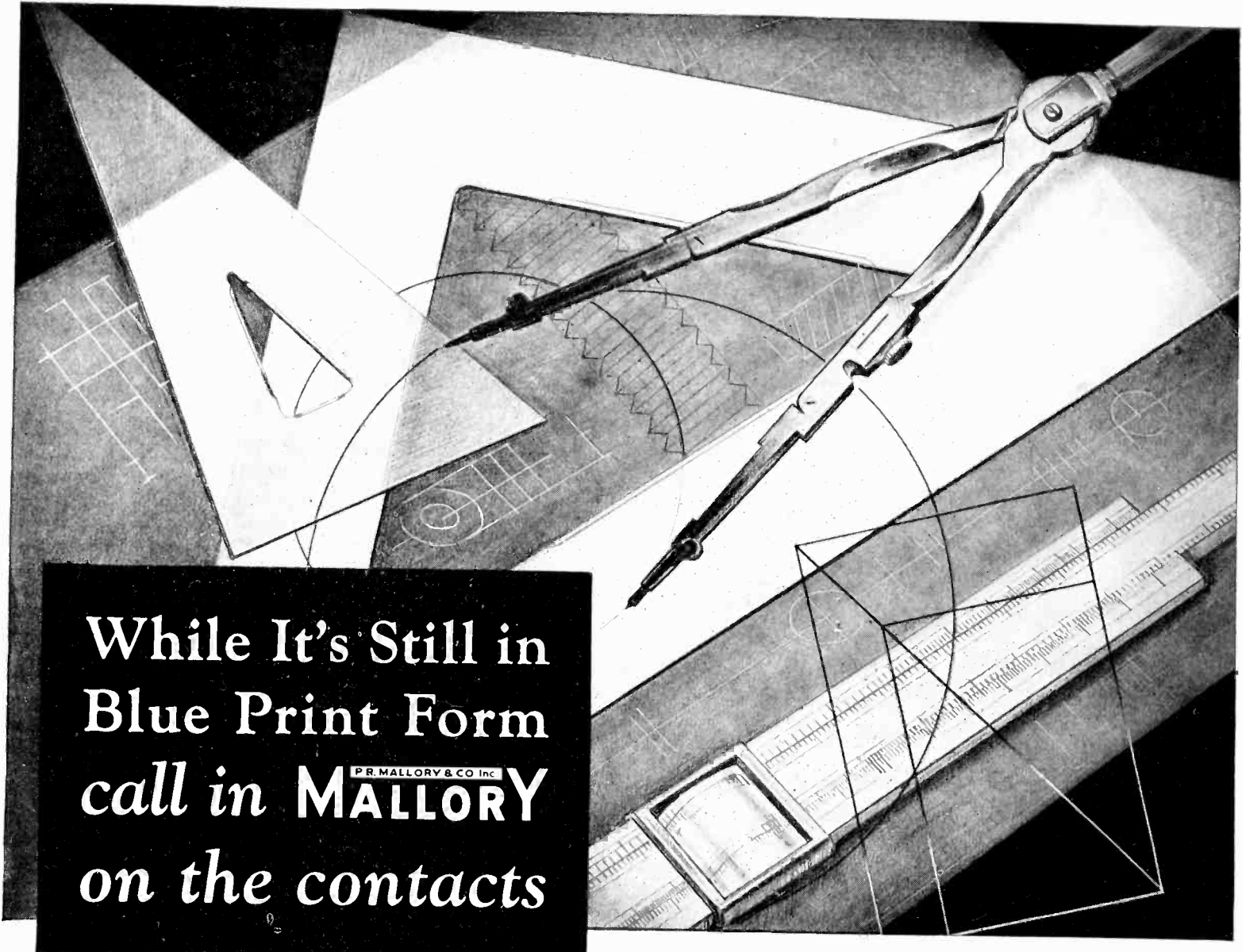

**While It's Still in
Blue Print Form
call in P. R. MALLORY & CO. Inc. MALLORY
on the contacts**

Successful production, performance and salability of electrical products begin at the drawing board.

That is the place where "materials" are selected.

It is the place where, for electrical contacts, not only materials, but design should be considered.

Costly changes are frequently forestalled when Mallory is consulted as to contacts while products are still in the blue-print stage. Worth-while savings are often made by slight design changes that permit the incorporation

of *standard* rather than *special* contacts. Mallory has devoted many years to the designing and manufacturing of contacts for every class of electrical service. Mallory covers the field in the perfection and production of everything from giant circuit breaker contacts to the tiny "pin-points" of metal used in automobile ignition circuits.

Have you an electrical product in the blue-print stage? Mallory will appreciate your contact inquiries. And —you'll appreciate the help that Mallory offers.



P. R. MALLORY & CO., Inc.
INDIANAPOLIS, INDIANA
Cable Address — PELMALLO

ELECTRICAL CONTACTS

ELECTRONICS

JANUARY
1938

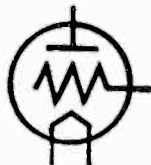

KEITH HENNEY
Editor

Crosstalk

► **YEAR END NOTES** . . . By rights these accumulata should have appeared in the December issue, but at that time they had not transpired.

Patent Office receipts for the fiscal year 1936-1937 reached an all-time high. These receipts are derived from inventors who pay for the right to file and obtain patents for their inventions.

Late in December Hazeltine Service Corporation licensed Radio Corporation of America under its patents, thereby adding a cheerful note looking toward greater industry solidarity.

Sad note at the year end was the report of overstocking of radio sets and tubes; the rather wholesale firing of factory employees and engineers; the pessimism regarding practically everything engendered by the present lack of courage. Despite these firings, circulation of *Electronics* at the year-end was very near 13,000 net paid (last year this time it was 11,000); many hundred readers taking advantage of the annual collection of Reference Sheets mailed to subscribers on or about December 26 (there are a few left for those who neglected to subscribe.)

The year saw noteworthy radio set changes. Various kinds and degrees of push-button or dial tuning easily took the prize for new things actually on the market. The remote control offering of the RCA License Lab intrigues the interest of industry as well as communications for future use. During the year the AT&T opened overseas services to the liners *Washington* and *Manhattan* and to the Arabian city of Bagdad in Irak. All you have to do (in New York at least) to talk to any of these three places, wherever the liners may be, is to use the Arabic numerals 211 (Long Distance) in the correct manner. Noteworthy event was the Toscanini broadcast of NBC Symphony orchestra. RCA deserves thanks of all listeners in for this treat.

A most happy event to electronics was the award of the Nobel prize to

C. J. Davisson of the Bell Laboratories, winner with G. P. Thompson of the prize in physics. Dr. Davisson's work was related to the proof that electrons exhibited characteristics of both waves and particles thus bringing into line the two opposing physicists' camps, those who claimed the electron was one thing, and those who claimed it was something else. Davisson and Germer proved they were both right.

A most sad event, coming on December 23, as *Electronics* was near the press was the death of Malcolm Ferris. Although at the November Rochester meeting Mr. Ferris told a few of his intimate friends of an imminent operation, the shock of the news of his death was very real indeed. All communication men knew of his work, starting in the basement of his home where he built his first signal generators, of how his business grew until a year or so ago he built a fine new laboratory in the hills near Boonton, N. J. All knew him as a gentleman and friend, unassuming, lovable.

► **WE PREFER PEAKS** . . . After listening to several programs monitored by one on the new "peak limiters" one must inevitably come to the conclusion that the control operator's dream of the ideal program as one of constant frequency and constant amplitude may, someday, be realized. These peak choppers, as we understand them, are to prevent over shooting or over modulation. In practice they are actually used to raise the average level of modulation, and unless carefully and honestly used they inevitably reduce the volume range. In other words the control man, under the constant pressure of the sales force which wants more coverage, will tend to let his program get as near the top of the modulation capabilities as possible relying upon his peak cutter-off to knock down the gain instantaneously and to

prevent actual overmodulation. Perhaps we've got this thing wrong, but several letters have come in recently protesting against substituting one form of distortion (volume range restriction) for another (over-modulation). We would be glad to get the views of both manufacturers and operators on this subject.

► **CLEAN-UP** . . . Deserving of an item by itself in the year-end notes is the amusing incident of Mae West cleaning up the radio. Having started the clean-up in the movies, Miss West now appears to have started a similar scourge in broadcasting, thereby earning for herself some degree of martyrdom. There is talk of taking licenses away from NBC for having broadcast the Adam and Eve skit—but that would be silly. In the meantime we bet there have been many revisions of pending skits; that classical music will have a sudden and perhaps temporary run during the good evening hours, and that broadcasting will benefit, just as the movies did.

► **CONSULTANTS** . . . Editorial department receives many inquiries for individuals and laboratories who can handle electronic problems, either in communication or in industry. Therefore, Editors would be delighted to hear from electronic experts. Who are they? What do they specialize in? What is their experience? What is their personnel? These are the questions we want to be able to answer.

► **SORRY, E. K. COLE** . . . In November *Electronics* a photograph showing seven English radio receiver cabinets molded from Bakelite did not state in its caption that these cabinets should be credited to our good friends Messrs. E. K. Cole Ltd., makers of receivers in England.

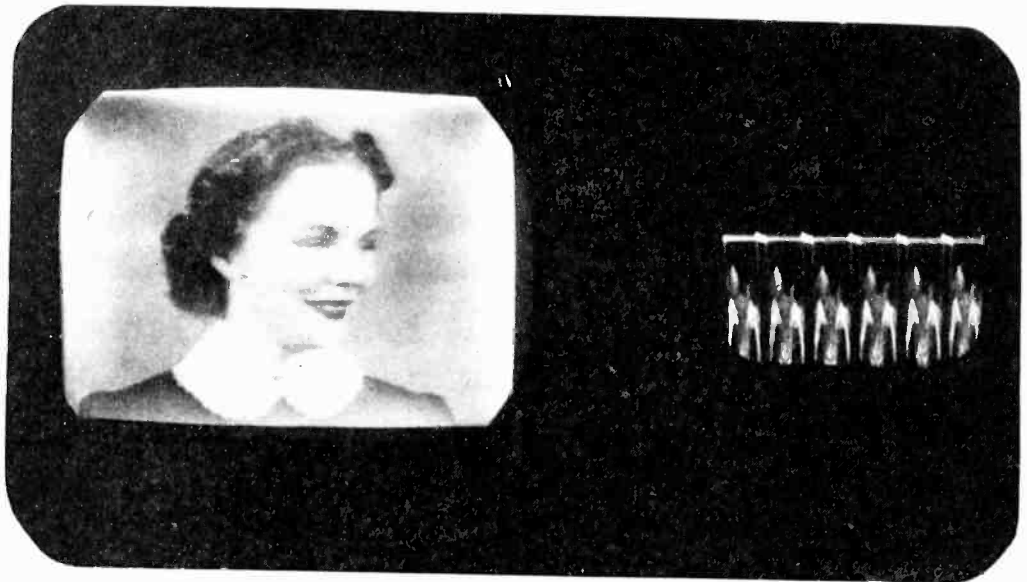

WHAT'S IN A FACE?

This NBC television operator, at the video monitor position, faces two cathode ray tubes. The larger one at the left shows the televised image, as it comes from the camera. The smaller tube is an oscilloscope which shows the form of the voltage wave in the lines of the image. The oscillogram above, right, shows six lines (wavy masses) of Jean O'Neil's face with five blanking and line-synchronizing pulses between them

REVIEWING THE VIDEO ART

Members of R.M.A. Committee on Television, meeting at Rochester, reveal status of work now in progress here and abroad

BEHIND the scenes of television development in this country there is no more important a group than the R.M.A. Committee on Television, which for the past three years has been active in formulating tentative standards and in evaluating progress made by various companies engaged in television research. In 1934, when cathode ray television began to emerge from behind locked doors, there was no agreement among the various companies on what constituted a good television picture. In fact, there were as many different ideas on television standards as there were experimenters. Now, scarcely four years later we find the industry, the technical part of it at least, presenting a solid front on television standards, and with such good effect that their recommendations have been accepted, substantially, by the Federal Communications Commission in setting up the allocation for the ultra-high frequencies. This achievement may be credited almost exclusively to the work of the R.M.A. Sub-Committee on Television Standards, reporting to the R.M.A. Committee on Television, in whose meetings many differences of opinion have been ironed out, and which is at present engaged in collecting information which will permit standardization on those points now the subject of discussion.

As evidence in this data-collecting program the R.M.A. Committee of which A. F. Murray is Acting Chairman, held a meeting during the Rochester R.M.A.-I.R.E. Convention with the purpose of reviewing the status of work being done by the various organizations represented and to report the results of visits in foreign countries made by members of the Committee. At this meeting eleven short reports were presented, seven regarding work being done by organizations in the United States and four on visits to Europe. Through the courtesy of the officers

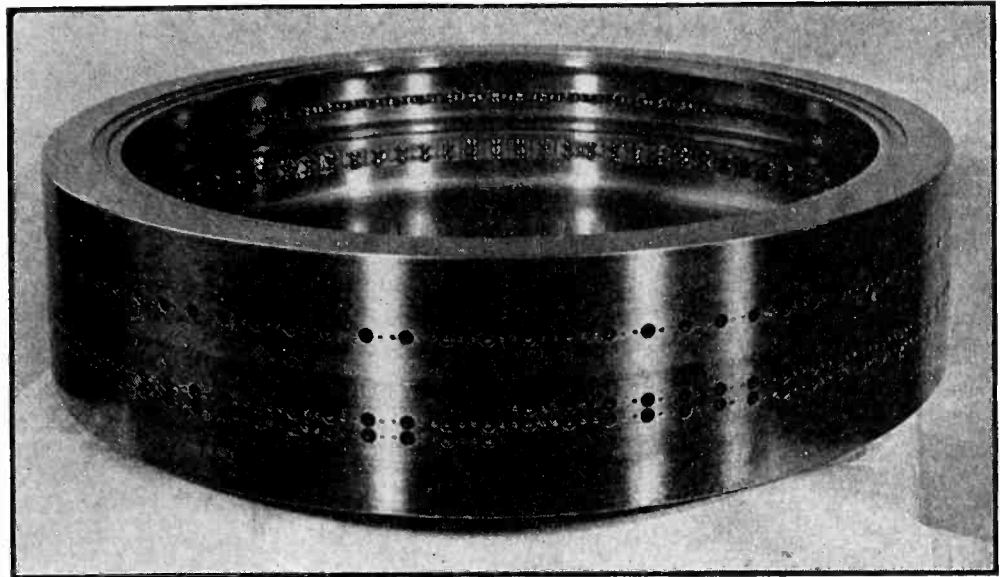

Typical of the newer methods of scanning film, used in Europe, is this Telefunken lens drum, equipped with microscope-type lenses, whose light-conserving properties permit the use of a six-ampere lamp, instead of the 120-ampere arc used formerly.

of the R.M.A., the following report of that meeting is presented in the pages of *Electronics*.

Synchronizing Problem Stressed by Hazeltine

Mr. D. E. Harnett, reporting for the Hazeltine Service Corporation, stated that in their program of television receiver development, Hazeltine has found that the British type of signal (discussed in the October issue of *Electronics*, p. 32), presents, in their experience, better synchronizing performance than the type of signal radiated last year by the Empire State station. It was revealed that a type of frame-synchronizing impulse has been developed in Germany which differs both from the American and the British system. In brief, the synchronizing pulses which initiate the beginning of each line in the image are omitted for a short interval at the end of each half frame. The frame-frequency oscillator is then tripped by the appearance of the next line impulse. During the interval between half-frames, the line impulses pull the line circuit oscilla-

tor back into synchronism before the beginning of the next half-frame. While the Hazeltine experimentation with this system is incomplete they have found that it offers considerable possibilities of smooth synchronizing performance.

Following Mr. Harnett's statement, Mr. E. F. Kingsbury of the Bell Telephone Laboratories reported briefly on the present status of the coaxial cable development. Mr. Kingsbury described the experimental television test of this cable, as reported in December *Electronics*, p. 18. One interesting fact revealed by Mr. Kingsbury is that the steel scanning disk used for generating the pictures in the coaxial cable system is slightly cup-shaped when stationary and hence the lenses in the disk must be focused while the disk is in motion, since at high speed the disk flattens out, changing the position of the lenses relative to the film. Mr. F. R. Lack of the Bell Laboratories pointed out that the demonstration of television over the coaxial cable was not primarily intended as a demonstration of television but was rather a

test in the frequency-band carrying capacity of the cable itself.

Bingley Reports on Modulation System and Synchronizing Impulses

Mr. F. J. Bingley then briefly reported work carried out by Philco during the past year, emphasizing particularly the subject of synchronizing signals, advocating the "narrow-vertical" type, and reporting the successful operation of the wide band modulation system which permits modulations of all frequencies from zero to above 4.5 megacycles in a standard television transmitter. Both of these aspects were discussed in papers at the Rochester Convention, as reported in the December *Electronics*, pages 12 and 14. Mr. Bingley also reported that progress has been made in the development of materials for cathode-ray screens, stating that some good black and white materials had been obtained.

RCA Reports on Propagation Study

Mr. E. W. Engstrom of RCA revealed that studies have been made by RCA of horizontal versus vertical polarization with relation to the noise picked up by the receiving antenna. These studies have revealed definitely that horizontal polarization produces the strongest signal in relation to noise and is freer from signal variations. Mr. Engstrom reported that experience at the boundary of a service area where noise is strong in relation to the signal, indicated that the "serrated" type used by RCA and the British Broadcasting Company produced better results than other systems tested by RCA, of which there were six or eight examined in the past two or three years. He stated a preference for d-c transmission, i.e., the variation of average carrier power in relation to the background light level of the picture, which would permit obtaining the bias value for the cathode ray tube directly from the output of the second detector of the receiver. This is in accord with present British practice. Decision on the polarity of transmission seems to hinge on methods of automatic volume control in receivers. RCA preference, in the event that a choice should be made immediately on the basis of systems now available, would be for negative transmission, i.e., an increase in carrier

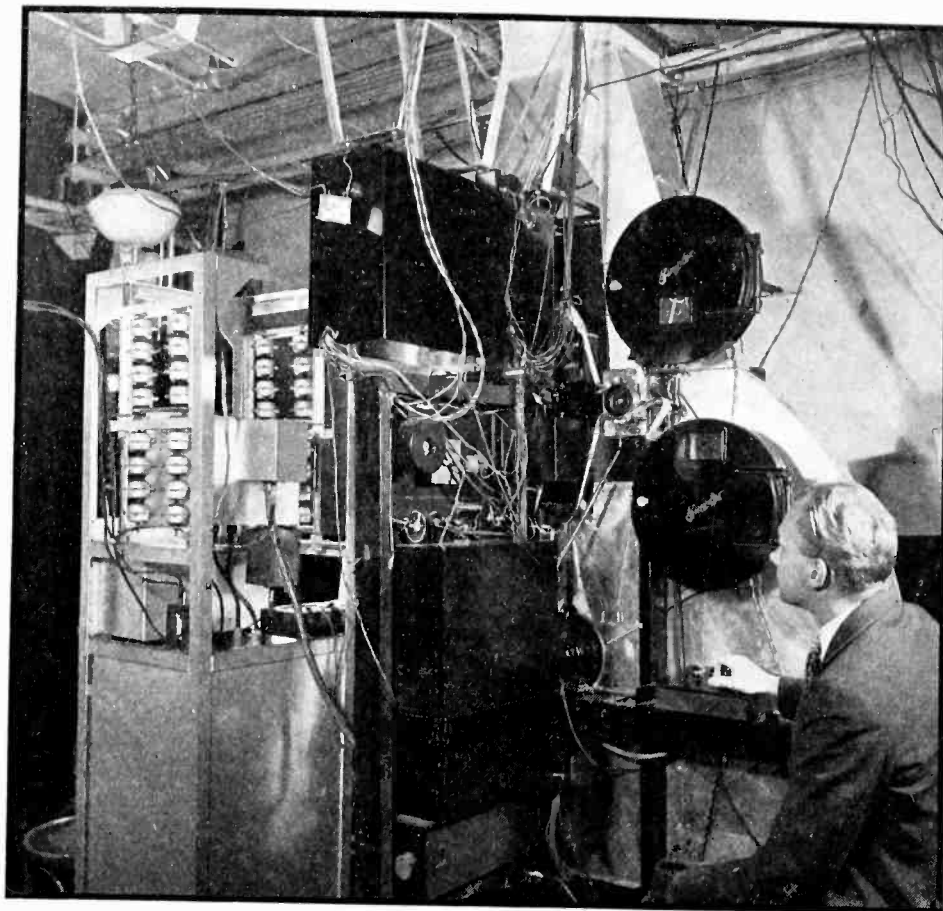

The sending end of the New-York Philadelphia coaxial cable television test. Inside the aluminum housing (behind film reels) is the six-foot steel scanning disc in which are set 240 wide-aperture lenses. The film is scanned while moving at a continuous rate past the disc, the scanning beam entering an electron-multiplier-type phototube (see *Electronics*, December, 1937, page 18)

amplitude corresponding to a decrease in light. Work is now being carried out by RCA to determine whether or not there is any difference in performance between single and double side band reception, when multiple path transmissions are encountered because of the presence of buildings, etc. in or near the path of transmission. Work on this aspect is not sufficiently complete to report.

CBS Prepares

Dr. Goldmark, in charge of the television activities of the Columbia Broadcasting System, reported that during 1937 CBS completed an experimental television transmitter operating on 52.5 Mc. which had been designed and built for the standard of 441 lines and 30 frames per second. The video signal is obtained from a film scanner using a dissector tube of the Farnsworth type, including a 9-stage electron multiplier. The film is moved continuously past the scanner. Two type 806 tubes operating in push-pull providing a 50-watt output are used. Dr. Goldmark reported that two standard RCA test patterns used as a basis for the signal had been re-

solved to about 90 per cent of their total content without appreciable phase shift. A considerable portion of Dr. Goldmark's report had to do with the new television studios now being installed at the Grand Central Terminal in New York. This studio measures 60 ft. x 130 ft. and will be equipped with two types of studio equipment (RCA and Farnsworth), which will be mounted side by side. A film channel of the RCA type and two of CBS design will be employed. Some time this year the high power television transmitter purchased from RCA by CBS will be installed.

Mr. Robert Morris in charge of the operation of the NBC television system reported the complete overhauling of the equipment to change from 343 lines to the RMA standard of 441 lines. This work, started in December 1936, is not yet complete; it involves adjusting all of the channels of eight or nine local monitors and five camera chains with their associated amplifiers, to a band width of $3\frac{1}{2}$ to 4 megacycles.

Lewis Reports on British Practice

H. M. Lewis of Hazeltine who wrote on British television in the

October issue of *Electronics*, reported briefly on his trip to Great Britain. The outstanding features of the British television images, according to Mr. Lewis, are their stability, freedom from faulty synchronizing, and their wide contrast range. The faults were a tendency of some receivers to exhibit weaving of interlace, and the shading effect present in the Emitron cameras. What projection tubes he saw he considered to be of inferior performance. The best results were obtained from mechanical scanning of film and with cathode ray tube reception.

Lack Recounts Foreign Impressions

Mr. Lack of the Bell Laboratories, reporting on his recent trip to Europe, emphasized the advantage and superiority of mechanically-scanned film. In Berlin he saw 180-line mechanically scanned film

in his opinion, was produced by a very simple arrangement: Film, mechanically-scanned, produced a signal in a multiplier photocell, the output voltage of the multiplier photocell being sufficiently high to operate directly the grid of the reproducing cathode ray tube, that is, without any intervening amplifier. This picture, which had excellent contrast and detail, was given as an ideal which more complex systems, including amplifiers, transmission lines and transmitters, will have to approach.

Mr. Engstrom reporting on his visit to Europe concurred with many of the statements made by the other speakers, attributing the technical excellence of the British system to the good job done on the transmission systems, and to the uniformly excellent performance of the transmitter and studio equipment. Of the receivers he saw not all produced good performance with relation to

to those of the direct pick-up. A demonstration of the Scophony mechanical projection system, which impressed Dr. Goldmark favorably on his visit, was reported by an executive of the CBS company to have been used on a 405-line, interlaced picture using the transmissions of the BBC. According to the report of this executive the picture was of very high quality, surpassing all other types in brilliance, definition, gradation and size.

In Germany, Dr. Goldmark viewed a 6-ft. wide picture projected from a cathode ray tube operating with an accelerating voltage of 20,000 volts. The 441-line image had excellent definition, gradation and freedom from geometrical distortion. The iconoscope type of camera developed by Fernseh A. G., according to Dr. Goldmark, does not show any shading effect and seems to have excellent sensitivity. Most of the German experimenters are employing scanning discs for the transmission of film, in conjunction with multiplier type phototubes.

Among the recent demonstrations of television viewed by the editors was that of RCA-NBC (for the ARRL) December 8. This program, the longest ever attempted by the NBC staff, included a full-length Sherlock Holmes play, acted in the studio, and shorter interludes of film and "live talent." The entire performance lasted one hour and was easily the best demonstration from a technical and artistic point of view yet given by this organization.

The Kolorama Laboratories of Irvington N. J. demonstrated a projected picture of about 3 by 4 feet, formed by a mechanical scanner and Kerr-cell arrangement. Only film subjects were shown, and no technical details of the system were released. The detail of the picture was less than that of other demonstrations.

The Peck Television Corporation has combined television methods with facsimile in their recently demonstrated "Television Bulletin Service". A message typed on transparent tape, is scanned by a lens disc, and converted into a video signal of low definition. The signal is then placed on conventional land wires and sent to the receiver which recreates the image by means of a Kerr cell and lens disc, projecting the image on a translucent screen.



NBC's new portable television station, mounted in two "telemobiles", for relaying outside pick-ups to the Empire State transmitter. Platforms on the roof hold Iconoscope camera and parabolic microphone pick-up, while the antenna (on pole, rear truck) delivers the 177 Mc. signal to the main transmitter, either directly or through intermediate relays

which appeared to have greater detail than pictures of many more lines shown in this country. This he attributed to the excellent contrast range present in the mechanically scanned picture. He agreed with Mr. Lewis that projection images in general were not satisfactory. At the Radio Show in Berlin, Dr. Lack had the opportunity of comparing equipment made by various manufacturers which were operating in adjacent booths. The best picture at this show,

interlacing, but several receivers did do so. It is believed that this question is one primarily of engineering design, requiring a fundamental understanding of the problem.

The concluding report was presented by Dr. Goldmark of Columbia Broadcasting System. In England he was impressed with the sensitivity of cameras employed and with the strength of the signal. The impression was that the non-mechanical transmissions of film were inferior

BATTERY RADIO DESIGN

By PAUL MARSAL
National Carbon Co.
Cleveland

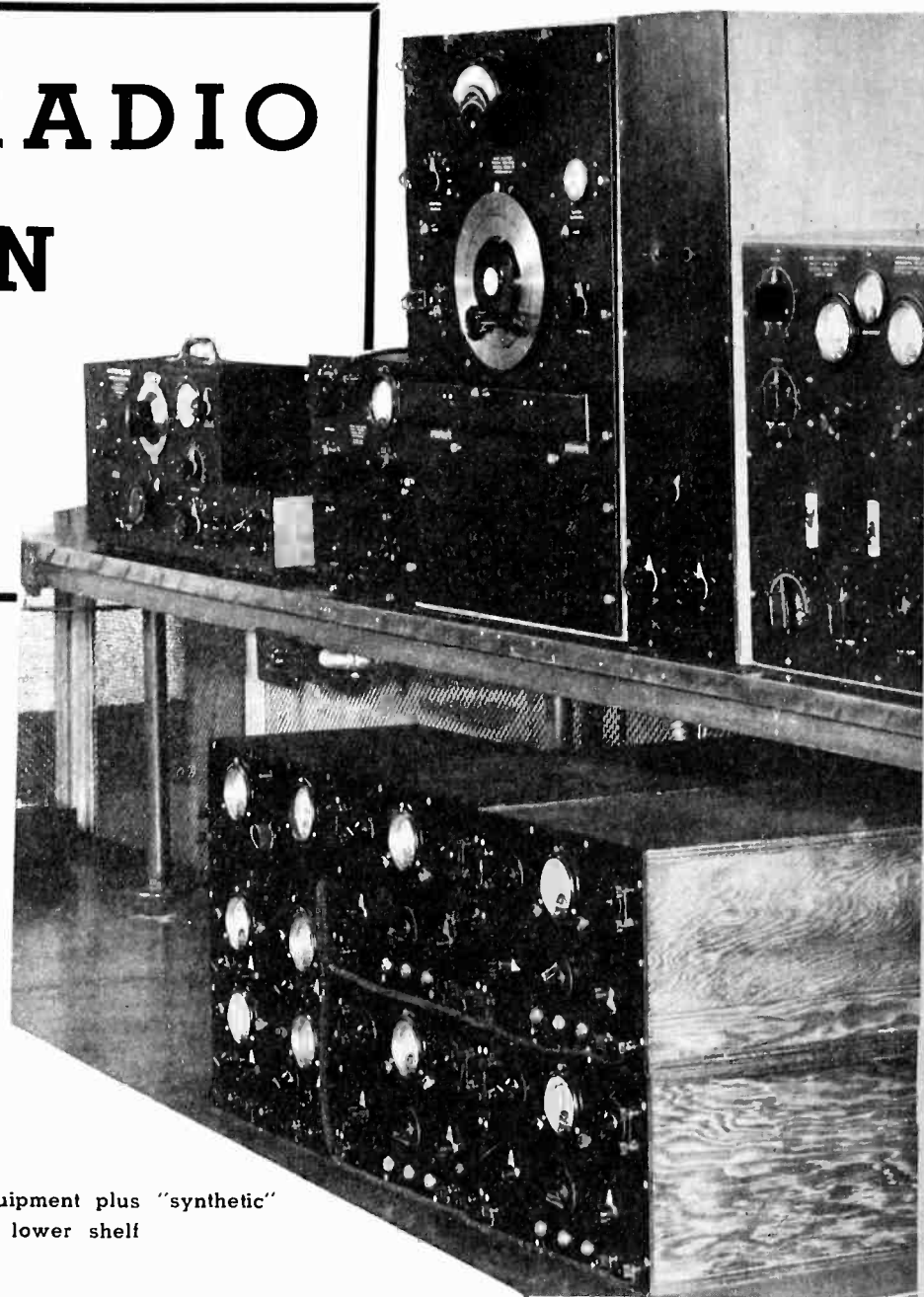

Measuring equipment plus "synthetic"
B batteries on lower shelf

FOR those living beyond the city mains, electrical power is expensive, by whatever means obtained, and it is therefore of more than usual importance that electrical devices for use in such homes be as economical in current consumption as is consistent with satisfactory performance.

In the case of battery operated radio receivers this economy of operation is doubly assured by an independent examination of such receivers from a battery service standpoint by the Research Laboratories of the National Carbon Company in cooperation with the set manufacturers. It is, of course, not within the province of these laboratories to design radio sets or any component parts, interest in receiver design being exclusively from the standpoint of increasing battery service. A similar cooperative service is available to the manufacturer of any dry battery powered device.

In the laboratory for radio set examination are synthetic "B" and "C" batteries to simulate actual "B" and "C" batteries in various states of discharge. (See lower shelf of photograph) The synthetic "B" batteries are made up of 6" dry cells with means for adjusting the voltage of each nominal $22\frac{1}{2}$ volt section through the range 24 to 12 volts.

The internal resistance of dry cells increases as they are discharged and in the case of "B" batteries becomes a significant factor when these are used down to relatively low voltages. When the synthetic "B" batteries are adjusted to give voltages lower than $22\frac{1}{2}$ volts per section, resistance is switched into the circuit to duplicate the internal resistance of a "B" battery which has fallen in voltage due to service. Where intermediate voltages are tapped off the "B" battery it is important that the equivalent internal resistance be distributed properly among the several "B" sections, rather than all lumped at one end.

The voltages per nominal $22\frac{1}{2}$ volt section of "B" battery at which radio receivers are usually tested and the

resistance added at each section to simulate the internal resistance of a "B" battery are as follows:

Voltage per Section of "B" Battery	Resistance Added to Simulate Int. Res. of "B" Battery
24	0
$22\frac{1}{2}$	0
20	10 ohms
17	50 ohms
15	110 ohms
12	250 ohms

These resistance values were obtained by the measurement of many different brands, types and sizes of batteries and are representative of the highest internal resistance values likely to be encountered with any batteries now on the market for "B" service. Obviously any receiver which will perform well under these

conditions will also perform well with batteries of lower internal resistance.

The receiver examination as it pertains to the "A", "B" and "C" circuits proceeds along the following lines:

"A" Circuit

Vacuum tube manufacturers recognize a working range of 2.2 to 1.8 volts for the 2 volt series of tubes. Most "A" sources have a voltage somewhat higher than 2.2 and it is necessary to provide series resistance to bring the voltage down to this value.

The correct series resistance to start the tubes off at 2.2 volts with a fresh Air Cell "A" battery may be obtained directly from Fig. 1 which takes into account the variation in initial voltage with different loads, shown in Fig. 2 and also the increased "A" current at the recommended filament starting voltage of 2.2 volts. Knowing the 2 volt current requirement for the tube complement to be used, the proper series resistance of the entire "A" supply circuit may be read directly from the curve in Fig. 1 and it is only necessary to subtract the resistance of the battery leads and wiring to obtain the proper value of the series resistor. This resistor may be permanently incorporated in the receiver wiring, since it never requires change or adjustment on account of the excellent voltage regulation of the Air Cell battery.

In sets equipped for dry "A" battery operation various arrangements have been used in an effort to flatten out the rather rapidly falling voltage characteristic which is inherent in dry cell "A" operation. Tapped resistors, the user to move a connection along on the resistor according to some usage schedule, ballast tubes and filament rheostats have all been used. Tapped resistors and rheostats are generally very unsatisfactory on account of the danger of filament overvoltage, and the natural tendency of the user to attempt to correct any subnormal operating condition by reducing this resistance. The ballast tube undoubtedly provides better average regulation but still leaves much to be desired.

Since most types of dry "A" batteries have an initial closed circuit voltage of 3.1 at loads within the

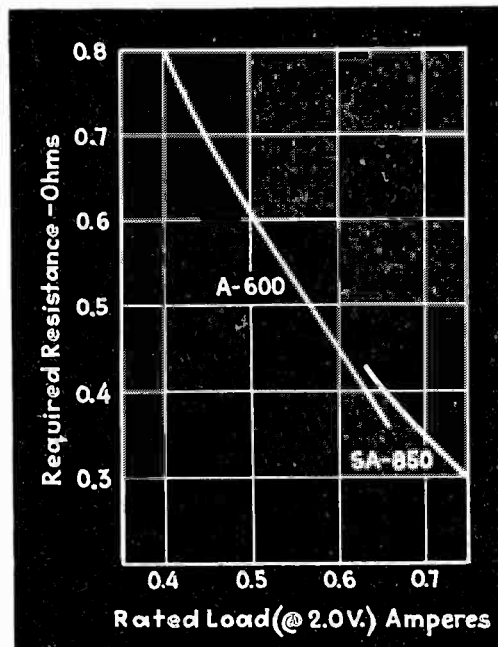

Fig. 1—Added resistance required, including leads, wiring and added series resistor as a function of rated load

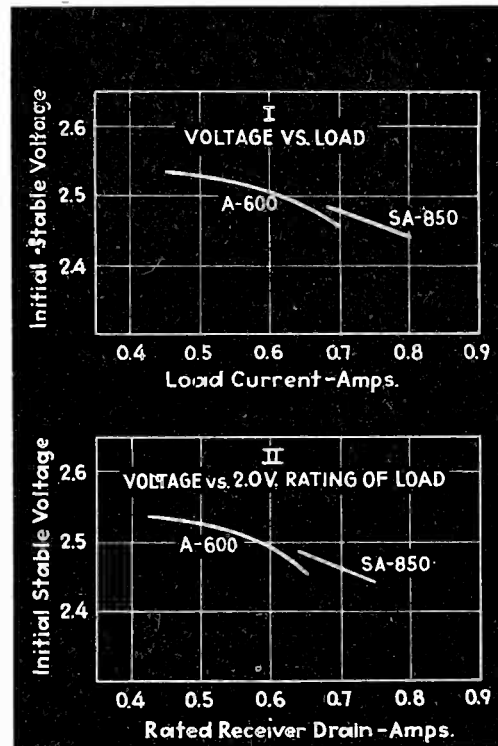

Fig. 2—Initial voltage characteristics of the Air-cell battery

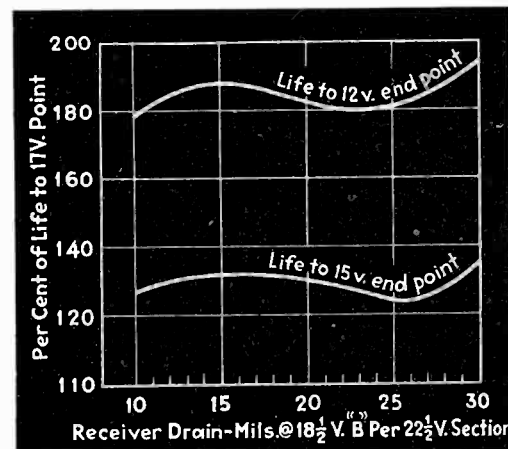

Fig. 3—B battery life to various end points. Heavy duty battery discharged 3 hours per day

range of present battery operated receivers, a series resistance having an IR drop of 0.9 volt must be provided to start the tubes off at the proper voltage.

"B" Circuit

In the early days of radio a "B" battery which had dropped below 17 volts per 22½ volt section, was considered to have reached the end of its useful life. With better tubes and, more particularly, with better batteries and improved receiver design, good performance was extended down to "B" voltages of 15 per section while for the past several years most receivers give acceptable performance down to 12 volts per "B" section with considerable increase in battery life as shown in Fig. 3.

Although most "B" batteries give increased service when used to the lower end points, the gain is greater in some brands than in others. From Fig. 4 it is seen that the brand giving the highest service to a 17 volt end point is in sixth place when used down to 12 volts, while the brand in sixth place to 17 volts moves up to first place at 12 volts. From this, it is apparent that the old-time 17 volt test information is worthless insofar as it aids the user of a modern battery operated receiver in estimating his "B" battery costs.

"C" Circuit

The successful use of "B" batteries to low end voltages is importantly related in almost all cases to some means of reducing the "C" voltage as the "B" voltage falls. For example, while a negative grid bias of 13½ volts is the proper value for a type 33 output tube when the "B" batteries are fresh and the plate voltage is 135 volts, it is much too high when the "B" voltage has fallen to 17 volts per 22½ volt section or to a total voltage of 102 volts and even more so when the "B" voltage has fallen to 12 volts per section or a total of 72 volts. Similarly, in the radio frequency stages, a rapid falling off in the sensitivity of the receiver will result as the plate voltage falls if a negative bias of 3 volts is maintained on the grids of the tubes throughout the life of the "B" batteries.

Unless some method of reducing the grid voltages to match the falling

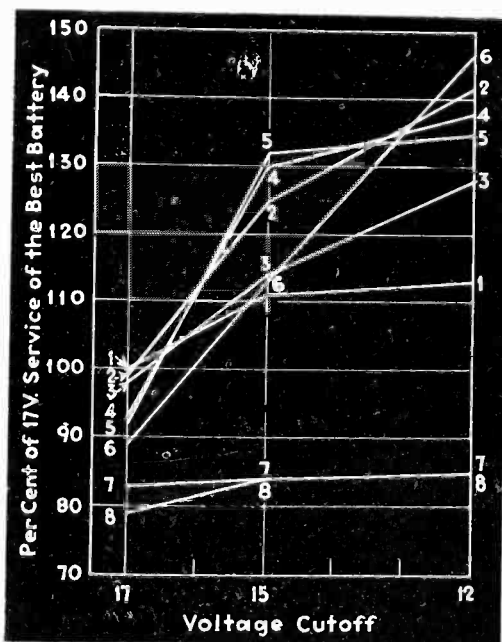

Fig. 4—Variation in service with voltage cut-off

plate voltage is employed, the end of useful life of the "B" batteries will be determined either by too great a loss in sensitivity, or by bad distortion of the received signals. The consumer is thus compelled to waste a considerable proportion of his investment in "B" batteries.

The principal methods of providing a satisfactory rate of reduction in grid voltage with falling plate voltage are: (A) intermittent discharge of the "C" batteries, and (B) self bias.

Where the bias voltage required is fairly high, say 16½ or 22½ volts, a "C" battery is preferable. With self bias, the highest "C" voltage used in the receiver is necessarily subtracted from the plate voltage of all the tubes and it is usually not economic to rob the "B" battery of voltages of this magnitude for bias purposes when a much smaller and lower priced battery is available.

The recommended method of reducing the bias with falling "B" voltage in the case of a separate "C" battery is by means of a bleeder resistor connected through a separate section of the on-off switch so as to impose a load on the "C" battery only during periods of set operation. A value of bleeder resistor is chosen such that the "C" battery will be reduced to 16 volts per 22½ volt section when the "B" battery has dropped to 12 volts per 22½ volt section.

The use of a 16 volt end point for the "C" battery is admittedly higher than the optimum value for tube op-

eration at the corresponding plate voltage, the reason for this choice being the necessity of achieving a satisfactory compromise with respect to battery life. If the "C" voltages are reduced too fast, the corresponding increase in total plate current as compared with that of the fixed bias system may actually result in a shorter "B" battery life than that obtainable under the latter system. In other words, it may require a shorter period of time for the receiver to discharge the "B" batteries completely under a falling bias system than would be required to discharge them partially to a higher voltage cut-off under a fixed bias system.

The recommended bleeder value is one which will give optimum economy when heavy duty "B" batteries are used. It is determined readily from Fig. 5 where receiver drain in milliamperes at a "B" voltage of 18½ per 22½ volt section with "C" voltage properly reduced is plotted against bleeder resistance in ohms per volt of "C" battery. For example, a set taking 15 milliamperes at 18½ volts per "B" section would require a "C" bleeder of 600 ohms per "C" volt or 9900 ohms for a "C" battery of 16½ volts.

At relatively low "C" voltages, self biasing becomes attractive and has much to recommend it, principally the following:

A. Improved performance at very low "B" voltages.

B. Reduced cost. Although a bias resistor must be added to the set, the following are eliminated: bleeder resistor, "C" battery cable and plug,

"C" battery, and one set of contacts on the on-off switch.

C. Correct "C" reduction at all "B" voltages, regardless of the size batteries used. Where receivers are to be used interchangeably for portable or permanent connection and therefore will be used with widely different sizes of "B" batteries, self biasing offers an excellent solution to the biasing problem. For maximum portability the set may be equipped with two "B" batteries while for optimum performance three may be used, the biasing voltage taking care of itself automatically. This, it would seem, is a step toward making battery operation as attractive as possible.

The use of some form of "C" voltage reduction has become almost universal, largely due to the activities of the National Carbon Company's Research Laboratories. In 1931 when cooperation with battery set manufacturers was first actively undertaken, 72 per cent of the receivers examined had no provision for reducing the "C" voltage as the "B" battery discharged. Last year 78 per cent of the sets used "C reduction".

In many cases improvements in performance and battery life have resulted from recommendations made on the basis of this independent test of battery operated receivers. The goal has been the maximum battery economy consistent with satisfactory performance and the tremendous increase in sales of battery operated receivers over the past six years would indicate that battery power is indeed giving satisfaction.

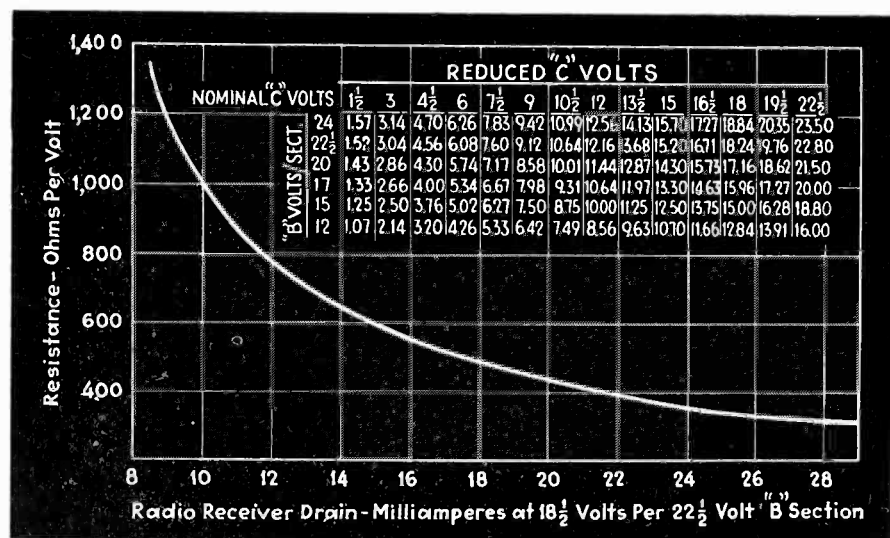

Fig. 5—Intermittent "C" battery discharge resistance vs radio receiver drain. Drain measured at "B" voltage of 18½ per 22½ volt section and with the "C" voltages reduced

REVERBERATION CONTROL in Motion Picture Recording

By JOHN K. HILLIARD
Studios of M-G-M Corp.
Culver City, Calif.

FOR some time past, it has been found desirable to increase the reverberation in an original sound track through the medium of re-recording. During the earlier years, this was accomplished by using staggered or offset tracks which were lined up a few frames apart and then mixed together to secure the desired effect. Attempts were also made to use loud speaker systems in highly reverberent echo chambers and then combine the pickup from them along with the original in varying degrees. This system has been used to effect varying degrees of "presence" in playbacks, depending upon the picture cut, to gain proper perspective. However when a large percentage of the track was taken from the echo chamber, it did not maintain the high degree of quality required, due to the deficiencies in the type of loud speakers available. Although this method has been attempted at various times during the last few years, it has not served as a reliable tool to the dubbing department for this reason.

Since the adoption of the current two-way loud speakers systems, it has been found practical to rerecord a sound track acoustically. When this track is compared back to back* with the original, the distortion introduced is a second order effect, often times not detectable. This improvement has made it very practical to add reverberation in rerecording with the addition of an echo chamber without loss of the frequency characteristic of the original recording.

This setup consists in splitting the

mixer in two banks. One bank is for control of those tracks which are intended to have reverberation added. The output of this bank is then split in two paths with isolation amplifiers. One path is directed into the echo chamber, the pickup from which then appears on one position of the second mixer bank. The output of the second path of the first mixer bank appears also on the second bank. In this manner, the sound entering the echo chamber is pre-mixed and later combined with the original track to complete the desired illusion with the picture in terms of perspective.

The echo chamber in which the horn and microphone are placed, may be a room of approximately 10,000 cu. ft. volume, having a relatively

long reverberation time. Experience in this studio indicates that a reverberation time of approximately 5 seconds will be ample to give any desired effect. This time period is accomplished by lining the walls with a glazed hard surface material of considerable weight; sheet rock or hard surfaced masonite covered with a hard paint has been found to be very practical. The floor may be painted wood or cement. To obtain a flexible system of operation, so that more than one sound track may be passed through the chamber, it is necessary to pre-mix the portion which is to have reverberation added.

* "Back to back" is a studio term for the direct comparison of two or more sound tracks simultaneously on interlocked sound projection machines.

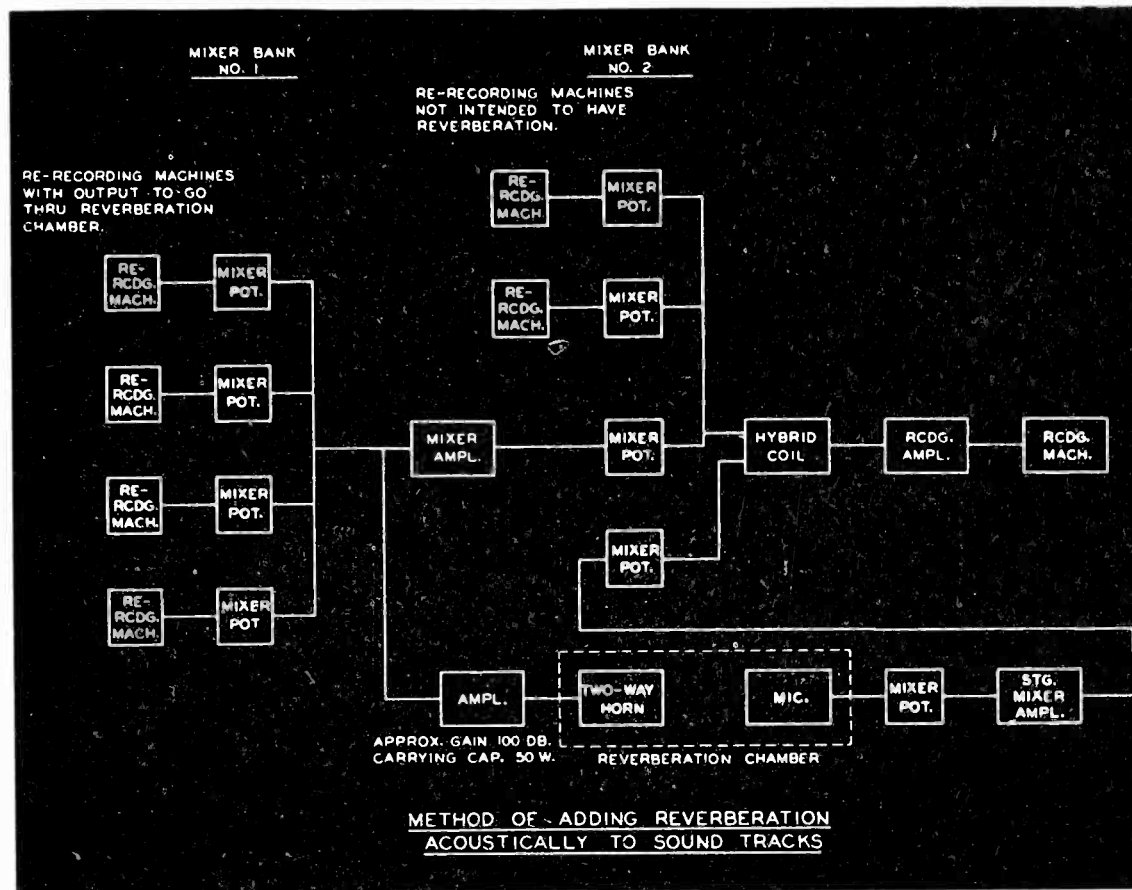

Block diagram of equipment used in acoustic reverberation control

WIDE-BAND TELEVISION AMPLIFIERS

By F. ALTON EVEREST

Oregon State College

Elementary theory, with examples, for extending the upper frequency range of video-frequency amplifiers

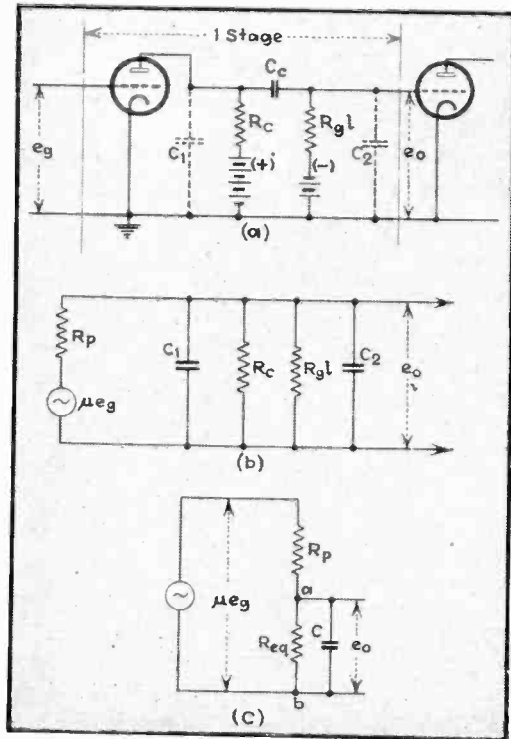

Fig. 1—Actual and equivalent circuits of RC-coupled amplifier

THE introduction of 441-line television images as suggested by the recent R.M.A. standards will place new demands on "video" amplifiers. These amplifiers are now used both in the amplification of the transmitting scanning-equipment impulses until a magnitude sufficient to modulate the carrier is obtained, and in the amplification of the received signal after demodulation until an amplitude sufficient to vary the electron density of the beam in the cathode-ray tube to follow the transmitted signal is attained.

At the present state of the television art, it seems highly probable that the newly developed electron-multipliers will, in time, supplant the old standby, the resistance-capacitance coupled amplifier. The tremendous gains attainable at very low noise levels with the electron-multiplier tubes will undoubtedly lead to their universal adoption for all but perhaps the output stages. However, the resistance-capacitance coupled amplifier has served long and well and, with a few minor compensations, is fully able to serve until such time

that it is outmoded by new developments. It is the purpose of this paper to present a brief summary of the methods by which satisfactory amplification of the high frequency components characterizing high-definition television can be attained.

The circuit of the simple resistance-capacitance coupled amplifier is shown in Fig. 1-a. The equivalent circuit to which this can be resolved for the high frequencies is shown in Fig. 1-b. The input signal voltage, e_g , in the grid circuit acts exactly like a voltage of μe_g acting in the plate circuit in series with the internal resistance (the plate resistance R_p) of the tube. At the higher frequencies the reactance of the coupling condenser C_c is negligible and is effectively short-circuited. The capacitance C_1 and C_2 are, respectively, the output capacitance of the first tube, and the input capacitance of the second, plus the stray wiring capacitance which can be minimized but not

eliminated. The plate coupling resistor, R_c , and the grid leak resistor, R_{gl} are in parallel and may be replaced by an equivalent resistor, R_{eq} , where

$$R_{eq} = \frac{R_p R_{gl}}{R_p + R_{gl}}$$

By combining the parallel capacitances C_1 and C_2 by addition to form the equivalent capacitance, C , Fig. 1-b can be further simplified to that of Fig. 1-c. Here we see that the voltage μe_g is impressed across R_p and R_{eq} in series, the output voltage being taken from across R_{eq} . At the higher frequencies, the reactance of the shunt capacitance represented by C decreases, lowering the impedance across the terminals a-b and thereby lowering the percentage of the voltage μe_g which will appear across terminals a-b as the output voltage e_o . As the stage gain is equal to $\frac{e_o}{e_g}$, it is evident that the

Fig. 2—Gain-frequency response of a typical RC-coupled amplifier, showing effect of plate-coupling resistor in extending range at expense of gain

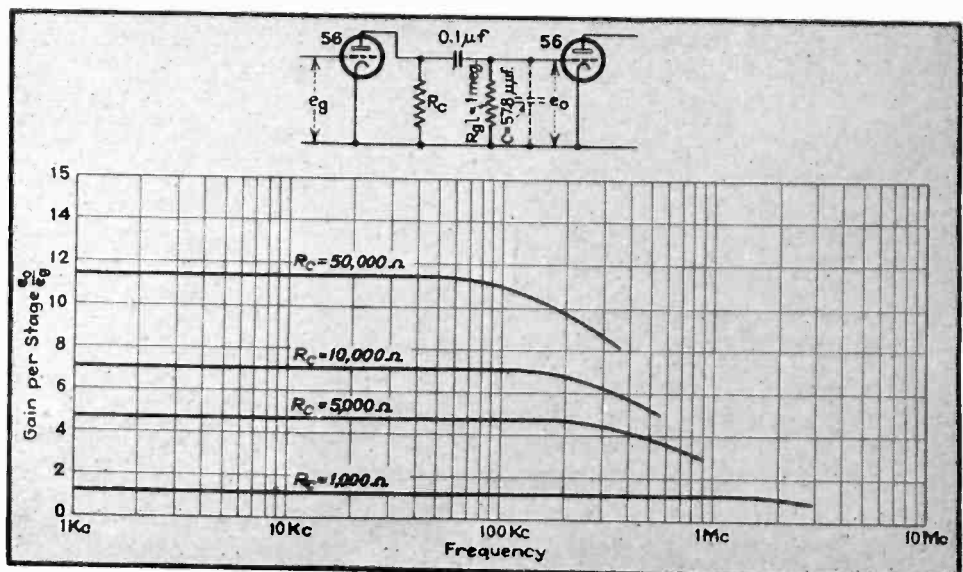

gain decreases as the frequency is increased, all other things being equal.

Minimizing the Shunting Effect

The first step in extending the high frequency range of the RC coupled amplifier is then that of minimizing the shunting effect of the capacitance C . If the value of R_{g1} is

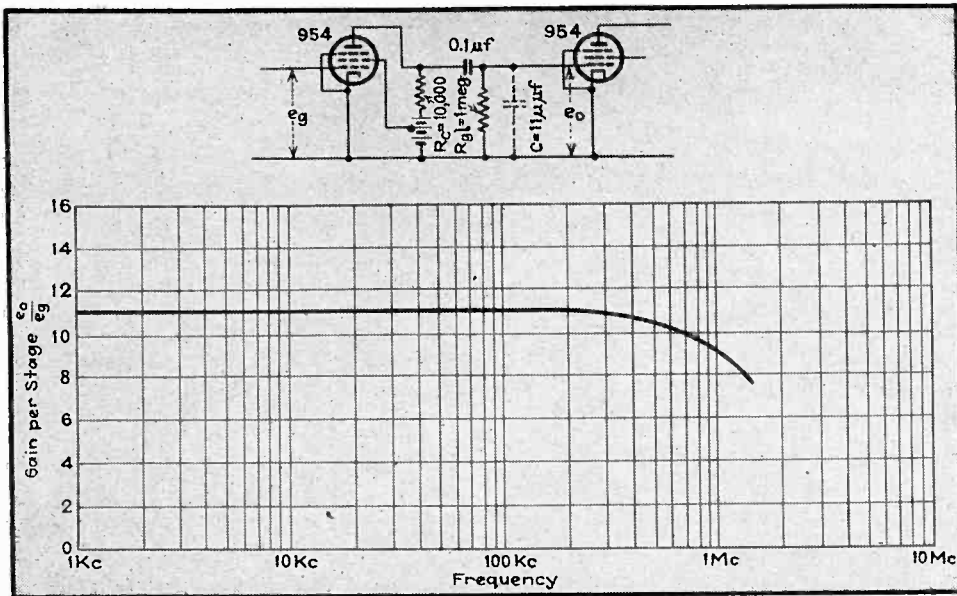

Fig. 3—Improved gain at high frequencies results from the use of acorn pentode tubes with low shunting capacities

chosen to be high in comparison with R_c , as it would be in practice, the value of R_c for a given shunting capacitance would largely determine the impedance across the terminals a-b. For high values of R_c , the equivalent impedance across a-b would be high resulting in a high stage gain, but the shunting effect of C would come into play at a lower frequency causing a narrow pass band. Figure 2 illustrates this point by means of calculated responses for a typical triode RC coupled amplifier using a type 56 tube working into a similar stage. The value of R_{g1} was kept constant at 1 megohm and the value of R_c varied from 50,000 ohms to 1,000 ohms. It is evident that, if one is satisfied with a stage gain of unity (in other words no net amplification), frequencies up to 2 Mc. can be passed with essentially the same response. A gain of 11 per stage can be easily attained if uniform response up to 100 Kc. is satisfactory. It is obvious, then, that for a given value of shunt capacitance, the selection of the value of coupling resistance

hinges upon a compromise between gain and high frequency response.

The curves of Fig. 2 were calculated from the expression:

$$\text{Stage Gain} = (\text{Max. Amplification}) \left[\frac{1}{\sqrt{1 + \left(\frac{R}{X_c}\right)^2}} \right]$$

in which:

$$\text{Max. Amp} = (\mu \text{ of tube}) \left[\frac{R_{oq}}{R_{oq} - R_p} \right]$$

signed amplifier, or value of C becomes:

$$C = 5 + 2.2 + 3.2 + 3.2(1 + 13.8)$$

$$C = 57.8 \mu\mu\text{f}$$

The last term, sometimes called the "Miller effect" causes the total shunting capacitance to be very large. This value of e was used in the calculation of the curves of Fig. 2.

Another possible way to minimize the shunting effect other than to lower A in (1) is to lower the value of the grid-plate capacitance. The screen grid accomplishes this by the introduction of the shielding screen between the grid and plate, the other interelectrode capacitances remaining essentially the same. This shielding effect, referring to Fig. 1-c, also increases the μ of the tube and the plate resistance, but in such proportions that little net gain can be expected from this effect. The mutual conductance is an excellent factor of merit in this respect and can be seen to vary only a little between the 954 and the 56.

A judicious choice among the available tubes may lead one to try the acorn pentode, Type 954, whose characteristics at normal voltages are:

$$R_p = 1 \text{ megohm} \quad C_{g-p} = 0.007 \mu\mu\text{f}$$

$$\mu = 1100 \quad C_{g-k} = 3 \mu\mu\text{f}$$

$$G_m = 1100 \text{ micromhos} \quad C_{p-k} = 3 \mu\mu\text{f}$$

$$C = 5 + 3 + 3 + 0.007(1 + 10)$$

$$C = 11 \mu\mu\text{f}$$

A value of A is here assumed to be 10, but it is obvious that it could be 100 without affecting seriously the total value of C . A comparison of the value of C of $11 \mu\mu\text{f}$ for the pentode with $57.8 \mu\mu\text{f}$ for the triode will indicate an advance toward the goal of a substantial amplification at several megacycles. Using a value of R_{g1} as 1 megohm, R_p as 10,000 ohms,

$$\text{where } R_{oq} = \frac{R_c R_{g1}}{R_c + R_{g1}}$$

R = Equivalent resistance of R_c , R_p , and R_{g1} in parallel.

X_c = Reactance of the total shunt

$$\text{cap.} = \frac{1}{2\pi fC}$$

From the tube manual we find the following characteristics listed for the type 56 tube:

$$R_p = 9500 \text{ ohms} \quad C_{g-k} = 3.2 \mu\mu\text{f}$$

$$\mu = 13.8 \quad C_{g-p} = 3.2 \mu\mu\text{f}$$

$$G_m = 1450 \text{ } \mu\text{mhos} \quad C_{p-k} = 2.2 \mu\mu\text{f}$$

The total shunting capacitance is not the simple sum of the interelectrode and the stray capacitances, but rather:⁽⁶⁾

$$C = C_s + C_{p-k} + C_{g-k} + C_{g-p}(1 + A) \quad (1)$$

where

C = total shunt capacitance, $\mu\mu\text{f}$

C_s = stray wiring capacitance, $\mu\mu\text{f}$

C_{p-k} = plate-cathode cap of stage under consideration, $\mu\mu\text{f}$

C_{g-k} = grid-cathode capacitance of output tube, $\mu\mu\text{f}$

C_{g-p} = grid-plate capacitance of output tube, $\mu\mu\text{f}$

A = a factor never exceeding the amplification factor of the tube, equal in value to the actual amplification of the output stage. A pessimistic value for A for triodes may be taken as the μ of the output tube. For screen-grid tubes, an estimate of stage gain is sufficient.

Assuming $5 \mu\text{f}$ capacitance for stray wiring capacitance of a carefully de-

Fig. 4—Equivalent circuit containing inductance in plate coupling impedance

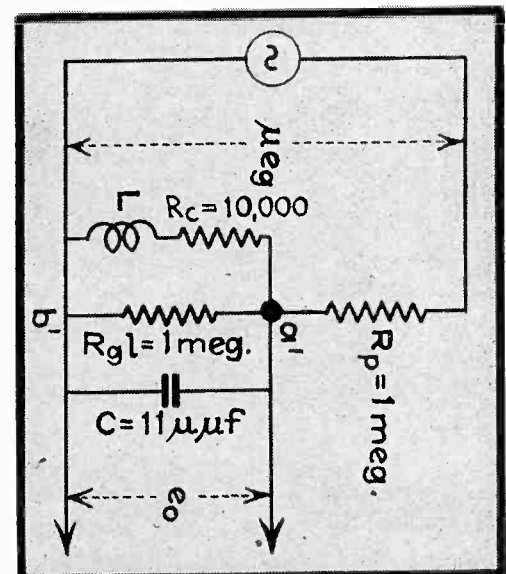

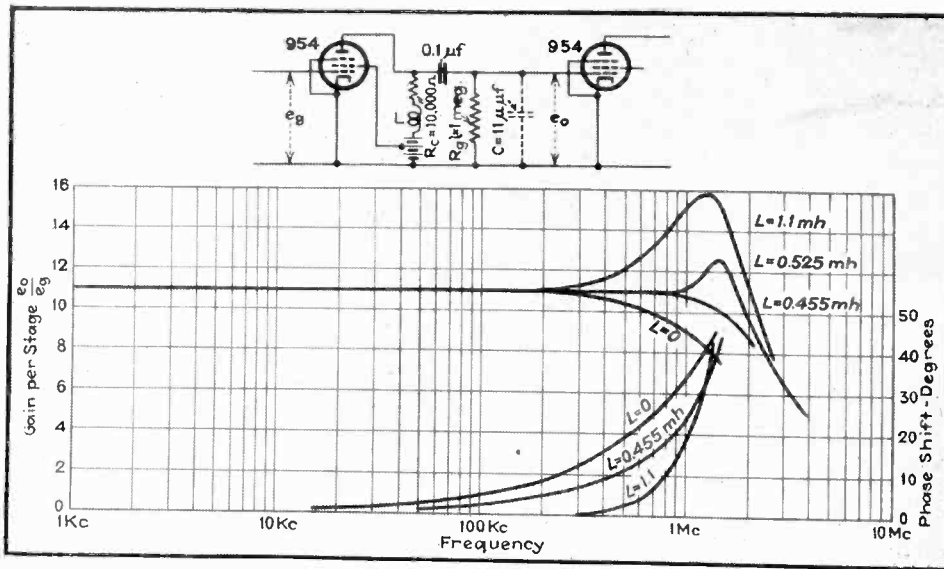

Fig. 5—Gain-frequency response curve for two acorn pentodes operated with resistance and inductance in plate circuit, the inductance resonating with the shunt capacitance to produce higher output at high frequencies

a stage gain of about 11 is realized which is down only about 20 per cent at 1 megacycle. For the high definition images that will be demanded by the public, however, this amplifier is still inadequate.

Neutralization of Shunting Capacitances

One of the most popular methods of extension of the frequency range of the above type of RC coupled amplifier has been the neutralization of the capacitive reactance of the shunting capacitance by means of the introduction of small amounts of inductance in series with the coupling resistor R_c . This actually forms a parallel resonant circuit whose resonant frequency is considerably higher than the highest frequency it is desired to amplify. The impedance across the terminals of a parallel resonant circuit is maximum at its resonant frequency. The absolute value of this maximum is determined largely by the resistance in the circuit, being infinitely large at zero resistance. The equivalent circuit of the amplifier of Fig. 3 with an inductance L inserted is shown in Fig. 4. Resulting response curves for different values of inductance are shown in Fig. 5. It will be noted for the curve for $L=1.1$ mh. that the impedance across the terminals $a'-b'$ (Fig. 4) has actually exceeded the value existing at middle-frequency points in such a way that a greater proportion of the voltage μe appears across $a'-b'$ as e_o . The inductance

value of $L=1.1$ mh is, then, more than enough just to neutralize the shunting effects of the capacitance C , in fact the parallel impedance of $L-C$ actually causes the stage gain to increase at the frequencies in the neighborhood of 1.25 Mc. This characteristic may be utilized to compensate for the drooping characteristics of other parts of the system. Care must be exercised, however, to guard against a succession of similar stages building up this peak to such an extent that the amplifier oscillates at this high frequency.

The actual calculation of the response of amplifiers of the type

shown in Fig. 4 is perfectly straightforward, but somewhat laborious. To find the proportion of the voltage μe_g appearing across $a'-b'$ as e_o , the equivalent impedance $Z_{a'-b'}$ must be found for that particular frequency. The stage gain is then

$$\frac{e_o}{e_g} = \mu \frac{Z_{a'-b'}}{R_p + Z_{a'-b'}}$$

The impedance $Z_{a'-b'}$ can be evaluated by means of elementary complex algebra for each frequency for which the gain is desired. Prepared graphs of the type prepared by Robinson² are helpful if much of this work is to be done.

By means of this type of amplifier frequency compensation, moderate stage gains are attainable to 2 Mc. and amplifications down only approximately 50 per cent at 3 Mc. are easily obtained. At the present state of the art a 3 Mc. band seems to be adequate.

Filter Coupled Amplifier

To understand the operation of this method of coupling which has been suggested in Europe³, it is necessary to examine a few of the phenomena surrounding the action of the π -section low pass filter. A diagram of this type of filter is shown in Fig. 6, familiar to everyone dealing with communication circuits. In the more usual applications, the impedance Z_1 is made equal to Z_2 and both equal to Z_o , the characteristic

Fig. 6—Equivalent circuit and response characteristics of the "filter-coupled" type of stage. With a given filter network, the ratio of driving impedance to load impedance determines the high frequency response

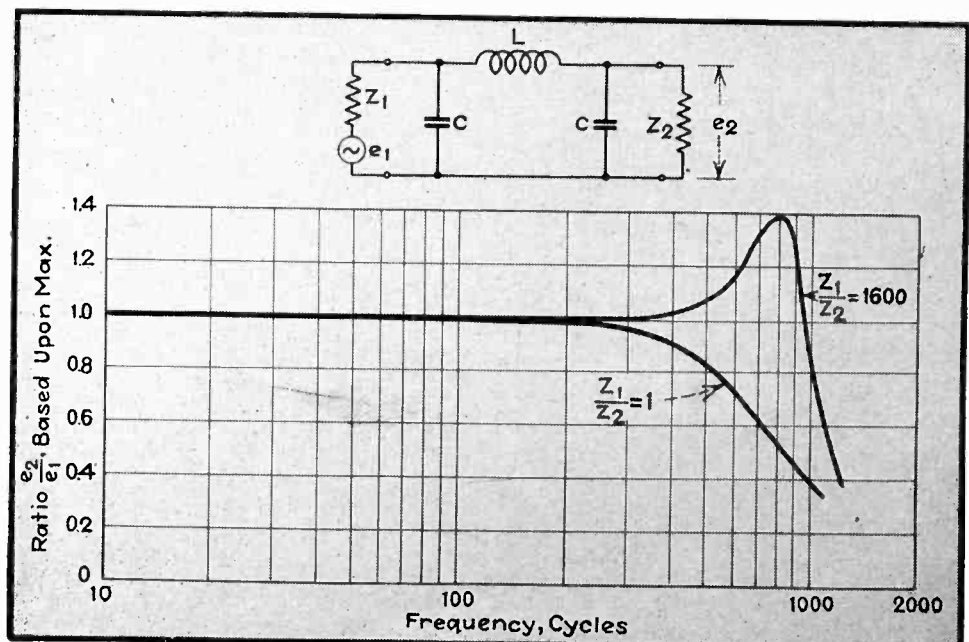

impedance of the filter, where

$$Z_o = \sqrt{\frac{L}{2C}}$$

When this condition exists, the relation of $\frac{e_2}{e_1}$ is a drooping characteristic of the type shown for $\frac{Z_1}{Z_2}$ in

Fig. 6. In telephone circuits, where multiple reflections can cause great damage, this is the condition used. Consequently, since the telephone interests have developed most of the filter theory, what happens under mismatch conditions is not widely known. If the input impedance Z_1 is made large compared to Z_2 , the ratio of $\frac{e_2}{e_1}$ has a rising characteristic as shown for the curve for $\frac{Z_1}{Z_2} = 1600$ in Fig. 6. These curves were plotted from measurements actually obtained from a low-pass filter section whose cut-off frequency is 1000 cycles. It is evident that by a proper adjustment of $\frac{Z_1}{Z_2}$, the ratio $\frac{e_2}{e_1}$ can be kept essentially constant to the region of the cut-off frequency.

Equivalent circuits for filter-coupling

Referring to Fig. 7-A it is seen that if an inductance L were placed between C_1 and C_2 , the two tubes would be coupled by a low pass filter of the type shown in Fig. 6. The coupling condenser C_c , as it is in series, could be omitted for it is essentially a short circuit at the frequencies in question. The circuit in Fig. 7-a can be resolved to its equivalent, Fig. 7-b. The capacitances C_1 and C_2 can be measured or closely estimated, and if not equal can be made so with small trimmers. By proper selection of inductance L and resistances R_{g1} and R_c , frequency-gain characteristics similar to those of Fig. 5 can be obtained. The stage gain and the location of the peak depend largely upon the selection of the cutoff frequency, f_c .

Steps in the design of a filter coupled RC amplifier will be given. The first step is to ascertain the values of C_1 and C_2 —they may be estimated quite closely by those familiar with these circuits. The only capacitance really in doubt is the stray wiring capacitance, for the tube capacitances are listed with their characteristics. Decide upon

a value for cutoff frequency, f_c , which is 2 to 10 times the maximum frequency desired. The further f_c is from this maximum frequency, the lower and flatter will be the response curve. After deciding upon f_c , calculate L from:

$$L = \frac{1}{2C} \sqrt{\frac{1}{\pi f_c}}$$

where

- $C = C_1 = C_2$ in farads
- $f =$ cutoff frequency in cycles per sec.
- $L =$ inductance in henrys.

The value of R_{g1} is then obtained from:

$$R_{g1} = Z_o = \sqrt{\frac{L}{2C}}$$

At intermediate frequencies the gain

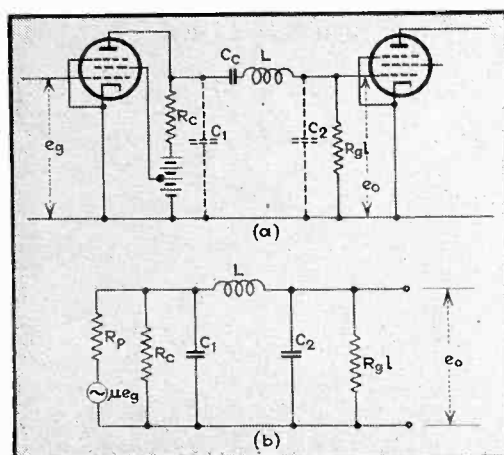

Fig. 7—Analysis of filter-coupling theory applied to a typical video stage

will be approximately:

$$\text{Gain} = G_m R_{g1}$$

where

- $G_m =$ mutual conductance in ohms
- $R_{g1} =$ grid leak resistance in ohms

The variation of L , R_{g1} and Gain per stage with f_c for two values of $C = C_1 = C_2$ is shown in Table I.

TABLE I

f M.	$C_1 = C_2 = C$ $\mu\text{mf.}$	L inh.	R ohms.	Approx. stage gain at intermediate freq. for $G_m = 1100$ micromhos
2	6	2.105	13,220	14.5
3	6	0.935	8,830	9.7
4	6	0.526	6,620	7.3
6	6	0.234	4,410	4.9
8	6	0.132	3,320	3.7
4	12	0.262	3,320	3.7
6	12	0.117	2,200	2.4
8	12	0.066	1,650	1.8

One of the most surprising things in the design of this type of coupling is the low value of grid leak resistance. It must be remembered, however, that the filter is designed so that this resistance value is equal to the characteristic impedance of the filter. On

the input side the equivalent resistance of R_c and R_p is chosen to be very much higher than this characteristic impedance, resulting in the rising characteristic of the curves for $\frac{e_2}{e_1}$ as shown in Figure 6.

Phase Shift

The phase shift accompanying the amplification of a signal may assume important proportions. While a 45-degree phase shift at the low frequency end of the band of frequencies taken to transmit a high definition image may be very serious (a condition which will not be elaborated upon in this paper), the same shift at higher frequencies may not be serious.

The effect of phase shift is merely a displacement of a picture element from its correct position. The magnitude of the displacement may or may not be visible to the eye. For a 300-line, 24-frame image received on a screen 10 inches wide, a 45 degree phase shift would result in a detail of the picture represented by this frequency being displaced about 0.009 inch from its proper position. Under ordinary circumstances this phase shift would undoubtedly be unimportant at the higher frequencies.

The phase shift introduced by the inductance placed in series with the coupling resistor is shown plotted against frequency in Figure 5. If phase shift is an important consideration as it might be in certain oscillograph amplifiers, it can be minimized² by proper selection of L . The phase shifts in the filter coupled amplifier are of the same order of magnitude as those shown in Fig. 5.

REFERENCES

- (1) Lane: "The Resistance-Capacity Coupled Amplifier in Television." *Proc. I. R. E.*, April 1932, p 722
- (2) Robinson: "Theoretical Notes On Certain Features of Television Receiving Circuits." *Proc. I. R. E.*, June, 1933, p 833
- (3) Beardsall: "Valve Couplings for Television Frequencies." *Television and Short Wave World* (London), Feb. 1936, p 95
- (4) Walker: "The Design of High-Definition Amplifiers." *Television and Short Wave World*, May 1936, p 305
- (5) Nagy: "The Design of Vision-Frequency Amplifiers." *Television and Short Wave World*, March 1937, p 160
- (6) Terman: "Radio Engineering" — McGraw Hill
- (7) Builder: "The Amplification of Transients." *The Wireless Engineer and Experimental Wireless*, May 1935, p 246 (See also reference 8)
- (8) Smith: "Amplification Of Transients." *The Wireless Engineer and Experimental Wireless*, June 1933, p 296
- (9) Oakey: "The Distortionless Amplification of Electrical Transients." *The Wireless Engineer and Experimental Wireless*, May, 1931, p 245.

X-Ray Tubes for Industry

THE modern tendency in constructional engineering is to obtain a maximum capacity with a minimum of expense. The need for apparatus to control the quality of material and workmanship in these structures is imperative. X-Rays provide a means to examine the finished product without destroying or harming it in the least. In fact, they provide a non-destructive test which will prove the soundness of the material beyond any doubt or determine flaws which can be located and eliminated readily. It is possible to examine any material by this method. The penetrating power of the rays depends upon the atomic weight of the material and on the wave-length of the radiation used. The thickness of the substance, of course, is another important factor.

There are certain other factors which determine the quality of the resulting exograph. Thus it is desirable to have an approximately point source of radiation to obtain fine details of the shadows. Contrast and definition are greatly added by eliminating scattered radiation which is caused by rays of undesirable wave-length. The last factor is the developing technique of the exposed film.

X-radiation is generated in a highly evacuated tube by cathode rays bombarding the anode. An exograph is the central projection of the examined object which is between the tube and the film. The maximum efficiency is dependent on the wave-length. By increasing the high-voltage at the tube the wave-length is shortened and a correspond-

ing increase in penetrating power is obtained. A definite blackening of the film is desired and therefore the bundle of rays must be uniform in quality. Since x-rays cannot be concentrated by means of lenses as is possible with light rays, the focus, (the area of the anode from which the rays emerge) must be kept as small as possible, since any increase in area causes blurring in the definition on the film.

Special tubes for industrial radiography are being made now which have the added advantage of an electron filter to eliminate scattered radiation as much as possible. These tubes are of compact design, completely x-ray- and shock-proof. The target is water-cooled and the tube may be connected with the high-voltage transformer by shock-proof cables up to 30 feet long.

As a result of the limited specific load capacity of the anode material the size of the effective focal area must increase in proportion to the tube load. There was an astonishingly simple way of giving the focal spot the appearance of a rectangle, instead of the more usual ellipse. Further, it was found necessary to place the anode at 71° with the horizontal axis of the tube, instead of the usual 45° . This change in the orientation of the anode is permissible since the emission of rays is uniform at an angle of 50° on both sides. The apparent dimensions of the focal spot as seen from the direction of the central beam are those of a square, as the focus is turned with its short side to the observer. Added to the advantage of larger focal area comes the advantage of a better heat dissipation, as the area of a rectangle is larger than the area of a square of equal width. Figure 2 illustrates diagrammatically the Goetze "line" focus.

A further improvement is the metal discharge chamber, which makes the tube self-protective in that it absorbs scatter and secondary radiation at the source. This is an important feature for industrial radiography where often fairly long exposures are required. This has

X-ray apparatus on the job, inspecting welded joints in pressure piping

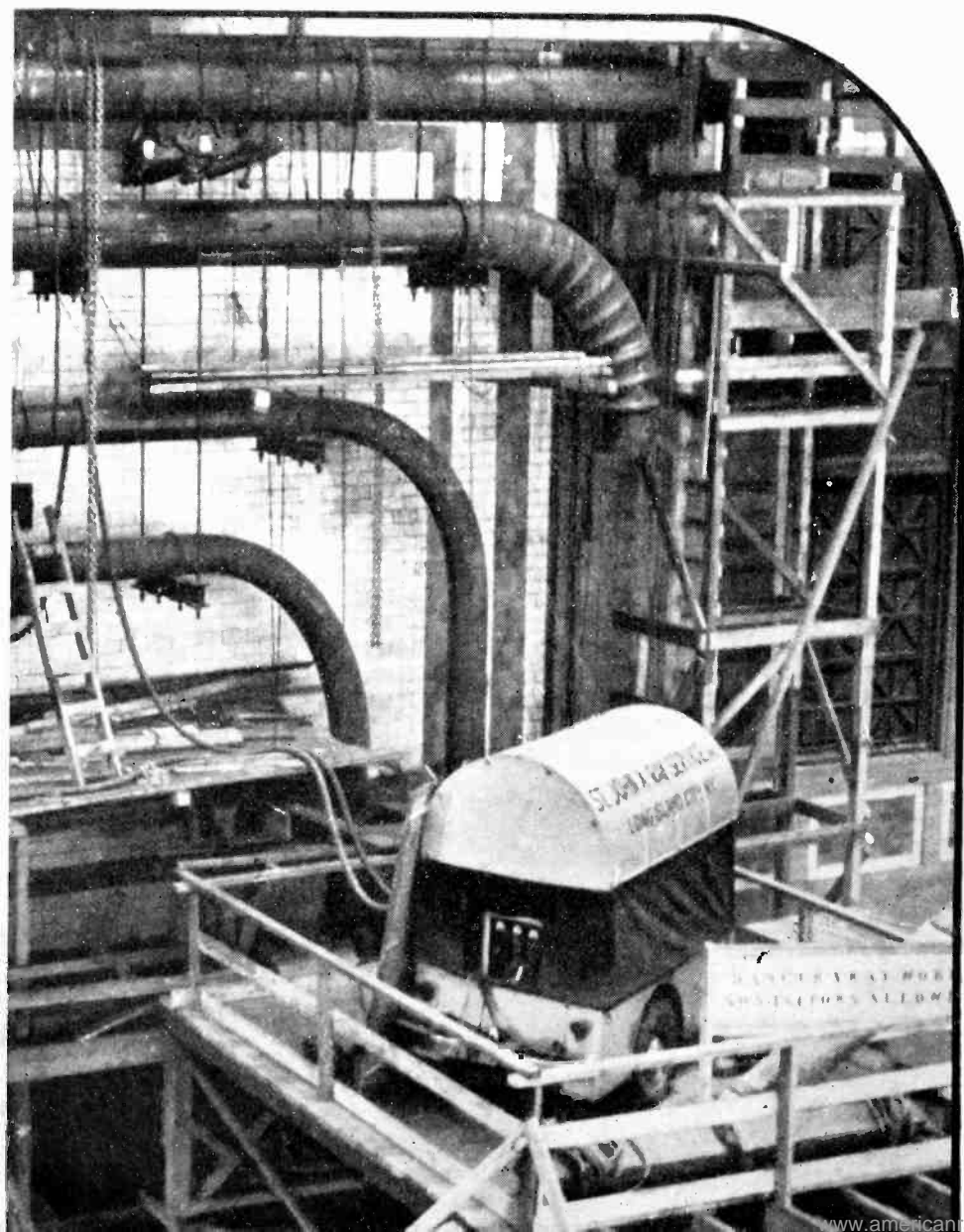

HERBERT R. ISENBURGER,
 President, St. John X-Ray Service, Inc.
 Long Island City, N. Y.

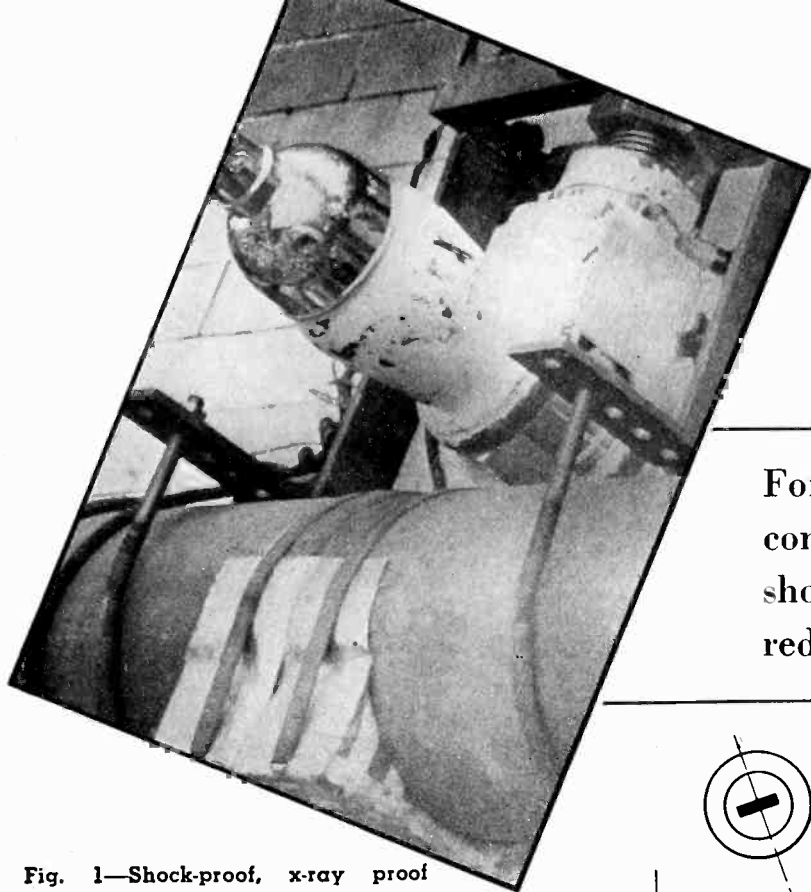

Fig. 1—Shock-proof, x-ray proof tube in situ

been obtained by constructing the discharge chamber entirely of metal and sealing this direct to a glass cylinder which encloses anode and cathode. A grounded metal shield houses the tube and permits its use for field inspection.

Electron Grid

The use of an electron filter in this tube operating on pulsating potential circuits¹ makes it possible to obtain the same x-ray output as is obtainable on constant potential. In tubes with grids, x-rays are generated near the vicinity of the crest of the voltage curve, and therefore, not only is the x-ray output almost as large as on constant potential but the half value layer is larger than that obtained with tubes of conventional design operated on pulsating potential. Figure 3A illustrates the principle of grid action. A small transformer and a condenser are used to obtain a pulsating potential which with respect to the cathode of the x-ray tube is positive only when the voltage across the tube is at its maximum.

As long as the potential of the grid is negative with respect to the cathode, electrons cannot pass from the cathode to the anode since the negatively charged potential repels them. When the grid is positive with respect to the cathode, the grid will not only allow passage of electrons but will favor it. Thus, a

¹St. John and Isenburger. "Industrial Radiography," 1934. John Wiley & Sons, New York. pp. 60-69.

For industrial applications, x-ray tubes should be compact; the operator should be protected against shock and radiation; Scattered radiation should be reduced as much as possible

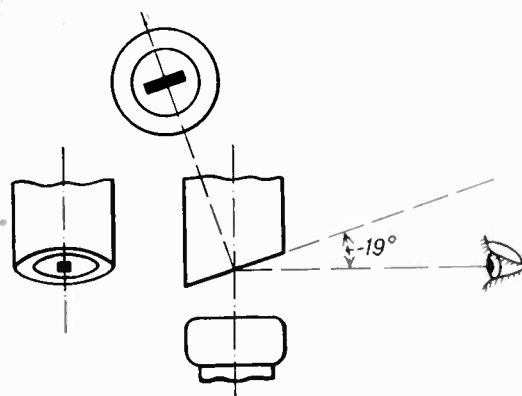

Fig. 2—Goetze "line" focus arrangement

high x-ray output with a high half value layer is produced.

Figure 3B shows the circuit diagram of the grid unit which is housed in the cable end-spheres of shock-proof tubes. The type of filament control may influence the efficiency of a grid tube. If the filament current is not adjusted by means of an ohmic resistance but by means of a choke, a phase displacement will occur between the high voltage and the filament voltage. With such a displacement, the maximum tube current will not flow when the tube voltage is maximum and, as a result, the production of x-rays will take place at lower values of the voltage curve. A very large phase displacement may result in an appreciable reduction of x-ray output of the tube. In those cases where a choke for filament control is employed, it may be necessary to substitute a resistance control.

The features of this new tube described above are of utmost importance to the industrial radiologist. They have increased the efficiency of his work one third. That is, where he used to employ a voltage of 300 kv. only 200 kv. are required with a grid tube. It is rated for continuous operation at 10 ma. and 220 kv. Another interesting feature is the cooling system. Water is forced by a pump through the anode cable. It circulates through the anode stem back through the same cable to the pump where it is cooled by a fan and recirculated through a system of hoses. Due to these features modern industrial x-ray equipment can be designed very compact and rigidly built, thus making it possible to take the apparatus to the material to be inspected.

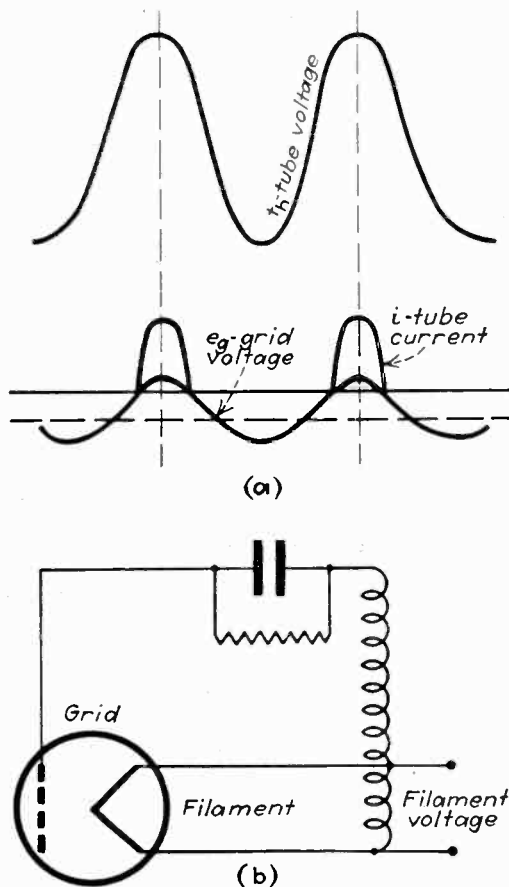
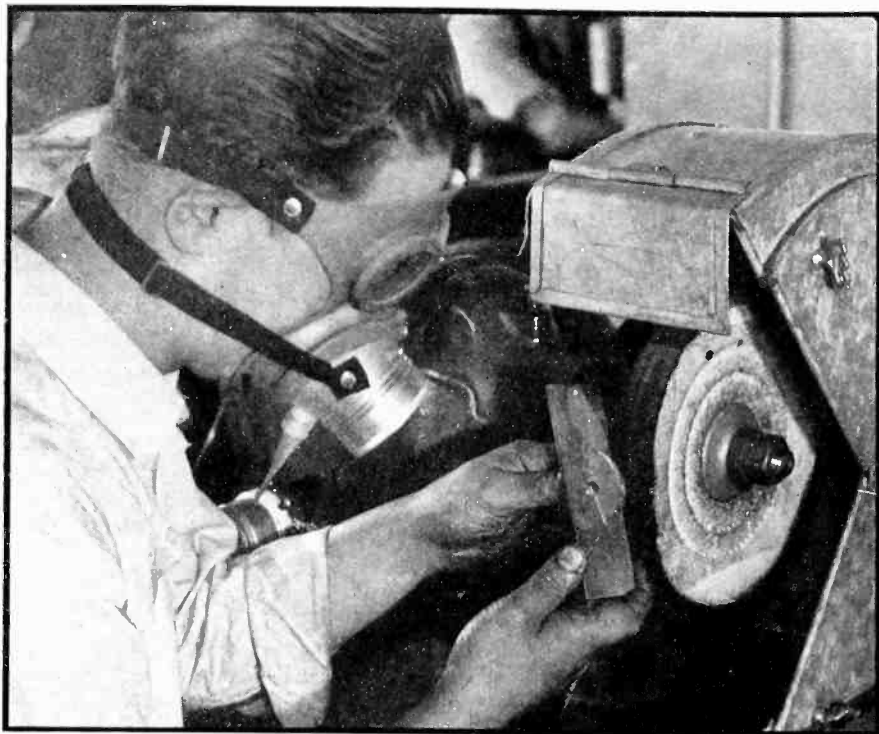

Fig. 3—Principle and circuit for grid control

large passage of tube current occurs during this period. Since the tube current flows when the high-tension is near or at its maximum value, a

Precision RECEIVER...



Polishing sides of condenser plates with a special buffing machine, removes burrs and smoothes surface for high surface electrical conductivity

Cam mechanism used in Super-Pro switch mounted eccentrically actuates Bakelite sections with silver plated knives. Switch is over 12 inches long; weighs nearly 3 pounds

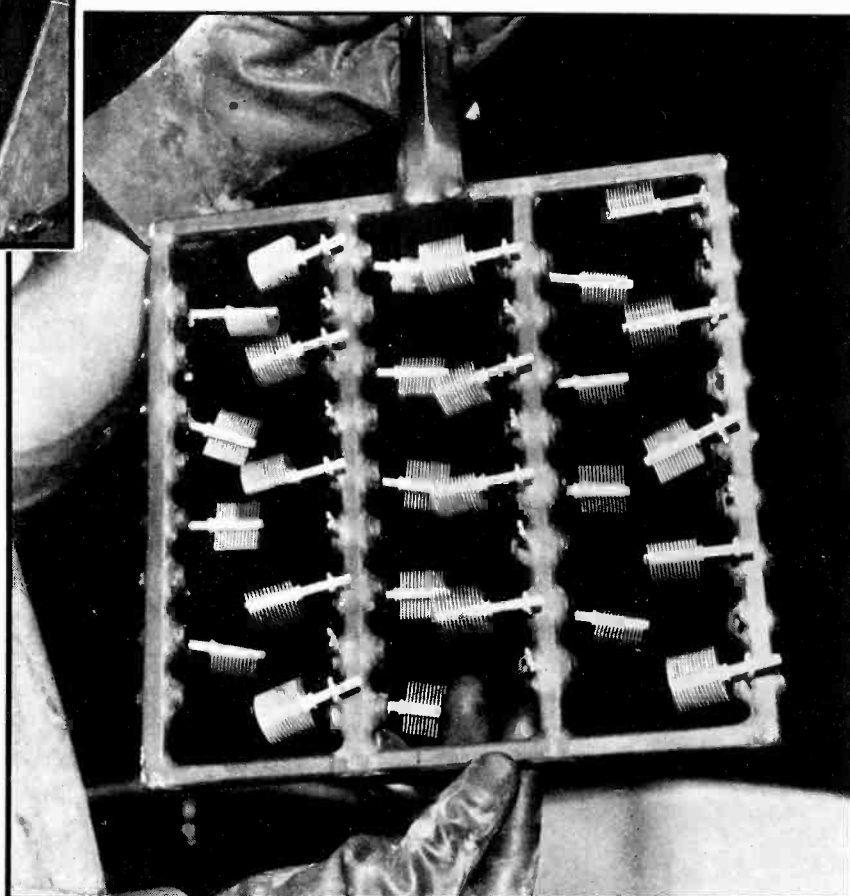

Plating rack with cadmium plated condenser sections hung up to dry. Plating insures non-corrosion and high electrical conductivity

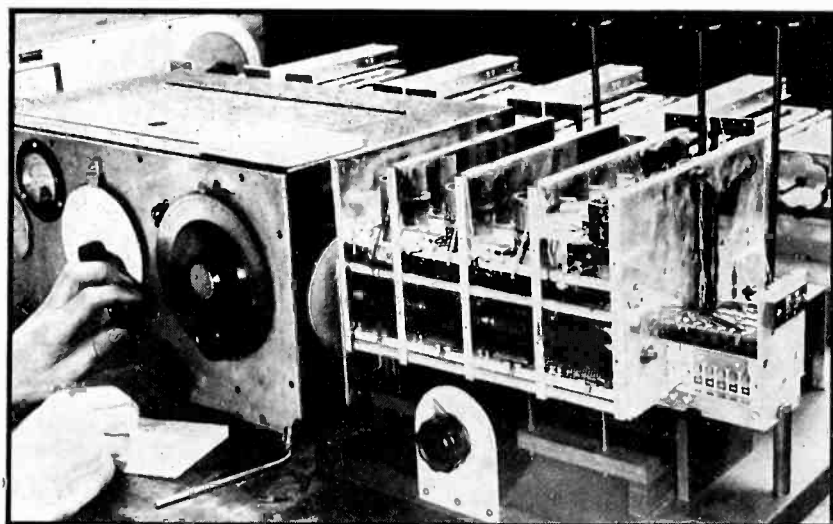

M A D E

Hammarlund Super-Pro receiver
people generally for monitoring,

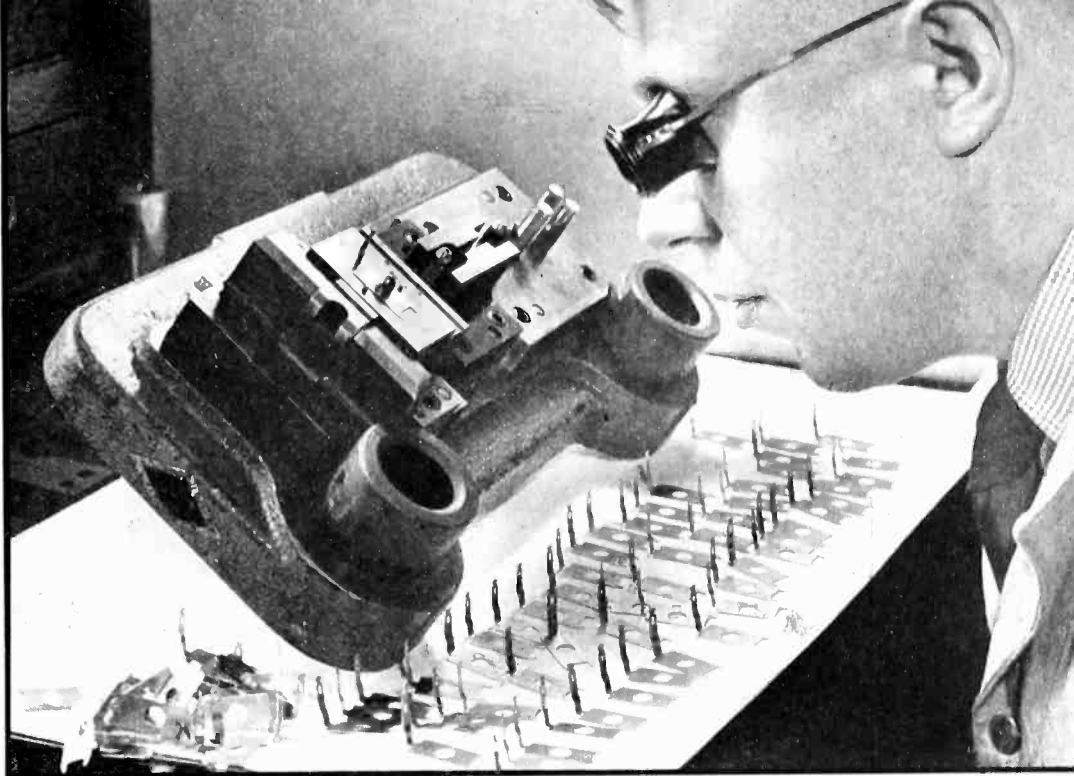

Progressive pierce, blank form and cut-off die for small intricate parts. Weighs 60 pounds, costs \$1000, takes a month to make

Isolantite base tuning coil—each of which is checked after winding, after installation on base, and after installation in unit. In the lower left of this photo may be seen the complicated wave band switch



Checking accuracy of condenser plates with micrometer. In background is a vernier height gage and below is a thickness gage to measure air gaps

Left—Matching the tuning and band spread condensers. There are 16 condensers in this unit, each to be measured and inspected

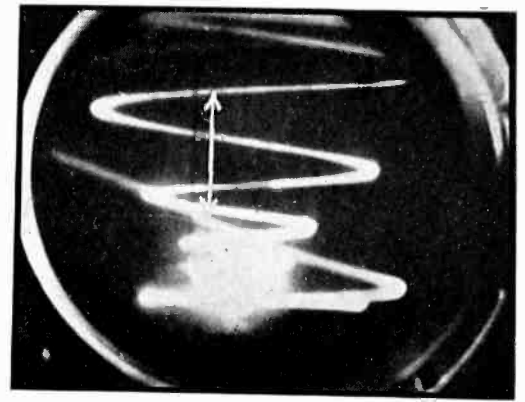
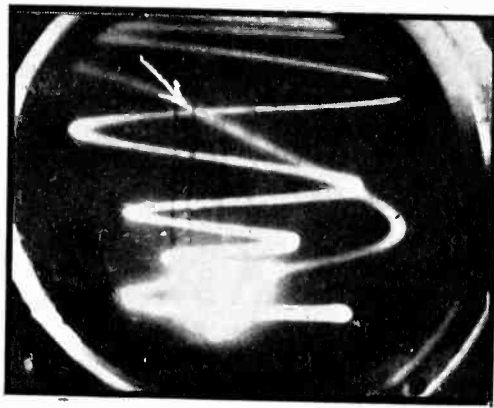
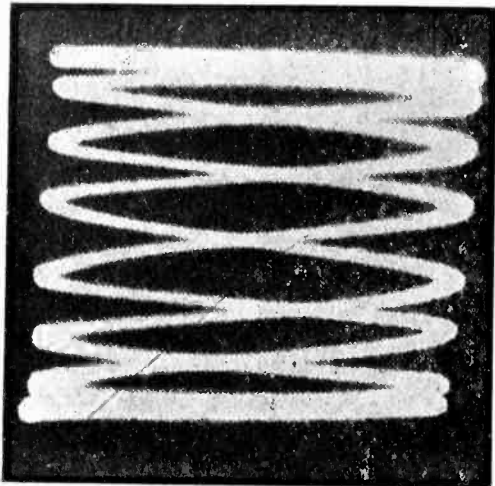

Fig. 2A (below)—Ideal Lissajous figure

Fig. 2B (right)—Actual image secured on phase-meter

Fig. 2C (right)—Image secured from actual body measurement

Fig. 2D (Page 25)—Calibration figure



By S. BAGNO and A. BARNETT, M.D.
New York City

CATHODE-RAY

Measurements of the phase angle of the human body have led to the device described by two researchers into this interesting subject. It will measure phase differences of the order of 0.0005 radian; will measure small capacities or inductances

RECENT interest in the measurement of the phase angle of the human body has made it desirable to provide an instrument which would permit Q-factor or phase angle determinations to be made rapidly, accurately and visually.

In this communication a cathode ray phasemeter will be described. It has certain novel features such as a phase amplifying system and an improved and easily readable Lissajous figures. This phasemeter is designed to indicate phase differences of the order of 0.0005 radian and, when coupled with appropriate resistances, may be used to measure small capacities and inductances. Inasmuch as the impedance of the body may vary under the effect of change in muscular tension, the phase indications must remain independent of varying impedance. It was because of the inflexibility of the Wheatstone bridge and the inability to measure phase angle during variations in impedance that the instruments described herein was developed.

The essential element in this apparatus is a phase bridge wherein a resistance R_1 (Fig. 1B) is connected in series with the impedance to be

measured (the body) and is given a sufficiently large value (20,000 ohms) to bring the current and the voltage substantially into phase across these two elements taken together. The voltage drop across the body is then compared with a second voltage drop across a condenser C_3 and a variable resistance R_0 acting as a phase rotator. These two voltages are thrown across the vertical and horizontal deflecting plates of a cathode ray tube. To amplify the phase reading, one of the voltages tapped off from the phase bridge is fed to a distorting tube which produces a series of harmonics. A tuned circuit picks off the eighth harmonic and this is fed to one pair of plates of the cathode ray tube. The purpose of these operations is to amplify the phase by an eight to one increase in frequency. The Lissajous figure produced should have the ideal form shown in Fig. 2A, but, because of the presence of sidebands accompanying the eighth harmonic and the voltage amplification of the potential picked off across the body which tends to magnify the central portion of the figure, the actual image obtained has the form repre-

sented in Fig. 2B. By means of a zero set device, the image may be changed so that intersecting portions thereof fall on a vertical reference line ruled on a transparent disc placed against the face of the cathode ray tube (Fig. 2B). The displacement of these intersecting portions obtained when the body is replaced by a pure resistance of equivalent impedance permits measurement of the phase angle.

The Circuit Used

Figure 1A is a circuit diagram of the complete instrument. It consists of an oscillator, a phase rotating section and a phase indicating section, each shielded from the other. The oscillator is of the series fed Hartley type and consists of a 37 tube connected to L_1 , L_2 , and C_1 . By switching coils and condensers provision is made for the unit to oscillate at 10 kc., 40 kc., and 125 kc. Oscillator current is fed through a low pass filter and then divided, one part going to the body through R_1 and the other through R_3 to a phase rotating network consisting of potentiometer R_0 whose centre leg is connected to one side of C_3 as shown. R_0 feeds the control grid of a 6C6 pentode. The pentode output is taken off across plate resistor R_2 through C_2 and fed to another 6C6 which is used as a frequency multiplier, coils L_3 and L_4 and a zero-set condenser being tuned so as



Home Facsimile Recording

RECENT activities amongst the broadcasters indicate that radio broadcasting of facsimile matter of general interest to the public is soon to become a definite adjunct to the broadcasting of sound.

At the N.A.B. convention in Chicago last June, Judge E. O. Sykes, who was at that time chairman of the Broadcast Division, said that the Federal Communications Commission was "very much interested to know whether the general public wants a facsimile broadcast service and if such a service can be supplied at this time." The Commission has modified its rules for broadcasting stations to open the way for checking the technical feasibility and listener acceptance of "still picture" transmission. Existing broadcasting stations are now enabled to engage in experimental facsimile broadcasting between the hours of midnight and 6 A.M. Upon due issuance of a license by the F.C.C., a station may transmit facsimile signals on its assigned radio frequency with its regular night-time power.

Several stations have already embarked upon experimental facsimile programs and others are applying for licenses to similarly extend their aural services. Four stations which have been licensed for several months now are WHO, KFBK, KMJ, and WGH. In December licenses were granted to WOR, KSTP, WGN, KSD, and WSM, and other licenses are pending.

In their effort to learn whether it is likely that home facsimile broad-

By **SAMUEL OSTROLENK**

*Patent Attorney
Ostrolenk, Greene and Marsen
New York, N. Y.*

casting is to become a medium of mass dissemination of facsimile information, comparable to aural broadcasting, the F.C.C. requires that the broadcasters install a minimum of fifty facsimile recorders in homes within their service area, and submit periodic reports of the results

achieved in such transmissions. The broadcasters are doing this at their own expense in a pioneering spirit, even though there is no immediate prospect of pecuniary return.

It is interesting to note the attitude which newspaper chains have taken in this field. Many of the stations to which licenses have already been granted are owned and controlled by newspaper chains which realize that this method of public entertainment or service is not a



Lenox Lohr demonstrates to Commissioner Lewis J. Valentine the value of facsimile as an adjunct to existing police communication systems. The illustration in the upper left corner of the page shows a facsimile recorder suitable for home use

threat or in any sense a competitor for their newspaper sales. In fact, they keenly sense such service as increasing the interest of the public in the value of a newspaper and resulting in greater circulation. Such attitude has no doubt resulted from the similar popular acceptance of the periodic news aural service broadcasts by the radio stations.

Four organizations are active in the development of facsimile equipment for home use. These are the Finch Telecommunications Laboratories, the Radio Corporation of America, and Fultograph, Inc., with headquarters in New York, and Radio Pictures, Inc., at Long Island City. The majority of the stations which have already been granted facsimile permits are being supplied with equipment developed by William G. H. Finch.

The simplified facsimile units which Mr. Finch has developed consists of a scanning arm which scans the picture or recording sheet line by line, one hundred times per minute. The facsimile signals are arranged to modulate a 3000 cycle audio frequency carrier wave, and the resultant signal is applied to the radio frequency carrier wave of the broadcast station through the ordinary voice current circuits. At the receiving station, the audio frequency output of the radio receiver is coupled to the compact facsimile recorder. The present equipment is arranged with a clock operated time switch to automatically turn on and off the unit between the facsimile broadcast periods of the radio station.

At present the facsimile program presents a continuous audio note through the ordinary radio loud speaker if it is connected to the facsimile programs. Developments portend simultaneous transmission of both sound and facsimile programs over a common radio channel, without any interference between the two classes of service. The facsimile signals would then not be heard on any receiver not equipped for its recording, and therefore would not interfere with reception of the aural part of the combined program.

The facsimile recorders have been simplified to such an extent as to make them capable of entirely automatic operation without attention from the home user. Their present

cost is \$125 per unit. However, estimates show that upon mass acceptance and therefore mass production of the units, the price would be about \$50 to \$60 and possibly even lower.

The present models operate at a rate of 1 inch per minute or 5 feet per hour. Accordingly, in a 6-hour broadcast between midnight and 6 A.M., 30 feet of facsimile copy is available for use at the breakfast table of the user. The recording is performed on a continuous sheet, which, at present is obtainable at 20 cents per roll. The recording paper is available in various color combinations including black, blue, green, or red upon a white background, or orange on a black background. The colored surface of the paper is broken



Typical printed matter as reproduced on home facsimile recorder. In order to show details of the recording stylus, the cover has been removed

down by the signal currents to produce a copy of the transmitted image. The 200 foot roll of sensitive paper is sufficient for a full week's supply for the facsimile recorder.

The present Finch recorder sketches lines 1/100 of an inch wide, so there are 100 lines per inch. Units are available having a line width of four inches or eight and one-half inches, corresponding to standard letter size width. The Finch recorders are also available for operation at greater recording speeds or with wider recording areas.

The recorders developed by Radio Pictures, Inc., make use of an electrically sensitive paper which produces a black and white image 6 inches wide. The image is permanent upon formation, and requires no subsequent photographic processing or other operations. An area of 6 square inches per minute is printed with a detail of 100 lines per inch. Equipment producing images corresponding to these initial standards is available.

With the experience of several years on point to point facsimile in back of them, the Radio Corporation of America is now offering on an outright sale basis to broadcast stations, its carbon recorder and facsimile system for home use. The equipment is intended for use by unskilled operators, and units will be complete with radio receiver and recording equipment. One type of recorder will be available for use in the 550-1600 kc. broadcast channel; another model will be designed for use in the 30-41 mc. band.

The recorder, which can be used with either receiver will record images on a roll of white paper 8½ inches wide. The unit will record at the rate of 65 to 75 words per minute, or the equivalent in picture detail, assuming 10 point type is used in the original copy. The recorders will be available in two designs. The present model, most suitable for home use at the present time, will record images on a roll of white paper. The more elaborate model to be made available will automatically cut this roll into sheets 12 inches in length, and will stack the pages neatly in a pile.

For optimum public benefit the facsimile equipment will eventually become standardized as to the detail in lines per inch and speed as to lines per minute, as well as in the width of the recordings employed. This is obviously necessary to permit any one home recorder to receive programs from the plurality of stations transmitting them. The first broadcast stations licensed for facsimile transmission by the F.C.C. under their present progressive policy have chosen Finch equipment, amongst them being KSTP, St. Paul, Minn., 25 kw., WHO, Des Moines, Iowa, 50 kw., WGH, Norfolk, Va., and WSM, Nashville, Tenn., 50 kw.

(Continued on page 60)

The Triograph

A three-phase cathode ray oscillograph for electrocardiography which delineates the heart potentials and gives their directions in the body and their rotations during each heart beat.

By H. E. HOLLMANN

Berlin, Germany

IT IS well known that electrocardiography is concerned with the measurement and registration of the bioelectrical potentials which are produced by the rhythmic contraction of the heart in human and animal organisms. Up to the present, interest has centered almost exclusively on the time-representation of these action potentials. Successive peaks on the potential-time curves provide data on the regularity, together with certain types of irregularities in the heart rhythm, while the oscillographic recording of the individual heart beats gives a comprehensive insight into the propagation of the excitation wave and the physiological activation processes of the cardiac muscle structure. This paper describes a new method and a new apparatus which not only makes possible the oscillographic delineation of the heart potential but in addition, its direction in the body and its rotation during each heart beat.

Contraction produces bioelectrical potentials throughout the entire heart, which are subject to highly intricate laws pertaining to the anatomical structure of the heart muscles. Outside the heart, however, these potentials combine to form a resultant vector potential, which is designated as the "electrical axis" of the heart. Ordinarily the heart axis has the position shown by E in Fig. 1 and is characterized by the angle α which it makes with the horizontal. The length of the arrow represents the potential prevailing at a certain instant.

For medical investigations either this potential or correctly proportioned potential components are tapped off the surface of the body.

The limb electrode connections introduced by Einthoven have been generally adopted and standardized for electrocardiography. These are:

Designation	Connections
Lead I	Right arm (R)—Left arm (L) cross conduction
Lead II	Right arm (R)—Left leg (B) slant conduction
Lead III	Left arm (L)—Left leg (B) lengthwise conduction

The properties of the various lead connections can be most simply illustrated by considering the heart to be located within an isosceles triangle formed by the three points, R, L, and B, where the extremities are joined to the body. (It has been shown that the exact location of the limb electrodes does not invalidate this assumption.) Then the potential differences occurring between the different electrodes, i.e., in leads I, II, and III are obtained by simply projecting the vector E on the three sides of the triangle, giving (Fig. 1)

$$\begin{aligned} E_1 &= E \cos \alpha \\ E_2 &= E \cos (60^\circ - \alpha) \\ E_3 &= E \cos (120^\circ - \alpha) \end{aligned}$$

If suitable registration apparatus, cathode-ray tubes with suitable amplifiers for example, is connected to the three points of the Einthoven triangle or on the above-mentioned extremities either simultaneously or successively, then there are obtained three different electrocardiographs which not only give the time changes in E but also permit the derivation of the angle α . For this purpose it is necessary only to combine vectorially the three deflections (or potentials) corresponding to a given instant at angles of 60° as shown in Fig. 2 to obtain a resultant vector

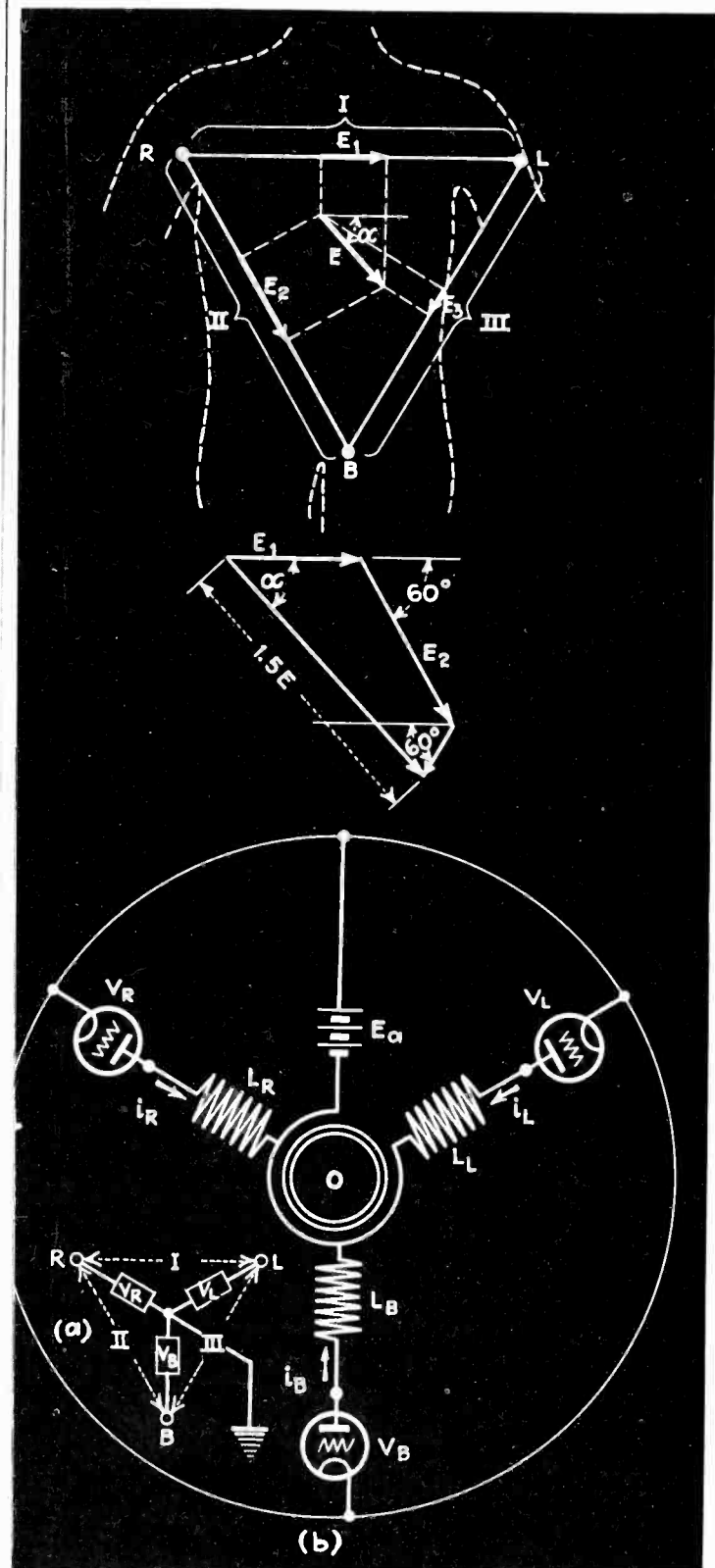

Fig. 1—Top, Production of heart potentials from Einthoven lead triangle. Fig. 2—Vectorial composition of heart vector E from Fig. 1. Fig. 3—Below, (a) inputs, (b) outputs of triograph

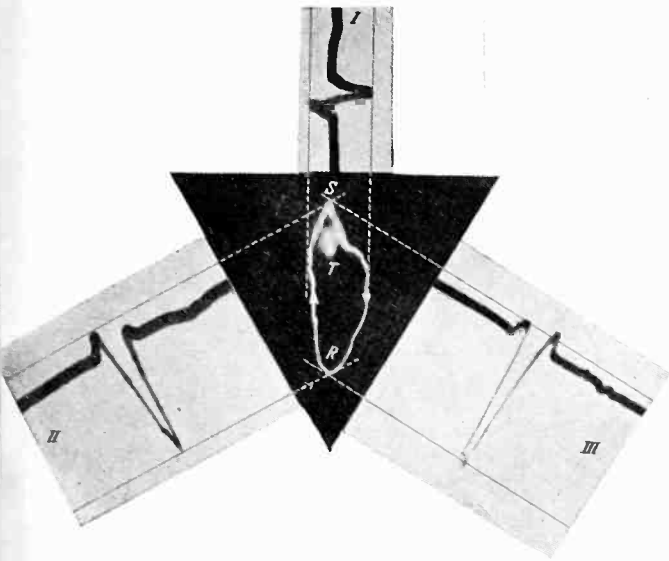

Fig. 4—Triogram of healthy heart and its components

of the Einthoven triangle, then the beam is deflected downwards at an angle of exactly 60° .

In Fig. 6 is shown a "Triograph" tube which is provided with 6 deflecting coils rather than three, in which the diametrically opposite coils are connected together. Adjustment of this star form deflecting system is most simply accomplished by supplying the three coils with 3 phase 60 cycle current. This results in a rotating field which deflects the beam into a circle. Such an adjusting circle is visible on the tube screen

Fig. 4 was produced by a healthy heart. For the purpose of clearly showing how it is produced, the three individual lead electrocardiograms from which the Triogram is built up, are copied in on the three sides of the triangle on an enlarged scale. It is clearly seen that the Triogram is inscribed within the limiting connecting lines of the electrocardiograms. The approximately perpendicular direction of the primary axes of the Triogram is indicative of a heart in a vertical position.

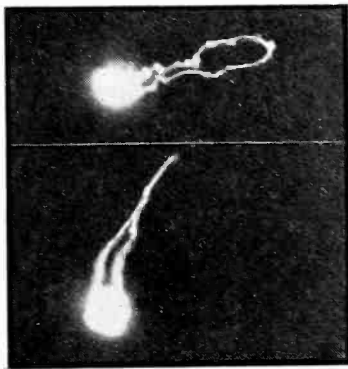

Fig. 5—Above, after deep inspiration, after expiration

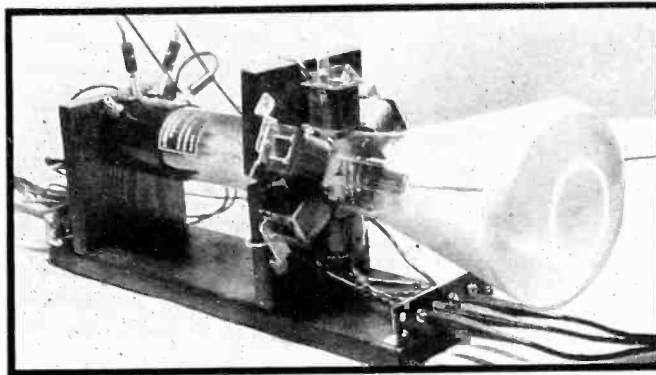

Fig. 6—Tube with 3-phase magnetic deflecting system

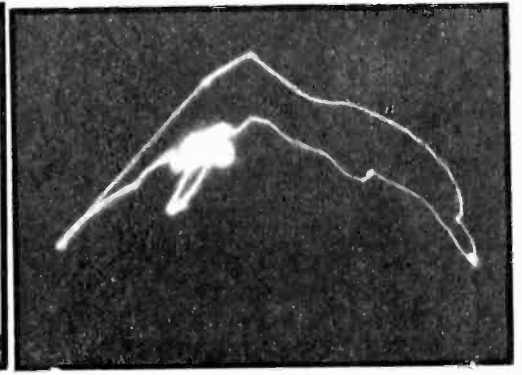

Fig. 7—Triogram of defective heart

which is inclined at exactly the angle α to the horizontal, although the vector magnitude may under certain conditions become 1.5 times as great as the original vector E .

That this combination of the three vector components gives the heart axis angle may be easily derived geometrically from the expressions for the components given above. The new apparatus, called the "Triograph" provides the required vectorial addition by oscillographic means. The arrangement is shown in Fig. 3. The three lead electrodes, R , L , and B , are connected to the inputs of three amplifiers, V_R , V_L , and V_B . The amplifiers themselves are star connected, with all three cathodes grounded, which permits the use of a common set of batteries. The potential differences between the limb electrodes are applied to the inputs of the amplifiers, which are push-pull controlled. The three corresponding output currents i_R , i_L , and i_B are passed through three coils L_R , L_L , and L_B which are grouped around a cathode-ray tube 120° apart. These deflect the beam in three directions where the connections or winding directions are so chosen that if three equal potentials directed as shown by the arrows in Fig. 1 are simultaneously applied to the three sides

in Fig. 6. The setup employed for taking "Triograms," as the 3 phase vector diagrams are called, is shown below. In the center may be seen the three amplifiers which are built into a single metal cabinet. From these the three conductors visible in the foreground lead to the patient, who is resting on a completely enclosable bed, the construction of which is similar to a Faraday cage to act as a shield against electrostatic pickup. To the right of the amplifiers may be seen the Triograph tube with its star formed coil system. Photographs of the tube are taken with an ordinary camera mounted on the amplifier housing.

In the remaining figures are shown a few of the experimental Triograms taken on various subjects. That of

With the high sensitivity to the slightest phase displacements between the individual lead potentials which this method possesses, it is not surprising that unimportant changes in the position of the heart in the body are clearly observable. Thus Fig. 5 shows two Triograms of which the first (a) is taken after full expiration and (b) after a deep inspiration. It is rather interesting to see how the heart is forced downwards in an almost perpendicular direction from its normal resting place by the air-filled lung chambers. Finally, a Triographic picture of a defective heart is shown in Fig. 7, whose deviation from the normal form shown in Fig. 4 is extremely interesting and illuminating to a medical man.

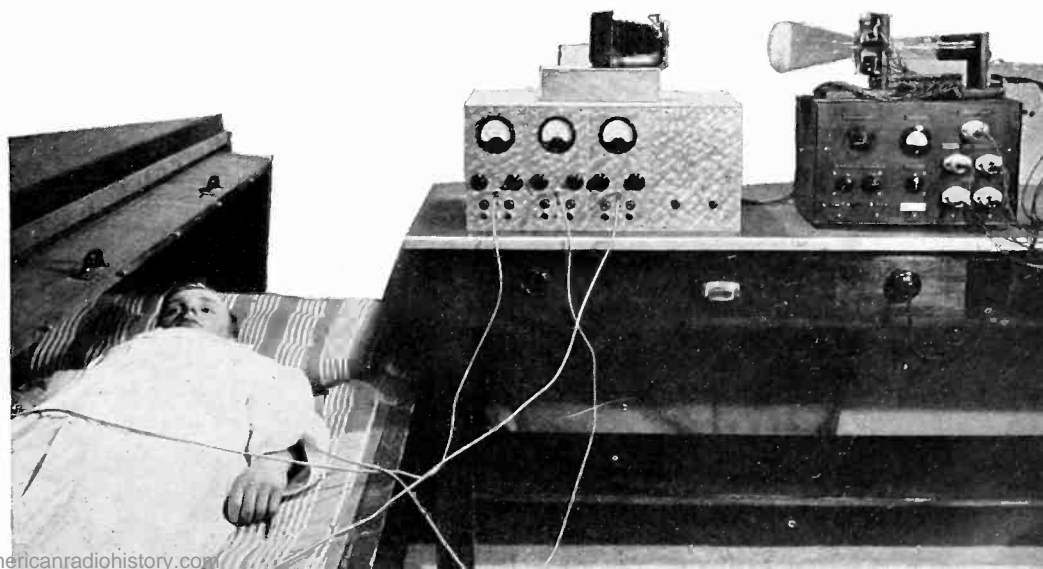

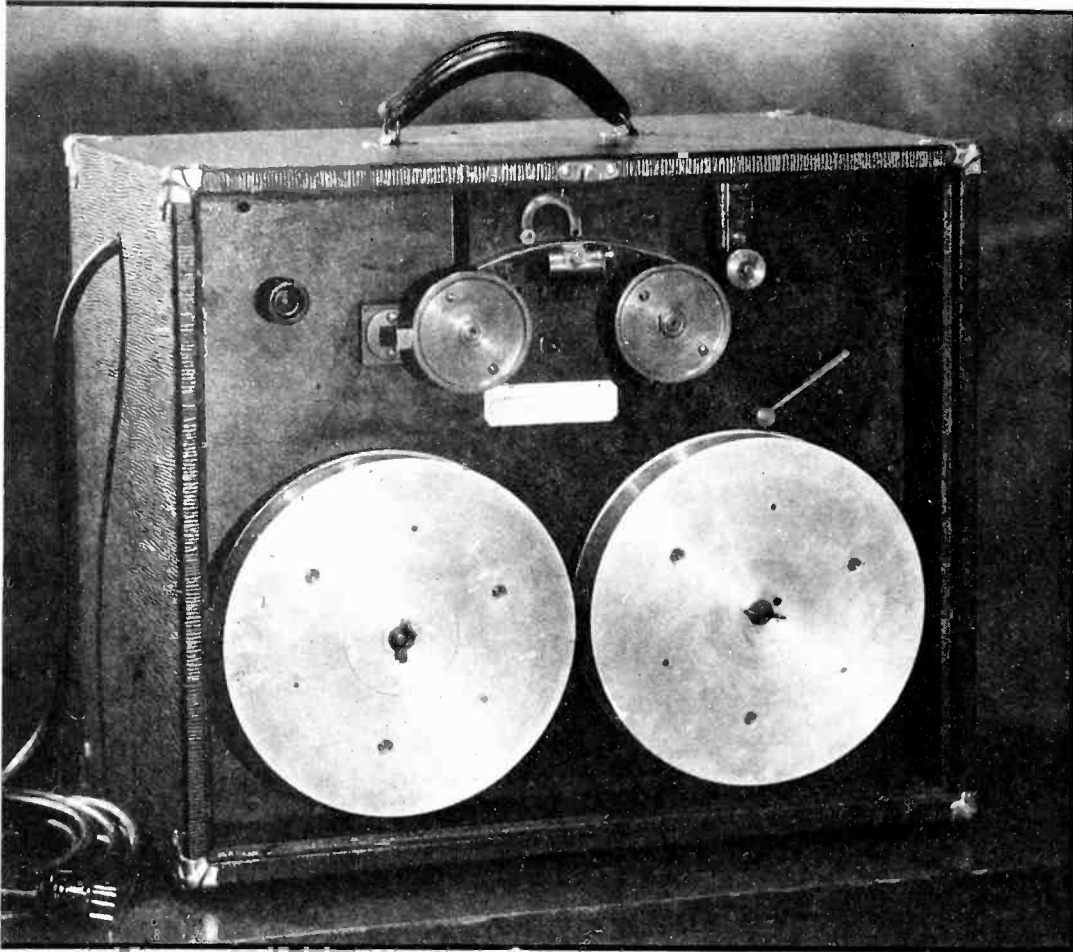

The device itself as developed by Mr. Malloy

A MAGNETIC

By T. J. MALLOY
Joplin, Missouri

THE principle of recording sound patterns upon a record of steel wire or tape by magnetization, has been known for many years. Valdemar Poulsen, a Danish engineer, introduced the method over thirty-seven years ago and demonstrated his Telegraphone at the Paris Exposition in 1900. It is also reported that his system was employed about the same time by a Danish telephone exchange to record and reproduce certain messages as a special service to subscribers.

The magnetic system of recording offers certain advantages over other methods in several respects but particularly in applications where records of a temporary nature are desired, inasmuch as the same medium may be used over and over again to make new recordings after the old ones have served their purpose. In such instances, the record may be cleared and made ready for reuse by simply causing it to pass through a steady magnetic field which performs an "erasing" operation at the same time a new recording is being made. Continuous recordings of long duration may be made upon a single medium thereby avoiding the necessity for multiple recorders or interruptions to change records. If a permanent record is required, the medium may be stored away for an

indefinite period without causing appreciable deterioration. A magnetic record may be played back hundreds of times without any noticeable loss in quality whereas disc types depreciate rapidly as the result of continued use.

Despite the interesting possibilities of the magnetic system, however, it has certain objectionable characteristics which have heretofore prevented its application to practical commercial use. Figure 1 shows a typical arrangement. A steel wire of small diameter, carried upon suitable reels or spools, is caused to move rapidly past the pole piece of an electro-magnet while the windings of the latter are in circuit with a signal source. Signal currents traversing the windings of the magnet create a fluctuating field in the pole piece which impresses corresponding longitudinal magnetic patterns in the wire. To reproduce the record, it is necessary only to connect the electro-magnet in the circuit with a telephone receiver or other translating device and run the wire again in the same direction and at the same rate of speed. In this instance the patterns in the wire influence the pole piece of the magnet and generate currents in the windings which correspond to the wave form of the original signals; thus the latter are heard in the

reproducing device. Single pole magnets have been used by some experimenters while others have found that two poles slightly offset with respect to each other, produce better results. The basic principle, however, is the same.

The principal problem in this method of recording is the high speed at which the medium must be driven in order to record the frequency range required for satisfactory reproduction and has been a chief cause of failure in numerous attempts to design machines for practical use. It has been shown, for example, that a speed of 10 feet per second has been required to satisfactorily record a maximum signal frequency of 2,000 cycles per second and that it would be necessary to increase the rate to 30 feet per second in order to extend the range to 6,000 cycles. In the latter instance, a supply of over 100,000 feet of wire would be required for an hour of use.

The necessity for high record speed under certain conditions, is due to the fact that an excessive longitudinal section of the medium is required to properly register each individual cycle of any given signal frequency. The flux surrounding the pole piece of the recording magnet has a tendency to spread and influence a larger portion of the medium

Many have been the inquiries to the editors of *Electronics* during the past year relating to recording broadcast programs or other material on wire. Here is a practical answer to many many of those questions plus a description of working equipment

RECORDER

than would be the case if the field could be confined to the dimensions of the contacting portion of the pole tip. By making the latter very thin, it is possible to minimize the spreading effect but not to a sufficient extent to permit a material reduction of record speed without loss of higher frequencies. Unless the medium is driven at a sufficient rate to move each recorded impulse far enough away from the pole tip to allow the proper amount of space for registration of the one immediately following, the signal patterns overlap and cause distortion or frequency loss.

Objectionable background noise during reproduction has also been a limiting factor in the practical use of magnetic recording mediums. Such noise is heard in the form of metallic clicks or fluttering sounds and is usually caused by mechanical vibration of the rapidly moving magnetized record as it passes the pole piece of the reproducing coil.

The Author's Recorder

In an improved magnetic recording and reproducing system designed by the author and shown in the photograph, the problems of excessive record speed, limited frequency response and extraneous noises, have been overcome by comparatively simple means. In the method to be described, a steel wire .010 inch in diameter, serves as the recording medium but the principle may be successfully applied to other forms. Wire is preferred by the author for the reason that a much greater length may be stored upon a relatively smaller reel, compared with a flat tape or ribbon.

A single pole electro-magnet of somewhat radical design is used for both recording and reproducing and

is shown at Fig. 2. A cylindrical iron shield (a) containing a narrow rectangular opening (b), encases an electro-magnet consisting of windings (c), laminated core and pole piece (e) extending upward to form jaws (f) which hold a removable pole tip (g), the latter being held firmly in place by pressure of set screw (h). The pole tip projects through the opening in the shield and guide member (j), which will be described later, and makes contact with the record (k). The pole tip is $\frac{1}{8}$ inch wide, $\frac{1}{16}$ inch thick, and the contacting edge is sharpened to a thickness of about .001 inch.

This form of construction provides a return path in the walls of

the shield for the flux surrounding the coil and core and minimizes spreading at the pole tip. Thus a relatively small section of the medium is required to properly register any given cycle and a higher range of frequencies may be recorded at a much lower rate of record speed. The shield likewise performs an important function when the record is played back inasmuch as it prevents the fields of the magnetic patterns in the record from influencing the pickup coil except during the instant of contact with the pole tip. The action is somewhat similar to a sound film system wherein the light ray of the exciter lamp is controlled by the "slit width" of the optical sys-

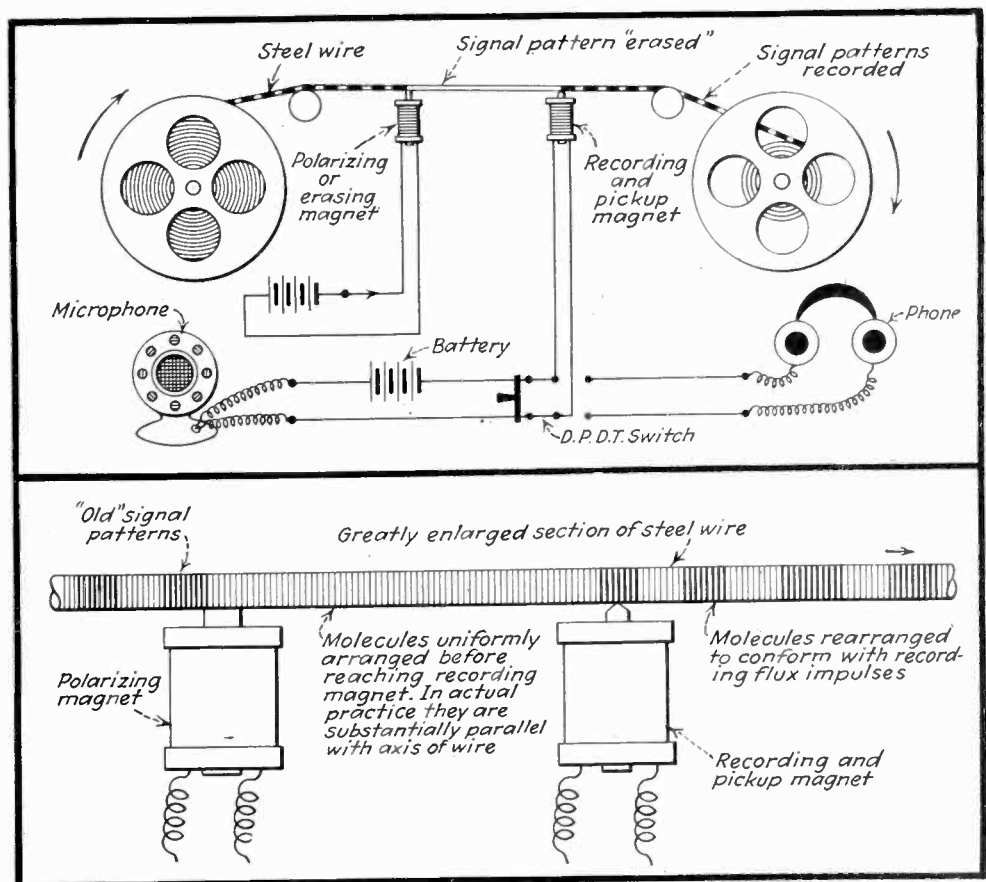

Fig. 1—The essential principle, and parts, of the magnetic recorder

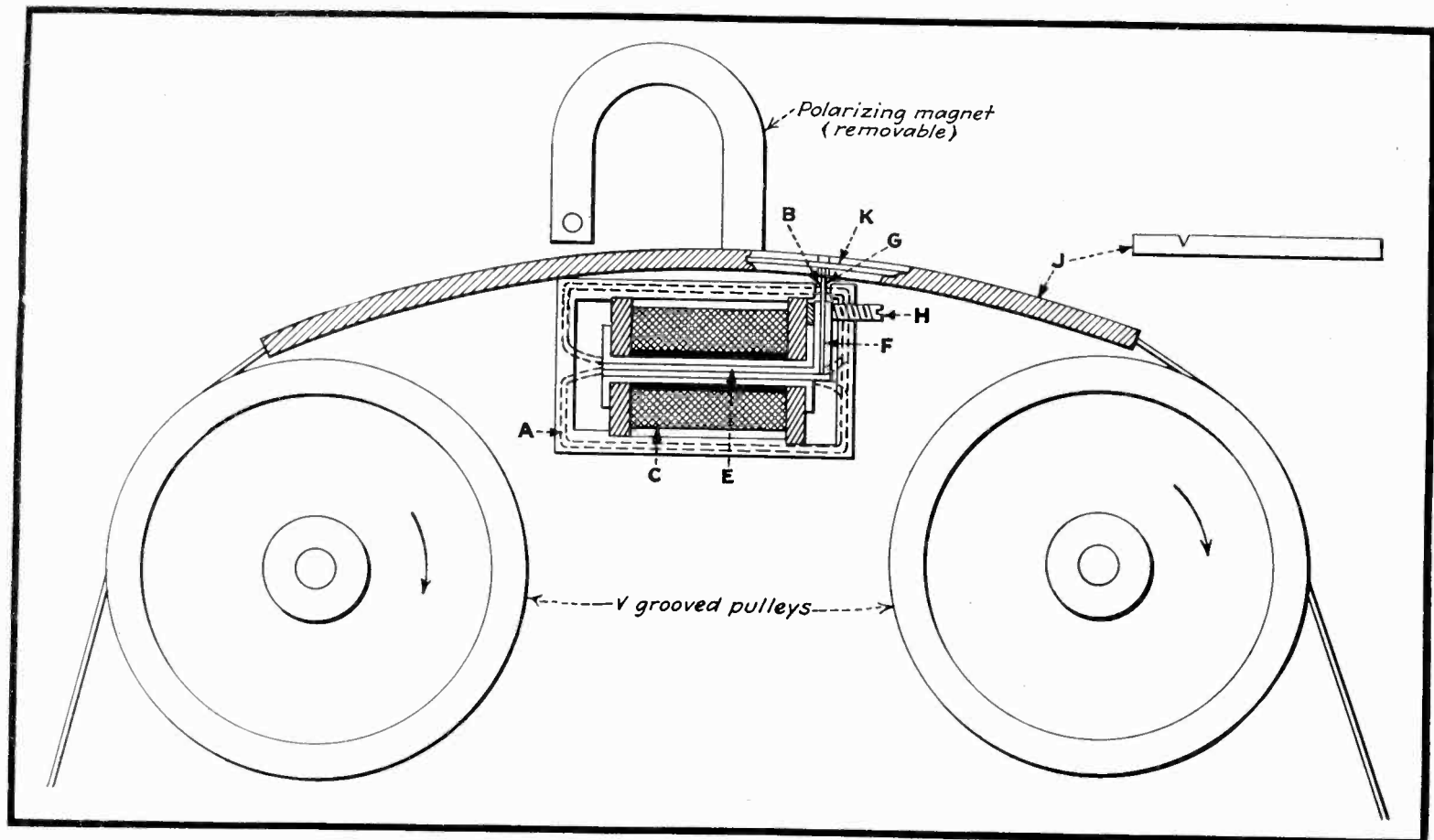

Fig. 2—The author's recorder which has an improved form of magnet for recording and for "taking-off"

tem. By employing a shielded magnet, a signal frequency of 6,000 c.p.s. may be recorded and reproduced at a maximum speed of 5 feet per second. Good speech reproduction may be obtained at 18 inches per second but for high quality recording of musical renditions, the maximum rate is required.

Provision has also been made for avoiding record vibration and resultant background noises by employing a curved plate or guide member shown at (j) in Fig. 2. This member is provided with a V shaped groove in which the wire is caused to travel. Being held in contacting relation with the converging walls of the groove by tension supplied by the driving mechanism, it is prevented from vibrating in any plane and is always accurately centered over the pole tip. This arrangement is also effective in instances where splices occur in the record as the result of adding or removing certain sections or in repairing accidental breaks. In such cases, the joint is allowed to pass freely through the machine without danger of catching in a tight fitting guide of some kind and causing further breakage and interruption of service. Suitable means are provided for moving the wire at a constant rate of speed and uni-

formly winding it upon the takeup reel. A simple mechanism also provides uniform tension and automatically stops the reels to prevent the wire from becoming loose or tangled. In the interest of brevity a complete description of these units will be omitted.

In making a record, the medium is simultaneously cleared of any previously recorded signal patterns and supplied with a polarizing or recording flux by means of a small permanent magnet which is placed in a position slightly above the record and a fraction of an inch to the left of the pole tip. This magnet does not make contact with the wire and its position is such that the polarizing flux is maintained at a minimum level with respect to the saturation point of the medium in order to prevent recording only half cycles. The magnet may be either removed entirely from the machine or swung out of influencing relation with the record when the recording is finished. This method of polarization eliminates difficulties of demagnetization and additional wear usually encountered when a polarizing electro-magnet is employed for the same purpose, inasmuch as the pole piece of the latter, in most instances, is allowed to bear directly upon the record when re-

recording and reproducing.

For experimental purposes, the model shown in the photograph has been employed by the author during the past two years in recording all types of radio programs directly from a home receiver. When recording in this manner, the lead from the recording coil is coupled directly across the output stage of the receiver, through a suitable impedance matching network. The author has demonstrated the apparatus before local civic organizations and during these demonstrations employed a microphone and high gain amplifier to record and reproduce group singing; the same amplifier, of course, being used for the playback. The present model has a capacity of one hour of continuous recording.

A maximum power of one watt is required for recording and a level indicator is employed to maintain the output peaks below a certain predetermined level in order to prevent saturation of the wire and subsequent distortion. The playback output of the pickup coil is approximately -85 db at 1,000 cycles; the impedance is about 500 ohms.

The system and apparatus herein described and illustrated are covered by U. S. Patent No. 2,089,287, under date of August 10, 1937.

Radial Ground System Chart

By George H. Brown

Signal strength in millivolts per meter at one mile from a vertical antenna using a radial-wire ground system. L = length of radial ground wires; λ = operating wavelength; a = antenna height; N = number of radial wires

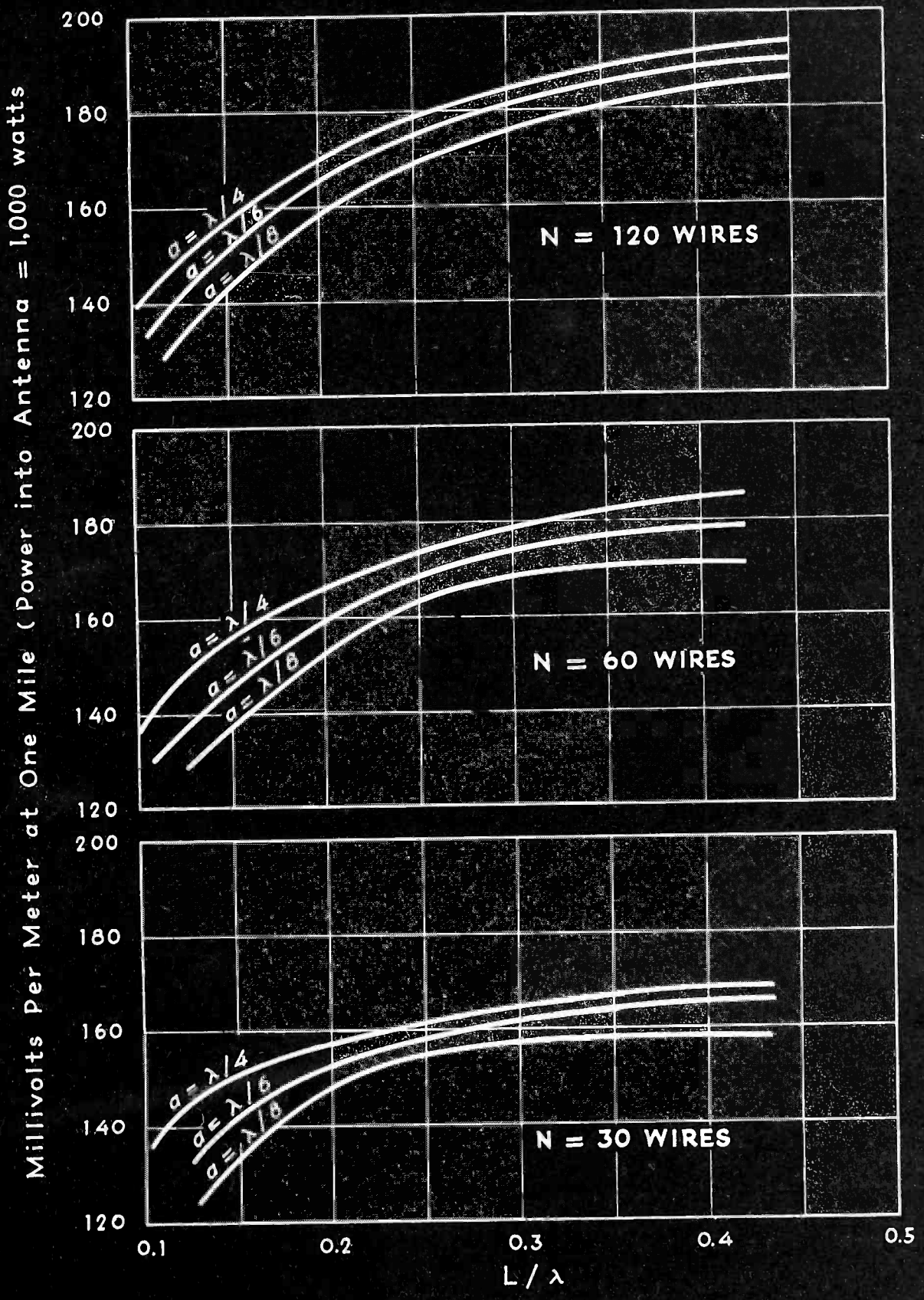

Ultrasonics and Supersonics

By
HARRY SCHECTER

THE FOLLOWING BIBLIOGRAPHY will serve as a guide to the large amount of work that has already been done in this rapidly growing field. The references are grouped according to subject, the items under each group being roughly in chronological order. Papers which are of a more comprehensive nature, or which contain numerous references, are marked with an asterisk (*).

Survey Articles:

- E. G. Richardson; "Sound," in *Physical Society (London) Progress Reports*, for 1934, 1935, 1936 (vols. I, II, III).
E. Grossman; "Ultra-acoustics," in *Wien-Harmon Handbuch der Experimentalphysik*, vol. 17, part 1 (published by Akademische Verlagsgesellschaft, Leipzig, 1934).
E. Hiedemann; "Ultra-sound," in *Ergebnisse der Exakten Naturwissenschaften*, vol. 14 (published by Springer, Berlin, 1935).

References of a general nature.

- *WOOD & LOOMIS; *Phil Mag* 4:417 (1927).
STRAUBEL; *Phys ZS* 32:379 (1931).
HOPWOOD; *Proc Roy Inst* 26:339 (1931).
*HUBBARD; *JASA* 4:90 (1932).
*BIQUARD; *Rev d'Acoustique* 1:93,315 (1932), 2:288 (1933), 3:104 (1934).
*RODEWALD; *ZS tech Phys* 15:192 (1934).
LITTLE; *Gen Rad Experimentor*, Feb. 1935.
*SOKOLOV; *Tech Phys USSR* 2:522 (1935).
*FLORISSON; *Bull Soc Belge Elect* 52:165, 263,339 (1936).
HIEDEMANN; *ZS VDI* 80:581 (1936).
HIEDEMANN; *Stahl & Eisen* 56:600 (1936).
SUITS; *Gen Elect Rev* 39:430 (1936).
COLWELL & HILL; *JASA* 8:60 (1936).
BERGMANN; *ZS tech Phys* 17:512 (1936).
HOPWOOD; *Nature* 128:748 (1931), 138:1059 (1936).

Instruments, apparatus &c.

- THOMPSON; *Rev Sci Instrs* 2:332 (1931).
YAGI & MATSUO; *Rep Radio Research Japan* 2:287 (1932).
SACERDOTI; *Alta Frequenza* 2:516 (1933).
BÜCKS & MILLER; *ZS f Phys* 84:75 (1933).
KING; *Canadian J Research* 11:135,484 (1934).
YEAGLEY; *Rev Sci Instrs* 6:148 (1935).
BEZ-BARDILI; *Phys ZS* 36:20 (1935).
GRUETZMACHER; *ZS f Phys* 96:342 (1935).
BEZ-BARDILI; *ZS f Phys* 96:761 (1935).
HARTMANN; *J de Phys et le Radium* 7:49 (1936).
GRUETZMACHER; *ZS tech Phys* 17:166 (1936).
KUNTZE; *Ann d Phys* 26:349 (1936).

Velocity and absorption.

- THOMPSON; *Phys Rev* 36:77 (1930).
VERHOEK & DANIELS; *J Am Chem Soc* 53:1186 (1931).
BÄR; *Helv Phys Acta* 8:500 (1935).
PUMPER; *Phys ZS Sowjetunion* 8:300 (1935).
BAZULIN; *Phys ZS Sowjetunion* 8:354 (1935).
SÖRENSEN; *Ann d Phys* 26:121 (1936).
*BIQUARD; *Annales de physique* 6:195 (1936).
*BOURGIN; *Phys Rev* 50:355 (1936).
BAZULIN; *Compt Rend USSR* 3:285 (1936).
PASSYNSKI; *Acta Physicochimica* 3:779 (1936).
LIEPMANN; *Helv Phys Acta* 9:507 (1936).
PARTHASARATHY; *Proc Indian Acad Sci* 2:497 (1935), 3:297,529 (1936), 4:213 (1936).
*LUCAS; *J de Phys et le Radium* 8:41 (1937).
*VAN ITTERBEEK & MARIËNS; *Physica* 4:207 (1937).
PARKER; *Proc Phys Soc* 49:95 (1937).

Dispersion and scattering.

- KNESER; *Ann d Phys* 11:777 (1931).
RICHARDSON; *Proc Roy Soc* A146:56 (1934).
RAILSTON & RICHARDSON; *Proc Phys Soc* 47:533 (1935).
PENMAN; *Proc Phys Soc* 47:543 (1935).
BIQUARD; *Compt Rend* 202:117 (1936).
STELL; *ZS Phys Chem* B31:343 (1936).

Optical effects; diffraction of light.

- DEBYE & SEARS; *Proc Nat Acad Sci* 18:409 (1932).
DEBYE; *Phys ZS* 33:849 (1932).
BÄR & MEYER; *Phys ZS* 34:393 (1933).
*BRILLOUIN; *Actualites Scientifiques et Industrielles* No. 59 (1933).
HIEDEMANN & ASBACH; *ZS f Phys* 87:442 (1934).
DEBYE, SACK & COULON; *Compt Rend* 198:922 (1934).
*LUCAS & BIQUARD; *Rev d'Acoustique* 3:198 (1934).
LUCAS; *Compt Rend* 199:1107 (1934).
BAUMGART; *Compt Rend* 199:1383 (1934).
BACHEM & HIEDEMANN; *ZS f Phys* 91:418 (1934), 94:68 (1935).

- GROSSMAN & HIEDEMANN; *ZS f Phys* 95:383 (1935).
HIEDEMANN & HOESCH; *ZS f Phys* 96:268 (1935), 98:141 (1935).
RYTOW; *Phys ZS Sowjetunion* 8:626 (1935).
RAMAN & NATH; *Proc Indian Acad Sci* 2:406,413 (1935), 3:75,119,459 (1936).
HIEDEMANN & SCHREUR; *ZS f Phys* 99:363 (1936).
ALI; *Helv Phys Acta* 8:503 (1935), 9:63 (1936).
BÄR; *Helv Phys Acta* 6:570 (1933), 8:591 (1935), 9:265,367 (1936).
LEVI; *Helv Phys Acta* 9:234 (1936).
NATH; *Proc Indian Acad Sci* 4:222,262 (1936).
BECKER; *Ann d Phys* 25:373 (1936).
SANDERS; *Canadian J Research* 14:158 (1936).
NOMOTO; *Proc Phys-Math Soc Japan* 18:402 (1936).
KORFF; *Phys ZS* 37:708 (1936).
RAMAN & NATH; *Nature* 138:616 (1936).
EXTERMANN; *Nature* 138:843 (1936).
PARTHASARATHY; *Proc Indian Acad Sci* 4:555 (1936).
EXTERMANN & WANNIER; *Helv Phys Acta* 9:520 (1936).

Mechanical effects and measurements.

- BÄR & WALTI; *Helv Phys Acta* 7:658 (1934).
SMITH; *Phil Mag* 19:1137 (1935).
HARTMANN & MATHES; *Phil Mag* 22:883 (1936).

Cavitation.

- TAYLOR & SPROULE; *Trans Roy Soc Canada* 23:91 (1929).
SÖLLNER; *Trans Faraday Soc* 32:1537 (1936).

Emulsification.

- MARINESCO; *Compt Rend* 196:346 (1933).
DANIEWSKI; *Acta Phys Polonica* 2:45 (1933).
RSCHEVKIN & OSTROWSKY; *Acta Physicochimica* 1:741 (1935).
BONDY & SÖLLNER; *Trans Faraday Soc* 31:835,843 (1935), 32:556 (1936).
BURGER & SÖLLNER; *Trans Faraday Soc* 32:1598 (1936).

Coagulation.

- BOUTARIC & BOUCHARD; *Bull Soc Chim* 51:543 (1932).
SÖLLNER & BONDY; *Trans Faraday Soc* 32:616 (1936).
BRANDT, FREUND & HIEDEMANN; *Kolloid ZS* 77:103 (1936).

Effects on smokes, fogs, &c.

- BRANDT & FREUND; *ZS f Phys* 94:348 (1935).
BRANDT & HIEDEMANN; *Kolloid ZS* 75:129 (1936).
BRANDT & HIEDEMANN; *Trans Faraday Soc* 32:1101 (1936).
ANDRADE; *Trans Faraday Soc* 32:1111 (1936).
PARKER; *Trans Faraday Soc* 32:1115 (1936).
SÖLLNER; *Trans Faraday Soc* 32:1532 (1936).

Effects on gels.

- MARINESCO; *Compt Rend* 194:1824 (1932).
FREUNDLICH, ROGOWSKI & SÖLLNER; *ZS Phys Chem* A160:469 (1932).
FREUNDLICH, ROGOWSKI & SÖLLNER; *Kolloid-Beihfte* 37:223 (1933).
FREUNDLICH & SÖLLNER; *Trans Faraday Soc* 32:966 (1936).

Chemical effects.

- KISTIAKOWSKY & RICHARDS; *J Am Chem Soc* 52:4661 (1930).
LIU & WU; *J Am Chem Soc* 54:791 (1932), 56:1005 (1934).
RICHARDS & REID; *J Am Chem Soc* 54:3014 (1932).
OLSON & GARDEN; *J Am Chem Soc* 54:3617 (1932).
SZENT-GYÖRGYI; *Nature* 131:278 (1933).
MORIGUCHI; *J Chem Soc Japan* 54:949,107 (1933), 55:749 (1934).
FLOSDORF & CHAMBERS; *J Am Chem Soc* 55:3051 (1933).
BEUTHE; *ZS Phys Chem* A163:161 (1933).
TEETER; *J Chem Phys* 1:251 (1933).
RICHARDS & REID; *J Chem Phys* 1:114,737 (1933), 2:193,206 (1934).

- STELL; *ZS Phys Chem* B31:342 (1936).
FLOSDORF, CHAMBERS & MALISOFF; *J Am Chem Soc* 58:1069 (1936).
SOKOLOV; *Tech Phys USSR* 3:176 (1936).
*SCHMID; *Angew Chem* 49:117 (1936).
SCHULTES & GOHR; *Angew Chem* 49:420 (1936).

Molecular phenomena.

- SZALAY; *ZS Phys Chem* A164:234 (1933).
SZALAY; *Phys ZS* 35:293 (1934).

Electrochemical effects.

- OKA; *Proc Phys-Math Soc Japan* 15:413 (1933).
NIKITIN; *Compt Rend USSR* 4:309 (1934), 2:47 (1936).
YOUNG & KERSTEN; *J Chem Phys* 4:426 (1936).
MEYER; *ZS f Phys* 102:279 (1936).

Biological and medical effects.

- WOOD & LOOMIS; *Phil Mag* 4:417 (1927).
SCHMITT, OLSON & JOHNSON; *Proc Soc Exp Biol & Med* 25:718 (1928).
HARVEY; *Am J Physiol* 91:284 (1929).
SCHMITT; *Protoplasma* 7:332 (1929).
WILLIAMS & GAINES; *J Infect Dis* 47:485 (1930).
HARVEY & LOOMIS; *J Gen Physiol* 15:147 (1931).
NEWS ITEM; *Science* 73: March 20 supplement p 10 (1931).
FREUNDLICH, SÖLLNER & ROGOWSKI; *Klin Wochenschr* 11:1512 (1932).
BIANCANI, BIANCANI & DOGNON; *Compt Rend* 194:2168 (1932).
SZENT-GYÖRGYI; *Nature* 131:278 (1933).
TAKAHASHI & CHRISTENSEN; *Science* 79:415 (1934).
STANLEY; *Science* 80:339 (1934).
HORIKAWA; *Tohoku J Exp Med* 28:357 (1936).
WIERCINSKI & CHILD; *Science* 83:604 (1936).

Effect on photographic materials.

- MARINESCO & REGGIANI; *Compt Rend* 196:858 (1933).
*CLAUS; *ZS tech Phys* 15:74 (1934).
MARINESCO & REGGIANI; *Compt Rend* 200:548 (1935).
MARINESCO; *Compt Rend* 202:757 (1936).

Treatment of metals.

- German Patent 621,200. French Patents 695,045 and 700,049.
SOKOLOFF; *Acta Physicochimica* 3:939 (1936).
SEEMAN; *Metallwirtsch* 15:1067 (1936).

Production of metallic colloids.

- REGGIANI; *Compt Rend* 200:123 (1935).
CLAUS; *ZS tech Phys* 16:80,109,202 (1935).
CLAUS & SCHMIDT; *Kolloid-Beihfte* 45:41 (1936).

Manufacture of photographic materials.

- DANGERS; *ZS f Phys* 97:34 (1935).
NEWS ITEM; *Science* 83: Jan 10 supplement p 8 (1936).

Effect on electrodeposits.

- YOUNG & KERSTEN; *J Chem Phys* 4:426 (1936).

Deflagration of explosives.

- MARINESCO; *Compt Rend* 201:1187 (1935).

Testing of materials.

- SOKOLOFF; *Phys ZS* 36:142 (1935).
NEWS ITEM; *Science* 83: May 1 supplement p 18 (1936).
SUSLOV; *Metal Prog* 30:60 (1936).

Interferometers.

- KLEIN & HERSHBERGER; *Phys Rev* 37:760 (1931).
HERSHBERGER; *JASA* 4:273 (1933).

Stroboscopic studies.

- HIEDEMANN & HOESCH; *ZS f Phys* 102:253 (1936).
BÄR; *Helv Phys Acta* 9:678 (1936).

Effect on Magnetic Barkhausen effect.

- HOLLMANN & BAUCH; *Naturwissenschaften* 23:35 (1935).

Measurement of directional characteristics of horns.

- GOLDMAN; *JASA* 5:181 (1934).



RESISTORS AND VOLUME CONTROLS



Standard
OF QUALITY THE
WORLD AROUND

INTERNATIONAL RESISTANCE COMPANY

403 NORTH BROAD STREET, PHILADELPHIA, PA.

Factories or Licensees in Canada, England, France, Germany, Italy, Denmark and Australia

MAKERS OF RESISTANCE UNITS OF MORE TYPES, IN MORE SHAPES, FOR MORE APPLICATIONS THAN ANY OTHER MANUFACTURER IN THE WORLD

Cathode-ray Phasemeter

[Continued from page 25]

tion with the auxiliary circuit shown in Fig. 3. This double bridge permits measurements of the impedance and Q-factor (or phase angle) of limited body segments such as the chest or the elbow joint through the skin which is a dielectric having a phase angle of the order of 70° . It may be used with proper adaptations to measure the impedance properties of any elongated conductor through an insulating sheath. Horton and Van Ravenswaay have described an a-c comparator for the same purpose using a special transformer circuit. Their comparator, however, is limited in use to a frequency up to 10,000 cycles. The double bridge was developed independently and has been operated over a frequency range extending from 10,000 to 125,000 cycles.

The general procedure, in the case of the body, is to immerse the hands in two saline baths which serve as current terminals and to tap off voltages from a pair of spaced metal bands applied to the saline moistened skin. Ordinary solder wire has been found to be perfectly satisfactory as a voltage tapping electrode material.

Operation of The Double Bridge

Two points along the potential path of the unknown impedance are fed to two grids respectively of tubes 1 and 2 (Fig. 3) connected in pushpull. The cathodes of these tubes are grounded. The plates serve to give the difference between potentials on the two grids across the plate load. This potential difference is independent of the input and output portions of the load. In other words, the current from an oscillator is fed to the unknown circuit, for example, the human body. Along the length of this unknown circuit there is a potential drop and if the circuit is as heterogenous as the human body, the potential drop across each section will be different and will depend on the phase angle and impedance of that section. Each section can be independently fed to the pushpull tubes and the output taken off as the potential difference across the section to be measured. When the voltages impressed on grids of tubes 1 and 2 are equal and in 0° relation, the currents flowing in

coils 3 and 4 will cancel out. For phase relations other than 0° , current will flow in these coils and will appear as a difference of potential in coil 5. Differences in amplitude of the currents in coils 3 and 4 have no effect on phase measurement because of the design of the cathode ray phasemeter circuit.

A transformer connects the plates of the tubes to a triode 6 for further amplification. The output of the triode fits into the phasemeter already described. When the potentials to be measured are small enough to produce negligible distortion in the amplifier tubes, it is necessary to calibrate the amplification and the phase rotation in the total amplifier circuit only to determine exactly how the impedance of the unknown section behaves. The current that is fed across the entire unknown impedance is generated out of the oscillator in the phasemeter and fed out to the body in the manner described.

Two points along the body whose potential difference is to be determined are connected to the input of the pushpull circuit. The output of the circuit is connected through a separate connection to the position where the body voltage on the phasemeter is normally tapped off.

To calibrate the output exactly, the 4PDT switch (Fig. 3) is used. This switch either connects the input to the body or to a calibrated non-inductive rheostat. It was found that more accurate results were obtained when the potential of the rheostat from ground was the same as the potential of the points to be measured. The rheostats were used to adjust these potentials by opening one grid and feeding the potential between ground and the contact closest to ground to one tube of the pushpull circuit through to the vacuum tube voltmeter in the phase bridge. The potential between one grid and ground, when the other grid was connected to the body, was made the same as the potential between that grid and ground, when the grid was connected to the 400 ohm rheostat, by adjusting the 400 ohm rheostat until the voltmeter gave the same reading when the switch was either on "body" or "resistance".

The grid that had been opened was now closed and the 300 ohm rheostat was adjusted until the potential difference across it gave the same indication on the vacuum tube voltmeter as the potential difference across the section of the body to be measured. With the 300 ohm rheostat connected to the

input of the pushpull circuit, the zero adjustment on the cathode ray phase bridge was set to a convenient intersection as had been previously described. With the switch thrown on "body" (B) the phase difference was determined by the phase balance on the phase bridge. The gain of the pushpull pentodes was made identical by means of the 250,000 ohm potentiometer in the screen grid circuit. To prevent inter-action between this amplifier and the phase bridge, a separate power supply was provided.

In operation, R is adjusted to zero and with switch S on point C and switch A in closed position, P is adjusted so that, on rotating double potentiometer DP throughout its range, the cathode ray image remains linear as shown in Fig. 2A. Switch A is then thrown into open position and DP is adjusted so that when S is thrown alternately from position B where the body is in circuit to position C where the body is replaced by non-inductive rheostat R , the reading on the V-T voltmeter remains the same. This operation introduces sufficient resistance in series with R to produce a potential drop equivalent to the above-ground potential of the lower voltage impressed on the body leads. The cathode ray image, at this stage appears as shown in Fig. 2B and varies in height with the magnitude of the above ground potential. The circuit is now in adjustment for a reading of Z and Q . To determine Z , switch A is again closed and switch S thrown alternately from point B to point C until, on adjusting R , the V-T voltmeter indicates the same reading. The voltage drop across the leads is then the same as that across the terminals of the rheostat and the resistance indicated by the latter corresponds to the impedance of the body segment included between the voltage taps. To measure the Q of this body segment, S is thrown to point C and, with R in circuit, the cathode ray image is adjusted as shown in Fig. 2C so that intersecting portions fall on the vertical reference line marked on the screen placed against the face of the cathode ray tube. Switch S is then thrown to point B so as to substitute the body segment to be measured for the pure resistance of R . In actual operation with this pushpull circuit, working in conjunction with the phase bridge, impedances between one and 300 ohms can be measured and the phase angle of this impedance determined to plus or minus 1%.

REFERENCES

- Brazier, M.A.B.; *J. Inst. Elect. Eng.* 73, 203, 1933.
- Barnett, A. & S. Bagno; *Am. J. of Physiol.* 114, 366, 1936.
- Horton, J. W. & A. Van Ravenswaay; *J. Frank Inst.* 220, 557, 1935.
- Gildemeister, M.; *Pfle. Arch.* 176, 8, 1919.
- Barnett, A. & S. Bagno; *Endocrinology*, 19, 668, 1935.
- Barnett, A. & S. Bagno; *Proc. Soc. for Exp. Biology and Medicine*, 36, 543, 1937.

NEW 3 TRACE CATHODE RAY TUBE

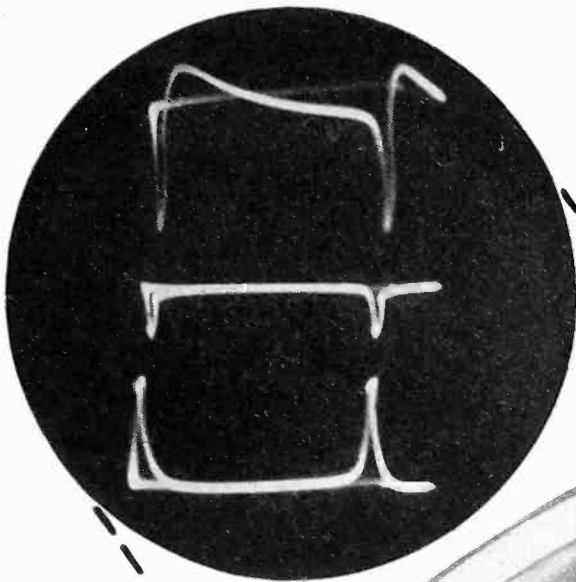

Photograph of three simultaneous electrical phenomena on a 330C screen.

... with 3 Outstanding New Features

- ① Three individual beams give three separate patterns simultaneously without resorting to switching devices.
- ② Twelve separate connections to deflector plates provide flexibility and balanced input.
- ③ Three modulators provide individual intensity control or suppression of each beam.

In addition to these unique features, this tube possesses all the high quality features found in the Western Electric 325 - 326 series of cathode ray tubes.

General Characteristics

Heater voltage.....	5 Volts
Heater current.....	1.65 Amps.
Accelerating Potential.....	1000-5000 Volts
Deflection Characteristic with Accelerating Potential of 2000 Volts.....	80 Volts / inch
Maximum Length.....	23-1/16 inches
Maximum Screen Size.....	7-1/8 inches

For full details write Graybar Electric Co., Graybar Building, New York City.



	330A	330B	330C
Fluorescent Characteristics	Green. Medium Persistence.	Blue-Green. Long Persistence.	Blue. Highly Actinic.
Application	Visual Observation. Photography with green-sensitive film.	Observation and Photography of non-recurrent and low frequency phenomena.	Photography with blue-sensitive film.

Western Electric

Distributed by GRAYBAR Electric Co.

In Canada: Northern Electric Co., Ltd.

RADIO TELEPHONE BROADCASTING EQUIPMENT

TUBES AT WORK

The WTAR Directional Array

By GEORGE H. BROWN
(*Godley & Brown, Montclair, N. J.*)

IT WAS RECENTLY the privilege of the writer to take part in the design and installation of the three-element directive array now in operation at Radio Station WTAR, Norfolk, Virginia. It is the purpose of this discussion to describe the radiating elements of this array, without going into the purpose or action of the directive system as a whole. The fundamental details of the array have been discussed elsewhere.*

The elements of the array were selected with the idea of obtaining the maximum efficiency at the minimum cost, while still maintaining ample mechanical tolerances. Each of the three antennas was furnished with an extensive ground system. Two of the radiators are 210 feet tall, while the third is 280 feet in height. The construction is of the vertical tubular

* G. H. Brown, "Directional Antennas," *Proc. I. R. E.*, vol. 25, No. 1, January, 1937, pp. 101-103.

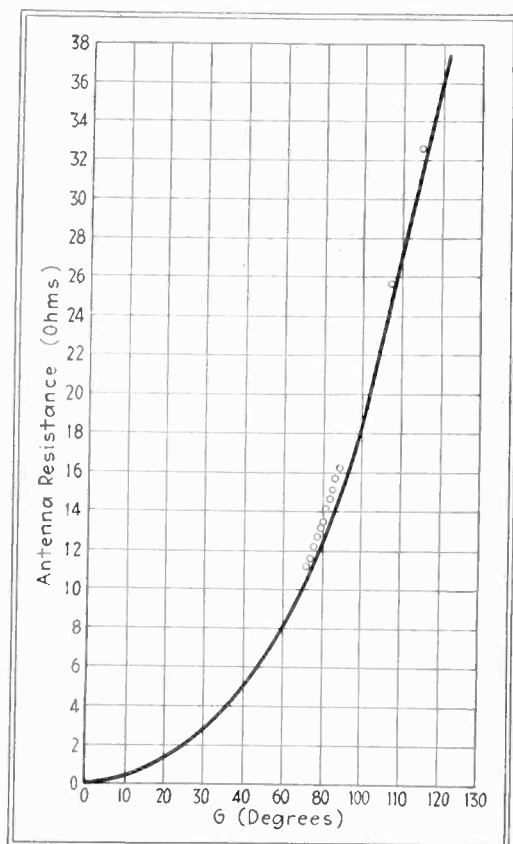

Fig. 2—Theoretical and measured values of radiation resistance versus antenna height

steel type, guyed at several points. Particular attention was paid to the positioning of the insulators in the guy wires so that there would be no energy absorption or reradiation from the guys.

Full advantage was taken of the experience of the John E. Lingo & Son, Inc., Camden, New Jersey, in providing a mechanically suitable structure. The shop joints were formed by a special process developed by the engineers of this company, while the field joints were carefully caulked, metal to metal, to insure a strictly weatherproof and reliable joint. Fig. 1 shows a view of one of the 210 foot masts. The 280 foot mast was equipped with a flashing beacon light.

Measurements on the individual elements soon revealed that a very close approach to the classical straight vertical wire, with sinusoidal current distribution had been obtained. At the same time, the extensive ground system held the dead losses to negligible values. Both the resistance vs. frequency curve and the measured field intensity were very close to ideal values.

Fig. 2 shows a curve of radiation resistance as a function of antenna height for a straight vertical wire antenna with sinusoidal distribution of antenna current. This is a well known theoretical curve that has been published several times. On this curve sheet, antenna height is indicated as G electrical degrees. For any given heights of antenna, a , and wave length, λ , the value of G is determined from the equation

$$G = 360^\circ : a/\lambda \text{ (degrees)}$$

On this same diagram, experimental points are shown, the results of measurement on one of the 210 foot radiators. The agreement with the theoretical results for an ideal antenna is striking. At 780 kilocycles, the operating frequency of WTAR, the 210 foot antenna is 60 degrees tall.

At this frequency, the field strength measured one mile from the antenna is 184.0 millivolts per meter when 1000 watts are fed into a single 210 foot element, with the other elements inoperative. When the 280 foot element was excited in the same manner, the field strength was found to be exactly the same.

The above measurements revealed that the power efficiency of the individual elements had the unusually high value of 94.0 per cent, with a field intensity within 3.0 per cent of the theoretical maximum for this height.

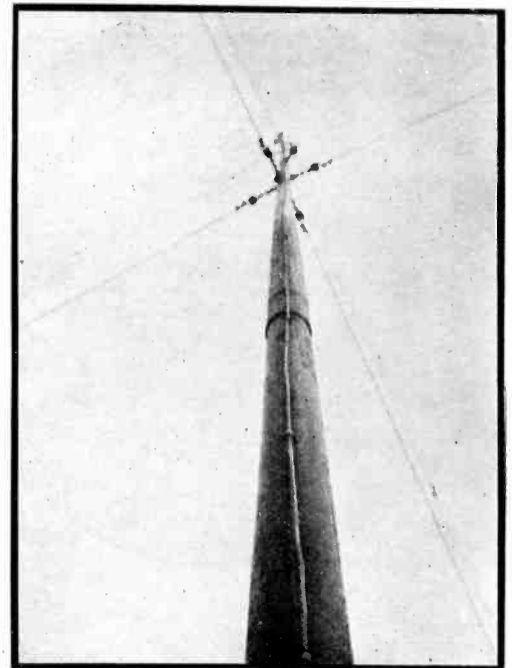

Fig. 1—View of 290-foot radiator

Midget Remote Amplifier Used at KCMO

By LLOYD C. SIGMON
*Chief Engineer
Kansas City, Mo.*

WITH THE DEVELOPMENT in the last years of smaller tubes, transformers, and other parts, smaller amplifiers and other equipment can be constructed, the over-all characteristics of which in most cases, are better than the larger units. The midget remote amplifier to

TELEVISION BY WIRE

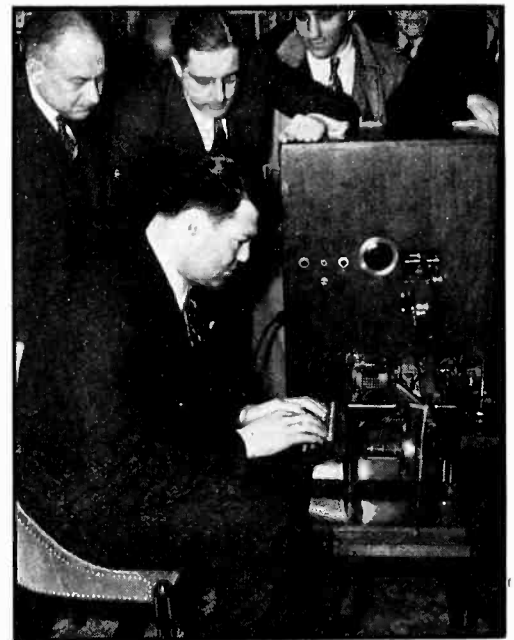

Jack Dempsey, typing a message on the new Peck Television Bulletin Service. The message, typed on transparent tape, is scanned by a lens disc, converted to a low-fidelity video signal, transmitted over conventional wire-lines, then recreated by a Kerr Cell and lens disc, which projects the received message.

KWICK-KUT writes . . .

"We have found the use of Parker-Kalon Self-Tapping Screws very profitable. They are great labor savers and they do a very satisfactory job. Our only regret is that we didn't start using them long ago."

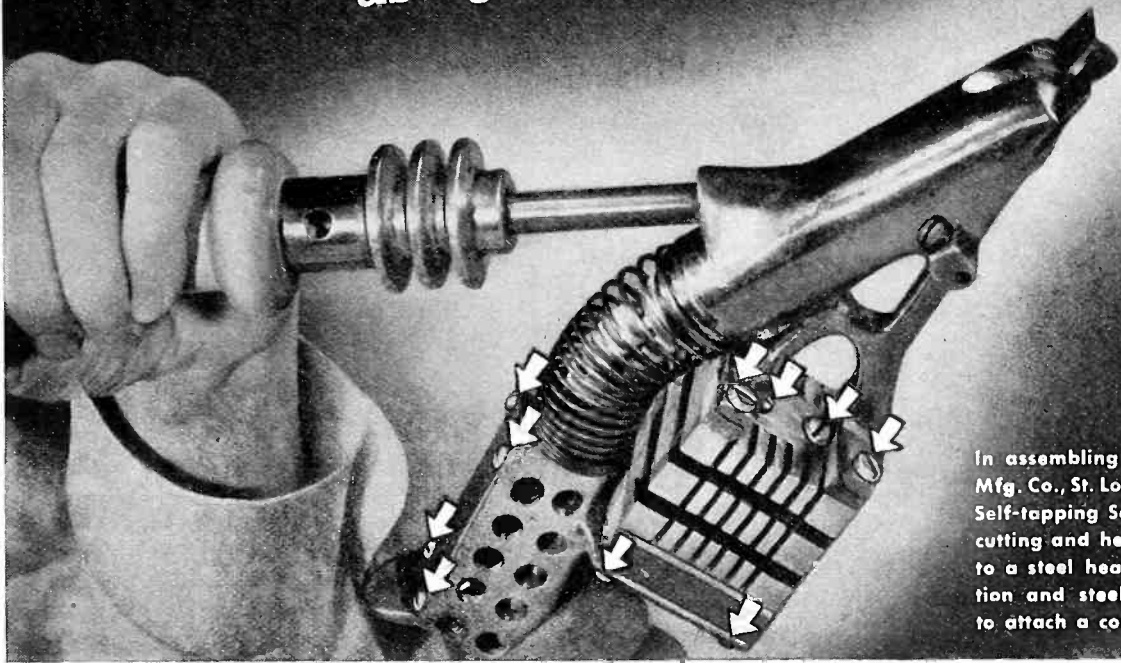

In assembling this Tire Groover made by Kwick-Kut Mfg. Co., St. Louis, Mo., sixteen Parker-Kalon Type "Z" Self-tapping Screws are used . . . to fasten the bronze cutting and heating head and cast aluminum handle to a steel heat dissipating unit . . . to join the insulation and steel sections of heat dissipating unit . . . to attach a cover to receptacle in aluminum handle.

BEGIN 1938 WITH THIS ASSEMBLY CHECK-UP!

Call in a Parker-Kalon Assembly Engineer . . . go over metal and plastic fastening jobs with him . . . make certain you won't miss economies that Parker-Kalon Self-tapping Screws would effect.

"Our only regret is that we didn't start using them long ago" . . . says the maker of the Kwick-Kut Auto Tire Groover. Essentially the same words come from hundreds of concerns who, during the past year, invited a

Parker-Kalon Assembly Engineer to show where and how Self-tapping Screws would do a better job, faster, with less labor and expense.

In 1937, more than a thousand other manufacturers who were already using this modern fastening method for certain assemblies obtained *new economies* through a check-up that disclosed overlooked opportunities for applying Parker-Kalon Self-tapping Screws.

Every manufacturer whose product involves metal or plastic assembly can profitably employ the specialized knowledge of a Parker-Kalon Assembly Engineer in a study of assembly work. Records show that 7 out of 10 such studies produce notable benefits. It will pay YOU to begin 1938 by writing us to have our engineer call and make certain that you are taking full advantage of Parker-Kalon Self-tapping Screws . . . the modern means of assembly that eliminates tapping and other costly, awkward operations . . . and makes stronger fastenings, too.

PARKER-KALON CORPORATION
Varick Street New York, N. Y.

PARKER-KALON *Modern* FASTENING DEVICES

TYPE "Z" HEX CAP A HARDENED SELF-TAPPING SCREW FOR EVERY KIND OF ASSEMBLY TYPE "A" TYPE "U"

SOLD ONLY THROUGH RECOGNIZED DISTRIBUTORS

VOLTAGE REGULATORS

REGULATORS

for Radio Transmitters

ACCURATE control of voltage to all plate, filament and bias circuits is now possible at lower cost and with greater efficiency through the use of Transtat Voltage Regulators. This new AmerTran product is a commutator-type, continuously variable auto-transformer regulator which offers both the smoothness of control of a potentiometer and the high efficiency, good regulation and flexibility of a transformer. Single-phase and polyphase types for either manual or automatic control are available for loads from 0.5 to 150 Kva. May we send complete data? Ask for Bulletin No. 51-1.



Above—Type "TH" Transtat Voltage Regulators of encased and open construction. These units are manufactured under U. S. Patents 1,993,007, 2,014,570, 2,085,255 and 2,089,434; also licensed under U. S. Patent 2,009,013.

APPLICATIONS

Master voltage control: Where the line voltage fluctuates throughout the day a Transtat Regulator in the main power line permits application of normal voltage to all equipment.

Rectifier output control: The d.c. output voltage from a rectifier may be controlled smoothly and efficiently over a wide range without sacrifice of voltage regulation by means of a Transtat Regulator connected in the primary circuit of the plate transformer. Power may be reduced without shutting down.

Filament control: Smooth, continuous control of filament voltage to insure efficient operation under all conditions and maximum tube life may be provided by a Transtat Regulator connected in the primary circuit of the filament transformer. Failure of one filament will not appreciably increase the voltage applied to the others.

AMERICAN
TRANSFORMER
COMPANY

178 Emmet St.
Newark, N. J.

AMERTRAN

Manufactured
Since 1901 at
Newark, N. J.

TRANSFORMERS

(Continued from page 38)

be described was made possible by the use of acorn tubes, and ultra compact high-fidelity audio transformers, such as are available from several manufacturers.

The following factors were considered in the design of the nine-pound midget remote amplifier: high-fidelity, low harmonic distortion, low noise level, high gain per channel, three microphone channels, a-c or d-c operated, simplicity of operation, light weight, and small size. The measured characteristics of the completed midget remote amplifier are: Frequency response within plus or minus two decibels from 50 to 9,000 cycles per second,

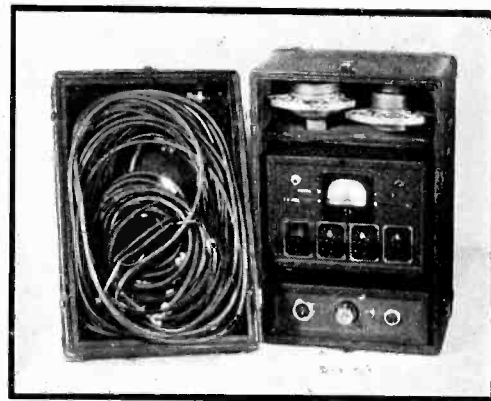

Fig. 1—Remote amplifier in case

harmonic distortion .15 per cent r.m.s. at .006 watts output power, background noise and hum level minus 45 decibels, gain per channel with output pad connected, 107 db, size 9 3/4" x 6 3/4" x 6 1/2", weight 9 lbs.

Figure 1 shows the remote amplifier as compared in size with the two Western Electric 619-A microphones. The three microphone gain controls are at the left, the right hand control being the master gain control.

The circuit diagram of the remote amplifier is shown in Fig. 2 and but for a few exceptions is self-explanatory.

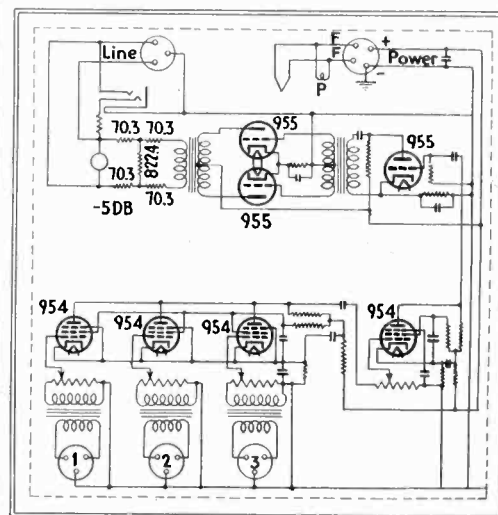
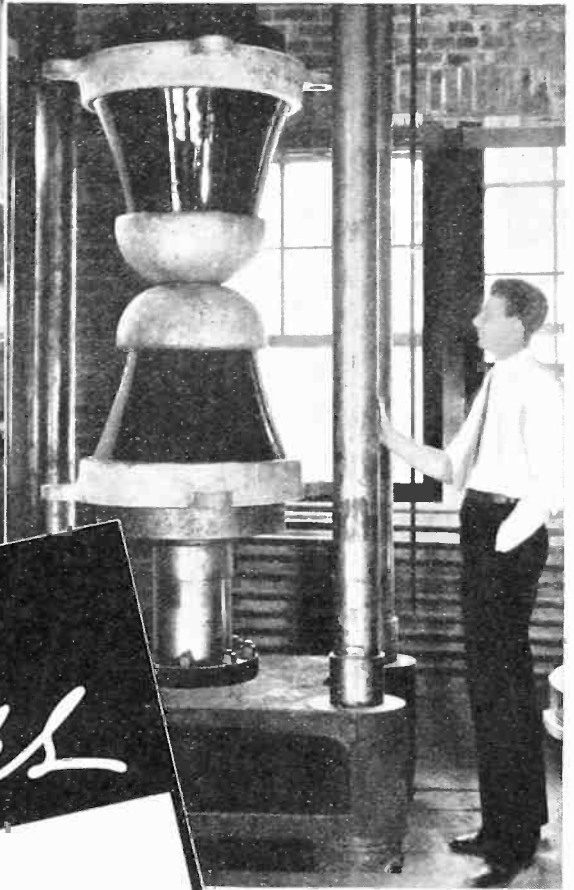

Fig. 2—Circuit diagram

tory. Any type of input impedance may be used with minor changes, depending on the type of microphones to be used. The transformers on channels 2 and 3 have a primary impedance of 30 ohms, while that on channel 1



proving ground for radio Insulators

Early in the history of radio transmission, Lapp established testing laboratories to aid in the development work on radio insulators. As a result, Lapp has been able, year after year, not only to provide insulators that meet advanced requirements of broadcasting technique, but also to anticipate new needs — indeed, to contribute to the growing knowledge of the science. Many of the newer ideas in radio insulators and consequent improvement in broadcasting have been Lapp conceptions, worked out in close co-operation by engineers of Lapp and of structure and equipment manufacturers. Lapp Bulletin 137 tells an interesting story of Lapp porcelain coils and insulators for tower footings and guys. If you do not have a copy, write for it today.

At left, radio frequency generator and equipment for flashover, heat run, corona point, loss and capacitance determinations. Right, three million pound radiator base insulator being proof-tested in hydraulic testing machine.

LAPP INSULATOR CO. INC

LAPP
INSULATORS

LE ROY - N.Y. - U.S.A.

Better **ANODES**
Better **TUBES**

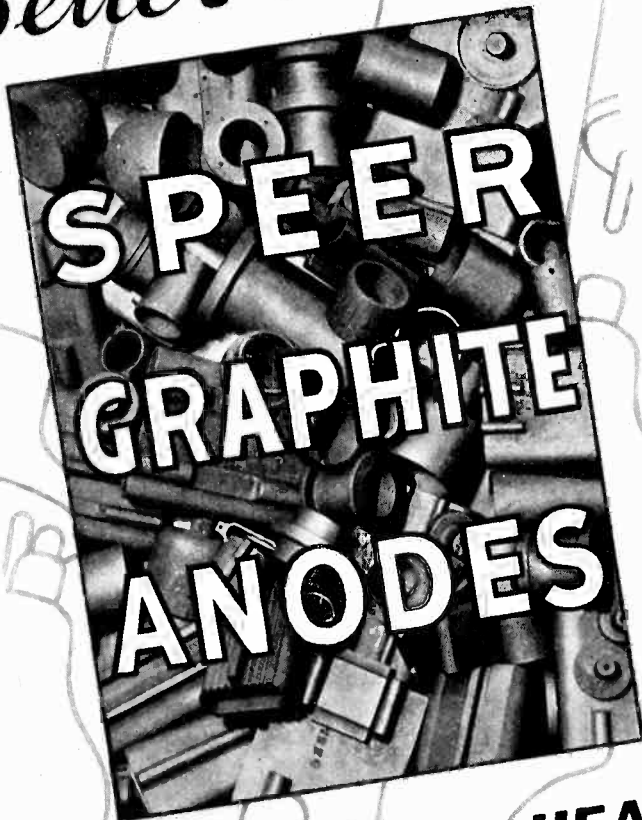

**STAND MORE HEAT
OPERATE COOLER**

Speer Graphite Anodes will not soften, melt, warp or blow out at any temperature whatever. On top of that they run cooler because they dissipate heat more rapidly than any other anode material. Their heat dissipating value is approximately 3 times that of tungsten, 4 times molybdenum, 5 times tantalum and 100 times that of nickel. Buy transmitting tubes with Speer Graphite Anodes. Sold only to tube manufacturers. Write for a list of users and Anode booklet.



SPEER CARBON COMPANY
ST. MARYS, PA.

has a tapped primary of 500, 333, 250, 200, 125, and 50 ohms. If at any time more than three microphones are needed in a remote broadcast, additional mikes can be used with an external two-position mixer feeding the primary of the latter transformer.

All input circuits are very carefully shielded and the input transformers placed so as to avoid any feed back. The chassis layout may be seen in Fig. 1. All input transformers feed directly into a simple potentiometer. The potentiometers are mounted in such a manner that they may be easily replaced when they become noisy.

Electronic mixing is employed for the mixing of microphones into the second audio stage through the master gain control. All the d-c plate current is blocked out of the transformer primary (between the 955's) to assure a linear characteristic, and low phase shift. It is important that the d-c plate current of each tube of the push pull 955's be matched in the primary of the output transformer. If the 955 tubes are not matched there will be a noticeable falling off in frequency response below 100 cycles, as well as an increase in distortion.

In using the acorn tubes for audio work it was found necessary to select the tubes as there was a noticeable variation in tubes as to plate current and microphonic noises. It was found even impossible to use some of the 955's even after being cushioned because of

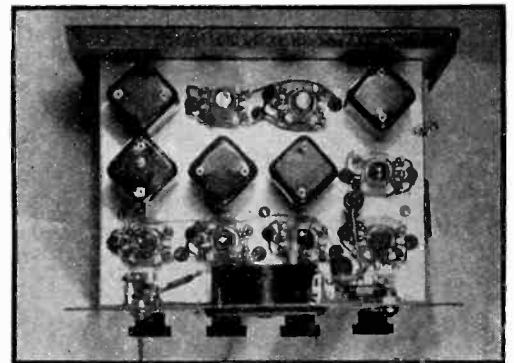

Fig. 3—Interior view

microphonic noises. Cushioning of the second and third audio stages of the amplifier did away with any noticeable microphonic noise after selecting the tubes.

The output transformer works directly into a 5 db. pad to prevent line reflection back into the secondary of the output transformer. A copper-oxide meter is connected directly across the output pad for the volume indicator as is the monitoring phone jack.

A 12 ft. program line cable is carried as part of the equipment; one end of the cable carries the male plug that goes to the amplifier. The other end has two Fahnestock clips mounted on a bakelite strip that connects to the program line. The power connector is of the four contact type, therefore it is impossible to plug it in wrong.

The a-c power supply may be seen in the bottom of the carrying case,

Ⓢ 7892

Check this WESTON

*Photronic Equipment... *against*

your own
photoelectric needs

- ✓ COUNTING
- ✓ SORTING
- ✓ WEIGHING
- ✓ PHOTOMETRY
- ✓ RESEARCH
- ✓ CONTROL

✓ **Photronic Cell**—The basic element behind WESTON Photronic equipment . . . simple, stable, dry type cell . . . rapid in response . . . generating sufficient energy to operate relays direct.



✓ **Sensitive Relays** — Positive operation on values down to 2 microamperes or 1/2 millivolt . . . "off-on" and indicating types, designed especially for Photronic-powered equipment. Companion *Power Relays* permit control of major circuits.



✓ **High-Sensitivity Instruments** —A complete line of DC panel instruments and portables, calibrated in microamperes or comparable units . . . for accurate measurement in Photronic circuits.



✓ **Industrial Control Equipment** —Light source, Photronic Cell and Relay Panel combinations for counting, timing, and general industrial control. Will operate "off-on" relays at speeds up to 500 light-beam interruptions a minute.



✓ **Illumination Meters and Controllers**—Foot-candle meters . . . the standard instruments for illumination level tests in industry and the home. Special high-sensitivity instruments for photometric research . . . Photronic Controllers which turn lights on and off at predetermined levels.



✓ **Photometric Potentiometer and Control Unit**—The latest step in high-speed, high-sensitivity control . . . provides positive operation of recorders and relay controls.



WHETHER your needs arise in the field of photometry, of modern industrial control, or in some special field where light must be converted to an electrical response, it will pay you to check with WESTON.

Thanks to the WESTON Photronic Cell, illumination levels have become understandable to the public, and light beams have become serviceable to industry. Today, this same cell is the basic element for an increasing number of Photronic-powered units for measurement and control . . . units engineered by WESTON to expand the practical usefulness of the photoelectric effect.

Perhaps one of the standard Photronic cell-and-relay combinations can provide a simple and direct answer to your particular problem. Or perhaps some individual assembly of relays or instruments designed specifically for Photronic circuits holds the key.

In any event, the same WESTON engineers who have brought the usefulness of Photronic equipment to its present point are still at your service. Their counsel may bring to light new possibilities; it may keep you from duplicating old errors. Simple or complex, if there is a photoelectric solution to the problem you have in mind, WESTON can help you solve it. Weston Electrical Instrument Corporation, 618 Frelinghuysen Avenue, Newark, New Jersey.

*PHOTRONIC—A registered trademark designating the photoelectric cells and photoelectric devices manufactured exclusively by the Weston Electrical Instrument Corporation.

WESTON *Instruments*

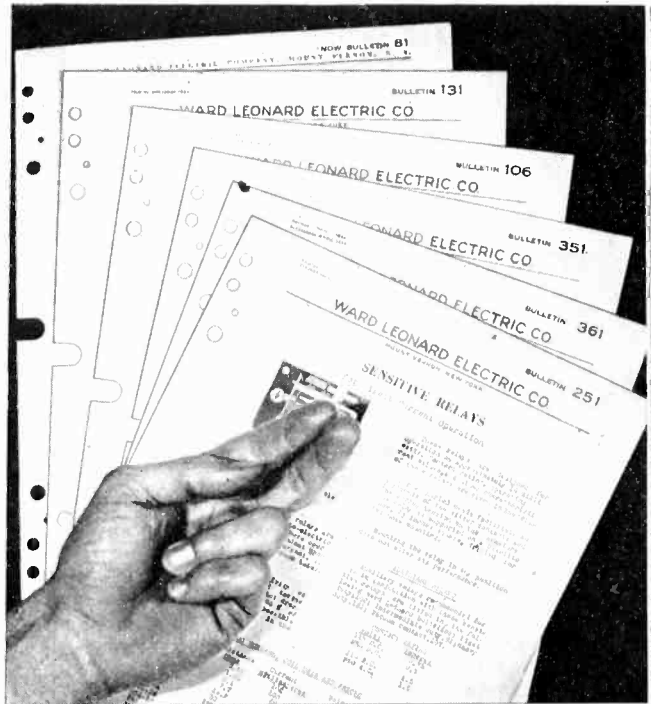

CONTROLS YOU SHOULD KNOW

These bulletins contain technical information about the new Ward Leonard Control Devices. Every designer and manufacturer of equipment for the generation and use of electricity will find them of great value. Send for any or all of the bulletins featuring controls listed below.



Resistors
Rheostats
Relays

Speed Regulators
Voltage
Regulators

Motor Starters
Rectifiers
Contactors

WARD LEONARD Control Devices Since 1892

Ward Leonard Electric Company, 32 South Street, Mount Vernon, N. Y.

Please send me bulletins relating to: Resistors , Rheostats , Relays , Speed Regulators , Voltage Regulators , Motor Starters , Rectifiers , Contactors .

Name

Company

Street

City and State

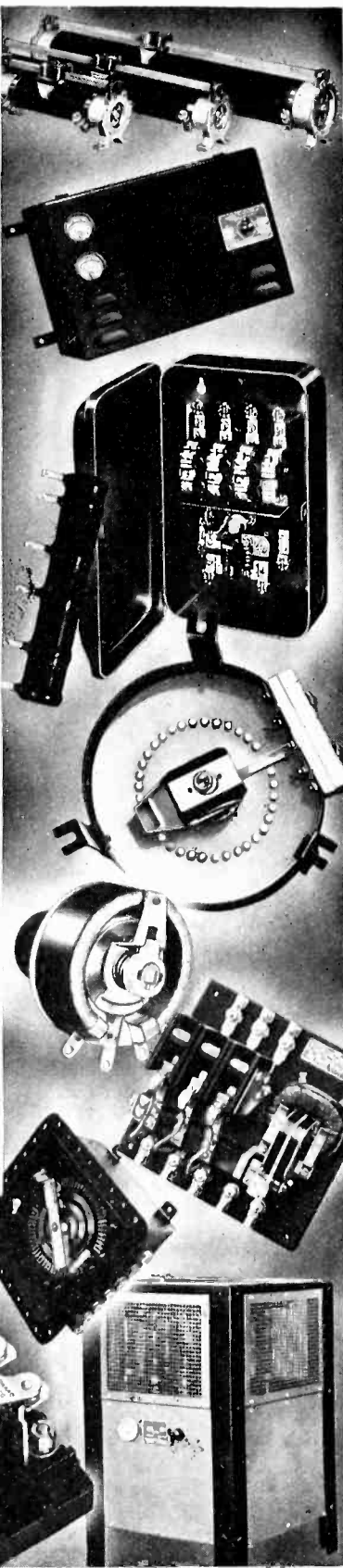

Fig. 1. The power supply circuit is of the conventional type, with the exception of very high filtering.

The carrying case was designed so that all remote equipment could be carried in one case. The lid contains 200 ft. of microphone cable, headphones, and all connecting cables. There is a removable door in the lid to hold the cables in place. The lid of the carrying case is detachable from the bottom for the ease of packing. The bottom of the carrying case is divided into three compartments. One for the power supply, middle for the remote amplifier, and the other compartment contains three microphones, two W.E. 618-A, and one "eight-ball" mike, two extra acorn tubes, and one 84 tube. The carrying case was made by a local trunk manufacturer. The outside of the case measures 17" x 11" x 11".

The midget remote amplifier has been in use at KCMO for several months and has proven its merits over the older and more cumbersome types. The time required to set the remote equipment up for operation is less than five minutes.

• • •

Direct Current Amplifier For Photocell Applications

BY R. W. GILBERT

Weston Electrical Instrument Corp.

FOR PHOTO-CELL APPLICATIONS where a substantial current output is essential, the difficulties involved in amplification of direct current have resulted in serious limitations to critical measurement or control. Although the modern blocking-layer type of photo-cell offers a high degree of stability and simplicity, efforts to apply amplification to its output current have heretofore necessitated methods which introduced new electrical or mechanical variables which fall short of the stability of the cell itself.

In general, the weakness of all such methods has resulted from the fact that external power supplies, vacuum tubes, and other complex electrical or mechanical elements have been included in the critical calibration circuit, subjecting the amplified output to variations arising from external sources, high temperature coefficients, etc., and requiring periodic manual readjustment. Furthermore, these circuits operate the cell either wholly or partially on its less desirable *voltage* characteristic, thus causing non-linearity and lowered stability within the cell itself. Conductively-coupled amplifiers have been used rather widely, in combination with various schemes to secure freedom from the effects of varying tube characteristics, battery voltages, and the like. A variation from this has been the use of an alternating current amplifier in combination with some means for securing an alternating component that varies with cell illumination and out-

FROM COAST TO COAST THE ISOLANTITE NETWORK

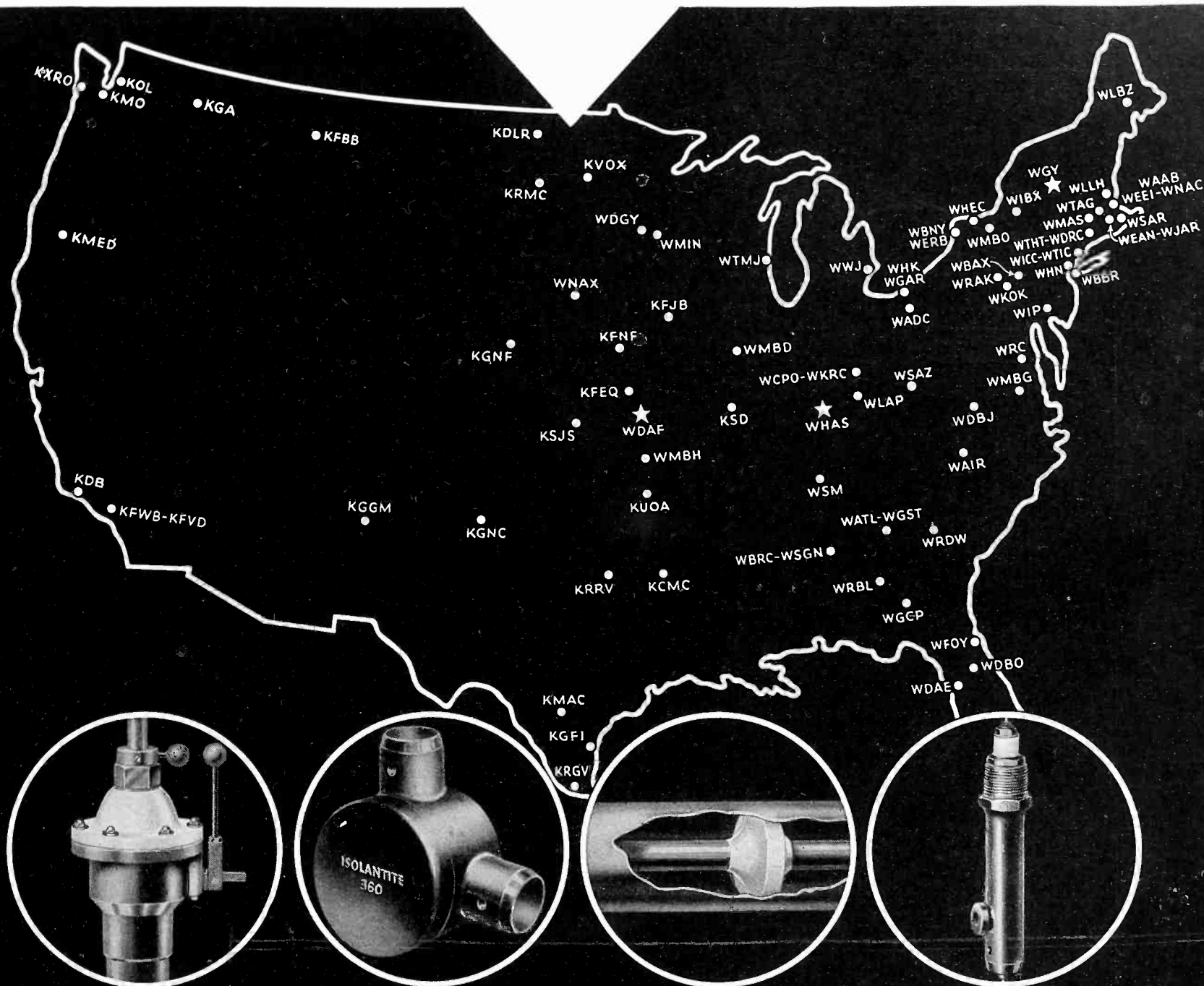

ACROSS the country from coast to coast spreads a great network of more than 75 broadcasting stations—the network of stations using Isolantite* co-axial transmission line. Selected by leading manufacturers of broadcasting equipment for their installations, Isolantite co-axial line has brought to broadcasters everywhere new standards of transmission line efficiency.

Isolantite co-axial line is more than two copper tubes held in concentric relation—it is a complete system from transmitter to antenna. Every detail has been carefully engineered and is being constantly improved. The heavy copper tubing and couplings, manufactured to close tolerances, assure trouble-free installation. Flexible internal connectors in right-angle fittings permit differential thermal expansion. Gas-tight end seals can be equipped, if desired, with lightning protection gaps. Low-loss insulators are scientifically designed for uniform flux density and maximum flash-over.

Isolantite co-axial transmission line is regularly furnished in diameters of $\frac{3}{8}$, $\frac{7}{8}$, $1\frac{5}{8}$, and $2\frac{5}{8}$ inches; other sizes are supplied when requested. The smaller sizes are extensively used in police radio, airway beacon, and communications equipment. Bulletin No. 101 describes the $\frac{7}{8}$ -inch line; information on other sizes will be sent on request.

* Registered Trade-name for the products of Isolantite Inc.

SOLD ONLY THROUGH GRAYBAR ELECTRIC CO. AND MANUFACTURERS OF TRANSMITTING EQUIPMENT

ISOLANTITE INC.

CERAMIC INSULATORS

Factory: Belleville, N. J. • Sales Office: 233 Broadway, New York, N. Y.

THAT *Tiny Motor*
YOU'VE BEEN LOOKING FOR

Utah
has it!

65,349 DELIVERED TO THE RADIO INDUSTRY
IN THE LAST 60 DAYS!

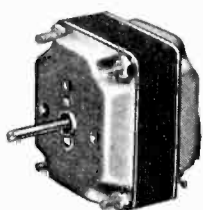

1/8 ACTUAL SIZE

A. C. Here is the 3-wire brushless reversible motor Utah pioneered for the electric tuning of radios. Other branches of industry are finding countless applications for this versatile little motor. It can be supplied for any A. C. voltage from 6 to 115.

Here is an arrangement that demonstrates the adaptability of these motors to a variety of applications. This Utah motor has an automatic clutch, a gear train, manual control shaft and mounting plate. Other gearing may be substituted. Silver contacts are used on the Thermostatic Switch and Muting Switch. Motor is squirrel cage induction type with self-aligning oil-less bearings.

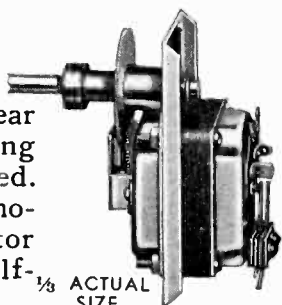

1/8 ACTUAL SIZE

D. C. Here is the 3-wire universal brush type, for D. C. and A. C., 25-50-60 cycles. Automatic clutch and driving pinion are standard equipment. All Utah motors are easily adapted to a variety of layouts. Though exceptionally compact, they are built to take the rigorous starting, stopping and reversing required by many applications.



1/8 ACTUAL SIZE

Send your specifications
for prices and details.
Address Dept. E1

PATENTS ISSUED AND PENDING
ON ABOVE MOTORS

UTAH RADIO PRODUCTS CO.

CHICAGO, U. S. A.

TORONTO

BUENOS AIRES

ONTARIO, CANADA

(UCOA RADIO PRODUCTS CO.)

“16 YEARS OF LEADERSHIP”

put. Periodic interruption of the light beam has been used for this purpose—also, modulation of a fixed alternating input by causing a gain of the first stage of amplification to vary with cell output. Other methods, involving optical or mechanical interpretations of a sensitive microammeter, have great practical utility as relay controls but lack the high-speed continuity of amplification desirable for many critical applications.

The characteristics of the most constant vacuum tubes available unfortunately are far too variable to impose directly in the calibration cycle if a stability and precision better than the order of that of the photocell is considered a requirement. Thus it becomes necessary to employ some principle whereby, if tubes are used, their function is secondary, and variation of their coefficients or supply voltages does not reflect on the amplification factor of the amplifier.

This requirement is achieved in a potentiometric method of control in

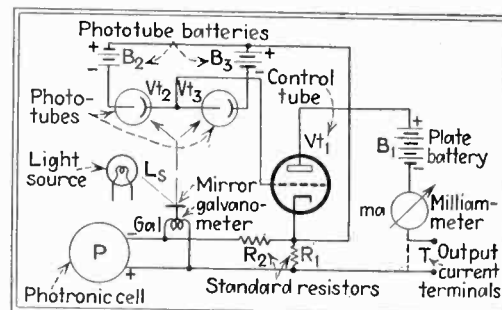
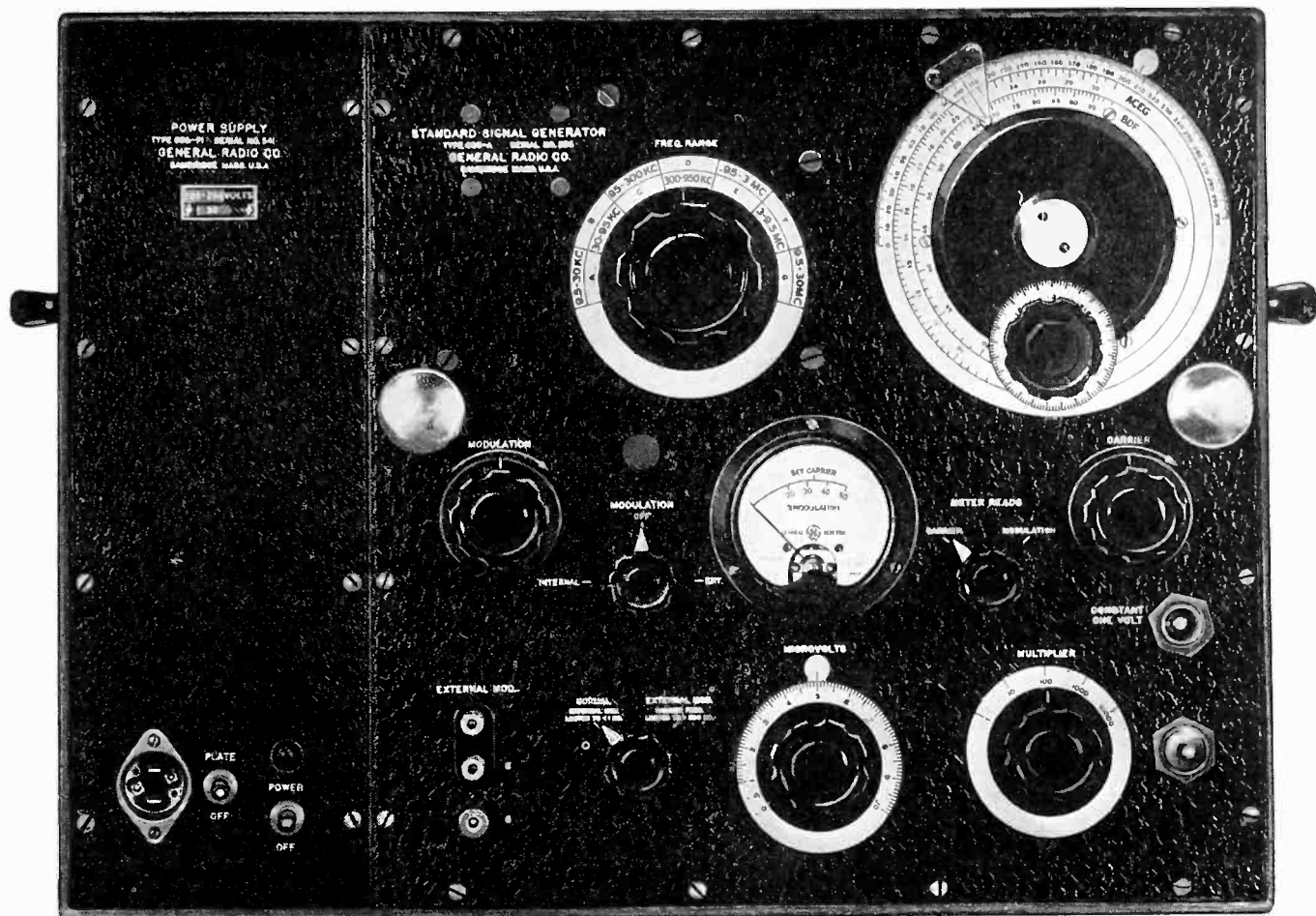

Fig. 1—Circuit of d-c amplifier

which the output current is rapidly and automatically adjusted and maintained in a null potentiometric relationship to the input current. With an electronic balancing system of high sensitivity and speed, the amplification factor is dependent only upon the value of the resistors composing the potentiometer circuit.

The operating principles of such a high-speed automatic potentiometer, as designed for measurement of voltage as well as current in a variety of applications, has been described previously in some detail. Figure 1 illustrates its use as a direct current amplifier for the purpose under consideration. For the sake of simplicity batteries are shown in place of the actual power-pack operating on the ordinary a-c supply.

The potentiometer circuit consists of two resistors, R_1 and R_2 , arranged to attenuate a portion of the relatively heavy output current into the photocell assisting the flow of normal cell current. At a certain value of output current, dependent upon cell illumination, the e.m.f. at the cell terminals is zero. The current flowing through the cell is then exactly the same as would be the case if the cell were disconnected, short circuited, and exposed to the same illumination; in other words, the cell is operating under exactly the same condition as with zero external resist-



Improved Standard-Signal Generator

THE new Type 605-B Standard-Signal Generator has a number of mechanical and electrical improvements which increases its usefulness many-fold. Included are: geared slow-motion drive for more precise setting and for obtaining selectivity curves; new condenser of better construction; range extended to 50 Mc; constant one-volt output; improved output cable.

This new generator is available in both a-c and battery powered models. The a-c model is supplied with built-in voltage-regulated power supply which assures constant output over normal line voltage fluctuations.

Type 605-B Standard-Signal Generator (either model) . . . \$415.00

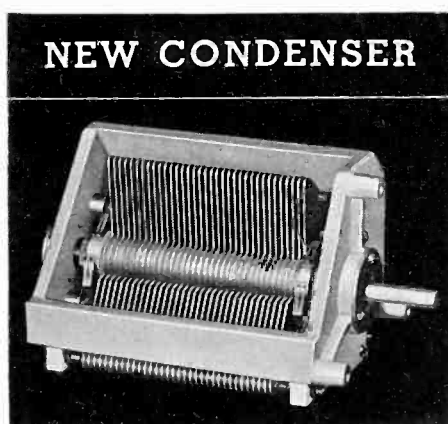

1 Better mechanical and electrical stability; one-piece cast aluminum frame; ball bearings; smoother running; four rotor spring contacts for equi-potential plates; lower r-f resistance.

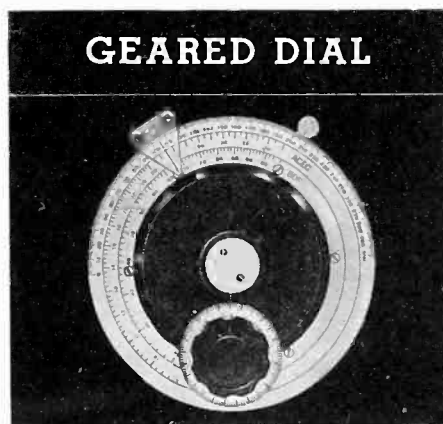

2 Slow-motion dial geared and engraved; one division on small dial equals 0.1% of carrier frequency; effective scale-length between 9.5 kc and 30 Mc is 38 FEET; direct-reading from 9.5 kc to 30 Mc, calibration curve 30 Mc to 50 Mc.

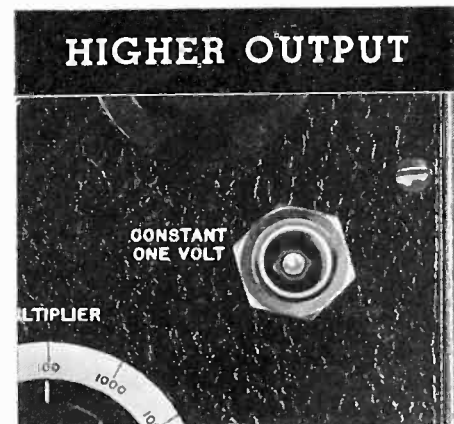

3 Constant one-volt output jack for general laboratory use, r-f bridge work, resonance tests with vacuum-tube voltmeter and measurements of conversion stage gain; improved output cable for more accurate r-f measurements.

● Write For Bulletin 215 For Complete Data



GENERAL RADIO COMPANY, Cambridge, Mass.



CERAMIC DIELECTRIC CONDENSERS WITH UNUSUAL CHARACTERISTICS

Erie Ceramicons consist essentially of a ceramic dielectric with coated plates of pure silver. The inherently stable capacity of these small fixed condensers is independent of frequency and has a definite temperature coefficient, which is either positive or negative depending on the type of dielectric used. Erie Ceramicons are available in capacities from 1 to 600 MMF. in sealed insulated types and non-insulated types.

Erie Ceramicons have been hailed with enthusiasm by engineers who foresee in them the solution to many problems. For example, Erie Compensating Ceramicons, consisting of either one or two Ceramicons with a definite predetermined temperature coefficient and housed in a single ceramic case, are an important contribution to the more efficient operation of push-button tuned receivers because of their ability to compensate for reactance changes in other circuit parts.

For complete information on Erie Ceramicons and Erie Compensating Ceramicons fill in and mail the coupon at the right today!

Erie Resistor Corp., Erie, Pa.
 Gentlemen: Please send me a copy of your bulletin giving engineering data on Erie Ceramicons and Erie Compensating Ceramicons. We are interested in using them in _____

NAME and TITLE _____
 COMPANY _____
 STREET _____
 CITY & STATE _____

ERIE RESISTOR CORPORATION, Erie, Pa.

TORONTO, CANADA • LONDON, ENGLAND • PARIS, FRANCE - J.E. CANETTI CO.

RESISTORS • SUPPRESSORS • CERAMICONS • INJECTION MOLDED PLASTICS

Left: Non-insulated Erie Ceramicons.
 Center: Insulated Erie Ceramicons.
 Right: Erie Compensating Ceramicon.

CHARACTERISTICS OF CERAMICONS

Range: 1 to 600 MMF.

Rating: 500 Volts D. C. Tested at 1,000 Volts D. C.

Types: P120 with positive temperature coefficient of capacity of 1.2×10^{-4} per °C.

N650 with negative temperature coefficient of capacity of 6.5×10^{-4} per °C.

Capacity: Extremely stable, practically unaffected by alternate heating and cooling.

Independent of frequency.

Less than .25% increase after 100 hours at 100% humidity, 40°C.

Power Factor: At 1,000 K. C. .09 for Type P120; .06 for Type N 650.

ance. For all conditions of potentiometric balance, or zero e.m.f. at the cell terminals, the attenuation of the R_1 - R_2 combination determines the proportion between the cell current (i) and the output current (I), or:

$$I = \left[\frac{R_1 + R_2}{R_1} \right] i$$

Thus $\frac{R_1 + R_2}{R_1}$ is the amplification factor

of the amplifier.

To maintain this condition of potentiometric balance the output current must be continuously adjusted to the value where the cell terminal e.m.f. is zero. A mirror galvanometer is arranged as shown, to deflect upon the appearance of cell terminal e.m.f. Deflection causes a change in the differential illumination of the phototubes, causing a proper change in the grid voltage of the control tube, which in turn increases or decreases the output current until potentiometric balance is again restored. Both phototubes are illuminated at all times, galvanometer deflection merely causing an increase in one and a decrease in the other, or vice versa depending upon the direction of unbalance.

As restoration of balance takes place instantly upon galvanometer deflection, speed and sensitivity are simply functions of galvanometer design in relation to the optical system. Spurious galvanometer deflections occasioned by vibration, drafts, etc. are instantly corrected by a flow of unbalance current, so control torque is unnecessary and no springs or torsion filaments are used. This eliminates the most serious galvanometer error, zero drift, gives rise to a high sensitivity, and allows deflection to new null positions without error. By proper design the amplifier is capable of rebalancing for an instantaneous full scale change of input within one second without overshooting.

The practical amplifier is built for operation from service power. It is designed as a universal potentiometer for potentiometric measurement or amplification of either voltage or current, but, for use as a photocell current amplifier, the current potentiometer circuit only is used. The potentiometer resistors, R_1 and R_2 of Fig. 1, are arranged for plug-in connection for convenience in changing the range of the instrument. These plug-in units are termed "range standards" and can be standardized in terms of amplification factor or cell current, or, when calibrated with the cell to be used they can be standardized in terms of the application, such as illumination, temperature, turbidity, transparency, reflection coefficient, etc.

The output current is of 10 milliamperere range; a suitably high value for operation of recorders, control relays, rugged indicating meters, etc. By means of an internal compensating shunt, the amplifier can be arranged for center zero indications for operating from differentially connected cells. The



Typical advantageous applications of Transparent Bakelite Molded: door handle in ruby color; decorative jar in tortoise-shell; instrument case in amber; ruby lens. Others are shown below.

NEW—Transparent BAKELITE MOLDED!

FOR MANY YEARS, users of plastics have sought a *transparent* material possessing molding characteristics similar to the well-known opaque Bakelite molding materials. In the new Transparent Bakelite Molded developed by Bakelite laboratories, a plastic of this type is now available for commercial application.

Transparent Bakelite Molded opens practically unlimited avenues to improvement in the design of

manufactured products. For housings, handles, dials, lenses, and many other uses, this new material adds visibility to the other advantages of Bakelite Molded. It is available in amber, ruby, green, tortoise shell and other enduring colors.

Various properties of Transparent Bakelite Molded are comparable or superior to those of General Purpose Bakelite Molded. It is less hygroscopic; and its tensile, im-

pact and flexing strengths are high. It withstands exposure at 225°F. to 300°F. without deterioration. Its dielectric properties, dimensional and chemical stability are excellent.

Makers and designers of electrical appliances, equipment or instruments and radio parts or devices are urged to investigate the many possibilities of this new material. Write for data sheet 13E, "Bakelite Transparent Molding Materials".

BAKELITE CORPORATION, 247 PARK AVENUE, NEW YORK, N.Y.
 BAKELITE CORPORATION OF CANADA, LIMITED, 163 Dufferin Street, Toronto, Canada West Coast: Electrical Specialty Co., Inc., 316 Eleventh Street, San Francisco, Cal.

BAKELITE

The registered trade marks shown above distinguish materials manufactured by Bakelite Corporation. Under the capital "B" is the numerical sign for infinity, or unlimited quantity. It symbolizes the infinite number of present and future uses of Bakelite Corporation's products.

PLASTICS HEADQUARTERS

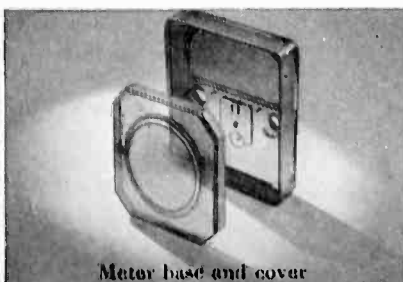

Motor base and cover

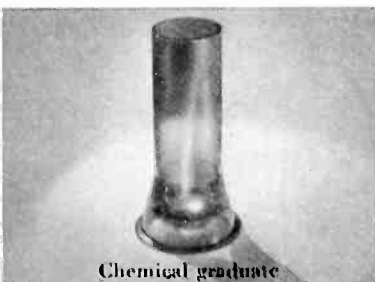

Chemical graduate



X-Ray Cone



Push button housing

POWER from weather

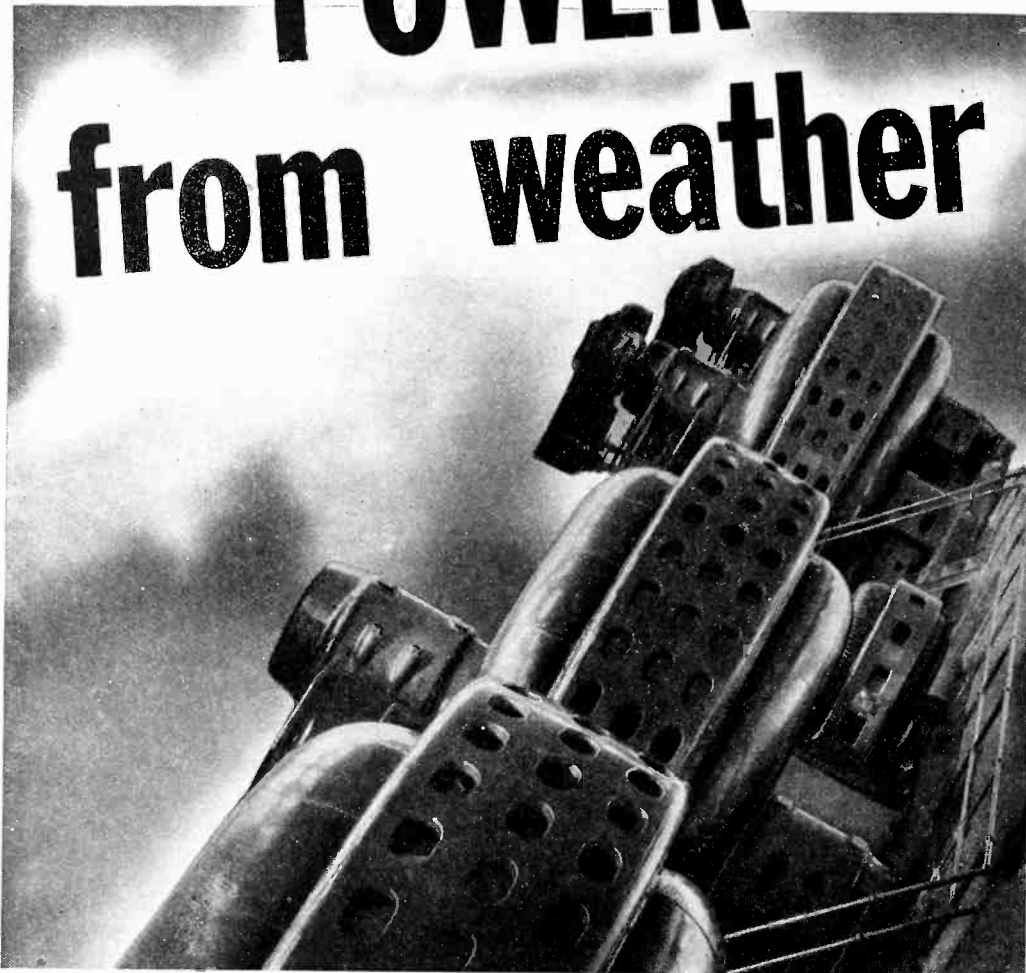

WILCO THERMOMETALS THERMOSTATIC BI-METALS

react Instantly to Temperature Changes

● Wilco Thermometal is the least expensive method of automatically producing power and motion because it eliminates the necessity for auxiliary impetus.

Today, you will find a decided preference for Wilco Thermometals in indicating and control devices because of their uniformity, dependability and constant behavior.

These factors of superiority are due to The H. A. Wilson Company's undeviating standards of excellence to which it has adhered for more than two decades.

THERE'S A
WILCO THERMOMETAL
FOR EVERY JOB



Write for "Wilco Blue Book of Thermometals."



THE H. A. WILSON CO.

105 CHESTNUT STREET, NEWARK, N. J.
BRANCH OFFICES • CHICAGO, ILL. • DETROIT, MICH.

Refiners and Workers of Platinum, Gold and Silver

Precious Metal Contacts • Wilco Thermometals (Thermostatic Bi-metals)



output current would then have a range of 5-0-5 milliamperes. The amplification factor and speed are entirely unaffected by loading the output circuit up to a load of 2000 ohms. Good and poor tubes can be interchanged at will with no effect except a very slight change in speed.

Variations causing error within the instrument are limited to a function of the magnitude of off balance current required to cause the galvanometer to operate, and so error is better expressed as the corresponding value of illumination, rather than a percentage of the range or amplification factor. Using a single Weston Photronic Cell, the amplifier has an overall sensitivity of about 0.02 foot candles or better. With precise standard resistors, this figure represents the maximum error within the instrument regardless of illumination level or amplification factor; an order of stability far past the capabilities of the most stable cells.

NEW BOOKS

Dictionary of Radio Terminology in the English, German, French and Russian Languages

By A. S. LITVINENKO AND EDITED BY V. I. BASHENOFF.
Bookniga Corp., New York, 1937.
(559 pages, Price \$4.00)

THIS GOOD SIZE VOLUME gives a systematic comparative review of modern radio terminology in four languages, although a number of fundamental terms related to acoustics, optics, mathematics, and electrical theory are also given. Because all terms are listed alphabetically in all four languages, terms may be translated from one language to another without the use of an index or other cross reference.—B.D.

GLOSSARY OF PHYSICS

By LEROY D. WELD, *Professor of Physics in Coe College.* McGraw-Hill Book Co., New York, 1937. (255 pages, price \$2.50).

THE VARIOUS BRANCHES of physics and engineering have become so specialized that it is no infrequent occurrence for a specialist in one branch to be somewhat at sea with the terminology employed in a less familiar branch of the subject. For some time, the need for a reasonably comprehensive dictionary or glossary of terms frequently used in physics has been evident.

The present volume contains definitions of about 3,200 terms used in physics and adjacent fields and frequently found in the literature on physical subjects. According to the preface "the

descriptive character of the glossary has been emphasized from the first, with deliberate intent to avoid any presumption of framing exhaustively accurate definitions or of authoritatively standardizing the use or the meaning of terms. The sole purpose is to give information as to actual usage and in such form as to be intelligible to the student as well as to specialists." Frequently, references are given to sources of additional information. The definitions given are compact and to the point without being too involved or splitting too many fine hairs in the interest of scientific precision.

In compiling this glossary, Dr. Weld has been assisted by a considerable number of special consultants, with the result that the selection of the material is well balanced. To an intelligent reader of literature on physical subjects, the "Glossary of Physics" should occupy the same position as the ordinary dictionary does to the average non-technical reader.—B.D.

Back-talk

Johnson-Rahbeck Effect

The writer recently did some work on an electrostatic type of relay. A slab of marble or limestone is polished on one side, and on the other side is pasted a piece of metal foil which serves as one electrode. If a polished metal plate is placed against the polished stone and the plate is connected in series with a phototube and a source of E.M.F. of 100 volts or more as long as the phototube is exposed to illumination, considerable adhesion takes place between the stone and the metal plate. If the light is interrupted, the adhesion disappears and if the plate is in a vertical position it will fall off. Higher voltages increase the adhesion. The phenomenon is known as the Johnson-Rahbeck effect. (See *Electronics*, Questions and Answers, September, 1937.)

If a sensitive microammeter is inserted in the circuit it will be found that a current is flowing through the marble and plate when the illumination is falling on the phototube. In using different pieces of stone it was found that the current flowing varied widely depending apparently on the moisture content of the stone and chemical composition. The adhesive effect on the other hand was related to surface characteristics of the stone, rather than the amount of flow of current in the material. This led to the supposition that the phenomenon was only a modification of the old familiar electrostatic attraction. According to the law of electrical force the attraction between two oppositely charged bodies varies inversely as the square of the distance

Focused on Accuracy

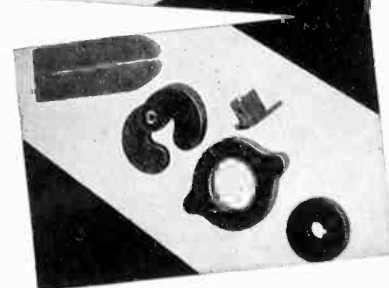
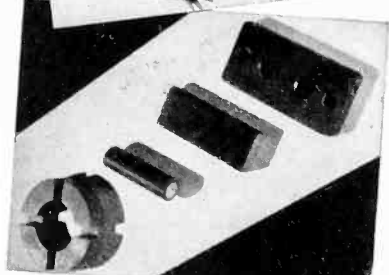

And accuracy in fabricated parts is important to your product. That is why a Zeiss Microscopic Micrometer is used for checking all Textolite parts before they are shipped to your plant for assembly. It does not matter what they are — tube sockets, threaded tubing, spiders or miscellaneous punched parts — Textolite laminated materials are continuously checked for insulation qualities during manufacture and for clean punching and accuracy during fabrication.

For complete information, write Section A-1, Plastics Department, General Electric Company, Pittsfield, Mass. Ask for publication GEA-937D.

FABRICATORS OF TEXTOLITE LAMINATED

General Laminated Products, Inc.

3113-3123 Carroll Ave.
Chicago, Ill.

233 Spring Street
New York, N. Y.

GENERAL ELECTRIC

Plastics

PLASTICS DEPARTMENT, GENERAL ELECTRIC COMPANY, PITTSFIELD, MASS.

FOR RECORDING STUDIOS THAT CAN AFFORD THE BEST



THE PRESTO STATIONARY RECORDER

Experienced recording engineers, those who are expected to get results *every time*, appreciate the refinements, the extra factors of safety and convenience, included in this Presto recording turntable.

Now that you know that instantaneous recording is a profitable fast growing business — give your engineer the best in equipment and be certain of producing the kind of records that keep your studios busy and make money for you.

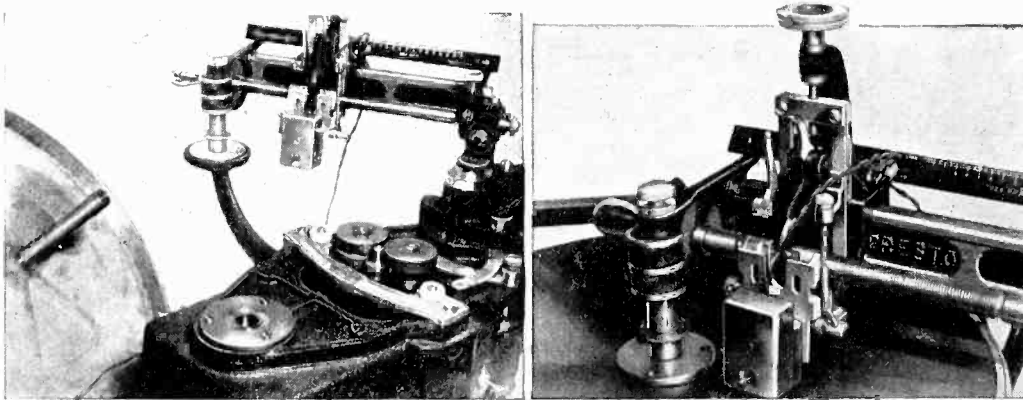

A heavy duty, constant speed motor drives a perfectly balanced cast iron turntable at the rim—the point of greatest leverage — providing ample power for recording and assuring absolutely steady speed. You can change speed from 78 to 33 $\frac{1}{3}$ RPM in less than 2 seconds.

Note the cam levers for lowering the cutting head and engaging the feed screw, the heavy guide bar for the cutter carriage, the scale indicating elapsed recording time, the quick adjustments of the cutting needle angle and pressure.

Send for the Presto catalog giving full technical description.

PRESTO RECORDING CORPORATION

143 W. 19th ST., NEW YORK

between them. For very small distances the force would therefore become large.

To set up a structure wherein the oppositely charged bodies are in very close proximity we must provide an insulator of extreme thinness, and conductors capable of bringing the charge of electricity to the opposite sides of this insulator. For the charge passed by the phototube to be dissipated for the release action to take place, there must be a slight amount of leakage between the oppositely charged bodies. The simplest form of the above structure would be two metal plates, ground and polished to fit each other exactly, one of which would be sprayed with lacquer having an excess of solvent so that the resultant film would be extremely thin.

If the effect noted with the limestone and metal plate depends on electrostatic attraction, we should get the same result from the two metal plates with lacquer film. The plates were made and lacquered, a voltage was applied to them, and the adhesion took place similar to the limestone. There was sufficient leakage in the lacquer film and the associated equipment to give release when the illumination of the phototube was interrupted.

We can therefore describe the limestone or marble as a poor natural equivalent of the above setup. The internal structure of the limestone has sufficient conductivity to bring the charge to the surface, over a period of time, but has an insulating film on the surface, probably due to the water used in polishing dissolving out the salts for a microscopic depth, which would tend to hold moisture and lower the insulating value of the surface film.

A simple oscillator may readily be constructed by interposing loosely a piece of metal foil between two metal plates, one of which has been sprayed with lacquer. The plates serve as the electrodes. The foil touches the bare plate loosely.

The action under these conditions is as follows. Due to the difference of charge on the lacquered metal plate and the foil, the foil tends to draw against the lacquer tightly. This in turn causes it to break connection with the bare plate, opening the circuit. The foil then becomes the same polarity as the lacquered plate and springs back making contact again with the bare plate. The action is then repeated. The motions of the foil may also be used as a relay to open and close auxiliary circuits.

To duplicate therefore, the effects obtained from a piece of limestone or marble with a piece of tinfoil pasted to one side, without bothering a stone quarry, the experimenter may use two pieces of any closely fitting materials, so long as they have some conductivity, for the electrodes, and prepare one of the surfaces so that actual contact cannot take place.

EVERETT H. BICKLEY,
Bala-Cynwood, Penna.

Report of ELECTRONICS Progress

FORM G-128

INTER-OFFICE CORRESPONDENCE

McGraw-Hill Publishing Company, Inc

TO Electronics Salesmen

FROM H. W. Mateer, Manager

LOCATION

LOCATION New York

SUBJECT

Electronics Progress

DATE

December 25, 1937

The following is the report of ELECTRONICS progress for 1937:
(Based on 12 issues, Jan. 1937-Dec. 1937 inclusive)

162 Advertisers Used 452.84 Display Pages

63 Advertising Agencies handled 87 of these Accounts

Display Advertising Increase over 1936, 16.2%

The Editorial Pages Numbered 547

Net Paid Circulation Figures for the 12 Months Follow:

January	11,239	July	12,205
February	11,645	August	12,259
March	11,572	September	12,318
April	11,680	October	12,370
May	11,629	November	12,610
June	12,000	December	12,656

Paid Circulation Increase Dec. 1936 (10,375) - Dec. 1937, 21.9%

There is every indication from contracts already coming in that 1938 will show consistent advance, despite the temporary lull in business. Apparently, confidence in the electronics industry remains high.

This successful publication is not only the recognized editorial authority, used by every important company and man, but is and always has been the one economical means of presenting sales messages to the many fields allied with electronics.

ADD electronics TO YOUR SALES ORGANIZATION

THE ELECTRON ART

EACH month the world's technical literature is scanned to see what physicists and engineers are doing with tubes, for presentation in tabloid form to Electronics' readers.

Graphical Determination of Impedances in Parallel

A RAPID and practical method for calculating complex networks, as for instance to impedances in parallel, has been given recently by P. Böning in *Hochfrequenz technik und Elektroakustik* (Vol. 50, No. 1, p. 32-34). It can be used both for checking calculated results and for solving complete problems in parallel impedances where small inaccuracies are permissible.

The method is based on elementary geometric proportionality theorems of tangents, secants and chords respectively. The tangent theorem provides that in the case of a tangent and a secant drawn from a common point outside of a circle the tangent is the mean proportional between the secant and its external segment. A related law stipulates for two secants drawn from a common point without a circle that the product of one secant and its external segment equals the product of the other secant and its external segment. Still another theorem states that the products of the segments of chords intersecting within a circle are equal to one another.

The method makes use of admittances; the geometric reciprocals of the given impedances are found, and the reciprocal of their sum gives the final answer in accordance with $1/Z_0 = 1/Z_1 + 1/Z_2 + 1/Z_3 + \dots + 1/Z_n$

Case 1: Two inductive impedances Z_1 and Z_2 in parallel, and having different phase angles. The impedance $Z_1 = R + jX$ is represented on the figure by vector OZ_1 , and Z_2 by OZ_2 . A circle is drawn through OZ_1 and OZ_2 such that the two vectors form secants

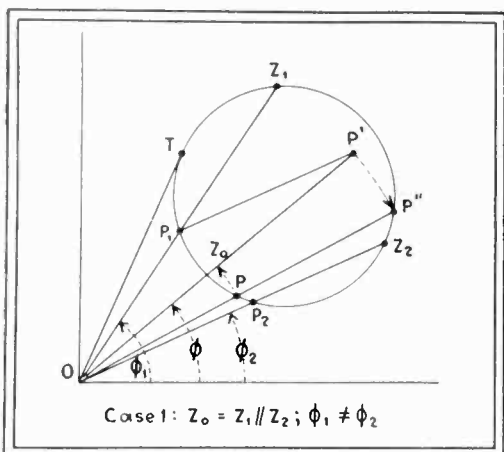

Graphical construction for two parallel inductive impedances.

with external segments OP_1 and OP_2 respectively. From the secant and tangent theorems

$$OZ_1 \times OP_1 = OZ_2 \times OP_2 = OT^2$$

The tangent term OT cancels out in the final calculations of the proof. For simplicity it is therefore assigned the value unity. Now

$$OZ_1 \times OP_1 = OZ_2 \times OP_2 = 1$$

Also $OP_1 = 1/OZ_1 = 1/Z_1$, and $1/OZ_2 = 1/Z_2$. Adding OP_1 to OP_2 vectorially gives

$$OP' = 1/Z_1 + 1/Z_2 = 1/Z_0$$

The direction of OP' is immediately the true direction of the final vector of Z_0 , and not the direction of $1/Z_0$.

Case 2: Three impedances in parallel, Z_1 , Z_2 and Z_3 with angles $\phi_1 \neq \phi_2 \neq \phi_3$ respectively. The construction differs from Case 1 only in that to the resultant of $OP_1 + OP_2$ is added a third reciprocal OP_3 .

This produces the resultant $OP' (= 1/Z_1 + 1/Z_2 + 1/Z_3)$ which as a secant OP'' has the external segment OP . This is projected upon OP' and appears as $OZ_0 = Z_0$ correct in magnitude and direction.

Case 3: Z_0 composed of Z_1 and Z_2 in parallel; $\phi_1 = \phi_2$.

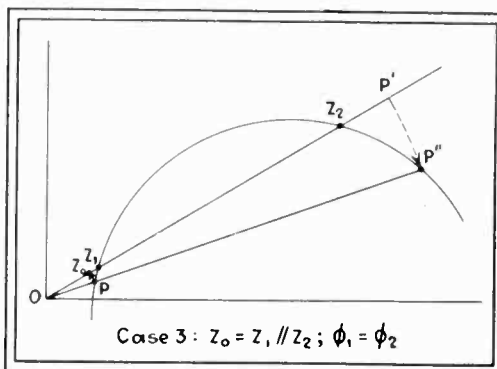

Construction for the resultant of two parallel impedances with equal phase angles

Since the phase angles are equal, the reciprocals are added linearly and the procedure continues as in the previous cases.

Case 4: Z_0 composed of Z_1 and Z_2 in parallel; $\phi_1 = 90^\circ$; $\phi_2 = 0^\circ$.

The procedure is the same as in the preceding cases, although it can be simplified considerably by drawing line $Z_1 Z_2$. Z_0 on the intersection of altitude OZ_0 with line $Z_1 Z_2$ is then the required point, and OZ_0 the required vector representing Z_0 .

Case 5: Any two impedance elements in parallel.

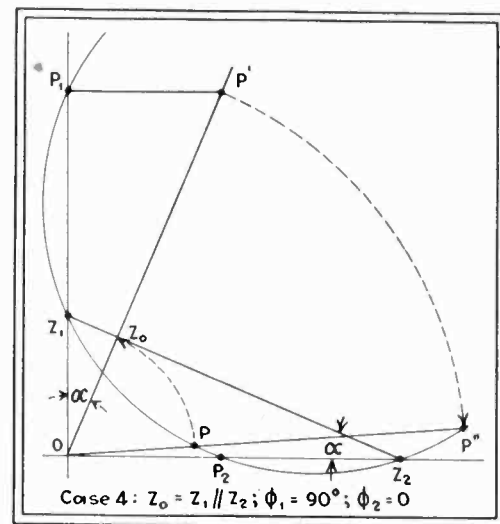

Construction for parallel combination of resistance and pure reactance

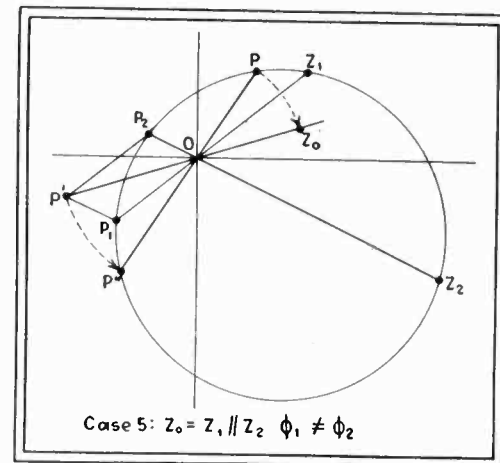

Graphical construction for any two impedances in parallel

Since the vectors fall within the circle the chord theorem is applied whereby $OZ_1 \times OP_1 = OZ_2 \times OP_2$. The product is treated in the same manner as in Case 1. The reciprocals OP_1 and OP_2 are added and the procedure continues as in Case 1. The vector OZ_0 finally represents the parallel impedance of Z_1 and Z_2 .

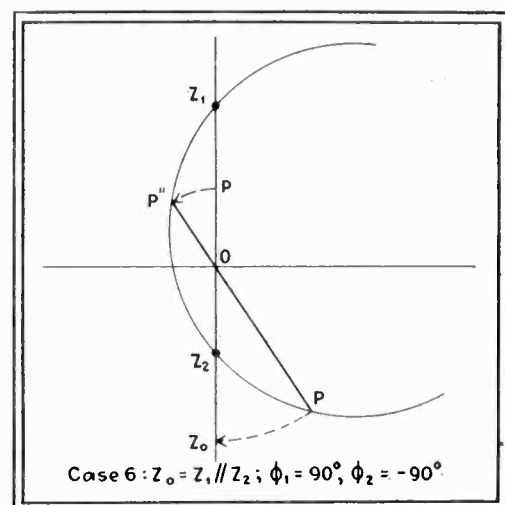

Resultant of parallel combination of inductive and capacitive reactances

Case 6: The effective reactance of a positive and negative reactance in parallel is found very rapidly. In this case, $OP' = 1/X_1 + 1/X_2$. Then $OP' = OP'' = 1/Z_0$ and OZ_0 is the effective reactance of Z_1 and Z_2 in parallel.

6E5 Detector Bridge Circuit

ALTHOUGH ALTERNATING CURRENT bridge methods usually make use of a telephone headset for indicating the condition of balance, visual indications of the balanced condition may be obtained by making use of the indicator tube such as the 6E5 or the 6G5. A simple bridge circuit balance indicator using the 6E5 is described by James M. Koehler in the November issue of the *Review of Scientific Instruments*, as shown in the accompanying illustration, the complete circuit consists of a linear voltage amplifier, the electron indicator tube and a rectifier and power supply.

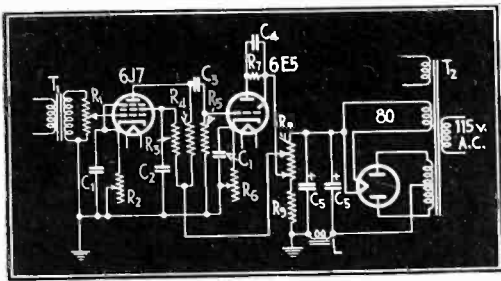

Wiring diagram for visual bridge balance indicator

The bridge balance indicator consists essentially of a linear voltage amplifier, a visual indicator using a 6E5 and a power supply using a rectifier and filter arrangement. The indicator tube is coupled to the amplifier through a resistance-capacitance network so that adjustment of grid voltage on the indicator tube may be made independently of voltage adjustment for the amplifier tube. The circuit is so adjusted that when no signal is applied to the amplifier, the shadow angle is reduced to zero through the application of the proper bias as determined by the cathode resistor of the indicator tube. When signal is applied, the plate current of the 6E5 increases so that a voltage is built up across R_7 and the shadow angle opens. The condition of balance is then that which obtains when the shadow angle is at its minimum opening. The condenser C_4 effectively smooths the plate voltage during the half cycles when the grid is bias below the cut-off voltage and is useful in maintaining a sharp edge of the shadow angle.

Ionosphere Characteristics

FOUR RATHER EXTENSIVE articles on the characteristics of the ionosphere appeared as a symposium in the November issue of the *Journal of Applied Physics*. These ionosphere articles are entitled "Fundamental Mechanisms in the Ionosphere," by N. E. Bradbury, "Terrestrial Magnetic Variations in the Ionosphere," by A. G. McNish, "Study Disturbances of the Ionosphere," by J. H. Bellinger and "Nature of Bright Chromospheric Eruptions," by R. F. Richardson.

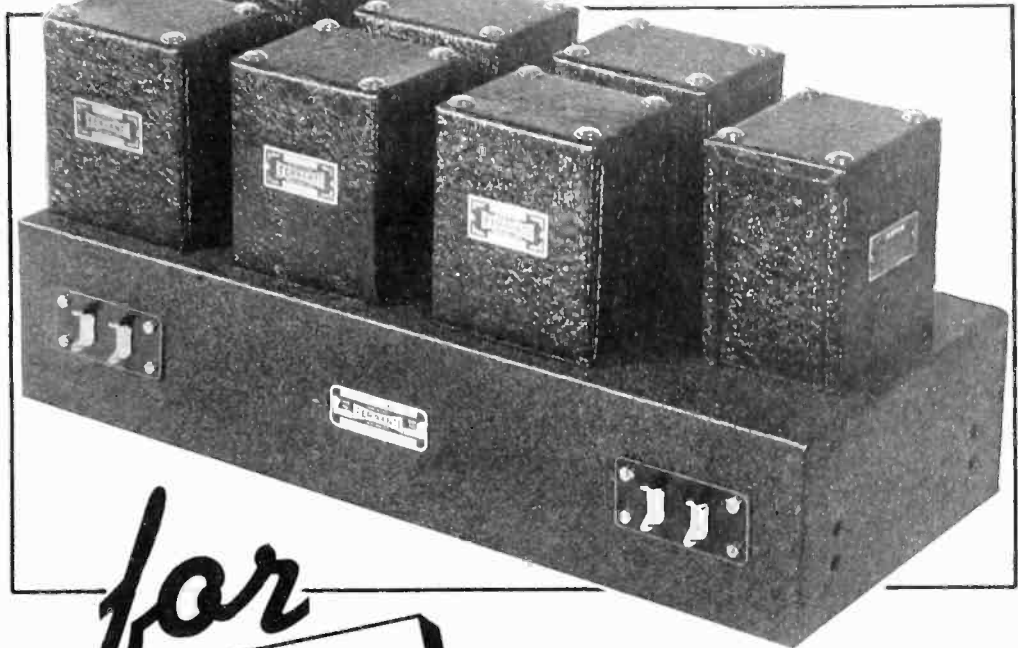

for

FILTERS — all types
EQUALIZERS
ATTENUATORS
HIGH Q COILS
REPEAT COILS
LOADING COILS
HYBRID COILS

POWER SUPPLIES
RECTIFIERS
MODULATION SETS
AUDIO TRANSFORMERS
PLATE FILAMENT TRANSFORMERS
TRANSMITTING EQUIPMENT

Band Pass Filter designed to pass
260 — 300 c.p.s. — Attenuation 40 db
— Exceptionally low insertion loss.

Send us your problems and specifications and be assured of IMMEDIATE attention to your inquiries.

FERRANTI ENGINEERING SERVICE IS FURNISHED WITHOUT CHARGE OR OBLIGATION.

Ferranti Electric Inc.

R. C. A. BUILDING, NEW YORK, N. Y.

The Ultimate in SUPER-SENSITIVITY

Model 1250



Dealer Price
\$36.67

★ Self-Calibrating . . . The most important advancement in circuit design for precision electrical instruments in recent years.

Laboratories and engineers will use and immediately appreciate the significance of this remarkable instrument. Indispensable also in the servicing field for measuring electrical impulses either A.C. or D.C. of low magnitude, such as the carrier wave of signal circuits, and particularly for television work.

The self-calibrating feature is automatic with the tube bridge circuit developed by Triplet engineers (Pat. Pending). The initial operation of adjusting the bridge at the zero level insures exact calibration independent of tube emission values or when replacing tubes.

Model 1250 is furnished with Triplet tilting type twin instrument. One instrument indicates when bridge is in balance. The other is a three range voltmeter with scales reading in peak A.C. and D.C. voltages. Ranges are 2.5, 10 and 50 volts.

Model 1250 is complete with all necessary accessories including 1-84, 1-6C6, 1-76. Case is metal with black wrinkle finish. Etched panel is silver and red on black. DEALER PRICE \$36.67

Model 1251. Same as above, but with ranges of 3-15-75-300 volts. DEALER PRICE . . . \$47.67

THIS IS A TRIPLET MASTER UNIT



MAIL THIS COUPON

The Triplet Electrical Instrument Co.
231 Harmon Dr., Bluffton, Ohio
Please send me more information on
Triplet Vacuum Tube Voltmeter. I am
also interested in
Name
Address
City State

Tube Listing

AN UNUSUALLY complete listing of voltage, current, resistance, amplification factor, and trans-conductance of British tubes appears in the November 25 issue of the *Wireless World*. This list also contains information on American made tubes although the American listing is not broken down according to manufacturers as in the case with the British tubes.

Along with the brief listing of tube characteristics is given a set of diagrams for the base connections of both British and American types of tubes.

New Television Publication

ACCORDING TO the foreword in the first issue of *Televisione* which made its appearance last August, it is stated that, "In the increasing development of the harmonious plan of its activities the international center of television of the I.C.E. has decided to publish this new review . . . The Review—which is published in four languages: English, French, German and Italian—shall be glad to accept articles, studies and works of scientists, experts and industrial directors of all countries."

This new journal may be obtained from the Direzione e Redazione presso il Centro Internazionale di Televisione dell'I.C.E., Via Lazzaro Spallanzani 1-a-Roma (Villa Torlonia).

RECORDING BIRD CALLS



The calls of rare birds on Kent Island, near the Bay of Fundy, are picked up by a party from Bowdoin College. Because recording equipment could not be transported to the island, the calls were relayed by amateur radio to Grand Manan Island, where they were recorded on film by a group from Cornell University

SHALLCROSS RESISTORS, SWITCHES and INSTRUMENTS

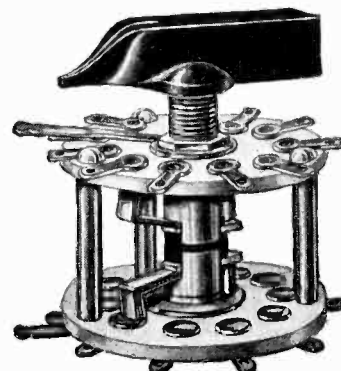

Our products have established an enviable reputation in many of the industrial and college laboratories in this country and abroad.

Write for Bulletin 140-KB

SHALLCROSS MFG. CO.
COLLINGDALE, PA.

ECCO

THE MOST MODERN
High Frequency Converters
for

BOMBARDING



Incorporate
Straight line power output control •
High conversion efficiency • Balanced
low loss circuits • Simplicity of operation,
safety, rugged construction and many
other New and Exclusive features.

Units from 1/4 to 25 KVA Available

ECCO High Frequency Corp.
120 W. 20th Street, New York, N. Y.

Cathode Ray Tube Characteristics

THE DECEMBER ISSUE of the British journal, *Television and Shortwave World* contains a rather extensive two-page spread in which are tabulated the operating data on oscillograph and television tubes available at the present time in Great Britain. The chart is similar to the abbreviated list of characteristics given in catalog and technical bulletins published by certain American tube firms. The listing includes not only those cathode ray tubes made in England but also those tubes made by Du Mont and RCA.

D-C Transformers

THE USE of thyratrons or grid control mercury arc rectifiers, in connection with d-c transformers for the purpose of transforming voltage on d-c systems without using a motor generator set are discussed in the November issue of *Electrical Engineering* by C. C.

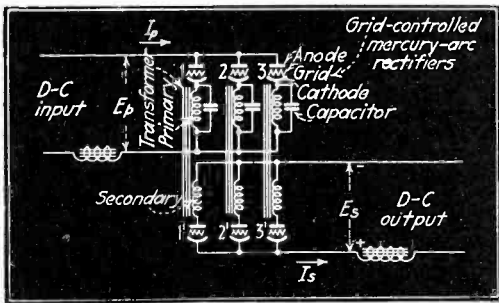

One of the circuits shown by C. C. Herskind for d-c transformation

Herskind in an article "New Types of D-C Transformers." One type of d-c transformer which is discussed has a constant current output characteristic, while the other has a constant voltage output relation.

Magnetic Recording for Broadcasting

VERY LITTLE information has been published in this country on the subject of magnetic recording on steel tape. Although true for the United States, this statement is also the opening sentence of a paper delivered before the Institution of Electrical Engineers in London, on December 1. This paper, entitled "Some Aspects of Magnetic Recording and Its Application to Broadcasting," by A. E. Barrett and C. J. F. Tweed presents a somewhat simplified consideration of the processes occurring in the magnetic recording of sound on steel tape and describes some of the apparatus and methods used in England in its application to broadcasting. A description is given of some of the methods and apparatus that have been developed by the British Broadcasting Corporation and Marconi's Wireless Telegraph Company in the past several years.

Undoubtedly this paper will appear in a forthcoming issue of the *Journal of the Institution of Electrical Engineers*.



for COMMUNICATIONS and ALLIED INDUSTRIES

INSUROK, in its varied forms and applications, has made possible many startling and revolutionary improvements in structure, appearance and performance of numerous parts and completely finished products in the widely diversified field of electricity. Of known physical, chemical and dielectric properties, INSUROK imparts its own superior qualities to every product on which it is used. In production equipment, too, INSUROK does many tasks with unmatched efficiency and economy. Copies of the INSUROK Catalogue and Handbook are yours for the asking.

The RICHARDSON COMPANY

Melrose Park, (Chicago) Ill. Founded 1858 Lockland, (Cincinnati) Ohio
New Brunswick, N. J. Indianapolis, Ind.
Detroit Office: 4-252 G. M. Building, Phone Madison 9386
New York Office: 75 West Street, Phone Whitehall 4-4487



SIGMA RELAYS

MODEL 2-A

A 12 milliwatt, D. C., semi-sensitive instrument for general electronic and industrial uses.
Controls 150 watts, noninductive load, at 115 volts, A. C., on single-pole double-throw silver contacts.

With coil resistances up to 2,000 ohms..... \$5.00
With higher coil resistances..... 5.50

MODEL M

Embodies Tobe Mu-Switch. Input, 50 milliwatts, D. C., Controls 1 kilowatt, noninductive load, at 115 volts, A. C., on single-pole double-throw contacts.

With coil resistances up to 2,000 ohms..... \$7.00
With higher resistances..... 7.50
Both models are mounted on 5-prong base to plug into standard tube socket.

SIGMA INSTRUMENTS, INC.

388 TRAPELO ROAD

BELMONT, MASS.

happy new year

so what?

Just this . . . there'll be no headaches and no hitches in your 1938 production schedule with **TURBO OIL TUBING** and **TURBO SATURATED SLEEVING**. Since 1920, Turbo has been the standard by which all insulating materials are judged:

No other insulating materials of their kind offer like advantages!

TURBO
INSULATING MATERIALS

Tough — flexible — flame resistant — oil — acid and moisture proof! **THOROUGHLY IMPREGNATED INSIDE and OUT . . . Absolutely free from inside obstructions!**

Write Department 201 For Standard Full Length Samples Catalog On Complete Line of Turbo Products Brand ships every order, regardless of quantities on the day received.

Other Turbo Products
Varnished Cambric
Varnished Silk
Mica Condenser Films
Varnished Paper
Built-up Mica Plate
Block Mica

WILLIAM BRAND & COMPANY 268 Fourth Ave. New York, N. Y. 217 N. Desplaines St. Chicago, Ill.

“Definitely Superior”

. . . the unanimous verdict of users of **NEW ALLIED “CLEAN-CUT” BLANKS**

- . . . cut easier.
- . . . have less surface noise.
- . . . wear longer.
- . . . are perfectly flat.
- . . . styli last longer.
- . . . thread is not statically charged.
- . . . make recording work a pleasure.
- . . . assure better results.
- . . . cost no more.



ALLIED RECORDING PRODUCTS COMPANY
126 W. 46th St. New York City

Cable Address: Allrecord Phone: Bryant 9-1435

Volume Indicator with Linear DB Scale

A NEW DESIGN of volume indicator for use in sound recording, and embracing the features of peak amplitude response and a linear decibel scale was described by F. G. Albin in the November issue of the *Journal of the Society of Motion Picture Engineers*, under the title “A Linear Decibel Scale Volume Indicator.” A standard indicating meter is used and linearity of the decibel scale is obtained through the use of vacuum tubes.

As shown in the accompanying diagram, the linear decibel volume indicator consists essentially of a stage of amplification, a full-wave vacuum tube

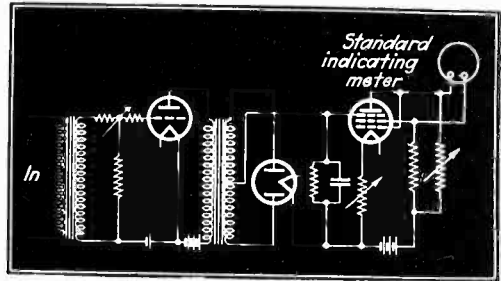

Diagram of volume indicator. The connections of the last tube result in logarithmic scale

rectifier, and a d-c amplifier having an exponential response to the input voltage. A triple grid tube is used for the d-c amplifier and the same envelope may also contain the two plates for the full wave rectifier. The first grid of this tube is connected to the plate through a resistance. The second grid is used as a space charge grid, while the third is the control grid. Through the use of a bridge circuit in which portions of the d-c amplifier tube form two arms of the bridge, the output circuit is so adjusted that the normal current through the meter is zero. The plate current is lowered when an input signal is received since this applies a negative voltage to the control grid. The current in the second grid thus increases with the decrease in plate current and both of these changes contribute to unbalancing the bridge so that current flows through the meter.

The author accounts for the exponential response of the d-c amplifier by stating that it is due to connecting the first grid to the plate. In the author's words, “As the plate current decreases, potential increases, and thus the first grid voltage and the current both increase. The combined plate and first grid current decrease, however, and in a manner that is proportional to the logarithm of the control grid voltage change over a limited range.” As is usual with tube circuits in which a logarithmic response is desired, best results are obtained through a selection of tubes having the most desirable characteristics. Establishing one-half db as a tolerance over a 24-db. range, the proportion of good to rejected tubes obtained on the open market was found by the author to be one to three.

Generator of Rectangular Wave Form

A DEVICE FOR the production of rectangular current waves of variable strength and duration through the use of electron tubes and without employing mechanical timing accessories is given by Hubert P. Dugnet in his article "A Source of Variable Rectangular Pulses" in the September issue of the *Review of Scientific Instruments*. The circuits depend for their operation upon the fact that a thyatron can be started by a positive grid voltage and stopped by a succeeding negative grid pulse. The attached schematic wiring diagrams show two forms of the circuit suitable for producing rectangular current pulses.

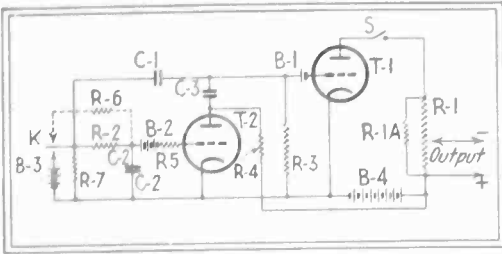

Circuit for generating variable rectangular pulses

In the first diagram tube *T1* is a thyatron which controls the flow of current to the resistor in its output or plate circuit. Tube *T2* is a thyatron whose discharge through the condenser *C3* and the resistor *R3* produces a negative voltage surge upon the grid of the thyatron *T1*, which terminates the current flow in the output resistor. The duration of the rectangular pulse is determined by the interval between the beginning of the flow of current through *T1* and its cessation, due to the operation of the tube *T2*.

When the key *K* is closed, a current flow to condenser *C1* produces a positive surge on the grid of the tube *T1*, thereby starting the flow of current through this tube. Closing the key also begins to charge the condenser *C2* to the resistor *R2* so that the negative grid bias on the tube *T2* gradually decreases. When the voltage across *C2* has reached the threshold or breakdown value, the thyatron *T2* breaks down and the current flowing to *C3* and *R4* imposes a negative surge upon the grid of the thyatron *T1*, so as to stop the flow of current in the latter tube. The initial condition of operation may be obtained by opening the

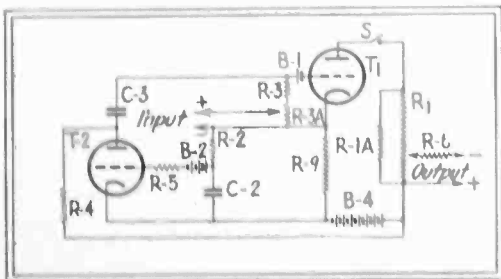

Alternative circuit for producing square waves

DU MONT

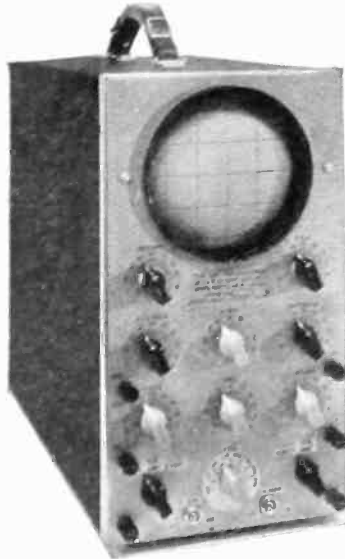

Type 168

Specializes!

In cathode ray tubes, oscillographs and accessory apparatus. Our entire engineering staff and production facilities are devoted to the development and manufacture of these products.

Our engineering department will assist you with your problems and suggest the proper cathode ray equipment.

Write

ALLEN B. DU MONT LABORATORIES, INC.
UPPER MONTCLAIR NEW JERSEY

COMPLETE SERVICE

From start to finish, the production of every HUNTER SPRING is Hunter controlled . . . quality known, because we do all the work (even assembly, if desired) in our own plant.

Thus our service is complete; we assume full responsibility for orders placed with us . . . can guarantee complete satisfaction with every detail of the finished job. You can't go wrong if they're Springs by Hunter!

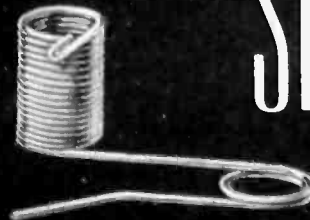

SPRINGS

HUNTER PRESSED STEEL CO.
LANSDALE, PENNSYLVANIA
"Spring and Stamping Specialists for 35 Years"



OSCILLOGRAPH PRICES REDUCED!

These fine new instruments, favorites of engineers and scientists for laboratory use, now available at amazingly low cost.

WAS \$84.50 NOW \$63.95

Stock No. 9545
**RCA 3-INCH CATHODE
RAY OSCILLOGRAPH**



This instrument offers the finest in quality and performance and is admirably suited for laboratory, production and experimental work. Its sensitivity is 0.7 volts (R.M.S.) per inch... linear saw-tooth sweep oscillator, 10 to 18,000 cycles... 2 wide range amplifiers, 10 cycles to 90 kilocycles. Gain 40... complete with 6 Radiotrons. (Also available for 110 volt 25 cycle operation—No. 9640—\$68.95.)

WAS \$47.50 NOW \$39.95

Stock No. 151
**RCA 1-Inch
Cathode Ray
Oscillograph**



This oscillograph will give you "big time" performance for every use. Its sensitivity is 1.75 volts (R.M.S.) per inch... amplifier range—30-10,000 cycles. Gain 50... Linear timing axis (horizontal sweep)—30-10,000 cycles... all controls on front panel... complete with 5 Radiotrons: Gray wrinkle lacquer finish with nickel trimming. (Also available for 110 volt 25 cycle operation... No. 151A—\$44.95.)

Over 300 million RCA Tubes have been bought by radio users... In tubes, as in test equipment, it pays to go RCA ALL THE WAY!
RCA presents the Magic Key every Sunday 2 to 3 P.M., E. S. T., on the NBC Blue Network.



TEST EQUIPMENT

RCA Manufacturing Co., Inc. • Camden, N. J.
A Service of the Radio Corporation of America

key. If the key is opened before the end of the normal pulse of operation, current will continue to flow indefinitely. The operation may be stopped by a second closure of the key which will act as a tube C_2 after an interval which is dependent upon the product R_2C_2 .

An alternative circuit is shown in Fig. 1B, which differs from that already discussed principally in that the grid voltage actuating the tube T_2 is obtained by a form of feedback from the resistor R_9 in series with the output current. Because of this feedback arrangement the circuit does not require the continuation of the starting current.

Counts 25,000 per Hour

A PHOTOTUBE COUNTER specially designed for folding machines and recently installed in several printing and book binding plants in New York, Cleveland and elsewhere has been developed by the Speedmaster Electronic Products Company of 85 Kennar Street, New York City. Taking the place of purely mechanical counters, now widely used on slower presses, this electronic device gets up to speeds in excess of 25,000 counts per hour by virtue of quick acting solenoid counters.

An undervoltage 32 volt lamp shines between rollers where the papers come out of the first fold. In the rear of the rollers is the amplifier and phototube. The counter may be installed anywhere even remotely from the press or binding machine.

Facsimile

[Continued from page 27]

The broadcasting stations are carrying on experimentation with a view toward developing a technique of presentation and determining the service area of the facsimile signals as compared to their aural service area. The regular reports to be received by the F.C.C. from the many stations cooperating in this activity will formulate the policy which the F.C.C. will pursue in the formal issuance of commercial licenses to broadcasting stations for facsimile transmission.

The prediction by President Roosevelt's National Resources Committee in their *Technological Trends and Their Social Implications* that home facsimile is one of the thirteen inventions which carry vast potentialities for changing the economic, social, and cultural status of the nation has thus been brought a great stride toward actual realization.

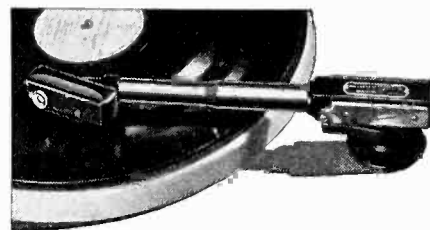

RECORD PERFORMANCE

WITH PROFESSIONAL

TRU-TAN MODEL B-16 ASTATIC CRYSTAL PICKUP

Offset Head Design maintains needle tangency to record groove, assuring finer reproduction and longer record life. Professional model for use on lateral transcriptions of all sizes. Foolproof cueing-in. Utilizes high fidelity type cartridge. Laboratory tested. Beautifully finished in black and chrome. Full year guarantee. LIST PRICE \$27.50



Astatic Microphone Laboratory, Inc.

DEPT. A-7, YOUNGSTOWN, OHIO

Licensed Under Brush Development Co., Patents



Dependable

MINIATURE FREQUENCY METERS

"FRAHM" Frequency Meters indicate by means of accurately tuned vibrating steel reeds which have the remarkable ability to hold original calibration for a very long time. Simple. Rugged. Unaffected by wave form or ordinary voltage or temperature changes. Made in both miniature and large sizes for any frequency between 15 and 500 cycles per second. Types for front-of-board or flush mounting, also for portable use.

Ask for Bulletin 1415-E.

JAMES G. BIDDLE, CO.

ELECTRICAL INSTRUMENTS
1211-13 ARCH STREET PHILADELPHIA, PA.

MANUFACTURING REVIEW

News

♦ Charles E. Wilson of Bridgeport, Conn., vice-president in charge of General Electric Appliance and Merchandise Department since 1930, has been elected executive vice-president of that company, a new position, it was announced recently by President Gerard Swope. At the same time the election of Philip G. Reed as assistant to the president was announced. Mr. Reed entered the employ of the General Electric Co. in 1926 and since 1934 has been general counsel of the Lamp Department with offices in New York.

♦ Capitalizing on years of experiencing in licensing the manufacture and sale of patented devices to others, as well as in actual manufacturing and marketing on a national scale, Eby Inventions, Inc., Philadelphia, has expanded the scope of its activities to accept items of definite merit for exploitation on a profit-sharing basis. This expanded activity offers a new and different kind of service to independent inventors.

♦ The Institute of Radio Engineers recently elected Haraden Pratt, vice president and chief engineer of Mackay Radio & Telegraph Co. as its president for 1938. Mr. Pratt was graduated as mechanical electrical engineer from the University of California in 1914 and began his work in radio immediately when he assisted in the construction of stations at Bolinas and Marshall, Calif., which were the most powerful of that day. In 1920 he joined the Federal Telegraph Co., where he was placed in charge of the company's factory at Palo Alto and also had charge of building its intercity radio-telegraph system. Mr. Pratt became chief engineer of Mackay Radio in 1928 and subsequently was elected vice-president.



Haraden Pratt, 1938 president of the I.R.E.

♦ Representatives of twenty of the principal commercial laboratories of the country recently completed the organization of the American Council of Commercial Laboratories. One of the purposes of the Council will be the promotion of the proper use of scientific testing methods for the protection and certification of quality in advertised goods.

In behalf of the Council it is stated that the members have been and will be carefully selected to include only organizations to which producers, retailers, and consumers may look for unbiased determinations of quality. Engaging in research and testing for a fee, these independent laboratories ascertain and report facts for clients.

♦ The appointment of George H. L. Norman as chief engineer of Aerovox Canada, Ltd., Hamilton, Ontario has recently been announced. Mr. Norman was born in England and graduated from Portsmouth Municipal College in 1922. He studied electrical engineering and wireless communications.

♦ At one of its recent meetings, the Board of Directors of Westinghouse Electric & Manufacturing Co. declared a dividend of \$2 per share on the preferred stock and on the common stock of the company, such dividends to be paid December 21, 1937 to stockholders of record at the close of business on December 7.

♦ According to a statement made to the stockholders of the International Telephone and Telegraph Corp., the net income of this corporation and its subsidiaries for the nine months ended September 30, 1937, amounted to \$7,044,070 as compared with \$2,442,140 for the nine months ended September 30, 1936.

♦ The Board of Directors of the RCA Manufacturing Co. has elected three new vice presidents and increased the responsibility of another according to George C. K. Throckmorton, president of the company. Robert Shannon, formerly vice-president in charge of manufacturing has been elected vice-president and general manager and will have general direction of all activities except those under the commercial vice-president. The three men advanced to the vice-presidency are Henry C. Bonfig, Frank R. Deakans and Vance C. Woodcox.

♦ Engineering and production facilities of the Bendix Radio Corp., have been increased with occupancy on November 1 of the company's new eastern factory at 920 E. Fort Ave., Baltimore, Md. The new plant, with modern facilities in every respect, contains 34,700 sq.ft. of offices, laboratories and shops.

♦ Charles E. Stahl, former vice-president and general manager of the Arcurus Radio Tube Co., of Newark, N. J., was elected president of the company at a board of directors meeting held December 1. In this new capacity, Mr. Stahl also retains the general manager-ship. J. A. Stobbe was elected a vice-president of the corporation and Jack Geartner was appointed sales manager in charge of all sales, including export.

♦ The General Electric paid its 161st or fourth quarter dividend on December 20 to 199,718 stockholders, the largest number in the history of the company according to W. W. Trench, secretary. This is an increase of 9,674 or 5 per cent over the number of stockholders a year ago.

♦ The formation of the Altec Service Corp., which will continue the service function of Electrical Research Products, Inc., has been announced by L. W. Conrow, Altec's president. Control and operation of the new company is vested in ex-ERPI personnel, including G. L. Carrington, vice-president and general manager; H. M. Bessey, secretary and treasurer; E. B. Walters, comptroller; B. Sanford, Jr., director of sales and S. W. Hand, staff representative.

♦ W. Paul Jones announces the appointment of Edward B. Passow as chief radio engineer for Fairbanks, Morse & Co., Home Appliance Division, Indianapolis. Mr. Passow has served as assistant chief radio engineer of this company for the past three years and previously had extensive radio engineering experience with several manufacturers in the Middle West. Mr. Passow has majored in electrical and radio engineering and is a graduate of Purdue University.



Edward B. Passow, new Fairbanks-Morse chief engineer

electronics

Catalog & Literature Service

Manufacturers' literature constitutes a useful source of information. To make it easy to keep up to date, "Electronics" will request manufacturers to send readers literature in which they are interested.

1. Electronic Control Equipment. A bulletin on light operated electronic control devices has recently been released by the Electronic Control Division of United Cinephone Corp., Long Island City, N. Y.

2. Invisible Ray. A 6-page folder outlining commercial applications of automatic electronic control and bearing the name "Invisible Ray and Visible Result" has been published by the Electronics Engineering Co., 8282 Melrose Ave., Los Angeles, Calif.

3. Photoelectric Equipment. Folders on scientific equipment are available from the Pfaltz & Bauer, Inc., Empire State Bldg., New York City. Two of these bulletins deal with precision balances and weights. A third bulletin deals with photoelectric cells and apparatus.

4. Aircraft Receivers. Four new aircraft receivers are described in form No. 2463 issued by the RCA Manufacturing Co., Camden, N. J.

5. Centralized Sound System. Custom-built centralized sound systems for schools, hospitals and hotels are outlined in a 4-page bulletin, published by the David Bogen Co., 663 Broadway, New York City.

6. Recording Equipment. Bulletin describing the Dictaphone Telecord recording equipment may be obtained from the Dictaphone Corp., Graybar Bldg., New York City.

7. Adjustable Transformers. An adjustable transformer having an output voltage of from 0 to 140 volts when operated from the 115-volt line and a maximum rating of 860 volt-amperes is described in Form 1137 of the Standard Electrical Products Co., St. Paul, Minn.

8. Potentiometers. Catalog E-50B (2) of the Leeds & Northrup Co., 4902 Stenton Ave., Philadelphia, describes the Brooks deflection potentiometer and accessories.

9. Test Equipment. Catalog sheet giving information on cathode ray oscilloscopes, multirange meters, oscillators and similar apparatus may be obtained from the Dayco Radio Corp., 201 Hickory St., Dayton, Ohio.

10. Manufacturing Test Equipment. A condensed catalog of measuring and testing instruments for the laboratory design and quality control of radio frequency components and materials is available from the Boonton Radio Corp., Boonton, N. J., by requesting Bulletin A.

11. Coil Winding Head. A bulletin describing a coil winding head for winding coils from 1 $\frac{3}{8}$ in. x 4 in. minimum up to 8 $\frac{1}{2}$ in. x 6 in. maximum, may be obtained from the Ideal Commutator Dresser Co., 1631 Park Ave., Sycamore, Ill.

12. Condensers. Copies of a bulletin describing small fixed condensers in which the conducting plates are plated upon a ceramic material are available from the Erie Resistor Corp., 640 W. 12th St., Erie, Pa.

13. Transmitting Condensers. A 16-page catalog describing condensers for transmitting purposes is available from the Solar Manufacturing Corp., 599 Broadway, New York City, by requesting catalog No. 2-X.

14. Radio Parts. A 20-page catalog of radio parts is available from the Birnbach Radio Co., 145 Hudson St., New York City.

15. Aircraft Transmitter. The model AVT-7B aircraft transmitter is described in a 4-page brochure available from the Aviation Radio Section, RCA Manufacturing Co., Camden, N. J.

16. Radio Receiver Power Supply. An extensive article on radio receiver power supply appeared in two parts in the *Aerovox Research Worker*. Copies are available from the Aerovox Corp., 70 Washington St., Brooklyn, N. Y.

17. Bakelite Products. A folder describing Bakelite polystyrene molding material is available from the Bakelite Corp., 247 Park Ave., New York.

18. Communication Equipment. A catalog describing resistors, pads, attenuators, and rack and panel mounted equipment has been issued by the Cinema Engineering Co., 7606 Santa Monica Blvd., Hollywood, Calif.

19. Resistance Bulletin. Bulletin No. 108 issued by the Ohmite Manufacturing Co., 4835 W. Flournoy St., Chicago, deals with two types of resistors available to within 1 per cent of the nominal resistance value.

20. Hammarlund Catalog. The 1938 edition of the catalog of the Hammarlund Manufacturing Co., 424 West 33rd St., New York, describes the complete line of Hammarlund condensers, insulators, transformers and related equipment.

21. Battery Charging Indicators. An instrument designed expressly for testing lead-acid storage batteries and known as the "Chargitator" is described in a bulletin of the Instrument Specialties Co., 70 Paterson Ave., Little Falls, N. J.

22. Industrial Thermometers. An industrial thermometer catalog, No. 1125-B has been published by C. J. Tagliabue Mfg. Co., Park & Nostrand Aves., Brooklyn, N. Y., makers of indicating, recording and controlling instruments.

23. Alloys. Catalog E-1, containing information on alloys in the form of wire rod and strips, used in the electrical, chemical and mechanical field is available from the Alloy Metal Wire Co., Inc., Graybar Bldg., New York City.

24. Library on Metals. A complete list of current literature on production and industrial applications of the nickel alloy steels, nickel cast iron and nickel from the International Nickel Co., 67 Wall St., New York City.

ELECTRONICS

January

330 W. 42nd Street, New York, N. Y.

Please request manufacturers to send me, without obligation, literature identified by numbers circled below.

1 2 3 4 5 6 7 8 9 10 11 12 13 14
15 16 17 18 19 20 21 22 23 24

NAME TITLE

COMPANY

ADDRESS

CITY STATE

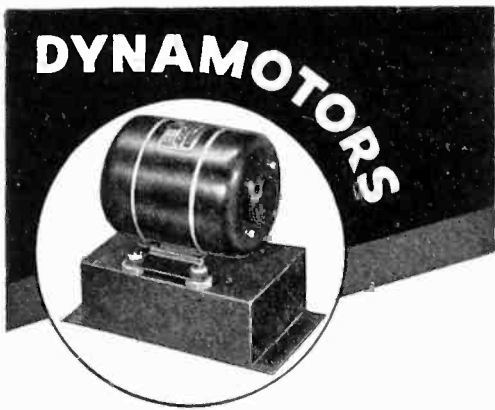

A DEPENDABLE POWER SUPPLY

Dynamotors, gen-e-motors and converters produced by this pioneer manufacturer of power supply units afford the last word in this type of equipment for air craft, police, marine and auto radios, public address systems, etc. Compact and light weight. Sturdily constructed to assure long, dependable service. For complete information address.

PIONEER GEN-E-MOTOR CORPORATION

Manufacturer of "PINCO" Products
Dept. R-4A, 466 W. Superior St., Chicago, Ill.

Export Division
25 Warren St.
New York, N. Y.

Cable:
Simonrice

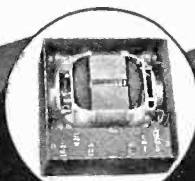

GEN-E-MOTORS



900 Times Finer Than A Human Hair

A 1/100 amp. Instrument LITTELFUSE platinum filament is 1/30 the diameter of a human hair. (A 1/200 amp. Littelfuse filament is just 1/2 that size!) It's 16,800 times heavier than air yet floats in it. These super-fine wires are HAND SOLDERED to the Littelfuse Bridge Construction, which is inserted in a hermetically sealed glass tube and then inspected rigidly—to ensure it will unflinchingly do its work—the protection of delicate instruments.

Instrument Littelfuses 1/200 amp. up; Hi-Voltage Littelfuses 1,000, 5,000, 10,000 volts, ranges 1/16 amp. up. Fuse mountings, etc. Write for quotations—ask for catalog.

LITTELFUSE LABORATORIES
4248 Lincoln Avenue Chicago, Ill.

New Products

New Tubes

THE RCA Manufacturing Co., Harrison, N. J., announces a new transmitting beam power amplifier tube having a filament voltage of 10, a filament current of 3.25 amperes, and a rated transconductance of 3,300 micro-ohms. The maximum plate voltage is 1,250

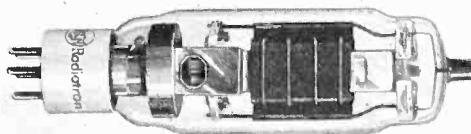

and the power output of 130 watts for class C operation may be obtained.

Another Radiotron announced is the gas triode RCA-884 with a 6.3 volt 0.6 ampere heater and a peak voltage between any two electrodes of 350 volts. This glass tube with octal base is intended for use as a sweep circuit oscillator or as a grid controlled rectifier for frequencies below 75 cycles per second.

The Raytheon Production Corp., 55 Chapel St., Newton, Mass., announce two new receiving tubes. One of these is the 6AC5G, a high μ triode power amplifier with a rated power output of 3.7 watts. Heater voltage is 6.3 volts, heater current 0.4 amperes and maximum plate voltage is 250 volts. The 6G6G is a pentode type of power amplifier with a rated power output of 1.1 watt. The heater voltage is 6.3 volts, heater current is 0.15 amperes and the maximum plate voltage is 180 volts.

Tubes recently announced by the Hygrade Sylvania Corp., Emporium, Pa., include the 6G6G power amplifier pentode, the 6J8G triode heptode converter and the VR150 voltage regulator. The new triode heptode converter, type 6J8G which combines a triode oscillator element with a heptode converter section. The tube is so designed as to avoid oscillator frequency drift with change in applied A.V.C. voltages.

Ganged Midget Condensers

A NEW LINE of ganged variable condensers, with capacitance rating up to 140 μmf per section are now available from the Bud Radio, Inc.

2-inch Oscilloscope

THE MODEL 931 oscilloscope made by the Supreme Instruments Corp., Greenwood, Miss., contains a 2-in. tube and power supply, intensity and focus control, input to vertical and horizontal plates and an internal sinusoidal sweep supply with gain control.

Let this Great Book Save You Time and Money

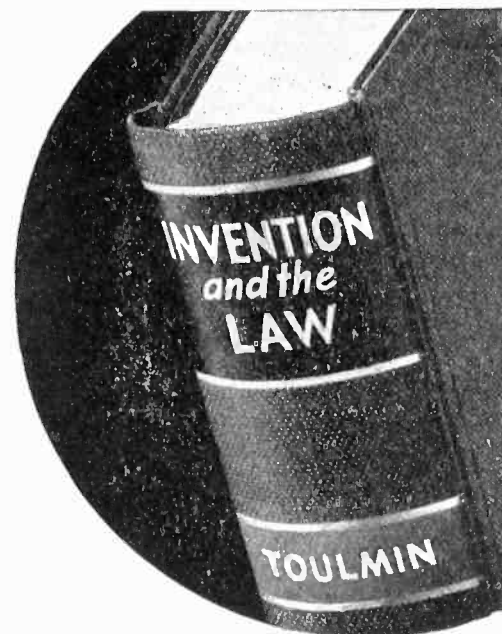

EVERY DAY this Toulmin book can help you. Don't just **THINK** you have a patentable invention . . . **KNOW!** Learn when Design is **NOT** Invention.

An opportunity is lost—because somebody lacked clear understanding of the true characteristics of Invention. Time and money are wasted—on an "invention" which could never satisfy the legal definition of the term. EVERY manufacturer might profitably know MORE about the essential principles of Patentable Invention. **INVENTION AND THE LAW** answers the various perplexing questions as to what is, and what is not—patentable invention.

Complete, Clear, Accurate

Gives you a clear statement of the **RULES** on each invention question. It summarizes the findings of the Federal courts—classified for ready reference. Two outstanding sections in particular: What Is Invention and What is Not Invention make the work invaluable.

The author presents the Background of Invention, the Characteristics of Invention, How Invention Is Determined, what you must do to determine the patentability of inventions, invention rules in other countries, etc., etc.

5 Days' Free Approval

Let us send you a copy of **INVENTION AND THE LAW** and decide its value for yourself. No obligation to buy unless you want to keep it—after examination. The price postpaid is only \$5.00.

PRENTICE-HALL, Inc.

Dept. 1P-27
70 Fifth Ave. New York, N. Y.

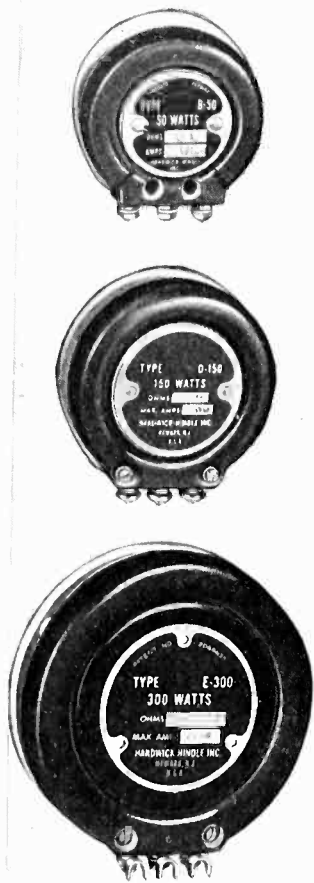

Our New RHEOSTAT CONSTRUCTION

which has been so widely accepted now includes a 300 watt size.

This exclusive design embodies:

1. Porcelain-vitreous enamel construction.
2. Completely enclosed contact system with spiral connector, resulting in but one wiping member.
3. Circuit elements insulated from all other metal parts.
4. Ruggedly constructed for dependability and long life.

May we send you literature on our Rheostats and Resistors?

HARDWICK, HINDLE • Inc.
136 PENNINGTON STREET — NEWARK, N. J.

the new DAVEN VOLUME INDICATOR

TYPE No. 185

An instrument designed to function as a power level indicating device when bridged across a source of audio frequency.
Full details and engineering specifications on request.

An outstanding feature of the Type 185 is that it may be used across lines of various impedances without the use of correction charts. To set up for operation across various line impedances, it is only necessary to rotate the inner Decibel Dial and set the zero opposite the impedance value of the line in test. The pointer on the meter multiplier control then reads Direct the value necessary to add to the indicating meter reading.

THE DAVEN CO.
158-160 SUMMIT STREET NEWARK, NEW JERSEY

Remote Amplifier

WEIGHING LESS than 10 lb. complete in its leather carrying case, the 12Y single channel remote amplifier recently announced by the Collins Radio Co., of Cedar Rapids, Iowa is completely a-c operated, has a gain of 83 db. and in-



corporates universal input device for use with any type of microphone. Frequency response is uniform between 40 and 10,000 cycles per second and the rated power output is plus 10 db.

Television Tubes

TWO TELEVISION TUBES have recently been announced by Allen B. DuMont Laboratories, Upper Montclair, N. J. The type 54-10-T has a 5-in. screen and a maximum third anode voltage rating of 2,000 volts. The type 144-10-T has a 6,000-volt rating with a screen 12 in. in diameter. Both tubes have a heater voltage of 2½ volts and are normally supplied with green screens although white screens may be obtained at a slight additional charge. Electrostatic deflection is used for both tubes.

High Voltage Condensers

THE TYPE TJ-U line of Dykanol filter condensers, manufactured by the Cornell-Dubilier Electric Corp., South Plainfield, N. J., are supplied with a safety improved mounting which permits the condensers to be mounted with

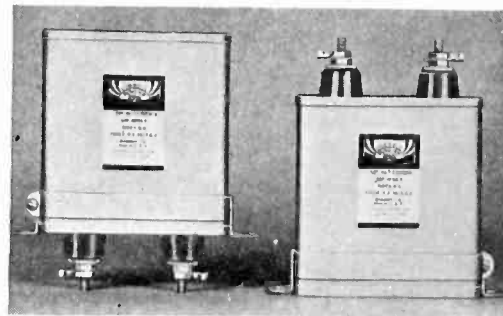

their terminals exposed if desired or with their terminals protected beneath the sub-base of radio equipment. By mounting high voltage filter condensers in an inverted position, the danger of shock from charged condensers is diminished.

Beat Frequency Generator

COMPACT, PORTABLE, two-range instrument, generating audio and video frequency voltages and operating on the beat frequency principle briefly describes the type 140-A beat frequency

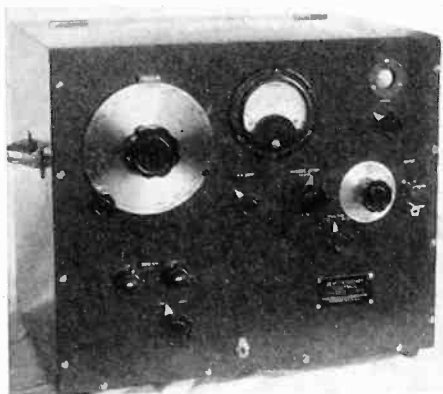

generator recently completed for sale by the Boonton Radio Corp., Boonton, N. J. The output voltage range is from 10 millivolts to 10 volts and the frequency ranges are 20 cycles to 20 kilocycles and 20 kilocycles to 5 megacycles.

Precision Resistor

A VACUUM impregnated, non-inductively pie-wound precision resistor of 1 per cent accuracy and with a 1 watt rating is available from the Ohmite Manufacturing Co., 4835 West Flournoy St., Chicago, and is known as their Ritehm "81".

Three Dynamotors

THREE NEW dynamotors known as type PS, CS and TS has been made available by the Pioneer Gen-E-Motor Corp., Chicago. The units are designed to deliver a continuous output of 45 watts, 250 watts, or 400 watts, respectively.

Voltage Regulator

THE TYPE "RH" transtat recently made available by the American Transformer Co., 178 Emmet St., Newark, provides smooth, uninterrupted control of voltage in steps of approximately 1 volt

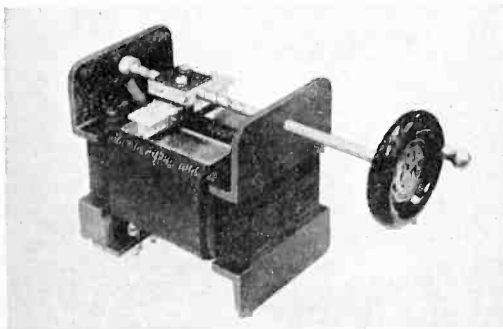

each. Designs have been developed for correcting voltage variations for a range of plus or minus 20 volts from the normal, on lines of 230 volts nominal rating, or lower. Current up to 35 amperes can be handled with these auto transformers.

To Quote
BILLY THE GOAT:

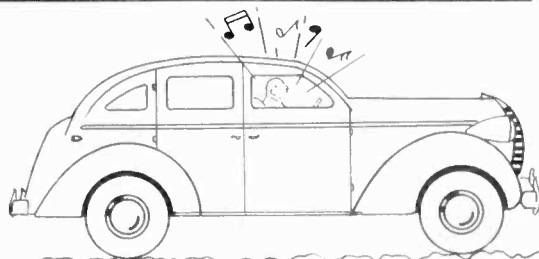

"Give them
JINGLES,
not JITTERS

wherever they go"

That's one reason for using

**GOAT
FORM-FITTING
TUBE SHIELDS**

in your new AUTO-RADIO SETS



GOAT RADIO TUBE PARTS, Inc.
314 Dean St. Brooklyn, N. Y.



CONTACT
CALLITE

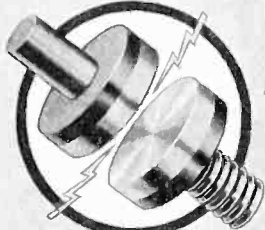

FOR
CONTACTS

FOR VIBRATORS
RELAYS AND
OTHER

Electronics
Devices

TUNGSTEN
and
MOLYBDENUM

Rivets and Screws
• SILVER & PLATINUM
• SPECIAL ALLOYS
• PRECIOUS METAL
LAMINATED
Silver and Platinum on Base
Metals

...AND CONTACT
CALLITE FOR...

TUNGSTEN

.. Rod, Sheets, Wire & Special Shapes
.. For Hard Glass Welds

MOLYBDENUM

.. Rod, Sheet, Wire & Special Shapes
.. For Grids, Round or Flat
.. For Grids, Supports, Heating Elements
.. For Hard Glass Welds

KULGRID

.. Kulgrid KK—A New Special Alloy Grid
Wire
—High Tensile Strength—Reduces Grid
& Elongation Emission
Write for Samples
.. Kulgrid "C" Tungsten Welds—For Hard
Glass Leads

CAL-LUX Fluorescent Materials

with
Measured Characteristics
.. for all applications

CALLITE PRODUCTS DIVISION

EISLER ELECTRIC CORPORATION

544-39th STREET

UNION CITY, N. J.

Lansing
Iconic

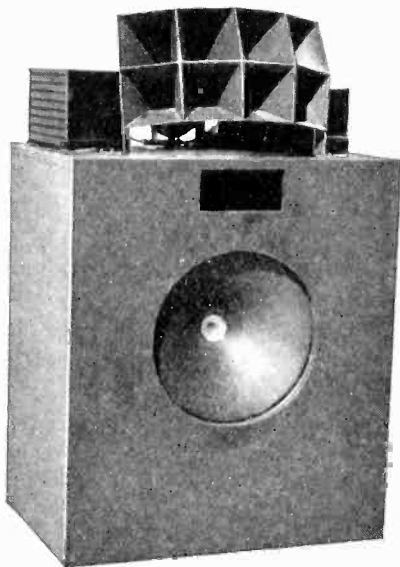

NEW

- Quality
- Uniformity
- Dependability

No other speaker can approach the flawless performance of the Lansing Iconic—An entirely NEW reproducing instrument—not just another speaker.

A demonstration by your distributor will prove these claims.

LANSING MANUFACTURING CO.
6900 McKinley Ave. ← Los Angeles, Calif.

Frequency Modulator

A FREQUENCY MODULATOR which may be used with any signal generator or oscillator in combination with the cathode ray oscilloscope for the visual alignment of radio receivers is announced by the Supreme Instrument Corp., Greenwood, Miss. It is known as their model 529 frequency modulator.

Sound Equipment

CRYSTAL PICK-UPS as well as phonograph motors operating at 78 and 33 1/3 r.p.m. have recently been announced for sale in this country by Stanley White, 140 Washington St., New York City. A.C., D.C. or universal motors which are self-lubricating and contain a Permaloy casing are available.

Filterette

CONFINING TO ITS SOURCE the radio interference created by relays used with police systems, the type UR-3 filterette made by the Tobe Deutschmann, Inc., Canton, Mass., is contained in a waterproof, cast iron housing for installation in the outdoor conduit system. It comprises the correct values and inductance and capacitance to prevent feeding back interference to the power line.

PLUGS—SOCKETS

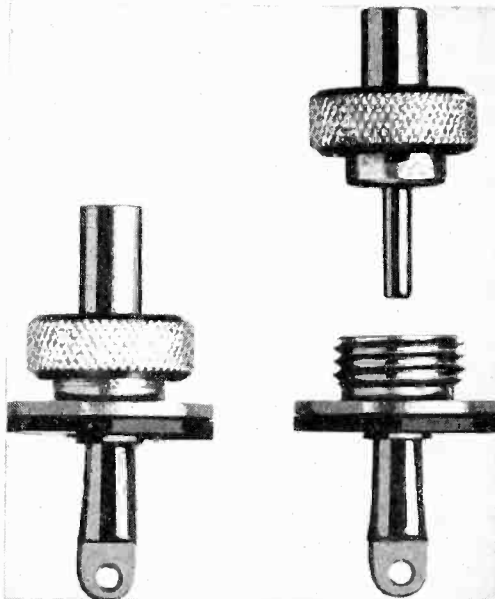

Type No. 101 shielded single contact plug and socket.

One type from our line of several hundred electrical plugs and sockets. We also supply manufacturers with terminal panels, standard or to blueprint.

Write for bulletins on complete line

HOWARD B. JONES
2300 Wabansia Ave.,
Chicago, Ill.

PROFESSIONAL SERVICES

Rates on Application

BLILEY ELECTRIC CO.

Designers—Manufacturers

Quartz Crystals for standard or special radio frequency applications.

Inquiries Invited.

200 Union Station Bldg.
Erie, Penna.

ELECTRICAL TESTING LABORATORIES

Characteristics and

Life Tests of Vacuum Tubes

Tests of photo cells, glow lamps, crater lamps.

Tests of electronic and optical devices.

80th Street and East End Avenue

New York, N. Y.

Phone: Butterfield 8-2600

THAD. R. GOLDSBOROUGH

REGISTERED PATENT ATTORNEY

Patent and Trademark Soliciting

Consulting Service

Patent Sale and License Negotiations

201-205 McLachlen Building

Washington, D. C.

INTERNATIONAL ELECTRONICS, INC.

AMERICAN CONSULTING ENGINEERS TO
FOREIGN MANUFACTURERS

Designs Specifications
Electrolytics Tubes Resistors
Transmitters Receivers

630 Fifth Avenue New York, N. Y.

Cable:— Interengin, New York

HAROLD J. McCREARY

Mem. A.I.E.E. & W.S.E.

Consulting Engineer

Research Electronics

Development Television

Design Radio

Factory Practise Railroad Signaling

Patent Studies Telephony

105 W. Adams St. Phone STate 4003 Chicago, Ill.

THE SOLUTION OF YOUR PROBLEM

in the field of Electronic devices may be found through enlisting the services of the Consultants whose cards appear on this page.

This is a highly specialized field and specialists are therefore better able to undertake the rapid developments necessary to keep in step with modern manufacturing progress.



FOR THE MOST
EXACTING
REQUIREMENTS

MORRILL HIGH FREQUENCY IRON CORES

Universal
Tuning
Pin

Circuit Figure of Merit
up to 360

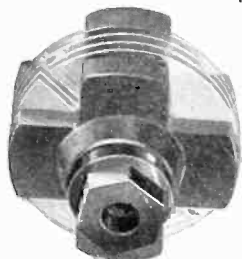

Cross Core
with
Subdivided
Coil Form
and
Holding
Screw

HIGH CONSTANT RESISTORS

Precision
Short Wave
(for frequen-
cies less than
30 meters)

High Megohm
up to 10,000
megohms

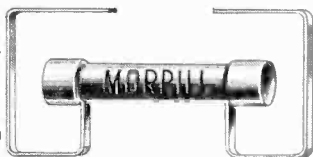

CONDENSERS

Glass Tubular—Cased—Uncased—Tropical

MORRILL & MORRILL

30 Church Street, New York, N. Y.

MONARCH MULTIVIBRATOR



LAST YEAR'S INNOVATION IS THIS YEAR'S NECESSITY

We, the originators, did not dream a year ago, when we brought out the MULTIVIBRATOR as a supplement to the signal generator, that it would gain such wide and quick acceptance by radio manufacturers. Today, just one year later, it has become practically a necessity and is now used as standard equipment by many of these same manufacturers. The reason is simply this. The MULTIVIBRATOR has proven its ability to speed up production and sets of top quality can be turned out at minimum cost.

1. No matter where the receiver is tuned the signal is there—ready to use—no hand switching or frequency controls.
2. Trimmers and padders for all receiver bands can be set more accurately and in a fraction of the usual time.
3. Oscillator padders can be adjusted without rocking the gang condenser.
4. Overall performance and output of any band can be checked throughout and almost instantly—not a few isolated points.

MONARCH MANUFACTURING CO.
3341 Belmont Ave. Chicago, Ill.

Power Level Indicator

A VACUUM TUBE voltmeter with a linear pre-amplifier operated from a 115-volt 50- or 60-cycle a-c power source forms the essential elements of the type 686-A



power level indicator of the General Radio Co., Cambridge, Mass. All tubes are accessible from the rear. Main calibration is in per cent utilization of the available channel and an auxiliary decibel scale is provided.

Resistance Indicator

A NEW RESISTANCE analyzer and indicator, just announced by the International Resistance Co., 401 North Broad St., Philadelphia, has a resistance which is continuously variable from zero up to 1 megohm. The unit is contained in a circular Bakelite case with external test leads. Up to 30,000 ohms the resistance is wire wound whereas above this value a metalized resistor is used.

Peak Kilo-voltmeter

THE HICKOK ELECTRICAL INSTRUMENT Co., Cleveland, Ohio, announces a voltmeter suitable for measuring instantaneous peak voltages of several thousand volts. This kilo-voltmeter consists essentially of a high voltage rectifier in series with a condenser and an electrostatic voltmeter. It measures the instantaneous maximum potential of the charges accumulated on the plate of a low-voltage condenser of high leakage resistance. Meters are available having a maximum voltage reading of 16,000 volts but instruments to other scales are being developed.

Low Loss Molding Material

A NEW BAKELITE polystyrene molding material with a loss factor of less than 0.00053, a power factor of less than 0.0002, and a dielectric constant of 2.6 at 60 cycles to 1,000,000 cycles has re-



cently been announced by the Bakelite Corp., New York City. The molding material has a dielectric strength in excess of 500 volts per mil, and a volume resistivity of 10^8 megohm-cms.

PERMANENT Magnet ALLOYS

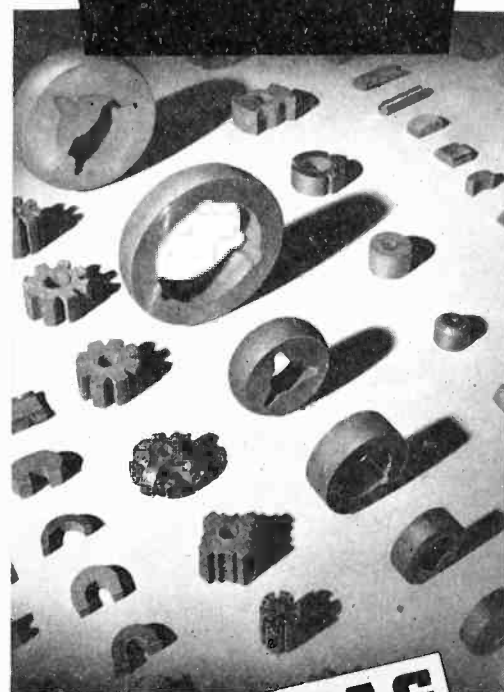

NIPERMAG

ALNICO

ALNIC

WE specialize in the manufacture of high quality nickel aluminum permanent magnets, designed, cast and ground to your requirements. Our extensive experience and our complete engineering and testing facilities assure you of highest magnetic efficiency, uniformity of product and dependability of service. Our Engineers will gladly cooperate with you on design or other problems with no obligation on your part. Technical data on request.

**CINAUDAGRAPH
CORPORATION**

Magnet Alloy Division

STAMFORD, CONN.



*Nationwide
Acceptance*

REMLER

HI-FIDELITY TRANSCRIPTION UNIT

Famous Remler quality . . . sturdily constructed with precision accuracy to stand up under the gruelling test of continuous service. Improved mechanical-filter drive system provides constant speed and freedom from wow at either 33 1/3 or 78 R.P.M.

FEATURES: True synchronous motor, condenser starting, mounted on rubber. Exclusive roller-bearing planetary speed reduces drive for 33 1/3 R.P.M. Speed change by simple lever. Oil-damped mechanical filter in drive shaft. Heavy 16" "flywheel" platter. High fidelity lateral pickup and equalizer gives response within 3 db. from 45 to 6600 C. P. S. Ball-bearing mounted long radius pick-up arm, with adjustable needle pressure—1/2 oz. to 6 oz.

Available in cabinet or as a unit for mounting in control table. All parts mounted in heavy cast iron framework assuring permanent alignment and simple installation. The price is unusually low. Send for complete information.

REMLER COMPANY, LTD., 19th at Bryant, San Francisco

REMLER—THE RADIO FIRM AS OLD AS RADIO



Frequency Measuring Service

Many stations find this exact measuring service of great value for routine observation of transmitter performance and for accurately calibrating their own monitors.



MEASUREMENTS WHEN YOU NEED THEM MOST
at any hour every day in the year

R.C.A. COMMUNICATIONS, Inc.

Commercial Dept.

A RADIO CORPORATION OF AMERICA SERVICE

66 BROAD STREET

NEW YORK, N. Y.

WAXES • COMPOUNDS • VARNISHES for ELECTRICAL INSULATION

Zophar offers prompt service on Insulating Compounds for a wide variety of electrical applications, including:

. . . insulation for CONDENSERS, TRANSFORMERS, COILS, power packs, pot heads, sockets, wiring devices, wet and dry batteries, etc. Also WAX SATURATORS for braided wire and tape. WAXES for radio parts.

Special compounds made to your order.

ZOPHAR MILLS INC.

130-26th St.

Brooklyn, N. Y.

FOUNDED 1846

Colored "Mikes"

IN VIEW OF THE greatly increased public consciousness of color scheming and interior decoration, the Amperite Corp., 561 Broadway, New York, announces that all of their velocity microphones and stands are now available in egg-shell white as well as in other pastel shades.

Magic Switch

A SMALL UNIT plugging directly into the 110-volt line, and suitable for control purposes by personal participation of a spectator, is the "Magic Switch" which is available from Teletouch Magic Mirror Corp., 37 W. 54th St.,

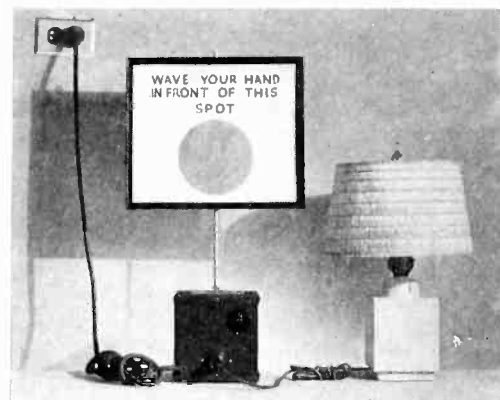

New York City. The unit may be made to turn on light, or operate other electrical equipment when the spectator approaches the control unit. Although it is applicable for a variety of industrial applications, this electronic instrument is especially suitable also for advertising purposes.

Tube and Set Tester

A NEW TUBE and radio set tester, designated as model 440, has been added to the line of radio testing equipment manufactured by the Simpson Electric Co., 5216 West Kinzie St., Chicago, Ill. Among the features provided in this instrument are screen fluorescence and angle test for the indicator type tubes such as the 6E5.

Ceramicons

THE ERIE RESISTOR CORP., Erie, Pa., announces three types of fixed condensers with unusual operating characteristics. These small condensers, manufactured under the name of Ceramicons, consist of a ceramic dielectric coated with plates of silver fired on at high temperature. This type of construction results in a condenser of unusual inherent stability. A change of less than 1/4 of 1 per cent may be expected after subjecting these units to 600 hr. of alternate heating and cooling from 40° F to 250° F.

Sensitive Meter

A MULTI-RANGE d-c meter having 8 voltage scales from 1/10 volt to 500 volts with a meter resistance of 5 megohms, two resistance ranges from 1/10 megohm to 1000 megohms, and twelve current ranges up to 10 milli-



amperes has been placed on the market by the RCA Manufacturing Co., Camden, N. J. The ultra-sensitive d-c meter is self-contained, uses three 1B4 vacuum tubes, and is battery operated. Essentially, this instrument consists of a multiplicity of input circuits, a feedback amplifier and a meter circuit. The overall precision of all ranges of current for voltage measurement is ± 2 per cent.

Oscilloscope

OSCILLOSCOPES with 2-in. and 3-in. screen and incorporating the turret tube mounting are offered by the Triplet Electrical Instrument Co., of Bluffton, Ohio. Linear sweep from 15 to 20,000 cycles.

New Crystal Microphone

A NEW CRYSTAL MICROPHONE, model T-9 and featuring a new shock-proof cartridge with characteristics suitable for both voice and music is announced to the trade by the Turner Co., Cedar Rapids, Iowa.

Dial Plate

MATCHED DIAL PLATES for all standard Yaxley controls, rheostats and voltage dividers, which will insure uniformity of assembled equipment has been an-

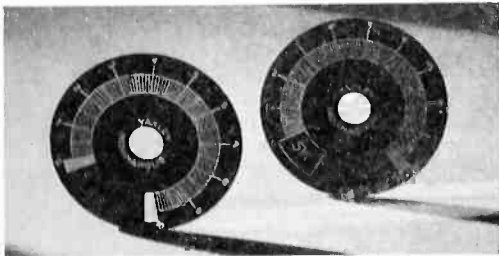

nounced by the P. R. Mallory & Co., Inc., Indianapolis, Ind. These dial plates are marked from 0 to 10 and each main division is sub-divided into ten parts so that there are 100 divisions in all.

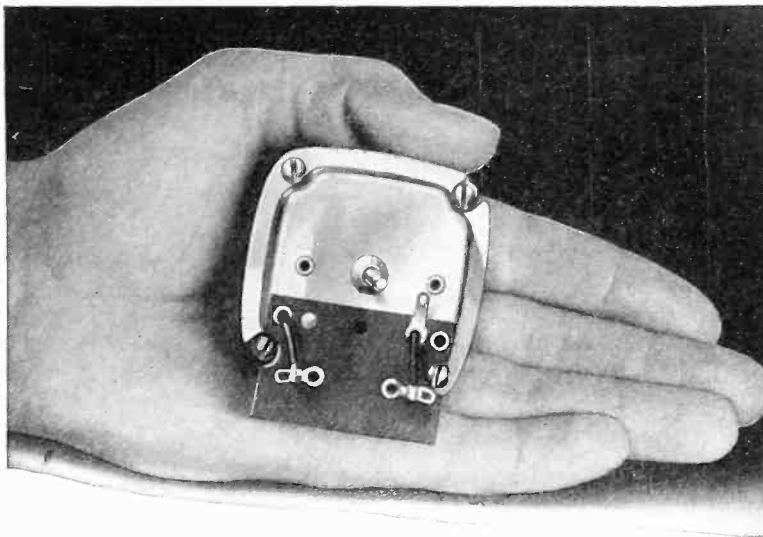

ALLIANCE
MODEL
"R"

A BETTER—MORE DEPENDABLE MOTOR for "Push-Button" Tuning

The tiny Model "R" motor, illustrated above, is specifically designed for use in radio tuning by "push-button" control.

Exclusive safety and dependability features make the Model "R" motor the most rugged and efficient of its kind. Securely mounted, self-aligning, oilless bearings guarantee permanent shaft alignment and noiseless operation. Thermostatic protection against accidental burning out, plus ample heat radiating area provided by the housing, make the Model "R" ideal for concealed positions. Yet the overall dimensions are only $2\frac{1}{8}$ " x $2\frac{1}{4}$ " x $1\frac{1}{2}$ ". The Alliance Model "R" motor can be had now in large quantities at low cost. Mounting and gear assemblies will be supplied to meet your particular demands and specifications.

Write, Wire or Phone for Complete Details

ALLIANCE MFG. CO. • ALLIANCE, OHIO

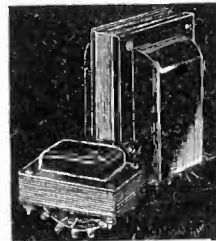

DEVELOPMENT

Rapid increase in the application of electronic principles to industry requires constant development of transformers having new characteristics for new services.

STANCOR today, as in the past, is eager to offer its facilities and experience to any manufacturer of electronic equipment who requires economical solution of his transformer problems.

STANCOR

STANDARD TRANSFORMER CORPORATION
850 BLACKHAWK STREET, CHICAGO

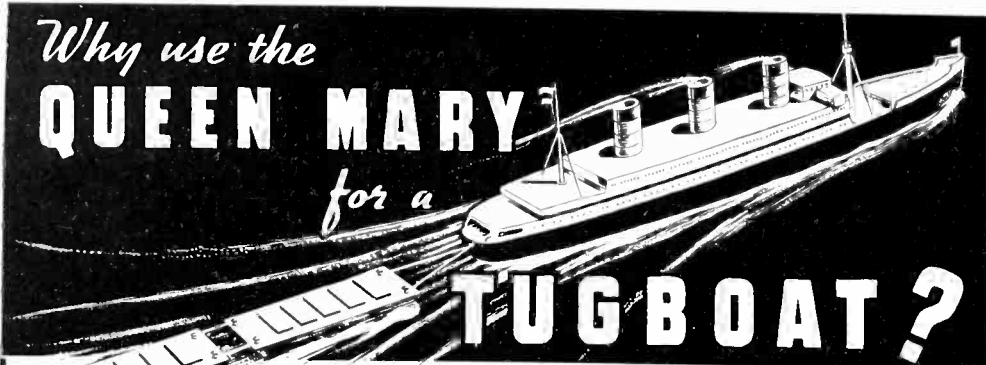

..... THERE'S A RELAY BY
GUARDIAN TO FIT YOUR JOB

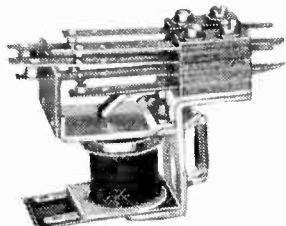

Unit shown is No. 110 AC. When ordering specify current, voltage, amperage, contact combination, etc.

The world's biggest, finest, most costly marvel of mechanical genius is worth less than nothing unless it is hitched to the right job. In designing and building your products, be sure your RELAYS are specifically engineered for the work expected of them. Not too big . . . nor yet too small. Ample in contact capacity . . . but low in current drain. Sturdily built . . . but compact in size.

As an aid in selecting the right types of Relays, stepping switches, mercury switches, solenoids, etc., WRITE TODAY FOR CATALOG E, and details of Guardian Free Engineering service.

GUARDIAN G ELECTRIC
1625 W. WALNUT STREET CHICAGO, ILLINOIS

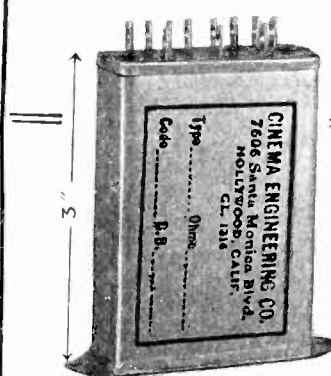

*Card and Can Type
PADS*

CINEMA offers CAN TYPE PADS wound in a manner similar to the card type and mounted in a shield can with heavy terminals at the top. Input is well isolated from output.

CAN TYPE PADS are available as follows:
T-Pads—any value. Special pads. H-Pads—any value.

Write for detailed information and prices.

Other CINEMA PRODUCTS include: non-inductively wound, moisture proof Resistors; rugged, smooth-operating Attenuators; high quality Rack and Panel Equipment.

DETAILS ON REQUEST.

CINEMA ENGINEERING CO.

7606 SANTA MONICA BLVD.
HOLLYWOOD, CALIFORNIA

• **RADIO HARDWARE** •

We carry in stock standard and many special items of radio hardware used by manufacturers of sets, radio parts, speakers, sound equipment, testing instruments, etc. Buyers of substantial quantities—manufacturers or jobbers—will save time and money by writing for our Bulletin 50A—available to Manufacturers—Jobbers—Laboratories.



MACHINE SCREWS & NUTS
TUBULAR RIVETS
EYELETS
EYELET LUGS
SPADE LUGS

ETC.

SOLDERING LUGS
BRASS WASHERS
STEEL WASHERS
FIBRE WASHERS
LOCKWASHERS

ETC.

METAL TAPPING SCREWS
SPEAKER MOUNTING SCREWS
ESCUTCHEON SCREWS
WOOD SCREWS
RUBBER GROMMETS

FEDERAL SALES CO., 26 S. JEFFERSON, CHICAGO

Adjustable Attenuator

A SMALL, compact, balanced-H adjustable attenuator designed for use in broadcast and recording studios is announced by the General Radio Co., Cambridge, Mass., as their type 449-A



attenuator. Input impedance of the three models is 500 ohms, output impedance 50, 250 or 500 ohms. The attenuation range of each unit is 60 db. in 10 db. steps.

Neutralizing Condenser

A NEW CONDENSER, "M-10" is the newest edition to the line of transmitting condensers manufactured by the Hammarlund Manufacturing Co., 424 W. 33rd St., New York City. The plates have rounded edges, polished over all surfaces, and are mounted on strong Isolantite bars. Adjustment of capacitance is made by means of a screw driver and the movable plate may be locked in position. Capacitance range of this condenser is from 2 to 10 μf . Voltage rating for minimum spacing is 3,000 volts.

Compact Relay

FEATURES OF the type D relay released by the G-M Laboratories, Inc., Chicago, are its small size together with either

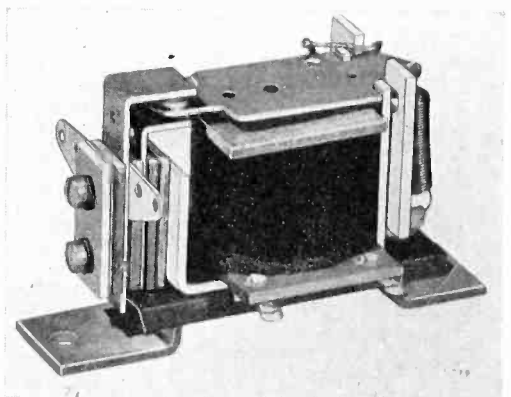

a-c or d-c operation. Various contact combinations are available and quick acting or slow acting relays may be obtained.

Plastic Lenses

ANNOUNCEMENT OF the commercial production of unbreakable plastic lenses, already produced in England, comes from the Unbreakable Lens Company of America, Inc., 401 North Maple Drive, Beverly Hills, Calif.

Station Selector

EXCLUSIVELY MECHANICAL in design and operation, is a new automatic sta-

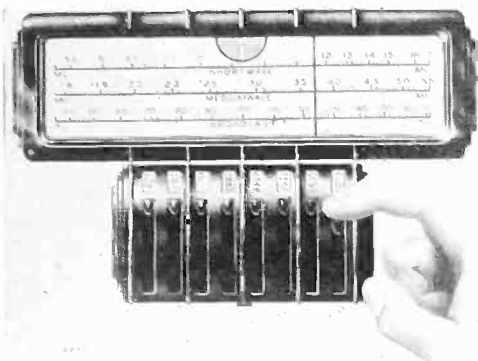

tion selector developed by the Belmont Radio Corporation, 1257 Fullerton Avenue, Chicago.

Terminal Strip

TWO NEW TYPES of terminals that embody several novel and useful features are available through the L. F. Barth Manufacturing Corporation, 55 Dicker-



son Street, Newark, N. J. These terminals are especially suitable for fire alarm signalling, radio telegraph and telephone, motor control, and similar communication and industrial applications.

Service Instrument

A COMPLETE TUBE tester with wide range set analyzer comprises the combination tester No. 5148 made by the Kickok Electrical Instrument Co., Cleveland, Ohio. The tube testing section which is of the dynamic test vari-

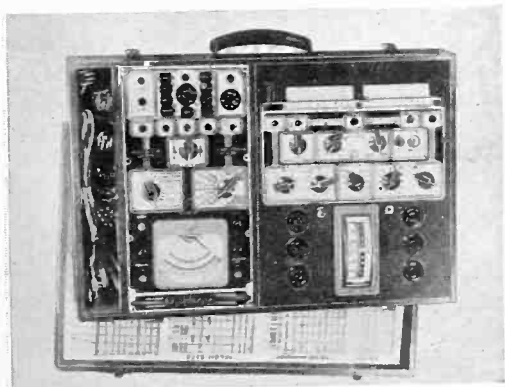

ety, tests the elements in multi-element tubes separately, checks for gas content, detects both open and short elements and tests for short circuit with the cathode either hot or cold.

Hushatone

THE BRUSH DEVELOPMENT Co., 3311 Perkins Ave., Cleveland, announce a new crystal-operated radio set speaker to be used under pillows and especially suitable for radio sets placed in a bedroom or hospital.

Decibel Meter

A RECTIFIER TYPE power level indicator and voltmeter, in which a new circuit network provides improved uniformity of operating characteristics, has been introduced by the Weston Electrical Instrument Corp., Newark, N. J. Known as the model 695 type 11 the unit has a constant internal resistance of 20,000 ohms, both into the instrument from the line under test, as well as from the instrument into the network or line.

Universal Mounting

MECHANICAL DIFFICULTIES in mounting high voltage filter condensers are eliminated with the universal mounting bracket recently introduced by the Cornell-Dubilier Electric Corp., of South Plainfield, N. J.

PLANNING A SHUNT EXCITED RADIATOR?

then you WILL need a
TYPE 174
COMPRESSED GAS
CONDENSER
send for information
and prices

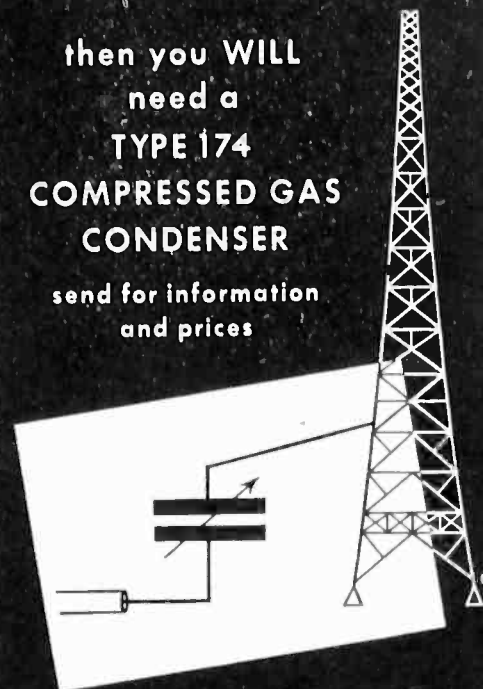

HEINTZ AND KAUFMAN
SOUTH CALIFORNIA
SAN FRANCISCO U. S. A.

MODEL RA

FIELD INTENSITY METER

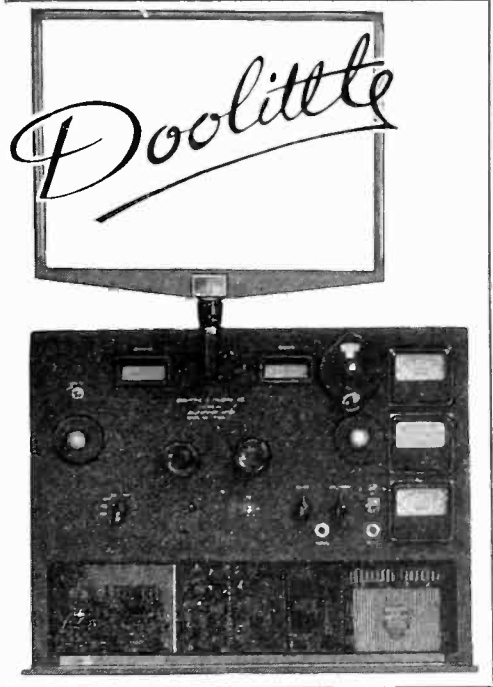

SIX IMPORTANT FEATURES

- Frequency range 500 to 15,000 K. C. S.
- Complete in one aluminum case
- Lightweight; only 43 lbs. complete
- Integral D. C. Recording Amplifier
- Low First Cost
- Low Operating Cost

The outside dimensions of the cabinet of the Model RA Field Intensity Meter are 10½ in. deep, 19 in. wide, and 14½ in. high. Complete information and price on request.

DOOLITTLE & FALKNOR, INC. 7421 South Loomis Blvd.
Chicago, Illinois

They Give "ULTRA" Performance at Low Cost!

SHURE "ULTRA" Crystal Microphones

You need only try them, test them, compare them with any others, to discover for yourself how far ahead Shure "ULTRAS" really are—how much more they give you in performance, in dependability, in value, than any other general-purpose crystal microphones available today, regardless of price! These are the microphones that have been adopted as standard equipment by eminent sound engineers and nationally-known sound-equipment manufacturers. Thousands of them are in use today in a wide variety of applications in more than 36 countries throughout the world.

Get the facts! Write for Data Sheet 125M.



"ULTRA" WIDE-RANGE RESPONSE HIGH-OUTPUT LEVEL — BUILT-IN DEPENDABILITY

With engineering refinements exclusively their own, Shure "ULTRA" Crystal Microphones give you remarkably faithful wide-range reproduction with a higher output level than that of any other crystal microphone of comparable response—plus extra-dependability features that insure day-after-day service even under the most rigorous conditions. Swivel, Spherical, or Grille-Type Models.

List Price.....\$25



Shure Patents Pending. Licensed under patents of the Brush Development Company.

CANNON Cable Connectors

World Wide Distribution Thru Following Representatives:

New York City, New York Lewis & Sachs Co. 220 Fifth Avenue Tel. Caledonia 5-7573	Seattle, Washington Jas. J. Backer Co. 109 Bell Street Tel. Main 9911	Bombay, India Eastern Electric Engineering Co. 175 Hornby Road, Fort. Post Box 459	London, England Films & Equipments Ltd. 145, Wardour Street London, W. 1. Tel. Gerrard 6711/2
Chicago, Illinois Kelburn Engineering Co. 600 W. Jackson Blvd. Tel. Haymarket 2421	San Francisco, California George C. Maudslay 835 Darien Way Tel. Randolph 3334	Sydney, Australia Hayward C. Parish 4th Floor State Shopping Block	Los Angeles, California Graybar Electric Co. 201 Santa Fe Avenue Tel. TRinity 3321
Detroit, Michigan Public Address Systems 7629 E. Jefferson Ave. Tel. Fitzroy 4700	Toronto, Ontario, Canada L. D. Cahoon Brush Crystal Products 180 Perth Avenue Tel. Lom. 0682	Buenos Aires, Argentina, S. A. W. Raimundo Campbell Sucre 2827	
Dallas, Texas Edward F. Aymond 3750 Urban Avenue Tel. 3-7067	Paris, France Nationale Societe Francaise 27, Rue De Marignan Tel. Balzac 20-44	Oslo 22, Norway Maskin-Aktieselskapet Zeta Drammensveien 26	

CANNON ELECTRIC DEVELOPMENT CO.
420 WEST AVENUE 33, LOS ANGELES, CALIFORNIA



LEACH LR RELAYS

ALWAYS ON THE JOB GIVING DEPENDABLE OPERATION

The new Leach Impulse Relays make possible many new developments such as new circuits, new lock-out schemes—alarm systems and safety devices. Operation is dependable, absolutely quiet, and fast . . . time required to shift from one position to the other is approximately 1/60 second.

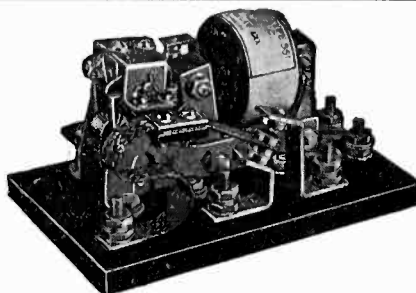

LEACH RELAY COMPANY
5915 Avalon Boulevard, Los Angeles, Calif.
15 E. 26th St., New York City

LEACH RELAY CO., 5915 AVALON BOULEVARD, LOS ANGELES, CALIF.

Please send me your new catalog. I am interested in _____ relay.
Name _____
Company _____
Address _____ City _____

Volume Indicator Panel

A NEW VOLUME INDICATOR panel for relay rack mounting was recently developed by the Cinema Engineering Co., 7606 Santa Monica Blvd., Hollywood.



The attenuation range is 40 db., the line impedance is 500 ohms, and the internal impedance is either 1,500 or 5,000 ohms.

Frequency Control

A NEW CRYSTAL unit designated as the type B5 with a maximum frequency temperature coefficient of 4 cycles per megacycle per degree Centigrade and manufactured for the 40- and 20-meter amateur bands has recently been developed by the Bliley Electric Co., Erie, Pa.

Rectifier Type Battery Charger

THE DEVELOPMENT OF a new type of charger using dry metallic rectifier units and suitable for heavy duty battery charging has been placed on the market by the B-L Electric Manufacturing Co., of St. Louis, Mo.

Variable Voltage Transformer

AN ADJUSTABLE "Vari-Volt" transformer which permits the user to adjust the line voltage in one volt steps from 0 to 256 volts and in ½ volt steps from 0 to 128 volts is available from the Halldorson Corp., 4500 Ravenswood Ave., Chicago, Ill.

Volume Control

A SMALL and light weight volume control that is inserted in the headset cord, between phones and outlets, has been announced for multiple headset installation by Centralab, 900 E. Keefe Ave., Milwaukee, Wis. This volume

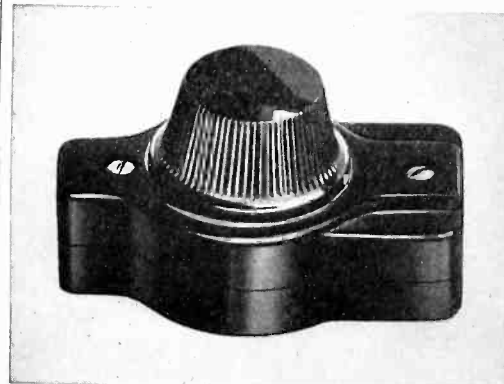

control incorporates an "L" pad attenuator so that the impedance looking from the outlet into the headset is maintained at the nominal impedance of the headset regardless of the volume control setting.

Patent Suits

1,920,162, Amy & King, Radio aerial attachment; 1,938,092, 2,002,844, Amy & Aceves, Radio receiving system; 1,976,910, same, Multiple radio receiving system; Re. 19,854, same, Duplex radio aerial system, D. C., S. D. N.Y., Doc. E 85/155, *Amy, Aceves & King, Inc., v. Technical Appliance Corp.* Consent decree for plaintiff (notice July 16, 1937).

1,403,475, H. D. Arnold, 1,403,932, R. H. Wilson, 1,506,016, L. de Forest, 1,506,017, same; Re. 18,579, Ballantine & Hull, D. C., S. D. N. Y., Doc. E 81/360, *R. C. A. et al. v. E. Dane et al.* Consent decree for plaintiff (notice June 18, 1937).

1,837,746, V. K. Zworykin, Photoelectric tube, filed June 21, 1937, D. C., E. D. Pa., Doc. 9771, *Nakken Patents Corp. v. Westinghouse Electric & Mfg. Co. et al.*

1,707,594, F. Bedell, Device for indicating oscillograph curves as stationary, filed July 21, 1937, D. C. Del., Doc. E 1214, *General Radio Co. v. A. B. Du Mont Laboratories, Inc.*

1,129,942, H. D. Arnold, Gaseous repeater in circuits of a low impedance; 1,465,332, same, Vacuum tube amplifier, C. C. A., 3d Cir., Doc. 6339—6342, *Biophone Corp. v. Western Electric Co. et al.* Decree affirmed Aug. 10, 1937.

1,297,188, 1,313,094, I. Langmuir, System for amplifying variable currents; 1,316,967, D. M. Moore, Gaseous conduction lamp; 1,614,214, A. Steiner, Means for supporting and driving films; 1,646,249, C. A. Hoxie, Narrow light aperture; 1,756,863, same, Method of making motion picture films; 1,729,048, G. F. Myers, Method of making talking motion pictures; 1,854,159, L. T. Robinson, Sound recording; 1,920,789, C. L. Heisler, Film driving apparatus, D. C., S. D. Calif. (Los Angeles), Doc. E 691-M, *R. C. A. et al. v. Balsley & Phillips, Inc., Ltd., et al.* Consent decree holding patents valid and infringed; injunction against Balsley & Phillips, Inc., Ltd., July 20, 1937.

1,313,094, I. Langmuir, System for amplifying variable currents; 1,729,048, G. F. Myers, Method of making talking motion pictures; 1,756,863, C. A. Hoxie, Method of making motion picture films; 1,840,351, W. L. Douden, Sound record and method of producing same; 1,854,159, L. T. Robinson, Sound recording, D. C., S. D. Calif. (Los Angeles), Doc. E 650-M, *R. C. A. et al. v. R. M. Like et al.* Decree for plaintiff holding patents valid and infringed; injunction July 3, 1937.

1,329,283, H. D. Arnold, Thermionic amplifier; 1,403,475, same, Vacuum tube circuit; 1,448,550, same, Thermionic amplifier circuit; 1,465,332, same, Vacuum tube amplifier; 1,520,994, same, Electron discharge; 1,231,764, F. Lowenstein, Telephone relay; 1,426,754,



"The standard by which others are judged and valued"

A pick-up for every need, delivering wider range and greater stability than you can secure elsewhere at the price, listing from...

\$7.50 to 260.00

AUDAK COMPANY 500E Fifth Ave., New York
"Creators of High Grade Electrical and Acoustical Apparatus Since 1915"

RESINOX

MOLDED PLASTIC DEVELOPMENTS ★ ★

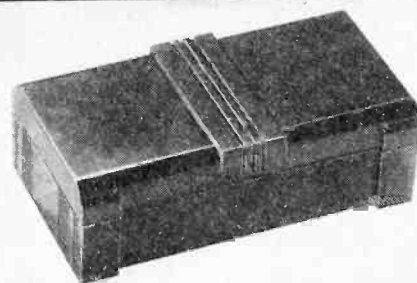

ATTRACTIVE UTILITY

A counter-part of an R. C. A. remote control unit, this molded case was used in the R. C. A. promotion program.

It was molded of Resinox by the **Mack Molding Company** of Wayne, N. J.

A hinge construction was obtained with a single brass pin and a molded extension—simple, low cost design. The Resinox organization will assist you in achieving similar attractive, and economical designs.

★ Send for the new Resinox Catalogs. They will give you many unusual ideas on adding eye appeal and utility to your product.

RESINOX CORPORATION 230 PARK AVE., NEW YORK

IT'S SAFE CONTROL

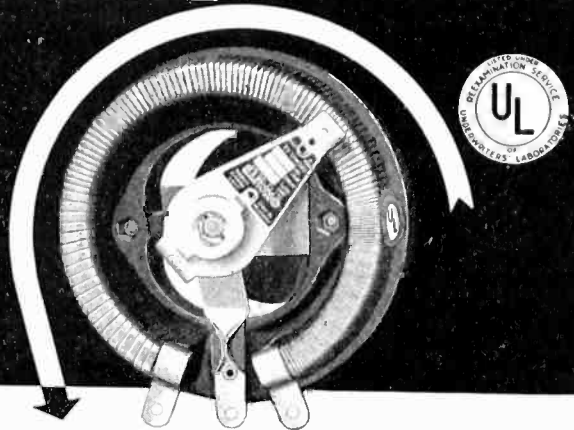

UNDERWRITERS' TESTS PROVE OHMITE DEPENDABILITY

★ With practically stepless resistance variation, Ohmite Wire-Wound Vitreous Enamelled Rheostats (Underwriters' Laboratories Listed) give you smooth, close control not found in other types of power Rheostats. More than adequate insulation — nothing to smoke

or char. The famous Ohmite all-porcelain and metal construction means extra Safety and Dependability in your product. Available in single or tandem units with straight or tapered winding to meet your specifications. Write for Catalog 16.

OHMITE

★ Manufacturing Company
4825 West Flourney Street
Chicago, Illinois, U. S. A.

Rheostats • Resistors • Tap Switches

McGraw-Hill

DIRECT MAIL LISTS



As business paper publishers for over fifty years, McGraw-Hill is uniquely equipped to offer complete, authoritative direct mail coverage of industry's major markets. Extreme accuracy is maintained (guaranteed to 98%) and through careful analysis of markets, complete classification of companies and personnel, etc., the widest possible selections are available. Send for handy reference folder, "Hundreds of Thousands of Reasons Why" which describes how McGraw-Hill Lists are built and maintained.

What Fields Do You Want to Reach?

Aviation
Bus & Electric Railways
Civil Engineering and Construction

Administrative Executives
Electrical Dealers & Wholesalers
Mill Supply Houses
Power Services
Product Engineering & Design
Production and Maintenance
Radio Dealers & Wholesalers
Radio Engineering & Design

For further details, selections from above basic classifications, counts, prices, etc., or estimates on special lists ask any representative or write to



Complete Lists Covering Industry's Major Markets

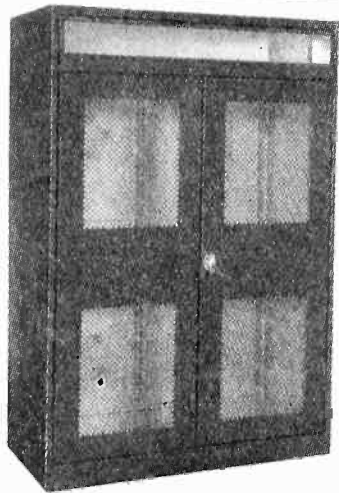

1938 MODELS NOW READY

TRANSMITTER and RELAY RACK CABINETS in MODERN DESIGN, and with distinctively improved features that are appreciated by users everywhere. Write today for details and low factory prices.

LEFEBURE CORPORATION

Manufacturers
CEDAR RAPIDS, IOWA, U. S. A.

R. C. Mathes, Circuit for electron discharge device, C. C. A., 2nd Cir., Doc.—*Western Electric Co. et al. v. General Talking Pictures Corp.* Decree affirmed (notice July 26, 1937).

1,403,475, H. D. Arnold, 1,403,932, R. H. Wilson, 1,507,016, L. de Forest; 1,507,017, L. de Forest; 1,936,162, R. A. Heising; Re. 18,579, S. Ballantine et al., D. C., S. D. N. Y., Doc E 82-94, et al v. M. Shapiro and H. Krantz, individually and doing business at Rite Radio Stores. Decree pro confesso sustaining patent and granting injunction (notice July 6, 1937).

1,446,247, L. de Forest, Light-controlling means; 1,466,701, same, Method of and means for controlling electric currents by and in accordance with light variation; 1,482,119, same, Means for recording and reproducing sound; 1,473,976, E. E. Ries, Sound recording method, D. C., S. D. N. Y., Doc. E 38-93, *General Talking Pictures Corp. et al. v. Fox Film Corp. et al.* Dismissed for lack of prosecution (notice July 1, 1937).

Re. 18,579 (a), Stuart Ballantine et al., Demodulator and method of demodulation; 1,297,188, Irving Langmuir, Systems for amplifying variable currents; 1,573,374, P. A. Chamberlain, Radio condenser, 1,618,017, F. Lowenstein, Wireless telegraph apparatus; 1,707,617, E. W. Kellogg, Sound-reproducing apparatus; 1,795,214, same, Sound-reproducing apparatus; 1,894,197, C. W. Rice et al., Sound reproducing apparatus, D. C., S. D. N. Y., Doc. E 82-95, *RCA et al. v. M. Shapiro and H. Krantz*, individually and doing business as Rite Radio Stores. Decree pro confesso sustaining patent and granting injunction (notice July 6, 1937).

1,342,885, E. H. Armstrong, Method of receiving high frequency oscillations; 1,734,038, L. Levy, Electrical transmission of energy, D. C., S. D. N. Y., Doc. E 56/249, *Westinghouse Electric & Mfg. Co., Inc. v. American Telephone & Telegraph Co.* Consent order of discontinuance without prejudice (notice May 27, 1937).

Adjudicated Patents

(C. C. A. N. Y.) De Forest patent, No. 1,507,016, for radio-signaling system, Held infringed. *Radio Corporation of America v. Andrea*, 90 F. (2d) 612.

(C. C. A. N. Y.) De Forest patent, No. 1,507,017, for wireless telegraph and telephone system, Held infringed. Id.

(D. C. Mass.) Amy and King patent, No. 1,920,162, for aerial attachment, Held valid and infringed. *Amy, Aceves & King v. Tobe Deutschmann Corporation*, 19 F. Supp. 673.

(D. C. Mass.) Amy and Aceves patent, No. 1,938,092, for radio receiving system, Held valid and infringed. Id.

SEARCHLIGHT SECTION

EMPLOYMENT : BUSINESS : OPPORTUNITIES : EQUIPMENT—USED or RESALE

UNDISPLAYED RATE:

10 cents a word, minimum charge \$2.00.

Position Wanted, (full or part-time salaried employment only), 1/2 the above rates, payable in advance.

Proposals, 40 cents a line an insertion.

INFORMATION:

Box Numbers in care of our New York, Chicago, or San Francisco offices count 10 words additional in undisplayed ads. Replies forwarded without extra charge.

Discount of 10% if full payment is made in advance for four consecutive insertions of undisplayed ads (not including proposals).

DISPLAYED—RATE PER INCH:

1 inch.....\$6.00
2 to 3 inches..... 5.75 an inch
4 to 7 inches..... 5.50 an inch

An advertising inch is measured vertically on one column, 3 columns—30 inches—to a page. Contract rates on request.

DO YOU NEED A REAL SPECIALIST FOR YOUR FACTORY?

Vacuum tubes | Twelve years of experience
Oscillographs | Chief of Developmt. laboratory
Metal tubes | USA—France—Germany—England
Transmit. tubes | Italy—speaks five languages.

Write immediately to P-133, Electronics, Aldwych House, Aldwych, London, W. C. 2.

POSITION VACANT

RECEIVER COMPONENT SPECIALISTS—Development and manufacturing engineers, capable preparing detailed, comprehensive reports. High fees for spare time consulting with prospect of high-salaried positions. Full details first letter. Replies strictly confidential. P-138, Electronics, 330 West 42nd Street, New York City.

POSITIONS WANTED

RADIO SERVICEMAN, amateur radio operator, young, experienced, desires job with chance for advancement into laboratory or research work, locate anywhere, particulars on request. PW-135, Electronics, 520 No. Michigan Ave., Chicago, Ill.

FACTORY EXECUTIVE, Superintendent, production manager, Age 38. Successful large scale electrical and mechanical record, 100 to 1000 employees. Planning, methods, time study, piece work; cost reduction, labor and material; inventory control, cost estimates, skilled labor relations, design, development new products. Steam, electric, vacuum, hydraulic equipment. Bakelite molding. Machine shop, engineering, purchasing. Complete management. Will consider short term industrial survey. PW-136, Electronics, 330 West 42nd Street, New York City.

JUNIOR ENGINEER or laboratory assistant. 3 years electrical engineering. Thoroughly grounded on theory and design of audio and radio receiving circuits. 3 years' experience design, construction of sound systems and tuners. Musical training. Fluent Spanish. Searching, alert mind. Salary secondary to future. PW-137, Electronics, 330 West 42nd Street, New York City.

WANTED

WANTED volumes of Proceedings I.R.E. from 1918. Must be cheap. W-134, Electronics, 330 West 42nd Street, New York City.

YOUR ORGANIZATION

Is it complete?
Are you expanding it?
Making replacements?

Naturally, you are anxious to secure the most suitable man or men available. You want men with the special training that will make them an asset to your organization. You can contact such men through a Position Vacant advertisement in the Searchlight Section of ELECTRONICS

QUARTZ

Quartz or Glass Apparatus—Gaseous Discharge Tubes of all descriptions.

Built to your specifications. We number among our customers America's largest manufacturers of Ultra Violet Equipment.

HYDE TECHNICAL LABORATORIES
1140 Venice Blvd., Los Angeles, Calif.



Radio Digest
25¢

Sensation OF THE RADIO FIELD!

- It's the ONLY magazine with the best from ALL branches of radio (except business and entertainment).
- Digests, extracts, reprints from QST, Radio, All Wave Radio, Radio News, Electronics, Service, Communications, Bell System and R.C.A. papers; house organs, overseas journals.
- Twelve issues for \$2.50 in U.S.A., Canada, and Pan-American countries. Elsewhere, \$3.00 or 12s. 6d. Sample copy, 25c.

RADIO DIGEST
7460 Beverly Blvd. L.A., Angeles

METERS REPAIRED, TESTED, REBUILT

Specialists on all makes and types
Designers and Manufacturers of Special Equipment and Devices
Used Meters Bought, Sold, Exchanged
Correspondence invited

Associated Research, Inc.
16 N. May Street CHICAGO, Illinois

GLASS BLOWING

Electronic Devices | Lead to Pyrex Seals
Cathode Ray | X-Ray Assemblies
Special Stems | Diffusion Pumps
Lime, Lead Glass | Nonex, Pyrex Glass
Scientific Apparatus | Metal Seals | Stopcocks

TECHNICAL GLASS LABORATORY
200 Pennsylvania Avenue | Hillside, N. J.
WAverly 6-0253

New "SEARCHLIGHT" Advertisements

must be received by the 25th of the month to appear in the issue out the following month.

Address copy to the
Department Advertising Staff
Electronics

330 West 42d St., New York City

CHAS. EISLER'S

Equipment
Has Produced

MILLIONS

750 S. 13th St. (Near Avon Ave.)

FOREMOST IN THE ELECTRONICS FIELD FOR OVER 20 YEARS!

Charles Eisler's equipment for the production of radio and electronic tubes, incandescent lamps, X-ray and cathode ray tubes, photo-electric cells, and neon signs has met the severest demands of industry in operating at the lowest cost and the highest efficiency. If you are in the market for any of this or allied equipment including electric spot welders up to 250 KVA, butti, and arc welders, get in touch with us. Write for our "college and glass working laboratory units" catalog if interested in equipment for instruction purposes.

EISLER ENGINEERING CO.

Newark, N. J.



Our 1938 Catalog

Contains items of interest to Laboratories and Engineers

Write for your free copy now.

CAMERADIO

963 LIBERTY AVE. • 30 TWELFTH ST.
PITTSBURGH, PA. • WHEELING, W. VA.

Established 1919

Meters repaired, made more serviceable. Conversion to higher sensitivity as high as 10 microamperes for Weston type I or 24-57.

Sensitive vacuum thermo-couples
For Sale used Weston panel meters. Rawson microammeters, Brown pyrometers. Reasonable Prices
Precision Electrical Instrument Co.
561 Broadway, N. Y. C.

DEPENDABLE

New and Used

ELECTRONIC TUBE EQUIPMENT

A complete line of equipment for the manufacture of Radio Tubes, Neon Tubes, Incandescent Lamps, etc.

Write for Bulletin showing savings from 25 to 75%

EISLER ELECTRIC CORP.
534 39th Street, Union City, N. J.

HIGH GRADE NEW AND USED

ELECTRON TUBE EQUIPMENT

Huge Stock of Equipment of Every Type and Variety

KAHLE ENGINEERING CORPORATION
Specialists in Equipment and Methods for the Manufacture of Neon Tubes, Radio Tubes, Incandescent Lamps, Photo Cells, X-ray Tubes, etc.
941 DeMott St., North Bergen, N. J.

VACUUM THERMOCOUPLES

Separate Heater and Contact Types, Mounted and Unmounted
Ranges from 1 Milliamp and up
Write for Bulletin "A"

American Electrical Sales Co. Inc.
65-67 E. 8th St., New York, N. Y.

GLASSBLOWERS

Manufacturers of rare gas production items. High vacuum glass apparatus. Special apparatus to blueprints.

Hudson Brothers Mfg. Co., Inc.

539-41 Forty-Second Street Union City, N. J.

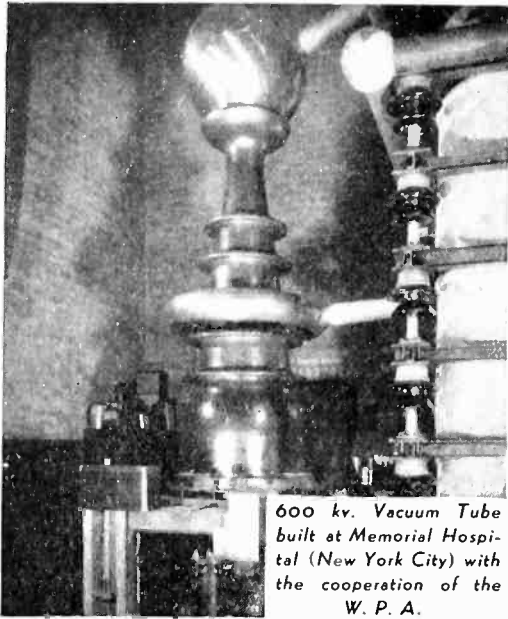

600 kv. Vacuum Tube built at Memorial Hospital (New York City) with the cooperation of the W. P. A.

COLLOIDAL GRAPHITE..

a Valuable Tool in Research

When glass, bakelite, paper, wood, metal and a variety of other substances are treated with "Aquadag" Brand colloidal graphite in water, they adsorb tenacious, homogeneous films of pure, electric-furnace graphite. These films are serving academic and industrial investigators in many ways. The neutron generator illustrated above, for example, is shielded with graphite films formed in this manner.

A similar application involves the Round-Hill Electrostatic Generator where Research Workers Van Atta and Van de Graaff* employed seven tractor inner tubes coated with graphite as a shield against radial fields.

Technicians are invited to avail themselves of the experience and cooperation of our technical staff.

Ask for Bulletins 210, 230, 270.

* C. M. Van Atta, R. J. Van de Graaff, and L. C. Van Atta, *Phys. Rev.* 51, 1013, (1937).



INDEX TO ADVERTISERS

Acheson Colloids Corp.	76
Alliance Manufacturing Co.	69
Allied Recording Products Co.	58
American Transformer Co.	40
Amperex Electronics Products, Inc.	Inside Front Cover
Astatic Microphone Laboratory, Inc.	60
Audak Co.	73
Bakelite Corporation	49
Biddle Co., James G.	60
Brand & Co., William	58
Callite Products Division	65
Cannon Electric Development Co.	72
Cinaudagraph Corp.	67
Cinema Engineering Co.	70
Centralab Div., Globe-Union Co.	Inside Back Cover
Daven Co., The	64
Delco Appliance Div., General Motors Sales Corp.	5
Doolittle and Faulkner, Inc.	71
Driver Co., Wilbur B.	76
Du Mont Laboratories, Inc., Allen B.	59
Ecco High Frequency Corp.	56
Erie Resistor Corporation	48
Federal Sales Co.	70
Ferranti Electric, Inc.	55
General Electric Co.	51
General Radio Co.	47
Goat Radio Tube Parts, Inc.	65
Guardian Electric Co.	70
Hardwick-Hindell, Inc.	64
Heintz & Kaufman, Ltd.	71
Hunter Pressed Steel Co.	59
International Nickel Co., Inc.	4
International Resistance Co.	35
Isolanite, Inc.	45
Jones, Howard B.	66
Lansing Mfg. Co.	66
Lapp Insulator Co., Inc.	41
Leach Relay Co.	72
Lefebure Co.	74
Littlefuse Laboratories	63
Mallory & Sons, P. R.	6
Monarch Mfg. Co.	67
Morrill and Morrill	67
Ohmite Manufacturing Co.	74
Parker-Kalon Corp.	39
Pioneer Gen-E-Motor Corp.	63
Precision Resistor Co.	76
Prentice Hall Publ. Co.	63
Presto Recording Corp.	52
RCA Communications, Inc.	68
RCA Manufacturing Co.	60, Back Cover
Remler Co., Ltd.	68
Resinox Corporation	73
Richardson Co., The	57
Shalleross Manufacturing Co.	56
Shure Brothers	72
Sigma Instruments, Inc.	57
Speer Carbon Co.	42
Standard Transformer Corp.	69
Superior Tube Co.	3
Triplet Electrical Instrument Co.	56
Utah Radio Products Co.	46
Ward Leonard Electric Co.	44
Western Electric Company	37
Weston Elec'l Instrument Corp.	43
Wilson Co., H. A.	50
White Dental Mfg. Co., S. S.	2
Zophar Mills	68
Professional Services	66

SEARCHLIGHT SECTION

Classified Advertising

BOOKS	75
EMPLOYMENT	75
WANTED TO PURCHASE	75
Quartz or Glass Apparatus	75
EQUIPMENT FOR SALE	
American Electrical Sales Co., Inc.	75
Associated Research, Inc.	75
Came Radio Co.	75
Eisler Electric Corp.	75
Eisler Engineering Co.	75
Electronics Machine Co.	75
Hudson Bros. Mfg. Co., Inc.	75
Kahle Engineering Corp.	75
Land, B. D.	75
National Radio Tube Co., Inc.	75
Precision Electrical Instrument Co.	75
Technical Glass Laboratory	75

MICROHM

WIRE WOUND RESISTORS

... of Highest Quality

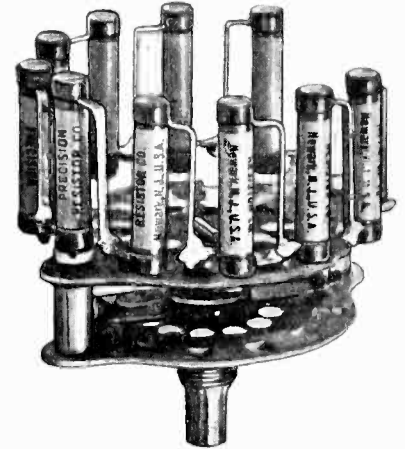

EASILY ASSEMBLED

The above illustration shows how easily TYPE PW and P-1 Power Resistors can be assembled in a standard 10-point switch.

Many other assemblies are facilitated by the flexibility provided in the terminals, which can be supplied at any angle in relation to each other.

Type PW Power Resistors are available in a resistance range from 10 ohms to 15,000 ohms. 1 Watt-Accuracy 1%.

Write for new catalog with prices.

PRECISION RESISTOR CO.

332 Badger Ave.
NEWARK, NEW JERSEY

- For the past 15 years every major improvement in the electrical alloy art has been sponsored by Wilbur B. Driver.
- And in "Tophet" (pronounced tof-fet) you are offered the sum total of the pioneer's experience, skill and good name.

WILBUR B. DRIVER CO.

NEWARK, NEW JERSEY

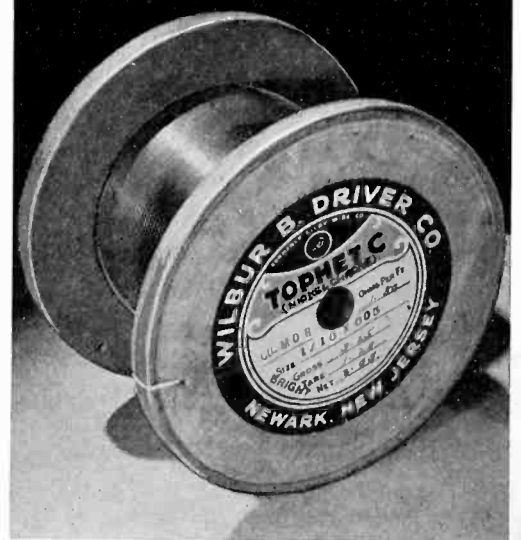

Resistance

to heat . . . cold . . . and the ceaseless humidity of the tropics . . . these are the problems that confront set builders. In its particular field CENTRALAB answers this problem of resistance with a Fixed Resistor whose characteristics are so constant that they oft times form the standard by which all others are judged.

Which is why so many set builders and service men turn to CENTRALAB for the satisfactory answer.



Centralab Resistors are a solid rod, hard as stone throughout, and not just a delicate resistor placed in a tube. That is why Centralab resistors will carry loads of many times their rating without damage.



By the patented Centralab process only the central portion of the ceramic is conducting. Externally the resistors are fully insulated. SETS STAY FIXED WHEN CENTRALAB RESISTORS, CONTROLS, and SWITCHES ARE USED.



TYPE	rating	1/2 watt	size
510	"	"	1/8 x 5/8"
514	"	1	" 1/4 x 1"
516	"	1 1/2	" 1/4 x 1 3/4"
710	"	1/2	" 1/8 x 5/8"

Centralab

CRL

CENTRALAB DIV. OF GLOBE-UNION INC.
MILWAUKEE, WISC.

Canterbury Rd. Kilburn London N. W. Eng'nd
118 Ave., Ledru-Rollin, Paris

17 YEARS OF RCA PROGRESS

**Boosts Performance,
Cuts Cost of Transmitting Tubes**

Here's Proof!

RCA pioneered the development and sale of transmitting tubes in 1921. Since then, RCA has greatly increased performance capabilities of these tubes, thereby insuring greater sales, which have consistently lowered price levels!

★ 1921 ★

These transmitting tubes were developed and sold by RCA.



UV-202
"5 watter"
\$8.00



UV-203
"50 watter"
\$30.00



UV-204
"250 watter"
\$110.00

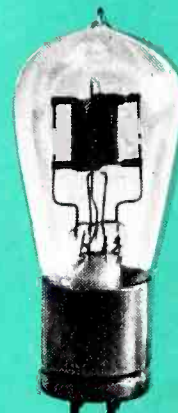

UV-216—DC Output:
20 watts at 350 volts
\$7.50



UV-217—DC Output:
150 watts at 1000 volts
\$26.50

★ 1938 ★

These RCA transmitting tubes give better performance at lower cost.

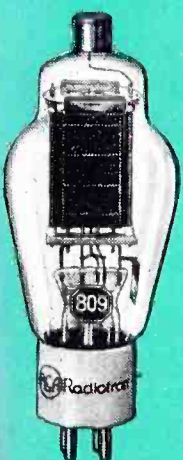

RCA-809
Plate Input* 75 watts
\$2.50

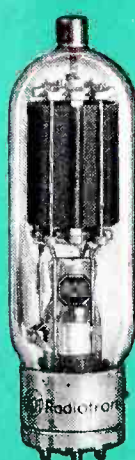

RCA-805
Plate Input* 315 watts
\$13.50



RCA-833
Plate Input* 1250 watts
\$85.00



RCA-866—DC Output:
550 watts at 2300 volts
\$1.50



RCA-872—DC Output:
2980 watts at 2300 volts
\$14.00

*Class C Telegraph Service

RCA presents the "Magic Key" every Sunday, 2 to 3 p. m., E. S. T., on the NBC Blue Network



Radiotrons

RCA MANUFACTURING CO., INC., CAMDEN, NEW JERSEY
A Service of the Radio Corporation of America

FIRST IN METAL
FOREMOST IN GLASS
FINEST IN PERFORMANCE