

*William B. Gould*

# electronics

radio, sound, communications and industrial applications  
of electron tubes . . . design, engineering, manufacture

A new  
electronics

see pages 237 and 238

♦ ♦ ♦

Ultra-high  
frequency  
antennas

R-F choke  
coil design

A time signal  
system for  
broadcasters

Radio-frequency  
inductance  
testing apparatus

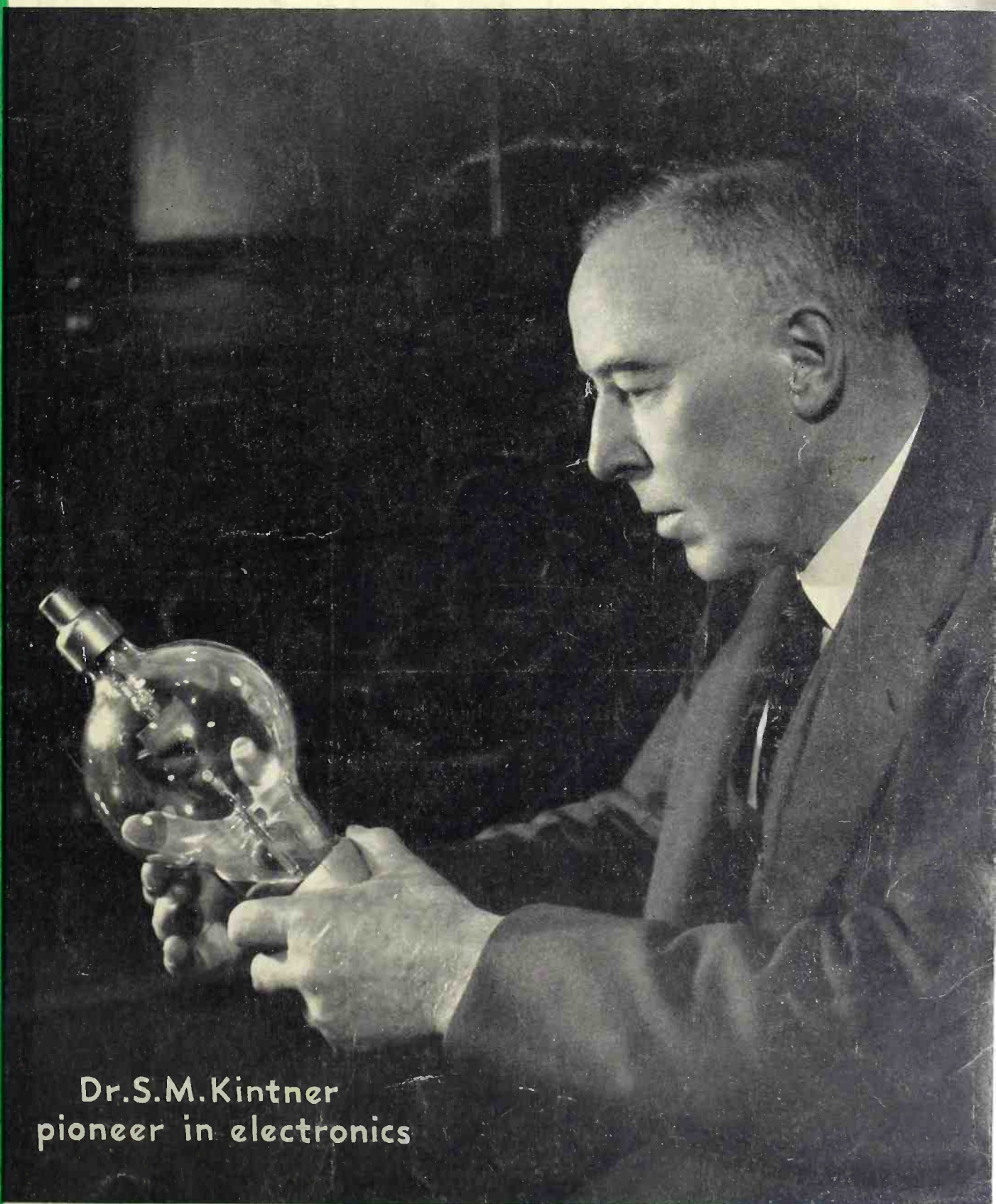

**Dr. S.M. Kintner**  
pioneer in electronics



McGRAW-HILL PUBLISHING COMPANY, INC.

Price 35 Cents

AUGUST, 1935



*In the interest of well designed radios we offer suggestion*

## No. 5 'CHINESE'

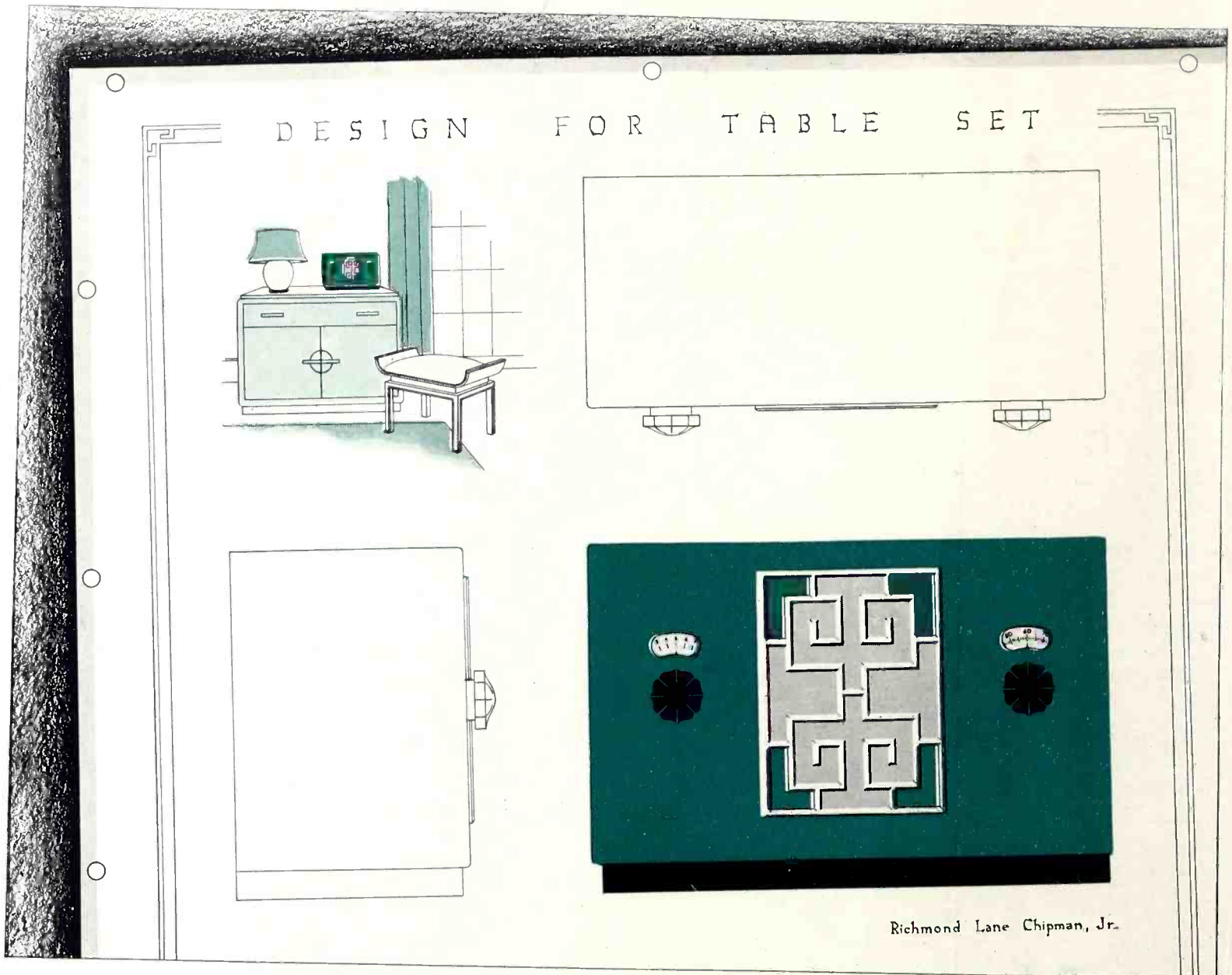

**T**HE BEAUTY of Oriental designs has always had a strong attraction for Occidentals. This is evidenced by the popularity of rugs, furniture, porcelains and lacquerware from the Far East. A century ago a number of Chippendale's designs were inspired by Chinese work, and this also is true of many of the creations of our modern designers.

It would appear that the inspirational possibilities of Chinese art

have been overlooked in cabinet design. For this reason we offer a suggestion distinctly Chinese in motif, which when formed of colored Bakelite Molded would strongly resemble lacquerware. We picture this design in green, but it would be equally attractive if formed of Bakelite Molded in Mandarin red, accented in black, or in lustrous black, accented in red or green.

The possibilities for Bakelite

Molded for radio cabinets of unusual and really beautiful designs appear to be unlimited. There is the further advantage that these cabinets, when quantities are sufficiently large, may be produced most economically. We would be glad indeed to discuss these possibilities with radio manufacturers, and to cooperate with them if this is desired.

Write for a copy of our illustrated Booklet 13M, "Bakelite Molded".

BAKELITE CORPORATION, 247 Park Avenue, New York, N.Y. . . . . 43 East Ohio Street, Chicago, Ill.  
 BAKELITE CORPORATION OF CANADA, LIMITED; 163 Dufferin Street, Toronto, Ontario, Canada

# BAKELITE

REGISTERED TRADE MARK  NUMERICAL SIGN FOR INFINITY, OR UNLIMITED QUANTITY. IT SYMBOLIZES THE INFINITE NUMBER OF PRESENT AND FUTURE USES OF BAKELITE CORPORATION'S PRODUCTS.

## THE MATERIAL OF A THOUSAND USES

ELECTRONICS, August, 1935. Vol. 8, No. 8. Published monthly, price 35c. a copy. Subscription rates—United States, \$3.00 a year. Canada, including duty, \$3.50 a year. All other countries, \$4.00 a year or 16 shillings. Entered as second class matter, April 4, 1930, at Post Office at New York, N. Y., under the Act of March 3rd, 1879. Printed in U. S. A. Cable address "McGrawhill, New York." Member of A.B.P. Member of A.B.C. Copyright 1935 by McGraw-Hill Publishing Co., Inc., 330 West 42d Street, New York, N. Y.

Printed by The Schweinler Press, N. Y.

*ultra  
sensitivity*

**IN PORTABLE TEST INSTRUMENTS**

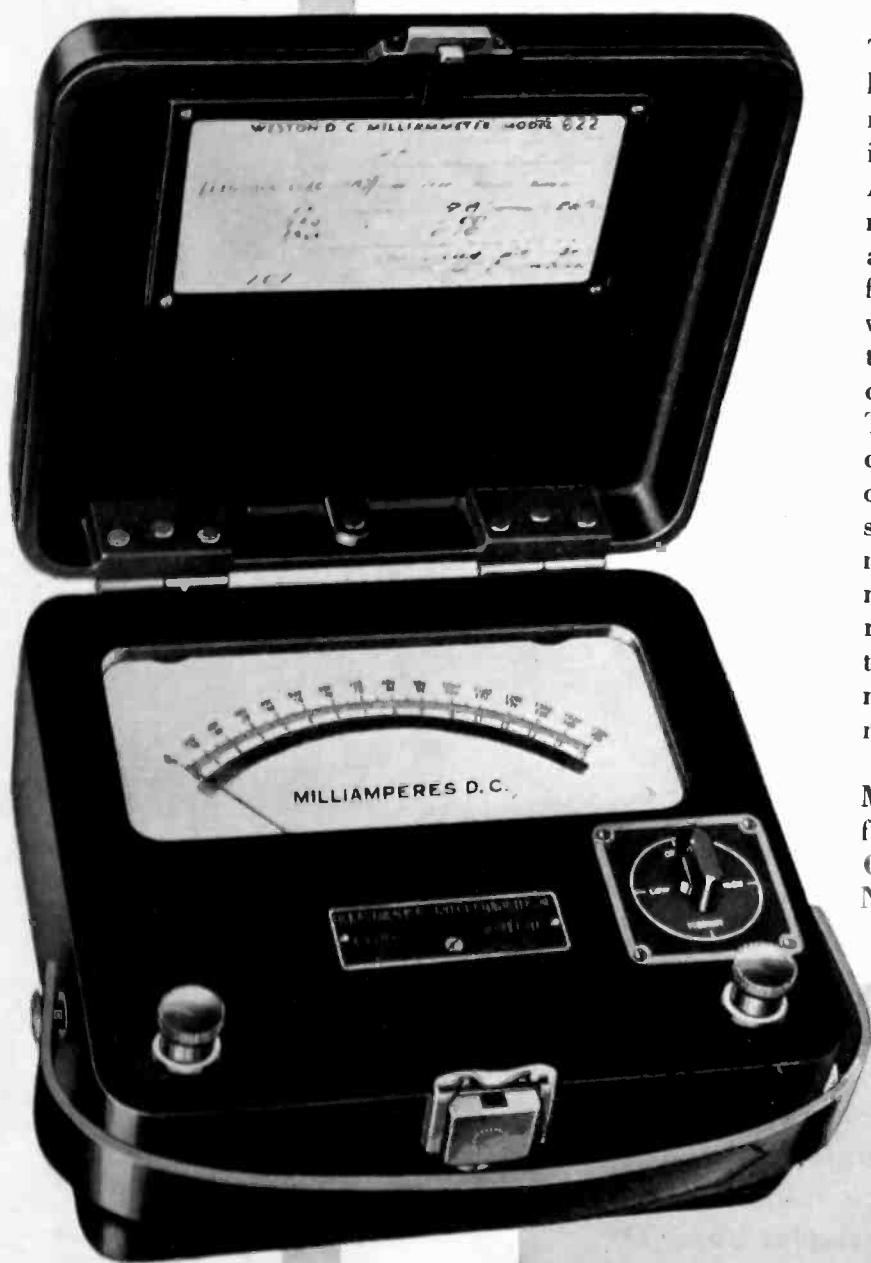

This new Model 622 Series of Weston Portable Electrical Indicating Instruments represents an outstanding achievement in instrument design. Including both DC and AC types, instruments in this series are magnetically and electrostatically shielded, and are available in ranges and sensitivities for ordinary field and laboratory work, as well as for service demanding ultra-sensitivity, such as circuits involving thermocouples, pyrometers, electron tubes, etc. The instruments are supplied in Bakelite cases of modern design, with large scale openings and increased length of scale to simplify accurate reading. All external connections are readily accessible, and in the multi-range units convenient switching arrangements have been made. In the AC thermocouple types, provision has been made for replacement of the vacuum thermocouple without exposing the movement.

You will want complete data on Weston Model 622 Series. Bulletins are freely offered . . . Weston Electrical Instrument Corporation, 618 Frelinghuysen Avenue, Newark, New Jersey.

**THE  
WESTON**

**MODEL 622 SERIES**

**... AN OUTSTANDING ACHIEVEMENT  
IN INSTRUMENT DESIGN!**

**WESTON**  
*Instruments*

# EQUIPPED *for the* UNUSUAL

*When the occasion arises,  
ERIE RESISTOR'S production facilities  
can adequately meet exceptional demands.*

It was 3 P. M. on a recent Monday afternoon. "We must have 3,000 resistors at once", phoned a large, well-known radio manufacturer. The order called for 10 different resistance values and two different wattage ratings. Although not all of the pieces were in stock, the complete shipment was on its way by 5 P. M. the same day and was received in time for the start of production Tuesday



*"We must have  
3,000 resistors  
at once, RUSH!"*

**MONDAY 5 P.M.**



*Order Shipped*

While filling rush orders is of extreme importance, it is the day after day handling of both large and small orders satisfactorily and promptly in which Erie Resistor prides itself.

Modern automatic machinery in practically every manufacturing and checking process makes large volume production possible without sacrificing rigid control. Every Erie Resistor and Suppressor is individually triple-tested for resistance value and performance is checked with random samples from various production stages.

Whether your order is for 100 or 100,000 pieces, you can entrust it to Erie Resistor.

**TUESDAY A.M.**



*Resistors received  
by set manufacturer --*  
**PRODUCTION NOT CURTAILED**

## ERIE RESISTOR CORPORATION

ERIE, PA.

**Factories in ERIE, PA. - TORONTO, CANADA - LONDON, ENG.**



# These SAMPLE CARDS will be helpful in working out your AUTO RADIO designs . . .

**SAMPLE CARD No. 1**  
**S. S. WHITE FLEXIBLE SHAFT for REMOTE CONTROL**  
 .150" Diameter SHAFT .255" Diameter CASING  
 DESIGNATION FOR ORDERING

**SPECIFICATIONS**

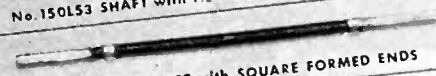
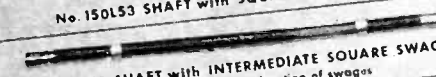
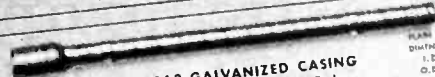
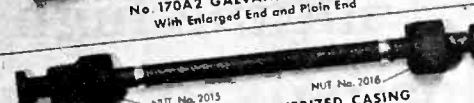
END DIMENSIONS Axial Flange - 137" Max. Axial Capstan - 134" Max. Length - 1 1/2" SHAFT BODY Diam. - 150" - 152"		No. 150L53 SHAFT with SQUARE SWAGED ENDS
END DIMENSIONS Axial Flange - 137" - 138" Axial Capstan - 132" Max. Length - 1 1/2" SHAFT BODY Diam. - 150" - 152"		No. 150L53 SHAFT with 3/8" OCTAGONAL SWAGED ENDS
END DIMENSIONS Axial Flange - 133" - 136" Axial Capstan - 130" Max. Length - 1 1/2" SHAFT BODY Diam. - 150" - 152"		No. 150L53 SHAFT with 1/2" OCTAGONAL SWAGED ENDS
END DIMENSIONS Axial Flange - 137" - 138" Axial Capstan - 137" Max. Length - 1 1/2" SHAFT BODY Diam. - 150" - 152"		No. 150L53 SHAFT with SQUARE FORMED ENDS
INT. SWAGE DIMENSIONS Axial Flange - 137" - 138" Axial Capstan - 137" Max. Length - 1 1/2" SHAFT BODY Diam. - 150" - 152"		No. 150L53 SHAFT with INTERMEDIATE SQUARE SWAGES When ordering, specify location of swages
ENLARGED END DIMENSIONS I. D. - 11 1/2" O. D. - 36 1/2" - 37" Length - 1 1/2" CASING BODY I. D. - 170" - 172" O. D. - 233" - 238"		No. 170A2 GALVANIZED CASING With Enlarged End and Plain End
FLANGED END DIMENSIONS I. D. - 7 1/2" O. D. - 18" - 19" Radius - 130" - 132" CASING BODY I. D. - 170" - 172" O. D. - 233" - 238"		No. 170A1 GRAY PARKERIZED CASING With Flange on both ends and with Nuts as required

Refer to SAMPLE CARD No. 2 for Description and Specifications of .130" Diameter Remote Control Shaft and its companion Casing

**SAMPLE CARD No. 2**  
**S. S. WHITE FLEXIBLE SHAFT for REMOTE CONTROL**  
 .130" Diameter SHAFT .235" Diameter CASING  
 DESIGNATION FOR ORDERING

**SPECIFICATIONS**

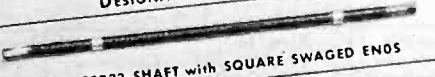
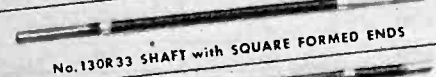
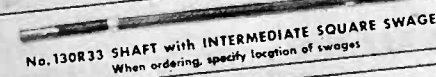
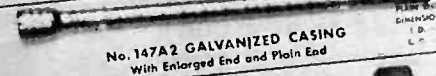
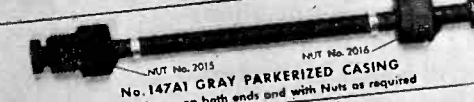
END DIMENSIONS Axial Flange - 130" - 131" Axial Capstan - 128" Max. Length - 1 1/2" SHAFT BODY Diam. - 130" - 132"		No. 130R33 SHAFT with SQUARE SWAGED ENDS
END DIMENSIONS Axial Flange - 127" - 128" Axial Capstan - 125" Max. Length - 1 1/2" SHAFT BODY Diam. - 130" - 132"		No. 130R33 SHAFT with 1/2" OCTAGONAL SWAGED ENDS
END DIMENSIONS Axial Flange - 127" - 128" Axial Capstan - 123" Max. Length - 1" SHAFT BODY Diam. - 130" - 132"		No. 130R33 SHAFT with 1" OCTAGONAL SWAGED ENDS
END DIMENSIONS Axial Flange - 120" - 124" Axial Capstan - 140" Max. Length - 1 1/2" SHAFT BODY Diam. - 130" - 132"		No. 130R33 SHAFT with SQUARE FORMED ENDS
INT. SWAGE DIMENSIONS Axial Flange - 120" - 124" Axial Capstan - 140" Max. Length - 1 1/2" SHAFT BODY Diam. - 130" - 132"		No. 130R33 SHAFT with INTERMEDIATE SQUARE SWAGES When ordering, specify location of swages
ENLARGED END DIMENSIONS I. D. - 11 1/2" O. D. - 36 1/2" - 37" Length - 1 1/2" CASING BODY I. D. - 162" - 167" O. D. - 231" - 238"		No. 147A2 GALVANIZED CASING With Enlarged End and Plain End
FLANGED END DIMENSIONS I. D. - 7 1/2" O. D. - 18" - 19" Radius - 130" - 132" CASING BODY I. D. - 162" - 167" O. D. - 231" - 238"		No. 147A1 GRAY PARKERIZED CASING With Flange on both ends and with Nuts as required

Refer to SAMPLE CARD No. 1 for Description and Specifications of .150" Diameter Remote Control Shaft and its companion Casing

Write us for Further Information and Samples

**The S. S. WHITE Dental Mfg. Co., INDUSTRIAL DIVISION**  
 152 West 42nd Street  
 New York, N. Y.

Engineers will find it helpful to have before them these cards containing samples of S. S. WHITE Flexible Shafting and Casings specially developed for Remote Control of Auto Radio.

This is the shafting that is also being used for coupling purposes *inside the receivers*—a recent development that makes possible the placing of elements in positions most desirable from the standpoint of circuit design, easy assembly and convenient servicing.

The samples show the various types of ends and other patented features which simplify application and reduce costs. All essential dimensions are given.

## SAMPLE CARD No. 1

Gives complete details of the .150" diameter shaft and its companion casing.

## SAMPLE CARD No. 2

Gives complete details of the .130" diameter shaft and its companion casing.

## FREE TO RADIO ENGINEERS

The cost of these cards precludes general distribution. We will, however, be glad to send them with our compliments, to radio engineers and others who are actually engaged in designing auto or airplane radios. Please make your request on your business letter-head.

**The S. S. WHITE Dental Mfg. Co. INDUSTRIAL DIVISION**  
 Knickerbocker Building, New York, N. Y.

**FLEXIBLE SHAFTS for POWER DRIVES, REMOTE CONTROLS and COUPLINGS**



**MALLORY METAL 3** combines the tensile and elastic properties of structural steel with the high electrical and heat conductivity of pure copper

The most amazing metallurgical advances that any civilization has ever known are those that are being made today. In these modern developments the Metallurgical Division of P. R. Mallory & Co., Inc., plays an important part. Its most recent contribution is Mallory 3 Metal, a copper alloy of unusual characteristics and wide application.

**✓ CHECK THESE COMPARISONS**

ALLOY	Elastic Limit lbs. per sq. in.	Ult. Strength lbs. per sq. in.	Elong. in 2" %	Brinell Hardness	% Conduct. (cu = 100%)
Mallory 3 Rods	50,000	70,000	15	140	80
Mallory 3 Castings	25,000	50,000	25	110	75
Bronze Castings	15,000	40,000	25	60	12
High Brass Rods	30,000	50,000	15	110	26
Phosphor Bronze Rods	60,000	80,000	12	150	15
Mild Steel	35,000	70,000	35	140	11
Copper (15% Cold Drawn)	7,000	35,000	35	90	98
Copper Castings	2,000	30,000	55	40	70+

**✓ NOTE THESE APPLICATIONS**

Mallory 3 Metal has been used extensively for spot welding tips, flash welding dies, and seam welding wheels, and has given much better performance and greater saving than copper and many other alloys, especially where proper water cooling is not obtainable. Mallory 3 Metal castings are being used in numerous applications where a high strength, high conductivity material is required.

Mallory 3 Metal may be substituted, with a few exceptions, in applications where brass, bronze, copper, or even structural steel is used at the present time.

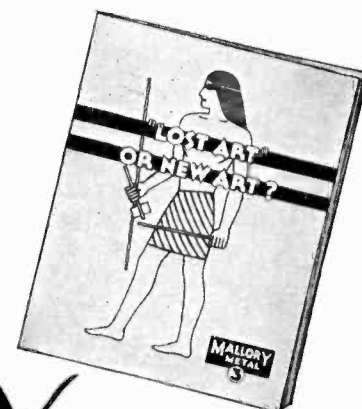

**✓ WRITE FOR THIS BOOKLET**

Complete details of the characteristics of Mallory 3 Metal are presented in the booklet, "Lost Art or New Art?"—a copy of which will be mailed on request. The edition is limited—write today!

**MALLORY**

PARTS FOR RADIO, ELECTRICAL,  
AUTOMOTIVE AND INDUSTRIAL FIELDS

**MALLORY 3 Metal Products:—**

Mallory 3 Metal can be supplied in the form of rods, bars, dies, drop forgings, regular forgings, cold drawn or extruded parts and sand castings.

Prices will be supplied upon request.

**P. R. MALLORY & CO., Inc. • INDIANAPOLIS • INDIANA**  
CABLE ADDRESS — PELMALLO

KEITH HENNEY  
Editor

HOWARD EHRLICH  
Vice-President

H. W. MATEER  
Manager

## *A new electronics to meet expanding field*

**A**DOPTION of the electron tube by industry continues at an accelerating pace. New tubes, new research, new industrial experience indicates that this pace will continue. It is freely predicted that the next two years will see greater developments based completely upon the vacuum tube than have occurred during the past five years.

*ELECTRONICS* has pioneered this industry from its very inception. It has constantly led in the thinking which has resulted in so many of its amazing developments. This acknowledged leadership now imposes new responsibilities, if engineers are to be kept fully informed of the progress of the art.

*ELECTRONICS*, therefore, will appear in September in a new and greatly expanded form. It will have a new dress, more pages and perform a vastly improved service to communication and industrial users of the electron tube.

**T**HE paper will be edited by Keith Henney, member of the staff since the first issue, April, 1930. His association with the radio industry as editor and author since 1925 have made him well known to the entire radio industry. His most recent book, "Electron Tubes in Industry," has brought him intimate knowledge of the multitudinous tasks now performed by electrons in motion. His own plans are discussed on a following page.

*Howard Ehrlich*

VICE-PRESIDENT

# A NEW ADVENTURE IN ELECTRONICS

... an editorial announcement ...

SEPTEMBER marks the beginning of a new phase of the adventure in which publisher, editor and reader of *Electronics* have had shares since the first issue, April, 1930.

At that time, over five years ago, the editors visioned a paper which would "bring about a community of interest on the part of engineers and executives in the industries based upon the thermionic tube." These industries were radio broadcasting, the manufacture of radio tubes and receivers, wire and space communication. But there was a broader vision. The electron tube which could originate and make possible broadcasting, which could so completely dominate long distance communication might conquer other fields. In industry it might find jobs which would not remotely resemble its functions in communication.

The electron tube was to be a new tool; it was to play a new role; and its stage was to be all industry.

In these five years *Electronics* has kept radio engineers abreast of their own art. And the original vision of new uses for the Aladdin's lamp of the popular radio writers has been realized, partially at least. For all industry has become conscious of the power of a moving stream of electrons. Largely through the medium of a single publication, *Electronics*, industrial men have learned the new concept of the usefulness of a beam of light, not to see by, but to be put to work, controlling heavy machinery, saving life and limb and property. The paper has told of this fascinating adventure in which were engaged all engineers who make and use vacuum tubes.

The editors have flattered themselves that they have been successful, if anything can be read into the fact that such a very high percentage of their readers annually renew their subscription to the paper. Editors and publishers alike have been proud that so many

readers boast of having complete files of back copies, of the continual demand from all over the world for issues long out of stock, of the readers who state that they are "charter subscribers." All of these indications of continued interest are pleasant and encouraging. Apparently the paper has been on the right track.

But the electron-tube industries expand; changes come rapidly as tube engineers extend their grasp of industrial problems; as industry, in turn, learns of the limitless possibilities of the tube. Radio stands at the border of a new domain, that of microwaves. On present frequencies, engineers promise tremendous changes, soon. Television approaches its day of commercial birth.

And the paper, *Electronics*, must grow with its field. It, too, must expand or find itself, like other publications, covering only a small portion of the electron-tube art.

IN SEPTEMBER the publishers of *Electronics* again take a forward step, like that in 1930 when the paper was founded. In September the editors will put before the reader a new version of *Electronics*, expanded in size, in editorial content, in longer articles, in better coverage of radio, of broadcasting, of set design, of the application of the electron tube to counting, sorting, to control of electrical, mechanical or chemical processes. The paper will look better, it will be more readable, it will be on better paper, it will be better interpreted. Charts, long a tradition of the paper, will appear in greater numbers. There will be more color, more industry news. In short, *Electronics* will perform a vastly better service than has been possible in the past.

In the past five years many suggestions have come from readers, suggestions which are always welcome by the editors, who hope the reader will continue to contribute to this enlarged adventure in electronics.



# Ultra-high frequency

# ANTENNA TERMINATIONS

By W. C. TINUS

*Bell Telephone Laboratories, Inc.  
New York City*

**T**RANSMISSION lines are widely used for efficiently transferring energy between radio antennas and the associated radio transmitters or receivers. Their use makes it possible to locate the antenna where it will be the most effective, and to locate the equipment where it is conveniently accessible for operation and maintenance.

The ultra high frequency band, usually considered as 30 to 300 megacycles, is rapidly being put to practical use. In the design of transmission lines for use in this band, an important feature of ultra high frequency antennas must be taken into consideration. This feature is that the antenna can nearly always be made a pure resistance at the operating frequency without the use of tuning coils or condensers. This desirable circumstance is due to the fact that these very high frequencies correspond to short wave lengths, making it feasible to use an antenna comparable in dimensions with the wave length.

## Properties of ultra-high frequencies

Before describing the location of an antenna for these very short waves, it is well to discuss some of the properties of the waves themselves. They are not reflected from the upper atmosphere as lower frequency waves are, and their use must therefore depend entirely on what is usually called the direct or ground rays. These rays are, however, reflected from the ground itself and from all conducting surfaces which are large compared with the wavelength. In a city such rays encounter many metal obstructions in their path and are scattered in all directions.

Short radio waves are frequently compared to light, since they exhibit similar properties of reflection, refraction, and interference. Light waves are extremely minute in length compared with familiar objects, however. A useful, though inexact, analogy can be drawn as follows: Consider an ultra-high frequency transmitting antenna as a brilliant light. Suppose it is desired to illuminate an entire city from this one source. Suppose further, that all conducting surfaces in the city (the ground, all steelwork, etc.) are mirrors. Now where should the one light be placed? Obviously, near the center of the city, at as high a point as possible, with no reflecting surfaces very near it.

From the foregoing, it can be assumed that an ultra-high frequency antenna should be placed in a high unobstructed position; for example, on the highest building or other structure near the center of the area to be covered. High buildings are usually equipped with steel flagpoles, and the most desirable location for the antenna is above the top of the flagpole. The mechanical structure of the antenna, the line leading to it, and the coup-

## —using concentric lines

ling means, must therefore be as simple as possible because they will be subjected to high winds and will not be easily accessible for repairs.

### Parallel and concentric transmission lines

An ideal transmission line might be defined as a line carrying energy in one direction without reflection at the ends, and therefore having no standing waves upon it. Such a line transfers energy efficiently at a uniform voltage level. In order to operate in this manner the line must be loaded at the end with a pure resistance equal in magnitude to the characteristic impedance of the line. This impedance is usually termed  $Z_0$ . Its value is the same for all radio frequencies for a particular size and type of line.

For two wire lines,  $Z_0 = 276 \log_{10} d/r$  ohms, where  $d$  is the distance between centers, and  $r$  is the radius of the wires.

For concentric lines,  $Z_0 = 138 \log_{10} r_1/r_2$  ohms, where  $r_1$  is the inner radius of the outer conductor, and  $r_2$  is the outer radius of the inner conductor.

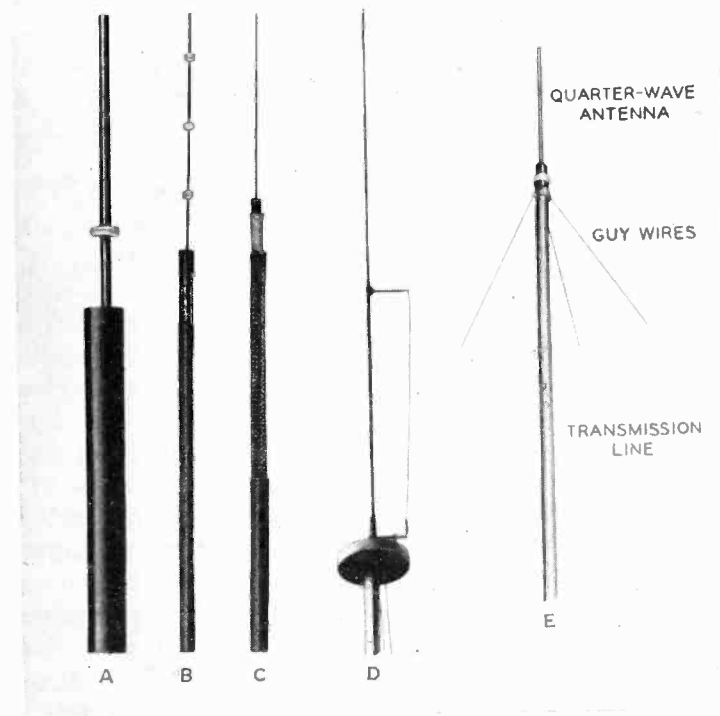

Fig. 1. Transmission lines and antenna structures. A, B, and C are 70 ohm type concentric transmission lines. D is a half-wave rod matched to the line by means of a parallel-wire transformer section, while E is a quarter-wave rod coupled directly to a concentric feeder

When these formulas are solved it is found that, consistent with practical dimensions, a two-wire line can be designed with a  $Z_o$  of from about 400 to 700 ohms, and a concentric line with a  $Z_o$  of from about 10 to 150 ohms. Some of the possible methods of connecting transmission lines to antennas will now be discussed.

Fig. 2-A illustrates an antenna one-quarter of an electrical wavelength long, located perpendicular to a conducting ground. The electrical properties of antennas of this type are investigated theoretically in standard texts, wherein it is assumed that the antenna current varies sinusoidally in magnitude along the antenna, as is indicated by dotted curves in the accompanying figures. The analysis is complicated but the conclusion is quite simple. The impedance of such an antenna, measured between its lower end and ground, is a pure resistance of approximately 35 ohms.

The antenna of Fig. 2-A may be connected to the end of a line as shown. If the characteristic impedance of the line is also approximately 35 ohms, the line will be properly terminated. This case demands the use of a concentric line because a two-wire line cannot be designed with such a low  $Z_o$ .

A method of using lines of various impedances is illustrated in Fig. 2-B. The line is terminated in shunt with a portion of the antenna and the load on the line can be

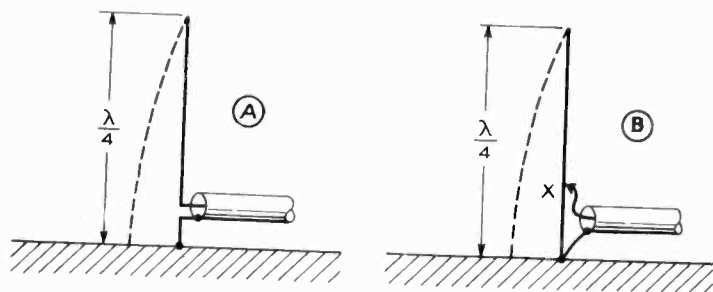

Fig. 2. A. Quarter-wave antenna terminated at ground plane. B. Terminated between ground and point X, increasing termination resistance

adjusted by moving the connecting point X. Experiments indicate that a 70-ohm line is, for practical purposes, correctly terminated with X about one-fourth the way up the antenna.

The methods illustrated in Figs. 2-A and 2-B can be used in installations wherever something approximating a conducting ground plane is present. In many cases there is no effective ground plane, and it is necessary to use a half-wave antenna as illustrated in Figs. 3-A and 3-B. A half-wave antenna may be regarded simply as two quarter-wave antennas in series, each supplying a ground for the other. The series resistance at the center is therefore  $2 \times 35$ , or 70 ohms. The connection shown in Fig. 3-A requires a concentric line with a  $Z_o$  of 70 ohms. In Fig. 3-B, the shunt connection is used and lines of various  $Z_o$  may be used by making the connections  $x$  at the proper distance either side of the center.

The simple antennas just discussed do not produce any signal in the direction of their axes. Hence, if one desires an installation to operate equally well in all horizontal directions, it is necessary to use a vertical antenna. The vertical antennas of Figs. 3-A and 3-B will work very well if the lines driving them are extended away, approximately perpendicular to the antenna, for some distance before they are brought down. This would involve a difficult mechanical problem in the case of an antenna on top of a flagpole. It appears desirable,

therefore, to find a satisfactory method of driving a vertical half-wave antenna from the lower end in order that the line will not distort the horizontal field pattern.

### The 70-ohm half-wave section

Antenna theory shows that the series impedance of a half-wave antenna is a pure resistance at *any* point along its length. It has a value of 70 ohms at the center as previously mentioned. At any other point it would be expected to have a series resistance of 70 divided by the square of the ratio of the current at that point to the current at the center. For example, at a point two-thirds of the way from the center to one end, the current (with the sinusoidal distribution assumed) is one-half the value of the current at the center. The series resistance measured at this point should therefore be  $4 \times 70$ , or 280 ohms. At the extreme end the current is assumed to be zero and a similar calculation would give an infinite resistance. This theoretical end-condition cannot occur in an actual antenna, the explanation being that the current distribution departs somewhat from the sinusoidal form assumed. In particular the current, although small, cannot be zero at one end of a half-wave antenna which is connected to a line delivering power to the antenna. If it were, the voltage at this point would have to be infinite. Experimental work indicates that the impedance between the end and a point near it acts much as if it were a resistance with a magnitude of the order of several thousand ohms.

One method of driving half-wave antennas at the end has been used for many years in amateur and commercial installations, and is illustrated in Fig. 3-C. The end of the antenna is simply connected to one side of a two-wire line and the other side of the line is left open. In the usual case, the two-wire line leading down to the equipment has dimensions giving it a  $Z_o$  of the order of 500 ohms. At point A, therefore, the line is loaded with much too high a resistance for proper termination and standing waves exist on the line as shown in the figure. Now suppose the line were cut at B and the impedance looking toward the antenna were measured. Since the currents are large at this point, it would be expected that the impedance would be low. Actually it is probably less than 100 ohms and much too low to properly terminate the line below B. Hence the standing waves continue all the way down the line to the equipment. The line in Fig. 3-C is not a true transmission line and is more properly called a feeder.

The concentric type of feeder illustrated in Fig. 3-D is a form that can easily be made self-supporting and has been used because of its mechanical simplicity. Such feeders have, however, some serious limitations. The presence of standing waves means that a relatively high voltage exists across the line conductors every half wavelength. If the line is very long, a large part of the energy may be consumed by dielectric losses. Also, if the line is required to transmit much power the diameter must be large to prevent flashover at the high voltage points.

A number of attempts have been made to find a satisfactory method of driving an antenna from the lower end with a true transmission line, and still retain a very simple mechanical structure at the top. One form is shown in the photograph of Fig. 1-E, which is supposed to operate the same as the antenna of Fig. 2-A. The outer line conductor is a  $2\frac{1}{2}$ -inch steel conduit and the inner conductor a  $1\frac{1}{2}$ -inch duralumin tube. The inner conductor extends through an insulator at the top for a

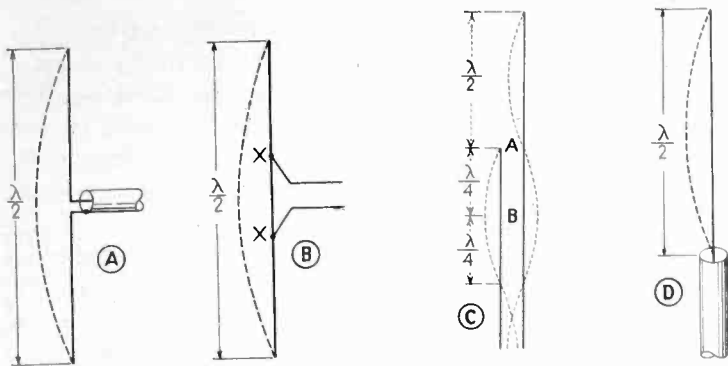

Fig. 3. A. 70-ohm half-wave antenna terminated at center. B. Terminated by parallel feeders. Both A and B types require feeders at right-angles to antenna. C. "Zeppelin" feeder system, using parallel feeders. D. Zeppelin, using concentric feeder system

quarter wavelength to form the antenna. The three guy wires are intended to serve as the required ground plane. While this form of antenna is useful in some low power applications where the short antenna is desirable, actually the ground plane is so ineffective that large standing waves exist on the line. Electrically, it is little improvement over the half-wave type of Fig. 3-D.

### Impedance transforming sections

Another method has been devised which is far superior to the one just described. It depends on the impedance transforming property of sections of line. The application of this principle to the matching of antenna and line impedances has been discussed in the literature, and will be reviewed briefly here. In Fig. 4-A is shown a half-wave section of line having the characteristic impedance  $Z_0$  and terminated at the left end in  $Z_1$ . If the impedance is measured looking into the right end of the line, it is found that  $Z_2 = Z_1$ . Fig. 4-B shows a similar situation with a quarter-wave section of line. In this case

$$Z_2 = \frac{(Z'_0)^2}{Z_1}$$

These equations mean that the half-wave line is a 1 to 1 transformer, and the quarter-wave line a variable ratio transformer, in which the ratio is determined by  $Z'_0$ . This is a convenient and efficient type of transformer for use at radio frequencies.

Fig. 4-C illustrates an application of a quarter-wave transformer section which reduces the antenna resistance of several thousand ohms down to 70 ohms for terminating a concentric line. An interesting feature is that at point A it does not matter which side of the transformer section is connected to the outer conductor of the line, which of course is grounded to the flagpole or other support. It is connected as shown in order that the highest point of the structure, the antenna itself, is simply an extension of the flagpole. This is important because ultra high frequency antennas in good locations are necessarily exposed to lightning.

The mechanical problems in designing a practical structure like Fig. 4-C are interesting, being most difficult at the lowest frequencies. At 30 megacycles, the total height of the structure above the support is over 20 feet. In order to be self-supporting the tapered rod comprising the antenna itself and one side of the transformer section must be at least  $1\frac{1}{2}$  inches in diameter

at A. It must be very securely mounted on the flagpole. For the typical case of a 70-ohm line, the  $Z_0$  of the transformer section must be about 450 ohms. If a large rod were also used for the other side of the transformer section, the spacing required for a  $Z_0$  of 450 would be impractically large. To get around this difficulty, a small wire spaced about 10 inches from the rod is used, and is supported by insulators mounted on the rod. In practice, the dimensions of the antenna and transformer are not critical, and a structure designed for a particular frequency will operate satisfactorily over a band extending several per cent on each side of that frequency.

### Types of concentric lines

An actual installation for 30.1 megacycles is shown in the photograph of Fig. 1-D. This antenna is on a 100-foot flagpole, and is 600 feet above the street. The 70-ohm concentric line is  $\frac{3}{4}$  inch in diameter, and is run up inside of the flagpole in order not to interfere with flag sheaves which are mounted on a swivel just below the antenna. The outer conductor of the line and the antenna rod are grounded to the pole. The inner line conductor is brought through a tube and insulator to the small wire forming one side of the transformer section. This installation has withstood high winds and is entirely satisfactory mechanically. It is also a very efficient radiator. The  $\frac{3}{4}$  inch line used is shown in Fig. 1-A. This size line will, when properly terminated, handle several kilowatts and the loss at 30 megacycles is only about 2db per thousand feet.

Two other types of line are also shown in Fig. 1. The  $\frac{3}{8}$  inch size (1-B) is suitable for receivers, or transmitters up to 100 watts, and has a loss at 30 megacycles of about 8 db per thousand feet. Both of these lines are insulated with low-loss ceramic bead spacers which are held in place by deforming the inner conductor slightly either side of each bead. At 1-C is shown a piece of W.E. No. 700 cable. This type is rubber insulated and, although designed for use in the broadcast band, has been found useful at ultra high frequencies when very short lengths are required. It has a loss at 30 megacycles of about 25 db per 1000 feet. All three have a  $Z_0$  of about 70 ohms.

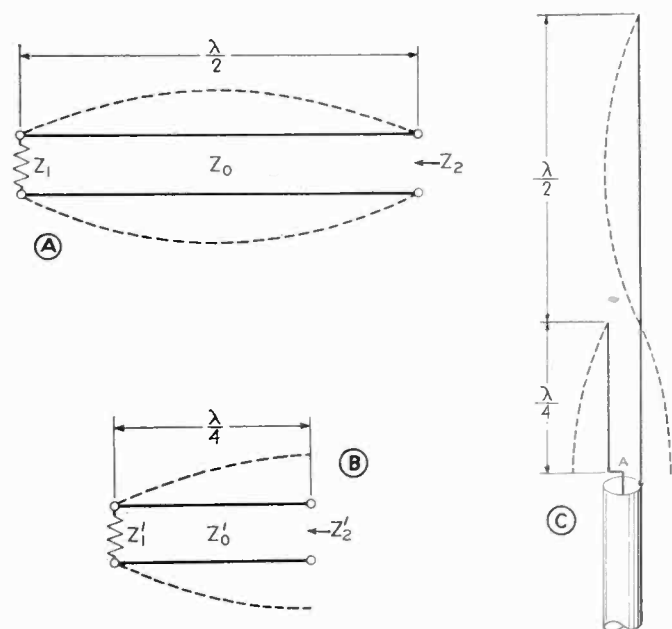

Fig. 4. One-to-one line transformer, composed of a half-wave section. B. Variable ratio transformer, of quarter wavelength. C. Use of quarter wave transformer for matching concentric line to end of half-wave section



# Crystal microphone design for single-direction pickup

By A. L. WILLIAMS  
and J. P. ARNDT

The Brush Development Company  
Cleveland, Ohio

**M**OST every engineer in the field of acoustics has at some time or other felt a great need for a truly uni-directional microphone. In motion picture sound recording, camera clicks and background noise are among the serious problems to be contended with. In remote broadcast pickups, audience and other background noises together with lack of acoustic treatment make uni-directional microphones highly desirable. The studio engineer has many problems that would be eased by a microphone with a "one sided" pickup and the life of the P. A. man would be simpler if he could obtain a good microphone with less feed back tendency.

Some of the older type microphones using relatively large diaphragms such as the carbon and condenser type have been found to be somewhat directional but afford very little help for the above problems because, as shown by Ballantine,<sup>1</sup> their directional properties were marked only at the higher frequencies, with consequent wave distortion for directions not normal to the diaphragm. Attempts to shield one side of a microphone with baffles resulted in the same form of distortion.

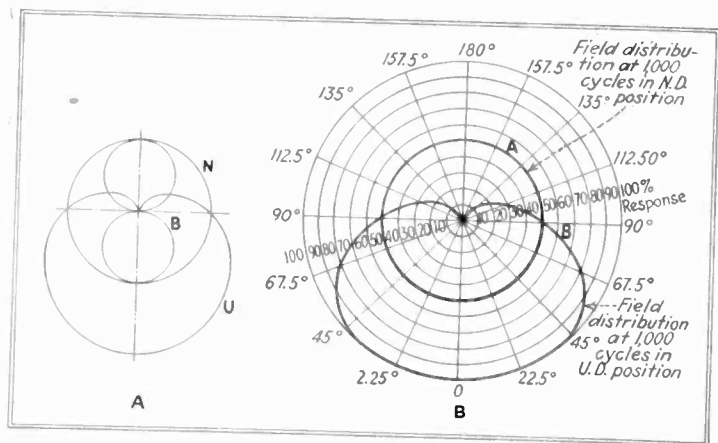

Fig. 1. (A) The combination of a bi-directional response with a non-directional one to produce a uni-directional resultant. (B) Polar response curve of the microphone described in this article, showing the actual result obtained from the principle shown in (A)

The ribbon microphone has been widely recommended as an aid in the above problems but in many cases its response to sound waves arriving at the back has been a serious drawback, and its narrow pickup field is often a real disadvantage. Olson and Massa<sup>2</sup> have shown that by combining the bi-directional properties of a pressure

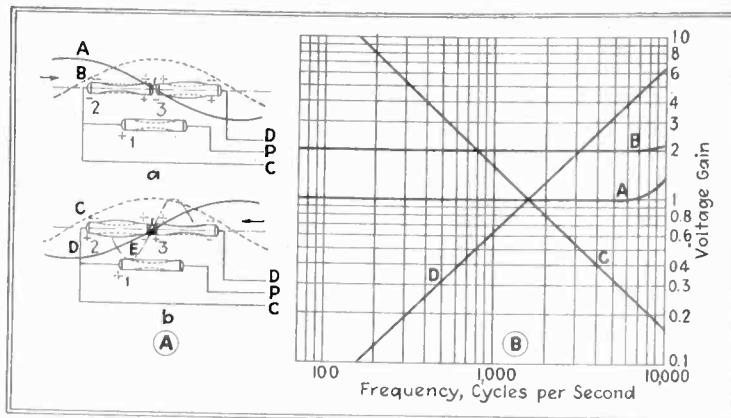

Fig. 2. (A) The construction of the crystal structure, whose action is described in the text. (B) Audio response curves of the microphone and amplifier

gradient microphone with the non-directional properties of a pressure operated microphone, uni-directional response may be obtained; and they illustrate a ribbon microphone performing both functions.

The response of a bi-directional microphone is illustrated at B in Fig. 1-A and the response of a non-directional microphone is illustrated at N in the same figure. For a given sound wave impulse the polarity of a bi-directional microphone depends on which side of the microphone is facing the sound wave, while the polarity of a non-directional microphone is independent of direction. Thus it can be seen that a bi-directional and a non-directional microphone may be combined to have the directional characteristics shown at U in Fig. 1-A. For sound waves arriving from a direction normal to the front of the combination microphone the two outputs add, and for sound waves from the back the two outputs cancel.

A recently announced uni-directional microphone<sup>3</sup> embodies a novel combination of small pressure-operated crystal sound cells to obtain the results illustrated in Fig. 1-A. The microphone is so arranged that the bi-directional section may be switched off for non-directional use without disturbing the remainder of the circuit.

A sound cell is made up of two small bimorph crystal elements sensitive to bending, arranged opposite each other inside a hollow bakelite square. Both sides of the square are covered over by thin membranes which contact and seal in the bimorphs and shield their inner faces from pressure variations of sound waves. Ballantine<sup>1</sup> has shown that such sound cells are non-directional over a very wide range of frequencies.

The non-directional portion of the microphone comprises a single sound cell; while the bi-directional portion comprises four cells in a novel arrangement. Two cells are necessary for bi-directional response and for reasons to be discussed later, two bi-directional pairs are used.

Fig. 2-A illustrates the non-directional cell 1 and one bi-directional pair 2 and 3 in their relative positions. Cells 2 and 3 are connected in opposed electrical relation and consequently when actuated simultaneously by equal pressures their outputs cancel. Obviously soundwaves reaching the cells from any direction at right angles to the central axis through the pair, affect both cells 2 and 3 equally and simultaneously and produce no output. Sound waves reaching the microphone from other directions do

not affect the cells simultaneously and their outputs do not completely cancel.

The combined output of pair 2 and 3 is the algebraic difference between their individual outputs and is maximum, for a given frequency within the range of the instrument, for sound waves reaching the microphone from the front or back; or, as shown in Fig. 2-A, from the direction of the arrows. The outputs of non-directional cell 1 and bi-directional pair 2 and 3 are 90 degrees out of phase with each other; with the output of pair 2 and 3 leading for waves from one direction and lagging for waves from the opposite direction. This phase relation may be better understood by again referring to *a* and *b* in Fig. 2-A.

In *a*, Fig. 2-A, curve *A* represents the pressure distribution in a plane sound wave, arriving from the front of the microphone (in direction indicated by the arrow) at the instant when the average pressure in cell 1 is zero. At this instant maximum difference in pressure occurs between cells 2 and 3 and their combined output therefore is maximum. Their polarities are shown in solid lines. The dashed line curve *B* represents the pressure distribution after the wave has progressed for a distance of  $\frac{1}{4}$  wavelength, or  $\frac{1}{4}$  cycle later. At this instant the pressure and hence the output of cell 1 is maximum, and the difference in pressure between cells 2 and 3 and hence their combined output, is zero. Their polarities for this instant are shown in dashed lines.

The solid and dashed outlines of the cells indicate the flexing of their faces for the different wave positions. The magnitudes of flexure are of course greatly magnified and are not comparable in magnitude in the two cases.

The solid line curve *D* in *b*, Fig. 2-A illustrates the effect of a similar wave arriving from the opposite direction; and the dashed line *C* illustrates the effect of the wave  $\frac{1}{4}$  cycle later. The polarity of pair 2 and 3 has reversed with respect to the polarity shown in *a* while the polarity of cell 1 is the same as shown in *a*. Since maximum outputs of cell 1, and pair 2-3 occur  $\frac{1}{4}$  cycle apart, they are 90 degrees out of phase.

The difference in pressure on cells 2 and 3 varies with frequency and is maximum, for sound waves from front or back, when the wave length is twice the center to center spacing of the cells. Below the frequency of maximum response, the combined output of differentially connected pair 2-3 increases substantially proportionally to frequency. At higher frequencies the combined response drops rapidly. Curve *E* in *b* represents a wave whose length is less than twice the center to center spacing.

Since the outputs of the two sections of the microphone are 90° out of phase and are not the same with respect

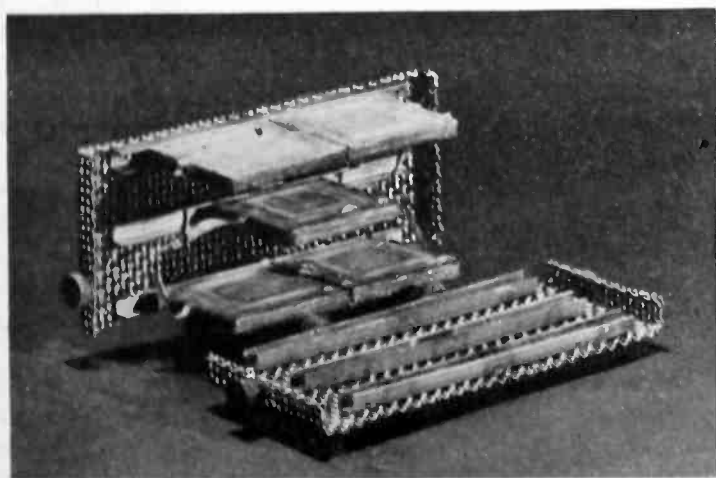

Fig. 3. Arrangement of the bimorph crystal elements within the case

to frequency they cannot be combined for uni-directional response by merely connecting them in series or parallel. In the case of the UD-3 microphone a special two channel amplifier is used and means are provided in one channel to shift the phase and correct the response of the bi-directional section. Two separately shielded conductors are employed to connect the microphone to the amplifier.

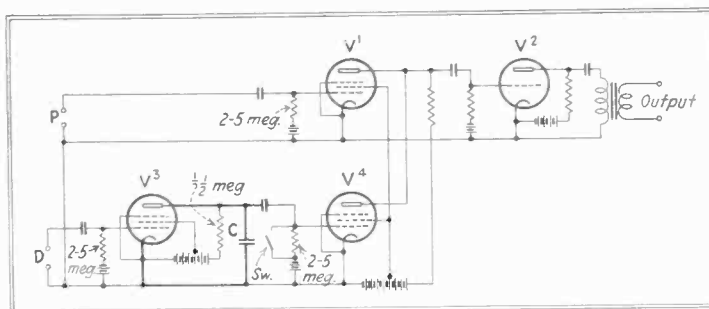

Fig. 4. Amplifier circuit used to boost the response of the bi-directional elements with respect to the non-directional element

In Fig. 2-B curve *A* is the response of the non-directional cell and curve *D* is the response of the bi-directional unit. They are equal at about 1500 cycles. Curve *C* shows the required voltage gain of the correction circuit necessary to level off the response of the bi-directional unit. A single pentode stage using a 6C6 tube and having a capacity in the order of .03  $\mu$ f. connected from plate to cathode provides the necessary correction and also shifts the phase substantially 90° over a wide range of frequencies. Fig. 4 is a basic circuit for the special pre-amplifier and condenser *C* is the phase shifting condenser. Due to the characteristics of the microphone and phase shifting function of tube *V*<sup>3</sup> the plate currents of *V*<sup>1</sup> and *V*<sup>4</sup> are in phase for sounds reaching the microphone from the front and are 180° out of phase for sounds reaching the microphone from the back. Curve *B* in Fig. 2-B is the response of the combination for sounds reaching the UD-3 from the front.

Switch *SW* in the amplifier is provided to short circuit the bi-directional output when the microphone is to be used for non-directional pickup. Thus the UD-3 may at the will of the operator, be used as a uni-directional microphone or as a completely non-directional microphone. Curve *A* in Fig. 1-B is a polar response curve of the non-directional section and curve *B* is the uni-directional response. When used with a properly designed amplifier the response is substantially flat up to 10,000 cycles over the whole useful pickup field. In addition to its uni-directional property, the wide pickup angle of the UD-3 is a marked advantage over the restricted field of a bi-directional microphone.

In order that various lengths of cable may be used without altering the balance between outputs of the two sections the bi-directional section is made up of two pairs of cells in series parallel and thus has the same impedance as the single cell. The two pairs are placed one above the other with the non-directional cell in between. They are clamped in light metal channels, spot welded to pieces of metal screen which form a supporting frame. The cell assembly, with one side removed, is shown in Fig. 3. In the complete microphone the cell assembly is mounted in the outer case on small pads of sponge rubber.

<sup>1</sup>Stuart Ballantine—Proc. IRE Vol. 22, No. 5, May 1934.

<sup>2</sup>Olson and Massa—Applied Acoustics, P. Blakiston's Son & Co. 1934, pages 136-141.

<sup>3</sup>Developed and manufactured by The Brush Development Company, under the name "UD-3 Uni-directional Microphone."

# A new thermionic motor speed regulator

By C. BOYD NORRIS

Department of Electrical Engineering  
Tulane University of Louisiana  
New Orleans, Louisiana

ACCURATE speed control has been a problem for engineers since the rise of the electrical industry, and many schemes have been devised for automatic speed regulation. With the development of the vacuum tube new possibilities have been opened for control applications, and vacuum tube regulators have been applied to both voltage and speed control. This paper discusses the construction and operation of an automatic speed regulator, using grid-controlled rectifiers and operating by the method of field control.

A circuit diagram of the regulator is shown in Fig. 1. A small magneto tachometer is directly coupled to the shaft of the shunt motor and the direct current voltage from this tachometer is fed into the grid circuit of a type 57 amplifier tube. The output of the amplifier tube is put into the grid circuit of two gaseous grid-controlled rectifier tubes, connected for full wave rectification. The rectifier tubes are each supplied with a plate voltage of 500 volts, 60 cycle a.c., and the grids are each supplied with 30 volts, 60 cycle a.c., the grid voltage lagging the plate voltage by  $120^\circ$ . The output of the rectifier is used to supply the total field current for the shunt motor. Lag of the grid voltage behind plate voltage is obtained by means of a center-tapped resistance in series with a condenser, as shown in the circuit diagram.

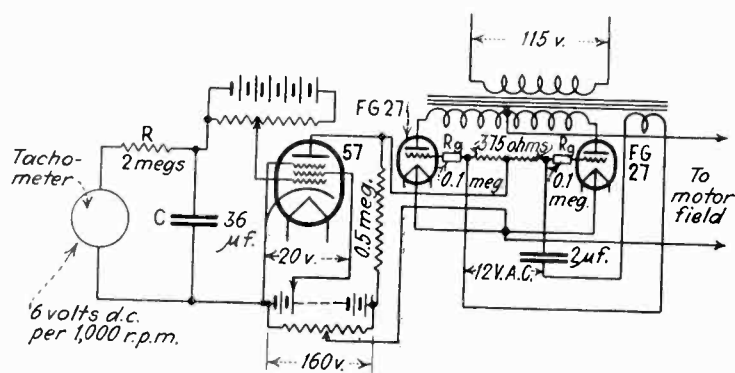

Fig. 1—Circuit diagram of the speed regulator. The tachometer voltage controls the field current through grid-controlled rectifiers

Any change in tachometer voltage, produced by a change in speed, causes a change in the d-c voltage in the grid circuit of the amplifier tube. This change in voltage is amplified and impressed in the grid circuit of the rectifiers, and causes a change in the rectified voltage output of the tubes to the motor field. This produces a change in field current, tending to bring the motor back to the original speed.

In any automatic regulator some provision must be made to prevent hunting. In this case a resistance-capacity time delay is used. The tachometer is connected to a resistance and a condenser in series, and the voltage across the condenser is then connected in the grid circuit of the amplifier, as shown in the circuit diagram, Fig. 1. With this arrangement any change in voltage of the tachometer cannot appear immediately in the grid circuit of the amplifier.

This control equipment was applied to a 230 volt, 22 amp., 1800 r.p.m. shunt motor, and oscillograph records were made of the speed and field current for periods during and immediately following load changes. In Fig. 2 are shown oscillograms of speed and field current for the case where full load was suddenly removed from the motor. The field current appears as a broad line because of the ripples present.

The data listed in the following table show the variation of speed and field current with load for the motor operating normally, and then for the motor with the regulator

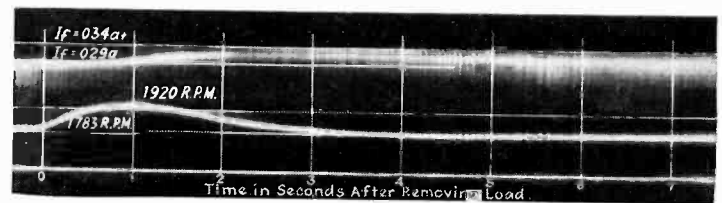

Fig. 2—An oscillogram showing speed control when load was removed from a five hp. motor. Control was regained in three seconds

in operation. The percent change in speed with the machine operating normally was 8.1%, and the corresponding change in speed with the regulator in operation was 0.78%.

	Armature Current	Field Voltage	Speed	% Change in Speed
Without Regulator: No Load	2.2 a.	230 v.	1797	
Full Load	23.0 a.	230 v.	1662	8.1%
With Regulator: No Load	2.2 a.	232 v.	1797	
Full Load	23.0 a.	197 v.	1783	0.78%

Satisfactory operation of this device depends upon the constancy of the alternating current voltage supply. If the a-c voltage suddenly rises a few volts the effect is the same as if the load on the motor had suddenly been increased, and the speed will drop. The regulator will then go into action and bring the speed back near its original value.

Some of the advantages of the regulator are: it has no moving parts, except the pilot generator; it can be quickly and easily adjusted to regulate for any desired speed, within the range practical by the method of field control; it can be applied to any shunt motor to which the pilot generator can be coupled.

The method of control as developed requires that the rectifiers have the necessary capacity to supply the total motor field power. However, low capacity rectifiers can be used to regulate the speed of a large motor if they are allowed to supply the field of an exciter, which in turn supplies the field current for the motor.



# A multi-stage photocell current amplifier

—applied to furnace  
temperature control

By WALTER RICHTER

A. O. Smith Corporation  
Milwaukee, Wisconsin

THE use of the photo-electric cell for temperature control, utilizing the light given off by heated bodies is not new. The control of furnace temperatures, however, has remained a laboratory application, no commercial instrument being available for this purpose. The reason for this is probably quite clear to research workers familiar with the characteristics of the photo-cell. If it is desired to control the temperature of a chamber furnace, it is necessary to have a hole through the furnace wall and for many quite obvious reasons it is impossible to have an opening of several square inches. A one inch hole is probably the maximum that the furnace manufacturers are willing to concede. The hole must accommodate a tube of approximately  $\frac{1}{8}$  in. wall thickness so that the opening for the light does not exceed  $\frac{3}{4}$  in. in diameter. The total amount

## GETTING AROUND THE D-C AMPLIFIER

When photocells must be used to control on the basis of small changes in light, more than one stage of amplification is usually needed to produce sufficient current to operate a sturdy relay. In this article is described a multistage amplifier capable of amplifying the d-c currents from the photocell, but with the use of superimposed a-c, so that the many difficulties of d-c amplifiers are avoided

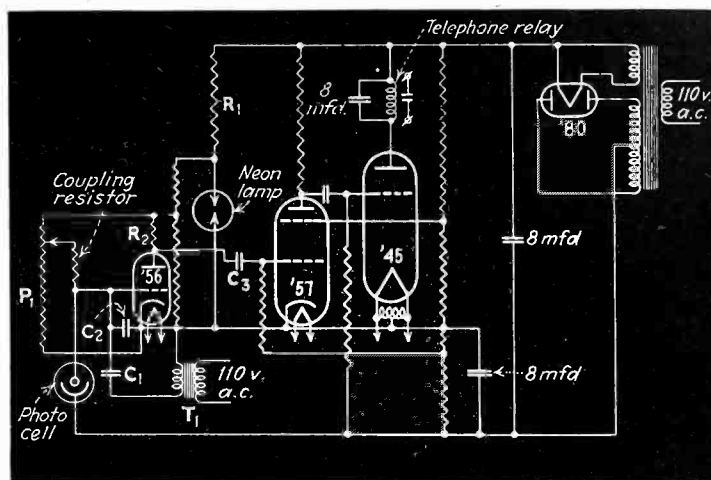

Circuit diagram of photocell circuit. The amplifier produces "d-c" amplification on an a-c basis, thus eliminating much cumbersome equipment

of light falling through this aperture on the photo-cell is rather small and experiments have shown that with a 10 megohm resistor is only in the order of two tenths of one volt with a temperature change of 10 to 15 degrees at temperatures of approximately 1800° F.

The mutual conductance of most available amplifier tubes does not exceed two to three milliamperes plate current change with a one volt grid voltage change so that with a single tube we cannot expect more than .4 to .6 milliamperes plate current change with the desired temperature change. A sturdy telephone relay equipped with a Burgess micro-switch takes a two to three milliampere change for the operation of the switch. In order to obtain the desired sensitivity for furnace chamber control it is therefore necessary to employ another stage of amplification. All research workers familiar with direct current amplifiers realize that this condition almost prevents commercial use of the apparatus and confines it to the laboratory. This is obvious when considering the various schemes available for direct current amplification.

## D-c amplifier a problem

For a commercial instrument intended to go into all kinds of industrial plants, the use of batteries should be avoided by all means and all power should be obtained by plugging the instrument into a light socket. Another disadvantage of the multi-stage direct current amplifier is seen in the following: it is well known that a phase-reversal takes place when going from one stage to the other. No matter whether we put a normally open or a normally closed relay in the final output circuit, there will be at least one tube, the plate current of which is supposed to increase with an increase in light or a corresponding increase in temperature. If this tube should fail, power will be kept on the furnace. With a more than one stage direct current amplifier we cannot, therefore, protect against the failure of any amplifier tube. It is, of course, true that we cannot protect against the failure of the photo-cell itself because if it should go blind it obviously cannot control any more, but the chances of the failure of the photo-cell, which does not contain any filament to burn out and passes only a fraction of a microampere are very much more remote than the failure in the amplifier tubes.

The problem of obtaining a satisfactory temperature control for furnaces by the photo-electric method has

[Please turn to page 247]

# A practical time signal system for broadcasting

By HERBERT J. MAYER

THE broadcasting of correct time signals is not only a real public service, but the hourly tone-beat is also frequently an aid to keeping the programs on schedule. Herewith are given the data on a cheap, foolproof, automatic time signal broadcasting system which has proved its practicability by nearly three years of continuous service. It is cheap because there is no upkeep expense (assuming that a Western Union clock is already in use), other than the 4½-volt "C" battery used for manual control, and the time is as accurate as the impulse which sets the W. U. clocks on each hour.

The schematic diagram in Figure 1 is self-explanatory. Advantage is taken of the beat note of approximately 1,000 cps. supplied by a General Radio Type 581-B frequency deviation meter used to monitor continuously the transmitter carrier frequency, which is coupled to one of the buffer stages preceding the modulated R.F. amplifier. Cutting in of the tone-beat has no effect whatever on the calibration of the frequency monitor. Any good frequency deviation meter could no doubt also be used to supply the beat-note with equally satisfactory results.

## Relay wired to clock circuit

A 6-ohm double-pole, single-throw relay ( $RY_1$ ) is wired in series with the Western Union Clock circuit. The D.C. resistance of the setting mechanism in the Self-Winding clock is approximately 12 ohms. The resistance of the tone-beat relay may be any value between 6 and 12 ohms without affecting the operation of the control

**EXPENSIVE time-signalling systems are not necessary if a Western Union time circuit is available in the broadcast control room. In this article is described a complete, practical, and inexpensive system which can be assembled by the operating staff of the station**

circuit. This relay may be purchased or a discarded telegraph sounder may be readily converted into one as shown in Figure 2. The stationary contact springs are taken from discarded telephone jacks. The contact screws on the bakelite strip, which is mounted on the armature, are taken from discarded telegraph keys or automobile spark coil vibrators, and are connected to separate binding posts through flexible copper pigtailed soldered to them.

If all circuits are adequately shielded to prevent any inductive or capacitive coupling it should not be necessary to break the output circuit of the coupling transformer  $T_1$ , which feeds the tone-beat into the speech circuit. In this case a single-pole, single-throw relay will be satisfactory to close only the input circuit of  $T_1$ , with the output connected directly to  $R_1$  and  $R_2$ , or to the 500 ohms speech circuit.

Resistors  $R_1$  and  $R_2$  may not be necessary in some installations. Their purpose is to prevent any R.F. picked up in the time circuit wiring from feeding into the speech circuit, and also to attenuate the tone-beat to the proper level. Their values will have to be determined by experiment, and will generally be somewhere between 100 and 2,000 ohms each.

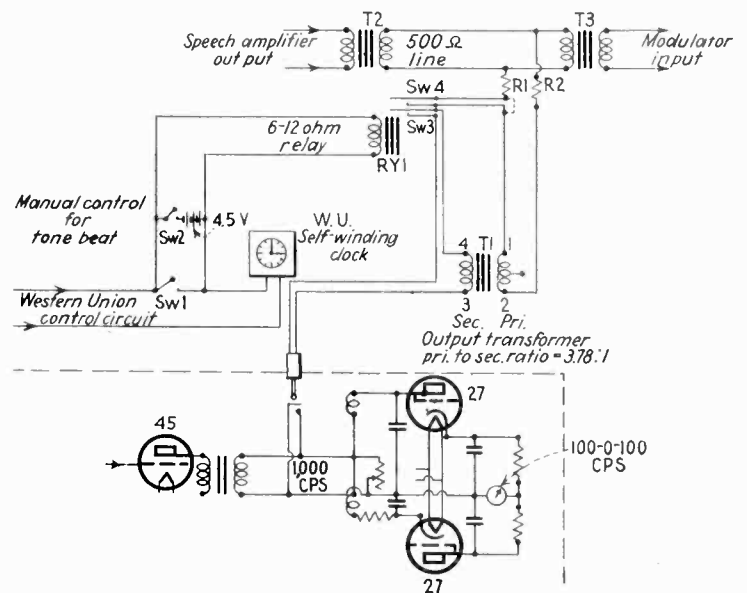

Fig. 1. Complete diagram of the signal system. The station frequency deviation meter (shown in dotted lines) supplies the 1000 cycle tone for the signal. Western Union time impulses are used

In the case of the installation made by the author these resistors were not required as the coupling transformer  $T_1$  used (Silver-Marshall S-M231 push-pull to-magnetic speaker output from 171A-245-250 tubes), happened to supply the proper level to modulate the transmitter 50%, as checked on an oscilloscope. No changes in the audio characteristics of the speech equipment were detected after installation.

The 1,000 cps supply is taken from the frequency monitor through a telephone jack on the front of the panel, and is left in circuit continuously.

The S-M231 transformer was used at  $T_1$  simply because it was the only one available at that time, and happened to have the desired characteristics for this particular installation. There are no doubt many other transformers on the market that would fill the bill as well. As a guide to selecting a proper transformer, the characteristics of the S-M231 at 1,000 cps are given:

Total Primary to Secondary turns ratio . . . . . 3.78:1  
 " " Inductance . . . . . 106 Henrys

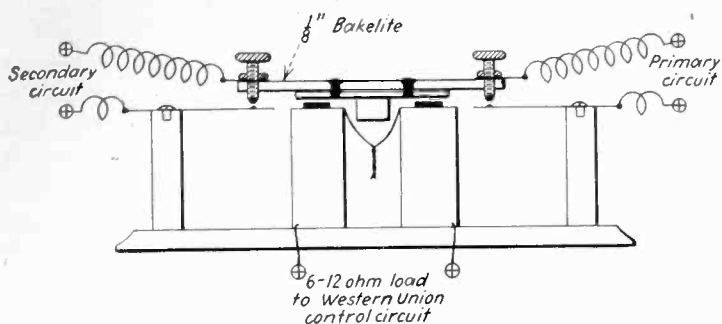

Fig. 2. A serviceable double contact relay, constructed from a telegraph sounder

Total primary	D.C. Resistance	660 Ohms
"	Impedance (Under load conditions)	640,000 Ohms
Secondary:	Inductance	7.9 Henrys
"	D.C. Resistance	184 Ohms
"	Impedance (Under load conditions)	50,000 Ohms

## Photocell amplifier

[Continued from page 245]

been solved by discarding the idea that the direct current had to be amplified as such. The principle of the circuit (patents for which have been applied for) is as follows: the voltage drop produced by the photo-cell current in a coupling resistor changes the grid bias of the first tube. At the same time, however, a small a-c signal is put on the grid of this tube. Since this first tube works with a very low plate voltage near the cut-off value, the amplification of the a-c signal is changed considerably with a small change in the direct current grid bias of this tube. The signal is then amplified once more by means of a screen grid tube and feeds into a power tube operated as biased detector. In its plate circuit is a normally open direct current relay operating the contactor of the power supply for the furnace directly. It is quite obvious that the failure of any one of the amplifying tubes, the detector tube or the rectifier will simply result in a shut-down of the furnace. The photocell is arranged in such a manner that an increasing amount of light increases the negative bias put on the first tube, reducing or stopping the amplification completely. A caesium-cell of the vacuum type is used for this purpose. Although this type of cell is less sensitive than a gas-filled type, it has the advantage of being practically independent of its supply voltage if the latter exceeds approximately 30 volts, and is considerably more stable than the gas-filled type.

### Description of circuit operation

Referring to the diagram, it can be seen that the necessary direct current voltages are obtained from a standard rectifier arrangement, an 8 $\mu$ fd condenser providing sufficient filtering. The cathodes of all tubes are at the same potential, and grounded. Negative grid bias for the second and third tube and also the necessary voltage to operate the photo-cell is obtained by passing the cathode currents of all the tubes as well as the current of the bleeder resistance furnishing the screen grid voltage to the second tube, through a resistor to the negative end of the power supply. This part of the power supply, from the cathodes to the negative end, is filtered

The electrical impulse coming over the Western Union wires on each hour energizes relay  $RY_1$ , which closes  $SW_3$  (also  $SW_4$ ) thus feeding the 1000 cps current into  $T_1$ , which in turn feeds it into the speech system through  $SW_4$  and  $R_1-R_2$ . Switch  $SW_1$ , when closed, serves to cut the station time signal circuit entirely out of the W.U. circuit.  $SW_2$  is a push-button or key on the control desk and allows the control engineer to manually broadcast a time signal at any time. This feature is especially desirable when recorded programs are broadcast from the control room, or when time signals are sponsored or given at short intervals.

The signals may be fed into most any part of the speech circuit if the coupling impedances and levels are properly matched. If no clock circuit is available at a remotely located transmitter an A.C. operated 1000 cycle A.F. oscillator may be used at the studios in place of the frequency monitor. Such an oscillator is practically foolproof in operation and maintenance if only quality materials are used throughout.

again to raise the efficiency of the detector. The first tube, a 56 type, obtains its operating voltage from a voltage divider across a  $\frac{1}{2}$  watt neon lamp which in turn is in series with 70,000 ohms across the power supply. The use of a neon lamp in this place assures that the operating voltages for the first tube change but very little with a change in line voltage. It is seen that not only the anode-voltage of the first tube is affected by this means, but also the potentiometer,  $P_1$ , furnishing the variable grid bias for this tube, the potentiometer being connected across part of this voltage divider. By this means the amount of light and therefore the temperature at which the apparatus functions can be changed. The characteristic of the vacuum type photo-cell is such that the current through it is practically independent of the anode voltage as long as the latter exceeds approximately 30 volts. The grid bias appearing on the first tube is equal to a part voltage across the potentiometer  $P_1$  minus the voltage drop across the resistor in series with the photo-cell. The first part is kept constant by means of a neon lamp, the latter is a function of the light only, so that the grid bias on the first tube is essentially independent of small changes in the line voltage. A small a-c voltage is now impressed on the grid from the separate transformer,  $T_1$ , or a winding placed on the core of the main power transformer. Condensers  $C_1$  and  $C_2$  prevent the shorting of the D-C grid bias derived from the photo-cell coupling resistor. In the plate circuit of the first tube is found the coupling resistor  $R_2$ , the A.C. component of the voltage appearing across this resistor being coupled by condenser  $C_3$  to the next tube in a conventional manner. Resistance coupling is again employed from this tube to the next 45 type tube which acts as a detector. As mentioned previously, the relay in the plate circuit of this tube is a telephone relay equipped with a Burgess vacuum switch, the coil of the relay being shunted by a 8 microfarad condenser.

The apparatus gives considerably closer control than a thermocouple. In the initial experiment the photo-cell did not look directly at the furnace wall, but at a closed nickel tube extending approximately four inches into the furnace. The possibility exists, however, to let the photo-cell look at the charge in the furnace directly which will permit an extremely close regulation.



# Coil testing methods for use in radio plants

By EDGAR MESSING

*F. W. Sickles Company  
Springfield, Massachusetts*

**T**HE production of successful radio receivers calls for correct design of the master models and then upon the correct duplication of these models. This second requirement depends to a considerable extent on the duplication of the components used in the production models of the receivers. Of these components, probably the most difficult to duplicate are the radio-frequency inductances; and yet they are kept to the closest tolerances.

It is proposed here to discuss proper testing means to insure oscillator, detector and antenna coils duplicating those in the designer's model; and to describe new and improved apparatus for this purpose. The duplication of i-f transformers is a separate problem.

The broad properties of the receiver that are dependent on coils are gain and selectivity. Coils must duplicate the characteristics of the masters by which the receiver was designed; oscillator coils, for example, must duplicate oscillation strength and frequency tracking characteristics.

For the usual two-circuit transformer the coupling between primary and secondary, the  $Q$  of both circuits, the effective  $L$  presented to the tuning condenser, and the primary  $L$  must be duplicated to secure the same receiver characteristics. For the single winding, increasingly popular as an antenna coil, the  $Q$  and effective  $L$  are the important characteristics. Modern coil testing must encompass these four points.

The usual practice has been to adjust the secondary  $L$  alone. The extension of the receiving range to 15 meters and the realization that performance on the short waves must compare with the 550-1,500 kc band performance has focussed attention on the need for more elaborate testing. A surprising slackness has attended the testing of small inductances—the mere duplication of number of turns often being considered sufficient. Engineering specifications, however, are being applied to short wave coils and coil testing is now obligatory.

The testing of  $Q$  will be considered later. Of the other three factors, the effective secondary  $L$  is dependent in part on the remaining two: primary  $L$  and coupling between circuits. Of course a certain tolerance is allowable in receiver performance and this tolerance can be reflected in coil features. For example, the very common practice of having a primary resonate in the receiver below the low frequency end of a range usually calls for resonance at least 12 per cent below. A variation of primary  $L$  or  $C$  of 4 per cent would mean a change in primary resonant frequency of approximately 2 per cent, which is allowable. No more than a periodical check is required to make sure that a unit will keep within a 4 per cent tolerance.

Similarly, since neither gain nor selectivity vary directly with variations in coupling, no more than a periodical check is required to keep the coupling within practical tolerances.

These variations are permissible from the standpoint from which they have been examined. However, when the tolerances in effective secondary  $L$  are  $\frac{1}{2}$  per cent or, in very particular cases, 0.1 per cent, the effect of these variations on secondary  $L$  must be taken care of. For example, in one coil representative of an average antenna coil a variation of coupling of 5 per cent is reflected as a change in effective secondary  $L$  of 0.5 per cent.

A resonant primary has been particularly mentioned, but the same considerations of allowable differences apply to low impedance primaries or oscillator ticklers.

On single winding coils the secondary  $L$  is, of course, the effective  $L$ . Where shields are used their effects must be included in the test.

From this discussion it develops that of the variables considered the important characteristic requiring closest examination is the effective secondary  $L$  and that this

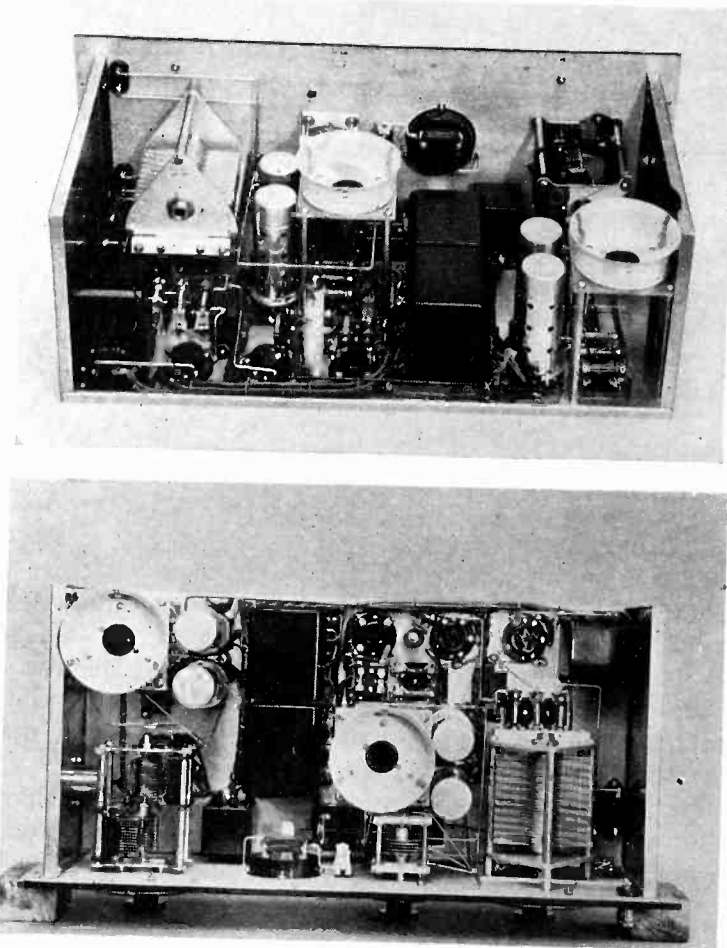

Two views of the General Radio Reactance Meter useful for coil testing

characteristic must be checked by some procedure that takes into account its dependence on circuits coupled to it.

Since it is desirable to maintain the primary coupling and the primary itself within the practical limits and since the secondary winding is the major part of the effective secondary  $L$ , it is this winding that is adjusted.

Five years ago the usual test fixture consisted of a fixed oscillator, possibly crystal controlled, coupled loosely to a wavemeter circuit. The test coil was made a part of the wavemeter circuit and a voltmeter or ammeter was used as indicator. The master coil controlled the setting of the wavemeter condenser and limits were set directly on the condenser. Mechanical measurements were the checks on primary effects.

This scheme was succeeded by the beat frequency method wherein the coil under test was made the tank coil of an oscillator circuit and an audible beat produced between this oscillator and a fixed oscillator. Secondary inductance alone was adjusted, usually in the manufacturing stage, where the secondary winding was the only coil on the form.

Movable primaries were, and still are, adjusted in a separate operation to exact mutual inductance values. Primaries of the solenoidal type were, and are, kept to mechanical dimensions. For small coils, however, it becomes increasingly difficult not only to adjust, but even to measure mutual inductance values.

An extension of this method of testing is to test and adjust the secondary after the primary is wound with the primary short circuited. This has the merit of realizing the effect of primary load on effective secondary  $L$  and works out very well practically. It does suffer from slight error in that if coils are not identical in every respect if adjusted with the primary shorted they will differ with another load on the primary. Short wave coils can be adjusted in the same way—using a high frequency fixed oscillator and adjusting to zero beat.

The objection to beat frequency testing of this type is that it is not necessarily indicative of inductance, but rather is proportional to an  $LC$  product. The true  $L$  may vary, but may be compensated on the beat test fixture by a similar variation in distributed  $C$ . Variations in  $C$  can usually be taken up by compensators on the main tuning condenser, but variations in  $L$  immediately cause mistracking.

For short wave coils one method that was extensively employed fed the primary current at an average frequency of operation in the set and adjusted the secondary to resonance with the aid of a vacuum tube voltmeter. The obvious reason for such testing was that it closely followed operating conditions in the receiver. Considerable trouble on short waves, however, can be experienced due to primary resonance.

Frequently it is possible to adjust the secondary to apparent resonance and later find that it is the primary that is really being tuned. Further difficulties occur when incoming test is made at a different frequency from the coil manufacturer's test. These troubles are due mainly to test fixture loading variations.

A new test instrument has been devised that measures true r-f inductance. Proper loading of the primary of the coil makes the test simulate actual working conditions. Short wave coils adjusted in this fixture have proven to be accurately adjusted by actual test in the receiver in quantity production. By suitable calibration it is possible to adjust inductances including short wave coils to 0.5 and 0.1 per cent.

The measurement of true  $L$  is accomplished by measurements taken at two frequencies. By using two known

Testing coils and condensers for Q values by the Boonton Radio Company Q-meter

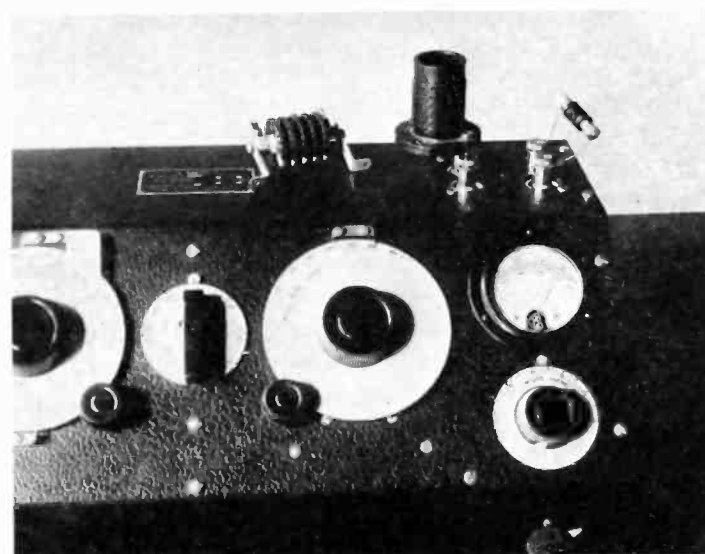
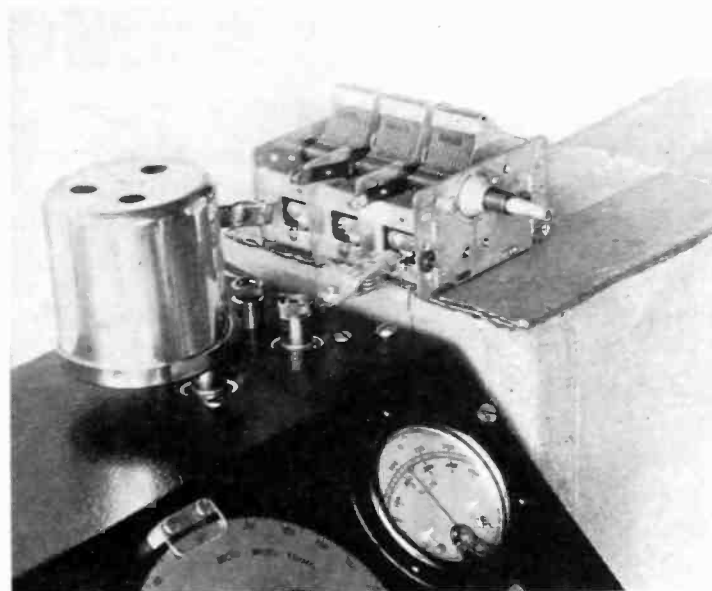

frequencies which may be harmonically related it is possible to make a direct reading true  $L$  meter. To simplify the derivation we may use the  $LC$  formula, in terms of wave length rather than frequency.

For a wavemeter circuit at resonance at the lower wavelength

$$\lambda_1 = K \sqrt{L(C_1 + C_0)} \quad (1)$$

Where  $C_0$  is the fixed circuit capacity and  $C_1$  is the tuning condenser reading.

At the higher wavelength:

$$\lambda_2 = K \sqrt{L(C_2 + C_0)} \quad (2)$$

Where  $C_2$  is the new condenser reading.

Squaring each side of both equations and subtracting (1) from (2):

$$\lambda_2^2 - \lambda_1^2 = K^2 [LC_2 + LC_0 - LC_0 - C_1L]$$

From which:

$$L = [\lambda_2^2 - \lambda_1^2 / K^2] [1 / C_2 - C_1]$$

For known wavelengths:

$$L = M / C_2 - C_1 = M / \Delta C$$

Where  $M$  is a constant and  $\Delta C$  is the change in tuning capacity required to tune from  $\lambda_1$  to  $\lambda_2$ .

It will be noted from the last equation that the true  $L$  is dependent only on  $\Delta C$ . The procedure therefore with the direct reading meter is to tune the test coil to the higher frequency, then note the additional capacity

required to tune to the lower frequency. Resonance indication may be by any of the well-known methods, such as current meter, voltmeter, beat frequency, or reactance reflection. The last two methods have apparently worked out best. The beat frequency method has been described above.

The reactance reflection method which has been in use for the longest period uses two oscillators and a wavemeter circuit containing the test coil. One oscillator is fixed and may be a crystal; the other is variable and may be adjusted to beat with crystal harmonics.

The wavemeter circuit is loosely coupled to the variable oscillator and the variable oscillator tuned to beat



Sickles coil testing unit

with a harmonic of the crystal. The wavemeter circuit is then tuned to resonance, the indication being a change in the beat from audibility to zero beat, and then to audibility as the reflection from the wavemeter circuit changes from inductance to resistance (at exact tune) to capacitance. To tune to the second test frequency a switch cuts in additional capacity in both the variable oscillator and the wavemeter circuits. The amount the beat then differs from zero beat is a measure of how far out the inductance value is.

The photograph shows one of the two frequency test fixtures in use at the F. W. Sickles Company for production testing. The two dials at the left are the scales for the condensers used for tuning the test coil at the high frequency end; the upper condenser being a vernier. The two scales next right, one above the other, are the low frequency tuning condensers, the upper one again being a vernier. After the high frequency end has been tuned the two right-hand condensers are switched in and tuned to resonance. The amount of capacity that has to be switched in to tune to the low frequency signal is the  $\Delta C$  in the equation above. Therefore, the two dials at the right, for given frequencies, can be calibrated directly in inductance. Actually no calibration need be made, but coils can be compared to a master.

A further appreciation of the accuracy of this method of adjusting inductance lies in the realization that exactly the same procedure is followed in aligning a receiver. On the 550-1,500-kc band, for example, a 1,400-kc signal is tuned in by means of compensators on the main tuning condenser. Then the tuning condenser is tuned to a 600-kc signal; with correct inductance values (and condenser) the condenser dial will read 600. Operating frequencies such as 700 and 1,400 kc for the broadcast band are always used.

The primary of the coil under test should be loaded exactly as it is in the receiver. An interstage coil in the receiver, for example, may "see" on the primary side a capacity of 30  $\mu\text{mf.}$ , etc.

The General Radio reactance meter is a slightly different instrument that can be employed for the same purpose.

All testing mentioned above has been against a master or standard coil—preferably one that has actually been in a receiver. This is always an excellent procedure and eliminates possibilities of error due to differences in measurements. It is not necessary that the master be regarded as unchanging, but it enables the coil manufacturer to record its character on his own equipment and to check production from these measurements.

The specification most commonly used is the inductance value measured on a 1,000-cycle bridge. There is a growing tendency to regard this not as a direct measurement of value, especially for shielded coils, at the operating frequencies. A two-frequency reading of true inductance is therefore specified by several engineers. Thousand-cycle readings work out satisfactorily for most coils. For small coils where such readings are difficult a master should be submitted.

The fourth characteristic,  $Q$ , remains to be discussed. In general, the  $Q$  of a winding depends on the type of winding, the size of wire, the quality of the winding (shorted turns, etc.), broken litz strands and the presence of loss-producing material (water, wax, etc.). The type of winding and size of wire employed are constant factors and can be considered a negligible factor in quantity production.

A broken litz strand in a coil of 250  $\mu\text{h.}$  may change the  $Q$  5 per cent at 1,000 kc for a 7/41 wind, 3.5 per cent for 10/40, etc. The use of a resistance check for determining the presence of a broken strand is, however, not reliable; variations in wire size and composition account for irregularities that bar definite results. It is a frequent occurrence to find coils which are rejected on the resistance bridge test to have seven or ten complete circuits, even though the resistance is apparently high. And, as indicated above, in many cases the occurrence of a broken strand is not sufficient cause for  $Q$  rejection.

A direct reading  $Q$  meter such as recently placed on the market by Boonton Radio Company is a good check simply performed. Research is now going on for a still simpler method that can be effectively used in quantity production.

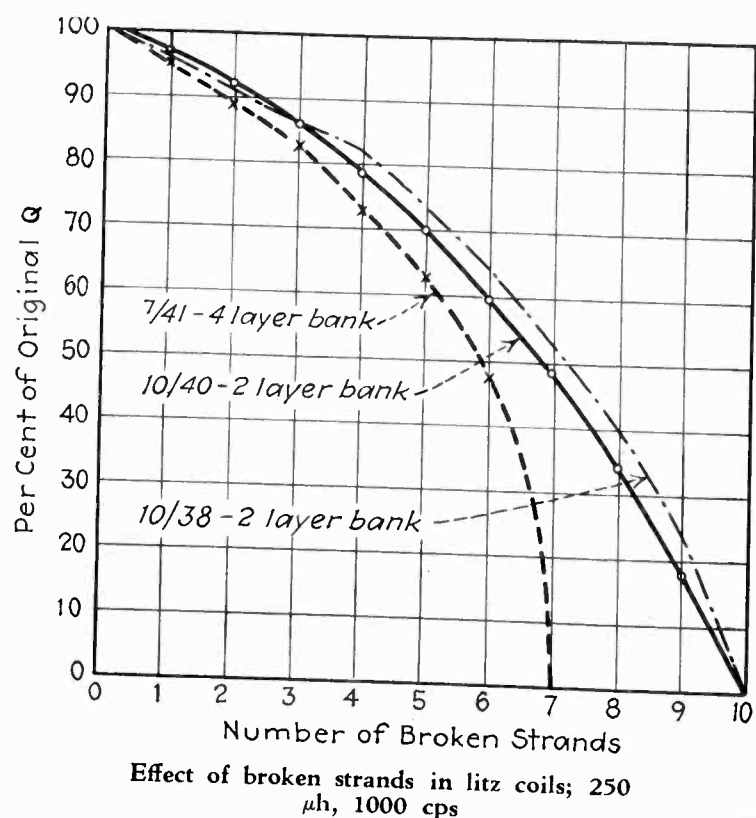



# BOOKS



## FOR ENGINEERS USING ELECTRON TUBES

### Les Circuits Oscillants (Oscillating circuits)

By J. Mercier, Professor at the University of Bordeaux. Published by Ch. Delagrave, 15 rue Soufflot, Paris, 1934. (200 pages, 121 figures, Price bound, 50 French francs).

THE BOOK deals with the elements and circuits inevitably found in radio frequency devices. It starts with the study of the closed oscillating circuit with or without an e.m.f. inserted in series with coil and condenser and a positive or negative resistance. Of special interest is the case where the impressed e.m.f. consists of single or of repeated pulses, (Chapter 8). This portion concludes with a discussion of anti-resonant circuits. The author then turns to coupled circuits, laying stress upon circuits with magnetic coupling. A special chapter deals with self-maintained oscillations in coupled circuits, that is oscillations which are possible when a negative resistance is inserted in one of the circuits. The discussion of the suppression of resonance observed in this case is of particular interest. Filter circuits follow and finally the open oscillating circuits.

While it may seem a pity that the author has not used his great experience to deal more extensively with the practical side of the question the brevity thus gained may be an advantage to those wishing to round off their theoretical knowledge. The book gives a clear picture of the role which circuits play apart from tubes in radio devices.



### Das flüssige Dielektrikum (Liquid Dielectrics)

By A. Nikuradse. Published by Julius Springer, Berlin, 1934. (226 pages, 82 figures. Price cloth-bound 19.50 German marks.)

THIS MONOGRAPH tends to group together all the effects which are observed when an insulating liquid comes under the influence of an electric field, whether constant, fluctuating or alternating in strength. These effects are more

numerous than is commonly realized. The book begins necessarily with a discussion of the variable which characterizes perfect insulators in the first place, the dielectric constant which expresses the influence of the electric field on the charges in the molecules; it then deals with the losses which are accounted for by the dielectric constant and the structure of the dielectric in alternating fields and their change with temperature and frequency. An account of the changes in the optical properties in the electric field (Kerr effect) and mechanical effects conclude this introductory part.

The author now turns to the case where after the saturation current has been reached the field strength applied to a pure liquid is allowed to increase to 100,000 or 200,000 volts per cm. The current starts to increase once more. This introduces the very complex problem of ionization in liquids which is examined in the main portion of the book (pp. 60 to 160) first for moderate fields and then for strong fields. The necessity of using pure liquids and preventing impurities from the electrodes to vitiate the results by electrolytic conduction is by far more imperative than in the case of gases and many tedious investigations have been rendered all but useless for failure to observe the utmost precautions in the choice of the material. Pure ionization currents play therefore an important part in the case of dielectrics, whereas in the case of gases the last stage only, breakdown, attracts most of the attention. Breakdown of liquids is reviewed in the last fourth of the book. A few pages in each of the sections of the book deal with the conditions at radio frequencies.

The work is based on a full year's course on dielectrics as given at the Munich Institute of Technology, and the author, known for his work on liquid dielectrics, is not afraid of showing the great variety of the problems in place of presenting an easily read review. The large number of references cited in the text, over 550, is also not likely to leave the reader with a feeling of knowing it all. To derive the fullest benefit, it should probably be read after having studied as an introduction an easier text such as Liquid Dielectrics by A. Gernant (see *Electronics*, April, 1934), although the present book is not simply an expansion of this subject which forms a necessary stepping-stone to the understanding of the behavior of solid dielectrics.

### Elements of Loud Speaker Practice

By N. W. McLachlan. Oxford University Press, New York, 1935. (160 pages, price \$1.75.)

THE AUTHOR, whose previous book on speakers was for the exclusive consumption of mathematicians, has gone to the opposite extreme in this elementary book.

There is an obvious attempt throughout this book to give it a technical air, but one has to read no further than the first few pages to realize that this material is best suited to the kind of radio "columns" found in the daily papers only a few years ago.



### Theoretical Physics

By Georg Joos, University of Jena; translated from the German by I. M. Freeman. G. E. Stechert & Co., New York. (750 pages, price \$6.50.)

THE FIRST 75 pages of the monumental work lays the mathematical groundwork for the text, handling in turn vector analysis, the mathematics of periodic phenomena, functions of a complex variable, and the calculus of variations. Throughout the book a good working knowledge of vector analysis is necessary but surmounting this hurdle, and here the reader will be aided tremendously by the first book chapter, a master of this book will find himself in complete command of the physical phenomena of mechanics, electromagnetic and optical phenomena, the theory of heat, the structure of atoms and molecules, and the theory of spectra.

Included in these chapters will be found, of course, such matters as the mechanics of rigid and deformable bodies, and liquids and gases, relativistic mechanics, electrostatic and magnetostatic fields, optics of crystals, electrolytic conduction, conduction of electricity in gases, metallic conduction, the laws of thermodynamics, the classical theories of radiation. This reader enjoyed particularly the chapter on relativistic mechanics. The thirty pages devoted to this subject seemed, to him, to be a most lucid dissertation in short space of this fascinating field explored by Lorentz, Einstein, Minkowski, et al.



# HIGH LIGHTS ON ELECTRONIC

## Photo-electric burglar alarms gain favor

FURTHER EVIDENCE that photo-electric burglar alarms are gaining in popularity is introduced by an application recently made during the construction of a new home in a western state, in which an infra-red (invisible light) alarm system has been installed as a built-in part of the dwelling's modern electrical equipment.

The electrical contractor, in designing and installing the equipment, strategically placed light sources equipped with infra-red color caps, so that anyone entering the owner's wing of the building necessarily must intercept one of the invisible light beams from these sources. The beams are focused on photo-electric relays which the contractor purchased from the General Electric Company, through his local jobber. Upon interruption of any beam, a relay operates and results in the breaking of a telephone circuit which sounds an alarm at a central burglar-alarm-system headquarters. Since the installation is arranged so that the circuit is normally closed, the alarm will also sound if the telephone wires are cut.

Another circuit, normally open, runs to an alarm signal on the top of the home and, when closed, calls the policeman on the beat. Later this circuit may also be used to floodlight the entire grounds around the house, making it

difficult for an intruder to get away without being seen.

Both alarms may be disconnected by means of switches placed within convenient reach for use by the owner and trusted servants, and other switches can be used to operate the alarm circuits manually.

Finally, in order to guard against the rare chance of failure of the electric power supply to the home, a trickle-charged battery system is used to provide power to the alarm installation.

♦

## Dramatic use of controlled sound

BY NOEL URGUHART, M.E., M.S.  
*Stevens Institute of Technology*

THE DRAMATIC SOCIETY at Stevens Institute, Hoboken, N. J., has been working for the past four years with the Department of Physics on the problem of the dramatic use of controlled sound. This work culminated this year in the presentation of a "Sound Show" which demonstrated that in the theater, sound can be controlled in direction, volume, and quality, just as definitely as light is controlled in direction, intensity, and color. A technique has been developed which permits of new or more effective dramatic interpretation thru the use of controlled sound and opens a new field

for further artistry in the legitimate theater.

Reduced to its simplest terms, "controlled sound" means the producing of any sound from any source, or group of sources, with any predetermined characteristics, so as to be heard from any source, or group of sources, or no apparent source. Effects, such as thunder, wind, cheering crowds, marching men, are easily obtained and their use is well understood, but because they have been used with reasonable effectiveness, such effects were not included in the demonstration.

The "Sound Show" consisted of several dramatic episodes from well known plays whose effectiveness was increased thru the use of controlled sound. The program was as follows:

1. Speech from an identifiable but invisible source as applied to a play involving the "alter ego." "Overtones," by Alice Gerstenberg.

2. Speech with unnatural, predetermined pitch and quality, and a translucent source. "Hamlet," by Shakespeare, Act 1—Scenes 4 and 5.

3. The reproduction and control of orchestral music as applied to a scene requiring fidelity, range of volume, and an invisible source of sound. "The Adding Machine," by Elmer Rice, Scene 6.

4. Speech in perspective as applied to pantomime. "The Only Jealousy of Emer," by W. B. Yeats.

5. The audible but unspoken aside; mental conflict expressionistically interpreted in sound and light. "The Adding Machine," by Elmer Rice Scene 2.

In "The Only Jealousy of Emer," as an example, the problem involved was recognized by Yeats, who intimates in the preface of his volume of plays for dancers that these plays could not be produced, since a dancer seldom has the breath to carry a large speaking part. The use of controlled sound overcame this hindrance by producing the lines of the dancers from the apparent direction of the individual performers, the lines being actually spoken by actors off-stage. Just as masks give dancers predetermined appearances, so by controlled sound the dancers were given predetermined voices. Moreover, pantomime being often accompanied by a Reader who sets the scene and delineates the action, it was possible to remove from the stage the Reader, a possible source of visual distraction.

### Equipment installed

The sound system installed in the Stevens Theater is typical of the equipment required for the dramatic use of controlled sound. Velocity ribbon microphones are employed, their most useful

## ELECTRONIC EGG CANDLER



In Warwickshire, England, 50,000 eggs per week are tested for edible qualities by phototubes

# DEVICES IN INDUSTRY + +

location being in microphone tents off-stage in the wings. These tents are made of an acoustic cloth and give practically studio conditions, prevent feedback, and allow the off-stage performers to follow the action on the stage. Due to their directional characteristics, the microphones can be used on-stage for reinforcing if necessary. High level mixing is made use of for all microphones. The speakers consist of two exponential-dynamics, two baffle-dynamics, and a tweeter set above the proscenium arch so as to give good overall coverage, and three combinations of baffle-dynamics and tweeters set on dollies so that they can be moved to any required position up-stage. The tweeters can be cut in or out and their intensity levels can be varied with respect to the baffle-dynamics.

The rest of the equipment is located in a sound booth on a fly gallery so as to allow the operator full view of the stage. There are two dual-speed turntables with pickups for disc transcriptions, the pre-amplifiers for the microphones, two voltage-power amplifiers, and the mixing system with monitor and intensity level meter. The mixing system is extremely flexible, permitting both input mixing to and output mixing from either or both voltage-power amplifiers. The input mixing allows for joint and individual control of three microphones, two pickups, and a sound track. The output mixing allows for the individual control of the several speakers. For perspective effects in the theater, output mixing is preferable to the three-channel method. The entire system has good response from 50 to 10,000 cycles. The auditorium intensity level at full gain is about 80 db. The noise and hum levels are imperceptible.

## Phototubes for testing power tubes

SPECIAL TESTING equipment recently installed in the laboratories of the Westinghouse Lamp Company in Bloomfield, N. J., will enable engineers to collect complete operating data on transmitting tubes in the positive grid region. A special 60-cycle, tuned-amplifier circuit permits the study of grid voltages and currents under actual operating conditions. In this way, engineers expect to gather the necessary data with which to design tubes of more uniform perform-

ance and to obtain the type of information required to permit the design of more efficient tube circuits. Other new features include an oscillograph and facilities for using photo-electric tubes in the comparison method for accurately measuring radio-frequency power output.

In 1932 Westinghouse engineers were the first to use an oscillograph to measure the operating characteristics of transmitting tubes. It photographs the currents and voltages of transmitting tubes in approximately 2/10ths of a second, thus eliminating the destructive meter method. Data, never before available to design engineers, are now obtained in this manner and are proving invaluable in the determination of tube performance.

The special 60-cycle tuned-amplifier circuit, which is larger than any in use today, makes it possible to obtain dynamic characteristics of transmitting tubes at the common commercial frequency of 60-cycles. It employs a 1/2-henry, air-core inductance coil, capable of carrying loads up to outputs of 5 kw. The coil measures 3 1/2 feet in diameter and stands 2 1/2 feet above the floor. Operating data on transmitting tubes up to and including the 1 kw size may be obtained with this circuit.

Six separate voltage supplies provide a flexibility which permits the general study of transmitting tubes over a wide range of voltages. All voltages may be

varied continuously and uniformly from zero to maximum output and in addition may be used simultaneously. All power supply circuits terminate at the meter table seen at the left in the photograph.

These voltage supplies are as follows:—two 1500 volt and one 10,000 volt direct current rectifiers; one 1500 volt and one 3000 volt direct current motor generator; and one 1500 volt alternating current grid-exciter unit. The rectifier circuits are supplied through hot cathode mercury vapor rectifier tubes.

The comparison method, in which the outputs of two incandescent lamps are matched by phototubes, is used in connection with the test equipment. Thus, while various types of transmitting tubes are operating at radio frequencies into an incandescent lamp load, their output is measured.

In this method a lamp of a wattage similar to the lamp load of the transmitting tube is lighted on 60-cycle a.c. to an equal intensity as indicated by the phototube current. A watt meter, showing the 60-cycle power that enters the comparison lamps, gives the radio-frequency power in watts in the lamp load.

A complete system of door interlocks assures maximum protection for test engineers. Doors to the cage, on the meter table, and on the front and rear of the units, are equipped with interlocking safety switches.

## POWER TUBE TEST EQUIPMENT

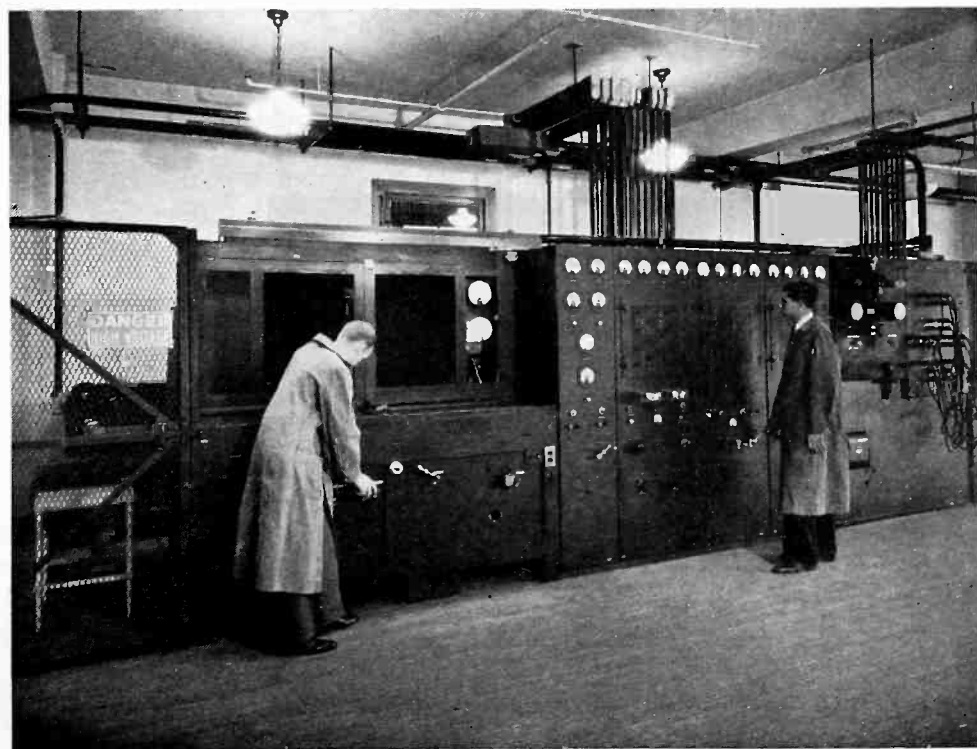

By a comparison method, phototubes measure the output of large transmitting tubes at the Westinghouse Lamp Company

# Multi-band r-f choke coil design

By HERMAN P. MILLER, Jr.  
Harrisburg, Pennsylvania

HOW can a radio frequency choke coil be made for effective use over a wide range of frequencies? Although a coil for a narrow range is a simple problem, it has sometimes been necessary to use a number of such coils to cover a wide range. How much more satisfactory it would be to use only one coil for an extended frequency range.

One of the best tests of the suitability of a choke coil is to connect it across the plate circuit of a vacuum tube oscillator in the manner shown in Fig. 1-A. At a particular frequency the coil will have an effective parallel reactance  $X'$  and an effective parallel resistance  $R'$ . These will both be in parallel with  $L$  and  $C$  of the plate circuit. Under normal load conditions the parallel circuit of  $L$  and  $C$  will have an effective parallel resistance of  $R$ . In order that the choke coil may not absorb too much power from the oscillator circuit,  $R'$  should be considerably higher than  $R$ . The value of  $R$  will depend upon the load conditions and may vary from 20,000 to 50,000 ohms.  $R'$  should be about 5 times  $R$ , or from 100,000 to 250,000 ohms. These might be called minimum allowable values since still higher values would be preferable. In the same way,  $X'$  should be consider-

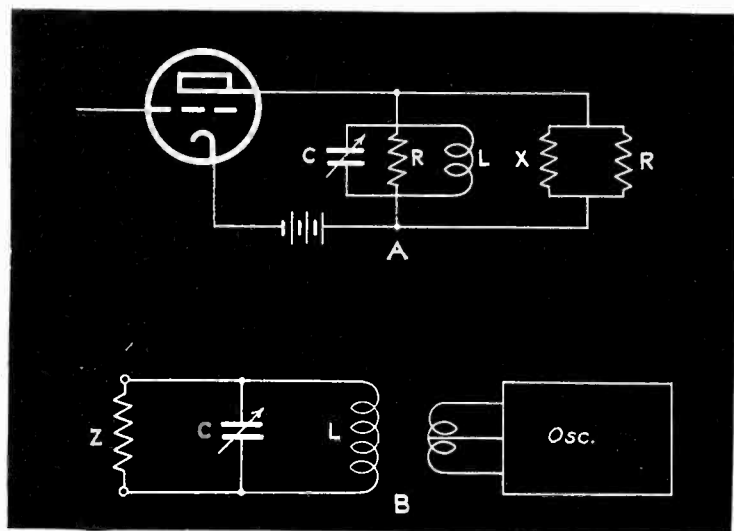

Fig. 1. (A) Test circuit for r-f chokes. (B) Method of measuring resistance and reactance of sample choke coil

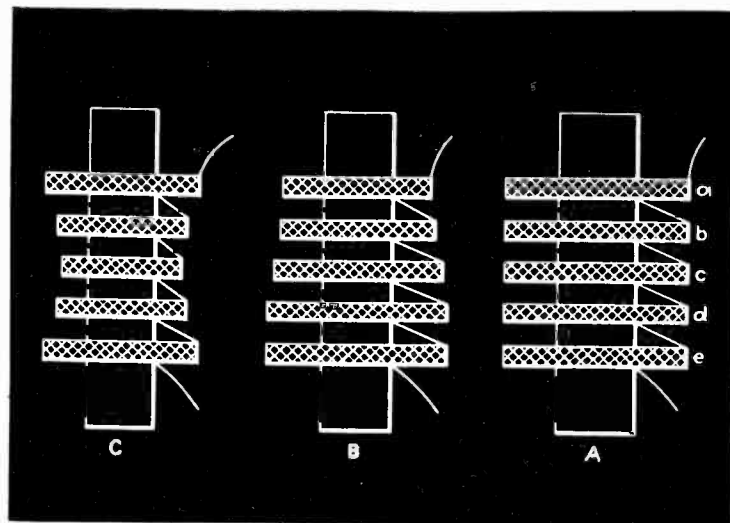

Fig. 2. Types of pie-wound chokes having different frequency characteristics. Type C is the final design evolved by the author

ably higher than the reactance  $X$  of either  $L$  or  $C$ . If it is too low, the choke coil will have too much effect on the tuning of the circuit. For best results  $X'$  should be about 5 times  $X$ . A choke coil to be suitable for a wide range of frequencies must meet these conditions for both  $R'$  and  $X'$  over the entire range.

These conditions may often be met by using a coil consisting of a single layer winding. It has been shown, however, that even this type of winding has a succession of points of high and low impedance.<sup>1</sup> The writer has made reactance measurements on such windings, using frequencies as high as 46,000 kcs. and found that in order for these high and low points to be separated as much as possible the winding diameter should be small in comparison with the length. These are not practical forms from the consideration of space, so that some other form that provides low distributed capacitance and high inductance in a small space is preferable. Coils designed to meet these requirements are shown in Fig. 2.

Coil A of Fig. 2 is a common form in which all of the pies are of the same diameter. A common theory for this design is that since each pie is of the same size, they will all have the same inductance and distributed capacitance and hence the same natural frequency. By putting them in series, the total impedance of the coil will be about 5 times the impedance of one pie. Operating experience has raised questions as to the correctness of this theory and the measurements to be described were made to investigate these questions.

A coil of this type was obtained which was intended for use on the four amateur bands between 1,700 and 14,400 kcs. Its effective parallel reactance  $X'$  and resistance  $R'$  were measured by placing it in the position Z of Fig. 1-B and noting its effects on the circuit of  $L$  and  $C$ . Without the coil, the circuit was first loosely coupled and tuned to the oscillator. This oscillator was of the push-pull type with a rating of 10 watts and had a biased milliammeter in the d-c grid supply to indicate the reaction of external circuits. The frequency of the oscillator was then measured with a calibrated receiver. The choke coil was placed at Z, the oscillator tuned to resonance with the circuit, and the frequency again measured with the receiver. From these two frequency readings and the inductance of  $L$  it was possible to compute  $X'$ . To obtain  $R'$ , the grid meter reading was noted when the oscillator was tuned to the circuit with

<sup>1</sup>A Study of R-F Choke Coils, by Reuben Lee, Electronics, Vol. 7, No. 4, April 1934, pp. 120-121.

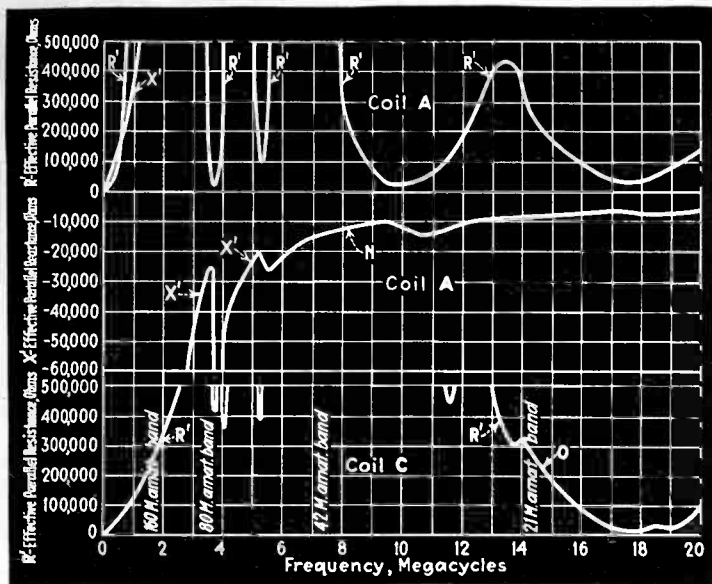

Fig. 3. Resistance and reactance characteristics up to 20 mc, measured for coils A and C

$Z$  in place.  $Z$  was then removed and a non-inductive resistor substituted for it.  $C$  was readjusted to bring the circuit into resonance with the oscillator and the grid meter again observed. By trying different values of resistance, two were obtained which caused meter readings above and below that caused by  $Z$ .  $R'$  was then obtained by interpolation between these two values.

The results of the measurements made on coil A are given in the  $X'$  and  $R'$  curves of Fig. 3. The  $X'$  curve has been drawn to 10 times the scale of  $R'$  in order to bring out the variations in  $X'$ . It will be seen that  $R'$  is low at 3,700, 5,300, 9,750 and 17,550 kcs. At each of these frequencies there is a marked drop in the  $X'$  curve, the drop being very pronounced at 3,700 kcs., less so at 5,300 kcs., and hardly distinguishable at 17,550 kcs. It will be readily seen that these drops are simply the familiar effects of coupled circuits.

Since the low points at 3,700 and 5,300 kcs. must be explained in some other way, they are believed to be due to non-uniform interaction between the individual pies. Possible causes of this would be variations in the distributed capacitance or in the mutual inductance of the individual pies. For example, the center pie  $c$  has more distributed capacitance than pie  $a$  since it has pies on both sides of it while  $a$  has a pie on only one side. Also the center pie  $c$  would have more mutual inductance with the other pies than the end pie  $a$ .

To check the mutual inductance between pies, the inductance of two pies in series was measured for different separations. From this it was possible to determine the mutual inductance between any two pies in the coil. The total mutual inductance of any one pie was then the sum of the mutual inductances between that pie and every other pie in the coil. In other words, the mutual inductance of  $a$  was the sum of the mutual inductance between  $a$  and  $b$ ,  $a$  and  $c$ ,  $a$  and  $d$ , and  $a$  and  $e$ . It was found that this amounted to 362 microhenries. Since one pie alone had a self-inductance of 555 microhenries, the total inductance of pie  $a$  was 917 microhenries. In the same way, the total inductance of the pie  $b$  was 1124 microhenries and of pie  $c$  1175 microhenries. The total inductance obtained by adding up the total inductances of each pie was 5257 microhenries and the measured inductance of the entire coil was 5270 microhenries, a close check. It should be noted that there were three different values of total pie inductance, just

one more than the number of low points in the  $R'$  curve apparently caused by this variation.

To determine the effect of making the values of pie inductance more nearly uniform, a few turns were removed from pies  $b$ ,  $c$ , and  $d$ . This raised the two low points in question. By removing still further turns it was possible to raise the low points to unobjectionable values.

The presence of the low points in the  $R'$  curve, such as occurred in coil A at 3,700 and 5,300 kcs., has already been noted in practice and several methods have been used to eliminate their undesirable effects. The first method has been to change the shape of the pies, still keeping all of the same size, so that the points of low  $R'$  do not occur near the frequency on which operation is desired. The other method has been to taper the diameters of the pies from one end to the other in the manner shown in B of Fig. 2. The generally accepted theory on this design is that each pie is resonant at a frequency slightly different from that of the next adjacent pie, and by adding them together in series the total impedance of the coil is high over a wider range of frequencies than is possible with a coil similar to A. By actual tests this has been found not to be the case. An  $R'$  curve obtained in the same manner as for coil A was similar to the curve  $R'$  for coil A above 9,750 kcs. but below this frequency there were four low points instead of the two obtained with coil A. It will be noted that in coil B all five pies have different characteristics. The number of low points due to their interaction is one less than the number of different pies, the same as with coil A.

At C in Fig. 2 is shown a coil worked out by the writer as the result of the above tests and in which the objectionable features of coils A and B have been eliminated. It will be noted in this coil that the end pies are of the same diameter, the next pies are smaller and the center pie is the smallest. The  $R'$  curve for this coil is shown at O in Fig. 4. This curve rises above 500,000 ohms between 2,500 and 13,000 kcs., except at four narrow bands where it does not drop below 365,000 ohms. Above 13,000 kcs., the curve drops off to a minimum at 17,750 kcs. In other words, the low point corresponding to that at 9,750 kcs. in curve M has been shifted to 17,750 kcs. The low points at 3,700 and 5,300 kcs. have been raised and shifted.

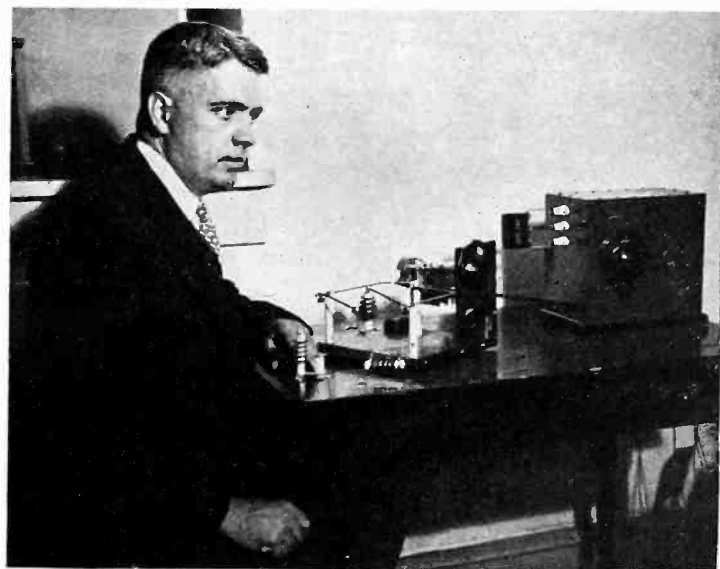

Fig. 4. The author with his test set-up, showing three different types of chokes and measuring equipment. The choke being measured is shunted across the tank circuit



# ★ ★ NOTES ON ELECTRON

## Crystal coupling for high quality i-f circuits

ATTEMPTS to provide high quality radio receivers have too frequently come to grief on the shoals of sideband-cutting I-F amplifiers. Whatever degree of success has been attained has been at the expense of complicated adjustments for controlling the coupling between the windings of the I-F transformers; this allows the user of the receiver to take advantage of the sharpness of tuning of the usual intermediate amplifier, and to "open up" for higher quality once the desired signal has been tuned in. However, neither sharp nor broad tuning of the intermediates eliminates any image interference which may—and all too often does—get past the first detector.

The answer to the problem of image interference still lies to a great extent in providing a sufficient number of tuned circuits between the antenna and the first detector; and, of course, each of these circuits contributes its share to the general sideband slicing. Quality control for these R-F circuits is within the realm of possibility, in fact the problem is quite simple *if* one is willing to revert to early standards and assume that the "best" receiver is the one with the greatest number of knobs.

Since the pre-detector stages are almost essential, and as they too must be

adjustable for high quality, it seems pertinent to examine the possibilities of crystal coupled I-F amplifiers, as disclosed in a recent patent,<sup>1</sup> with the idea of removing the intermediates from the "controlled" class and concentrating the quality adjustments in the so-called pre-selectors where they are really needed.

The patent referred to above is one of several which have been issued to members of the staff of the Bell Telephone Laboratories and all of which pertain in a broad sense to crystals and their use as circuit elements. In addition, other members of the Laboratories' staff have published extensive data on the preparation of quartz crystals which have, for all practical purposes, negligible temperature coefficients.<sup>2</sup> This should prove a distinct relief to those readers who may have been envisaging receivers further complicated with temperature control ovens for the crystals.

The accompanying diagrams show several of the possible arrangements for use as I-F coupling devices. These circuits, known to telephone engineers as the bridged-T type, can be shown mathematically to be exact equivalents of the so-called lattice type. For purposes of design, the bridged-T is changed (mathematically) to its equivalent lattice structure. A network which is the electrical equivalent of the crystal<sup>3</sup> is substituted for the crystal in the equivalent lattice structure and, the terminating impedances and the mar-

ginal frequencies of the transmitted band being known or assumed, the values of the coils, condensers and resistances of the lattice are derived by

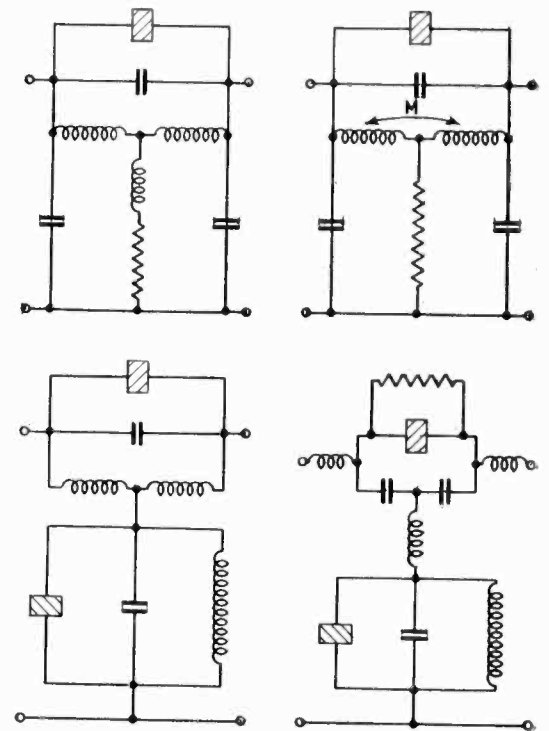

Four band-pass crystal filter structures

means of formulae published some years ago.<sup>4</sup> The coils and condensers which make up the electrical equivalent of the crystal are, of course, among those of the lattice whose values are derived; it remains only to reduce these values to terms of length, width and thickness for an appropriately sized plate<sup>5</sup> which will, if properly cut and finished, accurately control the resonant frequency and band width of the intermediate system.

These coupling units, properly enough termed band-pass filters, exhibit a response curve which is little short of phenomenal when compared with curves from present day intermediate units. Under proper conditions of termination, the curve is symmetrical about the axis of resonant frequency and the top of the curve is essentially flat. Since no resistance appears in the electrical equivalent network of the crystal—although strictly speaking there is some resistance present—this equivalent network has, for design purposes, practically an infinite  $Q$ . Other resistances in the structure are ingeniously balanced out<sup>6</sup> so that the over-all effect is a circuit with a  $Q$  as high as is humanly possible to attain, at least at this stage of the art. This freedom from resistance effects has the advantage of an extremely low insertion loss over the range of the transmitted frequency band, and it results further in

## RADIO-CONTROLLED PLANE FLIES WITHOUT PILOT

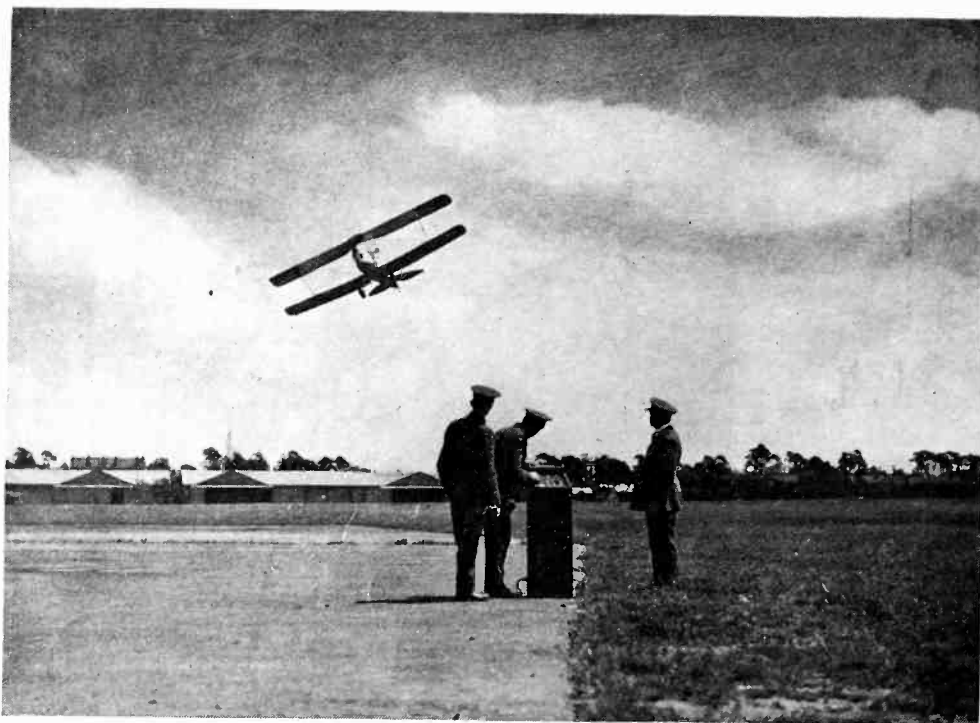

The British Army has demonstrated a radio-controlled plane which will take off, fly, and land without a pilot on board. The plane is shown above flying at Farnborough, Hants

# TUBES AND CIRCUITS + +

an increased slope to the sides of the response-frequency curve.

In addition to these highly desirable square response curve characteristics, the structure shows a very high attenuation to frequencies outside of the transmitted range. Heretofore it has been necessary to use more than one section of filter to obtain this high attenuation outside of the band; and each added section likewise increased the insertion loss over the desired range, sometimes enough so to require additional amplifier gain to compensate for it.

<sup>1</sup>U. S. Patent 1967250.

<sup>2</sup>Bell System Tech. Jour., 3, XIII, page 453 *et seq.*

<sup>3</sup>Bell System Technical Jour., 3, XIII, page 408.

<sup>4</sup>Bell System Technical Jour., 2, III, page 259 *et seq.*

<sup>5</sup>U. S. Patent 1921035.

<sup>6</sup>Bell System Technical Jour., 3, XIII, page 405 *et seq.*

+

## Milwaukee amateurs present ten-meter program

RADIO AMATEURS in the vicinity of Milwaukee have been presenting a Saturday night program consisting of notes on local amateur activities, the exchange of ideas between experimenters and talks by leading amateurs over station W9XAZ, the ten meter experimental station of the *Milwaukee Journal*. W9XAZ which operates on a frequency of 31.6 megacycles with a power of 500 watts, has been received consistently by amateurs in the vicinity during experiments with high fidelity transmission. The daily program schedule developed a wide following among amateurs and their reports on the transmission led to the formation of Saturday night amateur programs. Reception of the program has been recorded as far as 35 miles from the transmitter. Since the transmitter's frequency is very close to the ten-meter amateur band, the amateurs in the Milwaukee area have been using the transmission as a wave meter for checking their individual amateur installations.

+

## Tests on r-f circuit hook-up wire

By RAYMOND G. ZENDER  
*Lenz Electric Mfg. Company*  
Chicago, Illinois.

SUPPLEMENTING previously presented information, there is given herewith the results on investigation in the field of

hook-up wire especially designed to possess characteristics suitable for use in connecting the radio frequency components of radio receivers.

After considerable experiment it was found that insulation material of special cellulose-acetate-treated textiles, thoroughly saturated in low loss moisture resisting compounds, most nearly approached the low losses of the ideal, which would be, of course, bare conductor, air-supported. Air-supported busbar wiring is, of course, impractical in production radio receivers because of obvious practical considerations.

Although the hook-up wire in a radio chassis seldom touches a grounded metal conductor along more surface than that presented by a single straight line, most of the tests, results of which are shown herein, were secured by completely immersing the conductor under test in mercury, thus giving the tested material the worst possible treatment.

The insulating material is impregnated in a special moisture resistant impregnating composition which is not adhesive in character and therefore allows this particular insulation to possess excellent push-back features. No rubber insulation of any sort was used because of temperature limitations.

The following results of tests made at 70° F. at 50% relative humidity, and 120° F. 90% relative humidity indicate

that this wire is of great value in r-f circuit use. Especial attention should be paid the power factor expressed in percentage loss and phase-angle figures:—

*At 70° F. 50% Relative Humidity*

Power Factor—0.5 per cent at 25 meters (12 megacycles) completely immersed in mercury.

Phase Angle—18° 7'.

Insulation Resistance—83,000 megohms per foot at 400 volts dc completely immersed in mercury.

Capacity (to ground)—22  $\mu\text{mf}$ , per foot at 25 meters, (12 megacycles).

AC Voltage Breakdown—1600 volts per foot, completely immersed in mercury.

*At 120° F. 90% Relative Humidity*

Power Factor—1% at 25 meters (12 megacycles), completely immersed in mercury.

Capacity (to ground)—28  $\mu\text{mf}$  per foot at 25 meters (12 megacycles).

Moisture Absorption—less than 1% by weight.

Great attention is always paid by engineers to the reduction of losses in the component parts used in the construction of radio receivers. While the losses which may occur in hook-up may not approach in magnitude these other losses, the circuit losses are nevertheless important. Careful attention paid them will result in an easily measurable difference in over-all performance.

## NEW VIBRATION METER RECORDS IN THREE DIMENSIONS



Professor James E. Shrader of Drexel Institute demonstrating his tri-dimensional vibrograph, a portable instrument for whose invention he received a medal from the Franklin Institute

# electronics

McGraw-Hill Publishing Company, Inc.  
330 West 42d Street  
New York City

KEITH HENNEY, *Editor*

DONALD G. FINK, *Associate Editor*

Vol. VIII

—AUGUST 1935—

Number 8

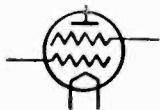

## Dr. Samuel M. Kintner

**T**O FEW engineers in the electronics and radio fields has been given the opportunity of watching over the young industry from its very beginnings in radio signaling, and then presiding over the later developments of the electron tube in large-scale industrial applications.

Dr. Samuel M. Kintner, vice-president of the Westinghouse Electric & Manufacturing Company, has been active in radio and electronics from the very first. A student and early associate of Reginald Fessenden, the brilliant Purdue professor, who saw so clearly the true nature of radio oscillations, Dr. Kintner—then young “Sam”—took a leading part in the Brant Rock experiments, which laid the foundations for commercial space communication. Soon Dr. Kintner, though still embarrassingly youthful, was himself heading large business enterprises in radio, at a time when most of the present radio industry was still wearing short pants.

A second constructive period in the Kintner career came when the Westinghouse company prevailed upon him to head its research and engineering work. Here, applying the insight and faster technical thinking of the radio expert, he was able to point out new possibilities and new solutions for straight electrical problems. Meanwhile, Dr. Kintner has continued to be a staunch enthusiast for electronic methods where economically advantageous.

Upon Dr. Kintner has fallen in large part the mantle of the incomparable H. P. Davis, whose vision created commercial broadcasting and kindled a hundred other revolutionary advances.

Dr. Kintner has a many-sided genius, an unerring grasp of essentials, and a friendly geniality that wins all whom he contacts. His brilliant leadership at East Pittsburgh has added new luster to the great name of Westinghouse.



## Coaxial television cable authorized

**W**ITH completion of the coaxial conductor cable between New York and Philadelphia by the American Telephone & Telegraph Company, authorized by the FCC late in July, television images can be carried between these two large Eastern cities. When television signals are not occupying the tremendously wide channel provided by the cable, as many as 240 telephone messages may be carried simultaneously in one direction, or 2,400 simultaneous telegraph messages can be handled by it.

When application for permission to install the cable was made, Western Union and Postal Telegraph objected; but all obstacles to its construction were removed with the withdrawal of the telegraph carrier objections. As licensed by the FCC the cable must be available to all parties having television images to transmit.

Thus, one more link is forged in the chain which must ultimately tie together the nation's cities into an image-transmitting network.



## European broadcasters quote commercial rates

**B**ROADCASTING is now reaching the international stage. Not only are broadcasts from abroad being featured on American stations, but American-sponsored programs are going out over European transmitters for short-wave consumption here and abroad.

A chain of European stations—“Radiodiffusion Européene”—has also opened offices in Radio City, for the sale of time on the “Chaine Rouge”

and the "Chaine Bleue" in France, Italy and Spain. A 15-minute program, including concert music, on the 60-kw. Radio-Toulouse transmitter on Isle de France, is quoted at \$265, while the 1-kw. Radio-Bordeaux and Radio-Agen stations each cost \$55. The 60-kw. Poste Parisien costs \$365 for 15 minutes. The 6-kw. Radio-Morocco in Northern Africa costs only \$53 per quarter-hour.

Italy's Chaine Rouge, including the 50-kw. Milan, 50-kw. Turin, 20-kw. Genoa, and 10-kw. Trieste, Florence and Bolzano (total 150 kw.), is quoted at \$1,390 per quarter hour. Radio-Rome (50 kw.), Radio Naples (20 kw.) and Radio-Bari (20 kw.), make up the Italian Chaine Bleue, at \$693 for 15 minutes. In each instance above, musical program material is furnished, together with two 30-second announcements.

Radio engineers will want to watch closely these new trends in broadcasting commercial practice, for it is in the business offices that their own bread is buttered.



## Volume expansion—a new agency for realism

**E**NGINEERS at the recent I.R.E. convention in Detroit were treated to a demonstration of circuits which automatically expanded the volume range of broadcast or recorded music. This idea (see *Electronics*, June, 1935) is designed to correct the volume range contraction made necessary at the transmitter by the limits imposed on the broadcast system by noise and by overloading.

Considerable applause greeted this demonstration by RCA Radiotron engineers indicating that a new element in high fidelity reproduction may have made its appearance.

In this connection it is interesting to note that the high-fidelity receiver of the Electrical and Musical Industries, England, selling for approximately \$600 (and selling very well indeed) has such a circuit in it, known as a "contrast expander." Thus it appears that the idea is not only worthy of attention, but that it has been tried commercially and with success. Receivers of the near future may have such circuits as part of their already complex make-up.

## The radio engineer and business

**O**UR front-page editorial under the above title, urging the radio engineer to take business initiative in radio enterprises, as do his fellow engineers in the chemical, mechanical and other industries (where engineer proprietorship is common)—has evoked warm praise from several readers who have themselves had financial responsibility in radio.

"Your editorial in June *Electronics* is about the most sensible advice for the radio engineer I've seen in years," writes one engineer whose investments built on business sagacity, now afford him a life of energetic independence.

"Most radio business organizations today are run by those who know nothing about radio, really. The engineer, who has spent his life in radio, is always in the background—led along by a lot of blind executives. One would think that sound business judgment on the part of the company owners would put engineers at the helm. Or at least would give the radio engineer a standing—in helping to shape policies and make decisions—along with the sales chief and the treasurer. The situation you depict, I have seen over and over again, in my many years in radio."

And so we repeat: Radio will be a better business when radio engineers become more business-minded and, as owner-executives, take their rightful posts at the top!

## FCC VIEWS COAXIAL CONDUCTOR



Appearing before the members of the FCC, Dr. Frank Jewett, president of the Bell Telephone Laboratories, explained the virtues of the new coaxial conductor. Left to right are Frank A. Walker, Irving Stewart and Judge Eugene Sykes of the Commission, and Dr. Jewett



# A REVIEW OF THE ELECTRONIC ART HERE AND ABROAD

## Permeability tuning introduced in I-F transformers

AMONG THE DEVICES which have been developed to minimize frequency shifts in intermediate frequency stages of superheterodyne receivers, are air dielectric trimmer condensers and special forms of coil windings, impregnating, and mounting. The usual mica type trimmer condenser is susceptible to changes in capacitance with changes in moisture and temperature.

A new attack on the problem which was suggested several years ago but which has not appeared in commercial practice until the present is that of permeability tuning. In this system a fixed condenser of good quality and low power factor is used in conjunction with coils whose inductance can be varied by means of changing the permeability of the coil on which they are wound. The change in permeability is accomplished by moving a powdered iron plunger inside the litz-wound inductance coil. The position of the iron core plunger is determined by screws which protrude through the shield can. According to reports this method of tuning the iron transformer results in much

more permanent setting than is possible with the conventional mica type trimmer condenser, and in addition the change in frequency with the change in the setting of the tuning screw is much slower with permeability tuning than with condenser tuning, which makes for accurate adjustment. The additional gain which is possible through the use of iron core coils, adds to the usefulness of this type of construction.

♦

## Receiving aerials

[E. SIEGEL, University of Prague, Czechoslovakia.] It is often stated that a grounded aerial is in resonance when the relation of  $LC\omega^2 = 1$  holds between its inductance  $L$  and capacity  $C$  and pulsation  $\omega = 6.28 f$ . In reality this resonance condition has only a meaning when the length of the antenna is much smaller than the wave-length being received; in the other case both  $L$  and  $C$  depend on the ratio of effective length of aerial to wave-length  $\lambda$  and also on the distribution of  $L$  along the aerial. This is readily seen when the aerial is replaced by an equivalent system consisting of two horizontal conductors of

length  $L = 2h$ , each, with an e.m.f. between them and so spaced that the characteristic or surge impedance is the same as that of the aerial. The surge impedance  $Z$  of a long vertical grounded aerial of height or length  $h$  and radius  $a$  is equal to  $120 (-1.36 + \ln(h\lambda)^{3/2}/a)$ . When  $h$  is smaller than  $\lambda/8$ , the surge impedance is equal to  $120 (-0.3 + \ln h/a)$  and is practically constant. The capacity of the vertical aerial is equal to the ratio  $\lambda \tan 6.28 h/\lambda : 3.14 cZ$ , and independent of  $\lambda$  only when  $h/\lambda$  is very small.

When the aerial possesses a horizontal portion, it is to be considered as an aerial loaded at the top by a condenser. The horizontal length  $L$  with its surge-impedance  $Z$  has the same effect as lengthening the aerial by a piece  $m$ , such that  $Z \tan 6.28 m/\lambda = Z \tan 6.28 L/\lambda$ , the effect depends therefore on the wave-length  $\lambda$ . When the entire length  $h + m$  is much smaller than  $\lambda$ , its capacity becomes equal to  $60(h + m) \frac{2 + L/Z}{\lambda}$  cm. In order to tune the aerial to the wave-length  $\lambda$  by means of a coil  $L_0$  inserted at the intersection of the vertical and the horizontal portion, it is necessary that

$$2\omega L_0 = Z \cotan 6.28 L/\lambda - Z \tan 6.28 h/\lambda$$

When the coil is placed at the foot of the vertical portion, the relation must hold that:

$$2\omega L = Z \cotan 6.28 (h + m)/\lambda$$

These formulas were checked by means of a vertical aerial 19.5 m. high and 0.8 mm. diameter (with  $Z = 800$  ohms) and one or several horizontal portions: 21 m. long (920 resp. 580 ohms).—*H. F. Tech. El. Ak.* 45 (No. 2): 51-61. 1935.

♦

## Wetless

The following letter was received by the editors regarding an announcement made in this column in the January issue. THE EDITOR, ELECTRONICS:

In the January issue of your periodical *Electronics* on page 23, we notice a paragraph reading as follows:

"WETLESS—In Australia they call the dry electrolytic condensers the reversed English term Wetless."

This name has nothing whatever to do with dry electrolytics as we do not make this particular class of condenser, but concentrate on fixed paper and mica condensers.

It might also interest you to know that the name Wetless is registered, and it is derived from the surname of Mr. A. P. J.

## ELECTRONIC RADIUM DETECTOR IN USE AT HOSPITAL

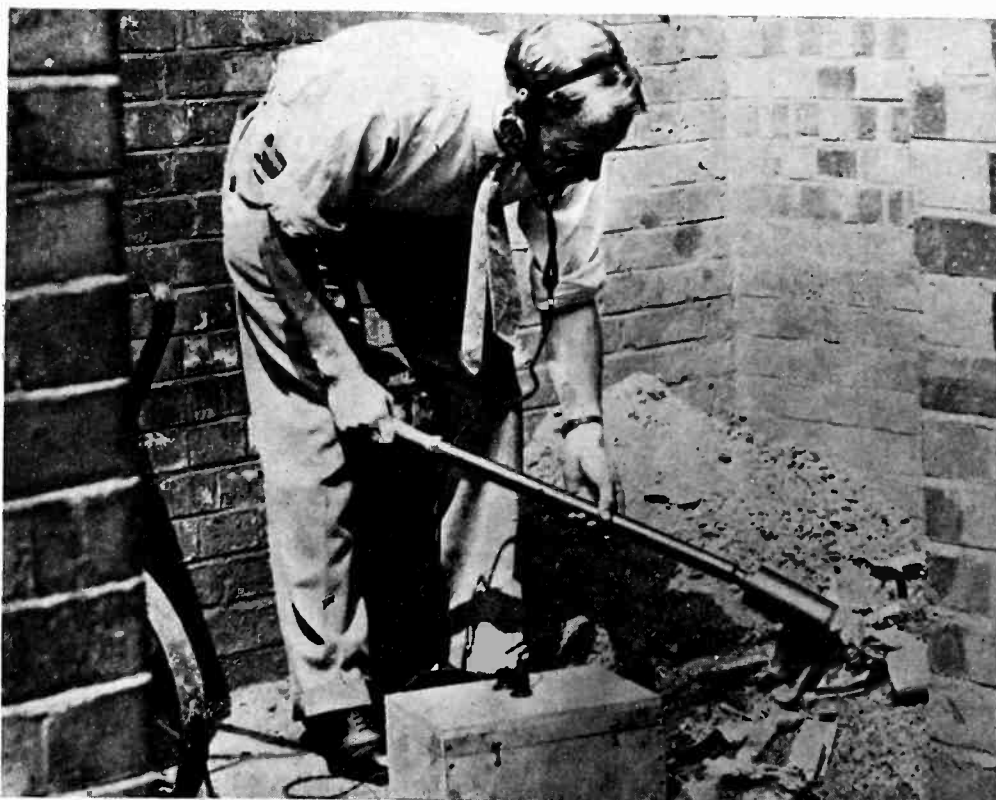

Lost radium, in refuse pile, being detected by radium detector, a development of the National Physics Laboratory in Teddington, England

Wetless who is the founder and managing director of this firm.

Your paragraph was received with great amusement in this country, and we received quite a lot of free advertising from this source, even to the extent of comments from several of our leading radio stations.

WETLESS ELECTRIC MFG. CO., LTD.  
Local papers please copy.

+

## Huge tube near completion

THE RESEARCH staff of the Round Hill Research Station of the Massachusetts Institute of Technology is nearing the end of its work on the huge vacuum discharge tube which will be used for experiments in nuclear bombardments, in conjunction with the 5,000,000 volt d-c generator developed by Robert J. Van de Graaff.

The tube, which is designed to handle large electron currents at several million volts, will consist of five identical units joined end to end and sealed with metal caps to extremities. At one end a source of electrons will be provided and at the other a target which will be bombarded by the electron seam stream. Each section of the tube is a hollow textolite cylinder one foot in diameter and connected for continuous pumping to provide the extremely high vacuum which is necessary for this work.

Focusing shields, which are used to focus the electron beam upon the target are provided inside the entire length of the tube. One of the features of the design are several specially designed resistors which run down inside the tube, connecting the metal shields in series. The leakage current through these resistors provides the proper voltage distribution throughout the length of the tube. Resistors capable of transmitting the required current at the enormously high voltages which will be used were successfully developed after many months of experimentation. The resistors used maintain approximately constant resistance under operating conditions.

During the coming year it is reported that the section of the tube now completed will be used in a series of nuclear disintegration experiments in the lower voltage range, while additional units of the tube, which will permit extension to higher voltage, are under construction.

+

## Measurement of condenser losses at 4000 kc.

[M. BOELLA, Electrotechnical Institute, Italian Navy, Livorno.] In the ordinary substitution method in which the unknown condenser is checked against a variable low loss comparison condenser, the losses of this condenser

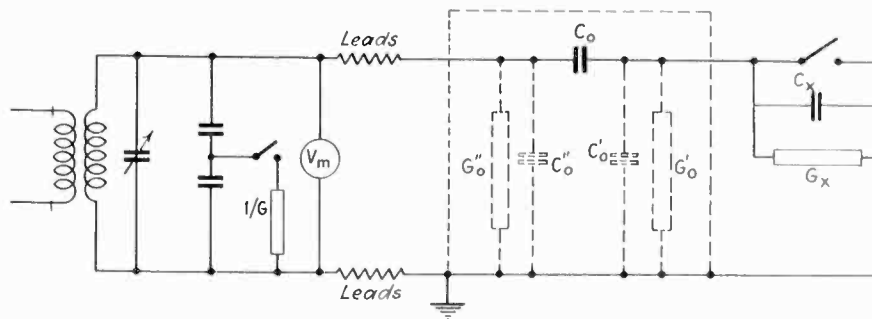

Measuring r-f losses in condensers

must be known at various frequencies. At low radio frequencies the comparison condenser may be considered as forming an ideal condenser in parallel with a resistance which varies with the frequency, but not with the capacitance. At the higher frequencies the losses when this current spreads in the metallic parts can no longer be neglected; they are conveniently represented by a resistance in series with the condenser and depending upon the relative position of rotor and stator. To become independent of the series resistance it is advisable to use as the comparison condenser two disks placed face to face at a distance which can be varied with great accuracy; the series resistance  $R_o$  or  $1/G_o$  remains constant while  $R_c$  is the resistance of the connecting wires and  $G_p$  represents the loss in the insulating material. The circuit is adjusted for resonance first with the unknown condenser  $C_x$  switched in (reading  $C_1$ ) and then without it, changing  $C_1$  to  $C_2$  and switching in  $G$ . The conductivity  $G_x$  is then equal to

$$G_x = G \left( \frac{C_x}{C_2} \right)^2 + G_o \left( 1 + 2 \frac{C_x}{C_1} \right)$$

The correction term with  $G_o$  assumes

large values when  $C_x/C_1$  is high. In order to get rid of the uncertainty caused by  $G_o$ , the two disks of the standard condenser are mounted upon two separate pieces of insulating materials fastened to an earthed metal gauze; the two halves then represent two resistances  $1/G_o'$  and  $1/G_o''$  and two capacitances to ground. The values of  $C_o'$ ,  $C_o$  and  $C_o''$  can be determined by the method used for measuring capacities between electrodes in a vacuum tube, for the condenser used (disks of 10 cm. diameter)  $C_o' = 4.8 \mu f$ ,  $C_o = 20$  to  $80 \mu f$ ,  $C_o'' = 13 \mu f$ .

Measurements at 4,200 kc. showed that the losses in the metal parts are not negligible and may even be larger than the losses in the insulating supports, expressed by the loss angle.—*Alta Frequenza* 4 (No. 1): 5-19, 1935.

+

## Measuring radio interference

[P. DAVID, Chief Engineer, National Radio Laboratory; M. DICK, Testing Laboratory, Society of El. Eng. Switzerland.] Two entirely different methods of evaluating the trouble produced by artificial static are used in Europe.

## PHOTOCELL WATCHES WEIGHING-SCALE DIALS

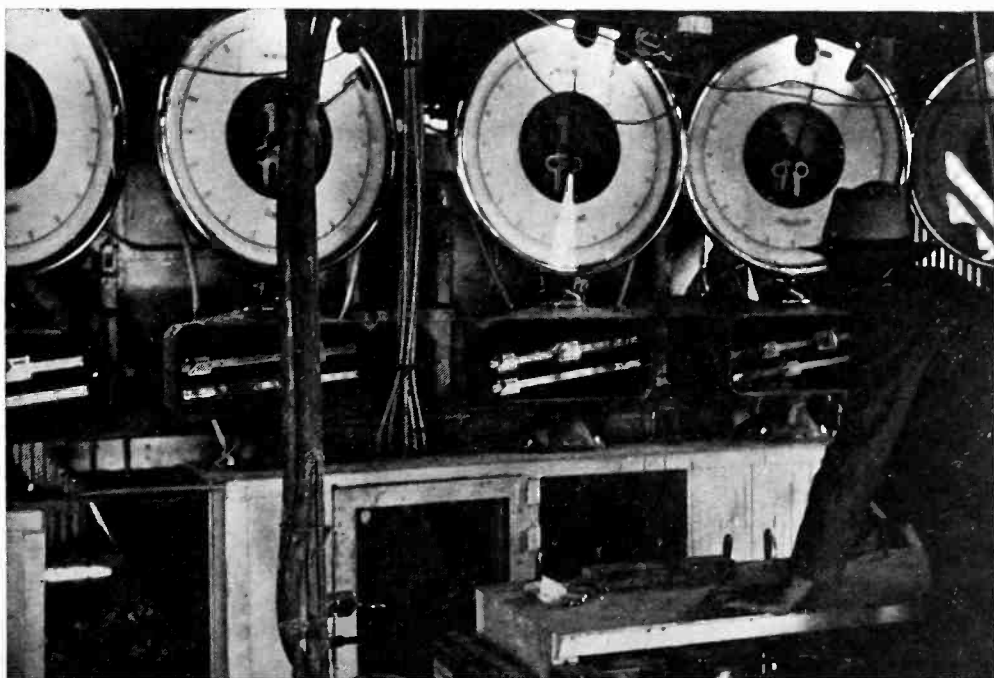

By means of automatic weighing of sand and gravel in a Colorado River concrete plant, accomplished by infra-red ray photocells, the correct mixture of sand, gravel, and cement is maintained without human aid

In France, for instance, the disturbance caused by a noisy appliance is studied by means of a battery-operated standard receiver. While a loop aerial might have certain advantages, a dipole is used, consisting of two vertical rods 1 m. long and serving as aerial and counterpoise. Experiments have shown that when a coil is connected over .007  $\mu$ f. condensers to the binding posts of the dipole on the set, an e.m.f. in the coil has the same effect as the same field strength per m. acting upon the standard receiver. The set is calibrated in this manner. Any completely screened normal battery set can be used as standard provided that its selectivity is comprised between the following limits: 5 kc from the carrier the attenuation of the signal shall be between 15 and 35 db, 10 kc from the carrier between 30 and 60 db, 20 kc from resonance between 40 and 70 db and at  $\pm$  30 kc between 70 and 90 db. Detection should be linear over the entire range covered by the signal and the static (about 26 db). After having passed through a filter-circuit which has the same relative sensitivity as the ear the current produced in the output tube is measured, in the absence of any carrier wave, by means of a milliammeter with a time constant of 0.2 sec. Reception is said to be disturbed if noises make themselves felt when the field strength is 1 millivolt per meter. This intensity corresponds to the field strength produced during the day in southern France by Radio Paris (1,648 m.). Any source producing more than 1/20 of the deflection obtained in the receiver by a 1 millivolt signal modulated at 800 cycles per sec. at 30% is considered as intolerable (26 db). Drawbacks of this method are that the disturbance produced by the loudspeaker is not taken into account and that irregular noises of short duration are hard to measure.

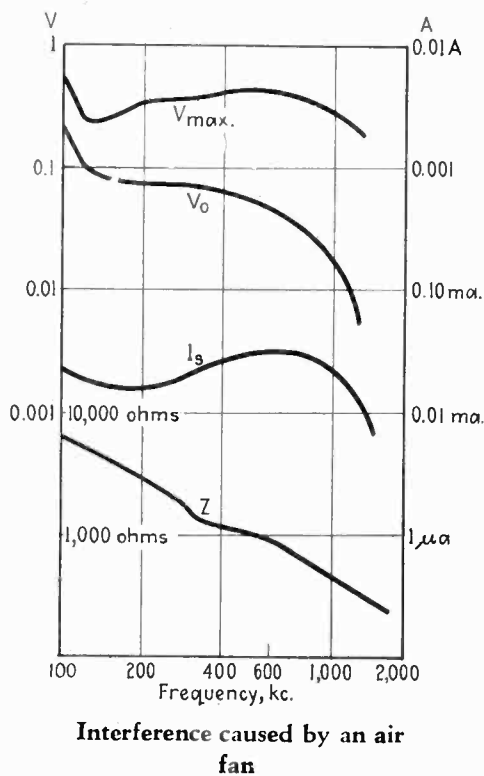

Engineers in Germany and Switzerland measure the noise at the source. Any source of artificial static is treated as a generator of radio waves, sending out its waves by way of the transmission lines. The extent of its disturbance is measured by the open circuit r-f voltage measured at its terminals, its short circuit r-f current, and its highest or resonant voltage. The open circuit voltage can be measured by connecting a high resistance r-f meter to the terminals, the voltage at resonance by adding capacity or induction to the circuit until resonance is obtained; this reading yields at the same time the internal non-ohmic resistance of the source. For ordinary work a less direct method is used. The three characteristic values vary, of course, with the frequency, and give a frequency spectrum. It is sufficient to establish the frequency characteristics for bands nine kc wide by means of instruments giving a uniform response over this band-width. In practice audio frequency voltages and currents are produced and measured, by using a local oscillator tuned to the center of the band which is being studied. Provided that the voltage of this search frequency is at least ten times higher than the high frequency noise voltage the audio frequency readings are independent of the voltage of the search tone and proportional to the voltage of the disturbance. While within a band this beat frequency instrument is made to respond in the same relative manner as the ear, it is calibrated with a single audio frequency so that the actual readings are a little above the correct value.

For measurements with the search frequency, the noisy appliance is connected to the input filter or anti-resonant circuit which allows to tune to the frequency to be measured (open circuit), or to establish short circuit conditions by shunting with a large condenser, or to tune to the natural frequency of the source. The filter is followed by an attenuator for the ratio 1:10,000,000, the mixing stage, r.f. amplifier, rectifier, band-filter, a.f. stage and vacuum tube voltmeter serving as noise meter (gerausch wert zeiger). Since the source may produce r-f voltages not only between the terminals, but also between the terminals and the frame of the appliance, a switch is provided for inserting a large condenser between the terminals. The method, slightly modified, is also applicable to the study of high tension insulators which cause static. The instrument is connected between the earth and the support of the insulator, a high tension condenser between the ground and the tie-wire completing the r-f circuit. The r-f short circuit current can be measured as usual, the values of the open-circuit voltage and the resonant voltage are less accurate than in other cases since the small capacity of the insulator between tie-wire and support represents practi-

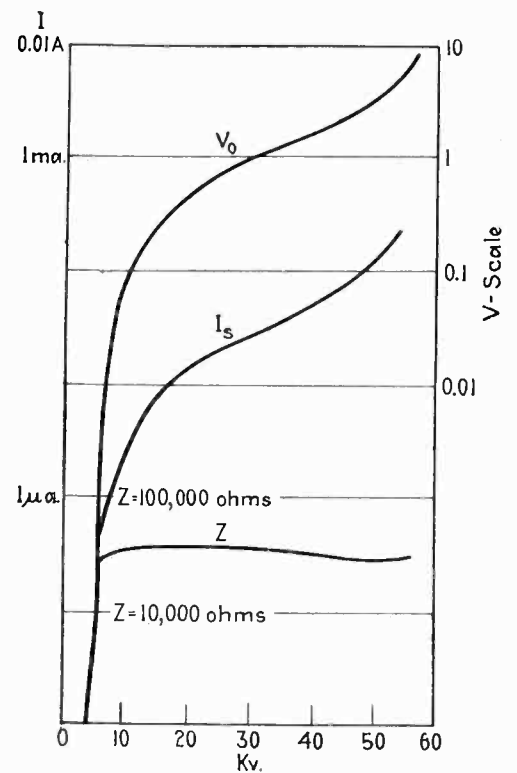

Static caused by a high tension insulator (600 kc.)

cally the entire internal resistance of the source.

A new portable instrument of this type is described by A. Dennhardt and E. H. Himmler in *El. Nachr. Tech.* 12 No. 2: 55-60. 1935.

An international comparison of the two methods is to take place in Berlin. —*Onde él.* 14 No. 159: 140-151. No. 160: 216-220. 1935. *Bulletin Ass. Suisse El.* 26 No. 8: 192-196. 1935.

+

## French conduct contest to find substitute for "Television"

The new Paris television station has been christened of "Poste nationale de Radiotélévision." Despite the fact that this name does not sound as bad as some French papers make their readers believe, the new French Postmaster General Monsieur George Mandel, being a man with sense of humor, agreed to the suggested contest to find a more fitting name than the word "télévision."

Some thousand letters have been flowing for weeks into the office of the Postmaster General. Among some names absolutely impossible there have been some quite acceptable ones. The most featured names have been "Téléorama, Téléoptique, Téléthéâtre, Radiooptique, Radiorama, Radiothéâtre." No decision as to the name to be used has been made, first because the "Academy Française," which is the acknowledged leader in all matter of language, has to be asked, and because the French Post Office makes not a bad business if the contest continues a few months more.

# + NEW PRODUCTS

## THE MANUFACTURERS OFFER

### Molded-case paper condensers

IN ASSEMBLIES where high-voltage insulation and a minimum of metal are desirable, Aerovox molded case paper condensers are proving popular. These units, available in 200, 400, 600 and 1,000 volt ratings, and capacities of .05 to 1. mfd., are especially applicable to radio and audio frequency by-passing

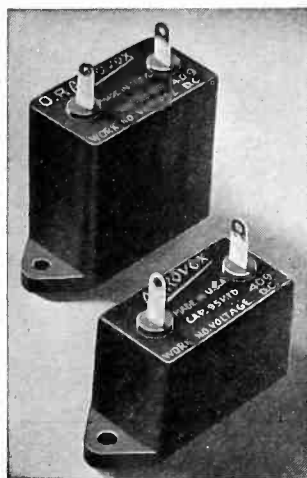

in resistance or impedance coupled amplifiers, and for any other purpose where a compact, high insulation resistance, non-inductive condenser is required. The molded case prevents leakage between terminals and makes for neatness in any assembly. It also means a minimum of metal in a high-frequency electro-magnetic field. These units are made by Aerovox Corporation, 70 Washington Street, Brooklyn, New York.—*Electronics*.

### Condenser catalog

THE SOLAR Manufacturing Corporation, 599-601 Broadway, New York City, manufacturers of fixed capacitors for radio use, announce the issuance of their latest Special Service Catalog No. 6-S.

Features of special interest to the service trade include Ultra-Compact Dry Electrolytics in various voltage ratings, Special Self-Healing Type Wet Electrolytic Condensers, Auto Vibrator and Suppressor Condensers, together with a wide assortment of Paper, Trimmer and Padding Condensers.

These catalogs may be secured direct from the Solar Manufacturing Corporation's New York City address.—*Electronics*.

### New shielded bridge

A NEW SHIELDED bridge assembly for precise yet rapid measurements of power factor of dielectrics up to 50 KC, and offering a number of important new advantages is announced by Leeds & Northrup Company, 4911 Stenton Avenue, Philadelphia, Pennsylvania.

This bridge is used for measuring phase angle of small (A.S.T.M.) samples of insulating oil, ceramics and other dielectrics; for calibrating other instruments; for studying specific inductive capacity. Measurements are reproducible to within a few parts per million; settings are constant to within limits imposed by changes in ambient temperature, humidity, etc.

The assembly consists of a Campbell-Shackelton Shielded Ratio Box and other a-c. instruments recently developed by the Leeds & Northrup Company. Method of assembly and shielding of leads represent a new technique which is an important contribution to the usefulness of these types of instruments. Easily used by anyone accustomed to precision instruments. The limit of error in capacitance measurements is 1  $\mu$ f.—*Electronics*.

### New universal oscillograph

A NEW INEXPENSIVE oscillograph with a variety of control panels, which are easily interchangeable so that the oscillograph will exactly fit field or industrial and laboratory investigations and a wide selection of galvanometers for producing up to eight records, is announced by the Westinghouse Electric & Manufacturing Company. Among other features 1) the new Type PA Universal Oscillograph offers simultaneous viewing, the phenomena can be viewed while photographing, 2) daylight loading holder which can use 5, 10, or 200 ft. of 5-in. wide film or paper, and arranged so exposed portion can be cut off at any time desired without disturbing supply, 3) wide range of film speed by variable speed motor, 4) interchangeable galvanometers and vibrators and 5) automatic type  $\frac{1}{2}$  cycle starting time. The complete oscillograph with controls exclusive of film-holder measures 25 in. long x 8 $\frac{1}{2}$  in. wide x 9 $\frac{1}{2}$  in. high and weighs approximately 50 lb.

The main case has an upper dust tight optical compartment and the simultaneous viewing is built in so that it

does not interfere in any way with photographing. The viewing screen consists of a hooded 5-in. square screen. The control panels are mounted in a compartment below the optical compartment and are easily removable. The industrial and laboratory types are supplied for either 6 volts D.C. or 110 volts A.C. or D.C.—*Electronics*.

### 230-volt variacs

TWO NEW MODELS of the popular variac auto transformer for use providing a continuous variable voltage of 115 volt

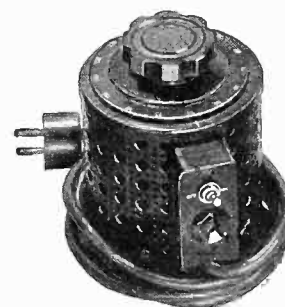

a.c. circuit are announced by the General Radio Company, 30 State Street, Cambridge, Massachusetts. They are intended for use on 230-volt input circuits and deliver output voltages continuously adjustable from 0 to 270 volts, or to provide output voltages from 0 to 230 volts with slightly higher wattage ratings, on 115-volt circuits to deliver output voltages from 0 to 270. Dial readings indicate the output voltages with an accuracy of plus or minus 2%. Type 200-CMH variac mounted model lists at \$21.50 and weighs 10 lb., while type CUH unmounted and intended for behind panel mounting lists at \$18.50 and weighs 9 lb.—*Electronics*.

### Pre-amplifier for ribbon microphones

QUIET NATURALNESS, ruggedness, disregard for weather conditions, and low feedback, are reasons given for the velocity microphone's gain in popularity. A battery-operated pre-amplifier for the velocity microphone is quite simple to build. Changing over to a-c operation, however, brought in the problem of hum elimination. Without considerable experience, it is quite difficult to build a humless a-c pre-amplifier. For this reason the Amperite Corpora-



tion, 561 Broadway, New York City, is giving velocity-microphone users the benefit of the work done during the past two years on a-c pre-amplifiers in the Amperite laboratories. Its new pre-amplifier model APP has a hum level of -100 db., which is far below audibility. Its gain of 63 db. brings the velocity up to a level of -10 db. An actual measured frequency response test showed it to cover frequencies of 40 to 10,000 cycle per second ( $\pm 1$  db.). Two 6C6 and one 80 rectifier tubes are used.—*Electronics*.

### High-fidelity amplifier

THE PACENT ENGINEERING CORPORATION, of 79 Madison Avenue, New York City, announces a new high-gain high-fidelity amplifier. Although designed primarily for theatre use, it is suitable for public-address work and other special applications.

The overall dimensions are 20 inches long, 17 inches high and 6 inches deep. Shielding is complete, the layout systematic, and construction is of the unit type, with condensers and resistors grouped in units in separate shield cans and sealed with wax. Wiring is cabled and covered with black varnished cambric tubing. The amplifier will operate continuously in an ambient atmosphere of 120 degrees and a humidity of 98%. Auditorium resonance or other low frequency difficulties may be reduced by opening several links in the circuit designed to reduce the bass response. Fader or volume control, range control (which adjusts both the high and low frequency response), magnetic pickup switch, line switch and pilot light are all located conveniently on the front panel. Five standard tubes are used, and total output of amplifier is 23 watts, although manufacturer claims only 10 watts undistorted. The gain is 108 db., sufficient to operate directly from photo cell or standard microphone. When operated with its associated speaker system, the overall response is said to be flat from 40 to 10,000 cycles.—*Electronics*.

### Suppressor catalog

THE ERIE RESISTOR CORPORATION has recently issued a four page bulletin describing the complete line of Erie Suppressors for eliminating high tension ignition interference on radio equipped automobiles.

It includes technical data on the electrical characteristics of these units and discusses the results of recent research which shows conclusively a definite relationship between voltage coefficient and suppression efficiency.

Copies of this bulletin may be secured by writing the Erie Resistor Corp., Erie, Pa.—*Electronics*.

### Air-operated electric spot welders

ELECTRIC SPOT WELDERS which utilize air pressure for closing the electrodes upon the work have recently been developed by Charles Eisler of the Eisler Engineering Co., 768 So. 13th St., Newark, N. J. These air-operated types are the latest addition to the line of foot-operated and motor-driven welders manufactured by the above company.

Available in sizes from five to seventy-five K.V.A. and capable of welding metals up to .750 in. in thickness, these new air operated welders because of the particular design of the air

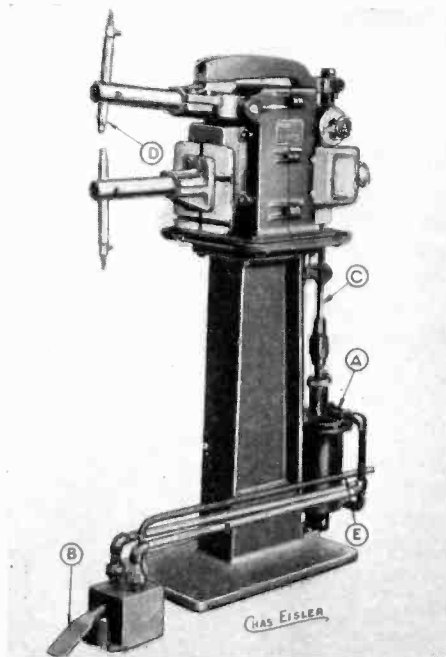

cylinder, require a very small volume of air for their efficient and economical operation. Air pressures up to 80 pounds are used; the pressure depending upon the size of welder used.

The use of air operated welders not only relieves the operator of supplying the force to bring the electrodes together, but permits, by means of a regulating valve in the supply line, exact regulation of electrode pressure upon the work, an essential factor for the production of uniform welds.—*Electronics*.

### Aviation receiver

ENGINEERS of Bell Telephone Laboratories have perfected a tiny "double duty" receiver measuring about 7½ inches each way and weighing 11 pounds with tubes and mounting, which can tune in equally well on the weather beacon band of 200 to 400 kilocycles and the commercial broadcast band of 550 to 1,500 kilocycles.

The set is a superheterodyne using only three tubes. Its sensitivity is such that it requires only a short antenna, suitable to the small scale of private planes. Though greatly reduced in size,

the receiver embodies the same principles of construction and operation incorporated in Western Electric radio systems standard on all large transport planes.

The set operates with earphones, making it suitable for the open cockpit as well as the cabin plane. It is capable of more than ½ watt output, enough to supply several extra sets of earphones. The earphones may be of either the high or low impedance type.—*Electronics*.

### Supersensitive mercury relay

THE AMINCO SUPERSENSITIVE MERCURY RELAY, which is designed for use with mercury thermoregulators and other devices with delicate contacts, has been improved by redesign of the supersensitive element. A flexure plate has been substituted for the armature pivot; and the improved relay can be changed from "normally open" to "normally closed" by merely exchanging the position of two screws. The characteristics of the improved relay are as follows:

Operating current: 0.007 ampere, at 6 volts d-c.

Contacts: mercury tube, rated at 10 amperes at 115 volts a-c.

Dimensions: Diameter of base, 5½ in.; height, 4¾ in.

The relay is made by the American Instrument Company, Inc., 774-776 Girard Street, N. W., Washington, D. C.—*Electronics*.

### Color-matcher

THE M-R-H Laboratories, Dowagiac, Michigan, announce a new "colorimeter," a scientifically designed instrument which accurately matches or compares colors, registering variations indiscernible to the human eye. With this device it is possible to match shades beyond commercial requirements. The instrument is light and compact, completely encased in Bakelite, and operates from any 110 volt light socket. Color comparisons are made very simply—the instrument is placed over the surface of the standard color, the switch is turned on, and readings are taken. The same process is repeated with the color which is to match the original.—*Electronics*.

### Cathode ray oscillograph

A CATHODE RAY oscillograph which sells for \$84.50 complete with tubes has been announced by the RCA Parts Division of the RCA Manufacturing Company, Inc., Camden, New Jersey. This oscillograph known as type TMV-122-B contains two power supplies, one for the

cathode ray tube and one for the amplifier, separate amplifiers for vertical and horizontal displacement, and a saw-tooth frequency generator.

The sensitivity of the overall system is 2 volts d.c. per inch for either vertical or horizontal deflection. The amplifiers have flat frequency characteristics between 20 and 90,000 cycles per second within 10 per cent. The instrument comes mounted in a convenient carrying case which weighs 35 lb. complete. A special control is provided on the front panel for focusing the beam, and screw driver adjustments are provided in the rear for centering the beam both vertically and horizontally. Suggested uses for the oscillograph include radio set service, manufacturing control, laboratory use, and amateur and experimental radio transmission monitoring.—*Electronics*.

♦

### Coil protectors

A NEW MAGNET and coil protector put on the market by Littelfuse Laboratories, 1772 Wilson Ave., Chicago, makes use of neon Tattelites (potential fuses)—which are electronic in principle.

The new magnet-protector Tattelite is designed to prevent insulation break-



downs in direct-current magnets, solenoids, shunt and compound-wound motors, and generators, coils, etc., due to high-voltage self-induced surges, which occur when the circuit is suddenly opened. Even in 110-volt service, 10,000 volt surges are not uncommon.

The protector is connected directly across the equipment to be protected. Its characteristics are such that no current flows until the voltage reaches a dangerous value; it then suddenly conducts and shunts out the surge.—*Electronics*.

♦

### New copper alloy

THE METALLURGICAL engineering department of P. R. Mallory & Co., Inc., of Indianapolis, Indiana, has developed in "Mallory 3 Metal" a material of high electrical conductivity, great mechanical strength and greatly diversified application.

Mallory 3 Metal is an alloy consist-

ing predominantly of copper and is the equal of copper in coefficient of resistivity, coefficient of expansion, modulus of elasticity and corrosion resistance. The electrical conductivity of Mallory 3 Metal forgings and rods is rated at 80 to 85% that of copper or better. Sand castings of the Mallory 3 Metal have an electrical conductivity of 75 to 85% that of forged copper.

Mallory 3 Metal may be substituted, with few exceptions, for brass, copper, bronze, or even structural steel. It has already been used extensively for spot welding tips, flash welding dies and seam welding wheels. It can also be used as scoreless commutator segments in motors and generators, overhead wire for electrical railways, telephone and telegraph service as its great strength will resist breakage from sleet and wind. Its high heat conductivity will permit its use under heat conditions where copper softens, such as welding wheels and tips, and hot water heating coils.—*Electronics*.

♦

### Non-directional microphone

A NEW MICROPHONE of the Western Electric Company saw public light for the first time at the NAB convention, Colorado Springs, July 6th. This non-directional, stream-lined unit is a product of the Bell Laboratories; it is useful over the audible range of 40 to 10,000 cycles; it is of the dynamic or moving coil type; and it is of exceptional small size. Actually it is 2½ inches in diameter. It can be mounted on a table, on a floor pedestal, or in suspension mounting. It is for sale through the Graybar Electric company in the United States, through Northern Electric in Canada and through International Standard Electric Company abroad.—*Electronics*.

♦

### Low resistance carbon resistors

A NEW LINE of resistors has been developed and put on the market by the Ohio Carbon Company, Lakewood, Ohio. These units come as low as 0.04 ohms in power ratings from one-quarter to 10 watts. They are known as the type LV and conform to the same standards of load, voltage, life, overload and humidity characteristics already set by the Company's regular line of Ohmhm carbon resistors of higher ohmic values. Laboratory tests show that these "LV" units will react satisfactorily under humidity conditions much more severe than those specified in the R.M.A. tests.

Special attention has always been given to this "heat-humidity" condition



for tropical conditions where the moisture and heat of the rainy season are exceptionally severe.

The closeness of the approximation of carbon to pure non-inductivity is generally recognized, and it is expected that the unusual stability of these "LV" units under variations of climatic conditions will fill a decided need.—*Electronics*.

♦

### High resistance, carbonized units

RESISTOR VALUES from 100 ohms to 100 megohms of high precision; long life; small dimensions; noise-free; non-reactive are available from Morrill and Morrill, 30 Church street, New York. These resistors have been available for some time but the virtues of the very high resistance values are worth noting. They are useful in phototube circuits, in electron tube amplifiers, and in other places where freedom from noise, and freedom from change while in use is desirable. Special units widely used for meter multipliers are available in tolerances of plus or minus 1 per cent.—*Electronics*.

♦

### Resistance manual

THE NEWEST booklet of the Wilbur B. Driver Company is one of interest to engineers. The booklet contains a number of temperature resistance charts, and tables illustrating the characteristics of the different types of "Tophet" wire. Copies may be had by writing to the main office of the Driver organization at Riverside Avenue, Newark, New Jersey.—*Electronics*.

♦

### Non-inductive, oil-filled condensers

FOR USE in portable and aircraft receivers, transceivers and transmitters and in high fidelity amplifiers, Cornell-Dubilier Corporation of 4377 Bronx Blvd., New York City, has announced a line of 1000-volt (d.c.) condensers which are 2 inches high and 1 inch square. They are available in capacities from 0.05 to 0.5 mfd.—*Electronics*.

# U. S. PATENTS IN THE FIELD OF ELECTRONICS

## Electron tubes and apparatus

**Cathode ray system.** A scanning system comprising a rectangular screen at an angle to the axis of the electron gun and magnetic pole pieces arranged to cause the electron ray to scan a key-stone area over a plane perpendicular to the axis. A. V. Bedford, R.C.A. No. 2,004,099.

**Modulated oscillator.** A grid blocking type of oscillator, the anode circuit of which is a variable impedance which automatically increases in absolute value with increase in frequency causing step-by-step increase in the total anode impedance which in turn reacts on the grid circuit to effect a corresponding control of the grid blocking action. Ralph Cole, Oceanport, N. J. No. 2,004,101.

**Light amplifier.** An envelope divided into two chambers, one being a high vacuum and the other a gas filled chamber, an electron permeable partition separating the chambers. A photoelectric element positioned in the chamber is subjected to a high vacuum, and a voltage source for producing flow of electrons from the high vacuum to the gas filled chamber where ionization occurs, producing a magnified effect of the light initiating the photoelectron stream. Otto Schriever, Telefunken. No. 2,004,177. See also No. 2,004,176, Fritz Schröter and Otto Schriever.

**Direct coupled amplifier.** An envelope containing triodes, the grid element of one being connected to the electron emission element of another. Fred B. MacLaren, Revelation Patents Holding Co. 26 claims. Application date Dec. 16, 1929. No. 2,002,207.

**Tube tester.** An assembly of sockets, method of supplying adjustable voltage to the filament terminals, network to supply several testing voltages, etc. J. R. Williams, Apparatus Design Co., Little Rock, Ark. No. 2,002,425.

**Tube tester.** Method of changing the plate potential and showing the difference in plate current as a means of indicating the condition of the tube. R. L. Triplett, Bluffton, Ohio. No. 2,001,945.

**Cathode ray tube.** A means of producing a concentrated electron ray pencil. Fritz Michelssen and Johann Richter, Telefunken. No. 2,003,301.

**A-c generator.** Ion valves for producing a-c comprising a cathode, several working anodes, control grids, etc. K. E. Eriksson and Uno Lamm, Sweden. No. 2,005,458.

**Secondary emission tube.** A photoelectric device comprising a primary cathode to emit electrons when subjected to illumination and a secondary cathode to emit secondary electrons when electrons from the primary cathode impinge thereon. W. F. Tedham, E&MI, Ltd. No. 2,005,059.

**Secondary emission tube.** In a vacuum tube circuit having a control electrode capable of emitting secondary electrons, an anode and means for applying a positive biasing potential to the

electrode such that the rate of change of current to it and the rate of change of secondary current drawn from it with changes of potential are substantially equal. F. E. Terman, Stanford University. No. 2,000,304. See also No. 2,000,673 to F. E. Terman, Wired Radio, Inc., on a voltage reducing electron tube.

**Phototube.** A tube with several collecting electrodes maintained at independent potentials. T. H. Long, W.E.&M. Co. No. 2,000,705.

**Light sensitive tube.** Process of manufacturing a carrier provided with a light-sensitive metal salt, comprising the steps of providing the carrier with a layer of an agglutinant and depositing the light-sensitive metal salt from its vapor phase on said agglutinant layer. J. H. de Boer and C. J. Dippel, Philips. No. 1,999,088.

## Radio circuits

**Oscillator circuits, etc.** Several patents to P. O. Farnham, R.C.A., on an oscillator circuit, automatic volume

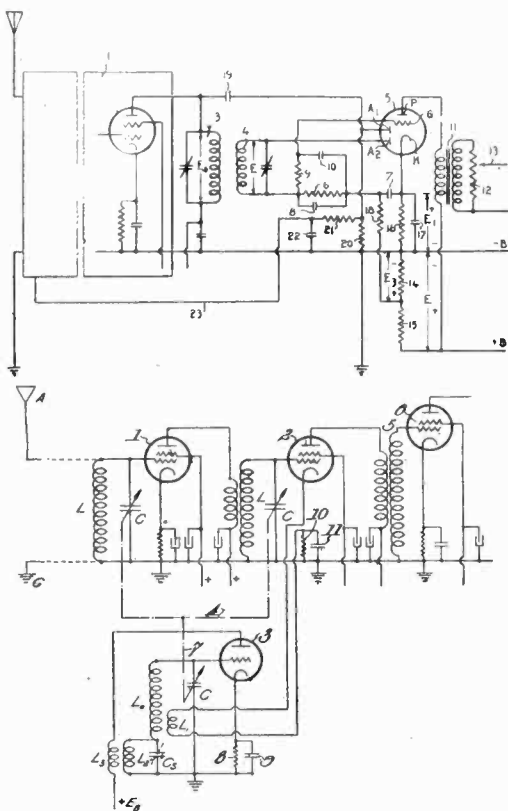

control, etc. No. 2,001,413; 2,001,694; 2,001,695; 2,003,110.

**Directional system.** Three-dimensional radio direction finder. J. W. Greig, Detroit, Mich. No. 2,003,932 and 2,003,933.

**Antenna system.** No. 2,002,197 to Norman Wells, R.C.A.

**Directional receiving system.** B. J. Chromy, Hopkins, Minn. No. 2,002,430.

**Directional receiver.** Walter Kühlewind, Telefunken. No. 2,003,372.

**Position controlling device.** A volume preventing overshooting of the re-level recorder comprising apparatus for corder. E. C. Wentz, B.T.L., Inc. No. 2,003,913.

**Antenna system.** Adapted to radiate chiefly in the direction of its length, comprising a straight, linear, vertical aerial having an electrical length approximately equal to an even multiple of a half wave, and loaded uniformly at substantially regular intervals throughout its length with capacities arranged at right angles to the length of the aerial, with at least eight capacities per wave length. H. J. Round, R.C.A. No. 2,005,805.

**Centralized radio.** Selector system to enable one of several subscribers to pick up one of several programs. B. E. Moritz, Jr., K.G.M. Radio Corp., Denver. No. 2,006,077.

**Multiplex system.** Frequency multipliers, a master time period device, beating oscillator, etc. G. A. Mathieu and O. S. Puckle, R.C.A. No. 2,005,795.

**Oscillation generator.** A tube with an elongated anode several half wave lengths long at the operating frequency sectionalized into elongated sections, the sections of the anode being relatively close to increase mutual inductance and means for producing standing waves on said elongated sections out of phase with respect to each other. N. E. Lindenblad, R.C.A. No. 2,005,793.

**Multiplex receiver.** In a communication system, the combination with a Wheatstone bridge having four branches of an input circuit conductively connected in parallel with one of the branches, this input circuit changing the effective impedance of the one branch and the output circuit is connected effectively to the diagonal of the bridge. R. E. Mathes, R.C.A. Reissue No. 19,626.

## Amplification, detection, etc.

**Filter.** Piezo electric bandpass arrangement. C. W. Hansell, R.C.A. No. 2,001,387, 2,005,083 and 2,005,084.

**Radio time control.** Power supply system and means for automatically tuning receiver to a particular station at a particular time. A. M. Nicholson, Communication Patents, Inc. No. 2,005,158.

**Output measuring device.** In a radio testing system for measuring the audio frequency energy in the output circuit, a meter of high sensitivity, combined with a rectifier. Floyd Fausett, Supreme Instruments Corp. No. 2,005,138.

**Magnetic testing.** Primary and secondary coils and filtering means in the circuit of the secondary coil for intercepting the fundamental component of current in the secondary and a separate filter to pass only a single selected harmonic component of the secondary current. Sigfrid Specht, Ferrous Magnetic Corp. No. 2,005,011.

**Oscillation generator.** Regenerative oscillation generator circuit of high internal resistance with a tuned circuit between anode and screen grid. Herbert Muth and Wilhelm Runge, Telefunken, Germany. No. 2,004,171.

**Phase modulating circuit.** For effecting modulation of this type on a transmitting carrier. J. Osawa, Tokyo, Japan. No. 2,001,107.

**Pretuning.** Method of automatically tuning several stages of a t-r-f type of receiver. H. M. Lewis, R.C.A. No. 2,001,146.

**Interstage coupling.** A transformer with a resistance in series with the primary winding, the resistance having a value equal to the surge impedance of the primary winding regarded as a transmission line, the secondary of the transformer being resonant at a relatively short natural wave length, the transformer as a whole passing all frequencies below a certain frequency at which the primary winding has an electrical length of one wave length. Klaas Posthumus, R.C.A. No. 2,002,187.

**Power supply circuit.** Use of a double anode cathode tube, the anodes connected in a parallel, and each cathode

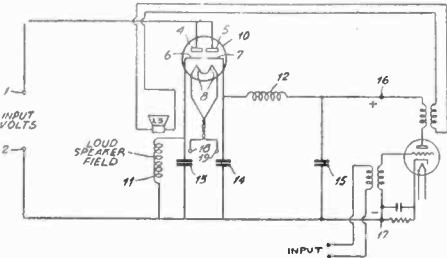

supplying a separate load circuit, for example, the loud speaker on one cathode and the amplifier tube on another. F. H. Engel, R.C.A. No. 2,002,343.

**One tube radioreceiver.** Use of a pentode-triode tube in a regenerative

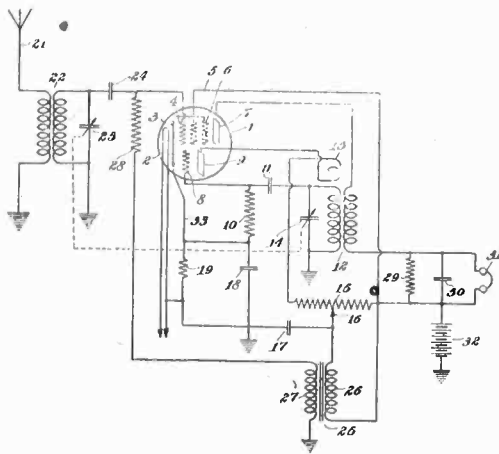

t-r-f set. W. R. Koch, R.C.A. No. 2,005,789.

**Frequency multiplier.** A tube arranged for ultra high frequency operation. C. W. Hansell, R.C.A. No. 2,005,782.

**Heterodyne receiver.** Circuit for getting rid of undesired signal image frequencies. H. Chireix, Paris, France. No. 2,005,772.

**Directive aerial.** Short wave antenna system comprising a vertical antenna and a horizontal conductor unsymmetrically coupled thereto. Albrecht Gothe, Telefunken, Berlin. No. 2,005,779.

**A-c supply.** Circuit showing a heater type of tube in which a resistance element (heater) is fed from the secondary of an a-c transformer, the center of which goes to the cathode. Application date June 1, 1926, 10 claims. E. L. Koch, Kellogg Switchboard & Supply Co. No. 2,007,764.

**Feedback arrangement.** A negative feedback amplifier of the type recently described by Bell Laboratories engineers in Electrical Engineering. H. S. Black, B.T.L., Inc. No. 2,007,172.

**Cascade amplifier.** Amplifier of three or more stages comprising two anode current sources independent of each

other, the anode of the odd stages connected to one source of supply while the anodes of the even stages are connected to the second source of supply. M. von Ardenne, D. S. Loewe, Berlin. No. 2,007,624.

**Frequency meter.** An independent source of periodic current, a synchronous motor, means for supplying the losses of the motor including an amplifier controlled by cooperation with a movable element on the synchronous motor and

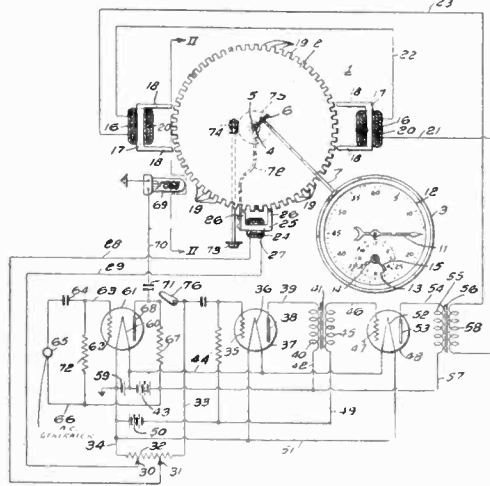

by the independent source of periodic current whereby the motor may be operated in synchronism with the frequency of the source without drawing substantial power from it. L. J. Wolf, WE&M Co. No. 2,006,935.

**Series oscillator.** Method of connecting several oscillators in series with each other and with the power supply circuit. A. Nyman, R.C.A. No. 2,006,872.

**Multi-grid amplifier.** A four-grid tube connected in a conventional circuit except that the output of the diode detector is impressed on a grid situated

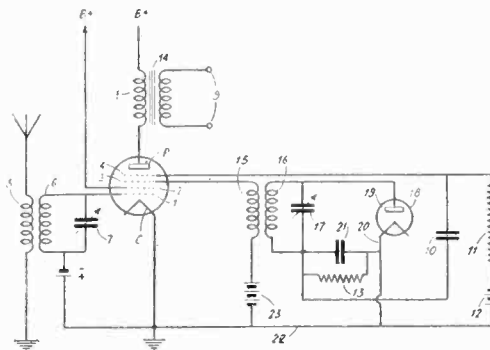

next to the anode. Karl Steimel and E. Klotz, Telefunken, Berlin. No. 2,006,969.

**Modulation system.** Variable condenser is rotated by a motor. There are two sets of stator plates, one connected to an inductance and the other to a capacity, which are then connected to a

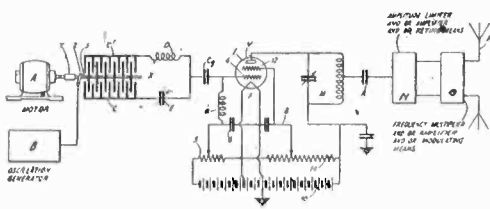

control grid of the circuit to be modulated. G. L. Usselman, R.C.A. No. 2,007,099.

**Frequency division.** Several tubes in polyphase relationship to which is applied a single phase current and from

which derived a polyphase current having a frequency which is a sub-multiple of the impressed frequency. W. F. Curtis, Washington, D. C. No. 2,006,346.

**Rectifier.** Circuit using grid-control rectifier in a full wave circuit. The output is taken from the center of the plate transformer and the cathode. Between the center of the plate transformer and the grid is a condenser and between the two grids and the cathode is an inductance in series with a resistance. G. B. Hagen, Telefunken, Germany. No. 2,006,806.

### Patent suits

1,382,738, M. C. Latour, Amplifying apparatus; 1,405,523, same, Audion or lamp relay or amplifying apparatus, filed May 9, 1935, D. C., E. D. N. Y., Doc. E 7616, Latour Corp. v. Busch's Jewelry Co., Inc., et al. Same, filed May 4, 1935, D. C., S. D. N. Y., Doc. E 80/193, Latour Corp. v. Chevrolet Motor Co. et al.

1,713,726, H. Vogt et al., Device for phonographs with linear phonogram carriers, D. C., Del., Doc. E. 923, American Tri-Ergon Corp. et al. v. Electrical Research Products, Inc. Doc. E 924, American Tri-Ergon Corp. et al. v. R. C. A. Photophone, Inc. Dismissed Apr. 24, 1935, in each of above cases. Doc. E 1081, American Tri-Ergon Corp. et al. v. Loew's, Inc., et al. Doc. E 1082, American Tri-Ergon Corp. et al. v. Warner Bros. Pictures, Inc. Dismissed Apr. 26, 1935, in each of above cases.

1,405,523, M. C. Latour, Audion or lamp relay or amplifying apparatus, filed May 4, 1935, D. C., S. D. N. Y., Doc. E 80/191, Latour Corp. v. Sears, Roebuck & Co., Inc.

1,297,188, I. Langmuir, System for amplifying variable currents; Re. 18,579. Ballantine & Hull, Demodulator and method of demodulation; 1,573,374, P. A. Chamberlain, Radio condenser; 1,618,017, F. Lowenstein, Wireless telegraph apparatus; 1,707,617, 1,795,214, E. W. Kellogg, Sound reproducing apparatus; 1,894,197, Rice & Kellogg, same, filed Apr. 16, 1935, D. C., S. D. N. Y., Doc. E 80/143, Radio Corp. of America et al. v. Lenox Equipment Co., Inc., et al.

1,507,016, L. deForest; 1,507,017, same; D. C., S. D. N. Y., Doc. E 79/339, R. C. A. et al. v. Fox Radio Corp. et al. Decree pro confesso for plaintiff (notice Apr. 17, 1935).

1,307,510, A. M. Nicolson, Thermionic translating device; 1,354,939, H. D. Arnold, Vacuum tube device; 1,479,778, H. J. Van der Bijl, same; 1,893,466, R. F. Gowen, Audion construction, filed Apr. 11, 1935, D. C., E. D. N. Y., Doc. E 7572, Radio Corp. of America et al. v. Amperex Electronic Products, Inc., et al.

1,852,710, L. A. Hazeltine, Antenna coupling system; 1,913,604, W. A. MacDonald, Wave signaling system, filed May 9, 1935, D. C., E. D. N. Y., Doc. E 7615, Hazeltine Corp. v. Busch's Jewelry Co., Inc., et al.

1,879,863, H. A. Wheeler, Volume control; 1,951,685, same, Peak detector, filed May 4, 1935, D. C., S. D. N. Y., Doc. E 80/192, Hazeltine Corp. v. Chevrolet Motor Co. et al.

1,755,114, L. A. Hazeltine, Unicontrol signaling system; 1,755,115, same, Variable condenser, filed May 4, 1935, D. C., S. D. N. Y., Doc. E 80/195, Hazeltine Corp. v. Chevrolet Motor Co. et al.



# BRITISH PATENTS

*British patents are important to American readers because these disclosures often forecast corresponding U. S. patents which may not be issued until a year later.*

## Radio circuits

**Modulation.** Small amounts of energy from the output circuit of a carrier wave amplifier are applied in the anode circuit of a triode rectifier, the grid of which is coupled to the modulating source. Marconi Co., J. L. Finch. No. 421,504.

**Detector oscillator.** A hexode tube for a superheterodyne to which signals are applied between the cathode and first grid, the second grid being grounded, the third and fourth grids being coupled over a tuned circuit to produce local oscillations. Telefunken. No. 422,029.

**Anti-coupling circuit.** Coupling between the input and output of a high frequency amplifier is reduced by a high-frequency connection from the side of the output impedance remote from the anode to an auxiliary grid so that the part of this connection which is common with the connection of this grid to the cathode is of low impedance. Philips. No. 422,310.

**Rejector circuit.** In a superheterodyne, energy of frequency near that of the intermediate frequency is prevented from reaching the first detector by a series resonance circuit connected across antenna and ground. Telefunken. No. 422,312.

**Gain control.** To obtain a sharp change in the a-c output of a tube as the input rises above and falls below a predetermined value, rectifying means are provided energized by the output of the tube to provide a voltage which is used wholly or in part as the whole or part of the grid bias of the tube. Marconi Co. No. 422,477.

**Distortion compensation.** Distortion due to a curved operating characteristic is eliminated by injecting into the amplifier input an auxiliary frequency higher than the highest working frequency and of small amplitude compared with the curvature of the characteristic. This amplified control frequency is utilized to correct the curvilinear distortion. Siemens & Halske. No. 421,516.

**Muting system.** An amplifier is followed by a diode detector which is disabled when signals of below a predetermined intensity are received, the cathode

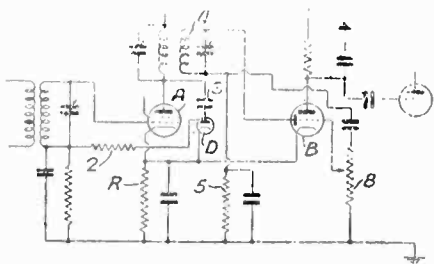

of the diode being connected to the cathode circuit of the amplifier whereby a change in the internal impedance of the amplifier, determined by the incoming signal, controls the release of the detector. E. K. Cole. No. 422,858.

**Superheterodyne.** A super-regenerative stage precedes the frequency changing stage. In one circuit the quenching oscillations for the super-regenerative

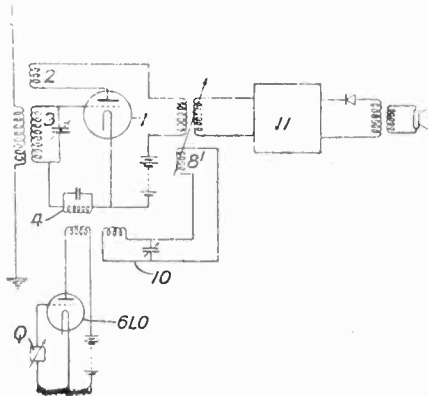

stage and the local oscillations for frequency changing are generated separately. Marconi Co. No. 422,866.

**Frequency doubling.** In a radio receiver in which the carrier frequency of a modulated wave is doubled, the modulation frequency remaining unaltered in order to increase selectivity by halving the percentage width of the side-band, the carrier is first heterodyned so that the frequency-doubling takes place at a medium or low frequency. P. A. Leblanc, France. No. 422,973.

**A-v-c.** The control tube has two grids positioned between the normal control grid and the cathode. These two additional grids are preferably coplanar and one of them is biased positively while the other has negative gain controlling

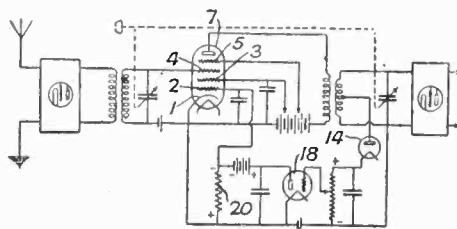

potentials applied thereto from the anode impedance of a tube amplifying the d-c output of a gain control rectifier. K. C. Black, Marconi Co. No. 423,389.

**Short wave transmitter.** A tuned circuit for use on wavelengths of the order of one meter comprises a pair of Lecher wires of an electrical length of half a wavelength provided with conductive plates in electrostatic association with one another and positioned at or near points of maximum voltage or zero current. Marconi Co. No. 421,616.

**Automatic volume control.** Noise suppressing circuit in which the noise suppressing means are rendered in an unstable condition so that the control progresses to produce maximum suppression or maximum output depending on the signal strength. This is achieved by rendering the delay voltage on the gain

control rectifier dependent upon the muting current. Plessey Co., Ltd. No. 422,284.

**Noise suppressor.** In a receiver having a-v-c an amplifying tube is positively biased to a condition of low stage gain, and superimposed on the grid is a nega-

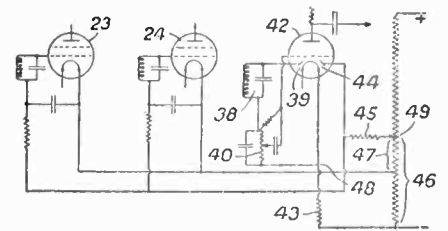

tive bias derived from rectification of the amplified signal. Murphy Radio, Ltd. No. 423,194.

**Dynatron oscillator.** The oscillator is operated for starting purposes with a positive potential on its plate or on an auxiliary outer grid, and a negative potential is substituted therefor after the oscillation has started. Marconi Co. and E. B. Moullin. No. 423,044.

**Short wave receiver.** A frequency changing stage in which the received signals are applied to the anode of the tube while local oscillations of longer wavelength are applied to the grid, the anode potential being adjusted so that rectification occurs in the anode circuit. Marconi Co. and E. B. Gill. No. 423,189.

## Television

**Color system.** Light filters are mounted in a moving slot. The slot is in a rotating disc which moves over another slot in a mask to form an effective scanning aperture cooperating with a rotating mirror drum. The number of filters corresponds with the number of component colors and the disc holding the filter performs a single revolution, while the scanning-drum performs the number of revolutions corresponding to the number of component colors. J. L. Baird. No. 418,527.

**Curvature distortion.** A method of neutralizing the light-intensity grid-voltage characteristic of a cathode-ray tube by means of a thermionic tube which produces an equal and opposite distortion at the transmitter or receiver or both. For example, when the characteristic is such that contrast is enhanced in the bright parts of a picture and depressed in the dark parts, modulated carrier current may be applied to a grid-leak rectifier whose screen grid carries a lower potential than usual while its anode resistance is connected to the cathode-ray tube in such manner that the brightness-distortion due to one tube compensates that due to the second tube. E&MI, Ltd. No. 420,065.

**Scanning system.** Intermeshed lines are scanned successively, the wave form representing the frame component repeating itself at frame frequency, and the wave form representing the line component repeating itself at the line frequency as usual. The number of lines scanned during each repetition of the frame component is a whole number plus a fraction, which is the reciprocal of the number of repetitions of the frame component necessary for a complete scanning. Marconi Co. No. 420,391.

# NEW OSCILLOGRAPH ASSURES COMPLETE RECORDS

*Anytime.. Anywhere..*

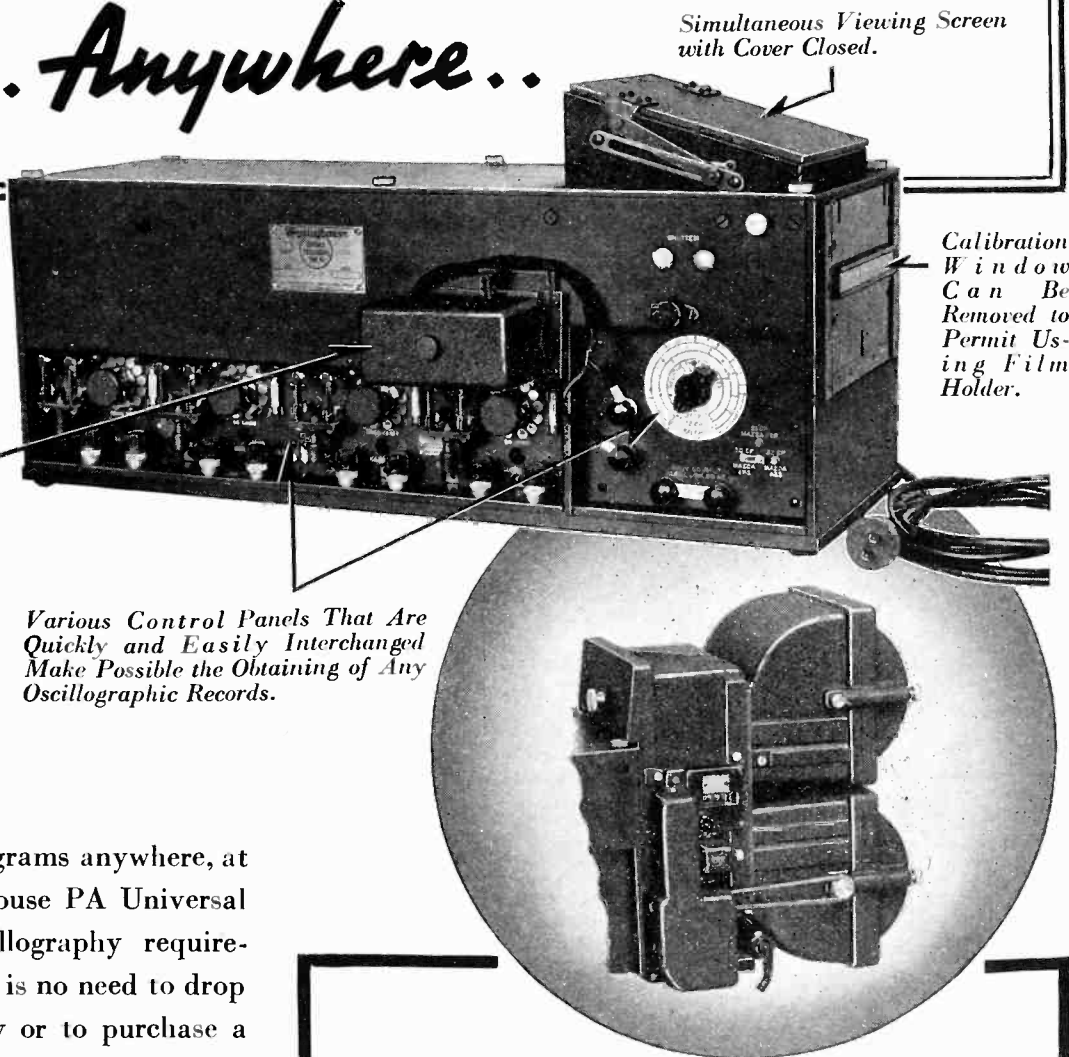

*Light Source Uses Automobile Type Lamps . . . Economical and Easy to Obtain.*

*Various Control Panels That Are Quickly and Easily Interchanged Make Possible the Obtaining of Any Oscillographic Records.*

*Calibration Window Can Be Removed to Permit Using Film Holder.*

YOU can make complete oscillograms anywhere, at any time with the new Westinghouse PA Universal Oscillograph. And as your oscillography requirements become more complex there is no need to drop the use of the instrument entirely or to purchase a complete new Oscillograph.

You can buy the PA complete . . . or just its main case with only the controls and galvanometers necessary for present requirements. Then, as your requirements change and grow, other controls and galvanometers can be obtained and installed in the original case. Thus, with only a modest initial outlay you can have an adequate oscillograph available at all times without the purchase of equipment not necessary to your present requirements.

R 57030



# Westinghouse

JUST A FEW OF THE MANY ADVANTAGES OF THE PA UNIVERSAL OSCILLOGRAPH ARE:

- 1 SIMULTANEOUS VIEWING—The actual phenomena can be seen on a screen—even while photographing.
- 2 TWO-HUNDRED FEET OF FILM OR SENSITIZED PAPER can be held in the film holder—cut off for any desired exposure without disturbing supply.
- 3 REMOVABLE resistance, current, and transformer control panels.
- 4 INTERCHANGEABLE galvanometers and vibrators.
- 5 TWIN GALVANOMETERS with external adjustments.
- 6 SEEPAGE-PROOF galvanometers; fuse protection; and automobile-type lamps for light source.
- 7 WIDE RANGE of film speed assured by a variable-speed, governor-controlled motor.
- 8 ONE-HALF CYCLE starting time for automatic PA.
- 9 OPERATES from either 120 volts a-c. or 6-10 volts d-c.
- 10 ONE TO EIGHT records can be obtained.



“Rich, not gaudy;  
For the apparel oft proclaims the man.”

—Shakespeare

Dress up your chassis with the new type Goat Form Fitting Tube Shields.

The impression of progress, dignity and costliness, created by metal-clad tubes, has helped sell many a set. Yet Goat Tube Shields actually cost less than shielding which does not contribute as much in either appearance or performance.



GOAT RADIO TUBE PARTS, INC., 314 Dean Street, BROOKLYN, N. Y.  
(A Division of THE FRED GOAT COMPANY, INC., Established 1893)  
43 E. Ohio Street, Chicago, Ill.      200 N. Edgemont Ave., Los Angeles, Calif.  
500 King Street, West, Toronto, Canada.

## ONE OF THE STRONG LINKS

**“DYKANOL”**  
THE STRONGEST LINK IN BROADCAST CIRCUITS

The sturdiest chain of equipment in a transmitter is only as strong as its weakest link. Until recently it was believed that condensers were one of the weaker components in the chain.

Years of study, engineering development, and manufacturing experience have produced DYKANOL, a non-flammable impregnator.

Hermetically encased in steel containers, these condensers are oil impregnated and oil filled with

Dykanol, whose advanced electrical characteristics have enabled C-D to reduce the size and weight of these condensers by 50% and increase their dependability by more than 100%.

Get the complete data on these condensers by writing for Catalog No. 127.



**CORNELL-DUBILIER**  
CORPORATION

4380 BRONX BOULEVARD • NEW YORK

## ENAMELITZ

Reduce manufacturing costs on I.F. and R.F. coils through the use of Enamelitz—“Litz” wire without a fabric covering.

Three Fold Savings—

1. Cost of wire
2. More coils per pound of wire.
3. Less space—Greater safety

Sample and Technical Bulletin on Request.

### Other Acme Wire Co. Products

Magnet Wire (all insulations)

Coils, Magnet Wire Wound

Varnished Insulations

(Cambric, paper, silk, tape)

Parvolt Condensers

(Filter, By-pass, Power Factor Correction)

Aerial Wire

(Stranded and Solid—Bare or Enameled)

For over 25 Years, suppliers to the largest radio and electrical manufacturers.

**THE ACME WIRE CO.**

New Haven, Conn.

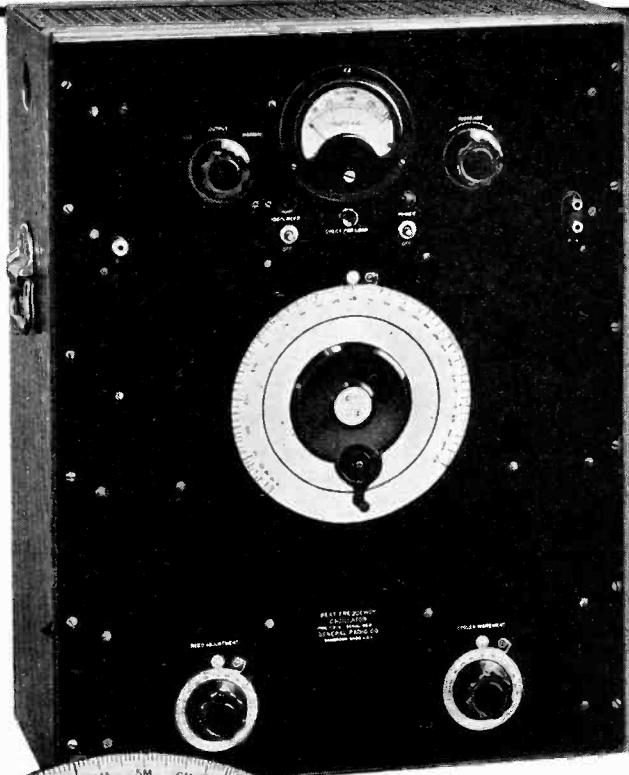
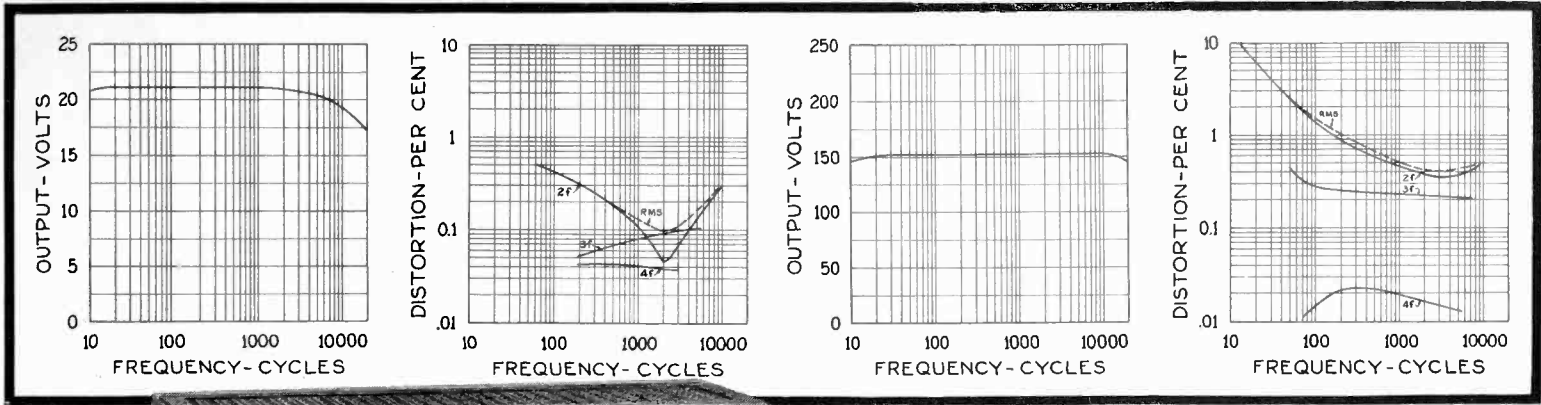

Type 713-A Beat-Frequency Oscillator  
Price: \$485.00

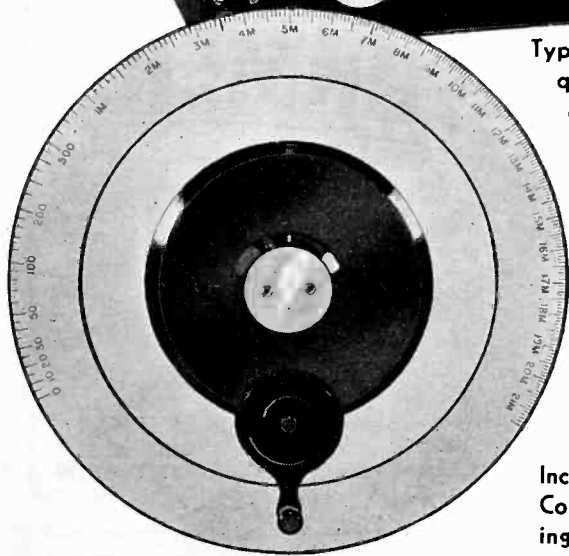

Main Frequency Control  
18-inch Scale Length

Incremental Frequency Control. Direct Reading at Any Frequency



## NEW High Power Oscillator

The new General Radio Type 713-A Beat-Frequency Oscillator has the same distinctive performance characteristics achieved through advanced engineering design and careful manufacture.

### HIGH OUTPUT

2 watts output . . . adequate for all laboratory needs without additional amplification . . . output voltage read on linear-scale vacuum-tube voltmeter.

### WIDE FREQUENCY RANGE

10 cycles to 20,000 cycles . . . uniform output over entire range.

### LOW DISTORTION

One of the more important features of this unique oscillator . . . per cent distortion for both the one-tenth and full output ranges shown in the curves above.

### SINGLE CONTROL

Calibration direct reading for every cycle throughout the entire range.

### HIGH STABILITY

Achieved through use of new oscillator circuits . . . buffer stage . . . balanced push-pull detector . . . balanced power amplifier. Frequency drift is negligible. 15 volt variation in power supply changes output by less than 1 cycle.

### SELF-CONTAINED

The oscillator is completely self-contained and operates direct from the 60-cycle a-c mains.

WRITE FOR complete details . . . ask for a copy of Bulletin EX-3507-E.



# General Radio Company

30 State Street

Cambridge A, Massachusetts



# SHAKEPROOF



**X MARKS  
THE SPOT WHERE  
TROUBLE STARTS**

**V**IBRATION strikes first at connection points. If it can loosen a nut or screw, then it isn't long until more serious damage occurs. The most positive protection against vibration any product can have is to be equipped throughout with Shakeproof. The *twisted teeth* of this powerful lock washer bite into both nut and work surfaces and never let go. No other method for keeping connections tight can compare with the spring-action and multiple locking effect of Shakeproof's exclusive *twisted tooth* design. Write for free testing samples today!

### FREE FOR THE ASKING!

Just off the press—our new 1935 catalog tells you how to solve your locking problems. Also illustrates and explains other patented Shakeproof products—a truly valuable book—send for your free copy today!



# SHAKEPROOF Lock Washer Company

Distributors of Shakeproof Products  
Manufactured by Illinois Tool Works

2539 N. Keeler Ave.

Chicago, Ill.



Type 12.  
Internal



Type 11.  
External



Type 15.  
Countersunk



Type 20. Locking  
Terminals

U. S. Pat. 1,419,564—1,604,122—1,697,954—1,782,387—Other Pat. Pending—Foreign Pat.



For Every Variety of  
Industrial Application

**A**UTELCO Relays have a unique history which particularly commends them for uses where *reliability of operation* is paramount. Forty years of design and manufacture for the exacting requirements of the telephone industry have resulted in a variety of perfected relay types which are now being applied with equal success to industrial requirements of every kind. Send for catalog 4016-A—free upon request—which gives a complete description of types available.

**AUTOMATIC ELECTRIC COMPANY... Chicago, Illinois**

# TRANSFORMERS

from  
**ACME**

## FOR ECONOMY

Engineers and manufacturers of transformers for Radio, Television, Neon, and other voltage regulation or adjustment applications.

**THE ACME ELECTRIC & MFG. CO.**  
1447 Hamilton Ave., Cleveland, Ohio  
**TRANSFORMER ENGINEERS**



Coils for every purpose—to your specifications—guaranteed within any tolerances you wish—at the most favorable prices in coil history. Send in your specifications for samples.

**EDWIN I. GUTHMAN and CO., Inc.**  
1036 West Van Buren St., CHICAGO, ILLINOIS



The new "super" trains suggest a smoothness . . . an effortless acceleration! Centralab Radiohms too, are famous for their smoothness . . . that permit easy attenuation without objectionable noises.

for CENTRALAB RADIOHMS employ the patented non-rubbing contact whereby a strip of polished metal rocks on the resistor so that the only rubbing is between an oil-less wood bearing and the polished metal.

The public demands smooth performance . . . therefore specify C E N T R A L A B.



Available with five types of switches. Single or double tapped. Twin and triple assembly with or without switch.

# Centralab

CRL

## RADIOHM

CENTRALAB Division of Globe Union Mfg. Co. Milwaukee, Wisc.

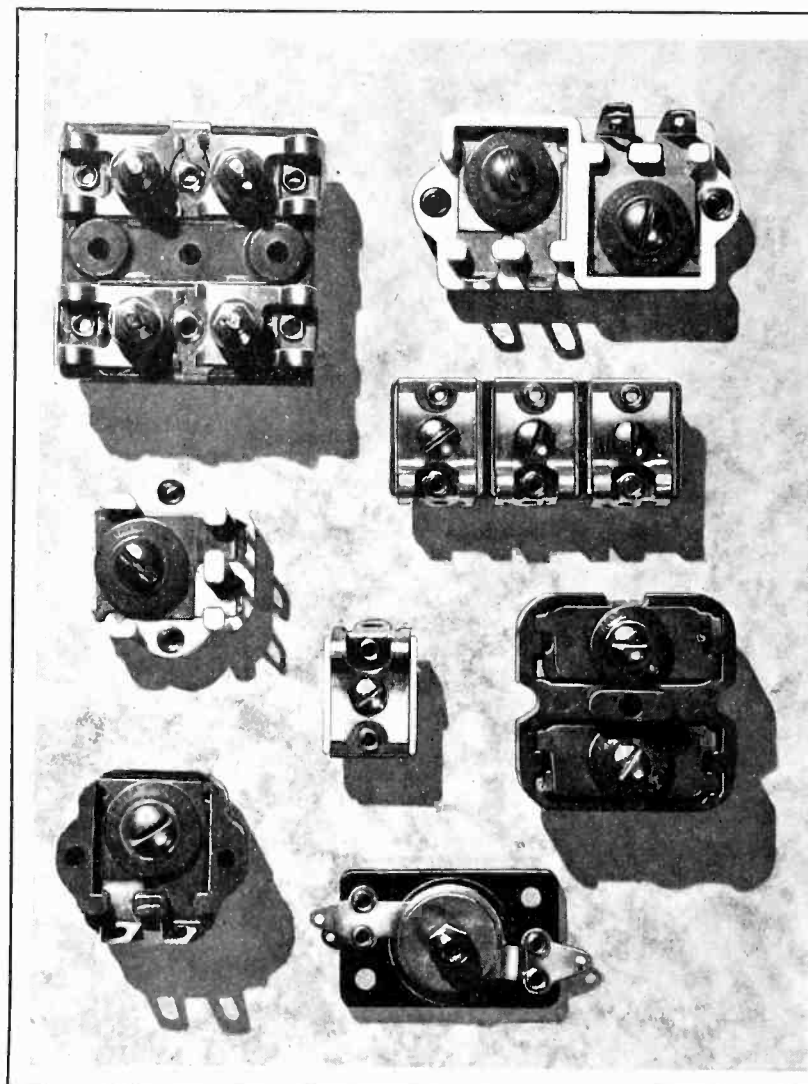

# Micamold

## TRIMMER CONDENSERS

A design is available to meet any electrical or mechanical requirement.

### THE MICAMOLD LINE INCLUDES:

1. Improved plate shapes, meaning more accurate adjustment and minimum capacity drift.
2. The use of XM-262 Molded Bakelite Bases eliminates breakage and assures the maximum in insulation quality.

Micamold designs are available in XM-262 Molded Bakelite, Ceramic, and also in Strip Bakelite Bases in single or multi-section units.

### Specify Micamold for:

Molded Mica and Paper Condensers,  
Electrolytic and Trimmer Condensers,  
Molded Carbon and Wirewound Resistors.

## MICAMOLD RADIO CORP.

1087-1095 Flushing Avenue  
BROOKLYN, N. Y., U. S. A.

# Dependability

**D**URING the last two years  
**CANNON** Plugs have been in-  
stalled in more than 200 planes used  
in daily transport service - - and in  
these two years not one Plug failure  
has been recorded . . . . **CANNON**  
Plugs **ARE Dependable.**

*New Airship Plug Catalog Available*

# CANNON PLUGS

CANNON ELECTRIC DEVELOPMENT CO.  
MANUFACTURING ENGINEERS

Main Office: 420 West Avenue 33, Los Angeles, California.

Eastern Sales Office: Lewis & Sachs Company,  
220 Fifth Avenue, New York.

#### REPRESENTATIVES:

CHICAGO: Jenkins & Adair, Inc., 3333 Belmont Ave.  
DALLAS: Edward F. Aymond, 3750 Urban Ave.  
BOMBAY, INDIA: Eastern Electric & Engineering Com-  
pany, 175 Hornsby Road, Fort, Bombay, India.



## MICROPHONES

for "Electric-Ear" Devices

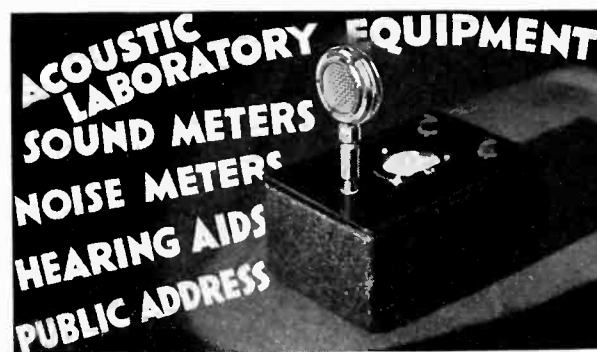

*A* Real Service for Manufacturers  
of "Electric Ear" Equipment...

If you are a manufacturer of noise meters, acoustic instruments, hearing aids, or sound amplifying equipment, the engineering department of "Microphone Headquarters" will gladly cooperate in the selection of suitable standard or special microphones to meet *your* particular needs. There is no obligation, of course.

*General Purpose, Wide-Range and High-Fidelity*  
... Crystal, Condenser, Carbon Microphones ...  
and Accessories.

### SHURE BROTHERS COMPANY

Manufacturers of Microphone Headquarters Telephone  
Engineers Delaware 8383  
215 WEST HURON ST. CHICAGO, ILLINOIS

# BELMONT uses the Best!

- In selecting the material and parts to be used in the new Belmont Radio Corporation line, William L. Dunn, Chief Engineer, was influenced only by the quality of the materials and the service rendered by suppliers over the years of his experience.
- Belmont uses Lenz Hook-Up Wire as well as Lenz Cords and Cables.

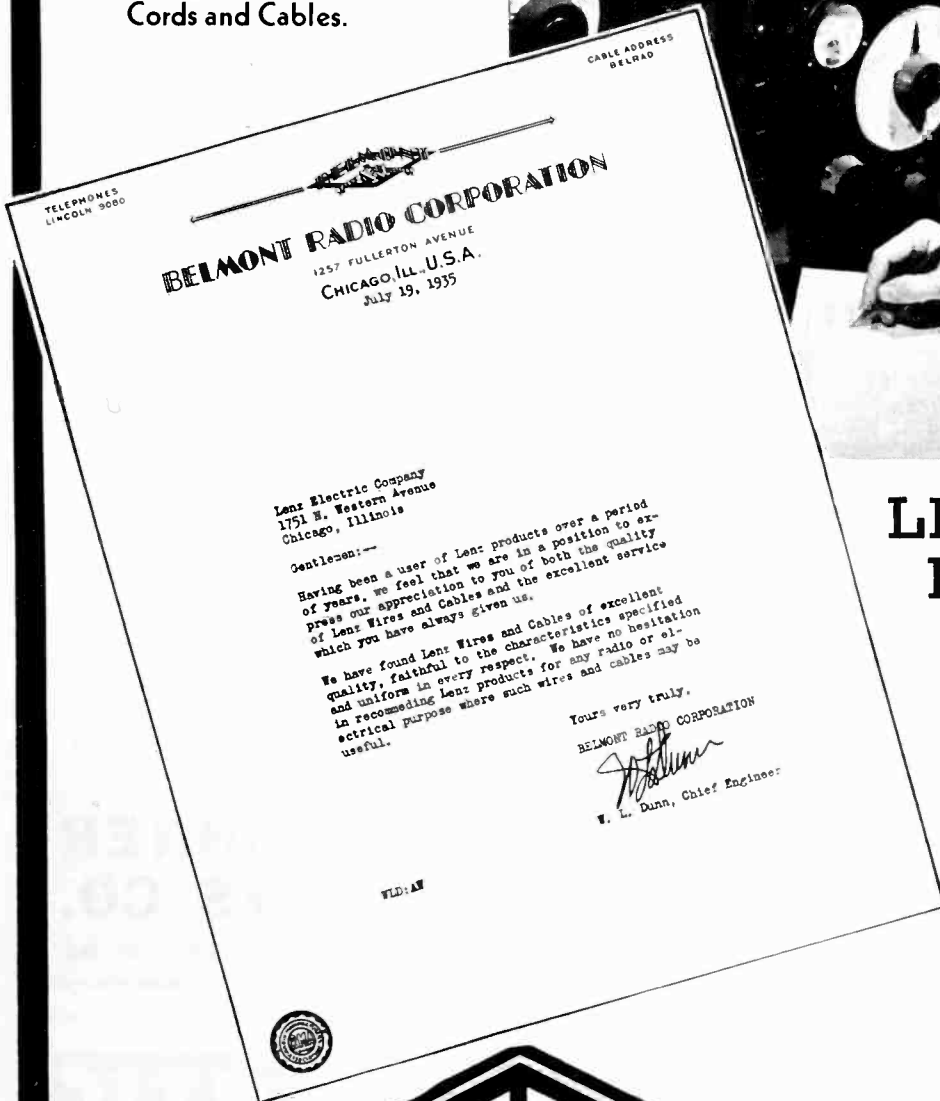

## LENZ R. F. CIRCUIT HOOK-UP WIRE

### DIELECTRIC CHARACTERISTICS

At 70° F. 50% RH.

- **Power Factor**—One half of one percent at 25 meters (12 megacycles), completely immersed in mercury.
- **Phase Angle**—18 degrees and seven minutes.
- **Insulation Resistance** — 83,000 megohms per foot at 400 volts DC. completely immersed in mercury.
- **Capacity (to ground)** — 22 MMF. per foot at 25 meters (12 megacycles).
- **AC voltage breakdown** — 1600 volts per foot, completely immersed in mercury.

At 120° F. 90% RH.

- **Power Factor**—1% at 25 meters (12 megacycles), completely immersed in mercury.
- **Capacity (to ground)** — 28 MMF. per foot at 25 meters (12 megacycles).
- **Moisture Absorption** — less than 1% by weight.

LENZ  
ELECTRIC  
MFG. CO.,  
1751 N. Western  
Ave., Chicago, Ill.

Gentlemen:  
Please send me FREE 10  
foot sample of Lenz R. F.  
Circuit Hook-Up Wire.

Size..... Solid  Stranded   
Name.....  
Address.....  
Company.....



**LENZ ELECTRIC  
MANUFACTURING CO.,**  
1751 NORTH WESTERN AVENUE, CHICAGO, ILL.



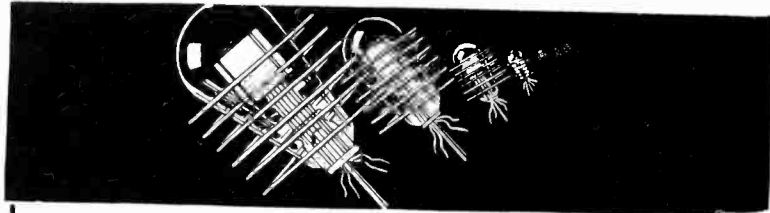

# EXPERIENCE COUNTS!

We have been designing and building high frequency converters for over 25 years.

## BOMBARDING EQUIPMENT

for

- Radio Receiving Tubes
- Transmitting Tubes
- Rectifying Tubes
- Gaseous Conduction Tubes
- Negative Glow Lamps
- Light Sensitive Cells
- Oscillator Tubes
- X-Ray Tubes

## HIGH FREQUENCY INDUCTION FURNACES

for

- Precious Metal Melting
- Melting or Heating in Vacuo
- Metallurgical Research
- Tempering
- Heat Treating, etc.

### USERS of LEPEL EQUIPMENT

As the manufacturer, we are in a particularly advantageous position to

MODERNIZE and REMODEL

your Lepel apparatus at the lowest possible cost.

Expert Maintenance Service

Write for Particulars to

# LEPEL

HIGH FREQUENCY LABS, INC.

39 WEST 60th STREET • NEW YORK

# REMLER

## PLUGS — CONNECTORS

### New List Prices

- Wall Receptacle . . . \$3.00
  - Panel Receptacle . . . 3.00
  - Cable Plug . . . . . 3.00
  - Cable Receptacle . . . 3.00
  - Plug, Shielded . . . . 3.50
  - Receptacle, Shielded . 3.50
- State number of contacts desired, 2, 3, 4, 5, 6 or 7

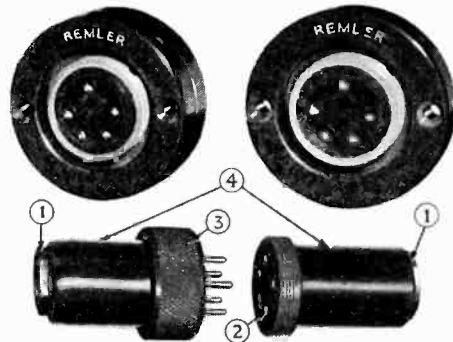

### INTERCHANGEABLE INSERTS WITH 2 TO 7 CONTACTS

Durable . . . accurate . . . dependable . . . hundreds of these attractive new type plugs and cable connectors used by broadcast stations, sound recording studios and industrial engineers.

Features: (1) Cable grip eliminates pull on contacts; (2) Female contact sleeves of hardened beryllium-copper, silver plated, assure positive contact. (3) Knurled brass screw-on nut locking device prevents accidental disengagement of connector; (4) Metal shielded body for extra heavy duty. MALE AND FEMALE UNITS WITH 2 TO 7 CONTACTS ARE INTERCHANGEABLE. Receptacles with side openings for cable run on exterior of walls or with inch high body for surface mounting and rear cable entry, or flush mounting for panel or outlet box. Write for new Remler catalogue sheets.

ATTRACTIVE DISCOUNTS

**REMLER COMPANY, Ltd.**

2101 Bryant Street

San Francisco, Calif.

**REMLER—THE RADIO FIRM AS OLD AS RADIO**

## A TRIAL WILL CONVINCING YOU

30 Years' Experience  
Insures Dependability

We Manufacture

- PERMANENT MAGNETS
- TOOLS and DIES
- METAL STAMPINGS
- LAMINATIONS

## THOMAS & SKINNER STEEL PRODUCTS CO.

23d St. at Alvord

Indianapolis, Ind.

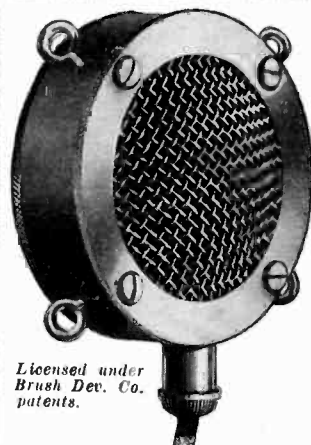

Licensed under Brush Dev. Co. patents.

# ASTATIC

D-104 CRYSTAL MICROPHONE

A MICROPHONE THAT  
"CAN TAKE IT"

A modern microphone with built-in ruggedness that "can take it." The D-104 will give remarkable service in remote control, public address, studio or amateur use. This beautiful instrument with excellent frequency characteristics also carries a one year guarantee. Write for bulletin 58.

ASTATIC MICROPHONE LAB., Inc., YOUNGSTOWN, OHIO

"Pioneer Manufacturers of Quality Crystal Products."

*Here's*  
**A NEW STEATITE**  
**COMPOSITION 352-N**

- **STRONGER**
- **WHITE GLAZE**
- **LOWEST IN LOSS**

**C**HANGE to this fine new R.F. ceramic, produced by one of America's oldest and largest manufacturers. Quickly available in a wide range of shapes and sizes at reasonable prices. Government approved, it should be considered at once for your government contracts. Tools available for hundreds of standard parts in either large or small quantities. Send us your drawings for quotations.

**EXTRUDED, MOULDED OR CAST**

**DIELECTRIC PRODUCTS CORPORATION**  
245 Custer Avenue, Jersey City, N. J.

●  
**SOLE DISTRIBUTORS FOR GENERAL CERAMICS CO.**

# Stackpole Presents a new Midget Control for Auto Radios

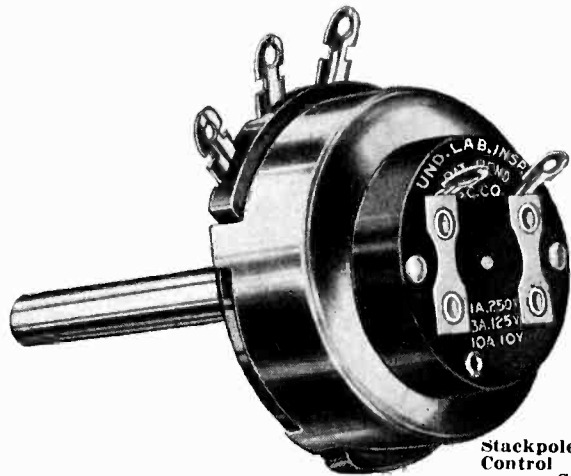

Stackpole Type "C"  
Control with Midget  
Switch

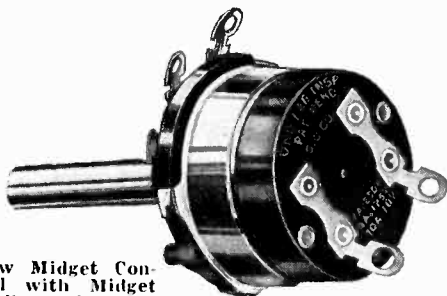

New Midget Control with Midget  
line switch.

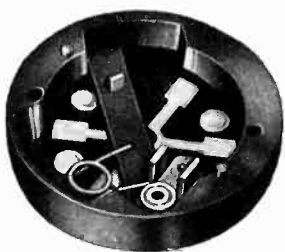

Interior Midget Switch  
(open)

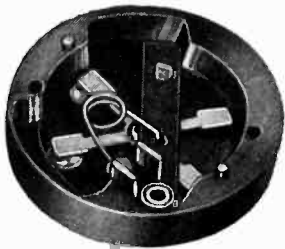

Interior Midget Switch  
(closed)

On behalf of modern design and engineering, you've repeatedly asked for a miniature control, with a dependable line switch, replete in all known advantages of larger size controls. You asked for it—our engineers went to work—and now after months of experimental work, we have it! A MIDGET CONTROL by STACKPOLE—100% accurate—not a single outstanding point of our larger controls is sacrificed.

The NEW MIDGET CONTROL is a "natural" for the makers of the new Auto Radios where, at best, space is at a minimum. It's a "find" for the makers of modern household receivers—the line switch carries the APPROVAL of the UNDERWRITERS LABORATORIES.

Each terminal of the switch has two contacts—insuring POSITIVE CONTROL and LOWEST possible CONTACT DROP. MIDGET CONTROLS are available in Types "MB" and "MP." In applications where space is at a premium and our type "C" control is essential—the MIDGET SWITCH is recommended in place of our S-1 Type switch.

Write for detailed data on complete STACKPOLE line.

Stackpole Carbon Company  
St. Marys, Pa. U. S. A.

# Q-MAX

## Outstanding Lacquers, Varnishes and Impregnants for Treating R. F. Components

Q-Max products were specifically developed for use in connection with radio frequency devices. They are greatly superior to industrial finishing compositions and insulating varnishes which were never intended for radio service.

The Q-Max line includes quick air drying lacquers, baking varnishes and waxes. All are extremely low in dielectric loss.

Hundreds of manufacturers, laboratories, broadcast stations, aircraft and marine organizations use Q-Max compositions to promote circuit efficiency and stability. A description of these products as well as prices will be sent on request.

Immediate delivery from New York and Chicago stocks.

## Communication Products, Inc.



245 CUSTER AVE., JERSEY CITY, N. J.



Hermetically-Sealed  
ELECTROLYTICS



All-aluminum metal components . . . rubber gasket seal taking spun-over can rim . . . thorough hermetic sealing . . . rigid chemical control and exact processing. No wonder AEROVOX metal-can electrolytics are chosen for trouble-proof, long-life service.

DATA: Latest AEROVOX catalog contains largest line of electrolytics, along with all other types, as well as a resistor line. Copy on request.

# AEROVOX

CORPORATION

75 Washington St., Brooklyn, N. Y.

LOW IN  
PRICE . .

high in  
quality and  
accuracy.



## Microhm Power Resistors

meet every requirement of compactness and high resistance. Accuracy 2%. 3 TYPES: "P-1" 5 watt; "BP" 10 watt; "VP" 20 watt. Resistance range up to 100,000 ohms. Exceptional value is offered in this combination of low price, accuracy, quality and small space requirements. Write for samples, further information and our new catalog.

PRECISION RESISTOR CO.

334 Badger Ave., Newark, N. J.

# MICROHM

## WIRE WOUND RESISTORS

P. R. MALLORY & CO. TALKING:  
 "VERY SATISFACTORY  
 MOUNTING MECHANISMS WERE  
 DEVELOPED FOR THIS CELL  
 BY CINCH"



## CINCH C-BIAS CELL HOLDERS

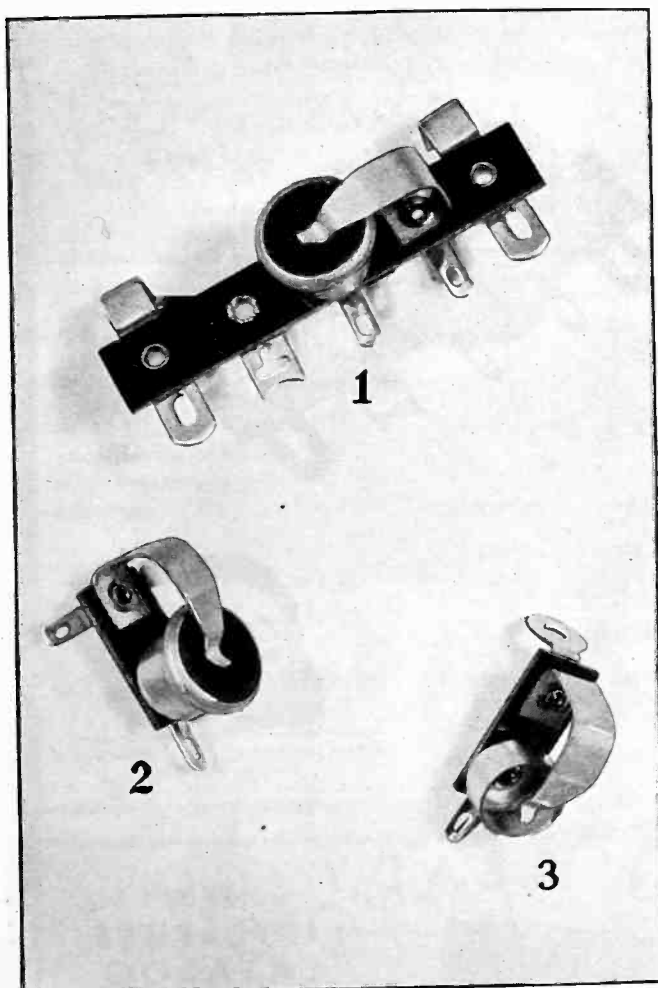

Our complete new catalog is now ready. It describes "CINCH" products, practical, efficient, "money-savers." Many of the items illustrated may be helpful to you. Send for your copy—Today!

A potential cell to give grid bias for various tubes is the Mallory Grid Bias Cell. It offers a new and unusual flexibility in design and solves the several bias problems. "Cinch" adds convenient, efficient mounting. "Very satisfactory," says the C-Bias Cell Manufacturer. The "Cinch" C-Bias Cell Holders in convenient mounting lug strip make a doubly efficient unit at a low price. The holder consists of a steel cadmium plated cup to receive the cell and a phosphorous bronze spring to retain it. The cell cannot be displaced nor lost under any condition due to vibration. Removal for replacement, however, is quickly, easily and simply made. (1) Several holders can be applied to one strip when more than one cell is necessary. In each case the cup may be had (as illustrated) with a soldering lug attached for quick soldering of wires. (2) Similarly the spring may have an attached insulated, independent lug for wire soldering or (3) may be fastened to the mounting lug for grounding when strip is riveted to chassis. All "Cinch" C-Bias strips are constructed so that simple vertical or horizontal mounting is possible. And so conform with the specifications of the cell manufacturer.

The new "Cinch" C-Bias Cell Holders are now ready for delivery—write for prices and samples.

# CINCH

**MANUFACTURING CORPORATION**

2335 WEST VAN BUREN STREET

CHICAGO, ILLINOIS

Subsidiary: United-Carr Fastener Corporation, Cambridge, Mass.



JUST PUBLISHED

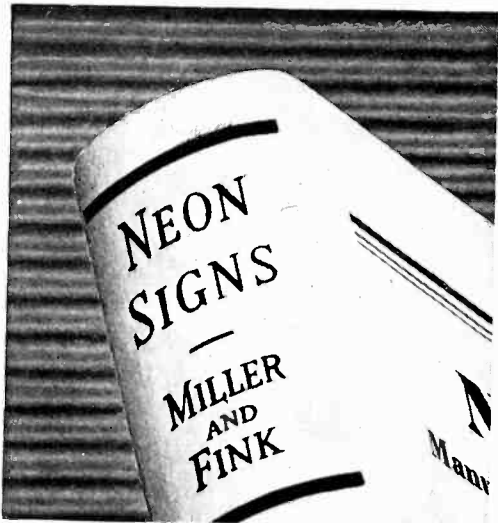

*How to produce better neon signs*

Told in this first adequate American book on the whole neon sign business.

**NEON SIGNS**

Manufacture • Installation • Maintenance

By Samuel C. Miller, General Manager, Tube Light Engineering Company, and Donald G. Fink, Editorial Staff, Electronics, 288 pages, 6x9, 105 illustrations, \$3.00.

A COMPLETE manual of procedure and latest developments, showing step by step how neon signs work, what materials and equipment go into their manufacture, and how these materials and equipment affect the efficiency and life of the sign. Informs the experienced sign manufacturer on the best practice of other manufacturers, new methods of handling installation and maintenance, suggestions for producing better tubes, improving his equipment, getting new color effects and types of animation, etc. Up-to-date, detailed, practical. Chapter on Tricks of the Trade alone worth price of the book.

Contents

The Neon Sign Industry	Glass Bending
The Why and How of Sign Making	Pumping Systems
The Luminous Tube	Bombarding
Materials Used in Constructing Tubes	Filling, Testing, Aging
Electrical Equipment	Tube-mounting Methods, Electric Wiring, Switching, Electric Testing
Types of Signs	Installation and Maintenance
Shop Practice, From Specifications to Completed Sign	Special Applications of Tubes
Designing the Sign	Tricks of the Trade

See it 10 days on approval!

SEND THIS McGRAW-HILL COUPON

**ON-APPROVAL COUPON**

McGraw-Hill Book Company, Inc.  
330 West 42d Street, New York, N. Y.

Send me Miller and Fink's Neon Signs for 10 days' examination on approval. In 10 days I will send \$3.00, plus few cents postage, or return book postpaid. (We pay postage on orders accompanied by remittance.)

Signed .....

Address .....

City and State .....

Official Position .....

Name of Company .....

(Books sent on approval in U. S. and Canada only.) L 8-1-35

**MICA STAMPINGS**  
**OF ALL KINDS**

Our mica stampings are made of the finest mica obtainable . . . Munsell's India Ruby Mica. Exceptionally accurate machining is one of their outstanding features. Send for further details, prices, samples.

Other Electrical Insulations: Write for New Price List No. 98 which describes our complete line of Micanite, Varnished Cambric, Laminated Bakelite, and other insulating materials.

**MICA INSULATOR CO.**

200 Varick St., New York, 542 So. Dearborn St., Chicago, 1330 Schofield Bldg., Cleveland. Branches: Birmingham, Boston, Cincinnati, Los Angeles, San Francisco, Seattle. Canada: Montreal, Toronto.



**Millions in Use**

THE superior quality and performance of millions of Duco Condensers are recognized all over the world.

- Two Year Guarantee
- Low Power Factor
- Long Life
- Self Healing
- Efficient & Compact
- Patented & Patents Pending.

NOW GUARANTEED FOR 2 YEARS

Manufactured by  
**DUMONT ELECTRIC CO., Inc.**  
514 Broadway, New York, N. Y.

Write for free Catalogs, Sales and Jobber Territory

**NOW READY**

**NEW LITTELFUSE CATALOG**

Send for your free copy

It's a real handbook of valuable information on LITTELFUSES for instruments and radio—special neon tubes, Tattelites, Surge Protectors—indicators and other Littelfuse Products. Just tear out ad, write name and address on margin and mail to



**LITTELFUSE LABS**

4511 Ravenswood Ave.  
Chicago, Ill.

**MUTER** *Certified*  
**RESISTANCE BRIDGE**

An accurate Bridge with ruggedness, flexibility and wide range. Its remarkably low cost allows a laboratory to own several of them without overloading the budget. Thoroughly practical for use on production lines. Write Dept. J-8 for complete details and new general catalog of Muter products.

List Price  
**\$49.50**  
Dealers Net  
**\$29.70**

The **MUTER** Co.  
1255 South Michigan Avenue, Chicago, Illinois

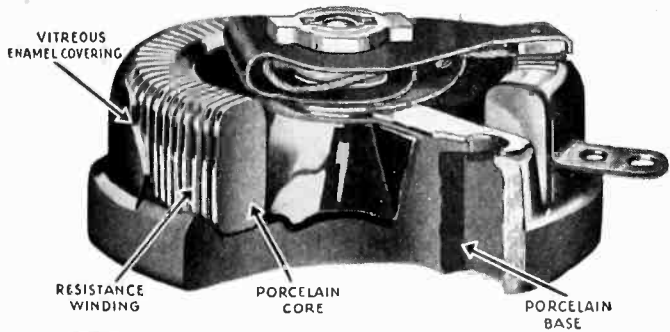

Dual Assurance  
of Quality

**OHMITE**

Two famous seals of quality now appear on OHMITE Rheostats in all sizes—the OHMITE Name-plate and the emblem of the Underwriters' Laboratories.

OHMITE Rheostats are all made with a patented construction using a solid porcelain core fused with vitreous enamel to the porcelain base—no organic materials to char or smoke. Write for Catalog 14, listing stock sizes from 25 through 500 watts. Our engineering department will assist in developing special rheostats to meet your particular requirements.

**OHMITE MANUFACTURING CO.**  
625 N. Albany Ave. CHICAGO, ILL.

Now **DECIBEL METER KIT**  
By **TRIPLET**

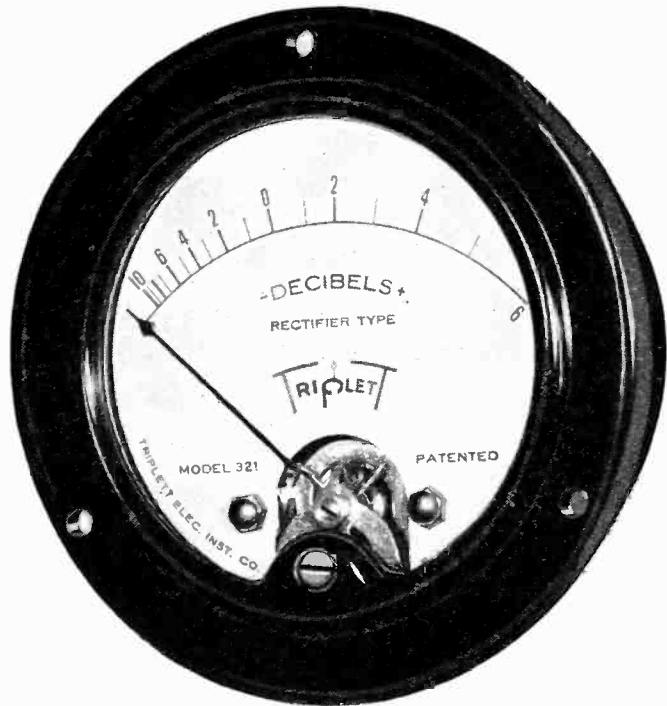

DECIBEL METER KIT

To Increase Meter Range—Use New  
Triplet Decibel Meter Kits!

THESE new Decibel Meter Kits increase range from up 6 to up 42 decibels. For 500 ohm input line. Furnished for either constant or non-constant impedance. The use of a decibel kit facilitates immediate adjustments and elimination of distortion.

No. 150 DECIBEL METER KIT—Non-constant impedance INCLUDES:

Triplet 3" meter, 2-deck selector switch, 9-wire wound multipliers with Bakelite mounting board, hook-up wire, blue prints and instructions. Complete—\$21.67, Net to dealers.

No. 200 DECIBEL METER KIT—Constant Impedance.

Similar to No. 150, but with Triplet 3" Constant Impedance Decibel Meter. Complete—\$23.50 Net to dealers.

The above kits are supplied with Triplet 2" Decibel Meters at \$1.00 net each less than above prices.

Kits are easy to assemble—all parts marked to correspond with blue prints.

**TRIPLET ELECTRICAL INSTRUMENT CO.**  
179 Main St. Bluffton, Ohio, U. S. A.

Triplet Electrical Instrument Co.  
179 Main St., Bluffton, Ohio

Gentlemen:

Please rush me at once more information about the new Decibel Meter Kits and your new catalog describing the 1936 line of Triplet instruments and testers.

Name .....

Street .....

Town ..... State .....

# There's a NEW *Selling* ERA ahead IN THE LEGALIZATION OF BANK LOANS for PLANT EQUIPMENT



A NEW story for your salesmen . . .  
A NEW copy slant for your advertising

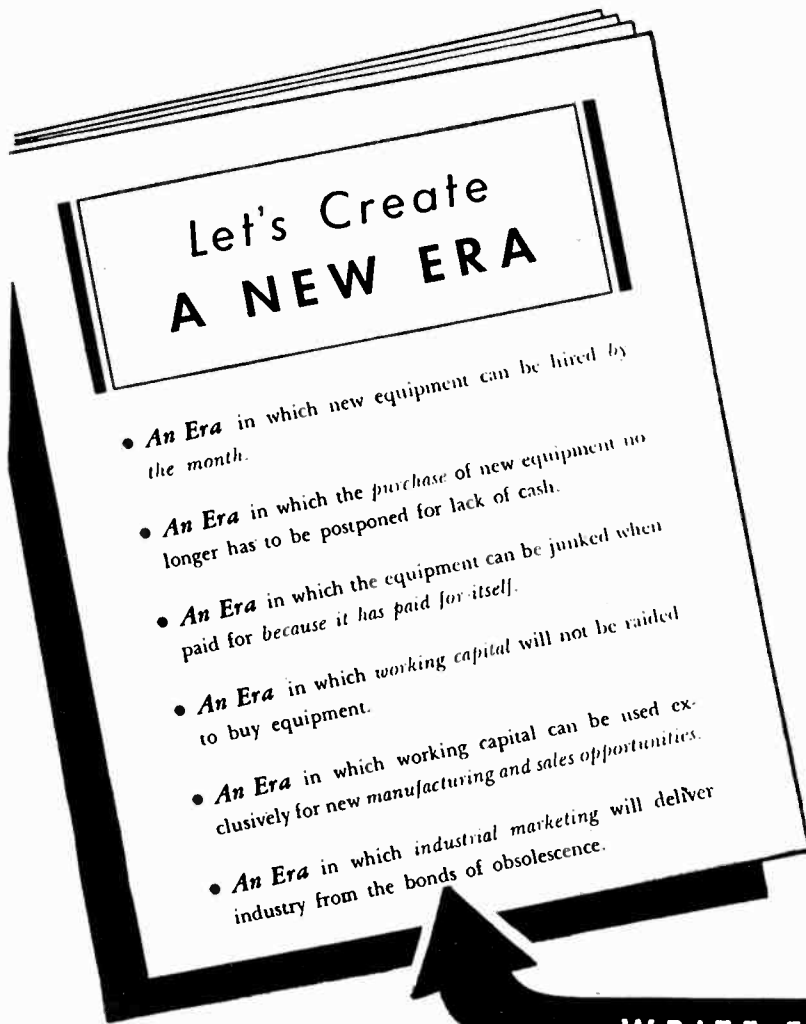

- *An Era* in which new equipment can be hired by the month.
- *An Era* in which the purchase of new equipment no longer has to be postponed for lack of cash.
- *An Era* in which the equipment can be junked when paid for because it has paid for itself.
- *An Era* in which working capital will not be raided to buy equipment.
- *An Era* in which working capital can be used exclusively for new manufacturing and sales opportunities.
- *An Era* in which industrial marketing will deliver industry from the bonds of obsolescence.

**T**HE new F.H.A. Plan legalizes bank loans up to \$50,000 per plant for modernizing plants or equipment. AND, under the plan, separate finance companies may be set up for financing sales of new equipment to other plants.

Everyone agrees that literally billions of dollars of plant improvements and modernization are needed. Here at last is a clean-cut, workable plan that brings buyer and seller together on terms each can employ to advantage. The last alibi of the buyer—"no money to spend"—is wiped away. The seller has a brand new approach to his market—a sales story that "can't be beat."

Manufacturers of industrial equipment who fail to use the F. H. A. Plan will miss the biggest sales opportunity of the decade. Get the facts—build this story into your Fall sales and advertising plans.

**WRITE FOR THIS BOOKLET—TODAY**

This comprehensive booklet written especially for industrial advertisers explains what the F. H. A. Plan is, what it covers, how loans are made, how "credit companies" can be organized by manufacturers—everything the sales and advertising departments need to know in

order to turn this sales opportunity into actual orders.

Get copies of this booklet for yourself and your company's executives. Additional copies will be available later for your salesmen. Write, 'phone or wire the nearest McGraw-Hill office.

## McGRAW-HILL PUBLICATIONS

McGraw-Hill Publishing Company, Inc., 330 West 42nd Street, New York, N. Y.

American Machinist  
Aviation  
Bus Transportation  
Business Week

Chemical and Metallurgical  
Engineering  
Coal Age  
Construction Methods  
Electrical Merchandising

Electrical West  
Electrical World  
Electronics  
Engineering and Mining  
Journal

Engineering News-Record  
Factory Management and  
Maintenance  
Food Industries  
Metal & Mineral Markets

Power  
Product Engineering  
Radio Retailing  
Textile World  
Transit Journal

# ALL METAL—Incorporating SUPERIOR SEAMLESS TUBING



The "All Metal" tube, with its self-shielding, compactness, quietness and ruggedness, is the subject of much discussion and interest. Already it has been adopted as standard equipment by a large group of manufacturers.

We are proud of the fact that Superior Seamless Tubing was selected by metal tube engineers—that we are able to supply exhaust tubing that adds to this latest development in electronic tube design.

## SUPERIOR TUBE COMPANY

NORRISTOWN, PA.

**CUSTOM DESIGNING & MANUFACTURING**  
for the BROADCAST • SOUND AND ELECTRONIC FIELD  
*We Have Every Facility at Your Disposal and Welcome Inquiries on Your Special Work or Problems.*

**TYPE WS-1502035 TRANSMITTING CONDENSER**

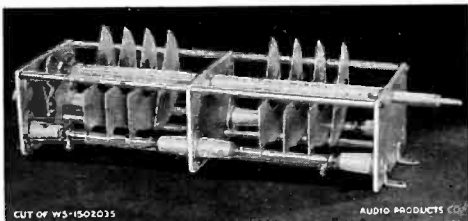

Shown is an example of our development for special applications. Designed for 15000 volt operation in high frequency transmitter. It may fit into your job. If not—we can build one that will. The WS-1502035 is 35 m.m.f. per section and sells for

**\$15.00** Plus  
NET Postage  
Shipping weight 9 pounds.

QUALITY PRODUCTS SINCE 1910

**AUDIO PRODUCTS CO.**

4189 W. Second St. A. J. EDGCOMB Los Angeles, Cal.

## HI-POWER FOR PORTABLE SOUND EQUIPMENT

The Carter GENEMOTOR supplies the most reliable and economical "B" Power for Class A or B Amplifiers from a 6 or 12 volt battery. Output up to 500 volts. Sturdy — Compact — Quiet in operation — Requires no oiling — Guaranteed. Write for Bulletin showing complete line of GENEMOTORS or specify your requirements.

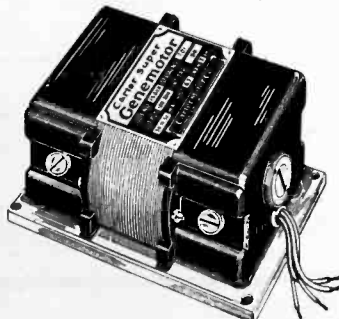

**CARTER MOTOR CO.**  
365 W. Superior St., Chicago

## Dynamic (Moving Coil) MICROPHONES

by

## RADIO RECEPTOR

*Now approach the sensitivity  
of good carbon microphones.*



Model 6A

Replace your carbon microphone without using a pre-amplifier—use Model 6B with type TMB input transformer.

Eliminate costly, troublesome, heavily shielded high gain amplifiers. Quiet in operation without tube or extraneous pickup noises.

**RADIO RECEPTOR CO., INC.**

108 Seventh Ave.

New York City



# SEPTEMBER

*starts a new and better*

# ELECTRONICS

- As outlined by the editors in the editorial pages of this issue, a new and better *Electronics* will start with the September issue.
- Printed on heavier, coated stock your advertising story will have greater display value. The new format will assure greater attention value.
- An exceptionally high renewal rate indicates plenty of reader interest. The improved *Electronics* will have even greater interest for readers—and consequent increased value for your advertising message among the 7000 subscribers to *Electronics*.
- Over 1000 foreign subscribers prove its international recognition. *Electronics* places your advertising story before the key men who buy your products in foreign markets.
- Radio set manufacturers, broadcasting stations, communication systems, sound pictures and public address manufacturers, industrial control and measuring equipment manufacturers—you can sell them all economically and effectively through the advertising pages of the improved *Electronics*. (116 advertisers have used the advertising pages of *Electronics* for this purpose during the past 20 months.)
- All the newness, the added interest, the dramatic effect of this new *Electronics* will assure unusual reader interest for your advertising message in this first issue. You can profitably capitalize on this increased interest—at no increase in advertising rates—by starting your campaign now; in the September issue.

What space shall we reserve for you in September *Electronics*?  
Forms close August 28th.

ABC

## ELECTRONICS

ABP

330 West 42nd Street, New York, N. Y.



# HIGH IMPEDANCE HEADPHONES



These phones present new distinct advantages for monitoring, testing and other applications where wide range response is required.

1. Reproduction Range 60-12,000 cycles.
2. Operating on the piezo-electric principle they have extremely high current sensitivity.
3. May be operated from any normal source regardless of impedance.
4. Non-magnetic and will consequently not affect compasses, watches or other instruments.
5. No overloading possible within usable range of sound levels.
6. Phones are extremely light in weight—six ounces including band and cord.

For further information write

**THE BRUSH DEVELOPMENT CO.**  
East 40th and Perkins Ave.  
CLEVELAND, OHIO, U. S. A.

# PIONEER GEN-E-MOTORS for 1935 BATTERY SETS

PIONEER makes a dynamotor for every purpose: a very small compact unit with exceedingly low power drain to replace "B" Batteries. Models to deliver outputs up to 35 watts, 50 watts and a job delivering 225 watts at 1,000 volts.

Other models are special aircraft units; a gas engine driven model delivering 110 volts AC; the AIR-FLO Charger, a

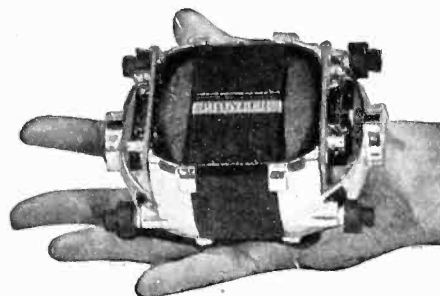

wind-driven generator to charge storage batteries for radio or lighting. PIONEER is the source for every type of dynamotor. Gen-E-Motors keep battery sets sold. Get in touch with the PIONEER engineers about it.

**PIONEER GEN-E-MOTOR CORP.**  
458-A W. Superior St., CHICAGO, ILL.  
Cable Address: SIMONTRICE, New York

## DIAMOND VULCANIZED FIBRE

**SHEETS - RODS - TUBES - PARTS**

Specialized service for radio and  
electrical manufacturers  
on all insulating  
problems

**CONTINENTAL-DIAMOND  
FIBRE COMPANY**

NEWARK DELAWARE

CHICAGO — CLEVELAND  
NEW YORK

# TRANSFORMERS for Auto Amplification

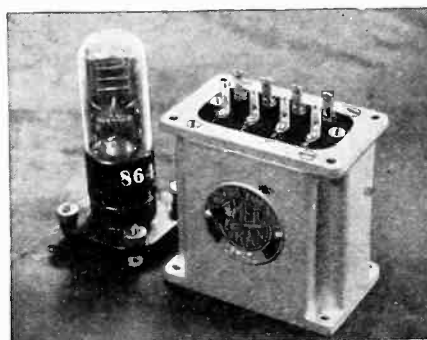

Users of high-fidelity portable amplifiers will find that AmerTran Type OP Miniature transformers will solve many of their knottiest problems. Not only are these units small in size and of light weight, but they are also high quality parts which meet broadcast station specifications.

Frequency characteristics are uniform within  $\pm 1$  dB from 30 to 12,000 cycles and all types are self-shielded electromagnetically. Windings of all transformers are in carefully balanced sections with at least four leads brought to the terminal board from each coil. Send for Bulletin No. 1002.

**AMERICAN TRANSFORMER CO.**  
180 Emmet St., Newark, N. J.

"a work we can unreservedly recommend"

—The Electric Journal

"excellent and authoritative"

—Review of Scientific Instruments

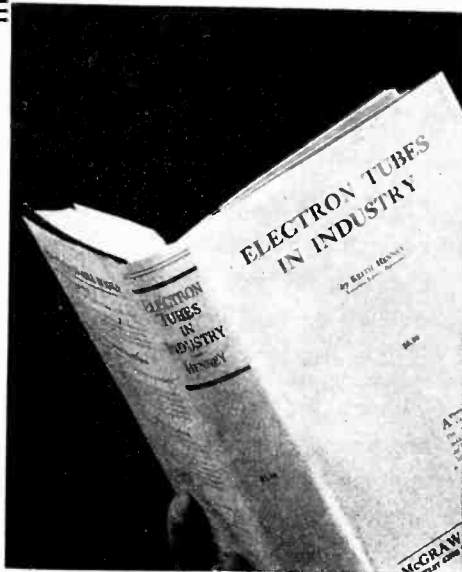

## Electron Tubes in Industry

By KEITH HENNEY  
Associate Editor, *Electronics*

490 pages, 6 x 9, illustrated, \$5.00

Engineers and manufacturing executives interested in cheapening or quickening industrial processes will find in this book a thorough presentation of the practical aspects of electronics—what the electron tube is doing toward making processes simpler, cheaper, safer, and in making possible new methods of control. The book describes all the various electron tubes that are useful in industrial operations.

The book is specific; it tells what is being done with tubes in industry now and how it is being done. It indicates the possibilities of the extended use of these tubes. In all possible cases the economics of such application is discussed. The book shows how much the electron tube system costs in a given instance compared with other competing systems.

### Some of the Applications of Electron Tubes discussed in this book—

Vacuum tube voltmeters	Inversion (d.c. to a.c.)
Automatic recorders	Rectification (a.c. to d.c.)
Telemetry	Welding control
Elevator control	Illumination control
Color matching	High speed counting
Sorting and grading	Register control
Door openers	Paper bag manufacture
Voltage and speed regulation	Traffic and train control
Battery charging	Smoke density control
Viscosity tests	Thickness control
Precision automatic testing	Humidity control
Noise measurement	Chemical analysis
Conveyor synchronization	

"I think that *Electron Tubes in Industry* is by far the finest thing that has ever been written on the subject. It is especially good where it relates to specific uses of tubes. The author has weeded out the theory and put the practical application into a form that will be most useful for industrial engineers who want to apply the art to their own practical purpose."

—R. D. McDILL

See this book 10 days on approval—Send this coupon

### McGraw-Hill ON-APPROVAL COUPON

McGraw-Hill Book Co., Inc., 330 West 42nd St., New York City  
Send me Henney's *Electron Tubes in Industry* for 10 days' examination on approval. In 10 days I will send \$5.00, plus few cents postage and delivery, or return book postpaid. (We pay postage on orders accompanied by remittance.)

Name .....

Address .....

City and State .....

Position .....

Company ..... F-L-8-35

(Books sent on approval in U. S. and Canada only.)

## TRANSFORMERS for Transmitting

Right—AmerTran air-cooled transmitting plate transformer—sizes up to 7 kva.

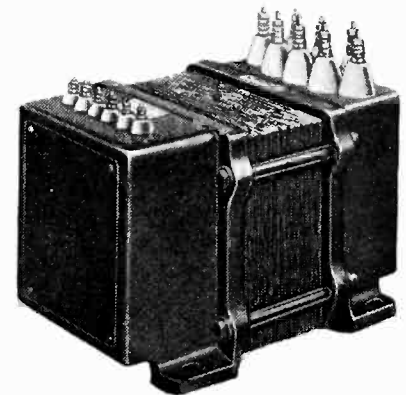
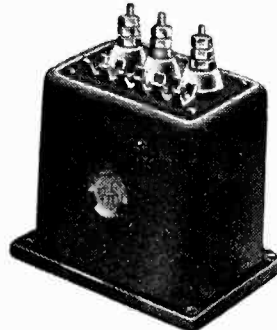

Left—AmerTran air-cooled transmitting filament transformer.

AmerTran's line of air-cooled transmitting transformers are designed to meet the most rigid broadcast station requirements. Units are of the highest quality and standard types are available to meet all usual requirements in rectifiers utilizing either type '66 or '72 tubes. The illustrations show our new improved mountings and standard ratings are listed in Bulletin No. 1002 . . . May we send you a copy?

**AMERICAN TRANSFORMER CO.**  
180 Emmet St., Newark, N. J.

## PROFESSIONAL SERVICES

### BLILEY ELECTRIC CO.

Designers—Manufacturers

Quartz Crystals for standard or special radio frequency applications.

Inquiries Invited.

240 Union Station Bldg.  
Erie, Penna.

### ELECTRICAL TESTING LABORATORIES

Characteristics and  
Life Tests of Vacuum Tubes

Tests of photo cells, glow lamps, crater lamps.  
Tests of electronic and optical devices.

80th Street and East End Avenue  
New York, N. Y.

Phone: Butterfield 8-2600

### HUDSON BROS. MFG. CO., Inc.

539-41 42nd St., Union City, N. J.

Designers and consultants for experimental glass apparatus, pyrex and soft glass.

Aspirator Pumps	Ground Joints
Graded Seals	Stop-Cock Grease
Stop-Cocks Pyrex and Soft Glass	McLeod Gauges
	Traps of all types.

Glass Apparatus Made to Blue Print Specifications.  
Tel. Palisado 6-2940

### PAUL G. WEILLER

Engineer

Consulting service, design and construction of special electronic timing devices, furnace controls, etc.

405 Lexington Ave., New York  
Telephone, Van. 3-6226

# SEARCHLIGHT SECTION

EMPLOYMENT : BUSINESS : OPPORTUNITIES : EQUIPMENT—USED or SPECIAL

UNDISPLAYED—RATE PER WORD  
*Positions Wanted*, 5 cents a word, minimum \$1.00 an insertion, payable in advance.  
*Positions Vacant* and all other classifications 10 cents a word, minimum charge \$2.00.  
*Proposals*, 40 cents a line an insertion.

INFORMATION:  
*Box Numbers* in care of our New York, Chicago or San Francisco offices count 10 words additional in undisplayed ads. Replies forwarded without extra charge.  
 Discount of 10% if full payment is made in advance for four consecutive insertions of undisplayed ads (not including proposals).

DISPLAYED—RATE PER INCH  
 1 inch ..... \$5.00  
 2 to 3 inches ..... 4.75 an inch  
 4 to 7 inches ..... 4.50 an inch  
*Other spaces and contract rates on request.*  
 An advertising inch is measured vertically on one column, 3 columns—30 inches—  
 to a page. E.  
 (Elect)

COPY FOR NEW ADVERTISEMENTS RECEIVED UNTIL 3 P. M. ON THE 3RD OF THE MONTH

## HERE IS YOUR OPPORTUNITY

To replace some of your obsolete equipment for Radio Manufacturing at very nominal prices. Included in our stock are:

Coil Winding Machines  
 Single or Multiple  
 Condenser Winding Machines  
 Impregnating Equipment  
 Plating Equipment  
 Assembly Benches  
 Conveyor Type, etc.  
 Punch Presses, Drills, etc.

Testing Equipment  
 I. F. Transformer Aligning  
 R. F. Coil Tests  
 Condenser, Capacity & Breakdown  
 Resistor and Continuity Tests  
 Choke Coil and Transformer  
 Variable Condenser Test  
 Temperature Recorders, etc.

Detailed Descriptions and Prices Furnished Upon Request

### GRIGSBY-GRUNOW COMPANY, INC.

in liquidation by order of the United States District Court

FRANK M. McKEY, Trustee  
 5801 Dickens Ave. Phone, Berkshire 7500 CHICAGO, ILL., U.S.A.  
 Cable Address—Grigaut

### "SEARCHLIGHT"

IS

Opportunity Advertising

—to help you get what you want.  
 —to help you sell what you no longer need.

Take Advantage Of It

For Every Business Want

"Think SEARCHLIGHT First"

G-7

### POSITION WANTED

YOUNG MAN (21), high school education, with 9 years' varied experience in radio work, desires position as assistant to an engineer or research worker, either in a radio engineering or research laboratory. Please write to Henry J. Walczak, 49 Osgood St., Springfield, Mass.

### HIGH GRADE NEW AND USED ELECTRON TUBE EQUIPMENT

Write for Bulletin Showing Savings From 20% to 80%

KAHLE ENGINEERING CORPORATION  
 Specialists in Equipment and Methods for the Manufacture of Neon Tubes, Radio Tubes, Incandescent Lamps, Photo Cells, X-ray Tubes, etc.  
 350 Manhattan Ave., Union City, N. J.

All types of High Grade New and Used Equipment for the manufacture of Electron Tubes.

Lowest prices on the market.  
 AMERICAN ELECTRICAL SALES CO.  
 65 East 8th St., New York, N. Y.  
 Cable Address "AMELSACOMP-NEW YORK"

### ELOQUENT!

Tubes reconditioned by NATIONAL — speak for themselves — the story is impressive to those concerned with low cost and long life. Why not Listen In by placing a trial order?

NATIONAL RADIO TUBE CO. INC.

3420 - 18th St. San Francisco, Calif.



# WE THANK THE ENTIRE ELECTRONIC INDUSTRY

for the largest three months in sales of **SVEA METAL** since its development. The days of experimental usage and sporadic sales of this metal have passed. **THUS**, the question "Can **SVEA METAL** be used successfully in radio tubes?" seems to have been answered in a big way by the radio tube industry. Its rapid replacement of other metals in luminous tube electrodes, mercury rectifiers, mercury switches, stroboscope lamps, etc., keeps abreast of its use in the radio vacuum tube field.

To all manufacturers and engineers not yet fully familiar with its numerous advantages in addition to substantial cost savings, we offer complete technical data and, within reasonable distance, personal engineering assistance.

## SWEDISH IRON & STEEL CORPORATION

17 BATTERY PLACE—NEW YORK CITY

Cable—SISCOSWEDE

### CONTENTS for AUGUST, 1935

A new <i>Electronics</i> to meet expanding field	237
A new adventure in electronics	238
Ultra-high frequency antenna terminations	239
By W. C. TINUS	
Crystal microphone design for single-direction pickup	242
By A. L. WILLIAMS and J. P. ARNDT	
A new thermionic motor speed regulator	244
By C. BOYD NORRIS	
A multi-stage photocell current amplifier	245
By WALTER RICHTER	
A practical time signal for broadcasting	246
By HERBERT J. MAYER	
Coil testing methods for use in radio plants	248
By EDGAR MESSING	
Book reviews	251
Highlights on electronic devices in industry	252
Multi-band r-f choke coil design	254
By HERMAN P. MILLER, JR.	
Notes on electron tubes and circuits	256
Editorials	258
A review of the electronic art	260
New products	263
U. S. Patents	266
British Patents	268

### INDEX TO ADVERTISERS

This index is published as a convenience to the reader. Every care is taken to make it accurate but *Electronics* assumes no responsibility for errors or omissions.

Page	Page
Acme Elec. & Mfg. Co. .... 8	Ohmite Mfg. Co. .... 12
Acme Wire Co. .... 6	Pioneer Gen-E Motor Co. .... 21
Aerovox Corp. .... 14	Precision Resistor Co. .... 14
American Transformer Co. .... 21-22	Radio Receptor Co. .... 19
Astatic Microphone Co. .... 12	RCA Mfg. Co. .... Back Cover
Audio Products Co. .... 19	Remler Co., Ltd. .... 12
Automatic Electric Co. .... 8	Shakeproof Lock Washer Co. .... 8
Bakelite Corp. .... Inside Front Cover	Shure Brothers .... 10
Brush Development Co. .... 21	Stackpole Carbon Co. .... 14
Cannon Electric Devel. Co. .... 10	Superior Tube Co. .... 19
Carter Motor Co. .... 19	Swedish Iron & Steel Co. .... 24
Central Radio Labs. .... 9	Synthane Corp. .... Inside Back Cover
Cinch Mfg. Corp. .... 15	Thomas & Skinner Steel Products
Communication Products, Inc. .... 14	Co. .... 12
Continental Diamond Fibre Co. .... 21	Triplett Elec'l Instr. Co. .... 17
Cornell-Dubilier Corp. .... 6	Westinghouse Elec. & Mfg. Co. .... 5
Dielectric Products Corp. .... 13	Weston Elec'l Instr. Co. .... 1
Dumont Electric Co. .... 16	White Dental Mfg. Co., S. S. .... 3
Erie Resistor Co. .... 2	Professional Services .... 22
General Radio Co. .... 7	SEARCHLIGHT SECTION
Goat Radio Tube Parts, Inc. .... 6	Classified Advertising
Guthman & Co., Inc., Edw. I. .... 8	EMPLOYMENT
Lenz Electric Mfg. Co. .... 11	EQUIPMENT FOR SALE
Lepel High Frequency Labs. .... 12	American Electrical Sales Co. .... 23
Littelfuse Labs. .... 16	Eisler Engineering Co. .... 23
Mallory & Co., P. R. .... 4	Grigsby-Grunow Co., Inc. .... 23
McGraw-Hill Book Co. .... 16-22	Kable Engineering Co. .... 23
Mica Insulator Co. .... 16	National Radio Tube Co. .... 23
Micamold Radio Corp. .... 10	
Muter Co., The. .... 17	

McGRAW-HILL PUBLISHING COMPANY, INC.,

330 WEST 42d STREET, NEW YORK, N. Y.

Branch Offices: 520 North Michigan Ave., Chicago; 883 Mission St., San Francisco; Aldwych House, Aldwych, London, W. C. 2; Washington; Philadelphia; Cleveland; Detroit; St. Louis; Boston; Greenville, S. C. James H. McGraw, Chairman of the Board; Malcolm Muir, President; James H. McGraw, Jr., Executive Vice-President; Howard Ehrlich, Vice-President; B. R. Putnam, Treasurer; D. C. McGraw, Secretary.



## A PERFECT LANDING

**T**hrough its reliability in radio and electrical equipment, Synthane contributes a vital part to the safety of night flying. You can secure this same reliable performance in *your* products if you use the same dependable insulation—Synthane laminated bakelite.

SYNTHANE LAMINATED BAKELITE  
SHEETS • RODS • TUBES  
FABRICATED PARTS

*Send for Sample Book*



**SYNTHANE**  
CORPORATION  OAKS • PENNA



# NEW!

## RCA VICTOR

### 70-A

#### TRANSCRIPTION TURNTABLE

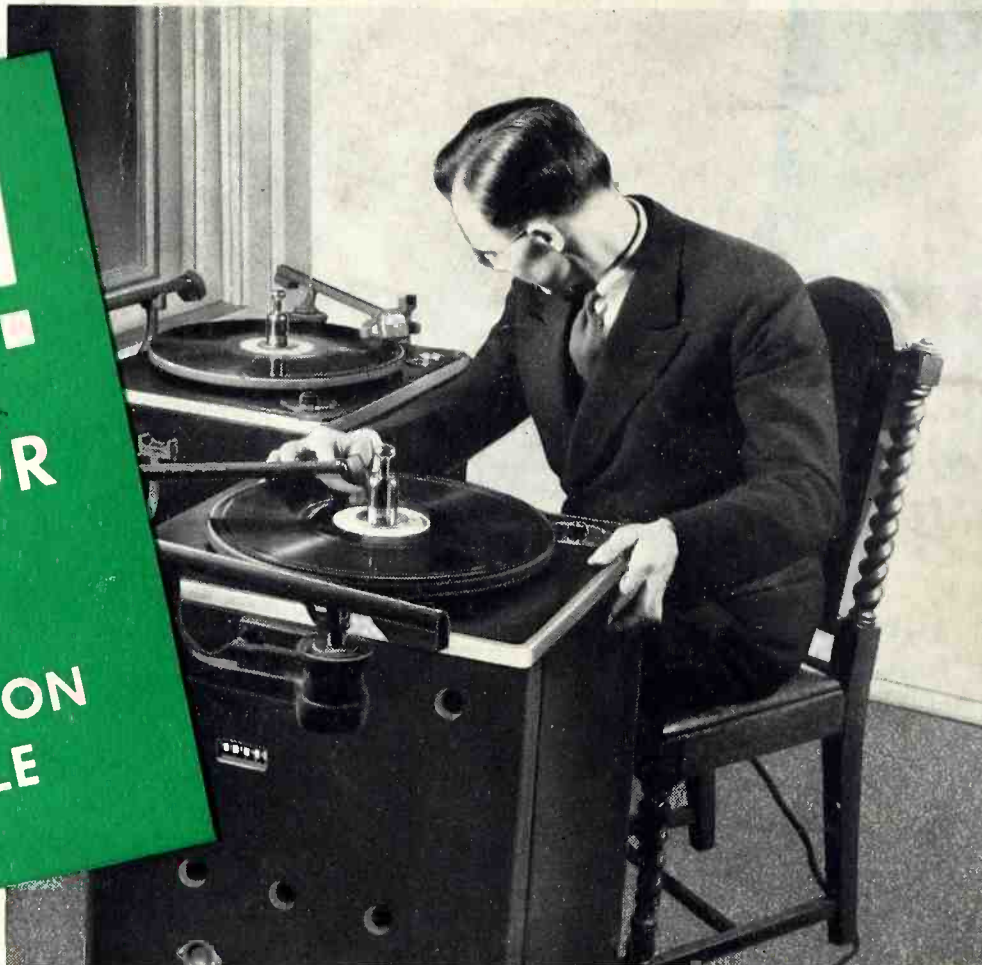

### *Economical Equipment for Higher Fidelity*

The new RCA Victor Type 70-A Transcription Equipment offers true high fidelity performance on all records, at a reasonable price. It will play lateral- and vertical-cut records with full usable range. Record speeds of 78 and 33 $\frac{1}{3}$  r.p.m. are available at will, and standard and long-playing records may be used in-

terchangeably. Thus this unit serves all record-playing needs. Only two units are needed to make it possible to switch instantaneously from one record to another, regardless of type, without loss of time on the air, in accordance with the best control-room technique. Write for complete technical bulletin.

#### **RCA VICTOR — THE ORIGINAL SOURCE**

It always pays to do business with those who know their business best. When considering transcription equipment, remember that RCA Victor possesses the greatest experience in the world in the recording and reproduction of phonograph records.



## **RCA MANUFACTURING CO., INC.**

**TRANSMITTER SECTION**

#### **SEE THESE ALL-INCLUSIVE FEATURES**

**High Fidelity Reproduction.** Full usable range of both lateral- and vertical-cut records.

**Two Speeds.** 78 or 33 $\frac{1}{3}$  r. p. m. Speeds are shifted easily and quickly.

**Compact Design.** Cabinet 31" high, 21 $\frac{1}{2}$ " wide, 19" deep.

**Easily Installed.** No special foundation or base required. Plug in and operate.

**Quiet Operation.** Microphone may be used nearby. To prevent transfer of motor vibrations to pick-up, motor is sound insulated from both cabinet and turntable, and pick-up arm is insulated from cabinet.

**Matched Frequency Response.** Frequency characteristics of both pick-ups have been designed to match recording characteristics, resulting in substantially flat over-all characteristics.

**High Output Level.** Output circuits of the pick-ups match a 200- to 250-ohm line. At 1,000 cycles either reproducer delivers approximately 0.01 volts r. m. s. to such a line which is about -48 db compared with a zero level of 12.5 milliwatts.

**Priced Right.** The low price for this complete equipment, plus the fact no additional equipment is necessary for the second speed, reduces the expense to the station. The units are sold outright and can be carried on your books as assets.

**CAMDEN, NEW JERSEY**