

# electronics

radio, sound, communications and industrial applications  
of electron tubes . . . design; engineering, manufacture

## TELEVISION—

Present systems  
Transmission problems  
Economics; Cost  
Prospects for 1935

All-metal  
vacuum tubes

German radio  
set design

Costs of 100-watt  
broadcast stations

Precision  
condenser  
calibration

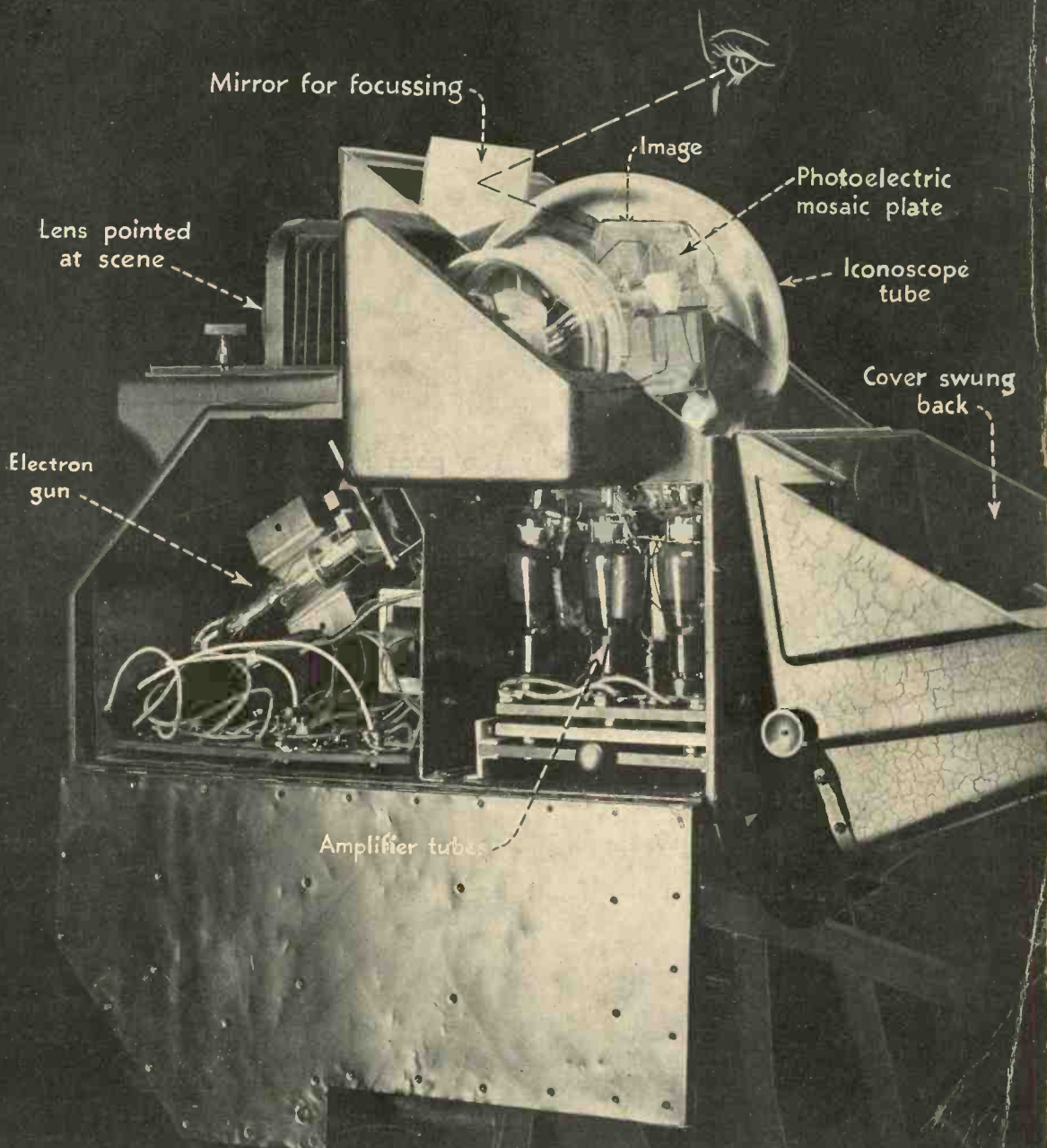

TELEVISION CAMERA

See page 300



McGRAW-HILL PUBLISHING COMPANY, INC.

Price 35 Cents

OCTOBER, 1934

WRAPPED TUBING *May Be...*  
 AS UNLIKE AS TWO PEAS

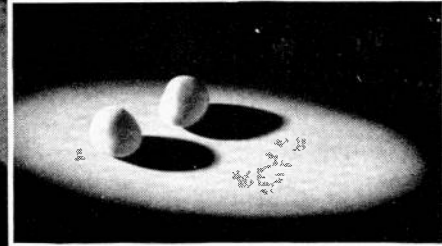
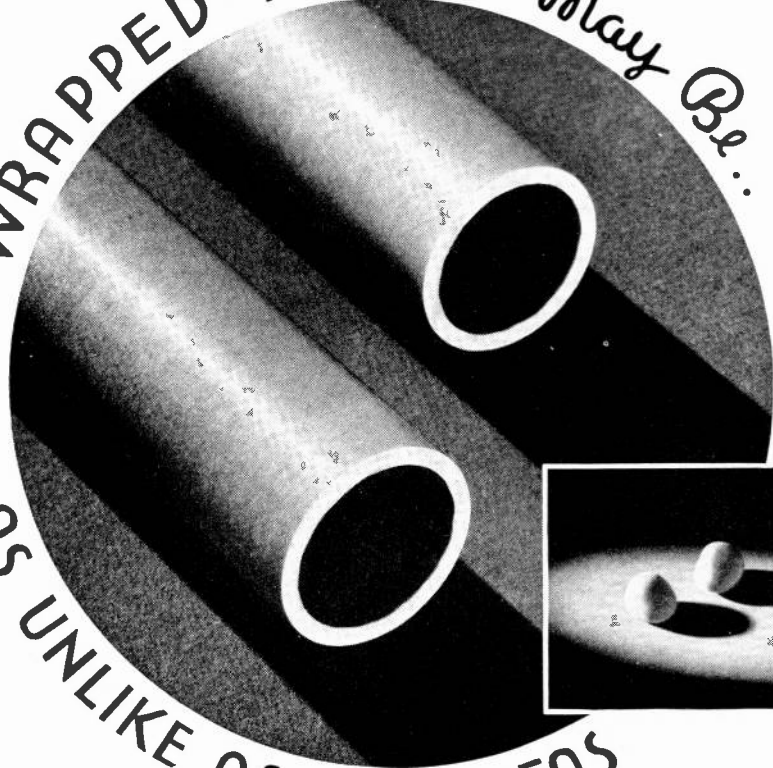

**S**uperficially two peas look alike. But a closer scrutiny, under a lens, will reveal rugged individualism most unbecoming for twins. So it is with laminated bakelite tubing. At first glance you might conceivably miss the distinctions which make Synthane Wrapped Tubing worth many times more at no extra cost. . . . Synthane Wrapped Tubing is processed from the finest base

materials procurable. Every step—impregnation, drying, wrapping, curing, grinding and polishing—is controlled to produce tubes precisely the equal of each other, grade for grade and size for size. Frequent and rigid inspections insure absolute uniformity in physical properties, machining qualities, structural and electrical characteristics.



● Send for SYNTHANE sample book. ●  
 (Actual samples limited to sheet stock.)

LAMINATED BAKELITE SHEETS · RODS · TUBES  
 FABRICATED PARTS · SILENT STABILIZED GEAR MATERIAL



# FACILITIES

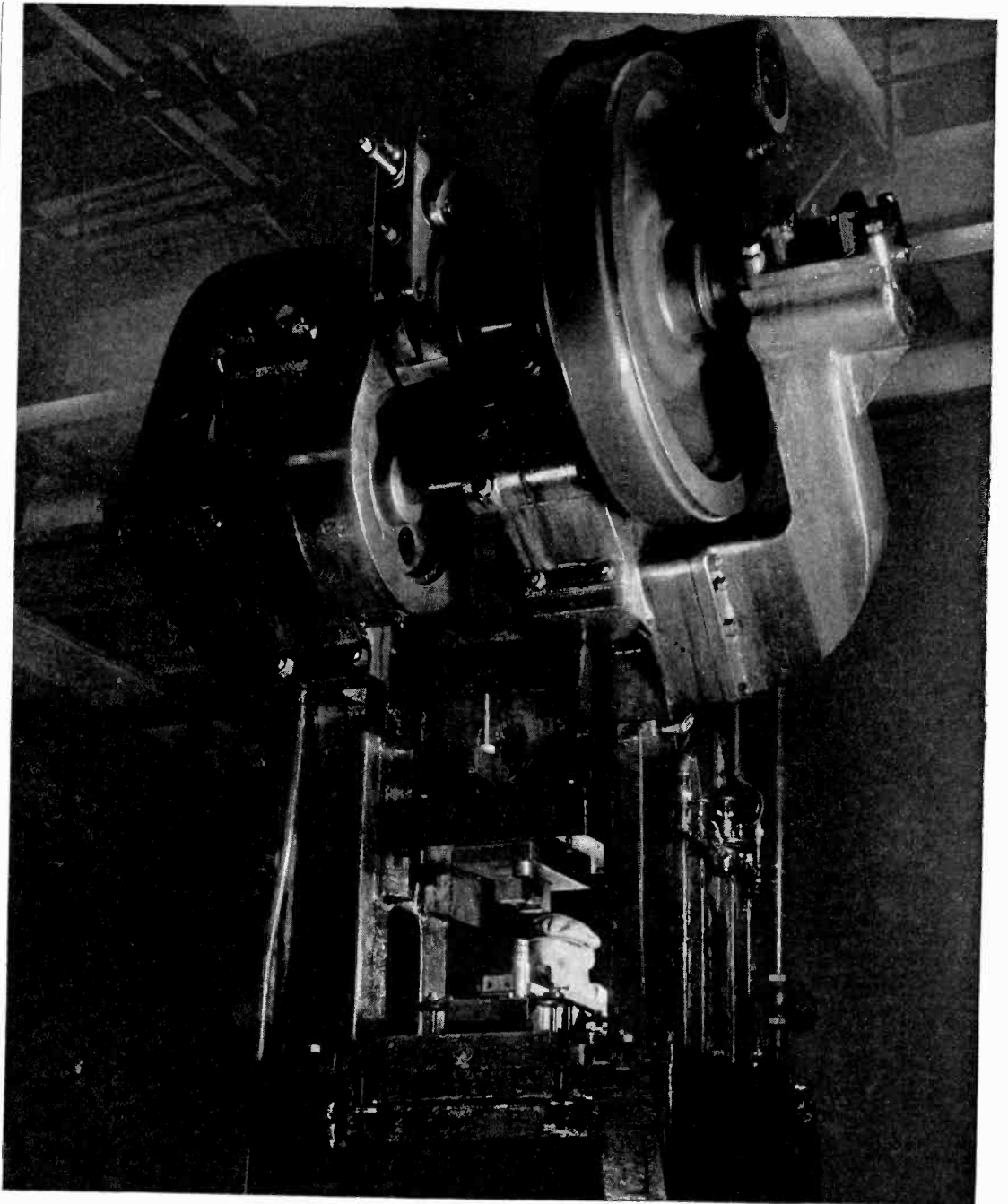

**P**OWER! Tremendous force!  
*The punch press! . . . Symbol of modern industrial efficiency and economical production!*

Such facilities count in more things than price when you are selecting a producer of components for your own products . . . when your own success may depend on the unflinching delivery of dependable precision-made speakers in quantity *on the promised date.*

Magnavox *enterprise* made the first speaker. Magnavox *background* . . .

nearly a quarter of a century of achievement in radio . . . is your quality guarantee. Magnavox *growth* based on that proven performance has made it today the one source of supply capable of handling the requirements of the largest manufacturer or smallest with complete satisfaction.

Magnavox Dynamic Speakers are the standard of quality. Magnavox has the facilities, the personnel and the finances to guarantee the stability and dependability of *your* speaker supply.

ONE OF A  
BATTERY OF  
POWERFUL  
PRESSES FOR  
ECONOMICAL  
PRODUCTION

**THE MAGNAVOX COMPANY**

FORT WAYNE, INDIANA, U. S. A.

CABLE ADDRESS: "MAGNAVOX"

ELECTRONICS — October, 1934





# JUDGE RESISTOR EFFICIENCY



by

## ALL-ROUND PERFORMANCE

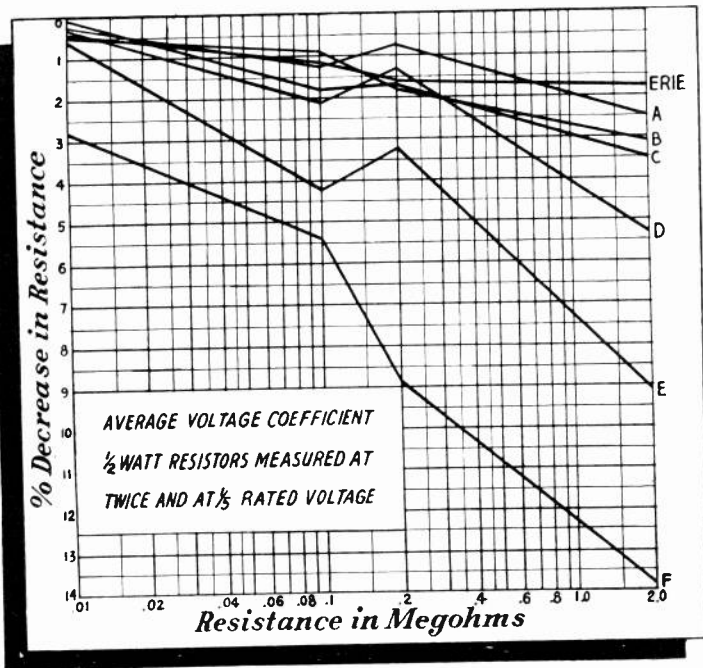

It is a comparatively easy matter to develop a carbon resistor that will surpass all other makes in some one electrical characteristic—at the expense of some other requirement.

But when it comes to actual performance in the set, the resistor that presents the best record in every characteristic is the one that will give the most satisfactory operation.

In the graphs of voltage coefficient and temperature coefficient of seven competitive makes of resistors this one fact stands out: That while they are not first in every result, ERIE RESISTORS ARE THE ONLY MAKE THAT STANDS HIGH IN BOTH TESTS.

It is this consistently high record in every standard measurement that accounts for the all-round efficiency of Erie Resistors.

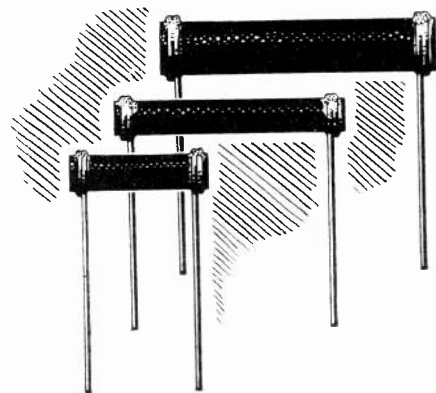
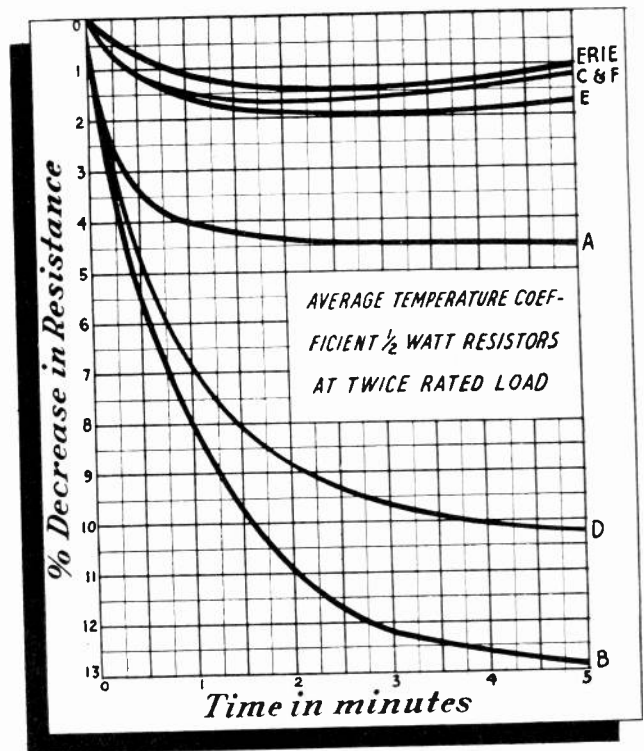

# ERIE RESISTOR CORPORATION

ERIE, PA.

Factories in ERIE, PA. - TORONTO, CANADA - LONDON, ENG.

There is a **Westinghouse**  
**ELECTRONIC TUBE**  
 for every **Application**

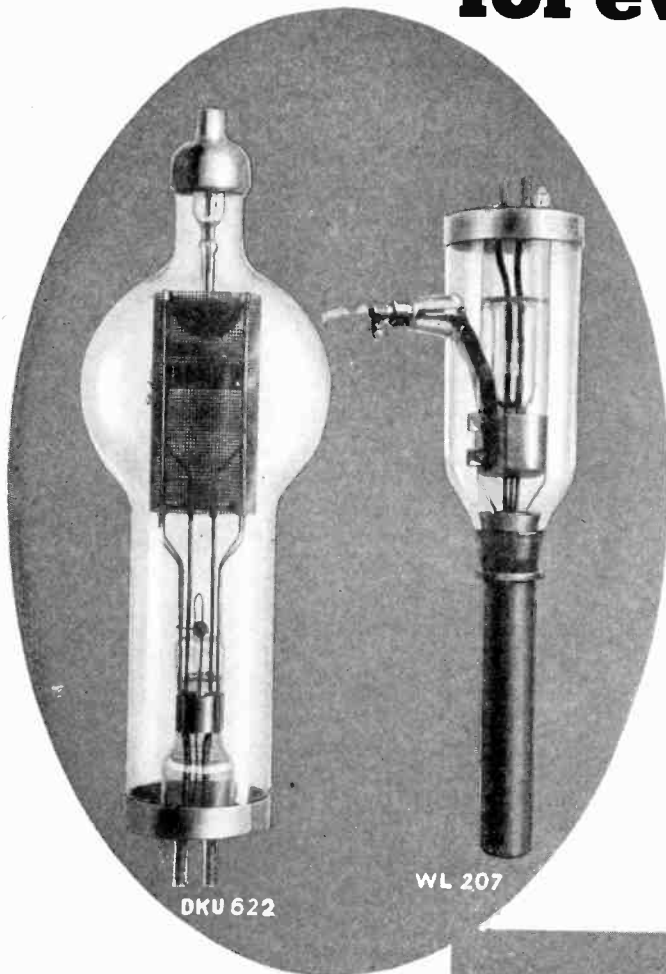

**W**ESTINGHOUSE has pioneered in the development and manufacture of Electronic Tubes and allied devices. Uniformity, long life and satisfactory performance are built into every tube.

Among the tubes available are:

- (a) **AMPLIFIER** and **OSCILLATOR** tubes for industrial applications as well as for use in State, County and Municipal radio transmitters and in aviation radio communication apparatus.
- (b) **RECTIFIERS**, high and low power, both vacuum and gas types for use in radio and industrial equipment.
- (c) **GRID GLOW TUBES**, both hot and cold cathode types.
- (d) **PHOTOTUBES** for automatically actuating and controlling industrial operations and those which have selective sensitivity to ultra-violet radiations making them particularly suited for measurements in specified wave bands.
- (e) **MISCELLANEOUS** items including Cathode Ray tubes; Pressure Indicating tubes; Thermocouples; Electrometer tubes; Voltage Regulator tubes; Sputtered Carbon Resistor and others.

Write to the nearest Westinghouse Lamp Company Division Office, or to the Special Products Sales Department, Westinghouse Lamp Company, Bloomfield, New Jersey, for full details on any type of tube.

New York, N. Y., 30 Rockefeller Plaza  
 Atlanta, Ga., 426 Marietta Street  
 Chicago, Ill., 20 North Wacker Drive  
 St. Louis, Mo., 411 North Seventh St.  
 San Francisco, Cal., 1 Montgomery Street  
 Pittsburgh, Pa., Gulf Building

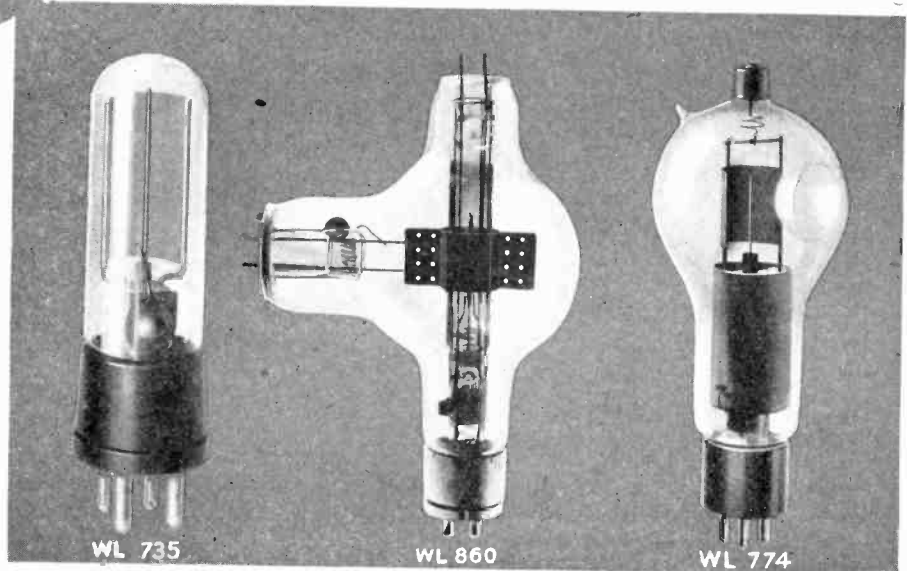

**WESTINGHOUSE LAMP COMPANY**

# A Dependable Source of Supply

## A Consistent Source of Sales

Mallory-Yaxley products for replacement or resale are popular with consumers on a basis of performance and popular with the trade on a basis of worthwhile profit.

The history of the Mallory-Yaxley combined engineering groups has been a history of anticipating and meeting the needs of an industry which recognizes outstanding contributions.



### MALLORY-YAXLEY PRODUCTS

- 
- Dry Electrolytic  
Condensers (A-C-DC)
- Radio
- Motor Start
- Volume Controls
- Rheostats
- Potentiometers
- Variable Resistors
- Circuit Selector Switches
- Tap Switches
- Push Button Switches
- Jack Switches
- Junior Jack Switches
- Midget Jacks
- Plugs
- Cable Connector  
Devices
- Dial and Pilot Lights
- Dial Plates
- Relays
- Cable Markers
- Radio Convenience  
Outlets
- Automobile Radio "B"  
Eliminators
- Automobile Battery  
Chargers
- Rectifiers for Chargers,  
"A" Powers, etc.
- Electrical Contacts
- Tungsten
- Silver
- Platinum
- Welding Electrodes
- Elkonite
- Elkaloy
- Sheet Tungsten
- Molybdenum
- Hard Facing Metal



in RADIO, ELECTRICAL,  
AUTOMOTIVE AND  
INDUSTRIAL FIELD

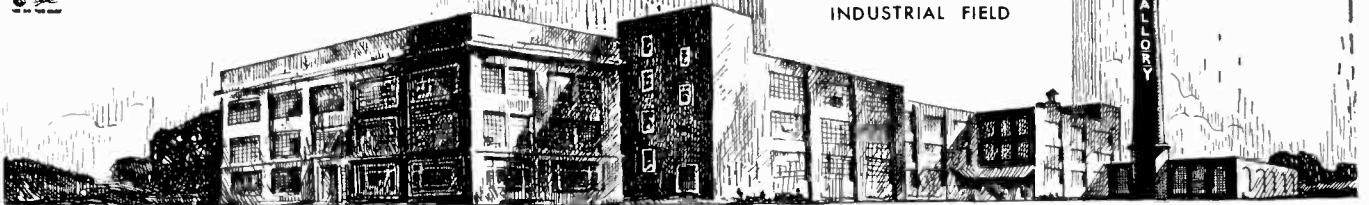

**P. R. MALLORY & CO., Incorporated**  
**INDIANAPOLIS, INDIANA**

CABLE ADDRESS PELMALLO

**YAXLEY MANUFACTURING CO., Inc.**  
Division of P. R. Mallory & Co., Inc.

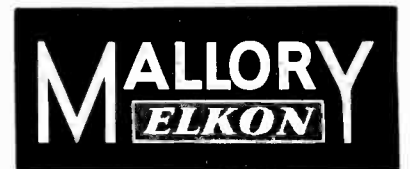

# electronics

O. H. CALDWELL  
*Editor*

KEITH HENNEY  
*Managing Editor*

DONALD FINK

McGRAW-HILL PUBLISHING COMPANY, INC.

New York, October, 1934



## Television—

### the transmitter problem and Federal funds

**T**ELEVISION is here, and ready for the public, so far as receiver technique is concerned. There can be no doubt of that in the mind of anyone who has made the rounds of the laboratories where serious work is being done. Television pictures today are clear, well illuminated, and compare in quality and detail with home movies.

But the *transmission* problem in television introduces tremendous difficulties, chiefly financial. To provide television programs throughout the country would require an initial investment estimated at fifty to two hundred million dollars or more.

This sum seems staggering to private capital. But to a government that is handing out billions for purposes that seem less constructive, even \$200,000,000 for television is not unthinkable.

**T**ELEVISION transmitters really have a sounder claim to government financing, in the present unemployment situation, than do many other enterprises that have received generous federal aid. For *each television transmitter built will be the means of initiating the manufacture of thousands of television receivers, involving starting up factories, restoring employment, and injecting vast new impetus into the lagging machine of national business.* Indeed, television may be the long-sought "new industry" to pull us out of the depression.

From a social and governmental standpoint alone, the implications of nation-wide television are tremendous. What would it mean, for example, to further national unity of thought and purpose, if at the time of the President's delightful fireside chats, he could *be seen* as well as heard?

**B**UT how many homes will purchase television receivers at \$200 to \$300 apiece, under present conditions, one naturally asks. Already a paternally-minded government has provided for financing these television receivers, under the terms of its Tennessee Valley authority, which is empowered to *make long-term loans for the purchase of home electrical appliances, and at the discretion of its directors, to make such loans available to citizens in all parts of the country.* Thus the New Dealers solve the problem of aiding the customer to buy.

To many conservative radio and electrical men, this picture of widespread government aid to our new infant prodigy of television, will seem repugnant. But other less worthy causes have already sought federal aid and have prospered. If nation-wide television can come only with government aid, perhaps scruples of old-time rugged individualism must be forgotten, and this 1935 miracle of ours be ushered in by new-deal financial methods.

At all events, television, large in its employment possibilities, is now "waiting at the gate" of a world that has long sought a new industry to pull it out of the depression.

# TELEVISION:—A SURVEY

## New methods produce pictures of high entertainment value

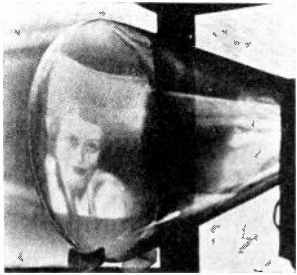

TELEVISION today is a controversial subject. The radio industry, demoralized more than once by ill-timed ventures into new fields, is determined that the new art shall be introduced when the time is ripe, and not before. But there is no definite agreement on just what constitutes the "ripe" time; in fact there is a wide divergence of opinion. The engineers are asked: "Is television ready for the public?" The executives wonder if the public is ready for television. Both of these questions are difficult to answer; but they are made all the more so because little definite information has been available.

In an effort to dispel some of the confusion which surrounds television development, *Electronics* has undertaken a comprehensive survey of the field, enlisting the cooperation of companies known to be actively engaged in television research. In each case the laboratory of the company has been visited and its engineers interviewed. The results of this work, compiled from the actual inspection of the principal systems of television and from interviews with a dozen men prominent in its development are presented on the following pages.

### The essential problems of television

The degree of satisfaction which the reception of a television image can give the observer is determined among other things by the detail of the image. This detail is in turn determined by the number of scanning lines into which the picture has been cut during transmission. The number used today varies from 60 lines to above 400 lines. E. W. Engstrom has argued that pictures capable of sustaining human interest must contain at least 200 lines; others feel that 120 are sufficient. The simpler systems employ 120 lines, while the cathode-ray systems use 240 or higher.

To produce the illusion of motion, many complete pictures must be transmitted each second. The standard projection rate of motion pictures, 24 per second, has been adopted by most workers in the field.

These two factors, the number of scanning lines per picture and the number of pictures per second are most important because in the transmission of any given image they determine the highest frequency in the television signal. If the degree of detail is the same in both horizontal and vertical directions, and if the picture length is  $1\frac{1}{2}$  the width, then to transmit a 240-line

Among the men interviewed in this survey are the following: W. R. G. Baker, P. T. Farnsworth, J. V. L. Hogan, W. E. Holland, A. F. Murray, W. H. Peck, W. H. Priess, and Arno Zillger.

picture 24 times a second requires a maximum communication channel 2,048 kc. wide. (Broadcasting stations today are allowed 10 kc. of space in the ether spectrum.) To be sure, the tremendous band width of 2048 kc. is not absolutely essential for satisfactory pictures, but it is generally agreed that 1,000 kc. will be required for every television channel.

This technical limitation is the most far-reaching of the many which confront television workers. It requires transmitting and receiving circuits of great complexity and high cost; it limits the available wave-band for broadcast television to the ultra-high frequencies between 30,000 kc. and 300,000 kc. (10 and 1 meters); and finally it makes the use of conventional wire lines for television program distribution to a network of stations a practical impossibility. The use of the ultra-high frequency band entails limited coverage, since the signals are useful only as far as the optical horizon; the man-

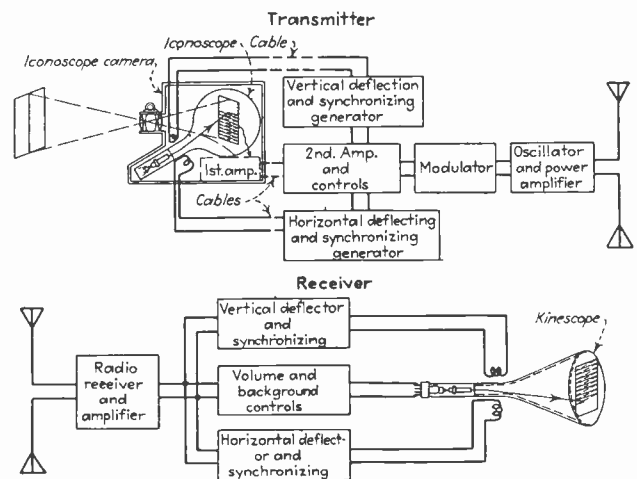

Block diagram of a typical cathode-ray television system, showing the necessary visual and synchronizing channels

made interference from automobile and airplanes is heavy in this region; and as yet no one knows how to build a really high-power transmitter for these frequencies.

In the effort to overcome the problems of television in the least expensive way several different systems have been developed. These systems are characterized by the method used to pick-up and scan the image before transmission and by the method used to recreate the image after the television signal has been received and amplified. The intermediate circuits and transmission paths between pick-up and reproducer are largely similar in all systems, being simply extensions of common practice.



# OF PRESENT-DAY SYSTEMS

## High cost of transmission an obstacle to commercialization

The three classes of systems now being developed are, in order of complexity: the mechanical systems, the light-valve projector systems; and the cathode-ray systems.

One of the most significant advances in the television art was announced last January by engineers of the RCA-Victor Company, Camden, with the publication by V. K. Zworykin of his I.R.E. paper on the iconoscope (Image-observer). This device bridges a great gap in that it permits a storage of the light of each element of the picture from one scanning period to the next, thereby greatly increasing the available output.

### Light-storage principle of Zworykin iconoscope produces great sensitivity

The iconoscope is an evacuated tube containing a source of cathode rays (electron gun), and a specially prepared photosensitive surface. This surface is in reality a mosaic, being composed of millions of minute droplets of caesium-oxide-silver deposited on a mica sheet, isolated and insulated from one another. The grain of this mosaic is extremely fine, finer by far than the maximum number of points required in the television image. Behind the mica plate (on the opposite side from the mosaic) is a metallic coating known as the signal plate. Each elemental droplet of the mosaic and this signal plate act as the two plates of a condenser, so that there is a myriad of individual condensers all having one common plate. The mica dielectric is flat and of uniform thickness.

The image to be televised is focussed on the photoelectric mosaic by means of a lens. The light from

each element of the picture causes electrons to be freed from the corresponding element of the mosaic, the number of freed electrons being proportional to the intensity of light falling on that particular element. The freed electrons flow through the vacuum to an anode-coating on the side of the tube, leaving the element charged positively. The signal plate and each element constitute, therefore, a charged condenser, the amount of charge being proportional to the light on that element.

It remains to discharge these condensers in the proper scanning succession in order to utilize the voltage across them as a television signal. This discharge is accomplished by the use of a cathode-ray beam, which is directed from the electron gun to the surface of the mosaic and caused to scan it by magnetic deflection. The cross-section of the cathode-ray beam, as it impinges on the mosaic, is sufficiently large to cover many elements of the mosaic at the same time, and hence the size of the beam determines the degree of detail of the picture.

It will be seen that during the time between successive scanings ( $\frac{1}{24}$  of a second), the light falls continuously on the elements, and during that time, the positive charge collected on each element increases continuously. A correspondingly large voltage builds up, and is available for signal purposes when discharged by the cathode beam. This process of light-storage accounts for the great increase in sensitivity over previous photoelectric pick-up devices.

Outdoor scenes, even in the dullness of a 500-foot-candle illumination, can be picked up with ease by the iconoscope and with a degree of detail far greater than the rest of the transmission system can handle.

### Direct outdoor pick-up possible with Farnsworth's image dissector

Philo T. Farnsworth of Television Laboratories, Ltd., Philadelphia, has developed a cathode-ray scanner of unusual design, which has the tentative name of "image dissector." This device, used in much the same fashion as a motion picture camera, will pick up outdoor scenes in sunlight, or even on cloudy days. The operation of the dissector is based on the use of a flat metal plate having a uniform photosensitive surface (caesium-oxide-silver) which is placed at one end of an evacuated glass bulb. At the other end of the tube is a metallic surface which acts as an anode.

The scene to be televised is focussed (by means of a camera lens) on the photosensitive plate. Under the influence of the light, each point on the plate emits electrons, the number of electrons emitted in a given time being proportional to the brilliance of that point in the optical image. The optical picture is thus transformed into a picture in electrons. The electrons are attracted to the positive anode at the other end of the tube, but

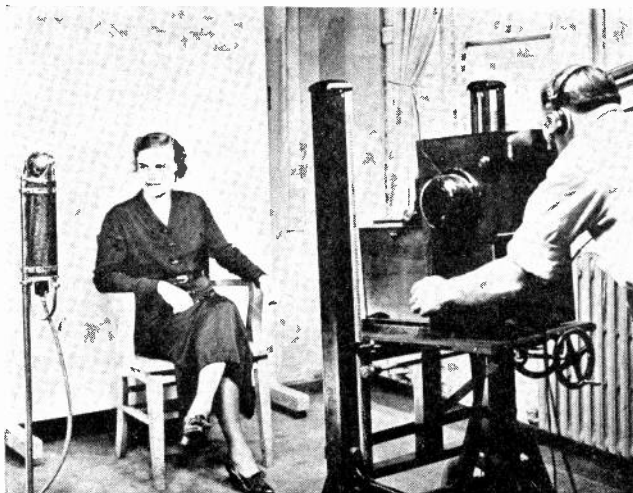

Studio technique, as practiced by engineers of the Philco radio and Television Corporation. The operator has constant visual and aural check on the proceedings

since all the electrons are negative and tend to repel one another, the "picture" diverges as it travels to the anode. To counteract this effect a magnetic field is applied outside the tube which brings the electrons into focus at the other end of the tube.

By means of two additional magnetic fields, the entire electron-image is moved bodily past a small square aperture. This aperture which leads to another section of the same tube, receives the electrons from each element of the picture in the correct scanning succession, i.e., 240 lines per picture, scanned line after line until the picture is completely covered, and then repeated 24 or 30 times a second.

At the other side of the aperture, but still a part of the same vacuum tube, is an electron multiplier (see *Electronics*, August, 1934, pages 242, 243) which multiplies the electron stream by approximately 1,000 times, using secondary emission for this purpose.

Direct scanning of outdoor scenes is possible because of the amplification afforded by this electron multiplier. This adjunct to the image dissector consists of two plates having surfaces of high secondary emission characteristics. The stream of electrons entering the multiplier from the aperture impinges on one of these plates. The secondaries liberated thereby (from two to eight times as many as the original stream) are attracted to the second plate and there repeat the process. The signal is progressively amplified in this manner until the output is roughly 1,000 times that of the original beam.

#### Cathode-ray reception methods provide wide range of detail—RCA Victor and Philco

The cathode-ray receiver has been the subject of an immense amount of experiment during the past five years. The results of this research have produced a type of receiver and reproducer which is more or less standardized. The three major exponents of cathode-ray television (RCA Victor, Philco, and Television Laboratories) now use receivers which differ from one another only in minor respects. The following description will serve, therefore, to illustrate the methods used in reception by these three companies.

The heart of the cathode-ray receiver is the reproducer or cathode ray tube, which has various names such as kinescope, oscillite, etc. depending upon the company developing it. This tube differs from the ordinary cathode-ray tube in that there are several auxiliary controls for the electron stream. The electrons are emitted from an

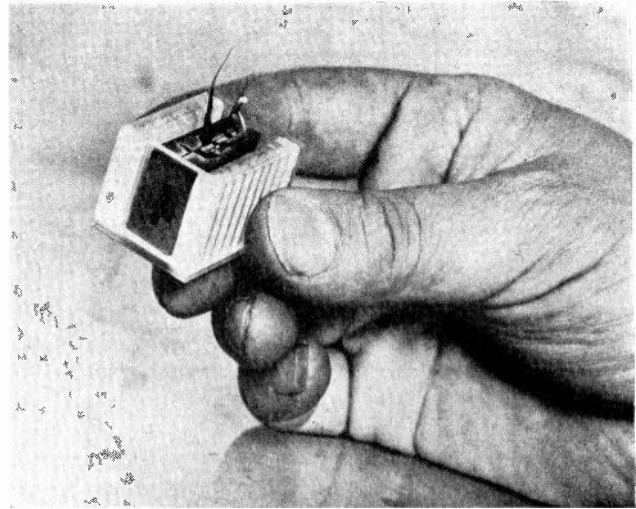

Kerr-cell used in the Peck receiver. This tiny device acts as a light-valve

indirectly heated cathode and immediately come under the influence of the signal electrode or control grid which modulates the beam intensity in accordance with the television signal voltage applied between it and the cathode. The modulated beam then comes under the influence of two anodes. The first anode imparts acceleration to the electrons, and at the same time provides apertures which limit the angle of emergence of the beam. The second anode, operating at a higher potential than the first, is a conducting surface on the inner walls of the tube, and serves the purpose of bringing the electron beam to a fine point at the plane of the fluorescent screen.

Outside of the tube, magnetic coils provide fields which cause the modulated electron beam to deflect, in a horizontal direction for the scanning lines, and in a vertical direction for the picture repetition. These coils must be fed with current of a peculiar wave-shape, known as a "saw-tooth" wave. The beam, while drawing one line of the image, is caused to move across the screen at very nearly constant velocity. When it reaches the end of the line, the beam is extinguished and returns very quickly to the start of the next line. During the return, time is available for the transmission of a synchronizing signal to keep the transmitter and receiver in step.

The fact that the picture size obtainable is definitely limited by the size of the fluorescent screen is no longer so important. Tubes which have sufficient brilliance for

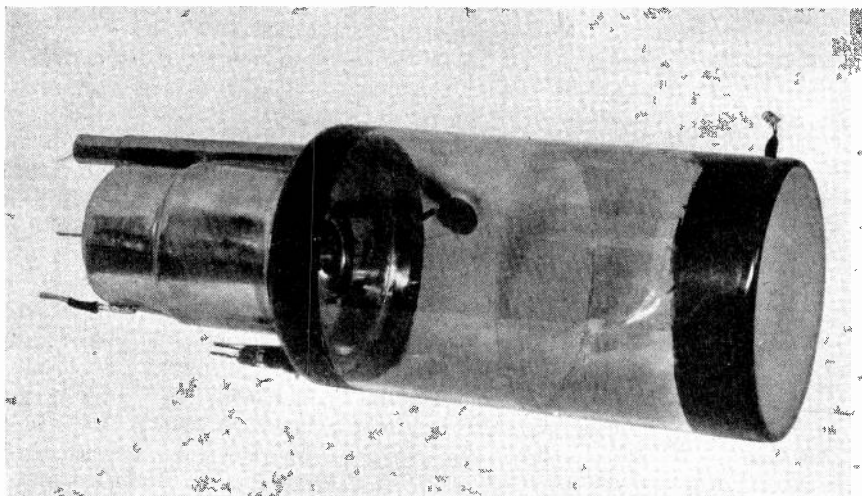

One form of the Farnsworth image dissector. This cathode-ray scanner is capable of televising outdoor scenes by virtue of the electron multiplier (shown at left of tube) which amplifies its output 1000 times

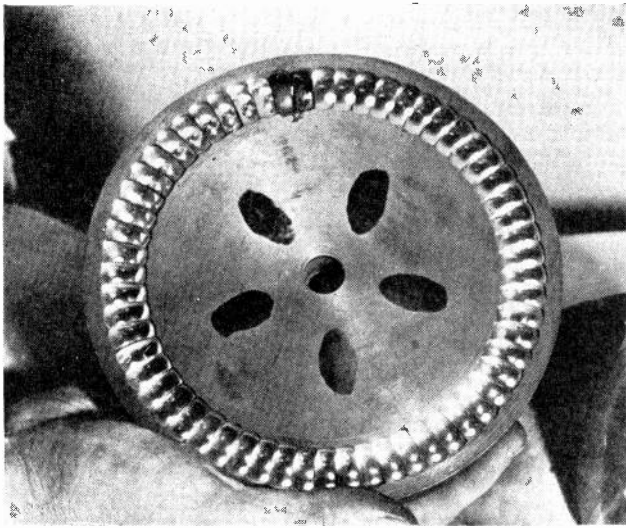

A disc of cast-glass lenses, silvered on the back, reflects the light from the Kerr cell to the viewing screen

reprojection, and which still retain the desirable qualities of rapid response are the subject of research at the present time, and it appears that this limitation will be overcome. It has been stated that when this difficulty is brought under control the cathode-ray system will definitely be the most flexible of all the systems now in operation or proposed.

#### Polarized light used in William H. Peck's optical system

Pictures of considerable entertainment value have been successfully produced by William H. Peck, of the Peck Television Corporation, New York. The essential features of the system are a modified form of Kerr-cell of extremely small size, and a system of mirrored lenses which project the light beam from the cell to the viewing screen.

Transmission is accomplished from standard-size movie film, a special 1,440-r.p.m. motor being used to provide a rate of 24 pictures per second without the use of gears. The vertical scanning is accomplished by the continuous motion of the film, while the horizontal scanning is performed by means of a disc containing 20 cast glass lenses, each mirrored on its rear surface. The light source, an auto headlamp of 21 candlepower, is placed within a unique collecting lens

which directs into a beam 83½ per cent of the total light available from the entire filament. This beam of light strikes the lens-disc (which is rotated by means of a synchronous motor) and is reflected by the lenses through the moving film to the photocell. 60-line transmission is used at present, but this rate may be increased by increasing the speed of the scanning wheel.

The receiver uses a modified Kerr-cell as a light valve. This cell, which consists of two parallel plates mounted condenser fashion in a small container has a capacity of only 6 μmf. Between the plates a solution of nitrobenzene is used, this liquid having the property when subjected to electric stress of rotating the plane of polarized light passing through it. Light from an auto headlamp similar to that used in the transmitter is polarized by passage through a Nicol prism, and is then directed through the Kerr-cell. The amount of light which passes through the cell is controlled by the voltage which is applied across its plates. Hence by applying the amplified television signal to the cell, the amount of light which passes is controlled in accordance with the signal. About 1/20 watt, at 1,300 volts, is required for operating the cell.

The modulated beam from the Kerr-cell is directed to a disc containing 60 glass castings, which is rotated synchronously with the disc of the transmitter. These castings, mirrored on the back, serve to reflect almost all of the light from the cell to a viewing screen. Since there are 6-degree angular displacements between adjacent mirror-lenses, the beam of light is directed to the screen in scanning sequence, and the image is built up. Pictures 12 by 14 inches in size, and of such brilliance that they can be viewed in a lighted room with ease, are thereby produced. The lens castings can be manufactured by a special molding process for 6 cents each, including the silvering. A complete television receiver of this type can be marketed, according to Mr. Peck, for about \$150.

#### Mechanical resonance used for synchronizing receiver and transmitter—other systems

A system based on the Kerr-cell principle is being developed by William H. Priess of New York. The subject is scanned by a spot of light reflected from a light source by means of a specially mounted mirror. This mirror is so arranged that it can vibrate about two axes at right angles to one another. It vibrates about its vertical axis at the scanning frequency (ap-

The Zworykin iconoscope, the essential element of the television camera shown on the front cover. The mosaic plate (shown inside spherical portion of tube) "stores" light between scanning periods, thus greatly increasing sensitivity

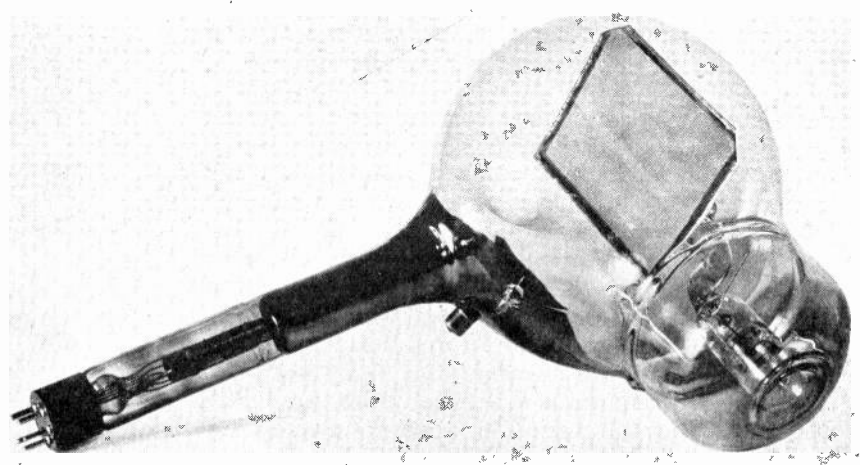

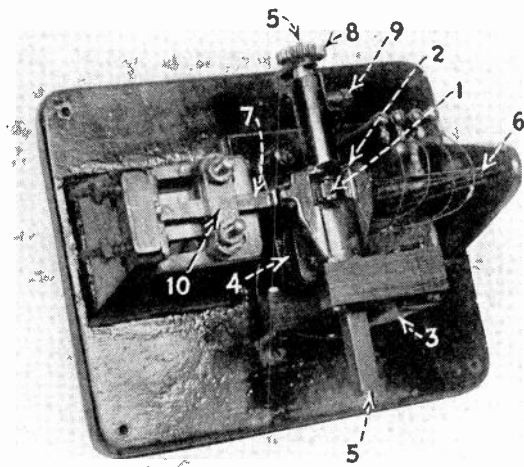

The Priess resonant scanner: 1. The mirror. 2. Line frequency magnet. 3. Frame frequency magnet. 4. Polarizing coil. 5. Line frequency torsional rod. 6. Frame frequency torsional rod. 7. Control for frame frequency. 8. Adjustment for line frequency. 9. Lock for setting line frequency. 10. Lock for setting frame frequency

proximately 5,000 cycles per second), and simultaneously about its horizontal axis at the picture frequency (24 cycles per second). The excitation of these two frequencies is supplied magnetically from small low-power oscillators. The elasticity and moment of inertia of the system are so proportioned that the period of mechanical resonance about each axis can be adjusted to a value very near that of the desired vibration, and as a result the entire system tends to keep in step. The power required to maintain the vibrations at constant amplitude is correspondingly very small, and the synchronizing impulse from the transmitter can be of any wave-form and of low power.

The scanning motion is sinusoidal in character, that is, the spot moves slowly at the ends of its path and fast in the center. Despite this fact, the light field as viewed by the eye is uniform, and corrective filters can be used to secure even greater uniformity. Because of the sinusoidal scanning velocity, this system will not produce signals which are interchangeable with those of the cathode-ray systems, in which the scanning velocity is substantially constant.

In the receiver the television signal is used to regulate the light output from a Kerr-cell. The modulated light-beam from the cell falls on a mirror mounted in identical fashion with that of the transmitter, and tuned to the same periods of mechanical resonance. The excitation of the scanning and picture frequencies is supplied at the receiver by energy filtered from the television signal, which contains synchronizing impulses. These impulses may be of very low power; a 15 degree solid angle of light can be obtained from the scanner with power inputs of  $\frac{1}{2}$  watt for the scanning frequency and 0.05 watt for the picture frequency. The motion of the entire system is equal about the neutral position of rest, and as a result no continuous stress, either mechanical or electrical is encountered. The entire scanning mechanism can be manufactured for the cost of an ordinary dynamic loudspeaker.

A system of scanning and viewing using a spirally shaped set of mirrors rotated by a synchronous motor developed by Arno Zillger of National Television was

described in September *Electronics*. The resulting picture as viewed by the Editors can be enjoyed through a wide angle and in broad daylight.

U. A. Sanabria, well known for his large-scale pictures is stated to have constructed at considerable cost a 150-line system which projects its image on a screen 12 feet in size. It is said that a carbon dioxide arc provides the illumination at the receiver.

John V. L. Hogan and numerous other radio engineers have done considerable work on mechanical and electron scanning which with other systems under development will be described in *Electronics* as soon as details are available.

### The prospects of commercialization

It appears to be the consensus of opinion that to launch television will require a great deal of money; more, apparently, than any company is willing to risk at the present time. The possibility of a government subsidy for a system of transmitting stations has already been proposed.

Since it appears that the commercialization of television will remain in the hands of the industry, the opinions of those in industry carry considerable weight. One point of view recently expressed is directly commercial. The chief engineer of one of the largest radio companies in America expressed himself as being reluctant to see television introduced while the industry is enjoying the new boom for all-wave receivers, which he believes will provide the industry with plenty to do for the next two years. He expressed his opinion, however, that the time is ripe to begin broadcasting television with one high power transmitter surrounded by a few receivers, in a sort of public laboratory, so that the problems of public acceptance can be worked out while the all-wave boom is still operative. When that is over, television will be in a position to take its place.

A different point of view is taken by another chief engineer, likewise of a corporation of the first rank. His is a well-worked out philosophy:

1. Novelty interest in television is not enough. The public, faced with a service requiring constant attention, cannot be allowed to lose interest after owning a receiver for six months.

2. Television must be available to all the people at once. Otherwise the radio business will be killed in those cities anticipating the coming of a television service already in use elsewhere. Radio is not in a position to receive such a blow.

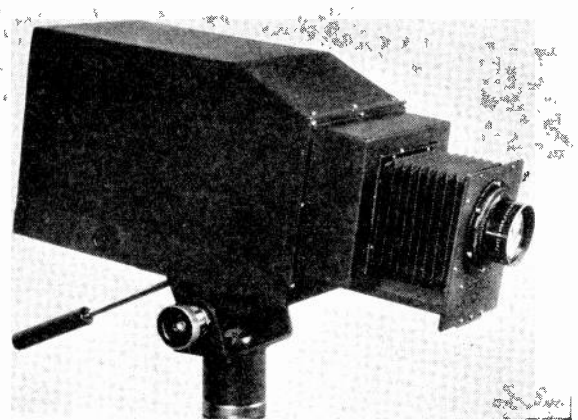

The Farnsworth camera, containing the "image dissector"



3. The art, when introduced, must be capable of growth, since a stagnant industry is not profitable or wholesome. But such growth must not render useless the sets already sold and in service. Each television receiver must retain its original usefulness, in the same way that the crystal set can still be used for broadcast reception.

4. Since the technical progress is at present so rapid, any attempt to "freeze" the art at this stage of the game would be wasteful and uneconomic. Further technical advances might be made inapplicable by virtue of the investment in a given system. When technical progress begins to slacken, commercialization may be safely assumed.

5. Sufficient money must be in the hands of the manufacturers and the broadcasters to insure public acceptance. This includes money for installing and maintaining a sufficient number of transmitters to serve more than half the population, and for programs.

6. The public must have enough money to buy a set (which at present indications will cost in the neighborhood of \$200, not counting the cost of the sound receiver), and to replace it occasionally with a better one. This implies better economic conditions than those of the present.

The sum and substance of these arguments are: Wait for better times, and fill in the technical gaps meanwhile.

Another leading television experimenter has different ideas on the subject. He says, "The reason we don't have television today is that no coordinated program has been undertaken by an organization having (1) engineering competence, (2) capital, (3) an adequate transmitter, (4) adequate program material with sound, and (5)—most important—a supply of receivers good enough and cheap enough. All of these prerequisites are available today." This man has been providing television programs for the benefit of experimenters continuously since 1928, and has been working since that time toward simplified television cheap enough for wide distribution and adequate to place it beyond the novelty stage. In his opinion neither the mechanical nor the cathode ray system has definitely demonstrated its superiority over the other. Nor does he believe that the medium short waves are totally unsuited to television. Television must be introduced gradually and simply, starting if need be with the equipment now available.

It may well be argued that the radio industry is in no position, financially or otherwise, to undertake the great task of introducing television. Certainly every effort must be made to keep the public from rushing the industry into a half-formulated and incomplete program. But the caution dictated by this fact should not be allowed to hide a reactionary and academic reluctance to undertake the job.

## REPRESENTATIVE TELEVISION SYSTEMS

Company	Type of subject	Method of scanning	No. of lines	No. of frames	Type of light sensitive device	Synchronization	Receiving light source and color	Method of light modulation	Method of image recreation	Type of screen
<b>CATHODE-RAY SYSTEMS</b>										
Philco Radio and Television	studio film outdoor	cathode-ray "camera tube"	240 to 360	24 to 60	mosaic plate	separate signal	fluorescence (green)	control electrode	cathode-ray tube	fluorescent
RCA-Victor Co.	studio film outdoor	cathode-ray "iconoscope"	240 to 360	24 to 60	mosaic plate	separate signal	fluorescence (green)	control electrode	cathode-ray tube	fluorescent
Television Labs (P. T. Farnsworth)	studio film outdoor	cathode-ray "image dissector"	240	30	uniform plate	separate signal	fluorescence (green)	control electrode	cathode-ray tube	fluorescent
J. V. L. Hogan	studio film	mechanical (not disc)	120-60	20-24	photocell	transmitted signal; also power system	glow-lamp (white)	direct	mechanical (not disc)	projection & direct
		cathode-ray	300-60	20-24-30			fluorescence (green) (white)	control electrode & special	cathode-ray tube	fluorescent
<b>MECHANICAL-OPTICAL SYSTEMS</b>										
International Television (W. H. Priess)	studio film	resonant mirror	60-120	24	photocell	transmitted signal plus resonance	incandescent lamp (white)	Kerr cell	resonant mirror	projection
Peck Television (W. H. Peck)	film	mirrored lens disc	60-120	24	photocell	power system	incandescent lamp (white)	Kerr cell	mirrored lens disc	projection

# Characteristics of German radio receivers

By WILHELM E. SCHRAGE

IMPROVEMENTS made in German radio sets during the past year were demonstrated by some 250 manufacturers at the recent annual Berlin show. Not only are the sets better technically—making evident a faster adoption to practical use of scientific inventions and discoveries but they looked radically different.

In the past it has often been the case that a new idea would be invented in Germany but put to use in America before the German manufacturers brought it to practical value. This is changing; this year's sets are modern and have features not found in American receivers.

More than 75 per cent of all sets sold in Germany in the last season have been of the two-tube type. There is a special reason for this. All the German manufacturers, by order of the government, are forced to make an exact copy of a two-tube set following an official design. This is the so-called "Folks-empfänger." Not only has the circuit of this set been exactly prescribed but the cabinet design and the retail price as well. It consists of one tuning circuit with a regenerative detector and a pentode output tube. The official price is 76 marks (about \$30). The main purpose of the German government in creating this "cheap" receiver has been to give all German families a chance to listen to the government propaganda broadcasts.

If we compare the price of this cheap set with the prices of sets in the American market it may seem that the German manufacturer should enjoy a large profit,

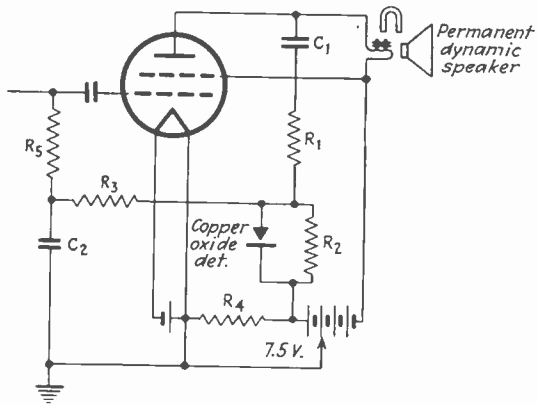

Fig. 1—Circuit of Folks-empfänger receiver. Note copper-oxide rectifier

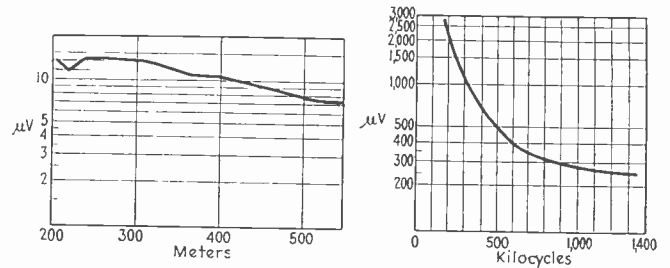

Fig. 2—Sensitivity and selectivity (right) characteristics of 5-tube German receiver

but it is not so. Taxes in Germany are enormous, especially the high contributions for social purposes as yet unknown in America.

The German government last year made an unprecedented advertising campaign on this small two-tube set. The German radio industry sold during this period over a half million of these receivers. It is true however that sales of the larger sets on which greater profits are possible suffered accordingly.

Of the Folks-empfänger sets there are three types, a.c., d.c. and battery operated. The battery type now has a most important device to decrease its current consumption. The receivers use tubes of a new type which

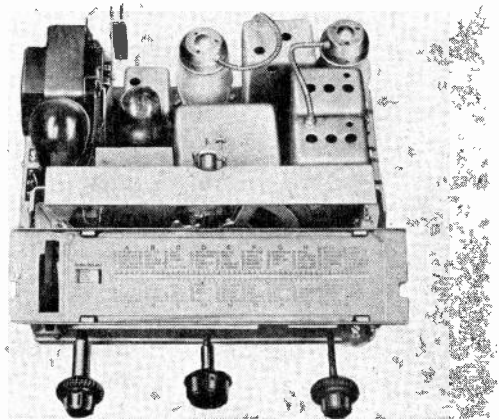

Fig. 3—Chassis of modern 3-tube reflex superheterodyne (A.E.G.)

consume only 0.065 amperes for the detector and 0.150 amperes for the power tube. By the use of a copper-oxide rectifier as shown in the circuit diagram the battery consumption of the power tube is reduced when signals are weak and automatically raised at higher signal levels. Normally the plate current is 7 to 8 milliamperes but when no signal is heard this will drop to 2 to 3 milliamperes securing the advantages of class B amplification without using push-pull tubes.

Economy of battery operation is the result; there is no sacrifice in the power output of the pentode tube. For use with these sets there are now special batteries giving a service of 750 to 800 hours compared to 350 to 400 hours for the older types.

It is interesting to note that all German manufacturers have agreed to charge about the same price for sets of a certain type and that they supply precise information about the selectivity and sensitivity of their products. Selectivity is figured on a 9 kc. separation basis. This means that if the receiver has a guaranteed selectivity of 1:100 the volume of the adjacent channel stations to the desired channel is in this ratio. Although the prices

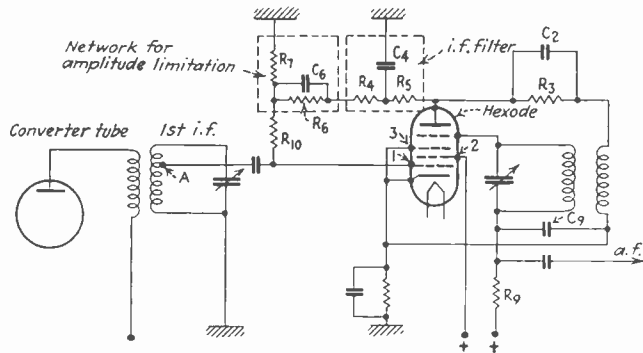

Fig. 4—Three-tube reflex super with amplitude limitation circuit

are high, it must be realized that only the finest of low-loss material is used. The switches have platinum contacts; the cabinets are of the finest woods.

The main idea in the construction of sets for the German market is to save tubes. The reason is very simple; tubes cost about 8 to 10 times as much in Germany as they do in the United States. And again the reason is not difficult to find. There are only two large manufacturers of tubes, Telefunken and Valvo. They are in possession of the patents and because of this virtual monopoly high prices are the rule.

High tube prices are reflected in set design. They have been an incentive for circuit engineers to pay much attention to reflex circuits. For example the diagram shows a three-tube reflex superheterodyne using a 4-grid hexode which serves as i-f tube, second detector and last a-f amplifier. The tap on the secondary winding of the first i-f transformer compensates for tube and wiring capacity. Grid 4 acts as plate for grid 1, and is con-

nected to the tuned primary of the second i-f transformer. Here amplified i.f. is obtained. By voltage limitation on grids 1, 2 and 3 electrons from the cathode are prevented from passing through grid. The electron charge of grid 4 gives this grid the function of a cathode, and grid 4 used in connection with the plate as a diode. This diode together with the condenser  $C_2$  and the resistor  $R_3$  is used as second detector. The remaining i.f. is stopped by the filter-network =  $R_5, C_4$  and  $R_4$ . The rectified a.f. is brought over  $R_6$  and  $R_{10}$  back to grid 1. The tube now amplifies the a-f impulses. Finally the a-f impulses are conducted over a tap near  $R_9$  to the following power tube. To eliminate distortion at the power tube the resistors  $R_7, R_6$  and the condenser  $C_6$  limit the amplitudes of the audio output to the power tube.

All the newly German sets are constructed for high efficiency. Most of the tuning coils have iron core material which gives them extremely high efficiency, favorable permeability and very low losses. There are now two kinds of these coils with iron cores available upon the German market. (Sirufer and Ferrocart) but they are used only for the medium and long wave coils. For short wave coils the German radio manufacturers prefer to use bobbins made of materials with very low dielectric losses such as Calit, Ultra Calit, or Frequenta.

Tuning condensers made with low loss insulation have been used in Germany for more than 3 years. But now they use by-pass condensers made of a new ceramic material with very low losses, and a very high dielectric constant (40-80). The condenser layers are directly burned upon the new ceramic material. The new by-pass condensers are of very small size, of a great constancy, and the breakdown rating of them is high.

The a-f frequency range of the bigger German radio sets generally covers 80-4,000 cycles. The 9 kc. separation of the European stations leaves only a maximum frequency range of 4,500 cycles available.

The design of the cabinets is very interesting. The front of the German cabinets is used only for two main purposes, firstly to allow a good radiation of the second waves ( $\frac{2}{3}$  of the front). The balance of  $\frac{1}{3}$  is used for the tuning dials. The tuning dials are of a much better quality than the dials used in America, and it is much easier to tune in any station with a German dial than with the average dials used here.

Set type	Tuned circuits	Tubes	Sensitivity microvolts	Selectivity $\approx 9$ kc.	Agreed price (Retail price)	Wavelength range etc.
Regen. det.....	1	2	125-1000	1:35	160 M. = \$64	19-50 meters 200-580 "
Regen. det.....	2	2	50-80	1:80 1:1000 (long waves)	200 M. = \$80	Dynamic speaker
R.f. and regen. det...	2	3	25-80	1:80	180 M. = \$72	No dyn. speaker
Superhet...	4	3	75-125	1:175	210 M. = \$84	No. A.V.C.
Reflex super.....	6	3	10-30	1:300	270 M. = \$108	A.V.C. 1:2000
3 r.f. and diode det..	3	4	20	1:175	270 M. = \$108	A.V.C. 1:3000
Superhet...	5	4	5-20	1:400 1:1000 (long waves)	300 M. = \$120	A.V.C. 1:40,000
Superhet...	6	5	10 for 10 watt output	1:700 1:1000 (long waves)	400 M. = \$160	A.V.C. 1:300,000

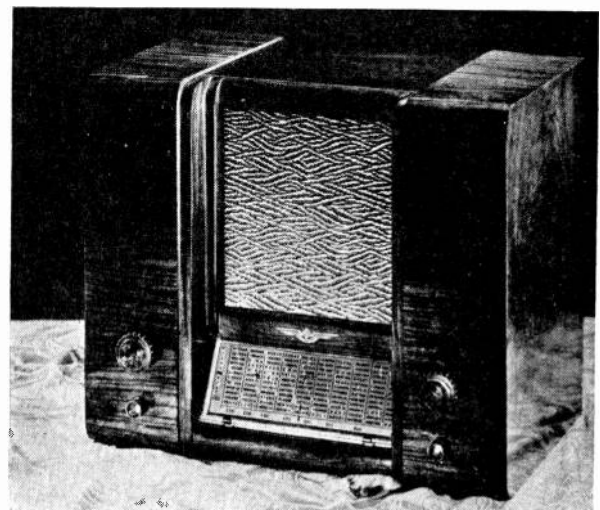

Fig. 5—Schaub receiver in which two-thirds of panel is used for loud speaker

# Capital and annual costs of 100 watt broadcast stations

**E**NACTMENT by Congress of the Davis Amendment to the Radio Law, in 1928, limited the number of broadcasting stations and the extent of radio facilities in each state, to a figure bearing the same proportion to the nation's total broadcasting facilities, as that state's population bore to the total population of the United States. As the result, practically no additional licenses for broadcast stations were granted, except in states far below quotas based on proportionality to population.

The 1934 radio law, setting up the Federal Communications Commission, relaxed this proportionality principle of radio facilities assigned to the states, in so far as it applies to *broadcast stations of 100 watts and under*. The new law gives to the Commission the discretion of awarding licenses for new 100-watt stations upon application, leaving it to the Commission's judgment to permit *new 100-watt stations to go into operation, regardless of the radio facilities already assigned to the applicant's state*.

The result has been a rush of applications to build and operate 100-watt broadcast stations, and there is now great interest in this field. Some seventy-five applications for hundred-watters are now before the Federal Communications Commission, awaiting action, and hundreds of other applications are in prospect. No permits have yet been granted during the brief official life of the new Commission since July, but action on these 100-watt applications, as definitely authorized by Congress, is now one of the first items in the Commission's agenda.

Although not in the class with the big transmitters in point of cost, a 100-watt station requires appreciable capital outlay, and certain unavoidable annual charges. The following data on the capital costs and maintenance of broadcast stations of this class have been obtained from several sources, including those companies which have supplied much of the transmitter equipment up to the present time. Naturally they are round figures, since labor costs as well as the individual requirements of each station will vary to a considerable extent. The

figures, however, are representative and give a good picture of what is required in the way of capital outlay, and annual expense for the important items listed.

Several studies of the capital outlay required and the annual charges for maintaining broadcast stations of various powers have been published in *Electronics*. The first of these in June, 1931, *Electronics*, gave the data compiled by the Committee on Engineering Developments of the National Advisory Council on Radio in Education. These figures were revised and appeared in *Electronics* in August, 1934. Data on the annual tube replacement costs for stations of various power classifications were given in April, 1934, *Electronics*.

The prospective operator and owner of a 100-watt station may derive some satisfaction in reviewing his costs with similar data on stations of higher power. For example, the average 1,000-watt station costs about \$17,500 installed plus about \$5,000 for studio switching and outside pick-up apparatus, plus another \$3,000 for speech input equipment if the studio is remote from the transmitter.

## ESTIMATE A

Transmitter and tubes.....	\$ 5,900.00
Installation of above.....	200 to 400.00
Single channel studio speech input equipment..	3,500.00
One outside pick-up equipment.....	600.00

## ESTIMATE B

Transmitter and tubes.....	\$5,000.00
Installation of above.....	1,000.00
Speech input equipment.....	3,000.00
Salaries of chief operator and two assistants...	5,000.00
Power.....	275.00
Maintenance of apparatus and towers.....	500.00
Tubes.....	600.00

## ESTIMATE C

Transmitter and tubes.....	\$3,665.00
Installation.....	1,500.00
Studio equipment.....	1,600.00

## ESTIMATE D

Transmitter.....	\$4,000.00
Installation of above.....	500.00
Two-studio, low level switching equipment....	3,400.00
Salaries, chief and one assistant.....	4,000.00
Power.....	500.00
Maintenance.....	300.00

For still larger stations aiming to serve a national as well as local audience, 5,000 and 50,000 watts in power, for example, the corresponding expenses are as follows: transmitter complete \$46,000 for 5,000 watts and for the 50,000-watt station this figure becomes \$150,000. These figures do not include antenna installation which still further increases the necessary outlay before the high-powered station can get "on the air."

Antenna costs for 100-watt stations will not be greatly different from those for 1,000-watt stations, i.e., about \$2,000, or perhaps somewhat higher. The transmitter apparatus indicated in each of the above cases is crystal controlled, of course, and the prices given include the control apparatus. In the case of Estimate A, a frequency monitoring unit is included in the price.

It is also worth noting that nearly all 100-watt stations will have transmitter and studio in the same building. Therefore it may be more typical to omit the costs of station speech input equipment charges.



# KILLING INSECTS BY SHORT-WAVES

At the right is shown a small 50-watt transmitter in one of the greenhouses, capable of generating frequencies up to 60,000 kc. This is one of three transmitters used in the Rutgers tests, the others being of 5 kw. and 100 watts rating. Food substances in which insects are concealed have little effect of shielding the insects from lethal effects, unless the material is very moist, providing paths for local induced currents in the substance itself

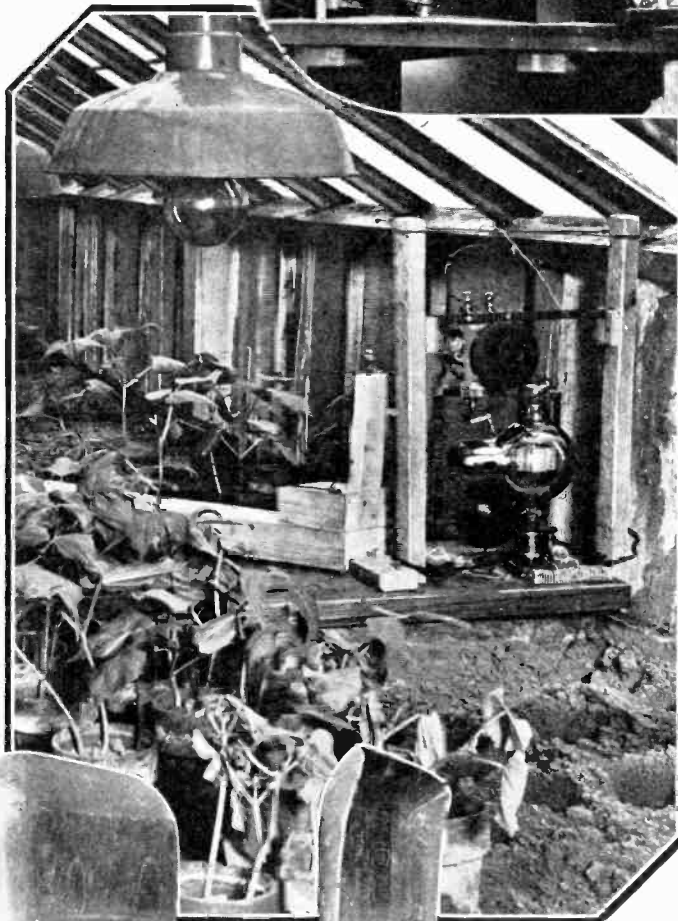
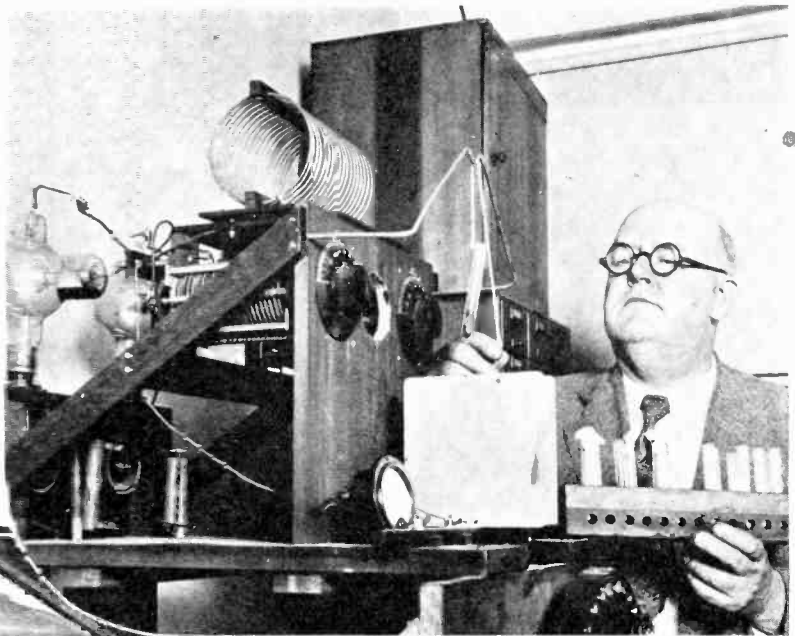

Dr. Thomas J. Headlee, of the New Jersey State Agricultural Experiment Station at Rutgers University, New Brunswick, N. J., with his 100-watt adjustable short-wave transmitter connected to condenser test plates, between which are placed the insects to be killed. Currents induced in the insects' bodies, make them hot to the touch. Death ensues in 10 to 30 seconds

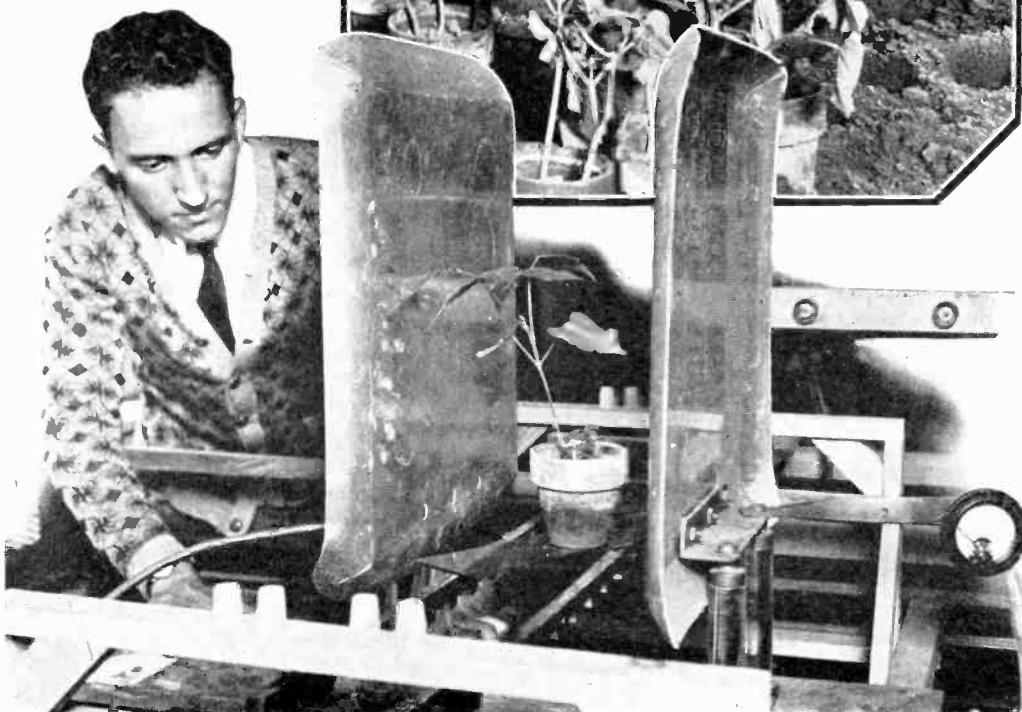

Frequencies which kill insects without injuring plants, have been defined during these tests. The margin of safety between the energy levels which kill plants and insects is very wide at the optimum of 3,000 kc, but very narrow at 16,000 kc. Frequency thus becomes a selective factor in the differential effects of electrostatic force on insects and plants

# Economical design for radio set transformers

By C. A. HULTBERG

Radio engineer, Hygrade-Sylvania Corporation,  
Emporium, Pennsylvania

ONE factor which separates the design of audio transformers and B filter chokes from that of a power transformer is the fact that the power transformer has no d.c. current flowing in either of its windings while the audio transformers and chokes frequently do have to accommodate d.c. This factor influences the operating point of the iron in the cores and causes considerable change in the inductance which is available from a given winding and core. Consequently all audio transformers or chokes carrying d.c. in any winding should be checked to see whether their inductance can be raised by using an air gap in the core. When testing for optimum air gaps use as close to the normal a.c. induction as possible. Sixty or 120 cycles is a satisfactory frequency for this purpose with respect to filter chokes and large size audio transformers. Small output transformers may require checking at some higher frequency such as 200 cycles, due to the difficulty of measuring low inductances accurately at low frequencies by the impedance method.

## Design of interstage audio transformers

Interstage audio transformers usually operate between two high impedances, so that care must be used to reduce leakage reactance, and distributed capacity while inductance values should be made as high as economically practical. It may be found necessary to load the secondary with shunt resistance to keep the frequency characteristic flat.

First design a preliminary sample transformer using



**NEW TRENDS** in the design of interstage and output audio transformers and of B-filter chokes are brought to light in this concluding installment of Mr. Hultberg's article, which began in the September issue

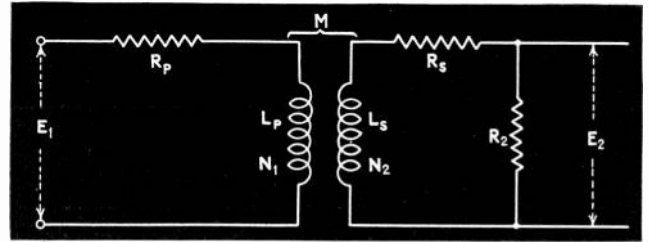

Fig. 1—Reference circuit for calculating inductance of output transformer (equation 7)

the desired voltage ratio. If no d.c. flows in the windings use a small wire<sup>1</sup> size such as No. 40 and place as many turns on the primary as the window space will permit. If d.c. is present adjust the air gap to an optimum value. Check the frequency characteristic, and if a push-pull transformer, check the secondary balance and phase relations. If the unbalance is too great, or if the phase angle between the two halves of the secondary is too far from 180 electrical degrees at any portion of the desired frequency spectrum, it may be necessary to wind the secondary in two equal parts symmetrically placed over the primary. In calculating the total space required for the windings use double values for paper thickness and add about 15 per cent.<sup>2</sup>

If the same size wire is used on both the primary and secondary, a simple calculation will predetermine the approximate maximum number of turns of a given size wire that will fit in a given space.

Let  $L$  = window length, in inches or cm  
 $W$  = window width  
 $M$  = paper margin  
 $T$  = paper thickness  
 $D$  = diameter of insulated wire  
 $Q$  = thickness allowed for tube and interwinding insulation.  
 $N$  = number of turns

$$\text{Then maximum } N = \left[ \frac{.87(L-2M)}{D} \right] \left[ \frac{(W-Q) \times .9}{D+2T} \right] \quad (4)$$

Or, if desired  $N$  is known the wire size may be determined:

Let  $L-2M = A$   
and  $W-Q = B$

$$\text{Then } D = T \pm \sqrt{T^2 + .78 \frac{AB}{N}} \quad (5)$$

The nearest smaller sized wire should be used where  $D$  does not correspond to a standard wire size. If this wire is found to be too small to carry the required current, an iron with a larger window is indicated.

For chokes, a rough check on the resistance is also necessary. This is readily calculated by estimating the length of the mean turn and obtaining the resistance from the relation:

$$R = \rho l n \quad (6)$$

Where  $\rho$  is the resistance per foot of wire  
 $l$  = mean length per turn, in feet  
 $n$  = total number of turns

If the resistance for a given inductance (or number of turns) is too great, a larger wire size (and possibly a larger core window) is indicated.

## Output transformer design

In general, if output transformers are made with wire large enough for high efficiency, no air gap will be needed for push-pull operation. Output transformers for single tubes or tubes in parallel will require an air gap in nearly all cases. This point should always be checked.

Use a primary wire size that gives a current density<sup>3</sup>

# NEW SUBSCRIPTION ORDER

Enter a new subscription to ELECTRONICS and bill me for:

1 year for \$3       2 years for \$5       3 years for \$6

Name \_\_\_\_\_ Position \_\_\_\_\_

Street \_\_\_\_\_

City \_\_\_\_\_ State \_\_\_\_\_

Company \_\_\_\_\_ Dept. \_\_\_\_\_

CANADIAN RATES—1 year \$3.50; 2 years \$6.00  
(including tax) payable in Canadian funds at par.

FOREIGN RATES—  
1 year \$4; 2 years \$7  
10-34

---

# NEW SUBSCRIPTION ORDER

Enter a new subscription to ELECTRONICS for the following:

1 year for \$3       2 years for \$5       3 years for \$6

Name \_\_\_\_\_ Position \_\_\_\_\_

Street \_\_\_\_\_

City \_\_\_\_\_ State \_\_\_\_\_

Company \_\_\_\_\_ Dept. \_\_\_\_\_

Send the bill to:

Name \_\_\_\_\_

Street \_\_\_\_\_ City and State \_\_\_\_\_

CANADIAN RATES—1 year \$3.50; 2 years \$6.00  
(including tax) payable in Canadian funds at par.

FOREIGN RATES—  
1 year \$4; 2 years \$7  
10-34

Postage  
Will be Paid  
by  
McGraw-Hill  
Pub. Co.

No  
Postage Stamp  
Necessary  
If Mailed in the  
United States

**BUSINESS REPLY CARD**

FIRST CLASS PERMIT NO. 64, SEC. 510 P. L. & R. NEW YORK, N. Y.

**ELECTRONICS**

McGRAW-HILL PUBLISHING CO.

330 WEST 42nd STREET

NEW YORK, N. Y.



Postage  
Will be Paid  
by  
McGraw-Hill  
Pub. Co.

No  
Postage Stamp  
Necessary  
If Mailed in the  
United States

**BUSINESS REPLY CARD**

FIRST CLASS PERMIT NO. 64, SEC. 510 P. L. & R. NEW YORK, N. Y.

**ELECTRONICS**

McGRAW-HILL PUBLISHING CO.

330 WEST 42nd STREET

NEW YORK, N. Y.





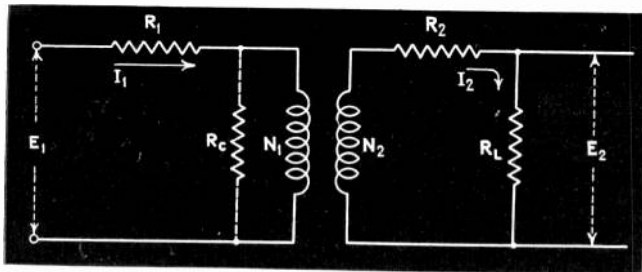

Fig. 2—Reference circuit for estimating core loss, current, and voltage in power transformers

between 600 and 1000 circular mils per ampere, and if possible, a secondary wire size such that the d.c. resistance of the secondary does not exceed 10 per cent of the d.c. resistance of the voice coil of the speaker with which it is to be used.

Neglecting the d.c. resistance of the primary winding and effects of core losses, the minimum inductance is given by the following formula: (see circuit in figure 1)

$$L_p = \frac{1}{\omega \sqrt{\frac{1}{K^2} - 1}} \left[ \frac{R_p(R_s + R_2)}{a^2 R_p + R_s + R_2} \right] \quad (7)$$

Where  $L_p$  = primary inductance.  
 $\omega = 2\pi f$  ( $f$  being the lowest freq. of interest).  
 $R_p$  = plate impedance of output tube.  
 $R_s$  = resistance of trans. secondary.  
 $R_2$  = impedance (usually D.C. resistance) of voice coil of speaker.  
 $N_1$  = primary turns.  
 $N_2$  = sec. turns.  
 $a = \frac{N_2}{N_1}$

$K$  is the ratio (expressed as a decimal) of the response at the lowest frequency of interest to the response at high frequencies.

The greatest power occurs in  $R_2$  when the voltage across  $R_2$  is a maximum (keeping the tube input constant).

The ratio  $\frac{E_2}{E_1}$  at high frequencies is

$$\frac{E_2}{E_1} = B = \frac{-j\omega M R_2}{(a^2 R_{pL} + R_s + R_2)j\omega L_p} = \frac{-a R_2}{a^2 R_{pL} + R_s + R_2} \quad (8)$$

Where  $R_{pL}$  = Recommended load impedance for the output tube in question, as given by manufacturer.

Taking  $\frac{dB}{d\alpha}$  of equation (8) and equating to zero

$$\text{Gives: } a^2 = \frac{R_s + R_2}{R_{pL}} \text{ or, } a = \sqrt{\frac{R_s + R_2}{R_{pL}}} \quad (9)$$

For most efficient impedance match.

If the primary inductive reactance is at least five times the reflected load impedance at the lowest frequency of interest (usually the natural resonance frequency of the speaker diaphragm) and if there is a reasonable balance between iron size and coil size for the power output required, no trouble from excessive flux densities should arise. A reasonable balance is usually dictated by experience, but may be checked experimentally by working the

transformer into a resistance load from a source of the same impedance as the reflected load and increasing the power input until it is 50 per cent over the normal maximum, if the percentage distortion due to the transformer is not excessive at this excitation the design is conservative. Transformers for competitive receivers in the lower price class are seldom checked as above and are considered satisfactory if, when used at about  $\frac{2}{3}$  maximum power output, no great difference is heard when switching from the cheap transformer to a conservatively designed transformer on music and speech.

### B filter choke design

B filter choke design falls into three major classes:

I. For a given size core design a coil with maximum inductance for a given current density (wire size fixed).

II. For a given size core design a coil with the maximum inductance for a given d.c. resistance.

III. Without limiting core size design a choke with desired inductance, resistance and current density.

Case I resolves itself into finding the maximum number of turns for a given window. (Formula (4).)

Case II. Calculate the maximum number of turns for two or three wire sizes with a given window size and roughly check the resistance (Formulae (4) and (5).)

Case III. This case becomes a cut and try method, especially where d.c. is present in the choke. Past experience and measurements on available chokes on hand form the best guide.

### APPENDIX

In the first installment of this article, in the discussion relating to power transformers, an approximate method of calculating currents and voltages was given. Following is a more accurate form.

From the winding data<sup>1</sup> calculate the primary resistance  $R_1$  and secondary resistance  $R_2$ . Estimate the core loss (usually about 2 watts per pound of iron) and replace this loss by an equivalent resistance  $R_c$  (see figure 2).

$$\text{Total core loss in watts} = \frac{E_1^2}{R_c}$$

or  $R_c = \frac{E_1^2}{\text{core loss (watts)}}$  (10)

If  $R_L$  is the load resistance, then the primary current  $I_1$  is:

$$I_1 = \frac{E_1}{R_1 + \frac{(N_1/N_2)^2(R_2 + R_L)R_c}{(N_1/N_2)^2(R_2 + R_L) + R_c}} \quad (11)$$

$$\text{and } E_2 \approx E_1 (N_2/N_1) - I_2 [R_2 + (N_2/N_1)^2 R_1] \quad (12)$$

1—If d.c. flows in the winding allow 600 to 1200 circular mils per ampere in determining wire size of the primary.

2—Methods of calculating the winding space, as well as other factors, are given in the first installment of this article (September *Electronics*, pp. 286, 287).

3—For Class A operation calculated from normal d.c. current, for Class B operation calculated from peak a.c. power output.

4—Estimate the probable winding temperature in order to most accurately determine the winding resistance.

## NEW TECHNIQUES OF NEUTRON AND POSITRON

Present-day discoveries regarding neutrons, positrons, deuterons and tritons may be expected to bring practical advances as important as those dependent on the electron.

—DR. WILLIS R. WHITNEY

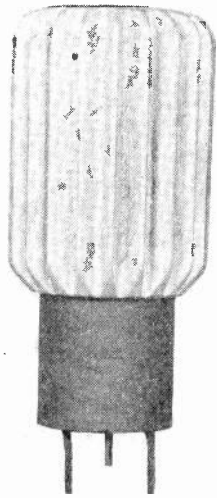

# All-metal vacuum tubes

By O. W. PIKE and G. F. METCALF  
*General Electric Company, Schenectady, N. Y.*

THE "all metal" type of vacuum tube for industrial and power purposes is one of the most revolutionary steps in making vacuum tubes real engineering tools. It is a far-cry from the fragile glass envelope vacuum tubes first used for relaying to the sturdy metal tubes now being offered for both industrial and power purposes. It means that these devices may take their place along with the motor and transformer as an accepted part of modern electrical apparatus.

One great advantage of the metal design lies in the manufacturing processes. It eliminates one of the great sources of trouble and expense in glass tubes; that is, the complicated glass work, and makes available to vacuum tube manufacture a wealth of technique worked out over many years of machine shop practice. Furthermore, the material cost is lower, particularly where the metal envelope also serves as one of the tube electrodes.

From the design standpoint, metal tubes are substantially more sturdy than glass, occupy appreciably less space and permit better methods of mounting and cooling. To those who have been timid about the use of tubes in industry, the psychological aspect of the new type of tube is of considerable importance.

The adaptation of the metal envelope to vacuum tubes is based upon three fundamental developments; namely, (1) a sturdy type of seal in which the insulating glass has the same expansion over a wide temperature range as the seal members, thus doing away with the troublesome and expensive feather-edge type of seal, (2) accurately controlled seam, spot and projection welding for the fabrication of the actual envelope, (3) a vacuum-tight means of sealing off a metal exhaust tubulation. It was possible to build "all metal" tubes prior to the development of these three fundamentals, but such tubes were only compromises with the glass design and did not lend themselves well to quantity manufacture.

For many years metal seals of the feather-edge design have been used in vacuum tubes. In this type little attempt is made to match the expansions of the metal and the glass. The metal is made sufficiently thin and of such shape that it readily follows the changes in the glass brought about by temperature. While this form of seal

has been satisfactory for many tubes, it is expensive and presents many mechanical difficulties; also, its strength is limited. The development of metals, such as Fernico, and glasses having substantially identical expansions over the range of temperatures encountered in tube manufacture and use, has presented new possibilities in seal design. Seals using similar expansion materials have been built in many forms which may be classed under two general headings: (1) the pillar type and (2) the concentric type.

The pillar type of seal illustrated by (a) of Figs. 1 and 2 consists of a cylindrical glass between two metal members, one in the form of a cup and the other suitable for attachment to the metal body of the tube. This type is particularly suitable for very high currents and voltages in that the glass cylinder may be lengthened or corrugated to stand high voltage and the current path is of low resistance and consequently has low losses. The latter point can be appreciated by noting that the high conductivity leads form the current path except, in some cases, for a thin disk of the higher resistance seal metal.

The concentric type of seal as illustrated by (b) and (c) consists of a conducting lead of the seal metal surrounded by the insulating glass and a cylinder of this metal. This type has the advantage of being somewhat less expensive than the pillar type and is more sturdy. However, it is limited in its current-carrying capacity by the center lead which is of high resistance seal metal, unless special and more expensive designs are used. Its voltage limitation is lower than the pillar seal, although the leakage path may be increased considerably by the addition of a glass pant-leg. It is possible to provide an additional conductor by using either a second concentric cylinder or a second lead.

## New welds made possible by tube control

In neither type of seal is highly skilled labor essential. In fact, the seals are being made in several sizes by machine methods in which the operators' skill plays only a small part. With their many variations, these types allow ample leeway for seal designs having capacities from a few milliamperes up to hundreds or even thousands of amperes.

The use of Thyatron control for the timing of resistance welds has been one of the most important improvements in welding practice in recent years. This has made possible new types of welds with materials previously unsuitable, and has insured the reproducibility of any given weld. In the larger sizes of envelopes, seam

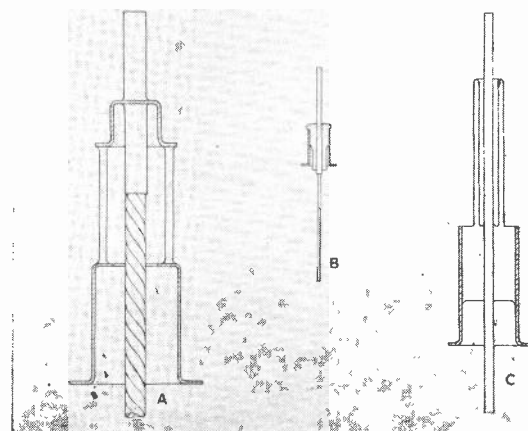

Fig. 1—Cross section of pillar and concentric seals

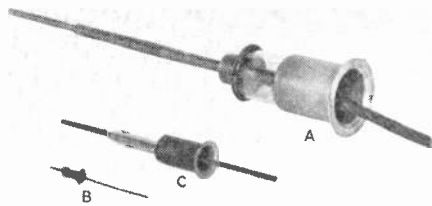

Fig. 2—Typical seals of types shown in Fig. 1

welding is used to seal the metal headers to the cylindrical body of the tube. These welds consist of a series of overlapping spots which are more dependable, from the vacuum standpoint, than the best glass seals heretofore. For the small envelope and for attaching seals to headers, spot welding is used. With proper design along the line of projecting rings, an entire seal or header may be attached with a single weld at reasonable power. In a tube 1 inch in diameter, the headers have been welded in at the rate of about one a second. In certain designs copper soldering is used as an alternate to this last method, in which case the seals must be fabricated on the headers.

There are various methods which have been used in sealing off metal exhaust tubulations. One successful design employs a combination press and solder joint. The tubulation is coated on the inside with solder. At the completion of the exhaust process the tubulation is pressed between jaws and heated to melt the solder and complete the seal.

### Designs of metal tubes

The adaptation of the metal envelope principle to the several classifications of tubes brings out a number of interesting design features. Most rectifier tubes are of

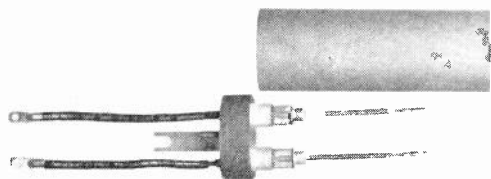

Fig. 3—Rectifier (25 amperes) of the all-metal type

the half-wave type. In this case the envelope itself may serve as the anode, which greatly simplifies the general tube design, eliminates the necessity for an anode seal, and allows excellent cooling of the anode. In addition, this design presents one of the easiest exhaust problems in vacuum tube manufacture.

In the case of the so-called "H" grid design, the envelope may form the shielding portion of the control grid, while with the latest shield grid designs it is suitable for the cylindrical portion of the shield grid. Such designs allow excellent cooling of the grid, which has particular advantage from the standpoint of grid emission. Where a cylindrical grid is interposed between the cathode and the anode, the envelope may serve as the anode, as in a rectifier tube.

With the high vacuum type of tube which often has a large amount of heat dissipated at the anode, the envelope serving as the anode provides an excellent means for improved cooling. In screen-grid designs the envelope may form the screen. In either case considerable space is saved over the glass type of tube, to say nothing of decrease in material cost and reduction in manufacturing labor.

With certain designs it is necessary to increase the radiating property of the envelope without increasing the general size of this member. Welded fins have been used for this purpose but a more suitable method is to cast an aluminum radiator directly to the envelope. In this way a several fold increase in radiating properties can be obtained and if a high conductivity material, such as aluminum, is used the rapid conduction of heat away from any given point prevents hot-spotting and the resultant danger of reverse emission from the spot. This feature is particularly desirable in certain types of tubes which operate with a highly concentrated gas discharge. On page 312 is a 60-ampere rectifier of this type.

One of the most troublesome and costly accessories used in the application of vacuum tubes has been the sockets. This is particularly true where the set is subjected to vibration or sea air. In addition, one of the

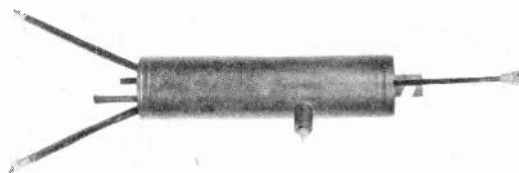

Fig. 4—Shield-grid Thyatron (3-element gas rectifier)

most expensive processes in vacuum tube manufacture is the basing of tubes. Metal tubes open a way to the complete elimination of these troubles. For industrial and power purposes it is rarely necessary to make quick substitution of tubes. If such dependability is required it is always better to provide for continuity of service by means of additional tubes or duplicate apparatus. Therefore, metal tubes can be mounted by means of simple studs and lugs attached to the cylinder and connections can be made by means of tube leads and studs on the mounting panel. Indications are that this method of mounting will be generally accepted as most suitable for this class of service.

Development of metal tubes has shown definitely that a metal container is superior in many ways to a glass envelope, and has demonstrated conclusively that metal tubes are not only more sturdy and smaller size, but also adapted to quantity production at low cost. Furthermore, the life of metal tubes is in every way comparable to glass tubes and in some cases superior.

Developments of this nature are always a result of cooperative action. The following members of the Vacuum Tube Engineering Department are among those

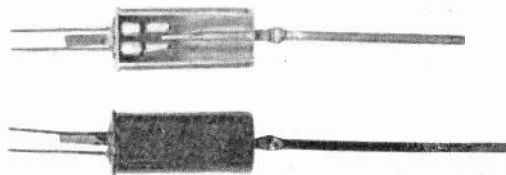

Fig. 5—Vacuum switch. Metal envelope allows mechanical movement of contacts

making major contributions to the results obtained: Messrs. J. E. Beggs, R. J. Bondley, T. A. Elder, A. C. Gable, H. T. Maser and H. J. Nolte. Recognition is also given to the Research Laboratory staff for valuable help and to Mr. W. C. White under whose direction the development was carried out.

# I.R.E. Fall meeting

## Rochester—Nov. 12, 13, 14, 1934

**A**NNUALLY the Fall Meeting of the Rochester Section of the I.R.E. is looked forward to, and long discussed later, as one of the bright spots in the engineers' calendar. Always well attended by those in the front ranks of technical advance, this session has come to be the place for not only progress reports but for speculation on new phases of the technical art

through which the industry later passes. Many circuits of considerable importance first were disclosed at one of the Rochester Fall Meetings.

The program of the 1934 papers (to be heard at the Hotel Sagamore) promises engineers in attendance with much to think over during the winter. Particularly worth noting are the papers on waves below 10 meters.

### PROGRAM

#### MONDAY, NOVEMBER 12

- 9:00 A.M. Registration  
Opening of Exhibits
- 10:00 A.M. Technical Session  
Iron Core Tuning Systems.  
A. Crossley, Consulting Engineer.  
High Fidelity Reproducers with Acoustical Labyrinths (With Demonstration),  
B. Olney, Stromberg - Carlson Telephone Mfg. Company.
- 12:30 P.M. Group Luncheon
- 2:00 P.M. Technical Session  
Automatic Reactance Control Systems,  
Charles Travis and Murray Clay, RCA License Laboratory.  
Putting Ultra-High Frequencies to Work (With Demonstration),  
L. C. F. Horle, Consulting Engineer, and C. J. Franks, Radio Frequency Laboratories.  
Diode Coupling Considerations,  
J. R. Nelson, Raytheon Production Corporation.
- 4:00 P.M. Inspection of Exhibits  
Meeting of RMA Committees on Receivers and Television.
- 6:30 P.M. Group Dinner
- 8:00 P.M. Joint Session with Radio Club of America  
Transmission and Reception of Centimeter Waves (With Demonstration),  
I. Wolff, E. G. Linder, and R. A. Braden, R.C.A. Victor Company.

#### TUESDAY, NOVEMBER 13

- 9:00 A.M. Registration
- 9:30 A.M. Technical Session  
The Use of Cathode Ray Tubes in Receiver Distortion Measurements (With Demonstration),  
Henry W. Parker, Rogers Radio Tubes, Ltd., and F. J. Fox, Rogers Majestic Corporation.  
Converter Tubes at High Frequencies,  
W. A. Harris, RCA Radiotron Company.

Input Losses in Vacuum Tubes at High Frequencies,  
B. J. Thompson and W. R. Ferris, RCA Radiotron Company.

- 12:30 P.M. Group Luncheon
- 2:00 P.M. Technical Session  
New Equipment for the Radio Designer and Engineer,  
C. J. Franks, Radio Frequency Laboratories.  
Detector Distortion,  
Kenneth W. Jarvis, Consulting Engineer.
- 4:00 P.M. Inspection of Exhibits  
Meeting of RMA Committee on Vacuum Tubes.  
Meeting of RMA Committee on Sound Equipment.
- 6:30 P.M. Stag Banquet  
W. E. Davison, Toastmaster.  
Entertainment.

#### WEDNESDAY, NOVEMBER 14

- 10:00 A.M. Joint Technical Session with RMA Engineering Division on Radio Interference  
Brief Discussions on Desirability of Reduction of Radio Interference From the Viewpoint of:  
The Consumer—O. H. Caldwell  
The Public Utilities—J. O'R. Coleman  
The Radio Manufacturer—L. F. Muter  
The Radio Dealer—Benjamin Gross  
The Federal Communications Commission—C. B. Jolliffe  
Summary—A. N. Goldsmith  
Investigation and Suppression of Inductive Interference,  
H. O. Merriman, Radio Branch, Department of Marine, Canada.
- 12:30 P.M. Group Luncheon
- 2:00 P.M. Technical Session on Radio Interference (Continued)  
Discussion by Interested Organizations on Promotion of Interference Reduction.



# Simplified inductance-coil calculations

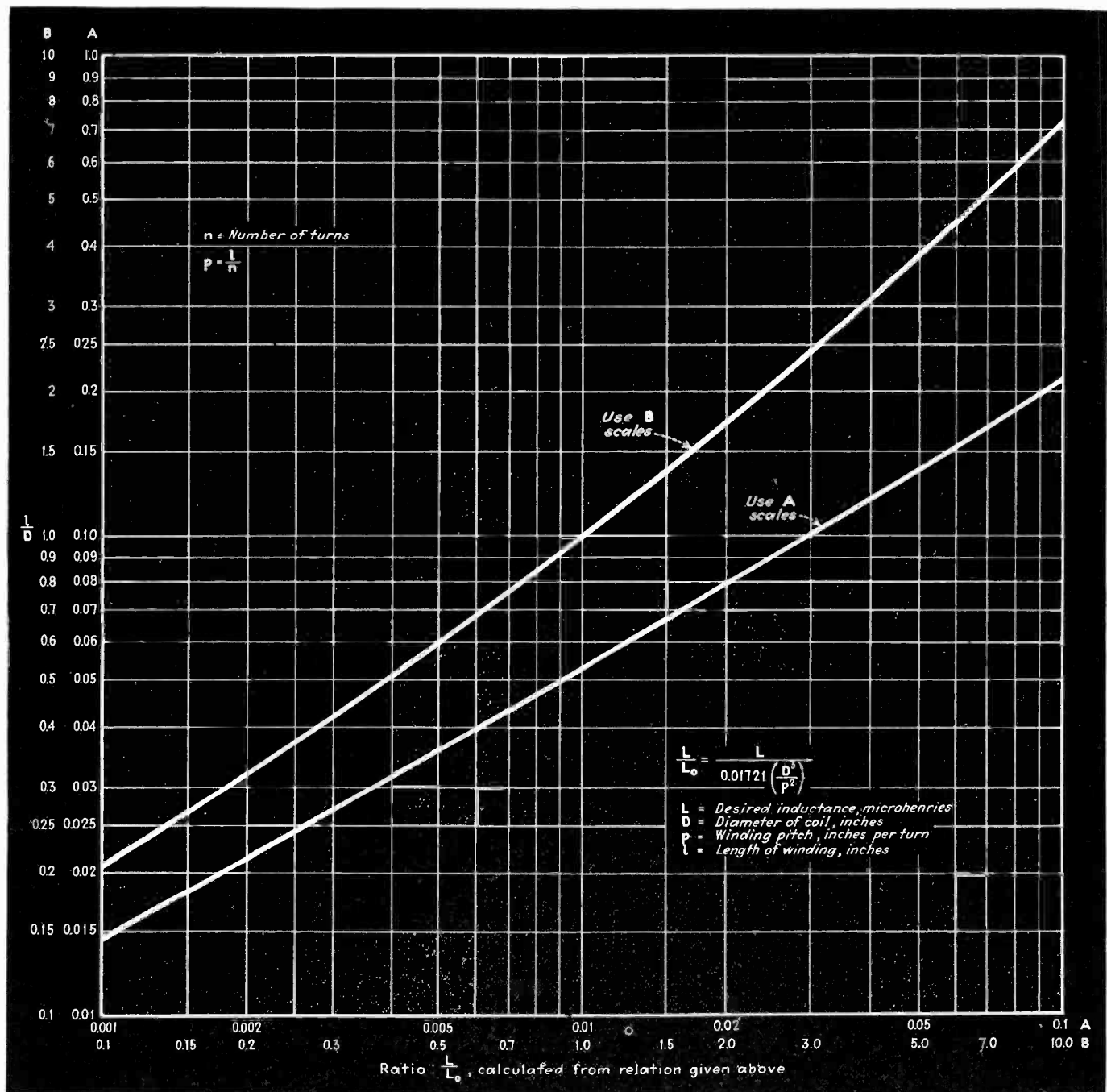

THE curves of the above chart, prepared by A. R. Rumble, transmission engineer at WNEW, are based on the well-known Nagaoka formula for calculating the inductance of single-layer solenoidal coils, given in the Bureau of Standards Bulletin No. 74. Besides eliminating the necessity of looking up the Nagaoka constant the curves provide a simple and rapid means of calculating the position of taps for given inductances.

To determine the number of turns required for a coil of given inductance, when the diameter and the winding pitch have been chosen: (1) Calculate the value of  $\frac{L}{L_0}$  from the formula given in the diagram, using the units

indicated. ("l" is the axial length of the coil.) (2) From the curves, find the value of  $\frac{l}{D}$  corresponding to the above value of  $\frac{L}{L_0}$ . (3) Multiply this value of  $\frac{l}{D}$  by the diameter to obtain the length of coil required. (4) Divide the length,  $l$ , by the winding pitch,  $p$ , to obtain the number of turns required to produce the given inductance.

In the case of a coil to have taps at several given values of inductance the procedure is the same except that it is only necessary to calculate  $L_0$  once.

# HIGH LIGHTS ON ELECTRONIC

## Photocells in Weather Bureau observations

By ELMORE B. LYFORD

THERE ARE AT LEAST three different uses to which photocells, particularly those of the self-generating type, may be applied to facilitate the routine measurements which every important weather observatory must make. These are the measurement of what might be termed "daylight intensity," the recording of the time and duration of sunlight periods (as opposed to those periods when the sun is obscured), and the measurement of visibility, or perhaps more accurately the lack of it, due to haze.

Of these three uses, that of the measurement of sky and sun-plus-sky brightness is perhaps the most obvious. For this purpose, all that is needed is a photocell, or a battery of several cells, so combined with an integrating surface that they will "scan" the entire surface of the sky at all times, and a recording galvanometer which keeps a continuous record of their current output. Since the output of a good photocell is practically linear with respect to the strength of the incident illumination, the record may be read directly, and calibrated against any convenient standard.

## SUBWAY CARS P.E. CONTROLLED



The new aluminum high-speed train for the Brooklyn Rapid Transit subway is equipped with photo-cell control of the car lights. When the train leaves elevated tracks to enter the tunnel section, the lights are automatically switched on by the equipment in the motorman's cab

For automatic recording of the periods of sunshine during the day, as contrasted to the periods when the sun is obscured, two photocells (or two sets) are required, one of which is exposed to direct illumination from the path of the sun, and the other of which is shielded from illumination coming from this particular direction. When the sun is obscured, both photocells will be illuminated with approximately equal intensity and, if their outputs are opposed, the resulting current will be practically nil. When the sun is shining, however, one cell will receive much greater illumination than will the other—its current output will be proportionately much greater—and the resulting differential current will be quite sufficient to actuate even a relatively insensitive recording device.

The third way in which photocells may prove of value in weather observations is in the measurement of the density of fog and smoke haze, or of the combination of the two which Weather Bureau officials like to term "smog." For this purpose, a fairly constant light source must be set up, with one photocell in close proximity and another at a considerable distance—preferably several hundred feet. Under clear conditions, with an absence of "smog," the output of the distant cell will be a small but measurable and definite portion of the output of the nearer cell (assuming that both are shielded from all other sources of illumination). Any appreciable smoke or fog will act to cut down the illumination being received by the distant cell much more than it will cut down the illumination of the nearer cell, and from the change in the ratio of current outputs of the two, as indicated possibly by a Wheatstone bridge measurement, the degree of "smog" may easily be computed, or made to record automatically.

## Photo-cell static discharger at WLW

THE TALL VERTICAL radiator of WLW, Cincinnati, collects considerable static, which is discharged from time to time through a spark-gap to ground. With each such static spark, the power of the station transmitter, 500 kw., also follows over to ground, through the heated path of the static spark, and would hang on, shutting down the station. Formerly an operator was detailed to watch for such flash-overs due to static, and to pull the power cut-off

switches as quickly as possible, restoring them an instant later after the spark had ceased.

This job is now done by a photocell which Joseph Chambers, chief

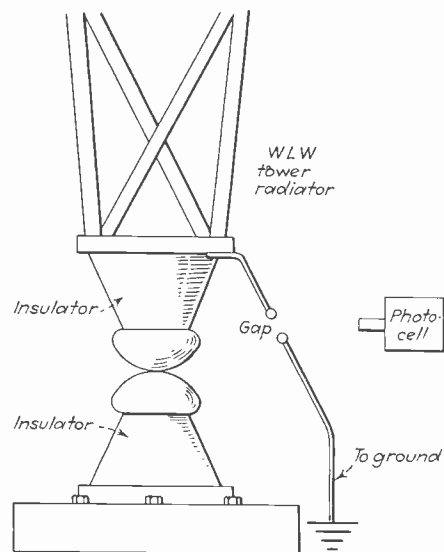

When a flashover takes place across the gap, the photo-cell opens the power cut-off relays

broadcast engineer of the Crosley Radio Corporation, has had installed, aimed at the spark-gap, as shown in the sketch. If a flash occurs at the gap, the resulting impulse in the photo-cell causes power cut-off relays to operate in the transmitter house, cutting off the high power supply circuits, and then automatically restoring these circuits after the flashover has ceased. In this way, the transmitter is shut down only momentarily during the brief passage of the spark and flashover, and considerable tube damage is prevented.

## Cathode-ray tube used to test fuses

By E. V. SUNDT  
*Littelfuse Laboratories, Chicago, Ill.*

"ELECTRONIC BULLETS" spattered on the fluorescent screen of a cathode ray tube are used to measure the time-current blowing characteristics of instrument fuses in a study now being made. As far as this writer can determine, this is the first time such a method has been used. It forms an almost ridiculously simple way of recording, with an ordinary camera, transient or recurring phenomena which otherwise would require expensive moving film equipment.

A large gear is very rapidly rotated close to a polarized electro-magnet by a

# DEVICES IN INDUSTRY + +

high speed synchronous motor. As each gear tooth passes the magnet, an impulse is created which is then amplified by a screen grid tube. In this way, five thousand impulses per second are produced and applied to the grid of the cathode ray tube. Many different types of mechanical contacts on the gear were tried, during the preliminary work, in the effort to make a positive counting system. They proved impractical, due to the cutting action of the gear at the high speeds used. In our present system, we combine positive mechanical accuracy with electrical fidelity.

With 500 volts on the focusing anode and 2,000 volts on the anode proper, the electron velocities from cathode to screen reach several thousand miles per second, depending a great deal, of course, on the potential of the grid. The circuit constants are so adjusted that during half of each impulse from the timing circuit, the electron beam of the cathode ray tube is completely shut off. During the other half, the beam is completely on, or nearly so, and is delivered to the screen in "shots."

It might seem that the full brilliance of the screen pattern could not be realized with the beam broken up into shots in this way. In practice, however, it was found that the photographic qualities were in no way impaired, since each "bullet" lights its portion of the screen fully as brilliantly as if the beam traced a continuous line.

It may be of interest to note that the time required for a fuse to open the circuit drops rapidly as the amperage is decreased. In the amperages of 1/32 ampere and up, we have been able to determine this characteristic quite well. In the 1/100 ampere size, however, the action seems to take place in less than 1/5000 of a second, and our present timing system, as fast as it is, seems inadequate. Some very interesting and beautiful patterns of recurring phenomena are obtained when using the above timing method.

## "Defective vision" classes get brighter lighting

IN SEVERAL CITY SCHOOL systems, pupils having defective vision or impaired eyesight have been gathered together in special schoolrooms, where by maintaining a much higher illumination intensity, it is found that the defective-eyesight pupils can make almost the same progress as normal students.

To keep the lighting intensity at high levels in such schoolrooms, independently of outdoor light values, photo-

cell control has been set up in several cities, and the schoolroom lighting kept above 20 ft.-candles, regardless of dark days, sudden storms, and early winter twilights. Pittsburgh, Pa., and Mansfield, Ohio, are two of the places where photocell control of illumination in classrooms for defective-vision students, is now under operation.

## Trans-Atlantic phone uses "Comparator" to overcome static

TO AID in overcoming the static and general noise-level encountered in transoceanic telephony, a device known as the Comparator (from Compressor and Expander) has been developed by engineers of the Bell Telephone Laboratories. At the transmitting end the Comparator compresses the range of volume in the voice frequencies, so that all of the speech sounds are as nearly equally loud as possible. All parts of the speech are thus equally effective in piercing static and the other noise encountered in the transmission overseas. At the receiving end the expander part of the comparator expands the range of volume to its original state thus restoring the naturalness of the

sound. The device is used in conjunction with the speech-inversion secrecy apparatus.

The need for some such system has been long recognized. The loudest parts of telephone speech are some 70 decibels more intense than the weakest, an energy ratio of 10,000,000 to 1. In order to compress partially this wide range, manually operated volume controls have been installed which bring the range of volume down to about 30 decibels, thus greatly increasing the effectiveness of the signal transmission. The compandor, completely automatic in operation, further compresses the volume range to 15 db., an energy ratio of only 32 to 1. The result of this compression is a more economical operation of the radio transmitter, which can thus be used at full capacity all of the time, and it has also made possible an increase in the time during which commercial transmission is possible, since about 5 decibels of additional noise can be tolerated in the transmission path.

The principle of the Comparator rests in the fact that the amplifying vacuum tubes used are operated on the non-linear portions of the characteristic curve. The resulting amplitude distortion is used to increase automatically the intensity of the weaker parts of the speech in an inverse proportion to their original strength.

## WASHINGTON'S "VOICE OF TRAFFIC SAFETY"

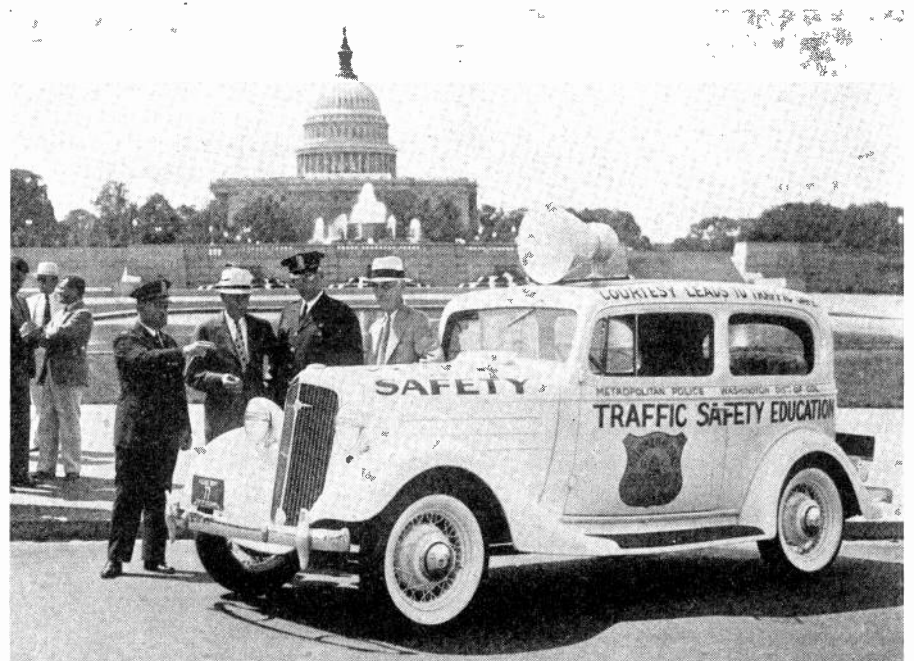

The Washington, D. C., police commissioners send this motorized loudspeaker to cruise around on the Capitol's streets and loudly call attention to infractions of traffic rules

# Precision condenser calibration at radio frequencies

BY E. L. HALL  
and W. D. GEORGE  
*Bureau of Standards  
Washington, D. C.*

A SIMPLE method in common use for calibrating a variable air condenser consists of connecting a suitable coil to the condenser terminals and tuning a radio-frequency generator to resonance with the coil-condenser combination (hereafter abbreviated as  $LC$ ). Resonance may be indicated by a simple series circuit containing a small coil, coupled to the coil in the calibrating circuit  $LC$ , a sensitive dc. microammeter, and a crystal rectifier. The capacity of  $C$  is determined by substituting a calibrated condenser for  $C$  and retuning the measuring circuit to resonance. A second calibration point is obtained in a similar manner, but the frequency is different, because the capacity has been changed, assuming that a fixed inductor is used for  $L$ , as is usually most convenient. A calibration made in this manner covers a range of frequencies. If it is desired to make a calibration at one frequency over the entire scale of the condenser, the above method is not feasible unless a suitable variable inductor is available.

A method sometimes used, which permits of such a calibration, provides for the connection of the calibrated condenser in parallel with the condenser to be tested. The amount of capacity added in one condenser is taken from that in the other and thus the total equivalent  $LC$  product is kept the same. However, errors are involved due to the inductance and capacity between the leads connecting the two condensers when the capacity is changed from maximum to minimum. There is also the difficulty of obtaining a sharp resonance indication resulting in error in adjustment of the condenser.

The method described in this paper<sup>1</sup> eliminates such errors, gives great precision of adjustment, calibration at one frequency throughout the scale range, and great convenience in operation.

In order to take advantage of the great precision possible with this method, it is necessary that condenser scales with very fine graduations be available, and that a

strictly linear calibration apply to the variable condensers used. The best construction possible, both as to design and workmanship, is required if the possibilities of the method are to be realized fully.

## Precise method of condenser calibration

The beat-note method of detecting small changes in capacity at radio frequencies has been used by a number of investigators.<sup>2</sup> However, the method described here incorporates several improvements whereby capacity measurements can be made to a greater degree of precision than that attained previously.

By this method of calibrating condensers advantage is taken of the fact that, with an  $LC$  circuit operating at its natural frequency by means of a vacuum tube oscillator, a small change in  $C$  causes a sufficiently large change in frequency to be readily detected. The method of detecting the very small radio-frequency change in this system is to compare the changing frequency with a constant radio-frequency source.

The method of adjusting the  $LC$  oscillator to a known frequency is by means of the beat note between it and a piezo oscillator or other frequency standard. A detector-amplifier, Fig. 1(b), and a telephone headset or loud speaker produce the audio-frequency beat note. The amount of coupling between the detector-amplifier and the  $LC$  oscillator should be just sufficient to give an audio-frequency beat note that can be definitely distinguished. A short wire or antenna connected to the detector is usually sufficient. When the  $LC$  oscillator is adjusted to a harmonic or a sub-harmonic of the piezo oscillator or frequency standard greater coupling is necessary. The increased coupling can be obtained by moving the antenna nearer the oscillator. Measurements of the capacity of a mica condenser, for example, can be readily made at a number of harmonics of the standard frequency and the change in capacity with frequency can be readily determined.

The condenser to be calibrated is connected in the tuned circuit of a vacuum-tube oscillator. In Fig. 1(a) this condenser is shown at  $C_x$  and is connected into the circuit by closing switch  $S$  to position 1. The inductor  $L$  is one of a set of interchangeable coils of the honey-comb type. By substituting various coils and adjusting condenser  $C$ , the oscillator is tuned to the frequency at which the calibration is desired. Variable condenser  $C$  must have a capacity equal to or greater than  $C_x$ , so that when  $C_x$  is changed to get different points of calibration,  $C$  can be increased or decreased to keep the oscillator frequency at the same value. With  $C_x$  set at the desired point on its scale and the frequency adjusted to the desired value, switch  $S$  is thrown to position 2;  $C_x$  is

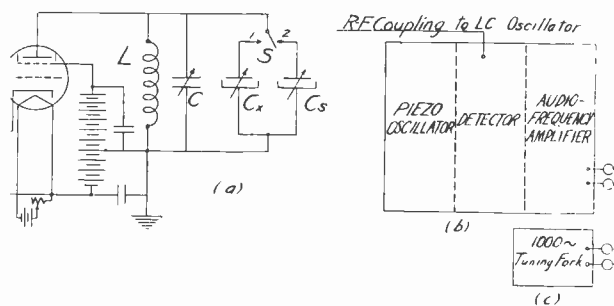

Fig. 1—Diagram showing essential parts used in calibrating condensers

then adjusted until the oscillator frequency is equal to its value with switch *S* in position 1. The capacity shown by the standard condenser  $C_s$  is then equal to the capacity of  $C_x$ , within the limit of accuracy of the equipment. Switch *S* can be rapidly changed from one position to the other many times during the adjustment. Any drift in the oscillator frequency can thus be detected.

The *LC* oscillator can be set approximately by tuning it to zero beat with a harmonic or sub-harmonic of the standard frequency. However, for an accurate frequency setting of the oscillator, the beat note is adjusted to a constant audio frequency, in this case 1000 cycles per second. To do this, the heterodyne note is adjusted to zero beat with the frequency of an electrically-driven 1000-cycle tuning fork, Fig. 1(c). Care must be taken to see whether the *LC* oscillator is adjusted 1000 cycles above or below the standard frequency, to determine the exact frequency of calibration. The condenser  $C_s$  could possibly be adjusted to give a frequency 2000 cycles different from the frequency with condenser  $C_x$  in the circuit thus giving an inaccurate calibration.

It will be noticed that the *LC* oscillator used is of the dynatron type, chosen because of its simplicity and frequency stability. If the oscillator is allowed a warming-up period of about an hour, the frequency drift is very slight. During the short time required to get a calibration point the frequency drift is very little indeed. All parts of the *LC* oscillator are shielded except the batteries and switch *S*, thus reducing to a considerable extent the effect of body capacity on the frequency stability. The standard condenser  $C_s$  has its rotor and shield grounded. If possible, the condenser under test is likewise grounded.

Some difficulty was encountered in obtaining a suitable means of switching from the standard condenser to the condenser under test. A low-capacity switch that would allow a rapid change from one condenser to the other was required; this procedure being repeated a number of times for each adjustment. In the final set-up, a switch such as is shown in Fig. 2 was used. This switch consisted of a movable copper arm (a) and pyrex tubes (bb) mounted on a bakelite frame. A small brass cup was placed in the top of each pyrex tube. One cup was connected to the insulated post of the standard condenser, and the other to the insulated post of the condenser to be tested. The arm (a) was soldered to a shaft (s). The shaft was mounted in brass bearings and connected to the plate of the *LC* oscillator tube. Mercury was placed in the cups, thus giving good contact when the switch was closed. A long wooden dowel rod having one end fastened to (s) was used to operate the switch. All leads were made symmetrical, as indicated in Fig. 1(a), and the switch was removed as far as possible from nearby objects.

The frequency range over which a condenser can be

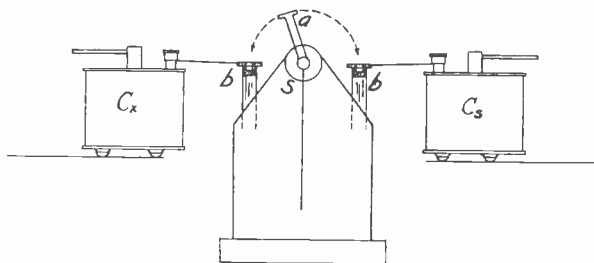

Fig. 2—Switch used for rapidly substituting standard condenser for condenser under calibration

calibrated depends on the capacity of the condenser and the range over which the circuit arrangement [Fig. 1 (a)] will sustain continuous oscillations. It has been shown that a dynatron oscillator will operate as long as the



**A MOST PRECISE method of calibrating condensers is given in this article. It utilizes a dynatron oscillator. By its means a condenser of 3000  $\mu\mu\text{f}$  can be measured accurately to within 0.02  $\mu\mu\text{f}$  at 300 kc/sec.**



impedance of the oscillating circuit is greater than the negative resistance of the vacuum tube. No special search was made for a vacuum tube having a low negative resistance. Condensers having a maximum capacity as listed below could not be calibrated above the frequency shown when a 25-turn honeycomb coil was used in the oscillating circuit.

3000 $\mu\mu\text{f}$ —	300 kc/s
2000 $\mu\mu\text{f}$ —	500 kc/s
1000 $\mu\mu\text{f}$ —	1000 kc/s

It will be understood that condensers having the maximum sizes given above can readily be calibrated at frequencies below those shown.

### Precision of measurement

A calibration made at one frequency with a fixed inductance in the oscillatory circuit allows a precision of setting which is practically the same throughout the range of a straight-line-capacity condenser. The method is most precise with a large inductance and small capacity or when the *L/C* ratio is large. A higher frequency would in general give a more precise calibration. There is a practical limit, however, as increasing the *L/C* ratio causes greater instability of the *LC* oscillator, as may be proved experimentally. Dissymmetry in the capacity or inductance of the switch or of the switch leads may cause an error in the calibration unless eliminated when first constructed by balancing the switch and leads with the standard and test condenser removed.

The small error introduced by different power factors or resistances of the two condensers is neglected because an equivalent effective capacity is given by the method. Inexact adjustment of the oscillator frequency probably accounts for the greatest error of calibration, although an examination of Fig. 3 shows the latter error to be very small. The chart (Fig. 3) shows the relation between inductance, capacity, and frequency as given in the formula

$$f = \frac{1}{2\pi \sqrt{LC}}$$

where *f* is frequency in cycles per second, *L* is inductance in henrys, and *C* is capacity in farads. At the frequencies given on the left of the chart a change in *f* of 10 cycles per second necessitates a capacity change of only the small amount shown at the bottom of the chart.



At 300 kilocycles per second a setting within 0.2  $\mu\text{mf}$  in 3000  $\mu\text{mf}$  can be obtained with a frequency adjustment correct to  $\pm 10$  cycles. At this frequency it is not difficult to adjust the oscillator within  $\pm 1$  cycle, thus giving a setting within 0.02  $\mu\text{mf}$  in 3000  $\mu\text{mf}$ . With small condensers of the order of 100  $\mu\text{mf}$  and a frequency near 1000 kilocycles per second a capacity setting within  $\pm 0.001$   $\mu\text{mf}$  is not difficult to obtain.

The method described offers a number of advantages over other methods for calibrating condensers at radio frequencies. The precision of adjustment possible is far beyond that with which the condenser scale may be read and greatly exceeds the accuracy with which the condenser can be relied upon to maintain its calibration. The apparatus used is easy to operate and allows rapid precise calibration of condensers having a range from a few to several thousand micromicrofarads. It permits of the precise calibration of a variable condenser throughout its range at one radio frequency; it makes possible the precise measurements of very small capacities. It also offers a convenient method for use in investigations such as the change in capacity with frequency of mica condensers, and the small change in capacity of condensers due to temperature, pressure or humidity changes.

#### BIBLIOGRAPHY

<sup>1</sup>Publication of this paper has been approved by the Director of the Bureau of Standards of the U. S. Department of Commerce. Additional information on methods of measurement utilizing an audio frequency difference between two radio frequency oscillators will be found in *Proceedings of the Institute of Radio Engineers*, vol. 17, p. 272, 1929; E. L. Hall, A system for frequency measurements based on a single frequency, and in the same publication vol. 18, p. 490, 1930, and in the *B. S. H. Journal of Research* vol. 4, p. 115, 1930, (Research Paper No. 135), E. L. Hall, Method and apparatus used in testing piezo oscillators for broadcast stations.

<sup>2</sup>Among a number of papers describing work in measuring dielectric constant and small capacities the following may be listed:

Versahren zur Messung sehr kleiner Kapazitäten und Induktivitäten. L. Pungs and G. Preuner. *Physik Zeitschr.*, vol. 20, pp. 543-545, 1919.

The electric moment of gaseous molecules of halogen hydrides. C. T. Zahn. *Phys. Rev.* (2), vol. 24, pp. 400-417, 1924.

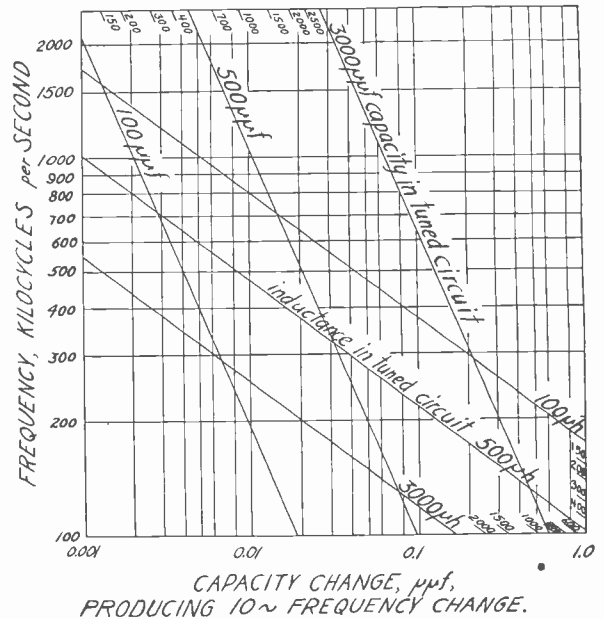

Fig. 3—Chart showing precision obtainable by method described if frequency adjustment is in error by ten cycles per second

A method for detecting very small changes in capacity and its application to changes in capacity of an air condenser due to pressure and humidity changes. G. D. Rock. Catholic University of America; 1927.

Beat-note method and apparatus for measuring small capacities. G. B. Gelder. *Radio Engineering*, vol. 8, p. 17, Sept., 1928.

A new method of dielectric constant measurement at radio frequencies. H. L. Andrews. *Physics*, vol. 1, pp. 366-379, Dec., 1931.

Double beat note method of frequency adjustment. Applications to the measurement of capacity and inductance. F. M. Colebrook. *Wireless Engineer & Experimental Wireless*, vol. 8, pp. 639-646; Dec., 1931.

*Radio Frequency Electrical Measurements*, H. A. Brown, pp. 15-19. McGraw-Hill Book Co., 1931.

*High-Frequency Measurements*, A. Hund, p. 224. McGraw-Hill Book Co., 1933.

## NEW BOOKS ON ELECTRON TUBES

### Electron tubes in industry

By Keith Henney, Managing Editor, Electronics. McGraw-Hill Book Company, New York. (490 pages. Price \$5.00.)

THE BOOK "Electron Tubes in Industry" fills a need that has existed in increasing degree for many years. It is a welcome addition to the great fund of available literature on ionic tubes. In spite of its crowded surroundings, this book stands almost alone as a comprehensive treatment of the many applications of vacuum tubes in the fields of measurement, photometry, color-analysis, relay control as well as in a host of other comprehensive capacities — particularly those industrial in character.

The author has done a careful job in the selection of material—no small task considering the complex ramifications of the tube art—particularly in relation to its manifold applications. Fortunately,

this selection is sufficiently inclusive not to rule out of consideration laboratory workers and other investigators as the title might imply. The treatment, particularly of direct-voltage amplifiers, voltmeters, including the logarithmic form, and cathode ray oscillographs is helpful in the broad aspects of tube applications.

The organization of the material gives evidence of careful weighing of values, for example, as to comparative importance of high vacuum and gas filled types of tubes. The space allotted to the different divisions is quite in keeping with the requirements of or adequate explanation of principles governing the operation of the individual vacuum devices themselves and separately the principles of their uses. This careful treatment should lead the reader to a useful appreciation of other new and related applications to his needs.

One may find the first chapter a bit misleading as to title and a bit questionable as to the light it throws on the substance of the book. Furthermore, it

would seem that more could have been said by way of an introduction to the subject of alternating current amplifiers including the very useful alternating current, transformer coupled indicating instrument. Something might also have been said as to the limitations tube and other circuit noises place on small impulse amplification, as a caution. In the same way many readers may wish for more material on the cathode ray tube and its application.

Fortunately, the treatment here given neglects neither the hard tube nor the gas filled device nor does it bring to light prejudices, obsessions or whims of the writer, a defect so often apparent in technical books. Those schooled in the high vacuum or hard tube field and those of the soft and gas filled tube field alike, will profit by including this work in their library.

Not only should this book be of value to the engineer of the field but also to the student and to the professional researcher and teacher as well.—EDWARD L. BOWLES.

## Applied acoustics

By Harry F. Olson and Frank Massa, both of the Research Laboratories, RCA Victor Company, Inc. P. Blakiston's Son and Co., Inc., Philadelphia. (430 pages, price \$4.50. 1934.)

SINCE THE DEVELOPMENT of electrical methods and instruments for use in acoustic engineering has occupied the foremost position in that field during the past ten years, it is to be expected that books dealing with acoustics should become increasingly concerned with electrical technique and apparatus. This book, although its title suggests a general treatment, is devoted almost exclusively to electro-acoustical instruments. Chapters are included which develop the equations of general acoustic theory and which treat architectural and psychological acoustics and noise measurement, but they are definitely subordinated to the discussion of electrical methods.

The chief value of the book to the engineer lies in its exhaustive description of the various types of electro-acoustical instruments: microphones, telephone receivers and loudspeakers. Nearly two hundred pages are devoted to description of mechanical and electrical details, underlying theory, operating characteristics, and methods of testing, of these instruments alone. Thirty separate frequency-response curves are included in this section.

The remainder of the book is occupied with the explanation of basic acoustical concepts, and with the methods used for their measurement. The first fifty pages are devoted to a rigorous mathematical development of the equations of dynamical systems. While this theory is the logical basis for the design and operation data which follow, it tends to discourage the reader whose primary interest is practical application.

★

## Loud speakers— theory, performance, testing and design

By N. W. McLachlan. Published by the Oxford University Press, 104 Fifth Avenue, N. Y. City, (412 pages, 165 figures. Price 40 s. (\$13.50).

THIS BOOK provides in one volume a great deal of the theory and experimental data relating to loud speakers, which have appeared in a number of classical works on sound, and in papers in the technical press. In addition, it includes much in the way of new material based on the author's own researches.

The subject is treated in twenty chapters, of which eleven are largely theoretical, and the remainder deal with considerations affecting the design and measurement of practical loud speakers. The theoretical portion commences with

the theory of sound propagation in air, and considers the radiation of sound from simple sources under various conditions. This is followed by chapters which treat of the reaction of the sound propagating medium on the source, the vibrational characteristics of various types of radiators with the limitations due to their practical use, the spatial distribution of sound from vibrating diaphragms, and the acoustic power radiated by vibrators of different shapes. The theory of the moving coil, or "dynamic" speaker is next treated in detail, and numerical examples relating to coil-driven disks are included in which the theoretical relationships are applied. A special chapter is devoted to the theory and practical performance of electrostatic loud speakers.

The theory of horns is taken up next, and a chapter is devoted to the distortion which may result when sound pressures of considerable amplitude exist at the throat of a horn. The final chapter of the theoretical portion deals with transients in coil driven disks.

In the succeeding chapters the theory is applied to the design and testing of various types of free-radiating and horn loud speaker. The various types of driving systems are described and the special considerations affecting the design of loud speaker magnets are very fully treated. Measurement methods are given for efficiency, electrical and mechanical impedance, frequency response and directional characteristics. One chapter deals with the measurement of vibrational frequencies or modes of conical shells, to which the author has made a number of original contributions. It is unfortunate in this that insufficient consideration has been given to the subject of circularly corrugated cones, in which the vibrational performance is not as complex as in the case of the flat cones which the author treats extensively.

The book closes with chapters on the design considerations of horn and hornless loud speakers, with specific examples worked out.

A considerable quantity of experimental curves and tabulated data useful for design purposes is included throughout the volume, and the author's comments at various points in the theoretical treatment, with regard to its applicability in practical cases, are illuminating and interesting. There are complete lists of symbols and definitions at the beginning, and a comprehensive, classified bibliography at the end.

The book is authoritative, clear and the most complete treatment of the subject which has as yet appeared. While it is of an advanced nature, and is a specialized treatment of a highly specialized field, it will serve especially well to give students a thorough grounding in the principles underlying acoustical apparatus; while those actively engaged in design work will find it stimulating and helpful as a reference volume.—  
J. WEINBERGER.

★ ★ ★  
**WINDING VOICE-COILS UNDER GLASS**

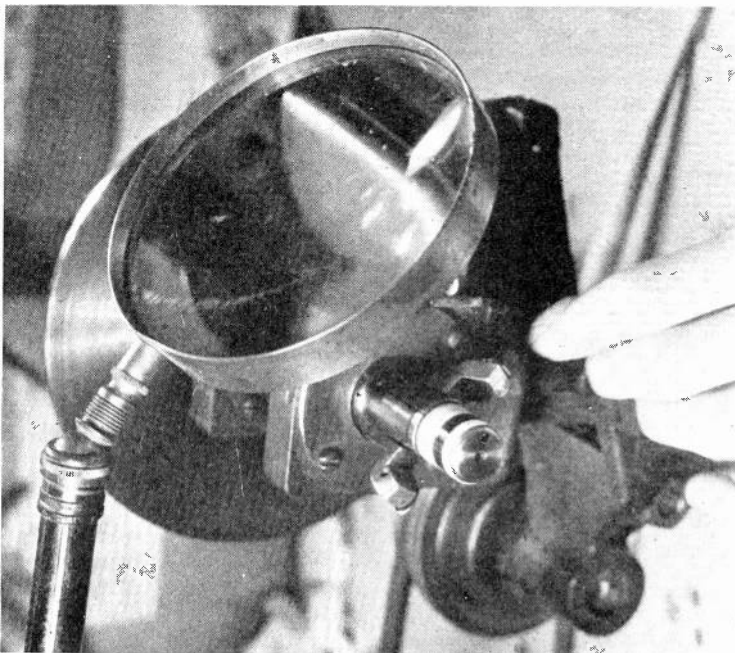

Magnifying glasses have to be used to wind the No. 38 enamel-covered wire onto the voice-coils of 5-inch speakers, in the Magnavox factory at Fort Wayne, Ind.

# ★ ★ NOTES ON ELECTRON

## A diode-triode peak voltmeter

By A. W. BARBER  
Consulting Engineer

VACUUM TUBE VOLTMETERS, while having an undisputed place in the ranks of the most useful of laboratory apparatus, often suffer from inaccuracy when applied to non-sinusoidal wave forms. Some voltmeters have used square-law regions of operation with success over a limited range of input values. A diode employing a large bias-producing resistor yields a current proportional to the peak of the applied voltage over a wide range. The current for nominal voltages is low in such a diode, but a d.c. amplifier overcomes this difficulty, making it possible to use an inexpensive indicating meter. The meter to be de-

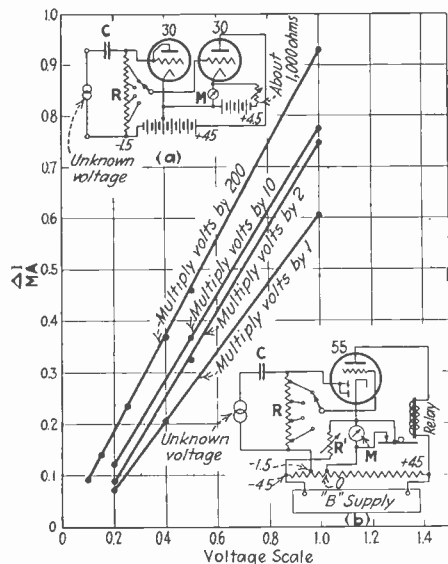

Fig. 1—Circuits and calibration of peak voltmeter

scribed gives full scale reading on a 500  $\mu$ a. meter for one volt peak applied.

Fig. 1(a) shows a type 30 tube acting as a diode rectifier charging condenser C, which in turn discharges at a steady rate through resistor R. For true peak voltage indication R should have several megohms total resistance. The second tube, which may also be a type 30, acts as a d.c. amplifier. A point on R is selected by means of the tap switch, such that the d.c. drop applied to the grid of the second tube gives a current change within the meter range. Since the taps are for d.c. voltage division only, this system introduces no frequency discrimination. The maximum voltage measurable by this method is determined by the inverse peak of the rectifier, which is of the order of a few hundred volts in the case of receiving type tubes.

There are several changes which may be made in Fig. 1 to improve its characteristics and simplify its operation. The diode plates of a duplex triode or pentode may be used as the diode peak rectifier in place of the first 30 tube of Fig. 1(a) and the triode or pentode elements may be used as the d.c. amplifier.

Fig. 1(b) shows a power operated voltmeter utilizing a 55 tube. The bias on the diode is for the purpose of reducing its initial current to zero; otherwise changing the range switch position changes the steady current in the meter and hence requires readjustment of the bucking current-resistor R'.

Since the diode bias is also the d.c. amplifier grid bias, a plate voltage of 45 volts is chosen which gives a point on the linear part of the plate-current grid-voltage characteristic of the tube. The calibration curves shown are of the meter of Fig. 1(b).

The relay shown in the plate circuit is for the purpose of protecting the meter while the tube is warming up. Since the bucking current would normally flow through the meter as soon as the power is turned on, the relay is connected to short the meter with no current flowing in its windings. When the plate current reaches a point where the bucking current minus the plate current can be safely passed through the meter, the relay operates and unshunts the meter.

Other tubes than the 55 may be used in this voltmeter. In choosing a tube, however, it should be remembered that the plate current variation must be linear over the range of rectified voltages plus unrectified a.c., since the a.c. voltage is applied to the d.c. amplifier grid. Plate rectification of the a.c. voltage under certain conditions may largely offset the effect of the diode rectification since the two have opposite effects on the plate current.

To conclude, the diode-rectifier d.c. amplifier vacuum tube voltmeter reads peak volts, covers a wide range of voltages, has a linear scale, uses an inexpensive current meter and has an excellent frequency characteristic.

## Telemetry system using vacuum tube detectors

A REMOTE METERING system using over-biased triodes has been developed by Esterline-Angus. The tubes are supplied with a.c. for plate and filament and rectified a.c. for the grid. The tubes acting as rectifiers produce a direct current

which changes when the quantity to be measured varies.

The system consists of a meter to measure the values to be transmitted, the tubes which produce current variations corresponding to these values, and a recording instrument at the receiving end. In the diagram  $M_1$  represents a primary meter, or a member actuated by it. Above it is  $M_2$ , which is the movement of a D'Arsonval meter. The latter carries a contact which floats between two contacts carried by the moving member of the primary meter. Two of the tubes are detectors, as mentioned, the third is a two-element rectifier furnishing bias for the other tubes.

If the reading of the primary meter increases, contacts A engage causing

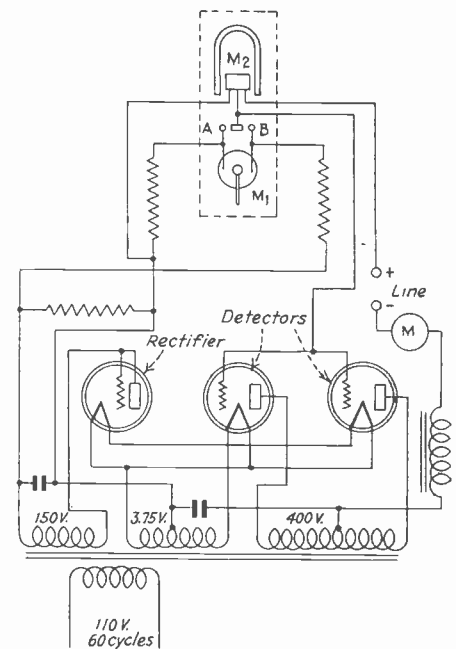

Telemetry system capable of transmitting impulses over 50 miles of telephone line

the grid bias to decrease, thereby increasing the plate current. This increased current flows through the line, the recording instrument and the D'Arsonval movement. As soon as the latter takes up the new position required by the increased current flow the contacts open and the bias voltage returns to its original position. The recording instrument changes its position only when the D'Arsonval movement changes its position. If the primary meter decreases its indication, the reverse cycle occurs.

Quantities that can be transmitted include power, voltage, current in a-c circuits, power factor, water level, etc. The power consumption of the device is approximately 150 watts.

# TUBES AND CIRCUITS + +

## Converting pentode characteristics

A CHART published as an engineering application note by RCA Radiotron

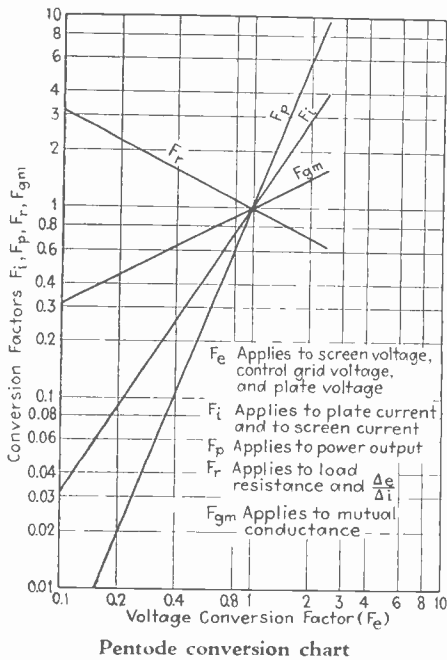

makes possible calculating the characteristics of a pentode when used with voltages for grids and plate other than that advised by the tube manufacturer. If, for example, it is desired to operate an 89-type tube with a plate voltage of 200 instead of the recommended value of 250 or 180, what will be the correct operating conditions?

The ratio of the new plate voltage to that given by the manufacturer's curves and data is  $200 \div 250 = 0.8$ . This is called the *voltage conversion factor* and is identified as  $F_e$ . Multiplying the screen and control grid volts given by the manufacturer for 250 volts on the plate gives the new values to be used with 200 volts on the plate.

This conversion factor, used with the curve shown gives all the rest of the data a designer will need.

## Simplified electronic units control theatre lighting

By J. W. DAWSON  
Westinghouse E. & M. Co.

BEFORE THE ADVENT OF ELECTRONIC control for theatre and other mobile lighting, rheostat "dimming" was used almost exclusively. For larger lamp groups, the rheostat sometimes con-

trolled not lamp current directly, but the saturating current of power amplifying reactors. Electronic control, when introduced, offered major advantages in ease and flexibility of manipulation. These advantages were made possible by the lightness and compactness of the new type operating controls. Minute grid currents only were now involved in the primary control. All power translating devices were removed to a remote location. Color grouping and blending, scene presetting and proportional fading were brought to the operator's finger tips. In short, large scale color lighting manipulation was, for the first time, placed on a basis comparable to that of music. Recent simplifications in electronic equipment have enlarged its field of usefulness through reductions in installation and maintenance expense, together with increased operating simplicity.

New electronic dimming control units operate entirely from a-c sources. The upper and medium range units contain little more than the two Grid-glow rectifying tubes required for delivery of variable d-c saturating current to power amplifying reactors. Grid control is applied to one of these for current variation, while the other serves merely as a rectifier. The low range unit contains but one tube, the cooperating rectifier being a unit of the copper oxide type mounted with the controlled reactor.

Through proper grid control the Grid-glow tubes are made to conduct current from the line only for the desired fraction of the voltage wave. In this manner the average voltage and hence the d-c reactor current is varied. Two sizes of tube are employed in these

units, the larger size being used only in the upper range unit.

Besides tubes the units contain fuses, two small transformers, filament and grid, and a potentiometer for adjustment of minimum illumination or "black out" of the lamps. (A resistor tube mounted with the reactor provides the maximum adjustment.) For grid control, no auxiliary tube is used nor are any d-c sources necessary. The illumination controlling potentiometers operate from a 50 volt a-c source which brings the operating control, with its various groupings and ramifications, within the scope of telephone type wiring and relaying. This control source as well as a permanent out-of-phase a-c grid bias potential is supplied by small auxiliary units, each capable of supplying 25 electronic units or 25 lamp circuits.

In comparing electronic and rheostat type dimming for a certain theatre installation, much depends upon the particular installation. In general, the greater power economy and superior quality of electronic control will very likely offset its somewhat greater initial and maintenance cost. Simplifications of electronic equipment have enlarged its scope of favorable comparison.

Particularly the electrical simplicity of the new electronic control permits its logical application to even very small mobile lighting installations such, for instance, as in store window merchandising displays. A number of exhibits at the 1933 Century of Progress Exposition were illuminated by this type of mobile lighting, lending greatly to their attractiveness. For some of these only a few cubic feet of space was available for reactors, electronic units and motor.

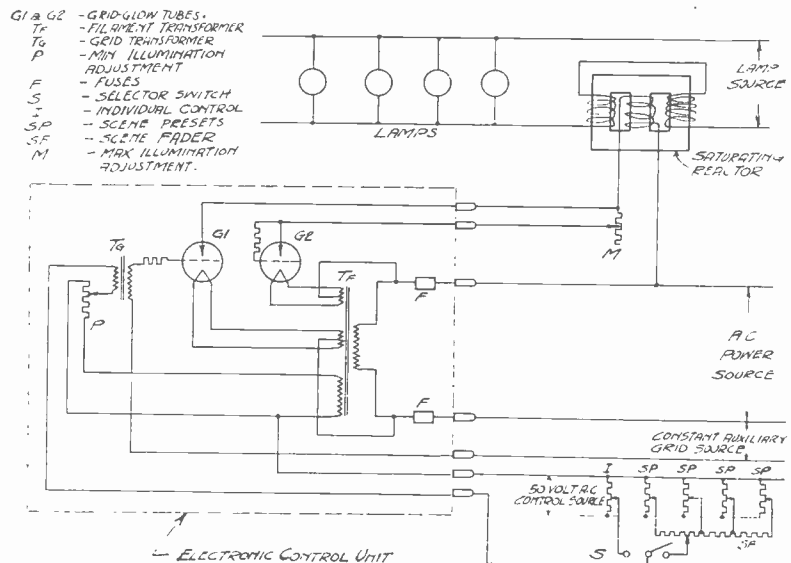

Compactness and simplicity of operation are features of this theater light control system

# electronics

McGraw-Hill Publishing Company, Inc.  
330 West 42d Street  
New York City

O. H. CALDWELL, *Editor*

Volume VII

—OCTOBER, 1934—

Number 10



## The RMA-NEMA NRA Settlement

THE radio-manufacturers' NRA code situation agreement, by which the radio industry will work under the NEMA Electrical Code, but with separate administrative authority, has worked out about as was to be expected in view of the present strong influence at Washington in the direction of fewer centralized codes, rather than separate special codes. Strong industry forces were marshalled on both sides of the controversy. But with NRA trending in the direction it is, the National Industrial Advisory Board apparently had no other solution to choose.

Under the plan as finally drafted, RMA and non-member radio manufacturers should obtain most of the benefits of radio-industry autonomy, even if working nominally under the code of the electrical industry.



## Reducing short-wave interference

DR. W. R. G. BAKER of Camden, N. J., chairman of the Engineering Division of the RMA, is to be congratulated on the leadership which he and his associates are putting behind the aggressive program to reduce radio interference. Working with that indefatigable wheelhorse of radio improvement, Virgil Graham, Dr. Baker is properly laying special emphasis on eradicating interference with short-

wave reception, for it is in these higher frequencies that the damage becomes more serious.

"The sources of interference are very numerous," says Dr. Baker, "and the causes are scattered through many other industries. For that reason a well organized and directed program is the only hope of securing results. The use of the short waves for broadcasting has tremendously broadened the scope of interference elimination work, and any public use of ultra-short waves will still further do so. As a specific instance, motor-car interference is not a factor in the standard broadcast range, but in many locations it is the limiting factor on short-wave reception."

The aid of various organizations who can help in this work will be enlisted. It is certain that many organizations now dabbling in the subject will welcome a definite program. To make this program a success the plan must have the active cooperation of all radio companies through their engineering departments. It will be necessary to call on the engineers to do experimental work to obtain data which cannot be had in any other manner, and which are up to the receiver manufacturers to furnish as their contribution.



## Transceivers on 5 meters— a large-volume market

THE interest which the public and radio fans are showing in transceivers and transceiver kits, suitable for operating on 5 meters, indicates that another volume market for radio merchandise might be opened up in this direction.

If for \$25 the layman could purchase a "radio telephone," capable of talking back and forth with a similar unit, over distances of two or three miles, many uses would be found for this new facility, we think. Farmers, campers, ranchers, workmen, automobile tourists, vacationists, owners of small pleasure craft, students and others, would all appreciate the service that dependable transceivers would give.

Of course, under the law, the operator of such a transceiver would be required to have a Federal license, if the emission of his unit crossed a state line. But with only half a watt of power, or thereabouts, it could be reasoned that for most

locations any effects of the tiny transmitter would be entirely intra-state, and therefore no license would be needed.

Already the Federal Communication Commission has wisely provided a special classification of "third-class phone" (without code requirements) for airplane pilots, police officers, and other non-technical men who are operating "fool-proof" transmitting apparatus. If the new transceivers for popular use could be brought out with fixed frequency characteristics, making it impossible for them to stray far from the assigned frequency, the Commission should then find it feasible to grant licenses with very simple requirements—not involving tests for code, and making the whole issuance of a transceiver license about as informal as that of obtaining an automobile license!

Here is another promising field for radio expansion.



## Press-Radio collapse points way to home facsimile

THE catastrophic Press-Radio agreement, by which stale and incomplete news is now being served to radio listeners, came in for discussion at the broadcasters' convention at Cincinnati. As we pointed out at the time of the press conferences, probably no more abject surrender of radio's rights was ever made, than this complete yielding to the newspapers by radio's spokesmen. A number of stations, seeing radio's larger interests thus violated, have established their own news services, and are sending out adequate news reports, promptly and frequently.

The present collapse of the press-radio entente once more points the inevitable future course for broadcasting, viz.: A separate radio news service, with facsimile transmission of a tabloid newspaper to home radio sets between 1 and 6 a.m., this little newspaper to carry radio programs, news headlines, cartoons, styles, and news pictures.

Radio is in top position when it comes to dealing with the newspaper publishers. Armed with the strength of facsimile, radio need ask leave of no other group,—any more than sound-movies asked permission of the silent films to replace them with an improved service.

## Wanted—a pocket radio

THE commercial advent of the tiny "shoe-button" or acorn radio tube, calls attention again to the popular market that exists for a pocket radio set. A real addition to radio convenience, would be such a battery-operated receiver, no larger than a pocket camera, with a self-contained ear-phone which could be used to listen to news reports, special speeches, time signals, etc. Business men, travelers, young people, would all find frequent use for a radio set always at hand.

As things now stand, the weight of the battery seems to be the hurdle that stands in the way of a pocket broadcast receiver. But surely the dry-cell makers can meet this need. Instead of building batteries bigger and heavier, there is a need for a light, compact, multi-cell unit, which will deliver the necessary voltage, even if it can supply only a few days' operation. Indeed, such dry-cell batteries might be reduced almost to the dimensions of cigarettes—to be purchased as needed, as frequently and conveniently as one buys his Murads and Luckies.

## SEES PHOTO-CELL AS SOLAR POWER SOURCE

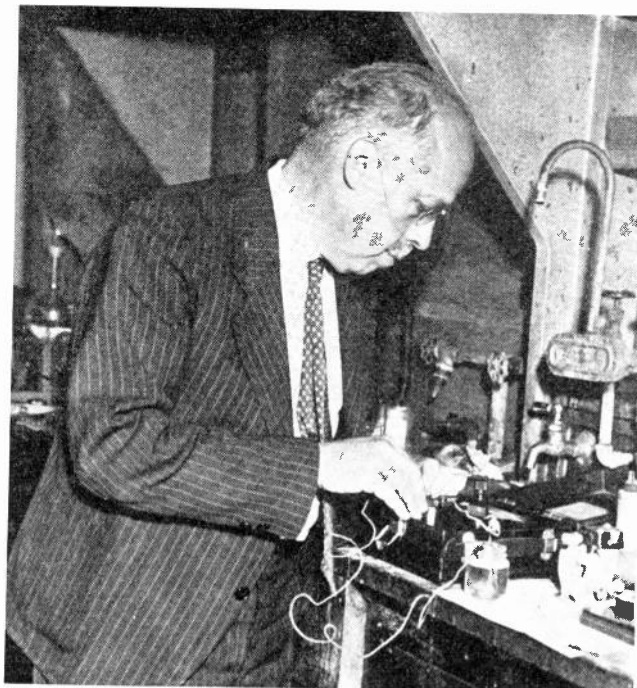

Dr. Colin G. Fink, of Columbia University, inventor of ductile tungsten, chromium plating, and other revolutionary processes, is now working on photo-voltaic cells. He thinks low-price cells, capable of capturing 75 per cent of the 150 watts per sq.ft. of sunlight, will eventually be developed



# REVIEW OF ELECTRONIC LITERATURE

## HERE AND ABROAD

### Silent tuning

[TH. STURM.] The sensitivity of a receiver equipped with automatic volume control increases as the tuning is varied away from the carrier, and a screech is produced by local and atmospheric noises when the set is brought through the sidebands. To remedy this defect a device is needed which blocks the loudspeaker or the output tube whenever the carrier amplitude to which the set is being tuned falls below a certain adjustable value. One method is based upon the fact that when the signal strength decreases the anode current in the controlled tube increases so that any point in the plate lead is made more negative than before. If the grid bias for one of the audio tubes be taken from a potentiometer inserted in the plate circuit it may be so adjusted that the audio tube is blocked in case of an excessive variation. To prevent the operating point of the a-f stage from being permanently displaced, or shifted into the positive region, it is necessary to insert a rectifier, preferably a tube, between the potentiometer and the grid of the audio tube. Current now flows only in one direction, and the grid bias remains unchanged until the contact point upon the potentiometer assumes a more negative value than the grid. In this latter case the rectifier gives to the grid a more negative charge and if the resistances  $R$  on the r-f side are higher than those  $P$  producing the audio grid bias, the output tube is blocked.

Instead of a diode a triode may be used in such a way that the grid bias resistors of the r-f tube and those of the a-f tube form a Wheatstone circuit with the grid-cathode space as the grid. The  $R$ 's may be so adjusted that normally no current flows through the tube. An a-f tube standing a very high bias must be chosen, and a second a-f amplifier be added if necessary.

Another method is the "grading tube," making use of the visual output indi-

cator, now commonly a neon tube, which is traversed by part of the plate current of the first tube. The variation which takes place in the current when the volume control enters into action produces voltage changes between any point in this circuit and the potentiometer  $P$ . The contact point on  $P$  is so chosen that the cathode, a long wire, is fully covered with the negative glow when the d-c current across the r-f tube is reduced to a low value (high signal strength). When the signal strength decreases and the plate current increases, the plate of the neon tube becomes more negative and the glow recedes part way. It is now only necessary to add a side electrode reaching close to the cathode of the neon tube. So long as the glow extends farther than the side tube, this electrode assumes nearly the potential of the cathode, which is so chosen that it is suitable as grid bias for the a-f. Whenever the glow recedes beyond this point, the side electrode loses its connection with the glow and the a-f tube becomes blocked by its own high bias. This tube must have an amplification factor of at least 10, and the time constants must be given a correct value.—*Funkt. Monatsh.* No. 7: 259-263. 1934. See also *Electronics*, p. 40, February, 1933.

### Designing tubes with exponential characteristics

[W. DEHLINGER, Emporium, Pa.] In order to wind the variable- $\mu$  grid for a tube with a space charge and a control grid, it is necessary to know the grid wire spacing  $y$  as a function of the distance  $x$  (fraction of the total length) from the turn (or half-turn) with the widest spacing. The relation between  $y$

and the reciprocal  $z$  of the amplification factor  $\mu$  is known from experience with ordinary tubes (formula of Vogdes and Elda). The value of the fraction  $x$  is given by  $1 - 2.71^{-\mu z}$  for a tube which is to have the exponential characteristic  $1 = (j I) 2.71^{\mu z}$ , where  $I$  is the total current obtained according to the space charge law. The combination of the two curves  $z$  and  $y$ , and  $x$  and  $z$  gives a curve  $y$  and  $x$ , or  $1/y$  as a function of  $(1 - x)$  from the latter one the geometrical relation between  $1/y$  and the order number  $N$  of the turns is readily established. The continuous curve representing  $y$  as a function of  $N$  may finally be replaced by a step curve which assigns a definite pitch to every integral order number  $N$ . A shortening of the length of most of the tubes now in use would not much change their characteristics.

A fuller treatment is given by J. Scheel and F. Marguerre in *Archiv. f. El. techn.* 28 No. 4: 210-233. 1934.—*Physics* 5 No. 7: 173-177. 1934.

### Time constant of circuits

[R. MESNY, Ecole Superieure d'Electricite, Paris.] When a sinusoidal voltage is induced in a tuned circuit containing  $C$ ,  $L$  and  $R$ , the time at which the steady value  $I$  is reached depends on an exponential function of  $a = R/2L$ . When the e.m.f. is cut off, the current dies down according to the law  $i = I/e^{at}$ , where  $\epsilon$  is equal to 2.71. The time constant  $t_c = 2L/R$  may be defined as the time (or number of cycles) necessary for the current to fall from the value 1 to the fraction  $1/2.7$ . Since  $1/\epsilon^2$  equals 0.05 and  $1/\epsilon^4$  equals 0.018, the current may be said to disappear after a time  $t$  which is equal to three or four times  $2L/R$ . But when a series of similar circuits are used with vacuum tubes between each stage, the current follows an entirely different law. At the time  $t$  it has fallen to the fraction  $(1 + at + a^2t^2/2 + a^3t^3/6)/e^{at}$  when there are four circuits for instance, and to a similar expression but with  $a^4t^4/4$  added to the series in the brackets for five circuits, etc. The time constant can no longer be given a simple meaning. As the number of circuits is increased, the current tends to maintain its value for a certain period after the source has been removed. A similar difficulty arises in connection with the selectivity of the circuits.—*Onde cl.* 13 No. 150: 237-243. 1934.

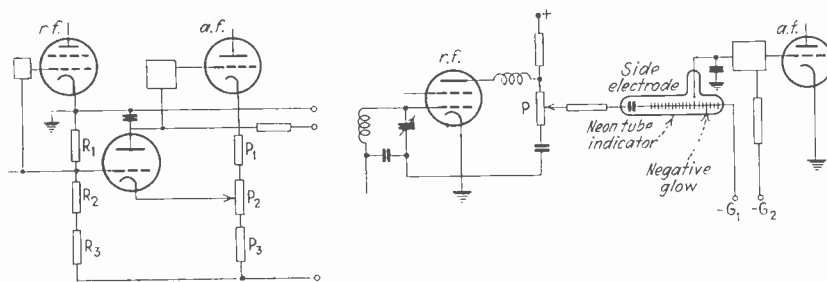

Silent-tuning systems (at right) using neon tube, and (left) using controlled rectifier in bridge circuit

## The behavior of selenium barrier film cells

[W. GRUNDMANN and L. Kassner, Meteorological Office, Breslau.] The recently improved photocells based on the barrier effect given by selenium films (these Digests, July, 1934) yield reproducible results at higher intensities than cells made more than a year ago, particularly when infra-red light is excluded by placing a vessel containing water in the path of the beam. Under these conditions there is no drop in the current when the cell is exposed for 15 minutes to an illumination of 700 foot-c., but with 1,000 foot-c., the current is found to decrease 2½% in the first five minutes. At 4,000 foot-c., it decreases 15% in the first five minutes, 23% in the first ten and 27% in the first fifteen minutes. After five minutes in the dark the cell has recovered its initial sensitivity. When not protected by water the cell should not be given more than 330 foot-c. When exposed for a day to the winter sun, the cells are unable fully to recover during the night. The smaller cells (2.8 sq.cm.) are more stable than those with a large area (9.7 sq.cm.); infra-red being excluded, they stand without aging 3,000 or 4,000 foot-c. It is to be hoped that the manufacturers will be able to furnish cells which can be freely exposed to the sun (10,000 foot-c.). The cosine law is obeyed for angles of incidence smaller than 50°.—*Meteor. Zeits.* 51 No. 7; 258-262. 1934.

## Elimination of fading by reverse field detector

[H. E. HOLLMANN, Heinrich Hertz Institute, Berlin] When the leads to grid and plate are reversed in the input as well as in the output circuits, the plate acts as a brake slowing down or repelling the electrons (*Proc. I.R.E.* 22: 630-656, 1934). The shape of the lower bend of the curve giving the current to the retarding plate as a function of its voltage depends mainly on the velocity with which the electrons leave the cathode and is therefore preferably used in detection. The load brought into the input circuit by the relatively low internal resistance of the tube may be reduced by placing an r.f. by-pass between plate and grid and an r.f. choke between this latter point and the output transformer.

The plate-grid conductance is proportional to the emission current. The correct bias is obtained automatically by placing a condenser *C* for audio frequency between filament and tuned input circuit (now connected to the plate) and a resistance from this point to the positive end of the grid battery or potentiometer tap. If the voltage building up across the condenser is applied to the

r.f. stages which precede the detector, a convenient system of a.v.c. is obtained. Another way of taking advantage of this voltage is to use a two-grid tube or a hexode as detector and to apply it to the grid nearest to the cathode.—*H. F. Techn. El. Ak.* 43: 131-135, April, 1934.

## Correct and incorrect uses of tubes

[K. STEIMEL, Telefunken Co., Berlin.] Designers of circuits often lose sight of the fact that before other values may be affected the plate current of vacuum tubes undergoes slow changes with time. The current should never be used for compensating or controlling voltages in other parts of the circuit or by other tubes. Complaints invariably arise in those types of automatic volume control in which the potential drop produced by the steady d.c. of the detector tube controls the bias of some or all of the preceding stages. On the other hand when diodes are used for automatic volume control the difficulties encountered are

sometimes attributed to the tube when in reality they are the fault of the circuit. Two such points are the much smaller range over which the amplification in the preceding tube can be varied and the distortion produced by the a.v.c. circuit. The grid bias of the amplifier before the diode must be higher than the radio frequency amplitude which it receives; on the other hand the bias itself is determined by the diode, or indirectly by the a-c plate voltage of the amplifier so that the tube must always be used under conditions where it enhances signals however strong they may be. With a modulated wave it should amplify fourfold or fivefold.

When the resistance  $R_2$  and the capacity  $C_2$  which control the grid bias are too small, there will be a partial loss of the low notes, and the quality of the reproduction will suffer. The d-c potential across the condenser tends toward a constant value  $V$  equal to that across  $R_1$ . When for any one reason the rectifying action is decreased or sets out for a time, the condenser sends a current across  $R_1$  and  $R_2$  and produces a voltage across  $R_1$  equal to  $R_1 V / (R_1 + R_2)$  which interferes with the functioning of the diode. Distortion re-

## STUDIO CHARACTERISTICS

In the Broadcast Issue of the *London Times*, August 14, 1934, considerable description of the British Broadcasting Company equipment, land lines, studios, transmitters, etc., appears. The table gives the reverberation characteristics of the several studios in London.

Studio	Principal Use	Reverberation time	Approx. dimensions (in feet)			Volume (cu. feet)
			Length	Width	Height	
BA.....	Vaudeville, Light Musical Programmes.....	1.1sec.	44	36	19	30,000
BB.....	Octets, Recitals, Dance Bands, Television....	0.85sec.	29	18	19	10,000
Concert Hall.	Orchestral and Band Performances.....	1.75sec.	106	42	31	125,000
3A.....	Children's Hour and Dance Band.....	0.6sec.	35	15	19	10,000
3B.....	Talks.....	0.35sec.	15	11	9	1,500
3C.....	Talks.....	Dead	15	11	9	1,500
3D.....	Talks.....	0.35sec.	15	11	9	1,500
3E.....	Religious Broadcasts...	0.8sec.	21	18	19	7,000
4A & 4B.....	News.....	Dead	12	7	8	670
6A.....	Large Production Studio.....	0.85sec.	36	16	18	10,000
6B & 7B....	Speech in Plays and Piano Music.....	0.6sec.	19	19	9	3,200
6C & 7C.....	Speech in Plays.....	Dead	19	19	9	3,200
6D.....	Effects.....	Dead	23	19	19	8,300
7D.....	Small Effects.....	Dead	13	12	9	1,400
6E & 7E.....	Gramophone Effects....	Untreated	12	8	9	860
7A.....	Speech in Plays.....	Dead	13	13	9	1,500
8A.....	Orchestral and Band Music.....	1.1sec.	51	33	16	27,000
8B.....	Debates and Discussions.....	0.45sec.	16	13	10	2,100

sults. To reduce this backward discharge  $C$  and  $R_1$  must be given small values. When the degree of modulation exceeds 50 per cent, and  $R_1$  is equal to  $R_2$ , the signal is distorted; when  $R_1$  equals  $R_2/4$ , the modulation may reach 80 per cent without any bad effects.

It is sometimes difficult to distinguish whether microphonic noises are due to tubes or to variable condensers. The sounds produced by tubes are strongest

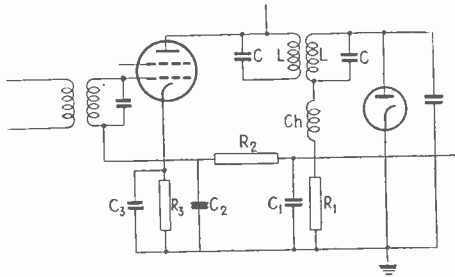

A.V.C. diode circuit using drop across  $R$ . Bias across  $R_3$  should not depend solely upon plate and screen currents

at exact tuning (amplitude modulation), those caused by the variable condenser are strongest in the sidebands. Tubes are so constructed that they give no sound when used under normal conditions. When r-f pentodes are controlled by a diode so that the grid bias is variable, tube noises can only be avoided by taking the screen voltage from a potentiometer. With fixed resistors the screen might assume high potentials, shift the characteristic curves of the tube toward the negative direction. The tendency to make up for the loss of signal strength by forcing the stages following the pentode often results in microphonic sounds.—*Telefunken Röhre*, No. 1, pp. 28-42. 1934.

♦

### Supplementary radio tubes in Germany

TO ALLOW set designers to become acquainted with hexodes, r-f pentodes and binodes, no new types of tubes have been brought out for a year. The choice of tubes has now been widened by adding a mixing hexode for a-c and d-c operation, a duo-diode for a.c. and d.c., an octode for a.c. and an output pentode for d-c operation. Typical receivers of this year are built with one mixing hexode feeding the filtered intermediate frequency to the second tube, a hexode (exponential hexode); the amplification of both stages is controlled by the automatic volume circuit. The output of the hexode is led through a band-pass filter to the diode electrodes in the binode (diode-tetrode) or duo-diode tube. The a-f output is brought through a potentiometer to the tetrode system of the binode. An a-f pentode is in the output stage.

The hexode makes use of the second grid (80 volts) and the third grid (−1.5 volt) to produce an artificial or virtual cathode between the second and third grid. When the potential  $V_2$  of the third grid is kept constant, the current to the second and fourth grid and to the plate all depend on  $V_1$  as in an ordinary tube. When  $V_2$  is made more negative,  $I_a$  and  $I_p$  decrease together, and the mutual conductance of the tube referred to grid 1, a variable- $\mu$  grid, decreases, it varies between 2 ma. and  $0.2 \mu\text{a.}$  per volt. The capacity between the first grid to which the signal is applied and the second grid is below  $0.001 \mu\mu\text{f.}$

The mixing hexode allows modulation of the local oscillation by the incoming wave in place of their mixing by addition. The third grid is more positive than the second, and the electrons are stopped only between the third and fourth grid.  $I_a$  and  $I_p$  change in opposite directions when  $V_2$  changes, but all the values  $I$  to the different electrodes depend on  $V_1$ , upon which the signal is superimposed.

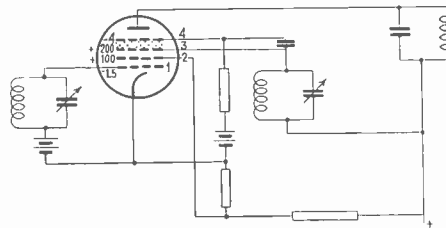

Mixing hexode circuit diagram

The so-called "fading-mixing" hexode may be considered as a hexode to which a separate three electrode oscillator has been added which has the cathode in common with the hexode and uses as a grid the third grid of the hexode. Thus this third grid is not controlled by the a.v.c., but modulates the local frequency

with the incoming signal. The oscillator plate is given 150 volts, the main plate 300 volts, the screen 70 volts.

The octode is also a combination of fading and mixing hexode having at the same time the properties of an r-i pentode. It corresponds to the pentagrid converter. The first grid of the

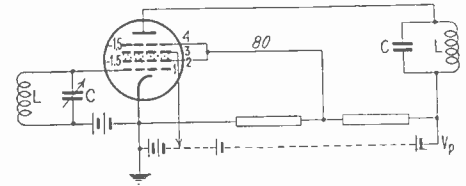

Connections for what the Germans call a "fading" hexode

tube is connected to the oscillating circuit, while the second grid functions as a plate. The third grid is a screen separating the oscillator from the fourth grid to which the signal and the automatic volume control are applied. Another screen grid follows. The sixth and last grid traps secondary electrons; it is connected to the cathode and gives the tube a high internal resistance. In contrast to the fading-mixing hexode the plate of the oscillator forms a part of the grid system.

	Fading Hexode A.C.	Mixing Hexode D.C.	Octode A.C. Only	Output Pentode D.C. Only
Filament voltage	4	24	4	30
Filament current	1	0.18	0.65	0.18
Plate voltage	300	200	200	200
Screen voltage	70	50	.....	100
Second, third and fifth grid voltage	.....	.....	70	.....
Plate current	10 $\mu\text{a.}$ to 2.5 ma	10 $\mu\text{a.}$ to 3 ma	0.8 ma	.....
Mutual cond.	.....	.....	.....	6.5 ma/V (max.)

(One half of the duo-diode tube can be used for feeding the audio system, the other half the automatic volume control (delayed a.v.c.).

The pentode for d-c operation gives an output of 5 to 8 watts.—*Funkt. Monatsh.* No. 8: 311-312. 1934.

♦

♦

♦

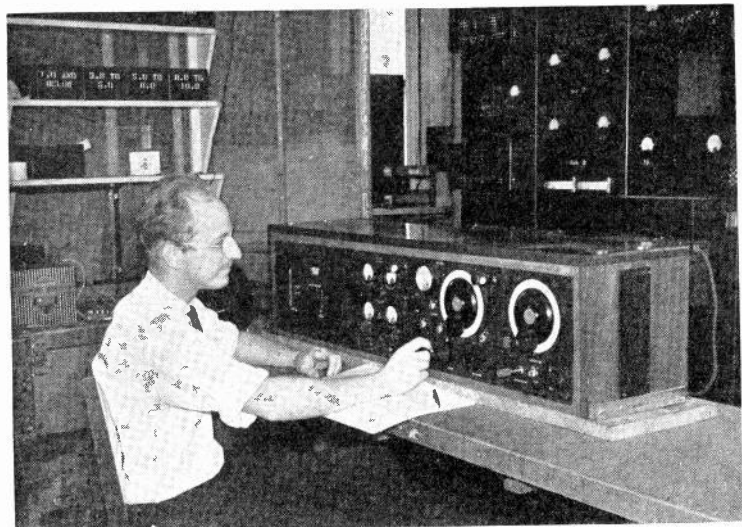

Portable frequency standard for F.C.C. being tested by J. O. Booth of Westinghouse, accurate within 3 parts in one million

# + NEW PRODUCTS

## THE MANUFACTURERS OFFER

### Cellophane-wrapped wire

A NOVEL insulation for electrical wire has been applied by engineers of the DuPont Cellophane Company and the Belden Manufacturing Company, Chicago, Ill., the development of a method of applying cellophane to magnet wire.

Special machinery has been developed and installed at the Belden plant for applying the cellophane to the magnet wire. Adhesive is first applied, then the cellophane strip is wrapped in place; the wire is then lacquered and baked.

Celenamel, as the new magnet wire is called, is a great space saver, has greatly increased dielectric strength, and can be furnished at approximately the same cost as cotton covered enameled wire. Tests show that Belden Celenamel has

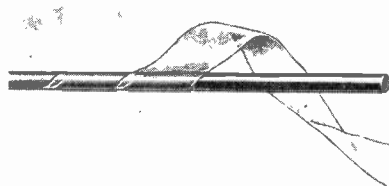

approximately the same space factor as silk enameled wire. In coils Celenamel has approximately 64% the volume of double cotton covered wire and 88% of single cotton covered enameled wire. Celenamel has already supplanted silk covered magnet wire in a number of applications.—*Electronics*.

### Flexible shafts for radio

FLEXIBLE SHAFTS now find a wide variety of uses in radio, even the control panels of broadcast transmitters being so equipped for convenience of manipulation. In the modern type of shaft developed by the S. S. White Dental Manufacturing Company, industrial division, 152 West 42nd street, New York City, the construction comprises not coils of wire or springs, but *real shafts*, built up solid of layers of special high grade wire held to rigid specifications as to uniformity. Shaft characteristics such as flexibility, torsional strength, etc., are secured through design of the shaft and a special winding process. This process and the machines for applying it, are the result of years of development.

The greater number of layers and the

increased number of smaller diameter wires per layer, have resulted in securing the characteristics essential to successful radio application, namely, minimum torsional deflection under load, and equal deflection for either direction of rotation. These features are combined with ample flexibility for operation in curves of small radius, a feature which greatly facilitates installation.—*Electronics*.

### Air-cell battery electrodes

"VENTILATED" ELECTRODES, which expose greater areas to the air and so withstand the heavier current drain imposed by some of the new all-wave receivers, are announced by National Carbon Company, Inc., as its latest improvement in its "air-cell" A battery.

The new heavy-drain Air Cell battery is known as No. SA-600 special, and it permits a current drain of 750 milliamperes as against the 650-milliamperes capacity of the standard Air Cell "A" Battery, with a guarantee of 800 hours' life. The new battery is priced the same as the standard.—*Electronics*.

### Hook-up wire

THE LENZ ELECTRIC MANUFACTURING COMPANY, 1751 N. Western Avenue, Chicago, has developed a new hook-up wire with a new type of insulation of exceptionally high dielectric characteristics, particularly insulation resistance. The fact that this wire is non-moisture-absorbent makes it especially adaptable for automobile use and in high-fidelity receivers.

Lenzite is the name of the new hook-up wire. The insulation consists of cellulose acetate-treated textile plus cotton braids thoroughly saturated in moisture resisting compounds. This wire can also be furnished saturated in slow burning high dielectric lacquer.

Lenzite is most suitable for use in all wave radios because it is non-moisture absorbent, thus preventing shifting of alignment and distortion.

Production managers will like this insulation because it pushes back freely and stays in position. There is no buckling or fraying of the braid that will interfere with production operation.—*Electronics*.

### Transmitting condensers

THE AUDIO PRODUCTS CO. (formerly the Wireless Shop), 4189 W. Second St., Los Angeles, Calif., has expanded its line of high-power transmitting condensers to include a complete range of capacities and voltage ratings up to 500 mmfd. and 20,000 volts. Both single section and split-stator models are available in each size.

Two frame sizes are employed. The smaller type requires a 4 in. x 5½ in. panel space and uses coorsite insulation. The large model occupies a panel space 6 in. x 9 in. and for the extremely high voltages, is insulated with both coorsite and victron, a new high frequency insulator second only to fused quartz in

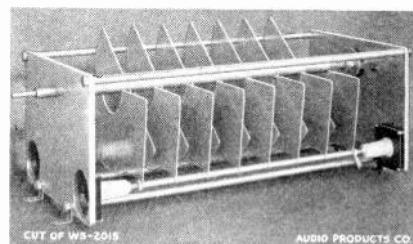

effectiveness. Extreme rigidity is obtained with large steel tie rods and thick dural end pieces, besides half inch removable steel shafts and heavy, rounded edge dural plates. Three large phosphor-bronze springs, wiping on a cadmium plated disc, afford positive rotor contact.

Prices range from \$8 to \$75 for regular models, with special values of capacity and voltage available on order.—*Electronics*.

### Electron tube fader

MAKING USE OF the characteristics of amplifier tubes instead of assemblies of resistors, an electronic fader for sound or broadcast purposes has been designed by the United Sound Engineering Company of St. Paul, Minn.

In this device, type 79 (or 53) tubes are used as the variable impedance whose value remains constant for any variation of the input. Thus as the gain is varied the impedance characteristics do not vary.

While its characteristics are superior to more conventional faders, it weighs less than 7 ounces.—*Electronics*.

## Cathode ray oscilloscope

THE ALLEN B. DU MONT LABORATORIES of 542 Valley Road, Upper Montclair, N. J., announces a new portable cathode-ray oscillograph (Type 142), with a 5-inch cathode-ray tube, power supply and linear sweep circuit, completely self contained.

A type 54-8 Du Mont cathode-ray tube utilizing an indirectly heated cathode and equipped with two sets of electrostatic deflection plates and high intensity screen is mounted in the unit. A graduated scale at the face of the tube enables accurate quantitative measurements to be made. A power supply furnishing the accelerating electrode voltage as well as the necessary filament and focusing voltages is incorporated in the unit, together with a linear sweep circuit having a range from 10 to 5,000 cycles per second. The sweep circuit is of the stabilized type which can be made to lock in step with a recurrent waveform if desired.

Terminals to the unit are mounted at the rear and the linear sweep may be connected or disconnected according to the use of the instrument. Separate leads from each deflection plate are brought out and are available for external connections, permitting operation of either set of plates balanced or unbalanced to ground.—*Electronics*.

+

## Condensers

COVERING ITS wide line of condensers, A. M. Flechtheim & Co., Inc., 136 Liberty Street, New York City, have just released their latest catalogue, No. 27, for 1934-35, which presents one of the most complete parts replacement lines in the industry giving detailed descriptions of all Flechtheim products inclusive of Flechtheim carbon resistors, automobile suppressors, dry electrolytic condensers, paper condensers and paper transmitting condensers.—*Electronics*.

+

## Record duplicating service

THE B. A. PROCTOR CO., INC., 17 West 60th Street, New York City, offers a new low cost acetate-record pressing service. Nothing is lost in the process—each pressed acetate record has on it exactly that which was recorded on the aluminum master. Records received are processed and shipped the same day. The reproduction from the processed records is better than reproduction from aluminum because of the fact that the pressed records are capable of being played with a steel needle, instead of the usual thorn or wooden needle which is responsible for the apparent losses on both ends of the spectrum. Thus a quality of reproduction from duplicates is possible that practically approximates the recording. Twelve-inch records

can be processed at \$2.50 each in quantities from one to three. Sixteen-inch records cost \$3 each for from 1 to 3. Larger quantities are available at correspondingly lower prices. There is a small base processing charge which is negligible especially in quantities of ten or more.

It is felt that this process opens new fields for recording and duplicating in the radio, commercial and educational fields.—*Electronics*.

+

## Micro-vernier dial

WIRELESS EGERT ENGINEERING, INC., 179 Varick Street, New York City, has developed its Model D-1 dial primarily for use on laboratory instruments, short-wave receivers, transmitters, etc., and for instrument manufacturers, amateurs, experimenters and set builders.

The model D-1 dial can be read accurately to 0.1 of one division at any point on the scale. Its double edged vernier pointer provides a means of obtaining accurate readings anywhere on the dial. The mechanism of the dial provides a spread of 270 degrees on the pointer for a 180-degree condenser.

The dial ratio is 16 to 1 over 360 degrees. The unit is free from backlash. Provision is made for mounting condensers directly on the dial itself, rather than on the panel. Both the scale and pointer are of metal to prevent any inaccuracy in readings due to shrinkage of the scale.

Diameter of scale is 3 inches; hub diameter one-quarter inch; overall depth,  $\frac{7}{8}$  inch. Weight 5 ounces. Price \$5.—*Electronics*.

+

## Resistors

THE ATLAS RESISTOR COMPANY of 423 Broome Street, New York City, announces a new eight-page catalog covering its complete line of wire-wound tubular resistors.

Among the new features is a line of pigtail resistors, which come complete with lug as well, in both 5 and 10-watt ratings. Of small dimensions, they can readily take the place of carbon jobs between 5 and 25,000 ohms.

Another item, the latest Atlas development, is the "combination resistor." Manufactured in stick form in 3 and 10-watt ratings, these units are composed of sections of like ohmages. The 3-watt form consists of five individual resistors of identical ohmages and the 10-watt stick has three individual units. The principal use of these resistors is for making up odd-sized ohmages other than standard, as they can readily be broken off individually, owing to the tubing being scored between sections. Or, the entire stick or portions thereof can be employed as one resistor, for each section is connected in series.—*Electronics*.

## All-wave line-noise filter

KEEPING LINE NOISES out of present-day all-wave reception is the function of the new Taco H-F all-wave line filter, just announced by Technical Appliance Corporation, 27-26 Jackson Ave., Long Island City, N. Y.

Housed in attractive brown metal case with receptacle, the device comprises separate filter circuits for broadcast and short-wave bands. The circuits have been worked out over a considerable period by Amy, Aceves & King, Inc., well-known engineers specializing in antenna problems and radio



noise elimination. The present device is made under license from them.

Filtering is said to be thorough in both broadcast and short-wave bands. Only pure, noiseless A.C. or D.C. (device can be used on either supply) reaches set. Device handles up to 250 watts. Installation consists of plugging in receptacle of filter, inserting filter plug in nearest electric outlet, and connecting binding post to convenient ground, grounded chassis or ground binding post of set. If preferred, filter may be inserted between any electric appliance causing line noises, and its power supply, thus combating interference at source. The filter lists at \$6.—*Electronics*.

+

## Battery-charging rectifier

NATIONAL UNION RADIO CORPORATION, 400 Madison Avenue, New York City, announces the development of a new 6-amp. rectifying tube for use in multiple battery chargers. Such rectifying tubes used extensively in the automotive and radio fields for multiple battery-charging, are commonly referred to as "Tungar type." Outstanding features of the new rectifier include ability to withstand increased voltages and a construction which makes them not critical on voltage fluctuations. These factors result in more output for less consumption of power.—*Electronics*.

## Direct-reading test oscillator

THE NEW Burton-Webber all-wave test oscillator, Model 10, has a full visioned direct-reading dial which permits speedy, accurate settings without reference to graphs or tables. Eight arcs provide a scale length of approximately 47 inches covering from 90 kilocycles to 25 megacycles all on fundamental frequencies. Attenuation is of the ladder type with adjustable control on high, medium and low steps, permitting any

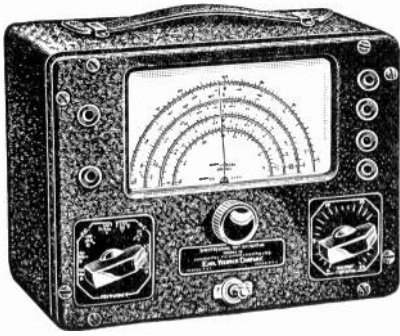

signal voltage to be obtained from maximum to practically zero, and affording excellent attenuation on signals as high as 25 megacycles.

A 400-cycle note, approximately 35 per cent modulated, is supplied by a separate modulator tube. The oscillator can be demodulated for adjusting radio receivers by the unmodulated method, and audio-frequency signal is available at panel jacks.

The new oscillator is manufactured and licensed under the approved circuits of the American Telephone & Telegraph Co., and each unit is carefully standardized with precision crystal-controlled frequency standards at six points on each band or arc, or at a total of 48 points. The Earl Webber Company, Daily News Bldg., Chicago, Illinois, or C. W. Burton, 755 Boylston St., Boston, Mass.—*Electronics*.

## Phototubes for ultraviolet

A NEW LINE of photo-electric tubes, sensitive only to definite bands of invisible ultraviolet radiations, has been announced by the Westinghouse Lamp Company, Bloomfield, N. J., to meet a demand growing out of an increasing use of ultraviolet radiating devices for therapeutic and germicidal purposes. They are available in various types with threshold values of sensitivity set at different points in the ultraviolet spectrum so that radiations can be studied qualitatively as well as quantitatively.

Some of the laboratory uses of these phototubes are: to test the transmission

and absorption of various types of glass and solutions in different parts of the spectrum; to test ultraviolet output of different light sources in different regions of the ultraviolet spectrum. In industry the tubes are used in equipment for the control of irradiation by ultraviolet or certain products for the production of Vitamin "D."

The new line of electronic tubes also includes several of the Caesium oxide type, which are sensitive in the visible range as well as in the infra-red.—*Electronics*.

## Loudspeaker

THE ROLA COMPANY, 2530 Superior Avenue, Cleveland, Ohio, is introducing its model K12, an entirely new 12-inch loudspeaker, which embodies high fidelity and practical engineering development gleaned from ten years of speaker manufacturing experience.

*Specifications*—Overall diameter 12½ in., Overall Depth 6½ in., Recommended Baffle Hole 10¼ in., Weight Packed 8¼ lbs., Voice-coil impedance 2.8 ohms at 400 cycles, Transformer size, optional, Field-coil resistance, optional, Net weight 6¼ lbs.—*Electronics*.

## Auto-radio vibrator condenser

TO TAKE CARE of condenser replacements in auto-radio vibrators, a line of tiny units specifically designed for the purpose is announced by the Aerovox Corporation, 70 Washington street, Brooklyn, N. Y. These replacement units



comprise oil-impregnated, oil-filled, pure linen paper sections in hermetically sealed metal containers, with mounting lug and pigtail lead. The units are designed to withstand heat, vibration, moisture and climatic conditions, as well as exceptional peak loads, without breakdown. They are available in several standard capacities.—*Electronics*.

## High fidelity audio transformers

THE UNITED TRANSFORMER CORPORATION, 264 Canal Street, New York City, have developed a new group of high-fidelity audio transformers for applications requiring extremely wide frequency range, such as impedance matching in television, facsimile, and supersonic apparatus.

Owing to the wide range of frequencies transmitted, a new core material and special coil structures are made necessary. Shielding also becomes a critical factor. These units are shielded in a cast alloy case having five times the permeability of normal cast iron. The unit illustrated has a frequency range of 30 to 200,000 cycles, with a total power loss not exceeding 2 db. Standard transformers for high-

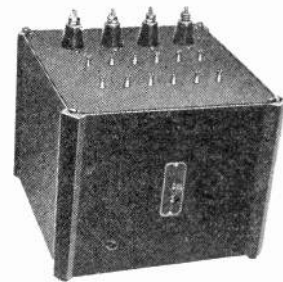

fidelity equipment are also available, having a frequency characteristic of 30 to 15,000 cycles. These audio units are now available in sizes from —120 db, up to 20,000 watts rating.—*Electronics*.

## Condensers

THE VICTRON "AA" CONDENSER is insulated with Victron material whose power factor at r.f. is only 0.0002. This condenser also has most practical shaped plates for station separation. These are carried on a self-centering, self-tightening cone bearing which cannot become loose or wear to produce a noisy rotating contact no matter how much used. Minimized metal construction without metal end plate insures very low minimum capacity.

The rugged two-point suspension mounting, reinforced by soldered brass plates, located with precision uniformity of spacing.

Contact is through silver pressure-contact to rotor, instead of resistive grease film or oxidation skin, as in bearing contacts.

Both rotor and stator are insulated from mounting bosses, yet rotor may be easily grounded to chassis if desired.

Two solder lugs are provided on both rotor and stator for convenient wiring. Made by Alden Products Company, Brockton, Mass. List price \$1.50 each, in 140 mmf. size.—*Electronics*.



# U. S. PATENTS IN THE FIELD OF ELECTRONICS

## Radio circuits

**Super regenerator.** A two-tube system in which an oscillating circuit is coupled inductively to the regenerative receiving circuit, a means offering a high impedance to the frequencies of the currents to be amplified and low impedance to the varying potentials for substantially eliminating loss of radio frequency due to leakage from one circuit to the other. L. A. Hyland, Eclipse Aviation Corp. No. 1,971,347.

**A-V-C system.** In a receiver using multi-purpose tubes the method of reproducing radio frequency signals into perceptible condition at uniform volume by amplifying the signals above audibility, translating the amplified signals into audio signals with a substantial translation gain through one of the electron paths in the multi-purpose tube, rectifying a component through another path, and utilizing the rectified signal component in regulating the amplification of the signals. V. M. Graham, Stromberg-Carlson Mfg. Co. No. 1,971,605.

**Diode detection.** A tube with the inherent characteristic of rectifying an impressed emf when the peak voltage exceeds that critical value which is the direct current voltage between the diode elements. Rectification is prevented until the peak radio voltage rises to a

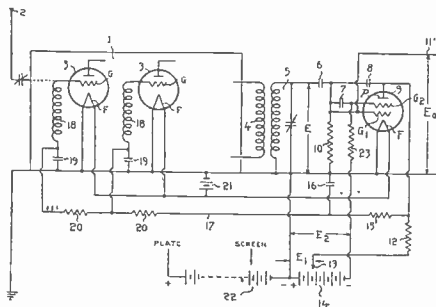

value differing from and greater than the critical value by a voltage increment of substantial magnitude. P. O. Farnham, assigned to R.F.L., Inc. No. 1,971,646.

**Single tuning system.** Combination of several circuits coupled together in cascade, each capable of being by itself tuned to a desired frequency, switching means for permitting connection of an antenna to any one of the said circuits, and a single means for simultaneously varying the tuning of each of the circuits by the same amount. E. F. W. Alexanderson, R.C.A. No. 1,971,762.

**Phonograph radio.** Circuit in which the detector tube acts as an amplifier whenever the phonograph pick-up device is connected properly. G. Anders, A.E.G., Berlin. No. 1,971,894.

**Microray system.** Transmission line and tube. No. 1,971,901 and No. 1,971,902. A. G. Clavier, International Communications Labs., Inc.

**Volume control.** Means for simultaneously varying the voltage impressed

upon the plate and screen of screen grid amplifier tube. W. T. Lewis, Racine, Wis. No. 1,972,387.

**Duplex aerial system.** An antenna system for receiving short wave and long wave signals, comprising coupling

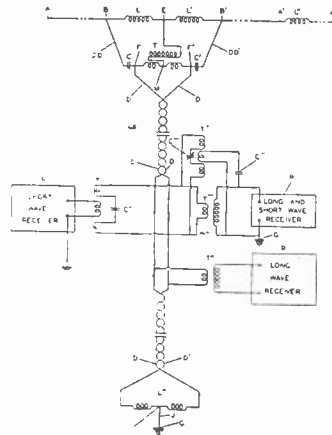

coils, transmission line, downlead etc. E. V. Amy and J. G. Aceves, Amy, Aceves & King, Inc. No. 1,965,539.

**Short wave amplifier.** A superheterodyne receiver for use on very short wavelengths with a frequency changer comprising two tubes with grids electrostatically coupled in parallel to a source of local oscillations and coupled in push-pull to an input signal circuit. G. A. Mathieu, RCA. No. 1,968,610.

**Directional receiver.** Adapted for mechanical high frequency elastic waves, including a rotatable reflector, stationary sensitive flame, etc. Frank Rieber, San Francisco. No. 1,969,037.

**Antenna.** An end-on antenna comprising a straight two-wire transmission line with transversals externally coupled to each wire, these transversals having overall length of one half wave length and spaced one half wave length apart along the transmission line so that each radiator is fed in phase opposition to the preceding one. P. S. Carter. No. 1,967,395. RCA.

**Iron core transformer.** A power transformer for use in radio frequency circuits having a broad transmission range, the core of which consists of iron carbonyl particles of less than .01 mm. in size, and a condensation product of phenol for insulating the particles. Andreas Jaumann, Siemens & Halske, Berlin. No. 1,965,649.

**Receiving transmission line.** A transmission line for connecting a radio antenna and a remotely located radio receiver, comprising a pair of twisted conductors, a step-up transformer, and a step-down transformer. Equal disturbing voltage impulses neutralize each other thereby reducing undesirable disturbances. Homer J. Loftis, Radio Corporation of America. No. 1,965,660.

**Television system.** Method of using a cathode ray tube by causing the electron stream to produce secondary emissions; the secondary electrons are ac-

celerated to produce an image through impact upon a fluorescent screen. V. K. Zworykin, R.C.A. No. 1,955,899.

**Oscillograph.** Method of causing a stream of electrons to rotate to trace a continuous coordinate line on the coating and means for varying the velocity of the stream to face a second coordinate line whereby a voltage wave may be portrayed in cylindrical coordinates on the cylindrical part of the envelope. H. W. Parker, Rogers Radio Tubes, Ltd. No. 1,962,873.

**Recording system.** An arrangement for recording the response of a broadcast receiver by recording the wave length to which a radio set is tuned. C. E. Robinson, R.C.A. No. 1,961,170.

**Input system.** In series with a conventional shunt circuit input to a radio receiver is an inductance shunted by its distributive capacity so that it is fixedly resonant to a frequency above the frequency range of the amplifier so that the ratio of signal voltage delivered to the amplifier at the low end of the range to that delivered at the high end is increased from a value of the order of 0.1 to a value of the order of 6.0. P. O. Farnham, assigned to R.C.A. No. 1,961,140.

**Uniform band width.** A receiver circuit for maintaining resonant band widths of the coupling system exactly constant throughout a frequency range. W. A. MacDonald, assigned to Hazeltine Corp. No. 1,961,154.

**Carrier wave television system.** Apparatus for the electrical transmission of images by generating rf carrier waves of different frequencies. Alfred Whitaker, The Gramophone Co. No. 1,962,417.

## Electron tubes

**Cathode ray tube.** Electrostatic deflecting plates connected to outside circuits through flexible coupling rods. Kurt Engel, G.E. Co. No. 1,954,666.

**Electron multiplier.** Means for producing a modulated electron stream, a pair of opposed surfaces to liberate electrons by secondary emission, and means for producing a potential gradient longi-

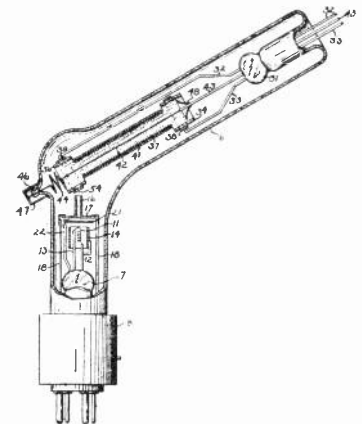

tudinally of said surfaces. P. T. Farnsworth, Television Laboratories, Inc. No. 1,969,399.

**Magnetron.** An oscillation generator using a tube with a split anode, the tube being inserted in an external magnetic field. N. Douglas, G.E. Co. No. 1,961,820.

**Glow cathode.** Electron - emissive cathode comprising heater element, and refractory enclosing means therefor comprising dehydrated silica-gel impregnated with an alkali metal. Werner Espe and Fritz Evers, Germany. No. 1,954,474.

**Rectifier-amplifier.** Construction for tube combining two functions. K. C. Black, R.F.L. Inc. Application April 21, 1930. No. 1,954,195.

**Multiple-unit tube.** Three tubes in one envelope, of the heater type, with coupling elements within envelope. Walter Akemann, AEG. No. 1,954,191.

**Construction methods.** A means of supporting the electrode assembly in a vacuum tube by means of a band member mounted on a collar. Victor L. Ronci, Brooklyn, N. Y., Bell Telephone Laboratories. No. 1,966,523.

**Photo tube.** A photo-electric cell containing a getter which reacts with the free alkali metal to form stable compounds. Harvey C. Rentschler, East Orange, and Donald E. Henry, Bloomfield, N. J., Westinghouse Lamp Company. No. 1,966,219.

## Electron Tube Applications

**Relaxation oscillator.** Polyphase oscillator, including several tubes, inter-

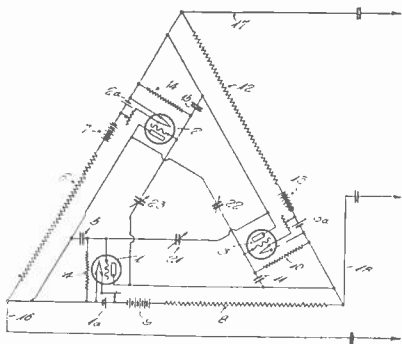

connected network, etc. R. M. Page, Washington, D. C. No. 1,972,535.

**A-c d-c system.** A method of supplying anode current from a source of a-c or a source of d-c comprising a full-wave rectifier which may be used for voltage doubling on a-c. Sarkes Tarzian, Atwater Kent Mfg. Co. No. 1,972,279.

**Reactance meter.** A transformer with a capacity for tuning a portion of transformer to a predetermined frequency. The unknown reactance is connected across another portion of the trans-

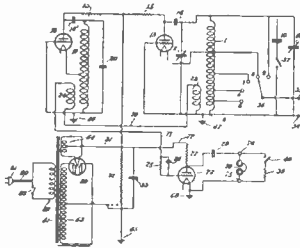

former so that the frequency is altered. Means are provided for changing the tuning so that the frequency is restored to its first value. A. W. Barber, Premier Crystal Labs., Inc. No. 1,971,310.

**Regulating system.** A speed-regulating system for rotating machine, involving changing the phase of a tube grid

with respect to its voltage to adjust its conductivity. S. A. Stage, WE&M Co. No. 1,968,575.

**Measuring system.** Indicating or measuring the distortion of telegraph signals by means of a cathode ray tube. No. 1,969,573, A. W. Montgomery and V. J. Terry, W.E. Co.

**Oil tester.** Light sensitive method of testing the characteristics of oils. V. A. Schoenberg, Light Research Corp. Re-issue No. 19,255.

**Standard frequency apparatus.** A pendulum alters the grid bias on a tube periodically by interrupting a light shining through a photocell. Corresponding impulses of plate current operate a timing device and maintain the pendulum in motion. V. E. Trouant, W.E.&M. Co. No. 1,971,086.

**Door opener.** Light-sensitive cell system with electro-hydraulic means which is maintained energized for a certain length of time before the door is returned to its original position. A. S. Fitzgerald, G.E. Co. No. 1,972,682.

**Motor control.** A rectifier supplies d-c from an a-c circuit to a d-c motor whose speed is controlled by variations in the characteristics of the motor varying the temperature of the cathode of a thermionic tube. F. W. Meyer, Cutler Hammer, Inc. No. 1,972,689.

**Illumination control.** A saturable reactance system involving a triode rectifier, etc. C. G. Suits, G.E. Co. No. 1,972,696.

**Vacuum gage.** An ionization tube with two filaments designed to indicate vacuum pressure. O. T. McIlvaine, McIlvaine Patent Corp. No. 1,971,423.

**Ignition interference.** In an automobile ignition system which produces oscillations causing interference to radio apparatus, means for suppressing such disturbance by means of inductances having low direct-current resistance, low distributed capacity, and high inductive reactance. J. M. Miller, Atwater Kent Mfg. Co. No. 1,971,497.

**Bandit alarm.** Apparatus for detecting the presence of magnetic material carried through a doorway by placing an electro-magnetic field around the door which is disturbed when magnetic ma-

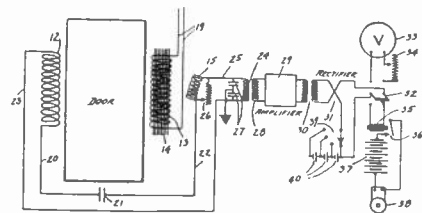

terial is carried through the door. These disturbances are amplified, rectified, and operate an alarm system. A. C. Woodward, Greensburg, Ind. No. 1,971,549.

**Frequency and load control.** A thermionic tube method of controlling the frequency and load of power generating apparatus. C. A. Hoxie, G.E. Co. No. 1,971,818.

**Relay.** A lock-in relay comprising a photocell, a triode, a screen grid tube and a gaseous relay tube. T. H. Long, W.E.&M. Co. No. 1,971,823.

**Speed control system.** In a control system for a direct current press drive motor driven by means of a rectifier from a-c, thermionic tube means for

starting the motor at low speed and bringing it up to the proper speed. H. R. Behr, assigned to A. J. Cline, Chicago. No. 1,970,507.

**Potentiometric indicator.** Use of a triode condenser and resistance, etc., for indicating potentiometer voltages. R. W. Gilbert, Neshanic, N. J. No. 1,972,141.

**Control system.** Light-sensitive system with a means for projecting a traveling beam of light so that the same

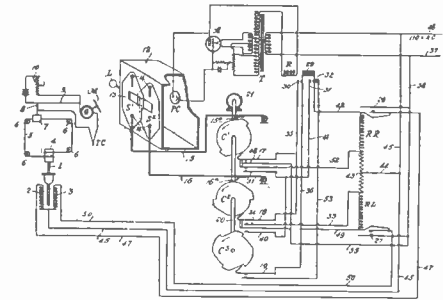

bundle of rays sweeps over different areas of an impinged object. 44 Claims. C. O. Fairchild, C. J. Tagliabue Mfg. Co. No. 1,970,559.

## Patent suits

1,231,764, F. Lowenstein, Telephone relay; 1,618,017, same, Wireless telegraph apparatus; 1,403,475, H. D. Arnold, Vacuum tube circuit; 1,465,332, same, Vacuum tube amplifier; 1,403,932, R. H. Wilson, Electron discharge device; 1,573,374, P. A. Chamberlain, Radio condenser; 1,702,833, W. S. Lemmon, Electrical condenser; 1,811,095, H. J. Round, Thermionic amplifier and detector; Re. 18,579, Ballantine & Hull, Demodulator and method of demodulation. D. C., E. D. Mich. (Detroit), Doc. 6370. Radio Corp. of America et al. v. Mark's Stores, Inc. Decree for plaintiff June 18, 1934.

1,710,073, 1,714,191, S. Ruben, Electrical condenser. filed June 19, 1934, D. C., E. D. N. Y., Doc. E 7288, Ruben Condenser Co. et al. v. Copeland Refrigeration Corp.

1,334,118, C. W. Rice, System for amplification of small currents; 1,501,831, E. F. Alexanderson, Wireless signaling system; 1,522,221, same, Method of and means for controlling alternating currents; 1,617,974, W. C. White, Wireless signaling system; 1,778,457, I. Langmuir, Alternating current generation, filed Dec. 5, 1933, D. C. Mass., Doc. E 3948, General Electric Co. v. Hygrade Sylvania Corp.

1,639,713, A. F. Sykes, Reproduction of sound; 1,885,001, H. F. Olson, Apparatus for converting sound vibrations into electrical variations; 1,897,732, Olson & Kreuzer, System for the conversion and transfer of energy, filed June 16, 1934, D. C., S. D. N. Y., Doc. E 78/201, Radio Corp. of America v. W. A. Bruno et al. (Bruno Laboratories).

1,533,858, L. A. Hazeltine, Method of and means for neutralizing capacity coupling in audions, D. C., E. D. Pa., Doc. 6549, Hazeltine Corp. v. A. A. Kent. Discontinued without prejudice Apr. 24, 1934.

1,423,956, Mitchell & White, Tipless incandescent lamp, D. C., E. D. N. Y., Doc. E 7143, General Electric Co. v. Amplex Electronic Products, Inc., et al. Consent decree for plaintiff June 12, 1934.

# BRITISH PATENTS

*British patents are important to American readers because these disclosures often forecast corresponding U. S. patents which may not be issued until a year later.*

**Harmonic eliminator.** Method of reducing harmonics from the output of a valve of an oscillator by connecting two or more acceptor circuits tuned to the various harmonics, as shunts across the whole or part of the main oscillatory circuit. Marconi Co. No. 410,182.

**Noise suppressor system.** A receiver is made quiet in the absence of a car-

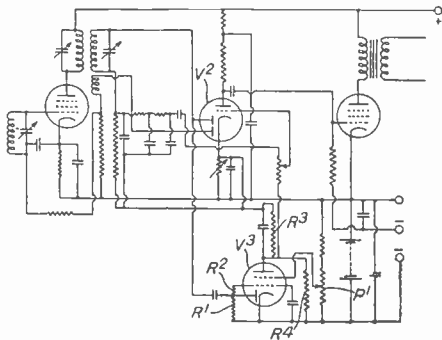

rier by paralyzing the first low frequency amplifier. Cromwell, Ltd. No. 410,010.

**Noise suppressor.** A muting device in a superheterodyne receiver comprises a circuit so sharply tuned to the intermediate frequency that the set is inoperative unless the frequency about which the frequencies in the output of the first detector are centered differs by less than 1,000 cycles from the intermediate frequency for which the set is tuned. In one method the tuned cir-

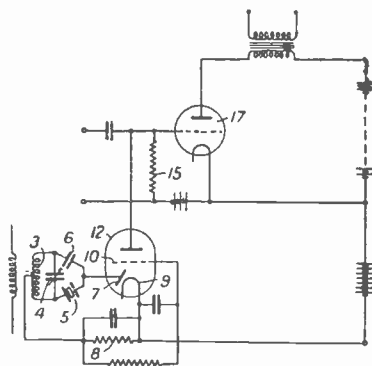

cuit comprises a piezo-electric crystal tuned to the intermediate frequency. G. E. Co. No. 410,549.

**Getter material.** A getter consisting of alkali and alkaline earth metals or their compounds is introduced into the envelope or an extension and the getter is evaporated simultaneously with the sealing of the tube from the pump or the extension from the envelopes. In one method, the getter is placed near where sealing off will occur, and this place is then heated. The getter vaporizes simultaneously with the melting of the glass and effecting of the seal. In a modification, the getter is

placed in a hard glass or metal extension which is melted off when the getter is vaporized. The extension may be connected to the tube by a glass tube which is afterwards sealed off. H. von Hartel, Berlin. No. 404,170.

**Oscillator.** Particularly for use on short wave superheterodyne receivers, a frequency determined circuit included in the feed-back coupling consisting of a variable inductance, a variable capacity and a fixed capacity. The idea is to maintain an optimum output-frequency characteristic throughout the tuning range, and may be so chosen as to facilitate the ganging of the oscillator and signal circuits. H. G. C. Fairweather, Hazeltine Corp. No. 405,768.

**Selective system.** In a highly selective receiver the tuning is automatically controlled by means responsive to changes in the frequency of the incoming signals. J. Robinson and British Radiostat Corp. No. 407,057.

**Short wave receiver.** Instead of using band-pass filters when operating at about 7 meters and suitable for television transmission, semi-aperiodic oscillating chokes are used. These constitute damped and tunable circuits having a logarithmic decrement whose value lies between 1 and 4; this is practicable because the side-band is relatively narrow for short wavelengths. M. Von Ardenne, Berlin. No. 407,166.

**Automatic volume control.** Signal is rectified and the direct current component of the voltage produced is amplified and applied to effect the gain control through a smoothing network incorporating a device having a unilateral characteristic so that the control voltage is effective only when it is negative with respect to the amplifier tube cathodes. E. Y. Robinson, Associated Electrical Industries. No. 407,317.

**Thermionic cathodes.** Hot cathode materials comprise admixtures of oxides of cobalt and nickel. Oxides of zinc, copper, aluminum, barium and magnesium may be added, or may be substituted for the nickel and cobalt. The mixtures in solid form may be obtained by melting the oxides together, or by precipitation, or by oxidizing alloys. Solutions or melts of nitrates or carbonates may be heated on a porcelain or other nonconducting support, for example, an aqueous solution of 10 per cent cobalt nitrate and 10 per cent nickel nitrate may be formed into an oxide coating. The oxide mixture may be sintered by further heating, under pressure if necessary. International G. E. Co. No. 404,598.

**Oscillating generator.** A screen grid tube having tuned output and input circuits coupled by two lines several half-wave lengths long. The circuits are grounded as regards the working frequency so that the long lines are energized in phase opposition and radiation is reduced. Marconi Co. No. 409,986.

**Short wave oscillator.** A generator for waves below 50 meters of the type in which the natural periodicity of the electron oscillation about the grid corresponds with incoming signals. E. W. B. Gill, Marconi Co. No. 404,708.

**Superheterodyne receiver.** Method of operating on the intermediate frequency amplifier to prevent the passage to the second detector of frequencies on either side of the intermediate frequency so that interference due to an unwanted transmission can be eliminated. In one circuit a balanced bridge is utilized. W. Baggally. No. 410,225.

**Super-regenerative receiver.** The input circuit has the grid connected in push-pull and the quenching-frequency source is coupled to the cathodes of the tubes in push-pull. Marconi Co. No. 410,275. See also No. 410,276 on super-regenerative receiver circuit.

**Inter-tube network.** Unmatched filters for use as inter-tube coupling in the intermediate-frequency amplifier comprises two or more series arms tuned to the desired frequency, and shunt arms tuned to produce a sharp cut-off. Marconi Co. No. 410,499.

**Tone control.** A tone regulating network comprising a transformer in the plate circuit of an amplifier is shunted

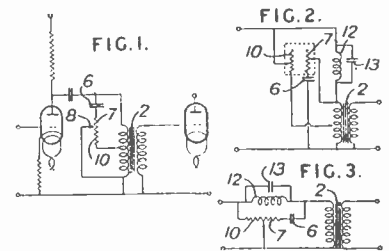

by condensers and variable resistances. Electric & Musical Industries, Ltd. No. 410,119.

**Broad band receiver.** In a receiver designed to cover a greatly extended scale of wave lengths, means are provided for subdividing the entire range into a smaller number, over each of which the full movement of the tuning condenser is employed. The receiver is a superheterodyne circuit in which interference due to beating of an undesired signal with the carrier is prevented by making the oscillator generate square-topped waves by having the grid positively biased. The oscillator therefore acts as a commutator interrupting the anode current of the mixing tube at the intermediate frequency. L. L. Kramolin, Berlin. No. 409,737. See also 409,756; Kramolin, on a method of preventing interference in superheterodyne receivers.

**Regenerative circuit.** In a plate or grid circuit detector, constant regeneration is obtained by the provision of a choke in the plate circuit arranged to resonate at a frequency just below the band to be covered while the regenerative coil is arranged to resonate at a frequency just above the band to be covered. The bypass condenser across the output of the tube has ten times higher capacity than the feed-back condenser while the feed-back condenser and feed-back coil have high losses. Cromwell, Ltd. No. 409,915.

ENGINEERS  
APPROVE

# EBY WAVE BAND SWITCHES

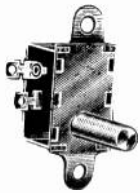

Model No. 14—SINGLE POLE A. C. Rotary Switch furnished in single or double throw. With or without bushing mounting.

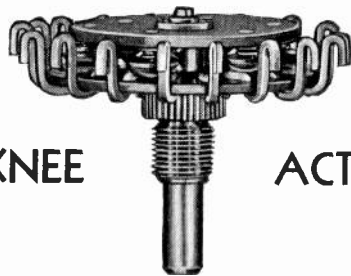

KNEE ACTION

Improved Model "34" Wave Band Switch—has proven its dependability and long life.

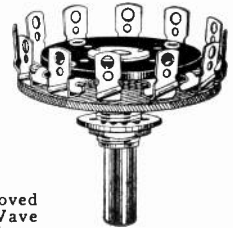

Top View Improved Model "34" Wave Band Switch—showing construction and compactness.

New Model "35" Wave Band Switch—represents a radical departure from previous methods of switch construction, characteristically sure and dependable in action.

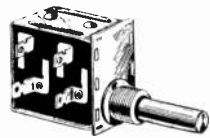

Model No. 14—DOUBLE POLE A. C. Rotary Switch furnished in single or double throw. With or without bushing mounting.

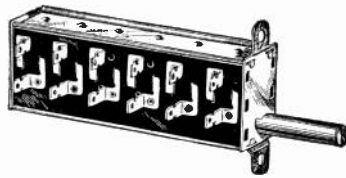

Model No. 77 — SIX POLE A. C. Rotary Switch furnished in single or double throw from three to six poles.

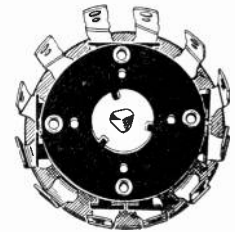

## MULTI-POLAR ROTARY SWITCHES

A high quality snap action switch, applicable to the wide variety of new circuit requirements and built to fit into restricted space at low cost. Recommended for any equipment or apparatus requiring one to six poles, either single or double throw where low capacitance between live parts and ground is essential.

*Suggested uses:* Two Band Radio Receivers — Universal Radio Receivers — Low Powered Transmitters—Test Equipment, Laboratory Apparatus — Signalling Systems — Electronic Equipment.

*Features:* Sturdy Construction, all steel corrosion proof frame—High Grade insulation, best phenolic materials used—Double Contacts, spring phosphor bronze, silver plated insuring low contact resistance—Bushing or Lug Mounting—Shaft, plain or flat.

Available from one to six poles—single or double throw.

## NEW EBY "35" WAVE BAND SWITCH

Embodies a new principle in Wave Band Switch construction. Stator contacts are laced and then staked in place and do not become loose after 50,000 cycles.

Rotor contacts are self leveling and self cleaning. Positive direct overhead pressure provides "Knee Action" effect.

These features guarantee long life, low resistance and low capacity in minimum space.

Single Pole—6 Throw illustrated above has 18 contacts and measures 2 inches diameter.

8 Pole—Double Throw, having 24 contacts measures 2½ inches diameter.

### Features:

Small, Compact, Rugged, Positive Indexing, Silver plated contacts, contacts polish as they turn, wide spacing means long leakage path. Reasonably priced.

### Wiring possibilities:

- 6 Pole—Double Throw (18 points) permits 150 wiring combinations.
- 8 Pole—Double Throw (24 points) permits 500 wiring combinations.

Available in 4 Pole—Single Throw to 8 Pole—Double Throw.

## IMPROVED "34" WAVE BAND SWITCH

Developed to meet the demand for a switch having certain definite characteristics. This EBY switch has proven itself to provide low resistance and give long life, free from service trouble.

In the construction of Model "34" only the highest grade Bakelite and phosphor bronze is used. Terminal Stator contacts are provided with silver plated terminals. Its design eliminates flux and solder covering contact surfaces. All Rotor and Stator Contacts are rigidly held in place. All contacts are silver plated.

*Features:* Compactness — Low Capacity—Low Contact Resistance —Self-Cleaning Knife Edge Contacts—Positive Indexing—Sturdy Construction—Single Hole Mounting—Light Torque, Easily Operated—Long Life.

Available in all combinations from single pole, single throw to four pole, double throw.

Send for complete information including Technical Bulletins

# HUGH H. EBY, INC.

2066 HUNTING PARK AVE.

PHILADELPHIA, PA.

Twenty-Three Years of Faithful Service to the Electrical and Radio Industries

# Audio Frequency Microvolter

*Gain Measurements  
Voltage Measurements  
Calibrations*

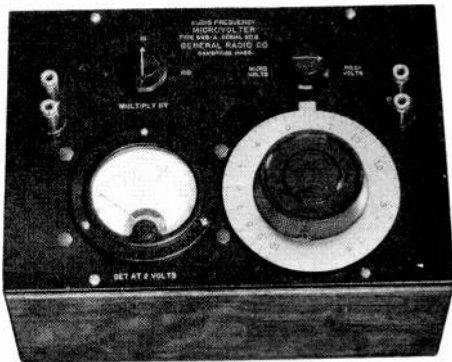

Type 546-A

An accurate attenuator at audio frequencies. Used with an oscillator it provides small audio-frequency voltages of high accuracy. Audio-frequency gain measurements may be made by the standard-signal method—familiar in radio-frequency practice.

Range 1 microvolt to 1 volt

Price \$70.00

*Described in Bulletin EX-3306-E*

GENERAL RADIO COMPANY  
Cambridge, A Massachusetts

# ASTATIC

*dependability*

"TECHNICAL EXCELLENCE AND SUPERIOR PERFORMANCE HAVE LED THOUSANDS TO DEPEND COMPLETELY UPON ASTATIC CRYSTAL DEVICES."

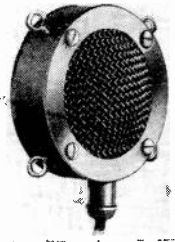

Crystal Microphone D-104

Professional in appearance but rugged in construction, the Astatic crystal microphone is especially adaptable to remote control service and Public Address systems. Built to withstand rough handling without adjustment, the D-104 crystal microphone will give remarkable performance and long service in this field.

Astatic Crystal S-type Transcription Pickup

*Licensed under  
Brush Development  
Co. patents.*



This light weight pickup is especially recommended for studio reproduction, and has been found highly satisfactory in the reproduction of transcription recordings.

**ASTATIC MICROPHONE LABORATORY Inc.**

Youngstown, Ohio, U. S. A.

# COLLOIDAL GRAPHITE

when used as a coating on the interior of cathode ray tubes, serves as an efficient ray focusing anode material. Colloidal graphite is taking the place of silver coatings in many instances because it

1. is easier to apply
2. is less expensive
3. adheres equally well to all types of glass.
4. due to the black matte surface formed, reduces light reflection.

Write for Technical Bulletin No. E 191 discussing this subject in detail.

ACHESON COLLOIDS CORPORATION  
FOUNDED (1908) AS ACHESON OILDAG COMPANY  
PORT HURON MICHIGAN





The  
**"Last Word"**  
 in TUBE CHECKERS

**OUTSTANDING FEATURES**

1. 9" METER
2. TRUE MUTUAL CONDUCTANCE TEST
3. SPARE SOCKETS
4. SHORT TEST
5. CATHODE LEAKAGE TEST
6. LINE VOLTAGE CONTROL
7. INDIVIDUAL TESTS ON DIODES AND FULL WAVE RECTIFIERS

**THE *New* WESTON MODEL 681**

Here is a tube checker and merchandiser that will help you make friends . . . help build your business. It does a thorough test job, and does it in a manner that is impressive and convincing to your customers. The design and color scheme are compelling; and the large 9" meter, set at an easy reading angle, gives direct indication of tube conditions in understandable terms.

And Model 681 has been designed and engineered to end obsolescence worries. Twenty-five sockets are provided in the panel with seven spares for use when and if new tubes are developed. It not only tests all present 4, 5, 6 and

large and small 7 prong tubes but also makes individual tests on each section of all double and triple plate combinations. It makes a complete inter-element short test, a high resistance cathode leakage test, and a mutual conductance test on all tubes.

Dealers, jobbers and engineers who have seen Model 681 have voiced their enthusiasm. All agree that its many outstanding features make it the greatest value available in tube checkers. You will want all the facts. Mail the coupon today . . . Weston Electrical Instrument Corporation, 618 Frelinghuysen Avenue, Newark, New Jersey.

**WESTON**   
*Radio Instruments*

WESTON ELECTRICAL INSTRUMENT CORPORATION  
 618 Frelinghuysen Avenue, Newark, N. J.  
 Send bulletin on Weston Radio Instruments.

Name.....

Address.....

City and State.....



# YOU WANT THESE RESISTOR BULLETINS

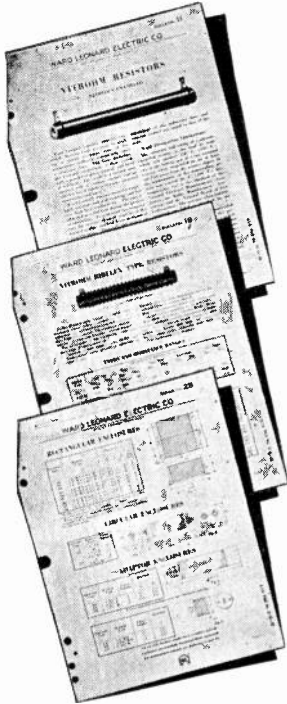

## BULLETIN NO. 11

Tells about Vitrohm Wire Wound Resistors, gives sizes, watt ratings and a fund of other valuable information.

## BULLETIN NO. 19

Describes Ribflex Resistors, a development of Ward Leonard that provides satisfactory Resistor Units for unusually heavy duties.

## BULLETIN NO. 25

Is a treatise of standard and special mounting and enclosures for all kinds and types of Ward Leonard Resistors.

FOR

## REFERENCE

All the reference data you need is in these three bulletins. Yes, Ward Leonard pioneered vitreous enamel coatings, silver soldered joints, thermal balance and a host of other features. Nearly fifty years of resistor experience is offered to you for the asking. Just fill in the coupon below and mail it to us.



# WARD LEONARD

RELAYS • RESISTORS • RHEOSTATS

WARD LEONARD ELECTRIC CO.,  
32 South Street, Mount Vernon, N. Y.

Please send me your bulletins Nos. ....  
Name .....  
Company .....  
Street .....  
City and State .....

## Let Us Solve Your Resistance Problems

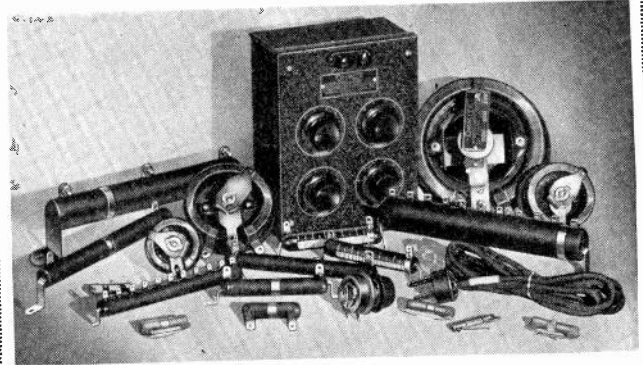

Ohmite now offers a most complete resistor and rheostat service; this service includes not only the specialized knowledge of our engineering department but also immediate delivery of units from our huge stock. The units illustrated above are only a few of the hundreds of different resistors and rheostats in stock at all times. These standard units are listed in Ohmite Catalog Number 10. In addition to stock units we are also equipped to make special resistors of all kinds; many of these are shown in Catalog Number 5 along with much useful technical information. Copies of both catalogs should be in the engineering and purchasing files of every electrical manufacturer. Write for your copies or send in specifications of your present units so that we may quote.

# OHMITE

MANUFACTURING COMPANY  
625 N. ALBANY AVE. CHICAGO, ILL.

THE MARRIAGE of currents  
is a continuous ceremony in  
practical telephony and radio.  
AND SO is their divorce when  
the time for parting comes.



From the chapter "Modulation,  
A Marriage of Currents" in

## JOHN MILLS' SIGNALS AND SPEECH IN ELECTRICAL COMMUNICATION

In short clearly written chapters, "one of the finest pieces of writing on technical subjects we have seen in many a day," says the *Scientific American*, John Mills explains the discoveries, inventions, and principles which underlie the various forms of electrical communication.

"I do not hesitate to recommend this book which will be of interest both to engineers and to the general public."—*Professor H. M. Turner, Proceedings of the Institute of Radio Engineers.*

"All the newer developments in the electrical extension of sight and hearing are cleared and simplified. . . . Admirable book which deserves a wide reading.—*N. Y. Times*

2nd printing, \$2.00

Harcourt, Brace & Company, 383 Madison Ave., New York

# *In your new Auto Radio Designs incorporate these latest* **FLEXIBLE SHAFT and CASING** *developments*

These developments, most of which are patented, include:

**No. 150L53 Shaft**, a 5-layer, 43-wire shaft having a minimum of torsional deflection under load, equal deflection when turned in either direction, and ample flexibility for free operation in curves of small radius.

**No. 170A1 Parkerized Metallic Casing**, a rugged rust-resistant casing only .255" outside diameter.

Shown in the illustration, actual size, in order from the left:

1. Shafting with ends swaged accurately square for square hole, collet or set screw attachment. Casing with integral formed flange and male nut.
2. Conventional die-cast gear end fitting on flexible shaft. Casing with plain end.
3. Conventional machined shaft end fitting. Casing with integral formed flange and female nut. We are prepared to make machined ends to specifications.
4. Shafting with regular square swaged ends ready for attachment of end fitting. Casing with plain end.
5. Shafting with ends octagonally swaged making possible easy calibration of control unit, condenser or volume control. Casing with integral enlarged end.
6. Shafting with one or more intermediate square swages for cutting to length in the field.

**No. 150L53**—Shaft can be supplied with ends identical or with any combination of ends.

**No. 170A1**—Casing can be supplied with or without enlarged or flanged ends or with any combination of ends.

## ENGINEERING COOPERATION

Get the benefit of the broad, practical auto radio experience of our engineers. Submit your requirements or designs for recommendations. There is absolutely no obligation involved.

**The S. S. WHITE Dental Mfg. Co.**



**INDUSTRIAL DIVISION**

Knickerbocker Bldg., New York, N. Y.

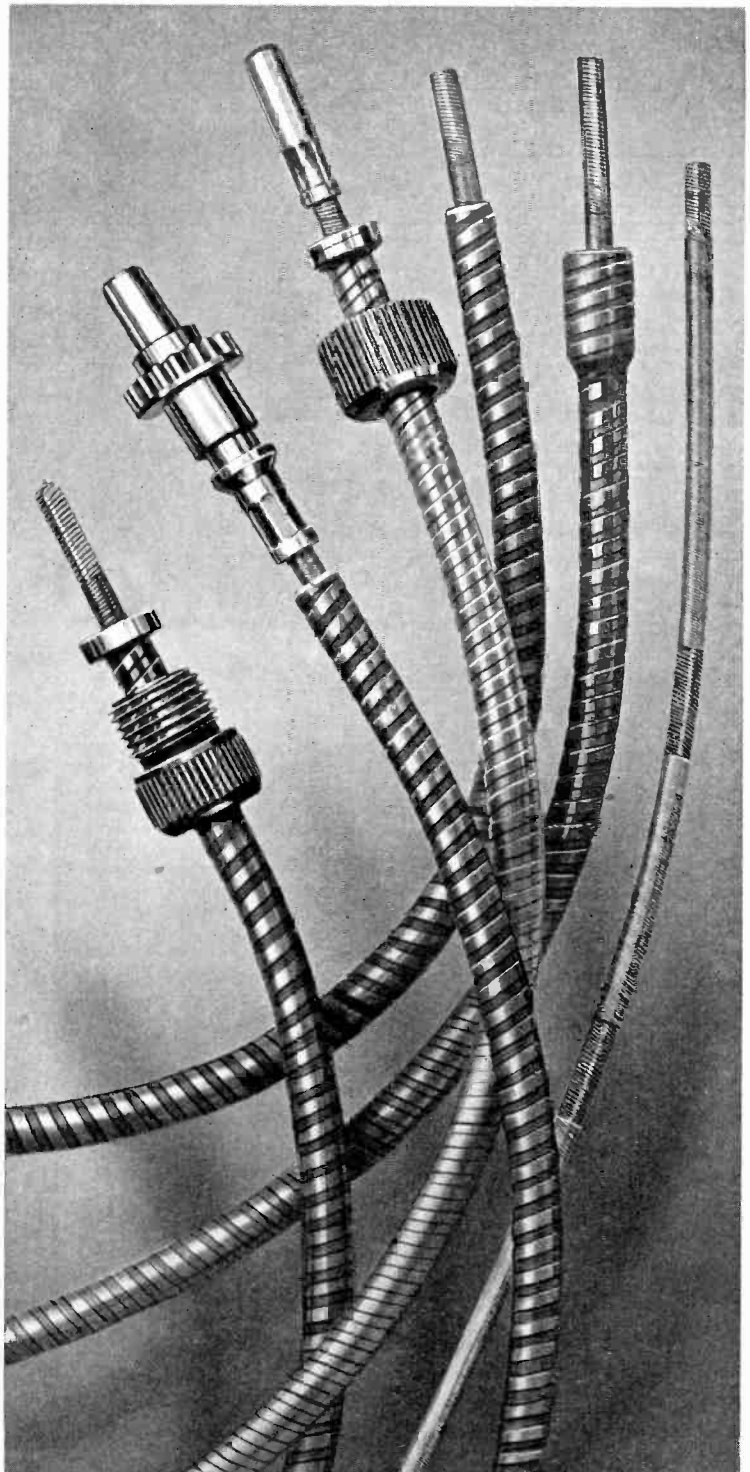

**S. S. WHITE for FLEXIBLE SHAFTS**

# SHAKEPROOF

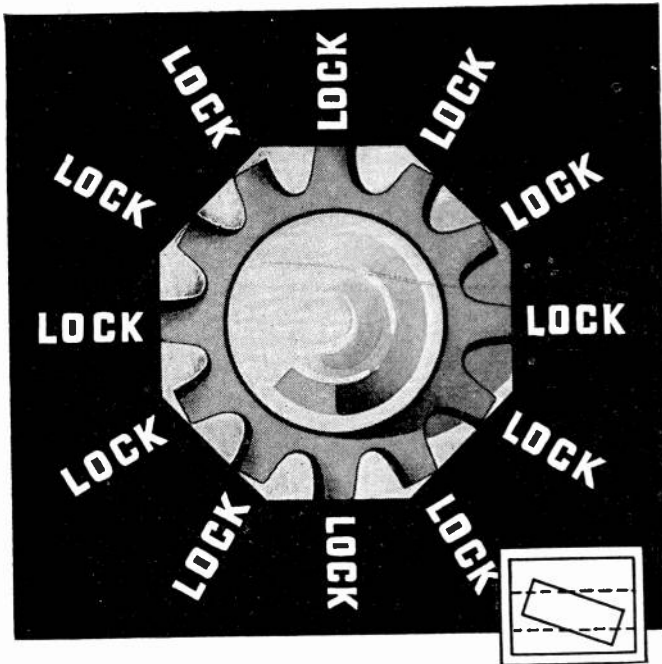

## MULTIPLE LOCKING

*assures perfect performance*

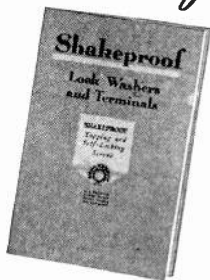

THE super-locking power of the Shakeproof Lock Washer is definitely due to its Multiple-Locking principle plus the positive holding action of its twisted teeth. As vibration attempts to loosen the nut, there is not just one lock to offer resistance but, instead, there are from ten to sixteen, depending on the size of the lock washer. Then too, each one of these locks is a direct contact between the work and the nut—each twisted tooth acting as a strut and digging in deeper as vibration increases. This all proves that Shakeproof not only locks tight, but in fact, it locks so tight that the safety factor is tremendous and, regardless of how roughly your product is handled, its connections are certain to remain secure. Try Shakeproof yourself—Write for free testing samples today!

Send today for your free copy of this complete Shakeproof Catalog. Explains thoroughly the many advantages that Shakeproof offers—also shows new patented Shakeproof products.



## SHAKEPROOF Lock Washer Company

Distributors of Shakeproof Products  
Manufactured by Illinois Tool Works

2539 N. Keeler Ave.

Chicago, Ill.

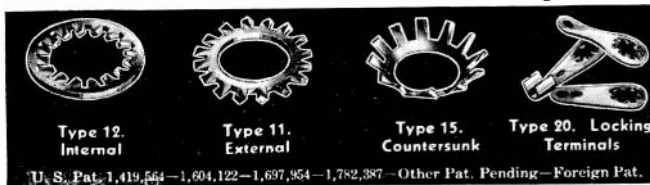

U. S. Pat. 1,419,554—1,604,122—1,697,954—1,782,387—Other Pat. Pending—Foreign Pat.

# ENAMELITZ

Reduce manufacturing costs on I.F. and R.F. coils through the use of Enamelitz—"Litz" wire without a fabric covering.

Three Fold Savings—

1. Cost of wire
2. More coils per pound of wire
3. Less space—Greater safety

Sample and Technical Bulletin on Request.

### Other Acme Wire Co. Products

Magnet Wire (all insulations)

Coils, Magnet Wire Wound

Varnished Insulations

(Cambric, paper, silk, tape)

Parvolt Condensers

(Filter, By-pass, Power Factor Correction)

Aerial Wire

(Stranded and Solid—Bare or Enameled)

For over 25 Years, suppliers to the largest radio and electrical manufacturers.

THE ACME WIRE CO.

New Haven, Conn.

## CANNON PLUGS Are Supreme

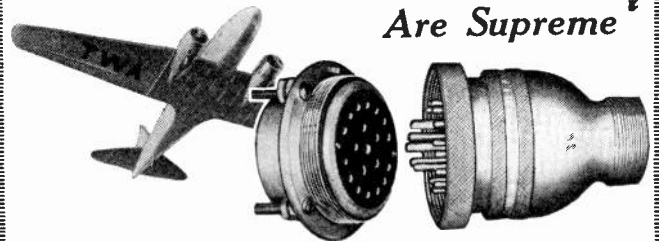

... in many fields —  
AIRSHIPS \* SOUND RECORDING  
BROADCASTING STUDIOS \* LABORATORY PANELS  
GEOPHYSICAL RESEARCH

CANNON Plugs are pre-eminent in these fields and for other important applications requiring positive contacts and reliable service. An ever-increasing variety of plugs (now well over 400 cable fittings) are available to meet the modern demand for progress in these fast-changing fields.

Thousands of stock parts and over a quarter of a century of experience are at your immediate command if you avail yourself of CANNON service.

A new airship plug catalog available soon.

CANNON ELECTRIC DEVELOPMENT CO.  
MANUFACTURING ENGINEERS

Main Office: 420 West Avenue 33, Los Angeles, Calif.

Eastern Sales Office: 220 Fifth Ave.

New York, N. Y.

Representatives:

Chicago: Jenkins & Adair, Inc., 3333 Belmont Ave.  
Bombay, India: Eastern Electric & Engineering Co.,  
175 Horby Road, Fort, Bombay, India



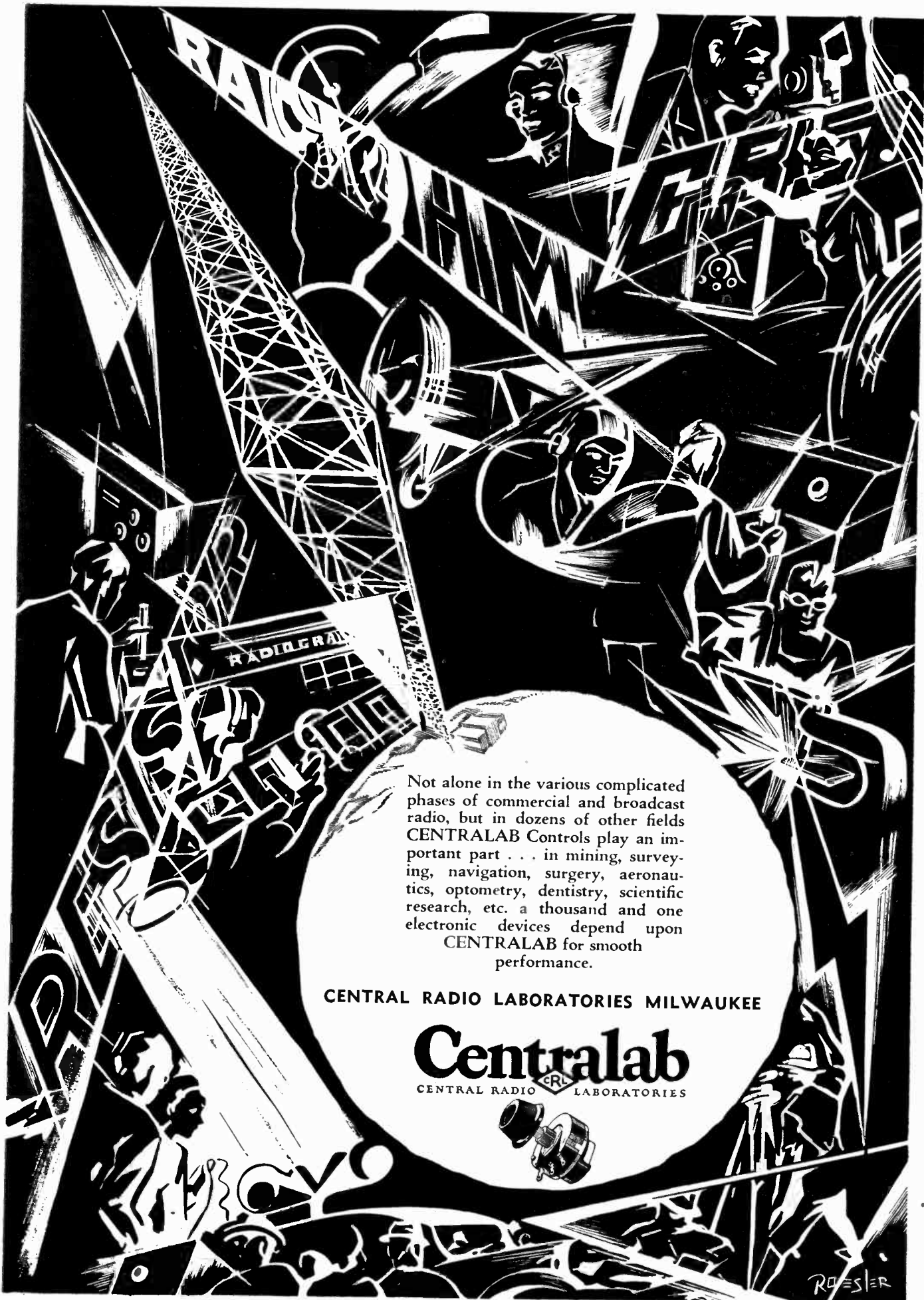

Not alone in the various complicated phases of commercial and broadcast radio, but in dozens of other fields CENTRALAB Controls play an important part . . . in mining, surveying, navigation, surgery, aeronautics, optometry, dentistry, scientific research, etc. a thousand and one electronic devices depend upon CENTRALAB for smooth performance.

CENTRAL RADIO LABORATORIES MILWAUKEE

**Centralab**  
CENTRAL RADIO LABORATORIES



# TODAY'S Most Modern

## Precision Measuring Instruments



When selecting your instruments for use in radio circuits you eliminate all guess work when you specify Triplet. There is a Triplet instrument for every radio application, designed for your particular needs. Your transmitter circuits should have Triplet instruments for best operating results, appearance and all-around efficiency.

D.C. Triplet instruments are of the moving coil type; A.C. Triplet instruments are of the repulsion iron type. Expertly designed. Craftsmanship unsurpassed. Bakelite and metal cases—2 in., 3 in., 5 in. round panel styles. Also rectangular, square and fan styles. Portable 3 in. have tilting scales; 5 in. have mirror scales.

Ultra sensitive instruments for special and standard applications; relays for low current operation; thermo-couple for high frequency; rectifier type for sensitive A.C. measurements. Every modern application where good instruments are required.

Consult your jobber for all standard instruments. Send your inquiries to

### The TRIPLET ELECTRICAL INSTRUMENT COMPANY

99 Main Street

Bluffton, Ohio



Triplet Electrical Instrument Company  
99 Main Street, Bluffton, Ohio

Gentlemen:  
Please send your latest literature on Triplet Instruments.

Name .....  
Address .....  
City ..... State .....

PERFECTLY  
**LAMICOID**  
REG. U. S. PAT. OFF.

## Engraving Panel Stock

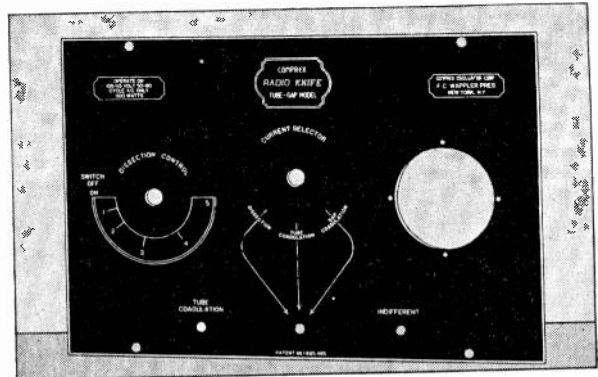

THE PANEL SHOWN, of Grade 7025 "Lamicoid" Laminated Bakelite Stock, is used by Comprex Oscillator Corp. for their precision radio instruments. Lustrous black surface. White core. Clean-cut red and white engraved lettering. No white letter filling required. No letter discoloration. QFabricated by Insulating Fabricators, Inc., New York City.

"Lamicoid" Laminated Bakelite  
Sheets—Tubes—Rods—Fabricated Parts

### MICA INSULATOR COMPANY

200 Varick Street, New York, N. Y.; 542 So. Dearborn Street, Chicago, Ill.  
1330 Schofield Building, Cleveland. Branches at Birmingham, Boston, Cincinnati, Los Angeles, San Francisco, Seattle. Canada: Montreal, Toronto.

## An Efficient A. C. Relay Compact, Noiseless, Non-Chattering

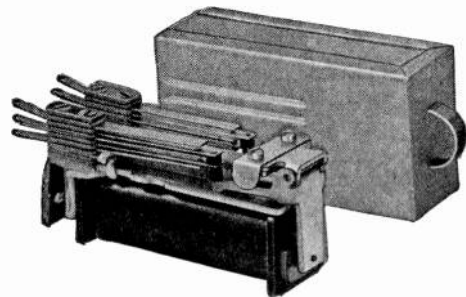

The Type FQA Relay, illustrated above, is one of the most useful of the extensive Autelco family. It has a firm, chatterless contact closure, and is quiet at all frequencies. May be equipped with any combination of contact springs up to a total of ten. Can be supplied for operation under a wide variety of voltages and frequencies.

Autelco Relays, developed and perfected over a period of more than forty years, include both A.C. and D.C. types for heavy or light duty, with an unlimited variety of contact combinations. Complete listing contained in Catalog 4016, copies of which will be gladly supplied on request.

### American Automatic Electric Sales Company

1033 West Van Buren Street

Chicago





# Permanently Accurate Dial of translucent Bakelite Laminated

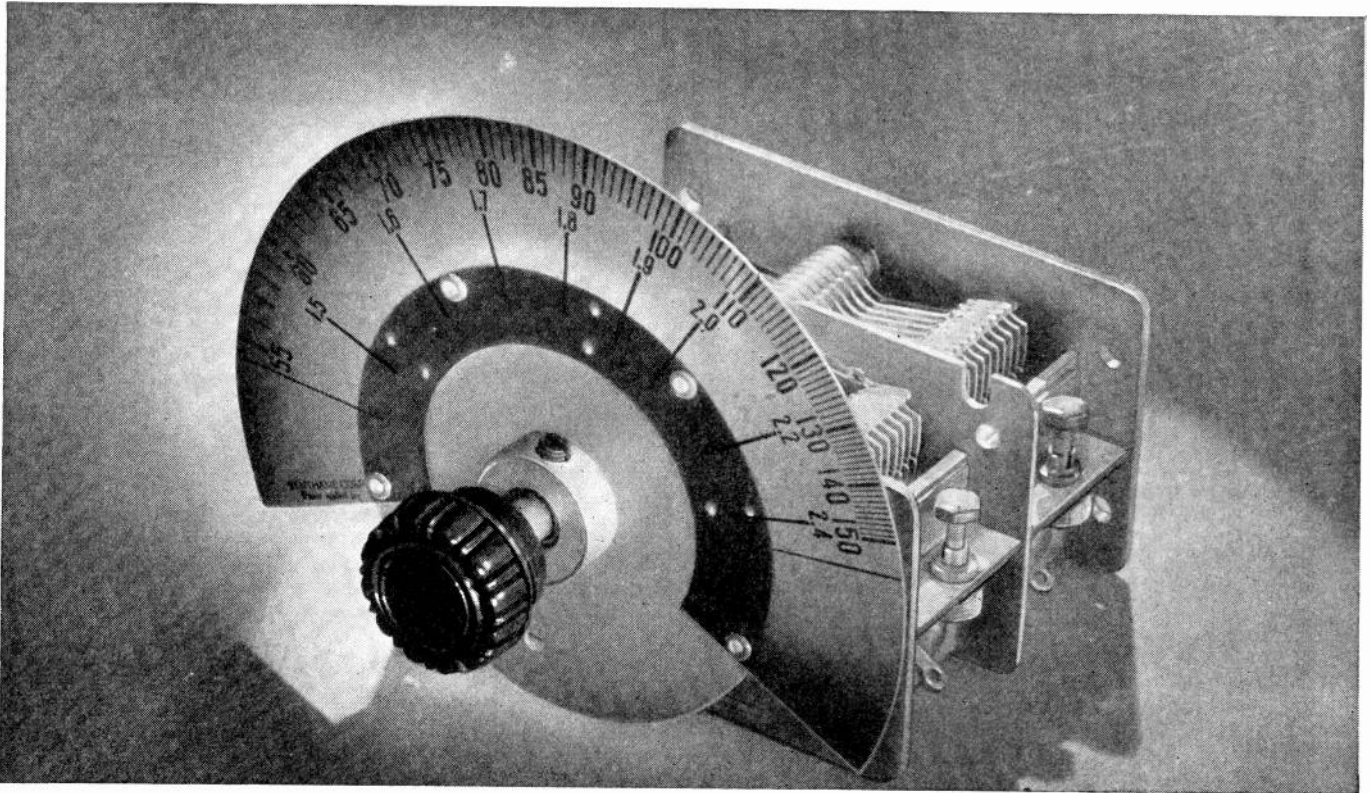

(Above) Philco Condenser with dial of translucent Bakelite Laminated, made by Synthane Corp., Oaks, Va.

**R**ADIO RECEIVER makers have long desired a translucent material for illuminated dials that would not be distorted under variations of temperature or humidity. A material that would maintain the accuracy of the dial markings under all conditions.

Such a material is now available in translucent Bakelite Laminated. It possesses the properties of strength, durability, resistance to

extremes of heat and cold, moisture and chemicals common to other forms of Bakelite Laminated, and in addition is uniformly translucent. It provides an excellent printing surface which makes possible sharp, accurate dial markings.

Again, a Bakelite Material has provided the solution of a troublesome radio problem. Whatever the difficulty that may be encountered in finding the right material for a

given purpose, there is always a probability that it will be found among the many types of Bakelite Materials that are now available.

We are always glad to cooperate with radio manufacturers and engineers, and will also, upon receipt of your request, mail copies of the new editions of our illustrated descriptive booklets 13L, "Bakelite Laminated" and 13M, "Bakelite Molded."

BAKELITE CORPORATION, 247 Park Avenue, New York, N. Y. . . . . 43 East Ohio Street, Chicago, Ill.  
BAKELITE CORPORATION OF CANADA, LIMITED, 163 Dufferin Street, Toronto, Ontario, Canada

## BAKELITE

The registered trade marks shown above distinguish materials manufactured by Bakelite Corporation. Under the capital "B" is the numerical sign for safety, or unlimited quantity. It symbolizes the safety number of patent and known uses of Bakelite Corporation's products.

### THE MATERIAL OF A THOUSAND USES



**PROVED**  
 in the 1934 Fall Season  
**NOW READY**  
 for the 1935 Spring Models



- VOLUME CONTROLS
- TONE CONTROLS
- CLINCH-GRIP WIRE WOUND FLEXIBLE RESISTORS
- METAL COVER FIXED POWER SUPPLY RESISTORS
- LINE BALLASTS
- L & T PADS
- SERIES MIXERS
- CONSTANT IMPEDENCE DEVICES
- STANDARD POTENTIOMETERS
- FIXED, VARIABLE AND CENTER-TAP RESISTORS

**AND**  
 ANY SPECIAL RESISTOR REQUIREMENTS

**SEND**  
*Clarostat your specifications*



**CLAROSTAT**  
 MANUFACTURING CO., Inc.  
 285 North 6th St.  
 BROOKLYN, N. Y.



**THE NEW SHALLCROSS**



**Wheatstone Bridge No. 630**

RANGE  
 .01 Ohms  
 to  
 11.1 Megohms

Designed to combine the features of reasonable cost, ruggedness, wide range, portability and accuracy.  
*Send for Bulletin 630-K describing this instrument.*  
**SHALLCROSS MFG. COMPANY, Collingdale, Penna.**

*SPECIFY*

**CETRON**  
**PHOTO CELLS**

*for dependable efficient performance*

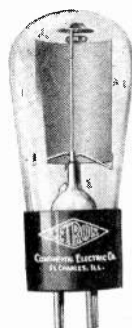

These fine photo cells are available in thirty-five different types. Also made to your specification.  
 Write for "new technical folder just issued." Samples sent to responsible Companies and Laboratories.

**CONTINENTAL ELECTRIC CO.**  
 First and Illinois Sts.  
 St. Charles, Ill.  
 Cable address: Continental

**A TRIAL WILL CONVINCING YOU**

←→ 30 Years' Experience →→  
 Insures Dependability

We Manufacture  
**PERMANENT MAGNETS TOOLS and DIES**  
**METAL STAMPINGS LAMINATIONS**

**THOMAS & SKINNER**  
**STEEL PRODUCTS CO.**

23d St. at Alford Indianapolis, Ind.

**CANDOHMS**

ARMoured WIRE WOUND RESISTORS

**WILL LOWER YOUR COSTS**

OVER EIGHT MILLION IN USE  
 MAY WE SAMPLE AND QUOTE

**THE MUTER COMPANY**

1255 So. Michigan Ave., Chicago

# BROADCASTERS Go *Sylvania*

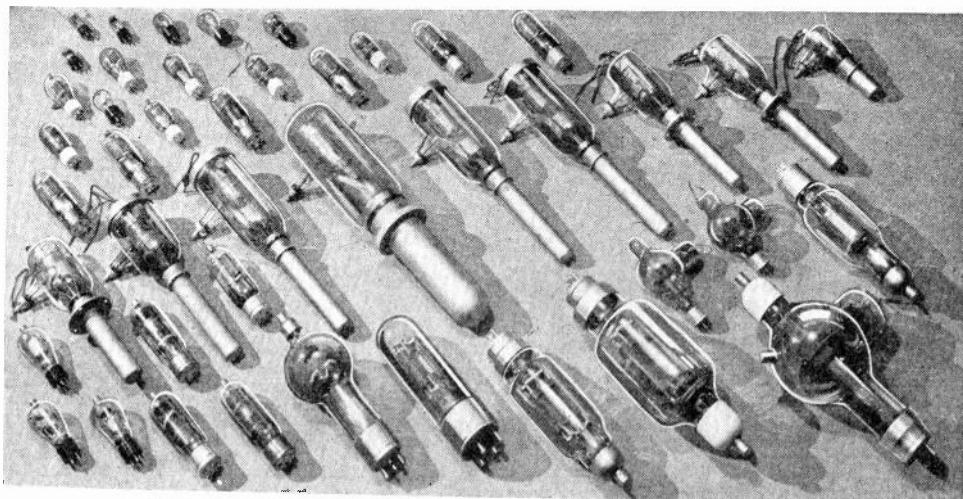

## SYLVANIA HAS THE ONLY COMPLETE LINE OF GRAPHITE ANODE TRANSMITTING TUBES

Broadcast engineers are becoming more and more SYLVANIA minded because they recognize the notably improved transmitting tubes which this company has developed and introduced. The progressive SYLVANIA achievements came after a long period during which no appreciable progress was made in power tube engineering. Leading scientists have proclaimed that the SYLVANIA Graphite Anode development marks the first fundamental improvement in transmitting tube design since the advent of broadcasting.

*More than half of the broadcasting stations in the country are either partially or entirely SYLVANIA equipped.*

Engineers in steadily increasing numbers are specifying SYLVANIA. This is true not only in the broadcast field but in all other fields of radio communication and for industrial applications where dependable heavy duty service is demanded.

The SYLVANIA line spans the entire range of popular air-cooled and water-cooled types.

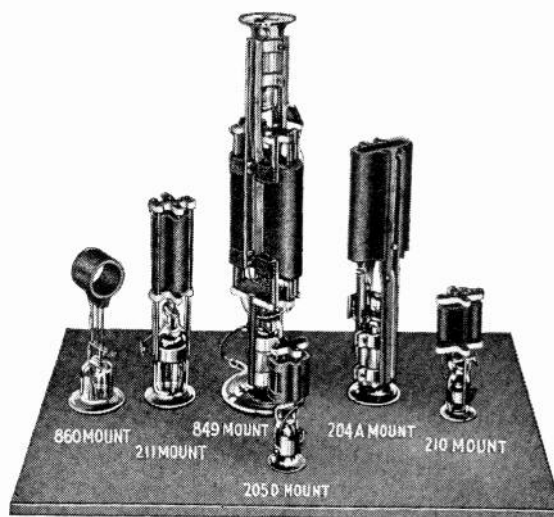
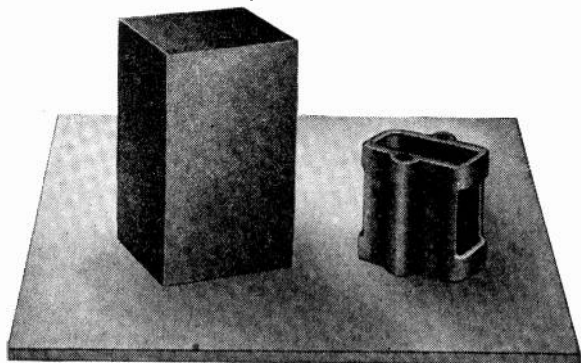

## HYGRADE SYLVANIA CORPORATION

ELECTRONICS DEPARTMENT  
CLIFTON, N. J.

Factories: SALEM, MASS.

EMPORIUM, PA.

ST. MARYS, PA.

CLIFTON, N. J.

Just Published

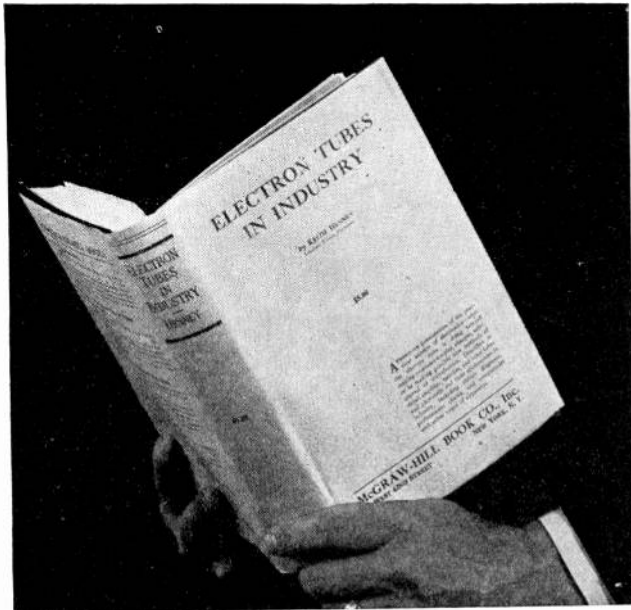

# Telling

the engineer and manufacturer  
what is being done  
with *electron tubes* in industry

— and how it is being done

"The electron tube acting alone or in combination is a useful tool; time alone will tell how important it becomes in industry," says Keith Henney in this book. He then describes the various electron tubes that are useful in industrial operations and discusses their applications to industry in motor control, laboratory measurements, power transmission, elevator leveling, counting, sorting, grading, color matching, chemical and mechanical measurement, process control, etc.

## ELECTRON TUBES IN INDUSTRY

By KEITH HENNEY  
Associate Editor, Electronics

490 pages, 6 x 9, illustrated, \$5.00

**E**NGINEERS and manufacturing executives interested in cheapening or quickening industrial processes will find in this book a thorough presentation of the practical aspects of electronics—what the electron tube is doing toward making processes simpler, cheaper, safer, and in making possible new methods of control.

The book describes all the various electron tubes that are useful in industrial operations:—

Amplifier tubes—High-vacuum tubes—Rectifier tubes—Mercury vapor tubes—Thyratrons—Grid-glow tubes—Oscillator tubes—Ballast tubes—Voltage and current regulators—Cathode-ray tubes—X-ray tubes—Photoelectric tubes—Ionization gages—Glow tubes.

The book is specific; it tells what is being done with tubes in industry now and how it is being done. It indicates the possibilities of the extended use of these tubes. In all possible cases the economics of each application is discussed. The book shows how much the electron tube system costs in a given instance compared with other competing systems.

### Applications of Electron Tubes discussed in this book—

- Vacuum tube voltmeters
- Automatic recorders
- Telemetry
- Elevator control
- Color matching
- Sorting and grading
- Door openers
- Voltage and speed regulation
- Battery charging
- Viscosity tests
- Precision automatic testing
- Tube wattmeter
- Noise measurement
- Conveyor synchronization
- Temperature control
- Inversion (d.c. to a.c.)
- Rectification (a.c. to d.c.)
- Time delay relays
- Welding control
- Illumination control
- High speed counting
- Flux meters
- Testing camera shutters
- Register control
- Paper bag manufacture
- Traffic and train control
- Exposure meters
- Illumination meters
- Smoke density control
- Thickness control
- Humidity control
- Chemical analysis
- Recording wire diameter
- Photometry
- High speed press control

### CHAPTER HEADINGS

1. Fundamentals of Electronic-Tube Circuits
2. Thermionic Tubes
3. Vacuum-Tube Amplifiers
4. Gaseous Triodes
5. Light-Sensitive Tubes
6. Applications of Light-Sensitive Tubes
7. Rectifiers, Cathode-ray Tubes, Miscellaneous Tubes and Circuits

See this  
new book  
10 days  
on approval  
Send this  
coupon

### McGraw-Hill ON-APPROVAL COUPON

McGraw-Hill Book Co., Inc., 330 W. 42d St., New York City

Send me Henney—Electron Tubes in Industry for 10 days' examination subject to approval or return. Within 10 days of receipt I will send \$5.00, plus a few cents for postage and delivery, or return the book postpaid. (We pay postage on orders accompanied by remittance.)

Name .....

Address .....

City and State .....

Position .....

Company .....

(Books sent on approval in U. S. and Canada only.) L. 10-34

**This Assembly holds  
A Valuable  
Lesson . . .**

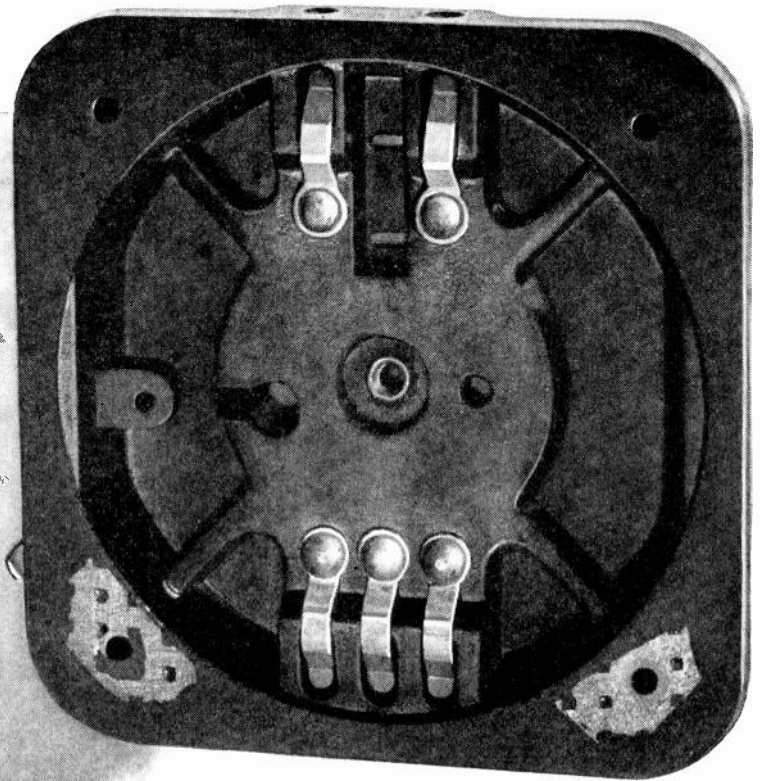

Hardened Metallic Drive Screws overcame difficulties of fastening contacts to this thin molded Bakelite microphone part shown enlarged.

**— for any man who may make fastenings  
in shallow, bottomed holes in molded parts**

IN making the "Audiphone", a microphone for deaf people, the Kurman Electric Company solved a difficult assembly problem that is common to many electrical devices.

In fastening six small contacts to a thin Bakelite molded case, much trouble was encountered in tapping bottomed

holes of one eighth inch depth for machine screws. Taps wouldn't stand up, and the holes in the molded part were so frequently mistapped that 30 percent spoilage of cases resulted. Also, the work was time-consuming for it was necessary first to true-up the molded holes with a drill, and then tap and re-tap each hole.

the time and labor. Because of the greater holding power of Self-tapping Screws, the contacts do not loosen as they once did.

Many assembly problems can be solved and most fastenings can be simplified and made cheaper and better with one of the several types of Self-tapping Screws. Try them wherever it is possible to use them. A trial will tell . . . send the coupon for samples and recommendations.

To avoid tapping is almost always desirable, but in this assembly it was particularly so because of the large waste of material and labor. Kurman ended all of the troubles merely by substituting Type "U" Hardened Metallic Drive Screws for machine screws. Now there is no spoilage, and the assembly is made with less than half

**PARKER-KALON**  
HARDENED  
**Self-tapping Screws**  
PAT. IN U.S. AND FOREIGN COUNTRIES

**Where and How to use:-**

**Type "Z" Hardened Self-tapping Sheet Metal Screws**



For joining and making fastenings to molded, cast and laminated plastics; die castings and sheet metal. Simply turn the Screws into drilled or molded holes. Can be removed and replaced without impairing holding power.

**Type "U" Hardened Metallic Drive Screws**

This type of Self-tapping Screw is for making permanent fastenings to molded, cast and laminated plastics, also steel and metal castings. Just hammer the Screws into molded or drilled holes for secure fastenings.



PARKER-KALON CORPORATION, 198 Varick Street, New York, N. Y.

Please send information on Self-tapping Screws and free samples for trial on the assemblies described on attached sheet.

Name, Title .....

Company .....

Address .....

# REMLER ATTENUATORS

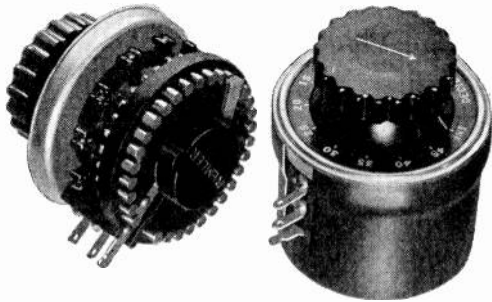

## Noise, Fading and Jerkiness Eliminated

Endorsed by leading engineers . . . highly recommended for broadcast apparatus, sound recording and projection equipment. Attenuation variable in 27 steps of 1 2/3 db. per step up to 45 db., fading in 3 additional increasing steps from 45 db., to infinity. Attenuation change halved as switch arm spans adjacent contacts resulting in attenuation of 5/6 db. per step. Impedance practically constant over entire range of the pad. Essentially flat frequency response.

Bakelite covered, moisture-proof bifilar windings. Handles power levels up to plus 24 db. Diameter 2 3/4"; depth back of panel 2 1/16"; mounts 2 3/8" hole or by three 6/32" screws on 1 7/16" diameter circle.

Standard impedances of 50, 200, and 500 ohms. Special values to order. LA-5 Ladder Type. Net \$10.80

Send for new Catalogue Sheets

REMLER COMPANY, Ltd.

2101 Bryant Street

San Francisco, Calif.

**REMLER—THE RADIO FIRM AS OLD AS RADIO**

# BRUSH MICROPHONES

Six Models Designed for Various Purposes in Recording, Reproduction and Measurement of Sound.

Complete Details on Request

Leading Manufacturers are now offering Public Address and Transmitting Equipment Specially Produced for use in Connection with Brush Soundcell Microphones.

Write us for information.

**BRUSH DEVELOPMENT COMPANY**  
East 40th St. and Perkins Ave., Cleveland, Ohio, U. S. A.  
Cable Address: BRUSH, Cleveland

# PROFESSIONAL SERVICES

## ELECTRICAL TESTING LABORATORIES

Characteristics and Life Tests of Vacuum Tubes  
Tests of photocells, glow lamps, crater lamps.  
Tests of electronic and optical devices.  
80th Street and East End Avenue  
New York, N. Y.  
Phone: Butterfield 8-2600

## JENKINS & ADAIR, INC.

Engineers

Designers, developers, and manufacturers of accessories and essentials for recording, broadcasting and testing at sound frequencies.

3333 Belmont Avenue, Chicago, U. S. A.  
Cable Address: Jenkadair Telephona: Keystone 2130

# Manufacturers —You have a Foreign Market

You probably know your market here in the United States. And most likely you have a good idea of how to sell that market.

But every manufacturer has another market that he forgets about. It's his market in foreign countries. And because he is in doubt as to how to sell the market outside the United States he does nothing about it. He forgets that his biggest selling aid is all ready to go to work for him. Whether he has foreign agents or not, he can carry word of his products into far places.

Manufacturers with a product that is bought here in the United States can sell that product to a foreign buyer too, and at no additional cost. Every advertisement appearing in Electronics goes to 993 subscribers outside the country. No wonder that present advertisers report frequent inquiries from the British Isles and France, Germany and Japan—but what's the use of trying to name countries! Electronics is read—and its products are bought—in practically every important country in the world.

Harness this buying power to your selling operations.

Advertise your product in Electronics and have our foreign readers and your potential buyers learn of your product and its advantages. Electronics Advertising Dep't, 330 West 42nd Street, New York.

# A NEW DUNCO RADIO RELAY

FOR USE AT ANY  
FREQUENCY  
WIDELY SPACED POLES  
AMPLY SHIELDED  
INEXPENSIVE

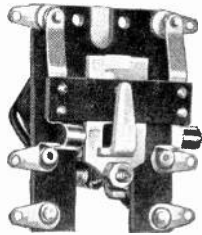

A relay, for use in high or low voltage circuits at short-wave, broadcast, intermediate or voice frequencies as well as in 25 cycle, 60 cycle or direct current power circuits.

Minimum capacity between poles, grounded frame, shielded poles, low loss at radio frequencies, low contact resistance, single break contacts, extremely fast operation (suitable for keying), many other features.

Complete details in new bulletin—send for it.

**STRUTHERS & DUNNING**  
148 N. JUNIPER ST. **DUNCO** PHILADELPHIA, PA.

## Why AEROVOX Electrolytics?

There's a more decided demand for Aerovox round-can electrolytics. Set designers this season seek quality. And they are finding it in these tried and proven products, because:

- Hermetic sealing . . . no absorption or evaporation . . . constant moisture content.
- Aluminum container dissipates internal heat . . . for continuous operation.
- Special composition spacer . . . an exclusive Aerovox feature . . . surgeproof.
- All internal parts of aluminum . . . no troublesome electro-chemical action or corrosion.
- Made in vast electrolytic condenser department . . . a complete plant in itself.
- All types, sizes, capacities, voltages . . . advanced engineering . . . attractive prices.

Just one of the many kinds of condensers, as well as resistors, supplied by Aerovox to the more critical radio buyers.

Send for Data on all Aerovox products and your particular condenser or resistor problems. Also sample copy of Aerovox Research Worker—a monthly engineering service.



75 Washington Street : : Brooklyn, N. Y.

# ZENITH

LONG DISTANCE RADIO

Goat Form Fitting Tube Shields are used in the Zenith Model 860 six-tube superheterodyne console.



There's  
eye appeal, too, INSIDE  
this beautiful Zenith Console

Zenith added eye-appeal to the chassis when its engineers added Goat Form Fitting Tube Shields.

Tailor-made to fit the product, Goat Shields improve sales appeal by contributing both better performance and better appearance.

Goat engineers will help you create buy-appeal by adding these essential sales stimulators.

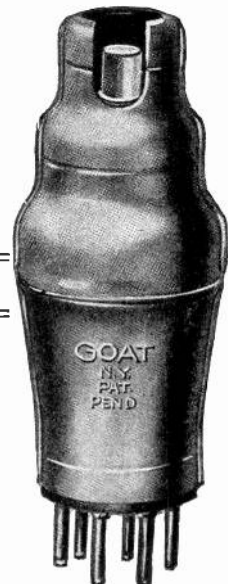

GOAT RADIO  
TUBE PARTS  
• INC. •  
314 Dean Street  
BROOKLYN, N. Y.



## "Winning New Friends"

### The RV-3 High Fidelity VELOCITY MICROPHONE

is now in regular use in 42 U. S. broadcasting studios while nineteen universities and numerous industrial institutions rate them as their acoustical standard.

The Bruno Model RV-3 is not "just a microphone." It is a scientific device designed and constructed in accordance with the most modern acoustic principles.

#### Characteristics

Frequency response of 30 to 14,000 C.P.S.  
Output level — 69 db (0 level = 6m.w)  
Highly directional.  
Not affected by humidity or temperature variations.  
Sparkling, faithful tone quality.  
High gain.  
Reduced feed back.

#### LOW HUM AC Pre-Amplifier

The Bruno Laboratories offers an AC-DC operated pre-amplifier having the same standards of quality and performance so strictly adhered to in its line of Velocity Microphones.

The pre-amplifier consists of a single unit employing two '77's and one 25Z5 tube—encased in a heavy sheet iron case 7"x12"x5" finished in crystalline black.

The various component parts are so disposed and so well segregated as to reduce the hum level well below audibility yet its gain is over 80DB.

The "BRUNO" AC Pre-Amplifier is especially adapted for remote pick-up and when connected to our Model RV-3 is capable of loading a telephone line well over zero level with full gain on. A switch regulates its output to a lower level if desired.

This Pre-Amplifier can be supplied for standard rack mounting or for portable use. Both types can be operated from either 115 volts-60 cycles AC or from 115 volts DC.

Write for Bulletin Series "B"  
**BRUNO LABORATORIES**  
20-22 W. 22nd St. New York City

*Bruno*

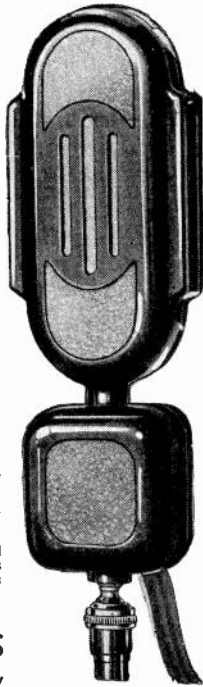

# TESTED QUALITY

Two words, the sum of 24 years of experience, of careful manufacture, of manual operations untiringly precise. Two words, weathering depression and eras of wild price-cutting. Always two words—Tested Quality!

RECEIVING  
TRANSMITTING  
AF & HF COUPLING  
BYPASS  
NEUTRALIZER  
TANK  
TELEPHONE  
WIRED RADIO  
EXPERIMENTAL  
MEDICAL  
INDUSTRIAL  
VOLTAGE DOUBLER  
THERAPEUTIC  
X-RAY  
PADDING  
FILTER  
POWER FACTOR  
MINERAL OIL  
VEGETOL  
PYRANOL

## CORNELL-DUBILIER

CORPORATION

4380 BRONX BOULEVARD  
NEW YORK

# SEARCHLIGHT SECTION

EMPLOYMENT : BUSINESS : OPPORTUNITIES : EQUIPMENT—USED or SPECIAL

UNDISPLAYED—RATE PER WORD

Positions Wanted, 5 cents a word, minimum \$1.00 an insertion, payable in advance.

Positions Vacant and all other classifications 10 cents a word, minimum charge \$2.00.

Proposals, 40 cents a line an insertion.

INFORMATION:

Box Numbers in care of our New York, Chicago or San Francisco offices count 10 words additional in undisplayed ads. Replies forwarded without extra charge.

Discount of 10% if full payment is made in advance for four consecutive insertions of undisplayed ads (not including proposals).

DISPLAYED—RATE PER INCH:

1 inch ..... \$5.00  
2 to 3 inches..... 4.75 an inch  
4 to 7 inches..... 4.50 an inch  
Other spaces and contract rates on request.  
An advertising inch is measured vertically on one column, 3 columns—30 inches—to a page. E.

COPY FOR NEW ADVERTISEMENTS RECEIVED UNTIL 3 P. M. ON THE 5TH OF THE MONTH (Elect)

## A New Service for 212D Users

Have your tubes converted to Modern Type with Graphite Plate-Mesh Grid and Thoriated Filament.

YOUR INQUIRY INVITED

NATIONAL RADIO TUBE CO.  
Inc.  
3420-18th St. San Francisco, Calif.

### HIGH GRADE NEW AND USED ELECTRON TUBE EQUIPMENT

Write for Bulletin Showing Savings From 20% to 80%

**KAHLE ENGINEERING CORPORATION**  
Specialists in Equipment and Methods for the Manufacture of Neon Tubes, Radio Tubes, Incandescent Lamps, Photo Cells, X-ray Tubes, etc.  
350 Manhattan Ave., Union City, N. J.

All types of High Grade New and Used Equipment for the manufacture of Electron Tubes.

Lowest prices on the market.

**AMERICAN ELECTRICAL SALES CO.**  
65 East 8th St., New York, N. Y.

### SAVE MONEY

Surplus Machine Screws and Insulated Wire all types and sizes.  
Several Stimpson Eyeletters and Eisler Spot Welders.

Send us your requirements.

**ECK ELECTRIC MANUFACTURING CO.**  
50 West 3rd St., New York City  
Phone ALgonquin 4-8133

Air Blowers  
Vacuum Pumps  
Aspirators  
Gas Boosters  
Spot Welders  
Gas Burners  
Accessories

### EQUIPMENT

Flare  
NEW—RECONDITIONED  
for making  
ELECTRONIC TUBES, RADIO  
TUBES, INCANDESCENT  
LAMPS, NEON SIGNS  
AND SIMILAR PRODUCTS  
Machines

**EISLER ENGINEERING CO.**

751 So. 13th St., Newark, N. J.

## "SEARCHLIGHT"

IS

Opportunity Advertising

—to help you get what you want.

—to help you sell what you no longer need.

Take Advantage Of It  
For Every Business Want

"Think SEARCHLIGHT First"

G-7

## CONTENTS for OCTOBER, 1934

Television—the transmitter problem and Federal funds .....	299
Television—a survey of present day systems.....	300
Characteristics of German radio receivers.....	306
BY WILHELM E. SCHRAGE	
100 watt broadcast station costs.....	308
Killing insects by short waves.....	309
Economical design for radio set transformers (part two) .....	310
BY C. A. HULTBERG	
All-metal vacuum tubes.....	312
BY O. W. PIKE AND G. F. METCALF	
I.R.E. Fall meeting program.....	314
Simplified inductance-coil calculations.....	315
Highlights on electronic devices in industry.....	316
Precision condenser calibration at radio frequencies..	318
BY E. L. HALL AND W. D. GEORGE	
New books on electron tubes.....	320
Notes on electron tubes and circuits.....	322
Editorials .....	324
Review of electronic literature.....	326
New products.....	329
U. S. Patents .....	332
British patents .....	334

## INDEX TO ADVERTISERS

This index is published as a convenience to the reader. Every care is taken to make it accurate but *Electronics* assumes no responsibility for errors or omissions.

Page	Page		
Acheson Colloids Corp.....	6	Ohmite Mfg. Co.....	8
Acme Wire Co.....	10	Parker-Kalon Corp.....	17
Aervox Corp.....	19	Remler Co., Ltd.....	18
Amer. Automatic Elec. Sales Co.....	12	RCA Radiotron Co.....	Back Cover
American Transformer Corp.....	21	Shakeproof Lock Washer Co.....	10
Astatic Microphone Lab., Inc.....	6	Shallcross Mfg. Co.....	14
Bakelite Corp.....	13	Synthane Corp.....	Inside Front Cover
Bruno Lab's.....	20	Thomas & Skinner	
Brush Dev. Co.....	18	Steel Prod. Co.....	14
Cannon Elec. Dev. Co.....	10	Triplett Elec. Instr. Co.....	12
Central Radio Lab.....	11	Ward Leonard Elec. Co.....	8
Clarostat Mfg. Co., Inc.....	14	Westinghouse Lamp Co.....	3
Continental Elec. Co.....	14	Weston Elec. Instr. Corp.....	7
Cornell-Dublier Corp.....	20	White Dental Mfg. Co., S. S.....	9
Dunn, Inc., Struthers.....	19	Yaxley Mfg. Co., Inc.....	4
Eby Mfg. Co., H. H.....	5		
Erie Resistor Corp.....	2	Professional Services .....	18
General Electric Co.			
(Tubes).....	Inside Back Cover		
General Radio Co.....	6		
Goat Radio Tube Parts, Inc.....	19		
Harcourt, Brace & Co.....	8		
Hygrade Sylvania Corp.....	15		
International Resistance Co.....	22		
Magnavox Co., The.....	1		
Mallory & Co., Inc.....	4		
McGraw-Hill Book Co., Inc.....	16		
Mica Insulator Co.....	12		
Muter Co.....	14		

### SEARCHLIGHT SECTION

Classified Advertising

EQUIPMENT FOR SALE	
American Elect. Sales Co.....	20
Eck Electric Mfg. Co.....	20
Eisler Engineering Co.....	20
Kahle Engineering Co.....	20
National Radio Tube Co.....	20

McGRAW-HILL PUBLISHING COMPANY, INC.,  
330 WEST 42d STREET, NEW YORK, N. Y.

Branch Offices: 520 North Michigan Ave., Chicago; 883 Mission St., San Francisco; Aldwych House, Aldwych, London, W. C. 2; Washington; Philadelphia; Cleveland; Detroit; St. Louis; Boston; Greenville, S. C. James H. McGraw, Chairman of the Board; Malcolm Muir, President; James H. McGraw, Jr., Vice-President and Treasurer; Mason Britton, Vice-President; H. C. Parmelee, Vice-President; Harold W. McGraw, Vice-President; B. R. Putnam, Secretary.

# INCREASE POWER

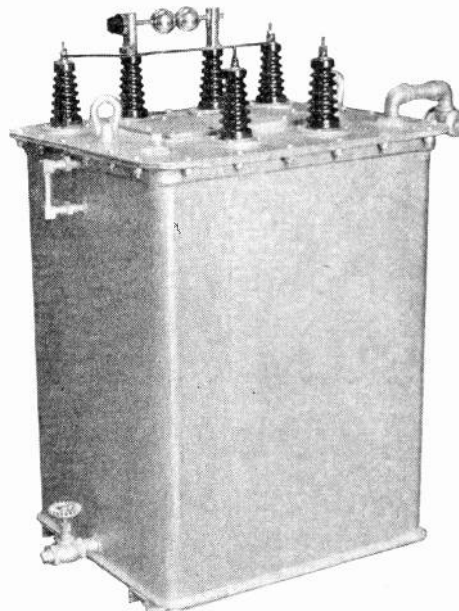

AmerTran Class "B" Output Transformer  
for operation at level of +65 dB.

## Add AmerTran Modulation Set to Convert your present 1 KW. Transmitter to 2½ KW. Output

You may take advantage of the Federal Communication Commission's recent permit to increase power from 1 KW. to 2½ KW. at minimum expense by adding an AmerTran Class "B" modulation set and AmerTran power supply to your present transmitter. Tube conversion is unnecessary, few changes have to be made in your equipment, and the cost of the new equipment is but a fraction of the cost of a new transmitter.

We will be pleased to send complete information if you will send us data on the equipment you are now using.

AMERICAN TRANSFORMER COMPANY

Transformer Builders for Over 32 Years

180 EMMET ST., NEWARK, N. J., U. S. A.



AMERTRAN  
TRANSFORMERS



# NOTE *the* FEATURES



## VOLUME CONTROLS

USING TIME-PROVED  
RESISTANCE PRINCIPLE OF  
*Metallized* RESISTORS

**M**ETALLIZED Resistors need no introduction to the radio trade. Now comes this same well-known resistance principle applied to Volume Controls to form units of outstanding quality.

Remember: For two years prior to this general announcement IRC Volume Controls in goodly quantity saw service in radio receivers made by numerous manufacturers *who now use them regularly.*

There can be no more convincing proof!

*Samples to your specifications gladly sent. Write for Catalog M-26 describing this new IRC development in detail.*

### INTERNATIONAL RESISTANCE COMPANY

2100 Arch Street, Philadelphia, Pa.  
(In Canada, 187 Duchess St., Toronto, Ont.)

#### RESISTANCE ELEMENT

Conducting material applied to Bakelite base with automatic machinery gives scientific control of taper. The use of Bakelite makes possible permanent bonding at high temperature.

#### HUMIDITY CHARACTERISTICS

Non-hygroscopic bakelite base prevents absorption of moisture. Only a small change in resistance occurs at 90% relative humidity at 40° C. Upon drying, the control returns to its original value.

#### QUIET OPERATION

Unique, three finger contact with spherical convex surfaces assure smooth change in resistance and low noise level.

#### NON-AGING

Practically unaffected by time. Nominal changes of only 1% or 2%.

#### WEAR

Average change in resistance is less than 10% with 50,000 rotations.

#### FLEXIBILITY

Standard controls from 200 ohms to 2 megohms. Can be made as high as 10 megohms. Special resistance curves supplied to order.

#### SWITCH

Underwriter's Approval. Low internal resistance makes it suitable for auto radio use.

#### LOAD CHARACTERISTICS

Will carry up to 1 watt with power dissipated over entire element.

#### TAPPED CONTROLS

The IRC method of making fourth terminal contact eliminates obstructions in the path of the slider, thus allowing a smoother increase in resistance and lower noise level at the tapped point.

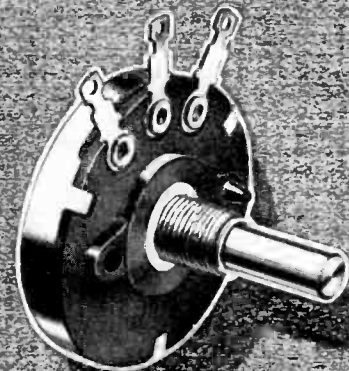
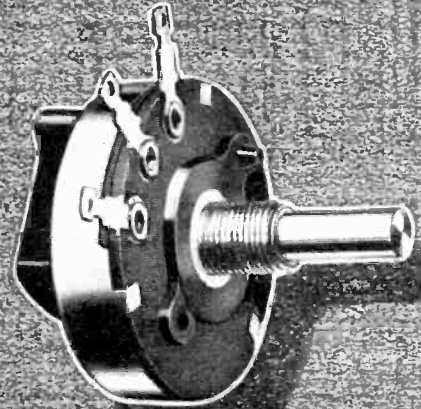

BY THE MAKERS OF METALLIZED, PRECISION AND POWER WIRE WOUND RESISTORS

# Jobs for Electron Tubes

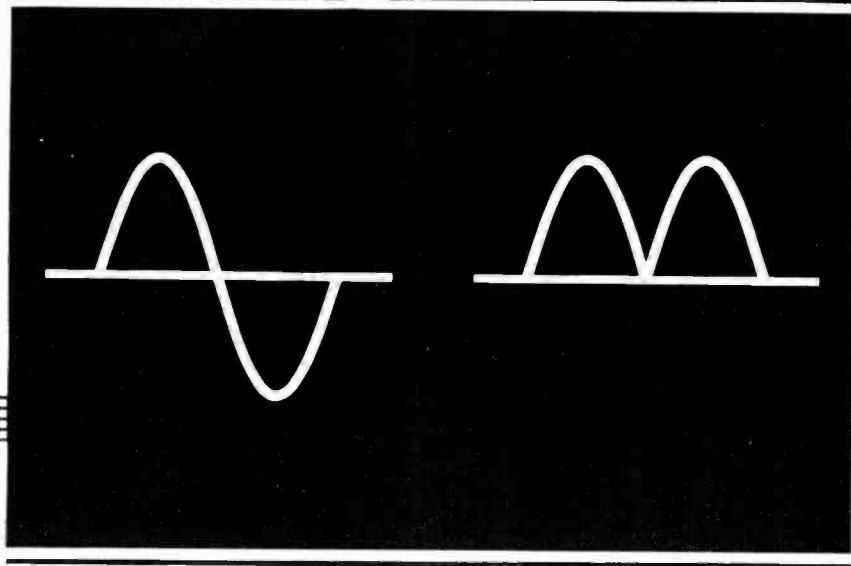

## RECTIFICATION

For engineers and scientists interested in the application of rectifier tubes to industrial and experimental problems, General Electric offers an extensive line of hot-cathode, mercury-vapor, and high-vacuum electron tubes.

The varied types, sizes, and characteristics available afford the user an opportunity of obtaining a "valve" best suited to his requirements. Satisfactory performance is assured by G-E tubes because of their high efficiency, good regulation, and long life.

Further details about G-E tubes for rectification will be sent at your request. At the same time, if you desire information concerning other G-E tubes for light-sensitive response, control, amplification, measurement, etc., our specialists will gladly supply it. When writing, please use your firm's letterhead, or mention your technical affiliations. Address the nearest G-E office, or General Electric, Dept. 6B-201, Schenectady, N. Y.

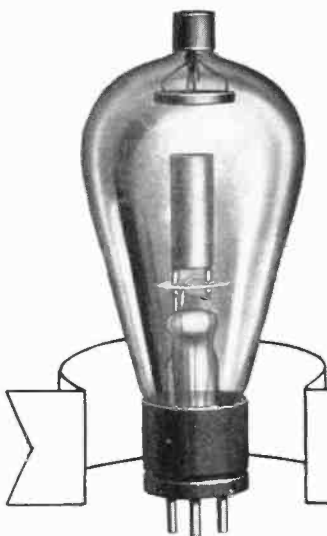

### STANDARD G-E RECTIFIER TUBES

High-voltage, high-vacuum type — KC-1, KC-3, KC-4, FP-78, FP-84, FP-92, KP-2  
High-voltage, mercury-vapor type — FG-64, PJ-28, FG-19, PJ-26, FG-15, FG-42  
Low-voltage, mercury-vapor, glass type — FG-26, FG-28, FG-32  
Low-voltage, full-wave, mercury-vapor type — FG-119  
Large, mercury-vapor, metal type — FG-52

180-4

**GENERAL**  **ELECTRIC**



THE RCA RADIOTRON COMPANY, INC.

*Announces*

# THE "ACORN-TYPE" TUBE

FOR AMATEUR AND EXPERIMENTAL USE ONLY

LOOK TO

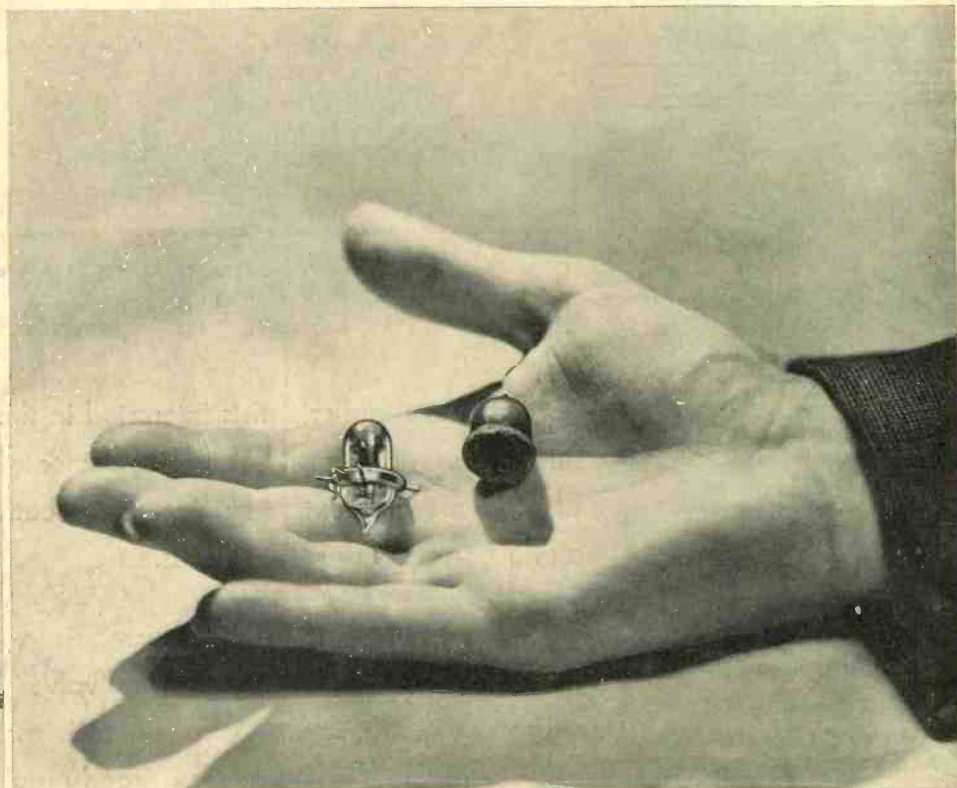
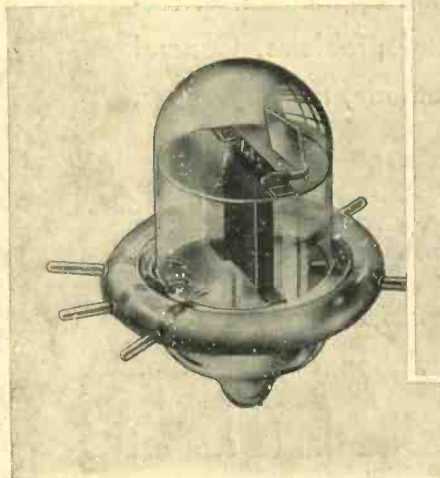

*New* **RCA-955** (*Acorn Type*)  
FOR ULTRA-HIGH FREQUENCIES

Out of the RCA Radiotron Research and Development Laboratory comes a radically new type of radio tube, resembling an acorn in size and shape, for use by amateurs, experimenters, and laboratory workers in ultra-high-frequency or micro-wave reception and transmission. (The new RCA-955 is a triode, having very low inter-electrode capacitances and lead inductances, suitable for operation at frequencies up to 600 megacycles. Although extremely small in size, it is rated for a maximum plate voltage of 180 volts. It will amplify, detect, and oscillate at frequencies not practical with conventional tubes. (The RCA-955 opens up new possibilities in the ultra-high-frequency bands and provides a needed tool for the exploration and practical application of these bands. In the laboratory, the low input capacitance (1 mmf.) and the small size of the 955 make it useful in many devices—as, for example, tube voltmeters. (The RCA-955 is now available to amateurs and experimenters only, at a net cost of \$3.75, connecting clips included. For complete technical information, write to

**RCA RADIOTRON COMPANY, INC.**

A Radio Corporation of America Subsidiary

HARRISON

NEW JERSEY