

electronics

radio, sound, communications and industrial applications
of electron tubes . . . design; engineering, manufacture

Communication—
an electron-tube
industry

A chart of
radio channel
assignments

Radio receiver
design trends

"Acorn" tubes
for ultra-high
frequencies

Design of
transformers
for radio sets

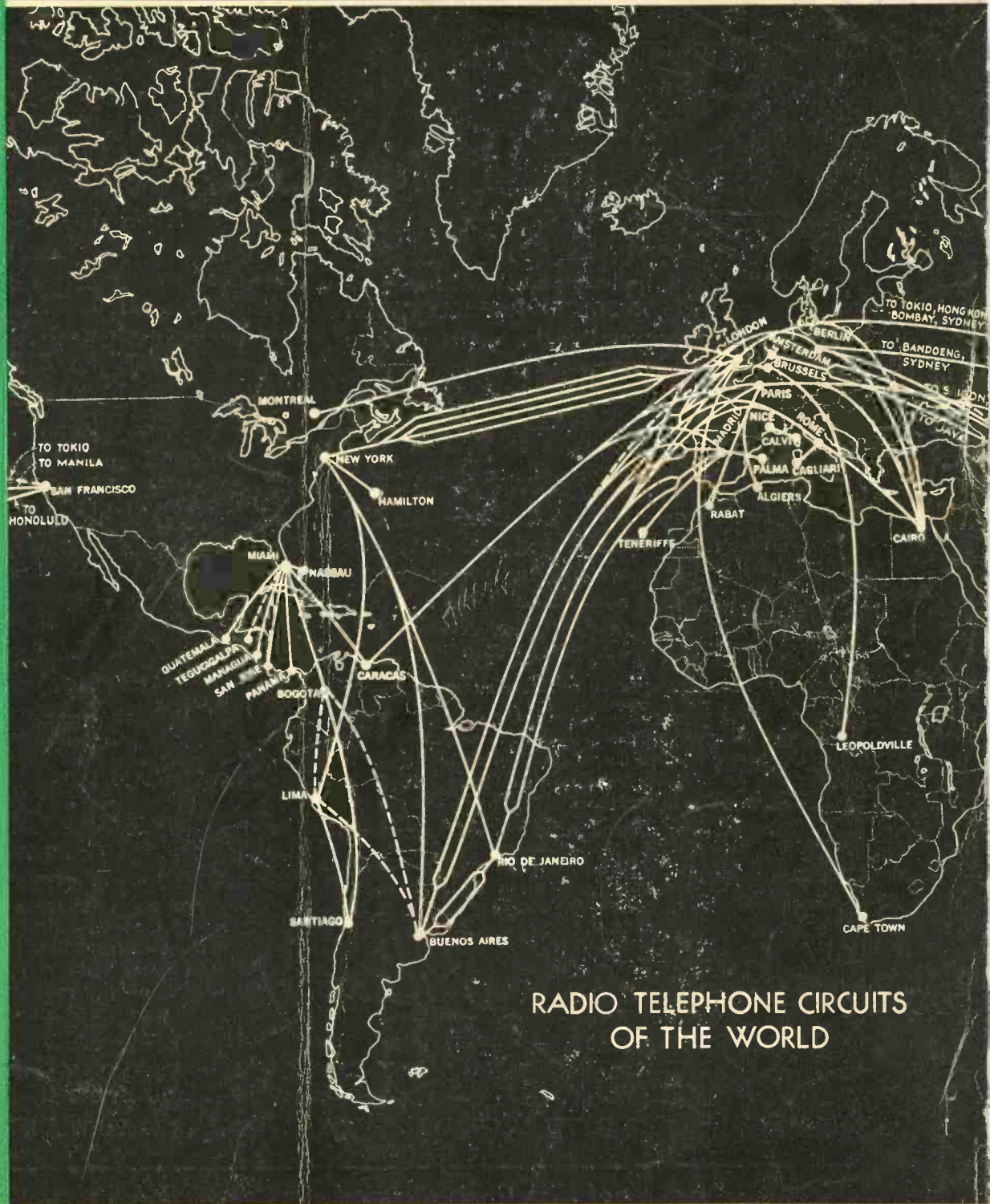

RADIO TELEPHONE CIRCUITS
OF THE WORLD

McGRAW-HILL PUBLISHING COMPANY, INC.

Price 35 Cents

SEPTEMBER, 1934



ELECTRONICS

*In every field of human endeavor,
there is a leader . . . an outstander,
who tops the others by sheer merit.*

AUDAX

Trade Mark

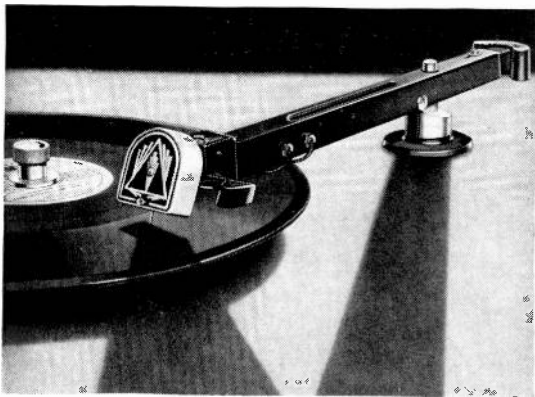

PROFESSIONAL MODEL

Engineers who have contributed to the advancement of SOUND REPRODUCTION will be interested to learn that we have developed instruments of

High Fidelity

NOT ONLY IN NAME, BUT IN FACT

for both true lateral and hill-and-dale use; with frequency range well beyond the most extreme requirements. Instruments worthy of the highest AUDAX traditions . . . and of your professional sponsorship!

We have also developed a pick-up particularly for portable purposes . . . weighing less than one-fifth the weight of an ordinary pick-up, and invaluable where space and weight are important factors.

This is representative of the pioneering enterprise and originality that put AUDAX at the top . . . you have always expected such achievements from us; we have never disappointed you.

SPECIAL RECORDING HEADS MADE TO ORDER
ALSO SPECIAL TRANSCRIPTION TURNTABLES

AUDAX COMPANY

500 FIFTH AVENUE

NEW YORK, U. S. A.

has been for years, and continues to be

THE STANDARD BY WHICH OTHERS ARE JUDGED AND VALUED

in practically all
**RADIO STATIONS
UNIVERSITIES
LABORATORIES**

in fact wherever QUALITY counts

AUDAX

instruments range in list price from
\$950 to \$39000

No Crystals or condenser materials used. Humidity and summer heat have no effect on AUDAX pick-ups. Available with impedance from a fraction to over 10,000 ohms.

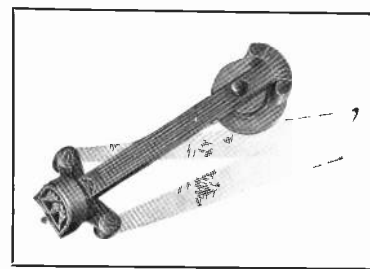

No. 33—ONE OF OUR MANY MODELS

Sound Engineers—

We offer you not only the finest reproducing apparatus that science has yet evolved, but a wealth of mature counsel based on years of experience in "tight corners," where only the very best was good enough. Call on us freely.

"Creators of High Grade Electrical and Acoustical Apparatus Since 1915"

ELECTRONICS, September, 1934. Vol. 7, No. 9. Published monthly, price 35c. a copy. Subscription rates—United States, \$3.00 a year. Canada, including duty, \$3.50 a year. All other countries, \$4.00 a year or 16 shillings. Entered as second class matter April 4, 1930, at Post Office at New York, N. Y., under the Act of March 3rd, 1879. Printed in U. S. A. Cable address "McGrawhill, New York." Member of A.B.P. Member of A.B.C. Copyright 1934 by McGraw-Hill Publishing Co., Inc., 330 West 42d Street, New York, N. Y.

Printed by The Schweinler Press, N. Y.

DETAILS COUNT

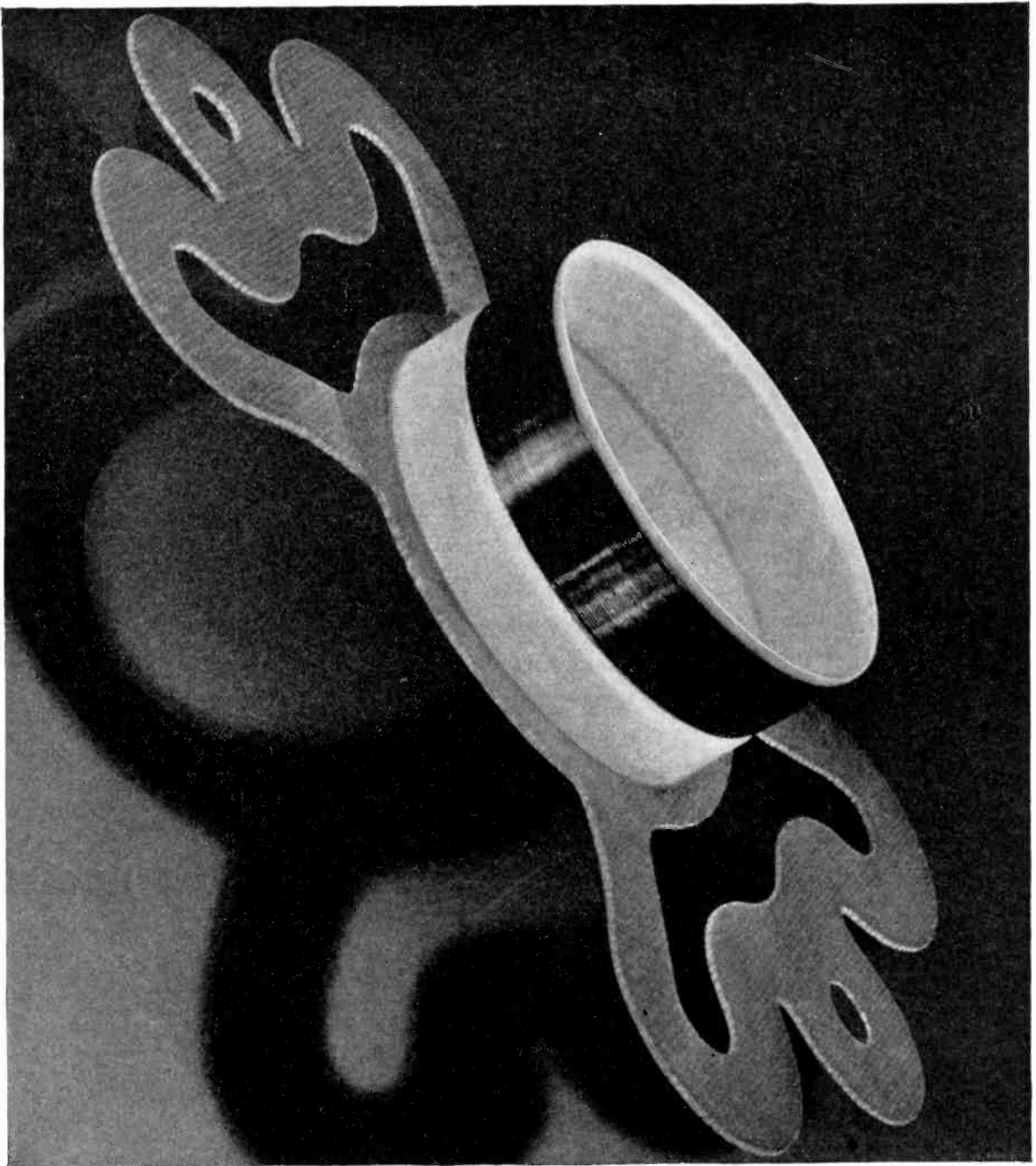

TRIFLES make perfection—but perfection is no trifle!" Magnavox Dynamic Speakers are designed and constructed with the fullest attention to details—small but important. The performance of a speaker is the sum of the perfections of every part—each a link in the strong chain that means correct reproduction, permanence and high fidelity.

A Magnavox Dynamic Speaker as a component part of your own product is an important detail upon which you can place the fullest reliance. The name "Magnavox" on a speaker means dependability, uniform quality, and supremely fine performance . . . made possible by a quarter

century of pioneering and development work . . . twenty-five years of "knowing how." Ably managed, adequately financed, with the most modern plant facilities for economical production, Magnavox has established and maintains a reputation as an authority on speakers and the one source of supply capable of handling the requirements of the largest manufacturer or smallest with complete satisfaction.

When you lay out your electrical design, save time, experimentation and money by specifying Magnavox Speakers and Capacitors. They are proven products, fairly priced, produced by an engineering organization that knows radio.

THE MAGNAVOX COMPANY

FORT WAYNE, INDIANA U. S. A.

CABLE ADDRESS "MAGNAVOX"

VOICE COIL
AND SPIDER
ASSEMBLY
THE HEART OF
A DYNAMIC
SPEAKER





Are you working with ultra high frequencies?

The new Western Electric 304A—an ultra-high frequency triode generator—is designed to give maximum power outputs and efficiencies in the 50 to 300 megacycles range. It extends the frequency spectrum in which the negative grid oscillator can be used to generate useful amounts of power.

Six outstanding design features make possible the 304A's unusual outputs and efficiencies. (1) Short, heavy lead-in wires through the top of the bulb, supporting grid and plate electrodes—lead inductance and resistance are thus minimized. (2) The hard glass of the bulb is the only material separating the three elements. Dielectric losses are thus held to a minimum. (3) Short electron paths. (4) Low interelectrode capacities. (5) Highly efficient anode of graphite. (6) Thoriated tungsten filament.

Like all Western Electric tubes, the 304A assures long life and uniform characteristics. For further information, write to Graybar Electric Co., Graybar Building, New York, N. Y.



Characteristics of the 304A Tube

Filament Voltage.....	7.5
Normal Filament Current.....	3.25 Amperes
Maximum D.C. Plate Potential.....	1250 Volts
Maximum D.C. Plate Current.....	100 Milliamperes
Maximum Plate Dissipation.....	50 Watts
Average Characteristics with a Plate Voltage of 1000 Volts and a Plate Current of 50 Milliamperes:	
Average Plate Resistance.....	4800 Ohms
Average Mutual Conductance.....	2300 Micromhos
Average Amplification Factor.....	11
Approximate Direct Interelectrode Capacities:	
Plate to Grid.....	2.5 $\mu\mu\text{f}$.
Plate to Filament.....	0.67 $\mu\mu\text{f}$.
Grid to Filament.....	2.0 $\mu\mu\text{f}$.
Maximum Overall Length.....	6-7/8 in.
Diameter of Bulb.....	2-7/16 in.

Frequency Megacycles	Output* Watts	Plate Efficiency
50	60	55%
100	55	50%
200	35	35%
300	10	17%
400		Limit of Oscillation

*Measured power in load circuit.

Western Electric

RADIO TELEPHONE BROADCASTING EQUIPMENT

Distributed by GRAYBAR Electric Company

In Canada: Northern Electric Co., Ltd.



Weston

POWER LEVEL INDICATORS

(DB Meters)

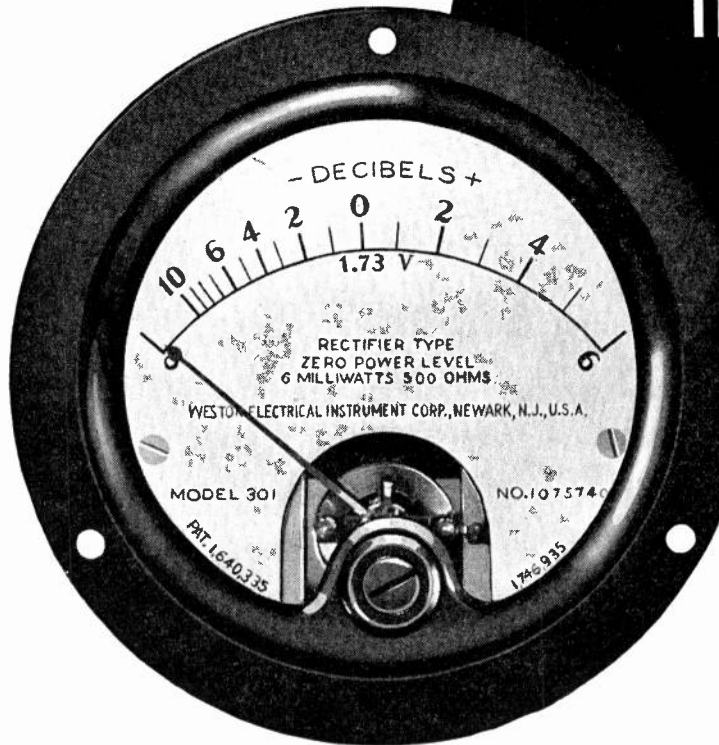

For maintaining the correct average level and the peak values below the distortion point in lines carrying voice or audio frequency currents, Weston now offers Model 301 Power Level Indicators in three types:

HIGH SPEED—for the indication of modulation peaks

LOW SPEED—for measuring integrated average modulation over approximately a one second period.

GENERAL PURPOSE—which integrates somewhat and shows heavy peaks.

These instruments normally are available adjusted to read either 0 DB or down 10 DB at 0 on the scale, based on a 6 milliwatt signal in either a 500 or 600 ohm line. The internal resistance is 5000 ohms for 0 DB or 1581 ohms for down 10 DB.

The above specifications are standard for the 301 line. Other instruments also are available for other levels, lines or resistances. Bulletins are available on standard models, and correspondence is invited on all special requirements . . . Weston Electrical Instrument Corp., 618 Frelinghuysen Avenue, Newark, N. J.



WESTON *Instruments*

SERVICE • UNIFORM QUALITY

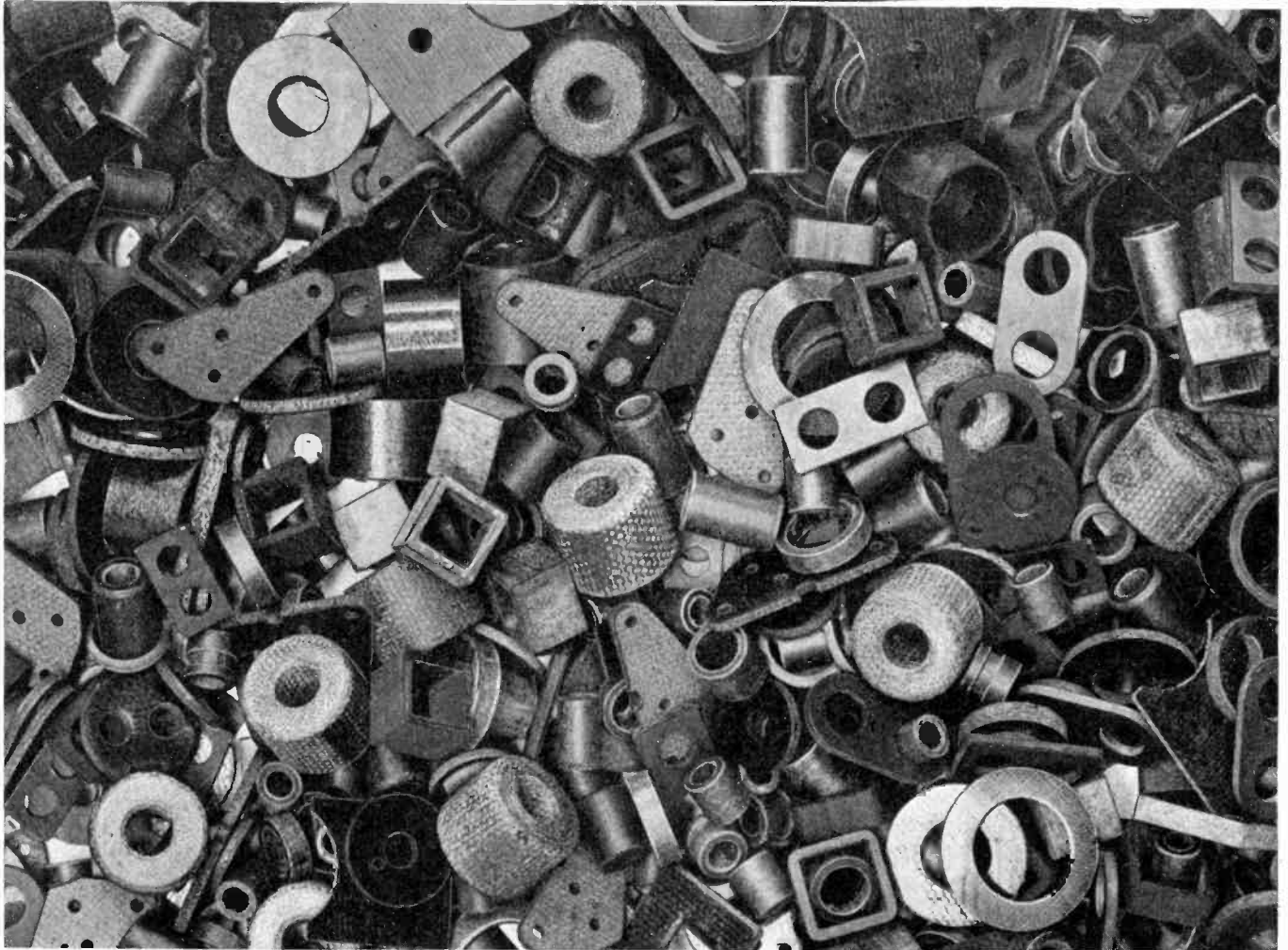

• • • **A** SERVICE on fabricated parts that is prompt and accurate has been offered to electrical manufacturers by Formica for many years. The company has a very large equipment of all kinds of machinery for punching, threading and cutting the material in various ways and can usually ship promptly. An exceptionally

well manned and well equipped laboratory concentrates on improving the material, adapting it exactly to the requirements of manufacturers, and maintaining uniform quality in the manufacturing process.

Send your next blue prints to Formica and try this service.

THE FORMICA INSULATION COMPANY

4638 Spring Grove Avenue, Cincinnati, Ohio

FORMICA

RADIO WIRE



PRODUCTS

Lenzite aids the airways

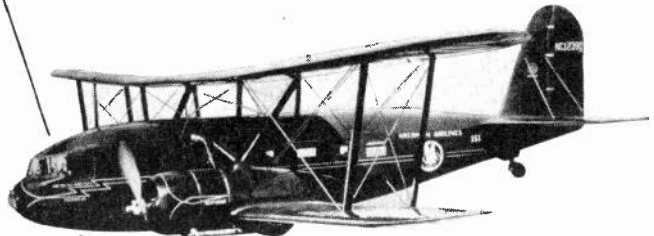

AMERICAN AIRLINES, INC.
MUNICIPAL AIRPORT
4848 WEST 63rd STREET
CHICAGO

August 7, 1934

Lenz Electric Manufacturing Company
1751 North Western Avenue
Chicago, Illinois

Attention: Mr. R. G. Zender, Sales Manager

Gentlemen:
During the development of a modified high frequency aircraft receiver we were confronted with the problem of selecting a suitable wire. Our problem was to modify a standard tuned radio frequency receiver to a super-heterodyne type covering a frequency range of 3000 - 6000 kc in two bands with provision for quickly changing from one band to another, automatic volume control and automatic temperature control of the oscillator frequency.

The final experimental model of this receiver was wired throughout with "Lenzite" wire, having two servings of cellulose acetate treated textile over the wire with an outer covering of cotton braid wax impregnated. We were gratified with the results of our laboratory tests of this receiver when wired with "Lenzite." During the tests the receiver was enclosed in an insulating chamber and the temperature dropped to twenty degrees below zero and kept at that temperature at the end of that period and then the internal frequency was raised twenty degrees and held at this temperature for thirty minutes. This process was continued in increments of twenty degrees until a maximum temperature of 120 degrees Fahrenheit was reached. The sensitivity and oscillator frequency were carefully measured at each temperature range and the oscillator frequency varied approximately 25 percent over this kilocycles.

Due to the very high humidity through condensation, ordinary push back wire used in previous tests of a similar nature developed very low leakage resistance between adjacent conductors. This made the receiver practically inoperative due to positive potentials from the plate supply leaking into the automatic volume control and noise suppression circuits.

As a result of our tests we have decided to use "Lenzite" wire for rebuilding our present type of high frequency aircraft radio receivers as we feel that the best wire obtainable for this purpose should be used.

Yours very truly,

C. C. Shaugraw
AMERICAN AIRLINES, INC.,
C. C. Shaugraw
Supt. of Communications

ccs:cg

RADIO HOOK-UP WIRES—the nerve centers of air travel! The course, day or night depends upon the signal—the flash of the beacon—the tone beat or the voice of the transmitter—are seen and heard because of these arteries—wires the ever present guides. Certain, sure guidance is vital. Upon **RADIO HOOK-UP WIRE** depends the safety of lives—property—it's no wonder then that **LENZITE** is chosen when the stakes are so great. That is why American Airlines use **LENZITE**.

LENZITE is the name of this new hook-up wire. The insulation consists of **cellulose acetate treated textile** plus **cotton** braids thoroughly saturated in moisture resisting compounds. This wire can also be furnished saturated in slow burning high di-electric lacquer.

Auto radio and all wave receivers both need a push-back wire having textile insulations of extremely high di - electric characteristics including low moisture absorption.

Production engineers will approve of **LENZITE** insulation because it pushes back freely and stays in position. There is no buckling or fraying of the braid that will interfere with production operation.

LENZ ELECTRIC MANUFACTURING CO.

1753 North Western Avenue
CHICAGO, ILLINOIS

ESTABLISHED 1904

Telephone: Armitage 4454 Cable Address: Lenzco Chicago

ELECTRONICS — September, 1934

Lenz Electric Manufacturing Co.

1753 No. Western Ave., Chicago

Gentlemen: Please send me 25-foot sample of number 20 solid LENZITE wax impregnated radio receiver hook-up wire.

Send price list on hook-up wire.

Please have your representative call.

Name Title.....

Company

Address

S. S. White

MOLDED RESISTORS



TYPE 16X—1 WATT

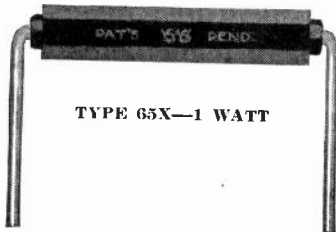

TYPE 65X—1 WATT



TYPE 25X— $\frac{3}{4}$ WATT



TYPE 40X— $\frac{3}{4}$ WATT



TYPE 15X—1.25 WATTS

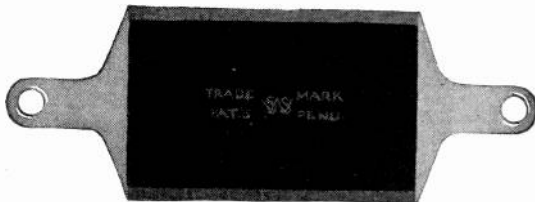

TYPE 70X—2 WATTS

Above actual size illustrations show a few of the types available.

RESISTANCE RANGES

COMMERCIAL FIELD—

For the varied commercial purposes, Resistors are supplied in the standard range from 1,000 ohms to 10 megohms.

LABORATORY AND EXPERIMENTAL FIELD—

For this field, Resistors of the 65X type are supplied from stock, from a comprehensive assortment of unusually high values ranging from 10 megohms to 1,000,000 megohms. These high resistance units are commonly used with the FP54 Photron tube, and are adapted for other electronic applications requiring resistance above the standard range. The NOISELESS operation of S. S. WHITE Resistors is of special importance in applications of this class.

Use them, especially where noise must be avoided

Critical tests show that S. S. WHITE Molded Resistors are virtually noiseless in operation. Because of this feature they are particularly suited for use in connection with microphone amplifiers, photo-electric amplifiers, and all other radio and electronic equipment where noise must be avoided.

In addition, S. S. WHITE Resistors are accurate in both high and low resistance values, non-inductive, mechanically strong and durable and with a non-hygroscopic structure that renders them impervious to moisture.

Users include many well-known manufacturers in the electronic and radio fields. A few of them are listed below. The fact that these concerns have found them satisfactory, both in test and in actual service in their equipment, provides a strong argument in favor of S. S. WHITE Resistors.

However, the surest way to find out just how satisfactory S. S. WHITE Resistors are for your own particular purposes, is to *try them*. **THEY INVARIABLY WIN THEIR OWN ACCEPTANCE.**

USERS INCLUDE

General Electric; Westinghouse E. & M.; RCA Telephone; RCA Communications, Inc.; U. S. Navy; Naval Research Laboratories; Pan American Airways, Inc.; International Broadcasting Equipment Co.; Automatic Signal Corp.; Carrier Microphone Co.; Leading University and Commercial Experimental Laboratories.

**WRITE for
DESCRIPTIVE CIRCULAR
and prices . . .
do it now**



The S. S. WHITE Dental Mfg. Co. INDUSTRIAL DIVISION

Knickerbocker Bldg.
New York, N. Y.

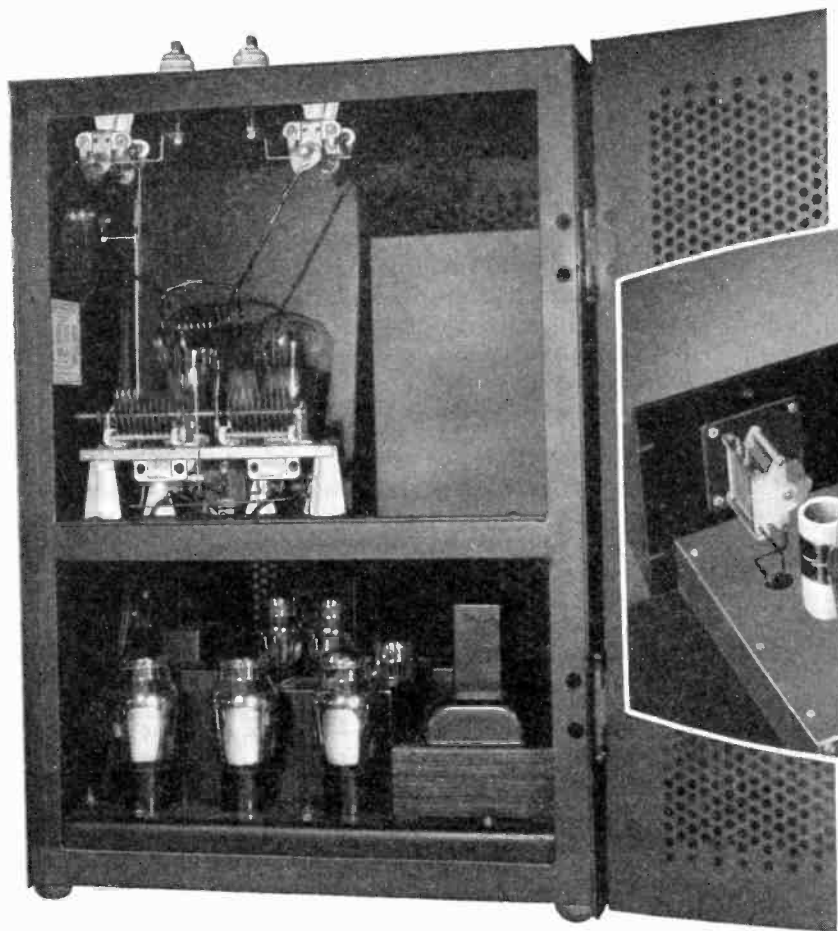

RCA Victor "Terra-Wave"—Ultra-short-wave Police telephone and telegraph transmitter, type ET-5004, using ISOLANTITE insulation.



The Collins Radio Co. employ ISOLANTITE extensively in the 10-J unit of their type 30 FXB short-wave transmitter.

DEPENDABILITY MUST BE THERE!

The new and rapidly developing field of Police Radio Communication—indispensable for curbing criminal activity—requires extreme dependability in transmitter construction. That is why manufacturers of police and other short-wave radio communication equipment employ ISOLANTITE insulation.

ISOLANTITE coil supports, stand-off insulators, tube sockets and bases, and many other elements too numerous to mention, are contributing daily to these exacting requirements.

For dependability and precision, specify ISOLANTITE insulation. Write for a copy of our Bulletin 100-F giving full details.

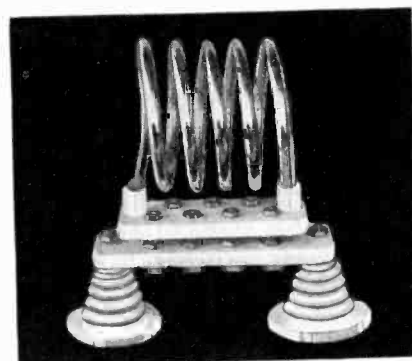

Short-wave power coils by Premier Crystal Laboratories are insulated with ISOLANTITE.

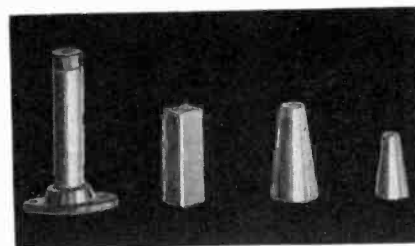

Standard ISOLANTITE stand-off insulators used in transmitter construction.

Isolantite Inc.

FACTORY at BELLEVILLE *New Jersey*

New York Sales Office 233 Broadway

The important details that make quality

YAXLEY

TAP . . . CIRCUIT SELECTOR AND SHORT WAVE SWITCHES

The Quality of a switch—by that we include exact aptitude for the desired purpose, mechanical perfection, superior electrical characteristics and long life—is manifest in the detail.

APTITUDE FOR THE DESIRED PURPOSE in Yaxley Circuit Selector Switches is obtained by means of the unusual flexibility possible due to its design. The number of switching circuits possible on one section ranges from one to six circuits. The switch has been built commercially up to twelve sections. In the latter case seventy-two circuits can be switched.

Contacts can be arranged by an ingenious method to provide for shorting or non shorting operation between terminals during switching. This feature is individual to each circuit, that is, in any switch any circuit can be specified as shorting or non shorting as desired. Multiple contacts can be used in any switch section. Shield plates can be provided between any specified sections to minimize coupling. Compactness in design permits the switch to be mounted in a chassis base or between equipment where space is at a premium.

MECHANICAL PERFECTION is obtained in Yaxley circuit selector switches by the use of high grade phosphor bronze springs operated well within the

elastic limit and providing an unusual factor of safety. A double spring roller index mechanism balances the index spring strain uniformly. All raw materials are tested with extreme accuracy to insure a uniform finished product.

SUPERIOR ELECTRICAL CHARACTERISTICS are brought about by the use of solid silver contactors and silver plated contact terminals. This provides a minimum of contact resistance—vitally important in the case of minute ultra high frequencies. Special high grade bakelite insulation of minimum water absorption characteristics provide for low losses and permanency. It improves with age. Spacers and other metal parts are permanently grounded resulting in absence of noise due to intermittent contacts. Terminals are made in one piece and fastened without use of eyelets or rivets.

LONG LIFE in Yaxley Circuit Selector Switches is shown by the fact that the contact resistance over 50000 cycles of operation is substantially equal to the initial resistance. All bearing surfaces are oversize and tolerances are held to extremely close limits. Two years of extensive production on one model has resulted in literally hundreds of life and operation tests to discover weak points in design.

The fact that Yaxley Circuit Selector Switches are found in the majority of short wave radio receivers discloses that radio set engineers have duplicated our tests in their laboratories and have checked our results as to Yaxley quality.

Complete technical information on request



A new and unique two pole double throw short wave switch from the Yaxley No. 2700 Series. Available up to four pole double throw. Circuits grounded if required.



Another unit of the Yaxley No. 2700 Series. Available up to six pole double throw. Circuits grounded if required.

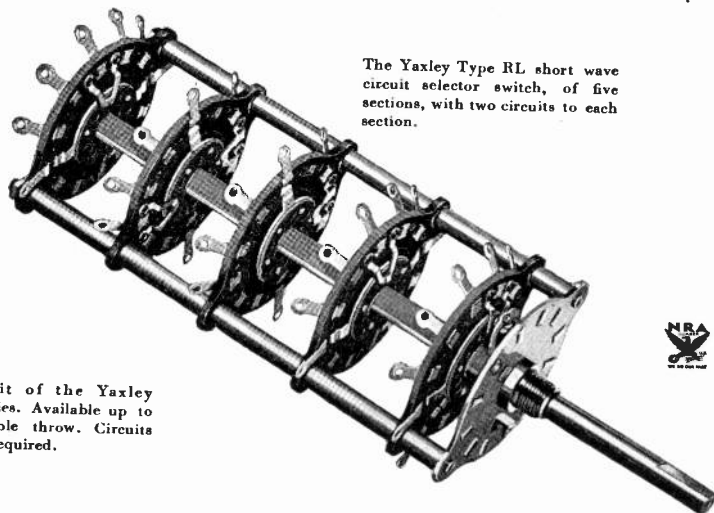

The Yaxley Type RL short wave circuit selector switch, of five sections, with two circuits to each section.



YAXLEY MANUFACTURING CO.
INCORPORATED
Division of P. R. Mallory & Co., Inc.
INDIANAPOLIS . . . INDIANA
Cable Address Pelmallo



electronics

O. H. CALDWELL
Editor

KEITH HENNEY
Managing Editor

DONALD FINK

McGRAW-HILL PUBLISHING COMPANY, INC.

New York, September, 1934



radio
sound
pictures
telephony
broadcasting
telegraphy
counting
grading
carrier
systems
beam
transmission
photo
cells
facsimile
electric
recording
amplifiers
phonographs
measurements
receivers
therapeutics
traffic
control
musical
instruments
machine
control
television
metering
analysis
aviation
metallurgy
beacons
compasses
automatic
processing
crime
detection
geophysics

The new day of Visual transmission

WE have been slow to concede that television in its pre-1934 forms has been anything but a crude scientific curiosity. We have felt that the dim, indistinct, flitting shadows we had previously seen on television screens, were far from the ultimate requirements for popular entertainment.

But now new clarity of detail, new brilliance of illumination, is being obtained, as new processes come to the front. Television systems of the scanning-disk, optical and cathode-ray types are all making important advances in picture value.

Before long, we think, we shall have television with us in real earnest—probably before conservative electrical and radio men fully realize that the new day is at hand. No longer the exclusive property of two or three laboratories, television advance now goes ahead on a hundred fronts. Its arrival to a waiting world cannot be far off. Next month we shall review some of these new systems that have great promise.

MEANWHILE television's less nimble cousin, facsimile transmission, progresses to large-scale commercial uses, as revealed on the following pages. Picture-transmitting equipment costing a million dollars to build, and another million each year to operate, is now under way for the great newspaper groups. New simplified home apparatus is also being developed, so that the dream of a "tabloid radio newspaper," printed from the home radio set between 1 and 6 a.m., is coming closer. Facsimile message services, "electric pens," stock ticker-tape, police-car records, all point the way to an important new facility of visual transmission.

It may not be very long before these new *visual services*,—by radio and by wire—may be sharing the commercial stage with sound.

COMMUNICATION—

THE FULL STORY OF THE ELECTRON TUBE in communication would require many volumes. Today no communication service except the most elemental can exist without amplifiers, known as "repeaters." Telephone, telegraph, wire and wireless, broadcast and directed communication all depend upon tubes in one form or another. Dots and dashes of code, transients of voice and music, the fine lines of facsimile and photo-

graph transmission, and finally the fleeting points of light constituting a television image cannot transport their messages of human intelligence without the electron tube.

On the following pages can be reviewed only some of the many features which will be of particular interest to the readers of *ELECTRONICS*. Together they make up the tremendous communications industry.

TELEPHONE AND TELEGRAPH ARTS FIND MANY ELECTRONIC APPLICATIONS

IT WAS IN THE TELEPHONE PLANT that the vacuum tube had some of its first applications. The story of how the amplifier made possible transcontinental telephone communication has been told many times. Cities were linked together so that the human voice, clearly and consistently, could be understood by persons hundreds or thousands of miles apart. Then by "carrier" the tube multiplied the carrying capacity of the physical lines. Today a single pair of wires carries simultaneously three telephone conversations and fifteen telegraph channels.

Another dazzling chapter in telephone communication was written when the land lines were linked up with trans-oceanic radio interconnecting thirty million telephones throughout the world, as indicated by the chart on the front cover of this issue of *Electronics*. Another landmark in communication, now considered as commonplace, was the

opening of ship-to-shore circuits. One of the most interesting and, to the layman, exciting places in the entire communications industry is the terminus of the trans-oceanic and ship radio telephone circuits in the long lines department of the telephone plant. Here operators are in constant telephone communication with Europe, Asia, the far East, South America, and ships at sea. Except for occasional fading and bursts of static the listener-in to a Buenos Aires-New York City conversation would not know but that the communication path lay across the street instead of through several thousand miles of ether.

Incidental to this telephone service are a number of other electron-tube controlled devices such as "voice scramblers," frequency and volume compressors and expanders, delay circuits, voice operated relays, and automatic monitors all contributing to the

economy, clarity and privacy of the service.

Oldest of the electrical communication arts, telegraphy has within recent years made application of electron tubes in a number of ways to supplement its classical electro-magnetic methods which came down from the early days of Morse and Edison.

Tubes are now used for "carrier-circuit" operation, for repeaters, for cable amplifiers, for switching controls, and for laboratory and testing operations. In the latter work, the electronic oscillograph has proven an invaluable device for investigating circuit and relay operation, and for detecting troubles and making adjustments possible in no other way. A large amount of experimental work in electron-tube circuits is now going on in the telegraph field, and it seems likely that shortly a much wider use will be made of these devices in both standard message service and also in the many supplementary services which the telegraph companies render.

The Western Union system makes use of a number of eight-channel two-way carrier circuits on lines more than 500 miles in length. On these carrier systems, the channels are so spaced that each can carry a standard quadruplex telegraph circuit, each serving two messages each way, or four messages simultaneously. Thus over a single pair of wires insulated from ground, sixty-four simultaneous message circuits can be operated, the carrier multiplication providing sixteen channels, each of which can be further split into four independent message paths by the commutating quadruplex device standard in telegraph practice.

Such multi-channel carrier circuits require repeater installations every 120 miles, and here again tube apparatus comes into play, taking the place of the old-line electro-magnetic repeaters which are capable of handling only the ordinary telegraph impulses.

Another widely used electronic aid, employed at many points throughout the Western Union system, is the single-circuit carrier, which can be superimposed on a standard single-wire ground-return telegraph line, and serves to furnish an extra two-way circuit, which can be treated at the terminal offices exactly like a standard telegraph line. Some 25 of these single-circuit carrier systems are now in use by Western Union. They have proven especially valuable in locations where there is a sudden short rush of seasonal business, which can be handled with the aid of the extra carrier circuit, the apparatus for which can be contained in a single trunk, and handily shipped to the point of sudden

TEN-CHANNEL TELEGRAPH CARRIER PANELS

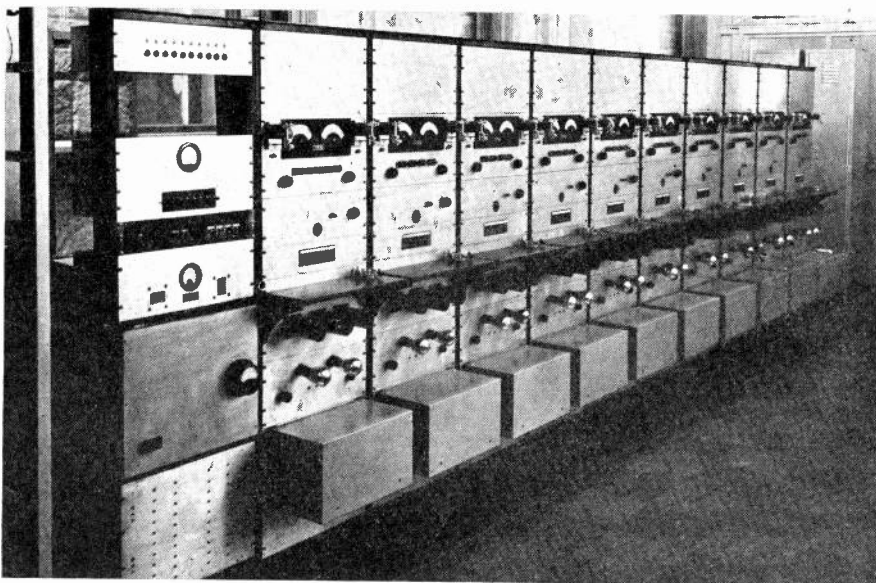

Carrier apparatus used by Postal Telegraph Company for New York-Washington business, giving 24 messages per wire-pair.

AN ELECTRON-TUBE ART

heavy traffic. Such a single-carrier circuit can be quickly imposed upon any telegraph wire without previous preparation or balancing, so that the electronic equipment here provides a quick and convenient substitute for an extra physical line.

The Postal Telegraph Company makes use of a ten-channel carrier system from New York City to Washington. In this carrier outfit, the ten two-way message circuits are superimposed on the regular four direct-current channels, so that twenty-four simultaneous messages may be transmitted, each with a message speed of 60 words per minute. One repeater outfit is used near the middle of the New York-Washington run. The carrier frequencies are taken from a multi-frequency generator, and are as follows: 500, 700, 900, 1100, 1300, 1500, 1700, 1900, 2100 and 2300 cycles.

Six-channel carrier apparatus in use by the Postal company employs fork-controlled frequency sources. Even at present low copper costs, the carrier system shows considerable economy over the equivalent physical wire circuits, and with any return to copper prices approaching the period of great business activity in 1929, the impetus to use carrier system will be very great.

Vacuum-tube amplifiers are now employed on the ocean cables of the Western Union group. These circuits are also available on occasion for the transmission of pictures by facsimile, at regular ocean-cable speed of transmission.

A vacuum-tube arrangement has provided a simple and effective method of giving a "busy test" on operating multiplex circuits, without disturbing the circuit if busy.

In testing relays and contacts and in balancing lines, the cathode-ray oscillograph now has wide use on the Western Union system by wire chiefs and laboratory technicians and provides a means of detecting troubles and localizing connections quickly.

FACSIMILE NOW IN COMMERCIAL STAGE

THE FACSIMILE TRANSMISSION of photographs is being made ready on a large scale for several nation-wide newspaper groups. Early in the year the Associated Press announced that the Western Electric Company would build for it twenty-six photo transmitting and receiving units, to be installed at twenty-six principal cities, each unit capable of transmitting to the rest of the system, a picture 12 by 17 inches, the picture detail to be 100 lines to the inch. It is understood

that a considerable part of this apparatus is now ready for installation and will be in regular service by the end of the year, when official announcement will be made.

The receiving equipment is understood to be of the daylight type, so that the machines operate in an ordinary room, the cylinders being loaded in darkrooms. Standard photocells are modulated by the reflected recording light beam, through light choppers. Synchronization is effected by tuning forks in fixed-temperature containers at each point. At the receiving end, light-gates of the motion-picture type in turn modulate the light-beam projected on the sensitized paper and negatives of quality comparable with the original photographs, are assured. A full 17 by 12 inch picture can be sent in 17 minutes, with a picture rate of one inch per minute, and a top frequency of 2400 cycles per second. According to the original announcements, this facsimile equipment for 26 cities was to cost about half a million dollars, and the wire charges and operating costs for the service would average as much more, each year. An important additional aspect of the new facsimile service is understood to be the transmission of typewritten copy between various Associated Press centers. When the system is not needed for transmitting pictures, the local correspondent simply puts his original "copy" into the local transmitter, and facsimiles of it, corrections and all, appear at the various receiving points.

Meanwhile the Hearst organization of thirty newspapers, together with some twenty-five associated papers, is having the Walter Howey photo-electric system of half-tone engraving extended for both photograph transmission and photo-engraving by wire, the work being directed by Mr. Howey who is one of the Hearst executives.

The Hearst facsimile system also operates in a daylighted room, and will receive a *positive* picture directly on the machine, thus eliminating the delays of developing a negative, drying it, and making a positive print. Negatives can also be received if desired, and the machine will work on either paper or film. The drum used is of the same diameter as the Associated Press drum, so that the apparatus may be used interchangeably if required. The detail obtained is 96 lines per inch, and a 12 by 12-inch picture can be sent in about 30 minutes, with a top frequency of about 1500 cycles. Two methods of synchronizing are used, one by means of tuning forks at each point, the other by means of a fork-generated frequency transmitted over the line with the picture. Already pictures of high photographic quality have been transmitted over 2,000 miles of wire, between two of these machines.

Since the new Howey picture-transmitter is an adaptation of the inventor's earlier method for engraving half-tone cuts by photocell control, provision is made for receiving half-tone engravings directly on the machine, from the wire, without the intermediate delay of making a negative, a posi-

FACSIMILE EQUIPMENT FOR NEWSPAPER OFFICE

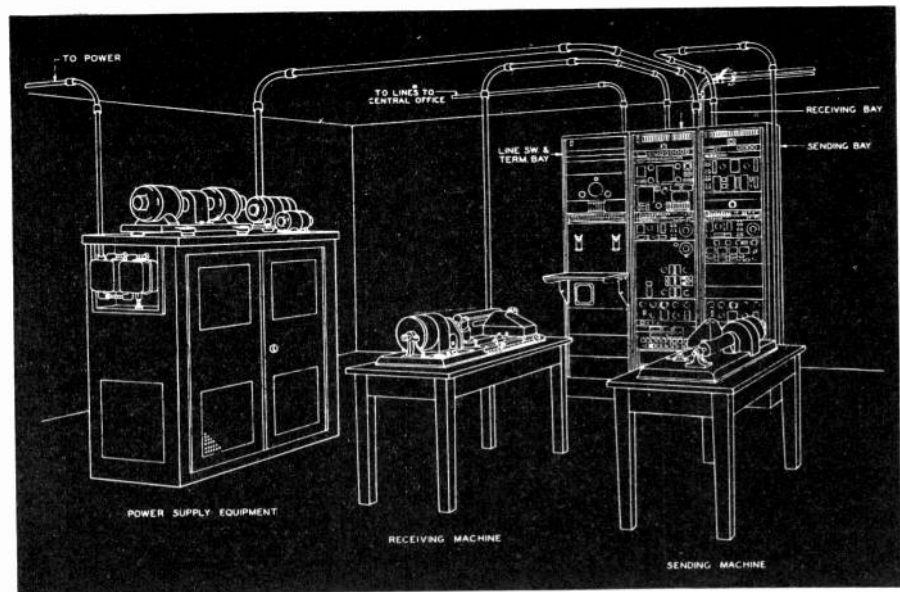

Type of photograph and "copy" transmitter and receiver now being developed for a nation-wide group of newspapers.

AIRCRAFT AND POLICE

tive print, and then an acid-etched halftone. Thus it will be possible to put a photograph on the wire at the Hearst headquarters office in New York City, and to make half-tone engravings of that photograph directly at various newspaper offices throughout the country. As so far developed, this direct half-tone process seems to be limited by practical considerations to shorter wire lines. For the longer transmissions, the picture can be received as a photograph. This is then scanned back on the same machine, and an engraving made in the way already described in these columns (see *Electronics*, November, 1932, page 334).

Work is also proceeding on the "message facsimile" apparatus for the local short-wave radio message circuits which have been set up by the Radio Corporation of America between the cities of New York, Philadelphia, Boston, Washington, San Francisco, New Orleans, and Chicago. At the outset

these are being operated as straight code message circuits, with rates comparable to wire telegraph rates, but sending 15 words instead of ten. Eventually it is planned to equip these message circuits across the continent with facsimile transmitters, so that the sender may write out his message, and have it received at the destination in his own hand-writing (see *Electronics* for February, 1934, front cover, and March, 1934, page 71).

It has been generally understood that this message service would be an experimental work-out of facsimile apparatus designed for operation in connection with home radio sets, for delivering a "tabloid radio newspaper" to the home, as mentioned variously in this and other issues. A distinct improvement in simplified home facsimile printing apparatus, is the new "lawnmower" or roller printer, which is referred to on page 288, but of which no official account is yet available.

by the dial-telephone system, so that they can be tuned and shut down automatically. Changing the frequencies of the ground transmitters from the day frequency to the night frequency is also accomplished by dialing. Crystal oscillators as a source of the beat frequency in superheterodyne receivers are being more and more used for aircraft work because of the high degree of stability. New crystal cuts which maintain an accuracy of 0.025 per cent without temperature control have recently been used.

A small "itinerant flyer" receiver will be ready by fall. This receiver, which operates from a twelve-volt storage battery, uses a dynamotor as the source of plate voltage. It is a rugged superheterodyne, designed for sportsman pilots in private planes. Two wavebands are provided, with a single change-over switch, both bands being tuned by a regulation dial. One band tunes the aircraft frequencies for beacon signals and weather. The other band covers the entertainment broadcast stations, thus enabling the pilot to combine pleasure with business.

Ultra-short-wave technique has not yet made any great headway in the aircraft field. Experiments have been made using these frequencies for beacon service, but the longer waves are still in use for all commercial work. One interesting use of ultra-high frequencies has been made at Hadley Field in the instruction of student pilots. A transceiver of the usual design is installed in the plane, and another on the landing field. When the student makes his first solo hop the instructor may advise him throughout the course of the flight. Since the antenna may be elevated several miles, the optical horizon which limits ultra-short-wave transmission may be pushed back a hundred miles or more. The main advantages of using this frequency band for aircraft is the small antenna required and the high radiation efficiency. Engineers now engaged in aircraft radio research feel that eventually the ultra-high frequencies will find a wide place in commercial aviation. Their use on blind landing has already been described in *Electronics* (June, 1933).

Two-way telephone service is provided for the pilots of almost all passenger planes running on regular schedule. Occasionally this service has been connected with the telephone wirelines, but only on an experimental basis. Thus, while it is technically possible to talk from any telephone station to a plane in flight, the time of flight is so short, and danger of interference with the radio navigation service so great, that no commercial telephone service to planes is available, and at the present time none is contemplated.

AIRCRAFT RADIO SERVICE IMPROVED IN MANY DIRECTIONS

THE USE OF RADIO as an aid to navigation is unquestionably its most important function in the aircraft industry, despite the numerous other uses in this field to which radio technique has recently been applied. Radio beam navigation, the reception of weather reports, dispatch-

ing orders, and the ability to communicate by telephone with terminals and intermediate landing fields have been the primary concerns of aircraft radio engineers, during the past year. As a result numerous refinements in these types of service have recently appeared.

What is believed to be the first application of the voice-operated relay to aircraft transmitters has been applied at the Mendham, N. J., station of the Bell Telephone Laboratories. The voice of the operator is used to turn the carrier on; when he stops talking the carrier shut down. Thus only one channel is required for transmission and reception. The transmitter is operated at maximum efficiency, since the carrier is on only during actual modulation.

Considerable experimentation, which is not yet successfully completed, has been aimed at the use of one channel for both radio beam signals and voice, the latter to be used for transmission of weather bulletins.

Commercial aircraft transmitters have been reduced in size and weight. The receivers are now remotely controlled from the pilot's seat by means of push-buttons which control a motor-driven tuner. On the ground, receivers are being installed at remote locations and connected by wire to the terminal station so that the relatively weak signals from the plane can be picked up regardless of its location. There is a growing tendency to control these remote receivers

RADIOTELEPHONE FOR AIRCRAFT

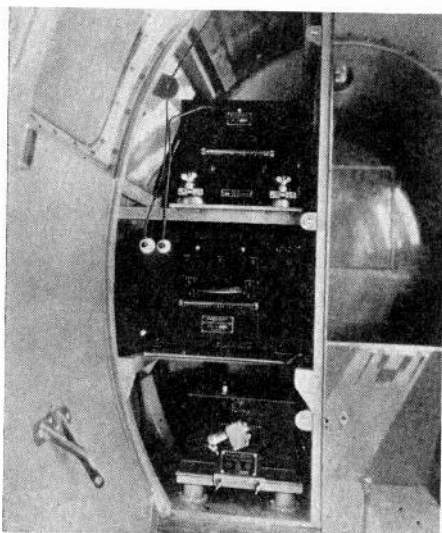

Top to bottom: Telephone receiver, transmitter, and beacon-weather receiver installed in fuselage of a new TWA Lockheed Orion.

RADIO SERVICES EXPAND

POLICE RADIO ADOPTS TWO-WAY SYSTEM ON ULTRA-HIGH FREQUENCIES

WITH APPROXIMATELY 130 municipalities in eight states equipped with police radio transmitters, and with more than 4000 police cars carrying receivers, the police radio business has assumed a position of major importance in the communications industry. 41,000,000 people, or one-third of the population of the country, reside in areas protected by these systems. The average time required for a police car to reach the scene of a crime after being called by radio is two and one-quarter minutes, a

POWER FOR POLICE PATROL CARS



The power supply of this ultra-short wave patrol car transmitter is placed in the rear trunk, an unobtrusive but easily accessible location.

record compiled from over 200,000 calls. The Superintendent of Police of Peoria, Ill., reports that in the five months following the installation of a police transmitter the value of stolen property in that area was reduced 75 per cent., and the number of auto thefts reduced 85 per cent. The value of police systems in combatting crime is being demonstrated in this way wherever they have been installed, and it is expected that as appropriations become available from municipal funds more and more cities and towns will avail themselves of this service.

During the past year a definite trend toward ultra-high frequency two-way systems for police use has been clearly apparent. While the conventional short-wave police bands between 1658 and

2490 kc. (181 to 120 meters) are in continuous use, and while several important installations have been made recently in this band, interest has centered on the 30 to 40 megacycle band (9 to 7 meters). At least five separate companies have made installations of ultra-high frequency two-way police radio during the past eighteen months.

Ultra-high frequencies

The limited number of frequency assignments available in the medium-wave bands for police work turned the attention of engineers to the possibility of using the ultra-high frequency region. The advantages of ultra-high frequency transmission are many. The waves travel, under ordinary conditions, only to the optical horizon, and are there attenuated below the noise level. Hence the problem of interference between neighboring communities, a serious difficulty on the medium waves, has been circumvented. In addition the ultra-short wave equipment can be operated much more efficiently, using small antennas, and without frequency stabilization. To date the only practical method of two-way police communication (that is, transmitters located not only at headquarters but in each patrol car) has involved the use of ultra-high frequencies. A nine-watt transmitter, installed in a patrol car will operate directly from the six-volt ignition battery, with a current drain of ten amperes during transmission periods. The familiar rod antenna is being replaced by an invisible radiator, so that the radio equipment of the car is not proclaimed to the public.

The range of such car transmitters is limited, except under extraordinary conditions, to three or four miles. Often a car patrols regions located five miles or more from headquarters, and the two-way feature becomes useless. This difficulty has been overcome by the use of special automatic receivers located in the remote sections of the community and connected by telephone wires to the headquarters. When a car, outside the three-mile range, desires to call headquarters, its signals are picked up by the nearest automatic receiver, and a light appears on the switchboard at headquarters, indicating that the car is calling. The area covered can be extended by this plan to meet almost any requirement.

The need for coordination between adjacent communities in crime prevention has been cited as an objection to the use of ultra-high frequencies, whose

waves are usually confined to one community. The plan suggested to meet this objection is a county-wide or state-wide system operating on conventional wavelengths, which connects the headquarters of as many communities as desired, which in turn can communicate with their own fleets of patrol cars on the ultra-high frequencies.

The Federal Radio Commission in February said in a release "it is conceivable that all of them (the 4000 police cars equipped with receivers) will eventually be equipped with transmitting sets permitting two-way communication." Whether this two-way system will be confined to ultra-short waves cannot be definitely stated, but experiments on medium waves have thus far proved impractical.

The ultra-high frequency system has a serious disadvantage in that dead spots due to reflections caused by resonance in buildings and in hills, etc., cannot be overcome except by great increases in power, a difficulty not nearly so troublesome on the conventional wavelengths.

All assignments to frequencies in the ultra-high frequency region have been made on an experimental basis. The frequencies now available for police use in this region are 30,100, 33,100, 37,100, 40,100, and 86,000 to 400,000 kc., the latter band being not yet in regular use.

The success of the two-way method of police patrol is attested by the fact that Jersey City, N. J., now has 22 patrol cars equipped with transmitters, 12 additional cars having been ordered

COMPACT POLICE TRANSMITTER



A medium wave transmitter of modern design. Note the simplicity of connections to power supply, microphone and antenna.

TELEVISION PROGRESS—

after the original 10 were in operation only six months. Kansas City plans to have 33 cars equipped for two-way communication.

The City of Newark, N. J., is one of the latest to join the fold of the ultra-high frequency users. A 50 watt transmitter, soon to be converted to a 500 watt outfit by the addition of an amplifier, is at present being installed. The fish-pole antenna is mounted on the top of the flag-pole of the tallest building in the city, thus assuring the necessary wide coverage. Crystal control is used in this installation, the first application of this method in a commercial police ultra-high-frequency transmitter. The frequency of the crystal, which requires no temperature control, is one-sixth that of the carrier, the multiplication being accomplished in two steps. 40 police cars will be equipped with transmitters to provide the "talk-back" feature.

Effective May first the FRC made several reassignments of frequencies for police work with the intention of reducing as far as possible the interference between transmitters. In addition, municipal police stations have been definitely limited in power according to the population, from a maximum of 50 watts for a city of 100,000 population to a maximum of 500 watts for cities over 700,000. State police systems have been allowed as much as 5,000 watts daytime, 1,000 watts night, because of the greater areas to be covered.

A recent survey based on many tests has indicated the necessary signal

strength required to cover adequately the various districts in a city. The resulting figures show that a one millivolt signal, necessary to override the high noise level of business districts can be radiated five miles by a 400 watt transmitter, but only 1.5 mile by a 50 watt transmitter. The 50 microvolt signal which is sufficient for rural districts will extend 23 miles from a 400 watt transmitter, and 8.5 miles from a 50 watt transmitter.

Tonal quality improved

Improvements in conventional police transmitters include the use of a wide band of speech frequencies (100 to 5,000 cycles) which, while not high

fidelity, is still a distinct advance over the former installations which had only telephone quality (250 to 2,750 cycles). Receivers for conventional wavelengths have been made more rugged, easier to remove from the police car for servicing, and have been provided, by one company at least, with a special jack which will receive a tuning meter. The tuning mechanism, which often becomes detuned from the transmitter's wave by the constant vibration of the car, can be adjusted by means of the tuning meter to maximum signal and locked in a few minutes. In addition a receiver for the medium wave bands which mounts on the handlebars of a motorcycle has been developed.

MECHANICAL AND CATHODE-RAY SYSTEMS SHARE IN TELEVISION ADVANCE

TECHNICAL PROGRESS in television during the past year has shown that interest in the mechanical systems has been definitely revived, although the cathode-ray systems are still the engineering favorite. Capable of being controlled at the will of the operator, the electron beam in the cathode-ray tube is nevertheless an expensive servant, requiring complicated circuits not necessary in the mechanical systems.

The announcement of the Zworykin iconoscope, utilizing a photoelectric mosaic structure on which the optical image of the scene is focussed, was the

signal for a considerable increase in the public interest in television. Outdoor scenes can be televised with ease, by this device, which likewise eliminates the necessity for any moving parts in the transmitting system.

Also in the cathode-ray camp are the developments of Philo T. Farnsworth in Philadelphia, whose pick-up camera for television was recently demonstrated (August 27th) before the Franklin Institute. The optical image is focussed on a photoelectric plate in this device, and the resulting "electron picture" is drawn from the plate to an anode in the same tube and focussed magnetically. The electron picture is then moved bodily past a small aperture, so that each element of the scene contributes its own signal impulse. A unique electron multiplier increases the sensitivity of the output by a thousand times, making outdoor scenes comparatively simple subjects. The receiving equipment is of standard design, scanning and picture frequencies being provided in the receiving cathode-ray tube by electric and magnetic fields.

Of the mechanical systems, that of William Preiss of New York, is of considerable interest since it eliminates the necessity of a powerful synchronizing channel. A mirror, mounted so that it can rotate about two axes at right angles to one another is the central feature of the scanner. The scanning frequency, 5000 cycles per second, and the picture frequency, 18 cycles per second, are the frequencies of mechanical resonance of the mirror about these two axes, respectively. Small ($\frac{1}{2}$ watt) oscillators are able to maintain the vibration of the mirror at steady state, since the mechanical resonance of the system tends to keep the mirror in step. The mirror reflects the output of a light-modulating

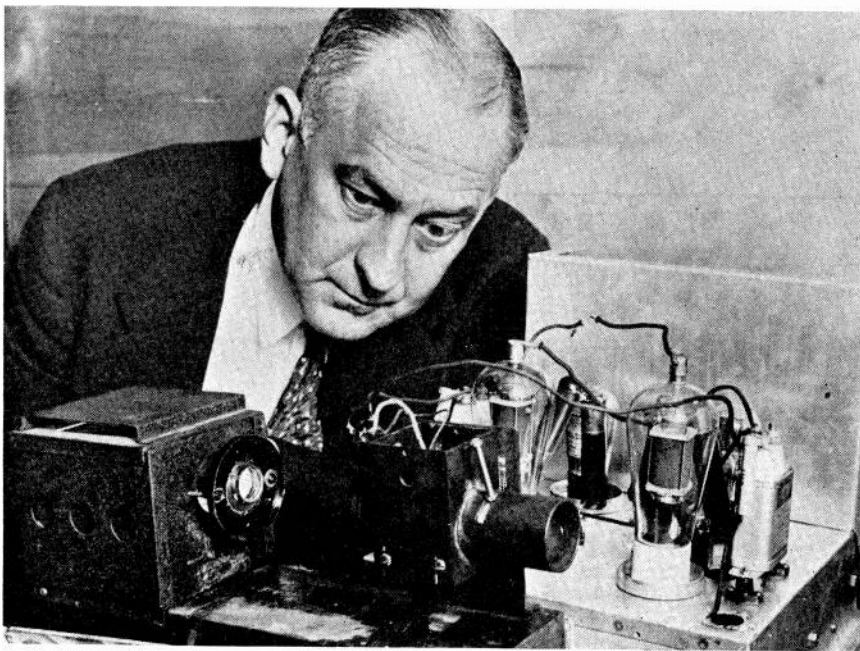

Three essential elements of the television receiver developed by William H. Peck, shown above. The light source (extreme left) provides a beam of white light which is modulated by the Kerr cell (center). The high-voltage amplifier (right) supplies the television signal to the Kerr cell.

ULTRA-SHORT WAVE USES

Kerr cell which admits light to the mirror in accordance with the incoming signal. Direct projection of pictures is possible with this method.

Arno Zillger has developed a mechanical system using a spirally shaped set of mirrors rotated by a synchronous motor. The resulting picture can be viewed in broad day-light and through a very wide angle, so that many "see-ers" may view the picture at once, seated in a semicircle about the receiver. The receiver is compact and can be used in conjunction with the sound receiver already possessed by the listener. In common with all the systems described here, transmission is intended for the five-meter band, so that local coverage of the large metropolitan areas is the limit, at least at present.

A mechanical system which has been developed to a high degree is that of William H. Peck. Using an automobile head-light lamp as the light source, and a small Kerr cell (consuming only 6

microamperes at approximately 1300 volts) for modulating the light beam provided from the lamp, black-and-white pictures of great detail and brilliance are obtained. The scanning mechanism in this system is a wheel of mirrored lenses, rotated at synchronous speed. A special motor having a speed 440 r.p.m. is used to transmit pictures directly from standard sound-picture film. Projected pictures two square feet in area are now available, but pictures eight times as large are claimed to be entirely feasible.

Several companies, particularly those interested in the mechanical methods see a distinct possibility of commercial television programs and receivers within the next year, at least for metropolitan areas.

Reports indicate that in Germany the use of film has progressed to the point where a picture is on the air 7 seconds after the camera is focussed on the scene. The endless film is wiped clear, resensitized, and re-exposed.

is being brought on the licensing authority to grant tickets to operate this kind of system without the necessity of standing a stiff examination on code or theory.

For some time the regular police wave-bands have been congested. But still more cities want police radio protection. And so, newer applicants for construction permits have been encouraged to try the very short wave band. A glance at the actions of the F.C.C. will show the acceleration in the granting of permits for police radio systems in the 30,100, 33,100, 37,100, and still higher frequency bands.

The number of channels available is very large; signals travel to the optical horizon and then disappear. Therefore the problems of long distance interference is nil. All the available frequencies are useful to as many communities as want them. The radiation efficiency of the antennas is high; little power is required. A 15-watt transmitter will cover an area 30 miles square with a suitable antenna. The transmitter and receiver are extremely simple.

Once the advantages of this region have enticed many services there, it is not unreasonable to expect a revision of our broadcast system, and other services offered to the listener. As the years go by an increasing migration to these high frequencies will be evident, and many of the trekkers will settle there never again to run the gamut of longer-wave difficulties.

TEN METERS AND BELOW — NEW SERVICES IN ONCE "USELESS" TERRITORY

WHAT PROMISES to be a gold rush to the nether regions seems to be starting into this vast territory. Already there are many services getting a foothold on various bands in the part of the spectrum once thought worthless. Police, aircraft, amateurs, television, facsimile, high fidelity broadcasting, all present uses of radio which do not require long distances to be spanned—all these are looking with interested eyes on the kilocycles below 10 meters.

Assignments to this region are now on an experimental basis, but it must be realized that once a service has got started—a municipal police system, for example,—it will be extremely difficult to chase it out. It has got a franchise on the ether which it will not relinquish without a struggle.

The increasing sales of so-called "transceivers," miniature combinations of receivers and transmitters, usually one or two-tube affairs operating from batteries, is an indication that the early days of radio may be re-enacted. Many of these small sets good for communication over a 5-mile range are being used by people who never heard of the F.C.C. and who have no idea of the Continental code. They bought a machine which enables them to talk to a friend several miles away, even though the two of them may be traveling in an automobile. It is not difficult to imagine this situation getting out of hand with millions of these cheap but effective personal communication stations getting on the air.

A band should definitely be set aside for this sort of service; the apparatus should be built so that adjacent services can not be jammed by inexperienced and untrained operators. Already pressure

ULTRA-SHORT WAVE BEACON GUIDES SHIP IN FOG



Signor Marconi and his wife aboard his yacht, on which is installed his newly developed safety beacon. An ultra-short wave beam and a submarine acoustic signal are used not only to guide the ship into harbor but to determine its exact distance from the transmitting location. The antennas and reflectors are shown mounted on the trussed platforms.

Assignments in the radio spectrum

ON JUNE 13, 1934, the distribution of radio frequency assignments issued by the Federal Communications Commission became officially effective for the United States, when the ratification of the acts of the International Radio Conference, held in 1932 at Madrid, was deposited in the archives of the Spanish government. The present picture of the radio spectrum thus becomes officially fixed for the next five years, since the acts of the next International Conference, to be held in Cairo, Egypt, in 1937 probably will not become effective until 1939.

Since the distribution of frequencies among the various radio services will be preserved without radical change until that time, the present situation is of particular interest to all those who have licenses or who anticipate applying for them. Recognizing this interest not only on the part of licensees but also of all engineers who have to do with radio transmission and reception in any of its forms, *Electronics* has prepared a chart based on the official compilation of the Federal Communications Commission. This chart, issued as a special supplement, will serve as reliable index of the radio spectrum for the next five years.

The chart shows the class of service which is used on each frequency. The license to use each channel is, of course, under the direct jurisdiction of the Commission, and may be revoked or transferred as required. Twenty-five different classifications of service, listed at the bottom of the chart, are included, each with its appropriate symbol. The bands of frequencies are not shown to the same scale as the individual channels but have been reduced in an approximately logarithmic proportion to their actual width.

Twenty-five classes listed

Those channels or bands which have no symbol are listed in the chart as "unassigned." These blank spaces are designated by the Commission as guard bands or as general communications channels. The guard bands on each side of the radio compass frequency at 375 kc. and those around the international distress and calling frequency at 500 kc. are typical examples; they serve the purpose of insuring that the guarded frequencies will not be subject to interference from adjoining channels.

The term general communication channel includes all channels which are not assigned to a specific service, such as fixed, aviation, amateur, broadcast, etc. This,

of course, also includes channels used by other nations, which would then not be assignable in the United States unless such assignments could be made without possibility of interference.

The new experimental broadcast frequencies, namely 1530, 1550, and 1570 kc. were specifically designated by the Commission for this new service, and the space between them is not at the present time assigned. The general feeling is that if the high fidelity broadcasting experiments are as successful as is now hoped for, it will be desirable to assign such stations on a 20 kc. channel basis rather than the 10 kc. channel separation used in the regular broadcast band from 550 to 1500 kc.

Basic divisions will remain unchanged

The chart represents at the present time the most up-to-date information available concerning the allocation of frequencies in the United States. It is expected that all the basic divisions will remain pretty much unchanged until after the Cairo Conference of 1937, although very minor changes in the allocation of specific frequencies to certain minor services may call for the redesignation of a channel here and there from time to time. All of this, of course, must be done within the general framework of the Madrid Convention and General Radio Regulations, and the North American Agreement.

Where channels are shown as shared in two or more columns in this chart, it means that the particular channel in question is shared by the services shown in the legend. Except for the frequencies below the broadcasting band, the allocation system is based upon an approximate separation of 0.1 per cent of the assignable frequencies, in accordance with Opinion No. 18 adopted at the 1929 meeting of the C.C.I.R. held at The Hague.

To aid in showing the various frequency bands, identifying backgrounds have been used in some cases. Hence the broadcast services (local, regional, cleared channel, experimental, relay) have been grouped together, as have the maritime services (ship telegraph, telephone, harbor, and coastal telegraph, telephone and harbor). Other predominant services, such as fixed point-to-point, government (including army and navy stations), and amateur are also shown with identifying backgrounds.

THE CHART OF FREQUENCIES WITH THIS ISSUE

Listing the class of service in use on every assigned channel from 30,000 meters to 75 centimeters, the supplement to this issue, "Frequency Assignments in the Radio Spectrum for Stations in the United States", is the only complete chart of frequency allocation now available. Based on the compilation of the Federal Communications Commission and effective as of June 13, 1934, the present distribution of frequencies may be expected to remain virtually unchanged for the next five years.

Counting traffic

Photo-cell circuits at
Cairo, Ill., bridge

AUTOMOBILES crossing the bridge over the Mississippi River at Cairo, Ill., are counted and reported to the toll-house by means of a totalizing installation which disregards foot-passengers. Two light-beams and two photo-cells are used, the horizontal beams being projected at an angle rather than directly across the bridge right-of-way. The device separately counts and records cars moving in either direction as rapidly as 35 miles per hour. Because of the angular position of the two beams, which must be simultaneously intercepted in order to register, both trailers and individuals on foot are ignored in the count. The slight angle of the beam (20 degrees) prevents the beam being re-established between a car and its trailer, and thus registering two vehicles instead of the single unit.

Traffic moves through the beams in both directions, so that there is a slight possibility of error if two cars happen to pass at the exact position of the beams, but this actual error in count has been shown by experience to be less than one-half of one per cent. Originally it had been planned to install four beams, two for traffic in each direction, so that a separate count would be obtained. But by going to the single pair of beams, projected across both lanes of travel, the initial cost was reduced fifty per cent.

The height of the beams, 44 inches, was selected after careful study and experiment. Wide variations were found in the heights of the cars, some of the old '23 and '24 models being in marked contrast with the under-slung late models. The beams, it was found, should be

as high as possible in order to avoid shooting under the bodies of large trucks, and also to avoid being intercepted by the spokes of wheels which would give false registrations.

With the light-sources and photo-cells at this low level, it meant that the photo-electric equipment was in danger of being tampered with by persons on the bridge. While the light-sources and photo-tubes were enclosed in weatherproof cases, which are padlocked and thus protected, there remained the possibility that some one might try to render the equipment inoperative by blocking the light-sources or the aperture of the photo-tube housings. In order to cope with this possibility, there were installed in the counter cabinet in the toll-house, three devices which become involved if the equipment is rendered inoperative by the external blocking just mentioned or because of the failure of one of the vacuum tubes. After an outage of a few seconds, a bell alarm in the counter cabinet is set off and continues to ring until the trouble is cleared and the machine restored to operating condition. In addition to the bell alarm, an "outage counter" registers the outage. At the same time, a self-starting electric clock, which is normally set at twelve o'clock, starts to run, thus indicating to the second the length of time that the counter was out of service.

"One of the problems of this installation," according to Russell C. Wenz of the Byllesby Engineering & Management Corporation, who supervised the job, "was to secure a counter which would consume a small amount

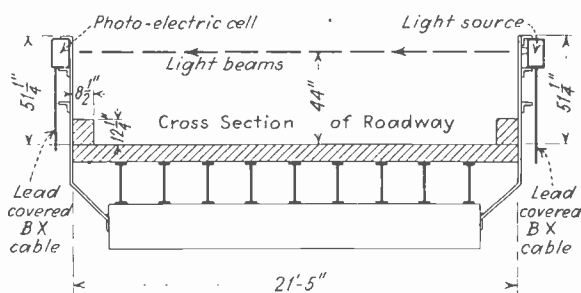

Showing height of light beams

of current and which could register an impulse and dissipate the residual current in time to register a car which might be closely following in the same direction the first one registered. This meant that the counter had to be energized, register the count and deenergize, all in a fraction of a second. We found that the Production Instrument Company of Chicago had a counter capable of registering 25,000 counts an hour, or approximately seven impulses a second. The total power used by this instrument is six watts. The pick-up current on 115-volt 60-cycle current is 0.213 amp. and the holding current is 0.13 amp."

The installation has now been in use over six months, during which time 40,000 vehicles have been counted. A two-weeks' test showed a photo-electric record of 4,068 vehicles, as against fare collections of 4,051, an operating error of four-tenths of one per cent.

During this two-week period of test, only two outages occurred. One "outage" was caused by a truck which stopped on the bridge opposite the lights long enough to cause the alarm bell to ring, and the incident to be recorded as an "outage." The second outage was caused by a painter working on one of the projection standards. Neither outage lasted more than a fraction of a minute.

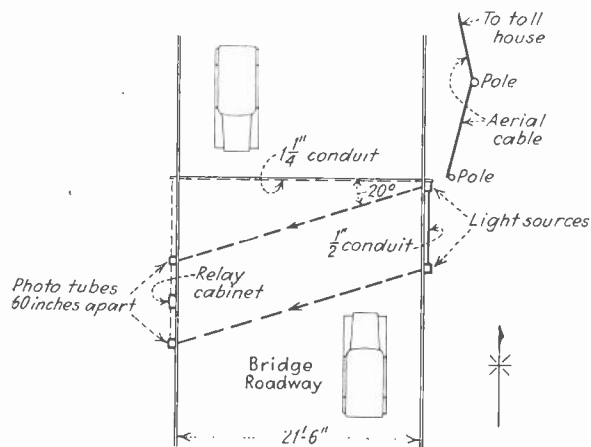

Layout of photo-cell light beams

NEW THINGS AHEAD IN

"All-wave" reception will continue to be
the star feature

SINCE the introduction of the a-c set, nothing has given the radio industry such a stimulus as the "all-wave" receiver. Each year radios were somewhat different, better in some respects—if not in tone quality—but the addition of the new service of short-wave reception at one stroke makes all previous receivers obsolete. It is not easy to demonstrate the advantages of automatic volume control, or the other tricks of circuit designers—but let the would-be purchaser tune in one of the foreign stations and his old gambling instinct is aroused, here is new adventure via radio. And once having given a new service to the public, they will never relinquish it. All receivers must be able to tune to at least one short-wave band from now on.

So important has the short-wave idea become that few receivers will be sold which do not offer part of the spectrum below 200 meters, and in time they must all cover the entire range down to 10 meters. The short-wave portions of most sets sold last year were pretty poor, a mere adjunct with little gain or selectivity and poorer quality, due largely to the character of the programs and the intervening ether path. But in 1934, late, new short-wave sets will be on the market which will begin to show the possibilities in this direction. Fortunately the higher frequencies are relatively efficient in getting across great distances, and fortunately again, the average listener antenna has about the correct dimensions for picking up a healthy voltage from an oncoming wavefront on wavelengths below 200 meters. And so, even if the set was poor, many listeners were able to re-

new their acquaintance with the old-time thrills of "dx," but with the difference that no one in 1925 would have dreamed of world-wide dx of the sort that is now possible.

The sets of Autumn and early 1935 will have better tuning systems; they will show better signal-to-noise ratio, they will have more selectivity and more gain. Tuning will be easier, programs will be improved.

It is rumored that several of the large American companies spending money on the air realize the present craze for listening to Madrid, England, France and Germany and are thinking of spending some of their advertising appropriation abroad sending programs back to this country via one of the foreign stations.

Improvements in short-wave reception will come about by better circuits, better switching systems, better coils, and perhaps better tubes. Some work is being done to overcome the type of fading in which the carrier becomes relatively weaker than the sidebands by installing a local carrier at the receiver to pick up the modulation from abroad and to transfer it without variation to the detector.

There has been some argument from the more conservative members of the radio industry that short-wave was a fad, and a poor one at that, and that most city dwellers would not get their money's worth because of local noise. Others feel, however, that the vast rural audience which resides in fairly noise-free areas will act as a buffer for the city listeners, absorbing the all-wave sets until engineers have mastered the present difficulties in the way of giving everyone good reception on the higher megacycles.

Short-wave reception represents a new service which must continue to be available; the listeners will not let go of it.

New tubes

It has been a good spell since rumors of new tubes flew so thick and fast. Tubes as small as your thumb, tubes in 199 type bulbs, tubes smaller than this, tubes with metal plates exposed to the cooling air currents, etc., etc.

Receiver design engineers struggling with the short-wave problem believe that smaller tubes with corresponding smaller capacities between elements would provide a much needed weapon for them to work with. What are needed are tubes for the first few sockets, in the pre-selector r-f stages where it is difficult to get much gain, and where it is of such importance to increase the signal to noise ratio. For these problems it is possible that a high frequency pentode of half the present size may appear.

Other engineers look at the English Catkin tubes with more than passing interest. The saving in space in having the anode of a power output tube on the outside where it can be its own radiator of heat would be con-

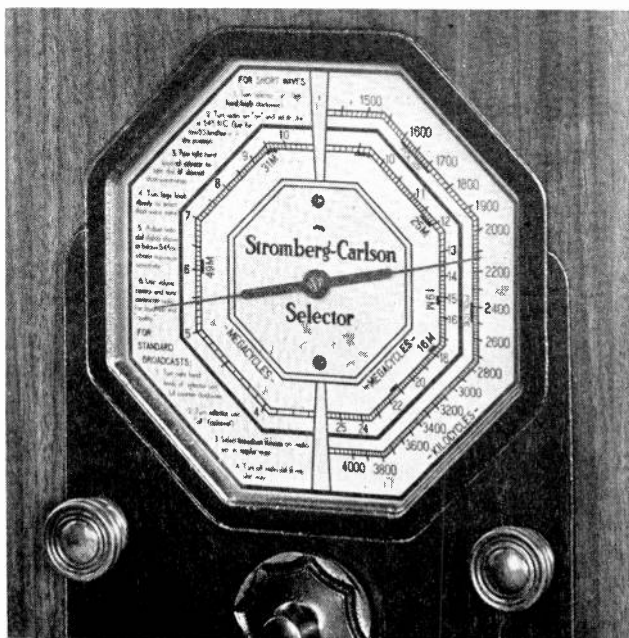

A good example of the airplane type dial, which came in with short-wave models.

RADIO SETS AND TUBES

Sales of sets and tubes greatly in excess
of 1933 at higher unit price

siderable. And so they hope some enterprising tube maker will develop for them, particularly for the automobile receiver, a small power tube.

Rumors have suggested the production of an electron-coupled oscillator with an internal shield—already in use abroad. And it is said that a set of tubes in 199 envelopes has been submitted to several of the tube and set makers with the ideas of adapting them to the 6-volt series. The objections to such a set of tubes are that there is scarcely enough differential in size to warrant their introduction, that what is needed is a much smaller tube. Furthermore since the bases would be different they would not be interchangeable with the older automobile tubes. And while a reviewer is on dangerous ground when he speculates as to what will happen, it seems unlikely that this set of tubes will grace the dealers' shelves.

First half-year figures are encouraging

Approximately 790,000 radio sets, representing \$16,000,000 at manufacturers' net prices, were produced and sold during the second quarter of 1934.

This represents a sharp reduction from the 984,746 sets produced and sold during the first quarter of 1934; also a drop below the corresponding unit figures for the same period of 1933, 848,302 sets, although an increase above the dollar volume for the 1933 second quarter, which was \$12,253,400. From this it may be concluded that the unit price of radio sets has risen considerably during the past twelve months, the average retail value having gone up from \$33.60 for the 1933 second quarter, to about \$40.50 for the 1934 second quarter.

An increase in unit set value of 20 per cent, is indicated

by these figures, showing that the consoles and higher-priced models are again coming to the fore, and that the recent popularity of the midget and cigar-box models is waning.

Automobile radio sets have not come up to expectations for 1934, it now is apparent. Sales of these units for automobile installation have run considerably behind the budgets set up by the makers at the beginning of the year, based on 1933 sales. It is this drop in automobile sets which mainly accounts for the 1934 second quarter figures falling behind 1933 for the same period.

Total sales of radio sets for the first half of 1934 are still considerably ahead of the first half of 1933. The first six months of 1933 produced 1,436,134 sets; and the first six months of 1934, 1,774,746 sets. The corresponding dollar volumes rose from \$21,000,000 to \$35,000,000.

Looking back on preceding years, 46 per cent of the total 1932 output was reported in the first half of that year; while 30 per cent of 1933's output came in the first six months.

Averaging these half-year ratios, and applying them to the figures for the first half of 1934, so far available, indicates that the total year's production for 1934 will be about 4,400,000 radio sets.

High fidelity—what of it?

Several truly high fidelity sets will be available for Fall trade, and of course there will be others using the name which will not have such good qualities, horning in on the merits of the others. Already there is at least one "high-fidelity" set which is no larger than a midget, tombstone model, and what its characteristics really are is not difficult to guess.

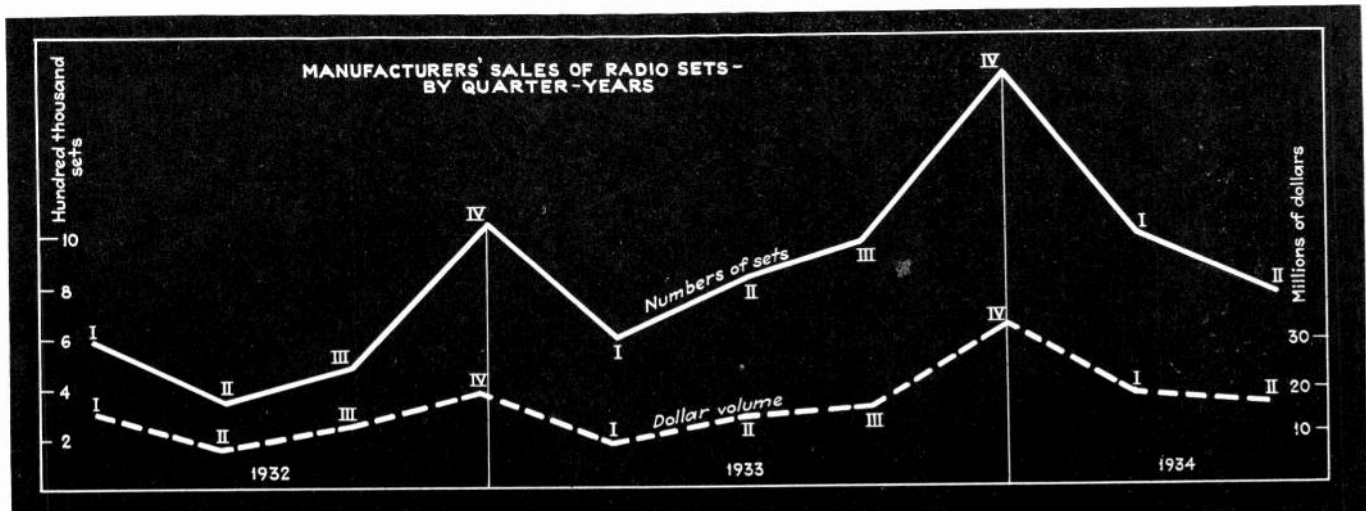

Radio manufacturers produced approximately 790,000 radio sets during the second quarter of 1934, or 1,774,746 sets during the first half of the year. Quarterly production figures for 1932 and 1933 are shown for comparison. Compared with 1933, dollar volume and unit prices are considerably up.

At present it seems that high fidelity will not create much of a stir. 1934-1935 will be "all-wave" years in the chronology of the industry. High-fidelity must take its winnings later, if ever. The chances are that high fidelity will be a slow process creeping into all phases of the industry. As soon as some really high class sets come on the market, others will try to get sufficient fidelity into cheaper sets to create competition—and all this will serve to better the general run of receivers, now admittedly poor. This Fall many receivers will mark new low-water marks in freedom from harmonic distortion, in power output, and in wide range of tone. The higher frequencies will be improved somewhat — but probably not much. Ultimately everyone will wonder why we tolerated the flat-toned, skimpy receivers of 1933 and 1934.

High fidelity is not a new service; it is an improvement difficult to demonstrate on the average station on the average program. Therefore it cannot hope to attract so much attention as the all-wave feature.

High-fidelity sets will not have short-wave at first and therefore the price differential between the best of the medium fidelity and the high fidelity will be relatively more than the actual list price indicates. The Philco 200X receiver, high-fidelity, will list at \$200; the next best set, which is all-wave and medium fidelity, lists at \$175. Will the listener pay \$25 more for better tone and forego the pleasures of listening to whatever he can get from Buenos Aires?

In time the bass must be improved; means must be provided for boosting it or lowering it to take care of bad microphone technique. For example what will be the practice in handling the announcing microphone circuits in the future? Will the announcer continue to break the ear drums of the listener or will his bass be attenuated somewhat so that the volume may be up to drill the sales talk into the listener with plenty of punch without booming too much? One engineer believes that in the future the announcing circuits should be dropped considerably at the low end while the program circuits are boosted, relatively, at the low end so that both program and talk sound more like their normal levels. He quotes Dr. Fletcher's work in showing the vast difference in output of the average speaking voice and a full orchestra. At present the announcer is cranked up at the microphone many db to attempt to get over the message at the same level as the music—an obvious distortion.

More power output will be necessary from high-fidelity receivers. Already there are on the market sets which will produce 10 to 15 watts of relatively distortion-free output. One set designed to deliver 18 watts was found to produce 30—on peaks, of course.

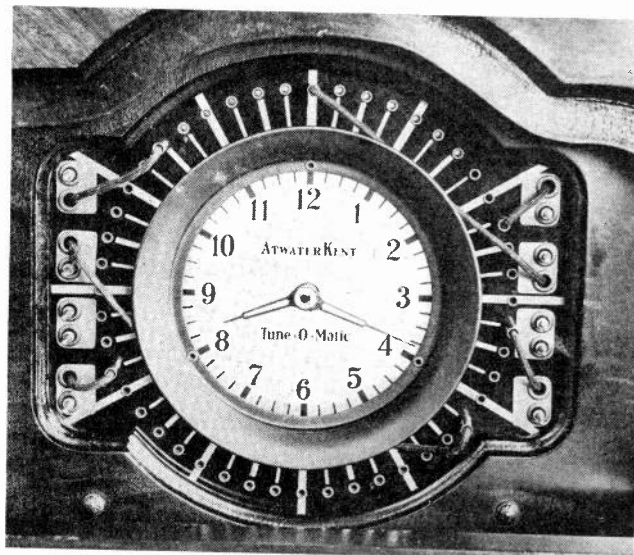

A program pre-selecting system—will it mark a new service ultimately to be in all models?

Equipment manufacturers state that they are receiving requests from broadcast station engineers for information on high-fidelity components, modulation equipment and for measuring apparatus that will enable the operators to prevent over-shooting and other types of distortion. These are encouraging signs. The broadcasters are still far ahead of the receiver people who are still nickel-conscious. Even under conditions of considerable noise, a high fidelity receiver sounds better, more alive, with better intelligibility provided it is comparatively free from internal distortion—and so as the tone range is broadened the public will slowly get accustomed to music and will forget radio.

New components, new materials

Parts manufacturers have, to some extent, sensed a let-up in the cry for lower prices. They have, during the past two years, redesigned their products with different raw materials, different methods of construction, different methods of mounting—all to save money for the set assembler. Iron for tubes and for coils has made its appearance and will continue to attract users. Already one nationally known receiver has used iron-core coils and at least two competitive products are on the American market. Mr. Polydoroff on a recent visit

[Please turn to page 293]

HOME RADIO WILL PRINT NEWSPAPER WHILE YOU SLEEP

The day will come when one will turn on the facsimile receiver when retiring and in the morning the paper tape will tell the story of what flashed through the sky while you slumbered. It will contain road maps, fashion designs, comic sketches for the children, and no end of things, for whatever a pen can portray facsimile radio will handle.

—M. H. AYLESWORTH
President, National Broadcasting Company

Testing capacitors and resistors—

for radio set

production

By C. G. SERIGHT

General Household Utilities Company
Marion, Indiana

MODERN radio set design calls for a multiplicity of small resistors and condensers, usually performing a circuit isolation function. These small units must have resistance or capacity values falling within certain prescribed limits, and although these limits may be rather wide, the units must be tested to determine if they will perform as the circuit demands.

It is convenient to call a test for condensers a capacity test, but it is interesting to note that small condensers are rarely actually tested for capacity; they are tested for reactance on an apparatus calibrated in capacity. Small capacities are best tested on an a-c bridge. Thus the circuit in Fig. 1 comprises two equal resistance arms, and two capacity arms, one of which is a calibrated variable condenser, and the other the condenser to be tested. Across the bridge are connected an a-c source, and an aural indicator, such as head-phones. The calibrated condenser is adjusted to its null-point whereupon the reactances and therefore the capacities of the condensers will be equal, and the unknown capacity can be read from the scale of the calibrated condenser.

Accurate measurement, rapid operation, and wide capacity range are the essential qualifications of a bridge for production testing. For such work, it would be advantageous to have the bridge indicate deviations of the tested condenser from rated capacity in percentage; but the effect of unavoidable distributed and ground capacities makes it impossible to construct such a bridge for testing an extensive range of small capacities. The percent-limit principle can be applied only indirectly.

A bridge designed for speed

For rapid testing of small condensers the writer constructed a bridge of rather novel design. The capacity range covered was 0.0015 to 0.15 $\mu\text{f.}$; the tolerance range, 0 to 15 per cent.

The circuit diagram is given in Fig. 2. To encompass the required range of capacities, a multiple ratio circuit was adopted, but no reliance other than constancy was placed upon the ratio of the arms in obtaining the capacity indication. The bridge was completely calibrated after construction.

A fixed resistance was inserted in one arm. The other resistance arm was tapped at twelve points, successive taps being related by a factor of $3/2$. The taps were connected to a twelve point switch, for controlling the bridge ratio. The switch was equipped with a pointer knob, and a scale on the panel indicating numbered positions, the scale bearing the superscription, "Use dial No."

In a third arm a 0.002 $\mu\text{f.}$ variable condenser, shunted by a 0.002 $\mu\text{f.}$ fixed condenser, provided a testing range of one-half of the maximum capacity tested on each setting of the ratio switch, with successive ranges overlapping about 20 per cent.

The variable condenser was fitted with a composite dial, consisting of a large knob and base-plate, twelve interchangeable scale plates calibrated for as many ranges in capacity, two adjustable limit pointers and a heavy, clamping ring, the whole assembly being bound together with two thumb-nuts. The knob and base-plate were locked permanently in place on the condenser shaft. The copper scale-plates were numbered to correspond with the settings of the ratio switch. They were stored in a rack, suggestive of a phonograph record file, fastened to the side of the cabinet.

A rheostat in series with the variable-fixed condenser combination provided the necessary phase-angle control. The range of this resistance was such that a null adjustment could not be obtained for tested condensers having an excessive power-factor; and defective condensers were therefore rejected.

To make contact to the tested condenser a pair of scissors-like clips, adjusted to accommodate various sized condensers were provided on a shelf projecting from the panel.

Other bridge equipment

So that it might be available for other uses the 1,000 cycle tuning-fork oscillator used to excite the bridge was not included in the cabinet; but a shielded input transformer was incorporated in the circuit, and its primary leads brought out to binding posts for connection of the oscillator.

To assure adequate volume to override high room-noise levels, a high gain output amplifier was incorporated in the test. Audio transformers were used which discriminated against harmonics of 1,000 cycles. (Harmonics transmitted through a bridge tend to mask the null-point of the fundamental. To eliminate these, a harmonic filter is sometimes used. Harmonics introduced after the bridge, as by output amplifier distortion, however, are of no consequence, as they disappear with the fundamental at its null-point.) Very low plate potential was used, to prevent ear-splitting volume on off-balance adjustments as when changing tested condensers.

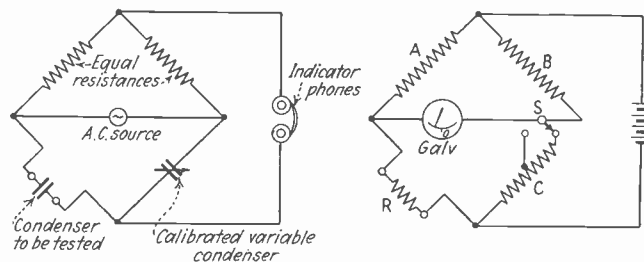

Fig. 1—Left: Fundamental bridge circuit for testing capacities. Right: Percent-limit resistor test circuit.

The amplifier simply overloaded when the maximum tolerable sound-pressure in the phones was reached. At the same time, quite enough gain was obtained on low inputs obtaining around the null-point. Non-microphonic, 227 type tubes were selected for the amplifier.

To avoid inaccuracies resulting from coupling between the input and output circuits, the input and audio transformers were placed in separate compartments, and magnetic coupling carefully eliminated. Space was provided in the cabinet for the battery complement: four No. 6 dry cells, and a small, tapped "B" battery.

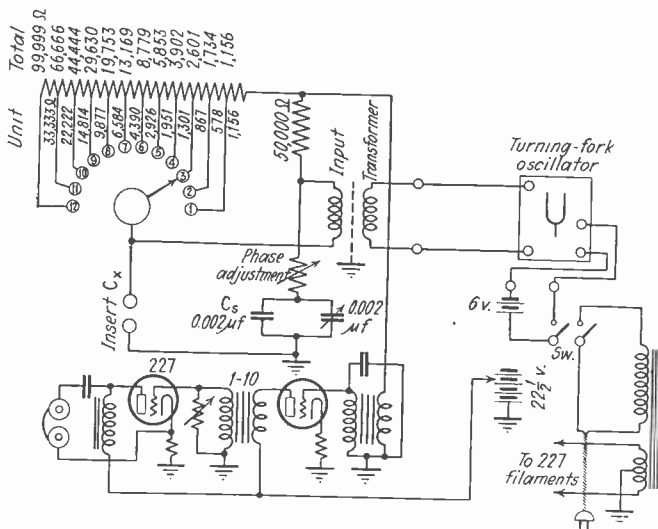

Fig. 2—Capacity-testing circuit, with range from 0.0015 to 0.15 $\mu\text{f.}$, adapted to rapid production inspection.

The cabinet was of sheet metal, with internal shielding between various parts of the circuit. To achieve professional appearance, the panel was finished in the conventional black enamel, with white lettering.

The calibration process

To begin the calibration, the ratio switch was set on position 1, and plate No. 1 fastened in place on the condenser dial. A standard condenser, adjustable between 0.1 and 0.2 $\mu\text{f.}$, was connected to the scissors clips. Marks were made on the scale-plate at the null-points obtained for representative settings of the standard capacity between 0.1 and 0.18 $\mu\text{f.}$ The plate was then removed, and a well divided graduation in microfarads laid out on it by interpolation. The rest of the scale plates were in turn calibrated in like manner. Then they were engraved, sanded to a satin finish, and nickel-plated. Thus, the capacity range 0.001 to 0.18 $\mu\text{f.}$ was covered by a continuous calibration which was spread over more than six feet of dial periphery, not counting overlapping portions at the end of each scale.

Procedure in testing

When tolerances were given in percentage they were first translated into microfarads. Then the dial scale having in its scope the required capacity range was selected from the rack and placed on the composite dial, the limit pointers adjusted, and the dial assembly locked together by tightening the thumb-nuts. The ratio switch was turned to the number of the dial scale.

A specimen of the condensers to be tested was inserted into the scissors clips. Using the left hand to adjust the phase-angle-balance knob, and the right to operate the dial, the null-point could be accurately and

quickly located. If the dial adjustment giving no sound in the phones came between the limit markers, the condenser was passed; if not, it was rejected.

As may be seen after the initial adjustments were made, absolutely no technical skill was required to operate the bridge. The capacity indication was reliable to within $\frac{1}{2}$ of 1 per cent.

Apparatus for rapid resistance testing

Two types of apparatus are used in testing resistances of the values most frequently encountered in radio work. These are the ohmmeter and the resistance bridge.

Each type of equipment has advantages not possessed by the other for certain classes of work. For instance, the ohmmeter is better adapted for such uses as continuity testing, testing volume controls for "taper," etc.; it is perhaps the simplest instrument yet devised which is capable of measuring resistances ranging from 1 ohm to 1 megohm accurately enough for most ordinary purposes.

On the other hand, highly accurate measurements are more easily obtained with the bridge. A modified circuit, the percent-limit bridge, in addition is quite rapid in testing quantities of resistors of like rating. For example it is convenient to express production tolerances in per cent plus or minus a nominal or rated value. No discrimination is ordinarily made between units falling anywhere within the tolerance limits. The percent-limit resistance bridge makes only one discrimination between tested resistors: either they are within the limits, or else they are not within the limits.

In Fig. 1, let us give R, the resistance to be tested, a rating of 10 ohms, with tolerance limits of plus or minus 10 per cent. A is a "standard" resistance of 10 ohms. B is, say 5 ohms, and C has a total resistance of 5.5 ohms (B plus 10 per cent) and is tapped at 4.5 ohms (B minus 10 per cent.)

It can be seen that if the galvanometer needle reverses its direction of deflection from the zero line when

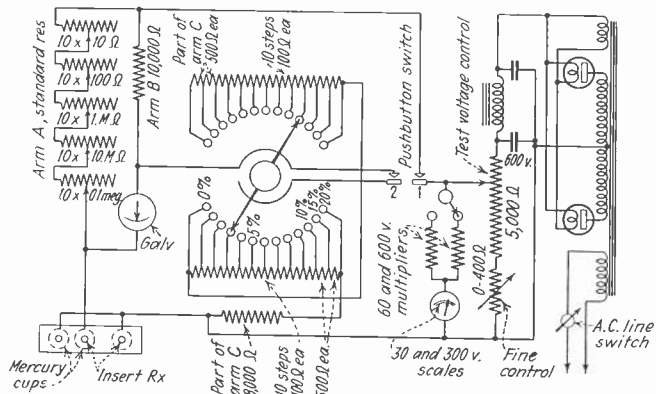

Fig. 3—The allowed tolerance can be set up directly by the operation in this resistance test circuit.

switch S is thrown, R will be within 10 per cent of 10 ohms. If the direction of deflection is unchanged but only the amount of deflection changes then R will be found to differ by more than 10 per cent from 10 ohms.

Thus, while not showing the actual resistance of a tested resistor, such a circuit will show whether or not the resistor is within the prescribed tolerance limits. Testing of quantities of resistors of like rating can therefore be accomplished at a very rapid rate by this method.

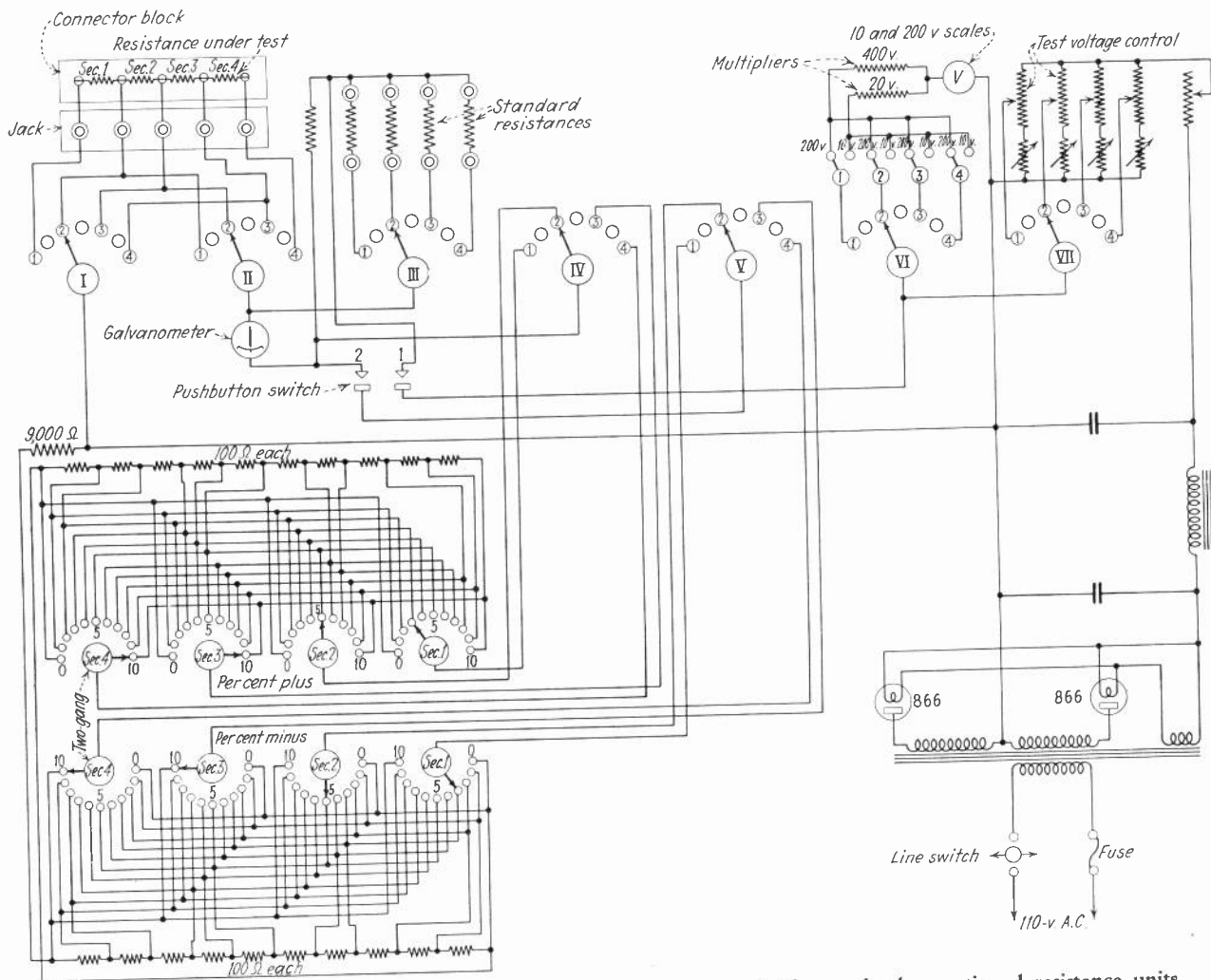

Fig. 4—A unique circuit for testing the individual sections of voltage dividers and other sectioned resistance units. It uses the same basic circuit as described in the text. The seven switches are mounted on a single shaft.

Carbon resistors used in modern radio sets range in resistance from a few hundred ohms to a megohm and more. They have a high voltage coefficient of resistance, making it desirable to test them on the same potential they will have to assume in the set. Also the allowable deviation from rated resistance may run anywhere up to perhaps 20 per cent. The necessary latitude of test conditions was provided for in the bridge in Fig. 3.

A very sensitive galvanometer of the string suspension type was used. The standard resistance arm of the bridge (A, Fig. 3) was made always equal to the rated resistance of the resistor being tested. This simplified preliminary adjustment of the bridge, and also facilitated measurement of the voltage applied to the resistor being tested. A five section decade was constructed to serve as the standard resistance. This decade covered the range of 0 to 1 megohm in 10 ohm steps.

The optimum resistance for arms B and C, being dependent upon both the resistance of A and R_x and the resistance of the galvanometer, was found by experiment to be about 10,000 ohms each, this value giving the highest sensitivity in testing high resistances.

A two-gang switch connected to a pair of tapped resistors included in arm C provided a selection of percentage limits up to 20 per cent. The switch picked out taps at points equidistant above and below the mean value of 10,000 ohms maintained in arm C, and connected these taps to the galvanometer switch.

A rectifier and filter circuit terminating in a low re-

sistance slider type voltage divider supplied any desired exciting potential up to 600 volts. The exciting potential was measured with a voltmeter equipped with 60 and 600 volt multipliers and 30 and 300 volt scales, so as to indicate one-half the voltage impressed across the bridge, which was substantially the portion of the impressed voltage appearing across the tested resistor.

A double push-button switch constituted the only active operating control. Pressing button No. 1 connected the exciting voltage to the bridge. Pressing the second button then changed the bridge ratio from the plus limit to the minus limit, thereby effecting the measurement.

To make the necessary adjustments preliminary to testing a batch of resistors, the percentage switch and voltage divider slider were set at 0, and the a-c line switch turned on. A specimen of the resistors to be tested was inserted into the mercury-cup contacts and the decade switches set at its rated resistance. Then, while holding down push-button No. 1, the voltage was raised until the voltmeter indicated the voltage on which the resistors were to be used. Then the percent-limit switch was turned to the desired limits, whereupon the bridge was ready for use, no further adjustments being necessary until resistors of a different rating were to be tested.

This bridge represented perhaps the nearest approach to absolute accuracy that would be practical for production work. It is worth noting, however, that speed in testing was not sacrificed in attaining high accuracy.

Design and use of

"acorn" tubes

for ultra-high frequencies

By BERNARD SALZBERG

Research and Development Laboratory
RCA Radiotron Co., Inc., Harrison, N. J.

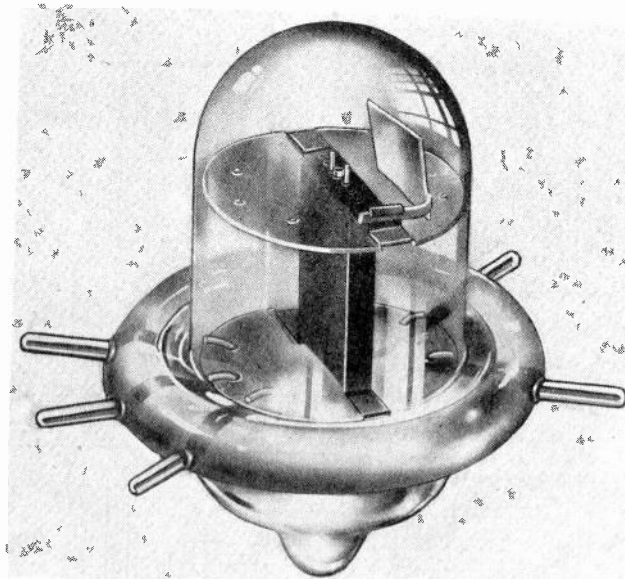
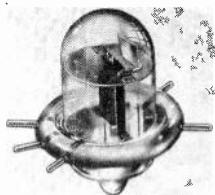

Fig. 1—Leads coming through the heavy glass seal form the base. The tube at the left is actual size.

EARLY work on the extension of the high-frequency limit of receiving equipment indicated that in conventional circuits employing standard tubes, the tubes became less and less effective as the frequency was increased and that ultimately, at frequencies of the order of 200 megacycles, tubes were practically useless. B. J. Thompson and G. M. Rose, Jr., conclusively demonstrated that the limitations to the successful operation of vacuum tubes at the higher frequencies may be overcome by reducing the dimensions of the tubes.^{1, 2} The small tubes which they built, being intended for a research study, were not suited for manufacture. However, the possibilities of these tubes aroused an interest sufficiently wide-spread to warrant their further development for use by experimenters. This article deals with the factors which were involved in the design and application of the first of such tubes, a Lilliputian triode.

If all of the linear dimensions of a tube are decreased by a constant factor, say n , then the plate current, transconductance, amplification factor, and plate resistance will remain substantially constant, but the lead inductances, the tube capacitances, and the time of transit will be decreased by the factor n . Furthermore, the re-

▼
FIRST announced in August 1933 issue of *Electronics*, the "acorn" tubes which amplify, oscillate, and detect on waves as short as 40 centimeters have now reached the stage of practical manufacture. The present article deals with the design and application of the triode and indicates that it may soon be available for experimental purposes, at least.

quired heater power will be decreased by n^2 , the allowable plate dissipation will be decreased by n^2 , the current densities will be increased by n^2 , and the bulb temperature will be increased by a factor somewhat less than n^2 . Physically, the tube will be reduced in its overall dimensions by factor n , and in its weight by a factor n^3 . For mechanical reasons, however, it is not feasible to reduce all of the tube dimensions to the same degree. For example, a reduction by a factor of four of all of the linear dimensions of the Type 56 would require grid side-rods of 0.00625 in. dia., grid wire of 0.00083 in. dia., a cathode sleeve of 0.0125 in. dia., and a cathode coating of approximately 0.00075 in. thickness. Parts of such minute dimensions would be extremely difficult to manufacture with present-day equipment. Consequently, as is usual in many engineering problems, it is necessary to arrive at a practical solution which will give the essential results.

Electrical and mechanical requirements

In addition to design limitations imposed by physical structure, a number of electrical requirements must be considered in the design of small tubes. For example, it is desirable that the triode be of the "general purpose" variety, i.e., that it be suitable for operation as an r-f amplifier, and an a-f amplifier, a grid- or plate-circuit detector, and a low-power oscillator. Furthermore, it should be suitable for battery and a-c operation and require a minimum of heater power. Its electrode voltages and currents should be such as to fit, in so far as possible, existing auxiliary circuit equipment. Good life performance is also an essential requirement. As regards external structure, it is imperative that the basing scheme permit aging and testing operations to be carried out conveniently in the factory and allow easy insertion of the tube in circuit equipment without introducing undue losses. The placing of the lead terminals should be made so that they permit short circuit connections. Finally, it is desirable that the tube design be suitable for economical production maintainable within reasonably close electrical limits.

▲
These considerations circumscribe the design of the tube. Its static characteristics must be set by a study

of the various uses to which the tube might be put and by a careful weighing of their relative importance. For the tube shown in Fig. 1, such considerations indicated the desirability of obtaining a plate resistance of the order of 10-15 kilohms and an amplification factor above 15,

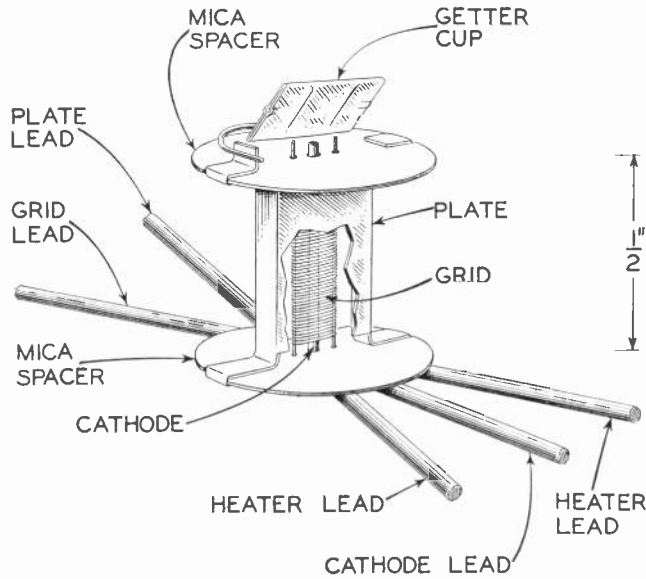

Fig. 2—Structural details of mount assembly. Note the half-inch scale.

together with a ratio of transconductance to plate current as high as possible. To effect a significant improvement in high-frequency behaviour, and yet have a tube which could be manufactured, the electrode spacings were reduced to minimum distances of the order of 0.005 in. This reduction extends the upper frequency limit of operation beyond that of existing commercial triodes by a factor of approximately 4 and at the same time, keeps the design of the tube within the realm of attainable manufacturing technique. To make the tube convenient for general battery and a-c use, the heater voltage was set at 6.3 volts. A conventional cylindrical cathode of the smallest practical diameter is employed in order to realize the minimum heater power. Its length was chosen so that the lowest plate resistance consistent with low interelectrode capacitances could be obtained. A plate voltage of 180 volts was found to be consistent with the low transit time requirement and with good life performance. To obtain short leads, low losses, suitable means for effective by-passing at the higher frequencies, and a practical form of base, it was necessary to abandon the conventional form of pinch stem and standard base assembly. Instead, the tube elements were connected to heavy leads suitably positioned and fastened to a mica spacer; these leads were then sealed in and used as base pins.

Constructional details

The actual calculations involved in the design of this small triode are similar in all respects to the usual tube-structure calculations. These are of a semi-empirical nature, based in part upon approximate analyses of the electrical field of tubes of ideal configurations, and in part upon known derivations of the space-charge-limited current between the elements of diodes of simple geometrical shape.³

A representative tube, based on these design considerations is shown in Fig. 1. Details of tube structure are illustrated in Fig. 2. The tube consists of a cylindrical

cathode enclosing the insulated heater, an elliptical grid with a large number of turns, and a rectangular plate. The cross section of the grid is elliptical to reduce the otherwise severe control effects of the side rods. The elements are spaced very closely along the minor axis of the grid—where the cathode emission is most useful—in order to reduce the transit time and increase the transconductance, and somewhat less closely along the major axis in order to decrease the capacitances and increase the structural strength. Two accurately punched mica spacers serve to hold the elements in position, the whole assembly being fastened in place by means of small lugs which are bent out from the ends of the plate. One of the mica spacers is used as a sort of stem, the heavy base pins and the lighter leads to the electrodes being fastened around its periphery as shown in Fig. 2. The getter material is enclosed within a flat tab welded to one of the plate lugs. The mount is placed within a bulb which consists initially of two cup-shaped heavy glass sections, the shallower one of which has an exhaust pipe attached to it. The seal is of the "joined-flare-seal" type, and is made at the plane of the tube leads between the two glass sections. After sealing, the tube is exhausted, the exhaust pipe is tipped off, and the base pins are cut quite short. The combination of the heavy glass of the joined-flare seal and the stub-pins constitutes a practical and extremely sturdy base. This arrangement obviates the need for soldering the tube to the circuit elements and also avoids the deleterious effects of the conventional base. The leads themselves are radial, the two heater leads being symmetrically placed 30 deg. on either side of the cathode leads, the grid and plate leads, 60

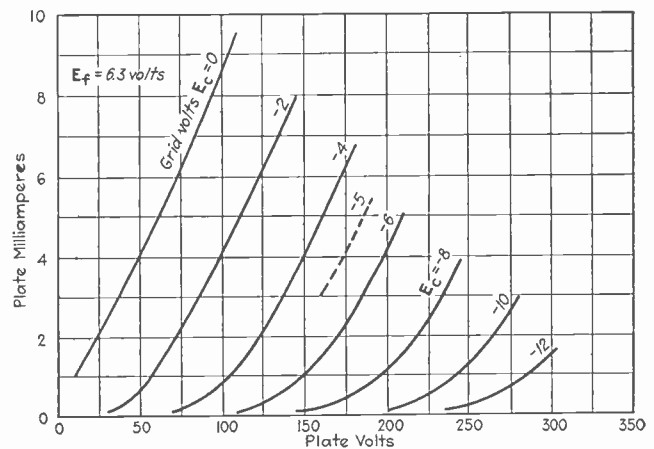

Fig. 3—Plate voltage-plate current characteristics of the triode.

deg. apart on the same diameter as the heater leads. This arrangement has proven to be very well adapted to the contemplated tube uses, since the grounded r-f leads are separated from the active r-f leads.

Tubes of this type may be used as grid- or plate-circuit detectors, low-power a-f and neutralized r-f amplifiers, and as low-power oscillators. At the highest frequencies, well beyond the limit of standard tubes, they may be operated in conventional circuits, the unusually high transconductance being useful in making up for the deficiencies of the circuits. The only precautions which need be observed with these small triodes are the use of

[Please turn to page 293]

HIGH LIGHTS ON ELECTRONIC

Accurate frequency control with thermionic tubes

THERE ARE many applications requiring very close control of motor speeds. Hence, the solution of the problem of accurate frequency adjustment as made in the case of the astronomical telescope drive illustrated herewith, might well find other uses in industry and in laboratories.

The telescope at the McMath-Hulbert Observatory, Lake Angelus, Mich., was formerly operated by a synchronous motor. But frequency variations during the daylight hours, caused by the widely varying industrial load of Detroit and nearby cities, led to the electronic-tube installation sketched in the diagram.

The control apparatus is in three parts: 1. The thermionic-tube oscillator. 2. The speed-control tubes. 3. The device which is to have its speed controlled, either a direct-current motor, or a rotary converter and synchronous motor.

The frequency desired is generated in the resistance-stabilized oscillator, at the left in the diagram. The thermionic frequency control in the second or middle section comprises a pair of tubes operating in parallel, whose grids are excited by the frequency generated at the left. The plate voltage is supplied by the speed-controlled device and has a frequency proportional to its speed. The instantaneous magnitude of the plate current is a function of the instantaneous plate and grid voltages, or more simply, of their phase difference. It is

this plate current, acting on the speed-controlled device at the right, which maintains synchronism between the left-hand and right-hand elements in the sketch.

At the right, the driving unit is a shunt-wound direct-current motor operating the telescope, with slip-rings installed to supply plate voltage for the control tubes and filament current for all tubes. The shunt field is opened at its electrical center and the circuit is completed by means of fixed resistances, thus forming a bridged circuit. The output of the plates of the control tubes of the center section is connected to this bridged circuit.

At the Lake Angelus installation, the range of control is from 57 to 60.5 cycles per second. The cost of the electronic outfit has proven less than that of a first-class weight-driven pendulum-controlled driving clock of conventional design.

Photocell controls car painting

A VALUABLE USE for a photocell has been turned up in the spray-painting of automobiles as they go through the production line. In one application, a black paint is applied to the bottom of the cars as they approach the delivery point.

Formerly a man was employed to turn the spray on and off as the car passed, but in a number of cases the attendant would forget or neglect to shut off the

spray promptly, and some of the black lacquer would go up over the back of the car, spoiling the paint and requiring refinishing.

Now, with a photocell, the paint spray is turned on accurately by the shadow of the car, as soon as the painting position is reached, and is turned off equally sharply as soon as the car passes, automatically preventing possibility of getting the black under-body paint on the back or sides.

Ships steered by "Electron Elmer"

USE OF THE CATHODE-RAY tube as a relay to control the steering of a ship, in the same way that the gyroscopic compass or "Metal Mike" has been applied, is described by Dr. F. E. Free in his "This Week's Science." Dr. Free writes:

"A new electronic compass for ships, working thousands of times faster than ordinary magnetic compasses and not affected by iron used in the ship's construction, has been devised by physicists of the National Physical Laboratory in England. A thin, pencil-like beam consisting of billions of electrons a second is generated inside a vacuum. Although these electrons move at speeds of more than 10,000 miles a second, the beam is swung this way or that by even very tiny magnetic or electric forces, including the forces of earth magnetism. This fact is used by letting the beam of electrons strike two tiny disk-like targets in such a way that half the electrons in the beam hit one target and half hit the other one, like a stream of water divided equally between two pails. The device is set so that this half-and-half condition corresponds exactly to the proper course of the ship as related to the direction of the earth's magnetism.

"The targets hit by the electron beam then are connected, through vacuum-tube amplifiers, to three signal lights; one white, one red and one green. So long as the ship is on its proper course the electron beam falls equally on the two targets and the white signal light is illuminated. If the ship swings to the right or left the electron beam falls on one target more than on the other and the red or green light is illuminated; red for a swing to the left, green for one to the right. The steersman needs merely to watch these lights, or the electric circuit can be connected to an automatic steering device like the Metal Mike now worked by magnetic or gyroscopic compasses."

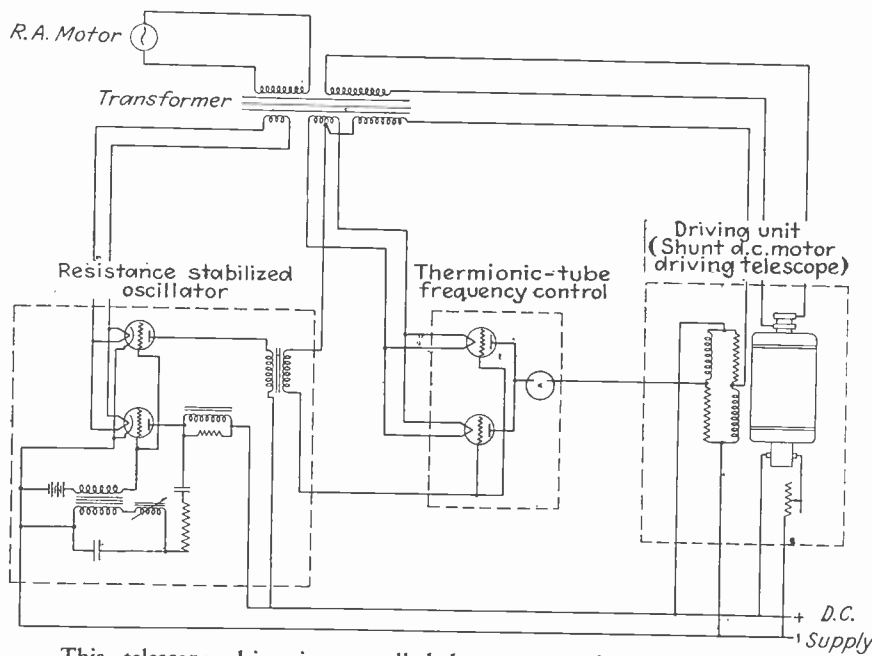

This telescope drive is controlled by accurate frequency adjustment independent of outside load changes

DEVICES IN INDUSTRY + +

Gloucester gets first harbor beacon

IT WILL BE EASY in the future for a vessel bound down East or to the Westward but buffeted by gales or blinded by rain, fog or snow, to find her way safely into a haven behind Gloucester (Mass.) Breakwater. This will be the first harbor radio beacon on the Atlantic Coast.

G. R. Putnam, U. S. commissioner of lighthouses, has approved and work has been started on two transmitters for a radio beacon to be installed in the "red-light" tower on the end of Dogbar Breakwater. The code signal of the beacon has not yet been assigned but the frequency will probably be 304 kilocycles. Its operation will be at times of fog or low visibility and also possibly on a definite schedule in clear weather such as the second or third quarter of each hour.

This beacon will also be available for the calibration of radio direction finders by vessels within the harbor, making unnecessary the heretofore essential trip to Boston Light Vessel for this purpose. Swinging the vessel in the smooth water of Gloucester Harbor will make the calibration work more accurate and the direction finders on vessels of the fishing fleet more dependable.

A strong and sustained effort was made to have this beacon speak the word "Gloucester, Gloucester," followed by a horn tone, rather than the conventional "dah-dit-dit-dah" code signal. A talking transmitter was built to demonstrate the practicability but the proposal was rejected by the Lighthouse Bureau because of the too narrow band of frequencies in which all of the ninety-nine radio beacons around the coast of the United States have to operate. This band, from 284 to 316 kilocycles, is all too narrow and not only denies the privilege of having the Gloucester beacon say "Gloucester" but also has limited the development of direction finders.

In the case of the Gloucester breakwater beacon, a vessel from the East would steer for the Boston Light Vessel signal until he hears the Gloucester signal. Then he would change his course and head directly for the end of the breakwater until he picks up the buoy or sees the breakwater. The rest is plain piloting.

The beacon will also be invaluable to yachts after passing through the Cape Cod Canal, Eastward bound. The beacon on the Western end of the breakwater will be so close to the deep water

channel that a direct course for the beacon may be safely steered until the red light or the tower itself is plainly visible.

Sticky material protected by photo-cell

RUBBER SHEETING as used in an Eastern shoe factory is so sticky that if it is allowed to touch the floor or to foul as it unrolls from a reel to a conveyor, disaster results. To prevent this, three photo-electric cells are mounted on a frame between the reel and the conveyor opposite spotlamps placed 1 ft., 3 ft. and 4½ ft. above the floor, according to H. H. Raymond, consulting engineer, Berlin, Conn.

As the rubber roll loops downward from the power-driven reel turning at constant speed, the slack festoons downward toward the floor. The rubber is highly fragile besides being sticky. The speed of the reel is slightly above that of the horizontal conveyor. If the loop approaches the floor within 1 ft. it interrupts the light ray passing from the lowest lamp to the lowest photo-cell, and this actuates the photo-cell relay and stops the reel motor. The conveyor

then gradually pulls up the slack and when the rubber sheeting loop reaches a height of 3 ft. above the floor it interrupts the ray between the intermediate lamp and its cell, starting the reel motor and again delivering the sheeting toward the conveyor without stoppage of the conveyor.

Occasionally the sheeting becomes caught on the reel and this sweeps the rubber sheet upward into the air. This interrupts the light ray between the top lamp and the corresponding photo-cell, and appropriate relays shut down both reel and conveyor motors to prevent extensive damage.

Measuring movie-film density

ENGINEERS OF THE Paramount Laboratory in Hollywood have developed a new type of visual "densitometer" for measuring the density of film to be printed or projected. The essential elements of the new device comprise a light source, a Weston Photronic cell, and a micro-ammeter. The density range of this new visual densitometer is from zero to unity density.

PHOTOELECTRIC COLOR ANALYZER

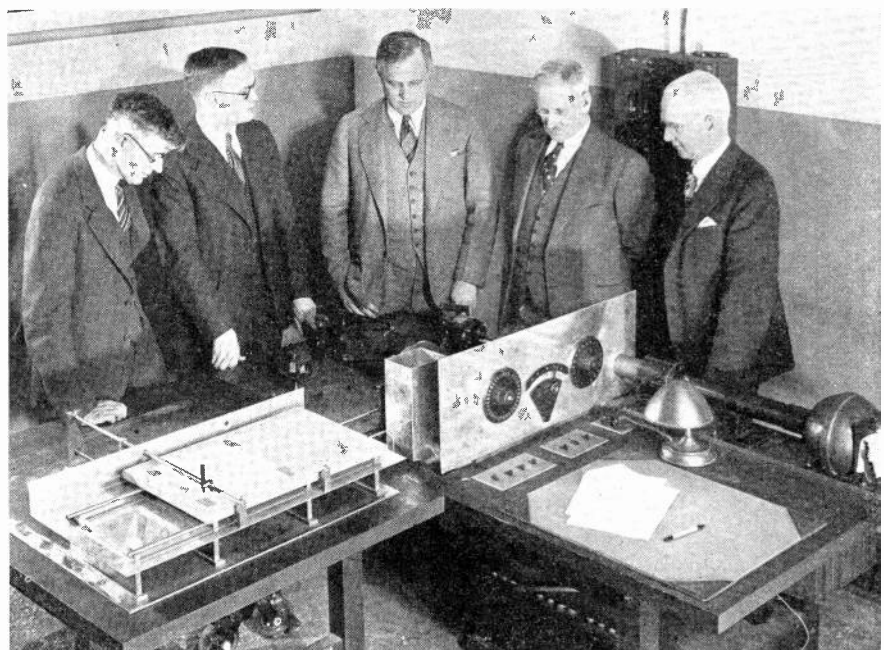

The colorimeter developed by Professor Arthur C. Hardy at the Massachusetts Institute of Technology. The device makes it possible to measure color quickly and accurately by photoelectric means. From left to right are Dr. Vannevar Bush, Professor Hardy, Dr. Karl T. Compton, Dean of Science Samuel C. Prescott, and Dr. Harry M. Goodwin.

Will some particular shape improve the space available on the chassis of the device it is to be used with?

Can an auto-transformer be used to advantage without losing the chance of Underwriters' approval?

Insulation and winding data

In designing coil windings using enamelled wire, some precaution to prevent crossed turns, and consequent danger of short circuits must be observed. Past experience of numerous coil manufacturers has shown that a winding factor of 85 percent to 87 percent is the most practical for any wire smaller than No. 30 B & S gauge. For sizes between No. 20 and No. 28, winding factors of 90 percent are satisfactory where necessary. Sizes larger than No. 20 may be wound with a winding factor as high as 93 to 95 percent.

When using the smaller wire sizes spacing closer than 87 percent will tend to cause shorts, and spacing larger than 85 percent winding factor will give uneven build up; turns in one layer sinking between turns in a lower layer. These winding factors and insulation data also apply to audio transformers and chokes.

Data for insulation layers are given in Table I.

TABLE I

Audio and Power Transformer Coil Interlayer Insulation (For Machine Wound Coils)

THICKNESS OF INSULATION AND MATERIAL	MAX. SIZE OF ENAMELED WIRE	RECOMMENDED MAX. RMS VOLTS PER LAYER OF WIRE	
		DOUBLE PAPER	SINGLE PAPER
.0005" Glassine	No. 38 A.W.G.	50 V.	25 V.
.0007" Glassine	No. 35 A.W.G.	75 V.	38 V.
.001" Glassine	No. 31 A.W.G.	100 V.	50 V.
.0013" Glassine	No. 29 A.W.G.	135 V.	63 V.
.002" Kraft	No. 25 A.W.G.	140 V.	70 V.
.003" Kraft	No. 23 A.W.G.	200 V.	100 V.
.005" Kraft	No. 16 A.W.G.	350 V.	175 V.
.005" Kraft	No. 12 A.W.G.	(Hand-Wound Filament Windings)	

In winding with paper insulation, the margins of paper extending beyond the winding vary according to the type of service. For audio transformers and small chokes, $\frac{1}{8}$ " to $\frac{1}{4}$ " is sufficient. In power transformer windings, primary windings should have $\frac{3}{16}$ " to $\frac{5}{16}$ " margin, while for the high voltage secondaries (1000 volts) not less than $\frac{3}{16}$ ", or for a 2,000 volt winding not less than $\frac{5}{16}$ ". Filament windings have margins of from $\frac{1}{4}$ " to $\frac{3}{8}$ ". More liberal margins will add to the safety factor, but the increased cost rarely justifies more than the values given above.

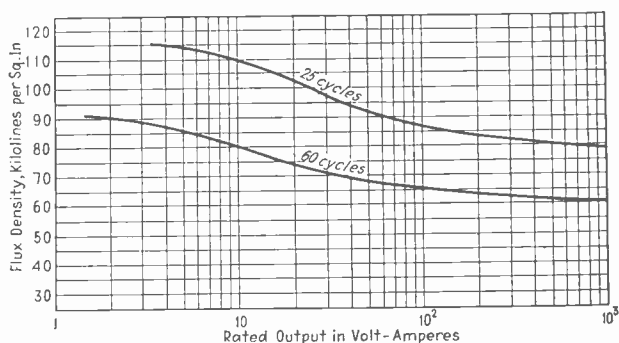

Fig. 1—Permissible flux-density in power transformer cores for 25 and 60 cycle operation, and for various output ratings.

Insulation between windings should be required to stand twice terminal voltage plus 1500 volts. Kraft paper, or varnished cambric is usually used, depending on the voltage and mechanical stress. In some cases both are used, viz., between a high voltage secondary and a heavy wire filament winding.

In all cases, a preliminary design is drawn up and samples are made. The samples are then carefully checked under operating conditions, recording all important data such as secondary voltage, primary and secondary current, and temperature rise, etc. Using these data, any necessary corrections or changes may be readily calculated so as to obtain the desired voltages and current densities in the various windings.

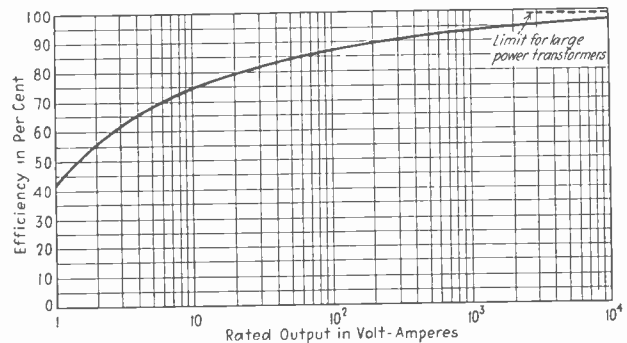

Fig. 2—Efficiency of transformers improves as the rated output is increased, the small transformers of present design have efficiencies as low as 60-70 per cent

Testing the transformer sample involves measurements of the voltage and current in both windings, for which purpose a.c. meters must be used. The calibration of these meters should be checked periodically to insure accuracy of the testing data.

Design corrections

The following method may be used for correcting the design of a multi-winding power transformer feeding a rectifier and associated filter circuit. Obtain readings of d-c voltage and current. If incorrect, by some reasonable percentage (10 percent or less), correct the number of turns on the winding at fault by the same percentage and re-check with the same filter network and rectifier tube as used for the first check. If the original error was large, two successive corrections may be necessary to obtain the desired result. If filament voltages are wrong by a smaller amount than can be compensated for by the addition or subtraction of one-half turn (or a full turn where a center-tapped winding is employed), it becomes necessary to change the number of turns on the transformer primary. If the transformer primary turns are changed to correct one secondary voltage, all other secondary windings must be changed in the same ratio. For an example, suppose a 1000 turn secondary and 200 turn primary gives a desired high voltage but that a 5.5 turn secondary gives a filament voltage that is 5 percent high. To compensate, the primary and the 1000 turn secondary are increased 5 percent each giving 210 turns and 1050 turns, respectively. (A one-half turn change in the filament winding would cause a 9 percent change in filament voltage.)

[Editor's note—In the second installment of this article, Mr. Hultberg will discuss the design of B filter chokes, interstage audio transformers, and output transformers, both from the standpoint of theory and practical manufacturing considerations.]

electronics

McGraw-Hill Publishing Company, Inc.
330 West 42d Street
New York City

O. H. CALDWELL, Editor

Volume VII —SEPTEMBER, 1934— Number 9



Home facsimile is on the way

ONE of the large broadcasting stations is reported preparing to put on an experimental facsimile service, to deliver printed text and pictures to those of its audience who have their radio sets tuned in from 1 a.m. to 6 a.m.

News print, headlines, display ads, cartoons, style sketches, weather maps, etc., will be included in this little newspaper which will unroll from a mandrel under the radio set, and will be printed without any manual preparation on the user's part.

The station owner proposes to handle the sales of the first experimental facsimile printers, which will be connected to be switched on in place of the usual speakers. The broadcaster also proposes to furnish, free of charge, the rolls of paper for the facsimile newspaper. These will be supplied upon written application of listeners, in order to show "display advertisers" just who and where are the users of this new advertising service on the air.



A handy "yard-stick" for high fidelity?

WITH rapid progress now under way in the direction of "high fidelity," how can the average radio engineer in a radio factory or broadcast station determine quickly and to his own full satisfaction whether he is getting adequate fidelity or not. Of course, we have the big elaborate instruments to measure tone quality. But is there not some compact handy "sound thermometer" which can be applied by an everyday practical man,

something like the new "light-meter" is used to measure illumination intensity?

If such a practical sound-measuring meter were available, to be sold at several hundred dollars, there would seem to be a market for it in a lot of places. Without such a meter available, we are bound to suffer a lot of both intentional and unconscious gypping of high fidelity, leading to abuses of the name, and to unsound practices. Perhaps devices already developed can be adapted in this direction. If so, right now, while high fidelity is on everybody's mind, is the time to offer such a device to the industry.



Electronic inefficiency

THAT electron-bombardment devices, such as the cathode-ray and x-ray tubes, are very inefficient, is seldom emphasized. When the electron stream impinges on the metallic or fluorescent surface, an extremely broad spectrum of radiation results, ranging from the extremely short x-rays to the long wave-lengths of heat. But it is seldom if ever that the engineer wants all of these radiations at once. In the x-ray tube he could well dispense with the heat, while in the fluorescent cathode-ray tube he would like to concentrate the energy of the electron beam into light.

There is a great field for fundamental research in the conversion of electronic energy into radiation at *desired* frequencies, that is, in developing methods of bombardment which produce useful radiation at the expense of useless radiation. Progress in cathode-ray television, x-ray practice, and many other arts will be greatly accelerated by new findings in this field, which apparently has been neglected by engineer and physicist alike.



Old transformer iron for new radios!

THE artifices of the price chiseler are many, and the efforts to which he resorts are worthy of a better cause.

Take the "old iron" racket now being practiced in some quarters. Instead of using modern sili-

con steel, some transformer makers are buying up old junk electric-light transformers and choke coils, for the old iron they contain. Some of these veteran pieces of electrical apparatus have served honorably for twenty years or so. Fatigued by many millions of alternations, they date back to the early days when far less was known about transformer iron than at present.

Laminations from these old sheets are worked over for radio use. The result obviously is a mixture of irons poor in magnetic qualities and uneven in character. This is the heterogeneous junk which goes into some cheap units, and eventually into cheap sets, resulting in appalling inefficiency and lack of uniform performance. It is price-whittling with a vengeance.



A simple facsimile printer

CONSIDERABLE impetus is given the coming of "home-facsimile" through ordinary home radio sets, by a new direct printing process using standard carbon paper and requiring no processing—other than to be picked up and read!

The paper to be printed on, accompanied by a piece of carbon paper, passes between a revolving roller and an oscillating knife-edge. Around the roller is embossed a raised spiral of a single turn. This roller and spiral revolve once, while the paper is being advanced the width of one line of the facsimile. Thus, if the straight-edge knife is pressed continuously against the roller, the point of contact with the spiral will run across the paper and a solid horizontal line will be drawn. If, however, the knife-edge is raised and lowered by the reproducer magnet, dots and dashes of the picture will be reproduced. The carbon paper is used over and over, and is the only part needing eventual replacement.



Auditory perspective

PERSONS of musical and artistic temperament sometimes complain that radio reproduction is "too flat"—that the tones issuing from a single loudspeaker, whatever the fidelity, are too

centralized and unreal. Someone has said that to listen to a great orchestra reproduced by a single speaker, is "like listening through a knot-hole in a fence!"

Of course binaural reproduction, with two microphones, two broadcast channels and two radio sets separately placed, would aid in the illusion of reality. But we are far from having sufficient channels for the general use of such true "auditory perspective" on the air.

But something approaching "stereoscopic hearing" might be accomplished with single-channel reproduction, by using two speakers, separated in the room, one speaker filtered for highs, and one for lows. The instruments of an orchestra would appear to have considerable spatial separation; a man and woman in a dialogue would seem to be on opposite sides of the room.

Experiments along this line might well bring a new—even if pseudo—dimension into radio reproduction.



RADIO-CONTROLLED TRACTOR AT CHICAGO FAIR



The International Harvester Company is exhibiting this remote-controlled tractor, which plows acreage while steered from the farmhouse porch.

REVIEW OF ELECTRONIC LITERATURE

HERE AND ABROAD

Screen grid tube circuits having high frequency stability

[K. P. SCHWEIMER and L. Pungs, Braunschweig Institute of Technology.] It is possible to design oscillators without quartz control, for which the frequency remains constant to within 20 cycles at 2,000 kc., even when the plate potential varies 50% and the filament voltage 20%. The theory of the simple oscillating circuit which takes into account the grid current shows that maintaining the ratio grid a.c. to total a.c. is the most important factor ensuring constant frequency. The current distribution in self-excited three-electrode tubes is fixed by the grid and the plate potential and the tube constants. Four-electrode tubes leave a means of controlling the distribution from the outside. When the plate potential is varied, the change in frequency produced is nearly opposite to that obtained by a similar change in the screen grid potential, and it is possible so to couple the two electrodes that the frequency remains constant so long as the ratio of the two electrode voltages is kept at a certain value.—*H.f. Techn. El. ak.* 43 No. 6: 181-189. 1934

Symmetrical oscillators and multivibrator

[J. MERCIER, University of Bordeaux.] The tuned circuit may be placed between the plates of two tubes and coupled to the grids by means of identical coils. The two tubes behaving as coupled oscillating circuits may oscillate in phase (or as a single tube) or in phase opposition, no high frequency current flowing in the latter case through the high tension battery. In order to prevent operation in phase which is of little interest, a choke coil

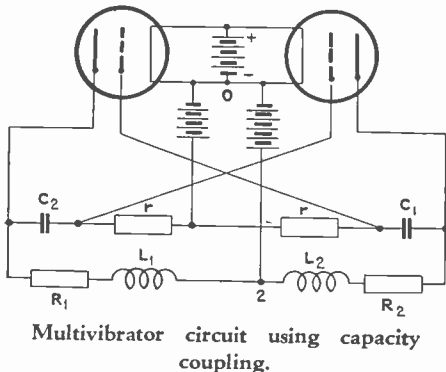

may be inserted in the high tension lead. The equation of the circuit is nearly the same as for a single tube, the only change in the conditions for oscillations being that $2R_p$ is to be written in place of R_p , that is $R + (L + M' + \mu M) / 2R_p C$ must be negative, M' being the coupling between the two halves of the plate coil. The pulsation is given by the square root of $1 / (L + M') 2C$.

The multivibrator can be considered as a symmetrical oscillator in which, however, the circuit constants are

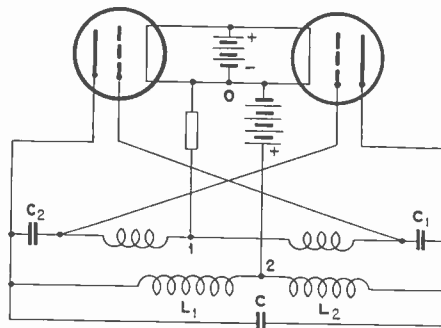

Symmetrical oscillator with mixed coupling.

aperiodic. When the value of $\mu - 1$ ($r - R_p$ is positive, the smallest disturbance is amplified in such a way that no steady state is reached. The condensers C_1 and C_2 are alternately charged and discharged.—*Onde él.* 13 No. 149: 197-219. 1934.

The cell space ratio in wood by a photo-electric method

[W. W. BARKAS, Forest Products Research Laboratory, Princes Risborough.] The common method of measuring the cell-space ratio is to traverse the section under a microscope with a micrometer measuring the total distances across the walls and the voids separately. In the new method the amount of light passing through the voids (varying between 0.01 mm. and 0.3 mm.) of a stained microsection of the wood (1 cm. square, 15 microns thick) is measured. The slide carrying the microsection is focused by means of an $f/2.4$ camera lens on to a rectangular aperture placed in front of the photocell. A correction is made for the amount of light reflected and transmitted by the stain. For Scots pine the photocell method gives a cell-space ratio of 42, the micrometer method 52, the projection method 39. The new Zeiss

sodium vapor lamp is used as a source, with a methylene blue stain possessing a strong absorption band in the region of the D-lines.—*Proc. Phys. Soc. DF* No. 4: 545-559. 1934.

Vacuum tubes with positive grid in place of thyratrons for electronic counting

[H. ALFVEN and P. Ohlin, University of Upsala.] In the thyratron counter developed by Wynn-Williams the circuit may be designed so as to operate the counting relay only at every second, fourth, eighth, etc., discharge, depending upon the number of tubes used. A self-oscillating vacuum tube with C and L in the grid circuit may be used for this purpose, at less cost and with greater stability, provided the grid is given a fairly high positive potential (100 volt). When the plate voltage is increased from minus 10 toward + 20 volts, the plate current increases suddenly at about $\frac{1}{2}$ volt to 1 mA., indicating that the tube oscillates, then rises gradually until 17 volts is reached. Here the oscillations stop and a second sudden increase takes place. On decreasing the voltage the sudden changes are found to take place at a several volts lower potential. The total electron emission remains constant. The range over which stable oscillations occur depends on the gridplate conductance G of the tube, the hysteresis being the more pronounced the smaller G. The tube is so adjusted that a steady small plate current flows, above the point

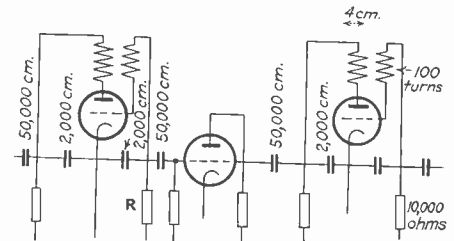

Circuit for recording every fourth symmetrical impulse

where it oscillates; any sudden symmetrical impulse throws it into oscillation with a sudden increase in the plate current and in the voltage drop across the lead R. The operating point slides toward the lowest point, and if an impulse of the same shape now occurs, it stops the oscillations. A single tube counts every second impulse.—*Zeits. f. Physik* 89 No. 11/12: 826-833. 1934.

Progress in the elimination of artificial static

[MICHEL ADAM.] Quiet operation of neon lights is obtained by welding and screening the high voltage connections. For periodically interrupted tubes (blinklights) the remedy is two 2- μ f. condensers across the motor with an induction coil from between the condensers and the ground, thoroughly screening the contact mechanism and using lead-sheathed cables. It has also been proposed to dispense with the motor for making and breaking the connections, and to use relaxation oscillations of a frequency determined by CR. Street-cars have caused tests to be made in various cities all over the world; remedies are expensive as a general rule. In dealing with small medical appliances the human body may be considered as a resistance of 10,000 ohms, to the midpoint of which a condenser of 40 μ f. is connected, the other side of the condenser being grounded. With regards to elevators, squirrel-cage motors give least trouble. For small house appliances a condenser is placed across the points between which the circuit is interrupted, or across the brushes of motors, or a twin condenser across the windings and the midpoint connected to the metallic mass. In several countries the fight against interference, first conducted by private initiative, has been taken over by the authorities. In Germany over 150,000 cases have been treated in 1933 (domestic appliances 33%, medical 13%, power stations 7%, street cars 4%, oscillating receivers 5%, faulty receivers 20%, atmospheric noises 17½%). A static-free town exists: Baden-Baden.—*Revue gen. El.* 36, No. 3: 97-109, 1934.

Electronic device for making visible infra-red images

[G. HOLST, J. H. DE BOER, M. C. TEVES and C. F. VEENAMANS, Philips' Research Laboratory, Eindhoven] The sensitive layer of modern infra-red sensitive photocells consisting of cesium atoms upon a salt or oxide layer is quite transparent. The layer of metal which acts as a support and supplies electrons to replace those emitted from the adsorbed atoms may also be taken so thin as not to affect the passage of the light. On projecting an image upon this composite layer, from the outside, the density of the electron stream set free will vary, depending upon the illumination which the different parts receive and provided that the plate potential is sufficiently high to draw the electrons in a straight line to the plate. When the plate is covered with a screen of fluorescent material, such as zinc silicate, or calcium tungstate, and is itself

a transparent metal foil, a visible image may be seen or photographed. The fluorescent anode is made by letting a thin film of silver, 30 millionth cm. thick, condense upon a plane glass plate, the fluorescent material being then precipitated from an alcoholic suspension. The infra-red sensitive layer is best taken 3 millionth cm. thick when it gives 3.4 μ A per lumen of incident light.—*Physica* 1 (4): 281-290, 1934.

Secondary vibrations in cone loud-speakers

[F. V. SCHMOLLER, Telefunken Labor.] When attempting to improve the efficiency of cone loud-speakers by increasing the strength of the magnetic field across the air gap, one observes in certain ranges a note of half the frequency of the sound which the speaker is desired to render. This "son range" is obtained only when the frequency is maintained for some time and above a certain power. When the power is just sufficient, the "hoarse sound" may take 20 seconds to establish itself, at a higher output less than 1/10 sec. It is obtained above about 500 cycles per sec. and with varying strength over a band more than 1,000 cycles wide. When fully developed it causes a loss in the strength of the desired frequency. The production of the unwanted sound can be accounted for by an additional elastic force, depending upon the frequency (Mathien's differential equation). The remedy is to give the cone a shape which does not allow it to be spread out in a plane.—*Telef. Zeit.* 15 No. 67: 47-54, 1934.

Formulas for the internal capacity of multi-layer coils

[HARRY ZUHRT, Berlin Institute of Technology.] The experimental method used in getting the value of the internal capacity, assuming the self-capacity to be constant over the entire length, gives results which contain an error of about 50% (Morecroft, *Exp. Radio*, p. 299) so that the use of simple formulas is justified. For single-layer solenoids wound on cylindrical forms the internal C of the coil alone is in μ f. equal to 0.48 R as long as the ratio of radius to half-length of the cylinder is within the range of 1 to 6. For flat coils, in particular, a correction must be added for the insulation and the support; when the outer radius r of the insulating layer having a dielectric constant e (about 4) is much smaller than 1, the value of C in μ f. is equal to 0.24 e_m R, where $(e_m - 1) = e \pi r/2l$. For coils with n layers wound in the same sense (in μ f.).

$$C = \frac{1}{n^2} (C_1 + C_n) + \left(\frac{n-1}{n^2} \right) \left(\frac{40 e R l}{36 d_w} \right)$$

In coils wound in continuous fashion the last term must be multiplied by 4/3. The letter C_1 means the capacity of the innermost layer, C_n that of the outer layer, and $d_w = d - 23r + 0.26h$, where r in this formula is the radius of the wire and h the distance separating wires of the same layer. *El. Techn. Zeit.* 55 No. 27: 662-665, 1934.

(Other methods of estimating internal capacity will be found in Moullin's *Radio Frequency Measurements*.—EDITOR'S NOTE.)

PERAMBULATOR RADIO

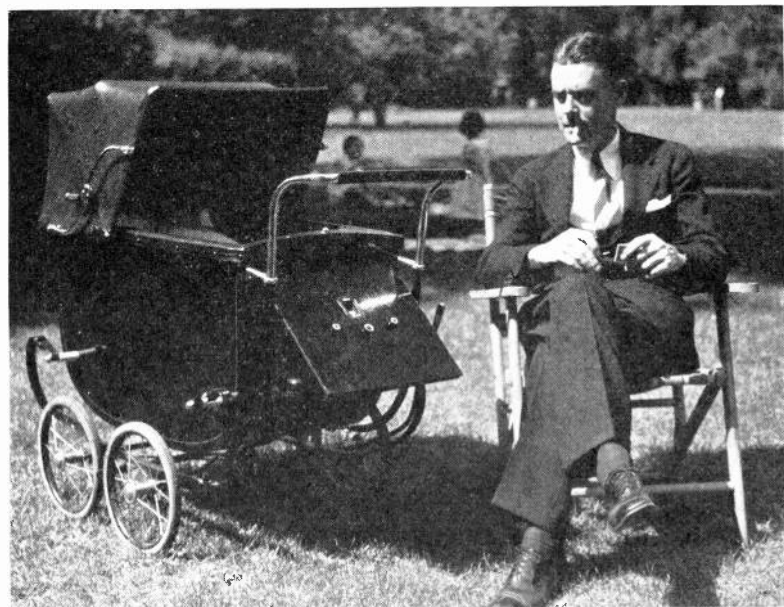

An enterprising middle-west manufacturer offers this solution to the depression. Father (or child) may get ball scores al fresco. D. H. Miller, Chicago I.R.E. Section Secretary in 1933, is the proud demonstrator.

Efficiency of oscillating tubes in the ultrashort range

[R. BECK, University of Jena.] Owing to the small value of L/C at short wavelengths and the small regenerative effect, it is best to use a grid-leak circuit which controls the operating point automatically. The efficiency, that is, the ratio of a.c. to d.c. power, depends on the value of the grid leak. It can be measured by comparing the d.c. power required in the oscillating and in the non-oscillating state for maintaining the warmest point of the bulb at the same temperature, thermo couples being placed near this spot (H. M. Turner). An 8-4-m. sender with an inductance of 340 cm. and a variable condenser (10 to 50 cm.) in the plate circuit, a large inductance (430 cm.) in series with a 9,700 cm. condenser shunted by a grid-leak in the grid circuit, the latter being so adjusted that a tourmaline plate can be placed in parallel without affecting the wave-length, gave an efficiency of 63% without the tourmaline and 48% with the crystal, or 41% (resp. 48%) when including the filament current. At 3.12 m., with the inductances reduced to the leads and a variable condenser between grid and plate, the oscillator had an efficiency of about 30% with or without crystal control.—*H.f. Techn. El. ak.* 43, No. 6: 199-205. 1934.

Short and ultrashort waves

[A. SCHEIBE, German National Physical Laboratory] As the frequency increases and the filament to grid capacity assumes relatively more importance, the ratio of the voltage induced in the grid circuit by the plate voltage, namely $\mu(1 + R_i/R)$ —where R_i is the internal resistance of the tube and $R = L/Cr$, that of the tuned plate circuit—falls below the normal value of about $\frac{1}{3}$. Moreover, the phase difference becomes a function of the speed of the electrons. The various attempts at producing efficient short and ultrashort-wave oscillators all try to bring amount and phase of the regeneration back to its normal value, by using separate seals for anode and grid, a potentiometer circuit in place of the transformer connection between grid and plate, resorting if necessary, to two variable condensers as potentiometer, and allowing the grid to discharge to the cathode over a high resistance.—*Phys. Zeits.* 35.1 (5): 206-215, 1934.

Direct current amplifiers

[P. DONZELOT and J. DIVOUX, University of Nancy.] When G is the grid-plate conductance of the tube, r the plate load, R the grid resistor, C_g the internal resistance between filament and

grid, s the current giving unit galvanometer deflection, the current sensitivity S , that is the deflection divided by the current flowing through R is given by $SGR C_p C_g / (r + C_p) (R + C_g)$. The voltage sensitivity is $RC_g / (R + C_g)$ times smaller. This latter factor tends to show that when R/C_g is negative, the theoretical amplification is very large but the results claimed by some authors are difficult to reproduce in this range. The use of floating grids is also likely to disappoint in work sustained over long periods. For $R = 100$ megohms with a tube giving 1 ma per volt a change of $10 \mu\mu\text{a}$. changes the plate current by only

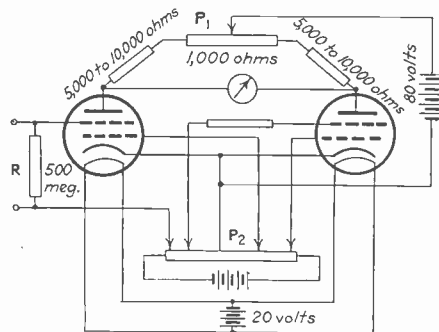

D-c amplifier. With a galvanometer of 2×10^{-7} a. sensitivity, 2×10^{-14} a. can be measured

one microampere so that the normal plate current must be compensated for in precise work. The theoretical sensitivity of a bridge circuit with two tubes is only one-half of the value obtained with direct compensation of the galvanometer, but it is many times more stable, allowing the use of a galvanometer sensitive to $1/100 \mu\text{a}$. Drift is caused by heat radiation from the plates to the filaments. In order to reduce the influence of changes in the supply voltage it is best to use indirectly heated

four-electrode tubes in a bridge circuit. It is somewhat difficult to find two tubes which are alike, but none of the tubes tried gave an ion current to the grid. Fused silica as an insulating material wherever possible improves the results.—*Journal de physique* 5 No. 7: 357-372. 1934.

Phase differences of insulating materials used in radio

[E. MULLER and O. ZINKE, Berlin Institute of Technology.] With recently developed materials, such as Calan, Frequentia (these Digests, May, 1934) and losses in radio coils corresponding to a value of R/pL equal to $5/1,000$, the losses in the coils are more important than those in the tuning condensers. When the condenser is placed in the tuned circuit, it acts as an ideal condenser C in series with a resistance r , so that $\tan d = prC$, and the voltage drop at resonance in the circuit including the meter M is equal to $i(R + M + r)$, while with a no-loss condenser the current is I and $r = (R + M)(I - i)/I$. The accuracy of the measured value r is small when I is nearly equal to i . At a wave length of 100 m., in a circuit having a coil with $3.14 R/pL$ equal to $1/100$ and C equal to $150 \mu\text{f}$., an error of 3% in the value of the current produces a possible error of over 100% in $\tan d$ when $\tan d$ is of the order of $1/10,000$ and of over 10% when $\tan d$ equals $1/1,000$. Another source of error which is never given proper attention is the stray capacity parallel to the condenser. When the materials are intended for transmitting sets and tubes, it is important to study the increase in phase difference with temperature.—*H. f. Techn. ak.* 43: 145-149, May, 1934.

BOOK REVIEW

Principles of Radio Communication

By J. H. Morecroft. Third edition. John Wiley & Sons, Inc., New York. (1084 pages. Price \$7.50.)

THOUSANDS OF RADIO ENGINEERS have been brought up on Morecroft's *Principles of Radio Communication*. Any of these readers who spends five minutes with the Third Edition will see many changes, much new material and may note the loss of some text matter in the earlier editions that has gone the way of the art; it has been eliminated in favor of more recent practice.

Morecroft's *Principles of Radio Communication* has changed with the growing industry and the new edition has been largely revised. The new material

consists of data on cathode ray oscillographs, more up-to-date information on filters, iron core coils, electrolytic condensers, wave transmission, ship-to-shore and aircraft-to-ground communication, ultra-short waves, shielding, detection, piezo-electric frequency control, the magnetron, multi-vibrators, multi-function tubes, transmission lines, microphones, modulation, loud speakers, broadcasting technique, antennas and radiation, automatic volume control, superheterodynes, etc., etc.

"Morecroft" has become a book of 1,000 pages and every attempt has been made to make it up to date and yet it is still the book the many engineers mentioned above have become familiar with. It is a fitting monument to its author, whose genial personality and continuous encouragement to young engineers, unfortunately, is no longer present.

Design and use of acorn tubes

[Continued from page 283]

short leads, good insulation and effective by-passing placed close to the tube terminals. An example of a suitable circuit arrangement for an oscillator is shown in Fig. 4. The small size and weight of the tubes also make them particularly adaptable to the design of special apparatus such as laboratory devices.

Tube characteristics

Tentative characteristics for Class A amplifier conditions are given below:

Heater voltage	6.3 volts
Heater current	0.16 ampere
Plate voltage (maximum)	180 volts
Grid voltage	-5 volts
Plate current	4.5 milliamperes
Amplification factor	25
Plate resistance	12500 ohms
Transconductance	2000 micromhos

The interelectrode capacitances are as follows:

Input	1.0 micromicrofarads
Output	0.60 "
Grid-plate	1.40 "

These characteristics are the result of the close spacings made possible by the development of a manufacturing technique capable of an unusual degree of precision. Surprisingly, these tubes in spite of their small size—actually because of it—are remarkably sturdy.

A typical plate family is shown in Fig. 3. Operated as a Class A audio amplifier with a load of approximately 19,000 ohms, the tube delivers an undistorted power output of 130 milliwatts. As r-f feedback oscillators, such tubes have been operated in set-ups, similar to that shown

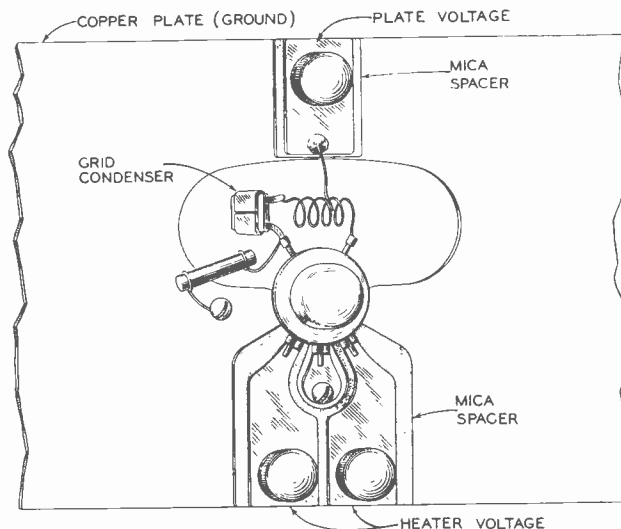

Fig. 4—Oscillator layout. Flat-type leads form effective by-pass capacities close to tube terminals, a most important point.

in Fig. 4, at wave lengths down to about 40 centimeters.

It is a pleasure to acknowledge the cooperation and work of Messrs. S. M. Reed and H. R. Seelen, of the Radiotron Development Factory, in the development of this tube.

¹B. J. Thompson and G. M. Rose, Jr., "Vacuum Tubes of Small Dimensions for Use at Extremely High Frequencies," *Proc. I. R. E.*, Vol. 21, p. 1707; December, 1933.

²B. J. Thompson, "Tubes to Fit the Wavelength," *Electronics*, August, 1933.

³For a concise and accurate statement of the principles involved in such calculations, see I. Langmuir and K. T. Compton, "Electrical Discharges in Gases. Part II. Fundamental Phenomena in Electrical Discharges," *Rev. of Mod. Phys.*, Vol. 3, p. 191; April, 1931.

Radio set and tube trends

[Continued from page 278]

to this country from Europe reports a rapid adoption of Poly-iron inductances in English, German and French receivers.

Such inductances may be too good for this country, that is, they may be too selective. Here the process of



English—a.c.-d.c. super with large station scale.

getting selectivity has been to employ several stages of relatively low-Q circuits, with the object of cutting down the "skirts" of the response band without too greatly attenuating the higher audio frequencies. It is said that high-fidelity may demand some such practice rather than over-coupling a single high-gain pair of coils. In the latter process there may be a loss of 6 db, or more, on frequencies very close to the carrier, e.g. 100 cycles or lower, due to the double resonance phenomenon. Abroad, however, where prices and license fees vary as the number of tubes, it is of considerable importance to pack as much of a wallop into each individual stage, as possible. Ferrocart has an American representative, and may be expected to make a determined effort to get some of the intermediate-frequency coil business.

Iron-core coils, however, have the disadvantage that they are made up of air coils put on an iron core. Therefore they must cost as much as conventional air coils plus the cost of the core; they will be more expensive. There is also the problem of uniformity which is already well on the way to solution.

The all-wave feature has forced the use of better insulation; the trend toward higher frequencies will still further enhance the sale of low-loss insulation for coil forms, for condenser frames, etc. And so each new development calls for new technique. The art never stands still.

+ NEW PRODUCTS

THE MANUFACTURERS OFFER

Loudspeakers

THE MAGNAVOX COMPANY, Fort Wayne, Ind., has introduced two new models of loudspeakers—No. 166, which is a 6-inch dynamic unit, and No. 132, a 12-inch dynamic.

Magnavox No. 166 has been introduced to fill the need for a 6-inch low-price speaker with performance capabilities which are unusual as to fidelity and sensitivity. The overall diameter of its cone-housing is $6\frac{5}{8}$ in., and the depth from front to back is $3\frac{3}{4}$ in., with a weight of maximum field coil accommodated, $\frac{1}{2}$ lb. The impedance of the voice coil at 400 cycles is 3.6 ohms.

Magnavox No. 132 measures $12\frac{5}{8}$ in. in overall diameter of cone-housing, and is $6\frac{1}{8}$ in. deep from front to back. It accommodates a maximum of $1\frac{1}{4}$ to $1\frac{3}{4}$ -lb. field-coil weight. The impedance of the voice coil at 400 cycles is 4.5 ohms.—*Electronics.*

All-wave filter

TWO MODELS of all-wave aerial Filterizer systems have been developed by the Tobe Deutschmann Corporation of Canton, Mass. Features are: Practical and inexpensive installation requirements, all-wave band efficiency, and great reduction in radio noise and interference pick-up. These all-wave aerial kits are readily adapted to one-quarter wave Marconi or one-half wave Hertz aerials.

One model used is a small line filter for by-passing noise to ground present on the whole wiring. Model 34 contains one aerial transformer, 50-ft. twisted pair weather-proof transmission line, one receiver transformer, complete aerial and ground equipment, and power line filter. Price \$6.95.

Model 35, same as Model 34 except without aerial and ground equipment and power line filter. List price \$4.95.—*Electronics.*

Power-supply unit

G-M LABORATORIES, INC., 1731 Belmont Avenue, Chicago, Ill., announce a new power supply unit for furnishing very thoroughly filtered direct current from 110-volt 60-cycle power lines. This unit, while similar to other G-M power supply units, is rated to furnish 450 volts or less, with a maximum direct current of 100 milliamperes.

The output of an '83-type full-wave rectifier tube is connected across the winding of a high-resistance, wire-wound Type L potentiometer from which any voltage from 0 to 450 volts may be obtained in minute steps. The unit is provided with a lock which can be set so as to limit the voltage available at the terminals, for safety purposes.—*Electronics.*

Midget plug

CINCH ENGINEERS who maintain the company policy of "your problems are our problems," were recently confronted by a request for an odd-size plug "about the size of a quarter." At the time it appeared to be an odd size—and was developed under that impression. The result was entirely satisfactory to the set manufacturer—and with that request was created the midget radio plug. It

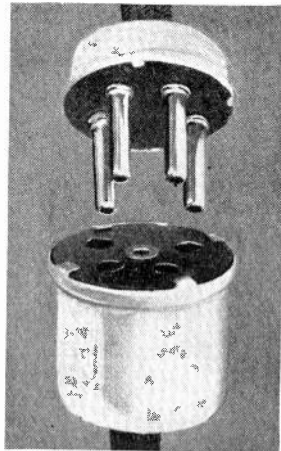

is a metal shielded midget plug designed and constructed to fill an immediate specific need, and is now finding a market in a long-felt need of other manufacturers. It may be had with two to six prongs from the maker, Cinch Manufacturing Corporation, 2335 W. Van Buren St., Chicago, Ill., which is a subsidiary of United-Carr Fasteners Corporation, Cambridge, Mass.—*Electronics.*

Spray-painting booths

THE DEVILBISS COMPANY, Toledo, Ohio, manufacturers of spray-painting and finishing equipment, announce a series of direct exhaust type spray booths designed especially for the pe-

culiar requirements encountered in the application of "flock." These new booths permit the concentration of spraying operations in one location, prevent material from scattering throughout finishing room, and reclaim all sprayed flock not applied to articles coated.

Booths range in sizes from two to ten feet frontal width. All are equipped with standard DeVilbiss direct type exhaust fans. Removable cheese cloth screens at rear of booths collect the flock and prevent it from passing out the exhaust pipe.—*Electronics.*

Engraving panels and parts

MANUFACTURERS interested in inexpensively marking panels or parts fabricated from sheet bakelite, fibre, hard rubber or similar materials will be interested in a new process developed by the Synthane Corporation of Oaks, Penna.

The results obtained with the new "Synthographic" process, as it is called, compare favorably with engraving in quality. The cost is, of course, much lower than engraving.

By means of this process effects may be produced which are either impossible or impracticable by engraving. For example, one may choose certain colors or combinations of colors. The intricacy of the ornament bears little relation to the time or cost of production. Properly applied, these letters, symbols, trade marks or other designs readily resist wear.—*Electronics.*

Microphone hand-set

A NEW product from the Inglewood, Cal., factory of the Universal Microphone Co. is a combination earphone and microphone which is mounted similar to French-phone hand-set. It has been designed for five-meter transmitters, and also the new five-meter transceivers. Since such equipment is necessarily portable, the new combination is extremely lightweight and compact and weighs but nine ounces.

The new product consists of a high output microphone in conjunction with 2000-ohm lightweight receiver. There is a five-foot cord terminal in three-phone tip terminals which gives microphone and earphone connection. The handle is rubber covered.—*Electronics.*

Felt-bonded metal

RATTLES IN RADIO receivers created by metal-to-metal contacts, and imperfect insulation with pads, rings, etc., which may get out of place in assembly or in use, are eliminated by a new material, felt bonded metal, which consists of sheet metal bonded to felt by a metal bond which will not separate. This material may be bent or cut with no damage to the bond; and thickness of metal or felt may be varied to suit requirements.

The value of felt in solving problems of acoustics has long been recognized; hence, in the construction of speakers, sound chambers, and cabinets this new material will be of interest to the designing engineer.

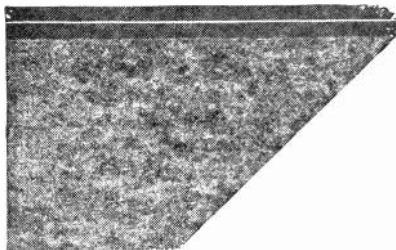

From the production angle felt bonded metal provides in one unit of material the results heretofore attained through the use of separate rings, washers, strips, and pads. It is made by the Felters Company, 210 South Street, Boston, Mass.—*Electronics*.

Capacity meter

THE NEW "MEGGER" capacity meter being marketed by James G. Biddle & Company, 1211 Arch Street, Philadelphia, Pa., is a portable, direct-reading, multi-range microfarad meter, which includes a self-contained source of test current. To make a test one simply connects the condenser or circuit, the electro-static capacity of which is to be measured, to the terminals, turns the crank of the hand-generator and reads the meter scale directly in microfarads. Since no outside source of current is necessary, the instrument may be used anywhere.

The "Megger" capacity meter was developed especially for industrial use by manufacturers of radio and other types of electrostatic condensers, and for miscellaneous capacity measurements in shop or laboratory. Also it should have valuable applications in the field, as for example—measuring the electrostatic capacity of condensers used in power factor correction.

The "Megger" capacity meter is similar in construction and appearance to the well-known "Megger" insulation testing instruments and ground testers.—*Electronics*.

Aircraft and high-voltage fuses

THE LITTELFUSE LABORATORIES, 4507 Ravenswood Avenue, Chicago, Ill., makers of special fuses for instrument protection, automobile and radio use, have now extended their line into aircraft fuses, offering what is believed to be the only fuses in the world designed especially for aircraft use. These glass-enclosed aircraft fuses are made in sizes of 1, 2, 3, 5, 10, 15, 20, 25 and 30 amperes rating. The voltage ratings run from 25 to 2,500 volts. Accelerated vibration life-tests on one of the weaker sizes of these aircraft Littelfuses ran over 500 hours, as against an average life of only five minutes for the same rating of regular glass-enclosed fuses on the market.

Another specialty is the high-voltage Littelfuse, a renewable line of fuses for operation in 1,000-, 5,000- and 10,000-volt ranges, in ratings from one-sixteenth to 2 amperes. Such fuses are designed for the protection of high-voltage power amplifiers, oscillators, rectifiers, meters, etc., and may be renewed by the user at negligible cost.—*Electronics*.

Wide-range sound-film amplifier

THE GATES RADIO & SUPPLY COMPANY, Quincy, Ill., has developed a new 44A wide-range sound-film amplifier for theatre use, which is all a.c. operated, using no batteries whatsoever. It is 22 inches long and 16 inches high, not including the additional height of tubes. The amplifier is so designed that stray currents from power transformers cannot enter the sensitive photocell circuit. The tubes are out in the open to assure full air circulation, prolonging tube life and making them accessible for quick change when necessary.

The usual multiplicity of controls is entirely absent with the 44A amplifier. Only the main volume control and changeover switch prevail. Above the volume control is a pilot light. Adjustments for the exciter lamps and photocell voltage are on the side of the amplifier. They are adjusted when installing and then never touched.—*Electronics*.

Audio-frequency test recordings

THE AUDIO-TONE OSCILLATOR COMPANY, of 1382 Page Boulevard, Springfield, Mass., has announced a series of technical test records to be added to its line of audio-frequency test equipment. One such recording covers the

entire range of frequencies from 50 cycles to 7,000 cycles, differing from the usual frequency record in that the recording is continuous throughout the range of the record; thus making it possible to check the audio-frequency characteristic of phonograph reproducers, amplifiers, loud speakers, or entire public address systems continuously over their frequency range and to note any variations which would not be observed with the usual point-to-point frequency check. An underlay voice recording announces each important frequency, thereby identifying the frequency being reproduced and indicating the range in which occurs any variations in the characteristic being checked.

These Audio-Tone test records have an accuracy of recording which agrees with the average of four types of commercial wax recorders with a maximum deviation of 1 db. over the entire frequency range.

These records are double-face, 12 in. and are priced at \$3.—*Electronics*.

Compensated smoke recorder

PHOTO-CELL SMOKE density recorders, compensated for variations in light source intensity to give accurate records of the true relative smoke density at all times, have been announced by the

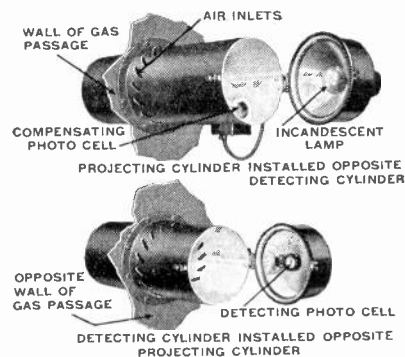

Bailey Meter Company, Cleveland. The equipment consists of the receiving element and 12-in. chart recorder mounted on the boiler panel and transmitting element, consisting of transmitting and detecting cylinders on opposite sides of the breeching or flue gas passage.

The galvanometer and electronic relays of the "Galvatron" relay circuit are mounted on the back of the hinged chart panel of the recorder casing. Two photo-cells are employed as shown, connected to separate potentiometers acting in opposition, with their moving contacts tied through a galvanometer. When smoke passes through the gas passage the difference in current from the two cells causes the galvatron to adjust the contact of one potentiometer until no current passes through the galvanometer. Movement of the contact is proportional to the smoke and is geared to the recorder pen.—*Electronics*.

U. S. PATENTS IN THE FIELD OF ELECTRONICS

Electron tube applications

Altimeter. Determining the distance between two bodies, one of which carries several capacity elements. One of these capacities is moved with respect to the other and the change in capacity as a function of distance is measured. O. E. Marvel, Bendix Aviation Corp. No. 1,965,147.

Vehicle lighting. An automobile lighting system involving a vacuum tube.

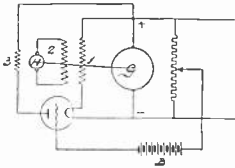

F. H. de Jong, Philips, Holland. No. 1,965,308.

Flaw detector. By means of establishing an electro-magnetic field around a conductor flaws in the conductor may be detected. H. C. Drake, Sperry Products, Inc. No. 1,967,812.

Ignition system. Vacuum tube generator of high frequency oscillations with the proper transformer is arranged as a

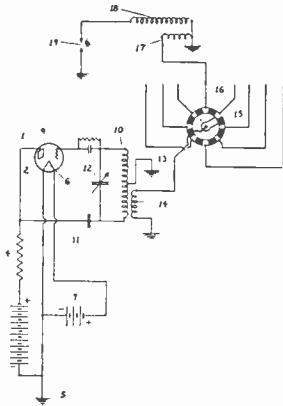

vehicle ignition device. W. F. Cotter and L. P. Kongsted, United American Bosch. No. 1,968,930.

Transparency meter. Measuring the transparency of newsprint paper by means of diffused light and light sensi-

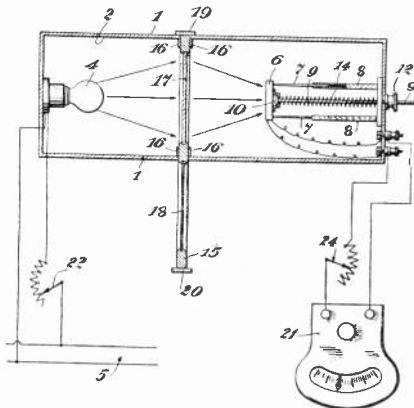

tive cells. M. D. McFarlane and W. Baumbrucker. No. 1,967,583.

Thickness control. A device for controlling the thickness of a moving strip of magnetic material by causing the variable thickness to change the speed of a circuit. H. A. Winne, G. E. Co. No. 1,969,536.

Altimeter. Several radio waves are transmitted from the craft to the ground. These waves are of different frequency. The reflected wave from the earth modifies the frequency of each wave and determines the altitude of the craft. E. F. W. Alexanderson, G.E. Co. No. 1,969,537.

Welding system. Using an arc discharge device for regulating the welding current. E. R. Evans, Washington. D. C. No. 1,969,550.

Smoke density recorder. Light-sensitive methods of measuring the density of smoke and of cleaning gas. Patents No. 1,969,626, No. 1,969,627. A. W. Simon, L. C. Kron and H. Raymond.

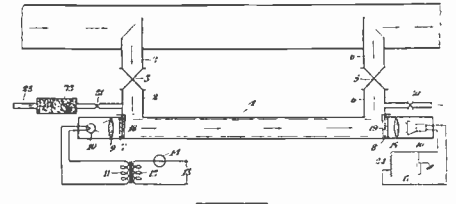

Electron tubes

Cathode. In combination, a filament containing about 90 per cent nickel, 7.5 per cent iron and a small amount of a deoxidizer capable of increasing the strength of the alloy and its electrical resistance and an electron-emissive oxide coating. E. F. Lowry, WE&M Co. No. 1,961,122.

Grid-controlled rectifier. A screen

VIBRATOR POWER SUPPLY PATENTS

Through the courtesy of Wm. W. Garstang of the Electronic Laboratories, Inc., Indianapolis, the following list of patents relating to vibrator power supply systems is presented. The devices and circuits covered by these patents are of interest at the moment to auto radio engineers, but may conceivably have even wider application later—THE EDITORS.

Patent No.	Date of Issuance	Date of Filing	Inventor	Subject Matter
345,720	7-20-86	8-10-85	PARCELLE	Vibrating type motor—Shows armature eccentric to pole
400,312	3-26-89	9- 4-88	DAVIS	Thermostat—center reed with 2 contacts
527,839	10-23-94	2-23-94	FARNHAM	Annunciator—center reed—2 outside contacts
534,595	2-19-95	5-28-94	ATWOOD	Bell ringer
844,240	2-12-07	10-21-05	BOPP	Induction coil
846,227	3- 5-07	1-25-07	MENDELSON	Vibrating motor—armature eccentric to pole piece
928,583	7-20-09	11-11-08	BURLINGAME	Vibrating rectifier — center reed—2 outside contacts
1,019,608	3- 5-12	9-17-08	DEMPSTER	Vibrating rectifier — center reed out of contact position
1,051,941	2- 4-13	11-29-09	WOODBIDGE	Vibrating rectifier—pressure contacts
1,061,550	5-13-13	10- 1-08	LARSSON	Vibrating motor — armature swings past pole piece
1,063,369	6- 3-13	6- 1-11	McELROY	Thermostat
1,085,393	1-24-14	7-22-12	WARD	Vibrator reducing circuit
1,128,383	2-16-15	8-31-14	STEVENS	Induction coil
1,131,919	3-16-15	10-29-09	FASSLER	Vibrating rectifier
1,131,920	3-16-15	11- 5-10	FASSLER	Vibrating rectifier—short circuiting electro magnet
1,181,216	5- 2-16	8-12-12	FALKENTHAL	Transforming apparatus — adjustable reeds and stops
1,188,157	6-20-16	9-18-14	DEMPSTER	Vibrating rectifier—air gap transformer
1,207,957	12-12-16	10-21-11	McELROY	Thermostat
1,296,269	3- 4-19	8- 2-17	CRAWFORD	Converter circuit—full wave primary
1,311,490	7-29-19	5-14-15	BRACKETT	Vibrating rectifier — transformer type
1,328,255	1-20-20	5-17-19	ANDERSON	Vibrating motor—fan
1,335,837	4- 6-20	12-17-18	JACOBSON	Induction Coil
1,361,229	12-7-20	5- 7-19	CRENSHAW	Vibrator motor — armature eccentric to pole piece
1,418,023	5-20-22	6-25-15	REISZ	Interrupter and rectifier
1,470,079	10- 9-23	1- 3-21	HOESCHEN	Thermostat
1,477,350	12-11-23	8- 6-20	HOESCHEN	Thermostat

and anode spaced by a gap sufficiently short to prevent gas ionization by the potential applied to the electrodes. J. D. Le Van, Raytheon. No. 1,962,159. See also No. 1,962,159 to C. G. Smith on a gaseous discharge tube.

Amplification, detection, etc.

High power output tube. Method of increasing the power output of a tube by connecting the grid of the second tube to the cathode of the first, which has a positive grid bias. The second tube

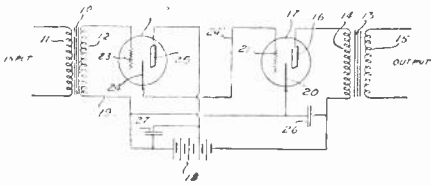

has a negative bias. F. B. MacLaren, Revelation Patents Holding Co. No. 1,959,540.

Tuning circuit. High frequency amplifier with an input network in which both inductance and condenser are variable simultaneously so that the impedance of the network, that is, the ratio between L and the product of $R \times C$ varies in a predetermined manner. Paul Müller, Siemens & Halske. No. 1,957,796.

Adjudicated patents

(D. C. Conn.). Langmuir patent, No. 1,244,217, claims 1 and 8; Nicolson patent, No. 1,307,510, claims 7 and 13; Arnold patent, No. 1,354,939, claims 10, 15, and 16; Nicolson patent, No. 1,459,412, claims 7 and 23; Van der Bijl patent, No. 1,479,778, claim 7; Schottky patent, No. 1,537,708, claim 1; Langmuir patent, No. 1,558,437, claims 20, 22, 23, and 28; Seibt patent, No. 1,696,103, claims 1 and 2; Mitchell patent, No. 1,748,026, claims 1 and 3; Langmuir reissue patent, No. 15,278, claims 1, 3, 8, 18, and 41. All held valid and infringed. Radio Corporation of America v. Majestic Distributors, 6 F. Supp. 87.

Wilson patent, No. 1,419,530, claim 2 held invalid. *Id.*

(D. C. Del.) Miller patent No. 1,756,000 for piezo-electric oscillator, patentee held not first and original inventor of subject matter. Miller v. National Broadcasting Co., 6 F. Supp. 47.

1,533,858, L. A. Hazeltine, Method and means for neutralizing capacity coupling in audions, D. C., E. D. Pa., Doc. 6549. Hazeltine Corp. vs. A. A. Kent. Consent decree discontinuing bill and counter claim without prejudice, April 24, 1934. Same D. C., S. D. N. Y. vs. E. B. Latham & Co., I. Jacobson (Audubon Music Shop), Bloomingdale Bros., Commodore Radio Corp., Cushman & Cushman, Inc., Davega, Inc., Fannill Radio Corp., Gimbel Bros., Inc., L. M. Greenberg, Inc., Heins & Bolet Radio & Electric Supply Corp., P. Heefer, Inc., J. Hoffman, (Hoffman Bros.); Howard Radio Co. Inc., Landay Bros., Inc., S. Lazarus, Inc., L. Baumann, Inc., R. H. Macy & Co., Inc., M. M. Mandel (Guarantee Phonograph Co.), J. McCreery & Co., Inc., Oscar's Radio Shop, Inc., Perfection Radio Corp. of America, S. Schwartz (Sun Radio Co.), Trans-Atlantic Radio Stores, Inc., Waltham Electric Co., Inc., J. Wanamaker, N. Y., Inc.; Vim Electric Co., Inc.; Yorkville Radio Co., Inc.; E. J. Edmond & Co., Inc.; Y. Haynes-Griffin, Inc.; R. Roemer Furniture Co., Inc.; City Radio Co., Inc.; Spear & Co., Inc. Dismissed with prejudice (notice April 30, 1934) in each of above cases.

1,867,249, Clark & McCann, Electrolytic device; 1,916,586, Robinson & Collins, same; 1,935,860, 1,938,464, P. Robinson, same; 1,948,289, H. I. Danziger, same, filed May 17, 1934, D. C., S. D. Ohio, W. Div., Doc. E 892, Sprague Specialties Co. v. Electro Formation, Inc.

1,648,808, L. A. Hazeltine, Wave signaling system, D. C., E. D. Pa., Doc. 5359, Hazeltine Corp. v. A. Kent Mfg. Co. Consent decree discontinuing suit without prejudice Apr. 24, 1934.

1,231,764, F. Lowenstein, Telephone relay; 1,618,017, same, Wireless telegraph apparatus; 1,403,475, H. D. Arnold, Vacuum tube circuit; 1,465,332, same, Vacuum tube amplifier; 1,403,932, R. H. Wilson, Electron discharge device; 1,658,346, R. C. Mathes, Amplifier circuit; 1,531,805, same, Oscillation generator; 1,573,374, P. A. Chamberlain, Radio condenser; 1,596,198, S. Loewe, System for generating oscillations; 1,702,833, W. S. Lemmon, Electrical condenser; 1,811,095, H. J. Round, Thermionic amplifier and detector; 1,896,780, F. B. Lewellyn, Modulating device; Re. 18,579, Ballantine & Hull, Demodulator and method of demodulation; Re. 18,916, J. G. Aceves, Supply circuits for radio sets, filed May 18, 1934, D. C., S. D. N. Y., Doc. E 78/151, Radio Corp. of America et al. v. J. & L. Sara Co., Inc., et al.

1,251,377, A. W. Hull, Method of and means for obtaining constant direct current potentials; 1,297,188, I. Langmuir, System for amplifying variable currents; 1,573,374, P. A. Chamberlain, Radio condenser; 1,728,879, Rice & Kellogg, Amplifying system, filed May 5, 1934, D. C., S. D. Calif. (Los Angeles), Doc. E 257-C, Radio Corp. of America et al. v. C. F. Sexton (Radio Products Sales Co.)

1,477,889	12-18-23	1-25-23	MORSE	Vibrating motor
1,537,796	5-12-25	6- 1-20	BOSSARD	Vibrating motor—armature eccentric to pole piece
1,671,245	5-29-28	4-15-26	KRAUS	Full wave primary—vibrating rectifier
1,682,748	9- 4-28	7-27-22	FAYER	Full wave rectifying transformer
1,688,826	10-23-28	10-18-23	NACHOD	Vibrating circuit controller
1,729,326	9-24-29	8-11-27	CAVANAGH	Full wave vibrating rectifier
1,741,017	12-24-29	1-10-29	FEILD	Interrupter on transformer
1,801,022	4-14-31	6-25-30	PONCEL	Power supply including interrupter and rectifier tube
1,813,541	7- 7-31	5- 7-25	LAURITSEN	Automatic control system
1,819,617	8-18-31	9-12-25	MOSER	Vibrating converter
1,832,474	11-17-31	9-23-29	BLUDWORTH	Remote control apparatus
1,834,129	12- 1-31	4-29-27	LOEWE	Pendulum type interrupter
1,844,502	2- 9-32	2-11-29	EATON	Power supply circuit—artificial load
1,846,100	2-23-32	11-18-29	GROTHE	Vibrating razor
1,846,101	2-23-32	11-18-29	GROTHE	Vibrating razor
1,850,848	3-22-32	2-16-29	PAYNE	Vibrating device
1,880,033	9-27-32	1-22-29	BOSSART	Vibrating oscillator
1,920,150	7-25-33	12- 7-32	ROCKWELL	Synchronous interrupter and rectifier
1,921,461	8- 8-33	7-30-32	GARSTANG	Power supply using artificial load
1,924,082	8-22-33	1-13-33	BARRETT	Full wave vibrator
1,935,568	11-14-33	1-27-30	KEOGH	Synchronous interrupter and rectifier-rotary
1,935,569	11-14-33	1-27-30	KEOGH	Synchronous interrupter and rectifier-vibrating
1,943,183	1- 9-34	9-27-32	MITCHELL	Series interrupter—split primary
1,943,240	1- 9-34	9-27-32	LEAR	Plug-in type interrupter
1,944,487	1-23-34	7- 3-33	BERTSCH	Vibrator mounted on a spring
1,946,563	2-13-34	6- 6-32	BARRETT	Vibrating type power supply-heater rectifier
1,951,614	3-20-34	3-10-30	KAEHNI	Vibrating system with R.F. choke
RE18,936	9- 5-33	4-25-30	WILSON	Vibrator power supply circuit

FOREIGN PATENTS

British	29,089	12-20-06	LODGE	Ignition coil
British	318,785	6-26-29	VALENTINE	Power supply circuit showing artificial load
Austrian	12,497	6-10-03	JEAN	Vibrator system
Australian	21,387	7-23-29	HOOPER	Vibrator power supply circuit

CLAROSTAT

offers another new essential component

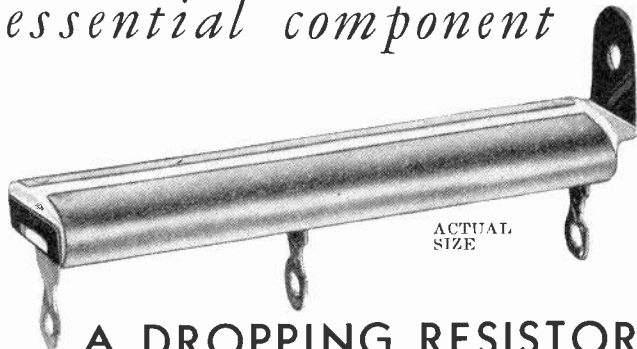

A DROPPING RESISTOR for AC-DC Receiving Sets

This new development—the result of Clarostat's long and specialized experience in meeting tough specifications—gives initial protection to the pilot light when the net work is cold and yet permits the pilot light to operate at its rated voltage.

These resistor units are made under Clarostat's well-known precision methods and are pre-tested to Clarostat's high standards of accuracy. They eliminate those costly comebacks resulting from too frequent burning out of pilot lights and assure adequate illumination of dials.

CLAROSTAT also offers

a new FIXED Center Top Resistor, standard tolerance of 10% or closer if specified. Special tolerances and resistances are also available as required.

Any Low Wattage Resistor Requirements

Whatever your resistor requirements, whether they be standard or special, Clarostat is ready to meet them and assure quality performance with wirewound-resistors, exact, and uniform as to values, yet at prices which compete with carbon.

Constancy of wattage rating, noiselessness and ease of assembly are inherent in all Clarostat Resistors. Samples will be sent on request, if you will write us your requirements on your business letterhead.

Call on Clarostat for engineering service on your requirements. You can depend on our manufacturing facilities for efficient handling and prompt shipment of your orders—in any quantity.

CLAROSTAT QUALITY PRODUCTS

Volume Controls; Tone Controls; Clinch-grip Flexible Resistors; Center Tap Resistors; Metal Cover Fixed Power Supply Resistors; Line Ballasts, L & T Pads; Series Mixers; Constant Impedence Devices; Standard Potentiometers.



CLAROSTAT
MANUFACTURING CO., Inc.
285 North 6th St.
BROOKLYN, N. Y.



KNOW *what will happen in the receiver*

MEASURE INDUCTANCE
CAPACITANCE

MATCH COILS
CONDENSERS

under operating conditions

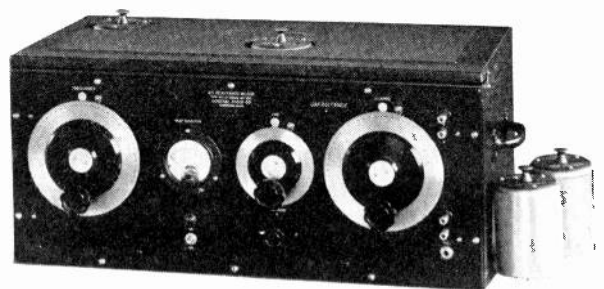

THE Type 421 Reactance Meter places the coil or condenser in an oscillating circuit, at the frequency of use—and measures it under operating conditions. Its uses include measurement of coil and condensers—adjustment of gangs, matching of coils, determination of coil capacitance, and similar measurements. It is entirely alternating-current operated.

TYPE 421-A REACTANCE METER

Range: 550-1500 kilocycles

125-300 kilocycles

1500-4000 kilocycles

Price: \$445.00

Described in Bulletin 434-E

GENERAL RADIO COMPANY

Cambridge A

Massachusetts

FIELD TESTED FOR TWO YEARS...

ANNOUNCED TODAY!

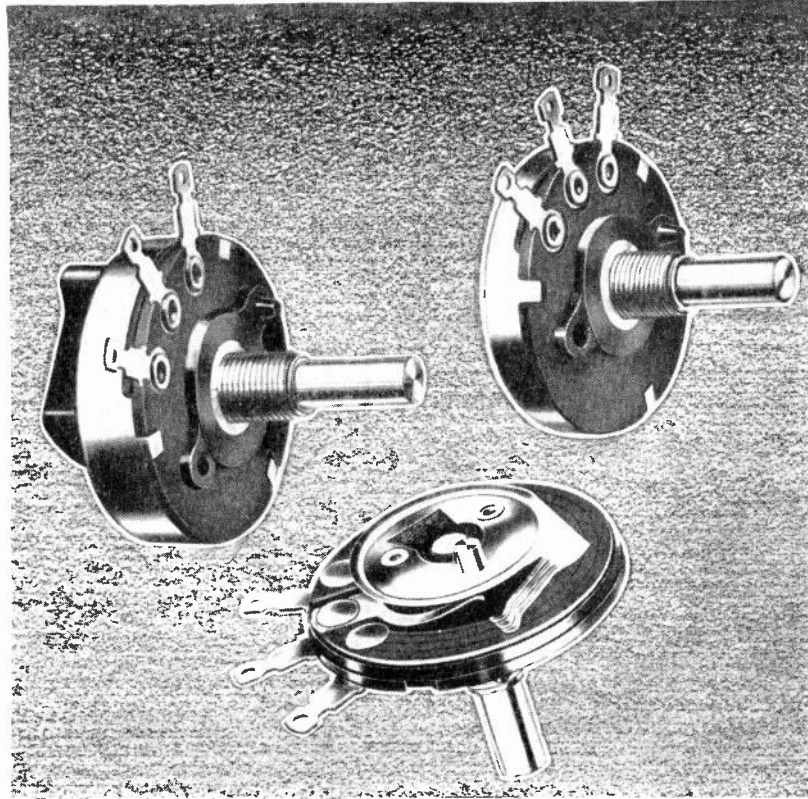

VOLUME CONTROLS

IRC Volume Controls are a logical development of the IRC method of applying resistance coatings to insulating bases, used so successfully for years in the well-known Metallized resistors.

Nor is this their only recommendation. For two years prior to this general announcement, they have seen extensive service under all conditions of use in radio receivers produced by several manufacturers. Constantly increasing orders from these same firms tell their own story of quality coupled with sound economy.

The IRC Volume Control is especially designed to resist humidity. The resistance coating is permanently bonded at a high temperature, to a hard, moisture-proof base. Contact is made by three slider fingers that always follow the same course and which positively eliminate any jumps in resistance due to shifting of the points of contact. Wear is reduced to a minimum.

Write for Catalog M-26 describing this new IRC development in detail.



INTERNATIONAL RESISTANCE CO.

2100 ARCH ST.

PHILADELPHIA, PA.

In Canada, 187 Duchess St., Toronto, Ont.

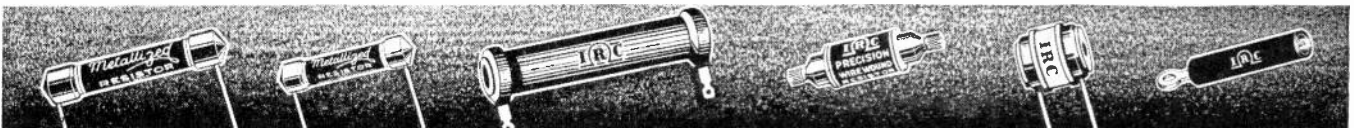

BY THE MAKERS OF METALLIZED, PRECISION AND POWER WIRE WOUND RESISTORS

THE NEW EBY "35" WAVE BAND SWITCH

(Pats. Pending)

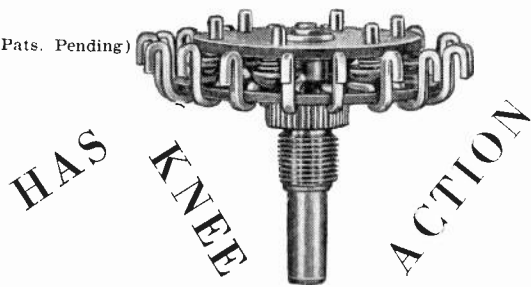

Eby engineers have developed a new principle in wave band switch construction.

All stator contacts are laced then staked in place and do not become loose after 50,000 cycles.

Rotor contacts are self-cleaning and self-leveling.

Positive and direct overhead pressure provide for "Knee Action" effect.

All of these features combine to produce long life, low resistance, and low capacity in minimum space.

Six Pole Double Throw (illustrated) has 18 contacts measuring 2" diameter.

Our Eight Pole Double Throw with 24 contacts measures only 2½" diameter.

8 Good Reasons Why You Should Want to Know More About the EBY "35"

1. Compact—2" Diameter—18 Contacts
2. Rugged Construction
3. Low Contact Resistance
4. Contacts polish as they turn
5. Low Capacity is unequaled
6. Positive Indexing
7. Wide Spacing Means long leakage path
8. Reasonably Priced

Send for complete information on this new EBY Wave Band Switch with *Knee Action*.

HUGH H. EBY, INC.

*Twenty-Three Years of Faithful Service to the
Electrical and Radio Industries*

2066 HUNTING PARK AVE., PHILA., PA.

SHAKEPROOF

CLOSE-UP VIEW OF A
SINGLE TWISTED TOOTH

TOP
BITING
EDGE

LOWER
BITING
EDGE

Look Closely

AT THIS TWISTED TOOTH

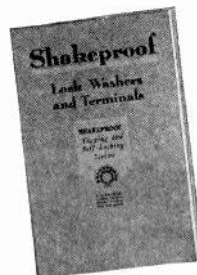

Send today for your free copy of this complete Shakeproof Catalog. Explains thoroughly the many advantages that Shakeproof offers—also shows new patented Shakeproof products.

HERE you see the reason for Shakeproof's great locking power. This exclusive feature makes possible the most positive method for holding nuts and screws absolutely tight. A solid, rigid contact is made between the nut and the work, producing a lever action which makes the two biting edges dig in deeper as vibration tries to loosen the nut. Now, consider that there are several twisted teeth on each Shakeproof Lock Washer—each one exerting its powerful force against any backward movement of the nut. The performance of your product is certain to be definitely improved by this modern locking principle—Write for free testing samples today.



SHAKEPROOF Lock Washer Company

Distributors of Shakeproof Products
Manufactured by Illinois Tool Works

2539 N. Keeler Ave.

Chicago, Ill.



Type 12.
Internal

Type 11.
External

Type 15.
Countersunk

Type 20. Locking
Terminals

U. S. Pat. 1,419,564—1,604,122—1,697,954—1,782,387—Other Pat. Pending—Foreign Pat.

7,258 HOURS!

Sylvania favored in Airway Communications

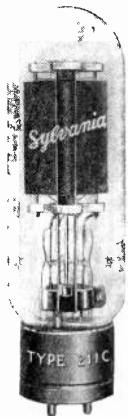

Sylvania Type 211-C
Graphite Anode Transmitting Tube.

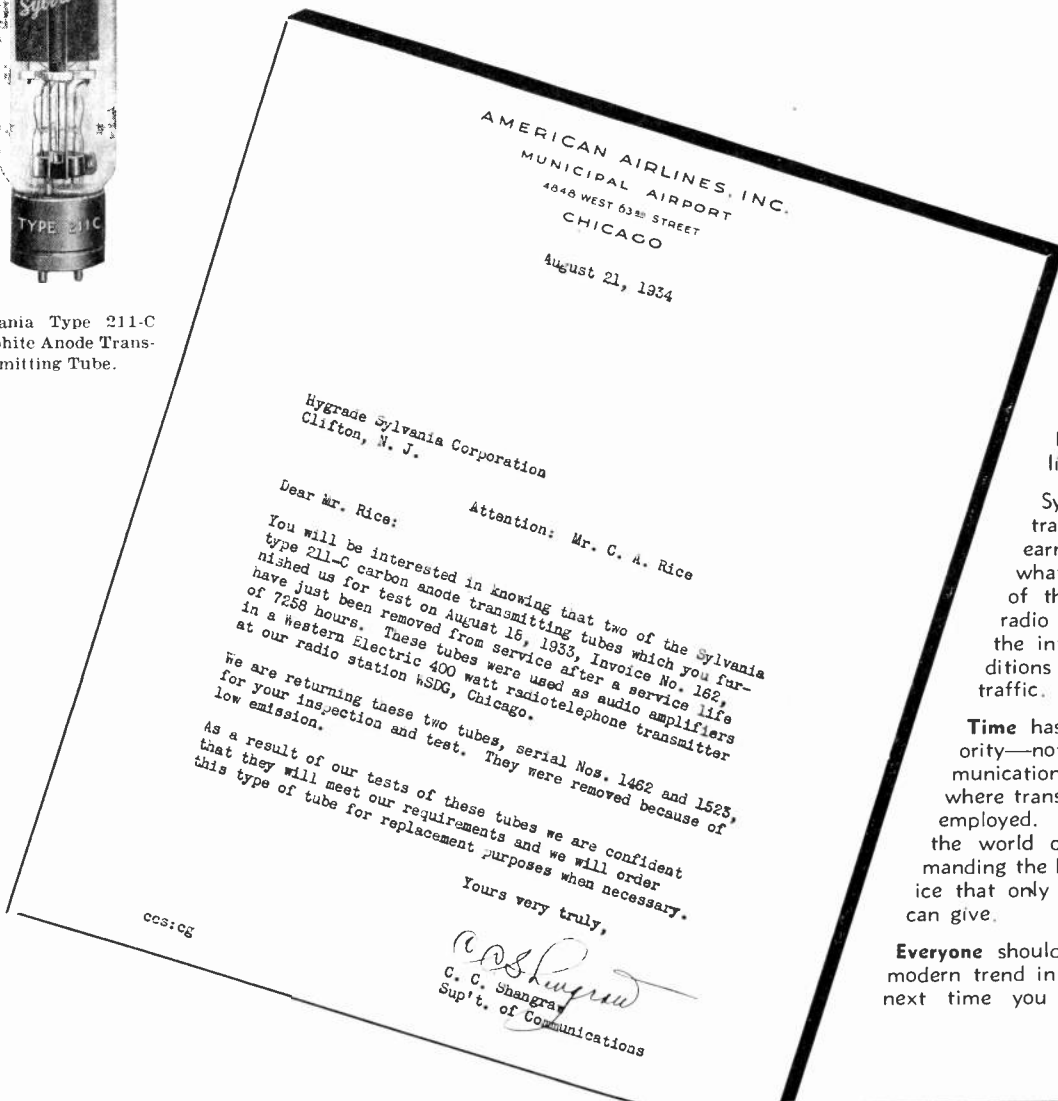

Enthusiasm prompted this letter from American Airlines.

Sylvania Graphite Anode transmitting tubes have earned high confidence in what might be termed "one of the most gruelling jobs a radio tube is subjected to"—the intermittent operating conditions of airway ground station traffic.

Time has proven Sylvania superiority—not only in airway communications, but in all other fields where transmitting vacuum tubes are employed. Broadcasters and amateurs the world over are vociferously demanding the highly enduring tube service that only Sylvania Graphite Anodes can give.

Everyone should keep in step with this modern trend in transmitting tubes. The next time you order, specify Sylvania.



HYGRADE SYLVANIA CORPORATION

Hygrade Lamps ELECTRONICS DEPARTMENT Sylvania Tubes
CLIFTON, NEW JERSEY

FACTORIES: SALEM, MASS. EMPORIUM, PA. ST. MARYS, PA. CLIFTON, N. J.

WAREHOUSE STOCKS IN
Portland, Oregon Atlanta, Georgia Denver, Col. Chicago, Ill. Salem, Mass. Dallas, Texas Philadelphia, Pa. Pittsburgh, Pa. Los Angeles, Cal.



TEXTOLITE Laminated

**SHEETS
RODS
TUBES**

... one piece or a truck load ...
Ready for immediate delivery

General Laminated Products, Inc., 233 Spring Street, New York City, is the exclusive distributor of G-E Textolite non-gear laminated materials. Its fabricating plant is the largest and most complete in the industry.

Satisfaction with the high quality of its fabricated parts is assured by the long experience and ingenuity of this corporation in making the most intricate parts.

With a special department for handling all small orders in 24 hours or less, and with complete stocks of every specification of laminated material available, its facilities for quick delivery are unsurpassed.

For detailed information on the properties and uses of Textolite, mail the coupon below.



SEND FOR USEFUL BOOKLET

Plastics Dept., General Electric, West Lynn, Mass.

Please send me a free copy of your new PLASTICS PRODUCTS PRICE LIST, GEA-937C.

Name.....

Company.....

Address.....

942-15

GENERAL  ELECTRIC

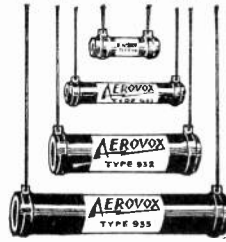
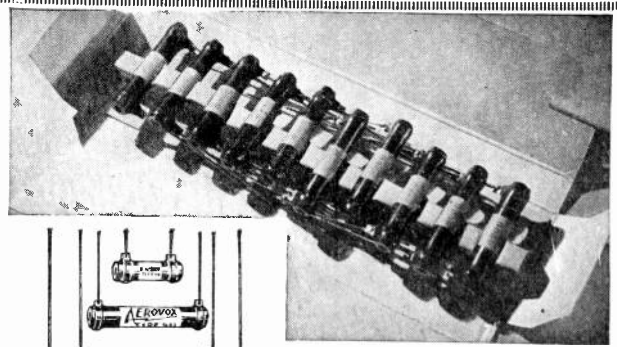

Types 930, 931, 932 and 933 — 5 to 20 watts. Wide range of resistance values. Wound on porcelain tube with special high-grade resistance wire of low temperature coefficient. Pigtail leads. Entire unit completely coated and permanently protected with vitreous porcelain enamel. Longest troubleproof life for new assemblies. New life for burnt out resistance networks.

**Just as small
BUT —
WIRE-WOUND**

No larger than usual carbon type resistors . . . costs little more . . . as convenient to handle and install . . . BUT, offering the undeniable advantages of a wire-wound job. That's the story of Aerovox Wire-Wound Vitreous Enamelled Resistors in the small sizes. Typical of the practical engineering back of Aerovox resistors as well as condensers.

Send for Data: Latest Aerovox Catalog covering complete line of condensers and resistors sent on request. Also sample copy of Aerovox Research Worker . . . a monthly compilation of practical radio data fresh from research laboratory and engineers who are doing things.



75 Washington Street

Brooklyn, N. Y.

DUNCORELAYS

There is a Dunco Relay to meet your requirements

- Broadcast Stations
- Point-to-point Transmitters
- Sound Recording
- Sound Theatres
- Public Address Telephone and Telegram Repeaters
- Traffic Signalling
- Railway Train Control
- Carrier Systems
- Remote Control Radio Receivers
- Photocell Devices

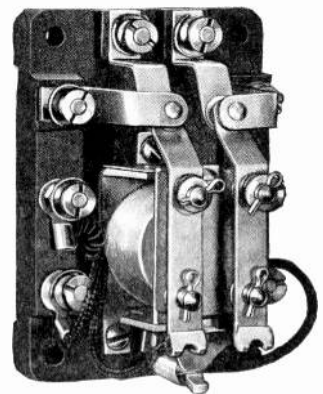

Use Dunco Relays to improve your communications or signalling systems. Relays for every purpose. We invite your inquiries.

STRUTHERS  DUNN, INC.
148 N. JUNIPER ST.  PHILADELPHIA, PA.

"A CINCH PLUG THE SIZE OF A QUARTER?"

—“and getting it so quickly—that’s service.” This engineer found himself with a standard size plug and no place to fit it. Then he thought of Cinch. “Let me have a plug,” he said, “about the size of a quarter.” Cinch radio engineers ever mindful of the policy “your problems are our problems” went to work. The result is another satisfied user of Cinch facilities. The needs of this manufacturer has helped us to serve the immediate needs of others. With this request for a new size was created the midget radio plug. Alert personnel, schooled in the supreme value of quick action and good service, a wide range of equipment, under skilled supervision! That is the reason for an outstanding service, *individual of Cinch.*

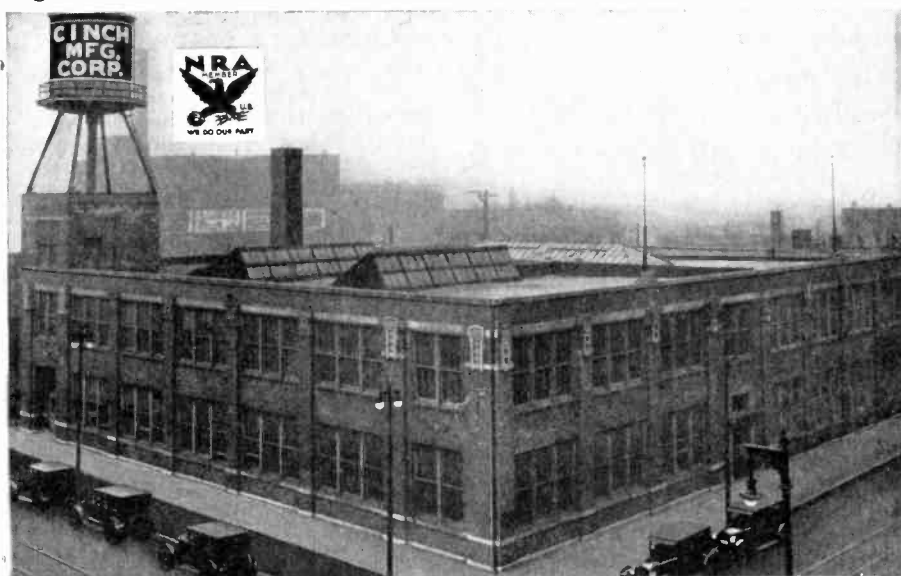

A CINCH FOR CINCH

Here is a new metal shielded midget plug designed and constructed to fill the immediate need of one manufacturer, it is already finding a market in a long felt need of numbers of others. Perhaps there is something other than standard plugs that you may want? Whatever the need, ask us. It is probable that we have something in stock. Cinch Manufacturing Corp., 2335 W. Van Buren Street, Chicago, Illinois. *Subsidiary of United-Carr Fastener Corp., Cambridge, Mass.*

Cinch radio sockets are licensed under H. H. Eby socket patents.



"KNEE ACTION"
something new
in RHEOSTATS



These new ring type Rheostats have a "knee action" contact arm. They are made in 1 $\frac{3}{8}$ ", 2 $\frac{1}{4}$ ", 3" and 4" diameters with watt ratings from 25 to 170 and a wide range in resistance values. Bulletin 1105 gives you the necessary technical information. Send for it and other bulletins describing large and small Ward Leonard Rheostats.

WARD LEONARD

CONTROLS • RESISTORS • RHEOSTATS

WARD LEONARD ELECTRIC CO.

32 South St., Mount Vernon, N. Y.

Please send me Bulletin about.....

Name

Company

Street

City and State

GEN-RAL
 Registered
COILS

ACCURACY—DEPENDABILITY
 TEN YEARS OF SERVICE

SKIP-BAND
 Combination
 No. 27
 Print
 No. 1029
 Layout
 No. 1029K

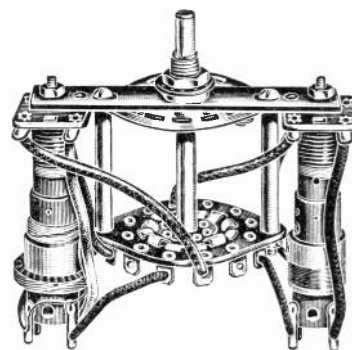

1935

Engineers Coil Guide
READY NOW

Request your copy on firm letterhead

GENERAL MANUFACTURING CO.
 8064 So. Chicago Ave.

Cable Address
 "GEN-RAL"

Chicago, Ill.

New 1935

REMLER

**Condenser
 Microphone**

Precision built by experienced technicians . . . used by hundreds of broadcasting stations . . . now with new improvements **AT NO INCREASE IN PRICE.**

New safety height adjusting device; 2-stage pre-amplifier—864 tubes; hermetically sealed nitrogen gas-filled head; acoustic equalizer and pressure equalized diaphragm. Back plate mica insulated. Completely moisture-proof. Head housing shielded and insulated. Noiseless plug-in contacts.

LOCK TYPE PLUGS—CONNECTORS—SOCKETS AND LADDER TYPE ATTENUATORS

These items conform to the high standards which characterize all Remler products, and together with remote amplifiers, speakers and associate broadcasting equipment, complete the Remler line.

List Price
 Complete
\$135

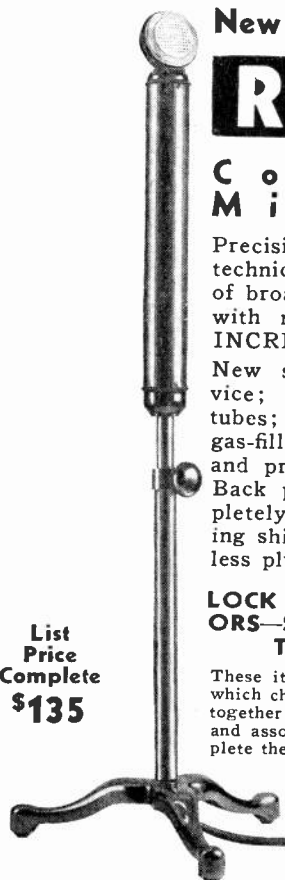

Send for illustrated catalogue sheets and prices.

REMLER COMPANY, Ltd.
 2101 Bryant Street San Francisco

REMLER—THE RADIO FIRM AS OLD AS RADIO

Even if Unit Production is small

One of World's Largest
X-Ray Machines—built
better at lower cost with
Self-tapping Screws!

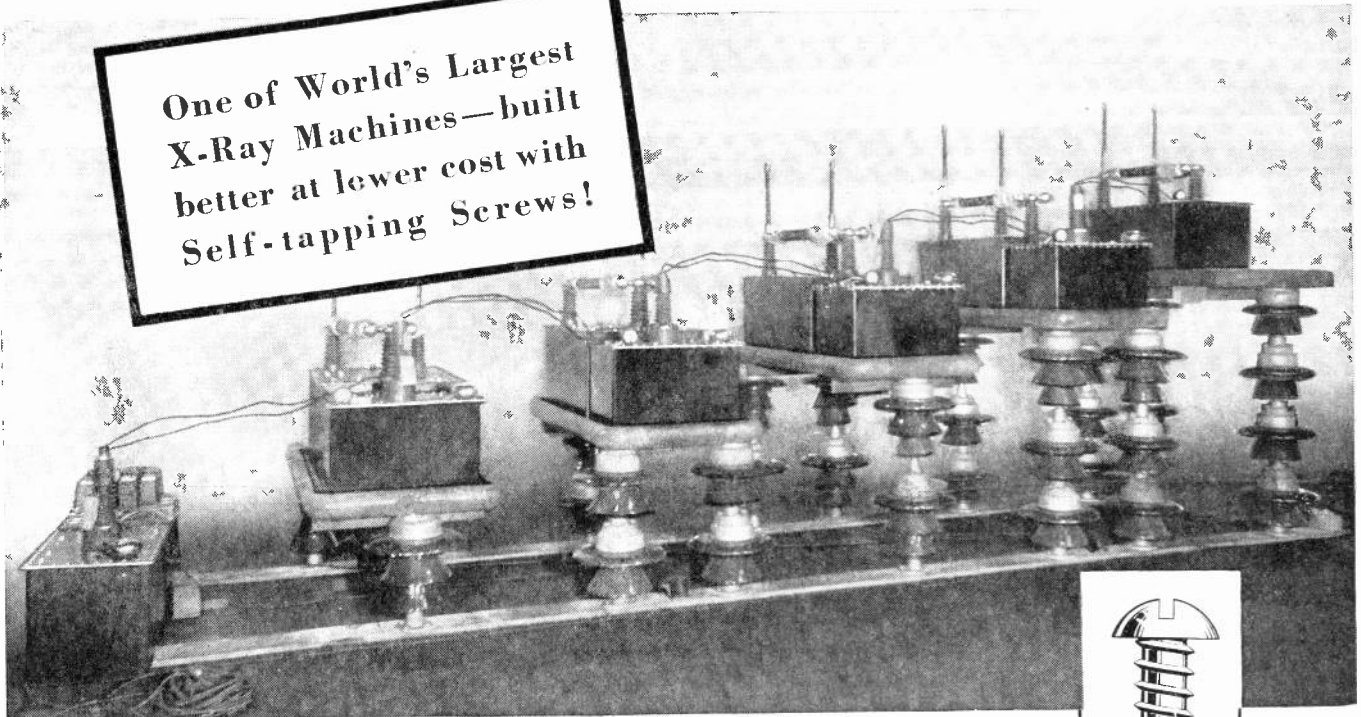

... notable economies result when Self-tapping Screws are used in assembly

IN building the giant Kelley - Koett X-Ray machine illustrated, it was convincingly demonstrated that Parker-Kalon Hardened Self-tapping Screws can be used just as advantageously in "special" or limited production assembly work, as in large volume manufacturing operations.

Without any special tools or changes in design, a 50 per cent saving of assembly time was made, merely by substituting Hardened Self-tapping Sheet Metal Screws for the machine screws or cap screws and nuts formerly used to fasten down oil-seal covers on the tanks. Moreover, the use of these Screws resulted in fastenings of far greater security.

more than 100 units a year. Others have a volume running to 100,000 units, but savings per unit are relatively the same.

Try these time and labor saving Screws. See what they will do on your work. Attach a brief description of your assemblies to the coupon and mail for free samples and recommendations of our Assembly Engineers.

Where and How to use:-

Type "Z" Hardened Self-tapping Sheet Metal Screws



For joining and making fastenings to molded, cast and laminated plastics; die castings and sheet metal. Simply turn the Screws into drilled or molded holes. Can be removed and replaced without impairing holding power.

Type "U" Hardened Metallic Drive Screws

This type of Self-tapping Screw is for making permanent fastenings to molded, cast and laminated plastics, also steel and metal castings. Just hammer the Screws into molded or drilled holes for secure fastenings.



Makers of all kinds of electrical apparatus are assembling parts made of steel, aluminum, Bakelite, slate, ebony asbestos and other materials, faster, cheaper and better with Self-tapping Screws. Some produce no

PARKER-KALON HARDENED Self-tapping Screws

PAT IN U.S. AND FOREIGN COUNTRIES

PARKER-KALON CORPORATION, 198 Varick Street, New York, N. Y.

Please send information on Self-tapping Screws and free samples for trial on the assemblies described on attached sheet.

Name, Title
Company
Address



Grunow says: "Look inside"



GOAT says:

"Look inside Grunow Models

450, 460, 550, 650, 651, 660, 661, 662

and see how GOAT FORM-FITTING TUBE SHIELDS contribute EYE APPEAL"

Quality—aside from modern appearance is reflected in better performance which after all is the sales objective in modern, high fidelity receivers.

GOAT RADIO TUBE PARTS, Inc.
314 DEAN STREET

BROOKLYN

NEW YORK



Autelco "Class A" Relays

A Wide Range of Characteristics
A Single Standard Design

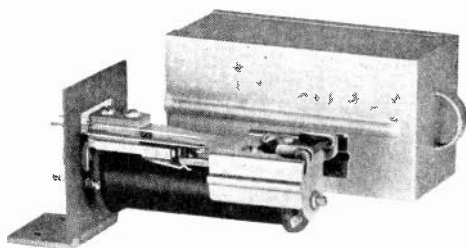

This "Class A" Autelco Relay is available in a wide range of characteristics to meet almost every conceivable condition of operation. All of them are of the same sturdy design—a design based on forty years' experience in the development and manufacture of relays for every remote-control purpose. A wide range of coil and spring combinations, for light or heavy duty, on D.C. or A.C. circuits, permits selection of the exact relay for a particular purpose.

The standardized design of "Class A" Relays permits quantity production, and low prices. Hundreds of manufacturers now use Autelco Relays in their products or in their manufacturing processes. They find it wiser to buy than to make their own.

Write for Catalog 4016, which gives full descriptions and ordering information for Autelco Relays.

American Automatic Electric Sales Co.
1033 W. Van Buren St., Chicago

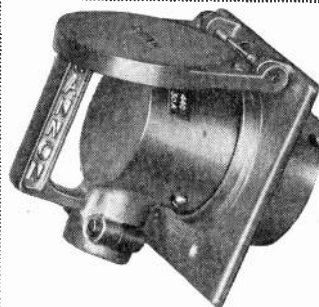

CANNON PLUGS

for
Every Purpose

MEETING the requirements of many industries, CANNON Plugs are specified for every purpose that demands the utmost in precision, efficiency, ruggedness, economy and dependability. Witness the recent action of Paramount's great West Coast studios in completely re-equipping with CANNON Heavy Duty Plugs for sound recording.

Furthermore, America's largest manufacturers have adopted CANNON Midget Plugs (1 1/8 in. diameter, now available up to 8 conductors) for portable sound channels and broadcasting equipment . . . Likewise, geophysical research institutions explore the bowels of the earth with cables connected by CANNON Plugs . . . Portable power equipment in pre-cooling car services, in warehouses, factories, etc., seek CANNON Plugs . . . On land, on sea and in the air, CANNON Plugs meet every requirement.

Another new catalog soon available.

CANNON ELECTRIC DEVELOPMENT CO.
MANUFACTURING ENGINEERS

Main Office: 420 West Avenue, 33, Los Angeles, Calif.

Eastern Sales Office: 220 Fifth Ave.
New York, N. Y.



Representatives:
Chicago: Jenkins & Adair, Inc., 3333 Belmont Ave.
Bombay, India: Eastern Electric & Engineering Co.,
175 Hornby Road, Fort, Bombay, India



Radio design advances rapidly—and *Bakelite Materials match its pace*

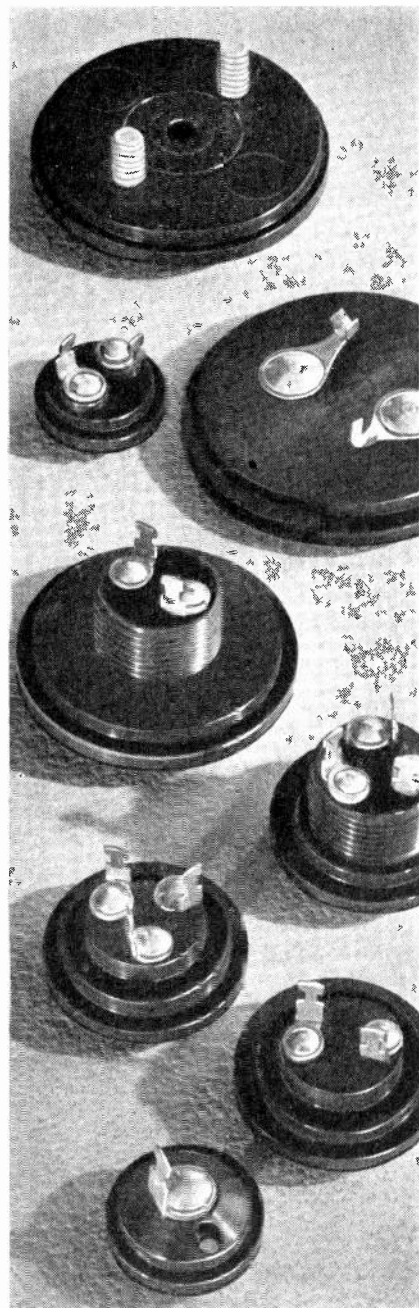

IN THE DAYS when a radio "fan" meant a set builder these enthusiasts were critical of the parts that they bought. With mica condensers the knowing ones chose those that were insulated with Bakelite Materials, either molded or laminated.

Now, with engineered, factory-made all-wave length receivers condenser requirements are more exacting and more varied. One manufacturer, Aerovox, lists can type, cardboard type, and mica, each in many styles and sizes. Notwithstanding the many improvements in design which these indicate, Bakelite Molded continues to be the choice for insulation.

In radio, for both transmitting and receiving apparatus Bakelite Insulation Materials—molded, laminated, and varnish—are specified by radio engineers and manufacturers alike for their known superior and dependable properties.

There is a type of Bakelite Insulation that will meet practically any radio requirement adequately and economically. All may be relied upon to retain their insulation value indefinitely in any climate and under any operating conditions.

There is much information of value to radio men in our booklets 13M, "Bakelite Molded" and 13L, "Bakelite Laminated." Your request will bring copies by return mail.

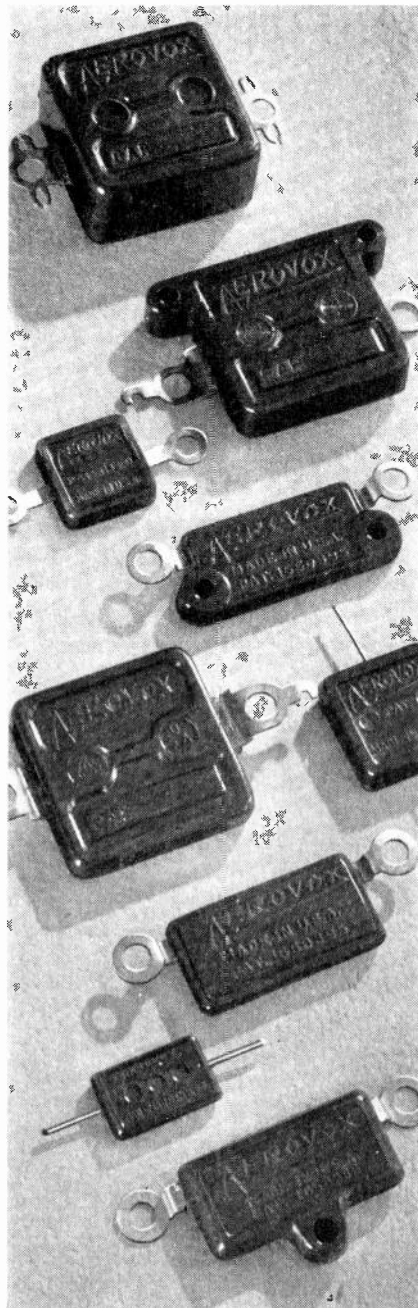

Insulating tops of Bakelite Molded for various types and sizes of can condensers, and mica condensers sealed in Bakelite Molded. By Aerovox Corp., Brooklyn, N. Y.

BAKELITE CORPORATION, 247 Park Avenue, New York, N. Y. 43 East Ohio Street, Chicago, Ill.
BAKELITE CORPORATION OF CANADA, LIMITED, 163 Dufferin Street, Toronto, Ontario, Canada

BAKELITE

REGISTERED  TRADE MARK

"The registered trade marks shown above distinguish materials manufactured by Bakelite Corporation. Under the design 'B' is the number of grams per hour and future use of Bakelite Corporation's product"

THE MATERIAL OF A THOUSAND USES

ELECTRICAL INSULATION



... Varnished Cloth, Tapes, Silks and Papers



... Plates, Segments, Rings, Tapes, Tubes, Washers



... Laminated Bakelite Fabricated Parts, Sheets, Rods and Tubes



... Untreated Papers, Linen and Silk Tapes, Varnishes, Fibre, Spaghetti Tubing, Cotton Sleeving, etc.

RAW MICA, Uncut blocks, or cut to size.
MICA SHAPES

200 Varick Street, New York; 542 So. Dearborn Street, Chicago; 1330 Schofield Bldg., Cleveland. Branches at: Birmingham, Boston, Cincinnati, Los Angeles, San Francisco, Seattle, Montreal, Toronto

MICA INSULATOR CO.



SPECIFY CETRON PHOTO CELLS

for dependable efficient performance

These fine photo cells are available in thirty-five different types. Also made to your specification.

Write for free technical data. Samples sent to responsible Companies and Laboratories.

CONTINENTAL ELECTRIC CO.
First and Illinois Sts.
St. Charles, Ill.
(cable address: Continental)

PROFESSIONAL SERVICES

ELECTRICAL TESTING LABORATORIES

Characteristics and Life Tests of Vacuum Tubes
Tests of photocells, glow lamps, crater lamps.
Tests of electronic and optical devices.
80th Street and East End Avenue
New York, N. Y.
Phone: Butterfield 8-2600

JENKINS & ADAIR, INC.

Engineers
Designers, developers, and manufacturers of accessories and essentials for recording, broadcasting and testing at sound frequencies.
3333 Belmont Avenue, Chicago, U. S. A.
Cable Address: Jenkadair Telephone: Keystone 2130

Now—a high-powered—

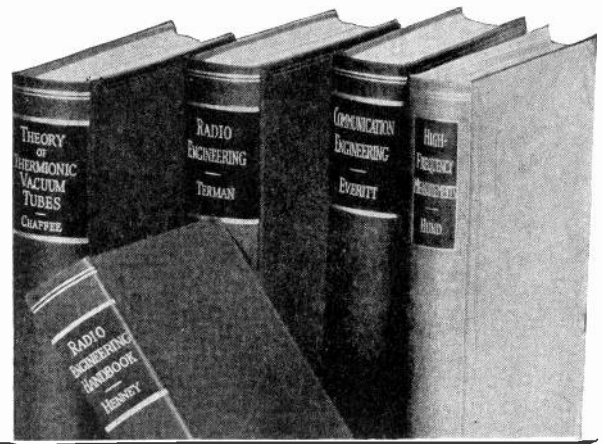

Radio Engineering Library

—especially selected by radio specialists of McGraw-Hill publications

—to give most complete, dependable coverage of facts needed by all whose fields are grounded on radio fundamentals

—available at a special price and terms.

THESE books cover circuit phenomena, tube theory, networks, measurements, and other subjects—give specialized treatment of all fields of practical design and application. They are books of recognized position in the literature—books you will refer to and be referred to often. If you are practical designer, researcher or engineer in any field based on radio, you want these books for the help they give in hundreds of problems throughout the whole field of radio engineering.

5 volumes, 2981 pages, 2000 illustrations

1. Everitt's COMMUNICATION ENGINEERING
2. Terman's RADIO ENGINEERING
3. Chaffee's THEORY OF THERMIONIC VACUUM TUBES
4. Hund's HIGH-FREQUENCY MEASUREMENTS
5. Henney's RADIO ENGINEERING HANDBOOK

Special low price and easy terms

Bought singly, the five volumes comprising this library would cost you \$26.00. Under this offer you save \$2.50 and in addition have the privilege of paying in easy installments beginning with \$2.50, 10 days after receipt of the books, and \$3.00 monthly thereafter. Already these books are recognized as standard works that you are bound to require sooner or later. Take advantage of these convenient terms to add them to your library now.

ON-APPROVAL COUPON

McGraw-Hill Book Company, Inc.
330 West 42d Street, New York, N. Y.

Send the Radio Engineering Library (5 volumes) for 10 days' examination on approval. In 10 days I will send \$2.50, plus few cents postage, and \$3.00 monthly until \$23.50 has been paid, or return books postpaid. (We pay postage on orders accompanied by remittance of first installment.)

Signed
Address
City and State
Official Position
Name of Company
(Books sent on approval in U. S. and Canada only.) L. 9-34

C-D
condensers

The Internationally-Accepted
Standards of Quality

ENGINEERS—

We Offer You **24** YEARS OF

EXPERIENCE
SPECIALIZATION
LEADERSHIP
FAIR DEALING

in the exclusive manufacture
of the world's finest condensers

PAPER ❖ MICA
OIL ❖ ELECTROLYTIC

In many thousands of types, sizes,
styles, capacities — from 12 volts to
100,000 volts

OUR ENGINEERING FACILITIES
ARE AT YOUR DISPOSAL. Write
for Catalogue No. 127.

**CORNELL-DUBILIER
CORPORATION**

4380 Bronx Blvd., New York City

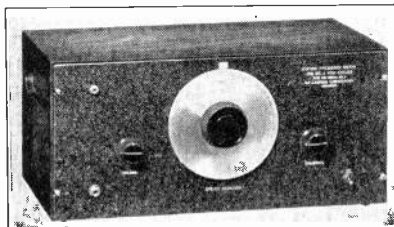

Check your
**STATION
FREQUENCY—
ACCURATELY
EASILY**

The Type 102 Station Frequency Meter is an exceptionally accurate means of complying with Rule 206 of the FCC. Direct reading, simple to use. It standardizes from WWV—accuracies within 0.002% are readily attained. For police, broadcast, or any type station above 1500 kc.

Also—the Type 101 Micrometer Frequency Meter, a band-spread, self-contained, heterodyne frequency meter, a.c. operated, individually calibrated, nominal accuracy 0.02%. Four ranges available.

Write for data on these high-grade, precision instruments.

LAMPKIN LABORATORIES 146 W. McMillan St.
Cincinnati, Ohio

SHALLCROSS

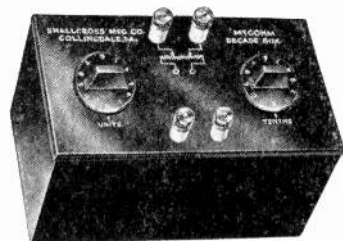

**MEGOHM
DECADE
Resistance
BOXES**

Employing the highest
grade non-reactive wire
wound resistor units
and the most modern method of insulation.

No. 935—Two Decade, Total 1.1 Megohms.
No. 945—Two Decade, Total 11 Megohms.

Send for Bulletin 900-K

SHALLCROSS MFG. CO., Collingdale, Penna.

UTC

High Fidelity . . . High Power Class B AUDIO TRANSFORMERS

UTC engineers take pleasure in announcing a new linear series of high power class B audio transformers for use with 800, 211, 203A, 204A, 851 tubes.

Standard designs are now available on these units having a frequency response of ± 2 DB from 30 to 12,000 cycles.



The output transformer illustrated, designed either for 204A's or 849's in class B, has a linear response from 30 to 12,000 cycles. The unit is oil immersed and shielded in a heavy gauge high permeability casting. All leads are terminated in high tension ceramic bushings. The transformer is insulated for 20,000 volts and will handle 1000 watts audio power.

The UTC ENGINEERING LABORATORIES have developed new

- Television transformers linear from 30 to 200,000 cycles.
- Hi Q audio reactors.
- Audio equalizers and filters.
- Automatic voltage regulators.
- Saturable control reactors.
- High potential and high current test sets.
- Oscillation transformers.
- Rectifiers for Radio, Sound, Communication and Industrial Purposes.



Write for the new **U 1000 C Manual**
24 pages devoted to basic Amplifier circuits, including fundamental Charts on Attenuation Network Data, Decibel Charts, Reactance Charts, Rectifier Constants and Class B Circuit Constants.

UNITED TRANSFORMER CORP.
264 CANAL STREET NEW YORK, N. Y.

New Noiseless Speech Equipment

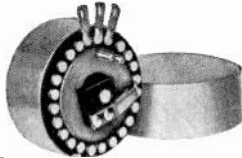

LA-250, Ladder network, 20 step, 1 1/2 and 2 d.b. per step, 100% shielded, 2 1/4" dia. x 1 7/8" deep, etched dial and pointed knob. \$8.50 net.

Daven Control and Resistor products are standard with broadcast chains and recording studios. Daven bulletins contain valuable data on control and resistor problems. Let us know of your standard or special problems.

Check items in which you are interested for literature.
 Speech Input Control Apparatus Attenuators Potentiometers Faders
 Volume Indicators Output Meters Line Equalizers Attenuation Boxes
 Multipliers Decade Resistances Resistances Glastor Super Davohm
 Precision Resistors

Name _____
 Company _____ Address _____

THE DAVEN COMPANY
 158-160 SUMMIT STREET, NEWARK, NEW JERSEY

PROCTOR Wide Range Turntable

featuring

- Hi-Fidelity Piezo Pickup
- Constant Speed (Synchronous Motor)
- 16-inch Turntable
- 7-point Frequency Balancer
- 78 and 33-1/3 R.P.M.
- Pre-setting Device Optional

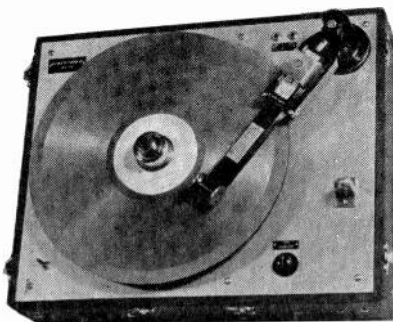

B. A. Proctor Co., Inc.
 17 West 60th St., N.Y.

Manufacturers of sound and recording equipment.

APPLIED ACOUSTICS

By
 H. F. OLSON, E.E., Ph.D. & F. MASSA, B.S., M. Sc.
 Acoustical Research Engineers, RCA Victor Co., Inc.
 444 Pages 228 Figs. Fabrikoid \$4.50

A MODERN book on the theory, design, construction, operation and analysis of modern acoustical and electro-acoustical apparatus. Includes analyses of rooms, studios, theatres and operation of microphones, loud speakers and systems in modern environments and conditions. Audio-frequency oscillators, amplifiers and electro-acoustical measurements are fully described.

P. BLAKISTON'S SON & Co., INC.
 1012 WALNUT STREET, PHILADELPHIA

A TRIAL WILL CONVINC YOU

30 Years' Experience
 Insures Dependability

We Manufacture
 PERMANENT MAGNETS TOOLS and DIES
 METAL STAMPINGS LAMINATIONS

THOMAS & SKINNER STEEL PRODUCTS CO.

23d St. at Alford

Indianapolis, Ind.

—ELMET— MOLY



FOR
 GRID WIRES
 SUPPORT WIRES
 ELECTRIC FURNACE HEATING ELEMENTS
 ALSO FOR
 SCREEN GRIDS—CATHODE COILS
 MANDRELS—CONTACTS, ETC.

ALL OF THE ABOVE PRODUCTS MAY BE HAD IN VARIOUS COMPOUNDS OF
MOLYBDENUM-TUNGSTEN



Write for Information and Prices

American Electro Metal Corp.
 Lewiston Maine

CANDOHMS

ARMoured WIRE WOUND RESISTORS

WILL LOWER YOUR COSTS

OVER EIGHT MILLION IN USE
 MAY WE SAMPLE AND QUOTE

THE MUTER COMPANY

1255 So. Michigan Ave., Chicago

COMMUNICATIONS?

Here are some of the articles which *Electronics* has published in the past twelve months:

- High-fidelity transmitter performance—by E. A. Laport
- Automatic recording of field strength—by C. M. Jansky, Jr.
- Commercial facsimile apparatus
- An analysis of efficient modulation—by E. N. Dingley, Jr.
- Measuring resistance of broadcast antennas—by Scott Helt
- Controlling receivers from the broadcast transmitter
- Radio acoustic ranging—by Davis Belcher
- Ultra short waves and new markets
- Radio system for landing aircraft during fog
 —by H. Diamond, Bureau of Standards

Electronics has and will continue to cover the field of communications and broadcasting.

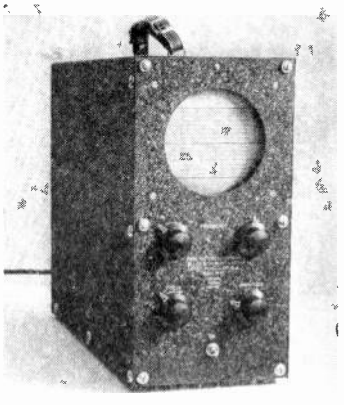

Price \$175.00

A NEW PORTABLE CATHODE RAY OSCILLOGRAPH

The Du Mont Type 142 portable cathode ray oscillograph is a compact and rugged self-contained instrument for general laboratory or industrial use. A type 5-4-8 Du Mont cathode ray tube with indirectly heated cathode and separate leads from each deflection plate is mounted in the unit behind a graduated scale. The power supply of the instrument furnishes all the necessary voltages for this tube and the linear sweep circuit provides a variable sweep voltage from 10 to 5000 cycles per second. Means for synchronization of recurrent patterns are provided.

Complete data on this instrument upon request. Also data on our complete line of cathode ray tubes and oscillographs.

ALLEN B. DU MONT LABORATORIES--Upper Montclair, N. J.

BRUSH MICROPHONES

Six Models Designed for Various Purposes in Recording, Reproduction and Measurement of Sound.

Complete Details on Request

Leading Manufacturers are now offering Public Address and Transmitting Equipment Specially Produced for use in Connection with Brush Soundcell Microphones.

Write us for information.

BRUSH DEVELOPMENT COMPANY
East 40th St. and Perkins Ave., Cleveland, Ohio, U. S. A.
Cable Address: BRUSH, Cleveland

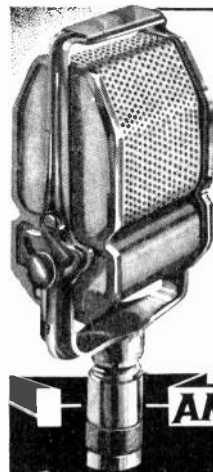

DOES the WORK of 3 MIKES

Because of its wider area of coverage, one Amperite Velocity Microphone replaces a plurality of other types of microphones. Most highly perfected means of translating sound energy into electrical energy. *Easiest, least expensive way to improve any studio installation.* Write for illustrated Bulletin SR-80.

AMPERITE Corporation 561 BROADWAY NEW YORK

AMPERITE Velocity MICROPHONE

SEARCHLIGHT SECTION

EMPLOYMENT BUSINESS OPPORTUNITIES EQUIPMENT—Used or Special

UNDISPLAYED—RATE PER WORD
Positions Wanted—(full or part-time salaried employment only) 5 cents a word, minimum charge—\$1.00 an insertion.
Positions Vacant and other classifications—10 cents a word, minimum charge \$2.00 an insertion. Allow 10 words for box address. No additional charge for forwarding replies.
Discount of 10% for payment in advance on 4 consecutive insertions of undisplayed advertisements.
Proposals—40 cents a line.

DISPLAYED—RATE PER INCH:
1 inch \$5.00
2 to 3 inches 4.75 per inch
4 to 7 inches 4.50 per inch
Other spaces and contract rates on request.
An advertising inch is measured vertically on one column, 3 columns—30 inches—to a page.

COPY FOR NEW ADVERTISEMENTS RECEIVED UNTIL 3 P. M. ON THE 4TH OF THE MONTH.

POSITION WANTED

WANTED—Competent Electronics engineer, design develop Electronics devices. International Electronics Company, Box 104, Winona, Minnesota.

FOR SALE

Audio Oscillator
General Radio 377B. Practically new. Price very reasonable. FS-62, Electronics, 330 West 42d St., New York City.

WANTED

ANYTHING within reason that is wanted in the field served by Electronics can be quickly located through bringing it to the attention of thousands of men whose interest is assured because this is the business paper they read.

SMALL LOT MANUFACTURE

We are especially fitted to manufacture samples and small lots of Electrical Equipment and Instruments both accurately and economically. Strictly commercial workmanship and finish.

GRAY ELECTRIC CORPORATION
Poughkeepsie, N. Y.

HIGH GRADE NEW AND USED ELECTRON TUBE EQUIPMENT

Write for Bulletin Showing Savings From 20% to 80%
KAHLE ENGINEERING CORPORATION
Specialists in Equipment and Methods for the Manufacture of Neon Tubes, Radio Tubes, Incandescent Lamps, Photo Cells, X-ray Tubes, etc.
350 Manhattan Ave., Union City, N. J.

All types of High Grade New and Used Equipment for the manufacture of Electron Tubes.

Lowest prices on the market.
AMERICAN ELECTRICAL SALES CO.
65 East 8th St., New York, N. Y.

SAVE MONEY

Surplus Machine Screws and Insulated Wire all types and sizes.
Several Stimpson Eyeletters and Eisler Spot Welders.
Send us your requirements.
ECK ELECTRIC MANUFACTURING CO.
50 West 3rd St., New York City
Phone ALgonquin 4-8133

National Radio Tube Co., Inc. (NARTCO)

Now entering our Tenth Year of Tube Reconditioning Service

Prompt and Dependable Service.
Prices Reasonable.

It Will Pay You to Give us a Trial

National Radio Tube Co., Inc.
3420 18th St., San Francisco, Cal.

EQUIPMENT
NEW—RECONDITIONED for making
ELECTRONIC TUBES, RADIO TUBES, INCANDESCENT LAMPS, NEON SIGNS AND SIMILAR PRODUCTS
Flare Stem Winding Sealing Exhaust Basting Machines
EISLER ENGINEERING CO.
751 So. 13th St., Newark, N. J.

SURPLUS MATERIAL

Send for our list of bargains, surplus and used material covering motors, generators, vacuum tubes, receivers and parts.
HEINTZ AND KAUFMAN, LTD.
South San Francisco, Calif.

TODAY'S *Most Modern* Precision Measuring Instruments



THERE is a Triplet Precision Measuring instrument for every radio purpose. Their advanced design, precision construction and many exclusive features represent the master achievement of some of today's most prominent instrument engineers. Prove their greater worth by a competitive test . . . learn why, more and more, they are being regarded as the yardstick of fine instrument performance . . . as today's most modern precision measuring instruments.

Triplet makes a Precision Measuring Instrument for every radio purpose, including: Thermo-Couple Ammeters (High Frequency), Universal A.C.-D.C. Motors (Copper Oxide), Portable Instruments, A.C. and D.C. Panel Instruments. These instruments are made in several sizes: 2", 3½", 5¼". They are obtainable in these types of cases: Wide flange, projection, portable—metal and Bakelite.

The metal dials of these meters are enameled permanently white with black figures. The contrast makes for easiest-reading scales. The finest sapphire jewel bearings are used. The aluminum needle and other parts are ribbed and made unusually strong throughout. The moving coil is light in weight. The scales are extra long, uniform and easy to read. All have zero adjustments.

The TRIPLET ELECTRICAL INSTRUMENT COMPANY

91 Main Street

Bluffton, Ohio



Mail Today For Details!

The Triplet Electrical Instrument Co.,
91 Main St., Bluffton, Ohio

Gentlemen: Please send me information about Triplet meters. Also catalog on servicing instruments.

Name

Street Address

City State

INCREASE POWER

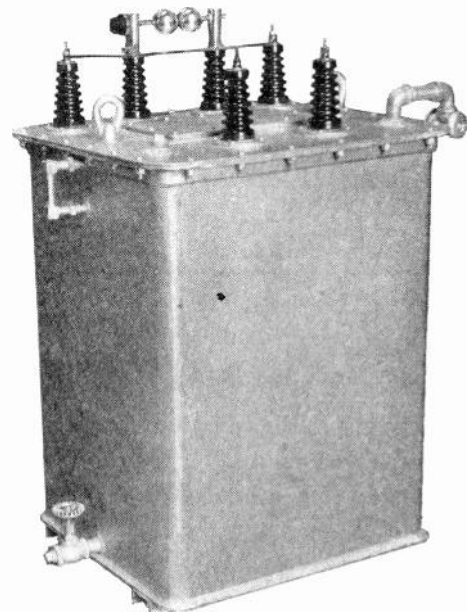

*AmerTran Class "B" Output Transformer
for operation at level of +65 dB.*

Add AmerTran Modulation Set to Convert your present 1 KW. Transmitter to 2½ KW. Output

You may take advantage of the Federal Communication Commission's recent permit to increase power from 1 KW. to 2½ KW. at minimum expense by adding an AmerTran Class "B" modulation set and AmerTran power supply to your present transmitter. Tube conversion is unnecessary, few changes have to be made in your equipment, and the cost of the new equipment is but a fraction of the cost of a new transmitter.

We will be pleased to send complete information if you will send us data on the equipment you are now using.

AMERICAN TRANSFORMER COMPANY

Transformer Builders for Over 32 Years

180 EMMET ST., NEWARK, N. J., U. S. A.



AMERTRAN TRANSFORMERS



CONTENTS for SEPTEMBER, 1934

The new day of visual transmission	267
Communication—an electron, tube art	268
Assignments in the radio spectrum	274
Counting traffic	275
New things ahead in radio sets and tubes	276
Testing capacitors and resistors	279
By C. G. SERIGHT	
Design and use of "acorn" tubes	282
By BERNARD SALZBERG	
Highlights on electronic devices in industry	284
Economical design for radio set transformers	286
By C. A. HULTBERG	
Editorial	288
Review of electronic literature	290
Book review	292
New products	294
U. S. patents	296
British patents	298

INDEX TO ADVERTISERS

This index is published as a convenience to the reader. Every care is taken to make it accurate but *Electronics* assumes no responsibility for errors or omissions.

Page	Page
Aerovox Wireless Corp.	14
Allen-Bradley Co.	26
American Electro Metal Corp.	22
American Automatic Elec. Sales Co.	18
American Transformer Co.	24
Amperite Co.	23
Audak Co.	Second Cover
Bakelite Corp.	19
Blakiston's Son & Co., Inc.	22
Brush Dev. Co.	23
Cannon Elec. Development Co.	18
Cinch Mfg. Corp.	15
Clarostat Mfg. Co.	10
Continental Elec. Co.	20
Cornell-Dubilier Corp.	21
Daven Co.	22
Dumont Lab's, Allen B.	23
Dunn, Inc., Struthers	14
Eby Mfg. Co., H. H.	12
Erie Resistor Corp.	Inside Back Cover
Formica Insulation Co.	4
General Electric Co. (Plastics)	14
General Mfg. Co.	16
General Radio Co.	10
Goat Radio Tube Parts, Inc.	18
Hygrade-Sylvania Corp.	13
International Resistance Co.	11
Isolantite, Inc.	7
Lampkin Lab's	21
Lenz Elec. Mfg. Co.	5
Magnavox Co.	1
Mallory & Co., P. R.	8
McGraw-Hill Book Co., Inc.	20
Mica Insulator Co.	20
Muter Co.	22
Parker-Kalon Corp.	17
Proctor Co., B. A.	22
RCA Radiotron Co., Inc.	Back Cover
Remler Co.	16
Shakeproof Lock Washer Co.	12
Shallcross Mfg. Co.	21
Stackpole Carbon Co.	25
Thomas & Skinner Steel Prod. Co.	22
Triplet Elec. Instr. Co.	24
United Transformer Co.	21
Ward Leonard Elec. Co.	16
Western Elec. Co.	2
Western Elec. Instr. Co.	3
White Dental Mfg. Co., S. S.	6
Yaxley Mfg. Co., Inc.	8

PROFESSIONAL SERVICES

SEARCHLIGHT SECTION

Classified Advertising

EQUIPMENT FOR SALE	23
Gray Electric Corporation	23
Kahle Engineering Corp.	23
American Electric Sales Co.	23
Eck Elec. Mfg. Co.	23
National Radio Tube Co., Inc.	23
Eisler Eng. Co.	23
Heintz and Kaufman, Ltd.	23

McGraw-Hill Publishing Company, Inc.,
330 WEST 42d STREET, NEW YORK, N. Y.

Branch Offices: 520 North Michigan Ave., Chicago; 883 Mission St., San Francisco; Aldwych House, Aldwych, London, W. C. 2; Washington; Philadelphia; Cleveland; Detroit; St. Louis; Boston; Greenville, S. C. James H. McGraw, Chairman of the Board; Malcolm Muir, President; James H. McGraw, Jr., Vice-President and Treasurer; Mason Britton, Vice-President; H. C. Parmelee, Vice-President; Harold W. McGraw, Vice-President; B. R. Putnam, Secretary.

NOW—perfect reception on all modern automobile radios with these new STACKPOLE specialties

For smoother and more perfect auto radio reception, Stackpole announces 3 timely improvements of interest to all radio engineers . . . (1) The New Spark Plug and Distributor Type Auto Spark Suppressors; (2) The New Paper Type Radio Volume and Tone Control and (3) Stackpole Fixed Resistors.

Eliminate Ignition Interference with the New STACKPOLE CARBON AUTO SPARK SUPPRESSORS

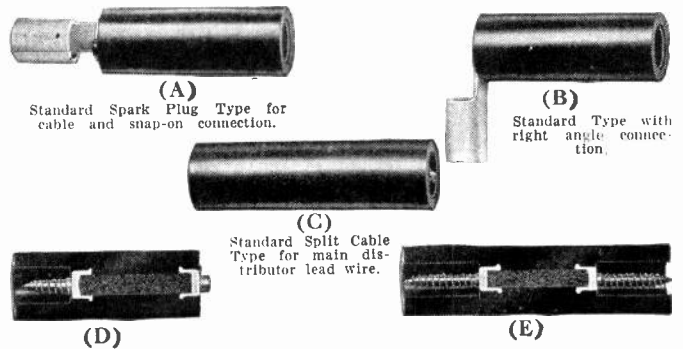

Designed especially to effectively suppress the high voltage discharge of automobile ignition on any car, Stackpole Suppressors consist of a resistor unit molded into a bakelite housing with connections molded into the bakelite at the same time . . . assures a solid, unified structure unaffected by heat, high humidity, vibration or rough usage. Direct electrical contact made from terminal to resistor element, eliminating troublesome steel wool and springs. Note cuts D and E above. Standard units have resistance value of 5,000, 10,000 and 20,000 ohms.

The New STACKPOLE Improved Paper Type RADIO VOLUME and TONE CONTROL

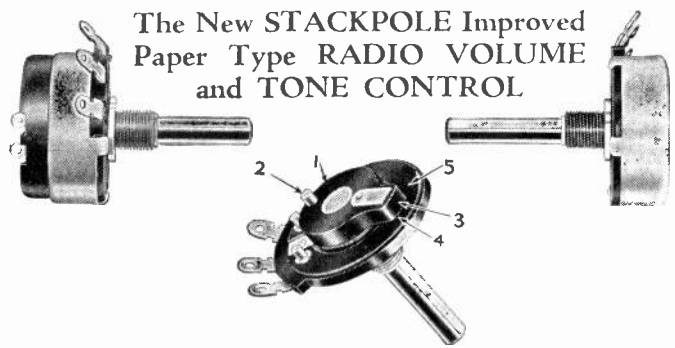

1. The bakelite hub, which carries the contact, fully insulates the moving contact and resistance element from bushing and shaft . . . very necessary in a great number of applications.
2. The Switch-Operating cam is fastened directly to the bakelite hub and therefore, fully insulated from the resistance element.
3. Uniform contact pressure is maintained by a specially designed coil spring carried within the bakelite hub—always maintains the correct contact pressure.
4. The newly designed contact maintains a true line contact with the resistance element, thus eliminating any possibility of noise due to contact resistance.
5. New type "P" resistance element made by depositing carbon on high grade paper. Element is fired at high temperature making it permanent and unaffected by changes of humidity and temperature.

Stackpole Fixed Molded Carbon Resistors

Non-inductive . . . unaffected by humidity . . . the standard of comparison in the radio and electrical fields . . . designed for voltage reducers, cathode bias resistors, grid leaks and suppressors, tube plate loads and all radio and audio circuits.

Write for descriptive catalogue

STACKPOLE CARBON COMPANY
ST. MARY'S, PA.

ALLEN-BRADLEY RADIO RESISTORS



Type J Bradleyometer showing mounting with C-washer.

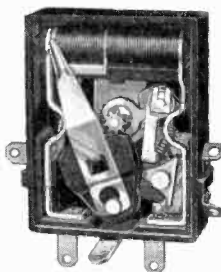

Type A Bradleyometer showing tapped resistor.

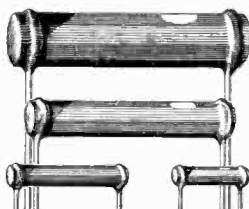

Bradleyunit resistors, standard R. M. A. color-coded. Furnished with leads.

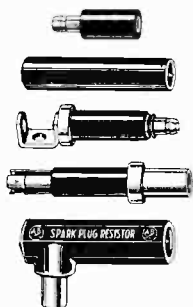

Bradley Suppressors for every automotive application.

BRADLEYOMETER—TYPE J

The most compact continuously adjustable radio resistor on the market. It is not a film-type unit—the resistor is solid-molded. Any resistance-rotation curve shape is obtainable. Bradleyometer Type JS is provided with built-in line switch. Types J and JS Bradleyometers are attached to panel with C-washer—no threaded bushing and nut. Shaft is insulated. Guaranteed for long life and dependable performance.



TYPE J RESISTOR—A solid molded ring, so constructed that any resistance-rotation curve is obtainable.

BRADLEYOMETER—TYPE A

The most outstanding adjustable resistor for volume control. Available in several standardized designs for volume and tone control applications. Allen-Bradley engineers will gladly co-operate in designing low-level tone compensation systems using the Type A Bradleyometer.



TYPE A RESISTOR—A column of resistor discs interleaved with silver discs upon which contact arm travels. Produces any resistance-rotation curve.

BRADLEYUNITS

These solid-molded fixed resistors are used by the leading set manufacturers. They have exceptionally low voltage coefficient. Moisture and age do not affect Bradleyunits, and uniformity of construction assures resistors that are quiet in performance. Specify Bradleyunit resistors for stable receiver performance after long service.



FIXED RESISTOR — A solid molded unit. Over 30 years of manufacturing experience is behind the design and production of Bradleyunits.

BRADLEY SUPPRESSORS

The prominent car manufacturers use Bradley Suppressors for dependability and superior performance. They do not open circuit in service; they do not drop in resistance and fail as suppressors; they do not fail from exposure to oil and water. Bradley Suppressors do not break due to car or engine vibration. Write today for data and performance curves on resistors for your requirements.



SUPPRESSOR RESISTOR—Solid-molded resistors encased in bakelite tubes (not fragile ceramic containers). They survive abusive treatment in automotive service.



ALLEN-BRADLEY CO., 110 W. Greenfield Ave., MILWAUKEE, WIS.

YOU GET THESE ADVANTAGES WITH SOLID MOULDED CARBON RESISTORS

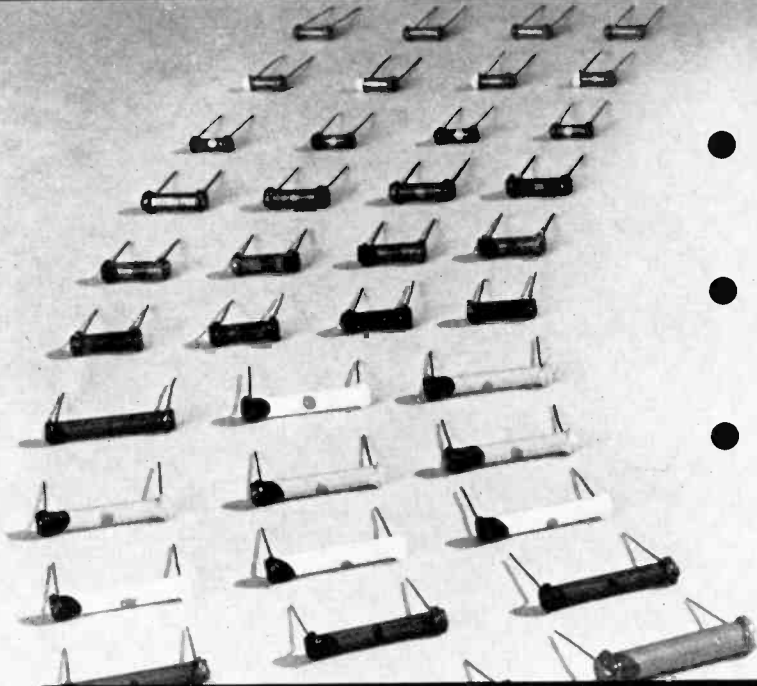

- GREATER MECHANICAL STRENGTH
- SOLID ONE PIECE CONSTRUCTION
- GREATER HEAT DISSIPATION

BUT DON'T BE FOOLED BY APPEARANCES

Check Everything

- ✓ VOLTAGE EFFECT
- ✓ TEMPERATURE EFFECT
- ✓ TYPE OF LEAD CONTACT
- ✓ LOAD CHARACTERISTICS
- ✓ HUMIDITY EFFECT
- ✓ UNIFORMITY
- ✓ LIFE
- ✓ NOISE

Though all carbon resistors may look alike, there is a vast difference in quality. Erie solid moulded carbon resistors present a uniform record of all-round quality on tests more exacting than R.M.A. specifications. Test data and samples will be sent on request.

ERIE RESISTOR CORPORATION

ERIE, PA.

Factories in ERIE, PA. - TORONTO, CANADA - LONDON, ENG.

LOOK TO

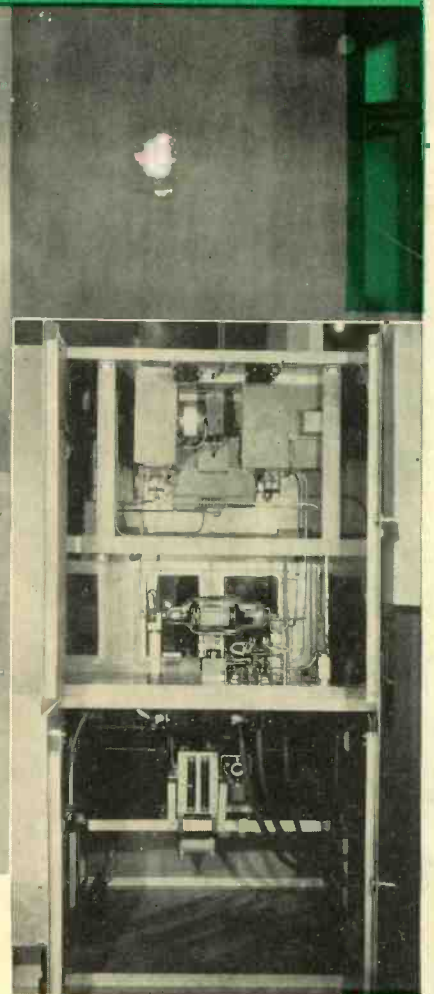
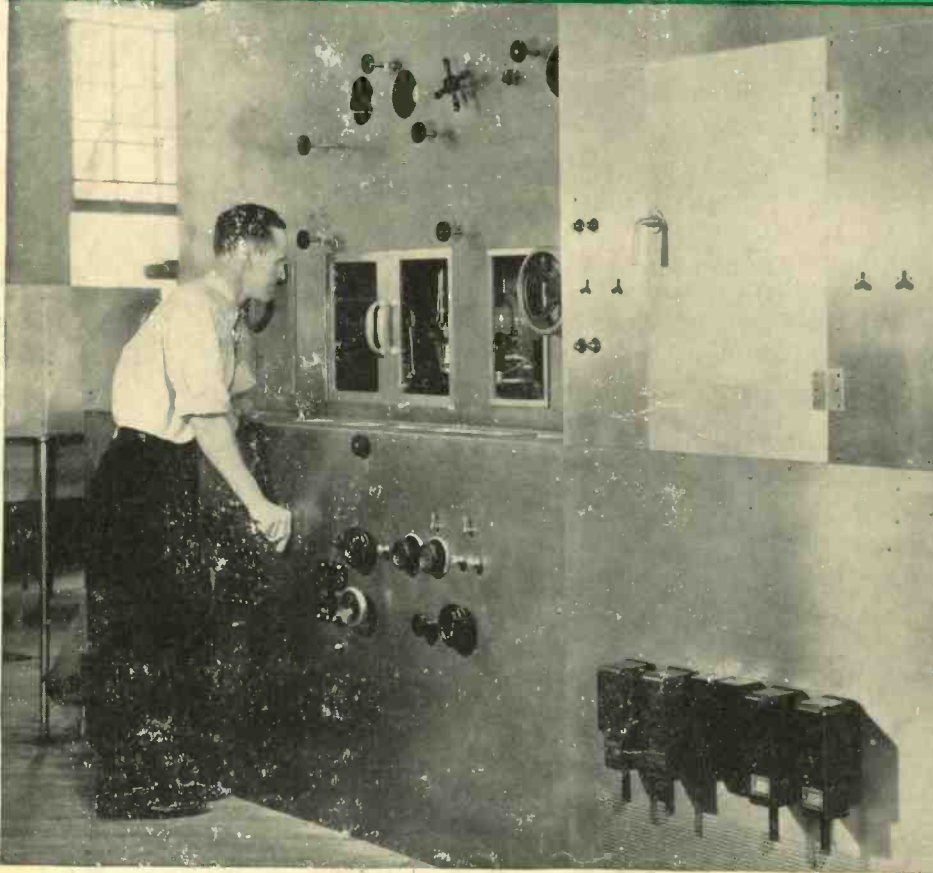

Above—Universal high voltage test set used by RCA development engineers for investigations and experiments on transmitting tubes.
Right—View of interior of test set showing some details of circuit arrangement.

Look to RCA for Thorough Development Work on Transmitting Tubes

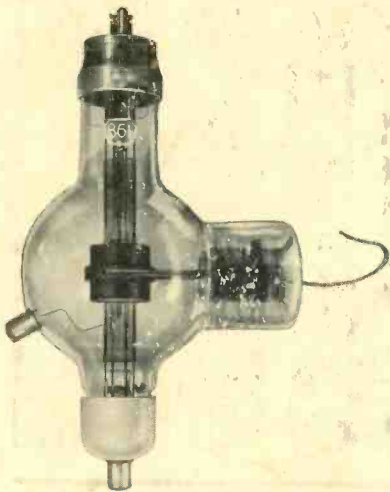

RCA transmitting tubes have a well-established reputation for their ability to stand up in hard service. Such a reputation is not accidental, but is the result of years of design experience gained by painstaking investigation and trial of each new development in the laboratory. A conservative factor of safety based on overload life tests is inherent in RCA transmitting tube designs.

RCA RADIOTRON CO · INC · HARRISON · NEW JERSEY

A RADIO CORPORATION OF AMERICA SUBSIDIARY