

electronics

radio, sound, communications and industrial applications of electron tubes . . . design, engineering, manufacturing

Industrial uses of sound equipment

Automobile radio progress

An analysis of super-regeneration

Antenna resistance measurement

AVC applied to A-F circuits

Acoustic treatment



RADIOGRAM

WORLD WIDE WIRELESS

Via RCA

Via RCA

R.C.A. COMMUNICATIONS, INC.
A RADIO CORPORATION OF AMERICA SUBSIDIARY

RECEIVED AT 64 BROAD STREET, NEW YORK, AT **January 24, 1934** STANDARD TIME
12.01 P.M.

Mr. O. H. Caldwell,
Editor, **ELECTRONICS**,
New York, N. Y.

Dear Mr. Caldwell:

This radiogram has been transmitted by modern commercial facsimile apparatus developed by the Radio Corporation of America. It shows how messages will look when transmitted over the proposed RCA intercity photogram circuits.

This means of transmitting messages by radio provides a new approach to the problem of record communication service, which heretofore has been limited to the dots and dashes of the Morse code.

Sincerely yours,
Dana Sarnoff
President, Radio Corporation of America

Telephone: **HAnover 2-1811** To secure prompt action on inquiries, this original RADIOGRAM should be presented at the office of R.C.A. COMMUNICATIONS, Inc. In telephone inquiries quote the number preceding the place of origin.

Form 11A TA-216

This newest "facsimile" message service foreshadows the broadcasting of facsimile to the homes of America, - and so indicates coming opportunities for broadcaster, radio manufacturer, distributor and dealer — *Editor*

McGraw-Hill Publishing Company, Inc.

Price 35 Cents

FEBRUARY, 1934

L A M I N A T E D B A K E L I T E S H E E T S · R O D S · T U B E S

SMOOTH production schedules are largely dependent upon materials with uniform machining qualities. Synthane laminated bakelite machines readily. It is applicable to widely diversified electrical and mechanical uses. And with Synthane the purchaser buys more than a material. He buys Synthane service also—an assurance of prompt,



intelligent and accurate handling of requirements. Samples for testing sent free on request.

F A B R I C A T E D P A R T S · S I L E N T S T A B I L I Z E D G E A R M A T E R I A L



"IT'S GOT TO FIT A THREE-EIGHTHS HOLE"



That was the message that came over the phone and "What's more we should have it *right now*", said the voice*. That was nine in the morning. Then an exchange of details! Another five minutes, and our technicians were assigned to their stellar role in another business drama. Two hours later the customer had the answer delivered in the form of the finished product—a plug button. Operations were resumed and what might have been a costly delay was averted. And so today we have another satisfied customer. We also have the satisfaction of knowing that our policy "your problems are our problems" has been put to the test and again proven. These little business dramas, often in themselves but a few hours of time may result in the most costly and momentous experience of the business routine. Cinch has helped in hundreds of instances such as this. One of them may have paralleled some of your problems. In any event for possibilities for greater profit phone, wire or write Cinch Manufacturing Corp., 2335 W. Van Buren Street, Chicago, Illinois.

HERE in our modern well equipped plant we operate (1) a tool and die department, specializing in small work, particularly that which can be run automatically. Dies are designed and completed. Because of volume and specialization, the cost is surprisingly low. There is a (2) press department, where the latest designs are stamped out with our own automatic feeding attachments. Millions of pieces are stamped each month. And in the (3) assembly department we have ample floor space where skilled assemblers are always ready to serve. In the (4) plating department is equipment for many kinds of mechanical burnishing and plating. Special rivets, headed products and special machine screws have a department under the most expert supervision available. We operate as the stamping department of many manufacturers. They find it more economical; to say nothing of the skilled and experienced workmanship, quality materials which insures products giving utmost satisfaction. Our organization is scientifically trained, flexible in supplying their services and alert to please. Send us blue prints or samples on any of your work others are doing for you and let us send you quotations.

*Name on request

*Cinch Radio Sockets are licensed under
H. H. Eby socket patents*

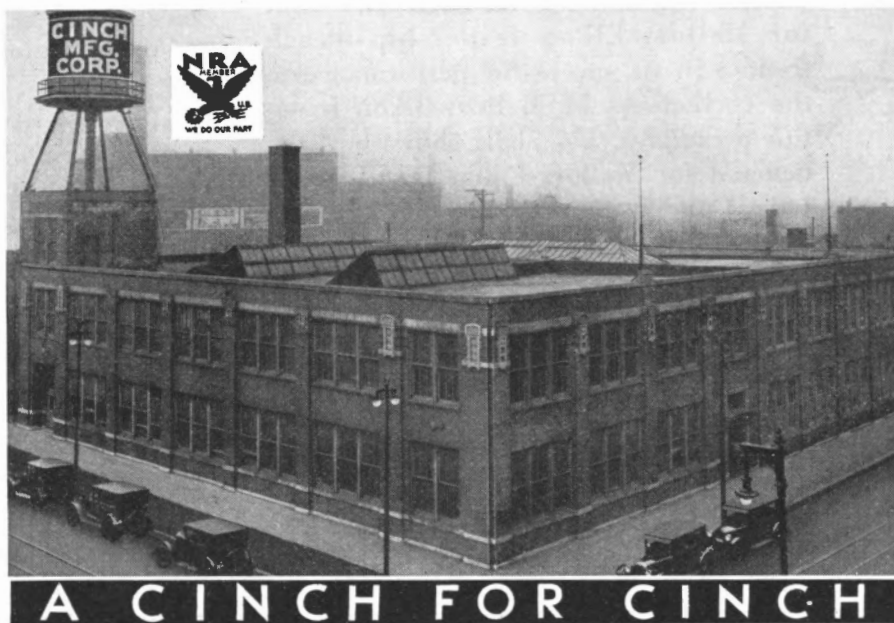

A CINCH FOR CINCH

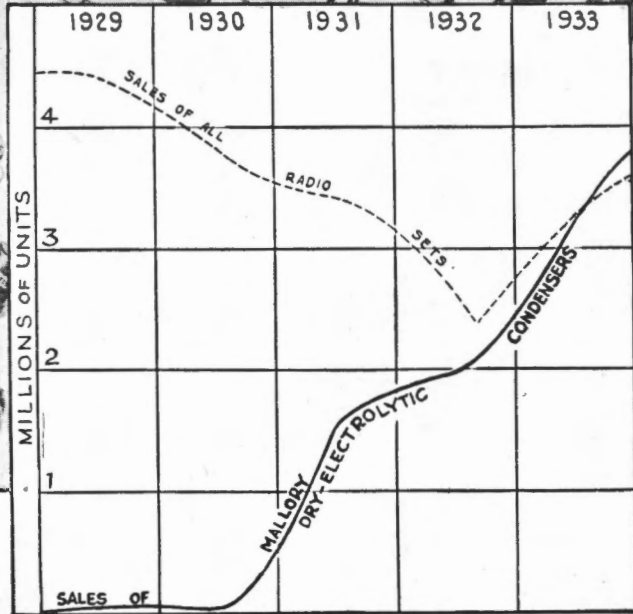
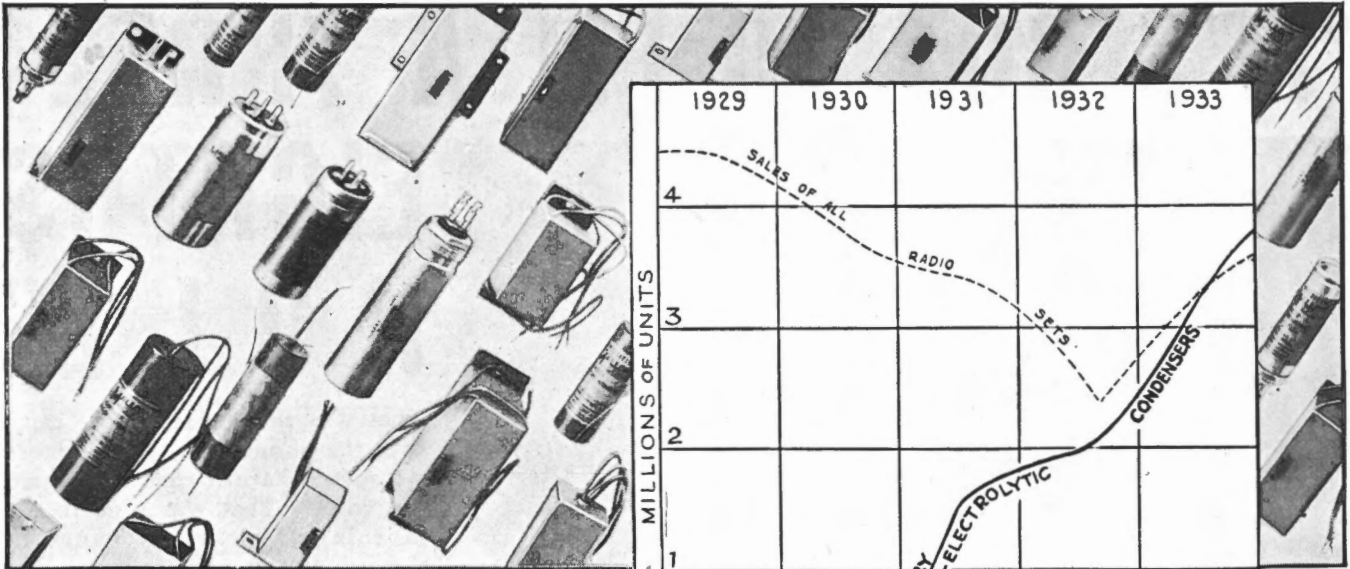

**MORE THAN
3,000,000**

Reasons for the leadership of MALLORY-ELKON DRY ELECTROLYTIC CONDENSERS

During 1933 Mallory produced and sold more than three and a half million Dry Electrolytic Condensers. Each one has played a definite part in the building of Mallory-Elkon prestige in the Dry Electrolytic Condenser field. Each is a *reason* for Mallory-Elkon leadership — each testifies in its successful performance to the correctness of Mallory-Elkon scientific principles. The chart shows how the demand for Mallory-Elkon Dry Electrolytic Condensers has grown. The use of Mallory-Elkon Dry Electrolytic will show you *why!*

Mallory-Elkon leadership in research, engineering and development is responsible for Dry Electrolytic Condensers of uniformly high quality. Mallory-Elkon Dry Electrolytic Condensers are stable in operation and guard against electrical and mechanical variations. They are compact, easily mounted, and excellent in filtering capacity.

Mallory-Elkon Dry Electrolytic Condensers are available in whatever form best suits the requirements of the Set Designing Engineer. We also invite inquiries concerning special Condenser applications such as A C Capacitors for motor starting, etc.



P. R. MALLORY & CO., Incorporated, INDIANAPOLIS, INDIANA
CABLE ADDRESS PELMALLO

Where seconds count



OUTSTANDING FEATURES

1. **No AUXILIARY POWER**—PHOTRONIC (dry-type) cells transform light energy directly into electrical energy.
2. **No AMPLIFICATION**—High current output of PHOTRONIC cells activate sensitive relays without complicated amplifiers.
3. **UNLIMITED LIFE**—PHOTRONIC cells do not deteriorate or wear out—deliver a constant output.
4. **EASY TO INSTALL**—PHOTRONIC equipment shipped ready to install and operate. Control box can be located remote from cell.
5. **SPECTRAL RESPONSE**—Like that of the human eye, PHOTRONIC cells accurately control by color and density changes.
6. **Low Cost**—The initial cost is low and maintenance practically negligible.

These doors, manufactured and installed in the Pennsylvania Terminal, New York City, by The Stanley Works, New Britain, Conn., are operated by Weston PHOTRONIC photo-cells and relays.

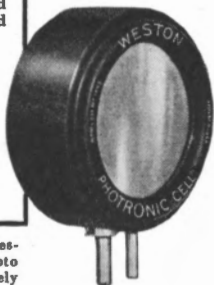

*PHOTRONIC—a registered trade-mark designating the photoelectric cells and photo electric devices manufactured exclusively by the Weston Electrical Instrument Corporation.

THEY USE RELIABLE WESTON * PHOTRONIC (PHOTO CELL) EQUIPMENT

Here are the most unique doors in any train terminal in this country. They open and close—automatically—several million times each month. Not a human hand touches them. A PHOTRONIC cell and a light beam are the sole activating source. What a comfort and convenience to travelers . . . what a help in facilitating movement of crowds.

In train terminals, as well as in other industrial and commercial activities where flawless operation is vital, *reliable* photo-cell control equipment must be used. And Weston PHOTRONIC equipment is reliable, because of the characteristics of the Weston cell, the simplicity of the circuit, and the ease of installing and maintaining PHOTRONIC control equipment.

Whether your problem is opening doors, counting, sorting, or controlling operations by color or density changes, Weston PHOTRONIC control should be considered. It is simple, reliable and economical. Its outstanding advantages are listed at the left. For further information write . . . Weston Electrical Instrument Corporation, 618 Frelinghuysen Avenue, Newark, N. J.

WESTON

Instruments



A Good Combination *for* Auto Radios

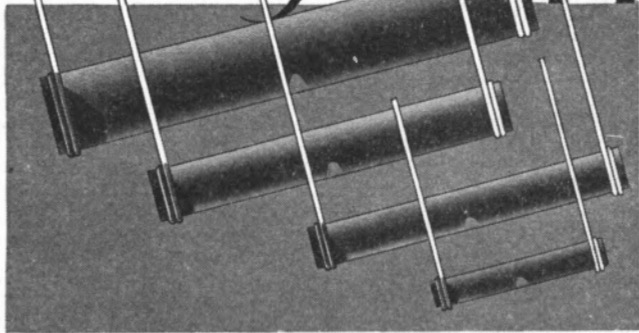

Erie moulded carbon resistors in the set . . . Erie Suppressor Resistors on the distributor lead and spark plugs . . . an unbeatable combination for automobile radios.

Erie Resistors

The conservative rating of Erie Resistors permits the use of smaller size units, an important factor in auto radios where compactness is essential. Overloads of 50% of continuous rating produce no failures after 2,000 hours of testing.

Vibration holds no terrors for Erie Resistors. Leads are permanently soldered directly to the body of the resistor; there are no metal caps to work loose.

Erie Suppressors

Exhaustive tests in our own laboratory and in actual use prove that Erie Suppressor Resistors change less than 5% in resistance value after 50,000 miles of service.

Durable Bakelite covers keep out engine heat, moisture and grease. Even at 120° C. and 100% relative humidity, they will not fail mechanically.

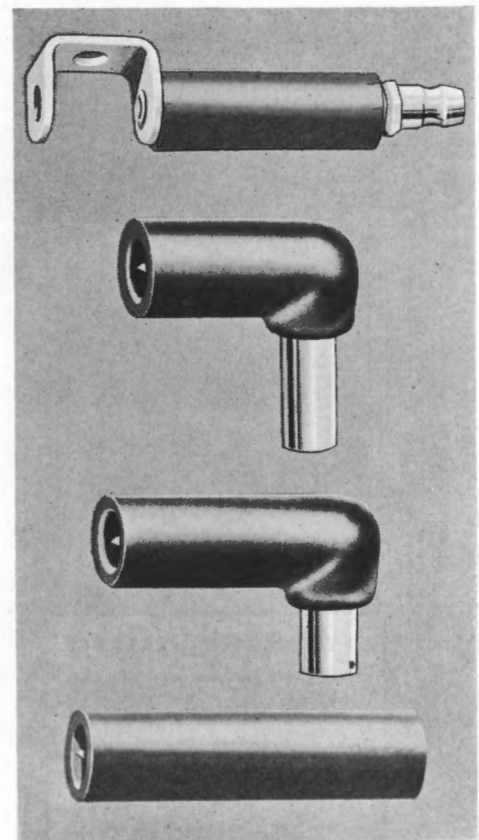

It will pay you to investigate the efficiency of these Erie products. Our engineering staff will gladly work with you on any problems you have.

ERIE RESISTOR CORPORATION

ERIE, PA.

Factories in ERIE, PA. - TORONTO, CANADA - LONDON, ENG.

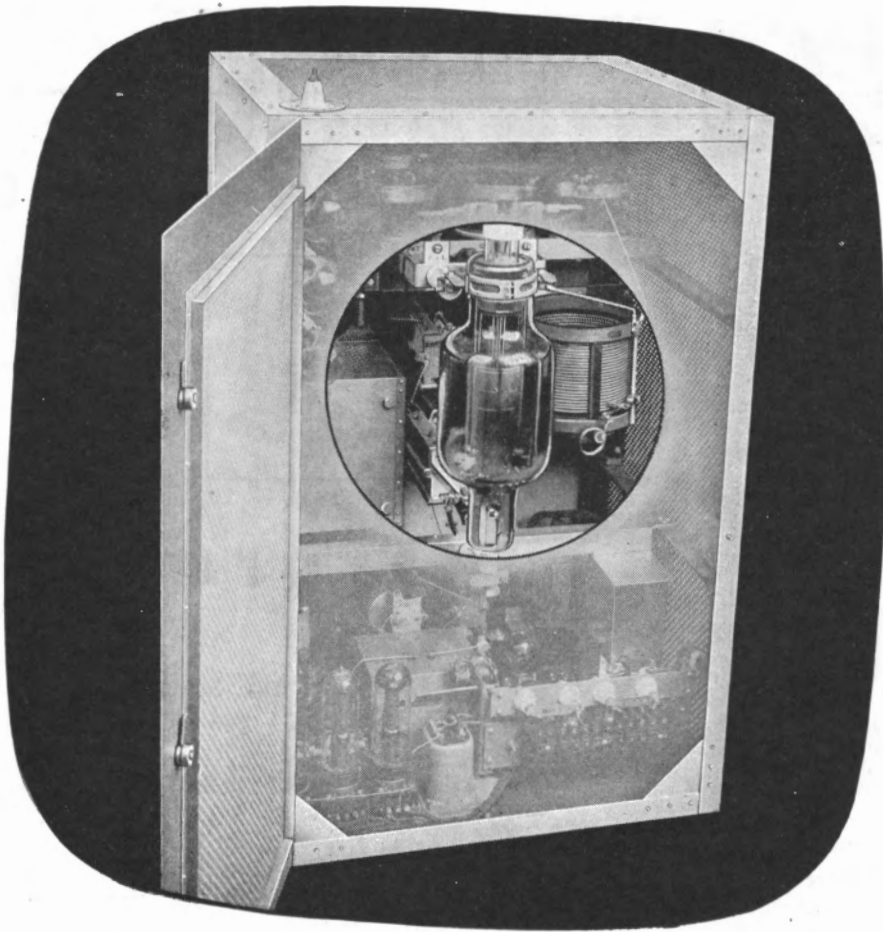

251A Tube mounted in Western Electric 9 Type Radio Transmitter—used by police and airlines.

Built for long life in short wave transmitters

The Western Electric 251A is a large radiation-cooled tube for use with short waves or ultra high frequencies. Designed with very low interelectrode capacities, this 1000 watt tube is suitable for operation over a very wide frequency range. It is capable of operating on frequencies as high as 60 megacycles, at somewhat reduced power rating.

Primary and secondary electrical emission from the grid of the 251A are made negligible by the unique cylindrical grid and anode structures. The method of mounting elements in the tube provides high insulation in a rugged structure. Terminal arrangement makes for ease of mounting and tube replacement.

These features, together with an adequate thoriated tungsten filament, assure a long life with uniform characteristics. Like all Western Electric tubes, the 251A is made to Bell Telephone standards of quality.

Characteristics of the 251A:

Filament Voltage.....	10
Filament Current.....	16
Maximum Plate Voltage.....	3000
Maximum Plate Current, Ampere.....	0.600
Maximum Plate Dissipation, Watts.....	1000
Average Amplification Factor.....	10.3
Average Plate Resistance, Ohms.....	2250
Average Mutual Conductance, Micromhos.....	4550
Approximate Direct Interelectrode Capacities:	
Plate to Grid.....	8 Mmf.
Plate to Filament.....	6 Mmf.
Grid to Filament.....	10 Mmf.
Maximum Overall Length.....	21-11/16"
Diameter of Bulb.....	6"

Western Electric

RADIO TELEPHONE BROADCASTING EQUIPMENT

Distributed by GRAYBAR Electric Company



E2-34

GRAYBAR ELECTRIC CO.
Graybar Building, New York, N. Y.

Gentlemen: Please send me full information on the Western Electric 251A Vacuum Tube.

NAME.....

ADDRESS.....

CITY..... STATE.....

For 1934 Auto-radio



ASSURE TROUBLE-PROOF POWER SUPPLY
Pioneer Gen-E-Motors

offer these advantages

- **Lifetime Trouble-Free Service.**
 Leading auto-radio set builders have found that freedom from failure and costly replacements makes a Pioneer Gen-E-Motor the lowest cost power supply.
- **No Adjustments or Lubrication.**
 Pioneer Gen-E-Motors have frictionless, wear-free ball bearings with sealed-in lubricant sufficient for life. No further lubrication or adjustments are required in service.
- **Better D.C. Output with Less Filter.**
 The Pioneer Gen-E-Motor supplies an output voltage requiring far less filter expense. The final filtered voltage output has less than 150 millivolts fluctuation, assuring superior receiver audio output.
- **Small Size Facilitates Set Design.**
 The pioneer Gen-E-Motor occupies the same or less space than that needed for other types of power supply and may be easily substituted in your chassis.

Write or wire for test sample and full details of the power supply that will make your auto-radio the choice of experienced dealers.

Pioneer 32 Volt and 110 Volt Power Units

The complete Pioneer Gen-E-Motor Line includes 32 volt D.C. to 225 volt D.C. units for plate power of 32 volts D.C. farm receivers; high voltage supplies for power amplifiers; 32 volts D.C. to 110 volts A.C. and 110 volts D.C. to 110 volts A.C. converters. Write for full information on any power supply need.



PIONEER GEN-E-MOTOR CORP.
 1158 Chatham Ct. Chicago, U. S. A.

KENYON



PRODUCTS

Light-Weight

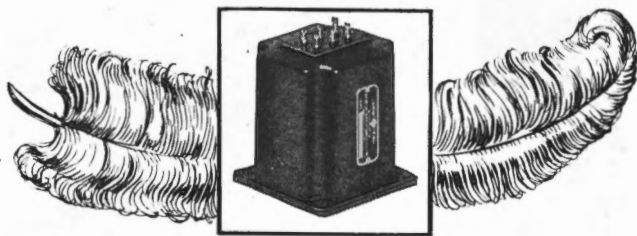

Transformers for Portable Sound Systems and Remote Control Amplifiers

KENYON scores again! New series of *light-weight* quality transformers and chokes provides maximum performance with minimum weight and bulk. Extreme gain in portability achieved through use of aluminum castings and special design, without sacrifice in superior performance which distinguishes the KENYON Laboratory Standard Audio Components.

Ideal for portable sound systems and remote control amplifiers. Highest output with least weight. Flat curve response—plus or minus 1 d.b. from 40 to 10,000 cycles. Weight average of twenty ounces, less than half that of corresponding units of KENYON Laboratory Standard Audio line. Complete Electrostatic shielding. Generous core structure and balanced windings. Simply a major technical achievement!

● INPUT	● OUTPUT
PLG—Multi-line to grid.	PPL—Plate to multi-line.
PDG—Dynamic Mike to grid.	
● CHOKES	● P2P1—Push Pull 31 to Multi-line.
P300-3—300 henries, 600 ohms.	P2P2—Push Pull 56 to Multi-line.
P45-10—40 henries, 3000 ohms.	
● COUPLING	● PLL—Multi-line to Multi-line.
P-31—Cascade, single plate to single grid. Also other coupling functions.	PDL—10, 20, 30 ohm Dynamic Mike to Multi-line.
P-12—One plate to two grids.	

KENYON Products and Engineering

Specify KENYON and forget your transformer problems, not only because of the inherent quality of KENYON products, but because KENYON engineering is always available to you in solving transformer problems to the best possible advantage.

SEND FOR ENGINEERING DATA

Detailed data on the Light-Weight Transformers and Chokes, as well as our general catalog describing the entire KENYON line of standard items, is yours for the asking.



KENYON TRANSFORMER CO., Inc.
 122-124 Cypress Avenue - - - New York City

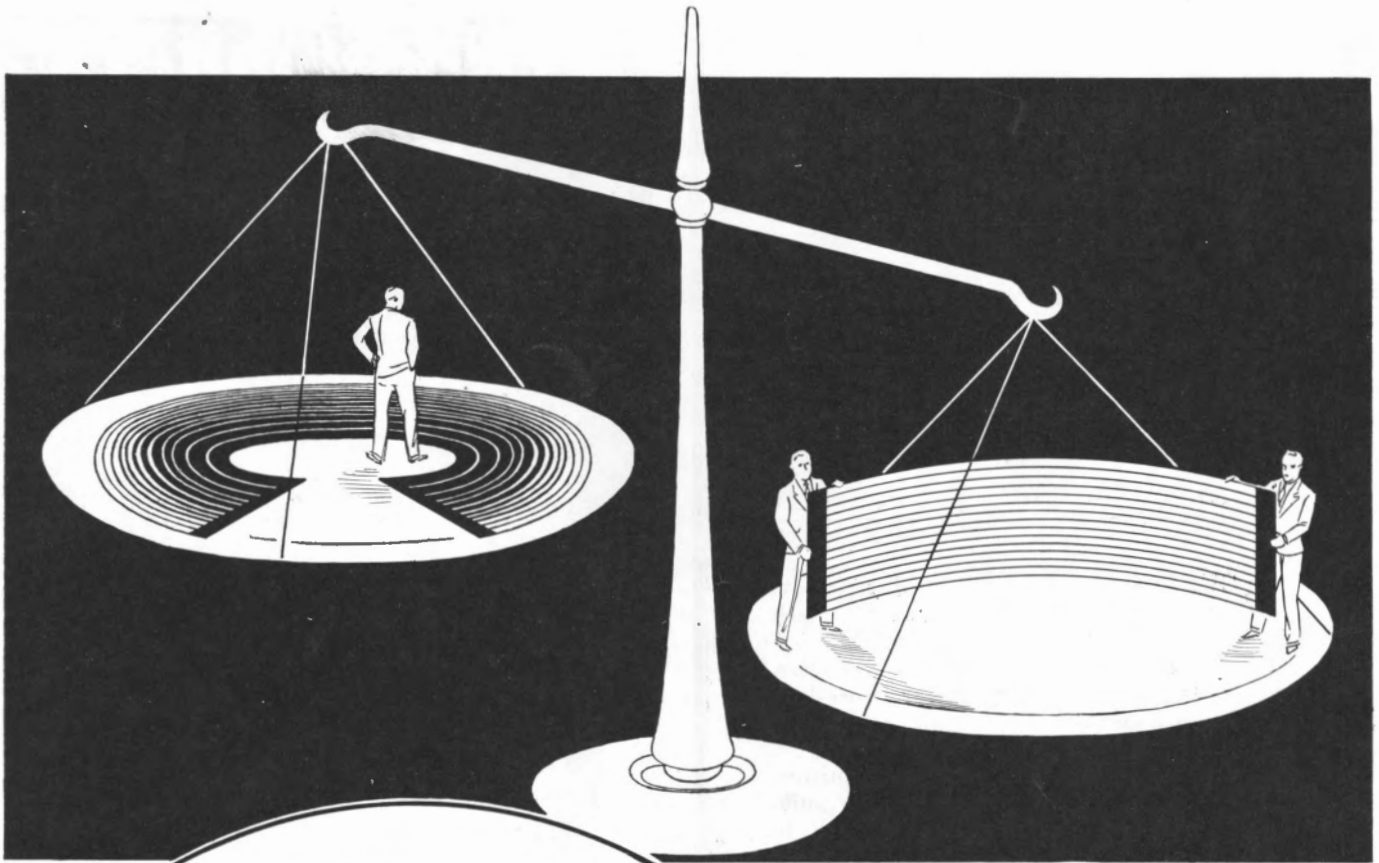

THE
new
OUTWEIGHS
THE OLD

THE new Centralab Radiohm permits smoother attenuation because of the greater effective length of the resistance strip employed.

The current path in the new Radiohm is more than twice as long as that in an old-style annular control of equal outside diameter. Current short cuts that might cause jumpy control are eliminated in the new Radiohm.

Since smooth control depends upon gradual resistance change the "doubled" length of current path in the new RADIOHM offers a still finer performance . . . again demonstrating Centralab superiority and reliability.

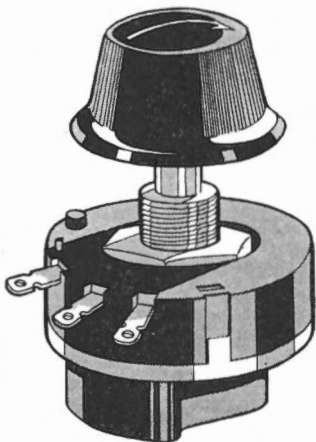

CENTRAL RADIO LABORATORIES MILWAUKEE

Centralab
 CENTRAL RADIO  LABORATORIES

RADIOHM

Modulation or Carrier-

which pays larger dividends?

Percentage Modulation	Signal Strength (Relative)	Carrier Power (Watts)	Signal Strength (Relative)
25	1	100	1
50	2	400	2
75	3	900	3
100	4	1600	4

DOUBLING the modulation degree pays the same dividend in signal strength as a 4 to 1 increase in carrier power.

Carrier power increases are expensive, necessitating, as they do, legal procedure to obtain a construction permit and extensive transmitter modification.

Proper readjustment of a transmitter, involving no expenditure, is usually sufficient to effect a substantial increase in modulation capability.

The economic aspect of increasing coverage demands that modulation capability be the first concern of owners of broadcasting plants.

Your best insurance against wasted power is an investment in the Type 66-A Modulation Meter.

Send for bulletin explaining the value of modulation measurement.

Other products:

Peak voltmeters.
Line equalizers.
Distortion measuring equipment.
Modulation measuring equipment.
Wide range voltage amplifiers.
Corrective networks.
Filter structures.
Special measuring instruments.

Some users:

WABC
WBBM
WJSV
WMCA
WHN
WCAE
WNEW
WBBR
KONO
WAAF

Inquiries are invited on special apparatus. This company specializes in filter structures, corrective networks and measuring instruments for all applications in research and industrial fields.

GENERAL COMMUNICATIONS



LABORATORIES - Incorporated

Ridgefield Park

New Jersey

Transformers for Class B amplification in broadcast transmitters

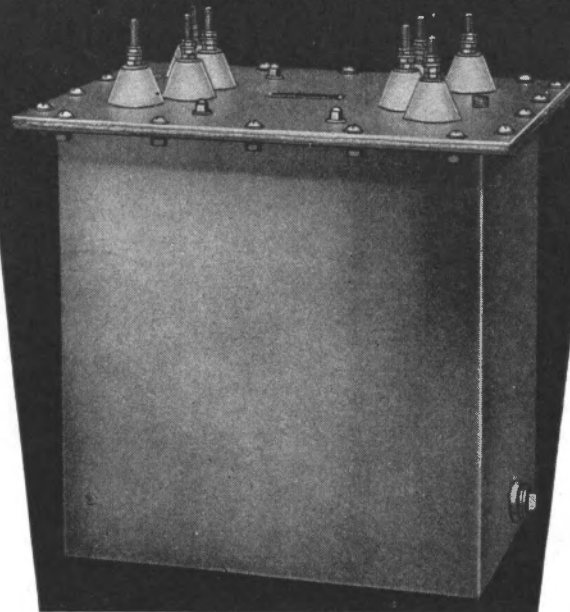

Output transformer for use between push-pull, class "B" stage using 204-type tubes and a class "C" amplifier. Operating level +50dB; primary 1500/1500 ohms; secondary 4750 ohms; tested at 15,000 volts; oil insulated.

FOR two years AmerTran engineers have been concentrating their efforts on problems associated with Class B modulation in broadcast transmitters. During this time they have designed transformer equipment for many of the country's best equipped stations.

AmerTran now offers a complete line of transformers (input and output) especially designed for tubes suitable for Class B operation. The above illustration shows the construction of AmerTran Class B output transformers which have the following features:

1. Oil immersed with Isolantite bushings. This permits insulation testing at a voltage which is considerably in excess of any peak which might be experienced in actual practice.
2. Welded aluminum tank provides complete r.f. shielding.
3. Wire used in primary and secondary windings is of a size which insures low d.c. resistance and ample current capacity.
4. Primary sections are balanced within 0.5% and the same phase angle exists in each section.
5. Core laminations of the best quality high-permeability alloy are operated at a low density.
6. Coil structure insures low distributed capacity, low capacity coupling, and high inductance coupling.
7. High efficiency insured by excellent regulation, constant input impedance, and unusually satisfactory frequency characteristics throughout the band of 30 to 10,000 cycles.

Complete information on transformers for use with a specific type of tube will be mailed promptly on request.

AMERICAN TRANSFORMER COMPANY

176 Emmet Street

Newark, N. J.

The AmerTran line includes transformers of every description for audio amplification and radio transmission.

AMERTRAN

Audio Transformers

February, 1934 — ELECTRONICS

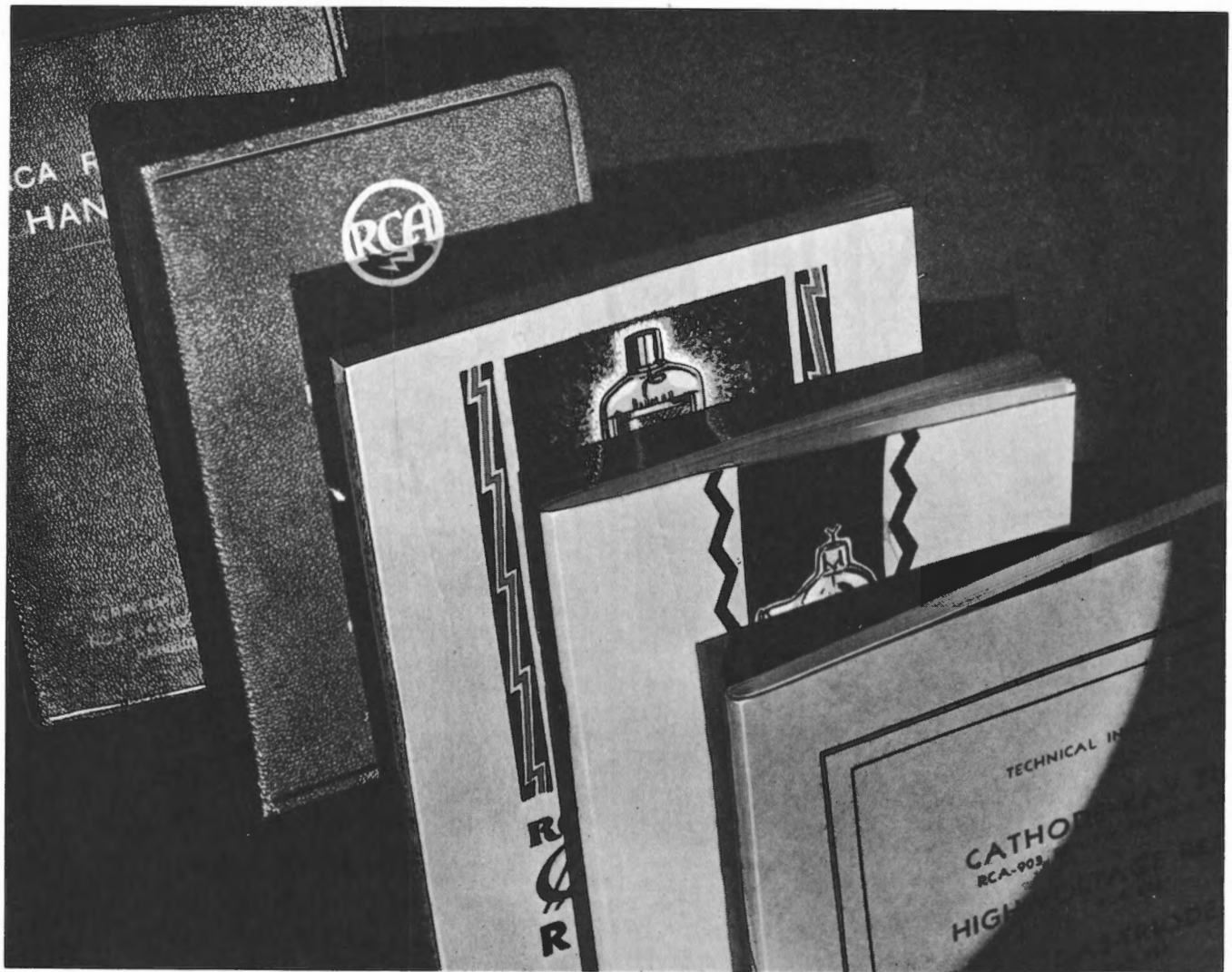

INDISPENSABLE RADIO ENGINEERING AIDS

★ ★ ★ ★ ★

RC-11 MANUAL •• This booklet was designed primarily for service men, experimenters and amateurs interested in the application of RCA Cunningham-Radiotrons. Free on request ★ ★ **RCA RADIOTRON HANDBOOK, CUNNINGHAM RADIO TUBE HANDBOOK** •• Designed primarily for radio receiving set engineers, the Handbook is a most accurate and complete tube data book, kept up-to-date at all times by a loose-leaf service. \$3.50 the first year, \$1 per year thereafter ★ ★ **TRANSMITTING RADIOTRON HANDBOOK** •• Similar to the receiving tube handbooks, but designed primarily for transmitting engineers, this loose-leaf handbook is a convenient source of accurate, concise technical information. \$3.50 the first year, \$1 per year thereafter ★ ★ **CATHODE-RAY TUBE BULLETINS** •• Treating fully of the fundamentals of cathode-ray tube operation and application, as well as of the two tubes used in associated rectifier and sweep circuits, this bulletin is a handy source of usable information. Free on request ★ ★ **BULLETIN ON RCA AMATEUR TRANSMITTING TYPES (No. 464)** •• This booklet incorporates practical and usable information on the installation, application, and operation of transmitting tubes in amateur radio stations. Free on request.

RCA RADIOTRON CO., INC.

A Radio Corporation of America Subsidiary

HARRISON • NEW JERSEY

A MILLIMETER or a MILE



YOU wouldn't expect to measure a millimeter on a scale long enough to measure a mile—yet the Type 603-A Standard-Signal Generator accurately divides a volt in even greater ratio.

The standard-signal generator is the basic instrument for evaluation of receiver performance. Indispensable to receiver and vacuum-tube manufacturers, it must cover very wide limits to meet the requirement of modern receiver design.

Wide ranges do not exhaust this generator's claim to superiority as a general laboratory standard. There are, for example, such convenience features as the space for user calibrations on the large dial, and glass for accurate reading.

RANGES: Frequency 100 kc. to 25,000 kc. Voltage 0.5 microvolt to 1 volt.

PRICE (with coils for broadcast band only)

\$600.00

To supplement the above inadequate description write the GENERAL RADIO COMPANY, Cambridge, Massachusetts, for additional details.

GENERAL RADIO

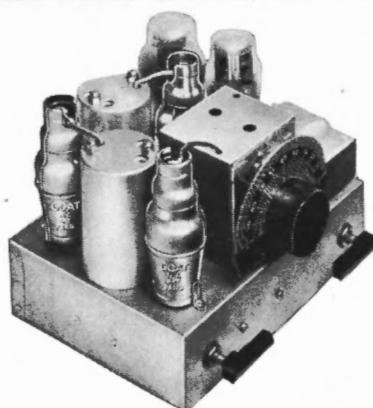

GOAT SHIELDS

now adopted by 62 manufacturers!

Because these modern form-fitting shields cost much less than old-fashioned "can" shields.

Because their use permits other important manufacturing economies through reduction of chassis and overall set dimensions.

New sets are now distinguished from old models by the fact that GOAT form-fitting tube shields are used—especially on auto radios, portables and compacts.

Write for samples. ~ ~ ~ ~



GOAT RADIO TUBE PARTS, INC.
314 DEAN ST. BROOKLYN, N. Y.

High-Frequency

C-D
condensers

Capacitors

Always anticipating radio progress, Cornell-Dubilier engineers have developed low-loss capacitors for those 1934 ultra-short-wave requirements. For instance:

■ MICA TRANSMITTING UNITS ■

Type 9—heavy-duty low r.f. loss molded bakelite capacitors. Ideal for high-current blocking (plate to grid) function. Also as by-pass for r.f. around any device or D.C. meter. Short-path connections for h.f. work. Voltages up to 2000. Capacities .00005 to .015 mfd.

■ MICA RECEIVING UNITS ■

Type 3—tiny molded bakelite units for low-current, low-voltage by-pass functions up to 400 volts. For receiving circuits primarily, but also applicable to transmitting circuits.

■ SULFINITE CAPACITORS ■

Type 54—Compact, extremely low loss at higher frequencies, arranged for stacking. Can be connected in series, parallel or series-parallel. 10 to 200 mmf. capacities.

Write for the new 1934 catalog covering not only the complete C-D transmitting line but also capacitors for every radio need.



CORNELL-DUBILIER CORPORATION

4377 Bronx Blvd. - - New York City

The "New World" Radio with Bakelite Molded Globe and Pedestal

A STRIKING example of designing a product to emphasize its function is offered in the "New World" radio made by Colonial Radio Corp. Departing from the conventional cabinet styles, this unique model, in which the chassis is housed in a globe, typifies radio's world-wide scope.

The material for the globe was readily available in Bakelite Molded, which, since the earliest days of radio broadcasting, has been the standby of radio engineers. All that was required was engineering skill of the highest type to design a five-tube super-heterodyne receiver to fit within a spherical housing.

In this clever receiver the globe is formed of Bakelite Molded in two sections. The lower half serves as the housing in which the chassis is securely mounted; the upper constitutes the cover which may be removed for inspection and servicing. The electro-dynamic speaker is housed within the pedestal, which also is formed of Bakelite Molded.

Bakelite Materials have contributed greatly to radio improvement. They keep pace with each new advance in radio design. Write for the latest editions of illustrated Booklets 13M and 13L for information on newest developments.



BAKELITE CORPORATION, 247 Park Avenue, New York, N.Y. 43 East Ohio Street, Chicago, Ill.
BAKELITE CORPORATION OF CANADA, LIMITED, 163 Dufferin Street, Toronto, Ontario, Canada

BAKELITE

REGISTERED U.S. PAT. OFF.
"The registered trade marks above distinguish materials manufactured by Bakelite Corporation. Under the capital "B" is the numerical sign for affinity, or unlimited quantity. It symbolizes the infinite number of present and future uses of Bakelite Corporation's products"

THE MATERIAL OF A THOUSAND USES



Improve your product this money-saving way

HERE'S an idea that deserves the attention of every designing engineer. The adaptability of the Shakeproof principle makes it possible to build this positive locking method right into any standard part. This means you have the powerful twisted teeth of Shakeproof biting into both work and nut surfaces and, at the same time, no separate lock washers are required. Thus you are providing the greatest possible protection against vibration and also saving time and money on the production line. Let us show you how this new idea can be applied to your product—write for complete information today!



Send today for your free copy of this complete Shakeproof Catalog. Explains thoroughly the many advantages that Shakeproof offers—also shows new patented Shakeproof products.



"It's the Twisted Teeth that LOCK!"

SHAKEPROOF Lock Washer Company

{Division of Illinois Tool Works}

2539 N. Keeler Ave.

Chicago, Ill.



U. S. Pat. 1,419,564—1,604,122—1,697,954—1,782,387—Other Pat. Pending—Foreign Pat.

NEW!

Non-Fatiguing

SPIDER

STOCK

for radio speakers

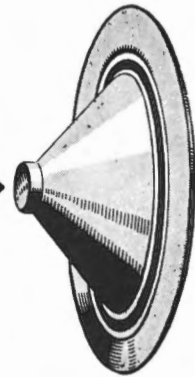

OF SPECIAL
PAPER BASE **LAMICOID**
LOW COST • FABRICATED
OR IN SHEETS • WRITE FOR
SAMPLES AND QUOTATIONS
MICA INSULATOR CO.

200 Varick Street, New York, N.Y. • 542 So. Dearborn Street, Chicago, Ill. • 1330 Schofield Building, Cleveland, O.
Branches at: Birmingham, Boston, Cincinnati, Los Angeles, San Francisco, Seattle. Canada: Montreal, Toronto

LOW RESISTANCE

SELENIUM CELLS

For Sound and Relay Work

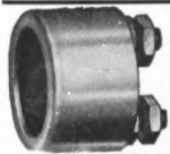

Dark resistance of cells average 10,000 ohms. Safe capacity 1 milliamperes.

When used for sound pick-up, quietness is comparable to caesium cells.

Dependable for burglar alarm systems and other light beam control of all kinds of relay circuits. Functions on extremely low light intensities.

\$7.50

List

Write for free literature and circuits.

ACOUSTO-LITE CORP., LTD.

2908 S. Vermont Ave., Los Angeles, Calif.

THE leaders in sales to the electronic industries not only in 1934, but in 1944, are the companies now laying a solid foundation for sales, through the use of advertising in "Electronics."

NO EMISSION DROP after 2,000 HOURS!



THE 851

Sylvania Type 851 Graphite Anode Transmitting Tube

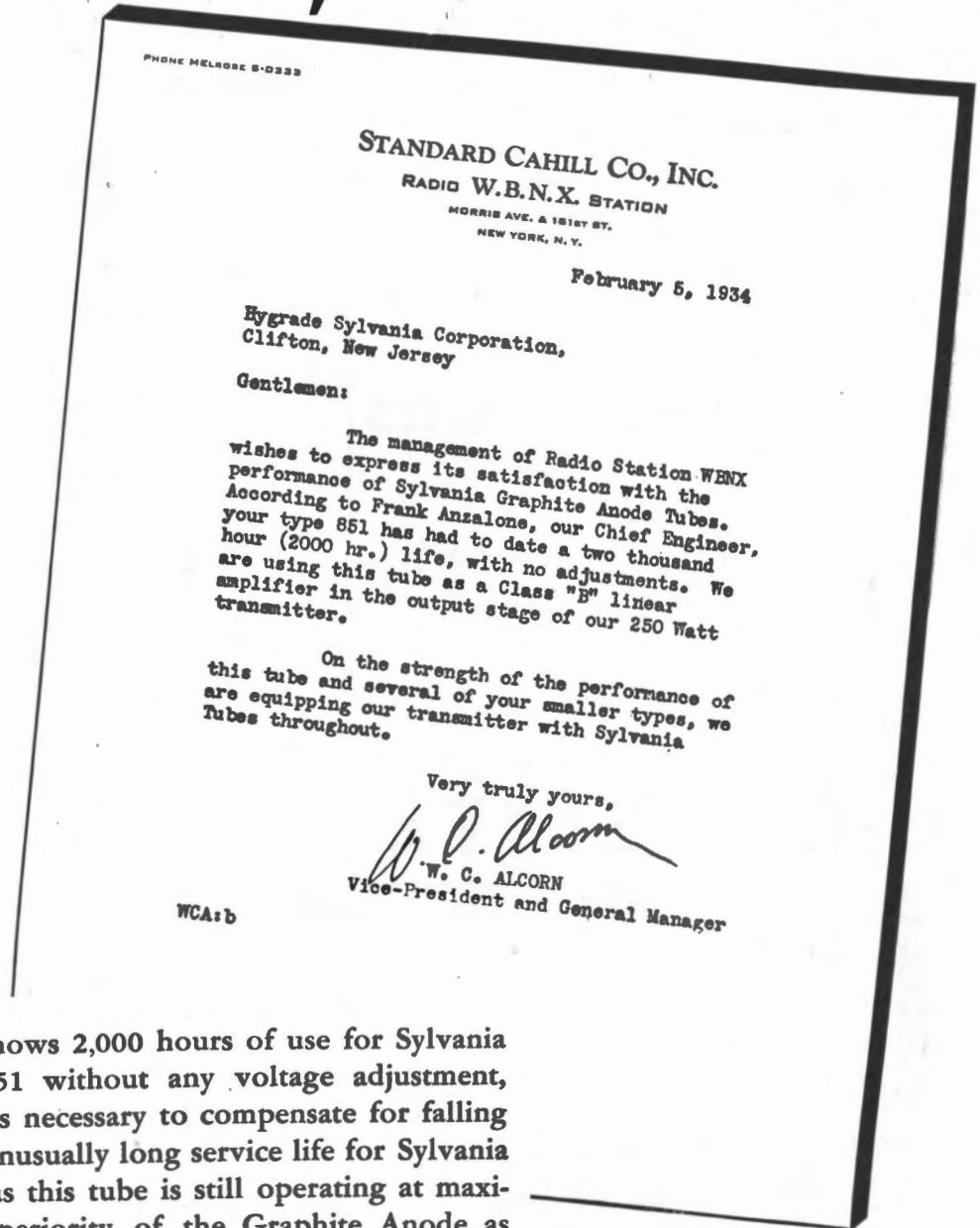

PHONE NERLORE 5-0333

STANDARD CAHILL CO., INC.
RADIO W.B.N.X. STATION
MORRIS AVE. & 181ST ST.
NEW YORK, N. Y.

February 5, 1934

Hygrade Sylvania Corporation,
Clifton, New Jersey

Gentlemen:

The management of Radio Station WENX wishes to express its satisfaction with the performance of Sylvania Graphite Anode Tubes. According to Frank Anzalone, our Chief Engineer, your type 851 has had to date a two thousand hour (2000 hr.) life, with no adjustments. We are using this tube as a Class "B" linear amplifier in the output stage of our 250 Watt transmitter.

On the strength of the performance of this tube and several of your smaller types, we are equipping our transmitter with Sylvania Tubes throughout.

Very truly yours,
W. C. Alcorn
W. C. ALCORN
Vice-President and General Manager

WCA:b

The record of WBNX shows 2,000 hours of use for Sylvania Graphite Anode Type 851 without any voltage adjustment, which in ordinary tubes is necessary to compensate for falling emission. This indicates unusually long service life for Sylvania Graphite Anode Tubes, as this tube is still operating at maximum efficiency. The superiority of the Graphite Anode as developed, processed and introduced by Sylvania, has been definitely proved by similar service records of many broadcasting stations, amateurs and other users.



HYGRADE SYLVANIA CORPORATION

Hygrade Lamps ELECTRONICS DEPARTMENT Sylvania Tubes
CLIFTON, NEW JERSEY

FACTORIES: SALEM, MASS. EMPORIUM, PA. ST. MARYS, PA. CLIFTON, N. J.

WAREHOUSE STOCKS IN
Portland, Oregon Atlanta, Georgia Denver, Col. Chicago, Ill. Salem, Mass. Dallas, Texas Philadelphia, Pa. Pittsburgh, Pa. Los Angeles, Cal.



NOT A MOUSE TRAP!

—but the world has beaten a path to *CONTINENTAL'S* door!

Without ballyhoo—without high pressure selling—the progress of Continental CETRONE Cells has been consistently forward. That companies large and small—engineers and individuals from almost all walks of industry—have come to us for better Photo Cell performance and practical engineering advice is a testimonial in itself. Only the unusual efficiency and thorough dependability of our cells can account for this world wide popularity.

CETRONS are made of the finest materials, to rigid standards, by an organization with an unusual background in the electronic industry. We manufacture a complete line of Photo Cells. There is a type for every purpose. In addition, we are equipped to manufacture special Photo Cells to your specifications.

If you are not already using CETRONS, write to us today for complete information.

CONTINENTAL ELECTRIC COMPANY
ST. CHARLES, ILLINOIS

CANDOHMS

ARMOURED WIRE WOUND RESISTORS

WILL LOWER YOUR COSTS

OVER SEVEN MILLION IN USE
MAY WE SAMPLE AND QUOTE

THE MUTER COMPANY

1255 So. Michigan Ave., Chicago

A TRIAL WILL CONVINCING YOU

←→ || 30 Years' Experience || →
Insures Dependability

We Manufacture

PERMANENT MAGNETS TOOLS and DIES
METAL STAMPINGS LAMINATIONS

THOMAS & SKINNER STEEL PRODUCTS CO.

23d St. at Alvord

Indianapolis, Ind.

ENAMELITZ

Reduce manufacturing costs on I.F. and R.F. coils through the use of Enamelitz—"Litz" wire without a fabric covering.

Three Fold Savings—

1. Cost of wire
2. More coils per pound of wire
3. Less space—Greater safety

Sample and Technical Bulletin on Request.

Other Acme Wire Co. Products

Magnet Wire (all insulations)

Coils, Magnet Wire Wound

Varnished Insulations

(Cambric, paper, silk, tape)

Parvolt Condensers

(Filter, By-pass, Power Factor Correction)

Aerial Wire

(Stranded and Solid—Bare or Enameled)

For over 25 Years, suppliers to the largest radio and electrical manufacturers.

THE ACME WIRE CO.

New Haven, Conn.

An Efficient A. C. Relay

Compact, Noiseless, Non-chattering

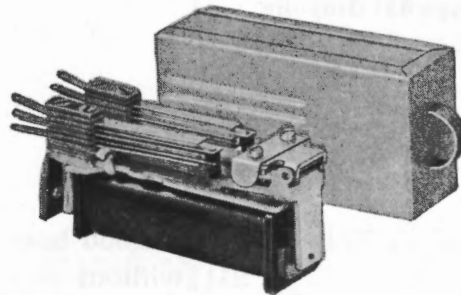

The Type FQA Relay, illustrated above, is one of the most useful of the extensive Autelco family. It has a firm, chatterless contact closure, and is quiet at all frequencies. May be equipped with any combination of contact springs up to a total of ten. Can be supplied for operation under a wide variety of voltages and frequencies.

Autelco Relays, developed and perfected over a period of more than forty years, include both A.C. and D.C. types for heavy or light duty, with an unlimited variety of contact combinations. Complete listing contained in Catalog 4016, copies of which will be gladly supplied on request.

Automatic Electric Company
1033 West Van Buren Street, Chicago

FOR CONSISTENT RESULTS IN

Resinox is odorless, water-resistant, and available in a wide variety of colors. Resinox molds perfectly, cures uniformly, and finishes with high luster, beauty, and strength.

KEEP IN TOUCH WITH RESINOX DEVELOPMENTS

MOLDING
Specify

RESINOX

Molding Resins Molding Compounds Laminating Varnishes

RESINOX CORPORATION

Subsidiary of Commercial Solvents Corporation and Corn Products Refining Company
230 Park Avenue, New York City

—ELMET—

MOLY



FOR

GRID WIRES

SUPPORT WIRES

ELECTRIC FURNACE
HEATING ELEMENTS

ALSO FOR

SCREEN GRIDS--CATHODE COILS
MANDRELS---CONTACTS, ETC.

ALL OF THE ABOVE PRODUCTS MAY
BE HAD IN VARIOUS COMPOUNDS OF
MOLYBDENUM-TUNGSTEN



Write for Information and Prices

American Electro Metal Corp.
Lewiston Maine

NEW
SECOND EDITION

of

"The Leader in
Its Field"

**PRINCIPLES
of RADIO**

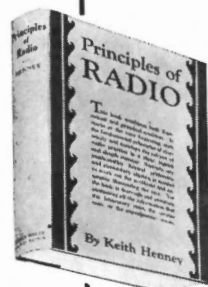

491 pages
5 1/4 x 7 7/8
\$3.50

WITH A SECTION
ON TELEVISION

By Keith Henney
Associate Editor "Electronics"

This widely accepted book has been completely rewritten and a large amount of new material has been added, including short-wave receiver design; police two-way systems; iron core r.f. components; practical facsimile; cathode ray technique; technical status of television; industrial applications of tubes. Written in language simple and easy to understand, in "non-mathematical treatment," this book leaves out nothing that is worthwhile in radio. \$3.50.

John Wiley and Sons, Inc., 440-4th Avenue, New York
Gentlemen: Please send me Henney's "Principles of Radio" for ten days' approval. I agree to remit the price of the book (\$3.50) plus few cents postage within ten days or return it postpaid.

Name
Address
City and State
Position
Employed by EL 2



JANUS

WE'VE always had a soft spot for Janus, that old Italic deity who had not one face, but two. This meant Janus could look east and west, backward and forward.

This habit of looking backward and forward is one all industries should cultivate—history's sole purpose seems to be guidance for the future. Hence *Electronics* is putting Janus in March, which means that our "Marketing and Statistical Issue" makes its bow next month.

Another reason we like Janus is that in the time of Hadrian, the natives gave Janus *four* faces. That's pleasing to us when we consider these electronics industries of ours with their four branches—**RADIO, BROADCASTING and COMMUNICATIONS, INDUSTRIAL MARKETS and SOUND EQUIPMENT.** Our editors, in the March "Marketing and Statistical Issue" of *Electronics* are going to apply the "backward-forward" technique to each of the four branches, all of which have one thing in common—the electron tube and its associated circuit.

In the "Marketing and Statistical Issue" will be presented statistics of production and the future outlook in the principal fields of electronic applications. These include not only the four major branches mentioned above, but also short-wave communication, facsimile, television, public address, sound pictures, acoustic engineering, instruments, power rectifiers, power tubes, etc.

For example, in this issue there will be a survey of the radio components market—what prices were paid in 1933, the number of condensers, resistors, loud speakers and other parts that were purchased by the radio set manufacturers or were made in their own factories. This will be contrasted with the trends in other years and a survey of 1934 will show how prices will change.

Then again, there will be a survey of the annual costs of maintaining radio broadcast stations, expenses for tubes and other replacement items.

High-fidelity broadcast reception—there'll be a discussion of the problem before broadcasters, radio set makers and installers to fur-

in March



nish an improved service to the public with a wide range of fidelity.

Also there'll be material on the new entities which research has introduced into the field of electronics, and which may become new tools for the man who develops vacuum tube devices.

Plus, of course, the regular feature articles that have made *Electronics* the mouthpiece and the leader of the industry.

WE think, with all due modesty, that when the 7,000 executives and engineers who read *Electronics* have studied their copy of the March "Marketing and Statistical Issue" they will know more definitely not only where the industry is going but what part each man must play in its further progress.

For this much is certain about our industry: never before have technical development and market planning needed to be so closely tied together as in 1934. Upon the engineer as well as his management rests the responsibility for immediate and future prosperity.

Isn't it logical to believe that the company with a product or service to sell to the electronics industries, can get in some heavy and effective selling at a time when prospects in these industries are doing market planning—at a time when these 7,000 men are reading their copies of *Electronics'* March "Marketing and Statistical Issue." To companies who want to join the rapidly growing roster of *Electronics'* advertisers, may we say that the advertising forms for our "Marketing and Statistical Issue" close in New York on March 1st.

electronics

a McGraw-Hill publication

Member ABP & ABC

330 W. 42d St., New York, N. Y.

NOW \equiv a high-powered radio engineering library

—especially selected by radio specialists of the McGraw-Hill Publications

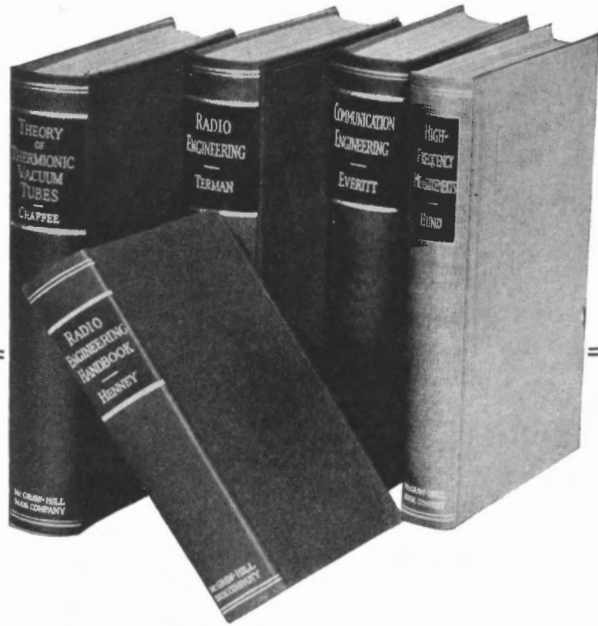

—to give the most comprehensive, useful, authoritative coverage of radio engineering

—available at a special price and on easy terms

Radio Engineering Library

5 volumes—2981 pages—nearly 2000 illustrations, \$23.50, payable \$2.50 in 10 days and \$3.00 monthly.

What the library contains:

Communication Engineering

By Professor W. L. Everitt of The Ohio State University. Expository treatment of fundamentals of communication. Stresses broad principles. Covers classification of impedance elements, networks using linear bilateral impedances, networks using unilateral impedances, networks using non-linear impedances, negative resistance effects, coupling between electrical and mechanical circuits, coupling between electrical circuits and free space.

Radio Engineering

By Professor Frederick E. Terman of Stanford University. Comprehensive engineering treatment of important vacuum-tube and radio phenomena. Analyzes circuits and tubes and reduces them to quantitative relations predicting performance of tubes and radio apparatus with accuracy and certainty. Includes material on radio aids to navigation.

Theory of Thermionic Vacuum Tubes

By Professor E. Leon Chaffee of Harvard University. Comprehensive treatment of fundamentals of thermionic emission and the vacuum tube. Covers use of tube as amplifier and detector as well as its general properties. New, original material on large-signal regeneration, regeneration in coupled circuits, detection, all types of amplifiers, non-linear elements, etc.

High-Frequency Measurements

By August Hund. Complete, thorough reference work on measurements of high frequency. For research workers, practical designers and engineers. Presents theory and practice of measuring all manner of electrical quantities as well as present-day radio apparatus. Methods presented in a manner practical enough to meet needs of anyone interested in the increasingly important high frequency art.

Radio Engineering Handbook

Editor-in-chief, Keith Henney, Associate Editor of *Electronics*, assisted by staff of specialists. Handbook of radio comparable to standard handbooks in other fields of engineering. Emphasizes design area, covers everything from fundamentals to latest practical applications. Covers new tubes and circuits, Class B amplifiers, transmitters, receivers, short-wave, television, sound pictures, aircraft radio, etc.

HERE is an announcement of importance to every radio engineer. These outstanding radio books, comprising a complete library of radio engineering essentials, now conveniently grouped and offered at terms that enable all to start using this library at once.

This is a real engineering library. Radio specialists of the McGraw-Hill publications selected the books for this library as those giving the most complete, dependable coverage of those facts needed by all engineers whose special fields are grounded on radio fundamentals. Covers circuit phenomena, tube theory, networks, measurements, and other subjects—gives specialized treatment of all fields of practical design and application.

These are books of recognized position in the literature—books that you will refer to and be referred to often. If you are a practical designer, researcher or engineer in any field that is based on radio, you want these books at hand for the help they can give you on hundreds of occasions, in scores of problems throughout the whole branch of radio engineering.

Space doesn't permit more than to suggest the value this library can have for you. Therefore we offer to send the entire set on approval, for your personal inspection and appraisal. If after examination you don't think these books will pay for themselves over and over as a needed and dependable reference tool in your work, return them without question. Take advantage of this offer.

Special low price and easy terms

Bought singly, the five volumes comprising this library would cost you \$26.00. Under this offer you save \$2.50 and in addition have the privilege of paying in easy installments beginning with \$2.50, 10 days after receipt of the books, and \$3.00 monthly thereafter. Already these books are recognized as standard works that you are bound to require sooner or later. Take advantage of these convenient terms to add them to your library now.

Examine this library 10 days—Send this coupon MCGRAW-HILL ON-APPROVAL COUPON

McGraw-Hill Book Company, Inc., 330 West 42nd St., New York City
Send me the Radio Engineers' Library, 5 volumes, for 10 days' examination on approval. Within 10 days of receipt I will send \$2.50, plus a few cents for postage and delivery, and \$3.00 monthly thereafter till \$23.50 is paid, or return the books postpaid. (We pay postage on orders accompanied by remittance of first installment.)

Name
Address Position
City and State Company
(Books sent on approval in U. S. and Canada only.)

L-2-34

Stable and
Reproducible

PHOTO-ELECTRIC CELLS IN GLASS AND FUSED QUARTZ

*Development and
Careful Consideration*

of Special Applications by Photo-Electric Experts. Quotations on request. Write for Bulletin 271a.

R. C. BURT
SCIENTIFIC LABORATORIES 211 Clay Street
Pasadena, Calif.

ask
'em
for
more
details

OUR advertisers are really a very agreeable group — naturally, they can't always put into each advertisement all the details and information that readers want. But if you'll drop them a line, mentioning that you're a reader of *Electronics*, they'll be glad to tell you more about their products and plans.

Two
stage
condenser—
Floor
Desk
Hand
Suspension
Types.

List
Prices
as low
as

\$110.

Discounts
to
commercial
users.



NOW used by more than 300
stations and sound studios

REMLER CONDENSER MICROPHONES

Attractive, efficient and low priced — the Remler Condenser Microphone is a sensation! Features: Hermetically sealed nitrogen-filled head; acoustic equalizer; pressure equalized diaphragm; mica insulated back plate; moisture proof; copper shielded and mica insulated head housing and noiseless safety plug-in contacts.

Two stages pre-amplification; essentially flat response 30 to 10,000 c.p.s.; overall output—15d.b.; output impedances supplied 50,200 or 500 ohms

NEW REMLER CATALOGS

—feature the entire Remler line: Speech input; A.C. Remote Control Amplifiers; Attenuators; Microphone Power Supply and P.A. equipment. Send for P.A. and Broadcast catalogs.

REMLER COMPANY LTD.
2101 Bryant St.
San Francisco, Calif.

REMLER—THE RADIO FIRM AS OLD AS RADIO

PROFESSIONAL SERVICES

Consulting—Design—Research—Testing
Measurement—Development—Acoustics—Patents

SEARCHLIGHT SECTION

POSITION WANTED

ENGINEER, 16 years' telephone, telegraph radio, sound. Patentee circuits, apparatus. 10 years' research and development. Bell system. Master's degree, physics. PW-58, Electronics, 330 West 42d St., New York City.

AGENTS WANTED

EARN from \$1 to \$5 an hour extra without interfering with your present employment. Whether office man, salesman, technical man, foreman or worker you can make ready cash quickly and easily each week showing our lists of business and technical books to fellow employees and others. You recommend them, we do the rest. No experience required. Complete equipment free. Write Tom Crawford, Dept. Elect., McGraw-Hill Book Co., 330 West 42d St., New York City.

ELECTRICAL TESTING LABORATORIES

Characteristics and
Life Tests of Vacuum Tubes
Tests of photocells, glow lamps, crater lamps.
Tests of electronic and optical devices.
80th Street and East End Avenue
New York, N. Y.
Phone: Butterfield 8-2600

ELECTRONICS MUSIC LABS.

Portable Electronic Organs
for professional and broadcasting use. Equal to largest pipe organs. Qualities based on Eremeeff-Helmholtz simultaneous and Eremeeff multi-step-by-step synthesis. Mechanical and photoelectric instruments and sound on film devices.
WCAU Building, 1622 Chestnut Street,
Philadelphia, Pa.

The Solution of Your Problem

in the field of Electronic devices may be found through enlisting the services of the Consultants whose cards appear on this page.

N. DINION Consultant

Design Solenoids
Electromagnets Electrical Coil Windings
162 Pennsylvania Ave. Easton, Pa.

JENKINS & ADAIR, INC. Engineers

Designers, developers, and manufacturers of accessories and essentials for recording, broadcasting and testing at sound frequencies.
3333 Belmont Avenue, Chicago, U. S. A.
Cable Address: Jenkadair Telephone: Keystone 2130

HIGH GRADE NEW AND USED ELECTRON TUBE EQUIPMENT

Write for Bulletin Showing Savings
From 20% to 80%

KABLE ENGINEERING CORPORATION
Specialists in Equipment and Methods for the
Manufacture of Neon Tubes, Radio Tubes, Incandescent
Lamps, Photo Cells, X-ray Tubes, etc.
350 Manhattan Ave., Union City, N. J.

All types of High Grade New and
Used Equipment for the manu-
facture of Electron Tubes.

Lowest prices on the market.

AMERICAN ELECTRICAL SALES CO.
65 East 8th St., New York, N. Y.

REMOTE CONTROL UNIT FOR AUTO RADIO



No. 5002 Remote control unit—Natural tuning—pointer turns in the same direction as the tuning knob making for greatest ease in tuning. This unit has an efficient lock with a real key in the knob and removable only when the set is turned off.

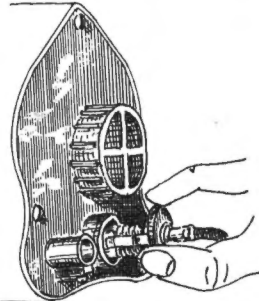

Light assembly may be slipped in or out of case by the thumb and finger. May be serviced by any one without disturbing any part of the equipment.

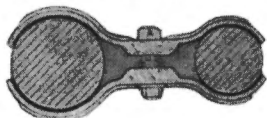

No. 5057—CLAMP for holding head to steering post—adjustable for size and position.

CABLES • HOUSINGS • END PIECES



No. GG-3 No. 255 5050-A Complete No. GG-1



No. GG-2 5050-B Complete No. 255 No. GG-1



No. 541 CABLE SQUARE ENDS



No. 255 HOUSING



NO. 541 CABLE OCTAGON ENDS



No. 5060—ADAPTER sleeve for connection between condenser and volume shafts and remote control shafts.

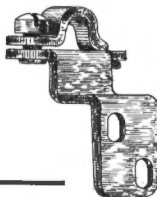

No. 5062—BRACKET which is attachable to the radio for holding the remote control shafts. It is adjustable up or down for alignment—it clamps around shaft instead of direct screw. One pair is needed for condenser and volume connections.

The above represents only a part of our complete line of auto radio accessories. Numerous designs of dial faces in stock or made up special from manufacturers' designs. Remote control shafts furnished to blue prints with or without end pieces, squared at ends or at intervals for service stations cutting. Our 20 years' experience in fabricating automotive speedometer cables gives us added experience for serving the automobile radio industry. We successfully served a number of the leading radio manufacturers last year. We will be glad to sample and quote your engineering and purchasing departments.

Send for complete illustrated descriptive Bulletin S.

F. W. STEWART MFG. CORP.

340 W. HURON ST., CHICAGO, ILLINOIS, U. S. A.

Telephone: Superior 2940

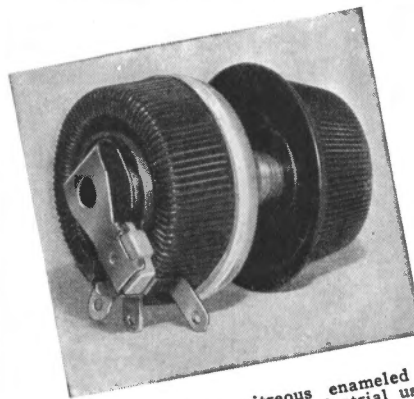

Modern
devices
need
modern
rheostats!

Ohmite all-porcelain, vitreous enameled rheostats are ideal for electronic, radio, and industrial use. Because of their unique, patented construction, each turn of wire is held rigidly in place by the enamel and acts as a separate contact step; thus these units offer much closer control than ordinary rheostats. Contact is made on the winding by means of special metal-impregnated carbon-graphite shoes which have been tested for several hundred thousand operations under full load. Three terminals are provided so that any unit may be used as a potentiometer without change.

A complete list of all stock values in 25, 50, 150, 300, and 500 watt sizes is contained in Bulletin No. 9, along with several hundred different fixed and semi-variable resistors which are kept in stock for immediate delivery. Special resistors which are quickly made up to order are contained in Bulletin No. 5. Write for your copies of these handy reference bulletins.

OHMITE Manufacturing Company

625 N. Albany Ave., Chicago, Ill.

CANNON PLUGS IN THE AIR

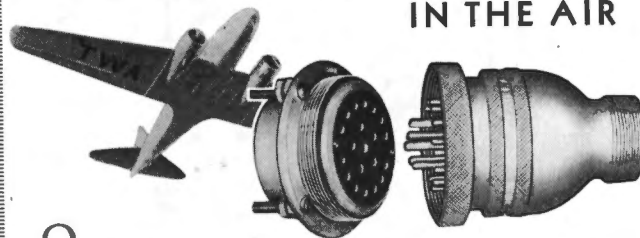

QUALITY—built-in quality—and co-operative engineering produced the logical result—the designation of CANNON Cable Connectors as standard equipment for the great airfleet of the TWA.

Fifth Douglas Luxury Airliners, now under construction, are being equipped throughout with CANNON Plugs of from one to 20 contacts each. Applications of CANNON Plugs consist of—

- Firewall fittings for miscellaneous instruments, ignition generator, starter, etc.
- Special plugs for Western Electric generator.
- Special 18-pole set for quick replacement of entire radio equipment.
- Ground battery plugs.

- Wing fittings for engine nacelles and landing lights.
- Special plugs for trailing antennae.
- Quick-connecting sockets and plugs for ship batteries.
- Shallow sockets for cabin lights.

When life and property are at stake on land, on sea or in the air, they use CANNON Cable Connectors.

CANNON ELECTRIC DEVELOPMENT CO.
MANUFACTURING ENGINEERS

Main Office: 420 West Avenue 33, Los Angeles, Calif.

Eastern Sales Office: 220 Fifth Ave.
New York, N. Y.

Representatives:

Chicago: Jenkins & Adair, Inc., 3333 Belmont Ave.
Bombay, India: Eastern Electric & Engineering Co.,
175 Hornby Road, Fort, Bombay, India





Founded
in 1920



For auto and midget radios—a more compact control . . . yet reliable and rugged.

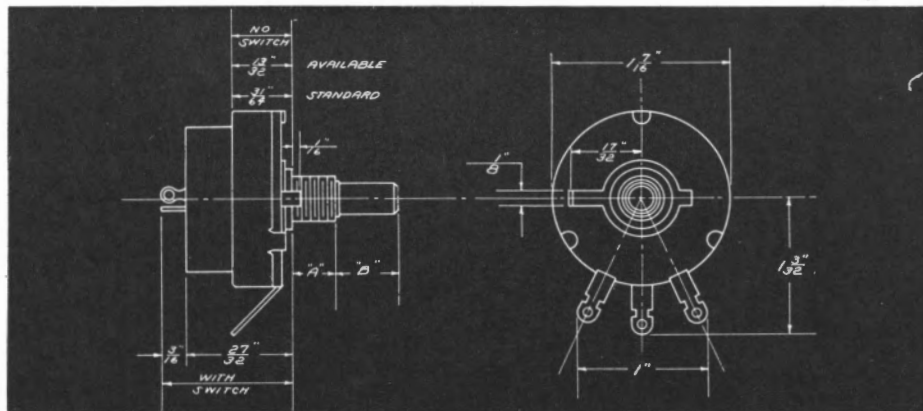

Drawing portrays three separate controls.

- (1) Series 33—without switch—shallow model—depth 13/32".
 - (2) Series 33—without switch—standard model—depth 31/64".
 - (3) Series 133—with power switch—depth 27/32".
- Standard dimensions of bushings and shafts are: "A" = 3/8"x32 thd. 3/8" long. "B" = .248"
—249" dia. x 3/8" long.
Bushings and shaft insulated although available grounded if requested.

Though permitting considerable saving in space, this control retains all the reliability and factor of safety found in Clarostat controls. It is available in all usual requirements, both mechanical and electrical. It is in production ready to service the production lines of current demand. WRITE FOR SAMPLES.

We solicit inquiries on mass production or special resistor problems for radio, sound, communication or industrial application.

Clarostat Manufacturing Co., Inc.
285 North 6th Street, Brooklyn, N. Y.

INDEX TO ADVERTISERS

This index is published as a convenience to the reader. Every care is taken to make it accurate but *Electronics* assumes no responsibility for errors or omissions.

Page	Page		
Acousto-Lite Corp., Ltd.	14	Parker-Kalon Corp.	24
Acme Wire Co.	16	Pioneer Gen-E-Motor Corp.	8
American Electro Metal Corp.	17	RCA Radiotron Co., Inc.	11
American Transformer Co.	10	RCA Victor Co., Inc.	Back Cover
Automatic Electric Co.	16	Remler Co., Ltd.	21
Bakelite Corp.	13	Resinox Corp.	17
Burt Scientific Lab's, R. C.	21	Shakeproof Lock Washer Co.	14
Cannon Elec. Dev. Co.	22	Stewart Mfg. Corp.	22
Central Radio Lab's.	9	Synthane Corp.	Inside Front Cover
Cinch Mfg. Corp.	3	Thomas & Skinner Steel Products Co.	16
Clarostat Mfg. Co., Inc.	23	Western Electric Co.	7
Continental Electric Co.	16	Weston Electrical Instrument Corp.	5
Cornell-Dubilier Corp.	12	White Dental Mfg. Co., S. S.	1
Erie Resistor Corp.	6	Wiley & Sons, Inc., John.	17
General Communications Lab's.	10		
General Electric Co.	Inside Back Cover	Professional Services	21
General Plastics, Inc.	2		
General Radio Co.	12	SEARCHLIGHT SECTION	
Goat Radio Tube Parts, Inc.	12	<i>Classified Advertising</i>	
Hygrade Sylvania Corp.	15	EMPLOYMENT	21
Kenyon Transformer Co., Inc.	8	EQUIPMENT FOR SALE	21
Mallory & Co., Inc., P. R.	4	American Elect. Sales Co.	21
McGraw-Hill Book Co.	20	Kahle Engineering Co.	21
Mica Insulator Co.	14		
Muter Co., The.	16		
Ohmite Mfg. Co.	22		

CONTENTS for FEBRUARY, 1934

Do radio listeners want high fidelity?	33
Amplifier units find new uses in industry	34
Auto radio forges ahead	37
The new music of electrons	39
Emergency acoustic treatment	40
A study of super-regeneration	42
Measuring resistance of broadcast antennas	45
By SCOTT HELT	
High lights on electronic devices in industry	48
AVC applied to audio frequency amplifier tubes	50
By J. R. NELSON	
Dynamic microphone amplifier	52
By ARTHUR J. SANIAL	
Books for engineers using electron tubes	53
Notes on electron tubes and circuits	54
Editorials	56
Review of electronic literature here and abroad	58
New products	60
U.S. patents	62
British patents	64

McGraw-Hill Publishing Company, Inc., 330 West 42d Street, New York, N. Y.

Branch offices: 520 North Michigan Ave., Chicago; 883 Mission St., San Francisco; Aldwych House, Aldwych, London, W. C. 2; Washington; Philadelphia; Cleveland; Detroit; St. Louis; Boston; Greenville, S. C. James H. McGraw, Chairman of the Board; Malcolm Muir, President; James H. McGraw, Jr., Vice-President and Treasurer; Mason Britton, Vice-President; Edgar Kobak, Vice-President; H. C. Parmelee, Vice-President; Harold W. McGraw, Vice-President; B. R. Putnam, Secretary.



On most radio assembly lines *This Famous Screw Simplifies Fastenings*

Five years ago, an alert Philco engineer saw in Parker-Kalon Hardened Self-tapping Sheet Metal Screws a means of fastening parts to chassis with unheard-of speed, simplicity and economy. Today, practically every radio manufacturer is assembling receivers with these unique Screws.

Almost universal use is the strongest possible testimonial to the worth of Hardened Self-tapping Screws. It proves that they have no equal for speed and economy in making fastenings in hard-to-get-at places. Also it shows that these Screws make secure fastenings . . . for builders of fine radios will not compromise with quality. Actually Parker-Kalon Hardened Self-tapping Sheet Metal Screws make fastenings which hold better under tension, shear and vibration than the ordinary devices such as machine screws and nuts and bolts. Scientific tests prove it!

Consider your own product . . . what you could gain by eliminating the fumbling and poor fastenings that go with riveting and bolts and nuts. Think how much time, labor and money you could save by eliminating tapping operations, the nuisance of tap plates and stripped threads involved in assembling with machine screws.

Send in a brief description of your assemblies and get free samples with our recommendations for a trial. It has paid hundreds of concerns to do this. It will likely pay you. Ask for a copy of our new Catalog — Data Book, too.

PARKER-KALON CORPORATION
198 Varick Street New York, N. Y.

PARKER-KALON
HARDENED
Self-tapping Screws

PAT. IN U.S. AND FOREIGN COUNTRIES

Get this new Data Book

Tells how and where you can simplify product design—shorten production routes—reduce assembly time, labor and cost—by making fastenings with unique Screws and Nails made by Parker-Kalon.



Where and How to use them

Parker-Kalon Hardened Self-tapping Screws
For making fastenings to sheet metal up to 6 ga., aluminum, die castings, Bakelite, etc. Turn Screw into drilled, pierced or molded hole. It forms a thread in the material as it turns in. Can be removed and replaced. Available in a full range of diameters and lengths, and 5 styles of heads as shown below.



electronics

O. H. CALDWELL
Editor
KEITH HENNEY
Associate Editor

McGRAW-HILL PUBLISHING COMPANY, INC.

New York, February, 1934



radio
sound
pictures
telephony
broadcasting
telegraphy
counting
grading
carrier
systems
beam
transmission
photo
cells
facsimile
electric
recording
amplifiers
phonographs
measurements
receivers
therapeutics
traffic
control
musical
instruments
machine
control
television
metering
analysis
aviation
metallurgy
beacons
compasses
automatic
processing
crime
detection
geophysics

Do radio listeners want

HIGH FIDELITY?

IN all of the talk about improving the broadcast system, one question remains unanswered, and points to a very fundamental problem. *Do radio listeners want wide-range tone transmission and reception?*

Transmission engineers believe that broadcast stations should handle equally well all frequencies out to 7000 or 8000 cycles. Many of them feel a reallocation of broadcast channels should be made on this basis.

SOME receiver engineers claim the average listener does not want such wide-range transmission. They point to the fact that tone controls on modern sets are nearly always turned as far as they will go toward the bass, and away from high notes.

This difference of opinion is of vital importance. The cost of broadcast-station equipment, cost of receivers, cost of telephone lines, cost of preparing programs, the number of stations that can be put into the broadcast spectrum, the musical appreciation of millions of youths growing up in radio homes—all these matters are vitally concerned with the proper settlement of this difference of opinion regarding high-quality broadcasting.

IF people do not like notes higher than 3000-4000 cycles, all the past musical experience is wrong. To judge by the best of present day "high-quality" receivers there is little use in transmitting much beyond 3500 cycles. But it is extremely difficult to believe this to be the fact. Certainly the experience in sound pictures does not bear this out. Higher fidelity has resulted in keener appreciation by the lay audience, and no one would go back to the poor-quality reproduction of the early days.

If people like high notes in the original music but do not like them from their radio, something must be wrong with the radio system. If the trouble is static, higher power is the answer. If the trouble is distortion products originating in transmitter or receiver and appearing in the higher portions of the audible range, the answer is clear. If inter-station racket or over-modulation is the trouble, the solution is evident.

BUT before going much further in the discussion of improving the broadcast system, it seems imperative that a clear-cut answer be found to the questions raised by proposing to widen the tone range. Do the listeners want the high frequencies that make for high fidelity?

AMPLIFIER UNITS FIND

Microphone, pick-up and loud-speaker being put to diversified tasks

IN the loudspeaker, the amplifier, the microphone and the phonograph pickup, arranged in their several combinations, a variety of useful new tools are made available for the general public and for industry, although so far these have been used on a relatively limited scale. Plant superintendents, business men, engineers and others have not yet realized the possible uses of these amplifier circuits, and so have not yet found uses for them in the many ways in which they can save time, money, labor, and material.

With this versatile electronic tool, the boss can speak at a distance to his whole factory crew, or he can listen in on any department. He can automatically inspect a machining operation, or his tester can quickly determine the performance of an engine or bearing. Faint sounds can be amplified to override room noises, while unwanted sounds are filtered out. New sanitary possibilities are brought into food handling and food selling. Operating rooms are made germ-proof while student groups follow every movement of the surgeon's knife and lips. Parasites in fruit can be detected, and costly blights eradicated. Wastes in water-supply mains can be located and repaired with a minimum of excavation.

In fact, into almost every field of activity, where the human voice, the human hearing, or the human sense of feeling needs amplification, these new amplifier combinations are now penetrating, and giving a good account of themselves.

For example, in an Ohio town, water supply records showed that a million gallons of water were leaking away daily at some point in the underground system. A microphone-amplifier survey of the surface was begun, and carried throughout the town, listening for any trace of this leak. Finally, in the middle of Main Street, evidences of a leak were found. The water could be plainly heard gurgling there underground. But the water-supply maps showed no mains whatever at this point.

Excavations were begun, and as the digging proceeded, the sound of the leak became more distinct. At a depth of fifteen feet below the surface, the workmen came upon an old forgotten spur of the water-main system, through which the leak was taking place. Thus the microphone test ended a heavy continuing loss, and prevented what might have been an almost endless series of test excavations to locate this elusive leak that had baffled the practical waterworks superintendent for years.

In the Bank of Manhattan, New York City, a novel installation of microphones permits detection of the presence of any person in any of the vaults, whether either accidentally imprisoned or intent on mischief. When a vault is closed and locked, the "electric ear" or carbon-button microphone in the vault, is automatically connected to the outside loudspeaking telephone for one minute, so that the chief of the guards may listen to sounds within the vault. To determine whether the lis-

DIVERSIFIED USES OF AMPLIFIER OUTFITS

Listening on interior of bank vaults.

Burglar alarms sound actuated.

Listening in on different rooms of warehouses, for intruders.

Detecting leaks in water mains.

Detecting Mediterranean fruit fly in oranges.

Listening to borers in timber.

Amplifying watch-ticks for diagnosis and repair.

Amplifying clock chimes for use as street chimes.

Tower chimes and carillons.

Surgical operating room with speakers in glassed-in gallery.

"Musical anesthesia"—diversion of patient's attention during operation with local anesthetics.

Inspecting gas-engine performance, internal sounds, etc.

Inspecting bearings, with extraneous frequencies filtered out.

Microphones at soda fountains, connecting with mixing clerks below.

Microphones in restaurants, connecting with loud speakers in kitchen.

Announcing loud speakers in railroad stations, bus depots, etc.

Calling system in department stores.

Conference loud speaker systems for utility operating staffs, connecting many plants, offices, shops, etc.

Directing traffic from police cars and stationary speakers.

Rerouting traffic and clearing traffic jams.

Sound trucks for political gatherings. Detecting flow of water, air or other fluids in pipes.

Aiding landing of dirigibles. Collecting emergency landing crews.

Aiding docking of vessels.

Advertising from airplanes or dirigibles.

Superstethoscopes for listening to heart, lungs, arteries and other internal organs.

Testing quality of papers, materials, etc., by sounds when bent or torn.

Music for work rooms to speed up production.

Talking electric signs—electric lighted

displays with appropriate sound effects.

Background sound effects for theatrical productions—mob sounds, wind, rain, Hamlet "ghost," etc.

Detecting surface faults in materials by passing under phonograph pick-up needle.

"Automatic salesmen"—demonstrating devices which give sales talk on approach of customer.

Listening in on children's room or nursery.

Amplifying chorus singing and musical effects in stage shows.

Operating special relays and contactors by inaudible frequencies.

Locating submarines and approaching vessels in fog.

Detecting presence of icebergs by echoes.

Locating obstructions in intestines.

Automatic depth measurements under ship.

Fire-department loud speakers for giving commands at fire.

Noise-meters for traffic and machinery surveys.

NEW USES IN INDUSTRY

Further expansion depends only on understanding and ingenuity of users

tening circuits are working properly, a test chime-gong sounds inside the vault during the minute and the attendant receives the sound at his switchboard. The switching mechanism then proceeds to the other vaults in succession, to detect any unusual disturbance. The chief of guards may listen in on any vault he wishes, at any time, and for as long as he wishes, to study the cause of any suspicious sounds. While the vaults are open during business hours, the attendant at the control board may listen to conditions within any vault, by turning on its microphone. So sensitive are the mikes, that the dropping of a penny in any corner of a vault, can be heard distinctly in the guards' quarters.

A street-car company's "conference circuit"

In Cleveland, Ohio, the management of the local transit system has just installed a "conference circuit" by means of which the executives of the street-car company, on short notice, can get into loudspeaker communication with a large percentage of the operating and maintenance personnel, scattered over ten car-operating stations, two bus garages, the main shops, the way-maintenance department, the power plants, and the main offices. Fifteen loudspeakers are fed from the master mike in the office of the president of the railway.

Emergency landing of a big dirigible has always been a problem, on account of the necessity of summoning an emergency ground crew. Formerly a note had to be dropped over a village, and landing delayed until the note was picked up and the information spread to enough men to handle the ship. But with a powerful loudspeaker, the great airship can cruise over a town, give directions that will be heard by thousands, and then instruct such amateur groundsmen in the method of handling their job.

A Forty-second Street candy store in New York, has a soda fountain counter in an expensive location, but by the use of microphones over which the clerks give their orders, the actual soda faucets can be placed in the basement, dumb-waiters carry the mixed drinks aloft, and the entire first-floor space is used for serving. Several restaurants use the same microphone principle for communicating orders to the kitchen, with moving belts to bring in the viands when ready.

Amplifying faint noises

An amplification plan under way for jewelers, contemplates microphone outfits which will pick up the chimes of small mantel clocks, amplify them tremendously, and send them echoing up and down the street outside, riding high above the noise of traffic. This scheme proposes to mark every jeweler's store by an audible signal on the hours, halves and quarters, and this for a nominal expense which will go into amplifying equipment.

Another aid to the jeweler and watchmaker is a microphone attachment on which a watch or clock can be placed, so that the watch repairman hears the machinery of the watch in greatly magnified fashion, and from the



Transcriptions and amplifier outfits used to provide background sounds in stage productions. Mob-scenes, storms, wind effects, choruses, "ghosts," etc., can be presented in this way



Police-booth panel board controlling microphones and amplifiers in large group of safe-deposit vaults. Presence of anyone in any vault can be detected during regular patrol sequence. For test purposes, gong automatically sounds in each vault to make sure amplifier circuits are working

clanking and pounding can diagnose the cause of the trouble.

Phonograph pick-ups have proven a useful tool to determine how smooth is a machined and polished surface, by running the pick-up needle over this surface and comparing the resulting ground-noise with an allowable standard. A system of this kind is in use at the Ford factory and was demonstrated at the recent Ford Exposition of Progress in New York City.

Experiments have been conducted with loudspeaker music in workrooms, to reduce errors and spoiled pieces, and the results have been most encouraging, savings of 15 per cent or more being effected. Music from phonograph records has been used in this industrial application. Experience in a Philadelphia factory has shown that not only does music speed up the working pace and reduce spoilage in departments where the workrooms are relatively quiet, but that even in noisy places like the punch-press rooms, where dozens of big machines are stamping out parts, the presence of a melody riding above the noise and clatter, seems to serve as an anodyne for the nerves of the workers and improves production.

Helping the surgeon in the operating room

"Musical anesthesia" has been applied with success during surgical operations conducted while the patient is under a local anesthetic. Instead of using chloroform, ether, or other general anesthetic under which the patient loses consciousness, it is now the modern practice to in-

ject a local anesthetic which renders insensitive that portion of the anatomy on which the surgeon is to work. As a result, the patient may have to undergo the ordeal of lying on the operating table fully conscious, while hearing the surgeons and nurses at work on an amputation. But with the new "musical anesthesia" developed by Dr. Erdman of Brooklyn, N. Y., comfortable earphones are attached to the patient's head, and he listens to music or interesting narratives, while the sounds of the operating room, the sometimes inconsiderate conversation of surgeons and nurses, and other sounds, are all shut out of his hearing.

Traffic control is another service in which loudspeaker combinations have proven valuable. In certain instances fixed speakers installed along the roadway, are used to speed up or to redirect traffic. In other cases police trucks have been fitted with microphones and speakers, and these trucks are then moved into zones where jams are expected. Loudspeaker units have also been of great value to battalion chiefs in fighting serious fires. Replacing the former megaphones used by the fire captains, the new and powerful loudspeaker units enable the commanding officer to give his men information and instruction, despite the roar of the conflagration.

Some interesting possibilities of a portable "noise microscope" or sound amplifier which can be carried in a suitcase, are outlined by Dr. E. E. Free of New York, who has developed this portable apparatus.

For example, a special microphone may be attached to the outer wall of a locked safe or bank vault which has failed to open on time and inside of which the time clock may or may not be running. If the clock is running properly the faint ticking of its one or more movements is transmitted through the safe wall to the microphone, magnified millions of times and may be listened to by the safe expert through a telephone receiver. The trained ear of the expert then can decide whether a part of the time-clock has stopped or whether anything else has gone wrong with it.

Physicians can listen in the same way to faint sounds produced inside human joints that are beginning to be diseased, or to tiny sounds from the heart, lungs, arteries or other internal organs, which sounds are too faint to be distinguished through the ordinary stethoscope. Engineers can listen to the flow of steam or water in pipes or inside pumps or engines. Watchmakers can tell what is wrong with a damaged or worn-out time-piece. The quality of tissue papers can be tested by listening to the faint crackling sounds which they give out when bent or crushed. Leather or catgut can be tested in the same way by listening to a magnification of its feeble "cry" when bent. Tiny faults in metal objects, especially those which have been welded, can be tested by the noise microscope in the same way in which larger defects, such as cracks in wheels on railway cars, have been detected for years by absence of the ringing sound when struck.

Using earlier and more complicated listening devices, inspectors have been able to detect shipworms inside dock piling or other submerged timbers by hearing the sound of these creatures boring in the wood. The new amplifiers are expected to make possible the detection of many similar infestations, such as weevils in grain, worms in fruit, insects in furniture and so on. Activities of bees in beehives can be listened to. Even the boiling of water in boilers, the cooking of food in ovens or the bursting of bubbles on fermenting beer or wine can be heard without opening the containers.

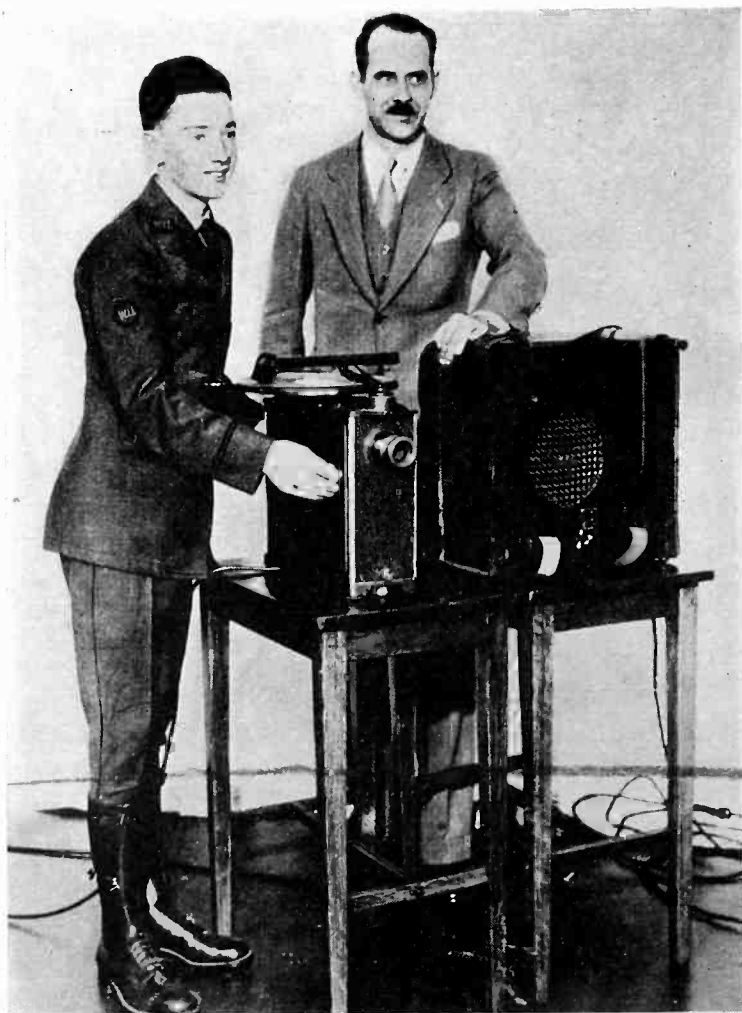

An electronic salesman. Western Union messenger delivers and operates the phonograph projector, which displays "stills" printed on a motion-picture film. Pictures are changed by relay operated by musical tone at appropriate points on record. The outfit shown is E. W. Wood's Visaphone

Auto radio forges ahead

Sales records to be broken again in 1934

SPURRED on by the remarkable expansion in 1933 of automobile radio sales, manufacturers look forward with eagerness to the 1934 market. Reports from Detroit of record-breaking orders for new cars following the Automobile Show in New York and elsewhere must be a sign of good omen to the radio industry, although it was rather discouraging to see the small turn-out of radio people at the New York Show and to note the apathy of those actually in attendance.

Sales figures for 1933 indicate that between 600,000 and 700,000 auto-radio sets were sold for installation in the nation's cars during the year just passed. This is a vast jump from the previous year and a great hurdle over the most optimistic estimates of the 1933 market made earlier in the year. Prognosticators, not to be caught napping again, place their estimates for 1934 between one million and a figure half again as large. What is even more encouraging is the fact that the cheap sets, cheap in price and performance, will probably disappear from the market in the coming months. Manufacturers (and consumers) have found that the minimum price for a good product is somewhat higher than the figures used last year. Several of the low-priced sets have already been discontinued.

From the standpoint of technical progress it is noteworthy that receivers seen recently are much more sturdy in construction than those of a year ago. These sets are not only stronger physically but easier to install, more immune from vibration troubles, and in addition easier to service when something goes wrong. Noblitt Sparks has an outstanding example of the new type of construction. The receiver is a case within a case and either chassis or cover may be mounted in any one of several positions with respect to each other or to the car. Thus the outer case, forming a secondary shield, is drilled so that the control knobs may project through

▼

The guessing contest is on—what will be auto-radio sales in 1934? This brightest spot in the radio industry promises many things this year—increased sales, higher prices, and most important, better sets.

▲

in one of several positions making most versatile the method of mounting not only the set to the car but the chassis within the outer case, which is snapped on with trunk locks.

There are few signs that radios will be installed where they can be tuned directly; the prevailing tendency being toward remote tuning and volume control by means of flexible shafting or its equivalent. The directly-controlled models are neither so easy to install nor to operate and of course their possible location in the car is much more limited. Control dials gravitate steadily

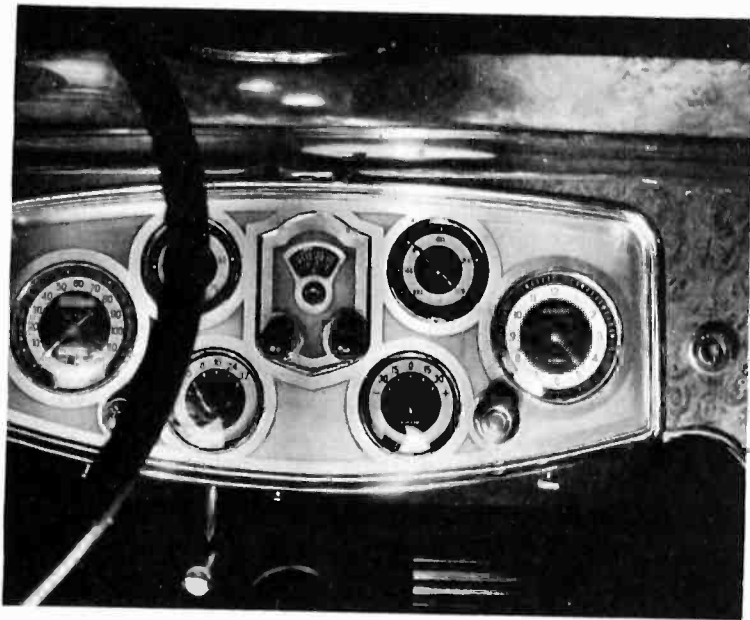

Radio controls move from the steering column to the dash as this Packard instrument board indicates. A decorative panel is used if car is not equipped with radio.

toward the dash and away from the steering column. More and more automobile manufacturers make special provision in the dash for the new accessory.

The remote oscillator types of tuning control are not so plentiful; they will probably pass out of the picture completely in 1934. The number of cars in which the radio is put in a glove or other compartment does not increase; in fact the trend is not to use space for the radio that was primarily designed for or useful for other purposes.

The trend is still toward two-unit sets, the increased flexibility in installation making it simpler to use than the one-unit type, even though the latter would be less expensive. Widespread use of mechanical vibrators for producing the higher d.c. voltages required from the car battery continues, although there seems to be some tendency to use tube rectification rather than mechanical conversion of a.c. to d.c.

At the New York Show no one seemed to be whooping up auto-radio to any extent. The automobile salespeople seemed aware of the existence of radio sets for cars, but the idea seemed to be that a radio was just another accessory, increasing the battery drain, and not very useful in selling cars to the public.

Automobile manufacturers are much more aware of radio than are the automobile salesmen. Mechanical and electrical problems produced by radio are being handled in a manner that will be advantageous to both radio and automotive industry. No manufacturer now overlooks the possibility of a car owner wanting to have a radio in his car. Many producers are making pro-

vision for installation of sets especially engineered by well-known radio companies in cars either by having special dashes with removable medallions or in other and more complicated ways.

Some of these radio sets will bear the automobile maker's name; others will bear the name of the radio set, and still others will have hyphenated names. Packard, Studebaker and Chrysler will actively sell radios especially built for them. These will be installed by car distributors or dealers usually employing a radio man in the vicinity experienced at this job. These men will be employed part time or on commission until sufficient business develops to make it possible to take them on full time.

Philco (Transitone) has been most active and successful in this special market making receivers for 7 automobile people. These sets look different from receivers sold to the trade through dealers and distributors. The other manufacturers, RCA Victor, Crosley, Zenith, et al., have one or more special clients using receivers made by them.

In still other ways the automotive engineers are recognizing the radio problem. New ignition systems, new disposition of car wiring and ignition apparatus and even research to apply electron tubes to the distributor problem—all are being worked out. Radio engineers have contributed materially to the improvement in the ignition problem by their study of what causes noise, how much is produced, and how to remedy it. It is currently reported that a prominent automobile manufacturer is working with an electron tube distributor to get away from the present sparking type which adds its quota to the program interfering noise.

Resistors placed in the spark plug leads have come down in value from early resistances of the order of 25,000 ohms to 10,000 or thereabouts. Battery drain still bothers the industry. Studebaker has a special high-rate charger which the car owner can have installed cheaply if he has enough gadgets on his car to warrant the extra charging rate. An automatic charging rate device to lengthen the speed range over which the charger operates has been put into Chevrolet and other cars. Thus, at low speeds the rate is higher, and at high speeds the charger does not go out of the circuit.

When will radio become standard equipment?

Automobile manufacturers are not keen to see anyone break the ice on the matter of putting radios in every car of a model or style. At present competition in the lower-priced cars has forced manufacturers to steer clear of increasing the cost of manufacture; the margin is already low. But all realize that someone may kick over the traces, put a radio in every car as it leaves the factory and make the radio industry very happy, indeed. Hudson will undoubtedly continue auto radio as standard equipment on the de luxe models. They will be optional at additional cost in other models. This receiver is made by Zenith.

Both radio and automotive people are keeping an eye on the market for radios among the thousands of cars now on the road. Thus the market is not limited to new cars coming from the factories in 1934. As the installation of sets becomes simpler, many of last year's cars may be equipped, and now that the public seems to have been severely bitten by the auto-radio bug, no doubt the 1934 sales figures will be pleasantly swelled by these installations in cars now in active use.

The question of who is to sell the public no longer worries either automotive or radio outlets. There will be plenty of business for both. Rather than try to discourage the installation of radio as a stock item, the radio trade should try to get this business by tying up with local automotive dealers—so states one of the most successful salesmen in this business. The auto-radio field needs more sets in use, because every satisfied customer passes the good word along to his friends. And as yet the automotive market for radios is barely scratched.

The very fact that perhaps one car in ten will be purchased complete with radio is favorable to the radio industry, especially the distribution end of the business. Automotive salesmen will be quick to develop a technique which will expose the customer to the pleasure of radio, but will not scare off the sale of the car by the extra cost. Once exposed, the car owner will be good hunting for the radio salesman. Half the sales job will be done. Straight radio outlets will secure a good share of the auto-radio business in 1934. Ultimately more of it may go through the hands of the automotive people, but there is no reason to cross this bridge until it is reached.

A bird's eye survey

Graham has a model with the RCA Victor radio installed in a drop-front ash receiver compartment on the dash. Studebaker has a Philco with controls in the dummy glove compartment. Ford puts its single-unit radio (Majestic) behind the dash with controls coming through. Auburn has a center-dash medallion for a Crosley receiver. Nash puts the radio in a compartment provided for the purpose. Chrysler has a dash medallion which can be removed for the radio when installed. So does Lafayette. RCA Victor has an "arm-rest" auto set with controls so located that the driver will have difficulty in "playing" the radio for his own amusement. Perhaps this is a safety feature to aid the driver in keeping his mind on his driving.

Introduction of batteries into the auto radio to boost the voltage applied to power and amplifier tubes without drawing excessive power from the battery will be attempted. The idea is to provide C bias for the power tubes from this battery. Thus the vibrator system need not put out so much voltage and need only take care of the requirements of plate circuit power. It is now recognized that from 2 to 2.5 watts power is necessary for satisfaction, despite the lowering of noise in the car to a matter of perhaps 70 db., compared to much higher figures a few years ago. Street traffic and the noise of tires on road coupled with high absorption of sound by the upholstery necessitates plenty of loud speaker power.

Coupled with this requirement is the poor electrical pick-up on present cars, a matter of a few microvolts at best. Therefore the voltage gain in the radio system must be higher than is required in a home receiver. The a.v.c. system must cover a range of voltages of 40 db. at least and better if possible. And although the space limitations seem to work in a direction opposite to the electrical requirements—radio engineers are clever at getting themselves out of such nasty technical and mechanical problems as this.

The distributing system will have better auto radios to sell in 1934, there will be much less grief, fewer returned sets, and prices will be higher.



The new music of electrons

New degrees of tone, volume, and timbre are now possible through applications of amplifying tubes and photo-cells

The "electrolin" or electronic violin, and the electronic viola developed by the Allencraft Laboratories, Orange, N. J. Mounted on the bridge of each instrument is an electro-magnetic pickup, which converts the vibrations of the strings into electrical oscillations which can then be amplified to any volume and heard through the loud-speaker. Electronic mandolins, guitars, etc., are also available.



An electro-static pick-up is used on this electronic guitar, produced by C. L. Beach, C. J. Noel, and H. A. Yeider, all of Grand Rapids, Mich. The electrostatic principle has also been applied by them to violins, violas and other string instruments.



The "Polly-tone" is an organ-like instrument employing photo-cells and was developed by Frederick M. Sammis, formerly of RCA-Photophone, Hollywood, Cal. By means of light-shutters and a revolving "pitch-disk," tones of any wave-form can be produced.

Emergency acoustic treatment

of the world's largest
auditorium, for
sound presentation

WHAT was perhaps the largest stage spectacle ever attempted was "The Romance of a People," a dramatic spectacle of light and sound depicting in various episodes 4,000 years of Jewish history.

The pageant was enacted before a scenic background 300 feet long and rising to a height of 100 feet. In front of this background was a circular stage 150 feet in diameter with a super-imposed stage, circular in form, 75 feet in diameter. The original plan called for three or four outdoor performances in the Polo Grounds. The stage and scenery, together with the lighting and sound apparatus, was set up and made ready for a rehearsal

on the day previous to its intended opening. However, in the midst of this rehearsal, a storm came on and high winds wrecked the scenery. The accompanying deluge of rain lasted three days. Owing to the fact that the lease on the Polo Grounds expired within a few days, it was impractical to hold the pageant in this location. However, the 258th Field Artillery Armory at Kingsbridge Road and Jerome Ave., Bronx, N. Y., was made available. The drill hall of this Armory is the largest in the world, having a free space of 300 feet wide, 600 feet long and 104 feet high, without columns or other obstructions. After preliminary tests, T. F. Bludworth, engineer in charge, advised the Pageant Committee that the acoustical conditions of the Armory precluded the possibility of presenting the spectacle there without major acoustical corrections. It has been known for years that the Armory has an exceptionally long reverberation period—approximately 20 seconds. Troops cannot march to music on the drill floor, and speech is unintelligible 50 feet away from the source. Another factor militating against the use of the Armory was that the elevated section of the subway at Jerome Ave. runs across the end of the building, introducing a tremendous amount of noise.

Acoustic control has never been attempted in an auditorium of such proportions. Consequently, it was doubtful if specifications based on standard mathematical equations would satisfy the conditions. To reduce the reverberation period to a tolerable value, calculations indicated the need for approximately 150,000 square feet of one-inch hair felt. Aside from the material cost and cost of installation, this quantity of hair felt exceeded the combined stocks east of the Mississippi River, and its

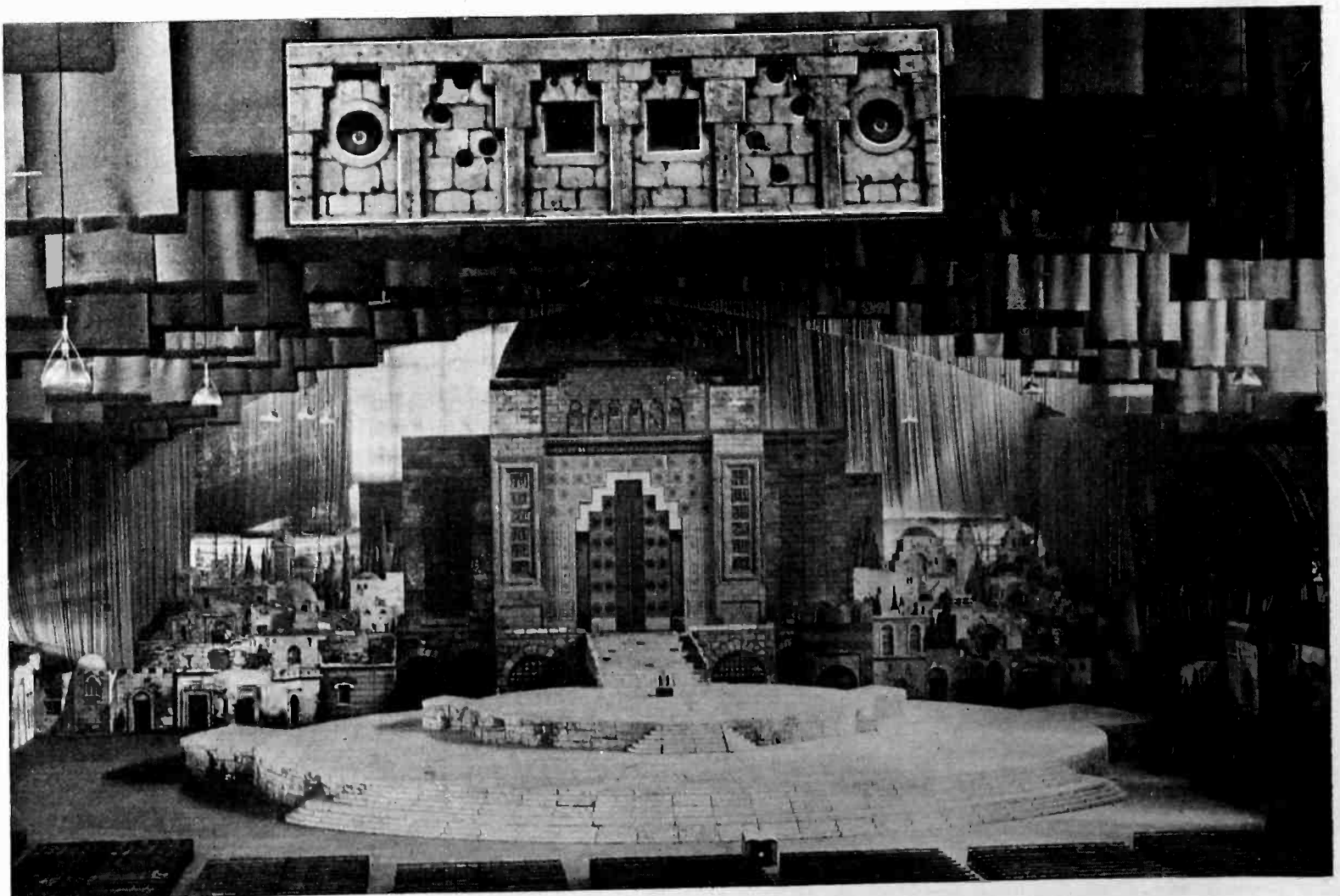

An idea of the size of the acoustic problem can be had from this photo. The insert shows (enlarged) the loud-speaker outlets

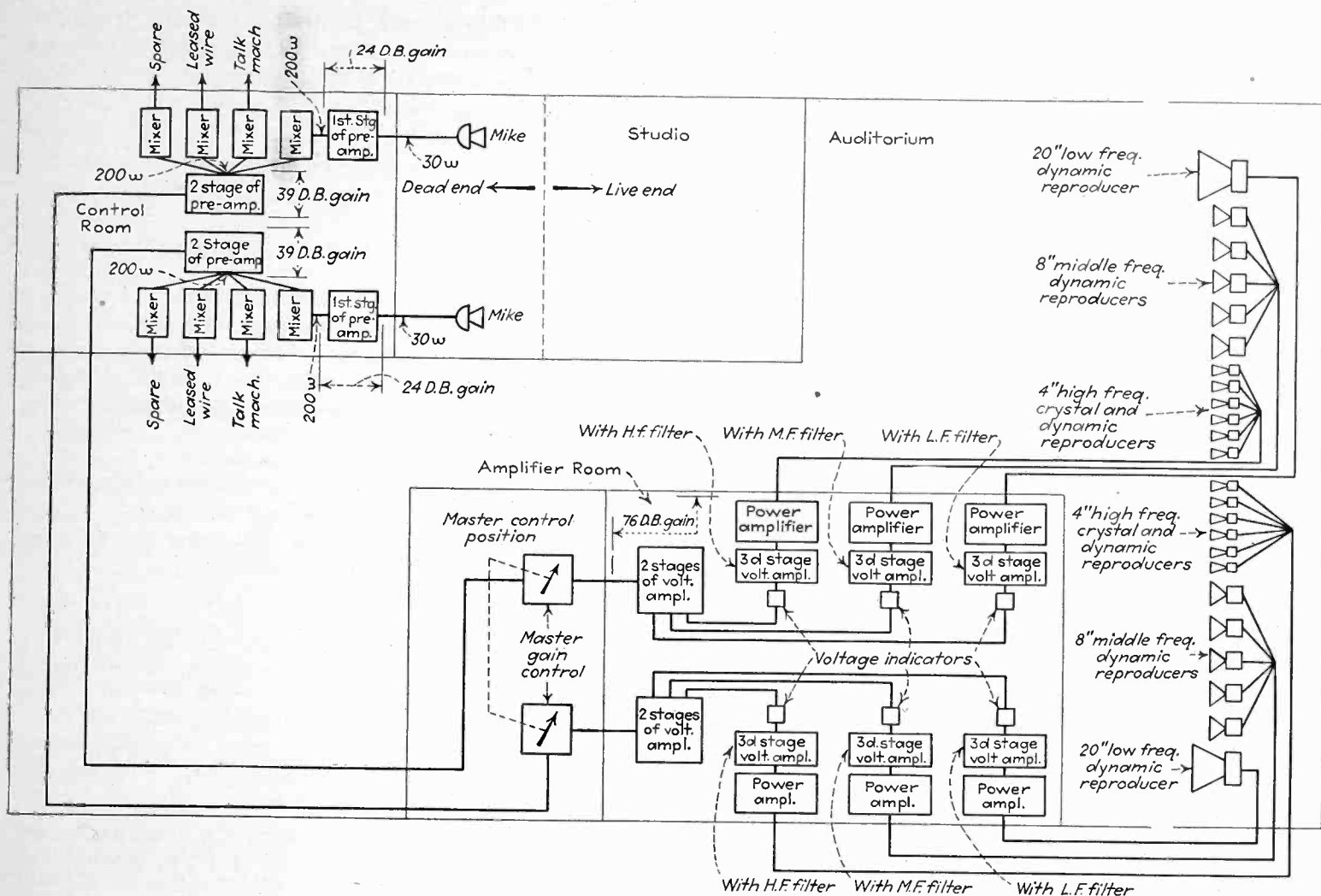

Complete block diagram of the acoustic apparatus, loud speakers, amplifiers controls, and microphones

installation in the conventional manner would require several weeks. Notices had been published that the show would open in the Armory within one week and tickets were being exchanged on that schedule.

After securing an appropriation sufficient to cover the estimated cost, a contractor was found who would undertake to hang the felt on edge from the trusses within the time specified and the American Felt Company was induced to discontinue all other production and work 24 hours per day in one of their plants until the necessary quantity of felt was manufactured. The erection of the felt began immediately and a pronounced effect became very evident after a few girders had been covered in the marked diminution of the noise of carpenters' hammers and saws and that from the subway. This preliminary evidence was very comforting and proved a splendid "nerve tonic" for those responsible for the rather large expenditure. Actually, 112,000 square feet of felt were used, and the last piece was being placed in position as the audience arrived for the first show. The most remarkable effect was the almost complete elimination of the terrific subway noise. The reduction of reverberation was greater than that anticipated by calculation.

In the meantime, the amplifiers, wiring, sound projectors, etc., had been installed. The show went on without a single rehearsal or test and the effects produced were amazing in spite of the extraordinary size of the auditorium. Available records indicate that the interior treated is the largest auditorium in the world (19,000,000 cubic feet). The sound projector took the form of a large wood baffle 18 feet high, 34 ft. long, erected in the face of the "temple" at one end of the auditorium.

Observations during the first performance showed that

the voice was very natural and clearly understood in every part of the auditorium, even in the most remote seats, 600 feet from the sound projector. The source or pick-up of all sound was located on the roof in the officers' dining room, which was acoustically treated for the pageant as a live end—dead end sound studio. In this room a 23-piece orchestra was placed in the live end, with an 18-voice chorus, four soloists and a reader or narrator. The musical director and the microphones were located in the dead end, as well as a glass enclosed sound-proof studio mixer control booth in which the mixing panels were located. It was not possible to see the stage or audience from the studio or mixer control room. The amplifiers were located in an amplifier room in the webbing of one of the center trusses at the floor level in the auditorium with the master control platform in the same truss forty feet above the floor with an excellent view of the stage and audience.

Three special resistance-coupled, three-register amplifiers were used, with a combined undistorted output of about 200 watts. Two were in constant service with one standby unit. In fact, the entire installation was practically in duplicate, to take care of possible failure, for a breakdown of only one minute at any time during the two-and-a-half hour performance would have destroyed the continuity. It so happened that there were no interruptions and the standby unit was not used.

The sound projector was an 18 ft. by 34 ft. tilted non-directional baffle serving the audience, and two 30 by 30 inch directional baffles directed at the stage from 60 feet above the floor. In the flat baffle two special 20-in. bass units, developed by Stromberg-Carlson, ten 8-in. middle [Please turn to page 59]

A study of super-regeneration

INCREASING interest in ultra-short waves, 10 meters and below has focussed attention on the super-regenerative circuit first described by Armstrong,¹ used by amateurs since that time, but neglected by circuit students. The following data on the circuit are based on a report of David Grimes and W. S. Barden of the RCA License Laboratory. The material is based on a study of the free oscillation in a series resonant

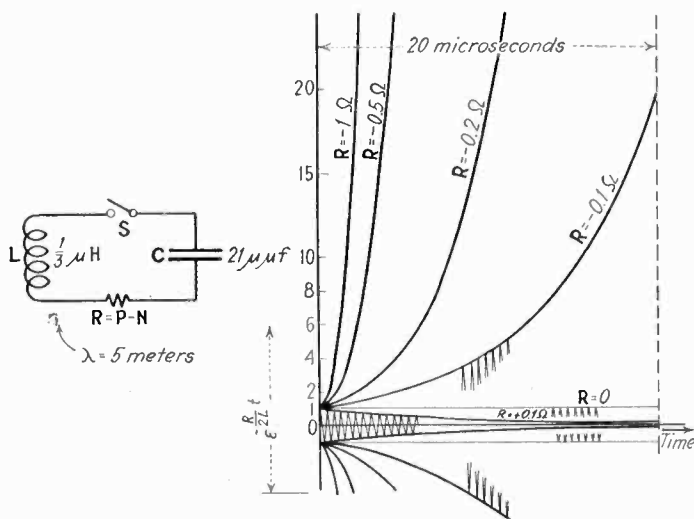

Fig. 1—Simple circuit and effect on it of negative resistance

circuit having a negative resistance. This resistance is produced by a dynatron, as a convenient example, and the report gives considerable data on this form of oscillator. A rectangular wave of quench frequency is assumed.

Free oscillation is considered with a minimum of confusion by examining a case where there is no forced oscillation. Noting the circuit at the top of Fig. 1, let C be charged to E_0 before closing S . Close S . When R is positive and small compared to ωL a decadent wave train results in the circuit. When R is zero, the wave train loses no energy from cycle to cycle and continues in the steady state as a perfectly continuous wave train. When R is negative, the wave train grows exponentially. These modes of free oscillation are shown on Fig. 1.

In such a series circuit the well-known expression defines the situation,

$$e = L \frac{di}{dt} + iR + q/c \quad (1)$$

As far as the present purpose is concerned, an exact solution of (1), as carried out in various popular texts, can be greatly simplified with only a very slight departure from fact, by using

$$\omega = \frac{1}{\sqrt{LC}} \text{ instead of } \beta = \sqrt{\frac{1}{LC} - a^2} \text{ where } a = \frac{R}{2L}$$

and by retaining only the highly predominant term containing e^{-at} as its coefficient. There then results the following close approximation:

$$e_c = E_0 e^{\frac{-Rt}{2L}} \cos \omega t \quad (2)$$

where e_c is the voltage across C at any time t after closing S , E_0 is the potential across C at the instant of closing S , etc.

C does not appear in the coefficient of (2); hence the contour $E_0 e^{\frac{-Rt}{2L}}$ is the same whatever value of capacity be used: e.g., $C = 20 \mu\text{mf}$ charged to $1 \mu\text{v}$, or $C = 50 \mu\text{mf}$ charged to $1 \mu\text{v}$, will result in the same contour of wave train, C affects only the periodic function $\cos \omega t$: i.e. C affects only the time per cycle under the envelope.

Only the factor $e^{\frac{-Rt}{2L}}$ is of immediate interest, since it alone determines the extent of growth or decay. It is plotted against time on Fig. 1 for several values of R , using $L = \frac{1}{3} \mu\text{h}$ —a suitable value of inductance for 5-meter reception.

When R is negative $e^{\frac{-Rt}{2L}}$ becomes an amplifying factor, and the wave train will build up to infinity if allowed to do so.

For the particular 5-meter circuit on Fig. 1 ($L = \frac{1}{3} \mu\text{h}$), the growth factor grows from 1 to approximately 20 when $R = -.1$ ohm is maintained for 20μ seconds—the time of one-half cycle at 25,000 cycles; hence an initial potential across C of $1 \mu\text{v}$ grows to $20 \mu\text{v}$ across C in 20μ sec. An initial potential of 1 volt would grow to 20 volts in 20μ sec.

Note the rapid rise of the contour curve for $R = -.5$ ohm, or for $R = -.1$ ohm. When $R = -.5$ ohm, the growth factor increases from 1 to 3,375,000 in 20μ seconds. An initial $1 \mu\text{v}$ across C would grow to 3.375 volts in 20μ seconds.

It is evident that a little negative resistance is extremely important when such a small inductance ($\frac{1}{3} \mu\text{h}$) is used. The potency of the growth factor, in a given time t , is due to R/L . If L be increased, R must be numerically increased proportionately. Thus, if $L = 100 \mu\text{h}$, R must be equal to $300 \times -.5$ ohm = 150 ohms to accomplish in a given time t the growth yielded by $\frac{1}{3} \mu\text{h}$ and $-.5$ ohm. This is an indication that the efficacy of super-regeneration is likely to be greater for short waves than for long waves, since smaller inductances are used for short waves. The indication contains no basis for prohibiting very high values of negative resistance at long waves. Very high values of negative resistance, however, lead to very poor selectivity at long waves.

Super-regeneration can be explained as a succession of growth trains. Each growth train must be damped to a negligible residue before the next growth train can

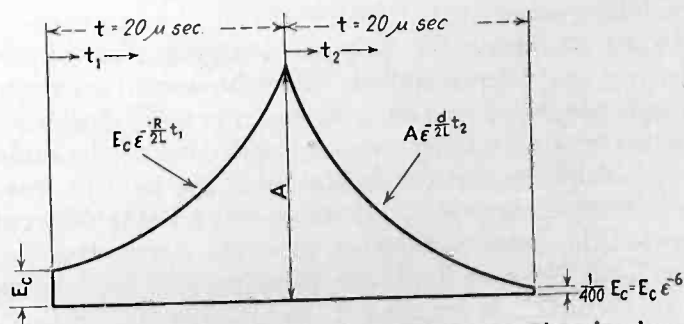

Fig. 2—Growth and decay in super-regenerative circuit

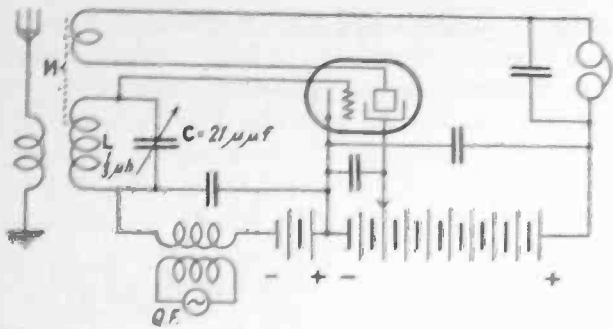

Fig. 3—Super-regenerative circuit on which analysis is based

be properly "touched off" by the received signal.

For any growth train on Fig. 1, at the end of 20 μ seconds let the *negative* resistance be suddenly changed to a *positive* resistance, so that during the *next* 20 μ seconds the ensuing damped oscillation will decay to $\frac{1}{4}$ of 1 per cent of the initial potential E_0 (Fig. 2). Then,

$$E_0 e^{-\frac{R}{L}t} e^{-\frac{d}{L}t} = E_0 e^{-\frac{d}{L}t} \quad (3)$$

If $L = \frac{1}{2} \mu\text{h.}$ and $t = 20 \mu \text{ sec.}$ Then (3) yields: $d = R + \frac{1}{2}$.

To leave not more than $\frac{1}{4}$ of 1 per cent of the cause E_0 , with equal epochs for growth and decay, for any value of E_0 , and for any value of negative resistance—any degree of "build up"—the positive resistance d must be at least $\frac{1}{2}$ ohm greater than the numerical value of the negative resistance. This calculation applies only to the circuit of Fig. 1, of course. A value of -0.5 ohm for growth requires $+0.7$ ohm for decay to the very small residue considered. Were the foregoing to be carried out experimentally, the positive resistance of any typical $\frac{1}{2} \mu\text{h.}$ coil would be found to be several ohms—plenty of natural damping at 5 meters. A 3-ohm coil would require that a tube provide -3.5 ohms in order that the growth be determined by -0.5 ohm. That amount of resistance is readily obtainable at 5 meters.

An analysis of a case where spaced excitations of unlike amplitude shows the strength to which a growth train contour builds up is directly proportional to the strength of its excitation. Likewise, the area enveloped by an individual contour (growth and decay) is directly proportional to the strength of the excitation. Therefore, were the voltage applied to a linear detector the a-f output would be a faithful reproduction of the modulation represented by the variable excitations. The a-f output would be a faithful reproduction of a "program" when there are a large number of excitations per a-f cycle. The distortion due to a square law detector would be the same as though a standard form of modulated signal were applied to the detector.

In Fig. 3, the variation of series resistance is caused by a variation of the mutual conductance due to a "quench frequency" emf. applied in the control grid analysis. Detection is obtained from curvature in the I_p vs. E_p characteristic.

Other forms of detection, or resistance variation, or type of tube than shown here may be used. This circuit is representative and the effects obtained with it will probably hold for other combinations or circuit elements.

Before applying the principles discussed above to Fig. 3, it is necessary to distinguish clearly between regeneration and super-regeneration. Let there be no Q.F. emf., and let M be so adjusted that $R = (P-N) = +0.1$ ohm. L being $\frac{1}{2} \mu\text{h.}$ and C being $21 \mu\mu\text{f.}$, $Q = 12,600$. Hence the amplification and selectivity are both

great. By increasing M until R is "almost zero" but still positive, the amplification and selectivity become enormous for a weak signal at the antenna, approaching infinity as R approaches zero. This is straightforward regeneration.

With the system adjusted for this high degree of simple regeneration, introduce a very small Q.F. emf., such that the amplification is made as great as possible without self-oscillation or unmanageable instability. Of the resulting amplification a large part is due to simple regeneration, and the principles of strictly free oscillation do not apply. This impractical case—variable "nearly critical" regeneration—requires that M be decreased and the Q.F. emf. strengthened. As this process is carried out, the amplification remains very great, and then when the Q.F. emf. is removed the amplification drops enormously.

Then without a received signal apply the Q.F. emf. and gradually increase it, so that R goes negative. The criterion of the consequent high degree of amplification is the tube noise, amplified from perhaps less than a microvolt, up to a volt or more, thus becoming plainly audible in the phones.

As an experiment, Fig. 3 was tuned to 30 meters, dummy antenna and signal generator were used, feed back and Q.F. emf. so adjusted that unquestionably stable operation was realized. A 30 per cent modulated 15 $\mu\text{v.}$ signal was reproduced (400-cycle tone) with a strength which was roughly equal to the tube noise.

For Fig. 3 to yield noise-free response when a 30 per cent modulated 15 $\mu\text{v.}$ signal is applied, it is desirable to add a-f gain = 10 or 20, and decrease the amount of super-regenerative amplification. The signal-to-noise ratio then becomes as favorable as for typical receivers.

As another experiment the Q.F. emf. was removed. Feed-back was adjusted for a high degree of straight regeneration. A sufficiently strong signal was applied (a few hundred $\mu\text{v.}$) to obtain suitable audibility. The Q.F. emf. was then gradually increased. Of course the audibility increased. The applied signal strength was then decreased as the Q.F. emf. was increased, to maintain a suitable signal level at the phones. This process was continued until instability was reached; then the Q.F. was slightly decreased to obtain definite stability. Now the antenna signal was very weak, and the super-regenerative amplification many times greater than the simple regeneration for which the feed-back was adjusted and then fixed.

Virtues of low quench frequency

By such an adjustment the side responses may be entirely eliminated. With 5,000 cycles, it is found easier to eliminate the side responses than when using a higher frequency, such as 25,000 cycles. To obtain a certain sensitivity, the strength of the emf. at 5,000 cycles is found to be far less than when using 25,000 cycles. And, for a given strength of Q.F. emf. and a given and fixed amount of feed-back the system becomes more sensitive as the quench frequently is decreased. A low quench frequency favors high amplification. With the system adjusted for suitable amplification (and negligible side responses) when the quench frequency is 25,000 cycles, the selectivity is definitely improved judged by tuning, by decreasing the quench frequency to 5,000 or 10,000 cycles and decreasing the Q.F. emf. to restore the former sensitivity. A low quench frequency favors both amplification and selectivity.

Super-regeneration is no more effective at short

waves than at long waves in a strictly technical sense. *LC* may be made to oscillate in the steady state at either long or short waves, with an ordinary tube. This is nearly the same as saying that the amplification may be made as great at long as at short waves. It is correct, however, to state that super-regeneration is the only known practical method

tionately, and both amplification and selectivity will remain at the same when *L/R* is held constant. Also *L* may be determined by the amount of capacity required to tune it to the desired wavelength. Then the amplification and selectivity are made maximum by decreasing *R* and increasing *T* (lowering the quench frequency) until the quench frequency is as low as can be tolerated.

It is well worth while to use as low a quench frequency as tolerable. *a* is directly proportional to *T*. Noting Fig. 4, let *a* = 9, and *R* = 0.15. Halve the quench frequency, and holding *R* = 0.15, *a* becomes 18. The amplification increases from 8,400 to 190,000. The selectivity remains the same, because *L/R* is not changed.

It is to be noted that the amplification *V/e* is proportional to ω . With suitable values of *L*, *R* and *T* for 5 meters to realize a certain amplification and selectivity, let ω be decreased to a case of 300 meters. Holding *T* constant, and *L/R* constant as *L* is increased the quantity $\frac{\sqrt{\epsilon^a}}{a}$

remains constant. But ω has decreased 60 fold; hence the amplification has decreased 60 fold. *Q* has decreased 60 fold. To restore the amplification to the value at 5 meters, *T* being as great as tolerable in the first place, *R* must be increased. This will still further decrease the value of *Q* at 300 meters. The result is poor selectivity at long waves. As an example, consider *a* = 12, and *R* = .2, at 5 meters, note Fig. 4. The amplification is 21,000, and *Q* = 630. For the same *T* and *R* at 300 meters (*L* sufficiently increased from its 5-meter value) the amplification is very low. Increase *R* until *L/R* has its former value (at 5 meters), and the 300-meter *Q* = 630/60 = 10.5, which becomes further decreased when *R* is increased to restore the amplification to 21,000.

It is usually a fact that experiment is the mother of a successful design. Stable operation, freedom from side responses, simplicity of adjustment, are chief concerns whose ultimate appreciation is a matter of experimental development. These results can be realized at short waves with markedly less difficulty than at long waves. At any wavelength it is important to have plenty of positive resistance. It should not be assumed that the coil resistance is great enough, although at less than 20 meters it is found that ordinary small coils have sufficient positive resistance.

Thirty meters is a suitable starting point for development work. With Fig. 3 adjusted for encouragingly "smooth" operation at 30 meters, 20,000 ohms was placed in shunt with *L*. (The tuned impedance of *LC* was 10,000 ohms.) Upon re-adjusting the circuit for the former amplification, it was found that the feed-back was less critical, and that the Q.F. emf. was less critical. Finally, 10,000 ohms was placed in shunt with *L*. Upon re-adjusting for the former amplification it was found that the selectivity had not decreased.

When using an audible quench frequency, and upon applying an unmodulated carrier, it is noted that the audibility of the Q.F. tone increases when the signal is applied. This is because the signal itself becomes modulated at the quench frequency, and this modulation is detected, of course, adding itself to the applied Q.F. emf. The quench frequency tone can be balanced out by using two super-regenerative tubes in push-pull, except when a signal is applied. Further decrease of the quench frequency tone requires that a Q.F. emf. be applied in the a-f system, with proper phase, and with adjustable strength—depending upon the signal level, etc.

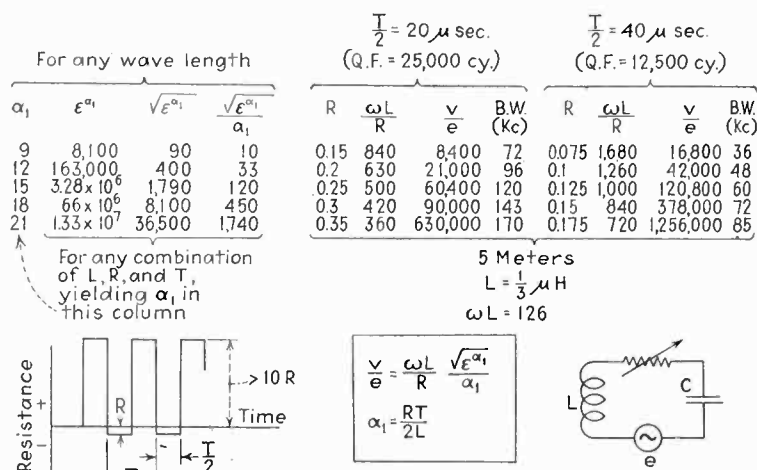

Fig. 4—Summary of super-regenerative effects showing virtues of circuit at high frequencies

of obtaining enormously great amplification (50,000 with ease) at short waves, with a single stage. Super-regeneration is the only method of realizing from a single stage any worthwhile degree of amplification at wavelengths of 5 meters.

Selectivity and amplification

As regards selectivity, assume a convenient value of *L* (say 200 $\mu\text{h.}$) at 300 meters, and a convenient value of *L* (say $\frac{1}{3} \mu\text{h.}$) at 5 meters. With the same quench frequency, and the same amplification in each case, the 300-meter system will be less selective, and the 5-meter circuit will be more selective, than could be realized with the coils and their inherent resistances. In a typical case at 300 meters, super-regeneration may decrease *Q* from 100 to 10 or 20, whereas at 5 meters super-regeneration may increase *Q* from 10 or 20 to 500 or 1,000. *Q* = 1,000 at 5 meters results in a band width of 60 kc. for 70.7 per cent response. Practical super-regenerative circuits at 5 meters, as evolved to date, do not allow even a remote approach to 10 kc. separation of carriers.

The voltage amplification in a super-regenerator circuit is not far from equal to

$$\frac{\omega L}{R} \frac{\sqrt{\epsilon^a}}{a} \quad \text{where } a = \frac{RT}{2L} \quad (4)$$

The values of the factors in this equation over a realizable range of values at 5 meters (or at any wavelength) may be calculated and other wavelength data reasoned therefrom, etc. Or, at a given wavelength, the table may be used to study the effect of *R*, *T*, *L*. Such a table is given in Fig. 4.

As shown in Fig. 4, the amplification and selectivity are much greater than could be achieved by means of simple coil design at 5 meters, and are far greater than could be practiced without unmanageably critical adjustments of simple regeneration.

Fig. 4 shows another group of data based on Q.F. = 12,500, with *R* ranging from 0.075 to 0.175. This halving of *R* and doubling of *T* holds *a* constant, but doubles the selectivity and amplification.

For a given value of ω and *T*, and for a given amplification, if *L* be changed *R* must be changed propor-

¹"Some New Developments of Regenerative Circuits," *Proc. I. R. E.* August, 1922.

Measuring resistance of broadcast antennas

By SCOTT HELT

Plant Engineer, Station WKBF,
Indianapolis, Indiana.

IT is of infinite importance that the resistance of a broadcast station antenna system be a matter of definite knowledge to the operating personnel, for it is the determining factor in calculating the power radiated. Without this knowledge the efficiency of an antenna system is unknown. It is likewise helpful in solving various other problems incident to the proper adjustment and operation of the equipment, and must always be known before a transmission line can be properly terminated. It is discouraging to note, therefore, that so many broadcasting stations have no knowledge whatsoever of this important information, and continue to calculate the station's output by the indirect method, i.e.,

$$\text{Operating power} = E_p \times I_p \times F$$

when E_p = Total plate voltage of the last radio stage.
 I_p = Total plate current of the last radio stage.
 F = Factor to be used in determining the operating power from the plate input power to the final stage.

The indirect method for calculating power is, of course, acceptable to the Commission, as is, also, the method arrived at through computation from field intensity measurements. However, the indirect measurement of power output is only an approximation since the general efficiency of the antenna system as a radiator does not enter, and is an unknown load into which the transmitter works. The radiated power, as computed from field strength measurements, may be accepted in lieu of antenna input power, provided sufficient measurements are made to insure accuracy, and an analysis of the antenna system is submitted to the Commission indicating the relative distribution of the radiation, i.e., ground and sky wave radiation. The latter method is the most efficient; it is also the most expensive. Consequently, it is often beyond the means of the average radio station, the costs involved in taking such measurements proving prohibi-

tive. We therefore resort to the direct method for calculating radiated power which involves measurement of the antenna resistance. This method is both efficient and relatively inexpensive. However, so many unsuspected sources of error are apt to enter, it is not an easy matter to secure accurate measurements, and great care should be exercised by the engineer.

When the resistance of the antenna is definitely established, then the operating power of the station may be calculated through use of the simple equation:

$$I^2 \times R = W$$

when, I = Antenna current at the base or current anti-node of the antenna, at the operating frequency.

R = Resistance of the antenna.

W = Operating power.

There are several elements of the total antenna resistance of which the only useful part is the radiation resistance, defined by Morecroft as a fictitious resistance, the value of which will absorb the same power as is radiated by the antenna. The other resistance components represent wasted power since energy consumed in heating these resistances is not radiated into space. The total antenna resistance, however, absorbs power, and a measurement of this total resistance is important. In a well designed antenna the radiation resistance represents the major part of this total resistance.

The writer will describe apparatus and methods for measuring the antenna resistance. An antenna resistance measuring set, while not part of the standard equipment of a broadcast station, is of great value. It can be assembled by the operating staff.

The apparatus involved consists essentially of a shielded r-f oscillator capable of covering the broadcast spectrum (550-1500 kc.), and having a power output of approximately ten watts. This oscillator is described in Fig. 1. It is used to induce an r-f voltage of known frequency into the pick-up inductance L_2 . The oscillator should be thoroughly shielded so that it will induce

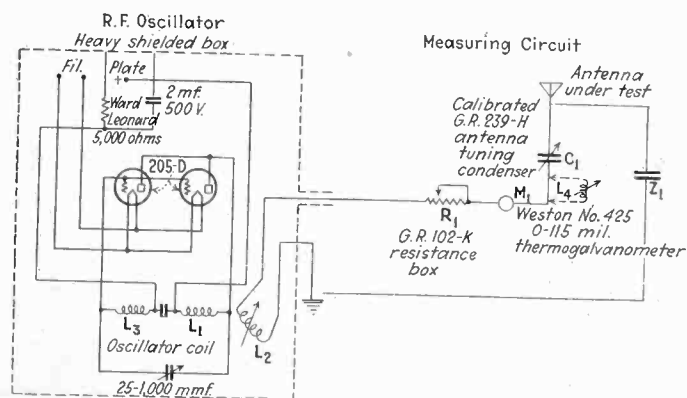

Fig. 1—Antenna resistance measuring set used in the added resistance method

voltage into the antenna measuring circuit at one point only, and will not induce spurious energy into the antenna or other components of the measuring circuit. The coupling between the oscillator and pick-up inductance should be fairly loose so as to limit the transfer of energy between these two circuits as to avoid any noticeable reaction on the performance of the r-f oscillator. If the coupling is not loose, the adjustment of the decade resistance box when taking measurements may greatly affect the loading and output of the oscillator. If this condition is apparent and experimentation with the engineer involved does not eliminate the difficulty, the engineer may connect an r-f ammeter in series with the

oscillator output or tank inductance, or the output may be held constant through the use of a rheostat in the oscillator circuit. The r-f ammeter in series with the output inductance will indicate any variation in the oscillator output, and it can therefore be compensated for.

Some station engineers attempt to excite the antenna and measuring circuit from one of the lower power stages of the transmitter, such as one of the buffer stages, but this practice is to be discouraged inasmuch as many errors are apt to arise. Also, measurements should be taken not only at the assigned frequency, but at other frequencies throughout the broadcast spectrum. With this information, a curve may be plotted, as in Fig. 2, the smoothness and slope of which give an indication of the accuracy of the measurements taken. The

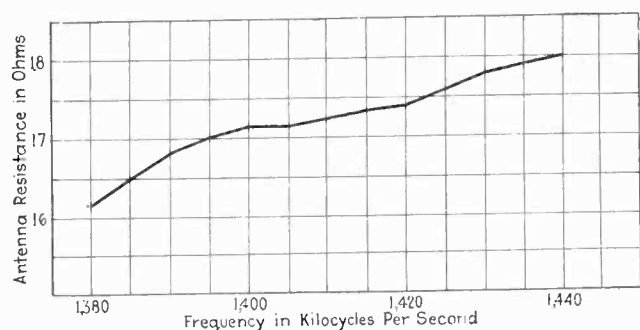

Fig. 2—Typical antenna resistance curve. This antenna was operated at 1410 kc.

Federal Radio Commission desires that such a curve be submitted when an antenna resistance measurement is submitted to it for acceptance.

An accurately calibrated wavemeter such as the General Radio Precision Type 224-L is also required for determining the wave length of the r-f oscillator at various adjustments within the broadcast spectrum, as measurements are taken. Care should be taken that the wavemeter is accurate, and is reliably calibrated. A statement of the accuracy of all the apparatus involved should be secured from the various manufacturers of the equipment, as the Federal Radio Commission may not accept antenna measurements unless a definite statement of the accuracy of the various components is submitted along with the measurements. Also, so many errors are apt to present themselves when inefficient equipment is used, that the sum total might introduce sufficient error to disturb the entire measurement.

Referring to Fig. 1, we find that various other miscellaneous equipment is required. A laboratory type variable condenser, C_1 , similar to the G. R. Type 239-H (min. cap. 25 $\mu\text{f.}$, max cap. 1,000 $\mu\text{f.}$); a variable resistance of negligible inductance throughout the broadcast band, similar to the G. R. 102-K (0-1111 ohms) and having an accuracy of approximately 1 per cent; a thermo-galvanometer similar to the Weston model 425 current squared galvanometer, logarithmic scale 0-115 mils, of accurate calibration; and, in some instances, a variometer of known inductance and resistance. The particular type of galvanometer mentioned should be used, because an instrument of this design has little resistance and relatively high efficiency.

The apparatus is connected as in Fig. 1, some suitable high frequency cable, such as that made by Packard or Belden, being used to reduce resistance losses within the circuit itself, thereby improving the efficiency of the set-up.

In taking the measurements, the oscillator is first adjusted to a frequency considerably lower than the station

operating frequency, the resistance in the decade box being set at zero. The antenna under measurement is then tuned to resonance with the oscillator, this condition being indicated by maximum deflection of the thermo-galvanometer. If it is impossible to tune the antenna, this may mean that the antenna will not tune to resonance at the frequency being supplied by the oscillator since it is lower than the natural period of the antenna. It is then necessary to insert a variable inductance, L_4 , in series with the antenna instead of the variable capacity, C_1 , in order to load the antenna to the resonance point.

The coupling between the oscillator tank inductance L_1 should now be adjusted in relation to the pick-up inductance L_2 until a convenient deflection of the thermo-galvanometer M_1 is secured. It must be made certain now that the oscillator output is not being too heavily loaded. This can be determined through rotating the capacity C_1 through 180 degrees and varying resistance R_1 , and noting if any deflection is observed in the scale of an ammeter located in series with the output of the oscillator. This can usually be corrected by loosening coupling, but some control of the oscillator output may be necessary as has already been described. If the oscillator output is found to be constant, the antenna is again carefully tuned to resonance with the oscillator through adjustment of the capacity C_1 . Now, the resistance in decade resistance box R_1 should be slowly increased from zero until the current entering the antenna, as indicated by the thermo-galvanometer, is exactly *one half* of the value found when tuned to resonance. The resistance then present in the decade box is equivalent to the antenna resistance at the particular frequency at which the measurement was taken, *plus* the resistances of L_2 , M_1 , C_1 , and the wiring in the measuring circuit. If the equipment used has been purchased from a reliable manufacturer, he will have furnished the purchaser with a statement of the resistances of this apparatus, or this

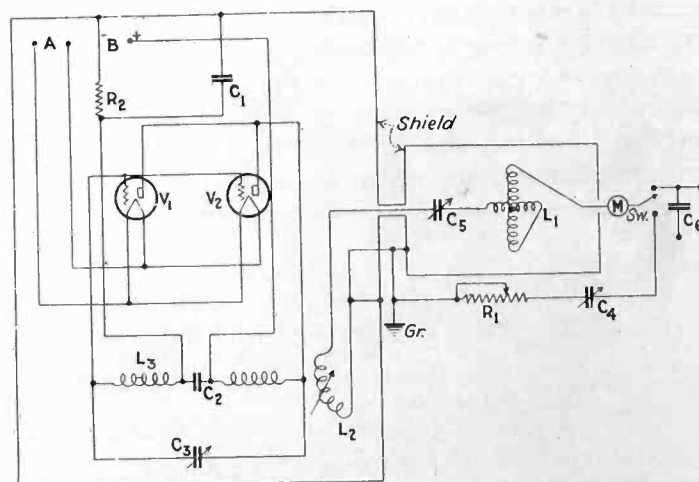

Fig. 3—Substitution method of measuring antenna resistance

information can be secured for the asking. The resistance of these components must be subtracted from the value of R_1 , the balance being the antenna resistance at the frequency at which it was measured.

The theory behind this measurement is simple. Thus, when the circuit is resonant, only resistance limits the flow of current, and the system follows Ohm's law. Therefore, if a non-reactive resistor is inserted in series with the circuit the decrease in current will follow this law. If the total resistance of the circuit is doubled, the current will be halved. Therefore, in practice, sufficient non-reactive resistance is added to reduce the antenna

current to one-half its value with no resistance inserted.

The value of resistance required to halve the current is the antenna resistance plus the resistance of the measuring apparatus.

Reactance variation method

In the method just described a variation of series *resistance* leads to the value of the antenna resistance. The resistance can be obtained, also, by varying a *reactive* element in the antenna circuit, for example, by varying the tuning capacity.

The theory behind this method will be found in most text-books on radio: Hugh A. Brown in *Radio Frequency Measurements* has a good account. The resonance value of a capacity plus another value of C and the corresponding currents may be used. A simpler method consists in using two values of tuning capacity, C_1 and C_2 , one on either side of the resonant capacity, which give the same values of current. The value of current at resonance is also needed. Then the resistance may be obtained from the expression,

$$R = \frac{1}{2\omega} \left(\frac{C_2 + C_1}{C_2 C_1} \right) \sqrt{\frac{I_1^2}{I_R^2 - I_1^2}}$$

In either the resistance variation or the reactance variation methods the value of the resistance of the measuring apparatus must be subtracted from the total measured resistance to get the antenna resistance. If the resistance of the individual elements is not known the value may be obtained by disconnecting the antenna from the measuring circuit, and connecting the antenna side of C_1 to the ground system of the station through a high quality impedance Z_1 . This impedance should be so efficient as to not greatly add more resistance to the circuit, and its reactance should be such as to approximate that of the antenna so as not to disturb the setting of C_1 , and so this capacitance will not have to be greatly changed. One of the antenna capacitors, or one of the inductors supplied as a part of the regular antenna equipment of the transmitter, may be used for Z_1 .

Now, the resistance of R_1 is again adjusted until the reading of M_1 is reduced to one half its former value. The resistance then present in the decade box is equal to the total resistance of the equipment and connections in the measuring circuit. This equipment resistance will be found a very low value, usually.

Where to insert the resistance

In taking resistance measurements of the antenna the apparatus should be inserted at the base or current antinode of the antenna and the transmission line terminating equipment, if used, or the tank circuit of the transmitter must be short circuited so as not to affect the performance of the measuring set, or the measurements taken. Whether this practice is correct in securing a perfect measurement of true antenna resistance is highly controversial. The Federal Radio Commission holds, however, that it is only interested in power actually entering the antenna, and does not want the antenna coupling and tuning equipment included in the circuit. The I.R.E. Standards Committee holds that the resistance of this equipment should be included. Few engineers agree on the subject and many expressions have been heard one way or the other.

Personally, the writer thinks that it should be included, for any inductance or capacity in series with the antenna is a part and parcel of the antenna circuit and affects the

general constants which determine the true resistance of the antenna circuit. However, the Commission holds otherwise, so this equipment must not be included, and the transmitter should therefore be tuned so as to deliver the licensed power to the antenna terminal regardless of any losses which are most surely present in the antenna tuning circuit.

A substitution method

Another method for securing antenna resistance measurements is known as the substitution or earthed-antenna total resistance method. Its principle was described by L. W. Austin as early as 1912. It is termed the substitution method, since the antenna constants may be determined by comparison with a dummy antenna, the constants of which are similar to those of the antenna being measured (i.e., substituted for the antenna). The circuit is shown in Fig. 3, and the parts included are the same components as were used in finding the antenna resistance by the method described above, great care being exercised to insure accuracy of the measurements taken.

The r-f oscillator is first tuned to resonance with the antenna at the frequency at which the antenna is to be measured, the switch *sw.* being in such position as to connect the antenna, the thermo-galvanometer, and the pick-up coil in series with the output of the oscillator and ground. When resonance is arrived at, this being indicated by maximum deflection of the meter, the magnitude of the current entering the antenna is noted. The switch, *sw.*, is then thrown to disconnect the antenna and include instead a variable capacity C_4 (same characteristics as C_5) and the decade box R_1 . Condenser C_4 is now varied and resonance is established with the oscillator as before. Then R_1 is increased from zero resistance to the point at which the thermo-galvanometer M_1 indicates the same as it did when connected in the antenna circuit. The readings of R_1 and C_4 now represent the resistance and the capacity of the antenna, respectively. Circuit resistance is considered as negligible, but may be allowed for if great accuracy is desired.

The antenna series condenser used in both methods theoretically permits measurements to be taken as much as 50 per cent below the fundamental wave length of the antenna, but actually it is difficult to go below 30 per cent lower than the fundamental. For the longer wave lengths it is necessary to load the antenna with inductance in order to secure a measurement. Another thing to remember is that the lower the total resistance the more efficient the antenna is as a radiator, and if the resistance at the operating frequency of a quarter-wave antenna is much over 25 ohms, the system should be looked at with suspicion.

It is sincerely hoped that the information contained in this paper, collected by the writer over a number of years and used in practice many times, may prove of interest to the plant engineer and operator.

METHODS and apparatus useful in measuring the resistance of a broadcast antenna by the resistance or reactance variation method or the substitution method are outlined in Mr. Helt's article. A knowledge of the total resistance of an antenna is useful to an engineer in determining a measure of the radiated power.

HIGH LIGHTS ON ELECTRONIC

Amplifiers used to study currents produced by thoughts

PROFESSOR LOUIS W. MAX, of New York University has been employing amplifier circuits in connection with a sensitive string galvanometer to measure the "thought currents" flowing in human muscles when the subject "thinks of making a muscular movement" without actually making the movement.

Studying deaf-mutes who are accustomed to expressing their thoughts through their fingers, Dr. Max measured the nervous impulses in their finger muscles when they were thinking "silently" and "aloud," that is, when they were expressing their thoughts with the use of their hands, or kept their hands still.

The experiments showed that even when the deaf-mute kept his hands still his thoughts were registering action-currents on the electrical measuring apparatus.

Next, the galvanometer was employed on the mutes during sleep. It was also employed on normal persons. It was determined that sleep yields practically no action currents, but that when a person is dreaming his dream is recorded by action currents. By observing the galvanometer it has thus become possible, Dr. Max states, to detect dreams in a sleeping subject.

Action currents, or "thought currents" from different parts of the body were also recorded simultaneously by two amplifier galvanometers. When a subject was engaged on a problem, his thinking was translated in terms of electricity, and the movements of the galvanometers were recorded photographically. So far 659 such "thought-photographs" have been obtained by Dr. Max, who is continuing his research.

The harder a subject thinks the greater the electric current registered on the instrument. A hard problem in arithmetic showed more "juice" on the "thought-current-photograph." When the problem was very easy hardly any current was recorded.

★

Transportation-noise intensities

THE ACOUSTIC CONSULTING DEPARTMENT of Electrical Research Products, Inc., New York City, has conducted a number of tests of various transportation-noise intensities, using its new noise meter, and has compiled the following table of representative intensities. These values are based on 0 db. equal to 10^{-16} watts per sq.cm. at 1,000 cycles per second, with a 40-db. equi-loudness contour.

★ ★ ★

TWO-WAY POLICE RADIO AT PIEDMONT, CALIF.

One central and four mobile transmitters operate on 30,000-40,000 kc. in the new Piedmont, Calif., two-way police radio system, which has just been installed by Elmer L. Brown, of Oakland, Calif. By means of the apparatus shown, the roving police cars can talk to headquarters or to each other

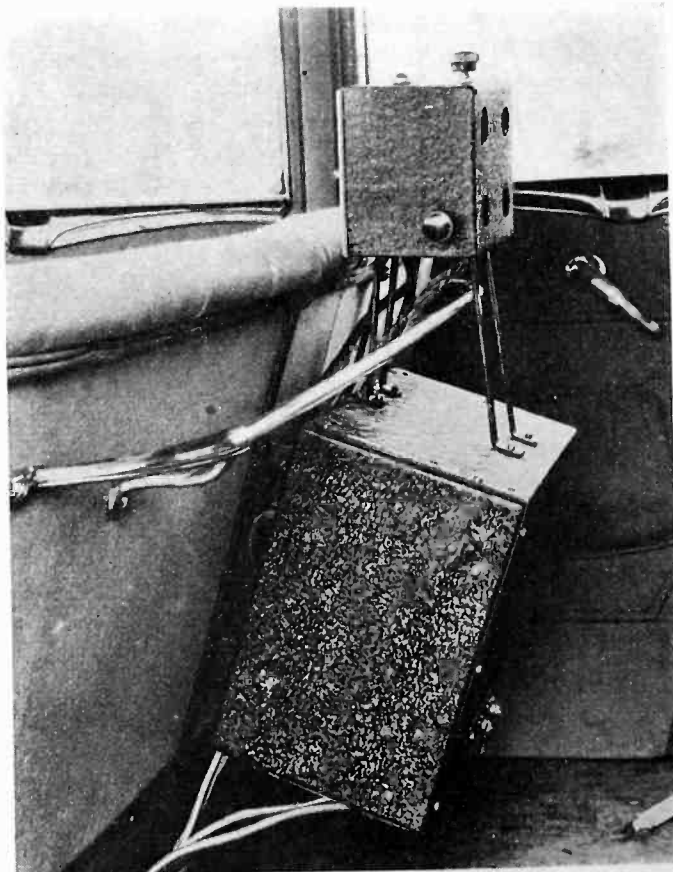

Type of noise	Loudness in db.
Unsilenced airplane engine — 15 feet.....	115
Interior of subway train in subway construction—average running speed.....	103
Group of 30 Army pursuit planes—distance ½ mile, altitude 3,500 feet.....	102
Interior of trimotor transport airplane—cruising speed	98
Interior of single-motor cabin airplane—cruising speed ...	97
Interior of twin-motor transport plane—cruising speed..	95
Tender of a mountain-type locomotive—60 m.p.h.	94
Cockpit of motor cruiser—cruising speed	92
Very heavy street traffic — from sidewalk	90
Interior of subway train in open air—40 m.p.h.	87
Interior of heavy suburban multiple-unit electric train—average running speed.....	80
Interior of Pullman car—windows open	80
Interior of low-priced 8-cylinder sedan—asphalt road—40 m.p.h.	77
Interior of low priced 8-cylinder sedan—asphalt road—30 m.p.h.	72
Interior of twin-motor transport plant—gliding to landing	70
Interior of low priced 6-cylinder sedan—asphalt road—40 m.p.h.	68
Interior of high-priced 6-cylinder sedan—asphalt road—40 m.p.h.	67
Interior of low priced 6-cylinder sedan—asphalt road—30 m.p.h.	65
Interior of high-priced 8-cylinder sedan—asphalt road—30 m.p.h.	64
Minimum street noise level—New York City.....	50
Minimum level obtained in special sound insulated rooms	13
Threshold of audibility.....	0

★

Wichita, Kansas, police loudspeaker

THE PUBLIC NOT ONLY must be protected from traffic hazards, but must protect itself. This is the basis of a novel idea being used by the traffic division of the Wichita, Kan., police department.

Nowadays an average traffic officer finds that a single pair of arms and a single pair of lungs are inadequate equipment with which to prevent crowds of jaywalkers from risking their necks or reckless motorists from taking the right of way. The Wichita police have found an answer to the problem in a unique public address system, the main feature of which is a six-volt "voice"

DEVICES IN INDUSTRY + +

that extends the command of the law vocally if not physically.

A loudspeaker is mounted on a Ford truck which wends its way through busy thoroughfares driven by an officer with eyes alert for traffic violators. Every three minutes, it is estimated, the cruiser finds a motorist or pedestrian breaking a safety regulation. In a moment the wrongdoer, and everybody else within hearing distance, is impressed with the breach by a firm and solemn warning.

Wichita authorities have found this public-address system especially effective for pushing traffic through during rush hours and for controlling the movement of pedestrians at busy intersections. Slow drivers are compelled to move along near the curb. Operators who park improperly are summoned to move their cars. Children are ordered to quit playing in streets. New uses for the equipment are being found continually.

At all times the operator is in contact with Wichita police headquarters through a short-wave set.

+

Cement bags registered by photo-cells

IN CONNECTION WITH THE paper-bag machine of the Associated Portland Cement Company, Limited, Gravesend, Kent, England, photoelectric cells and British Thomson-Houston controls are used to keep the running strip of paper in place during the printing process.

The object of the equipment is to keep the moving web of paper from getting out of line—that is, to control the side-play. The two photoelectric cells are mounted side-by-side above the lowest roller; with the projector lamps in front. If the paper moves a quarter of an inch to either side, so that the light conditions on the cells become the same—that is, both in light or both in shade—an alarm signal is sounded so that the operator is warned to adjust the machine.

+

Photocells correct for cable stretch

STRETCH OF THE STEEL ELEVATOR CABLES in one tall New York building was indirectly the reason for installing photocells to compensate for this stretch.

When the car at the bottom of its 700-ft. run, takes on a heavy load, the steel cable lengthens perceptibly, so that it is necessary to move the car upward a short distance to keep it at floor level. Photoelectric tubes prevent the car-door from closing on passengers.

Soundings from a plane by acoustic echo

A FRENCH SYSTEM ALLOWING of acoustic soundings from an airplane, the methods suitable on ships not being here satisfactory, uses a triode in a novel manner. The siren sends a signal during 1/100 sec., simultaneously closing the transformer circuit and thus causing the neon tube to glow. The echo returning from the ground, after amplification and rectification, puts a negative voltage into the neon-tube circuit and thus extinguishes it. During the interval the condenser C charges up to a voltage depending on the lapse of time, and on the arrival of the echo this voltage is applied to the grid of the triode and the change in plate current measured—the milliamperemeters are of course graduated directly in meters of altitude. Before the next sounding the condenser is momentarily short-circuited.

The accuracy claimed is within 50 centimeters from 3 meters to 20 meters, and around 5 per cent, thence upwards. The upper limit of measurement depends on the nature of the ground. Over irregular rocks, forests, etc., it may be as little as 50 meters, but normally one can be fairly sure of 150 meters, increasing to 250 meters above water. Winds of a velocity up to 150 km./hour relative to the plane do not appreciably affect the results.

As will be obvious, the amplifier contains a filter accepting only the audio frequency of the siren. The simple addition of other filtered amplifiers actuating separate relays allows of ground sirens giving the pilot visible or audible indications (e.g. limit and axis of the landing-ground).

Paper mills use stroboscope

STROBOSCOPES ARE NOW BEING USED for checking stability and synchronism of paper-mill rolls with a master-frequency generator. The stroboscope is fed power from the master frequency generator and a neon tube on front of the unit flashes its light on a stroboscopic disk located on the end of the paper mill roll. An adjustment is provided to control the voltage on the neon tube to give best definition.

+

Areas of leaves registered by photo cells

THE PHOTOELECTRIC CELL had a new role added to its already long list of versatilities at the meeting of the American Society of Plant Physiologists by R. B. Withrow of Purdue University. He uses it to measure the area of leaves, which is a datum of considerable importance in estimating the efficiency of various plants in the capturing of sunlight for the manufacture of food, according to *Science News Letter*. Methods hitherto in use have been exceedingly tedious and time-consuming; the "electric eye" does it at a glance.

The photoelectric cell is put inside a box. Over it is placed a ground glass plate. Above the plate is a circle of twelve 100-watt frosted electric lamps.

When the lamps are turned on, the cell responds to their stimulus and generates a current which is read with a suitable instrument. Then the leaves to be measured are laid on the glass, cutting off part of the light. The response of the cell is diminished in proportion to the amount of light cut off, and therefore also in proportion to the area of the leaves causing this eclipse.

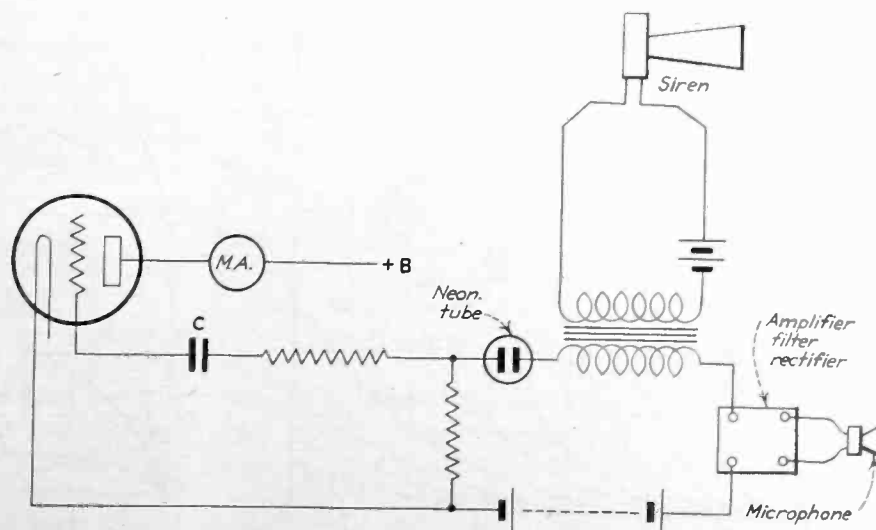

Circuits of the airplane apparatus for measuring height above ground by means of air echo

AVC applied to audio frequency amplifier tubes

By J. R. NELSON

Raytheon Production Corporation,
Newton, Massachusetts.

AUTOMATIC volume control has come to be one of the essential features of a successful receiver. An examination of a considerable number of various makes of receivers made it evident that not enough care and engineering has been spent on the proper design of AVC systems. The greatest fault in design is that the diode feeder systems do not deliver enough power to properly drive the diode due either to poor transformer design or the wrong voltage conditions on the tube. These matters are easily remedied and will not be discussed here.

Even after the system feeding the diode is properly designed the automatic volume control in most sets using a diode is not very satisfactory. This defect is caused by

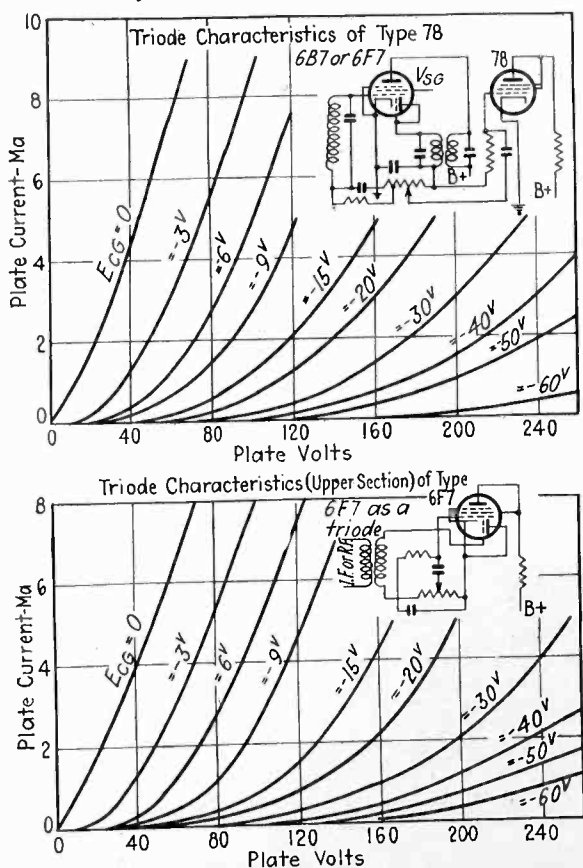

Fig. 1—Triode characteristics and circuits showing 6B7 or 6F7 as r-f amplifier feeding diode

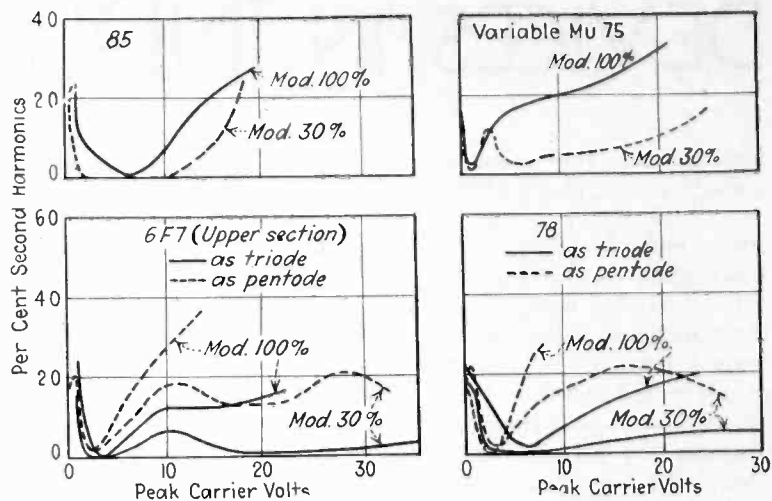

Fig. 2—Overload characteristics of various controlled audio amplifiers

the characteristics of the diode itself along with the large AVC voltage required to cut off the variable-mu tubes. For example, some of the early sets with AVC had a tube in parallel with the detector tube which amplified the voltage available for AVC so that a small change in voltage across its input, after reaching a certain set value, cause a large change of voltage available for AVC. The voltage across a diode on the other hand increases almost proportionately with the signal, so that a large change of diode rectified voltage results in going from a very weak to a very strong signal. For example, a reference signal of 10 microvolts might be taken with two volts across the diode and a signal of one-half volt might give 40 volts across the diode. The diode voltage would thus change twenty times in this signal range. The audio voltage applied to the grid of the detector would thus change twenty times as the a-f voltage is directly proportional to diode voltage for constant modulation.

Several remedies or partial remedies exist to prevent the a-f voltage from varying so much with input voltage. For example, some system of d-c amplification might be used which would prevent the diode voltage from varying so much. This is practical but somewhat expensive, so that this method will not be considered here. A delay voltage which causes the AVC to start at a certain level is at times helpful, while in other cases does not do much good. Another possible remedy is to use sharp cutoff

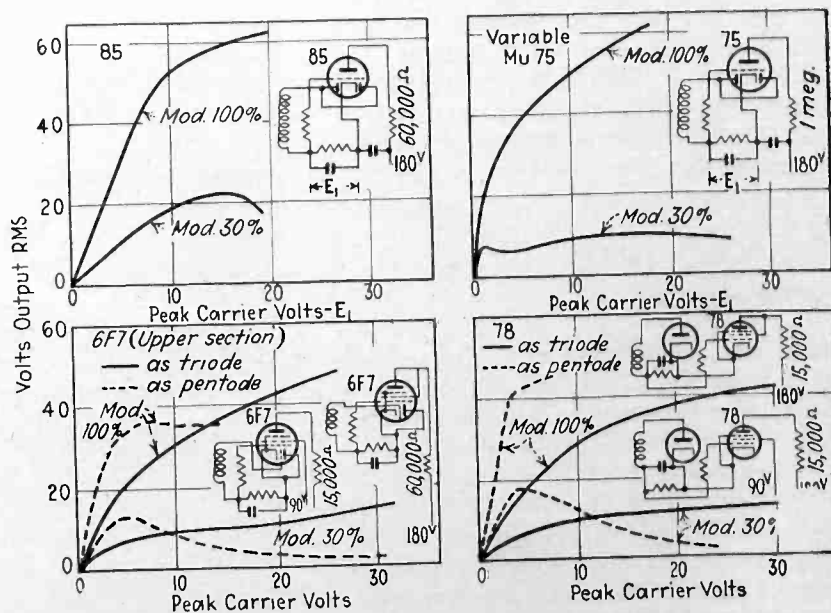

Fig. 3—Second harmonic distortion from various controlled audio amplifiers

tubes, as this prevents the diode voltage from rising so high, as not much AVC voltage is required for these tubes. The sharp cutoff tubes,¹ however, cause cross modulation and modulation rise, so that their use in general is not recommended. A large number of stages under control reduce the diode voltage variation, but in small sets this remedy is impractical. Another method not in general use but long advocated by this laboratory is to place either the detector or first audio stage under control also.

An ideal tube for this purpose should have the output proportional to the signal up to a certain signal value and then have constant output for all signals greater than this value. A practical tube would thus necessarily have a variable mu so that the a-f voltage would be amplified less as the signal increases.

Experimental investigation

The first step in the investigation was made by making some variable mu 75 tubes suitable for audio AVC. Since the start of this investigation several types of tubes such as the 2B7 and 6B7 tubes and the 6F7 tubes have been brought out. Tubes such as these introduce several new possibilities as these are variable mu tubes suitable for a-f amplifiers, and the operation of this type was studied after the data were obtained with variable mu 75 tubes. For example, the 2B7 or 6B7 may be used as a high frequency amplifier feeding into its own diodes and the rectified voltage used to control the bias of an a-f amplifier tube and thus its gain. Investigation showed that the lower section of the 6F7 might also be used as a diode by either tying the plate and grid together or by using the grid as a diode with the plate tied to the cathode to act as a shield. The capacity coupling the two units is not excessive, and while it is not quite as low as in a well shielded type 85 tube, it is low enough for most purposes. Thus the 6F7 tube might be used either as a diode with the upper sections as a triode or pentode, or used like the 2B7 or 6B7 with the upper section as a high frequency amplifier driving its own diode. A variable mu tube with its bias proportional to the carrier might thus be used after the diode as the first a-f tube in order to obtain better AVC. RF pentode tubes are not very suitable for audio amplifiers, as will be shown later. The pentode tubes may be used as triodes, however, by tying the plate and screen together. This raises the cathode current cutoff bias considerably, as the screen potential is raised to the plate potential.

The upper curve of Fig. 1 shows the triode characteristics of the 78 tube and the insert shows a possible circuit using either a 6B7 or a 6F7 as a high frequency amplifier feeding the lower section as a diode. The lower curve shows the 6F7 used as a diode triode with the lower triode section as a diode and the upper pentode section as a triode amplifier. It is readily seen that the variable mu audio amplifier bias is proportional to the carrier strength in either case.

Figures 2 and 3 show the output and distortion obtained with various types of tubes used with the bias controlled by the carrier and full modulation voltage applied to the grid of the tube for 30 per cent and 100 per cent modulation. The 30 per cent modulation with the full tap should correspond to 100 per cent modulation and one third tap. Thus the distortion for various a-c input taps and various modulations may be determined from the data given here. The output of the 85 tube is proportional to the carrier voltage until the bias is too great. Bad distortion begins to occur at this point as would be

expected. The curves for the experimental variable mu 75 type tube are also shown. The distortion is rather high for both cases, but the output voltage for 30 per cent modulation is fairly constant past about one volt input. The two lower curves show the output of the 6F7 upper section and the 78 type tube, both tubes being connected as a triode and as a pentode. The results for both tubes are much better as a triode than as a pentode both as regards constant output and distortion.

The results using the 6F7 or 78 are better than for a variable mu 75 tube. The mu of the variable mu 75 tube is too high for good quality and would have to be lowered so that its sensitivity advantage over the other tubes would be less. It is believed that the mu of the r-f pentodes used as triodes is as high as warranted.

One point should be emphasized in the use of tubes under the above condition. The output of the variable mu a-f amplifier tubes is somewhat limited so that it is better to use an audio stage between the variable mu tube and the output stage if distortion is to be kept low.

Figure 4 illustrates the action of a variable mu a-f amplifier tube used in conjunction with two high frequency amplifier tubes also on AVC. The curves were

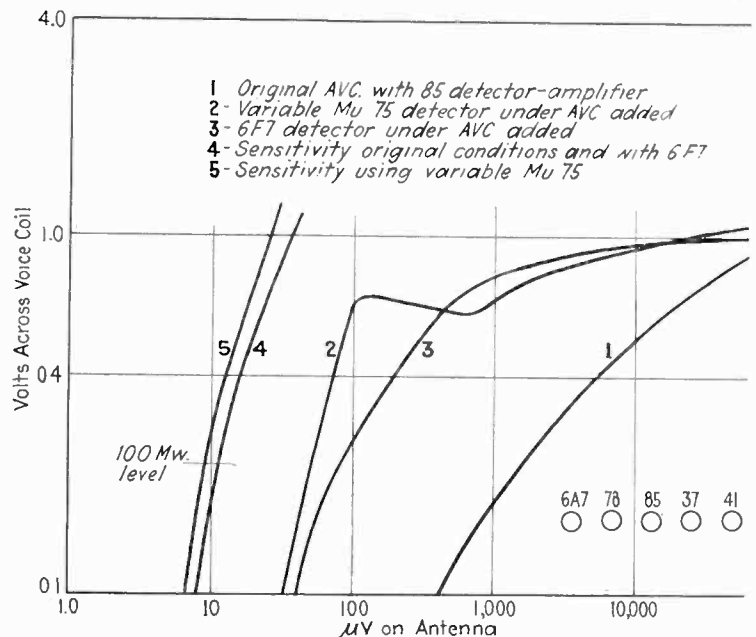

Fig. 4—Automatic volume control characteristics with two r-f and one a-f amplifiers under control

all taken with the volume control set so as not to overload the audio amplifier. The tube layout of the receiver under investigation is shown in the lower right hand corner. The 78 and 6A7 were on AVC. The original AVC characteristic is shown by curve 1. The variable mu 75 was then substituted for the 85 and placed on control. The results are shown by curve 2. The 6F7 was then connected as a triode shown by curve 3.

The initial sensitivities for the various tubes are shown by curves 4 and 5. It is thus seen that either curve 2 or 3 is considerably better than curve 1. There is very little difference between curve 2 and 3 which shows that tubes are available for putting the a-f amplifier on AVC.

The results show that it is possible to make a small receiver with good AVC. The receiver is inexpensive because there are only two high frequency tubes and considerable audio gain is employed in this receiver. Its final AVC characteristics are more satisfactory than most of the six tube receivers using the conventional diode for AVC as well as rectification.

¹Stuart Ballantine and H. A. Snow. "Reduction of Distortion and Cross-Talk in Radio Receivers by Means of Variable-Mu Tetropdes." *Proceedings of the Institute of Radio Engineers*, Volume 18, Number 12, Page 2102, December, 1930.

Dynamic microphone amplifier

for sound news recording

By ARTHUR J. SANIAL

THE dynamic microphone, because of its advantages over older types, is of particular interest to those using portable sound pick-up equipment, notably sound newsreel companies.

This microphone is free from hiss, requires no polarizing energy, and is practically devoid of cavity resonance. The diaphragm is smaller, so that the frequency characteristic is not greatly affected with changes in the angle of incidence of the sound wave.

The low impedance of the dynamic microphone (about 30 ohms) is a distinct advantage, as this allows several hundred feet of small cable to be used with it directly. Its freedom from climatic changes gives it a great advantage over the condenser transmitter. With the latter, it is necessary to take many extra precautions, especially when used in damp localities or in the Tropics. It is not an uncommon practice to carry as many as six of this kind of transmitter around in dessicators so as to have a supply of spares in readiness.

To make use of dynamic transmitters with existing equipment, it has been customary to mount a suitable input transformer on the regular condenser transmitter amplifiers. To utilize the full flexibility and convenience of the dynamic microphone, it is far better to design a small pre-amplifier which may be plugged directly into the main amplifier, and preferably fastened to it. This amplifier provides the correct input impedance and the added gain necessary for the new microphone. An example of a typical case will perhaps best illustrate the factors involved.

This amplifier was to be used with a system which was extremely small and light in weight, and of comparatively low cost. Like similar systems there was sufficient gain for average pick-up, but in sound news work there are many times when the ability to record speech twenty feet or more from the mike is of inestimable value. This can be done with the dynamic mike pre-amplifier described, which plugs directly into the regular input socket. Filament and plate power for the pre-amplifier are obtained from the common battery supply through this connection. In this way, the usual connecting cable and a step-up as well as a step-down transformer are eliminated.

By adhering to a relatively low step-up ratio, of the order of 1:40, a small, inexpensive, alloy core input transformer was designed and built. It was very light in weight and had a suitable gain-frequency characteristic. The circuit of the pre-amplifier using this transformer is shown in the figure. The tube chosen was an automobile screen-grid type as vibration effects are small, and the power consumption is not excessive. The circuit itself is quite conventional.

The main problem was that of discovering and eliminating the sources of noise. With a gain of 118 db. noises usually disregarded assume an important rôle. The chief sources originate from the plate resistor, the tube, and pick-up of extraneous fields. In attempting to get rid of the resistor noise, many different kinds were tried. Wire-wound resistors were the best, but unsuitable in other ways. A composition type was finally found which

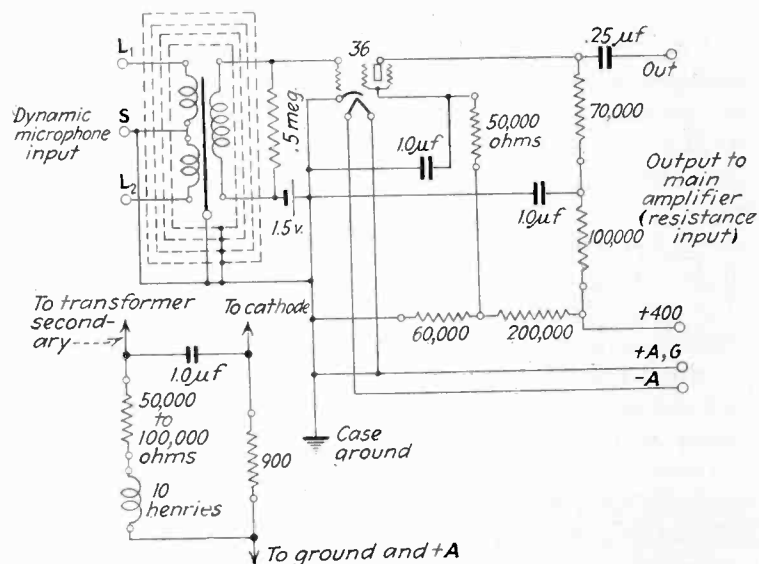

Circuit diagram of pre-amplifier, with alternative bias system

was nearly as quiet. Tubes were next investigated, and a type 36A was ultimately chosen as the quietest of the automobile types.

Pick-up of electrostatic and electromagnetic fields in the vicinity, gave the most trouble. This was remedied by quadruple shielding of the transformer, the first and third shields being copper (or brass), and the second and fourth steel. By using a closed E type of core in designing the transformer a considerable portion of the stray magnetic fields are balanced out.

The frequency response of the pre-amplifier and main amplifier is flat from 20 to 10,000 cycles within 1 db. Some loss at 100 cycles and below is intentional, as this amount at least is required in field recording with this system. This requirement aids in the design of a smaller input transformer than would result if it were necessary to hold up the low frequencies. The rise at the high frequency end due to leakage tuning is adjusted to a suitable value by the proper shunt resistance. This varies with individual transformers, but is of the order of 0.5 megohm. The insertion gain of the pre-amplifier was 28 db.

There was no difficulty in picking up normal speech 20 or 25 feet from the microphone and recording it at the average level (+ 15 db. above .006 watt) without undue interference from noise. It is seldom necessary to do this in practice, nor can it be done without a high level of extraneous sounds being present in the output, except in very quiet locations. When such an occasion arises, however, the extra gain may mean the difference between success or failure to the sound crew.



BOOKS



FOR ENGINEERS USING ELECTRON TUBES

Photoelectric cell applications

A practical book describing the uses of photoelectric cells in television, talking pictures, electrical alarms, counting devices, etc. By R. C. Walker and T. M. C. Lance. London: Issac Pitman and Sons, Ltd. 1933. Price: 8s. 6d. 193 pp. 111 Fig.

THE BOOK, A COMPANION TO Campbell and Ritchie's Photoelectric Cells, begins with a short chapter on the properties of vacuum and gas-filled cells in which alkali metals are used, giving only those details which are of importance to the industrialist and general reader interested in the possible uses of photoelectric devices. Then follows a chapter on the circuits containing a phototube together with a vacuum or grid-controlled discharge tube and relay. With the third chapter the book enters upon the simple practical uses of the cell in counting and timing gear, in alarm, indicator and safety devices and finally for advertising purposes. The second half of the book describes the more intricate uses which the photoelectric cell has found in the field of talking films, phototelegraphy, television and scientific work (measuring devices).

While the book does not give to the reader the vast outlook that may be gained from the study of the list of applications published in October, 1933, *Electronics*, it presents in simple language the general fields of usefulness. The authors, connected with the Research Laboratories of the General Electric Company in England, have preferred to record their experience with alkali cells rather than present the hearsay evidence of others on barrier plane and selenium cells. A list of articles published before or during the year 1931 concludes the book.



The technical man sells his services

By Edward Hurst, McGraw-Hill Book Company, Inc., New York City, 1933, 239 pages. Price, \$2.00.

A TECHNICAL MAN attacking an engineering problem would go about it in a scientific manner, and Mr. Hurst proposes that he use the same method to

find a job. This book is for the technical college graduate seeking employment, but anyone who has specialized in some particular branch of learning may profit from it. The author takes into consideration the many well-trained and able men who are not necessarily salesmen equipped to sell their training to an employer.

Mr. Hurst proposes to solve the problem of overcoming what he terms "employer resistance," the negative force a man must overcome to obtain employment. He points out that the act of getting a job is essentially the act of making a sale; someone must be convinced that the intrinsic value of the work to be done will be greater than the pay received for it, thus making employment a profitable enterprise.

In a distinctly logical manner, and in sufficient detail, the book describes virtually every stumbling block to be encountered. Each difficulty is analyzed and a practical remedy is supplied. After general details are discussed, the case method is used for greater elaboration. Ten cases of men who actually obtained employment by attacking the problem logically and scientifically, as the author suggests, are described.

Mr. Hurst admits that a hundred cases would be better than ten. However, so many situations are covered that the reader is supplied with abundant material for a practical reconstruction of his job-getting technique. The book suffers the distinct limitation of any work on the subject of obtaining employment—it can tell how to get the job, but it cannot obtain the job for its reader—that, after all, depends on the man, and somewhat upon circumstances. —Ferd. Mann.



Application of the cathode ray oscillograph in radio research—

By R. A. Watson Watt, J. F. Herd and L. H. Bainbridge-Bell. (H. M. Stationery Office, 1933) 290 pages, 113 figures, 17 plates. Price, bound: 10 sh.

AS THE AUTHORS STATE in the foreword, the title of the book is at once too wide and too narrow: the volume deals only with those applications of the cathode ray tube which have been developed at

the laboratory of the British Radio Research Board; but the use of the equipment described is, on the other hand, not confined to the oscillograph and to the research end.

After a short historical sketch, quite remarkable for its fairness, the authors proceed to give a clear description of the cathode ray tube, its main advantages and defects, adding valuable instructions on how to put a new oscillograph into service. A few tried methods of obtaining a linear, circular, or sinusoidal time base are mentioned. The possibility of synchronizing the repetition of the time axis to a common master frequency, such as the supply mains or a received pulse frequency, is of general interest, and the use of the cathode ray tube as an oscilloscope a special outgrowth of this branch of the work.

The methods of using the instrument fall into two main classes: the tracing of an electromotive force as a function of the time (pages 99-132, wave form of atmospherics, echo of short impulses), and the comparison, at any given moment, of two electromotive forces (pages 133-242, direction finder or voltage comparator). In the cathode ray direction finder the two signals are the two components of a single signal as received by two coils placed at right angles; on leaving the coils the signals pass through amplifiers having exactly the same gain and phase shift for every frequency in the accepted band. It has been found advantageous to adopt the superheterodyne principle in place of straight signal frequency amplification. The authors are moreover of the opinion that a cathode ray direction finder using a spaced-aerial system in place of a closed coil or loop system will be the only equipment applicable in difficult cases, although they have not found time to construct such an apparatus for frequencies above 2 Mc. per sec. In a simpler form the finder is useful as "collision preventer." Another branch of the work is its application to the study of the state of polarization of radio waves.

The list of references is intended to be illustrative only and not exhaustive.

In some places the treatment is rather broad, apparently because so many inquiries have been received by the authors that they considered it useful to publish fully the necessary details which would allow other workers to understand the advantages of the methods finally adopted.

★ ★ NOTES ON ELECTRON

High-gain amplifier

IN ELECTRONICS, JULY, 1933, page 195, Meissner described a high gain two stage amplifier using 58-type tubes. A recent addition to the literature on methods of attaining high percentages of the mu-factor of a high-mu tube appeared in the Review of Scientific Instruments December, 1933, where Otto H. A. Schmitt of the Department of Zoology, Washington University, describes an amplifier which gives a gain up to the full amplification factor of the tube and with moderate plate supply voltages.

Two 57's are used, one as the nearly infinite resistance load of the first. Schmitt notes that a 57 at first has a

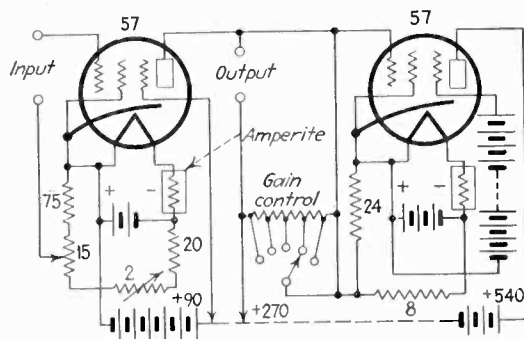

rapidly rising plate current characteristic, and then a very slowly rising characteristic. Thus at 200 volts the static resistance (E_p/I_p), is of the order of 100,000 ohms while the dynamic resistance approaches 10 megohms or more. Therefore if the 57 is used as a load for a first 57 at this point the d-c voltage drop will not be too great and the dynamic load will permit an exceedingly high order of amplification (2500 if the mu-factor is this high).

The circuit is shown. It requires separate batteries, but according to the designer is remarkably stable and free from drift and tendency to oscillate. Output voltages of the order of 450 with a 600-volt supply are possible.

WBBM and KFAB to be synchronized

THE FIRST MOVE TO BE made toward synchronizing two broadcast stations on a common frequency since the North American Radio Conference in Mexico has been made by stations WBBM Chicago, key station of the Columbia Broadcasting System and KFAB, Lincoln Nebraska. The stations will be tied together by a reference frequency originating in the Bell Telephone Laboratories.

Upon being brought into the station by wire line this 4-kc. reference frequency passes first through an amplifier. The output of the amplifier is fed into a frequency multiplier which generates the fifth harmonic (20 kc.) of the fundamental frequency. This 20-kc. frequency is used to control a 10-kc. multivibrator. The output of the multivibrator contains the 10-kc. fundamental frequency and all its harmonics up through the broadcast range. The 10 kc. fundamental frequency is passed through one amplifier and the harmonics are passed through another.

The amplified harmonics then are fed into a selector which selects and further amplifies that harmonic which is 10 kc. above the assigned carrier frequency of the station. The carrier frequency, generated by the crystal oscillator, which may be assumed to differ from the assigned value by some difference D is combined with the selected harmonic in a detector.

The amplified harmonic beats with the carrier frequency in this detector producing a difference frequency of $10 \text{ kc.} \pm D$. This $10 \text{ kc.} \pm D$, together with the amplified 10-kc. reference frequency from the multivibrator unit constitutes the input to a pair of balanced modulators.

The 10-kc. reference frequency before being applied to one of these modulators

is passed through a phase shifting network which retards its phase by 90 degrees. The output of each modulator becomes one phase of a two phase alternating current of the frequency D . The output of both modulators is then fed into the corrector unit which consists of a small synchronous two-phase motor mechanically connected to a small variable condenser associated with the crystal oscillator circuit. The two-phase current from the modulator stage has a direction of phase rotation which depends directly upon whether the carrier frequency is above or below the assigned value. If the carrier departs from the assigned frequency, the synchronous motor will revolve in the proper direction so that the resultant change in the variable condenser will alter the frequency of the crystal oscillator and so bring it back to the assigned value.

Any deviation of the carrier frequency from the assigned value operates the frequency corrector, providing an exceptional precision of carrier frequency control.

To operate a chain of widely separated stations on a common frequency system, all that is required is a connection to the 4000-cycle reference frequency. Of course there must be a program service in addition to the reference frequency wire if these stations are to transmit the same program.

Effect of spark suppressors on auto performance

MANY QUESTIONS ARE ASKED regarding the effects on car operation of resistances placed in spark plug connections to lessen radio interference. Answers from automobile engineers indicate that no general statement can be made. At times these resistors have some effect on car performance, but not always.

SCHEMATIC DIAGRAM OF NEW EQUIPMENT FOR COMMON FREQUENCY BROADCASTING

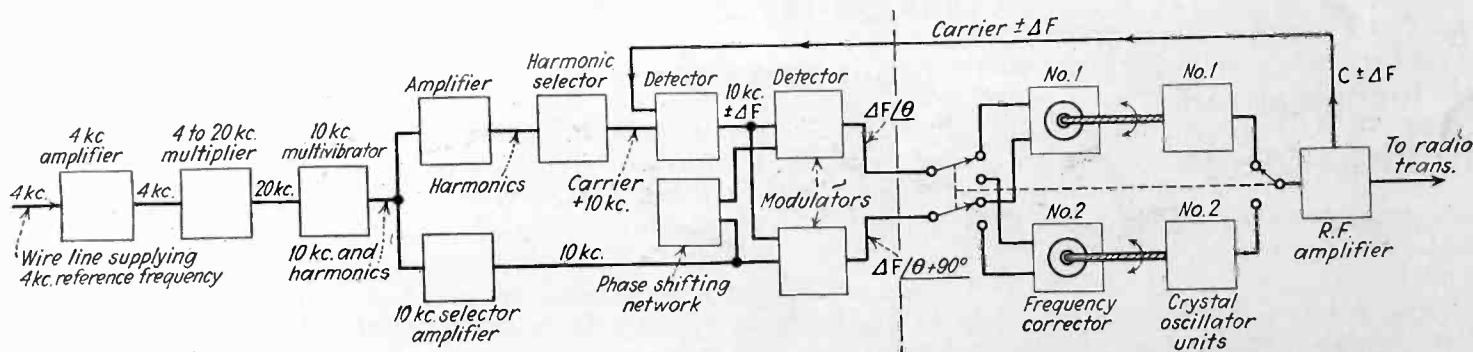

The above diagram represents in schematic form the Western Electric equipment for operating stations on a common frequency. Each unit contains its own power supply apparatus; they are completely a-c operated

TUBES AND CIRCUITS + +

A radio engineer with one of the large automobile companies has this to say regarding a test at high speed on a 6-cylinder engine. "There is absolutely no effect on the performance of the engine that would fall within the error of our instruments, whether or not there are suppressors on the spark plugs and in the secondary lead from the coil to the distributor. Personally, we have never been able to verify any of the complaints concerning poor engine performance that have been blamed on the introduction of radio suppression either in our cold room or at various atmospheric pressures."

The editors of *Electronics* will be glad to hear of other experience of this nature.

Making a-c and d-c scales correspond on a universal voltmeter

By CARL F. MATHIESON

EXAMINATION OF THE SCALE of a d-c meter fitted for a-c measurements by the use of a copper oxide rectifier shows that on the a-c scale the divisions from about $\frac{1}{2}$ full scale to full scale are practically equal, although smaller than the corresponding d-c divisions. Therefore if the meter were made more sensitive for a-c measurements to the point where the a-c divisions were made equal in size to the d-c divisions and the zero point raised for a-c measurements there would be no necessity for a separate a-c scale except for the first fifth of the scale. Such adjustment may be attained with no great difficulty, as illustrated.

If the meter is increased in sensitivity as much as 25 per cent on opening its internal calibrating shunt, it will be possible to use its original d-c scale. If this is not the case it will be necessary to decrease sensitivity for d-c measurement rather than increase it for a-c work.

The source of current may be a small flash light cell. The zero of the scale should be raised about 7 per cent of full scale so if a 1 ma. movement is used R_3 should be about 18,000 ohms and the rheostat R_4 10,000 ohms. R_1 should be of such a value as to increase the d-c range of the meter about 25 per cent, and R_2 , preferably variable, of such value as to make the a-c scale correspond to the d-c scale, $Sw 1$ is on 1 on d.c. and on 2 for a.c. $Sw 2$ is closed for a.c. A capacity should be in the multiplier circuit for a.c. to prevent the A current from affecting the circuit being measured. This arrangement in addition to the usual ac-dc switching is

all that is necessary to make the a-c and d-c scale correspond well enough for all ordinary purposes where a full scale of 10 or even 5 volts is desired, depending on the value of the rectifier resistance, provided that a series capacity instead of resistance multiplier is used for the lower a-c voltages so as to overcome the inaccuracy caused by

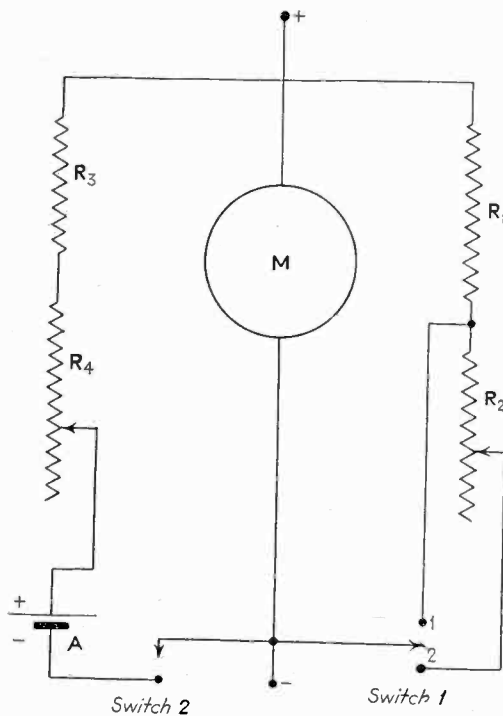

variation in rectifier resistance at different current values.

If the full scale is to be lower than 5 volts, for ammeter use for example, additional compensation must be switched in to raise the a-c zero of the scale still higher and to make the

meter somewhat less sensitive than for the higher voltages. This may be done without difficulty and it does not seem necessary to show the changes necessary.

Announcer killers

VARIOUS SCHEMES have been devised by radio engineers (for their own receivers, of course) to take the talk out of radio. These devices consist in manual methods such as shorting the antenna-ground with sufficient resistance to reduce the talk to mere audibility (W. MacDonald, technical editor of *Radio Retailing*), a photocell which controls the on-and-off switch of the receiver at the will of the owner (Dr. Lee DeForest) who carries a pocket flashlight and by a beam of light extinguishes the sales talk, or methods of shorting the loud-speaker terminals, or even time clocks which automatically turn off the receiver at the quarter-hour periods when talk is most prevalent.

Now no less a scientist than Professor G. W. Kenrick of Tufts has demonstrated an automatic system for removing the blah from broadcasting. A detector amplifier similar to an a.v.c. system has a time constant such that if silence of one quarter-second occurs in the program the announcer killer system (a.k.s.) shuts off the radio for a period of 10 seconds.

This device was demonstrated before no less an august body than the American Association for the Advancement of Science at Cambridge, Mass., at the December 1933 meeting.

ADVERTISING ELIMINATOR



Dr. G. W. Kenrick, Tufts College, with his radio voice eliminator which automatically shuts off radio during announcements

electronics

McGraw-Hill Publishing Company, Inc.
330 West 42d Street
New York City

O. H. CALDWELL, Editor

Vol. VII —FEBRUARY, 1934— Number 2

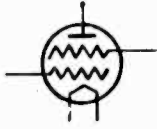

A pedestal for the radio engineer!

IN his presidential address, C. M. Jansky, Jr., the new president of the Institute of Radio Engineers, sounded a timely reminder that the lay world recognize the radio engineer and distinguish between the quacks and the profound practitioners in the profession.

Following President Jansky's lead a step further, it is also high time that the Institute itself show the industry and the world at large the great achievements of the radio engineer. An annual IRE meeting might be held, at which the radio engineers' contributions would be visualized. The Institute's new Committee on Industrial Relations, or more accurately "on the improvement of the status of the radio engineer," could bend some of its efforts in this direction.

No technical group's achievements so nearly border on the miraculous, in the public's mind, as do the works of the radio engineer. For years he has modestly stood aside, while others reaped the plaudits. It is now time the radio engineer himself stepped forward and took his own bow!



Electron optics—new research opportunities

SCIENTISTS still argue the question "What is an electron?" At times it is a wave; at times it is a particle. Engineers working with cathode-ray tubes seem undisturbed by this apparent versatility. For them it is both a wave and a particle.

Its wave-like characteristics make it possible to

concentrate and focus a beam of electrons by electrical lenses. Its projectile-like nature shows up at the end of the tube where its energy of motion becomes luminous energy of delicate complexity.

Whatever its nature, the speeding rain of electron bullets on the fluorescent screen is capable of portraying the breakdown of a spark in 1/100 of a microsecond, or of following the complex detail of a 300 line 24 frame television picture.

Dr. A. N. Goldsmith has suggested that technical schools add courses on "electron optics" to their curricula so that scientists-in-the-making may follow in the steps of J. J. Thomson, Millikan, Davidson and Germer and, using the cathode ray—in which the electrons were first discovered—attempt to penetrate the secret of this amazing dual personality.



The promise of "facsimile"

WITH the new facsimile message service, a sample of which is reproduced on our front cover, RCA begins an interesting series of experiments on short-waves between American cities, destined to have wide future influence on American life. The possibility of sending manuscript messages, sketches, diagrams, music, etc., by facsimile opens attractive possibilities for the public. The relay stations for this short-wave service will also provide important experience in relaying future television impulses.

But above all, in our opinion, this direct move into commercial facsimile foreshadows the coming

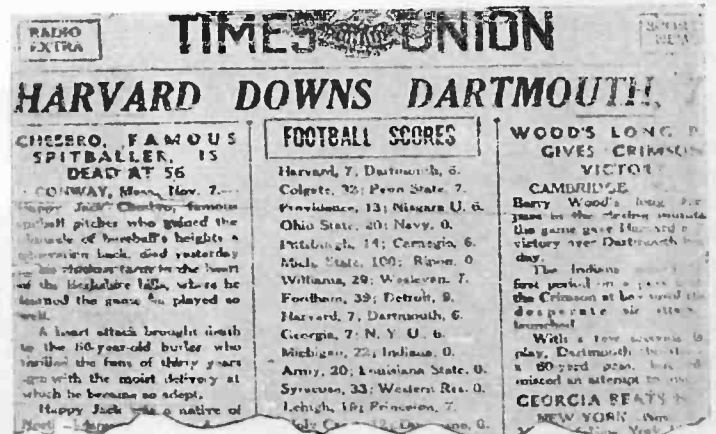

Sample of newspaper page transmitted by facsimile, such as might be sent over broadcast channels during early morning hours

of facsimile broadcasts of printed matter direct to homes, using existing broadcast receivers and the present broadcast channels and transmitters which now stand idle from one to six a.m. Here is a means for delivering printed broadcast programs into the listeners' hands if the newspapers hold back. It involves new recording apparatus to be plugged in, in place of the loudspeaker, at a cost of \$50 to \$25 retail. And it opens up new commercial opportunities for the broadcaster, manufacturer and radio trade.



Bullet speeds measured by photocells

PHOTO-SENSITIVE devices may soon have to themselves the whole field of speed measurements. Already horse-races and athletic contests are most accurately timed in this way. Photocell speed-traps in the roadway paving have given accurate notice of automobile speeding to police further along the road.

And now photronic cells have been used by the Army bureaus for timing the speed of bullets from regulation army rifles. The bullets are fired through a series of focussed light beams, each impinging on its photocell. Although the eclipse of each cell lasts only one twenty-thousandth of a second, the indications are unfailing, and bullet velocities as high as 3000 ft. per second can be measured within one foot per second.



Escalator started by photo-cell

THE thrifty Germans do not have their public escalators operating continuously like those in the United States, which are in motion whether carrying passengers or not. Accordingly a novel use of photo-cells has been made in the new Innsbrucker Platz railway station in Berlin.

Ordinarily the Innsbrucker escalator is at a standstill. But if a passenger approaches, intercepting a beam of almost-invisible infra-red light, the light-sensitive selenium cell operates through relays to start up the escalator, which then runs

through a complete cycle of travel necessary to deliver the passenger to the top of the rise. If meanwhile other persons come along, the machinery continues running until the movement has been sufficient to deposit the last passenger at the top.



Supersonic carrier waves in air

AN interesting new field of "carriers," available without benefit of the Federal Radio Commission, is opened up by Professor G. W. Pierce's recent experiments at Harvard in using high-pitched, supersonic air waves as the modulated carriers of audible sound. Frequencies of 20,000 to 80,000 cycles per second are radiated by the sender mechanism, frequencies to which the ear is insensible. But when voice or music is impressed on such a carrier, and the wave is picked up at a distant point and demodulated, the original sounds are recognizable. Such carrier-waves in air proceed in beams like a searchlight's rays; are capable of being reflected from flat surfaces as from a mirror; and are intercepted by objects obstructing their path.

Already in his experiments, Dr. Pierce has conveyed music half a mile on the wings of his inaudible high-frequency carrier waves.

CONTROLLING "AUDITORY PERSPECTIVE"

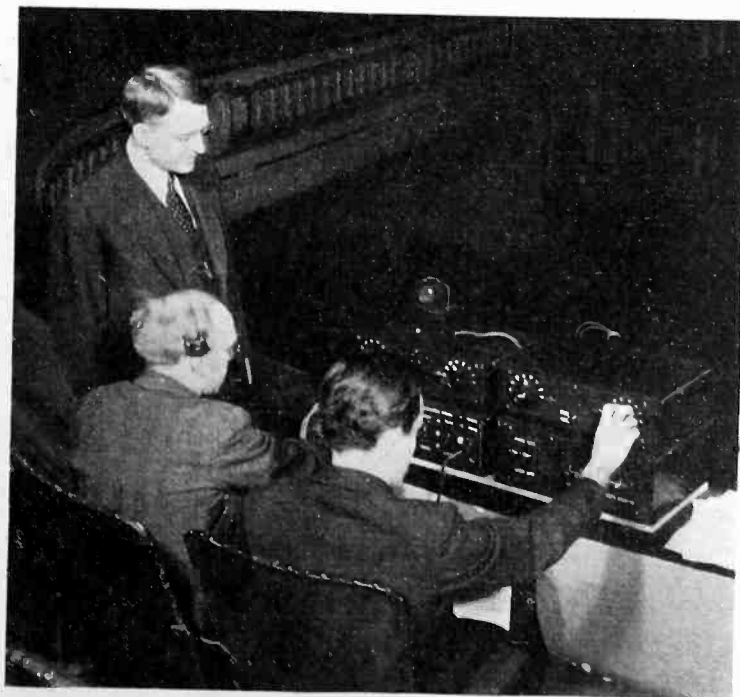

Dr. Harvey Fletcher, physical research director of the Bell Laboratories, and the control panels for the three channels which produced effects of "auditory perspective" demonstrated before New York engineering societies last month

REVIEW OF ELECTRONIC LITERATURE HERE AND ABROAD

Progress in insulating materials for r-f

[L. ROHDE, Physical Laboratory, Munich]. The interest has shifted from materials which are easy to work to materials which keep their shape, are mechanically strong and have low losses. Metal sheets used for r-f condensers are replaced by mica sheets on which a film of silver has been deposited. The properties of quartz depend on the amount of carbon which is present as impurity, and the film of moisture clinging to its surface causes losses which disappear only above 60° C. At a wave length of 100 meters the best quartz glass gives a loss of $\tan d$ (in thousandths) equal to 0.11, fused quartz an average of 0.18. Frequentia (a magnesium silicate of yellowish or greenish color occurring naturally as soapstone with less than 1.6% of iron oxide) gives 0.38, and Calan 0.19. The raw material for Calan is talc; the kilned mass presents, in contrast with porcelain, a predominantly crystalline structure. Coils are obtained by depositing metal films on supports of Calit, a similar product. The damping of oscillating circuits may be kept below 0.0015 at 100 m.—*Zeits. techn. Physik* 14: 480-483. 1933.

Electronic flaw detector for nonmagnetic metals

[D. W. DANA, Engineering Dept., G. E. Vapor Lamp Company.] The piece to be inspected, a short length of tungsten wire such as is used for instance in lamp seals, is passed axially through a coil forming part of the circuit of a vacuum tube oscillator. A piece of metal in an alternating field has a non-uniform flux distribution due to the presence of eddy currents. The losses are influenced by the presence of cracks or rough spots, the frequency of the impressed e.m.f. determining the depth to which the exploring action reaches. When using 6 Mc. the response is limited to flaws near the surface of the conductor. If the output of another radio frequency oscillator is heterodyned with the first source, so that zero beat obtains when a perfect wire is in the center of the coil, and the combined output applied to an equal ratio arm resistance type Wheatstone bridge changes of 5 per cent in the diameter of the wire will produce beat notes of roughly 1000 cycles per sec. The remainder of the audio spectrum is available for ascertaining flaws.—*Rev. Scien. Inst.*, 5: 38-41. Jan. 1934.

Depressed propagation for broadcasting

[O. Böhm, Telefunken Laboratory] While power is saved by using narrow beams for communication between fixed points, ordinary broadcasting stations can at least improve their service by eliminating the radiations sent skyward. In the case of short waves, the solution is to use several dipoles (half wavelength antennas) and to place them in a straight line one above the other, supplying them with power from Lecher wires. Another method is to bend the dipoles into half circles and place them parallel to the ground one above the other, or use them in the form of circles or polygons fed in phase. The electric lines of force spread in concentric circles parallel to the ground (Zeesen antennas built by Telefunken). In the case of longer waves the radiation leaving under a high angle with the ground is reduced to small values by compensation, using a disk antenna or several antennas forming a cylindrical surface or an antenna with a current node, the main purpose being to get rid of night time fading at 60 miles distance.—*Hochfr. Techn. El. Ak.* 42: 137-145. 1933.

Carrier current communication

[J. GARCZYNSKI, Telegraph Service of the French Army.] Development of the equipment has progressed along different lines in Europe and in the United States. Until recently three of the European manufacturers, Telefunken (now Siemens, and A.E.G.), Peregó (Italy), Haute fréquence (France), used one wire and the ground, and only one (Telefonwerke) two wires as is the rule in America where the distances to be bridged are considerable. An assembly of condensers shaped like Leyden jars is now invariably used for coupling receiver and sender to the line, inductances being added to match the equipment to the impedanc of the line which is purely ohmic. To prevent the current from entering branch lines, rejector circuits are used in Europe; in America the custom is to make up for the losses by using more power, 50 watts and more in place of 10 watts. Only one carrier frequency is used here, whereas European engineers resort to several different frequencies for telephonic conversation. The available channels are rapidly being occupied and in Switzerland, for instance, agreements as to the distribution of frequencies had to be concluded between power companies.—*Onde electr.* 12: 385-413. 465-500. 1933.

STETHOSCOPE FOR WATCHES

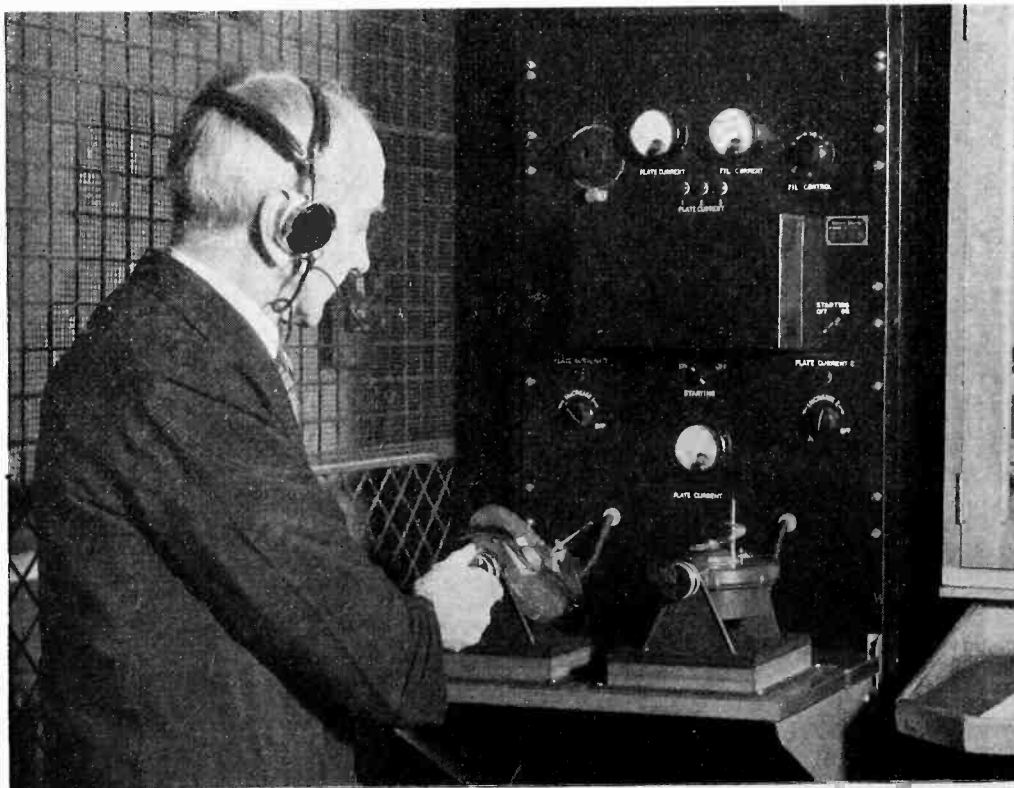

A sick watch is compared to a master watch, by an electronic stethoscope by F. T. Haschka, head of Tiffany & Company's watch shop

General properties of photoelectric cathodes

[G. DEJARDIN, University of Lyons] In the course of a report on recent work in the field of vacuum and gas-filled photoelectric cells, which includes the part which the relative positions of anode and cathode play as well as screens, normal and selective effect, thin and massive layers, a list is given of the results recently published regarding the sensitivity of photo cells in white light of a definite composition.

Surface of cell

	μ A per lumen	Color temperature of source O K
Sodium treated with sulphur	2.4	2848
Sodium after vaporizing sulphur and sodium	4.3	2848
Sodium treated with sulphur and air	6.5	2848
Sodium treated with sulphur and oxygen	6 to 8	2848
Potassium treated with hydrogen	1	2848
Potassium treated with hydrogen	1	2710
Potassium treated with hydrogen	0.5	2800
Potassium treated with sulphur	1.8	2848
Potassium on oxidized copper	0.8	2650
Potassium film on copper or silver	1.0	2800
Potassium on oxidized silver	3 to 29	2700
Rubidium	0.44	2650
Rubidium film on silver	5.0	2800
Cesium	0.17	2650
Cesium on barium fluoride	1.7	2680
Cesium on cesium oxide	12	2680
Cesium on cesium oxide with cesium	200	2680
Cesium on oxidized silver	25 to 35	2710

Revue gen. Electr. 34: 515-526. 555-566. 591-607. 629-637. 1933.

Push-pull detector for decimeter waves

[H. E. HOLLMANN, Heinrich Hertz Institute, Berlin.] The Barkhausen circuit with positive grid may be considered as an ordinary oscillating circuit, and in which the dynamic char-

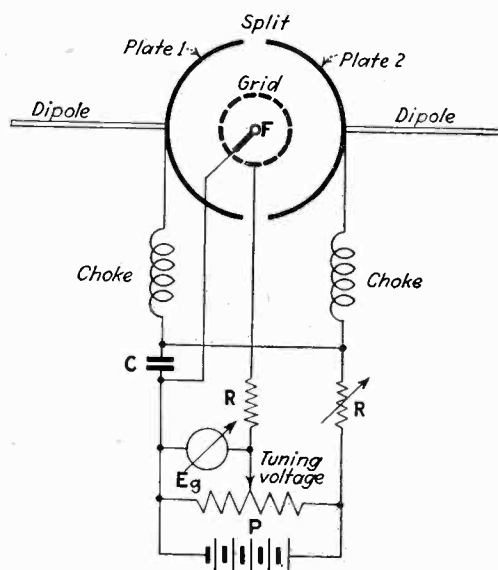

acteristics are determined by the finite time of travel of the electrons (phase lag between voltage and current which may cause a falling curve). The lower and upper bend of the characteristic allow the tube to function as detector. The voltages available are not fully utilized, therefore, when the two Lecher wires coming from the antenna are connected to grid and plate, or if it is

done it is much better to use two tubes in push-pull, the output resistance being placed between the grid and the positive pole of the grid battery, or to use a single tube in which the cylindrical plate is split in two. The plates influence the path of the electrons and a falling characteristic curve may result, along which oscillations may take place. The tuning is nearly independent of the Lecher wire system and by merely varying the grid potential a wide range of frequencies may be tuned in.—*H. F. Techn. u. El. Ab.* 42: 185-190. 1933.

Theory of detection

[M. J. O. STRUTT, Philips Research Laboratories, Eindhoven] a source of modulated r-f voltage ($E \cos x + e \cos y$) having the internal resistance r is applied to the combination of an impedance Z in series with a rectifier. It is shown that the actual characteristic curve of rectifiers may often be represented by a sum of exponential functions of the form $\epsilon^{a \sin pt}$. A single term suffices at low voltages (Barkhausen). The advantage of the method is that it furnishes without any further work the strength of the constant term and all the higher harmonics, because the exponential term can be simply expressed by the corresponding series of Bessel functions which may be found in mathematical tables.—*H. F. techn. El. Ak.* 42: 206-208. 1933.

Emergency acoustic treatment

[Continued from page 41]

register units with Stromberg-Carlson cones, and 12 Boonton Research Laboratory high-frequency units were installed in a non-symmetrical arrangement. These units were arranged for binaural reproduction and each group was served by a separate output amplifier—six in all. The bass units weighed 300 pounds each and the total weight of the sound projector with the baffle was approximately three tons.

Although there were 6,000 persons on the stage at one time in some of the episodes, the stage action was in pantomime without vocal expression. The sound, perfectly synchronized, came from the sound studio far removed from and out of sight of the stage. Some of the sound effects required a tremendous sound level and at all times it was necessary to maintain sufficient level to mask the noise made by actors entering or leaving the stage in groups of a thousand or more. No overloading was experienced and no trouble with sound projector units except a few repairs to the bass unit cone spiders. No cones have probably ever been required to withstand such severe service or as heavy loads.

Every evening, as a prelude to the performance, the

Riverside church Rockefeller carillon and organ were transferred to the auditorium over special, high-quality telephone circuits. The effect of the bell and organ music in that tremendous auditorium was beyond description and evoked much favorable comment.

The location of the sound room and the necessity for close coordination made two auxiliary sound systems and an elaborate telephone system necessary—one for eavesdropping the general director, another as a monitor for the dressing room and lighting control. Every operation and action depended on a cue from the music or speech. The sound-control men had to be able to read and follow the musical score to anticipate changes in set-up and place extraordinary emphasis on certain passages.

In describing the sound, critics stated that it was the first time they had ever heard faithful reproduction and such tremendous volume levels.

"The Romance of a People" played 21 performances to more than 400,000 people in New York. Preparations are now being made for performances of the Pageant in London, England, and several cities in the United States.

The fact that it was possible to correct the acoustics and make everybody hear in this largest auditorium in the world (and one of the poorest from an acoustic standpoint) is an indication that a great many other old buildings can be reclaimed for such purposes.

+ NEW PRODUCTS

THE MANUFACTURERS OFFER

Noise meter

ELECTRICAL RESEARCH PRODUCTS INC. 250 W. 57th St., New York City is introducing a new general purpose noise meter, RA-138. An unusually high degree of accuracy has been obtained by providing a stable oscillator for secondary overall field calibration of the transmitter and amplifier. A special moving-coil microphone requires no polarizing potential. It may be placed as far as 200 feet from the sound-meter case, when desired.

A true ear characteristic is obtained by providing an amplifier frequency response characteristic like that of the average ear for sounds of 40 db loudness. Damping in the indicating meter is also designed to simulate the ballistic characteristic of the ear.

The whole equipment is contained in a single, steel-reinforced, leatherette covered case. It is simple to operate and accurate readings may be made very rapidly.—*Electronics*.

Airplane radio receiver

THE CROSLY RADIO CORPORATION, Cincinnati, Ohio, has put on the market a special five-tube superheterodyne for airplanes, which receives throughout both the broadcast and radio beacon ranges (540 to 1,700 kc., and 235 to 600 kc.). Such a set gives the aviator instant contact with weather stations, beacons and other radio guides to safeguard air travel. B batteries are eliminated by the Crosley Synchronode power unit. The receiver weighs under ten pounds, complete, and the B source weighs 9½ pounds. A companion ground-station radio receiver is also provided by the manufacturers. Crosley Air Roamio airplane set, \$100; ground-station receiver, \$59.50.—*Electronics*.

Stiffness and resiliency tester

SMITH-TABER, CONSULTING ENGINEERS, North Tonawanda, N. Y., have developed a new precision stiffness and resiliency tester. This instrument is for measuring the degree of rigidity of flexible materials, such as paper, cloth, thin metals, filaments, springs, strips, insulation, etc. The finest filament up to 0.050 in. diameter wire, or thinnest foil up to sheet material, .010 in. thick may be quickly and accurately tested with the Smith-Taber precision tester. Price, \$170.—*Electronics*.

A-C converters

A COMPLETE LINE of converters for changing 32 volt and 110 volt direct current to 110 volt alternating current has just been added to the Pioneer Gen-E-Motor Corporation of 1160 Chatham Court, Chicago, Ill.

Two series are available; the standard series which has a 110 volt-ampere rating which supplies ample power for operating all usual size alternating-current radio receivers and most light electrical appliances; and the heavy-duty series which has an output of 150 volt-

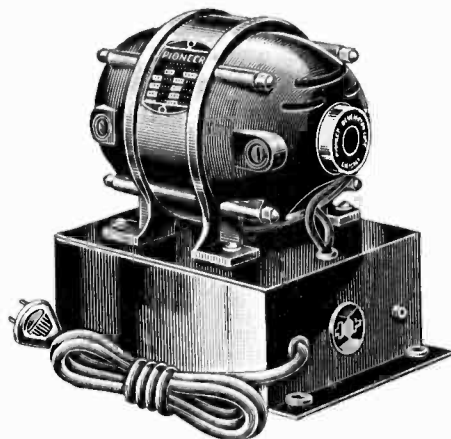

amperes and will operate the largest receivers and many electrical appliances.

These units are provided with complete filter systems which assure noise-free operation of radio receivers.—*Electronics*.

Two way police radio

SIMPLER, MORE COMPACT and lower in cost, the 5-watt answer-back transmitter for use in police patrol cars, now being developed by the Electronics Division of the Hygrade Sylvania Corporation, Clifton, N. J., is expected to extend the popularity of two-way ultra-short-wave police radio systems. This new transmitter, according to D. E. Replogle, chief engineer of the organization, means a transmitter not much larger than the receiver already installed in many police patrol cars for one-way systems. There is no longer need for separate batteries. Power for the transmitter is supplied by the regular storage battery of the car, while the high plate and bias voltages are made available by a small motor-generator unit operating on the car's battery. The new transmitter can be employed for a two-way police radio system, either simplex or duplex.—*Electronics*.

Visual signal

THE NEW KIRKLAND BULLS-I-UNIT, manufactured by the H. R. Kirkland Company, New York City, and distributed by Graybar Electric Company, is a simplified device for effecting visual signals without the usual complex maintenance and installation problems. The unit is a complete annunciator, consisting of light-chamber, terminal block, socket, slip cap, and symbol insert.

The socket is completely insulated from the chamber, and takes a standard candelabra-base lamp, or miniature-base lamp with adapter. Various lamps up to 120 volts are available. For low voltages, 6, 12, 18 or 24 volts, a G 6 type lamp or elevator lamp is recommended. The magnifying lens shows up the symbol clearly, and permits it to be seen from nearly every angle.—List price, \$3.—*Electronics*.

Tapering battery-charger

P. R. MALLORY & COMPANY, Indianapolis, Ind., have developed a new "5535" battery charger, so named because the initial charging rate of 5.5 amp. automatically tapers to 3.5 amp. as the battery becomes fully charged. Thus it never overcharges and cannot harm the battery. The fuses are mounted externally, where they are easy to change, and a spare fuse is provided. Installation is made by an easy thumb-screw dash attachment, two wires to ammeter and ground. On inserting the plug and turning on the switch the battery charges. Pull out plug, turn off switch, and the battery is off charge. As the charger is compact it can be hung on the garage wall, mounted on window sill, or placed on running board. When touring the charger can be carried in the car. The charger is attractively finished, economical, effective and fool-proof.—*Electronics*.

Double lapel mike

THE LAPEL MICROPHONE, boon of portable, remote and special-event broadcasts, has found another improvement. In the past whenever a speaker turned his head, even if ever so slightly, part of the words were lost. Now along comes Universal Microphone Company, Inglewood, Cal., with two lapel microphones corded together with a special line. One of the tiny instruments goes on each lapel.—*Electronics*.

Crystal speakers for centralized radio

THE NEW CRYSTAL SPEAKER is particularly adapted for centralized radio in schools, hospitals and hotels, according to A. L. Williams, president Brush Development Company, 3715 Euclid Ave., Cleveland, Ohio.

This most compact of all speakers gives a good response throughout the broadcasting range and has a sensitivity much greater than that of the magnetic speaker and somewhat greater than that of the ordinary dynamic.

The crystal speaker gives a clearer tone and is less heavy and bulky. In comparison with other types, the crystal speaker requires less power for operation and only a two-wire lead is necessary, since there is no field current to be supplied, which represents the further large saving in power consumption where a number of speakers have to be operated simultaneously. Speakers installed three years ago have had no servicing since.—*Electronics*.

Voltage Adjuster

NO LONGER NEED AN electrical appliance, radio or refrigerator be operated below normal performance because of poor voltage conditions of the supply line. The variable-voltage adjuster, designed and manufactured by The Acme Electric & Manufacturing Company of Cleveland, Ohio, is a unique voltage regulating device, that permits the regulation and adjustment of the primary line voltage from either below or above normal to the proper operating voltage. Built similar in construction and appearance to an ordinary step-down transformer, a series of taps has been created within the case. A manually operated dial provides the regulating medium for control. A sensitive and extremely accurate instrument indicates the secondary voltage in connection with the regulation from the operating dial.—*Electronics*.

Sensitive relay

A RELAY THAT OPERATES ON low current values and is especially adapted to photoelectric cell application is announced by Ward Leonard Electric Company, Mt. Vernon, N. Y. The design and construction of the magnetic circuit gives high sensitivity at low induction, good contact torque at pull-up and a drop-out that can be adjusted to 85 per cent of pull-up value. These relays will operate on about 14 milliwatts and where small gaps are permissible they can be adjusted to give positive operation on 4 milliwatts.—*Electronics*.

Transmitting tube

THE NEW 354 GAMMATRON TRANSMITTING TUBE, designed and made by Heintz & Kaufman, Ltd., 311 California St., San Francisco, Calif., is a departure from conventional-type transmitting tubes in many ways. Structural strength is a feature of this new greatly-simplified design. No internal insulators are used, entirely eliminating this source of

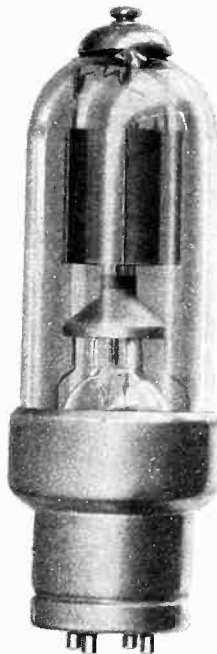

gas during service. Both grid and plate elements are made of tantulum, as a further prevention against gassing. And, proceeding on the principle that a tube properly evacuated needs no getter, this manufacturer eliminates the getter. The filament of thoriated tungsten is completely shielded. The plate has no collar on the stem to break down, being entirely supported from the glass envelope. Its rated output of 100 watts, it is said, can be greatly exceeded with proper handling. Present selling price \$22.50.—*Electronics*.

Stationary and portable amplifiers

THE SIMPLEX ELECTRIC COMPANY, Inc., 100 Fifth Ave., New York City, announces a new complete line of stationary and portable amplifiers, of both Class A and Class B types, in the category of single-unit amplifiers, drivers and power stages, in a range of power output conservatively rated at 3.2 watts to 175 watts. A self-contained microphone current supply, over-all gain or mixing control, volume controls for microphone and pickup, and tone control, are other features. The input and output have tapped impedance transformers for readily matching the impedances of the input apparatus and loudspeakers. The Simplex Electric Co.'s catalog No. 7 describes this equipment.—*Electronics*.

Supersensitive relay

THE AMERICAN INSTRUMENT COMPANY, 774 Girard St., Washington, D. C., announces a new supersensitive mechanical relay for use with thermoregulators, contact-making instruments, and other low-current devices. An operating current of 6.9 milliamperes at 6 volts d.c., or 0.041 watt, and a contact rating of 1,100 watts, give it the remarkably high relaying ratio of 24,000 to 1. The high resistance of the coil of this instrument makes it ideal for use with vacuum-tube relay circuits. Its small size suggests that it will find application as a component part in many types of equipment.

Overall dimensions are: Length, $3\frac{5}{8}$ in.; height, $3\frac{1}{2}$ in.; width, $1\frac{3}{4}$ in. Coil rating: 875 ohms, 6.9 milliamperes at 6 volts.

Contact rating: 10 amp. at 110 volts, or 5 amp. at 220 volts, a. c.; available in normally open, normally closed, or single pole double throw model.—*Electronics*.

Tube-making machinery

THE KAHLE ENGINEERING CORPORATION of Union City, N. J., manufacturers of incandescent-lamp, radio-tube and neon-tube equipment, has acquired the entire line of rights, designs, patterns, drawings and machinery of the Arrow Manufacturing and Machine Company of North Bergen, N. J.

The Arrow Company is an old, long established manufacturer of high grade modern automatic and semi-automatic machinery whose catalog includes equipment of the most modern development for high speed precision production.—*Electronics*.

Rectifier for amplifying systems

AN IMPROVED RECTIFIER for use with all amplifying systems in the broadcast, recording, and talking-picture fields where direct current is required for the filaments of the amplifying tubes, has been developed by the Gates Radio & Supply Company, Quincy, Ill. This Model A9S low-voltage rectifier takes the place of storage batteries and motor-generators also for telephone service, laboratory work, burglar-alarm systems, railway signals, etc.

Eight amperes at 12 volts or 4 amp. at 24 volts, is delivered from duplicate sections, 4 amp. from each. The rectifier panel measures 19 in. wide and 30 in. high, carried on a heavy angle-iron frame, 10 in. deep. Rheostats permit line-voltage adjustments; the voltmeter allows checking of both rectifiers by the plug-jack method. The energy consumption is 110 watts per unit, or 220 watts in all, and the ripple content is one-tenth of one per cent. Price \$245.—*Electronics*.

U. S. PATENTS IN THE FIELD OF ELECTRONICS

Electron Tube Applications

Electrometer. Method for measuring potentials or small quantities of electricity which are positive with respect to ground, consisting in applying an input to the cathode plate terminals and reading the result in the grid cathode circuit. The tube is a four-element tube. William Henry Crew, Annapolis, Md. No. 1,938,136.

Inductor compass. A synchronous alternating current inductor compass. Ross Gunn, Washington, D. C. No. 1,939,690.

Distance measuring equipment. An altimeter for aircraft involving the use of a source of X-rays on the aircraft. P. N. Bossart, Union Switch & Signal Co. No. 1,940,114.

Recorder. Method of recording electrical energy by projecting a stream of marking fluid on a record sheet and controlling the stream by electrostatic attraction exerted transverse to and directly on the marking fluid in accordance with the energy. C. W. Hansell, R.C.A. No. 1,941,001.

Oil testing. Light is projected through a uniform thickness of the oil to be tested into a light sensitive device. V. A. Schoenberg, Niles Center, Ill. No. 1,940,373.

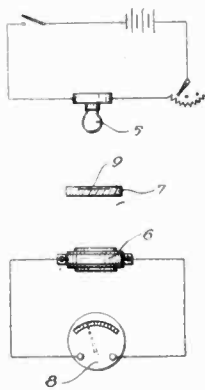

Electrical musical instrument. Patent 1,933,294 to 1,933,299, inclusive, to the Miessner Inventions, Inc., on electrically controlled musical instruments and electrical production of music.

Vacuum tube voltmeter. Method for maintaining the heater current of the vacuum tube constant, including a potentiometer for detecting variations of the current from a predetermined value. Marion S. Sanders, Bristol, Va. No. 1,931,558.

Testing system. A method of detecting and measuring physical conditions and properties of materials by passing the output current of a thermionic tube circuit rapidly first through the material to be tested and secondly through a material of known electrical condition. J. J. Dowling, Dublin, Ireland. No. 1,932,337.

Voltage regulator. Electron tube method of regulating an electric generator, involving rectifier, voltage regulator and amplifier tube. D. V. Edwards, assigned to Electrons, Inc. No. 1,941,076.

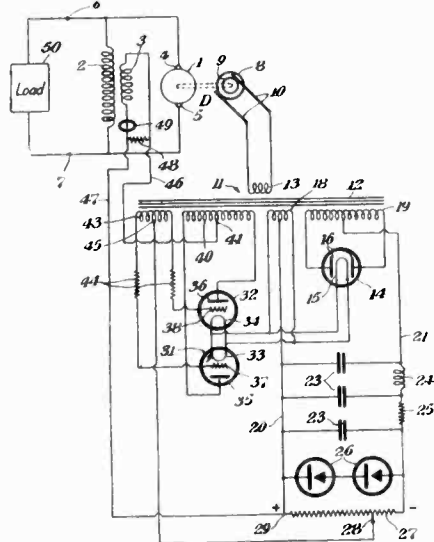

Treatment of metals and alloys. Process of treating ferrous metals and alloys by subjecting them to vibrations of a frequency of the order of ultra audible sound without establishing a marked differential between the temperature in the surface and the temperature in the interior. Georges Mahoux, La Garenne, France. No. 1,939,712.

Electrical musical instrument. Method of simulating vibrato in a fundamental note by means of a second low frequency oscillator. C. D. Lindridge, Bell, Inc. No. 1,940,093.

Traffic signal. Regulating street traffic by light sensitive cell. R. H. Worrall, Washington, D. C. No. 1,940,831.

Electron Tube Apparatus

Testing system. In a three-electrode-tube testing circuit, means for supplying plate and filament energy, plate current indicating means, and means for supplying unidirectional current opposed to the plate current in the indicator. J. H. Miller, to Jewell Electrical Instrument Co. No. 1,940,222.

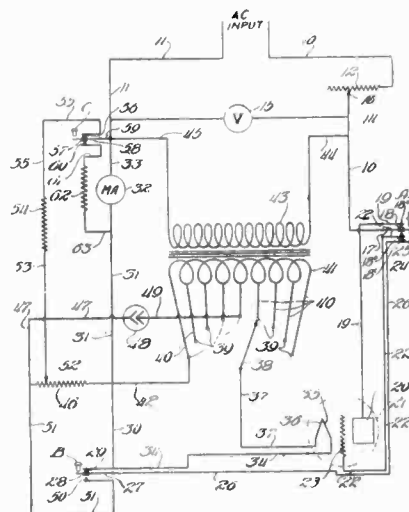

Gaseous rectifier. Construction patent on a rectifier having small rod-like electrodes and large cup-shaped electrodes. C. Spaeth and H. Peary, assigned to Old Colony Trust Co. No. 1,941,421.

Metal-to-glass seal. A vacuum tube seal comprising a copper cylindrical shell, an insulating cylindrical shell member welded to one surface of the copper, and a second insulating cylindrical shell welded to the other surface of the copper shell, members being independent of each other, out of contact with the ends of the copper shell and co-axial therewith. C. V. Litton, Federal Telegraph Co. No. 1,940,870.

Gaseous tube. A grid controlled rectifier with an auxiliary electrode to which is connected a periodically reversing voltage between this electrode and the grid. C. Stansbury, Cutler-Hammer, Inc. No. 1,940,029.

Screen-anode grid-glow tube. D. D. Knowles, W. E. & M. Co. No. 1,939,063.

Light-sensitive cell. A photo-voltaic cell using a copper base having a thermally integrally formed etched crystalline cuprous oxide surface, a co-operating electrode and an electrolyte. S. Ruben, New Rochelle, N. Y. No. 1,941,494. Also a circuit for same. No. 1,941,493.

Glass feeding machine. Apparatus for automatically controlling the weight of glass articles made by the gob feed automatic machine process. The device involves light sensitive cells. K. M. Henry and B. A. Noble, assigned to Hartford-Empire Co. No. 1,941,552.

Vehicle headlight control. Apparatus for the control of illumination involving light sensitive cell, amplifier tube, etc. Richard Hipp, Jr., Pomaria, S. C. No. 1,942,289.

Amplification Detection, Etc.

Electromechanical oscillator. An oscillator, comprising a body of vitreous material of low elastic hysteresis and low temperature coefficient, armatures are attached to antinodal points of the body, and are given an electric charge. Electrodes held in definite relation to armatures bring electric charges of periodically varying value and sign to act in n-1 of said electrodes to constrain body to oscillate. Noel Deisch, Washington, D. C. No. 1,941,445.

Condenser manufacture. Apparatus for producing condensers of uniform capacitance by connecting the condenser under manufacture in the grid circuit of an oscillator, a press for compacting the condenser and means connected in the plate circuit of the oscillator for automatically stopping the operation of the press. P. S. Edwards and C. D. Barbulesco. No. 1,939,883.

Iron core coil tuning system. A method of using an inductance with a compressed magnetic body in the field of the coil, said body having insulated magnetic particles and being of such characteristic that the amplifying circuit has selective properties substantially the same as when said magnetic body is withdrawn. W. J. Polydoroff, assigned to Johnson Laboratories, Inc. No. 1,940,228. Filed Aug. 26, 1929.

Electron coupled oscillator. In a screen grid tube oscillations of a non-regenerative type occur, the screen acting as anode for the oscillatory circuit. The work circuit is connected between the plate of the tube and the B battery voltage. J. B. Dow, Washington, D. C. No. 1,937,512.

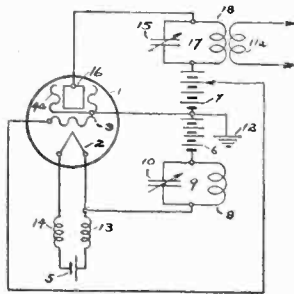

Interstage coupling system. Method for coupling a single ended circuit with a double ended circuit. The primary consists of two windings wound in opposite directions and connected in parallel. The secondary circuit consists of two windings wound in the same direction and connected in balanced relation. Hans Roder, G. E. Co. No. 1,936,438.

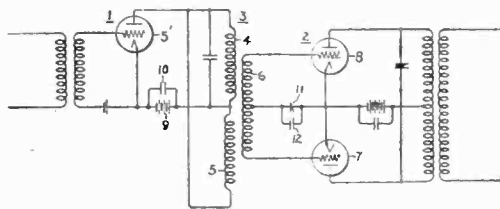

Neutralizing system. Method of coupling of output circuit of two electron amplifiers. E. L. Bowles. No. 1,941,384. See also Bowles, No. 1,941,385, an acoustic system responsive to receive energy over a range of predetermined frequencies.

Resistance amplifier. Resistance capacity amplifier for operating over a wide range of audible and super-audible frequencies, uses a combination of a resistor in series with a capacity connecting the anode and cathode of such magnitude that the phase shift introduced by the coupling capacitor is neutralized. W. A. Fitch, G. E. Co. No. 1,941,345.

Radio Circuits

Automatic volume control. An impedance in the output circuit of the amplifier is non-linear over a portion of its characteristic curve. The voltage across this impedance is used to maintain the level of the system constant. Means are provided for compensating for the non-linearity to produce a linear voltage response across the impedance. H. I. Metz, assigned to W. E. & M. Co. No. 1,940,874.

Remote control system. System for transmitting indications of an instrument to a distance, involving high frequency transmitter. Kurt Wilde, assigned to Builders Iron Foundry, Providence, R. I. Re-issue No. 19,039.

Frequency modulation. A system of receiving a frequency modulated wave. E. H. Armstrong, New York, N. Y. No. 1,941,066. See also E. H. Arm-

strong, No. 1,941,067 on a radio broadcasting system as a means for transmitting an inaudible frequency while certain portions of the program are being broadcast, means to render the reproducers of said receivers inoperative while the inaudible frequency continues to be received. Also No. 1,041,068 on a method for producing a frequency modulated current from a source of fixed phase and frequency. Also No. 1,941,069 on an interference elimination method. See also No. 1,941,447.

Amplifier system. A distortionless amplification system using an auxiliary amplifier to maintain the input at a constant ratio to the input. Walter Hahnle, Siemens & Halske, Berlin. No. 1,940,414.

Modulation system. Wilhelm Kummerer, Telefunken, Berlin. No. 1,940,423.

Vibrator system. A combination transformer and vibrator system for supplying high voltage d-c from a low voltage source. Stephen F. James, Chicago, Ill., applied for Dec. 7, 1931. No. 1,940,496.

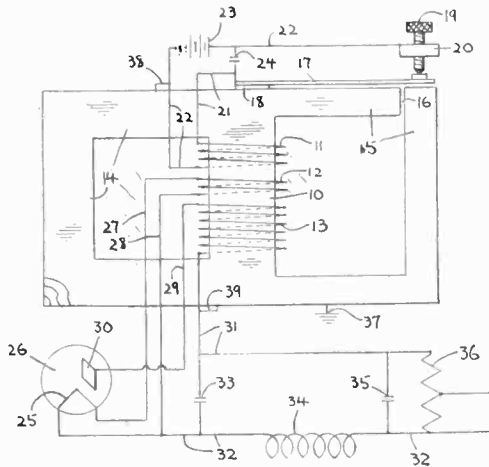

Tuning system. Method of adjusting both condensive and inductive reaction in a tuning system simultaneously. Applied for July 10, 1924. 23 Claims. No. 1,934,722. L. J. Lesh, assigned to Associated Electric Laboratories.

Electron Tubes

Tube construction. A three-element tube control member consisting entirely of metal being coated with one of the following group: silver, copper, lead. Frederick Barton, assigned to G. E. Co. No. 1,934,477.

Polyphase current generator. Several grids symmetrically disposed about a cathode and several anodes constituting separated segments of a hollow cylinder surrounding the cathode, grids being between the anodes and the cathode. H. A. Affel, assigned to A. T. & T. Co. No. 1,935,594.

Cathode ray tube. Method of producing a beam of current, a circuit including said beam and having two parallel branches and method for adjusting the beam so that a definite amount is included in each of the branches. R. G. Richardson, assigned to Associated Electric Laboratories, Inc. No. 1,932,637.

Photo-electric tube. Method for coating and vaporizing material and condensing it upon the interior of the bulb,

admitting hydrogen to the bulb until a condition is reached at which a glow discharge takes place between the electrodes, removing the hydrogen and applying a source of potential until the tube obtains a maximum sensitivity, then admitting hydrogen until a pressure is reached which gives the desired sensitivity. T. W. Case, assigned to Case Research Laboratory, Inc. No. 1,935,939. Also 1,935,940. T. W. Case on a condenser light.

Patent Suits

1,195,632, W. C. White, Circuit connections of electron discharge apparatus; 1,251,377, A. W. Hull, Method of and means for obtaining constant direct current potentials; 1,297,188, I. Langmuir, System for amplifying variable currents; 1,728,879, Rice & Kellogg, Amplifying system; 1,811,095, H. J. Round, Thermionic amplifier and detector; Re. 18,579, Ballantine & Hull, Demodulator and method of demodulation, D. C., S. D. Calif. (Los Angeles), Doc. E 12-J, Radio Corp of America, et al. v. D. W. Rogers (Los Angeles Radio Mfg. Co.) et al. Patents held valid and infringed Oct. 9, 1933.

1,231,764 (a), F. Lowenstein, Telephone relay; 1,618,017, same, Wireless telegraph apparatus; 1,403,475, H. D. Arnold, vacuum tube circuit; 1,465,332, same, Vacuum tube amplifier; 1,403,932, R. H. Wilson, Electron discharge device; 1,507,016, L. de Forest, Radio signaling system; 1,507,017, same, Wireless telegraph and telephone system; 1,702,833, W. S. Lemmon, Electrical condenser; 1,811,095, H. J. Round, Thermionic amplifier and detector; 1,896,780, F. B. Llewellyn, Modulating device, filed Sept. 27, 1933, D. C., N. D. Ill., E., Div., Doc. 13,499, Radio Corp. of America et al. v. Roots Auto Radio Mfg. Corp.

1,231,764 (b), F. Lowenstein, Telephone relay; 1,618,017, same, Wireless telegraph apparatus; 1,403,475, H. D. Arnold, Vacuum tube circuit; 1,465,332, same, Vacuum tube amplifier; 1,573,374, P. A. Chamberlain, Radio condenser, D. C., S. D. Calif. (Los Angeles), Doc. E 11-C, Radio Corp. of America et al. v. D. W. Rogers (Los Angeles Radio Mfg. Co.) et al. Patents held valid and infringed Oct. 9, 1933.

1,239,852, F. K. Vreeland, Receiver of electrical impulses; 1,251,377, A. W. Hull, Method of and means for obtaining constant direct current potentials; 1,297,188, I. Langmuir, System for amplifying variable currents; 1,544,081, F. K. Vreeland, Transmitting intelligence by radiant energy; 1,573,374, P. A. Chamberlain, Radio condenser; 1,728,879, C. W. Rice, Amplifying system; 1,820,809, E. W. Kellogg, Electrical system, filed Sept. 25, 1933, D. C., S. D. Calif. (Los Angeles), Doc. E. 77-H, Radio Corp. of America et al. v. Westone Radio Corp.

Re. 18,579, Ballantine & Hull, Demodulator and method of demodulation; 1,239,852, F. K. Vreeland, Receiver of electrical impulses; 1,544,081, same Transmitting intelligence by radiant energy; 1,251,377, A. W. Hull, Method of and means for obtaining constant direct current potentials; 1,297,188, I. Langmuir, System for amplifying variable currents; 1,573,374, P. A. Chamberlain, Radio condenser; 1,707,617, 1,795,214, E. W. Kellogg, Sound reproducing apparatus, filed Sept. 27, 1933, D. C., N. D. Ill., E. Div., Doc. 13,498, Radio Corp. of America et al. v. Roots Auto Radio Mfg. Corp.

BRITISH PATENTS IN THE FIELD OF ELECTRONICS

Electron Tube Application

Recording system. Making sound records of the variable width or of the variable density-type in which the position of the zero line of the sound track in relation to the edge of the record track, or the average transparency, is displaced as the amplitude of the sounds recorded varies so that the displacement of the zero line or the average transparency is varied more rapidly than the amplitudes as these increase. Furthermore, the displacement is effected more slowly than the amplitudes as these decrease. A record so produced not only masks ground noises but avoids sudden changes in passing from reproduction to silence, and vice versa. British Acoustic Films, Ltd., London. No. 397,514.

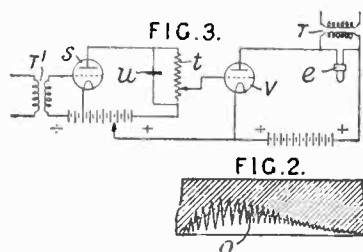

Television. The scanning ray is of constant intensity but scans with a variable speed, by preventing frequencies lower than the frequency at which the picture is completely scanned from modulating the potentials deflecting the scanning ray. M. von Ardenne, Berlin. No. 397,688.

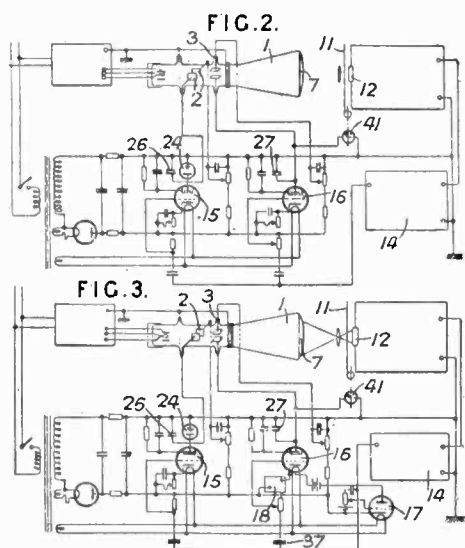

Regenerative amplifier. Resistance capacity or resistance inductance elements which bring about a phase displacement of 180 deg. in the desired frequency, and reaction, which is strongly negative for other frequencies, prevents amplification of these frequencies. Philips. No. 395,596.

Radio Circuits

Hum elimination. In a heater-type tube grid bias voltage is obtained from a resistance in the plate circuit. The biasing resistance is so chosen that the voltage drop across it is large enough to saturate the electron discharge path between heater and cathode to eliminate hum. Telefunken. No. 393,495.

Distortion compensation. To compensate for distortion due to curvature of the tube characteristic or to variation in the external impedance in a voltage amplifier coupled to a power amplifier an out-of-phase voltage is tapped off from one point on the anode impedance and fed back to the grid while at the same time a suitable grid bias is derived from a second point on the anode impedance. Telefunken. No. 393,520.

Automatic volume control system. Use of a pentode tube coupled to the detector output to provide a.v.c. E. A. Tubbs, Marconi Co. No. 393,550.

Neutralized circuit. High-frequency screen-grid amplifier in which the screen grid and cathode are connected to opposite ends of a bridge circuit thus preventing a potential difference existing between screen and cathode due to the current flow through the capacity between screen and plate. Telefunken. No. 393,553.

Direction finding apparatus. A stroboscope device rotates synchronously with a group of two mutually perpendicular frame aerials, the stroboscope device being illuminated by the amplified current from the loop and comprises controlling two lamps one of which indicates the direction of the transmitting station and the other which removes the 180 deg. ambiguity. R. J. Hardy, Paris. No. 393,595.

Band convergence. Electric oscillations of a primary band of frequencies are converted into oscillations forming a secondary band of different width with the aid of two tuned circuits, one of which automatically adjusts its resonance frequency to that of the incoming signal and at the same time alters the tuning of the other circuit. As application the patentee suggests its use in multiplex telephony, a number of secondary bands being sent over a telephone circuit or a single such band being sent over an unloaded line. Mechanical or optical sound records may be made of the secondary band, re-conversion taking place in the reproducer. G. W. Walton. No. 2 Dean St., London. No. 397,880.

Diversity reception. Method of preventing the effects of fading on radiotelegraph signals by using several aerials coupled to high frequency amplifiers through super-regenerative detectors, audio quenching frequency supplied from a common oscillator. E. F. Carter, British Thomson-Houston Co. No. 397,762.

Television. Involving cathode ray tube synchronizing signals developed by a Nipkow disk, etc. A. W. Vance, Marconi Co. No. 395,499. See also No. 396,455. E. W. Gent, E.R.P.I. on a light valve for television use.

Superheterodyne circuits. The intermediate carrier frequency is filtered off from an intermediate frequency amplifier, collectively amplified and re-injected into the circuit of a succeeding detector for demodulation. The intermediate frequency is thus re-injected into the circuit of a detector at a higher amplitude than the side bands which have passed through other amplifying valves. R. M. Barnard, Standard Telephones & Cables, Ltd. No. 396,772.

Electron Tubes

Television lamps. A glow-discharge lamp for use in photographically recording sound, and in television circuits, energized by a current producing continuous ionization and modulated by an additional current. V. T. Braman, New York, N. Y. No. 397,466.

Two-stage tube. A high-frequency amplifying valve consisting of two stages in the same envelope separated by a metallic screen, one stage consisting of tube plus coupling element, such as condenser and grid leak. D. S. Loewe and P. Kapteyn, Berlin. No. 397,612.

Thermionic cathodes. Following patent granted to J. T. Randall of the G.E. Co., London. No. 397,656.

Thermionic cathodes, particularly for discharge lamps, of the type consisting of a self-supporting mass heated by means, for example a tungsten spiral, which do not contribute to the rigidity of the mass, are prepared by forming a mass of the desired shape out of alkaline earth peroxide and decomposing the peroxide by heat. Metal, particularly tungsten, powder, may be mixed with the peroxide. The peroxide may be bound with a 10 per cent solution of nitro-cellulose in amyl acetate, in the proportion 20 grams of barium peroxide to 4 to 5 grams of the binder. Gum tragacanth is not suitable. In one example the mixture is squirted into rods 4.5 mm. in diameter, and heated in a vacuum furnace. The temperature is raised to 125° C. during a period of 30 minutes, then from 125° C. to 250° C. during a further period of 30 minutes; this decomposes the binder. The temperature is then raised to 1150° C. during a period of 90 minutes, whereby the peroxide is decomposed. To sinter the rods they are placed in a molybdenum boat lined with tungsten in a hydrogen-filled furnace and the temperature is raised to 1620° C. during a period of 30 minutes and held there for 10 minutes. A magnesia lining may be used instead of tungsten.

Electronic emitter. A reducing agent, such as aluminum or carbon, is mixed with alkaline earth compound such as hydroxide, carbonate or nitrate, used to form an electron emitting coating on the cathode, for example, of platinum. The carbon may be deposited on the cathode, after decomposition of the alkaline earth compound oxide by catalytic decomposition of hydro-carbon vapor in the tube. Telefunken. No. 397,836.

JOBS FOR ELECTRON TUBES



RELAYING



Standard G-E Control Tubes

Thyratron tubes with quick-heating filaments, requiring small controlling power—FG-17, FG-27, FG-65

Thyratron tubes with heater-type cathodes, requiring small controlling power — FG-29, FG-57

Shield-grid Thyratron tubes for power applications where the controlling power is extremely limited — FG-95, FG-97, FG-98, FG-105

Gas-filled Thyratron tubes for control purposes where effects of low ambient temperatures are important — FG-81

“Normally-off” Thyratron tubes for special control purposes — FG-33

Large metal Thyratron tubes for control of high power — FG-53

Thyratron tubes for the control of power at high voltage — FG-41

FOR engineers and scientists interested in the application of control tubes to industrial and experimental problems, General Electric offers an extensive line both of mercury-vapor and of gas-filled hot-cathode tubes.

The varied types, sizes, and characteristics available afford the user an opportunity to obtain the “valve” best suited to his requirements. With G-E tubes, successful performance is assured, for they are efficient, dependable, and long-lived.

Write for details about these G-E control tubes. Also, if you desire information regarding other G-E tubes for amplification, light-sensitive response, rectification, measurement, etc., our specialists will gladly assist you. Address the nearest G-E office, or General Electric, Dept. 6A-201, Schenectady, N. Y.

080-5

GENERAL ELECTRIC

HIGH QUALITY

Broadcast Studio Equipment



1

1 TYPE 44-AP VELOCITY MICROPHONE

- uniform frequency response—uniform directivity
- the microphone without a diaphragm
- the choice of the leaders

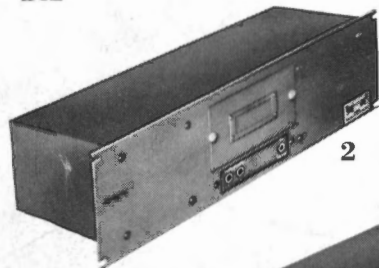

2

2 TYPE 41-B PRE-AMPLIFIER

- designed to insure full realization of the improved fidelity and greater artistry made possible by the use of velocity microphones

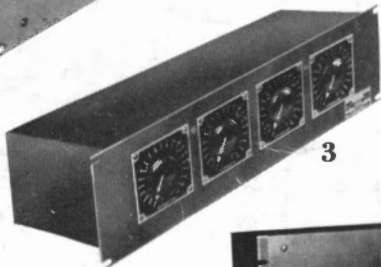

3

3 TYPE 46-A FOUR POSITION MIXER PANEL

- for use with high quality microphones
- balanced variable ladder network—positive contact
- absolute minimum of noise

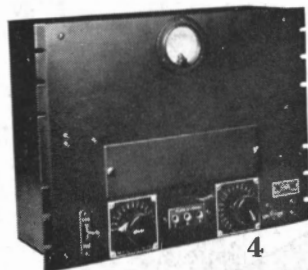

4

4 TYPE 40-C PROGRAM AMPLIFIER

- complete a-c operation
- self-contained volume indicator
- supplies power for pre-amplifiers and auxiliary microphone
- an all purpose amplifier

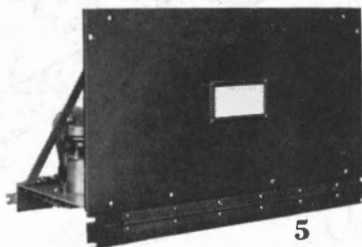

5

5 TYPE AA-4194-B MONITORING AMPLIFIER

- another completely a-c operated amplifier designed especially for use with high quality monitoring speakers

6 REMOTE CONTROL STATION

Supplied with AA-4194-B Monitoring Amplifier

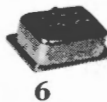

6



7

7 TYPE UZ-4209 SPEAKER

- used with the AA-4194-B Monitoring Amplifier

The demand for this new line of broadcast studio and control equipment is adequate assurance that it fulfills definitely the **REQUIREMENTS SET BY** the ever advancing standards of broadcasting. Write the nearest office for bulletins and prices.

RCA VICTOR COMPANY, Inc.

CAMDEN, N. J., U. S. A.

"Radio Headquarters"

New York: 153 E. 24th St. Chicago: 111 N. Canal St. San Francisco: 235 Montgomery St.
Dallas: Santa Fe Bldg. Atlanta: 144 Walton St. N.W.

