

electronics

radio, sound, communications and industrial applications
of electron tubes • • • design, engineering, manufacture

Cost versus
quality in
radio parts

New tubes for
ultra-short waves
(See page 214)

The Radio
Industry Code

Outdoor movie
theaters

New high-speed
electron guns

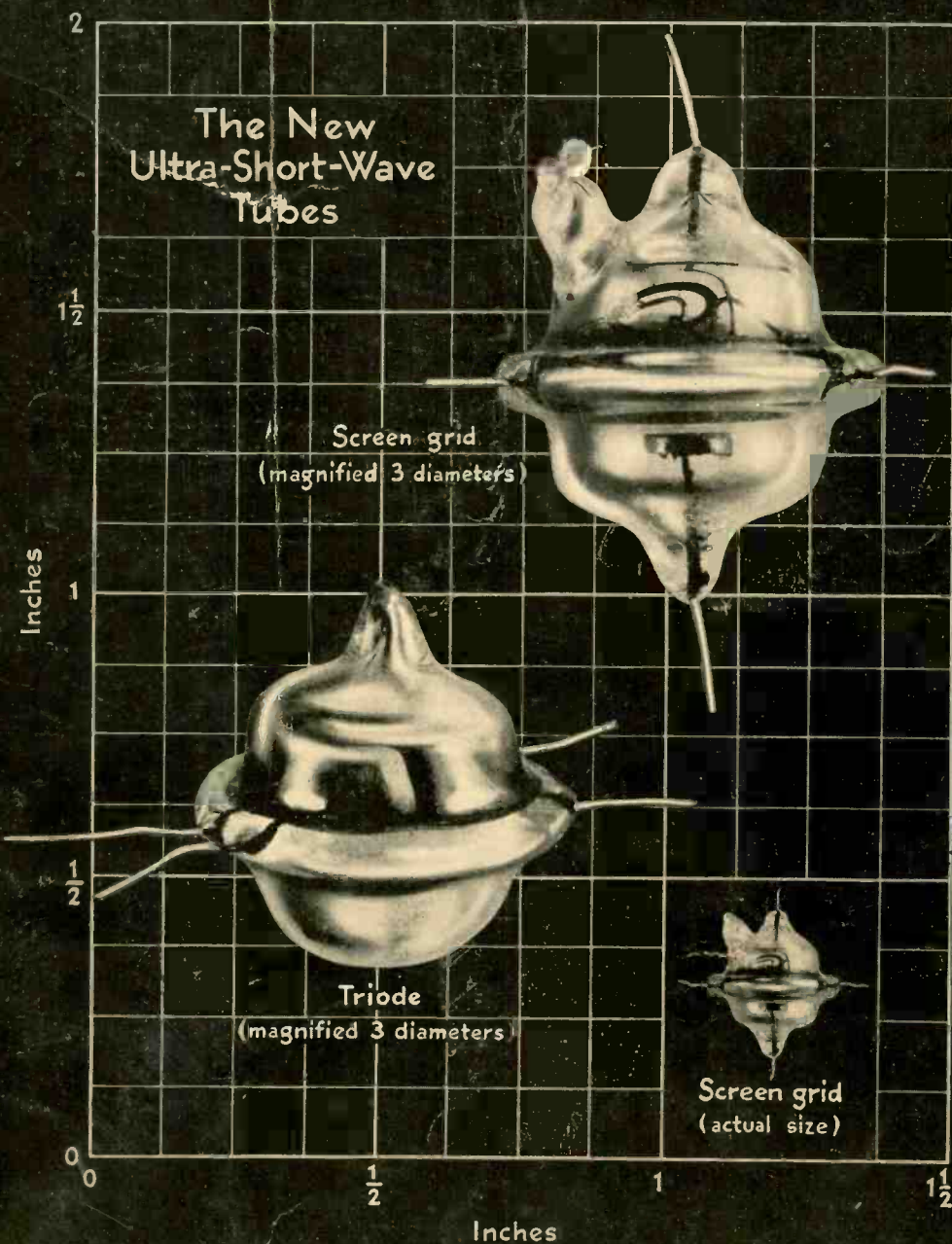

McGRAW-HILL PUBLISHING COMPANY, INC.

Price 35 Cents

AUGUST, 1933



Seems like 1929 *Again*

so enthusiastic is
the reception
of our New

1933

Centralab

CENTRAL RADIO LABORATORIES

RADIOHM

Wires buzzing, cables calling for more Radiohms, 'phone calls with insistent voices on the other end . . . all bring back the good old hectic days. Today—in 1933 Centralab is still producing the outstanding control—the standard by which all others are judged.

For original equipment or for replacements use
CENTRALAB Radiohms.

CENTRAL RADIO LABORATORIES
MILWAUKEE



Announcing..

the WESTON METHOD of SELECTIVE ANALYSIS



ANALYZER OBSOLESCENCE IS BANISHED!

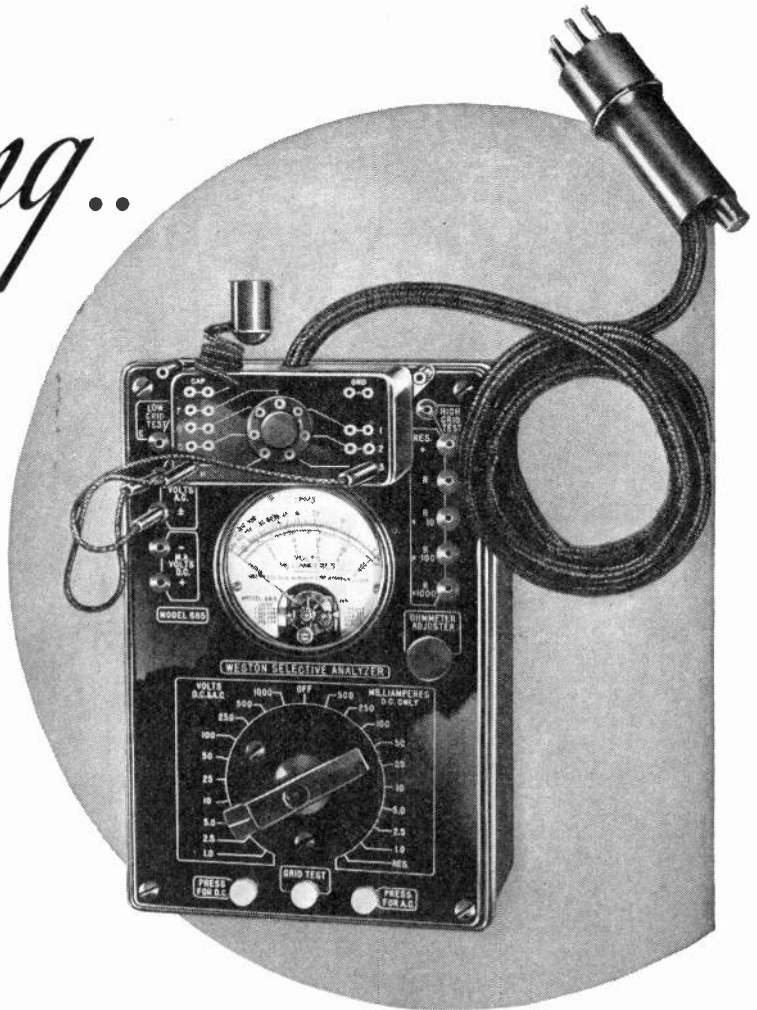

NO LONGER is there the slightest need for worrying about Analyzer obsolescence. Weston has found the solution, providing a design which is always up-to-date regardless of tube developments. It's a method of Selective Analysis involving the new Weston Model 665 Selective Analyzer and suitable Tube Selectors.

Weston Model 665 Selective Analyzer contains all the necessary voltage, current and resistance ranges. Tube Selectors to accommodate 4, 5, 6 and 7 prong tubes are provided. You merely attach the proper Tube Selector to the Selective Analyzer. Next insert the plug into the tube socket of the radio set. Then by plugging into the proper jacks, voltage, current and resistance may be read in any part of the entire network leading to the tube socket.

The Weston Model 665 Selective Analyzer with Tube Selectors truly is universal in its capacity to analyze radio receivers. New tubes merely mean a new, inexpensive Tube Selector. That's how obsolescence is eliminated. Return the coupon today for complete information . . . Weston Electrical Instrument Corporation, 618 Frelinghuysen Avenue, Newark, N. J.

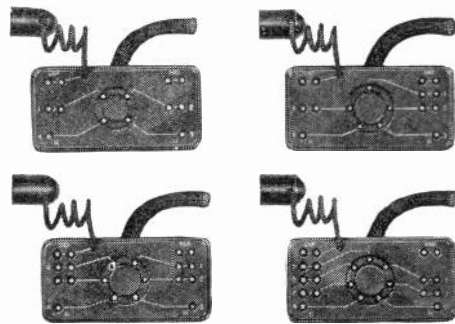

MODERNIZE YOUR ANALYZER with Weston Socket Selector Units

Your present Analyzer can be brought up-to-date and kept that way by means of the new, inexpensive Weston Tube Selectors which can be used with all models and makes of Analyzers. Return the coupon for descriptive bulletin.

WESTON *Radio Instruments*

Weston Electrical Instrument Corporation,
618 Frelinghuysen Avenue, Newark, N. J.
Please send bulletin describing Model 665 Selective Analyzer and
Tube Selectors.

Name

Address

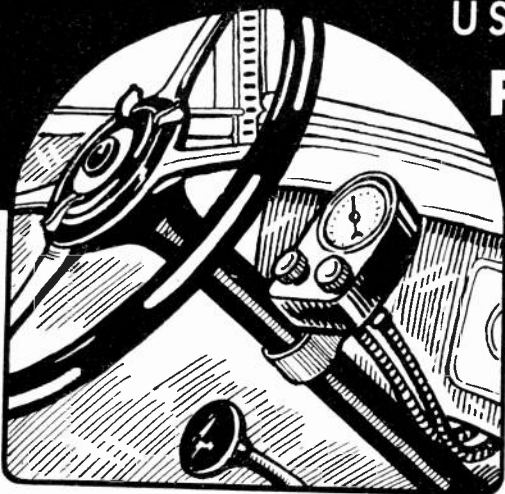

USE

FLEXIBLE SHAFT operated remote control . . .

. . . It's **BETTER** for all concerned

Leading auto radio manufacturers, including PHILCO, RCA VICTOR, GENERAL ELECTRIC, CROSLY, WELLS-GARDNER, GULBRANSEN, FADA, UNITED MOTORS, UNITED AMERICAN BOSCH, PIERCE-AIRO, DETROLA, STROMBERG-CARLSON and many others, are using remote controls mounted on the steering column and operated by S. S. WHITE Flexible Shaft No. 150L53 designed and built expressly for this purpose. They recognize the advantages of this type of control.



Better for you, the **SET MAKER**

because: flexible shaft remote control simplifies the design and improves the performance of your set. It provides not only accurate and simple tuning control, but also remote control of volume and switch, permitting location of volume control in the set proper—the most desirable position in the circuit.

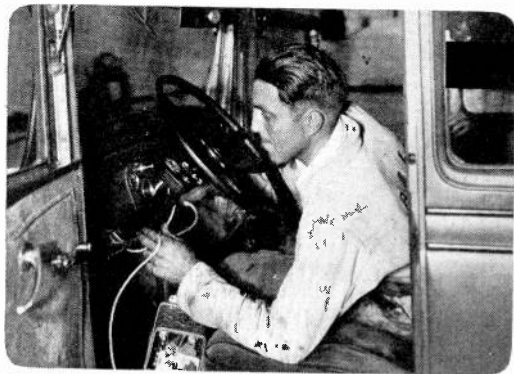

Better for your **DEALERS**

because: the flexible shaft controlled set can be easily installed in any car, giving wide latitude for locating receiver in the position that will avoid electrical, structural and physical interference, with control always convenient to driver. Control "stays put" and does not eat up profits in servicing.



Better for the **OWNERS**

because: Flexible shaft control provides effortless, accurate tuning and volume control. **IT IS SAFE**, for it brings the control directly under the driver's hand where perfect tuning can be accomplished without leaning forward or taking eyes off the road. It never gets out of order or adjustment.

WRITE FOR complete details about S. S. WHITE Special Remote Control Shaft No. 150L53 and Special Small-diameter Casing No. 170A1. Samples furnished to responsible manufacturers.

TO SET MANUFACTURERS

We will be glad to furnish names and addresses of manufacturers of remote controls using S. S. WHITE Shafting. These controls can be adapted to your set.

The S. S. WHITE Dental Mfg. Co. INDUSTRIAL DIVISION

Knickerbocker Building

New York, N. Y.

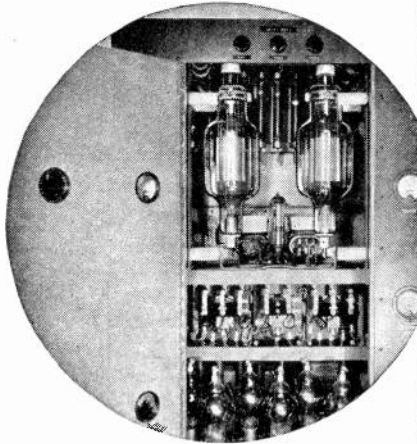

Typical mounting of two Western Electric 279A tubes in a radio telephone transmitter.

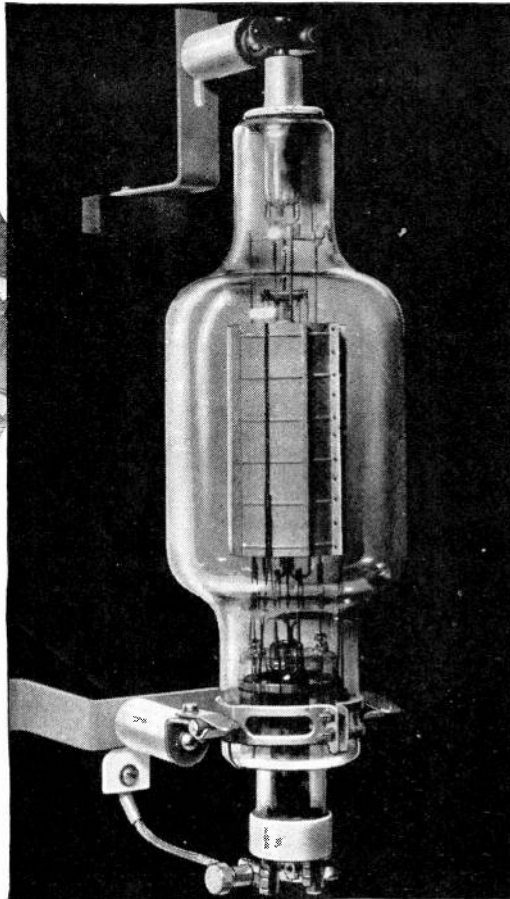

Two Western Electric 279A tubes mounted in the Western Electric 305A transmitter used by the police of the City of New York.

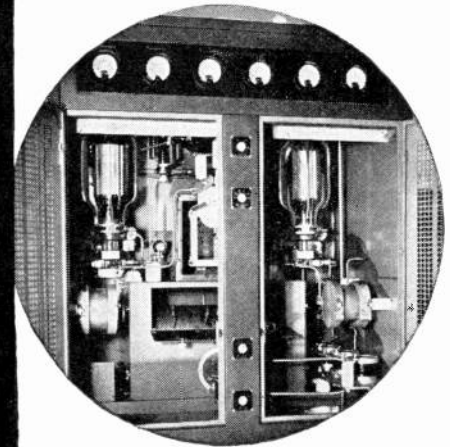

In a class of its own ... the Western Electric 279A

Developed for service in the new Western Electric radio transmitters using only radiation-cooled tubes, the 279A has the highest rating of any tube of this type. C . The anode with its 9 radiating fins has been designed to give maximum energy radiation. The thoriated tungsten filament assures adequate electron emission for full, efficient usage of the tube's energy capabilities. Mounting of the 279A's elements provides high insulation in a rugged structure — while terminal arrangements make for ease of mounting and replacement. C . A Western Electric product — long life and uniform characteristics are assured.

Western Electric 279A Tube

A general purpose tube having the following characteristics:

Filament Voltage.....	10
Filament Current, Amperes.....	21
Average Plate Resistance, Ohms.....	1800
Average Mutual Conductance, Micronthos.....	5550
Amplification Factor.....	10

Approximate Direct Interelectrode Capacities

Plate to Grid.....	18 Mmf.
Plate to Filament.....	8 Mmf.
Grid to Filament.....	15 Mmf.
Maximum Plate Voltage.....	3000
Maximum Plate Current, Amperes.....	.800
Maximum Plate Dissipation, Watts.....	1200
Maximum Overall Length.....	21 11/16"
Maximum Diameter.....	.6"

Western Electric

RADIO TELEPHONE BROADCASTING EQUIPMENT

Distributed by GRAYBAR Electric Company

GRAYBAR ELECTRIC CO. E 8-33
 Graybar Building, New York, N. Y.
 Gentlemen: Please send me full information on the Western Electric 279A tube.

NAME.....

ADDRESS.....

CITY..... STATE.....

... RIGHT IN PRINCIPLE



SUCCESSFUL IN PERFORMANCE

List of
**RADIO-ELECTRICAL
PRODUCTS
SERVING THE GREAT
RADIO INDUSTRY**

-
- Condensers**
- Volume Controls**
- Selector Switches**
- Jack Switches**
- Push Button Switches**
- Tip Jacks**
- Resistances**

Mallory-Elkon Dry Electrolytic Condensers are backed by a major company serving the Radio—Electrical and other key industries. Mallory-Elkon Dry Electrolytic Condensers are dependable because they are engineered and manufactured in accordance with the most scientific principles.

Modern facilities and high grade personnel assure Mallory-Elkon users of dry electrolytic condensers of uniformly high quality. Dry Electrolytic Condensers produced by Mallory-Elkon are stable in operation and guard against electrical and mechanical variations.

Compact and easily mounted, they have excellent filtering capacity, and owing to the character of the Electrolyte used, their efficiency is not impaired by low temperatures.

Mallory-Elkon Dry Electrolytic Condensers are available in whatever form best suits the requirements of the Set Designing Engineer: rectangular cardboard container types with or without mounting flanges, of the shape most suitable for the application involved; tubular cardboard containers, for use where this shape proves most suitable; rectangular metal cans—round metal cans, either for upright or inverted mountings with either lugs or insulated lead connections. In no other type condenser has the Designing Engineer so much flexibility as to shape, mounting facility or types of connections.

Mallory-Elkon Condensers will MEET YOUR PRODUCTION REQUIREMENTS and the PERFORMANCE REQUIREMENTS of those who use your products—with an unrivalled degree of certainty and satisfaction.

P. R. MALLORY & CO., INCORPORATED
Indianapolis, Indiana
YAXLEY MANUFACTURING CO., INCORPORATED
Division of P. R. Mallory & Co., Inc.

MALLORY
ELKON **YAXLEY**

electronics

O. H. CALDWELL
Editor
KEITH HENNEY
Associate Editor

McGraw-Hill Publishing Company, Inc.

Vol. 6, No. 8. New York, August, 1933



radio
sound
pictures
telephony
broadcasting
telegraphy
counting
grading
carrier
systems
beam
transmission
photo
cells
facsimile
electric
recording
amplifiers
phonographs
measurements
receivers
therapeutics
traffic
control
musical
instruments
machine
control
television
metering
analysis
aviation
metallurgy
beacons
compasses
automatic
processing
crime
detection
geophysics

THE RADIO CODE

THE "Code of Fair Competition for the Radio Industry," drawn up and submitted by the Radio Manufacturers Association, is a carefully composed document and should serve as an effective influence for stabilizing the radio business and creating more jobs—which latter is the primary purpose of the NIRA administration.

All in all, the Code work was well done, under most difficult conditions of pressure, trade cross-currents and counter-proposals, and summer heat. Its text, as submitted, is summarized on a following page.

But engineers will detect several points of injustice in the Radio Code. Engineers, for example, are excluded from the limiting hours of labor. As intellectual workers, engineers might take pride in this distinction, were it not for certain manufacturers who drive their engineers to continuous overtime at starvation wages and then drop them without notice.

The clause specifying that no new radio tubes shall be introduced for the next year has a certain justification, as things stand in radio today; but any such principle of technical "stand-still" is unsound, and its extension will prove ultimately destructive. Another novel economic principle offered in the tube chapter provides that sales below cost of production, if made to meet competition, are not to be regarded as selling below cost!

MANY radio manufacturers are still in a quandary whether the NRA labor requirements are to prove a blessing or a curse to their own businesses. But there can be no doubt that industry as a whole will benefit, and that with national recovery radio sales will grow.

A summary of the
provisions of the

NRA Radio Industry Code

THE radio industry will henceforth have its control centered in a Radio Emergency National Committee, made up of the executive committee and division chairmen of the Radio Manufacturers Association. The "code of fair competition" as submitted to the National Recovery Administration on July 29, further provides six divisions of the radio manufacturing industry, for purposes of administration:

1. Radio Receiving and Television Set Division.
2. Radio Tube Division.
3. Radio Parts, Cabinets, and Accessories Division.
4. Radio Loud Speaker Division.
5. Sound Distribution Equipment Division.
6. Fixed Condenser Division.

Other divisions may later be established, upon approval of the National Committee and the executive committees of the existing divisions.

At the outset of the Radio Industry Code, it is expressly stated that their Code shall not be used, interpreted or applied in such a manner as to permit or promote monopolies or monopolistic practices, nor to eliminate or oppress small enterprises, or operate to discriminate against small enterprises.

Provisions for employment

Conditions of employment have a prominent position in the Code. Employees have the right to organize and bargain collectively, and to be free from restraint or coercion by employers, nor are employees to be required to join any company union nor to refrain from joining or assisting labor organizations of their own choosing.

In radio factories, no one under 16 years of age shall be employed. The minimum wage of factory or processing employees shall be 40 cents per hour, unless the rate was less on July 15, 1929, but in no event shall any rate less than 30 cents per hour be paid. Casuals and incidental labor and learners, not to exceed 5 per cent of the factory payroll, may receive 80 per cent of the regular rate. Such factory and processing employees shall not work more than 36 hours per week.

For other employees, office workers, etc., but not including commission salesmen, the minimum rate of pay is to be \$15 per week, although office boys and girls and learners, may receive 80 per cent of the regular scale.

For all such other employees, except executive, administrative, research, engineering, and supervising employees, and traveling and commission salesmen, the hours of work shall not exceed 40 hours per week. It is provided, however, that where seasonal or peak demand requires an unusual or temporary burden of work, the schedule may be extended but each such case must be reported fully to the Federal Administrator, through the National Committee.

Section 6 of the main Code further provides that no manufacturer shall sell or offer for sale any radio products which have been made by employees receiving less than the standard minimum wage or working more than the standard maximum hours, or by employees under 16 years of age—except products already in process of manufacture prior to the date the Code becomes effective.

No sales below cost of production

Section 7 provides that in order to meet such labor and payment conditions, no manufacturer shall sell his products for less than a sum sufficient to compensate him therefor—that is, he shall not sell for less than the cost of production. Such cost of production is defined by the Code as embracing the costs of selling, advertising and administration and all other expenses of every kind and character which the manufacturer shall incur in the operation of his business, unless excluded by the Code.

Section 8 authorizes each manufacturer to add to the cost of production, as so defined, such amounts or percentages as he may deem advisable to constitute the net prices or list prices of his products, which prices shall be national and applicable whether sold within the state where manufactured, or in interstate commerce. In determining such price, however, no manufacturer shall discriminate between his various types of radio products in allocating overhead for production, selling, advertising, and administration. No method of price discrimination between customers shall be employed.

The Radio Emergency National Committee is defined as the general planning and co-ordinating agency for the radio industry. It is empowered to act for the divisions, call for reports from divisions, investigate infractions of the Code, and enforce provisions of the Code, and its decisions become conclusive on all manufacturers under the Code.

The National Committee is to adopt a standard uniform cost-accounting system, select public accountants, and require from all members of the industry information as to factory capacity; production, orders and shipments during the month; inventory of finished merchandise on hand; number of persons employed, wages, earnings and hours; and net or list prices in effect at the time reported.

The National Committee is also empowered to act as a tribunal to reach adjustments, in cases where the costs of completing contracts entered into prior to the enactment of the Code, are increased by the provisions of the Industrial Recovery Act.

Set, tube and other chapters

Supplementary chapters to the Code relate to the special conditions surrounding each division. The first chapter relating to receiving and television sets presents detailed classification of products by lines, and by numbers of tubes, as the basis of analysis and cost study
[Please turn to page 230]

THE "DRIVE-IN" MOVIE

High-power sound projectors expected to parallel peewee-golf

HIGH-POWER sound systems and wide-screen projectors developed for the very large movie houses, have now made possible a new entertainment device, the outdoor automobile movie. The first of these "drive-in theaters" occupies a seven-acre field near Camden, N. J., and the idea is expected to spread widely next season for roadside entertainment, much as the golf-course craze spread three years ago. Visitors drive their cars right into the enclosure, and on cool evenings or during light rain can hear perfectly even with all windows closed. Whole families, with infirm elders, can be transported bodily, with minimum effort of unloading, parking, etc.

Since almost the entire investment goes into projector and sound equipment, and simple housing of the screen and projectors, the overhead cost is very low. The Camden movie is understood to pay the local farmer only \$30 per month ground rent. Four hundred cars can be accommodated. The screen width is 60 ft. and R.C.A. Photophone high-fidelity speakers delivering 80 acoustic watts are used, enabling those seated in the rear rows, 500 ft. from the screen, to hear with the same clarity, as do auditors up in front. Richard M. Hollingshead, Jr., is the inventor of the "Drive-In" movie theater and has applied for patent rights.

How the automobiles are parked on inclined ramps with wide aisles between rows. Motor cars thus become private theatre boxes, in which occupants can smoke, chat or enjoy refreshments

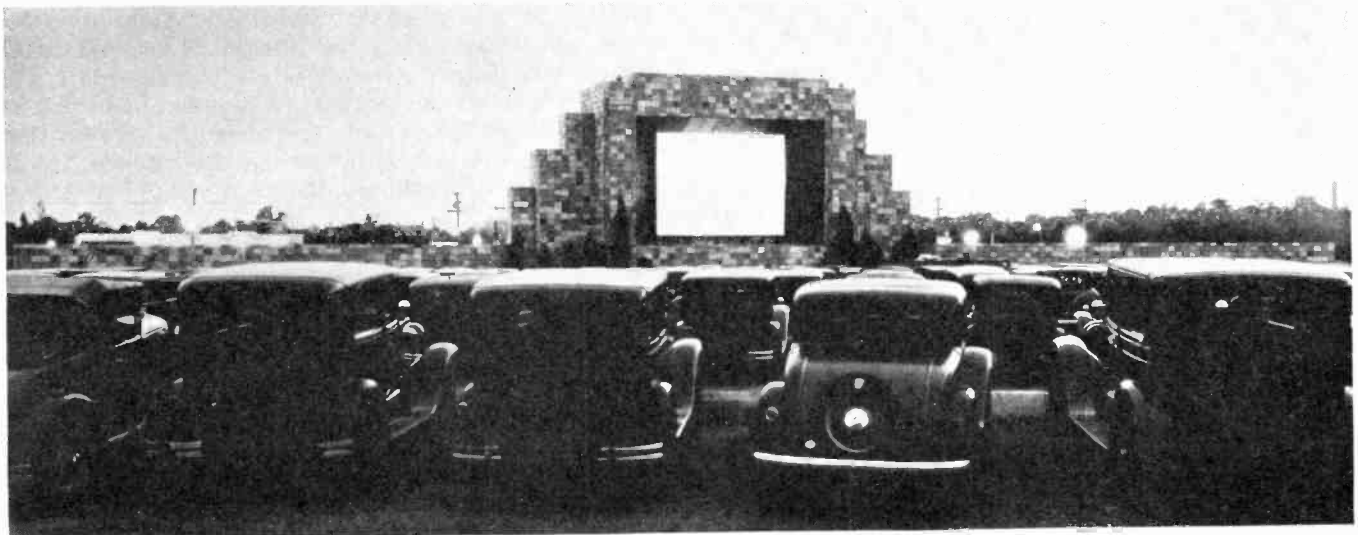
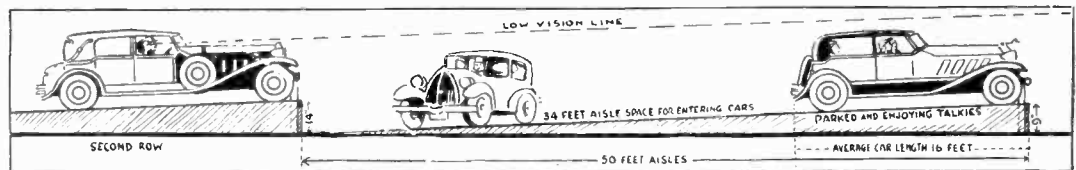
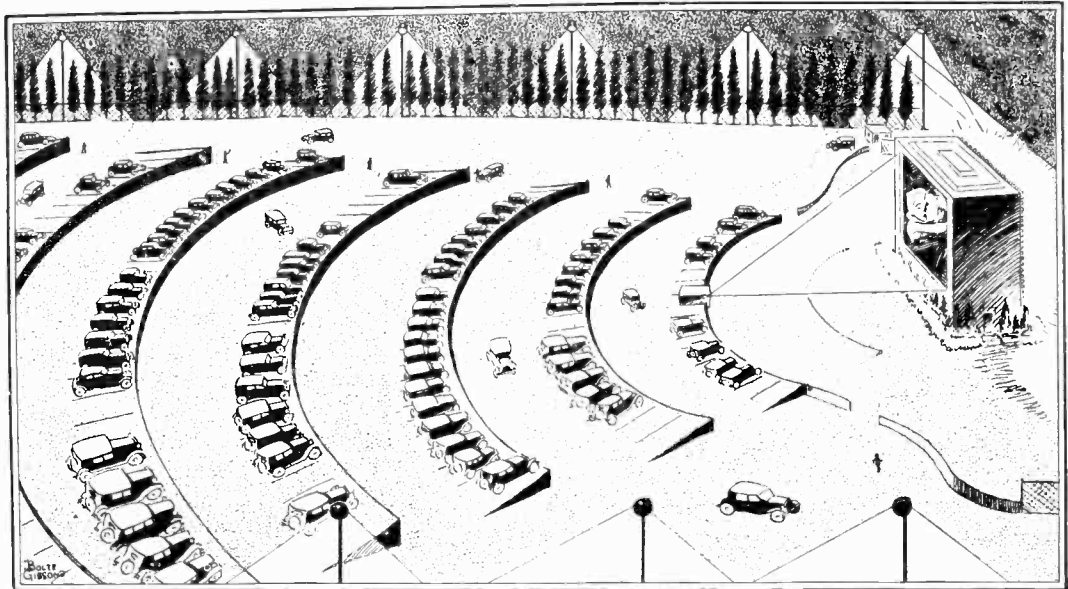

COST VERSUS QUALITY IN

A symposium of papers delivered at
the annual I.R.E. convention in Chicago

Broadcast receiver coils

By F. N. JACOB
Meissner Manufacturing Company

RADIO receiver manufacturers are constantly striving to secure the best possible performance in their sets with the smallest possible expenditure for component parts and their assembly. During the last few years the more general practice has been to purchase component parts from concerns which concentrate on the production of one or more of these units, since they are usually in a position to make these parts of the highest quality at the lowest cost and hence should be able to supply the assembler with the best cost balance obtainable.

Before discussing whether or not superior quality is accompanied by higher cost of the finished unit, it might be well to define some of the terms to be used. Quality may be defined as mechanical perfection as well as electrical performance, where the latter term is taken as the ability of an r-f tuning system to sufficiently amplify a desired signal and to reject any other signal but the desired one.

The cost of any part in this system is the selling price of a complete unit ready to be installed into the receiver in any stage preceding the demodulator tube. The selling price will be assumed to be proportionate to the cost of manufacture, which again may be resolved into that of material, labor, and the use of any necessary machinery.

Considering first the use of machinery in the fabrication of coils, it is a fact that any saving effected by the use of machinery, no matter how elaborate the device

may be constructed, can be applied in the making of a poor coil as well as one of the highest quality.

On the question of labor, what holds true for other lines of manufacture is true here. To secure a perfect assembly at the finish of the job, the use of skilled labor thoroughly familiar with a particular operation is absolutely essential. To keep the cost of an operation as low as possible, an operator who can perform the work quickly is preferred. A worker capable of satisfying these two requirements is paid considerably more than one who is only proficient in one respect, consequently adding to the cost of a quality product.

A phase of coil manufacture which plays a large part in ultimate cost, perhaps more than in other lines, is the test and inspection for electrical requirement. The general run of coils receives about six electrical tests before the unit is accepted. Unquestionably the better the product is to perform, the more exacting must be the electrical tests, and the more closely tolerances must be held. Thus a high quality coil requires more time to test and adjust to specification of inductance, etc., and calls for the services of a higher grade operator and more elaborate and costly test equipment. The controlling factor as to cost would be the tolerances to be observed and the number of tests required.

Where savings are made

The cost of actual manufacture of a unit is dependent not so much on the kinds of operations as upon the physical and electrical specifications, since coils used for similar purposes but of different quality require about equal amounts of handling.

The largest saving in attempting to secure a cheaper coil will result in the use of less costly materials. This however is not accomplished without an accompanying lowering of quality standard. Any manufacturer of reputable receivers is interested not only in the appearance and performance of his sets at the time they leave the factory, but also after they have been in operation for considerable time. Here the mechanical construction is the essential factor. Outside of the vacuum tubes it is doubtful whether any component part can be held more responsible for the ultimate operation of a receiver than the coil system. Since the set may be subjected to all types of climatic conditions, the treatment of coils should receive considerable attention. The less costly way would be to use materials that had not been treated to withstand heat and humidity both from the mechanical as well as the electrical standpoint. The best practice of coil design calls for the use of wax or varnish impregnation of complete assemblies. A more recent and superior method is to dehydrate the unit and then flash dip it in a high grade sealing compound, immediately after removal from the drying chamber. This produces an excellent mechanical and electrical seal but is more involved than the impregnation method and is more expensive.

The forms on which coils are wound vary quite

▼

A MOST interesting and instructive symposium was part of the program at the annual I.R.E. Convention. This symposium consisted of papers by well-known engineers on the relation between the cost of components entering into radio receiver manufacture, and the quality of those products. The papers dealing with loudspeakers by Hugh S. Knowles, on resistors by Byron B. Minnium and on circuits by H. D. Mysing will be presented in a near issue of *Electronics*.

▲

RADIO SET COMPONENTS

Cheapening the product is shown to give the purchaser a poorer product for his money

widely. Universal coils as a rule make use of wooden dowels, although porcelain and fibre cores have been used where the ultimate in quality is desired. The use of the latter materials naturally adds to the cost. Under the proper treatment a wooden dowel should be very nearly the equivalent of these expensive cores, save for mechanical strength.

A large saving may be effected through the use of treated paper tubing in the place of phenol fibre. However the paper tubing does not possess the strength of bakelite and the latter would be preferred in any case where one wishes to secure the best quality. Again paper tubing is not well adapted to the winding of space-wound coils and is limited in other respects also.

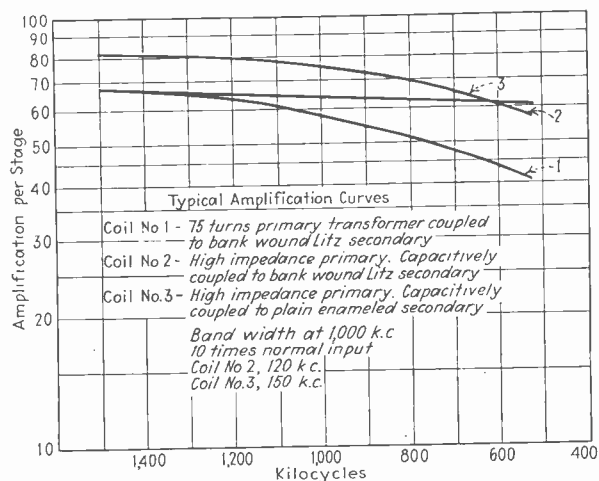

Comparison of broadcast frequency coils as function of wire used

Fairly wide range in quality and cost is available in the use of different wire and types of windings. At present, in i-f transformers, the general run of coils may be grouped into three classes, namely: paper layer, random wound, and universal or duo-lateral wound. All three types generally consist of a primary and a secondary wound coaxially and having a 1 to 1 turns ratio.

Random wound transformers are becoming rare, their biggest advantage lying in the simplicity of winding equipment necessary. The cost of bobbins for these coils is relatively high and the finished coils when wound to a given number of turns will not run uniform in performance and inductance.

Paper layer i-f transformers find favor with those manufacturers having equipment for winding power transformers and coils of like construction, as the same machine may be used in winding both types. These coils have excellent electrical properties even when only plain enamel wire is used. However they must pass through an elaborate finishing process after leaving the winding machine so that the final cost is usually in excess of that of a similar coil wound duolaterally.

The universal type is the most widely used and the

cost and performance is almost entirely dependent on the wire used. Consider for instance, the following measurements made on i-f transformers, under standard operating conditions where the unit was inserted in a stage working between a type 58 tube and a 57 tube used as a detector. These measurements, while they may not be considered absolute, will serve for purposes of comparison. The coils were all wound on the same size dowels, tuned by the same type of condenser, both primary and secondary, and adjusted for maximum coupling in a shield can large enough so as not to affect the coil to too great an extent.

At 456 kc. a transformer wound with No. 36 single cotton enameled wire having an inductance of approximately 1.75 milli-henries, had a gain of 103 and a band width of 200 kc. at 100 times normal input. Another coil of about the same inductance and dimensions wound with 7-41 silk litz wire had a gain of 156 times and a band width of 140 kc. at 100 times normal input. Still another transformer using No. 36SSE wire having slightly lower inductance provided a gain of 115 times and a band width of 190 kc.

At 175 kc. a coil wound with No. 36SCE wire with an inductance of approximately 7 mh., had a gain of 100 times and a band width of 70 kc. at 40 db. down. A similar coil of 7-41 silk litz had a gain of 125 times and a band width of 64 kc.

From the above comparisons it is visible that in each case the more expensive wire, namely the litz, produced a coil having not only more gain, but a smaller band width.

The r-f, antenna and oscillator coils to be had which follow general practice, will be found to vary not only in the wire on the primary and secondary but also in the manner of coupling between the two windings. We may dispose of the oscillators by saying that the coils having a tank winding with a better figure of merit will produce a more uniform voltage over the entire tuning range than one having a poorer figure as a result of the utilization of cheaper wire.

In r-f. and antenna transformers, a less costly coil may be had by using inductance coupling between a low turn primary and the secondary, but the resultant amplification will change markedly from one end of the band to the other. An impedance coupled coil will produce more uniform gain but can only be had at an increase in cost due to the use of a high impedance primary coupled to the secondary through the medium of a capacitor.

A shielded r-f coil with a bank wound litz secondary and a seventy-five turn primary, inductively coupled to secondary, had a gain of 66 at 1,400 kc. and 44 at 600 kc. An impedance-coupled coil having a bank wound litz secondary, provided an amplification of 68 times at 1,400 kc. and 64 at 600 kc. The band width at 20 db. down was 120 kc. at 1,000 kc. Another impedance coupled coil with a plain enamel secondary of about the

same dimensions as the last coil mentioned, had an amplification of 82 times at 1,400 kc. and 62 times at 600 kc. The band width at 1,000 kc. was 150 kc. at 10 times input.

Here again it will be noticed that litz wire produced the best performing coil as regards band width for a given gain. It can be said that a universal wound r-f or antenna coil will effect a saving of space and may be placed in a small sized shield can but it is not as efficient as the solenoid type and will not be much less in cost because of increased production difficulties.

Quality requires completely shielded coils to insure receiver stability, but gives rise to higher cost because of the added expense of the shield can.

In conclusion, it would seem that the mechanical quality is jeopardized by using cheaper labor and material and that improved electrical performance requires more expensive materials and methods of manufacture. While it is only possible to improve the quality of a unit to a certain degree by more expensive construction, without increasing the cost beyond any advantages received, nevertheless, until that point is reached there can be no compromise with cost if real quality is being sought.

Transformers

By W. J. LEIDY, *Chicago Transformer Corporation*

THE subject of cost versus quality as applied to transformers used in a radio receiving set is a question that should interest all set manufacturers.

Transformers used in radio receiving sets are divided into two general classes, power and audio. The quality of an audio transformer is usually defined in terms of frequency response.

The term cost is usually limited to the initial cost of the unit as furnished by the supplier and does not take



Cost and quality are related in tube manufacture. This scene was made in Majestic's tube plant

into consideration the ultimate cost to the set manufacturer as a result of replacements due to failures.

A difference in cost of a fraction of a cent has been known to induce the use of some small over rated part which endangered the life of other quality parts in the assembled set. No single part can stand on its own and must rely on the good qualities of numerous other parts.

The term quality must be defined. We associate the grade of material and the kind of workmanship with the quality, the assumption being that the best grade of materials and the best workmanship will produce the highest quality.

It is only possible for the set manufacturer to determine the quality of the parts by their performance over a period of service. Numerous changes in design each year have made it difficult for the manufacturer to accurately determine the cause for transformer failures in the field. Unfortunately for the transformer manufacturer, most failures of parts in a set are reflected back on the power transformer resulting in an overload and burnout. Primary fuses do not give the protection required. A one hundred per cent overload in one secondary winding will increase the primary load by less than 50 per cent on the average set.

The set manufacturer limits to some extent the overload capacity of a power transformer when he specifies the maximum temperature rise and also the size. Five years ago it was not unusual for a set manufacturer to limit the temperature rise to thirty degrees. Today we have set manufacturers giving limits as high as twice this amount. A certain temperature limit may be entirely satisfactory in one location in a chassis but may be doubtful in another when surrounded by other parts. The transformer manufacturer cannot set the temperature limits as this will vary with the conditions under which the transformer is used.

This gradual increase in temperature limits over a period of years has had a decided effect on the transformer design, especially the materials used. The materials must be of a better grade and they must be more uniform in quality.

Old materials picked up at bargain prices from sources that are questionable are bound to affect the quality. Even though these materials have the same trade name applied to a particular grade, the quality will vary. For example, silicon steel sheets of a certain grade of five years ago are not the same quality sheets produced today under that same grade name.

Electrolytic condensers

By R. O. LEWIS,
P. R. Mallory & Company

THE cost of condensers like the cost of almost any other thing depends upon the degree of quality the buyer is willing to accept. For most suppliers this condition is tempered by judgment as to what they are willing to supply. Acceptance specifications are the criterion as to what the purchaser demands and standard manufacturing specifications are the limiting factors as to what the supplier is able to furnish.

When acceptance specifications are more severe than the supplier is able to supply at a standard price the item becomes a "special" and the price must be adjusted to meet the conditions.

By numerous conferences the electrolytic condenser industry has established standards under which they are

able to produce condensers of standard rating without special processing.

Whenever the radio industry follows these standards the lowest prices and quickest deliveries are possible. These standards are easily obtainable from the condenser manufacturers. At the same time the condenser industry has standardized on methods of testing and rating condensers as follows; the capacity test shall be made at 70 deg. F. or a correction applied at other temperatures; a d-c polarizing voltage of 80 per cent of rated voltage with a superimposed r.m.s. ripple voltage of 15 volts, 60 cycles for capacitors rated at 100 volts or higher; 3 volts for the range from 25 to 100 volts, and 2 volts ripple for units between 6 and 25 volts.

Standard capacity tolerances are minus 10 per cent and plus 100 per cent of rated capacity when rated up to 99 volts; minus 10 per cent and 50 per cent plus for units to operate between 100 and 200 volts; and for

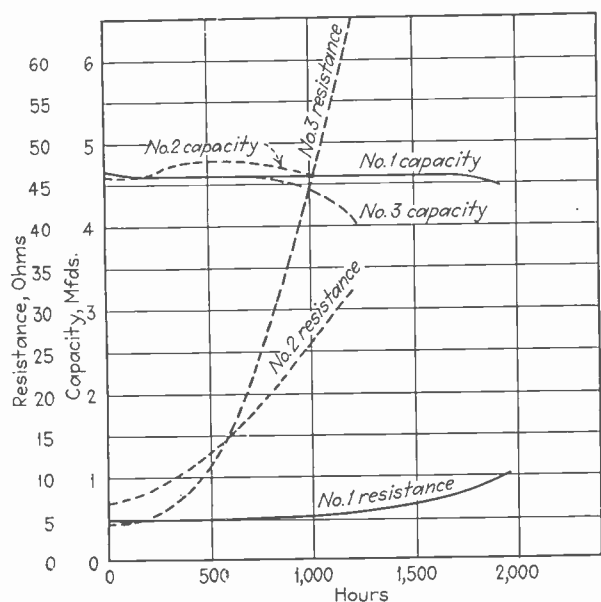

Dependence of condenser life on proper electrolyte

units rated above 200 volts, minus 10 per cent and plus 50 per cent for 3 μ f or less, minus 10 per cent and plus 20 per cent for units of over 3 μ f.

Under the same conditions as specified for capacity and at 120 cycles, the guaranteed maximum power factor will not be less than 10 per cent for single gauze and 15 per cent for double gauze capacitors rated 100 volts or higher and for capacitors of 2 mfd. or higher.

While no standards have been definitely arranged for leakage specifications, engineers should avoid excessively low leakage requirements due to the possibility that the cost will be greater than necessary because of excess time or material required for their manufacture. Normally a leakage specification that calls for less than 0.15 milliamperes per microfarad is considered a low limit.

Among other definitions agreed upon by the condenser industry, maximum surge voltage is most important. This represents the maximum potential the condenser will withstand without breakdown or permanent injury, for a period of five minutes when applied to a series combination of the condenser and a resistance, the resistance having a value in ohms, equal to $20,000/C$ (where C is the rated capacity in microfarad.)

The voltage at which the plate is formed determines

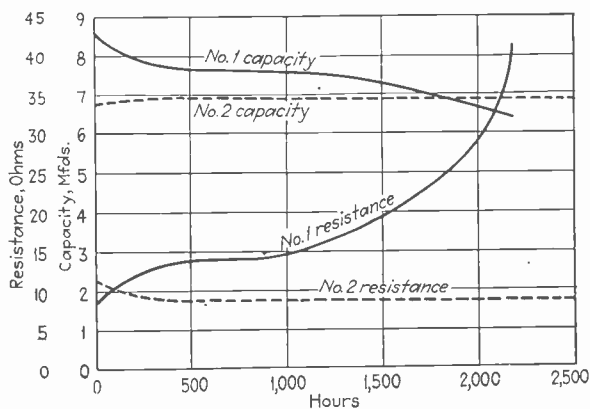

Effect of increasing by 20 per cent plate formation and electrolyte cost (450 volt units)

to a very large degree the maximum voltage which the condenser will stand. The plate area is directly proportional to the formation voltage for any given capacity rating. Furthermore the capacity of a condenser for any given voltage rating varies directly with the area of the plate. Therefore prices on electrolytic condensers have been established on a plate-area basis. This means that the voltage rating of the condenser and capacity rating of the condenser do not entirely determine its price. If the leakage specification is too low or the power factor specification is too low, it may be necessary to use a greater area of plate than is allowable for a condenser of the capacity and voltage rating for standard prices.

An interesting point in connection with the plate area control of price is the fact that some manufacturers delight in promising condensers at the standard price but with capacity higher than the capacity rating. It would be well for the engineer to remember that to get the higher capacity under a plate limitation price set-up it is necessary to form the condensers at lower-than-standard voltages. It is well known that condensers with formation voltages too close to the working voltage increase in resistance rapidly and drop in capacity rapidly in service.

It can be seen from these facts that the plate area limitation is also a quality control to a very large degree. For instance, on the low voltage condensers there is a capacity tolerance of plus 100 per cent, but to get this 100 per cent plus capacity with the same plate area it is necessary to reduce the plate formation to the point where the condenser will have a very much shorter life in service.

It is a fact that plate formation is not the only criterion as to the life of electrolytic condensers. A curve sheet is presented herewith showing three identical condensers as far as plate formation is concerned and having three different electrolytes. These curves show that the rate at which the resistance increases and the capacity decreases throughout the life of the condensers is very much dependent upon the electrolyte. The condenser represented in curve 1 has an electrolyte which costs about 15 per cent more than the electrolyte in curve 2 which has an electrolyte that costs about 15 per cent more than No. 3.

Needless to say, the 15 per cent increase in cost of condenser No. 1 over No. 2 is thoroughly justified from the results obtained. Another curve sheet is presented to illustrate the difference in performance of 450-volt condensers in which both plate formation and electrolyte

[Please turn to page 215]

Tubes to fit the wavelength

Less than one inch in size; for
use at one meter and below

By B. J. THOMPSON

RC.A Radiotron Company,
Harrison, N. J.



AS the development of radio communication led to the use of continually shorter wavelengths, refinements of the conventional types of tubes and circuits proved adequate to meet the needs for receiving equipment down to a wavelength of somewhat less than five meters. For wavelengths of less than a meter, however, further refinement was considered to be entirely impracticable, and, consequently, new types of tubes and circuits have

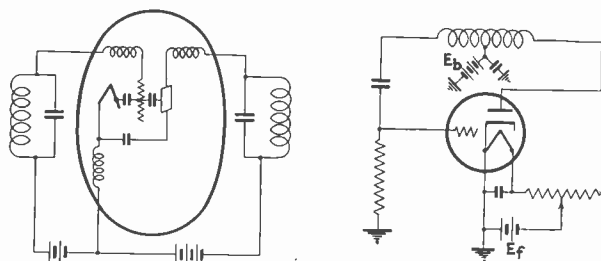

Fig. 1—Lead inductances (left) and capacitances in an amplifier tube and (right) circuit used in the short-wave oscillator

been used. In general, these make use of electron oscillations within the tube, and parallel wire tuning means. These tubes and circuits make possible reception at very short wavelengths, but, in comparison with conventional long-wave apparatus, they have a number of serious disadvantages. Among these are the impossibility of obtaining signal frequency amplification, and the high power and voltage which must be supplied to the tubes to produce oscillations. In view of these difficulties, it was decided to make an attempt to lower the minimum wavelength limit at which conventional type tubes and circuits may be used. The method and results of this attempt are described here.

Figure 1 shows a simple tuned radio frequency amplifier circuit. The inductances and capacitances shown within the bulb of the tube are those inherent in the tube leads and electrodes. Neglecting other effects, it will be seen that as the wavelength is reduced by reducing the external inductance and capacitance the external circuit becomes a smaller part of the total, with a loss in available ampli-

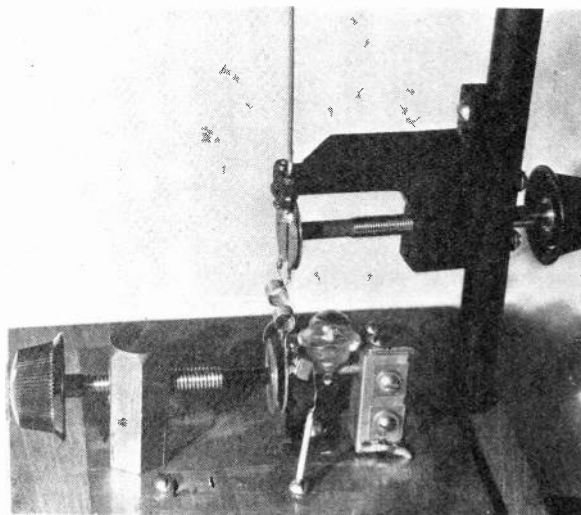

Fig. 2—Transmitter working on 100 centimeters

fied signal, until, in the limit, the plate lead inductance and plate to ground capacitance form a tuned circuit alone, and no amplified signal is available. The remedy for this condition, of course, is to reduce the internal inductance and capacitance. To obtain useful amplification, no appreciable reduction in transconductance should accompany this reduction.

To effect this reduction of internal inductance and capacitance, advantage is taken of the following principle: if all linear dimensions (length, breadth, and thickness) of a vacuum tube are held in a constant ratio, plate current, amplification factor, and transconductance are constant, regardless of the magnitude of the linear dimensions, while lead inductance and inter-electrode capacitance are in proportion to the magnitude of the linear dimensions. Therefore, under conditions where the tube is a limiting factor, *tube and circuit dimensions should be in proportion to the wavelength.*

Since conventional sized tubes operate fairly well at five meters, a ten-fold reduction in dimension is required to produce tubes to operate at 50-cm. wavelength. Tubes approximating this reduction have been made and tested. The maximum overall dimensions of these tubes are about three-quarters inch.

Both tubes have indirectly-heated cathodes. A parallel plane structure is used, with the cathodes and anodes shaped as flat bottomed cups, and the grids as flat disks. No stem is used in the assembly, the leads being sealed directly through the bulb. When it is said that the inter-electrode spacings are of the order of 0.005 inch, it will be understood that mounting these tubes is a delicate task.

TRIODE CHARACTERISTICS:

Plate voltage	= 67.5 v.	Amplification factor	= 14.7
Grid voltage	= -2.0 v.	Grid-cathode capacitance	= 0.7 $\mu\mu\text{f}$.
Plate current	= 4.0 ma.	Plate-cathode capacitance	= 0.07 $\mu\mu\text{f}$
Plate-resistance	= 9,500 ohms	Plate-grid capacitance	= 0.8 $\mu\mu\text{f}$
		Transconductance	= 1550 $\mu\text{a}/\text{v}$.

SCREEN-GRID TUBE CHARACTERISTICS:

Plate voltage	= 135 v.	Plate resistance	= 360,000 ohms
Screen voltage	= 67.5 v.	Amplification factor	= 400
Control grid voltage	= -0.5v.	Input capacitance	= 2.5 $\mu\mu\text{f}$
Plate current	= 2.5 ma.	Output capacitance	= 0.5 $\mu\mu\text{f}$
Transconductance	= 1100 $\mu\text{a}/\text{v}$.	Plate-grid capacitance	= 0.015 $\mu\mu\text{f}$

These tubes compare favorably with conventional tubes in all electrical characteristics, and represent a large reduction in interelectrode capacitance. Due to the very short leads, a large reduction has been made in lead inductance also.

The triodes have been operated as oscillators to determine their short wave limit. The coils are one-eighth inch

in diameter. The only tuning capacitance was that formed by the tube electrodes. It was found that a minimum wavelength of slightly below 30 cm. was reached with one turn in the coil. At this wavelength the minimum plate voltage that could be used was 115 volts, and the plate current 3 ma. At 40 cm. and more, oscillations were very stable the tube operating at 45 volts and 0.5 ma.

A 100-cm. transmitter using one of the small triodes modulated from a broadcast receiver was set up. A two-stage tuned radio frequency receiver using two of the screen-grid tubes, and two of the triodes for detector and audio amplifier, was used to receive the signal. The receiver was found to operate well, an estimate of the r-f gain being about four fold per stage.

Another transmitter and receiver were set up to operate at 75 cm. The receiver consisted of one tuned radio-frequency stage and a detector. In this receiver no variable capacitors were used to tune the circuit, the tube capacitance alone being used. The gain was slight, being estimated at little more than unity.

Considering the excellent performance of these tubes as oscillators and detectors, and the fair performance as radio-frequency amplifiers, it is to be expected that good superheterodyne receivers could be constructed at wavelengths approaching 50 cm. In such a receiver the principal function of the r-f stage would be to block the local oscillator from the antenna.

It is therefore concluded that after suitable refinement of size conventional types of tubes and circuits may be applied to the reception of wavelengths of less than one meter.

This paper could not be complete without an acknowledgement of the ingenuity, skill, and perseverance of Mr. George M. Rose, Jr., whose efforts were largely respon-

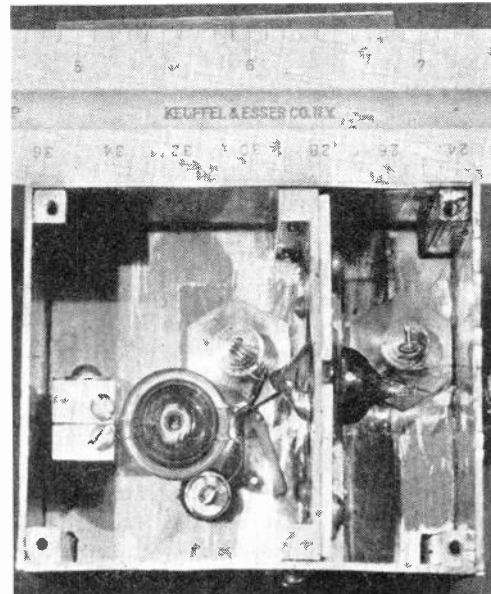

Fig. 3—Receiver for 75-cm. waves. The input tuned circuit is at the right. The entire receiver is of the order of 3 inches square

sible for the successful construction of these very small tubes.

Last of all, it must be stated that these tubes are not now available. They are not now being manufactured, nor is their manufacture contemplated at the present time. This paper has no commercial significance, being merely the report of what was considered an interesting and perhaps important technical study.

Cost versus quality in radio set components

[Continued from page 213]

cost have been increased making a total of 20 per cent increase in cost over condenser No. 1.

The plate areas selected for the standard voltage and capacity ratings have been selected from field experience with electrolytic condensers. The plate area limitation is liberal enough in each case so that the standard condensers will deliver satisfactory service when they are used in circuits which do not cause overloads beyond their ratings.

In writing acceptance specifications there is certain information which should be available to the condenser engineer for design purposes. The mechanical factors which, of course, are always with us, should be clearly shown. Surge voltage to which the condenser is to be subjected should appear. Capacity rating, with the tolerance, is necessary. The leakage specification and either resistance or power factor limitation should be on the specifications. In connection with the mechanical requirements, it is a fact that unless the space allowable is sufficient, it is impossible to furnish a condenser with sufficient plate and thick enough spacer to deliver maximum service. This factor more than any other has caused condensers of barely sufficient quality to be made.

Another factor which should be recognized especially at the present time when practically all of the suppliers to the condenser industry are asking for more and more time, is delivery of condenser materials. It is advisable to use a standard construction whenever it is in any way possible to do so.

Certain condenser designs reduce the manufacturing cost and create savings that will result in lower prices. Wherever it is possible to use a common cathode construction the cost is low. Whenever more than one unit may be placed in a single container the overall cost is lower. Lapped cathode construction results in higher resistance units and multiplied manufacturing difficulties so that the cost is no lower than separate units in a single container.

It is also a fact that electrolytic condensers in paper containers are entirely satisfactory; a fact that has been proven by field experience over a long period of time. With metal-wrapped condensers in a paper container it is easily possible to make units which are as high in quality as those which are housed in metal cans. This results in lower costs to the purchaser.

Life tests and field experience have demonstrated many times the fact that electrolyte composition and plate formation process are the most important items in manufacturing quality condensers. If the electrolyte is not stable no housing of any kind will make the condenser deliver long life.

It must again be emphasized that if engineers want quality condensers at low cost on rapid delivery schedules, they should use the standards as set up by the condenser industry. In any case, the condenser engineer should be given the full information as to working voltage, surge voltage, capacity tolerance, leakage requirements, resistance tolerance and peak ripple.

HIGHER-VOLTAGE VACUUM

In California and in the East, higher potentials are leading to new achievements in X-rays and transmutation

1. Higher-voltage vacuum tubes.
2. Faster speeding electrons.
- 3A Shorter and more penetrating X-rays.
- 3B Greater penetration of electron bullets into the nuclei of atoms, with resulting transmutation of elements.

* * *

There, in a nutshell, you have the sequence of cause and effect behind the work with high-tension vacuum tubes now going forward on half a dozen fronts in America, as well as in several laboratories abroad.

At Pasadena, Calif., the effort is to speed up the electronic or cathode-ray discharge and so get X-rays so short as to simulate the gamma rays of radium.

At Berkeley, Calif., the machine-gun fire of high-speed electrons has been concentrated on the atoms of one element, turning it into another,—converting beryllium into carbon, for example.

At Schenectady, N. Y., a succession of pushes administered electrostatically to the electrons, results in new kinds of X-rays being set up when the electrons strike their target, so that X-radiation of improved curative power is produced. One of these great multi-stage X-ray tubes is now in operation at the Chicago World's Fair.

At Washington and at Pittsburgh high voltages in vacuum tubes have produced electron velocities reaching within a few per cent of the speed of light, 186,000 miles per second.

And at the South Dartmouth, Mass., estate of Colonel Green, Dr. Van de Graff has constructed his new electrostatic generator on a huge scale, with 15-ft. brass spheres carried on railroad trucks. This machine is ex-

pected to produce eventual potentials of ten to fifteen million volts, to be applied to the same problem of cracking the atom.

At the University of California, Berkeley intense magnetic fields have been used to accelerate the particles, attaining the equivalent of electrical charges of 1,330,000 volts. Such high-velocity particles, striking the walls of the lithium atom, release alpha particles or helium nuclei having electric charges of 12,600,000 volts, a charge nearly ten times as great as the projectile particle. The next step will be to utilize these 12,600,000-volt alpha particles in turn as projectiles directed at other atoms, thus by a progressive series of steps "unlocking the cosmic cupboard of energy," as well as bringing about actual transmutation of elements from one to another.

At the California Institute of Technology, Pasadena, where high-voltage X-ray tube development has been underway, a novel porcelain tube has been constructed which operates successfully up to 650,000 volts. This X-ray tube was built from a 750,000-volt transformer bushing, and is maintained pumped down to a vacuum of 10^{-5} mm. Cold emission from the anode, rather than gas current or breakdown of the porcelain, limits the voltage which can be applied. For a given voltage, a porcelain tube of this kind is found much more compact than a glass tube, while the strength of its walls against puncture makes elaborate internal shielding unnecessary.

There at "Cal-tech," plans are also going ahead for the construction of another revolutionary type of X-ray tube, to be operated at 2,000,000 volts, and to produce radiation more penetrating than radium. Completion of this new tube will also permit investigations into the

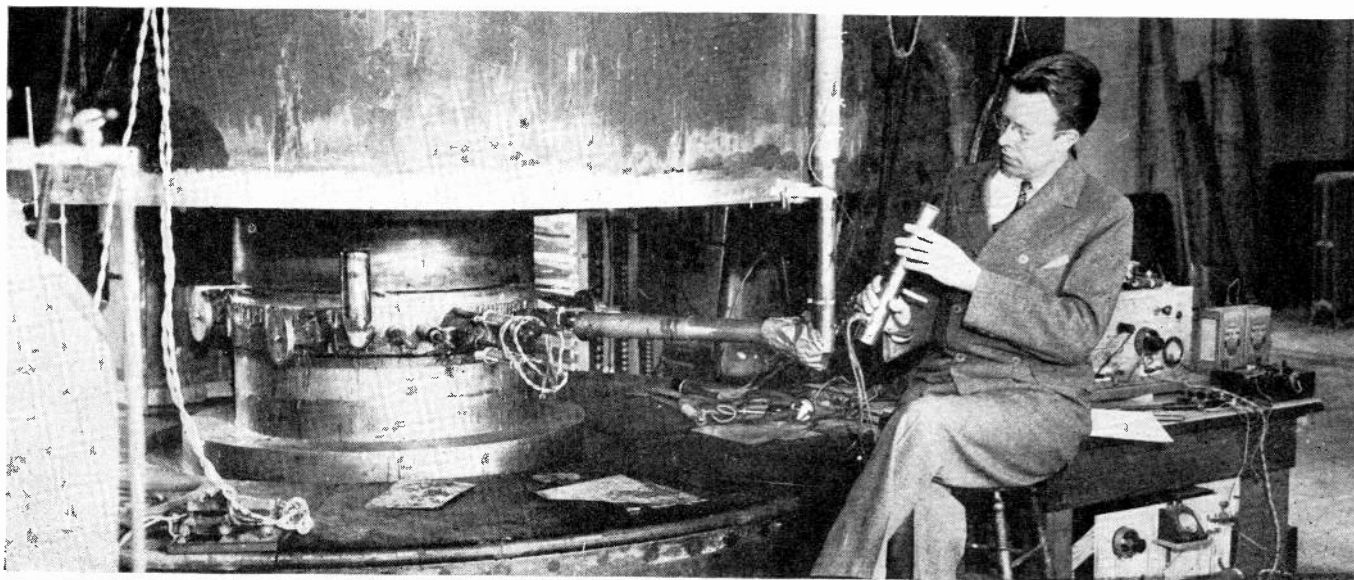

Intense magnetic fields produce tremendous velocities of particles in this "element transmuter" or "atomic-energy liberator" of the University of California, at Berkeley

TUBES—FASTER ELECTRONS

Fundamental problems of physics and physiology being attacked with new tools provided by high-speed cathode streams

theory of restricted relativity, as applied to electrons of very high energies. The new tube construction is described by Dr. Jesse W. M. DuMond, its designer, as follows:

"The proposed apparatus is a modification of the freely suspended vacuum Tesla coil patented by Sloan of the University of California. The bottom end of a large helical copper coil (shaped like a huge bed spring) suspended in a large metal vacuum box alternately assumes positive and negative potentials of 1,000,000 volts with extremely high frequencies. This much is Sloan's coil. I propose to add to this a source of electrons consisting of a small electrically heated filament mounted on the bottom end of the coil. When the potential is near its highest negative value electrons will be repelled from this 'cathode' with an energy of 1,000,000 volts through a large hole in a partition and will coast along with this energy in a vacuum space relatively free from electric fields. A magnetic 'lens' will serve to neutralize any tendency for the beam of fast electrons to diverge from the source and will refocus them much

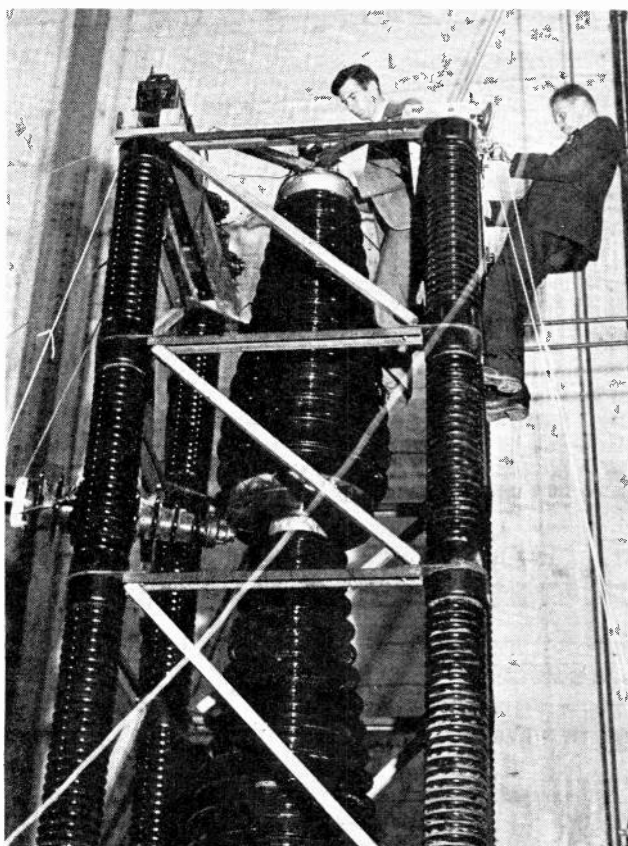

The "neutron mill" of the California Institute of Technology, Pasadena. Under a million-volt potential, electrons can be stripped from helium atoms, forming artificial alpha particles

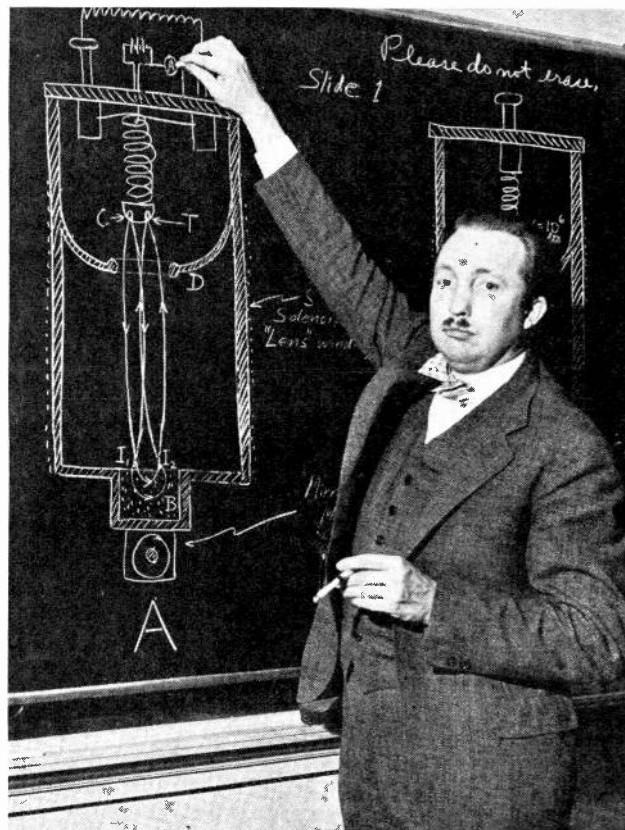

Radical new design for a 2,000,000-volt X-ray tube, sketched by Dr. Jesse W. M. DuMond, California Tech, Pasadena

as an ordinary lens focusses light. At or near the new focus this beam of electrons will encounter a strong magnetic field which will act in the same way as a mirror acts for light rays, turning the electron beam back along a return path nearly identical to the first. The same magnetic lens will refocus the electron beam on a target suspended near the cathode from the bottom end of the Tesla coil.

When the device is to be used for X-ray or artificial gamma ray generation the rapid oscillations of the Tesla coil will be so timed as to catch the electrons on their return to the target a half-cycle later when the latter is positive, thus imparting to them another million volts on top of the million they already possess. They will thus impinge on the target with an energy of 2,000,000 volts and will generate there X-rays of corresponding 'hardness.' As an apparatus for measuring the dynamical properties of high energy electrons, the proposed device bears interesting analogies to the methods of the late Dr. Albert A. Michelson in determining the velocity of light. Instead of light, I propose to use electrons."

Another powerful tool at Pasadena developed to batter
[Please turn to page 230]

How manufacturers
can cash in on radio

Prosperity Campaign

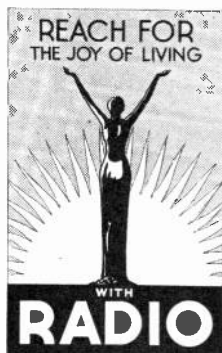

By EARL WHITEHORNE

*RMA Campaign Director,
330 W. 42d Street, New York City*

THE radio industry has organized under the Radio Manufacturers Association to lift itself out of the depression this Fall with a Radio Prosperity Campaign and radio sales drive during the month of September. Local committees in each community will work together to increase the sales of new radio sets, tubes, parts and accessories. The campaign will reach its climax in Radio Progress Week, Oct. 2 to 7—a week of special broadcast programs designed to develop popular appreciation of modern radio broadcasting and equipment, and to enlarge the radio audience.

Following is a list of suggestions for radio manufacturers and their organizations, pointing out how the makers and designers of radio sets can cash in on this Rebuild Radio Prosperity Campaign:

1. Study the Campaign Plan in the Campaign Announcement folder and figure out how you fit into it.
2. Sit down with your sales manager and advertising manager and work out a campaign of your own to tie your product into the national program.
 - a. Decide how you will force your line to the front in the September Sales Drive and capitalize the Radio Progress Week broadcasting.
 - b. Work out in detail how you will feature your product in this organized demonstration of the present perfection of radio equipment so that you will get your share of the business.
 - c. Design and schedule your company advertising for this summer and fall, so that it will help your distributors and dealers increase their local sales in competition with the automobile, refrigerator, travel, clothes and the other appeals that are after the same money. Build it around the popular appeal of Radio Progress Week.
3. Call in your district managers and sell them on the Rebuild Prosperity Program and your Company Campaign. Send them back to their districts with enthusiasm so they can inspire their salesmen and distributors and take leadership in the work of the local committees.
4. Write a letter to all your distributors and tell them that you are behind this Radio Prosperity Program and

are developing a Company Campaign that will give them the edge on this fall's selling in their territories. Ask them to start working out the local plans to tie in all their dealers.

5. Throw your whole sales staff into this campaign with the idea that you are going to run away with this Radio Prosperity Program. Offer prizes for the district manager who does the best job and the salesman who makes the record.

6. Inform your entire organization—factory, shipping, service, accounting and other departments—on this Rebuild Prosperity Campaign. Tell them that you are going to jump the gun and win a new leadership in radio manufacturing. Get them all pulling for faster shipments, lower costs and better service to help put it over and bring back your prosperity.

“The sun's come over the mountain!”

7. Call in your distributors for one day meetings in the East and West and South to instruct them on the part they are to play. Sell them all the idea of jumping into the local committee work and taking leadership with your line. Raise the banner of a real campaign—your campaign tied into the National Radio Prosperity Program—and make them feel that the Sun's Come Over the Mountain and you are going to fight right back into Good Times again.

8. Start at once a systematic cultivation of your distributors and dealers by mail and personal contact to tune them up and speed them up for the work they must do in this campaign. Make sure that they get ready in August, that they drive for quick sales, with all the energy and brains they've got in September, and that they follow through Radio Progress Week and continue their high pressure selling on through the season, while business is coming.

9. Make definite arrangements to insure that the Campaign Dealer Help materials are used by every dealer who sells your line and intelligently combined with your own display and advertising matter. Be sure your district managers and distributors understand that every dealer's store must be tied into Radio Progress Week by featuring the emblem and the slogan of the campaign and mailing out the folders to customers and prospects.

Get new models ready now, for September showing

10. If new models are to be presented this Fall in your line, have them out in August ready to be shown early in September. Prepare distributors and dealers so that the dealers will hold new model receptions to help close sales ahead of Radio Progress Week.

11. Merchandise your own product advertising to your dealers so that they will key it into Radio Progress Week and use it in their daily selling. Hammer home the point that Radio Progress Week broadcasting is provided to demonstrate the quality of radio sets. Make sure they will properly present the quality of your set.

12. Renew the pressure upon every distributor and on your own sales department during Radio Progress Week to impress upon them that they need not let down in their selling when the special broadcasting week is past. Keep up the pace and capitalize the unusual popular attention which has been captured by the continued advertising, canvassing and merchandising of the September Sales Drive.

A thyatron laboratory rectifier

By R. MILFORD KIME

THE quiet operation and high efficiency in small and moderate capacities make a thyatron tube power rectifier a very desirable piece of equipment for a student or technical laboratory. The laboratory makes two additional demands upon the rectifier as a source of direct current power. It must possess good regulation and provision must be made for protecting the tubes in case of short circuits that are apt to occur when students are at work. In other words, the rectifier should have constant voltage over the normal range of operation and constant current at some value a little in excess of the maximum rated load current.

To accomplish the required voltage characteristic, advantage is taken of the fact that the grid of the thyatron can be used to control the portion of the alternating current cycle during which the tube carries current, and hence to control the average value of the d-c output voltage. By combining a component of the output ripple with a grid bias, a grid voltage is obtained which phase controls the firing of the tubes. This is illustrated in Fig. 1: where E_a is the a-c anode or plate voltage, E_b is the negative d-c grid bias, E_c the tube characteristic, and E_r is the ripple component. For simplicity only one phase is shown. The other phases would follow in sequence, their exact time relation depending upon the number of phases employed in the rectifier.

Due to the peaked form of the grid voltage wave,

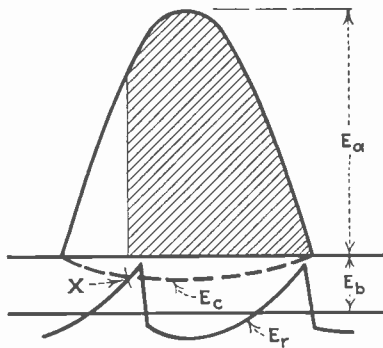

Fig. 1—Phase control of thyatron firing. The point in the cycle at which current starts governs the output voltage

decreasing the grid bias E_b causes its point of intersection X with the tube characteristic curve to move to the left, firing the tube earlier and increasing the portion (shaded area) over which the tube conducts. Firing the tube earlier in the cycle advances the phase of the ripple voltage by slightly altering its form so that the peaked portion is moved to the left. Thus each tube is caused to conduct earlier in its respective cycle and over a higher portion of the voltage wave. Since the d-c output voltage is proportional to the area under the voltage wave when the tube is conducting, it is therefore raised. In like manner, an increase of grid bias retards the phase of the grid voltage causing the tubes to fire later and reduces the average value of the output voltage.

The grid bias is obtained from a regulating device consisting chiefly of a resistance in series with a neon lamp.¹ The neon lamp, due to its non-linear volt-ampere char-

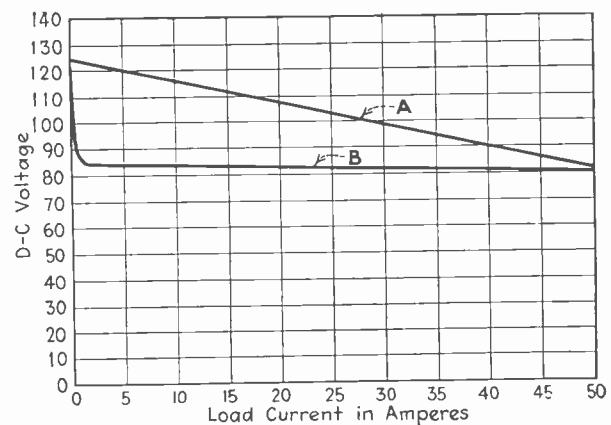

Fig. 2—Regulation curves of a two-element rectifier compared to that of a grid-controlled rectifier

acteristic, has been used as the constant element in several voltage regulating devices.² The tube tends to maintain constant voltage across its terminals, causing any variation in rectifier output voltage to appear across the series resistance. Thus a rise in output voltage produces the desired increase in grid bias to retard the point in the cycle at which each tube fires (breaks down) and restores the terminal voltage to the normal value. A drop in terminal voltage produces a corresponding drop across the resistance and a reduced grid bias to fire the tubes earlier. Small adjustments in the output voltage can be made by means of a variable potentiometer in the grid circuit.

Figure 2 shows the regulation curve of a small (5 kva.) experimental rectifier. Curve A shows its very poor regulation characteristic and curve B illustrates the result obtained by means of grid control of the same rectifier. The transformers for the final laboratory rectifier were designed to give 120 volts instead of 80 as here shown.

One method of protecting the tubes on short circuits consists in dropping the terminal voltage at a pre-determined overload current. Use may be made of a non-linear resonance circuit; a circuit consisting of a condenser, a resistance and a saturable iron-cored inductor; from which the current at resonance is rectified and applied to the grids of the thyatrons, as a negative bias sufficient to prevent them from firing. A current transformer in the a-c lines supplies current to the non-linear resonance circuit tuned for a current proportional to the overload current at which cut-off is to take place.

¹A two element tube filled with neon gas at a low pressure.

²A Corona Tube Voltage Regulator, by H. W. Dodge and C. H. Willis. *Electrical Engineering*, February, 1932.

An electron-tube time-delay relay

By G. C. HOLLOWAY

THE electron tube as an inexpensive time-delay relay is being used successfully for the automatic stopping of mandrelless filament coil-making machines in the Westinghouse Lamp Company, Bloomfield, N. J. By stopping the machines and signaling an attendant when trouble occurs the time-delay relays have reduced shrinkage and increased the rate of production over an experimental period of about two years.

The tube used for these time-delay relays is known as the type WL-712 glow tube. Filled with argon, it contains two anodes and a cold cathode. The time factor is obtained by charging a condenser, the current passing through an adjustable resistor which permits a regulation of the time-delay period to conform with individual requirements. The voltage across the condenser is applied between the cathode and the starting

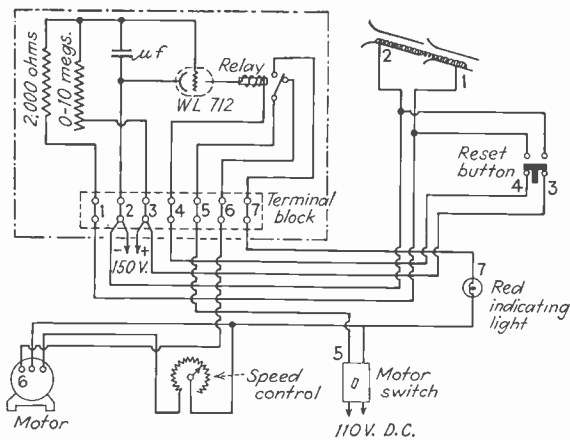

Schematic wiring diagram showing general circuit arrangement for a simple electronic time-delay application

anode and when it reaches a certain value, the relay trips and stops the machine.

Operating characteristics of the WL-712 tube permit its use in a simple, inexpensive circuit arrangement. A wide variation in time adjustment may be obtained merely by changing the values of the condenser and the resistor through which the charging current passes.

The magnetic relay of the time-delay device is a standard commercial type, having its coil rated at 60 volts, d.c., 5 watts, and its contacts at 110 volts, 10 amp. The WL-712 tube is particularly suitable for use with a power relay of this type because its relatively high output eliminates the need of delicate relays and contacts. After functioning as an automatic stop, the time-

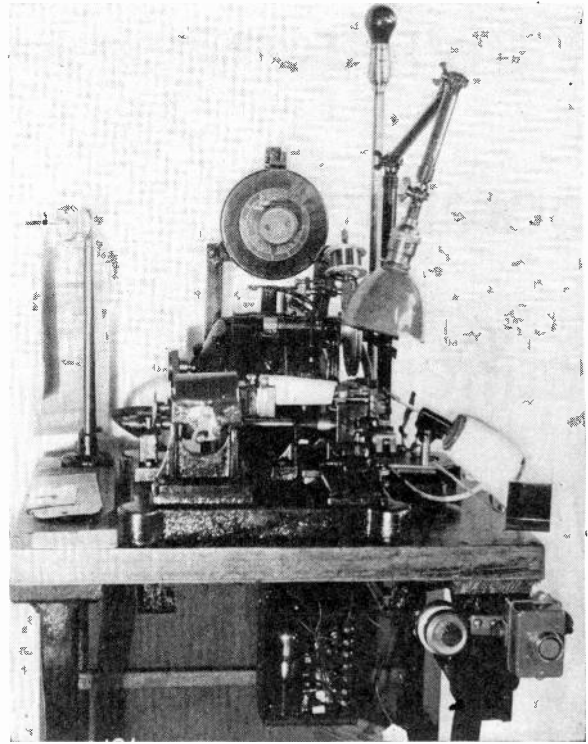

The complete mechanism for an electron-tube time-delay relay fits compactly into a metal box 6 in. by 8 in. by 4½ in. and can be mounted in a small area, as seen on this mandrelless coilmaking machine

delay relay may be reset by the push button which also serves to start the machine.

Mandrelless coil-making machines are so delicate in construction that the ordinary mechanical or electrical methods of automatic stopping have not been applicable. As a result considerable material has been wasted when trouble occurred in the past.

On these machines the filament wire is projected against a diamond die. When deflected it forms helical-coiled filaments, which resemble hair-like springs. As they leave the machine, being cut off at the rate of approximately 80 per minute in lengths of a few inches, the filament coils pass through two funnel-shaped contacts insulated from each other. These contacts are connected in series with a 2,000-ohm resistor which is in shunt with the 0.5 μ f condenser that controls the electron-tube device.

If for any reason the machine fails to produce a filament coil within the pre-set time, the voltage across the condenser builds up to the critical value of the tube and trips a relay, stopping the machine. At the same time, an indicating lamp lights and attracts the attention of a supervising operator.

During the period these time-delay relays have been used as automatic stops on the mandrelless coil-making machines, shrinkage has been reduced approximately one-third. The resultant saving made it possible to write off the cost of the installation in six months.

Its economical operation, as a result of its cold cathode construction, and its characteristics of reliability and positive action make the WL-712 tube particularly suitable for any application of a time-delay relay, especially where resetting must be accomplished at high speed by electrical means and by delicate contacts. Its field of use, however, is not limited to time-delay devices only. It may be used for a variety of industrial applications to control a large output with a small input.

Audition panel at KFWB

A COMPLETE dial system for tuning in on programs of other broadcasting stations has been installed in the studios of Station KFWB, the Warner Brothers broadcasting station at Hollywood, Calif., and makes an added convenience for the program department in studying talent, conducting auditions, etc.

Four Philco standard sets and one all-wave set form the radio end of the panel and are normally all tuned to the principal five competitive local broadcast stations. Five additional channels are also provided, which can be connected with the stations own studios in which auditions are being conducted.

With the new panel system, which includes a special shielded antenna array supported by one of the main antenna towers, it is possible for the manager of KFWB

to sit at his desk, and by operating a standard telephone dial, to select any of the stations which are permanently tuned in to the system, or to reach audition studios.

The set-up calls for the auto-telephone switchboard in ten different offices—each office equipped to listen to any five stations at separate times, or five different auditions—or all ten offices may listen to the same program or audition at the same time!

The dial is swung from the set number and as it swings back into position the main selector bank on the panel steps around and clicks into place and as the dial rests, the required station is heard!

The selectors minimize the number of lines needed to each office. At the present four are used—where without the selector something like twenty would be necessary. The selector steps around to the number dialed by the user.

Such an "Audition Panel," according to Leslie Hewett, chief engineer, does away with a multitude of radio receivers—gives clearer reception in a shorter space of time and, allows the listener to choose any station or any audition which he cares to hear.

By means of a standard telephone dial, any station studio or any local broadcasting program can be instantly tuned in

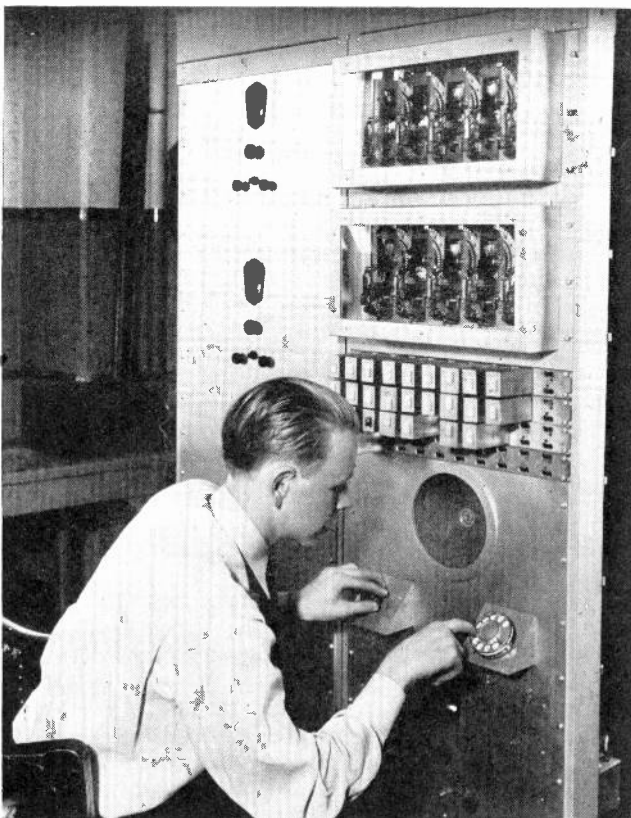

Audition panel being operated from the monitor position. At left are panels for the various receiving sets

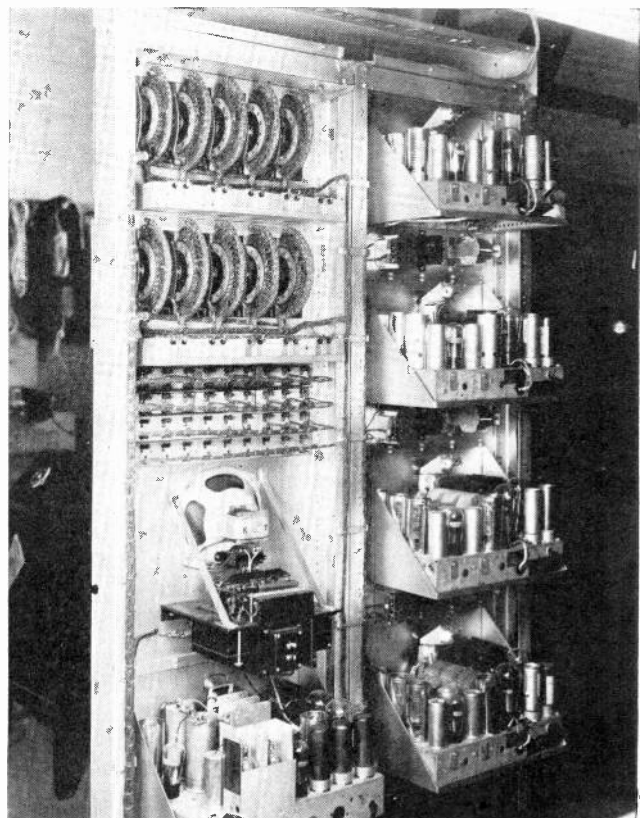

Rear view, showing main selector banks, relays, loudspeaker and standard receiving-set chasses employed

HIGH LIGHTS ON ELECTRONIC

Photo-cell engraving saves time at Detroit

THE DETROIT TIMES, one of the Hearst newspapers, is now making use of the photo-electric halftone engraver on its "rush" work. This machine, invented by Walter Howey of the Hearst organization at New York, was described and illustrated in *Electronics* for November, 1932.

The photo-electric engraver at Detroit gave an especially good account of itself during the recent earthquake disaster in California. Photographs of earthquake scenes were sent to Detroit over the telephone wires by facsimile. Within ten minutes of the time of receipt of photo-facsimile, regular two-column cuts were made and ready for printing.

Compared with this ten-minute service by the new photo-electric process, the ordinary time of making a similar cut by the standard half-tone process is forty-five minutes. The photo-cell thus registered a beat of thirty-five minutes over its fastest photographic rival.

Photo-cell safeguards oil-burning power plant

THE PROCTER & GAMBLE COMPANY, Cincinnati manufacturers of Ivory Soap, Crisco, Chipso and similar products, had a problem which threatens every business using oil-burning boilers. Where the fire accidentally goes out in such boilers, the oil may flow over and is likely to cause an explosion when the flame resumes.

Procter & Gamble has provided against this contingency by the use of a Photronic cell mounted in a pipe, leading directly into the fire-box. The device is removed far enough from the furnace so as to keep it cool and prevent the cell from being damaged by the heat.

In case the fire goes out, the light fails. The cell then opens its sensitive relay which in turn opens a power relay. This de-energizes the starter coil, allowing the starter to drop to the stop position, which shuts down the blower motor and closes the electrically operated valve. In a jiffy the flow of oil to the burner is discontinued. Hence there is no danger of oil accumulating in the boiler and the likelihood of an explosion is prevented. All this takes place in a fraction of the time that it takes to tell it.

Usually the flow of oil into boilers is shut off by some sort of thermal relay, when the fire fails. But this particular photo-cell installation is more positive in

its action than the usual fuel cut-off, for it is bound to shut off the fuel when the light goes out. The system operates un-failingly the instant the beam of light is interrupted.

Procter & Gamble put in this one installation as an experiment. They are so well pleased with the results that they are putting similar equipment in other plants.

Photocell anemometer reads wind velocity directly

CLINTON W. HOUGH, president of Wired Radio, Inc., New York City, makes use of a photocell to get a direct reading of the wind's velocity from the anemometer on his Riverside Drive apartment.

Ordinarily, in weather bureaus and other places where the familiar four-cupped anemometers are used, counters record the total rotations and then the speed of the wind must be calculated. To avoid this, Mr. Hough has arranged a photocell to be operated by a small lamp each time the anemometer shaft rotates. The pulsating current generated by the photocell is then amplified and carried to a coil-wound frequency meter, which is calibrated to read directly in miles per hour the speed of the wind.

Confidential voting with photocells

DR. NEVIL MONROE HOPKINS, research and development engineer, 111 East 10th St., New York City, has developed a method for confidential voting by means of black and white disks held in the hands of the voters, while a photocell measures the total reflection of light from the white sides of the disks, signifying "yes". Dr. Hopkins has applied for patents on the method, which can be extended to infra-red light, so that the audience of voters sits in literal darkness and cannot see what each other's vote is. By measuring the output of the photocell with a meter, however, the percentage of voters holding up their disks with the white side front, can be quickly read off. The method is designed for secret voting in confidential canvasses, psychological tests, opinions, etc.

Before conducting the vote, the audience is first "balanced up" by measuring the light from faces, clothes, etc., for a zero line. Then a top reading for 100 per cent of white disks is made. Any percentage of "yes" votes will then be indicated by the position of the meter between these two points. Allowance is made for rows of voters further from the photocell by having them hold up larger disks.

Perforated steel sheets pass sound waves

A NOVEL METHOD OF acoustic treatment is being employed in the deadening of the dome of the new planetarium of the Franklin Institute at Philadelphia. This domed ceiling is the inside of a hemisphere 20 m. in diameter (about 65 ft.), on which are projected the images of the planets, stars, and other heavenly objects viewed by the audience. Yet while the dome must reflect optical images like a projection screen, it is also necessary that it reflect back no sounds of lecturer or audience—for such echoes would create a veritable whispering-gallery.

"Our problem was to simulate acoustically, the conditions of a hill-top under an open star-lit sky," explains James Stokley, director of the new Philadelphia planetarium. "Such a hill-top would be acoustically absolutely dead, since the sound would be absorbed in every direction by the open air."

Dr. Paul E. Sabine and Dr. Dayton C. Miller were consultants on the sound-treatment of the dome, and the surface now being installed comprises eight-foot sections of Allegheny metal, perforated

CHARTS CHANGE AT WAVE OF HAND

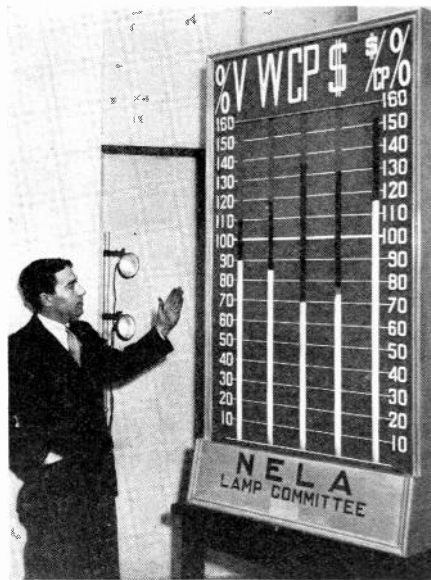

These charts co-relating lamp voltage, candlepower, costs, etc., can be manipulated to any set of inter-related values, by merely waving the hands, eclipsing a pair of photo-cells

DEVICES IN INDUSTRY + +

with one-sixteenth inch holes, one-eighth inch apart. The metal plates (18 per cent chromium, 8 per cent nickel.) are shaped to the curvature of the dome surface, and are then "shot-welded" in place while being held on a special steel-arm form, pivoted at the center of curvature. Adjustable bolts hold the steel dome to the building framework. All wall surfaces above and behind the dome are also treated with a sound-proofing consisting of mineral-wool pads, one inch thick. The Allegheny-metal surface will be painted with a special white pigment, to secure maximum light reflecting power, while the sound-waves will pass unimpeded through the myriad of small holes.

Music controls fountains in changing colors

SINGING COLOR FOUNTAINS controlled by strains of music which automatically regulates the flow of water and bathes each jet in colored light of changing hues corresponding to the rhythm, the mood and the tonal volume of the music, have been developed by the RCA Victor laboratories and put into operation for the first time at the Firestone exhibit at the Chicago World's Fair.

Vacuum tube relays in a "link circuit" change the electrical impulses produced by sound, into light or mechanical motion. By this means, the tonal frequencies are separated electrically into groups so that each will automatically correspond to a given color combination. The Singing Color Fountain utilizes the same fundamental principles as the automatic "color organ" developed by the same laboratories in Camden, N. J., which translates music into terms of colored light that may be projected on the walls of an auditorium in changing patterns. This color organ is also to be seen at the Chicago Fair in the RCA-Victor exhibit in Radio Hall.

The Firestone exhibit includes six fountains situated in a 100-foot pool of water, surrounded by terraced walks. Each jet is capable of spurting water to a height of 20 feet. Powerful colored light projectors hidden near the surface of the pool are automatically operated and controlled by the music, which also controls the water pressure of each fountain. As the music swells to a crescendo of volume and power, the colored hues reflected on the fountain deepen and the water wells up to its highest projection. When the music is light and airy, the fountain jets seem to dance in time with the music and the colors reflected on the moving water columns

melt in and out in changing patterns of light. Similarly, the voice of a soloist or of a chorus can produce the same effects. Colors are known to influence definite emotional reactions. Thus it is known that green is restful, blue is cold, and that orange and red are warm and passionate.

Photocell effects large savings in demand charges

A PHOTO-CELL UNIT has been applied by the Electric Power Construction Company, 201 North Broad Street, Philadelphia, Pa., to make any stylus-type curve-drawing electric or steam meter operate as a maximum-demand limiter or controller.

Light reflected from the polished stylus on the curve-drawing meter serves to operate the photo-cell which may in turn control a relay or switch for performing any function, such as merely giving a visual or audible warning, or actually interrupting part or all of the circuit. By means of a time-delay device, the maximum-demand feature can be limited to peaks which continue for a predetermined period. Where the unit is arranged to interrupt some circuit which can be turned off temporarily without inconvenience, savings in the demand charge as high as 10 to 25 per cent are not unusual, according to the makers.

Radio invaluable in forest-fire fighting

R. D. WATERHOUSE, electrical engineer of the U. S. National Park Service, Rainier National Park, Longmire, Wash., has applied short-wave radio for communication between forest patrols and between crews engaged in forest fire fighting. Two sizes of radio transmitters are used for this purpose.

The larger of these two sets weighs about 60 lb. and has a voice range of 50 to 60 miles daytime (code much farther). This is a sort of field-headquarters set, which is moved about on truck or pack horse.

The smaller set is designed to be carried conveniently in a pack-sack, and hence goes right up onto the firing line wherever a man can go. This set has a range of 3 to 5 miles for voice and, of course, much more by code. Its function is to keep the front-line trenches in communication with the larger set on the truck, which, in turn, reaches to the outer world.

The purpose of this equipment, of course, is for maintaining constant communication in combating forest fires. The combination of these two sets makes it possible for the forest supervisor or the fire-crew foreman to plunge into the wilderness, go hurriedly through the roughest country, and still never be out of touch with the supporting lines.

PHOTO-CELL STEERS FROM PRINTED GRAPH

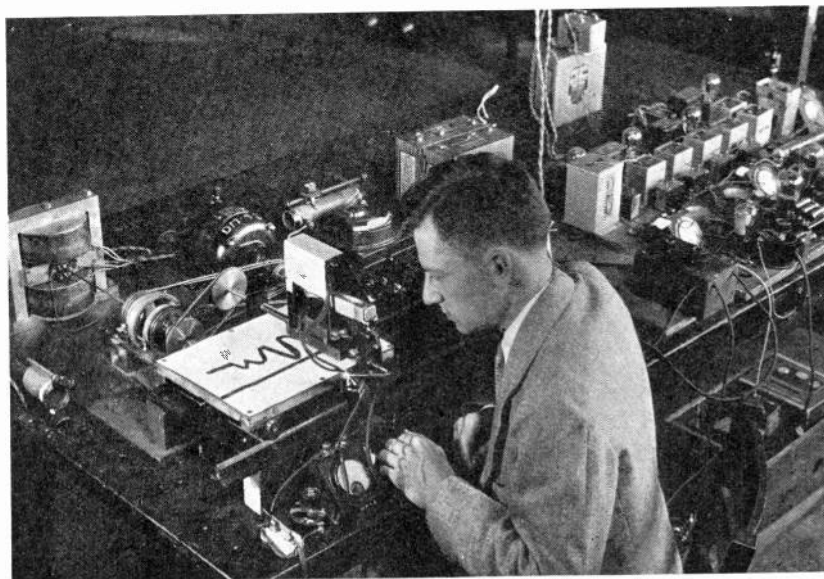

A plane or ship might be steered across the Atlantic on a great-circle course, automatically, by this photo-electric servo-mechanism developed at Massachusetts Institute of Technology, Cambridge, as an outgrowth of photo-cell calculating machines. Response occurs in one-twentieth second

* * ELECTRONIC NOTES

Combined photo and amplifier tubes

By H. A. McILVAINE*

IN AN ARTICLE APPEARING in December, 1932, *Electronics*, by Mr. Koechel, it was stated that the grid of ordinary vacuum amplifier tubes was light sensitive and that tubes of the conventional type could be made to pass current when illuminated by light. The writer has done much work for a number of years

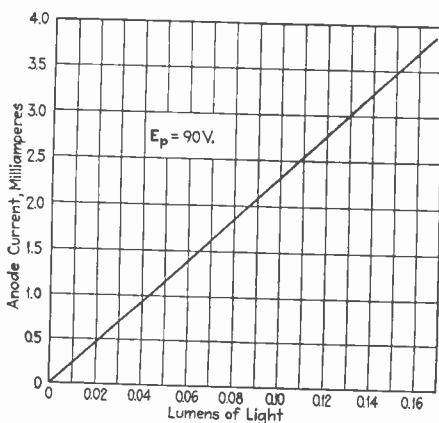

on this phenomenon and especially with combinations of photo-tubes with vacuum tube amplifiers in the same envelope.

In a typical circuit the light sensitive cathode and the triode anode are at opposite ends of a voltage divider with the

grid and filament between these voltages, the grid being negative with respect to the triode cathode. In this case when the light sensitive cathode closes electrons they go to the grid and decrease its voltage, causing plate current change of appreciable proportions.

In the figure is shown the result of plotting anode current against illumination for a particular tube showing it to be linear and since it is a vacuum cell good at the higher frequencies. The combination of cell and tube has made possible loudspeaker operation from a modulated light beam without the medium of intervening amplification.

The writer has filed in the Patent Office a number of applications on various phases of this work; many of these applications are of several years' standing; several of them have been issued. It seems that there are many possibilities of useful combinations in this direction.

*Continental Electric Company.

Vacuum tubes and calculating machines

IN THE DETERMINATION OF secondary stresses in bridges, sets of linear equations involving from ten to twenty unknowns may occur, and the labor involved in the solution of the otherwise simple system of equations becomes very great. To solve the equations $a_1 X$

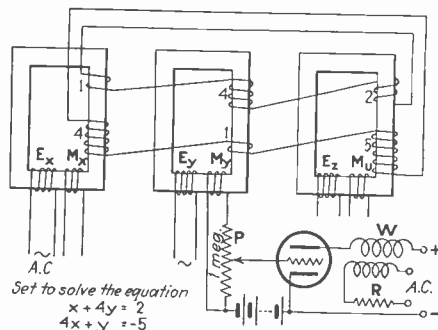

$+ b_2 y + N_2 = 0$ and $a_2 X + b_2 y + N_2 = 0$ —R. R. M. Mallock (Cambridge Instrument Company) uses three a-c transformers X, Y, N provided with the coils a_1, b_1 and N_1 respectively, with the end of N_1 directly connected to a_1 , and carrying a second set of coils a_2, b_2 and N_2 . If alternating voltage is applied to an independent coil E on the transformer X, the current flowing in the coil will induce a flux in the core of X, hence e.m.f.'s in all the other coils and fluxes and e.m.f.'s x, y, u on the other transformers. If the e.m.f.'s induced in the set of independent coils S_x, S_y, S_n are measured the ratio $x/u, y/u$, are the solutions of the equations. The reading instrument consists of a wattmeter W with vacuum tube, and the instrument constructed contains 10 coils and transformers. Proceedings Royal Society 140:457-484, 1933 has the description of this work.

* * * THE ICONOSCOPE

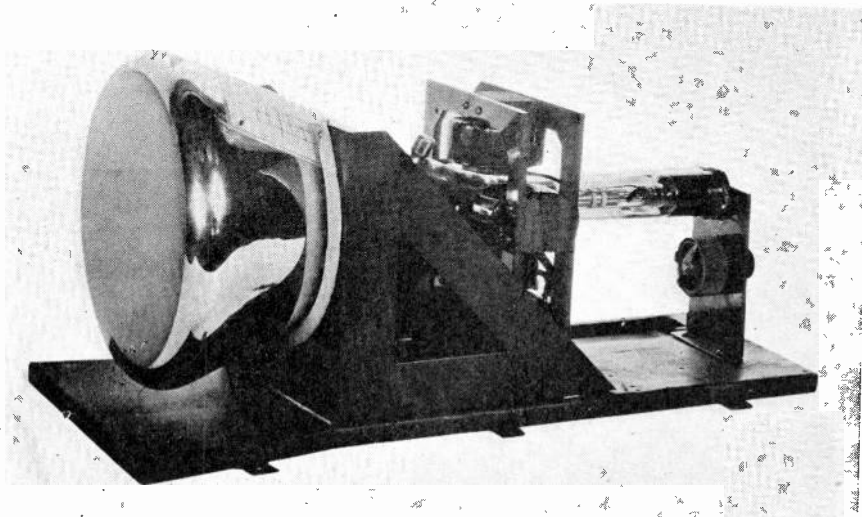

Cathode-ray scanning tube of Zworykin. The scene, focussed upon a mosaic of photocells, charges thousands of condensers whose discharge currents, produced by the cathode-ray beam, are transmitted to the receiver where the scene is re-created

The Lucerne plan

THE WAVELENGTH DISTRIBUTION coming into effect in Europe and the Mediterranean countries on January 15, 1934, provides for 11 channels between 1,875 and 1,107 m. divided among 17 stations. In the band between 200 and 1,000 m. 53 channels used by 86 stations are above 300 m. and 53 channels used by 87 stations are below 300 m. Four cleared long wave and four exclusive medium wave channels are given to Russia, four medium waves to France, Germany has one long wave of its own and 11 medium waves, Italy four medium waves, Great Britain one long wave, two medium waves and one national wave (203.5 m.)

The power of stations having waves above 1,000 m. will be limited to 150 kw. (with the exception of Moscow); between 550 and 273 m. not more than 100 kw. are permitted (excepting Budapest, Leipzig, Prague, Rennes, Toulouse, Vienna, 120 kw. each). Between 273 and 240 the maximum permissible is 60 kw. and between 240 and 200 30 kw. The plan has resulted in shared wavelengths for a number of stations.—*Wireless World*, June 23, 1933.

FROM THE LABORATORY ++

Orientation mechanism

By A. L. RUBENSTEIN

THE DESIGN OF A mechanism which automatically directs itself at a moving light source was first achieved by Mr. B. F. Miessner during the World War. Its practical applications were investigated at that time—and its limitations

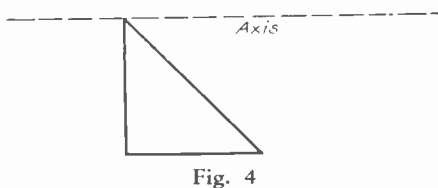
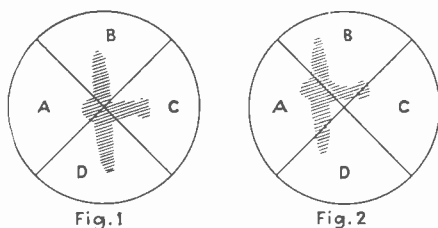

were principally due to the inadequate development of photo cells and accessory equipment. This inadequacy no longer exists, and this article describes an orientation mechanism which attempts to take advantage of more recent developments in electronics.

In general, the device should maintain a line of sight between itself and some external object or light source in motion relative to the device. Successful operation in different fields will require some special adaptation. For example, the tracking of a lighthouse or lightship from a vessel at sea may be more easily accomplished than the automatic training of an airplane machine-gun on an enemy airplane. Conditions of poor visibility may require the operation of the device with infra-red sensitivity. The installation of the mechanism on a torpedo which shall follow its target, must necessarily be rugged and positive. In celestial photography where the telescope is moved by clockwork or more recently by a synchronous motor, automatic orientation may replace the present necessity for occasional slight manual correction of the field.

It is evident that we need an optical-electrical-mechanical sequence, with image position as the variable in the optical function. Image position is secured by a division of the optical field into segments. Image position variation is then completely expressed by the coordinates of light quantity variation in the segments. Orientation involves a return to the initial image position by

maintaining a relative constancy of light in the optical segments. Figure 1 shows the initial position of the image in such a field, while Figure 2 shows some new position which is to be restored to the initial position of Figure 1. Assuming that the image is that of a dark object with a light background, it appears from the figures that movement of the object has resulted in a decrease of light in quadrants A and B. Assuming here that the decrease of light in one quadrant results in the motion of the optical field in the direction of that quadrant with respect to the center of the optical field, the net effect is the restoration of the image to the initial position.

Figure 3 illustrates an actual form of the complete device. An image of the object or light source to be tracked is focussed at the front plane surface of a circular glass prism the geometrical form of which is developed by the rotation of a right-angled isosceles triangle round the axis shown in Figure 4. Light from the image is thus reflected into planes approximately at right angles to the optical axis of the objective lens. The periphery of the cylindrical prism is divided into four quadrants, the light from each quadrant falling on a photoelectric cell. The extent of the field is limited to the region immediately surrounding the object by an adjustable diaphragm.

In the case of a light object on a dark background or a light source or point source of light, the photoelectric cell circuit for each quadrant is actuated by an increase of light in the corresponding quadrant. In the case of a dark object on a light background the circuits are actuated by a decrease of light in the corresponding quadrants. A single switch effects the transfer between the

two types of image. The switch positions corresponding to dark and light objects (relative to background) are indicated at the switch by DO and LO respectively. Motion of the image relative to the optical device actuates the photoelectric cell circuits corresponding to one quadrant or to two adjacent quadrants. The circuit corresponding to a quadrant operates a mechanism—in this case a relay which brings a pulley into contact with a continuously rotating drum—which in turn moves the optical device to restore the quadrant concerned to its initial position with respect to the image. Use is made here of a grid-glow tube circuit—four complete circuits being provided, one for each optical quadrant. The variable condenser shown in the circuit adjusts the operating point of the grid-glow tube.

As an illustration of the use of the instrument for tracking a virtually point light source rather than an appreciably dimensional object, the point source of light is viewed through the eyepiece which is positioned to offer a virtual image of the plane of the front surface of the cylindrical prism; the latter being pierced by a small hole at the center. The optical device is then acting as a telescope with the circular prism acting as a diaphragm. Under these circumstances, practically no light from the point source is falling in any quadrant. Motion of the point source throws light into one quadrant or possibly two adjacent quadrants, actuating the corresponding mechanisms which restore the image to the central hole.

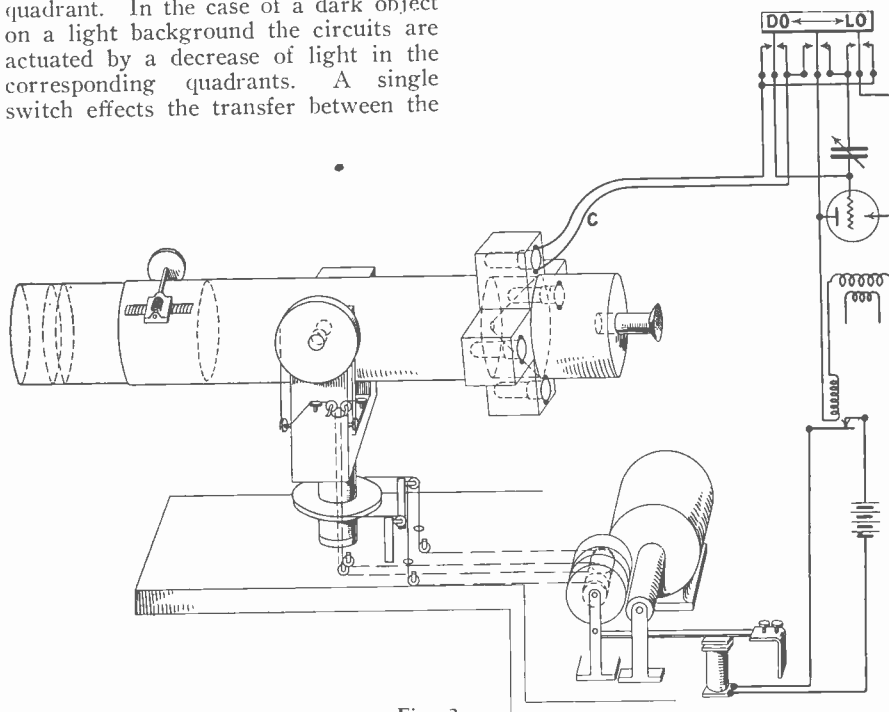

Fig. 3

electronics

McGraw-Hill Publishing Company, Inc.
330 West 42d Street
New York City

O. H. CALDWELL, *Editor*

Volume VI —AUGUST, 1933— Number 8

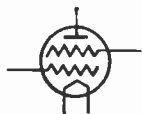

We may lose our shirt at Mexico City

THE North American Radio Conference is now going on at Mexico City.

Reports from the meeting indicate that Mexico's application alone called for sixteen clear channels, out of the present forty clear or near-clear channels. Also that if all of the requests from our neighboring nations were to be complied with, there would be just four channels left to the United States, on which to operate its 600 broadcast stations.

Very clear it is already, however, that out of this conference the United States is going to come away the loser, and that the pressure is going to fall on American clear-channel stations as the presumptive victims in a necessary new allocation.

The technical staff which accompanied the U. S. delegation is well-qualified. But unfortunately there is no one on the U. S. Committee itself who is personally equipped in a radio sense to grasp the situation and protect the interests of American broadcasting.



Radio sets will be smaller

UNDER demand from the automobile manufacturer for smaller radio sets for installation on future cars, tube engineers have gone into huddles to see what can be done. In this issue of *Electronics* will be found a description of the development of laboratory types of tubes directly aimed at very short wavelengths. The physical dimensions of these new tubes have been reduced

by a factor of ten; but the electrical characteristics are as good as present standard sized tubes. This shows what can be done toward reducing tube size.

Fortunately the tube manufacturers have agreed not to turn loose on the market smaller tubes, especially made for auto radio, until the first of the year; there is no guarantee that new tubes will be available then. But it is certain that time will be provided in which the tubes may be thoroughly designed and tested.

In Germany a new core material containing iron is being used for interstage transformers, reducing the size of these components. In this country Polyiron seems to be winning more and more recruits. Iron core coils and iron core tuning will reduce the size of radio sets still further.

And so the tuning mechanism of radio sets is steadily being reduced in size. Time may come when the loud speaker must be separated from the tuner because the latter will be fitted into dimensions so small that not even a poor speaker could go into the space.



Forty centuries of sunspot cycles

RADIO reception is still showing the fading and distortion due to intensive reflection of the sky-wave from a Heaviside Layer undisturbed by sunspot activity. Long-range reception continues

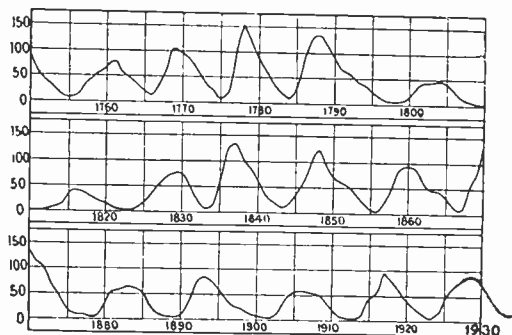

exceptional. We are again in such a period of sunspot minimum as we were back in the early days of broadcasting, when also a small station could be heard across the continent.

All over the world astronomers are watching for the breaking out of the first of the high-latitude spots on the sun which will indicate that another

sunspot cycle is on its way. Each new 11-year cycle is ushered in by spots near the sun's poles, and these groups drift toward the equator as the cycle progresses.

But radio engineers who have waited patiently for an end of present broadcast distortion and fading, can find encouragement in the fact that the sun has been through a dozen such cycles recorded by human observers. And similar cycles stretch back through the centuries, as recorded by tree-rings.

Recently the editor of *Electronics*, strolling through the Egyptian rooms of the Metropolitan Museum of Art, New York, was confronted with unmistakable evidences of sunspot cycles recorded in the tree-rings of wooden caskets and statues, made of the cedar of Lebanon, and dating from 1900 B.C.!

For 40 centuries, evidently, the sun has been going through these same antics. Probably 350 complete cycles have taken place since those cedars of Lebanon set down their record. So there is every probability that the sun will come safely out of this present cycle and that radio will soon be itself again.



Why not a signal bell to call the radio listener?

EACH day striking news events are inserted into the broadcast programs, changing the routine schedules. Yet unless the listener has his own radio set continuously tuned in, he misses these most thrilling features of the radio day.

Every telephone is provided with a bell to attract the user's attention. Without a bell, a telephone would be only 50 per cent as useful.

Yet the average radio receiver is like a telephone without a bell.

The listener misses some of the best things on the air because he has no way of being notified. If there were some way of calling him to his radio set by means of a bell or a signal light, he would be able to enjoy special features. And so the public's appreciation of broadcasting generally would go up.

A low-frequency control tone on the station's carrier-wave, inaudible to the ear, but capable of operating a signal relay, might be one way to do the job. Clock control for special periods would

be another solution. Radio engineers can suggest other ways so that the home or office radio set will ring a bell or light a lamp when a special announcement or superlative feature is on. Such a service would help popularize radio and bring the public to realize more fully the wonderful things the broadcasters provide.



H. D. Arnold, 1883-1933

THE loss of H. D. Arnold, director of research of the Bell Telephone Laboratories is a loss to science and engineering, and particularly to the arts with which users of electron tubes are familiar. Dr. Arnold had contributed materially to the general fields of communication, thermionics, and magnetism. In particular his early recognition of the necessity for high vacuum in amplifier tubes, his development of oxide-coated cathodes, his contributions in magnetic alloys have advanced to a high state the arts of wire, cable and space telephone and telegraph, phonograph recording and reproduction, sound motion pictures, improving the hearing of the partially deaf, and finally the newer art of electronics.

BEAT THE ELECTRIC EYE — MAKE \$20

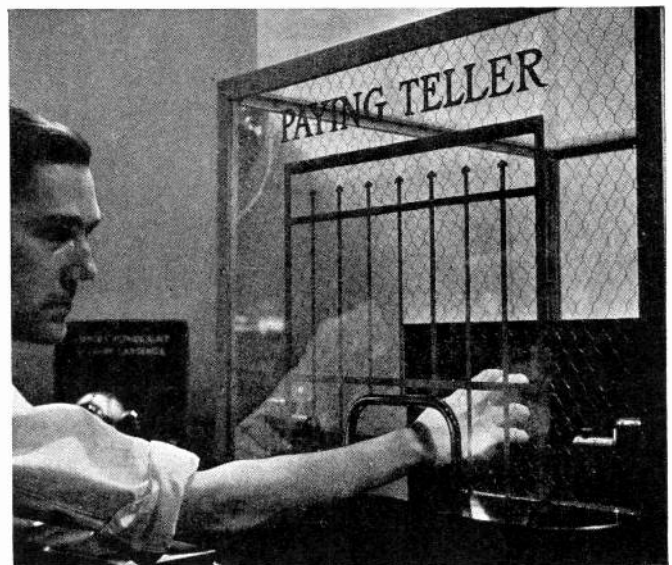

At the Chicago World's Fair, the Westinghouse company has a photo-cell protecting a \$20 bill lying in apparent easy reach behind this bank-window. But when your hand goes in, a barrier goes up!

Soil properties at radio frequencies

[R. L. SMITH, Nat. Phys. Laboratory; see also M. J. O. STRUTT, Philips Research Lab. Eindhoven]. The change in reactance of a vacuum tube oscillating circuit is determined when it is coupled to another or measuring circuit which contains the sample under investigation. The coil of the oscillator is coupled to that of the measuring circuit and as the conductivity in this circuit is adjusted, the reactance of the oscillating circuit, and the frequency change. The conductivities vary from less than 10^8 e.s.u. for dry soil to a value of several times 10^8 e.s.u. for normal moisture content, the corresponding dielectric constant from 2 to 3 to about 20, measured at the higher radio frequencies (the entire range being 1,000 cycles to 10 million cycles). The results indicate that at Rugby over 90 per cent of the ground current is carried within the first five feet of soil (10^7 cycles). For soil of 10^8 e.s.u. and 20 as dielectric constant the current will have decreased to 1/10 of the amplitude which it has at the surface at depth of about 5, 12 and 25 m. for 10,000; 1,000 and 200 kc. (30 m., 300 m., 1,500 m.)—*Proc. Roy. Soc.* 140: 359-377, 1933. *Annalen d. Physik* 17: 376-384, 1933.

The influence of load on gain and selectivity

[H. G. BAERWALD, Heinrich Hertz Institute] When the load is a pure resistance equal to the internal resistance, we speak of matching; when inductance and capacity are present and the conjugate complex quantity of the load can be made equal to the internal resistance, we speak of resonance and have maximum output. It is shown how difficulties in matching account for the poor results obtained with feed back detectors. When several r-f stages are used, gain is a byproduct and selectivity is what counts, that is the width of the band in which the strength falls from 100 to 50 per cent (width y_{50}) and from 100 to 1 per cent (width y_{100}) and the approach to a rectangular top of the band, ratio g . The first case examined is that of a tube followed by a band pass filter in which the coupling of the resonance circuits varies only slowly with frequency. The treatment is then extended to "n," possibly staggered, circuits giving a symmetrical resonance curve. Staggering increases the width at the top. Without staggering it is useless to go beyond four stages as the ratio g increases only slowly above $g = 0.22$. With staggering and individually matched circuits g would increase with the number of stages to about $g = 0.6$ for ten stages.—*El. Nachr. Techn.* 10: 258-276, 1933.

Metal rectifiers for intermediate r.f.

THE WESTINGHOUSE BRAKE AND SAXBY SIGNALING COMPANY, London, has developed the Westector, intended for the rectification of h.f. currents. In size it resembles a grid leak, and is a metal detector which can replace a diode tube in the detection without amplification of i.f. in a superhet receiver. In this case, it may be preceded by an ordinary screen grid or variable—mu r.f. amplifier, but at r.f. a low impedance high mutual conductance screen grid tube is recommended.—*Electrician* 110: 489. (April 14) 1933.

Conductivity of cuprous and cupric oxide

[M. LEBLANC, H. SACHSE and H. SCHOPEL, University of Leipzig; F. ROTHER and H. BOMBKE, University of Berlin]. The conductivity of cuprous

oxide Cu_2O depends a great deal upon its purity; when it contains oxygen, or traces of pure copper, the value increases. It varies in general between 3.6×10^{-9} and 6.6×10^{-9} in the compact form, and between 4.7×10^{-9} and 3×10^{-9} in powdered form. Cupric oxide CuO conducts about one thousand times better.

It is found that when sheets of copper are left at about $1,065^\circ C.$ for nine hours instead of the usual much shorter period used when preparing photocells, the cuprous oxide migrates from the surface into the pure copper. The layer thus formed is conducting where it neighbors the pure copper, and gives no photoeffect; near the surface we have pure cuprous oxide; the photoelectric effect is produced in the cuprous oxide; but the electrons cannot traverse the boundary layer of pure cuprous oxide between the mixture of copper and cuprous oxide and the mixture of cuprous and cupric oxide near the surface.—*Ann. de Physik.* 17:334-344. 1933. *Zeits. f. Physik* 81: 771-775. 1933.

Improved beat frequency oscillator

[R. V. RADINGER, Heinrich Hertz Institute, Berlin.] Both oscillators are built alike as much as possible and the stray field of the grid coil is reduced to a low value by choosing a small value of L/C. Not only were the coils screened, but special condensers with a small temperature coefficient used, and the tubes so arranged that their heat was dissipated without heating the rest of the set-up. As the coupling must not change over the required frequency range, it is made close for each oscillator so that overtones appear; their strength is kept low by small L/C and coupling the r-f amplifier in such a way to the oscillator that the higher frequencies are damped out. The more one r-f oscillator exceeds the other in strength near the detector, the smaller the percentage strength of the overtones. Distortions in the audio stage

are minimized by giving generous dimensions to the core and by using push-pull output. R-f currents were prevented from entering the audio stages by a filter having a high input resistance. The audio frequency amplifier is straight from 10 to 10,000 cycles as long as there is no load, but the output drops rapidly at the higher frequencies when

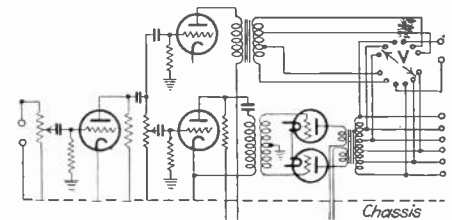

loaded, so that the device was designed to give two ranges, 0 to 750, and 750 to 10,000 cycles. Above 100 cycles the strength of the overtones was 0.5 per cent at one watt, the frequency variation 0.3 cycles within an hour.—*Zeits. techn. Phys.* 14: 197-202, 1933.

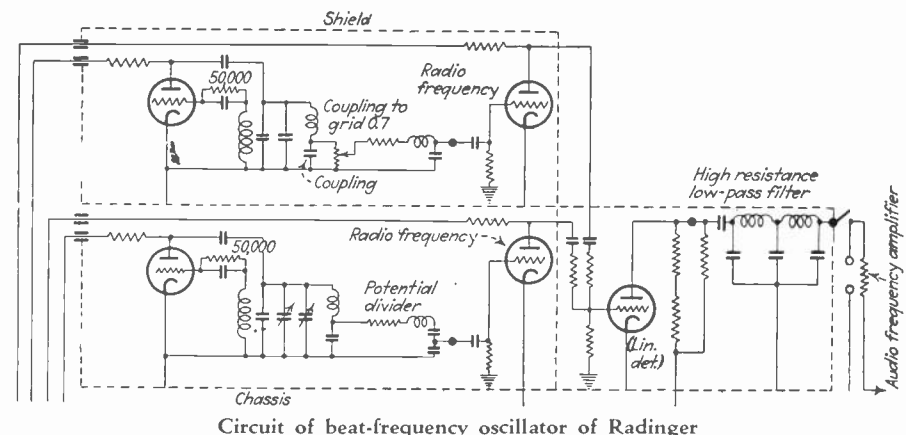

Circuit of beat-frequency oscillator of Radinger

Higher voltage vacuum tubes— faster electrons

[Continued from page 217]

down the foundations of the atom, is the "neutron mill" designed by Dr. Crane and Dr. Soltan under the direction of Dr. Charles C. Lauritson. For this "neutron factory," the raw materials are electrons, helium gas, beryllium, lead and paraffin. With an ultimate intensity of more than 1,000,000 volts, electric particles are shot through the helium, knocking off electrons surrounding the helium atom, which then becomes an artificial alpha particle. The next stage in the process consists in using the alpha particles as ammunition with which to blast neutrons out of the beryllium. Next to cosmic rays, neutrons have the greatest penetrative power of any ultra microscopic entity. Whereas a 1,000,000-volt X-ray penetrates less than an inch of lead, it has been found that the neutron penetrates more than four inches of lead. After passing through a lead plate of that thickness, neutrons obtained at Caltech shoot through a cake of paraffin, knocking off particles from the paraffin atoms. A supersensitive electroscopes reveals the presence of the new-born neutrons by registering the degree of activity of the particles they smash from the paraffin atoms.

Results to be accomplished by the great high-voltage X-ray tube constructed by the Massachusetts Institute of Technology to be driven by the 10,000,000-volt Van de Graff static machine at South Dartmouth, Mass., were outlined by Dr. Karl Compton, president of M. I. T., speaking before the convention of the Associa-

tion for the Advancement of Science at Chicago.

So far on preliminary tests the huge Van de Graff machine has delivered only 6,000,000 volts of its expected 10,000,000 volts, but the trouble has been traced to the stealing of electrostatic charge by the metal walls of the great hangar in which the static machine is housed. These walls are now being insulated, said Dr. Compton, and in September "Goliath" (as the great generator is nicknamed), will be ready for test with the great X-ray tube now nearing completion at Cambridge by Dr. Van de Graff, L. C. Van Atta, and E. W. Samson. For this tube, it was found that glass would not withstand the terrific electrical strains imposed by the high voltage on which the tube is to operate, so the designers had to resort to other materials.

The velocities which the electrons will attain in this great tube under the 10,000,000-volt potential of the electro-static generator, are comparable to those of the cosmic-ray particles themselves, so that the M. I. T. tube is in effect a "cosmic-ray tube." At 10,000,000 volts the electron penetration will be two and a half times as great as the penetration of the gamma rays of radium, which have energies corresponding only to about 4,000,000 volts. Beyond the spectrum of the gamma rays lies the enormous range of the cosmic rays, which reach up to three billion volts, so that the new tube will mark the entry of man's experiments into the cosmic-ray field.

Thus science will have reached a new landmark, commented the speaker, creating artificially for the first time electron velocities comparable to those coming from interstellar space, and designated by Dr. Millikan as the birth-cries of matter, when heavy atoms are built up from lighter ones.



NRA Radio Industry Code

[Continued from page 208]

by the firm of public accountants. Upon complaint that a manufacturer has sold below cost, the National Committee may upon its own motion have the books of the suspected manufacturer investigated and audited, and if the audit discloses that sales were made actually below cost of production, the National Committee is required to report all facts to the National Recovery Administration.

Dropped lines or surplus stocks which it is necessary to convert into cash, must be first reported to the executive committee of the radio-set division, and its approval obtained before proceeding with the sale.

Each manufacturer is permitted without restraint or restriction whatever, to determine the amount and character of the radio products which he produces.

Nothing in the Code applies to radio and television sets sold for export and actually exported and retained in foreign countries.

Chapter II, relating to radio-tube manufacturers, stipulates that the provisions in the main Code referring to cost-of-production shall not be applicable to manufacturers of radio tubes, except as outlined in the tube chapter. Also, the radio-tube manufacturing industry is defined to mean "the manufacture for sale of electronic tubes or valves." Section 6 of the tube chapter specifies that no tube manufacturer shall sell his tubes

at terms or conditions that will result in the customer paying for the goods received less than the cost to the seller—provided, however, that dropped lines, seconds, or inventories which must be converted into cash to meet emergency needs may be sold on conditions approved by the National Emergency Committee—also further that selling below cost in order to meet existing competition on products of equivalent design, quality, character or specifications, shall not be deemed a violation of this section of the Code.

Where tubes are sold by price lists, new lists embodying revised prices must be filed with the executive committee ten days in advance of the change. The committee will then supply copies of the new prices to all known tube manufacturers, who are in turn privileged to file copies of their revised price lists and discount sheets which become effective with the date of the first price revision filed.

For a period of one year from the adoption of the Code, it is agreed that no new radio receiving tubes will be introduced, except for experimental purposes, without the approval of the executive committee of the tube division.

The Radio Industry Code was submitted to the National Recovery Administration for revision, on June 29. A public hearing will be held at which interested persons may express objections to provisions in the Code. Acting upon this evidence, revisions will be made, and the revised Code submitted to the President of the United States for his approval. When so approved by the President, the Code takes effect within ten days.

+ NEW PRODUCTS

THE MANUFACTURERS OFFER

Trimming condensers

THE H. H. EBY MANUFACTURING COMPANY, 21st and Hunting Park Ave., Philadelphia, Pa., announces a new line of trimming condensers. The featured number is the new trimming condenser in double form. As shown, this item is similar in its general aspects to the single trimmer. However, the double feature has some exceedingly novel aspects. For instance, a single assembly can be used in the intermediate frequency transformer and adjusted from

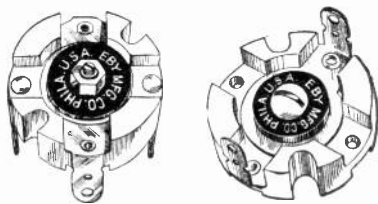

one side for each condenser which is respectively connected to the primary and the secondary of the transformer to be tuned.

The assembly is easily and quickly mounted and is compactly designed. These new Eby trimming condensers are made of the highest grade ceramic material with a power factor of between 0.4 per cent and 0.5 per cent. The plates are of spring, non-ferrous material. The single or double assembly can be made in any practical range that an engineer might require, the low range being 10—80 μ mf and the high range 700—1000 μ mf. — *Electronics, August, 1933.*

Universal output meter adapter

A HANDY CONNECTOR for oscillators and output meters, is offered by the Alden Manufacturing Company, 715 Center St., Brockton, Mass. The clip is so designed that it will contact the plate prong or any other small prong of any tube, whether it has 4, 5, 6 or 7 prongs on either the small or large sized base. It is also properly insulated for use in the closely shielded sockets. With all these valuable features it becomes a necessary adjunct to every output meter. So flexible is the design of this connector that it may also be used for attaching microphones, tone controls, pickups, extra speakers, amplifiers, volume controls, volt meters, etc. to the cathode, plate or various grid prongs of any tube.—*Electronics, August, 1933.*

Intermediate voltage cathode ray tube

THE 342-G IS A high vacuum tube of the heater-cathode type for use in studying wave forms of alternating currents at any frequency between zero and sixty million cycles. It is capable of reading voltages from one to one thousand volts without amplifier or voltage divider. The tube has a grid so that the intensity of the spot may be varied at any frequency between 1 and 100,000 cycles. The spot is focused electrostatically by two anodes. The size of the spot is one millimeter. The color of the spot is either green very nearly white or blue and is determined at the factory. The color of the tube purchased should be chosen by the purchaser in accordance with the use to which the tube is to be put. The life of the tube is rated conservatively at 300 hours. This tube is manufactured by the Telephoto Corporation, 135 W. 19th St., New York City, and retails at \$30.

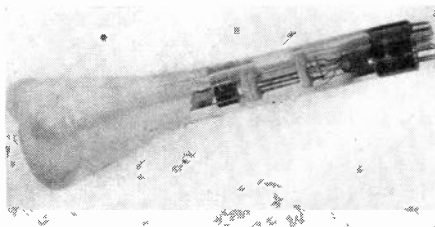

Characteristics

Cathode	2.5 volts	2.75 amps.
		(heater)	
Anode A ₁	$\frac{1}{2}$ anode voltage on A ₂	
Anode A ₂	700 to 2,000 volts	
Sensitivity	5% of A ₂ potential to deflect beam one inch	
Grid	-45 to -90 with respect to cathode	
Frequency range	deflecting plates 0-60 megacycles	
		grid, 0-100 kilocycles	

—*Electronics, August, 1933.*

Sparks suppressor

A NEW SUPPRESSOR FOR automobile radio sets has been developed by the Erie Resistor Corporation of Erie, Pa. Tests made by manufacturer on this suppressor have shown that it will not change more than 10 per cent in resistance value in 50,000 miles use, provided one suppressor is used in each high tension lead.

It is stated that an unusual "mix" has been perfected which stands up in the extremely short length used in this unit.—*Electronics, August, 1933.*

Paper condensers

THE SOLAR MANUFACTURING CORPORATION, 599-601 Broadway, New York City, in addition to its line of electrolytic and mica condensers, is now manufacturing paper condensers in a new department recently installed for this purpose. This department is equipped with automatic winding and impregnating machinery designed to take care of both standard and special types of paper-dielectric condensers. The complete Solar line now covers all fixed condensers used in the radio and allied industries, including wet and dry electrolytic condensers, paper condensers, and molded mica condensers.—*Electronics, August, 1933.*

Automatic weld timer

FOR USE IN CONNECTION WITH resistance welding machines, Electric Controller & Manufacturing Company, Cleveland, Ohio, announces an automatic weld timer. This timer does not provide a definite amount of time for each weld, but varies the time automatically in inverse proportion to the rate of current flow to produce a 100 per cent weld at each operation. The standard type of automatic weld timer consists of a rectifier tube which charges a fixed condenser in proportion to the rate of current flowing in the welding circuit. When the charge reaches an amount sufficient to pass current through two neon-gas-filled tubes a small relay is operated, which in turn opens the

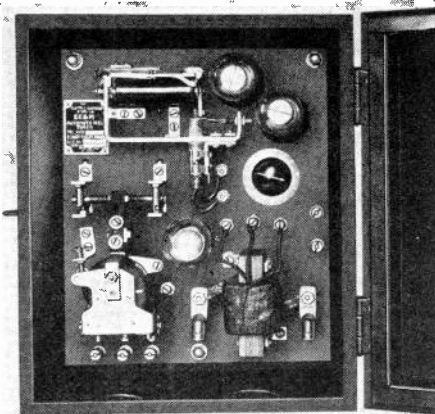

relay controlling the main line contactor. The tubes are in the circuit only when the welding current is on, so that as soon as the main welding circuit is opened the weld timer is ready for the next operation.—*Electronics, August, 1933.*

Fuse retainer for auto receivers

DEVELOPED TO MEET THE DEMAND of manufacturers of automobile and battery-operated sets for a fuse mounting that would not take up any additional space in the set and still be readily accessible for servicing and renewals. Littlefuse Laboratories, 1772 Wilson Ave., Chicago, Ill., are marketing their No. 1061 fuse retainer, which is hung directly in the line between the storage battery and the radio power supply. A tension spring at all times furnishes good contact to the fuse, which is fully protected by the fiber casing.—*Electronics*, August, 1933.

Multi-range testing set

FERRANTI, INC., 130 West 42nd St., New York City, is marketing a multi-range testing set for making accurate measurements in both the laboratory and field. Designed for alternating-



current use, this self-contained set consists of two long-scale moving iron instruments and may be used on direct current at a very slight reduction in accuracy. The set has a range from one-half volt to 600 volts, and will measure from 50 mills to 5 amperes.—*Electronics*, August, 1933.

Station frequency meter

AN INGENIOUS METHOD of comparing the frequency of a transmitter directly to the 5,000-kc Bureau of Standards transmission has been devised by the G. F. Lampkin Laboratories, Cincinnati, Ohio, and is offered in a single instrument. The accuracy of the calibrating signals, which can be heard over a large part of the world, is within one part in five million. The Lampkin device can be set and the frequency of the transmitter determined within an error of 0.003 per cent or less. The meter can be supplied for any channel from 1,500 to 23,000 kc.; employs a stable oscillator operating on an odd low frequency such that when one harmonic falls exactly on 5,000 kc.,

another harmonic falls within the range of the deviation dial on the meter. The price of the instrument is \$105.—*Electronics*, August, 1933.

Reactance meter

PREMIER CRYSTAL LABORATORIES, INC., 63 Park Row, New York City, have recently announced a new instrument for making rapid measurements of inductance and capacity. This instrument is known as model SA-165, and is provided for complete a.c. operation.

No external standards or apparatus of any type are required, except a pair of high impedance headphones. The instrument operates on the zero beat principle and by incorporating a new system of detection, it is possible to read values of inductance or capacity with an accuracy comparable to that obtained with a highgrade bridge set-up. No false readings, due to improper grounds, are encountered, inasmuch as one side of the unknown is grounded to the entire system.

The range of the standard instruments is from $10\mu\text{h}$ to 1 henry for inductance and from $1\mu\text{f}$ to $5\mu\text{f}$ for capacitance. For measurements of actual inductance and capacity, an accuracy of 1 per cent for full scale reading of each decade position is attainable and an accuracy of 2 per cent for minimum scale values. For matching inductances or capacities, an accuracy to within 0.17 per cent may be obtained.

The instrument is designed for operation on 60-cycle, single-phase, alternating current, and is provided with a panel indicating voltmeter and a line voltage regulating device, capable of compensating for any line voltage variation from 100 to 125 volts.

The instrument is priced at \$275 complete with all tubes and calibration charts.—*Electronics*, August, 1933.

Sound-effect transcriptions

THE GENNETT RECORD DIVISION of the Starr Piano Company, Richmond, Ind., now has available a very complete library of electrically-transcribed sound effects of all kinds, taken from life. There are hundreds of these 10-inch 78-r.p.m. records, and they include all standard sounds that might be wanted as features or background in a sound studio or broadcast station, as well as unusual effects such as the following, picked at random from the long list:

Animals in the zoo; automobile crashes; bacon frying; coffee percolating; blizzard; calliope; campfire; chimes; elephant trumpeting; milking cows; typewriters; rainfall; washing clothes; bowling alleys; fire engines at fire; shuffling and dealing cards; rattling poker chips; putting ice into pitcher; Indian dances, etc.—*Electronics*, August, 1933.

A-C utility meter

THE SHALLCROSS MANUFACTURING COMPANY, 700 Parker Ave., Collingdale, Pa., has designed its alternating-current utility meter No. 685 to provide essential a.c. voltage measurements and a wide range of impedance measurements using the universally available 110-volt 60-cycle commercial power.

In order that this instrument will be



of maximum value the impedance ranges are calibrated in inductance, capacity and resistance. As a result, it is possible to obtain any of the following voltage, capacity, inductance and resistance ranges.

A-C volts	10-125-500-1000
Resistance	(1000 ohms per volt) 25-50,000-500,000-5,000,000 ohms
Capacity	.0005 to .1-1-10 mfd.
Inductance	.5 to 100-1000-10,000 Henrys

—*Electronics*, August, 1933.

Manufacturers' bulletins and catalogs

Electronic tubes—Transmitting tubes, radio, sound and industrial rectifiers, made by the Granger Manufacturing Company, 170-172 Bruce St., Newark, N. J., are described with full specifications in a bulletin just issued.

Rheostats and resistance units—Catalog No. 9 of the Ohmite Manufacturing Company, 636 North Albany Ave., Chicago, Ill., covers rheostats and resistance units of both fixed and variable types.

Rheostats and potentiometers—The DeJur-Amsco Corporation, 95 Morton St., New York City, describes its equipment for power control of sound and movie systems in a new specification sheet.

Midget relays—Bulletin No. 6 of the Ward Leonard Electric Company, Mount Vernon, N. Y., lists 130 midget magnetic relays, with circuit diagrams and contact arrangements.

Oiled tubing—Turbo insulating materials, varnished cloths, tapes and papers, oiled tubing and saturated sleeving, are described in Bulletin No. 10, of William A. Brand & Company, 268 Fourth Ave., New York City.

Sound equipment—Sound reproducing and sound-recording equipment made by Audio Research, Inc., 105 East 16th St., New York City, is the subject of a new bulletin by the company.

Organ-type sound systems—Organ-type sound reproducing systems for churches, schools, clubs and private homes, etc., are described in a booklet issued by RCA-Victor Company, Camden, N. J., special products division.

Tube data—The Arcturus Radio Tube Company, Newark, N. J., has issued a pamphlet of technical data covering its radio tubes, with complete characteristics.

Transmitting tubes, rectifiers—A complete catalog of the products of the Federal Telegraph Company, 200 Mount Pleasant Ave., Newark, N. J., covers its transmitting tubes, short-wave tubes, general-purpose tubes, rectifiers, and other electronic products.

U. S. PATENTS IN THE FIELD OF ELECTRONICS

Amplification, Detection, Etc.

Cold cathode tube. Glow discharge tube for amplification, rectification or oscillation. Nos. 1,914,044 and 1,914,045 to George Seibt, Berlin, Germany.

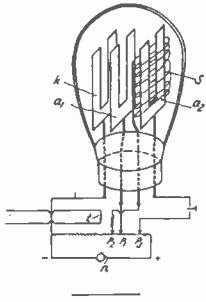

Triple modulation system. A directive radio beacon using triple modulation. H. Diamond and F. G. Kear, assigned to the Government of the United States. No. 1,913,918.

Static suppressor. Method of using a conductor in the output of a set having normally high resistance and having a substantial reduction in resistance upon the application of voltage above a certain value. C. S. Wolfe, Norristown, Pa. No. 1,913,909.

Phase Shift Circuit. Use of an alternating potential with a self-saturating transformer in the secondary winding of which is induced a peaked wave form and a source of magneto-motive-force for determining the point in the cycle of alternating potential at which the resultant m.m.f. passes through zero and thus the phase of the secondary potential. B. D. Bedford, assigned to G. E. Co. No. 1,918,173.

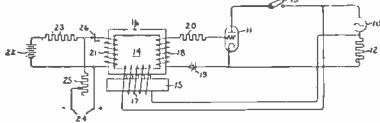

Hum prevention. System for energizing a detector by a.c. on the filament and means for energizing the grid as a rectifier whereby disturbing hum production is avoided. B. F. Miessner, assigned to R.C.A. No. 1,917,728.

A.C.-D.C. system. Method of producing A.C. from a battery in an automotive system. W. J. Williams, Chicago, Ill. No. 1,917,565.

Radio circuits. Interstage coupling system. H. A. Wheeler, assigned to Hazeltine. No. 1,913,693. See also No. 1,913,604 to W. A. MacDonald.

Super-regenerative receiver. Circuit and receiver employing especially designed tube. L. Tonks, assigned to G. E. Co. No. 1,915,076.

Oscillator. An oscillator with several piezo-electric crystals of opposite tem-

perature coefficient of frequency connected in the circuit for compensating the effect of temperature variations. F. R. Lack assigned to B. T. L., Inc. No. 1,915,368, filed Aug. 8, 1928.

Amplifier. Method of utilizing a positive grid voltage-plate current region of the tube characteristic. Lincoln Thompson assigned to R.C.A., Inc. No. 1,915,629, filed Dec. 26, 1928.

Aircraft Compass. Combination of a directional absorber of radio energy having a figure-of-eight characteristic, an untuned non-directional absorber, and means for combining the signal energies from the two absorbers. G. R. Fisher, assigned to Federal Tel. Co. No. 1,915,274, filed May 26, 1930.

Harmonic reduction. In a vacuum tube, the combination of a grid electrode, a plate electrode, and a V-shaped electron-emissive cathode filament, said cathode filament having such resistance, normal heating current, and distance separating its ends, that the following formula is fulfilled

$$e_p + \mu v = \sqrt{\frac{1}{32 M \frac{8}{L^2}}}$$

where e_p is plate electrode operating voltage and e_g is grid electrode operating voltage, where M is the decrease of the plate current due to the magnetic effect arising when one volt is impressed between ends of the cathode filament, K is the decrease of plate current due to attraction of electron to the positive end of the cathode filament when one volt is impressed between ends thereof and L is half the distance between the ends thereof. Lee Sutherland, assigned to W. E. & M. Co. No. 1,916,446, filed Oct. 10, 1928.

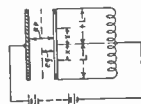

Coupling arrangement. Method of including in the output circuit of an amplifier an inductance included in the cathode circuit. L. C. F. Horle, Newark, N. J. No. 1,917,204, filed Jan. 24, 1930.

Power amplifier. An amplifier using two tubes which have impressed upon them simultaneously the input voltage. The output circuits are arranged with respect to each other so that the currents in a common portion are superimposed on each other in such a way as to effect in a portion of the output circuit of the first tube a characteristic having on opposite sides of its operating point curves which are symmetrical but inversely disposed to each other. E. P. Bertram, assigned to B. T. L., Inc. No. 1,917,015, filed June 25, 1931.

Short-wave generator. Two tubes with plates and grids respectively in parallel but with an anti-resonant circuit in part of the common filament circuit. Abraham Esau, Jena, Germany. No. 1,917,105, filed July 25, 1929.

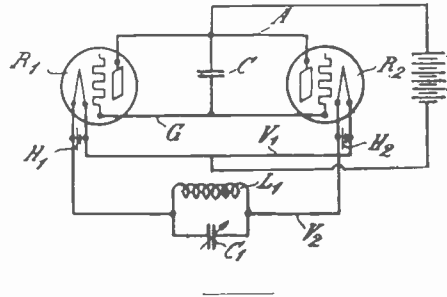

Automatic volume control. A radio system having an r-f amplifier, a power supply including a voltage divider with a poor regulation characteristic and provided with a detector to function over a large input voltage range and an avc system. H. M. Threlkeld, assigned to Grigsby-Grunow. No. 1,913,461.

Diversity reception. Method of coupling several antennas and receivers to an i-f amplifier and detector. E. Bruce, assigned to B. T. L. No. 1,913,428.

Metal oxide rectifier. Radio circuits employing a metal oxide rectifier coupled to the output of an amplifier. W. P. Place, assigned to Union Switch & Signal Co. No. 1,917,898.

High-frequency generating system. A tube with coiled grid and plate electrodes each serving as open-ended inductances, and the circuit for high-frequency generation in which the two electrodes serve as the sole means for inductively coupling the input and output circuits of said device. A. B. DuMont, assigned to DeForest Radio. No. 1,915,356, filed Nov. 26, 1928.

Elimination of fading. John Hayes Hammond, Jr. Nos. 1,915,782 to 1,915,786 inclusive.

Automobile radio. Means for excluding electrical oscillation surges from the electrical energy source for the conveyance comprising a r-f filter and an a-f filter, means for supplying energy to the receiver from the same electrical energy source as the conveyance, and means for controlling the receiver from a remote point. L. M. Clement, assigned to Brandes Laboratories. No. 1,915,290, filed Oct. 5, 1929.

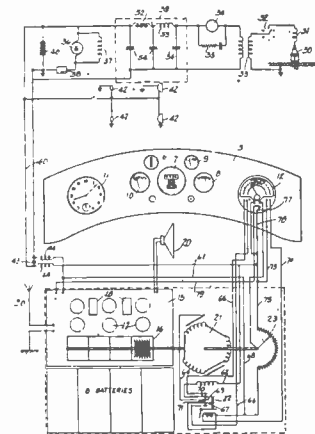

Electron Tube Applications

Musical instruments. Methods of utilizing the vibration of a tuned string with a mechanico-electric transmitting device. B. F. Miessner, Millburn, N. J. Nos. 1,915,858 to 1,915,861 inclusive.

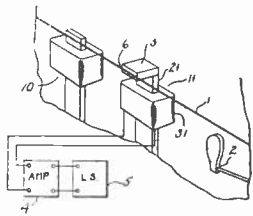

Sleet melting device. Method of using an antenna conductor consisting of a high electrical resistance core and an outer low-resistance shell for the purpose of removing sleet. L. C. F. Horle, Newark, N. J. No. 1,917,205, filed June 20, 1932.

Fiber treatment. Process for treating fibrous material by immersion in a vessel permeable to magnetic waves containing water having a slight electrical conductivity and placing the vessel in a high frequency field until the fats and oils are broken down and the fibers separated. Alfred Uhlmann, Berlin, Germany. No. 1,917,168, filed Jan. 18, 1928.

Frequency and phase indicator. Method involving the multiplication of the frequency of the unknown source and the frequency of a known source. Alfred Crossley, Washington, D. C. No. 1,916,782, filed June 11, 1928.

Regulator system. Method of controlling the excitation of an a-c generator by means of a copper-oxide rectifier operating on a non-linear portion of its resistance-voltage curve. J. H. Sole, B. T. L., Inc. No. 1,915,389, filed May 29, 1931.

Magnetic material. Method of producing a magnetic material in finely divided form comprising mixing a metal and an element in a desired proportion and heating said mixture at a temperature below the fusion point of the metal and the element and sufficiently high to effect the substantial diffusion of said element and metal. E. E. Schumacher and W. C. Ellis, Bell Telephone Laboratories, Inc. No. 1,915,386, filed April 16, 1932.

Statistical machine. Method of using photo-electric cells in a statistical machine. P. W. Handel assigned to G. E. Co. No. 1,915,993, filed April 27, 1931.

Direct-current commutator. Method of using three element tubes as a d-c commutating system. Erwin Kern, assigned to Brown Boveri. No. 1,915,790, filed May 30, 1929.

Tube tester. Testing device for electron tube circuits. John H. Miller, assigned to Jewell Elec. Inst. Co. No. 1,913,766.

Regulation control. Method using a three-element tube, a carbon pile, and saturated and unsaturated transformers. L. H. Von Ohlsen and F. W. Godsey, assigned to the Safety Car Heating & Lighting Co. No. 1,914,545. See also No. 1,917,474 and No. 1,917,473.

Elevator control. Method for using light sensitive devices and amplifier tubes for controlling an elevator. M. A. Whiting, assigned to G. E. Co. No. 1,915,042, filed Sept. 26, 1929.

Automatic dimming. Method of controlling the light of a vehicle when meeting an oncoming lighted vehicle by means of a selenium cell. Rudolph Loewenstein, Paris, France. No. 1,917,532.

Time delay circuit. Method of using a condenser and a gas-filled tube and a relay for electric delay circuits. M. L. Almquist and A. C. Thompson, assigned to A. T. & T. Co. No. 1,917,418.

Speed control. Method using tuning fork whose frequencies are slightly above and slightly below the normal value of a controlled frequency. H. W. Dreyer, assigned to R.C.A. No. 1,917,295.

Machine for producing printing plates. Method of scanning a picture, amplifying the scanning currents to operate a plate-cutting tool. Walter Howey, New York, N. Y., filed Oct. 19, 1929. No. 1,914,258.

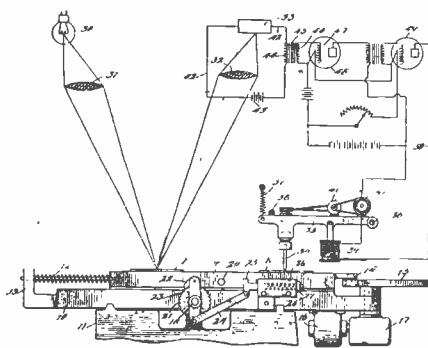

Patent Suits

1,614,136, M. C. Latour, Thermionic amplifying apparatus, D. C., S. D. Calif. (Los Angeles), Doc. E Y-74-C, Latour Corp. v. Trans Continental Radio Co., Inc., et al. Decree for plaintiff Mar. 15, 1933.

1,173,079, E. F. Alexanderson, Selective tuning system; 1,195,632, W. C. White, Circuit connections of electron discharge apparatus; 1,239,852, F. K. Vreeland, Receiver of electrical impulses; 1,544,081, same, Transmitting intelligence by radiant energy; 1,251,377, A. W. Hull, Method of and means for obtaining constant direct current potentials; 1,573,374, P. A. Chamberlain, Radio condenser; 1,618,017, F. Lowenstein, Wireless telegraph apparatus; 1,728,879, Rice & Kellogg, Amplifying system, D. C., N. D. Ill., E. Div., Doc. 12,501 Radio Corp. of America et al. v. E. H. Scott Radio Laboratories, Inc. Dismissed without prejudice Dec. 29, 1932.

1,251,377, A. W. Hull, Method of and means for obtaining constant direct current potentials; 1,297,188, I. Langmuir, System for amplifying variable currents; 1,811,095, H. J. Round, Thermionic amplifier and detector; Re. 18,579, Ballantine & Hull, Demodulator and method of demodulation, D. C., S. D. N. Y., Doc. E 74/457, Radio Corp. of America et al. v. H. F. Lyman (Lyman Mfg. Co.) et al. Consent decree for plaintiff (notice Apr. 27, 1933.)

1,231,764, F. Lowenstein, Telephone

relay; 1,618,017, same, Wireless telegraph apparatus; 1,403,475, H. D. Arnold, Vacuum tube circuit; 1,465,332, same, Vacuum tube amplifier; 1,573,374, P. A. Chamberlain, Radio condenser, filed May 19, 1933, D. C., S. D. N. Y., Doc. E 76/56, Radio Corp. of America et al. v. Insuline Corp. of America.

1,251,377, A. W. Hull, Method of and means for obtaining constant direct current potentials; 1,297,188, I. Langmuir, System for amplifying variable currents; 1,702,833, W. S. Lemmon, Electrical condenser; 1,811,095, H. J. Round, Thermionic amplifier and detector; Re. 18,579, Ballantine & Hull, Demodulator and method of demodulation, filed May 19, 1933, D. C., S. D. N. Y., Doc. E 76/57, Radio Corp. of America et al. v. Insuline Corp. of America.

1,710,073, 1,714,191, S. Ruben, Electrical condenser; 1,891,207, same, Electrolytic condenser, filed May 17, 1933, D. C., S. D. N. Y., Doc. E 76/50, Ruben Condenser Co. et al. v. The Rudolph Wurlitzer Co., Doc. E 76/51, Ruben Condenser Co. et al. v. Alan Radio Corp. Doc. E 76/52, Ruben Condenser Co. et al. v. Howell Electric Motors Co.

1,755,114, L. A. Hazeltine, Unicontrol signaling system; 1,755,115, same, Variable condenser, D. C., E. D. N. Y., Doc. E 6723, Hazeltine Corp. v. Abraham & Straus, Inc. Consent decree for plaintiff May 16, 1933.

1,815,768, A. Georgiev, Electrolyte, C. C. A., 2d Cir., Doc. 12589, Aerovox Corp. v. Concourse Electric Co., Inc. Decree reversed (notice May 15, 1933).

1,845,306, 1,857,055, W. A. McDonald, Coupling system, D. C., E. D. N. Y., Doc. E. 6724, Hazeltine Corp. v. Abraham & Straus, Inc. Consent decree for plaintiff May 16, 1933.

1,852,710, L. A. Hazeltine, Antenna coupling system, D. C., E. D. N. Y., Doc. E 6725, Hazeltine Corp. v. Abraham & Straus, Inc. Consent decree for plaintiff May 16, 1933.

1,231,764, F. Lowenstein, Telephone relay; 1,403,475, H. D. Arnold, Vacuum tube circuit; 1,465,332, same, Vacuum tube amplifier; 1,507,016, L. de Forest, Radio-signaling system; 1,507,017, same, Improvement in wireless telegraph and telephone system; 1,618,017, same, Wireless telegraph apparatus, D. C., S. D. N. Y., Doc. E 73/253, Radio Corp. of America et al. v. John Wanamaker of N. Y. Consent decree for plaintiff (notice May 13, 1933).

1,173,079, E. F. Alexanderson, Selective-tuning system; 1,195,632, W. C. White, Circuit connections of electron discharge apparatus; 1,239,852, F. K. Vreeland, Receiver of electrical impulses; 1,544,081, same, Transmitting intelligence by radiant energy; 1,573,374, P. A. Chamberlain, Radio condenser; 1,728,879, Rice & Kellogg, Amplifying system; Re. 18,579, Ballantine & Hull, Demodulator and method of demodulation, D. C., S. D. N. Y., Doc. E 73/254, Radio Corp. of America et al. v. John Wanamaker of N. Y. Consent decree for plaintiff (notice May 13, 1933).

1,648,808, L. A. Hazeltine, Wave signaling system, D. C., E. D. N. Y., Doc. E 6722, Hazeltine Corp. v. Abraham & Straus, Inc. Consent decree for plaintiff May 16, 1933.

KADETTE says...

....A Bakelite Molded case "retains its good looks through all kinds of service"

"IN THE HANDS of thousands of owners the original Kadette has proven the complete desirability of Bakelite Molded where continuous portability is essential. Bakelite Molded will not dent nor is it easily marred. It retains its good looks through all sorts of service." This is the endorsement of the manufacturer of Kadettes, who is again using Bakelite Molded for the case of his new portable model.

The manufacturer of midget receiv-

ers will find that Bakelite Molded has many other advantages too. Any design, whether simple or ornate, may be faithfully reproduced. A variety of effects may be obtained through taking advantage of the different colors of Bakelite Molded which are available. Production economies are secured through the reduction of assembly operations made possible by the use of this material.

Bakelite Molded is the ideal mate-

rial for radio receiver cases and knobs. It is strong, has a rich, lustrous surface, resists moisture, and is unaffected by climatic conditions or changes in temperature. It also possesses high insulation value. To obtain additional information about this material and its possibilities write for illustrated Booklet 13M, "Bakelite Molded".

Don't miss the Bakelite Exhibit when you visit the Century of Progress Exposition.

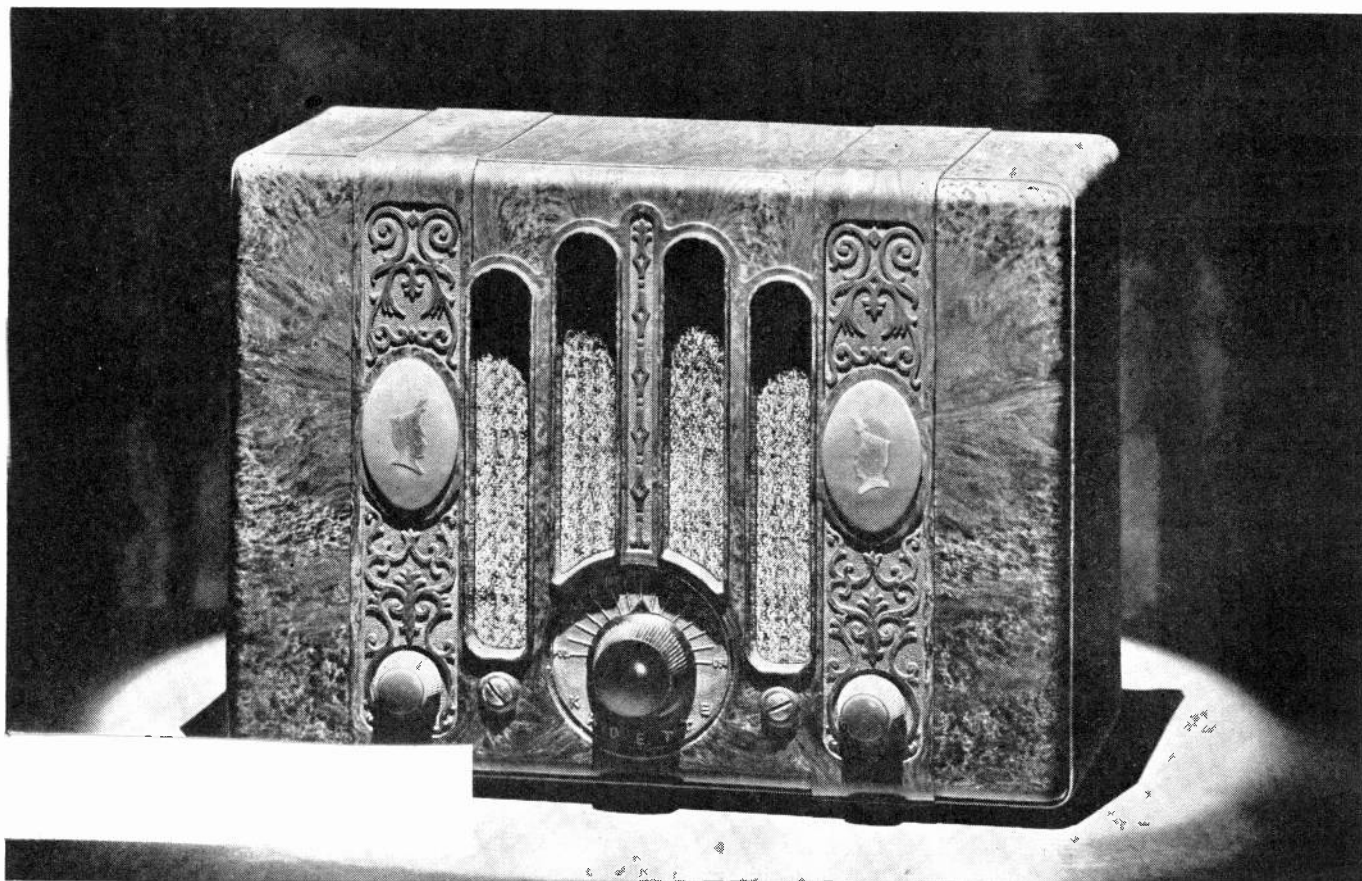

New model Kadette with Bakelite Molded case and knobs. Product of International Radio Corp., Ann Arbor, Mich.

BAKELITE CORPORATION, 247 Park Avenue, New York, N.Y. 43 East Ohio Street, Chicago, Ill.
BAKELITE CORPORATION OF CANADA, LIMITED, 163 Dufferin Street, Toronto, Ontario, Canada

BAKELITE

REGISTERED U.S. PAT. OFF.



"The registered trade marks shown above distinguish material, manufactured by Bakelite Corporation. Under the capital 'B' is the numerical sign for infinity, or unlimited quantity. It symbolizes the infinite number of present and future uses of Bakelite Corporation's products"

THE MATERIAL OF A THOUSAND USES

BRITISH PATENTS IN THE FIELD OF ELECTRONICS

Amplification, Detection, Etc.

Gas-tube amplifier. A pair of vapor electric tubes connected in push-pull and across a d-c supply. The grids are supplied with a 60-cycle input together with a 1,000-cycle frequency from a tube arranged to provide oscillations of triangular wave form. The high frequency stimulates the tube in alternate half cycles, while the induced voltage across a reactance in the high voltage supply cooperates with a condenser to reduce the plate potential of each tube in succession below the critical threshold value. The combined voltage applied to each grid is shown in curve 1; curve 2 is an oscillogram of the output from one of the tubes, the effect of the applied signal being to increase the time period during which each tube is conductive from a minimum to a maximum in rhythm with the signal voltage, and curve 3 represents the amplified signal output after the high-frequency component has been removed. B. D. Bedford, assigned to British Thomson-Houston Co. No. 389,855.

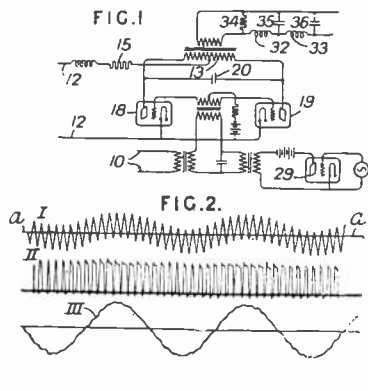

Impedance network. Tuned circuit coupled to an a-c source usually with another tuned circuit to form a band-pass filter by means of a resistance of approximately the same value as the impedance of the tuned circuit at resonance. R. E. H. Carpenter and P. P. Eckersley, Chelsea, London. No. 389,896.

Harmonic producer. For use in tone frequency multiplex telegraphy harmonics are extracted from a square, triangular or other wave form comprising odd harmonics only and their amplitudes are equalized by means of condensers or inductances. Thus from a fundamental of 60 cycles, signaling frequencies of 420, 540, 660, etc., may be obtained. D.C. Espley, G. E. Co., Ltd. No. 389,917.

High-frequency generator. A low-frequency arc in a medium of high dielectric strength, such as liquid hydrogen, is ignited and maintained by an auxiliary circuit having a condenser and a spark gap fed by an alternator with a frequency exceeding 200 cycles and preferably between 500 and 1,000 cycles. Societe l-Air Liquide, Paris. No. 389,946.

Trigger circuit. A trigger relay in which the output is independent of the input so long as it is above a critical value. G. E. Co., Ltd. No. 389,970.

Uniform amplifier. Method of giving uniform amplification over a band of frequencies by giving the input circuit of a receiver a higher amplification at low frequency than at high frequency. This is achieved by connecting an inductance in series with the aerial system which is resonant at a frequency higher than the highest frequency in the received band. Marconi Co. No. 391,021.

Television system. A color television system, a transmitter utilizing a non-color record or film. H. E. Ives, assigned to E. R. P. I. No. 390,158.

Television system. Picture currents of constant frequency and varying amplitude are rectified and combined with a screen frequency to produce signals of constant amplitude and frequency but varying duration which are shaped so as to be of square wave form and used to key a carrier frequency. The screen frequency governs the frequency at which the signals of constant amplitude occur and therefore the detail of the reproduced picture. H. Shore and J. N. Whitaker, Marconi Co., 390,400.

Variable mu tube. Various methods for obtaining variable mu effect, for example, a cathode of different emissivity at different parts, an anode with non-uniform openings, and a control or screen grid non-uniform as regards mesh or distance from the cathode. Telefunken. No. 390,998.

Screen grid amplifier. To increase the energy amplification of the screen grid stage of a radio transmitter the screen voltage is raised so that the plate current reaches a saturation value with a control grid voltage that does not produce grid current. Phillips. No. 391,392.

Automatic volume control. Means which serve both as a d-c amplifier for the d-c component of the normal detector and also as a rectifier for producing d-c component for gain control. P. O. Farnham, Marconi Co. No. 391,373.

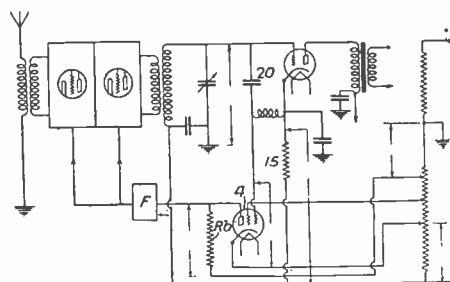

Push-pull. A series-connected diode detector coupled to a push-pull low-frequency amplifier by means of a pair of resistances or impedances between

ground and the tube cathode and the low potential end of the tuned input circuit. H. Jackson, Lancashire. No. 390,669.

Protective system. To prevent dangerous rises in voltage in a thermionic amplifier a neon tube is connected across the input circuit the breakdown voltage being such that voltages exceeding a certain value are suppressed. J. F. Cook, Marconi Co., No. 390,688.

Television. The received picture signals are combined with impulses generated at the receiver to form square-front waves to compensate for the absence of high frequency components in the received signals. Television Laboratories, San Francisco. No. 390,565.

Removal of gas. Occluded gas is removed from a cathode by bombardment by electrons emitted from a substance applied to another electrode, such as the anode or grid. Barium azide may be attached to the inside of the anode which is heated by a high frequency field during evacuation so as to evolve nitrogen and leave barium. A positive potential is applied to the cathode and the anode is heated so that electrons are emitted from the barium. After the cathode has been freed from gas the anode may be raised to a higher temperature so that barium is deposited on the cathode to form an electron emitting coating. Philips, No. 382,520.

Control circuits. A relay for tripping a circuit breaker is energized with a time delay varying inversely with a potential drop across a resistance. This delay is provided by a tube, the grid of which is biased by the potential of a condenser slowly charged through a resistance. O. C. Traver, British Thomson Houston Co. No. 386,370.

Distortion compensation. In an amplifier having a drooping characteristic, an auxiliary tube is arranged to supply additional energy to the amplifier so as to strengthen the characteristics. C. W. Hansell, Marconi Co. No. 386,540 and No. 386,501.

Electron Tube Application

Control device. The temperature of a heated object is controlled by directing the light alternately with the standard light to the light sensitive cell. D. C. Prince, British Thomson-Houston Co. No. 390,776.

Medical apparatus. High-frequency (over 3×10^7) generator connected with the actual treatment apparatus by means of a transmission system of the Lecher wire type. Siemens & Halske, Berlin. No. 390,247.

Burglar alarm system. Method of detecting the presence of an approaching person or body by means of a gas-filled rectifier whose discharge is initiated by a capacity effect. F. Dobosz, Vienna. No. 390,307.

Sodium vapor lamp. Control circuits. Philips, No. 390,729.

AGASTAT.. A NEW TIME DELAY RELAY

Wide Range—Adjustable—Compact—Immediate Recycling

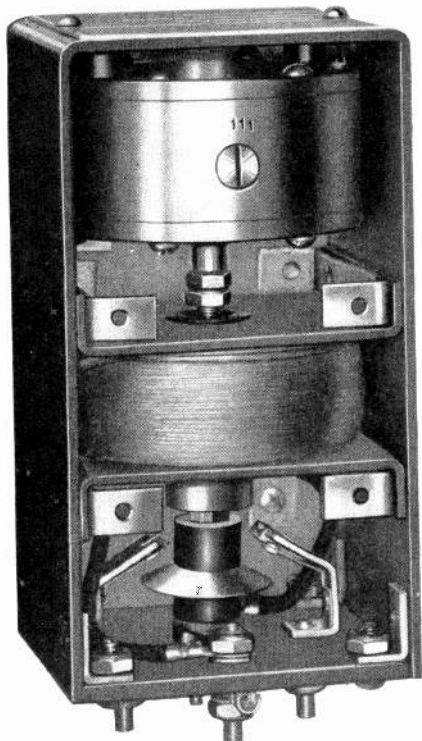

Size 5 1/4 in. high x 2 3/8 in. sq.

Principle—The timing unit, being hermetically sealed and compensated, is unaffected by dust, temperature or humidity changes. The timing period is not affected by fluctuations of voltage. The design of the timing head is based on twenty-five years of experience in the manufacture of diaphragm type timing devices for marine lighthouses. A volume of inert gas is confined in the timing head by two special diaphragms. These diaphragms are made from the same type of special leather that has been used so successfully in AGA flashing marine lighthouses. These marine lighthouses, flashing more than ten million times per year for many years, accurately maintain the period of light and dark in accordance with a predetermined setting. The conditions under which these unattended lighthouses operate are very severe and range from the humid heat of the Tropics to the intense cold of the Arctic. The reliability of AGA diaphragm operated devices is known all over the world.

Application—For all types of plate voltage switching; voltage limitators; general automatic timing of electrical and mechanical processes; photo-switch time delay for temporary darkness; delaying and sustaining of photo-electric and thyatron controls; alarm systems; for cathode ray and special tube supply voltage switching; telephone and telegraph central office time delay; remote control and switching of power line equipment; elevator control.

Available in a wide range of types of operation, voltages, frequencies, time limits and initial settings.

Write for
Technical Details
and Design Information

AMERICAN GAS ACCUMULATOR COMPANY
ELIZABETH • NEW JERSEY



AUTO RADIO SALES RISE WHEN THIS COMBINATION IS SPECIFIED

Airplane Dial — Mounts Anywhere — Styled to match car interiors — Standard Finishes Include Black & Chromium. Special Finishes to order.

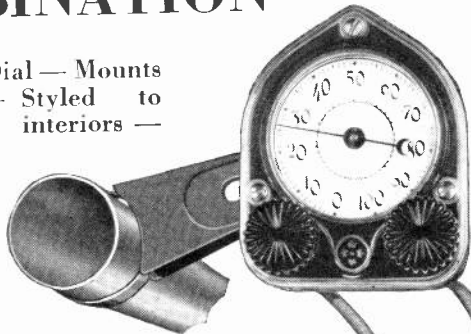

One of a number of Dial Types

Here is why—

1. Styled eye value adds sales appeal
2. Renders the set adaptable to any car
3. Simple installation enlists dealer enthusiasm
4. Service free operation results in user's satisfaction
5. Permits volume control to be mounted on chassis
6. Condenser geared especially for auto radio tuning
7. Both units have high safety margin required in auto radio usage

The new matched DeJur Control and Geared Condenser are made available in the spirit that permanent sales success of auto radios dependent on trouble free installation and use. The DeJur Control uses the highest quality shaft, Genuine Bakelite Knobs, Key Lock Control, Waterproof Die Cast Case and a specially designed mounting bracket that fastens with but one screw yet permits universal mounting. Our engineers will be glad to work with recognized manufacturers. Set design data upon request.

Other DEJUR-AMSCO PRODUCTS

1.8 to 1 Gear Condensers—6 to 1 Gear Condensers—Variable Condensers—Pilot Light Holders—Power Rheostats—Varitors—Dials

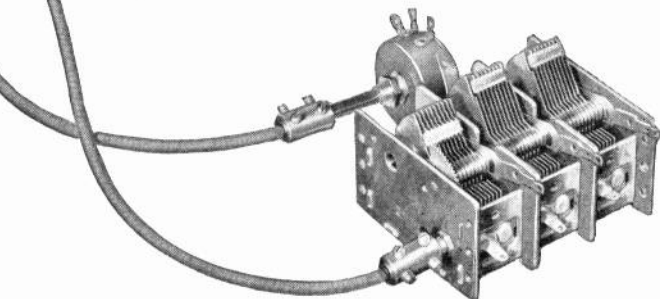

DeJUR-AMSCO CORPORATION

95 Morton Street, New York City

AmerTran Announces



New Lower Prices Improved Designs of AmerTran De Luxe Transformers

AmerTran De Luxe Transformers listed below are of the same high quality as similar units manufactured during the past 10 years but prices have been considerably reduced and designs have been revised to permit full advantage of new tube ratings. They are recommended as the best available standard equipment for use in precision amplifiers in broadcasting stations, recording studios, and laboratories.

New AmerTran SilCor Audio Transformers of modern design at popular prices

AmerTran SilCor Transformers have been developed to satisfy the demand for quality audio transformers at popular prices. They are similar in design and construction to "De Luxe" transformers but have core laminations of silicon steel instead of high permeability alloy. They are highly satisfactory for all usual requirements in public-address equipment and other commercial requirements.

	DE LUXE LINE		SILCOR LINE	
	Type No.	List Price	Type No.	List Price
Interstage: 1 pl. to 1 gr., 0 dB	D-12	\$7.00	J-711	\$4.50
Interstage: 1 pl. to p/p gr., 10 dB	D-21	8.50	J-721	5.00
Interstage: p/p pl. to p/p gr., 18 dB	D-51	10.00	J-751	6.00
Input: 200 or 500 w. to 1 gr., 0 dB	D-81	10.00	J-771	5.50
Output: 1-227 pl. to 200 or 500 w., 10 dB				
Mixer: 200 or 500 w. to 200 or 500 w., 0 dB	D-31	8.50	J-731	5.50
Output: p/p 2A3 pl. to 15/71/5/31 w., 34 dB	D-91	8.50	J-791	5.50
Output: p/p 2A3 pl. to 500 and 15 w., 34 dB	D-64	18.00	J-822	5.50
Output: 500 w. to 15/71/5/31 w., 34 dB	D-103	18.00	J-752	5.50
Output: 500 w. to 15/71/5/31 w., 34 dB	D-132	12.00	J-831	8.00

NOTE: Above tabulation lists only nine popular types—complete catalog on request. List Prices effective August 1, 1933.

American Transformer Company
Transformer builders for over 31 years
178 Emmet St., Newark, N. J.



**AMERTRAN
TRANSFORMERS**



RESINOX

MAY BE THE
ANSWER TO YOUR
MOLDING PROBLEM

With Resinox came a new standard of excellence in molded products—new molding economies. Perhaps Resinox holds the answer to your particular molding problem.

Specify RESINOX

MOLDING RESINS
MOLDING COMPOUNDS
LAMINATING VARNISHES

RESINOX CORPORATION

A SUBSIDIARY OF COMMERCIAL SOLVENTS CORPORATION
AND CORN PRODUCTS REFINING CO.
230 PARK AVE. NEW YORK CITY

KEEP IN TOUCH WITH RESINOX DEVELOPMENTS

4 T H Q U A R T E R

RADIO manufacturers are girding for the best selling season of their year—the fourth quarter of 1933. Recent sixty and ninety day developments have encouraged all of them to an expectation that sales in the fourth quarter of the year may exceed the most optimistic quotas.

This will probably mean considerable last-minute purchasing of the things that go to make up radio sets. Such a condition points to a favorable prospect for the manufacturers who sell to radio factories. It means that an advertisement in *Electronics'* September and October issues and even in its November and December issues may be able to pick up those extra, last minute orders that radio and allied manufacturers may have to place before the year closes.

Naturally, an advertisement in the next four issues of *Electronics* serves notice to over 7,000 executives and engineers that your product is available to help them in their manufacturing work.

electronics

a McGraw-Hill publication
330 West 42nd Street, New York, N. Y.

**Where contact resistance
is critical - - -**

**ON MEASUREMENTS IMPEDANCES
BRIDGES WIRE NETWORKS
R. F. CIRCUITS, ETC.**

USE

**Elastic Stop
NUTS**

Reliability and permanency of electrical contacts is assured through the use of Elastic Stop Nuts. Their use assures terminal connections of low contact resistance. They make simple, permanent and dependable terminal fastenings. They can be tightened and loosened, used indefinitely with no impairment in locking effectiveness.

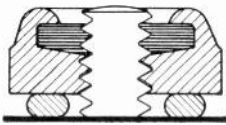

Users of Elastic Stop Nuts for regular production include manufacturers of quality radio receivers, government aircraft equipment and ship communications apparatus, instruments, etc.

Technical data on terminal lock nuts and their application is available.

A. G. A. COMPANY

Elastic Stop Division

ELIZABETH, N. J.



ACME WIRE PRODUCTS

All ACME products are made to recognized commercial standards, including those of:

Nat'l Electric Mfrs. Assn.
Radio Manufacturers' Assn.
Amer. So. for Testing Materials.

Magnet Wire

(All Insulations)

Coils, Magnet Wire Wound

Varnished Insulations

(Cambric, paper, silk, tape)

Parvolt Condensers

(Filter and By-Pass)

also condensers for Power Factor Correction

Aerial Wire

(Stranded and Solid)

For over 25 Years, suppliers to the largest radio and electrical manufacturers.

THE ACME WIRE CO.

New Haven, Conn.

**Submounted dust-
proof contacts
insure long life**

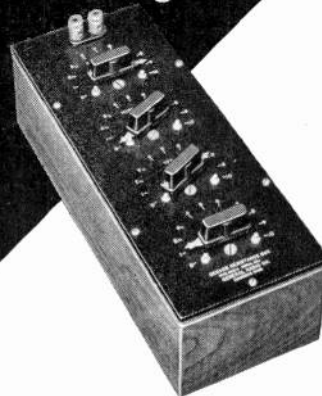

**DECADE-RESISTANCE
BOXES . . . Improved
design means improved
performance**

Complete shielding, new resistor construction, and sub-mounted switches that markedly reduce switch resistance are the principal advantages of the new General Radio Type 602 Decade-Resistance Boxes over previous designs. Each of these features contributes to the unequalled performance of these instruments.

Sub-mounting the switches, for example, protects the contact surfaces from abrasive, dirt and dust. Thus the life of the contact surfaces is materially lengthened, increasing by so much the amount of service per dollar of investment.

Consider design features like this when buying new equipment for your laboratory. Complete description will be found in Catalog G-F, a copy of which is yours for the asking. Address General Radio Company, Cambridge, Massachusetts.

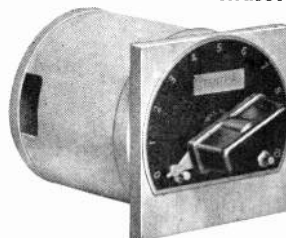

*For assembly in
equipment of your
own design*

Individual decades of resistors as used in the decade-resistance boxes are available for use in your own laboratory-built instruments. Prices range from \$8.50 to \$16.00. Consult Catalog G-F.

GENERAL RADIO

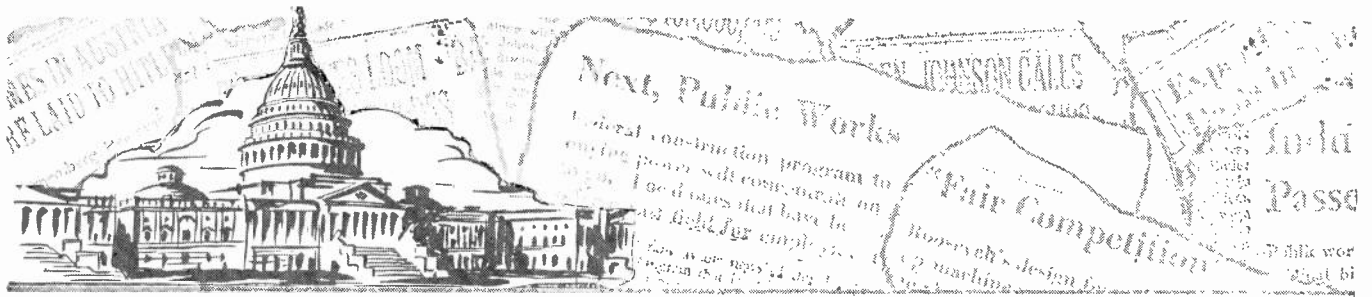

"But" . . . asks Business, "what

Industrial Bill Becomes Law
An Act . . . To encourage without restricting working in heavy industry . . .

INDUSTRIAL POWER GETS A NEW DEAL

What's in the Recovery Act
The new controls are designed to regulate industry by giving industry a chance to regulate itself.

The government as a partner
WHAT is the exclusive partner of industry going to do with his big stick? Shall the electrical industry rush to Washington and grab hold of the stick, either in fear or in expectation of having it used to its advantage, or shall it stay home and capitalize upon the present up-turm in business?

There is no necessity for precipitate action. More than 500 codes of practice have already been submitted to the Administration or are ready for submission. The industrial recovery act is a labor act and the primary questions applied to each code will be: What is your minimum wage and your maximum hours of labor? Will you raise wages and will you employ more people under this code? . . .

Recovery Setup
Industry plan will swing into action under one-man control, but advisory boards will play important part in program. First objectives are more work, more wages with a brake on prices.

So McGraw-Hill expands

Epoch-making news is coming out of Washington. The newspapers are full of it. Headline-writers dramatize it. Editors comment on it. Cartoonists play with it.

But the business man wants to know what it means to him, to his employees, and to his stockholders. He wants to know how the National Recovery Act is going to affect business. He wants to know what "Industry Control" will do to prices and wages and competition. The reports and comments in his favorite daily are not sufficient. He must look elsewhere for information, interpretation and expert opinion on matters of such far-reaching economic importance.

This is where the business paper fits into the picture. McGraw-Hill Publications, individually and collectively, have long been serving business. They are not limited in man-power or facilities to the editorial staff of any one publication. The combined staffs of 21 different McGraw-Hill publications are continuously contacting nearly every major industry and trade.

This industry contact is augmented by special correspon-

McGRAW-HILL PUBLISHING

New York • Boston Philadelphia • Washington • Greenville • Cleveland • Detroit

<p>Business men, industrialists and engineers regularly read the McGraw-Hill Publications. More than 3,000,000 use McGraw-Hill books and magazines in their business.</p>	<p>Radio Retailing Food Industries Chemical & Metallurgical Engineering</p>	<p>Electrical World Electrical Merchandising Electrical West Electronics</p>	<p>American Machinist Product Engineering Engineering News-Record Construction Methods</p>	<p>Transit Journal Bus Transportation Aviation Textile World</p>
---	---	--	--	--

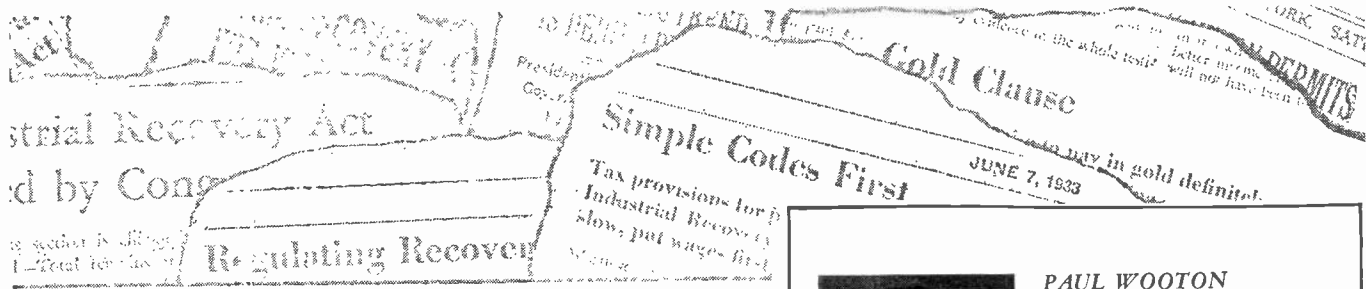

does it all mean?"

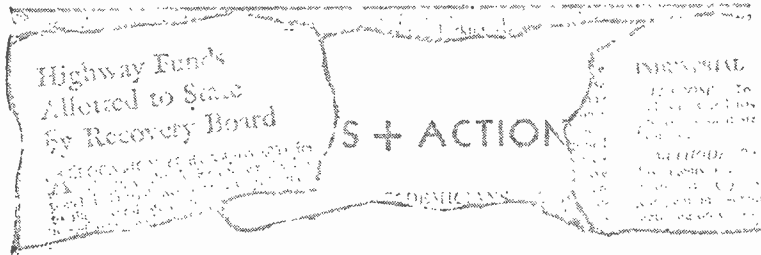

its Washington service . . .

dents assigned to the seat of national recovery activities. McGraw-Hill has maintained a Washington Bureau for many years to keep its readers apprised of National developments. Paul Wooton, veteran Washington correspondent, has reported the National news for McGraw-Hill papers since 1917. With him in recent years have been associated Carter Field and Irvin D. Foos. To this eminent Washington staff have now been added the full time services of Wallace Thompson, editor of *Ingeniería Internacional*. In New York, Edward P. Warner, editor of *Aviation* and former Assistant Secretary of the Navy, has been assigned the task of editorial direction and coordination of effort in matters relating to the National Recovery Act. Another McGraw-Hill representative, O. Fred Rost, has been assigned to devote his entire time to the various trade associations which have suddenly been lifted to a position of heretofore undreamed-of responsibility.

McGraw-Hill is thus serving its readers with the most prompt and valuable business news service it has ever been its privilege to offer. This service is reflected in the news and editorial columns of the various publications.

COMPANY, Inc.

Chicago • St. Louis • San Francisco • London

Engineering and Mining Journal
(Domestic and Export Edition)
Metal and Mineral Markets
Coal Age

Factory Management and
Maintenance
Power
Business Week



PAUL WOOTON

Taught school and did newspaper work in Mexico. With New Orleans Times-Picayune since 1911, Washington correspondent in 1914. McGraw-Hill Washington correspondent since 1917. Associated with many activities of the corps of correspondents in Washington. President of Overseas Writers and two terms chairman Board of Governors of National Press Club. Has covered various assignments for McGraw-Hill Publications in Europe.



CARTER FIELD

McGraw-Hill correspondent and feature writer for Bell Syndicate since 1929. Former Washington correspondent of the New York Herald-Tribune and its predecessor the New York Tribune from 1915-1929. Former President National Press Club. Member of the National Press, Gridiron and Metropolitan Clubs.



WALLACE THOMPSON

Chief editor of *Ingeniería Internacional* and author of books on industrial relations with Latin America. A member of the original staff of the United States Daily as expert on foreign affairs, later of trade and industry. Newspaper experience in Paris and Mexico City. Member Century, Explorers, National Arts, Cosmos and National Press Clubs. Fellow of the Royal Geographical Society.



IRVIN D. FOOS

Business paper correspondent in Washington since 1920. A member of the Washington staff of McGraw-Hill since 1929 and also Transportation Editor of *BUSINESS WEEK*. Active in organization of Business Paper Correspondents Committee in Washington. Member National Press Club.



O. FRED ROST

Marketing Editor of *BUSINESS WEEK*. Since 1928 director surveys of distribution, McGraw-Hill Publishing Co. For 19 years active in national trade associations of important industries as member or observer. Author of books and articles on the practical mechanics of business and cooperative effort in business. Received McGraw Award, electrical industry, 1927.

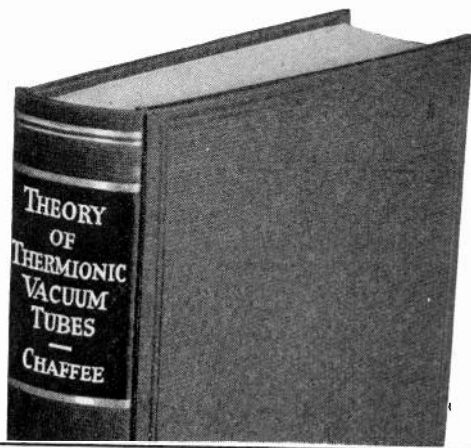

5 important McGRAW-HILL Books for the Radio Engineer

RADIO ENGINEERING

by **FREDERICK EMMONS TERMAN**
Associate Professor of Electrical Engineering
Stanford University
688 pages, 6 x 9, 418 illustrations, \$5.00

A COMPREHENSIVE treatment covering all phases of radio communication, written from the viewpoint of the engineer who is interested not only in qualitative descriptions of radio phenomena, but also in making quantitative analyses for facilitating design and research.

The first part of the book covers the theory of tuned circuits and the fundamental properties of vacuum tubes and vacuum tube applications. The latter part, specialized radio topics, such as radio receivers and transmitters, wave propagation, antennas, and direction finding. It is a complete reference book containing the fundamentals involved in most of the problems faced by the practicing engineer.

RADIO ENGINEERING HANDBOOK

Prepared by a staff of 22 specialists
under the editorship of
KEITH HENNEY
Associate Editor, *Electronics*
583 pages, 4½ x 7, 482 illustrations, \$5.00

THIS book gives the radio engineering profession its own handbook, equal in all ways to the standard handbooks available in other fields of engineering. Written by engineers for engineers, the book is thoroughly technical, with broad emphasis on design. It is comprehensive and up-to-the-minute, covering all fields and aspects of radio engineering from fundamentals to latest practical applications.

Every section has been written by a specialist. Newest tubes and circuits, television, aircraft radio, short wave, photocells, etc., are covered, with emphasis throughout on design data, presented in a profusion of tables, charts, equations, formulas and diagrams, rather than descriptive matter subject to frequent change.

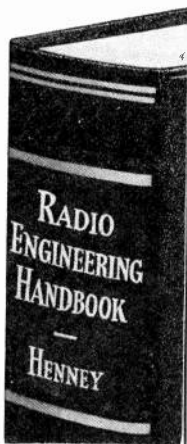

THEORY OF THERMIONIC VACUUM TUBES

Fundamentals—Amplifiers—Detectors
by **E. LEON CHAFFEE**
Professor of Physics, Harvard University
666 pages, 6 x 9, fully illustrated, \$6.00

A LONG awaited book by one of the country's foremost authorities on vacuum tubes. Its purpose is to cover the foundation of the subject fully for those engaged in any branch of vacuum tube technique. It gives a comprehensive theoretical treatment of the fundamentals of thermionic emission and the vacuum tube, and, besides the general properties of the vacuum tube, covers in detail its use as an amplifier and detector. It avoids discussion of multifarious circuits, but covers those principles, an understanding of which makes possible the analysis of any circuit and any application.

The book has been in preparation eight years and embodies much original material developed by the author, some of it published here for the first time. Among this material is that on such subjects as the path of operation, large-signal regeneration, regeneration in coupled circuits, detection, non-linear elements, etc.

HIGH-FREQUENCY MEASUREMENTS

By **AUGUST HUND**, Fellow of the American Physical Society,
Member Institute of Radio Engineers, *International Series in
Physics*, 491 pages, 6 x 9, 373 illustrations, \$5.00.

A REFERENCE book for research workers, giving a thorough discussion of high frequency phenomena applied to measurements. The subject matter is treated critically, presenting up-to-date practice and theory. The applications are presented in a manner elementary enough to meet the needs of any one interested in carrying on high frequency measurements and research work. The book represents a considerable amplification and modernization of the author's *Hochfrequenzmesstechnik*, published in Germany.

STANDARD HANDBOOK FOR ELECTRICAL ENGINEERS

Prepared by a staff of specialists, **FRANK F. FOWLE**, Consulting
Engineer, Editor-in-Chief, *New Sixth Edition*, 2316 pages 4½ x 7,
profusely illustrated, \$7.00.

THIS well-known Handbook has recently been published in a thoroughly revised, greatly enlarged sixth edition. Now 600 pages larger than the fifth edition; three-quarters new in subject matter. Every section has been revised, many rewritten—whole new sections added—much new material in telephony, telegraphy, radio and other parts of book—contributors increased to 91—new mechanical features improving usability—every step to make it representative of latest standards and practice—to continue it as the one complete, dependable reference manual of the electrical engineering profession.

McGRAW-HILL FREE EXAMINATION COUPON

McGraw-Hill Book Co., Inc., 330 W. 42nd St., New York City
Send me the books checked below for 10 days' examination on approval. I will pay for those I keep, plus a few cents for postage and delivery, and return the rest postpaid within 10 days of receipt. (We pay postage on orders accompanied by remittance.)

- Chaffee—Theory of Thermionic Vacuum Tubes, \$6.00.
- Terman—Radio Engineering, \$5.00.
- Henney—Radio Engineering Handbook, \$5.00.
- Hund—High-frequency Measurements, \$5.00.
- Standard Handbook for Electrical Engineers, \$7.00.

Name

Address

City and State..... Position..... Company..... L. 8-33
(Books sent on approval in U. S. and Canada only.)

ELMET

Molywire

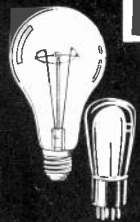

Exact in Diameters
Lengths to 1500 Meters
Moderate Prices
Elongation Uniform
Tested for Grids

Write for Information and Prices to Box E-8

BEST BY EVERY TEST

ELMET stands for the best there is in MOLYWIRE. *Use the Best. It Saves You Money.* Furnished on Bakelite Spools or Iron Bands up to 1500 Meters.

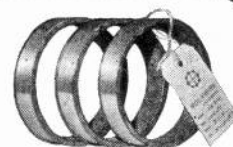

IRON BANDS

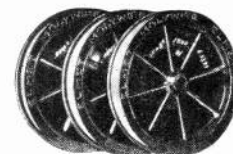

BAKELITE SPOOLS

AMERICAN ELECTRO METAL CORP.

LEWISTON, MAINE

A TRIAL WILL CONVINCING YOU

30 Years' Experience
Insures Dependability

We Manufacture
PERMANENT MAGNETS TOOLS and DIES
METAL STAMPINGS LAMINATIONS

**THOMAS & SKINNER
STEEL PRODUCTS CO.**

23d St. at Alvord

Indianapolis, Ind.

CANDOHMS

ARMoured WIRE WOUND RESISTORS
WILL LOWER YOUR COSTS

OVER SIX MILLION IN USE
MAY WE SAMPLE AND QUOTE

THE MUTER COMPANY

1255 So. Michigan Ave., Chicago

PROFESSIONAL SERVICES

Consulting—Design—Research—Testing
Measurement—Development—Acoustics—Patents

ELECTRICAL TESTING LABORATORIES

Characteristics and Life Tests of Vacuum Tubes
Tests of photocells, glow lamps, crater lamps.
Tests of electronic and optical devices.
80th Street and East End Avenue
New York, N. Y.
Phone: Butterfield 8-2600

The Solution of Your Problem

found through enlisting the services of the in the field of Electronic devices may be Consultants whose cards appear on this page.

ELECTRO-ACOUSTICAL ENG. CO. OF AMERICA

Acoustical Correction—Soundproofing
Reverberation Control Systems
Electrical Testing
Research Development
Offices and Laboratories
1609 Vine St., Philadelphia, Pa.

RALPH H. LANGLEY, E. E.

Licensed Professional Engineer Fellow I.R.E.
Twenty years' experience in the Development Design, Production of Radio Transmitters and Receivers and in Radio Patents and Inventions.
Barclay 7-0398
165 Broadway, New York

JENKINS & ADAIR, INC.

Engineers
Designers, developers, and manufacturers of accessories and essentials for recording, broadcasting and testing at sound frequencies.
3333 Belmont Avenue, Chicago, U. S. A.
Cable Address: Jenkadair Telephone: Keystone 2130

Thos. U. White & Associates, Inc.

Electrical development work of all kinds undertaken. Patents arranged and all necessary work preparatory to manufacturing. Electrical and mechanical inventions completed for market. Excellent laboratory facilities and model shop.
128 N. Wells St., Chicago, Ill.

EMPLOYMENT

POSITION VACANT

RADIO PRODUCTION SUPERVISOR wanted familiar with American methods, for limited engagement in Europe. Engineering knowledge desirable. Salary and expenses paid. Give full details and references in first letter. P-53, Electronics, 330 West 42nd Street, New York City.

POSITION WANTED

GRADUATE ENGINEER, age 27. Two years ship radio operator. Two years with RCA as power tube engineer. 1930 to date with Federal Radio Commission as inspector and inspector-in-charge. Desires position offering opportunity for advancement. PW-53, Electronics, 330 West 42nd Street, New York City.

electron tube equipment

New—Reconditioned and "As Is"

Used equipment available—Stem, Sealing, Exhaust, Flare, Basing, and Bead Machines, Also Air Blowers, Gas Boosters, Spot Welders, Aspirators, Vacuum Pumps and etc. Buy Direct from the Manufacturer—Be Assured of Full Value—Advise Us of Your Requirements.

EISLER ELECTRIC CORPORATION

Manufacturers of Electron Tube, Neon Sign and Incandescent Lamp Equipment
756 So. 13th St., Newark, N. J.

HIGH GRADE NEW AND USED ELECTRON TUBE EQUIPMENT

Write for Bulletin Showing Savings
From 20% to 80%

KAHLE ENGINEERING CORPORATION
Specialists in Equipment and Methods for the Manufacture of Neon Tubes, Radio Tubes, Incandescent Lamps, Photo Cells, X-ray Tubes, etc.
300 Manhattan Ave., Union City, N. J.

AQUADAG

REG. U. S. PAT. OFF.

COLLOIDAL-GRAPHITED WATER

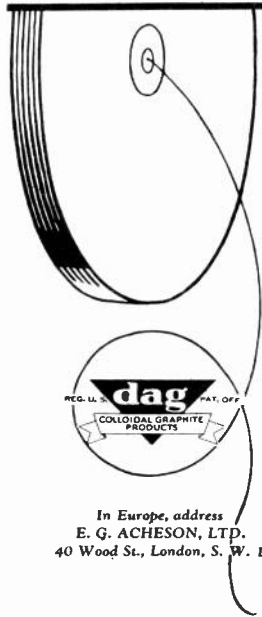

Free of the impurities which occur in powdered natural graphite, "Aquadag" is produced from pure electric-furnace graphite colloidalized by the Acheson Process, and dispersed in a concentrated form in distilled water.

Colloidal graphite is a necessity in the efficient drawing of tungsten and molybdenum. It discourages grid emission and finds utility as a getter.

A characteristic of colloidal graphite which has proved of great importance in the field of applied electronics, is its ability to form inert, homogeneous, conducting films of graphite on glass.

Send for Technical Bulletins Nos. 11 and 31.

In Europe, address
E. G. ACHESON, LTD.
40 Wood St., London, S. W. 1

ACHESON OILDAG COMPANY
PORT HURON, MICHIGAN

REMLER

New Ring Screw Lock Plugs and Receptacles
Microphone and Sound Equipment Connectors

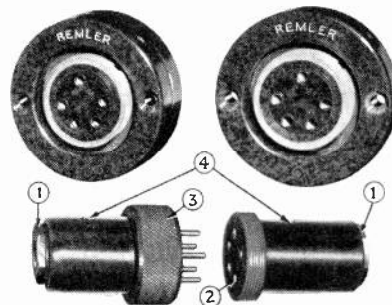

Plug and Receptacle FEATURES

1. Safety Cable Grip eliminates pull on contacts. 1/2" cable opening.
2. Positive contacts 2, 3, 4, 5, 6 or 7 prongs.
3. Metal screw ring diameter 1 1/8."
4. Bakelite or metal shielded body. 4 1/2" united.

	List Price		List Price
Top left: S.R. surface receptacle.....	\$3.50	Bottom left: L.P. plug --fits all receptacles..	\$3.00
Top right: P.R. panel receptacle.....	3.25	Bottom right: L.R. receptacle.....	3.00
Not illustrated: S.R.W. wall receptacle with side apertures to allow cable run on exterior of wall or baseboard..	3.50	L.R. and L.P. plugs with metal shielded bodies for heavy duty use, per unit.....	4.00

Pin circles—diameter 3/8 in. on all connectors.
Specify whether 2, 3, 4, 5, 6, or 7 prong units are desired.
Usual trade discounts to commercial users.

CONDENSER MICROPHONES

2 stage pre-amplifier—Cunningham 864 tubes. Sealed nitrogen-filled head and acoustic equalizer. Floor, desk, hand, bomb types, etc. Discounts to commercial users. Send for folder.

Remler Company, Ltd.
2101 Bryant St. San Francisco

Suspension Type
LIST PRICE
\$100



REMLER—THE RADIO FIRM AS OLD AS RADIO

A Premium on Well-Informed Buying

NOT least among the results of present-day tendencies in American industrial development under Governmental guidance, is the premium that is being placed upon intelligent, well-informed buying.

Working hours are being stabilized. Wages are being standardized, which means in many cases higher labor costs. Selling below cost is viewed with stern disapproval by the powers that be.

Hence, manufacturers in a business like Radio, for example, must turn to manufacturing economies, among other measures, to enable profitable competition. Part and parcel of manufacturing economies is intelligent buying of parts, materials, equipment and services. Intelligent buying does not mean buying that which is cheapest. Certainly the element of Quality and all that Quality denotes plays a significant role in the buying that will be done by the radio manufacturing industry, and for that matter, by all of the electronic industries.

What does this new procedure mean to you as a manufacturer of materials, parts or equipment or as a supplier of services to the various industries that have grown up around the electronic tube? It means that your present customers are going to review your wares and the merchandise of your competitors with extreme care. It means that in many cases their established sources of supply will be discarded and other sources given the business.

You stand to gain or lose in the shuffle. But this much is certain: both your customers and your prospects are going to scrutinize the products they buy as never before. One of the important places where this inspection—this scrutiny—will take place will be the advertising pages of this magazine you're reading—*Electronics*. Hence the wisdom of advertising in that medium.

We'll be glad to furnish additional details.

electronics a McGraw-Hill Publication
330 West 42nd Street, New York, N. Y.

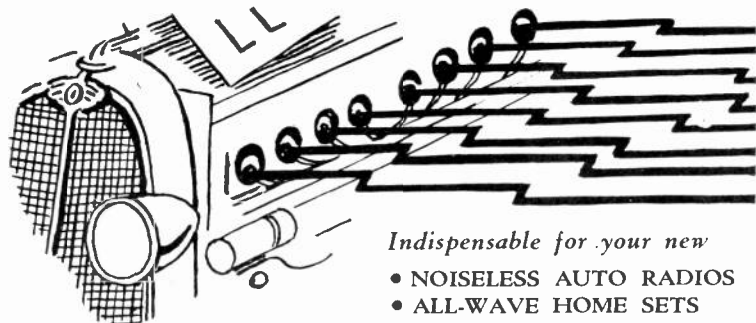

Indispensable for your new

- NOISELESS AUTO RADIOS
- ALL-WAVE HOME SETS
- COMPACT MIDGETS

GOAT form-fitting TUBE SHIELDS

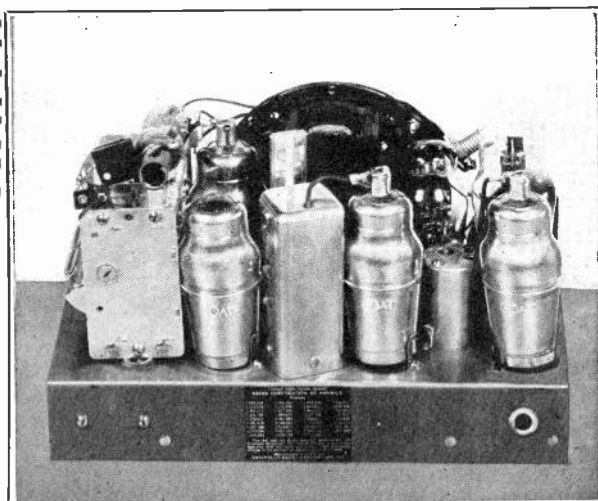

SAVE SPACE • REDUCE NOISE • CUT COSTS

Every manufacturer of modern radio receivers should investigate, at once, the value of these new-type shields which are now available in various models to fit closely around present-day radio tubes. Each shield

is made in two halves, held tightly together in service by a clamping ring, and is easily grounded by a clip fastened to the chassis. The snug fit around the tube gives better shielding, cuts the cost of the shield itself, and permits important economies in both shield assembly costs and chassis space. Complete information will be furnished, promptly on request, to recognized manufacturers.

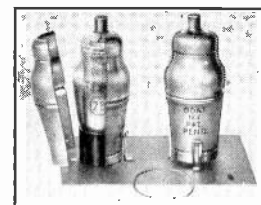

Goat Radio Tube Parts, Inc., 314 Dean St., Brooklyn, N. Y.

INDEX TO ADVERTISERS

This index is published as a convenience to the reader. Every care is taken to make it accurate but *Electronics* assumes no responsibility for errors or omissions.

Acheson Oildag Co. 14	Remler Co., Ltd. 14
Acme Wire Co. 9	Resinox Corp. 8
American Gas Accumulator Co. 7-9	RCA Victor Co., Inc. Back Cover
American Electro Metal Corp. 13	Shakeproof Lock Washer Company 16
American Transformer Co. 8	Thomas & Skinner Steel Prod. Co. 13
Bakelite Corp. 5	Western Elec. Co. 3
Central Radio Lab's Inside Front Cover	Weston Elec. Instr. Corp. 1
De Jur Amsco Corp. 7	White, S.S., Dental Mfg. Co. 2
Erie Resistor Corp. Inside Back Cover	■
General Radio Co. 9	Professional Services 13
Globar Corp. 16	■
Goat Radio Tube Parts, Inc. 15	SEARCHLIGHT SECTION
Graybar Elec. Co. 3	Classified Advertising
Mallory & Co., Inc., P. R. 4	EMPLOYMENT 13
McGraw-Hill Book Co. 12	EQUIPMENT FOR SALE .. 13
Mica Insulator Co. 16	Eisler Electric Corp. 13
Muter Co. 13	Kahle Engineering Co. 13

CONTENTS for AUGUST, 1933

Copyright, 1933, by McGraw-Hill Publishing Company, Inc.

The Radio Code—an editorial.	207
A summary of the provisions of the NRA Radio Industry Code.	208
The "drive-in" movie.	209
Cost versus quality in radio set components. . .	210
Tubes to fit the wavelength.	214
By B. J. THOMPSON	
Higher-voltage vacuum tubes—faster electrons.	216
How manufacturers can cash in on radio prosperity campaign.	218
By EARL WHITEHORNE	
A thyatron laboratory rectifier.	219
By R. MILFORD KIME	
An electron-tube time-delay relay.	220
By G. C. HOLLOWAY	
Audition panel at KFWB.	221
High lights on electronic devices in industry. . .	222
Electronic notes from the laboratory.	224
Editorials.	226
Review of electronic literature here and abroad.	228
New products.	231
U. S. patents.	233
British patents.	236

McGRAW-HILL PUBLISHING COMPANY, INC., 330 WEST 42d STREET; NEW YORK, N. Y.

Branch offices: 520 North Michigan Ave., Chicago; 883 Mission St., San Francisco; Aldwych House, Aldwych, London, W. C. 2; Washington; Philadelphia; Cleveland; Detroit; St. Louis; Boston; Greenville, S. C. James H. McGraw, Chairman of the Board; Malcolm Muir, President; James H. McGraw, Jr., Vice-President and Treasurer; Mason Britton, Vice-President; Edgar Kobak, Vice-President; H. C. Parmelee, Vice-President; Harold W. McGraw, Vice-President; B. R. Putnam, Secretary.

SHAKEPROOF

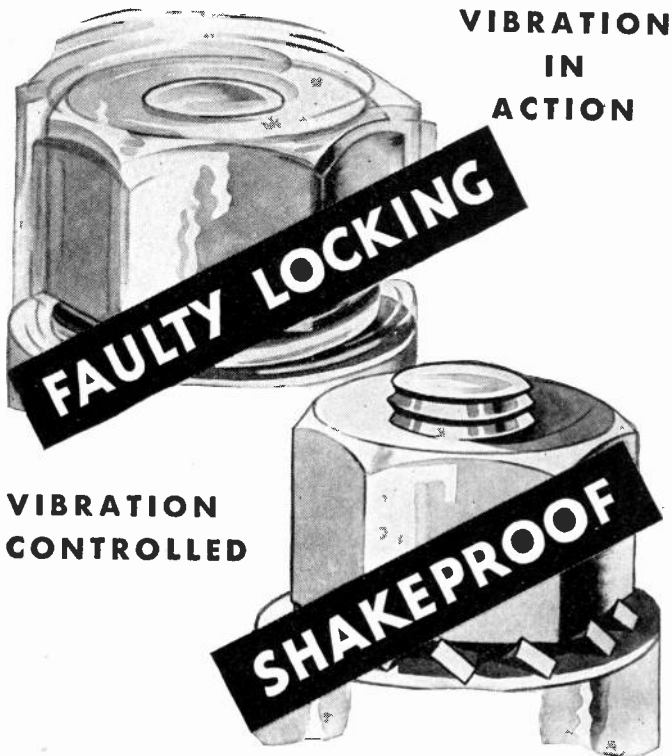

The Answer to Your LOCKING PROBLEMS!

NOW you can provide your product with positive protection against the ravages of vibration. The Shakeproof principle of "Vibration Control" keeps all nuts and screws absolutely tight and avoids the serious dangers of loose connections. Improved performance and lasting satisfaction for your customers is certain when you use ShakeproofLock Washers. The twisted teeth bite into both the nut and work surfaces—as vibration increases they bite in deeper and only applied force can release their hold. Write today for free testing samples and see for yourself what Shakeproof can do for you.



"It's the Twisted Teeth that LOCK!"

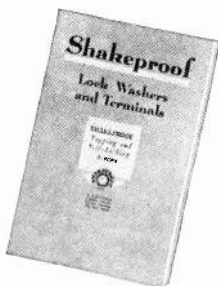

Send today for your free copy of this complete Shakeproof Catalog. Explains thoroughly the many advantages that Shakeproof offers—also shows new patented Shakeproof products.

SHAKEPROOF Lock Washer Company

{Division of Illinois Tool Works}
2539 N. Keeler Ave. Chicago, Ill.

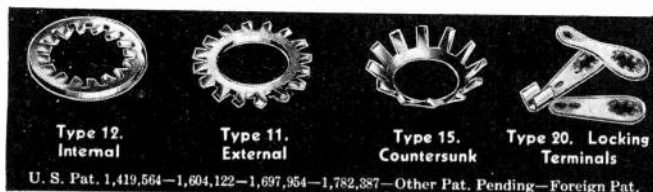

Type 12. Internal Type 11. External Type 15. Countersunk Type 20. Locking Terminals
U. S. Pat. 1,419,564—1,604,122—1,697,954—1,782,387—Other Pat. Pending—Foreign Pat.

GIANTS

in carrying capacity

MIDGETS

in Size

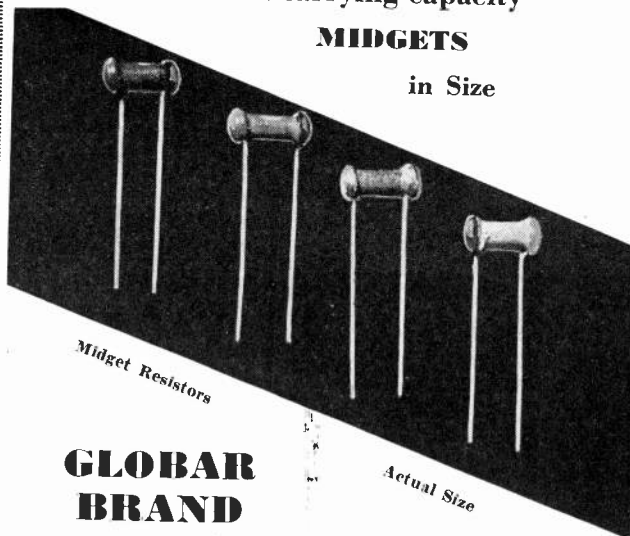

GLOBAL BRAND

Giant-Midget Resistors

Now available, a new series of Global Resistors—Tom Thumbs in size—Goliaths as carriers.

Glad to send samples and complete information as to sizes, wattages, etc.

GLOBAL CORPORATION

A Subsidiary of The Carborundum Company
Niagara Falls, N. Y.

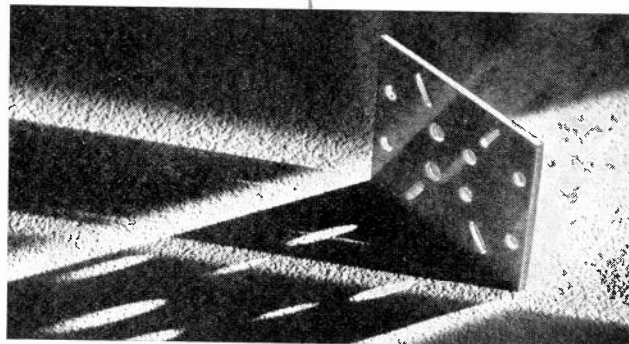

For critical buyers of LAMINATED BAKELITE

Use of the most advanced automatic control equipment and the finest of raw materials, including genuine Bakelite resins, enable us to produce "Lamicoid" Laminated Bakelite parts which meet the severest specifications.

Ask us for samples of parts we have made for radio manufacturers and others. You are sure to be impressed by their clean-cut edges, fine workmanship, and other highly desirable qualities.

"Lamicoid" is furnished in various types, finishes and thicknesses; in fabricated form; and in sheets, tubes and rods.

MICA INSULATOR COMPANY

200 Varick Street, New York, N. Y.; 542 So. Dearborn Street, Chicago, Ill.; 1330 Schofield Building, Cleveland. Branches at Birmingham, Boston, Cincinnati, Los Angeles, San Francisco, Seattle. Canada: Montreal, Toronto.

PRODUCTION

FACILITIES

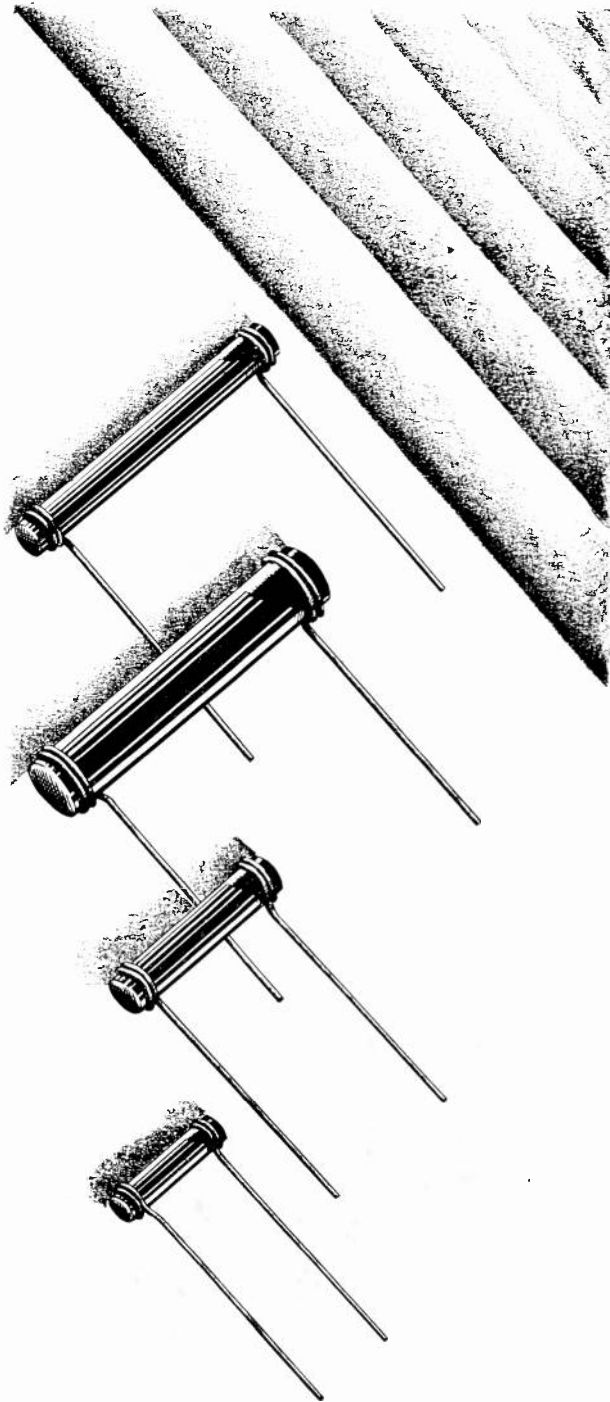

FOR THE GREATEST DEMANDS

Erie Resistor Corporation's capacity to serve its customers is equal to the greatest demands.

Three factories—in the United States, Canada and England—are equipped with the very latest types of automatic machines to produce Erie Resistors quickly and in large quantities.

Ratings are checked by machines especially designed for the purpose—laboratory technicians constantly check all steps in the manufacturing process.

Everything possible is done to serve the manufacturer promptly but speed is never given preference over precision and accuracy in manufacture.

May we send you samples, prices and more detailed information?

ERIE RESISTORS



ERIE RESISTOR CORPORATION, ERIE, PA.
Factories in Erie, Pa. and Toronto, Canada

IT'S NEW

*and invaluable for laboratory research
and development work*

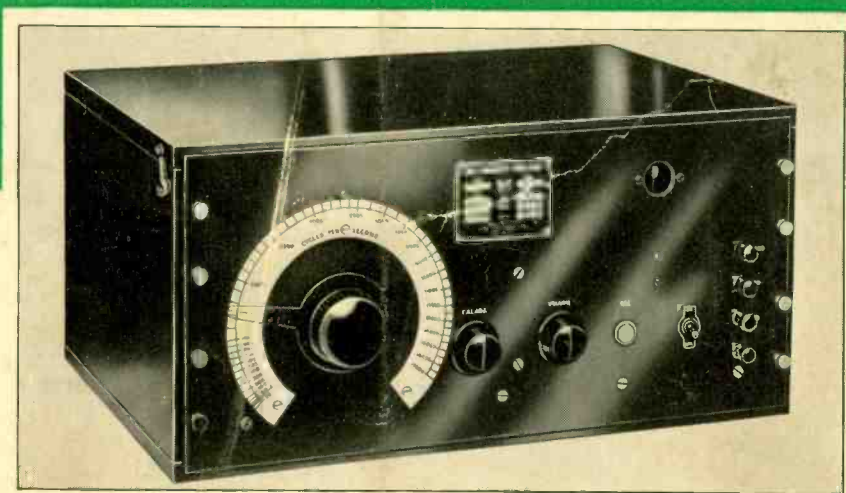

Type TMV-52-A
Beat Frequency Oscillator

RCA Victor has recently produced another new and interesting precision instrument for the laboratory.

It is the Type TMV-52-A Beat Frequency Oscillator. This instrument is also valuable for improving the overall fidelity of audio frequency networks in broadcasting equipment, sound motion picture equipment and in the many other subdivisions of radio and electrical sound work.

A great aid for obtaining frequency characteristics is a continuously vari-

able Audio Frequency Generator, and the many advantages found in the use of the Beat Frequency Generator principle makes this type of oscillator practically indispensable in the laboratory.

The new Beat Frequency Oscillator shown above can also be supplied for rack mounting. It is carefully engineered throughout . . . a product characteristic of "Radio Headquarters."

You are invited to write for technical details and full information about the type TMV-52-A Beat Frequency Oscillator.



Industrial Products Section

RCA Victor Co., Inc.

(A Radio Corporation of America Subsidiary)

CAMDEN, N. J.

"RADIO HEADQUARTERS"