

VIII

# electronics

radio, sound, industrial applications of electron tubes + + + design, engineering, manufacture

radio  
 sound pictures  
 telephony  
 broadcasting  
 telegraphy  
 carrier systems  
 beam transmission  
 photo-electric cells  
 facsimile  
 amplifiers  
 phonographs  
 measurements  
 receivers  
 therapeutics  
 television  
 counting, grading  
 musical instruments  
 traffic control  
 metering  
 machine control  
 electric recording  
 analysis  
 aviation  
 metallurgy  
 beacons, compasses  
 automatic processing  
 crime detection  
 geophysics

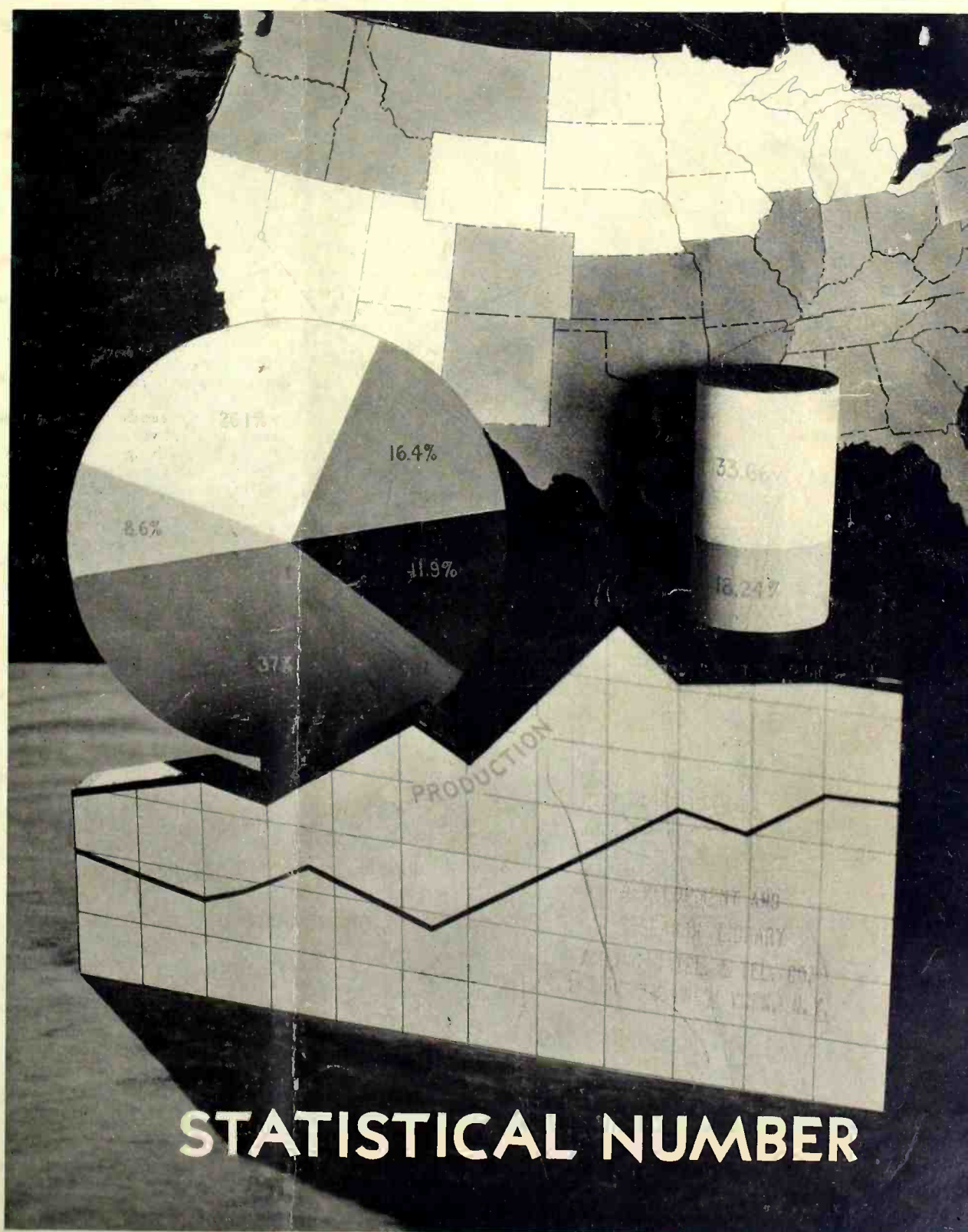

## STATISTICAL NUMBER

A MCGRAW-HILL PUBLICATION

Price 35 Cents

MARCH 1931





## Simplifying 1931 Circuits...

### THE NEW VARIABLE-MU TUBE

The constant quest for improved, yet simplified circuits never ends for radio engineers.

Now, for 1931 receivers, Arcturus presents the new Variable-Mu Tube, Type 551. This tube contributes vital advances of great interest to set engineers... vastly improving operating efficiency of any receiver and making possible definite economies and simplification of the circuit arrangement.

The Arcturus Type 551 Tube renders unnecessary the use of double pre-selectors, dual volume controls; eliminates the necessity of a "local-long distance" switch.

This new Variable-Mu Tube permits distortionless operation with signal input voltages approximately 25 times greater than with present-day tubes and extends the range of automatic and manual volume controls by this factor. It divides maximum cross-talk by five hundred. And it effects a marked reduction in receiver "hiss."

This is accomplished by a new principle in construction whereby the current-voltage characteristic is specially shaped so as to reduce the higher-order parameters responsible for distortion and cross-talk.

A special technical bulletin on the Arcturus Type 551 Variable-Mu Tube will be sent to manufacturers, engineers, and all others interested in this new development.

ARCTURUS RADIO TUBE COMPANY, Newark, N. J.



Licensed under patent applications of Boonton Research Corp.

# ARCTURUS

**"The TUBE with the LIFE-LIKE TONE"**

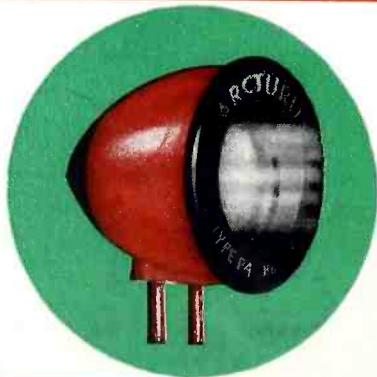

### For Every PHOTO-ELECTRIC Device *The Arcturus* PHOTOLYTIC\* CELL

- 1—Absolutely no lag. 2—Uniform frequency response.
- 3—Low coupling impedance. 4—No background noises.
- 5—No excitation or adjustment required. 6—Shock-proof and non-microphonic. 7—Exceptional resistance to overloads. 8—Easily applied to any photo-electric circuit. 9—Unsurpassed for long life.

*Write for Operating Data.*

© A. R. T. Co., 1931

\* Trademark Reg. U. S. Pat. Off.

# electronics

A MCGRAW-HILL PUBLICATION

New York, March, 1931

O. H. CALDWELL  
Editor

FRANKLIN S. IRBY, Ph. D.  
Associate Editor

KEITH HENNEY  
Associate Editor

## Radio at the cross-roads!

ON the following pages will be found a mass of significant figures relating to radio manufacturing and design, sound pictures, sound devices, and the associated arts.

The radio industry sold a total of 3,706,900 receiving sets in 1930,—only half a million, or 14 per cent, less than the year before. But its 1930 “dollar volume” of set sales dropped from \$525,000,000 in 1929, down to \$302,529,500 in 1930, a reduction of 45 per cent.

Tube sales during the same interval fell off 25 per cent. And, taking all products, the industry as a whole sold a grand total of \$500,951,500 in 1930, as compared with \$842,548,000 in 1929, a reduction of about 40 per cent.

MEANWHILE unit prices have also sharply decreased. Whereas the average radio set sold in 1928 for \$115 and in 1929 for \$110, the 1930 average price was only \$81.50 per set, reflecting the influence of the 1,130,400 midgets which made up 45 per cent of the 1930 set volume. This ratio of midgets to large sets is growing, and based on the demands just observed in the winter months of the 1930-31 season, midget sets may be expected to make up at least 75 per cent of the 1931 volume!

The radio industry thus faces an ordeal and a problem—the problem of *smaller unit sales* but comparable numbers of units. It must re-organize to handle the same set volume, at half the dollar total. From this situation one way out will be through energetic increase in the number of sets sold.

“Two and three sets per home,” radio for the business man’s office, and “a radio set on every automobile”—these are all projects which have been discussed and are worth developing. For such efforts now, if ever, the hour has struck.

A NEW price level of buying power has been tapped, and this should be utilized to swell sales. But price alone will not build a substantial radio industry. Quality and tone value, and right distribution policies and practices all along the line, are essentials in facing the new situation. *A sound industry makes profits*, and profits have been a missing factor during the past year in receiver manufacture. Indeed, so far as *Electronics* can determine, not a single radio manufacturer (except those having other lines of operation besides radio), made any profit whatever during 1930. This is the deplorable but insistent fact.

Radio today stands at the crossroads. The trends and developments of the next ten months will indicate which way the future lies. Statistics like those presented here form the best possible guide for any radio executive as to the right road to take.

Statistics in this issue reveal vital changes radio industry is undergoing. New problems of 1931.

# STATISTICS OF RADIO

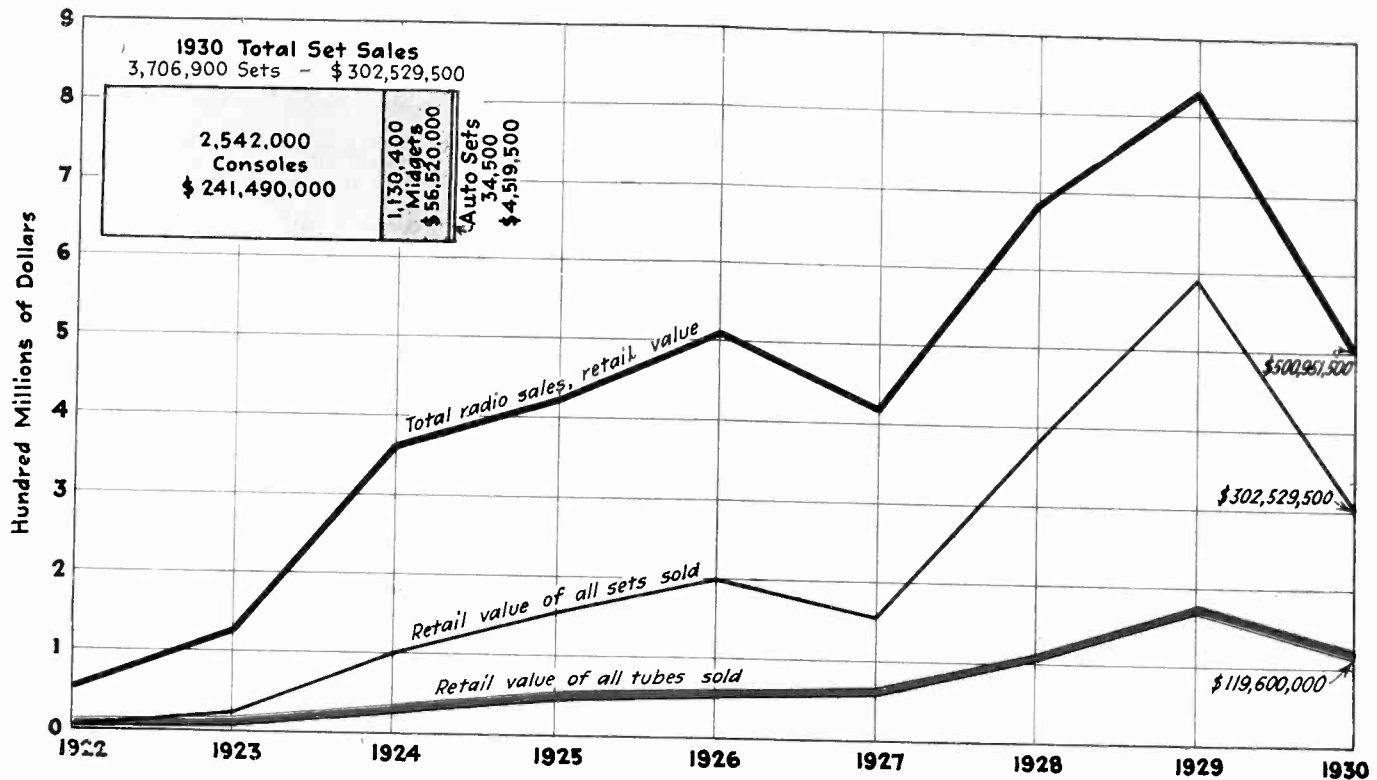

How radio sales to the public have varied from year to year. For the purpose of the above graphs, the 1930 sales of automobile sets (shown separately in the table below) have been included with consoles and midgets in the grand total of radio receiving sets

## Analysis showing numbers and dollar volume of radio sets, tubes, batteries,

	1922	1923	1924	1925	1926	1927	1928
Radio Sets, factory-built (including consoles and built-in reproducers).....	100,000 \$5,000,000	250,000 \$15,000,000	1,500,000 \$100,000,000	2,000,000 \$165,000,000	1,750,000 \$200,000,000	1,350,000 \$168,750,000	3,200,000 \$350,000,000
Radio-Phonograph Combinations.....							81,000 \$38,000,000
Tubes.....	1,000,000 \$6,000,000	4,500,000 \$17,000,000	12,000,000 \$36,000,000	20,000,000 \$48,000,000	30,000,000 \$58,000,000	41,200,000 \$67,300,000	50,200,000 \$110,250,000
Reproducers (excluding those in consoles and combinations).....	25,000 \$750,000	500,000 \$12,000,000	1,500,000 \$30,000,000	2,000,000 \$32,000,000	2,000,000 \$30,000,000	1,400,000 \$28,000,000	2,460,000 \$66,400,000
A-B-C (Dry) Batteries.....	\$4,500,000	\$6,000,000	\$55,000,000	\$66,000,000	\$80,000,000	\$68,000,000	\$50,400,000
A-B Power Units, Storage Batteries and Chargers.....		\$7,000,000	\$25,400,000	\$30,000,000	\$55,000,000	\$34,000,000	\$17,500,000
Other accessories*.....	\$3,750,000	\$4,000,000	\$11,600,000	\$24,000,000	\$33,000,000	\$38,550,000	\$46,000,000
Parts (does not include sales to manufacturers).....	\$40,000,000	\$75,000,000	\$100,000,000	\$65,000,000	\$50,000,000	\$21,000,000	\$12,000,000
Totals							
Sets, plus Combinations....	\$5,000,000	\$15,000,000	\$100,000,000	\$165,000,000	\$200,000,000	\$168,750,000	\$388,000,000
Parts.....	\$40,000,000	\$75,000,000	\$100,000,000	\$65,000,000	\$50,000,000	\$21,000,000	\$12,000,000
Accessories.....	\$15,000,000	\$46,000,000	\$158,000,000	\$200,000,000	\$256,000,000	\$235,850,000	\$290,550,000
Total Sales for year.....	\$60,000,000	\$136,000,000	\$358,000,000	\$430,000,000	\$506,000,000	\$425,600,000	\$690,550,000

\*Includes aerial equipment, meters, pick-ups, turntables, headsets, furniture, etc.

# SALES DURING 1930

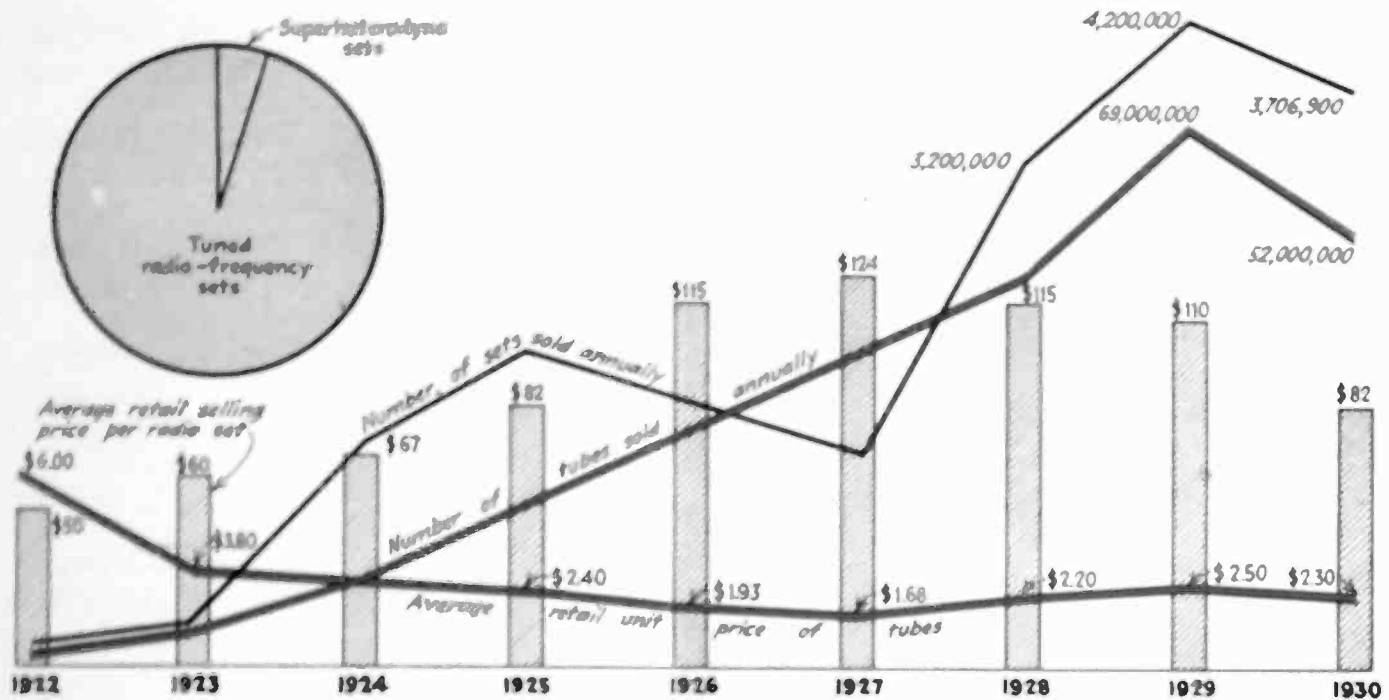

Trends of radio set and tube sales, as shown in numbers of units and in unit prices. The shaded vertical columns represent the respective average retail selling prices of sets by years, dropping from \$124 in 1927, and \$110 in 1929, down to \$82 in 1930

## accessories and parts, 1922 to 1930

1929	1930	Product
4,200,000	3,672,400	Consoles and Midsize Receivers.
\$525,000,000	\$298,010,000	
230,000	155,400	Radio-Phonograph Combinations.
\$67,050,000	\$34,188,000	
69,000,000	52,000,000	Tubes.
\$372,500,000	\$119,600,000	
800,000		Speakers (excluding those already in receivers).
\$16,000,000	\$3,500,000	
\$20,850,000	\$21,514,000	A-B-C (Dry) Batteries.
\$14,550,000	\$6,920,000	A-B Power Units, Storage Batteries and Chargers.
\$9,000,000	\$6,700,000	Other Accessories*.
\$2,500,000	\$6,000,000 (estimated)	Parts (not to manufacturers).
\$302,000,000	\$4,519,500	Automobile-Radio Sets and Combinations.
7,500,000	332,185,000	Parts.
242,900,000	6,000,000	Accessories (inc. tubes).
\$822,545,000	\$500,951,500	Total Sales for Year

## REGARDING STATISTICS IN THIS ISSUE

From the very beginning of radio broadcasting, statistics of radio sales have been compiled annually by the staff of the McGraw-Hill Publishing Company, publishers of *Electrical Merchandising*, *Radio Retailing* and *Electronics*. The figures for 1930 continue the series collected annually by these associated publications, and were compiled from confidential reports of production and sales, furnished through the co-operation of the manufacturers and licensors, diligently cross-checked and compared.

These figures are copyrighted and must not be reproduced without credit to *Electronics*.

# Materials and parts entering into radio manufacture

## GLASS (TUBES)

3,000 tons

## BRASS

2,500 tons

## BRONZE

1,500 tons

## TIN

1,800 tons

## ALUMINUM

4,000 tons

## PAPER

4,500 tons

## CLOTH

1,000 tons

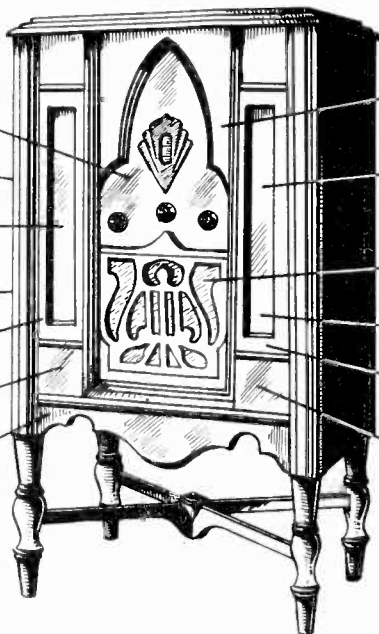

## COPPER

12,000 tons

## STEEL, SETS

76,000 tons

## STEEL, SPEAKERS

35,000 tons

## NICKEL

1,500 tons

## ZINC

1,200 tons

## SYNTHETIC INSULATIONS

2,600 tons

## Component parts purchased by set manufacturers in 1930

	Sets Reported On In Questionnaire (71%)	Total Number of Sets Supplied (100%)	No. Per Set	Cost Per Set	Total Dollar Volume	Number of Units Purchased
Sockets	1,280,340	1,800,000	7	\$ 35	\$630,000	12,600,000
Cabinets	1,045,290	1,470,000	1	8 90	13,100,000	1,470,000
Audio Transformers	849,500	1,190,000	2	90	1,070,000	2,380,000
Radio Freq. Coils	471,000	665,000	3	75	500,000	1,995,000
Tuning Condensers (Gang)	493,490	695,000	1	1 50	1,040,000	695,000
R. F. Chokes	509,390	715,000	4	40	286,000	2,860,000
By-pass Condensers	674,530	950,000	10	96	910,000	9,500,000
Filter Condensers	1,343,140	1,890,000	2	1 15	2,300,000	3,780,000
Filter Chokes	872,350	1,230,000	1	47	577,000	1,230,000
Power Transformers	1,373,780	1,935,000	1	1 45	2,800,000	1,935,000
Fixed Resistors	1,979,530	2,780,000	4	35	975,000	11,120,000
Variable Resistors	2,421,845	3,400,000	2	70	2,380,000	6,800,000
Loudspeakers	565,000	1,258,000	1	3 50	4,400,000	1,258,000
					<b>\$30,968,000</b>	

Radio set manufacturers either build or buy components. A survey answered by makers of 71 per cent of 1930 set production indicated that sockets were bought for 1,280,340 receivers. This number projected into entire 1930 production indicates 1,800,000 receivers for which sockets were bought. All above data secured in similar manner.

## Radio and sound-picture investment for 1930

	Total investment United States	Annual gross revenue	Number of employees	Annual payroll
Radio manufacturers, <sup>1</sup> distributors, etc.	\$200,000,000	\$500,000,000	2100,000	\$200,000,000
Broadcasting stations	\$25,000,000	\$35,000,000	10,000	\$20,000,000
Listeners' sets (15,000,000)	\$1,500,000,000			\$200,000,000 <sup>2</sup>
Commercial radio stations	\$20,000,000	\$8,000,000	17,000	\$4,000,000
Sound-picture manufacturers, producers and distributors	\$900,000,000	\$360,000,000	65,000	\$115,000,000
Sound-picture theatres (22,000 with 11,000,000 seats)	\$1,500,000,000	\$1,100,000,000	185,000	\$275,000,000

1. Radio set manufacturers, licensed and unlicensed, now number 155.

2. Employees at peak of seasonal employment.

3. Annual operating expense of listeners' sets, for tube replacements, electricity, batteries, servicing, etc.

# Radio markets of the world.

## Sets in use, by countries, states, etc.

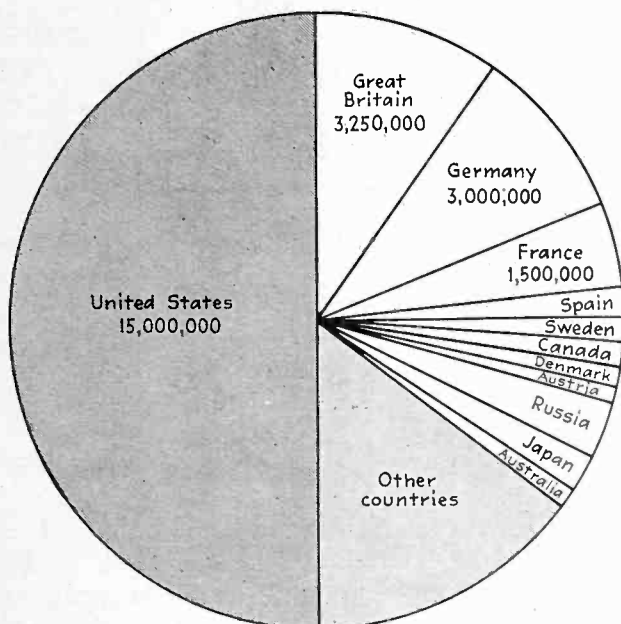

Radio Sets of the World

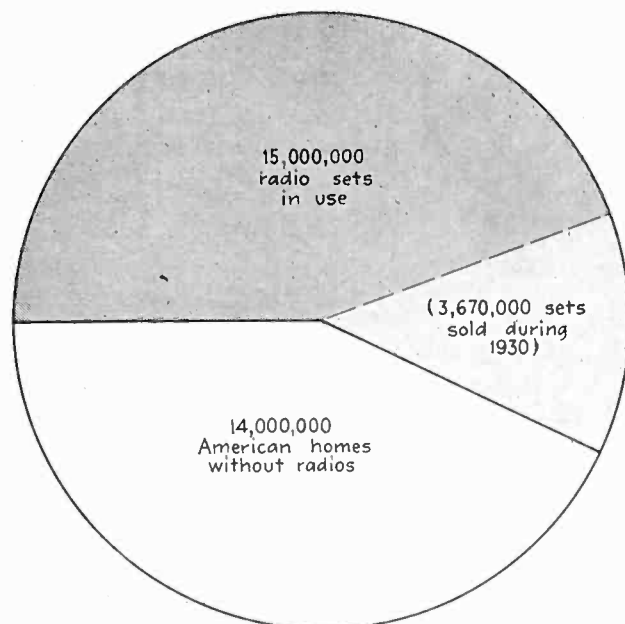

Radio Sets in United States

### Exports of radio and sound equipment

THE year 1930 was the first for which effort was made by the Bureau of Foreign and Domestic Commerce of the Department of Commerce, to collect figures on radio and sound-equipment exports from the United States.

Transmitting tubes, sets and parts	\$1,143,690
Receiving sets	11,549,621
Receiving set tubes	2,363,234
Receiving set components	4,375,481
Loud speakers	1,635,698
Other receiving set components	2,826,235
<b>Total</b>	<b>\$23,893,959</b>

### Canada's half-million licensed radios

IN CANADA where every radio set owner is by law required to pay an annual license fee of \$1.00 to sustain the Dominion's radio administration, 444,676 receiving sets were licensed at the end of 1930. It is believed, however, that the total sets in use greatly exceeds this, reaching perhaps 700,000 or more. Canada's population is now 9,934,000 and 1,436,000 Canadian homes are wired. Radio set sales for 1930 numbered 200,000.

### Fifty-five police radio stations

THIRTY-SEVEN state and local police radio stations are now in operation in American cities and 18 others are now building, according to the Federal Radio Commission's newest police-radio station log. Most of the stations are used for local low-power broadcasting to squad cars via the short waves, although Pennsylvania's state police have five long-wave stations.

### U. S. Census figures on radio sets, to date

WITH the taking of the 1930 Census, a count was made of radio sets. With the preliminary tabulation of the census population figures, the radio-set count is being made available by states. Following are the states available as we go to press:

Area	Number of Families	Persons per Family	Families Having Radios	
			Number	Per Cent
<b>Alabama (state)</b>	592,530	4.5	56,491	9.5
Anniston	5,244	4.3	750	14.3
Bessemer	5,430	3.8	794	14.6
Birmingham	64,443	4.0	17,228	26.7
Gadsden	5,546	4.3	1,107	20.0
Huntsville	3,126	3.7	704	22.5
Mobile	16,909	4.0	3,090	18.3
Montgomery	17,195	3.8	3,206	18.6
Selma	4,956	3.6	824	16.6
Tuscaloosa	4,578	4.5	905	19.8
<b>Arizona (state)</b>	106,630	4.1	19,295	18.1
Phoenix	12,666	3.8	3,655	28.9
Tucson	8,266	3.9	1,945	23.5
<b>New Hampshire</b>	119,660	3.9	53,111	44.4
Manchester	18,832	4.1	7,652	40.6
Nashua	7,612	4.1	3,557	46.7
Berlin	4,292	4.7	1,524	35.5
Concord	6,181	4.1	3,043	49.2
Dover	3,404	4.0	1,707	50.1
Keene	3,637	3.8	1,743	47.9
Laconia	3,178	3.9	1,535	48.3
Portsmouth	3,604	4.0	1,934	53.7
Claremont	3,030	4.1	1,266	41.8
Rochester	2,650	3.8	1,164	43.9
<b>Delaware (state)</b>	59,295	4.0	27,183	45.8
Wilmington	25,694	4.1	13,720	53.4
<b>Arkansas (state)</b>	439,408	4.2	40,248	9.2
Blytheville	2,682	3.8	433	16.1
El Dorado	4,466	3.7	1,081	24.2
Fort Smith	8,200	3.8	2,120	25.9
Hot Springs	5,428	3.7	1,096	20.2
Jonesboro	2,597	4.0	726	28.0
Little Rock	25,148	4.1	7,575	30.0
Pine Bluff	5,449	3.7	1,257	22.7
Texarkana, Ark.	2,917	3.7	592	20.3

# SOUND PICTURE

SOUND PICTURE EQUIPMENT SALES 1930	
Sales sound equipment (U. S.) . . . . .	\$29,200,000
Accessories, installation material, etc. . . . .	3,435,000
Total domestic sales . . . . .	\$32,635,000
Total export sales . . . . .	8,250,000
Total sales 1930 . . . . .	\$40,885,000

## Sound picture theater installations 1930

THE installation of sound equipment for theaters during 1930 progressed at a much slower pace than in 1929. Installations for the year amounted to approximately 4,100, including those theaters in which earlier equipment was replaced, bringing total installations for the United States to 12,900.

From the best information available, it appears that not more than 18,400 houses have potentialities for sound equipment at present. Of the 12,900 theaters already equipped, some 2,500 have disk equipment only, which will undoubtedly require replacement or sound film projection equipment added during the next year. This is due to the recent improvement in film recording and reproduction, and a definite trend from disk to film releases in a majority of studios.

In addition to the theaters now having only disk

equipment, it is estimated from the above figures that between 3,500 and 5,000 small theaters remain to be equipped. Competition with sound-equipped theaters and lack of good silent films, together with expected improved economic conditions during the year, will be factors governing the rate of installation of the remaining theaters. Total installations of sound equipment for theaters throughout the world at the end of 1930 is shown in graphical form in Fig. 1.

## Sound picture production U. S.

THE Bureau of the Census has issued some interesting data, collected by the biennial census taken in 1930, of organizations in the United States engaged in the production of motion pictures, and in the development and printing of films. These figures, which are taken only every two years, indicate the total cost of work done for the year 1929, amounting to \$180,864,319—an increase of 34.6 per cent as compared with \$134,343,350, reported for 1927, the last preceding census year. Comparative data is presented for 1930 in the accompanying table from our information and is an estimate of the industry's development for the past year.

The industry, as constituted for census purposes, embraces all studio and laboratory activities connected with the production of motion pictures and processing of film, and does not include distribution and projection in theaters.

It is interesting to note from the figures taken from the biennial census report, that the annual earnings for the 8,298 salaried officers and employees amounted to \$58,920,014 for 1929, or an average of \$7,112 per person classified in this group.

The cost of sound equipment for theaters is not included in the summary for studios but is included in the \$32,635,000 of total domestic sales.

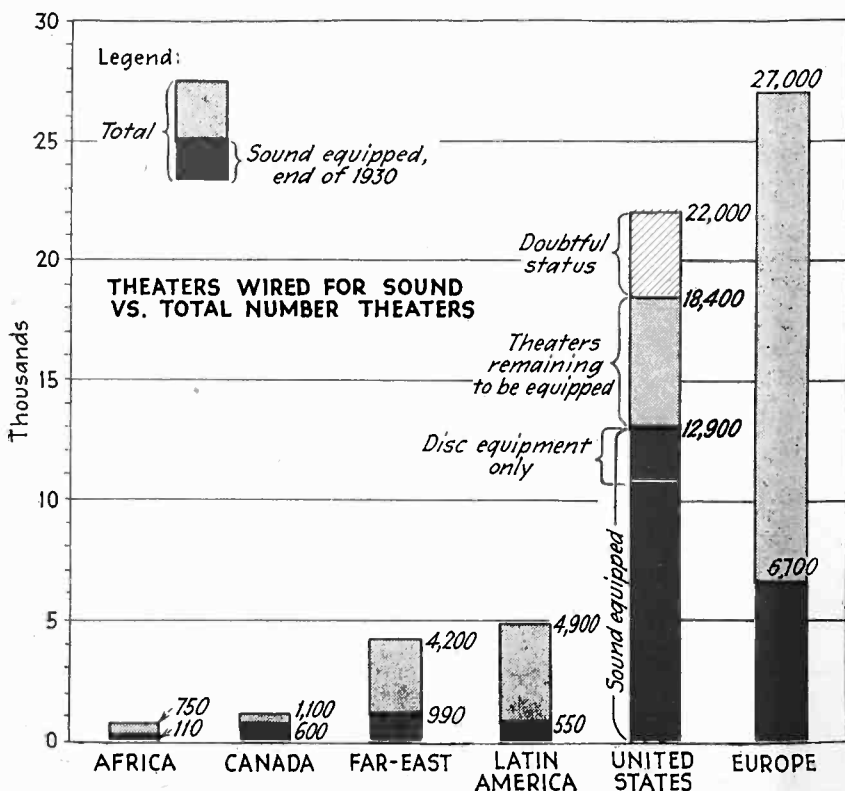

Fig. 1—Sound picture theater installations throughout the world at the end of 1930 are shown in comparison to total theaters. Installations for the world 21,850



# STATISTICS FOR 1930

## Summary for the motion picture industry

	1930 (Estimated)	1929	1927
Number of establishments (studios and laboratories) . . . .	152	143	142
Salaried officers and employees . . . . .	8,800	8,298	7,598
Wage earners (average for the year) . . . . .	11,000	10,785	8,415
Salaries . . . . .	\$60,000,000	\$58,920,014	\$56,298,560
Wages . . . . .	\$25,500,000	\$24,722,053	\$18,637,005
Cost of materials, fuel, and purchased electric current . . . . .	\$40,000,000	\$38,166,988	\$34,867,472
Paid for contract work . . . . .	\$12,000,000	\$9,437,452	\$15,476,548
Cost of work done during the year . . . . .	\$192,000,000	\$180,864,319	\$134,343,360

The following table gives the export figures on motion picture films by geographical location for the years 1929 and 1930.

## American film exports by geographical location

Countries	1929		1930	
	Feet	Value	Feet	Value
Europe . . . . .	110,081,478	3,341,435	122,670,362	4,340,171
Latin America . . . . .	79,697,600	1,926,551	73,518,089	1,730,252
Far East . . . . .	62,828,477	1,388,983	50,049,020	1,168,193
Canada . . . . .	16,446,073	690,595	16,476,472	627,442
South Africa . . . . .	5,343,073	130,394	4,414,679	120,132
Other countries . . . . .	7,818,779	144,358	7,222,719	132,546
<b>Total . . . . .</b>	<b>282,215,480</b>	<b>\$7,622,316</b>	<b>274,351,341</b>	<b>\$8,118,736</b>

## Export of films — 1925 - 1930

PRELIMINARY figures issued by the Department of Commerce for the year 1930 indicate a slight falling off in the total linear feet of film exported, but an increase in value, as compared with 1929. The United States exports of film for 1930 totaled 274,351,341 linear feet, with a declared value of \$8,118,736, as compared to 282,215,480 linear feet, valued at \$7,622,316 for 1929.

Of the total film exported in 1930, sound film amounted to 186,436,913 linear feet, as compared to only 87,914,428 feet of silent film. Though negative and positive sound film have been exported since 1927, this past year was the first time that classification between silent and sound films has been made. It is encouraging to see that exports of sound film have balanced a loss in export of silent film, in view of the increasing number of foreign film laboratories and sound studios that have come into existence since 1928.

Since sound pictures were first introduced, Europe has become our largest export market. Our exports to Europe for 1930 increased by 12,500,000 feet over 1929, reaching the total of 122,670,372 feet. Our exports to Latin America fell some 6,000,000 feet, and the Far East showed a decline of 12,500,000 feet in 1930 from the 1929 total. This may be attributed to the smaller number of theaters that have been sound-equipped in these two territories and the resulting loss in demand for sound films.

The motion picture industry faces a new crisis in the export field outside of the English speaking countries. Unless Hollywood can supply sound films to meet the future demands of such countries, the motion picture industry will become national in the narrowest sense. This indeed will be unfortunate as 85 per cent of the films shown throughout the world in the past have been made in this country. These films have been an excellent means of exploiting American goods in all parts of the world.

## Sound equipment exports 1930

FOR the first nine months of 1930 sound equipment exports totaled \$6,247,299 and for the year, is estimated at \$8,250,000. These figures show custom statistics value only, for such equipment. This is the first year that information has been available on sound equipment exports.

From the advent of sound pictures in 1927 our exports of equipment for this field have risen from zero to the present figures. While thousands of theaters remain to be equipped throughout the world it is difficult to foresee just how far this export market for American equipment will extend. As a result of patent agreements concluded in Paris in July, 1930 (*See Sept., 1930, Electronics*), certain European states were reserved for German manufactured apparatus. The total possible exports of American equipment will probably not be greatly affected by this agreement. Great Britain, France, Italy and Spain are open to apparatus from any source and represent the largest individual markets in Europe. Other foreign countries which were reserved for American manufactured apparatus include Canada, Australia, New Zealand, India and Russia accounted for considerable exports to these outlets. Export sales for 1930 represent 25 per cent of total sales of sound equipment.

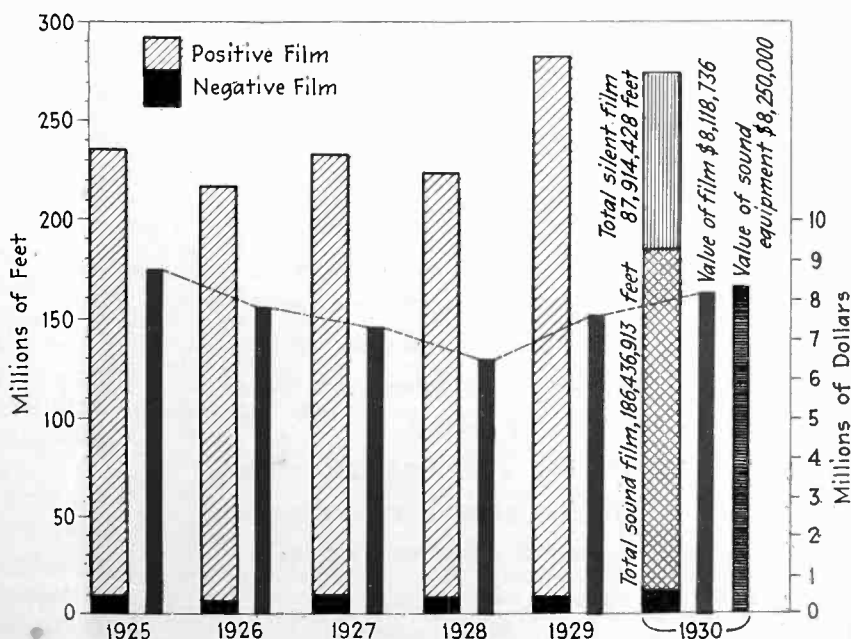

Fig. 2—Film exports for 1930 show first classification between silent and sound films. Value of sound equipment exports equaled films exports for the year

# The new tubes— Characteristics of variable-mu tetrodes

By KEITH HENNEY

Associate Editor, *Electronics*

**D**EMAND for undisturbed reception from near or distant broadcast stations has forced receiver designers to find means of achieving greater and greater selectivity and sensitivity. Advent of high power on the part of many stations increased the difficulty caused by an over crowded condition of the ether until even city listeners found high signal levels from distant stations a cause for annoyance because of antiquated receivers.

Multi-stage radio frequency amplifiers made possible receivers with sensitivity of the order of 30 to 50 microvolts; ultimate adoption of screen-grid tubes (at first claimed by the industry to be of little value) increased this sensitivity by a factor of ten times. At the same time this increased gain made possible advances in detection and simplification in audio amplification. Shift of amplification to a point ahead of the detector increased the input level to this part of the circuit to such an extent that linear detection was possible, as well as the elimination of part of the audio frequency gain. Decreased hum, increased fidelity, greater selectivity and sensitivity were the result.



**RADIO executives and engineers have expressed wide interest in the improved screen-grid tubes and their effect on 1931 set design.**

Here are the complete operating data, based upon manufacturers' tests, completed just as *Electronics* goes to press.

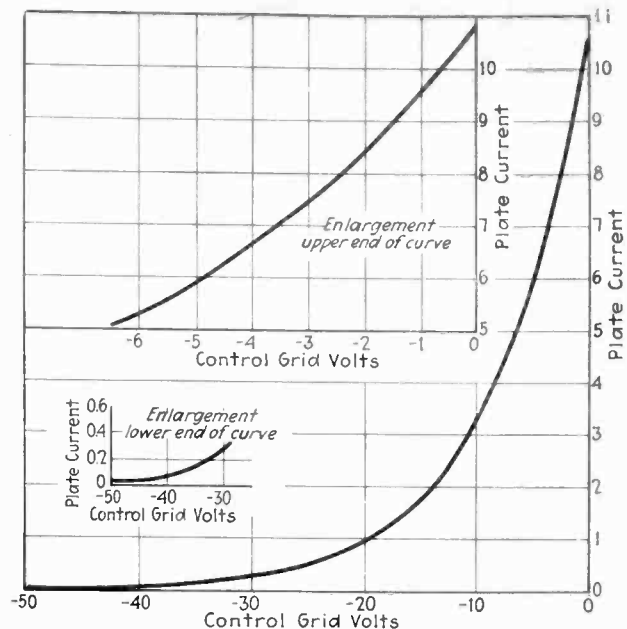

Fig. 1—Characteristic of preliminary tube showing long plate current-grid voltage curve

The screen-grid tube is a high amplification tube and it suffers in accordance. It has a relatively small grid swing before distortion results. Hence high-gain screen-grid receivers were in difficulty almost as soon as their superior advantages were appreciated. Strong local signals drove the grids of amplifier tubes so far negative that plate current cut-off resulted. The effect was to modulate the desired program with an undesired, which

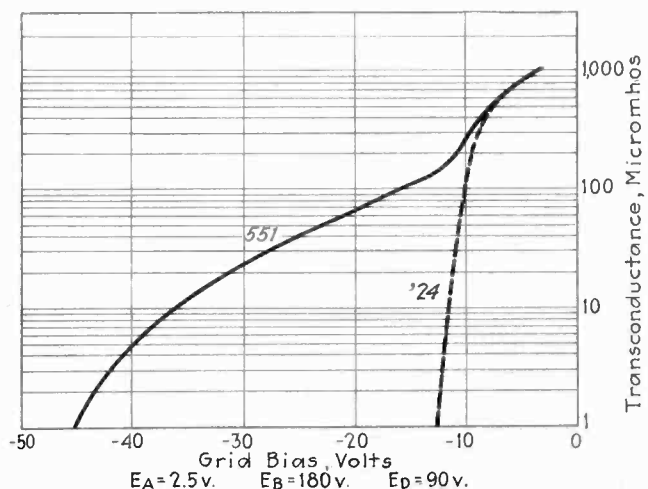

Fig. 2—Comparison of mutual conductances of standard screen-grid tube and variable-mu tube

either hashed up the program continuously or caused gasps and gurgles of interference to crash through, or produced a peculiar hum modulation.

Use of pre-selection (between antenna and first r.f. stage) double volume-control potentiometers, local-distance switches, better power pack design brought some relief to this situation. But into such a picture was thrust the midget, a set so small that refinements of multi-stage amplifiers, pre-selection and other tricks could not be utilized.

## A new screen-grid tube

In October, 1930, Stuart Ballantine and H. A. Snow described a new type of screen-grid tube which has come to be known as the "variable-mu" or "exponential" tube. In November the tube was discussed at a meeting of the

Institute of Radio Engineers at Rochester and in January *Electronics* Mr. Ballantine showed further use of the tube in making measurements over very wide ranges.

This tube, some of whose characteristics are given here, fits into a disturbing situation with particular felicity. It has a very long characteristic, enabling it to tolerate very strong grid biases before the plate current reaches zero; this characteristic does not suffer from bad curvature; the gain due the tube does not suffer appreciably from comparison to a 224.

In effect the signal coming from the antenna system picks out the part of the characteristic it chooses to work upon, fixed by the carrier voltage of this signal, and because there is no appreciable inflection of the characteristic demodulation does not take place. A strong local signal may bias the grid as low as 30 or more volts while the desired weaker signal may be working about a point perhaps only a few volts or even tenths of volts negative.

Such a tube makes unnecessary the precautions taken to overcome cross-talk, modulation hum and distortion thereby not only increasing the value of the receiver to the owner but decreasing its production cost to the manufacturer.

In midget receivers this tetrode is specially useful, but its value is not restricted to the small set. Its ability to handle large voltages, the fact that its transconductance (mutual conductance) varies exponentially with grid bias indicates that a much more uniform control of gain is possible. In receivers using automatic volume control the range over which control is secured may be increased by a factor of 20. Other advantages offered by the tube

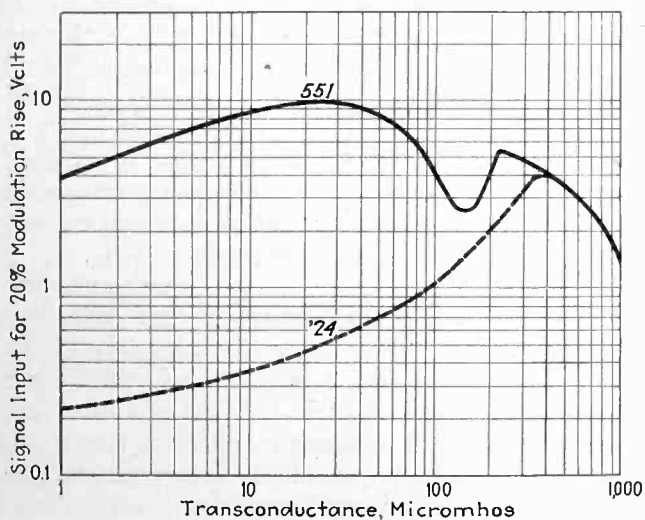

Fig. 3—Curve showing decreased modulation distortion of new tube compared to present type of screen-grid tube

are: the input voltage may be increased by a factor of 20 before distortion appears; cross-talk may be reduced by a factor of several hundred times; hum on the carrier (due to modulation in the r.f. tubes) will be decreased; the receiver will seem quieter in operation due to that fact that less attenuation will occur to the signal between the antenna and the first amplifier thereby increasing the signal-to-hiss ratio.

Antenna potentiometers, double pre-selectors, local-distance switches may be eliminated all to the benefit of the manufacturer in decreasing cost and complexity.

Reception of the screen-grid tube by radio set manufacturers although not instantaneous was ultimately complete; apparently the same process will be gone through in the introduction of the new tube. While some manufacturers were openly skeptical, Majestic seized upon the

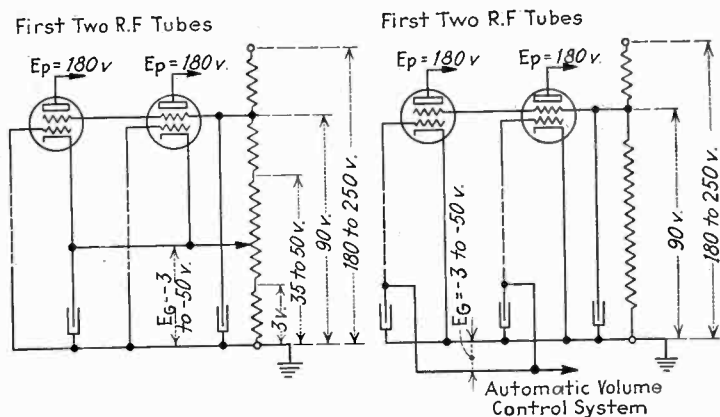

Fig. 4—Methods by which proper bias for new tubes may be secured

tube both for its technical and economic advantages and for its hoped-for sales appeal, went into production on four models of receivers using their "multi-mu" tube; other wide awake tube and set manufacturers display more than a passing interest. A conservative estimate upon the number of such tubes that will find their way into receivers this year is of the order of 7 to 10 million.

### Importance of the tube

It is certain that nothing else so uniquely important has appeared upon the radio horizon. The screen-grid tube clearly suffered from faults which nothing but a radical change in design would remedy. This the exponential, or variable-mu, tube provides. It is more than possible that other screen-grid tubes for the detector position, and a tetrode or pentode (damned by the industry a year ago) will arrive to improve the power end of the receiver.

In the interest of economy and efficiency it is bad practice to have more types of tube than are necessary. At the present moment there seems a chance of two kinds of this new improved screen-grid tube with slightly different characteristics. Such a condition is deplorable, and probably will not be tolerated by the industry. On the other hand such simplification as having but two types of tube, a general purpose tube such as the 224 and a power tube seems to be reducing matters to such simplicity that efficiency begins to suffer. If tube and circuit engineers can produce a screen-grid tube (like the exponential or variable-mu) which is much better adapted to amplifying r.f. signals, it is not too much to expect that they will produce a better detector and a better power tube.

### Tentative ratings and characteristics

	RCA 235	Arcturus 551
Filament voltage	2.5 volts	2.5 volts
Filament current	1.75 amperes	1.75 amperes
Plate voltage (Recommended)	180 volts	180 volts
Screen voltage (Recommended)	75 volts	90 volts
Grid voltage	-1.5 volts	-3 volts
Plate current	9 milliamperes	5.5 ma.
Screen current	Not over 1/3 of plate current	less than 2 ma.
Plate resistance	200,000 ohms (approx.)	300,000 ohms
Mutual conductance	1100 micromhos	1000 micromhos

### Approximate interelectrode capacitances

Grid to plate	0.010 mmfd. maximum	.006 mmfd.
Input capacitance	5 mmfd.	
Output capacitance	10 mmfd.	

The above characteristics and those represented by the curves shown here may not be those of the final tubes as manufactured. They were made from preliminary tubes and it is possible that the future may see some changes.

# Progress in sound-picture recording

By CARL DREHER

*Director of Sound,  
RKO Productions, Inc., Hollywood, Calif.*



THE advances of the past year in sound picture recording, such as the introduction of microphone booms, are now taken as a matter of course. This is a normal line of development of technical devices. In the first stage, no one can see how a problem is to be solved; in the second stage, it is solved, although the solution often enough is disparaged by those not responsible for it; in the third stage, it is generally accepted and improvements are made in it; in the fourth stage, it is taken as a matter of routine and people assume that it has always been in use. Talking movies are now old enough so that some of the equipment has graduated into the last stage.

However, numerous other products of technical progress are coming to the fore. Some of these have reached the point where their characteristics may be discussed and their value estimated. Among these are a number of methods of anti-ground noise recording.

Figure 1(a) illustrates a variable area sound track on film. The upper part of this record (Section A) shows a condition of no modulation, with half the width of the track black and the other half clear. This means that with the recording mirror at rest, half the track is exposed to light and the other half remains unexposed, the dividing line between the exposed and unexposed portions being the median line of the track. When modulation begins, this straight median line breaks up into the familiar serrations of the variable area track which, as drawn in Fig. 1(a), are first of small amplitude in the section marked B, and then increased to the full width of the track in Section C.

In reproduction light passing through the transparent portion of the track encounters irregularities, such as dirt and scratches on the film. With the subsequent amplification, this results in the familiar rush or ground noise, which, under the conditions of Sections A and B in Fig. 1(a), when modulation is low or absent, may be very annoying. Moreover, the reproducing photocell, when excited by light, adds a certain increment of noise. Even if the modulation is at times high enough to dominate the total noise, the presence of the disturbance in the intervals constantly reminds the audience that it is listening to a mechanism. Hence the elimination of ground noise is a very desirable development.

In the case of the variable area track, a marked reduction in ground noise may be secured by the method shown in Fig. 1(b) which dates back several years. The dividing line between the dark and transparent portions of the film, it will be noted, is no longer always in the middle of the track, but goes over toward the edge of the track as far as possible. When there is no modulation, as shown in Section A of Fig. 1(b) the black portion of the print goes almost all the way over to the edge of the track. Hence very little light will get through to reproduce irregularities on the film or excite the photocell.

When, as in Section B of Fig. 1(b), modulation sets in, the center line of the modulation moves over far enough so that the peaks will be accommodated on the track. When full modulation is reached, as shown in Section C of this figure, the center line of the modulation moves over all the way and once again coincides with the median line, thus utilizing the maximum volume carrying capacity of the track.

The apparatus accomplishing this was devised some years ago by C. R. Hanna, of the Westing-

house company, and C. W. Hewlett, of the General Electric Company. It is shown in a general way in Fig. 2. A part of the audio output of the recording amplifier is diverted, subjected to further amplification, rectified, and then used to bias the recording galvanometer obversely. That is, when the output of the recording amplifier is small, the galvanometer is biased to such an extent that almost the whole width of the positive track is black. As the audio output of the recording amplifier increases, the bias changes correspondingly until, for full modulation, the mirror is in the position which it would occupy in ordinary variable area recording.

This is a simple and effective method. Its only drawback is that low modulation is close to the edge of the track, and if in reproduction the scanning beam is incorrectly located, the modulation might not come through at all. Hugh McDowell, of RKO Radio Pictures, has devised a method whereby the serrations always remain in the middle of the track, but the clear portion of the print is matted out by the action of an auxiliary light-blocking device. The McDowell method is outlined in Fig. 3. As in the preceding system, a portion of the output of the recording amplifier is rectified, but instead of being

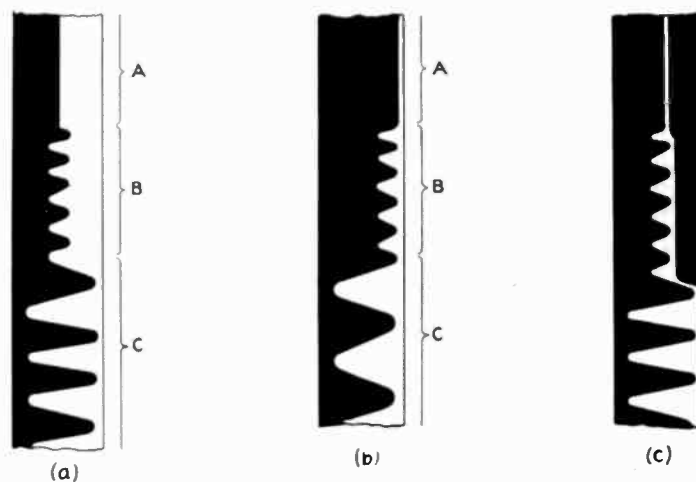

Fig. 1—(a) Represents typical "variable area" sound track while (b) and (c) illustrate methods of obtaining anti-ground noise recording by blanking off clear portion of track

applied to the recording galvanometer, it actuates an electromagnetic or other form of motor, which moves a small shutter and interposes it an appropriate distance into the recording beam. The appearance of a variable area positive track recorded by the McDowell anti-ground noise method is shown in Fig. 1(c). A mat of variable width follows the modulation closely, with a clearance of about five mils, keeping out the greater part of the ground noise.

The RKO-McDowell system of silent recording was described and demonstrated before the Academy of Motion Picture Arts and Sciences in Hollywood in January, 1931. It has been applied commercially in RKO Radio Pictures' "Dixiana," "Half Shot at Sunrise" and other current releases.

### Biased light valve recording

The variable density recording experts have likewise been busy on ground noise reduction. In a paper presented by H. C. Silent of Electrical Research Products, Inc., before the Academy of Motion Picture Arts and Sciences in Hollywood Dec. 5, 1930, the biased light valve was described.

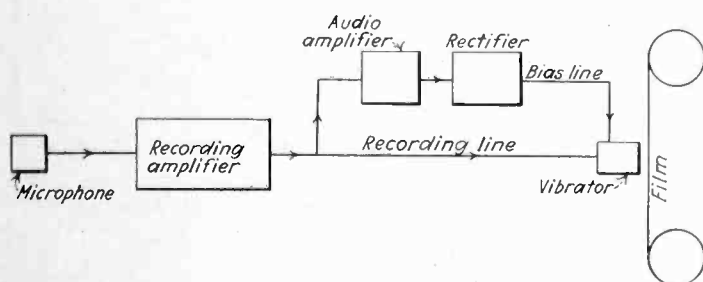

Fig. 2—Schematic circuit showing method of diverting part of output of recording amplifier to bias recording oscillograph

This method takes advantage of the fact that when the light transmission of the film is low, the ground noise is also low. However, when the sound track is printed in this way with a high density, modulation must also be kept low, since in this case the volume carrying capacity of the film is also low. (There is a particular value of density or transmission which allows the greatest volume range to be secured from the emulsion without photographic overloading), hence a recording valve which varies the light transmission in accordance with the envelope of the audio input will act as an anti-ground noise device. The usual light valve method used for recording in the Western Electric system is described in a paper by Donald McKenzie: "Sound recording with the Light Valve," *Transactions of the Society of Motion Picture Engineers*, Volume 12, No. 35, September, 1928. Briefly, the valve consists of a pair of ribbons normally spaced 0.001 in. apart. The sound currents cause these ribbons

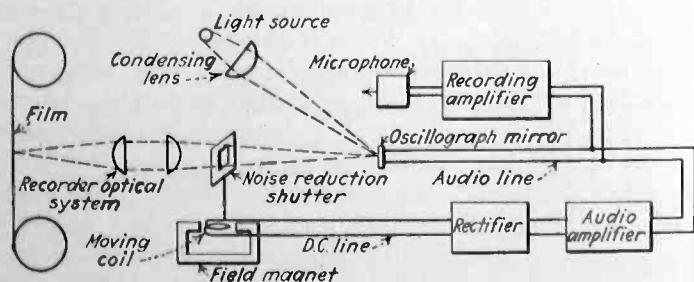

Fig. 3—Further modification in method of biasing oscillograph in order to keep serrations (for low modulation) in center of sound track

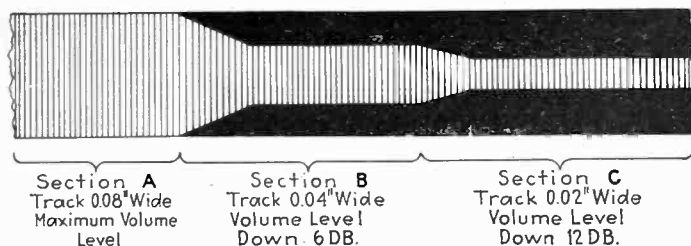

Fig. 4—Illustrates method of automatic volume control by "squeeze track" method, applicable to variable density recording

to vibrate, slightly for weak currents and a correspondingly greater distance for higher inputs. Therefore, for weak currents which correspond to the intervals when ground noise is most annoying, the spacing of 0.001 in. is considerably greater than is necessary and, if reduced, will result in lower ground noise. The biased light valve moves the ribbons close together for small recording amplitudes and draws them apart to the full spacing of 0.001 in. only when the amplitude is great enough to require this. The average spacing of the ribbons follows the envelope of the modulation. Hence the general density of the print is high during intervals of low modulation and less during intervals of high modulation. Of course, some margin must always be retained so that the ribbons will not touch even when the modulation is low.

The electrical method whereby the ribbons are moved closer together, or further apart, is substantially the same as in the variable area systems above described. A noise reduction amplifier follows the envelope of modulation and biases the valve to the proper degree. A decrease in ground noise of about 10 db. is claimed and it is probable that greater reductions will become possible with further development.

### Increasing total volume range

All methods of reducing ground noise are, to some extent, automatic volume controlling methods. As is well known, space or photographic limitations on the film set an upper level of amplitude, while ground noise, whether in recording or reproduction, sets a lower limit. The space between these limits, which is of the order of 25 db. in film recording (sometimes more, under favorable conditions) is not sufficient to accommodate the full range of amplitudes encountered under natural conditions. This may be as high as 60 db. for orchestral music or, say, 40 db. for dramatic speech. It is customary, both in talking picture recording and in the broadcasting field, by varying the amplification manually, to compress the volume range of the original performance within the allowable limits of the recording medium. But if the ground noise level, which sets the lower limit, is reduced by, say, 20 db., part of this added leeway may be used for additional volume range in recording and reproduction. For example, the recording may be carried 10 db. lower for speech. If, then, the reproducing amplifier is set at a level 10 db. higher than normal, the reproduced volume will remain the same, but the full amplitude of the track will be reproduced 10 db. louder than before, thus affording louder and more effective crescendos.

A discontinuous method of automatic volume control applicable to the variable density track was developed earlier in 1930 by the Metro-Goldwyn-Mayer Studios and described by Wesley Miller: "Volume Control by the Squeeze Track," in the *Journal of the Society of Motion Picture Engineers* for July, 1930. The squeeze

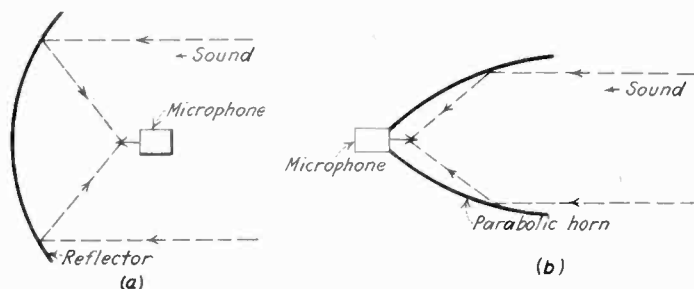

Fig. 5—(a), (b) Two types of beam microphone concentrators used in sound picture recording

track method is shown in Fig. 4. Section A shows maximum volume. When it is desired to reduce the volume, the variable density track is matted out at the sides, changing from the maximum track width of 0.080 in. down to 0.020 in., as in Section C, a range of 12 db. is secured. This is added to the normal volume range of the variable density striations. The squeeze matting is taken care of in printing. As the track is narrowed, the surface noise is reduced in proportion so that with the full extent of squeezing, there is no added ground noise. Of course when the reproducing amplification is raised, there is always danger of running into noise interference from the projection apparatus itself. This, however, is equally the case with other methods of automatic volume control which utilize a higher projection gain. The remedy is to improve the reproducing equipment so that it will be quiet in operation even at high gains.

The above methods of ground noise reduction and automatic volume control have been applied commercially with considerable success. There is no doubt that progress will continue to be made in this field and that ultimately sound picture projection will cover a wide range of volume with an immaterial amount of ground noise at the lower limit. Talking movies are eliminating their own static.

### Microphone developments

Among microphone developments is the reflector type of pickup described by the writer in the *Journal of the Society of Motion Picture Engineers* for January, 1931: "Microphone Concentrators in Picture Production." Fig. 5(a) shows the method in outline. A parabolic or ellipsoidal sound mirror, 3-5 feet in diameter, picks up sound, sometimes at a considerable distance from the source, and concentrates it on a microphone placed at or near the focus of the curve with its back to the action. Sounds of wave lengths small in comparison to the dimensions of the bowl gain about one stage in amplification. This, it will be noted, is secured acoustically instead of electrically, entailing certain advantages in that the process of electrical amplification is started at a higher level, and extraneous sounds and reverberation on the set are partially suppressed. The device is directional and permits picking out significant dialogue from traffic noise, etc., with considerably more effectiveness than the human ear or an unaided microphone. Thus, in a scene taken in a railroad roundhouse, the concentrator microphone picked up intelligible dialogue at a distance of about 12 feet from the speakers, whereas an open microphone 3 feet from the same speakers was ineffective because of the locomotive noise and other disturbances. Not only is it possible with the concentrator microphone to make spectacular shots which could not be secured conveniently in any other way, but it also considerably increases speed of shooting and hence lowers cost of production. Be-

cause of reverberation, its use is more limited indoors and, up to now, the principal commercial applications have been in outdoor shooting.

An earlier type of microphone concentrator was developed by RCA Photophone in the form of a metal horn, as shown in Fig. 5(b). This type of concentrator is described by Olsen and Wolff: "Sound Concentrators for Microphones," in the *Journal of the Acoustical Society of America*, April, 1930. The amplification in the treble and upper audio range is not as high as that of the bowl type of reflector, but the horn functions as an acoustic amplifier for the lower frequencies.

The addition of reflectors to microphones contains many possibilities for improving pickup and it is probable that a great deal of work will be done in this field during the next few years. By means of microphone reflectors sound pickup approaches the flexibility of camera technique, with its panning, dolly shots, and

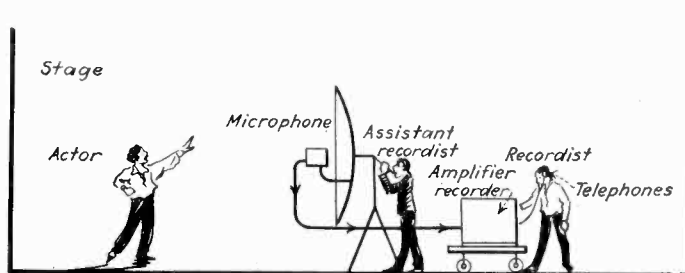

Fig. 6—Sketch showing possible simplification of recording equipment for future studio use, monitoring booths and recording rooms not required

changing of lenses. It is interesting to follow the evolution of the microphone from its original immobility, inherited from the broadcast field, and its subsequent release through the development of the microphone boom and acoustic concentrating adjuncts.

This increase in recording mobility is likely to continue, and it is not confined to the microphone. The need for mobility was not at first recognized in talking picture installations. Engineering tradition plays a great part in the form which early apparatus in any field assumes.

In the earlier installations a separate monitoring room adjacent to the stage, and which was large enough to simulate the acoustics of a theater, was considered necessary. The recording rooms are usually located at some distance from the stage. The next step in development provided a somewhat simple layout with the large monitoring room replaced by a portable monitoring booth, containing the necessary amplifier and film recorders and located directly on the stage.

It may be that the developments of the future will produce a system like that shown in Fig. 6. Here the recordist in charge is on the stage as close to the action as the cameras. An assistant, under his immediate supervision, manipulates a microphone concentrator, while the first recordist stands by the recording amplifier, the output of which he hears through high quality head receivers. The sound camera, enclosed in a sound insulating blimp like the picture cameras, is also directly under his observation. The point is that the recordist in charge is in direct and constant touch with the director, the first camera man, and the sound assistants; he sees all the action clearly and supervises the recording without having to work through intermediaries at a distance. This may not be feasible now, nor for a number of years, but it represents a goal toward which the development of the art is tending.

## Equipment for testing

# Radio receivers in production

By L. C. HOLLANDS

Engineering Dept., Howard Radio Co.

A RADIO receiver, which has been engineered through the laboratory and is then turned over to the production department to build in large quantities, represents the best efforts of the engineering staff and it is then the production department's job to reproduce it as near as possible. Without test equipment, this is an utter impossibility.

The question naturally arises as to the performance requirements of the test apparatus. These requirements may be grouped under three main heads, namely (1) accuracy, (2) ease of manipulation and (3) adaptability to varying conditions.

In discussing accuracy, we might say that the test equipment should be just as accurate as the design or laboratory equipment. In this day of high speed production and with the rapid developments made in laboratory apparatus, the question of being as accurate as laboratory apparatus and yet be able to make routine measurements and keep pace with the production schedule, becomes a well nigh impossible order. Therefore, the accuracy must be compatible with the speed of production. In the apparatus to be described this degree of accuracy is fulfilled.

Ease of manipulation goes hand in hand with high speed production schedules. This should be qualified to some extent in that the equipment should be rugged enough to withstand handling and operation by inexperienced personnel.

During the past year adaptability to varying conditions has been of major importance due to the rapid rise of the so-called "midget" or "mantel" type of receiver, which usually has

characteristics that are a radical departure from the previous year's production. Since the test apparatus represents a large initial expenditure, it should not become antiquated with each new model of receiver produced.

### Receiver characteristics to be tested

In the design of a receiver there are three main features which must be engineered to completion in the laboratory: sensitivity, selectivity and fidelity. Of these, sensitivity is the most important to the production department, since the selectivity and fidelity are more constant when once produced in the laboratory. This simply means that only a small percentage of the day's production is given tests for selectivity or fidelity. These few sets may be tested in the laboratory without tying up the facilities with production receivers. Thus, we see that the major piece of test equipment must of necessity be something for measuring the sensitivity of the production receiver.

In the Howard laboratory it was determined that the receiver's performance over the broadcast spectrum could be fairly accurately determined by selecting three frequencies for testing the sensitivity: 1,400 kilocycles, 950 kilocycles and 560 kilocycles. These frequencies were selected so that none of the high power broadcast stations in the near vicinity caused interference due to heterodyning with the frequencies of the test generator.

Each of the generators for the three frequencies is of the crystal-controlled shunt-feed type. In the plate circuit of each oscillator is the tuned oscillatory circuit which also contains a current measuring meter and a one-half ohm resistor. Since a known current is passed through this resistor, there exists across its terminals a known potential difference. This voltage is fed to a single

step of attenuation within the oscillator compartment and from here it feeds a radio-frequency transmission line to which are connected the test positions.

This equipment is built in the rack and panel form and is shown in Fig. 1. The first, second and third panels are the three radio frequency oscillators and modulator units. The meters are, oscillatory current meter on the left the plate voltage, filament voltage meter on the right. Directly under the filament voltmeter is the percentage modulation control knob. To the left of this knob is a small knob and dial of the filament rheostat. The jack is for plugging in the plate current meter. The oscillatory circuit condenser also protrudes through the panel and has a screw driver slotted shaft for adjusting the oscillatory current to a predetermined value.

In order to determine the percentage of modulation, a vacuum tube voltmeter was placed across the oscillatory circuit and various plate voltages were applied, with the modulator disconnected, noting oscillation voltage in each case. A curve was plotted from the resulting data in order to determine over what values of plate voltage the oscillating voltage curve was linear. With this determined, an operating plate voltage in the center of this

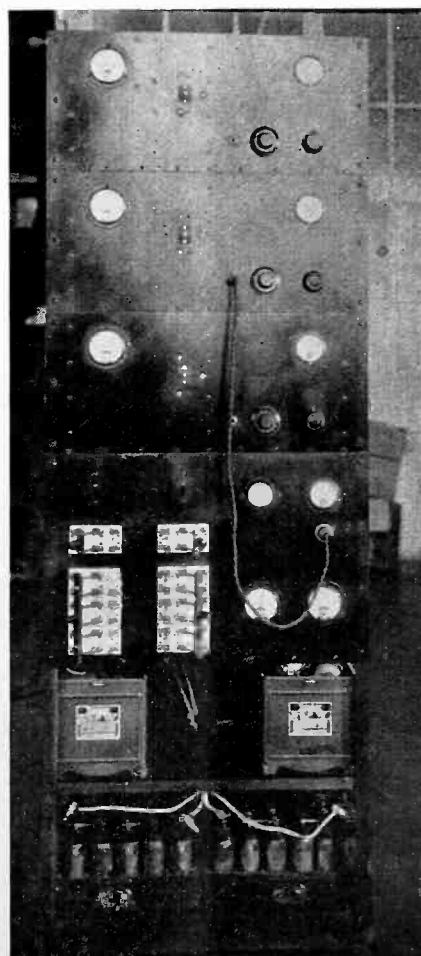

Signal generator with power supply and modulating equipment

linear part of this curve was chosen. The modulator was then connected and a vacuum tube voltmeter was placed across the Heising choke. The input was adjusted until the vacuum tube voltmeter gave a deflection corresponding to 30 per cent of the operating voltage on the radio frequency oscillator.

Various special transmission lines are run from the equipment. One is used on the final factory test of all receivers to set the pointers of the escutcheon correctly. This line is taken directly from the oscillator tank circuit and is terminated by various potentiometers, for signal adjustment, whose resistances are high enough so that the oscillatory circuit is but slightly affected by them.

Another transmission line is run to another part of the factory and is terminated by another high-resistance potentiometer. Connected to the center arm of this potentiometer is a regulation receiver which has instead of a loudspeaker an audio indicating device. Into this receiver are placed various detector tubes which must give a certain specified output regardless of what other tests may show concerning their characteristics.

Other transmission lines are connected to the repair benches so that the repairmen can work without the necessity of a regular tester and thus do not break into any schedule set for the regular testers.

The maintenance of the apparatus even after a year and one-half of continuous operation is very small. About once every six months the crystals are removed, inspected and washed and the inside of the equipment blown out with compressed air. Once a month the batteries are disconnected and filled with water. This does not mean an entire shut down of the apparatus as the entire power supply is furnished in duplicate. While one set of batteries is being serviced the signal generator operates on the duplicate set. While one set of batteries is being used the other set is on charge, and since the equipment has been placed in use there has never been a complete shut down for a greater period

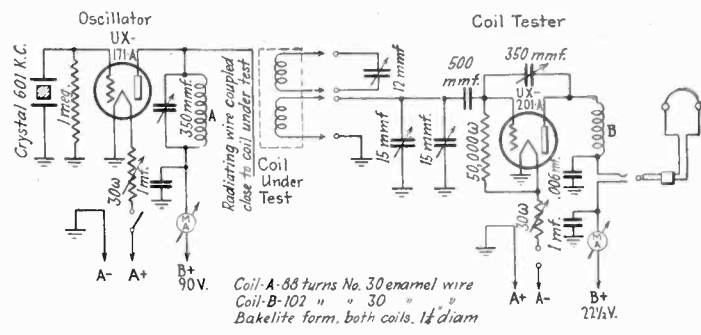

Crystal oscillator and resonance indicator for testing r.f. coils and transformers

than five minutes. Thus there is no loss of service.

The next most important item of test equipment is, necessarily, the equipment which tests those assemblies which go to make up the receiver itself. One of these pieces of test equipment, is the radio-frequency transformer tester.

The tester in use at the Howard Radio Company consists of two oscillators, one of which is a fixed crystal-controlled type, and the other one is built up around the coil which is under test. The accompanying schematic diagram shows the connections used. For the sake of speed and accuracy, both visual and aural methods of indication of zero beat of the two oscillators are used.

In order to make contact with the coil under test, a fixture is made equipped with plugs for insertion into the tester and connected to these plugs are phosphor-bronze contact fingers which make contact with the solder lugs at the base of the coil under test. Since various arrangements of lugs are used for the various types of receivers built, it is only necessary to change the coil holding fixture and thus the equipment is rather universal in nature.

There are four grades of coils used in our production and the greatest change in tuning capacity is hence only 2.4 micromicrofarads. In order to calibrate the testing device, a large number of coils were made up and tested in the laboratory. These coils were measured very accurately by means of an inductance bridge and then were placed in receivers. From these receivers were selected the radio frequency transformers which were considered as the upper and lower limits of inductance variation. These coils were then placed in the coil tester and the limits were determined on the grading dial. The change in capacity of the grading condenser was then measured on a precision capacity bridge and the change found was divided by the number of grades to obtain the change in capacity per grade.

Four grades of coils were used, which represent a plus-one-per-cent change in inductance for grade A coils, plus-one-half-per-cent change in inductance for grade B, minus-one-half-per-cent inductance change for grade C and minus-one-per-cent change in inductance for grade D coils. Larger changes in the per-

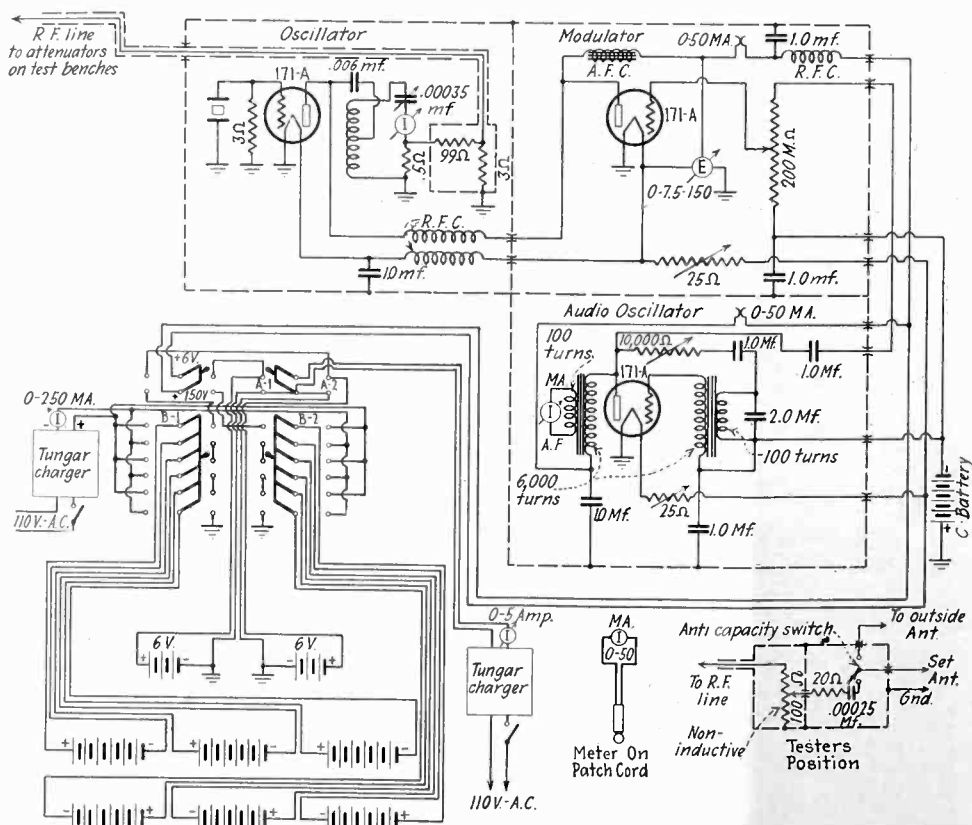
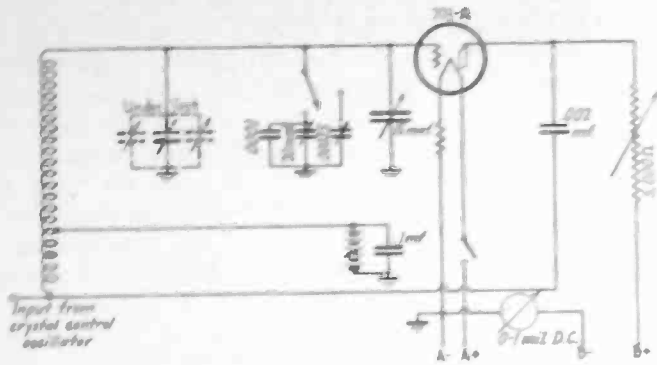

Diagram of the generator, modulator, and power supply equipment. Only one of three generators is shown here. The others are identical





Vacuum tube voltmeter circuit for testing tuning condensers

centage of standard inductance are rejected.

The calibrating method may seem laborious to the reader, but a year and one-half's operation of the equipment has proved to the writer that the labor of calibrating has adequately repaid the initial labor of calibrating

### Production tests on variable tuning condensers

Ranking in importance with the coil tester is the variable tuning condenser tester. This tester consists of an oscillator and a regenerative vacuum tube voltmeter. The oscillator is crystal controlled and the same scheme of connections was used as was used on the crystal oscillator used with the coil tester.

A schematic diagram of the vacuum tube voltmeter is also given. This voltmeter is of the conventional type with the exception that regeneration is added to increase the sensitivity. A bias battery was used instead of a grid leak and condenser so the condition of resonance would cause an increase in deflection of the resonance indicating device.

Three positions of testing the capacity of the condenser were selected as being adequate to judge the capacity variation. In the schematic diagram these three positions are shown as three separate variable condensers. Since the fundamental of the crystal only was used there were required padding capacities to bring the circuit back to resonance as the capacity of the condenser under test was decreased. These are shown connected to a second three-point switch, one contact of which is blank. With the pad condenser switch on the blank contact, the variable condenser under test is in its maximum capacity position. The third variable condenser is the grading condenser and is calibrated in the capacity limits corresponding to the particular capacity of the condenser under test.

### Method of calibration

The calibration procedure is as follows: The condenser under test is connected mechanically to the tester and is rotated until the resonance indicator shows resonance, the small grading condenser having been set previously to approximately its three-fourths of full capacity position. The condenser under test is then removed and its capacity determined on a precision capacity bridge. The limits are then determined at this capacity setting ( $\frac{1}{2}$  of 1 per cent = of test capacity). A precision condenser is then inserted in place of the test capacity and set at either the upper or lower determined limit. The small grading condenser is then rotated until resonance is again indicated and this position is marked. The other limit is then set on the preci-

sion condenser and the grading condenser is again rotated until resonance is indicated. The procedure is the same for the other positions of the test condenser with the exception that the small grading condenser is adjusted at approximately one-half capacity position and for the third test position it is set at one-quarter capacity position. This is done so as not to confuse the operator as to what limits correspond to each test position.

In order that the angular rotation of all condensers are alike a fixture for holding the condenser under test is rigidly mounted to the test equipment. Engaging the condenser shaft is a collet which is fastened to a shaft extending through the tester. On the shaft is a handle for rotating the condenser plates which has at its upper end a bullet-type catch which drops into depressions in a circular guide ring. These depressions correspond to the angular rotation of the rotor plates for each test position of the condenser. Any slight inaccuracies of setting on the part of the operator means a negligible change in capacity and are well with the limits of test on the condenser.

Fixtures have also been made to test gang condensers by segregating each section of the gang condenser by means of single pole multiple-point switch. Each section of the gang is treated as a single unit in making the test. One precaution must be observed in testing gang con-

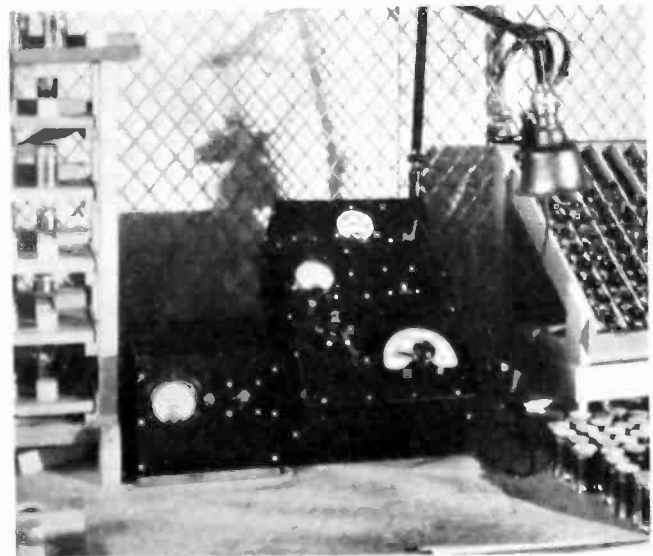

Coil tester with its crystal generator at left

densers and this is to see that the inductance of the leads to the various sections of the gang are compensated for. This may be done by adding inductance to the shorter leads equivalent to the inductance of the longest lead or by compensating for the inductance in the test limits. The former is by far the most successful if inexperienced personnel is to operate the equipment.

After close observation over a period of a year of operation of this apparatus, we have determined that the error of setting due to mechanical inaccuracies is in the order of one-tenth of a micromicrofarad. This is well within the commercial variation limits.

In conclusion, the writer wishes to acknowledge his indebtedness for helpful suggestions to Mr. A. Crossley, chief engineer of the Howard Radio Company, under whose supervision this equipment was built, also to L. H. Hansen, mechanical engineer, who collaborated with the writer on the mechanical design and to Mr. Ralph L. Arthur, machinist, who built the apparatus.

# Soviet Russia's "five-year plan for radio"

By MARTIN CODEL

**L**LOUD-SPEAKERS at street corners, in the public squares, in school rooms and assembly halls, in hotel rooms, in railway waiting stations and on railway passenger coaches—radios everywhere that people congregate, in city and village alike. That's the picture you get of radio in Soviet Russia. For the rulers of the Union of Socialist Soviet Republics, perhaps more than the heads of any other governments, have a keenly developed sense of the power of "audible journalism" and radio showmanship.

"No matter at what hour I was awake in my room in the hotel at Leningrad," writes a recent traveler, "the loud-speaker in the market place across the way was constantly blaring forth words, words, words. . . . In Moscow the room was much better, the bed was bigger, the furniture was more adequate, there were even table covers, and marvel of marvels, just above the bed a little radio switch.

"There were hours in the day when the most exquisite music stole into the room via that radio. But always in the evening there was speech-making. No matter which way the switch was turned, always some man was making a speech on something. And not only in my hotels or in the big cities, but in thousands of Soviet halls in villages throughout Russia, those same speeches were carrying messages to men and women alike."

Propaganda? Certainly—over a propaganda system

that might not be tolerated in any other country in the world; surely not in these United States, where listener preferences and predilections are the only hallmarks of broadcast material. It is indeed a remarkable system of propaganda that Communist Russia is making of her radio. Leaving aside that aspect of Russia's radio system, there are other factors in the essential structure of radio in Russia that must inevitably hold the interest of the men who are building radio and the electronic arts in these capitalistic United States.

## A \$45,000,000 undertaking

All this activity in radio means business—not business for private broadcasters or distributors or dealers, for broadcasting and the sale of radio receiving sets remain a government monopoly in Soviet Russia. Nor yet does it mean the stimulation of private business enterprises by radio advertising, since Soviet Russia does not advertise its communal goods over the radio, much as it advertises with great emphasis and zeal the communal idea.

It means business in the sense that thousands of workers must be employed to produce radio equipment for an empire nearly three times the area of the United States and embracing some 150,000,000 population. From 2,746,000 radio receivers in use in all the Russias at the end of 1930, the Five-Year Plan of the Soviet government contemplates having 14,000,000 sets (about the number now in use in the United States) in operation by 1933.

It means some business, too, for American radio manufacturers and the American producers of raw materials that go into the making of radios. Though the Russians have allocated the task of producing these sets to their Weak Current Trust, they have had to come to the United States for some equipment, especially transmitters and tubes, and have sought more than a little technical assistance in this country.

The export figures are not particularly impressive, showing that, where Russia bought about \$415,000 worth of radio transmitters, receivers, tubes and parts from this country in 1929, it imported less than \$20,000 worth in 1930. The Weak Current Trust's avowed purpose is to become entirely self-sufficient in the production of radio equipment. It is under no patent restraint. Men and materials are all it needs to accomplish that sufficiency.

Then, too, there is no way of calculating the amount of raw materials purchased in this country and entering into the making of Russia's radios. Nor can any dollars and cents evaluation be placed upon the services of the American technicians, who have helped and are helping build Russia's radio system; or upon the agreement for

## The Russian program for broadcasting and communication

14,000,000 radio receiving sets in use by 1933

Forty-seven broadcasting stations now in operation (largest, 100 kw.)

Sixty additional broadcasting stations (20 to 500 kw.) being built

A complete system of "audible journalism" for the education of Russia's

150,000,000 people

Loud-speakers on all street corners, in public places, schools, assemblies

Short-wave telegraphy connecting Moscow with all parts of Soviet Union

Regular radio communication with United States and other countries

Total equivalent radio investment under Five-Year Plan, \$45,000,000

an "exchange of technical assistance" that exists between the Soviet Commissariat of Posts and Telegraphs, operating agency of Russia's communications systems, and certain American radio interests.

### Youths and prisoners build radios

Whatever we think of the basic ideas of the Soviet State, one must credit the prime movers in the U.S.S.R. for their far-sighted appreciation of radio as a medium of conveying information and propaganda and entertainment. One must credit their plan of placing radios in places of assembly and in hotel rooms and on trains—uses of radio that are progressing all-too-slowly in the United States. We must pay tribute to the Russian leaders for their efforts on the radio to reduce the large illiteracy remnant of the Czarist regimes.

Even "wired radio" is being developed as part of the telephone expansion scheme of the Five Year Plan. Amateur radio is encouraged by urging youth to organize local clubs for the study of radio; like the youthful hobbyists of the American Radio Relay League, these amateurs will one day take their places as the technical brains of Russia's radio system and industries. We are informed that even in the prisons where trades are taught, courses in radio construction and operating are among the most popular.

When Dr. Eugene V. Hirschfeld, the 31-year-old chief of the international department of the Soviet Commissariat of Posts and Telegraphs, was in the United States this winter to study American broadcasting and communications methods—and, incidentally, to open the new RCA radiotelegraph circuit between New York and Moscow—he gave interviewers some interesting sidelights on the development plans of Russian radio. Apace with the economic development of the country, broadcasting and radio communications are expanding fast, he pointed out.

### Soviet's radio centers

Soviet Russia's chief radio centers are Moscow, Leningrad, Kharkov (Ukraine), Sverdlovsk (Urals), Khabarovsk (Far East), Tashkent (Central Asia), Novosibirsk (Siberia) and Tiflis (Transcaucasia). Not only broadcasting but long and short-wave radiotelegraphy and radiotelephony are being developed at these and auxiliary points to carry official and press communications to all parts of the Soviet Union. Moscow has short-wave stations which regularly communicate with European and Asiatic countries as well as with various countries of the western hemisphere, including the United States.

Emphasis is being placed in the Five-Year Plan on broadcasting, and higher and higher powers are being developed. Russia's 47 broadcasting stations range in powers from 1 to 100 kilowatts, with Moscow having three stations of 100, 40 and 20 kilowatts, respectively,

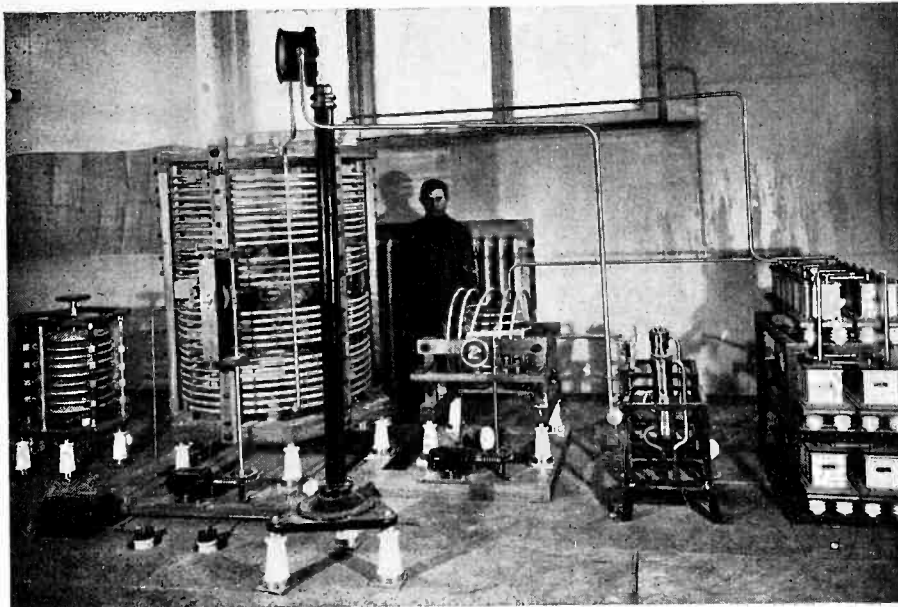

Interior of Soviet Russia's 100-kw. broadcasting station "Moscow Komintern" at Shchelkovo near Moscow



Opening the radio circuit to the United States, Nov. 13, under direction of the Soviet Peoples' Commissar Smirnov

and Sverdlovsk, Tiflis, Kharkov and Tashkent having 25 kilowatts each. There is also a short-wave broadcaster of 20 kilowatts operating on 70 meters at Khabarovsk.

Under the Five-Year Plan, it is proposed to construct 60 stations and the lowest powered will be 10 kilowatts. They are to be linked, like the big national networks in America, for events of great social significance. The radiotelephone is not to be neglected; indeed, even now radiotelephony is being used to convey press traffic from the main news centers to newspaper offices in the outlying regions, and there is a radiotelephone service between Moscow and Sverdlovsk.

From Amtorg, the official Russian trading agency in New York, adds:

"There is a general drive being made to provide all long-distance trains with radios. Up to the present time the best results have been attained on the Northern Railroad. Furthermore, the continuous and speedy development of the collectivization movement in agriculture

[Continued on page 572]

# High level plate circuit rectification

By J. R. NELSON

Raytheon Production Corp.

**D**URING the past several years a rather complete theory of detection or rectification for small signals has been built up mathematically. The theory, however, is only satisfactory for practical purposes when the input voltage is small and the higher order terms of the series expressions derived in the mathematical theory are negligible and may be neglected, for as the input voltage is increased the higher order terms became increasingly important making computations too difficult for practical purposes.

The experimental procedure for attacking the problem of plate rectification with large input voltages is receiving considerable attention at present. The necessary experi-

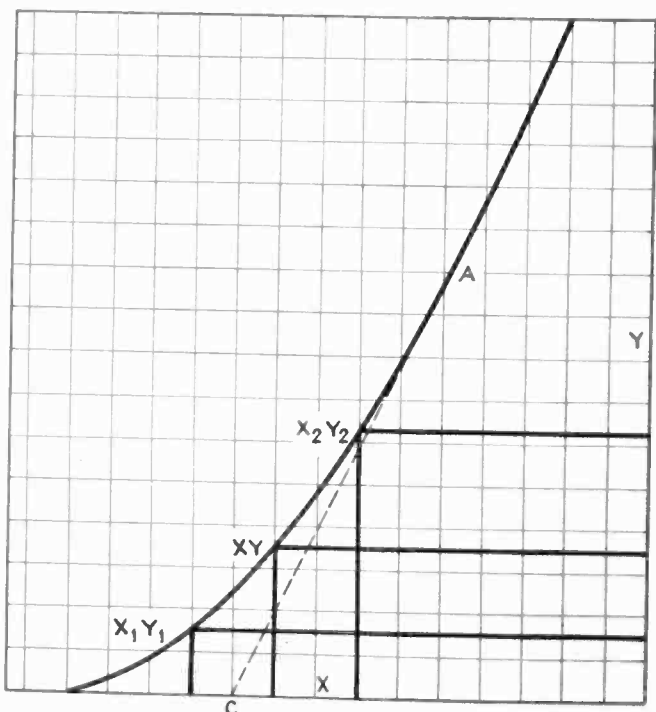

Fig. 1—Typical characteristic on which rectification takes place

mentally determined curves may be obtained very easily so that anyone with measurable a.c. voltages and a fairly accurate d.c. milliammeter may plot his own rectification characteristics for a resistance load. The fundamental relation in the experimental procedure is the relation between the direct current and the a.c. voltage impressed on the grid of the tube with either a constant grid bias and a variable plate voltage or a constant plate voltage and a variable grid bias.

The device having a linear relation between the current such as shown by the line AC in Fig. 1 would be an ideal rectifier for the usual signal provided that the operating point was located at C. The current for a voltage to the right of point A is  $I = E/r$  where  $r$  is the resistance

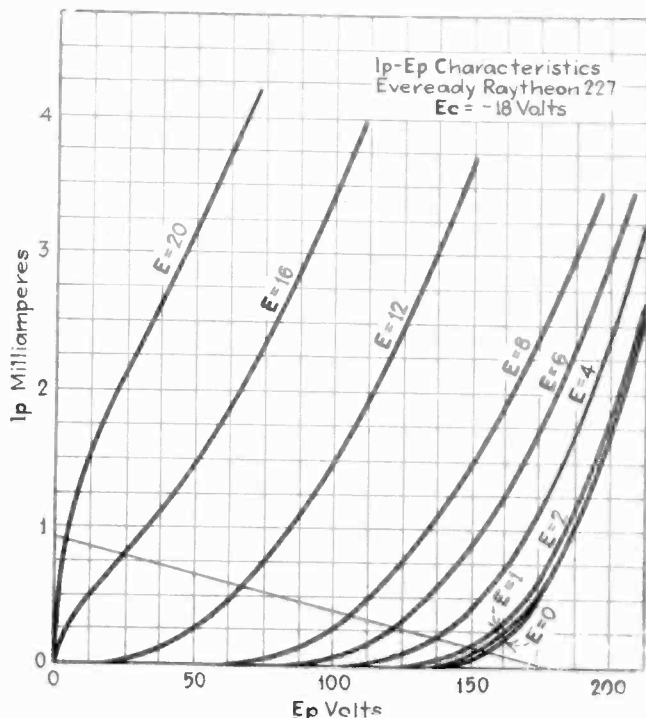

Fig. 2—Plate current as function of plate voltage and carrier input voltage

of the device and the current for a voltage to the left of the point A is zero.

If a voltage  $E \sin \omega t$  is applied to the ideal rectifier and if the operating point is located at the point C the average current would be

$$(1) I = \frac{E}{\pi} \frac{1}{r}$$

If a resistor  $R$  is inserted in series with the device the current will be

$$(2) I = \frac{E}{\pi(r + R)}$$

The rectified voltage will be  $RI$  or

$$(3) V = \frac{E}{\pi} \frac{R}{r + R}$$

The sensitivity which will be defined as  $\frac{dV}{dE}$  is

$$(4) S \text{ or } \frac{dV}{dE} = \frac{1}{\pi} \frac{R}{r + R}$$

If the external resistor is by-passed for the carrier the sensitivity will be increased by the ratio  $\frac{r + R}{r}$ , hence the sensitivity is

$$(5) S = \frac{1}{\pi} \frac{R}{r}$$

If a 100 per cent modulated input is applied as shown in Fig. 1, the plate current will vary between the values for zero and twice the input voltage. If the modulation percentage is any value, the audio frequency output voltage may still be found readily, for the output will vary between the values given by  $E - ME$  and  $E + ME$  where  $M$  is the percentage modulation.

The action of the tube rectifier will be considered next. The curve in Fig. 1 shows an experimentally determined characteristic curve of  $I_p$  plotted versus  $E_p$  with  $E_g$  constant. It is to be noted that the curve approximates the straight line characteristic of the ideal rectifier provided that the input voltage is made large enough and the operating point is located near the point  $C$  so that area under the curve to the left of the line  $AC$  is made small compared to the area to the right. It is to be noted that for small signal voltages the detector will act as the normal square-law detector and as the input voltage increases the working characteristic approaches a straight line. The audio frequency output first varies as the square of the input voltage and then approaches linearity as the signal voltage increases.

The output voltage could be calculated by determining experimentally either the  $I_p - E_p$  curves with  $E_g$  constant and various  $AC$  input voltage impressed on the grid or the  $I_p - E_p$  characteristic with  $E_p$  constant and  $E_g$  variable with various a.c. voltages in the grid. The latter method is somewhat restricted as it is necessary to take the curves with some fixed external plate resistor so that in a general study many curves will have to be taken. The method of using the  $I_p - E_p$  curves with a given  $C$  bias on the other hand allows a very general study to be made with comparatively few sets of readings so that the output may be calculated for any  $B$  voltage and any value of external resistance from one set of curves. A general study of any type of tube may be made from several groups of curves with different  $C$  bias voltages.

The rectified output voltage or the d.c. voltage across the external plate resistance is found from the  $I_p - E_p$  curves for various a.c. input voltages. Figure 2 shows

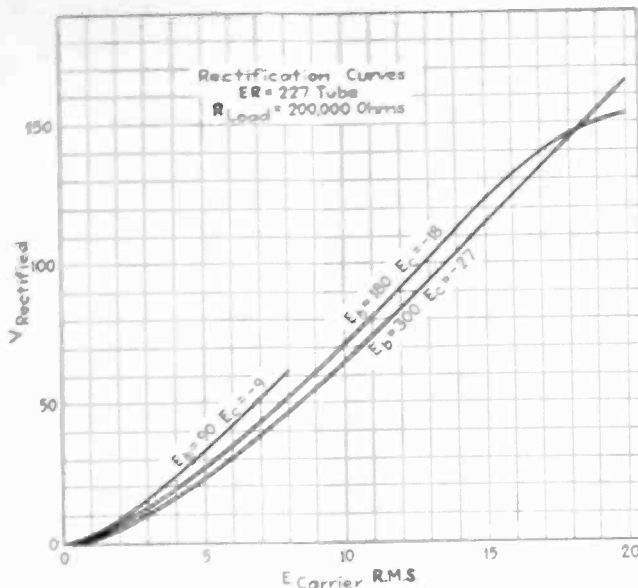

Fig. 3—Rectified output voltage of typical detector

typical  $I_p - E_p$  curves taken with an ER-227 tube with 18 volts  $C$  bias. A load line for a 200,000-ohm external resistor is shown plotted in from 180 volts. Any other resistor or battery voltage could be used just as well. In general though, it is not advisable to use over 200,000 ohms for the external resistor because the various capacities which shunt this resistor change the effective value of impedance if the resistor is made too high. The result is that the effective impedance decreases with increasing frequency, thus cutting off the higher audio frequencies.

The most useful information derived from this curve

is the rectified output voltage curve. This curve is the change of voltage across the external load resistor and is a measure of the output voltage as will be noted below. In Fig. 2 the point where the load line crosses the curve for zero input voltage is taken as the reference voltage. The rectified voltage for any carrier voltage is then the difference between the two intersections. It is to be noted that the voltage should be greater than the voltage at which the curve for zero input voltage starts otherwise considerable distortion will result. For example, if the  $B$ -voltage is 125 volts there would be no rectified output voltage until a 2-volt carrier is impressed.

Figure 3 shows typical rectified curves for three different grid voltages obtained using an ER-227 tube. As was explained previously the rectified output voltage for any carrier will fall along the load line for  $E - ME$  and  $E + ME$ . The output voltage for any carrier and percentage modulation may be found quite readily from these curves. For example, with  $E_b$  300 volts and  $E_g = 27$  volts assume a 12-volt carrier modulated 33 per cent. The total audio swing will then be between 12 - 4 and 12 + 4 or 8- and 16-volts carrier. For a 16-volt carrier the output is 124 volts and for an 8-volt carrier it is 47 volts so that the resultant peak audio

frequency voltage is  $\frac{124 - 47}{2} = \frac{77}{2}$  volts or 38.5 volts.

Similarly, the peak audio frequency voltage may be found for any other carrier and percentage modulation.

Curves like those in Fig. 2 give complete detection data.



## A 1931 VICTORY CREED FOR EXECUTIVES

TO foster individual talent, imagination and initiative, to couple with this a high degree of co-operation, and to subject these to a not too minute direction; the whole vitalized by a supreme purpose which serves as the magic key to unlock the upper strata of the energies of men.

GEORGE OWEN SQUIER,  
Major-General, U. S. Army, Retired.

# Impedance matching networks

By ARTHUR E. THIESSEN

General Radio Company

THERE are many times when experimenting with various electrical circuits at communication frequencies that it is necessary to connect two circuits together in such a way that each of them works into or out of some correct terminating impedance. These terminating impedances may have almost any values, but by far the most usual condition is when the termination has an impedance equal to the impedance of the circuit or network itself. When the impedances of two circuits are the same, such as two similar telephone lines, it is only necessary to connect them directly together, and the condition is fulfilled. Often, however, the proper terminating impedance for one circuit is not correct for the other. In this case, some special kind of coupling device is required.

As an example, the output of a vacuum-tube is to be coupled to a telephone line in the most efficient possible manner. The impedances of the two circuits in this case may be widely different. The output circuit of the amplifier may have an impedance of, for instance, 2,000 ohms. The line impedance may be only 500 ohms. If

IT does not always happen that an engineer finds himself equipped with the proper terminating impedance for the circuit upon which he is working. How to calculate the proper network to terminate this circuit, and how to build it up are discussed, briefly, in this article.

the output from the plate circuit were connected directly to the line, the resulting impedance mis-match would cause a reduction in the power delivered to the load, (termed "reflection loss"<sup>1</sup>), of 1.58 to one. In logarithmic units, it is two decibels. This loss may be calculated by a formula which gives the reflection loss directly in decibels, in terms of the two impedances.

$$N_{DB} = 20 \log_{10} \frac{R_G + R_L}{\sqrt{4 R_G R_L}}$$

Where  $N_{DB}$  = the attenuation in decibels,  $R_G$  = the generator impedance, and  $R_L$  = the load impedance, or in this special case, the plate impedance of the tube and the line impedance respectively.

To reduce this loss, it is common practice to make use of a device called an impedance-matching transformer. This is a transformer having a turns ratio between the primary and secondary windings equal to the square root of the ratio of the impedances that it is to couple.

Aside from the power loss that results from the mismatching of impedances, there are many other cases when correct operating conditions are obtained only when proper terminating impedances are used. For example, if a calibrated attenuation network is not properly terminated its calibration is worthless, unless a correction term is applied. Loud-speakers, audio frequency amplifying transformers, and such instruments are all designed for correct operation from a circuit of some

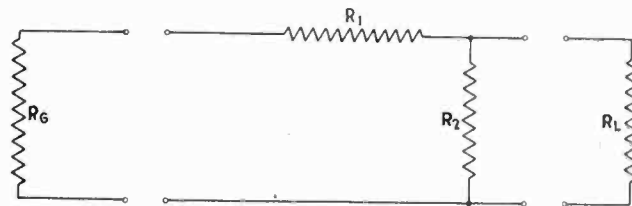

Fig. 1—Taper pad circuit diagram

definite impedance. For all of these uses, the right impedance-matching transformer may not always be available. To build one up is a lengthy and tedious job. Fortunately a most convenient substitute is available. This is a simple resistive network called an impedance-tapering network or "taper pad." It can easily be built up of two decade resistance boxes. Once the resistance values have been decided upon for any particular circuit, fixed resistors may be substituted.

A taper pad has a number of definite advantages. It has a fixed and known loss, it is not affected by frequency to the extent that a transformer may be, and the values can be readily and accurately determined.

## Calculating a taper pad

Figure 1 shows a taper pad at the junction of a generator whose impedance is of some value,  $R_G$ , and a load,  $R_L$ . It is desired to calculate the value of the series branch,  $R_1$ , and the shunt branch,  $R_2$ , so that both the generator and the load see their respective impedances,  $R_G$  and  $R_L$ , looking toward the junction. Assume  $R_G$  to be the greater to fix the direction that the network points.

Looking from the generator,  $R_G$ , there is a combination of resistances to be equal to  $R_G$ , so

$$R_G = R_1 + \frac{R_2 R_L}{R_2 + R_L}$$

Looking from the load,  $R_L$ , there are the resistances

to be equal to  $R_L$ ; thus

$$R_L = \frac{R_2(R_1 + R_G)}{R_1 + R_2 + R_G}$$

Here are two simultaneous equations with two unknowns,  $R_1$  and  $R_2$ . Solving them (which is a straightforward if laborious process) the following result is obtained:

$$R_2 = \frac{R_L R_G}{\sqrt{R_G(R_G - R_L)}} \quad (1)$$

Knowing the generator and load impedances, this is immediately solved. Then

$$R_1 = R_G - \frac{R_2 R_L}{R_2 + R_L}$$

and by a similar process:

$$R_1 = \sqrt{R_G(R_G - R_L)} \quad (2)$$

There are, thus, two general equations which permit the calculation of an impedance-tapering network to match any two impedances. They are rigorous, and assuming that the constants of the generator and load are definitely known the result obtained is exact.

### Losses introduced by network

Such a network always introduces some loss in the circuit. It is a function of the ratio of the two impedances and may be calculated from the formula,

$$1/2 \left( \frac{n+1}{n} \right) = \sqrt{\frac{R_G}{R_L}}$$

Let  $\sqrt{R_G/R_L} = \rho$ , and the expression becomes

$$\begin{aligned} n^2 - 2\rho n + 1 &= 0 \\ \text{and } n &= \rho + \sqrt{\rho^2 - 1} \end{aligned} \quad (3)$$

The loss,  $n$ , is the ratio of the voltage or current that would appear in the load,  $R_L$ , if the load were coupled to the generator,  $R_G$ , by an ideal impedance-matching transformer, to the voltage or current that actually appears in the load when the resistive taper pad is in the circuit. An ideal impedance-matching transformer is the most efficient conceivable coupling device. It neither stores nor dissipates energy.<sup>2</sup> Its transformation ratio is such that when its secondary is connected to the load, its primary impedance is exactly equal to the generator impedance. The ratio of the power that can be delivered to the load through such an ideal transformer, to the power actually delivered, is the accepted way to measure the efficiency of an impedance-matching device. We have taken this ratio in terms of voltage or current and called it  $n$ . The arithmetic ratio,  $n$ , may be expressed logarithmically in decibels:

$$N_{DB} = 20 \log_{10} n$$

The fact that this loss is so definitely known is often a great help when calculating the total gain or loss of a circuit. (See Fig. 2.)

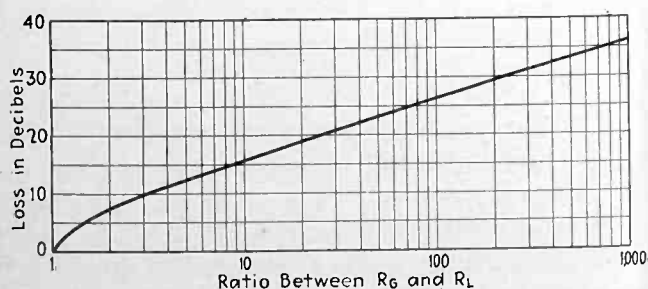

Fig. 2—Loss in network as function of impedances to be matched

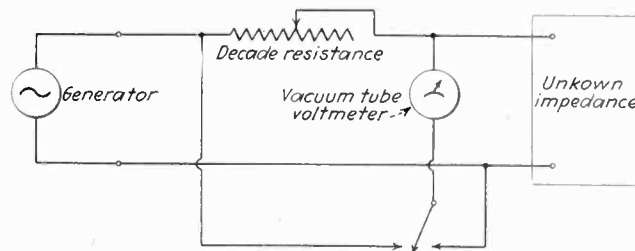

Fig. 3—Method of measuring impedance by means of decade resistance box and vacuum tube voltmeter

There is one question that arises in this connection, and that is, if the impedances to be matched are not definitely known, how can they be determined.

### To measure an unknown impedance

There are, of course, a great variety of bridge measurements that can be made, and these are probably the most accurate methods. The proper bridges are not always at hand, however, and the method may be unduly complicated. Figure 3 shows one very convenient method of finding the impedance of a circuit. It is quite accurate at the audio frequencies but stray admittances, unsuspected mutual couplings, and other errors are apt to creep in at radio frequencies which makes the method unsuitable if high accuracy is necessary. The resistance,  $R$ , is an ordinary decade-resistance box. The vacuum-tube voltmeter, the input impedance of which must be very high with respect to the circuit being measured, is used to compare voltage across the unknown to that across the decade box. The box is adjusted until the voltage is the same across both circuits. With this condition, since the current is the same through both the known and unknown units, the impedance of the unknown is equal to the resistance setting of the decade box. It must be remembered that the circuit impedance so measured includes both the resistive and the reactive component. If it is necessary to separate these components which, as was previously mentioned, is not usually important, a calibrated inductance or capacitance is required. If the unknown is inductive the capacitance, of course, is used, and vice versa. It is placed in series with the unknown, the voltmeter placed across both, and the reactance adjusted until the voltmeter reads a minimum. When this is done the reactive component has been canceled and all that remains is the resistance. The decade resistance is then adjusted as before until the voltage reading is the same across the two circuits. The resistance of the calibrated reactance must be subtracted from the result to give the net resistance of the unknown circuit.

It is hoped that these remarks about the design and use of resistive taper networks will bring to the attention of experimenters a very useful, and somewhat neglected tool, for working with those circuits in which impedance matching is a considerable factor. In problems connected with the transmission, recording, and reproducing of the voice frequencies the question is often of the greatest importance.

<sup>1</sup>"Transmission Networks and Wave Filters," by T. E. Shea (D. Van Nostrand Company, Inc., 1929) contains a most complete discussion of this question. It must be noted that in order to discuss the problem in the most general way, the phase angle of both the generator and the load must be considered. Fortunately, considering the impedance as purely resistive is a close enough approximation for most practical cases.  
<sup>2</sup>K. S. Johnson, "Transmission Circuits for Telephone Communication," Chap. IV, has a complete discussion of ideal transformers.

# Electron devices in D.C. power transmission

Revolutionary practices, and re-  
sulting economies and advantages

By C. W. STONE

*General Electric Company*

---

**W**ITH a direct-current power transmission system, the amount of power flow from any generator is easily controlled by the voltage of the generator.

But with an alternating-current system, the amount of

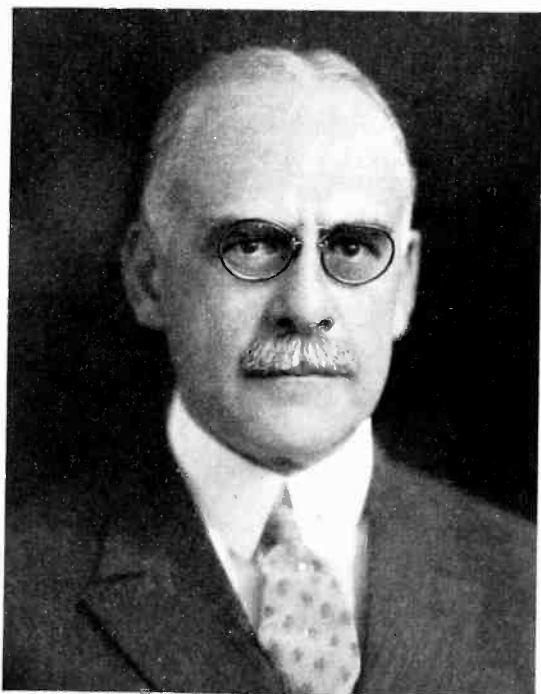

C. W. STONE

Mr. Stone was for many years head of the lighting and central-station departments of the General Electric Company, and more recently has been developing sound pictures and electronic applications

power flow can be controlled only by means of the governors of the prime movers, and changes of voltage results only in changes in the amount of circulating current between generators.

Direct-current systems are thus much more stable in operation. The operators are in control of the system, while with alternating current, the system controls the operator to a certain extent.

Another fundamental difference refers to losses and insulation difficulties. Cable insulation, for instance, when subjected to alternating current produces dielectric loss, and corona is ever present, usually intensified by any small void in the insulation. With alternating currents, we also have such effects as capacity and inductance to contend with.

But with direct-current cable systems, dielectric loss disappears; voids have little, if any, effects; corona does not appear except at much higher potentials than with alternating currents.

As power systems grow in size and more power stations are connected together, there is danger of having too much resistance or reactance in the connections between them. But on the other hand, unless there is something to limit the flow of current, such as reactance or resistance, short-circuit power concentration becomes so great as to destroy apparatus, or, more important, to cause a system shutdown.

## Short-circuit shocks reduced

But if all feeders from an alternating-current generating station and all tie feeders were operated with direct current, using thyratrons, the very nature of these devices is such that the direction and amount of power flow is determined by their connection to the system, and the amount of this power flow is also easily controlled by the operator. Large concentrations of power in a fault will not take place, and shocks to the system, therefore, become much less.

As the feeders leaving such stations would be direct current and as the thyratrons connected to the other ends of these feeders would be used to invert direct current to alternating current, the frequency of this alternating current can be made almost anything desired. Thus, power stations of like or unlike frequency can be connected together and can be operated with no fear of loss of synchronizing power and no trouble from hunting.

In many of our cities, we have 60-cycle alternating current systems and also 25-cycle systems, but the only way such systems could be connected together is through motor-generator sets and these are expensive, inefficient, and more or less uncontrollable.

However, thyratrons, when used for such ties, are very efficient as the voltage drop in them may be only 25 volts for the mercury-pool type and as low as 14 volts for the hot-cathode type, and since the voltage used for such ties may well be as high as 30,000 volts, you can see that the efficiency is higher than with any other known device.

## Increased efficiency and stability

Such a system as the Commonwealth Edison Company, Chicago, has many 25-cycle rotary converters for feeding the Edison direct-current network. If the feeders to these rotaries were changed to direct-current feeders and this current were inverted at the sub-station,

From an address by Mr. Stone before the Midwest Power Engineering Conference, Chicago, February 11.



the rotaries would operate at their own frequency and the alternating-current systems back of them could be either 25 or 60 cycles. And if there were a tendency for them to hunt against each other, the rotaries would not know or care, as they would continue to operate at their own frequencies, thus greatly increasing the stability of the system.

Another application of thyratrons would be as ties between the alternating and direct-current networks. In this case, the thyratrons would be connected as rectifiers and by a simple automatic control with no moving parts, power would flow from the alternating-current network into the direct current if it were needed, as long as the alternating-current voltage was maintained high enough. But if it dropped, current flow would stop and in no case could it flow in the reverse direction. In case of a drop in voltage on the direct current network, the current flow from the alternating current network could be limited to any amount desired.

As such installations would be static and non-synchronous, they would act in many ways like a storage battery, always staying on the system and carrying load as long as the alternating-current voltage was maintained and picking up their loads without attention as soon as the alternating-current voltage came back to normal.

### **Supplying distribution network**

As most of our primary cables used in our cities are operated at voltages around 13,200 volts and as most of these cables have full insulation to ground and as they should be capable of standing at least double potential if direct current were used, we can consider another way of operating such feeders.

Where a feeder is run to a sub-station, it is usual to run out more than one such feeder and this means there are at least six wires in the ground.

If we go back to the old Edison three-wire network system, we could connect each of the three wires of one cable to a thyatron rectifier, the other side being connected to ground. Thus, all three wires in one cable on a 13,200-volt circuit could have 26,400 volts and each of the three wires in the other cable could be operated in the same way but at opposite polarity, and we would have three circuits instead of two and the operating potential would be 52,800 volts per circuit.

Such an installation would mean a large increase in

circuit capacity, probably more than was required to meet load conditions.

Assume a circuit operated at 13,200 volts, 3 phase, and 300 amperes on each cable. With three-phase alternating current, the capacity would be  $13,200 \times 1.73 \times 300 \times 2 = 14,000$  kw. These two cables would make three circuits and we would have  $300 \times 52,800 = 15,840$  kw. per circuit, or in round figures 45,000 kw. for the three circuits.

Using direct current and not raising the voltage per conductor higher than used with alternating current, we would have  $26,400 \times 300 \times 3 = 24,000$  kw. for the three circuits.

### **Three times as much power**

The above examples indicate clearly that the same underground circuits can be used to transmit 50% more power with direct current than they now do with alternating current, or by raising the voltage, at least three times as much power with greater safety and complete control.

There is no theoretical reason why thyratrons cannot be built for as high voltage as desired and we have found that they can be operated in series or in multiple.

At present, we are confining our developments to a capacity per bank of tubes of 300 amperes, 15,000 volts, as that seems to be the current capacity of most underground cables. Also the voltage is ample to meet most conditions. Two such banks operated on an Edison three-wire system would give us 30,000/15,000 volts, 300 amperes, or 9,000 kw. capacity.

For the present, we may say that any such transmission with direct current will not transmit the wattless component which is met with on most alternating current systems, but will be used for energy transmission only and the wattless current required will either have to be obtained locally by means of static capacitors or rotary condensers or will have to be transmitted by other feeders which are operated with alternating current.

Several schemes for handling this wattless current have been proposed and are now being investigated but it is too early to discuss them at this time. I mention it only so that you will not get the impression that it is a problem which cannot be solved; in fact, we have such a system in operation which can be used to feed into a circuit of any power factor.

## **With direct-current transmission using electronic devices**

**Generators could be designed for any frequency which would give cheapest and most reliable operation**

**High-voltage oil circuit-breakers would be replaced by thyratrons operating as both rectifiers and switches**

**Short-circuit and synchronizing troubles would disappear**

**Systems of different frequencies could be tied together. Loads of various frequencies could be fed from common supply**

**Circuits could transmit three times as much power, with greater safety and with complete control**

# HIGH LIGHTS ON ELECTRONIC

## Controlling cut-off knives for accurate packaging

AUTOMATIC MACHINES, accurate as they are, are sometimes not as exact as modern industry wants them to be. The H. J. Heinz Company of Pittsburgh, Pa., has adopted an automatic machine which vigilantly checks another automatic machine to prevent errors in packaging their product.

Heinz cereals are packed in cartons protected by a sealed, waxed paper envelope. The waxed paper, however, was found to cover up and obscure the design and imprinting on the carton, so the Kalamazoo Vegetable Parchment Company, makers of the paper, devised a process of printing the design, directions, etc., on the waxed paper itself. The waxed wrapping paper is manufactured and shipped completely imprinted but in large rolls, and is cut into proper lengths by the automatic machine which does the wrapping.

Here another difficulty arose. The automatic wrapping machines which cut the waxed paper into proper lengths, wrap it around the cartons and seal it, were not accurate enough to cut the paper off at the correct point of printing. Even the best machines allowed a small amount of slipping or creepage of the paper in passing through the feeding rolls, and the cumulative error resulted in packages wrapped with the design in various undesirable positions.

The problem was solved by the use of a General Electric photo-electric equipment actuated by variations in the intensity of a beam of light. A small printed spot is placed on the printed waxed paper in register with the design and spaced at regular intervals. A concentrated beam of light shines through the waxed paper upon the photo-electric tube and, as the paper moves along, these printed spots cast shadows on the tube causing it to send electric impulses which are amplified to operate power relays. The impulses and relays thus serve as a means of registering or gearing the paper properly to the machine as it is unwound and cut into sheets and delivered for wrapping around the carton.

The method thus evolved was found to be generally applicable to automatic wrapping machines using a continuous method of paper feed, consisting of a rotary knife and continuously moving paper feed rolls. The paper feed rolls are driven by gears from the cut-off knife and are set to deliver a sheet of a certain length at every revolution of the knife. Where printed paper is used, however, it is necessary to vary the amount of paper fed to the knife slightly from time to time to correct for the slippage of the rolls. To control this slippage a variable speed drive is placed between the knife and the feed rolls instead of the gears. The control of this variable speed transmission is actuated by the electric impulses from

the photo-electric tube acting through amplifying circuits.

In operation the amplifying tube flashes at regular intervals and from time to time either one or the other of two relays close and the control lever of the variable speed transmission moves from the neutral position either to the right or left, then returning to its original position. In addition a set of signal lights in front of the operator shows that a correction is taking place and in which direction. While the correction takes place the paper is either speeded up or slowed down slightly, depending on whether the knife is cutting the paper ahead or behind the point set. The apparatus keeps the cut within  $\frac{1}{8}$  inch of the correct line of cut, the sheets of paper being all of the same length when measured as required for correct wrapping, and the control will work at any wrapping machine speed. The variable speed control mechanism was designed and built by the Lewellen Manufacturing Company of Columbus, Ohio.

For proper wrapping, in addition to the cut-off control, the wrapping machine must work very accurately in placing the sheet of paper around the carton. Certain additions were therefore required on the wrapping machine to make this possible.

The wrapping speed is 72 packages per minute. The automatic wrapping machine is a product of the Johnson Automatic Sealer Company of Battle Creek, Michigan.

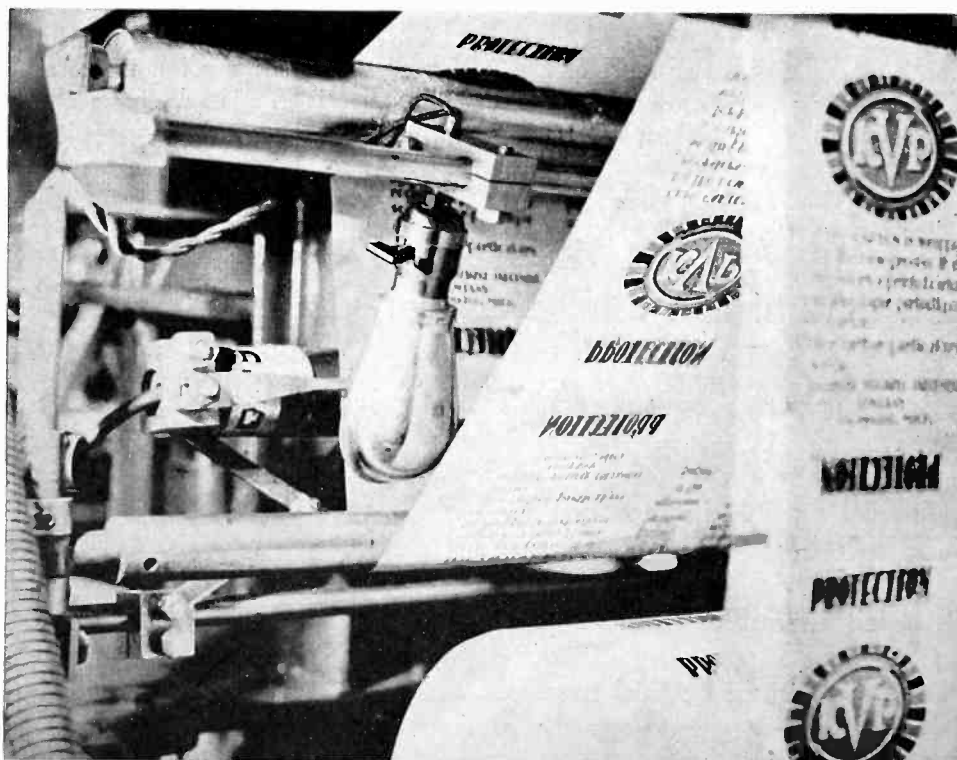

Control mechanism for registering accurate printing of labels and actuating cut-off knives at proper points to secure uniform packaging

## Eliminating radio interference

IN A REVIEW OF THE principal commercial products for interference removal, at the receiver and at the source, ranging from simple pairs of condensers to filters embodying chokes, described in *Berlin Radio*, one of the most interesting is the "Jenalit," with two series chokes, one in each line, and two parallel twin condensers, the mid point of one being grounded and that of the other being attached to a metal sheath to be slipped onto the handle of a violet-ray apparatus (when the filter is to be so used). This protector contains also a neon lamp which glows should it be improperly used, and particularly should the operator lose contact with this metal sheath.

A new phonograph record has been developed with typical interference-noises, alone and with music, to aid in the identification of the source of interference. The disk is prepared by the Telefunken Company, and fourteen types of noise are represented.

# DEVICES IN INDUSTRY ★ ★

## Photo-cell saves half of lighting bill

A SIGNIFICANT EXPERIMENT has just been completed on the lighting of a large machine shop in Pennsylvania, which was controlled one half in the ordinary way by hand-operated switches, and half by photo-cell switches which turn the lights on when it gets dark or cloudy outside.

A year's test has shown that the control by automatic photo-cell lighting consumed only about one-half as much electricity during the year as was taken by the same number of lights switched on by the workmen (but then often left burning when not further needed). The records showed that the automatic lights often came on at times when the hand-controlled lighting was not lighted, because the foreman or attendant, busy elsewhere, did not operate the switches until the factory interior had fallen far below the allowable limit of illumination.

★

## Short waves make worms spin more silk

EVEN SILKWORMS WORK better to radio. Waves to make such worms spin more silk have been found successful by two Italian biologists, Signors G. Mezzadroli and E. Varetton. The waves were between two and three meters long, like those used recently by scientists to create fever in the bodies of men and animals. Taking a batch of silkworms 15 days after hatching from the egg, the Italian experimenters exposed these worms for 30 minutes each day to the radiation from a powerful generator of these ultra-short waves. Exactly similar worms hatched at the same time and fed with the same food were kept as a standard for comparison. The radiated worms grew faster both in length and weight, it was found, than did the worms which had no radio. Also, the radio worms began to spin their silken cocoons sooner and produced an appreciably higher average of silk. Every feature of the experiment indicates, the two biologists reported recently to the Academy of Sciences in Rome, that the radio treatment quickened the life-cycle of the worms so that more silk could be produced in less time and on smaller quantities of the mulberry leaves which silkworms use for food. Probably the radio waves act chiefly by heating the worms just as similar waves cause slight fever in other animals. Whether the experiment will lead to practical

trials of short-wave radio to speed up silkworm farming is doubtful because of the cost.

★

## Photo cells in factory inspection processes

PRACTICAL APPLICATIONS of photo cells in factory processes were described by Nicholas Heyman, consulting industrial engineer, Verona, N. J., before the Society of Industrial Engineers at Newark, N. J., February 24.

Collapsible metal tubes used for shaving creams, tooth pastes, etc., are now inspected for air-holes by whirling them rapidly over a light in front of a photo cell. If any light leakage occurs, the cell operates a relay which marks the tube and throws it aside.

Bottles of white, green and brown glass are sorted by the relative amount of light passed. Almonds are sorted by size, into three groups. Paper bags are automatically "registered" by marks on their labels, before being cut apart from their rolls. Sheet metal is classified by thickness, varying from one-quarter of a thousandth of an inch. Bottle caps are inspected by a grid-glow contact process, faulty caps being

thrown aside as the bottles pass by.

Theater ticket sellers are checked up by light-beam counters which record the number of persons entering the theater, this number later being checked with ticket sales. Some trouble was experienced with patrons who walked back through the light beam. Mr. Heyman suggested a solution in a "one-way" beam, utilizing two cells, which would record only in one direction.

★

## "Electric eye" sees through fog

THE MODERN PHOTO-ELECTRIC CELL, better known as the "electric eye," can perceive light invisible to the human eye. "Infra-red rays," states George Lewis, vice-president and engineer of the Arcturus Radio Tube Company, Newark, N. J., "while not visible to humans, are readily picked-up by the photo-electric cell. With the ability of this ray to pierce fog for a distance of ten miles and this, in turn, picked-up by the extremely sensitive photo-electric cell, there opens up a vast field for research and development.

"As safety factors for ships and airplanes cruising in fog, the application of the photo-electric cell is important.

★ ★ ★

## MAKES MOVING MACHINES STAND STILL

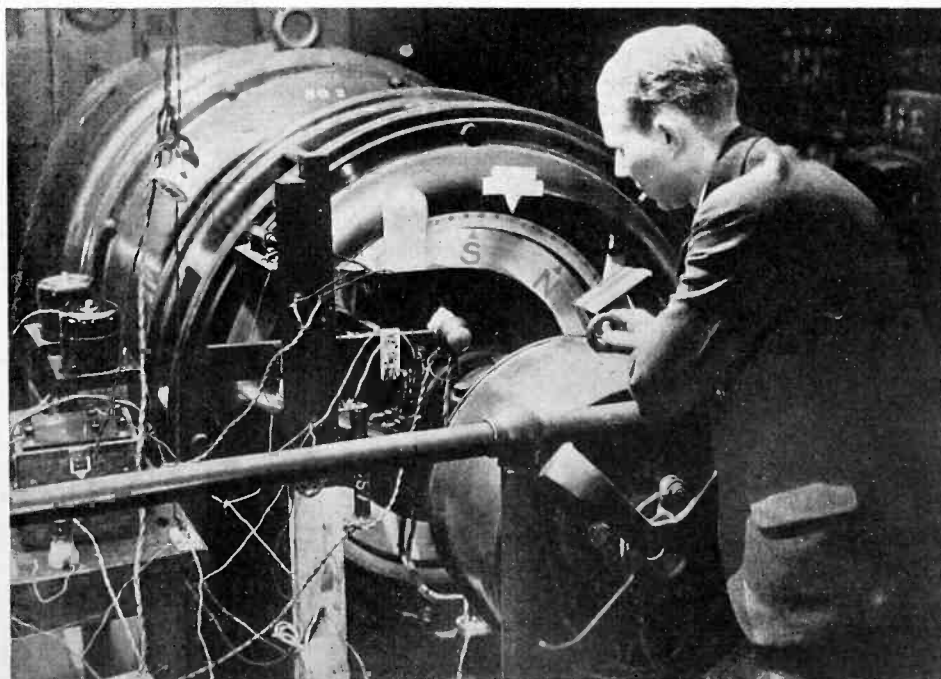

This electronic stroboscope has been developed at Massachusetts Institute of Technology, Boston, by Harold E. Edgerton. The 160-hp. motor, running at a peripheral speed of 95 miles per hour, appears stationary

# Engineering applied to packaging

By DUNCAN CASSIDY

---

**N**O INDUSTRY has done more to stimulate and test the ingenuity of the package engineer than that devoted to the production of electrical appliances. Though this industry consumes the second largest number of corrugated fibre packages it consumes by far the largest number of specialized packages. This demand is not explained solely by the large volume of output, or by the great variety of shapes encountered among electrical appliances. It is accounted for chiefly by the fact that the electrical industry, having been developed recently by inventive and original minds, is not governed by habit and tradition to the extent of most industries. Minds which could pioneer in new regions of science were also responsive to methods which, in the distribution of products, promised to eliminate waste.

Just as the mechanical engineer would be helpless without steel, so the box engineer could not produce his varied designs without corrugated fibre board. This

▼

**THE design of proper packing so that a radio set shall reach its destination in good working condition, is no less important than the proper design of its operating circuits—for both are essential to the customer's satisfaction.**

▲

material is composed of tough, waterproofed fibre sheeting, trussed with cross braces of minute corrugations,—a type of mechanical construction which combines a maximum of both strength and lightness. When such material is under pressure or is struck a blow it will compress but its rigidity is not affected.

## The "raw product"

Corrugated fibre board is used, in the several stages of its manufacture, for wrapping and padding goods. "Unlined" board is a single corrugated sheet, usually shipped in 500-ft. rolls. Single-faced board has one flat facing cemented to the corrugated sheet to prevent flattening of the corrugations, while double-faced board has plain facings cemented to both sides of the corrugations. The double-faced board, used for making containers, is faced on both sides with tough, resilient sheets whose thickness and consequent tensile strength are graduated to meet the requirements of the article to be packed and the transportation service to be used.

The puncture resistance of board is tested in a Mullen testing machine. Non-test board, which may test under 175 lbs. puncture resistance, is used chiefly for the smaller mailing boxes adapted to light articles. Boards which resist puncture at a pressure of 175 lbs. and 200 lbs. respectively, per square in., are used for express and freight boxes. A board of extra strength, which resists puncture at 300 lbs., is also manufactured. This material is used for out-size boxes or those intended to carry extra weight.

## The unit package—its economies

Working with these materials the packaging expert has made himself most useful to the electrical industry. The unit package is probably his most important contribution as such a large percentage of electrical appliances now reach the consumer in single units and quite frequently in the original factory container. The unit package achieves great economy of time and effort. The middleman is relieved of the work of unpacking a shipment to verify the invoice. He knows that each package contains one unit, or a specified number of units. He counts the packages, unpacks one or two for display purposes and stores the remainder of the articles in their dust-proof containers. This eliminates shop wear and breakage in storage. In a shipment of desk lamps, for example, each box contains shade, base and cord, firmly held in place by stays and braces.

Three fundamental principles are observed in designing a unit package for any article. First, the contents must be so anchored in the box that they cannot wedge or shift in handling; second, no two separate articles are allowed to touch each other; and, third, no highly polished, fragile or protruding parts are permitted to come in contact with the walls of the container.

The box engineer displays his ingenuity in designing the interior packing. Safety is the first requirement and obviously there is always the best way for insuring safety. The box specialist's job is to discover the best way and at the same time to give attention to ease and speed of packing and economy of spacing and weight. When the expert announces solution of a problem every cut and scored piece of board has its own proper place into which it fits perfectly; every delicate part of the article to be shipped is securely anchored at a safe distance from all sides of the container. Through severe and careful tests it is ascertained whether the contents

will remain suspended in place, unharmed by treatment far rougher than it is likely to receive during shipment. As a consequence, breakage in transit, which once imposed a heavy burden on the shipper, need no longer be taken into account.

### Containers for radio receivers

Millions of these specially designed containers are used each year by the electrical industry. But of all problems presented to the packaging expert by the electrical industry, involving odd shape and fragility, that of the radio set is most complex. The many shapes and sizes of delicate parts which compose the sets cause the difficulty.

Nevertheless, all packaging problems involving radios have been mastered by the packaging experts. The Simplex Radio Company of Sandusky, Ohio, reports that damage in transit is too negligible to be considered. The company has specially designed containers for three models, prepared by the Hinde and Dauch engineers.

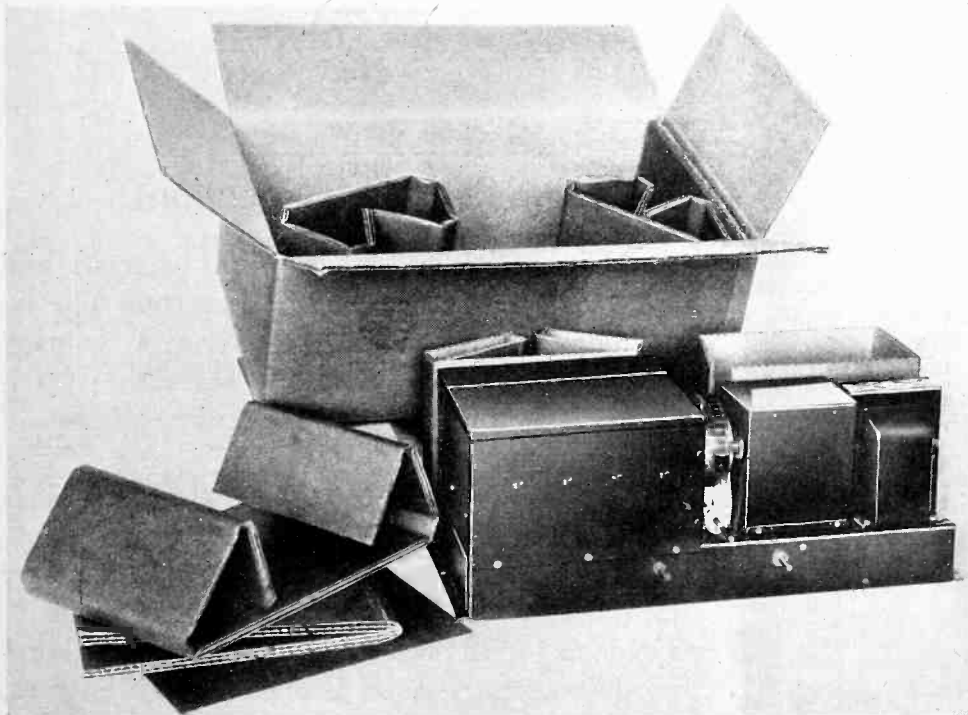

A chassis is protected by buffer cushions, top, bottom, and sides

The Gothic or midget model, is protected by "rat trap" cushions at the bottom and four sides. These cushions are of double-faced board and are folded to give three thicknesses of the material. A facer cushion fixes the set firmly in place, while a cushion of double-faced board at the top completes the interior packing. This model is 12½ in. wide, 18 in. high and 7 in. deep, and weighs 23 lbs. When packed it weighs 31 lbs.

The Moderne is a modernistic design with steps at the sides, and requires, in addition to the "rat trap" cushions two stays of double-double board exactly fitting the steps. The container and interior packing for this set also weigh eight lbs.

The Beverly is 20 in. wide, 36 in. high and 10½ in. deep. The cabinet is supported by four legs. The container is of double-double material. The leg anchorage is composed of a cushion which exactly fits the container except at the corners where there are notches in which the legs rest. Double-faced flaps or pads hold the cabinet in place a half inch from all sides. The cabinet is topped

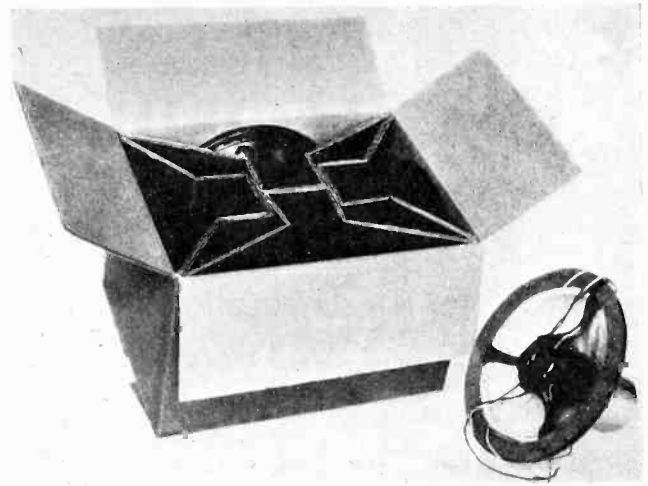

Loud speakers, four to a package, are shipped in this manner

by a single sheet and a cap composed of three thicknesses of double-faced board. The Beverly weighs 42 lbs. and 60 lbs. when packed.

Packing of the sets goes forward swiftly and noiselessly. New workers quickly learn how to adjust the interior packing. The sweep of a brush seals the package. Containers come folded, occupying in this form one-tenth the space they will contain when set up. A fiber container weighing three pounds will contain 2½ cubic ft. One of the old-style containers of the same cubic contents would weigh from 6 to 15 lbs.

A visit to the modern box factory is a revelation to the uninitiated. In a brief time one begins to appreciate the importance to industry—and especially the electrical industry—of the scientifically designed container. It is evident from the variety and complexity of designs produced that the packaging expert has fairly earned the title of engineer.

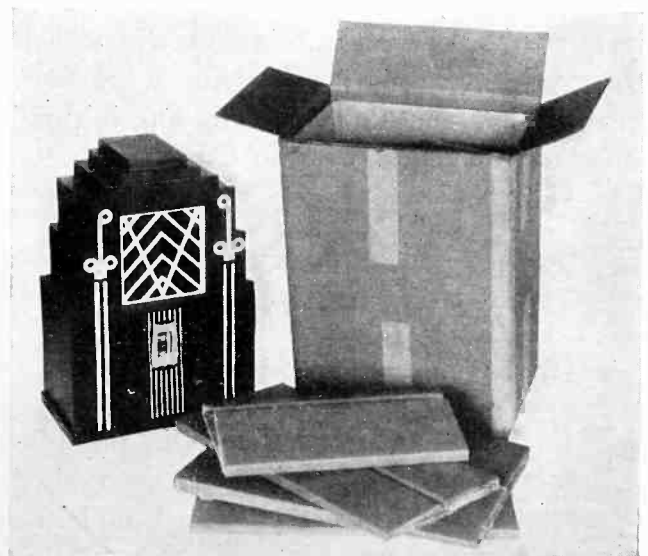

A modern radio receiver and its packing carton

# electronics

McGraw-Hill Publishing Company, Inc.  
Tenth Avenue at 36th Street  
New York City

O. H. CALDWELL, *Editor*

Volume II—MARCH, 1931—Number 3

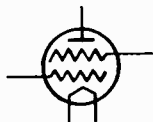

## Keep the efficient Radio Division out of politics

**P**RACTICAL radio men, and many of the 16,000 amateurs of the country, are opposing the latest effort by Senator Dill to put the capable and efficient Radio Division of the Department of Commerce under the politically-constituted Federal Radio Commission.

The record of the Radio Division under W. D. Terrell as chief has been one of splendid achievement. Last year with a personnel of only nine supervisors, 68 inspectors and 57 clerks in 20 offices in different parts of the country, the Radio Division inspected 11,334 ship radios; measured 45,695 frequencies or wave lengths, 44,923 being those of broadcasting stations and 470 being those of foreign stations; built the world's most sensitive radio receiving station at Grand Island, Neb., designing the equipment itself and operating the station to detect interference on all wavelengths used here and abroad; established nine "secondary standards," or "sub-policemen of the air"; regulated the 16,829 amateur radio stations, including the examination and licensing of 2,165 new ones—and otherwise did its usually fine job of back-stopping the Federal Radio Commission.



## Physiological research

**F**UNDAMENTAL research in physiological reaction has resulted in many scientific developments which has later produced modern apparatus. A recent example of this is a new motion picture screen developed by Albert Hurley, a New

York physicist. This screen was developed upon physiological rather than upon physical principles, with the effect upon the eye as the chief consideration. The result of this development is a screen which reflects less light than the old-type screens, although to the eye it is *apparently* brighter. The surface of the screen is treated with pigments that have a highly diffusing quality, resulting in even illumination and reflection from all viewing angles. By regulating the amount, intensity and quality of light transmitted and reflected to the eye, less eye fatigue and nerve strain results.

This is only another indication that physiological research, after all, should be the basic starting point for new developments.



## Instead of patenting, they publish their inventions

**O**UT of the welter of patent contests and patent litigation in radio has come one interesting patent policy on the part of a company which maintains an important research department that is continuously making inventions and improvements.

The executives of this company frankly declare that they are *not interested* in patents. They do *not* take out patents. Instead, they have found that the best way to avoid patent difficulties is to *publish*, as soon as possible, whatever their laboratory develops. As soon as publication is effected, of course, no one else can patent the device. Everyone is then free to use it, but the company producing the invention already has had a head start. Their executives feel that this "open-door" policy saves them infinitely more patent worries and litigations, than it costs them in foregoing the (questionable) monopoly of their own inventions and discoveries.



## Radio to moving trains

**I**N one branch of radio, at least, the Canadians and Europeans are continuing to show the way to the United States. That is the use of radio aboard trains, for some years demonstrated as practical by the Canadian National Railways and

by certain lines in France, Germany, Poland and Russia. First on the plea of impracticability, and then on fainter pleas of economy, American railroad officials have attempted to excuse that lack on all but a few of the more progressive lines in this country.

From France comes the report that the year 1931 will see at least 500 cars equipped to provide constant telegraphic communication en route between passengers on trains and the Post Office Central station at Pontoise. The Canadian National Railways has proved, by actual everyday installation on its Toronto-Montreal run, with an extension in the service to Chicago projected, that telephone conversations as well can be carried on between moving trains and the connected telephone system of Canada.

Perhaps some day the Century, the Broadway and other crack fliers will be brought truly up-to-date.

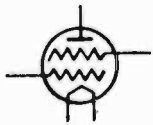

## Do you use our monthly review of patents?

FOR nearly a year readers of *Electronics* have had prepared for them each month a digest of the patents issued in this field. This work was undertaken with the hope that an up-to-date report and discussion of patents would be appreciated and that by divesting the claims as published, of their legal language, engineers might discover what the inventor had done, without lengthy perusal on their own part of the entire patent.

The editors find difficulty in judging the usefulness of this patent material to their readers. Of several engineers asked as to its value, engineers whose standing in the industry is acknowledged, there are some who believe the material is useful, some who think the time and space had better be employed in some other manner. Some engineers praise the material; one executive states that his engineers find it not useful at all.

Readers of *Electronics* who will be good enough to indicate to us their views in this matter will find attentive ears in the editorial office.

Shall we continue the Patents department now found at the end of each issue? Or, shall it be dropped?

## "A Platform for American Business"

PRESENTED as a supplement to this issue of *Electronics* is a program prepared by the McGraw-Hill Publishing Company, designed to assist in planning future business progress and to guard against severe economic setbacks, such as that through which we have been passing.

General objectives set forth in this plan, which include maintenance of present standards of living, and stabilization of future business growth, should have a particular significance to the whole electronics industry. For only so long as the millions of American families can maintain present standards of living, giving them a surplus purchasing power in excess of the necessities of life, can radio manufacturers, sound-picture interests, and other electronic industries find outlets for their products.

Stabilization of future business growth through long-term planning has particular application to our industries at those points where it touches upon market analysis, sales control, product development and research. Coordination in industry and trade covers the basis of future stability in the radio field. No industry requires stronger support of its national trade and manufacturers' associations. Without this cooperation, the industry will not receive its share of national prosperity.

The radio industry, through international broadcasts, can do much to aid in the promotion of international business cooperation. Here this industry serves as a direct medium for other industries to benefit from the friendship developed with foreign nations. Sound pictures, another development of the electronic family, can play an equally important role in carrying by sight and sound the spirit of American good-will and cooperation to the four corners of the globe.

REAL EARNINGS OF EMPLOYED WORKERS

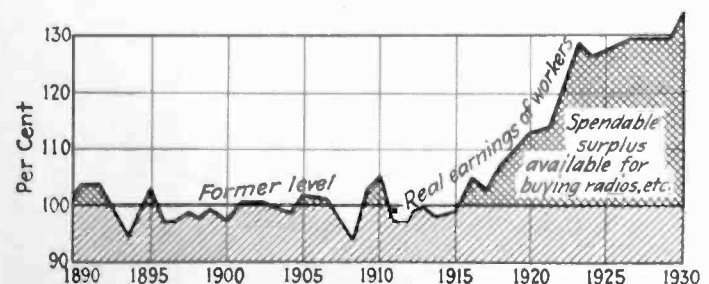

How the real earnings of employed workers have increased in the United States since 1915—measured in terms of the cost of living and purchasing power of the dollar

# The march of the electronic arts

## Deforest obtains permanent injunction in tube suit

THE FEDERAL CIRCUIT COURT OF APPEALS, sitting in Philadelphia, affirmed a previous decree of the District Court of Delaware in its decision issued on February 13th that the Radio Corporation of America, and associated companies had by their agreements with their licensees attained a "patent pooling" monopoly over the sale of vacuum tubes to dealers and set manufacturers in violation of the Clayton anti-trust act.

The original injunction ordered against the Radio Corporation by Judge Morris was sustained by the Court of Appeals to which RCA carried the case. When, after a final hearing, he granted a final injunction, the Appellate Court again sustained him, and the latest decision, written by Judge Buffington, senior member of the Circuit Court, brings the case to a close.

Referring to the opinion handed down by the Circuit Court of Appeals, the Radio Corporation made the following statement:

"We shall apply as promptly as possible to the Supreme Court of the United States for a Writ of Certiorari. The clause to which the litigation was directed, as a matter of fact, has not been in force since July, 1928. Nevertheless, the case raises important and novel questions as to the rights of an owner of patents in the granting of licenses. These questions have not yet been passed upon by the Supreme Court."

## Radio wholesalers protest tube evils

PRESENT PRICE DEMORALIZATION in the marketing of radio tubes was emphatically protested by J. Newcomb Blackman, president of the Radio Wholesalers Association, whose 250 members met at Indianapolis February 15-17.

"Such demoralization follows when tube manufacturers sell direct to large retail outlets at the distributors' wholesale price," declared Mr. Blackman. "Then results a retail, resale price which cannot be met by the regular dealer who buys from a wholesale tube distributor, and whose cost is the same as that of the large retail outlets."

"List prices of radio tubes have become practically null and void, in relation to retail sales price. Tube manufacturers are competing keenly, and quoting extremely low prices to set

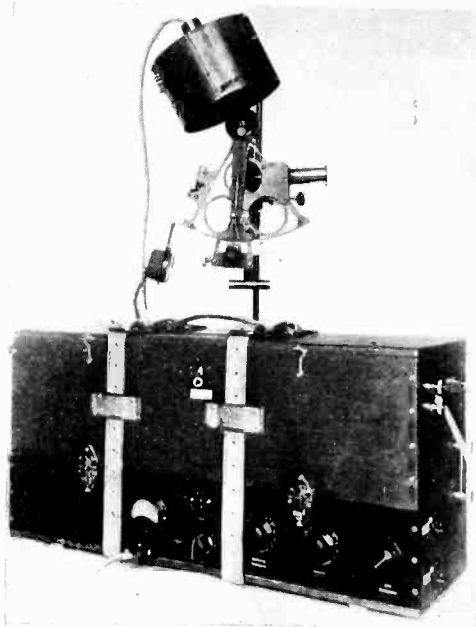

The Macneil all-weather sextant uses photocell (sensitive to infrared rays) with amplifier to indicate sun's altitude in foggy weather

## Guard radio interests in copyright law

IMPORTANT INTERESTS of radio manufacturers belonging to the RMA in the Vestal Copyright Bill before the Senate are being guarded during the strenuous effort being made to get the bill passed before Congress adjourns March 4th. The bill already has passed the House of Representatives. It was caught in the pre-adjournment jam and did not pass the Senate.

The RMA is not opposing the provision for reasonable royalties to authors and composers, nor the automatic copyright provision of the Vestal Bill. The organization of radio manufacturers, however, is urging many important amendments affecting radio makers, as well as broadcasters. These amendments were presented to the Senate Patent Committee, at its hearings January 28-29, by Frank D. Scott, Washington legislative counsel for the RMA. Also appearing before the Committee was H. E. Capehart, president of Capehart Corporation.

Another important amendment being urged by the RMA and already approved by the House of Representatives is that royalties on broadcasting should stop at the broadcast station and not be extended to hotels, restaurants, cabarets, and similar places.

manufacturers. "We believe that the tube situation cannot be stabilized until the radio sets are priced in one way only, that is, complete with tubes."

## ELECTRONIC TUBE FOR INTERIOR LIGHTING

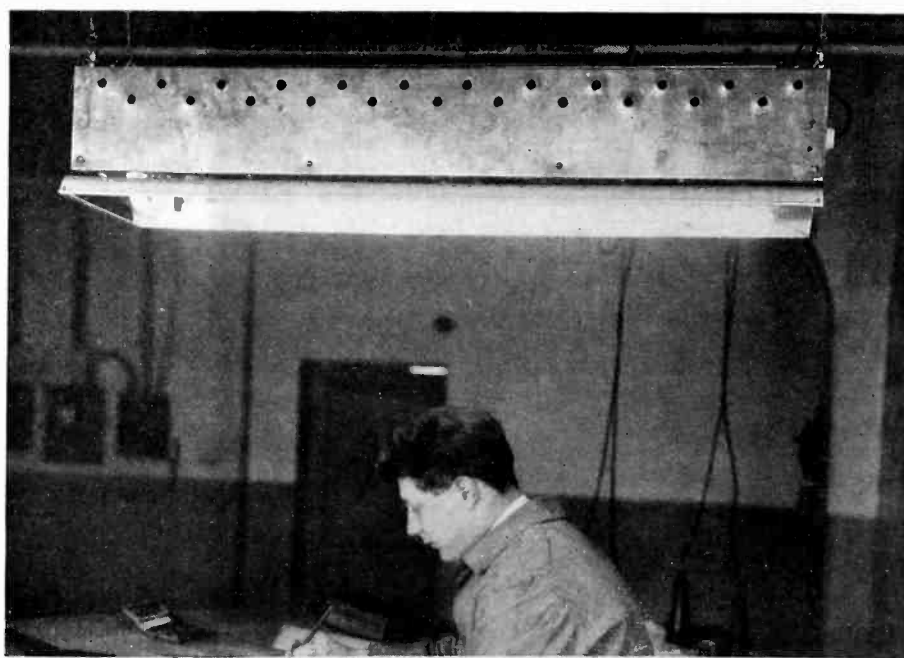

Claude Neon low voltage illuminating unit of 500-watt intensity, designed for industrial lighting. This light claims 40 per cent reduction in radiated heat and life of 3,000 hours



## \$8,000,000 liner to have centralized radio

THE NEW \$8,000,000 liner President Hoover, largest American-built merchant vessel, which was recently launched at Newport News will be equipped with the most extensive radio system ever installed on a vessel, according to radio engineers who are making the installation.

Arrangements have been completed with the engineering products division of the RCA Victor Company for the installation of a centralized radio system with over 50 loudspeaker outlets built into various parts of the giant liner. A powerful central receiving station with an electric phonograph will be installed amidships, on the promenade deck. From this point a sensitive superheterodyne receiver capable of picking up shore radio stations without interference from the ship's wireless antennae will deliver the programs simultaneously to the various public rooms as well as to more than 35 special staterooms and suites.



This combination receiving and sending headset used by Boeing pilots on their air-mail and passenger planes enables them to talk to ground stations 200 miles away.

## Supreme Court to review the Langmuir patent case

THE SUPREME COURT of the United States has consented to review the Langmuir high-vacuum patent case. This suit involves the validity of Langmuir patent No. 1,558,436, issued to the General Electric Company. The patent in question has been licensed by the General Electric Company to the Radio Corporation of America.

The Supreme Court, as a general rule, does not review patent cases unless there is a conflict between decisions of the Appellate Courts, in different circuits. It has made an exception in this case because of its importance, not only to the radio industry, but other electronic uses of the vacuum tube.

Previous decisions on this case conflict. Judge Morris in the District Court at Wilmington, held the patent invalid on three grounds: Because of anticipation and want of invention, because of prior invention, and because of prior use. The case was appealed to the Circuit Court of Appeals for the Third Circuit, which on October 2, 1929, affirmed the decision of the District Court.

On a petition for re-hearing the case was re-argued on November 11, 1930, and in an opinion written by Judge Buffington, the majority of the Court reversed the District Court and entered judgment accordingly. (See *Electronics*, January, 1931, pages 476-477).

The case has thus been heard three times—twice the decision has been adverse to the patent, and once in its favor. Four judges have at various times decided adversely to the patent, while three judges have decided in its favor.

The Supreme Court having now accepted the case, the plaintiffs will next file their "moving briefs" which will then have to be answered by the defendants, so that a decision by the Supreme Court may not be forthcoming until the end of the year.

## RMA reports less failures in 1930 than 1929

FROM THE Radio Manufacturers Association we learn that 1930 saw only 22 failures of radio manufacturers involving \$4,300,000 to compare with the 25 failures involving \$12,000,000 in

1929. Cut-rate and bargain stocks are about depleted. Production has been keyed to demand. The radio manufacturers have learned their lessons from overproduction. If only the broadcasters will learn the lessons of overcommercialization—in a word, of doing offense to the good taste and morals of the public,—all will be well.

## FRENCH PRODUCE NEW SOUND EQUIPMENT

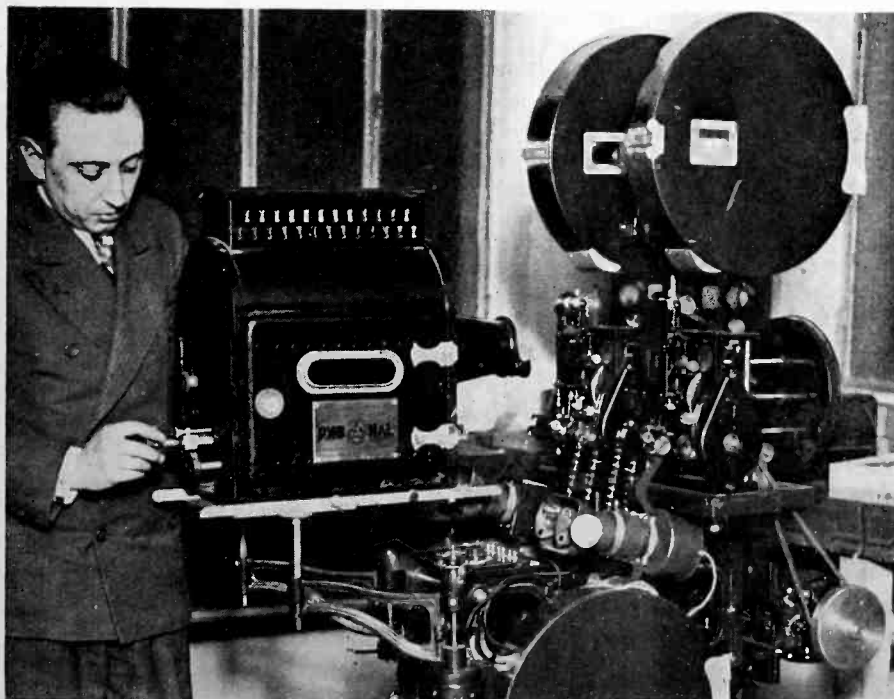

Theater reproducing equipment consisting of two projectors mounted on one base developed by M. Lhar, Paris. Photocell amplifier for each unit is mounted on top of lower film magazine

## Looking to synchronization nets acquire more stations

WITH THE ACQUISITION of WENR by the National Broadcasting Company and the remaining one-third interest in WBBM by the Columbia Broadcasting System, each of the American network organizations now owns or directly controls six clear channel broadcasting stations. Step by step, they have been gaining a stronger foothold on the clear channels with the object in view of ultimately establishing sectional or national synchronized networks which will give them full time outlets of their own for their programs.

# REVIEW OF ELECTRONIC LITERATURE HERE AND ABROAD

## Relaying on ultra-short waves to improve city reception

[GEHNE] The original von Ardenne proposal was to pick up the desired distant transmission at a favorable point, relay it over land-lines to within the city, and retransmit on the original wavelength by a relay sender there: criticism was chiefly directed on the probable interference to be feared between the original and the relayed wave. Another method suggested was that, instead of land lines, ultra-short (below 10 meter) waves should be used, this carrier wave being modulated at the frequency of the original wave (at radio, not at audio frequency therefore) and demodulated at the relay-sender. This subsidiary point has now become the essential feature of von Ardenne's new suggestion, which he claims avoids the disadvantages criticized in the earlier suggestion. He now proposes that receivers outside the city should pick up the distant transmissions, pass them at radio-frequency over land-lines to a relay sender within the city, and modulate therewith the ultra-short carrier wave of this sender. The demodulation must now be performed at the receiver of each listener, but a simple detector suffices. It is claimed that in many cases a crystal is enough. The demodulated wave-band contains as many transmissions as were originally impressed on the ultra-short-wave carrier, and these transmissions are separated in the normal manner by any ordinary receiver, to the input terminals of which the simple demodulator is connected. The receiver is of course also available for ordinary reception by replacing the demodulator by antenna and ground connections. Gehne however points out that this proposal was anticipated in its essentials by Anderson three years ago (*Radio World*, New York, March 17, 1928).

The advantage of the proposed system over the obvious alternative of relaying each distant program on a separate ultra-short wave-length is that the demodulator tuning can be pre-set, and the user need only know how to handle his normal receiver. It has been proved practical to impress two distant transmissions on an ultra-short carrier, and to demodulate them by a simple apparatus. It still remains to be seen whether a larger number can thus be treated; there seems no reason why they cannot.—*Funk, Berlin, January 23, 1931.*

## Synchronous-deflection relay for cathode-ray oscillographs

[J. KAMMERLOHER] The author describes an improved arrangement for cathode-ray oscillographs as used more and more frequently in production testing of the audio and rectifier performance of radio receivers. When a steady picture of the wave-shape is desired, on a screen which is stationary, it is necessary to apply to the deflecting plates a supplementary electric field which displaces the beam proportionally to the time, falls suddenly to a low value at the end of one or a few wavelengths and allows the beam to snap back to a former position. The whole cycle is then repeated without interruption. For permanent records the curves when stabilized in this way may be photographed by means of a camera, the deflection spreading out the curves as if the screen were moved. The audio frequency is

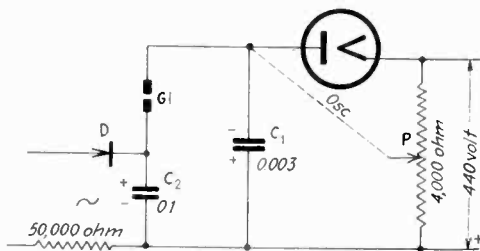

Deflection relay apparatus  
for oscillograph

applied to a good audio transformer which has a high input resistance even at frequencies as low as 50 cycles and charges a condenser over a resistance of about 50,000 ohms and a small dry rectifier D.

Another, smaller, condenser is charged at a uniform rate from a 400-volt battery over a tungsten filament vacuum tube operated at saturation. The potential at the electrodes of the neon glow-lamp G1 is equal to the sum of the two condenser potentials, it increases up to the starting potential of the discharge, falls then suddenly to a 30 or 40 volts lower value, the discharge stops and the charging begins again.

By means of the potentiometer P, the curves may be spread at will. Lack of synchronism, shown by a drift of the curve can be corrected by varying the rate of charging through the vacuum tube (See also a recent article by F. Bedell and J. G. Kuhn, *Review of Scientific Instruments*, April, 1930).—*El. Techn. Zeitschr, January, 1931.*

## New method of measuring small alternating potentials

[HAAK] The alternating potential to be measured is connected across the filament of a suitable small electric lamp (with a series resistance if necessary as protection) and the illumination equalized photometrically by means of an auxiliary lamp with that of the same lamp fed by a direct current of measured potential. An accuracy of 2 per cent (1 per cent with practice) is easily obtained.—*Funk, Berlin, January 16, 1931.*

## Measurements of field strength

[LEMOINE] A consideration of such measurements with special application to Sweden (where the author is chief engineer of the Government Telegraph Department), with plans. It is suggested that the quantities I (antenna current) and H (effective height) in the Austin formula may with advantage not be measured directly but their product calculated from field-strength measurements at distances less than ten wave-lengths from the antenna and under conditions such that the attenuation can be taken as nil.—*L'Onde Electrique, Paris, "December," 1930, (published January 14, 1931).*

## Radio direction-finding for aerial navigation

[ETIENNE] Description, with photographs and diagrams, of the principal French systems in use commercially. In this article (the first of a series) those systems using ground direction-finding stations are described, where the plane has no special apparatus other than the normal radio receiver and transmitter: All these types use loop antennas capable of rotation, the Bellini-Tosi type not being represented.—*Radioélectricité, Paris, February, 1931.*

## Oxycycle cathodes

[RICO] Final article of a series (these Digests, July, September, 1930) describing the commercial manufacturing processes of radio tubes as employed in France; with some theoretical notes.—*Radioélectricité, Paris, February, 1931.*

## Glow-lamps and their technical uses

[MICHELSEN] General theory, use of heated cathodes, colors available. Uses for economical lighting; as pole-finders; for advertising; for stroboscopic observation. Special lamps for television, with particular reference to the Leit-hauser lamp using the anode glow and giving a blue-white light for use with the Weiller mirror-wheel, with hollow tubular cathode; and to those for the same purpose (Schroter-Ewest) using again the anodic glow within a ring-shaped anode and with heated cathode to reduce the working voltage. Large advertising-sign lamps, in particular those developed by Pirani with heated electrodes, for low voltages and high currents, and his yellow sodium-vapor lamp where an efficiency of 75 per cent is attained. Uses as rectifiers; as voltage stabilizers; as safety devices for over-voltages, lightning protectors, etc.; as relays, with a third electrode; as audio-frequency generators (up to 5,000 cycles with neon and/or helium, to 100,000 cycles with hydrogen); for measuring purposes (these Digests January, 1931); as heterodyne generator at radio frequencies, using the harmonics. Mention is made of the attempts to use the glow-lamp as an amplifier.—*Funk, Berlin, January 30, 1931.*

## Short wave transmission

[UNSIGNED] Ultra-short wave results in cities, based on a report of the German Postal Department. A range of 6-8 kilometers in city areas is reported using 250 watts on 7 meters. The receivers used short (1 meter 50) antenna or none. Practically no interference from electrical machinery, etc. was experienced. Experiments are being continued both by the Postal Dept. and the Lorenz and Telefunken firms. The most suitable receiver seems to be a simple detector, feeding the audio-frequency amplifier of a normal receiver.—*Radio, B.F.f.A., Stuttgart, February, 1931.*

## Dynatron theory

[YOJI ITO] In order to discuss the phenomena present when the grid voltage of an anode (normal) dynatron or the anode voltage of a grid dynatron (these Digests, January) is not constant, it is desirable to divide the (negative) inner resistance into its parts, cathode-grid and grid-anode, instead of considering only the cathode-anode resistance. This being done, a complete study of the grid dynatron is made, and all phenomena readily explained: the extension to the anode dynatron is easy.—*E. N. T., Berlin, January, 1931.*

## The Hellertion

[P. LERTES] The well known German radio engineer describes a new vacuum tube musical instrument. The horizontal displacement of one finger, as on a violin, changes the pitch of the sound, the more or less intense downward pressure of the same finger varies the loudness of the sound. This object is accomplished by making use of a wire resistance wound on a flat rounded piece of insulation and forming part of a conventional vacuum tube audio oscillator giving frequencies from 16 to 3,000 hertz. A flexible strip mounted above the rheostat, when pushed down by the finger, cuts out part of the windings, and changes the pitch. It moves at the same time a coil mounted at one end of the rheostat and traversed by the audio current, the resistance strip being flexible and free to slide over a short distance at this end. According to the position of the coil, a larger or smaller audio voltage is induced in a second, fixed coil which is connected to an amplifier. The instrument showed great possibilities for imitating different instruments, flute, organ, accordion and for reproducing sounds of all kinds, the noise of a crowd, of a factory, etc.—*Die Umschau, January, 1931.*

## Argon full-wave rectifier with oxide-coated cathode

[M. KNOLL and F. HAUFFE, RECTRON LABORATORIES, BERLIN] A low priced rectifier tube for 0.3 ampere at 350 volts d.c. output is described. Gas-filled rectifiers are more efficient than vacuum rectifier tubes, but due to the fact that the anodes had to be placed in separate side arms their construction, similar to that of the mercury rectifier, was expensive and cumbersome. By placing the anodes inside a metal cylinder which was isolated or connected with the cathode, the authors were able to dispense with the sidearms and to reduce the size of the rectifier to that of ordinary vacuum tubes. A doubly coiled oxide-coated cathode procured a uniformly heated emission surface.—*Elektro Techn. Zeitschrift, January, 1931.*

## The present stage of ultra-short wave developments

[GERTH] Communication from the Lorenz Co. Laboratories. A historical sketch from Esau's experiments of 1925 to the present day, with special application to the possibilities for broadcast purposes: a workable range of 7 kilometers in city areas is quoted, using 1-kilowatt on 7 meters, elevated some 30-50 meters above surrounding buildings.—*E. N. T., Berlin, January, 1931.*

## Experiments on interference

[UNSIGNED] Experiments made at the request of the Syndicate of Radio Industries. Tests were made on ultra-violet-ray apparatus, it being found sufficient to ground the vibrating contact-breaker through a 2 mfd. condenser with a battery-fed receiver on loop antenna in the next room: with a mains-fed receiver two pairs of 2 mfd. condensers with center points grounded, across the feeds to the apparatus and those to the receiver respectively sufficed: but it was impossible to eliminate the interference with an outdoor antenna. A diathermy apparatus gave similar results, as also an X-ray apparatus. The placing of this last within an elaborate Faraday cage gave absolutely no improvement. Tests on tramways showed that the interference due to motors was readily removed, but that nothing reduced that due to the trolley-contact.—*L'Antenne, Paris, January 11 and 18, 1931.*

## Radioelectric music

[WEISS] Description of the Givélet-Coupleux principle (these Digests, November). Only one octave of twelve tubes and twelve loud-speakers is provided, but an oscillatory circuit (tuned by a movable iron core in the inductance) is provided for each key, the depression of any "C" key (for example) connecting the corresponding oscillatory circuit to that tube which is common to all the "C" keys. Quality and "attack" are said to be variable, but no details are given.—*Science et la Vie, Paris, January, 1931.*

## A selenium photo-cell of low inertia

[NOAK] In the new Thirring cell a spot of selenium of about 2 millimeters diameter and 0.05 millimeters thick is placed on the side of an assembly resembling that of a fixed condenser, with copper-foil leaves separated by mica: it appears that the selenium extends between the leaves by capillary effect, thus giving an extremely intimate contact. With 30 volts polarization (the maximum) a sensitivity of 40,000 micro-amperes per lumen is attained. The sensitivity is somewhat less for the higher frequencies, necessitating compensation.—*Radio B.F.f.A., Stuttgart, February, 1931.*

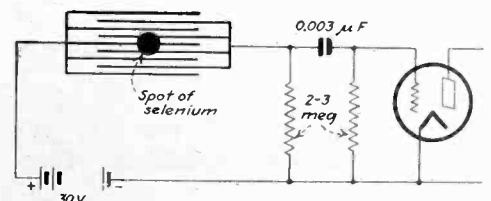

# + NEW PRODUCTS

## THE MANUFACTURERS OFFER

### Ultra-sensitive relay

OPERATING ON ONE milliamperere of direct current and capable of withstanding 10 milliamperes without damaging any part are two of the desirable features of the new Type FA-2630 relay recently brought out by the Leach Relay Company, 860 South Los Angeles

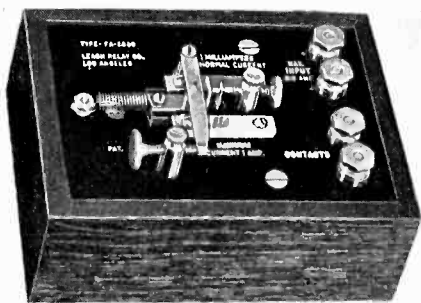

St., Los Angeles, Calif. The contacts are of a special alloy and the relay is provided with two adjustments, one for the contact spacing and the other for shifting the armature from one side of the magnetic center to the other. There are no armature springs and the armature returns to the open position by magnetic attraction only. All metal parts (except the contacts and carrier) are finished in polished nickel and mounted on a Bakelite panel. This whole assembly is fitted into a cabinet with cover which may be closed after the relay is installed. This relay is very adaptable to vacuum tube work. Price, \$22.50. — *Electronics, March, 1931.*



### Selenium tube

A SELENIUM TUBE designed for general purpose use is announced by the General Electric Company, Schenectady, N. Y. This tube, designated as Type FJ-31, consists of a glass plate on which a layer of selenium is deposited between two electrodes, the unit being mounted in a tube with a standard socket base. Although d.c. polarity for the tube has been specified, it may be operated on a.c. and will pass current in both directions. It is designed for the following operating conditions: maximum voltage, d.c. or a.c. 125 volts (r.m.s.), maximum current 1.0 milliamperere. Detailed characteristics of this tube are described in Bulletin GEJ-245, issued by this company. A curve is included, giving the light current characteristics of the tube for different operating conditions.—*Electronics, March, 1931.*

### 16 mm. sound picture equipment

THE PACENT ELECTRIC COMPANY, 91 Seventh Ave., New York City, has announced a complete 16 mm. portable talking picture system. The portable equipment comprises three individual units, the projector unit, the amplifier and speaker unit, and the sound screen. The projector unit includes a high grade projector, synchronous turntable, and electric pick-up, as well as the controls for both projector and sound operation. The projector is operated by special induction motor equipped with an adjustable speed control, and reverse control for re-winding film. The turntable is securely mounted on one cover of the projector case and folds up with the projector when in the closed position. The electrical pick-up unit is a Pacent Phonovox type. The turntable is provided with a volume and tone color control. The amplifier-speaker unit can be had in two types; Type "A" where an audience of 150 or less are to



be served, and Type "B" for an audience not exceeding 300. This equipment is designed primarily for industrial and educational uses. It is equipped with provisions for microphone pick-up, which may be used when desired.—*Electronics, March, 1931.*



### Sound recording lamps

AN IMPROVEMENT IN design and quality of sound recording lamps has been attained recently by Joseph B. Zetka, of 313 Grant Ave., Nutley, N. J. The new lamp is capable of 100 per cent added efficiency in light value, plus 50 per cent increase in operating life. List price, \$37.50 net.—*Electronics, March, 1931.*

### Base amplifiers

DESIGNED FOR HOME USE, small halls, and for portable equipment where compactness and light weight are essential, a new series of base amplifiers is announced by the Webster Electric Company, Racine, Wis. The small size of these units make them adaptable to

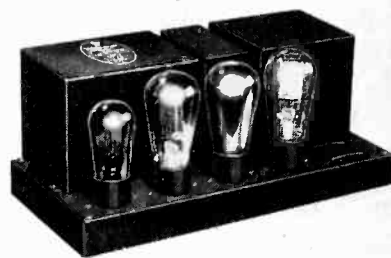

many varied and special requirements. They measure 13 $\frac{3}{4}$  in. x 6 in. x 6 $\frac{3}{4}$  in., and are part of the Webster line of power amplifiers for sound distribution services. Three models are available and may be used with either a.c. or d.c. dynamic speakers. They are known as 2-stage 245 Webster Electric power amplifiers.—*Electronics, March, 1931.*



### High-voltage electrolytic condenser

AFTER TWO YEARS of research and engineering development on electrolytic condenser problems, the Dubilier Condenser Corporation, 4377 Bronx Blvd., New York City, announces the Dubilier Hi-Mike condenser—a refined, semi-dry, high-voltage electrolytic condenser with the following features: Aluminum can, dimensions 4 $\frac{1}{2}$  in. x 1 $\frac{1}{8}$  in.; interchangeable with other standard dry electrolytic units; available in upright and inverted mounting types; standard capacity of 8 mfd; working voltage

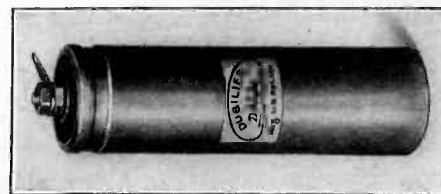

conservatively rated at 400, with peak of 430, or more than ample for requirements of set with 80 type rectifier. The units are compact, clean, non-spillable and, due to minimum leakage, quite efficient, providing ample filtering action for most requirements.—*Electronics, March, 1931.*

## Continuous automatic record-changer

AN AUTOMATIC RECORD-CHANGER which plays twenty 10-inch records of any make continuously, and which will repeat or reject any given record, has been developed by Hardray, Inc., 644 Broadway, New York City. The records are played in the upright position. The chassis is made entirely of alumi-

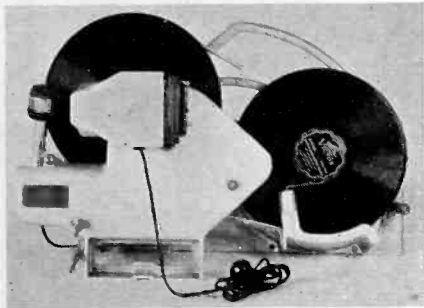

num castings, which complete with motor and pick-up, weighs 20 lbs. Its overall dimensions are—length, 22 in., height, 14 in., depth, front to rear, 11½ in. This is the full space required for operation, and also includes room enough for the smaller types of dynamic speakers. This allows a very compact combination with radio sets.—*Electronics, March, 1931.*

## New d.c. power unit

A COMPACT, SELF-CONTAINED power unit, known as Type CAB-4, consisting of a 4-volt storage battery automatically kept at full charge by a rectifying unit, is announced by Fansteel Products Company, Inc., North Chicago, Ill. The entire unit is housed in a ventilated steel cabinet, measuring 9½ in. wide x 8½ in. deep x 8½ in. high. Six and eight-volt models will soon also be available. Designed primarily for magneto-operated telephone exchanges, this unit is also useful and economical for intercommunicating telephones, local telegraph circuits, signals, recording instruments, annunciator or calling systems, small electroplating or electro-

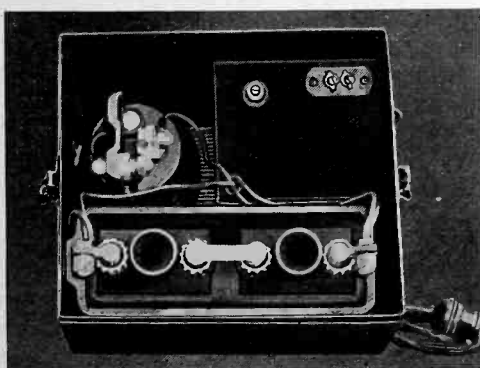

chemical equipment—in short, any purpose where low voltage direct-current is required. The unit operates from an ordinary light socket, consuming only 10 watts when operating at full capacity.—*Electronics, March, 1931.*

## Fire-proof insulating material

ACOUSTIC MATERIAL, having a high coefficient of absorption and fire-proof characteristics, and known under the trade name of Rock Wool Insulation, is manufactured by the General Insulating & Mfg. Co., Alexandria, Ind. Detailed description of the various acoustical products made by this company is covered in Bulletin No. 100-A. Two products, Gimco Rockwool, and Gimco Acoustic Plaster, have coefficients of absorption ranging from .32 to as high as .72. This material claims high absorption characteristics and heat-insulating properties. Gimco Acoustic Flex felt is designed particularly for sound studios, theatres, auditoriums, etc.—*Electronics, March, 1931.*

## Output meter

THE WESTON ELECTRICAL INSTRUMENT CORPORATION, Newark, N. J., has recently brought out an output meter known as Model 571. This instrument



is rugged, portable and especially useful in checking radio sets, sound projection equipment and public address systems during both manufacture and servicing. It consists of a five-range copper oxide rectifier type voltmeter, enclosed in a Bakelite case. The ranges, 150, 60, 15, 6 and 1.5 volts, are brought out to two binding posts through a dial range-selector switch which is mounted on the front of the instrument. This model has a non-inductive impedance of 4,000 ohm for all ranges.—*Electronics, March, 1931.*

## High voltage voltmeter resistors

VERY HIGH POTENTIALS 20 kv. to 400 kv. can now be indicated directly on a suitable instrument using the Taylor high voltage resistors recently announced by the Shallcross Manufacturing Company, Collingdale, Pa. Bulletin No. 200, entitled, "Measurements of Very High Voltages," may be obtained by writing the company direct.—*Electronics, March, 1931.*

## Midget high-voltage condenser

KEEPING PACE WITH what seems to be the midget age, A. M. Flechtheim & Company, 136 Liberty St., New York City, announces a complete line of midget high voltage condensers. They are now being installed in power packs, amplifiers, television receivers, portable sets, transmitters, midget radio sets, aircraft radio, etc. They are also being utilized in Loftin-White direct-

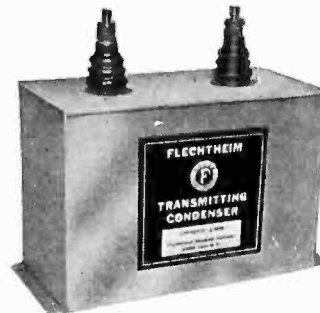

coupled amplifiers by research laboratories and L-W licensees and they are used by air-transport companies in their radio transmitters and receivers. They are available in two types—the HS type for '50 tube amplifiers and the HV type for '45 tube amplifiers. An engineering data sheet has been prepared on these condensers, showing ratings, capacities, sizes, etc. This will be mailed gratis upon request to the Allied Engineering Institute, Suite 544, 98 Park Place, New York City.—*Electronics, March, 1931.*

## Series of midget condensers

PRODUCTION OF A series of midget-type tuning condensers ranging in capacity from 19 mmfd. to 322 mmfd., and known as the "Midland" type, has been announced by the Hammarlund Manufacturing Company, 424 West 33rd St., New York City. The smallest condenser is 2¼ in. long, and the largest is 4 in. long. All "Midland" types are 2 in. wide, with plates fully extended.

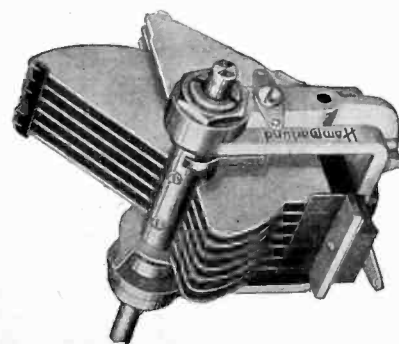

No screws or nuts are used anywhere in the construction of this type condenser, soldered eyelets being employed. Thus all possibility of parts vibration is eliminated. This feature is desirable for airplane and automobile sets.—*Electronics, March, 1931.*

## Portable public address system

MANUFACTURE OF A portable public address system, designed for carrying in two equipment cases and weighing only 90 lbs., has been announced by the Macy Manufacturing Company, 1449 39th Street, Brooklyn, N. Y. The complete outfit consists of: One 6-ft. exponential air column horn mounted in a suit case, one 2-stage amplifier

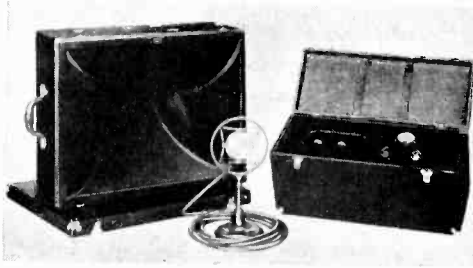

with microphone transformer, one 2-button carbon type microphone, one microphone stand, one exciter for batteryless operation, three power tubes, 15 feet of microphone cable, four dry batteries, one high-frequency electrodynamic receiving unit and one matching transformer. Price, \$275 complete. *Electronics, March, 1931.*

## Bulletins on graphite

A SERIES OF BULLETINS have been published by the Acheson Oildag Company, Port Huron, Mich., covering the following subjects: Colloidal graphite as a retardant of secondary emission in vacuum tubes; "Aquadag" as a resistance material; a method of making electrical contact with ebonite and soft rubber for insulation tests; the use of "Oildag" as a radio parts lubricant. Each of these various subjects are discussed in detail in the bulletins. Copies may be had by writing the company direct.—*Electronics, March, 1931.*

## Solventless varnish

A METHOD OF INSULATING wires applicable to all fields of the electrical industry, ranging from tiny clock motors to the largest size motors, circuit-breaker coils, radio equipment, etc., has been developed by Westinghouse Electric & Manufacturing Co., East Pittsburgh, Pa. It consists of a new insulating material, called solventless varnish, which completely fills the pores of the fibrous material between the wires, and becomes a solid integral part of the electrical apparatus. The application of this material is similar to the present process and does not require any additional equipment. Coils, motors or similar pieces of electrical equipment, when treated with solvent-

less varnish, are completely impregnated. This new process claims to eliminate "white" or hot spots in such windings. It is further claimed to increase the life of insulation about 25 per cent by elimination of air pockets, and thus preventing greater resistance to moisture.—*Electronics, March, 1931.*

## 100-watt radio transmitter

SIMPLIFICATION HAS BEEN the keynote of the design of the 100-watt transmitter announced by the Western Electric Company, 195 Broadway, New York City. The transmitter itself consists of a quartz crystal-controlled oscillator, two buffer stages of radio-frequency amplification, and an output stage in which modulation is effected. Modulation is accomplished without the use of audio amplifiers, the program being taken directly from the speech input equipment. The entire transmitter and power equipment are mounted in a single unit 36 in. wide, 25 in. deep, and 6 ft. 6 in. high. This unit is factory-wired, so that installation becomes a very simple matter. All apparatus is accessible from the front of the panel. This unit claims 100 per cent modulation, and also a stability within 50 cycles of the assigned frequency. The frequency stability is obtained by using a crystal-controlled oscillator.—*Electronics, March, 1931.*

## Transcription turntable

A NEW AND IMPROVED Type VB-94 transcription turntable is offered to broadcast stations by the Gates Radio & Supply Company, Quincy, Ill. This unit is constructed on a heavy walnut table 40 in. long, 26 in. wide and 30 in. high. A graduated fader with by-passed motor



starting switches is placed in the center front of the unit. Motor speed controls are placed to the left and right of the fader. Sixteen inch aluminum cast turntables are pivoted on a uniform speed motor which is suspended on springs. The pickups are constructed of chromatic steel and have a moderately loose construction to prevent resonant points, and yet stiff enough to maintain the neutral position of the armature. The output impedance is 200 ohms to match the standard input of the average mixing panel. List price, \$200.—*Electronics, March, 1931.*

## Public address turntable

EQUIPPED WITH TWO standard induction-type a.c. motors and two special Audak pick-ups, a portable public address system unit, known as the DTT-



100 is being marketed by the Allen-Hough Carryola Company, 115 W. Walker St., Milwaukee, Wis. The cover is removable permitting motor board only to be attached to control panel, if such installation is desired. All mechanical units are easily accessible. The entire unit is enclosed in a sturdy, water-proof fabrikoid case. List price, \$97.50.—*Electronics, March, 1931.*

## New modulation meter

TYPE 457-A MODULATION METER, recently announced by the General Radio Company, Cambridge, Mass., takes about 0.5 watt from the transmitter output and applies it to a linear rectifier, in the output circuit of which appears a wave identical in shape with the envelope of the modulated carrier wave. The maximum and minimum values of the rectified wave are examined by a circuit which includes a peak voltmeter. The values of percentage modulation for the positive and negative peaks are given directly by a dial reading. Two 227-type tubes are used. Power is supplied from a 90-volt battery (drawn about 2 milliamperes) and from the 105-115 volt, 50-60 cycle supply. The output of the rectifier is available for use with other analyzing equipment.—*Electronics, March, 1931.*

## Galvanometers

LEEDS AND NORTHRUP COMPANY, 4901 Stenton Ave., Philadelphia, Pa., has issued a bulletin covering a wide variety of galvanometers suitable for many needs in testing and development fields. Complete descriptions of the various types designed for special purposes, including pointer type; high sensitivity a.c.; vibration galvanometer, standard reflector types, etc., are described in catalog No. 20 issued by this company.—*Electronics, March, 1931.*

# PATENTS

## IN THE FIELD OF ELECTRONICS

A list of patents (March 3) granted by the United States Patent Office, chosen by the editors of *Electronics* for their interest to workers in the fields of the radio, visio, audio and industrial applications of the vacuum tube

### Facsimile, Television, Etc.

**Facsimile transmission.** Several light rays separated by certain amounts directed toward a record surface, alternately and successively changing the composition and re-composition of the picture from one to another of the two bevel light rays. Fritz Schröter, Berlin, Germany, assigned to Telefunken. No. 1,792,767.

**Picture transmission.** Cathode-ray receiver for reception of pictures. R. D. Kell, assigned to G. E. Co. No. 1,793,406.

**Facsimile transmitter.** A method of receiving black and white signals, and for reducing the echo effect of one of the receivers on the other. J. W. Labus, assigned to G. E. Co. No. 1,792,312.

**Picture transmitter.** A rotating lens system which continuously exposes a light-sensitive paper. E. F. W. Alexanderson, assigned to G. E. Co. No. 1,792,264.

**Light relays.** A path of interfering luminous rays, vibratory means for changing the path and phase relationship of each of these rays, a means for directing the rays through a light-sensitive recording means whereby a record of the light intensity as a function of the said vibratory motion is produced. Fritz Schröter, assigned to Gesellschaft für Drahtlose Telegraphie. No. 1,792,766.

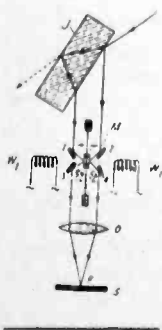

**Television scanning system.** A pair of mirrors, rotating in right angle planes, one mirror being not more than  $\frac{1}{4}$  in. in width and a lens to focus a point of light on the mirror. Oscar Tervo, Norway, Me. No. 1,791,481.

**Picture transmission.** Several devices and scanning discs for transmitting different pictures, and a means of indicating when said pictures are similarly framed. Wm. A. Tolson, assigned to G. E. Company. No. 1,792,259.

**Light chopping disk.** A patent granted to R. H. Ranger. No. 1,789,686 and assigned to RCA, describes a light chopping disk.

**Scanning system.** A mirror disk, used for scanning and reproducing lines at a rate commensurate with persistency of vision. C. A. Smith, assigned to R.C.A. No. 1,790,491.

**Light control system.** A method of controlling a light-beam by a Piezo-electric body permeable to light, and a crystal in the path of the light, for compensating for color dispersion produced by the control crystal. F. Michelssen, assigned to Gesellschaft für Drahtlose Telegraphie. No. 1,792,752.

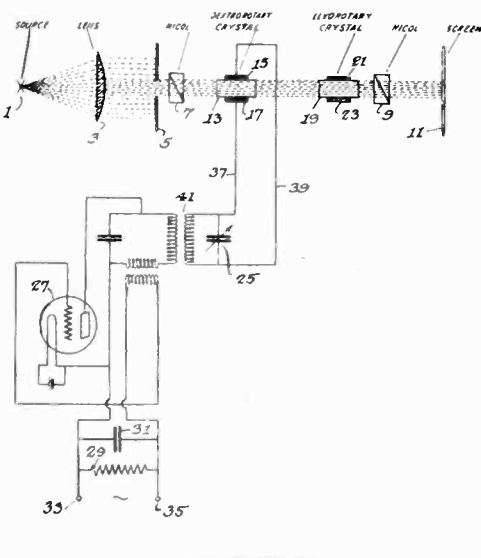

**Duplex photomodulator.** A method of representing variations of light intensity by electric current, consisting in translating values of light intensity on one side of some pre-determined intensity into impulses differing from those light intensities on the other side of this given intensity. The patent has 41 claims, and was filed July 16, 1924. R. H. Ranger, assigned to RCA. No. 1,790,722.

**Picture transmitter.** A cathode ray method of transmitting pictures, which causes an electron stream to traverse the picture when the latter is focused upon a photo-electric material maintained at a negative potential. T. W. Case, assigned to Case Research Laboratory, Auburn, N. Y. No. 1,790,898.

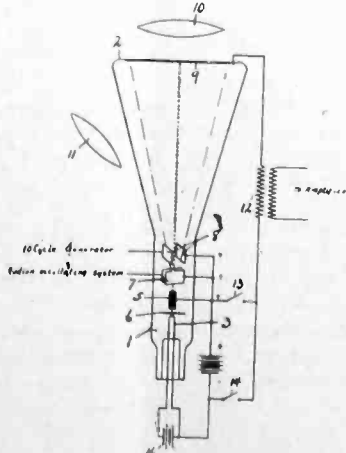

### Radio Circuits

**Single-stage audio radio receiver.** Combination of a high gain r.f. amplifier, grid-bias detector, single audio stage amplifier, and loud speaker. The grid is biased so that a linear portion is provided that if utilized, the detector output need only be amplified by a single stage amplifier to produce full loud speaker volume. Lester L. Jones, Oradell, N. J. No. 1,791,030.

**Communication system.** Method of using a vacuum tube to vary the potential across the grid-filament circuit of a power tube in a transmitting system. E. N. Dingley, Jr., Washington, D. C. No. 1,792,417.

**Polarized wave antenna.** A radiating loop having its sides in a horizontal plane, having a length equal to at least one-quarter of the wavelength of the radiated wave. The loop is at least one-eighth of a wavelength above the ground, and a means is provided for supplying high frequency current to the loop. E. F. W. Alexanderson, assigned to G. E. Co. No. 1,790,646.

**Tuning system.** A radio-frequency amplifier in which a fixed condenser is across an inductance coil, a portion of the windings of which is wound in reverse direction to the main winding of the coil. A metallic cylinder slides over the two windings and varies the inductance and hence the tuning. Louis Cohen, and August Hund, Washington, D. C. No. 1,792,144.

**Wave antenna system.** Parallel antennas staggered longitudinally a fraction of a wavelength with respect to each other. A. G. Chapman, assigned to A. T. & T. Co. No. 1,790,742.

**Radio signalling system.** Two sinusoidal currents of high frequencies are simultaneously interrupted in accordance with signals, such interrupted high frequencies are amplified, and beat with another high frequency midway between the two original high frequencies, to obtain a low frequency current. R. F. Ohl, assigned to A. T. & T. Co. No. 1,792,600.

**Water-cooled transmitter.** A system by which the water-cooled transmitter controls the connection of alternating current to the power supply. M. E. Fultz, assigned to B. T. L., Inc. No. 1,788,513.

**Screen-grid amplifier.** Regenerative amplifier in which there are two separate means for producing regeneration, one of which is most effective at high frequency and the other at low frequency. B. J. Thompson, assigned to G. E. Co. No. 1,791,435.

**Power supply system.** The field winding of a dynamic speaker is tapped and therefrom the various voltages for various tube plate circuits are obtained. Fulton Cutting, New York, N. Y. No. 1,792,077.

**Stabilized amplifier circuit.** Choke coils are in series with the filament terminals of a tube, are coupled to each other, and coupled finally to the inductance in the output of the tube. A capacity connection exists between the grid of the tube and the ground. L. M. Hull, assigned to R.F.L., Inc. No. 1,792,984.

**Radio frequency gain set.** Apparatus comprising a generator and attenuator, coupling systems, etc., to measure the sensitivity of radio frequency amplifiers. Malcolm Ferris, assigned to R.F.L. Inc. No. 1,793,601.

**Radio receivers.** Double detection receiver. In a double detection receiver method of impressing first and second harmonics upon incoming signals, and for neutralizing the first harmonic waves. W. T. Powell, assigned to Stromberg-Carlson Tel. Mig. Co. No. 1,793,959.

**Inter-stage coupling.** An inter-stage coupling device in which a high frequency coil is in series with a low frequency transformer to produce uniform transmission. Marius Latour, assigned to Latour Corp., Jersey City. No. 1,791,965.

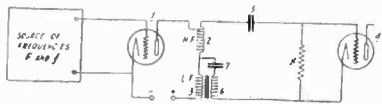

**Gang tuning.** A tuned radio frequency amplifier in which the input circuit to the various stages are simultaneously tuned by a single control. L. M. Hull, assigned to R.F.L. Inc. No. 1,794,230.

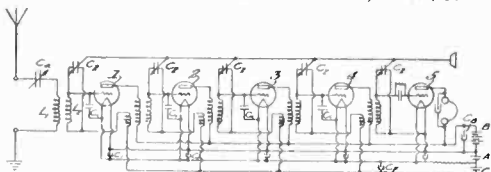

## Amplification, Modulation, Etc.

**Alternating current amplifier.** Amplifier made from tubes having a filament physically and electrically proportioned to be heated by a current in amperes greater or equal to the impressed potential in volts this current to be of the proper magnitude to produce a temperature at which relatively large changes of temperature produces relatively small changes of space current. B. F. Miessner, assigned to RCA. No. 1,790,874.

**Hum neutralizer.** Method of connecting to an anode of a vacuum tube circuit, voltages of the proper phase and value to neutralize the effect of variations in the supply voltage. C. W. Carpenter, assigned to G. E. Co. No. 1,792,275.

**Inter-stage coupling system.** Screen-grid amplifier in which the inter-stage coupling system has between its high potential ends a capacity, and in which the two couplings are out of phase with each other. W. L. Carlson and Ralph S. Holmes, assigned to G. E. Co. No. 1,792,274.

**Inter-stage coupling system.** An inter-stage transformer having a large wire for the current winding which feeds the following vacuum tube, and a potential winding for the preceding tube made of small wire wound turn by turn in the same sense along with and corresponding to the turns of at least part of the current winding. F. H. Drake, assigned to R.F.L. Inc. No. 1,791,236.

**Interference suppressor.** A source of pulsating direct current, a load circuit and intervening circuit, including a filter network, for causing a phase shift of 180 deg. between the ripple currents. P. H. Craig, Cincinnati, Ohio. No. 1,792,001.

**Rectifier protection.** A switch responsive to a pre-determined differential condition between anode and cathode currents of rectifier. E. Kern, Wettingen, Switzerland. No. 1,792,099.

**Power supply system.** A source of direct current is interrupted by a commutator on a motor, and supplied to the plate circuit of an oscillator, through a

transformer. F. A. Kolster, assigned to Federal Tel. Co. No. 1,792,746.

**Modulation system.** A magnetic modulator, comprising an elongated non-magnetic inductor core, a sheath of magnetic material enveloping the core of such thickness that variations in impedance due to variations in iron loss substantially exceed variations in impedance due to inductance loss. Mandel Osnos, assigned to Gesellschaft für Drahtlose Telegraphie. No. 1,792,756.

**Uniform gain amplifier.** Resistance is inserted in the primary of the output circuit in excess of the normal self-resistance of the circuit, so that reduction in the amplification of signals at high frequencies is caused, although no reduction takes place in the lower frequencies. F. H. Drake and P. O. Farnham, assigned to R.F.L., Inc. No. 1,792,970.

**R.f. amplifier.** Circuit for providing a substantial reactive balance at one frequency, although resulting in a reactive unbalance at other frequencies within the range of adjustment of the tuned circuit. L. M. Hull, assigned to R.F.L. No. 1,793,367.

**Oscillation generator.** Starting and stopping oscillations in an electric circuit by including a crystal in an enclosure for containing gaseous atmosphere. Gunther Thilo, Berlin, Germany. No. 1,792,781.

**Balanced amplifier.** Coupled to the input of a vacuum tube amplifier is a series circuit composed of an inductance, capacity and resistance, the high potential end of which is connected to the plate of the tube. Stuart Ballentine, assigned to R.F.L. Inc. No. 1,792,961.

**Control circuit.** A vacuum tube used to control the direct current into a load circuit. Irving Langmuir, assigned to G. E. Company. No. 1,793,329.

**Power supply circuit.** A transformer, rectifier and filter system for supplying power to a radio or other load requiring rectified alternating current. G. T. Royden, assigned to Federal Telegraph Co. No. 1,793,016.

**Modulating system.** Microphone and push-pull amplifier modulates the plate voltage of an oscillating tube. Means are provided for independently adjusting the voltage of the oscillator, and the amplifier tube. C. A. Culver, assigned to Federal Telegraph Co. No. 1,790,576.

**Piezo oscillator.** A method of spacing one of the electrodes of a Piezo crystal holder away from the crystal, a distance which is a non-integral number of air wavelengths of the oscillation frequency. R. C. Hitchcock, assigned to Westinghouse E. & M. Company. No. 1,790,148.

## Vacuum Tubes, Photo-Cells, Etc.

**Heater-type tube.** The heater is separated electrically from the cathode or emitting surface and an external battery is shunted across the filament transformer. F. S. McCullough, Wilkinsburg, Pa. No. 1,791,141.

**X-ray tube.** An X-ray tube enclosing a focusing device surrounding the cathode. Montford Morrison, assigned to Westinghouse E. & M. Co. No. 1,787,699.

**Light source.** A gaseous discharge tube comprising an alkaline metal for producing photographic records of light wave variation. C. W. Case, assigned to Case Research Laboratories, Inc., Auburn, N. Y. No. 1,788,355.

**Electron discharge device.** Unitary structure comprising in one compartment a three-element tube, in another a vacuum tube rectifier for supplying power, and in the third compartment a voltage-limiting device. A. Mavrogenis, Milwaukee, Wis. No. 1,789,186.

**Photo-electric cell.** A gas type photo-tube in which a magnetic means is provided for changing the trajectories of the electronic steam flowing between the photo-electric element and the anode, for increasing the number of electronic impacts in the gas. August Karolus, Leipzig, and Fritz Schröter, Berlin, Germany. No. 1,791,928.

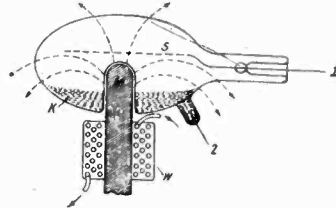

**Cathode material.** Thermionic cathode, consisting of a metal having a fusing point above .0001 deg. C. and an electron emissive material, composed of a mixture of oxide of an alkaline earth, and a rare earth metal oxide,—one of the oxides by weight amounting to 1% of the other. A. Just, assigned to G. E. Co. No. 1,794,298.

**Vacuum tube.** A grid having a surface mechanically roughened to decrease the emission of secondary electrons. D. A. Mullaney, assigned to G. E. Co. No. 1,794,315.

**Multi-element vacuum tube.** A tube with two anodes and two grids, and a single filament. The anodes surround different portions of the filament, and a grid is between the anode and the filament, one of the grids overlapping the other. Gabriel Pelletier, assigned to Grammont, Paris, France. No. 1,794,242.

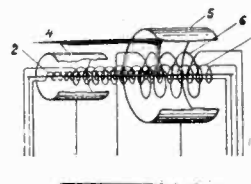

## Miscellaneous Applications

**Field strength measuring set.** A heterodyne method of measuring field strength and signals. E. Bruce, assigned to B.T.L. Inc. No. 1,793,835.

**Apparatus for identifying elements.** Electron tube method of differentiating substances. M. E. Simon, San Francisco, and J. A. O'Connor, Berkeley, Calif. No. 1,793,970.

**Current-limiting device.** A method of limiting cross modulation between several receiving channels operating on carrier frequencies. T. A. Jones and W. A. Phelps, assigned to B.T.L. Inc. No. 1,793,491.

**Alarm system.** Burglar alarm system, in which on the wall of a structure to be protected is an inertia-type transmitter, but responsive to vibrations imparted to the wall. A. F. Bennett, and C. E. Mitchell, assigned to B.T.L. Inc. No. 1,792,479.

**Wireless-controlled aerial torpedo.** A patent filed December 18, 1917, renewed February 23, 1928, containing 56 claims involving an aircraft and a means of



# What a Whale of a Difference a Few Cents make

to paraphrase this popular slogan, CENTRALAB Volume Controls do cost more.

But it is hardly possible to build for less a control that embodies the exacting specifications, the painstaking care, the fine engineering skill that make CENTRALAB CONTROLS a necessary part of millions of modern radios.

When dealers predicate the purchase of a line with a definite demand that it be CENTRALAB equipped, it is safe to assume that "such popularity must be deserved." More than twenty million

## Centralab

### Volume Controls

have been built—a real tribute to *quality*—a splendid testimonial to the desire of the radio set manufacturer to give their public the best.

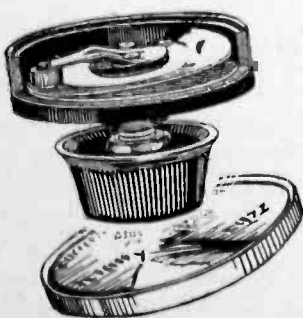
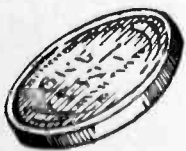

**MAIL COUPON NOW**

Central Radio Laboratories  
 940 Keefer Ave., Milwaukee, Wis.  
 Enclosed find 25c. for which send me new  
 VOLUME CONTROL GUIDE.

Name .....

Address .....

City ..... State .....  
 Electronics

## PATENTS—

changing its direction after having traveled a pre-determined distance, from some distant point. E. A. Sperry, assigned to Sperry Gyroscope Co. No. 1,792,937.

**Regulator system.** A vacuum tube detector has impressed on its input a potential from a condenser proportional to the rate of change of a dynamo electric machine which is to be regulated. E. C. Manderfeld, assigned to B.T.L. Inc. No. 1,792,650.

**Magnetic properties test.** A-C. circuit tuned to operate on the slope of its resonance curve, modifying the tuning of the circuit by exposing the material to be tested to a flux field linked with the circuit and determining the resulting change in tuning due to this exposure. J. T. Serduke, assigned to G. E. Co. No. 1,792,249.

**Electrically-driven fork.** A vacuum tube amplifier for driving a tuning fork. A. M. Curtis, assigned to B.T.L. Inc. No. 1,792,630.

**Protective arrangement.** At one point in an electric circuit, a generator and modulator are provided. Modulations are in accordance with the characteristic of the circuit at this point. At another point the carrier wave is demodulated and circuit-controlling means are operated by the modulation. A. F. Fitzgerald, assigned to G. E. Co. No. 1,792,291.

**Magnetic testing.** A method of testing a magnetizable body. Carl Kinsley, assigned to Magnetic Analysis Corp., Long Island City, N. Y. No. 1,790,819.

**Train control system.** Alternating current is supplied to a track wave. By means of vacuum tubes, it is possible to determine if the harmonics of this wave are retained in the wave form, or if they are suppressed. A. G. Williamson, assigned to Union Switch & Signal Co. No. 1,791,780.

**Gaseous discharge tube.** Method of producing light of different colors by the generation of a positive column in a gas tube. The tube contains at least one rare gas and one vapor, and has an inner-diameter gradually increasing from

one end to the other. Gustave Zecher, Eindhoven, Netherlands. No. 1,792,347.

**Train control system.** An indirect pick-up circuit on the car under control, and a direct pick-up circuit controlled by the second circuit, both circuits using vacuum tubes. A. G. Williamson, assigned to Union Switch & Signal Co. No. 1,791,779.

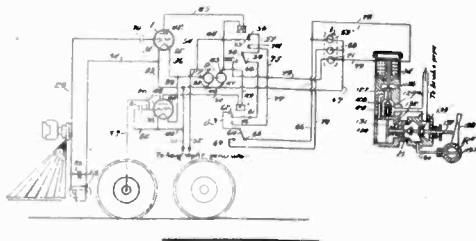

**Circuit breaker.** Method of connecting a condenser across the contact of a switch to reduce the discharge current. Bertram Wellman, assigned to G. E. Co. No. 1,792,340.

**High frequency testing apparatus.** Method of testing a winding on an electrical machine by impressing a high-frequency voltage upon the winding, adjusting the constants of the circuit, including a second winding, to make the circuit resonant to this frequency, and observing the value of current. J. F. Peters and John L. Rylander, assigned to Westinghouse E. & M. Co. No. 1,792,320.

**Storage battery charge control device.** Combination of relays, rectifier tubes, etc., to control the charge of storage batteries. F. G. Beetem, Philadelphia, Pa. No. 1,791,156.

**Apparatus for determining the force of gravity at sea.** Combination of a torsion and gravity pendulum oscillating at its natural periods. Light is reflected from two mirrors on the pendulum into a telescope and thence into some light-sensitive device. H. C. Hayes, Washington, D. C. No. 1,792,013.

**Facsimile transmission.** A method of illuminating the picture surface, separating it into units and transmitting it. R. H. Ranger, assigned to RCA. No. 1,789,687.

**Party line signalling system.** Two oscillators, super-impose alternating currents of inaudible frequencies on a calling telephone line. Means are provided

for connecting the two oscillators to the line to produce an audible beat note, indicative of the class of the calling line, for instance of various kinds of coin. Maximilian Mathias, assigned to Siemens & Halske, Berlin, Germany. No. 1,792,651.

**Control system.** Two photocells connected so that the currents produced by them are in opposition, are used to control relays when light is shut off from one of the cells, and disturbs the balance. W. R. Whitney, assigned to G. E. Co. No. 1,794,222.

**Optical micrometer device.** Patents granted to Malcolm Parkhurst and assigned to Brown & Sharpe Mfg. Co., Providence, R. I. No. 1,794,340, and 1,794,341. The process involves using a light ray, focussing method, photo-electric cells, amplifiers and recording meters for facilitating the use of micrometers.

**Thermo-static control system.** When the mercury in a thermometer rises to a certain height, contact is made so that the grid of a vacuum tube has its bias potential changed, thereby closing a relay in the plate circuit and heating or decreasing the heat in the crystal chamber. Alfred Crossley, assigned to Federal Tel. Co. No. 1,791,804.

**Electrical musical system.** Several oscillators, corresponding to several notes of the musical scale, a method of combining frequencies to produce chords, and filters for varying the tone quality of the combined frequencies. F. E. Miller, New York, N. Y. No. 1,791,319.

**Infra-Red railway signalling system.** On the train is a receiver comprising a pick-up coil at the focus of a mirror. The heating effect of this coil changes the potential on a vacuum tube grid circuit, and operates tuned relays for safety devices. Fritz Schröter and Fritz Michelssen, Berlin, Germany, assigned to Telefunken. No. 1,791,938.

**Magnetic material.** Material including nickel between 10 and 80 per cent; cobalt, between 5 and 80 per cent; iron, between 9 and 50 per cent, heat-treated to have desirable magnetic properties with small magnetizing forces, and including from a substantial quantity up to 12 per cent chromium. Gustaf W. Elmen, assigned to B.T.L. No. 1,792,483.

## Soviet Russia's "five year plan"

[Continued from page 549]

makes it essential to extend the radio network to all agricultural centers, not only for amusement and educational purposes but as a means of keeping the collective farms informed of plans and results throughout the country.

"Local broadcasting stations are responsible for working out programs and ascertaining the special interests of the local population. The main programs comprise special items for workers, peasants, women, youth and army organizations, etc. Musical programs alternate with general political programs, news, lectures in foreign languages, talks on health, etc. In addition to the special programs, there are those of a general artistic nature—orchestras, singing, etc.

"As a result of the widespread desire for education among the working masses, a special section for home-study courses has been established at the various radio centers. The so-called radio universities are organized

on a large scale. There is also a large department which handles correspondence from listeners-in with suggestions for improvements, etc."

Russia is not a party to the Washington Radiotelegraph Convention of 1927, which set aside certain bands of frequencies for certain services, and so presumably has the whole range of radio frequencies at its disposal. On the whole, however, the Russians have adhered to the long, intermediate and short-wave bands set aside for broadcasting purposes that are used in other countries in conformity with the treaty. Russia was not invited to the Washington conference because the host government, the United States, was not on diplomatic terms with the Soviet regime. It is significant to note that, though diplomatic relations still do not exist between this country and Russia, the American delegates at the recent international radio engineers conference at The Hague were thrown together most intimately. At the next conference of the engineers to be held in Copenhagen this year, American and Russian technicians will find themselves presumably, with the same technical objectives in view.

# A PLATFORM FOR AMERICAN BUSINESS



*A Statement of Underlying Principles  
with some Practical Suggestions to  
Guide in Planning Future Progress*

PRESENTED BY MCGRAW-HILL PUBLISHING COMPANY, INC.

**T**HE BUSINESS DEPRESSION of 1930 was no mere passing episode. The appalling loss and suffering entailed have struck home the more forcibly because they followed a period of unparalleled prosperity in a country that still possesses vast wealth and abundant resources. As a result of its duration and severity, the depression has shocked business, governmental and social agencies into commendable activity for the relief of human suffering and distress.

But, what is more significant for the future, it has also aroused an insistent demand for a searching analysis of the weak spots of the business and economic systems under which such a calamity was possible. It is an encouraging sign that men are beginning to question whether these recurring periods of boom and depression are not preventable; whether it is possible under better management to insure greater security to all classes of people who are willing to work; whether their faith in American achievement and standards of living can be preserved.

Evidence is multiplying that these questions can be answered in the affirmative; that this challenge to the American business and economic systems can be met in such a manner as to justify our confidence in them. Instead of regarding business depression as a storm to be weathered or a condition that must be endured and allowed to "work itself out," thinking men are beginning to look

upon it as an economic plague that can be averted and wiped out by preventive measures. Sentiment is stirring in favor of doing something about it, heeding the warning of our latest experience and preparing actively to meet the issue it raises.

It is the responsibility of the business press to crystallize constructive policies and to encourage progressive leadership. Therefore, the McGraw-Hill Publishing Company desires to do its part in helping to clarify the situation and to stimulate thought and action. It believes in the philosophy of individual enterprise and cooperative effort on which American achievement has been based. And it has confidence in the ability of American management to recognize and adopt sound economic principles as a basis for constructive business policies. But it is equally certain that only by conscientious effort on the part of each business unit, large or small, can American business as a whole return to normal and pursue a steady course.

**P**LANNING IS ESSENTIAL for uninterrupted progress. To assist in such a program the McGraw-Hill Publishing Company offers through its publications the following principles and practical suggestions as a guide in formulating individual plans. They are not presented as a ready-made formula for success, but as a foundation on which business can be built with some protection from the shocks and dislocations that have plagued it.

money may be placed in capital expenditures—modernization, research for development, new patents, etc.

**B.** Each business enterprise has a responsibility to aid in the development of regional and national resources.

### Development of National Resources

- (1) Encourage and cooperate in the coordination and promotion of the economic area in which you are located through constructive programs for the improvement of agricultural, commercial, industrial and community development. (*Example*—New England Council.)
- (2) Assist in the work of national associations devoted to the improvement of business ethics, the promotion of higher standards in the commercial, industrial, financial and political administration of the country, and the simplification of the laws governing business. (*Example*—Chamber of Commerce of the United States.)

## IV—Maintenance of World Business

Probably the greatest potential market for present and future American products lies in that foreign field represented by the present difference between the living standards of the American public and those of a billion and a half people in many other countries. Any slight increase in the living standards of these vast populations will bring immediate benefits to American manufacturers, as the largest producers of those commodities contributing to labor saving and luxury.

**A.** Support cooperative studies and formulation of world policies among business interests through international business organizations on such subjects as —

### International Business Cooperation

- (1) World tariffs.
- (2) Trade discriminations.
- (3) International movement of capital.
- (4) War debts and reparations.

**B.** Promote uniformity in foreign trade practice by encouraging coordination among organized industries.

**C.** Carry this long term planning into sales control, involving distribution methods, sales forecasting and pricing.

### Sales Control

- (1) Revise present methods of distribution and service to conform to the best interests of the customer. (*Example*—establishment of retail stores by mail order houses.)
- (2) Prepare sales forecasts by products and by markets with regard to competition. (Leading institutions have found that modern sales forecasting can be correct within 2 to 3% for a year ahead and within 5 to 15% for three years ahead.)
- (3) Know costs and stop selling at a loss. Maintain firm minimum prices based on production costs. (Business history shows a high degree of prosperity among those companies, large or small, which have had the courage to stand on a minimum price that insured a profit.)
- (4) Plan sales organization, sales program and advertising on at least a three-year basis.

**D.** Plan for uniform production as far ahead as possible on the basis of sales requirements already determined.

### Production Modernization

- (1) Modernize and replace every existing production facility, including plants, factory and office equipment and methods where it is possible to effect cost reduction and greater production flexibility. (Stores, banks, and offices have a production problem no less than factories.)
- (2) Do not expand production facilities in the mere hope for lower costs through larger production, but only where the long term forecast shows the necessity for additional facilities.
- (3) Base purchase of materials, supplies and equipment upon the marketing and production program for the three-year period and make purchases as far ahead as practicable.

**E.** Stabilize financing. Working capital requirements for labor and material, and business capital requirements for development and expansion, can be determined with reasonable accuracy for a period ahead by long term planning.

### Financial Policies

- (1) Do not depend permanently upon bank credit for purposes other than short-term loans for current working capital. (In the interim partial payment financing of equipment, etc., is widely accepted as sound business practice.)
- (2) Raise needed fixed capital requirements by bond or stock issues whenever reasonably advantageous.
- (3) Invest surplus in short-term commercial paper or good bonds rather than employing it in call money or for purely speculative purposes.

Many of America's soundest corporations have adopted these financial policies.

## GENERAL OBJECTIVES

*The following general objectives are fundamental in planning sound business developments:*

### 1. Maintenance of Established Standards of Living

The belief that there is danger of a general over-production of wealth, that technical development necessarily involves unemployment, or that standards of living cannot be indefinitely increased is an economic fallacy. American business should not yield to it in any of the policies it

pursues. Rather it must protect and preserve our economic standards and social traditions by maintaining high purchasing power and regularity of employment and dividend disbursements, based on more stabilized methods of management and financing made possible by long-term planning.

**RECOMMENDATION:** Conserve and add to the gains achieved in the past ten years through technical advance, improved forms of industrial organization and methods of management, and new devices for financing industrial and market expansion. Increase efficiency in the economic production and distribution of goods and services so as to facilitate their widest possible consumption and thereby raise the standard of living of the American people.

### 2. Stabilization of Future Business Growth

So long as there are wide fluctuations in business and in price levels, the gains to some groups are cancelled by losses to others and there is no net gain to the country as a whole. The interests of the speculative and creditor groups should be subordinated to the interests of those concerned with the production and distribution of goods and services. The latter should have a larger measure of leadership in business policy to insure sound and lasting prosperity.

This leadership can be exercised only by a more deliberate process of long term planning and

organization for the direction and development of business operations. Such effort involves market analysis, sales control, product development, modernization of factory and office methods, foresight in purchasing, long-term financing of fixed capital requirements and a stimulated program of capital investment in 1931 for the restoration of business volume. All this must be supported by broader policies of coordination within the industry or trade, cooperation with labor and participation in the organized development of regional and national resources.

**RECOMMENDATION:** Direct individual and organized effort to check excessive and unbalanced industrial and financial expansion, and prevent wide changes in price levels. This will remove the incentive to speculative gain, avoid conflict of creditor and debtor groups, and promote confidence in long-term investment and borrowing. It will also encourage productive and commercial enterprise, maintain a steady increase in consumer purchasing power and stabilize business progress.

### 3. Promotion of International Business Cooperation

The world is economically interdependent. Though the United States is the dominant factor in world prosperity, she cannot maintain or increase her own prosperity indefinitely without sharing it with the world, nor can her business system survive unless, by sharing its benefits, the other nations of the world can preserve their faith in it. This calls for a more active policy of interna-

tional cooperation on the part of American business to assist in the gradual reduction or removal of unnecessary trade barriers that interfere with the natural exchange of goods and services between peoples, the development of a more stabilized international mechanism for the movement of capital and control of credit, and the revision of war debts and reparations.

**RECOMMENDATION:** Support individual or organized effort to promote cooperation among business and financial interests of the United States and other countries, in order to facilitate the normal international movement of goods, services and capital, and thereby enhance economic stability at home and elevate standards of living abroad.

#### 4. Encouragement of Private Initiative and Responsibility vs. Extension of Governmental Activity

American business should encourage self-government. It has already shifted enough of its responsibility and thereby yielded enough of its initiative to government and must stand its ground against further extension of governmental action in matters in which it can assume responsibility itself.

The essential function of government is to keep clear the field of economic activity for private business initiative and to assure a basis of fair and

equal competition in domestic and foreign trade. It should refrain from competing with any kind of business itself. It should facilitate and encourage the development of necessary controls upon business through organized self government. It should safeguard the economic stability of the country by maintaining stability in its own fiscal and international policies. It should reduce to the minimum the number of laws affecting business.

**RECOMMENDATION:** Oppose governmental regulation, control or expenditure which tends to limit or weaken private individual initiative or cooperative effort, or to diminish the responsibility of the individual business concern or organized industry, for the accomplishment of the objectives stated above.



### RESPONSIBILITY FOR ACTION

This course of action for (1) the maintenance and elevation of American standards of living, (2) the stable development of American business, (3) the promotion of international cooperation and (4) the restriction of governmental encroachment

upon private initiative and cooperative effort cannot be carried out without the earnest participation of individuals and organized groups representing all types of business and industrial activity.

*Upon the following major groups the main burden of responsibility rests:*

**A. Industrial and Business Management:** A few thousand business concerns in this country employ the bulk of the wage-earners, originate most of the consumer income, and produce the chief part of the goods and services that determine the standard of living. Upon the management of these concerns therefore rests the main responsibility for action that will:

- (1) Formulate long-term plans for research, production, distribution, purchasing and financing.
- (2) Support cooperative effort through industrial, trade and commercial organizations.
- (3) Maintain wage scales that permit a high standard of living and purchasing power.
- (4) Maintain and equalize employment by adjustment of working hours.
- (5) Establish a reserve to protect the security of employment in times of reduced production.
- (6) Establish and maintain stable prices.
- (7) Maintain reasonable, stable dividends, conserving surplus accumulated in periods of prosperity for such use in slack times.

**B. Industrial, Trade and Commercial Organizations:** The power of business units is multiplied and their leadership is strengthened by vigorous, intelligent and far-sighted trade organizations. Through them it is possible to carry the foregoing principles into action on an industry-wide basis, which is necessary to their realization in each industry as a whole and to the even balance among all industries requisite to stable progress. They should cooperate in:

- (1) Collection of data on costs, stocks, production, potential productive capacity and market conditions.
- (2) Interchange of credit information.
- (3) Development of codes of practice.
- (4) Establishment of standards of employment salaries and wages within the industry.
- (5) Development of opportunities for stabilizing business.
- (6) Study of market development.
- (7) Economic development and use of natural resources.

# A CHECK SHEET

## of Practical Suggestions

### for Planning a

# Company Program

### I—Long Term Planning of Business Operations

**A.** Definitely abandon the yearly period as the basis for business operations, except in accounting matters.

(1) Project business policies and planning, wherever possible, upon a three-year period or longer as a unit.

**B.** Initiate research from the customer's standpoint to determine:

(1) To what extent established lines should be replaced, improved or simplified.

(2) What additional markets can profitably be penetrated with these lines.

(3) What new products can logically be added for present and new markets

**Analyzing  
the Business**



## II—Coordination with Industry or Trade

**A.** The success of long term planning for an individual business is multiplied and secured when similar policies are established throughout the industry.

- (1) Aid in the establishment and share in the active development of an industry, trade or commercial organization —
  - (a) to collect data on costs, stocks, production, potential productive capacity and market conditions.
  - (b) to interchange credit information.
  - (c) to develop codes of practice.
  - (d) to take full advantage of legal trade cooperation.
- (2) Cooperate to establish standards of employment, salaries and wages within your industry. (Labor is particularly susceptible to advantages offered by a business where long-term planning gives stable employment.)

## III—Promotion of National Prosperity

**A.** The net profits of a modern business depend not only on its own activities but on sustained business stability throughout the country. There is a vital responsibility upon each business enterprise to do its share to provide national stability of purchasing power through —

- (1) A policy for employment.
  - (a) Establish a minimum payroll based on the planned program of production and sales and consider this minimum payroll as a fixed charge on the business. (*Example*—the Procter & Gamble plan.)
  - (b) Maintain a salary and wage scale that permits a high standard of living and thus of purchasing power.
  - (c) In slack periods, preserve the organization of trained personnel by reducing hours of work per man rather than reducing number of employees.
  - (d) Set up a reserve to protect the security of employment in times of reduced production.

### Stabilization of National Purchasing Power

- (2) A policy for dividends.
  - (a) Resist the temptation to pay out excessive sums in dividends in boom times. Rather place excess earnings in reserve and do not hesitate to use this reserve in slack times to maintain national purchasing power through dividend disbursements. (*Example*—U. S. Steel Corp. policy.)

**C. Banking and Financial Institutions:** Next to the will and intelligence of individual and organized business, the most important factor in achieving the four objectives of this platform is the understanding and cooperation of the banking system in checking excessive inflation in times of prosperity and excessive deflation in times of depression. In the exercise of this function, business itself may well expect banking and financial institutions to:

- (1) Require business management to think in terms of long-time planning where financial assistance is provided.
- (2) Encourage corporations to accumulate substantial reserves in good times to be used in slack times for development and dividends.
- (3) Discourage the extension of excessive credit in periods of unusual prosperity and in like measure facilitate legitimate credit in times of stringency.
- (4) Assist in the promotion of mergers where real benefits can be obtained but oppose the merging of corporations for stock selling purposes.
- (5) Lead in the development of international financial cooperation.

**D. Labor:** Stability of industrial and business operations requires a sympathy by American workers with the policies expressed in this platform, and a willingness to cooperate in making them effective. Responsibility rests upon labor as well as upon management if the worker is to enjoy the benefits of our business system. To this end labor should actively support these principles:

- (1) That increased wages are dependent upon increased efficiencies in production and distribution.
- (2) That business must be conducted profitably if labor is to enjoy higher standards of living.
- (3) That employers operating on a program of long-time planning provide the maximum stability of employment.
- (4) That labor should demand of their leaders an understanding of sound business principles.
- (5) That the welfare of labor will best be served by recourse to arbitration and the avoidance of industrial strife.
- (6) That the development of international trade is essential to domestic prosperity.
- (7) That the extension of governmental activity hampers business in assuming its social responsibilities.

**E. Government:** The essential function of government is to keep clear the field of economic activity for private business initiative and to assure a basis of fair and equal competition. It can best promote sound economic development through these policies:

- (1) Refrain from competing with any kind of business itself.
- (2) Encourage the development of the necessary control of business through self-government rather than by legislation.
- (3) Safeguard the economic stability of the country by maintaining stability in its own fiscal and international policies.
- (4) Exercise the greatest economy in public expenditures.
- (5) Reduce to a minimum the number of laws affecting business.
- (6) Cooperate with foreign nations for the fullest development of international trade.



## AND IN CONCLUSION

**T**HESSE RECOMMENDATIONS can have value only as they are applied in the planning of individual company operations and in the programs of those industrial, commercial, financial and governmental agencies that are responsible for the conduct of our economic affairs. But taken broadly they constitute a platform of economic principles and business policies upon which far sighted management may well make a stand.

New conditions of our modern industrial civilization have laid new social responsibilities upon those men who guide the destinies of business enterprise. The protection of the welfare of workers and their security of employment and the assurance of permanent income to investors have become basic factors in the attitude of public opinion towards industry. And public opinion in the end has the power to preserve or to curtail that freedom of initiative around which the whole philosophy of American life has been organized.

Business management must meet the call of these responsibilities, therefore, if the people of

the world are to be lifted out of the present depression and given assurance of greater stability of earning power in the future. Business leadership itself must strengthen and secure the success of this system of private initiative and cooperative effort upon which the prosperity of this country has been founded and of which it stands today as practically the sole exponent.

This proposed platform is being presented to American business through McGraw-Hill publications reaching into nearly every major industry in the country. It will be developed and interpreted editorially as a guide to the formulation of individual plans and business policies.

**A**S A FURTHER AID in that direction the reader will find within this supplement a check sheet of practical suggestions. Many of them are known to be practised by successful, well managed business concerns. It is believed that they will be of value and assistance to all American businessmen in planning for future progress and prosperity.