

*W. Schaffer*

# electronics

electron tubes—their radio, audio,  
visio and industrial applications

radio  
sound pictures  
telephony  
broadcasting  
telegraphy  
carrier systems  
beam transmission  
photo-electric cells  
facsimile  
amplifiers  
phonographs  
measurements  
receivers  
therapeutics  
television  
counting, grading  
musical instruments  
traffic control  
metering  
machine control  
electric recording  
analysis  
aviation  
metallurgy  
beacons, compasses  
automatic processing  
crime detection  
geophysics

## The future of the electronic art:

Thomas A. Edison      H. P. Davis  
Dr. Lee DeForest      Dr. W. R. Whitney  
J. Ambrose Fleming      Dr. F. B. Jewett  
Dr. Robert A. Millikan

The power pentode:      B. V. K. French  
Sound-picture problems:      Dr. A. N. Goldsmith  
Tuned rf. amplifiers:      Dr. Louis Cohen  
Photo-electric cells:      Dr. H. C. Rentschler  
Magnetic storms:      Dr. A. E. Kennelly  
High frequency fields:      W. C. White  
Ocean telephony:      Dr. H. E. Mendenhall  
Electronic measurements:      J. W. Horton  
Tubes in industry:      S. M. Kintner  
Beyond the electron:      Dr. Vladimir Karapetoff



A MCGRAW-HILL PUBLICATION

APRIL 1930



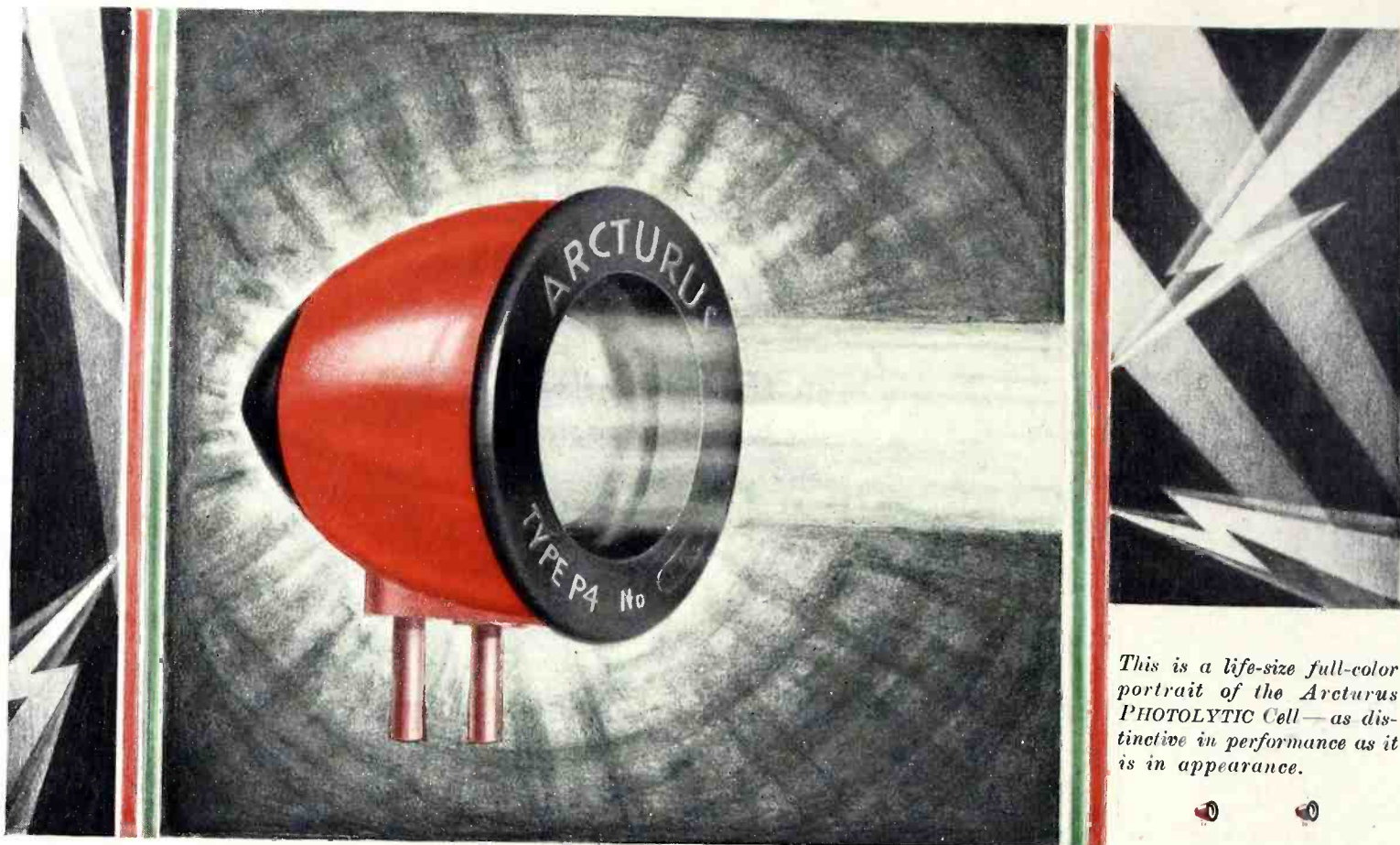

This is a life-size full-color portrait of the Arcturus PHOTOLYTIC Cell—as distinctive in performance as it is in appearance.



**Features of the PHOTOLYTIC Cell**

- 1—More uniform frequency response.
- 2—Low coupling impedance.
- 3—No background noises.
- 4—No excitation or adjustment required.
- 5—Shock proof and non-microphonic.
- 6—Exceptional resistance to overloads.
- 7—Easily applied to any photo-electric circuit.
- 8—Long life unsurpassed by ANY cell.

**NEW in Design...ADVANCED in Principle**

**FAR MORE EFFICIENT in Action**

**E**VERY engineer, every manufacturer of electrical apparatus, every person directly or indirectly interested in any type of equipment using the photo-electric principle, will be vitally interested in this first announcement of an extraordinary photo-electric device—the *Arcturus Photolytic Cell*.

In developing this advanced cell, Arcturus has done far more than improve existing designs. Arcturus has pioneered with a fundamentally new type of cell, based on revolutionary principles never before applied successfully to photo-electric equipment.

In uniformity, accuracy, and speed of response, the Arcturus *Photolytic Cell* establishes new operating standards. It

# ...Arcturus PHOTOLYTIC CELL

far outdistances the average life span of the best present-day cells. Its efficiency is unimpaired by any overload. And because new principles make possible a basically new design, this cell is so durable, so rugged, that it is unharmed by shocks that instantly destroy the fragile glass-bulb cell.

Seldom in the swiftly changing history of electronic research has any product been offered that represents such a radical improvement over existing devices. Yet this remarkable low

impedance cell, so far advanced, can be used in *every* circuit now controlled by standard cells with but a few minor changes that actually *simplify* the system.

We are confident that the new performance of the Arcturus *Photolytic Cell* will open new possibilities in a field that seems already limitless. But these statements are best proved by an actual comparison of this and other photo-electric cells. Write the Photo-Electric Division, Arcturus Radio Tube Co., Newark, N.J., for complete information.

For the Improved Operation of  
Sound Picture Equipment;  
Sorting, Checking, and Matching  
Equipment; Railway and  
Highway Signal Systems;  
Chemical and Medicinal Analysis;  
Burglar Alarms; and  
dozens of other mechanical  
and electrical devices. . . .



# ARCTURUS

## PHOTOLYTIC CELL

*The Electric Eye for Every Industry*

© 1930 A. R. T. Co.

PRODUCT OF ARCTURUS RADIO TUBE COMPANY . . . MAKERS OF ARCTURUS BLUE TUBES









The Allen-Bradley plant, private sub-station and electric furnace building face upon four streets, assuring daylight in all departments.

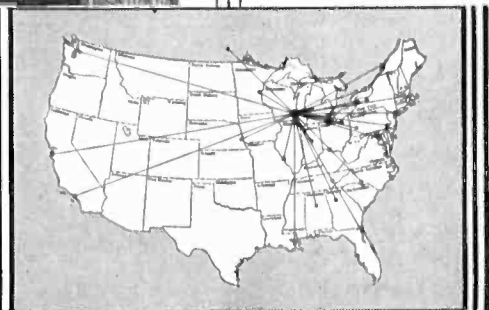
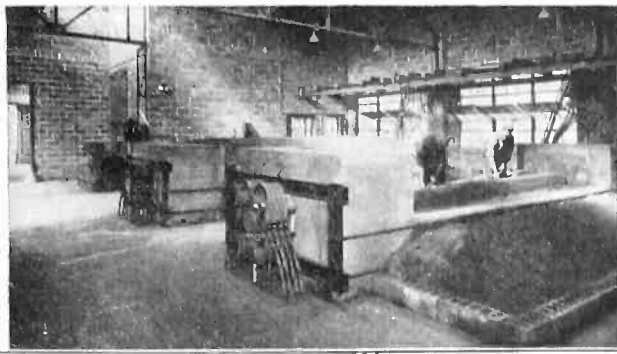

Sales offices are located in all leading cities. Consult your nearest Allen-Bradley district office.

# There's a Big Plant and 25 Years of Resistor Experience

back of the huge production and uniform quality of Bradleyunits

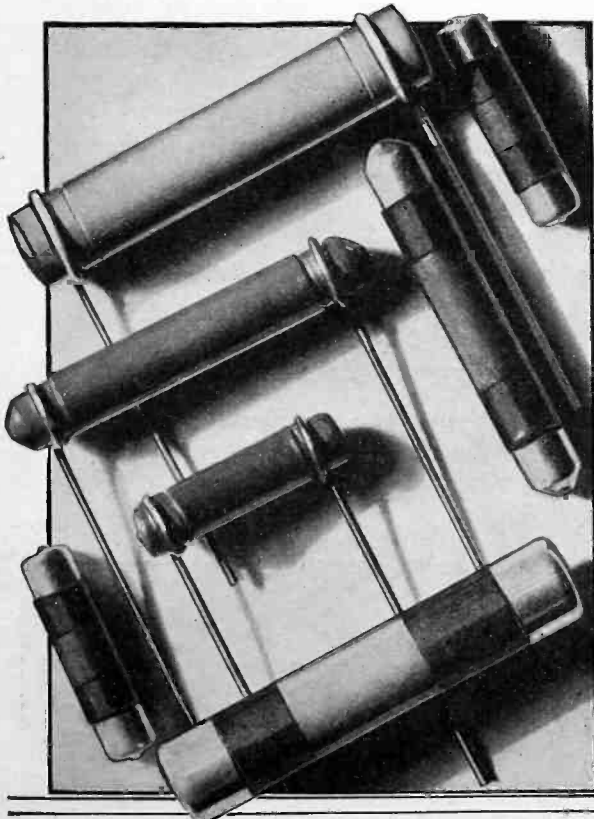

WHEN radio was popularized, a few years ago, the Allen-Bradley organization had already achieved distinction as producers of electric controlling apparatus and resistors. To meet the demand, at that time, for a reliable filament rheostat, millions of Bradleystats were sold to radio manufacturers and amateur set builders.

Today, Allen-Bradley Fixed Resistors—Bradleyunits—are used by the world's largest set builders.

Floor after floor of automatic machinery and precision testing equipment, under the supervision of skilled engineers, produce Bradleyunits in stupendous volume. Such facilities are your best insurance of a continuous supply of reliable resistors to meet your specifications.

ALLEN-BRADLEY CO., 278 Greenfield Ave., Milwaukee, Wis.

## ALLEN-BRADLEY RESISTORS

Produced by the makers of Allen-Bradley Control Apparatus

**THE  
SOURCE  
OF  
SUPPLY**

*for*  
**Molybdenum**  
(99.95% pure)

**Tantalum**  
(99.9+% pure)

*Also several standard  
and special alloys for  
use in vacuum tubes.*

Fansteel metals and alloys are available in bars, rods, sheets and wire. For the convenience and protection of users, all Fansteel wire is furnished on special Bakelite spools which fit all standard machines. Each spool, packed in a separate carton, is labeled plainly to identify the metal, its length, diameter and other characteristics. The carton displays the same information.

No purer Molybdenum can be obtained than Fansteel Molybdenum, made from American ore by American methods. Fansteel "Moly" is uniform and dependable—chemically, physically, electrically.

For many forms of tube work, no metal has so many advantages as Tantalum, with its ease for forming and welding, its gas absorbing properties, and its extremely low vapor pressure. The use of this metal in common receiving tubes is justified despite its slightly higher original cost.

*Write for full information  
and prices.*



*Fansteel wire doesn't get "mixed" in stock. Carton and Bakelite spool are both plainly labeled.*

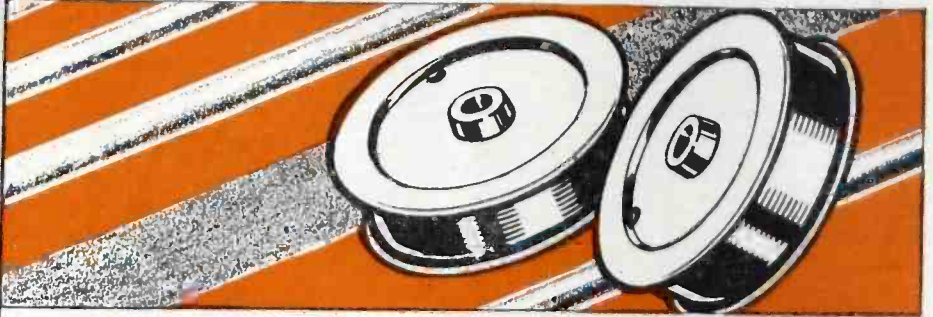

## Improve Your Tubes

*with*

# FANSTEEL WIRE AND METALS

When tubes go bad, it is often because the metal has failed to retain its shape, failed to live up to its requirements, failed to fulfill the purpose for which it was bought.

Use of Fansteel Tantalum, Molybdenum, and alloys makes for improved, more dependable tubes—rejections are held down, tubes perform better, they're easier to sell, and they *stay sold*.

This is because Fansteel metals are refined especially for use in tubes. Strict laboratory control guards every step in the process. Uniform purity, uniform dimension, uniform physical characteristics are assured.

*Samples of Fansteel metals furnished to tube manufacturers—better still, ask for a Fansteel engineer to call.*

**FANSTEEL PRODUCTS  
COMPANY, INC.  
North Chicago, Illinois**



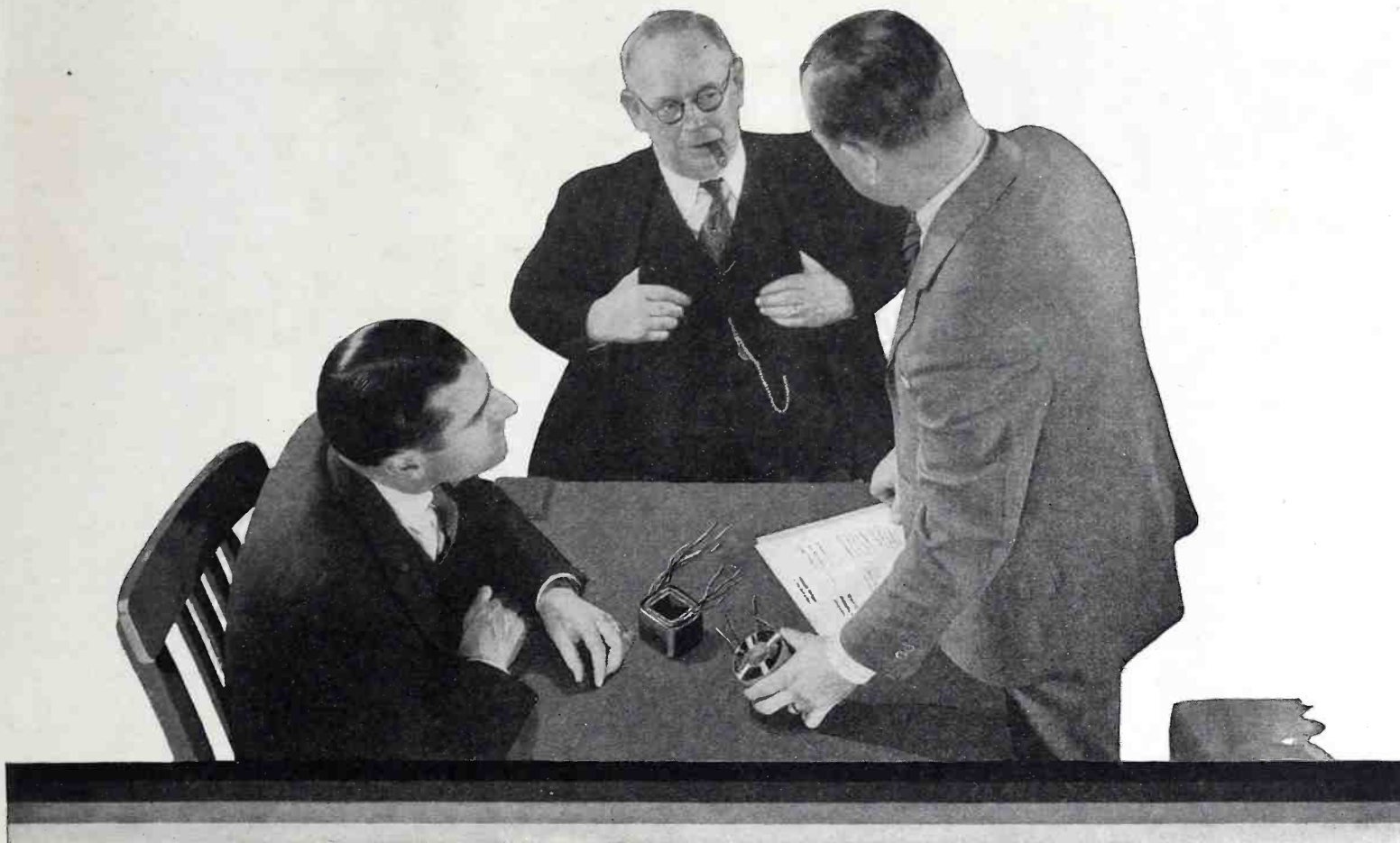

## When the Coil's **IN CONFERENCE**

When the coil's up for consideration in a radio factory, it faces a *real* inquisition. Here "quality" is only one factor out of half a dozen with which it is confronted. The purchasing agent demands uniformity . . . he visualizes ideal coil shipments in which there are no rejects. The engineer demands accuracy, adherence to specifications, and able engineering assistance.

The General Manager, with an eye toward economy, wants the cost kept down without sacrificing quality. Altogether a tough proposition, and one that only a *good* coil would want to tackle. The fact that Dudlo coils have become standard in the country's finest receivers is conclusive evidence of their ability to pass the demands of any conference.

# DUDLO

DUDLO MANUFACTURING COMPANY, FORT WAYNE, INDIANA

Division of General Cable Corporation

# Welcome Electronics!

THE leaders of the tube industry congratulate the McGraw-Hill Publishing Company on its foresight and leadership in launching this new publication, Electronics.

But a few years ago the radio industry was an infant. Now we are on the verge of opening the markets of another industry, employing radio principles, but bidding to outshine the radio broadcast field in importance and size. The magazine Electronics should be the leader in this new field, because of the McGraw-Hill Publishing Company policy of service. The RCA Radiotron Company will continue its position of leadership, a position merited through the maintenance of a high quality product and service.

*RCA Radiotron Company's Research Laboratories  
and Engineers to develop the field*

NO order is too large for the RCA Radiotron Company to fill—no problem too difficult to solve. With six factories located at Newark, Harrison, Cleveland, and Indianapolis, the RCA Radiotron Company is the largest producer of electron tubes in the world.

At the present time these factories provide 1,050,000 square feet of floor space, employ 6,100 people and have an installed daily output of 270,000 tubes. And as industry increases its demands, we are ready to expand to take care of them.



RCA RADIOTRON CO., INC. HARRISON, N. J.





T. W. FRECH  
*President*

G. C. OSBORN  
*Vice-President  
in Charge of Sales*



W. T. L. COGGER  
*Vice-President in  
Charge of Manufacturing*



MEADE BRUNET  
*Sales Manager*



F. H. CORREGAN  
*Secretary and  
Treasurer*



W. H. THOMPSON  
*Sales Operation*



J. W. McIVER  
*Manager Sales Promotion  
and Advertising*

AND now the RCA Radiotron Company, with its staff of engineering and manufacturing experts stands ready to serve a new industry. RCA Radiotron Research Laboratories welcome new problems. Many of the developments of RAC Radiotron engineers are years ahead of their application and the market. We are ready with the product—the industry has but to make the application.

Backed by the broad research facilities of the General Electric Company, and the Westinghouse Electric and Manufacturing Company as well as the Radio Corporation of America, places the RCA Radiotron Company in a superior position for the scientific and commercial development of the field of electronics.

We cordially invite you to bring your problems to the RCA Radiotron Company where a staff of trained and experienced engineers and scientists are at all times waiting and eager to render service.

# RCA Radiotron

*THE HEART OF YOUR RADIO SET*



## Many things to many different men . . .

SIXTY below . . . an airplane, part of the equipment of the Byrd Expedition, flying at 120 miles an hour, roaring over the frozen wastes of Antarctica. In the cabin of this plane—radio—tubes, coils, condensers—forty pounds of “gadgets” . . . streams of electrons—and the whole world hears the story.

“Reds”—a riot . . . the “talkie” newsman and his portable equipment of two hundred pounds of “what-nots”—tomorrow, in any one of a thousand theatres, we may “see and hear.”

MacDonald—“short radio waves”—a special radio hook-up, and at noon we hear words spoken in England at dusk. We actually beat the clock.

Man moves swiftly, communicates while in motion, yet “travels light.” Making these things possible—looking ahead from a background of efficiency, speed and light weight—are a few thousand “hopeful sceptics” . . . workers in the field of Electronics, men who live for science. Their language—graphs, curves, tests. Their enemies—corrosion, electrical losses, excess weight. Their gods—efficiency, low cost, light weight, ease of fabrication of the materials chosen to bring reality to their findings.

Working with equal precision, the research and development engineers of Aluminum Company of America have produced a series of light, strong Alloys of Alcoa Aluminum which possesses unique physical properties. All of these alloys are light—weighing approximately  $\frac{1}{3}$  as much as old-fashioned metals. When heat treated they attain a tensile strength equal to many heavy commercial steels—55,000 lbs. per sq. in. minimum. All of them are resistant to corrosion. All conduct heat 5 times faster than iron or steel.

Wherever mass is in motion, the Alloys of Alcoa Aluminum bring dead-weight reduction, cut power costs to the minimum—retain structural safety. Trains, with cars built partially of these Alloys, hum swiftly along the tracks of several leading railroads. Equipped with aluminum alloy pistons, our millions of automobiles flash over the highways. Made of these alloys, truck and bus bodies have their dead-weight reduced to a fraction. In all manufacturing, where light weight is a factor, strength a necessity and corrosion resistance desirable, the strong Alloys of Alcoa Aluminum are the ultimate answer.

A dependable source of supply and quick delivery is assured. We solicit your inquiries for Ingot; Sheet; Extruded Shapes; Rolled Shapes; Tubing; Forgings; Die Castings; Permanent Mold Castings; Sand Castings; Stampings; Screw Machine Products; Draw Press Products; Wire; Bar; Rod. All of the light, strong Alloys of Alcoa Aluminum—as well as commercially pure Alcoa Aluminum—are available in large or small quantities. ALUMINUM COMPANY of AMERICA; 2474 Oliver Building, PITTSBURGH, PENNSYLVANIA.

# ALCOA ALUMINUM





# electronics

A MCGRAW-HILL PUBLICATION

New York, April, 1930



## A clearing-house for facts— A camp-fire for counsel

**N**EARLY fifty years ago Edison made a discovery now recognized as the most epochal in all his eventful career. Working on his incandescent lamp, he found a faint stream of electricity from the hot filament, flowing *across the vacuum*.

► There the basic phenomenon of electronics stood revealed. But the great inventor was busy with many problems. And so, for a generation, the famous "Edison effect" remained a mere scientific curiosity. Finally, Fleming in England and DeForest in American harnessed this feeble electron action and put it to work—Fleming in his rectifying valve; DeForest in his revolutionizing three-electrode tube whose "grid" control opened up new worlds of possibilities in communication.

► The way once pointed, inventors, physicists and engineers rushed in, until today a far-flung army numbering thousands of workers is engaged in all the diverse fields of electronic applications, in laboratories around the world.

**A**LREADY billion-dollar industries are built upon the vacuum tube—in telephony, in radio, in talking pictures, and in power applications. Electronics revolutionized the first three. And in the power field it is now affording an entirely new engineering approach to electrical problems of every kind. For although the electrical engineering of the past was built almost wholly upon the single principle of electro magnetic induction, the electrical designer of today finds he now has a second string to his bow—electronics—and that in electronic apparatus he commands a medium *paralleling magnetic-induction in importance*, and its equal in wide adaptability, whether for control or for heavy-duty uses.

► All of these diverse applications of the electron tube will, of course, further expand and multiply. And a thousand *new* uses are coming in increasing volume. The engineering complexity of the situation grows. Specialists are working intensely in their own fields. New developments are coming from unexpected quarters. Chemistry and physics continually uncover new electronic methods and uses. One industry after another provides new ingenuities which can be used elsewhere.

**F**OR this vital, pulsing electronic art a clearing-house is needed—an engineering journal that will gather together these widespread activities; chronicle scientific and industrial advances abroad and here, and provide practical usable information which can be put to work. Such a journal must have scientific vision to look above and beyond the present; it must be courageous and devoted in its stand for progress and for expanding applications.

► And it must be independent in its editorial and publishing administration, giving due regard to the rights of established groups which have pioneered along the electronic path and prospered, and also to the rights and opportunities deserved by those independent inventors and developers who will help make the next decade even more brilliant and productive than the past. In short, *Electronics* must be a forum for discussion of all points of view—it must serve as a camp-fire around which all may gather for counsel and for exchange of the best thought of the electronic industries.

► The art of the electron tubes goes forward to great and greater achievements. To the engineers and executives in all the ramified branches of electronics, the editors and publishers pledge a service worthy of this field of unparalleled opportunity.

O. H. CALDWELL  
Editor

FRANKLIN S. IRBY, Ph. D.  
Associate Editor

KEITH HENNEY, M.A.  
Associate Editor

LEE DEFOREST, Ph.D.  
Consulting Editor

# THE FUTURE SERVICE OF

The editors present timely messages from seven great men who are shaping present developments in the tremendously

## By THOMAS A. EDISON



*Discoverer in 1883 of "the Edison Effect," the first-known evidence of electronic action in a vacuum*

I HAVE been asked by the editor of *Electronics* to answer the question "What will be the greatest service to humanity to be rendered by vacuum tubes?" To this question my reply can only be that such verdict belongs to the future.

Other questions put to me concern what future applications of electron tubes I foresee, in power transmission, in talking pictures, in chemistry, in medicine, in education? I am also asked whether we may not expect tremendously increasing powers and capacities in future vacuum-tube design and operation, just as in the past the powers of early lighting generators have been increased.

The applications are almost infinite with the three kinds of tubes. They open a field for research in physics, chemistry, electricity, heat and light, beyond imagination.

Improvement in rectifying tubes will, I feel, reach a point which will enormously simplify the transmission of power over great distances.

## By DR. LEE DEFOREST

*Inventor of the three-electrode vacuum-tube*

HAVING watched the first slow growth of the audion as wireless detector, amplifier of radio and telephone currents, and oscillator for almost any frequency, until at last it underlies the entire structure of radio, it is naturally a source of deep pride to observe its entrance into many other fields of man's activity and progress.

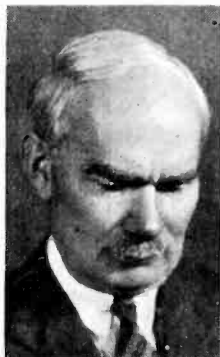

Now that 100 kw. power tubes are a reality of daily manufacture it requires no daring imagination to predict that in the field of power conversion and transmission the free electron confined in glass and copper will soon replace tons of electric generators. Direct-current high-tension transmission over unprecedented distances may be one result. And by contrast, oscillator tubes of minute dimensions will enable physicists to generate undamped wave-trains having frequencies approaching the infra-red; and supply new tools for autographing the electron and exploring inter-electronic space.

In the realm of Medicine new sciences of therapeutics and diagnosis, of gland and growth and life control, of bacteria culture and elimination, will be founded on man's new knowledge of the electron and his ability to harness its myriad frequencies in the cause of human health.

Similarly in Agriculture for accelerating plant growth, the elimination of pests, both plant and insect, we shall become

largely independent of seasons and climatic accidents.

In Aviation the electron will become man's faithful pilot ever at the controls, a piercer, or annihilator, of fog, and fending against blind accident. Likewise in Navigation at sea. In Industrial processes of many sorts, where today the electron is unknown, tomorrow it will serve as founder, laborer, and guide, in processes of smelting, welding, sorting, indicating, measuring—with an efficiency in time, results, and accuracy of which today we little dream.

Whereas in the fields of Communication and Television by radio and wire, for entertainment, education and culture, in school, theatre, and the home—its present great accomplishments are but vague hints, mere promises of the immeasurable benefits and transformations which the Electron and its Tube have in store—all for the betterment and peace of humanity, to make more easy the lot of labor, and to the enlargement and enrichment of life.

## By PROF. J. AMBROSE FLEMING

*University College, London, England  
Inventor of the thermionic rectifier*

[ BY CABLE ]

IN 1904 I invented the rectifying valve for wireless reception. It formed the starting point for great improvements, giving us wireless telephony and broadcasting. In large size it will be used in the future to rectify a.c. current for railway electrification and electrical transmission of power. In three- and four-electrode form, it is the essential element in talking pictures and television. Its employment in cable work will increase earning power by making possible multiple cable telegraphy. Perhaps even trans-Atlantic television will become possible.



## By DR. R. A. MILLIKAN

*California Institute of Technology, Pasadena  
The first experimenter to isolate and measure the electron*

THE Mergenthaler typesetting machine involves little more than levers and cams, physical devices invented thousands upon thousands of years ago—so enormous and so cumulative may be the influence upon the future of the introduction of a single new physical principle. No new physical appliance ever invented has found such a multitude of enormously important practical applications in so short a time as has the vacuum tube amplifier. This gives some slight indication of the magnitude of the influences upon the future of the race of the invention of the electron tube.





# ELECTRONICS TO MANKIND

pioneers and leaders who laid the foundations and  
expanding art and science of the vacuum tube

## By H. P. DAVIS

*Vice-President Westinghouse Electric  
& Manufacturing Co.*



I FEEL strongly that the whole subject of electronics is going to be very far reaching in its effects on the electrical industry, and that the vacuum tube has a great future not only in radio but in other fields than radio. In these applications vacuum-tube devices will take many forms other than the well-known and standard types we now know.

Meanwhile power ratings of electronic tubes are being increased at a rapid pace. Whereas in the development of the electric lighting art it was almost a generation before a 200-kilowatt generator was produced, yet in a few short years the once-feeble phenomenon of electron emission has been expanded to a scale of 200 kw. and larger, in a single tube. And we have only begun. Tubes have almost unlimited possibilities, it would seem, as rectifiers, converters, transformers, arresters, etc., on power lines and in industrial applications.

In the daily life of the world, during the next decade, electron devices seem destined to create changes as sweeping and revolutionary as those of the past 50 years.

## By DR. W. R. WHITNEY

*Vice-President General Electric Company  
Director Research Laboratory*



MOST scientists dislike predicting futures of anything. But I rather like to think that there is no end to the service which the application of electron tubes may bring about. In addition to what this journal calls the radio, audio, and visio, there is certainly also the multo, but not the ultimo.

Electron tubes are already changing alternating into direct current, and direct into alternating. They are changing frequencies from one value to another. They are altering wave shapes, and picking out for service any part of successive waves which is wanted. They are cutting off or heading off currents in place of switches, circuit breakers and lightning arresters, and are giving us such assets as electric fevers, for high-frequency biological researches.

When we realize that small glass vacuum tubes do so many things not done a few years ago, we naturally look anticipat-ingly toward corresponding apparatus of metal, designed for large scale operation.

Heretofore, when electric power was shoved about, rotated, reversed, switched or modified, it was necessary to move large masses of metal, but electronics seems to separate the mass or weight of apparatus from its electrical properties, so that

in a sense we may leave the masses fixed, and just move or direct, put brakes on, or stop, the electricity itself.

Electron tubes were developments from incandescent lamps. But we no longer make use of the light they give, and many modern glass tubes are already metal coated. It isn't much of an extension to proceed without the glass or the modified forms of bases or the limited sizes which were evidently determined by lamp bulb conditions. We are probably still just slow and unappreciative.

And, in addition to the foregoing obvious applications, the tubes will doubtless become necessary in future services where we cannot now recognize any want, just as occurred in the case of the X-ray tube, which is an electronic device, which was neither wanted nor anticipated. Having seen our bones, we ought now to see what more we can see.

## By DR. FRANK B. JEWETT

*President Bell Telephone Laboratories*



THE future applications of vacuum-tube devices, particularly the three-electrode thermionic vacuum tube, are perhaps best indicated by their past. Designed originally for use as detectors of radio telegraph signals, they were in 1914 developed to the point of being regularly utilized as amplifiers or repeaters in trans-continental wire telephony. In 1915 they were employed both at transmitting and receiving stations in the first transoceanic radio telephony, and in 1924 in high speed suboceanic cable telegraphy. During this same period two- and three-electrode vacuum tubes found extensive use in the field of radio broadcast and in numerous applications where the valuable rectifying and amplifying properties of thermionic vacuum tube devices were advantageous.

Today a great many thousand vacuum tubes of all sizes and descriptions are in use in the communication networks of the Bell System and other numerous thousands in similar networks throughout the world. The number of tubes involved in radio broadcast and in special services throughout the world is extremely large.

During the past fifteen years, as a result of fundamental research and development work, great improvements have been made in the character and efficiency of electronic devices as well as in the enlargement of the field of possible useful application. Starting with the erratic and inefficient tubes handling almost infinitesimally small amounts of energy, the research and development work thus far done has resulted in producing rugged relatively efficient devices which in some cases are designed to handle in a single unit many kilowatts of energy. The end of the progress of this research and development work is not as yet in sight, either with regard

[Continued on page 22]

# THE ELECTRON TUBE . . . . A

► Amazing has been the penetration of the vacuum tube throughout industry, the arts and the sciences. The tabulation on these pages bears eloquent testimony to the ingenuity, patience and courage of the workers in the electronic arts so far.

► Yet the achievements of the tube to date are but the beginnings of greater and more widespread uses. Mere scrutiny of the list here shown must offer a powerful stimulus to any engineer or executive in suggesting new uses and adaptations of thermionic or photo electric cells *in his own industry* and in the *solution of his own special problems*.

► Looked at broadly, the importance of the invention of the electron tube can be compared only with Archimedes' classical discovery of the power of the lever, and his

proud boast that, given an adequate fulcrum, he "could move the world!" For the vacuum tube is, in effect, an *electrical lever*; its grid input represents the short arm and its anode output the long arm. And just as the principle of the lever is used again and again in every element of every machine built in this mechanical age—so the introduction of the vacuum tube and its associated circuits presents almost inconceivable potentialities in the electrical future.

► So rapidly are new electronic applications coming that, within a few years, one may safely predict that—

*There will be nothing that the average man sees, hears or buys but what will be controlled, regulated or affected in some important respect by an electronic tube!*

## SOME PRESENT APPLICATIONS:

### Communication

Telephone repeaters  
Radio receivers  
Radio transmitters  
Ship, shore, and point-to-point  
Broadcast transmitters  
Broadcast receivers  
Telegraph multiplexing  
Telephone carrier frequencies for multiple channel operation  
Carrier-current telephony over transmission lines, for dispatching  
"Wired radio" over lighting distribution systems  
Public-address systems, in large halls and outdoor places  
Facsimile transmitters, for sending charts, maps, styles, documents, etc.  
Facsimile receivers  
Beam radio transmission  
Apartment-house centralized antenna systems (radio-frequency)  
Program distribution "to every room" for hotels, hospitals, etc. (audio frequency)  
Automatic recorder for telephone conversations  
Microphones for crime observation

### Motor Control

Starting equipment  
Circuit breakers  
Frequency-control for variable-speed motors  
Synchronizing equipment for two or more motors  
Source of high-frequency supply for high-speed motors

Current regulators  
Relays, switches  
Elevator control for leveling at floors  
Field control of generators driven by varying-speed motors (airplane, locomotive headlight turbine, etc.)

### Industrial Applications

Safety guards on hazardous machines  
Counting  
Grading by size, color, etc.  
Sorting  
Inspecting  
Tabulating  
Automatic calipering of products, parts  
Alarms—temperature, fire, smoke, burglar  
Process control  
Smoke indicators in plant stacks  
Smoke precipitators, supplied with high-voltage d.c. through tubes  
Measuring candlepower  
Lighting control (automatic switching, on approach of darkness for factories, schools, signs)  
Relays, and elimination of contacts  
Light-controlled locks (bank vaults, garage doors)  
Detection of foreign objects (as metal in logs entering veneer-mill saws)  
Color matching  
Food preservation  
Sensitive microphones for listening to stresses and strains in materials, products  
Reversing-mill control in steel plants

Source of oscillations for induction furnaces

X-ray analyses of materials and products

Industrial heat control

Alarms against trespassing

Control of secondary clocks from master-clock

Recording pressure cycles in gas-engines, big guns, etc.

Continuous control of product thickness and moisture in paper mills

Continuous weighing of sheet products, such as rubber, textiles, etc.

Induction heating of inaccessible metal parts

Dielectric-hysteresis heating of insulating materials

Accelerating chemical reactions and processes

Analyzing sugar solutions

Inspecting high-speed operations

Pressure and level alarms and controls

### Electric Power Transmission

Direct-current high-tension transmission

Inverters, d.c. to a.c.

Frequency converters

Rectifiers

Frequency dividers

High-tension switches

Lightning arresters

Generator-voltage regulation

Transformer regulation

Carrier-current dispatching over transmission lines

Phase-control

Synchronizing equipment



# UNIVERSAL TOOL IN INDUSTRY

By O. H. CALDWELL

*Editor of Electronics*  
*Former Federal Radio Commissioner*



Tele-metering (distant metering over power lines)  
Remote switching  
Relays and contacts  
High-voltage voltmeters  
High-voltage energy meters  
Detecting flashovers on commutating machines and automatically applying extinguishers  
Remote control of two-rate meters  
High-tension aviation marker lights, operating directly from transmission-line voltage  
High-tension safety equipment and interlocks

## Entertainment and Cultural

Broadcast receivers,  
Home, portable, automobile  
Recording sound pictures  
Projectors for sound pictures  
Binaural sound pictures (two sound tracks, producing acoustic depth)  
Electric recording of phonograph records  
Electric phonographs  
Automatic phonograph devices  
Musical instruments  
Theremin-type, capacity control  
Adjustable timbre, capable of reproducing variety of instruments  
Vacuum-tube organs  
Home sound movies (16 mm.)  
The "talking book"  
Sound pictures as wills and legal documents  
Television transmitters  
Television receivers

## Train and Traffic Control

Railway signals  
Automatic cab signals  
Street traffic signals  
Light-beam control  
Magnetic-inductor control  
Remote control of car, boat, etc.  
Automatic flashing traffic signals  
Voice control of car, etc., as stunt

## Medicine and Therapeutics

Diathermy  
Body-temperature control  
Aids to the deaf  
Treatment of specific diseases  
Elimination of special disease germs  
Effects on evolutionary changes  
Counts of bacteria

Analysis of muscle sounds  
Diagnosis of heart murmurs by comparison with phonograph records  
Surgeon's cauterizing knife  
High-frequency electrostatic and electromagnetic fields for therapeutic use  
Electro-cardiograph, amplifying the actual voltage generated by the heart  
Promoting cell growth  
Destroying tissue and tissue development  
Experiments toward transmutation of species  
X-ray applications  
Aiding blind to "read" ordinary print by sound  
Blood analysis, urine analysis

## Navigation and Aviation

Radio communication, code and phone, ship to shore, ship to ship  
Radio compasses  
Radio beacons  
Directional beams  
Landing systems, for fog  
Ship channel locaters  
Altimeters  
Photo-electric communication with planes over 'phone modulated light beams  
Depth sounders  
Supersonic sounding  
Supersonic signalling  
Automatic switching on of field landing lights  
Automatic control of marker lights

## Measurements

High temperatures  
Low temperatures  
Minute changes in temperature  
Minute electrical currents (down to  $10^{-17}$  amp.)  
High-voltage voltmeters  
Frequency indicators  
Electrical resistance and impedance  
Tachometers  
Stroboscopes

Integrating ultra-violet meters  
High-vacuum measurements, by ionization gauge  
Oscillographs for analyzing wave motion  
Foot-candle meters  
Color analysis  
Energy analysis of spectrum, infra-red to ultra-violet  
Traction dynamometer  
Pressures, explosion  
Mechanical measurement, to the one-hundred-millionth of an inch  
Moisture determination  
Astronomical—heat and light of distant stars  
Time—transit of stars  
Chemical quantities  
Metering gas in large quantities  
Gas analysis

## Lighting

Control of illumination in factories, schools, public places, etc., by automatic switching  
Automatic turning on of signs at dusk  
Remote switching of signs, street lights, etc., over power-supply lines  
Gaseous conductor signs (neon, helium, argon, etc.)  
Current source for gaseous signs in d.c. districts  
Theater dimmers  
Sign flashers

## Mining and Metallurgy

Detector methods of locating minerals  
Geophysical location of oil deposits  
Source of oscillations for induction furnaces  
Automatic temperature control of furnaces  
Detecting flaws in steel rails  
Analysis of metal structure produced by heat treatment, rolling, etc.  
Billets in steel mill automatically reversed by own shadow  
Controlling oil-well drilling, to make shaft vertical

## Miscellaneous

Determining genuineness of gems  
Detecting fruit-fly larvæ in fruit  
Police short-wave alarm systems  
Bank hold-up alarms, vault alarms  
Emotion recorders and "lie detectors"  
Heat regulators  
Safety device for oil-burners, shutting off oil if pilot flame goes out

# The power pentode

## Its characteristics and applications

By **BENEDICT V. K. FRENCH**

*Engineering Division  
American Bosch Magneto Corporation*

---

CONSIDERABLE interest has been evidenced during the past several months in the possible introduction of the power pentode as an output tube for broadcast receivers. Very little data concerning this type of tube have appeared in American technical journals and for this reason many misconceptions have arisen concerning the capabilities of the tube and its adaptation to power amplification problems. It should be understood that although the particular configuration of electrodes used in the power pentode is new to American tube structure, the possibility of its use and the actual application had been realized in Europe several years ago. The reason for its hastened development in Europe lies in the fact that the complication of power supply systems caused a concentration of effort in the design of battery operated receivers and the power pentode is

▼

There has been a great deal of talk about the power pentode but few engineers have actually done much about it, from the standpoint of receiver design. For several years Mr. French's Company has designed, manufactured, and sold receivers for the European market. These receivers use pentode power tubes, and because Mr. French has been engaged in the actual production of pentode tube receivers, he is one of the few men in America who has a practical knowledge of the new tube.

—The Editors.

▲

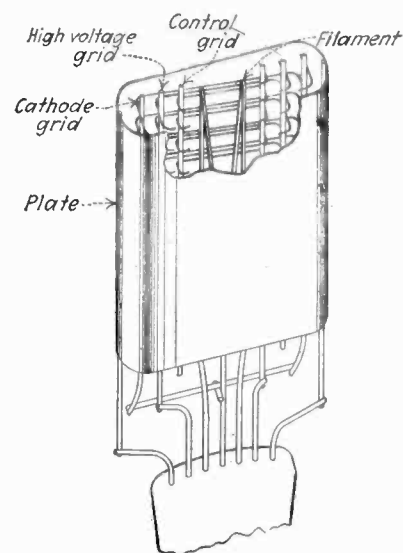

Fig. 1—Internal construction of power pentode

ideally adapted to the problem of battery operation. The adaptation of the pentode to alternating current operated receivers raises several important considerations and the recent statements that it possesses no outstanding advantage over present power tubes should be carefully considered. The present article will describe the structure and characteristics of this type of pentode and will compare a particular tube with the familiar UX 245.

### Description of the pentode

In Fig. 1 is shown a sectional view of the tube elements. Starting from the center can be seen a cathode of the filament type, usually constructed in the form of a W. Next in order is the control grid which serves the same function as the grid of the present triode or tetrode. Beyond the control grid is the high voltage grid. This grid serves practically the same purpose as the screen grid of the familiar tetrode. It functions to accelerate electrons through the mesh of the control grid and thus to annul to some extent the deleterious effect of the space charge which exists near the cathode of a triode. It is the presence of this high voltage grid which allows the construction of a high mutual conductance tube of high amplification factor. This grid has been called, somewhat loosely, a space charge grid because of the fact that it tends to annul the space charge and it has also been called a screen because of its similarity in action to the screen of the tetrode. Both of these terms are misleading, the first because of confusion with the type of tetrode or pentode in which a grid is positioned between the cathode and the control grid for the purpose of dispelling the space charge and the second because the primary purpose of this grid is to accelerate electrons and not to screen the input from the output circuit.

### The fourth electrode or cathode grid

The fourth electrode called the cathode grid is the distinguishing structural element in the power pentode. In this regard it differs from the screen grid tetrode. It is usually connected internally to the center of the filament and serves as a barrier which prevents electrons emitted by the plate due to collision from reaching the high voltage grid when this latter element is higher in potential than the plate. This secondary emission by the plate is a familiar characteristic of the radio frequency tetrode but fortunately the operating range of the tube is such

that the region of the characteristic exhibiting secondary emission is not utilized during operation. In the pentode, however, the use of higher voltages and a different magnitude of output voltage swing make it necessary to prevent the ill effects of secondary emission. The fifth electrode is the conventional plate which serves the same purpose as in the more familiar types of tubes.

### Characteristic curves of the pentode

In Figs. 2 and 3 are shown the static curves of some representative pentodes. Fig. 2 shows the grid voltage versus plate current and grid voltage versus high voltage grid current curves of an experimental American pentode. These curves are of interest in comparison with the familiar three element tube curves because of the convergence of the plate current curves as the plate voltages increase. It will be seen that at low plate voltage the high voltage grid current is high in value and conversely at high plate voltage the high voltage grid current is low in value. The reason for this fact is that the total emission current from the filament is shared by these two electrodes and the electrode of highest potential at any instant will collect the greater number of electrons and thus exhibit relatively greater current.

In Fig. 3 is shown the plate voltage versus plate current curves of the same pentode and it will be noted that these curves exhibit a rising characteristic as the plate voltage is increased. This is due to the fact that although the cathode grid prevents the effect of secondary emission from the plate it cannot prevent secondary emission from the high voltage grid from contributing to the plate current, since in this region of the characteristic the plate is higher in potential than the high voltage grid. This grid emission can be minimized by proper design of the grid mesh and spacing. In Fig. 4 is shown the plate voltage versus plate current curve of the Mullard type PM 24, a very popular battery operated tube sold in Great Britain. This tube develops about five hundred milliwatts output power with a plate and high voltage screen potential of one hundred and fifty volts, a grid bias of twelve and a half volts with an RMS input signal of about 8.8 volts.

### Importance of mesh and spacing

The mesh and spacing of the three grids have a pronounced effect upon the characteristics of the tube and present a fruitful field for experimentation. A group of tubes of over one hundred different types has been constructed in the laboratories of a well known tube manufacturer to determine the optimum grid mesh and spacing for a given output power. The pentode described in this article unfortunately is not the best of these tubes as the data presented was taken some time ago on an early model. Some effects of alteration of the various meshes might be of interest. The cathode grid spacing and mesh have a profound effect upon the operation of the tube and this grid should be so arranged that it does not directly obstruct the flow of electrons through the mesh of the high voltage grid. In tubes which were constructed with this grid intentionally blocking direct electron flow the high voltage grid was seen to become red hot in the areas shaded by the cathode grid. When the high voltage grid becomes overheated copious secondary emission and curvature of the plate characteristic occurs. The length of the cathode grid is also another important design consideration since this grid must interpose a low

potential barrier between the plate and the high voltage grid.

The mesh and spacing of the control grid are effective in altering the amplification factor and plate resistance of the tube. The size of this grid must be carefully chosen to realize maximum output.

The current drawn by the high voltage grid represents wasted power and fortunately the characteristics of tubes in which this current is held at a low value by proper design are better than those in which this grid is allowed to draw high current.

The usual fundamental tube constants; amplification factor, plate resistance and mutual conductance must be

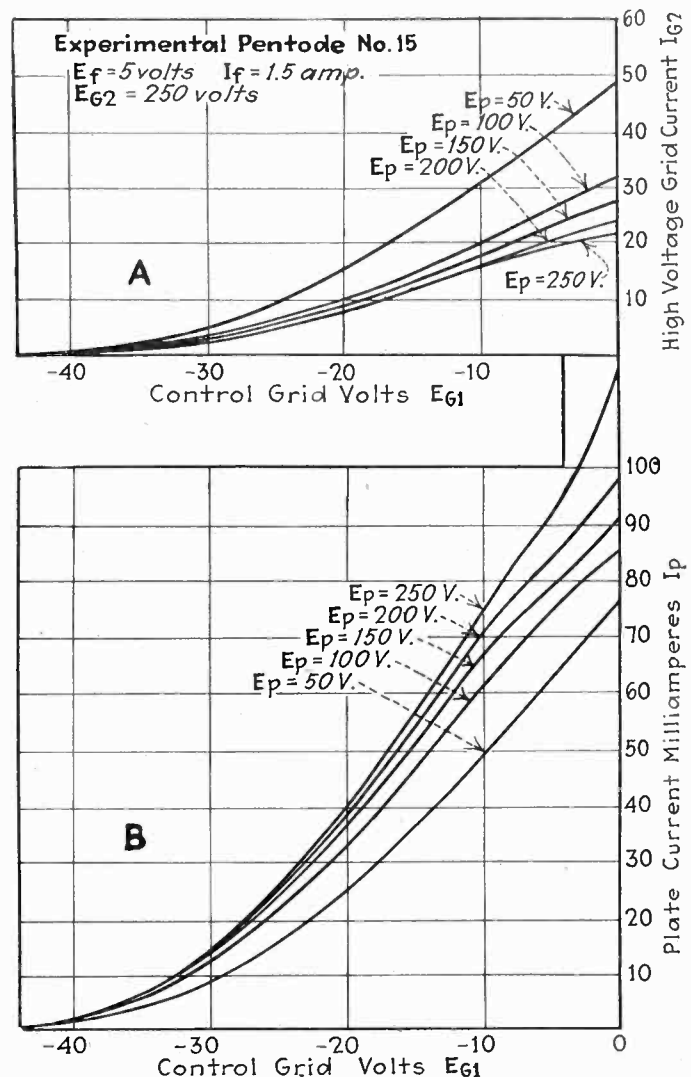

Fig. 2—Static characteristics of power pentode

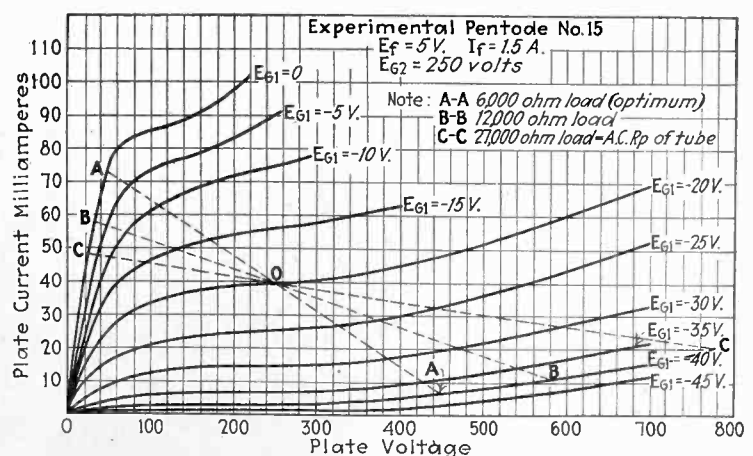

Fig. 3—Load lines drawn on static characteristics of an American experimental pentode



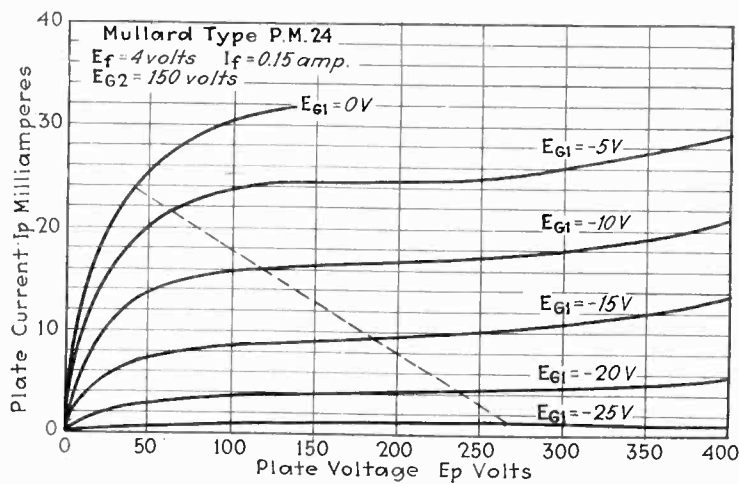

Fig. 4—Static characteristics of a well-known English pentode

used advisedly in applying them to the more complicated tetrode and pentode. These values have arisen as significant and useful means of rating tube performance as a consequence of the fact that in the three element tube throughout its operating range these parameters have nearly constant value. As has been pointed out many times the term mutual conductance is in reality a misnomer because it is not the expression of an actual conductance and since grid and plate action are not usually reversible is not a mutual expression. In the pentode particularly the amplification factor and alternating current plate resistance are variable through wide limits and although these factors can be evaluated for any given point in the operating range the same value does not hold for all points. The particular pentode described in this article when measured at the supply potentials of 250 volts on the high voltage grid, 250 volts on the plate and 20 volts negative grid bias has value of 95 for the amplification factor, 27,000 ohms for the plate resistance and 3,500 micromhos for the mutual conductance.

A far more significant rating for the power pentode would be an expression of the power sensitivity. This is the ratio of the watts output to the square of the RMS input voltage for a given limiting percentage distortion.

This method of power tube rating has been proposed by Hanna, Sutherland and Upp and the comparison of various types of three element power tubes as well as pentodes has been given by Rhodes and Henney in an

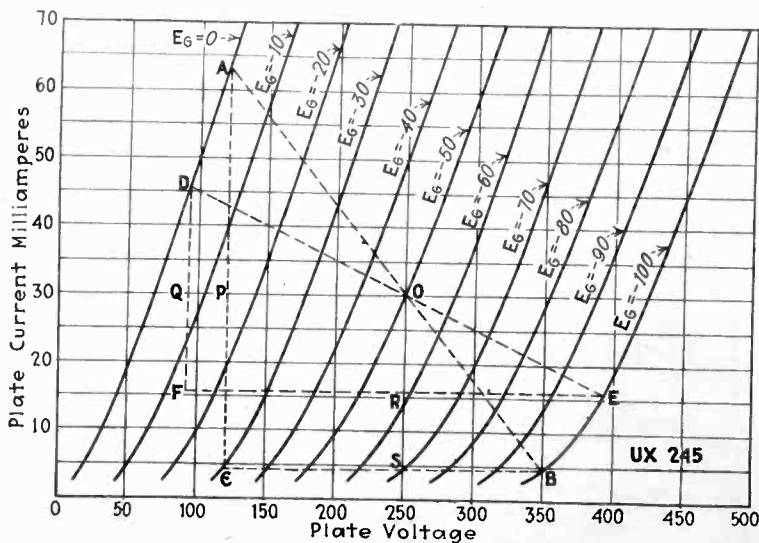

Fig. 6—Use of load lines to calculate power output

article entitled "Characteristics of Pentodes," *Radio Broadcast*, March, 1930.

Another "power sensitivity" rating has been proposed by Stuart Ballantine and H. L. Cobb (Proceedings of the I.R.E., March, 1930) as follows: "The power sensitivity is defined as the square root of the power output divided by the effective value of the applied sinusoidal grid voltage." One of the reasons advanced for this type of rating is that sound pressure from the loud speaker is proportional to the square root of the power rather than directly proportional to the power and also by means of this rating we can compare directly the equivalent gains of two different types of output tubes of the same power capacity.

### Calculation of power output

In calculating the output power and load conditions necessary to develop maximum output from a vacuum tube, it is convenient to make use of the plate voltage versus plate current characteristics of the tube and to plot upon these characteristics power output triangles. The method of doing this can be understood by reference to Figs. 5 and 6. Fig. 6 shows the plate characteristics of a UX 245 (an average tube of this type).

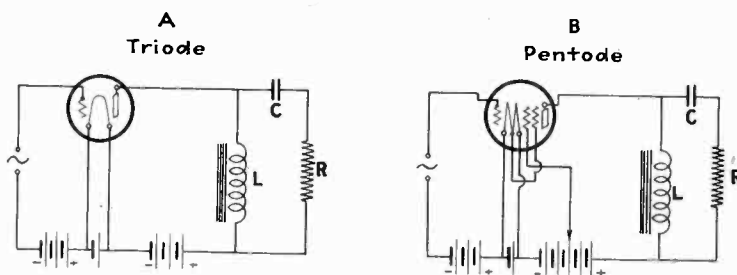

Fig. 5—Circuits for measuring power output of UX 245 and pentode power tubes

The line AOB represents a load resistance of 3,900 ohms which is the value of resistance for maximum undistorted output from this tube. From the area of triangle ACB the power output is seen to be 1,690 milliwatts. In Fig. 3 is shown a similar set of curves for the experimental pentode No. 15. In this case the line AA represents the optimum load of 6,000 ohms and the output power is 3,350 milliwatts. This power is obtained with a grid swing of only twenty volts peak or fourteen and one-tenth volts RMS. The UX 245 required an RMS voltage of 35.1 to develop a power output approximately half as great. These figures serve to convey a comparison of the two tubes as regards power sensitivity since the operating plate voltage and plate current are about equal.

An interesting fact in connection with Fig. 3 is disclosed by an examination of the effect of altering the value of the plate load. Line BB, which represents twice the optimum value of load resistance causes an instantaneous plate potential of 580 volts and line CC which represents a load resistance equal to the plate resistance of the tube at the operating point is seen to intersect the curve for twice the operating bias at a value of 780 volts. These high voltages which are encountered by improper load conditions can cause breakdown of insulation of the output transformer or supply filter and failure of the press in the tube. Such swings of voltage would be

[Continued on page 58]

# Industrial uses of vacuum devices

By S. M. KINTNER

*Manager of Research Laboratory  
Westinghouse Electric & Manufacturing Co.  
East Pittsburgh, Pennsylvania*

**A**LITTLE more than fifty years ago, Edison invented the incandescent lamp. This simple structure of a heated filament mounted in a vacuum, marks the real beginning of what we now look upon as the vacuum-tube art.

Frequent failures of his lamps by burnouts of the filaments at the ends caused Edison to investigate and he found that nearly all of the failures took place at the positive end of the filament. In a special lamp in which he placed a plate terminal he found an actual passage of current between the plate terminal and the positive end of the filament, but when the plate with galvanometer in circuit was similarly connected to the negative end of the filament no current passed. This was the first ob-

served electron current,—discovered as the result of a trouble, and not made use of for twenty-two years!

In 1905 Fleming in England discovered that this effect could be used as a rectifier of radio currents, or as a detector, as it was then called. In the meantime J. J. Thompson had proposed a theory that is now generally accepted as the correct explanation of the phenomenon. O. W. Richardson had also done some very valuable work in further studies of the phenomena.

Shortly after Fleming's announcement of his "wireless detector," DeForest, in America, brought out his three-electrode tube. Using the third electrode, called a "grid," made it possible to exercise control, by a very small amount of energy, of a considerably larger amount. While the old coherers of Marconi had released by trigger action a local supply of energy to operate the indicator, and thus controlled a large amount of energy by a very small amount, they differed from this new device of DeForest's in that they did not reproduce accurately the characteristics of the controlling signal energy. The DeForest device, called the Audion, was immediately used by him in "wireless" receivers. However, it did not attain any high order of popularity during the following six or seven years with either the United States Government radio service or the other operating radio companies. In fact, crystal rectifiers and electrolytic detectors continued to be the favored types until E. H. Armstrong discovered the feed-back circuits and proved that the audions could be made to generate oscillating currents of nearly any desired frequencies.

The Armstrong discovery stimulated a new interest in the audion which was at once recognized as offering the best opportunity for getting continuous-wave generators to displace the old damped-wave types for radio

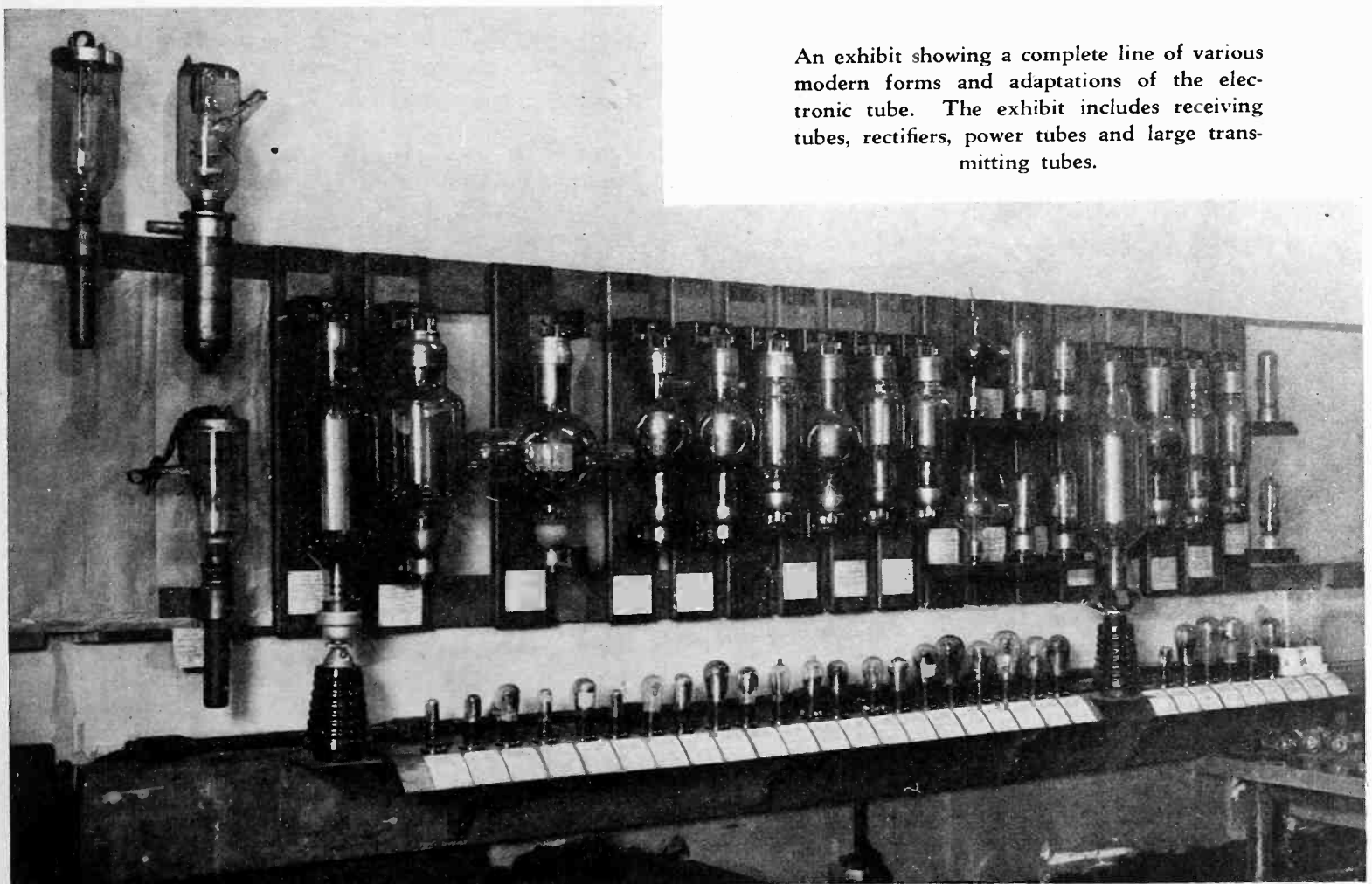

An exhibit showing a complete line of various modern forms and adaptations of the electronic tube. The exhibit includes receiving tubes, rectifiers, power tubes and large transmitting tubes.

An electron-tube organ developed at East Pittsburgh. The keys close circuits setting up oscillations each of the proper frequency.

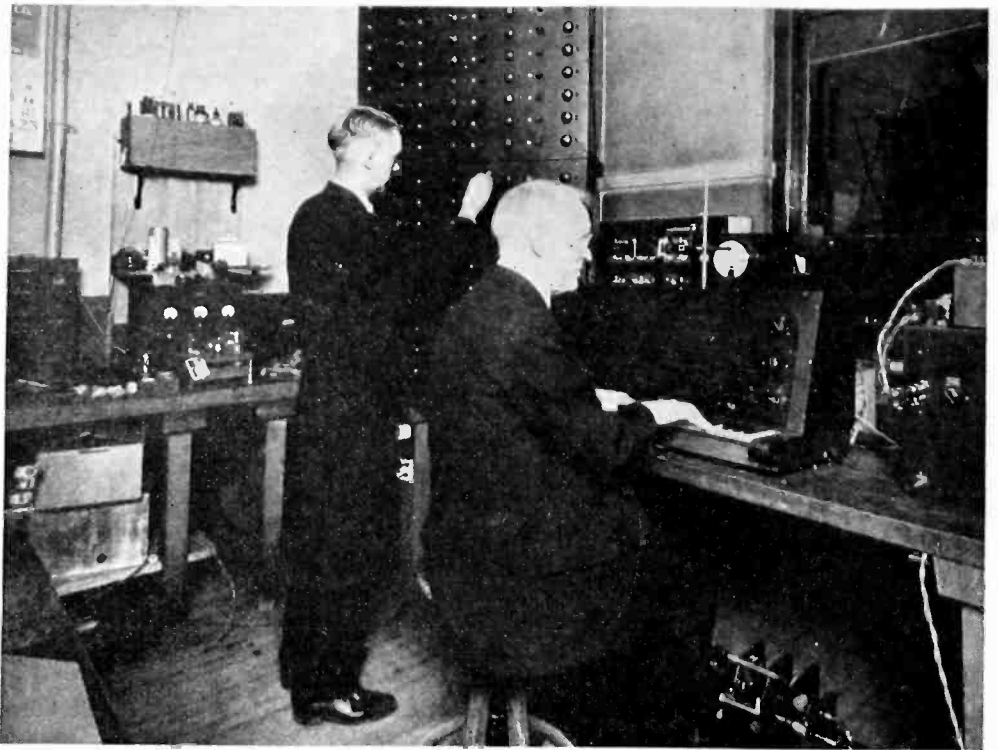

sending stations. It did another thing also; it caused the Bell Telephone Company to recognize the possibility of securing its long desired and much sought two-way telephone repeater. They soon purchased rights to the DeForest invention and actively started the development of the audion structure. Shortly after this, other electrical companies initiated active research programs in the development of this highly important vacuum device. The greater part of this investigational work was done for the purpose of utilizing these principles in other than radio service. However, the opening of the World War changed all of these plans and started these manufacturers into the production, for radio purposes, of great quantities of these tubes. The close of the war found them equipped with facilities for continued production but no market to take them. It was at this time that Station KDKA at Pittsburgh initiated the radio broadcast service, and again quantity production of radio tubes was resumed, but this time in numbers that dwarfed all previous figures. Then followed ten years of intensive developments of tubes for radio service and productions of them that ran into millions of tubes per year.

#### Capacities up to 200 kw.

Meanwhile in this decade of radio development much progress has been made in the vacuum devices. In size alone, tubes have grown in that time from those limited to less than one watt to those of approximately 200,000 watts, and corresponding advances have been made in certainty of operation, reliability in service and fidelity of reproduction.

All development effort has not been expended on the three electrode vacuum tube alone. On the contrary, much effort has been devoted to various gaseous-discharge tubes of two, three, or more electrodes and on "light-sensitive" tubes. The gaseous-discharge tubes have been used principally as rectifiers or as relays. The number of applications of

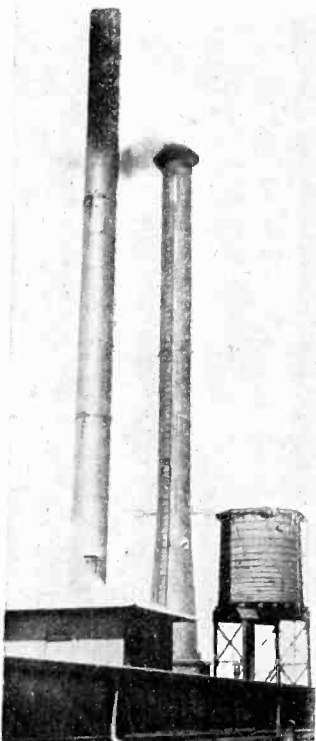

Photo-cell used as smoke recorder. Note the transverse mounting for the light source which sends a beam across the stack.

them in such service that have already been proposed, and in part made, is quite astounding. No doubt as larger tubes are available and newer types are developed, these fields of application will be increased many fold.

#### The field of measurements

Among the earliest applications were those to meters. Thus very small a.c. voltages were determined to an order of accuracy equal to that of the d.c. instrument indicating the balancing voltage applied to the grid.

High voltages can be measured by applying them to the plate circuit of a suitable high-voltage three-electrode tube of known amplification factor and then increasing the d.c. grid voltage until the plate current becomes zero.

Many other uses are made of three-electrode tubes to build up feeble currents from scientific instruments to values that are readily measured. The exceedingly minute current, produced by the heat of a distant star as its energy is concentrated by a telescope on a suitable thermocouple or a bolometer, can be amplified and measured just as can the temperature of a nearby electric furnace or even that of the massive open-hearth furnace. In the case of the furnace, however, additional tubes can be employed to regulate the temperature.

The three-electrode tubes can be employed to secure voltage or current regulation. In some of the airplane radio equipments the electrical supply for the sets was secured from wind-driven generators. As the planes were subject to wide variations in speed and yet constant voltage was needed from the wind-driven generators, this created a very difficult problem. This was finally solved by control of the generator field strength by means of a tube with its plate circuit in series with the generator shunt field, and its grid so connected to a resistance across that field as to cause it to hold down the field current as the generator voltage increased with speed and raise it as the voltage dropped. Similar methods have operated successfully as current regulators.

Amplifying means created new interest in photoelectric cells and made it possible to build up their feeble



currents until rugged relays can now be operated by them. This interest also resulted in intensive studies of photoelectric cells, which has greatly increased their sensitivity as well as their reliability. The mystery attached to their operation has made them exceedingly popular and many inventors have turned their attention to this field.

The results of these efforts are evidenced by picture transmission systems, by talking movies and by television. All of these are absolutely dependent upon photoelectric cells and tube amplifiers. Photo cells also assist in counting objects; in controlling ventilation to meet the requirements of vehicular tunnels; in detecting fires, or flashovers on commutating machines and starting into action the necessary correcting means; they give warning of a burglar; they give an indication of the density of smoke from a stack; they see the finish of a close race and accurately record the time without bias of partisanship or unreliability from excitement; they turn on the lights when the illumination falls too low; they measure and regulate the ultra-violet ray bath; they never tire, in an inspection of sheet material, in searching for holes or imperfections of surface; they regulate street traffic and eliminate unnecessary delays at crossings; they measure the intensity of illumination, and even assist in matching colors. These are but classes of service to which the photo cell is applicable.

The vacuum tube amplifiers carried on trains are strengthening the feeble signals picked up from the tracks of our railroads and giving the locomotive engineers constant information regarding track conditions ahead.

Similar tube amplifiers make possible transcontinental telephone conversations and, in combinations with wire lines and other types of vacuum devices in radio sending stations, are rapidly extending this service to all points of the earth.

Combinations of vacuum tubes are being employed in efforts to increase the safety of aviation; first, in keeping the flier on his course; second, in reporting weather and landing conditions, and third, in giving indications of height of plane above ground when within a few hundred feet.

Vacuum tubes, as oscillators, provide alternating currents of any frequency or wave form. They can be made to operate electric furnaces and melt metals or to assist the surgeon in his operations with a knife

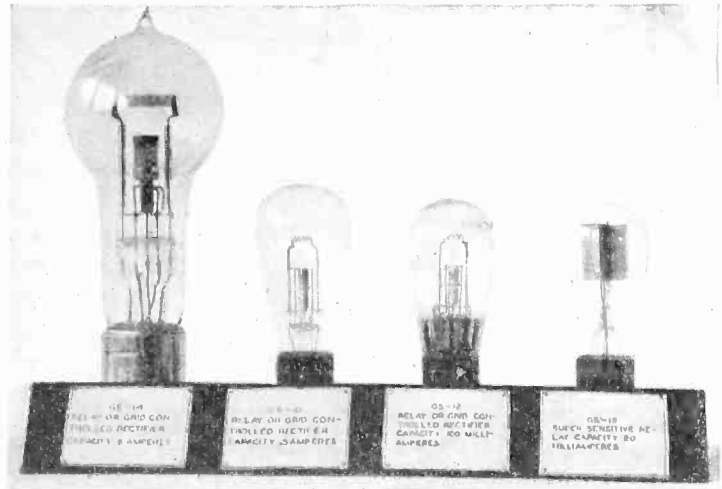

Four new tube developments. The three left-hand tubes are relay or grid controlled rectifiers, with capacities respectively of 6 amp., 0.5 amp. and 0.1 amp. The right-hand tube is a supersensitive relay with a capacity of 20 milliamperes.

which simultaneously cuts and cauterizes. They may create high frequency electrostatic or electromagnetic fields of possible use in the treatment of diseases of animals or in the creation of transmutations in plant life.

The value of x-rays is being appreciated more and more as their fields of application are being extended. They are no longer limited in their uses to the production of shadowgraphs depicting the imperfection of structural parts or to examinations of the human body in searches for damaged bones, foreign substances, or pus sacs, although these are of great importance. The study by x-rays of the structure of the elements and of compounds is producing results of inestimable value to science. It is assisting the metallurgist to a better understanding of why metals behave in certain ways as the result of special heat treatments or rolling operations. Also x-rays are proving of great value in therapeutic and biological applications. Scientists have found that certain kinds of treatments stimulate cell growth while others inhibit or actually destroy plant or animal life. Again still others cause transmutation of species which under some conditions are permanent and under other

[Continued on page 56]

## INDUSTRY CONFIDENCE:

### MANUFACTURER INDIVIDUALITY

Our first problem seems to be one of getting the component suppliers to announce their new devices and improvements as soon as they are ready, but first to the set manufacturer, then to the consumer. Our second problem is to get the set manufacturer to feel that it is not necessary for the whole industry to stay in line in lock-step fashion, but that each manufacturer can have his product individualistic, incorporating those advances in the art which he feels are desirable and sufficiently reliable to pass on to the public.

H. B. RICHMOND

President Radio Manufacturers Association

# Electron tubes in scientific measurements

By J. W. HORTON

Chief Engineer  
General Radio Company  
Cambridge, Mass.

IN the fundamental study of the vacuum tube and in its engineering applications, as in all scientific work, progress has been dependent upon measurement. It is entirely logical that those familiar with the possibilities of the vacuum tube should be the first to employ it in their measurements. This is simply a manifestation of a characteristic shared by all artisans; each uses those facilities with which he is most familiar. A plumber, for example, will build almost any structure which he might desire from pipes and fittings; a seaman, on the other hand, satisfies his requirements by the skillful manipulation of ropes and hitches. The utility of the vacuum tube in measurements, however, has been so great that it is no longer limited to the field of electrical communication. In fact, it is doubtful if there is any branch of scientific measurement to which the vacuum tube has not been applied.

A comprehensive survey of the use of vacuum tubes in measurement work is quite beyond the scope of this article. In fact, it is probable that the entire issue of this magazine for one year would be required merely to outline the uses to which the vacuum tube has been put. In order to prepare an adequate bibliography of these applications, it would be necessary to scan every technical journal in the world. There are, however, certain features underlying the application of the tube in scientific measurements to which mention may justly be called.

Perhaps the most striking thing about the use of vacuum tubes in measurement is its entire lack of that stability and constancy of performance so generally considered essential to successful measuring equipment. In a very small number of measurements does the vacuum tube appear as a calibrated instrument. As in its commercial application, the importance of the vacuum tube arises largely through its extension of the scope of existing methods and through widening the limits inherent in other equipment.

Let us consider first the purely electrical measurements. These may, of course, be grouped into current

and voltage measurements and impedance measurements. It is, perhaps, too obvious to liken the vacuum tube to the microscope and to the telescope. Yet, since it permits us to deal with magnitudes hitherto beyond the scope of our measuring instruments, such a comparison is strictly valid. Due to its variability and the consequent impossibility of relying upon a single calibration, it is necessary to employ methods in which the vacuum tube

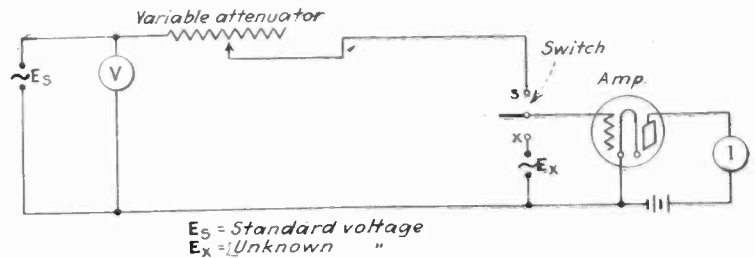

A method of comparing a portion of a large known voltage with an unknown small voltage.

may be calibrated as it is used. In other words, substitution methods must be employed. To measure a potential of the order of a fraction of a microvolt, for example, it is usual to start with a potential of sufficient magnitude to be measured by a conventional calibrated instrument. This potential is then attenuated by networks of known constants to a point where it may be compared with the unknown voltage. This comparison may be readily effected by using the vacuum tube as an amplifier to supply sufficient power to operate any convenient indicating instrument. By adjusting for equality of response on this indicator with both the unknown and the known voltage, the magnitude of the former is determined. See above. A similar situation exists in connection with the measurement of small currents.

In impedance measurements, the vacuum tube has proved to be a most useful adjunct of the impedance bridge. On one hand, in the vacuum-tube oscillator, it furnishes a source of measuring current, permitting as it does the adjustment of frequency over a practically unlimited range. Again, the use of a vacuum-tube amplifier for detecting the null point not only serves to increase the sensitivity obtainable, but also permits bridge measurements to be made with much lower voltages on the sample. This is of extreme importance in such cases as the study of iron-cored inductances, and the measurement of the conductance of electrolytes.

## The heterodyne detector

In the heterodyne detector, the vacuum tube exhibits a property of considerable utility. Here, the application of the current of one frequency may result in a current of an entirely different frequency, but of proportional amplitude. The device, therefore, permits quantitative observations to be made on currents having frequencies beyond the range of the human ear or of other indicating devices.

An interesting example of some of the points already mentioned is to be found in the study of the characteristics of power transmission networks. The use of a full-scale model is obviously out of the question because of the enormous cost and because of the danger of the voltages which would be used. In a small-scale model, on the other hand, many of the effects to be observed would be so minute that they could not be easily observed.

By the aid of vacuum-tube amplifiers, however, these minute quantities may be accurately measured. Thus, through the proper use of the vacuum tube in problems of this type, observations on scale models become thoroughly practical.

It is difficult to think of a single electrical measuring instrument, the utility of which may not be increased by the help of the vacuum tube. The features noted in connection with ammeters and voltmeters apply equally in connection with the oscillograph. In all cases, the outstanding advantages are: first, an increased sensitivity; second, a reduction in the disturbance of the quantity being measured; and third, an extension of the frequency range over which observations may be made. This last, as has already been noted, is due to the ability of modulators to effect what may be considered a translation of the frequency scale.

### Possibilities of increased precision

In the electrical measurements thus far considered, the most important contribution of the vacuum tube appears to be an extension of the range of values which may be measured, rather than an increase in the precision obtainable. In the case of the bridge, it is true, an increased sensitivity is generally accompanied by an increased precision. In the measurement of frequency, however, the advent of the vacuum tube has been marked by an enormous increase in the precision with which the quantity could be measured. In order to measure frequency, it is desirable to have at some time a periodic occurrence of fixed rate to which to refer.

In the measurement of time, for example, all measurements are referred to the period of the earth's rotation.

Inasmuch as frequency is the reciprocal of time, the rate at which the earth rotates must be taken as the basis for the measurement of frequency. For the frequencies encountered in electrical measurements, however, this rate is too far removed from the rate with which we are concerned. It is necessary, therefore, to provide some other phenomena of fixed rate which are more nearly of the order of magnitude of the quantities with which we must deal. Such phenomena are found in the mechanical resonance of certain bodies. The mechanical properties of crystalline quartz, for example, permit us to produce vibrating plates admirably suited to our purpose. To maintain such mechanically resonant systems in continuous vibration, it is necessary that energy be supplied regeneratively. If the coupling between the frequency-determining system and the energy-supply system is too close, the desirable properties of the former are impaired. Here again the vacuum tube comes to our assistance; through its inherently high impedance and through its ability to amplify energy, it permits us to maintain oscillations with a minimum disturbance due to coupling. The piezo-electric property of crystalline quartz affords a most convenient method of coupling the electrical and the mechanical systems where plates or rods of this material are used. The advantages of quartz as a frequency standard are due, however, to its mechanical properties rather than to its piezo-electric effect; its decrement and temperature coefficient of frequency being superior to those of any other substance. Quantitatively, the motions and forces accompanying the vibration of quartz plates are such that it is doubtful if vibration could be maintained regeneratively without resource to the tube.

Today, the measurement of any frequency occurring

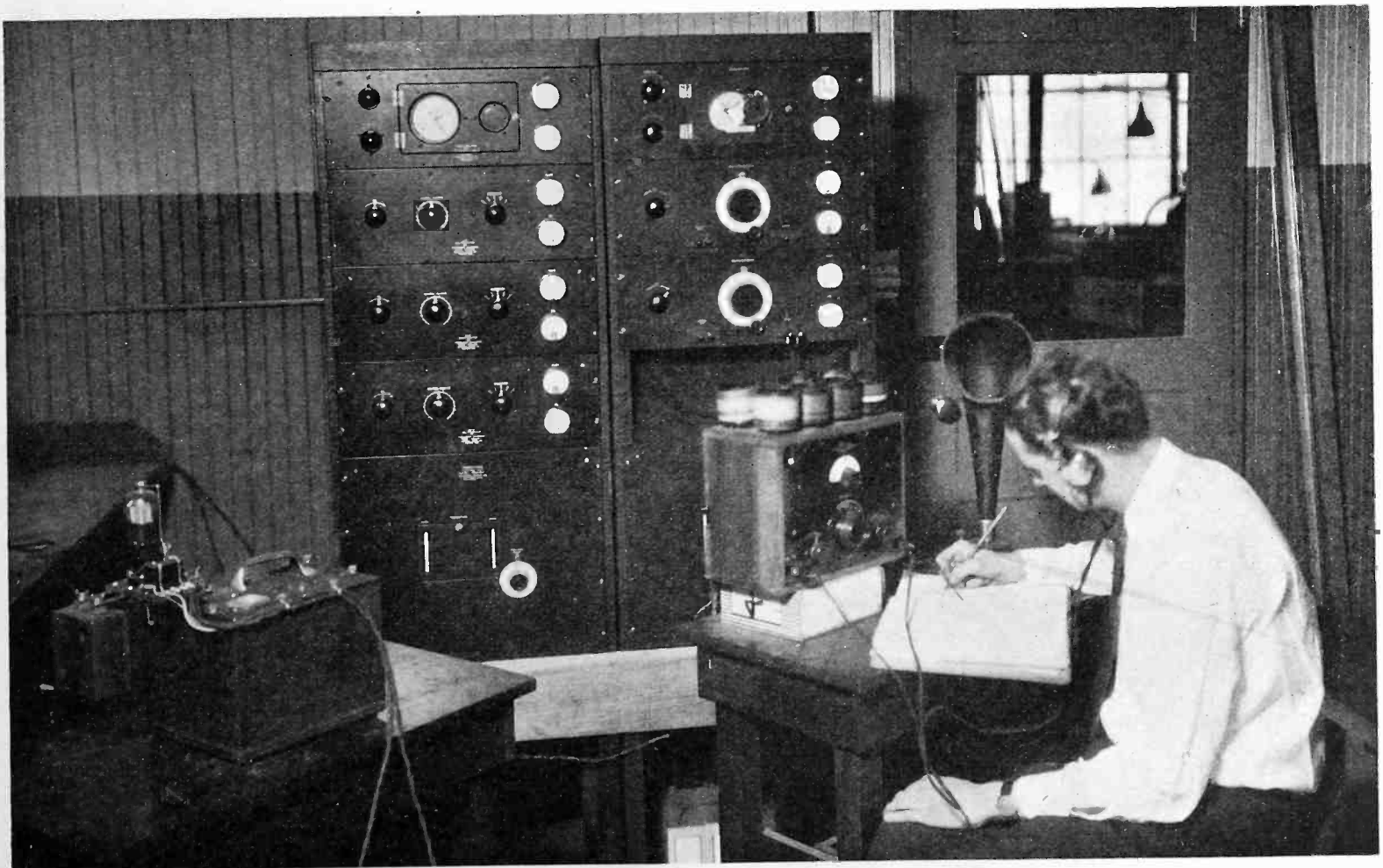

The standard-frequency assembly in use. A heretodyne wavemeter at the left is being calibrated by means of harmonics generated by the apparatus on the panel. The operator is listening in another circuit in which the beats between the two oscillators are reproduced.



in the range used for electrical communication may be made with an accuracy approaching one part in one million. It is safe to say that without the vacuum tube this precision would have been quite out of the question. In addition to the measurement of frequency itself, it is probable that the increased precision obtainable in this quantity will have a pronounced effect upon the measurement of other electrical quantities. Heretofore, frequency has been determined in many cases, in terms of known inductances, capacities and resistances. The accuracy with which such quantities were known has been one of the factors limiting the accuracy with which frequency could be measured. With the precision now available in the measurement of frequency, it is entirely probable that the procedure will be reversed, and that inductances, capacities and resistances will be measured in terms of known frequencies. In fact, it appears at the moment that the only possibility of measuring impedances at the higher radio frequencies must be based upon this method.

We find that improvements in electrical measurements, many of them due as we have seen to the vacuum tube, have resulted in their application to some of the more fundamental measurements of physical quantities. Time, as we have already seen, is directly related to frequency. The advances made in the measurement of frequency by the use of mechanical systems having suitable properties have already reached the point where they are capable of precision equal to that of the best clocks previously known. The requirements imposed upon timekeepers and upon frequency standards are practically identical; in timekeepers, therefore, we also have a mechanical system executing periodic variations and regeneratively maintained. The pendula employed in the earliest clocks are based upon this principle. During the centuries through which they have undergone development great ingenuity has been displayed in arranging for the supply of energy to the pendulum from its driving system. As we have seen, the vacuum tube has certain characteristics which make its use in this connection of considerable advantage. In spite of the fact that no work of major importance has yet been done, it is to be expected that shortly the technique of the vacuum-tube oscillator will be applied to the maintenance of the pendulum with a consequent improvement in its performance. Although the application of the vacuum tube to the maintenance of pendula has not yet been carried to its logical conclusion, the performance of other constant-frequency systems, such as the electrically maintained piezo-electric oscillator, has already reached the point where they may be considered as active competitors. Considered as clocks, frequency standards now in commercial use are accurate to better than one-tenth of one second a day. In special

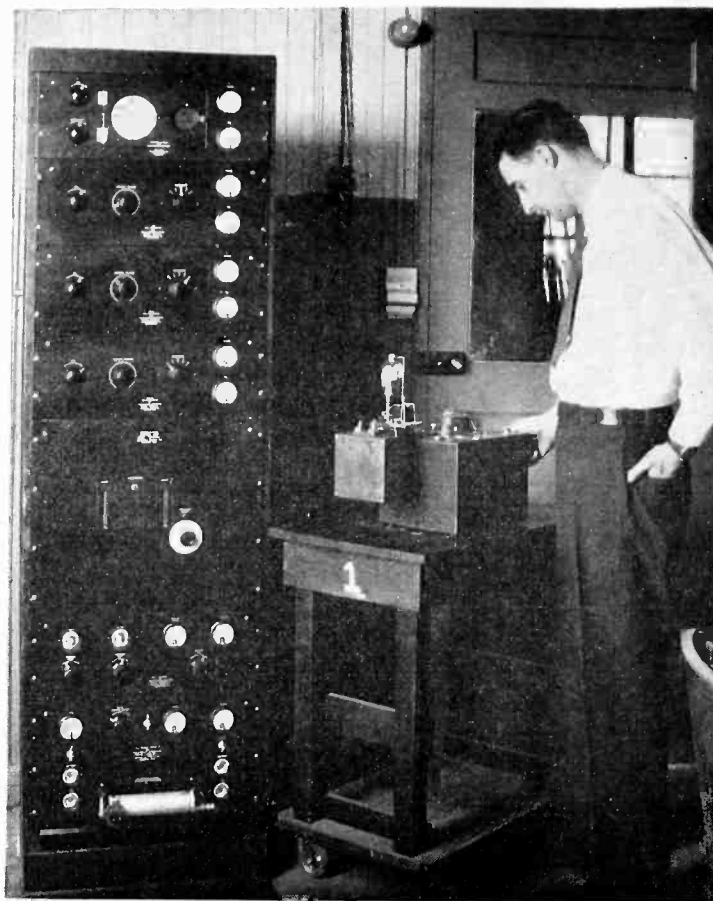

Making a calibration run on a heterodyne wavemeter. The coil of the wavemeter is coupled to the output coil of a multi-vibrator which generates the harmonics.

cases, a constancy of at least ten times this amount has been obtained. Partly because of the very high frequencies naturally present in such systems, they are admirably suited to the measurement of short time intervals. In this connection, through the use of small synchronous motors driven directly by vacuum tubes, these frequency standards have been used in many applications associated with chronographs, stroboscopes and similar instruments.

In measurements of length, we find the vacuum tube actually competing with the microscope and with the telescope. Devices known as ultra-micrometers have been known for some time. These are based upon the principle of the heterodyne detector—or modulator—in which a change of any given amount in a high-frequency current appears as a change of the same absolute amount in a low-frequency current; the percentage change in

[Continued on page 57]

## EVERY HOME A FUTURE ELECTRONIC THEATER

I have not been worried, by the fact that two or three organizations have control of the theatres of this country, because there are only 20,000 theatres in the United States. Potentially there are 26,000,000 theatres in this country awaiting development. Every home can ultimately become a theatre itself.

DAVID SARNOFF,

President Radio Corporation of America.

# Tuned radio-frequency amplifiers

By LOUIS COHEN, Ph. D.

Consulting Engineer, Washington, D. C.

IN THE literature dealing with problems relating to the vacuum-tube art, it has not, as far as I know, been brought out clearly that the problem of the tuned radio-frequency amplifier is essentially a coupled-circuit problem, and that all the considerations and conclusions relating to coupled circuits are applicable to this problem. In many publications dealing with the subject of tuned radio-frequency amplification the problem is treated from the standpoint of conductance, and the impression is created thereby that some new phenomena are associated with the operation of a vacuum tube amplifier which are not present in ordinary coupled circuits. It is my opinion that analyzing the problem from the standpoint of coupled circuits makes more evident and simpler to understand the factors that govern the efficiency of an amplifier either from the standpoint of sensitivity or selectivity, and the method should be, therefore, more useful to the student of the subject or to one who seeks improvements in design. Besides, the entire body of knowledge of coupled-circuit theory is immediately available for the solution of any problem which may arise in connection with any modifications in the design of a vacuum tube amplifier.

Expressing the results in terms of conductances, as has been done by some writers, would seem rather to obscure than clarify the problem. If it is stated that for the efficient operation of a tuned radio-frequency amplifier it is necessary that a certain relation between input conductance and plate conductance should obtain, it does not make it at all clear in which way these conductances depend upon the circuit constants of the amplifier, and it is not always easy to appreciate the dependence of the conductances upon the circuit constants. On the other hand, interpreting the amplifier problem in terms of resistances and mutual inductance an expression is obtained, the significance of which is at once evident.

It will be shown that the formulæ for tube amplifiers in terms of coupled-circuit theory are convertible into conductance formulæ, which establishes the fact, of course, that the formulæ are identical and that nothing new is added to the subject by expressing the formulæ in terms of conductances.

A tuned radio-frequency vacuum-tube amplifier may

be represented as a coupled circuit, the primary of which is untuned, and the secondary tuned. The voltage applied to the primary circuit is the voltage applied to the

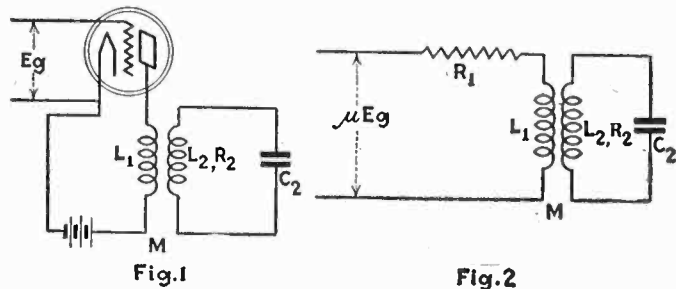

grid of the tube multiplied by the amplification factor, and the resistance of the primary circuit is to include the plate-filament resistance. Fig. 1 shows the circuit of a tuned amplifier, and Fig. 2 is the equivalent coupled circuit.

The notations used here are as follows:

$R_1$  = internal resistance of tube

$R_2$  = resistance of the tuned circuit

$L_1$  = the plate inductance

$L_2$  and  $C_2$  = the inductance and capacity of the secondary tuned circuit

$M$  = the mutual inductance between the circuits

$\mu$  = amplification factor

$\omega = 2\pi \times$  frequency.

By the usual theory of coupled circuits it can be readily shown that for this condition the expression for the current in the secondary circuit is as follows:

$$I_2 = \frac{-\mu Eg M j \omega}{-(L_1 L_2 - M^2) \omega^2 + \frac{L_1}{C_2} + R_1 R_2 + j R_1 \left( L_2 \omega + \frac{R_2}{R_1} L_1 \omega - \frac{1}{C_2 \omega} \right)} \quad (1)$$

For resonance,

$$\left( L_2 + \frac{R_2}{R_1} L_1 \right) \omega - \frac{1}{C_2 \omega} = 0, \quad (2)$$

$$\omega = \frac{1}{\sqrt{C_2 \left( L_2 + \frac{R_2}{R_1} L_1 \right)}}$$

Since  $\frac{R_2}{R_1}$  is very small, ( $R_2$  is of the order of 10 ohms, while  $R_1$ , the plate filament resistance, is of the order  $10^4$  ohms),  $\frac{R_2}{R_1} L_1$  is negligible in comparison with  $L_2$  and (2) reduces to,

$$\omega = \frac{1}{\sqrt{L_2 C_2}} \quad (3)$$

For the resonance condition, the expression for the current in the secondary circuit reduces to,

$$I_2 = \frac{-\mu Eg M j \omega}{M^2 \omega^2 + R_1 R_2} \quad (4)$$

The current is of maximum value when the mutual inductance is adjusted to satisfy the condition,

$$M^2 \omega^2 = R_1 R_2 \quad (5)$$

For this value of mutual inductance, a tuned amplifier operates at the highest degree of sensitivity. Since the resistances of the circuits are more or less fixed, the controlling factor in the sensitivity of a tuned amplifier is the mutual inductance. It is not at all a question of ratio of turns or low primary inductance, as has been insisted on by some writers, but altogether a matter of the proper adjustment of the mutual inductance between the circuits.

For frequencies appreciably different from the resonance frequency, the current in the secondary circuit

is to a fair degree of approximation given by the following expression:

$$I_2' = \frac{-\mu E_g M \omega}{R_1 \left( L_2 \omega - \frac{1}{C_2 \omega} \right)} \quad (6)$$

A measure of selectivity is the ratio of the current at resonance, and the current off resonance. By (4) and (6) we have

$$S = \frac{I_2}{I_2'} = \frac{R_1 \left( L_2 \omega - \frac{1}{C_2 \omega} \right)}{M^2 \omega^2 + R_1 R_2} \quad (7)$$

In the expression (4) for the current at resonance, which determines the sensitivity, the mutual inductance factor occurs in the numerator and denominator, while in the selectivity expression, formula (7), the mutual inductance factor occurs only in the denominator. Decreasing the mutual inductance below the critical value given by (5) decreases the sensitivity, but not in the same degree as the increase in selectivity, that is, at the expense of a small loss in sensitivity, by reducing the mutual inductance, a considerable gain in selectivity is obtained.

The amplification of a tuned amplifier may be expressed in this way: The voltage developed across the condenser of the secondary circuit is given by

$$E_2 = \frac{-\mu E_g M}{C_2 (M^2 \omega^2 + R_1 R_2)} \quad (8)$$

and

$$\text{Amplification} = \frac{E_2}{E_g} = \frac{-\mu M}{C_2 (R_1 R_2 + M^2 \omega^2)} \quad (9)$$

Hazeltine\* derived an expression for amplification in terms of plate conductance and input conductance which may give the impression that some factors are involved peculiar to the tube and that therefore the usual coupled circuit theory is not applicable to the problem. The formula given by Hazeltine is as follows:

$$\frac{E_2}{E_g} = \frac{\tau \mu g_p}{g_p + \tau^2 g_s} \quad (10)$$

As a matter of fact it can be readily shown that formula (9) transforms into formula (10); one is the equivalent of the other.

Replace  $R_2$ , the series resistance by an equivalent parallel resistance, by the well-known relation,

$$R_2 = \frac{1}{R_s C_2 \omega^2},$$

and (9) transforms to

$$\begin{aligned} \frac{E_2}{E_g} &= \frac{\mu M}{C_2 \left( \frac{R_1}{R_s C_2 \omega^2} + M^2 \omega^2 \right)}, \\ &= \frac{\mu M}{C_2 \left\{ \frac{R_1}{R_s} \frac{L_2}{C_2} + \frac{M^2}{L_2 C_2} \right\}}, \\ &= \frac{\mu}{\frac{L_2}{M} \frac{1}{R_s} + \frac{M}{L_2} \frac{1}{R_1}} \end{aligned} \quad (11)$$

$$\frac{1}{R_s} = g_s \text{ input conductance}$$

$$\frac{1}{R_1} = g_p \text{ plate conductance}$$

hence

$$\frac{E_2}{E_g} = \frac{\mu g_p}{\frac{L_2}{M} g_s + \frac{M}{L_2} g_p} \quad (12)$$

For unity coupling, the condition assumed by Hazeltine in the derivation of his formula,

$$\begin{aligned} \frac{L_2}{M} &= \frac{N_2}{N_1} = \tau, \\ \frac{M}{L_2} &= \frac{N_1}{N_2} = \frac{1}{\tau}, \end{aligned}$$

where  $N_1$  = number of turns on primary  
 $N_2$  = number of turns on secondary

$$\text{and} \quad \frac{E_2}{E_g} = \frac{\mu \tau g_p}{g_p + \tau^2 g_s} \quad (13)$$

which is the Hazeltine formula (10).

It is clear, therefore, that expressing the amplification in terms of conductances amounts to nothing more than transforming the well known coupled circuit formula to express the same results in different terms, and nothing is added to the knowledge of the subject by so doing. It is rather an advantage to retain the coupled circuit formula; it makes more evident the dependence of amplification on the resistances of the circuits and the mutual inductance, and shows that the amplification is controlled principally by the mutual inductance.

The analysis of the problem from the standpoint of coupled circuit theory offers the additional advantage that the method is readily applicable to types of coupling other than the magnetic coupling discussed above. The problem of condenser coupling, for instance, is readily solved and it can be shown that by the proper choice of coupling condenser equally good amplification and selectivity is obtained as by magnetic coupling. I shall present an analysis of the condenser coupled amplifier another time.

## The future of electronics

[Continued from page nine]

to the devices themselves or to their fields of application.

In the field of communication alone they have assisted materially not only in great extensions in the range of communication but have brought about economies, particularly by allowing smaller gauge conductors to be used and by making possible the so-called carrier current systems of multiplex telegraphy and multiplex telephony, in which several messages are simultaneously transmitted over the same circuit.

Within certain limitations any very feeble current of electricity or any small difference of electrical potential may be amplified through vacuum tube circuits into an appreciable current or voltage without loss of its distinguishing characteristics. When it is remembered that many of our chemical processes, and particularly many of those of physiological chemistry, involve minute electrical currents or changes in potential, it becomes apparent that the vacuum tube is a powerful tool for investigation in a multitude of different situations, only a few of which are so far being attacked by physiologist or chemist. Although we cannot today predict the procedure or results, we can, I believe, confidently expect that the near future will profit amazingly by the application of electronic devices to the investigation of living processes.

Likewise, in many fields not involved with matters of life organisms, there seem to be great potential possibilities involved in the further development and application of thermionic devices.

\*Proceedings of the Institute of Radio Engineers, Vol. 14, pp. 395-412.



# Some unsolved problems of sound-picture technique

By DR. ALFRED N. GOLDSMITH

Vice-President and General Engineer  
Radio Corporation of America  
RCA Photophone, Inc.

ONE of the most striking modern applications of electronic phenomena is the sound motion picture. Built around the vacuum tube amplifier, both in studio recording and theatre reproduction, it necessarily depends for the accompanying speech or music upon the flying (but suitably controlled) electron in the vacuum tube. The development of the sound motion picture art has been an unusually rapid one, after a long period during which it lay dormant. While sound motion pictures were one of Edison's earliest dreams in the pioneer days of his development of the phonograph and motion picture projector, yet the large-scale commercial exploitation of this field necessarily awaited the modern vacuum tube amplifier and the acoustic knowledge which enabled its proper utilization.

It is quite clear to the workers in the sound motion picture field that development, while rapid, has by no means come to an end and that the apex of performance has not been attained. A number of normal lines of development are becoming increasingly clear to the students of the field. While it is, of course, possible that sound motion pictures may suddenly take an entirely new turn, involving a radical change in the methods employed, yet this appears unlikely. Development will more probably proceed along fairly conventional and well-defined lines.

## The heir of the pantomime

The sound motion picture is, in a sense, the heir of the legitimate theatre. The silent motion picture was really a lineal descendant of the pantomime performances—a rather limited type of theatrical entertainment which had practically disappeared from the legitimate stage at the time of the advent of the silent motion picture. It is a

tribute to the ingenuity and artistic taste of the producers of the silent motion pictures that they were able to turn so apparently unpromising a method as pantomime performances into a highly interesting form of theatrical entertainment. The wide pictorial possibilities of the camera, as compared to the restricted scenic capabilities of the legitimate stage, were a substantial factor in the ultimate success of the silent motion picture.

The sound motion picture, however, is the heir rather of the legitimate spoken drama or comedy. This is at once an advantage and a handicap. The spoken theatrical performance has been highly developed through centuries of experience, and there has been built up an acting group capable of presenting adequately the subtle shades of meaning of a modern theatrical performance. Accordingly, sound motion pictures found themselves in the difficult position of direct comparison with a highly developed art.

## Difficulties with auditoriums

In the theatre, too, the sound motion pictures ran into physical difficulties. Theatres for many centuries have been designed either by chance or, at best, to meet the requirements of the spoken performance. The acoustic output of the average actor—that is, the amount of power radiated by him in the form of sound—is very limited. Hence, theatres were designed in such fashion as to make the most of this limited sound output. And audiences adjusted themselves to a charitable attitude toward the actor when they failed to hear a portion of the dialogue. After all, he was "human."

When, however, a close-up face of an actor is projected on a screen, about ten feet high, and apparently speaks to the audience, all kindly tolerance of acoustic defects vanishes. Everybody in the theatre expects to hear every word and intonation clearly. Otherwise stated, the audience desires nothing more than "sound reproduction which is *more* human than a human being." The obvious conclusion is that theatre acoustics must be

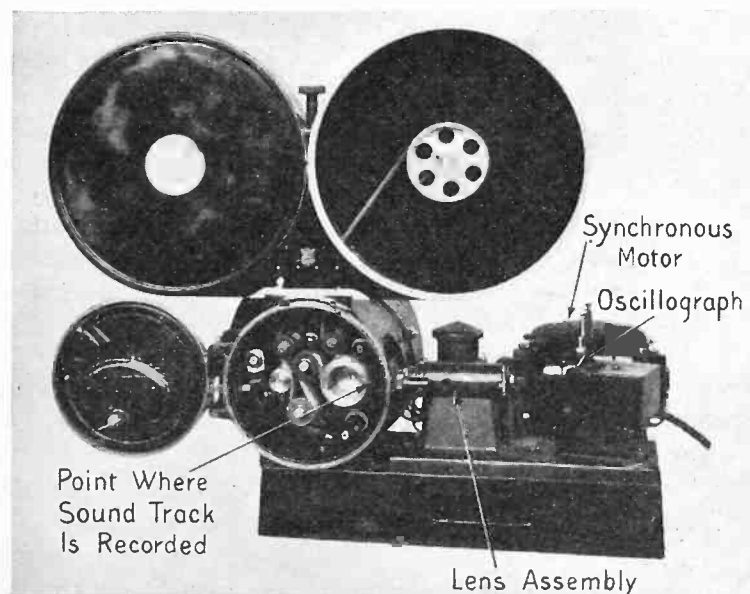

Photophone recorder, showing path of film threaded through the machine. The voice currents are recorded on the film as microphotographs giving a variable-area sound track.

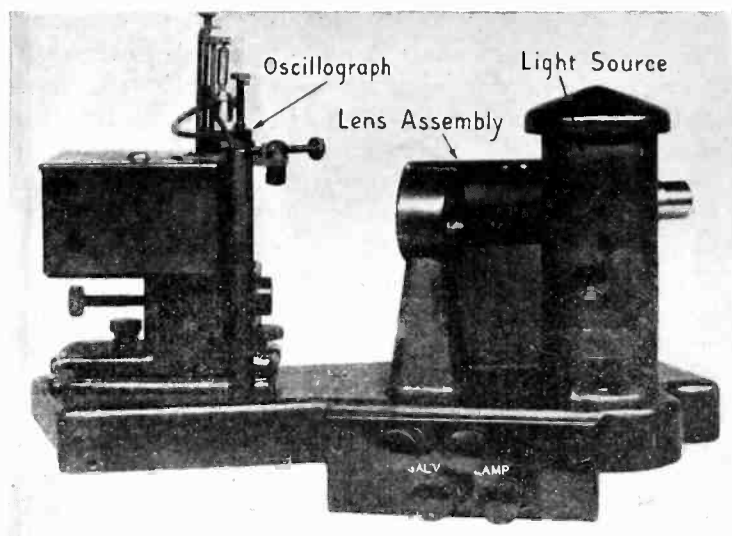

Oscillograph and optical system by means of which the electrical energy from the amplifier system is recorded on the sound track.

the subject of close study and that changes in the construction and acoustic treatment of theatres may properly be anticipated as a part of the development of the sound motion picture field.

Theatres are vendors of glamour. All they have to sell, after all, is illusion, and the better the illusion the more satisfied the audience. Showmanship is presumably the art of creating acceptable illusions and inducing the public to witness them (at a price).

### Appealing to all the senses

If we coldly examine the elements of an illusion—which is exactly what the audience should never be permitted to do—we find that it is merely the synthesis of a number of sense impressions. If we could, by physical means, duplicate the sound, appearance, solidity, and odor of a scene in a flower garden, for example, with so high a degree of perfection that all our sense organs were deceived, the audience would believe itself to be looking upon an actual flower garden. We are far from having attained this ideal, but nevertheless, it should be kept in mind as the most important aim of showmanship.

Some may object, at this point, that many desirable theatrical performances are purely fantastic and represent, quite properly, scenes, peoples, and acts which never existed and perhaps never could exist. While this is true, the fact remains that the theatrical performance in this case is merely the accurate reproduction of a vision or dream in the mind of the author of the drama and the more accurately it is reproduced, the better the performance from the viewpoint of the audience. In other words, even a fantasy should be accurately reproduced.

As soon as we examine sound reproduction by electrical means in a theatre we find that it differs rather markedly from sound reproduction in actual life. For one thing, an actor is a sound source of curious shape and small dimensions, he is highly mobile, and his range of sound intensities from a shout to a whisper is enormous. An orchestra, on the other hand, is a highly distributed source of sound, each component of which has its own directional characteristic. The sound volume range of the orchestra is even more extreme, as is clear when one contrasts the faint notes of a softly played

violin solo with the thunderous crash of the full orchestra. He would be a bold man who would claim that our present methods of sound reproduction in the theatre, generally satisfactory as they are to present-day audiences, represent more than a first approximation to a perfect imitation of the original performance.

### Some limitations put on tone fidelity

The range of frequencies adequately reproduced in the sound motion picture theatre is at present limited by the house acoustics, the reproducing system, and the limitations of the recording process. Obviously, if the recording process is one in which a large amount of "ground noise" is inherent (perhaps in the form of a hiss during supposedly silent portions of the performance) the reproduction of soft speech or faint music is difficult, if not impossible. All musical and speech reproduction is affected because, in an attempt to get rid of the annoying ground noise, it is rather usual practice to insert cut-off filters which reduce the high frequencies above 3500 cycles which give so much crispness to music, and characteristic quality and naturalness to speech. It is unfortunate that the sound spectrum of ground noise should lie predominantly in a region which is of real importance in the reproduction of speech and music.

It is desirable to pass over the control of the color and intensity of theatre lighting, the dissemination of perfumes, and the production of other sensational effects through electrical control in the theatre at this time, since these refinements may well await further progress along lines of major and more important development. The production of color in motion pictures, and of the impression of solidity, are not primarily electronic problems in their present state. Colored motion pictures are developing apace and probably will be found in widespread use on a large scale within the next few years. Pictures giving the impression of actual solidity (that is, true stereoscopic vision) are in a much more rudimentary condition, and it cannot be said that any generally satisfactory and practicable method for the production of such pictures has as yet been demonstrated or particularly plausibly suggested.

### Better portable recorders needed

In the recording end of sound motion pictures, there are a number of divisions which require careful consideration. The subject of studio acoustics is certainly in dispute at present and articles by authorities of supposedly equal rank will differ sharply on the nature of desirable acoustic treatment for studios and on the proper placement of microphones.

The extremely light and portable recorder is only partially developed, and lack of these devices is felt in news-reel work and in certain types of location recording. There are types of outdoor scenes where a highly portable recording outfit would be of great value, but presumably such an outfit depends, in part, on the production of vacuum tubes of suitable characteristics.

In general, it may be said that the vacuum tube, through its important application in the amplification of sounds, has revolutionized the sound motion picture field and is likely to bring about fundamental changes in the construction and utilization of theatres and the equipment used in the theatre, all with the aim of the production of a more perfect illusion of the actual event.

# THE ELECTRON TUBE AT WORK

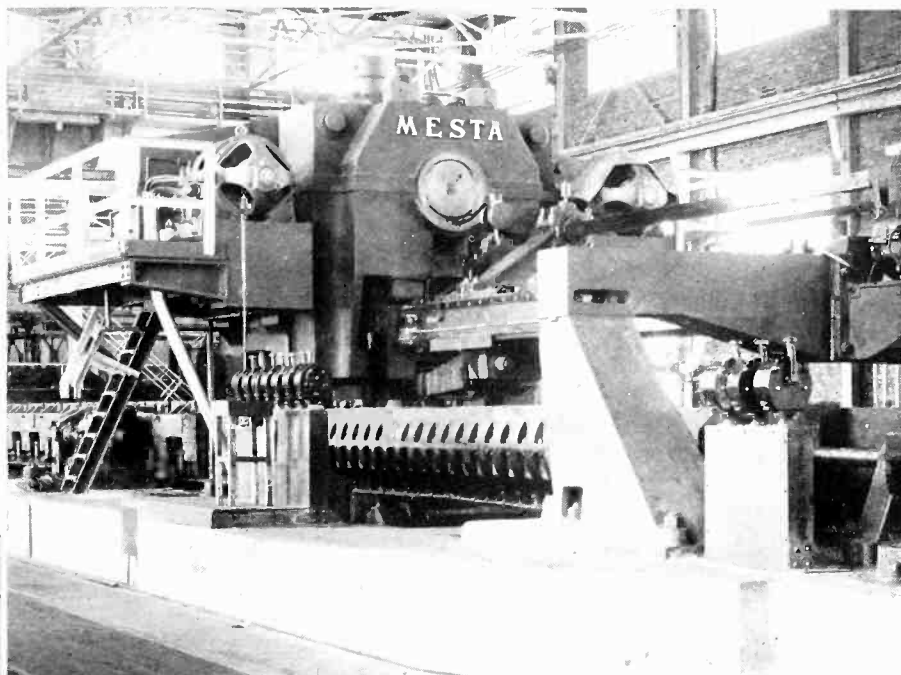

ABOVE—In steel mills, the red-hot billets are reversed as they come from the rolls, by photo-cell controls.

BELOW—This big electric sign at Newark, N. J., is lighted at dusk each evening by the photo-cell at right of window.

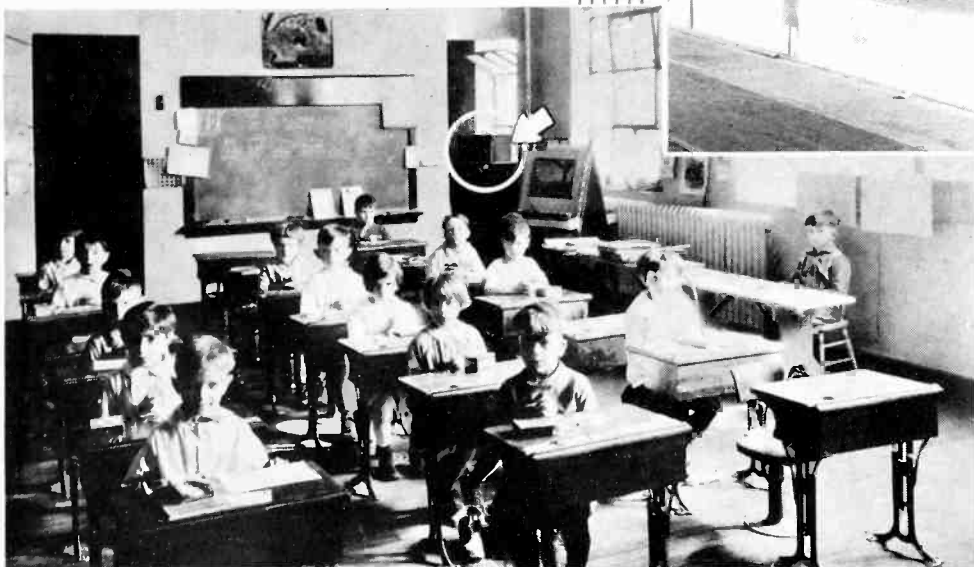

ABOVE—Little eyes are safeguarded by this photo-cell switch, which turns on the school room lights when darkness falls outside.

BELOW—A power-line carrier-current dispatching system, by which operators can talk over high-tension lines.

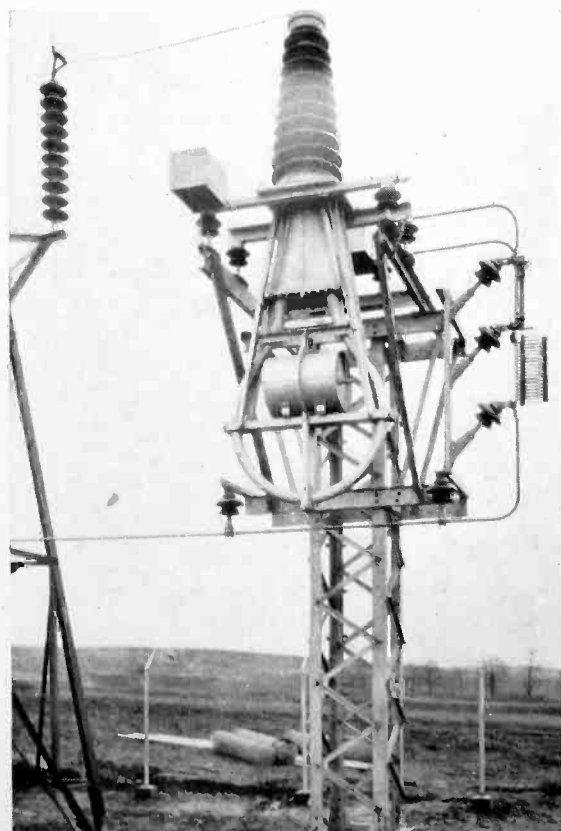

BELOW—The electron-tube control of the stage lighting in the great new Chicago Civic Opera House, using selsyns, and thyatronns.





# THE RADIO SPECTRUM

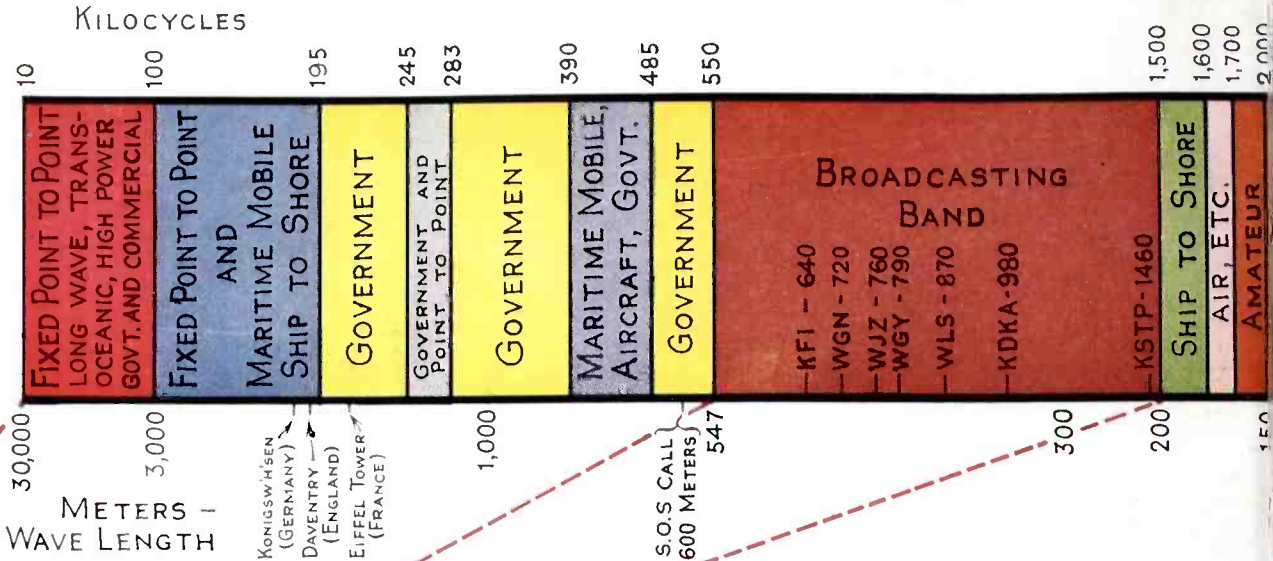

# THE ETHER SPECTRUM

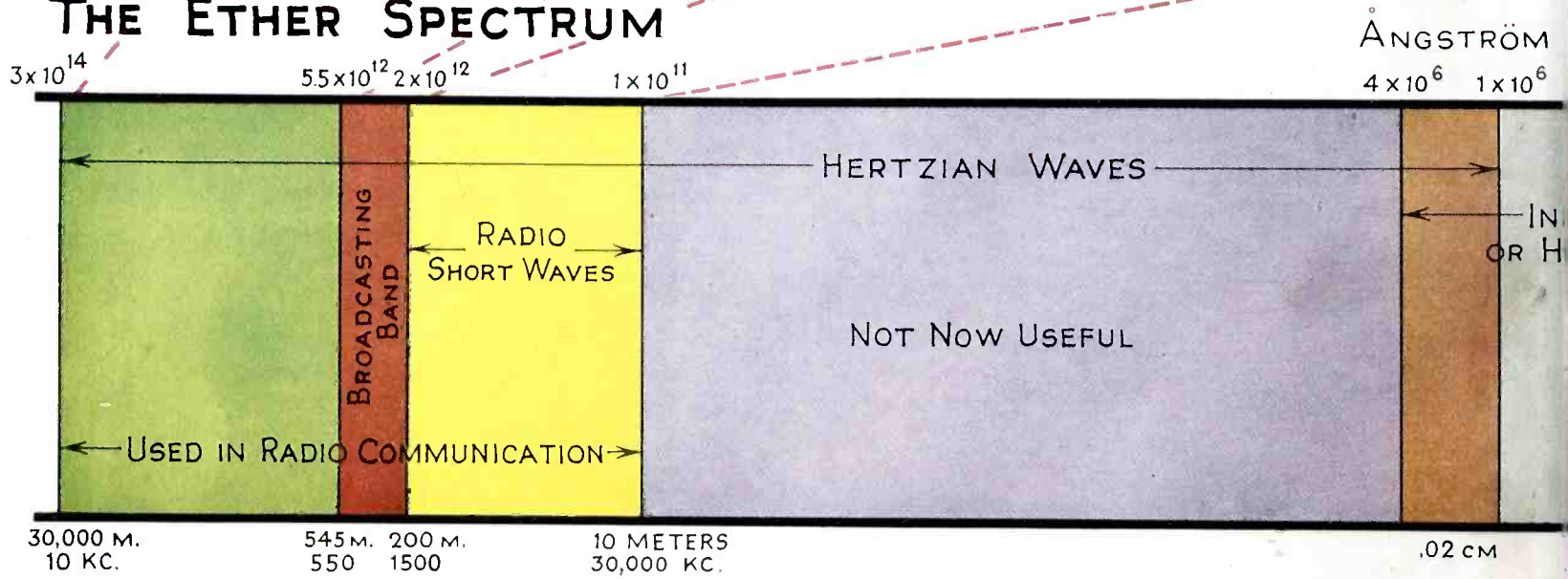

# THE AUDIBLE SPECTRUM

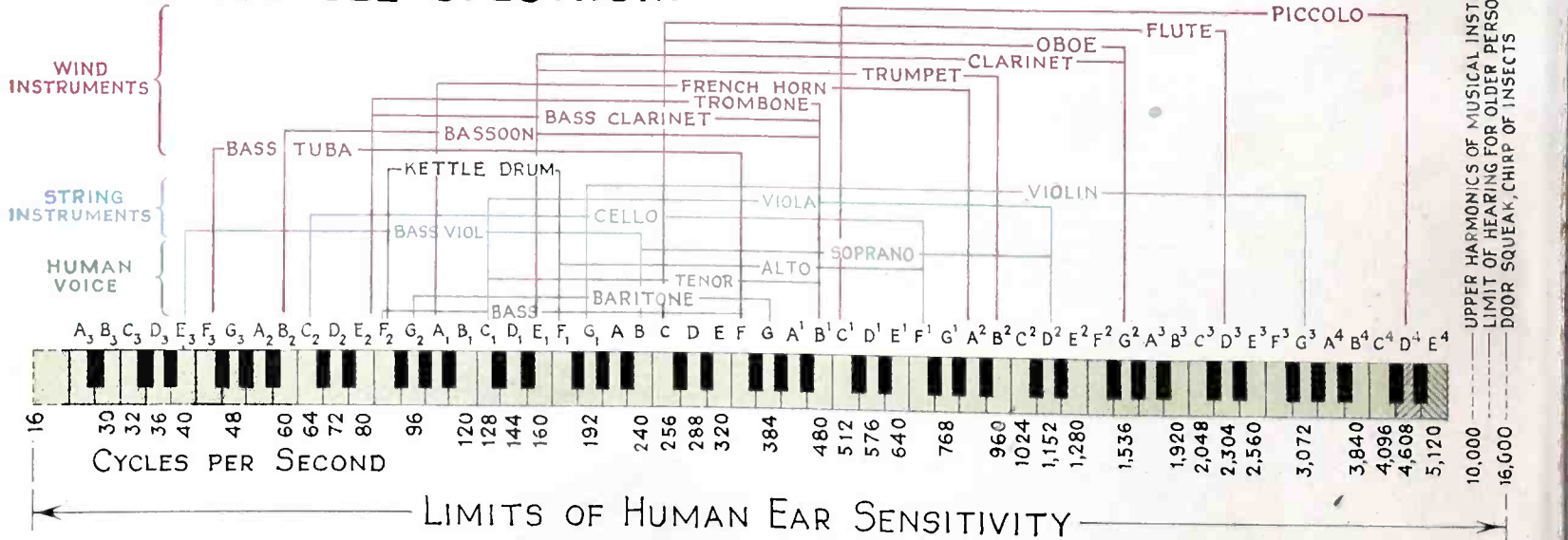

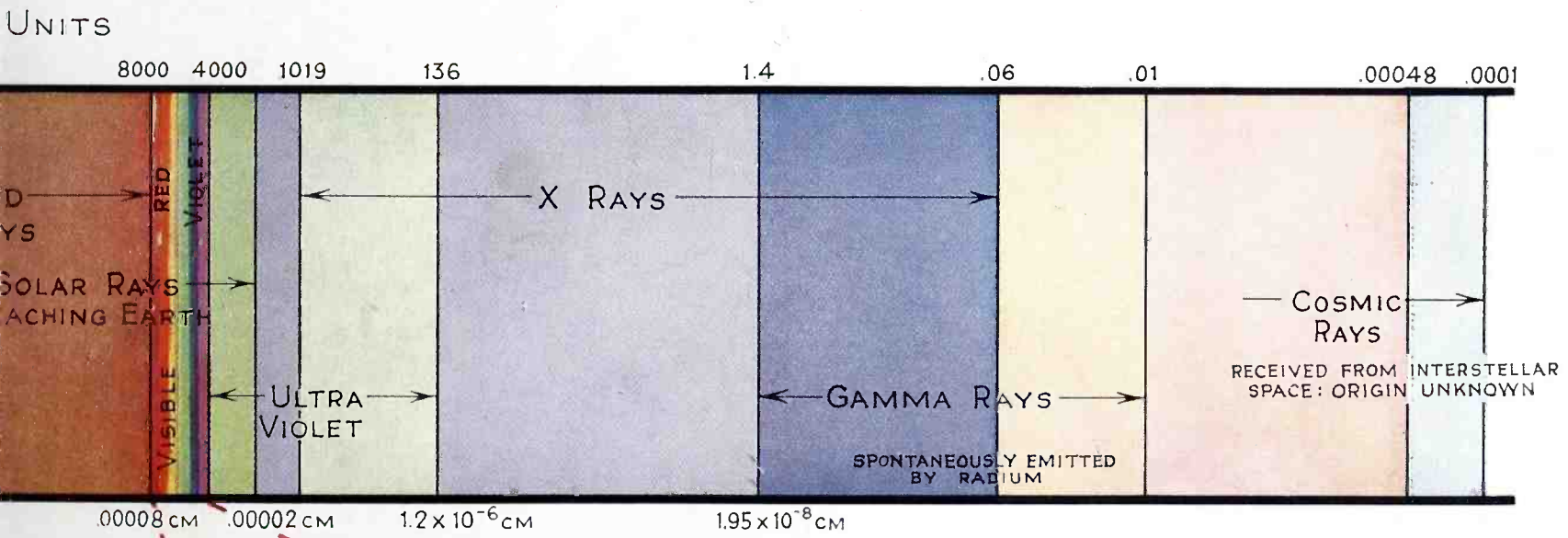
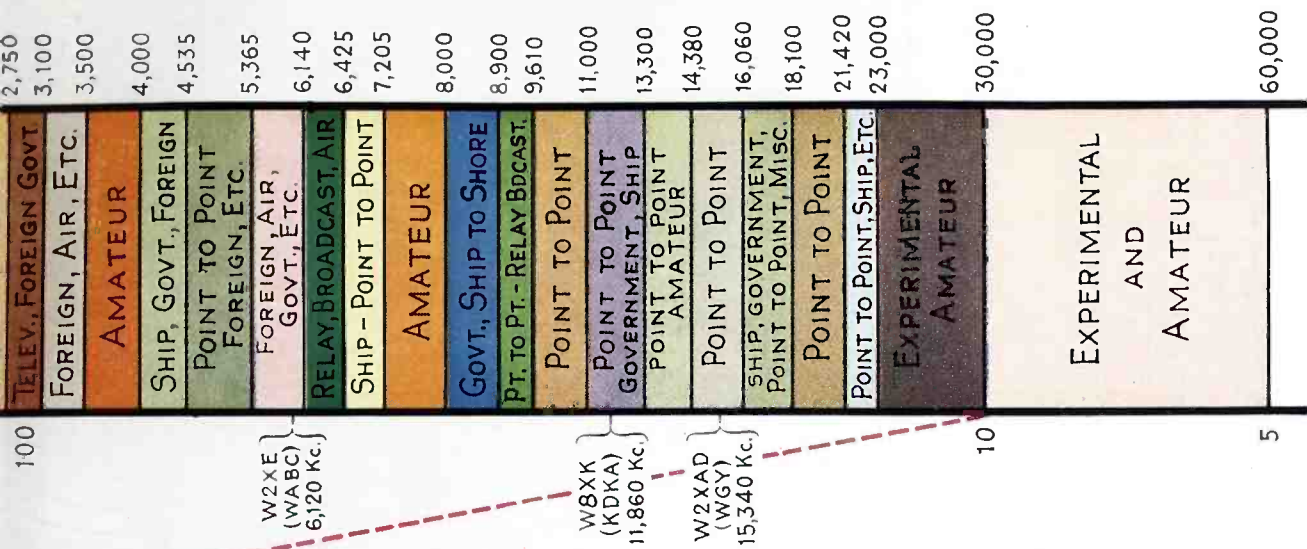

# THE PHOTO-ELECTRIC SPECTRUM

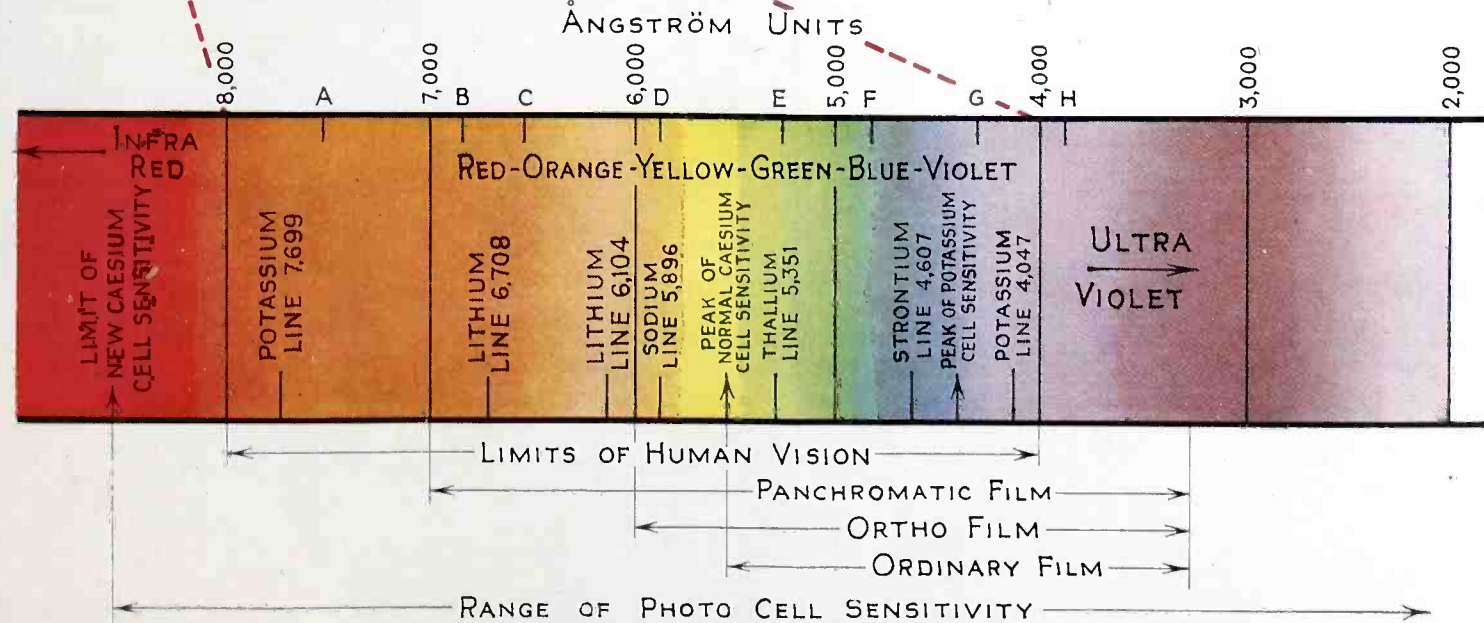

April, 1930



# The photo-electric cell — Its properties and characteristics

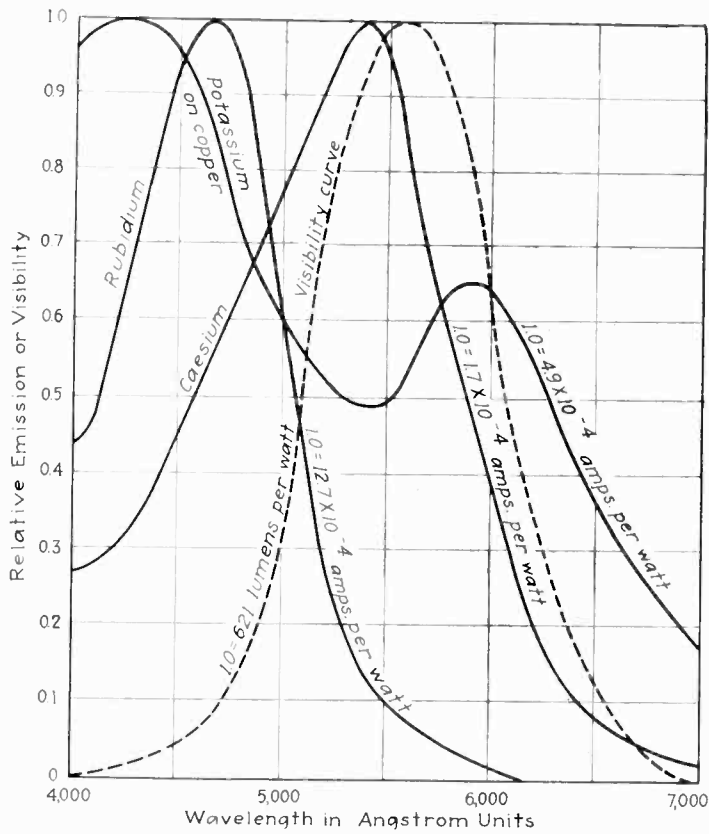

CELLS made from different substances have peaks of sensitivity in different parts of the spectrum, as well as different outputs. The ordinate of these curves are relative; to compare the output of one cell to another, note the data giving the emission per watt of energy collected by the cell if it were a perfect absorber. (Photo-electric Cells, Campbell and Ritchie, Pitmans, 1929.)

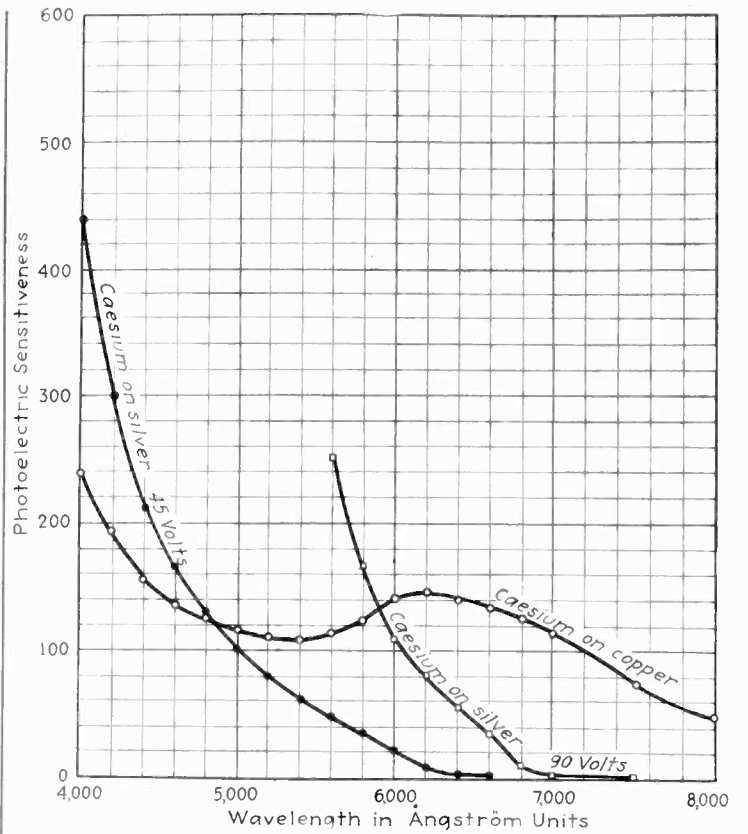

CONSIDERABLE ENERGY emitted by incandescent lamps is in the red region of the visible spectrum. This curve, taken from "A Study of Color Sensitiveness of Various Types of Photo-electric Cells," W. F. Hess, Rensselaer Polytechnic Institute Bulletin No. 23, shows the results of efforts to increase the photo-cell's sensitivity in this region.

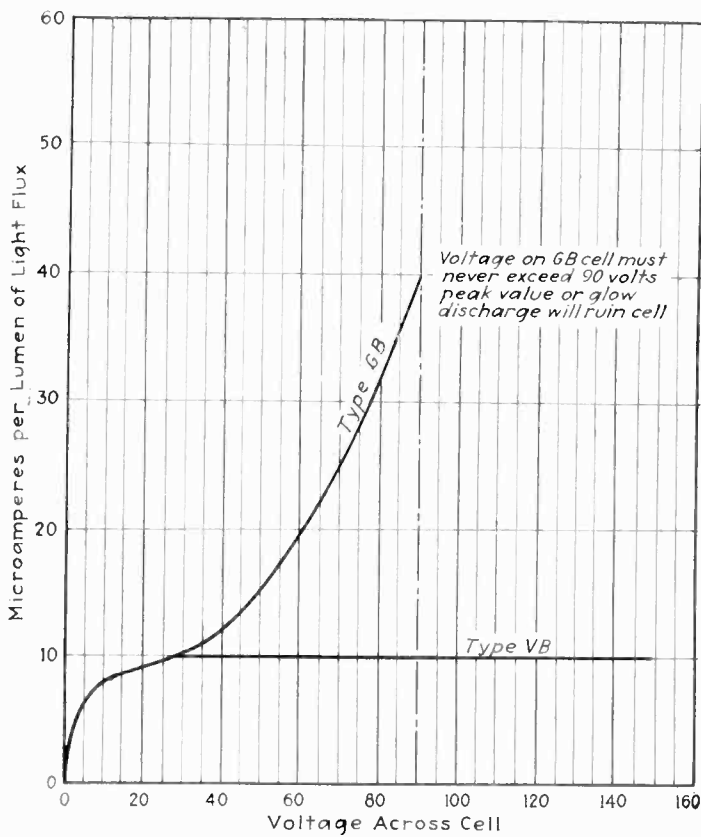

TYPICAL CURVES of average output of a commercial cell showing the emission at one lumen of light flux. The cells are Westinghouse Type GB, gas-filled, and VB, vacuum type. The superior sensitivity of the gas cell is evident, as is the early saturation of the vacuum cell and its subsequent uniform output.

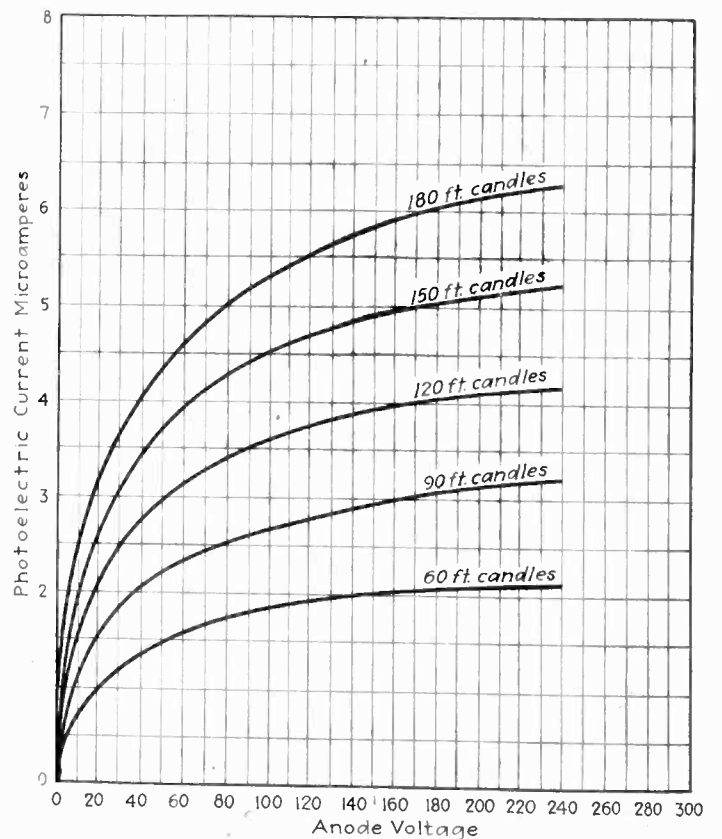

CHARACTERISTIC curves of the vacuum type of commercial cell (Eveready Raytheon Fotocell type 3VS). The output in micro-amperes as a function of both anode voltage and intensity of illumination is shown in this chart. The linearity of response with illumination can be easily demonstrated from these data.



# Photo-cells for special applications

By DR. HARVEY C. RENTSCHLER

Director of Research,  
Westinghouse Lamp Company

EVERYONE who has worked with radio tubes knows that when a battery is connected to the plate and filament of a two electrode tube, no current will pass through the tube until the filament or cathode is heated above a certain temperature. The strength of the current depends upon the temperature of the cathode, the area of the cathode surface, the material of the cathode and to some extent upon the potential of the plate with reference to that of the cathode. For ordinary tubes used in radio, this current varies from a few milliamperes to a hundred milliamperes or more depending upon the tube. The operation is explained by saying that heating the cathode causes it to give off negatively charged particles called electrons which are attracted to the plate by the electric field supplied by the battery.

In many respects the operation of the photo-electric cell is very similar to that of the two electrode radio tube. There are two electrodes, the cathode which is a metal plate or a metal deposit on part of the inside wall of the cell and an anode or positive electrode which is usually a wire spaced a short distance in front of the cathode. These electrodes are mounted in a glass or quartz bulb and are connected to the outside of the bulb through suitable lead wires sealed through the bulb. The bulb is exhausted and the electrodes are carefully treated to properly activate the cathode surface. As in the case of the two electrode radio tube, a battery is connected to the anode and cathode of the cell. *Again there is no current in the circuit as long as no light reaches the cathode.*

Most metals respond to ultra violet light only, but a few are sensitive into the visible region of light and cells are now available which respond to light even beyond the red into the infra red or region known as heat rays. To get a clear picture one must remember that the two-element radio tube becomes a conductor when the cathode is heated. Similarly the photo-electric cell becomes a conductor when light of proper color or wavelength strikes the cathode. The current which can pass from the cathode to the anode of the radio

tube is of the order of milliamperes *but* the current through a photo electric cell when the cathode is illuminated is of the order of a fraction of a micro ampere to a few micro amperes depending upon the intensity of the light, the cathode surface material, the area of the cathode and the kind of light used that is the wave length or color.

## Current is proportional to illumination

The operation of the photo-electric cell is explained by saying that when the proper light strikes the cathode it too gives off negatively charged particles or electrons which carry the current across the vacuum space between the electrodes. The current which can pass through a given cell is directly proportional to the intensity of



Dr. H. C. Rentschler and his ultra-violet dosage meter. A condenser is permitted to charge by the photo-electric cell so long as radiation falls upon the latter. The condenser discharges at regular intervals and registers the amount of ultra-violet that has fallen on the cell—and on the patient.

the light falling upon the cathode and is independent over a *wide* range of the temperature of the cell. Further the response of the cell to light is instantaneous. Thus Lawrence and Beams have found that the time lag between the striking of the light upon the sensitive surface and the emission of the photo electrons is less than one hundred millionth of a second. *See Physical Review. Vol. 32 page 478, 1928.*

In other words the photo-electric cell is simply a valve which permits a current of electricity to flow in a circuit (of which the cell is a part) when the cathode is properly illuminated. It is conceivable therefore that a machine may be started or stopped or even the speed controlled by playing a beam of light upon the cathode of a suitable cell. Unfortunately the currents which can be obtained with the most sensitive photo-electric cells are too small to directly operate even the most sensitive mechanical relays. This is largely responsible

for the long delay in putting to practical uses this very interesting tool. For most practical uses of cells it is desirable to use an artificial light source such as an incandescent lamp. But the radiant energy for such a light is greatest in the infra red and decreases rapidly toward the blue and ultra violet region. It is, therefore, at once evident that for such uses, cells should be as sensitive as they can be made for red and infra red light. During the last year or two photo-electric cells have been very greatly improved in this respect as well as in reliability and constancy of operation. Also the sensitivity is greatly improved by the use of an inert gas in the cell. These so-called gas cells, although much more sensitive, are more critical and less constant than the vacuum cell and are not suitable for exact measurement purposes.

### Three principal uses

The practical applications of photo-electric cells may be considered to fall under three separate groups.

1. Those applications where the device must faithfully follow the exact variation in light intensity. As illustrations of this class we have the production of sound from the variation of the light intensity of a beam of light passing through a moving film as in the talking movies, etc. As another illustration we have the production of electrical current variations by light falling on a photo cell as for transmission of pictures or television. For such purposes it is best to have the photo-electric current amplified by the use of three electrode tubes such as are used as amplifiers for radio purposes.

2. Such applications as simply require trigger action. This class includes such cases as the setting off of an alarm when a light beam is interrupted, or the starting or stopping of a machine by flashing a light beam on to a photo-electric cell. This class has perhaps far the greatest use for photo-electric cells. It is at once evident that the photo-electric current could be amplified by radio tube amplifiers as in the first case until a sufficient current is obtained to operate a mechanical relay. It is much simpler, however, to use glow discharge relay tubes intermediate between the photo cell and the mechanical relay. For detail regarding these glow relay tubes the reader is referred to the articles by Knowles in the *Electric Journal* for April, 1928, Vol. 26, page 176, and February, 1930, Vol. 27, page 116.

3. To integrate the light intensity over a given time as in the ultra violet dosage meter described, page 113, *Journal of the American Institute of Electrical Engineers*, February, 1930. Here still another type of glow relay tube is used which can also be used for most purposes described under Class 2. Evidently the result desired under the third class could be accomplished by first obtaining a continuous record using amplifiers as described under Class 1 and then integrating the curve thus obtained, but for most cases this would be far more awkward.

Summing up the present situation regarding photo-electric cells we may say that cells are now available which respond only to the very short ultra violet region, others which are sensitive to the entire ultra violet, still others which are sensitive to the ultra violet and the blue end of the visible and still others which are sensitive to the entire visible and even to near infra red light. The proper choice of cell depends upon the particular light to be measured or used.

# Economic evolution with the introduction of sound pictures

By FRANKLIN S. IRBY, Ph.D.

Associate Editor *Electronics*

---

THE motion picture industry during the past two years has undergone a tremendous economic evolution. The signs of this evolution were apparent earlier but began to take definite form when Warner Brothers produced the talking picture *The Jazz Singer* with Al Jolson in the leading rôle in October, 1927. The immediate success of this synchronized sound picture was the turning point from silent to audible pictures.

Since the introduction of sound, the total investment in all branches of the moving-picture industry has increased by \$500,000,000, bringing the present total to approximately two and one-half billion dollars. There are 22,624 moving-picture theaters in the United States, of which about 9,250 have been equipped with sound reproducing apparatus during the past two years. Approximately 500 new theaters are being built each year. In Europe there are 27,000 theaters with an estimate of 2,500 equipped at present to show sound pictures. The number of theaters being equipped with sound apparatus is increasing daily. Europe is lagging behind the United States owing to the lack of foreign equipment, high cost of American equipment with import duties added, and (up to the present at least) insufficient trained personnel to handle this apparatus. Theaters throughout the world have been equipped with sound reproducing apparatus. One American company alone has equipped theaters in 41 foreign countries.

The introduction of sound recording apparatus required the rebuilding or redesign of all existing studios to meet the new conditions. Soundproof studios were one of the major requirements. In addition, amplifier rooms, generator rooms, battery rooms, recording rooms, wax preparation rooms, etc., have all been required to handle the new technique in pictures. Additional investment in the studios to make sound pictures amount to



DR. FRANKLIN S. IRBY, was formerly Lieutenant-Commander in the U. S. Navy, having graduated from Annapolis in 1917. He served during the World War on cruiser duty with the North Atlantic cruiser force and later was chief engineer in destroyers until selected for a post-graduate course in engineering in 1921. After one year at the Post Graduate School, Annapolis, he continued his post-graduate work at the University of Chicago under such well

known physicists as Dr. Michelson, Dr. F. R. Moulton, Dr. H. G. Gale, Dr. MacMillan and others, receiving his M.Sc. degree in 1923 and his Ph.D. in 1924. Later he resigned from the Navy, has been concentrating on sound-picture work as engineer for Electrical Research Products, Inc., the commercial division developing products of the Bell Telephone Laboratories.

\$30,000,000. Some idea of the electrical equipment required for a modern sound studio may be obtained from the accompanying picture. This shows an amplifier room equipped for eight recording channels. The "recording channel" is the term usually applied to the equipment necessary for recording on one stage.

### New manufacturers enter field

The change-over in the industry has introduced a new demand for man-power as judged by the increase of 100,000 employees over the 250,000 two years ago, or a total of 350,000 to date. A great part of this increase can be attributed to the number of manufacturers who have entered this field. At the beginning of 1927 there were perhaps not five companies actually engaged in the manufacture of sound apparatus. By the end of 1929 there were 154 manufacturers in this field and as many as 182 different makes of sound reproducing apparatus on the market. The range of names adopted for this equipment extends from the better known Vitaphone, Movietone, Phonofilm, etc., to both ends of the alphabet, Audiotone, to Wondertone. Indeed it almost seems that the lack of names only has prevented further manufacturers from entering this market. The total sales of sound apparatus for 1929 are estimated at \$125,000,000. Such figures are astounding for an infant industry.

The former engineering personnel actively working in this industry were limited to certain well-defined crafts. This has all been changed. The studios are now staffed with large numbers of electrical engineers, acoustic engineers, transmission experts, and so on. This transformation in engineering personnel will perhaps have a greater influence in the motion picture industry of the future than the new apparatus which has been installed. It is said that machines are no better than the men who make them.

### Effect upon other industries

Prior to the advent of sound in the moving-picture theater, the acoustic requirements of the majority of theaters were either neglected or else not considered of the same importance as artistic or other architectural features. The use of loud speakers behind the screen have brought new problems to the acoustic field. The time of reverberation, echoes, and the suppression of extraneous noises all require a correct solution if perfect reproduction in the theater is to be expected. The acoustic engineers will have an increasing importance in the design of future theaters and the correction of acoustic faults in existing ones. The manufacturers of acoustic materials have a profitable outlet for their products in the thousands of theaters equipped and still to be equipped with sound apparatus. The introduction of sound recording within the studio has caused a change in the type of high-candlepower lights required. The former type of sputtering arc light, which would easily ruin any recording because of its pickup by the sensitive microphone, has given way to newly designed incandescent lamps. The problem of silencing the camera itself has required the most intensive study. The employment of a soundproof camera booth using clear plate glass for a window has been used as a temporary expedient. Pantomime had reached such perfection before the silent screen that elocution was a lost art. This problem has been successfully met by many former screen artists and the influx of trained talent from the legitimate stage. The increased popularity of the audible picture over the silent is shown by the increase of 15,000,000 paid admissions to theaters each week. It is significant to note that there is not a single legitimate play on Broadway today.

With theaters throughout the world equipped for



Amplifier room of a modern sound studio. Amplifier equipment for eight recording channels is shown at right with power control panels at left. Estimated cost of the total electrical equipment involved, \$1,000,000.



# THE MOTION PICTURE INDUSTRY

Total investment in U. S. ....	\$2,500,000,000	Number of manufacturers of sound equipment, U. S. ....	154
Total theatres in World .....	53,000	Total sales sound equipment in 1929 .....	\$125,000,000
Total theatres in U. S. ....	22,624	Average weekly attendance U. S. in 1929.....	115,000,000
Theatres in U. S. equipped for sound.....	9,500	Increase in weekly attendance since introduction of sound, U. S. ....	15,000,000
Estimated number of theatres in U. S. to be equipped with sound in 1930.....	5,000	Total positive film produced in U. S. in 1929— linear feet.....	1,000,000,000
New theatres built in U. S. annually .....	500	Total exports U. S. film in 1929—linear feet .....	282,215,480
Total theatres in Europe .....	27,000	<small>(Mostly negative film from which many millions of additional positive film is made)</small>	
Theatres in Europe equipped for sound.....	2,500	Total paid admission U. S. theatres estimated annually.....	\$1,560,000,000
Total employees in motion picture industry, U. S. ....	350,000		
Increase in employees with introduction of sound.....	100,000		

sound, new problems of language will have to be considered. Heretofore the silent picture was universal in its appeal—the print destined for foreign countries needed only the translation of sub-titles in the foreign language. This is impossible with sound prints which have a continuous sound track recorded in English. This can be partially overcome by a “double shooting process” in which two separate groups of players, directors and technicians, are used with one story, and one group of settings. The cost of this plan exceeds that of a single-language version by about 30 per cent. The lack of proper screen talent and the duplication of the above procedure for every foreign country limits its application, especially when it is realized that there are 72 foreign languages! In spite of this apparent handicap of language, it is interesting to note the increase of United States film exports in 1929 over 1928:

## AMERICAN FILM EXPORTS

Countries	1928 Linear Feet	1929 Linear Feet
Europe.....	69,998,393	110,031,551
Latin America.....	78,960,444	79,697,870
Far East.....	54,335,108	62,829,477
Canada.....	8,814,462	16,446,073
South Africa.....	3,772,094	5,343,073
Other countries.....	6,242,085	7,867,436
Total.....	222,122,586	282,215,480

The above increases may be partially accounted for by the fact that other countries have not yet full sound recording facilities. It is estimated that 85 per cent of the motion pictures shown throughout the world are produced in the United States. Of the remaining 15 per cent, Germany has 8 per cent of the showing, England and France about 2 per cent each and the remaining 3 per cent accounted for by all other producing countries. With the universal adoption of sound and the present foreign markets supplied by this country, it is seen that anglicizing speech throughout the world may not be far behind. Tests conducted on a group of school children in Denmark indicated their progress in the study of English was 300% greater by the use of sound dialogue picture than over the best methods previously used. Certain governments by actual restriction and contemplated legislation are trying to prevent the introduction of foreign sound pictures because of the effect on their national language.

Entirely new methods are opened to the advertising and educational fields with sound moving pictures. The

outlets for portable sound recording apparatus in these fields are almost unlimited, once this market gets started. The adoption of equipment for the above purposes is held back at present by the limited facilities for making sound pictures except in the theatrical field.

## New developments ahead

After two years of most hectic and revolutionary development, the motion-picture industry might well pause for breath but this appears improbable. New technical developments that may be as far reaching as the introduction of sound are crowding upon the scene and the producers must embrace them or be left behind in the race for supremacy. Two major developments in the offing are: the growing use of color and the introduction of wide film. Color has been used in the past to a limited extent. The companies working in this field, Technicolor, Photocolor, Eastman-Sonochrome, Multicolor and Harris, are overcoming their technical difficulties. One of the obstacles of color photography has been the excessive production costs and lack of technical perfection in the past. The use of color does not make it necessary for theaters to alter their reproducing equipment.

The use of a sound track on color film has introduced some new problems in reproducing at uniform volume level but solutions for this appear feasible. The introduction of wide film, however, with the resulting panoramic picture requiring a much larger screen, will demand changes in reproducing as well as recording equipment. The universal adoption of the panoramic picture will perhaps cost the industry one-half as much as the introduction of sound. Previous to adding the sound track the proportions of the picture frame on standard 35 mm. film are shown in the accompanying view. This picture frame is in a ratio of 4 wide by 3 high. The addition of the sound track of 100 mils width inside the sprocket holes, reduced the width available for the picture by approximately 12 per cent. The subtraction of this width for the sound track has reduced the former rectangular dimensions of the picture frame to almost a square. This change in shape of the projected picture gives an area the proportions of which are extremely unsatisfactory from the standpoint of pictorial composition and practical utility. The projectionists in order to overcome this problem have resorted to

various artifices. One method provides for a combination of reduced aperture with a lens of shorter focal length. An aperture is inserted in the film gate which masks out the sound track and a strip from the top and bottom of the picture sufficient to reduce the height to about three-fourths of the reduced width. The resulting smaller picture is enlarged by using a one-half inch shorter focal length lens to fill the screen. Recentering of the picture is accomplished by moving the lens on the machine from left to right or by moving the projector in the horizontal plane.

### The new wide films

The above modifications have brought out the need for a wide film together with the great advantages to be gained in adopting the panoramic picture.

Grandeur film which has been promoted by the Fox Film Corporation is shown in another diagram. This film is 70 mm. in width, the picture area being twice the width of standard 35 mm. film and 25% greater height. Other producers are working on the development of wide film of 56 and 65 mm. widths and up to the present no standard has been agreed upon. It is obvious that standardization for the industry will be a necessity. By comparison of Grandeur film with the standard 35 mm. film, it is seen what a marvelous panoramic view is possible. In viewing the projected wide film, one gets a sense of stereoscopic photography, though actually stereoscopic cameras are not used in taking the picture. A recent production of "Happy Days," was shown on Grandeur film at the Roxy Theater, where a projection screen 21 by 42 feet was used. The sound track on this new film is 250 mils in width, compared to 100 mils for standard film. This increase in sound track width allows a greater volume range in reproduction with less amplification required. This increase may also have interest-

ing possibilities in the future. If binaural recording and reproduction becomes feasible, it may be possible to "split" the wide sound track to allow recording and reproduction of two separate systems from the same film. This wide film also allows space on either side of the sound track and picture frame for pressure pads which are considered desirable but was not possible with standard film.

The new film has five sprocket holes per frame as against four in standard film. The same number of frames are projected per second as before, which with the greater height of each frame results in an increase of speed to  $112\frac{3}{10}$  feet per minute as compared to 90 feet per minute for standard 35-mm. film. This increase in speed will give better response to recording the higher frequencies.

### A universal language

The evolution which has been brought about in a great industry has been made possible by the application of the photoelectric cell and vacuum tube to new uses. Without the thermionic tube the amplification of the microphones to actuate the recording device would not be possible, while the sensitivity of the photo-cell makes possible the reproduction from the recorded film.

The new applications to which the tube has been put in recent years has come about primarily through the adjustment of the apparatus in different relations to its surroundings, rather than through any fundamental change in the apparatus itself. The psychological aspects of the upheaval that has just transformed the picture industry have not yet been fully realized. Just what the final result on mankind may be, the future alone can tell. If from it all, there should emerge one universal language in decades to come and a better understanding between the nations of the world, a national shrine may some day be built to the little vacuum tube that made it all possible.

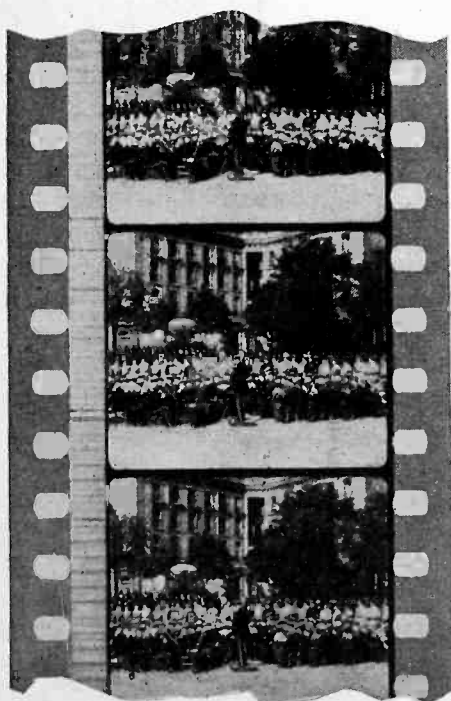

ABOVE—Standard 35-mm. film with sound track of 100 mils width used at present.



AT THE RIGHT is shown new 70-mm. "Grandeur" film, with sound track of 250 mils width. Both reproductions are one-and-one-half times actual size.

# Producing very high frequencies

## by means of the magnetron

By W. C. WHITE

Vacuum Tube Engineering Department  
General Electric Company

FROM time to time during the past few years, methods of obtaining frequencies of the order of 100,000 kilocycles (100,000,000 cycles) per second or higher and involving the use of vacuum tubes, have been described. In general, however, these methods have resulted in the production of only small amounts of power at these high frequencies.

It is the purpose of this article to describe briefly a special form of vacuum tube and its associated circuit that allows the production of relatively large amounts of power at the very high frequencies. By this means, electro-magnetic and electro-static fields of unusual intensity for these very high frequencies can be produced. Such fields should be of interest in connection with researches in therapeutics, bacteriology, chemical reactions, the properties of insulating materials, etc.

Magnetrons for the production of high frequencies have been mentioned in the literature occasionally. (The term "magnetron" is the General Electric Company's trade name for magnetically-controlled high-vacuum tubes.) However, the full possibilities of these tubes and their design and practical method of application do not seem to have been fully realized.

### Construction of the tube

In its simplest form, this type of magnetron tube consists of a cylinder, split so as to form two equal semi-cylindrical anodes, with a filament as a hot cathode at the axis of the cylinder.

In the small tubes, the two similar anodes are, as in the case of the conventional three electrode tubes, made of nickel, molybdenum or other suitable high melting point metal and are cooled by radiation. In the tubes of large size, water-cooled anodes are employed.

The type of filament or other form of cathode utilized is either tungsten, thoriated tungsten or coated depending, as in the case of the three-electrode tube, upon the rating of the tube and the anode voltage and current.

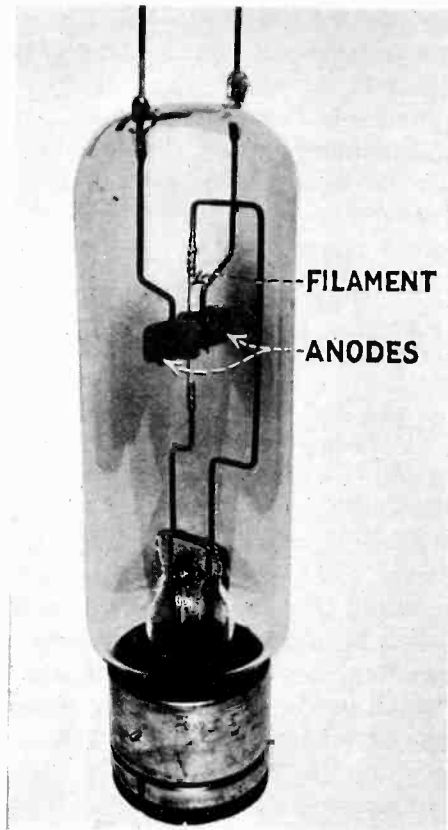

Fig. 1  
Small split-anode magnetron

The frequency obtained from this form of magnetron oscillator is not a function of the time of passage of the electrons from the cathode to the anode except to a very minor extent. Therefore, the anode diameter is not directly a factor in the design of a tube for a desired frequency. It follows then that the oscillations from this form of magnetron oscillator are not of the so-called Barkhausen type.

As potentials up to several thousand volts are utilized on the anodes of these magnetron tubes a technique of design and manufacture similar to high-power three-electrode transmitting tubes must be employed.

The action and path of travel of electrons under a combined electrostatic and electromagnetic field have been described by Dr. A. W. Hull and the reader is referred to that description for a thorough discussion of this subject. (Refer to 6 in the list of references.)

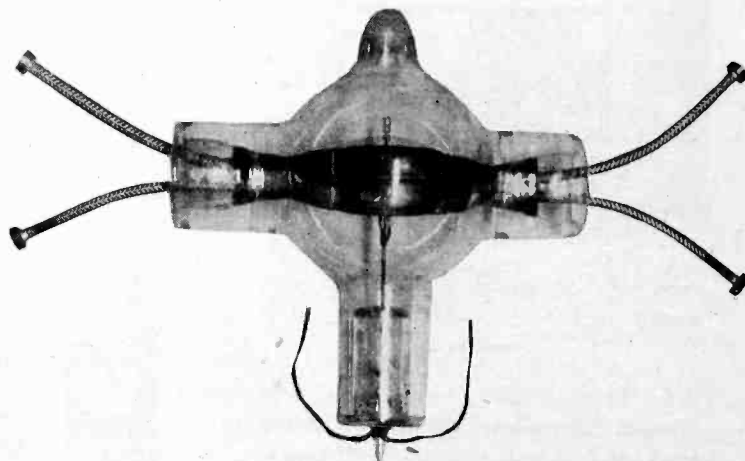

Fig. 2  
Water-cooled split-anode magnetron



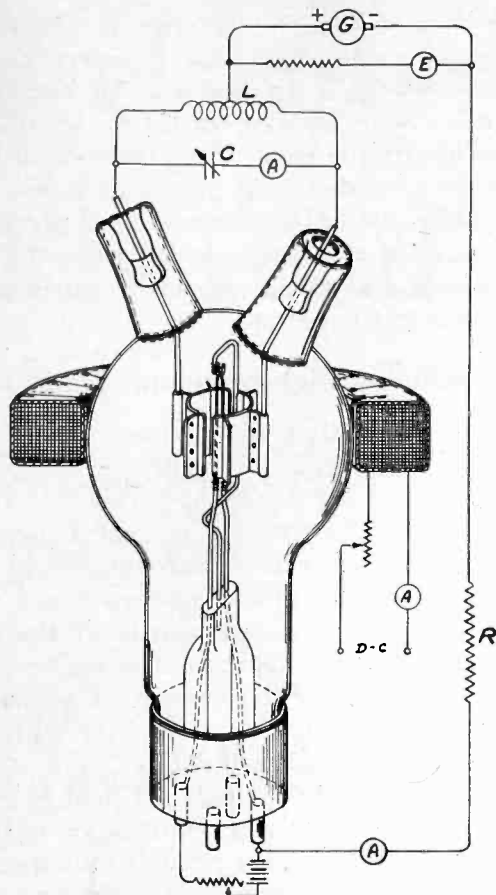

Fig. 3—Arrangement of tube in magnetic coil and fundamental circuit

L = inductance  
E = plate voltmeter  
C = capacitance  
G = d.-c. supply  
A = ammeter

A small form of radiation cooled split anode magnetron is shown in Fig. 1. A large water cooled tube is shown in Fig. 2. In the smaller tube, a single strand of filament is employed whereas in the larger tubes several strands of filament are grouped together around the geometrical axis of the split cylindrical anode.

### Form of magnetic field employed

Magnetic lines of force parallel to the axis of the split cylindrical anode are employed. These are most conveniently obtained from one or two air core electromagnetic coils placed around the tube and supplied by direct current.

A typical arrangement of tube and electromagnetic coil is shown in Fig. 3.

A strength of field is required, under non-oscillating conditions, more than sufficient to cut the anode current to zero at the plate voltage utilized.

In the case of the small tube shown in Fig. 1 operating from a 1,500-volt d.-c. supply to the anodes, a magnetic field strength of 750 gauss should be provided. A similar field strength is required for the tube shown in Fig. 2 when operated at 10,000 volts. As the optimum magnetic field varies with the d.-c. supply voltage to the anodes, a control of the d.-c. current through the electromagnetic coils is advisable.

Owing to the fact that the oscillation frequency is not a function of the time of travel of the electrons to the anodes, the frequency does not depend upon the strength of the magnetic field. Therefore, great constancy of the magnetic field is not necessary.

### Circuit arrangement

The essential parts of the circuit are shown in Fig. 3. It will be noted that the oscillating circuit includes the two anodes. The frequency obtained is primarily dependent upon the LC product in the external oscillating circuit. However, in the case of the very high frequencies, the inductance of the leads between the external coil and the anodes inside the tube is a factor as well as the capacitance between the leads and anodes.

In the case of the extreme frequency obtainable from some particular tube of this type, no external lumped capacitance is employed, and the external inductance is reduced to the length of conductor required to connect the two anode leads together. Therefore, in the design of the circuits using these tubes capacitance between the leads to the two anodes must be kept at a minimum. The inductance between the anode proper and their external anode connection should also be minimized.

An actual set up with a water cooled tube is shown in Fig. 4. With this arrangement of tube and apparatus, an output of 2.5 kilowatts at 75,000 kilocycles is obtainable. In this view, the upper electromagnet which is mounted on a hinge is swung upward to show the tube. The cooling water for the anodes is supplied through the coiled hose shown at the bottom of the picture.

A stabilizing resistance shown at R has been found helpful in the operation of this circuit particularly under experimental conditions. (See Fig. 3.)

The question may well be raised as to why higher power outputs at the very high frequencies can be ob-

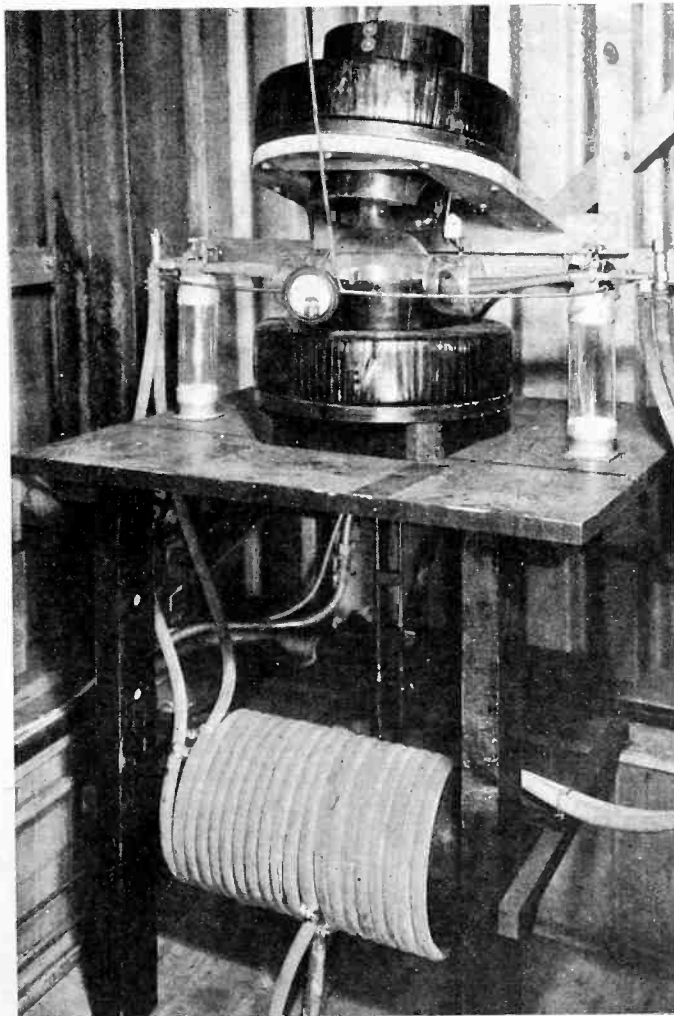

Fig. 4—Water-cooled split-anode magnetron and associated apparatus for production of high-power high-frequency oscillations

tained from this form of magnetron and its circuit than from a special design of a conventional form of three electrode tube.

There are probably two principal reasons for this. First, the effective capacitance between the two anodes of the magnetron can be made smaller than the grid to plate capacitance of a conventional three electrode tube. Second, it is difficult, under high frequency conditions, in the usual form of three electrode tube to maintain a  $180^\circ$  phase relationship between grid and plate voltages.

The combination of magnetron tube and circuit that has been described here seems to be particularly well suited to production of high frequency power in the frequency range between 40,000 and 400,000 kilocycles. At frequencies lower than this range special forms of three electrode tubes are available and for the still higher frequencies a magnetron of this type requires in its design a considerable sacrifice of power output.

Technically, of course, very low frequencies such as 60 cycles are obtainable from the split anode magnetron by the use of very large inductances and capacitances.

### Efficiency and output

The efficiency of a tube and circuit arrangement as has been described is practically the same as in the usual three electrode tube oscillating circuit, when the power required in the magnetic field is excluded. As is the case in all very high frequency circuits the output is difficult

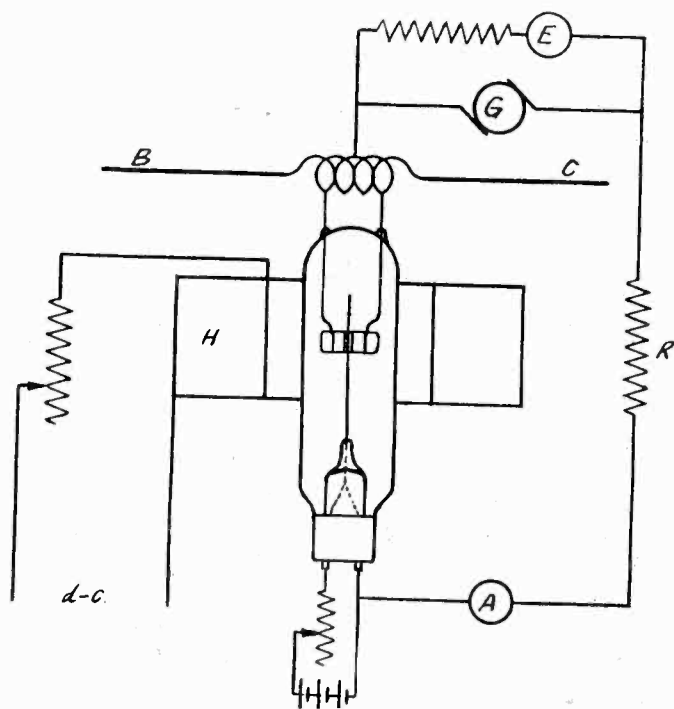

Fig. 5—Open resonator rods (B and C) added to a split-anode magnetron oscillating circuit of an intense electro-static field. H = electromagnet

to measure; it is here considered to be the difference between the d.-c. input to the circuit of the anodes less the loss in the two anodes.

From a tube as shown in Fig. 1, an output (as defined in the preceding paragraph) of about 10 watts at 400,000 kilocycles is obtainable with a plate voltage of 1,500 volts. At a frequency of 100,000 kilocycles or lower, an output of about 40 watts is obtainable.

With the water cooled tube shown in Fig. 2, an output

of 1 kilowatt at 85,000 kilocycles is obtainable. At a frequency of 20,000 kilocycles or lower, this tube will give an output of 5 kilowatts. An anode supply of 10,000 volts d.-c. is utilized for these outputs.

In the case of the small tube, the overall efficiency is very low because the filament power is about 25 watts and the power lost in the electromagnet about 150 watts.

In the case of the water cooled tube, the power lost in the filament and electromagnet is not nearly so large in proportion to the output.

### Producing high-frequency static field

It will be noted that the particular tube and circuit combination described is inherently an oscillator and not an amplifier.

If it is desired to create a powerful high frequency electrostatic field, this can be accomplished by connecting the two plates or electrodes, between which the field is desired, to the two anode terminals of the magnetron. The size and distance apart of the electrodes must be governed, of course, by the amount of additional capacitance that can be added to the circuit without causing undue changes in its characteristics.

If an intense but highly localized field is desired near the minimum wavelength of the tube, it is best accomplished by the addition to the circuit of an open resonator. This consists of two rods in a straight line end to end. The length of each one should be adjustable but together they should be about one-half a wavelength long. They are connected to the magnetron circuit as shown in Fig. 5.

In the immediate vicinity of the outer end of each rod, when they are adjusted to resonance, there is an intense electrostatic field.

*NOTE.*—The so-called Barkhausen oscillations mentioned by Mr. White are interesting phenomena, although of a different sort than those generated by the magnetron. They are generated in a triode by making the grid positive and the plate negative. Electrons go through the grid, are repelled by the plate and again come into the field of the grid; then they repeat the cycle. The time for one cycle is controlled by the geometry of the tube.

Such very high-frequency oscillations offer extremely interesting possibilities in communication, therapeutics and other services.

—THE EDITORS.

### BIBLIOGRAPHY

1. Production of Extra Short Electromagnetic Waves by Split-Anode Magnetron. By Kinjiro Okabe, Tohaku Imperial University, Sendai. Proceedings of the Imperial Academy III, 1927, No. 8.
2. Beam Transmission of Ultra Short Waves. By Hidetsugu Yagi. Proceedings of the Institute of Radio Engineers. June, 1928, Vol. 16, p. 715.
3. On the Production of Intense Undamped Waves of Extra Short Wave Lengths. By Kinjiro Okabe. Technology Reports of the Tohaku Imperial University. Vol. 7, No. 4.
4. On the Short Wave Limit of Magnetron Oscillations. By Kinjiro Okabe. Proceedings of the Institute of Radio Engineers. April, 1929, Vol. 17, p. 652.
5. Eine neue Generatortröhre. By E. Habann. Jahrb. für drahtlose Telegraphie und Telephonie. Vol. 24, p. 115, 1924.
6. The Magnetron. By A. W. Hull. Journal of American Institute of Electrical Engineers. Vol. XL, Sept. 1921, p. 715.
7. Book: Hochfrequenztelephonie und Telegraphie Auf Leitung. By Erich Habann. (Friedr. Vieweg & Sohn. Publishers Braunschweig, Germany.) See p. 12.

# The electron— and beyond

By VLADIMIR KARAPETOFF

Professor of Electrical Engineering  
Cornell University

---

**A**N ENTIRELY new language will be necessary before we can truly say *what* the electron is, or for that matter express in terms other than mathematical, the concepts of our modern physical philosophy.

This future language must transcend our present limited modes of expression—mathematics, speech, or pictures—by means of which we are attempting in vain to present a concept of physics and physical forces mechanically or by analogy. Only some super-human being could speak this unknown language at present; and were he to attempt an explanation of electricity, we could not understand him.

Electricity is analogous to nothing else in the material world that we know anything about. According to our present idea, it is really comprised of three apparently independent entities—negatively charged particles, or electrons; positively charged particles such as alpha rays, protons, clusters, etc.; and various types of electro-magnetic radiations, as gamma rays, X-rays, and cosmic rays.

## Electron is further divisible

From some recent experiments we have been led to the belief that under certain conditions the electrons behave somewhat like electro-magnetic pulses. And conversely, there is some evidence to indicate that electro-magnetic radiations may display properties of the discrete particles. In other words, all three manifestations of electricity seem to be endowed simultaneously with inertia and charge, to be found in material objects, and with some wave properties such as frequency and wave length as ascribed to ethereal or non-material oscillations. So electricity and the electron become neither flesh, fowl, nor good red herring, but something entirely apart. It is for this reason that a new terminology is needed.

That physical science and metaphysics are definitely interrelated seems evident, especially in view of this line of negative reasoning on subjects where it becomes possible to tell what a concept is not, but still not define it.

The human mind is never satisfied with a mere knowl-

---

From an address before the Science Forum, New York Electrical Society.

edge of facts, but insists always on grouping them and trying to develop some philosophical explanation in general terms, in spite of the argument from the metaphysician and logician that this is hopeless. An expression of this sort, in terms of ultimate realities, would call for nouns, adjectives and verbs encompassing and pertaining to ultimate realities. Those words would come as a part of this new language I mention—and which I do not expect to read or hear.

A line of thought somewhat revolutionary from the standpoint at least of the popular conception of matter

structure in which the electron or particle of electricity has been considered the ultimate indivisible entity or "bundle" of energy or waves leads to the conclusion that the electron is after all, not the ultimate unit, but is further divisible.



We have been accustomed to call the electron the smallest particle of all matter, and to say that it was

indivisible, as we did with the atom, until that was divided into electrons. Yet we endow the electron with physical properties (perhaps our language error again, of insisting on mechanical analogies) such as radius, mass, axis of spin, electric and magnetic fields, accompanying waves, etc.; and as soon as we do this, allowing it some structure, this structure must be divisible and those parts must have their structure ad infinitum. So the explanation of the electron only shifts the difficulty one step further along an infinite ladder, and seems to accentuate this inevitable necessity for a so far inconceivable mode of expression if we must arrive at this ultimate reality we all seek.

## Einstein limiting speed may not hold

Another apparently "ultimate" factor which has been disturbed by recent experiments is the Einstein equation declaring that material particles cannot move at a velocity greater than that of light, which travels at the rate of approximately 186,000 miles a second.

Some recently observed phenomena make it necessary to assume that electrons and positive carriers of electricity partake both of the nature of matter and of waves, and that the phase of these waves is propagated at a velocity greater than light. The comforting statement that those waves are not material, and therefore not hindered by material things in their enormous velocities, only brings us to the deeply philosophical problem of how these immaterial waves can manifest themselves by affecting the behavior of material particles. One of the basic problems of the metaphysics student is to discover the mechanism of interaction between the material and immaterial, and some day he may formulate this new language which will express a dual structure our senses today refuse even to conceive.



# Tubes for short-wave transatlantic phone service

By Dr. H. E. MENDENHALL

Member of the Technical Staff  
Bell Telephone Laboratories  
New York City

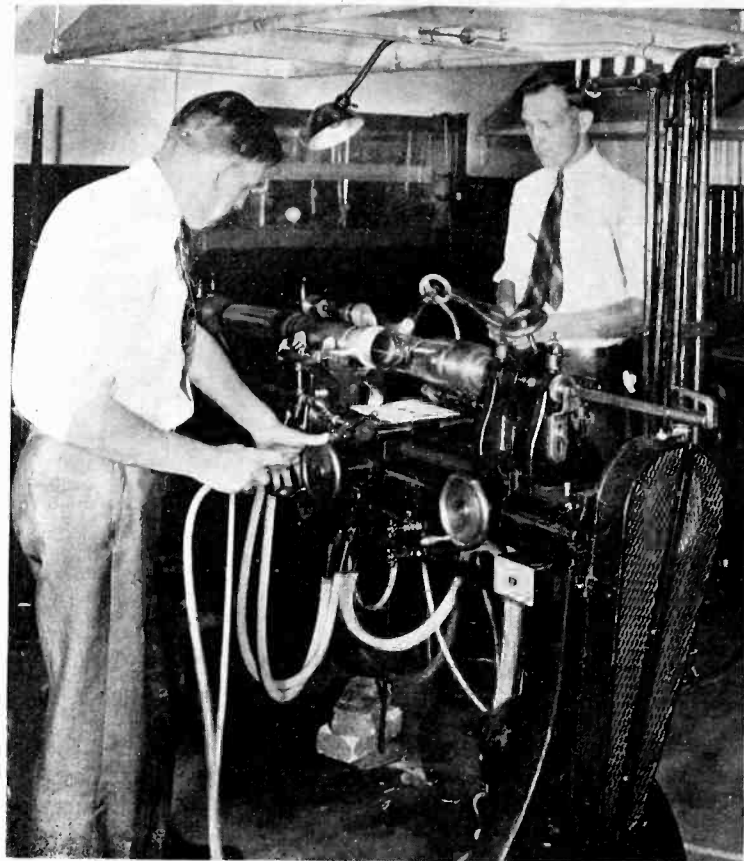

Glass-to-copper seals for short-wave high-power tubes are made on this lathe-like machine.

WHEN transmission studies showed that carrier frequencies of the order of thirty thousand kilocycles would play a part in transatlantic radiotelephone communication, investigations were immediately undertaken in Bell Telephone Laboratories to determine the type of vacuum tube most suitable for transmission systems operating at such high frequencies. It was found that the vacuum tubes which had met the requirements of the transmission systems of the American Telephone and Telegraph Company's long-wave transatlantic service, transmitting abroad since 1926 from Rocky Point, Long Island, on a carrier frequency of the order of seventy-five kilocycles, were unsuited for short-wave systems. Such tubes could not be operated in parallel at the high frequencies; and, even when used singly, they were extremely short lived unless operated at considerably reduced plate voltages and output powers. There are several reasons why tubes that were structurally satisfactory for the low-frequency range were inadequate for the high-frequency range.

In the first place, at the high frequencies the inter-electrode capacitance of the elements of the tube becomes very important from the circuitual standpoint. The "charging" or displacement currents which flow through every

dielectric in an alternating electric field increase with the frequency of the alterations. These displacement currents heat the various dielectrics whose power factors are not zero, used in and around the tube, thereby causing the ultimate failure of the tube. A "high" vacuum is the only perfect dielectric, for heat is not developed in it through dielectric losses. It can only fail when leaks or a slow evolution of gas from the parts of the tube change both its status as a vacuum and its insulating properties. The air separating the elements

on the outside of the tube will be only about one-tenth as effective an insulator when the tube is oscillating at thirty thousand kilocycles as compared with the non-oscillating condition. The same air gap will be disrupted, moreover, by one-twelfth of the applied voltage if it be alternating at thirty thousand kilocycles instead of at 60 cycles.

Another reason for the failure of earlier types of vacuum tubes when used in short-wave circuits is to be found in the "skin effect." A high-frequency current passing through a conductor is forced to travel through a very thin layer at the outside of the conductor. The effective size of the conductor is thus reduced, its resistance correspondingly increased, and overheating engendered.

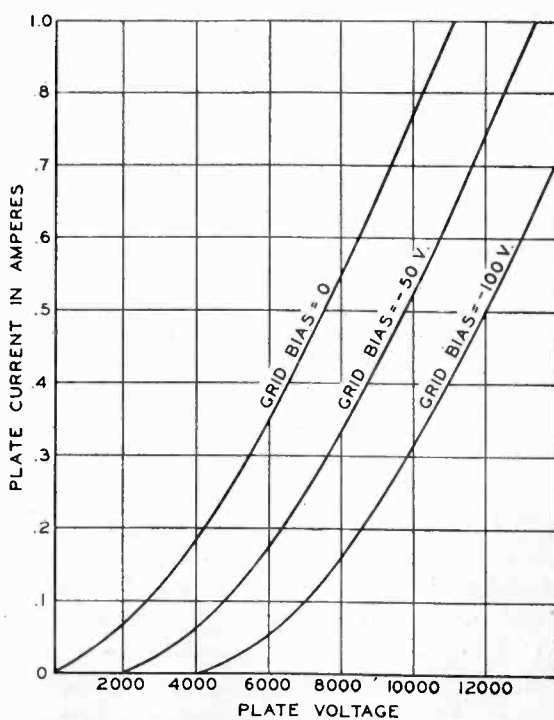

Plate-voltage-to-plate-current characteristics of Western Electric 240-A tube

In view of such facts as these, new tubes had to be developed and old types modified to work with the new circuits. Dr. M. J. Kelly, in charge of Bell Telephone Laboratories' vacuum-tube research and manufacture, suggested several years ago that water-cooled power-amplifiers for short waves be made double-ended: with the filament structure and leads supported on glass at one end, a water-cooled anode in the middle, and an oversize grid lead supporting the grid structure from the glass on the other end. In this construction a maximum of insulating glass and air separate the leads to the tube elements, and the leads can be made large in "skin" area.

Preliminary models of water-cooled tubes embodying these features were made in the laboratory, and these models were supplied for transmission development work at the Deal experimental radio station of Bell Telephone Laboratories. While this work was in progress, development activities were directed toward the final commercial design of water-cooled tubes so constructed. Such tubes were standardized and made available for the transoceanic short-wave service.

Photographs of the Western Electric 240-A vacuum tube are shown here. It has an output rating of ten kilowatts in the high-frequency transmission range.

### Testing high-power tubes

This tube was designed to meet short wave circuit requirements, and then adopted after experimental tubes had weathered a long series of severe tests. The circuit used for these tests consists of a shielded push-pull oscillator. A heavy straight lead, tapped in the center with a grid leak, connects the grid terminals of two 240-A tubes under test, which are mounted vertically on Pyrex insulators. The anodes are connected by means of a water-cooled coil, about eight inches in diameter, of three turns of copper tubing. The capacitances of the tubes between grid and plate complete the oscillating circuit. The load is applied by shunting a small section of the inductance coil with hollow water-cooled carbon rods. The temperature rise and the volume of the cooling water supplied to the rods give a measure of the total power output.

Minute as are the capacitances between the test circuit and other unrelated circuits in adjacent rooms, the frequency of the testing currents is so high that considerable amounts of power can be transferred across the intervening space. In spite of radio-frequency chokes in the high-voltage lines of the test set, and the shielding afforded by enclosing the whole circuit in a large aluminum case, enough high frequency energy radiates through the holes in the shielding for electric and water-supply lines, to upset galvanometer readings, reverse manometer micro-ammeters and burn out thermocouples in adjoining laboratories. The tests are, therefore, conducted out of regular working hours.

### New evacuating technique

Another interesting phase of the development has been the technique used for evacuating tubes of this style. The tube is supported on insulators at the middle, and has special ovens fitted over both glass ends. The grid, filament, anode and glass parts are outgassed simultaneously by heating each of these parts to the highest temperature which it will stand and still keep its form. The evacuation process consequently becomes a relatively

short one, as compared with that for other water-cooled tubes whose various parts must be outgassed separately. The water jacket becomes an integral part of the tube after it has been pumped.

In order that these tubes may be operated successfully in parallel, without singing at still higher frequency, their characteristics and thus their construction must be as nearly alike as possible. Careful attention to mechanical design and manufacturing specifications is thus necessitated. Manufacture has been facilitated by building machines resembling lathes but with fires for their tools, on which are made the glass to copper seals for the filament and grid leads and for the anodes. Glassblowers are still necessary for assembling the parts in their proper alignment—one of the most important steps in the manufacture.

When the Bell Telephone Laboratories undertook the development of a system of telephony between ship and shore, the inconvenience of water-cooling vacuum tubes aboard ship made the use of radiation-cooled tubes seem desirable. Accordingly a high-power tube, to provide one kilowatt of power in the frequency range of thirty thousand kilocycles without water-cooling, took shape and was standardized as the Western Electric 251-A. In this tube radiation is assisted by a very large glass bulb, and by a plate of unusually large diameter, which also reduces the interelectrode capacitance. The 251-A tube is finding use not only in ship-to-shore communication but in Bell Telephone Laboratories' rapidly augmenting airplane-to-ground telephone systems.

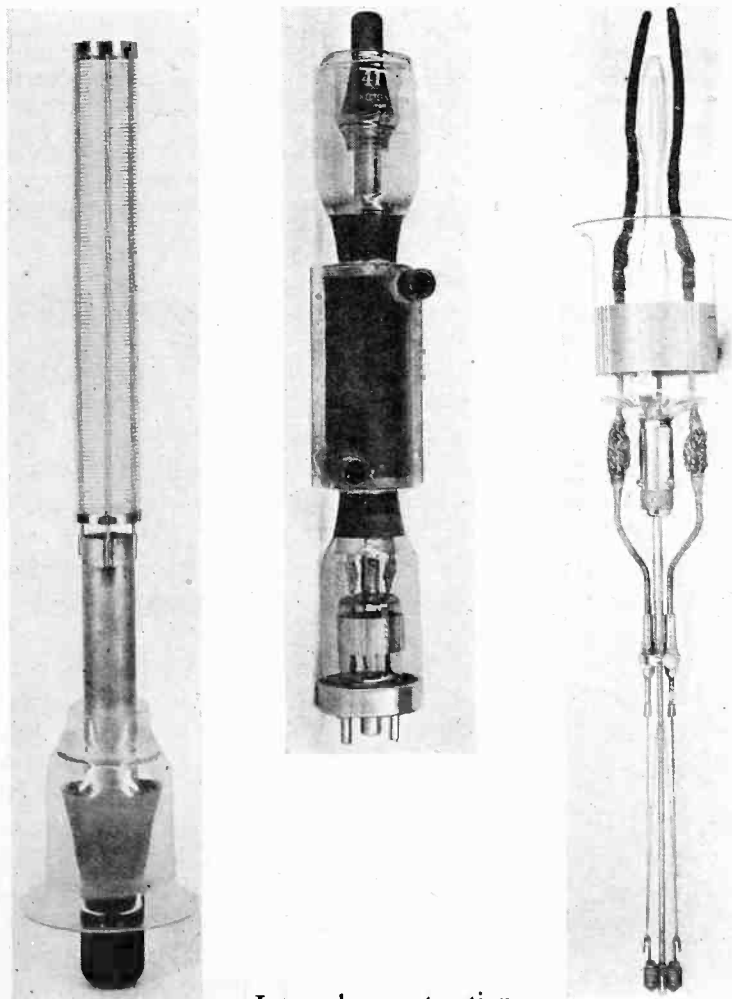

Internal construction and outward appearance of double-ended power tube for Atlantic radio-telephone service

To clear up the confusion about the

# Two kinds of pentodes

By KEITH HENNEY, M.A.

Associate Editor, *Electronics*



KEITH HENNEY who is well known as an authority on vacuum tubes and radio received his Master's degree from Harvard in 1925 in physics after post-graduate work at Harvard in radio communication under Drs. Pierce and Chaffee. Mr. Henney had previously been graduated from Western Reserve University in 1921. During the war he served as radio operator for the U. S. Shipping Board and for a time taught radio to U. S. Signal Corps recruits. In 1923 and 1924 he was an engineer at the Bell Telephone Laboratories; was Director of the Laboratory of Radio Broadcast Magazine from 1925 to 1930; and is a Member of the Institute of Radio Engineers. His textbook "Principles of Radio" was published in 1929 by John Wiley and Sons; he has presented several technical papers before the Radio Club of America, the most recent one being on the Pentode Tube; and is a writer of popular science, his most recent article appearing in *World's Work* for February, 1930.

---

WITHIN the past six months two five-electrode tubes have been demonstrated to radio engineering bodies and through the newspapers announced to the lay public. These two tubes differ widely in construction, in purpose, in application, and in operation. Their only similarity lies in the fact that they each have three grids and therefore are distinct from triodes, which have one grid, and from tetrodes, which have two grids.

Merchandising experts and present inventories may dictate whether or not either or both of these five-element tubes shall appear widely in radio sets or less widely in other applications. But it is only the engineer who can state whether or not the tubes are any good; it will be up to him to judge their technical worth. He will give his verdict regarding the merit of each type of tube after some considerable experimentation and certainly not before the technical facts are known.

## The European or power pentode

The first of these tubes to be demonstrated is a type of "pentode" or five-electrode tube already known and in fairly wide use in Europe and elsewhere. It is a power output tube and at present has no other application. It may take one of two forms, either a low plate voltage

tube with comparatively low power output; or it may be a tube with present-day plate voltage (say 250 volts) with more power output than present-day triodes. It should properly be called a "power pentode" to distinguish it from other five-electrode tubes.

The other tube is a screen-grid tube of greater amplification possibilities but of the same general construction as the present 222 and 224 types. The extra grid is between the filament and the control grid; its purpose is to neutralize partly at least, the deleterious space charge. In the power pentode the extra grid is between the plate and a high voltage grid. The screen-grid pentode has small plate currents, high inter-element capacity, low power output, and is designed to fit into either r.f. or a.f. stages or possibly the detector stage. It cannot be used as a power-output tube. It should properly be called a "screen-grid pentode" to distinguish it from other five-electrode tubes.

Despite the fact that these two tubes differ widely in application and in construction (their additional grids are in altogether different places within the structure and serve altogether different purposes) there are certain similarities.

## Some similarities of operation

Both tubes exhibit the presence of secondary emission, i. e., the flow of electrons away from the plate instead of toward it. The power pentode shows very little of this effect, or perhaps none of it; the screen-grid pentode has the entire lower part of its  $E_p$ - $I_p$  curve given over to the effect. In neither case is the presence of these non-worker electrons harmful; although better tubes might be built if secondary emission could be eliminated entirely.

From the standpoint of voltage gain both tubes are better than their present counterparts. The power pentode is about five times as sensitive as a 245 type of tube; the screen-grid tube is roughly 1.75 times as sensitive. But from the standpoint of application, both tubes suffer in comparison with present tubes because of the pentodes complexity, and because of other considerations.

The power pentodes which have been demonstrated in this country are high-voltage tubes (250 volts). On a given input voltage they deliver about 10 to 15 times as much power output. In this tube the extra grid serves the purpose of turning back into the plate any electrons which are knocked out of that plate by filament-electrons; it is put into the tube to do away with secondary emission; it may also partly neutralize that cloud of loafer electrons that congregates near the filament and limits the emission.

## The screen-grid pentode

The screen-grid pentode has the extra grid near the filament and is connected to a positive part of the battery or supply system. Its purpose is to speed up the electrons; it keeps traffic moving. Therefore the mutual conductance of the tube is somewhat greater and therefore greater amplification is possible. It is unfortunate that the grid-plate capacity of the tube increases in almost the same ratio as the possible voltage gain. This may be the single fact that will prevent the tube from becoming a standard tube.

The difficulty of working with a tube in a high-gain high-frequency circuit probably goes up faster than the first power of the grid-plate capacity. Thus a 100-per



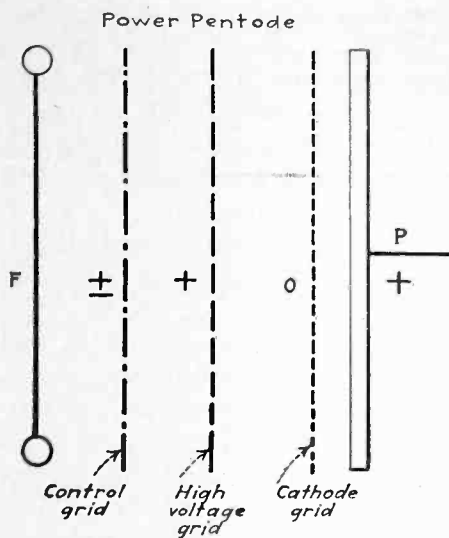

## THE TWO PENTODES

DIFFERENCES between the two pentodes may be made clear by these diagrammatic illustrations. In the power pentode the additional or cathode grid is between the control grid and the plate. In the screen grid pentode the additional or space charge grid is between the control grid and the filament. Because of these different positions within the tube the new grids serve different functions and adapt the tube to different services. Both pentodes have high voltage as well as control grids, making three grids in all.

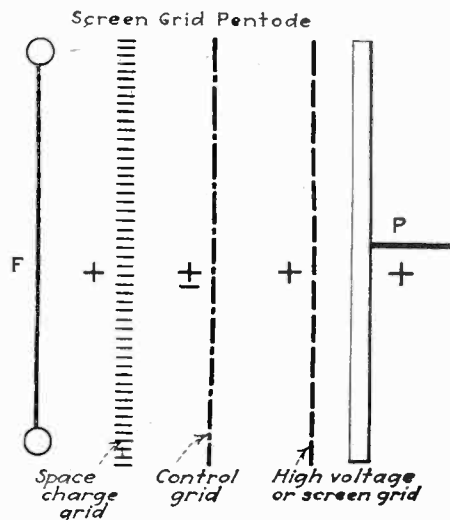

cent increase in this capacity may make it four times as difficult to work with—and judging from many radio receivers, engineers do not welcome problems that tax their ingenuity.

It is possible that improving the amplification in a screen-grid stage by 1.75 times is not worth the effort, especially if it will cost much more to shield the stage from preceding or following stages. On the other hand the tube promises to be a very fine audio amplifier and may become a standard detector.

### Greater sensitivity of power pentode

The power pentode has one great advantage; it is more sensitive than a triode with similar plate power consumption. This means simply that you can get along with less tubes. On the other hand, it will be more difficult to operate with present loud speakers because there is a range of load resistance of only three or four to one over which the second harmonics in the output are less than the traditional 5 per cent. In the case of the triode, the second harmonics will be less than this figure for all values of load resistance greater than twice the tube resistance.

At the same time, if manufacturers use a single power pentode to work into a loud speaker instead of push-pull tubes, they must use more expensive output transformers to avoid saturation and consequent distortion.

Experiments conducted by Ballantine (reported in the proceedings of the I.R.E., March, 1930) indicate that the power pentode is about 3.3 times as sensitive as power triodes now in use. This means simply that using a power pentode is equivalent to using an additional stage, with a voltage gain of 3.3 times.

Superior sensitivity, however, is not the sole advantage of the power pentode. It is more efficient, i.e., with a given expenditure of power taken from the plate-supply system, more power output can be secured. Comparing a type of pentode in common use in Europe delivering 570 milliwatts output, a plate current drain of 15 milliamperes was required when the plate voltage was 167. To deliver the same amount of power a 171-type triode required a plate current of 21 milliamperes. In other words the pentode consumes about 70 per cent of the power required by the triode to deliver the same output. The same figures are true when a pentode designed to operate from a 250-volt plate-supply system and delivering 2100 milliwatts of power is compared to a 245 with the same plate voltage. In this case the plate currents are respectively 33 and 43 milliamperes.

There seems to be at least one service that the power pentode might fill. That is in the battery-type set and other markets where a comparatively small output is desired at great economy. If tube manufacturers will develop a low-voltage power pentode they may also discover an eager market of no mean proportions.

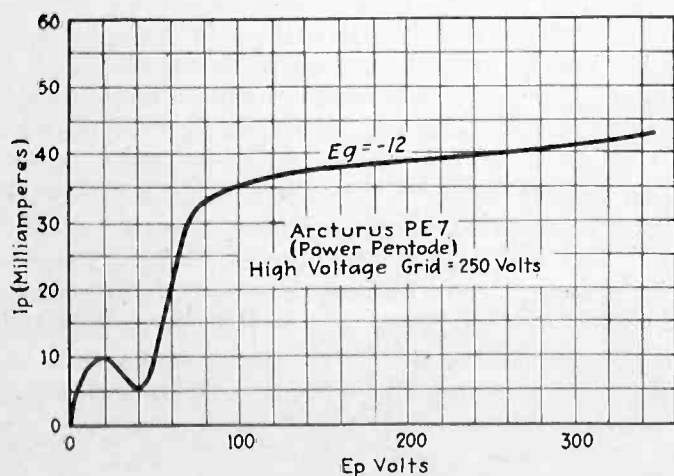

NOTE the high plate current, and the valley or fold in the characteristic at lower plate voltages—a sign of secondary emission.

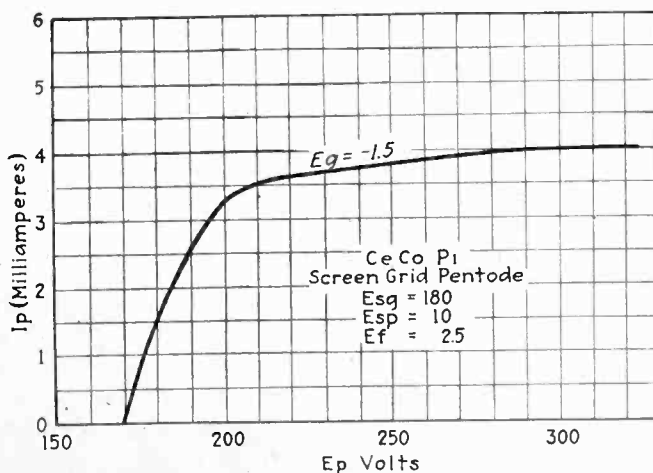

NOTE the low plate current, and the fact that no characteristic below 170 volts is shown. Below this point secondary emission makes the plate current flow backwards.

# Magnetic disturbances and long-distance reception

By **A. E. KENNELLY**

*Professor of Electrical Engineering  
Harvard University  
Chairman U.R.S.I. Co-operation Committees*



---

**I**N TRANS-ATLANTIC radio-telephony, a magnetic storm is sometimes followed by failure of the radio-electric waves to be received. The magnetic storms in their turn, as recorded in magnetic observatories, are often associated with cosmic disturbances emanating from the sun. In this manner, we are led to infer that sun-storms may deleteriously affect long-distance radio communication over our earth; so that solar tranquility has a certain value to earth dwellers that may even be estimated in money.

It has been shown, moreover, by Austin and Pickard, that taken over periods of many months, there is marked correlation between the range of terrestrial magnetic disturbance and the strength of received radio signals from certain long-distance stations. The precise nature of this correlation is as yet undetermined, and can only be guessed at. Thus, it may be surmised that with disturbances in the earth's magnetism, may be linked disturbances in the ionized conducting layer or layers of the upper atmosphere, so causing the long-distance radio waves to fail, especially at high frequencies.

## **The sun a huge electron tube!**

It is generally believed that matter is ejected from the surface of the sun into his vacuous surrounding space. It is not clear whether this ejected material consists of gas molecules, ions, electrons or all three; but if electrons play a prominent part in the process, it may be more than a mere figure of speech to say that the sun itself, in our cosmos, acts like a huge electron tube with somewhat irregular effects on our radio communication over the surface of our little earth, which effects we have to observe, follow and try to understand.

The study of these underlying cosmic phenomena may

be of great importance, not only to the radio-using public and to radio-engineers; but also to all who study cosmic—viz., geophysics, meteorology and astrophysics, especially solar physics. It seems likely that statistical observations of cosmic phenomena capable of affecting radio, may bring forth important knowledge in both basic and applied physics.

The Scientific Union of Radio-Telegraphy, or U.R.S.I. (Union Radio Scientifique Internationale) was organized in 1919 for the scientific study of radio. It has held conventions at Brussels (1922 and 1925) and at Washington, D. C. (1927). Eleven countries are represented in it. Its secretariat is at Brussels, and its President at this time is General Ferrié. The U.R.S.I. seeks to promote and publish researches in radio and all that belongs to it. Up to 1928, the secretariat had distributed 150 printed papers in English and French, emanating from its various national committees.

The U.R.S.I. maintains five standing international committees as follows:—I. Measurements and standardization. II. Radio Wave Propagation. III. Atmospheric. IV. Cooperation or Liaison. V. Radio Physics.

The American Section of the U.R.S.I. has as its chairman Dr. L. W. Austin and as its secretary, Dr. J. H. Dellinger, both at the Bureau of Standards. It also maintains committees similar and parallel to those of the international body. Its committee on Cooperation aims to act not only as a channel of communication to the other national cooperation committees; but also to enlist the sympathies and support of other scientific bodies engaged in cosmic studies. It believes that the U.R.S.I. can be of help to astronomers, geophysicists and meteorologists in certain branches of their work and reciprocally that workers in those fields can sometimes help the U.R.S.I. in its own fields of study.

## **Daily reports on solar and terrestrial disturbances**

About a year ago, the French opened the field of international exchange in broadcasting radio-cosmic disturbances, by issuing daily from the Eiffel tower at Paris, radio-telegrams giving brief notices in plain language (French) of geophysical and astrophysical disturbances, along with certain regular meteorological bulletins. These radio-cosmic bulletins are regularly broadcast at 11:20 g.m.t. or 6:20 a.m. eastern standard time, on a wave length of 1,485 meters (202 kiloc.y.p.s.). The data given are solar disturbances reported from the astronomical observatory at Meudon, near Paris, terrestrial magnetic disturbances and atmospheric electrical disturbances as recorded each day. The national Meteorological Office at Paris collects these data each morning and prepares the bulletin, in conjunction with the weather report. Interested radio observers, anywhere within the range of the Eiffel tower, are able to record these data, along with the observed strength of the signals they receive from distant stations, so as to accumulate material for later statistical examination.

The U.R.S.I. American section committee on Cooper-

ation decided that these French radiocosmic bulletins would be much more generally accessible here, if repeated from the powerful long-wave Lafayette radio station near Bordeaux, and sent a request last summer to President Ferrié for this retransmission, if possible.

### Rebroadcast of bulletins

Information has just been received from President Ferrié that the French Ministry of Posts and Telegraphs has acceded to the request, and has commenced the daily repetition of these radiocosmic bulletins from two stations simultaneously; namely, from the long-wave Lafayette station FYL (erected by the U. S. Navy in 1918), on a wave length of 16,900 meters (17.7 kilocycs.), and also from the short-wave station FLJ of Issy-les-Moulineaux near Paris, on a wave length of 32.5 meters (9.2 megacycs). Both these stations emit these bulletins

immediately after the time signals of 20.00 g.m.t. (15:00 eastern standard time or shortly after 3 p.m. by 75th meridian time). They occupy approximately from 3:10 to 3:20 p.m.

The first recognized reception of these new bulletins, since President Ferrié's letter, has been with the aid of the Eastern Massachusetts Amateur Radio Association, i.e., Station WITL of Concord, Mass., and W1KH of Weston, Mass., both of which have identified and copied the short-wave bulletin.

It is hoped that the American authorities at Washington may soon organize a similar daily radiocosmic bulletin service in conjunction with the meteorological daily bulletins now regularly issued from Arlington, Va., and other coastal radio stations; so that interested radio operators may be able to receive the data not only over the American continent but also over distant seas.



## NEW BOOKS ON ELECTRONIC SUBJECTS

### X-ray technology

By H. M. Terrill, Ph.D. and C. T. Ulrey, Ph.D., New York; D. Van Nostrand Company, Inc., 250 pages. Price \$4.50.

A PRACTICAL HANDBOOK relating to the production, measurement and applications of X-rays, this book covers the broad range of subjects of interest to the laboratory worker and engineer, but gives especial attention to the quantitative measurements involved in X-ray therapy and industrial applications. Following an outline of fundamental physical principles involved in the specialized X-ray electronic tube, chapters are given on tube operation, high-voltage generators, voltage and current measurements, ionization, energy measurements, wave length determinations, biological measurements, radiography, and X-ray analysis. The last-named section covers emission spectra of elements, sensitivity of measurement (determinations of one part in 1,000 are sometimes possible), the determination of crystal structure, powder-diffraction method of analysis, the study of compounds and solid solutions, and the use of the "pin-hole" method.

### Principles of radio

By Keith Henney, M.A., New York; John Wiley & Sons, 477 pages, 306 illustrations. Price \$3.50.

THIS BOOK is not an academic discussion of a theoretical subject. It gets down to the facts any student or engineer is looking for to improve his knowledge of modern radio practice. The in-

roduction is limited to six lines. Mr. Henney by his experience as a technical writer and for five years Director of the Radio Broadcast Laboratory is particularly fitted to write this book. The reader will find the latest information on the new tubes which have been put in commercial use. The text is complete with diagrammatic illustrations, all of which have practical application. Theoretical mathematical dissertations have been mercifully avoided and in their place one will find simplified mathematics which is of practical use to the engineer. The book can be put to excellent use as a student's text book, since every subject is covered with problems. The information contained in "Principles of Radio" is particularly useful to laboratory, service and experimental engineers. With the many uses for which vacuum tubes are being adapted to new industries, engineers in other fields will find this book a valuable addition to their libraries.

### Photoelectric cells

By N. R. Campbell and D. Ritchie, London; Sir Isaac Pitman & Sons. Ltd. 209 pages. Price \$4.50.

THIS BOOK, written by two members of the research staff of the General Electric Company Ltd., Wembley, England, is particularly timely with the increasing applications of the photoelectric cell in industry. The book is divided into three parts. Part one treats of the theory of photoelectric cells, part two discusses their uses, and part three treats of their applications. The text is non-theroetical in its treatment and therefore comparatively free of mathe-

matical equations. It is well written, concise and easily understood by the non-physicist. The curves presented, giving the variation of emission with different wave lengths and values for the alkali metals are interesting, but it is regretted they are not more complete in this text.

Part three of the text, which is intended to cover the applications of the photoelectric cells, treats only briefly of general classifications such as, measurement of luminous flux, illumination, color and absorption. A more detailed and comparative discussion would be desired. Industrial engineers will find this book a valuable introduction to the subject of photoelectric cells. A study of the various industrial uses to which the photoelectric cell is being put, will make this volume well worth its addition to one's library.

### Atoms, molecules, quanta

Arthur E. Ruark and Harold C. Urey, New York; McGraw-Hill Book Company. 780 pages. Illustrated. Price \$7.

THE PHYSICIST AND ENGINEER interested in the basic phenomena of electronic emission will find that this book deals with the history and chief experimental facts of the quantum theory and of atomic and molecular structure, as well as with Hamiltonian dynamics, the fundamentals of quantum mechanics, and the wave properties of material bodies. There are also chapters on X-rays and X-ray spectra, molecular and atomic spectra, hydrogenic atoms in wave mechanics, spectral intensities, and the diffraction of electrons and atoms by crystals.



# Physicists survey electronic advances

THE increasing importance of photoelectric and thermionic phenomena is indicated by the number of papers presented before the American Physical Society at their New York meeting held at Columbia University, February 21-22. One day of the two-day session was devoted to papers covering the most recent theories of photoelectric and thermionic action.

In following the development of the vacuum tube the fundamental work of the physicists in paving the way for practical developments in this field should be kept in mind. It also may be stated that the tempo of

present-day industry is shortening the period between the experimental reports of the physicist and practical development of the idea in the commercial article. With this thought in mind the abstracts of certain papers relating to photoelectric and thermionic phenomena presented before the Physical Society are given for the benefit of the readers of *Electronics*. Space does not permit giving the complete abstracts of all papers. As is customary the American Physical Society will publish the papers presented in *The Physical Review* or the *Physical Review Supplement*.



## Some phenomena in oxide coated filaments

E. F. LOWRY, *Westinghouse Research Laboratory, East Pittsburgh, Pa.*

THE use of the oxide coated or Wehnelt cathode in radio receiving tubes became so general a few years ago as to cause serious inroads on the world's supply of platinum, since this metal had always been used as the core or base upon which the alkaline earth oxides were spread.

In the search for a metal which could be substituted for platinum for this purpose, the alloy known as "Konel" was developed. It has been found that this material is not merely a satisfactory substitute for platinum for this purpose, but is really quite superior.

The superiority of Konel for this purpose lies in the fact that the same electron emission may be obtained from oxide coated Konel at 750°C. as can be obtained from oxide coated platinum at

ing. Unless this theory is modified in some way, it is difficult to account for the core metal having any effect.

If, however, we assume that the source of emission is a layer of metallic barium on the surface of the core, this effect may readily be accounted for. The emitted electrons must then diffuse through the interstices in the oxide coating. This assumption serves also to explain other peculiar phenomena met with in oxide coated filaments such as non-saturation and gradual decay of activity during life. For example, if the coating sinters due to prolonged heating, the pores of the coating will gradually close and cause a corresponding decrease in the ease of diffusion of the electrons.

If this explanation is correct, Konel filaments upon which metallic barium is deposited should have as high electron emissions as oxide coated Konel filaments and at the same time should show much better saturation characteristics. The correctness of this assumption is

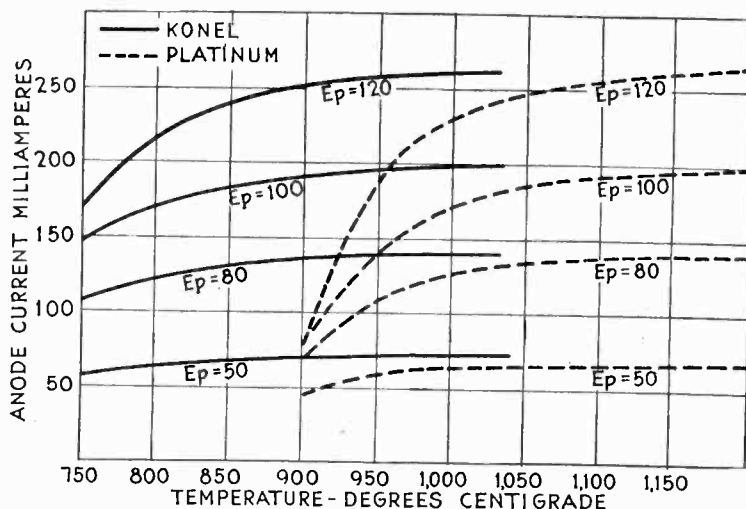
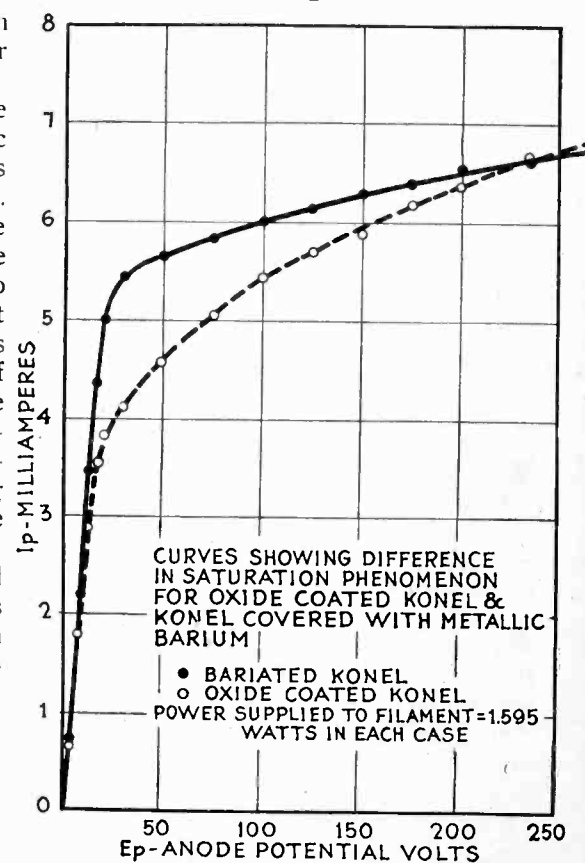

Fig. 1

950°C., as shown in Figure 1. This result was entirely unexpected on the basis of present day theories, which hold that the source of electron emission is a mono-molecular layer of metallic barium on the surface of the oxide coat-

shown in the curves of Figure 2, in which we find that "bariated" Konel is quite as active thermionically as oxide coated Konel and also that there is a much more pronounced bend in the saturation curve.

Fig. 2



## The quantum theory of the photoelectric and thermionic effects in metals

W. V. HOUSTON, *California Institute of Technology*

ACCORDING to the quantum theory of the electrical properties of metals, a metal contains a number of electrons which may be called free. They are free in the sense that they are not attached to any one atom, but on the other hand they may be considered as bound to the metal. The number of these electrons is of the same order of magnitude as the number of atoms and is essentially independent of the temperature. Their contribution to the specific heat of the metal is very small.

The electrons in states of sufficient

energy to escape from the metal constitute the thermionic or photoelectric current. An increase in temperature increases the number in the high energy states in accordance with the quantum statistics of electrons. In the photoelectric effect the electrons are excited to the higher energy states by the absorption of light.

For a pure metal there is a well defined minimum of energy which an electron must have to escape. An electro-positive surface layer, or a strong electric field, modifies the surface in such a way that a fraction of the electrons with smaller energy can get out. This makes the work function a less sharply defined quantity in these cases.

It is possible, by means of the quantum theory, to treat in a fairly satisfactory way many of the electrical properties of metals.

### Density distribution of electron gas in equilibrium with a hot body

A. T. WATERMAN, *Yale University*

THE variation of potential and of electron concentration with distance from a plane emitting surface is investigated, using Poisson's equation and the equilibrium relation between electron concentration and potential. Solutions are found for the equilibrium condition in the absence of applied field and for negative fields, and assuming the electron gas within the body to be degenerate or classical. Results indicate: (1) that on the average an electron is closer to its neighbors than to the surface, except when very close to the latter, and therefore that the image force explanation of the work function is here not applicable; (2) that space charge is quite competent to give the magnitude of the work function; (3) that if the electron concentration within the body is that of atoms, the external gas remains degenerate to approximately  $10^{-7}$  cm. from the surface; (4) that an applied negative field of the magnitude required for cold field currents materially alters the electron concentration down into the degenerate region. The current obtainable under retarding fields is discussed with a view to estimating the feasibility of experimental proof of the relations and of the electron concentration within conductors.

### Photoelectric cell thermo-regulators

F. G. BRICKWEDDE and R. B. SCOTT,  
*Bureau of Standards*

THERE are many laboratory problems requiring automatic regulation to which the photoelectric cell can be applied. Photoelectric cell regulators possess great sensitivity, small lag, and a

wide range of temperatures over which they can be used and quickly and conveniently adjusted for operation at any desired temperature. Not only do these applications reduce the number of observers required for an experiment but in most cases even better control

heater  $W_a$  in  $X$ . The steady heating current is varied by  $W_1$  and the thermostating current by  $W_2$ .

The photoelectric cell regulator described is operated on 240 volt d.c. power, without batteries, using only one slide wire rheostat with four sliding con-

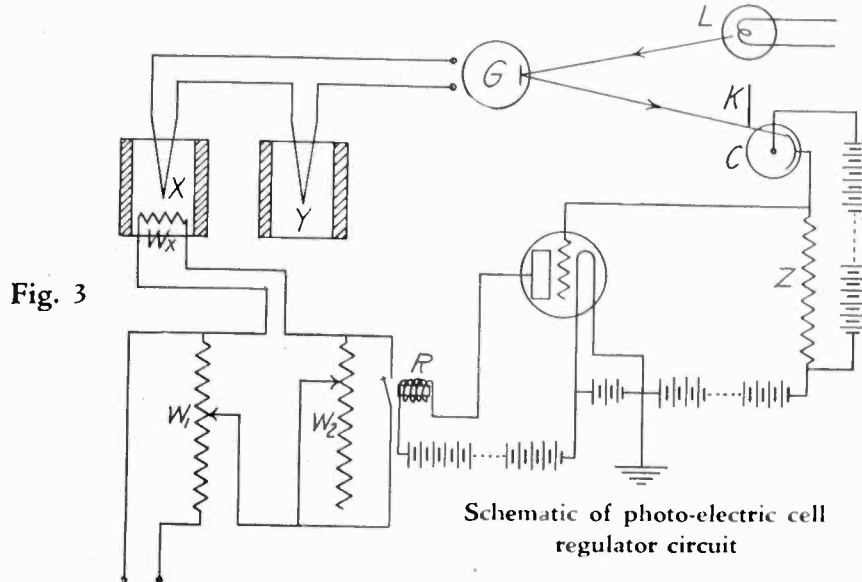

can be secured than through manual operation.

A photoelectric cell has been used as a thermoregulator in the Low Temperature Laboratory of the Bureau of Standards to maintain temperatures between  $-180^{\circ}$  and  $0^{\circ}$  C, constant to a  $0.001^{\circ}$  C.

In Figure 3  $X$  is to be maintained at the same temperature as  $Y$ , e.g. the shield of an adiabatic calorimeter to be kept at the same temperature as the container or to keep the guard ring of a thermal conductivity apparatus at the same temperature as the plate.

In  $X$  and  $Y$  are the heat sensitive ends of a thermoelectric cell circuit to which is attached a sensitive galvanometer,  $G$ . The mirror of the galvanometer forms an image of the lamp  $L$  on a screen  $K$  placed in front of a photoelectric cell  $C$ .

The positions of the lamp, screen and photoelectric cell are so adjusted with respect to the galvanometer that when  $X$  is at the same temperature as  $Y$  and no current flows through the galvanometer the image of the lamp filament is focused on the edge of the screen  $K$ . When the temperature of  $X$  changes from that of  $Y$  the image moves across the edge on to the screen or photoelectric cell depending upon the direction of the temperature change. The change in the illumination on the photoelectric cell varies the photoelectric current through the cell. Since the photoelectric current and its changes are too small to operate a relay they are amplified, by a radio tube amplifier in the plate circuit of which is connected the relay  $R$ . The photoelectric current is made to vary the potential of the grid by connecting the grid between the photoelectric cell and a high resistance  $Z$ , of the order of 40 megohms, connected in the photoelectric cell circuit. The relay  $R$  opens and closes a shunt circuit across a resistance  $W_2$  connected in series with the

contacts to furnish all the sources of potential for the photoelectric cell and its amplifier thus making the regulator less expensive and obviating all the inconveniences of run down batteries.

### Photoelectric properties of extremely thin films of alkali metals

HERBERT E. IVES and H. B. BRIGGS,  
*Bell Telephone Laboratories*

FILMS of alkali metal much thinner than those previously studied have been investigated by using an electrometer of approximately 100 times the sensitiveness of the galvanometer used before. Attention has been directed to the variation of emission with the angle of incidence and plane of polarization of the exciting light. In agreement with the earlier work, the ratio of emissions for obliquely incident light polarized with the electric vector in and perpendicular to the plane of incidence decreases as the film is reduced in thickness. The new measurements show further that this ratio continues to decrease with film thickness to the value unity, where no variation of emission with angle occurs, and that with further decreases in film thickness, the relationship reverses ("normal" greater than "selective") and the emission increases with the angle of incidence of the light. It is suggested that when the alkali metal particles become sparsely distributed their absorption of light corresponds to that of a matt surface (Lambert's law). When the particles are still more widely separated, deviation from Lambert's law occurs and the exciting light is in part that reflected from the underlying platinum surface, stronger for light polarized with the electric vector parallel to the surface.

# electronics

McGraw-Hill Publishing Company, Inc.  
Tenth Avenue at 36th Street  
New York City

O. H. CALDWELL, *Editor*

Volume 1 — APRIL, 1930 — Number 1



## What industry is next?

A FEW years ago a small group of engineers developed a new method of cutting wax phonograph records. The record manufacturers when first shown the device said "We are already turning out the finest records on the market, we have thirty years' experience behind us." Finally, when a rival concern was licensed to use the new device, it was another story. Today we have electric recorded records and electric reproducers as standard equipment throughout the world.

The leading motion picture producers when given a demonstration of talking films, said "The public are satisfied with silent pictures, you will spoil their illusion." What is the situation today? The world gone "talkie" mad, and millions in increased revenues flowing to the box office. Great opportunities and new developments have been opened to the fourth largest industry by the upheaval created by the new applications of the vacuum tube.

Manufacturers of foodstuffs, clothes, dyes, metals and hundreds of other products and by-products should take cognizance of the new electronic devices that have transformed other industries and look closely to the possible applications of the vacuum tube to their own processes.

Generally speaking our foresight is 2 per cent, our hindsight 98 per cent. It is unfortunate that it is not the other way about. Experience *behind you* is no criterion as to whether your product can not be better handled, processed, measured and inspected by some application of the photo-electric cell and its twin brother the thermionic tube.

Look to the road where you are going—but look aloft for a change in the weather!

## A great opportunity for safety protection

A BROAD and invaluable application of photo-electric devices is bound to come in the protection of human life and limbs around hazardous machines.

For a punch-press, for example, a beam of light forms the most dependable safety guard conceivable. It interferes in no way with the normal operation of the machine, it interposes no mechanical obstruction in the way of the operator. Yet simple circuits can be so arranged that as long as the operator's hand or hands are anywhere in the danger zone, the machine will be inoperable. When the hands are removed, the machine is instantly restored to operating condition. Such a photo-electric safeguard is foolproof, sure and instantaneous. It has marked advantages over the cruder mechanical protection devices.

Safety protection of machines attracts a large amount of interest throughout American industry today. A large field of application awaits the photo-cell in this direction of machinery protection. Here is an opportunity for ingenuity and resourcefulness which will earn large rewards.

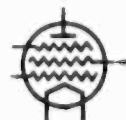

## Pentode confusion

IN SPITE of the fact that technical data on two types of pentode tubes have been available for several months, confusion still reigns supreme in the lay and engineering mind. To the average engineer and executive a five-electrode tube is a pentode no matter what its purpose, and the fact that two entirely different five-element tubes exist does not seem to have become a well-known fact as yet.

At the risk of too much repetition it must be said that there are two utterly distinct pentodes, or "five-electrode" tubes; also that they have little resemblance to each other except the fact that they each have three grids. Neither tube performs functions now unattainable with present triodes or tetrodes; neither tube is interchangeable for the other; and whether either is adopted by the industry, in whole or in part, does not depend on the other pentode.

Therefore to state, as one newspaper radio



editor did in a recent feature article, that the pentode will not be adopted until it has been determined if it is better than present day screen-grid tubes is only to speak ambiguities and words of little meaning.

One pentode is a high-resistance, low-power output tube designed for radio or audio amplification only; it is of the screen grid type. The other tube is a low-resistance (comparatively) high-output tube designed only for the final stage in an audio amplifier. It cannot be used as a radio amplifier; similarly the screen-grid pentode cannot be used as an output tube.

Such confusion would be eliminated if writers and manufacturers of five element tubes would speak of them as power-pentodes on the one hand, or screen-grid pentodes on the other,—or of any other special function the tubes may be called upon to serve.

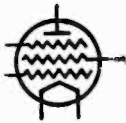

## A subject for confidential industry discussion

**W**HATEVER the merits of the pentode tube are technically, the situation in which the radio industry today finds itself with respect to stabilization of receiver models, indicates that the subject of the pentode is one not for immediate public discussion but first for industry conferences between manufacturers of tubes and sets.

In such confidential groups of qualified engineers, let the advantages and disadvantages of the five-electrode tubes be brought out without fear or favor. Let the searchlight of technical investigation be turned on every claim and counter-claim concerning this new development. Let the pentodes' friends and skeptics make the most of their good points and their weak points.

The sooner the engineers of the radio industry get all the facts about the characteristics of the new pentodes and understand clearly the applications and uses of the different forms of five-element tubes (whether properly called "pentodes" or not), the better for all concerned.

But this technical discussion should for the present be kept inside the ranks of the industry. It will do no good to take the case at this time to the general public who are in no way equipped technically to understand the points involved.

## Cardinal principles of broadcast allocation

**E**VERY friend of radio broadcasting will look with consternation on efforts that are being made to break down those fundamental principles of good broadcasting allocation which secure the best radio reception for the greatest number of listeners. These fundamentals are few and simple: "Clear" or exclusive channels for great stations serving vast audiences; 50-kilocycle separations between all stations in the same community; and adequate geographic intervals between stations of 1,000 watts and less operating on the same wavelengths.

Clear channels mean good radio for our millions of farmers and remote listeners who are located 100 miles away from good broadcasting stations. Proper separations of 50 to 100 kilocycles between stations in the same community are necessary to prevent cross-talk and interference between programs in listeners' sets.

These two principles are cardinal, as the art now stands. Attacks on them should be resisted by every engineer who has the interest of radio and the listening public at heart.



## Getting ideas into circulation

**P**ROGRESS in the field of electronics can only be made by the interchange of ideas between the engineers in this wide spread field. No single laboratory or group of men have a monopoly on knowledge. The art as a whole can move forward only under the stimulation of the mind on new and different methods.

Competition is as necessary today as it ever was—if real progress is to continue, but cooperation has lost none of its prestige and its influence for good is ever on the increase. The day of the inventor in the garret is at an end and we should be thankful for it. There are probably thousands of good ideas buried with the men who kept them and which might have become a real product on the markets today had some common medium been available to suggest an application or a suggestion to make it a success.

# REVIEW OF ELECTRONIC LITERATURE

## HERE AND ABROAD

### **Braun tube for direct photographic recording**

[MANFRED VON ARDENNE] This is a new low voltage hot cathode tube which permits direct photography from the fluorescent screen of periodic or non-periodic phenomena. The increased brilliance which permits instantaneous exposures is due to:

1. The fluorescent screen, which consists of a suspension of calcium tungstate in water glass spread on the base of the bulb and emitting fluorescent light of high actinic value.

2. Concentration of the rays, which is accompanied by (a) the arrangement of the electrodes so that the electric field is in the desired direction, (b) a trace of gas to overcome the space charge and so neutralize the electrostatic repulsion and (c) the use of a small coated section of the cathode to approximate a point source of electrons.

3. The anode potential. Since the brilliance of illumination rises very rapidly with anode potential the lead from this electrode is brought through a separate seal, thus permitting, but not requiring, potentials up to 4500 volts.

The total emission of the tube is of the order of  $10^{-3}$  to  $10^{-4}$  amperes and the sensitivity is given as 1.5 per millimeter at 400 volts anode potential.—*Experimental Wireless and Wireless Engineer, February, 1930.*

### **Excellence in auditoriums**

[W. A. MACNAIR] The author gives a brief discussion of the time of reverberation in auditoriums to obtain good acoustic conditions. For a true physical criterion it is suggested that some quantitative acoustic feature of an auditorium should be used which has the same value for all auditoriums in their best acoustical arrangement. A step toward such a quantity can be made by choosing, instead of the reverberation time, the time taken by the sound from a standard 1000-cycle source to decay to the threshold of audibility—after the source has been cut off. A stream of speech or music can be made to sound considerably louder without augmenting its peak amplitudes by merely "livening" the auditorium. In recording sound pictures, therefore, it will be possible to obtain apparent loudness, without overloading the vacuum tubes and vibrating parts of the recording system, by livening the recording stage.—*Bell Laboratories Record, March, 1930.*

### **Nobel prize for thermionics**

[O. W. RICHARDSON] A biographical outline of the career of the distinguished physicist, now of King's College, London, who for six years was in America as a member of the Princeton College faculty, during which period he made many outstanding contributions to the science of thermionics, i.e., the emission of electrons from hot cathodes and filaments. He was the author of Richardson's Law of electronic emission, and produced some thirty-four professional papers during his short American residence. His books "The Electron Theory of Matter" and "Emission of Electricity from Hot Bodies" are classics of the subject. Among his experiments was the important demonstration that the electrons leaving a hot body have a Maxwellian distribution of velocities and a mean kinetic energy the same as that of an assemblage of gas molecules of the same temperature.—*Scientific Monthly, March, 1930.*

### **Evolution and perfection of radio tubes**

[P. HEMARDINQUER] A review of the history of European vacuum-tube development, giving accounts of the various models used in French, German, Dutch and English practice. Specifications and characteristics of the newer alternating-current tubes are included in considerable detail.—*La Nature, Paris, January, 1930.*

### **Properties and calibration of photo-cells**

[JAKOB KUNZ and V. E. SHELFORD] The authors present their experience in the use of photo-electric cells for measuring sunlight and investigating the effects of light on animals, both in nature and in climate-simulation experiments. Forty gas-filled (hydride) cells were constructed, tested and standardized, and employed in actual outdoor applications. Three cells were of caesium, three of rubidium, two of sodium and the remainder of potassium. The methods used in standardizing and testing the cells, using artificial light and sunlight, are discussed. The relation of current to light intensity is given in graphical presentation for the different cells used.

The conclusions drawn from these tests indicated that cells capable of be-

ing used at 200 microamperes with a direct-proportionality limit of 250 microamperes should cause little or no variation in sensitivity within the working range of light and voltage. It is suggested that the preparation of cells with several metals instead of one be undertaken as a means of increasing the range of color sensitivity, for the investigation of effects of colored lights on organisms.—*The Review of Scientific Instruments, February, 1930.*

### **Emission of positive ions from tungsten and molybdenum**

[LLOYD P. SMITH] An examination of the positive ion emission from tungsten and molybdenum was made to determine the following points: (1) the nature of the ions emitted at various temperatures; (2) the temperature variation of the positive ion current; (3) the theory of positive ion emission with regard to where and how the ions are formed; (4) the positive ion work function for these metals.

The mass spectrum for tungsten and molybdenum filaments taken at moderate temperatures ( $1700^{\circ}$  to  $2000^{\circ}$  K) has shown that the emitted ions consist of sodium, the two isotopes of potassium, and aluminum. At high temperatures these impurities disappear, and finally both tungsten and molybdenum filaments yield positive ions of their own metal. The author discusses the possible effects on the filament surface, such as a layer of thorium on tungsten and oxygen on tungsten.—*The Physical Review, February 15, 1930.*

### **Electrical standardizing body asked**

Unification of standardization activities in the electrical field, nationally and internationally, is the purpose of action just taken by the A.I.E.E.

The organization twelve years ago of the American Engineering Standards Committee was a forward step for which the A.I.E.E. was largely responsible. Its successor, the American Standards Association, has, because of constitutional limitations, been able to do little to eliminate duplication and jurisdictional difficulties among its member associations. In order to accelerate the clarification of the situation, the A.I.E.E. board of directors has suggested the creation of a new centralized electrical standardizing body.—*Electrical World, March 1, 1930.*

## Photo-electric cells for measuring colour

[G. T. WINCH] The author describes a Wheatstone Bridge arrangement consisting of a pair of equal resistances and two photo-electric cells, one sensitive to one end of the luminous spectrum and the other sensitive to the other end. To measure both filament temperature and lumens output a switching arrangement is incorporated so that either the ratio or the sum of the two photo-electric currents may be measured. Both the temperature and the lumens scales are linear, thus facilitating the calibration of the apparatus.—*Journal of Scientific Instruments, London.*

+

## Distribution of space charge

[HRISHIKESH RAKSHIT] The distribution of potential under the conditions of a plane hot cathode and a parallel anode, both for the case when the anode is charged and when it is uncharged, has been worked out by Richardson, Fry and several others. The corresponding problem of electron distribution has been worked out by Langmuir for the case of an uncharged anode. The author undertakes the problem of finding the electron distribution when the anode is charged and current flows from anode to cathode.

Curves are presented showing the electron density between anode and cathode for different values of plate current. These curves indicate that near the cathode the electron density decreases as the current increases but at greater distances from the cathode it increases with the plate current. These curves also show that the variation in electron density all occurs quite near to the cathode, the distribution being practically uniform, for any given plate current, at points more remote from the cathode.—*Philosophical Magazine, January, 1930.*

+

## Measuring characteristics of radio receivers

[H. A. THOMAS, M. SC.] A contribution from the National Physical Laboratory, England. The author injects into the receivers under test the input voltage by means of a voltage divider made from No. 47 S.W.G. Eureka resistance wire. He describes the construction of the shielded cabins in which the work is carried out, and gives the results of some measurements on British receivers. A vacuum-tube voltmeter across 100 ohms in the plate circuit of the power tube gave an indication of the output from the receiver. Owing to the fact that English receivers use regeneration, some difficulty was experienced in getting consistent results.—*Institution of Electrical Engineers.*

## Acoustics of radio broadcasting studios

[L. E. VORHEES] A discussion of the principles of sound control, with application of engineering methods to the treatment of a typical studio. Mathematical formulas are given for development of best acoustic coefficients for various building materials. The problem of studio layout, it is shown, is primarily one of making the reproduction satisfactory with respect to the microphone, which is a different kind of an organ of hearing from the human ear. For this reason sound tests in the studio itself will not always show how satisfactorily it is performing its function.—*Journal A.I.E.E., March, 1930.*

+

## Measurements of high frequency response

[JESSE MARSTEN]—Curves and actual data secured in actual measurement on modern radio receivers showing the suppression of high audio frequencies. The reasons in so far as they are controlled by circuit design, are pointed out.—*Radio Broadcast, April, 1930.*

+

## Nomograms

[JOERGEN RYBNER] A summary of the theory of preparing calculating charts involving three or more variables, using the common case of three parallel lines and also special cases of curved lines. The article describes the use of nomograms for complex hyperbolic functions and for conversion between rectangular and polar coördinates.—*General Electric Review, March, 1930.*

+

## Behavior of dielectrics

[R. R. BENEDICT] A study of the anomalous charging current and the variation of dielectric energy loss and capacitance with frequency in solid dielectrics, especially the relation between the "anomalous charging current" under a direct voltage test and the dielectric energy loss for impressed a.c.

After a review of the theory of this relationship, the methods developed in this study for observing the anomalous charging current in condensers in the time range from 0.0007 to 0.100 seconds after impressing a steady potential are described. The methods used in observing the "normal leakage current" and the alternating energy loss and capacitance in the frequency range from 200 to 4,000 cycles per sec. are also outlined.

The results of measurements by these methods on mica, glass, treated cloth, and paraffin-paper condensers are given. These measurements include a series giving the effect of varying temperatures.—*Journal A.I.E.E., March, 1930.*

## Distortion in sound-film recording and reproducing

[C. O. BROWNE] The main causes of distortion in sound-film recording and reproduction are pointed out and methods of eliminating or neutralizing them are indicated. The author purposely omits all discussion of recording studio technique and the acoustics of auditoriums. The types of distortion considered come under two main headings: A, Amplitude distortion, due to the non-linear characteristics of the apparatus employed and B, Frequency distortion, due to the use of apparatus having an impedance which varies with the frequency.

The main cause of distortion in the reproducing stage is the input capacity of the first amplifier which is especially important due to the fact that the photo-electric cell impedance is of the order of one thousand megohms under working conditions. This results in a low frequency cut-off which is usually compensated for by making the recorder characteristic the mirror image of the reproducer characteristic over the working range. Unless care is used this may involve amplitude distortion if high compensation is required.

The discussion of recording systems is mainly devoted to how the various systems may be adjusted to compensate for frequency distortion in the reproducing system. Both variable width and variable density systems are considered. Under the former heading are considered the twin wave recorder and the oscillograph recorder; under the latter are considered the neon lamp and the light valve. The author points out the fact that the variable density system may introduce additional trouble due to photographic distortion.—*Experimental Wireless and Wireless Engineer, February, 1930.*

+

## Automobile receiver design

[R. S. KRUSE] Description and engineering data on the V Bosch automobile receiver.—*Radio Broadcast, April, 1930.*

+

## Theory of the grid-glow tube

[D. D. KNOWLES] The grid-glow tube has three electrodes but differs appreciably in its operation from the usual triode. The tube is not pumped "hard" but there is a certain amount of gas in it. Hence when the grid is negative the decrease in current is compensated by the attraction of positive gas ions and so the effect of the grid is nil. On the other hand by a proper choice of potentials, etc., the discharge that takes place within the tube can be started through wide variations by means of the grid. Thus the tube may have an amplification factor of  $100 \times 10^6$ .—*The Electric Journal, February, 1930.*



# ★ NEW PRODUCTS

## THE MANUFACTURERS OFFER

This section is prepared by the editors of Electronics purely as a service to readers. Its aim is to present announcements of all new products, devices and materials of interest in the field of the paper. All items are published solely as news, and without any charge or any advertising consideration whatsoever.

### Photo-electric cell

THE Arcturus Radio Tube Company, Newark, N. J., has announced a "wet" photo-electric or "photolytic" cell as shown in the accompanying view. The manufacturers report that this cell combines the sensitiveness of the vacuum or gas cell and the ruggedness of the liquid cell. Modulated light tests indicate no appreciable damping

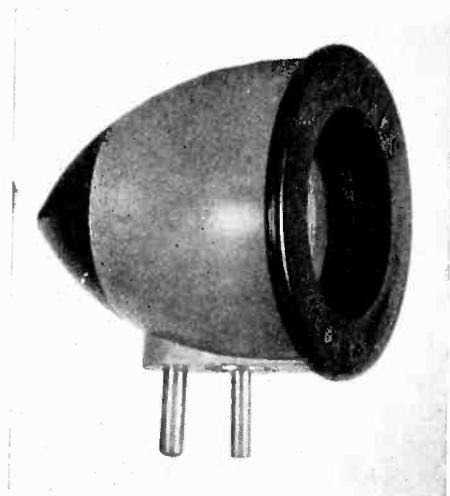

or phase difference as high as 10,000 cycles and polarization over light intensity ranges employed in sound reproduction systems is undiscernible. This cell is characterized by a desirable low internal impedance which lends itself readily to the design of a practically distortionless reproduction circuit. Price per unit, \$31.50.—*Electronics*, April, 1930.

### ★ Controls

THE Central Radio Laboratories, 16 Keefe Avenue, Milwaukee, Wis., has recently marketed a constant input resistance for independent volume control of each speaker in multiple speaker circuits. The resistance element is divided into two special tapers, one that will maintain a constant resistance in the line; the other tapered to give a smooth and gradual control of volume. The first resistance is in series with the line and the second shunted across the speaker. Both are regulated by one knob. The manufacturers state that hotels and apartments contemplating the installation of centralized radio reception will find this unit satisfactory for reception by individual guests.—*Electronics*, April, 1930.

### Experimental television receiver

THE Jenkins Television Corporation of Jersey City, N. J., has announced a Model 100 "Radiovisor." This device includes scanning disc, motor, lamp and magnifying lens for the reception of standard 48-line, 15 pictures per second radiovision signals. Attachments available in the future will permit of receiving other standard signals.

The motor of the Jenkins radiovisor is of the Faraday eddy current type, comprising six electro-magnets operating in conjunction with a toothed rotor and a copper disk, and operates as a synchronous motor, for automatic synchronism when used on the same a.c. power system as the radiovision transmitting station. A speed control permits of slight variations in speed, so that the scanning disk may be brought to exact speed when operated on a different power system than the transmitter. The operation of the radiovisor

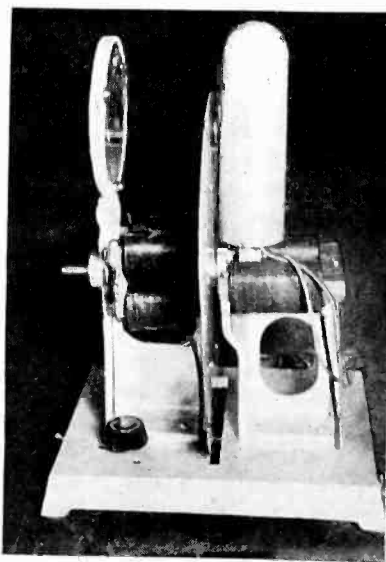

is practically silent. Price, Model 100 Radiovisor is \$75, without neon lamp, which is supplied extra.—*Electronics*, April, 1930.

### ★ Tone regulator

TO vary tone quality in the radio set, phonograph, power amplifier, pick-up or talking motion picture equipment, the Samson Electric Co., Canton, Mass., is making its "Qualpensator." By simply turning a switch and adjusting the knob, the desired tone can be obtained. There are three knobs labeled

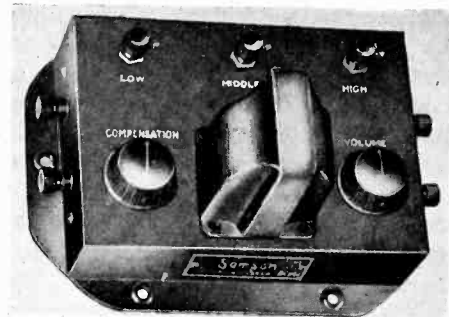

low, middle and high for pitch and two larger knobs labeled compensation and volume. The intended retail price is \$25.—*Electronics*, April, 1930.

### ★ Double control unit

ELECTRAD, Inc., 173 Varick St., New York City, announces a Model B Super-Tonotrol which is particularly adapted for use by manufacturers on account of its compact size and arrangement, whereby, if desired, two completely isolated circuits may be controlled by one shaft. Single control units are also available. The contact is a pure silver multiple type which floats over the resistance element with amazing smoothness. An advantage offered by the dual or tandem type Super-Tonotrol is that a tapered resistance can be used in the antenna circuit, while a uniform resistance, operated from the same shaft can control the grid circuit.—*Electronics*, April, 1930.

## Short-wave receiver

THE DeForest Radio Company, of Passaic, N. J., has recently announced a short-wave receiver that is radical in appearance from familiar types. This receiver consists of four tubes enclosed in an aluminum case measuring only 5 x 6 x 8 inches. This receiver although

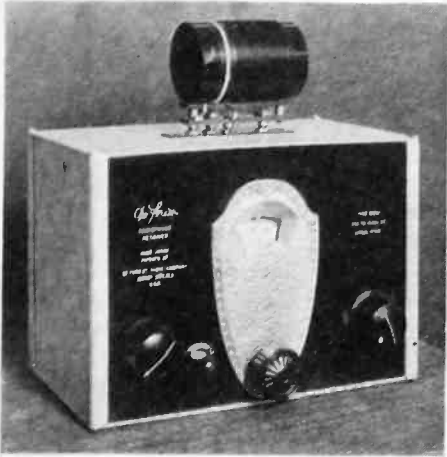

primarily designed for aircraft, police car, and motor-boat use, has been made available to the public. Its tuning range covers the band of popular interest from 20 to 200 meters. The receiver, known as the type HM-1, is battery operated. If used with a storage battery, two type-22, a -01-A, and a 12-A tube, are required. If dry-cell operated, a 422-A and three type 499 DeForest audions are necessary. The receiver contains a separate C-bias lead, permitting the use of any other type of output tube without requiring changes in the wiring circuit. Although small in size, the receiver incorporates all the necessary adjuncts to satisfactory short-wave reception.—*Electronics, April, 1930.*

## Light intensity meter

THE Westinghouse Electric and Manufacturing Company of East Pittsburgh, Pa., has a light intensity meter, as shown in the accompanying view, which



is particularly adapted to the motion picture industry and photographic work in general, where light intensities are high and it is desirable to maintain constant brilliancy or duplicate previous settings. This unit is 5x9x12 inches and weighs approximately 25

pounds. The photo-electric cell is suitably encased so it may be moved about as it is attached to the end of a flexible rubber insulated lead 6 ft. long. The current generated by this cell due to light falling on it, is passed to a very sensitive indicating microammeter where readings are given directly in foot candles. The scale of this unit can be calibrated for any of the following capacities: 0-100, 0-200, 0-500 or 0-1000 foot candles. Price complete with tube, \$200.—*Electronics, April, 1930.*

## Automatic record changer

THE automatic record changer shown herewith is offered by the Technidyne Corporation, 644 Broadway, New York City. The model shown plays twenty 10-in. records consecutively on one side only. Records are loaded into the front left-hand slot and the machine started

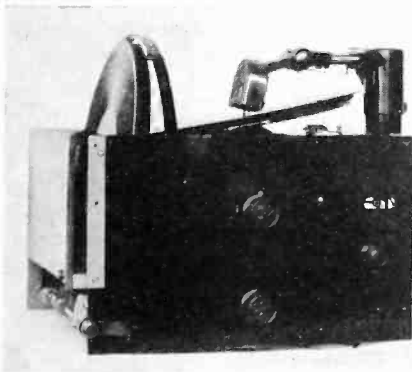

by the upper control knob. Reject and repeat features are included as well as automatic power cut-off after the last record has been played. The magazine may be unloaded without playing the records by raising the left hand lever. The pick-up may be swung forward and tilted upward to facilitate needle change. These features permit the chassis being installed in a closed top cabinet and with installation space of only 14 in. width and height and 11 in. depth. The device operates with standard phonograph motors.—*Electronics, April, 1930.*

## Vacuum tube for elevator control

THE General Electric Company of Schenectady, N. Y., has announced a vacuum tube control system by means of which elevator cars are automatically brought to the correct floor level. The elevator car leveling unit shown in the above view uses a plotron tube. The use of this tube in the automatic leveling of elevator cars is based on the characteristic increase of plate current where the tube changes from an oscillating to a non-oscillating condition. A suitable number of tubes are mounted on each elevator car and are normally in oscillation. By an arrangement of coils and vanes, the motion of the car

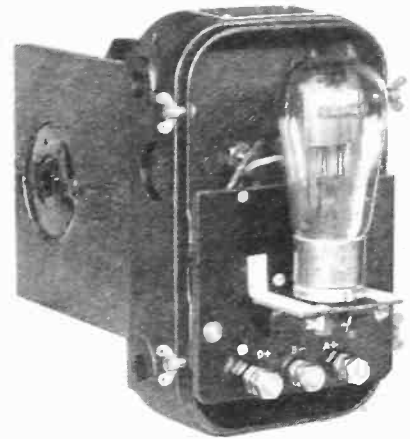

as it approaches a floor level, is made to stop the oscillation of the tubes, thus actuating relays. The relays govern control circuits which slow up the car and stop it at the correct position.—*Electronics, April, 1930.*

## Noise eliminator

THE Insuline Corporation of America, 78 Cortland St., New York City, announces the development of an improved light-duty noise eliminator for a.c. receivers, known as the "Filtervolt, Jr." It is particularly adapted for use in eliminating the more common disturbances from household appliances, the switching on and off of lights and the use of dial telephones. The intended retail price is \$3.—*Electronics, April, 1930.*

## Short wave receiver using pentode

THE new pentode tube is employed in the short-wave receiver of Norden-Hauck, Inc., Marine Bldg., Philadelphia, Pa. It is an a.c. model with six tubes: one pentode, two 227's, two 245's and one 280. The r.f. stage has a tuned input and uses the pentode. Due to design of coils and shielded condensers, a wide wave length range is covered.

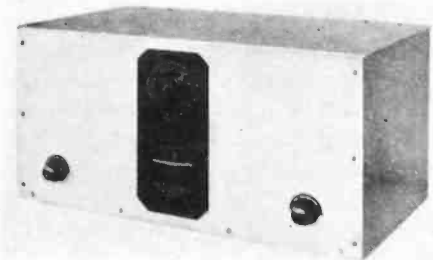

The coils are wound on hard rubber forms to minimize losses in efficiency. The cabinet is aluminum, 9 in. high x 10 in. deep x 19 in. wide. It is available in natural color, satin finish, or in walnut finish. A d.c. model may also be had with the same specifications except that only five tubes are used and of different types.—*Electronics, April, 1930.*

# NEWS

## OF THE ELECTRONIC FIELD



### Talking picture held to be legal evidence

TALKING motion pictures can be used as legal evidence in trials, according to a ruling by Judge James Gordon, Jr., of Philadelphia, March 28.

Judge Gordon's decision is said to establish a precedent which will open the way for a plan to make the "talkies" a regular part of the police work in Philadelphia.

"Photography and the mechanical reproduction of sound being both admissible in evidence, we see no reason for refusing to accept the combination of the two, when the results are shown to be accurate and reliable," declared the judge in his written opinion.

"Where the picture presented is not that of a reconstructed scene but of the occurrence under investigation, there seems to be nothing, in reason or authority, which would prevent its acceptance in evidence. If true, its very impressiveness would give it an inherent weight that its accuracy would justify and, in our judgment, it would go far, in the case of the photographing of confessions, to negative the contention, so often falsely made, that a confession was secured by force and coercion, or disclose circumstances indicating the presence of such impropriety."

### Census of home radio sets taken this month

A FORCE of 100,000 census employees began making an enumeration of the home radio sets in use throughout the nation, beginning April 1. This radio information will be collected in addition to the usual statistics on general population, race, age, sex, employment, etc.

The counting of radio sets has been undertaken to determine how effective broadcasting has become as a means for a general appeal or as a channel of spreading information.

Figures will be released for each census district as soon as the work has been completed. Dr. Steuart, in charge of the census, believes the population figures for the entire country should be available early in May. The law provides that enumerators in cities shall complete their work in two weeks, and those in rural districts in a month.

### Einstein writes equation for gravitation and magnetism

ANOTHER important contribution to the attempt to unravel the true nature of the universe was made at Berlin, March 27, by Professor Albert Einstein, in a paper presented to the Prussian Academy of Sciences by him and Dr. W. Mayer jointly. The paper apparently presents solutions to two cases of his uniform-field theory which connects gravitation and magnetism, the dream of scientists for many years.

The purpose of the present paper, supplementing his monograph of 1929, is to express in a single mathematical equation the phenomena of gravitation and those of electromagnetism. If such can be done and the mathematics verified by experiment, it may mean that gravitation is a wave phenomenon and therefore that our entire universe is made up of waves.

Scientists in the United States were unwilling to commit themselves as to the value or meaning of the latest of Dr. Einstein's contributions until the work itself had been viewed, but they were unanimous in stating that it was another milestone along the route to a final understanding of our universe.

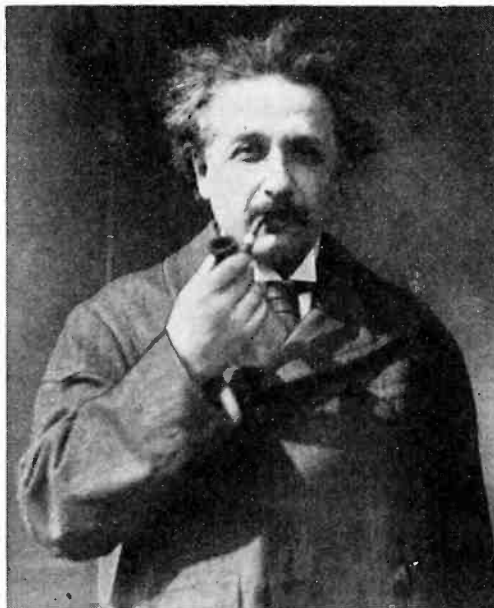

PROFESSOR Albert Einstein who on March 27, at Berlin, presented additional mathematical proof of his recent theories pointing to the fundamental identity of gravitation, electricity and electro magnetism.

### Marconi short-wave lights Australian exposition 11,000 miles away

FROM his yacht "Electra," in the harbor of Genoa, Italy, March 25, Senator Marconi flashed a short-wave signal which lighted thousands of electric lights in Sydney, Australia, about 11,000 miles away.

The electric power feeding the lamps, of course, was not supplied from Genoa; merely the power to close the switch which turned on the lights.

Over the short-wave circuit, Senator Marconi also had a long talk with the mayor of Sydney and the president of the electrical exhibition being opened there. Then he dictated a message for the opening. His words were clearly heard in Sydney, as were the replies from Australia.

The chief importance of the experiment, Senator Marconi said, is that it clearly demonstrates the possibility of having wireless telephone apparatus aboard every ship afloat, which would permit the passengers to communicate by telephone with the most distant parts of the world.

### Audio Research Foundation states purpose

AT A MEETING of the executive committee of the Audio Research Foundation, Inc., held at Buffalo, N. Y., March 21, a statement of the plans and purposes of the organization was issued as follows:

"The Audio Research Foundation membership consists of a group of manufacturers whose business has to do with sound reproduction.

"The purposes of the Audio Research Foundation are perhaps best outlined in an excerpt from its charter—

"To promote the progress of science and useful arts, insofar as they apply to systems for transmitting and reproducing sound, and to preserve the freedom of such science and useful arts."

"The membership now contains many of the leading manufacturers of apparatus relating to sound amplification.

"One of the first problems which the Foundation has taken up in a vigorous manner is 'ironing out' the Patent situation."

On the executive committee are—  
C. C. Colby Louis G. Pacent

A. C. Kleckner J. McWilliams Stone  
The Foundation has offices in both Chicago and Washington.

Mr. John Howell, 134 South La Salle St., Chicago, is executive secretary.



## Coming meetings

**National Association of Broadcasters**—New York City, April 22, (Special Committee), April 24, (Commercial Committee), April 25, (Joint Committees). L. S. Baker, 11 West 42nd St., New York City.

**American Physical Society**—Washington, D. C., April 25-26. W. L. Severinghaus, Columbia University, New York City.

**Society of Motion Picture Engineers**—Washington, D. C., May 5-8. J. H. Kurlander, 2 Clearfield Ave., Bloomfield, N. J.

**Acoustical Society of America**—Westinghouse Institute, Grand Central Palace, New York City, May 9-10. Wallace Waterfall, Celotex Company, 919 North Michigan Ave., Chicago, Ill.

**Radio Club of America**—Columbia University, May 14. W. K. Wing, 55 West 42nd St., New York City.

**National Electrical Manufacturers Association**—Hot Springs, Va., May 18-23. E. H. Hubert, 420 Lexington Ave., New York City.

**American Electrochemical Society**—St. Louis, Mo., May 29-31. Colin G. Fink, Columbia University, New York City.

**Radio Manufacturers Association**—Convention and Trade Show, Atlantic City, N. J., June 2-6. Bond P. Geddes, 11 West 42nd St., New York City.

**American Institute of Electrical Engineers**—Toronto, Canada, June 23-27. F. L. Hutchinson, 29 West 39th St., New York City.

**Institute of Radio Engineers**—Toronto, Canada, Aug. 18-21. Harold P. Westman, 33 West 39th St., New York City.

## RMA appoints committees to study pentodes

**PENTODE** sets will not be presented this season, according to a number of set and tube manufacturers who attended a meeting of the Radio Manufacturers Association, March 6, at the Hotel Astor, New York.

During the meeting, presided over by President H. B. Richmond of the RMA, it became evident that many of the larger set manufacturers had already completed their plans for 1930 and no sets using the pentode tube had been included. Those reporting results of their circuit developments on the new tube painted a picture of many unsolved technical problems and the lack of any agreement among the tube and set manufacturers as to just what the characteristics of the tube should be.

A joint sub-committee consisting of five receiving-set engineers and five tube engineers were appointed to collect and study all data on the five-element tube and to formulate, as soon as possible, definite pentode characteristics.

R. H. Langley of Cincinnati, Ohio, Chairman of the RMA Receiving Set Committee of the Engineering Division, and George Lewis of Newark, N. J., Chairman of the Tube Committee, summarized the views of the respective groups and called on many engineers and other radio representatives present

for news and views regarding experiments with the five-element tube.

"If we deliberately withhold advance technical information," said President Richmond, "so that the public feels we are making definite plans to make their current purchases obsolete, they will lose confidence. If, also, we make statements which lead the public to believe a new revolutionary development is just around the corner, and the public find that this development is only one of nominal improvement, again they will lose confidence.

"Never let there be any withholding of technical information. Neither let there be any premature consumer announcements of a nature tending ultimately to destroy consumer confidence."

## Jail deliveries prevented by photo-cell-controlled guns

**COMING** on the heel of news of many serious penitentiary outbreaks during the past six months, the Illuminating Engineering Society of Boston on March 19 was shown a demonstration of the photo-cell as a means of foiling escapes of prisoners.

Edwin H. Veeder of the Westinghouse company described the mechanism and supervised the demonstration. For dramatic purposes, a puppet indicating a prisoner crept up a model prison wall, and as it came within the range of vision of an "electric eye," a revolver

trained on the prisoner was fired and a bell on the prison wall set up a furious clangor.

The result was accomplished by projecting a beam of light along the top of the prison wall, to a photo-cell at the distant end. This cell was connected through a grid-glow tube to the relay actuating the revolver and the alarm bell.

## Engineering features of radio trade show Atlantic City, June 2-6

**IN SIZE** and diversity of features the Radio Trade Show of the Radio Manufacturers Association, to be held at Atlantic City, N. J., June 2 to 6, inclusive, is expected to break all records. Some 200 makers of radio sets, tubes, parts and accessories will exhibit in the big \$15,000,000 auditorium, occupying 30,000 sq.ft. of space.

On Tuesday, June 3, the Institute of Radio Engineers will hold a special session at the show. The Radio Manufacturers Association with its engineering divisions, will be in session during the week of the show, and there will also be meetings of the Radio Wholesalers and the National Federation of Radio Associations.

Jess B. Hawley, of Chicago, is chairman of the show committee, and G. Clayton Irwin, Jr., is show manager.

## ADMIRAL IN "FLYING FLAGSHIP" DIRECTS APRIL MANEUVERS

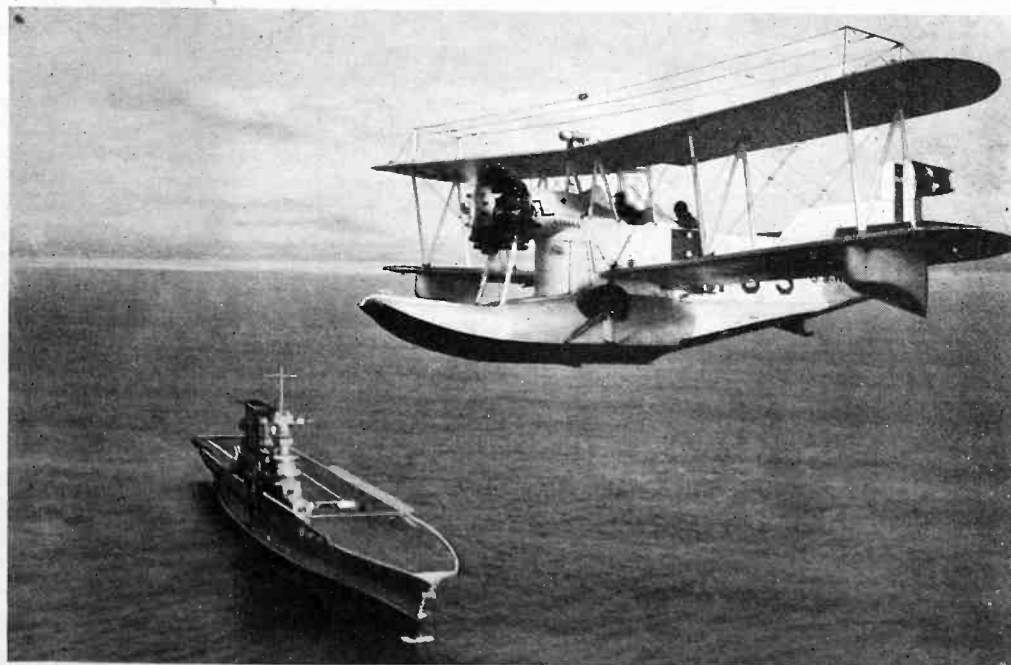

**IN** the U. S. Fleet maneuvers taking place this month off Guantanamo, Cuba (April 4 to 28), radio on Navy airplanes plays an important part in directing the operations of the cruisers and battleships. The plane here shown, flying the admiral's flag, is the "air flagship" of Rear Admiral H. V. Butler, commander of the aircraft squadron of the Battle Fleet, from which orders or information are transmitted to the attacking or defending fleets below.

# PATENTS

## IN THE FIELD OF ELECTRONICS

A list of patents (up to March 18) granted by the United States Patent Office, chosen by the editors of *Electronics* for their interest to workers in the fields of the radio, visio, audio and industrial applications of the vacuum tube

1,748,171 and 1,748,192. Alva B. Clark and Joshua P. Satterthwaite of the A. T. & T. Co. Measurements of echoes on telephone lines.

1,748,186. Harry Nyquist. A. T. & T. Co. Method of cutting off one side band of a modulated carrier by varying the transfer admittance as a function of frequency.

1,748,277. E. Leon Chaffee, assigned to John Hays Hammond Jr. Secret transmission system receiver. Circuits tuned to different frequencies have impressed on them another frequency differing an equal amount from the two frequencies are connected to a receiver tuned to the beats produced by the generator with one of the frequencies but not to the beats produced by both.

1,748,279. Edward E. Clement, Washington, D. C. System of transmitting broadcast matter over wires to several subscribers. System consists in sending to each subscriber the modulated radio wave, heterodyne frequencies, etc.

1,748,407. Charles A. Bottorff, assigned to Trimm Radio Manufacturing Company. Loud speaker unit.

1,748,432. Theodore F. Vollten, assigned to Percival D. Lowell. Radio frequency amplification system. Method of coupling a closed loop to the inductance of a radio frequency amplifier of proper resistance to prevent oscillation of the stage.

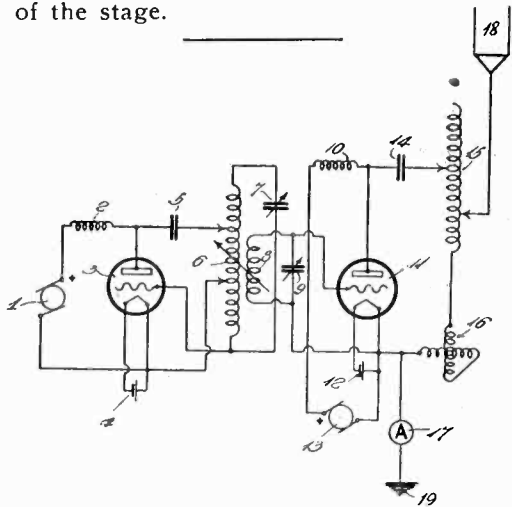

1,749,269. F. Trautwein, Berlin, Germany. Externally controlled vacuum tube transmitter. Apparently an amplifier feeding energy to an antenna circuit whose input is tuned to a harmonic of the antenna frequency to prevent self-oscillation in the amplifier. The input is coupled to the driving oscillator by a transformer.

1,748,441. William H. Clayton, Pine Bluff, Ark. Telephone Transmitter.

1,748,481. Charles Horton, assigned to Pilot Radio & Tube Corp. Straight line frequency condenser.

1,748,482. Charles Horton, assigned to Pilot Radio & Tube Corp. Radio reception device.

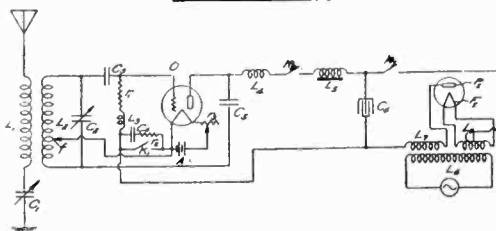

1,749,660. Hugo Benioff, assigned to Carnegie Institution. Oscillating tube supplied with plate power from a condenser and method of charging condenser.

1,748,499. Arthur Senauke, New York, N. Y. Means for energizing radio apparatus from d.c. mains.

1,748,515. Bernard Kwartin, Philadelphia. Regulating mechanism for bringing up slowly the speed of a rotating turntable from slow speed to a constant speed.

1,748,620. Samuel Ruben assigned to Ruben Patents Company. Microphone.

1,748,640. Leroy F. Dyer, Quincy, Mass. On the same shaft with the tuning condensers of a radio set is an inductance which turns between other inductances as in a variometer. Connected to the shaft is a mechanical arrangement which, when the condensers are rotated, changes the coupling between this inductance and other inductances situated nearby.

1,748,713. Ernest Green, assigned to the Radio Corporation of America. Thermionic generator.

1,748,725. Howard J. Murray, assigned to R. M. Company. Radio light-transformation system. A light susceptible circuit arranged to create a high frequency magnetic field positioned to intercept a ray of light, means of varying the light ray and means for connecting modulated light ray to a broadcasting system.

1,748,726. Mendel Osnos, assigned to the Gesellschaft fur Drahtlose Telegraphie. A means of neutralizing the saturation in a transformer produced by input currents.

1,748,730. R. H. Ranger assigned to the Radio Corporation of America. A three electrode tube with a condenser in the grid lead, a variable resistance across this condenser arranged to vary in accordance with the output currents, and thereby varying the grid bias and thus the output.

1,748,797. Philip T. Russell, Mount Ranier, Md. Apparatus for measuring distances. Uses tubes and amplifiers.

1,748,834. Alvarado L. R. Ellis, assigned to the General Electric Company. A Piezo-electric oscillator.

1,748,847. John H. Miller assigned to Jewell Electrical Instrument Company. A method of testing tubes by connecting the grid, through a single pole double throw switch, either to the positive or to the negative leg of the filament, thereby changing the bias on the tube and changing its plate current. The apparatus determines essentially the tube's mutual conductance.

1,748,883. Ray D. Kell, assigned to the General Electric Company. Method of transmitting color pictures.

1,748,901. Eugen Reisz, Berlin, Dahlem, Germany. Membrane for electrostatic loud speakers.

1,748,928. John Harry Dunn Ridley, London, England. Microphone.

1,748,969. E. E. Blankenstein and C. M. Coulter assigned to the Western Electric Company. A method of testing materials by adding to a known circuit the material having the unknown characteristics and again measuring the characteristics of the circuit.

1,748,990. E. C. Nilson. Acoustic diaphragm.

1,748,996. Frank J. Reichman. Loud speaker of the cone type.

1,749,102. William Henry Kitto, Ferrisdale, Mich. Radio receiver in which the usual transformer connects the antenna to the first two tubes which have their grids in parallel but their plates in series with the following transformer primary.

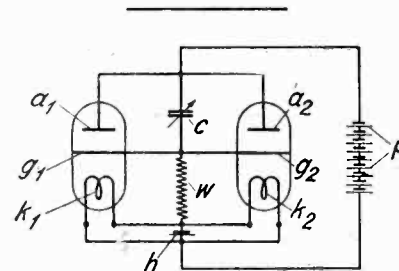

1,750,000. Abraham Esau, Jena, Germany. Generator of short electric waves.

1,749,159. William R. Respass assigned to Leonard C. L. Smith. Heat, cold, and sound insulating material.

1,749,187. John H. Leavell, Los Angeles. Apparatus for supplying olfactory impressions to a moving picture theater audience.

1,749,284 also 1,749,285. Harvey C. Hayes, Washington, D. C. Means for converting sound energy into electrical energy. Sound is conducted to a coil or wire suspended in a magnetic field. Variations in the position of the conductor produce electrical modulation.

1,749,295. Gerhard Messtorff, Berlin, Germany. Method of using photoelectric cell to modulate an oscillating tube circuit.

1,749,301. Roy J. Pomeroy, assigned to Paramount Famous Lasky Corp. Sound producing and controlling system.

1,749,306. Wilhelm Scheppman, Berlin, Germany. Method of using vacuum tube circuit for controlling speed of prime mover.

1,749,348. F. A. Kolster assigned to the Federal Telegraph Co. Directional radio system.

# TUBES *and* CONTROL

In millions of radio receivers—in countless electrical apparatus where characteristic curves must be adhered to you will find one or more CENTRALAB controls.

CENTRALAB is keeping pace with tube development—and CENTRALAB controls are increasing their sphere of usefulness wherever new uses for tubes are found.

If you have a resistance problem CENTRALAB engineers are ready to serve you.

Write for Bulletin "E" on  
Types and Dimensions.

# Centralab

CENTRAL  
RADIO  
LABORATORIES

■ 16 KEEFE AVENUE, MILWAUKEE, WISCONSIN ■



## PATENTS—

1,749,364. Sidney Weisberg, Brooklyn, N. Y. Protective system for radio tubes in receiving or other radio circuit.

1,749,423. Almon J. Fenton, assigned to Atwater Kent Mfg. Co. A cold electrode glow discharge tube comprised of a hollow foraminous cathode structure of tantalum, and a plurality of rod-like anodes all in an atmosphere of helium.

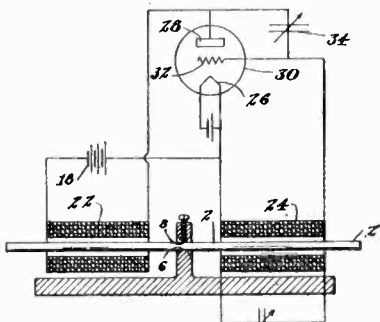

1,750,124. George W. Pierce, Cambridge, Mass. Magnetostriction controlled oscillator.

1,749,780. H. C. Rentschler, assigned to Westinghouse Lamp Co. Rectifier composed of a large iron anode, small thorium cathode, and tungsten heating coil in series with cathode.

1,749,568. Robert L. Davis, assigned to the Westinghouse Electric and Manufacturing Co. A protective system for vacuum tubes. When the operating temperature of the tubes is exceeded a switch automatically opens the anode circuit.

1,749,592. Donald G. Little, assigned to Westinghouse Electric and Manufacturing Co. Method of connecting resistances in the grid leads of modulating tubes.

1,749,610. Otto Schaller, Berlin, Germany. Gaseous conduction lamp.

1,749,611. Fritz Schroeter, Berlin, Germany. Assigned to Safety Car Heating and Lighting Company (New Jersey). Method of rectifying alternating currents using gaseous conduction rectifying tubes.

1,749,635. Erwin Gerlach, Berlin, Germany. Assigned to Siemens & Halske. Diaphragm for electroacoustic apparatus.

1,749,739. Wm. G. Flaharty assigned to Western Union Telegraph Co. Carrier wave telegraph transmitter.

1,749,772. Charles Fred. Lorenz, assigned to Westinghouse Lamp Co. Contact resistance lamp.

1,750,102. Walter Hahnemann, Berlin, Germany. Discharge tube system in which negative resistance between two electrodes is controlled.

1,750,053. Walter W. Robinson. Vacuum tube socket.

1,749,841. Harry Nyquist, assigned to A. T. & T. Co. Voice operated relay.

1,750,238. O. T. McIlvaine, assigned to The Radio Television Company (Cleveland). Thermionic tube composed of a filament and a flat tapered metal plate supported by the filament and in thermal conduction relation to the filament.

1,750,242. Samuel Ostrolenk, assigned to Westinghouse Electric and Manufacturing Co. Remote metering system using photoelectric cell.

1,750,304. Carl F. Goudy, assigned to Patent Radio Corp. Phonograph pick-up unit.

1,750,386. Walter John Brown, Brooklands, England. An oscillation generator vacuum tube of the space current type.

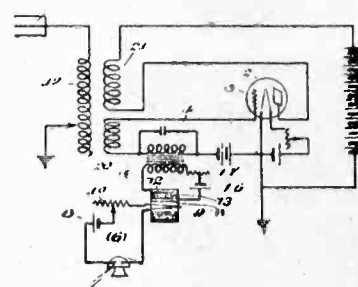

1,750,579. H. C. Dunwoody, Interlaken, N. Y. Modulator for radiophones. Essentially a method of effecting grid circuit modulation.

## Industrial uses of vacuum devices

[Continued from page 17]

conditions are not. A new world of possibilities lies before us in the use of this valuable vacuum device.

Cathode rays from which the x-rays start are also of great interest in the treatment of materials for the purpose of (a) examining the genuineness of gems, (b) producing acceleration of chemical reactions, and (c) causing particular physiological effects. They are also of great use in a vacuum oscilloscope for the examination of ultra-high speed electrical phenomena. Also, they are being employed in one of the best types of television receivers.

Gaseous discharge devices are being made to do many of the things that were formerly thought possible only

with the three-electrode high-vacuum devices. They perform many relay operations with greater capacities than are yet possible with the vacuum devices. Amperes are employed in gaseous devices where milli-amperes must be used in the high-vacuum ones. They also act wonderfully as rectifiers and, to some extent, as producers of oscillations. A. C. power distribution and d.c. motors to utilize the rectified currents from hot-cathode gaseous-discharge tubes are at hand in a small way, but rapidly growing in size of units.

Gaseous-discharge devices are also assuming considerable importance for advertising signs and marker lights, with every indication of still greater growth. The remarkable possibilities of speed of modulation of these devices is resulting in the production of television lamps for stroboscopic study of rapidly moving objects.

## Vacuum tubes in scientific measurements

[Continued from page 20]

frequency is, therefore, increased in the ratio of the high frequency to the low frequency. In the ultramicroscope, the frequency of a high-frequency oscillator is determined by the mechanical separation between the plates of an electrostatic condenser. Minute changes in the separation of these plates cause corresponding changes in the frequency of the oscillator. By observing the effect of this change upon the frequency of a suitable current in the output of a heterodyne detector, quantities may be measured which could not otherwise be detected. It has been reported that by the use of a device of this sort the deflection of a 3-inch plank caused by the alighting thereon of an ordinary housefly may be readily determined.

A number of methods have been devised for measuring distance in terms of the time required for the transmission of sound. A good example of this is in subaqueous depth finding. Here, a sound of very high frequency is produced near the surface, and the time required for the echo to return from the bottom is noted. Again, both in marine work and in geophysical exploration distances have been determined by measuring the difference in time required for the transmission of a pulse or sound through two different media.

In view of the short time during which the possibilities of the vacuum tube have been generally known, its present extensive use bears witness to its value. As knowledge of the tube and information regarding its properties becomes more general, it is certain to play an even more important part, both in scientific work and in industry.

**YAXLEY MANUFACTURING CO.**  
**MANUFACTURERS INFORMATION SHEET.**

SUBJECT: -10MAP - 10MAP DUAL VOLUME CONTROL      CUSTOMER:   
 -699-6 SOCKET

SPECIFICATIONS: -DUAL VOLUME CONTROL - 10,000 OHMS FRONT; 10,000 OHMS REAR.  
 COMMON SHAFT, INSULATED  
 -SOCKET-6-PRONG

SEE SHEET 1 FOR COMPLETE DESCRIPTION, PRICES, DELIVERY, SCHEDULE, ETC.

# FOR THE MOST EXACTING NEEDS OF PRECISION MANUFACTURING

**BAKELITE SEPARATORS**

**COUPLER TURNS ARMS TOGETHER.**

**CONTACT ARMS**

**BAKELITE**

**YAXLEY**  
APPROVED RADIO PRODUCTS

has attained an unusual place in the design, development and production of finer radio parts. The manufacturers of leading radio equipment have learned to rely on this organization for an unfailing supply of parts that will not break down in vital places.

Before tooling and tuning up for production in your own plant, it might be much to your advantage to investigate our facilities for taking good care of some of your requirements. Write today for full information.

**RIVET HEADS BAKELITE P...**

**RIVET #27 DRILL**

**BAKELITE SOCKET BASE.**

**WITH 7/8" HOLE PRONGS ON PLUG HOLES AS SOCKET INS. PLATE IS (INSULATOR)**

**SUPPLIED IN 2, 3, 4, 5, OR 6 CONTACTS.**

Send for Data Sheets and other information on our Design and Development Services.

**Address Dept. E**  
**YAXLEY MFG. CO.**  
 1528 W. Adams St., Chicago, Ill.

**VOLUME CONTROLS . . .**  
**PHONE TIP JACKS . . FIXED**  
**AND GRID RESISTANCES . .**  
**PLUGS . . RHEOSTATS . . SOCKET**  
**ASSEMBLIES . . TERMINAL CLIPS**  
**. . TERMINAL STRIPS, ETC., ETC.**



# The power pentode

[Continued from page 14]

caused if the loud speaker were disconnected while the tube is in operation or if the impedance of the speaker varies excessively with frequency.

The fact that the optimum load resistance for the pentode is low in value in spite of the fact that the AC plate resistance is much higher than the ordinary type of output tubes is a seeming paradox due to the fact that the three-electrode tube develops its undistorted optimum power in a load resistance of about twice the AC plate resistance. The reason for this strange state of affairs lies in the fact that the triode has a practically constant alternating plate resistance over the entire operating characteristic accompanied by a constant amplification factor and mutual conductance. In the pentode, however, the alternating current plate resistance is a variable through rather extreme limits as is the value of its amplification factor. At the point A the AC plate resistance is seen to be much lower than at the operating point O, and since the curve for zero grid volts limits the useful grid swing the alternating current resistance of this point determines the optimum load resistance value.

## The problem of fidelity

In Fig. 7 are shown the shapes of the output waves of the pentode and triode when operated with the various load resistances shown on the plate characteristic curve. It will be seen that with the triode, wave shape does not vary from a sinusoid when the load resistance is varied through quite wide limits. The wave shape obtained from the pentode, on the other hand, is seen to be terribly distorted with slight variations of the load resistance. The dotted curve shown beneath curve A is a sinusoid plotted to the same scale as A which is the curve for optimum load.

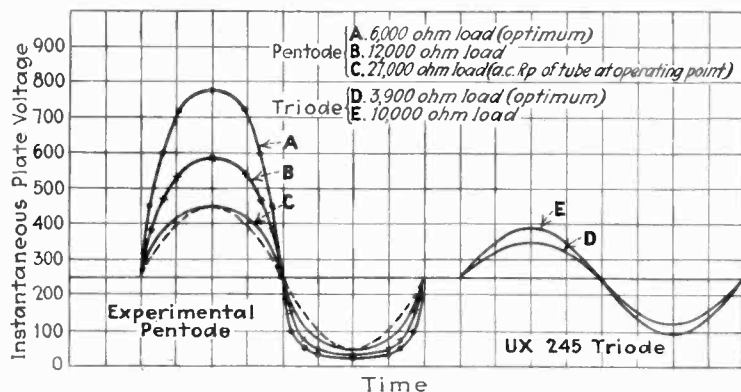

Fig. 7—Shape of output wave of pentode and triode with various loads. The pentode output becomes greatly distorted when worked into high resistance loads

Modern dynamic speakers designed for operation from triodes usually exhibit a rising impedance characteristic with increasing frequency. In several types measured by the writer the value of moving coil impedance for 5,000 cycles was found to be over three times the low frequency impedance. Such variations would cause extremely disagreeable quality when used with a pentode because the output wave shape at high frequencies would be similar to that shown in curve B of Fig. 7. A similar

shape of wave is also obtained when the load resistance is replaced by a magnetic type speaker. In this case the variation of effective impedance with frequency is much greater than in the case of the dynamic type.

The rise of impedance of the loud speaker as viewed from the output transformer has not been sufficiently troublesome when operating with triodes to merit investigation. If the pentode becomes adopted as an output tube the speaker engineers will have to consider means of holding the impedance of speakers more nearly constant over the frequency range.

## Applications of the pentode

It has been stated recently that since there are available on the American market three electrode power tubes of adequate output and characteristics to handle all the required conditions of service, that no need exists for the more complicated five electrode output tube. It is possible however to outline a number of conditions which would be ideally met by a suitably designed pentode.

The increasing use of the so called bandpass or tuned filter type of radio stage for gaining additional selectivity occasions a loss of stage gain due to decreased coupling. In order to compensate for this loss of radio gain it is desirable to use a tetrode detector. Since power output requirements demand the use of pushpull UX 245's a method of coupling the tetrode detector to the power tube without loss of fidelity is a baffling problem. If a pentode of equivalent power output is used in place of the pushpull tubes, adequate grid swing for its operation may be obtained by a resistance coupling from the UY 224.

Another application of the power pentode is the problem of a low cost phonograph amplifier. A single pentode of suitable characteristics can be made to serve as the entire amplifier for the reproduction of phonograph music by supplying its grid with the voltage from a low impedance phonograph pickup connected to a high ratio stepup transformer. Such an amplifier would have a surprisingly small number of component parts and could be made very cheaply. A phonograph amplifier of this type has been built for sale in Great Britain.

A more definite need exists for the pentode in the field of battery operated receivers. It would be possible to design a pentode for storage battery operation which would simplify the construction and supply requirements of receivers for use in automobiles and on farms where dependence is placed upon storage batteries for filament supply and dry cells for plate potential. Such a pentode should have filament characteristics similar to the UX 112A or UX 171A and be designed to deliver at least 500 milliwatts with a grid swing of not more than 20 volts peak.

## Power detection

An unrealized dream of the radio engineer is the possibility of designing a detector of some type which could be made to operate the loud speaker directly without the interposition of audio frequency amplifying tubes. The pentode offers a possible solution of this problem. No data are available at present but the characteristics of the tube suggests this application. When worked as a high signal voltage plate rectifier, the pentode should be capable of delivering an adequate loud speaker signal providing the percentage of modulation were high enough. A low percentage modulated radio signal would overload a pentode detector before sufficient audio voltage could be reached.



# NEW JOBS BY ELECTRONICS



## MACHINE NOISES

*As fan speed varies, electronic instruments measure independently the noise curves of motor and blades. Our new air-flow relay keeps check on the anemometer. Intensities and pitches of machine noise now can be measured as accurately as volts or amperes, usually the first step to quieting them.*

## USEFUL MUSIC

*The world's first soundproof piano, built especially by Steinway and Sons. Selected tones can be let out for electronic study. Musical sounds now have such practical jobs as measuring airplane heights, controlling dynamo speeds and maintaining precise levels in tanks or boilers.*



## NEW RAYS

*Ultra-violet rays from health lamps or through window glasses are measured by special photo-electric cells. Our equipment for quantitative research with ultra-violet or infrared we believe to be unique.*

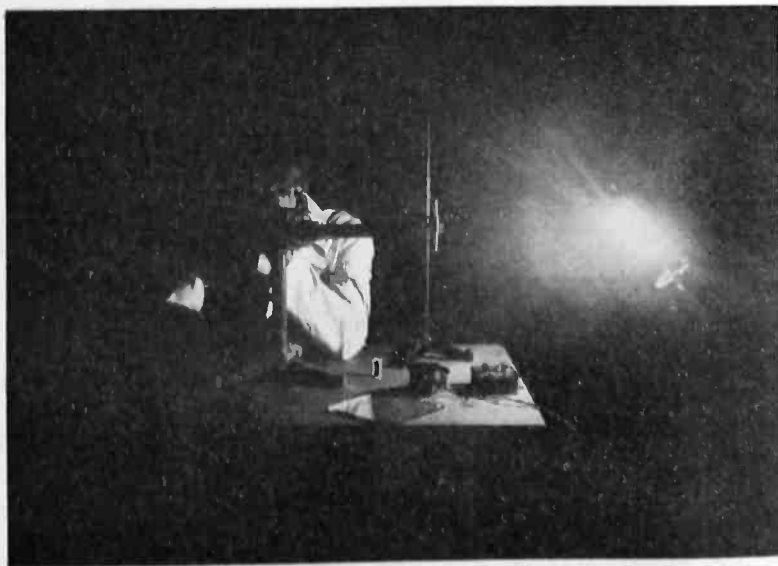

## E. E. FREE LABORATORIES

Consultation—Research—Development

175 FIFTH AVENUE, NEW YORK CITY

Clarence C. Clark, Laurence M. Cockaday, Carl Dorf,  
E. E. Free, Raymond R. Hartman, Carl A. Johnson,  
Ronald Millar, J. L. Sheek

Consultation on Industrial Problems  
invited without fee or obligation.

D. D. Knowles, research engineer, with an early form of the Grid-Glow Tube, from which numerous industrial applications have been developed



Station KDKA, pioneer broadcasting station of the world, as it appeared on November 2, 1920, when its inauguration of scheduled broadcasting gave tremendous impetus to the development of the radio industry

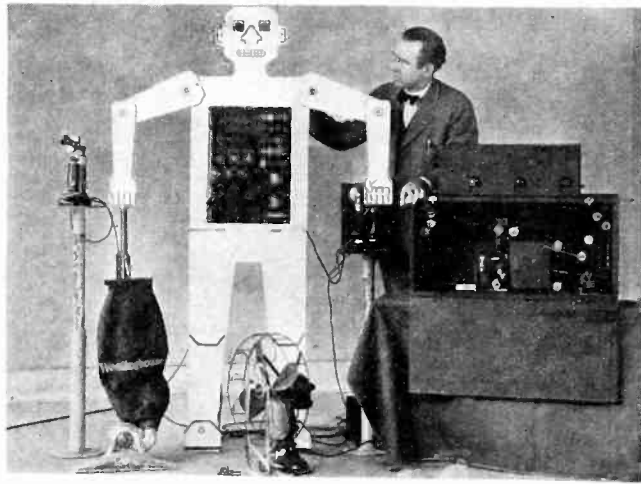

Televox, the mechanical man, which utilizes the Grid-Glow Tube and which symbolizes the application of automatic control to industry



*Westinghouse Serves the  
Electronics Industry with:*

Amplifier Tubes  
Grid-Glow Tubes  
Photo-Electric Cells  
Micarta  
Fractional hp. Motors  
Transformers

Ammeters  
Voltmeters  
Rectifiers  
Light Relays  
Magnetic Relays  
Condensers

# IN ELECTRONICS, too

*...pioneering the way*

*for Industry*

THREE years ago, a Westinghouse research engineer, assigned to the study of the electron tube, realized a dream comparable to those of the most imaginative writers of fairy tales.

Glancing at a row of glow tubes in a test rack under a window in the company's laboratories, he noticed, to his surprise, that some of the tubes were glowing, while others were not; some glowed when the sun was shining but were dark on cloudy days, while others responded when his hand touched the glass. Two new Westinghouse developments of the electron tube had come to light—the photo-glow tube and the grid-glow tube.

This discovery had been preceded by that epochal event in radio history, which gave such great stimulation to the industry—the inauguration of broadcasting by KDKA on November 2, 1920. And in practically every industrial adaptation of the electron tube Westinghouse engineers have contributed important basic developments. Outstanding among these contributions, is the development of tubes of long life and great constancy, so essential to industrial use.

Building upon the foundation of present applications, Westinghouse will continue this pioneering work to the end that electricity will play a greater role in the advancement of industry.

For the electronics industry Westinghouse manufactures many products, some of which are listed in the accompanying panel. For further information write our district office nearest you.

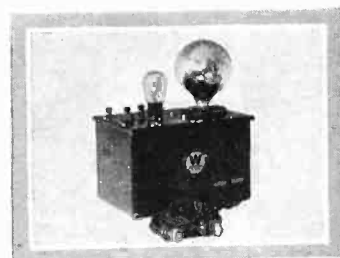

The Grid-Glow Tube demonstration set, largely used in show windows and for other advertising purposes

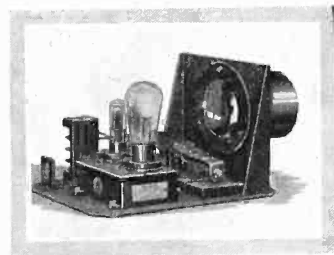

The LB Light Relay which operates by the breaking or making of a beam of light. This device has numerous industrial applications. (Supplied with a metal cover)

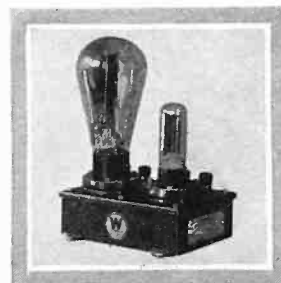

Photo-Electric Cell Amplifier Unit, a simple, low-cost device particularly adapted for experimental work in connection with industrial photoelectric problems

*Service, prompt and efficient, by a coast-to-coast chain of well-equipped shops*

# Westinghouse

T 31239





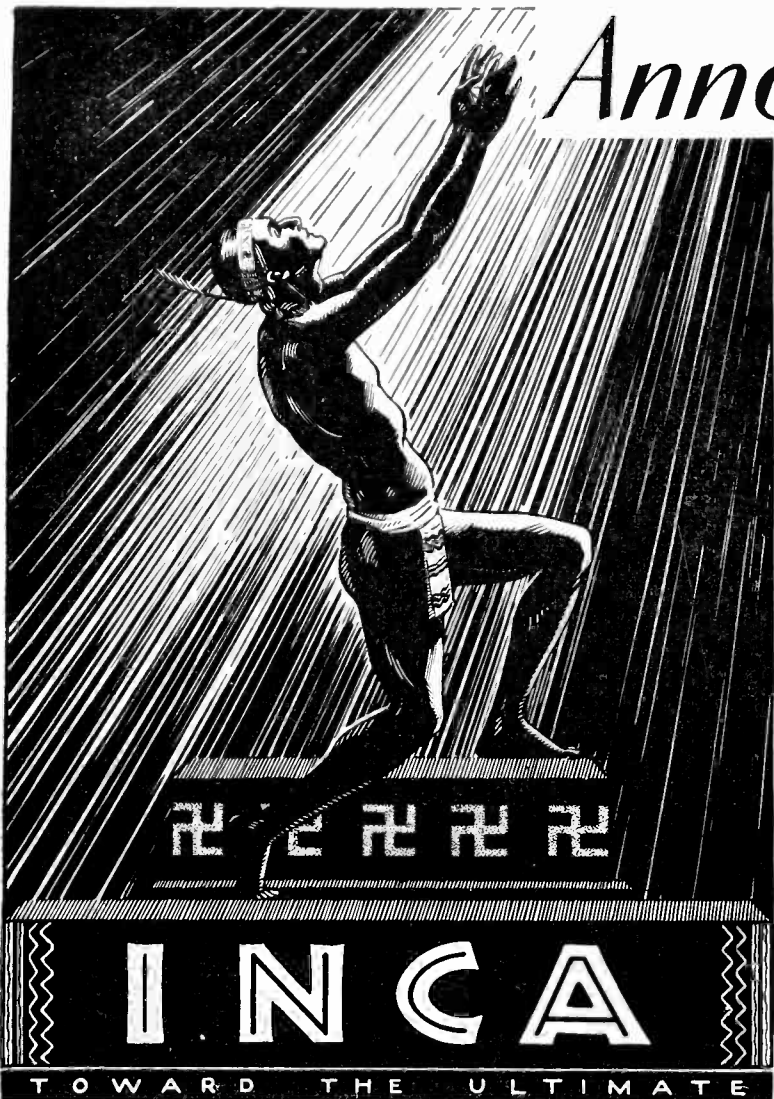

Announcing the

# NEW INCA COIL

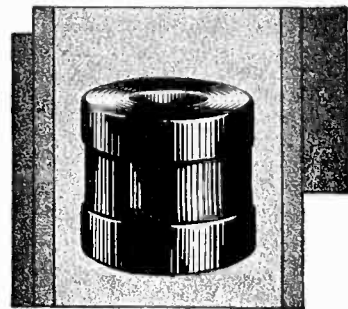

Patent Applied For

An  
*improved dynamic field  
coil many strides in  
advance* / / /

Mechanically and electrically the best on the market today! That is the claim unhesitatingly made for INCA'S latest development—the new field coil for dynamic speakers—a product of the engineering skill and facilities of INCA'S new and most efficiently designed plant. This coil supplies a basic need of the radio manufacturer—namely, enameled wire in coil form, *without the spool*. There are many superior features. The circumferential bands, for instance, add strength and provide instantly available terminals. Therefore the customer may order with or without leads. This and other coils are built to the precise specifications of the manufacturer.

Picturization of Inca Indian, derived from Sir Clement Markham's "The Incas of Peru"—the original copper workers of early American history, noted for the perfection and skill with which they fashioned products from metal.

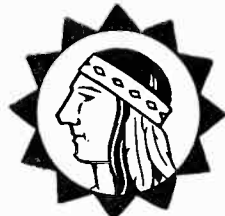

**INCA**

*engineers will be pleased to  
confer with you on any of your  
magnet wire or coil problems*

**INCA MANUFACTURING CORPORATION**  
*Copper Wire Products* *Fort Wayne, Indiana*

WESTERN REPRESENTATIVE: A. S. Lindstrom, 274 Brannan Street, San Francisco, California  
EASTERN OFFICE: Newark, New Jersey—Industrial Office Building

# EISLER ELECTRIC

## MACHINERY

FOR THE MANUFACTURE OF  
RADIO TUBES ▾ TELEVISION TUBES  
NEON SIGN TUBES ▾ INCANDESCENT LAMPS  
GLASS PRODUCTS

THE MOST COMPLETE CATALOG OF ITS KIND

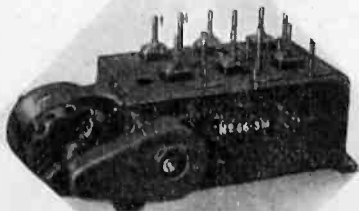
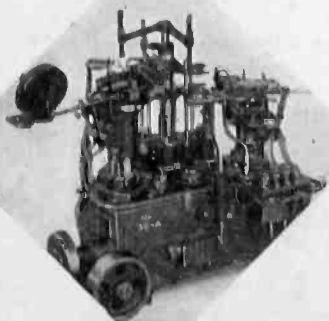
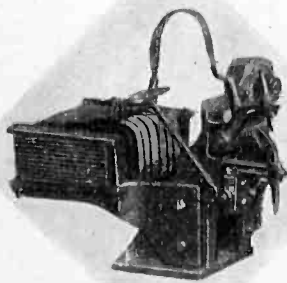
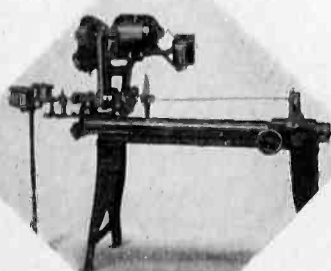
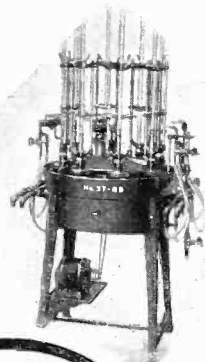
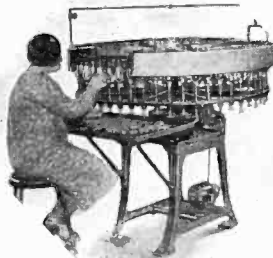
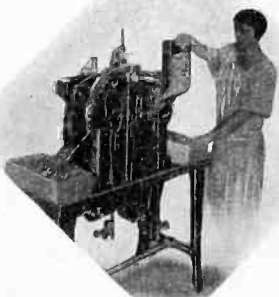
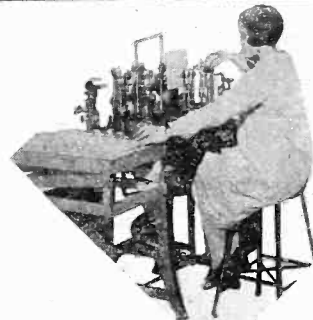
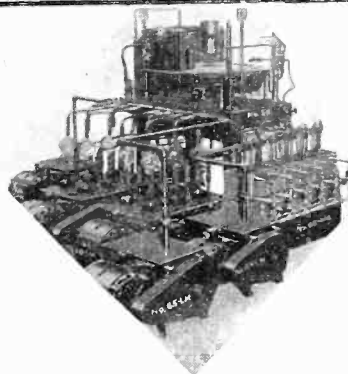
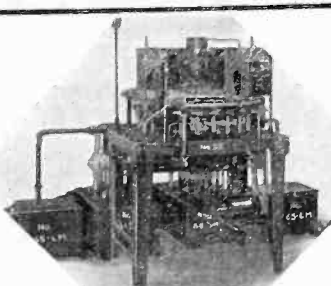
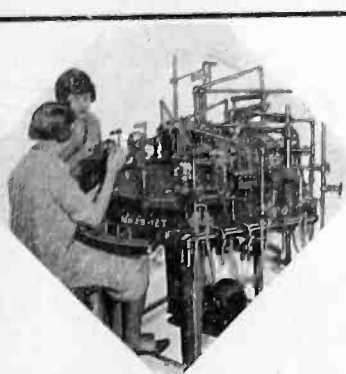

### Cover Design of the New "Eisler Electric" Catalog

THE Eisler Electric has recently presented a new 136 page catalog containing over 700 illustrations of various types of machines employed in the manufacture of Radio Tubes, Television Tubes, Neon Sign Tubes, Incandescent Lamps and Glass Products. . . every item shown has been proven under actual service conditions. . . reliability is built-in as a cumulative result of years of experience and progress.

IF YOU HAVE NOT RECEIVED YOUR COPY, WRITE US IMMEDIATELY.

Eisler Electric Corporation  
756 South Thirteenth Street  
Newark, New Jersey

CATALOG ▾ C



# MORE RECTIFIED CURRENT FOR

Many of the new and recent applications of the electronic tube developed the need for a larger and more stable source of supply of rectified current.

To meet this need, the Perryman laboratories made the P. R. 866, a hot cathode mercury vapor rectifier. It has a rectified current capacity of 0.6 peak amperes maximum output. Because the P. R. 866 has a low and practically constant voltage drop, it furnishes a stable source of plate voltage.

Built with the same rugged strength for which all Perryman Tubes are famous, combined with the low operating temperature of the oxide-coated filament and the extremely low voltage drop resulting from its mercury content, the P. R. 866 possesses an unusually long life.

Today the 866's are in wide use — and tomorrow? No doubt new applications and new circuits will be developed. These may dictate new characteristics, a new tube to procure the desired results.

The Perryman Company stands ready. It offers the complete facilities of its modern laboratories. Here problems are submitted to the unbiased scrutiny and careful study of those who have been closely identified with the development of the art since its inception. Here you will receive the advice of men whose counsel has been sought for years by many of the oldest and most noted engineers in the radio industry. It is this service the Perryman Company places at your disposal.

Submit your problem. Your letter will be held in strictest confidence. The recommendation of our laboratories will be forwarded within one week.

**Broadcasting Stations  
Transmitting Amateurs  
Sound Pictures • Public  
Address Systems • Other  
Commercial Applications**

*and Tomorrow!*

P. R. 866	
Fil. Volts .....	2.5
Fil. Amps. ....	5
Peak Inverse Volts .....	5,000
Peak Plate Amps. ....	0.6
Voltage Drop (Approx.) .....	15
Overall Length .....	6 1/2"
Overall Diam. ....	2 3/8"
Price .....	\$8.00



*Perryman Radio Tubes are manufactured under patents owned or controlled by the Radio Corporation of America and patent claims of Perryman Electric Co., Inc.*

**PERRYMAN—  
ELECTRIC CO., INC.  
4901 Hudson Blvd., North Bergen, N. J.**



# Where Performance demands *efficiency*

Whenever technical problems confront engineers or scientists, the engineering facilities of the American Transformer Company laboratories are at your service for developing the specific type of transformer best suited for your requirements.

Especially important is this service in connection with the many applications of the Electronic Tube. Only transformers of the highest quality can meet the demands of efficient operation required. For 26 years American Transformers have passed the most exacting tests in laboratories, in industrial plants, and in all fields of electrical energy.

The illustrations depict the range of American Transformers. Whatever your needs, there is an American Transformer to fill it. Bulletins with complete descriptions sent upon request.

## AMERICAN TRANSFORMER COMPANY

178 EMMET STREET

NEWARK, N. J.

### Representatives

Atlanta, Ga. — H. Douglas Stier,  
101 Marietta Street

Knoxville, Tenn. — Arthur L. Pollard

Minneapolis, Minn. — Elliott Equipment  
Co., 708 Sixth Avenue, South

Montreal, Canada — W. O. Taylor  
& Co., Ltd., 415 Canada Cement Bldg.

Philadelphia, Pa. — L. D. Joralemon,  
112 South 16th Street

San Francisco, Calif. — James H.  
Southard, 682 Mission Street

St. Louis, Mo. — J. W. Jones,  
432 Pennant Building



Audio Transformer  
—Type AF8 designed  
for radio and experi-  
mental use.

A 100 KVA Trans-  
former arranged for  
double star connection  
—used in broadcasting  
stations.

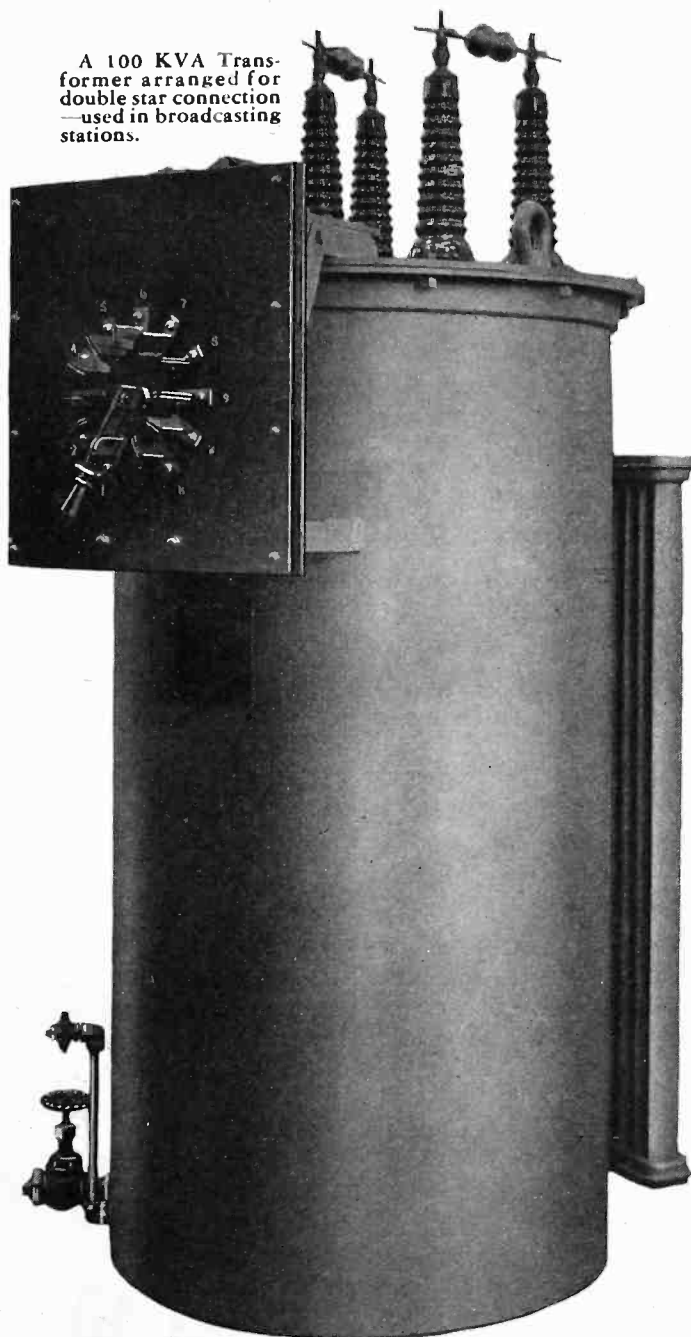

---

# AMERICAN TRANSFORMERS

---

# Specialists in RESISTANCE UNITS!

Complete range of all ratings and all types for Radio, Broadcasting, Sound Pictures, Public Address Systems, Photo-Cell Uses, Television, Wired Radio and all Industrial Uses.

As specialists in the design and manufacture only of Resistance Units, this organization has achieved a position of leadership second to none.

We are now in standard production of units of all ratings and all types for all kinds of electrical work, with accuracies to  $\frac{1}{2}$  of 1% and exceptional efficiency.

New uses for Durham Resistances are being developed by our experimental laboratories in cooperation with electrical engineers.

The laboratories of this organization and their experience in the solution of resistance problems are at your disposal. Samples of any Units and Engineering Data Sheets will be sent gladly upon request. Please mention ratings and types desired.

The new Precision Wire Wound Resistor for use where accurate, high value, non-inductive, low distributed capacity resistors are required. Widely used as milliammeter and voltmeter multipliers.



DURHAM Metallized Resistors and Powerohms... 100 to 200,000 ohms in powertypes; 1 to 100 megohms in resistor types; ratings for all limited power requirements; standard, pigtail or special tips.

# DURHAM

## RESISTORS & POWEROHMS

INTERNATIONAL RESISTANCE COMPANY • 2006 Chestnut St., Philadelphia, Pa.

# *Out of the Vacuum—* **MIRACLES!**

**S**CIENCE has evacuated a few inches of enclosed space, and with this modern magic wand is working miracles every day!

From the research laboratories of General Electric have come hundred-kilowatt vacuum tubes to fling the human voice around the earth; Coolidge x-ray tubes to aid medical investigation; photoelectric tubes that bring television closer to everyday reality and give greater realism to sound motion pictures.

How has industry benefited? G-E Thyratrons\* are effecting high-speed spot welding, high-speed paper cutting, greater flexibility and efficiency in power conversion. Photoelectric tubes, sensitive to color and light, are performing routine operations of sorting, counting, and grading. G-E Pliotrons\* add safety and convenience to pre-registering elevator control systems, and in automatic control circuits they guard fast-moving trains.

With Thyatron control, mobile floodlighting of structures, the lighting of theaters, show windows, etc., and the interior decorating of homes and public buildings have been made more beautiful and effective.

These are only a few of the applications for G-E vacuum-tube equipment. General Electric is ready to supply vacuum-tube apparatus for scores of industrial and scientific purposes. Write your nearest G-E office for full information.

\*Thyatron and Pliotron are trade-marks of the  
General Electric Company

JOIN US IN THE GENERAL  
ELECTRIC HOUR, BROADCAST  
EVERY SATURDAY EVENING  
ON A NATION-WIDE N.B.C.  
NETWORK



301-52  
**GENERAL ELECTRIC**  
SALES AND ENGINEERING SERVICE IN PRINCIPAL CITIES



# W L

## when *Your* problems — are *Ours*

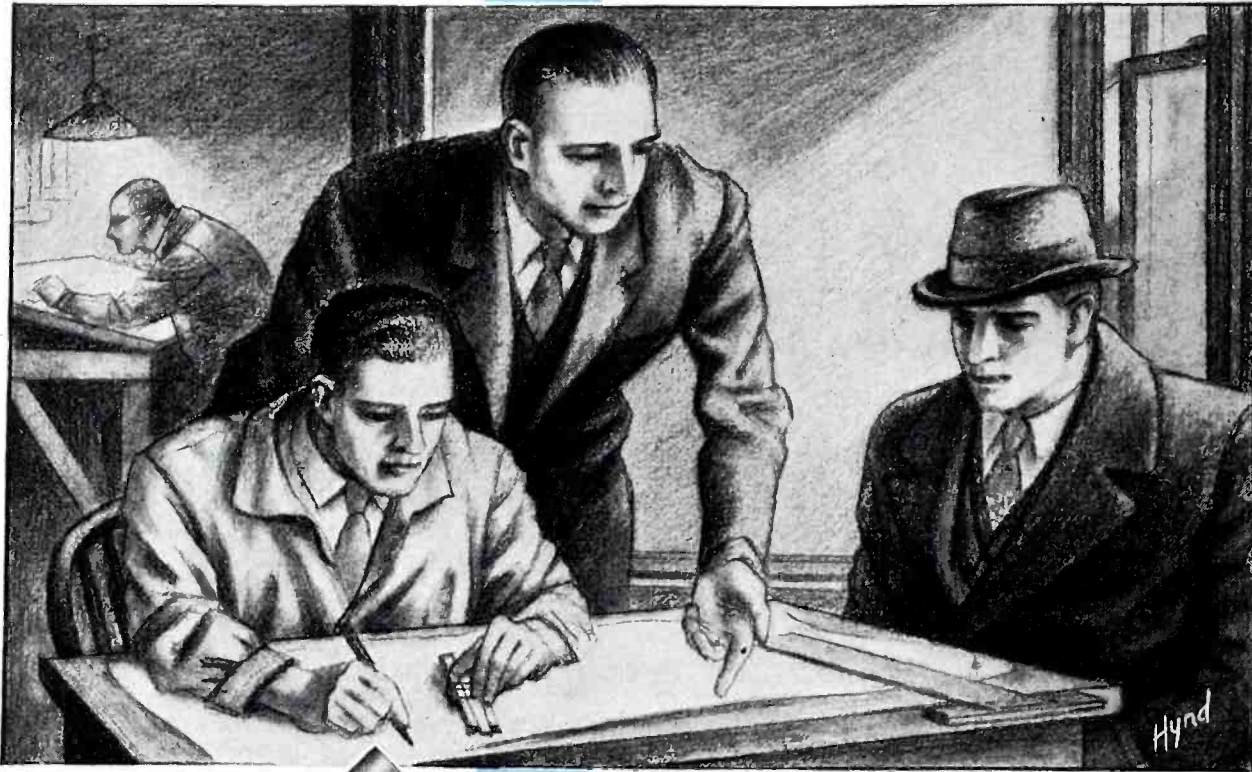

The Vitrohm Resistor illustrated above is equipped with ferrule terminals for insertion in fuse clips. It can be supplied for all National Electric Code standard diameters.

Other types of terminals and mountings are available to meet every requirement and condition of service.

### WARD LEONARD ELECTRIC CO.

31 South Street  
Mount Vernon, N. Y.

Resistor Specialists for More Than  
Thirty-Nine Years

**W**HEN you invite us to help decide the proper resistor for use in your equipment, the chances are good that you will save time and future expense. Make your resistor problems ours and you have the cheerfully-given advice which comes from more than 39 years' experience in the design and manufacture of Vitrohm Resistors.

It is surprising how frequently difficulties in space, mounting or heat dissipation are difficulties no longer when reference is made to the records of one of the more-than-a-million jobs turned out by Ward Leonard.

You have in Ward Leonard an auxiliary plant, modern, skilled in the development of new resistor requirements, speedy and accurate in production, and capable of meeting your production requirements, however large.

Meet and know the Ward Leonard Sales Engineer serving your territory. His knowledge of the industry in general, and control equipment in particular will interest you. Ward Leonard manufactures a wide variety of products\* and operates in many divisions of the electrical industry.

\* Vitrohm (vitreous enamelled) Resistors and Rheostats . . . . Voltage Regulators . . . . Theatre Dimmers . . . . A.C. and D.C. Motor Starters and Controllers . . . . Field Rheostats . . . . Arc and Spot Light Rheostats and Ballasts . . . . Mobile Color Lighting Equipment . . . . Adaptors . . . . D. C. Battery Charging Equipment . . . . Circuit Breakers

# EVEREADY BATTERIES &

# EVEREADY RAYTHEON TUBES

## Important factors in the field of Electronics

The Research Organizations of Eveready and Eveready Raytheon have played and continue to play an important role in the development of Electronics.

Eveready "B" and "C" Batteries, developed to a high state of perfection to serve as sources of power for Electronic devices, continue to lead in the field of non-radio, industrial applications. The crowning achievement of research in the "B" Battery field is the exclusive Eveready Layerbilt construction.

The Eveready Raytheon 4-Pillar Vacuum Tube is further tangible evidence of the Eveready guiding principle—to make a good product, and to make it so it will *stay good*.

Eveready Raytheon Foto-Cells, Kino Lamps, Recording Glow Tubes and gaseous rectifiers are other Eveready Electronic devices daily finding new and useful applications in the industrial as well as the radio entertainment field.



Eveready Raytheon  
4-Pillar Tube



Eveready Layerbilt  
"B" Battery

# EVEREADY

NATIONAL CARBON COMPANY, Inc.

General Offices: New York, N. Y.

Branches: Chicago Kansas City New York  
San Francisco

Unit of **UCC** and Carbon  
Union Carbide Corporation



# Almost daily new uses

## Electronic

### Showing a few » » »

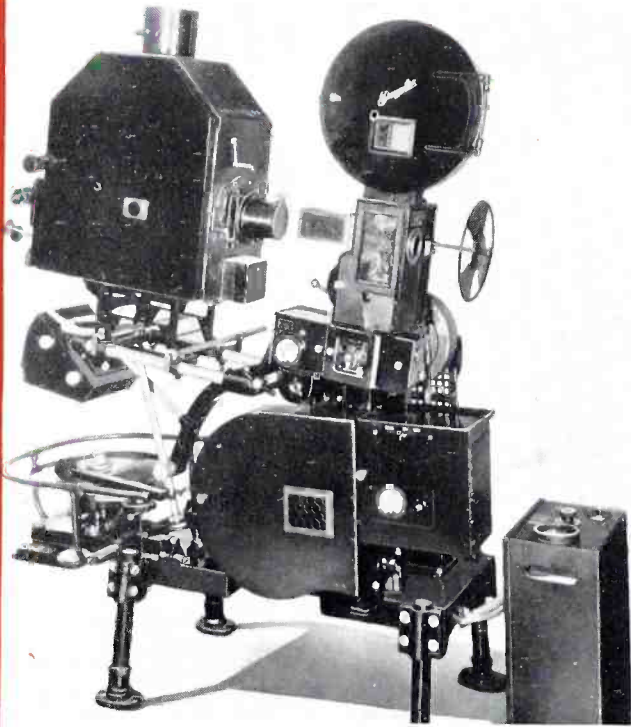

Above—Nils Asther and Raquel Torres on set at the M-G-M Studios



Upper Left—Western Electric Projector for Sound Pictures

*Courtesy Bell Telephone Laboratories*

Right—Phonograph Recording

*Courtesy of Brunswick Balke Collender Co.*

Left—Radio Broadcasting—The Eveready Hour



Eveready Raytheon Radio Tube ER-227



Eveready Layerbilt "B" Battery



Eveready Raytheon Kino-Lamp



Eveready Raytheon Foto-Cell



Eveready "C" Battery



# are developed for Eveready devices

## possible applications

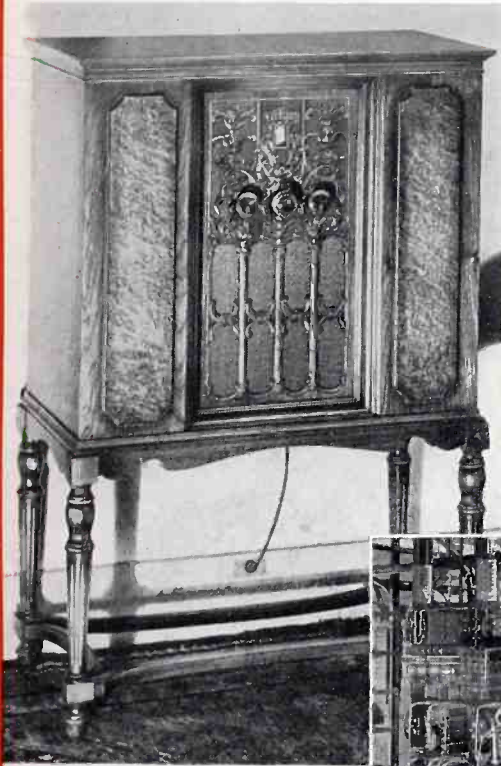

*Above*—Electric Radio Receiver

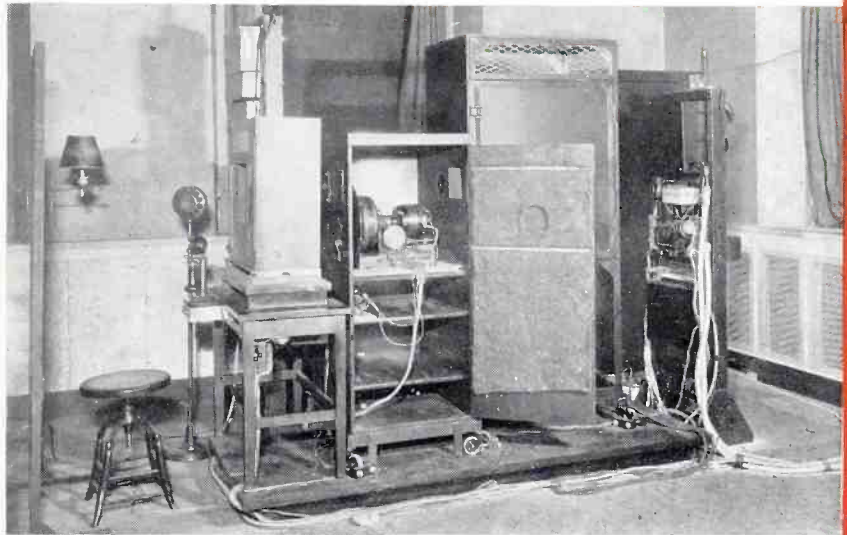

*Above*—Television Transmitting Apparatus  
Courtesy Bell Telephone Laboratories

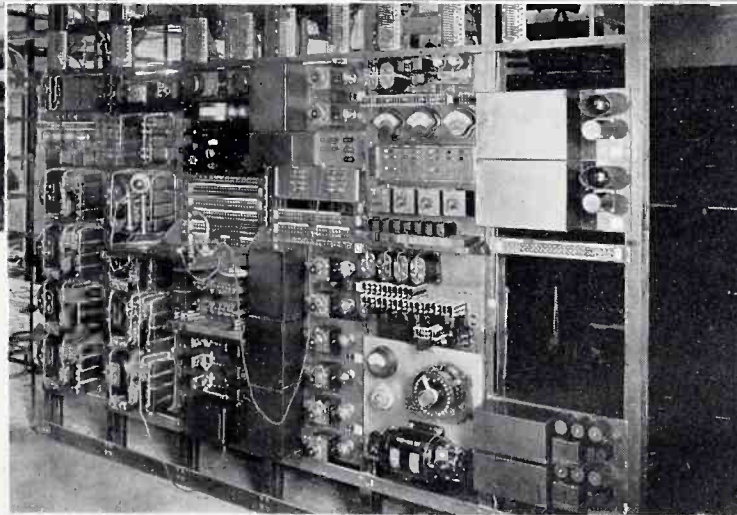

*Left*—Long-distance Telephone Repeater and Signaling Equipment  
Courtesy Bell Telephone Laboratories

# EVEREADY



Eveready Raytheon Radio Tube ER-227



Eveready Layerbilt "B" Battery



Eveready Raytheon Kino-Lamp



Eveready Raytheon Foto-Cell



Eveready "C" Battery



Showing a few

possible Applications

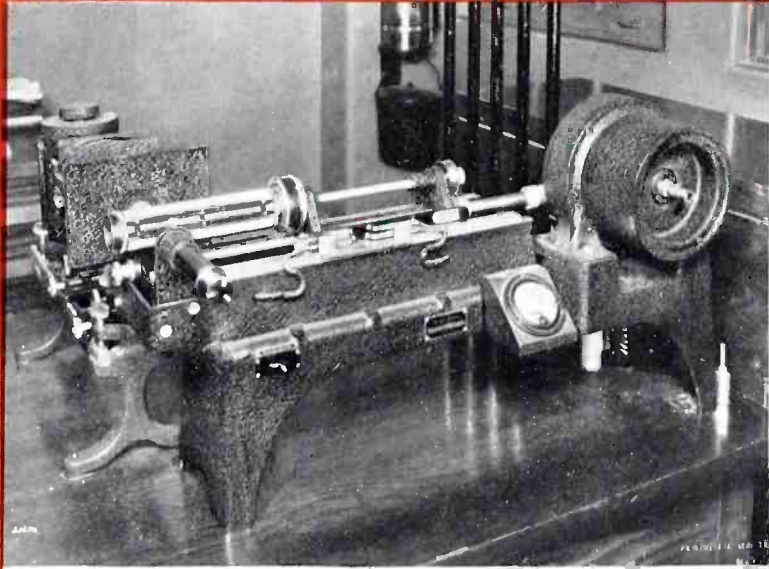

Left—Telephotograph Receiver

*Courtesy Bell Telephone Laboratories*



Above—Electric Eye—Traffic Control Room on the Ambassador Bridge at Detroit. System illustrated devised by Benjamin Cooper of New York.

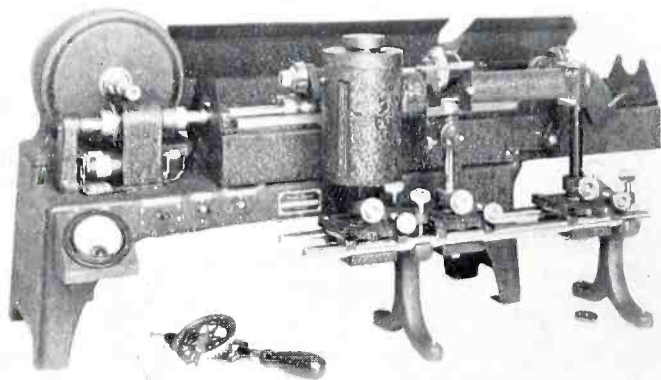

Center—Telephotograph Transmitter

*Courtesy Bell Telephone Laboratories*



Left—Airplane Radio Receiver

*Courtesy National Air Transport Co.*

**EVEREADY**  
ELECTRONIC DEVICES



Eveready Raytheon  
Radio Tube ER-227



Eveready Layerbilt  
"B" Battery



Eveready Raytheon  
Kino-Lamp



Eveready Raytheon  
Foto-Cell



Eveready "C" Battery



# SPEAKER

# BY

# OXFORD



*The MOST COMPLETE LINE of ELECTRO-DYNAMIC SPEAKERS IN the WORLD*

... There is an Oxford Speaker for Every Radio, Public Address and Theatre Purpose.

... Write for our new literature, listing our New Speakers in Eighty-four Models.

... Lektophone Licensee—Manufactured under designs and Patents of Frank Reichmann.

**OXFORD RADIO CORPORATION**

New Address .. 2035 West Pershing Place .. Chicago, Illinois



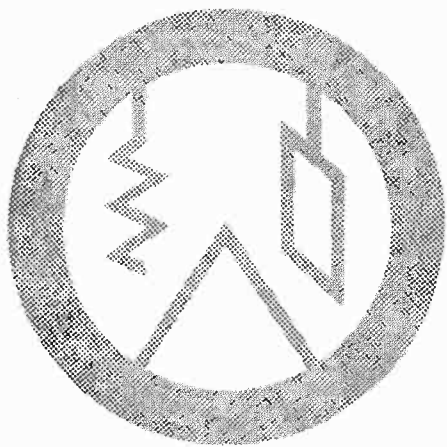

## The Engineer Visits Dilecto Laboratories!

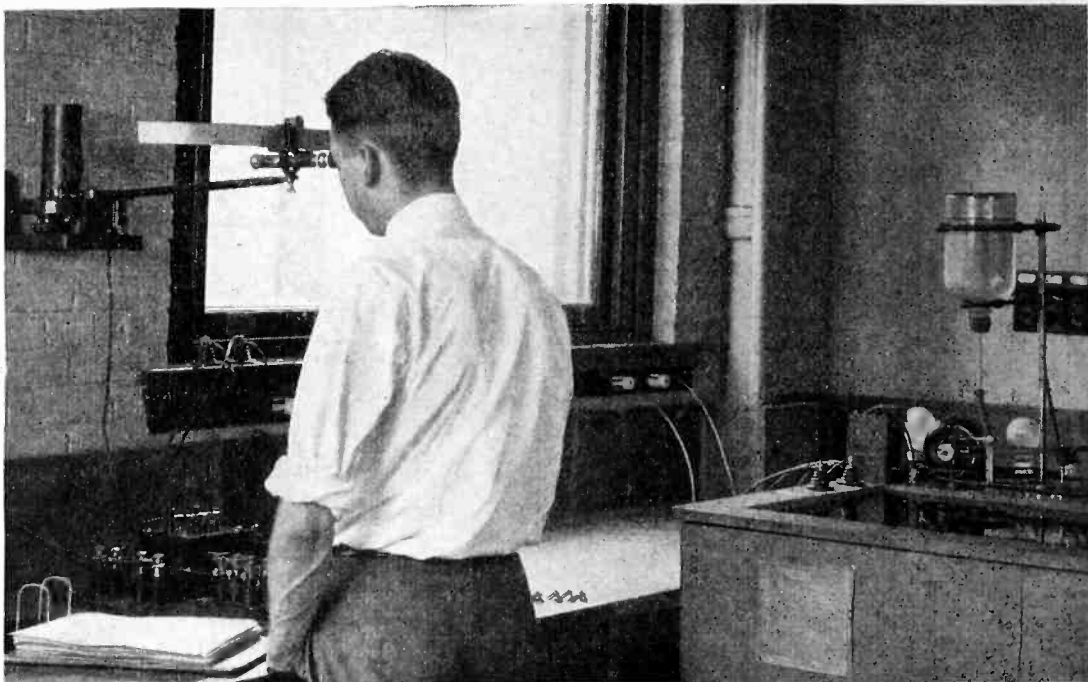

**M-I-T-N-O**

*... and meets the Weather Man*

Dilecto, a laminated phenolic insulation is available in the form of sheets, rods and tubes. It is easily machined. It is highly resistant to heat or cold, oil, water, and chemicals. It has both high mechanical and high dielectric strength. Dilecto engineers will work with you in developing insulation to meet your special requirements.

In the manufacture of Dilecto insulation, guesswork as to results has been definitely wiped out—and the most exacting control methods set up to insure uniformity of specifications.

Moisture conditions must be met and overcome. So, on a visit to Dilecto Laboratories, the engineer will find climate being manufactured in order that the dielectric strength of Dilecto insulation may be tested and maintained under humid atmospheric conditions.

This is but one of the precautions taken in the manufacture of Dilecto Insulation which insures the standards of quality on which Dilecto is guaranteed.

Dilecto service in the laboratory or in the field is available to assist engineers and manufacturers in achieving the utmost efficiency and economy in insulation. Our nearest engineering office is at your disposal any time.

## CONTINENTAL-DIAMOND FIBRE COMPANY

*Manufacturers of Dilecto—Diamond Fibre—Celoron*

**NEWARK, DELAWARE**

LOS ANGELES, CAL.  
SAN FRANCISCO, CAL.  
SEATTLE, WASH.  
KANSAS CITY, MO.  
MILWAUKEE, WIS.  
ROCHESTER, N. Y.

CHICAGO, ILL.  
CLEVELAND, O.  
BOSTON, MASS.



*In Canada*  
DIAMOND STATE FIBRE CO. OF CANADA, LTD.  
350 Eastern Avenue, Toronto

NEW YORK, N. Y.  
SPARTANBURG, S. C.  
PHILADELPHIA, PA.

ST. LOUIS, MO.  
WASHINGTON, D. C.  
DETROIT, MICH.  
NEW ORLEANS, LA.  
INDIANAPOLIS, IND.  
MINNEAPOLIS, MINN.

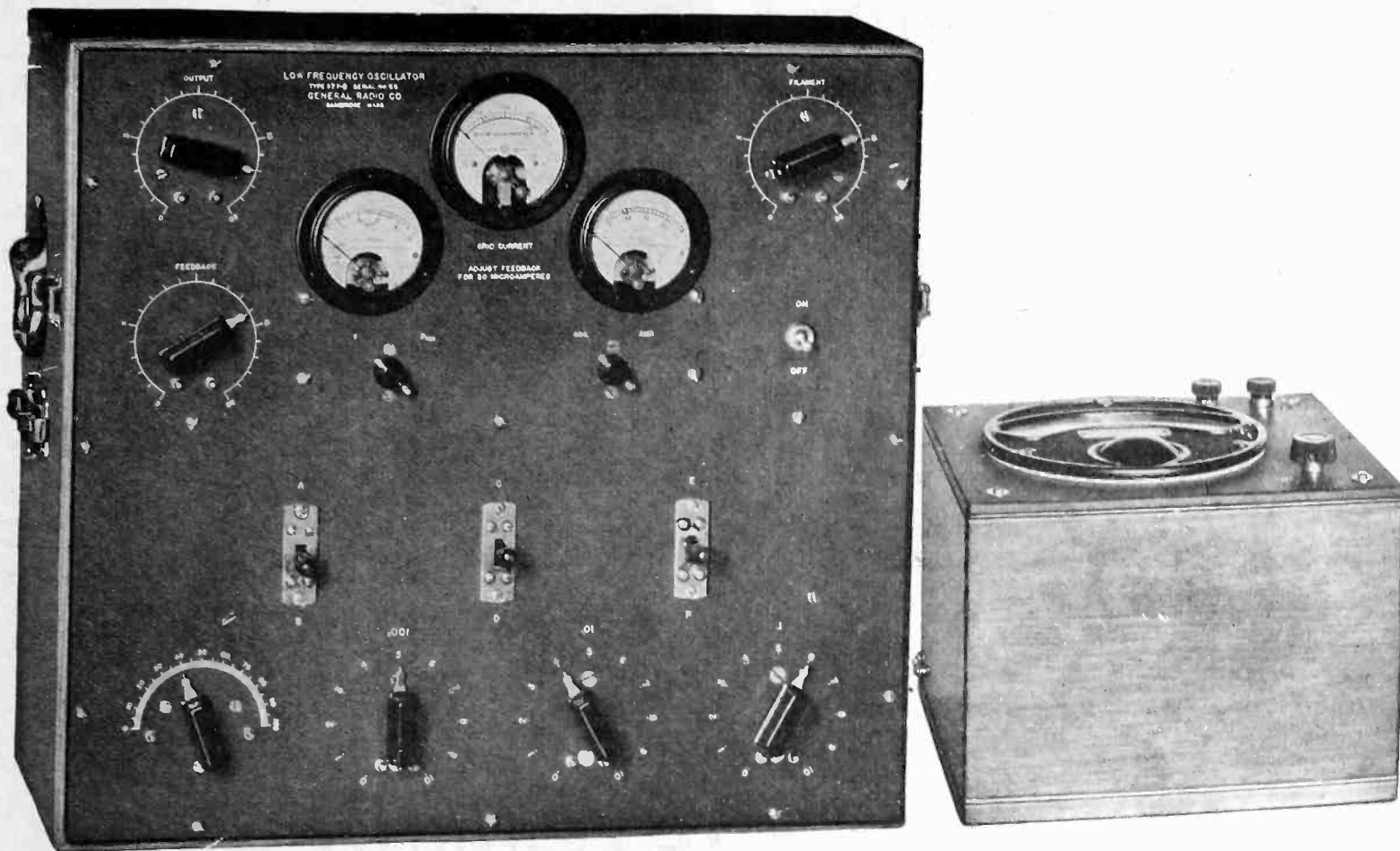

## VACUUM TUBES IN MEASURING INSTRUMENTS

WHEREVER electrical measurements are being made at other than the commercial power frequencies (25 and 60 cycles per second) there are a hundred chances to one that thermionic vacuum tubes are doing a part of the work. The photograph shows two General Radio instruments: a vacuum-tube oscillator and a vacuum-tube voltmeter. The oscillator is a battery-operated source of alternating current at any frequency between 25 and 70,000 cycles per second that the user may select. It is used in making all kinds of tests on communications, talking motion picture, and other electro-acoustical equipment.

### OTHER GENERAL RADIO PRODUCTS

Frequency Standards  
 Tube and Tuning-Fork Oscillators  
 Vacuum-Tube Bridges  
 Variable Air Condensers  
 Thermionic and Oxide-Rectifier Voltmeters  
 Rheostats, Transformers, Relays,  
 Tube Sockets, etc.

*Send for Catalog F-E*

The voltmeter is unique among voltage-indicating devices because it operates over a wide band of frequencies. Its input terminals present an impedance of more than ten megohms to the source and, therefore, it absorbs a negligible amount of power.

Both instruments find many applications in the general engineering industries as well as those allied to radio. They are essential elements in the development of most of the measuring methods that involve application of the thermionic vacuum tube, but they represent only a portion of the General Radio line of instruments.

*This advertisement is published to suggest that the General Radio Company's fifteen years' experience with the applications of vacuum tubes and of radio engineering principles is available to you for assistance in solving some of your own problems.*

# GENERAL RADIO COMPANY

CAMBRIDGE A, MASSACHUSETTS

A PRODUCT OF SPECIALISTS  
IN RESISTORS EXCLUSIVELY



*Here's a resistor that*  
**LAUGHS at heat!**

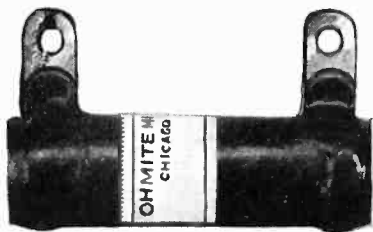

**High Resistance Units**

Up to 250,000 ohms  
on units  
only 4 in. in length  
Up to 100,000 ohms  
on units  
2 in. in length

The 4 in. size will dissipate 10 watts and the 2 in. size will dissipate 5 watts at these high resistances.

**Single Layer Wound  
Vitreous Enameled**

This new Reference Catalog should be in every electrical engineers' library. Sent promptly on request.



**BECAUSE** its Vitreous Enamel coating, which completely encases the wire and terminals with a glassy hard protection, quickly dissipates the heat from the wire to the outside air.

**BECAUSE** the special Ohmite vitreous enamel is so applied that the wire permanently retains its even spacing just as it was wound.

**BECAUSE**, due to this even winding, the heat is uniformly distributed throughout the unit, allowing no hot spots.

**BECAUSE** the resistive element itself is the highest grade alloy wire obtainable and perfectly adapted to the purpose and size of the resistor.

*and finally . . .*

**BECAUSE** Ohmite Resistors are the product of an organization of specialists making resistance units exclusively.

While we list an extensive line of standard sizes and styles, we can furnish special resistors in any quantity on short notice.

Prices and samples on request.

**OHMITE**

Ohmite Manufacturing Company  
631 N. Albany Ave., Chicago, Ill.



*“The quality and life of CeCo Tubes  
compare with any that are manufactured today”*

*R. C. HINER, May, Stern & Co., Pittsburgh, Pa.*

“Give me any radio engineer. Let him spend two hours alone in our 3½ acre plant . . . seeing for himself why million dollar equipment and 42 engineers are needed to make CeCo an outstandingly better tube. He’ll know that CeCo tubes can be relied upon for specialized service . . . the 64 tests insure uniform characteristics.”

**DO YOU  
KNOW?**

1. Over 10,000,000 CeCo Tubes are in use today. The U. S. Government, ocean steamships, and countless commercial organizations are daily users of CeCo Tubes.

2. In the last five years CeCo has outgrown two sizable factories and now has the largest plant devoted exclusively to the manufacturing of radio tubes.

*Ernest Kauer*  
PRESIDENT  
CECO MANUFACTURING CO., INC.  
PROVIDENCE, R. I.

**CeCo**

1930

*Radio Tubes*

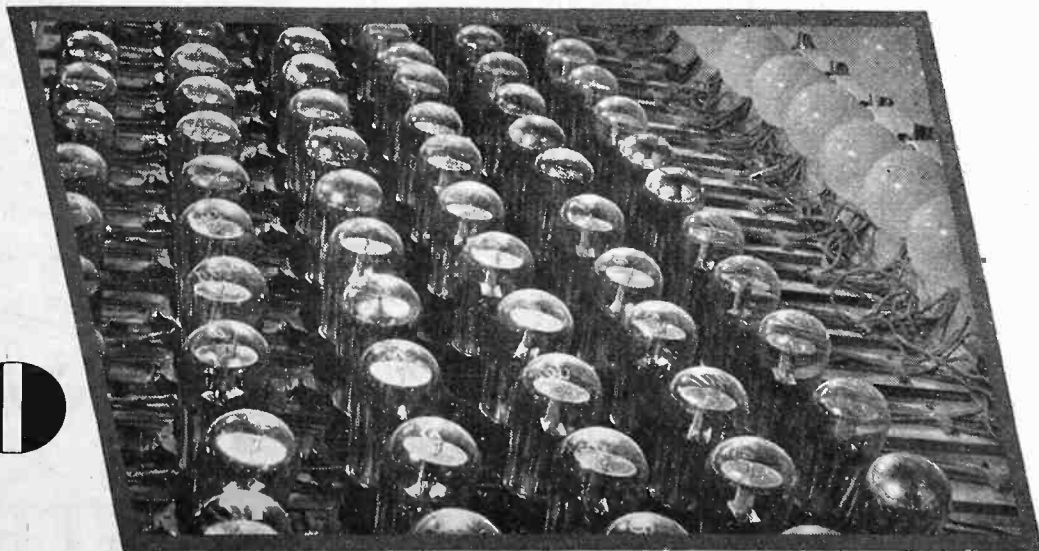

The CeCo Couriers broadcast every Monday night at 8:30 P. M. Eastern S. T. over the Columbia Chain from 22 stations. This program is rated as one of the most popular periods on the air. Listen in next Monday

All CeCo Tubes are licensed under the patents and applications of the Radio Corporation of America, General Electric Company, Westinghouse Electric and Manufacturing Company, and Associated Companies.

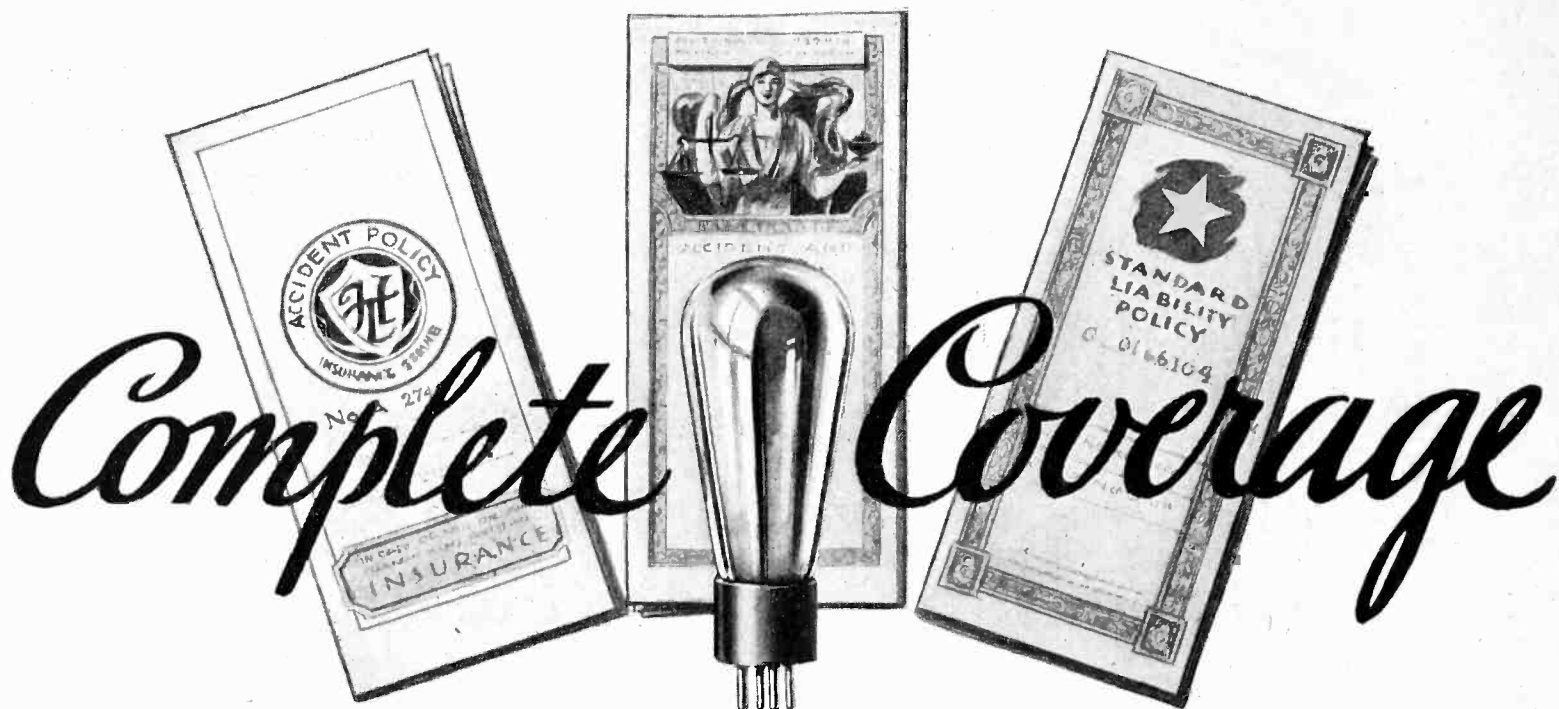

## TUBE INSURANCE WHICH PROTECTS MANUFACTURER — DEALER and CONSUMER

**T**HE use of the Weston Model 526 Type 7 Tube Tester in the final stages of inspection protects the manufacturer against the shipment of imperfect tubes. It makes all the required measurements, including tube characteristics, short test and gas measurement by **DIRECT INDICATION**—no computations or correction factors necessary. Its use as a production tester speeds up inspection, helps maintain a high standard of quality, and reduces losses by minimizing rejections from the field.

The Model 533 Counter Tube Checker enables the dealer to quickly check tubes at the time of sale. It operates from any 50 or 60 cycle—90 to 130 volt A. C. source of supply. It provides for line voltage compen-

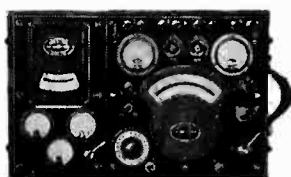

*In the Factory  
Use Model  
526*



*In the Store  
Use Model  
533*

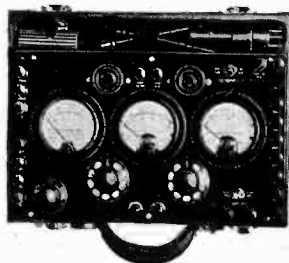

*In the Home  
Use Model  
547*

sation, and it tests the condition of any A. C. or D. C. tube with Weston reliability.

The Model 547 Radio Set Tester is a portable serviceman's outfit for making a complete electrical inspection of any make of A. C. or D. C. receiver in the home. Compact, light weight and dependable.

The employment of these three instruments on the part of manufacturer, dealer and serviceman gives all concerned assurance of longer tube life and better operating performance. Install "Westons". They provide a business insurance policy which affords complete coverage to all—at lowest cost.

No tube is better than its tests indicate. Weston Instruments are the world's highest standards of quality. They are made in hundreds of models and thousands of ranges for every electrical testing need.



**WESTON ELECTRICAL INSTRUMENT CORP., 618 Frelinghuysen Avenue, Newark, N. J.**

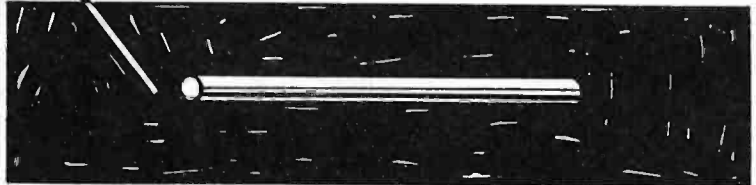
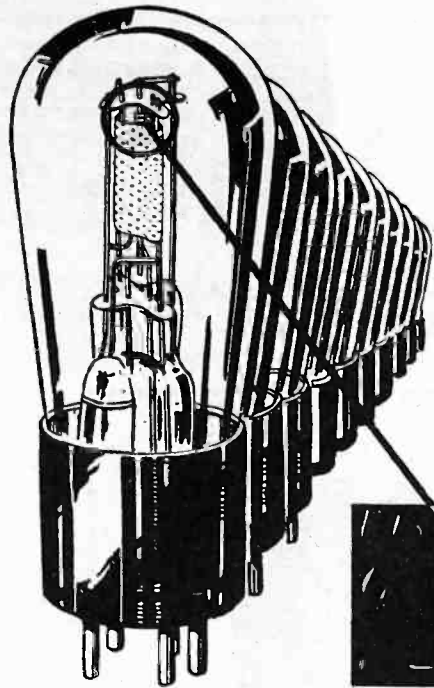

## SEAMLESS NICKEL TUBING IS VITAL TO QUICK- HEATING TUBES

Manufacturers of quick heating tubes have found that there is no economy in using formed metal cathodes, because of the uneven quality and waste.

Summerill Seamless Nickel tubing cuts this spoilage because it is produced accurately according to specification and because it insures absolutely even wall thickness at a fractional difference in cost.

For 30 years Summerill has been supplying precision tubing to industry—therefore they are exceptionally equipped to meet the specification and production demands of the radio industry.

Modern machinery and efficient production methods have effected economies reflected in a recent 40% reduction in prices.

Tube design embodying the use of the Summerill product pays dividends in accuracy, quality and long life. [We'll gladly send you a sample on request.

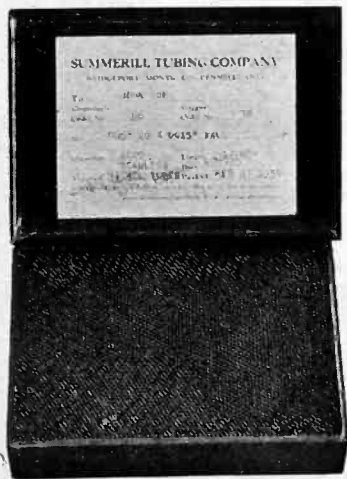

The scientific care used in the making of Summerill seamless nickel tubing is carried through until it reaches you. Summerill tubing is packed in a sturdy box carefully made to insure the contents against all shocks in transport. It assures perfect condition of the tubing when it reaches you.

**Summerill can make prompt deliveries—anywhere—anytime—any quantity.**

## THE SUMMERILL TUBING CO.

*Founded in 1889*  
Bridgeport, Penna.  
(Philadelphia District)



# A New Voice for the Electronic Industry

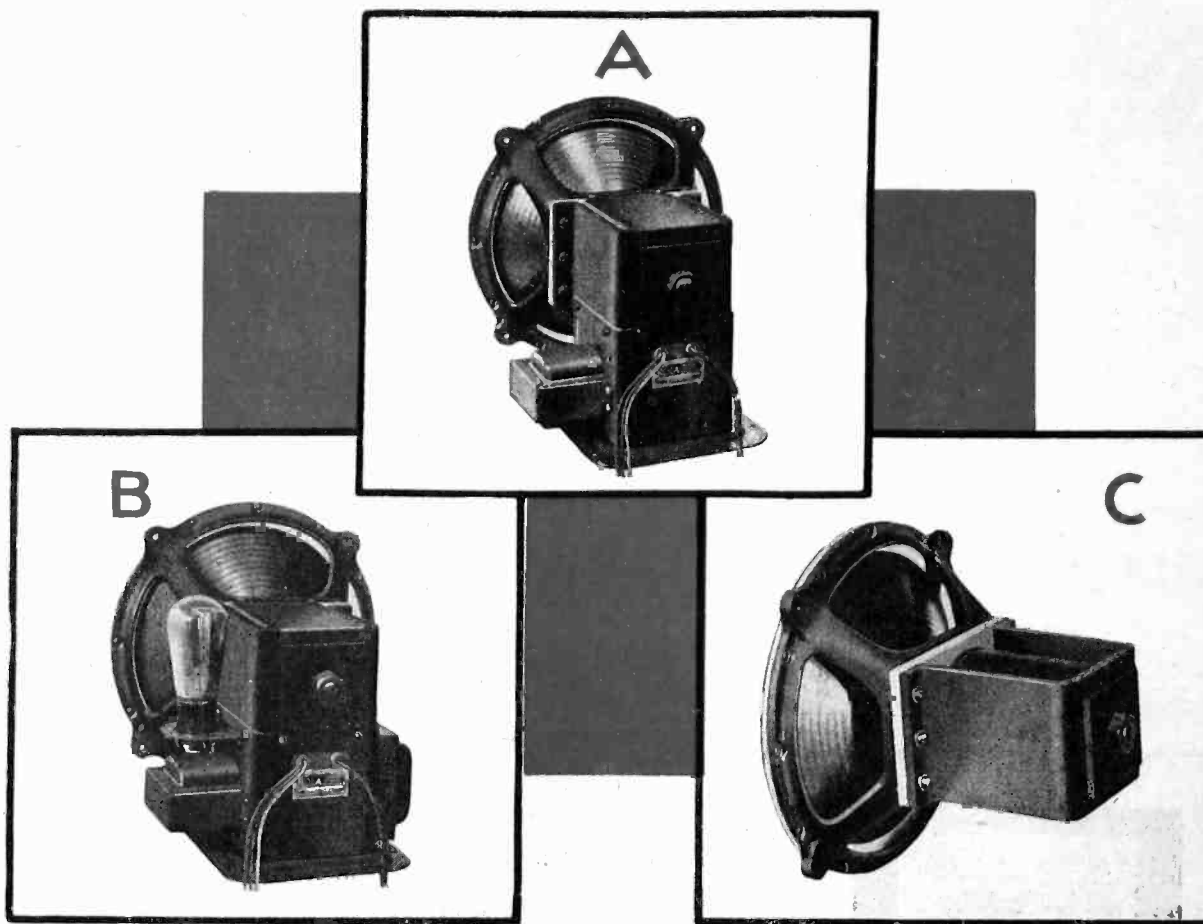

**A** Model R-AC For 280 Tube Rectifier. Realistic tone — greater power—more structural sturdiness.

**B** Model R-AC 225. Identical with R-AC but is without tube rectifier equipment and is designed for use with a separate source of field excitation.

**C** Model R-AC 225M. Like Model R-AC, but without base, bracket and input transformer. Splendid for Radio Receiving Sets where ultimate efficiency and tone quality is demanded.

Rola—veteran maker of Electronic voices, announces a new and better one—A new power reproducer series—unique in extraordinary output efficiency.

Another milestone for Rola, which has withstood the turbulent strife of the industry since broadcasting began.

Exclusive makers of speakers—Rola has always been in the van of progress—always been a source of supply upon which manufacturers could rely for the highest quality reproducers obtainable.

It has required staying power; like all new industries, radio has gone through many changes. But these changes have come with a frequency and suddenness unparalleled in the world of business.

Through it all, Rola has steadily grown—constantly produced quality.

## THE ROLA COMPANY

CLEVELAND, OHIO  
2570 East Superior Avenue

OAKLAND, CALIFORNIA  
Forty-fifth and Hollis Streets



# BIG KNOWLEDGE

## FOR INSULATING SERVICE

FORMICA has at a centrally located point where prompt service can be given leading manufacturers, the largest plant in the world devoted exclusively to laminated phenolic insulation. More floor space, more machinery, and more men concentrated on this one manufacturing problem.

For 17 years this specialization has been going on and it has produced results that are appreciated by a large number of the leading American electrical organizations who have used the service without interruption for many years.

*Send your blue prints for prices*



**THE FORMICA INSULATION CO.**

4626 Spring Grove Ave.

Cincinnati, Ohio

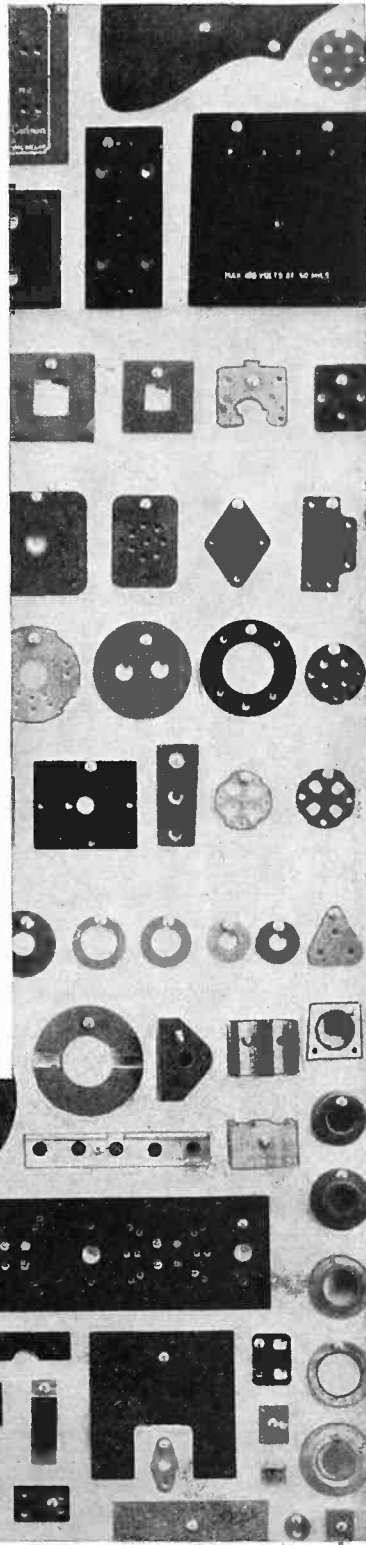
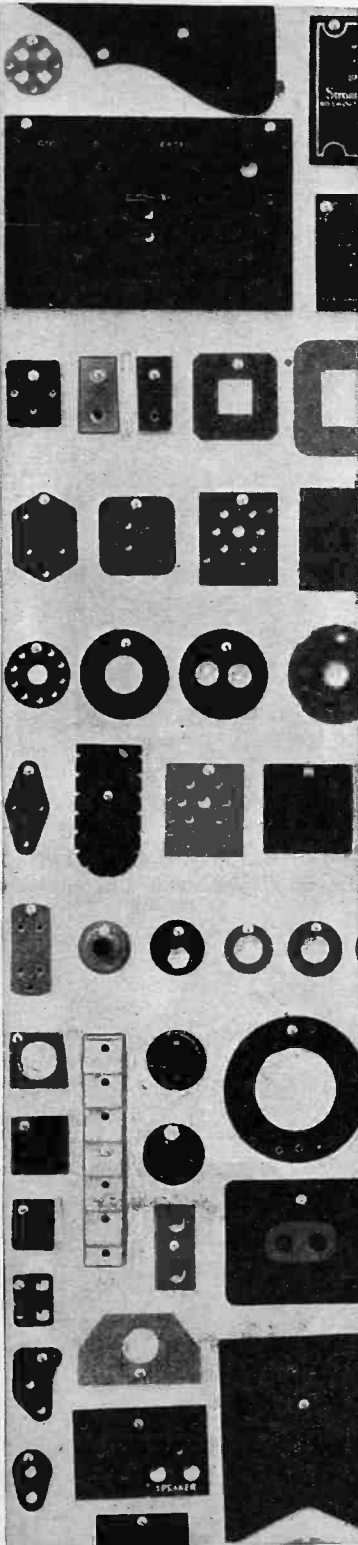

# FORMICA

# EBY

## TUBE SOCKETS

EBY Moulded Bakelite Tube Sockets are standard equipment in the tube testing racks of most of the important American tube manufacturers. The unique design of their phosphor bronze contact prongs makes it impossible to damage them, even in this most abusive service. For the same reason most manufacturers of tube testing equipment use these sturdy sockets exclusively. They look like the aristocrats they are and can be assembled in any way desired. A simple twist in the built-in groove guides the prongs of the tube into the holes.

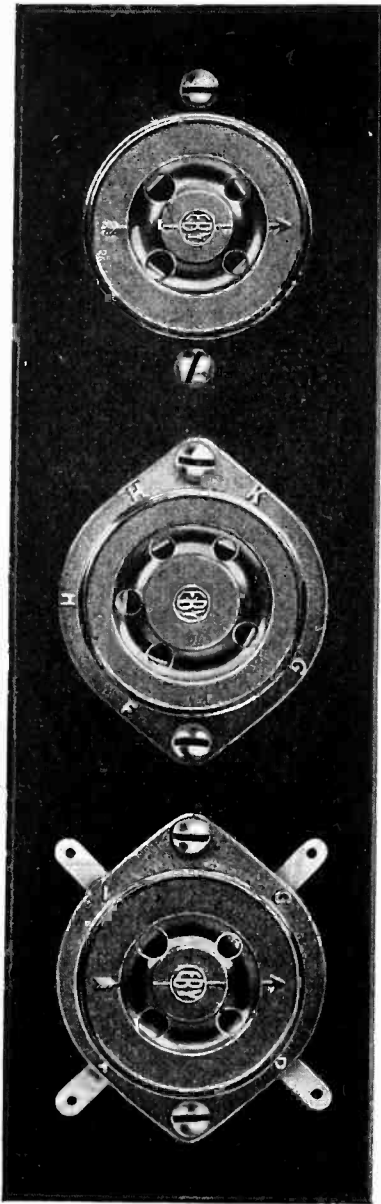

MODEL 12—"UNIVERSAL"  
Top view showing different ways  
to mount



UX—MODEL 12  
Bottom view without base, showing  
type of contact used

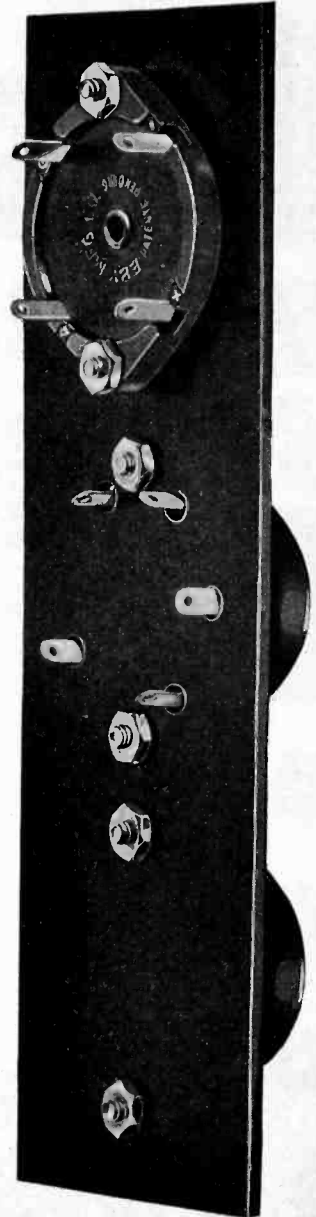

MODEL 12—"UNIVERSAL"  
Bottom view showing different ways  
to mount

## LAMINATED BAKELITE SOCKETS

EBY Laminated Bakelite Sockets are a little less expensive than the moulded type and are widely used in radio receivers. Assembled with *two* Bakelite punchings. The top plate in addition to completely insulating the contact eyelets in accordance with approved Underwriters' Standards also acts as a Bakelite barrier between the contacts and minimizes the chances of breakdown. Built-in guide for tube prongs. Each socket marked with number of tube to be inserted.

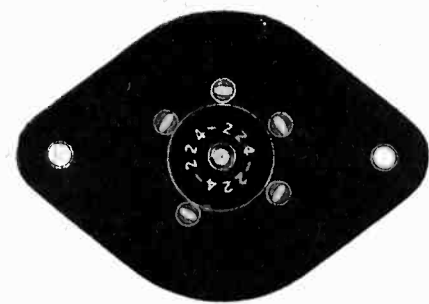

MODEL 5-27 UY  
Also available in UX type

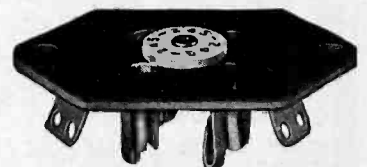
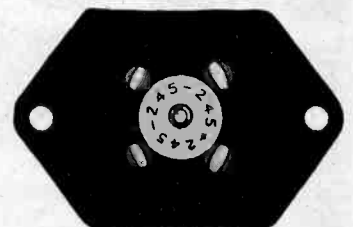
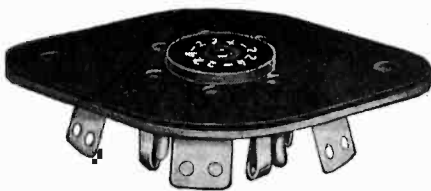

MODEL 5-9 UX  
Not available in UY type

**The H. H. EBY MFG. CO., Inc.**  
**22nd St. and Lehigh Ave., Philadelphia**



. . . to the Scientists, Engineers  
and Designers who have made this  
great new Industry possible . . .

**T**HE world salutes you! You men who  
have been responsible for the devel-  
opment of the Electronic tube and the  
Photo Electric Cell deserve the unstinted  
praise of the entire world!

It has been the privilege of our Electro-  
metallurgical technicians to have worked  
with some of you—to have known with  
you the discouragements, the hopes and  
the thrill of successful attainment.

For the past year the major activity of  
our research laboratory has been the de-  
velopment of new products to serve you  
and to further perfect those materials and  
products which we have and are supplying  
to you.

Our new plant in Indianapolis and our  
enlarged engineering and research labora-  
tory is at the disposal of all manufacturers  
in this field.

The products to the right are indicative  
of how we are serving this field.

## ELKON

Division of P. R. Mallory & Co., Inc.  
Indianapolis, Ind.

Sales Offices: New York, Chicago, Detroit, Indianapolis

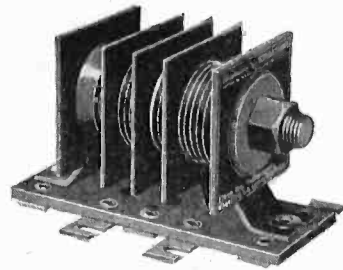

The New ELKON Rectifier

New in appearance and oper-  
ating efficiency. Units may be  
supplied up to 10 amperes.  
Small, compact, efficient, long  
lived.

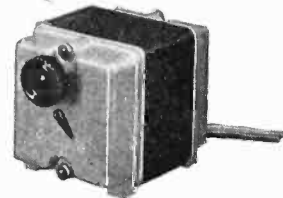

The New ELKON Reactor

The Elkon Reactor gives a  
smooth micrometer current  
variation without loss of energy.  
No sliding contacts or interrup-  
tion of the circuit. Particularly  
suited to talking picture work.  
Twelve sizes in stock, from  
0.406 to 200 ohms and from 3  
to 0.5 amperes.

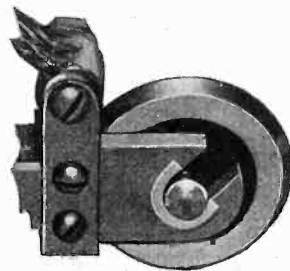

ELKONITE Welding  
Dies and Electrodes

Elkonite dies and electrodes  
are being used for welding the  
grid wires in radio tubes. Out-  
last copper many times with only  
very infrequent redressings.



CONTACTS for all

purposes: Elkon has long  
been considered contact head-  
quarters. Elkon is the only source  
of supply for all contacts. Con-  
tacts for any service made of  
tungsten, silver, platinum, or  
their alloys.

### RARE AND PRECIOUS METALS

#### MOLYBDENUM

Shapes, Sheets, Boats

#### TUNGSTEN

Shapes, Bars, Tubes, Sheets, Contacts

Alloys of Silver, Gold, Platinum,  
Tungsten for all uses

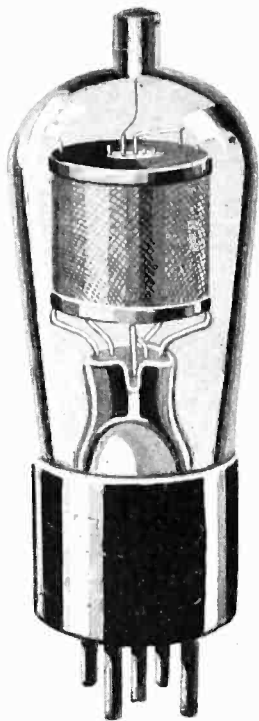

# WE MAKE PURE NICKEL FOR ALL TUBE PURPOSES

## GILBY PRODUCTS

---

1. Filament Wire
2. Mesh—Gilby Selvage  
(Pat. app. for)
3. Mesh—Plain
4. Support Wire
5. Ribbon—Plain and  
Carbonized
6. Seamless Tubing
7. Grid Wire

MANUFACTURERS can be assured that their tubes will perform satisfactorily if Gilby Pure Nickel is used. Gilby products are backed by years of experience on the part of a skilled staff. Gilby Nickel adds to the quality of a tube.

### Pure Nickel

We produce nickel of the highest commercial purity—free from cobalt if required—in wire, ribbon and sheets for plates, cathodes, support wires and other uses. Gilby Pure Nickel Filament Wire, for example, is recognized by many leading manufacturers as The Standard—they rely implicitly on its accuracy, uniformity and long life.

We also produce Gilby Resistance material in wire, sheet and strip of every recognized commercial alloy—bare, enamelled, cotton covered and silk covered. All of highest quality. Our catalog gives details of regular line. We can supply special alloys for unusual needs.

Samples of any Gilby products will gladly be sent to responsible manufacturers. We invite your inquiries.

## GILBY WIRE CO.

Wilbur B. Driver, President  
NEWARK, NEW JERSEY



**PHILCO'S** / / / / /

*extraordinary*

# BALANCED UNIT RADIO



WIRT has a part in the performance which distinguishes the present Philco A. C. radio—for, we are pleased to say, Wirt Resistance Units were and are specified by Philco's engineers.

For Philco, Wirt designed a unique, and exceptionally practical, cord-wound unit. For other large users, Wirt has designed specialized units—including vitreous enamel.

Wirt supplies units for many fields, covering all ranges of electrical and radio manufacturing, and has specialized on such units for more than 30 years. Whatever your needs are, for resistance units, Wirt will supply. We solicit your correspondence.

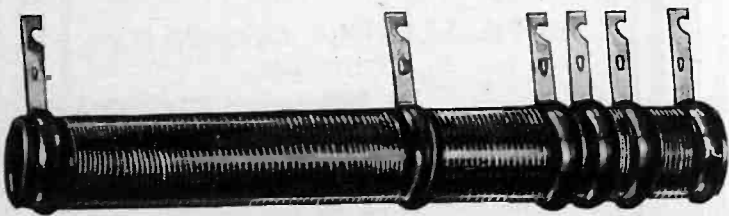

*This is an enlarged photograph of one of the several Wirt Resistance Units designed for Philco*

/ / / / /

## **WIRT COMPANY**

5221-27 GREENE STREET

PHILADELPHIA

PENNSYLVANIA



# BETTER CONNECTIONS WITH CRESCENT! PUSHBACK WIRE!

Conductors Should Be—

1. well insulated
2. of low resistance
3. easily identified
4. fray-proof—non-bunching braid

**C**RESCENT is equipped to supply all types of cords. Orders—large or small—get prompt attention. Deliveries on time. Send your specifications.

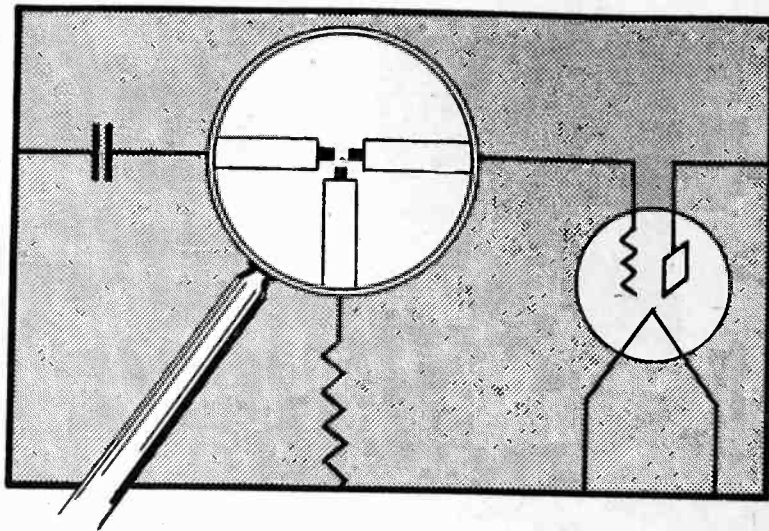

Crescent Braid is—

1. moisture proof—beeswax impregnated—voltage, 1450 volts wet, 1950 dry
2. easily and quickly soldered
3. any color—specified—15 combinations
4. double braid

Cords for Speakers (complete with 4 and 5 prong Plugs)  
Harness for Chassis Hook-Up  
Harness for Power Packs  
Conductor Cord  
Battery Terminals

Low Voltage Cords and Cables

Special Cords and Special Cables

Any Type—any Quantity

## CRESCENT BRAID, Inc

Established 1916

PROVIDENCE

RHODE ISLAND

San Francisco, 274 Brannan St.  
Salt Lake City, No. 4 Interurban Bldg.  
Chicago, 506 S. Canal

Cleveland, O., 3221 Carnegie Ave.  
New York City, Room 332 E,  
30 Church St.



has for years



supplied the country's largest manufacturers with high grade



**Power Transformers -**

**Chokes - Audios - Coil Winding Equipment**

Write ACME for a quotation on your requirements

**THE ACME**

Electric & Manufacturing Co.  
ESTABLISHED 1917

1444 Hamilton Ave., Cleveland, Ohio

## B-L RECTIFIERS

### RECTIFICATION for Low Voltage Work

Wherever a rectifier for low-voltage current is required, you can depend upon B-L Rectifiers to supply it—safely and quietly. They are available in many standard types and sizes for ordinary applications.

If you have a special or difficult rectification problem, write us—our Engineers are prepared to make specific recommendations. Tell us the voltage limits permissible—the voltage and amperage desired—whether the output will vary—if the application is in conjunction with a battery, (if so, what type) and whether a filter system will be employed. No obligation. This service is free.

The B-L ELECTRIC COMPANY  
ST. LOUIS, MO.

B-L can serve you wherever rectification is involved—write for complete literature explaining many uses.—

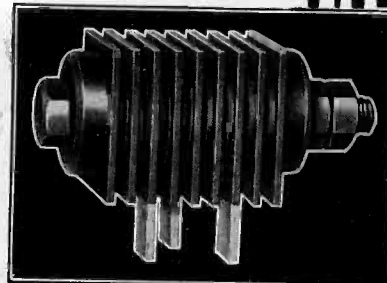

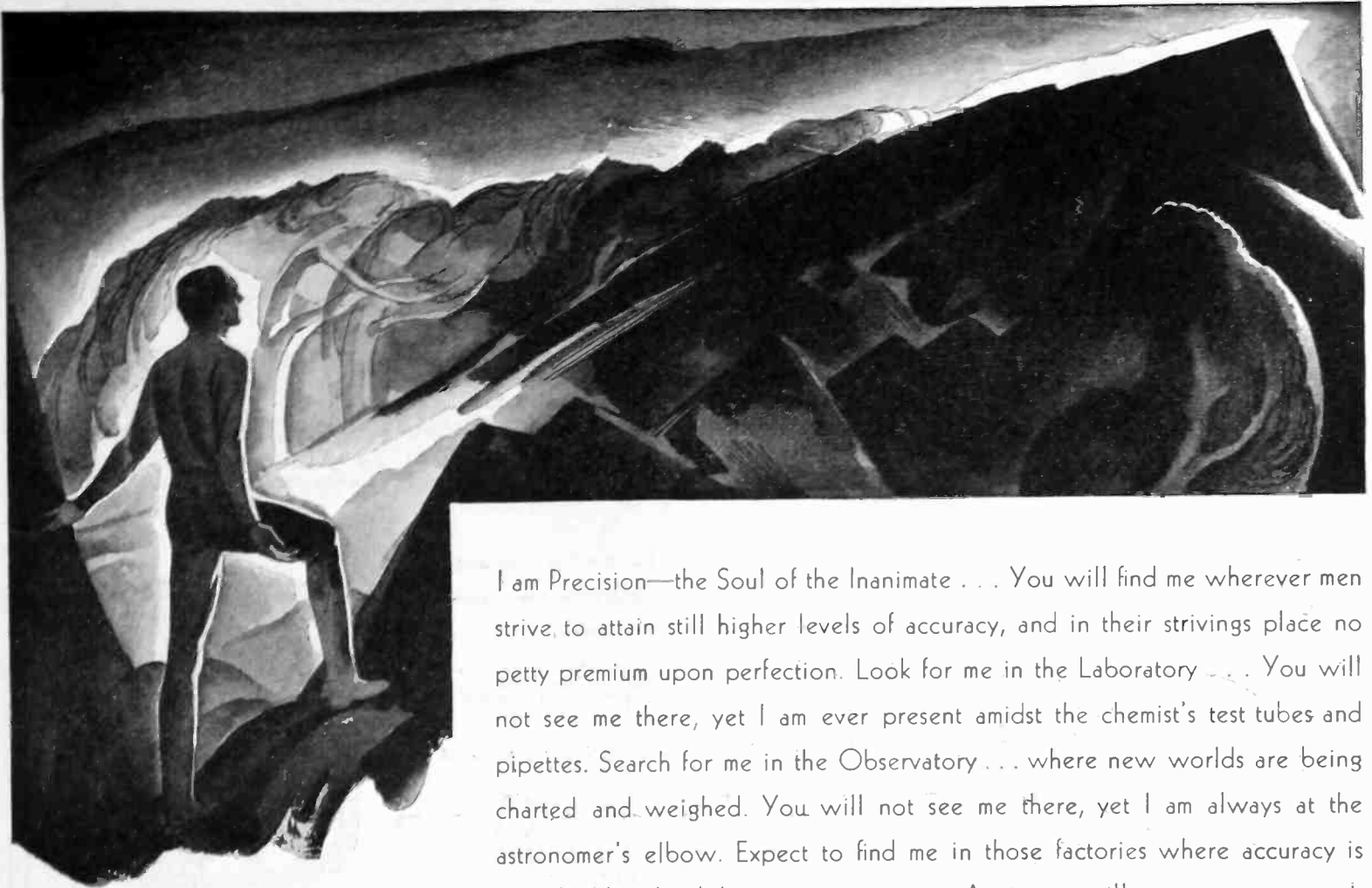

FROST-RADIO  
 THE WORLD'S  
 LARGEST . . .  
 MANUFACTURERS  
 OF HIGH GRADE  
 VARIABLE  
 RESISTORS.  
 HERBERT H. FROST,  
 INC. MAIN OFFICE  
 AND FACTORY  
 AT ELKHART,  
 INDIANA. IN  
 CHICAGO AT 160  
 NO. LASALLE ST.  
 FROST-RADIO

I am Precision—the Soul of the Inanimate . . . You will find me wherever men strive to attain still higher levels of accuracy, and in their strivings place no petty premium upon perfection. Look for me in the Laboratory . . . You will not see me there, yet I am ever present amidst the chemist's test tubes and pipettes. Search for me in the Observatory . . . where new worlds are being charted and weighed. You will not see me there, yet I am always at the astronomer's elbow. Expect to find me in those factories where accuracy is more highly valued than mere acquisition. Again you will not see me, yet each day I guide the fingers of a million pairs of hands, and direct the destinies of countless busy machines. Wherever cutting, grinding, drilling and boring tools run hot against protesting metal you will find me present amid the reek of oil and the welter of fast-flying fragments . . . for I am Precision.

While no man has ever seen me, you may know me by my symbols—those aids which man has devised to help him in his ceaseless search for perfection—the slide rule, the micrometer, the divider, the gauge block and the scale. Where you find these visible aids you will find me invisibly present, also. I direct the world's destinies more surely than any earthly monarch. In the air, on and below the surface of the earth, and beneath its waters, my aid is invoked to hasten and protect the comings and goings of mankind, to bear man's messages and to transport his goods. Communication could not exist without me. Today's use of telephone and telegraph, of radio broadcasting and reception, would be impossible but for my good offices. When I am present even in the smallest part or unit of a manufactured product, trouble ceases. When I am absent chaos enters.

Most manufacturers know me well and respect my power. Some, however, slight me, caring nothing for my laws. Those who search for me with diligence and with patience I reward with the world's esteem. For those who treat me with contempt I feel only pity, for without me they can do little that will permanently benefit themselves or others. Look for me in products that must serve mankind faithfully and well, and when you find me know that their maker is worthy of your utmost confidence. For into his goods he has built an invisible quality which to him is of greater value than any mere outward and visible evidence of merit. For I am Precision, the Soul of the Inanimate—patron saint of those conscientious people who are satisfied only with the closest possible approach to that unattainable goal men know as Absolute Accuracy.

F R O S T  R A D I O

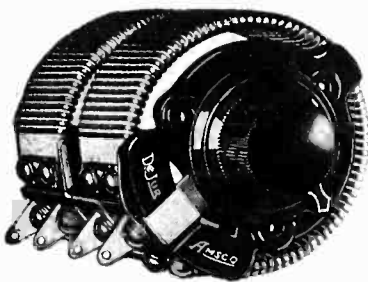
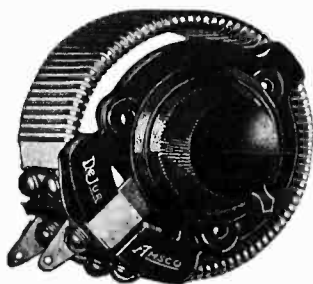
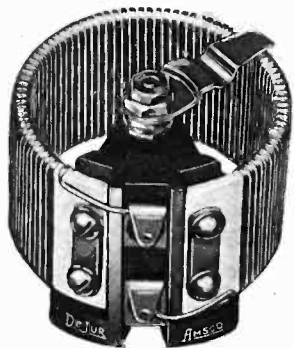

Power—Delicately Controlled by

# DeJUR-AMSCO

POWER RHEOSTATS AND POTENTIOMETERS

DeJur-Amsco power rheostats and potentiometers are engineered mechanically and electrically to fill the exacting requirements of talking movies and other photo-sound reproducing systems where the apparatus must be designed to control consistently and unvaryingly the currents in the modulated light and associated circuits.

Give us your ohmic and power specifications between one and two thousand ohms and up to 150 watts, and we shall prepare samples demonstrating the production features of—

- Conservative power rating.
- Insulation with heat resisting Bakelite and steel braced asbestos.
- Full power dissipation at projection room temperatures.
- Self-cleaning, non-microfonic contacts.

Our orders with manufacturers of photo-electric control apparatus recommend a 2 ohms, 75 watts rheostat for modulated light control. We are prepared to supply these immediately.

*Literature and further information on request.*

## DeJUR-AMSCO CORP

FAIRBANKS BUILDING,  
Broome and Lafayette Sts., New York City



Grid Wire of High Quality. Our Moly-wire is wound on moulded spools, of which we are the originators.

**M  
O  
L  
Y**

Molybdenum Sheet is another of our specialties. Made according to specifications.

**MOLY**



**WIRE**

All "Elmet" products are widely known for their superior excellence and uniformity.

**W  
I  
R  
E**

The American Electro Metal Corporation

Factory: LEWISTON, MAINE

Executive and Sales Offices:

65-67 Madison Ave.

New York, N. Y.





# JEFFERSON

## AIDS NEW INDUSTRIES

*By Engineering Co-operation  
Experience and Careful  
Manufacturing*



INVENTION is one thing.  
Manufacturing is another.

Many a good idea has failed because its originator did not have co-operation in working out the practical details.

New industries requiring transformers secure full co-operation and valuable help at Jefferson. The radio industry for example, the oil burner industry, the neon sign industry . . . these and others credit Jefferson Engineers with much valuable co-operation.

The co-operation of Jefferson Engineers is valuable because of the long experience behind their advice . . . experience which is equally valuable when the design is finally completed and transformers are actually being manufactured. It means transformers designed right for the job.

JEFFERSON ELECTRIC COMPANY  
1595 S. Laflin Street - - - Chicago, Illinois



### YOUR NEW IDEA

If you now have, or have in the future an application of the electron tube, enlist the co-operation of Jefferson Engineers. They will give you the immediate benefit of experience it would take years for you to secure first hand. Let Jefferson Engineers know your problem.

# JEFFERSON

## TRANSFORMERS

(A-1040)

## A standard work on radio engineering

THIS new revised and enlarged edition of one of the standard works on radio engineering gives the latest and best basic information on the most recent developments in radio communication.

301 pages

227 illustrations

6 x 9



See it for 10 days FREE

Second Edition

Lauer & Brown's

### Radio Engineering Principles

\$3.50 net, postpaid

The book covers in detail the science and practice surrounding the three electrode vacuum tube, and treats with adequate fullness the principles involved in the functioning of all forms of radio apparatus. In the development of the principles involved, the electron theory is made use of frequently, since it gives a clearer conception of what takes place under certain conditions. Mechanical analogies are avoided and mathematics is resorted to only to indicate the applications in the problems of design, or the relations, in concise form, existing among the various quantities of a radio circuit.

#### Just a few of the hundreds of topics covered

- electricity and matter;
- electromagnetic radiation of energy;
- forced oscillations;
- free oscillations;
- mathematical interpretation of the oscillatory condenser discharge;
- wave front;
- aircraft radio compass;
- the oscillating arc;
- heterodyne reception;
- electron emission by hot bodies;
- quantitative expression of vacuum-tube properties;
- mutual conductance;
- differential interplate resistance;
- mathematical theory of the push-pull amplifier and frequency doubler;
- quantitative theory of oscillation generation;
- radio-telegraphic transmitting circuits;
- multivibrator and negative-resistance circuits;
- ferromagnetic or detuning modulation methods;
- single frequency band radiotelephony;
- mathematical theory of the balanced modulator;
- piezo-electric resonators and oscillators;
- etc., etc., etc.

Lauer and Brown's RADIO ENGINEERING PRINCIPLES is a book you will want to examine. By all means do so—for 10 days free. Just mail the coupon.

## McGraw-Hill FREE EXAMINATION COUPON

McGraw-Hill Book Co., Inc., 370 Seventh Avenue, N. Y.  
Send me for 10 days free examination Lauer and Brown's RADIO ENGINEERING PRINCIPLES, Second Edition, \$3.50, net, postpaid.  
I agree to remit for the book or to return it, postpaid, within ten days of receipt.  
Name .....  
Address .....  
City and State .....  
Position .....  
Company .....  
(Books sent on approval to retail purchasers in U. S. and Canada only.)

L. 4-30

## MICA

All You Have Hoped for in Bakelite Moulded Condensers

Predetermined Capacity

Accurately Tested

Tinfoil Plates

India Ruby Mica Dielectric

Convenient Terminals and Mountings

Sealed Against Moisture and Chemical Action

Here's Your Copy of

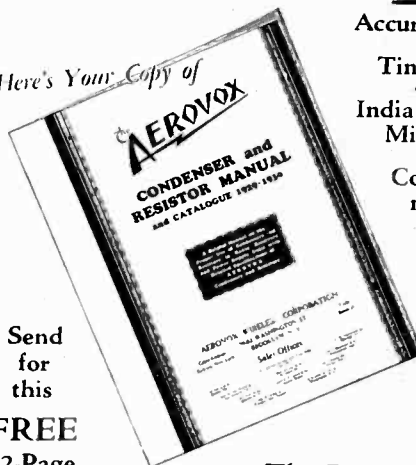

Send for this FREE 32-Page Manual and Catalog

The Research Worker is a free monthly publication treating on the proper application of condensers and resistors. Write for it.

AEROVOX WIRELESS CORP.  
74 WASHINGTON STREET, BROOKLYN, N. Y.

## CONDENSERS

## MOLYBDENUM

WIRE—ROD—SHEET

For Grids, Plates and Special Supports. Highest quality and uniformity, easily welded and formed. Tempers to suit each application.

## TUNGSTEN ALLOY

WIRE—ROD—SHEET

For Filaments, Heater and Hook Wires, Plates, Grids and Special Supports. Specially alloyed and processed for use in all types of Vacuum Tubes. Ground rod to exact sizes for seal in wires for Transmission Tubes and Neon sign work.

## RADIO TUBE PARTS

FILAMENT WIRES—CATHODES—SPECIAL PARTS

Special Alloy and Oxide Coated Filament Wires for high Electronic Emission for all types of Vacuum Tubes. Cathodes and Cathode Parts, Sleeves, Insulators, Heater Wire and Special Coils, insulated and uninsulated. Lead-in wire and Welds, Nickel Wire and Ribbon, Plates, Grids, and other miscellaneous Parts.

CALLITE PRODUCTS COMPANY, Inc.  
UNION CITY, N. J.

radio engineers do not guess—



THEY

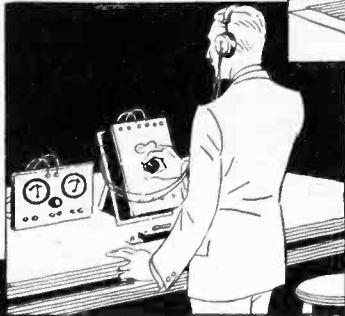

KNOW

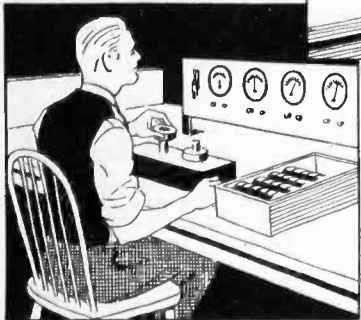

☪ Where reputations—of both products and men—depend on exactness, there is no room for guesswork. ☪ Modern measuring instruments, plus the trained scientific mind, determine radio receiver performance *in advance*. The certainty of this performance is guaranteed by the use of tested and

proven parts. ☪ Polymet Products have been approved by the engineering laboratories of practically all leading receiver manufacturers. Over 80% of them use Polymet Products in their production — — —

**which is possibly the best proof that “Polymet Engineers do not guess;—they know, too!”**

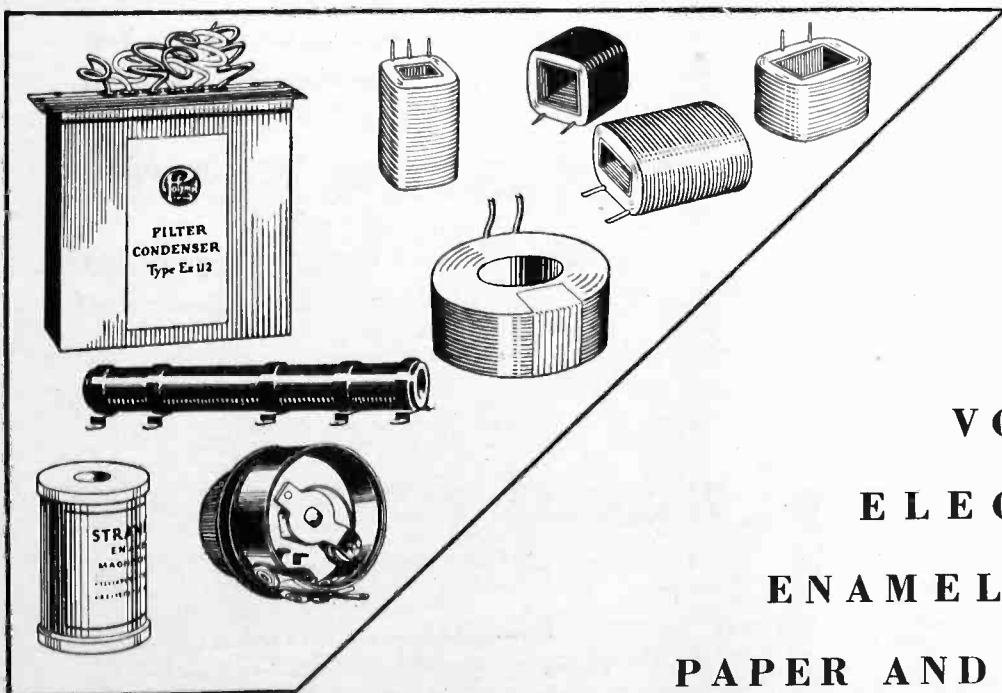

R E S I S T O R S

T R A N S F O R M E R S

V O L U M E C O N T R O L S

E L E C T R I C A L C O I L S

E N A M E L E D M A G N E T W I R E

P A P E R A N D M I C A C O N D E N S E R S

POLYMET MANUFACTURING CORP., 833-a East 134th St., New York City

**Polymet Products**



# SEND US YOUR PROBLEMS

Standard or Special Parts Built to Fit Your Individual Needs

For over eight years CARTER has served the manufacturing trade. Our engineers are at all times ready to assist you in the development of special items. Send us a list of your requirements on standard as well as non-standard parts. Requests for samples and prices will receive our immediate attention.

To publish a list of Carter items is but a gesture, since it is likely to be obsolete tomorrow. Scarcely a day passes that we do not, at the request of the radio, telephone, electrical instrument, talking picture or other industry, design a new resistance, switch or other control device. Below, however, is given a partial list of those items now in quantity production. It will give you some idea of the variety and magnitude of the Carter line.

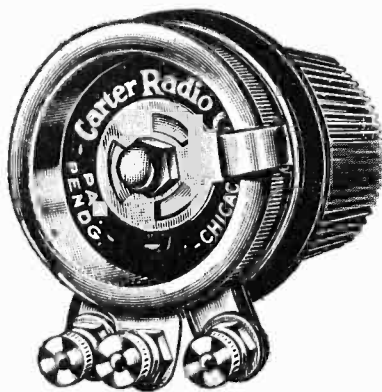

Volume Control

## Rheostats

Midget: 12 types, 144 resistances  
 "Imp": 12 types, 144 resistances  
 Heavy Duty: 6 types, 98 resistances  
 Large Heavy Duty: 1 type, 29 resistances  
 Super Heavy Duty: 1 type, 19 resistances

## Potentiometers

Midget: 12 types, 72 resistances  
 "Imp": 12 types, 72 resistances  
 Heavy Duty: 6 types, 56 resistances

Super Heavy Duty: 1 type, 16 resistances  
 Tapered: 1 type, 7 resistances  
 Hum Adjusters: 3 types, 24 resistances

## Volume Controls

Midget: 12 types, 84 resistances  
 Hi-Ohm: 12 types, 84 resistances  
 Hi-Pot: 12 types, 84 resistances  
 Tapered Pot: 3 types, 21 resistances  
 Tapered Rheo: 3 types, 21 resistances  
 Portable: 2 types, 14 resistances  
 Attenuator Pads

## Switches

Channel Selectors  
 Toggle: 21 types  
 Power: 18 types  
 Jack: 13 types  
 Inductance: 36 types  
 "Imp": 6 types

## Hum-Adjusters

Potentiometer: 3 types, 24 resistances

## Fixed Resistances

Heavy Duty: 3 types, 102 resistances  
 Upright: 1 type, 34 resistances

Super Heavy Duty: 5 types, 245 resistances  
 Center Tapped: 5 types, 45 resistances  
 Fireproof: 3 types, 36 resistances  
 Vitreous Enameled: 9 types, 126 resistances

## Wall Plates

22 Different Types and Styles  
 Channel Selector

## Transformers—Chokes

12 types of Audio Transformers  
 3 types of Filter Chokes

## Tip Jacks

Channel Selector Switches with Impedance Matching Coils



## WAXED PAPER

CONDENSERS THAT OUTLAST ANY SET

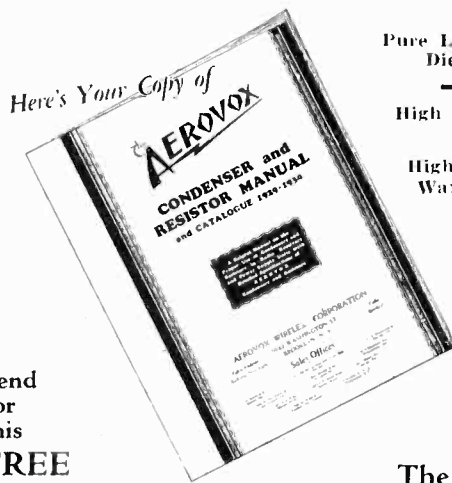

Send for this FREE 32-page Manual and Catalog

- Pure Linen Paper Dielectric
- High Safety Factor
- High Melting Point Wax Impregnation
- Non-Inductive
- Conservatively Rated

The Research Worker

is a free monthly publication treating on the proper application of condensers and resistors. Write for it.

AEROVOX WIRELESS CORP.  
 74 WASHINGTON STREET  
 BROOKLYN N. Y.

## CONDENSERS

## POWERIZER

Transformers and Amplifying Systems mean Transformers and Amplifiers adapted to your special purposes. You can profit by our experience in matching up to various photolytic and photo-electric cells, to get the maximum results.

Powerizer Sound Systems Reproduce with accuracy the original source of Sound.

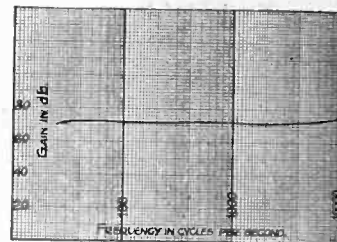

Typical Response Curve—13 Watt Amplifier  
 Bulletin 1029E yours for the asking.

## RADIO RECEPTOR CO.

INCORPORATED  
 106 Seventh Avenue, New York City, U. S. A.

Cable Address: RECEPTRAD N.Y.



## TUBE TEST FACILITIES ENLARGING

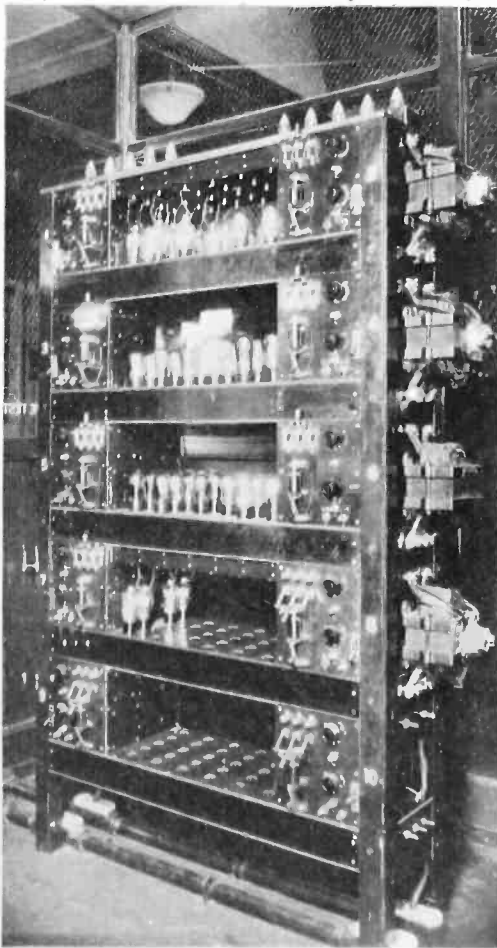

The insistent demand for life tests of radio tubes prompted the installation of suitable equipment at E.T.L.

The original facilities, already found inadequate for orders now booked, are being rapidly enlarged.

Other test facilities now adequate to cope with requirements, provide for

Determination of static characteristics and filament emission of three and four element tubes.

Interelement capacitance of three element tubes.

Determination of dynamic characteristics of D.C. output of rectifiers.

**KNOW**

*-by Test*

**Electrical Testing Laboratories**

80th Street and East End Ave.

New York  N.Y.

*Thirty years in the Service of the Electrical Industry*

# THERE'S A SUPER OHM

## Wire Wound Resistance Unit for Every Purpose

Engineers in almost every branch of the radio and electrical industries are choosing SUPER-OHM RESISTORS to meet their specifications for units of closer tolerances. In addition to being extremely accurate and having a low temperature coefficient, their distributed capacity and inductance have proved to be practically negligible.

SUPER-OHM resistors are manufactured in values ranging from .25 of an ohm to 5,000,000 ohms with a tolerance of only 1% plus or minus the rated value. There is a SUPER-OHM type to meet every requirement. Write your specifications to our Engineering Dept. Samples will be shipped within 24 hours.

**SUPERIOR RESISTOR CORP.**

334 Badger Avenue  
Newark, N. J.

## May . . . Five Market Places

Conventions are people . . . And people are markets, particularly when they are engineers in the Electronic Industries.

The Merry month of May will convene five groups in the Electronics Fraternity:

May 5-8

Society of Motion Picture Engineers  
Washington, D. C.

May 9-10

Acoustical Society of America  
New York City

May 14

Radio Club of America  
New York City

May 18-23

National Electric Manufacturers Association  
Hot Springs, Va.

May 29-31

American Electro Chemical Society  
St. Louis, Mo.

These pioneers who hobnob with the electron are in the vanguard of science. They are convening to exchange experiences in the most recent developments of their respective arts.

The chronicle of electronic tube progress will feature in May the key interests of these conventions. . . .

Special Articles—Trained Editors—Extra Convention Copies . . . every facility of technical journalism will be made available.

These technicians await a message . . . results of tests, characteristics, product descriptions from those who would supply their billion dollar market.

May . . . a month of conventions . . . shall your product be there when the curtain rises?

▲  
Advertising forms close April 25

▼  
**Electronics**

10th Ave. at 36th Street  
New York, New York



# SAMSON A F COMPONENTS

## PRODUCTS

APPLICATIONS	SOUND PICTURE	AC PAM AMPLIFIERS	DC PAM AMPLIFIERS	AC MICROPHONE AMPLIFIERS	DC MICROPHONE AMPLIFIERS	AC MICROPHONE MIXERS	DC MICROPHONE MIXERS	AUDIO PARTS	FADERS	QUALPENSATOR	BROADCAST PARTS	BROADCAST UNITS	POWER SUPPLY PARTS	POWER SUPPLY UNITS	RACK AND PANEL UNITS	VISUAL MONITORS	HEAD AMPLIFIERS	SPECIAL AUDIO PARTS AND UNITS		
		BROADCASTING		✓	✓	✓		✓	✓		✓	✓	✓	✓	✓	✓	✓			
		RADIO RECEIVERS	✓	✓					✓		✓			✓	✓					
		RECORDING		✓		✓		✓	✓		✓	✓	✓			✓	✓			
		PROJECTION	✓	✓					✓	✓	✓	✓	✓	✓	✓	✓	✓			
		GROUP ADDRESS	✓	✓	✓	✓	✓	✓	✓		✓	✓	✓	✓	✓	✓	✓			
		RECORDING		✓		✓		✓	✓		✓	✓	✓			✓	✓			
		PHONOGRAPH	✓								✓									
		CENTRALIZED RADIO AND PHONOGRAPH	✓	✓	✓	✓	✓	✓			✓			✓	✓	✓	✓			
		PHOTO ELECTRIC DEVICES	✓	✓															✓	
CALLING SYSTEMS	✓	✓	✓	✓											✓	✓				
SPECIAL AUDIO APPLICATIONS																		✓		

An electronic product is only as good as its audio amplifier.

If you have an audio problem, avail yourself of our recognized experience in its solution.

*Samson Electric Co.*

MANUFACTURERS SINCE 1882

Main Office:  
Canton, Mass.



Factories: Canton  
and Watertown, Mass.



You can examine any of these books for 10 days FREE!

[Just send the Coupon]

## McGraw-Hill Books in the Field of Radio Engineering

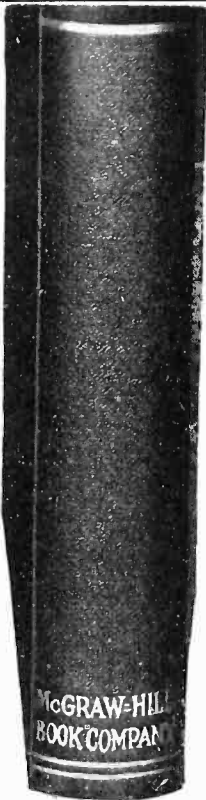

### 1. Lauer and Brown—*Radio Engineering Principles.*

By HENRI LAUER and HARRY L. BROWN. 301 pages, 6x9, 227 illustrations, \$3.50.

A standard work on the underlying principles of radio engineering. In addition to all that material contained in the first edition which applies to modern practice, much new material has been added in the revision. All phases of the science and practice of the use of three-electrode vacuum tubes are given detailed consideration. The electron theory forms the basis of all functional descriptions. The use of mathematics has been kept at a minimum.

### 2. Peters—*Theory of Thermionic Vacuum Tube Circuits.*

By LEO JAMES PETERS, Assistant Professor of Electrical Engineering, University of Wisconsin. 266 pages, 6x9, 110 illustrations, \$3.00.

A detailed discussion of thermionic vacuum tube circuits that develops conventions and methods which may be used in treating electrical networks and systems containing tri-electrode devices. The circuits and topics discussed are those which best illustrate and fix in the mind of the reader the methods used in arriving at the performance of triode circuits.

### 3. Van der Bijl—*The Thermionic Vacuum Tube and Its Applications.*

By H. J. VAN DER BIJL, formerly Research Physicist, Western Electric Co., New York. 391 pages, 6x9, 232 illustrations, \$5.00.

A detailed description of the principles of operation of thermionic vacuum tubes with proper consideration of the applications of these principles. The book is elementary enough to meet the demands of those who are interested in this subject, but who are not sufficiently acquainted with the properties and behavior of electrons to understand the operation of these tubes.

### 4. Moyer and Wostrel—*Radio Receiving Tubes.*

By JAMES A. MOYER, Director of University Extension, Massachusetts Department of Education, and John F. Wostrel, Instructor in Radio Engineering, Massachusetts Department of Education. 296 pages, 5 1/2 x 8, 181 illustrations, \$2.50.

In this book the essential principles underlying the operation of vacuum tubes are explained in as non-technical a manner as is consistent with accuracy. The book covers the construction, action, reactivation, testing and use of vacuum tubes as well as specifications for vacuum tubes and applications for distant control of industrial processes and precision measurements.

## McGraw-Hill FREE EXAMINATION COUPON

McGraw-Hill Book Co., Inc., 370 Seventh Avenue, New York.

You may send me for 10 days' free examination the books checked below:

- Lauer and Brown—Radio Engineering Principles—\$3.50.  
 Peters—Theory of Thermionic Vacuum Tube Circuits—\$3.00.  
 Van der Bijl—The Thermionic Vacuum Tube and Its Application—\$5.00.  
 Moyer and Wostrel—Radio Receiving Tubes—\$2.50.

Name .....

Home Address .....

City and State .....

Name of Company .....

Occupation .....

(Books sent on approval to retail purchasers in U. S. and Canada only.)

L.4-30

# ECONOMY WITH THE S-2244 CARDWELL for Tube Bombarders

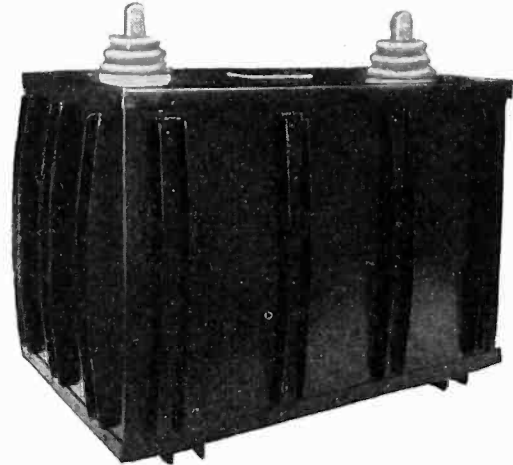

IN tube bombarders, possibilities of transient overloading conditions are always present, making the use of condensers not subject to permanent injury highly desirable. To meet the demand for a condenser that will fill this requirement the CARDWELL S-2244, an oil dielectric fixed condenser, was developed, affording high capacity and having self-healing characteristics.

Quantities of these S-2244 condensers in constant service in the plants of the largest tube manufacturers in the world, afford proof of their unquestioned economy and desirability.

Actual cost records have demonstrated that by the installation of S-2244's initial savings as high as 50% are possible, with *no future replacement expense*. If such manifest economy appeals to you we shall be glad to send particulars and comparative figures.

Included in the CARDWELL line also, are Fixed and Variable transmitting condensers for Commercial, Broadcast and Amateur use and receiving condensers in a broad range of capacities.

*Inquiries are solicited.*

## CARDWELL CONDENSERS

THE ALLEN D. CARDWELL MFG. CORP.  
81 Prospect Street · Brooklyn, New York

*Since broadcasting began*

"THE STANDARD OF COMPARISON"

*Every type of tube uses  
pure nickel*

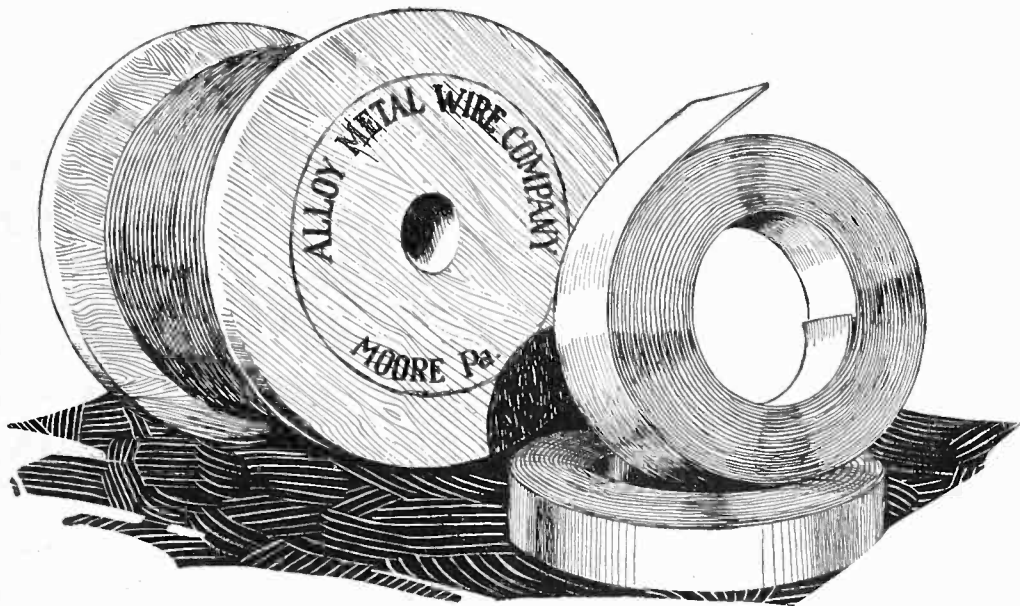

*We supply accurate, uniform  
pure nickel  
strip, wire and rods*

It is important to be sure of pure nickel. It is doubly important to be sure of a reliable source of supply where material for nickel parts used in the millions of tubes produced annually can be obtained easily and true to size.

We have sufficient production facilities to take care of any demand. Our nickel materials are absolutely uniform in quality and true to gauge. They can be annealed or tempered to your specifications.

**ALLOY METAL WIRE COMPANY, INC.**  
**MOORE, PENNSYLVANIA**



# HARNESS

*for your tubes!*

Wild tubes, like wild horses, have no value. A harness is essential to put them to useful work. And that harness, in the form of proper controls for various circuits, spells

## CLAROSTAT

Not the name of a product. Nor again a line of products. CLAROSTAT is an engineering service dedicated to the harnessing of vacuum tubes for every conceivable purpose.

The CLAROSTAT line includes VARIABLE RESISTORS—from adjustable grid leaks to wire-wound volume controls, and again to super-power units of 250-watt capacity; FIXED RESISTORS—in strip form and flexible form, tapped or plain; and AUTOMATIC RESISTORS—notably the LINE BALLAST CLAROSTAT, for automatic control of applied voltage irrespective of line voltage fluctuations.

There is no better known name in radio technique than CLAROSTAT. Millions in use bear out that statement. And with the vacuum tube stepping out into new fields, CLAROSTAT joins "Electronics" in enlarging upon the benefits of radio technique.

**WRITE** for data regarding the complete CLAROSTAT line. No matter what your problems, our engineers are ready to serve you.

**CLAROSTAT MANUFACTURING CO., INC.**

*Specialists in Variable, Fixed and Automatic Resistors*  
294 North Sixth Street, Brooklyn, N. Y.

# FIXED

VITREOUS ENAMEL PYROHMS  
EDISON BASE PYROHMS  
VOLTAGE DIVIDERS  
TAPPED RESISTORS  
GRID LEAKS  
GRID SUPPRESSORS  
FILAMENT RESISTORS  
NON-INDUCTIVE LAVITES

## You'll Find Them All

with Detailed Specifications in the 32-Page Condenser and Resistor Manual and Catalog

Sent Free on Request



SEND  
FOR  
IT

AEROVOX WIRELESS CORP.  
74 WASHINGTON STREET  
BROOKLYN N. Y.

# RESISTORS



## G-M "VISITRON" Photoelectric Cells

Made by the oldest commercial manufacturers of alkali metal photoelectric cells in the United States.

**Industrial Appliances—Talking Movies—Television—Research**



No. 71 VISITRON

**GM LABORATORIES INC**

Grace & Ravenswood Ave.

Chicago, U. S. A.

## "KH" PHOTOCELLS

uniform sensitive non-microphonic

TELEVISION LAMPS • SOUND RECORDING LAMPS • TUNGSTEN AND MOLYBDENUM WIRE • BOMBARDING MACHINES •

*Special Developments*

**ARGCO**

LABORATORIES, INC.

150 W. 22nd St.

New York

## PAUL L. CLARK

will Form Company or Sell these Eight (8)

LIVE PATENTS

5 Issued, 3 Pending; 5 Basic, 3 Detail; Fac-simile Transmission; Wire or Radio.

## TELEVISION

- |                                     |   |
|-------------------------------------|---|
| 1. Scanning                         | 5. Synchronizing by Scanning                |
| 2. Phasing, Framing                 | 6. Non-Interference with Audio Broadcasting |
| 3. Light Valve, High Speed Response | 7. Scanning and General                     |
| 4. Scanning                         | 8. Synchronizing by Scanning                |

For Information regarding these Patents; Write, Call or Telephone NAVarre 1969. *Inquiries, strictly confidential.*

PAUL L. CLARK, 1017 E. 38th St., Brooklyn, N. Y.

# QUALITY

## Sprague Precision Condensers are the Standard of Condenser Quality

WHEN critical engineers get together, they all agree that Sprague Condensers are superior . . . They know that Sprague Condensers have stood the severest tests of service — that they can be depended upon to perform their duties with unfailing faithfulness. Sprague Condensers are designed by the nation's foremost condenser engineers and assembled by skilled craftsmen . . . And here are a few reasons why Sprague Condensers are better:

### THE SPRAGUE ELECTROLYTIC CONDENSER

A single unit allowing maximum flexibility for mounting in circuit. No welded or riveted joints in its one piece anode, made of purest aluminum. A lower leakage and better power factor than any other electrolytic unit, wet or dry. Rigid construction prevents possibility of internal shorts. Screw type socket makes for ease in mounting. Edge effect 10% of spiral type.

### THE SPRAGUE BLOCK CONDENSER

Dielectrically superior due to patented paraffin layer process: Ruggedly protected by extra heavy sheet metal can. Impervious to moisture due to dipping of individual condensers, wrapping of assembled block in moisture-proof material, and triple sealing. Highest leakage resistance guaranteed above 5000 megohms per microfarad.

### THE SPRAGUE ONE MICROFARAD UNIT

Flexible mounting — either unique stud or flange as desired. Correctly protected against moisture by double seal and only one small open end. Also furnished in midget assemblies using up to five sections of low capacity.

### THE SPRAGUE MIDGET

A compact and unusually strong unit. Tested to high voltage breakdown — waterproofed with asphalt covering and special process of triple impregnation. Easily and quickly mounted . . . Dual type of winding if desired.

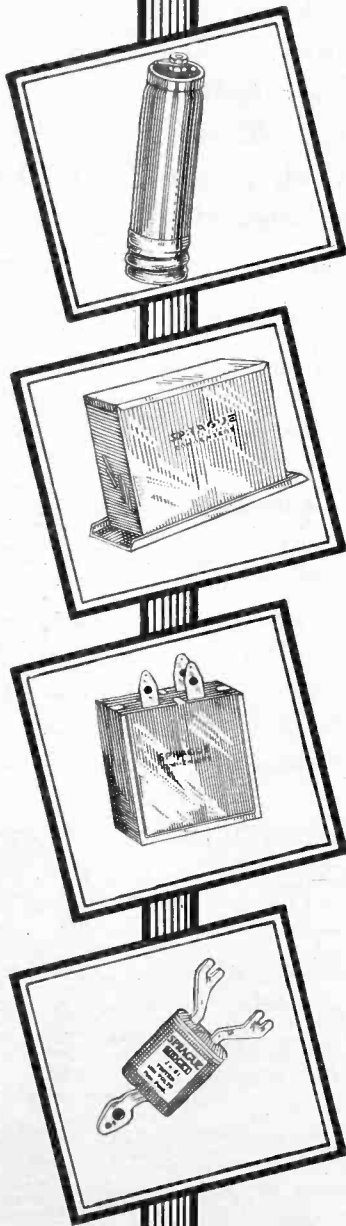

**SPRAGUE SPECIALTIES COMPANY**  
QUINCY, MASSACHUSETTS

SPRAGUE ELECTROLYTIC AND PAPER CONDENSERS  
WILL SOLVE YOUR CONDENSER PROBLEMS



# AEROVOX DRY ELECTROLYTIC FILTER CONDENSERS

## A NEW Condenser for Filter Circuits

We shall be glad to go over with you, the advantages in quality, performance and savings which Aerovox Dry Electrolytic Condensers will make possible in your filter circuits.

FEATURES  
\* \* \* \* \*  
Dry  
\* \* \* \* \*  
Low Cost  
\* \* \* \* \*  
High Capacity  
\* \* \* \* \*  
Improved Filtering  
\* \* \* \* \*  
Better Tone Quality  
\* \* \* \* \*  
High Voltage Rating  
\* \* \* \* \*  
Long Lived  
\* \* \* \* \*  
Surge Proof  
\* \* \* \* \*  
Safe

Aerovox Dry Electrolytic Condensers are admirably suited for use in filter circuits in which the following characteristics increase the efficiency and safety of the filter circuits and reduce their cost.

- 1. DRY:** Aerovox Dry Electrolytic Condensers have no solution to spill or evaporate. They eliminate all trouble usually encountered in packing, shipping and servicing electrolytic condensers in which a liquid electrolyte is employed.
- 2. FILTER ACTION:** The filter action per microfarad of Aerovox Dry Electrolytic Condensers is equivalent to that of paper condensers.
- 3. COST:** The cost of Aerovox Dry Electrolytic Condensers is much lower than paper condensers of equivalent capacity and voltage rating.
- 4. COMPACTNESS** The cubic contents of an Aerovox Dry Electrolytic Condenser is much less than that of a paper condenser of equivalent capacity and voltage rating.
- 5. EFFECT ON TONE QUALITY:** The Improved filtering obtainable from the higher capacity which can be utilized with Aerovox Dry Electrolytic Condensers per dollar of cost, makes possible a great improvement in tone quality by eliminating modulation of signals by the fundamental frequency and harmonics of the power supply.
- 6. VOLTAGE RATING:** An improved process employed in making Aerovox Dry Electrolytic Condensers has resulted in a marked increase in rating of this type of condenser to 500 volts D.C. maximum peak, permitting their use without resorting to expensive series connections, in circuits where ordinary electrolytic condensers cannot be employed because of voltage limitations. This feature is particularly important in connection with power supply units designed for operation with 245 type power tubes at rated characteristics.
- 7. SURGE PROOF:** Puncture of the dielectric, due to surges, does not injure the condenser, the dielectric film healing itself automatically when the temporary surge dies out.
- 8. SAFETY:** Within a short time after the voltage or charging source is discontinued, the energy of the residual charge is dissipated through leakage, thus eliminating the danger from shocks, often met with in paper condensers which hold their charge for long periods.
- 9. LIMITS SURGES:** The comparatively high leakage current drawn temporarily as the power supply unit is turned on, limits the peak no-load voltages applied in the power supply circuits and protects by-pass condensers in the various receiver and amplifier circuits.
- 10. LONG LIFE:** Self-healing characteristics of the Aerovox Dry Electrolytic Condensers eliminates permanent breakdowns due to temporary overloads from surges and increases the life of the condenser almost indefinitely.
- 11. HUM ELIMINATION:** Because of the much lower cost per microfarad of the dry electrolytic condenser, it is economically practical to use higher capacities than with paper condensers with consequent reduction of hum in filter circuits to a negligible minimum.
- 12. UNAFFECTED BY ATMOSPHERIC CONDITIONS:** The Aerovox Dry Electrolytic Condenser sections are sealed to prevent any harmful effects from atmospheric conditions.

### THE RESEARCH WORKER

is a free monthly publication treating on the proper application of condensers and resistors. Write for it.

A 32-PAGE MANUAL AND CATALOG containing detailed specifications of condensers and resistors is yours for the asking.

AEROVOX WIRELESS CORP.  
74 WASHINGTON STREET, BROOKLYN, N. Y.

# QUALITY DEPENDS ON DETAILS!

—and it is the infinite care built into every detail that has made the quality of Triad Tubes famous! Rigid inspection accompanies every manufacturing process. When completed every Triad Tube is subjected to nine final tests for vital characteristics. Even the Filament used in Triad Tubes is coated in the factory chemical laboratory! These, and many additional manufacturing features, plus the skill of Triad engineers and the experience of Triad officials, have enabled the quality of their product, Triad Radio Tubes, to rank with the highest in the radio tube world.



Triad Tubes, types 50 and 81, have again proved their merit by actual test. At present, one of the country's largest manufacturers of amplifier apparatus has them under test. To date they have withstood 900 hours of continuous service without the slightest change in characteristics. Still further proof of Triad Quality!

### The Triad line includes Types

T-27	T-45	T-81
T-71	T-12	T-10
T-80	T-26	T-24-AC
T-01A	T-71A	T-12-A
T-50	T-22-RF	

Also, types T-PEC, photo electric cell and T-TEL, for television use.

Triad Radio Tubes are manufactured under R.C.A., General Electric, and Westinghouse Electric patents.



# TRIAD RADIO TUBES

TRIAD MFG. CO., Pawtucket, R. I.



# PROFESSIONAL SERVICES

## AMY, ACEVES & KING, Inc.

*Consulting Engineers*

Inventors of the Multicoupler, Antenna System for apartment houses.

Specializing in Radio Design—Test—Development.

55 W. 42nd St., New York City  
Phone: Longacre 6622.

## ELECTRICAL TESTING LABORATORIES

### TUBE TESTING

Electrical—Mechanical—Chemical and Photometric Tests.

Inspection at manufacturers' plants.  
80th St. and East End Ave., New York

## PATENTS

### WM. G. H. FINCH

*Patent Attorney*

(Registered U. S. & Canada)

Mem. I. R. E. Mem. A. I. E. E.  
303 Fifth Ave., New York  
Bogardus 1263

Have you  
Engineering or  
Other Services  
Special  
Opportunities  
(Employment or Business)  
to offer other  
readers of  
"electronics"?

"electronics" is a McGraw-Hill publication serving the field of electronic tube developments . . . engineers and manufacturers of vacuum tubes and their various applications, radio sets, sound pictures . . . and covering Research, Design, Engineering, and Administration.

The circulation of this issue is among over 6,000 men . . . who select or specify the raw materials, parts and equipment that enter into electronic products . . . vacuum tubes, radio sets, talking pictures, etc., etc., etc. . . . radio chief engineers, acoustical engineers, tube engineers, physicists, economists, government engineers, marketing executives and administrative officers.

"Searchlight" and "Professional Service" advertising—appearing on this page—offers you inexpensive but effective publicity for bringing your services or opportunities to the attention of these men.

# SEARCHLIGHT SECTION

EMPLOYMENT and BUSINESS OPPORTUNITIES—USED and SURPLUS NEW EQUIPMENT

### UNDISPLAYED—RATE PER WORD:

*Positions Wanted*, 5 cents a word, minimum \$1.00 an insertion, payable in advance.

*Positions Vacant* and all other classifications, 10 cents a word, minimum charge \$2.00.

*Proposals*, 40 cents a line an insertion.

### INFORMATION:

*Box Numbers* in care of our New York, Chicago or San Francisco offices count 10 words additional in undisplayed ads.

*Discount* of 10% if full payment is made in advance for four consecutive insertions of undisplayed ads (not including proposals).

### DISPLACED—RATE PER INCH:

1 inch . . . . . \$5.00  
2 to 3 inches . . . . . 4.75 an inch  
4 to 7 inches . . . . . 4.50 an inch  
*Other spaces and contract rates on request.*  
An advertising inch is measured vertically on one column, 3 columns—30 inches—to a page.

## POSITION WANTED

ARE you available for employment? Are you thinking of making a change to broaden your experience? Are you looking for a bigger opportunity? An inexpensive advertisement under this heading can render you invaluable service in bringing your qualifications to the attention of many readers of Electronics, who can undoubtedly offer you the employment desired.

## BUSINESS OPPORTUNITIES

BUYERS of, or associates for business ventures of interest to the field served by Electronics can be reached quickly and economically through an advertisement under this heading.

## WANTED

ANYTHING within reason that is wanted in the industry served by Electronics can be quickly located through bringing it to the attention of thousands of men whose interest is assured because this is the business paper they read.

## GLASS TUBING AND GLASS MACHINERY FOR SALE

We will be pleased to receive offers of the following equipment and material For Sale—Perfect Condition

- |                             |   |
|-----------------------------|---|
| 2—Glass Cutter Machines.    | Glass Tubing— $\frac{1}{8}$ in.— $\frac{1}{4}$ in.— $\frac{3}{8}$ in. |
| 1—Stem Machine—6 Head.      | — $\frac{5}{8}$ in.— $\frac{5}{16}$ in.— $\frac{1}{2}$ in. O. D.      |
| 1—Seal Machine—5 Head.      | and other sizes.  |
| 2—Trolley Exhaust Machines. |   |

### L. S. BRACH MANUFACTURING CORPORATION

127 Sussex Avenue, Newark, N. J.

## Poor Aladdin . . .

The best service at Aladdin's command was rubbing a lamp and WISHING for what he wanted while YOU have the "Searchlight" at your disposal to FIND what you want!

May we serve you?

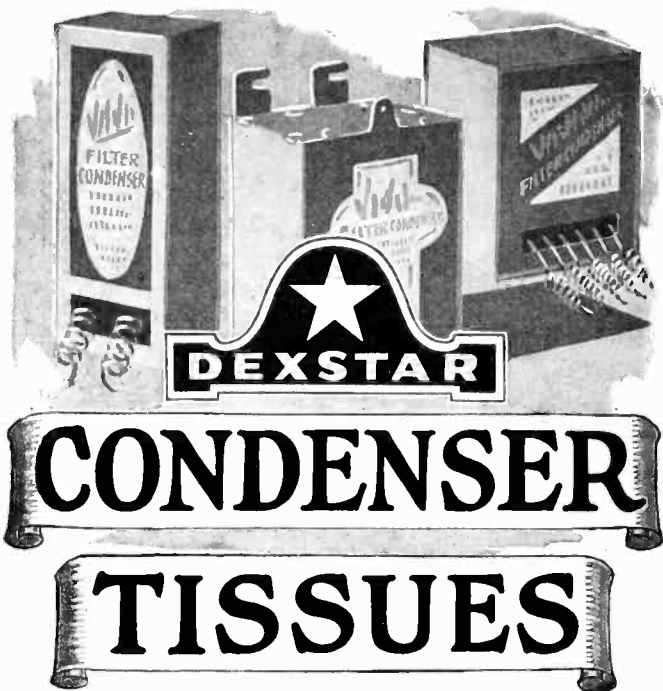

**N**O Radio set is any better than its weakest link, and the weakest link is very often a filter Condenser. No Condenser is any better than the thin strips of Insulating Tissue which separate the layers of metal foil. A pinhole or a speck of metal in the Condenser Tissue means a break down of the Condenser, with the entire set put out of commission.

DEXSTAR Condenser Paper is regarded by Radio experts as being the highest grade Insulating Tissue ever made—the freest from defects, the most uniform in quality, the most lasting under exacting and unusual requirements. DEXSTAR Condenser Tissue is the specialized product of a paper mill which has excelled in Tissue Paper production for three generations.

*RADIO designers and builders should have the assurance that Condensers which they use are made with DEXSTAR Condenser Tissues. It is insurance against many radio troubles. The leading Condenser manufacturers are now using DEXSTAR Condenser Tissues exclusively.*

**C. H. DEXTER & SONS, INC.**  
Makers of Highest Grade Thin Papers  
WINDSOR LOCKS, CONN.

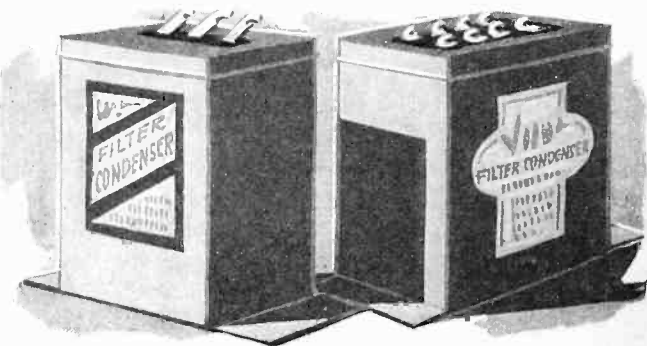

## electronics

M. E. HERRING  
Publishing Director

M. CLEMENTS  
Sales Manager

### Contents for April, 1930

Copyright, 1930, by McGraw-Hill Publishing Company, Inc.

A clearing-house for facts—a camp-fire for counsel . . .	7
EDITORIAL	
The future service of electronics to mankind . . . . .	8
By THOMAS A. EDISON, DR. LEE DEFOREST, PROF. J. AMBROSE FLEMING, DR. R. A. MILLIKAN, H. P. DAVIS, DR. W. R. WHITNEY, DR. FRANK B. JEWETT	
The electron tube—a universal tool in industry . . .	10
By O. H. CALDWELL, Editor, <i>Electronics</i>	
The power pentode, its characteristics and applications . . . . .	12
By BENEDICT V. K. FRENCH	
Industrial uses of vacuum devices . . . . .	15
By S. M. KINTNER	
Vacuum tubes in scientific measurements . . . . .	18
By J. W. HORTON	
Tuned radio-frequency amplifiers . . . . .	21
By LOUIS COHEN, PH.D.	
Some unsolved problems of sound-picture technique .	23
By ALFRED N. GOLDSMITH, PH.D.	
The tube at work . . . . .	25
The radio spectrum . . . . .	26
The photo-electric cell—its characteristics . . . . .	28
Photo-cells for special applications . . . . .	29
By DR. HARVEY C. RENTSCHLER	
Economic evolution with the introduction of sound pictures . . . . .	30
By FRANKLIN S. IRBY, PH.D., Associate editor, <i>Electronics</i>	
Producing very high frequencies by the magnetron . .	34
By W. C. WHITE	
The electron—and beyond . . . . .	37
By VLADIMIR KARAPETOFF	
Tubes for short-wave transatlantic phone service . .	38
By DR. H. E. MENDENHALL	
There are two kinds of pentodes . . . . .	40
By KEITH HENNEY, M.A., Associate editor, <i>Electronics</i>	
Magnetic disturbances and long-distance reception .	42
By A. E. KENNELLY	
Physicists survey electronic advances . . . . .	44
<b>DEPARTMENTS</b>	
New books on electronic subjects . . . . .	43
Editorials . . . . .	46
Review of electronic literature here and abroad . . . .	48
New products . . . . .	50
News of the electronic industries . . . . .	52
Patents . . . . .	54

### McGRAW-HILL PUBLISHING COMPANY

Cable Address:

JAMES H. MCGRAW, Chairman of the Board	MASON BRITTON, Vice-President
MALCOLM MUIR, President	EDGAR KOBAK, Vice-President
JAMES H. MCGRAW, JR., Vice-Pres. and Treas.	HAROLD W. MCGRAW, Vice-President
EDWARD J. MEHREN, Vice-President	H. C. PARMELEE, Editorial Director
C. H. THOMPSON, Secretary	

# electronics



## Index to Advertisers

Acme Electric & Mfg. Co., The	86
Aerovox Wireless Corp.	90-92-98-100
Allen-Bradley Co.	1
Alloy Metal Wire Company, Inc.	97
Aluminum Co. of America	6
American Electro Metal Corporation, The	83
American Transformer Company	65
Arcturus Radio Tube Company	Inside Front Cover
Argco Laboratories, Inc.	98
B-L Electric Company, The	86
Callite Products Company, Inc.	90
Cardwell Mfg. Corp., The Allen D.	96
Carter Radio Co.	92
CeCo Manufacturing Co., Inc.	77
Central Radio Laboratories	55
Clark, Paul L.	98
Clarostat Manufacturing Co., Inc.	98
Continental-Diamond Fibre Company	74
Crescent Braid, Inc.	86
DeForest Radio Co.	Back Cover
DeJur-Amsco Corp.	88
Dexter & Sons, Inc., C. H.	102
Dudlo Manufacturing Company	3
Eby Mfg. Co., Inc., The H. H.	82
Eisler Electric Corporation	63
Electrical Testing Laboratories	93
Elkon	83
Fansteel Products Company, Inc.	2
Formica Insulation Co., The	81
Free Laboratories, E. E.	59
Frost, Inc., Herbert H.	87
G-M Laboratories, Inc.	98
General Electric Company	67
General Radio Company	75
Gilby Wire Company	84
Holed-Tite Packing Corp.	103
Inca Manufacturing Corporation	62
International Resistance Company	66
Jefferson Electric Company	89
Jewell Electrical Instrument Company	Inside Back Cover
McGraw-Hill Book Co.	90-96
National Carbon Co.	69-72
Ohmite Manufacturing Company	76
Oxford Radio Corporation	73
Perryman Electric Co., Inc.	64
Polymet Manufacturing Corporation	91
RCA Radiotron Company, Inc.	4-5
Radio Receptor Co.	92
Rola Company, The	80
Samson Electric Co.	95
Searchlight	101
Sprague Specialties Co.	99
Summerill Tubing Co., The	79
Superior Resistor Corp.	94
Triad Mfg. Co.	100
Ward Leonard Electric Co.	68
Westinghouse Elec. & Mfg. Co.	60-61
Weston Electrical Instrument Corp.	78
Wirt Company	85
Yaxley Mfg. Co.	57

INC., Tenth Ave. at 36th St., New York, N. Y.

"Machinist, N. Y."

NEW YORK District Office, 285 Madison Ave.  
 WASHINGTON, National Press Building  
 CHICAGO, 520 North Michigan Ave.  
 PHILADELPHIA, 1600 Arch Street  
 CLEVELAND, Guardian Building  
 ST. LOUIS, Bell Telephone Building

SAN FRANCISCO, 883 Mission Street  
 BOSTON, 1427 Statler Bldg.  
 GREENVILLE, S. C., 1301 Woodside Bldg.  
 DETROIT, 2-257 General Motors Bldg.  
 LOS ANGELES, 632 Chamber of Com. Bldg.  
 LONDON, 6 Bouverie St., London, E. C. 4

ELECTRONICS — April, 1930

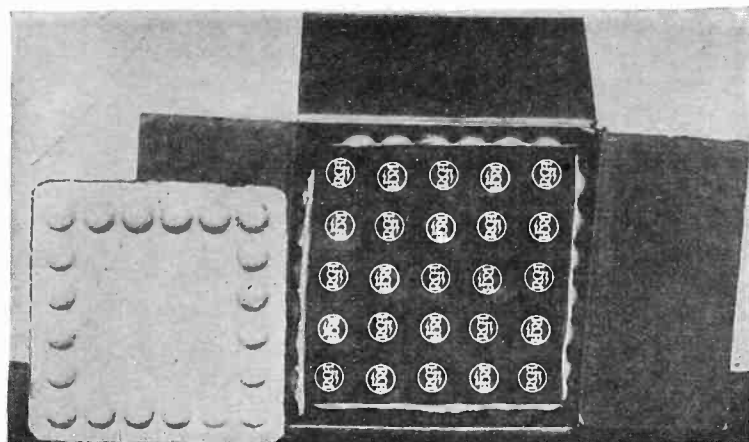

## Standardize

your tube packing and  
**REDUCE COSTS!**

**HOLED-TITE**  
 Radio Tube Pads  
 have revolutionized  
 the packing and ship-  
 ping of tubes. This  
 unique molded pulp  
 pad (1) prevents  
 breakage, (2) costs  
 less, (3) requires  
 smaller shipping con-  
 tainers (4) simplifies  
 operation of packing,  
 (5) saves storage  
 space, (6) is always  
 clean — never mussy.

This Does It:

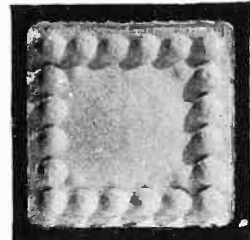

Pad size 11½ x 11½ inches  
 to pack tubes No. 112A,  
 171A, 200A, 201A, 226,  
 227, 240.

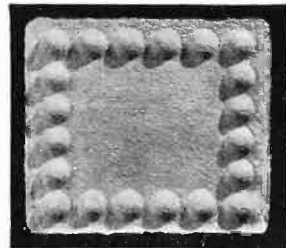

Pad size 11½ x 13¼ inches  
 to pack No. 224 and 222  
 screen-grid type tubes.

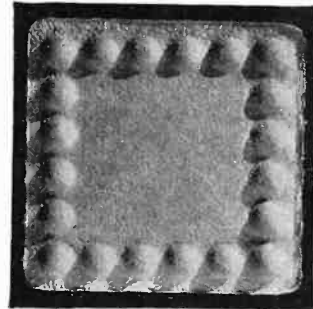

Pad size 13x13 inches to pack  
 tubes No. 245 and 280.

**ARE YOU MAKING  
 NEW TYPE TUBES?  
 SEE US.**

If you are bringing out new  
 sizes, shapes, or types of  
 Tubes, let our Packing Engi-  
 neers shoulder your packing  
 problem right at the start.  
 We'll design a Holed-Tite pad  
 that exactly suits—a saving in  
 money to you.

*For Packing Any Type Tube  
 in Any Quantity, Write*

**1930  
 requires  
 Good Tubes  
 packed  
 right!**

**HOLED-TITE  
 PACKING  
 CORP.,**

100 E. 42nd St.  
 New York City

Affiliated with  
 International  
 Paper Co.

**HOLED-TITE**  
 TRADE MARK NEW YORK

*Radio Tube Pads*



# Human Grids

**S**IX thousand men . . . like other men in most respects. But quite different in respect to their concentrated influence on the marketing of electronic products.

Six thousand *selected* men . . . human grids, as it were . . . who have amplified the feeble first impulses of electron phenomena into wide-spread streams of power and application, delighting the world and building a new billion-dollar industry.

For example:—

300 human grids—*Electronics'* subscribers—technicians and executives—will control the design, construction and composition of vacuum tubes going into 13 millions of homes this year.

500 of them will direct the manufacture of sound picture equipment that will entertain 115 millions of Americans each week during 1930.

500 of these active engineering authorities will decide the character and make-up of radio receiving sets that will enter 4 millions of American homes this year.

1,000 of them are men who will design and specify the various kinds of electronic equipment used in tens of thousands of industrial plants throughout the world.

*It is the grid in the tube which controls the flow of the electron stream.*

*It is the engineer in industry who controls the flow of equipment to the factory, to the home.*

It is seen from the foregoing examples that market determination is not so complex as it has sometimes appeared, if approached as a simple problem in elimination. *Electronics'* unit coverage pares it down to a list of vacuum tube markets known and charted. ■■■■

This "unit coverage" circulation policy of McGraw-Hill consists of getting subscriptions from *all* in the chosen field . . . and *none* outside that field. That policy gives readers the benefit of a directly-aimed editorial policy, completely covering the special field but not spread thin in an attempt to please too diversified an audience.

*Electronics* is the specialized engineering paper of experts. Five thousand had subscribed before this first edition was published. A little more than six thousand constitutes the entire field. No others will be asked to subscribe. No amateurs, dealers, or service men. Only technicians and executives in charge of research, invention, design and administration . . . men whose buying influence extends from the center of the industry out to the millions of men, women and children who through radios, talking pictures, and myriads of other applications, now enjoy the benefits of an Electronic Age.

Manufacturers and advertising agencies are invited to call upon us for assistance in marketing and sales promotion plans to distribute electronic products.

  
Manager, *Electronics*

# An Outstanding Instrument ... SERVICE!



199 Set Analyzer



210 Tube Checker

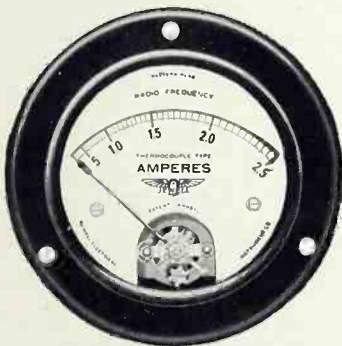

68 R. F. Ammeter



579 Test Panel



409 Set Analyzer

**F**ROM the very inception of radio and throughout the development and application of thermionic tubes, Jewell Instruments have contributed in a big way to the advancement of the industry.

From miniature instruments, such as the Pattern 88, supplied to manufacturers of radio apparatus in great quantities for production testing, to the Pattern 579 Service Test Panel with Remote Control (the last word in convenient, accurate, and complete apparatus for high speed testing of radio receivers) Jewell has provided an outstanding instrument service to experimenters, manufacturers, and service men.

Working hand in hand with radio engineers, Jewell has increased accuracy and economy in checking materials in process through improved testing apparatus.

Jewell radio service instruments produced through painstaking field studies of radio service requirements have been a vital factor in the growth of the radio industry.

But Jewell contributions to the thermionic industry have not stopped. Today Jewell engineers are working more painstakingly than ever before with many leading engineers in the development of instruments which will promote the growth of the entire industry. Write them about your problems.

JEWELL ELECTRICAL INSTRUMENT COMPANY  
1642-O Walnut Street, Chicago

30 YEARS MAKING GOOD INSTRUMENTS  
**JEWELL**



173 Wattmeter



135 Ohmmeter



41 Ohmmeter



1906—

24 Years of Prestige

—1930

*de Forest*  
AUDIONS

**RADIO RECEIVING AND TRANSMITTING TUBES**

The De Forest reputation for engineering skill and painstaking precision has been zealously guarded in the production of all De Forest receiving and transmitting

Audions. The De Forest Engineering staff is continually bringing out new developments. Here are some of the standard, and newer types of transmitting and receiving Audions.

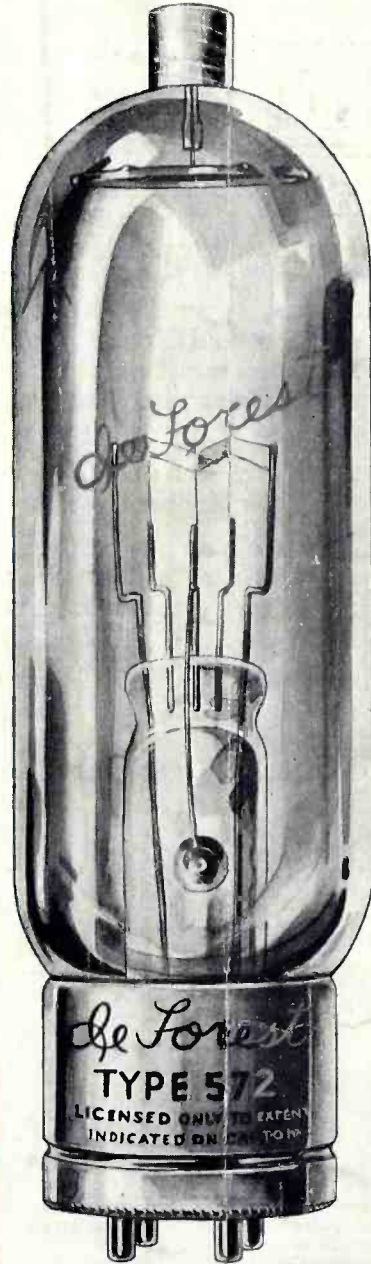

**TRANSMITTING  
AUDIONS**

510—15 Watt Oscillator	\$ 9.00
503A—50 Watt Oscillator and R. F. Power Amplifier	40.00
511—50 Watt Oscillator, A. F. Amplifier, Modulator or R. F. Power Amplifier	40.00
545—50 Watt A. F. Amplifier and Modulator	45.00
552—75 Watt Oscillator and R. F. Amplifier	32.50
504A—250 Watt Oscillator, Modulator or R. F. Power Amplifier	140.00
500—500 Watt Special Oscillator	130.00
520B—5000 Watt Oscillator, Modulator and R. F. Power Amplifier — water Cooled	250.00
565—7½ Watt Screen Grid R. F. Amplifier	22.00
560—75 Watt Screen Grid R. F. Amplifier	50.00
561—500 Watt Screen Grid R. F. Amplifier	390.00
566—A half-wave hot cathode, mercury vapor rectifier. Medium Current	12.50
572—A half-wave hot cathode, mercury vapor rectifier. Heavy Current	30.00

**AUDION 572—**

Audion 572 is a half wave hot cathode mercury vapor rectifier. Its special construction raises the flashover point beyond the usual 72 type. Interchangeable with UV-872.

**RECEIVING  
AUDIONS**

401A—Detector-Amplifier	\$ 1.25
410—Power Amplifier	8.00
412A—Detector - Amplifier, Power Amplifier	2.25
420—Power Amplifier, Last Audio Stage	3.00
420A—60 m.a. Power Amplifier. Last Audio Stage	3.50
422—Standard D.C. Screen Grid Amplifier	4.00
422A—A 60 m.a. D.C. Screen Grid Det.-Amp.	4.50
424—A.C. Screen Grid Amplifier	3.00
426—Amplifier (A. C. Fil.)	1.75
427—Detector - Amplifier (A. C. Heater Type)	2.00
440—High Mu Audion	3.00
445—A.C. Power Amplifier	2.50
471A—5 Amp. Fil. Power Amplifier, Last Audio Stage	2.25
471B—.25 Amp. Fil. Power Amplifier, Last Audio Stage	2.25
480—Full-Wave Rectifier (125 M.A.)	2.50
481—Half-Wave Rectifier (110 M.A.)	6.50
450—Power Amplifier	10.00
499 60 m.a. General Purpose	2.50

For further information address

**DEFOREST RADIO CO., PASSAIC NEW JERSEY**