

# Electronics World

MARCH, 1971  
60 CENTS

**EW LAB TESTS VOLT-OHM-MILLIAMMETERS**

**CATV—Its Future Starts Now**

**COLOR TV FOR 1971**

**DIGITAL INSTRUMENTS—More on Electronic Counters**

*EW Lab Tests*

## **NEW DOLBY-IZED CASSETTE DECKS**





# NOW you can measure resistors accurately **IN CIRCUIT!**

in solid state devices



**FE20 HI-LO**  
with hi-voltage probe and large  
six-inch meter **\$129.50**



**FE21 HI-LO**  
with 4½-inch  
meter **\$99.50**

## WITH THE NEW HI-LO FIELD EFFECT MULTIMETERS

**USES ONLY .08 VOLTS TO POWER OHMMETER TO PREVENT TRANSISTORS FROM CONDUCTING AND UPSETTING READINGS**

Look at these extra features to see why the Hi-Lo meter belongs on your want list:

- Unbelievable specifications of 15 megohm input impedance on DC and 12 megohms on AC
- Laboratory accuracy of 1.5 percent on DC and 3 percent on AC
- 9 DC voltage ranges from as low as .1 volts full scale to 1000 volts
- 3 hi-voltage ranges of 3 KV, 10 KV and 30 KV
- 9 DC zero center ranges from .05 volts to 500 volts . . . a must for delicate transistor bias measurements
- 7 resistance ranges from 1000 ohms full scale to 1000 megohms
- 9 DC current ranges from 100 microamps to 1 amp
- Automatic built-in battery test . . . never a worry about rundown batteries, just push the switches under the meter and read.
- Standard .6 amp fuse to protect the ohms and milliamps scales if voltage or overload is accidentally applied. No more need to return the meter to factory for repair . . . just replace the fuse.
- Special probe with 100K isolation resistor in probe to prevent AC pickup or to prevent loading oscillator circuits. Leave in normal position for most tests.

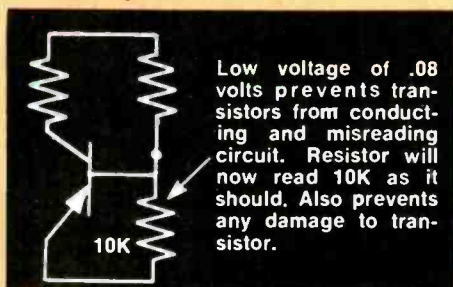

**Here is why you should have both HI and Lo battery voltages for correct in-circuit resistance measurements in solid state circuits:**

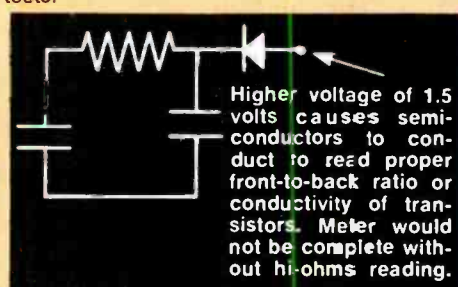

**SENCORE** INC. 3200 Sencore Drive • Sioux Falls, South Dakota 57107

CIRCLE NO. 123 ON READER SERVICE PAGE



# Special introductory offer to new members of the ELECTRONICS AND CONTROL ENGINEERS' BOOK CLUB

	404/437 <b>SOURCEBOOK OF ELECTRONIC CIRCUITS</b> by J. Markus Pub. price, \$19.75 Club price, \$14.75		A494/754 <b>ENGINEERING MANUAL, 2/e</b> by R. H. Perry Pub. price, \$12.50 Club price, \$10.65
	570/426 <b>THE NEW ELECTRONICS</b> by B. Shore Pub. price, \$10.00 Club price, \$8.50		A523/401 <b>CHARACTERISTICS AND OPERATION OF MOS FIELD-EFFECT DEVICES</b> by P. Richman Pub. price, \$10.00 Club price, \$8.50
	A286/507 <b>SOLID-STATE ELECTRONICS</b> by R. G. Hibberd Pub. price, \$9.50 Club price, \$7.95		A037/604 <b>DIGITAL LOGIC AND COMPUTER OPERATIONS</b> by Baron & Piccirilli Pub. price, \$14.50 Club price, \$11.95
	124/035 <b>HANDBOOK OF PHYSICS, 2/e</b> by Condon & Odishaw Pub. price, \$34.75 Club price, \$14.95		350/434 <b>DIGITAL COMPUTER USER'S HANDBOOK</b> by M. Klerer & C. A. Korn Pub. price, \$27.50 Club price, \$23.35
	A347/506 <b>ELECTRONIC DIGITAL TECHNIQUES</b> by P. M. Kintner Pub. price, \$12.50 Club price, \$10.65		A565/031 <b>AMPLIFIER HANDBOOK</b> by R. F. Shea Pub. price, \$37.50 Club price, \$29.50
			A637/377 <b>TRANSISTOR CIRCUIT DESIGN</b> by Texas Instruments, Inc., Staff Pub. price, \$16.50 Club price, \$13.95
			A610/037 <b>MODERN COMMUNICATION PRINCIPLES</b> by Stein & Jones Pub. price, \$15.00 Club price, \$12.75
			092/32X <b>DIGITAL COMPUTER PRINCIPLES, 2/e</b> by Burroughs Corp. Pub. price, \$9.95 Club price, \$8.45
			A259/607 <b>COMMUNICATION SYSTEM ENGINEERING HANDBOOK</b> by D. H. Hamsher Pub. price, \$29.50 Club price, \$24.95

**ANY ONE**  
of these great professional books  
for only **\$1.00**  
VALUES FROM \$9.50 to \$37.50

Special \$1.00 bonus book comes to you with your first club selection

## Save time and money by joining the Electronics and Control Engineers' Book Club

HERE is a professional club designed specifically to meet your day-to-day engineering needs by providing practical books in your field on a regular basis at below publisher prices.

How the Club operates: Basic to the Club's service is its publication, the *Electronics and Control Engineers' Book Club Bulletin*, which brings you news of books in your field. Sent to members without cost, it announces and describes in detail the Club's featured book of the month as well as alternate selections which are available at special members' prices.

When you want to examine the Club's feature of the month, you do nothing. The book will be mailed to you as a regular part of your Club service. If you prefer one of the alternate selections—or if you want no book at all for that month—you notify the Club by returning the convenient card enclosed with each *Bulletin*.

As a Club member, you agree only to the purchase of four books over a two-year period. Considering the many books published annually in your field, there will surely be at least four that you would want to own anyway. By joining the Club, you save both money and the trouble of searching for the best books.

## MAIL THIS COUPON TODAY

ELECTRONICS AND CONTROL ENGINEERS' BOOK CLUB  
582 Princeton Road, Hightstown, N.J. 08520

Please enroll me as a member of the Electronics and Control Engineers' Book Club and send me the two books indicated below. I am to receive the bonus for just \$1.00, and my first selection at the special Club price shown. These books are to be shipped on approval, and I may return them both without cost or further obligation. If I decide to keep the books, I agree to purchase as few as four additional books during the next two years at special Club prices (approximately 15% below list).

Write Code No. of  
bonus book  
here

Write Code No. of  
first selection  
here



Name \_\_\_\_\_

Address \_\_\_\_\_

City \_\_\_\_\_

State \_\_\_\_\_ Zip \_\_\_\_\_

E33155



**There's  
a big  
plus...**

When you specify Mallory semiconductors. It's always been the most dependable line . . . for more of what you want, when you want it. And now there are more extras than ever before.

For one thing, we've added items to make the selection better than ever . . . from pre-tested multiple-cell rectifiers—such as the popular VB, CTN, FW, and FWL types—to hard-to-find items like our 2.5 amp rectifiers.

Then there's performance — it's even higher than before. Our rectifiers have higher forward-current capacity and lower reverse leakage. And our Zener line has higher wattage ratings and sharper knee characteristics.

And don't forget Mallory semiconductor prices: they're just about unbeatable . . . take our focus rectifiers and epoxy case rectifiers, for example.

So specify Mallory for silicon rectifiers, prepackaged rectifiers (voltage doublers, center-tapped full waves, full-wave bridges), color TV selenium rectifiers, Zener and dual-trigger diodes. Your Mallory distributor has them now.

**MALLORY**

**MALLORY DISTRIBUTOR PRODUCTS COMPANY**

a division of P. R. MALLORY & CO. INC.  
Box 1568, Indianapolis, Indiana 46206; Telephone: 317-636-5353

Batteries · Capacitors · Controls · CRIME ALERT® · DURATAPE® · Recorders · Resistors · Semiconductors · SONALERT® · Switches · Timers

# Electronics World

MARCH 1971

VOL. 85, NO. 3

## Contents

### Electronics World



THIS MONTH'S COVER shows the three new Dolby-ized cassette decks that we tested and are reporting on in this issue. At the top left is the Harman-Kardon CAD-5; at the top right is the Fisher RC-80; and at the bottom right is the Advent 200. Complete details on performance and prices will be found in our report on these three products. Photograph by Dirone-Denner.



*Publisher*  
**LAWRENCE SPORN**

*Editor*  
**WM. A. STOCKLIN**

*Technical Editor*  
**MILTON S. SNITZER**

*Managing Editor*  
**PRISCILLA B. HOEFER**

*Associate Editor*  
**MURRAY SUNTAG**

*Contributing Editors*  
**WALTER H. BUCHSBAUM**  
**Prof. ARTHUR H. SEIDMAN**  
**FOREST H. BELT**

*Art Editor*  
**RICHARD MOSS**

*Technical Illustrator*  
**J. A. GOLANEK**

*Advertising Manager*  
**JOSEPH E. HALLORAN**

*Advertising Service Manager*  
**MARGARET DANIELLO**

*Assistant Publisher*  
**J. ROYCE RICHARD**

*Group Vice President*  
*Electronics & Photographic*  
**FURMAN H. HEBB**

- 25** EW Lab Tests New Dolby-ized Cassette Decks *Julian D. Hirsch*
- 29** Triggering Logic Circuits *James E. McAlister*  
A collection of simple circuits used to keep logic elements from being triggered incorrectly because of contact bounce in relays, push-buttons, and toggle switches.
- 30** Recent Developments in Electronics
- 32** Digital Instruments *Donald L. Steinbach*  
**Part 6. More About Electronic Counters**
- 34** EW Lab Tests Volt-Ohm-Milliammeters *Julian D. Hirsch*  
A survey of v.o.m.'s, including their features, performance, and prices. Included are measurements on eighteen of newest models from half-dozen manufacturers
- 39** CATV—Its Future Starts Now *Walter H. Buchsbaum*  
Will wired, cable television take over from on-the-air TV? Some answers may be found in trend-setting installations in New York City and Akron, Ohio.
- 42** How to Locate Buried-Conductor Faults *John T. Bailey*  
Although the electronics man doesn't usually work with buried cables, he can use his knowledge of bridge circuits and a.c. v.t.v.m.'s to find underground faults.
- 43** Color TV for 1971 (Part 2) *Forest H. Belt*
- 50** The "Perfect" Customer *John Frye*
- 62** Make Your Own Integrated-Circuit Modules *Frank H. Tooker*
- 70** Solid-State Probe Thermometer *Gordon Gregg*
- 
- 7** Reader Service Page
- 12** EW Lab Tested  
Harman-Kardon "Citation 12" Stereo Amplifier  
Advent "Advocate 101" Noise-Reduction Unit
- 59** Test Equipment Product Report  
Hy-Tronix Model 900 Automatic Transistor Analyzer  
E.F. Johnson Model 250 CB Transceiver Tester  
Sencore PM-157 A C Power Monitor

### MONTHLY FEATURES

- 4** Coming Next Month **22** Letters
- 5** Radio & Television News **52** Books
- 74** New Products & Literature

Copyright ©1971 by Ziff-Davis Publishing Company. All rights reserved



# what does TDK® stand for\*...



TDK stands for cassettes with wider frequency response, low noise, low distortion and greater dynamic range—not to mention freedom from tape jamming and dropouts.

That's because TDK's SD Super Dynamic tapes are made with ultra-fine magnetic oxides—up to 8 times as many particles per inch of tape as ordinary cassettes—and because our cassettes are precision engineered for easier, smoother tape flow.

TDK SD tape is available in 30, 60 and 90 minute cassettes and is sold by all leading audio, music, department & camera stores.

You'll learn more about TDK's Super Dynamic Tape, and how to get the most from all cassettes in a free booklet you'll find at your TDK Dealer. Or write to:

**TDK ELECTRONICS CORP.**  
23-73 48th Street,  
Long Island City, N.Y. 11103

\*TDK's initials stand for Tokyo Denki Kagaku, or Tokyo Electrical Engineering Company, recognized as a pioneer in ferric oxides for electronics.



World's leader in  
tape technology since 1932.

**TDK ELECTRONICS CORP.**  
LONG ISLAND CITY, NEW YORK 11103  
CIRCLE NO. 124 ON READER SERVICE PAGE

## Coming Next Month Special Feature Article



### HIRSCH-HOUCK LAB TESTS SOLID-STATE V.O.M.'s

These test instruments—used by service and maintenance technicians in many fields—are gaining wide popularity because of their convenience and compactness. Hirsch-Houck Labs has tested a number of available units especially suited for radio and TV servicing and reports on performance, specifications, and special features of each of these transistorized units.

#### Behind the UL Label

Today's emphasis on consumer protection is "old hat" to Underwriters' Laboratories which has been protecting the consumer against hazardous products since 1894. How UL tests various consumer products, including such devices as radios, TV sets, microwave ovens, phonographs, hand tools, etc., is revealed in this timely story.

#### Multi-set TV/FM Systems for the Home

Eliminate clutter and improve reception by installing a multi-set system in your home. What's available in the way of active and passive couplers, splitters, combiners, baluns, and complete signal-distribution systems is covered by Thomas R. Haskett in this comprehensive and informative survey.

#### Unusual— But Useful— Digital Circuits

What happens when you need a resistor-transistor logic element and you have none on hand? Here is a collection of digital circuits that have been designed to serve as substitutes in RTL setups operating at speeds up to 100 kHz at the input.

All these and many more interesting and informative articles will be yours in the April issue of *ELECTRONICS WORLD* . . . . on sale March 18th

### ZIFF-DAVIS PUBLISHING COMPANY

William Ziff, President  
W. Bradford Briggs, Executive Vice President  
Hershel B. Sarbin, Senior Vice President and Secretary  
Stanley R. Greenfield, Senior Vice President  
Philip Sine, Financial Vice President and Treasurer  
Walter S. Mills, Jr., Vice President, Circulation  
Phillip T. Heffernan, Vice President, Marketing  
Frank Pomerantz, Vice President, Creative Services  
Arthur W. Butzow, Vice President, Production  
Edward D. Muhfeld, Vice President, Aviation Division  
Irwin Robinson, Vice President, Travel Division  
George Morrissey, Vice President  
Sydney H. Rogers, Vice President

Editorial and Executive Offices  
One Park Avenue  
New York, New York 10016  
212 679-7200

NEW YORK OFFICE  
212 679-7200  
Joseph E. Halloran, Adv. Mgr.

MIDWESTERN OFFICE  
307 North Michigan Avenue  
Chicago, Illinois 60601 312 726-0692  
George B. Mannion, Jr.

WESTERN OFFICE  
9025 Wilshire Boulevard  
Beverly Hills, California 90211  
213 CRestview 4-0265; BRadshaw 2-1161  
Western Advertising Manager, Bud Dean

JAPAN: James Yagi, Oji Palace Aoyama  
6-25, Minami Aoyama, 6-Chome, Minato-ku  
Tokyo 407-1930/6821

CIRCULATION OFFICE  
P.O. Box 1093, Flushing, N.Y. 11352



Member  
Audit Bureau of  
Circulations

Radio & TV News • Radio News • Radio-Electronic Engineering Trademarks Reg. U.S. Pat. Off.  
SUBSCRIPTION SERVICE: Forms 3579 and all subscription correspondence should be addressed to Electronics World, Circulation Department, P.O. Box 1093, Flushing, N.Y. 11352. Please allow at least six weeks for change of address. Include your old address, as well as new—enclosing if possible an address label from a recent issue.  
EDITORIAL CONTRIBUTIONS must be accompanied by return postage and will be handled with reasonable care; however publisher assumes no responsibility for return of safety of art work, photographs, or manuscripts.  
ELECTRONICS WORLD (March, 1971), Vol. 85, No. 3) Published monthly at One Park Avenue, New York, New York 10016, by Ziff-Davis Publishing Company—also the publishers of Airline Management and Marketing Including American Aviation, Boating, Business & Commercial Aviation, Car and Driver, Cycle, Flying, Modern Bride, Popular Electronics, Popular Photography, Skiing, Skiing Area News, Skiing Trade News, Stereo Review, and Travel Weekly. One year subscription rate for U.S., U.S. Possessions, and Canada, \$7.00; all other countries, \$8.00. Second Class postage paid at New York, N.Y. and at additional mailing offices. Authorized as second class mail by the Post Office Department, Ottawa, Canada and for payment of postage in cash.

ELECTRONICS WORLD

# Radio & Television NEWS

By MURRAY SUNTAG/Associate Editor

## Technology Graduates Fare Well

According to survey conducted by the Engineering Manpower Commission of Engineers Joint Council, starting salaries for new engineering technicians and technologists, despite economic downturn, showed an increase. Graduates of two-year program averaged \$616 per month while those with bachelor's degrees averaged \$806. Average salary compared favorably with the \$862 per month received by bachelor-degreed engineers. Salaries, which varied considerably, were found to be directly related to curriculum and type of school, with some institutions reporting offers of above \$1000 per month to their graduates.

Bachelor of technology programs are designed to prepare men and women for technical and managerial positions in industry which do not require as rigorous a science and mathematics background as typical engineering jobs. A copy of this 40-page report, "Prospects of Engineering and Technology Graduates—1970," may be obtained from Engineers Joint Council, Department "PT," 345 East 47th Street, New York, N.Y. 10017 at \$2.00 per copy, postage prepaid.

## Microwaves Protect Grade Crossings

One little-known fact, especially to urbanites, is that of the 225,000 railroad grade crossings in U.S. 180,000 are without automatic protection. As a result, the ratio of death to injury in grade-crossing accidents is second only to aviation accidents and approximately 15 times greater than highway accidents in general. Why isn't something done about it? Well, up to now the only excuse for lack of adequate grade-crossing protection has been the high cost of buried-cable electrical systems now in use.

To remedy this anachronistic condition, the U.S. Department of Transportation at Cambridge, Mass., reflecting government's increasing concern for its citizens, is conducting exploratory research into a highly reliable economical microwave system to protect unguarded railroad grade crossings. This system, which can operate in all types of weather, would transmit a continuous microwave signal from up-track to grade crossing. When train triggers a sensor, the microwave signal is turned off and the grade-crossing warnings—flashing lights or gates—are activated. System will also be capable of indicating to motorist the length of train and suggest, through a signal, that he consider an alternate route, be flexible enough to allow for varying speeds of trains, and give motorist a consistent 25 or 30 second warning regardless of train's speed. In addition, although this represents only one system for a much-too-long-ignored condition, it also opens up an area where aerospace and defense engineering know-how could effectively be put to use. (See February's "Radio & Television News" item, "Taking Up the Slack.")

## CBS's EVR Team Grows

*Hitachi, Ltd.* of Tokyo, Japan, in a license agreement with The EVR Partnership of London, joins CBS's EVR international team. T. Yoshida, executive managing director of *Hitachi*, affirmed his belief in EVR's future by pledging his company's resources for manufacturing and marketing EVR teleplayers for both the Japanese market and other countries throughout the world. Other members of the EVR teleplayer manufacturing team are: the *Rank Organization* for the United Kingdom, *Robert Bosch, GmbH* for Germany, *Thomson C.S.F.* for France, *Industrie A. Zanussi* for Italy, and a consortium of *Luxor, Bonnier, and Esselte*, formed as *A.v.s. Norden* for Switzerland. The senior member of this team is *Motorola Inc.*, for North America, under license from the *CBS Electronic Video Recording Division*.

## Atomic Battery

Before the Apollo 12 astronauts blasted off the moon's surface they deployed an "atomic battery" called SNAP-27 to power the experiments left on the moon. SNAP-27, which is a compact radio-isotope thermo-electric generator (RTG), was built by *General Electric's Space Systems* to provide 63.5 watts of electrical power for one year. When left on moon last year it produced 73.59 watts of power during the 170°F lunar days and 73.98 watts in the -280°F nights. Latest checks indicate that after one complete year of operation, the generator continues to provide over 70 watts of power. According to A.J. Arker, *GE's* manager of Isotope Power Systems Operation, "The SNAP-27 has exceeded all requirements and barring any unforeseen conditions on lunar surface, it will continue to generate power at the design level for the next five or six years."

The SNAP-27 contains no moving parts and weighs 43 pounds (slightly over 7 pounds on moon). Electric power is produced by inserting a plutonium-238 heat source into a thermopile composed of lead-telluride thermocouples. The thermocouples produce electricity when a temperature difference is maintained across their length. GE is now in the process of designing a Multi-Hundred Watt RTG (MHW-RTG) that will generate 100-200 watts of continuous power for up to 12 years. Modular in construction, it will provide a basic building block for space power systems up to 1000 watts for advanced weather, earth resources, and communications satellites, as well as for the "Grand Tour" interplanetary exploration scheduled for late 1970's.

Just a thought, but wouldn't it be nice if we could develop similar, but less expensive editions of these batteries for such mundane things as electric cars?

## Computers and Genetics

With the aid of a space-age computerized process, developed at Caltech's Jet Propulsion Laboratory, man may soon be able to get a better picture of his genetic makeup. A JPL scientific team, headed by Drs. Kenneth R. Castleman and Robert Nathan, has devised a system whereby pictures of the chromosomes in a human blood cell (46 in all) can be analyzed in three minutes—about one-tenth the time required to do the same job manually. Since the chromosomes are the tiny bodies that contain the basic patterns for life—the genes—this speedy, low-cost procedure will make it feasible to perform blood tests on newborn infants and people contemplating marriage to determine presence of any hereditary disorders. The chromosome-analysis procedure presently used is limited to only those *suspected* of hereditary disorders because it is both time-consuming and expensive.

Although the present system at JPL is too large for hospital and medical laboratory use (full-room size), design refinements currently being investigated will make it more desirable for clinical applications. It is anticipated that within a year or two commercial production of an economical chromosome-analyzing system, within the means of many hospitals and clinical laboratories, will evolve. Estimated price range for such a system would be from \$50,000 to \$90,000.

## Coming Events

For those scientists and engineers "orphaned" by sudden demise of the defense and aerospace industries and who are looking for new fields in which to make use of their special talents, their attendance at the 17th Annual Meeting & Equipment Exposition of the Institute of Environmental Sciences is suggested. The date April 26-30, the place—Biltmore Hotel, Los Angeles, Calif. A special mix of innovative environmental programs, including a two-phase series of technical sessions devoted to earth sciences and aerospace and military environmental science programs, will be presented. There will also be an ecology oriented three-day tutorial program with certification from a California college; an air-pollution seminar; and an equipment exposition. . . . And for those who found our last month's "Scanning Electron Microscopes" article interesting and with their appetites whetted in that area, a Fourth Annual Scanning Electron Microscope Symposium is scheduled for April 27-29 in Chicago. Symposium is sponsored by IIT Research Institute. Quantitative information from the scanning electron microscope will be primary theme of symposium. Special sessions will treat dynamical techniques and applications of the SEM in practical problems. In addition, major SEM manufacturers will exhibit instruments and a special one-day workshop on "Forensic Applications of the SEM" will be held April 30, 1971, the day following the meetings. For those interested, contact Dr. Om Johari, Director, Fourth Annual SEM Symposium, IIT Research Institute, 10 W. 35th Street, Chicago, Ill. 60616.

## Bits and Pieces

*Rectilinear Research Corp.* has installed a direct telephone line to its plant from its exhibit at SEE 70, the permanent audio-industry showroom on Park Avenue, New York. Line is for convenience of visitors who would like to ask questions of the firm's engineering, sales, or other technical personnel. Telephone will be in operation weekdays from 9:00 a.m. to 5:00 p.m. Sign at exhibit will also note hours of operation and give regular telephone number should visitors wish to contact factory at other times. . . . New York's loss is Connecticut's gain. *General Telephone & Electronics Corp.* announced that its world headquarters (composed of its executive offices and six subsidiaries) will move from New York City to new 10-story building being constructed within the Stamford Forum. Approximately 1000 employees will be affected by move. . . . Dr. Robert Adler, *Zenith Radio Corporation* vice-president and director of research, received the "1970 Consumer Electronics Outstanding Achievement Award" during National Electronics Conference meeting held in Chicago on December 7-9. Award was presented to Dr. Adler for his "outstanding contribution to the consumer electronics industry through engineering achievements." ▲



# Electronics World

## READER SERVICE PAGE

### FREE INFORMATION SERVICE!

Here's an easy and convenient way for and to get additional information about products advertised or mentioned editorially (if it has a "Reader Service Number") in this issue. Just follow the directions below . . . and the material will be sent to you promptly free of charge.

**1** On coupon below, circle the number(s) that correspond(s) to the key number(s) at the bottom or next to the advertisement or editorial mention that is of interest to you. (Key numbers for advertised products also appear in the Advertisers' Index.) Print or type your name and address on the lines indicated.

**2** Cut out the coupon and mail it to:  
Electronics World,  
P.O. Box 7842,  
Philadelphia, Pa.  
19101

### NOTE:

If you want to write to the editors of ELECTRONICS WORLD about an article on any subject that does not have a key number, write to ELECTRONICS WORLD, One Park Avenue, New York, N.Y. 10016. Inquiries concerning circulation and subscriptions should be sent to ELECTRONICS WORLD, P.O. Box 1093, Flushing, N.Y. 11352

<b>Electronics World</b>																									Void 60 days after date of issue				
																									371				
P.O. Box 7842 Philadelphia, Pa. 19101																													
1	2	3	4	5	6	7	8	9	10	11	12	13	14	15	16	17	18	19	20	21	22	23	24	25					
26	27	28	29	30	31	32	33	34	35	36	37	38	39	40	41	42	43	44	45	46	47	48	49	50					
51	52	53	54	55	56	57	58	59	60	61	62	63	64	65	66	67	68	69	70	71	72	73	74	75					
76	77	78	79	80	81	82	83	84	85	86	87	88	89	90	91	92	93	94	95	96	97	98	99	100					
101	102	103	104	105	106	107	108	109	110	111	112	113	114	115	116	117	118	119	120	121	122	123	124	125					
126	127	128	129	130	131	132	133	134	135	136	137	138	139	140	141	142	143	144	145	146	147	148	149	150					
Name (Print Clearly) _____ Title _____																													
Company Name _____																													
Address _____																													
City _____ State _____ Zip Code _____																													
sa																													

<b>Electronics World</b>																									Void 60 days after date of issue				
																									371				
P.O. Box 7842 Philadelphia, Pa. 19101																													
1	2	3	4	5	6	7	8	9	10	11	12	13	14	15	16	17	18	19	20	21	22	23	24	25					
26	27	28	29	30	31	32	33	34	35	36	37	38	39	40	41	42	43	44	45	46	47	48	49	50					
51	52	53	54	55	56	57	58	59	60	61	62	63	64	65	66	67	68	69	70	71	72	73	74	75					
76	77	78	79	80	81	82	83	84	85	86	87	88	89	90	91	92	93	94	95	96	97	98	99	100					
101	102	103	104	105	106	107	108	109	110	111	112	113	114	115	116	117	118	119	120	121	122	123	124	125					
126	127	128	129	130	131	132	133	134	135	136	137	138	139	140	141	142	143	144	145	146	147	148	149	150					
Name (Print Clearly) _____ Title _____																													
Company Name _____																													
Address _____																													
City _____ State _____ Zip Code _____																													
sb																													

# NRI “hands-on” training in TV-Radio, Electronics can give you as much as 2 years of on-the-job experience.

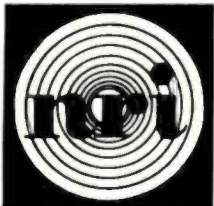

## EARN YOUR FCC LICENSE – OR YOUR MONEY BACK

NRI Communications training programs will qualify you for a First Class Commercial Radiotelephone License issued by the FCC. If you fail to pass the FCC examinations for this license after successfully completing an NRI Communications course we will, on request, refund in full the tuition you have paid. This agreement is valid for the period of your active student membership and for *six months* after completion of your training. No school offers a more liberal FCC License agreement.



# Experience is still your best teacher



**NRI Achievement Kit** is educator-acclaimed and the original "starter" kit in home study training. Imitated but never duplicated, this kit is designed and personalized for you and your training objective. It has one purpose — to get you started quickly and easily.



**"Bite-Size" Texts** average an easily-digested 40 pages of well-illustrated, scientifically prepared subject matter in the course of your choice. Questions in each book are carefully hand-graded and returned to you with helpful instructional notes. You get unlimited personal help from the day you enroll.



## Designed-For-Learning Equipment

Like this phone-cw transmitter (Kit #7 in the Communications course) is engineered from chassis up to demonstrate principles you must know. NRI does not use modified hobby kits for training, but the finest parts money can buy, professionally and educationally applied.

March, 1971

*...here's how you get it with unique NRI training at home*

Ask any teacher, job counselor, engineer, technician or prospective employer about the need for practical application of theory in Electronics. He'll tell you Electronics is as much a "hands-on" profession as dentistry or chemistry. That's how you learn at home with NRI. You prove the theory you read in "bite-size" texts, by actual experimentation with the type of solid-state, transistor and tube circuits you'll find on the job today — *not* hardware or hobby kits. You introduce circuit defects, analyze results, discover quickly the kind of trouble-shooting and design techniques that will make you employable in Electronics.

## Train with the leader — NRI

NRI lab equipment is designed from chassis up for effective, fascinating training — not for entertainment. The fact that end results are usable, quality products is a bonus. In Communications, for example, you build and analyze, stage by stage, your own 25-watt phone/cw transmitter. It's suitable for use on the 80-meter amateur band, if you have an interest in ham radio. In TV-Radio Servicing your practical training gives you your choice of monochrome or color TV sets. All training equipment is included in the low tuition — you pay nothing extra. Discover for yourself the ease, excitement and *value* of NRI training. Mail postage-free card today for new NRI Catalog . . . or use the coupon below. No obligation. No salesman will call on you. NATIONAL RADIO INSTITUTE, Washington, D.C. 20016.

### APPROVED UNDER NEW GI BILL

If you have served since January 31, 1955, or are in service now, check GI line on postage-free card or in coupon.

MAIL THIS COUPON IF CARD IS GONE

	<b>NATIONAL RADIO INSTITUTE</b> Washington, D.C. 20016		2-031
	Please send me your new NRI Catalog. I understand no salesman will call and there is no obligation.		
Name _____		Age _____	
Address _____			
City _____		State _____	Zip _____
<input type="checkbox"/> Check for facts on new GI Bill <b>ACCREDITED MEMBER NATIONAL HOME STUDY COUNCIL</b>			

# HI-FI PRODUCT REPORT

## EW LAB TESTED

by Hirsch-Houck Labs

Harman-Kardon "Citation 12" Stereo Amplifier  
Advent "Advocate 101" Noise-Reduction Unit

### Harman-Kardon "Citation 12" Stereo Amplifier

For copy of manufacturer's brochure,  
circle No. 1 on Reader Service Page.



MANY audiophiles remember the Citation Series of components produced by *Harman-Kardon* nearly a decade ago. In those pre-transistor times, the Citation 2 power amplifier was a huge, sixty-pound brute, but it delivered over 60 continuous watts per channel with extremely low distortion. With the advent of transistors, the Citation 2 and its fellows became obsolete, but now *Harman-Kardon* has re-introduced the Citation name on its top-quality line of audio components.

The first of the new units is the Model 12, a basic stereo power amplifier. Although it is roughly equivalent to the old Model 2 in power rating, it outperforms it in every respect, but is a fraction of its size and weight. Even the price, adjusted for the inflation of the past decade, has not changed materially.

The Citation 12 is rated at 60 watts per channel, continuous output. Each channel has its own power supply, with the two sharing nothing but the line cord, so that it makes no difference whether one channel or two are driven. The packaging is compact and attractive, with all amplifier connections except the line cord coming from the front, where the four output transistor heat sinks are also located. The amplifier measures  $5\frac{7}{16}$ " high  $\times$   $12\frac{5}{16}$ " wide  $\times$   $12\frac{5}{8}$ " deep and weighs about 30 pounds. It has no controls—not

even a power switch—and must be fully controlled from the associated preamplifier.

The amplifier circuit is direct-coupled throughout, except for the input blocking capacitor. The differential input amplifier receives the signal on one input (at a 30k-ohm input impedance) and the negative feedback from the output on the other. Since the feedback is direct-coupled, the average voltage across the speaker is maintained at d.c. ground, within a fraction of a volt. Following the input are the pre-driver and driver stages, and the output amplifier which uses a pair of husky silicon power transistors. Except for the output stages and power supplies, the amplifier is constructed on a single printed-circuit board.

The unit is thoroughly protected against damage from output shorts or overloads. The power-transformer primaries are individually fused, with a thermal circuit breaker in series with each fuse sensing the operating temperature of the output transistors in that channel. If it rises above 80 degrees C, the power is interrupted. In series with each speaker line is a current-limiting relay which opens when excessive current is drawn by the load and resets when the overload is removed. In addition, the output transistors are operated at about half their maximum ratings. During our extended full-power measurements, the thermal breakers opened and we repeatedly shorted the outputs to trip the relays. We did not succeed in damaging the amplifier in any way.

The rated frequency response is  $\pm 0.5$  dB from 1 Hz to 70 kHz. We measured it as  $\pm 0.1$  dB from 5 Hz to 50 kHz, down 1 dB at 100 kHz, and down 3 dB at 200 kHz. The unusually extended low-frequency response of the amplifier implies a very low phase shift in the audio band and this was emphasized by the response to square waves as low as 20 Hz, which had very little "tilt." *Harman-Kardon's* philosophy is that low phase shift is important throughout the audible range. This is certainly expressed admirably in this unit, whose low-frequency phase shift is unmatched by any hi-fi amplifier we know of. Its high-frequency phase shift and square-wave response are also excellent.

The amplifier is rated at less than 0.2% distortion between 20 Hz and 20 kHz at 60-watts output into 8 ohms. This was most conservative, as our tests showed. We measured the harmonic distortion at less than 0.07% under

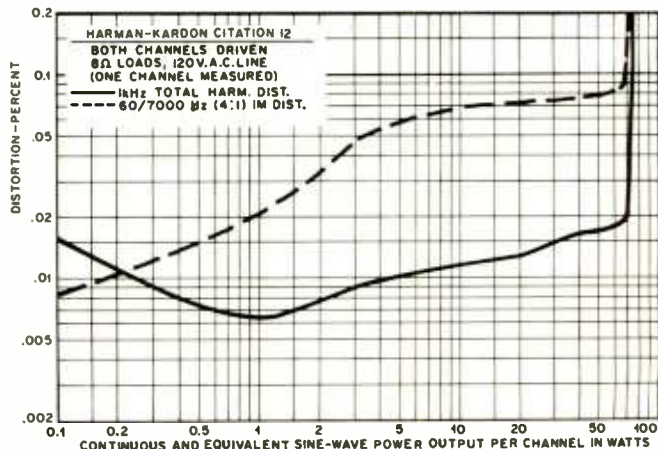
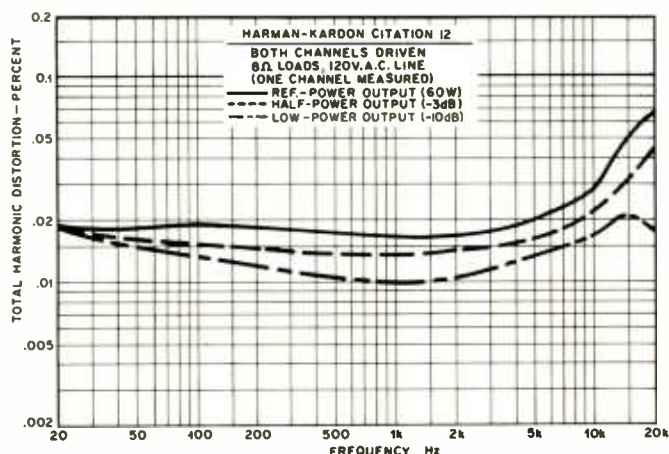



## ELECTRONICS TECHNICIANS:

If you really want  
to go places in this  
Age of Electronics...

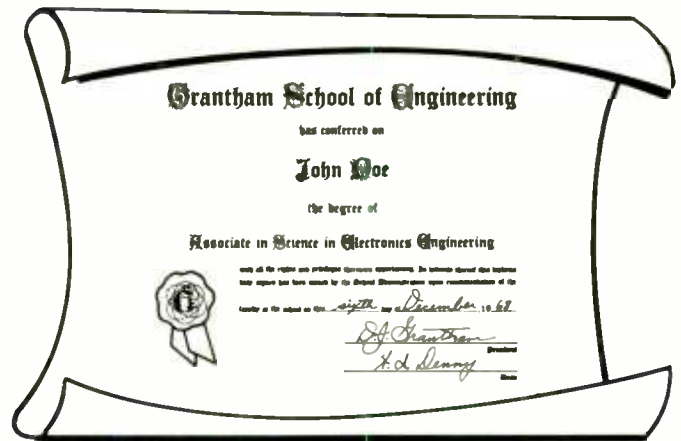

# EARN YOUR DEGREE

## AND GET INTO ELECTRONICS ENGINEERING!

Advance beyond the technician level. Become an engineer. If you are a high school graduate and have at least one year of experience as an electronics technician, you can earn the Degree of Associate in Science in Electronics Engineering

## MOSTLY BY STUDYING AT HOME

while you remain on your present job. Grantham School of Engineering (GSE) offers a home-study program, followed by a two-week class, for the ASEE Degree. This degree is accredited by the Accrediting Commission of the National Home Study Council.

In this college-level program (presented at the same level as resident-college engineering courses), the lessons have been prepared especially for *home study*. They have been written, revised, added-to, revised, expanded, revised, re-oriented, revised, etc., over a period of many years, by home-study experts in the teaching of engineering, with the one objective of providing a *better way* for technicians to learn engineering.

This *accredited* ASEE Degree program includes a review of basic electronic circuits and systems, a thorough coverage of applied engineering mathematics (including algebra, trigonometry, and calculus), classical and modern physics, technical writing, computer science, electrical networks, and semiconductor circuit analysis and design.

We award the *associate* rather than the bachelor's degree because our educational program covers only engineering and engineering-related subjects and does not cover general subjects such as English, History, Foreign Languages, etc. Notice, however, that it is a degree in *engineering* rather than the usual junior-college kind of associate degree.

### We Teach Better Because We Specialize

The main purpose of the GSE educational program is to *upgrade* electronics technicians to the *engineering level*. Therefore, as a GSE student, you are not, for example,

studying math with accounting students or studying physics with medical students. Instead, all of the lessons covering all subjects are written for students just like yourself — for electronics technicians upgrading to the engineering level. This method allows electronics engineering examples and applications to be tied in with the study of all subjects in the curriculum.

Since all of our students have backgrounds similar to yours and the same professional objective as yours, we can teach all of the required subjects more directly to the point — the way they should be taught (for maximum advantage) specifically to electronics technicians who are upgrading to the engineering level — not generalized to the extent that they apply equally well to a dozen different professions! So *our way* of teaching electronics engineering is more applicable to *your need*.

For complete details, mail postcard or coupon.

### Grantham School of Engineering

EW-3-71

1505 N. Western Ave., Hollywood, Calif. 90027

Gentlemen:

I have been in electronics for \_\_\_\_\_ years. I am interested in the Grantham degree program in Electronics Engineering. Please send me your free bulletin.

Name \_\_\_\_\_

Address \_\_\_\_\_

City \_\_\_\_\_ State \_\_\_\_\_ Zip \_\_\_\_\_

CIRCLE NO. 140 ON READER SERVICE PAGE

these conditions. Below about 5 kHz, it was less than 0.02% at any power up to 60 watts per channel. The 1-kHz harmonic distortion was 0.016% at 0.1 watt, falling to 0.006% at 1 watt and increasing to only 0.02% at 70 watts. The clipping power level was 74 watts, with distortion under 0.1% up to that point. Into 4 ohms, the output was 103 watts per channel; into 16 ohms it was 44 watts.

An input of 0.48 volt was needed for 10-watts output, with hum and noise 35 dB below that level. The ampli-

fier was completely stable and remarkably free from "bugs."

Needless to say, the *Harman-Kardon* Citation 12 can drive the least efficient speaker systems without strain. Even in this day of "state-of-the-art" amplifiers, it ranks with the two or three best we have seen. It sells in kit form for \$225, and appears to be simple to construct. It is also offered factory-wired for \$295. A two-year warranty applies to all parts and, in the case of the factory-wired model, to labor as well. ▲

**Advent "Advocate Model 101" Noise-Reduction Unit**  
*For copy of manufacturer's brochure, circle No. 2 on Reader Service Page.*

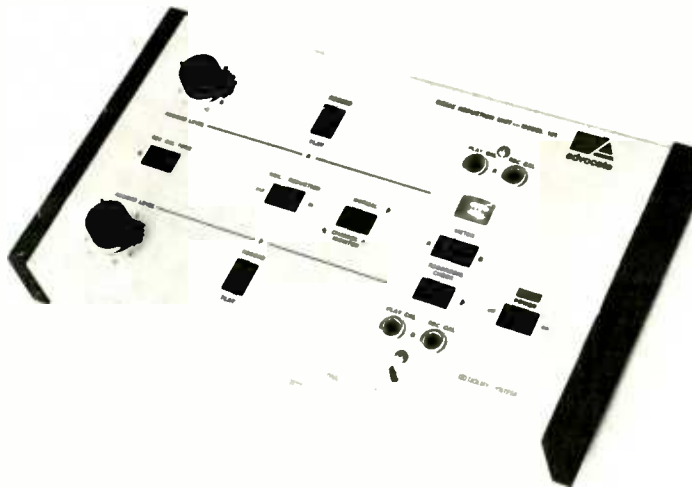

**T**HE Advocate Model 101 noise-reduction unit, a product of *Advent Corporation*, is a "B-Type" Dolby system signal processor which provides up to 10-dB of noise reduction in home tape recording. It is connected between the signal source and the recorder inputs and between the recorder outputs and the amplifier.

Since the same Dolby circuits are used for recording and playback, the Model 101 contains two identical sections (for the two stereo channels), with switches to change them from recording to playback modes. After calibration to standard playback and recording levels, the circuits have a flat response at 0 dB (the Dolby reference level). In recording operation, as signal level is reduced, the frequencies above 600 Hz are progressively boosted. In playback, lower signal inputs produce a roll-off above 600 Hz. Both actions are automatic, effectively instantaneous, and undetectable by the listener.

The recording and playback circuits have identically shaped but complementary response characteristics at all signal levels. The reduction in high-frequency output during playback cancels the recording boost, leaving the overall system response unaffected. However, any hiss introduced in the tape-recorder circuits is reduced by the system during playback. The maximum reduction is approximately 3 dB at 600 Hz, increasing to a value of 10 dB at 4 kHz and higher frequencies.

Since the Model 101 must be manually switched from record to playback operation, it cannot be used to monitor a program from the tape while recording on a three-head machine. This facility, as well as microphone inputs and mixing, is offered on the considerably more expensive *Advent* Model 100. The Model 101 does have a monitor switch which can be used with a three-head recorder to simultaneously record and play back through the system, but on one channel only. Since most recording will probably be done in stereo, this is of limited value, but it is convenient for comparing the noise levels with the system switched on or off. This is something that every new owner of a unit

should do at least once to convince himself of the effectiveness of the system.

The Model 101 is supplied with both reel and cassette playback calibration tapes. A template fitting over the panel shows the correct control positions for playback and record calibration. Once calibrated, the process need not be repeated unless a change is made in the recorder, the type of tape used, or the settings of the recorder controls.

The calibration process is simple. The reference tape or cassette, which contains a 0-dB level 400-Hz signal, is played and the "Play Cal" adjustments are set for a reading of 8 on the meter, which is switched between channels. Then with the regular tape in the recorder, a 400-Hz, 0-dB reference signal from an oscillator in the Model 101 is recorded and played back. If the meter does not read 8, the "Rec Cal" controls are set in successive approximations until they produce the correct

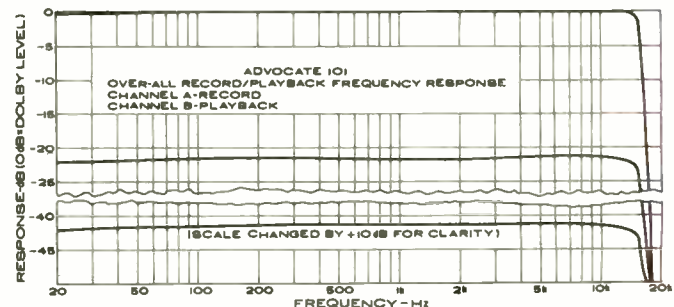
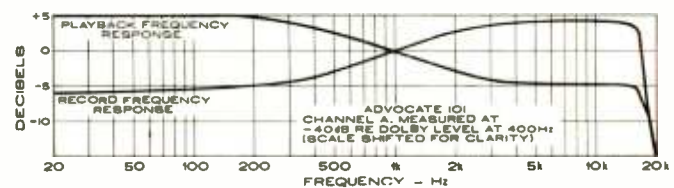



# 10 million reasons why it pays to promote matrix, the brightest, sharpest color picture tube in RCA history!

Reasons 1 to 10,000,000. Large-screen MATRIX can upgrade the performance of at least 10 million color TV sets now in use. The RCA MATRIX 23VALP22 is a direct replacement for the 23VANP22, 23VARP22, 25AP22A, 25BAP22 (Chromacolor), 25BCP22, 25BGP22, 25XP22, and 45 other industry types! Giant-screen sales potential for the RCA MATRIX—practically unlimited!

More RCA Color Picture Tubes are stocked and sold by

distributors than any other color picture tubes in the industry. So, MATRIX is more readily available to you no matter where you are, to give your customers faster service and ring up more profitable sales.

MATRIX is the brightest and sharpest color picture tube in RCA history!

Here's why:

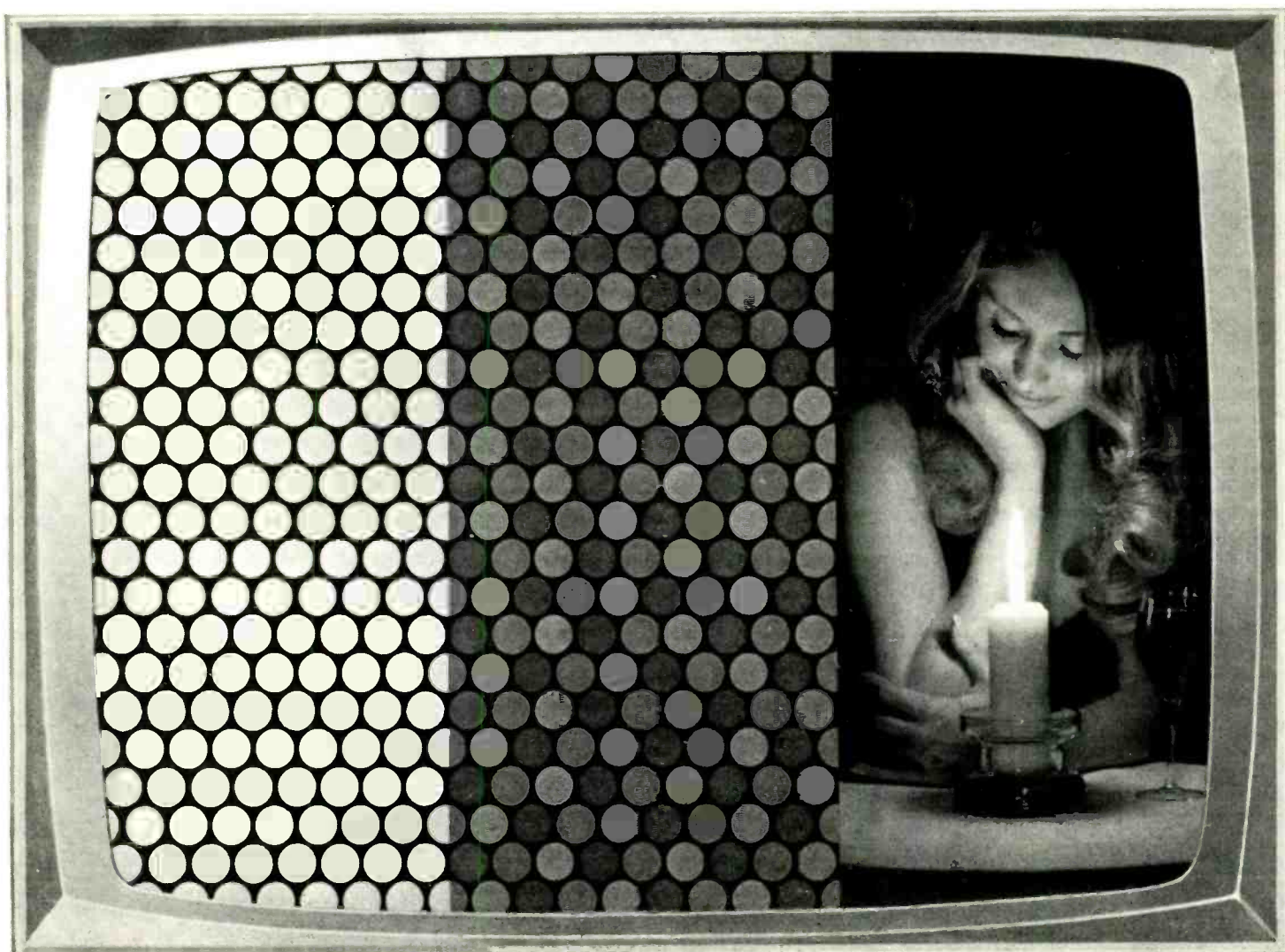

#### The RCA jet-black matrix®

It soaks up room-light normally reflected back at the viewer from the face of the tube. Result: brighter pictures because now there's no need to "filter out" brightness to maintain contrast under strong room-light conditions.

#### The RCA MATRIX phosphor-dot process®

First, we developed brilliant new phosphors and a unique screening process incorporating a jet-black matrix. Then we deposited the 1,200,000 red, green, and blue high-intensity phosphor dots precisely within the black matrix. Result: brightness doubled with dramatic improvement in contrast and clarity.

#### The RCA MATRIX picture®

Spectacular! In operation, a new, unique high-resolution gun "shoots" the phosphors with more energy than any other gun previously available. Result: black matrix + phosphors + high-resolution gun = maximum sharpness over the entire brightness range, truer colors under all viewing conditions.



New 4-color consumer flyer on MATRIX is available from your RCA Distributor.  
RCA | Electronic Components | Harrison, N. J. 07029

\*Magnified drawing \*\*Simulated

# RCA



## Need high temperatures in tiny places?

The amazing Little Torch is so tiny it can throw a flame of 6300°F. through the eye of a needle. It solders, brazes, welds and heats with exacting precision in the smallest places; uses oxygen and acetylene,

hydrogen, propane, natural gas or Mapp. It's available with five tips ranging in size from one large enough to weld 16 ga. steel to one small enough to weld .002" copper wire. For free brochure write to:



Dept. 333-1 2633 S.E. 4th St., Minneapolis, Minnesota 55414  
CIRCLE NO. 120 ON READER SERVICE PAGE

## Build this pipelike Schober Recital Organ



for only  
\* \$1850!

\*Includes finished walnut console. (Only \$1446 if you build your own console.) Amplifier, speaker system, optional accessories extra.

You couldn't touch an organ like this in a store for less than \$4,000—and there never has been an electronic instrument with this vast variety of genuine pipe-organ voices that you can add to and change any time you like! If you've dreamed of the sound of a large pipe organ in your own home, if you're looking for an organ for your church, you'll be more thrilled and happy with a Schober Recital Organ than you could possibly imagine—kit or no kit.

You can learn to play it—and a full-size, full-facility instrument is easier to learn on than any cut-down "home" model. And you can build it, from Schober Kits, world famous for ease of assembly without the slightest knowledge of electronics or music, for design and parts quality from the ground up, and—above all—for the highest praise from musicians everywhere.

Send right now for the full-color Schober catalog, containing specifications of all five Schober Organ models, beginning at \$499.50. No charge, no obligation. If you like music, you owe yourself a Schober Organ!

The Schober Organ Corp., Dept. RN-87  
43 West 61st Street, New York, N.Y. 10023

- Please send me Schober Organ Catalog and free 7-inch "sample" record.
- Enclosed please find \$1.00 for 12-inch L.P. record of Schober Organ music.

NAME \_\_\_\_\_  
ADDRESS \_\_\_\_\_  
CITY \_\_\_\_\_ STATE \_\_\_\_\_ ZIP \_\_\_\_\_

CIRCLE NO. 126 ON READER SERVICE PAGE

## ELECTRONIC TECHNICIANS!

Raise your professional standing and prepare for promotion! Win your diploma in

## ENGINEERING MATHEMATICS

from the Indiana Home  
Study Institute

We are proud to announce two great new courses in Engineering Mathematics for the electronic industry.

These unusual courses are the result of many years of study and thought by the President of Indiana Home Study, who has personally lectured in the classroom to thousands of men, from all walks of life, on mathematics, and electrical and electronic engineering.

You will have to see the lessons to appreciate them!

NOW you can master engineering mathematics and actually enjoy doing it!

WE ARE THIS SURE: you sign no contracts—you order your lessons on a money-back guarantee.

In plain language, if you aren't satisfied you don't pay, and there are no strings attached.

Write today for more information and your outline of courses.

You have nothing to lose, and everything to gain!

## The INDIANA HOME STUDY INSTITUTE

Dept. EW-3, P.O. Box 1189, Panama City, Fla. 32401

CIRCLE NO. 137 ON READER SERVICE PAGE

reading. From this point on, the recorder's gain controls must not be disturbed; all recording gain adjustment is made with two controls on the Model 101. The recorder's level meters are used in the normal manner for recording.

We measured the frequency response of the Model 101 in recording and playback modes, at levels of 0 dB, -20 dB, and -40 dB. The recording and playback frequency-response curves showed the expected boost (or cut) above 600 Hz. More important is the matching of the two characteristics at all levels, which we checked by feeding the output of channel A ("Rec") through channel B ("Play"). The resulting over-all frequency response was flat, within  $\pm 0.5$  dB, from 20 Hz to 15 kHz at any level from 0 dB to -40 dB. A built-in notch filter removes any 19-kHz or 38-kHz components which might exist in the output of a stereo-FM tuner, and which could interfere with proper operation. The 19-kHz response was down more than 40 dB from the 15-kHz level.

The harmonic distortion, through both sections of the unit, was less than 0.02% at 0-dB level. The IM distortion at 0 dB was 0.40%, decreasing to 0.15% at -5 dB and to 0.08% or less at levels of -10 dB or below. The noise in the output of the Model 101 was unmeasurably low, less than 100 microvolts (75 dB below the 0-dB output level of 0.55 volt). An input of as little as 25 millivolts was sufficient to produce a 0-dB recording level, and any larger signal could be reduced with no danger of overload, since the level controls were ahead of all active circuits.

We used the unit with a good-quality cassette deck and a very high quality open-reel recorder. In both cases, an impressive reduction in hiss level was realized. With the cassette machine, the signal-to-noise ratio when playing back recorded stereo-FM broadcasts was essentially that of the received signal when using the Dolby system. The open-reel machine, operating at 3 $\frac{3}{4}$  in/s, had less internal noise than the stereo-FM signal, so that no benefit was realized from the Dolby in this case. However, when taping mono-FM or stereo records, the Model 101 provided a dramatic reduction of hiss, with either machine.

The unit is constructed in flat, book-like format, measuring 12 $\frac{3}{4}$ "  $\times$  7" and is 2 $\frac{1}{2}$ " high, including knobs and feet. Operating and calibration instructions are screened on the front edge of the unit, but after a brief period of use, there is no need to refer to them.

No matter how modest or how elaborate a home tape-recording installation may be, the Advocate Model 101 would be a most worthwhile addition to it. The price is \$125. ▲

ELECTRONICS WORLD



# 50% off on FET experimenter kits and the Siliconix FET handbook



**The Handbook:** The ink is barely dry on this one. It takes you from basic FET principles and manufacture through characterization and biasing to audio and RF amplifiers, VCRs, current limiters, switches, chopper and analog gates . . . just to mention a few. More than 30 practical circuits are shown. Additional references are included for those who want to go deeper into a given subject.

*KIT #1*

2N3368 Amplifier	1.40
2N4223 VHF Amplifier	1.50
E300 VHF Amplifier	1.40
U183 Amplifier	1.40
VCR7N VCR	2.25
CL2210 Current Limiter	3.25
and new FET Handbook	2.50
VALUE	\$13.70
<b>LIMITED-TIME PRICE</b>	
<i>Only \$16.50</i>	

*KIT #2*

2N3368 Amplifier	1.40
2N3437 Amplifier	1.90
E101 Amplifier	2.20
E300 VHF Amplifier	1.40
U202 Switch	2.95
VCR7N VCR	2.25
CL1020 Current Limiter	3.25
U234 Matched Dual FET	5.00
and new FET Handbook	2.50
VALUE	\$22.85
<b>LIMITED-TIME PRICE</b>	
<i>Only \$11.50</i>	

*KIT #3*

2N3370 Amplifier	2.15
2N5398 UHF Amplifier	4.50
E101 Amplifier	2.20
U184 HF Amplifier	2.75
U241 10 Ohm Switch	9.70
CL1020 Current Limiter	3.25
U234 Matched Dual Fet	5.00
LM201H Op. Amplifier	6.50
and new FET Handbook	2.50
VALUE	\$38.55
<b>LIMITED-TIME PRICE</b>	
<i>Only \$16.50</i>	

Kits may be purchased less handbook as noted on coupon. This is your half-price chance to really get to know FETs, so send in the coupon today!

**Siliconix**  
incorporated

2201 Laurelwood Rd. • Santa Clara, Calif. 95054  
(408) 246-8000 Ext. 201 • TWX: 910-338-0227

**SILICONIX INCORPORATED**

P.O. Box 185, Agnew Station—Santa Clara, Calif. 95054

Please send items as checked below, for which payment is enclosed. (Sorry, no Purchase Orders or CODs.)

<input type="checkbox"/> Kit #1 \$ 6.50	<input type="checkbox"/> Kit #1 Less Handbook \$ 5.00
<input type="checkbox"/> Kit #2 \$11.50	<input type="checkbox"/> Kit #2 Less Handbook \$10.00
<input type="checkbox"/> Kit #3 \$16.50	<input type="checkbox"/> Kit #3 Less Handbook \$15.00
<input type="checkbox"/> Handbook only \$2.50	

Name \_\_\_\_\_

Address \_\_\_\_\_

City \_\_\_\_\_ State \_\_\_\_\_ Zip \_\_\_\_\_

(California residents add 5% sales tax)  
Offer expires August 31, 1971

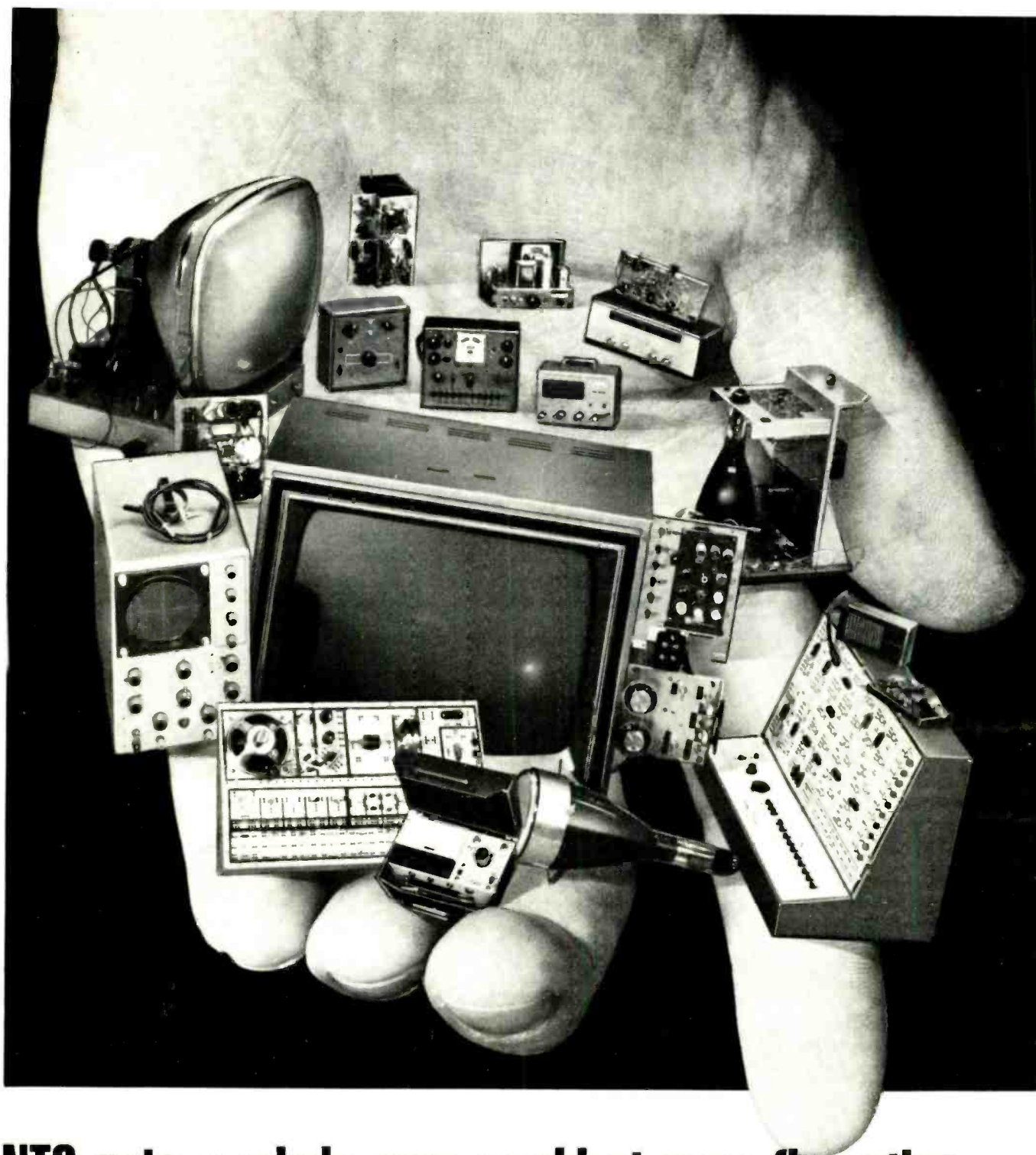

## NTS puts a whole new world at your fingertips.

NTS home training can put a whole new way of life in the palm of your hand. A new, exciting job, a much bigger income is now easily within your reach.

NTS training is something special. We provide all the kits you need for the most effective training. National Technical Schools sends kits with every course, and teaches you to build and test a

wide range of professional equipment — the same kind of equipment you'll actually use on the job.

That's the NTS "Project Method" — training that's practical and in-depth. You learn everything from fundamentals to the latest innovations. From beginning to end, NTS makes it fascinating and fun to learn this way. And all you need is a little

spare time and an interest in electronics.

Each year, men are moving into important new jobs, or their own businesses, straight out of NTS electronics training. NTS is what's happening to men everywhere. Check the coupon. Take hold of the career you want most. Do it now. No obligation. No salesman will call.



**We pack your electronics course with kits to make your training fast. You'll enjoy every minute of it.**

**NTS COLOR TV SERVICING**

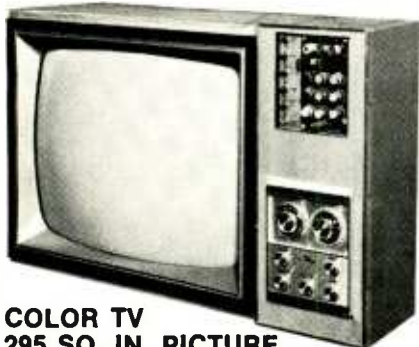

**COLOR TV  
295 SQ. IN. PICTURE**

NTS training provides an easy way to become a professional home-entertainment service technician. You receive a big screen Color TV with many unique features. The unit even includes self servicing equipment that permits you to make all normal test operations. No additional test equipment is needed for adjusting your set. In addition you get an AM-SW radio, Solid-State radio, Field-Effect Transistor Volt-Ohmmeter, and Electronic Tube Tester. You learn about Electronic principles and trouble shooting, hi-fi, multiplex systems, stereo, and color TV servicing.

**NTS COMPUTER ELECTRONICS**

This is the future. And it's happening now. The number of computers will increase many times in the next few years.

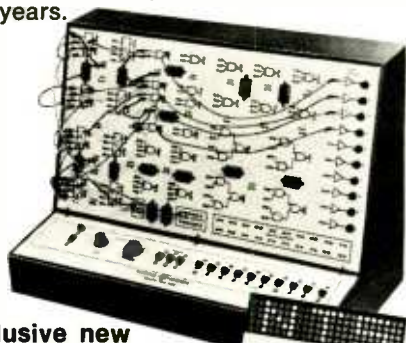

**Exclusive new Compu-Trainer®**

If card is missing check coupon and mail for free color catalog and sample lesson. Now.



**National Technical Schools**  
4000 S. Figueroa St., Los Angeles, Calif. 90037  
Please rush Free Color Catalog and Sample Lesson, plus information on course checked below. No obligation. No salesman will call.

NTS offers a solid grounding in computer operation, wiring, data processing and programming. One of the 10 important kits included is our exclusive Compu-Trainer®. It's a fully operational computer logic trainer — loaded with integrated circuits — the first ever offered in home study. It introduces you quickly to how, what, when and why of computers . . . from theory to practical servicing techniques. This unit is capable of performing 50,000 operations per second.

**NTS ELECTRONICS COMMUNICATIONS**

Choose from two exciting courses to get into the big-paying fields of transmitting and receiving equipment: (1) The FCC License Course. (2) The Master Course in Electronic Communications (more comprehensive, with Citizens' Band Two-Way-Radio). Either Communications program qualifies you for your FCC First Class Commercial Radio-Telephone License — *NTS assures you will pass this FCC exam within six months after successfully completing your course or your tuition is refunded.* Kits include an Amateur-Phone 6 Meter VHF Transceiver — NTS exclusive, 6 transistor Solid-State Radio, Volt-Ohmmeter (fully transistorized).



**5 Watt AM Transmitter/Receiver**

**NTS AUTOMATION/ INDUSTRIAL ELECTRONICS**

Let NTS put you into the age of electronic controls. Systems Automation is rapidly becoming the emphasis of modern industry. Your NTS training in automation electronics includes equipment like a 5" wide band Oscilloscope. You also get the new NTS Electronics Lab. It's an exclusive NTS experimental laboratory — a complete workshop that simplifies learning about solid-state, miniature and integrated circuits.



**5" Oscilloscope**

**CLASSROOM TRAINING AT LOS ANGELES**

You can take classroom training at Los Angeles in sunny Southern California. NTS occupies a city block with over a million dollars in facilities devoted exclusively to technical training. Check box in coupon.

**NATIONAL TECHNICAL SCHOOLS**  
WORLD-WIDE TRAINING SINCE 1905

4000 South Figueroa Street  
Los Angeles, Calif. 90037, U.S.A.

**APPROVED FOR VETERANS**

Accredited Member: National Association of Trade and Technical Schools; National Home Study Council.

- Master Course in Color TV Servicing
- Color TV Servicing
- Master Course in TV & Radio Servicing
- Practical TV & Radio Servicing
- Master Course in Electronic Comm.
- FCC License Course
- Master Course in Electronics Tech.
- Industrial and Automation Electronics
- Computer Electronics
- Basic Electronics

Name \_\_\_\_\_ Age \_\_\_\_\_

Address \_\_\_\_\_

City \_\_\_\_\_ State \_\_\_\_\_ Zip \_\_\_\_\_

- Check if interested in Veteran Training under new G.I. Bill
- Check if interested only in Classroom Training at Los Angeles

Dept 240-031

ALWAYS INSIST  
ON  
**CQC\***

\*CONTROLLED  
QUALITY  
CRYSTALS

for your Communications

THE  
"ON-CHANNEL"

CRYSTALS by

**CRYSTEK**



NOW YOU CAN  
**ZIP-ORDER**

THE CQC CRYSTALS YOU WANT

Your electronics dealer has new, fast, direct-factory ZIP-Order Purchase Certificates to enable you to get CRYSTEK CB, Monitor or Amateur Controlled Quality Crystals mailed direct to you promptly. Ask about them.

**CRYSTEK**  
formerly

TEXAS CRYSTALS

Div. Whitehall Electronics Corp.

1000 Crystal Drive  
Fort Myers, Florida 33901

4117 W. Jefferson Blvd.  
Los Angeles, California 90016

CIRCLE NO. 146 ON READER SERVICE PAGE

22

# LETTERS

## MORE ON 4-CHANNEL SOUND

To the Editors:

Your December editorial, "More on 4-Channel Sound," discusses some of the possible ways of matrixing to use two channels for increased dimensional benefits. Apparently because of lack of space many of the important details of my proposals were not included and I would like to add to what has been said.

First, I have suggested that front and back sound can be added to two conventional stereo channels and reproduced with a simple connection system of two extra speakers. Second, I have pointed out that in *existing* stereo material there is frequently extra dimensional material which can be brought out with these extra speakers. Your October issue contained a very simple presentation of this second idea.

Both of these ideas utilize an optional sum speaker in front and a difference speaker in the rear. The sum speaker provides the well-known "center-channel." As pointed out in your editorial, this reduces the spread between the left and right speakers. I have suggested that they then be placed farther apart in order to restore the spread and to get the benefit of three sound sources over a wide area rather than two sound sources over a narrow area. Information which is in both channels in the same phase will add in the center speaker.

The same information will cancel in the rear speaker which is connected to produce the *difference* of the two channels. I think that at this stage of recording art we can forget about the conditions of improper phase relationships between the two channels, as mentioned in your editorial. Should one channel be incorrectly phased with respect to the other, as happened sometimes in the early days of stereo, then the front and back relationships would be incorrect in *any* matrix system. The Scheiber proposal, being a similar form of matrixing, also requires a control of the phase relationships; and source locations would be inverted if the phase of one channel were to be switched.

Your editorial mentions that if we had out-of-phase information in the two channels, the soloist would be heard in the rear speaker *and* in the

two side speakers. This is quite correct and is exactly what we want to achieve if we want sound in the rear. For such cases in which it is *desired* to have a rear source, this source should be recorded in opposing phase in the two channels. Then it will add in the *difference* speaker in the rear, and it will be canceled from the *sum* speaker in the front. The sound will also appear in each side speaker (at a lower level than in the rear); but because of mis-phasing, it will have an uncertain location relative to those speakers. Therefore, the rear sound will create a firm localization. You feel that this rear sound would be unnatural, but it is not if it is recorded that way intentionally.

Again, I mention that accidental mis-phasing which might produce this effect is something which does not occur now. However, much existing material does have reverberant sound with random phase relationships. These kinds of sound will be beneficial when reproduced in a rear loudspeaker.

There are several practical ways to combine four channels into two by linear combination. I am sure that Mr. Scheiber and many others have done what I have done in examining the algebra of all feasible matrix combinations. I have suggested one which gives front and rear extra speakers rather than four corner speakers for several reasons:

1. It can be played back without any extra equipment (except loudspeakers).
2. A single extra speaker can be used for economy with the front speaker eliminated.
3. Conventional material exhibits improved sound when played on the configuration even though not recorded with the intention of using this arrangement.
4. It provides proper localization for headphone use with rear sound appearing at the back of the head.
5. It provides completely normal separation for conventional 2-channel playback with no inter-channel cross-feeding resulting from the matrixing.

Other matrices are not distinctively different in concept, and the end results as 4-channel systems should be almost identical with most of them. However, they all require additional equipment plus the extra loudspeakers,

ELECTRONICS WORLD



and they have some serious problems of conventional 2-channel stereo compatibility.

It is evident that a variable-gain system can be used with any matrix system to achieve greater ping-pong effect. Where the extra dimension is designed to add ambience, there seems little need for gain-riding. Where localization of instruments away from the front area is desired, then gain-riding has a potential function. However, gain control is a separate function from matrixing and the merits of the various matrix systems should be judged without regard to whether gain control is included.

Regardless of which 4-channel system ultimately becomes standard—matrix, 4-track, or whatever—I feel that the use of rear sound obtained by differential connection adds a new dimension to *present* stereo material. To the description in the October issue, I would like to add that the advantage of the system is at least as great on most material as the transition from mono to 2-channel stereo.

DAVID HAFLER, President  
*Dynaco, Inc.*

\* \* \*  
**FRYE IN HOT OIL**

To the Editors:

I've enjoyed reading *ELECTRONICS WORLD* for many years. I particularly like the column by John Frye, and it's usually one of the first things I read; he has a down-to-earth way of putting problems in perspective. Maybe it was partly due to my general respect for his opinions that made me see red over the slap he took at major oil companies (November issue), or maybe it was because the major oil companies have become the general whipping boy for anyone who wants to complain about anything these days.

I've worked for a major oil company as a petroleum geologist for about 18 years, and I've seen the company take all kinds of uncalled-for abuse from self-styled do-gooders, and just downright thieves who wanted to take advantage of the fact that the big company wouldn't take an individual to court for fear of looking like a bully.

The fact is that it isn't the major companies that are in favor of restrictions on the importation of foreign oil, but the small domestic independent who wants to maintain a market for domestic production. Incidentally, we've lost all chance of ever getting cheap foreign oil—tanker rates have become so high that it's no longer cheaper to produce and ship oil to the U.S. As for the price of a gallon of gasoline; compare the increase in the cost of gasoline during the past twenty years to the increase in the cost of almost any other commodity; I think you'll find there are very few things that have increased

less. Most of the increase has probably been due to taxes.

E. H. DOREMUS  
Verona, Pa.

*John Frye's column, believe it or not, was not about oil companies but about RCA's "ServiceAmerica." The single sentence in the column objected to was "Look how American oil interests demand and get protection from the importation of foreign-produced oil, even though that means we pay more at the gas pumps." Above was one of the milder letters we received on this remark. Evidently, oil men are touchy these days in view of the recently announced major government investigation into the increase in crude oil and gasoline prices by a number of oil companies.—Editors*

\* \* \*  
**C.E.T. TEST**

To the Editors:

This is in reference to question 9, C.E.T. Test, Section 10, in the November, 1970 issue.

I answered (b) and according to the answers on page 80 of the December issue, I missed it. I do agree that the highest forward resistance will be between emitter and collector. However, in all my experience I have noticed that the forward resistance of the base-collector junction is *slightly lower* than the forward resistance of the base-emitter junction.

I have just checked twenty different types of transistors with my v.o.m. One transistor had equal resistances to emitter and collector from the base and the other 19 all showed lower base-collector resistance than base-emitter resistance. Both forward resistances naturally read low on my v.o.m., however, I believe that the base-collector resistance is the lower.

DON GAUGER  
Tulsa, Okla.

*Evidently the transistors that were checked by the authors of the test differ from those checked by Reader Gauger. We can't argue with 19 out of 20 transistors, so we will consider either answers (b) or (c) as correct for question 9.—Editors*

\* \* \*  
**KLH 27 HEADPHONE JACK**

To the Editors:

In your December "EW Lab Tests New Stereo Receivers," you state that the *KLH 27* was the only receiver lacking a front-panel stereo-headphone jack. Not so; there is a jack on mine at the bottom of the front panel between the two tuning dials.

RICHARD MAXON  
Glen Cove, N.Y.

*Reader Maxon is right. We apologize for this oversight.—Editors* ▲

# NEW exciting NRI home training plan



## BE A COMPUTER TECHNICIAN

**PROGRAM INCLUDES COMPLETE, OPERATING DIGITAL COMPUTER WITH MEMORY. AS YOU BUILD IT YOU LEARN ORGANIZATION, DESIGN, OPERATION, CONSTRUCTION, PROGRAMMING, TROUBLE-SHOOTING AND MAINTENANCE.**

What you see above may well be the most unique educational aid ever developed for home training. Not simply a "logic trainer," but an actual small scale integrated-circuit digital computer. It's yours as part of NRI's newest home training in Complete Computer Electronics. NRI is the way to go in the "Computer Age." Qualified men are urgently needed. Exciting NRI program gives you the priceless confidence to step into a Computer Technician's job and know just what to do.

### TRAIN WITH THE LEADER

This exceptional new course has been planned from the start to include unique training equipment in the NRI tradition. Training is as much *fun* as it is education. Mail coupon. NRI Catalog you get tells about new Computer training plus other NRI training plans. No obligation. No salesman will call. NRI, Washington, D.C. 20016.

### MAIL FOR FREE CATALOG



**NATIONAL RADIO INSTITUTE**  
Washington, D.C. 20016 93-031

Please send me FREE Catalog giving complete facts about your NEW Complete Computer Training. (No salesman will call.)

Name \_\_\_\_\_ Age \_\_\_\_\_

Address \_\_\_\_\_

City \_\_\_\_\_

State \_\_\_\_\_ Zip \_\_\_\_\_

ACCREDITED MEMBER NATIONAL HOME STUDY COUNCIL

# THE SANSUI QS-1 QUADPHONIC SYNTHESIZER®



## SANSUI QS-1

### 4-CHANNEL SOUND FROM ANY 2-CHANNEL SOURCE

**Senses and recovers the ambient information hidden in your stereo discs, tapes and broadcasts**

After having discovered that the ambient components of the original total sound field are already contained in hidden form, in conventional stereo records, tapes and broadcasts, Sansui engineers developed a method for sensing and recovering them. These subtle shifts and modulations, if re-introduced, breathtakingly recreate the total of the original sound as it existed in the recording or broadcast studio.

The heart of the Sansui Quadphonic Synthesizer® is a combination of a unique reproducing matrix and a phase modulator. The matrix analyzes the 2-channel information to obtain separate direct and indirect components, then redistributes these signals into a sound field consisting of four distinct sources.

This type of phase modulation of the indirect components, applied to the additional speakers, adds another important element. It sets up a complex phase interference fringe in the listening room that duplicates the multiple indirect-wave effects of the original field. The result is parallel to what would be obtained by using an infinite number of microphones in the studio (M1 through Mn in the accompanying illustration) and reproducing them through a corresponding number of channels and speakers.

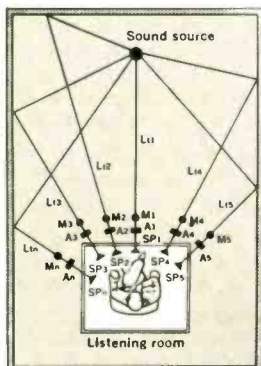
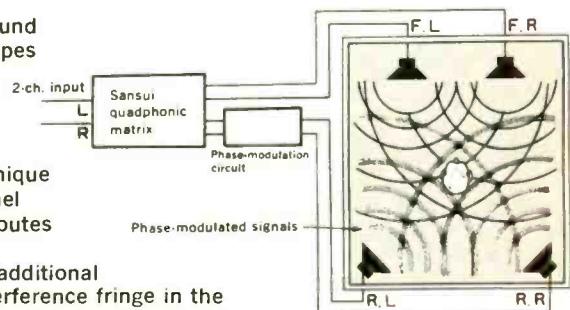

The startling, multidimensional effect goes beyond the four discrete sources used in conventional 4-channel stereo, actually enhancing the sense of spatial distribution and dramatically expanding the dynamic range. Also, the effect is evident anywhere in the listening room, not just in a limited area at the center. And that is exactly the effect obtained with live music! This phenomenon is one of the true tests of the Quadphonic system.

The Sansui Quadphonic Synthesizer QS-1 has been the talk of the recent high-fidelity shows at which it has been demonstrated throughout the country. You have to hear it yourself to believe it. And you can do that now at your Sansui dealer. Discover that you can hear four channels plus, today, with your present records and present stereo broadcasts. \$199.95.

\*Patents Pending



**SANSUI ELECTRONICS CORP.**

Woodside, New York • Gardena, California

SANSUI ELECTRIC CO., LTD., Tokyo, Japan • Frankfurt a M., West Germany  
Electronic Distributors (Canada), British Columbia



# EW Lab Tests New DOLBY-IZED CASSETTE DECKS



By JULIAN D. HIRSCH/Hirsch-Houck Laboratories

***Results of our measurements on three of the newest models show that, whichever one you choose, the addition of Dolby circuits has made the cassette a true high-fidelity medium.***

IN June, 1969, ELECTRONICS WORLD presented a report on several cassette tape decks and recorders. Our initial experience with the better-quality cassette machines convinced us of the potential of this recording medium. Having encountered reel-to-reel machines capable of high quality at 3 $\frac{3}{4}$  in/s, it was startling to find comparable frequency response in some of the new cassette recorders operating at half that speed.

Then, as now, the most objectionable characteristic (to a critical hi-fi ear) of cassette sound was the hiss level. This is principally due to two factors: (1) less treble roll-off in the playback equalization (as compared to reel-to-reel machines) which is necessary to extend the frequency response to 10 kHz or higher at 1 $\frac{7}{8}$  in/s, and (2) the extremely narrow track width of 24 mils (0.024") resulting from fitting four tracks on a 150-mil (0.150") wide tape. The playback amplifier input noise is essentially the same as that of other tape machines, but the output of the heads from the narrow cassette tracks is considerably lower. For these reasons, the signal-to-noise ratio of a cassette machine is inherently poorer than that of a reel-to-reel machine.

Since that time, head designs have been improved and there are special tape formulations such as TDK SD and DuPont Crolyn, which allow more energy to be stored in the tape and have a fine-grain structure which reduces "drop-outs," another characteristic deficiency of the cassette

medium. Recent tests we have made on a number of cassette decks show a dramatic improvement in their average performance level, with several of them subjectively meeting true high-fidelity standards under optimum conditions.

The noise problem remains, however. It can be minimized by maintaining a high average recording level, but this involves a compromise with distortion on high-level passages, which many critical listeners find objectionable. A logical solution is the application of the Dolby noise-reducing technique to the cassette deck, and this has now been done.

The Dolby system has been used for several years in professional recording studios and is responsible for the lower noise level on many recent stereo discs. (See "The Dolby Noise-Reduction System—Its Impact on Recording" by John Eargle in our May, 1969 issue.—Editor) A comparison between a five-year old record and a recent release provides proof of this fact.

Essentially, the technique employs identical signal-processing circuits, operated in a mirror-image relationship, in the recording and playback channels. Loud-signal passages are not affected by the system, either in recording or in playback. As the level is reduced, the system begins to increase the recording gain, in an inverse relationship to signal level. During playback, the gain is reduced by an equal amount so that the program balance and frequency response are un-



Mfgr. & Model	Playback Response	Rec/Play Response (Dolby Off)	Rec/Play Response (Dolby on)	S/N (Dolby off) (dB)	S/N (Dolby on) (dB)	Wow (%)	Flutter (%)	Price (\$)
Advent 200	40-10,000 Hz ±1.5 dB	50-12,000 Hz ±1 dB	50-12,000 Hz ±2 dB	48	51	0.01	0.19	260
Fisher RC-80	40-10,000 Hz ±2.5 dB	50-12,000 Hz ±1 dB	50-12,000 Hz ±1.5 dB	46	50	0.02	0.22	200*
Harman-Kardon CAD-5	40-10,000 Hz ±1.5 dB	45-14,000 Hz ±3 dB	45-14,000 Hz ±3.5 dB	47	52	0.01	0.20	230

\*Includes microphone. Note: High-frequency response varies somewhat with different tapes.

Table summarizing the results of our laboratory tests on the three cassette tape decks listed.

affected. However, any noise introduced in the recording and playback process is reduced by the amount of playback gain reduction.

In the "A-Type" Dolby used professionally, the spectrum is divided into four bands, whose gains are individually controlled, depending on the signal level existing within each band. In this way, hum, rumble, and other low-frequency disturbances are reduced together with the usually more audible high-frequency hiss. The "A-Type" system is relatively bulky and expensive, and is obviously unsuited for home use.

Over a year ago, *Dolby Laboratories* licensed consumer-product manufacturers to use a simplified version, known as the "B-Type." Previously, *KLH* had been licensed exclusively and the "B-Type" was used in its reel-to-reel tape recorders. Now, however, a number of other manufacturers are authorized to use it. The "B-Type" system operates in a single frequency range, from about 600 Hz upwards. It reduces noise by about 3 dB at 600 Hz, increasing to 6 dB at 1200 Hz, and to 10 dB at 4000 Hz and above. The "A-Type" system provides a 10-dB reduction of noise across the full frequency range. Subjectively, as far as hiss is concerned, there is little difference between the two systems. As compared to any other previously available noise-reduction system, the Dolby is notable because it does not affect frequency response or distortion and cannot be heard in operation. It simply reduces unwanted noise, in a most impressive fashion.

The "B-Type" circuits are relatively simple and can be economically incorporated in home tape recorders and cassette machines. In recent months, three cassette decks with built-in Dolby circuits have been announced—the *Advent*

Model 200, the *Harman-Kardon CAD-5*, and the *Fisher RC-80*. A fourth, from *Vivitar*, was not available in time for testing.

Critical comparisons among these three cassette decks are especially interesting since their transport mechanisms, heads, and portions of their electronics come from a single Japanese manufacturer. Nevertheless, each manufacturer has expressed his own philosophy in the total design of his product. As a result, there is little or no external resemblance among the three units, and a considerable spread in selling price. With the three recorders having so much in common, it is reasonable to ask if the differences are significant, more than skin deep, and worth the price differential. Our tests have given us a definite "yes" answer to the first two questions but, of course, the last one is for each prospective buyer to decide, based on his own needs.

We will present a brief description of each machine and performance data from our own measurements. It must be understood that we tested a single sample of each model, in each case a very early production or pre-production unit. It is quite possible that future production variations could substantially obscure some of the minor differences that we measured. However, we feel that these cassette decks are truly representative of the current stage of development in this medium.

The machines will be discussed in descending order of price. Since many of their characteristics are quite similar, they will be covered in detail in the section on the *Advent Model 200*, and only the differences will be stressed in the reports on the other two units. All the machines are decks whose outputs must be played back through separate stereo amplifiers and speakers.

## ADVENT MODEL 200

The *Advent Model 200* has the greatest flexibility of



these decks, as well as being the most expensive at \$260. The cassette transport controls, operated by flat "piano-key" levers, are conventional. They include Stop/Eject, Play/Record, Record interlock, Fast Forward, Rewind, and Pause functions. The cassette is fully visible through the tinted plastic cover, so that the amount of operating time remaining can be readily estimated. There is a push-button reset, three-digit index counter. When the end of the cassette is reached, the motor stops. An automatic shut-off circuit then removes power from the motor and a light on the deck flashes to alert the user.

The Model 200 has four more levers, beside the transport controls. They include the a.c. power switch and a Mono/Stereo switch which parallels the two inputs for making mono recordings. A third lever controls the Dolby circuits, with a light signifying that they are activated. In most cases, these will be left on when making a recording or playing a "Dolby-ized" cassette, but should be switched off when playing a cassette recorded without the Dolby process, or



when making one which will be played on a conventional cassette deck.

The fourth lever is marked Tape-Regular/Special, and gives the machine its special versatility. In the Regular position, the recorder's bias and equalization are optimized for standard cassette tapes such as the 3M #271 or BASF. In the Special position, the recording bias and both the recording and playback equalization are changed for best results with *Du Pont* Crolyn chromium dioxide (CrO<sub>2</sub>) tape. This tape offers advantages in signal-to-noise ratio, high-frequency response, and reduced drop-outs, and is available from *Advent* under the "Advocate" brand name. By the time this appears in print, it will be available from other manufacturers as well. The choice of bias and equalization characteristics provides an excellent compromise for *TDK* SD tape, which should be recorded with the Special setting of the Tape switch and played back with the Regular setting. This ability to get the most from any presently available tape is one of the unique features of this recorder.

Another unusual and valuable feature of the machine is the single "vu" meter. It is larger than that of any other cassette deck, well illuminated, and very accurately calibrated. Most such meters are little more than crude indicators of level; this meter gives an accurate reading of relative signal level. The meter amplifier is equalized to emphasize the higher frequencies, reducing the chance of inadvertently recording at excessive levels.

The meter can be switched to read either channel, A or B. Separate channel level controls are used for initial balance. Then, the meter is switched to read "Higher of A or B," which simultaneously monitors both channels and displays the level of the stronger one. A single master gain control sets the final recording level, without affecting channel balance.

The Dolby circuits require very precise control of recording and playback levels, not only to operate properly in a given machine, but to insure compatibility with tapes made on another machine. *Advent* supplies complete alignment facilities with its recorder, and sent us a standard-level Dolby cassette. While playing this cassette, two playback calibration screwdriver adjustments in the rear of the unit are set for 0-dB meter readings on each channel. With a blank cassette of the tape to be used in the machine, a push-button switch in the rear of the deck supplies a standard recording level signal, which is set for a 0-dB meter reading

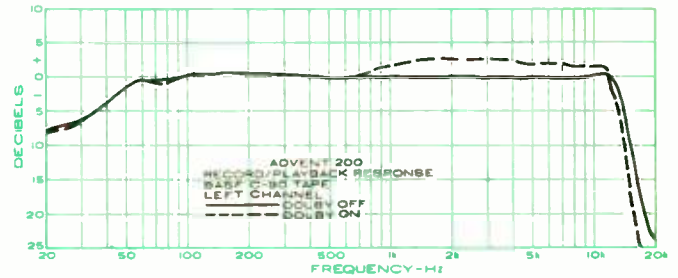
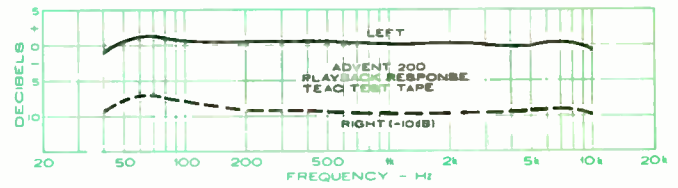

with another pair of adjustments. The machine is set up correctly as delivered, so that a check every few months is all that is needed to keep it in tip-top shape. It is also desirable to check the adjustments if a tape of very different characteristics, such as a C-120 cassette, is used.

To demonstrate the capabilities of the unit, the purchaser of the recorder receives a cassette with several musical selections, dubbed in real time on Crolyn tape. This serves to illustrate the proper recording levels for different kinds of music, as well as to show the caliber of performance which the deck can deliver.

The measured playback frequency response, with a *Teac* standard test tape, was within  $\pm 1.5$  dB from 40 Hz to 10 kHz. Over-all record/playback frequency response varied slightly with different tape formulations, but typically (with *BASF* or *TDK* SD) was  $\pm 1.0$  dB from 50 Hz to 12 kHz. With the Dolby circuits operating, there was a slight increase in output above 700 Hz (at a -20 dB recording level), but the over-all response was still within  $\pm 2$  dB from 50 Hz to 12 kHz.

The unweighted signal-to-noise ratio was 48 dB with the Dolby off and 51 dB with it on (referred to 0-dB recording level). The unweighted wow and flutter, with the *Philips* TC-3 test cassette, were 0.01% and 0.19%, respectively.

The subjective performance of the Model 200 will be discussed, together with the other units that were tested, later in the article.

## HARMAN-KARDON CAD-5



In our June, 1969 cassette report, we commented on the outstanding performance of the *Harman-Kardon* CAD-4. Today, it still ranks among the best conventional cassette decks, although several others now offer comparable quality. The new CAD-5, which physically resembles the CAD-4, is actually a totally different machine, quite similar to the *Advent* unit in its design and performance. The *Harman-Kardon* CAD-5 sells for \$230.

The CAD-5 transport controls are similar to those of the

*Advent* 200. To make room for the added Dolby switch, the knob-operated level controls of the CAD-4 have been replaced by a pair of slider-type controls. The two meters are mounted behind a single window, with vertically oriented scales.

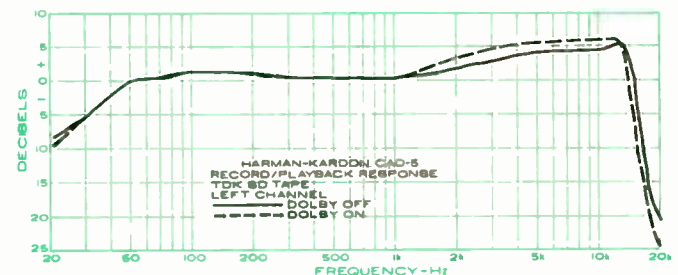
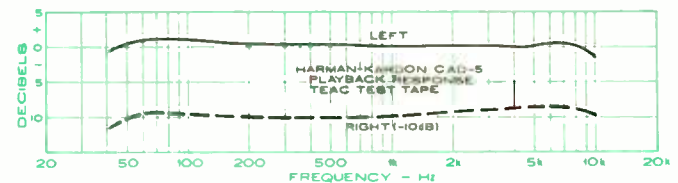

Below the transport control levers are four signal lights. One is a Power On indicator. An Auto light is on when the motor is running and goes out at the end of play when the automatic shut-off removes power from the stopped motor. The Dolby light indicates that these circuits are activated. Finally, the CAD-5 has an Overload light, which flashes if proper recording levels are exceeded, even momentarily. If the overload signal is present in both channels the light flashes at +2 dB, a single channel overload of 8.5 dB is needed to operate the light.

The CAD-5 has a full complement of Dolby level calibrating adjustments in the rear, plus a switch-operated standard-level oscillator to set recording levels. It includes a two-position slide switch which changes bias and equalization for standard or CrO<sub>2</sub> tapes.

The playback frequency response of the CAD-5 is  $\pm 1.5$  dB from 40 Hz to 10 kHz. The record/playback response was flattest with 3M #271 tape, measuring  $\pm 2$  dB from 45 Hz to 14 kHz. Using TDK SD tape, the highs were somewhat emphasized, with an over-all response within  $\pm 3$  dB from 45 Hz to 14 kHz. The Dolby circuits produced a broad high-frequency emphasis with 3M #271 tape, but had less effect on the response with TDK SD tape, which inherently produced a slight increase of high-frequency response.

The unweighted signal-to-noise ratio was 47 dB without the Dolby and 52 dB with it. The unweighted wow and flutter were 0.01% and 0.20%, respectively. The subjective performance of the Harman-Kardon CAD-5 cassette deck will be covered later.

## FISHER MODEL RC-80



Fisher's RC-80 cassette deck is the smallest and least expensive (\$200) of the Dolby-ized decks which we tested. Although it is small and light enough to be held comfortably in one hand, it presents an exceptionally business-like and professional appearance.

Although the transport mechanism is similar to the other two machines, the Fisher has "piano keys" molded flat to fit the fingertips, like typewriter keys. Combined with their very legible markings, this gives it an unusually good operating "feel." Two push-button switches control power and Dolby operation. There are signal lights for power on and recording indications, but no light for the Dolby system. Fisher has made a single light do double duty as illumination for the index counter and as a motor shut-off indicator. When the motor stops at the end of play, the automatic circuits remove its power and shut off the index light.

Unlike the other two decks, the RC-80 has no user-operated calibration adjustments. Playback and recording gains are set at the factory for the preferred tape (BASF, which is

also packaged in Fisher cassettes). There is no special provision for CrO<sub>2</sub> tape.

We measured the RC-80 playback response as  $\pm 2.5$  dB from 40 Hz to 10 kHz on one channel. The other channel was down 9 dB at 10 kHz. In both cases, the loss in output was principally above 8 kHz. Since our test sample was one of the first pre-production units, we surmise that this was due to a misadjustment and may not be typical of regular production units.

The record/playback frequency response was within  $\pm 1$  dB from 50 Hz to 12 kHz on one channel. The other was similar but reached a peak of +5 dB at 13 kHz (referred to 1 kHz) and had considerable response up to nearly 15 kHz. Similar results were obtained with 3M #271 and TDK SD tape. The Dolby circuit had the same affect on high-end response that we noted with the other decks.

The unweighted signal-to-noise ratio was 46 dB without the Dolby and 50 dB with it. Unweighted wow and flutter were 0.02% and 0.22%, respectively.

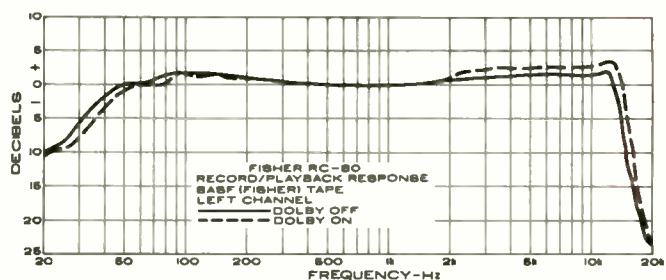
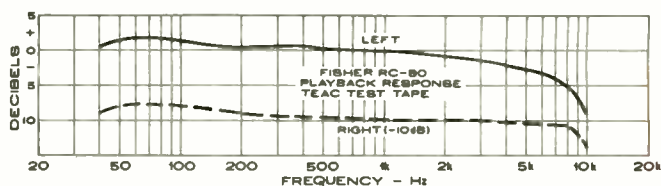

## HOW DO THEY PERFORM?

To anyone whose experience with cassette machines has been limited to low-priced or portable models, the performance of these three decks will be nothing less than amazing. Only the best reel-to-reel recorders can compare to them at 3 $\frac{3}{4}$  in/s (and even these might not sound as quiet), and many 7 $\frac{1}{2}$  in/s machines cannot match the fidelity of the Dolby-ized cassette decks.

All three machines can record stereo-FM broadcasts (whose signal-to-noise ratio and frequency range are generally limited by the transmission medium) with virtually no alteration of frequency response or increase in noise level. We dubbed portions of the STEREO REVIEW Demonstration

Record, using the best available phono-reproducing equipment, on cassettes with the three decks and played them back for a true A-B comparison with the original program. In this test, some slight differences could be detected between the original and reproduced sound, and among the three machines.

The Advent Model 200 was the most accurate recorder of the group, due principally to its exceptional flatness, which is matched by only a few very good reel-to-reel machines. The reproduction was distinguishable from the original record only by a minute trace of hiss at high listening levels,

(Continued on page 77)



# Triggering Logic Circuits

By JAMES E. McALISTER

**Simple circuits that can be used to keep logic circuits from being erroneously triggered by contact bounce usually associated with relays, push-buttons, and toggle switches.**

THERE are many instances in which push-button or toggle switches are used to trigger logic circuits. In such cases, contact bounce within the switches themselves may lead to erratic and perhaps erroneous circuit operation.

Contact bounce is a characteristic of switches in which the switch's contacts actually slam together (as opposed to sliding) in order to complete a circuit. Instead of staying closed, however, the contacts may actually "bounce" apart and close again. This process may repeat several times (like a bouncing ball) before the contacts actually come to rest.

When a switch is used to drive electronic circuits, a signal will be generated from the switch each time the contacts close. Therefore, if contact bounce is present, several signals may easily be generated for each physical closure of the switch. These spurious signals can lead to erroneous outputs from counters or other logic circuitry.

The effects of contact bounce can be eliminated with very few components. The classical approach is to use a simple "latching" circuit (see Fig. 1A).

With the switch in the "off" position, a "0" (ground) is continuously being applied to gate A, maintaining output 1 at "1" and output 2 at "0". Note that even if the "0" is removed from gate A's input (but not applied to gate B), output 1 will remain high because of the "0" fed back to gate A's other input by output 2. With the conditions as indicated, output 2 remains at "0" because two "1's" are being applied to gate B. Since the "0" from the switch can be removed and then re-applied to gate A without the outputs changing, the circuit is said to be "latched."

When the switch is moved to the "on" position, a "0" is immediately placed at gate B's input, forcing output 2 to "1" and output 1 to "0." The gates once again latch. If the switch contacts bounce (essentially removing the "0" from gate B), the gate outputs will not change because of the latching action ("0" from output 1 holds output 2 at "1"). The contacts may actually bounce open and back closed any number of times, but the latch will allow only one output signal to be generated (in this case a "1" at output 2). When the switch is turned "off" again the circuit will return to its initial operation (output 1 at "1" and output 2 at "0").

Anytime the circuit in Fig. 1A is used, the output signals generated for each switch position will remain until the switch position is changed. Nevertheless, there are times when it may be desirable to generate a single output pulse rather than the constant level. The circuit shown in Fig. 1B will produce such a pulse.

Gates A and B form the latch to defeat the effects of

contact bounce, and gates C and D form a one-shot multivibrator. Whenever the switch is depressed, gate A applies a signal to the one-shot, causing a single negative-going output pulse. If the latch were not included, the one-shot might produce a pulse for each bounce of the contacts, even though the switch is depressed only once.

(Continued on page 63)

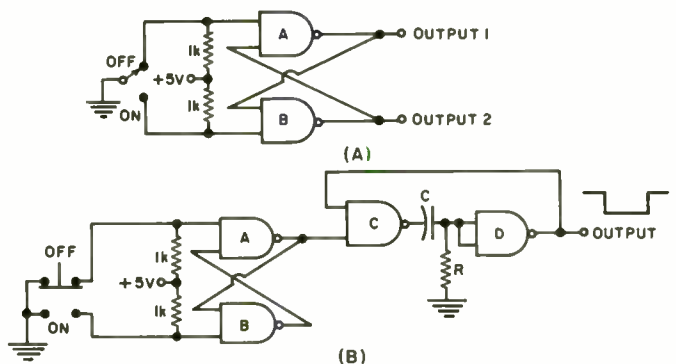
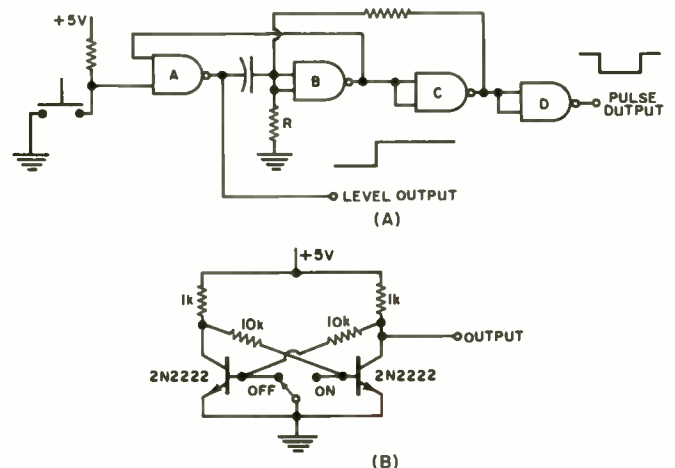

Fig. 1. Diagrams of two simple circuits (A) a bistable latching circuit and (B) a single-pulse output circuit used to eliminate effects of contact bounce (spurious signals) when triggering logic circuits with push-buttons or toggle switches.

Fig. 2. Two additional circuits used to eliminate contact bounce. (A) A single-pulse output circuit that also provides a level output and (B) a transistorized latching circuit equivalent to the one shown in Fig. 1A. Note that circuit shown in (A) requires only a momentary-type switch.





# Recent Developments in Electronics

**Airborne Computer System for SAC.** (Top left) We are looking at a part of the computer installation aboard the Strategic Air Command's "Looking Glass" aircraft. This is the computer controller's console, with the computer itself at the left, and the input keyboard and page printer before the operator. The experimental system, designed by RCA, is the first ever developed to provide computerized information management capabilities aboard aircraft in flight. New data entered into ground-based computers at Air Force SAC headquarters can now be relayed directly and automatically to the computer installed in the aircraft. Now under development is an operationally secure data link between the plane and the ground. The data link will permit extensive tests and evaluation of air-ground communications between the computers under actual operating conditions.

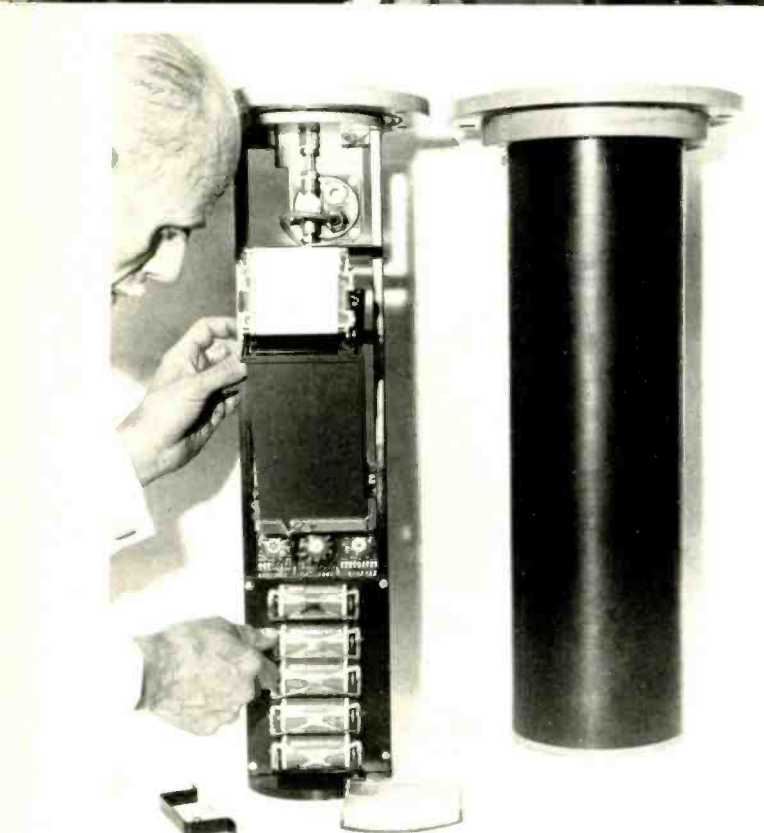

**Electronic Tide and Wave Recorder.** (Center) The first general-purpose electronic tide and wave recorder—which is battery-operated and portable—has been developed in Britain for use in hydrographic studies. Capable of operating in water at depths of down to 100 feet, it works on the principle that a change in water level produces a change in pressure. Variations in pressure are electronically processed and then transmitted to a chart recorder within the unit for print-out. Designed to meet the need for a low-cost, accurate apparatus, the recorder shown here runs on five Mallory 1.4-volt mercury or alkaline batteries. The mercury batteries operate the recorder continuously for five weeks; the alkaline batteries for two weeks.

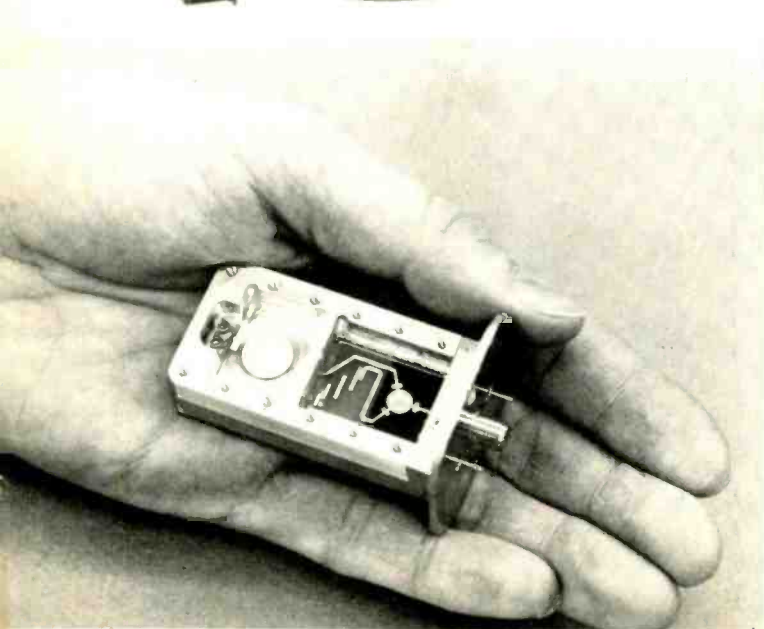

**Microwave Radar for Autos.** (Below left) Microwave IC technology has made it possible to engineer a microwave Doppler radar that is inexpensive and reliable enough to use in autos, or at least that's the claim of Hewlett-Packard Co. Entering the consumer applications field for the first time, the company is introducing a radar transmitter-receiver module that will sell for less than \$150 in quantities of 1000. Possible industrial uses for the module are in intrusion alarms, automatic traffic controls, railroad speed controllers, and automatic aircraft landing systems. The device is a completely solid-state module built with hybrid thin-film integrated microcircuits. The source of microwave energy within the unit is a Gunn diode that produces 50 mW of power at 10.525 GHz. This power is coupled to the output port through a circulator. Some energy from the diode is shunted through a 10-dB coupler to a hot-carrier diode mixer, to serve as the Doppler reference signal. The returning r.f. signal, shifted in frequency as a result of its reflection from a moving object, passes back through the circulator. The circulator isolates outgoing and incoming signals, even though they pass through the same port to and from the associated antenna. The received signal, coming in from the circulator, moves through a bandpass filter to remove spurious responses, and then to the mixer, where the incoming and outgoing signals subtract to generate an audio signal whose frequency is directly proportional to velocity. All that is needed to form a complete microwave Doppler radar is the module, an antenna, a display, and a low-power source.

ELECTRONICS WORLD



**Troubleshooting Computers by Computer.** (Top right) A computer service specialist at a strategically located technical center is shown using a tele-processing network and the power of a remote centralized computer to diagnose malfunctions from a distance. The specialist, working with the customer engineer at a customer location, can search data for solutions, or together, may use a data link to run maintenance programs. The output can be displayed both on the customer's and on the specialist's display terminal. The system, which is installed at IBM's Raleigh, N.C. Test Center, is accessible by phone from all over the country.



**Phones for the Handicapped.** (Center) The young lady in our photograph is using a telephone attachment that permits deaf or deaf-blind persons to communicate with each other. Field trials of the device started about five years ago, but regular commercial service using it have just begun in Columbus, Ohio. The Bell System calls the service "Code-Com," and charges \$3 per month for the unit plus the regular charge for phone service. The attachment contains a light, a sending key, and a vibrating disc. Voice signals are converted into flashes of light and vibrations of the disc. A deaf person can watch the light flashes, while a deaf-blind person can feel the vibrations of the sensor disc. The key is used to transmit messages, using a prearranged code for simple messages or regular Morse code for longer messages.



**Film-Mounted IC's.** (Below left) In order to more effectively compete with inexpensive or foreign-made IC's, General Electric is using a very highly automated production and packaging technique for some of its IC's. The integrated circuits end up embedded one after another on a roll of plastic film that looks like 35-mm movie film, sprocket holes and all. The circuits, designed mainly for original-equipment manufacturers, can be cut apart with an industrial shears or even an ordinary scissors. In the new packaging method, called "miniMod," IC chips are dropped into depressions along the film. Previously printed in foil on the film is a pattern of connecting leads which mate with pads on the IC chips. The leads are bonded to the pads, and the entire chip is sealed in epoxy, forming the finished circuit package.

**Magnetic Bubble Memory.** (Below right) The light circles are magnified magnetic bubbles (0.0003" diameter) moving through a circuit pattern formed on a thin magnetic film of uniaxial garnet. One bubble, slightly elongated, can be seen moving from one element in the pattern to another. The technology is being used as part of an experimental shift register made at Bell Labs, where the garnet films fabricated thus far have measured about one-third inch across. Eventually this technique may permit fabricating memory devices with more than a million bubbles per square inch for use in future computer and digital-communications applications.

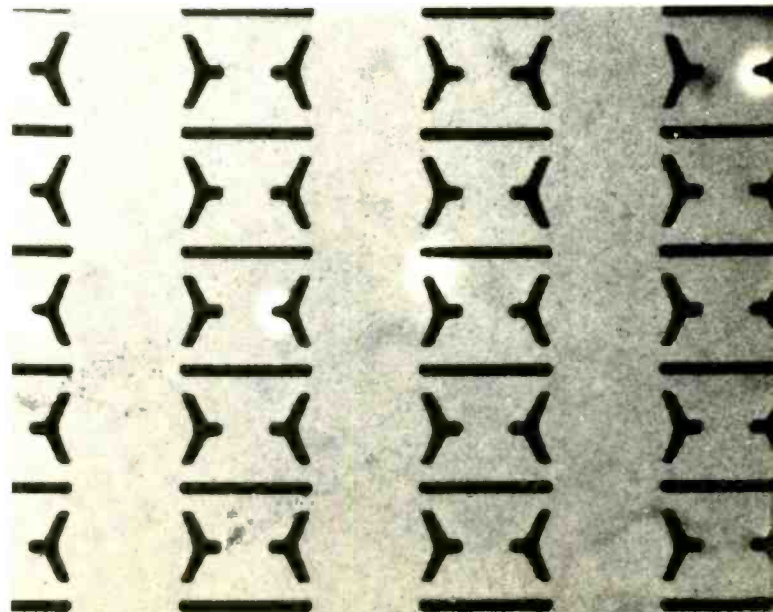
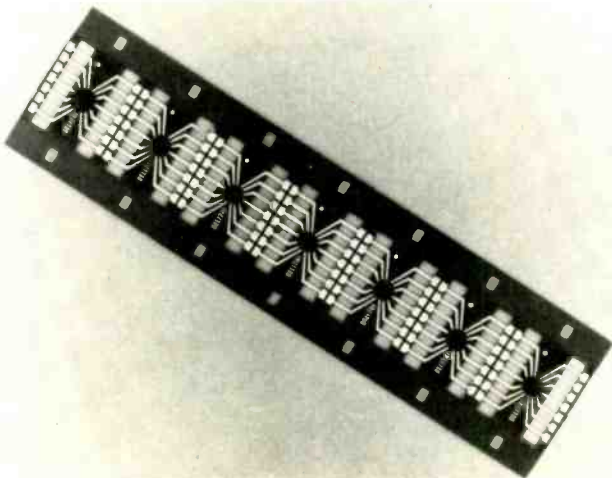

# Digital Instruments

## Part 6—More About Electronic Counters

By DONALD L. STEINBACH / Research Engineer, Sr., Lockheed Missiles & Space Co.

*Design details that help bridge knowledge gap between the simple 3-mode counter described in Part 5 and more sophisticated counter configurations.*

PART 5 of this series discussed the fundamentals of electronic-counter design and concluded with a practical three-mode, 4-MHz electronic-counter circuit. The mechanics of adding more operating modes, a discussion of measurement errors, and an evaluation of the methods for increasing the electronic counter's operating frequency should be covered before introducing a more sophisticated electronic-counter configuration.

### Adding More Operating Modes

The electronic counter developed in Part 5 demonstrated that the Totalize, Frequency, and Period modes of operation can be achieved in even the most basic electronic counter; the remaining five operating modes may be readily added to the basic electronic-counter configuration. Fig. 1 illustrates basic design differences among the eight electronic-counter operating modes as outlined in Part 5. Fig. 2 details the evolution of an eight-mode electronic counter beginning with a string of decade counters and a single input channel.

Incorporating the Scale mode requires modification of the counter chain so that the output of each decade counter in the counter chain is accessible at a convenient panel connector. If a single connector is used, some means of selecting the one decade counter output that will be presented to that connector at a given time must be provided (one possible approach is shown in Fig. 3). The modification of the time base to accommodate the Multiple Period mode allows some of the time-base decade dividers to serve either as time-base dividers or as multiple-period scalers. The sec-

ond input channel added for the Ratio mode is usually an exact replica of the existing original input channel, and the same second channel is used in both the Ratio and Time Interval modes. Fig. 4 shows how the various functional elements of a complete electronic counter might be interconnected *via* a mode-selector switch to provide an eight-mode electronic counter.

### Measurement Errors

Time-base frequencies are usually derived from high-frequency crystal oscillators (100 kHz and up). Some electronic counters contain an internal oscillator of only moderate accuracy and stability, but include provisions for an external reference signal (at the internal-oscillator frequency) so that a high-performance "house standard" can be substituted for the electronic counter's internal oscillator. A typical commercial crystal oscillator with an accuracy of  $\pm 0.02\%$  (*International Crystal* OX oscillator and type EX crystal) costs about \$6.90; a unit with  $\pm 0.0005\%$  over-all accuracy (*International Crystal* type OE-10 oscillator element) from  $-10^\circ\text{C}$  to  $+60^\circ\text{C}$  costs around \$19.00. Oscillators in the  $1 \times 10^{-8}$  stability class carry price tags in the \$400 range and, for the most exacting applications, a cesium-beam frequency standard can be purchased for something in the order of \$16,000.

Since the accuracy of the electronic counter described in the January, 1971 issue is limited to the  $\pm 0.1\%$  accuracy of the 60-Hz line frequency, the accuracy *implied* by the resolution of the 6-digit display exceeds the *real*  $\pm 0.1\%$  measurement accuracy. For example, a 4.000000-MHz input

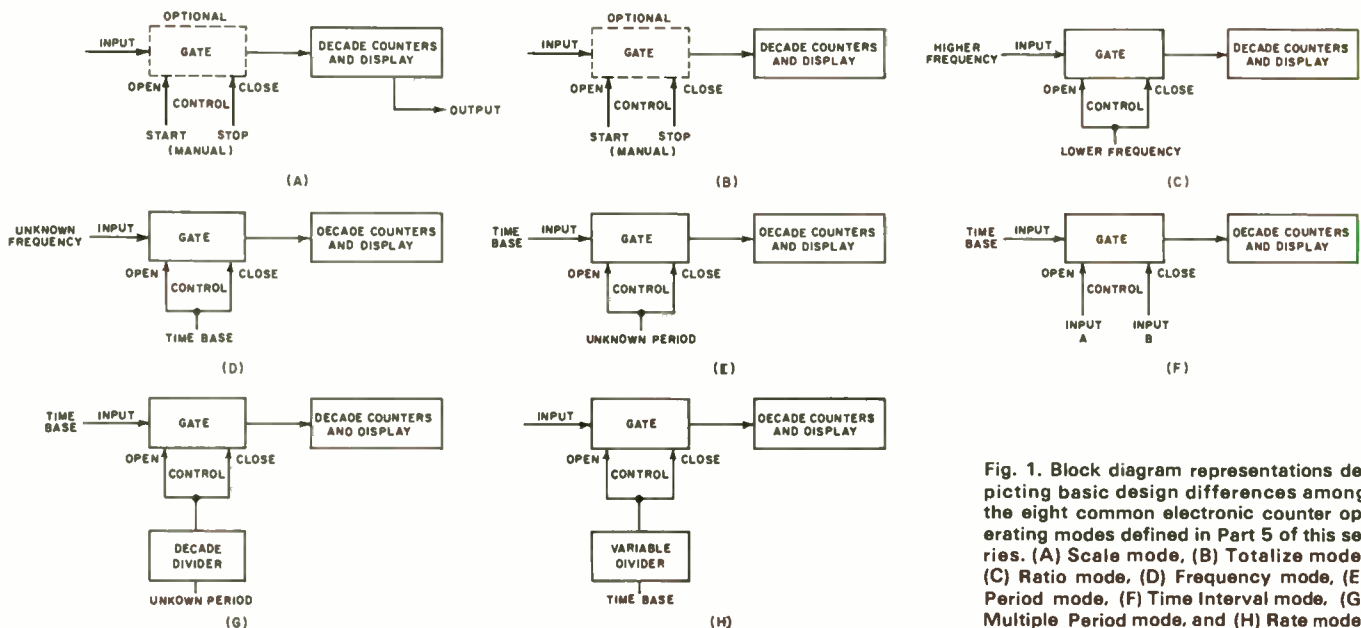

Fig. 1. Block diagram representations depicting basic design differences among the eight common electronic counter operating modes defined in Part 5 of this series. (A) Scale mode, (B) Totalize mode, (C) Ratio mode, (D) Frequency mode, (E) Period mode, (F) Time Interval mode, (G) Multiple Period mode, and (H) Rate mode.



signal frequency counted over a 0.1-second sampling period would be displayed as 4.00000 MHz if the time base were accurate to  $\pm 0.0001\%$  or better. If, however, the time-base accuracy is  $\pm 0.1\%$ , the displayed count could range from 3.99600 MHz to 4.00400 MHz. The inconsistency between real and implied accuracy is a characteristic of many multi-function digital instruments—a fact that users of digital instruments must keep in mind.

The various sources of error applicable to each of the eight operating modes are identified in Table 1. The  $\pm 1$  count ambiguity in the Scale and Totalize modes applies only if the optional gating is used and the effects of the  $\pm 1$  count ambiguity and trigger error in the Multiple Period mode are reduced in direct proportion to the increase in the number of periods sampled. The effect of the  $\pm 1$  count ambiguity on the accuracy of measurements made in the Period, Time Interval, and Multiple Period modes can be reduced significantly by gating the standard-frequency input into the time-base dividers, rather than gating the time-base divider output into the decade counters. The maximum timing error then reduces to the period of the standard frequency rather than the period of the chosen time-base divider output. However, this method does not offer any improvement over the much simpler technique of just selecting a time-base period one order of magnitude shorter than the desired data resolution.

Frequency and period are related ( $f=1/T$ ) and one can be calculated once the other is measured. Accurate high-frequency period measurements and accurate low-frequency frequency measurements are difficult to obtain directly, so the period of a high-frequency signal is usually calculated from a frequency measurement, while the frequency of a low-frequency signal is usually calculated from a period measurement. Resolution improves and uncertainty is reduced as the measurement interval is lengthened. Nevertheless, it must be remembered that the time-base stability (the drift rate in particular) may become a significant source of error over extended measurement intervals.

### Increasing Operating Frequency

There are three ways to increase the maximum counting rate (or upper operating frequency) of an electronic counter: (1) design at least part of the electronic counter around one of the higher-speed logic families such as MECL™, (2) prescale or divide the unknown input frequency prior to applying it to the electronic-counter input, or (3) mix the unknown input frequency with a known stable local-oscillator signal to produce a difference frequency within the operating range of the electronic counter. Each method has its own advantages and disadvantages.

Mixing is generally used to process input signals whose frequencies are beyond the range of even the highest speed logic. The system accuracy is a direct function of the accuracy and stability of the local-oscillator signal and care must be taken to assure that no spurious mixer outputs (at least none that lie within the frequency capability of the electronic counter) are presented to the electronic-counter inputs. The basic electronic-counter accuracy is preserved if a harmonic of the counter time-base oscillator frequency is used as the heterodyning signal for the frequency conversion. The unknown input frequency is the sum of the local-oscillator frequency and the frequency displayed by the electronic counter.

Prescaling, like mixing, translates the unknown frequency down to a frequency within the operating range of the electronic counter. The prescaler is simply a divider (or counter) such as might be used in the first stage of a high-speed electronic counter. The prescaler usually divides the unknown input frequency by ten, although any arbitrary integer division is permissible. The prescaler does not impact electronic-counter accuracy, although electronic-counter resolution is reduced in direct proportion to the prescal-

er division ratio. The unknown input frequency is the product of the division (prescale) ratio and the frequency displayed by the electronic counter.

Mixers and prescalers can be used as accessories to an electronic counter rather than an integral part of the elec-  
(Continued on page 68)

Operating Mode	Sources of Measurement Error		
	$\pm 1$ count ambiguity	Time base	Trigger
Scale	X		
Totalize	X		
Ratio	X		X
Frequency	X	X	
Period	X	X	X
Time Interval	X	X	X
Multiple Period	X	X	X
Rate	X	X	

Table 1. Various sources of error applicable to each of eight operating modes discussed by author.

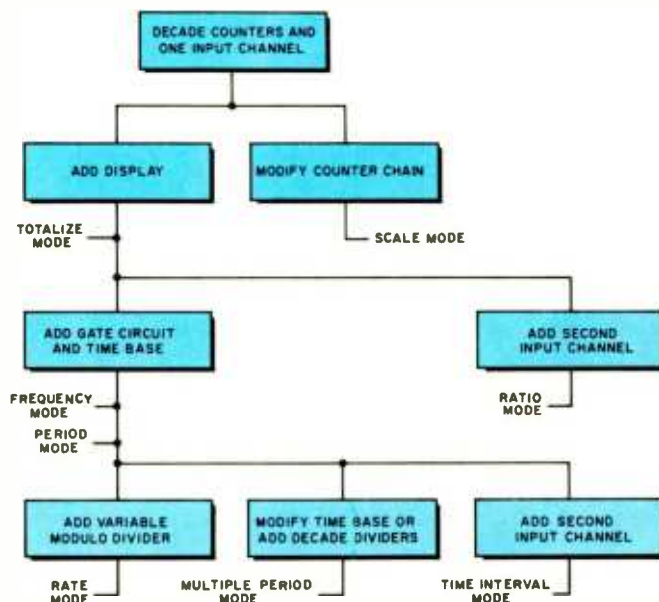
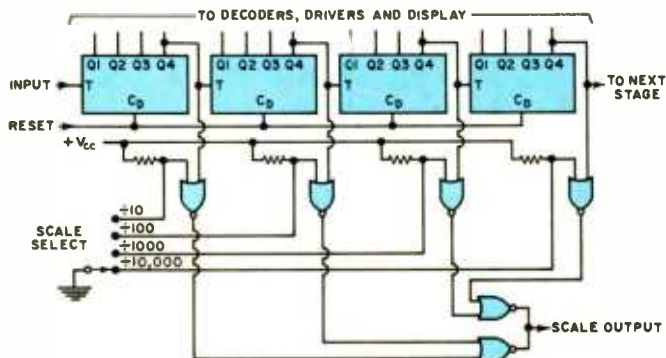

Fig. 2. Diagram showing evolution of an 8-mode counter starting with a string of decade counters and a single input channel.

Fig. 3. How a "nor" gate switching arrangement added to a decade counter provides Scale mode capability in an electronic counter. Modification provides a means of selecting one decade counter output at given time. As many gates as required may be added to "longer" decade counter chains.



# *EW Lab Report*

## **Volt-Ohm Milliammeters**

**EW**  
**LAB TESTED**  
by  
**Hirsch-Houck**  
**Labs**

By JULIAN D. HIRSCH

*A survey of v.o.m.'s, the technician's most widely used test instrument—including their features, performance, and prices. Laboratory measurements on eighteen of the newest models from a half-dozen manufacturers are given.*

**P**ROBABLY the single, most useful test instrument for the serviceman, technician, or experimenter is the volt-ohm-milliammeter, or v.o.m. The ability of a v.o.m. to measure d.c. and a.c. operating voltages and currents and to make point-to-point resistance or continuity checks, combined with its portability and moderate cost, make it ideal for service calls and general field use, as well as on the shop or laboratory bench.

### **V.O.M. Features**

The v.o.m. is a passive instrument, using only a meter movement, rectifier diodes, and switched resistors for range selection. Internal batteries supply the current for resistance measurements. Early v.o.m.'s used a 1-mA basic meter movement, requiring a series multiplier resistance of  $1000\Omega$  for each volt of full-scale reading. This limited their usefulness for low-voltage measurements to low-impedance circuits where the meter current would not unduly affect the circuit conditions. Obviously, low-current measurements were limited by basic meter sensitivity.

With improved meter designs, economical manufacture of very sensitive, yet rugged, meter movements has become practical. Most modern v.o.m.'s have a sensitivity of  $20\text{ k}\Omega/\text{V}$  for d.c. measurements ( $50\mu\text{A}$  basic meter sensitivity). Some v.o.m.'s have a sensitivity of  $100\text{ k}\Omega/\text{V}$  or even higher. Conventional jewel-pivot d'Arsonval movements become quite fragile when designed for high sensitivity so that most of the high-impedance meters (and many of the  $20\text{ k}\Omega/\text{V}$  models as well) now use a *taut-band* suspension. A slender wire supports the moving coil and pointer and supplies the restoring torque which is provided by a flat spiral spring in pivoted meters. The taut-band suspension is inherently more rugged than a pivoted-suspension type and it has less friction; however, it is not intrinsically more accurate.

For a.c. measurements, practically all v.o.m.'s use a full-wave germanium diode rectifier. Unlike the copper-oxide or selenium rectifier used in older designs, germanium diodes have a frequency response extending well beyond the audio range, usually to 100 kHz or higher. The meter input impedance for a.c. measurements is lower than for d.c., typically  $5\text{ k}\Omega/\text{V}$ , but as high as  $10\text{ k}\Omega/\text{V}$  on some very

sensitive meters that are currently available, and as low as  $1\text{ k}\Omega/\text{V}$  on one of the meters evaluated for this report.

Before the widespread use of solid-state circuits, resistance measurements were a simple matter of forming a series circuit consisting of a battery, meter (with its own internal resistances), and the unknown resistance to be measured. The meter read the current through the circuit and was calibrated in terms of external resistance. Problems can arise when making resistance measurements in transistor circuits or on a transistor or diode alone. Most ohmmeters apply at least 1.5 V to the external circuit (on the higher ranges, as much as 30 V). This is sufficient to bias a transistor junction or diode into conduction, giving a false resistance reading. If the circuit resistance appears to change when the meter leads are reversed or the range is changed, this condition can be assumed to exist. Also, some solid-state devices can be damaged by excessive current from an ohmmeter, which can reach hundreds of milliamperes on the lower ranges.

Several v.o.m.'s now feature "low-power" resistance measurements, usually on the lower ranges. The maximum voltage appearing on the test leads is on the order of 0.1 V, too low to "turn on" a semiconductor junction, and the maximum current is limited to a few milliamperes. With these meters, accurate resistance measurements can be made in transistor circuits without disconnecting the transistors. Normal or "high-power" resistance measurements are still useful, since they simplify checking the forward and reverse resistances of diodes and transistors.

Today's highly sensitive meter movements are easily damaged or burned out by overloads. Almost every v.o.m. manufacturer guards against this by placing a pair of back-to-back silicon diodes directly across the meter terminals. Even when reading full scale, the voltage drop across the meter is far below the value needed to "turn on" a silicon junction, so they have no effect on meter accuracy. A massive overload, producing a voltage sufficient to cause the diodes to conduct, causes them to shunt the meter and limits the maximum voltage across the meter to about 0.6 V. A meter protected in this way can withstand a severe overload for short periods and, if it is well made, the pointer can withstand a remarkable amount of abuse.



Protecting only the meter movement against overload may not be sufficient since severe overloads or improper operation, such as making a resistance measurement on a "live" circuit, can burn out the precision resistors in the meter.

Fuses are used in many meters, principally to protect the ohmmeter ranges or high-current ranges. Some v.o.m.'s are designed with positive overload protection in the form of a relay that senses the current through the meter and opens the input circuits to the entire v.o.m. when an overload becomes excessive. Usually a button pops out of the meter case when this happens and after the overload is removed the button will latch in when pressed. This feature adds considerably to the price of a v.o.m., but may still be an economy if the meter is to see rough service or be used by inexperienced personnel.

### Accuracy Specifications

For most applications, the accuracy specifications of typical v.o.m.'s are perfectly adequate. They are typically  $\pm 2\%$  of full scale for d.c. measurements and  $\pm 3\%$  of full scale for a.c. measurements, with some degradation of accuracy at frequencies above 20 kHz or on the very high a.c. voltage ranges. A few instruments, usually those with larger meters, are rated at  $\pm 1.5\%$  or even  $\pm 1\%$ , while very small portab-

le v.o.m.'s may carry a  $\pm 3\%$  rating. These differences are not significant for service work, but laboratory applications may warrant the higher cost of a more accurate meter. However, our tests suggest that the actual accuracy of most meters is much better than their published specifications and there often seems to be little relation between the two figures.

Two other factors can have a profound effect on the actual reading accuracy. The size of the meter—actually, the length of its scales—often limits the visual reading accuracy. One should not expect to read a hand-held meter having a 2" scale with the accuracy possible in a bench meter with a 6" or 7" scale. Even more important is the choice of scale ranges offered. Since meter accuracy is normally rated in terms of a percentage of the full-scale reading, a "2%" meter may have errors of 4% at half scale or 6% at one-third scale. Clearly, it is desirable to make a reading as far up on the scale as possible.

Any meter claiming an accuracy of better than 2% should have an anti-parallax scale. Generally this is a mirror backing in which the visual alignment of the pointer with its reflection assures a correct viewing position. The *Weston Model 80* uses a two-layer plastic scale to achieve the same result, with somewhat easier viewing than most mirror scales.

## Test Results



◀ RCA WV-517A is one of a line of five new inexpensive v.o.m.'s priced from \$10 to \$48.



Simpson 202 has unusual logarithmic scales. Company has very large line of v.o.m.'s. ▶



▲ Triplet 100 kit contains Model 310 v.o.m. with clamp-on ammeter adapter and line separator. Company has one of the most extensive lines of v.o.m.'s available.

### B&K Model 120

**FEATURES:** D.c. volts ( $\pm$ ) 9 ranges from 0.3 to 6000 V, 20 k $\Omega$ /V,  $\pm 2\%$  accuracy. A.c. volts 8 ranges from 1.2 to 6000 V, 5 k $\Omega$ /V,  $\pm 3\%$  accuracy. Output ranges with blocking capacitor up to 600 V. D.c. current ( $\pm$ ) 7 ranges from 60  $\mu$ A to 12 A, accuracy  $\pm 2\%$ . Resistance 5 ranges, center readings from 2 $\Omega$  to 200 k $\Omega$ . Jewel pivot movement, mirror scale 3 $\frac{3}{4}$ " long. Dimensions 7"  $\times$  5 $\frac{1}{4}$ "  $\times$  3 $\frac{1}{8}$ ". Weight 2 lbs. 14 oz. Price \$64.95.

**PERFORMANCE:** D.c. volts +0.3%, -0.7%. A.c. volts +0.3%, -0.4%. D.c. current +0, -0.4%. Ohms +1%, -2%. Frequency response 0.1%.

**COMMENTS:** Moderate meter overshoot (under-damped). Balance OK. Transit switch position damps meter heavily.

### Medistor Model N-2

**FEATURES:** D.c. volts 9 ranges from 12 mV to 600 V, 20 k $\Omega$ /V,  $\pm 2.5\%$  accuracy. A.c. volts 6 ranges from 1.5 to 600 V, 4 k $\Omega$ /V,  $\pm 3.5\%$  accuracy to 500 Hz,  $\pm 7.5\%$  to 30 kHz. D.c. current 9 ranges from 30  $\mu$ A to 6 A,  $\pm 2.5\%$  accuracy. A.c. current 8 ranges from 150  $\mu$ A to 6 A. Accuracy same as a.c. voltage measurement. Resistance 2 ranges, center readings 300 $\Omega$ , 30 k $\Omega$ . Temperature (with optional thermocouple probe) +68° to +460°F, +68° to -150°F. Taut-band movement, glass pointer, scale length 3 $\frac{3}{4}$ ". Fuse protection. Dimensions 6 $\frac{1}{8}$ "  $\times$  3 $\frac{3}{4}$ "  $\times$  1 $\frac{3}{8}$ ". Weight 12 oz. Price \$39.95.

**PERFORMANCE:** D.c. volts +0.6%, -1.5%. A.c. volts +0, -1.3%. D.c. current +1.1%, -0%. A.c. current -1.3% (at 10 mA). Ohms +3%, -2%. Frequency response 1.3%.

**COMMENTS:** Selector switch relatively difficult to read. Only meter tested with a.c. current ranges. Balance shift approx. 1%. Considerable overshoot (under-damped). Manufactured in Austria.

### RCA Model WV-516A

**FEATURES:** D.c. volts 4 ranges from 5 to 1000 V, 2 k $\Omega$ /V,  $\pm 3\%$  accuracy. A.c. volts 4 ranges from 5 to 1000 V, 2 k $\Omega$ /V,  $\pm 4\%$  accuracy. D.c. current 3 ranges from 0.5 to 250 mA,  $\pm 3\%$  accuracy. Resistance 2 ranges, center readings 27 and 2700 $\Omega$ . Jewel pivot movement. Scale length 2 $\frac{1}{2}$ ". Dimensions 4 $\frac{5}{16}$ "  $\times$  3 $\frac{3}{8}$ "  $\times$  1 $\frac{3}{4}$ ". Weight 11 oz. Price \$9.95.

**PERFORMANCE:** D.c. volts +0, -1.6%. A.c. volts +0, -2.4%. D.c. current +0, -2.1%. Ohms +0, -10%. Frequency response 0.4%.

**COMMENTS:** Very compact hand-held meter. No range switch; separate pin jacks for each range. Fast response, slightly over-damped. Balance shift 1%. Made in Japan.

Although most meters are designed to give maximum accuracy in a horizontal position, their movements should be balanced so that the pointer does not shift between vertical and horizontal positions. The response time and damping of the meter movement also affect its usefulness. An under-damped meter can oscillate wildly when reading a changing level, while an over-damped meter takes an appreciable time to reach its final reading. Critical damping—a rapid pointer movement with virtually no overshoot—is ideal, but rarely found. A slightly over-damped meter is probably preferable to an under-damped movement, however.

Most meters have a ratio of 4 or 5 between adjacent scale ranges. Obviously, many readings will be well below half scale, yet above the next lower range. Compare your own special measurement needs to the ranges offered when considering the purchase of v.o.m. All other factors being equal (as they often are), this may be the deciding factor in your choice. Two meters of the group tested for this survey minimize this problem in very different ways. The *Triplet Model 800* can divide each of its normal ranges by two, so that the gap between adjacent ranges is reduced to 2 or 2.5. In many cases, this feature could appreciably improve the measurement accuracy, at the cost of a bit more switching when selecting ranges. The *Simpson Model 202*, on the other hand, has logarithmic scales with a rated d.c. measure-

ment accuracy of  $\pm 2\%$  of *actual reading*. Most of its ranges are in a 10:1 ratio, giving high accuracy with a minimum of switching.

Almost all v.o.m.'s have a.c. and d.c. voltage ranges from about 3 V to at least 1000 V, and sometimes a high-voltage range of about 5000 V. For measurements in high-voltage circuits, it is usually preferable to use the optional high-voltage probes offered by many manufacturers. They are insulated to protect the user and contain the multiplier resistors extending the meter's range to tens of kilovolts for measurements in TV and other high-voltage circuits.

Clamp-on a.c. current probes are available for some meters. They are current transformers which allow a.c. currents from an ampere or so up to hundreds of amperes to be read on the low-voltage a.c. ranges of the v.o.m. The clamp-on probe can only measure current in a single conductor, but line-splitting adapters are available to facilitate measurements in two-conductor circuits without disturbing the wiring. One of the meters tested (*Medistor Model N-2*) is unique in having a.c. current ranges from 150  $\mu$ A to 6 A full scale. However, the circuit must be interrupted for these measurements. Other probes for specialized measurements, such as r.f. voltage and temperature, can be purchased for many meters.

The accuracy of a resistance measurement with a v.o.m.

## -Test Results (Continued)

Weston 80 has unique sloping meter face. Also available in rack-mount configuration. ▶



### RCA Model WV-517A

**FEATURES:** D.c. volts 6 ranges from 0.3 to 600 V, 20 k $\Omega$ /V,  $\pm 3\%$  accuracy. A.c. volts 4 ranges from 12 to 600 V, 10 k $\Omega$ /V,  $\pm 4\%$  accuracy. Blocking capacitor for Output measurements. D.c. current 3 ranges from 60  $\mu$ A to 300 mA,  $\pm 3\%$  accuracy. Resistance 3 ranges, center readings 54  $\Omega$  to 54 k $\Omega$ . Jewel pivot movement. Scale length 2 1/2". Dimensions 4 3/8" x 3 3/16" x 1 1/2". Weight 13 oz. Price \$18.00.

**PERFORMANCE:** D.c. volts +1.7%, -0%. A.c. volts +1.2%, -1.7%. D.c. current +1%, -0%. Ohms +2%, -12%. Frequency response 1.7%.

**COMMENTS:** Compact meter suitable for holding. Fast response, moderate single overshoot. Balance shift 0.8%. Made in Japan.

### RCA Model WV-518A

**FEATURES:** D.c. volts 7 ranges from 0.5 to 500 V, 20 k $\Omega$ /V,  $\pm 3\%$  accuracy. A.c. volts 4 ranges from 15 to 500 V, 10 k $\Omega$ /V,  $\pm 4\%$  accuracy. D.c. current 4 ranges from 0.5 to 500 mA,  $\pm 3\%$  accuracy. Resistance 4 ranges, center readings 22 to 22 k $\Omega$ . Jewel pivot movement, mirror scale, length 2 1/4". "Ohms" range fuse-protected. Dimensions 5 1/4" x 3 3/8" x 2". Weight 1 lb, 2 oz. Price \$28.50.

**PERFORMANCE:** D.c. volts +0.8%, -2%. A.c. volts +0.7%, -2.7%. D.c. current +3%, -0%. Ohms +1%, -8%. Frequency response 0.7%.

**COMMENTS:** Range switch has "Off" position. Fairly fast response, over-damped. Balance OK. Made in Japan.

### Simpson Model 160

**FEATURES:** D.c. volts ( $\pm$ ) 8 ranges from 0.25 to 1000 V, 20 k $\Omega$ /V,  $\pm 2\%$  accuracy. A.c. volts 6 ranges from 2.5 to 1000 V, 5 k $\Omega$ /V,  $\pm 3\%$  accuracy. D.c. current ( $\pm$ ) 6 ranges from 50  $\mu$ A to 500 mA,  $\pm 2\%$  accuracy. Resistance 5 ranges, center readings 30 to 300 k $\Omega$ . Taut-band movement, scale length 3". Dimensions 4 3/8" x 3 3/16" x 1 3/4". Weight 12 oz. Price \$55.00.

**PERFORMANCE:** D.c. volts +0.3%, -0.2%. A.c. volts +3.8%, -0%. D.c. current +1.5%, -1.0%. Ohms +0%, -2%. Frequency response 0.2%.

**COMMENTS:** Very small, portable instrument. Legibility of scales and selector excellent. Critically damped, no overshoot. Balance OK.

### Simpson Model 202

**FEATURES:** D.c. volts 6 ranges from 330 mV to 1100 V, 20k $\Omega$ /V. Accuracy  $\pm 2\%$  of reading. A.c. volts 4 ranges from 11 to 1100 V, 5 k $\Omega$ /V. Accuracy  $\pm 3\%$  of reading. D.c. current 5 ranges from 110  $\mu$ A to 1.1 A. Accuracy  $\pm 2\%$  of reading. Resistance 5 ranges, center readings 4 to 700 k $\Omega$ . Taut-band movement, mirror scale, length 7 3/4". Fuse protection. Meter shunted by varistor instead of diodes. Dimensions 6 3/4" x

▶ B&K Model 120 has very low ohms scale, with mid-scale resistance reading of 2 $\Omega$ .

Medistor N-2 has molded leads with locking jacks, permitting it to be hung by its leads.





cannot be expressed simply. The resistance scale is highly non-linear and accuracy is specified as a percentage of scale length, which means little to most users. If your resistance measurement is principally for continuity or rough circuit checks, accuracy is of minor importance. However, in working with power equipment, such as motors and transformers, it is often necessary to make reasonably accurate measurements of small resistances. To evaluate the suitability of a meter for such measurements, look at the resistance reading at the center of its ohms scale. Some meters have a center-scale reading of 30 $\Omega$  or even more on their lowest range, while others have about a 4- $\Omega$  center reading. One of the group tested (*B&K* Model 120) has a very low ohms scale, with a center reading of 2 $\Omega$ , allowing measurements down to less than 0.1 $\Omega$ .

On the other hand, very high resistance measurements (of leakage paths or insulation resistance) require a high center scale reading on the highest ohms range. Values of 200 k $\Omega$  or 500 k $\Omega$  are typical, allowing rough measurements up to 20 M $\Omega$  or more. The *Simpson* Model 257, used with an external d.c. source of 100 to 240 V, can read up to about 500 M $\Omega$ .

Any v.o.m. is small and light enough to be taken into the field and most have convenient carrying handles. The larger models, with meter scales as long as 7", are clearly in-

tended for bench use. At the other extreme are the tiny, palm-sized *Triplet* Model 310 Series 2 and the only slightly larger *Simpson* Model 160, which are ideal for carrying to the job, but whose short scales make them less desirable for regular use on the service bench.

When shopping for a v.o.m., consider its convenience for your own type of work. For example, some meters use a simple rotary switch for all range and function selection. In others, a separate switch is provided for choosing d.c. or a.c. operation, or selecting current or resistance modes of measurement. This is sometimes combined with a polarity-reversing function, or a separate switch may be used for that purpose. On some meters, the range in use can be identified at a glance; others require examination of two or three controls. The same situation exists on the meter scales, which can get rather cluttered in a multi-scale meter.

### Test Program

A number of v.o.m. manufacturers were invited to submit samples for our evaluation. We proposed to go beyond the customary listing or tabulation of specifications, which is readily obtainable from manufacturers' literature. In addition, actual measurements were to be made with each meter, all under identical, controlled conditions, to see how well they lived up to their claims. (*Editor's Note: Within*

tion. Meter shunted by varistor instead of diodes. Dimensions 6 $\frac{3}{4}$ " $\times$  7 $\frac{3}{4}$ " $\times$  3 $\frac{3}{4}$ ". Weight 4 lbs, 7 oz. Price \$100.00.

**PERFORMANCE:** D.c. volts  $\pm 0\%$ ,  $-1.5\%$  of reading. A.c. volts  $+1.4\%$ ,  $-0\%$  of reading. D.c. current  $+0.5\%$ ,  $-2\%$  of reading. Ohms  $+1\%$ ,  $-2\%$ . Frequency response 0.5%.

**COMMENTS:** Only meter tested having logarithmic scales. Effective accuracy very good. Single knob range/function selector. Heavily damped for transit. Pointer movement rapid, considerable overshoot.

### Simpson Model 257

**FEATURES:** D.c. volts ( $\pm$ ) 9 ranges from 0.1 to 5000 V, 100 k $\Omega$ /V,  $\pm 1.5\%$  accuracy. A.c. volts 4 ranges from 10 to 1000 V, 20 k $\Omega$ /V,  $\pm 2.5\%$  accuracy. Blocking capacitor for Output measurements up to 250 V. D.c. current ( $\pm$ ) 8 ranges from 10  $\mu$ A to 1A, accuracy  $\pm 1.5\%$ . Resistance 3 ranges with internal battery, center readings 30 to 100 k $\Omega$ . 2 ranges with external a.c. and d.c. sources of 100 to 240 V, center readings 1 M $\Omega$  and 10 M $\Omega$ . Capacitance with external a.c. supply of 100 to 240 V, from 2000 pF to 5  $\mu$ F. Taut-band movement, mirror scale, length 3 $\frac{1}{4}$ ". Fuse protection. Overload relay with push-button reset. Dimensions 8 $\frac{1}{4}$ " $\times$  4 $\frac{1}{4}$ " $\times$  3 $\frac{1}{4}$ ". Weight 2 lbs, 9 oz. Price \$95.00.

**PERFORMANCE:** D.c. volts  $+0.6\%$ ,  $-0.8\%$ . A.c. volts  $+0.5\%$ ,  $-1.6\%$ . D.c. current  $+1.0\%$ ,  $-0.6\%$ . Ohms  $\pm 0\%$ . Frequency response 1%.

**COMMENTS:** Exceptional high ohms capability with external supply. Fast-acting overload relay protects entire meter. Single selector for all ranges and modes. Meter under-damped, overshoots. Balance OK. Manufactured in Austria.

### Simpson Model 260-5P

**FEATURES:** D.c. volts ( $\pm$ ) 7 ranges from 0.25 to 5000 V, 20 k $\Omega$ /V,  $\pm 2\%$  accuracy. A.c. volts 6 ranges from 2.5 to 5000 V, 5 k $\Omega$ /V,  $\pm 3\%$  accuracy. Blocking capacitor for Output measurements up to 250 V. D.c. current ( $\pm$ ) 6 ranges from 50  $\mu$ A to 10 A, accuracy  $\pm 2\%$ . Resistance 3 ranges with center values 12 to 120 k $\Omega$ . Taut-band movement. Scale length 4 $\frac{1}{8}$ ". Fuse protected. Fast-acting overload relay with push-button reset. Dimensions 7"  $\times$  5 $\frac{3}{8}$ " $\times$  3 $\frac{1}{4}$ ". Weight 3 lbs. Price \$97.00.

**PERFORMANCE:** D.c. volts  $+0.4\%$ ,  $-0.1\%$ . A.c. volts  $+2\%$ ,  $-0\%$ . D.c. current  $+1.2\%$ ,  $-0\%$ . Ohms  $+4\%$ ,  $-2\%$ . Frequency response 0.3%.

**COMMENTS:** Contains separate rectifier and transistor amplifier to operate overload relay. Meter response fast, single moderate overshoot. Balance OK.

### Simpson Model 269-3

**FEATURES:** D.c. volts 9 ranges from 0.8 to 4000 V, 100 k $\Omega$ /V,

$\pm 1.5\%$  accuracy. A.c. volts 6 ranges from 3 to 800 V, 5 k $\Omega$ /V,  $\pm 2.5\%$  accuracy. D.c. current 7 ranges from 16  $\mu$ A to 8 A,  $\pm 1.5\%$  accuracy. Resistance 6 ranges, center readings from 12 to 1.2 M $\Omega$ . Taut-band movement, mirror scale, length 6 $\frac{1}{8}$ ". Fuse protection. Dimensions 6" $\times$  7 $\frac{1}{4}$ " $\times$  3". Weight 3 lb, 12 oz. Price \$98.00.

**PERFORMANCE:** D.c. volts  $+4.5\%$ ,  $-0\%$  (highest error on 400 V range; maximum error elsewhere  $+1.8\%$ ). A.c. volts  $+2.5\%$ ,  $-0\%$ . D.c. current  $+1.4\%$ ,  $-0\%$ . Ohms  $+0\%$ ,  $-2\%$ . Frequency response  $-0.25\%$ .

**COMMENTS:** Response very slow, over-damped. Single knob range/function selector. Balance shift approximately 0.3%.

### Simpson Model 270-3

**FEATURES:** D.c. volts ( $\pm$ ) 7 ranges from 0.25 to 5000 V, 20 k $\Omega$ /V,  $\pm 1.25\%$  accuracy. A.c. volts 5 ranges from 2.5 to 1000 V, 5 k $\Omega$ /V,  $\pm 2\%$  accuracy. Blocking capacitor for Output measurements up to 250 V. D.c. current ( $\pm$ ) 6 ranges from 50  $\mu$ A to 10 A,  $\pm 1.25\%$  accuracy. Resistance 3 ranges, center readings 12 to 120 k $\Omega$ . Taut-band movement, mirror scale, length 4 $\frac{1}{4}$ ". Fuse protection. Dimensions 7" $\times$  5 $\frac{3}{8}$ " $\times$  3 $\frac{1}{4}$ ". Weight 3 lbs. Price \$78.00.

**PERFORMANCE:** D.c. volts  $+1.2\%$ ,  $-0\%$ . A.c. volts  $+0\%$ ,  $-1.2\%$ . D.c. current  $+1.7\%$ ,  $-0\%$ . Ohms  $+5\%$ ,  $-2\%$ . Frequency response 0.5%.

**COMMENTS:** Accuracy specification reduces to 1.75% d.c. and 3% a.c. over 67-87 $^{\circ}$ F temperature range. Response rapid, slight overshoot. Balance OK.

### Triplet Model 310-2

**FEATURES:** D.c. volts 5 ranges from 3 to 1200 V, 20 k $\Omega$ /V,  $\pm 3\%$  accuracy. A.c. volts 5 ranges from 3 to 1200 V, 5 k $\Omega$ /V,  $\pm 4\%$  accuracy. D.c. current 4 ranges from 0.6 to 600 mA,  $\pm 3\%$  accuracy. Resistance 4 ranges, center readings 200 to 200 k $\Omega$ . Jewel pivot movement. Scale length 2 $\frac{1}{8}$ ". Dimensions 4" $\times$  2 $\frac{3}{4}$ " $\times$  1 $\frac{1}{8}$ ". Weight 8 oz. Price \$44.00 (\$78.00 as Model 100, with current probe and line adapter, in case).

**PERFORMANCE:** D.c. volts  $+0.6\%$ ,  $-0\%$ . A.c. volts  $+0.7\%$ ,  $-1.2\%$ . D.c. current  $+0.7\%$ ,  $-0.8\%$ . Ohms  $+0\%$ ,  $-4\%$ . Frequency response  $\pm 0\%$ .

**COMMENTS:** Smallest and lightest meter tested. With Model 10 clamp-on current probe and Model 101 current-splitting adapter, measures a.c. currents up to 300 A. Error at 3.0 A on 6-A range,  $-2.3\%$  of full scale. Very legible scales and selector marking. Response very fast, critically damped. Balance OK.

### Triplet Model 630-2

**FEATURES:** D.c. volts 6 ranges from 3 to 6000 V, 20 k $\Omega$ /V,  $\pm 2\%$

# How to Locate Buried-Conductor Faults

By JOHN T. BAILEY

*By setting up a bridge circuit and using an a.c. v.t.v.m. as a null indicator, exact location of fault can be determined.*

**O**FTEN an electronics technician can solve problems that stump others who would seem to be better qualified for the task. For instance, suppose a long underground power line, consisting of two-conductor Romex cable buried in soil several feet below the surface, has developed a dead short to ground or even a high-resistance short to ground. Obviously, it would be nice to know where the fault has occurred so that the entire line would not have to be dug up in order to fix it. Since this line is a 60-Hz power line furnishing power to a remote motor, lights, heater, or other similar power load, it would be logical to call in an electrician. But, chances are that an electronics technician can understand the circuitry needed to locate the fault better than the average electrician and will have the test equipment needed.

Let's assume a typical situation where you plan to connect driveway lights to 300 feet of buried Romex underground-type cable at 75-foot intervals. (Romex cable used

consists of two #14 copper conductors and ground wire.) This you do, by making a splice underground at each light location, being careful to tape the splices thoroughly to exclude ground moisture. Now, *before* you put in the lamp bulbs and *before* you connect the house end to a power circuit, you make a resistance check between each conductor and a waterpipe ground with your v.o.m. But when you do, one conductor shows an infinite resistance to ground and the other shows leakage of 50,000 ohms. Of course, a fault of that magnitude isn't too serious in a power circuit. Nevertheless something went wrong and it might get worse with time so you want to fix it. Here's how to locate the fault without digging up the entire cable.

## Locating Fault

First, connect the two conductors together at the extreme end of the run away from the house. This can be done easily at the remotest lamp socket. At the cable end closest to the house wire up a Wheatstone-type bridge circuit, as shown in the diagram, using the cable conductors as two arms of the bridge. Power the makeshift Wheatstone bridge from a suitable filament transformer connected through a Variac to the home power source. Use your v.t.v.m., set at its most sensitive a.c. scale, say 1 volt, as the null detector. A 6.3-volt filament transformer will be adequate in this example, but for other conductor sizes and lengths of cable a quick check using Ohm's Law should be applied.

Table 1 shows the d.c. resistance of the various copper wire sizes per hundred feet of conductor. Be sure to double the length of the cable run to get the length of the two conductors when connected in series across the transformer. Also shown are safe current-carrying capacities for various wire sizes. In this connection it should be noted that these values are merely safe figures and not code ratings which vary with the type of insulation and other considerations. The maximum current through the cable probably will be limited by the current rating of the transformer winding. In this case, the total conductor resistance is  $0.2575 \times 2 \times 300 / 100 = 1.545$  ohms. Since #14 conductors will safely carry 15 amperes, almost any available 6.3-volt transformer will do. The more current through the cable the more accurate the location of the fault will be.

R1 and R2 should be precisely equal. Their value is not important; 25 ohms each will do. Equality can be obtained by using a potentiometer or a wirewound resistor with a slider. The pot arm or the slider is set using the v.t.v.m. to get equal voltages across resistors R1 and R2 when they are connected across the transformer.

(Continued on page 53)

Table 1. The d.c. resistance of various copper wire sizes per hundred feet of conductor. The safe (not code ratings) current carrying capacities of these wires are also listed.

Copper Wire Size	Ohms/100 Feet	Safe Current (A)
18	0.6510	3
16	0.4094	6
14	0.2575	15
12	0.1619	20
10	0.1018	30

Table 2. Resistance of nichrome wire sizes that can be used to fabricate variable resistor R3.

Nichrome Wire Size	Ohms/Foot
22	1.055
20	0.659
18	0.422
16	0.260

Bridge circuit for determining exact location of cable fault.

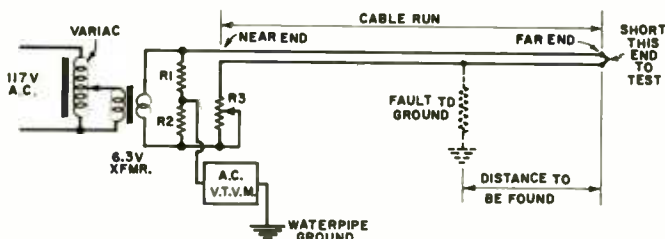



# COLOR TV for 1971

By FOREST H. BELT  
Contributing Editor

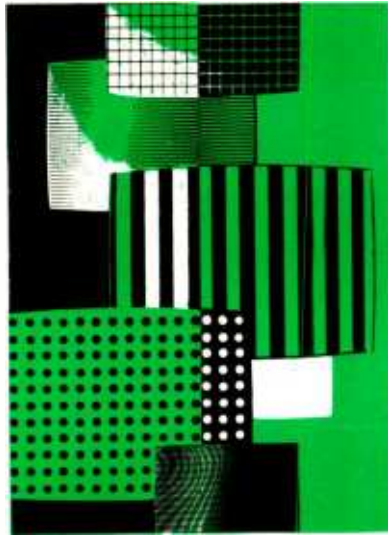

**Part 2. Integrated circuits are coming into use in the new receivers, as are varactors for tuning and more solid-state high-voltage rectifiers. Automatic tint controls are also more common. Here are the new circuit designs and trends.**

**L**AST month we gave an over-all picture of the new color sets and showed how more and more transistors are being used in the new chassis. Now, we will go into the use of IC's, along with other solid-state components.

## Integrated Circuits

Among the companies making the greatest strides this year in color-set integrated circuits is *Zenith*. The entire color processing is integrated. Only three transistors are used, for final amplification of color-difference signals.

Fig. 1 pictures the integrated circuits and shows the plug-in Dura-Modules on which they're mounted. External circuits consist of a very few resistors, capacitors, and coils.

Fig. 2 shows what's inside the IC's. The first one, in Fig. 2A, is the chroma amp IC. Each function triangle represents several transistors, resistors, and capacitors on the IC chip.

Chroma signal from the video detector goes first to a gain-controlled broadband amplifier, the a.c.c. amp. Output of the a.c.c. amp is held at constant level by a control voltage from the subcarrier regenerator IC.

The steady chroma signal goes to a chroma level amp. Its gain can be set manually by the Color control. Some of the chroma signal is split off and fed to the subcarrier regenerator IC, where color-sync burst can be separated. The main chroma output signal goes to the demodulator IC.

The a.c.c. amp also sends a voltage to the killer stage. That voltage overrides the killer threshold voltage, operating the killer amp and letting the chroma level amp work. If no color is actuating the a.c.c., the killer cuts off the chroma level amp.

The subcarrier regenerator (Fig. 2B) takes composite chroma from the a.c.c. amp in the chroma amp IC. It's fed to a phase-control detector (a.p.c.) and an a.c.c. detector. Both are much the same in operation as their counterparts in any color section. The color-sync burst is compared with the output of a 3.58-MHz oscillator. Any variance in phase produces a voltage shift that corrects the oscillator phase, keeping it locked to the station's color subcarrier. The a.c.c. detector senses the strength of the chroma signal and pro-

duces a d.c. voltage that, applied to the a.c.c. amp in the chroma amp IC, holds chroma level steady.

Output from the phase-corrected 3.58-MHz oscillator goes through a d.c.-operated hue-control amp. This kind of stage was described earlier. It allows viewer control of sub-carrier phase over a narrow range, so hue from the demodulators can be varied. The 3.58-MHz output is then fed to the demodulator IC.

The gate amp is merely a stage of buffering for a keying pulse from the flyback transformer. The pulse blanks everything off during horizontal retrace.

The demodulator IC is illustrated in Fig. 2C. This chip was used in earlier *Zenith* color sets, although packaged differently.

Chroma input comes from the chroma amp IC. The 3.58-MHz signal reaching the demodulator IC has already been phase-shifted for R-Y and B-Y injection. The solid-state demodulators produce R-Y and B-Y signals. A matrix stage produces G-Y. All three are subjected to a stage of preamplification and then fed to their respective transistor output stages, which drive the CRT where Y signal is added.

Fig. 1. Entire color processing in two Zenith chassis is carried out with integrated circuits. Three dual-in-line type IC's mounted on two Dura-Modules are subcarrier regenerator (221-42), chroma amplifier (221-43), and color demodulator/amp (221-46).

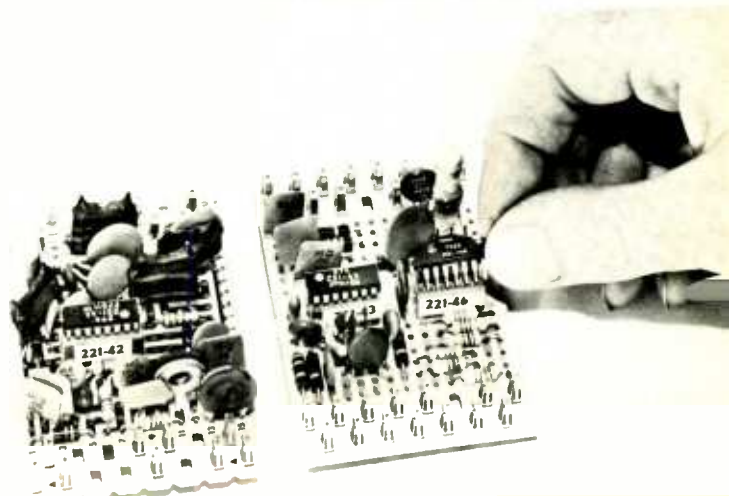

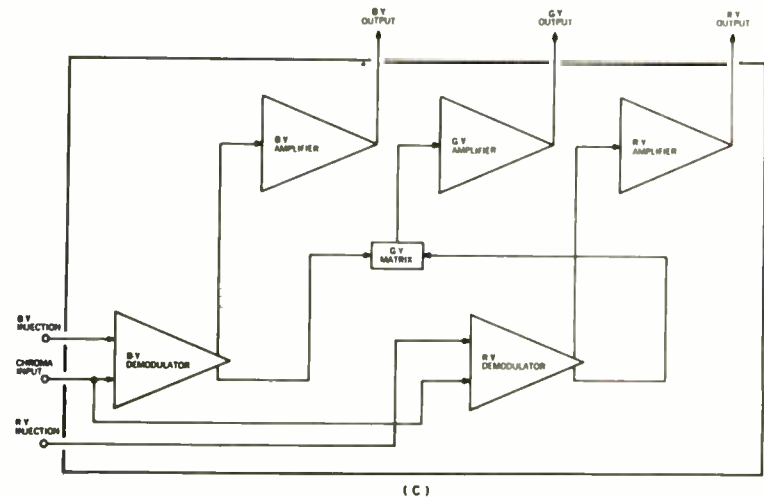
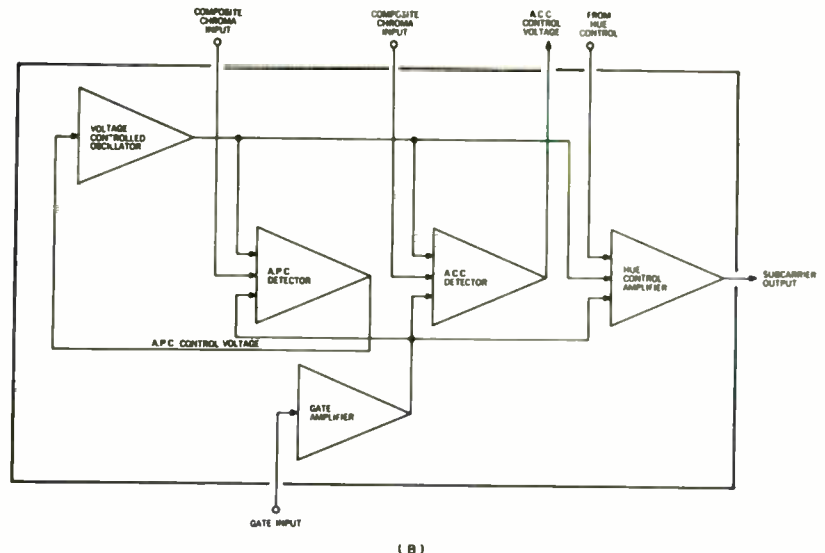
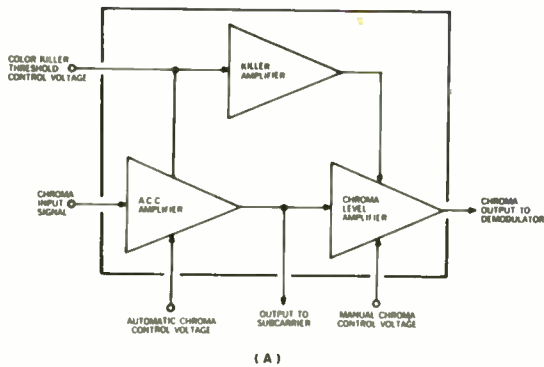

Fig. 2. What's inside the Zenith color-section IC's. (A) Chroma amplifier. (B) Subcarrier regenerator. (C) Demodulators and color-difference preamplifiers. Outputs of IC shown in (C) are connected to three transistor color-difference amps.

The Zenith sets and the new RCA CTC49 chassis represent the most elaborate use of integrated circuits in the 1971 models. But plenty of other manufacturers have IC's in some stages. They include: *Andrea, Channel Master, Electrohome, Heath, Magnavox, Midland, MGA, Motorola, Packard Bell, Panasonic, Philco-Ford, Sony, and Sylvania.* An analysis of how IC's are used in some of the 1971 models follows:

Sound Section (i.f., detector, a.f. preamp): *Andrea, Heath, MGA, Midland, Motorola, Packard Bell, Panasonic, RCA, Sony, Sylvania, Zenith*

Audio Amp (drives speaker): *Magnavox*

Picture Section (i.f., detector, preamp): *RCA*

Chroma Demodulator (includes R, G, B preamps): *Electrohome, Heath, Motorola, RCA, Zenith*

Color Oscillator (3.58 MHz): *Heath, Packard Bell, Philco-Ford*

Chroma Amplifier: *RCA, Zenith*

Subcarrier Regenerator: *RCA, Zenith*

Automatic Frequency Control: *Heath, Panasonic, RCA*

Vertical Oscillator: *Sony*

As you can see, the sound i.f./detector/preamp IC is by far the most popular. *RCA* was the first to use it, several years ago. Many have joined in. There are differences in the IC's used in this spot, but only minor. A few variations also appear in the stages that precede and follow this integrated circuit.

For example, *MGA* chassis CH-120 and CH-140 have a stage of transistor amplification for the sound i.f. before the IC gets it, and a stage of audio amplification between the IC preamp and the audio output transistor. The *Motorola* and *Heath* chassis use extra audio amplification before the

output transistor, too. Most sound-section IC's drive the audio-output transistor directly.

The chroma demodulator IC's in all chassis are similar to the IC already described for *Zenith*. They include color-difference preamps. A single stage of transistor amplification follows for each color, then the CRT.

### Modular Plug-Ins

A number of companies have pursued the plug-in road to ease of servicing. There are certain manufacturing advantages, but generally cost is not one of them. Eventually, when most of a set-maker's chassis are modular, there may be substantial savings.

*Motorola* began the modular trend four years ago, with the first Quasar. That basic chassis remains in the line for 1971. The newer version is called Quasar II. It is pictured in Fig. 3.

The original Quasar was also the first all-transistor color set sold in the U.S. The new Quasar II has some tubes. Actually, only horizontal sweep, high voltage, and vertical sweep stages have tubes.

Whereas previous Quasar models had ten boards, Quasar II chassis have only five. More circuits and stages are included in each board. Nevertheless, *Motorola* spokesmen say that replacement prices of the boards will not exceed the highest price for replacement boards for previous Quasar models. That was \$33, somewhat less since. The Quasar II boards carry a 2-year free-exchange warranty, too.

*Heath Company* has also switched to plug-in modules for its newest color-TV kits. All four new models—the GR-270, GR-370, and GR-371 table and floor models, and the GR-169 portable 14-inch—are of modular construction. For an



idea of what the chassis looks like, see the January issue. Eight of the plug-in printed boards are along the top and bottom of the hinged swing-out chassis pan; one is at the left side just below the i.f. shield cover.

*Zenith* has put several of its Dura-Modules into its two major new color chassis for 1971. The all-transistor 40BC50 and the mostly transistor 4B25C19 both have several of the computer-designed plug-in boards. Two of the modules were shown in Fig. 1 and the chassis they fit into is in Fig. 4.

Quite a few private brands have modular construction for 1971. This is thanks to *Wells-Gardner*, a company which makes no sets for direct sale. All its chassis go into private-label sets.

The 1971 *Wells-Gardner* line includes a 25-inch model that will be sold under several brand names. Among them are: Catalina (*White Stores*), MGA (*Mitsubishi*), Penncrest (*J.C. Penney*), and *W.T. Grant*.

The chassis is mostly tubes, but on plug-in circuit boards nevertheless. There are only four boards. Horizontal output and high voltage are on one. Vertical sweep and horizontal oscillator—and one transistor sync separator—are on another. A much larger board contains the entire color-processing section. Sound, video, and i.f.'s are on another large board.

All connections between boards and the main chassis are through plugs that attach the boards to the chassis pans. These boards are not as readily exchangeable as those of other brands because they're so large and each one contains so much of the circuits. But they are accessible for repair; you can unplug a board and take it out of the chassis while you replace parts on it.

*RCA* recently announced its CTC49 all-transistor chassis for 110-degree picture tubes. The chassis has 11 plug-in modules. The new AccuCircuit modules don't have prongs like the others described. The circuit board is etched right out to the edge, forming contacts that slide into gripping connectors. If you've seen computer circuit cards, you know what an AccuCircuit board looks like. (For details, refer to our January issue.—Editor)

*JVC* (*Nippon Victor*) has one chassis that uses four plug-in modules, but we have no information about their nature.

Quite a few manufacturers have for years grouped circuits this way on printed boards. But interconnections are soldered to points on the board. If the plugs used for modular boards are improved a bit to make connections more dependable, and if redesign can reduce the number of interconnections needed, almost all manufacturers will make the changeover.

### Tuning with Varactor Diodes

Electronic tuning for both u.h.f. and v.h.f. is not a new idea. But the 1971 line is the first to see it in any number. Three brands have varactor tuning and a couple of experimental sets use it. Here are a few details.

*Electrohome* had a varactor tuner in last year's line. It's in the 1971 line too. You may remember the C8 chassis. Channels are actuated by touching a finger between a metallic bus-bar and the metallic button for the desired channel. An elaborate sensing system applies voltages to switching diodes and varactor diodes in the tuner to select the band and tune the channel. The C8 tuner gives the viewer a choice of any six u.h.f. channels in addition to the regular twelve v.h.f. channels.

The v.h.f. tuner in the company's C9 chassis is varactor-tuned and diode-switched. But neither push-button nor touch-button is used to select channels. Instead, a sliding-contact lever switch does it.

The mechanism behind the panel is deceptively simple. The sliding-contact switch has one row of contacts that connects one of the fifteen tuning potentiometers to a tuning-voltage line. Each pot is set for whatever voltage tunes that channel.

At the bottom end of the slider's travel, one potentiometer happens to be for u.h.f. manual tuning. It lets the viewer tune anywhere in the u.h.f. band by hand.

Automatic fine tuning (a.f.t.) stages in the main chassis make any minor alterations in tuning voltages to tune the station precisely. That's necessary for color and makes up for any small tolerances in pots or other components.

Also part of the sliding switch is a bar that puts a switching voltage on one of three lines—to the low v.h.f. switching diode, to the high v.h.f. switching diode, or to the u.h.f. tuner.

Another row of contacts turns on the dial light beside the lever, showing whatever channel is selected. The lighted number is silhouetted on the dial.

*Sylvania*, too, has a varactor tuner in the new all-transistor E01 chassis. The mechanism that operates it is an 11-button channel selector. Any button can be adjusted to tune any channel, either v.h.f. or u.h.f. That means the viewer can have any eleven channels available at the touch of a button. If the locality has fewer than eleven channels, the same station can be put on more than one button.

Each push-button operates enough contacts to apply a band-switching (or tuner-changing) voltage, apply a potentiometer-set tuning voltage, and light a channel-number indicator. A technician must preset the channels, but the tuner supplies equal tuning for both v.h.f. and u.h.f. (That's one of the advantages expected from electronic tuning. The Federal Communications Commission is demanding that u.h.f. soon tune as easily as v.h.f.)

The other U.S. manufacturer with a varactor tuner is *Ze-*

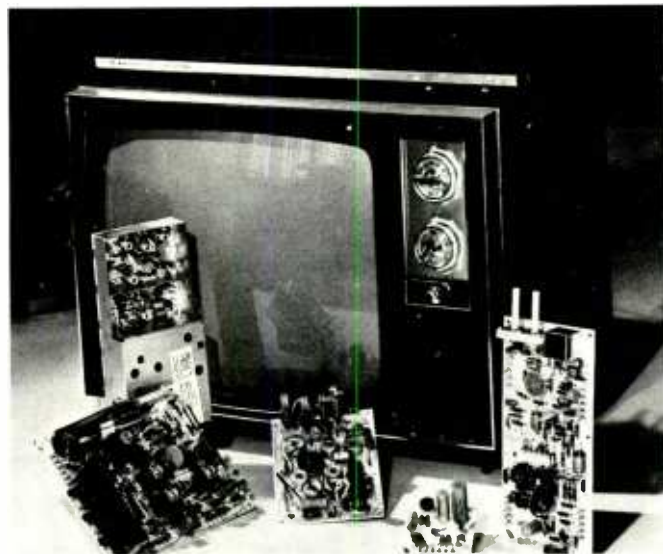

Fig. 3. Plug-in modules for Quasar II, latest Motorola color chassis. Some tubes are used although original Quasar is all solid-state.

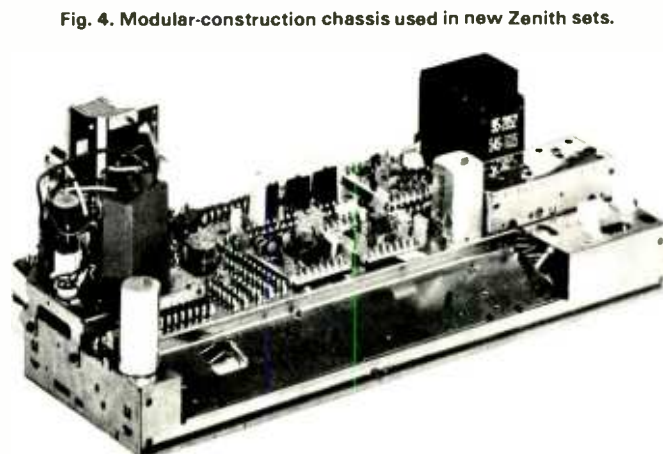

Fig. 4. Modular-construction chassis used in new Zenith sets.

nith. It's part of the company's all-transistor 40BC50 chassis.

It is operated from a 14-position drum. The mechanism of the drum has several functions: (1) switch bands in the v.h.f. tuner or switch to the u.h.f. tuner; (2) apply "B+" to whichever tuner is active; (3) apply voltage to the correct band-indicator light; (4) switch to a.g.c. that suits the FET r.f. amp in the v.h.f. tuner or to a.g.c. that suits the bipolar r.f. amp (something unusual) in the u.h.f. tuner; (5) change the a.f.t. pull-in range to suit the band being used; (6) apply voltage from the selected tuning resistor to the correct tuner.

The tuning resistors are part of the drum assembly. A gear connected to the fine-tuning knob can be pushed in to engage the active resistor. That allows the customer to make his own channel adjustments for each position of the drum. Each position can be programmed for any u.h.f. or v.h.f. channel.

Panasonic has an experimental chassis it hopes to put into the line later in 1971. It has a varactor tuner. Admiral expects to have a varactor tuner in some models, but did not furnish information on it.

### Automatic Tint Controls

Magnavox started it and several other manufacturers pursued the idea. In the 1971 line, there is considerable confusion because of it.

We're talking about automatic tint control (a.t.c.). The system used with some Magnavox color chassis takes automatic control of demodulator phase. The circuit senses the phase of signals near 57 degrees—the orange or fleshtone angle in the demodulator. If a signal in that vicinity slips a bit, making face tones become greenish or purplish, the a.t.c. corrects demodulator phase. (Editor's Note: The Mag-

navox system was explained in our September 1969 issue.)

But this year, other kinds of systems are being described as automatic tint controls. They are not, however, like that original a.t.c. They operate on other principles.

An example is the Zenith Automatic Tint Guard. Briefly, the main objective of the ATG circuit is to broaden the demodulator matrix in the vicinity of fleshtones, so slight signal phase shifts don't produce such drastic hue shifts. The angle between R-Y and B-Y demodulator outputs is widened, and the G-Y output is reduced somewhat. If you turn on the ATG circuit while watching rainbow color bars, you see the red bars move slightly left and the blue bars move slightly right.

The RCA Accutint system operates on a different principle. One serious cause of fleshtone color shift is a change in amplitude of Q modulation at the transmitter. (The Q signal happens to be about 90 degrees away from the 57-degree angle of fleshtones.) The Accutint switch reduces the sensitivity of the set's demodulator to signals at or near the Q angle. As a result, variations there have little effect on fleshtones. Nothing is really lost, because colors that fall near the Q angle aren't so important to the eye. Besides, the troublesome variations there are usually amplitude and not phase.

At the same time, the 9300-degree (K) color temperature (gray scale) of the screen is lowered to 6800 degrees (K)—a warmer, faintly sepia shade. That, too, reduces the effects of slight color shifts near fleshtones.

General Electric has what is called Customatic Tint Lock. Except that the demodulation angle is 110 degrees between B-Y and R-Y, operation resembles the Zenith system. When the Tint Lock switch is in its "0" position, demodulation is normal. Moving the switch to its "1" position increases the demodulation angle between B-Y and R-Y to 130 degrees. Signals of incorrect phase don't produce as noticeable a hue change. With the switch in the "2" position, the demodulation phase angle is 150 degrees. The demodulators are then fairly insensitive to signal phase shifts in the vicinity of fleshtones.

All these systems affect other colors, too. But the warmer appearance of all colors seems to please most viewers. The pictures don't shift face tones so radically, and that's what these circuits are for. When broadcast techniques reach the state where such phase and amplitude changes are inconsequential, tint correction of any kind will be unnecessary.

Another system being called "automatic" consists of an extra set of tint and color (and sometimes also brightness and contrast) controls inside the set. They are set one way—perhaps for one station's broadcast characteristics—and the regular viewing controls another way. A switch lets the viewer pick whichever is best for any particular viewing situation. Just recognize that these "preset" systems—common on imported color sets—are not automatic tint controls.

### Solid-State H.V. Sections

The concern over x-rays awhile back accelerated the use of solid-state high-voltage rectifiers and non-tube h.v. regulating circuits. The major innovation for 1971 models is a hermetically sealed solid-state voltage multiplier. It's made by Varo Semiconductor.

The solid-state multiplier offers several advantages. (1) No h.v. rectifier tube. (2) The critical h.v. winding on the flyback transformer is no longer needed. (3) A separate focus voltage or rectifier is unnecessary. (4) The h.v. system is easily regulated by feedback of the same horizontal output pulse that drives the multiplier, eliminating the shunt regulator tube. (5) Less wear and tear on horizontal deflection components.

Fig. 5 is a diagram of the more popular versions. The quadrupler in (A) is from an RCA chassis. The tripler at (B)

(Continued on page 69)

Fig. 5. Multiplier-type high-voltage systems eliminate rectifying large high-voltage pulses. (A) Quadrupler in RCA CTC44. (B) Tripler in Sylvania, Zenith, and (C) Wells Gardner sets.

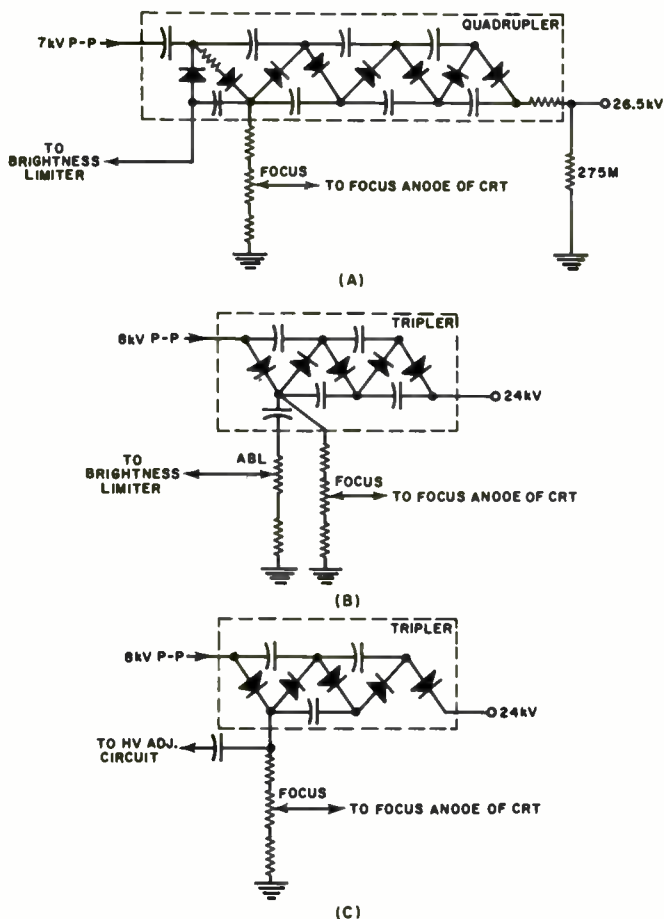



# Important New SAMS Books



New 10th Edition of the Sams

## Transistor Substitution Handbook

by the HOWARD W. SAMS ENGINEERING STAFF. Fully updated to include tens of thousands of substitutions. Covers all manufacturers and gives proper substitutions for all types of bipolar transistors: U.S. and foreign, home-entertainment and industrial. Computer-compiled for accuracy. Also includes manufacturers' recommendations for general-replacement transistor substitutions. Order 20773 *only*..... \$1.95

## Color-TV Training Manual, 3rd Edition

by the HOWARD W. SAMS ENGINEERING STAFF. The completely revised third edition of this famous training guide covers all the latest developments in the field. Written for the technician preparing to service color TV receivers. Describes the science of color, requirements and make-up of the color signal, latest color circuits, and practical setup and servicing procedures. Includes full-color picture tube photos. Order 20736, *only*... \$6.95

## ABC's of Air Conditioning

by ERNEST TRICOMI. This book presents a non-technical explanation of the laws of physics which relate to air conditioning and shows how these laws are applied practically in the design and manufacture of all types of air conditioning units and their components. Covers components common to all systems, electrical systems, estimating capacity and installation methods, and air conditioning repairs. Order 20725, *only*..... \$2.95

## 1-2-3-4 Servicing Transistor Color TV

by FOREST H. BELT. The "1-2-3-4 Method" is a simple, logical, step-by-step process which helps do the service job the right way and the easy way. In this book, the fundamentals of transistor color TV are covered, followed by a detailed explanation of how to apply the method for quick troubleshooting and easy repairs. Supported by a wealth of illustrations, charts, and block and schematic diagrams to make understanding easy. Order 20777, *only*..... \$4.95

## Tape Recorder Servicing Guide

by ROBERT G. MIDDLETON. Thoroughly explains the principles and characteristics of magnetic recorder circuitry, describing the various components and systems. Provides comprehensive instructions on preventative maintenance, adjustments and minor repairs, and solving tape transport, recording, and reproduction troubles. Order 20748, *only*..... \$3.95

## 1-2-3-4 Servicing Automobile Stereo

by FOREST H. BELT. This book first applies the ingenious "1-2-3-4" repair method to both mechanical and electrical equipment and then proceeds to cover the electronic and mechanical principles of automobile stereo, fm multiplex and tape cartridge systems. Finally, the book shows how to apply the method to auto stereo systems. Includes many schematics, charts and illustrations. Order 20737, *only*..... \$3.95

## Workshop in Solid State

by HAROLD E. ENNES. Presents the technology of transistor operation in terms familiar to those educated in tube technology. Provides an orientation in solid state principles, and a detailed analysis of the diode; covers transistor parameters, linear switching and pulse circuits, a wide variety of practical design problems and applications and basic testing and servicing techniques. Order 20735, *only*..... \$9.95

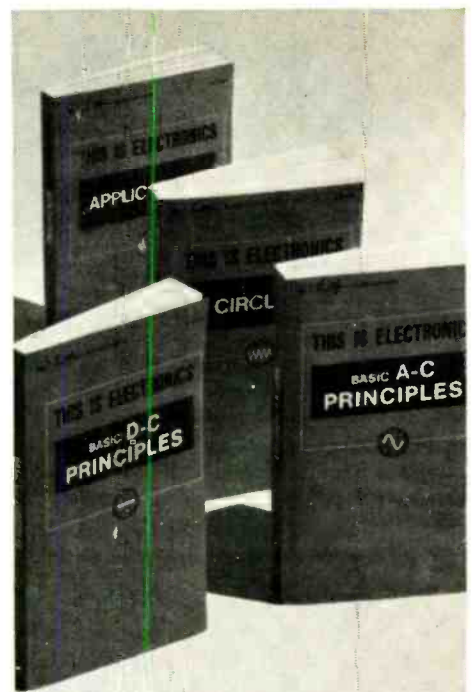

## THIS IS ELECTRONICS Series

by IIT EDUCATIONAL SERVICES, INC. These books provide a remarkable introduction to electronics, imparting to any reader a clear understanding of the basics of this vital technology. All topics are covered and readily mastered.

### Vol. 1. Basic D-C Principles

Covers electronics—past and present; electronic components and symbols; matter and electricity; current, voltage, and resistance; series and parallel circuits; conductors, semiconductors, and insulators; resistors; sources of d-c power. Order 20657, *only*..... \$5.95

### Vol. 2. Basic A-C Principles

Covers alternating voltage and current; capacitors and capacitive reactance; magnetism and electromagnetism; electrical measuring instruments; and inductors and inductive reactance. Order 20727, *only*..... \$6.95

### Vol. 3. Circuits

A-c and d-c principles and components are used to illustrate how vacuum tubes and semiconductors operate. Describes various amplifier and oscillator circuits of both tube and transistor types. Order 20759, *only*..... \$6.95

### Vol. 4. Applications

This volume explains how amplifier and oscillator circuits are used in actual applications. Explains principles of modulation, broadcast receiver fundamentals, a-m and f-m receiver circuits, etc. Order 20760, *only*..... \$5.95

4-Vol. Set. Order 20761, *only*... \$23.50

## HOWARD W. SAMS & CO., INC.

Order from your Electronic Parts Distributor, or mail to Howard W. Sams & Co., Inc., Dept. EW-031  
4300 W. 62nd St., Indianapolis, Ind. 46268

Send books checked at right. \$\_\_\_\_\_ enclosed

Send FREE 1970 Sams Book Catalog

Name \_\_\_\_\_

Address \_\_\_\_\_

City \_\_\_\_\_ State \_\_\_\_\_ Zip \_\_\_\_\_

- |                                |                                |
|--------------------------------|--------------------------------|
| <input type="checkbox"/> 20773 | <input type="checkbox"/> 20735 |
| <input type="checkbox"/> 20736 | <input type="checkbox"/> 20657 |
| <input type="checkbox"/> 20725 | <input type="checkbox"/> 20727 |
| <input type="checkbox"/> 20777 | <input type="checkbox"/> 20759 |
| <input type="checkbox"/> 20748 | <input type="checkbox"/> 20760 |
| <input type="checkbox"/> 20737 | <input type="checkbox"/> 20761 |



# The "Perfect" Customer

*A do-it-yourself rule for consumer protection:  
to get better service—be a better customer.*

By **John Frye**

**A**BOISTEROUS March wind was making the metal sign suspended above the front of Mac's Service Shop squeak and rattle as the owner stepped inside and leaned his weight against the door to close it. As the roar of the wind died out of his ears, they were greeted by the sound of subdued hilarity from Matilda, the office girl, and Barney, his assistant technician, perched on her desk.

"What's all the giggling about?" Mac asked. "Don't tell me spring fever has hit both of you already!"

"Nope," Barney answered; "we're just designing the perfect service customer."

"Yeah, and when you're through with that I suppose you're going to start creating that other chimera, the Purple Cow," Mac scoffed. "What brought this on?"

"Oh, you know all the things we've been reading in the newspapers and magazines and seeing on TV about how imperative it is that customers be protected from the gouging service people," Matilda explained. "Barney and I started out trying to imagine what some customers apparently expect in the way of an ideal service technician."

"This ought to be good; let's hear it," Mac said, lighting his pipe and draping a leg across a corner of her desk opposite Barney.

"Okay," Matilda said, glancing down at the sheet of paper in her typewriter. "The ideal technician looks like a young Robert Taylor combined with the best features of Rock Hudson and Richard Chamberlain. He dresses as though he just stepped out of a colored-page catalogue advertisement of clothing suitable for work and play—razor-sharp pants creases and all—and he looks that way all day long, no matter what the temperature or how many dirty TV sets he has been inside. He has the natural good manners of Pat Boone and is as witty and entertaining a conversationalist as a talk-show MC.

"He loves children and is as good with them as a Sesame Street actor. He doesn't mind at all if they play with his tools, twist the knobs on his instruments, and pepper him with questions. If you want to run next door for a cup of coffee with the girls, he will be glad to watch the kids for you while he is fixing your TV set.

"His brain is stored with complete, detailed, and accurate knowledge of all the circuitry and weaknesses of all models of all makes of color and black-and-white TV sets, stereo amplifiers, record players, tape recorders, garage-door openers, and other miscellaneous electronic devices; so all he has to do is take a casual look at a malfunctioning piece of equipment to know instantly what is wrong with it and how to repair it—I mean repair it right there in the home, because he never, *never* has to take a TV set into the shop or go any farther than his truck parked at the curb for any replacement part he needs. He is lightning fast in his work and is as dexterous with his tools as a brain surgeon. And when he repairs something, it *stays* repaired. He has some sort of magic so that if he replaces just one tube in a set, none of the other tubes, resistors, capacitors, transformers, or other components he hasn't even touched will *dare* to fail for a long, long time.

"No, he never has to make callbacks, and he always leaves the house looking better than he found it. But best of all, his charges are no higher than they were back in 1950. He enjoys working on electronic equipment so much that he is satisfied with the pay of an illiterate odd-jobs man, even though to be truly proficient in his work he must have a technical knowledge equal to that of a lawyer or a doctor. What's more, he must maintain a technical library running into thousands of dollars; and the parts inventory he carries, plus the cost of his expensive, fragile, precision instruments runs into more thousands. No matter; he still is happy to work for peanuts."

Mac was grinning broadly as she finished. "You two have done a pretty good job, especially considering that you've had to study your subject by looking into a distorting mirror, as it were. Now let's hear what the perfect customer is like."

"We've not finished working on her," Matilda said. "You can help us. I'll read you what we've come up with so far:

"The perfect customer is an intelligent, reasonable, responsible woman. She doesn't expect her electronics equipment to last forever without needing service, and she considers the cost of such service part of the price she pays for enjoying that equipment. The original cost is merely the other part of that price.

"Being intelligent, she reads, comprehends, and *keeps* the instruction manual that comes with her clock radio, TV receiver, or what have you. She reviews this manual before she calls the service technician to make sure she has not forgotten or overlooked anything about proper operation: Is the set plugged in? Is the circuit breaker latched? Are all controls properly set? Is the antenna connected? When convinced something is really wrong, she notes the make, model number, and serial number of the unit so that she can give this to the service technician when she calls him. That enables him to have the proper service literature and parts that are likely to fail with him when he makes his call. She also describes the malfunctioning of her set as clearly and simply as she can: When did it start misbehaving? Is the trouble present on all channels? Does the condition come and go or is it present all the time? Is only the picture, the sound, or a combination of both affected? Finally she and the technician agree on when he will call, not necessarily as to the exact hour, but at least as far as the forenoon or afternoon of a particular day. This allows both parties to plan their schedules more intelligently.

"Incidentally, she realizes she's not the only person in town with difficulty and she does not request immediate service unless there is a genuine emergency. If there is a good reason for requesting speedy service, she explains that reason frankly to the technician, not trying to exaggerate the emergency."

"And when he arrives," Barney picked up the discourse, "she is home and ready for him; you know: hair freshly done, soft music on the stereo, wearing a slinky negligee—"

"That's *not* what we said!" Matilda interrupted. "We said she has removed any objects, especially those easily broken,



from the top of the TV set. She also has her sweeper sitting handy with the crevice tool attached so that the technician can clean the interior of the receiver. That will save him the trouble of lugging his own sweeper in from the truck. But she need not spread newspapers around on the floor. He'll bring his own dropcloth. Suppose you curb your romantic imagination and stick to the script, Buster!"

"Okay," Barney agreed with a teasing grin. "Actually she should not try to entertain the technician with spritely conversation or expect him to entertain her. The ideal customer remembers his time is money—her money."

"Yes," Mac said, "and if he is like a certain redheaded technician I know, he needs every cell of his small brain to figure out what is wrong with the receiver and how to repair it. If she talks to him and distracts him from the problem at hand, it will take him twice as long to make the repair, if he is able to make it at all."

"I'm ignoring your snide remarks," Barney said loftily; "but on the subject of distractions, the good customer keeps her children out of the technician's equipment and out of his hair. It takes a better man than I am to concentrate on a convergence job while the little monsters are plugging in my soldering pencil or playing catch with tubes from the caddy. It's just as bad when they keep asking over and over: 'Why are you doing that? What does this little button do? If you're a crook, like my daddy says all TV men are, where's your gun? Oh, here it is in your tool box. It has a light on the front. Is it a ray gun?'"

Mac chuckled at Barney's description. "Know what you mean. The ideal customer corrals the children in the kitchen, nursery, or playroom while the technician is working unless she has them under better control than most mothers do these days. This not only helps the technician; it also protects the children from possible injury from sharp tools, burning tools, and irritating or freezing electronics chemicals that are usually to be found in the technician's tool box.

"Your ideal customer doesn't insist that the technician perform all work in her home any more than she insists her doctor perform an appendectomy on one of her children on the kitchen table or that the garageman do a major overhaul on her car in the carport. She does not believe he wants to take her TV set to the shop just so he can secretly charge her for work he doesn't do nor for parts he doesn't install. She realizes not all of the fragile, easily damaged equipment in his shop is portable and that occasionally something goes wrong with a set that requires the use of this shop equipment. The technician

is not wild about having to remove the heavy chassis and lug it in and out of his truck several times, but occasionally he hasn't any other choice. He much prefers to service the receiver right in the cabinet if that is possible."

"That brings us to the subject of estimates and service charges," Matilda said. "The ideal customer doesn't hesitate to ask for an estimate of repair costs as soon as the technician has located the trouble. He certainly does not consider her 'cheap' for doing so. She, on the other hand, expects to pay for this estimate if she decides not to have the set repaired or if she wants to get another estimate, as she may want to if it involves a major expense, such as changing a color picture tube.

"She understands that locating the trouble is the most technically demanding, time-consuming part of the technician's work; and she doesn't expect free estimates from him any more than from her doctor. Also, she understands that if the technician quotes her a range of possible cost in his estimate, he is trying to protect her interests as well as his own. Quite often he can't tell if there are minor troubles with the set until the major malfunctioning is corrected; for example, a set may have had some things wrong with it before a picture tube or sweep transformer went west, and he can't know of these things until the new component is installed. The lower figure in his estimate takes care of only this major trouble. The higher figure is intended to take care of other things that may show up when the major malfunctioning is corrected. If she insists he quote a hard-and-fast figure and stick to it, he naturally will quote a figure high enough to take care of such eventualities. If the major trouble is all that's wrong, the customer is the loser."

"And if he must stick with a too-low estimate," Mac said, "he simply will not correct things he sees wrong with the set but the customer doesn't. In this case the customer is still the loser because correcting those things, when they become bad enough, will mean another service charge.

"It is this kind of callback charge that usually gets the customer hopping mad—even if the technician can 'prove' that the new trouble has nothing to do with the earlier call.

"Well," he said as he slid off the desk and stretched until his bones cracked, "we're never going to see the ideal service technician nor the ideal customer. But maybe it doesn't hurt either group to try and see itself through the eyes of the other. And it's sound psychology that the person who expects the worst of a technician usually gets it, while the customer who tries to be a good customer is the one who has least trouble with service people." ▲

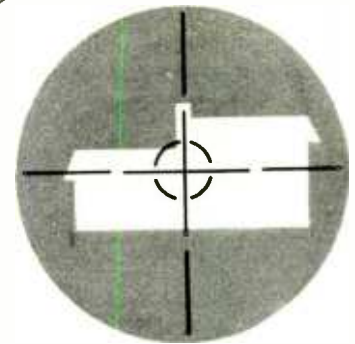

TONIGHT, YOUR  
PROPERTY COULD BE  
SOMEONE'S

# Target

PROTECT IT WITH  
DELTALERT!

Don't let unwanted visitors set their sights on your home or business. For total family and business safety get DeltAlert protection... before it's too late.

Enjoy new peace of mind with a reliable DeltAlert detection and alarm system. DeltAlert detects motion in 150 to 300 sq. ft. of critical space with a silent ultrasonic blanket... turning on lights automatically to drive away prowlers.

When the separate DeltaHorn is plugged into the DeltAlert unit, the intruder faces the additional obstacle of loud, ear-shattering noise. A built-in 20-second delay switch allows authorized persons to turn off the horn when entering the monitored area. The sturdy units, finished in handsome walnut veneer, are maintenance-free, economical and need no installation.

At home or work, proven economical security begins with DeltAlert alarm and detection protection.

DELTALERT  
10 3/4" x 3 1/4" h x 3 1/4" d  
\$69.95 ppd

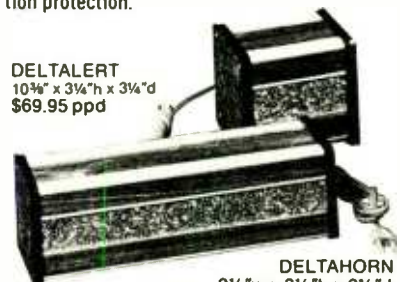

Made in U.S.A.

DELTAHORN  
3 1/4" w x 3 1/4" h x 3 1/4" d  
\$24.95 ppd

Order your DeltAlert Security System today!  
Superior Products At Sensible Prices

DP 70-26  
**DELTA PRODUCTS, INC.**

P.O. Box 1147 EW Grand Junction, Colo. 81501  
(303) 242-9000

Please send me literature immediately:   
Enclosed is \$ \_\_\_\_\_  Ship ppd.  Ship C.O.D.  
Please send \_\_\_\_\_ DeltAlert(s) @ \$69.95 ppd.  
Please send \_\_\_\_\_ DeltaHorn(s) @ \$24.95 ppd.

Name \_\_\_\_\_  
Address \_\_\_\_\_  
City/State \_\_\_\_\_ Zip \_\_\_\_\_

CIRCLE NO. 144 ON READER SERVICE PAGE

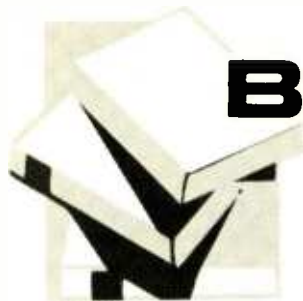

# BOOKS

**"73 VERTICAL, BEAM, AND TRIANGLE ANTENNAS"** by Edward M. Noll, W3FQJ. Published by *Editors and Engineers, Ltd.*, New Augusta, Ind. 159 pages. Price \$4.95. Soft cover.

If you are one of the hams who feels the excitement has gone out of your hobby with the advent of pre-packaged rigs, here is your chance to build part of your station equipment from the "ground up" and improve your operations as well.

The author has built and used the 73 antennas he describes in this compact handbook. Any ham can do likewise, whether he wants a simple quarter-wave vertical or elaborate yagis, quads, and triangles. The formulas for figuring antenna sizes and the instruments needed to optimize the designs and obtain maximum performance are covered.

The text is well illustrated, concisely written, and comprehensive.

\* \* \*

**"1-2-3-4 SERVICING TRANSISTOR COLOR TV"** by Forest H. Belt & Associates. Published by *Howard W. Sams & Co., Inc.*, Indianapolis, Ind. 220 pages plus foldout schematics. Price \$4.95. Soft cover.

This is the second volume in which the author applies his "1-2-3-4" servicing technique—this time to transistorized color sets. The method involves diagnosis, location, isolation, and pinpointing of the specific trouble by breaking the set down into sections, stages, circuits, and then individual components.

As is the case with all of Mr. Belt's writings for technicians, this volume is informal, yet informative. Servicing experience is assumed on the part of the reader so no time or space is allotted to basics. The material is well illustrated with graphs, charts, schematics, photographs, and block diagrams. Complete schematics are provided for four transistorized color-TV receivers: *Hitachi, Motorola, Sony, and RCA* models.

\* \* \*

**"UNDERSTANDING SOLID-STATE CIRCUITS"** by Norman H. Crowhurst. Published by *Tab Books*, Blue Ridge Summit, Pa. 17214. 189 pages. Price \$7.95 hardcover, \$4.95 paperbound.

This volume can be used as a primer for those wanting to learn more about solid-state circuitry without having to delve into the physics of why solid-state devices work. The author covers diodes, transistors, SCR's, FET's, LED's, and voltage-sensitive elements and then discusses their applications.

The text material is well illustrated, the writing is clear and concise, and the entire presentation such that the book can be used either as a reference work or for its general information content.

\* \* \*

**"RCA SOLID-STATE HOBBY CIRCUITS MANUAL"** compiled and published by *RCA Distributor Products*, Harrison, N.J. 363 pages. Price \$1.95. Soft cover.

This new edition of one of *RCA's* most popular manuals contains over 60 practical solid-state circuits which range in sophistication from simple power supplies to amplifiers, counting circuits, clocks, and a wide range of novelties and gadgets. In each case, the circuit is diagrammed, a parts list

provided, and a photograph of the completed project provided. PC board and drilling templates are included, along with information on suppliers of the various components that are needed.

Five informative chapters precede the construction material and deal with the theory and operation of solid-state devices, general circuit considerations, mechanical considerations, testing and troubleshooting, and suggested circuit uses.

No matter what your experience in working with solid-state circuits, there should be some project presented in this handy volume that will appeal to you—as a challenge to build or as a useful piece of equipment to have.

\* \* \*

**"ELECTRONIC COMPONENTS AND MEASUREMENTS"** by Bruce D. Wedlock & James K. Roberge. Published by *Prentice-Hall, Inc.*, Englewood Cliffs, N.J. 332 pages. Price \$12.00.

It is heartening to find these two MIT professors devoting the first chapter of this practical how-to-do-it manual to safety in the laboratory and the "do's and don't's" for working with electrical, mechanical, and chemical devices.

With that important start, the discussion continues with basic laboratory practices, elements of data presentation and analysis, elementary scopes, basic d.c. and a.c. meters, graphical displays, resistors, capacitors, inductors and transformers, d.c. power sources, advanced scopes, storage and sampling scopes, advanced voltage and current measurements, signal and pulse generators, frequency and waveform analysis, operational amplifiers, digital IC's, r.f. impedance measurements, coaxial cables, thermal measurements and heat sinks, and the basic characteristics of semiconductor devices.

Although originally written as a classroom text for freshman or sophomore classes at MIT, the material is basic enough and so clearly written that anyone wanting to learn measurement techniques or brush up on his own procedures will find this volume invaluable.

Lavish illustrations and the inclusion of a wide variety of "exercises" for the student offer the instructor extensive scope for presenting this material to his class.

\* \* \*

**"THE SYNTHESIS OF TRANSISTOR AMPLIFIERS"** by Michael Kahn & John M. Doyle. Published by *Holt, Rinehart and Winston, Inc.*, New York. 397 pages. Price \$10.95.

This is a specialized text written at the junior college/technical school level and is designed to give the student a working knowledge of the principles of amplification and of the transistor's role in providing such amplification.

For an understanding of the material the student should be familiar with a.c. and d.c. circuits, and be able to handle intermediate algebra and trig. The first three chapters cover basics, chapters 4 through 9 analyze various transistor amplifier designs, while the concluding chapter is a practical "how-to" exercise in designing amplifiers. Problems and exercises are included with each chapter.

\* \* \*

**"TV SERVICE MANUALS"** published by *Tab Books*, Blue Ridge Summit, Pa. 17214. Each \$7.95 leatherette cover, \$4.95 paperbound.

The three latest volumes in this publisher's series of service manuals cover *RCA* monochrome receivers (by Carl H. Babcoke), *General Electric* color sets (by Robert L. Goodman), and *Sylvania* color receivers (by Stan Prentiss). All three follow the same format with special hints regarding specific models; information on adjustment, setup, and convergence; troubleshooting; tuner alignment; video circuit and audio circuit problems; remote controls; case histories and modifications; and other pertinent data.

Each manual is 8½" × 11" and contains large and clear illustrations, partial schematics, and foldout diagrams of the sets being covered. ▲



## Locating Faults (Continued from page 42)

The maximum value of  $R_3$  should be not less than the resistance of both conductors in series—a little more than 1.5 ohms in this example. The best way to get a precisely adjustable resistor of low resistance for  $R_3$  is to set up a slide wire consisting of a short length of nichrome wire stretched out along a yardstick with a jumper of copper wire connected from one end and a movable clip on the other. Table 2 shows the resistance of nichrome wire sizes that can be used. This wire must carry the full current through the cable.

Now you are ready to measure the location of the fault. Merely adjust  $R_3$  until you get a null on the v.t.v.m. The resistance of the fault, whatever it is, will not affect the null of the v.t.v.m. Next, determine the resistance of  $R_3$ . This is simple, knowing the resistance per foot of the nichrome wire used and the position of the clip as measured on the yardstick. Then solve the formula: *Distance of fault from far end* =  $(R_3 \times \text{length of cable}) / \text{resistance of both conductors in series}$ .

For this example, suppose  $R_3$  turns out to be 0.384 ohm (7 inches of #20 nichrome wire); the length of the cable is 300 feet; and the resistance of both conductors in series is 1.545 ohms ( $0.2575 \times 2 \times 300 / 100$ ). Therefore, the fault is located  $0.384 \times 300 / 1.545$  or 75 feet from the far end. Dig at this spot and you will find the fault.

The application of this detection scheme is limited to the situation where there is only one fault, one good conductor not open or faulted, and both conductors are of the same size and length. It can be adapted to any situation similar to the example chosen, such as remote-control lines, relay cables, or other radio functions. ▲



"Just about everything around here is automated, but thank goodness they'll always need me to push these buttons."

March, 1971

## The does-it-all turntable at a do-it-yourself price.



It's the BSR McDonald 310/X, and it's the best buy in automatic turntables. Anywhere.

This is no "little brother" turntable, either. It's got a full-size platter, cue and pause control, low mass tone arm system and a visible stylus pressure indicator.

And because it's a famous BSR Total Turntable, it comes complete with a tinted dust cover, custom molded base and a Shure

**BSR**  
**McDONALD**

M-75 magnetic cartridge—all factory-installed and balanced and included in the low price.

The BSR McDonald 310/X. It's perfect for people who want the best, no matter how little it costs.

Send for free full color catalog on all our automatic turntables. BSR(USA)Ltd.,Blauvelt,N.Y.10913

CIRCLE NO. 149 ON READER SERVICE PAGE

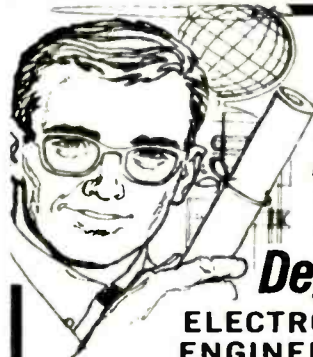

**Earn  
Your  
Degree**

**ELECTRONICS  
ENGINEERING**

**through HOME STUDY**

**HIGHLY EFFECTIVE**

**HOME STUDY COURSES IN:**

- Electronics Engineering Technology
- Electronics Engineering Mathematics

Earn your Associate in Science Degree in Electronics Engineering and upgrade your status and pay to the engineering level. Complete college level courses in Electronics Engineering. We're a forward looking school. Outstanding lesson material—thorough and easy to understand. Engineering taught on the basis of application and understanding rather than on the basis of memorization. Up to date in every respect. Acquire the knowledge and ability that means the difference between a low paying technician job and a high paying engineering position. Low tuition cost with low monthly payments. Free engineering placement service for our graduates. Write for free descriptive literature. Ask for bulletin J. no salesman will call on you.

**COOK'S INSTITUTE**  
*of Electronics Engineering*

Forest Hill Road  
P. O. Box 10634  
Jackson, Miss. 39209

Established 1945  
Formerly Cook's School of Electronics

CIRCLE NO. 147 ON READER SERVICE PAGE

## NEW Signal Generator Capability



The new "A" model of the Lampkin DIGITAL FREQUENCY METER / SYNTHESIZER / SIGNAL GENERATOR has FM-modulation capability. Now—AM modulation, or FM modulation, from variable-frequency internal AF generator (50 to 3000 Hz), or from external source, at option.

- ☆ Range 10 KHz to 500 MHz.
- ☆ Frequency Readout on Digital Dials.
- ☆ Accuracy: better than 0.0001%, self contained.
- ☆ Power Supply: 115V AC or 12 V DC, at option.
- ☆ All solid state. Price \$2,390.00
- ☆ Write, wire or phone — NOW

Name \_\_\_\_\_  
Address \_\_\_\_\_  
City \_\_\_\_\_ State \_\_\_\_\_ Zip \_\_\_\_\_

**LAMPKIN LABORATORIES, INC.**  
MFM Div., Bradenton, Fla. 33505

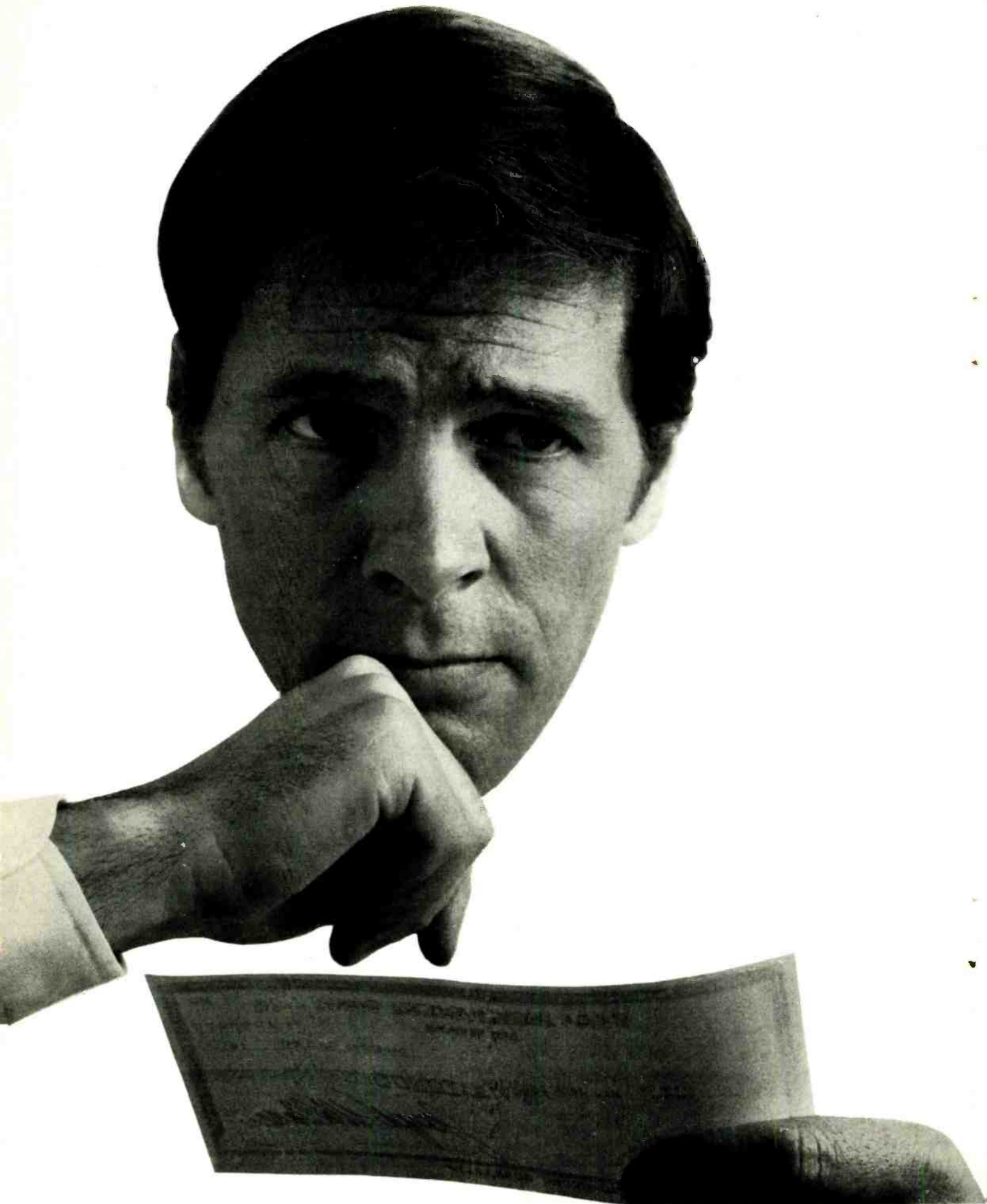



# Your paycheck says a lot about you

It tells you more than how much you make. It tells you how far you've come. And if your paycheck looks very much the same as it did last year, or the year before, it simply means that *you* look very much the same as *you* did last year and the year before.

But times change, and you should be changing with them. Old dull jobs are disappearing. New exciting ones are being created. There are challenging new fields that need electronics technicians...new careers such as computers, automation, television, space electronics where the work is interesting and the earnings are greater.

RCA Institutes has one of the nation's largest and most respected home study schools devoted to electronics. They can get you started even if you've had no previous training or experience. RCA Institutes has developed a faster, easier way for you to gain the skills and the knowledge you need for a fascinating, rewarding electronics career. And you don't have to quit work and go back to school. With RCA Institutes Home Study Plan you can do

both. You set your *own* pace depending on *your* schedule.

Check over these RCA benefits:

- You get Hands-On Training—over 300 experiments and as many as 25 kits with some programs.
- You get RCA's unique "Autotext" method of learning—individual programmed instruction, the *easy, faster, simplified* way to learn!
- You get the widest choice of electronics courses and programs—everything from Electronics Fundamentals right up to Solid State Technology and Communications Electronics.
- You get a selection of low-cost tuition plans!

Sounds great, and it is! For complete information, without obligation, send in the attached postage paid card...or return the coupon below. That will say a lot about you.

Veterans: Train under new GI Bill. Accredited Member National Home Study Council. Licensed by N.Y. State—courses of study and instructional facilities approved by the State Education Department.

<b>RCA Institutes</b>	
Home Study Dept. 240-003-1 320 West 31st Street, New York, N. Y. 10001	
Please rush me FREE illustrated catalog. I understand that I am under no obligation.	
Name _____	Age _____
(please print)	
Address _____	
City _____	State _____ Zip _____
Veterans: Check here <input type="checkbox"/>	

If reply card is detached—send this coupon today

# Electronics World SUBSCRIBER SERVICE

Please include an address label when writing about your subscription to help us serve you promptly. Write to: P.O. Box 1093, Flushing, N.Y. 11352

**CHANGE OF ADDRESS:** Please let us know you are moving at least six to eight weeks in advance. Affix magazine address label in space below and print new address in space provided. If you have a question about your subscription, attach address label to your letter.

**TO SUBSCRIBE:** Check these boxes:  5 years \$26  3 years \$18  1 year \$7  New  Renewal

**SPECIFY:**  Payment enclosed—You get 1 extra issue per year as a BONUS!  Bill me later.

← AFFIX LABEL →

If you have no label handy, print OLD address here.

name	please print	zip-code	0364
address			
city			
state			

name      please print      zip-code

name	please print	zip-code
address		
city		
state		

name      please print      zip-code

Add'l postage: \$1 per year outside U.S., its poss. & Can.

## DON'T SETTLE FOR A HIT AND MISS IGNITION SYSTEM



### Install a JUDSON ELECTRONIC MAGNETO

It offers the combined advantages of both the standard transistorized and capacitive discharge systems in one simplified patented circuit. Provides better performance, a smoother running engine and keeps your car in tune. Installed in twenty minutes.

Write Today for Literature

**JUDSON**  
RESEARCH & MFG. CO.  
CONSHOHOCKEN, PA. 19428

CIRCLE NO. 136 ON READER SERVICE PAGE

## CATV—Its Future Starts Now

(Continued from page 41)

converter is shown in Fig. 3. An earlier version is used in over 30,000 subscriber's homes serviced by *Sterling Manhattan Cable TV*. The converter is connected between the CATV wall outlet and the antenna terminals of the TV receiver. A 26-position switch selects the CATV channel and there is a fine-tuning adjustment. Channel 12 is used on the TV and 26 channels are available on the converter. Other converters are currently under development and will provide push-button or thumb-wheel switch-selector tuning using voltage-controlled capacitors and frequency-synthesizer techniques for 26 or more channels.

A complete "head-end" installation with all necessary converters and distribution amplifiers is shown in Fig. 5. Highly reliable solid-state circuits and a completely modular approach make this type of equipment an outstanding engineering achievement. Intended as a line amplifier, the solid-state unit shown in Fig. 4 can handle up to 26 channels and is also available with a variety of options. The bandpass and gain characteristics, dynamic range, channel separation, a.g.c. characteristics, and harmonic suppression achieved in much of the new CATV transmitting equipment should warm the hearts of all circuit designers.

Since CATV companies can now originate their own programs, they are also in the market for TV-station equipment, such as TV cameras and video recorders.

### Two-Way Transmission

One of the key requirements of the New York City franchise is two-way transmission capability in newly installed CATV systems. Practically all new CATV installations are oriented toward two-way operation since this increases the potential services CATV can offer. This two-way transmission capability permits the monitoring of which programs a subscriber is watching or the connection of fire and burglar alarms through the CATV system. At its most sophisticated level, this capability would implement the great wonders promised by cable TV in the future, such as remote shopping, banking, and direct access to computer terminals. The two-way CATV systems are not in use yet, but plans are being made to implement this particular capability.

As mentioned before, *TeleVision Communications Corporation* is already installing two cables in each subscriber's home in its Akron system. A number of equipment manufacturers are now offering two-way amplifiers

for trunk and line circuits and *Tele-prompter*, in conjunction with *Hughes*, has a two-way subscriber terminal under development. Others are also working on a variety of two-way techniques.

There has been a lot of discussion concerning the frequency to be used for the return transmission path, with most favoring a band from about 10 kHz up to 20 or 50 MHz. No matter what the ultimate standards are, two-way cable TV will probably start in operation before the end of 1971.

The CATV industry has been reasonably profitable for many years. But now that program origination and advertising revenues will be available and now that FCC standards and regulation foster growth, the CATV industry has started on its first really dynamic growth level. Between 1970 and 1972 the number of CATV systems is expected to more than double. In the same period of time the number of subscribers should increase several-fold. A whole new generation of equipment, particularly in the area of CATV converters, amplifiers, and studio equipment, is coming on the market. It is clear then that cable TV represents one of the outstanding new growth areas of the electronics industry, a very welcome "shot in the arm" at a time when other fields of electronics seem to have reached a plateau. ▲

Fig.5. A CATV "head-end", such as this one by *Blonder-Tongue*, consists of all needed converters and distribution amps.

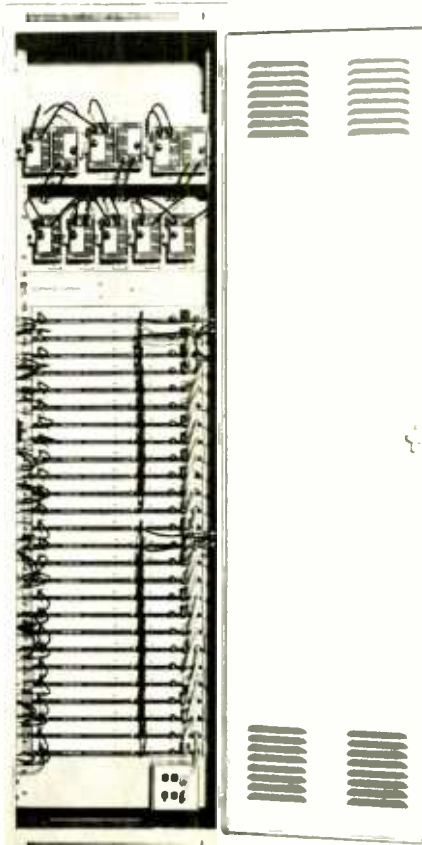



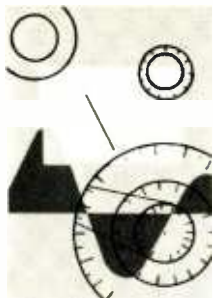

# TEST EQUIPMENT

## Product Report

### Hy-Tronix Model 900 Automatic Transistor Analyzer

For copy of manufacturer's brochure, circle No. 3 on Reader Service Page



HERE'S a new transistor tester that is really unique. It uses a blinking display of multicolored lights along with a beeping Sonalert to identify and check transistors and diodes. Separate tests are made on the emitter-base and collector-base junctions. It's not even necessary to know whether your transistor is an *n-p-n* or *p-n-p* type; the tester tells you this by the color of the blinking display at the center of the meter scale. If there are shorts or opens in the transistor, then the light display changes to show this condition. In all there are 24 different combinations of light patterns, using one amber, two red, and two green lights, that indicate automatically the various transistor and diode faults.

Not content with the effective visual display, a beeping Sonalert can be switched in to accompany the blinking lights. This permits the operator to perform in-circuit tests, using the special 3-pronged probe, without having to actually look at the lights to determine whether the device is good.

After performing these qualitative tests, the operator sets up the instrument to use its 8-in meter for quantitative tests. Transistor *beta*, from 0 to 50 or 0 to 500, can be measured at three different values of base current. Then collector-emitter and collector-base

leakage currents can be measured directly using one of the six ranges on the meter; these read from 100 mA down to 1  $\mu$ A full-scale. Finally, there is an Ident function provided, which indicates to the user whether his transistor is a germanium or silicon type.

We used the tester to check a large number of transistors and diodes and it quickly identified and checked them all for us. Although the unit will not check FET's, it can handle just about every other signal or power transistor and diode in current use. For in-circuit testing, as long as the transistor under test has over 270 ohms across its junction, the Model 900 will not be affected by the surrounding circuitry.

The tester is from *Hy-Tronix Instruments*, a new division of *Vanguard Electronic Tools*, manufacturer of pencil soldering irons. It is ruggedly built and the heavy anodized extrusions used as side panels make the instrument look and feel like it comes from a tool company. The case measures almost 9-in wide by 7-in high by 4½-in deep and it weighs almost 7 lbs. A number of IC's are used in the instrument for switching, logic, and to drive the indicator lamps. An a.c. power line is required for operation.

Price of the Model 900 is \$287 plus \$15 for the in-circuit test probe. ▲

### E. F. Johnson Model 250 CB Transceiver Tester

For copy of manufacturer's brochure, circle No. 4 on Reader Service Page

WITH all the illegal operation on the Citizens Band these days, we welcome any piece of CB test gear that

will help keep responsible CB'ers operating on the right side of the FCC Regulations. *Johnson* has recently come

# BINAURAL SOUND...

a remarkable listening experience for stereo headphone owners!



Created specifically for playback through stereo headphones, this unique record presents the listener with sound of unsurpassed realism. It recreates at each of the listener's ears the precise sound that each ear would have heard — independently — at the original scene.

Binaural recording re-creates the directions, distances, and even the elevations of sounds better than any other recording method. The super-realism of binaural recording is accomplished by recording the acoustical input for each ear separately, and then playing it back through stereo headphones. Thus the sound intended for the left ear cannot mix with the sound for the right ear, and vice versa.

Binaural recording offers the listener the identical acoustical perspective and instrument spread of the original. The sound reaching each ear is exactly the same as would have been heard at the live scene.

#### "MAX" — GENIE OF BINAURAL RECORDING.

"Max," is a specially constructed dummy head, cast in silicone rubber, which duplicates the role of the human head as an acoustical absorber and reflector of sound. Super-precision capacitor microphones were installed in Max's ears so that each microphone would pick up exactly what each human ear would hear. The result is a demonstration of phenomenal recorded sound.

**STARTLING REALITY.** The Binaural Demonstration Record offers 45 minutes of sound and music of startling reality.

You'll marvel at the eerie accuracy with which direction and elevation are re-created as you embark on a street tour in binaural sound—*Sounds Of The City*... *Trains, Planes & Ships*... *Basketball Game*, a *Street Parade*, a *Steel Fabrication Plant*, *The Bird House at the Zoo*—all demonstrating the incredible realism of binaural sound reproduction.

**MUSIC IN BINAURAL.** The musical performances presented on the Binaural Demonstration Record transport you to the concert hall for a demonstration of a wide variety of music. Selections total 23 minutes, and include examples of jazz, rock, organ, and chamber music.

The Stereo Review Binaural Demonstration Record is the ultimate in sound reproduction. It has been made without compromise for the owner of stereo headphones. If you own stereo headphones, this record is a must.

Note: Although headphones are necessary to appreciate the near-total realism of binaural recording, the record can also be played and enjoyed on conventional stereo systems.

Order your Stereo Review Binaural Demonstration Record today. ONLY \$5.98.

RECORDS, Ziff-Davis Service Division EW-371  
595 Broadway, New York, N.Y. 10012

Please send \_\_\_\_\_ Binaural Demonstration Records at \$5.98 each, postpaid. My check (or money order) for \$ \_\_\_\_\_ is enclosed. (Outside U.S.A. please send \$8.00 per record ordered.) N.Y. State residents please add local sales tax.

Print Name \_\_\_\_\_  
Address \_\_\_\_\_  
City \_\_\_\_\_  
State \_\_\_\_\_ Zip \_\_\_\_\_

PAYMENT MUST BE ENCLOSED WITH ORDER

**The Most Spectacular  
Sound Exhibition of  
STEREO FIDELITY  
Ever Available on  
one Disc.**

Stereo Review **STEREO  
DEMONSTRATION  
RECORD**



This record is the result of two years of intensive research in the sound libraries of Deutsche Grammophon Gesellschaft, Connoisseur Society, Westminster Recording Company and Cambridge Records Incorporated. The Editors of Stereo Review have selected and edited those excerpts that best demonstrate each of the many aspects of the stereo reproduction of music. The record offers you a greater variety of sound than has ever before been included on a single disc.

It is a series of independent demonstrations, each designed to show off one or more aspects of musical sound and its reproduction. Entirely music, the Record has been edited to provide self-sufficient capsule presentations of an enormous variety of music arranged in a contrasting and pleasing order. It includes all the basic musical and acoustical sounds that you hear when you listen to records, isolated and pointed up to give you a basis for future critical listening.

**WIDE RANGE OF DEMONSTRATIONS**

- Techniques of Separation & Multiple Sound Sources
- Acoustic Depth
- Ambiance of Concert Hall
- Sharp Contrasts of Dynamics
- Crescendo & Diminuendo
- Very High & Very Low Pitched Musical Sounds
- Polyphony (2 or more melodies at once) With Both Similar & Contrasting Instruments
- Tonal Qualities of Wind, String & Percussion Instruments
- Sounds of Ancient Instruments
- Sounds of Oriental Instruments
- Sound of Singing Voice, Both Classically Trained and Untrained
- Plus a Large Sampling of Finger Snapping, Hand Clapping, Foot Stamping & Other Musical & Percussive Sounds.

**13 SUPERB SELECTIONS**

- STRAUSS: Festive Prelude, Op. 61 (excerpt) DGG
- DEBUSSY: Feux d'artifice (excerpt), Connoisseur Society
- BEETHOVEN: Wellington's Victory (Battle Symphony) (excerpt from the first movement) Westminster Records
- MASSAINGO: Canzona XXXV & 16 (complete) DGG Archive
- CORRETTE: Concerto Comique Op. 8, No. 6, "Le Plaisir des Ombres" (third movement) Connoisseur Society
- KHAN: Raja Chandranandan (excerpt) Connoisseur Society
- RODRIGO: Concerto-Serenade for Harp and Orchestra (excerpt from the first movement) DGG
- MANITAS DE PLATA: Gypsy Rhumba (complete) Conn. Soc.
- MARCELLO: (arr. King): Psalm XVII "The Heavens are Telling" (complete) Connoisseur Society
- PRAETORIUS: Terpsichore: La Bourrée XXXII (complete) DGG Archive
- BERG: Wozzeck (excerpt from Act III) DGG
- BARTOK: Sonata for two Pianos and Percussion (excerpt from the first movement) Cambridge Records.
- BEETHOVEN: Wellington's Victory (Battle Victory) (excerpt from the last movement) Westminster.

**AVAILABLE IN YOUR CHOICE OF 33 1/3 RPM OR 45 RPM**

The Stereo Demonstration Record is processed and pressed on a newly developed improved vinyl. It is permanently anti-static, repels dust and dirt and promotes longer stylus wear. The use of this material is conducive to low surface noise and contributes to the production of full dynamics and frequency range. The record continually looks new, sounds new and wears longer.

**FREE** Descriptive Booklet Enclosed includes discussion of the selections on the record, plus a complete description of each selection and the purpose behind its demonstration.

**RECORDS • Ziff-Davis Service Division  
595 Broadway • New York, N.Y. 10012**

Please send me \_\_\_\_\_ Stereo Review Stereo Demonstration Record Albums at \$5.98 each, postpaid. My check (or money order) for \$\_\_\_\_\_ is enclosed. Check One:  33 1/3 rpm  45 rpm (outside U.S.A. please send \$8.00 per album ordered.) New York State residents please add local sales tax.

Print Name \_\_\_\_\_  
Address \_\_\_\_\_  
City \_\_\_\_\_ EW-371  
State \_\_\_\_\_ Zip \_\_\_\_\_

**PAYMENT MUST BE ENCLOSED WITH ORDER**



out with a multi-function CB transceiver tester that should help do this job.

The unit is designed not only for troubleshooting but it can also be used for continuous monitoring of the on-the-air CB signal. It reads r.f. power output directly in watts (up to 6 W), modulation directly in percentage, and standing-wave ratio (s.w.r.) when inserted into the r.f. feedline. An audio jack permits headphone monitoring of the transmitted signal, and the tester

can be installed in transceivers without S-meters to read received signal strength on the tester's meter.

A built-in 50-ohm dummy load permits the operator to make tests and adjustments off-the-air and, without changing cables, switch to his antenna in order to transmit normally. Hence, the transmitter is always kept fully loaded. As can be seen in the diagram below, there is also a built-in audio and r.f. generator, and a crystal-activity tester for CB crystals. Comparative field-strength readings with different antennas or transmitters can also be made using the tester's built-in 42-inch telescoping whip antenna.

A detailed instruction manual supplied with the instrument tells how to make all the measurements as well as indicating any modifications required in order to install the unit as an S-meter for your transceiver.

The transceiver tester is all solid-state, operated by a 9-volt transistor-radio battery, compact in size, and readily portable. Price is \$49.95. ▲

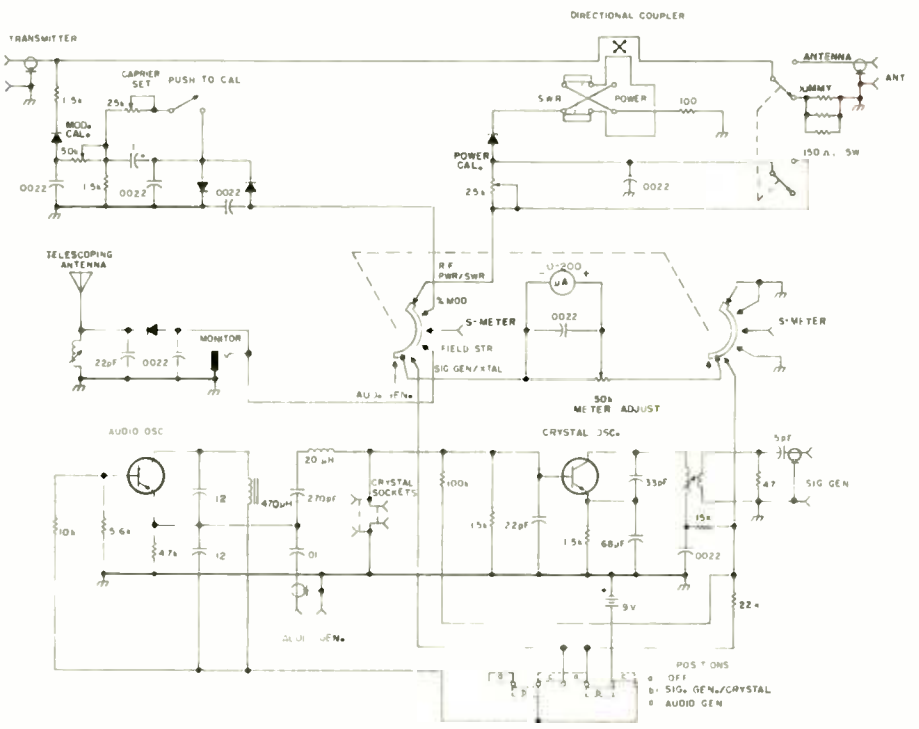

**Sencore PM-157 A.C. Power Monitor**

For copy of manufacturer's brochure, circle No. 5 on Reader Service Page

**E**VERY service or lab bench should have some means of monitoring the incoming a.c. line voltage used to power the equipment being worked on. Some troubles in TV receivers for example are directly related to excessive or insufficient line voltage, so the line should certainly be checked in case of such troubles. Of course, it is possible to use an accurate v.o.m. to check the line, but it is usually undesirable to tie up such a meter which must be used for routine troubleshooting.

More convenient would be an a.c. line monitor that is left permanently connected across the line.

The new Sencore PM-157 is such an instrument. This power monitor has an a.c. receptacle on its front panel into which the equipment being worked on can be plugged. Not only does the meter monitor the line voltage on an expanded-scale to an accuracy of ±2 percent (at 115 V a.c.), but it will also check on the a.c. line current drawn through the a.c. receptacle or through





separate test leads. There are three ranges of line current that can be measured: 1 A, 3 A, and 10 A. In addition, the power in watts at 115 volts is indicated on the meter. Finally, several scales are provided for checking fuse resistors of various sizes.

The heart of the PM-157 is a 1-volt full-scale a.c. voltmeter (actually a d.c. movement connected to a full-wave bridge). The meter is connected across a voltage divider and through a pair of back-to-back silicon diodes to read line voltage. The diodes do not start to conduct until the voltage across them is greater than 0.5 volt, and this effectively suppresses the zero and low-voltage readings, permitting the scale to start at about 65 volts. Maximum reading is 135 volts. To measure line current, the meter is shunted across 1-ohm, 1/3-ohm, and 1/10-ohm series resistors. A 10-A circuit breaker is used in the instrument to protect it and the equipment that is plugged into it.

Price of the Sencore PM-157 a.c. power monitor is \$69.50. ▲



"Humpf, Redbuck's picture quality improving—not so much snow!"

March, 1971

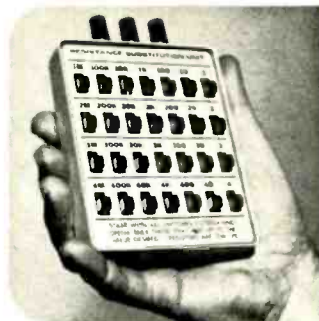

### Resistance Substitution Unit

Useful for circuit design and development as well as instrument repair and trouble shooting. Supplies 1 ohm to 11,111,110 ohms in 1 ohm steps. Comes in 4" x 6" x 1/2" case and furnished with a set of 30" leads, banana plug to alligator clips. **\$48**

**PHIPPS & BIRD, INC.**

A SUBSIDIARY OF GENERAL MEDICAL CORPORATION  
Manufacturers & Distributors of Scientific Equipment  
6th & Byrd Streets Richmond, Virginia 23219

CIRCLE NO. 130 ON READER SERVICE PAGE

## ABOUT YOUR SUBSCRIPTION

Your subscription to **ELECTRONICS WORLD** is maintained on one of the world's most modern, efficient computer systems, and if you're like 99% of our subscribers, you'll never have any reason to complain about your subscription service.

We have found that when complaints do arise, the majority of them occur because people have written their names or addresses differently at different times. For example, if your subscription were listed under "William Jones, Cedar Lane, Middletown, Arizona," and you were to renew it as "Bill Jones, Cedar Lane, Middletown, Arizona," our computer would think that two separate subscriptions were involved, and it would start sending

you two copies of **ELECTRONICS WORLD** each month. Other examples of combinations of names that would confuse the computer would include: John Henry Smith and Henry Smith; and Mrs. Joseph Jones and Mary Jones. Minor differences in addresses can also lead to difficulties. For example, to the computer, 100 Second St. is not the same as 100 2nd St.

So, please, when you write us about your subscription, be sure to enclose the mailing label from the cover of the magazine—or else copy your name and address exactly as they appear on the mailing label. This will greatly reduce any chance of error, and we will be able to service your request much more quickly.

## TAPE CARTRIDGE TRANSPORTS

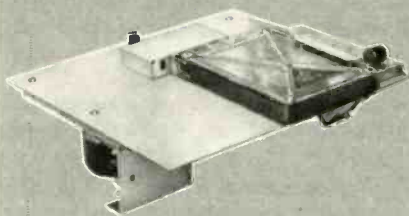

Broadcast quality transports for all NAB type endless loop tape cartridges. Three models — manual, semi automatic or automatic for broadcast, industrial or commercial applications. Available in various monaural or stereo head configurations, single or dual speed. From \$86.00. Tape cartridges, associated record/playback electronics available. Made in U.S.

PRODUCTS OF SOUND RESEARCH

**TELEX**  
COMMUNICATIONS DIVISION

9600 Aldrich Avenue South  
Minneapolis, Minnesota 55420

CIRCLE NO. 121 ON READER SERVICE PAGE

OUR STORE  
AT YOUR DOOR



Fill in coupon for a FREE One Year Subscription to **OLSON ELECTRONICS** Fantastic Value Packed Catalog — Unheard of LOW, LOW PRICES on Brand Name Speakers, Changers, Tubes, Tools, Stereo Amps, Turners, CB, HI-FI's, and thousands of other Electronic Values. Credit plan available.

NAME \_\_\_\_\_  
ADDRESS \_\_\_\_\_  
CITY \_\_\_\_\_ STATE \_\_\_\_\_  
GIVE ZIP CODE \_\_\_\_\_

If you have a friend interested in electronics send his name and address for a FREE subscription also.

**OLSON ELECTRONICS**  
Dept. EO 260 S. Forge Street  
Akron, Ohio 44308

CIRCLE NO. 132 ON READER SERVICE PAGE

Before potting, here's the module.



Make  
Your Own

# Integrated-Circuit Modules

By FRANK H. TOOKER

*IC modules can be assembled using potted-in-epoxy discrete components, along with ultra-compact assembly.*

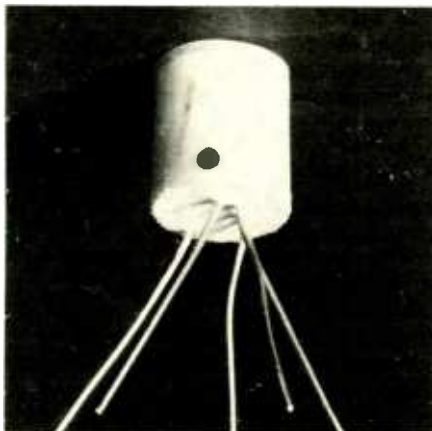

After potting, it looks like this.

DO you have a particularly useful and frequently used circuit that you wish some manufacturer would make up as an integrated circuit? Well, maybe it can't be done economically at the present state of the art. But you can take a worthwhile step in the direction of miniaturization by putting the circuit together as an "integrated-circuit module," using discrete components and an ultra-compact assembly, then potting in epoxy. It's easy, it saves space, it's moisture-proof, and the potted components are protected against damage.

Take a look at the schematic in Fig. 1, for example. This is the potted part of an audio-frequency amplifier and sine-wave clipper. Used in the circuit of Fig. 2, it has a high input resistance (similar to that of a vacuum tube), low distortion, a signal voltage gain of 60, and a frequency response that is down only 2 dB at 20 Hz and 100 kHz. An input signal of 10 mV provides a clean output signal of 0.6 volt. Double the values of the input capacitor and the bypass capacitor, and the frequency response will be extended down to 10 Hz.

Run the input signal level of this circuit up to somewhere

between 0.5 and 0.75 volt, to overdrive the amplifier severely, and the output signal becomes a square wave—quite acceptably rectangular and symmetrical, if the input signal is a clean sine wave. As a sine-wave clipper, the circuit of Fig. 2 operates well over a frequency range of 50 to 5000 Hz.

Furthermore, the encapsulated circuit can be used with a 9-V, 12-V, or 18-V power supply, as shown in Fig. 3. To use it with a 12- or 18-volt supply, all that is needed is an additional resistor to increase the collector load resistance. Required values are given in the inset table of Fig. 3.

As may be noted from an inspection of the table, the gain goes up directly as the supply voltage and load resistance are increased. With an 18-volt power supply, the signal voltage gain is 120. To stay within the breakdown voltage limits of the transistors, the setup should not be used with supply voltages higher than 18 volts. Sine-wave clipper operation is not recommended at potentials higher than 9 volts.

Obviously, the circuit of Fig. 1 has all the characteristics of usefulness that would make a very worthwhile integrat-

Fig. 1. Schematic diagram of the module.

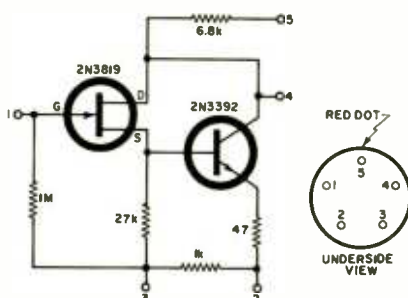

Fig. 2. Amplifier or clipper connections.

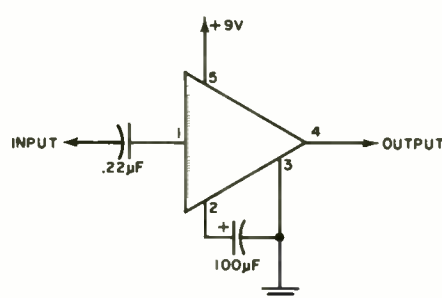
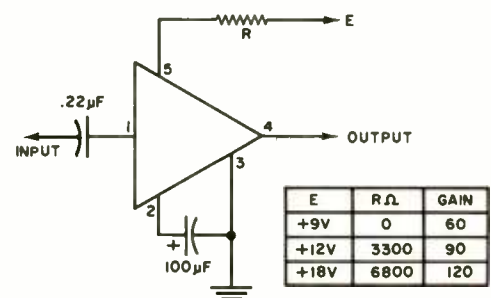

Fig. 3. Use with a higher supply voltage.





ed circuit, if it were only possible to form it that way. Using discrete components, it can be put together very compactly, however. As the photo shows, the author's assembly is a mass of transistors and resistors cemented tightly together. Even though half-watt resistors were used in this particular unit, it pots in a plastic cup measuring only 5/8" in diameter by 3/4" long, outside dimensions, with space to spare for an additional resistor should the circuit have required it. If quarter-watt resistors had been used, the assembly could have been made into a much smaller package.

Despite the compact assembly, the amplifier is perfectly stable, even when being severely overdriven for use as a sine-wave clipper. After all, if integrated circuits can get by with their ultra-compact assemblies, we should be able to get by with something like this! We can, and we do. Just bear in mind to keep input components and leads as separated as possible from output components and leads.

Whether you pot this or some other circuit, it is always advisable to breadboard the circuit first. Transistor characteristics vary from one unit to another, even those having identical type numbers, and breadboarding enables the selection of resistor values that will give optimum performance of the set-up. Use exactly the same components in the final assembly.

For the final assembly, you will need a miniature soldering iron and a few tiny heat sinks. Some of the transistor leads will be as short as 1/8". In general, it's best to cement a component in place, let the cement harden, then perform the lead-shaping and soldering operations. It takes a little longer doing it this way, but you will end up with a structure that is compact and least likely to develop a short-circuit somewhere, either before or during the potting process.

Clear epoxy resin, hardener, and pigments for coloring, are available from marine-supply outlets and from *Sears Roebuck*. The secret of using epoxy successfully for potting or for cementing is to follow the manufacturer's directions exactly. Measure the resin and the hardener accurately and mix them together thoroughly. You can do this more easily and most effectively with a small flexible spatula rather than with a stiff wooden paddle. Put a small amount of the epoxy mixture in the bottom of the cup, fit the assembly of components into it, then fill the cup to the brim.

Finally, mark the side of the cup with a dot of red fingernail polish to identify the positive power-supply lead, then put the whole thing aside where it will be undisturbed for the time required for hardening.

## Triggering Logic Circuits

(Continued from page 29)

There is one disadvantage to using a latching-type configuration as in Figs. 1A and 1B—a double-throw switch is required. If it is desirable to use a single-throw switch, another approach must be taken.

Fig. 2A shows a one-shot which will generate a single output pulse for an input pulse. Once an output pulse has been started by placing the switch input to gate A at "0," a "0" is fed back to gate A from gate B. This feedback essentially latches gate A for the duration of the output pulse. Consequently, gate A will remain latched and will not respond to spurious inputs caused by contact bounce as long as an output pulse is in progress. Thus, the output pulse itself must be longer than the duration of the contact bounce (5 ms is a safe pulse length). Note that the circuit of Fig. 1B is not restricted to a certain pulse length, but it does require a double-throw switch.

If an output level (rather than a single pulse) is desired, the circuit of Fig. 2A can also be used to supply it. The output of gate A gives a "1" output when the switch is depressed, and a "0" fed back from gate B holds gate A's output at "1" during the period of contact bounce. After contact bounce has ceased and the input rests at "0," gate A's output will stay "1" for as long as the switch remains depressed. In this case, too, the output pulse must last longer than the contact bounce.

A transistor circuit may also be used as a latch (see Fig. 2B). This circuit is equivalent to the logic-gate latch in Fig. 1A.

The circuits discussed here are actually quite simple, but extremely effective. Since contact bounce is the rule, rather than the exception (especially in low-cost toggle and push-button switches), one of these circuits should be employed whenever a switch is used to excite counting and timing circuits which might interpret contact bounces as inputs.

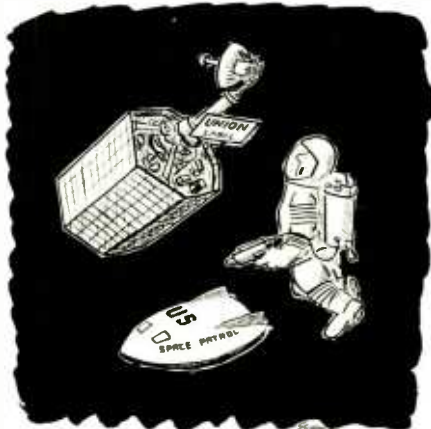

It's definitely one of ours.

## ALL-IN-ONE COLOR TV SCHEMATIC/SERVICING MANUALS



Each Manual contains EVERYTHING you need to service all models of the brand covered

Now, in one convenient manual, you can have immediate access to all the pertinent information you need to service brand-name Color TV receivers. Each manual contains descriptions of unusual circuits, field-service change data, causes and cures for repetitive and unusual troubles, alignment instructions, setup and convergence procedures, and other helpful servicing data. Also included are full-size schematic foldout sections with complete schematic diagrams for virtually all models produced by each manufacturer. Choose from 3 large 8 1/2 x 11" manuals now available in either paperback or long-life leatherette cover.

**RCA COLOR TV SERVICE MANUAL**  
Covers 23 different chassis designations, from CTC-12 to all solid-state CTC40. 176 pages, plus 36-page foldout containing 12 schematic diagrams.

No. 496 Leatherette cover \$7.95; paper \$4.95  
**ZENITH COLOR TV SERVICE MANUAL**  
Covers all chassis designations from 27KC20 to 14Z-8C50. 160 pages, plus 36-page foldout containing 12 complete schematic diagrams.

No. 502 Leatherette cover \$7.95; paper \$4.95  
**MOTOROLA COLOR TV SERVICE MANUAL**  
Covers all models using chassis designation TS-907 through TS-924. 160 pages, plus 18-page foldout containing 6 complete schematic diagrams.

No. 509 Leatherette cover \$7.95; paper \$4.95  
**PHILCO COLOR TV SERVICE MANUAL**  
Covers all chassis designations from 15M90-91 through hybrid 20QT88. 160 pages, plus 36-page foldout containing 12 complete schematic diagrams.

No. 522 Leatherette cover \$7.95; paper \$4.95  
**MAGNAVOX COLOR TV SERVICE MANUAL**  
Covers all chassis designations from Series 37 through 7940. 160 pages, plus 36-page foldout containing 12 complete schematic diagrams.

No. 526 Leatherette cover \$7.95; paper \$4.95  
**G. E. COLOR TV SERVICE MANUAL**  
Covers all chassis designations from CA through KE. 160 pages, plus 36-page foldout containing 12 complete schematic diagrams.

No. 536 Leatherette cover \$7.95; paper \$4.95  
**SYLVANIA COLOR TV SERVICE MANUAL**  
Covers all chassis designations from 576 through ED1. 160 pages, plus 36-page foldout containing 12 complete schematic diagrams.

No. 539 Leatherette cover \$7.95; paper \$4.95  
**ADMIRAL COLOR TV SERVICE MANUAL**  
Covers all chassis designations from the O11 to the K10 hybrid. 160 pages, plus 36-page foldout containing 12 complete schematic diagrams.

No. 545 Leatherette cover \$7.95; paper \$4.95

### OTHER TERRIFIC SERVICE AIDS

**RCA MONOCHROME TV SERVICE MANUAL**  
Covers 33 B & W models, from KCS136 to KCS178. 176 pages, plus 36-page foldout containing 16 complete schematic diagrams.

No. 549 Leatherette cover \$7.95; paper \$4.95  
**ZENITH MONOCHROME TV SERVICE MANUAL**  
Covers 54 B & W chassis designations from 13A16 to 22AB55. 160 pages, plus 36-page foldout containing 19 complete schematic diagrams.

No. 552 Leatherette cover \$7.95; paper \$4.95  
**1970 POPULAR TUBE/TRANSISTOR SUBSTITUTION GUIDE**

All-in-one guide lists only readily-available and popularly-priced substitutes — no need for you to search through lists of tubes and transistors you'll rarely see in use. 224 pp.

No. 525 Leatherette cover \$4.95; paper \$2.95

**HOW TO REPAIR SOLID-STATE IMPORTS**  
A large, diversified collection of schematics and service data for nearly 100 of the most popular foreign-made radios, tape recorders, and TV sets. Includes extensive list of suppliers. Also tells you what to do when a schematic isn't available. 160 pages, 8 1/2 x 11 1/2". plus 32-page schematic foldout section.

No. 532 Leatherette cover \$7.95; paper \$4.95

Use Handy Coupon Below to Order Manuals on 10-DAY FREE TRIAL!

TAB BOOKS, Blue Ridge Summit, Pa. 17214  
Please send me the manuals checked:

496  502  509  522  526  536  
 539  549  552  525  532

I have enclosed \$ ..... Send post-paid.  
 Please invoice me on 10-day free trial.

Name .....

Address .....

City..... State..... Zip .....

If paying in foreign currency, add 10%. Pa. residents add 6% sales tax. EW31

CIRCLE NO. 122 ON READER SERVICE PAGE



**Hunting for a better job?**

**Here's the  
license  
you need  
to go after  
the big ones**





**A Government FCC License can help you bring home up to \$10,000, \$12,000, and more a year. Read how you can prepare for the license exam at home in your spare time—with a passing grade assured or your money back.**

**I**F YOU'RE OUT TO BAG A BETTER JOB in Electronics, you'd better have a Government FCC License. For you'll need it to track down the choicest, best-paying jobs that this booming field has to offer.

Right now there are 80,000 new openings every year for electronics specialists—jobs paying up to \$5, \$6, even \$7 an hour... \$200, \$225, \$250, a week... \$10,000, \$12,000, and up a year! You don't need a college education to make this kind of money in Electronics, or even a high school diploma.

But you *do* need knowledge, knowledge of electronics fundamentals. And there is only one nationally accepted method of measuring this knowledge... the licensing program of the FCC (Federal Communications Commission).

**Why a license is important**

An FCC License is a legal requirement if you want to become a Broadcast Engineer, or get into servicing any other kind of transmitting equipment—two-way mobile radios, microwave relay links, radar, etc. And even when it's not legally required, a license proves to the world that you understand the principles involved in *any* electronic device. Thus, an FCC "ticket" can open the doors to thousands of exciting, high-paying jobs in communications, radio and broadcasting, the aerospace program, industrial automation, and many other areas.

So why doesn't everyone who wants a good job in Electronics get an FCC License and start cleaning up?

The answer: it's not that simple. The government's licensing exam is tough. In fact, an average of two out of every three men who take the FCC exam fail.

There is one way, however, of being pretty certain that you will pass the FCC exam. And that is to take one of the FCC home study courses offered by Cleveland Institute of Electronics.

CIE courses are so effective that better than 9 out of 10 CIE graduates who take the exam pass it. That's why we can back our courses with this iron-clad Warranty: Upon completing one of our FCC courses, you must be able to pass the FCC exam and get your license—or you'll get your money back!

**They got their licenses and went on to better jobs**

The value of CIE training has been demonstrated time and again by the achievements of our thousands of successful students and graduates.

**2 NEW CIE CAREER COURSES**

**1. BROADCAST (Radio and TV) ENGINEERING...** now includes Video Systems, Monitors, FM Stereo Multiplex, Color Transmitter Operation.

**2. ELECTRONICS ENGINEERING...** covers steady-state and transient network theory, solid state physics and circuitry, pulse techniques, computer logic and mathematics through calculus. A college-level course for men already working in Electronics.

Ed Dulaney, Scottsbluff, Nebraska, for example, passed his 1st Class FCC License exam soon after completing his CIE training...and today is the proud owner of his own mobile radio sales and service business. "Now I manufacture my own two-way equipment," he writes, "with dealers who sell it in seven different states, and have seven full-time employees on my payroll."

Daniel J. Smithwick started his CIE training while in the service, and passed his 2nd Class exam soon after his discharge. Four months later, he reports, "I was promoted to manager of Bell Telephone at La Moure, N.D. This was a very fast promotion and a great deal of the credit goes to CIE."

Eugene Frost, Columbus, Ohio, was stuck in low-paying TV repair work before enrolling with CIE and earning his FCC License. Today, he's an inspector of major electronics systems for North American Aviation. "I'm working 8 hours a week less," says Mr. Frost, "and earning \$228 a month more."

**Send for FREE book**

If you'd like to succeed like these men, send for our FREE 24-page book "How To Get A Commercial FCC License." It tells you all about the FCC License... requirements for getting one... types of licenses available... how the exams are organized and what kinds of questions are asked... where and when the exams are held, and more.

With it you will also receive a second FREE book, "How To Succeed In Electronics," To get both books without cost or obligation, just mail the attached postpaid card. Or, if the card is missing, just mail the coupon below.

**ENROLL UNDER NEW G.I. BILL.** All CIE courses are available under the new G.I. Bill. If you served on active duty since Jan. 31, 1955, or are in service now, check box on reply card for complete details.

**CIE Cleveland Institute of Electronics**

1776 E.17th St., Cleveland, Ohio 44114

Accredited Member National Home Study Council  
A Leader in Electronics Training... Since 1934



**Cleveland Institute of Electronics**  
1776 East 17th Street, Cleveland, Ohio 44114

Please send me without cost or obligation:  
Your 44-page book "How to Succeed In Electronics" describing job opportunities in Electronics today, and how your courses can prepare me for them.  
Your book on "How To Get A Commercial FCC License."

I am especially interested in:

<input type="checkbox"/> Electronics Technology	<input type="checkbox"/> Electronic Communications
<input type="checkbox"/> Broadcast Engineering	<input type="checkbox"/> Industrial Electronics
<input type="checkbox"/> First Class FCC License	<input type="checkbox"/> Electronics Engineering

Name \_\_\_\_\_ (PLEASE PRINT)  
Address \_\_\_\_\_  
City \_\_\_\_\_  
State \_\_\_\_\_ Zip \_\_\_\_\_ Age \_\_\_\_\_

Check here for G.I. Bill information EW-87

# versatile new 14-Piece, 1/4" Sq. Drive socket wrench set drives fasteners 7 different ways



**REVERSIBLE RATCHET** — Precision made, long life, fully enclosed mechanism. Short handle swing for close quarter work.

**UNIQUE SPINNER/EXTENSION** — 5-3/4" overall. Plastic (UL) handle with 1/4" sq. drive socket insert for ratchet. Use also as regular nutdriver.

**2" DRIVE EXTENSION** — Fits on ratchet or either end of spinner/extension.

**RUGGED, HEAT TREATED, ALLOY STEEL SOCKETS** — Nine for hex sizes 3/16" thru 1/2". Two dual purpose for hex and square sizes 1/4" and 5/16".

**FREE STICK-ON INITIALS** personalize the sturdy plastic case and help prevent loss or mix-up.



No. 1001 SET

Made in U.S.A.

nationwide availability through local distributors

REQUEST BULLETIN N770



XCELITE, INC., 12 Bank St., Orchard Park, N. Y. 14127  
In Canada contact Charles W. Pointon, Ltd.

CIRCLE NO. 118 ON READER SERVICE PAGE

## Digital Instruments (Continued from page 33)

tronic counter, thus providing an added degree of system flexibility and easing electronic-counter packaging restrictions. Spurious mixer products do not occur with a prescaler but the mixer is, in general, capable of operating at a higher frequency than the prescaler. Neither the mixer nor the prescaler requires a gate between the unknown signal and its input.

Designing the first stages of the electronic counter around high-speed logic elements is certainly the most straightforward approach, although the high-frequency input signal must be gated (to preserve resolution) and several inter-family translators are required unless the entire counter is designed around the same logic family. This direct approach is the most convenient operationally, since the unknown frequency can be read directly from the electronic-counter display without further mental computations.

There is obviously no one single approach best suited to extending the frequency range of an electronic counter—and all three methods are often used in a single counter system. The basic counter is usually designed to accept a moderately high input frequency to avoid reducing the resolution unnecessarily through the use of large-ratio prescalers or to ease the mixer selectivity requirements. A typical counter system might use RTL IC's for frequencies to 4 MHz, coupled with TTL (10 MHz), DTL (20 MHz), or ECL (40 MHz) IC's in the first decade counter stage. An external +10 prescaler could extend the upper frequency range to 100 MHz, 200 MHz, or higher.

High-speed is not a requirement of all eight electronic-counter operating modes since some modes are useful

only at relatively low frequencies. Furthermore, some of the functional blocks within the electronic counter do not operate at high speeds even in a high-speed electronic counter. The highest frequency present within the time base, for example, is the time-base oscillator frequency (typically 1 MHz) which is clearly independent of the operating mode or the operating speed of the electronic counter. Thus, neither the logic elements within the time base nor the logic elements within the Rate mode variable divider are required to operate at frequencies greater than (typically) 1 MHz.

The Period, Time Interval, and Multiple Period modes are useful only for those measurements where the period of the unknown input or control input is much greater than the period of the highest frequency available from the time base. Thus, if the highest time-base frequency is 1 MHz, none of the elements in the electronic counter is ever required to operate at a frequency greater than 1 MHz during Period, Time Interval, or Multiple Period measurements. Even restricting the maximum input frequency of the Multiple Period mode decade divider (usually part of the time base) to 1 MHz rarely results in any operational inconvenience.

The remaining five operating modes (Scale, Totalize, Ratio, Frequency, and Rate) are, however, often used for high-frequency measurements and the electronic-counter system must be capable of high-speed operation in these modes. High-speed operation in these five operating modes requires that the electronic-counter input channel(s), gating circuitry, and the first one or two decade counter/display stages be designed for high-speed operation unless prescaling or mixing is used to reduce the input frequency that is applied to the circuit. ▲

Fig. 4. Switching and functional blocks required to create an 8-mode electronic counter.

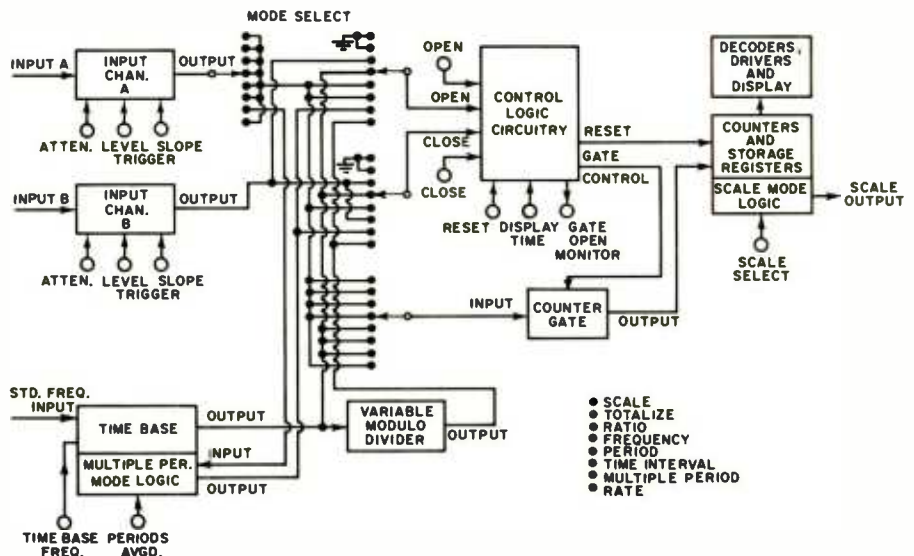



**Color TV for 1971**  
(Continued from page 48)

is in certain chassis of both *Sylvania* and *Zenith*. The tripler in (C) is used in some models made by *Wells-Gardner* for private brands: *Catalina*, *MGA*, and *Penncrest*, among others.

Here's the principle, as illustrated by Fig. 5A, as an example. A 7-kV pulse from a high-voltage winding of the fly-back transformer is coupled to the first full-wave diode pair. On the positive swing, one diode conducts. The other conducts on the negative excursion, and adds to the charge that built up from the first excursion. The first capacitor (bottom) soon accumulates a charge equal to full p-p voltage.

After the first several cycles, the diodes all along the chain have produced the same effect. The charges on the capacitors at the top are added to the negative excursions and applied to the capacitors at bottom. As a result, there are four capacitors in series along the bottom, each with 7 kV of d.c. across it. Being in series, the four voltages add, making 28 kV. The time constant is long, which allows the accumulated d.c. to stay near the peak value of each pulse. Losses lower net d.c. output to 26.5 kV.

The ground return for the high voltage is through the brightness-limiter transistor. Thus the limiting circuit is accurately sensitive to beam current drawn by the picture tube.

A voltage tap between the first two capacitors gives a d.c. source of about 7 kV for focus. A resistive divider network that includes the Focus control drops the voltage to the 4.5 to 5.5 kV needed by most color picture tubes.

The triplers in Figs. 5B and 5C operate much the same way, except a higher-voltage pulse is used. Again, the 8-kV d.c. voltages develop—after a few cycles—across the three bottom capacitors. In series and working into a long time constant, the voltages add up to 24 kV.

The version in Fig. 5C eliminates some of the capacitors. Still, the d.c. voltages across the capacitors (after a few cycles) are in series. So, the output is again 24 kV. As before, the focus voltage comes from a tap at the first of the three "sections."

The new design trends covered in this article and in last month's Part 1 show what the various color-TV set manufacturers have been doing to make their receivers perform better, be more reliable, and easier to service. It's now up to the consumer to decide whether he wants a color set in the first place and whether he can afford to buy one in the second. Set makers are hoping the answer to both questions is "yes." ▲

March, 1971

**Study this free book.**  
**IT MAKES ANY TEST EASY.**



Just look through the 1971 B&K Test Equipment Catalog. You'll see how easy electronic training, testing and trouble-shooting can be with our highly advanced equipment. At down to earth prices. Featured in the '71 Catalog: TV ANALYSTS/NEW F.E.T./VOM METERS—VTVMs/TUBE TESTERS/COLOR GENERATORS/TRANSISTOR ANALYSTS/CRT CHECKERS/OSCILLOSCOPES/RF SIGNAL GENERATOR/SINE/SQ. WAVE GENERATOR/PROBES—ACCESSORIES

**B&K TEST EQUIPMENT**  
Products of DYNASCAN

Send coupon for free catalog to:  
DYNASCAN CORPORATION  
1801 West Belle Plaine Avenue  
Chicago, Illinois 60613

NAME \_\_\_\_\_  
OCCUPATION \_\_\_\_\_  
ADDRESS \_\_\_\_\_  
CITY \_\_\_\_\_ STATE \_\_\_\_\_ ZIP \_\_\_\_\_

There is a difference in Test Equipment... ours works



CIRCLE NO. 117 ON READER SERVICE PAGE

Cooperate With The  
Zip Code Program  
of The Post Office  
Department.  
Use Zip Code  
In All Addresses

GET INTO **ELECTRONICS**



**VALPARAISO TECHNICAL INSTITUTE**  
Dept. RD, Valparaiso, Indiana 46383

V.T.I. training leads to success as technicians, field engineers, specialists in communications, guided missiles, computers, radar and automation. Basic & advanced courses in theory & laboratory. Electronic Engineering Technology and Electronic Technology curricula both available. Assoc. degree in 29 mos. B. S. also obtainable. G.I. approved. Graduates in all branches of electronics with major companies. Start September, February, Dorms, campus. High school graduate or equivalent. Write for catalog.

**"SUPER"**  
IS THE WORD FOR  
WORKMAN COLOR TV  
CRT BRIGHTENERS



WE START WITH A STURDY MOLDED PLASTIC CASE. NOW WE FILL IT WITH A HEAVY DUTY TRANSFORMER. THIS WILL DELIVER THE HIGHEST POSSIBLE VOLTAGE FOR MAXIMUM BRIGHTNESS. OUR SUPER-BRIGHTENER WILL STAY COOL FOR LONGER-LASTING, EFFICIENT PERFORMANCE.

ASK FOR OUR COMPLETE LINE OF BRIGHTENERS IN A FREE VEST POCKET SIZE CROSS REFERENCE No. X62.

MANUFACTURED BY  
**WORKMAN Electronic**  
PRODUCTS, INC.  
P.O. BOX 3428 SARASOTA, FLORIDA 33574

CIRCLE NO. 119 ON READER SERVICE PAGE

# Solid-State Probe Thermometer

By GORDON GREGG

*Temperature characteristics of silicon diodes make them ideal sensors for monitoring the ambient or power electronic-equipment temperature.*

**S**ILICON diodes make good temperature sensors. Used in a probe on a cable, an accurate remote-reading thermometer, with direct readout on a panel meter, can be built rather easily. In this application, practically all silicon junction diodes of all types will work. The instrument can be used to monitor temperatures outdoors, in attics, of photographic solutions, refrigerators, ovens (below about 200°F), and power electronic equipment.

The effect used is the forward voltage drop of a *p-n* junction at a constant current. The current, typically 1 milliamp, is a value above the knee of the *E-I* curve. The curve of forward voltage drop vs temperature is a characteristic of the semiconductor itself rather than of the mechanical construction of the diode; and semiconductor-grade silicon is a very pure and uniform material.

Fig. 1 shows the basic circuit, stripped of all frills, together with voltage vs temperature data. Between 0° and 100°F, the voltage changes by 182 millivolts. The supply does not need to be precisely regulated because the voltage drop

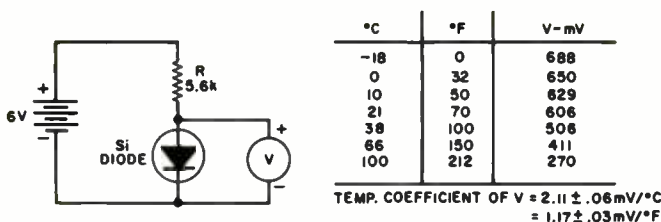
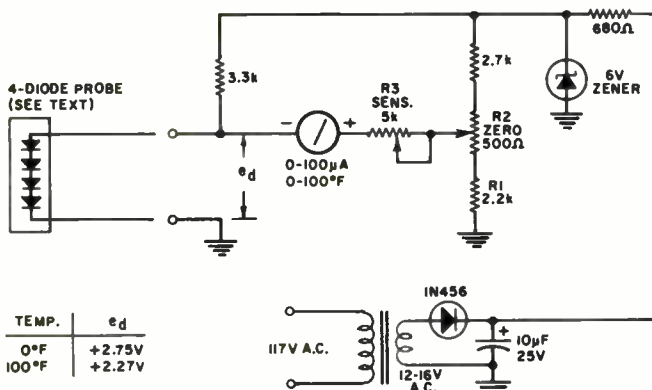

Fig. 1. Schematic diagram of a basic silicon-diode thermometer circuit and forward voltage drop versus temperature data.

Fig. 2. Schematic showing a complete, practical remote-reading thermometer circuit using a four-diode (in series) probe.



varies more slowly, percentage-wise, than the current. An ordinary zener regulator and a fixed series resistor, *R*, are adequate for normal use. If a battery supply is used, mercury cells are recommended.

## Complete Circuit

Fig. 2 is the complete circuit of a practical diode-thermometer. Four diodes, in series, are used in the probe in order to get a wider range of signal wattage to operate the meter. A simple rectifier and transformer power supply, with a zener regulator, is used. Mercury cells can be used, without the zener, but then a "push-to-read" switch should be included. Current drain on the battery supply (not counting the zener) is 2.3 mA. The indicating meter is connected in a bridge circuit so that "zero" can be positioned at will and the desired temperature range spread out over the whole scale. The "Zero" pot, *R2*, sets the location of the temperature range on the meter scale. These are screw-driver adjustments, set only once. Good-quality wire-wound pots and high-quality film-type or wire-wound resistors should be used. With the zener regulator, as shown in Fig. 2, a change in line voltage of 10 percent induces a meter reading error of about 1°F.

The sensor diodes (Fig. 3) are glass-cased 1N916's, obtained from a surplus source. They are soldered in series in a bundle, and the free leads soldered to the end of the cable. The whole bundle is then dipped in coil dope or other insulating material to protect the probe when it is calibrated in a water bath. Suitable diodes include the 1N456-1N464, 1N482-1N488, and 1N4383-1N4385 series. Silicon rectifiers will do, too. For the cable, two-conductor speaker wire is handy. The cable shown in Fig. 3 is Teflon-insulated subminiature coax picked up in a scrap-metal yard. Cable length doesn't matter. It could be 100 feet.

The circuit was built into a 6" × 2" × 3½" utility box. Considerations of wiring capacitance and insulation leakage are pretty well out of the picture since the highest frequency involved is around 1/10th Hz and the impedances are all low.

## Calibration

The only equipment needed to calibrate the meter is a conventional thermometer, to be used as the standard, and two temperature sources. The cold source is a glass of ice water which will remain between 33°-40°F as long as some ice is present. The high source, for the 0°-100°F range, is a glass of lukewarm water at around 100°F. First place the thermometer and probe (making sure that the insulating



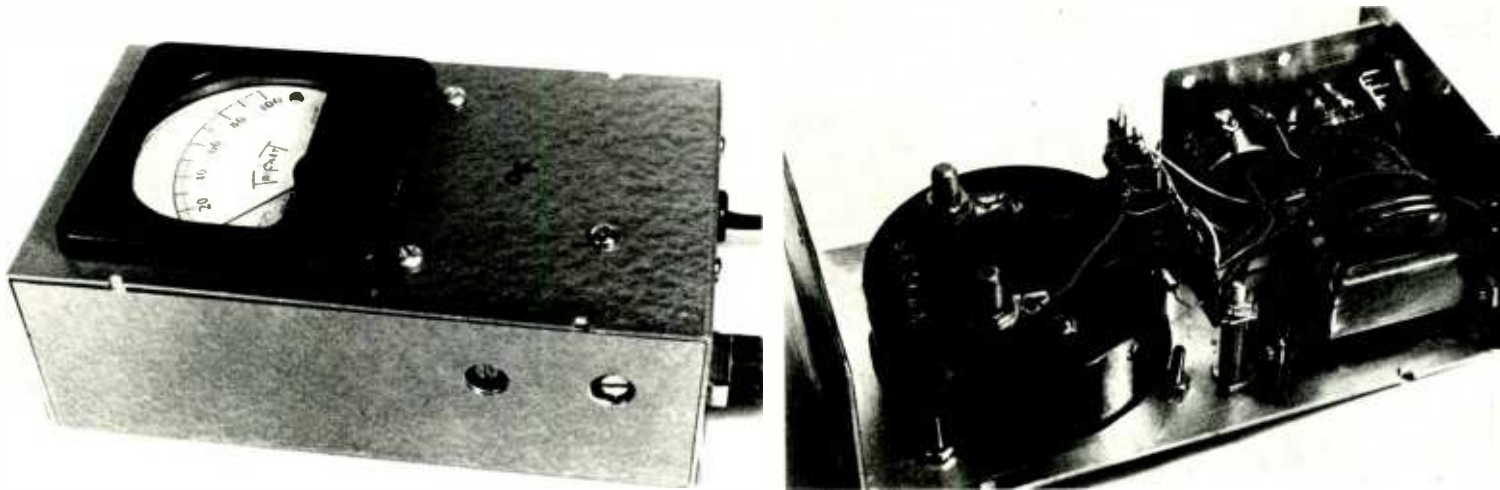

(Left) External and (right) internal views of the solid-state thermometer built by the author.

coating on the diode probe has dried) into the ice water. Stir and then adjust "Zero" pot *R2* until both instruments (thermometer and meter) agree. Then put the thermometer and probe into the lukewarm water and set "Sens." pot *R3* until both instruments are once again in accord. Since the cold source is not at 0°F, this procedure should be repeated four or five times for best accuracy. The solid-state thermometer is now ready for use.

#### Variations

To extend the range to, say, 0–100°C, or 0–150°F, merely add a 5k-ohm resistor in series with "Sens." pot *R3* and then make the necessary changes on the meter face.

The data in Fig. 1 was calculated at the National Research Council of Canada, where some dozens of various diodes were tested (see "Semiconductor Diodes and Transistors as Electrical Thermometers," by A.G. McNamara in the *Review of Scientific Instruments*, Vol. 33, pgs. 330–333, 1962). Diode temperature probes are especially useful in a physics or chemistry lab that is equipped with potentiometric-type chart recorders. With such recorders, the elementary circuit of Fig. 1 is all that is required. The "Zero" and "Span" controls on the recorder take care of the rest; 0–120 millivolts d.c. is an input range that fits these instruments nicely.

For panel-meter readout, however, 120 millivolts is inconveniently low. A typical 100- $\mu$ A panel meter has an internal resistance of around 800 ohms and so needs 80 millivolts full-scale. This internal resistance is all in the copper-wire coil of the meter, and copper resistance changes by about 4 percent per 100°C. Not a lot, but something; we don't want the meter doing thermometry on its own. In normal practice, the copper effect is swamped out by using a low-temperature-coefficient external multiplier resistor that is several times higher in value than the meter resistance. This we do here, getting more volts of signal full-scale by using more diodes in the probe. There is no advantage in using a more sensitive meter, such as 0–50 $\mu$ A, because in practical meters the internal resistance goes up a little faster than the full-scale current goes down.

Germanium junction diodes can be used in place of silicon, but offer no particular advantage. The forward drop is smaller and the temperature coefficient is a bit lower. At 0°C (32°F), the drop is about 340 millivolts and the coefficient  $-1.83 \pm 0.07$  millivolt/°C (compared with  $-2.11 \pm 0.06$  for silicon). To use the circuit of Fig. 2 with germanium probe diodes, merely change the value of *R1* from 2.2k-ohms to 1k-ohm.

It is also possible to use a transistor as a temperature sensor and get some amplifying action out of it at the same time, although the general stability of the circuit is not as good as with diodes. Fig. 4 shows a transistor circuit, adapted from the referenced article. The forward drop of the base-emitter junction of transistor *Q1* varies with temperature the same as any silicon junction. Due to the low impedance of *R1* in the base-emitter circuit, the transistor is effectively connected in a common-base configuration; therefore, collector leakage current is not amplified. The collector current, which is nearly the same as the emitter current, produces a relatively large voltage drop across collector load resistor *R3*, providing a fairly adequate signal on the order of 2 volts to work the meter. The meter is in a bridge circuit, generally like that of Fig. 2, using *R5* and *R6* to provide a return point. Sensitivity is set by *R7* and zero by *R8*. Almost any silicon transistor, such as the 2N697, 2N708, or 2N929, will work. The operating point, however, is highly dependent on the supply voltage, which must come either from mercury cells or a double-regulated, temperature-compensated zener supply. ▲

Fig. 3. The diode-probe used with the solid-state thermometer. Sensor diodes are shown soldered in series in a bundle at end of Teflon-insulated coax.



Fig. 4. Solid-state thermometer circuit using a transistor as an amplifying sensor instead of a diode. This circuit requires more stable resistors and power supply than circuit of Fig. 2.

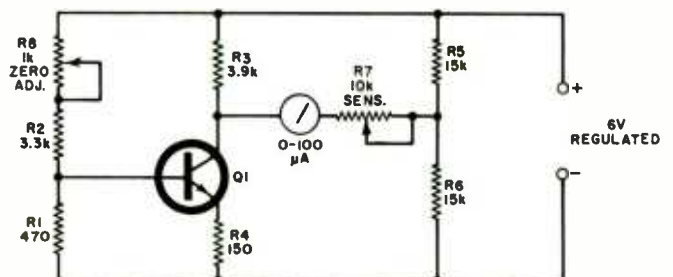

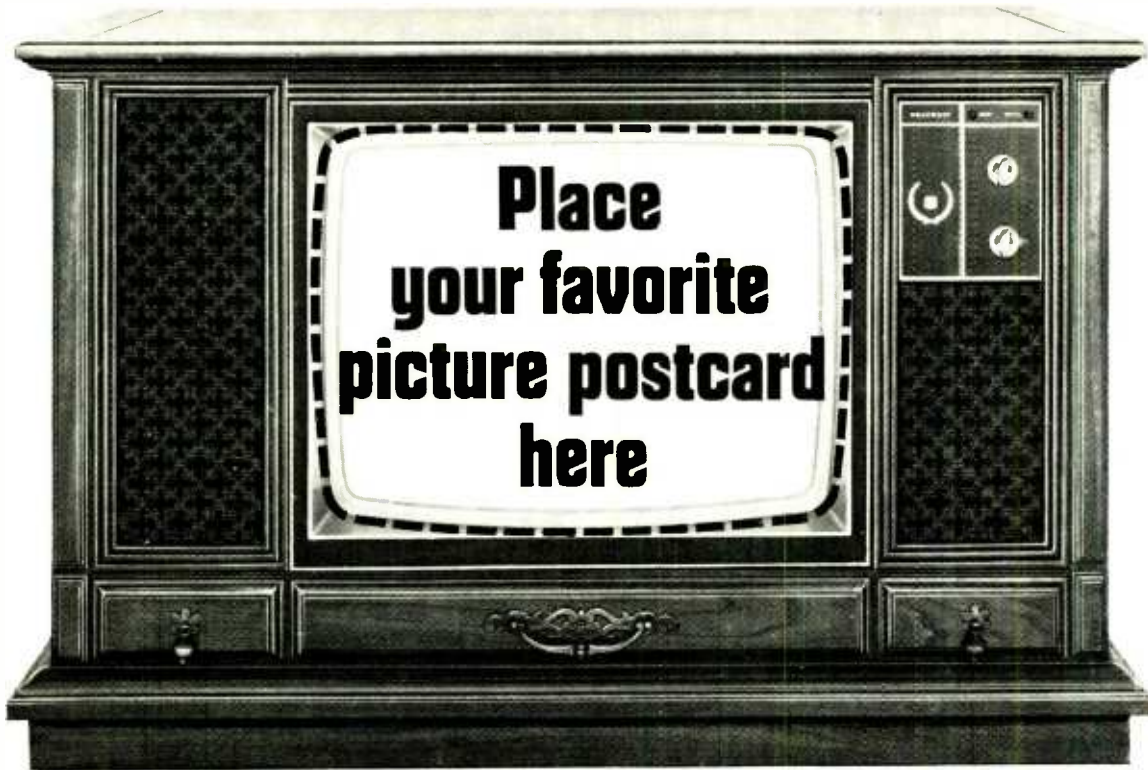

## ...the new Heathkit® 25" ultra-rectangular TV color picture is that perfect.

"Picture postcard perfect"...an apt description for the quality of color reproduction in the new Heathkit GR-371MX 25" ultra-rectangular solid-state color TV. And the reasons are as clear as the expanded 315 sq. in. view:

**New Heath MTX-5 ultra-rectangular matrix picture tube.** Developed in conjunction with leading domestic tube manufacturers to produce a sharper picture, purer colors, more natural flesh tones. Specially formulated etched face plate cuts out unwanted glare, increases contrast without sacrificing brightness. Matrix screen around phosphor dots eliminates reflected light, allows use of higher transmission glass for greater light output. New square-corner rectangular design opens up the largest picture in the industry...25" diagonal measurement, a full 315 sq. in. of viewing enjoyment. New shape allows complete transmitted image to be seen for the first time. Pictures don't wrap around sides of tube as before. And 25,000 volt high voltage assembly assures optimum picture quality.

**Unique solid-state design:** 45 transistors, 55 diodes, 2 silicon controlled rectifiers; 4 advanced ICs containing another 46 transistors and 21 diodes; and just 2 tubes (picture and high voltage rectifier) combine to deliver performance and reliability unobtainable in conventional tube sets.

**Other plus-performance features include:** High resolution circuitry for improved picture clarity, plus new adjustable video peaking that lets you select the degree of sharpness and resolution you desire; an exclusive solid-state VHF tuner with MOS Field Effect Transistor for superior reception even under marginal conditions; Memory Fine Tuning; 3-stage solid-state IF, factory-assembled and aligned; Automatic Fine Tuning; VHF power tuning; "Instant-On"; Automatic Chroma Control; adjustable noise limiting and gated AGC; adjustable tone control; hi-fi sound output to your stereo or hi-fi system.

**Exclusive owner-service capability...**only Heath offers you this money-saving advantage: built-in dot generator and tilt-out convergence panel let you do periodic dynamic convergence adjustments required of all color TVs. Modular plug-in glass-epoxy circuit boards with transistor sockets permit fast, easy service

and adjustment. Volt-Ohm meter supplied for detailed troubleshooting right down to the smallest part.

**Available in choice of factory-assembled, pre-finished cabinets:** Mediterranean, Early American, Contemporary...or without cabinet for custom installation.

**Kit GR-371MX, 125 lbs., (less cabinet) . . . . . 579.95\***

**Choose from the complete line of Heathkit solid-state Color TVs... for every size and budget requirement:**



14" portable solid-state color TV

**Kit GR-169, 69 lbs., including cabinet . . . . . 349.95\***

20" solid-state color TV

**Kit GR-270, 109 lbs., less cabinet . . . . . 489.95\***



23" solid-state color TV

**Kit GR-370, 124 lbs., less cabinet . . . . . 539.95\***





Ⓐ

New 25-pedal  
"Legato"  
1,495\*

Ⓑ

New  
microwave  
oven  
399.95\*

Ⓒ

New solid-state  
amateur receiver  
319.95\*

Ⓓ

New 15 MHz  
frequency counter  
199.95\*

## And while you're at it, picture these Heathkit newsmakers in your den, kitchen, ham shack or shop.

### Ⓐ New Heathkit solid-state "Legato" 25-pedal Theater Organ

One of the world's most versatile musical instruments...now in money-saving kit form. Designed exclusively for Heath by Thomas Organ craftsmen. All solid-state. Features 15 manual voices, 4 pedal voices...any or all at the flip of a tab. 25-note heel & toe pedal board, range 16' & 8' C0 to C3. Color-Glo® key lights and comprehensive organ course supplied have you playing like a pro in minutes. Two 44-note keyboards; accompaniment range 8'...F1 to C5. Solo manual 16', 8', 4', 2'...F1 to C7. 200 watts peak power from two solid-state amplifiers...one for the 2-speed rotating Leslie speaker and one for the two 12" speakers. Tape record/playback jack on amplifier. Band Box & Playmate accessories available.

Kit TO-101, 299 lbs. .... 1,495\*

### Ⓑ New Heathkit microwave oven

The cooking revolution of tomorrow, here today in easy-to-build kit form...saving you hundreds of dollars over comparable electronic ovens. Exclusive patent-pending Heath double door interlock system provides absolute safety...oven cannot be turned on if door is open. Prepares meals in minutes, not hours. Cooks on china, glass, even paper plates in spacious, roast-size oven cav-

ity. Low-profile, countertop design fits unobtrusively into kitchen decor. Portable convenience, too...can be used on patio, at poolside, etc...wherever a 120 VAC grounded outlet is provided. Give your wife a break from kitchen drudgery...with this new miracle of microwave cooking.

Kit GD-29, 97 lbs. .... 399.95\*

### Ⓒ New Heathkit solid-state 80-10 meter amateur receiver

All the quality you'd expect in a new Heathkit receiver...and solid-state to boot. Tunes USB, LSB, AM, CW & RTTY, 80-10M. 15 MHz WWV coverage. 100 & 25 kHz calibration. Dual gate MOSFET front end for greater dynamic range. Solid-state factory-assembled & aligned linear master oscillator for rock-solid tuning with 1 kHz readout. ¼ µV sensitivity for 10 dB S+N/N. 2.1 kHz selectivity with built-in SSB crystal filter...optional AM & CW crystal filters available.

Kit SB-303, 21 lbs. .... 319.95\*

### Ⓓ New Heathkit solid-state 15 MHz frequency counter

Another Heathkit first...highly accurate frequency measurement at a price you can afford to pay. Delivers stable, accurate counting from 1 Hz to over 15 MHz. All integrated circuitry for top performance, high reliability. Automatic trigger level for wide range input without adjustment. Five digit cold-cathode readout with Hz/kHz ranges and overrange indicators give 8-digit capability. Input Z 1 megohm shunted by less than 20 pF for low circuit loading.

Kit IB-101, 7 lbs. .... 199.95\*

### See these and 300 other Heathkit suggestions at one of the following Heathkit Electronic Centers:

CALIFORNIA: Anaheim, 92805, 330 E. Ball Road; El Cerrito, 94530, 6000 Potrero Avenue; La Mesa, 92041, 8363 Center Drive; Los Angeles, 90007, 2309 S. Flower St.; Redwood City, 94063, 2001 Middlefield Rd.; Woodland Hills, 91364, 22504 Ventura Blvd.; COLORADO: Denver, 80212, 5940 W. 38th Ave.; GEORGIA: Atlanta, 30305, 5285 Roswell Road; ILLINOIS: Chicago, 60645, 3462-66 W. Devon Ave.; Downers Grove, 60515, 224 Ogden Ave.; MARYLAND: Rockville, 20852, 5542 Nicholson Lane; MASSACHUSETTS: Wellesley, 02181, 165 Worcester St.; MICHIGAN: Detroit, 48219, 18645 W. Eight Mile Rd.; MINNESOTA: Hopkins, 55343, 101 Shady Oak Rd.; MISSOURI: St. Louis, 63123, 9296 Gravois Ave.; NEW JERSEY: Fair Lawn, 07410, 35-07 Broadway (Rte. 4); NEW YORK: Jericho, L.I., 11753, 15 Jericho Turnpike; New York, 10036, 35 W. 45th Street; OHIO: Cleveland, 44129, 5444 Pearl Rd.; Woodlawn, 45215, 10133 Springfield Pike; PENNSYLVANIA: Philadelphia, 19149, 6318 Roosevelt Blvd.; Pittsburgh, 15235, 3482 William Penn Hwy.; TEXAS: Dallas, 75201, 2715 Ross Avenue; Houston, 77027, 3705 Westheimer; WASHINGTON: Seattle, 98121, 2221 Third Ave.; WISCONSIN: Milwaukee, 53216, 5215 W. Fond du Lac  
Retail Heathkit Electronic Center prices slightly higher to cover shipping, local stock, consultation and demonstration facilities. Local service also available whether you purchase locally or by factory mail order.



HEATH COMPANY, Dept. 15-3  
Benton Harbor, Michigan 49022

Enclosed is \$ \_\_\_\_\_, plus shipping.

Please send model (s) \_\_\_\_\_

Please send FREE Heathkit Catalog.  Please send Credit Application.

Name \_\_\_\_\_

Address \_\_\_\_\_

City \_\_\_\_\_ State \_\_\_\_\_ Zip \_\_\_\_\_

\*Mail order prices; F.O.B. factory.  
Prices & specifications subject to change without notice. CL-403

# NEW PRODUCTS & LITERATURE

For additional information on items identified by a code number, simply fill in coupon on Reader Service Page. In those cases where code numbers are not given, may we suggest you write direct to the manufacturer on business letterhead.

COMPONENTS • TOOLS • TEST EQUIPMENT • HI-FI • AUDIO • CB • COMMUNICATIONS

## STEREO MUSIC SYSTEMS

A new line of compact music systems, offering various options to meet individual requirements, has been introduced as the "Festival" series.

Available in eight models, all units feature AM/stereo-FM tuners with usable FM sensitivity of 2.7  $\mu$ V (IHF) and stereo-FM separation of 30 dB. Each model includes a four-speed record changer equipped with a statically and dynamically balanced tonearm and magnetic pickup. A choice of speakers is offered with all models. Four of the models include a stereo tape cassette recorder which plays and records in mono or stereo and records from AM, FM, stereo-FM, phono, and microphones.

The Model 445 is the top of the new line and



provides 110 watts output. Complete details on this and other models in the line will be supplied on request. Harman-Kardon

Circle No. 6 on Reader Service Page

## CB TRANSCEIVERS

A new line of hand-held CB transceivers designed for both personal and commercial use has been put on the market.

Three of the models are rated at 5 watts, one at 2 watts, one at 1 watt, one at 500 mW, and one at 100 mW. The 5-watt line includes the Models T-1000 (23-channel operation), T-909 (any 6 of 23 channels), and T-808 (any 6 CB channels). The Model T-707 provides 2 watts of power and has delta tuning. The Model T-606 is rated at 1 watt and offers any 6 of the 23 CB channels. Two three-channel models are available as the Model T-505 (500 mW) and the Model T-404 (100 mW).

Complete information on these new portable transceivers and details on available accessories to be used with them are available on request. Fanon

Circle No. 7 on Reader Service Page

## TRANSISTORIZED RADAR

A transistorized radar no bigger than a breadbox has been introduced as the Model 2900. The new unit has an unusually compact indicator to simplify installation in tight quarters found aboard most smaller vessels. Its rotating antenna is protected from the weather and is kept from fouling halyards by an over-all, lightweight plastic radome. The antenna assembly is 33 $\frac{1}{2}$  inches in diameter and weighs only 48 pounds in spite of the fact that elements of the transmitter and receiver are installed in it.

For ease of servicing, the complete antenna assembly can be removed by loosening one knurled hand nut and unsnapping a quick-disconnect cable. The electronic portion can then be taken below decks adjacent to the indicator for tune-up or alignment.

Range is 32 miles and the radar generates 7

kW of power to bring in targets at long range. The unit will operate from line voltages of 12, 24, 32 volts d.c. and 110 volts a.c. Raytheon

Circle No. 8 on Reader Service Page

## MIXER MODULES

A new "Mixable Mixer" which permits the custom design of a mixer/preamp with up to six inputs, as needed, from the firm's standard modules is now available as MIX-6.

This flexibility provides the systems engineer with design freedom to create exactly the input/output configuration required or to change the configuration as needed. Modular construction also permits the integration of telephone, microphone, and program preamps with signaling or alarm tone generator. Control functions such as priority paging, remote volume control, or volume limiting are also available as standard plug-in modules.

Among the functions available in standard modules are: high and low impedance microphone preamp; 600-ohm balanced input preamp; remote volume control; volume limiter; and siren, chime, or yelp tone generator.

Spec sheets, price lists, and other detailed information (including a complete list of modules) are available on request. Bell P/A

Circle No. 9 on Reader Service Page

## P.A. AMPLIFIER

Two lines of public-address amplifiers, one using tubes and the other transistorized, have been introduced recently.

The "S" tube line offers two microphone/two auxiliary, master, treble, and bass controls with a trumpet saver in models rated from 10 to 100 watts. The "ST" transistorized line provides

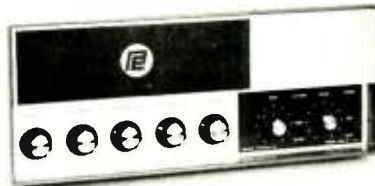

four channel inputs which may be used for either microphone or auxiliary inputs (4 inputs), master, treble, and bass controls with trumpet saver also in power ratings from 10 to 100 watts. Grommes/Precision

Circle No. 10 on Reader Service Page

## 110-WATT STEREO RECEIVER

The Model 636 AM/stereo-FM receiver incorporates the company's "Perfectune" automatic tuning circuitry, lights on the front panel to indicate reception of AM or FM, and a full complement of front-panel controls.

Virtually all solder joints have been eliminated in the construction of the 636 by use of a tension-wrapped electrical connection technique, which effects a permanent bond. According to the company, such connections are resistant to vibration, shock, and aging and provide better contact than traditional solder joints.



Silver-plated FET's are used in the front end and in the tone control for a maximized range of tone-control adjustment. The all-silicon output circuitry provides maximum power. H.H. Scott

Circle No. 11 on Reader Service Page

## CASSETTE DECK

The new Model A-24 cassette deck features automatic pinch-roller disengagement by means of a special end-of-cassette sensing circuit which not only stops the cassette but completely disen-



gages the mechanism, thus avoiding flats and deformation of the critical drive components. The deck also has its own input selector for tuner or line sources or can be connected into an existing stereo system.

Operation is simple and foolproof with piano-key push-buttons to control stop, rewind, record, play, non-latching fast-forward, cassette pop-up, and instant pause functions. There are dual clutch-type record and output controls for optimum balance and level adjustments in all modes.

The Model A-24 includes a dual vu meter for accurate level and balance during recording or playback and a 3-digit counter for easy indexing of selections within the cassette or locating them for cueing. A pause button provides editing facilities with push-button simplicity.

Frequency response is 40-12,000 Hz  $\pm$  3 dB and S/N ratio is 45 dB or better. The two heads (erase and record/playback) provide 4-track, 2-channel stereo capability. The deck operates from 117-volt, 60-Hz power source and measures 13 $\frac{3}{8}$ " wide  $\times$  9 $\frac{3}{8}$ " deep  $\times$  4 $\frac{3}{4}$ " high. Teac

Circle No. 12 on Reader Service Page

## V.H.F./FM MARINE UNIT

The Model B is an all solid-state v.h.f./FM marine radiotelephone with 25 watts maximum permitted power output. There are 12 two-way communications channels plus ESSA weather reception facilities.

The unit features G-10 glass epoxy circuit boards rigidly mounted with plug-in connectors, pretested components machine soldered for trouble-free operation, a front-mounted speaker, push-button channel selection, an any-position mounting cradle with quick-release catches, reverse-polarity protection, fully adjustable gate squelch, MOSFET receiver front-end, silicon transistors, IC's, and a 1-watt transmitter power switch.

The radiotelephone measures 10" wide  $\times$  12 $\frac{1}{2}$ " deep  $\times$  3 $\frac{1}{2}$ " high and weighs 8 $\frac{1}{2}$  pounds. Simpson Electronics

Circle No. 13 on Reader Service Page

## CB BASE STATION

The "Cobra 25" is a 23-channel, solid-state transceiver which has been specifically designed for use as a base station wherever reliable communications must be maintained, according to the company.

ELECTRONICS WORLD





An FET mixer stage eliminates crosstalk and the circuitry includes ceramic filters and IC amplifiers. Other features include delta tuning for reduction of off-channel interference, a speech compressor, 5 watts input and 4 watts output, crystal-controlled transmit and receive on all 23 channels, and two front-panel meters (power/S and s.w.r./modulation).

The receiver is a dual-conversion superhet with a switch-controlled noise limiter, a.g.c., better than 50-dB rejection of spurious signals, and facilities permitting the unit to be used as a p.a. system.

The station is housed in a tan case with black die-cast front panel. It measures 13" x 5 1/2" x 9" deep and weighs 11 1/2 pounds. It operates from 117 V, 60 Hz. Dynascan

Circle No. 14 on Reader Service Page

#### MARINE POWER HAILER

The "Seacall" power hailer has been designed to permit voice communications between vessels separated by distance or over the sounds of inclement weather. It can also be used for communicating with a marina when docking. An automatic control permits the device to be used as a fog horn that sends out a continuous signal every 3 seconds, or it can be operated manually.

Included is an intercom control for use as a complete intra-ship intercom system, an intrusion alarm, an auxiliary control for tape player and FM tuner, and a jack for separate remote unit for the flying bridge.

Of watertight construction, the unit measures 9" d. x 8 3/4" w. x 3 1/2" h. and has a maximum power output of 70 watts. Unimetrics

Circle No. 15 on Reader Service Page

#### MULTI-CONTROL ROTATOR

A new antenna rotator which can be controlled from two, three, or four different rooms has been introduced as the Model 9513.

Dual or triple controls are available on the 9513 semi-automatic rotator drive and control set. Any of up to four control units can be used to operate the drive unit. Any competent electronics technician can modify the 9513 rotator for multi-control use. All that is required is that a 130- $\mu$ F capacitor be replaced by a 65- $\mu$ F capacitor and the control units be interconnected as instructed. Channel Master

Circle No. 16 on Reader Service Page

#### LORAN-A RECEIVER

A new loran-A receiver which provides complete facilities for both manual and automatic tracking of loran-A signals has just been introduced as the Model 6809.

The compact unit (10 1/2" wide x 9 1/2"



high x 12" deep) uses integrated-circuit techniques, improved time-averaging capabilities, and automatic indication of loran time delay independent of manual switch settings. It also permits easy determination of time delay through a direct digital readout on the face of the CRT.

Requiring only 35 watts to operate, the automatic tracker provides effective operation in weak-signal areas, according to the company. It has a differential gain adjustment of over 70 dB and the ability to provide spurious-free operation under adverse conditions. Mico

Circle No. 17 on Reader Service Page

#### STEREO TAPE DECK

A three-motor, three-head stereo tape deck has been added to the Sony line as the Model 640.

The new unit incorporates many of the features found on the more expensive Model 650 including a record-equalization selector switch, a die-cast tape guide and head block mounting

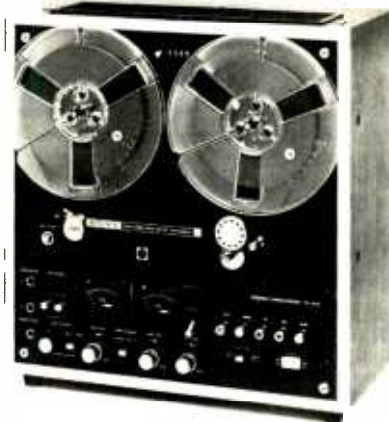

frame for permanent alignment of critical transport components, front-panel sound-on-sound and echo controls, and microphone and line mixing. It also features mechanical memory capability which permits timer-activated recording, playback, and shut-off; and positive-acting lever-type transport controls. Superscope

Circle No. 18 on Reader Service Page

#### PREAMP/AUDIO EQUALIZER

The "Citation Eleven" solid-state preamplifier/audio equalizer control center is fitted with six push-button switches for secondary functions as well as five control knobs and five slide controls for audio equalization.

There are speaker-switching facilities and two low-impedance headphone receptacles which are activated when the preamp is connected to a power amplifier. Conventional tone controls have been eliminated in favor of a professionally calibrated five-position audio equalizer. The equalizer is calibrated to operate over a narrow spectrum which permits precise adjustment of tone at the exact frequency at which adjustment is required.

Frequency response is 2-200,000 Hz  $\pm$  0.5 dB with corresponding square-wave rise time at 20,000 Hz of 1.0  $\mu$ s in all functions. Square-wave tilt at 20 Hz is less than 3 degrees and harmonic distortion at 2 V r.m.s. output from 20-20,000 Hz is virtually unmeasurable, according to the company. Harman-Kardon

Circle No. 19 on Reader Service Page

#### V.H.F./FM TRANSCEIVER

The "V-Com" hand-held v.h.f./FM transceiver is designed to be fully compatible with other FM systems operating in the 148-174 MHz range.

The circuit is all solid-state and uses IC's for the i.f. amplifiers and second mixer to insure greater reliability. Both mechanical and crystal filters are used for improved selectivity. The unit operates from an internal rechargeable Ni-Cad battery pack.

The transceiver comes with a leather carrying

case with two straps, earphone and holder, flexible whip antenna, a 3" speaker which doubles as a microphone, battery and battery charger, and one set of crystals of the user's choice. Vari-tronics

Circle No. 20 on Reader Service Page

#### STEREO TUNER/AMPLIFIER

The new Model 8 AM/stereo-FM tuner-amplifier combines the essential features of the company's Model AU999 control center and



amplifier with those of its Model TU999 stereo tuner.

The 200-watt direct-coupled amplifier (IHF music power) is driven by both positive and negative power supplies, uses negative feedback down to d.c. for steady damping. Continuous power at 4 ohms is 160 watts. Response is 5 to 50,000 Hz  $\pm$  1 dB with distortion less than 0.3% total harmonic and less than 0.4% IM.

Tuner sensitivity is 1.7  $\mu$ V IHF and the circuit features three dual-gate FET's in a 4-gang front-end with two r.f. stages. The i.f. amplifier uses 3 IC's while a crystal filter is used in addition to a block filter.

Complete specifications and additional information are incorporated in a 6-page folder which will be forwarded on request. Sansui

Circle No. 21 on Reader Service Page

#### KITS FOR PC BOARDS

The do-it-yourself construction of prototype printed-circuit boards and the hands-on approach to training are now possible with the introduction of two versions of a hand-tool kit and two new 8 1/2-inch high, double-sided collage mounting boards in double or quad height.

According to the company, the larger surface areas and greater flexibility of the new collage boards allow users to collect logic functions from a group of modules. Each of the hand-tool kits, housed in a sturdy plastic carrying case, is complete with all the tools and equipment needed to construct solid-state boards. Included in the H816 kit are fifteen 16-pin IC wire-wrap sockets, 75 wire-wrap pins, a 30-gauge hand wire-wrap tool, a 30-gauge hand unwrap tool, a wire stripper with spring, and 10 feet of 30-gauge insulated wire.

Complete information on these units is available on request. Digital Equipment

Circle No. 22 on Reader Service Page

#### CONFERENCE-CALL SELECTOR

A new conference-call selector which lets the user dial his own conference calls immediately and at any time without prior booking with the telephone company operator has been introduced into the United States by Orient Electronics.

The unit plugs into all 5-line push-button telephones. No batteries or external power is required. Of solid-state design, the unit is compact and lightweight. It measures 7" wide x 2" high x 5" deep.



To operate, the first party is dialed on outside line No. 1 and the corresponding switch on the unit is flipped to "conference." Then the process is repeated for lines 2, 3, 4, and 5. When the conference is over, the switches are returned to the "normal" position and the phone is ready for regular operation. Tradeship

**Circle No. 23 on Reader Service Page**

#### BATTERY-POWERED SCOPE

A new dual-trace, high-frequency scope that draws only 18 watts and can operate up to 6 hours on internal batteries without recharging has just been introduced as the Model 1701A.

Designed for all types of service and maintenance applications, the scope offers delayed



sweep, a full 6 × 10 cm display, and a frequency range of d.c. to 35 MHz. Its lab-scope performance, coupled with easy portability, makes the unit attractive for various applications. The company suggests that a computer service engineer will find it more convenient to move the scope around a large installation if he doesn't have to bother with a line cord. Since it is small enough to slip under an airliner seat, it is handy for traveling service engineers. With its front-panel cover housing power cord and probes and with the batteries installed, the scope weighs 35 pounds and without cover and battery it weighs 24 pounds. Hewlett-Packard

**Circle No. 24 on Reader Service Page**

#### SCR/TRIAC/DIODE TESTERS

A new series of SCR, Triac, and diode testers is now available as the ST-90, ST-100, and ST-110.

The ST-90 is a low-cost unit designed to provide shop and field personnel with a capability to perform a wide range of dynamic tests. The ST-100 offers all of the features of the ST-90 plus selected forward and reverse blocking test voltages from 200 to 500 volts in standard semiconductor-industry increments. The ST-110 includes the features of both the other models with the added ability to program all tests to the exact manufacturers' specifications for the device being tested. This unit can be used as an incoming inspection instrument as well as a laboratory tester for matching SCR's and Triacs. Alfred-Thomas

**Circle No. 25 on Reader Service Page**

#### TRANSISTOR TRANSFORMERS

A kit of nine miniature transformers, designed for the latest solid-state circuitry, is now available as the Model 500K selector kit.

The kit encompasses a broad range of impedance values, power-handling capacities, and physical sizes. This kit of open-frame transformers was designed to save engineers valuable time in optimizing breadboard circuitry for servo, audio, instrumentation, and control applications.

Impedance matching values range from 600 ohms c.t. to 50,000 ohms c.t. Primary and secondary may be interchanged to give an even greater selection of impedance ratings. Transformer sizes range from 1/4" × 3/8" × 3/8" to 3/4" × 3/4" × 1". Microtran

**Circle No. 26 on Reader Service Page**

#### NEW V.O.M. LINE

A new line of five general-purpose v.o.m.'s with broad application in the electronics servic-

ing, educational, experimenter, and industrial production and maintenance markets has been announced.

All of the meters in the new line feature meter movements that have protection diodes to prevent damage from accidental overload, precision range resistors (±1%) to insure accuracy, 3-color or easy-to-read meter scales, and high-impact plastic cases.

The five models are the WV-516A, WV-517A, WV-518A, WV-519A, and WV-520A. Detailed technical information on all of these units is available for the asking. RCA Commercial Engineering

**Circle No. 27 on Reader Service Page**

#### HAND-HELD TRANSCEIVERS

A new line of hand-held CB transceivers that offers solid-state performance and reliability has just been introduced. Four models cover all CB needs from 3-channel, 100-mW units for moderate-range communications to a full 5-W, 23-channel rig.

The top of the line is the Model CCT-4, a heavy-duty unit for commercial or personal use. It offers full 23-channel operation with all crystals supplied, at full 5 watts with 100% modulation.

Each of the units features an FET front end, IC's, superhet receiver with tuned r.f. amplifier, ceramic filter, delta tuning, a.g.c. and noise limiting, an S/r.f. meter, and separate speaker and dynamic microphone for maximum noise response and undistorted communicating. Courier

**Circle No. 28 on Reader Service Page**

#### TUNER CARTRIDGES

Two new cartridge tuners for automotive stereo tape players have been added to the Audiotex line. They are an AM-FM tuner and a stereo-FM tuner. Both are designed to slip into the cartridge loading slot of all automotive 4- and 8-track tape cartridge players.

The AM-FM tuner, Model 30-3075, is powered by an internal 9-volt transistor-radio battery. The stereo model, 30-3076, is similar to the



AM-FM unit and has a stereo/mono mode selector switch as well as an indicator light that flashes on when a stereo station is being received. A special switch on the bottom of the tuner adjusts the input circuitry for nearby and distant FM stations. GC Electronics

**Circle No. 29 on Reader Service Page**

#### PAGING PROJECTORS

Two newly designed, low-cost paging projectors, the 12-watt PA12 and PA12F, have just been introduced to the market. Both units feature computer-calculated horn flare, a design factor that provides excellent response characteristics and dispersion. A newly designed diaphragm and voice-coil assembly, plus a powerful Alnico V magnet structure, make it possible to drive the horns to the desired sound-pressure level with less amplifier power.

The PA12's round horn provides a nominal 130-degree dispersion angle. It may be oriented in any desired position in a vertical plane by

loosening a single wing-nut on the mounting base. Frequency response is 325-14,000 Hz. The PA12F is a compact re-entrant type designed for flush mounting between ceiling joists or wall studs. Its frequency response is 500 to 14,000 Hz. Electro-Voice

**Circle No. 30 on Reader Service Page**

#### TRIGGERED-SWEEP SCOPE

The B&K-Precision Model 1460 triggered-sweep oscilloscope permits viewing the entire complex TV color signal or any portion thereof, including the vertical interval test signal (VITS) and the backporch of the horizontal sync pulse,



with the color-burst information, all automatically synchronized and locked in. Two sweep-selector positions, TVH and TVV, enable the user to switch back and forth and see steady patterns of horizontal and vertical signals, without any adjustments being made.

Except for the CRT, the 1460 is solid-state. The instrument measures 9" × 10" × 17" deep and weighs only 7 1/2 pounds. A combination direct and 10:1 probe is furnished with the instrument. Dynascan

**Circle No. 31 on Reader Service Page**

#### RECEIVER/TAPE PLAYER

A solid-state AM/stereo-FM receiver and 8-track tape player has been introduced as the Model WTP-802. It features 80 watts of peak music power and a blackout dial when playing tapes.

The unit includes two high-efficiency 6 1/2" woofers, encased in an air-tight cabinet, and 3" tweeters. Slide switching is included for easy settings and power/loudness control. Speaker, auxiliary, and phono jacks on the new unit are RCA pin types.

Finished in polished walnut with a chrome panel, the cabinet measures 5 1/2" × 18 1/2" × 10 1/4". The weight is 25 pounds, including speakers. Weltron

**Circle No. 32 on Reader Service Page**

#### MARINE RADIOTELEPHONE

The Model 608 v.h.f./FM marine radiotelephone features a molded handle which protects against protruding knobs and allows for easy removal and carrying. The white molded Cyclocac front panel with integral carrying handle, gold mesh speaker grille, and blue case with color-matched microphones are designed to enhance the appearance of most boats.

Featuring six and one-half channels with an r.f. output of 8 watts, the unit is suitable for pleasure craft, workboats, and small commercial vessels. It is completely transistorized and meets



**ELECTRONICS WORLD**



or exceeds requirements of the FCC, EIA, and the Canadian DOC, Class V. It comes with mounting tray, microphone, and crystals for channel 6 (ship-to-ship), channel 16 (Safety), and ESSA Weather Broadcast. Comco

**Circle No. 33 on Reader Service Page**

### STEREO COMPACT

The Model KS-505P compact features a PE-2010 automatic turntable, an AM/stereo-FM receiver, a Pickering V-15/AT-3 cartridge, diamond stylus, and a "Dustomatic" brush.

Power output is 60 watts at 4 ohms ( $\pm 1$  dB), 20/20 watts at 4 ohms (r.m.s.), and frequency response is 20 to 20,000 Hz  $\pm 2$  dB. Input for a second phonograph and terminals for a tape recorder give the KS-505P expansive possibilities. FM sensitivity is 2.5  $\mu$ V (IHF), capture ratio is 4 dB, and IHF selectivity is 35 dB.

Optional two-way speakers incorporating 6 1/2" woofers and 3" cone tweeters are available in pairs. An optional deluxe dust cover is also available. Kenwood

**Circle No. 34 on Reader Service Page**

## MANUFACTURERS' LITERATURE

### SPEAKER BOOKLET

A 20-page booklet on speaker parameters and design philosophy, plus a catalogue section listing specifications on the company's speakers and audio components, has just been published.

Lavishly illustrated with photographs, graphs, IM distortion charts, polar patterns, radiation patterns, and mechanical specifications, this is a veritable handbook of speaker design. McIntosh

**Circle No. 35 on Reader Service Page**

### INDUSTRIAL ELECTRONICS

The 1971 edition of the Industrial Electronic Components Catalogue (#FR-71-1) containing nearly 1700 items is now ready for distribution.

The new 84-page catalogue has been extensively revised and expanded. It lists such diverse hardware items as connectors, adapters, alignment tools, clips, plugs and jacks, binding posts, cable clamps, and cable ties—all available in OEM quantities.

A broad selection of the company's chemicals is also included as well as such items as nylon and metal mounting hardware, PC materials, PC connectors, spacers, switches, test prods, production-type wire strippers, grommets, and lacing cord.

A special appendix provides part-number cross-references which allow purchasing agents to identify parts made by other suppliers. GC Electronics

**Circle No. 36 on Reader Service Page**

### TV ANTENNA BROCHURE

A four-page, four-color brochure covering its line of "Color Crossfire" u.h.f./v.h.f./FM, v.h.f./FM/stereo-FM, and v.h.f./FM antennas is now ready for distribution.

In addition to picturing and describing each antenna, details are provided on the special components making up the antenna designs. Channel Master

**Circle No. 37 on Reader Service Page**

### TV ANTENNA CATALOGUES

Three new catalogues detailing a complete line of home and MATV products have just been released for distribution.

The 16-page home-products catalogue contains specifications and photos of mast-mounted preamplifiers, broadband amplifiers, amplified signal dividers, u.h.f. converters, antenna rotators, antennas, and miscellaneous home-TV system accessories. (Catalogue 70-62)

The 30-page MATV products catalogue contains detailed information on preamplifiers, broadband amplifiers, filters, traps, multiplexers, tap-offs, MATV electronic accessories, and hardware items. Information on the FSM-2

field-strength meter and its accessories is also included. (Catalogue 70-72)

The 16-page engineered MATV systems products catalogue includes specifications, descriptions, and photographs of single-channel amplifiers, low-noise preamplifiers, custom converters, tap-offs, and a complete line of 75-ohm test equipment. (Catalogue 70-82)

Requests for any of these catalogues will be honored. Please specify by number the catalogue desired. Blonder-Tongue

**Circle No. 38 on Reader Service Page**

### HOME MUSIC SYSTEM

A 20-page brochure which describes and pictures the various components which can be selected to make up a "Musicom" home music/intercom system is now available.

The stereo entertainment center consists of a master unit with amplifier/tuner, cassette player/recorder, and a record changer; a record/tape storage cabinet; speakers; and optional intercom facilities designed to match and work with the entertainment center components. Nu-Tone

**Circle No. 39 on Reader Service Page**

### R.F. POWER TRANSISTORS

RCA's Solid-State Division has just issued an 8-page catalogue describing its r.f. transistor product line in a series of matrices which combine product groupings by output power and frequency with suggested applications.

Transistors designed for 12.5-volt operation are detailed separately for easier reference. Information on high-reliability types of microwave IC's is also included.

For a copy of RFT-700G, send your letterhead request to RCA Commercial Engineering, Harrison, N.J. 07029.

### CABLE-FAULT LOCATOR

A handy, pocket-sized, 60-page booklet on locating buried cable faults is now ready for distribution.

## Dolby-ized Cassette Decks

(Continued from page 28)

with BASF tape. With Crolyn tape, even this small defect was virtually eliminated. We could not hear any loss of treble, although the recorder response fell off above 12 or 13 kHz. Probably the program material had little content up there, and since we used an excellent wide-range record, the practical utility of the cassette deck is merely emphasized.

The *Harman-Kardon* CAD-5 and *Fisher* RC-80 sounded identical, as far as we could tell. Both had a trace of brightness, which could only be detected in direct comparison with the record, and a very low hiss level which was only audible at rather high listening levels. The brightness and hiss, which was subjectively slightly greater than that of the *Advent*, were due to the slight peaking of the highest frequencies.

All three machines were easy to use and their flutter level of about 0.2% was not audible, even on the usually revealing piano and organ passages.

It seems quite clear that, while all three recorders are capable of truly hi-fi performance, the price differentials among them are related to their flexibility and adaptability to various tape characteristics. For the user who does

not wish to concern himself with the technical details of Dolby circuit performance, or experiment with CrO<sub>2</sub> tape, the *Fisher* machine offers superb performance for \$200, not matched by any other machine of that price that we have tested.

The *Harman-Kardon* deck offers similar performance, with the addition of facilities for CrO<sub>2</sub> tape and for the user to periodically adjust the Dolby levels or optimize them for a different tape formulation (although the playback gains should not be adjusted without a standard Dolby level cassette). *Advent* has gone all the way, giving the user everything he needs to keep the instrument in its proper operating condition. In addition, the *Advent* metering system is the most satisfactory we have seen.

Whichever one you choose, the Dolby-ized cassette deck has finally made the cassette a true high-fidelity medium. No reel-to-reel recorder we have seen which sells for the price of any of these cassette machines surpasses their performance from a subjective, listening standpoint. And, when it comes to convenience, the cassette has a powerful advantage. Commercially recorded cassettes will soon be available with Dolby processing, allowing the Dolby playback circuits of these recorders to be used with equal effectiveness with pre-recorded or home recorded cassettes. ▲

### SHORT-WAVE "PRIMER"

A pocket-sized "primer" on short-wave listening, prepared especially for DX-ers, beginning and advanced short-wave listeners, hi-fi buffs, travelers, and radio hams, is now available without charge.

Entitled "Short-Wave Puts You Where It's At," the multi-colored primer takes the reader through the many adventures he can experience with short-wave; explains graphically and in simple terms the meaning of short-wave; and tells the reader what he can hear on short-wave and what to look for in a radio to receive short-wave broadcasts. Hallicrafters

**Circle No. 41 on Reader Service Page**

### PHOTO CREDITS

Page	Credit
12, 27	Harman-Kardon
14, 26	Advent Corporation
28	Fisher Radio Corp.
40	Sterling Manhattan Cable TV
41	Jerrold
43, 46 (bottom)	Zenith Radio Corp.
46 (center)	Motorola Inc.
58	Blonder-Tongue
59	Hy-Tronix Instruments
60	E. F. Johnson
61	Sencore

# ELECTRONICS MARKET PLACE

COMMERCIAL RATE: For firms or individuals offering commercial products or services. \$1.00 per word (including name and address). Minimum order \$10.00. Payment must accompany copy except when ads are placed by accredited advertising agencies. Frequency discount: 5% for 6 months; 10% for 12 months paid in advance.

READER RATE: For individuals with a personal item to buy or sell. 65¢ per word (including name and address). No minimum! Payment must accompany copy.

GENERAL INFORMATION: First word in all ads set in bold caps at no extra charge. All copy subject to publisher's approval. Closing Date: 1st of the 2nd month preceding cover date (for example, March issue closes January 1st). Send order and remittance to: Hal Cymes, ELECTRONICS WORLD, One Park Avenue, New York, New York 10016.

## FOR SALE

**GOVERNMENT** Surplus Receivers, Transmitters, Snoproscoops, Radios, Parts, Picture Catalog 25¢. Meshna, Nahant, Mass. 01908.

**CONVERT** any television to sensitive big-screen oscilloscope. Only minor changes required. No electronic experience necessary. Illustrated plans, \$2.00. Relco-A22, Box 10563, Houston, Texas 77018.

**INVESTIGATORS, LATEST ELECTRONIC AIDS. FREE LITERATURE.** CLIFTON, 11500-J NW 7th AVE., MIAMI, FLORIDA 33168.

**TREASURE HUNTERS!** Prospectors! Relco's new instruments detect buried gold, silver, coins. Kits, assembled models. Transistorized. Weighs 3 pounds. \$19.95 up. Free catalog. Relco-A22, Box 10839, Houston, Texas 77018.

**SENCORE, B & K TEST EQUIPMENT UNBELIEVABLE PRICES. FREE CATALOG AND PRICE SHEET.** FORDHAM RADIO, 265 EAST 149TH STREET, BRONX, N.Y. 10451.

**METERS** Surplus, new, used, panel or portable. Send for list. Hanchett, Box 5577, Riverside, Calif. 92507.

**ELECTRONIC PARTS,** semiconductors, kits. Free Flyer. Large catalog \$1.00 deposit. Bigelow Electronics, Bluffton, Ohio 45817.

**BURGLAR ALARM SYSTEMS** and accessories. Controls, bells, sirens, hardware, etc. OMNI GUARD radar intruder detection system, kit form or assembled. Write for free catalog. Microtech Associates, Inc., Box 10147, St. Petersburg, Florida 33733.

**ELECTRONIC COMPONENTS**—Distributor prices. Free catalogue. Box 2581, El Cajon, California 92021.

**CITIZEN BAND** radios, SSB, AM, Swan, CB, Amateur. Accessories, Free catalogue. Dealers send letterhead for factory prices. Call 714 894-7755. Baggy's Radio, 6391 Westminster Ave., Westminster, Calif. 92683.

**JAPAN & HONG KONG DIRECTORY.** Electronics, all merchandise. World trade information. \$1.00 today. Ippano Kaisha, Ltd., Box 6266, Spokane, Washington 99207.

**ELECTRONIC Ignition.** Various types. Information 10¢. Anderson Engineering, Epsom, N.H. 03239.

**BACKGROUND MUSIC,** continuous commercial-free. Solid-state MUSICON SCA ADAPTER plugs into any FM tuner. Receiver. Line powered. 5-year guarantee! Only \$39 postpaid. K-LAB, Box 5722, South Norwalk, Conn. 06856.

**NEW SEMICONDUCTOR LIGHT EMITTING DIODES.** Bright red lights replace light bulbs. Typical life 100 years. Operate at 1.65 volts, 50 milliamps. Order 2 for \$2.98 NOW. Data sheet and instructions included. Monsanto Company, Hobby Section, 10131 Bubb Road, Cupertino, California 95014.

**GOLF** the easy way! Simple instructions, guaranteed results. Unique, nothing like it. Complete package \$24.95. Vahl Co., Box 492, San Bernardino, Calif. 92402.

**COLOR** converter for B&W television. Electronic patented system. Free brochure. Bele Electronics Corp., 111 Northeast Second Avenue, Miami, Florida 33132.

**TELEVISION**—Instant starting! Convert receivers for pleasure-profit! Schematics, complete instructions. Guaranteed \$3.95. DLW Company, 1304 Magnolia, Richardson, Texas 75080.

**CONSTRUCTION PLANS:** Laser . . . \$2.00. 2-FM microphone transmitters . . . \$1.00. FM telephone transmitter . . . \$2.00. Sound telescope . . . \$2.00. Space monitor-missile tracker . . . \$2.00. Equipment and kits available. Howard, 20174 Ward, Detroit, Michigan 48235.

**DIGITAL** Frequency Meter for CB—Service Shop—Hams. AM or SSB transmitters to 35 MHz. 100 Hz readout with NIXIE tubes. Kit or assembled. Micro-Z, Box 2426, Rolling Hills, Calif. 90274.

**FREE** Electronics Catalog. Tremendous bargains. Edu-Kits, Department C-118E, Hewlett, New York 11557.

**DIFFERENT?** You bet. Monthly catalog of Industrial & Government Electronic Surplus. Get it! Startronics, Box 17127, Portland, Oregon 97217.

**COLOR** TV picture tubes. Save factory to you. 21 . . . \$59.50, 25 . . . \$59.00, 23 . . . \$95.75, 19 . . . \$63.00. Precision TV Tube Co., 7129 So. Chicago Ave., Chicago, Ill. 60619.

**CAPACITOR** TESTER—value and leakage used with VTVM. \$14.95 postpaid. E.P. Lafko, 6723 Ralston Beach Circle, Tampa, Florida 33614.

**FREE ILLUSTRATED CATALOG!** covering wide range of low-cost stock business forms from 2-Way Radio to TV Service. Write today. Free catalog; samples, too. OELRICH PUBLICATIONS, 4040 N. Nashville East, Chicago, Illinois 60634.

**EXCITING LISTENING:** Police—Fire—Emergency calls on your broadcast radio, \$19.95 up. Also Crystals, receivers, Scanners, dualband. Salch Company, Woodsboro 4B, Texas 78393.

**COLOR ORGAN** Control, exclusive design. Free catalog. MECHANI-LAB, Box 284, South Euclid, Ohio 44121.

**BACKGROUND MUSIC:** ORTRONIX HARMONIX Receiver adaptor. 13 Tran. 9 diode unit complete with power supply in attractive cabinet, \$44.50, w/o cabinet, \$37.50. Schematic & Inst. incl. BRANBRO, Box 1735, Winter Park, Fla. 32789.

**LAMPKIN** PPM Package 103B and 111. \$255.00. Peder-sen, East Andover, Me. 04226 (207) 392-2552.

## ELECTRONICS ENGINEERING AND INSTRUCTION

**LEARN ELECTRONIC ORGAN** SERVICING at home. All Makes including transistors. Experimental kit—troubleshooting. Accredited NHSC. Free Booklet. NILES BRYANT SCHOOL, 3631 Stockton, Dept. A, Sacramento, Calif. 95820.

**ELECTRONICS!** Associate degree—29 months. Technicians, field engineers, specialists in communications, missiles, computers, radar, automation. Start September, February. Valparaiso Technical Institute, Dept. N, Valparaiso, Indiana 46383.

**ATTENTION** Electronic Technicians and Engineers! Upgrade your qualifications and ability. Highly effective College-Level home study course in "Technical Writing." Diploma awarded. Excellent employment opportunities with high pay. Interesting work. Write for revealing Free Descriptive Literature. Cook's Institute of Electronics Engineering, P.O. Box 10634, Jackson, Miss. 39209 (Established 1945).

## LIBERTY PAYS MORE! WILL BUY FOR CASH

ALL TYPES:

- ★ ELECTRON TUBES
  - ★ SEMICONDUCTORS
  - ★ TEST EQUIPMENT
  - ★ Military Electronic Equipment
- WIRE—WRITE—PHONE COLLECT!  
We pay freight on all purchases—

## LIBERTY OFFERS MORE! PRESTEL FIELD STRENGTH METER

(Model 6T4C)

Only

\$120.00

F.O.B.  
New York

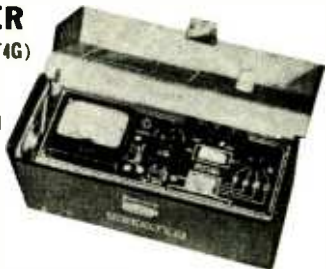

- ★ Never Anything Like It!
- ★ 1-Man Can Do A Better Job than 3 In the Same Time!

★ A Gold-Mine for Antenna Installers!  
Calibrated from 40 to 230, and 470 to 860 in 4 Bands Megahertz, from 10 to 50,000 Microvolts. Nothing makes it easier to properly and speedily find the correct place to install TV, FM and Communication Antennas. You can measure and hear the signals with this 4½ volt battery economically powered unit.

## LIBERTY ELECTRONICS, Inc.

548 Broadway, New York, New York 10012  
Phone (212) 925-6000

CIRCLE NO. 135 ON READER SERVICE PAGE

## JOHN MESHNA JR.

### HAND CRANK GENERATOR

Small hand crank fun-generator. Turning the crank puts out over 100 volts. Shock your friends, no-dig-worm-filler, etc. Surplus govt. nger generator. fun galore.

#GEN \$3.50

**TRANSISTOR IGNITION COIL \$3.50**  
Brand new trans. ign coil w/ckt. for automotive trans. ignition. Possibilities for patio-bug-killer. #TRANS \$3.50

**2000 FEET FIBRE OPTICS \$1.00**  
FIBRE OPTICS light pipe 200 fibre bundle unweathered, 10 ft. length. Pipes right around corners under water, etc. Unbelievable price of only \$1.00 for 10 foot length. #FLP-10 \$1.00

**LED LIGHT EMITTING DIODE \$1.25**  
FANTASTIC price break thru on this INFRA-RED-LED. You've been reading about them, now you can experiment. #LED 1.25

**10.7MC IF XFMR'S 5 \$1.00**  
Transistor type midjet chrome plated

**VISIBLE LIGHT LED #LED-V \$1.25**

**TUNNEL DIODE GE #TD-717 75¢**  
Open a new world of experimentation

**3 Ft. NYLON PARACHUTE \$1.00**

**16 BIT MEMORY DIP PACKAGE \$1.75**  
Dual in line package at new low price

**SIGNETICS CORP. DTL DIP PACKAGE**  
On boards - You remove 'em .40 ea. 4.00/doz.

ST616A Dual 4 input expandable mand gate  
ST620A Dual JK Flip flop  
ST629A RS/T Binary element  
ST631A Quad 2 input gate expander  
ST659A Dual 4 input buffer/driver  
ST670A Triple 3 input mand gate  
ST680A Quad 2 input mand gate

**CA3008 RCA OP AMP \$1.50**

**MOTOROLA DUAL INLINE IC'S**  
Factory marked, new.  
MC724P Quad 2 input NOR gate \$1.00  
MC725P Dual 4 input gate \$1.00  
MC790P Dual JK flip flop \$1.50  
MC792P Triple 3 input gate \$1.00  
MC799P Dual buffer \$1.00  
MC826P JK flip flop \$1.00

**MOTOROLA TRANSISTORS FACTORY MARKED**  
JAN 2N2907A 1.8 watt 60 volt 125mc 3/\$1.00  
2N2218A 3 watt 40 volt 250mc 2/\$1.00

**7400 SERIES IC GRAB BAG**  
Pack of assorted dual inline (10 units) unmarked, untested. Schematics included. Pkg. of 10 IC's \$1  
IC SOCKET for DUAL INLINE 50¢

Add Postage. New Catalog now out.

**MESHNA, PO Box 62, E. Lynn, MA 01904**

CIRCLE NO. 133 ON READER SERVICE PAGE



**\$975.00 #65B SIGNAL GENERATOR FOR \$295.00!**

Meas. Corp. generators from the test line of a multi-million-dollar Radio Mfr. We bought strictly as-is but at the right price so can sell strictly as-is but at the right price. Instruction Book with each! #65B is the FAA's favorite because the CW can also be AM up to 100%, 7.5 kHz to 30 mhz manual or motorized. Calif. Vo 0.1 uv to 2.2 VOLTS across 50 ohm load.

#65B Overhauled & Certified, w/book ..... 450.00

Meas. Corp. #82: 20 Hz to 50 MHz CW or AM up to 50%, Output calib. to 1 v into 50 ohms. It is the only I.F. Gen. with Piston Attenuator; easy to use, no resistor burnouts. Overhauled, certif., w/book 395.00

Gen. Radio 1001A .005-50 mhz OHC, w/book 395.00

URM-25 compact .01-50 mhz, OHC, w/book .. 275.00

URM-25D adds xtl calib., OHC, w/book ..... 350.00

Hewl-Packard #606A like new. OHC. book ..... 950.00

**SIGNAL GENERATOR SIMILAR H.P.'s 608D:**  
 Marconi TF-801D/1: 10 to 470 mhz, CW & AM up to 90%. Crystal-calibrated each 2 and 5 mhz and movable cursor, hairline indicator to reset the dial at each zero beat, gives freq. accuracy 0.01%. Standard 50 ohm Zo from Type N plug, Vo calib. accurately 0.1 uv to 1 v. Leakage & FM too low to measure. Capacity-coupled contactless turret bandswitching eliminates down time. Very handsome design, carefully engineered \$1650.00 instrument. Like new appearance, completely overhauled, with calib. sticker and certificate traceable to N.B.S. **\$95.00**  
 With Book .....

Hewl-Packard 608A 10-500 mhz. OHC, w/book .. 495.00

Hewl-Packard 608B 10-400 mhz, OHC, w/book .. 450.00

Hewl-Packard 608D 10-420 mhz, OHC, w/book .. 850.00

MIL #608D (TS-510A) OHC, w/608D book ..... 750.00

Bronton #202B FM-AM generator 54 to 216 mhz: Deviation calib. on meter 0-24, 0-80, and 0-240 kHz. AM calib on meter 0-50%. OHC, w/book ..... 375.00

New London #100D: 27-230 mhz, FM, deviation 0-30 & 0-251 kHz, calib. Vo, a gorgeous setup, like new. OHC, w/book, satisfaction grtd. .... 375.00

Marconi TF1064/2 FM to 15 kHz, small portable for mobile radio: 30-50, 118-183, 450-470 mhz 350.00

SG132 has 5" scope to see while aligning. AM/FM, 15-400 mhz, dev. to 600 kHz. Like MIL AM/TRM-3, w/book on TRM-3. Looks fair cond., as is only 250.00

IF OHC'd ..... 450.00

Jerrold #900A with D50 Detector: Sweep Generator 200 khz to 900 mhz: swp width 100 khz to 200 mhz: OHC, with book ..... 595.00

Jerrold #900B: Later model. OHC, with book ..... 750.00

**PLUS 31 OTHER ITEMS IN OUR SIGNAL GENERATOR CATALOG. PLUS SCOPES, COUNTERS, ETC. IN FACT: GOOD LAB TEST EQUIPMENT IN THE COUNTRY. BUT PLEASE DO NOT ASK FOR A GENERAL CATALOG! ASK FOR SPECIFIC KINDS OF ITEMS YOU NEED! WE ALSO BUY! WHAT DO YOU HAVE?**

**R. E. GOODHEART CO. INC.**  
 Box 1220-A, Beverly Hills, Calif. 90213  
 Phone: Area 213 272-5707

**RECTIFIERS & TRANSISTORS**  
**Silicon Rectifiers**

PIV	25	50	100	200	400	600	800	1000	1200
1A*	-.03	.04	.06	.08	.10	.14	.17	.22	
18A**	.09	.15	.19	.29	.39				
20A	.23			.59	.75	1.13	1.35	1.73	2.10
40A	.38			1.35	1.80	2.25	2.70	3.15	3.60

\*Tophat, Flangeless. \*\*Prestat. 3, 20, 40 Studs

**Silicon Controlled Rectifiers**

1500 PIV RECT. STUD 1 AMP 25¢ EA.	PRV	25	50	100	200	400	600
	1A*	-	-	-	.30	.55	.85
	7A	.11	.14	.20	.45	.90	1.20
	18A**	.15	.23	.35	.60	1.10	1.40
	20A	.18	.32	.45	.70	1.15	1.95

\*Tophat \*\*Prestat. 7 & 20 Amp Stud

**Germanium Power Transistors**

- 150W-T0-3-7A
- 2N456A-40V-.25 2N 458A-80V-.45
- 2N457A-60V-.35 2N1021A-100V-.60
- 2N1038-40V-8/\$1.00-20W T0-5-3A

**Silicon Power Transistors**

- 2N 389A 85W, 60V-.55 2N1047A 40W, 80V-.40
- 2N 424A 85W, 80V-.65 2N1718 10W 60V-.15
- 2N 497 4W, 60V-.10 2N1724 50W 80V-.65
- 2N 498 4W, 100V-.12 2N2151 30W 80V-.25

**Silicon Small Signal NPN. T0-5**

- 2N696 7/\$1.00. 2N697 6/\$1.00. 2N699 5/\$1.00
- 3N34 Tetraode-60c: IN34A Diodes 100/\$2.98; 2N1142 Ger. Hi-Freq. Amplifier 3/\$1.00; Thermistor Beads, 5000 ohm or 1200 ohm-3/\$1.00; Varicaps-27, 47, or 100 pf. 4V-\$1.25 ea.; P.C. Board 6"x6"x1/16" 1 oz. Copper-2/\$1.00; Photo Cells, Herm. Glass, 5 Diff. for \$1.00; 2N1300 Series, T0-5 Assorted-25/\$1.00; R.F. Coil Assort. 25/\$1.00, I.C. T0-5-15/\$1.00. Epoxy Diodes, 200 MA, 3000 PIV 49¢, 6000 98¢, 10 Watt Zeners 7 Volt Thru 185 Volt 49¢, P.C. Connector 15 Contact 2/\$1.10.

**ASSORTMENTS**

- Precision resistors film 50/\$1.00
- Precision resistors wirewound 40/\$1.00
- Ferric Chloride Etchant, 16 oz. bottle 98
- Relays 6 different types 6/\$1.00
- Terminal lugs, assorted 200/\$1.00
- Tie lugs, assorted 50/\$1.00
- Push button switches, on-off, panel 6/\$1.00
- Pots, 2-4 watt, different 10/\$1.00
- Free \$1.00 pack with \$10.00 order; min. order \$3.00; send sufficient postage, overage refunded; fully guaranteed; free catalog. 25% down on COD's.

**GENERAL SALES CO.**  
 254 E. Main St. (713) 265-2369  
 Clute, Tex. 77531

CIRCLE NO. 141 ON READER SERVICE PAGE

**INTEGRATED CIRCUITS & RECTIFIERS**  
**SEMICONDUCTORS & TRIACS**

TRIACS			
PRV	1A	10A	15A
100	.40	.70	1.00
200	.70	1.10	1.40
300	.90	1.35	1.80
400	1.10	1.60	2.20
500	1.50	2.00	2.60

**ER900 TRIGGER DIODES.** These bidirectional trigger diodes are one of the best and cheapest methods to trigger SCR's and triacs ..... 3/\$1.00

**UNIJUNCTIONS!**  
 Similar to 2N2419. RB of 5-7 stand off ratio of .6 and ip of 12 with data sheet ..... \$ .60

**MRTL IC'S**

- 908 Full Adder ..... 70
- 912 Half Adder ..... 50
- 913 Register ..... 50
- 940 JK Flip Flop ..... 50

**MOUNTING HARDWARE KITS.**  
 These kits are used to mount our SCR's, Zeners and Rectifiers etc.  
 6x32 stud (3, 12 amp rectifiers, 7A SCR's) 6 sets/\$1.00  
 1/4x28 stud (30 amp. rectifiers; 20 amp SCR's.) 4 sets/\$1.00

**Silicon Power Rectifiers**

PRV	3A	30A	12A
100	.09	.30	.50
200	.16	.35	.80
400	.20	.45	1.20
600	.30	.70	1.50
800	.40	.85	1.60
1000	.55	1.10	2.20

Terms: FOB Cambridge, Mass. Send check or Money Order. Include Postage. Average Wt. per package 1/2 lb. No C.O.D.'s. Minimum Order \$3.00

**14 PIN DUAL IN LINE SOCKETS 4/\$1.00**  
 Rated companies 30 days net

**Send for our Fall catalog featuring Transistors and Rectifiers; 325 Elm St., Cambridge, Mass.**

**OLD TATE SALES**  
 Post Office Box 748 Somerville, Mass. 02143 Tel. (617) 547-4005

CIRCLE NO. 125 ON READER SERVICE PAGE

**WANT AN F.C.C. 1st CLASS LICENSE? WANT TO BECOME A DISC-JOCKEY? REI** has a school near you VA approved call toll free: 1-800-237-2251 or write REI, 1336 Main St., Sarasota, Florida 33577. Florida Residents call: (813) 955-6922.

**DEGREE** in Electronics Engineering earned mostly by correspondence. Free brochure. Dept. G-9, Grantham School of Engineering, 1505 N. Western Ave., Hollywood, California 90027.

**LEARN Digital Logic and Integrated Circuits.** Training system-\$47.50. Performance Enterprises, Inc., 4706 NE 12th Ave., Ft. Lauderdale, Fla. 33308.

**AIR-CONDITIONING** Service Training Center. Veterans approved. Free booklet. Write Refrigeration Schools, Inc., 3216 East Washington, Phoenix, Arizona 85034.

**COMPUTER programming-Learn, use \$3,000,000 computer.** Schroeder, 19 Mary, Arlington, Mass. 02174.

**MEMORIZE, STUDY:** "1971 Tests-Answers" for FCC First and Second Class License.-plus-"Self-Study Ability Test." Proven! \$9.95. Satisfaction guaranteed. Command, Box 26348-P, San Francisco 94126.

**PLANS & KITS**

**INTEGRATED CIRCUIT KITS-Free Catalog.** FRAZER & ASSOCIATES, 3809 Surfwood Road, Malibu, California 90265.

**TUBES**

**TUBES-Lowest prices.** Foreign-American. Obsolete, receiving, special purpose, transmitting tubes. Send for tube, parts catalog. United Radio Company, 56-E Ferry St., Newark, N.J. 07105.

**TUBES, SEMICONDUCTORS, ELECTRONIC EQUIPMENT & COMPONENTS.** Quality merchandise only! Serving engineers, Purchasing Agents, TV/Hi-Fi Servicemen and Hams for 20 years. Write for Catalog or call 212-WA 5-7000. BARRY ELECTRONICS, 512 Broadway, New York, N.Y. 10012.

**RECEIVING & INDUSTRIAL TUBES, TRANSISTORS,** All Brands-Biggest Discounts. Technicians, Hobbyists, Experimenters-Request FREE Giant Catalog and SAVE! ZALYTRON, 469 Jericho Turnpike, Mineola, N.Y. 11501.

**TUBES-36¢ each.** Year guarantee. Tuner Cleaner \$1.00. Free catalog. Cornell, 4213-W University, San Diego, Calif. 92105.

**WANTED**

**QUICKSILVER,** Platinum, Silver, Gold. Ores Analyzed. Free Circular. Mercury Terminal, Norwood, Mass. 02062.

**QUICK CASH . . .** for Electronic Tubes, Semi-conductors, Equipment (Receivers, Transmitters, Scopes, Vacuum Variables, etc.) Send lists now! Write: BARRY ELECTRONICS, 512 Broadway, New York, N.Y. 10012 (212-WA 5-7000).

**DO-IT-YOURSELF**

**PROFESSIONAL ELECTRONICS PROJECTS-\$1.00 up.** Catalog 25¢. PARKS, Box 25665A, Seattle, Wash. 98125.

**TAPE AND RECORDERS**

**OLD Radio Programs on tape.** 6 hours for \$8.00. Catalog 50¢. Don Maris, 1926 Cherokee, Norman, Okla. 73069.

**STEREO TAPE TRANSPORT-7" reel-2 speeds-pause control-made for famous manufacturer-50 to 15,000 Hz-with rec/play and erase heads, without case.** Send m.o. or check for \$19.50 to Stereo Center, 218 Columbia St., Utica, N.Y. 13502. \$2.50 for prepaid shipping and insurance.

**STEREO TAPE RENTAL** for particular people. Free catalog. Gold Coast Tape Library, Box 2262, Palm Village Station, Hialeah, Fla. 33012.

**RENT 4-track open reel tapes-all major labels-3,000 different-free brochure.** Stereo-Parti, 55 St. James Drive, Santa Rosa, California 95401.

**RECORDS**

**POPULAR organ albums** factory direct. Concert Recording, Lynwood, Calif. 90262.

**HIGH FIDELITY**

**HI-FI EQUIPMENT-GET Our "ROCK BOTTOM" prices on NAME BRAND amplifiers-tuners-tape-recorders-speakers FRANCHISED-60 YEARS IN BUSINESS.** Write for this month's specials-NOW! Rabson's 57th St., Inc., Dept 569, 119 W. 57th St., New York, N.Y. 10019.

**LOW, LOW quotes: all components and recorders.** Hi-Fi, Roslyn, Penn. 19001.

**DIAMOND NEEDLES AND STEREO CARTRIDGES** at low, low prices for Shure, Pickering, Stanton, Empire, Grado and ADC. Send for free catalog and price sheet. We will be happy to quote on any cartridge-Magnetic, Ceramic or Crystal. All merchandise brand new and shipped PREPAID. LYLE CARTRIDGES, Dept. E, 265 East 149 Street, Bronx, New York 10451.

**HI-FI components, tape recorders, sleep learning equipment, tapes.** Unusual Values. Free catalog. Dressner, 1523 R Jericho Turnpike, New Hyde Park, N.Y. 11040.

**IMPOSSIBLE? SURPLUS TTL INTEGRATED CIRCUITS BRAND NEW IN ORIGINAL MANUFACTURERS' CARTONS**

B & F has one of the worlds largest inventories of surplus integrated circuits. All are new, meeting all manufacturers original specifications, and in factory packaging. The low prices should speak for themselves. Manufactured by Texas Instruments, National, Signetics or Philco, no choice. All packages are 14/16 lead silicone Dual In-Line Pak. Write for additional RTL and DTL lines not listed. Many other I. C. items in stock including nixies, 5 volt power supplies, indicators, logic breadboards.

- 7400 Quad 2-Input NAND Gate . . . . . \$ .50
- 7401 Quad 2-Input NAND Gate . . . . . .50
- 7402 Quad 2-Input NOR Gate . . . . . .50
- 7404 Hex Inverter . . . . . .50
- 7405 Open Collector Hex Inverter . . . . . .50
- 7408 Quad 2-Input AND Gate . . . . . .50
- 7410 Triple 3-Input NAND Gate . . . . . .50
- 7411 Triple 3-Input AND Gate . . . . . .50
- 7420 Dual 4-Input NAND Gate . . . . . .50
- 7421 Dual 4-Input AND Gate . . . . . .50
- 7430 8-Input NAND Gate . . . . . .50
- 7440 Dual 4-Input NAND Buffer . . . . . .50
- 7441 BCD To Decimal Decoder Driver . . . . . 3.00
- 7450 Dual 2-Wide 2-Input Expandable A-O-I Gate . . . . . .50
- 7451 Dual 2-Wide 2-Input A-O-I Gate . . . . . .50
- 7453 4 Wide Expandable 2-Input A-O-I . . . . . .50
- 7454 4 Wide 2-Input A-O-I . . . . . .50
- 7460 Dual 4-Input Expander . . . . . .50
- 7470 J-K Flip-Flop . . . . . 1.00
- 7472 J-K Master Slave Flip-Flop . . . . . 1.00
- 7473 Dual J-K Master Slave Flip-Flop . . . . . 1.00
- 7474 Dual D Flip-Flop . . . . . 1.00
- 7475 Quad Bistable Latch . . . . . 1.75
- 7476 Dual J-K Master Slave Flip-Flop . . . . . 1.00
- 7480 Full Adder . . . . . 1.50
- 7490 Decade Counter . . . . . 2.00
- 7491 8 Bit Shift Register . . . . . 3.00
- 7492 Divide By 12 Counter . . . . . 2.00
- 7493 4-Bit Binary Counter . . . . . 2.00
- 8T01 NIXIE Decoder/Driver . . . . . 3.00
- 8T04 Seven Segment Decoder/Driver . . . . . 3.00
- 8162 Variable One-Shot . . . . . 1.00

80 PAGE CATALOG . Free with any order or send \$0.25

ALL ITEMS POSTAGE PAID IN THE U.S.A.  
Charges Welcome  
BankAmericard - Mastercharge - \$10.00 min.

**B. & F. ENTERPRISES**

PHONE: 617 532-2323  
P.O. Box 44, Hathorne, Massachusetts 01937

**CIRCLE NO. 150 ON READER SERVICE PAGE**

**\$1 PEP \$1**  
**Dollar Sale**  
**EACH PACKAGE**  
**MONEY BACK GUARANTEE**

- 1 AMP SILICON RECTIFIER
- Choice of Package
- Bullet-Glass-Relin-Metal
- 20-50V  5-800V
- 17-100V  4-100V
- 12-200V  3-1200V
- 1 AMP GLASS 50-100V 15/\$1.00
- 1 AMP METAL 600V 10/\$1.00
- 15 AMP TRIAC PRESFIT 5-50V 7/\$1.00
- 7 AMP SCR FLANGE PACKAGE 3-1100V 10/\$1.00
- 3 AMP
- 15-50V  4-600V
- 10-100V  3-800V
- 8-200V  2-1000V
- 5-400V  1-1200V
- 2 AMP BULLETS
- 12-200V \$1.00
- 10-500V \$1.00
- 8-800V \$1.00

**I. C. SPECIAL**

14 lead dual in-line package. Perform same function as 700 series.

Master Slave Flip-Flop . . . . . 75¢ each—5 for \$3.00  
Quad 2 input nand gate . . . . . 75¢ each—5 for \$3.00

FULL WAVE BRIDGES				
PRV	2Amp	3Amp	5Amp	10Amp
50V	1.25	1.35	1.50	1.70
100V	1.50	1.60	1.75	1.95
200V	1.75	1.85	2.00	2.20
400V	2.00	2.10	2.25	2.45
600V	2.50	2.60	2.75	2.95
800V	3.00	3.10	3.25	3.45

SILICON CONTROL RECTIFIERS				
PRV	1 AMP	3 AMP	5 AMP	7 AMP
50	.20	.25	.30	.35
100	.25	.30	.35	.40
200	.40	.45	.50	.55
300	.60	.70	.80	.90
400	.75	.85	.95	1.00
500	1.00	1.10	1.20	1.30
600	1.20	1.30	1.40	1.50

TRIACS					
PRV	1 AMP	3 AMP	5 AMP	10 AMP	15 AMP
100	.40	.50	.75	1.00	1.20
200	.65	.75	1.00	1.40	1.80
300	1.00	1.10	1.25	1.90	2.20
400	1.30	1.40	1.80	2.30	2.60
500	1.60	1.80	2.10	2.75	3.10

**NO SALES TAX—WE PAY POSTAGE OTHER PRODUCTS ON REQUEST**  
**PARK ELECTRONIC PRODUCTS**  
P.O. Box 78, N. Salem, N.H. 03073  
603-893-0276

**CIRCLE NO. 131 ON READER SERVICE PAGE**

**GOVERNMENT SURPLUS**

JEEPS Typically From \$53.90 . . . Trucks from \$78.40 . . . Boats, Typewriters, Airplanes, Multimeters, Oscilloscopes, Transceivers, Electronics Equipment. Wide Variety, Condition. 100,000 Bid Bargains Direct From Government Nationwide. Complete Sales Directory and Surplus Catalog \$1.00 (Deductible First \$10.00 Order.) Surplus Service, Box 820-K, Holland, Michigan 49423.

**AUTHORS' SERVICES**

**AUTHORS!** Learn how to have your book published, promoted, distributed. Free booklet "ZD," Vantage, 120 West 31 St., New York 10001.

**PERSONALS**

**MAKE FRIENDS WORLDWIDE** through international correspondence. Illustrated brochure free. Hermes, Berlin 11, Germany.

**HYPNOTISM**

**SLEEP Learning. Hypnotic Method. 92% effective.** Details free. ASR Foundation. Box 7021 EW, HC Station, Lexington, Ky. 40502.

**FREE Hypnotism, Self-Hypnosis, Sleep Learning. Catalog!** Drawer H400, Ruidoso, N.M. 88345.

**PHOTOGRAPHY—FILM, EQUIPMENT, SERVICES**

**SCIENCE Bargains—Request Free Giant Catalog "CJ"—148 pages—Astronomical Telescopes, Microscopes, Lenses, Binoculars, Kits, Parts, War Surplus bargains.** Edmund Scientific Co., 300 Edscoop Bldg., Barrington, New Jersey 08007.

**EMPLOYMENT INFORMATION**

**FOREIGN and USA job opportunities available now.** Construction, all trades. Earnings to \$3,000.00 monthly. Paid overtime, travel, bonuses. Write: Universal Employment, Woodbridge, Conn. 06525.

**EDUCATIONAL OPPORTUNITIES**

**LEARN WHILE ASLEEP.** Hypnotize! Strange catalog free. Autosuggestion, Box 24-ZD, Olympia, Washington, 98501.

**INVENTIONS WANTED**

**PATENT Searches** including maximum speed, full airmail report and closest patent copies, \$6.00. Quality searches expertly administered. Complete secrecy guaranteed. Free Invention Protection forms and "Patent Information." Write Dept. 23, Washington Patent Office Search Bureau, 711 14th Street, N.W., Washington, D.C. 20005.

**MAGAZINES**

**OVER 2,000,000 Backdate magazines!** Specify needs. Midtown, Box 917EW, Maywood, New Jersey 07607.

**JAPAN PUBLICATIONS GUIDE** business, pleasure, education. \$5.00. INTERCONTINENTAL, CPO 1717, Tokyo 100-91.

**BUSINESS OPPORTUNITIES**

**FREE CATALOGS.** Repair air conditioning, refrigeration. Tools, supplies, full instructions. Doolin, 2016 Canton, Dallas, Texas 75201.

**I MADE \$40,000.00 YEAR** by mailorder! Helped others make money! Start with \$10.00—Free proof. Torrey, Box 318-N, Ypsilanti, Mich. 48197.

**FREE BOOK "999 Successful Little-Known Businesses."** Work home! Plymouth 445-W, Brooklyn, N.Y. 11218.

**MAKE BIG MONEY** raising chinchillas, rabbits, guinea pigs for us. Catalog—25¢. Keeney Brothers, New Freedom, Pa. 17349.

**\$200.00 DAILY** In Your Mailbox! Your Opportunity To Do What Mailorder Experts Do. Free Details. Associates, Box 136-EW, Holland, Michigan 49423.

**GREGORY ELECTRONICS**  
**Your Best Buys In**  
**QUALITY USED**  
**FM 2-WAY RADIO EQUIPMENT**

**WORLD'S LARGEST**  
**INVENTORY—MORE THAN**

**10,000**

**USED FM 2-WAY**  
**RADIOS MFG. BY**

*General Electric*  
*Motorola and*  
*R. C. A. . . .*

- **BASE STATIONS**
- **MOBILE UNITS**
- **ACCESSORIES**

**27 to 54, 148 to 172**  
**and 450 to 470 MHz**

- **Tuning & Crystals**

IF DESIRED . . . . .

**Send For New**

**'71 Catalog!**



249 Route 46, Saddle Brook, N. J. 07662  
Phone (201) 489-9000

**CIRCLE NO. 139 ON READER SERVICE PAGE**

**MAILORDER!** Make big money working home. Free report reveals millionaire's trade secrets! Executive (1K3), 333 North Michigan, Chicago 60601.

**MUSICAL INSTRUMENTS**

**30% DISCOUNT** name brand musical instruments. Free catalog. Freeport Music, 127-L Sunrise Hwy, Freeport, N.Y. 11520.

**RUBBER STAMPS**

**RUBBER ADDRESS STAMPS \$2.00. SIGNATURE \$3.50. FREE CATALOG. JACKSON'S, BOX 443-G, FRANKLIN PARK, Ill. 60131.**

**CALL letters included!** Pocket stamp. \$3. Brown's, 321 Price, Philadelphia, Pa. 19144.

**RUBBER ADDRESS STAMPS \$1.75. SIGNATURE \$2.25.** Good quality. Prompt service. JOSEPH, Box 1602-W, Battle Creek, Mich. 49016.

**ELECTRONICS WORLD**



# U.S. GOV'T ELECTRONIC SURPLUS

• Nationally Known-World Famous SURPLUS CENTER offers finest, most expensive, Government Surplus electronic units and components at a fraction of their original acquisition cost.

## IBM COMPUTER POWER SUPPLY

• (ITEM #22-934) -- Full-wave, regulated unit. Fine for college labs, research centers, service shops, etc. Pure AC over a wide range of voltages. DC output voltages 6, 12, 24, etc. Wide range of AC voltages available.

• Linear transformers, filters, transistor load regulation system, independent of line voltage fluctuations. Contains five separate rectifier systems. Unit is furnished without small "regulating card" which can be easily made or can be purchased. Data and circuit diagrams furnished. 30" x 12" x 16". 1.25 lbs.

Cost Gov't Over \$300.00 **\$24.95**

ONCE-IN-A-LIFETIME SPECIAL



## BURGLAR-FIRE ALARM SYSTEM



• (ITEM #1135-A) -- Dual alarm system given warning of fire or break-in. Operates on 115-V AC. Control unit, 2 1/2" wide flash lamp, emergency column, 3-door window actuators, alarm bell, 100 ft. wire, instructions. 8 1/2" x 7 1/2" x 2 1/2" (7 lbs.)

**\$29.95**

## STANDARD DIAL TELEPHONE

• (ITEM #715) -- Standard, commercial telephone same as used throughout U.S.A. Attractive polished black, like new condition. Use as extension phone in private systems or connect several phones together for local intercom system. Full instructions are furnished. Wt. 9 lbs. Original Cost \$24.50 **\$7.49**



## STEP-BY-STEP TELEPHONE SWITCH

• (ITEM #7-906) -- Amazing telephone selector switch. Great experimental item when used with low-voltage telephone dial (H) select any number from 0 to 100. Make intercom or private system. Use to turn on remote light, start motor, etc. Complete contact bank. 12 1/2" x 6 1/2" x 3 1/2" (16 lbs.) Cost Over \$80.00 **\$6.29**



• Telephone dial for use with above switch. Order as (Item #708) **\$1.97**

## MAGNETIC DIGITAL COUNTER (12 to 18-VDC)

• (ITEM #21-959) -- Use to count electrically. Use to count number of times door is opened after business is closed, to show changing prices, laboratory uses, etc. Will count 1 for each pulse and will transfer 10th count to next unit. 4 1/2" x 4 1/2" x 1 1/2". Orig. Cost Over \$19.00 Each **\$1.99** Three For **\$4.99**

1 1/2 lbs.

## TYPICAL BUYS FROM OUR 1970 CATALOGS

- \$ 10.00 115-Volt DPDT Relays..... **\$1.69**
- \$101.00 Regulated Transformer, Wide Range..... **\$14.91**
- \$ 75.00 20-Relay Telephone Panel..... **\$4.39**
- \$250.00 Gyroscope, Twin Rotor, 24V..... **\$9.89**

## AC PROGRAM TIMING CLOCK

• (ITEM #158) -- 24 with 115-V AC unit. Use for periodic timing, work breaks, classes, turn on radio, etc. 4 1/2" clips permit ON/OFF switching any time in 24-hour period. Also has "skip" feature. Can be multiple programmed. 13 amp. contacts. 8 1/2" x 6 1/2" x 4 1/2" (8 lbs.) Cost Gov't Over \$20.00 **\$15.75**



## SNAP AROUND VOLT-OHM-AMMETER

• (ITEM #24-944) -- Measures AC current without opening the line. Simply press handle and snap the probe around the conductor. Reads currents from .25 to 125-amps, reads voltages to 300, reads ohms up to 300. Test motors, appliances, etc. Three current ranges. Two voltage ranges. With crank, test leads. 3 1/2" x 3 1/2" x 1 1/2". Rec. Price \$39.95 (2 lbs.) **\$36.90**



## SPECIAL SALE

**Correspondence Course in ELECTRICAL ENGINEERING**  
**\$8.79** Prepared in U.S.A.  
**\$10.79** outside U.S.A.



• (ITEM #A180) -- Obtain technical training at low cost! Lincoln Engineering School has suspended its Correspondence Courses because of rising costs. A limited number of Electrical Engineering Courses are available, but without the examination grading service. The course consists of 15 lesson books, each with associated exams and standard answers. Book describing price winning Home Experimental Laboratory Bench furnished at no extra cost.

## RUNNING TIME METER

• (ITEM #2188) -- Record number of operating hours of electric lights and electrical devices such as refrigerators, furnaces, etc. Records total hours, tenths and hundredths up to 9999.99 hours. For 115volts, 60cycles. Size 4 1/2" x 3 1/2" x 2 1/2". Shipping weight 2 lbs. **\$4.39** Cost Over \$20.00



## COMPUTER TRANSISTORS ON HEAT SINKS

IBM Computer Quality Units

• (#22-928) -- Unit consists of one 130-watt power transistor on heavy, ribbed, aluminum heat sink. Many experimental uses. (1 lb.) Cost Gov't Over \$10.00 **\$1.99**

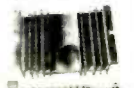

• (#22-915) -- Unit consists of two 100-watt power transistors, 2 pairs, several diodes, capacitors, resistors, etc. on heavy, ribbed aluminum heat sinks. Ideal for use as motor speed control. (4 lbs.) Cost Gov't Over \$35.00 **\$4.91**



ALL ITEMS SHIPPED F.O.B. LINCOLN, NEBR. Order Direct From Ad. Money Back Guarantee.

## SURPLUS CENTER

DEPT. EW-031 LINCOLN, NEBR. 68501

# TEXAS-NATIONAL-TRANSITRON TTL DUAL INLINE "IC'S"

Any 3 - 10% Discount!

TYPE	DESCRIPTION	SALE
<input type="checkbox"/> SN7400N	Quad 2-input NAND gate	\$.88
<input type="checkbox"/> SN7401N	Same as 7400 but with open collector output	.88
<input type="checkbox"/> SN7402N	Quad 2-input NOR gate	.88
<input type="checkbox"/> SN7404N	Hex inverter	.99
<input type="checkbox"/> SN7410N	Triple 3 input NAND gate	.88
<input type="checkbox"/> SN7420N	Dual 4-input NAND gate	.88
<input type="checkbox"/> SN7430N	8-input NAND gate	.88
<input type="checkbox"/> SN7440N	Dual 4-input NAND buffer	.88
<input type="checkbox"/> SN7441N	BCD-to-Nixie tube driver	4.95
<input type="checkbox"/> SN7442N	BCD-to-decimal-decoder	4.50
<input type="checkbox"/> SN74460N	Dual 4-input expander	.88
<input type="checkbox"/> SN7472N	J-K Master slave flip flop	.99
<input type="checkbox"/> SN7473N	Dual J-K master slave flip flop	1.19

## COUNTING SYSTEM

3 PC. KIT

**\$10**



Includes SN7490 decade counter, SN7441 BCD decoder-driver, SN7475 quad latch with hookup instructions

**NIXIE\* TUBE \$5.95**

(0-9), wide angle Similar to Burroughs

## 6 AMP FULL

PIV	SALE
50	\$0.88
100	.99
200	1.25
400	1.50
600	1.75
800	1.95
1000	2.25

WAVE BRIDGE RECTS

## FAIRCHILD IC "AMP"

Any 3 10% Discount!

Type	Description	Each
<input type="checkbox"/> 702	Wide Band DC	1.19
<input type="checkbox"/> 703	RF-IF Amp	1.19
<input type="checkbox"/> 709	Operational	1.19
<input type="checkbox"/> 710	Hi-Speed Diff.	1.19
<input type="checkbox"/> 2809	Dual 709's	1.98
<input type="checkbox"/> 2747	Dual 741's	2.98
<input type="checkbox"/> 741	Freq. Comp. 709	1.59

## SPRAGUE- IC's

Your Choice 3 for \$1

- 908 Full Adder
- 909 Buffer
- 912 Half Adder
- 913 Shift Register
- 915 Dual 3 In. Gate
- 921 Dual 2 In. Gate
- 940 JK Flip Flop
- 960 Dual Buffer

## LIGHT-EMITTING DIODES (LEDs) \$1.50

- Visible LED "Brite Red" ..... 2.69
- Visible "Brite Red" Detector
- Invisible "Infrared" Detector
- Invisible LED "Infrared"



## 4,000 BIT MEMORY \$8.50

From IBM Computers, Guaranteed! W/Spec Sheets



10¢ Catalog on Fiber Optics, IC's, Semis, Parts

Terms: add postage. Rated: met 30, col's 25%. Phone Orders: Wakefield, Mass. (617) 245-3829. Retail: 211 Albion St., Wakefield, Mass.

## POLY PAKS

P.O. BOX 942 W LYNNFIELD, MASS 01940

CIRCLE NO. 129 ON READER SERVICE PAGE

## PRINTING

SOMETHING DIFFERENT, 1,000 personalized name address labels with zip code, imprinted CB/HAM call letters, or phone number, \$1.00. Bargain catalog FREE. D. Electronics, 4725 45th NE, Seattle, Wash. 98105.

## REPAIRS AND SERVICES

MIDWEST'S only AR/DYNA Independent repair station. We serve over 20 states from Oregon to Tennessee with a factory-trained staff and the largest parts stock in the Midwest. Write: HAYNES MICROELECTRONICS, P.O. Box 457, Lawrence, Kansas 66044.

## MISCELLANEOUS

WINEMAKERS: Free illustrated catalog of yeasts, equipment. Semplex, Box 122-76, Minneapolis, Minn. 55412.

SPECIAL interest records available, produced by the editors of the world's leading special interest magazines. Send for free catalog. Record Catalog, EW, Ziff-Davis Publishing Company, One Park Avenue, New York, N.Y. 10016.

STOP BURGLARS THE EASY WAY! Affix authentic "Protected by Electronics Sentry Alarm" decals to auto windows, doors and windows of home, retail stores, vending machines, etc. Whether you have an alarm or not—thieves stay away! Only \$1.00 for each set of two. J. Ross, 80-34 Kent St., Jamaica, N.Y. 11432, Dept. EW.

AS YOU SCAN THESE COLUMNS, more than 175,000 monthly buyers of ELECTRONICS WORLD are doing the same. These men are all Electronics Professionals—individuals involved actively in electronics from a business or hobby viewpoint—they are doubly interested in those advertisements which will enhance their careers or their leisure hours. They look to the pages of the ELECTRONICS MARKET PLACE for prime sources of products and services of interest to them. They will buy from you if your advertising appears regularly in their favorite magazine. Send copy and payment now to: Hal Cymes, Classified Advertising Manager, ELECTRONICS WORLD, One Park Avenue, New York, New York 10016. REMEMBER: May issue, on sale April 20th, closes March 1st.

## POWER TRANSISTORS

STOCK NO.	TYPE	POWER	MFG.	CASE	PRICE
H4022	(2N1546 MP1546*)	100W.	Mot.	TO-3	.75 3/2.00
H4023	#108 2N1100	40W.	Delco Mot.	TO-36	.75 3/2.00
H4028	2N1011	35W.	Mot.	TO-3	.75 3/2.00
H4016	2N1137B	80W.	Mot. T.J. Bendix	TO-3	.60 6/3.00
H4107	2N3765	20W.	Trans.	TO-66	.60 6/3.00
H4108	2N555	10W.	Keaf.	TO-3	.40 6/2.00
H4109	2N2015	150W.	Mot. RCA	TO-3	ea. 1.25
H4110	2N1487	75W.	RCA	TO-3	ea. 1.00

\*MP1546 is high reliability version of 2N1546. All above power transistors are Germanium, except 2N3766, 2N2015, and 2N1487.



Honeywell Computer boards, 4 1/2" x 12". Transistors, diodes, zeners, capacitors, precision resistors, heat sink, trimmers etc. 2 Different boards \$1.00. 3 lb. Stock No. H9082  
 Honeywell Boards 5 1/2" x 6". Loaded with late no. transistors, diodes, resistors and capacitors. 2 different boards \$1.25. 2 lb. Stock No. H9094

## COMPUTER GRADE CAPACITORS

H2040	Sangamo or Pyramid 4 1/2" x 1 3/4"	
	4000 MFD 50V	.50 5/2.00
H2039	Pyramid 4 1/4" x 1 3/4"	
	3500 MFD 55V	5/2.00

\$1.00 FREE WITH \$10.00 ORDER  
 MINIMUM ORDER \$3.00

Many other items—send for new 28 page catalog. Please include sufficient postage; excess will be refunded.

**DELTA ELECTRONICS CO.**  
 BOX 1, LYNN, MASSACHUSETTS 01903

CIRCLE NO. 145 ON READER SERVICE PAGE



**KEEP PACE WITH SPACE AGE! SEE MOON SHOTS—LANDINGS, SPACE FLIGHTS, CLOSE-UP!**  
**AMAZING SCIENCE BUYS**  
**for FUN, STUDY or PROFIT**  
**FREE GIANT CATALOG!**

**1st QUALITY OPAQUE UNDER \$200**  
 Terrific Buy! Top Quality! Projects brilliant sharp 4 1/2 ft. sq. image from 8" using up to 5"x3" color, h&w illustrations. Retains all original colors, proportions, enlarges drawings, coins, maps, etc. Revolutionary peanut-size quartz halogen lamp (50hr. life), 200mm anastigmatic lens (f3.5, 8" F.L.), unique internal reflecting system gives maximum brightness, entire field focus. Can be used upside down. Turbo-cooled. 5 1/2 ft. cord. Stock No. 71,272 AK ... (Wt: 11 1/4 lbs) ... \$89.75 Ppd.

**3-CHANNEL COLOR ORGAN BARGAIN!**  
 Create tremendous variety of unusual & beautiful lighting effects with this low-cost top-quality 1500-Watt unit (500 W. per channel). Compare with others selling for twice the price. Has pilot light, plus individual sensitivity controls and channel indicator lights. Can operate ten 150 W. "spots" or 200 Christmas lights. Uses reg. house current. Attaches to audio source w/RCA-type phone plug. 5 1/4" x 6 3/4" x 2 1/2". 2 1/2 lbs. Thermal setting plastic case. 8 ft. cord. Includes carrying case. Stock No. 71,223 AK ... \$44.50 Ppd.

**LONG-WAVE BLACK LIGHT FIXTURE**  
 Extremely versatile, compactly designed, long wave (3200-4000 angstroms) black light (ultraviolet) fixture. Has 8-watt, 110-v lamp with built-in filter—eliminates harmful shorter wave ultraviolet rays. Use to identify minerals, fungi, bacteria—check for surface flaws, oil and gas leakage—perfect for displays with fluorescent paper, paints, chalk, crayons, trace powders. Includes carrying case, connecting plug. Mount vert., hor., or on corner. 10" L. 1 1/2" W., 1 1/4" H. Stock No. 70,364 AK ... \$12.50 Ppd. REPLACEMENT BULB Stock No. 60,124 AK ... \$4.75 Ppd.

**MIRRORED BALLS BOUNCE LIGHT**  
 Yesteryear's ballrooms echo in mirrored lights that ricochet to the beat of today's discotheque. Up to 1,000 lustrous, clear, handmade glass mirrors on each ball create fantastic lighting effects. Motorized—they cast reflections that blow the mind! Ideal for light shows, displays, restaurants, hotels and modern stores. Stock No. 71,066 AK ... (12" Diam.) ... \$30.00 Ppd. Stock No. 85,180 AK ... (16" Diam.) ... \$75.00 Ppd. Stock No. 71,065 AK ... (17 1/2" Diam.) ... \$45.00 Ppd. Stock No. 60,744 AK ... (Ceiling Motor) ... \$12.50 Ppd.

**BLACK-LIGHT MIGHTY MITES**  
 Relatively small (12") fixtures give surprisingly bright blacklight. Mirror-finished reflector makes instant starting 8-watt, high-intensity bulb look like 40-watt. Up to 5,000 hours of safe, long-wave (3660A) blacklight to really turn-on parties, light & theatrical shows, psychedelic decors, holiday decorations. Shock-proof end-caps remove for safe, easy replacement of bulb and starter. Stands upright or horizontal. Alum. case. Stock No. 71,274 AK ... \$14.95 Ppd. DELUXE OUTDOOR INDOOR MODEL Stock No. 71,299 AK ... \$19.95 Ppd.

**PSYCHEDELIC LIGHTING HANDBOOK**  
 100 information packed pages! Fully explains latest in psychedelic lighting equipment, techniques, development. Covers all facets of psychedelic light-show production including: mirrors, blacklights, projectors, crystals, organs, slides, mirrors, color organs, polarized color light boxes, MusicVision, etc. Shows how to "psychedelize" parties, musical groups, shows or how to set looseleaf paper punched for 3 ring binder. Stock No. 9100 AK ... \$3.00 Ppd.

**MAIL COUPON FOR GIANT FREE CATALOG**

**148 PAGES—1000's of BARGAINS**  
 Completely new 1971 edition. New items, categories, illustrations. Dozens of electrical and electromechanical parts, accessories. Enormous selection of Astronomical Telescopes, Microscopes, Binoculars, Magnifiers, Magnets, Lenses, Prisms. Many war surplus items: for hobbyists, experimenters, workshop factory. Mail coupon for catalog "AK".  
**EDMUND SCIENTIFIC CO.**  
**300 EDSCORP BUILDING.**  
**BARRINGTON, N.J. 08007**

NAME \_\_\_\_\_  
 ADDRESS \_\_\_\_\_  
 CITY \_\_\_\_\_  
 STATE \_\_\_\_\_ ZIP \_\_\_\_\_

**SPECIAL VISUAL EFFECTS PROJECTOR SET**

Dazzling, avant-garde visual effects! Fantastic variety. Incredibly beautiful. Special package offer contains all necessary apparatus. Create floating, exploding, fiery bursts of color-like "Symphony of Spheres," "Chromatic Starbursts," "Crystal Starburst." Features 35mm 500 W. fan cooled projector—produces big image at short distance. Accepts two 9" diam. wheels (Dry Kaleidoscope & Hexidroscope. 2 cylindrical accessories. Colored Cloud & 3" Hexidroscope w/six internal mirrored walls). Perfect for entertaining, parties, photography. Complete instructions. Stock No. 71,212 AK ... \$79.50 Ppd. Deluxe Model No. 71,295 AK (w/Kaleidoscopic lens) ... \$99.50 Ppd.



**1st COMPLETE CRYSTAL SLIDE SET!**

Five brilliantly colored crystal slides create dramatic effects! Fit 35mm slide projector. Add polarizing spinner—delicate, crystalline patterns appear to move, change colors. Sets contain 2 types of crystals: 4 Resorcinol Slides—brilliantly colored, wispy patterns; 1 Acetanilide Slide—jagged and rigid brown & purple patterns; 2" square. Glass-mounted. Sandwiched with Mylar® polarizing material—less than 1/10" thick. Stock No. P-382 AK ... Set A ... \$10 Ppd. No. P-41,381 AK ... Set B ... \$10 Ppd. MOTORIZED POLARIZED SPINNER KIT Stock No. 71,132 AK ... \$12 Ppd.



**50-150-300 POWER MICROSCOPE**

Amazing Value—3 Achromatic Objective Lenses on Revolving Turret! Color-corrected, cemented achromatic lenses in objectives give far superior results to single lenses usually found in this microscope price range. Results are worth the difference! Fine rack and pinion focusing. Imported. Stock No. 70,008 H ... \$19.50 Ppd. MOUNTED 500 POWER OBJECTIVE: Threaded objective lenses, 3mm F.L. Stock No. 30,197 H ... \$5.00 Ppd.



**TUNE IN-AND TURN ON YOUR OWN**

Psychedelic Light Show. Take one bookshelf sized conservative looking oiled walnut finished light box—with its built-in kicker, an indiv. controlled 3-channel color organ. Activate by attaching to hi-fi or stereo speaker. Plug in and switch on! Music fills the room and the prismatic screen leaps into pulsating life. Patterns are wild and wonderful, or soft and soothing—responding directly in time and intensity to music. Perfect home entertainment, little theater or combos. House current. Stock No. 80,126 AK ... (18" W x 12" H x 9" D) ... \$49.95 Ppd.



**1st LOW COST XENON STROBE**

Price breakthrough in bright, reliable electronic strobes. 50W/Second Xenon tube. Variable flash rate—60 to 500 per minute. Long life—more than 1,000,000 flashes. Printed circuit board design. Safe, durable Bakelite case. Externally mounted bulb, plastic shield. 6 1/4 x 3 3/4 x 2 1/4 oz. Perfect for psychedelic stop-action lighting effects for home light shows, parties, displays. Stock No. 71,342 AK ... \$24.95 Ppd. BUILD-IT-YOURSELF STROBE KIT Stock No. 71,343 AK ... \$19.95 Ppd.

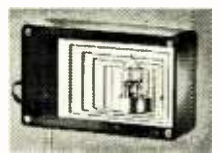

**CHROMATIC "MACHINE-GUN" STROBE**

Red, Green, Blue & White light barrage the eyeballs every 6 seconds with this low-cost mechanical strobe that can run continuously without fear of burning up. Devastating effects over 500 ft. sq. area. Created by rotating color wheel in front of 100W, 120v reflector floodlamp (incl.)—elements seem to flash on off as colors fluctuate. Turns store windows, posters, parties into flashing, pulsating productions. Convection cooled. Walnut cabinet. Brass handle. Res. house current. Stock No. 71,271 AK ... (9" X 10" X 6 1/4") ... \$28.50 Ppd.



**NEW Music Vision MINI-MODEL**

Actually "see" music in dazzling action with compact, self-contained unit designed for portability. Produces fantastic patterns in beautiful color—each individual note, creating its own unique, twisting, radiating shape—each shape dancing and prancing, whirling and swirling IN PERFECT TIME with the music. Features big patterns with low levels of sound at short projection distances. Perfect for window displays, rear projection, clubs, parties. Stand or hang, 4 1/2 lbs. Uses reg. 110-120V. L Pad needed for use w/big amplifiers. Stock No. 71,124 AK ... \$56.50 Ppd. Stock No. 41,140 AK (L-PAD) ... \$ 2.00 Ppd.



**ELECTRONICS WORLD**

March 1971  
**ADVERTISERS INDEX**

R.S. No.	ADVERTISER	PAGE
150	B. & F. Enterprises	80
149	BSR (USA) Ltd.	53
	CREI, Home Study Division, McGraw-Hill Book Company	45, 46
148	Cleveland Institute of Electronics	64, 65, 66, 67
147	Cooks Institute of Electronics Engineering	53
146	Crystek	22
145	Delta Electronics Co.	81
144	Delta Products, Inc.	51
117	DynaScan Corporation	69
143	Edmund Scientific Co.	82
142	Electronics and Control Engineers, Book Club	1
96	Empire Scientific Corp. FOURTH COVER	
141	General Sales Co.	79
	Goodheart Co. Inc., R.E.	79
140	Grantham School of Engineering	13
139	Gregory Electronics Corporation	80
138	Heath Company	72, 73
137	Indiana Home Study Institute, The...	16
136	Judson Research & Mfg. Co.	58
	Lampkin Laboratories, Inc.	53
135	Liberty Electronics, Inc.	78
134	Mallory & Co., Inc., P.R.	2
133	Meshta Jr., John	78
	National Radio Institute 8, 9, 10, 11, 23	
	National Technical Schools	18, 19, 20, 21
132	Olson Electronics	61
131	Park Electronics Products	80
130	Phipps & Bird, Inc.	61
129	Poly Paks	81
	RCA Electronics Components	15
	RCA Institutes, Inc.	54, 55, 56, 57
128	Sams & Co., Inc., Howard W.	49
127	Sansui	24
126	Schober Organ Corporation, The	16
123	Score Inc. SECOND COVER	
	Siliconix, Incorporated	17
125	Solid State Sales	79
	Surplus Center	81
	Sylvania	THIRD COVER
124	TDK Electronics Corp.	4
122	Tab Books	63
121	Telex Communications Division	61
120	Tescom Corporation	16
	Valparaiso Technical Institute	69
119	Workman Electronic Products, Inc.	69
118	Xcelite, Inc.	68
	Classified Advertising	78, 79, 80, 81





## Thirteen cures for 78 headaches.

Integrated circuits are replacing transistor circuits in many stereos, radios, B & W and color TVs.

That means more parts to stock and more money tied up in inventory.

Now, Sylvania ECG can take some of the pain out of these stocking headaches.

Our 13 ICs will replace 78 part numbers, including RF, IF and audio amplifiers, sound detectors, oscillator/mixers, chroma demodulators, and automatic fine-tuning systems.

That's 65 fewer items to stock. And our 13 ICs are just part

of our ECG replacement line. That's the line that lets you replace 35,000 semiconductor types with just 87 Sylvania ECG types.

It's the line that lets you put a complete stockroom on one shelf.

Maybe the same shelf where you used to keep the aspirin.

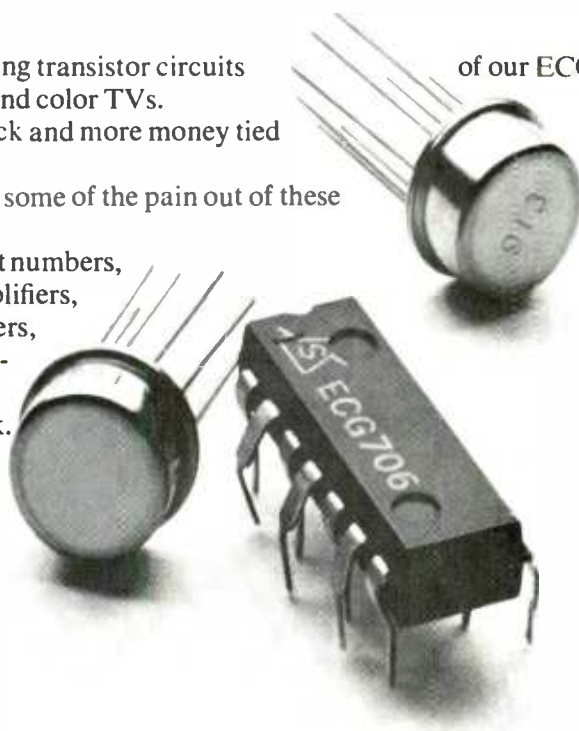

**SYLVANIA**  
GENERAL TELEPHONE & ELECTRONICS



# matched pair

Empire's model 598 Troubador turntable system  
and 1000 ZE/X long playing stereo cartridge.

Here are two of the world's greatest stereo components. Empire's model 598 turntable system exceeds every broadcast specification for professional playback equipment while the 1000 ZE/X cartridge allows you to track any record at forces so low you never get stylus or record wear. Superb alone—they are spectacular

together. Ask your hi fi dealer for a totally unforgettable demonstration.

Write for a free *Guide to Sound Design for 1971*: Empire Scientific Corp., 1055 Stewart Ave., Garden City, N.Y. 11530

**EMPIRE**



CIRCLE NO. 96 ON READER SERVICE CARD

[www.americanradiohistory.com](http://www.americanradiohistory.com)