

Electronics World

APRIL, 1970
60 CENTS

SPECIAL ISSUE

ELECTRONICS AND PARAPSYCHOLOGY

IC MEMORIES—Growth and Future

HOW AIR CONTROLLERS SEE THROUGH WEATHER

VARIABLE CAPACITORS

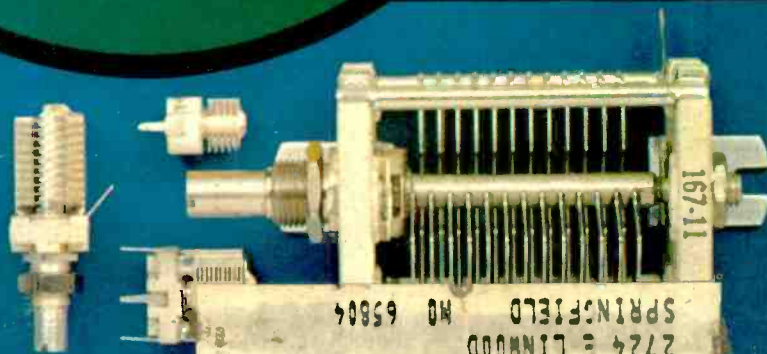
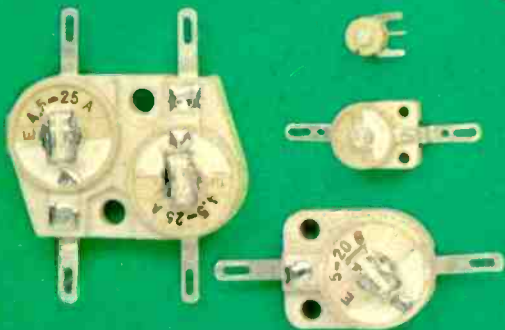
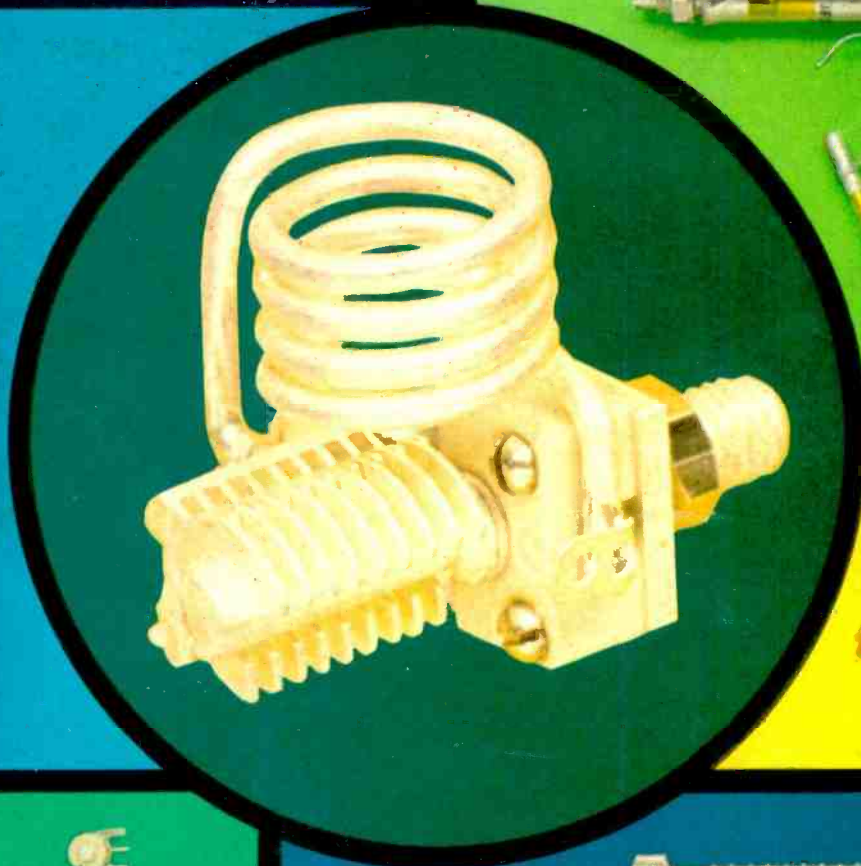

514706 HND 2724L097 OCT76 1 M
M J HINDMAN
2724 E LINWOOD
SPRINGFIELD MO 65804
4
64



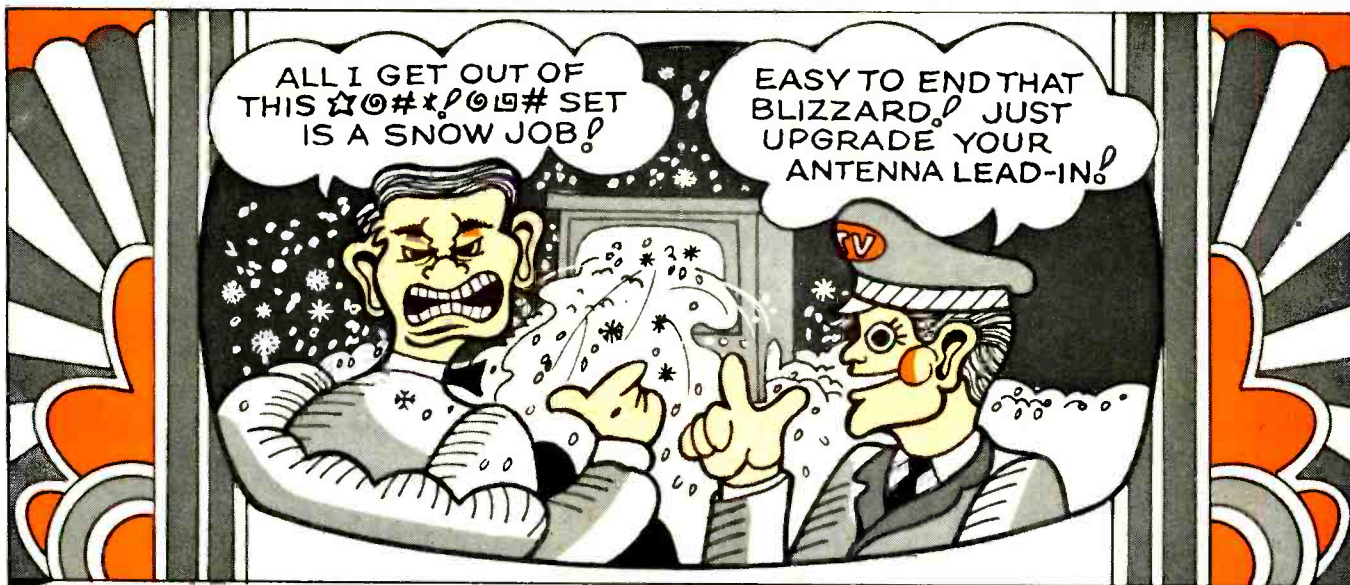

FOR BLACK & WHITE VHF, LOCAL UHF

**Belden
8275
Celluline®**

UHF TRANSMISSION LINE PAT. NOS. 27B2251-2814666

Strong
Copperweld
conductors

Tough
polyethylene
jacket

Unicellular polyethylene
core, each cell
filled with inert gas

How Come Dept.

Here's a black and white set owner. His receiver is in good shape.

So's his antenna. Yet, from Channels 2 to 83, he sees a lot of snow. How come?

Answer: That dirty, weathered flat twin-lead he's using.

Here's your chance to keep an old customer faithful. Or to turn a new customer into a steady one. Upgrade him to Belden 8275 Celluline lead-in. Moisture and dirt are the bugaboos of the flat twin-leads. But Celluline helps keep 'em out. And, by doing so, delivers a signal over 4 times stronger on

Channel 2 and 90 times stronger on Channel 83 (see chart).

Sure, Celluline costs a couple of dollars more than flat twin-lead. But it delivers when the other's performance has gone to the dickens.

So, upgrade your customers and keep 'em happy. Call your Belden Distributor for 8275 Celluline. He has it in 50, 75 and 100-ft. coils. And in 250, 500 and 1000-ft. spools.

If you have customers in congested, in-city areas, out on the fringes, in MATV equipped buildings—or if you're talking color—your Belden Distributor has other high-performance lead-ins that provide the right answer to these requirements.

Remember: the right lead-in is fully as important as a good antenna.

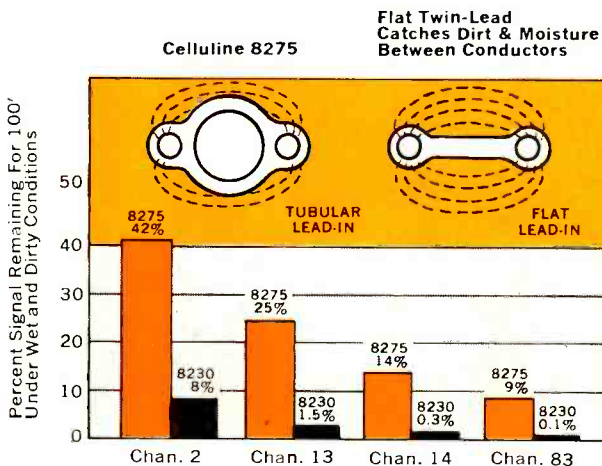

AWG & (Stranding)	Color	Nom. O.D. (Inch)	Nom. Velocity of Propagation	Nom. Capacitance (mmf/ft.)	Nom. Attenuation per 100'	
					mc	db
20 (7x28)	Brown	.300	80%	4.6	100	1.05
		x			200	1.64
		.400			300	2.12
					400	2.5
					500	2.98
					700	3.62
					900	4.3

For a reprint of the informative magazine article, ELECTRONIC CABLES, send to: Belden Corporation, P. O. Box 5070-A, Chicago, Illinois 60680.



... new ideas for moving electrical energy

Don't forget to ask them what else needs fixing?

CIRCLE NO. 150 ON READER SERVICE CARD

Special introductory offer to new members of the ELECTRONICS AND CONTROL ENGINEERS' BOOK CLUB

	A042/500 NUMERICAL CALCULATIONS AND ALGORITHMS by Beckett & Hurt Pub. price, \$10.50 Club price, \$8.95		A494/754 ENGINEERING MANUAL, 2/e by R. H. Perry Pub. price, \$12.50 Club price, \$9.95
	A101/094 MICROELECTRONIC CIRCUITS AND APPLICATIONS by J. M. Carroll Pub. price, \$12.00 Club price, \$10.25		A523/401 CHARACTERISTICS AND OPERATION OF MOS FIELD-EFFECT DEVICES by P. Richman Pub. price, \$10.00 Club price, \$8.50
	A286/507 SOLID-STATE ELECTRONICS by R. G. Hibberd Pub. price, \$9.50 Club price, \$7.95		A037/604 DIGITAL LOGIC AND COMPUTER OPERATIONS by Baron & Piccirilli Pub. price, \$14.50 Club price, \$11.95
	A287/457 SUCCESSFUL ENGINEERING MANAGEMENT by T. G. Hicks Pub. price, \$8.95 Club price, \$7.25		A423/814 PULSE, DIGITAL AND SWITCHING WAVEFORMS by Millman & Taub Pub. price, \$18.00 Club price, \$15.30
	A347/506 ELECTRONIC DIGITAL TECHNIQUES by P. M. Kintner Pub. price, \$12.50 Club price, \$10.65		A565/031 AMPLIFIER HANDBOOK by R. F. Shea Pub. price, \$37.50 Club price, \$29.50
			A637/377 TRANSISTOR CIRCUIT DESIGN by Texas Instruments, Inc., Staff Pub. price, \$16.50 Club price, \$14.05
			A126/070 PRINTED CIRCUITS HANDBOOK by C. F. Coombs, Jr. Pub. price, \$17.75 Club price, \$14.95
			A610/037 MODERN COMMUNICATION PRINCIPLES by Stein & Jones Pub. price, \$15.00 Club price, \$12.75
			A259/607 COMMUNICATION SYSTEM ENGINEERING HANDBOOK by D. H. Hamsher Pub. price, \$29.50 Club price, \$24.95

ANY ONE
of these great professional books
for only \$ **1.00**
VALUES FROM \$8.95 to \$37.50

Special \$1.00 bonus book comes to you with your first club selection

Save time and money by joining the Electronics and Control Engineers' Book Club

HERE is a professional club designed specifically to meet your day-to-day engineering needs by providing practical books in your field on a regular basis at below publisher prices.

How the Club operates: Basic to the Club's service is its publication, the *Electronics and Control Engineers' Book Club Bulletin*, which brings you news of books in your field. Sent to members without cost, it announces and describes in detail the Club's featured book of the month as well as alternate selections which are available at special members' prices.

When you want to examine the Club's feature of the month, you do nothing. The book will be mailed to you as a regular part of your Club service. If you prefer one of the alternate selections—or if you want no book at all for that month—you notify the Club by returning the convenient card enclosed with each *Bulletin*.

As a Club member, you agree only to the purchase of four books over a two-year period. Considering the many books published annually in your field, there will surely be at least four that you would want to own anyway. By joining the Club, you save both money and the trouble of searching for the best books.

MAIL THIS COUPON TODAY

ELECTRONICS AND CONTROL ENGINEERS' BOOK CLUB
330 West 42nd Street, 18th fl., New York, N. Y. 10036

Please enroll me as a member of the Electronics and Control Engineers' Book Club and send me the two books indicated below. I am to receive the bonus for just \$1.00, and my first selection at the special Club price shown. These books are to be shipped on approval, and I may return them both without cost or further obligation. If I decide to keep the books, I agree to purchase as few as four additional books during the next two years at special Club prices (approximately 15% below list).

Write Code No. of
bonus book
here

Write Code No. of
first selection
here

Name _____

Address _____

City _____

State _____ Zip _____

E33131

Need an 80-db blast?

Actual size



You'll get it from our 1 $\frac{1}{4}$ -ounce Sonalert® electronic audible signal.

With as little as 6 VDC and 3 ma., Sonalert produces a piercing sound that's hard to ignore. Yet it weighs only a couple of ounces because it's all solid state. Even the transducer is a crystal. This makes Sonalert reliable, efficient and long lasting. And because it's solid state, there's no danger of arcing, no RFI or EMI noise, important considerations in computer and other control signal applications.

Standard units vibrate at a fixed frequency of 2900 \pm 500 Hz or 4500 \pm 500 Hz depending on model. In

® Registered trademark, P. R. Mallory & Co. Inc.

addition, pulsing, warbling and AC models are available. The penetrating sound covers a wide area than alarm lights and demands instant action. This makes Sonalert ideal where ignoring warnings would be hazardous or cause damage. Examples: aircraft fuel warning, electrical overload, computer error, automobile door ajar or headlights-on warning. Other applications include communications, shipboard, missile and medical electronics alarms.

For an informative 48-page booklet of projects and circuit ideas, write for folder No. 9-406. Address Mallory Distributor Products Company, a division of P. R. Mallory & Co. Inc., Indianapolis, Indiana 46206.

MALLORY

MALLORY DISTRIBUTOR PRODUCTS COMPANY

a division of P. R. MALLORY & CO. INC.
Box 1558, Indianapolis, Indiana 46206; Telephone: 317-636-5353

Batteries • Capacitors • Cassette Tapes • Controls • Resistors • Semiconductors • Sonalert® • Switches • Timers • Vibrators • ICs

CIRCLE NO. 131 ON READER SERVICE CARD

ELECTRONICS WORLD

Electronics World

APRIL 1970

VOL. 83 NO. 4

CONTENTS



THIS MONTH'S COVER shows variable capacitors used for tuning and trimming. The enlarged tuned circuit in the circle, from E. F. Johnson Co., consists of a milled-plate air-dielectric variable capacitor shunted by a coil. At top left is an ITT Jennings high-voltage (10,000-V) vacuum capacitor. Below this is a group of ceramic disc trimmers from Erie Technological Corp. At the top right are a couple of glass piston trimmers along with a tuned circuit—all from JFD. Below these is a group of miniature air-tubular trimmers from Johanson. At the bottom right are air-plate trimmers from E. F. Johnson. Photo by Dirone-Denner.



Publisher LAWRENCE SPORN
Editor WM. A. STOCKLIN
Technical Editor MILTON S. SNITZER
Associate Editors P. B. HOEFER
MURRAY SUNTAG
Contributing Editors WALTER H. BUCHSBAUM
Prof. ARTHUR H. SEIDMAN
FOREST H. BELT
Art Editor RICHARD MOSS
Technical Illustrator J. A. GOLANEK
Advertising Manager JOSEPH E. HALLORAN
Marketing Manager ROBERT UR
Advertising Service Manager MARGARET DANIELLO
Group Vice President Electronics & Photographic
FURMAN H. HEBB

- 27** **Electronics and Parapsychology** *L. George Lawrence*
A review of some of the more sophisticated experiments being conducted today in parapsychology to test man's latent ability to communicate with animate and inanimate objects.
- 30** **Recent Developments in Electronics**
- 32** **Air Controller's Radar Sees Through Weather** *Howard L. McFann*
A new FAA device that, while eliminating weather clutter, still maintains outline of bad-weather front. Air traffic controller can then safely steer aircraft around turbulence.
- 34** **Integrated Circuit Memories—Growth and Future (Part 2)** *Dele Mrazek*
Concluding article describes the advances being made in IC memory field and what the future holds as far as competition with both older and more recently developed memory devices.

SPECIAL SECTION: VARIABLE CAPACITORS

- 37** **Air-Dielectric Trimmers** *Jack L. Bowen*
- 41** **Polystyrene Trimmer Capacitors**
- 42** **Ceramic Tubular Trimmer Capacitors** *William G. Tuscany*
- 44** **Mica Compression Trimmers**
- 45** **Glass Piston Trimmer Capacitors** *Kenneth F. Miller*
- 49** **Ceramic Disc Trimmer Capacitors** *John F. Moulthrop*
- 51** **Teflon Trimmer Capacitors** *Larry G. Fischer*
- 52** **Air Tubular Trimmer Capacitors** *Robert Howering*
- 54** **Designing LC Tuned Circuits** *A. H. Seidman*
- 59** **Vacuum Variable Capacitors** *Murray Suntag*
- 61** **Computerizing Your Grocery List** *John Frye*
- 64** **Single-Signal S.W. Receiver** *Larry Lisle, K9KZT*
- 65** **Electronic Crosswords** *John D. Richard*
- 66** **Feedback Module for Motor Control** *R. F. Schwabenlender*
- 67** **C. E. T. Test, Section #3** *Dick Glass*
- 82** **Multirange Transistor Checker** *J. E. Orme*
- 92** **Answers to C. E. T. Test, Section #2**

- 13** **EW Lab Tested**
McIntosh MC-3500 Power Amplifier
Tandberg Model 11 Tape Recorder
- 74** **Test Equipment Product Report**
Melsey SN-2 Wave Dip Meter
General Radio Type 1808 A.C. Voltmeter
Eico Model 465 Oscilloscope

MONTHLY FEATURES

- 4** **Coming Next Month** **25** **News Highlights**
- 5** **Radio & Television News** **72** **Books**
- 22** **Letters** **84** **New Products & Literature**

Copyright © 1970 by Ziff-Davis Publishing Company. All rights reserved.

April, 1970

3

PERFORM WITH CHAMPIONS



ONLY \$44.95 ppd.

BUY THE BEST MARK TEN[®] CAPACITIVE DISCHARGE IGNITION SYSTEM

DELTA KIT only \$29.95 ASSEMBLE IT YOURSELF!

Now discover for yourself the dramatic improvement in performance of your car, camper, jeep, truck, boat—any vehicle! Delta's remarkable electronic achievement saves on gas, promotes better acceleration, gives your car that zip you've always wanted. Find out why even Detroit has finally come around. In four years of proven reliability, Delta's Mark Ten has set new records of ignition benefits. **No re-wiring!** Works on literally any type of gasoline engine.

COMPARE THESE PROVEN BENEFITS . . .

- ▲ Dramatic Increase in Performance and in Fast Acceleration
- ▲ Promotes more Complete Combustion
- ▲ Points and Plugs last 3 to 10 Times Longer
- ▲ Up to 20% Mileage Increase (saves gas)

Order Your MARK TEN Today Shipped Postpaid at once . . .



P.O. Box 1147 EW • Grand Junction, Colo. 81501

Enclosed is \$_____ Ship ppd. Ship C.O.D.

- Please send:
- Mark Tens (Deltakit[®]) @ \$29.95 (12 VOLT POSITIVE OR NEGATIVE GROUND ONLY)
 - Mark Tens (Assembled) @ \$44.95
 - 6 Volt: Negative Ground only
 - 12 Volt: Specify Positive Ground Negative Ground

Car Year _____ Make _____
 Name _____
 Address _____
 City/State _____ Zip _____

CIRCLE NO. 142 ON READER SERVICE CARD

Coming Next Month

Special Feature Article

POWER TRANSISTORS

-a Status Report

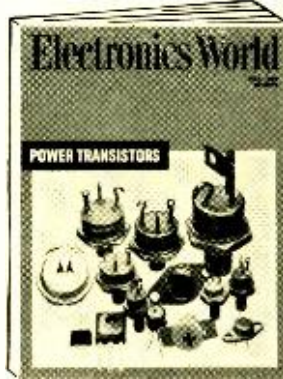

What's available now? What can we expect in the future? Paul Franson of Motorola explains how improvements in production techniques, in die design, and in packaging have resulted in better products and lower costs. Don't miss this comprehensive, up-to-the minute report.

Here are details on a simple \$8.50/decade circuit that can be cascaded to divide or scale by any number from 1-9, 1-99, or 1-999. It can be used for counters, photo timers, lab scalars, frequency synthesizers, computers, and in calculators. Three IC's make construction easy.

PREDETERMINING DECIMAL COUNTERS

ULTRA-LOW-FREQUENCY WOOFER ENCLOSURE

A unique speaker system, which has been designed for frequencies below 64 Hz, makes use of vibrating side panels and slot loading to achieve effect.

DO YOU WANT TO BE CHIEF ENGINEER OF A RADIO STATION?

A Vocational Profile which explains what the job involves, along with its requirements. Because duties are so varied, most small stations make good training grounds for step to big-time broadcasting and telecasting. Learn how it's done.

RCA'S SOLID-STATE COLOR CHASSIS—CTC 40

Even with an advanced horizontal sweep section using SCR's, servicing problems on this color-TV receiver chassis are not unduly complicated.

PANIC BUTTON

Do you want to have some fun? Here are two sirens you can build—one manual, the other automatic—that are guaranteed to panic your friends.

All these and many more interesting and informative articles will be yours in the May issue of ELECTRONICS WORLD . . . on sale April 16th.

ZIFF-DAVIS PUBLISHING COMPANY

- William Ziff, President
- W. Bradford Briggs, Executive Vice President
- Hershel B. Sarbin, Senior Vice President
- Stanley R. Greenfield, Senior Vice President
- Philip Sine, Financial Vice President
- Walter S. Mills, Jr., Vice President, Circulation
- Phillip T. Heffernan, Vice President, Marketing
- Frank Pomerantz, Vice President, Creative Services
- Arthur W. Butzow, Vice President, Production
- Edward D. Muhlfeld, Vice President, Aviation Division
- Irwin Robinson, Vice President, Travel Division
- George Morrissey, Vice President
- Sydney H. Rogers, Vice President

Editorial and Executive Offices
 One Park Avenue
 New York, New York 10016
 212 679-7200

NEW YORK OFFICE
 212 67-7200
 Joseph E. Halloran, Adv. Mgr.
 Michael E. Keltman

MIDWESTERN OFFICE
 307 North Michigan Avenue
 Chicago, Illinois 60601 312 726-0892
 George B. Mannion, Jr.

WESTERN OFFICE
 9025 Wilshire Boulevard
 Beverly Hills, California 90211
 213 875-1425; Bradshaw 2-1161
 Western Advertising Manager, Bud Dean

JAPAN: James Yari, Ishikawa Manston,
 #4, Sakurazaka Shibuya-ku,
 Tokyo 462-2911-3

CIRCULATION OFFICE
 P.O. Box 1093, Flushing, N.Y. 11352



Member
 Audit Bureau of
 Circulations

Radio & TV News • Radio News • Radio-Electronic Engineering Trademarks Reg. U.S. Pat. Off.
 SUBSCRIPTION SERVICE: Forms 3579 and all subscription correspondence should be addressed to Electronics World, Circulation Department, P.O. Box 1093, Flushing, N.Y. 11352. Please allow at least six weeks for change of address. Include your old address, as well as new—enclosing if possible an address label from a recent issue.
 EDITORIAL CONTRIBUTIONS must be accompanied by return postage and will be handled with reasonable care; however publisher assumes no responsibility for return or safety of art work, photographs, or manuscripts.
 ELECTRONICS WORLD (April, 1970, Vol. 83, No. 4). Published monthly at One Park Avenue, New York, New York 10016, by Ziff-Davis Publishing Company—also the publishers of Airline Management and Marketing, Including American Aviation, Boating, Business & Commercial Aviation, Car and Driver, Cycle, Flying, Modern Bride, Popular Electronics, Popular Photography, Skiing, Skiing Area News, Skiing Trade News, Stereo Review, and Travel Weekly. One year subscription rate for U.S., U.S. Possessions, and Canada, \$7.00; all other countries, \$8.00. Second Class postage paid at New York, N.Y. and at additional mailing offices. Authorized as second class mail by the Post Office Department, Ottawa, Canada and for payment of postage in cash.

ELECTRONICS WORLD

Consumer Electronics Show Expands

Nearly 200 exhibitors will show their 1971 lines of home entertainment electronics at the annual Consumer Electronics Show. This year, the show runs from June 28 through July 1. As usual, it is at the New York Hilton and Americana hotels in Manhattan, and EIA Consumer Products Division's Jack Wayman will, as usual, be programming the seminar sessions. Some would-be exhibitors haven't yet been accommodated, but show officials are looking for more room. This show gets bigger every year, despite a few big-name manufacturers who don't participate. However, most of them can be found set up in nearby hotels the same week, taking advantage of the crowds of dealers and distributors attracted by the Show.

U/V Tuners to Tune Alike

The issue of tuner "parity" has kicked around a long time. The FCC finally decided. The u.h.f. and v.h.f. tuners in all TV sets with 9-inch screens or larger, made or sold after May 1, 1971, must tune "with comparable ease." That could mean detented or switch-type u.h.f. as well as v.h.f. This could hasten development of all-electronic, diode-switched front-ends. Some RCA's already have them. Forthcoming tuners may include both bands on a single knob, such as Zenith and Sarkes Tarzian units, which provide six detented u.h.f. positions. Latest word, however, is that set makers intend to petition FCC for 1-year delay. So, users may have to struggle with their u.h.f. tuning for some time yet.

Inflation is Rampant, Except . . .

There are signs of slight checking in the wild inflation that besets today's prices. But there's not enough slowdown to keep rises from overtaking repair parts for home entertainment. Receiving and picture tubes felt the inflationary needle recently. Price hikes ranged around 5 percent, and some twice that. Yet, there's no extra profit at the retail level.

Food and housing costs are still going up, so workers demand more wages. With the serious lack of really competent technicians, the best ones are wising up and insisting on pay that matches their training and skill. Shop owners with business sense are pushing repair charges upward to cover the cost of better technicians. And that makes service costs to the consumer seem right up there on the inflation ladder.

There's one consolation. But shop owners and technicians have to tell the customer about it or he never knows. TV service is still a bargain. The cost of owning a TV, even with maintenance figured in, makes it the cheapest entertainment an American family can buy. Count the hours the set is on each week, multiply by how many viewers watch it, multiply that by 50, and then divide these viewer-hours-per-year into half the cost of the TV set plus the year's repair charges. More than 20 cents an hour means you figured wrong or you don't watch enough TV to bother owning one. And this formula pretends the set is worn out in 2 years, which it isn't. Every way you calculate, TV and repairs are real bargains.

Unfair-Laws Department

There's a strange legislative bill pending in California. It could keep a technician from being paid for a service call. If the customer decides not to have the set fixed after the technician has made a diagnosis in the home, the would-be law says it isn't a true service call. The same idea applies if the set needs shop repairs and the customer won't let it go. In neither case would the customer have to pay for the service call. Such a law, if applied this way to other professions, could make a lawyer's fee illegal unless he took the case. The absurdity of this kind of regulation seems obvious. The technician who comes into the home and uses his knowledge to make a diagnosis of trouble performs a useful service. This is no different from paying a doctor to diagnose a medical problem or paying a diagnostic car clinic to check your car.

Horizontal FM is Okay

Many FM stations, when car-radio FM got so popular, added vertical polarization. This was at some expense, because it required a change in the transmitting antenna. But it helped reception distance in

automobiles. It made a great improvement for car-bound listeners to stereo FM. But vertical polarization can soon end. What should have been done long ago has been done this year. Auto antennas are at last horizontally polarized. New *General Motors* cars have a tiny wire dipole embedded in the windshield glass. The dipole matches the receiver's FM input better than any whip antenna of the past. It does an okay job for AM—although a few owners report they can't hear AM stations quite as far away. Insurance companies approve this denial of one more temptation to walk-by vandals; there's nothing about this new antenna they can break off.

Hunting Old Recorder Parts?

Anyone having trouble finding parts for old or imported record changers or tape machines should ask his electronic parts distributor about *Game Industries'* catalogue 70D. You can get centerposts, drive wheels and belts, pulleys, idlers, even battery-operated motors for inexpensive import recorders. This Freeport, N.Y. company has an exhaustive stock to fit almost every changer or recorder ever built. If your distributor doesn't have the part you need, he can order it.

However, mechanical parts—such as trip pawls, change-cycle slides, cycling cams, etc.—still seem to be a problem to every technician. The only source is the manufacturer. And we hear continuing service reports that even they don't seem to have what's needed when it's needed. We keep hoping to hear of improvements in these parts situations, in place of mere buck-passing. If something effective isn't done soon, the problem will filter down to the consumer level. After that, the consumer-protection elements in government will have one more victim to feed to their lions.

It Could (Does) Happen To You

The other day I was leaving a hearing of the National Product Safety Committee. It had been about fire and smoke in color-TV sets (see "Another Political Fire to Quench," January, 1970, page 15). As I walked down one long corridor, the words "color TV" sifted out from behind a closed door. From the keyhole, I saw a man in a hard chair facing several others at a table.

A guy at the table was pointing his finger.

"You have a responsibility. You sell those monstrosities, and just pocket your profits with no concern. We can't let you get away with that."

The man in the chair looked worried. He said, "But Congressman, how could we know people would try to lift their color sets? The dealers put them down wherever the customer says."

"That's immaterial. These hernias have got to be stopped. That's the purpose of this committee hearing. Even a single hernia caused by a heavy color TV is too many, and our survey has turned up seventeen. Not one—not ten—mind you—but *seventeen*. What do you say to that Mr. Setmaker?" His voice rose a notch with every sentence.

"Well—I—well, yes—but I understand three of those were in Texas. And. . . ."

"Come on, now, sir, you're not going to try copping out on those three just because the sets were bigger, are you? It won't help your case, you know."

"But, Congressman, there are 25 million color sets. We have statistics. . . ."

"We? WE? You don't mean to imply you and other manufacturers are in collusion on this thing? In flagrant and defiant violation of the antitrust laws?"

"No. It's just that our association uncovered some facts that. . . ."

"Look," shouted the Congressman, "we're not in this hearing room for your facts. We have all the facts we want." He was pounding the table.

Another committee member jumped up. "It's clear that you'll have to put a label saying every color set can be injurious to humans."

The first man was talking again, waving his fist in the air. "Furthermore, we're going to require that no color set manufactured after next week can weigh over eleven pounds. And they all must have no less than five wheels, each one no smaller than six-and-a-half inches outside diameter and made of material that can withstand continual pounding by a toddler or chewing by a half-grown puppy. Each cabinet must have at least three handles. Floor models must have a built-in hydraulic jack. And safety belts." His voice became eloquent. "My constituents, the American people, deserve no less than complete safety from these diabolic cripples."

I began backing down the hall.

The last thing I could hear was the lame voice of Mr. Setmaker. "Well. . . . my company has made arrangements for each set-owner, at no cost of course, to receive a complete. . . ."

I went outside. It all sounded too much like the "smoke and fires" story. I had to move quick to miss being run over by reporters hurrying out to file this latest "news." ▲

There are now eight new SK devices to broaden replacement coverage in AGC, horizontal deflection, vertical deflection, damper, and audio stages of color TV; and in transmitting stages of CB radio, amateur radio, and communications equipment. Result: RCA now offers you a complete system of 47 "Top-of-the-Line" universal semiconductor replacements. Use them with confidence in all entertainment-type electronic equipment.

Every SK device has electrical characteristics comparable with, or superior to, those they replace. And in virtually all cases the recommended SK replacement transistor, rectifier, or integrated circuit can be installed without changes in mechanical mounting arrangements, circuit wiring, or operating conditions.

Get the SK habit. You'll save time, reduce call-backs, and win a reputation for making your customers' sets look and sound like new.

Maybe even better.

For complete information, call your RCA Distributor.

RCA Electronic Components | Harrison, N.J. 07029

RCA

8 more SK ways to repair and forget

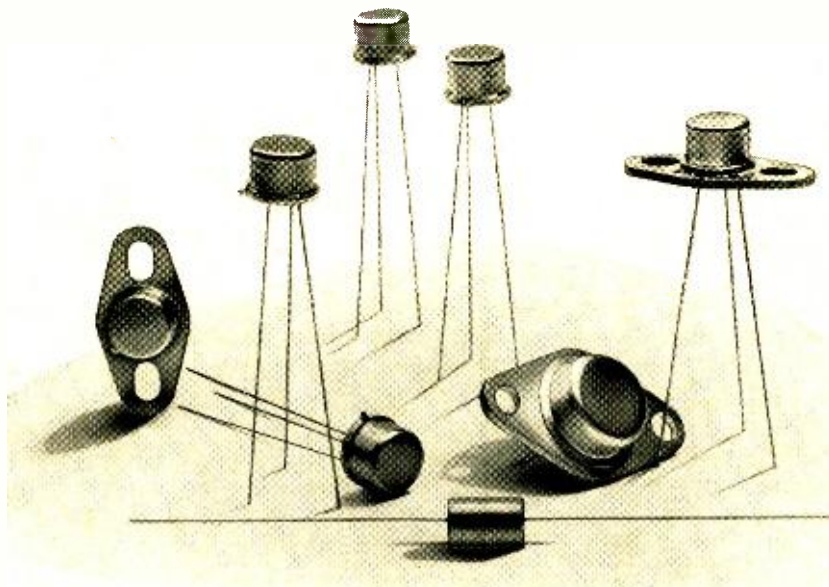

CIRCLE NO. 107 ON READER SERVICE CARD

Discover the ease and excitement of NRI's

3 DIMENSIONAL METHOD

of Electronics, Communications, TV-Radio Training

12 HOME STUDY PLANS TO CHOOSE FROM

Practically all vocational and engineering schools require students to conduct carefully planned laboratory demonstrations to prove theory presented in textbooks. So does NRI. Why? Because the only way to really learn at home . . . to recognize and understand circuits . . . is to get your hands on actual equipment, including transistors, printed circuits and today's other solid-state devices. NRI's unique, 3-Dimensional training method puts theory you learn into actual practice. You learn with your hands as well as your head. You learn by unique "discovery" methods the WHY of Electronics, Communications, TV-Radio . . . WHY circuits do the things they do. NRI training starts with carefully, condensed "bite-size," interesting books programmed with ab-

sorbing, revealing experiments using the finest parts money can buy. You get the kind of technical training that gives you experience equal to many, many months of performance on the job.

Whatever your interest, whatever your education, the NRI 3-Dimensional training method can fill your needs. Learning becomes as close to being *fun* as any school can make it. Tens of thousands of men have learned the NRI way. Pick the field of your choice and mail the postage-free card today for your FREE NRI Color Catalog. NATIONAL RADIO INSTITUTE, Electronics Division, Washington, D.C. 20016.

**BEGIN NOW AN ABSORBING
ADVENTURE—LEARN ELECTRONICS
THE NRI WAY—MAIL CARD TODAY**

OVER 50 YEARS OF LEADERSHIP



IN ELECTRONICS TRAINING

1 Start Fast with NRI's Educator-Acclaimed Achievement Kit

The day you enroll with NRI this remarkable starter kit is on its way to you—regardless of the course you choose. It is specifically designed for *you* and your training objective. It has one purpose—to get you started quickly and easily. It is an outstanding way of introducing you to NRI training methods . . . an unparalleled "first dimension" that opens the way to new discoveries, new knowledge, new opportunities. The Achievement Kit is worth many times the small payment required to start your training. Find out more about it. Mail the postage-free card now.



2 NRI "Bite-Size" Lesson Texts Program Your Training

Reading is a necessary part of any training program, but it takes a great deal of stamina to wade through a 300-page technical textbook. Every NRI course is condensed into "bite-size" texts that are simple, direct, well-illustrated, averaging an easily-digested 40 pages. These are "programmed" with NRI training equipment you build, experiments you perform, to bring to life the fundamental laws of electronics, the theory, the training of your choice. You are always kept well supplied with these books, NRI does not require you to "pay as you go."

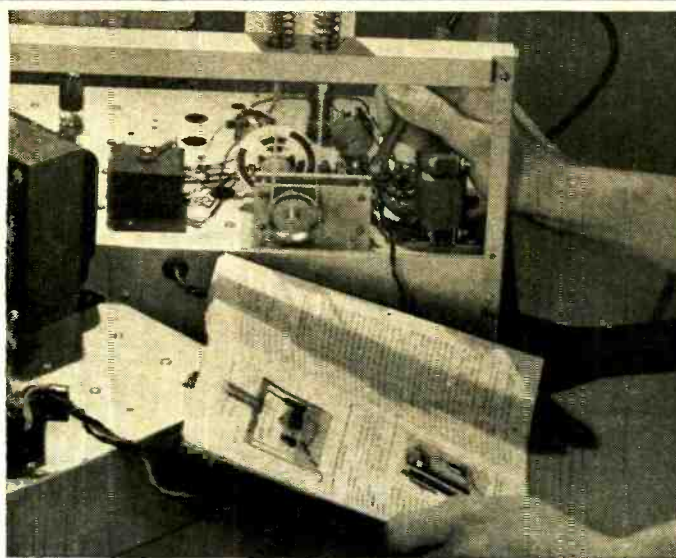

3 You Get Practical Experience With Actual Electronic Equipment

NRI does not leave the practical side of Electronics to your imagination. Electronics becomes a clear, understandable force under *your* control as you build, experiment, explore, discover. NRI pioneered the concept of home-lab training equipment to give you 3-Dimensional knowledge and experience. Every kit is designed by NRI to demonstrate principles you must know and understand. Kits contain the most modern parts, including solid state devices. NRI invites comparison with equipment offered by any other school, at any price. Prove to yourself what nearly a million NRI students could tell you . . . that you get more for your money from NRI. Mail postage-free card for your NRI Color Catalog. No obligation. No salesman will call.

APPROVED UNDER GI BILL If you served since January 31, 1955, or are in service, check GI line in postage-free card.

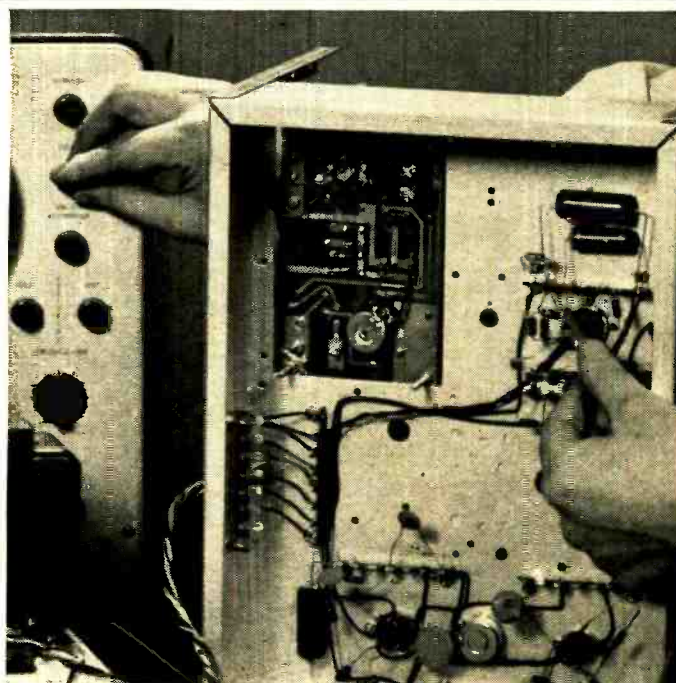

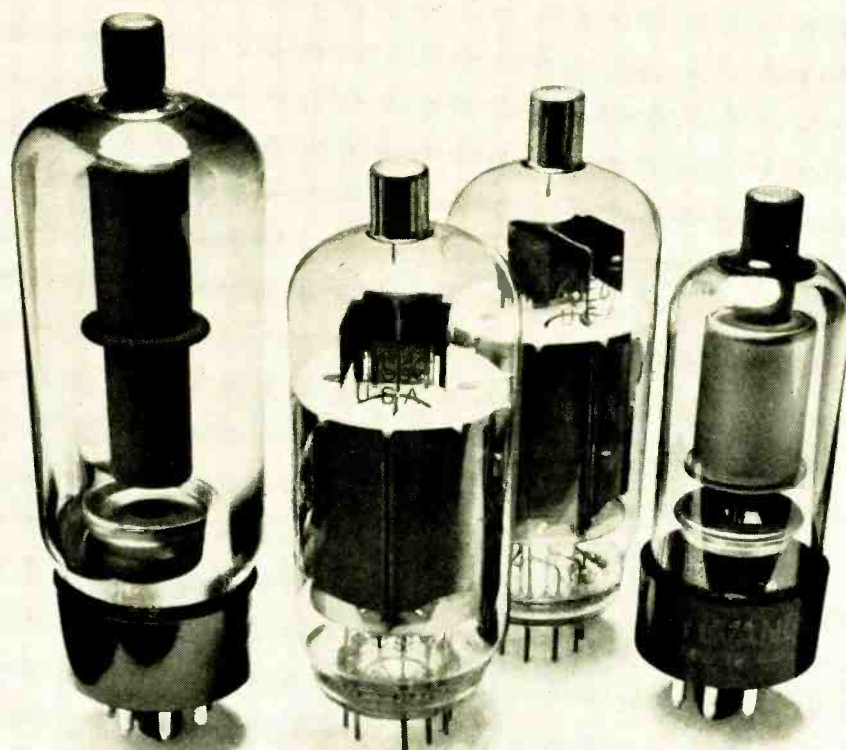

Our hot ones are the last to go.

The last thing you need is to be called back a day or two after you've replaced the sweep or high voltage tubes in somebody's color TV.

But, they're usually the first to go. Because they get so hot.

So we figured out how to cool them. Now, they last a lot longer.

Take our 6JE6C/6LQ6, for example. It's the horizontal deflection tube that takes such a beating when the set gets hot.

Well, we've given it special patented radiator fins that first absorb the heat and then radiate it out of the tube.

Now it runs cooler and lasts longer. Same for our 6JS6C.

Or take our 6BK4C/6EL4A. That's the shunt regulator that eliminates runaway high voltage. We gave this one a whole new anode and shield design to improve heat transfer and stability.

Now it also runs cooler and lasts longer.

Or take our 3A3B high voltage rectifier. This one's got leaded glass for added protection. And it lasts longer too.

So next time you have to replace any of the hot ones, just cool it. You'll both last longer.

SYLVANIA
GENERAL TELEPHONE & ELECTRONICS

ELECTRONICS WORLD

HI-FI PRODUCT REPORT

EW LAB TESTED

by Hirsch-Houck Labs

McIntosh MC-3500 Power Amplifier
Tandberg Model 11 Tape Recorder

McIntosh MC-3500 Power Amplifier

For copy of manufacturer's brochure, circle No. 1 on Reader Service Card.



WHEN it comes to the McIntosh MC-3500 power amplifier, nothing less than superlatives will do. The MC-3500 is a basic mono power amplifier. It is the largest, heaviest, most powerful, and most expensive amplifier sold for home use. Its performance is of such a high caliber that we would have been unable to measure it before we acquired our Radford ultra-low-distortion oscillator and distortion analyzer.

The unit is a vacuum-tube amplifier—one of the last of that vanishing breed on the high-fidelity market. Transistors that can deliver 350 watts, while they have been made, are not yet economically practical for home audio equipment. Yes, we said 350 watts—the nominal and very conservative continuous power rating of this huge amplifier.

The amplifier weighs 125 pounds and measures 19 inches wide by 10½ inches high by 17 inches deep. Behind its imposing satin-finished panel (which is drilled for rack mounting) is a seven-

stage amplifier—push-pull throughout, except for the cathode-follower input stage—that culminates in eight husky output tubes of a type (6LQ6) normally used for deflection-amplifier service in TV receivers. A unity-coupled pentafilar (five-winding) output transformer, exclusive with McIntosh, couples the output tubes to load impedances switchable from 1 to 64 ohms. The five windings of the output transformer connect to the cathode, plate, grid, and screen circuits of the output tubes, plus a negative-feedback winding supplying 32 dB of over-all feedback and an additional 6 dB in a local loop.

A large meter on the front panel serves several functions. In eight of the twelve positions of its selector switch, it reads the cathode currents of the output tubes for setting their grid biases. Two positions are for monitoring the output power in decibels, relative to the rated 350-watt output. One of them is 10 dB more sensitive than the other, so

that normal power levels down to a fraction of a watt may be read. Another position reads the output voltage—up to 150 volts—for laboratory applications, where the MC-3500 can be used (in conjunction with an oscillator) as an ultra-low-distortion, variable-frequency a.c. power generator. There is a gain control on the panel—a necessity since only 1.1 volts will drive the amplifier to 350 watts! A massive combination switch/circuit breaker turns the amplifier off and on. Parallel inputs with phono and lab-type BNC connectors are provided on both front and rear panels. The binding-post outputs on the front are also duplicated by screw terminals in the rear, where there is also a switch that rolls off the response at 6 dB per octave below 5 Hz.

The specifications of the MC-3500 are impressive. The output is 350 watts from 20 to 20,000 Hz, with less than 0.15 percent harmonic or IM distortion. Frequency response is within +0, -3 dB from 1 to 70,000 Hz at 1 watt. Hum and noise are 95 dB below 350 watts.

We had to parallel all our oil-cooled load resistors to handle the power of the MC-3500. At rated power and at half power, the harmonic distortion was less than 0.08 percent from 20 to 20,000 Hz, and under 0.03 percent over most of that range. At one-tenth power (a respectable 35 watts) the distortion was down to 0.02 percent from 70 to 20,000 Hz.

When the unit was operated at 1000 Hz into an 8-ohm load, the harmonic distortion was between 0.01 and 0.02 percent from 1.5 to 90 watts, increasing to 0.03 percent at 450 watts, and reaching only 0.08 percent at 500 watts. The IM distortion test merely indicated the

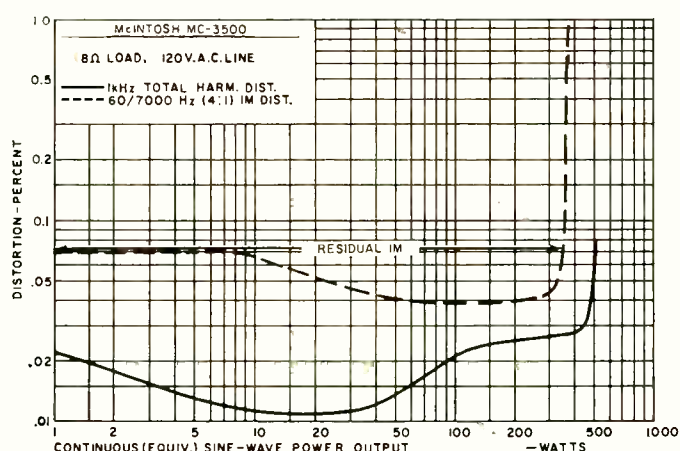
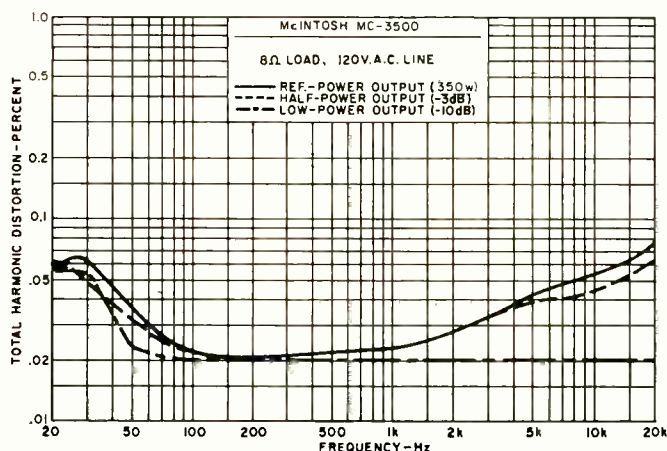

In ONE Educational Program Earn BOTH Your

F. C. C. LICENSE

And Your

A. S. E. E.

(Associate in Science in Electronics Engineering)

DEGREE

In an electronics career today, an FCC license is important—sometimes essential—but it's not enough! Without further education, you can't make it to the top. Get your FCC license without fail, but don't stop there. To prepare for a still better position, continue your electronics education and earn your Associate in Science Degree in Electronics Engineering.

This is the common-sense approach for those who want to make both money and reputation in the expanding field of electronics. Also, it makes good sense to prepare for your FCC license with the School that gives degree credit for your license training—and with the School that can then take you from the FCC license level to the Degree level.

The home-study program which accomplishes both of these objectives is the Grantham Associate-Degree Program in Electronics Engineering. This educational program consists of a total of 370 correspondence lessons, followed by a two-week period of review and evaluation at the School. The prerequisite for enrollment is high school graduation (or equivalent) and at least one full year of experience as an electronics technician. Upon completion of the first 160 correspondence lessons, you are prepared for your first class FCC license and radar endorsement. Then, upon completion of the remainder of the program, you are awarded the ASEE Degree.

This accredited ASEE Degree program covers a review of basic electronic circuits and systems, applied engineering mathematics (including algebra, trigonometry, analytic geometry, and calculus), classical and modern physics, technical writing, computer systems, electrical networks, and semiconductor circuit analysis and design. The ASEE Degree is awarded upon satisfactory completion of the 370 correspondence lessons and the final two-week residency at the School.

Accreditation and G.I. Bill Approval

Grantham School of Engineering is accredited by the Accrediting Commission of the National Home Study Council, is approved under the G.I. Bill, and is authorized under the laws of the State of California to grant academic degrees.

Grantham School of Engineering

• Established in 1951 •

1505 N. Western Ave.
Hollywood, Calif. 90027

Telephone:
(213) 469-7878



Mail the coupon below for our free Bulletin.

Grantham School of Engineering EW-4-70
1505 N. Western Ave., Hollywood, Calif. 90027

Please mail me your free Bulletin, which explains how the Grantham educational program can prepare me for my FCC license and Associate Degree. I understand no salesman or counselor will call.

Name _____ Age _____

Address _____

City _____ State _____ Zip _____

residual distortion of our test instruments—less than 0.07 percent from 1 watt to 350 watts. The frequency response was ± 0.1 dB from 20 to 20,000 Hz at 10 watts, and was down 3 dB at 70,000 Hz. Only 0.16 volt was needed for 10-watts output (our standard reference power level), and hum and noise were 73 dB below 10 watts, which is completely inaudible.

The amplifier was cool in operation, and quiet, even with its built-in cooling fan. Our loads, however, heated their oil baths to a new high. The MC-3500 clipped cleanly when overdriven and showed no tendency to blow tubes or fuses.

All of this naturally raises the question of why anyone would want an amplifier capable of delivering 500 watts in his home music system. We are not really sure, but properly fused, very

rugged low-efficiency speakers such as the AR-3a and Bose 901 could be used safely—and would perform beautifully—with the MC-3500. But under no circumstances would we advise using this particular amplifier without a suitably rated fuse in order to protect the loudspeaker.

The McIntosh MC-3500 is clearly the ultimate in high power and low distortion among amplifiers offered for home use. (No doubt many recording engineers and industrial users will also be interested in this amplifier.—Editor) It sells for \$1099, which is certainly not inexpensive for a single channel. But if money is no object, it is safe to say that when a pair of MC-3500's are installed, the amplifier can once and for all be eliminated as a potential limiting factor in any type of music-reproduction system. ▲

Tandberg Model 11 Tape Recorder

For copy of manufacturer's brochure, circle No. 2 on Reader Service Card.



VIRTUALLY all new components coming to us for testing have been stereo models. In the case of tape recorders, mono models are still very much on the scene, but they are almost never meant for serious listening or professional use. An impressive exception to this rule is the Tandberg Model 11, a professional-quality portable mono reel-to-reel recorder.

The Model 11 is fully transistorized, and can be operated from a self-contained battery pack from which it draws 2 to 3 watts. If ordinary dry cells are used (ten 1.5-volt "D" cells are required), the battery life is about 5 to 6 hours in continuous operation, or about 20 hours if the machine is used half an

hour per day. Rechargeable nickel-cadmium cells can also be used for long-term economy. For a.c.-line operation, Tandberg provides an optional battery eliminator that physically replaces the internal battery pack. It can also be used externally to recharge nickel-cadmium batteries in the recorder, through an accessory connector. We tested the Model 11 with the a.c. power supply installed.

This is a half-track machine that takes 7-inch reels. It has three heads and separate recording and playback electronics for off-the-tape monitoring while recording. The microphone input, for a 200-ohm balanced dynamic microphone, uses a locking professional-type

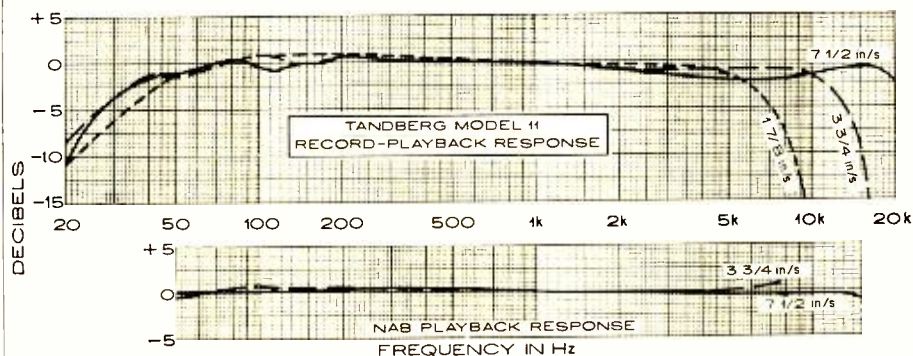

connector. Two line inputs are provided, for high- and low-level signals. Separate recording-level controls for the microphone and line inputs make it possible to mix signal sources.

There are two playback outputs using miniature phone jacks. One is a monitoring output for 200-ohm unbalanced headphones; the other is a 600-ohm balanced output. Both are controlled by a single playback-level control. A small built-in speaker can be switched on to monitor either incoming or outgoing signals, but the line outputs are disconnected when the speaker is on. A meter indicates recording level, and when the "Play" button is depressed, it indicates the level at the line output. A battery-test button switches the meter to check the condition of the batteries.

The tape-transport control is a single lever that provides fast-forward and reverse when pushed right or left; normal speed is obtained by pushing it up. A separate recording-interlock button must be pressed simultaneously to record. The "Stop" lever starts and stops the tape instantly without causing the machine to switch out of the record mode.

The three operating speeds of 1 $\frac{7}{8}$, 3 $\frac{3}{4}$, and 7 $\frac{1}{2}$ in/s are selected by a rotary switch that sets the unique electronic speed-control circuits of the Model 11. Precise and consistent speed is a necessity for professional applications and when operating on batteries there is no a.c. power line to establish the motor speed. A very effective electronic substitute was developed by *Tandberg* engineers.

A tachometer wheel on the capstan drive shaft generates an a.c. voltage in a special pickup head. This voltage is amplified, clipped, and then detected in a ratio detector whose d.c. output is proportional to the frequency or to the motor speed. The output of a separate 20-kHz square-wave generator is integrated to produce a triangular waveshape which is summed with the d.c. output of the ratio detector. The summed voltage controls a Schmitt-trigger circuit, the output of which is a series of 20-kHz pulses whose width is a function of the motor speed. The average value of these pulses, after filtering, is a d.c. voltage whose value is a function of motor speed. After amplification, it drives the d.c.-operated capstan-drive motor.

This system maintains an extremely accurate motor speed, since any tendency for the speed to change produces a corresponding compensating change in the d.c. voltage that operates the motor. For speed change, the tuning of the ratio-detector is changed, and the motor speed then changes accordingly to maintain a balanced condition.

We tested the *Tandberg* Model 11 with 3M type 150 tape, for which it had

LOOKING FOR ACCURACY?

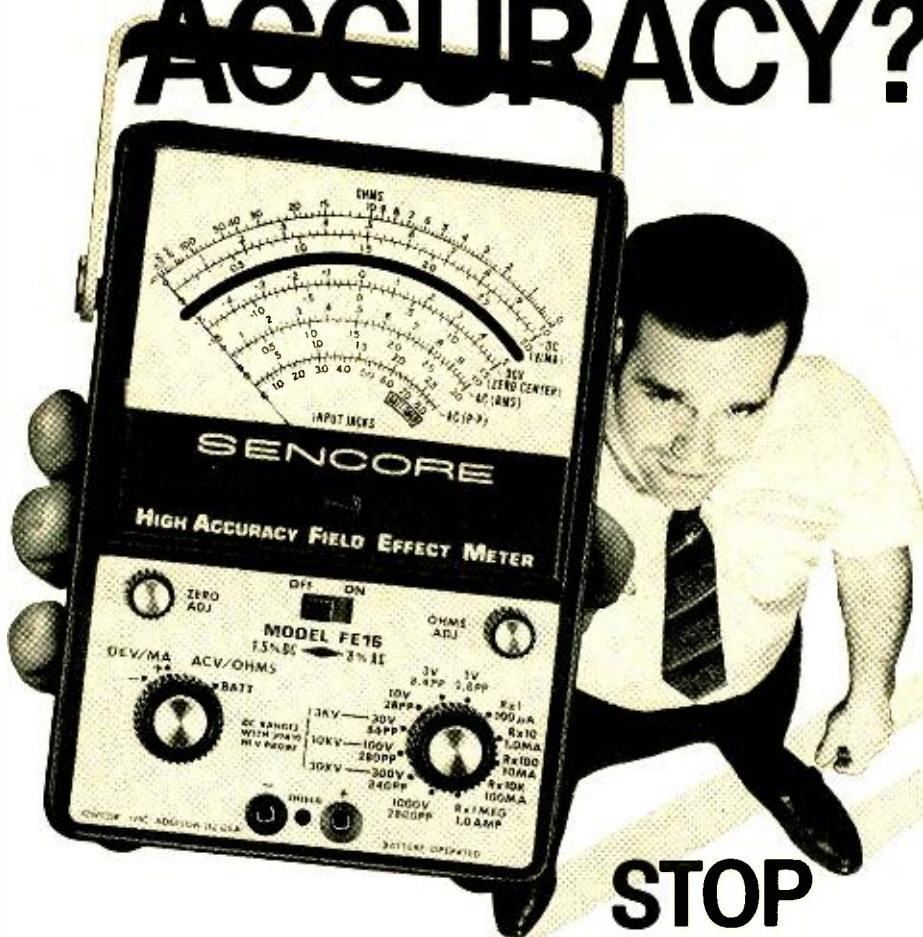

STOP RIGHT HERE!

Take a close look at a revolutionary new multimeter. The Sencore Field Effect Meter. This beautifully styled FE meter virtually obsoletes all VTVMs and VOMs. Why? Exclusive FET circuitry. A totally new concept in multimeter design that prevents circuit loading. Interested? Here's more. The FE16's 15 megohm input impedance on DC and 10 megohm on AC is 750 times less loading than a standard 20,000 ohm/volt VOM, 50% less loading than a standard VTVM on DC volts and 10 times less loading on AC volts. Here's a real package of dynamite that means accuracy. FET ACCURACY that's 1.5% on DC, 3% on AC. (An unbelievable 1/2% full scale accuracy on 1 VDC.)

Want more? Look a little closer. An exclusive true zero center scale starting at $\pm .5V$ DC, DC current ranges from 100 μA to 1-amp, complete meter and circuit overload protection, mirror back scale, built-in battery check, rugged vinyl clad all steel case, and . . . that's it. If you still want a closer look, you'll have to buy it. Remember the name *FIELD EFFECT METER*. Only Sencore makes them. Your Distributor has them in stock at \$84.50—less than the cost of a good VOM or VTVM.



SENCORE

NO. 1 MANUFACTURER OF ELECTRONIC MAINTENANCE EQUIPMENT

426 SOUTH WESTGATE DRIVE, ADDISON, ILLINOIS 60101

CIRCLE NO. 119 ON READER SERVICE CARD

There Is a Difference In Quartz Crystals

Space age communication equipment demands a crystal that meets all standards of technical advancement. Crystals that were acceptable some years ago do not meet present day specifications. As a general rule, your crystal must be selected from the best quartz . . . (no throw off cuts). Tight tolerances demand selected angles of cut. The x-ray is important in making this selection. The crystal should be preaged with stress cycling. It should be checked for frequency change vs temperature change. It must be checked for optimum spurious response. It should be calibrated to frequency with the correct oscillator. International Crystals are manufactured to meet today's high accuracy requirements. That's why we guarantee all International crystals against defective materials and workmanship for an unlimited time when used in equipment for which they were specifically made.

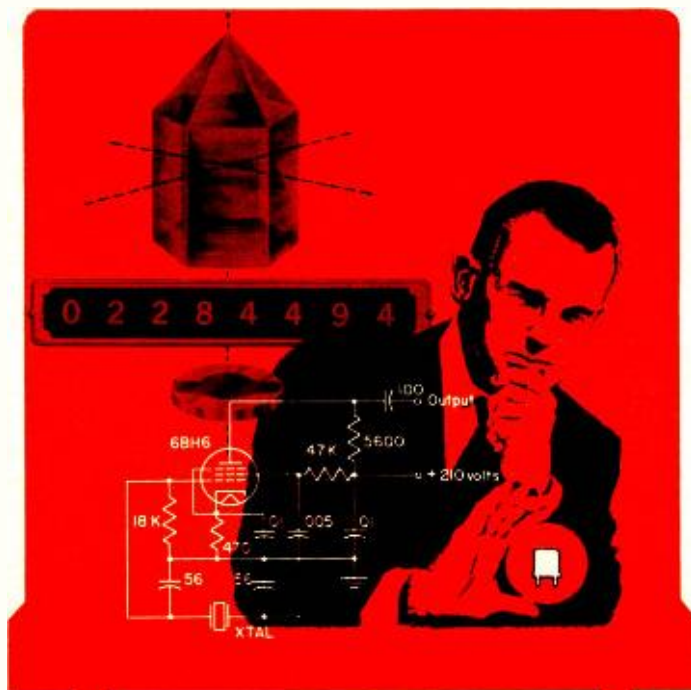

WRITE FOR CATALOG



CRYSTAL MFG. CO., INC.

10 NO. LEE • OKLA. CITY, OKLA. 73102

CIRCLE NO. 136 ON READER SERVICE CARD

been adjusted. Its performance was well within specifications, and was of a fully professional caliber. At 7½ in/s, the over-all record-playback frequency response was ±1.5 dB from 35 to 20,000 Hz, and the NAB playback frequency response was ±0.5 dB from 50 to 15,000 Hz. The unweighted signal-to-noise ratio was 60 dB. Wow and flutter were 0.03 and 0.09 percent, respectively.

At 3¾ in/s, the record-playback response was ±2.5 dB from 30 to 12,500 Hz, and the NAB playback response was +0.4 dB from 50 to 7500 Hz. The signal-to-noise ratio was 59 dB, and wow and flutter were 0.5 and 0.1 percent, respectively. The 1⅞ in/s speed produced very listenable quality, although with a somewhat restricted frequency response of ±2 dB from 40 to 6500 Hz. The signal-to-noise ratio was about the same as it was for 3¾ in/s.

The "High" line input required 0.12 volt and the "Low" required 3.4 millivolts for a 0-dB recording level. At 0 dB, the over-all distortion was 2.4 percent, dropping to less than 1 percent at -10 dB. The maximum line output before clipping was 3.3 volts. In wind and rewind, about 2 minutes were required to handle 1200 feet of tape. The normal operating speeds were exact, as determined by a tape stroboscope.

The Model 11 is not for the casual hobbyist, but should be an excellent choice for recording interviews for broadcast (the built-in switchable automatic level control will be useful) or other field operations where the weight and bulk of conventional professional recorders would be prohibitive. Its performance, both mechanical and electrical, leaves nothing to be desired for such applications. The unit measures 4 × 10 × 13 inches and weighs 12.1 pounds with batteries.

The Tandberg Model 11 sells for \$449.50. A full-track unit and a pilot-tone version for motion-picture sound synchronizers are also available. The optional a.c. power supply is \$44.95, and a leather carrying case with shoulder strap is \$29.95. ▲



"Don't worry about my husband . . . he's out back fooling with his crazy closed-circuit TV gadget."

ELECTRONICS WORLD

New SAMS Books for every electronics interest

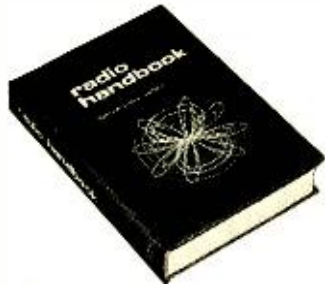

New 18th Edition of the famous E & E RADIO HANDBOOK

by WILLIAM I. ORR, W6SAI. Completely updated edition of the famous communications handbook which is the electronics industry standard for engineers, technicians and advanced amateurs. Explains in authoritative detail how to design and build all types of radiocommunications equipment. Includes SSB design and equipment, RTTY circuits, latest semiconductor circuits and IC's, as well as special-purpose and computer circuitry. Order 24020, only..... \$13.50

New 13th Edition of the famous TUBE SUBSTITUTION HANDBOOK

Lists over 12,000 direct substitutions. A complete guide to substitutions for receiving, picture tube, miniature, industrial, and communications types; also includes foreign tubes. Tells how and when to make proper substitutions.

Order 20769, Twin-Pak (regular size for bench use; pocket-size for caddy) both for only..... \$2.25
Order 20768, shop edition, only..... \$1.75



Color-TV Trouble Clues, Vol. 3

by HOWARD W. SAMS EDITORIAL STAFF. Helps speed diagnosis of color-TV troubles. Tells how to get right to the heart of the problem, how to make positive checks, how to use meaningful clues for quick troubleshooting. Supplements popular earlier volumes, but contains all-new material, especially on late-model color chassis. Order 20762, only..... \$3.50

ABC's of Voltage-Dependent Resistors

The Voltage-Dependent Resistor (VDR) is relatively unknown, and its advantages have gone largely unrecognized and unused. This book explains in simple language the principles of VDR's, and describes the many types available, and how they are used in a variety of applications. Order 20771, only..... \$2.95

SWL Antenna Construction Projects

Provides detailed information on how to construct 35 different antennas for improved short-wave reception. Explains basic antenna principles and then presents the construction projects which fall into six basic classes of design. Order 20766, only..... \$2.95

Auto Radio Servicing Made Easy

2nd Ed. Explains the circuitry of both new and old auto radios, covering each of the tube and transistor stages. Provides step-by-step troubleshooting and repair details; explains how to eliminate noise and interference, and how to make proper adjustments. Order 20719, only..... \$3.95



THIS IS ELECTRONICS Series

by ITT EDUCATIONAL SERVICES, INC. These books provide a remarkable introduction to electronics, imparting to any reader a clear understanding of the basics of this vital technology. All topics are covered and readily mastered.

Vol. 1. Basic D-C Principles

Covers electronics—past and present; electronic components and symbols; matter and electricity; current, voltage, and resistance; series and parallel circuits; conductors, semi-conductors, and insulators; resistors; and sources of d-c power. Order 20657, only..... \$5.95

Vol. 2. Basic A-C Principles

Covers alternating voltage and current; capacitors and capacitive reactance; magnetism and electromagnetism; electrical measuring instruments; and inductors and inductive reactance. Order 20727, only..... \$6.95

Vol. 3. Circuits

A-c and d-c principles and components are used to illustrate how vacuum tubes and semi-conductors operate. Various amplifier and oscillator circuits of both tube and transistor types are fully described. Order 20759, only..... \$6.95

Vol. 4. Applications

This volume explains how amplifier and oscillator circuits are used in actual applications. Explains principles of modulation, broadcast receiver fundamentals, a-m and f-m receiver circuits, etc. Order 20760, only..... \$5.95
4-Vol. Set. Order 20761, only..... \$23.50

Record Changer Servicing Guide

Provides a complete understanding of record changers, how they operate, and the various systems employed. Provides detailed instructions on how to track down troubles encountered in record changers and how to repair them in the fastest and most effective way. Order 20730, only..... \$3.95

Electronic Organs—Vol. 2

Explains the fundamental principles of electronic organs, including theory, development, features and operation. In block diagram and schematic illustrations, the book shows what is inside an organ. Order 20754, only..... \$5.50



Color-TV Waveform Analysis

This book provides both the theoretical and the practical knowledge of waveform analysis essential for profitable and efficient color TV servicing. It begins with the rf and i-f sections, and proceeds through the video-amplifier, bandpass-amplifier, color-sync, color-demodulator, and matrix circuits. Also includes a full discussion of vectorgrams. Order 20763, only..... \$3.50

ABC's of Thermistors

Explains in detail this simple, but extremely useful solid-state device with which many technicians are unfamiliar. Discusses thermistor fundamentals, instrument applications, control and alarm applications, amplifier and oscillator applications, thermistors in communications, and supplementary circuits. Order 20765, only..... \$2.95

101 Questions & Answers About Hi-Fi and Stereo

A practical and useful reference book explaining the essential facts about hi-fi and stereo, with important help on troubleshooting and maintenance. The six sections of the book cover: high-fidelity systems; amplifiers; tuners; record and tape players; maintenance and troubleshooting procedures. Order 20753, only..... \$3.50

Amateur Radio Incentive Licensing Study Guide

Fully explains the new incentive licensing which affects both newcomers and old-timers. Covers all the new FCC Regulations and band allocations. Includes sample exams for Novice, Technician, Conditional, and General-Advanced- and Extra-Class licensing. Order 24004, only..... \$2.75

Space-Flight Simulation Technology

Presented as a primer covering the contributions, capabilities, and future potentialities of a very rapidly expanding industry. Deals in detail with simulation and the simulator—a training innovation without which manned space flight would be impossible. Order 20756, only..... \$4.95

How to Use Integrated Circuit Logic Elements

Written for the engineer or technician who has not previously used or designed digital logic circuits. Also, electronic hobbyists will find this book interesting and understandable and will appreciate the fascinating logic circuits dealt with in the material. Order 20755, only..... \$3.95

HOWARD W. SAMS & CO., INC.

Order from any Electronic Parts Distributor, or mail to Howard W. Sams & Co., Inc., Dept. EW-4
4300 W. 62nd St., Indianapolis, Ind. 46268

Send books checked at right. \$_____enclosed.

Send FREE 1970 Sams Book Catalog

Name _____
PLEASE PRINT

Address _____

City _____ State _____ Zip _____

- | | |
|--------------------------------|--------------------------------|
| <input type="checkbox"/> 24020 | <input type="checkbox"/> 20760 |
| <input type="checkbox"/> 20769 | <input type="checkbox"/> 20761 |
| <input type="checkbox"/> 20768 | <input type="checkbox"/> 20730 |
| <input type="checkbox"/> 20762 | <input type="checkbox"/> 20754 |
| <input type="checkbox"/> 20771 | <input type="checkbox"/> 20763 |
| <input type="checkbox"/> 20766 | <input type="checkbox"/> 20765 |
| <input type="checkbox"/> 20719 | <input type="checkbox"/> 20753 |
| <input type="checkbox"/> 20657 | <input type="checkbox"/> 24004 |
| <input type="checkbox"/> 20727 | <input type="checkbox"/> 20756 |
| <input type="checkbox"/> 20759 | <input type="checkbox"/> 20755 |

CIRCLE NO. 123 ON READER SERVICE CARD

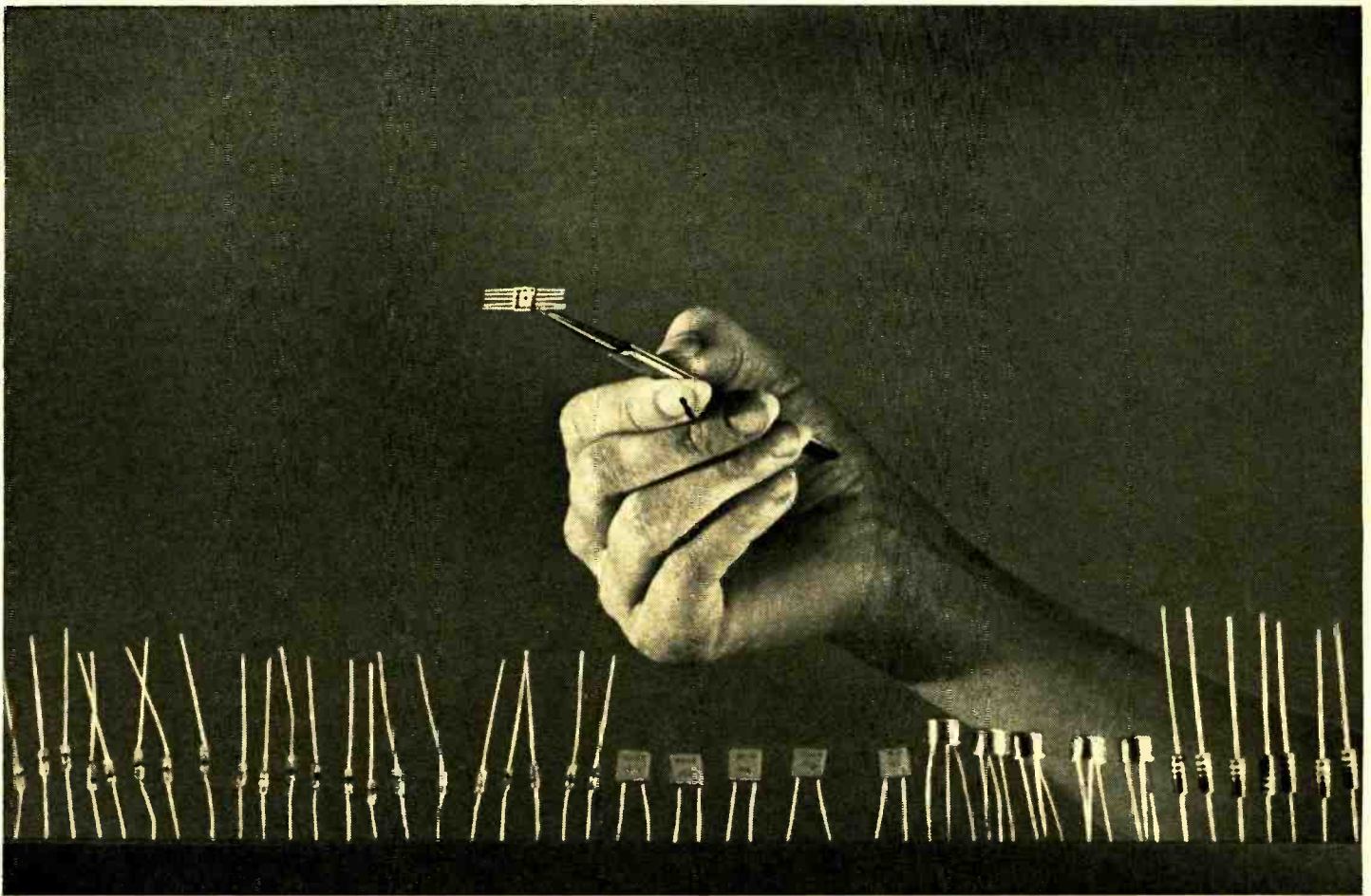

50 functions in a single chip. *The functions of 50 separate transistors, diodes, resistors and capacitors can now be performed by the tiny dot in the center of the integrated circuit held by the tweezers.*

The "Chip" ...will it make or break your future job?

THE DEVELOPMENT OF INTEGRATED CIRCUITRY is the dawn of a new age of electronic miracles. It means that many of today's job skills soon will be no longer needed. At the same time it opens the door to thousands of exciting new job opportunities for technicians solidly grounded in electronics fundamentals. Read here what you need to know to cash in on the gigantic coming boom, and how you can learn it right at home.

TINY ELECTRONIC "CHIPS," each no bigger than the head of a pin, are bringing about a fantastic new Industrial Revolution. The time is near at hand when "chips" may save your life, balance your checkbook, and land a man on the moon.

Chips may also put you out of a job...or into a better one. "One thing is certain," said *The New York Times* recently. "Chips will unalterably change our lives and the lives of our children probably far beyond recognition."

A single chip or miniature integrated circuit can perform the function of 20 transistors, 18 resistors, and 2 capacitors.

Yet it is so small that a thimbleful can hold enough circuitry for a dozen computers or a thousand radios.

Miniature Miracles of Today and Tomorrow

Already, as a result, a two-way radio can now be fitted inside a signet ring. A complete hearing aid can be worn entirely inside the ear. There is a new desk-top computer, no bigger than a typewriter yet capable of 166,000 operations per second. And it is almost possible to put the entire circuitry of a color television set inside a man's wristwatch case.

And this is only the beginning!

Soon kitchen computers may keep the housewife's refrigerator stocked, her menus planned, and her calories counted.

Money may become obsolete. Instead you will simply carry an electronic charge account card. Your employer will credit your account after each week's work and merchants will charge each of your purchases against it.

When your telephone rings and nobody's home, your call will automatically be switched to the phone where you can be reached.

Doctors will be able to examine you internally by watching a TV screen while a pill-size camera passes through your digestive tract.

New Opportunities for Trained Men

What does all this mean to someone working in Electronics who never went beyond high school? It means the opportunity of a lifetime—if you take advantage of it.

It's true that the "chip" may make a lot of manual skills no longer necessary.

But at the same time the booming sales of articles and equipment using integrated circuitry has created a tremendous demand for trained electronics personnel to help design, manufacture, test, operate, and service all these marvels.

There simply aren't enough college-trained engineers to go around. So men with a high school education who have mastered the fundamentals of electronics theory are being begged to accept really interesting, high-pay jobs as engineering aides, junior engineers, and field engineers.

How To Get the Training You Need

You can get the up-to-date training in electronics fundamentals that you need through a carefully chosen home study course. In fact, some authorities feel that a home study course is the best way. "By its very nature," stated one electronics publication recently, "home study develops your ability to analyze and extract information as well as to strengthen your sense of responsibility and initiative." These are qualities every employer is always looking for.

If you do decide to advance your career through spare-time study at home, it makes sense to pick an electronics school that specializes in the home study method. Electronics is complicated enough without trying to learn it from lessons designed for the classroom instead of correspondence training.

The Cleveland Institute of Electronics has everything you're looking for. We teach only Electronics—no other subjects. And our courses are designed especially for home study. We have spent over 30 years perfecting techniques that make learning Electronics at home easy, even for those who previously had trouble studying.

Your instructor gives your assignments his undivided personal attention. He not only grades your work, he analyzes it. And he mails back his corrections and comments the same day he gets your lessons, so you read his notations while everything is still fresh in your mind.

Always Up-to-Date

Because of rapid developments in Electronics, CIE courses are constantly being revised. Students receive the most recent revised material as they progress through their courses. This year, for example, CIE students are receiving exclusive up-to-the-minute lessons in Microminiaturization, Logical Troubleshooting, Laser Theory and Application, Single Sideband Techniques, Pulse Theory and Application, and Boolean Algebra. For this reason CIE courses are invaluable not only to newcomers in Electronics but also for "old timers" who need a refresher course in current developments.

ENROLL UNDER NEW G.I. BILL

All CIE courses are available under the new G.I. Bill. If you served on active duty since January 31, 1955, or are in service now, check box on reply card for G.I. Bill information.

Tiny TV camera for space and military use is one of the miracles of integrated circuitry. This one weighs 27 ounces, uses a one-inch vidicon camera tube, and requires only four watts of power.

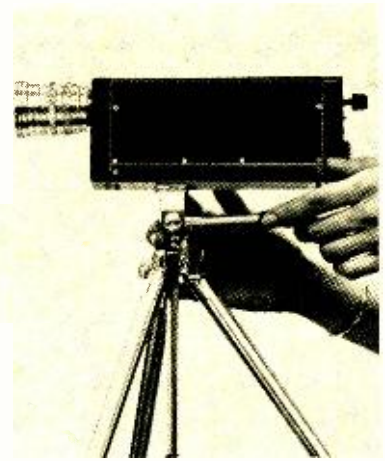

Get FCC License or Money Back

No matter what kind of job you want in Electronics, you ought to have your Government FCC License. It's accepted everywhere as proof of your education in Electronics. And no wonder—the Government licensing exam is tough. So tough, in fact, that without CIE training, two out of every three men who take the exam fail.

But better than 9 out of every 10 CIE graduates who take the exam pass it.

This has made it possible to back our FCC License courses with this famous Warranty: you *must* pass your FCC exam upon completion of the course or your tuition is refunded in full.

Mail Card for Two FREE Books

Want to know more? The postpaid reply card bound in here will bring you a FREE copy of our school catalog describing today's opportunities in Electronics, our teaching methods, and our courses, together with our special booklet on how to get a commercial FCC License. If card is missing, use the coupon below.

CIE Cleveland Institute of Electronics

1776 East 17th Street, Cleveland Ohio 44114

NEW COLLEGE-LEVEL COURSE IN ELECTRONICS ENGINEERING

for men with prior experience in Electronics. Covers steady-state and transient network theory, solid state physics and circuitry pulse techniques, computer logic and mathematics through calculus. A college-level course for men already working in Electronics.

Cleveland Institute of Electronics

1776 East 17th St., Cleveland, Ohio 44114

Please send me without cost or obligation:

1. Your 44-page book "How To Succeed In Electronics" describing the job opportunities in Electronics today, and how your courses can prepare me for them.
2. Your book on "How To Get A Commercial FCC License."

I am especially interested in:

- | | |
|--|--|
| <input type="checkbox"/> Electronics Technology | <input type="checkbox"/> Electronic Communications |
| <input type="checkbox"/> Broadcast Engineering | <input type="checkbox"/> Industrial Electronics and Automation |
| <input type="checkbox"/> First-Class FCC License | <input type="checkbox"/> Electronics Engineering |

Name _____ (please print)

Address _____

City _____

State _____ Zip _____ Age _____

Check here for G.I. Bill Information.

Accredited Member National Home Study Council
A Leader in Electronics Training... Since 1934

EW-72

ENGINEERS

- Evaluation and Test
- Manufacturing
- Others

Automatic Electric, a leading innovator of computerized electronic switching systems and the largest producer of communications equipment for the independent telephone industry, has numerous entry level and experienced technical positions available in the following areas: **EVALUATION & TESTING** Electronic and electrical engineers to initially learn the design of new electronic and computer systems and then perform prototype and/or field evaluation thereon. Entry level requirements — BS degree in EE, ET, or computer science with some knowledge of programming. Higher level positions exist for those with experience in electronic common control systems.

MFG. ENGINEERING Degreed electronic or electrical engineers (new or experienced) initially learn new computerized electronic telephone switching systems, design test equipment and associated test procedures and troubleshoot the mass production of this equipment.

Additional Positions currently available include:

- Component and Circuit Design Engineers
- Automation Engineers
- Chemical Engineers
- Switching System Planning Engineers
- Traffic Analysts

If you are interested in a progressive, growing company that offers well equipped modern facilities, a policy of promotion from within, and a pleasant West suburban location (15 miles from downtown Chicago), send your resumé in confidence to:

Bruce Bullock

Professional Employment Representative

AUTOMATIC ELECTRIC

Subsidiary of General Telephone & Electronics

400 North Wolf Rd., Northlake, Ill. 60164
An Equal Opportunity Employer



LETTERS

FOUR-CHANNEL STEREO

To the Editors:

On June 2, 1964 I filed a patent application entitled "Monoaxial Quadraphonic Recording System," and received patent number 3,375,329 dated March 26, 1968. An abstract of the disclosure follows: "A method for recording and reproducing sound for creating a true environmental transposition of a given audio situation in which a quadrangular arrangement of microphones defining a plane is positioned in an overlying and surrounding relationship with respect to the audio sound stage from which a source of sound originates . . ."

My patent describes a method of reproducing the precise acoustical geometry of the sound stage by sampling the outputs of microphones surrounding the action, feeding the sampled output into a single-channel amplifier, and recording or transmitting the information received. Recovery embraces the inverse progression whereby the quadrangular placement of loudspeakers complements the microphone placement, and the output of microphone #1 is received only by loudspeaker #1, etc.

The rewarding virtue of such a single-channel system is that the phase-amplitude relationship throughout the transposition cannot be altered by any means. An increase or decrease in amplitude affects all relationships equally. A further advantage is that no FCC regulations are required. Picked up by an ordinary radio or TV receiver, straight monophonic reproduction is heard.

ROBERT PROUTY
Olney, Md.

There are a good many patents extant for various systems providing multi-channel stereo. It will be interesting to see which one, if any, of them will be used in the finally accepted 4-channel system. No doubt, compatibility with 2-channel stereo and with mono will be an important prerequisite for any 4-channel method.—Editors

* * *

ELECTRONICS AND PLANTS

To the Editors:

I was happy to see the article "Electronics and the Living Plant" in the October issue. Enough work has been done in this field by groups and individual experimenters, from the University of Alberta to the Presidency College of Cal-

cutta, to assure us there is an important and practically untapped field of knowledge here.

One of the reasons for the lack of progress in this field is the fantastic difficulty of the subject. Not only are there 350,000 species of plants, but they can be subjected to an almost unlimited number of combinations of signal strengths and frequencies, from the fringe of the perceptible to the lethal, and from d.c. to light. Their response—as we have learned from the poinsettia—may be to narrow frequency bands and voltage ranges. Even audio—music—has been reported to have an effect on the growth of grain.

Another reason is the lack of communication. Many experimenters have been quite unaware of what others were doing, or indeed that any others were working in the field. This article should stimulate intercommunication, and the references may open new doors to some.

I did regret that no mention was made of possibly the first serious worker in this field, Sir Jagadis Chandra Bose. After distinguishing himself in wireless research in the '90's, he devoted the rest of his life to the study of plants. His results were so far in advance of his time that good orthodox scientists shunned him as a "mystic" and even suspected his mental competence.

Is it possible that the ostracism he suffered at that time has caused him to be forgotten entirely? If so, researchers would do well to look up his "Response in the Living and Non-Living" and "Plant Response." Some of his less-known (and later) books might be even more important, and the ingenious instruments that gained him envious praise from persons who could not accept his conclusions might still be useful.

Now that the times have caught up with him, modern researchers may not find him so "far out." Indeed, they may have surpassed him. Though Dr. Bose suggested that plants might be sentient beings, he never went so far as to claim extra-sensory perception for them!

FRED SHUNAMAN
Plainfield, N. J.

* * *

PRINTED-CIRCUIT REPAIR KITS

To the Editors:

In the October issue of **ELECTRONICS WORLD** Mr. Sal DiNuzzo, in his article entitled "Printed Circuit Tech-

nology," wrote on page 41: "Repair kits are available which not only contain unique tools but also such items as copper foil, epoxy cement, conductive cement, conductive epoxies, eyelets, solvents, swabs, and other special items."

I would appreciate your sending the addresses of manufacturers of such kits.

JOEL T. WHITE, JR.
Monticello, Miss.

The repair kits referred to were made by Hazeltine especially for their own use and are not commercially available. There are some military repair kits available but here again these are strictly for military applications. We're sorry we do not know of any commercially available repair kits, although as our article "Printed Circuit Kits For Short Runs" indicated, there are quite a few printed circuit kits currently on the market.—Editors

* * *

IC 12- TO 6-V CONVERTER

To the Editors:

With reference to my article in the January, 1970 issue on the converter for 12 to 6 V (p. 68), several of your readers have pointed out that we did not show values of resistors R1 and R2 either in Fig. 2 or in the text. The proper values are as follows: R1 is 330 ohms and R2 is 220 ohms.

E. A. SACK, V. P./Gen. Mgr.
Integrated Circuits Div.
General Instrument Corp.
Hicksville, N. Y.

* * *

ELECTROMAGNETIC SPECTRUM CHART

To the Editors:

I enjoyed your Electromagnetic Spectrum Chart in the January, 1970 issue (p. 37) of *ELECTRONICS WORLD* very much. It is a beautiful chart. However, there was a small typographical error; namely, "hard" and "soft" should be interchanged as follows: Soft—X-rays—Hard, since hard x-rays are the more penetrating ones.

If you have some of these charts available for distribution, I would appreciate having some for showing to my students.

YSBRAND HAVEN, Prof. of Physics
Wake Forest Univ.
Winston-Salem, N. C.

Thanks to Prof. Haven and to all the other readers who found this chart useful in spite of the transposition of the words "hard" and "soft." We are sorry that we do not have for distribution extra copies of the Spectrum Chart or the Sound Chart on reverse side.—Editors.

* * *

DUAL 1219 PRICE CHANGE

The price that was given in our February lab-tested report on the Dual 1219 automatic turntable is no longer correct (page 69). The present price of the unit is \$175 plus the base. ▲

April, 1970



World Famous
Simpson 260®
Millions now
in use!

Better than ever

New
Taut Band
Movement
cannot develop
error-causing
friction.

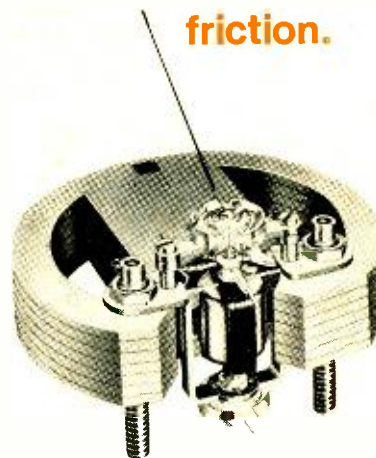

- SELF-SHIELDING, SHOCK PROOF . . . for outstanding accuracy and repeatability.
- VARISTOR PROTECTED against even 200,000% overloads.
- RUGGED DEPENDABILITY that has no equal.

New Taut Band 260®-5 complete with test leads, batteries, and 40-page operator's manual . . . \$65.00
New Taut Band 260®-5M with anti-parallax mirror scale and knife-edge pointer . . . \$67.00
New Taut Band 260®-5P with circuit breaker overload protection of VOM circuitry . . . \$97.00

GET "OFF-THE-SHELF" DELIVERY FROM
YOUR LOCAL ELECTRONIC DISTRIBUTOR

Simpson

ELECTRIC COMPANY



5200 W. Kinzie Street, Chicago, Illinois 60644 • Phone (312) 379-1121
Export Dept: 400 W. Madison Street, Chicago, Illinois 60606. Cable Simelco
IN CANADA: Bach-Simpson Ltd., London, Ontario • IN INDIA: Ruttonsha-Simpson Private Ltd., International House, Bombay-Agra Road, Vikhroli, Bombay

INSTRUMENTS THAT STAY ACCURATE
CIRCLE NO. 117 ON READER SERVICE CARD



**INSTALL
FOUR ...**

**... IN THE
TIME IT NOW
TAKES TO INSTALL
ONE
MICROPHONE**

Install multiple microphones as quickly as you can plug them into the Shure M68 Microphone Mixer. No splicing or soldering, no need to change impedances. Makes it easy to achieve Total Communications*.
(* A superior sound installation in which everybody who needs a microphone has one at his fingertips.)

**SHURE
MICROPHONE
MIXER**

...YOUR KEY TO TOTAL COMMUNICATIONS
© 1967 Shure Brothers, Inc.



**OPERATE
FOUR ...**

**... AS
EASILY AND
COMPETENTLY AS
ONE
MICROPHONE**

The Shure M68 Microphone Mixer enables you to teach inexperienced users how to operate a multiple-microphone sound system in seconds! It is your best tool for selling Total Communications*.
(* A superior sound system in which everybody who needs a microphone has one at his fingertips.)

**SHURE
MICROPHONE
MIXER**

...YOUR KEY TO TOTAL COMMUNICATIONS
© 1967 Shure Brothers, Inc.
CIRCLE NO. 118 ON READER SERVICE CARD



**MIX
FOUR ...**

MICROPHONES

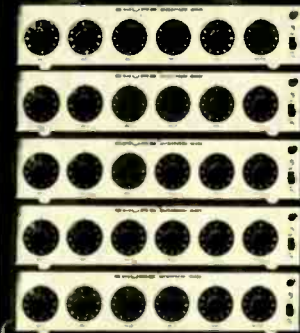

**OR
5-8
9-12
13-16
17-20**

**... WITH ONE
VOLUME CONTROL
FOR EACH
MICROPHONE AND
ONE MASTER
VOLUME CONTROL**

Shure M68 Microphone Mixers can be stacked and interconnected to accommodate virtually any number of microphones regardless of impedance. They are unusually compact, singularly flexible, and modest in cost. They make Total Communications a practical reality.

**SHURE
MICROPHONE
MIXER**

...YOUR KEY TO TOTAL COMMUNICATIONS
SHURE BROTHERS, INC., 222 HARTREY AVE.
EVANSTON, ILL. 60204
© 1967 Shure Brothers, Inc.

ELECTRONICS WORLD



NEWS HIGHLIGHTS

Radar-Controlled Brakes

Bentley Associates of Chelmsford, Mass. has developed a radar-controlled braking system for automobiles that may put tailgaters out of business. Working on principle of Doppler radar, the system (depending on closure rate between car and object in front) operates vacuum-powered brake controls and throttle linkage; accordingly, higher closure rates cause longer braking durations than slower closure rates. System reaction time, measured in milliseconds, will keep vehicle at least one car length behind car in front and stop vehicle 8 to 10 feet from stationary objects. An audio beeper that warns driver of braking action and an overriding feature that cuts out all but beeper, allowing driver to pass slower objects, is included. Unit can be operated in either a high-speed ("country") or slow-speed ("city") mode. Transportation Secretary John A. Volpe has said that "... I think that it could potentially save a great many lives in this country." Device now costs \$800 but can be reduced to \$200 through mass production.

Navigators Obsolescent?

When first 747 superjet took off for London from N.Y. in January it was guided across Atlantic by an inertial navigation system similar to the one that took our astronauts to moon and back last year. Applying space-age technology to commercial applications, *General Motors' AC Electronics Div.* created the Carousel IV inertial navigation system that can automatically steer aircraft, from starting point to destination, without radio, radar, magnetic aids, or the sun and stars. System supplies a multitude of information such as: instant position, distance and time to destination, wind speed and direction, etc. Extreme accuracy of system (five times better than standard form of transoceanic navigation) aids in shortening flight time and saving fuel. It also offers the possibility of narrowing the air corridors over oceans from the present 120-mile spacing to 60 miles—with safety.

Computer Time Sharing

Despite the slowing trends forecast for the computer hardware industry, computer-time-sharing sales, which grew from \$80 million in 1968 to about \$150 million in 1969, will probably double in 1970. Long-time projections indicate that by 1972 sales should reach \$1 billion and exceed \$2 billion by 1975.

Electronic Roll Call

An automatic vehicle monitoring system that can electronically identify and locate the position of over 1000 transponder-equipped vehicles in a matter of seconds has been developed by *Hazeltine Corp.* of Little Neck, N.Y. According to James W. Evans, vice-president of the firm's Industrial Products Div., this system will help alleviate congestion on city-agency and transportation-system radio voice channels in large urban areas. Upon receipt of a synchronizing signal from a central transmitter, each vehicle responds sequentially by transmitting a digitally coded pulse train at a frequency of 1000 MHz (L-band) to fixed receiving stations. Part of the pulse train is used by two pairs of these receiving stations to mathematically determine vehicle's position. This is then fed back to the central control station, together with the rest of the pulse train containing such digitally coded information as operational status, output of a passenger counter, or need for emergency assistance, to be processed by computer and

displayed. In a previous experiment conducted in a densely packed 1-square-mile high-rise area in midtown New York City, involving 274 individual tests, the error was less than 300 feet in 95% of the cases and less than 175 feet in 77% of the cases. Recently we witnessed a similar demonstration here in New York and were impressed with the results. System lends itself to such applications as: freight cars and passenger trains, police cars, ambulances, taxi fleets, cabs, delivery trucks, etc.

Monitoring the Monitor

Tedium experienced by guards with constant vigilance of security system monitors can now be eliminated. *GBC Closed Circuit TV Corp.*, N. Y. has come up with a motion detector, called the VS-101 Video Sensor, which lights a lamp or rings an alarm or siren to alert a guard to watch TV monitor when any unauthorized or unusual movement of light occurs on TV screen. Sensor uses two tiny sensing units which stick to front of monitor and can be positioned to monitor entire screen, or to concentrate on a particular area or item such as safe or file cabinet.

Ersatz Moondust

You don't have to go to the moon to have your own moon-dust. *Edmund Scientific* of Barrington, N. J. has come up with a product called "Moondust" that is so much like the real lunar soil that leading experts, using an 80-power microscope, can not tell them apart. Although chemically different, the physically similar properties suggest a myriad of uses for checking effects of lunar soil and dust on equipment destined to be used on moon's surface. For example, "Moondust" could be used to determine whether such instruments as sensitive gages, computers, and computer parts are "moondust-proof." And then again, wouldn't having your own moondust be a tremendous conversation piece? "Moondust" is available direct from *Edmund*.

Search for Blind "Readers"

Unknown to many, one of the programs of Library of Congress is to look after "reading" needs of the blind. Program includes Braille books and "Talking Book" long-playing records and machines on which to play them. Recently, the Division for the Blind and Physically Handicapped, administrators of the program, purchased 10,000 GE portable cassette recorders to give handicapped persons opportunity to enjoy benefits of talking books while traveling or away-from-home situations. Although 1000 new "readers" are added each month, only 20% of those eligible are reached. Goal of Division's public information program is to reach remaining 80%.

Electronics a'Sea

Chris-Craft Corp. recently introduced its new integrated marine electronics system, which consists of standardized navigation and communications equipment designed specifically for the boat and *vice versa*. An impressive array of equipment, including depth sounder, automatic pilot, automatic direction finder, 150-watt AM radiotelephone, and v.h.f.-FM radiotelephone, are set up like the flight deck of a jetliner rather than with the usual back-of-the-store workbench appearance which is characteristic in the boating industry today. The ice is broken and hopefully the rest of the boating industry will follow suit, providing added safety and increasing the range and enjoyment of cruising. ▲

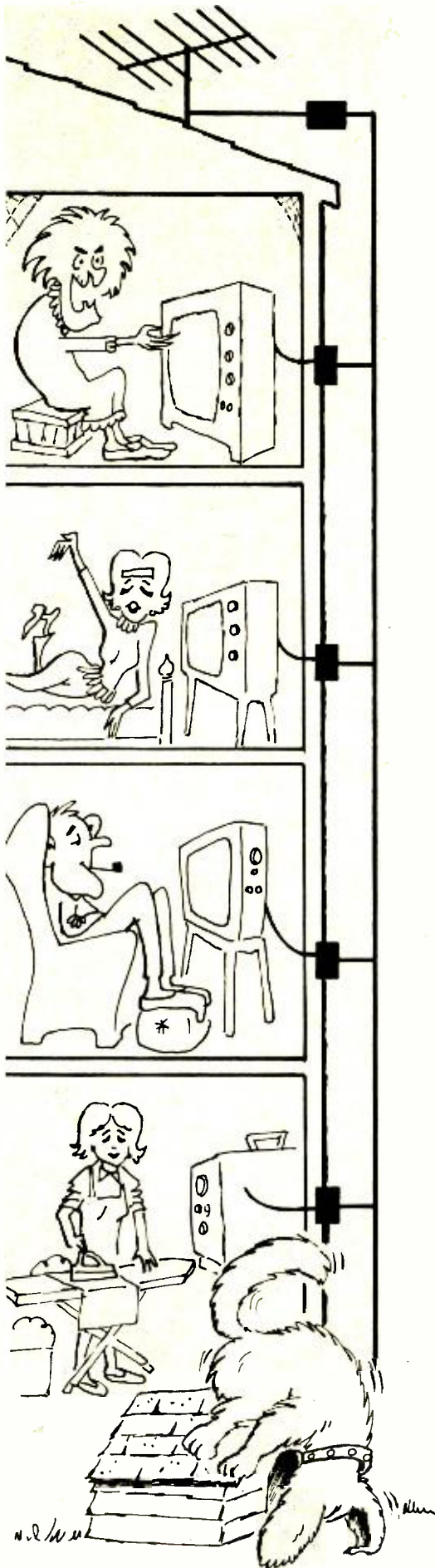

Set 'em up... anywhere!

These days when tiny TV's and FM radios are the rage and everybody wants one, you've probably had people asking you about master antenna systems to plug them into.

Well, stop turning them away — all you need is the Channel Master Home MATV Kit!

The Channel Master complete kit makes professional quality home MATV systems faster and easier to install than you'd think. We've included the industry's finest VHF/UHF/FM amplifier, four outlets, and all necessary hardware, wire and equipment needed (for 300 or 75 ohm installations) to watch TV upstairs, downstairs, in the cellar ... or for those special occasions ... in the doghouse.

And, all it takes to do it is the tools in any tool kit. So go ahead and set 'em up anywhere ... and start enjoying TV!



CHANNEL MASTER

DIVISION OF AVNET, INC., ELLENVILLE, N.Y. 12428

Conductive mannequin head used in electronic dream experiments to simulate electrical surface properties of cranium. Technician is shown taking skin and related measurements.

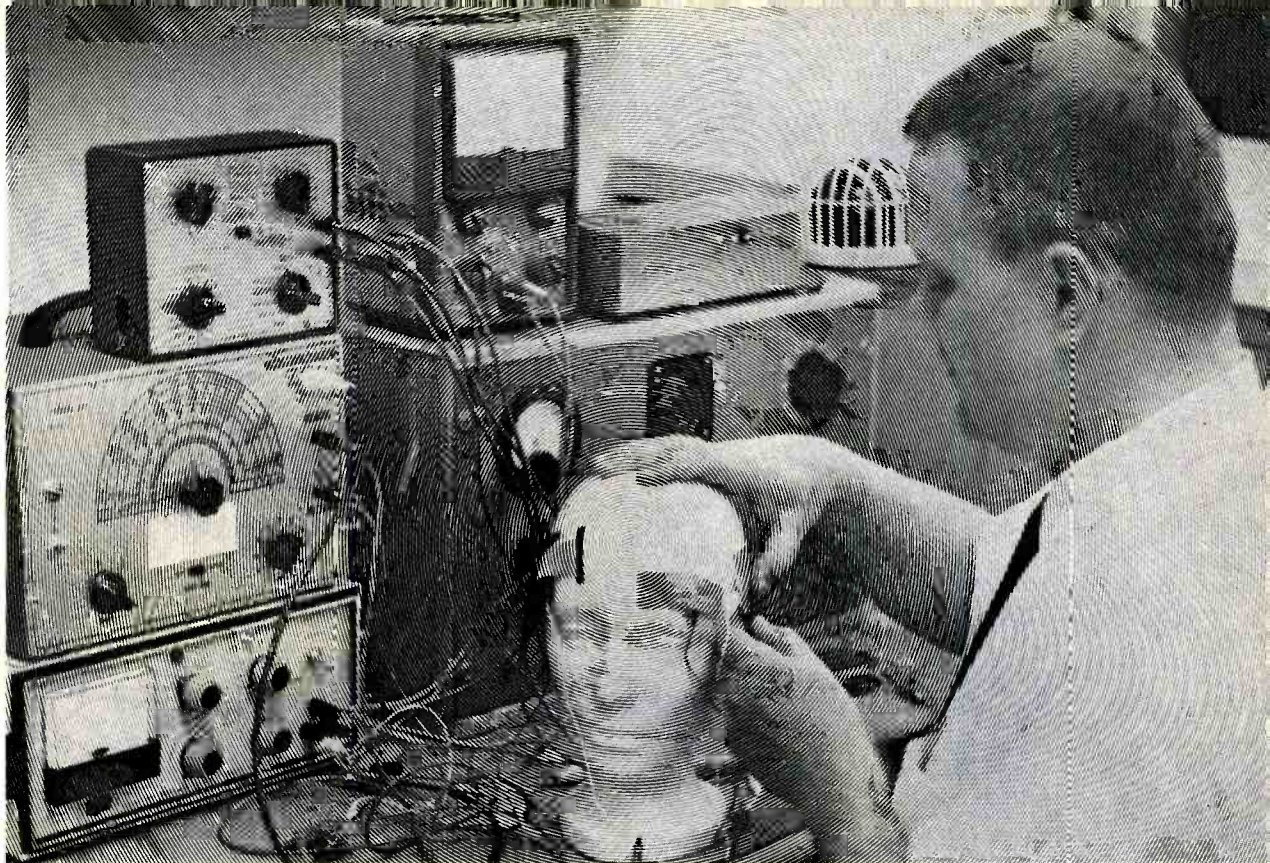

Electronics and Parapsychology

By L. GEORGE LAWRENCE

Does man possess latent psi-sensitivities that have been stifled by modern communications systems? Parapsychology, an aspiring science using modern electronic methods, has been working to unleash this "natural" ability in man.

PARAPSYCHOLOGY, or psychic research, deals with the world of "psi." Extrasensory perception (ESP), psychokinesis (PK), and other *mind*-based phenomena are its way stations. Long suspect because of an occult background, the field continues to fight for a secure place among the accepted sciences; but some progress has been made. Today, the application of electronic instruments to this unique area has permitted dramatic experiments and brought forth a few stunning discoveries of excellent promise, which has prompted those most active in this field to predict that, in time, parapsychological methods might well rival the orthodox communications arts and sciences currently in use. Of course, due caution is suggested.

Its Beginning

Critical experiments in parapsychology started in the second half of the 19th century. The "Society for Psychic Research," founded in 1882 in London, first used scientific methods for its studies, dissociating psychic phenomena

from superstition, spiritualism, and the various "mediumships: so fashionable at that time. Later, in 1906, Dr. Duncan MacDougall of Massachusetts General Hospital detected a small loss of weight at the instant of human death. Around 1930, Dr. William McDougall established a research group at Duke University, which attained considerable prominence under Dr. J. B. Rhine. To date, only a handful of university-connected ESP labs exist throughout the world; the oldest is at the State University of Utrecht in Holland, the newest at Andhra University in India. The bulk of research is carried on by interested individuals, private groups, and *ad hoc* societies.

Concepts

The need for machine systems, capable of testing for ESP and PK in an unbiased, impartial manner, was recognized at an early date. It was the Italian scientist F. Cazzamalli who developed, around 1923, a u.h.f.-type of apparatus for testing human telepathy.

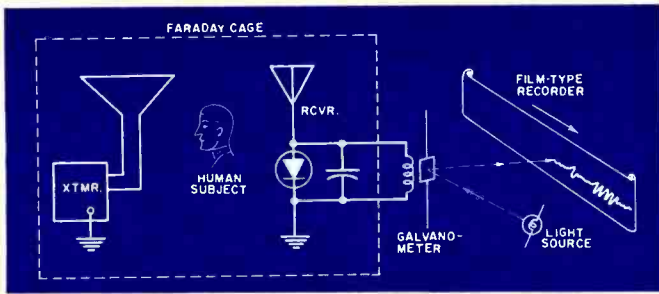

Fig. 1. Setup used by Italian scientist, Prof. Cazzamalli to do human telepathy research. An r.f.-beat signal was produced at receiver when transmitter and emotionally stimulated human brain radiate at near-identical electromagnetic wavelengths.

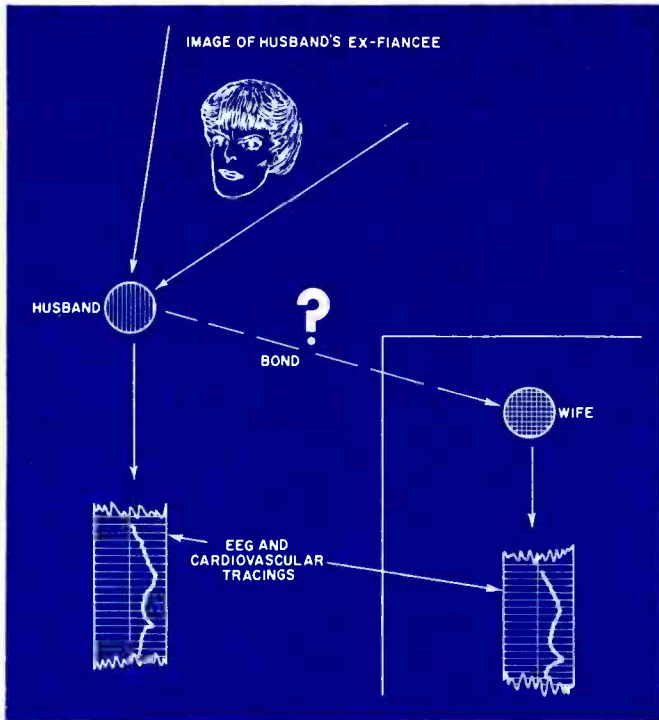
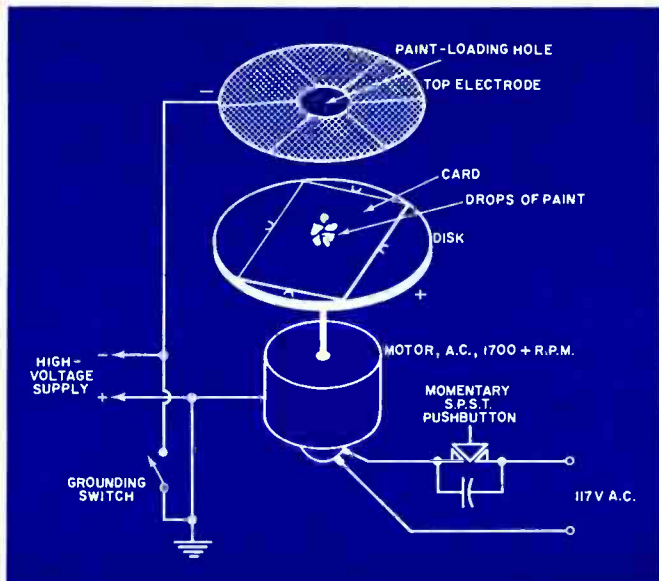

Fig. 2. Experiment performed to show evidence of "psi" bond between emotionally knit human subjects. EEG and cardiovascular tracings are identical for both husband and wife although image of husband's ex-fiancée is shown only to the husband.

Fig. 3. Color centrifuge equipment used to confirm existence of psi fields. With experimenter concentrating on an image on a separate card, while directing his thoughts on the card containing drops of paint, an identical or quasi-identical image of the original should be produced when the motor is energized.



As shown in Fig. 1, Cazzamalli placed his human subjects inside a Faraday cage and claimed that some of these individuals could produce r.f.-beat pulses when undergoing emotional stimulation of the brain. Since v.h.f./u.h.f. techniques were rather crude, it is open to conjecture whether this purported "brain radiation" was heterodyning with fundamental frequencies between 60 and 400 MHz of the local oscillator or interacting with more or less high harmonics. Unfortunately, Cazzamalli's experiments have never been repeated in depth. It is believed that his last paper appeared in 1941, at which time Benito Mussolini (Italian premier and dictator from 1922 to 1945) declared the work secret.

But, of course, progress never stops. A somewhat strange offspring of Cazzamalli's ideas and machinery is the "Integratron" designed by UFO-man G. W. Van Tassel. The apparatus, located at Yucca Valley, California, promises such wonders as rejuvenation of older people's body cells, anti-gravity, and the epitome of psychic ecstasies—time travel.

These two basic examples might have shown, perhaps, that parapsychology's instrumentation phase has two faces: hardcore science at one side, science-fiction type concepts at the other. But the psi-phenomena do persist and can be verified.

Recent Experiments

At the research center of Rockland State Hospital, N.Y., scientists used instruments linked to a computer to record EEG, changes in blood volume in a finger, and heart rate. The human subjects (in this instance, husband and wife) were placed in separate rooms and subjected to emotional stimuli. When, for example, the husband was shown a projected picture of his ex-fiancée (Fig. 2), the record of his emotional response was matched on the wife's tracings, even though her projection screen was blank. As Dr. Esser, the principal investigator points out, only a very few people have this bond. He also reports that *alpha* waves (brain waves) in identical twins are synchronized. This ties in with the odd observation that twins frequently have an almost identical psychic life.

Owing to the uniqueness of such and related happenings, researchers are hard pressed to come forth with some kind of working theory. This leads to a consideration of the hypotheses evolved by both Drs. Roll and Wassermann, among others.

Here, W. G. Roll's concept of "psi-fields" is analogous to electromagnetic or gravitational fields, supposing that all objects, whether organic or inorganic (*i.e.*, nonliving), possess such fields. Psi-fields are seen as interacting with known physical fields and with each other, giving rise to phenomena at both animate and inanimate matter systems.

G. D. Wassermann, on the other hand, relates his postulates to quantum mechanics. Psi-fields, which enable individuals to have paranormal experiences, are regarded as having "very narrowly spaced energy levels" and "occupy wide regions of space." Thus, according to Wassermann, psi-fields emit and receive "extremely small quanta of energy"—typically smaller than quanta which can be absorbed by matter fields of classical physics.

Various efforts have been made to prove these hypotheses. An instrument for this purpose is the color centrifuge shown in Fig. 3. The device consists of an electric motor activated for a fraction of a second by pushbutton and a high-voltage field exciter. A paper card, upon which there are deposited a few drops of paint of different colors, is spun by the motor's disk. The entire assembly is housed in a transparent vacuum vessel.

To use this equipment as a psi-confirming aid, the experimenter concentrates on the image on a separate card and directs his thoughts upon the card in a centrifuge. With the paint in place and the motor energized, the machinery should now produce an identical or quasi-identical image of the original. This appears to work with some people and may be classified as telepathic/psychokinetic, since thought triggered a mechanistic replica.

Psi-type work of this kind ties in with experiments in the

"dream" area. At the Maimonides Medical Center in Brooklyn, for example, it appears that its dream laboratory was able to induce mental images telepathically in sleeping persons by an "agent" located in another room, about 100 feet away. The transmitting person, the agent, concentrates on a picture chosen from a group of famous paintings and tries to direct this thought-image at a sleeper. The lab was established in 1962 and, according to Drs. M. Ullman and S. Krippner, results have been good.

Dream-type work apparently has much promise for electronics, since sleep itself can be induced by electronic pulse generators. No standards can be fixed at this time, since different people have much different susceptance to artificial pulse trains.

Attempts at inducing dreams by purely electronic methods are stifled by the fact that there are no "bulk"-picture transmitters available. TV-type video signals are unpleasant to induce and sensations are restricted to a "feel" of the low-frequency vertical blanking pulses.

But even if the transmission mode could be solved, a number of parallel problems require major attention as well. Exterior and interior conduction properties of the human cranium apparently are much more complex than suspected. Sweat, for example, is a highly conductive agent which causes odd current paths and spread patterns. Skin and related measurements, as shown in the lead photo of this article, can be made by simulating the cranium's exterior with conductive mannequin heads. Although respective data can be valuable, questions attached to the explicit propagation of dream-provoking electronic signals towards given receptor and processing areas *within* the human brain remain unanswered.

Paranormal Matrix

Dr. Gardner Murphy, recognized as a psychologist of distinction, is a prolific contributor to parapsychology. He suggested the idea that man's failure to use interpersonal psi communications frequently may be due to our "psychological insulation" from one another. To that end, others see electronics-based communications as an awkward crutch and primitive substitute for latent, natural abilities. However, the lack of performance at psi-type levels can also be understood as Nature's safeguard against devastating telepathic impact. Otherwise, the world of man would function like an untuned radio receiver—too many messages would trigger chaos, intelligent action become impossible.

These considerations, taken together, have invited a search for discriminating devices and specific mind-intercoupling agents.

One of the most intriguing things to emerge in that area is the now-famous *Backster Effect* (ELECTRONICS WORLD, October, 1969). Here, since living plants seem to react bioelectrically to thought-images directed at their over-all well-being, New Jersey cytologist Dr. H. Miller thinks that the phenomenon is based upon a type of "cellular consciousness."

These and related considerations lead to the idea that psi is but a part of a so-called "paranormal matrix"—a unique communications grid that binds all life together. Its phenomena apparently work on a multi-input basis which operates beyond the known physical laws.

Some of these constituents can be seen in highly refined experiments of the Backster type. For example, a variety of electronic systems is employed to furnish pure audio tones, music, red light (as a growth stimulant), and excitation currents to the plants (Fig. 4). This provides the specimen with an emphatic "work psychology" or environment which can be disturbed for data-gathering purposes *after* lengthy conditioning.

To that end, psi-sensitivity can reach such a highly cultivated level whereby a plant (in our example) reacts to its owner's state of mind emotionally—even while he is far away. The data is expressed, of course, in the form of an electronically derived and processed biogram which is supplied with



Fig. 4. Experimental setup using Backster Effect for checking psi phenomena in living plants by subjecting them to artificial excitations (currents, red light, etc.), and monitoring responses. Note the red-light growth stimulator on Faraday cage.

time markers for identification purposes, as shown in Fig. 5.

Conclusion

Only a small family of experimental systems and approaches could be described. The field is complex, quite strange in many ways, but wide open for improvement. Indeed, as it appears from here, there is enough promise to warrant intensified research efforts. From an educational point of view, it's also necessary for investigators to look beyond their specialties and acquire more background knowledge in order to do meaningful work in a field such as this. ▲

REFERENCES

- Rao, K. R.: "Experimental Parapsychology." C. C. Thomas, Springfield, Ill., 1966
- Ed.: "ESP: More Science, Less Mysticism," Medical World News, 10:12, 20-21, March 21, 1969
- MacDougall, D.: "Journal of the American Society for Psychical Research," May, 1907
- Roll, W. G.: "The Psi Field." Presidential Address, 7th Annual Convention Parapsych. Association, Oxford U., England, 1964
- Wassermann, G. D. in Ciba Foundation Symposium ESP, Little Brown, Boston, 1956

Fig. 5. Biogram demonstrating psi-sensitivity level of plants in response to emotional state of owner who is at a distance.

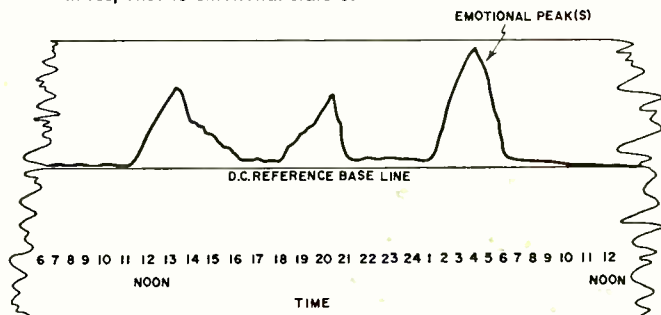



RECENT DEVELOPMENTS IN ELECTRONICS

TV Eyes for Delaware Bridge. (Top left) From this vantage point 220 feet above the road surface of the twin-span Delaware Memorial Bridge, a TV camera will keep constant watch over traffic flow and road conditions. A second TV camera will be installed on the span's other tower, and two more cameras will be located atop the other span's two towers. Located in special housing in which they will be free to pivot and tilt in all directions, the cameras will be monitored on four 23-in TV monitors in the communications room below. Special windshield wipers are used to keep camera housings clear and clean. The cameras are specially adapted Sarkes Tarzian transistorized units, equipped with 1¼-in Plumbicon pickup tubes and zoom lenses. In designing the packages for the TV cameras, they had to be made small enough to fit through the small doors of the bridge-tower elevators. The TV system will be linked to the extensive communications and signaling network already in use by the Delaware River and Bay Authority. The CCTV system is being installed by U.S. Underseas Cable Corporation.

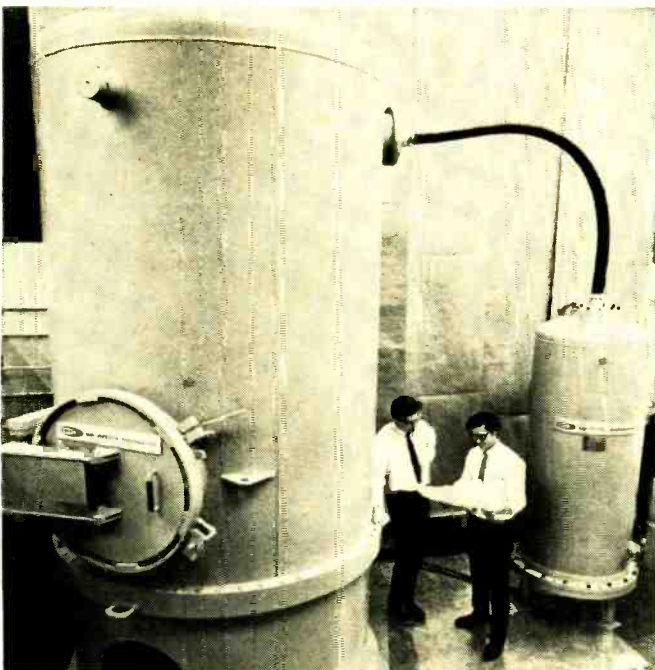

Million-Volt Radar Modulator. (Center) The two huge components in the photo are the radar modulator for an experimental Air Force radar. This radar is being developed to demonstrate the feasibility of a very high peak power, nanosecond radar system. By using higher powers, radar range should be increased so that targets will be detected at greater distances. By using shorter pulses, range resolution, or the ability to pick up separate targets that are closer together in range, should be improved. The modulator operates in the megavolt range, and it can produce extremely short pulses that are measured in nanoseconds (billionths of a second) rather than microseconds (millionths of a second). The equipment is produced by Ion Physics Corporation for Varian Associates.

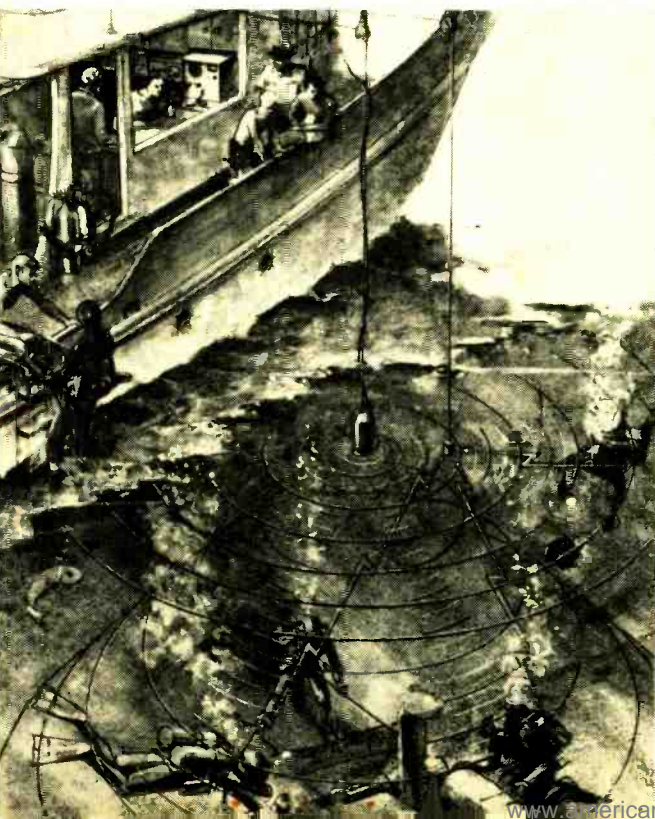

Underwater Public-Address System. (Below left) An advanced high-fidelity public-address system is being used in a unique film-making venture—to search for the great white shark which inhabits the waters of the Indian Ocean. The underwater system provides communications between crew members while engaged in their beneath-the-surface activities. Heart of the system is a tiny audio projector operated by a 200-watt amplifier that can illuminate a large underwater work area with acoustic signals. This enables cameramen working in deep waters to hear communications signals at a level equivalent to normal conversational speech at a distance of more than 100 feet from the projector, without special receiving apparatus. Speech signals are not only originated at the shipboard control center but also any member of the crew working below can broadcast over the system to every other member of the crew. This is made possible by a wireless sonar link to a receiving hydrophone suspended in the water. Each cameraman-diver has a microphone in his mask connected to a belt-mounted transmitter. The signal is picked up by the receiving hydrophone, demodulated, and rebroadcast over entire work area via the projector. System was developed by CBS Labs.

Electronic Particle Counter for Metal Research. (Top right) This high-speed counter, working in conjunction with its 300-power microscope, can count the thousands of tiny silicon particles in a polished surface area of an aluminum-silicon alloy in less than a second. To do the same job manually requires several hours. A CCTV camera scans the surface and flashes a picture onto a monitor. Electrical pulses from the particles in the study area are fed into the instrument's logic network, triggering the counters whose output is recorded for later evaluation. The instrument, designed by Reynolds Metals, is used in the company's research laboratories to measure particle size and distribution which affect the characteristics of aluminum.

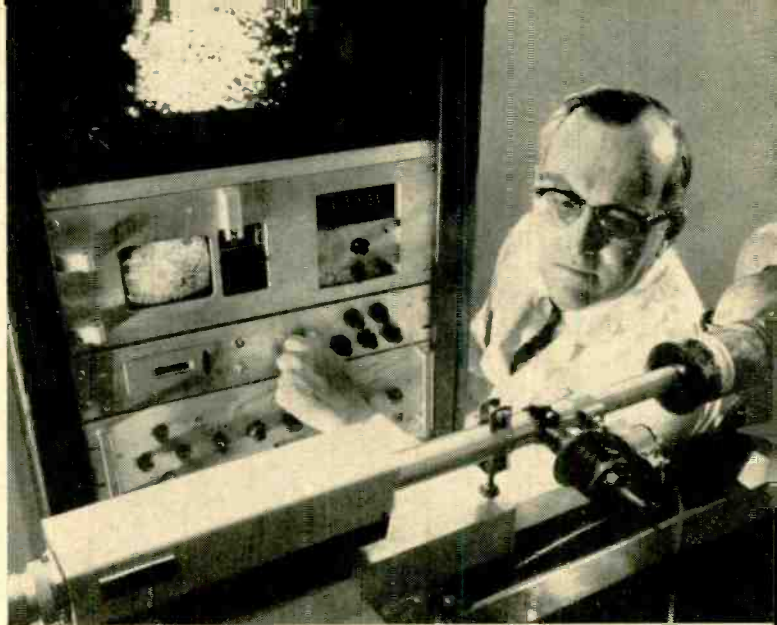

Two-Ton Speaker for Expo '70. (Center) Two gigantic loud-speaker systems, each weighing two tons, have been installed at the Festival Plaza of Expo '70 at Osaka, Japan. Each system has four 20-in woofers, 24 8-in mid-range speakers, and 14 multi-cellular tweeter horns, for a total of 42 speakers. The curved enclosures are suspended from the ceiling of the covered site, and are fed with 400 watts of power each. The loudspeaker systems will be used for public-address purposes. Systems were manufactured and installed by Pioneer Electronic Corp.

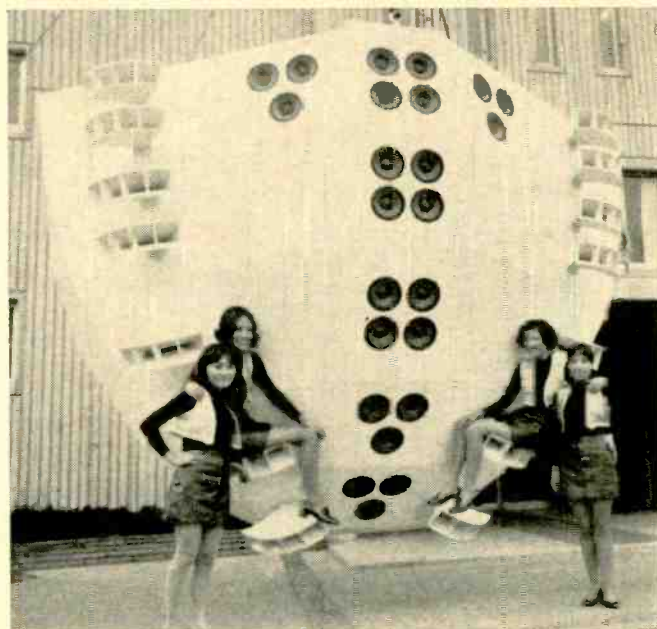

Computer Traffic Control for Boston. (Below left) Anyone who has done any driving in downtown Boston knows that the traffic and traffic-control leave much to be desired. Perhaps this computerized electronic traffic control system will improve things in the area it covers. The computer changes the traffic-light signals to meet the around-the-clock, constantly changing traffic needs. The traffic board in the photo shows the 32 light signals plus 24 walk/don't walk boxes, and four lighted pedestrian push-buttons in the Government Center area handled by the new system. System was developed for Boston's Traffic Department by Computer Systems Engineering.

Laser Velocimeter. (Below right) The components of a new laser velocimeter capable of measuring moving strip steel at better than 0.25-percent accuracy is shown. The device, located up to 15 feet from the moving strip, operates on Doppler-effect principle. The gas-laser beam is split to strike the metal from two angles. The difference in wavelength of the reflected light indicates speed of moving material. Readouts of material length and surface area can be in the form of digital display, printed cards, logs, or other printed records. Cost of equipment, made by GE, is in \$25,000 to \$30,000 range.

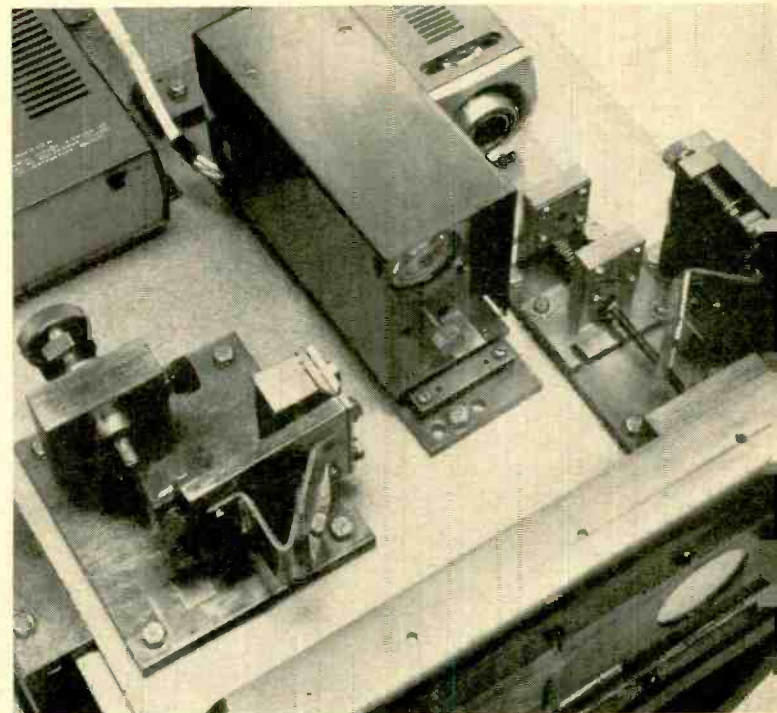
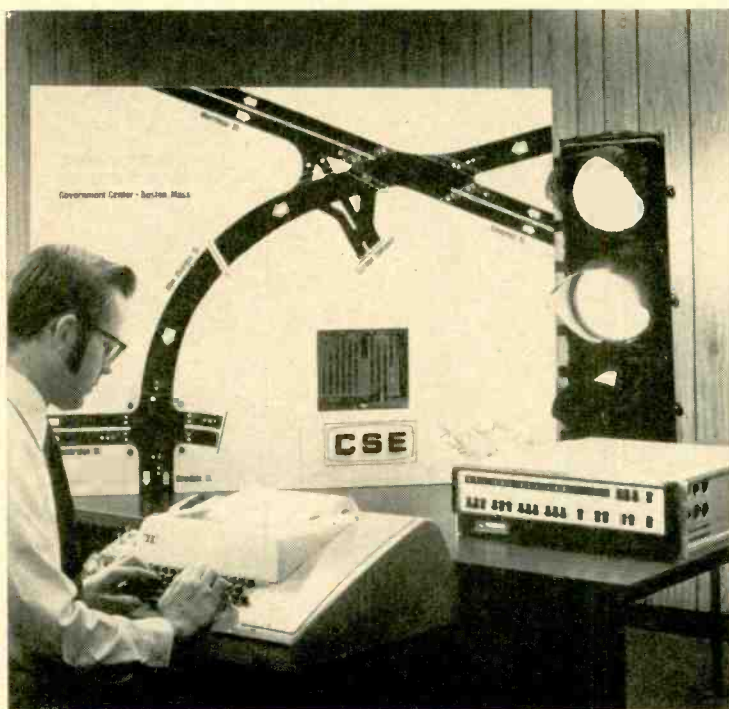

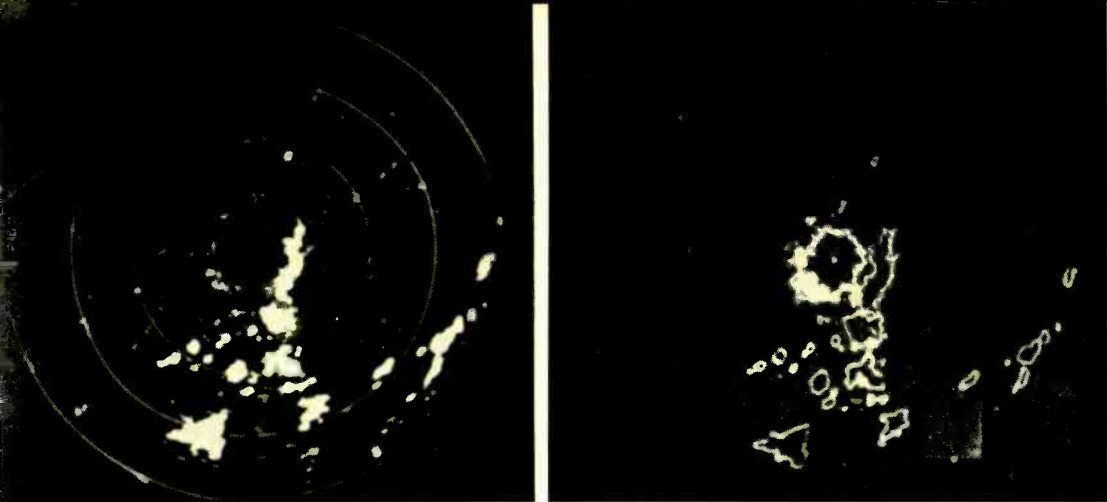

Radar scopes showing comparison between (left) conventional display of weather and (right) display using weather outline generator that only shows the outer contours of storms.

Air Controller's Radar Sees Through Weather

By HOWARD L. MCFANN / Project Manager, National Aviation Facilities Experimental Center, FAA

Worried about flying in "bad" weather? Here's a new FAA weather-device that makes it possible for air traffic controllers to guide aircraft safely around all types of hazardous weather conditions.

IN an attempt to cut through the weather clutter that obscures vital target data on the air traffic controller's radar displays, engineers inadvertently created another potentially serious operational problem. As a result, a device, described in this article, was developed that solved this problem and opened new vistas for examining a storm's awesome proportions.

Weather Clutter Obscures Aircraft

How would you like to control aircraft with your radar scope cluttered by heavy weather as shown in Fig. 1 (left)? The appearance of such clutter on radar scopes has long been considered unavoidable and it is obvious why it is necessary to clear up the display so aircraft target data can be followed more efficiently.

Persistent engineering effort resulted in design improvements, called "fixes," which enable the air traffic controller to cut through some of the interference. Most field radars are now equipped with several of these fixes; circular polarized antennas that discriminate against the signals returned by spherical particulate matter, such as raindrops, and

logarithmic receivers with fast time constants to break up long clutter blocks.

A breakthrough in the problem of reducing weather returns appeared to have been made with the adoption of digital processing and narrow-band transmission of the radar video. The need to maintain low data rates on the telephone lines used to carry target information required stringent control of the false alarm rate, i.e., transmission of noise pulses as aircraft targets. The digitizer circuit that does this job is aptly referred to as an "automatic clutter eliminator."

The effectiveness of the clutter eliminator can best be judged by comparing the radar-scope photos shown in Fig. 1. Note that the radar signals on the time-correlated photograph of the digital display shown on the right are well defined symbols and that most of the dense clutter has been eliminated.

The Problem

It soon became evident that complete removal of weather clutter by the digitizer gave rise to an equally serious operational problem. The air traffic controller was no longer able to provide pilots with essential weather advisories based on his personal observation of the radar clutter, and it became exceedingly difficult to maneuver aircraft around potentially hazardous weather such as convective storms containing damaging hail.

Clearly there was a need to satisfy both requirements: provide a see-through-clutter capability at low data rates *without* a loss of information about the storm's location, general size, and movement.

The Solution

In attempting to answer this need, the Federal Aviation Administration worked with private industry to develop the weather-outline generator, a device that generates isoecho contours around the weather returns at any of

Fig. 1. Typical air traffic controller's radar PPI scopes showing (left) weather clutter interfering with identification of aircraft target data and (right) after removal of weather clutter by use of "automatic clutter eliminator."

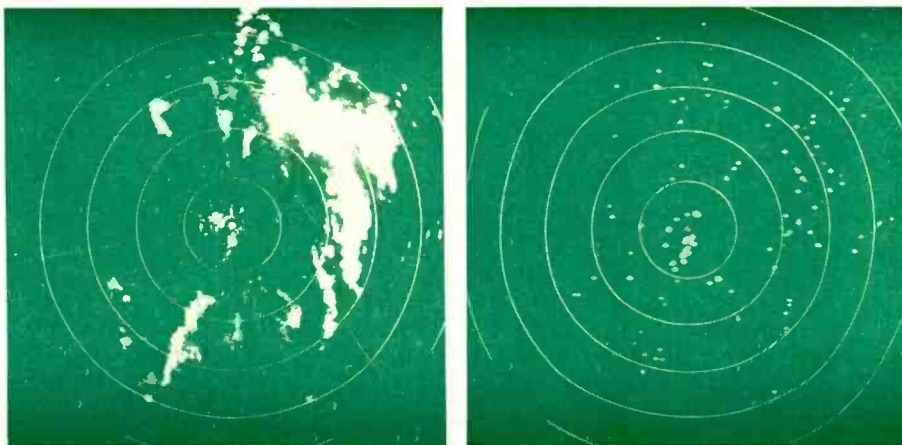

several preselected intensity levels. When coupled to the radar digitizer, the outlines are transmitted over the telephone lines along with aircraft identification and position data on a non-interfering basis.

With this additional input to his display, the controller can now see the storms picked up by his radar as sets of distinctive symbols outlining the precipitation areas.

System Description

Fig. 2 is a simplified block diagram of the weather-outline generator. The device computes a continuous voltage estimate of the mean reflected power returned from small incremental areas of the storm scanned by the radar beam and is derived by integrating the clutter signals over an area 1.0 nmi in range by eight radar triggers (approximately 0.8 degree) in azimuth. The estimate is computed in this manner to reduce the likelihood of targets or strobo-type interference being contoured as weather.

In range, the voltage is obtained by simply dividing the summed output of a tapped delay line by the number of taps. This produces a current sweep estimate of the mean clutter power received during the delay-line interval. Seventy-five percent of this voltage is then combined in another adder with 25 percent of the estimate computed for the previous sweep over the same range interval. The antenna has, of course, moved slightly during this period so that the resulting voltage represents the average clutter power received by the radar over the area bounded by both delay parameters; that is, the delay in range and azimuth. The weather outline points are generated from this voltage in threshold comparators, or slicers. Two slicers are presently used and they can be set to trigger at any level within the range of the system.

For best operation, the video input to the outline generator should be logarithmic with at least a 60-dB dynamic range to cover the intensity levels encountered in the strongest storms, and the radar fixes, used to reduce clutter, should be either turned off or bypassed.

Several refinements are incorporated to improve the integrity of the weather intensity estimate. Examples are the feedback loop that compensates for drift in the radar receiver's ambient noise level, and the swept-gain circuit, called the Sensitivity in Range Control (SRC), that corrects for the decrease in received signal power as a function of range. The SRC is needed because the echo power from precipitation varies as the inverse square of the range. If this correction were not applied, a close-in storm of low intensity would appear as strong as more severe weather farther away.

Performance

The prototype outline generator was tested at the FAA's National Aviation Facilities Experimental Center near Atlantic City, New Jersey and far surpassed the original performance requirements. Not only did the system effectively outline the periphery of storms (photo on right of lead figure), it probed deeply into the clutter to define the stronger, more dangerous cells. This now provides a capability the controller did not have with his conventional display because of its narrow dynamic range.

Fig. 3 demonstrates the ability of the system to look into the heart of a storm. The weather activity portrayed consisted of widespread rain showers containing a small, yet dangerous tornado. The picture on the right is what the controller would normally see on his display scope. Note that it is impossible to discern the tornado from the relatively harmless rain that surrounds it. A picture of the outline generator output after transmission over the telephone lines is on the left. The outer edges of the storm were outlined by the series of dots, while the heavier, more dangerous cells were indicated by the "x" symbols. The location of the tornado was clearly displayed to the controller.

A production contract has been issued for procurement of equipment incorporating improvements in the original design. For example, the long time delay used to store the clutter power estimates from sweep-to-sweep was accomplished in a range-ordered core memory, which will now be done by less expensive shift registers. All of the mathematical operations in the prototype were performed by analog circuits; the new system is a hybrid that uses both analog and digital processing to best advantage.

Constructed with integrated circuits, the production unit will be housed within a 21" x 25" x 30" cabinet. As the equipment comes off the line, it will be included in the FAA's semi-automated air traffic control systems now being installed at high-density Air Route Traffic Control Centers around the country.

The development of the weather-outline generator is a good example of how the FAA continuously improves the electronic systems used by the air traffic controller to keep aircraft moving safely along the busy airways. ▲

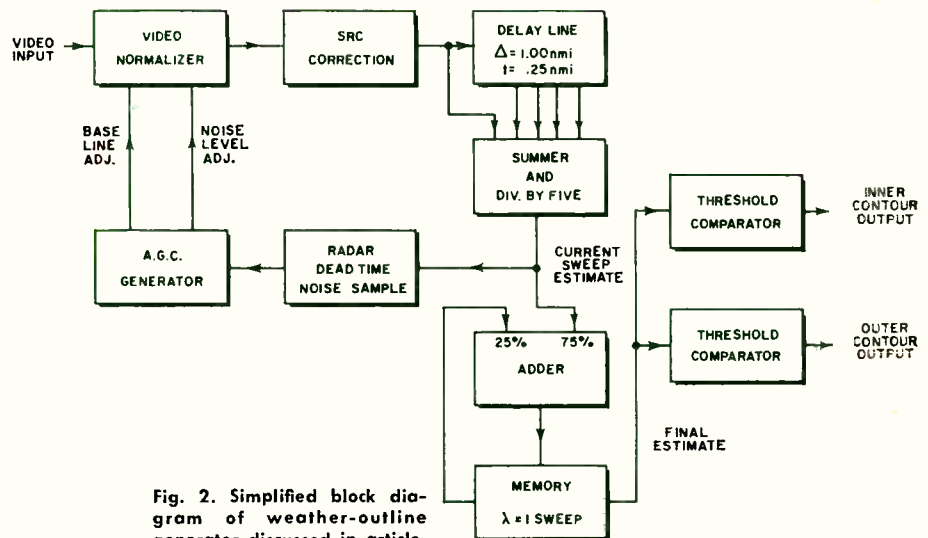
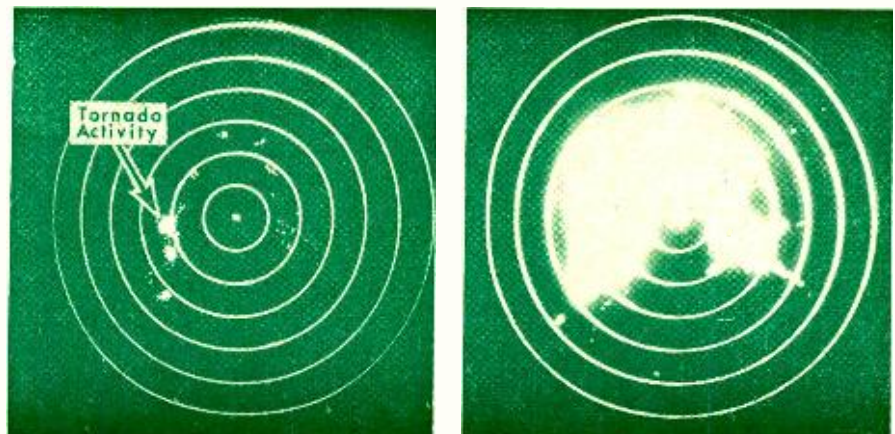

Fig. 2. Simplified block diagram of weather-outline generator discussed in article.

Fig. 3. Comparison of (left) digitized and (right) conventional wide-band radar display responses to tornado activity.



INTEGRATED CIRCUIT MEMORIES

Growth and Future (Part 2)

By DALE MRAZEK
National Semiconductor Corp.

New assembly methods and anticipated technological advances paint a bright picture for the IC memory market—and especially for bipolar devices.

LAST month, Part 1 of this article described the read-write and read-only (ROM) memory IC's being developed for the computer memory field and the bipolar and MOS technologies used in producing them. This month we will describe the use of IC memories in such applications as scratchpad memories and shift registers and how, through circuit innovations, larger and faster storage memory arrays can be arranged. In addition, considering present design trends, the future of IC memories will be examined.

Bipolar Scratchpads

The high cost of bipolar memory IC's limits their applications at present. One notable exception is found in bipolar scratchpads, which began replacing small, magnetic-film memories in computer main frames more than three years ago. Some scratchpad IC's are also used as registers and *vice versa*.

State-of-the-art in bipolar scratchpads is a capacity of 16 bits and a cycle time of 100 ns. Bipolar registers, designed as storage building blocks, typically attain a data rate of 25 MHz, while dissipating about 35 mW per bit. However, many designers still prefer to use standard TTL quad latches in these applications.

The bipolar scratchpad IC's generally contain set/reset flip-flops as the storage cells. One popular cell design, shown in Fig. 1, top, looks simple, but took a few years to produce

reliably. Until recently, IC developers called it the "forgetter" because of its tendency to change state randomly. Although the example of the storage cell shown in Fig. 1, bottom, appears more complex than the "forgetter," it is still being produced four years after its inception and is located on one of the few bipolar scratchpad IC's that contains an integral decoding network.

This type of scratchpad design was originally made for *Scientific Data Systems' Sigma 7* computers, and has been used to build registers and scratchpads containing up to 4096 bits. These storage cells have four applications in the Sigma 7 computer: (1) general registers that speed up the central processing unit's response to interrupt requests, (2) main-memory mapping, (3) key and lock storage for memory protection, and (4) input-output channel buffers. With external comparator logic to identify stored data by a key-word matching technique, the chip can also be used as a content-addressable (CAM) building block.

A representative 16-bit scratchpad array that is used to form larger arrays is shown in Fig. 2. Some manufacturers are assembling the multi-array planes as hybrid IC's; for

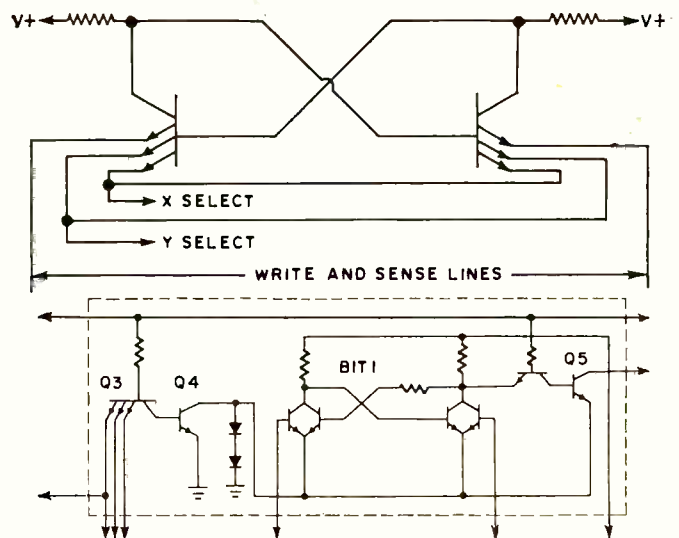
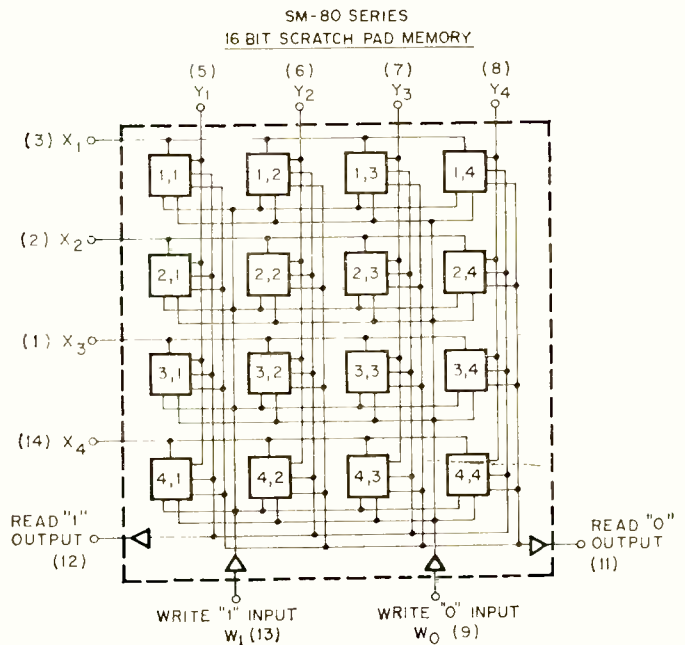

Fig. 1. (Top) Typical bipolar read-write, random-access set/reset flip-flop storage cell used in high-speed scratchpad IC's and (bottom) storage cell used on one of the few bipolar scratchpad/register IC's also containing decoder network.

Fig. 2. Sylvania's 16-bit bipolar scratchpad memory array.



example, eight 16-bit chips would be used to make a 128-bit hybrid IC. A typical hybrid IC is about an inch square and can cycle somewhat faster than 100 ns due to shorter lead lengths. The hybrids are an interim step between the 16-bit blocks and the large bipolar arrays of 32 and 64 bits that are being developed with LSI techniques.

In contrast, MOS monolithic scratchpads storing 64 bits do not utilize the present capabilities of MOS technology economically. Monolithic 256-bit MOS scratchpads will soon be in production and will feature random-access read-write, nondestructive readout, multiple-package decoding on the chip, operating rates of 4 MHz, and input-output compatibility with bipolar logic.

Fig. 3 outlines the configuration of such a scratchpad designed to go into a 16-pin package that will be faster than ferrite-core scratchpads, cost less to build, and be more efficient volumetrically. Alternate configurations include storage of 256 1-bit words with the pin arrangements shown, 128 2-bit words, and 64 4-bit words.

MOS Shift Registers

MOS shift registers are the semiconductor equivalent of delay lines and can also be used as drum-type memories. These applications generally demand high capacity (several thousand bits of serial storage per chip) but not necessarily high speed. MOS registers with up to 512 storage stages are now being produced, compared with the bipolar maximum of 16 bits.

The main advantage that shift registers have over conventional delay lines in storage applications is clock control. Other advantages include elimination of transducers, amplifiers, and electromechanical drives, thereby reducing system "overhead" costs, and relatively low power dissipation. At present, the capacity at which it is cheaper to use MOS registers is several thousand bits in delay-line applications and about 200,000 bits in drum-memory applications.

Since shift rates are clock-controlled, storage or delay time is electrically variable. This feature may be used to synchronize parallel delay lines or drum-memory channels, to read in at low speed and read out at high speed in buffering applications, to reduce clock rates and conserve power between accumulator read-in and read-out operations, and to independently vary the times in delay-line segments. At minimum clock rates, average power dissipation in the range of a microwatt per bit can be achieved with MOS dynamic registers.

Words stored in a shift register or accumulator may be selected by applying a time address to the output control or by the CAM key-match technique. Words can be read out sequentially from a channel in a drum-type system (Fig. 4A) or a few channels can be organized to present word bits in parallel. The TTL/MOS multiplexing technique shown in Fig. 4B multiplies the apparent speed of the MOS registers and achieves very high data rates. The speed record for this type of system appears to be 50 MHz, which *American Astrionics* reportedly achieved in a hybrid MOS/TTL IC, using specially designed shift registers.

A recirculation, or data-feedback, loop is generally used to obtain long-term storage. Several examples of register recirculation controls are: external TTL control gates (Fig. 5A), a 4-MHz accumulator with internal MOS controls (Fig. 5B), and a 3-register chip with internal controls (Fig. 5C). The taps at the 60th-bit positions (Fig. 5C) enable external bipolar logic IC's to make logi-

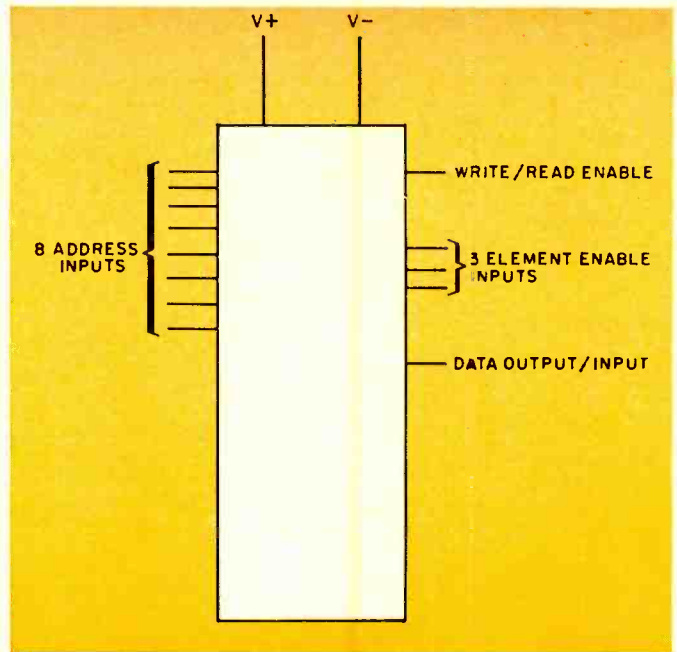

Fig. 3. Configuration of 256-bit, 16-pin package MOS scratchpad that is faster and less expensive than core scratchpads.

cal corrections to the data in four clock periods without retarding the recirculation flow.

The two generic types of MOS registers are static and dynamic. The storage cells of static types are latching circuits that will retain data while the clock is stopped, while dynamic registers must be clocked at some minimum frequency. The dynamic registers depend upon charge storage for data retention. If the clock is stopped, the charge will dissipate as leakage current, in a time that varies with temperature. Low-leakage types can be clocked as slowly as 100 Hz at room temperature. Standard dynamic registers are clocked with a two-phase signal, as in Fig. 1 (Part 1), and standard static registers take a single-phase clock and generate complementary clocks internally.

The main thrust of bipolar LSI development is aimed at the enormous computer memory market that is still dominated by cores, chiefly computer main memories. LSI is expected to increase bipolar IC capacity to 64 bits in the near future and to as much as 256 bits in the mid-1970's. Bipolar ROM's with capacities of 512 bits and content-addressable building blocks with capacities of 8 bits are also in development.

Fig. 4. (A) Drum-type register, built with shift registers, permits words to be read out sequentially from the selected channel. MOS switches at left of register control data read-in and recirculation. (B) Multiplexing data into parallel MOS storage registers multiplies the effective shift rate. With four channels, four times the normal MOS rate can be had if bipolar elements are used for control logic.

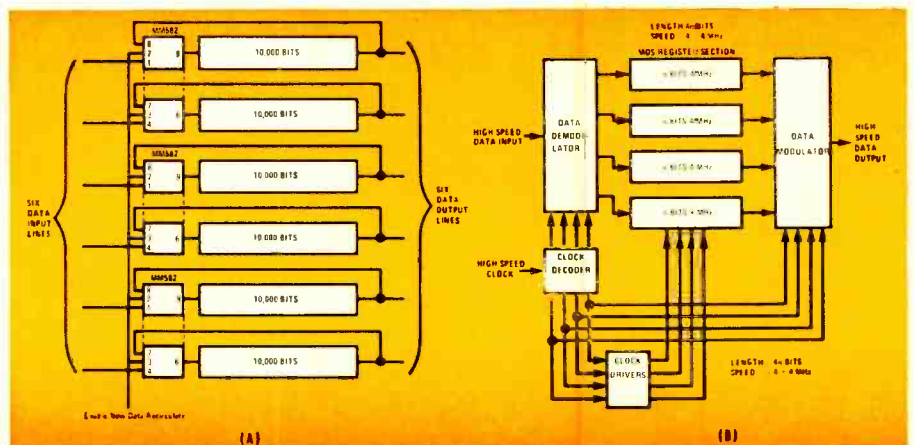

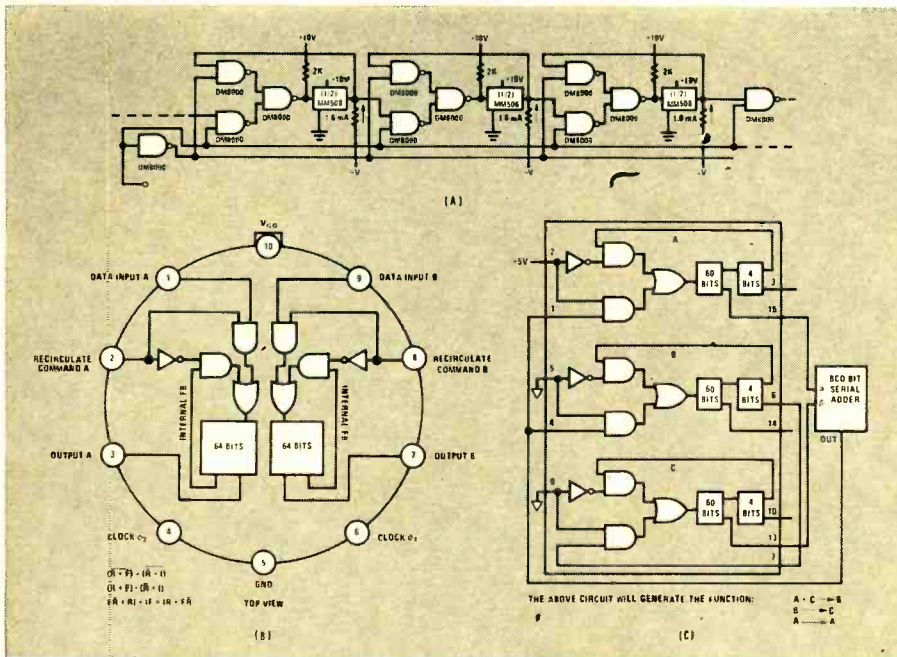

Fig. 5. Examples of recirculation loops. (A) TTL controlled high-speed segmented delay line, (B) dual accumulator with internal MOS controls, and (C) triple-shift register with internal controls for electronic calculators. Data can be corrected by external bipolar logic during the 61-64th bit intervals and re-inserted in loop without changing shift rate.

Considerably higher capacities and lower costs can be expected from the *p*-channel or *p*-MOS process in ROM's, registers, and medium-speed, read-write RAM's. A process known as C-MOS, using complementary *n*-channel and *p*-channel storage devices (Fig. 6A), looks promising for high-speed, low-power scratchpads. RCA, which has been developing this process under an Air Force contract, reports cycle times of 100 ns with standby power dissipation in the nanowatt range. However, C-MOS densities are low compared with *p*-MOS (see table in Fig. 6), and the larger number of packages required limits speed to about 250 ns

core proponents hope to cut their costs in half in the 1970's. If that happens, it may be a very slow phaseout. However, cores are not the only competition on the horizon, since developers of thin-film, sonic-film, cryoelectric and optoelectronic memories are also competing with core memories as far as performance and cost are concerned.

No significantly new semiconductor process has been developed for several years. LSI, whether MOS or bipolar, is an extension of earlier techniques, made possible by improvements in masking optics and other processing methods and equipment. Increases in producible (Continued on page 63)

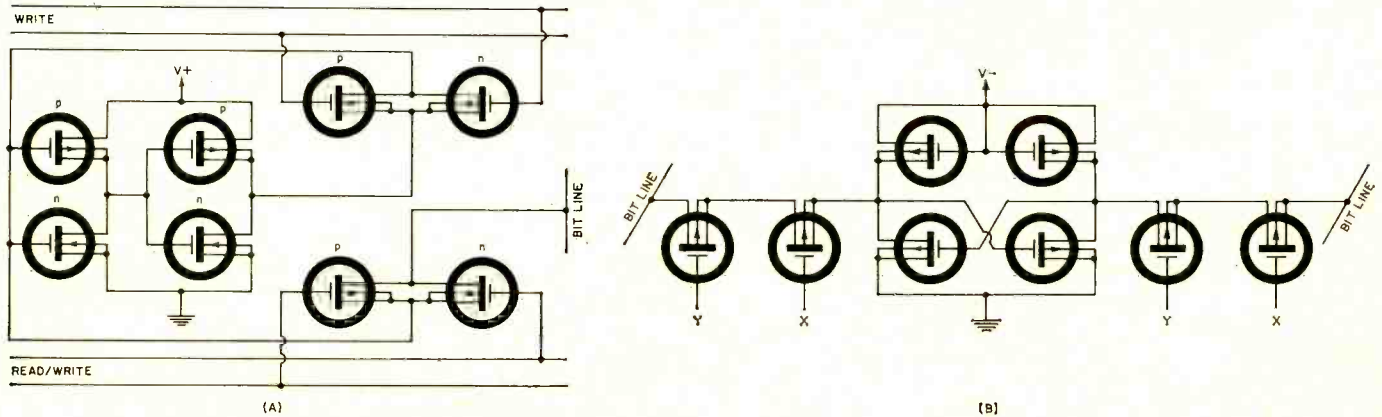
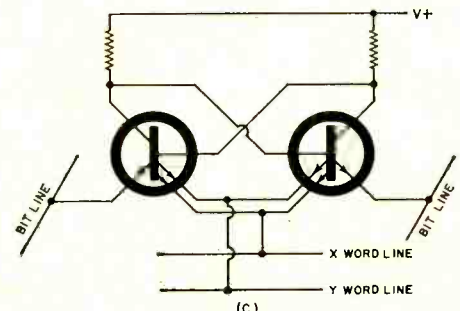

Fig. 6. Anticipated future LSI memory characteristics and schematics of the (A) C-MOS, (B) p-MOS, and (C) bipolar storage cells used in laboratories today to develop IC memories that will be competitive with ferrite core and other memory devices as far as performance and cost are concerned.

TECHNOLOGY	CELL AREA (sq. mils)	SPEED (ns)	POWER (Cell only, mW)	TYPICAL CELL
C-MOS	80	200	10 ⁻¹⁰	Fig. 6A
P-MOS	15	250	0.01	Fig. 6B
Bipolar	10	100	0.5	Fig. 6C





The author joined E.F. Johnson Co. in 1966 and in his present position is responsible for all development engineering pertaining to the entire component line. From 1962 to 1966, he was associated with General Electric Co.'s General Purpose Control Dept. He received his BSME degree from the University of Nebraska in 1962 and an MSME from Bradley University in 1965. He will complete requirements for an MBA degree at Mankato State College this June. He holds patents in capacitor, connector, and switch devices. He is a registered professional engineer in Minnesota and Illinois.

Air-Dielectric Trimmers

By JACK L. BOWEN / Manager, Component Development, E.F. Johnson Co.

Relatively small size, top performance, and low cost are main features of the air-dielectric, plate-type trimmer described. Here is what must be known in order to specify such trimmers.

AIR trimmer capacitors are among the most popular trimmers due to the very favorable trade-off between cost and performance compared to solid-dielectric trimmers. Air trimmers are used in countless circuit applications. A few basic, specific examples are: tank circuits, filters, stable oscillators, helical resonators, and attenuators. These circuits are frequently used by manufacturers of communications equipment, such as business and personal two-way radio and aircraft transceivers. Manufacturers of such test equipment as oscilloscopes and counters, as well as medical electronics gear, also utilize these trimmers.

Some confusion exists between the terms "air trimmer" and "air tuner." Most manufacturers agree that tuner capacitors exhibit a rotational life in excess of 1000 tuning cycles while air trimmers most frequently exhibit rotational lives between 250 and 1000 tuning cycles. A tuning cycle is defined as 180 degrees rotor rotation in one direction and a corresponding 180-degree rotation back to its original position. Air trimmers are typically used inside equipment to peak or null a circuit and generally are not readjusted except for equipment calibration or repair. Tuner capacitors are typically used where frequent capacitance variation is required. Tuner capacitors are usually supplied to a straight-line-frequency or straight-line-wavelength tuning curve, while trimmers are commonly straight-line-capacitance devices (see Fig. 1).

Air trimmers can be categorized by construction, performance, mounting, and size. They range in price from one of the very lowest priced trimmers to one of the very highest priced trimmers. All have two features in common: (1) all use air as the primary dielectric, and (2) all require supporting members to position the rotor and stator. Because of these two features, we are faced with certain limitations.

The basic equation for the capacitance between two flat plates with air as the dielectric is: $C = 0.0085KA/t$ where C = capacitance in pF, K = dielectric constant (for air, $K = 1$), A = facing area in cm^2 , and t = distance between plates, in cm.

As you can see, capacitance of an air trimmer can be increased only by using more plate area or by decreasing

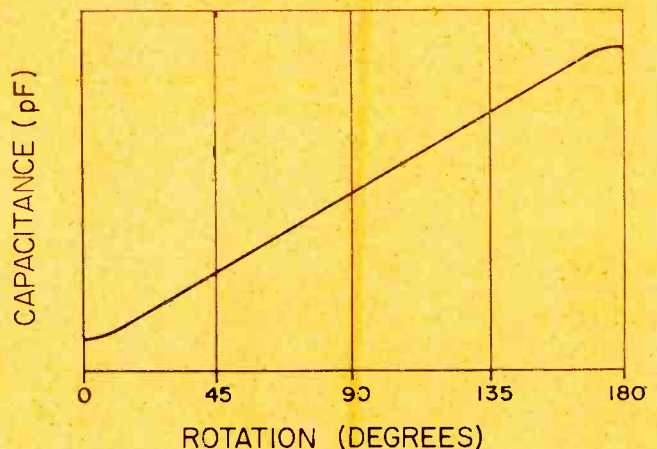
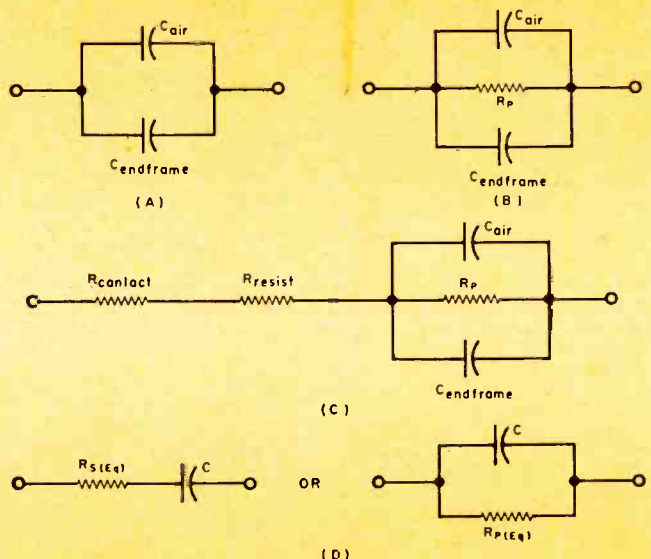

Fig. 1. Normal air trimmer tuning curve shows a capacitance variation that is linear with degrees rotation.

Fig. 2. Equivalent circuits of air trimmer capacitors.



DIELECTRIC MATERIAL	DISSIPATION FACTOR (at 1 MHz, 25°C)
Air	0.0000
Teflon	0.0002
Quartz	0.0002
High Alumina (95%)	0.0003
Steatite Grade L-5	0.0020

Table 1. Dissipation factors of some common dielectrics.

the plate spacing. Of course, as the spacing is decreased, the breakdown voltage decreases proportionally. Obviously, as the trimmer size decreases, capacitance values and/or voltage breakdown values must decrease. Certain capacitor configurations make more efficient use of the volume required. These configurations will be discussed later.

All air trimmers are, in reality, a composite of two capacitors; the air capacitor plus a solid-dielectric capacitor whose characteristics reflect the properties of the capacitor supporting member(s) or endframe. The endframe characteristics are important because the equivalent capacitor appears as shown in Fig. 2A.

If the capacitance through the endframe represents a significant percentage of the total capacitance, the resulting capacitor may be appreciably degraded in operating characteristics from the anticipated air-dielectric capacitor.

As an example, let's consider capacitor "Q," temperature coefficient (TC), and humidity performance. The "Q" of a capacitor is defined as the *cotangent* of the loss angle and is generally considered to be better as its value approaches infinity. The "Q" value, also known as the "quality factor" may also be defined as follows: $Q = 1/DF = R_p/X_C = X_C/R_s$ where: DF = dissipation factor of the capacitor dielectric, R_p = equivalent parallel resistance, R_s = equivalent series resistance, and X_C = capacitive reactance.

Thus, we see that a low dissipation factor dielectric will yield a high-"Q" capacitor. Table 1 lists dissipation factors of common capacitor dielectrics and endframe materials. As can be seen from this table, any endframe material will degrade the "Q" of an air trimmer and it must be considered when selecting a high-"Q" air trimmer. Additionally, most dielectrics exhibit different dielectric constants (K) at various temperatures. If the endframe K varies with temperature, then its TC will also vary.

Steatite and alumina ceramics are porous materials which will take on moisture unless they are treated. "Q" and voltage breakdown may be appreciably degraded upon exposure to moisture if the endframes are not treated. The most common ceramic treatment is a fired silicon process which performs adequately in most situations. Some manufacturers glaze the ceramic to achieve the same goal.

An equivalent circuit of an air trimmer which reflects endframe losses can now be represented as in Fig. 2B.

We have shown that an air trimmer necessarily falls a

Table 2. Various types of air trimmer capacitors along with applications and their maximum performance characteristics.

Air Trimmer Capacitor	MIL-Spec Number	Typical Application	Relative Cost Range	Typ. Max. Cap. (pF)	Typ. Max. Volt. Rat. (V d.c.)	Relative Size	Current-Carrying Cap.	Typ. Nom. TC (ppm/°C)
Soldered plate	MIL-C-92A, Styles CT04, CT06, CT12, CT13, CT14, CT15	Used in low to med.-power transmitter tuning, loading, and matching networks. Can be used in oscillators, resonators, attenuators, and filters.	Medium	5-200	4500	Medium	Low-medium	0-100
Staked plate	MIL-C-92A, Styles CT06, CT12, CT13, CT14, CT15	Used in high-power transmitter tuning, loading, and matching networks.	Medium	5-200	4500	Medium	High	0-100
Bolted plate	none applicable	Used in very high power r.f. generating equipment and in transmitter tuning, loading, and matching networks. Good at high temp.	Medium-high	25-1000	13,000	Large	Very high	100
Milled plate	MIL-C-92A, Style CT16	Used in low-power circuitry where low cost, high "Q," small size, and stability are most important. Examples include oscillators, resonators, attenuators, and filters.	Low	5-60	1000	Small	Low-medium	34-45
Concentric ring	none applicable	Used due to low inductance, low TC and high "Q." Applications in microwave receivers and v.h.f.-u.h.f. communications equipment.	Medium-high	5-60	1000	Very small	Low	0

NOTES: Ratings represent maximum available for a given design type and may not
 *Mountings: 1 = PC board; 2 = Panel mounting; 3 = Chassis mounting

little bit short of a perfect capacitor due to losses in the supporting endframe. Let's now look at the balance of the device. Since the trimmer is a variable capacitor, it must also have a sliding contact between the rotor and the rotor connection. This contact necessarily has some finite resistance and therefore appears as a series resistance to the total capacitor, thus further reducing "Q." Another resistance, that being inherent in the resistivity of the conductors themselves, adds still another series resistance. The air trimmer total equivalent circuit thus appears as in Fig. 2C. The equivalent circuit may be shown as in Fig. 2D, where: $R_{S(EQ)}$ = total equivalent series resistance and $R_{P(EQ)}$ = total equivalent parallel resistance.

Through the use of a nearly lossless primary dielectric, an air trimmer which is functionally designed will naturally exhibit better and more stable "Q" and TC characteristics than solid-dielectric trimmers.

Many circuits require the use of air trimmers at u.h.f. and higher frequencies where the inductance of the capacitor leads may become critical. Both the resonant frequency of the capacitor and the "Q" at high frequencies are very important. The length of the conductors, plating materials, and endframe materials are all important in determining high-frequency trimmer characteristics. Units particularly well suited for high frequencies include the concentric-ring (Fig. 3) and the milled-plate designs (Fig. 4) which utilize low-loss endframes and short terminals.

"Q" measurements are very difficult to obtain at frequencies beyond 250 MHz. No standard "Q"-meter is

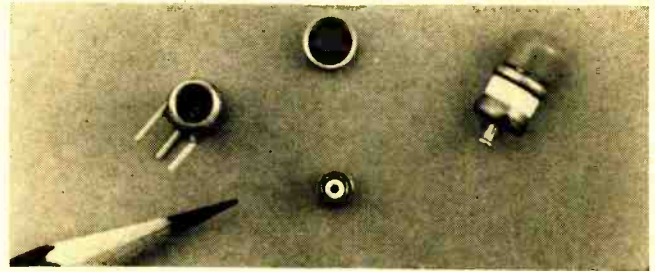

Fig. 3. Concentric-ring air trimmer capacitor is shown disassembled. Glazed ceramic and multiple rotor contacts are used in this device in order to keep losses very low.

available for measurement at these frequencies but many users obtain an indication of "Q" by looking at the relative bandwidth of a resonator or by looking at the insertion loss of a unit. Network analyzers are also used to obtain "Q" comparisons at high frequencies.

Capacitor manufacturers publish data based upon readings taken on either the *Boonton Radio 190A* "Q"-meter or a *Boonton Electronics 75-series* capacitance bridge. The "Q"-meter has a variable frequency feature which allows "Q" measurements up to 250 MHz with appropriate working coils. The capacitance bridge is a highly accurate device but its frequency is fixed at 1 MHz.

A need exists for equipment to accurately measure capacitor "Q" up to and beyond 1 GHz. Today, performance data beyond 250 MHz must be extrapolated from lower frequency data. The circuit designer has one bench mark in the fact that all trimmers exhibit lower "Q" with increasing frequency as is shown in Fig. 5. If "Q" is critical at high frequencies, a trimmer must be selected which exhibits high "Q" at lower frequencies.

Outstanding Features

The outstanding features of the air trimmer are high "Q," great stability, and low cost. Other features include their consistency of capacitance, "Q," and TC from lot to lot and from year to year. The typical temperature-coefficient curve (Fig. 6) shows excellent retrace and a nearly constant value for TC throughout the temperature range. Fig. 7 shows a common TC characteristic exhibited by solid-dielectric capacitors. However, TC is not readily modified in air trimmers and a negative TC is nearly impossible to obtain due to the growth of the meshing plates with increasing temperature. Typical air trimmer TC's range from zero ± 10 ppm/ $^{\circ}$ C for units manufactured with Invar plates or tubes to about $+100 \pm 20$ ppm/ $^{\circ}$ C. Negative temperature coefficients can be obtained only through the use of special endframe materials or by the use of one or more bimetal plates.

An obvious limitation to air trimmers is the direct dependence of voltage breakdown upon physical size. Air trimmers are susceptible to reduced voltage breakdown in reduced pressure or in extremely "dirty" environments. Sealed versions, of course, do not have these shortcomings.

Regular and Special Types

Air trimmers are typically constructed by one of the following methods: soldered plate, staked plate, bolted plate, milled plate, or concentric ring (press fit or soldered tubes, impact extrusions or castings).

Table 2 lists the characteristics and applications of each type trimmer. Each type is best suited for a particular application. Table 2 should serve as a guide in the selection of an air trimmer. The milled-plate units are one of the newer configurations and are one of the best low-cost, high-performance small air trimmers available.

The milled-plate devices eliminate loose plates and offer sturdy, one-piece, current-carrying elements which are suitable at high frequencies. The concentric-ring devices

Typ. "Q" at 1 MHz	Typical Plating	Mounting Avail.*	Tuning Resolution
10,000	Nickel	1,2,3	Medium
7000	Nickel	1,2,3	Medium
4000	Unplated aluminum plates	2,3	Coarse
20,000	Silver	1,2,3	Fine
20,000	Gold	1,2,3	Extra fine

*agree with a particular manufacturer's standard devices.

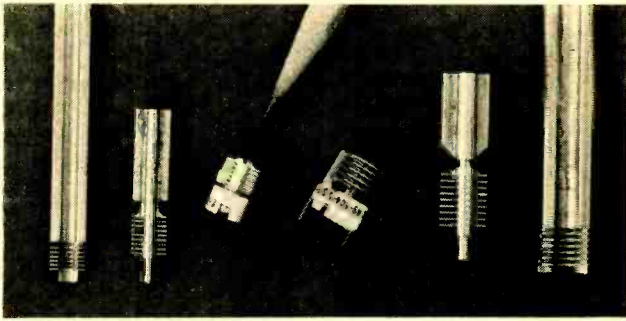

Fig. 4. Milled-plate air trimmer capacitors are shown with their respective brass rotor and stator extrusions. These units are especially suited for high frequencies.

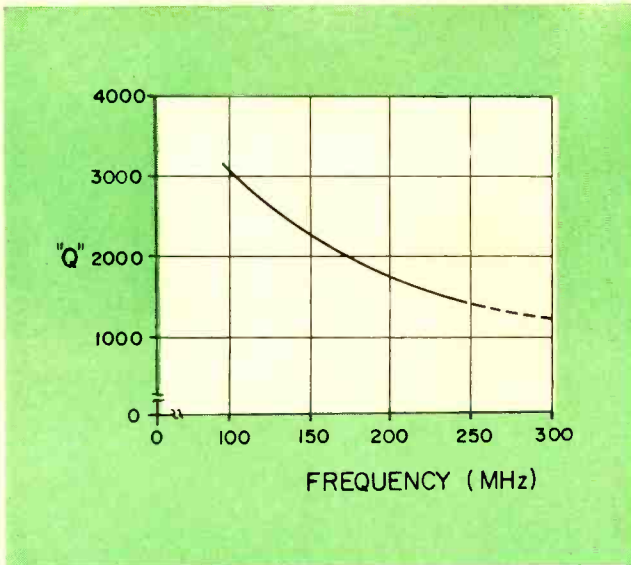

Fig. 5. Typical air-trimmer "Q" versus frequency. Above 250 MHz data must be extrapolated from lower frequencies.

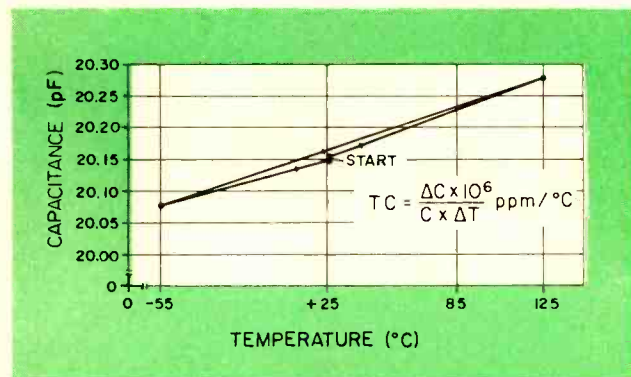

Fig. 6. Capacitance vs temperature of milled-plate trimmer. The temperature coefficient is approximately +50 ppm/°C.

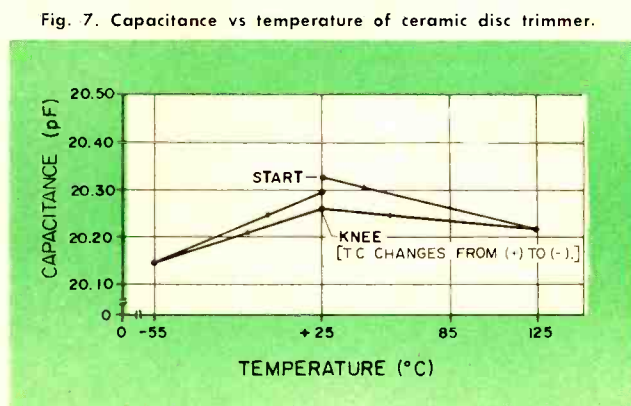

Fig. 7. Capacitance vs temperature of ceramic disc trimmer.

offer the shortest lead length and are most suitable at very high frequencies where cost is secondary to performance.

As can be seen from Table 2, each trimmer style has its outstanding characteristics. The user must first decide what capacitance is required, what "Q" is needed, and then decide which type trimmer he should use. The five types of units available have overlapping capacitance ranges and often share both desirable and undesirable features.

Variable capacitor manufacturers are conditioned to the needs of the user and consequently make available numerous special configurations upon request. For example, Fig. 8 shows a miniature low-cost tank circuit that can be supplied. Special terminations, plating, torque, voltage ratings, and capacitance ranges are frequently supplied to volume users of air trimmers. Low-torque trimmers utilizing ball bearings are frequently used to lengthen the rotational life and reduce tuning torque. Special plate shapes may be supplied to produce special tuning curves. Special terminal temper is often supplied to allow a user to stake-over the printed-circuit type terminals prior to wave soldering. This staking permits the PC board to be turned over without allowing the trimmer to fall off the board.

Selection and Specification

Selection and specification of a standard catalogue air trimmer will save the user both time and money. Selection should begin with a list of *required* performance specifications. A wise applications engineer will insist on guaranteed ranges but will not select ranges beyond those specified by the circuit designer. Also, the use of a fixed padder in series or parallel with the trimmer should be considered if it can result in the utilization of a lower cost or a more standard trimmer. Let's now assume that we need to specify a trimmer. What do we need to know? A list of characteristics must be prepared defining:

1. Cost
2. Capacitance range (maximum minimum and minimum maximum)
3. "Q" required (minimum value at 1 MHz)
4. Voltage rating required (use safety factors to de-rate for contamination, moisture, or altitude)
5. Rotational life (torque)
6. Resolution of tuning
7. Space available
8. Temperature coefficient and drift characteristics
9. Environmental conditions

In order to limit our problem, let's assume that we have decided to use an air trimmer because of its stability, "Q," cost, or other reasons. However, certain characteristics do not complement each other. For instance, a high capacitance and high voltage breakdown cannot both be offered in a small space. In other words, in a given space, additional capacitance in a given style trimmer can be obtained only at the cost of decreased voltage rating. Some style trimmers, however, offer a more efficient use of space (see Fig. 3) but will cost appreciably more than a unit such as the capacitor shown in Fig. 4.

Capacitor "Q" is largely dependent upon endframe and plating materials. When used at frequencies above 100 MHz, look for multiple rotor contacts, silver or gold plating, and low-loss high alumina endframes. Measurement of capacitance and "Q" in a shielded enclosure on a *Boonton Electronics* capacitance bridge is recommended for establishing and correlating vendor-user capacitance and "Q" readings.

Rotational life of air trimmers is usually 250 to 1000 cycles. A longer life can be offered at a premium price by using ball bearings in standard trimmers. The torque of trimmer capacitors usually ranges from 1 to 10 ounce-inches to enhance the mechanical stability of the capacitance setting. Most manufacturers test their air trimmers

for vibration and for shock according to MIL-Std-202C.

Resolution of tuning is important to some users. A higher degree of resolution indicates more degrees of rotation are required for a given change in capacitance. The concentric-ring construction offers a high degree of resolution.

Space availability often determines which type trimmer should be used. Small size does not necessarily mean high cost as can be seen in Table 2. The applications engineer must carefully weigh *all* criteria before selecting a capacitor.

Temperature coefficients of air trimmers can be selected with a high degree of confidence. A zero TC (0 ± 15 ppm/ $^{\circ}\text{C}$) trimmer can be obtained by use of Invar tubes in the concentric-ring design. Small positive TC values such as 35 ± 15 ppm/ $^{\circ}\text{C}$ are available in milled-plate devices. This TC merely reflects the coefficient of linear expansion of the brass rotors and stators used in their construction. Larger air trimmers offer a TC of up to $+100 \pm 20$ ppm/ $^{\circ}\text{C}$ but, as can be seen by tight tolerance, these trimmers are extremely consistent. Air trimmers, as a family, offer excellent retrace of capacitance and exhibit very little drift upon temperature and/or humidity cycling. The use of poor endframe materials will, however, induce unwanted variations.

Environmental conditions place one of the most important limitations upon the use of air trimmers. Let's look at the three most important environmental factors: 1. temperature, 2. pressure (altitude), and 3. humidity.

Air trimmers are most commonly constructed by soldering the stator to the endframe with a standard 60-40 solder. The typical maximum temperature rating of such devices is 125°C to 140°C . This is not an ambient rating but a total temperature rating of the capacitor itself. Most manufacturers will supply identical devices with high temperature solder (H-T) which will boost the operating temperature allowed to as high as 200°C . These temperatures must not be exceeded and extreme thermal shock should be avoided.

Air trimmers which are not sealed must be de-rated for use at high altitudes. As an example, the atmospheric pressure at 50,000 feet is 3.4 inches of mercury and a typical milled-plate trimmer will break down at 50% of its sea-level d.c. breakdown voltage.

Humidity will affect air trimmers if condensation develops on the endframe or on the capacitor plates. The effect of a severe humidity condition will be to lower "Q" and voltage breakdown and raise capacitance of the trimmer. Typical air trimmers exhibit less than 1% change in capacitance and not more than 20% reduction in "Q" and

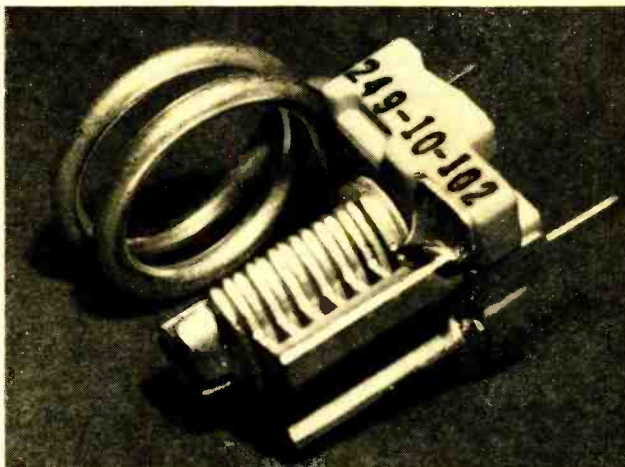

Fig. 8. Miniature low-cost tank circuits can be supplied.

voltage breakdown after 24 hours at 60°C and 95% RH (relative humidity). In general, this performance is far superior to that of solid-dielectric devices.

The applications engineer must use judgment in specifying an air trimmer. He must specify measurable quantities and the specified characteristics must allow for required manufacturing tolerances. An air trimmer specification should spell out at least the following characteristics:

1. Guaranteed minimum capacitance
2. Guaranteed maximum capacitance
3. Voltage breakdown (d.c.) at sea level
4. Minimum and maximum torque
5. Maximum physical dimensions
6. Mounting and/or terminal dimensions
7. "Q" minimum at 1 MHz
8. Type plating on all metal parts
9. Endframe material and treatment (if required)
10. Maximum and minimum TC
11. Solder type or maximum temperature of application
12. Acceptable supplier

Selection of the particular trimmer to be used must depend upon the relative importance of the various characteristics. Each application must be completely analyzed and the optimum trade-off of features must be established prior to the selection of the air trimmer. The ultimate trimmer selection must represent the best compromise of characteristics and cost for each individual application.

Many manufacturers offer sample kits and display boards to aid the applications engineer in his ultimate trimmer decision. ▲

POLYSTYRENE TRIMMER CAPACITORS

BECAUSE of its excellent dielectric properties, polystyrene has been used in a variety of capacitor applications. One of these is in trimmer capacitors.

Polystyrene trimmers are available in both disc and tubular forms

Two styles of polystyrene trimmer capacitors.

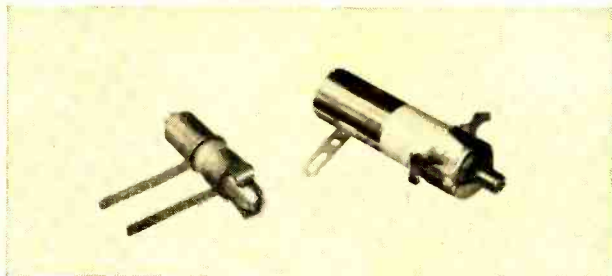

and are generally rated at 75°C (167°F) maximum temperature. Above this temperature the plastic softens enough to cause physical movement of any parts under stress. This thermal creep can cause a change in capacitance as well as possible mechanical failure.

With the low dielectric constant of 2.1, the capacitance ranges of polystyrene trimmers are low. Maximum capacitance of 8 pF is typical. The trimmers do exhibit excellent "Q," 1000 minimum, and good temperature coefficient. Polystyrene trimmers are economical capacitors intended for high-frequency applications. Typical price range for these trimmers is 10¢ to 15¢ each.

Soldering and cleaning operations are critical when using polystyrene trimmers. Because of the low temperature rating, these parts should be soldered using a very hot soldering iron. The heat can be transferred to the joint quickly and then removed before the trimmer itself reaches a temperature hot enough to cause damage. Also, since some solvents may dissolve the polystyrene, tests should be made on samples to determine their solvent resistance. ▲

The author received his B.S.E.E. and B.S.Ch.E. from Purdue University and from 1959 to 1966 served Erie Technological Products in various engineering capacities. Prior to that he was sales manager for Irvin Aaron Associates, and from 1949 to 1957 he served as assistant sales manager of the Centralab Division of Globe-Union. He is a member of IEEE and is the Chairman of the Ceramic Glass & Vitreous Capacitor Section, Parts Division, of the Electronic Industries Association.



Ceramic Tubular Trimmer Capacitors

By WILLIAM G. TUSCANY / Manager, Applications Engineering, Centralab Electronics Div., Globe-Union Inc.

Where reliable, low-cost capacitance trimming is required, the ceramic tubular meets the need. Information is included on ceramic dielectrics for both fixed and variable capacitors.

IN the early 1930's a salesman from one of the ceramic supply houses had the foresight to realize the potential that could be developed for a new barium titanate ceramic material which he had heard about from component activity in Germany. This material could provide what in those days was high capacitance for a given size and at very reasonable cost. Soon two manufacturers in the United States started to use this material in fixed disc and tubular capacitors. From these meager beginnings, the ceramic capacitor industry has grown by leaps and bounds.

At the time the first material was used, little was known of its electrical characteristics. After application experi-

	THREAD	A	B
MOUNTING DETAIL	# 6-32	.152"	.225"
	# 4-36	.126"	.190"

Tolerances $\pm .005$ " Unless Otherwise Specified

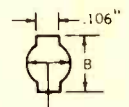
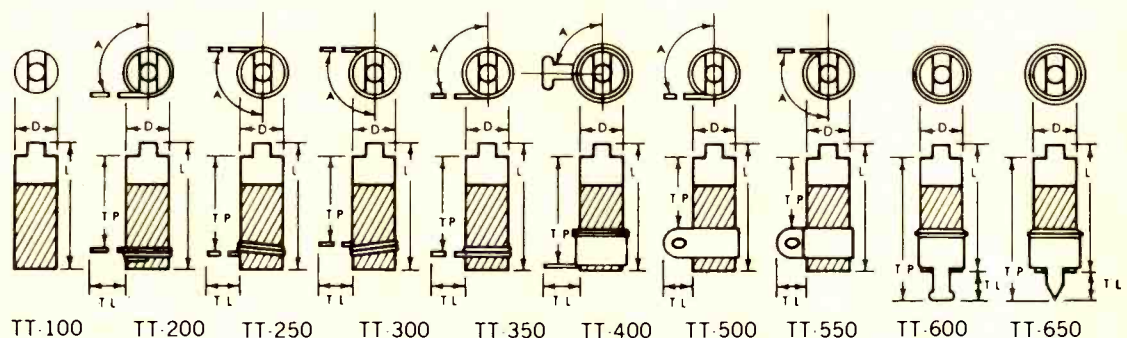

Fig. 1. Mounting-hole dimensions for tubular trimmers.

ence, it was found that it had definite and predictable temperature characteristics. This material evolved into what is now known as the N750 body, one of the temperature-compensating ceramic materials. It was found that this characteristic would be ideally suited to compensate for the positive temperature characteristic of coils

Fig. 2. Terminal configuration and dimensions for various types of ceramic tubular trimmer capacitors.



DIAMETER (D)	#6-32	.215	.215	.215	.215	.215	.215	N.A.	N.A.	.215	.215
	#4-36	.180	.180	.180	.180	.180	N.A.	.180	.180	N.A.	N.A.
TERMINAL (TL) LENGTH $\pm .032$	N.A.	1-1/2 Min.	1-1/2 Min.	1-1/2 Min.	1-1/2 Min.	.210	.160	.160	.160	Variable	Variable
TERMINAL POSITION (TP)	VARIABLE										
ANGLE (A)	—	ANGULAR RELATIONSHIP BETWEEN MOUNTING LUGS AND WIRE LEAD OR TERMINAL LUG IS VARIABLE									
LENGTH (L)	SEE CAPACITANCE-RANGE CHART (TABLE 1)										

(N.A.—NOT AVAILABLE. ALL DIMENSIONS IN INCHES)

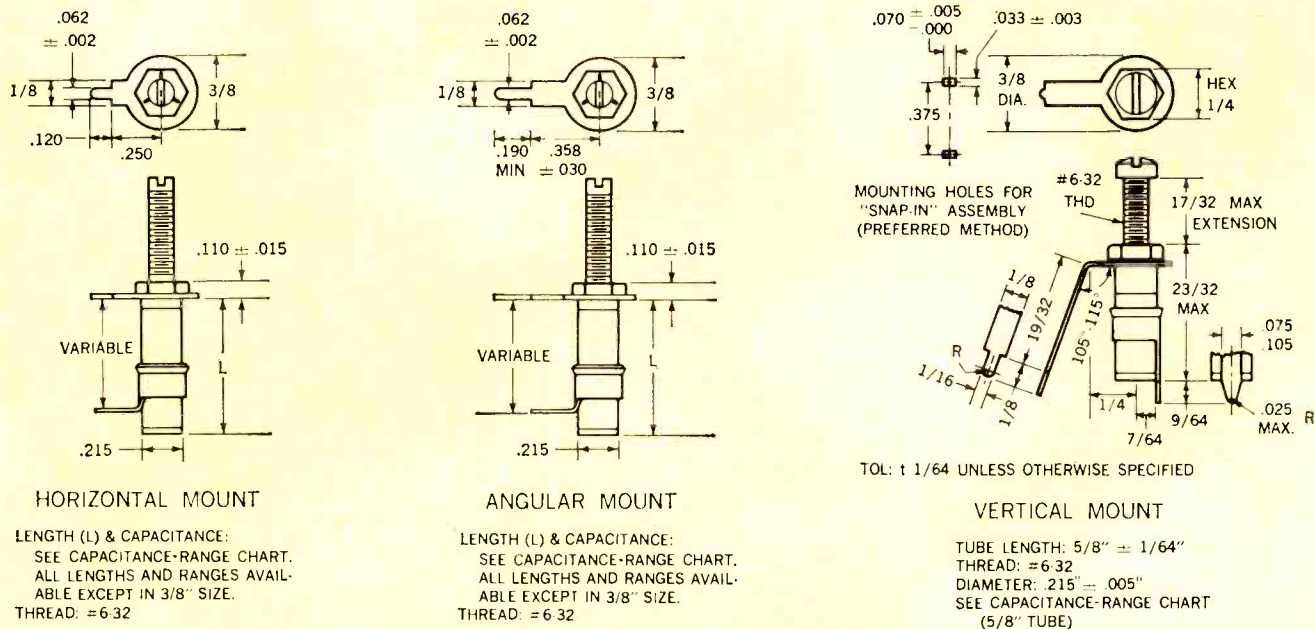

Fig. 3. Ceramic tubular trimmers with stamped terminals designed for horizontal, angular, or vertical chassis mounting.

and chokes and would help provide uniform non-temperature-dependent performance of tuned circuits.

Eventually two groups of ceramic formulations were developed—the temperature-compensating bodies, such as described above, and the Hi-K (high-dielectric-constant) dielectric materials. The temperature-compensating bodies are now available in characteristics of from P100 (positive 100 ppm/°C) to N5250 (negative 5250 ppm/°C). Since a variety of temperature-coefficient (TC) characteristics are available in this class of materials, the particular TC can be selected to provide the proper compensation required.

In this family is the NPO (negative-positive zero) body which, as its name implies, has little or no change, negative or positive, over a given temperature range. The NPO body is deservedly popular since it is very stable (usually varies no more than ±30 ppm/°C from -55° C to 125° C), and has excellent dissipation factor, high insulation resistance, high "Q", plus good frequency characteristics. This NPO dielectric, in fact, is more stable than many glass dielectrics.

The Hi-K ceramic materials are designed to give the most capacitance in the smallest size. They usually have their highest capacitance value at 20° C (68° F) and drop in value as the body is cooled below or heated above room temperature. There are a variety of Hi-K bodies available, but the user should realize the higher the K, the greater the changes in capacitance values as the capacitor is heated or cooled. A K value only as high as necessary to obtain the value in the required size should be used. In this way the minimum capacitance variation with temperature change will be obtained.

Ceramic in Trimmers

Fixed ceramic capacitors available on the market include tubular, disc, feed-through, and some of the newer types, such as the monolithics and capacitor clips. However, in this Special Section, we are concerned with variable capacitors and trimmers.

In the ceramic trimmer capacitors, only the temperature-compensating dielectrics are used, and for good reasons. These dielectrics offer the highest "Q", the highest insulation resistance, and the most predictable change in capacitance with temperature. Most trimmers are used in frequency-determining circuits, and the improved characteristics and greater stability of the temperature-compensat-

ing dielectrics are essential for these particular applications.

It is important to understand that the use of temperature-compensating dielectrics in trimmers does not mean that the dielectrics will perform exactly the same as when these materials are used in fixed disc or fixed tubular capacitors. In any ceramic trimmer capacitor, the capacitance obtained is not simply dependent upon the characteristics of the dielectric itself. In series with the dielectric in any ceramic trimmer is an air gap or a volume filled with a grease or lubricant with a higher dielectric constant than air alone. Therefore, the temperature characteristics of a ceramic trimmer capacitor are generally broader than the fixed capacitor made of the same material. Also, ceramics with larger TC's usually have higher dielectric constants, so that higher capacitance values may be obtained.

The ceramic disc trimmer is discussed in another article in this Special Section. Here, we want to focus on the ceramic tubular capacitor.

The Tubular Configuration

This type of trimmer capacitor is used in electronic circuitry because it has excellent reliability coupled with low cost. A variety of capacitance ranges can be supplied or tailored to a particular requirement. These values range from 0.5 pF up to 25 pF.

The most popular tubular configuration has one end that is notched to fit into a key-hole mounting (Fig. 1). A screw threaded into the ceramic body of the trimmer serves several functions. In addition to holding the capacitor upright from the chassis, the screw also serves as the adjusting element (rotor) to vary the capacitance. The stator electrode is a metal band painted on the ceramic body. There is a wide variety of terminal configurations available from several manufacturers. (See Fig. 2.)

There are two basic diameters of the tubular trimmers, one designed for use with a #6-32 screw has an outside diameter of 0.215", while the other is designed for use with a #4-36 screw in an outside diameter of 0.180". These trimmers are available in five different lengths: 3/8", 1/2", 5/8", 3/4", and 1" long. These are available in up to ten terminal combinations, including various types of wire break-outs, solder terminals, tabs, etc. to more readily facilitate their attachment and wiring into the circuit where they will be used. Another version of this trimmer is supplied with stamped terminals for both rotor and stator electrodes. These trimmer capacitors are designed for horizontal, an-

gular, or vertical mounting to the chassis. (See Fig. 3.)

The ceramic materials that are used for these trimmers fall into the temperature-compensating class. Materials used have TC's of N220, N400, and N750. In addition, steatite ceramic (a type of electronic porcelain) is employed in these trimmers. Steatite is quite dense, is very stable, and functions admirably as an inert dielectric. Steatite is used for the minimum capacitance ranges.

Capacitance values are determined by the selection of the dielectric materials as well as by use of the different diameters and lengths. The higher TC body together with the larger diameter and greatest length affords the highest capacitance (up to 25 pF) while the smallest diameter and shortest length with the steatite body offers the minimum value (0.5 pF to 2.0 pF). A listing of the most popular values is given in Table 1.

Some 20 percent increases in minimum and maximum capacitance limits can be obtained if the space between the screw thread and the inside thread of the ceramic body is filled by the manufacturer with a silicone grease. This option, available at a nominal price increase, provides a higher dielectric constant in series with the ceramic dielectric and increases the total capacitance accordingly.

The capacitance *versus* rotation curve for the tubular trimmer is a modified sawtooth curve since the contact between the screw thread and the internal ceramic thread varies as the adjustment screw is rotated. However use of the silicone grease tends to level out the variations in this capacitance change with rotation. ▲

Length	Steatite (P120)	N220	N400
3/8"	.5-2.0	.9-3.0	1.5-6.0
	.8-2.5	1.0-4.0	2.0-7.0
	1.0-3.0	2.0-5.0	2.5-9.0
	1.0-3.5**	2.5-5.5**	3.5-10.0**
1/2"	.3-2.5	.5-4.0	1.0-7.0
	.5-3.5	1.0-6.0	1.5-9.0
	1.0-4.0	2.0-7.0	2.5-12.5
	1.0-5.0**	2.5-8.0**	3.5-13.0**
5/8"	.2-3.0	.5-6.0	.8-8.0
	.5-4.5	1.0-8.0	1.5-12.0
	1.0-6.0	2.0-9.0	2.0-15.0
	1.0-6.5**	2.5-10.0**	2.5-16.0**
3/4"	.2-4.0	.5-8.0	.8-11.0
	.4-6.0	1.0-10.0	1.0-14.0
	1.0-7.5	2.0-11.0	3.0-18.0
	1.0-8.0**	2.5-12.0**	3.5-20.0**
1"	.4-6.0	1.0-10.0	1.0-14.0
	1.0-7.5	2.0-11.0	3.0-18.0
	1.0-8.0	2.5-12.0	3.5-20.0
	1.0-10.0**	2.5-15.0**	3.5-25.0**

*Note: The addition of silicone grease will increase both the minimum and maximum capacitance limits approximately 20%.

**Available only on tubular trimmers without mounting lugs.

Table 1. Capacitance-range chart for the five standard trimmer lengths. All values are given in picofarads (pF).*

MICA COMPRESSION TRIMMERS

MICA compression trimmer capacitors consist of a low-dielectric-loss ceramic base and a number of metal plates separated from each other by a mica dielectric. The movable top plate is made of a spring material so that uniform torque can be applied to the lower mica dielectric and plates when the adjusting screw is tightened or loosened.

Depending on circuit application, two types of variable mica compression capacitors are available from such companies as *Electro Motive Mfg. Co.* (Elmenco): the physically larger padder type containing from 2-15 plates with nominal maximum capacitance ranges of 130 to 3055 pF for 250 WV d.c. and 120 to 2525 pF for 500 WV d.c.; and the smaller trimmer type containing from 1 1/8 to 15 plates with nominal maximum capacitance range of 7 to 1400 pF for 175 WV d.c.

The padder types come in three sizes: a 7/8" x 1 5/16" single padder, a 1" x 1 5/32" single padder with a nominal maximum capacitance range of 80 to 240 pF for 175 WV d.c., and a 1 1/16" square dual padder (shown at the left photo) with nominal capacitance range of 80 to 240 pF for 175 WV d.c. The trimmer types also come in three sizes: standard (3/4" x 5/8"), miniature (3/8" x 3/16"), and midget (3/8" x 3/4"), with both chassis-mounting and printed-circuit mounting types available. For printed-circuit use, solid terminal lugs are provided to permit ease of mounting and to facilitate positioning and support of the capacitor. ▲

These capacitors are normally supplied with the capacitance adjusted to near nominal values, which occur between 1/4 and 1/2 turn from tight, where "tight" is defined as the maximum clockwise rotation of the adjusting screw. Minimum rated capacitance occurs at 3 turns from tight.

Capacitance of mica compression trimmers does not vary linearly with adjustment. For example, a mica capacitor with six plates will reduce to half the nominal maximum value within one opening turn while those with a greater number of plates require further screw disengagement for a similar percentage reduction in capacitance value. On the other hand, a capacitor with two plates will reach one-half the nominal maximum capacitance in less than one-half turn.

The "Q" factor for mica compression trimmers and single padders at nominal capacitance values of 400 and 1000 pF is 700 and at nominal capacitance values of 1 to 40 pF varies from 100 to 700. When the capacitors are subjected to a 100-hour humidity test at a temperature of 40°C and a relative humidity of 90-95%, and then allowed to remain at room temperature for one hour in circulating air, the "Q" factor will be reduced 50% for all capacitance values.

Both padder and trimmer capacitors can be obtained with special adjusting screws for ease of tuning. Special mounting brackets (shown in the right photo) are available for mounting one, two, three, or more trimmer capacitors simultaneously. ▲

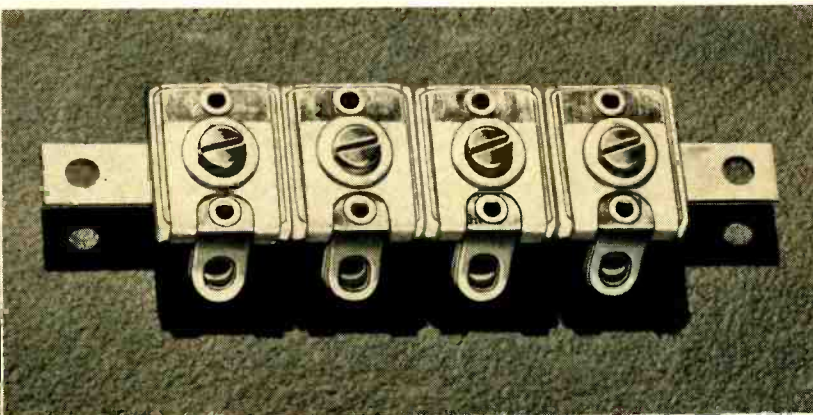
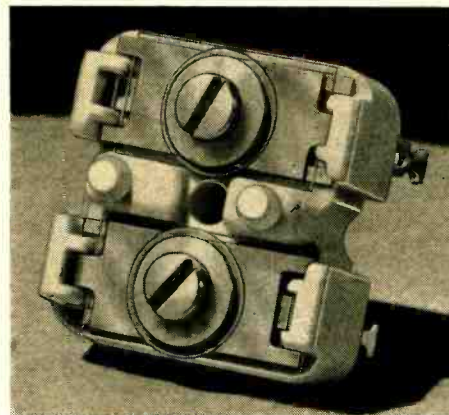

The author is responsible for all components engineering, including piston trimmers, fixed and variable ceramic capacitors, and tuners. A graduate of the University of Southern California, he has been active as a design engineer and executive in the electronics industry since 1949. Prior to joining JFD, he was Director of the Applied Research Department of Bourns, Inc. and Executive Vice-President and General Manager of Monolithic Dielectrics Inc. He holds a dozen U.S. patents for electronic components and related items, including several patents in the ceramic and thick-film areas.



Glass Piston Trimmer Capacitors

By KENNETH F. MILLER / Chief Engineer
JFD Electronics Corp., Components Div. (subsidiary of Riker-Maxson Corp.)

Providing high capacitance for their size, wide adjustment range, high "Q", precision adjustment, and ability to withstand unfavorable environments, these trimmers are widely employed in aerospace and military equipment.

PISTON trimmers are very useful for circuits where stable and finely adjustable capacitances are required and where space is at a premium. For example, they are often used to tune filters for i.f. amplifiers.

A wide variety of piston trimmer types is available. A single manufacturer may offer as many as 2500 different standard and custom designs, to meet all types of requirements.

There are many different ways to classify piston trimmers: by dielectric, by size, sealed and non-sealed, precision and non-precision, by capacitance range, rotating or non-rotating piston, by type of mount, by temperature coefficient, and by number of operating cycles.

Piston Trimmer Construction

Fig. 1A shows the construction of a typical panel-mount piston trimmer. The piston is one capacitor electrode (rotor) and a metalized coating on the glass tube is the stator. Current flows through the panel-mount terminal, the bushing, the adjustment screw, to the piston electrode. The stator is connected to the other capacitor terminal. When the adjustment screw is turned, it pushes the piston into the stator or pulls it out, increasing or decreasing capacitance.

The first step in manufacturing a glass piston trimmer is to draw the glass dielectric tube to a size slightly larger than the specified final diameter. The glass used is carefully compounded to produce the desired dielectric properties of high K and high "Q." Then silver bands are printed around the glass. It is important that the silver bands be solid and homogeneous with a high-strength bond to the glass tube. The bond is achieved by fusing the bands at

1400° F. During fusion the diameter of the glass tube is reduced to the precise diameter required in the final product. The bands are then plated to reduce resistance and improve the solderability. Finally, the glass is cut to the necessary lengths, fitted with bushings and terminals, and an adjustment mechanism.

Fig. 1B shows the construction of a sealed miniature telescopic mechanism. The diameter is about the same as that of a standard piston trimmer, but the unit is much shorter.

A typical sealed panel-mount glass piston trimmer capacitor.

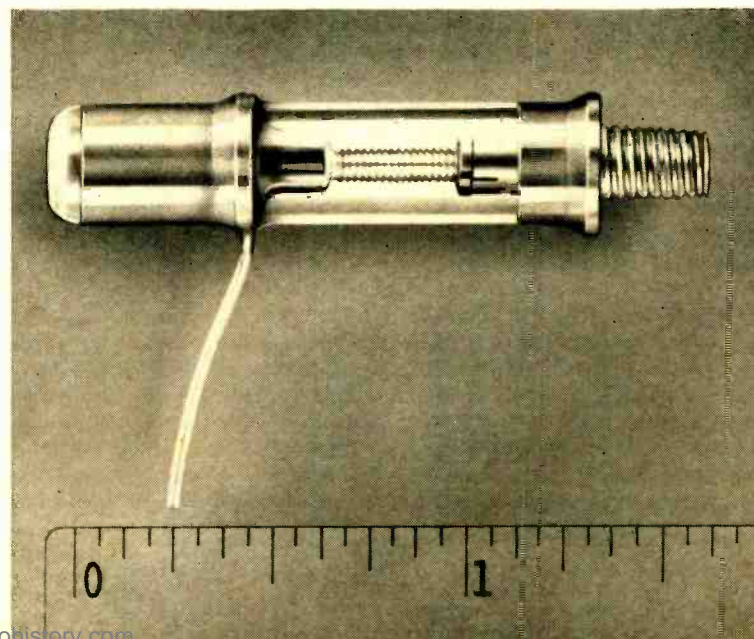

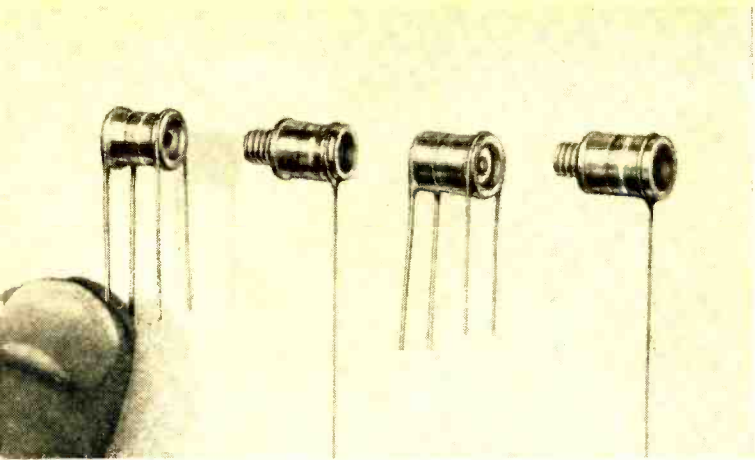

Some examples of typical unsealed glass piston trimmer capacitors, including printed-circuit and panel-mounted types.

The threads of the screw engage mating threads on a slotted flange extension of the inner bushing. Torque is supplied by the tension ring, which fits in a slot on the flange. The O-ring seal increases moisture resistance, insulation resistance, and dielectric strength.

A long-life sealed telescopic piston trimmer is shown in Fig. 1C. This type of mechanism is designed to permit a very large number of adjustments (500 or more cycles). Tension is applied to the adjustment screw by two axially spring-loaded tensioning nuts. These tensioning nuts fit into 90-degree opposing channels of the mounting bushing and provide torque to prevent accidental rotation of the lead-screw as well as eliminate backlash.

Some piston trimmers use a non-rotating, or direct traverse mechanism. At the end of the piston are two shaped slots. The arms of the bushing fit into these slots, keeping the pistons from rotating. As the tuning screw is turned, the piston moves from thread to thread, producing in and out movement. The tuning screw rotates, but does not move in and out with the piston.

The mechanism shown in Fig. 1D is a very long-life (10,000 cycle) non-rotating type. Backlash is eliminated by two tension nuts, one of which is an integral part of the inner piston assembly. The other tension nut rides in 180-degree opposed slots in an extension of the mounting base. A simple spring is mounted between the two tension nuts. This prevents backlash with the tuning screw, which remains stationary in the adjustment well. Torque can be preset to any value between 1 and 10 inch-ounces (± 0.5 inch-ounce). Torque is controlled by an axial biasing spring between the bushing and the adjustment screw. This

trimmer uses an embedded stator to increase capacitance.

The MIL-Spec for piston trimmers is MIL-C-14409C. This spec covers 15 different types of piston trimmers, plus concentric-shell air-dielectric trimmers.

When to Use Piston Trimmers

The prime advantage of a piston trimmer capacitor over other types is that it provides higher capacitance for a given size. Equally important, the capacitance-adjustment range of a piston trimmer is greater than that of almost any other trimmer type. Also, piston trimmers provide good temperature compensation, high "Q," and the ability to withstand unfavorable environments.

Piston trimmers have been widely used in missiles, satellites, space vehicles, as well as in other military and industrial applications. Piston trimmers, for example, have been used in the Apollo 11 and 12 lunar modules, Gemini and Minutemen "birds," as well as in more down-to-earth equipment.

On the other hand, piston trimmers are not recommended for extremely high capacitance or microwave applications. They are not the best choice for frequencies above 1.0 GHz because the "Q" is reduced rapidly at higher frequencies and stray inductance causes self-resonance at about this frequency.

The maximum capacitance that currently available piston trimmers can provide is about 300 pF. They can also be made for capacitances as low as 0.5 to 2 pF.

How to Select Piston Trimmers

Because such a wide range of piston trimmers is available, it's not always easy to select the best one for each specific application. The following guidelines should be helpful.

1. Precision or Non-Precision

Most piston trimmer capacitors used today are precision types. The air gap between piston and the dielectric wall is held to about 0.0004 inch. This requires that the inner diameter of the tube and the outer diameter of the piston be very precise. Further, dielectric tubing is made virtually stress- and scratch-free and inner walls are polished to a smooth, mirror-like finish, reducing friction. That users can buy piston trimmers this precise for less than \$1.00 is a tribute to modern manufacturing techniques.

Non-precision piston trimmers are also available, but they are not as widely used. They cost less, of course, and are therefore suitable for consumer applications, such as TV sets and other home-entertainment equipment.

Precision 4-gang tuning capacitor made from glass piston capacitors, showing movement of tuning mechanism.

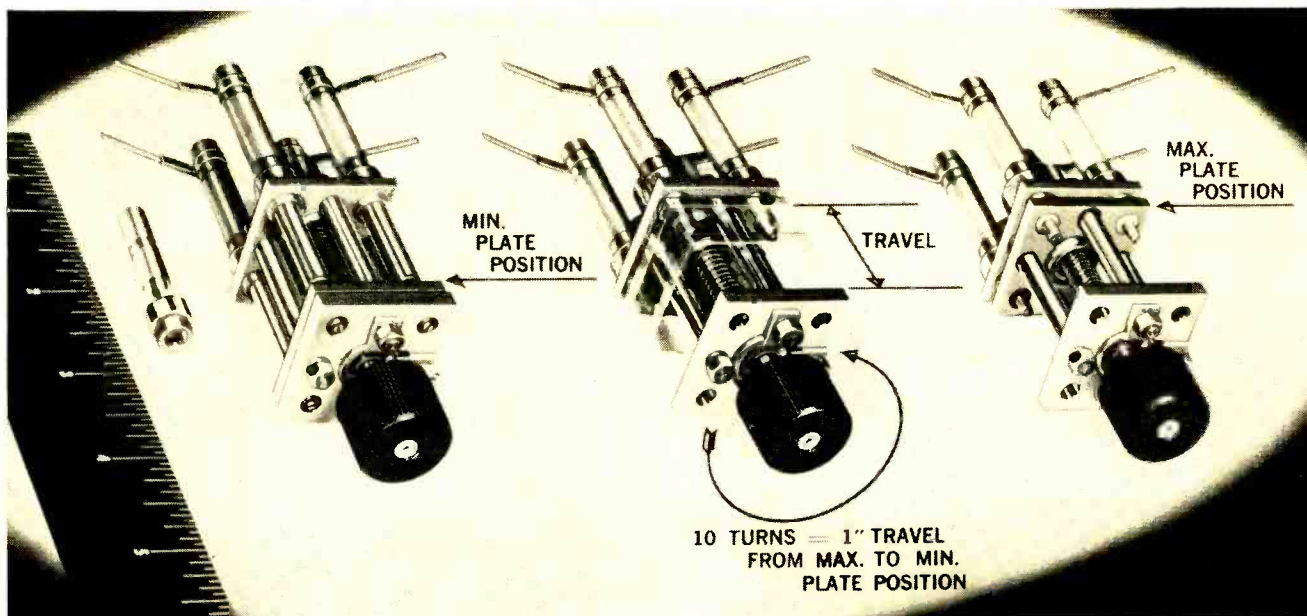

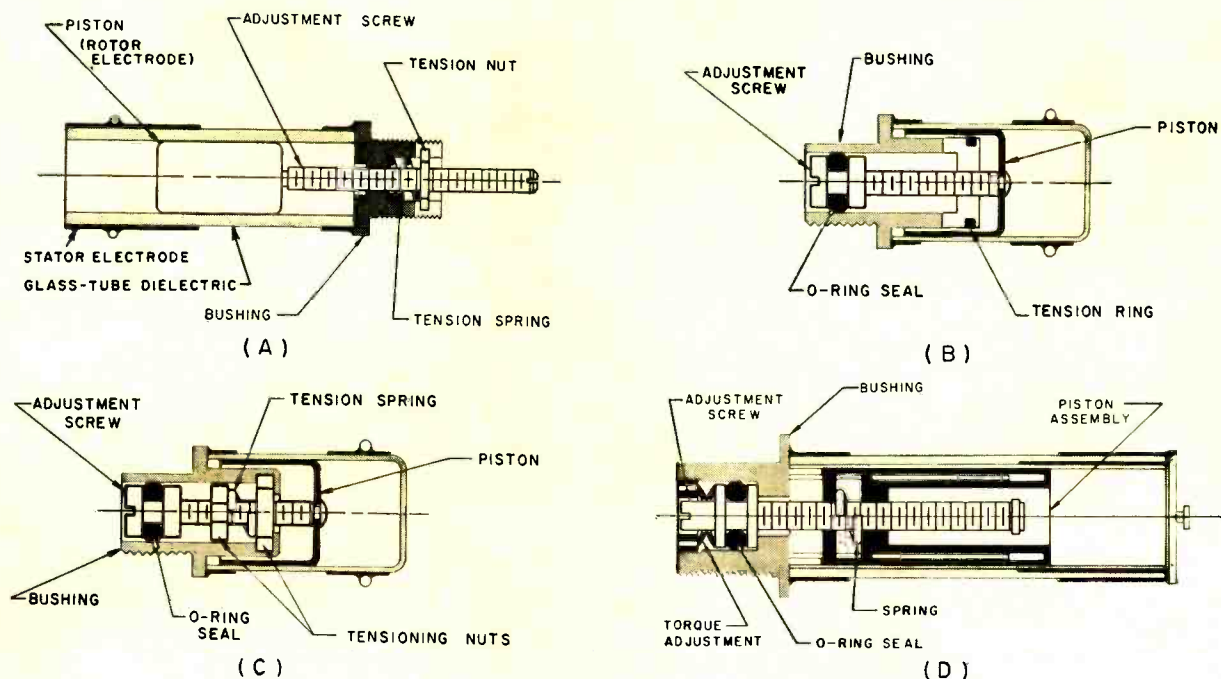

Fig. 1. (A) Cross-section of a typical panel-mount piston trimmer. (B) Telescopic adjustment mechanism used in miniature sealed trimmer. (C) Long-life (500 cycles) mechanism used in miniature sealed trimmer. (D) Very long-life (10,000 cycles) sliding travel adjustment mechanism, along with embedded electrodes and sealed construction.

2. Type of Dielectric

Piston trimmers use four kinds of dielectrics: standard glass, green glass, quartz, and ceramic. You choose the dielectric on the basis of the capacitance, size, voltage, and "Q" required in your circuit.

If size is not a problem, you will probably select an ordinary glass dielectric with a dielectric constant (K) of about 6.7 and a dissipation factor of approximately 0.0012 at 1 MHz. If you need more capacitance in a given size, you will probably choose green glass as a dielectric. Green glass has a dielectric constant of 8.3 and a dissipation factor of 0.0007. Thus, it can increase both capacitance and "Q." Green-glass trimmers typically have capacitances about 30 percent greater and "Q" about 25 percent higher than ordinary glass types.

If very high "Q" is required, quartz may be the solution. Quartz is expensive but its dissipation factor is extremely low. However, the dielectric constant is only about 3 so that the available capacitance is lower or the size must be increased. Quartz units can also provide better temperature compensation.

Ceramic dielectric with a dielectric constant of 88 is called for when a low-cost high-capacitance trimmer is desired. The operating temperature range of ceramic piston trimmer capacitors is also higher, being -55 to $+150^{\circ}\text{C}$ compared with -55 to $+125^{\circ}\text{C}$ for glass. These advantages are offset by considerably higher temperature coefficient than for quartz or glass.

For maximum capacitance in a given size, embedded bands may be employed. Obviously, reducing the distance between the plates increases capacitance. In a piston trimmer, we do this by embedding the stator metalization between two layers of glass tubing (see Fig. 1D). The first layer is very thin (0.004 to 0.006 in compared with 0.020 in used on ordinary piston trimmers). It is coated with a metalized band and is then bonded to a thicker outer glass layer for strength. Contact electrodes are coated on the outside of this thicker layer of tubing. Thus, the stator is only as far away from the piston as the thickness of the thin inner glass layer of

tubing. Embedded piston trimmers provide a 300 to 600 percent increase in capacitance.

3. Sealed or Non-Sealed

As indicated in Fig. 1, some piston trimmers use an O-ring seal at the tuning-screw end. These trimmers also use a glass or metal seal at the other end of the piston trimmer. Such units are known as "sealed" piston trimmers and they provide environmental protection against dust and moisture. Sealed glass piston trimmers can also handle higher voltages, since glass has greater dielectric strength than air. If you anticipate a hostile environment, use a sealed unit. Otherwise a non-sealed piston trimmer is a better choice, since it costs less.

4. Type of TC

Temperature coefficient is usually specified in ppm/ $^{\circ}\text{C}$ (parts per million per degree centigrade) over the operating range of the piston trimmer. Some glass units go as high as $+450$ ppm/ $^{\circ}\text{C}$, but most are in the range of ± 50 ppm/ $^{\circ}\text{C}$ to ± 100 ppm/ $^{\circ}\text{C}$. The TC of quartz is better, generally about ± 25 ppm/ $^{\circ}\text{C}$.

5. Type of Leads

Once you have chosen the desired electrical characteristics, you will have to consider the problem of mounting. Piston trimmers are available with a wide variety of lead types, but four styles are basic: panel-mount, 4-wire printed-circuit mount, 2-wire printed-circuit mount, and lug and lead printed-circuit mount. If the trimmer is to be welded, rather than soldered, a dumet lead (a gold-plated nickel alloy) is preferred.

Normally, panel-mounted piston trimmers are grounded. However, most panel-mount units can be ordered with nylon bushings to insulate them from ground. Top-end tuning may be desirable on a printed-circuit-mounted unit. This can easily be accomplished by using special miniature PC-mount trimmers.

6. Type of Tuning Mechanism

As discussed previously, you can choose between two basic types of tuning mechanisms: rotating or non-rotating. There has been a controversy within the industry as to

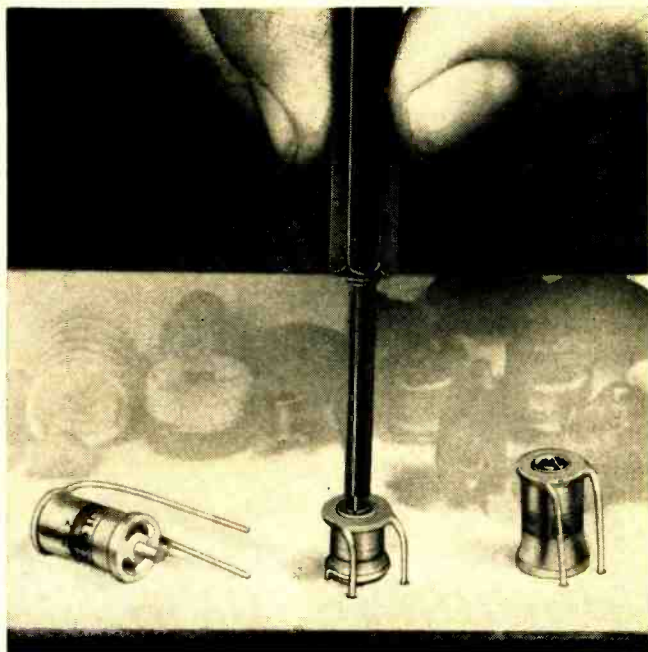

Mounting and top-end tuning of trimmers on PC board.

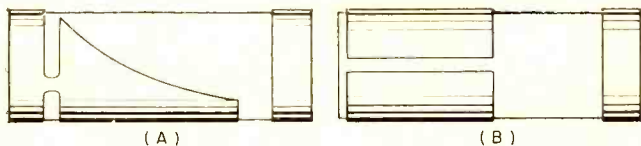

Fig. 2. (A) Straight-line frequency stator metalization is available, and (B) split-stator metalization.

which is better. Proponents of direct traverse mechanisms claim that rotating mechanisms cause reversals. They say that because the piston moves closer and farther away from the stator, capacitance sometimes changes in the wrong direction. This, of course, could be very disconcerting to the engineer or technician tuning the circuit. In truth, however, reversals are virtually unknown in precision piston trimmers of any type. Rotating piston trimmers are subject to flats (places where capacitance does not change when the tuning screw is adjusted), but this is seldom detectable in practical use.

Non-rotating mechanisms provide better linearity, but rotating mechanisms have advantages too. Dollar for dollar, they are more stable and last longer. One way of putting the controversy into perspective is to consider sales figures. At present, rotating types outsell non-rotating types by a ratio of at least 10 to 1.

Another important factor in choosing a tuning mechanism is the number of cycles of adjustment that will be required during the life of the piston trimmer. Most piston trimmers are specified to 500 cycles or more. Where long life is required, spring-loaded mechanisms are used (Fig. 1C) rather than the simpler split-collet (Fig. 1A) types. The mechanism shown in Fig. 1D is better still, providing an adjustment life of 10,000 cycles.

The unit with the longest adjustment life is not always the best choice, however, since long-life mechanisms cost more than ordinary mechanisms. Since trimming is basically a touch-up adjustment, it is rare that a piston trimmer is tuned more than 500 times during its lifetime.

Special Piston Capacitor Types

A number of unusual piston capacitors can be made to meet specific requirements. For example, most piston trimmers provide straight-line capacitance adjustment, but exponential capacitance for straight-line frequency adjustment units are also available.

To make an exponential trimmer, the glass tube is metalized in a pattern that is an exponential function of distance, as shown in Fig. 2A. Exponential metalizing is available as a "special" on almost any type of piston trimmer. It is very useful for applications where the top end of a frequency band is crowded, requiring very precise adjustment. Special spiral metalizing is also available to form inductors, LC tuners, and transformers.

Fig. 2B shows the stator assembly of another specialized piston trimmer, the split-stator type. Because of split-stator metalizing, this is actually two capacitors in one. Each separate stator electrode has capacitance to the common piston. Thus, tracking is virtually error-free. Split-stator units are ideal for push-pull applications. Another application is to reduce piston inductance by connecting to the two stator electrodes and insulating the moving piston.

Another special configuration is obtained by differential metalizing. In this case two separate complete (not split) stator bands are used and the piston moves between the two stator bands. As capacitance between the piston and one stator is increased, capacitance between the piston and the other stator is decreased. The crossover point is where the piston is equidistant from the two stators. Tuning is quite linear and sensitive. What's more, the sum of the two capacitances is nearly constant.

Some special piston trimmers are available to vary temperature compensation, rather than capacitance. When you tune a variable-TC piston trimmer, TC changes from maximum positive to maximum negative while the capacitance remains constant. This is accomplished by use of a special type of split-stator design in which the materials used and the construction of the piston are such as to change the TC depending on the position of the piston. The TC range of variations may be as high as ± 800 ppm/ $^{\circ}$ C. These units are especially useful to trim the temperature coefficients of crystal-controlled oscillator and filter circuits.

Piston Tuners

Most piston capacitors are used as trimmers, but the design is also excellent for tuning capacitors and tuned circuits. The coil for the tuned circuit is a silver metalized inductor fired onto the glass tubular element at the same time as the capacitor electrodes are formed.

Piston tuners are remarkably small, stable, and versatile. They can be used to provide precise tuning with high linearity for both straight-line capacitance and straight-line frequency applications.

The main difference between a piston tuner and a piston trimmer is the tuning mechanism. Piston tuners have linearities as good as one percent and are capable of 30,000 to 50,000 life cycles.

A 4-ganged piston tuner is shown in one of the photos. Units of this type utilizing modular construction can be provided with up to eight sections. Thus, a very wide range of types is available on a custom basis. Tuners may be strictly a number of piston capacitors ganged together or the capacitors may have metalized coils on the glass dielectric, resulting in ganged tuned circuits.

The Future of Piston Capacitors

Over the next 5 to 10 years, piston trimmers will probably retain their edge over other trimmers as the use of integrated circuits increases, except where extremely small size is the prime consideration. However, it is unlikely that piston trimmers will find a place in thick-film circuits. They will probably be replaced by some as yet undeveloped type of trimmer.

Sales of piston trimmers are likely to continue strong during the early 1970's, but they will probably begin to fall off during the last half of the decade. Piston tuners, on the other hand, will probably become much more popular in the near future, as new applications are found. ▲

The author graduated in Mechanical Engineering in 1963 from Gannon College, Erie, Pa. He has worked in various capacities in engineering ceramic, glass, air, and plastic-dielectric trimmers.



Ceramic Disc Trimmer Capacitors

By JOHN F. MOULTHROP / Supervising Engineer
Trimmer Products, Erie Technological Products

This popular trimmer type has undergone an evolution in size and voltage rating to keep pace with needs of industry.

CERAMIC disc trimmer capacitors have been manufactured in the United States for about 30 years and have become the most popular type used. During this time they have undergone an evolution in size and voltage rating to keep pace with the requirements of the electronics industry. They have found wide acceptance because of their good volumetric efficiency, high "Q," ease of tuning, numerous terminal configurations, and unique construction.

A ceramic disc trimmer has three main parts: the stator, rotor, and dielectric. The stator electrode is a metallized pattern deposited on a lapped low-loss ceramic base. The rotor electrode is a metallized pattern deposited on the rotor. The dielectric is a temperature-compensating ceramic disc lapped to a given thickness. Turning the rotor varies the overlapped area between the rotor and stator electrodes, thus varying the capacitance. Trimmers are available in capacitance ranges from 1-3 pF to 11-110 pF depending on the rotor size and the dielectric material used. The typical "Q" of a ceramic disc trimmer is in excess of 1000 at 1 MHz.

The full capacitance range in most disc-style trimmer capacitors is covered in 180-degree rotation of the rotor. The best designs allow the greatest possible rotation in the linear portion of the tuning curve (Fig. 1).

To obtain the various capacitance ranges, dielectrics with dielectric constants (K) of 7 to 190 are used. These correspond to temperature characteristics of P120 and N1500. Because of the construction of disc-style ceramic trimmers, the completed trimmer does not exactly reflect the temperature coefficient (TC) of the dielectric material used. For this reason these trimmers should *not* be relied upon as temperature compensating capacitors. This wide range of TC is reflected in the requirements of MIL-C-81, which is the military specification covering five styles of ceramic trimmers. These broad limits are shown in Table 1.

The five styles covered in MIL-C-81 have two separate diameters and voltage ratings. CV11, CV14, and CV21 have 0.656-in diameter rotors and are rated at 500 V d.c. CV31 and CV34 are 0.375-in diameter and 350 V d.c. rated. The specification temperature range is -55°C to $+85^{\circ}\text{C}$ but the trimmers are capable of 125°C operation.

Ceramic trimmers are available in two general temperature ranges: -55°C to $+85^{\circ}\text{C}$ and -55°C to $+125^{\circ}\text{C}$. The 85°C -rated styles use certain materials in their construction which limit the upper working temperature. For equipment designs which will not exceed 85°C , these trimmers are available at generally lower prices than the 125°C

C-rated units. Only ceramic and metal parts are used in the design of 125°C -rated trimmers.

Specifying a Disc Trimmer

When a user needs to specify a trimmer capacitor, he must first consider what capacitance range he will require to tune his circuit by taking into account various tolerances of other components. In any disc-style trimmer the slope of the tuning curve varies with the capacitance range since the full range is covered in a maximum of 180 degrees. The larger the capacitance range the greater the change of capacitance per degree rotation of the rotor.

Voltage requirements are another factor for the designer to consider. Ceramic trimmers are designed so that they will withstand life testing at twice their rated voltage at the

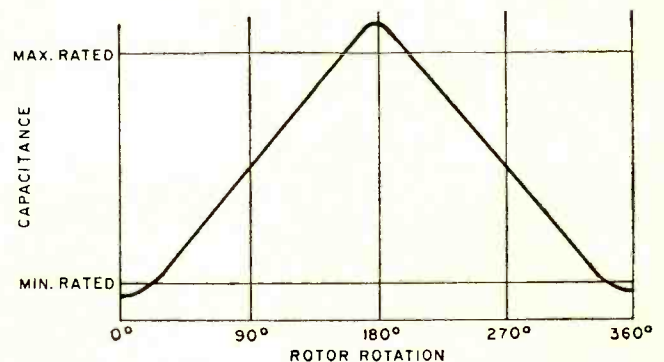
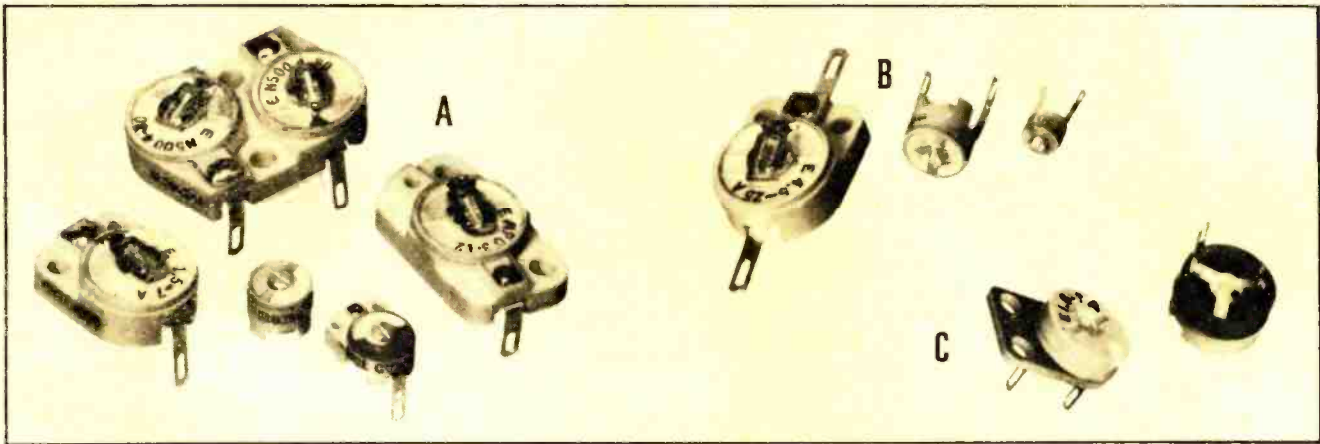

Fig. 1. Capacitance vs rotation for ceramic disc trimmer.

Table 1. Capacitance change limits versus temperature.

DIELECTRIC		PERCENT CAPACITANCE CHANGE FROM VALUE @ 25°C					
		-55°C		+85°C		+125°C	
Nominal Constant	Type Code	Min.	Max.	Min.	Max.	Min.	Max.
30	A	-4.5	+2.0	-2.5	+2.0	-4.2	+3.4
45	B	-1.0	+3.5	-2.5	-0.5	-4.2	-0.8
50	C	-1.0	+6.5	-4.0	-1.0	-6.7	-1.7
57	D	+1.5	+7.0	-5.0	-1.5	-8.5	-2.5
90	E	+1.75	+8.0	-5.75	-1.75	-9.5	-2.8
180	F	+6.0	+16.0	-11.0	-6.0	-15.0	-9.0



(A) These are the five styles of trimmer capacitors covered in MIL-C-81B. (B) Ceramic disc trimmers shown actual size illustrate the evolution in size over a period of 30 years. (C) Examples of 85° C-rated trimmer capacitors.

maximum operating temperature for 1000 hours without serious degradation. Some ceramic dielectrics have voltage characteristics which make it necessary to de-rate the voltage rating above 85° C. The early designs used dielectrics about 0.020-in thick and were rated at 500 V d.c. As the units became smaller the dielectric thicknesses had to be reduced to furnish useful capacitance ranges. Today, through the use of monolithic construction, dielectrics less than 0.005 in are common. Trimmers using this range of thickness are rated at 100 V d.c. or less.

With the use of smaller and more tightly spaced components, size becomes an important consideration in trimmer requirements. Because of the higher K 's available in ceramic dielectrics, ceramic trimmers are smaller than other types. Also with a wide choice of K 's many capacitance ranges are possible.

Another important point is that ceramic trimmers do not change size with capacitance range as do most tubular or plate-type air trimmers.

However, there are two reasons for limiting the use of dielectrics with K 's exceeding 200. The first is that these dielectrics are characteristically too thermally unstable for use in a trimmer. It would be very difficult to tune a circuit using such a trimmer because of the vague capacitance drift associated with the trimmer. The second reason is that a ceramic disc trimmer is actually two capacitors in series. One capacitance is due to the dielectric and the other due to the air gap between the dielectric and the stator. The total capacitance is affected by the dielectric constant multiplied by the air-gap thickness. As the K becomes larger, the trimmer capacitance does not increase in direct proportion. When K is increased above 200, the increase in total capacitance is slight and does not justify the use of such materials.

The "Q" or dissipation factor of the trimmer usually does not affect "Q" of the circuit since other components have much higher losses than the capacitor. Most ceramic trimmers have a minimum "Q" in excess of 500 at 1 MHz. Typically, "Q" exceeds 1000 in nearly all cases.

Geometric Shapes and Mounting

The geometric shape of the trimmer and its mounting configuration have as much effect on its frequency characteristics as the dielectric. In the case of ceramic disc styles, the resonant frequency is in the 400-600 MHz range. This does not mean that the dielectrics used are limited to these frequencies but only that the particular combination of components shows these characteristics.

Tubular-style trimmers show much higher resonant frequencies than disc ceramic styles. Glass trimmers are good to approximately 1 GHz. Coaxial air trimmers exhibit resonant frequencies well above 1 GHz. These figures depend on capacitance setting, configuration, and fixturing.

When the type of trimmer and capacitance range are de-

ecided upon, the mounting style must be investigated. There are a great many terminal configurations and mounting types available in all styles of trimmers. Ceramic trimmers offer a large number of printed-circuit, point-to-point, horizontal, vertical, and hardware mountings. The type of mountings available to fit an individual application is best determined from manufacturers' catalogues or by contacting the manufacturer directly. Most suppliers welcome a chance to help a user by providing special configurations.

Some hints on installing printed-circuit-style trimmers may be useful. When terminals are inserted through the board and crimped, care should be taken that undue force is not applied to the terminals when they are crimped. This may physically damage connections or even break the part. When the board is passed over a solder wave, the temperature of the solder and the duration of high temperature exposure must be noted. Too much time or too high a temperature can damage solder joints in the trimmer. With trimmers which utilize organic materials, temperatures must be reduced to avoid damage.

Flux during both the soldering and cleaning operations can cause problems. Flux residues can form around the rotor shaft and between the lapped surfaces. This can cause frozen rotors, poor "Q," and rough adjustment torque. A minimum amount of flux is recommended for soldering. The Freon or chlorethene solvents must be kept clean to

Table 2. Comparison of several styles of trimmer capacitors.

TRIMMER TYPE & APPROX. COST	ADVANTAGES	DISADVANTAGES
Ceramic disc \$.30-.40 each	Small size, rugged, fast accurate tuning, stable	Limited in operating frequency
Glass tubular \$.60-.90 each	Fine tuning, good TC, good high-frequency performance	Fragile, relatively large in size
Air disc \$.25-.30 each	Fast accurate tuning, high "Q," stable, good at r.f. frequencies	Large in size, susceptible to voltage breakdown and dirt contamination
Air coaxial \$1.75 each	High "Q," good at r.f. frequencies, fine tuning, excellent TC	Expensive, relatively large in size, susceptible to voltage breakdown
Mica compression \$.10-.15 each	Large capacitance ranges, low cost	Non-linear tuning, poor stability
Ceramic threaded tubular \$.04-.05 each	Low cost	Poor stability
Plastic \$.15-.20 each	High "Q," good stability	Limited in temperature range and in capacitance range

prevent dissolved flux from hardening on all surfaces. The time in cleaning solvents must be kept to a minimum to avoid washing away the lubricants from between the rotor and base. Certain solvents will attack the organic parts of some styles of trimmers. The user should experiment with his particular soldering and cleaning procedures in order

to determine the best processing methods to be applied.

Ceramic trimmers are available from domestic and foreign sources. Presently there are four U.S. suppliers as well as European and Japanese manufacturers. Table 2 has been included for easy comparison of the various style trimmer capacitors currently available. ▲

TEFLON TRIMMER CAPACITORS

By LARRY G. FISCHER / Components Development Engineer, E.F. Johnson Co.

The Teflon trimmer capacitor has been made possible by the development of Teflon (*duPont* registered trademark) tetrafluoroethylene resins. These resins are members of the fluorocarbon family and possess unique electrical and mechanical properties which are highly desirable in trimmer capacitors.

Teflon is often used for its outstanding chemical inertness and low coefficient of friction. Other desirable physical properties include a low moisture adsorption rate of less than 0.01% which contributes to its high surface resistivity (greater than 10^{11} ohms at 100% relative humidity). The material has exceptionally good thermal stability between -400°F and $+500^{\circ}\text{F}$. The tetrafluoroethylene resins are excellent insulators and have high arc resistance. When exposed to an arc, the material vaporizes and leaves no carbonized path. The short-term dielectric strength of Teflon is quite high, varying around 500 volts per mil, depending on the thickness. The dielectric constant is low (approximately 2.02) and is unchanged from 60 Hz to 3000 MHz.

Because the dissipation factor of Teflon is small—less than 0.0003 from 60 Hz to 3000 MHz, "Q" is relatively high. "Q" will also be quite constant over a wide frequency range because the dissipation factor is quite constant. Data obtained from a batch of Teflon trimmer capacitors is shown in Fig. 1.

When tetrafluoroethylene resin is properly used as a dielectric, one can obtain a capacitor which is electrically stable over a wide range of conditions. The Teflon trimmer capacitor, constructed as shown in Fig. 2, is such a device. By designing the parts so that the Teflon displaces all possible air from between the rotor and the stator, the chance of variations in capacitance due to entrapped air is held to a minimum. The Teflon must be compressed when it is forced into the stator shell. The rotor screw then fits tightly into the Teflon. This method of construction also keeps all foreign particles, such as dust, moisture, and solder flux, from contaminating the dielectric and degrading the performance of the capacitor.

The capacitance is adjusted by turning the rotor screw in or out of the Teflon dielectric. The fine threads on this screw give a high degree of resolution to the adjustment so minute changes in capacitance can be made easily. This construction also reduces the number of parts needed in the capacitor, resulting in lower cost and greater reliability.

Capacitors using Teflon as a dielectric may also be constructed by two other methods: (1) substituting Teflon for air in a multi-plate capacitor, and (2) sliding a Teflon coated rotor in or out of a shell. Neither method utilizes Teflon to its fullest advantage because air is not completely eliminated. Contaminates may therefore come between the Teflon dielectric and rotor or stator to affect the set capacitance.

The high-voltage resistance of Teflon enables the trimmer to be used where other dielectrics would suffer from breakdown. The trimmer is especially useful in filter networks that require careful adjustment and long-term stability. Test-equipment manufacturers have found it ideal for use in equipment subject to extreme environmental conditions

where moisture, dust, or shock could disrupt other types of capacitors. Circuits used over very wide frequency ranges, especially in the v.h.f. and u.h.f. regions, will benefit from the exceptionally stable "Q." A limitation of this capacitor, however, is the maximum capacitance that can be easily obtained. Values above 5 pF are not common in this type of trimmer capacitor.

The unique mounting features of this trimmer provide two distinct advantages: (1) It can be readily used in circuits where minimum lead length is of vital importance. (2) The printed-circuit mounting features of the device enable it to be placed directly on the PC board by modern assembly equipment. Panel-mounted versions are also available. Typical prices are from 40¢ to 60¢ in small lots. ▲

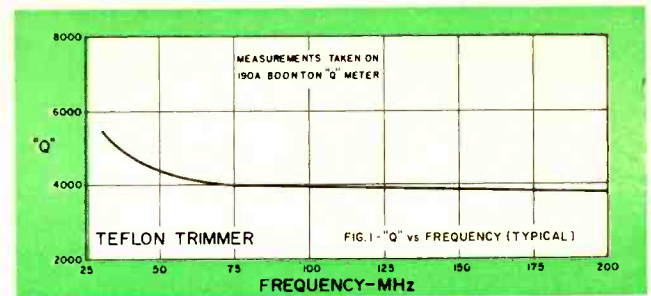

FIG. 1

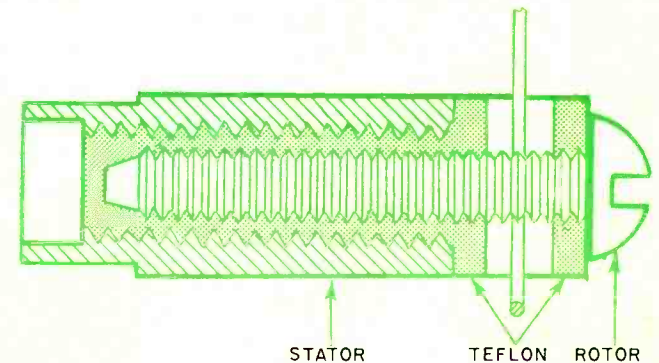
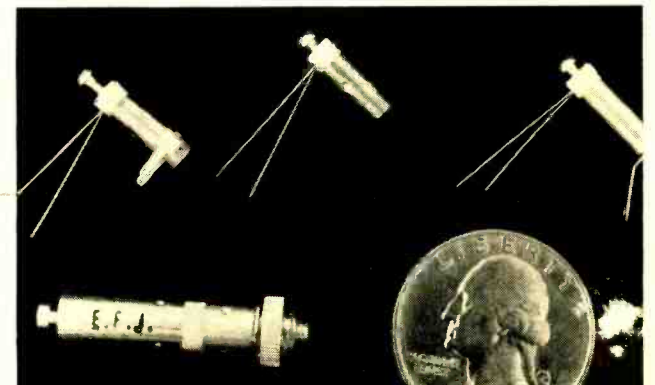

FIG. 2

Four common versions of Teflon dielectric trimmer capacitors showing the various mounting configurations used.





The author joined JMC in 1951. For the past ten years he has been actively engaged in the development of new products. At the present time, he is working on improving capacitor production methods.

Air Tubular Trimmer Capacitors

By ROBERT HOWERING / Manager of Engineering
Johanson Manufacturing Corp.

This precision trimmer features small size, good stability, high resolution, and a maximum "Q," particularly at the higher operating frequencies.

A VARIABLE capacitor must perform in a predictable and consistent manner. It must be accurate, stable, and may have to be small enough to be used with micro-circuits. It cannot have dips or reversals which will give false peaks or null points. It should provide high resolution through fine tuning, which is especially important in making critical adjustments at the higher frequencies. Once adjusted, it should be able to hold that adjustment under a wide range of stresses, both physical and electrical.

The air tubular trimmer meets all these requirements. Its tubular construction has the physical strength of a column, where stress is equally distributed. Indeed, air tubular trimmers have landed on the Moon—have been dropped from planes—and have even been shot from cannons. Because of its axial construction, it also has both lower inductance and higher "Q" values. And it has no detrimental mechanical resonant frequency points which might induce microphonics or physical fatigue. Lastly, a tubular air trimmer employs the stable, consistently predictable, and least expensive dielectric there is—air.

However, there are factors that may dictate the use of other dielectrics. One of these is dielectric strength or breakdown. Because size is often important, the dielectric thickness must be kept small. This results in lower breakdown voltages, around 1000 V d.c. or less. Other dielectrics will afford higher voltage ratings, but equally important characteristics, such as "Q," stability and mechanical strength, may have to be compromised. Another factor may be the need for higher capacitance in a given size. This requires the use of a dielectric with a dielectric constant that is greater than air.

Still another factor is cost. The use of air in a miniature trimmer requires the electrodes to be held in precise position relative to each other over the entire capacitance

range, and to tolerances of tens of thousandths of an inch. This must be accomplished without the use of any guides or supports in between the electrodes to degrade the properties of air. This means relatively expensive production. But today the tubular air capacitor can be produced more economically than ever before due to careful design; the use of high-speed precision equipment, and accurate, skillful assembly by experienced people. So cost is becoming less of a consideration in selection. (Present prices range from about \$3.50 to \$6.00 each in quantities up to 1000.)

The stability and dependability of the tubular air capacitor have led to considerable acceptance of it for applications in critical and even hostile environments, such as the satellite and space programs. There are 74 in Syncom II alone, and others are destined to land on Mars. It is not insignificant that the air tubular, which works at frequencies from v.l.f. up to u.h.f. is the only capacitor that will work into the microwave ranges. Some smaller models, which work in the C- and X-band regions, are self-resonant above 10 GHz. One interesting miniature type for such applications is supplied for mounting the same way that a fixed chip capacitor is mounted. The vertical mounting style has become very popular because it facilitates mounting the trimmer in approximately half the usual space, anywhere in the circuit.

Types and Characteristics

Specifications permitting, the tubular air trimmer can be used in any application currently using other trimmers. And it is usable where higher orders of "Q" and optimum stability are required. A listing of typical specifications is given in Table 1.

While at least four designs of rotors and associated torque-maintaining devices are available, the basic structure in all cases is similar. Capacitance is established and varied

by means of coaxial tubes moved laterally, with the air dielectric between the tubes. These tubes are housed in a ceramic insulator, with the assembly joined by solder.

Units of $\frac{1}{32}$ -in diameter, in the 0.8 to 10-pF range and with standard connections are the most in demand, thus are produced in the largest quantity and represent the lowest cost. This demand does, however, appear to be stabilizing, while demand for the smaller sizes (0.220-in diameter, 0.4 to 10 pF, and 0.145-in diameter, 0.35 to 5 pF) is rapidly increasing.

MIL-Specification

In mid-1969, MIL-C-14409 was revised, and the tubular air trimmer was for the first time included in a MIL-Spec. Styles PC 25 and PC 26 are listed under /12 and /13 of MIL-C-14409C. This Spec offers only a limited choice, two configurations of the $\frac{1}{32}$ -in diameter, 0.8 to 10 pF, being listed. The MIL requirements are substantially less than the capability of these units; stock trimmers offer greater stability and stress-handling capability than the Spec calls for.

Certain designs present problems in connection with the phenomenon termed "dynamic noise." This condition is the result of varying contact resistance between the rotor and its mount, and is apparent only under certain conditions of higher frequency and of circuit configuration. "Noise-free" designs are available, and the user is strongly advised to make his parts choice carefully where noise may be a consideration.

Future Outlook

As frequencies go higher, the obvious direction for the capacitor is toward still smaller sizes. We look to narrower air gaps in the coaxial structure. This will be accomplished by refining manufacturing techniques to allow less air gap without affecting linearity or other parameters. This will result in higher capacitance in the same package, or equal capacitance in a smaller package.

We look forward to development, by the instrument makers, of an accurate "Q"-measurement device at the higher frequencies—the higher the better. We would also hope for more accurate capacitance bridges at the lower values of capacitance.

The concern with "noise" will no doubt increase. This will probably lead to the development of comprehensive noise specifications.

As user knowledge and acceptance increase, we expect

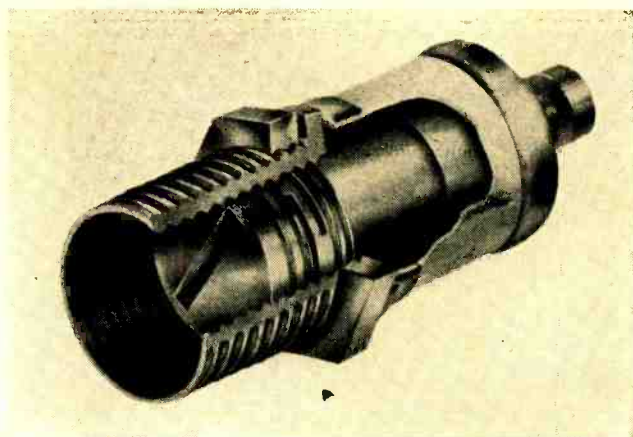

Cutaway view of a typical air tubular trimmer capacitor. The stator and rotor electrodes are coaxial metal tubes, separated by air as the dielectric, which intermesh as the adjustment screw is rotated to provide the variation in capacitance. A threaded-on cap with a silicone rubber washer is normally used to cover the screw and seal the trimmer. Units are available in gold, silver, chromate finish. The materials used in the trimmer are Invar and brass, while the supporting ceramic insulation is glazed alumina. High-temperature solder is used in the assembly.

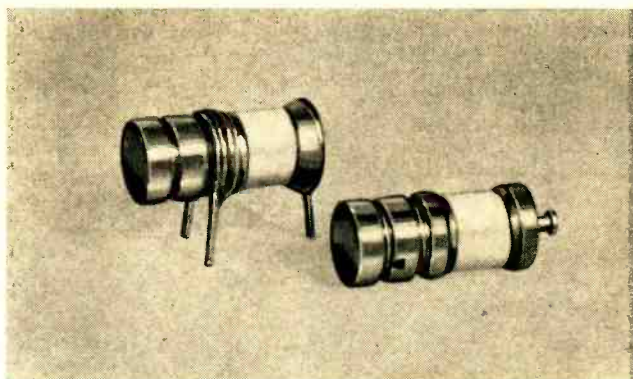

The air tubular at left is designed for PC-board mounting; unit at right is for panel mounting, with turret terminal.

that a MIL-Spec will develop for this type—satisfying the demand for stress capabilities in excess of MIL-C-14409. In the process, we believe the demand for the air tubular trimmer will continue to rise. ▲

Table 1. Specifications for a line of air tubulars. The various types are available in a variety of mounting configurations, including panel-mount, PC-board mount, and strip-line mount. Lug, lead, or turret terminals are available.

SERIES	5200	5400	5500	5600	5700	5800
Capacitance (pF)	0.8-10	1-14	1-20	1-30	0.6-6	0.4-3.5
Dielectric Strength (V d.c.)	500	500	500	500	500	500
"Q"	>5000	>3000	>1500	>1000	>10,000	>10,000
Insul. Res. (MΩ)	>10 ⁶	>10 ⁶	>10 ⁶	>10 ⁶	>10 ⁶	>10 ⁶
TC (ppm/°C)	0 ± 15	0 ± 25	0 ± 30	0 ± 30	0 ± 15	0 ± 15
Torque (in-oz)	1-5	1-5	1-5	1-5	0.4-4	0.3-3

Notes: Capacitance measured at 1 MHz; "Q" measured at 100 MHz at max. C: Temp. Range - 65 to +125° C.



The author, Assoc. Professor of Electrical Engineering at Pratt Institute, received his B.E.E. cum laude from CCNY in 1951 and attended Columbia and Hofstra Universities (M.A. in Physics, 1958). His areas of interest are solid-state electronics and computer logic. He is the co-author of "Semiconductor Fundamentals: Devices and Circuits" and is currently at work on a new book, "Electronic Circuit Analysis" which will be published very soon.

Designing LC Tuned Circuits

By A. H. SEIDMAN / Contributing Editor

How to choose the proper capacitance value for a given tuning range and how to properly temperature compensate resonant circuits. Also included are many practical examples illustrating circuit design.

THE other articles in this Special Section described several types of variable capacitors that represent the present state-of-the-art. Information gained from these articles should enable the engineer and technician to select the right variable capacitor for a particular application. There are some questions, however, that remain unanswered. For example: What range of C is required to cover a band of frequencies? What is the significance of the L/C ratio? What should the voltage rating of a capacitor be? If a variable capacitor having a negative temperature coefficient is needed, how should it be specified?

The object of this article is to supply the reader with

design procedures, illustrated by practical examples, to permit him to arrive at answers to these and other questions pertaining to LC tuned circuits.

Series RLC Circuits

In communications circuits, like those found in receivers, one desired frequency must be selected from many while all other frequencies are rejected. Two methods generally employed for accomplishing this depend on the properties of series and parallel RLC resonant circuits.

Consider the series RLC tuned circuit of Fig. 1A. Its impedance Z_s is:

$$Z_s = R + j(\omega L - 1/\omega C)$$

where $\omega (= 2\pi f)$ is the angular frequency in radians per second. Resistance R is the total series resistance of the circuit including the winding resistance of the coil. The variations in reactances $X_L = \omega L$ and $X_C = -1/\omega C$ with frequency are shown in Fig. 1B. Note that at one, and only one frequency, f_r , $X_L = X_C$. Frequency f_r is the *resonant* frequency and at this frequency the circuit is said to be in resonance. At the resonant frequency of a series tuned circuit, $Z = R$ and is therefore real, and current I is maximum and in phase with the impressed sinusoidal voltage E (power factor is therefore unity). The resonant frequency f_r may be determined by equating X_C to X_L , and solving for f_r ; the result obtained is:

$$f_r = \frac{1}{2\pi\sqrt{LC}} = \frac{0.159}{\sqrt{LC}} \text{ Hz} \dots \dots \dots (1)$$

where L is in henrys and C is in farads.

Plots of Z and I as a function of frequency are given in Fig. 2A. To obtain further insight into the series RLC circuit it is useful to plot the magnitude of the ratio of the admittance Y ($Y = 1/Z$) to its value at resonance (which is equal to $1/R = G$) as a function of frequency. This *normalized* plot is shown in Fig. 2B. The expression for $|Y|/G$ is given by:

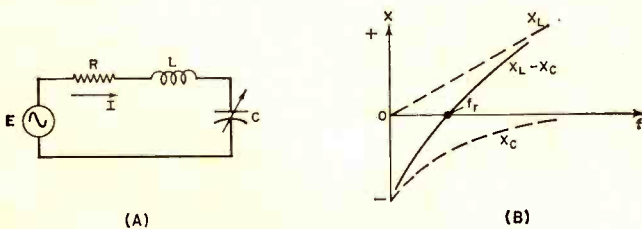
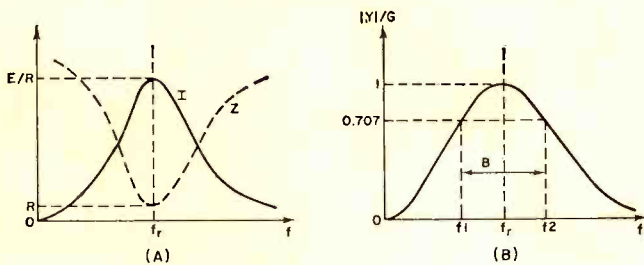

Fig. 1. The series RLC circuit along with its characteristics.

Fig. 2. Current, impedance, and admittance of series RLC circuit is shown here along with the bandwidth.



$$\frac{|Y|}{G} = \frac{1}{\sqrt{1 + \frac{1}{R^2} \left(\omega L - \frac{1}{\omega C} \right)^2}} \dots (2)$$

We can now define the Q of such a series circuit as:

$$Q_s = \omega_r L / R \dots (3a)$$

Since $\omega_r = 1/\sqrt{LC}$, we can also express Q_s by:

$$Q_s = \frac{1}{R} \sqrt{\frac{L}{C}} \dots (3b)$$

In terms of Q , equation (2) may be expressed by:

$$\frac{|Y|}{G} = \frac{1}{\sqrt{1 + Q_s^2 \left(\frac{f}{f_r} - \frac{f_r}{f} \right)^2}} \dots (4)$$

From Fig. 2B, it can be seen that the bandwidth, B , of the series RLC circuit is equal to the range of frequencies $f_2 - f_1$ where the magnitude of $|Y|/G = 0.707$ its value at the resonant frequency; the frequencies at which the magnitude is equal to the 0.707 value are also referred to as the half-power or -3 dB points. Using equation (4) we obtain:

$$B = 2\pi f_r / Q_s \text{ or } 2\pi R f_r / \sqrt{L/C} \dots (5)$$

Based on equation (5) we can then state that for a given value of R , the bandwidth varies *inversely* with Q_s or $\sqrt{L/C}$. Therefore, a high Q or a high L/C ratio yields a narrow bandwidth whereas a low Q or a low L/C ratio results in a wide bandwidth.

From a practical standpoint the Q of the circuit (Q_s) is approximately equal to Q of the coil itself (Q_L) that is:

$$Q_s \approx Q_L = 2\pi f_r L / R_L$$

where R_L is the effective series resistance of the coil winding. Resistance R_L is not constant but increases with frequency owing primarily to skin effect. Some typical curves showing the variation of Q_L as a function of frequency for single-layer coils with different coil length-to-diameter ratios and different wire size are shown in Fig. 3. Generally, a $Q \geq 100$ is obtainable and for some coils the Q is nearly constant with frequency. If, in Fig. 1A, resistance R includes, for example, the input resistance of a junction transistor, the Q of the circuit will be much less than the coil Q .

The Q of a good quality variable capacitor can be greater than 1000 at frequencies of 100 MHz and higher. For this reason, the Q of the coil is usually the dominant factor in determining the bandwidth of a tuned circuit.

At resonance in a series RLC circuit, the magnitude of voltage $|E_L|$ across the coil is $|E_L| = |E| X_L / R = Q_s |E|$. But at resonance the voltage across the coil is equal to the voltage across the capacitor $|E_C|$; therefore, the magnitude of the voltage across the capacitor at resonance is $|E_C| = Q_s |E|$. This must be considered in specifying the capacitor, as well as the coil.

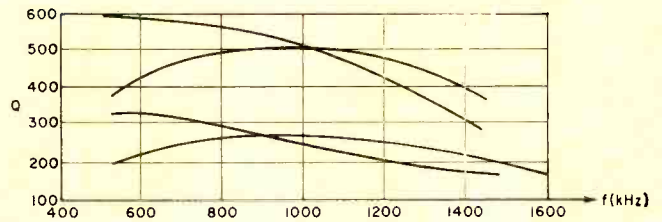

Fig. 3. Some typical Q values for single-layer coils.

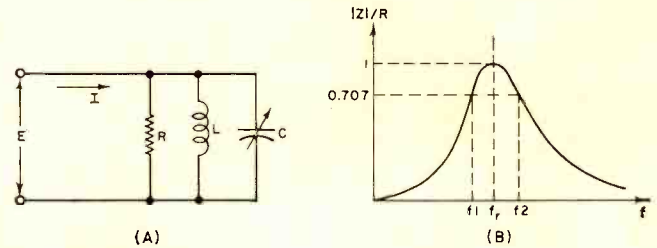

Fig. 4. Parallel RLC circuit along with its characteristics.

Parallel RLC Circuits

Let us now examine the parallel RLC circuit of Fig. 4A. The impedance Z_p of the circuit is:

where Q_p is the Q of the parallel resonant circuit and is defined by:

$$Z_p = \frac{R}{1 + jR \left(\omega C - \frac{1}{\omega L} \right)} = \frac{R}{1 + jQ_p \left(\frac{f}{f_r} - \frac{f_r}{f} \right)} \dots (6)$$

finied by:

$$Q_p = \frac{R}{\omega_r L} = R \sqrt{\frac{C}{L}} \dots (7)$$

At resonance $\omega_r C = 1/(\omega_r L)$ and the resonant frequency of the parallel circuit is identical to that of the series circuit and is expressed by the same equation (1). Impedance Z_p is maximum and current I is minimum at resonance, opposite to that for the series case. Fig. 4B shows a normalized plot of $|Z|/R$ as a function of frequency. The bandwidth of the parallel circuit can be expressed as:

$$B = 2\pi f_r / Q_p \text{ or } \frac{2\pi f_r}{R \sqrt{\frac{C}{L}}} \dots (8)$$

Unlike the series circuit, from equation (8) it is seen that for a given value of R the bandwidth of the parallel resonant circuit varies *inversely* with a high C/L or with a low L/C ratio.

A more typical parallel tuned circuit is that of Fig. 5A where the coil resistance R_L is shown in series with L . It can

Fig. 5. (A) Parallel tuned circuit with resistance shown in series with coil. (B) Use of the series capacitor to expand tuning range. (C) Use of trimmer and padder capacitors in circuit.

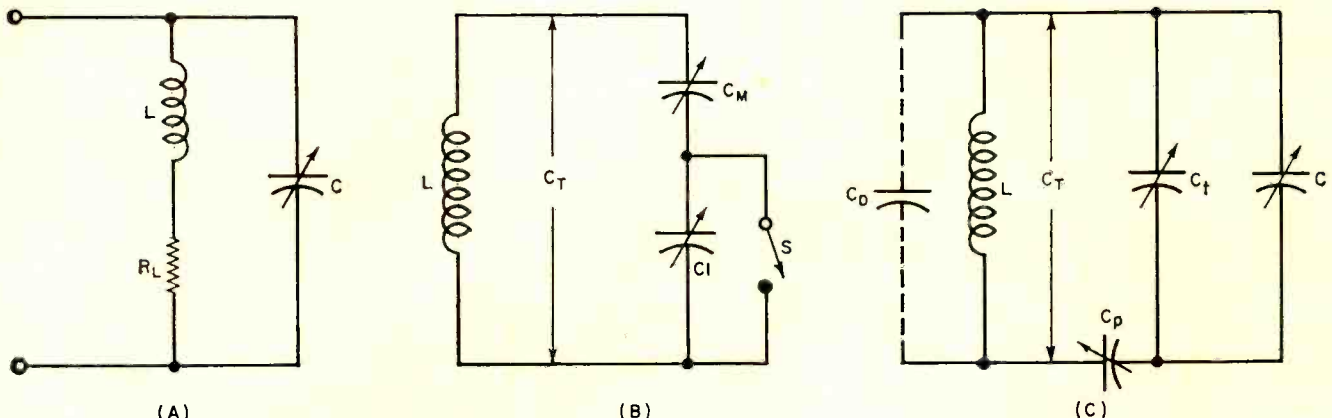

be shown that the impedance Z of the network is:

$$Z = \frac{R_L Q_s^2 \left(1 + j \frac{f_r}{Q_s f} \right)}{1 + j Q_s \left(\frac{f}{f_r} - \frac{f_r}{f} \right)} \dots \dots \dots (9)$$

For $Q_s \geq 10$ the imaginary term in the numerator may be neglected in the vicinity of the resonant frequency and expression (9) becomes identical to (6) where $R = Q_s^2 R_L$ and $Q_s \approx Q_p$.

Returning to (9) when $f = f_r$, impedance Z is not real because the numerator is still complex. Analysis shows that two resonant frequencies can be defined: (1) for unity power factor $f_{ru} = f_r \sqrt{1 - 1/Q_s^2}$ and (2) for maximum magnitude of Z , $f_{rm} = f_r \sqrt{1 + 1/Q_s^2}$. For $Q_s \geq 5$, these expressions are, for all practical purposes, equal to f_r .

For parallel resonance the current flowing in C and L is equal to $Q_s I$. The voltage across L and C is equal to the impressed circuit voltage.

Practical Examples

At this point we shall apply the results of the previous section to solve some practical problems dealing with tuned LC circuits. Each application will be illustrated with an example. For many calculations a computer terminal will reduce the arithmetic drudgery often encountered in solving tuned-circuit problems. If a computer is not available, the next best bet is a reactance slide rule or a reactance chart like that shown in Fig. 6. To find reactance on the chart, enter the frequency and proceed vertically until the chosen value of C or L is intersected. At the point of intersection a horizontal line projected to the left vertical axis determines the reactance. For example, at 10 kHz and $L = 100 \mu\text{H}$, $X_L \approx 6.3$ ohms.

To find the resonant frequency, determine the intersection of the L and C lines corresponding to the values in your design. A line projected vertically down from the point of intersection determines the resonant frequency. For example, if $L = 20 \mu\text{H}$ and $C = 100 \text{ pF}$, the resonant frequency $f_r \approx 3600 \text{ kHz}$. If L (or C) and f_r are shown, the value of the other component C (or L) can be determined by entering f_r and projecting a line vertically until the value of L (or C) is intersected. For example, if $f_r = 100 \text{ kHz}$ and $L = 0.001 \text{ H}$, $C \approx 0.0025 \mu\text{F}$.

The analytical methods developed for the design of tuned circuits will enable the engineer to arrive at component values that will, in general, be excellent approximations of expected performance. For practical reasons, however, the final choice of components may be dictated by other factors, such as cost and availability. If, for example, a $Q_p = 50$ is required for a parallel tuned circuit, it may be more economical to use a coil with a $Q_p = 100$ and shunt a resistance across the circuit to bring the Q down to 50.

If the tuned circuit were connected across the input of an active device whose input capacitance varied with operation, the minimum value of capacitance used in the tuned circuit would have to be much greater than the input capacitance to "swamp" its effect on the resonant frequency. These practical situations must always be recognized in the design of tuned circuits.

Example 1:

Design a parallel tuned LC circuit to cover the AM broadcast band from 550 kHz to 1600 kHz. It is assumed that a practical bandwidth for the circuit is a minimum of 20 kHz at the lower frequency of 550 kHz. Select the values of L , Q_s , and C . Assume that the distributed capacitance of the coil and the wiring capacitance are on the order of 20 pF. The minimum capacitance of this variable tuning capacitor is 25 pF.

Solution. Value of L is selected for minimum capacitance in the circuit ($20 \text{ pF} + 25 \text{ pF} = 45 \text{ pF}$) at 1600 kHz. Using

the reactance chart of Fig. 6 or equation (1), $L \approx 220 \mu\text{H}$.

The maximum value of C is determined at the lower frequency, 550 kHz, using this value for L . From the reactance chart $C \approx 380 \text{ pF}$. But there is 20 pF of distributed capacitance; therefore the maximum capacitance required is $380 - 20 = 360 \text{ pF}$. A variable capacitor with a range of 25 pF to 360 pF is selected.

From equation (5) $Q_s = 2\pi f_r / B = (6.28 \times 550 \times 10^3) / (20 \times 10^3) = 173$.

Example 2:

The frequency range of a tuned circuit may be extended by inserting a capacitor C_1 in series with the main tuning capacitor C_M as shown in Fig. 5B. The value of two capacitors in series (C_T) is:

$$C_T = C_1 C_M / (C_1 + C_M) \dots \dots \dots (10)$$

The value of C_1 is determined from equation (10):

$$C_1 = C_T C_M / (C_M - C_T) \dots \dots \dots (11)$$

Because L is the same whether C_M or C_M in series with C_1 is present, then for two frequencies f_1 and f_2 , from (1) we can write:

$$\frac{(0.159)^2}{f_1^2 C_M} = \frac{(0.159)^2}{f_2^2 C_T} \text{ or } C_T = f_1^2 C_M / f_2^2 \dots \dots \dots (12)$$

Suppose the maximum capacitance of $C_M = 100 \text{ pF}$ and C_1 is shorted, that is, switch S closed. The circuit tunes from $f_1 = 1 \text{ MHz}$ to $f_2 = 2 \text{ MHz}$. (a) What values of $C_{M(\text{min})}$, C_1 , and L are required so that the minimum frequency with S open is 2 MHz? (b) What is the maximum frequency the circuit can tune to with S open?

Solution. (a) Equation (12) may be used for finding $C_{M(\text{min})}$ with S open. From equation (12), $C_T = C_{M(\text{min})} = (1)^2 100 \text{ pF} / (2)^2 = 25 \text{ pF}$. This represents the minimum capacitance of the main tuning capacitor. Using equation (11), $C_1 = (25 \times 100) / (100 - 25) = 33.3 \text{ pF}$.

Inductance L will be chosen so that it will resonate with $C_M = 100 \text{ pF}$ at 1 MHz when S is closed. Using the reactance chart of Fig. 6, $L \approx 250 \mu\text{H}$.

(b) $C_{T(\text{min})} = (25 \times 33.3) / (25 + 33.3) = 14.3 \text{ pF}$. From the reactance chart $f_{\text{max}} \approx 2.5 \text{ MHz}$.

Example 3:

An oscillator circuit which may be used in a superheterodyne receiver is shown in Fig. 5C. Capacitor C is the main tuning capacitor, C_t is the trimmer, and C_p the padder capacitor. The distributed capacitance across L is represented by C_D . The net capacitance across L , defined by C_T , is:

$$C_T = \frac{(C + C_t) C_p}{C + C_t + C_p} + C_D \dots \dots \dots (13)$$

Solving (13) for C_p we obtain:

$$C_p = \frac{(C + C_t) (C_T - C_D)}{C + C_t + C_D - C_T} \dots \dots \dots (14)$$

To keep the numbers simple, assume that a receiver tunes from 550 kHz to 1550 kHz and the intermediate frequency is 450 kHz. The oscillator, therefore, must tune from $(550 + 450) \text{ kHz} = 1 \text{ MHz}$ to $(1550 + 450) \text{ kHz} = 2 \text{ MHz}$. Let inductance $L = 200 \mu\text{H}$, C tunes from 10 pF to 240 pF, C_t is set to 10 pF, and $C_D = 10 \text{ pF}$. Select C_p and check to see if for the chosen value of C_p the oscillator tunes to 2 MHz at the high end.

Solution. The value of C_p is determined at the lowest frequency of the oscillator, that is, at 1 MHz in this example. Using the reactance chart it is found that for $f = 1 \text{ MHz}$ and $L = 200 \mu\text{H}$, $C_T \approx 130 \text{ pF}$. From equation (14), $C_p = (240 + 10) (130 - 10) / (240 + 10 + 10 - 130) = 230 \text{ pF}$.

For the value of $C_p = 230 \text{ pF}$, the minimum capacitance in the circuit is: $C_{T(\text{min})} = [230 (10 + 10) / (230 + 10 + 10)] + 10 \approx 28.4 \text{ pF}$. From the reactance chart, the maximum frequency of oscillation is approximately 2.1 MHz, which is slightly greater than the required 2 MHz. The trimmer capacitor C_t may be adjusted to obtain the exact value of 2 MHz. Varying the trimmer will have negligible effect on the low frequency limit of the oscillator.

REACTANCE CHART

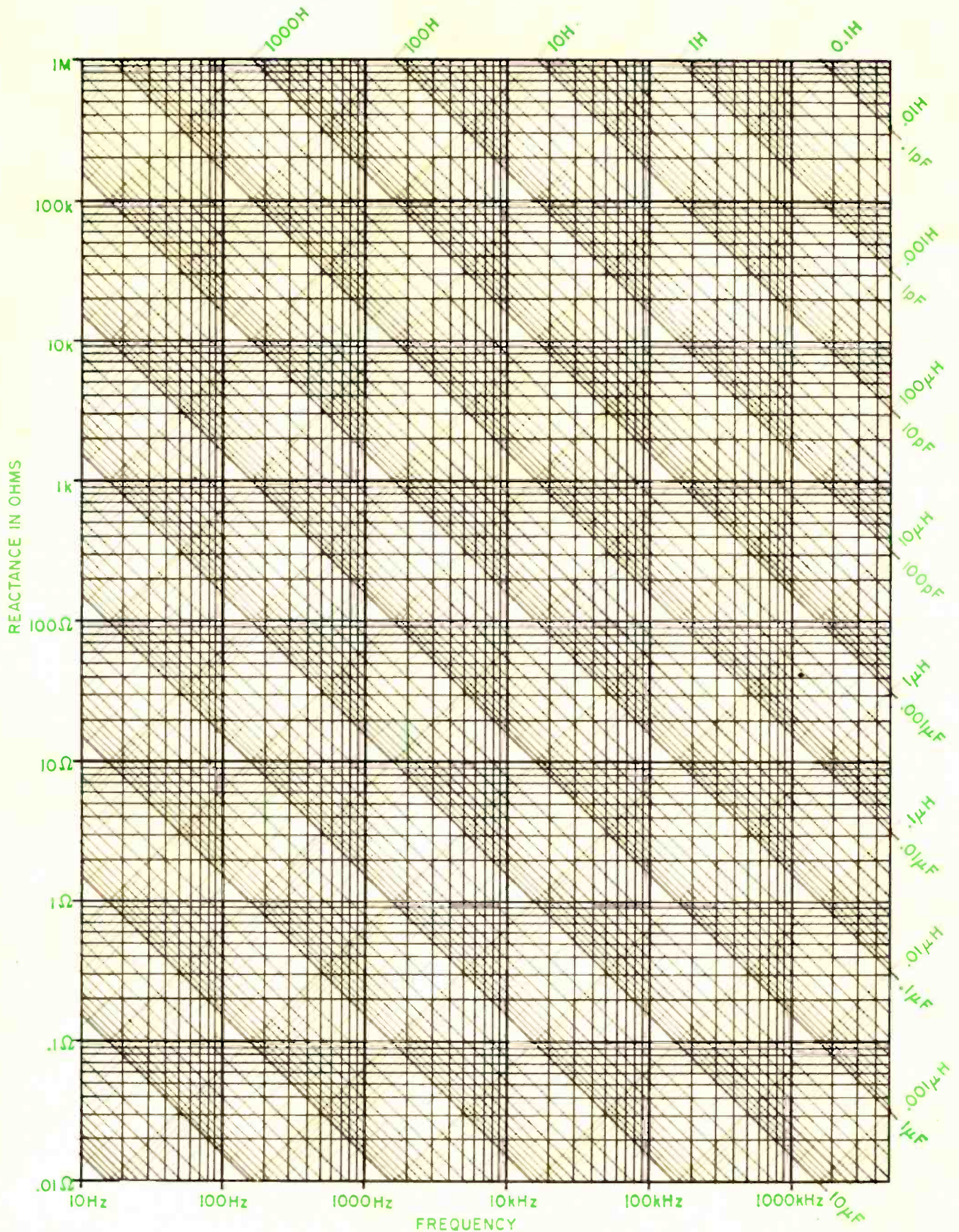

Fig. 6. Inductive and capacitive reactance over a wide range of operating frequencies.

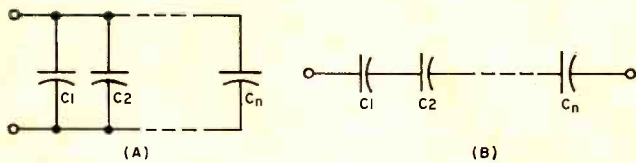

Fig. 7. Capacitors in parallel and in series have differing equivalent temperature coefficients as described.

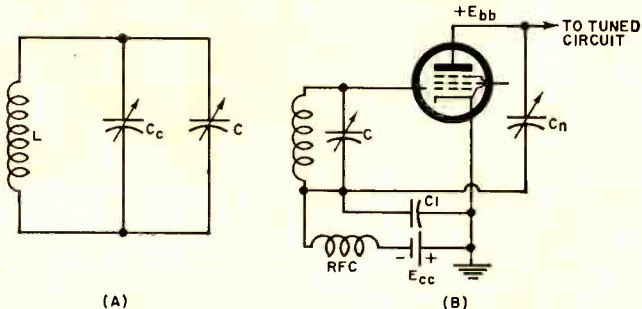

Fig. 8. (A) Circuit showing use of temperature-compensating trimmer across main tuning capacitor. (B) Circuit diagram illustrating the use of neutralizing trimmer.

Temperature drift may be a serious problem for tuned circuits such as those used in an oscillator. Because coils exhibit a positive temperature coefficient, it is possible to introduce an appropriate capacitor in the circuit, such as a ceramic type, which has a negative temperature coefficient to cancel the positive coefficient of the coil. Temperature coefficient, TC , of a capacitor is defined as:

$$TC = \frac{(C_2 - C_1) 10^6}{C_1(T_2 - T_1)}$$

where TC = temperature coefficient in parts per million per °C (ppm/°C); T_1 = reference temperature, normally taken at 25°C; T_2 = maximum test temperature, typically 85°C or 125°C; C_1 = value of capacitor at T_1 ; and C_2 = value of capacitor at T_2 .

If TC is positive the letter "P" precedes the values of the coefficient; if negative, the letter "N" precedes the coefficient. For a zero temperature coefficient, the designation "NPO" is used.

For a number of capacitors in parallel (Fig. 7A) it can be shown that the equivalent temperature coefficient TC_p for the combination is:

$$TC_p = \frac{C_1(TC_1) + C_2(TC_2) + \dots + C_n(TC_n)}{C_1 + C_2 + \dots + C_n} \quad (15)$$

where TC_1 is the temperature coefficient of C_1 , etc.

In the case of capacitors in series (Fig. 7B), the equivalent temperature coefficient TC_s is:

$$TC_s = C_T (TC_1/C_1 + TC_2/C_2 + \dots + TC_n/C_n) \quad (16)$$

where $C_T = 1/(1/C_1 + 1/C_2 + \dots + 1/C_n)$.

Example 4.

Assume that two capacitors in parallel have the following nominal values: $C_1 = 30$ pF and $TC_1 = P200$; $C_2 = 20$ pF and $TC_2 = N500$. Determine the equivalent temperature coefficient of the combination.

Solution. From equation (15), $TC_p = [30(200) + 20(-500)] / (30 + 20) = -80$ ppm = N80. Total capacitance is, of course, 50 pF.

Consider the parallel tuned circuit of Fig. 8A where C_c , a temperature-compensating capacitor, is shunted across main-tuning capacitor C . Let $C_T = C_c + C$. Accounting for the effects of the temperature coefficient, equation (1) may be expressed as:

$$f_r = \frac{0.159}{\sqrt{LC_T (1 + TC_L) (1 + TC_n)}}$$

where TC_L is the temperature coefficient of the coil (a typical value is +30 ppm) and TC_p is the temperature coefficient of C_T . Expanding terms under the radical we obtain:

$$LC_T (1 + TC_L + TC_p + TC_L TC_p)$$

Because TC_p and TC_L are in ppm, the product $TC_L TC_p$ is much less than either TC_L or TC_p and may be neglected; therefore, the preceding expression reduces to:

$$LC_T (1 + TC_L + TC_p)$$

If $TC_L = -TC_p$, then the expression is equal to LC_T and the frequency becomes independent of temperature.

Example 5:

For the parallel-tuned circuit of Fig. 8A, $C = 200$ pF and $TC = +50$ ppm; $C_c = 20$ pF. Determine the temperature coefficient of the temperature compensating capacitor C_c to compensate for the positive temperature coefficient (+30 ppm) of the coil.

Solution. From equation (15) $TC_p = -30 = [20(TC_c) + 200(50)] / (20 + 200)$. Solving for TC_c , a value of $TC_c = -830$ ppm is obtained. A capacitor with a negative temperature coefficient close to this value would be used.

Practical capacitors have tolerances on their values of temperature coefficient and capacitance. Although, for simplicity, these were neglected in our examples, they most likely will have to be considered in the design. Furthermore, the temperature coefficients of capacitors are not constant with temperature. For this reason it is necessary to make temperature runs or calculations to determine the tracking of frequency with temperature.

Although ceramic trimmers have been used for temperature compensation, their TC is variable and their use is therefore not recommended when high precision is required. Special types of stable ceramic or glass piston trimmers are available, but at a premium price. Generally, a standard fixed ceramic capacitor having the required TC is used in the temperature compensation of tuned circuits.

Tuned circuits are often temperature-compensated experimentally. For example, suppose an oscillator, having a tuned circuit like that of Fig. 5C is set to frequency f_0 at temperature T_1 . At an elevated temperature T_2 the change in f_0 is measured to be f_1 . The circuit is cooled to its initial temperature T_1 and a negative-temperature-coefficient capacitor C_1 having a coefficient of N500 or N750 is shunted across the main-tuning capacitor. The padder is adjusted to provide the same initial frequency f_0 . The modified oscillator is again elevated to temperature T_2 and the new frequency drift f_2 measured. The actual value of C_c required is:

$$C_c = \frac{C_1 f_1}{f_1 \pm f_2}$$

The plus sign is used if $f_2 > f_1$ and the minus sign is used if $f_2 < f_1$.

Although it is usually avoided if possible, there are occasions when it is necessary to neutralize an r.f. power amplifier to keep it from breaking into oscillation. A number of schemes exist and one example using a neutralizing capacitor C_n is illustrated in Fig. 8B. The voltage rating of the neutralizing capacitor is equal to the plate voltage E_{bb} for c.w. and SSB operation and $2E_{bb}$ for AM. A typical value for C_1 is 1000 pF and its voltage rating is equal to E_{bb} .

$$\text{For neutralization, } C_n C_i = C_1 C_{gp} \text{ or } C_n = C_1 C_{gp} / C_i$$

where C_{gp} is the grid-plate capacitance of the tube and C_i includes the grid-cathode capacitance (C_{gk}), stray capacitance, and the endframe capacitance of C . At very high voltages the neutralizing capacitor used is a vacuum type.

An attempt has been made to pick out from a multitude of LC tuned-circuits those designs that are fundamental in illustrating the selection and specification of variable capacitors. The literature is rich in other examples, charts, and nomograms for various tuned circuits and filters. Some books worth exploring include "Fundamentals of Circuit Theory" by Balabanian, "Essentials of Radio" by Slurzberg and Osterheld, ARRL's "The Radio Amateur's Handbook," and Ferman's "Radio Engineers' Handbook."

The author wishes to thank William F. Geist, Design Supervisor at Hazeltine Corporation, for his comments on LC tuned-circuit design. ▲

Vacuum Variable Capacitors

By MURRAY SUNTAG / Associate Editor

Widely used in broadcast transmitters and in other high-power equipment requiring high-voltage and high-frequency operation.

VACUUM capacitors are distinguished from other capacitors by their use of a vacuum instead of a "mass" (gas, liquid, or solid) dielectric. Variable capacitors use vacuum or gas (which includes air) dielectrics, of which the vacuum types offer the highest maximum-to-minimum capacitance-change ratio. Actually, about 70% of all vacuum capacitors produced are variables.

If electrical performance, rather than size and cost, were the only consideration in selecting a capacitor, then the vacuum type would be almost the only choice. In addition, since most capacitors are used in low-energy applications, the high efficiencies associated with vacuum types are generally not required. Consequently, over 95% of the capacitors manufactured use mass dielectrics.

Vacuum capacitors, both fixed and variable, are manufactured using either an evacuated glass or ceramic envelope with copper anodes at both ends. The enclosed heavy copper capacitor plates, shaped like tubular cans of different diameters telescopically arranged, are separated from each other by the vacuum dielectric. Each of the plate assemblies is provided with a heavy copper connection to fully utilize the high current-carrying capability of the copper plates. The capacitance of the vacuum variable capacitor is changed by turning the capacitance-adjustment screw causing one set of plates to move in or out with respect to the other set, varying the overlapping capacitor plate area (capacitance is directly proportional to plate area). As shown in the diagram, movement of the plates is effected in the vacuum by the use of bellows.

Characteristics

Vacuum capacitors are characterized mainly by their ability to handle high current at high frequencies (up to 1000 MHz) and high voltages. As frequency and power are increased, this type becomes the smallest and most economic capacitor to use. In fact, for a given capacitance rating, the vacuum capacitor, due to its enormous dielectric strength can tolerate the highest possible voltage of any capacitor. The nominal maximum capacitance ranges in which both ceramic and/or glass vacuum variable capacitors are available, and their voltage ratings, are listed in the table.

Although a vacuum capacitor will withstand internal arc-over that would ordinarily destroy solid-dielectric capacitors, continuously applied voltages should never exceed 60% of its rated test (peak) voltage to obtain maximum capacitor efficiency and life, except as noted below. For d.c. plus r.f. applications, the sum of the d.c. plus the peak r.f. voltage should never exceed 60% of the peak test voltage.

Since vacuum capacitors are rated for a maximum peak test voltage and a maximum operating current, limited by temperature rise, it may be impossible to apply rated voltage without exceeding rated current at low capacitive-reactance values; hence, the capacitor will be current-limited. Likewise, at high capacitive-reactance values it may be impossible to apply rated current without exceeding rated voltage; hence, the capacitor will be voltage-limited.

With normal convection cooling in a room ambient of 22°-26° C, ceramic vacuum capacitors are rated for an operating temperature of 120° C and glass vacuum capacitors for 87° C. However, by cooling the anodes of the capacitor externally with heat sinks (large straps, forced air, or water cooling) the current rating can be increased by a maximum of 50%. In addition, special vacuum capacitors can be constructed with forced-air-cooled bellows that will operate safely at 200% of the convection-cooled rating, or

with water-cooled bellows that will be limited only by voltage and be able to pass any current that can be impressed on them, through 32 MHz. Under no conditions should the current rating exceed 150% of the convection-current rating.

Because of its vacuum dielectric and low-loss glass or ceramic envelope, extremely low losses occur in vacuum capacitors. Consequently, the vacuum capacitor is a very efficient capacitor since the slight loss that does occur is only due to the r.f. resistance (few milliohms) of its copper construction. Typically, the ratio of stored energy to dissipated energy or "Q" factor is on the order to 1000 to 5000, or higher.

Applications

Vacuum capacitors are mainly used in the tuning and neutralizing circuits of high-power r.f. generating devices, such as broadcast transmitters, induction and dielectric heating equipment, and r.f. sputtering equipment. In fact, the use of vacuum capacitors is almost mandatory for plate-tank circuits of high-power transmitters. They are also widely employed in high-voltage communications equipment where space and weight are critical and/or where they are exposed to severe environments (e.g., aircraft or marine vehicle transmitters and antenna couplers). ▲

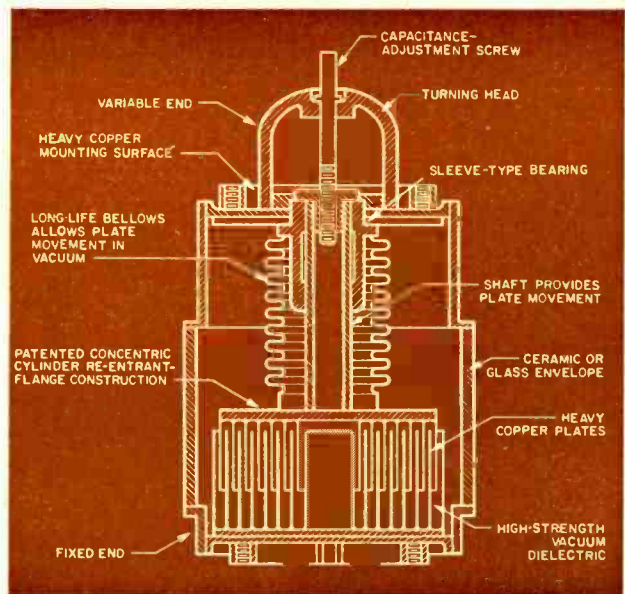

Typical construction and electrical characteristics for ceramic and glass vacuum variable capacitors made by Jennings ITT.

NOMINAL MAXIMUM CAPACITANCE RANGE (pF)		VOLTAGE RATING (kV)
CERAMIC	GLASS	
200-3000	250-5000	2-5
---	8-5000	7.5-15
30-2300	---	7.5-20
---	25-500	20
250-2000	---	25-65
---	35-1000	25-60

Announcing the **NEW STANDARD** in Stereo Testing!

Get the All-New Model SR12 STEREO TEST RECORD

The most complete...most sophisticated...most versatile
Test Disc available today... **For Just \$4.98!**

Who Needs the New Model SR12?

If you've read this far, you do. Whether you're an avid audiophile who'll settle for nothing but peak performance from his stereo components . . . a casual listener who'd like more insight into the challenging world of stereo reproduction . . . or a professional technician who needs precise standards for lab testing . . . the new MODEL SR12 will be the most important disc in your entire collection.



Like its predecessor Model 211, MODEL SR12 has been produced by Stereo Review Magazine (formerly HiFi/Stereo Review) as a labor of love — by music lovers . . . for music lovers who want immediate answers to questions about the performance of their stereo systems and how to get the best possible sound reproduction.

Now greatly expanded and updated with the most modern engineering techniques, MODEL SR12 is the most complete test record of its kind — containing the widest range of checks ever included on one test disc. An ear-opener for every serious listener!

AND, for the ultimate in stereo

testing, 7 critical TEST EQUIPMENT checks . . .

You'll make these important stereo checks BY EAR... (no test instruments of any kind required)

- ▶ Frequency response—a direct warble-tone check of nineteen sections of the frequency spectrum, from 20 to 20,840 Hz, which will pinpoint any frequency response defects in your system.
- ▶ Separation—an ingenious test which indicates whether you have adequate separation for good stereo.
- ▶ Cartridge tracking—the most sophisticated tests ever devised for checking the performance of your cartridge, stylus and tone arm.
- ▶ Channel balance—two broad-band, random-noise signals which permit you to eliminate any imbalances originating in cartridge, amplifier, speakers or room acoustics.
- ▶ Hum and rumble—foolproof tests that help you evaluate the actual audible levels of rumble and hum in your system.
- ▶ Flutter—a sensitive "musical" test to check whether your turntable's flutter is low, moderate, or high.

PLUS! ● Cartridge and Speaker Phasing ● Anti-Skating Adjustment ● "Gun Shot Test" for Stereo Spread ● Multi-purpose Musician's "A" ● Equal-tempered Chromatic Octave ● Guitar-tuning Tones.

Don't waste another minute on less-than-perfect stereo—Order Your Model SR12 Stereo Test Record NOW!

Consider the hundreds—even thousands—you've spent on your set-up and you'll agree \$4.98 is a small price to pay for the most valuable performance tool ever made. So to be sure your order is promptly filled from the supply available, mail the coupon at right with your remittance . . . today!

Attention professionals: Stereo Review's new Model SR12 Stereo Test Record is also designed to be used as a highly efficient design and measurement tool. In the following tests, recorded levels, frequencies, etc. have been controlled to laboratory tolerances—affording accurate numerical evaluation when used with oscilloscope, chart recorder, output meter, intermodulation-distortion meter and flutter meter.

- 1,000-Hz square waves to test transient and high-frequency response of phono pickups.
- 500 to 20,000 Hz frequency-response sweep.
- Sine-wave tone-bursts to test transient response of pickup.
- Intermodulation test using simultaneous 400-Hz and 4,000-Hz signals.
- Intermodulation sweep to show distortion caused by excessive resonances in tone arm and cartridge.
- 1,000-Hz reference tones to determine groove velocity.
- 3,000-Hz tone for flutter and speed tests.

Sample waveforms—illustrating both accurate and faulty responses are provided in the Instruction Manual for comparison with the patterns appearing on your own oscilloscope screen.

FREE Instruction Manual Includes Detailed Instructions, Charts, Tables and Diagrams.

Nothing is left to chance . . . or misinterpretation. Every segment of every band is fully, clearly, graphically explained. You'll know exactly what responses to listen for in each test. Which sounds and patterns indicate accurate performance . . . which ones spell trouble . . . as well as the cause of trouble and precise corrective measures to follow and help you pinpoint, analyze and cure your stereo headaches!

Records • Ziff Davis Service Division
595 Broadway • New York, N.Y. 10012

EW-4-70

Please send _____ test records at \$4.98 each, **postpaid**.

My check (or money order) for \$ _____ is enclosed.

(Outside U.S.A. please send \$7.00 per record ordered.) N. Y. State residents please add local sales tax.

Print Name _____

Address _____

City _____

State _____

Zip _____

PAYMENT MUST BE ENCLOSED WITH ORDER



COMPUTERIZING YOUR GROCERY LIST

By the end of the decade, computers promise to become indispensable in managing chain stores.

By **John Frye**

MATILDA, the office girl at Mac's Service Shop, returned from her lunch hour grocery shopping in an obviously irritated frame of mind. "Sorry I'm late, Boss," she said to Mac, "but that supermarket was impossible today. I stood in that checkout lane a full half hour to get this ten-inch grocery slip. Now I wonder if I got everything I intended to get. You can't tell much by looking at this slip unless you're a genius at connecting prices marked only 'Mt' or 'Gr' with the items on your shopping list. Right now I feel more like 'Gr-r-r-r-r!'"

"Cheer up, Matilda; help is on the way," Mac solaced her. "My wife's younger brother, who works for a large computer company, stopped in last night on his way across the country; and this morning at breakfast he was regaling us with an enthusiastic account of how computers are just starting to move into supermarket management. I think you might like to hear about it—especially right now."

"I want to hear about it too," Barney said, sticking his head out of the door of the service department.

"You'd listen to me read tube price lists to get out of work," Mac retorted; "but come on. Suppose we start by picturing how a trip to the supermarket will be seven or eight years from now:

"First, Matilda, you will notice that the gondola or shelf carrying each item will carry a unit price, but the individual cans, jars, or boxes will not be price-marked. Instead each unit will carry a distinctive number made up of several digits. You will collect the various items in your cart just as you have always done and take them to the checkout counter. There the girl will place each item so that an Optical Character Recognition (OCR) scanner can read the identifying number and flash it to a computer that may be miles away. It will recognize the number, identify and price the item, and send back this information to be displayed for your benefit. Meat and other items sold by the pound will be placed on a scales there at the counter so that its number may be read as it is weighed, and it, too, will be identified and priced by the distant computer.

"Each item will be identified almost instantly and then placed on a conveyor belt that will take it to an automatic boxing device that will arrange all the items of your order neatly in a container ready to be carried out. When all the items in your cart have been identified, the girl will push a button and the computer will give you a grocery slip on which each item is identified by code number, description, and price. For example one line may read: '3489475 Orange Juice .49.' The bill will be totalled; taxes will be added; tendered coupons will be subtracted; trading stamps will be issued. If you prefer to use your credit card, you will place it in a slot and your hand in a little compartment. The computer will compare the outline of your hand with the outline on file assigned to the person to whom the card was issued. If the topography is the same, it will query the bank about your credit. If all is OK on both counts, this will be indicated and the amount of the grocery bill will be transferred from your account to that of the store. All this will take

place in a split second, and at the same time the items you bought will be automatically subtracted from the store's inventory and, if necessary, replacement stock will be ordered."

"Hey, I like the sound of that!" Matilda exclaimed. "I especially like that business of having items on the grocery slip identified, and it sounds as though it will take much less time to get checked out."

"Sounds pretty far-fetched to me," Barney said skeptically.

"I'm not talking crystal-ball stuff," Mac answered. "Supermarkets and computer manufacturers are already experimenting with systems similar to what I have described. When I tell you that *IBM*, *National Cash Register*, *Inventory Management Systems*, *General Electric*, *RCA*, the *Frieden Division of Singer*, the *Sveeda-Kimball Division of Litton Business Systems*, the *American Totalisator Co.*, *Alpex Computer Corporation*, and the *ADS Anker Corporation* of West Germany are all deeply interested in computerizing the supermarkets, you will know I am not talking science-fiction.

"On the West Coast last fall *Inventory Management Systems, Inc.* arranged a pilot installation of its 'Marketron' system in a *Food Fair* store in Baldwin Hills, California. Nine combination cash register-inventory controller terminals were installed at checkout stations and hooked to a remote *Honeywell* computer on a real-time basis. In this instance the check-out operator key-punched the department, the quantity, and the code number of each item into the terminal. It flashed this information to the computer which recorded the price and displayed it for the customer to see on a readout at the terminal. At the same time the item or items were subtracted from inventory. At the end of the transaction the computer issued a totalled grocery slip such as I have described. In the *IMS* installation, however, the customer's bill identified each item by code number, department, and price but not by name; nor were there any provisions for credit card verification or automatic boxing.

"Inputs from different 'Marketron' terminals were fed to a modem/multiplexer and then over leased wires to a communications computer controller which separates inputs from different stores. From the information supplied, the computer gave instructions to the individual checkout counters. The operation was obviously a success because it is being expanded to several more *Food Fair* stores in Los Angeles this spring as well as in *Ralph's Grocery Store* chain units. Next month it is planned to start installing the 'Marketron' system in several of the *Daitch-Shopwell* stores in New York and Connecticut."

"Seems to me the store benefits more than the customer," Barney said.

"And you're right," Mac agreed. "Joseph Davis, *IMS* vice-president, says the real advantage of the 'Marketron' system is in inventory control. The store manager can interrogate the computer at any time as to what has been sold, he can find how much cash is in each 'Marketron,' he can instantly change the price of any item, and—most important of all—the computer can be made to perform automatic ordering and restocking functions. Finally, the system practically elimi-

nates checkout operator under-rings, which is estimated to represent an average loss of .7% of sales."

"How about the over-rings?" Matilda asked. "I'd think they would cancel out the under-rings. Why is there a net loss of .7%?"

"Ned Harwell, author of *Checkstore Management*, gives cogent reasons based on actual studies. Seems the checkout girl encountering a smudged price is much more likely to give the customer the benefit of the doubt and under-ring the item rather than over-ring it. In the 'Marketron' system, the computer detects most punching errors and warns the operator by a flashing red light and an audible signal.

"IMS is not a manufacturer of computer equipment; so it does not make its own hardware or software. IBM, on the other hand, also conducted a test for four weeks in a *Safeway* store to gather some specific information they needed, and of course they used IBM equipment. They installed terminals at two checkout stands and code numbered a little less than 3000 items. However, since not all stands could receive un-priced items, it was necessary to have the price as well as the code number on each item. This made it impossible to observe the answer to an intriguing question: what will be the customer's reaction to items without prices on them? The IBM slips given the customer

had the name of the item as well as the code number and the price. At the present time they are evaluating the results of these tests."

"Sounds to me as though IMS has stolen the ball and run with it while the computer giants are hesitating," Barney observed. "Since there are so many advantages for store managers and since it is potentially such a huge and lucrative market for computer manufacturers, why the hanging back?"

"There are good reasons according to my brother-in-law," Mac replied. "First, such an installation represents a lot of money. No store chain wants to put huge sums into a system that may soon become obsolete. Secondly, for the system to work, there should be a universal system of code numbering. Ideally the code would be put on the label by the manufacturer; but he doesn't want to go to the expense of changing his labeling equipment, his present computer setup, his billing, his warehousing, etc., until he is sure there will be equipment to utilize it.

"Probably the code is the biggest bottleneck at this time. When using a punch code, the most commonly sold items are given the lowest, or two-digit numbers; the next-most-popular items are given three-digit numbers, etc. But if we go to an OCR system of number scanning, which seems inevitable in the long run, this will not be necessary. The National

Association of Food Chains, with help from others, has been working on such a code for several years but still has not decided on a code structure. When it comes, probably in the next year or two, it will likely be a seven- or eight-digit number, too long to key. Then it will likely take three to five more years for the manufacturers to produce the necessary equipment to use the code. RCA and Kroeger have been working together to produce a suitable OCR device, and it is said that *National Cash Register* and IBM are working hard on this same project.

"GE has a 'Tradar' (Transaction Data Recorder) system which is a complete package of terminals, coding and communication devices, special software programs, computers, and peripheral equipment that reads magnetically encoded merchandise tickets and verifies credit cards. The J. C. Penney retail chain has signed a \$10,000,000 contract with GE for 'Tradar' and plans to have the system in all fifty of the Penney outlets in Los Angeles by the end of the year.

"But progress will probably be made a little gingerly because we are dealing with that mysterious quantity, a woman shopper," Mac continued, grinning mischievously at Matilda. "No one is quite certain whether she really wants to be speeded through her recess from home and sometimes the kids." ▲

THE WORLD'S MOST ADVANCED HIGH FIDELITY AMPLIFIER

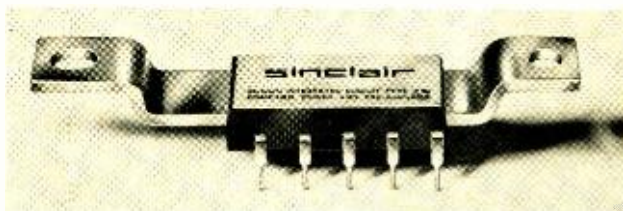

SINCLAIR IC-10

actual size

The Sinclair IC-10, the world's first monolithic integrated circuit high fidelity amplifier and preamp, is now available for professional or hobby applications. The silicon chip contains 13 transistors, 3 diodes and 18 resistors. This rugged device is encapsulated in plastic and bonded to a supporting heat sink bar. The IC-10 is a true high fidelity amplifier possessing distinct advantages over conventional types, the most important of which are freedom from thermal runaway and a very low distortion level. The IC-10 may be used with batteries or with the PZ-7 regulated power supply. As an audio amplifier the IC-10 requires only the addition of tone controls, speaker and a power source. A 32 page manual describing applications in addition to audio is supplied with each IC-10.

SPECIFICATIONS

Output: Class AB. 10 watts peak, 5 watts RMS
Distortion less than 1% at full output
Response: 5 Hz to 100 kHz \pm 1 dB
Gain: 110 dB (100,000,000,000 times)
Supply voltage: 8-18 volts DC
Sensitivity: 5 mv. Input impedance adjustable externally up to 2.5 meg ohms.

PLEASE SEND ME:

IC-10's @ \$12 ea. + 35c postage

PZ-7 Power Supplies @ \$14.95 ea. + 75c shipping

FREE AUDIONICS Catalog

Total enclosed: \$

AUDIONICS, INC., Dept. E-4
9701 S.E. Mill, Portland, Ore. 97216

Name _____

Address _____

City _____

State _____ Zip _____



STEREO/HI-FI DIRECTORY

Giant 180 page buyer's guide listing more than 1,600 individual Stereo/Hi-Fi components by 176 manufacturers. Nine individual sections complete with specs, photos, prices—the works!

1970 #98 \$1.35
1969 #82 \$1.25



TAPE RECORDER ANNUAL

Over 130 pages covering every aspect of tape recording. Complete buyer's guide to the brands and models on the market. Expert tips on equipment—making better tapes—editing—copying—everything you want and need to know about tape recording.

1970 #99 \$1.35
1969 #81 \$1.35

Ziff-Davis Service Division—Dept. W • 595 B'way, New York, N.Y. 10012

I am enclosing \$ _____ for the annuals circled below. My remittance includes an additional 25¢ per copy for shipping and handling (Outside U.S.A. all magazines are \$2.00 per copy, postpaid.)

\$1.35 each

81 98 99

\$1.25 each

82

Print Name _____

Address _____

City _____

State _____

Zip _____

PAYMENT MUST BE ENCLOSED WITH ORDER

EW-4-70

CIRCLE NO. 148 ON READER SERVICE CARD

IC Memories

(Continued from page 36)

chip sizes and decreases in cell sizes account for much of the present and predicted rises in chip capacity.

Experimental Processes

Bell Telephone Laboratories is currently experimenting with a semiconductor production process that may help bipolar LSI capture the large-memory market. This process, which involves the formation of a very thin *p*-type layer on the semiconductor wafer, allows transistor bases and collectors and resistors to be diffused in one cycle, thereby obviating the need for big bathtub isolations now required around transistors. The process is reported to shrink element size approximately 60 percent and to be almost as simple as that used for MOS. The cells must operate at both low voltage and low power levels, which can be an advantage in memories, and switching speed is in the present bipolar range.

Several R&D groups are attempting to develop electrically alterable ROM's with a new version of MOS. The MOSFET gate insulation is made with layers of silicon oxide and silicon nitride.

High-potential electrons injected through the gate get trapped in the nitride, altering the switching voltage threshold for more than a year. The effect is somewhat like the oxide-programming technique now used, but the trapped charge can be erased and the transistors reprogrammed if the situation warrants it.

A more immediate use of silicon nitride in MOS IC's will probably be as a passivation coating. The nitride appears impervious to moisture and contaminants, and may permit MOS IC's to be packaged in plastic at much lower cost than hermetic packaging. The technique seems to work well for bipolar IC's, but long-term reliability tests must be completed before it can be determined that this is an acceptable substitute for sealed MOS packages. ▲

REFERENCES

- Potter, G.B., et al: "Integrated Scratch Pads Sire New Generation of Computers," *Electronics*, April 4, 1966, pg. 118
- Mrazek, D.: "Low Power MOS Clock-Modulated Memory Systems," AN-19, National Semiconductor Corp., January, 1969
- : "MOS Delay Lines," AN-25, National Semiconductor Corp., April, 1969
- Cserhalmi, N., et al: "Efficient Partitioning for the Batch-Fabricated Fourth Generation Computer," *Proc. of 1968 Fall Joint Computer Conference*, AFIPs. Vol. 33, Part II, pg. 857
- Sander, W.B.: "Semiconductor Memory Circuits and Technology," *op cit*, pg. 1205
- Murphy, B.T., et al: "New, Simplified Bipolar Technology and its Application to Systems," *International Solid-State Circuits Conference*, Philadelphia, 1969
- : "Hughes Sers New Kind of Trap to Wed MOS to Silicon Nitride," *Electronics*, April 28, 1969, pg. 39.

Introducing the world's only \$339 triggered scope.

Before you say you don't need a triggered scope, look what's happening to TV servicing: tubes are out, transistors and IC's are in.

With tubes you could play hit-or-miss, knowing the tube would take the overload. Try the same thing now, and good-bye transistors.

For new-era circuitry, Leader introduces a new-era troubleshooter. A triggered scope, just like the ones the TV designers use.



Now the wave shape is locked in and continuously displayed. Now you can look at a waveform containing high and low frequency components. Now you can determine voltage directly and instantly.

Before you say \$339 is a lot of bread, look what it buys: Leader's LBO-501 5-inch triggered scope, with a bandwidth of DC to 10MHz and a solid state package.

Going like hotcakes at your Leader distributor.

Seeing is believing.

LEADER INSTRUMENTS

37-27 27th Street, Long Island City, N.Y. 11101, (212) 729-7411

CIRCLE NO. 133 ON READER SERVICE CARD

Build this pipelike Schober Recital Organ for only \$1850!*



* Includes finished walnut console. (Only \$1446 if you build your own console.) Amplifier, speaker system, optional accessories extra.

You couldn't touch an organ like this in a store for less than \$4,000—and there never has been an electronic instrument with this vast variety of genuine pipe-organ voices that you can add to and change any time you like! All four families of formal pipe tones are present in variety to delight players of classic and religious music. Yet you can change the entire organ for popular and theatrical sounds, or plug in special voices for baroque, romantic, or modern repertoires. If you've dreamed of the sound of a large pipe organ in your own home, if you're looking for an organ for your church, you'll be more thrilled and happy than a Schober Recital Organ than you could possibly imagine—kit or no kit.

You can learn to play it—and a full-size, full-facility instrument is easier to learn on than any cut-down "home" model. And you can build it, from Schober Kits, world famous for ease of assembly without the slightest knowledge of electronics or music, for design and parts quality from the ground up, and—above all—for the highest praise from musicians everywhere.

Send right now for the full-color Schober catalog, containing specifications of all five Schober Organ models, beginning at \$499.50. No charge, no obligation. If you like music, you owe yourself a Schober Organ!

The Schober Organ Corp., Dept. RN-76
43 West 61st Street, New York, N.Y. 10025

- Please send me Schober Organ Catalog and free 7-inch "sample" record.
- Enclosed please find \$1.00 for 12-inch L.P. record of Schober Organ music.

NAME _____

ADDRESS _____

CITY _____ STATE _____ ZIP _____

CIRCLE NO. 122 ON READER SERVICE CARD



Here's the simple speedy way to cut smooth, accurate holes in metal, hard rubber, plastics, epoxy, etc.

Save hours of hard work . . . punch clean, true holes in seconds for sockets, controls, meters, and other components. Easy to operate. Simply insert punch in a small drilled hole and turn with a wrench. For use in up to 16-gauge metal. Available at leading radio and electronic parts dealers.

GREENLEE TOOL CO
DIVISION OF GREENLEE BROS. & CO.
1866 Columbia Avenue, Rockford, Ill. 61101
A Unit of Ex-Cell-O Corporation

CIRCLE NO. 109 ON READER SERVICE CARD

ENJOY THE "MUSIC ONLY" FM PROGRAMS

M. A. D.

MUSIC ASSOCIATED'S DETECTOR

for continuous, commercial-free music with ANY FM tuner or receiver

Kit \$49.50 Wired \$75.00 Cover \$4.95 List of FM stations with SCA authorization \$1.00. For complete information write or call:

MUSIC ASSOCIATED
65 Glenwood Rd.
Upper Montclair, N.J. 07043
phone 201-744-3387

FINEST QUALITY
HARD-TO-FIND TOOLS

NEW CATALOG

Unique collection of hard-to-find versatile hand tools and small power tools rarely found in stores or other catalogs. Large selection of new and unusual electronic tools and woodworking tools including pliers, knives, diamond glass cutters, soldering jigs, tungsten carbide saw blades, silver solder, micro miniature tools and scores of other fascinating items to make projects easier, more fun. All are top quality with money back guarantee. Used extensively by electronic technicians, researchers, model makers. Write to:

BROOKSTONE CO.

4065 Brookstone Building, Peterborough, N.H. 03458.

IDEAS TO CASH

We are seeking prototype toys, games and educational items. If you can or have created a good item, we can convert your effort into a cash asset. Write to: R.A.I. Research Corp., Dept. 5W, 36-40 37th Street, L.I.C., N.Y. 11101.

Single-Signal S.W. Receiver

By LARRY LISLE, K9KZT

NEED an extra short-wave receiver? —one you can leave tuned to WWV, a favorite short-wave broadcast station, or to an often-used amateur frequency? For less than five dollars you can convert an old a.c.-d.c. table radio into a crystal-controlled s.w. receiver for one frequency between 5 and 20 MHz.

The necessary modifications are extremely simple. The converter stage of a typical broadcast receiver is shown in Fig. 1A, while the same stage after conversion is shown in Fig. 1B. The set's loop antenna has been replaced by a s.w. coil, L_1 (15 t. ± 20 plastic-covered solid hookup wire, closewound on $\frac{3}{4}$ " insulated form), the cold end of which is connected to ground instead of to the a.v.c. line to keep the stage from being blocked by the local oscillator. A crystal, either above or below the signal frequency by the amount of the intermediate frequency (usually 455 kHz) has been substituted for the oscillator coil. (Crystals are available from *International Crystal*, 10 N. Lee, Oklahoma City, Okla. 73102. Specify "EX" type. Price \$3.95 postpaid.) The tuning capacitor of the oscillator section is not used. A 150-pF capacitor couples the antenna to the receiver and a small choke, RFC_1 , in the screen circuit keeps the r.f. where it belongs. If reception of c.w. signals is desired, the i.f. stage may be made to oscillate by connecting a very small capacitor (1 or 2 pF) between the grid and plate of the i.f. tube.

One other modification should be made in the interest of safety. *Ground the chassis to a good earth ground, and connect only the ungrounded side of the line cord to the wall outlet.* Unless this step is taken, if the antenna-

coupling capacitor should fail, the full line voltage may appear between the antenna and ground. Aside from this danger, grounding the chassis is always a good idea when modifying an a.c.-d.c. set, since it is extremely easy to bypass a safety feature installed by the manufacturer without being aware of it. This is especially important when using the set in the vicinity of other electronic equipment, whose chassis are grounded (or should be).

Construction is not critical, and parts may be placed in any available space. In the receiver modified by the author, a single-section 365-pF variable capacitor replaced the original tuning capacitor which was badly rusted. The crystal was placed on the front chassis lip, but may be placed elsewhere if desired. Instead of a conventional crystal socket, a nine-pin miniature tube socket was used, as this fit an existing hole.

After wiring has been completed and double checked, attach the chassis ground wire to a water pipe, ground stake, etc. Connect the antenna, and plug the "hot" side of the power cord into a wall socket. If the tubes fail to light, reverse the plug. When the set warms up, rotate the tuning capacitor to the point of best reception.

The i.f. transformers may be adjusted by ear for maximum output. Begin with the primary of the first transformer, and work towards the detector. Then repeat each step, proceeding from the detector back to the mixer. Once placed in operation, the receiver will require no adjustment: Sensitivity and selectivity will be roughly equivalent to that which may be expected of one of the smaller short-wave sets. ▲

Fig. 1. (A) Converter stage of a typical a.c.-d.c. broadcast-band table radio. (B) The same, except for modifications (in heavy line), for short-wave conversion.

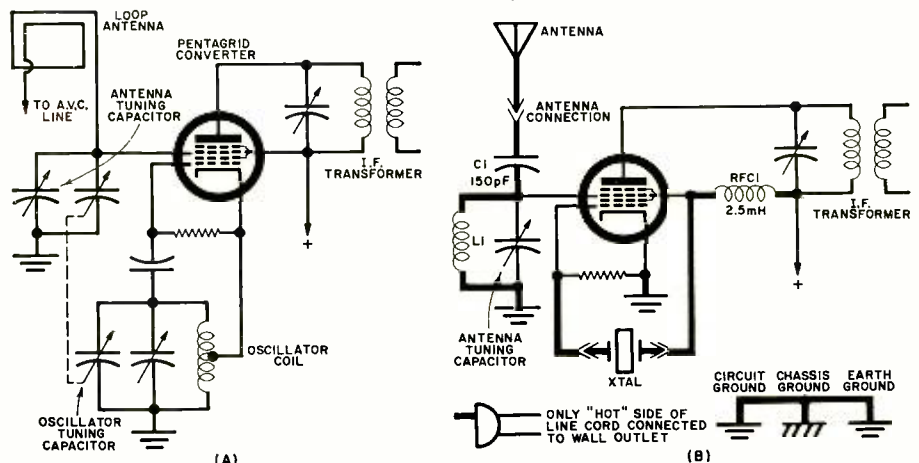

ELECTRONIC CROSSWORDS

By JOHN D. RICHARD

(Answer on page 92)

ACROSS

1. Useful sort of scatter for v.h.f. DX.
8. Tube filaments.
9. 90 from quadrature.
11. Heat units.
14. So nice, this base over hypotenuse arrangement!
15. If the solution is acid, this reads less than 7.
16. A gripping affair in the workshop.
17. What you hear when reading c.w.
18. This character just will not agree with computer logic.
19. Colloquially, to produce coherent light.
21. One is one bit, this is the other bit.
23. The capacitor could be micro-this!
25. Can offer piles of power.
26. Similar to 4 down, vet finds a home in a thermojunction.
29. An effect which provides an apt cure for similar-channel FM interference.
30. Add a neutron or two to produce this.
31. The frequency between first and second detectors.

DOWN

1. Signal these for radio trouble-shooting.
2. If coulomb = C, this is 1 C/s.
3. Expel what's hidden.
4. The conductors of a transmission circuit.
5. *Caveat* this when shopping for components.
6. What you must do to visualize *j*.
7. The effect when light produces an e.m.f.
10. Like the saxophone, this instrument can incorporate a vibrating reed.
12. Old insulating varnish.
13. Precedes electric and motors.
14. Funny how the capacitor dielectric is also employed for pots!
20. Could describe a languorous lateral camera scan.
22. Those early wet electrolytics would occasionally do this.
23. One of several that the digital voltmeter displays.
24. Can result from high voltage spikes.
27. Non-kinky tetrode.
28. Tie.

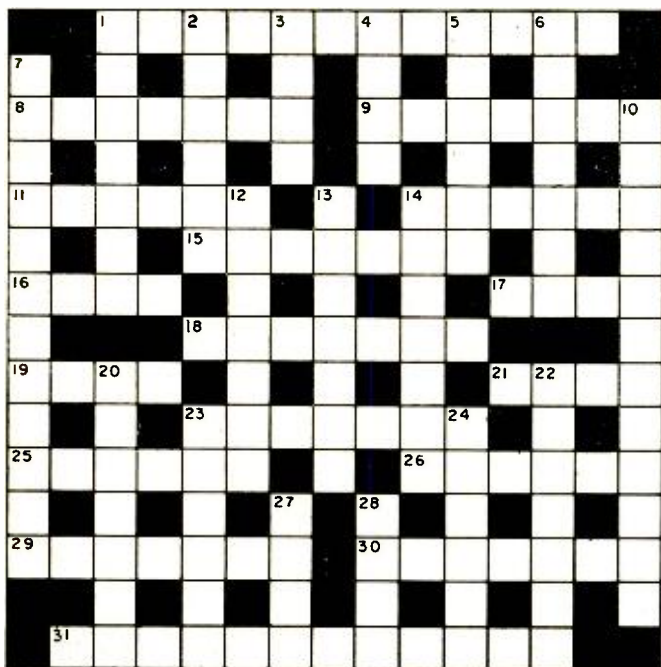

Weller® simplifies soldering



New TEMPMATIC® Temperature Controlled Soldering Tool

Combines all the advantages of a pencil iron, a fast heating soldering gun, and tip temperature control. Exclusive removable Powerhead contains Weller's temperature control system. Protects components even in the most delicate work situations. Tool weighs 7 oz. Use it for light or heavy duty soldering. Model GT-7A has 700°F. 3/16" chisel point Powerhead. Model GT-6B has 600°F. 1/8" conical point Powerhead.



The original Dual Heat Guns

Fast heating. Long-life tips. Exclusive trigger-controlled dual heat. High soldering efficiency. Spotlight. 3 models from 100/140 watts to 240/325 watts.



Dependable MARKSMAN Irons

They outperform other irons of their size and weight. Long-reach stainless steel barrels. Replaceable tips. 5 models from 25 watts to 175 watts.



Weller 25-watt Iron for intricate work

Industrial rated. Weighs 1 3/4 oz. Delivers tip temperatures to 860°F. Cool, impact-resistant handle. Model W-PS with 1/16" tip.

Weller®

WELLER ELECTRIC CORP., Easton, Pa.
WORLD LEADER IN SOLDERING TOOLS

CIRCLE NO. 110 ON READER SERVICE CARD

"Look what Lampkin's type 107 Digital Frequency Meter can do for YOU..."

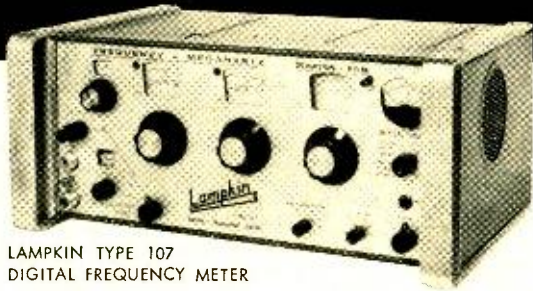

LAMPKIN TYPE 107
DIGITAL FREQUENCY METER

- ★ Accuracy guaranteed better than 0.0001%, in the field, independent of WWV. Dial precision 0.00002%.
- ★ Operates as **FREQUENCY METER** or **SIGNAL GENERATOR**, to above accuracy, all channels, from 10 KHz to 500 MHz — IF, RF, UHF.
- ★ Extremely simple and easy to operate. Simply set frequency on digital dials. Easier and faster than a counter. Shows **DIRECTION** and **AMOUNT** of transmitter error — no arithmetic.
- ★ Dual power supply, either 110 volts AC or 12 volts DC. Weight only 22 lbs. Leasing terms available.

\$2,390 F.O.B. Bradenton, Florida

For complete specifications — Mail coupon today

Name
Address
City State Zip

LAMPKIN LABORATORIES, INC.
MFM Div., Bradenton, Fla. 33505

The Motorola Home Study Course on Servicing 2-Way Radio.

If you'd like to get into a top-paying prestige job, maybe FM 2-way radio is for you. Each year, more and more businesses are buying 2-way. That means service. And service means money. We can train you to get in on the action. Our special home study course is the place to start. We teach you FM 2-way radio servicing, and prepare you for an FCC license.

- Send me FREE Evaluation Examination.
- Send details on Home Study Course on FM 2-way radio servicing.
- Send details on how you can prepare me for an FCC license.

Name Occupation

Address

City State Zip



MOTOROLA
TRAINING INSTITUTE

1301 Algonquin Road, Dept. 19, Schaumburg, Ill. 60172

CIRCLE NO. 130 ON READER SERVICE CARD

FEEDBACK MODULE for MOTOR CONTROL

By R. F. SCHWABENLENDER / Manager
Information Services, Cutler-Hammer, Inc.

Using an SCR sensing and power circuit, device monitors motor speed, changing power with load.

DESIGNED to do for small motor appliances what the automatic transmission did for the automobile, a new electronic speed-control module performs the electrical equivalent of shifting gears. When the module detects increased strain, it automatically boosts power to the motor; if it detects lessened strain, it cuts power.

Developed by the Specialty Products Division of *Cutler-Hammer, Inc.*, the module uses an SCR sensing and power circuit to monitor motor speed and automatically increase or decrease power proportionate to the load. This module, shown in the diagram, constitutes the smallest SCR power drive, with feedback, that is available for commercial use.

Combined with a variable resistor and an "on-off" switch, the module provides stepless motor speed control. The effectiveness of the feedback circuit is made obvious by an almost constant-speed characteristic under varying load.

The variable-speed package has applications on fractional horsepower universal motors with normal loads less than 4 amperes, which would benefit from high torque capability, such as sewing machines, food blenders, hand-held mixers, floor scrubbing and polishing equipment, etc.

Power tool manufacturers have also incorporated a trigger-switch version of the variable-speed package on electric hand drills and jig saws. Hand tools equipped with the switch have particular appeal to craftsmen needing precise speed control. The feedback package allows precise drilling at slow speeds through such objects as concrete and hardwood.

A decrease in speed due to loading of the motor results in an advanced SCR firing angle which provides more power to the motor and compensates for the increased load. A consistent firing angle (speed) at any setting or load eliminates cogging, loping, or other noise-produced speed variations.

The variable-speed module requires three leads: two power leads of 18-gauge wire and a control lead of 22-gauge wire.

The module is available for under \$3 in quantities of 10,000 or more, with package variations such as the trigger-switch version running slightly more.

The feedback module, which is an integral part of the control circuit, must be engineered to the specific characteristics of each motor's application. Delivery time is thus dependent on motor characteristics of each application and the resultant engineering requirements.

For several years *Cutler-Hammer* has offered a full-wave quadrac circuit without feedback. The full-wave module without feedback provides stepless, variable control in light dimmers, table lamps, slide projectors, and heating units, in addition to variable-speed control of small universal motors such as those incorporated on a centrifuge. ▲

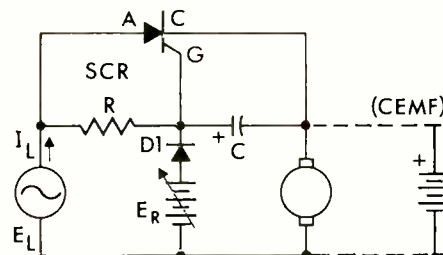

Schematic of electronic speed-control module that monitors the motor speed and, depending on the load, automatically increases or decreases power input.

C.E.T. Test, Section #3

Components

By DICK GLASS*

**What is your electronics servicing I.Q.?
You must get 75% on entire exam to pass.**

This is the third in a series of 12 test sections to be published monthly. While these test exam sections are not part of the actual NEA C.E.T. examinations presently being administered, they are similar in nature. Should you find you are able to correctly answer 75% or better, you might be a candidate to become a registered CET. You can take the exam in your area but you must show 4 years of experience to qualify.

(Answers will appear next month.)

Answers to last month's quiz appear on page 92

1. A capacitor marked "P1500" will react to temperature increases by:
 - (a) increasing in capacitance
 - (b) decreasing in capacitance
 - (c) remaining constant within a specific range of temperature
 - (d) marking has nothing to do with its capacitance characteristics
2. The fourth color code band on a carbon resistor means:
 - (a) 10% tolerance when gold colored
 - (b) number of zeroes following significant digits
 - (c) 20% tolerance when missing
 - (d) 2-watt resistor when red
3. X-radiation is least likely to be produced in a color picture tube:
 - (a) at the face of the tube and the shadow mask
 - (b) when a neck shadow is produced by yoke placement
 - (c) in the electron gun assembly
 - (d) at the front and sides of the funnel assembly
4. To compensate for yoke resistance as the temperature increases, a is used in series with the yoke windings
 - (a) thermistor
 - (b) surgistor
 - (c) voltage dependent resistor (VDR)
 - (d) NPO capacitor
5. Capacitor specifications are least important:
 - (a) in vertical oscillator grid circuits
 - (b) as screen bypasses in color bandpass amplifiers
 - (c) as coupling capacitors in horizontal oscillator circuits
 - (d) as oscillator trimmers in auto radios
6. To reduce hum pick-up in long audio-cable runs, you might:
 - (a) change from a magnetic pick-up to a crystal
 - (b) use a ceramic microphone
 - (c) use a low-impedance microphone
 - (d) use high-impedance audio cable
7. Integrators have time constants which allow:
 - (a) high-frequency pulses to be changed to sharp spikes
 - (b) low-frequency pulses to be passed through
 - (c) low-frequency pulses to be filtered out of the desired signal
 - (d) high-frequency pulses to be filtered out of the desired signal
8. Line transformers generally are used in multi-speaker paging systems to:
 - (a) increase voice-coil losses
 - (b) match impedance and increase line losses
 - (c) decrease power from output transformer
 - (d) simplify the installation of various speakers
9. Normally, a filter capacitor may not be replaced by another with:
 - (a) less than 90% of the rated capacitance value
 - (b) less than 80% of the rated capacitance value
 - (c) more than 60% over the rated capacitance value
 - (d) more than 50% over the rated capacitance value
10. Capacitors often used because of their thermal stability are:
 - (a) silver mica capacitors
 - (b) ceramic disc capacitors
 - (c) tubular
 - (d) hi K

*Executive V.P., NEA, 12 South New Jersey St., Indianapolis, Ind. 46204, assisted by Lew Edwards, chairman of Test Make-up Subcomm.

COMPARE CLOSE-UPS

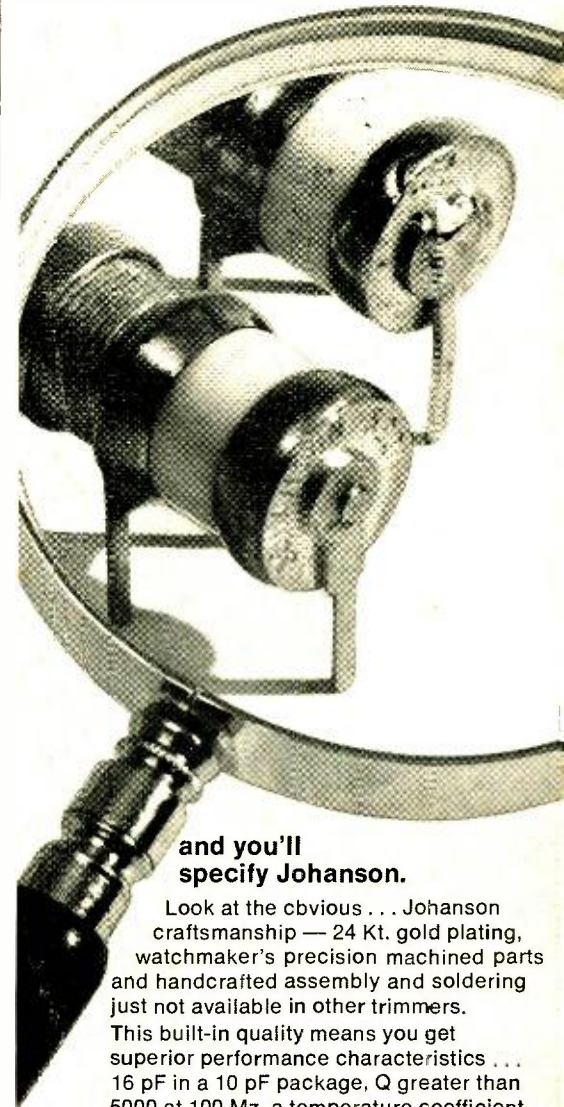

**and you'll
specify Johanson.**

Look at the obvious . . . Johanson craftsmanship — 24 Kt. gold plating, watchmaker's precision machined parts and handcrafted assembly and soldering just not available in other trimmers.

This built-in quality means you get superior performance characteristics . . . 16 pF in a 10 pF package, Q greater than 5000 at 100 Mz, a temperature coefficient of $0 \pm 15 \text{ PPM}^\circ/\text{C}$, with tuning stability and long life.

Why settle for ordinary trimmers when the best is available — send today for our new catalog sheet on our 5200 series . . . and start comparing.



Johanson

MANUFACTURING CORPORATION

Rockaway Valley Road, Boonton, N.J. 07005
(201) 334-2676

Electronic Accuracy Through Mechanical Precision

**“Get more
education
or
get out of
electronics**

...that’s my advice.”



**IN-DEPTH
COVERAGE OF
SOLID STATE
ELECTRONICS
...including
integrated circuits!**



Ask any man who really knows the electronics industry.

Opportunities are few for men without advanced technical education. If you stay on that level, you'll never make much money. And you'll be among the first to go in a layoff.

But, if you supplement your experience with more education in electronics, you can become a specialist. You'll enjoy good income and excellent security. You won't have to worry about automation or advances in technology putting you out of a job.

How can you get the additional education you must have to protect your future—and the future of those who depend on you? Going back to school isn't easy for a man with a job and family obligations.

CREI Home Study Programs offer you a practical way to get more education without going back to school. You study at home, at your own pace, on your own schedule. And you study with the assurance that what you learn can be applied on the job immediately to make you worth more money to your employer.

You're eligible for a CREI Program if you work in electronics and have a high school education. Our FREE book gives complete information. Mail postpaid card for your copy. If card is detached, use coupon below or write: CREI, Dept. 1104A, 3224 Sixteenth Street, N.W., Washington, D.C. 20010.



**CREI, Home Study Division
McGraw-Hill Book Company
Dept. 1104A, 3224 Sixteenth Street, N.W.
Washington, D.C. 20010**

Please mail me FREE book describing CREI Programs. I am employed in electronics and have a high school education.

NAME _____ AGE _____

ADDRESS _____

CITY _____ STATE _____ ZIP CODE _____

EMPLOYED BY _____

TYPE OF PRESENT WORK _____ G.I. BILL

I am interested in

Electronic Engineering Technology Computers

Space Electronics Nuclear Engineering Technology

Industrial Automation NEW! Electronics Systems Engineering

APPROVED FOR TRAINING UNDER NEW G.I. BILL

It's yours
free



for the asking!

**GIANT 274 PAGE
1970
RADIO-TV
ELECTRONICS
CATALOG**

YOUR BUYING GUIDE FOR . . .
TV's, Radios, Recorders, Phonos, Amateur and CB equipment,
electronic parts, tubes and test equipment . . . featuring B-A's
famous big bargain packed section!

Write to:

**BURSTEIN-APPLEBEE CO.,
DEPT. EW-4 3199 MERCIER ST.,
KANSAS CITY, MO. 64111**

Name _____

Address _____

City _____

State _____

Zip Code _____

CIRCLE NO. 146 ON READER SERVICE CARD

SELETRON WORKS!



IMPROVES SOLDERABILITY

- **SOLDERING PROBLEMS**—Selectron simplifies soldering to aluminum, stainless, refractories, glass, without acid fluxes.
- **PRINTED CIRCUITS**—Selectron repairs breaks; gold or rhodium plates tabs; plates flexible cable.
- **MACHINING**—Selectron builds mismachined parts back to tolerance.
- **CORROSION RESISTANCE**—Selectron replates selected areas with chromium, nickel, tin, etc; refurbishes rejects.

SELETRON MEETS ALL MILITARY SPECIFICATIONS

SELETRONS, LTD.

116 EAST 16th STREET • NEW YORK, N.Y. 10003

Tel: (212) CA 8-6800

CIRCLE NO. 120 ON READER SERVICE CARD

BOOKS



"WRITING FOR TECHNICAL AND BUSINESS MAGAZINES" by Robert H. Dodds. Published by *John Wiley & Sons, Inc.*, New York. 188 pages. Price \$7.95.

This book is for that army of engineers and the technically knowledgeable who want to share their expertise with their fellow engineers and/or enlightened laymen.

The author presents a number of cogent arguments for the engineering writer: because it is part of his work, because he "owes" his profession information on new developments, because it brings recognition to the author, and because recognition is essential to professional success.

A number of information-packed chapters are devoted to the bread-and-butter techniques of writing and marketing articles for the technical press. The appendices include a style guide, copyreading symbols, and a listing of technical and business publications that accept contributed articles, along with their addresses.

* * *

"1-2-3-4 SERVICING AUTOMOBILE STEREO" by Forest H. Belt & Associates. Published by *Howard W. Sams & Co., Inc.*, Indianapolis. 189 pages. Price \$3.95. Soft cover.

The booming market for in-car stereo equipment has opened up a new field for service technicians and provided plenty of headaches for those who don't know how to handle such servicing. By the very nature of the "beast" auto stereo equipment usually requires more frequent and better servicing than in-home systems. Vibration, dust, dirt, and moisture all take their toll and the author suggests a program of preventive maintenance to keep all such equipment in top-notch condition.

The first chapter explains the author's plan of "1-2-3-4 Servicing" which is applicable to all electronic equipment once mastered. This technique consists of diagnosing, locating the faulty stage, isolating the trouble to a small portion of the instrument, and pinpointing the fault to a specific part. The second chapter shows how this same procedure can be applied to mechanical equipment such as record changers. The next five chapters cover the specific auto stereo equipment while the final four chapters explain how the "1-2-3-4" system is applied to this specific problem.

The text is concise, well-illustrated, and written in an informal but no-nonsense format.

* * *

"ELECTRONIC CIRCUITS FOR THE BEHAVIORAL AND BIOMEDICAL SCIENCES" by Mitchell H. Zucker. Published by *W. H. Freeman and Company*, 660 Market St., San Francisco, Calif. 94104. 235 pages. Price \$9.75.

Although this is a book for a rather specialized audience of researchers who must work with or devise electronic equipment for use in their studies, many of the circuits covered are adaptable to non-research applications.

Since the author is an electronics technician at the University of California's Department of Psychology, he is familiar with the problems faced by researchers and is well aware of their deficiencies when it comes to working with and understanding electronic equipment. The circuits he describes have all been tested and are foolproof. He further assists his colleagues by providing complete parts lists with sources.

The book opens with three basic chapters dealing with semiconductor operation, understanding circuit diagrams,

and construction techniques. The balance of the book is concerned with troubleshooting, power-supply circuits, sensing and control circuits, programming and time-delay circuits, and audio circuits.

* * *

"INSTALLING & SERVICING HOME AUDIO SYSTEMS" by Jack Hobbs. Published by *Tab Books*, Blue Ridge Summit, Pa. 17214. 250 pages. Price \$7.95 hard cover, \$4.95 paperbound.

This book is for practicing or potential service technicians who are interested in getting a slice of the burgeoning audio market. The author is convinced that there is "gold in them thar decibels" and technicians are making a mistake in not mining this lode.

After the persuasive chapter on why the technician should take up audio service work and the equipment he will need to do a professional job, the author deals with AM receiver maintenance, FM tuners, servicing stereo-FM equipment, preamps and amps, combination units, solid-state power supplies, tape recorders and players, mobile radios and tape players, automatic record changers, how to sell and install audio systems, commercial audio work, and home and business intercom installations.

Since the book's audience is assumed to be professional, the author does not deal in basics but in how to work effectively with his present technical skills and in improving his work habits. To this end, the book is filled with professional hints and shortcuts, schematics, photographs of servicing procedures, typical equipment of various types, and waveforms.

* * *

"101 QUESTIONS & ANSWERS ABOUT HI-FI & STEREO" by Leo G. Sands and Fred Shunaman. Published by *Howard W. Sams & Co., Inc.*, Indianapolis, Ind. 124 pages. Price \$3.50 soft cover.

This book is designed for anyone interested in hi-fi sound reproduction—beginner or advanced audiophile as well as audio service technician. The format is one of questions and answers but the material has been divided into six parts so that the reader doesn't need to go through all 101 Q&A's to find the material he needs.

The first section deals with hi-fi systems, next comes the part on amplifiers, then tuners, record and tape players, speakers, and finally troubleshooting and maintenance. Each part has an index listing the questions and answers covered in that section.

The text is lavishly illustrated and easy to read. The only reservation is that, as so often happens when experts discuss their specialty, the material swings wildly from over-simplification to discussions of circuits and standards without any explanation (*viz.*, no explanation of Hz, references to phase inverters, push-pull output tubes, modified class-A, decoupled stages, feedback-type controls, etc.). Thus, if you are not quite the "beginner" that the authors envision, you should have no trouble understanding the material.

* * *

"ELECTRONIC CIRCUITS" by J. Richard Johnson. Published by *Holt, Rinehart and Winston, Inc.*, New York. Two volumes, \$9.95 each hardbound, \$6.50 each paperbound.

These two volumes, designed for technical institute and junior college courses, cover direct current (Vol. 1) and alternating current (Vol. 2).

The author, who is with *Bell Telephone Laboratories*, offers a carefully developed presentation for those embarking on a career in electronic technology. The student should have a working knowledge of algebra and trigonometry but other than that requirement, these volumes are complete and the student can develop his skills as he goes along. The inclusion of a number of worked out problems as well as hundreds of exercises for the student enables the instructor to check on the student's comprehension before going on to the next topic. ▲

April, 1970

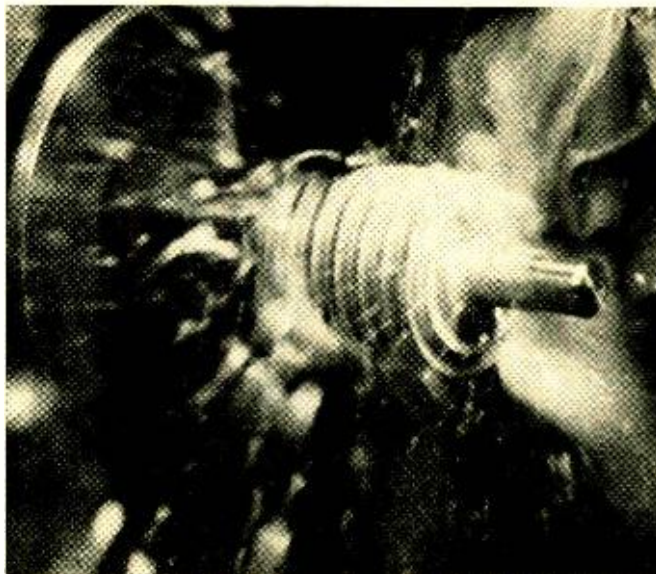

Shown actual size

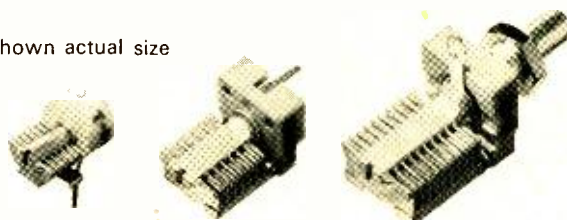

TYPE: T

Mtg. Area: 0.1 sq. in.
Q: > 2000 @ 150 MHz
pF: 1.3-5.4 to 1.9-15.7
TC: plus 30 ± 15 ppm/°C

TYPE: U

Mtg. Area: 0.2 sq. in.
Q: > 2000 @ 150 MHz
pF: 1.2-4.2 to 2.4-24.5
TC: plus 45 ± 15 ppm/°C

TYPE: V

Mtg. Area: 0.3 sq. in.
Q: > 2000 @ 150 MHz
pF: 1.4-13 to 2.2-34
TC: plus 50 ± 20 ppm/°C

It takes brass
to machine capacitors
like these.

Johnson precision machines each rotor and stator from solid brass extrusions. That's what gives them such low temperature coefficients, consistently high Q and outstanding mechanical stability and electrical uniformity. All at a cost probably lower than what you are now paying.

Type T, U, and V air variable capacitors are available in a variety of mounting configurations from your nearest E. F. Johnson distributor (see Yellow Pages). For more information, mail the coupon below.

E. F. JOHNSON COMPANY
1104 Tenth Ave. S.W./Waseca, Minn. 56093

Please send new 1970 Capacitor Catalog.

NAME _____

ADDRESS _____

CITY _____

STATE _____ ZIP _____



E. F. JOHNSON COMPANY
® WASECA, MINNESOTA 56093
CIRCLE NO. 108 ON READER SERVICE CARD

73

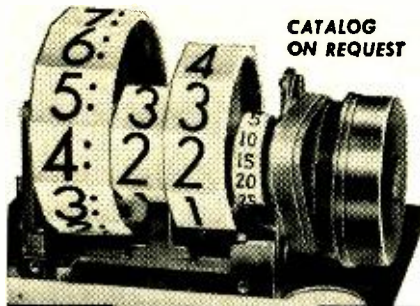

CATALOG
ON REQUEST



CLOCK MOVEMENTS

DIGITS RESETTABLE INDIVIDUALLY

Available in 50, 60 cy., all voltages, AC. UL approved motor, cord. One Year Guarantee.

#130...12-HOUR #131...24-HOUR

#75
Tymeter
Elapsed
Time
Digital
Computer



Made in U.S.A.

Complete Line: Delay, Interval
and Cycle Timers, Digital Computers

PENNWOOD NUMECHRON CO.
TYMETER ELECTRONICS
7249 FRANKSTOWN AVE., PITTSBURGH, PA. 15208

CIRCLE NO. 126 ON READER SERVICE CARD

**Earn
Your
Degree**
**ELECTRONICS
ENGINEERING**
through HOME STUDY

HIGHLY EFFECTIVE
HOME STUDY COURSES IN:
- Electronics Engineering Technology
- Electronics Engineering Mathematics
Earn your Associate in Science Degree in Electronics Engineering and upgrade your status and pay to the engineering level. Complete college level courses in Electronics Engineering. We're a forward looking school. Outstanding lesson material—thorough and easy to understand. Engineering taught on the basis of application and understanding rather than on the basis of memorization. Up to date in every respect. Acquire the knowledge and ability that means the difference between a low paying technician job and a high paying engineering position. Low tuition cost with low monthly payments. Free engineering placement service for our graduates. Write for free descriptive literature. Ask for bulletin J, no salesman will call on you.

COOK'S INSTITUTE
of Electronics Engineering
Forest Hill Road
P. O. Box 10534
Jackson, Miss. 39209
Established 1945
Formerly Cook's School of Electronics

CIRCLE NO. 143 ON READER SERVICE CARD

74

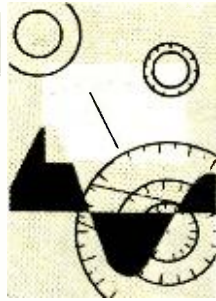

TEST EQUIPMENT

Product Report

Melsey SN-2 Wave/Dip Meter

For copy of manufacturer's brochure, circle No. 3 on Reader Service Card.



IF you talk to just about any knowledgeable ham about a grid-dip meter, he should be able to give you at least a half dozen uses for this versatile, compact piece of test equipment. These include finding the resonant frequency of tuned circuits, acting as a signal generator or field-strength meter, measuring L , C , and Q . The Melsey SN-2 is a transistor version of the grid-dipper but operating at the u.f. frequency range of 400 to 1150 MHz. This 6-in., 10½-oz unit provides continuous tuning and is directly calibrated to better than 1 percent by use of a 30-in steel tube on which the frequency is marked.

Power for the instrument is obtained from a single 9-V transistor-radio battery. Current drain is only 1 mA when the unit is used as a wavemeter, and 2.5 mA when used as an oscillator.

The oscillator circuit (see diagram)

is a modified Colpitts in a cavity configuration. Tuning is by means of a patented variable capacitor (T_c), consisting of a precision glass tube with silver-plated brass bands around the outside. A copper-plated Invar slug traveling within the tube forms a glass-piston variable tuning capacitor with the outer bands. There are no wiping contacts and the piston moves smoothly through the tube without rotating. A second glass capacitor assembly ($C1$ and $C2$), fitted over the variable tuning capacitor, forms the transistor base and collector coupling capacitors.

The entire capacitor assembly is mounted within the forward section of a double compartment case and contact with the front and rear walls of the section completes the cavity structure ($L1$). The rear compartment shields

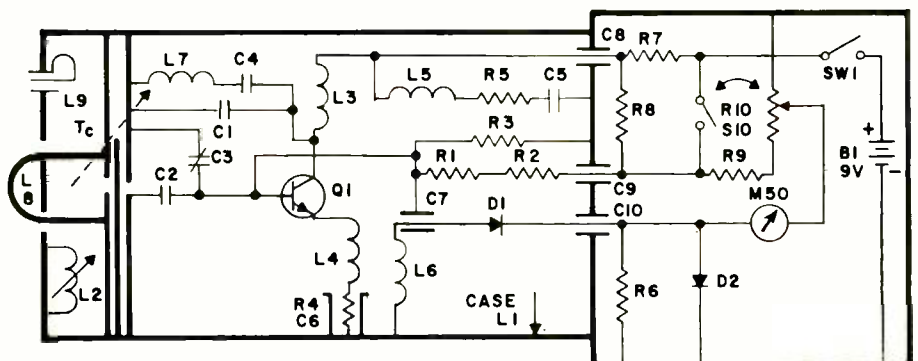

ELECTRONICS WORLD

the retractable tuning slug and accommodates the isolation feedthrough capacitors (C8, C9, and C10).

The oscillator output is inductively coupled by means of L4 and L6 through a pair of crystal diodes to the indicating meter. With the oscillator operating and with external coil L8 brought close to a resonant circuit, the current will dip sharply as the wave/dip meter is tuned through the same frequency as the resonant circuit. The exact frequency can then be read directly from the calibrated dial of the instrument. With the oscillator turned off, the unit is used as a wavemeter or

field-strength meter. Now the meter peaks to a maximum value when the instrument is tuned to the same frequency as the external circuit. Note that when used as a dipper, power need not be applied to the circuit under test, but when the instrument is used as a wavemeter, the external circuit must be powered.

A miniature coax receptacle is also provided for direct connection to a 50-ohm cable. The connector assembly can be rotated to provide at least 30 dB variable attenuation.

Price of the *Melroy* Model SN-2 wave/dip meter is \$185. ▲

General Radio Type 1808 A.C. Voltmeter

For copy of manufacturer's brochure, circle No. 4 on Reader Service Card.

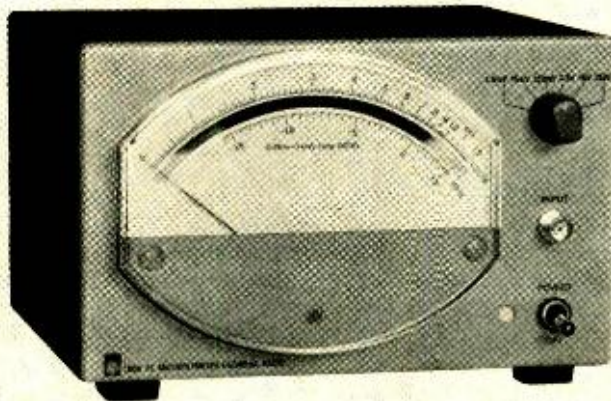

An a.c. voltmeter is a general-purpose instrument that is sensitive enough to measure a.c. signals in the millivolt range. Such an instrument is widely used to take audio measurements or measurements in the ultrasonic and low r.f. ranges. It is also used for attenuator testing and for calibrating various types of transducers.

The new *General Radio* Type 1808 is a laboratory or production-line instrument of this type. It is a sensitive, average-reading voltmeter calibrated to read r.m.s. values of a sine wave. The most sensitive of the meter's six ranges reads up to 1.5 mV full-scale, while the highest range is 150 volts. A separate attenuator probe is available to extend this to 1500 volts. The dynamic range is high, 20 dB per range, permitting a single scale to be used for all readings. The usual dB scale is also provided on the meter. Frequencies can be measured over the extremely wide range of from 10 Hz up to 10 MHz and the meter accuracy is ± 1 percent of reading over most of this range.

An FET input buffer provides the high 10-megohm input impedance and frequency-compensated resistive dividers add to the uniform frequency response. The diodes that are used to convert a.c. signals to d.c. values that can be read on the meter are inside the feedback loop of the amplifier used. This prevents any diode nonlinearity from affecting meter reading. The amplifier provides high open-loop gain even at the top frequency of 10 MHz.

Compared to a service-type a.c. voltmeter, this instrument is expensive. The Type 1808 sells for \$295 while a service-type meter might cost around \$90. However, the less expensive instrument is not as accurate (it may be 2 to 3 percent of full-scale rather than 1 percent of the actual reading); not as sensitive (the lowest range might be 10 mV rather than 1.5 mV); not as wide in frequency coverage (it may go up to 1 or 1.5 MHz rather than 10 MHz); and it may not be as stable. Hence, when the need exists for this better performance, a higher price must be paid. ▲

Eico Model 465 Oscilloscope

For copy of manufacturer's brochure, circle No. 5 on Reader Service Card.

OVER the years we have built and used a number of *Eico* oscilloscopes. The company has always prided itself on its scope line and it is continuing this tradition. There are now four

scopes in the manufacturer's line, one 3-in scope and three 5-in scopes. The Model 435 is a wide-band (d.c. to 4.5 MHz) 3-incher, priced at \$119.95 as a kit or \$169.95 factory-wired. The Mod-

Enjoy Relaxing Background
Music at Home with . . .
NO COMMERCIALS!



Our SCA-1 Decoder makes possible reception of this "private" musical programming, transmitted by nearly 400 FM stations around the country. YOUR FM tuner or receiver can recover this "hidden" music with the simple addition of an SCA-1.

Hook-up in minutes—full instructions supplied. SCA-1 is self-powered . . . uses all solid-state circuitry (FET's, IC's, NPN's). Works with any quality FM Tuner or receiver.

Send check or m.o. for either . . .

SCA-1 (Wired, ready to use) . . . \$64.50

SCA-1K (Kit, all needed parts) . . . \$49.95

Etched, drilled P.C. Board plus special IC and full construction plans . . . \$12.50

N.Y. State Residents Add Appropriate Sales Tax

One year parts guarantee
Prohibited for commercial use

FREE National S.C.A. station list
supplied with every order.

SCA Services Co., Inc.

Box 601 EW, Port Washington, N.Y. 11050

(516) 883-5694

CIRCLE NO. 124 ON READER SERVICE CARD



Fill in coupon for a FREE One Year Subscription to OLSON ELECTRONICS Fantastic Value Packed Catalog — Unheard of LOW, LOW PRICES on Brand Name Speakers, Changers, Tubes, Tools, Stereo Amps, Tuners, CB, Hi-Fi's, and thousands of other Electronic Values. Credit plan available.

NAME _____
ADDRESS _____
CITY _____ STATE _____
GIVE ZIP CODE _____

If you have a friend interested in electronics send his name and address for a FREE subscription also.

OLSON ELECTRONICS

Dept. ED, 260 S. Forge Street, Akron, Ohio 44308

CIRCLE NO. 128 ON READER SERVICE CARD

*In 1948, University Sound
made home high fidelity possible.*

In 1970, we made it perfect.

In 1948 University unveiled the world's first popularly priced, full fidelity speaker, the 6201 — and home high fidelity was born.

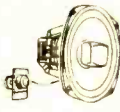

In 1970 University unveils the finest, fullest line of high fidelity products in the world—and home high fidelity is now perfected.

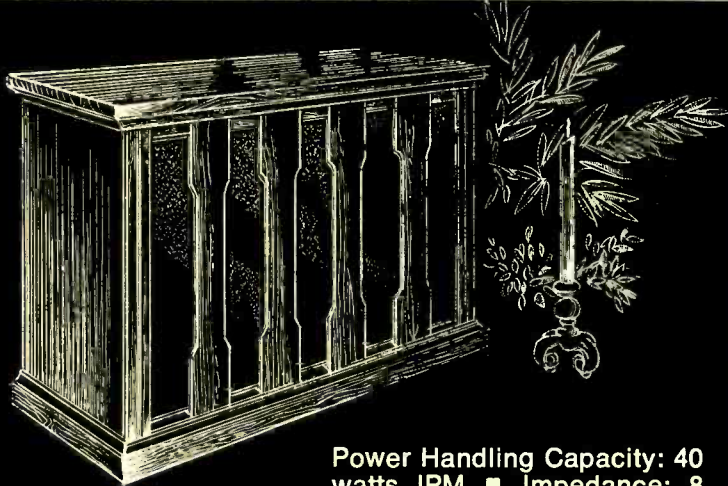

EL PRESIDIO

Nothing we say can possibly sound as good as the speaker itself. It is, quite simply, a floor model unit that matches systems twice its size for sound and fine cabinetry. El Presidio provides crystal-clear, note-perfect highs . . . bass you can feel . . . a mid-range you can hang your hat on. Look at its specifications. Free-standing, four-way, two-speaker system ■ Frequency Response: 20-40,000 Hz ■

Power Handling Capacity: 40 watts IPM ■ Impedance: 8 ohms ■ Components: University's incomparable Model 312 full-range, three-way, Dif-faxial speaker with patented Diffusicone mid-range and patented Sphericon tweeter, complemented by University's famous Aerodynamic Bass Energizer ■ Controls: Continuously variable Brilliance control recessed in back ■ Finish: Lustrous oiled walnut ■ Dimensions: 23" x 24" (W) x 15" (D) ■ Price: \$199.95.

PRICE SLIGHTLY HIGHER ON WEST COAST.

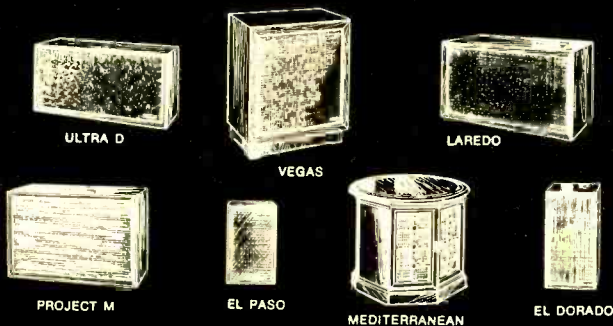

UNIVERSITY SOUND: the finest, most complete line of high fidelity speaker systems in the world, from the world's leading manufacturer of electroacoustics products.



UNIVERSITY SOUND P.O. Box 26105, Oklahoma City, Oklahoma 73126
A quality company of LTV Ling Altec, Inc.



el 427 is a more sensitive 5-incher with a response from d.c. to 500 kHz, priced at \$99.95 as a kit or \$139.95 factory-wired. The Model 460 is a 5-incher that is only slightly less sensitive but with a wider frequency band (d.c. to 4.5 MHz), priced at \$99.95 in kit form or \$149.95 factory-wired. The top of the Eico scope line and the subject of our report this month is the Model 465, which the company refers to as its professional oscilloscope. More expensive than the other scopes in the line (\$179.95 as a kit, \$249.95 factory-wired), this model offers more features and better performance.

The new Model 465 has a vertical-amplifier response from d.c. to 8 MHz, which is more than adequate for color-TV service. The horizontal-amplifier response is from d.c. to 1 MHz. Both amplifiers are push-pull and direct-coupled throughout, permitting true voltage measurements and observations of just about any waveform. The scope can also be used as a vectorscope for color-TV work. A pair of zener-controlled voltage reference sources provide an accurate source of calibration voltages for both the vertical and horizontal channels. Vertical sensitivity is 12 mV (r.m.s.)/cm; horizontal sensitivity is nearly as great at 17 mV (r.m.s.)/cm. Four-step calibrated and frequency-compensated input attenuators are provided for both channels.

The scope has automatic sync with a sync limiter and amplifier to provide rock-steady waveforms over the entire sweep range. A flat-face CRT is used with a Mumetal neck shield to minimize the effects of external magnetic fields.

One problem that comes up in the design of any high-gain scope such as this one is the presence of residual hum, especially in the low-level vertical-input stage. If this stage uses a tube with only a very slight amount of heater-cathode leakage, the hum voltage will be amplified along with the signal to be observed. As a result, the horizontal portions of the waveforms will be thicker

than they should be, making accurate study of the waveform difficult. To prevent this, the low-level tubes must be carefully selected or hum-balancing circuitry must be used.

We used one of the early *Eico* 465's, and we discovered this very problem. By merely substituting another pair of 6AUS input tubes, the residual hum was cut way down and the waveforms seen on the screen were extremely sharp. The company has been selecting these tubes carefully so that this problem should not occur in subsequent models of the scope.

The two removable side panels, each held with only four screws, make it simple to perform internal adjustments or do any servicing that may be required. One side panel exposes all the tubes and adjustments while the other side panel exposes all the below-chassis point-to-point wiring.

After using the new *Eico* Model 465 for a while, we can say that it is certainly a worthy addition to the company's line of scopes. ▲

"SWITCHLESS" DUAL-RANGE VU METER

By WINSTON THARP

ASSUME that you have to provide an option of a vu meter or a vu meter through an 8-dB pad for monitoring 600-ohm balanced audio lines in a patch panel.

How do you handle it? The existing patch panel used shorting type "stereo headphone" jacks rather than the more common (and expensive) double phone jacks. The vu meter was to be used with a series 3600-ohm resistor so that 0 vu was indicated for a line level of +4 dBm. This meant that the 8-dB pad had to be switched in and out on the meter side of the 3600-ohm resistor and had to exhibit 3900 ohms impedance in and out in order to maintain a constant load on the 600-ohm lines to be monitored. Switching the pad in and out would be simple if it were on the other side of the 3600-ohm resistor, but this would upset the bridging impedance of the vu meter circuit.

The secret is to take advantage of the non-polar nature of the vu meter. To see how it is done, refer to the diagram below. ▲

Method of hooking up the non-polarized vu meter so that it indicates two ranges depending on where the plug is inserted.

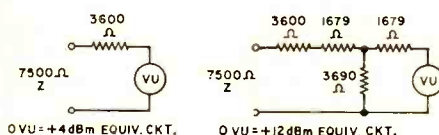
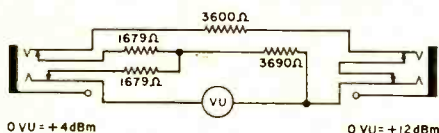

April, 1970

77

DON'T SETTLE FOR A HIT AND MISS IGNITION SYSTEM—

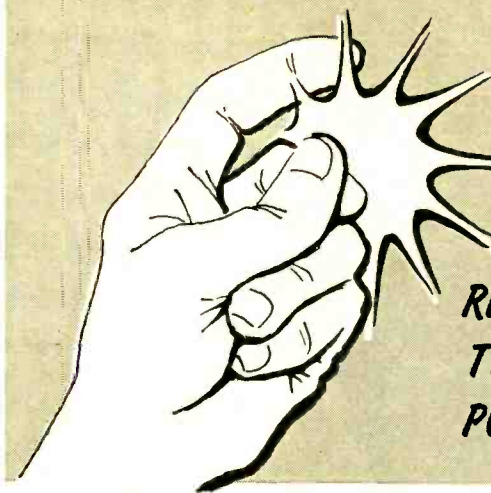

FEEL THE...

SNAP

AND SURGE OF
REAL PERFORMANCE
THAT COMES FROM
POSITIVE IGNITION!

INSTALL A

JUDSON ELECTRONIC MAGNETO

It offers the combined advantages of both the standard transistorized and capacitive discharge systems in one simplified patented circuit. Over 100,000 users will tell you that it provides better performance, a smoother running engine and keeps your car in tune. You will feel the difference right from the start. Installed in twenty minutes.

Sold at better automotive performance dealers and electronic supply stores everywhere.

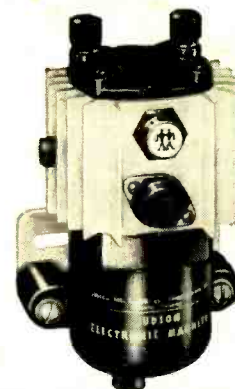

Write today for free literature

JUDSON 
RESEARCH & MFG. CO.
CONSHOHOCKEN, PA. 19428

CIRCLE NO. 134 ON READER SERVICE CARD



FREE Catalog Of The **WORLD'S**
FINEST GOV'T
SURPLUS ELECTRONIC BARGAINS

Now **BIGGER** and
BETTER Than Ever!

MAIL COUPON TODAY

NAME:
ADDRESS:
CITY: STATE: ZIP NO:

FAIR RADIO SALES

Dept. EW • BOX 1105
LIMA, OHIO 45802

CIRCLE NO. 140 ON READER SERVICE CARD



**Look! You get 25 kits...
more than ever before at no extra
cost...for your practical "hands-
on" learning of electronics and
TV with RCA Institutes Home
Training! Send postcard today!**

RCA

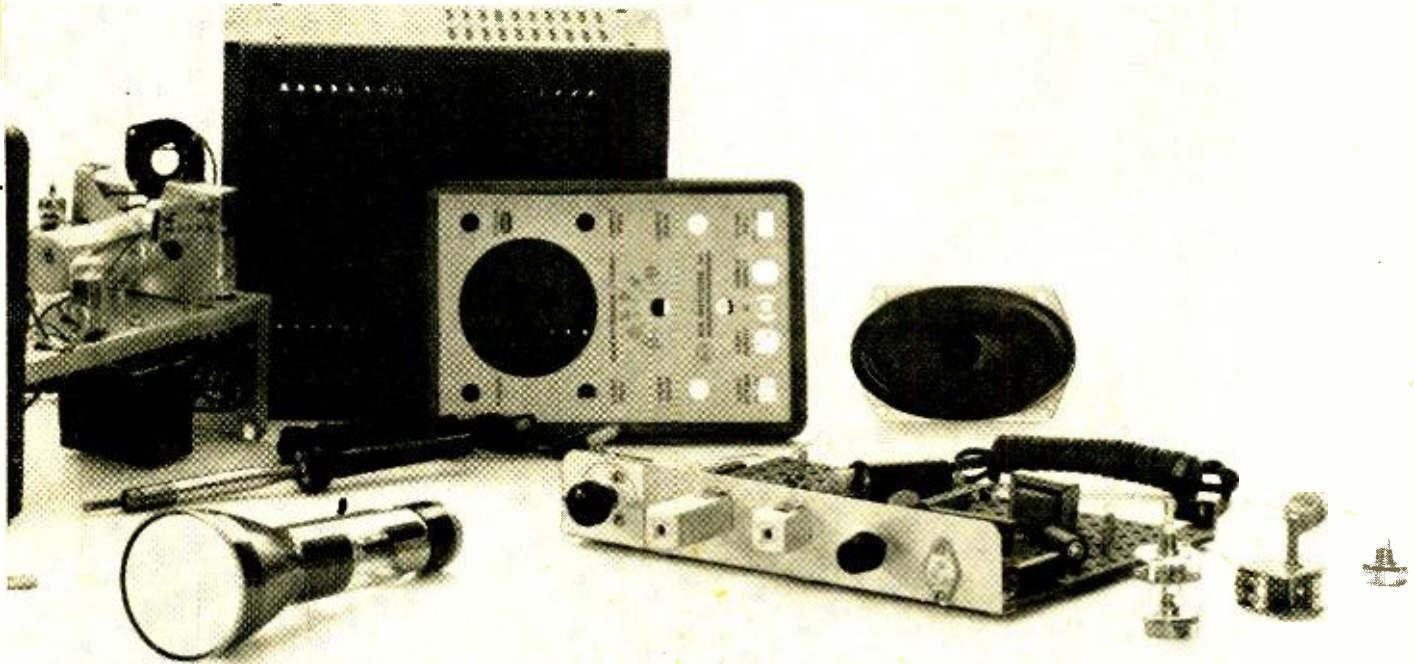

Now, RCA supplies 25 kits in its home-study career program—at no extra cost! Be sure to compare this with other home-study electronics programs. And note, you never have to take apart one kit to build another piece of equipment because there are literally thousands of parts making up the kits. Information on them is included in the catalogue which you'll get when you mail in the reply postcard or the coupon.

Absolutely practical, your kits are used to build such permanent, professional and useful equipment as an oscilloscope, a signal generator, a multimeter, and a fully transistorized breadboard superheterodyne AM receiver. They will give you years of valuable service.

In addition, an easy way to learn—the career programs are all based on the easy, step-by-step AUTOTEXT method. AUTOTEXT is unique and exclusive with RCA Institutes. Math and circuitry problems simply melt away! So check the wide range of electronics and TV career programs.

Eleven Career Programs: Television Servicing (including color TV and

CATV) • FCC License Preparation • Automation Electronics • Automatic Controls • Industrial Electronics • Nuclear Instrumentation • Electronics Drafting • *including these four all-new:* Semiconductor Electronics • Digital Electronics • Solid State Technology • Communications Electronics.

Also check the new Computer Programming course—trains you to work on today's largest data processing systems including IBM/360 and RCA Spectra 70, the Third Generation Computers.

You get tuition plans as flexible as you wish: pay-as-you-order or pay-by-the-month...you choose! No interest charges! No other electronics home study school offers both these choices.

Classroom training also available—day and evening coeducational classes start four times a year. No previous training required—you can take preparatory courses if you haven't completed high school.

Placement service, too—with RCA Institutes classroom training, you get the full benefits of the RCA Job Placement Service. RCA Institutes grad-

uates are now with companies that include Bell Telephone, GE, Honeywell, IBM, RCA, Westinghouse, Xerox, and major radio/TV networks. This placement service is also available to Home Study Graduates.

Veterans: enroll now— all courses are approved under the GI bill

Accredited Member National Home Study Council.

If reply postcard has been removed, mail this coupon.

.....

• RCA INSTITUTES, INC. •
 • Home Study Dept. 240-004-0 •
 • 320 West 31 Street, New York, N.Y. 10001 •

• Please send me free illustrated career •
 • catalog. •

• Age _____ •

• Name _____ •
 • (please print) •

• Address _____ •

• City _____ •

• State _____ Zip _____ •

• For GI information, check here •

.....

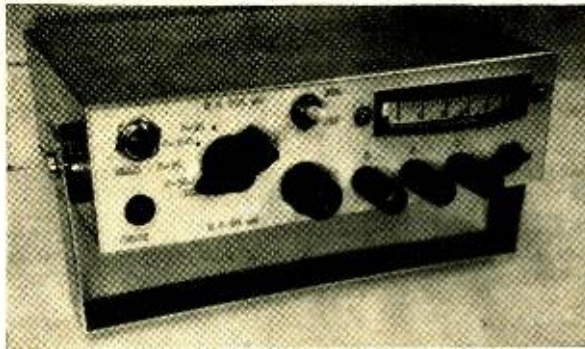

Fig. 1. Low-cost, multirange transistor checker.

Multirange Transistor Checker

By J. E. ORME

Inexpensive, portable tester measures beta on two ranges at two different collector power levels. Also checks for opens, shorts, and leakage of transistors and diodes.

SOME commercially available transistor checkers are found to be somewhat inaccurate and limited in versatility; usually they give only an indication of quality, *i.e.*, a "yes-no" answer as to whether the transistor is operative or not. Thus, these models are unsuitable for matching transistors or for precise measurements of *beta* under varying conditions of base current or collector power. Furthermore, many commercial units are a.c.-line operated which leads to problems when servicing units in the field. One would think that battery-operated devices should be checked with testers which are also battery operated, thus leading to a greater degree of portability. Last, but not least, commercial units are expensive, starting at about \$100 while the unit described here is capable of measuring more variables than the average tester and can be built for about \$20 or less, depending on what spare parts the technician may have available.

Description

The multirange transistor checker (Fig. 1) can measure *beta* on two ranges, 0-50 and 0-500, at two different collector power levels, making a total of four *beta* ranges in all. It also tests diodes, measures transistor leakage currents, and indicates short- and open-circuit conditions. The schematic diagram of the unit is shown in Fig. 2.

The circuit is essentially a constant-current base drive to a common-emitter transistor circuit. The collector current is measured by a 0-50 microammeter (*M1*) that is calibrated directly in terms of *beta* (0-50) and microamperes (0-50). The higher *beta* range (0-500) is obtained by shifting the decimal point in the 0-50 range reading.

A 2-pole, 5-position wafer switch (*S1*) selects the proper base current and meter shunt resistors simultaneously. A 4-pole, double-throw toggle switch (*S2*) selects the correct transistor polarity "NPN/PNP" by reversing both battery and meter connections. A push-to-make "Read" switch (*S3*) is the test switch. Some of the component values, such as shunt resistors *R4* and *R5*, may have to be changed to match the resistance of the meter used. A 1600-ohm meter (50 μ A) was used in this case.

Because the transistor checker is used intermittently in most testing applications, only four 1½-volt "C" or "D" cells are required to power the unit. The midpoint between the four cells is used for the base drive circuit. No "on-off" switch is required since the "Read" switch (*S3*) is spring loaded and is in series with the battery supply. No current can be drawn unless a transistor or diode is connected to the test terminals or plugged into socket *SO1*. When the

transistor is in place, base current will be drawn continuously, while collector current will flow only when the "Read" button is pressed. Transistors can be left connected when the switch is in the "*I_{CEO}*" position, as no base current can be drawn under this condition.

Measuring Beta

The parameter *beta* (β) is, of course, the current gain or amplification, considered with the base terminal as the input and the collector as the output. This configuration, the common-emitter circuit, is the most commonly used one in present-day circuits. This transistor checker measures d.c. *beta*, *i.e.*, the ratio of d.c.-output to d.c.-input current, whereas some instruments measure the a.c. or dynamic *beta*, using an alternating-current signal for this purpose.

Strictly speaking, *beta* is defined as $\left| \frac{I_C}{I_B} \right|$ where *I_C* = collector current and *I_B* = base current.

When using the multirange transistor checker to measure β , the results change very little if the collector voltage, depending on the transistor, is allowed to vary from test to test. This is because transistor characteristics, analogous to those of a pentode, are independent of collector voltage as long as the operating point is maintained in the "plateau" region. What is considered more critical is the constancy of the base drive current which is obtained in this circuit by a "constant-current generator" approach with $I_B = (V_{BB} - V_{BE}) / R_B$ where *V_{BB}* = base supply battery voltage, *V_{BE}* = base-emitter junction voltage drop, *R_B* = base current-limiting resistor, and *I_B* = base current.

Fig. 2. Schematic and parts list of transistor checker discussed in article.

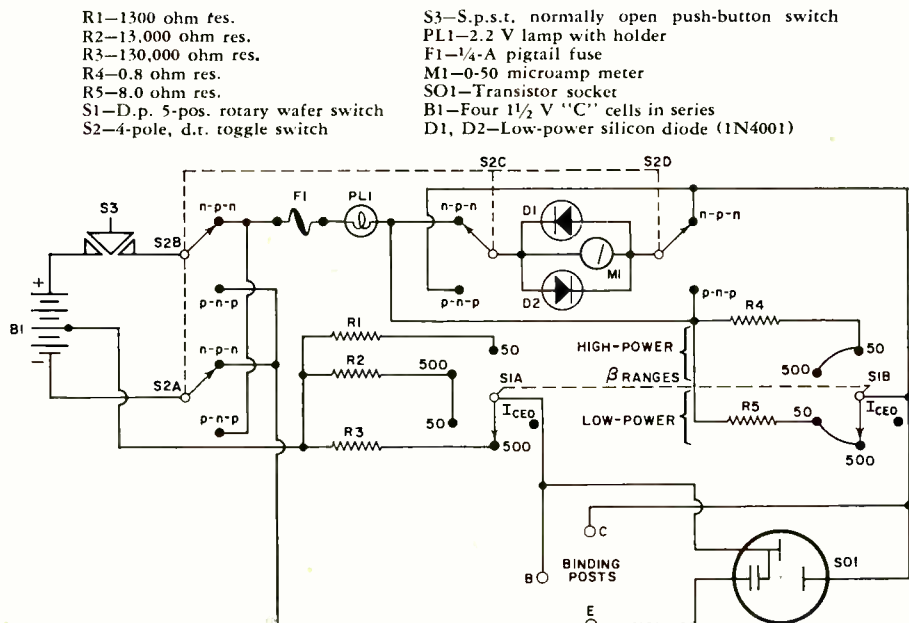

- R1—1300 ohm res.
- R2—13,000 ohm res.
- R3—130,000 ohm res.
- R4—0.8 ohm res.
- R5—8.0 ohm res.
- S1—D.p. 5-pos. rotary wafer switch
- S2—4-pole, d.t. toggle switch

- S3—S.p.s.t. normally open push-button switch
- PL1—2.2 V lamp with holder
- F1—¼-A pigtail fuse
- M1—0-50 microamp meter
- SO1—Transistor socket
- B1—Four 1½ V "C" cells in series
- D1, D2—Low-power silicon diode (1N4001)

Thus I_B is constant (0.02 mA to 2.0 mA in four ranges), as long as V_{BB} and V_{BE} are constant. Depending on the transistor being checked, small variations of V_{BE} (± 0.1 V) might result in a 5 percent error in β . With a constant-current base drive, it is only necessary to calibrate the microammeter on the collector output directly in terms of β . Different values of R_B are selected by switch S1 to change the β range, which also causes the meter shunt resistors to change (Fig. 2).

To obtain a measurement that indicates how β varies with base drive, it is only necessary to switch between the high- and low- β ranges (within the same power level setting). The β will be read for two base currents, 0.02 and 0.2 milliamperes. The constancy of the base current is assured by driving the base from a high-impedance source (constant-current drive), as previously mentioned. However, the voltage source for the base drive circuit is kept at 3 volts to ensure that the BV_{BE} (emitter-base reverse breakdown voltage) is not exceeded in case of accidental reverse connection. In many common transistors, the BV_{BE} is surprisingly low; approximately 6 volts.

To measure β variation with temperature, it is only necessary to place the transistor, with extension leads, in an oven with a thermometer. The foregoing tests can then be carried out at different temperatures, and an accurate plot of the transistor behavior with changing temperature obtained. In addition, with this transistor checker, the collector current-voltage characteristic can be plotted by altering the collector battery voltage. For this purpose, an external variable voltage series supply can be inserted at the binding posts.

As mentioned previously, β can be measured at two power levels. The low-power range is 60 milliwatts maximum, proportional to meter reading and the maximum power level on the high setting is 600 milliwatts. Small-signal transistors can be measured at the 60-milliwatt level while the

600-milliwatt level corresponds roughly to the dissipation of power transistors without a heatsink attached. These two power levels are obtained by driving the base at different currents to get 10 milliamperes collector current for the low power β ranges, and 100 milliamperes maximum for the high power range. With a 6-volt battery, the 60-milliwatt and 600-milliwatt levels are obtained, as: $Collector\ Power\ Dissipation = V_C \times I_C$.

Diodes can be tested by connecting them between the emitter-to-collector terminals of the tester; the meter will then read 0-100 milliamperes maximum in the forward-bias direction. The polarity across the diode can be reversed by operating the "NPN/PNP" switch (S2), allowing the reverse leakage to be checked on the 0-50 microampere " I_{CEO} " range of the tester.

Short circuits are indicated when "Short" lamp (PL1) glows and extreme meter overload is prevented by the inclusion of diode, lamp, and fuse protection in the meter circuit.

A test of I_{CEO} (collector leakage with base open) is provided on the 0-50 microampere meter range.

Operating Procedures

When operating the multirange transistor checker follow these procedures:

1. Plug in transistor and choose the correct polarity by placing the "NPN/PNP" switch in the appropriate position, as given by the maximum β reading.
2. Check transistor for shorts on the low-power, high- β range. Shorts show as infinite β or the "Short" lamp (PL1) glowing. Open circuits show β equal to zero.
3. Measure β on the four β ranges as required; use the low-power range first.
4. Check I_{CEO} only if no shorts are evident. Read I_{CEO} (leakage current) on the 0-50 microampere scale.
5. Disconnect transistor after testing. ▲

TWO NEW BELL RINGERS FROM DELTA

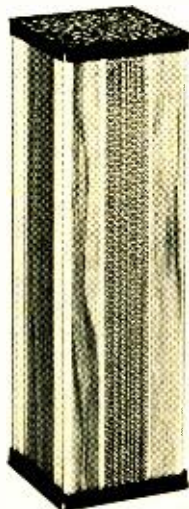

DELTA ALERT... Your night watchman for pennies a month!

Delta introduces its all new ultrasonic silent sentry, the total motion detection, intrusion and monitoring alert system. The system plugs into any wall outlet. It also features variable sensitivity control and adjustable timing which provides the most advanced sentry system on the market.

SPECIFICATIONS:

Ultrasonic Frequency: 35 KHZ Δ
 Area Coverage: 15-30 feet (depending on shape of area) Δ Controls: On-Off Switch; Built in Timer; Variable Sensitivity Control Δ Output:

110-130V at 1 Amp. Δ Power Requirements: 110-130V, 60 HzAC Δ Dimensions: 10 $\frac{3}{4}$ "W x 3 $\frac{1}{4}$ "H x 3 $\frac{1}{4}$ "D Δ Complete with 110-130V Drop Cord Δ Walnut designer finish.
 For Complete Unit, Ready to Use ONLY \$59⁹⁵ ppd



DELTA PRODUCTS, INC.

P.O. BOX 1147 • GRAND JUNCTION, COLORADO 81501
 PHONE: (303) 242-9000



HIGH VOLT ANALYST Tune your car like a pro.

Delta's new concept in automotive tune-up, The High Volt Analyst, is a unique and complete auto analyzer which provides all the primary advantages of a scope and is completely portable.

SPECIFICATIONS:

Accuracy - Tachometer $\pm 2\%$ of full scale (all ranges) • Dwell Meter $\pm 1\%$ (both ranges) • OHMS Scale $\pm 5\%$ • Low Voltage $\pm 2\%$ of full scale • High Voltage $\pm 5\%$ of full scale Δ
 General - Fully protected meter circuit* • Size: 6 $\frac{1}{2}$ "W x 8"H x 3 $\frac{1}{2}$ "D • Weight: 3 $\frac{3}{4}$ lbs. Δ Ranges - DC Volts 0-15V, 15KV and 45KV • OHMS: 0-1 Meg. (10K center scale) • Dwell: 4, 6 and 8 cylinders • Tachometer: 0-1500 RPM, 6000 RPM

*Batteries (8 Type AA cells) included. Comes complete with standard lead set, a special probe, and high tension lead.

\$79⁹⁵ / \$59⁹⁵
 ppd / ppd
 Assembled Kit Form

DELTA: Please send me literature immediately.

I am enclosing \$ _____ for items checked.

- DELTA ALERT
 High Volt Analyst, Assembled
 High Volt Analyst, Kit form

Please ship immediately.

Name _____

Address _____

City/State _____ Zip _____

EW-4-70

NEW PRODUCTS & LITERATURE

For additional information on items identified by a code number, simply fill in coupon on Reader Service Card. In those cases where code numbers are not given, may we suggest you write direct to the manufacturer on business letterhead.

COMPONENTS • TOOLS • TEST EQUIPMENT • HI-FI • AUDIO • CB • COMMUNICATIONS

MODULAR STEREO SYSTEMS

A new line of audio components which provides capability to custom-tailor two-, three-, or four-channel stereo systems has been introduced in both kit and factory-wired versions.

The first units in the new line are the HL-100 preamplifier and control unit and the HL-210



power amplifier and speaker-switching panel. The units feature solid-state circuitry throughout, IC's and transistors combined for optimum performance. These modules can be combined into a complete four-channel system using the HL-110 (two preamps) and HL-120 (two control units) connected to a four-channel volume level indicator (HL-330 or HL-340) for on-line monitored input. Four-channel power amplifiers may be used alone, in combination with speaker selectors, remote location controls, or with bi-amplification provided by the variable crossover dividing networks. Hegeman Labs

Circle No. 6 on Reader Service Card

H. V. METER KIT FOR COLOR TV

The safe, accurate, and continuous monitoring of picture-tube anode voltage of all color-TV chassis under test is now possible with the new 10J110 meter kit.

Designed to enable service technicians to adjust precisely the high-voltage output to manufacturers' specifications, the new unit helps avoid excessive voltage and possible abnormal x-radiation.

The kit has been designed for quick and easy installation into any of the company's color test jigs—10J102, 103, 104, 105, and the 11A1015A. It can also be adapted for universal mounting in any other test jig. The kit consists of a 3½-inch rectangular 50- μ A meter with a dial scale calibrated for a range of 0 to 35 kV d.c. with 70 scale divisions, a meter multiplier and cable assembly, a meter ground lead, and meter mounting hardware and instructions for installation in color test jigs. RCA Parts and Accessories

Circle No. 7 on Reader Service Card

AM/STEREO-FM RECEIVER KIT

A deluxe medium-power AM/stereo-FM receiver has been put on the market as the AR-19. The kit incorporates new circuitry ideas and a power output considered to be ideal for most home stereo systems.

The receiver incorporates five IC's with a total of 57 transistors and 35 diodes. Frequency response is 6-35,000 Hz with less than 0.25% har-

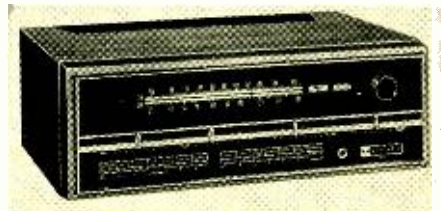

monic and IM distortion at any power level, according to the company.

Eight circuit boards which snap in and out in seconds make the AR-19 easier to build. It also has built-in test circuitry (probes and meters) to enable the builder to check each circuit part without the need for external test equipment.

The factory assembled and aligned FM tuner has a 2- μ V sensitivity. For AM the set has a built-in antenna that swivels in two planes for better signal reception.

Further information on this new receiver will be supplied on request. Heath

Circle No. 8 on Reader Service Card

TREASURE/METAL LOCATOR

The Model KG-366 treasure metal-locator kit can be assembled even by beginners.

The unit is sensitive enough to detect an object as small as a half-dollar six inches under ground. When the search coil approaches metallic objects, a clear audible indication is heard through the unit's built-in speaker. This eliminates the need to watch a meter and makes easy nighttime use possible. It is also possible to distinguish between ferrous and non-ferrous metals by the pitch of the signal.

The locator has a dynamically balanced, telescoping 36" tubular aluminum handle and a waterproof 6½"-diameter hermetically sealed search coil. The unit operates from a single 9-volt battery. Allied Radio

Circle No. 9 on Reader Service Card

R.F. LOAD RESISTORS

The new Models 8166 and 8164 "Termaline" r.f. load resistors are the latest additions to a family of dry air-cooled line terminations designed for use in any position.

With the announcement of the new 150 and



100-watt units, Bird Electronic Corporation now has two 10-watt units with integral male or female N connectors, and basic 25, 100, and 150-watt units with a choice of 17 common coaxial connectors each. This QC "Quick-Change" connector feature provides unique flexibility at the time of order or in the field and eliminates performance-degrading adapters.

For complete specifications on the new units as well as the other models in the line, write to H. H. Heller, Senior Staff Engineer, at 330303 Aurora Road, Cleveland (Solon), Ohio 44139.

REPLACEMENT RECTIFIERS

Universal 2.5- and 3.5-amp silicon rectifiers, capable of replacing all diodes having voltage characteristics up to 100 volts, are now available. These new units permit the service technician to carry two rectifiers instead of stocking hundreds of replacement types. The 2.5-amp subminiature rectifier (R250F) has a 50-amp maximum surge

while the 3.5-amp unit (R350F) has a 70-amp maximum surge.

The 2.5-amp rectifier is suitable for TV, radio, and communications applications and replaces HEP157 through HEP170, GE504A, GE509, 1N2069/A, 1N2070/A, and 1N2071/A, among others. The 3.5-amp unit is suitable for higher power circuits in original and replacement applications as well as for industrial circuits requiring ratings up to 1000 volts p.i.v. International Rectifier

Circle No. 10 on Reader Service Card

ULTRA-HIGH-SPEED STROBE

For high-speed motion analysis and optical experimentation, a new full-capability stroboscope with a continuous repetition rate of 600,000 flashes per minute has been introduced.

The instrument features vernier frequency

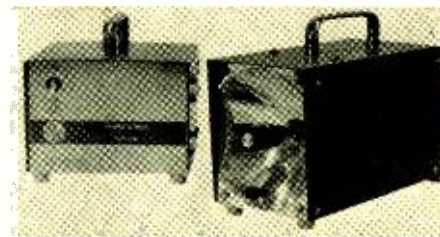

control, ultra-short-duration light pulses, and ultra-high stability for precise synchronization and examination of subjects without spread, blur, or confusion of the image for motion analysis, according to the company.

The virtual point-light source, 0.20-microsecond light-pulse duration, and high repetition rate allow adaptation to many optical applications, including ranging and visual communications. U.S. Scientific Instruments

Circle No. 11 on Reader Service Card

FIRE AND INTRUDER ALARM

The "Alert DC-6" is a low-cost fire and burglar alarm system for home or office use. The system consists of a special hair-thin wire, contact switches for doors and windows, and mounting pins.

The system is key-locked so only the key holder can turn off the alarm. An electronic delay timer permits the owner to leave the protected property and close the door before the alarm system is activated. The latched circuit allows the alarm to operate even if the protected door or window is closed after entry. MRL, Inc.

Circle No. 12 on Reader Service Card

MARINE RADIOTELEPHONE

The Model MWW-18 radiophone is all solid-state except for the last three transmitter stages. The unit has been type-accepted by the FCC and meets all requirements of the recent FCC ruling on marine radiotelephones: 0.001% frequency tolerance; \pm 5 kHz frequency deviation; 25 watts maximum allowable power output; 1-watt output "low power" capability for in-harbor use; and a post-limiter audio roll-off filter. This means that the MWW-18 will require no modification during the new rule implementation period from March 1, 1969 to January 1, 1974 or thereafter.

The unit features full coverage of both marine v.h.f.-FM bands, with six transmit/receive channels which may be distributed within the two bands as the user requires. It is designed around a plug-in control head measuring only 4¼" w. x

3 1/4" h. x 3 1/4" d. An accessory extension cable is also available to permit the control head to be placed in one location and the chassis elsewhere.

Full specs on this new marine radiotelephone will be forwarded on request. Heath

Circle No. 13 on Reader Service Card

FM TUNER CHANNEL SELECTOR

The Model 804 FM tuner features digital read-out tuning to replace the conventional FM dial. Instead of the familiar tuning band and dial for an FM tuner, the face of the 804 contains a black rectangular window which flashes the number of the channel which has been set. Tuning is positive to the exact center of the channel.

According to the company, all drift, misalignment, and mistuning have been eliminated. The new technique pinpoints the frequency since it is tunable only to the one-hundred discrete channels designated by the FCC for FM broadcasting. Selection of the desired channel is made by activating the dual-function channel selector switch, manually or automatically. The tuner can also be programmed for 24 hours of selected listening by means of an accessory clock programmer. C/M Laboratories

Circle No. 14 on Reader Service Card

CONTINUOUS CASSETTE PLAYBACK

A new cassette "circulator"—a snap-on device that gives continuous playback capacity to automatic cassette changers—has been introduced as the Model CC6.

The circulator, which has no moving parts, makes possible 12 hours of non-stop, no-repeat playback and then starts the cycle over again. It functions with four to six cassettes, automatically flips each for second-side play, and restacks the cassettes for playing again.

Functionally styled in tinted plastic and stand-

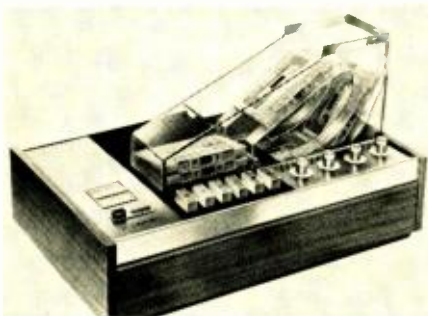

ing 5 inches high, the CC6 is simply snapped on for instant use. It is compatible with Norelco cassette changer models 2401, 2401A, and 2502 as well as Bell & Howell models 332 and 337 and Ampex Micro 90 and 95 units. Norelco

Circle No. 15 on Reader Service Card

INTEGRATED MUSIC SYSTEM

The "Landmark 100" is a complete music system which incorporates an AM/stereo-FM tuner and record changer and comes with "Acoust Array" speaker systems. Each system incorporates three full-range loudspeakers and a tweeter in a relatively small truncated cube enclosure. One speaker faces forward but the others are placed at asymmetrical angles at the back of the cabinet, radiating sound so that it is reflected into the listening area. The cabinets are walnut finished and have dark brown grille cloths. Each measures 10" x 10" x 10".

The tuner features all-silicon transistor circuitry with an FET front-end. Four IC's perform



April, 1970

the functions of AM and FM i.f. and multiplex. The unit has automatic mono/stereo switching with a stereo indicator light. A zero-center tuning meter aids accurate tuning.

A Garrard automatic turntable is included and features the new "Stereo-V" magnetic cartridge. Electro-Voice

Circle No. 16 on Reader Service Card

WORLD TIME DIAL FOR SWL's

A new, easy-to-use, pocket-size world time dial combined with radio frequency charts that lets the SWL, DX'er, ham, or electronics hobbyist quickly convert the time differences between local standard times to that of other cities through-



out the world, as well as GMT, is now available for \$1.00 a copy.

The compact, two-color selector measures 4" x 5" and can be used with the turn of a big, easy-to-read dial. The frequency charts include the international SW broadcast bands, radio and TV broadcast bands, communications and navigation frequencies, ham bands, standard time and frequency signals.

Send your order, with payment, direct to Dept. PR, The Hallicrafters Co., 600 Hicks Road, Rolling Meadows, Ill. 60008.

STEREO RECEIVER WITH IC's

The Model 5000A 180-watt AM/stereo-FM receiver features all solid-state design with IC's in the four i.f. amplifiers and an all-new 4-gang capacitor and FET in the 1st r.f. stage, plus two FET's in the 2nd r.f. and mixer stage. The unit also features linear tuning in the FM section for pinpoint station location.

Specifications include 180 watts of IHF music power providing 75 watts per channel of continuous power at 4 ohms. FM tuner sensitivity is 1.8 μ V (IHF), selectivity is better than 50 dB at 98 MHz, and stereo separation is better than 35 dB. The amplifier section provides a flat frequency response from 10 to 50,000 Hz.

Complete specifications on this new receiver will be forwarded on request. Sansui

Circle No. 17 on Reader Service Card

5-MHz QUARTZ FILTERS

The Piezoelectric Division of Gould Inc., 232 Forbes Road, Bedford, Ohio 44146 has announced the availability of a new Clevite 6-pole coupled-mode quartz filter with a center frequency of 5 MHz.

The filters are designed for matching solid-state circuitry in communications receivers operating in the v.h.f. and u.h.f. frequency ranges, as well as in telemetry, radar, and aerospace voice radio systems.

These filters have a 3-dB bandwidth of 14 kHz and a 60-dB bandwidth of 70 kHz. They are supplied in a flat-pack coldweld case.

Complete specifications on these filters are available upon letterhead request to the Marketing Services department of the company.

STEPPING MOTORS

The Kearfott Division of Singer-General Precision, Inc., Little Falls, New Jersey is supplying specially designed Size 11 stepper motors and power/logic supplies for use in the U.S. Geological Survey's stereo-image alternator system—an

image-separation arrangement for viewing either black-and-white or color stereoscopic models in projection-type stereoplotters without need for filters.

Consisting of rotating cylindrical shutters in both projection and viewing fields, and synchronized so that each eye sees only the image emanating from a corresponding left or right projector, the system is an improvement over earlier anaglyphic viewing instruments.

Stepping rates for projector and viewer motors are controlled by switches on the C70 4919 002 power/logic modules, while the CR 0191 010 stepper motor provides 1.8 in-oz holding torque, 90°/step stepping angle, 220 steps/s stepping rate, and 450-ohm winding resistance.

MULTI-FREQUENCY OSCILLATORS

A new series of multi-frequency fork oscillators for use in inverters, data communications test sets, peripheral computer equipment, and other related applications has been introduced by American Time Products of Bulova Watch Company's Electronics Div.

The series consists of FS-300, which provides frequency outputs of 60, 120, 240, and 480 Hz, and the FS-400 with frequency outputs of 50, 100, 200, and 400 Hz. Input is +5 V d.c. at 100 mA; output is square-wave compatible with logic circuitry such as TTL. Standard accuracies are as great as ± 0.002 percent.

All units are hermetically sealed, weigh approximately 2 1/2 ounces, and measure 1 1/2" square by 1 3/16" high.

For additional information, address your letterhead request to the attention of the Product Sales Manager at 61-20 Woodside Ave., Woodside, N.Y. 11370.

INTRUSION ALARM

The Model ACA-140 ultrasonic intrusion alarm system is completely self-contained with the sensitive detection device and 8" alarm bell housed in a walnut wood cabinet measuring 7 3/8" x 8 1/8" x 11 3/8".

Identical in appearance to a bookshelf speaker



cabinet, the "Space Probe" projects an ultrasonic beam which blankets a given area. Any intruder interrupting this beam activates the unit, turning on a light and, in about 15 seconds, the alarm bell. The unit cannot be bypassed or defeated. No installation is necessary—the unit is merely plugged into an 117-volt a.c. outlet, turned on, and adjusted for the required range sensitivity. Bourns Euphonics

Circle No. 18 on Reader Service Card

AUDIO CONTROL CENTERS

Designed for home and professional sound installations, the new CC series of audio control centers allows up to four or six stereo speaker systems to be selected for simultaneous operation. The centers will provide full stereo sound in every room throughout the house with simple push-button operation.

The unique "push-on and push-to-release" switches are housed in a black metal case which looks like leather. A contrasting brushed aluminum escutcheon plate houses ivory white push-buttons and identification plate.

No external power is required for operation and the center may be used in low or high im-

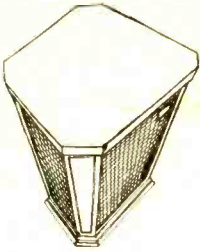

Where
do you
put
your
speakers
in a
room
shaped
like
this?

No matter what shape your room is in, Scott's new Quadrant Q-100 speakers solve your placement problems. Scott Quadrants, with two woofers and four midrange / tweeters placed around the enclosure's four sides, project full-frequency sound in a complete circle. The sound is both projected directly at you and reflected off your walls, to

heighten the live stereo effect. No matter where you place the Quadrant speakers, your entire listening area becomes a giant stereo sound chamber. Go anywhere in the room . . . even sit on a speaker . . . you're surrounded by rich, full-range stereo sound!

Unbelievable? Hear the Quadrant's wall-to-wall stereo, at your Scott dealer's. You'll become a believer. \$149.95.

For more details, write:

SCOTT
H.H. Scott, Inc., Dept. 160-01, Maynard, Mass. 01754

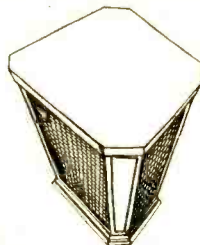

pedance circuits. Currently six models are available in the series. Full details on features and price are available on request. Alco

Circle No. 19 on Reader Service Card

NOISE-LOADING TEST SET

Electronic Communications, Inc., Box 12248, St. Petersburg, Fla. 33733 has developed a noise-loading test set for measuring intermodulation distortion of h.f./SSB equipment and components in accordance with MIL-Std.-1311 and 188.

Designated the Model 975, the unit has an output power which is continuously variable from 10 mW to 100 watts. Minimum notch depth is 50 dB, accommodating signal-to-intermodulation distortion measurements up to that figure. Eliminating the interpretation of spectrum analyzer displays inherent in two-tone testing, the unit provides direct meter indication of distortion level.

The basic model provides a 12-kHz bandwidth notched noise test signal centered at any given frequency in the 2 to 30 MHz h.f. range (4 MHz typical). An option provides a baseband notched noise signal in accordance with MIL-Std.-188C.

Inquiries and requests for additional information should be sent to the Director of Customer Requirements at the above address.

2000-WATT LINEAR AMP

The SB-220 linear amplifier uses a pair of Eimac 3-500Z's in the grounded-grid final to provide up to 2000 watts p.e.p. input on SSB and 1000 watts on CW and RTTY, yet requires only 100 watts drive for full output. A pretuned broadband pi input delivers maximum efficiency and low distortion throughout the 80-10 meter ham bands, according to the company.

Features include a built-in solid-state power supply that can be wired for either 120 or 240 volts a.c. and circuit-breaker protection. A zener diode regulates operating bias and reduces zero signal plate current for cooler operation and longer tube life.

The company estimates that the kit can be assembled in 20 hours. Heath

Circle No. 20 on Reader Service Card

HIGH-POWER ENERGIZER

The new SE460 solid-state energizer incorporates all of the features of the company's SE400S

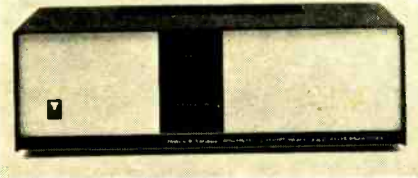

plus 120 watts of continuous r.m.s. output. Among the features of the new model are custom equalizer boards that tailor the signal for the specific speaker system connected to it, all solid-state circuitry, and low distortion. JBL

Circle No. 21 on Reader Service Card

COLOR-ORGAN KIT

An easily assembled color-organ kit which can be connected to the speaker terminals of any receiver, amplifier, or console has been introduced as the Model KG-338.

The all-solid-state three-channel circuitry separates the high, middle, and low frequencies into

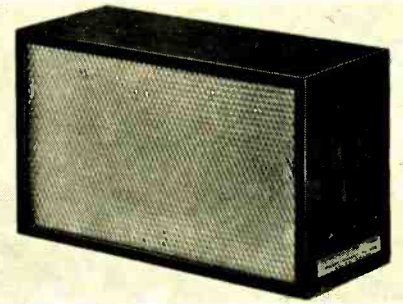

blue, green, and red colored lights that provide a three-dimensional display through the prismatic screen.

The organ is supplied complete with a vinyl-clad wood case which is finished in simulated walnut veneer. It measures 8 1/4" x 14 1/4" x 5 3/4". Allied Radio

Circle No. 22 on Reader Service Card

CONTACTLESS SOLID-STATE SWITCH

A contactless digital-output switch element that can cycle up to one million times a minute has been introduced by Micro Switch, 11 W. Spring St., Freeport, Ill. 61032.

The ISS1 solid-state switch combines a Hall element, an amplifier, and unique switching circuitry in a miniature package to control discrete and/or integrated logic circuits. Since the switching element is magnetically actuated, the life of the ISS1 is virtually unlimited, according to the company.

The switch package is constructed around an IC chip only 0.040-inch square, bonded to a metal grid. The entire switch measures 1/2" x 1/2" x 1/8" and is housed in a plastic case and wrap-around aluminum shield.

Complete technical specifications on the ISS1 are available upon letterhead request.

PORTABLE P.A. SYSTEM

The Model 280 portable p.a. system features all solid-state circuitry, extended voice projection, a dynamic microphone, and weighs less than four pounds with its six standard "D" cells.

The unit is suitable for use by tour guides, in schools, by civic groups, or other organizations where voice amplification is necessary when addressing a crowd. The VP Company

Circle No. 23 on Reader Service Card

DUAL-PURPOSE NEON DEVICE

Signalite Inc., 1933 Heck Avenue, Neptune, N.J. 07753 has introduced a new neon device which acts as a suppressor for light-powered transients and as an audio pass device on telecommunications lines.

As a transient suppressor, the Type A280 will arrest all transient peaks which exceed 205 volts, the firing voltage rating of the device. After re-

moval of the transient, the device will extinguish at 45 volts. Operation does not interfere with normal line voltage.

As an audio pass device it is turned on with the application of d.c. pulses on the telephone line. A bias voltage is supplied to keep the device in the maintaining mode after the turn-on pulse has been removed. An audio signal can be superimposed on the bias and passed by the tube to the instrument.

The A280 is housed in a glass tube 1" long x 0.244" diameter. It has one-inch tinned leads.

NEON READOUT

Alco-Display Division, P.O. Box 1348, Lawrence, Mass. 01842 is now marketing the "Elfin" MG-19, a 9-segmented cold-cathode indicator that forms numerals 0 through 9, +, -, decimal point, and some alpha characters and the MC-17, which is similar except it has 7 segments to form 0 through 9, -, two decimal points at upper left and lower right, and alphabet indications.

Both units have a combination spacer and mount that simplifies PC wiring and changes leads from round to straight lines.

For technical assistance in application planning and additional information, address your letterhead request to Philip Mignanelli, the product sales manager of the firm.

FM SIGNAL GENERATOR

A new FM signal generator designed specifically for laboratory use and in production-line testing of sensitive and distortion-free hi-fi FM receivers has been introduced as the Model 188.

According to the company, two-speed tuning control and electronic incremental tuning provide exceptionally fast and accurate receiver alignment. Internal or external modulation may be measured in three convenient ranges without need for an external voltmeter. The unit may also be used with existing multiplex modulators.

An all-solid-state power supply provides regu-



lated plate, heater, and low-distortion audio voltages. The unit features double shielding, 50-ohm source impedance at a low v.s.w.r., and wide deviation with low distortion.

A technical data sheet on this instrument is available on request. Measurements

Circle No. 24 on Reader Service Card

MOTION-DETECTION SYSTEM

The new ultrasonic motion detection system, called "DeltaAlert", is designed to detect any motion or intrusion and can be used both as an anti-burglary device and as a convenience item. The convenience aspects of the system include activation of night lights in carports, garages, offices, warehouses, or homes.

Operating on a frequency of 35 kHz, the unit

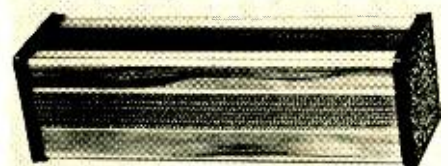

will monitor an area of 15-30 feet, depending on environmental conditions such as shape of the area. The receiving and transmitting elements are coupled both electrically and acoustically and the unit has been designed to yield a relatively broadband characteristic, forcing oscillation to occur at a point of maximum acoustical sensitivity.

The unit is designed to plug into any wall outlet. The lights, alarms, or bells to be activated are simply plugged into a receptacle on the back of the unit. No rewiring is necessary. Delta Products

Circle No. 25 on Reader Service Card

TIME-LAPSE VIDEO RECORDER

A video tape recorder that has been specifically designed for time-lapse recording is now available as the Model EV-330TLV "Videocorder."



The unit can continuously record more than 60 hours of picture on a single reel of 1-inch video tape. One image is recorded in approximately one second. The tape can be played back at the recorded speed or up to 60 times faster to locate a particular scene on the tape. Tapes recorded on this unit are interchangeable with any other EV series Videocorder.

The time-lapse recording can be used in research and science, time and motion studies, and for surveillance. As a regular video tape recorder the unit is suitable for any industrial, educational, medical, or other CCTV application. Sony Corp.

Circle No. 26 on Reader Service Card

FULL-RANGE SPEAKER SYSTEM

The "Quadrant Q-100" is a full-range speaker system which produces a 3-dimensional stereo effect throughout the room, according to its maker.

The new system is especially suited to the requirements of the recently introduced 4-channel stereo, either with two Quadrants used as the front pair or four systems all around.

Each system uses two 8" woofers and four 3" tweeters. Frequency range is 38-20,000 Hz and impedance is 6-8 ohms. The system will handle 80 watts of integrated program material in its air-suspension enclosure. Amplifier power requirements are 10 watts minimum.

The cabinet, which measures 14 1/4" w. x 14 1/4" d. x 22" h., is of contemporary walnut design with a brown cane-pattern grille cloth. H. H. Scott

Circle No. 27 on Reader Service Card

SOLID-STATE TAPE RECORDER

The first in a new series of tape recorders to be introduced in the 1970's has made its appearance as the three-speed, solid-state 6000X stereo deck—a 57-transistor instrument.

The compact new deck offers four precision-gapped, Mumetal screened heads with the unique crossfield design. It is available in quarter-track and half-track models; may be used with low-noise, high-output tape; operates in vertical or horizontal position; and is housed in a walnut cabinet.

Important features include peak-reading vu meters for record and playback levels; automatic overload protection; independent mike/line rec-



ord-level controls for each channel; push-button control for electrical functions and channel selection; and a single-level tape transport control.

Frequency response is 40-22,000 Hz at 7 1/2 in/s ± 2 1/2 dB. Tandberg

Circle No. 28 on Reader Service Card

CASSETTE TAPE

A new blank tape cassette which features "Super Dynamic SD" tape is capable of extending the high-frequency response of most cassette recorders. The cassette offers virtually flat response from 50 to 10,000 Hz, with good frequency response above and below these figures.

A new ferric oxide formulation uses a needle-like particle shape which permits eight times greater density of magnetic particles, improving resolution and reducing sound distortion, according to the company. The new binder system reduces cross-modulation and static charge and there is no shedding of magnetic coating, thus dropouts are eliminated. TDK Electronics

Circle No. 29 on Reader Service Card

MANUFACTURERS' LITERATURE

PRESSURE-SENSITIVE TRANSISTORS

Stow Laboratories, Inc., 159 Kane Industrial Drive, Hudson, Mass. 01749 has just issued an 8-page brochure describing the physical sensing and transistor characteristics of its "Pitran" pressure-sensitive transistors.

The latest technical and applications data is included, along with typical circuits.

AUDIO EQUALIZERS

A new 6-page catalogue describing a complete line of audio equalizers is available from Melcor Electronics Corp., 1750 New Highway, Farmingdale, New York 11735.

The equalizer line includes amplifier models, graphic module units, shelf module, and active program equalizers. These equalizers are used in the broadcasting, recording, and sound systems industry.

The publication includes detailed electrical and mechanical specifications for all units. Photos, wiring diagrams, performance curves, and general descriptive information are also provided.

Address your letterhead request for a copy of the catalogue to N. Sakellarios, vice-president of the company at the above address.

CENTRIFUGE FOR TESTING

A new 44-page engineering data file on its "Centrisafe" centrifuge for acceleration testing of semiconductors, integrated circuits, hybrid circuits, and other solid-state devices has been announced by Trio-Tech Inc. of California, 2435 N. Naomi Street, Burbank, California 91504.

Complete descriptions, specifications, and safety features are included for variable-speed and fixed-speed models. Also included is data on centrifuge accessories consisting of rotors, G-converters, acceleration multipliers, and spindle adapters.

THERMOCOUPLE DATA

Omega Engineering, Inc., Box 4047, Stamford, Conn. 06907 has announced the availability of its free 36-page thermocouple catalogue. It contains both technical and price information on thermocouples, thermocouple probes, bare and insulated

(Continued on page 92)

Exciting New Kit Ideas from Heath

New Heathkit 100-Watt AM/FM/FM-Stereo Receiver

World's finest medium power stereo receiver . . . designed in the tradition of the famous Heathkit AR-15. All Solid-State . . . 65 transistors, 42 diodes plus 4 integrated circuits containing another 56 transistors and 24 diodes. 100 watts music power output at 8 ohms — 7 to 60,000 Hz response. Less than 0.25% distortion at full output. Direct coupled outputs protected by dissipation-limiting circuitry. Massive power supply. Four individually heat sunk output transistors. Linear motion bass, treble, balances and volume controls. Push-button selected inputs. Outputs for 2 separate stereo speaker systems. Center speaker capability. Stereo headphone jack. Assembled, aligned FET FM tuner has 1.8 uV sensitivity. Two tuning meters. Computer designed 9-pole L-C filter plus 3 IC's in IF gives ideally shaped bandpass with greater than 70 dB selectivity and eliminates alignment. IC multiplex section. Three FET's in AM tuner. AM rod antenna swivels for best pickup. Kit Exclusive: Modular Plug-In Circuit Boards . . . easy to build & service. Kit Exclusive: Built-In Test Circuitry lets you assemble, test and service your AR-29 without external test equipment. The AR-29 will please even the most discriminating stereo listener.

Kit AR-29, (less cabinet), 33 lbs. \$285.00*
AE-19, Assembled oiled pecan cabinet, 10 lbs. \$19.95*



Kit AR-29
\$285.00*

New Heathkit 60-Watt AM/FM/FM Stereo Receiver

The AR-19 circuitry reflects many of the advanced concepts of the AR-29. It uses 108 transistors and 45 diodes including those in 5 integrated circuits. It delivers 60 watts music power at 8 ohms. At any power level, Harmonic and IM Distortion is less than 0.25%. Frequency response ranges from 6 to 35,000 Hz. Direct coupled outputs are protected by dissipation-limiting circuitry. A massive power supply includes a section of electronically regulated power. The assembled, aligned FET FM tuner has 2.0 uV sensitivity.

A preassembled and factory aligned FM IF circuit board gives 35 dB selectivity. The multiplex IC circuit provides inherent SCA rejection. It features two switched noise muting circuits; linear motion controls for bass, treble, volume and balance; input level controls; outputs for 2 separate stereo speaker systems; center speaker capability; two tuning meters; stereo indicator light; front panel stereo headphone jack. The Modular Plug-in Circuit Board speeds assembly. Built-in Test Circuitry aids assembly, simplifies servicing. "Black Magic" panel lighting, black lower panel, chrome accents. Compare it with any model in its price range . . . the AR-19 will prove itself the better buy.

Kit AR-19, (less cabinet), 29 lbs. \$225.00*
Assembled AE-19, cabinet, 10 lbs. \$19.95*

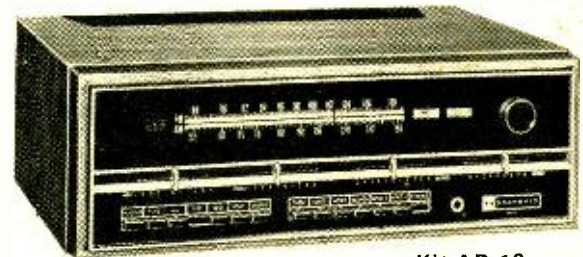

Kit AR-19
\$225.00*

New Heathkit Deluxe 18-Watt Solid-State Stereo Phono

Looks and sounds like it should cost much more. Here's why: 16-transistor, 8-diode circuit delivers 9 watts music power per channel to each 4 1/2" high-compliance speaker. Speaker cabinets swing out or lift off . . . can be placed up to 10' apart for better stereo. Has Maestro's best automatic, 4-speed changer — 16, 33-1/3, 45 & 78 rpm. It plays 6 records, shuts off automatically. Ceramic stereo cartridge with diamond/sapphire stylus. Has volume, balance & tone controls. Changer, cabinet & speaker enclosures come factory built . . . you build just one circuit board . . . one evening project. Wood cabinet has yellow-gold & brown durable plastic coated covering. This is a portable stereo you can take pride in.

Kit GD-109, 38 lbs. \$74.95*



Kit GD-109
\$74.95*

New Heathkit 80-10 Meter 2 KW Linear Amplifier

Incomparable performance and value. The new SB-220 has 2000 watts PEP input on SSB & 1000 watts on CW and RTTY. Uses a pair of Eimac 3-500Z's. Pretuned broad band pi input coils. Requires only 100 watts PEP drive. Solid-state power supply operates from 120 or 240 VAC. Circuit breaker protected. Safety interlocked cover. Zener diode regulated operating bias. Double shielded for max. TVI protection. Quiet fan — fast, high volume air flow. Also includes ALC to prevent over-driving. Two meters: one monitors plate current; the other is switched for relative power, plate voltage and grid current. Styled to match Heath SB series. Assembles in about 15 hours.

Kit SB-220, 55 lbs. \$349.95*



Kit SB-220
\$349.95*

New Heathkit Portable Fish-Spotter

Costs half as much as comparable performers. Probes to 200 ft. Spots individual fish and schools . . . can also be used as depth sounder. Manual explains typical dial readings. Transducer mounts anywhere on suction cup bracket. Adjustable Sensitivity Control. Exclusive Heath Noise-Reject Control stops motor ignition noise. Runs for 80 hrs. on two 6 VDC lantern batteries (not included). Stop guessing — fish electronically.

Kit MI-29, 9 lbs. \$84.95*



Kit MI-29
\$84.95*

NEW IMPROVED 1970 HEATHKIT® COLOR TV

New Lower-Than-Ever Prices



Here's How The Color TV That Thousands Call Best Became Even Better and Lower In Price

Since the very first model was introduced, thousands of owners, electronic experts, and testing labs have praised the superior color picture quality and extra features of Heathkit ColorTV. Now Heath has made improvements that make the 1970 models even better.



Sharper, More Detailed Pictures. Latest design improvement in the circuitry of Heathkit Color TV video amplifiers has increased their bandpass capabilities. The result is an increase in the number of lines of resolution . . . greater than in any other brand of color TV we have tested. This improvement means you get sharper, more detailed pictures as shown by test pattern measurements. You not only get the superior color pictures Heathkit Color TV has always been noted for, but you also get sharper pictures.

New Brighter Tube. Now all Heathkit Color TV models include the new brighter picture tube you've read so much about. These new tubes produce noticeably brighter pictures with more life-like, natural colors and better contrast. (We also offer the RCA Hi-Lite Matrix tube as an extra-cost option for the Heath GR-681 and GR-295 kits.)

New Safety Features. As an added safety precaution, AC interlocks have been added to all Heathkit Color TV cabinets.

New The Best Costs Less. How can Heath make improvements in its Color TV Models and still reduce the prices? We have passed on to you the savings which have accrued due to reduced picture tube prices. The result is your 1970 Heathkit Color TV will cost you \$20 to \$55 less depending upon which model you choose . . . proof that Heathkit Color TV is a better buy than ever.

All Heathkit Color TV's Have These Superior Features

- New brighter American brand rectangular color tube with bonded-face, etched anti-glare safety glass
- Exclusive built-in self-servicing aids so you can adjust and maintain the set for best performance always
- Automatic degaussing plus mobile degaussing coil
- New broader video bandwidth for better resolution
- 3-stage video IF
- Improved retrace blanking
- Gated automatic gain control for steady pictures
- Automatic color control
- Exclusive Magna-Shield surrounds picture tube for better color purity
- Deluxe VHF tuner with "memory" fine tuning and precious metal contacts (models with automatic fine tuning also are available in all 3 picture tube sizes)
- 2-speed UHF solid-state tuner
- Completely shielded hi-voltage supply
- Extra B+ boost for better definition
- 2 hi-fi sound outputs for built-in speaker or your hi-fi system
- 300 ohm & 75 ohm antenna inputs
- Circuit breaker protection
- Optional wireless remote control can be added anytime
- Factory assembled and adjusted tuners. IF section, and hi-voltage supply
- Exclusive 3-way installation capability — in a wall, custom cabinet or Heath cabinets

Choose Your Heathkit Color TV Now . . .

It's Better Than Ever in Performance . . . and A Better Buy Than Ever

New Lower-Than-Ever Prices On All Models

Heathkit GR-681
(295"-AFT)
save \$30

Now only **\$46995***



Heathkit GR-681MX
(with Matrix tube)
save \$55

Now only **\$47995***



Heathkit GR-295
(295")
save \$30

Now only **\$41995***



Heathkit GR-295MX
(with Matrix tube)
save \$55

Now only **\$42995***

cabinets from \$65*

Heathkit GR-581
(227"-AFT)
save \$20

Now only **\$39995***



Heathkit GR-227
(227")
save \$20

Now only **\$35995***

cabinets from \$39.95*

Heathkit GR-481
(180"-AFT)
save \$30

Now only **\$32995***



Heathkit GR-180
(180")
save \$30

Now only **\$29950***

cabinets from \$27.50*



NEW

FREE 1970 CATALOG!

Now with more kits, more color. Fully describes these along with over 300 kits for stereo/hi-fi, color TV, electronic organs, guitar amplifiers, amateur radio, marine, educational, CB, home & hobby. Mail coupon or write Heath Company, Benton Harbor, Michigan 49022.

HEATH COMPANY, Dept. 15-4
Benton Harbor, Michigan 49022

Enclosed is \$ _____, plus shipping.

Please send model (s)

Please send FREE Heathkit Catalog.

Please send Credit Application.

Name _____

Address _____

City _____

State _____

Zip _____

*Mail order prices; F.O.B. factory. Prices & specifications subject to change without notice.

CL-377



a Schlumberger company

thermocouple wire, ultra-miniature thermocouples, connectors, panel boards, ceramic insulators, cold-junction compensators, ice-point reference chambers, portable pyrometers, and many thermocouple-related items.

SWITCH CATALOGUE

An 8-page catalogue covering a line of snap-action, rocker-actuated, paddle, toggle, and push-button switches has been issued by McGill Manufacturing Company, Inc., Valparaiso, Indiana 46355.

Bulletin MC-90 contains data on several new switch series, including lighted miniature rocker switches, three-pole and four-pole toggle and rocker switches, and a sealed splash-proof switch.

The line includes miniature standard size snap-action, rocker, and paddle switches. Most types are available in a variety of ratings, circuitry, actuator styles, colors, and mounting arrangements.

STOCK PLASTIC BOXES

The 1970-71 Bradley Industries catalogue of stock plastic boxes, listing more than 300 standard sizes in 16 different styles, is now available for distribution.

The 36-page illustrated brochure provides complete information on stock rigid polystyrene boxes in square and rectangular hinged and non-hinged boxes, the "Heritage Line," round (non-hinged), compartmented, slide top, pegboard, specialty, and stock drawers and trays—also stock vials and stock semi-rigid containers. Style is illustrated for each, with individual dimensions and prices per thousand.

For a copy of the brochure, write on your letterhead to Dept. SB of the company at 353 Main Avenue, Norwalk, Conn. 06852.

SOLID-STATE A.C. RELAYS

A new brochure summarizing the specifications of TO-5 and solid-state a.c. relays is now available from Teledyne Relays, 3155 W. El Segundo Blvd., Hawthorne, Calif. 90250.

The six-page publication presents specifications and drawings for each line of relays produced by the company, including basic and hybrid military TO-5's, industrial TO-5's, and industrial solid-state relays. One page in the brochure describes five lines of military hybrid TO-5's, which may be ordered with transistor drives and/or operational amplifiers inside the TO-5 case.

H. V. RECTIFIER COLUMNS

A 24-page illustrated engineering bulletin (B-107) describing a line of high-voltage rectifier columns has been issued by the Semiconductor Division of International Rectifier, 233 Kansas Street, El Segundo, California 90245.

The columns are designed to meet the demand for high-voltage and high-power rectifiers used in power supplies and for other blocking and steering diode applications. They are available in 14 basic series with peak-reverse voltages up to 500,000 volts. Continuous current ratings range from 1 to over 220 amps.

FLUIDIC CONTROL MODULES

The Fluidic Products Department of Corning Glass Works, Corning, N. Y. 14830 has just published a 28-page illustrated booklet (EDP-FBR-2) describing its complete family of fluidic industrial control modules (FICM) and associated mounting manifolds.

A two-page introduction to fluidics and a two-page explanation of basic fluidic technology is followed by five pages of FICM component descriptions. A fold-out chart gives symbols and truth tables for the various elements and their corresponding symbols in other technologies.

PLASTIC BONDING ADHESIVES

A new 4-page, 2-color illustrated catalogue (Z-PB) describing a new line of six "Scotch-Grip" plastic bonding adhesives that offer a wide variety of properties to meet many plastic bonding applications is now available from the Adhesives, Coatings and Sealers Division, 3M Company, St. Paul, Minn. 55101.

A guide lists the six plastic bonding adhesives and 17 types of plastics, and designates the proper adhesive for each plastic bonding application. A physical properties and applications data chart describes the outstanding features, application methods, solvent, color solids content, consistency, coverage, and bonding range for each adhesive.

CONVERTER TABLES

Commercial Plastics & Supply Corp., 2001 W. Clearfield St., Philadelphia, Pa. 19132 is now offering its "Square Foot Converter Tables" in combination with a "Dial-a-Decimal" circular two-way table with readout of decimal and metric equivalents of fractions, or vice versa. Both can fit into a shirt pocket.

The converter applies to plastic sheets up to 96 in by 120 in as well as to aluminum, copper, steel, or other metallic sheets. This pocket-sized combination kit further aids precise cutting or shearing and quickly determines measurements.

RESISTOR HANDBOOK

RCL Electronics, Inc., 700 South 21st St., Irvington, New Jersey 07111 now has available its new 1970 "Handbook on Precision and Power Wire Wound Resistors."

Included are new developments in the resistor field as well as updated technical information on over 35 series of wirewound resistors.

LIGHTED PUSH-BUTTONS

The Specialty Switch Division of Arrow-Hart, Inc., 103 Hawthorne Street, Hartford, Conn. 06106 has published a 12-page catalogue section describing its new line of lighted push-button switches.

Called "Adapt-a-Switch," the new line was designed with a building-block concept to enable the user to build more than 25,000 switching variations from 31 stock components.

The catalogue section contains rating and circuit data on the new switches along with detailed information on components, applications, operating characteristics, optional features, and ordering information.

ARTWORK FOR PC BOARDS

The 1970 edition of the combined technical manual and catalogue 104A has been released by Bishop Graphics, Inc., 7300 Radford Ave., North Hollywood, Calif. 91605.

Describing more than 15,000 pressure-sensitive electronic-component drafting aids, techniques, and systems, the 68-page manual illustrates new ways to save time and money in preparing master artwork for printed wiring boards.

New products include the preparation of negatives for prototype boards without photography by using the "B neg" negative drafting system developed by the company. ▲

Answer to ELECTRONIC CROSSWORDS Appearing on page 65

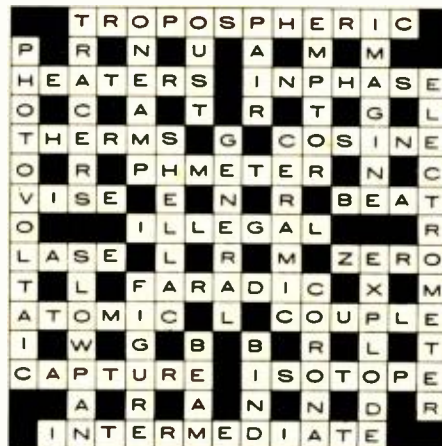

PHOTO CREDITS

Page	Credit
13	McIntosh Laboratory, Inc.
14	Tandberg of America, Inc.
32, 33	Federal Aviation Administration
41	Erie Technological Products
44	Electro-Motive Mfg. Co.
59	Jennings ITT
74	Melsey Corporation
75	General Radio Company
76	Eico Electronic Instruments Co., Inc.

Answers to C.E.T. Test, Section #2

Published in Last Month's Issue:

- (a) Blanking is considered black; sync is considered "blacker-than-black" as the picture tube is cut off by sync more than by the darkest portion of video.
- (d) The sound normally comes from a separate transmitter. Amplitude is fixed and not related to the video waveform. Frequency of the audio varies with modulation.
- (c) The "hammerhead" is used to cause the integrator to charge in the same manner on both even and odd fields.
- (d) Sync tips are the moments of maximum transmitter power or maximum modulation. White areas are periods of least modulation or power.
- (a) Significant i. f. frequencies are 41.25 MHz (sound carrier); 42.17 MHz (color subcarrier); 45.75 MHz (picture carrier); 47.25 MHz (adjacent sound carrier); and 39.75 MHz (adjacent picture carrier).
- (c) The 4.5-MHz sound i. f. frequency is derived by beating the sound carrier against the video carrier in the video-detector circuit. Ahead of this point, the sound is at 41.25 MHz.
- (c) The 8 cycles of burst are located on the "back porch."
- (a) The vertical scanning frequency is 60 Hz while the horizontal scanning frequency is $262\frac{1}{2}$ times this, or 15,750 Hz.
- (d) Modern FM receivers use 10.7-MHz i. f. carriers.
- (b) The equalizing pulses during vertical blanking control the precise timing of the vertical oscillator, and interlace.

ELECTRONICS MARKET PLACE

COMMERCIAL RATE: For firms or individuals offering commercial products or services. 85¢ per word (including name and address). Minimum order \$8.50. Payment must accompany copy except when ads are placed by accredited advertising agencies. Frequency discount: 5% for 6 months; 10% for 12 months paid in advance.

READER RATE: For individuals with a personal item to buy or sell. 50¢ per word (including name and address). No minimum! Payment must accompany copy.

GENERAL INFORMATION: First word in all ads set in bold caps at no extra charge. All copy subject to publisher's approval. **Closing Date:** 1st of the 2nd month preceding cover date (for example, March issue closes January 1st). Send order and remittance to: Hal Cymes, **ELECTRONICS WORLD**, One Park Avenue, New York, New York 10016.

FOR SALE

JUST starting in TV service? Write for free 32 page catalog of service order books, invoices, job tickets, phone message books, statements and file systems. Oelrich Publications, 4040 North Nashville Avenue, Chicago, Ill. 60634.

GOVERNMENT Surplus Receivers, Transmitters, Sniperscopes, Radios, Parts, Picture Catalog 25¢. Meshna, Nahant, Mass. 01908.

METERS Surplus, new, used, panel or portable. Send for list. Hanchett, Box 5577, Riverside, Calif. 92507.

CONVERT any television to sensitive big-screen oscilloscope. Only minor changes required. No electronic experience necessary. Illustrated plans, \$2.00. Relco-A22, Box 10563, Houston, Texas 77018.

INVESTIGATORS, LATEST ELECTRONIC AIDS. FREE LITERATURE. CLIFTON, 11500-J NW 7th AVE., MIAMI, FLORIDA 33168.

FREE ELECTRONICS PARTS FLYER. Large catalog \$1.00 deposit. BIGELOW ELECTRONICS, BLUFFTON, OHIO 45817.

EUROPEAN wholesale new products catalog. \$1.00 refundable. Deecow, 10639 Riverside, North Hollywood, Calif. 91602.

TREASURE HUNTERS! Prospectors! Relco's new instruments detect buried gold, silver, coins. Kits, assembled models. Transistorized. Weighs 3 pounds. \$19.95 up. Free catalog. Relco-A22, Box 10839, Houston Texas 77018.

MUSIC LOVERS, CONTINUOUS, UNINTERRUPTED BACKGROUND MUSIC FROM YOUR FM RADIO, USING NEW INEXPENSIVE ADAPTER. FREE LITERATURE, ELECTRONICS, 11500-Z NW 7th AVE., MIAMI, FLORIDA 33168.

JAPAN & HONG KONG DIRECTORY. Electronics, all merchandise. World trade information. \$1.00 today. Ippano Kaisha Ltd., Box 6266, Spokane, Washington 99207.

FREE Catalog low priced, high performance sub-miniature listening devices direct from manufacturer. Dealer welcome. Emery LT-104, 156 Fifth Avenue, New York, N.Y. 10010.

ULTRA-SENSITIVE AND POWERFUL METAL DETECTORS—join the many who are finding buried coins, minerals, relics and artifacts. Don't buy till you see our **FREE** catalog of new models. Write Jetco, Box 132-EW, Huntsville, Texas 77340.

SENCORE TEST EQUIPMENT UNBELIEVABLE PRICES. FREE CATALOG AND PRICE SHEET. FORDHAM RADIO, 265 EAST 149TH STREET, BRONX, N.Y. 10451.

SEMICONDUCTORS and Parts. Catalogue free over 100 pages. J. & J. Electronics, Box 1437, Winnipeg, Manitoba, Canada. U.S. Trade directed.

ELECTRONIC ignition, various types. Free literature. Anderson Engineering, Epsom, N.H. 03239.

REPAIR TELEVISION TUNERS. FREE TRICKS. Plans, Details, Complete Courses: Frank Bocek, Box 3236 (Enterprise), Redding, Calif. 96001.

FREE CATALOG surplus bargains: fans, Bodine reduction motors, switches, relays, steppers, PC Boards, Many others. IEM Inc., Box 4280, Irvine, California 92664.

CONSTRUCTION PLANS: LASER . . . \$2.00. Surveillance Devices—two F.M. Bugging Transmitters . . . \$1.00. Tail Transmitter . . . \$1.00. Telephone Transmitter . . . \$1.00. Infinity Transmitter . . . \$2.00. Equipment and kits available. Howard, 20174 Ward, Detroit, Michigan 48235.

NEW SEMICONDUCTOR LIGHT EMITTING DIODES. Bright red lights replace light bulbs. Typical life 100 years. Operate at 1.65 volts, 50 milliamps. Order 2 for \$2.98 NOW. Data sheet and instructions included. Monsanto Company, Hobby Section, 10131 Bubb Road, Cupertino, California 95014.

HOBBYISTS, experimenters; black and white television converted to color by means of a new patented color converter adaptor circuit. Installation all do it yourself. Write for free brochure. Bele Electronics Corp., 111 N.E. Second Ave., Miami, Florida 33132.

BURGLAR ALARM SYSTEMS and accessories. Controls, bells, sirens, hardware, etc. **OMNI GUARD** radar intruder detection system, kit form or assembled. Write for free catalog. Microtech Associates, Inc., Box 10147, St. Petersburg, Florida 33733.

STROBES, color organs, the incredible Strobot. NEW! Heavy-Duty CD ignition. **ELECTRIC CANDLES** for flameless candle-light. **REMOTE (WIRELESS) SWITCH** for anti-prowler system. **TOUCH SWITCH** for space-age lamps, lights. **ASSEMBLED and KITS.** Send 25¢, specify interest. Teletronics, Box 1266A, South Lake Tahoe, Calif 95705.

PLANS AND KITS

BUILD color organs, computers, stereos, alarms, slide-synchronizers. Catalog. Workshop, 33E Cain. Plainview, New York 11803.

AUTOMOBILE HEADLIGHT ALARM. Pleasant tone reminds you to turn off lights when ignition is turned off. Complete plans, parts list and instructions \$3.00. PG Electronics, Box 4981, El Paso, Texas 79914.

ELECTRONICS ENGINEERING AND INSTRUCTION

LEARN ELECTRONIC ORGAN SERVICING at home. All Makes including transistors. Experimental kit—troubleshooting. Accredited NHSC. Free Booklet. NILES BRYANT SCHOOL, 3631 Stockton, Dept. A, Sacramento, Calif. 95820.

DEGREE in Electronics Engineering earned mostly by correspondence. Free brochure. Dept. G-9, Grantham School of Engineering, 1505 N. Western Ave., Hollywood, California 90027.

MEMORIZE, STUDY: "1970 TESTS-ANSWERS" FOR FCC FIRST AND SECOND CLASS LICENSE. Plus "Self-Study Ability Test." Proven. \$5.00. Command, Box 26348-W, San Francisco 94126.

GOV'T SURPLUS SPECIALS!

SEND 25¢ FOR OUR 68 PAGE ILLUSTRATED CATALOG, OR FREE WITH ANY ORDER.



CB8T05

INSTANT LOGIC!



CBFP

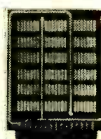

CBDIP

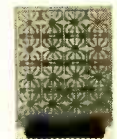

CB10T05



CBFDC

These boards are the most useful items we have ever offered for breadboarding with low cost integrated circuits. The cards are made from 1/16" G 10 Glass Epoxy, and are available in five styles as shown above. Part number CBDIP has a pattern for 9 dual-in-line (DIP) integrated circuits. Part number CBFP mounts six flat packs. Part number CB10T05 mounts 16T0510 pin integrated circuits, part number CB8T05 mounts nine eight pin TO-5's, and part number CBFDC has a pattern suitable for transistors and other discrete components. Discrete Transistors and components can be mounted in the locations between the I.C.'s, and power supply leads are already routed around the board. Our competitors charge \$9.50 each for circuit card and mating connector. We give you a surplus, unused p.c. board with components on it (that you can keep for your junk box), a connector and its mate, and our great circuit card. You drill out the desired hole pattern, unsolder the connector from the surplus card and install it on the new card, wire in the I.C.'s and compute. A few minutes of your time, and you save over 80% of the cost of comparable P.C. cards. Get enough for your breadboarding needs now because these are going to go fast.

PRICES
(Part Number)—2
2 Boards and Mating Connectors\$3.50 Postpaid
(Part Number)—10
10 Boards and Mating Connectors.....\$15.00 Postpaid
(Part Number)—100
100 Boards and Mating Connectors. \$125.00 Postpaid

BF Enterprises

P.O. BOX 44, HATHORNE, MASS. 01937
Phone 1-617-532-2323

BC-645 TRANSCIEVER

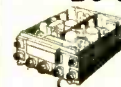

15 tubes.
495 to 500 Mc. Easily adapted for 2 way voice or code on Ham Mobile, Television Experimental and Citizens' Bands. With tubes, less power supply in factory carton. **\$16.95**
Brand new **BC-645 SPECIAL PACKAGE OFFER:** Transceiver, dynamotor and all accessories, including mountings, UHF Antenna Assemblies, control box, complete set of connectors. **PLUS BRAND NEW \$26.95**

AN/ART-13 TRANSMITTER makes fine Ham transmitter for 80, 40, 20 and 10 meters. Power output 100 Watts on AM, CW, MCW. 10 preset channels. Complete with all tubes, crystal, exc. Used, clean. **\$69.50**

Low-Frequency Oscillator Coil for above, 200-1500 kc. Exc. Used **\$7.95**

APN-1 TRANSMITTER-RECEIVER FM 400-450 Mc. Exc. Used, with all tubes, dynamotor & wobulator **\$8.95**

R-4/ARR-2 RECEIVER 234.258 Mc. Tunable, complete with 11 tubes. Excellent Used **\$5.95**
BRAND NEW, including dynamotor \$9.95

SCR-274-N, ARC-5 COMMAND SET HQ!

Free Range	Type	Exc. Used	Like New	BRAND NEW
RECEIVERS, Complete with Tubes				
190-550 Mc.	BC-453	\$16.95	\$19.50	\$27.50
3-6 Mc.	BC-454	\$16.50	\$19.50	\$22.50
6-9.1 Mc.	BC-455	\$14.95	\$17.95	\$21.50
1.5-3 Mc.	R-25	—	\$19.50	\$21.50

Free Range	Type	Exc. Used	Like New	BRAND NEW
TRANSMITTERS, Complete with Tubes				
4.5-3 Mc.	BC-457	\$ 6.95	\$ 8.95	\$11.95
5-3.7 Mc.	BC-458	\$ 6.95	\$ 8.95	\$12.95
7-9.1 Mc.	BC-459	\$17.95	\$19.50	\$23.50
2-1.3 Mc.	T-18	—	\$ 9.95	\$11.95
3-4 Mc.	T-19	—	\$12.50	\$16.95

R-11 COMMAND RECEIVER ARC 190-550 Kc. Commercial late model. Excellent Condition. **\$12.95**

AN/APR-4Y FM & AM RECEIVER "FB" FOR SATELLITE TRACKING!

High precision lab instrument, for monitoring and measuring frequency and relative signal strength, 38 to 4000 Mc. in 5 tuning ranges. For 110 V 60 cycle AC. Built-in power supply. Original circuit diagram included. Checked out, perfect. **\$88.50**
LIKE NEW
All Tuning Units Available for Above

600-OHM HEADSET, permoflux units, chamois cushion, with cord & telephone plug. **\$3.49**

NEW G & G CATALOG!

24 PAGES, crammed with Gov't Surplus Electronic Gear. Biggest Bargain Buys in America! It will pay you to **SEND 25¢ for your copy**—Refunded with First Order!

TERMS: 25% Deposit with order, balance C.O.D. OR—Remittance in Full. Minimum Order \$5.00 F.O.B. NYC. Subject to prior sale and price change.

G&G RADIO ELECTRONICS COMPANY
Tel.: (212) CO-7 4605
45 Warren St., 2nd Floor, New York, N.Y. 10007

INTEGRATED CIRCUITS / RECTIFIERS SEMICONDUCTORS / TRIACS

TRIACS

PRV	10A
100	1.20
200	1.75
300	2.25
400	2.75
500	3.25

ER900 TRIGGER DIODES. These bidirectional trigger diodes are one of the best and cheapest methods to trigger SCR's and triacs 3/\$1.00

UNIUNCTIONS!

Similar to 2N2419, RBB of 5-7 stand off ratio of .6 and Ip of 12 with data sheet \$1.00

ZENERS 1 watt \$.40
10 Watt 7-180V \$.75

MOUNTING HARDWARE KITS.

These kits are used to mount our SCR's Zeners and Rectifiers etc. 6x32 stud (3, 12 amp rectifiers, 7A SCR's) 6 sets/\$1.00

1/4x28 stud (30 amp. rectifiers, 20 amps SCR's.) 4 sets/\$1.00

Send for our latest catalog featuring Transistors and Rectifiers; 325 Elm St., Cambridge, Mass.

- N-CHANNEL FET'S TO-18 plastic units. low noise, low leakage, 25 volts source to gate. 50 ma gate current Gain to 9000 μ mho's. \$.80
- NEON LIGHT OR NIXIE TUBE DRIVERS. An NPN, TO-18, S1 Transistor. With a VCBO of 120 3/\$1.00

NEW TTL IC SERIES

- DECADE DIVIDER 5.95
- RF 112 Dual JK Flip Flop \$2.50
- MC 415 JK Flip Flop \$1.50
- MC 408 Dual 4 input NAND/NOR
- 4 Bit Storage Register \$3.50
- MC 403 Exclusive or with Comp. \$1.50
- MC 2057 Dual 4 input AND/OR \$1.50

Silicon Power Rectifiers

PRV	3A	12A	30A
100	.09	.30	.50
200	.16	.50	.80
400	.20	.70	1.20
600	.30	1.00	1.50
800	.40	1.25	1.80
1000	.55	1.50	2.20

Terms: FOB Cambridge, Mass. Send check or Money Order. Include Postage. Average Wt. per package 1/2 lb. No C.O.D.'s. Minimum Order \$3.00

**WE LEAD THE WAY
IN SERVICE AND QUALITY!**

Rated companies 30 days net

FIBRE OPTICS

1/32" 2.5 mil. fibers in PVC packet \$.33/ft.

COMPLETE LIGHT GUIDE BUNDLE

consisting of an 11" length of 1/32" dia. fiber optic with bound ends \$2.00 ea.

10,000 PRV 50 MA RECTIFIERS \$2.00 EA.

LINEAR CIRCUITS

- CA 3011 FM IF AMPLIFIER \$.90
- 709C OPERATIONAL AMPL. \$1.45
- 710C HI SPEED DIFF. AMP. \$1.45
- 711C DUAL COMPARATOR \$1.45

Controlled Avalanche or Epoxy Rectifiers 1 AMP.

PRV	100	.07
200	.09	
400	.12	
600	.18	
800	.22	
1000	.35	

Silicon Control Rectifiers

PRV	3A	7A	20A	70A
50	.35	.45	.70	
100	.50	.65	1.00	4.00
200	.70	.95	1.30	8.00
300	.90	1.25	1.70	
400	1.20	1.60	2.10	12.00
500	1.50	2.00	2.50	
600	1.80	2.40	3.00	16.00

FCC First Class License in six weeks—approved for Veterans Training Schools in Dallas, Atlanta, Chicago, New Orleans, Minneapolis and Houston. Write Elkins Institute, 2603C Inwood Road, Dallas, Texas 75235.

R.E.I.'s famous (5) week course for the First Class Radio Telephone License is the shortest, most effective course in the nation. Over 98% of R.E.I. graduates pass F.C.C. exams for 1st class license. Total tuition \$360.00. Job placement free. Write for brochure Radio Engineering Incorporated Schools, 1336 Main Street, Sarasota, Florida 33577—or 3123 Gillham Road, Kansas City, Missouri 64109—or 809 Caroline Street, Fredericksburg, Virginia 22401—or 625 E. Colorado Street, Glendale, California 91205.

F.C.C. License training by correspondence. G.I. Bill approved. Money-Back Warranty. Free brochure. Write: Dept. Z-9, Pathfinder School of Electronics, 1505 N. Western Ave., Hollywood, Calif. 90027.

ELECTRONICS! Associate degree—29 months. Technicians, field engineers, specialists in communications, missiles, computers, radar, automation. Start September. February. Valparaiso Technical Institute, Dept. N, Valparaiso, Indiana 46383.

ELECTRONICS Home Study Course by programmed tape—(Lecture-Tape) developed by instructor who trained Apollo satellite tracking equipment technicians. Brochure on request. Write: Findlay Technical College, 1041 N. Main, Findlay, Ohio 45840.

MATHEMATICS. ELECTRONICS. Satisfaction guaranteed. Free Brochure. Indiana Home Study, Dept. EW, 1189, Panama City, Florida 32401.

TUBES

TUBES—33¢ each. Year guarantee. Tuner Cleaner \$1.00. Free catalog. Cornell, 4213-W University, San Diego, Calif. 92105.

TUBES, SEMICONDUCTORS, ELECTRONIC EQUIPMENT & COMPONENTS. Quality merchandise only! Serving engineers, Purchasing Agents, TV/HiFi Servicemen and Hams for 20 years. Write for Catalog or call 212-WA 5-7000. BARRY ELECTRONICS, 512 Broadway, New York, N.Y. 10012.

RECEIVING & INDUSTRIAL TUBES, TRANSISTORS, All Brands—Biggest Discounts. Technicians, Hobbyists, Experimenters—Request FREE Giant Catalog and SAVE! ZALYTRON, 469 Jericho Turnpike, Mineola, N.Y. 11501.

TUBES—Lowest world prices. Foreign-American. Obsolete, current. Receiving, Special Purpose, Transmitting tubes. Send for tube and parts catalog. United Radio Company, 56-E Ferry St., Newark, N.J. 07105.

DO-IT-YOURSELF

PROFESSIONAL ELECTRONICS PROJECTS—\$1.00 up. Catalog 25¢. PARKS, Box 25665A, Seattle, Wash. 98125.

TAPE AND RECORDERS

BEFORE renting stereo Tapes, try us. Postpaid both ways — no deposit — immediate delivery. Quality — Dependability — Service — Satisfaction — prevail here. If you've been dissatisfied in the past, your initial order will prove this is no idle boast. Free Catalog. Gold Coast Tape Library, Box 2262, Palm Village Station, Hialeah, Fla. 33012.

TAPEMATES make available to you ALL 4-TRACK STEREO TAPES—ALL LABELS—postpaid to your door—at tremendous savings. For free brochure write: TAPEMATES, 5727 W. Jefferson Blvd., Los Angeles, California 90016.

RENT 4-track open reel tapes—all major labels—8,000 different—free brochure. Stereo-Parti, 55 St. James Drive, Santa Rosa, Calif. 95401.

CASSETTE and 8-track blanks, language tapes, dozens of accessories and recorders. Literature 25¢. CASSETTES UNLIMITED, P.O. Box 13119W, Pittsburgh, Pa. 15243.

TAPES . . . blank recording . . . pre-recorded music. Catalog 10¢. Tower, Lafayette Hill, Pa. 19444.

STEREO TAPES, save 20, 30% and more, postpaid anywhere U.S.A. We discount batteries, recorders, tape/cassettes, 80-page catalog 25¢. SAXITONE TAPES, 1776 Columbia Road, N.W., Washington, D.C. 20009.

OLID TATE SALES

Post Office Box 74B

Somerville, Mass. 02143

Tel. (617) 547-4005

CIRCLE NO. 116 ON READER SERVICE CARD

RECTIFIERS & TRANSISTORS

Silicon Rectifiers

PIV	25	50	100	200	400	600	800	1000	1200
1A*	—	.03	.04	.06	.08	.10	.14	.17	.22
18A**	.09	.15	.19	.29	.39	—	—	—	—
20A	.15	.20	.25	.39	.50	.75	.90	1.15	1.40
40A	.25	.35	.60	.90	1.20	1.50	1.80	2.10	2.40

*Tophat. Flangeless. **Presmit. 3, 20, 40 Studs

Silicon Controlled Rectifiers

1500 PIV	PRV	25	50	100	200	400	600
RECT.	1A*	—	—	—	.30	.55	.85
STUD	7A	.11	.14	.20	.45	.90	1.20
1 AMP	18A**	.15	.23	.35	.60	1.10	1.40
25¢ EA.	20A	.18	.32	.45	.70	1.15	1.95

*Tophat **Presmit. 7 & 20 Amp Stud

Germanium Power Transistors

150W-TO-3-7A

- 2N456A—40V—.25
- 2N457A—60V—.35
- 2N1038—40V—8/\$1.00—20W TO-5-3A

Silicon Power Transistors

- 2N 389A 85W, 60V—.55
- 2N 424A 85W, 80V—.65
- 2N 497 4W, 60V—.10
- 2N 498 4W, 100V—.12
- 2N1047A 40W, 80V—.40
- 2N1718 10W 60V—.15
- 2N1724 50W 80V—.65
- 2N2151 30W 80V—.25

Silicon Small Signal NPN, TO-5

- 2N696 7/\$1.00, 2N697 6/\$1.00, 2N699 5/\$1.00
- 3N34 Tetrode—60g; IN34A Diodes 100/\$2.98;
- 2N1142 Ger. Hi-Freq. Amplifier 3/\$1.00; Thermistor Beads, 5000 ohm or 1200 ohm—3/\$1.00; Varicaps—27, 47, or 100 pf, 4V—\$1.25 ea.; P.C. Board 8"x8" 1/16". 1 oz. Copper—2/98g; Photo Cells, Herm. Glass, 5 Diff. for \$1.00; 2N1300 Series, TO-5 Assorted—25/\$1.00; R.F. Coil Assort. 25/\$1.00, I.C. TO-5—15/\$1.00. Epoxy Diodes, 200 MA, 3000 Piv 49¢, 6000 98¢, 10 Watt Zeners 7 Volt Thru 185 Volt 49¢, P.C. Connector 15 Contact 2/\$1.10.

ASSORTMENTS

- Precision resistors film 50/\$1.00
- Precision resistors wirewound 40/\$1.00
- Ferric Chloride Etchant, 16 oz. bottle98
- Relays 6 different types 6/\$1.00
- Terminal lugs, assorted 200/\$1.00
- Tie lugs, assorted 50/\$1.00
- Push button switches, on-off, panel 6/\$1.00
- Pots, 2-4 watt, different 10/\$1.00
- Free \$1.00 pack with \$10.00 order; min. order \$3.00; send sufficient postage, overage refunded; fully guaranteed; free catalog. 25% down on COD's.

GENERAL SALES CO.

254 Main (713) 265-2369
Clute, Tex. 77531

CIRCLE NO. 139 ON READER SERVICE CARD

LIBERTY PAYS MORE!

WILL BUY FOR CASH

ALL TYPES:

- ★ ELECTRON TUBES
- ★ SEMICONDUCTORS
- ★ TEST EQUIPMENT
- ★ Military Electronic Equipment

WIRE—WRITE—PHONE COLLECT!

We pay freight on all purchases—

LIBERTY OFFERS MORE! PRESTEL FIELD STRENGTH

METER

(Model 6T4G)

Only

\$120.00

F.O.B.
New York

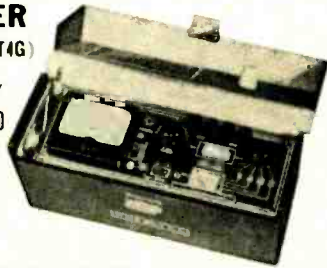

- ★ Never Anything Like It!
- ★ 1-Man Can Do A Better Job than 3 in the Same Time!

★ A Gold-Mine for Antenna Installers!
Calibrated from 40 to 230, and 470 to 860 in 4 Bands Megahertz, from 10 to 50,000 Microvolts. Nothing makes it easier to properly and speedily find the correct place to install TV, FM and Communication Antennas. You can measure and hear the signals with this 4 1/2 volt battery economically powered unit.

LIBERTY ELECTRONICS, Inc.

548 Broadway, New York, New York 10012
Phone (212) 925-6000

CIRCLE NO. 132 ON READER SERVICE CARD

OLD Radio Programs on tape. 6 hours for \$8.00. Catalog 50¢. Don Maris, 824 Owl, Norman, Okla. 73069.

WANTED

QUICKSILVER, Platinum, Silver, Gold. Ores Analyzed. Free Circular. Mercury Terminal, Norwood, Mass. 02062.

QUICK CASH . . . for Electronic Tubes, Semi-conductors, Equipment (Receivers, Transmitters, Scopes, Vacuum Variables, etc.) Send lists now! Write: **BARRY ELECTRONICS**, 512 Broadway, New York, N.Y. 10012 (212-WA 5-7000).

RECORDS

SPECIAL interest records available, produced by the editors of the world's leading special interest magazines. Send for free catalog. Record Catalog EW, Ziff-Davis Publishing Company, One Park Avenue, New York, N.Y. 10016.

POPULAR organ albums factory direct. Concert Recording, Lynwood, Calif. 90262.

OLDIES—45 RPM—original hits. Over 4000 available. Catalog 25¢. C & S Record Sales, Box 197, Wampsville, N.Y. 13163.

HIGH FIDELITY

FREE! Send for money saving stereo catalog #E4W and lowest quotations on your individual component, tape recorder or system requirements. Electronic Values, Inc., 200 West 20th Street, N.Y., N.Y. 10011.

HI-FI Components, Tape Recorders at guaranteed "We Will Not Be Undersold" prices. 15-day money-back guarantee. Two-year warranty. No Catalog. Quotations Free. Hi-Fidelity Center, 239 (L) East 149th Street, New York 10451.

HI-FI components, tape recorders, sleep learning equipment, tapes. Unusual Values. Free catalog. Dressner, 1523 R Jericho Turnpike, New Hyde Park, N.Y. 11040.

HI-FI EQUIPMENT—GET Our "ROCK BOTTOM" prices on **NAME BRAND** amplifiers—tuners—tape-recorders—speakers **FRANCHISED—60 YEARS IN BUSINESS**. Write for this month's specials—**NOW!** Rabson's 57th St., Inc., Dept. 569, 119 W. 57th St., New York, New York 10019.

LOW, LOW quotes: all components and recorders. Hi-Fi, Roslyn, Penn. 19001.

AMAZING DISCOUNTS on famous brand high fidelity stereo components. No small wonder that we have set new sales records each year since 1959. Write: Arkay Electronics, 1028-02 Commonwealth, Boston, Mass. 02215.

BACKGROUND MUSIC—SOLID-STATE SCA DECODER DELIVERS SUBCARRIER COMMERCIAL-FREE MUSIC PIGGYBACKED ON MANY FM STATIONS. LINE-POWERED ADAPTER SIMPLY PLUGS INTO ANY FM TUNER. NO ADJUSTMENTS OR TUNING. NEW DESIGN BREAKTHRU GUARANTEES OPTIMUM PERFORMANCE. LOWEST PRICE EVER! \$35 POSTPAID. K-LAB, BOX 572, S. NORWALK, CONN. 06856.

SAVE over 33 1/2% on a pair of one of the world's best speaker systems shipped direct to you from factory. Try them in your home for thirty days. Write KGLL Inc., Water St., Lewiston, Maine 04240.

HARTLEY CONCERTMASTER in home demonstration: West Orange, Ridgefield Park, N. J.; Port Jervis, Buffalo, Spring Valley, N. Y.; Newtown Square, Pa.; Miami, Florida; Holland, Mich.; Albuquerque, N. M.; Logan, Utah; Daly City, Chico, Calif.; Dedham, Brookline, Mass.; Columbus, Ohio; Dixon, Illinois; Helena, Mont.; Kensington, Md. **ALSO:** Tokyo, Hong Kong, Noumea, Johannesburg, Basle, Taipei, Manila, write **HARTLEY**, Box 68W, Ho-Ho-Kus, N. J. 07423.

DIAMOND NEEDLES AND STEREO CARTRIDGES at low, low prices for Shure, Pickering, Stanton, Empire, Grado and ADC. Send for free catalog and price sheet. We will be happy to quote on any cartridge—Magnetic, Ceramic or Crystal. All merchandise brand new and shipped **PRE-PAID. LYLE CARTRIDGES**, Dept. E, 265 East 149 Street, Bronx, New York 10451.

STEREO COMPONENTS at low discount prices. Send for our low quotes today and our cartridge trade-in specials (Shure, ADC, Pickering, Empire, etc.). Send \$1.00 for our discount catalog. **DEFA ELECTRONICS**, 2207 Broadway, New York, N.Y. 10024.

1000's OF UNUSUAL SCIENTIFIC BARGAINS including . . . SPECIAL UNIQUE PSYCHEDELIC LIGHTING for Fun, Profit, Effects!

GET YOUR OWN 4'7" SLAVE



Ideally spectacular 4-channel color organ translates every note, beat and variation of sound into dazzling, throbbing, criss-cross patterns of vibrant color. Individual train controls—supersensitive master adjustable to flick up faintest music with bright response. Easily attached to amplifier, stereo, 120V, cabinet, 60 each for Master and identical "Slave" unit listed below. house current. 55"H x 19"W x 8"D light column.
No. 85.188AK (57 lb. Shpg. Wt.) . . . \$249.50 F.O.B.
"SLAVE" UNIT—(Works Only in Tandem W/Master)
No. 85.189AK (57 lb. Shpg. Wt.) . . . \$149.50 F.O.B.

50-150-300 POWER MICROSCOPE



Amazing value—3 achromatic objective lenses on revolving turret! Imported! The color-corrected, cemented achromatic objective lenses give you far superior results compared to the single lenses found in most microscopes selling in this price range. Results are worth the difference! Fine rack-and-pinion focusing.
No. 70.008AK \$19.50 Ppd.

LONG-WAVE BLACK LIGHT FIXTURE

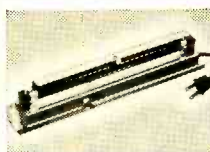

Extremely versatile, compactly designed, long wave (3200-4000 angstroms) black light (ultraviolet) fixture. Has 9-watt, 110V lamp with built-in filter—eliminates harmful shorter wave ultraviolet rays. Use to identify minerals, fungi, bacteria—check for surface flaws, oil and gas leakage. Perfect for display with fluorescent paper, paints, chalk, crayons, trace powder. Incl. adjustable aluminum reflector, push-pull switch, connecting plug. Mount vert., horiz., or on corner. 10" L., 1 1/2" W., 1 1/2" H.
Stock No. 70.364AK . . . \$12.50 Ppd.
REPLACEMENT BULB
Stock No. 60.124AK . . . \$4.50 Ppd.

ROTATING MULTI-COLORED LIGHT

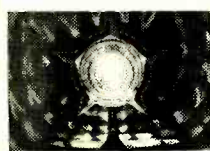

Dazzling colors stream endlessly from constantly rotating light. Faceted, transparent globe has lozenge-shaped inside with red, green, blue & yellow stars. Bulb reflects flickering star points on walls, ceilings, etc. while individual globe facets present constantly changing array of brilliant colors. 9 3/4" dia—approx. 12" high on table. TV, fireplace, or Xmas tree top.
Stock No. 71.000AK . . . \$6.00 Ppd.

NICKEL-CADMIUM BATTERY BARGAIN!

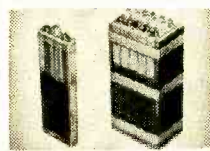

Terrific value—slightly used govt surplus. Lightweight 3 cell, 9 volt, 3 Amp-hour battery with almost unlimited life. Extremely high current output. Recharges in 1 hour with Edmund kit. Won't deteriorate when left discharged. Contains maintenance-free drops of water per year. Resistant, shock and vibration resistant aluminum case. Delivered partially charged, filled with electrolyte. 3 1/4" x 2" x 6", 2 lb.
BATTERY
Stock No. 70.942AK . . . \$15.00 Ppd.
(CHARGER KIT)
Stock No. 70.807AK . . . \$8.00 Ppd.

PSYCHEDELIC LIGHTING HANDBOOK



100 information packed pages! Fully explains latest in psychedelic lighting equipment, techniques, developments. Covers all facets of psychedelic light show production including strobes, black lights, projectors, crystals, organic slides, mirrors, color organs, polarized color light boxes, MusicVision, etc. Shows how to "psychedelize" parties, musical groups, shows or how to set up "electric trips" for private teachers.
Stock No. 9100AK . . . \$3.00 Ppd.

HI-VOLTAGE ELECTROSTATIC GENERATOR



Van De Graaf low-amp type, 200,000 volt potential, yet completely safe. Demonstrates lightning, St. Elmo's fire, repulsion of charges, electrostatic dust collection, many other electrical wonders. Motor, 110V, 60-cycle, AC Humidity range, 0-90%. Current, 1.5 to 3 microamps. Aluminum base frame and charge collector. Unbreakable plastic insulating column. Ht. 17", dia. 6 3/4". Full instructions.
Stock No. 70.264AK . . . \$94.50 Ppd.

VISIT OUR FACTORY RETAIL STORE!

5 Minutes From Jersey Turnpike Exit #3, 15 Min. to Philadelphia, either bridge. See 4,000 Unusual Bargains Plus Exclusive Store Sale Items. **FIELD SHOW EVERY AFTERNOON. Store hrs.—8-5:30. Saturday 8-4:30. Closed Sun.**

AMAZING "TRICK" PHOTOGRAPHY KIT

Now any amateur can produce all kinds of weird, wild, way-out photo effects. No special knowledge, or equipment required. Unique kit enables you to turn friends into moisters, show house with water to 2nd floor, make up psychic slides, kaleidoscopic photos, impressionistic photo-art . . . unlimited possibilities. Complete instructions reveal the secrets . . . includes all accessories needed.
Stock No. 71.292AK . . . \$10.50 Ppd.



3" ASTRONOMICAL TELESCOPE

See moon shots, orbits—stars, phases of Venus, planets close up, 60 to 180 power. Aluminum and over-coated 7" diameter, 410 primary mirror, ventilated cell. Equatorial mount, with locks on both axes. Equipped with 60x eyepiece and mounted Barlow lens. 3x double telescope, hardwood tripod. Included FREE: "STAR CHART" 272-page "HANDBOOK OF HEAVENS"—"HOW TO USE YOUR TELESCOPE."
Stock No. 85.050AK . . . \$29.95 Ppd.
4 1/2" REFLECTOR . . . \$49.50 FOB
Stock No. 85.105AK . . . \$239.50 FOB
6" REFLECTOR . . . \$239.50 FOB
Stock No. 85.086AK



ASTRONOMICAL TELESCOPE KITS

Grind your own mirror for powerful telescopes. Kits contain fine annealed pyrex mirror blank, tool, abrasives, diagonal mirror, and eyepiece lenses. Instruments and built-in value from \$75 to hundreds of dollars.
1 1/2" DIAMETER—3 1/2" Thick
No. 70.003AK \$29.75 Ppd.
6" DIAMETER—1 1/2" Thick
No. 70.004AK \$13.95 Ppd.
8" DIAMETER—1 3/4" Thick
Stock No. 70.005AK \$21.00 Ppd.
10" DIAMETER—1 3/4" Thick
Stock No. 70.006AK \$34.25 FOB



A COOL ADVENTURE . . . WITH LIGHT!

The almost hypnotic spell of ever-changing firelight has been captured in a cool-light display box! With the liquid motions of a rising and cascading fountain blowing in the wind, psychedelic colors appear, intermingle and wash to rise again in new patterns and drift away. This soothing light show housed in a handsome 11 1/2" square, deep walnut finished lumia light box is an effective addition to any room—your living room, bedroom, rec-room, doctor's office. Especially effective among a wall picture group. Modern as tomorrow—available today!
Stock No. 71.180AK . LUMIA LIGHT BOX. \$29.95 Ppd.



SPECIAL VISUAL EFFECTS PROJECTOR SET

Dazzling, avant-garde visual effects. Fantastic variety. Incredibly beautiful. Special package offer contains all necessary apparatus. Create floating, exploding, fiery bursts of color like "Symphony of Spheres," "Chromatic Starbursts," "Crystal Starburst." Features 30mm 300 W. fan-cooled projector—produces big image at short distance. Accepts two 9" diam. wheels. Dry Kaleidoscope & Hexidoscope. 2 cylindrical accessories (6" Colored Cloud & 5" Hexidoscope w/six internal mirrored walls). Perfect for entertaining, parties, photographs, complete instructions.
Stock No. 71.212AK . . . \$79.50 Ppd.



FIND BURIED METAL TREASURE!

Detect individual coins, rings as deep as 12"; bags of coins, tools to 3'; metal chests, safes to 6 feet! Best fully transistorized, induction-balance loop detector at moderate price. Dry-cell, lightweight (3 1/2 lbs.) battery powered. Perfect for treasure hunters, collectors, explorers, beachcombers. Has visual and audible indicators, adjustable soil conductivity knob, on-off switch control. "Humless" solid state circuitry. 32" overall, adl. 1 1/2" diam. loop. Includes 9 volt (150 hr.) battery.
Stock No. 80.119AK . . . \$147.50 Ppd.



MAIL COUPON FOR GIANT FREE CATALOG

148 PAGES—1000's OF BARGAINS
 Completely new 1970 edition. New items, categories, illustrations. Dozens of electrical and electronic parts, accessories. Enormous selection of Astronomical Telescopes, Microscopes, Binoculars, Magnifiers, Magnets, Lenses, Prisms. Many war surplus items; for hobbyists, experimenters, workshop, factory. Mail coupon for catalog. **AKT**

EDMUND SCIENTIFIC CO.
300 EDSORP BUILDING,
BARRINGTON, N.J. 08007

NAME _____
 ADDRESS _____
 CITY _____
 STATE _____ ZIP _____

ORDER BY STOCK NUMBER • SEND CHECK OR MONEY ORDER • MONEY-BACK GUARANTEE
EDMUND SCIENTIFIC CO. 300 EDSORP BUILDING
BARRINGTON, NEW JERSEY 08007
CIRCLE NO. 141 ON READER SERVICE CARD

LATEST ARCTURUS SPECIALS

- Color focus rectifiers, 14,000 P.I.V. at 1 MA, 99¢ each. 6.5 KV-79¢.
- Color TV yokes 70° & 90° types. Fit almost all sets: \$10.95 each.
- 1700 Transistor types—39¢ each.
- DS-501, 2N278 power transistor types. Cat. #349, 69¢ each.
- HEP170, Motorola HV/Current epoxy silicon rectifiers, 2.5 amps at 1,000 PIV, 49¢ each.
- Fully transistorized UHF tuners. Fit most sets. Cat. #UHF567, \$4.95 each.
- UHF tuners, 1 tube type. Fit most sets. Cat. #UHF3, \$3.95 each.

Complete listings of electronic items at similar bargain prices are available. Write for our latest catalog. Minimum order \$5.00, plus postage.

ARCTURUS ELECTRONICS CORP.

502-22nd St., Union City, N.J. 07087 Dept. EW
Phone 201 - UN4 5568

CIRCLE NO. 149 ON READER SERVICE CARD

\$1 PEP \$1

Dollar Sale
EACH PACKAGE
MONEY BACK GUARANTEE

- 1 AMP Silicon Rectifier**
Choice of Package
Bulb-Glass-Min-Metal
- | | |
|----------------------------------|----------------------------------|
| <input type="checkbox"/> 20-50V | <input type="checkbox"/> 5-800V |
| <input type="checkbox"/> 17-100V | <input type="checkbox"/> 4-1000V |
| <input type="checkbox"/> 12-200V | <input type="checkbox"/> 3-1200V |

- 3 AMP**
- | | |
|----------------------------------|----------------------------------|
| <input type="checkbox"/> 15-50V | <input type="checkbox"/> 4-600V |
| <input type="checkbox"/> 10-100V | <input type="checkbox"/> 3-800V |
| <input type="checkbox"/> 8-200V | <input type="checkbox"/> 2-1000V |
| <input type="checkbox"/> 6-400V | <input type="checkbox"/> 1-1200V |

- 5 AMP**
- | | |
|---------------------------------|----------------------------------|
| <input type="checkbox"/> 10-50V | <input type="checkbox"/> 4-400V |
| <input type="checkbox"/> 8-100V | <input type="checkbox"/> 3-500V |
| <input type="checkbox"/> 6-200V | <input type="checkbox"/> 2-1000V |
| <input type="checkbox"/> 5-300V | <input type="checkbox"/> 1-1200V |

- 12 AMP STUD**
- | | |
|---------------------------------|----------------------------------|
| <input type="checkbox"/> 5-100V | <input type="checkbox"/> 2-800V |
| <input type="checkbox"/> 3-500V | <input type="checkbox"/> 1-1000V |

- 20 AMP STUD**
- | | |
|---------------------------------|----------------------------------|
| <input type="checkbox"/> 4-50V | <input type="checkbox"/> 2-500V |
| <input type="checkbox"/> 3-100V | <input type="checkbox"/> 1-1000V |

- 15 AMP STUD**
2-1000V-1.00
- 60 AMP STUD**
(2-50V-\$1.00
(1-1000V-1.25
(60 AMP STUD

ZENER-DIODES
250-400 MW
1 EA 4V-6V-8V-10V

- 1 WATT**
1 EA 4V-6V-8V-10V

- 3 WATT**
12-40V 3-\$1

16 Bit Memory Cell—\$4.25
Dual In-Line package

SILICON-CONTROLLED RECTIFIER
TO-5 PACKAGE

- | | |
|---------------------------------|--|
| <input type="checkbox"/> 5-50V | <input type="checkbox"/> 2-200V \$1.00 |
| <input type="checkbox"/> 4-100V | <input type="checkbox"/> 2-400V \$1.25 |

GENERAL PURPOSE GERMANIUM TRANSISTOR
SINGLE (2N404)
8 UNITS

FULL WAVE BRIDGES

PRV	2Amp	3Amp	5Amp	10Amp
50V	1.25	1.35	1.50	1.70
100V	1.50	1.60	1.75	1.95
200V	1.75	1.85	2.00	2.20
400V	2.00	2.10	2.25	2.45
600V	2.50	2.60	2.75	2.95
800V	3.00	3.10	3.25	3.45

NO SALES TAX—WE PAY POSTAGE
OTHER PRODUCTS ON REQUEST

PARK ELECTRONIC PRODUCTS
P.O. Box 78, N. Salem, N.H. 03073
603-893-0276

CIRCLE NO. 127 ON READER SERVICE CARD
96

CLASSIFIED ADVERTISING ORDER FORM

Please refer to heading on first page of this section for complete data concerning terms, frequency discounts, closing dates, etc.

1	2	3	4	5
6	7	8	9	10
11	12	13	14	15
16	17	18	19	20
21	22	23	24	25
26	27	28	29	30
31	32	33	34	35

_____ Words { @ .50 Reader Rate } = \$ _____
 { @ .85 Commercial Rate }

Insert _____ time(s) Total Enclosed \$ _____

NAME _____

ADDRESS _____

CITY _____ STATE _____ ZIP _____

SIGNATURE _____

WORD COUNT: Include name and address. Name of city (Des Moines) or of state (New York) counts as one word each. Zip Code numbers not counted. (Publisher reserves right to omit Zip Code if space does not permit.) Count each abbreviation, initial, single figure or group of figures or letters as a word. Symbols such as 35mm, COD, PO, AC, etc., count as one word. Hyphenated words count as two words. EW-4-70

GOVERNMENT SURPLUS

JEEPS Typically From \$53.90 . . . Trucks From \$78.40 . . . Boats, Typewriters, Airplanes, Multi-meters, Oscilloscopes, Transceivers, Electronics Equipment. Wide Variety, Condition, 100,000 Bid Bargains Direct From Government Nationwide. Complete Sales Directory and Surplus Catalog \$1.00 (Deductible First \$10.00 Order). Surplus Service, Box 820-K, Holland, Michigan 49423.

TREASURE FINDERS

TREASUREPROBES patented transistorized detector signals "dig" by earphone "beeping." 5" search head, PC boards, two colpitt oscillators improve stability. Kit \$13.95, assembled \$18.88, with speaker \$24.88. 60 day guarantee. Send for Free bibliography, "Treasure Maps and Books of U.S." Treasurehouse, EH40, Tennent, N.J. 07763.

PERSONALS

MAKE FRIENDS WORLDWIDE through international correspondence. Illustrated brochure free. Hermes, Berlin 11, Germany.

SECRET LOANS BY MAIL. Borrow \$100 to \$1500 for any good reason in absolute privacy. No interviews, no endorsers, no co-signers. Fast service. Write Dial Finance Co., Dept. D-594, 410 Kilpatrick Bldg., Omaha, Nebraska 68102.

HYPNOTISM

FREE Hypnotism, Self-Hypnosis, Sleep Learning. Catalog! Drawer H400, Ruidoso, N.M. 88345.

AMAZING self-hypnosis record releases fantastic mental power. Instant results! Facts free. Write: Forum (AA3), 333 North Michigan Avenue, Chicago 60601.

MUSICAL INSTRUMENTS

30% DISCOUNT any name brand musical instrument. Free catalog. Freeport Music, 127 West Sunrise, Freeport, N.Y. 11520.

PHOTOGRAPHY—FILM EQUIPMENT, SERVICES

SCIENCE Bargains—Request Free Giant Catalog "CJ"—148 pages—Astronomical Telescopes, Microscopes. Lenses, Binoculars, Kits, Parts, War Surplus bargains. Edmund Scientific Co., 300 Edscorp Bldg., Barrington, New Jersey 08007.

EMPLOYMENT INFORMATION

FOREIGN and USA job opportunities available now. Construction, all trades. Earnings to \$3,000.00 monthly. Paid overtime, travel, bonuses. Write: Universal Employment, Woodbridge, Conn. 06525.

EDUCATIONAL OPPORTUNITIES

LEARN WHILE ASLEEP, Hypnotize! Strange catalog free. Autosuggestion, Box 24-ZD, Olympia, Washington 98501.

INVENTIONS WANTED

PATENT Searches including maximum speed, full airmail report and closest patent copies, \$6.00. Quality searches expertly administered. Complete secrecy guaranteed. Free Invention Protection forms and "Patent Information." Write Dept. 23, Washington Patent Office Search Bureau, 711 14th Street, N.W., Washington, D.C. 20005.

INVENTORS! Sell your invention for cash or royalties! Our client manufacturers eagerly seek new items. Patented. Unpatented. Financial assistance if needed. 25 years proven performance. For free information, write Dept. 25, Gilbert Adams, Invention Broker, 80 Wall St., New York, N.Y. 10005.

BOOKS

PUBLISH your book! Join our successful authors; publicity advertising promotion, beautiful books. All subjects invited. Send for free appraisal and detailed booklet. Carlton Press, Dept. ZDD, 84 Fifth Avenue, New York 10011.

MAGAZINES

BACK DATE MAGAZINES! Send needs. Midtown, Box 917-EW, Maywood, N.J. 07607.

BUSINESS OPPORTUNITIES

FREE CATALOGS. Repair air conditioning, refrigeration. Tools, supplies, full instructions. Doolin, 2016 Canton, Dallas, Texas 75201.

I MADE \$40,000.00 YEAR by mailorder! Helped others make money! Start with \$10.00—Free proof. Torrey, Box 318-N, Ypsilanti, Mich. 48197.

JAPANESE Electronics New Products Monthly! Specimen copy \$1. deductible. Dee, 10639-W Riverside, North Hollywood, Calif. 91602.

FREE BOOK "999 Successful Little-Known Businesses." Work home! Plymouth 445-A, Brooklyn, New York 11218.

MAKE BIG MONEY raising chinchillas, rabbits, guinea pigs for us. Catalog—25¢. Keeney Brothers, New Freedom, Pa. 17349.

\$20,000—\$50,000 year. Ohio Bonding School. 7101 Lake, Elyria, Ohio 44035.

EMPLOYMENT OPPORTUNITIES

TWO-WAY RADIO TECHS for positions in the U.S. Virgin Islands. 3 hours from New York in the Caribbean Playground. Send resume to: Electronics Unlimited, P.O. Box 2326, St. Thomas, U.S. Virgin Islands 00801.

RUBBER STAMPS

RUBBER ADDRESS STAMP \$2.00. SIGNATURE \$3.50. FREE CATALOG. JACKSON, BOX 443-G, FRANKLIN PARK, ILL. 60131.

MISCELLANEOUS

WINEMAKERS: Free illustrated catalog of yeasts, equipment. Semplex, Box 122-76, Minneapolis, Minn. 55412.



\$100,000 INTEGRATED CIRCUIT PENNY SALE!

Imagine — buy 1 Integrated Circuit at our bargain price get the 2nd one for ONLY 1¢ . . .

Fairchild No.		EACH	1c MORE
900	Buffer	1 for 1.49	2 for 1.50
910*	Dual Two Input Gate	1 for 1.49	2 for 1.50
914*	Dual Two Input Gate	1 for 1.29	2 for 1.30
915	Dual 3 Input Gate Nand/Nor	1 for 1.49	2 for 1.50
923	JK Flip Flop	1 for 1.49	2 for 1.50
925*	Dual 2 Input Gate, Expander	1 for 1.49	2 for 1.50
930	Dual 4 Input Gate Nand/Nor	1 for 1.49	2 for 1.50
933	Dual Input Gate, Expander	1 for 1.49	2 for 1.50
944	Dual 4 Input Power Gate	1 for 1.49	2 for 1.50
945	Clocked Flip Flop	1 for 1.69	2 for 1.70
946	Quad 2 Input Gate Nand/Nor	1 for 1.49	2 for 1.50
948	Clocked Flip Flop	1 for 1.98	2 for 1.99
953	2-2-3-Input and Gate	2 for 1.69	4 for 1.70
RTL-908D*	Full Adder	1 for 2.98	2 for 2.99
RTL-912D*	Half Adder	1 for 2.49	2 for 2.50
RTL-913D*	Shift Register	1 for 2.98	2 for 2.99
RTL-940D*	JK Flip Flop	1 for 1.98	2 for 1.99
RTL-960D*	Dual Buffer	1 for 1.98	2 for 1.99

* In TO-5 metal can package



EPOXY SILICON TRANSISTORS

5 for \$1

Type	Sale
2N706	5 for \$1
2N2222	5 for \$1
2N2368	5 for \$1
2N2711	5 for \$1
2N3396	5 for \$1
2N3565	5 for \$1
2N3568	5 for \$1
2N3638	5 for \$1
2N3641-3	5 for \$1
2N3645	5 for \$1
2N3662	5 for \$1
2N3683	5 for \$1
2N3692	5 for \$1
2N3793	5 for \$1
2N4140-1	5 for \$1
2N4248-9	5 for \$1
2N4284-5	5 for \$1
2N4288-9	5 for \$1
2N4290-1	5 for \$1

INTEGRATED CIRCUIT AUDIO AMPLIFIER!

★ 8 Transistors ★ Dime Size **149**

Never before offered! Self-contained, integrated circuit—size of a DIME! TO-5 case, 8 leads. Use for phono, tape, intercom & 100's of microminiature audio circuits, mike, phono, tape. Output: 3 to 16 ohm speaker. Complete with data.



709C OP AMPLIFIER

Guaranteed! With Spec. **149**



2 AMP SILICON 1000 PIV RECTIFIERS

5 for \$1

Terms: add postage. Rated: net 30, cod's 25% Phone Order: Wakefield, Mass. (617) 245-3829 Retail: 211 Albion St., Wakefield, Mass.

GIANT SPRING CATALOG ON: Parts, Rectifiers.

Transistors, SCRs, I.C.'s, Equipment. **10¢**

POLY PAKS

P.O. BOX 942W LYNNFIELD, MASS 01940

SALE ON FAIRCHILD COUNTING "ICs"

3 for \$14

Guaranteed!

No.	Description
958	Decade Counter
959	Quad Latch
960	Decoder-Driver



CIRCLE NO. 125 ON READER SERVICE CARD

Electronics World SUBSCRIBER SERVICE

Please include an address label when writing about your subscription to help us serve you promptly. Write to: Electronics World, P.O. Box 1093, Flushing, N.Y. 11352

CHANGE OF ADDRESS:

Please let us know you are moving at least four to six weeks in advance. Affix magazine address label in space to the right and print new address below. If you have a question about your subscription, attach address label to your letter.

AFFIX LABEL

If you have no label handy, print OLD address here.

name
address
city
state
zip-code

please print

TO SUBSCRIBE:

- Check boxes below.
- New Renewal
- 5 years \$26
- 3 years \$18
- 1 year \$7

SPECIFY:

- Payment enclosed—You get 1 extra issue per year as a BONUS!
- Bill me later.

Add postage: \$1 per year outside U.S., its possessions & Canada.

name _____ please print _____ 0327

address _____

city _____

state _____ zip-code _____

40 AMERICAN MADE HIGH SPEED DRILL BITS WORTH AS MUCH AS \$20

Yours for only \$3.49

These are 1/8" to 1/2" high-speed drills—professional quality. The same drills used by big industry... metal fabricators, machine shops and professional carpenters. Your money back if not completely satisfied.

- 40 High Speed Drills only \$3.49**
- Save! 2 Sets (80 Drills) only \$6.49**
- 13 pc. High Speed Set only \$1.49**
- add 35¢ postage & handling

CONSUMER'S BARGAIN CORP. Dept. EW-1
225 Westchester Avenue, Port Chester, N.Y. 10573
(N.Y. City & State residents add sales tax)

Cooperate With The Zip Code Program of The Post Office Department. Use Zip Code In All Addresses

BARGAINS IN SURPLUS ELECTRONIC EQUIPMENT, OVERHAULED, CERTIFIED, AND SOLD WITH MONEY-BACK GUARANTEE!

We are too busy buying the things you need . . . and getting them overhauled and certified (traceable to National Bureau of Standards) . . . to keep changing these ads each month. . . so **TELL US WHAT YOU NEED!** Please do not ask for a general catalog . . . yesterday we didn't have a Tek 343B with a JAI plug-in . . . today we do . . . so what good is a general catalog? we do keep Master Lists up to date by types of equipment. . . with sensors and paste pot . . . so get **THE SPECIFIC LISTS YOU NEED** . . . out of our posterboard . . . and if you don't see the type of material listed below . . . **ASK FOR WHAT YOU NEED!** Lists: Aeron. Radio-Shot/Amplifiers & Attenuators/Audio Test/Bridges (includes pots, gainvs, Q-Meters, etc.) Communications/Counters/Freq. Changers/Freq. Meters/Mergers/Megohmmeters/Meter Calibrators (includes Differential Voltmeters & Digital-Setting (pwr splitters) Meters, Digital Meters, Phase Angle, Precision Lo-Freq. Wattmeters, VFL's/Microwave Items/Noise & Field Strength (RFI)/Oscilloscopes & accessories/Panadapters & Spectrum Analyzers. Per spike . . . use generators/Radar & IFF Testers/Recorders/Regulators. line voltage/Semicond. Servo & Tube Testers/Signal Generators/Tuning Fork Oscillators/Wattmeters. **RE. WE ALSO BUY WHAT DO YOU HAVE? WHAT ARE YOU ASKING FOR IT?**

SOME SAMPLES OF OUR COUNTER LIST:

- 10 Hz to 220 MHz:**
- Hewlett-Packard 524D (8 DCU's) & 525A & B **\$90.00**
 - Now-Pack 524C (8 high numbers) & 525A & B **\$99.00**
 - N.E. Engr 14-20CV (8 DCU's) & 525A & B **\$75.00**
 - CMC 226A (10 DCU's) 730C/Plugs/Pre-scaler **675.00**
 - Solid-State 7 Nixie CMC 730U & plugs . . . **1050.00**
- 10 Hz to 510 MHz:**
- Substitute 525C for B in any above, add . . . **150.00**
- 10 Hz to 220 MHz:**
- Beckman 7370 (8 DCU's) & 7370/7371/7572 **795.00**
- 10 Hz to 1000 MHz:**
- Beckman 7370 (8 DCU's) & 7370 . . . **72/73 . . . 995.00**
- 10 Hz to 12,400 MHz:**
- Add H.P. 540B Transfer Osc. to any above. **375.00**
- 12,000 MHz WITH NO CALCULATIONS:**
- Beckman 7370 (8 DCU's) and 7380 . . . **1295.00**
- 10 Hz to 120 KHz:**
- Hewl-Pack = 522B (5 DCU's), Universal . . . **199.50**

HIGH-SENSITIVITY WIDE-BAND RECEIVER COMMUNICATIONS • BUG DETECTION • SPECTRUM STUDIES

38-1000 MHz AN/ALR-5: Consists of brand new tuner/convertor CV-253/ALR in original factory pack and an exc. used, checked OK & grid main receiver R-4 modified for 120 v., 50/60 Hz. The tuner covers the range in 4 bands; each band has its own Type N Ant. input. Packed with each tuner is the factory inspector's checkout sheet. The one we opened showed **SENSITIVITY: 1.1 uv at 38.4 mhz, 0.9 at 133 mhz, 5 at 538 mhz, 4 1/2 at 778 mhz, 7 at 943 mhz.** The receiver is actually a mhz IF amp, with all that follows, including a diode meter for relative signal strengths; an atten, calibrated in 6 db steps to -4 db, followed by an AVC position; Video & AF outputs; switch select pass of ±200 khz or ±2 mhz; and SELECT AM or FM! With Handbook & jw-instr. plus; all only . . . **275.00**

R. E. GOODHEART CO. INC.
Box 1220-A, Beverly Hills, Calif, 90213
Phones: Area 213, office 272-5707, messages 275-5342

GREGORY ELECTRONICS

**New Low Prices On
General-Electric
Progress Line 2-Way
Mobile Equipment**

30-50 MHz Vibrator Power
14" Case Complete Access.
Fully narrow-band (Tx & Rx)
MA/E 13 6/12v, 30w **\$148**

MA/E 16 6/12v, 60w **\$178**

MD/Y 16N 6/12v, 60w
Dynamotor Power Supply **\$128**

MD/Y 17 6/12v, 100w
Dynamotor Power Supply **\$138**

\$218

MT/13 30w, low band **\$178**

MT/17 12v, 100w **\$268**

Transistor Power Supply
148-174 MHz Vibrator Power
14" Case Complete Access.
Fully narrow-band **\$168**

MA/E 33 6/12v, 30w **\$198**

MA/E 36 6/12v, 60w
Vibrator Power Supply **\$158**

FA/E 33 6/12v, 30w **\$218**

MT/33-6/12v, 30w **\$238**

MT/36-6/12v, 60w

450-470 MHz 15w Vibrator
Power Supply MA/E 42,
with accessories **\$118**

MT 42 12v, 15w
Transistor Power Supply **\$148**

**450-470 MHz General-Electric
Progress Line Accents**

10 watts, 12 volts/transistor power supply; front or
rear mount. Complete accessories. Model No. EG48S

Wide Band.....\$138. Narrow Band.....\$158.

EG 48CT (Trunk) EG 48CF (Front)

GE Progress Line L.B. Receiver Strips 25-50 MHz
Narrow Band \$40. (4ER24) Wide Band \$30.

UHF Transmitter Strips 4ET24 \$20.

RC-4 Remote Control \$75.

BRAND NEW

DUMONT M43ORTN 450-470 MHz Special!
50-watt transistor power supply meets latest
FCC narrow-banding specifications, 5 K.C.
deviations.

IN FACTORY-SEALED CARTONS **\$295.**

With tone added, minus reeds **\$345.**

MOTOROLA X43GGV Special!

In 10" case. 150-170 MHz. 30 watts with
accessories. Transmitter N.B., receiver W.B.
Transistorized receiver power supply and vi-
brator powered. 2 freq. transmitter. Receiver
only private line, single squelch, 2
freq. receiver. **\$158.**

**Motorola and RCA EQUIPMENT
AT NEW LOW PRICES**

Reconditioned & Used FM 2-Way Radio Equipment
We Buy Late Model Equipment for Cash
SEND FOR NEW 1970 CATALOG



**GREGORY
ELECTRONICS
CORPORATION**

249 RT. 46, Saddle Brook, N.J. 07662
Phone: (201) 489-9000

CIRCLE NO. 138 ON READER SERVICE CARD

GET INTO ELECTRONICS



V.T.I. training leads to success
as technicians, field engineers,
specialists in communications,
guided missiles, computers, ra-
dar and automation. Basic &
advanced courses in theory &
laboratory. Electronic Engi-
neering Technology and Elec-
tronic Technology curricula
both available. Assoc. degree in
29 mos. B. S. also obtainable.
G.I. approved. Graduates in all
branches of electronics with
major companies. Start Sep-
tember. February. Dorms. cam-
pus. High school graduate or
equivalent. Write for catalog.

VALPARAISO TECHNICAL INSTITUTE
Dept. RD, Valparaiso, Indiana 46383

ELECTRONICS WORLD

April 1970

ADVERTISERS INDEX

READER			READER		
SERVICE NO.	ADVERTISER	PAGE NO.	SERVICE NO.	ADVERTISER	PAGE NO.
149	Arcturus Electronics	96		Lampkin Laboratories	66
148	Audionics, Inc.	62	133	Leader Instruments Corp.	63
	Automatic Electric	22	132	Liberty Electronics, Inc.	94
147	B & F Enterprises	93	131	Mallory & Co., Inc.,	2
150	Belden Corp.	SECOND COVER	130	Motorola Training Institute	66
	Brookstone Co.	64		Music Associated	64
146	Burstein-Applebee Company	72	129	McGraw-Hill Book Co.,	
	CREI, Home Study Div., McGraw-			Electronic & Control Engineers	
	Hill Book Co.	68, 69, 70, 71		Book Club	1
145	Channel Master	26		National Radio Institute	8, 9, 10, 11
144	Cleveland Institute of		128	Olson Electronics, Inc.	75
	Electronics	18, 19, 20, 21	127	Park Electronic Products	96
	Consumer's Bargain Corp.	97	126	Pennwood Numerchron	74
143	Cook's Institute of Electronic		125	Poly Paks	97
	Engineering	74		R.A.I. Research Corp.	64
142	Delta Products, Inc.	4, 83	107	RCA Electronic Components &	
141	Edmund Scientific Co.	95		Devices	7
111	Electro-Voice, Inc.	FOURTH COVER		RCA Parts &	
140	Fair Radio Sales	77		Accessories	THIRD COVER
	G & G Radio Supply	93		RCA Institutes, Inc.	78, 79, 80, 81
139	General Sales Co.	94	124	SCA Services Company	75
	Goodheart Co., Inc., R.E.	97	123	Sams & Co., Inc., Howard W.	17
	Grantham School of Engineering	14	122	Schober Organ Corp.	63
109	Greenlee Tool Co.	64	121	Scott, H.H., Inc.	86
138	Gregory Electronics Corp.	98	120	Selectrons, Ltd.	72
137	Heath Company	88, 89, 90, 91	119	Sencore, Inc.	15
136	International Crystal Mtg. Co.,		118	Shure Bros., Inc.	24
	Inc.,	16	117	Simpson Electric Company	23
135	Johanson Mtg. Co.	67	116	Solid State Sales	94
108	Johnson Electronics Company,			Sylvania Electric	12
	E.F.	73	115	University Sound	76
134	Judson Research & Mtg. Co.,			Valparaiso Technical Institute	98
	Inc.	77	110	Weller Electric Co.	65

CLASSIFIED ADVERTISING 93, 94, 95, 96, 97

The call-back killers...

Genuine RCA replacement parts.

They're famous for silencing customer complaints and wiping out costly call-backs.

That's because they're specially designed and fabricated . . . every electronic value, every material, every mechanical dimension . . . for particular applications in specific RCA home instruments.

In effect, they're original parts. They restore original performance and original customer satisfaction.

You can spread that satisfaction around by using many of them for universal application, too. They're great for upgrading performance wherever you use them.

Call your RCA distributor. He'll set you up with a supply of the fastest moving ones today.

Parts and Accessories, Deptford, N.J.

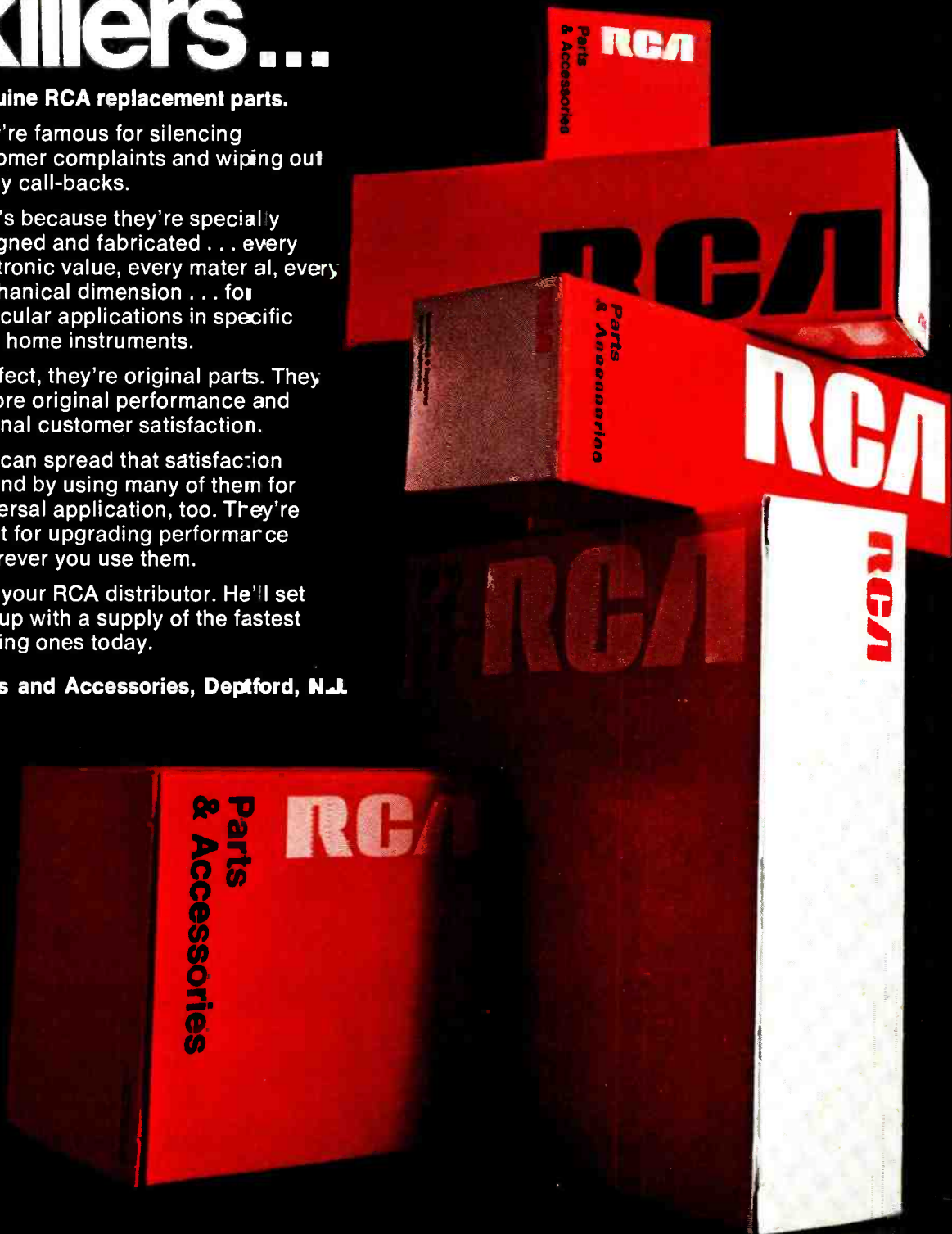

**Inside the
new E-V
Model 626
and 627A
we've put
one good
idea after
another.**



Strong protective grille screen.

Acoustifoam[®] filter to stop "pops" and wind noise, bar dust and dirt.

Metal screen against magnetic particles.

Element locked positively in place. Helmholtz resonator extends high end.

Stainless steel side grilles.

Virtually indestructible Acoustalloy[®] diaphragm that shrugs off heat, humidity, mechanical shock.

Sophisticated dynamic cardioid Single-D element for smooth control of feedback plus added bass and extra-high level when working close.

Shock absorbing internal "nesting" construction that soaks up abuse and noise.

High efficiency magnetic structure for full volume from any modern amp.

Integral rear cavity maintains "like new" bass response for years, eliminates tiny air leaks.

Reliable, easy to use On-Off switch.

Modern "black chrome" satin finish plating.

Threaded steel insert for long connector life.

Sturdy cable strain relief.

Fawn beige Micomatte[™] non-reflecting finish.

It all adds up.

To more bass, higher output, and better feedback control when working close, than any other Single-D microphones at any price.



Model 626 \$46.50

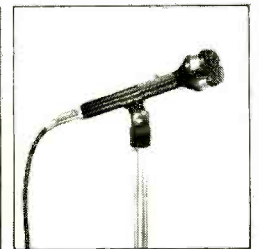

Model 627A \$63.00

Nationally Advertised List Prices

ELECTRO-VOICE, INC., Dept. 402N, 629 Cecil Street, Buchanan, Michigan 49107

Electro-Voice[®]
A SUBSIDIARY OF GULTON INDUSTRIES, INC.

FOR INFORMATION ON E-V PRODUCTS:

Microphones
CIRCLE NO. 111 ON READER SERVICE CARD

Musician's speakers/microphones
CIRCLE NO. 113 ON READER SERVICE CARD

PA Speakers/Accessories
CIRCLE NO. 112 ON READER SERVICE CARD

High Fidelity speakers/electronics
CIRCLE NO. 114 ON READER SERVICE CARD