

Electronics World

JULY, 1969
60 CENTS

SPECIAL ISSUE

A Status Report on Our
COMMUNICATIONS SATELLITES

Build a New Inductive-Type
ELECTRONIC IGNITION SYSTEM

METHODS OF MEASURING ATOMIC RADIATION

SOLID-STATE DIODES

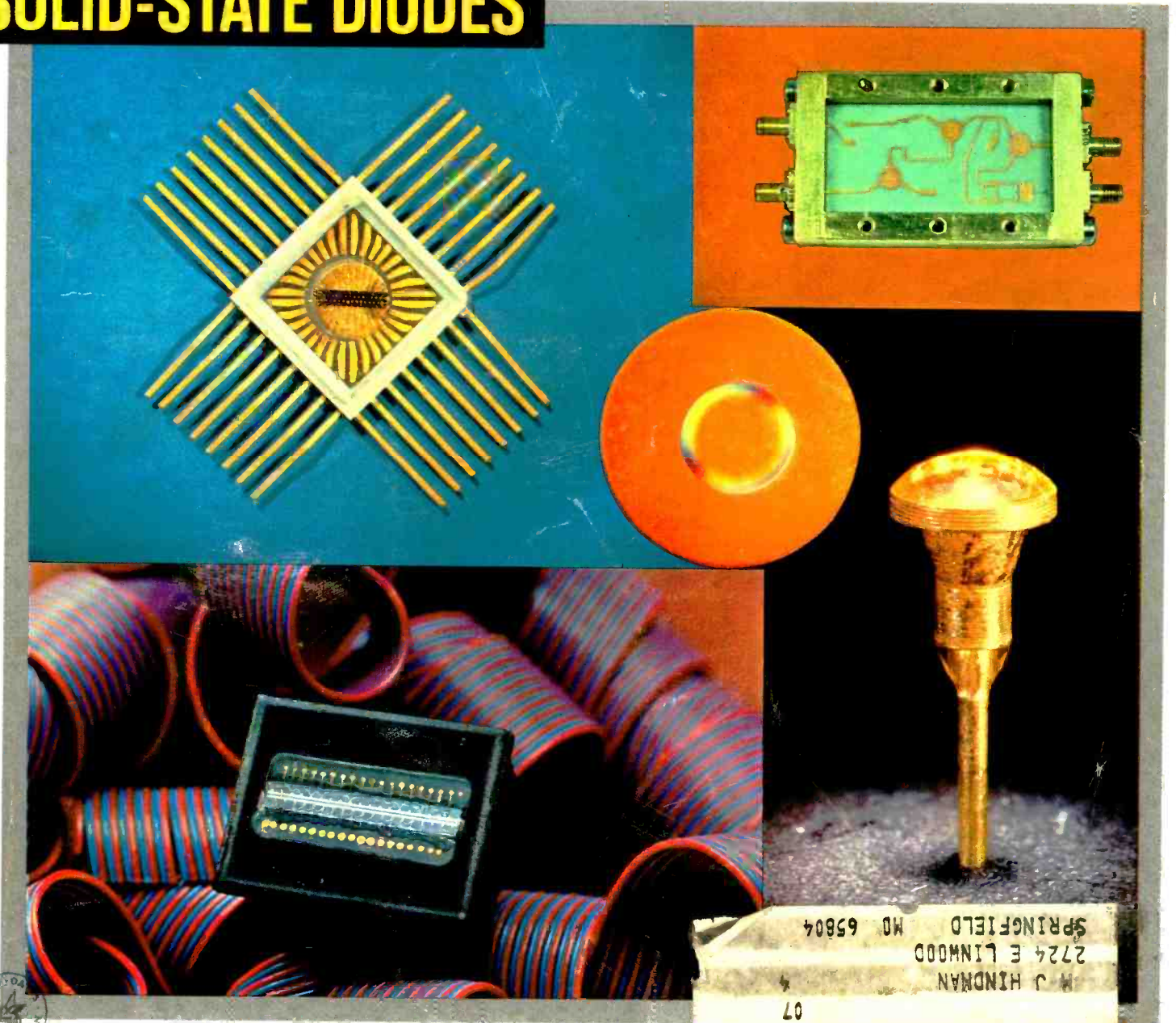

514700 HND 2724L097 OCT76 1 M
M J HINDMAN
2724 E LINWOOD
SPRINGFIELD MD 65804
07



Talk about electronic supermarkets



OVER 800 POPULAR, NEW CALECTRO PRODUCTS

for every
household use!

- TEST EQUIPMENT — TOOLS
- EXPERIMENTERS & LAB SUPPLIES
- ELECTRONIC ACCESSORIES
- MIKES — PHONO & TAPE ACCESSORIES
- SPEAKERS & AUDIO ACCESSORIES
- RESISTORS & CONTROLS ■ CAPACITORS
- METERS — COILS — RELAYS — TRANSFORMERS
- SWITCHES — LAMPS ■ WIRE — CABLES
- ANTENNA HARDWARE
- PLUGS — JACKS — BATTERY HOLDERS

Now at each location, hundreds and hundreds of items for everyone . . . hobbyist, enthusiast, amateur, home-owner, executive, do-it-yourselfer. See the SELF-SERVICE G-C CALECTRO display at your CALECTRO ELECTRONIC SUPERMARKET TODAY!



Telephone Amplifier for Group Listening

Perfect for family calls at home, conference calls at the office, or "hands-free" operation when taking orders or instructions by phone. Suction cup pickup attaches to outside of phone, brings in conversations loud and clear. Built-in volume control governs loudness. Battery in kit. Ask for Catalog No. N4-103 \$695



Automatic Timer On-Off Switch

Convenient remote control unit for any appliance, timer control sets for any interval up to 60 minutes. Beautiful green and white case, extra-long 12 foot cord. Installed in seconds, plugs into any wall outlet. Ask for Catalog No. N4-005 \$695



Dynamic Microphone with switch

For high fidelity recording of words and music. Built-in on-off switch. Folding desk top stand. Dual plug for most tape recorder inputs. Ask for Catalog No. Q4-186 \$395

Frequency Response: 80-8000 cps
Impedance: 200 ohm. Sensitivity: -56DB



CALECTRO

GC ELECTRONICS
Division of Hydrametals, Inc.
400 SO. WYMAN ST.
ROCKFORD, ILLINOIS 61101



700 Locations

all over the country
and Canada

See your electronic parts distributor
and SAVE!

LOOK

In the Yellow Pages under "Electronics"
and call your Calectro source.



This "G-C CALECTRO HOBBYIST HANDBOOK" is available at G-C CALECTRO ELECTRONIC SUPERMARKETS. WRITE TODAY and we'll give you the name of your nearest.

Far Superior TO ANY VTVM OR VOM A NEW STANDARD OF THE INDUSTRY...

- Only Sencore makes a true field effect meter
- Less circuit loading than VTVM/obsoletes VOM
- Zero warm-up time — instant stability
- Complete circuit and meter protection
- Complete portability
- Greater frequency responses than most scopes

FE149 SENIOR FET METER

The only true Senior FET meter available today with outstanding accuracy and unbelievable ease of operation.

- **Unmatched Accuracy.** 1.5% on DC, 3% on AC, plus large 7-in. meter and mirrored scale, assure the most accurate tests possible.
- **Eight AC and DC ranges** .5V to 1500V full scale.
- **Zero center scale** with .25 v. either side assures measurements to less than .1 v. for transistor bias measurements.
- **AC peak to peak** readings to 4500V maximum with freq. response of 10HZ to 10MHZ \pm 3DB.
- **Eight resistance ranges** to R x 10 megohms with 6 OHMS center scale.
- **Nine DC and nine AC current ranges** 150 μ a to 5 amps.
- **Eight decibel ranges** for audio measurements.
- **Three HI-Voltage ranges**, 5 KV, 15 KV, 50KV with 39A21 high voltage probe. **\$14.95**
- **Absolute meter and circuit protection** against circuit overload.
- Non-breakable, scuff-proof, vinyl-clad steel case.
- **Three-way power.** Operates on AC, on self-contained rechargeable batteries, or on AC with batteries plugged in. Same readings all three ways.



\$149.50

Exclusive push-button design. Just push two buttons for any test — top row selects function, bottom row selects range. Action is instant and automatic.



\$69.95

FE14 — STANDARD FET METER

ACCURACY DC \pm 2.5%
AC \pm 4.5%

- 4½-inch meter, vinyl-clad steel case.

FE14 and FE16 popular 4 1/2 inch FET Meters

- **Hi Accuracy.** For unsurpassed measurements. Mirrored scales prevent parallax errors.
- **Minimum circuit loading.** 15 megohm input resistance on DC; 10 megohm on AC.
- **Zero center scale** \pm 0.5 v. readings for transistor bias measurement.
- **Full meter & circuit protection** against possible circuit overload.
- **7 DC & AC voltage ranges** 1 to 1000 volts full scale.
- **AC peak to peak readings** 2800 v. maximum with freq. response of 10HZ to 10MHZ \pm 3DB.
- **5 resistance ranges** to 1000 megohms.
- **5 DC current ranges** 100 μ a to 1 amp.
- **3 Hi-Voltage ranges**, 3 KV, 10 KV, 30 KV, extended with 39A19 (\$9.95) high voltage probe.



\$84.50

FE16 HI ACCURACY FET METER

ACCURACY DC \pm 1.5%
AC \pm 3%

- 4½-inch high-styled meter, high-styled knobs, and special meter-tilting metal handle. Vinyl-clad steel case.



See your Sencore distributor today or write factory for complete line catalog.

SENCORE
STANDARD OF THE ELECTRONIC INDUSTRY

426 SOUTH WESTGATE DRIVE,
ADDISON, ILLINOIS 60101

CIRCLE NO. 115 ON READER SERVICE CARD



**The sensibly priced tape cassette
...from MALLORY.**

Just what you've been waiting for. The new Mallory DURATAPE[®] Cassette.

You get the quality and performance of expensive tape cassettes at a nice, lots-less price. But not the poor performance or the problems of the special-discount cheapies.

And since they're from Mallory — a company long known for quality electronic products—you can expect high fidelity, smooth operation, and long reliability. And get it . . . every time!

They'll fit any cassette recorder, player, cassette-radio. Even the new cassette changers. And you pick the recording time: 30, 60, 90, 120 minutes.

Our DURATAPE[®] Cassettes are tough but we put them in unbreakable, easy-to-stack containers just for extra protection. Like in the rain or through the mail.

And we make a head cleaner that's perfect for Cassette Recorders, too.

You'll find this great new thing in sound wherever Mallory products are sold.



MALLORY DISTRIBUTOR PRODUCTS COMPANY

a division of P. R. MALLORY & CO. INC.
Box 1558, Indianapolis, Indiana 46206; Telephone: 317-636-5353

Batteries • Capacitors • **Cassette Tapes** • Controls • Resistors • Semiconductors • Sonalert[®] • Switches • Timers • Vibrators • ICs
Circle No. 128 on Reader Service Card



THIS MONTH'S COVER shows a number of new and unusual solid-state diodes discussed in our Special Section. The circular photo at the center is a photomicrograph of a Fairchild FH1100 hot-carrier diode intended for use as the mixer in u.h.f. tuners. At the top left is a Motorola array of 31 silicon photo (light-sensing) diodes in an IC package with a glass face. Another such array consisting of an in-line arrangement of 36 photo diodes is at the lower left. This array, custom made by Fairchild, as well as the one previously mentioned, are used in character-recognition (reading) machines. At the top right is a microwave radar (X-band) front-end designed by Sylvania. It uses an avalanche diode as local oscillator and Schottky diode as mixer in a microstrip circuit. At the bottom right is a new RCA gallium-arsenide infrared light-emitting diode (type 40598A). The radiation is focused into a 15° half-angle cone by a polished parabolic reflector built right into the package.



Publisher
PHILLIP T. HEFFERNAN

Editor
WM. A. STOCKLIN

Technical Editor
MILTON S. SNITZER

Associate Editor
P. B. HOEFFER

Contributing Editors
WALTER H. BUCHSBAUM
Prof. ARTHUR H. SEIDMAN
FOREST H. BELT

Art Editor
RICHARD MOSS

Technical Illustrator
J. A. GOLANEK

Advertising Manager
JOSEPH E. HALLORAN

Advertising Service Manager
ARDYS C. MORAN

Associate Publisher
LARRY SPORN

July, 1969

Electronics World

JULY 1969

VOL. 82, No. 1

CONTENTS

- 23 Communications Satellites—Success in Space (Part 1)** *Francis A. Gicca*
These successful satellites have had a greater effect on our daily lives than just about any other development in space. Part 1 of this important 2-part series covers early problems and achievements and describes some early units.
- 28 Atomic Radiation: Measuring Techniques (Part 3)** *Joseph H. Wujek, Jr.*
Description of some of the basic measuring circuits and techniques that are currently being used in nuclear spectroscopy.
- 31 Recent Developments in Electronics**
- 32 High-"Q" Inductive Electronic Ignition System** *Herbert I. Keroos*
How to build a highly efficient transistor system that uses a special storage choke coil and pulse transformer to generate high spark-plug voltages.

SPECIAL SECTION: SOLID-STATE DIODES

- 35 A Survey of Silicon Junction Diodes** *A. H. Seidman*
- 38 Variable-Capacitance Diodes** *Irwin Carroll*
- 41 Light-Emitting Diodes** *R. S. Myers & J. O'Brien*
- 45 Light-Sensitive Photodiodes**
- 46 Hot-Carrier Diodes** *Stephen F. Adam*
- 49 Microwave Power Diodes** *Walter K. Niblack & Clifford A. Levi*
- 53 Tunnel Diodes**
- 77 High-Gain Audio Input Stage** *Frank H. Tooker*
- 82 Simple Frequency Counter** *Ronald L. Carroll*

- 20 EW Lab Tested**
Tannoy "Monitor Gold" Speaker System
Garrard SL 95 Automatic Turntable
- 58 Safety in Medical Electronics** *John Frye*

MONTHLY FEATURES

- 4 Coming Next Month** **11 Reflections on the News**
- 7 Radio & Television News** **18 Letters From Our Readers**
- 72 New Products & Literature**

Electronics World: Published monthly by Ziff-Davis Publishing Company at 307 North Michigan Ave., Chicago, Illinois 60601. One year subscription \$6.00. Second Class Postage paid at Chicago, Illinois and at additional mailing offices. Subscription service and Forms 3579: Portland Place, Boulder, Colorado 80302. Copyright © 1969 by Ziff-Davis Publishing Company. All rights reserved.

Earn Your DEGREE in Electronics!

The Grantham Electronics Degree Program (available mostly by correspondence) is divided into two main courses—(1) *Electronics Engineering Technology*, which leads to the Associate Degree, and (2) *Electronics Engineering*, which leads to the Bachelor Degree. The second course is an extension of (or addition to) the first course, both courses together making up the entire degree curriculum.

The Associate Degree Course

The Associate Degree program consists of five "correspondence semesters" made up of a total of 360 correspondence lessons, followed by a two-week resident period of review and examination at the School. The prerequisite for enrollment is high school graduation (or equivalent) and at least one year of experience as an electronics technician. The Degree of *Associate in Science in Electronics Engineering*—the ASEE—(accredited by the Accrediting Commission of the National Home Study Council) is awarded upon satisfactory completion of the 360 correspondence lessons and the final two-week residency at the School.

The Bachelor Degree Course

The curriculum in Electronics Engineering (leading to the Bachelor of Science Degree) includes all of the Associate Degree course and, in addition to that, includes three *resident* semesters at the School (covering advanced mathematics and advanced engineering). Also, credits in English, Business, etc., must be earned in other colleges and transferred to Grantham.

The Grantham educational program in electronics places heavy stress on fundamental concepts of logic and mathematics rather than on superficial manipulative skills. Since these fundamental ideas are largely unfamiliar to many electronics technicians, it is necessary to develop them in a systematic manner, before real advancement is possible.

Accreditation and G.I. Bill Approval

Grantham School of Engineering is *accredited* by the Accrediting Commission of the National Home Study Council, is *approved* under the G.I. Bill, and is *authorized* under the laws of the State of California to grant academic degrees.

Grantham School of Engineering

• Established in 1951 •

1505 N. Western Ave.
Hollywood, Calif. 90027

Telephone:
(213) 469-7878

Mail the coupon below for our free Bulletin.



Grantham School of Engineering EW-7-69
1505 N. Western Ave., Hollywood, Calif. 90027

Please mail me your free Bulletin, which explains how the Grantham educational program can prepare me for my Associate in Science Degree, and my Bachelor of Science Degree in Electronics Engineering.

Name _____ Age _____

Address _____

City _____ State _____ Zip _____

COMING NEXT MONTH

SPECIAL FEATURE ARTICLE:

COMMUNICATIONS ON THE MOON

How our astronauts will communicate from the Moon's surface and the equipment they will use to keep in touch with each other, the mother ship, and the earth is the subject of a fascinating as well as an authoritative article. Details of the equipment are provided, along with information on the special antennas and their exotic construction.



THE TRUTH ABOUT FM

Are you a bit confused about this important hi-fi medium? A lot of people are. Thomas R. Haskett tells you about the differences in mono and stereo FM transmissions, what SCA service is, and how a station may combine such services in their FM broadcasts.

WILL THERE BE AN ELECTRONIC MAIL SERVICE?

Will your letters be transmitted via microwave radio links some day? Can electronics bail out our postal system? What about a merger of the Post Office and Western Union? Walter H. Buchsbaum tells you about current tests and future plans.

All these and many more interesting and informative articles will be yours in the August issue of ELECTRONICS WORLD . . . on sale July 17th.

COMMUNICATIONS SATELLITES—SUCCESS IN SPACE

In this final article of a two-part series, Francis A. Cicca of Raytheon describes the Intelsat system, tells how it is used for international TV and telephone services, goes into satellites for aero communications and domestic use, and then delves into the revolution in communications we can expect when new, sophisticated satellites go into operation.

INFRARED LOCATES DISEASED TREES

By combining IR sensing and video tape recording, the U.S. Forest Service is spotting distressed timber from the air. Learn how it is done.

ZIFF-DAVIS PUBLISHING COMPANY

William Ziff
President

W. Bradford Briggs
Executive Vice President

Hershel B. Sarbin
Senior Vice President

Philip Sine
Financial Vice President

Walter S. Mills, Jr.
Vice President, Circulation

Stanley R. Greenfield
Vice President, Marketing

Phillip T. Heffernan
Vice President, Electronics Division

Frank Pomerantz
Vice President, Creative Services

Arthur W. Butzow
Vice President, Production

Edward D. Muhlfeld
Vice President, Aviation Division

Irwin Robinson
Vice President, Travel Division

Furman Hebb
Administrative Vice President

George Morrissey
Vice President

Sydney H. Rogers
Vice President

Editorial and Executive Offices
One Park Avenue
New York, New York 10016 212 679-7200

NEW YORK OFFICE 212 679-7200
Joseph E. Halloran

MIDWESTERN OFFICE
307 North Michigan Avenue
Chicago, Illinois 60601 312 726-0892
Midwestern Advertising Manager, Robert J. Ur

WESTERN OFFICE
9025 Wilshire Boulevard
Beverly Hills, California 90211
213 CRestview 4-0265; BRadshaw 2-1161
Western Advertising Manager, Bud Dean

JAPAN: James Yagi, Ishikawa Mansion,
#4, Sakuragaoka Shibuya-ku, Tokyo 462-2911-3

CIRCULATION OFFICE
Portland Place, Boulder, Colorado 80302



Member
Audit Bureau of
Circulations

Radio & TV News • Radio News • Radio-Electronic Engineering Trademarks Reg. U.S. Pat. Off.
SUBSCRIPTION SERVICE: Forms 3579 and all subscription correspondence should be addressed to Electronics World, Circulation Department, Portland Place, Boulder, Colorado 80302. Please allow at least six weeks for change of address. Include your old address, as well as new—enclosing if possible an address label from a recent issue.
EDITORIAL CONTRIBUTIONS must be accompanied by return postage and will be handled with reasonable care; however publisher assumes no responsibility for return or safety of art work, photographs, or manuscripts.
ELECTRONICS WORLD (July, 1969, Vol. 82, No. 1). Published monthly at 307 North Michigan Avenue, Chicago, Illinois 60601, by Ziff-Davis Publishing Company—also the publishers of Airline Management and Marketing, Boating, Business & Commercial Aviation, Car and Driver, Cycle, Flying, Modern Bride, Popular Electronics, Popular Photography, Skiing, Skiing Area News, Skiing Trade News, Stereo Review, and Travel Weekly. One year subscription rate for U.S., U.S. Possessions, and Canada, \$6.00; all other countries, \$7.00. Second Class postage paid at Chicago, Illinois and at additional mailing offices. Authorized as second class mail by the Post Office Department, Ottawa, Canada and for payment of postage in cash.



DELTA will tell you *everything!* — Complete Specs including schematics!

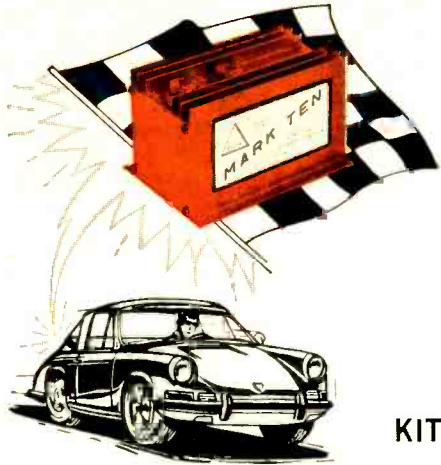

MARK TEN[®] SCR

CAPACITIVE DISCHARGE IGNITION SYSTEM

Now discover for yourself the dramatic improvement in performance of your car, camper, jeep, truck, boat — any vehicle! Delta's remarkable electronic achievement saves on gas, promotes better acceleration, gives your car that zip you've always wanted. Find out why even Detroit has finally come around. In five years of proven reliability, Delta's Mark Ten has set new records of ignition benefits. No re-wiring! Works on literally any type of gasoline engine.

- ▲ Dramatic Increase in Performance and in Fast Acceleration
- ▲ Promotes More Complete Combustion
- ▲ Points and Plugs Last 3 to 10 Times Longer
- ▲ Up to 20% Mileage Increase (saves gas)

KIT FORM **\$2995**
12V ONLY

ASSEMBLED **\$4495**
ONLY ppd.

MODEL 3000 FET VOM

Delta now offers a compact, versatile, and extremely sensitive VOM which combines FETs and ICs for extreme accuracy. Compact (6½"W x 8"H x 3½"D), portable. Wt. 3¾ lbs.

IN KIT FORM: Feedback network with pre-selected components to eliminate all final calibration. Ready to use when assembled!

NEW DELTA FEATURES:

- ▲ Mirror scale 200 A D'Arsonval meter
- ▲ Integrated circuit (IC) operational amplifier for extreme accuracy
- ▲ FET input stage with current regulator
- ▲ Two stage transistor current regulator and Zener diode on OHMS for absolute stability and accuracy
- ▲ Voltage clippers for protection of input stage

- ▲ Fully temperature compensated for low low zero drift
- ▲ Ten turns ZERO and OHMS adjust potentiometers
- ▲ Epoxy glass circuit boards and metal case
- ▲ Enclosed switches
- ▲ Uses readily available type AA cells
- ▲ Uses standard test leads for maximum flexibility and ease of measurement
- ▲ 10 Megohms input impedance

ONLY
\$7495
ppd.

Only **\$5995**
ppd.

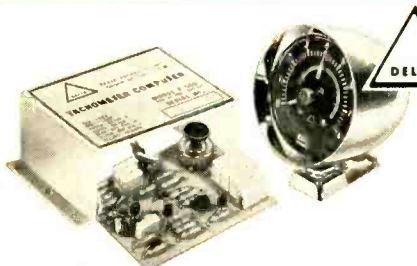

COMPUTACH[®]

Delta, pioneers in CD ignition who produced the fabulous MARK TEN[®], now offer a precise computer-tachometer which obsoletes any type tachometer on the market today! You achieve unbelievable accuracy in RPM readings due to the advanced, solid-state electronic matched components used in the computer, coupled with the finest precision meter in the world. Works on all 2, 3, 4, and 6 cylinder 2 cycle and with 4-6-8 cylinder — 4 cycle 12 volt engines.

- ▲ 0-8000 RPM range
- ▲ Perfect linearity — zero paralax
- ▲ Adjustable set pointer
- ▲ Wide angle needle sweep
- ▲ Translucent illuminated dial
- ▲ Chrome plated die-cast housing
- ▲ All-angle ball & socket mounting
- ▲ Use it with ANY ignition system
- ▲ Meter: 3½" dia. X 3¾" deep
- ▲ Calibration kit included, no test eqpt. needed.

*An exclusive computer-tachometer for precise RPM measurement in easy-to-build Kit form!

\$2995
ppd.

KIT FORM ONLY

DP 9-B

DELTA: Please send me literature immediately.

I am enclosing \$_____ for items checked.

- Mark Ten SCR (Kit Assembled)
 Model 3000 FET VOM (Kit Assembled)
 Computach (Kit only)

Please ship immediately.

Name _____

Address _____

City/State _____ Zip _____

*My car is (Model) _____ (Year) _____

EW



DELTA PRODUCTS, INC.

P.O. BOX 1147 • GRAND JUNCTION, COLORADO 81501

CIRCLE NO. 139 ON READER SERVICE CARD

NEW KENWOOD QUARTET

...variations on a theme of excellence

Whether you go lavish or low-budget, one of KENWOOD's superb new stereo receivers is waiting to enrich your listening pleasure. And whatever the price, you'll find that KENWOOD has a knack for adding the extra touches that make the difference between the ordinary and the excellent! Check the specs. Check the performance. Then pamper yourself with a KENWOOD for the greatest stereo you've ever heard!

FOUR NEW KENWOOD STEREO RECEIVERS TO CHOOSE FROM:

KENWOOD KRS-44 . . . 48-Watt, FET, IC, SOLID STATE FM AM RECEIVER and TWO MATCHING SPEAKERS

Complete with its own duo of compatible stereo speakers, the KRS-44 brings "Instant Stereo" to the budget-minded who want to play now, add-to later **\$239.95***

Stereo Receiver KR-44, also available separately, provides ample tape, phono, and other inputs for a complete stereo system . . . terminals for second speaker set **\$179.95***

KENWOOD KR-70 . . . 75-Watt, FET, IC, SOLID STATE FM STEREO RECEIVER

For the FM buff, this excellent and economical FM receiver with great sensitivity of 1.9 μ V IHF . . . excellent stereo separation . . . alternate channel selectivity of 45 dB . . . and a raft of professional convenience features that will keep any FM devotee devoted to KENWOOD **\$199.95***

KENWOOD KR-77 . . . 75-Watt, FET, IC, SOLID STATE FM / AM STEREO RECEIVER

A multitude of professional features not generally found in the medium-price range make the KR-77 an extremely popular model. Inputs for 2 record players, left- and -right channel output and main amp input, allow the greatest flexibility in creating a diversified stereo system **\$239.95***

KENWOOD KR-100 . . . 140-Watt, FET, IC, SOLID STATE FM AM STEREO RECEIVER

Featuring a particularly efficient silicon power transistor amplifier and an extremely sensitive front-end, the KR-100 is a truly deluxe stereo receiver with superior broadcast reception and controls to accommodate the most sophisticated stereo system **\$299.95***

*Including cabinets



... the sound approach to quality



3700 S. Broadway Pl., Los Angeles, Calif. 90007
69-41 Calamus Ave., Woodside, N. Y. 11377
Exclusive Canadian Distr. — Perfect Mfg. & Supplies Corp. Ltd.

Radio & Television news

By FOREST H. BELT /Contributing Editor

Where Do You Find Technicians?

That's the question most electronics-service-industry leaders are asking. New blood is hard to attract and harder to hold. Just as important is how to make present technicians more able and efficient. The answers take several directions.

The Electronic Industries Association is concentrating right now on vocational instructors and guidance counselors. Better instructors of servicing can stimulate more interest among students and turn out graduates better qualified to repair home-electronics gear. And guidance counselors can influence students considering electronic careers. School systems can find out about this program for vocational instructors from EIA, 2001 Eye St., Washington, D.C. 20006.

National Electronic Associations is putting its effort into an improved apprentice program. New NEA director of apprenticeship is Charles Cave, 7902 Bardstown Rd., Louisville, Ky. 40291. He initiated the Louisville plan (this column, October 1968, page 6) whereby public-school vocational students go to class half-days and work in local shops half-days (for pay). The plan is so successful, shops are on a waiting list for the next class to start. With Cave, NEA is helping the Indiana Board of Education set up a similar program statewide.

Whap—You're X-Rayed

Get your x-ray picture taken. Put a piece of film behind you and sit in front of a color-TV set. . . . That's what two U.S. Congressmen imply. They call for Government action against what they keep calling "hazardous" x-radiation from older color sets. Facts make their position overstated. You'd have to sit in front of the set continuously, with the high voltage almost impossibly misadjusted, for over four months just to get the same amount of x-radiation you get in a normal chest x-ray. And, since even the worst color-set x-rays are soft, with very low energy, you'd still be disappointed; they wouldn't penetrate you enough to ever reach the film.

Sorry to get your hopes up. Pretending that color-TV x-rays are a menace to health can only grab headlines. The only problem these x-rays have created is the one of trying to quiet the fears of people who have read misleading publicity about them. (P.S. Now the Public Health Service is planning to test devices used in schools for radiation.)

Lots of New Color-TV's

Makers of color-TV are always busy this time of year. They're bringing out their new lines for next year, and this time even more companies plan to market color. That's in spite of how "slow" color sales have been the first part of this year. (It's not really that slow; sellers are accustomed to big yearly jumps in sales, and 1969's increase so far has been a disappointing under-10%.)

Hitachi is bringing over (from Japan) all-transistor color sets with 12- and 14-inch screens; a larger model has a system to let the viewer preset fine tuning, color, tint, contrast, and brightness and then return to the same settings at the push of a button. *Webcor*, a brand name that has been in and out of electronics a couple of times, will be on some color-TV sets this fall. The *Muntz* brand is appearing again, too, on 18- and 20-inch color sets, both portable. *Magnavox* has 18-inch color, and perhaps a smaller one. *Mitsubishi* is another Japanese company shooting for the U.S. color market, later this year. *Channel Master* has told the press some color portables will carry its name later this year. *Hayakawa* tells of a new color set with a new way of adjusting Tint (phase) by coinciding two lines on the screen; what happened to good old flesh tones as a criterion?

By the time you read this, most distributors will have seen the 1970 lines. Dealers get to see them at the Consumer Electronics Show in New York at the end of June, and at distributors' open houses throughout the summer months.

Country's Oldest Service Association

This writer recently went to a birthday party. Associated Radio-Television Service Dealers (ARTSD) of Columbus, Ohio was 25 years old. Founded in 1944, ARTSD is the forerunner of service associations

in this country. Their convention, besides celebrating the anniversary, honored John P. Graham, founder of ARTSD and the only living member of the Electronics Hall of Fame—Service Division. Graham is a still prime influence in service association work. He's active on service-industry committees and in the National Federation of Independent Businessmen. He was elected to the Electronics Hall of Fame earlier this year. Congratulations, John!

P.S. The service industry's biggest shindig, National Electronic Association's Fifth Annual Convention begins July 22 in Waterbury, Conn. at the Quality Courts Motel. This gala family affair runs through July 27th. The chairman says technicians everywhere are invited. There's an impressive list of industry leaders slated to speak that week.

Transistors Okay in Sockets

Technicians who worried about socket troubles in *Sylvania* hybrid color chassis can relax. A survey recently disclosed that transistor socket troubles were almost nil in these chassis. That's good to know, because there are more transistors than ever in *Sylvania's* color line this season. John Borlaug, national service manager, warns that you shouldn't plug a replacement transistor into its socket with the set on; it could (probably will) blow the transistor.

Line-Voltage Regulator for Quasar

Motorola is showing its "Power Line Guard" that smooths out fluctuations in input voltage for Quasar solid-state color receivers. This improves transistor life, and also cuts down overvoltage that has been blamed for some x-radiation from CRT faces. Most Quasar models now have a solid-state h. v. rectifier (eliminating another alleged source of x-radiation). *Motorola* long ago changed to the pulse-type h. v. regulator. That adds up to a set with practically no possible source of x-rays. Incidentally, the Quasar model has been so successful, *Motorola* may—any time now—claim second place in the over-\$600 color market.

Today's Bargain: Consumer Electronics

Radios, TV's, and phonographs are cheaper than ever—at least in comparison to other commodities. The general Consumer Price Index stands at 123.7 (with 1957-59 as reference at 100). However, radio prices are at 76.8, TV sets at 80.5, and phonos at 96.7. All three are less than they were last year. TV and radio repair work, too, which is believed by some consumers to be so expensive, stands at only 102.6 on the Index. That means service for home entertainment equipment costs less than 3% more than it did 10 years ago. And that's a bargain in anybody's inflation-bloated economy. We should be telling consumers what a bargain they're getting.

Mini-Mini IC TV

Two Japanese companies have shown tiny black-and-white TV receivers with all-integrated circuits. Some of the IC's in both units are thick-film hybrid types. The *Panasonic* set has a 1½" screen with a magnifier in front. It sells at \$199, but only a few will be available this year. The other, by *Sanyo*, has a 3" screen. However, this one is only a prototype, and no one will say when it becomes available—or at what price. Japanese companies commonly show advanced products many months, even years, before production models are available.

Flashes in the Big Picture

Technicians want more wages, just like everybody else; recent strikes against both *Sears, Roebuck* and *RCA Service Co.* have netted gains for service people; guess it pays to be organized. . . . Modular panels for first *Motorola* Quasar sets go out of warranty about now; suggested list prices for replacement boards start at \$6.25 (FTI boards) and go to \$14.00 (Horizontal board); dealer can charge more if he wishes (or less). . . . Slider-type controls, first used on TV by *Motorola*, appear on several new sets this season. . . . *Tenna Corp.* "Untouchables" tape players sound off with loud alarm if anyone tries to take them out of their mountings. . . . 50-millionth *RCA* picture tube came off the line this spring (*RCA* has made almost 13 million color CRT's). . . . *Lear-Jet*, *Motorola*, *RCA*, *Columbia*, long major proponents of 8-track tape cartridges, have all entered the cassette field, too. . . . An FCC report says frequencies in land-mobile two-way radio band are not assigned for best use of spectrum. With better coordination, the land-mobile service probably wouldn't need the TV channels they are agitating for. ▲



Capture that top 10% (at least) engine performance you're now blowing out the exhaust!

Announcing a new generation C. D. Ignition System—the Tiger SST.

Here, in a compact new unit, are all of the advantages of previous capacitive discharge systems that have been chalking up such impressive performance records the past several years—plus a good deal more. The dramatic results:

- gas mileage is increased up to 25%
- points and spark plugs last up to 5 times longer
- you go up to 5 times longer between tune-ups

The added performance your engine delivers with the Tiger SST is the fun part. You'll enjoy sharper acceleration to higher speeds—a smoother running engine at all speeds. And your engine will last longer.

Our new Tiger C. D. System is compatible with all domestic and foreign cars and trucks with 12 volt, negative ground systems. In Simpli-Kit form, the unit is easy to assemble and install in less than 60 minutes—no special skills or tools required. The unit is moisture proof and is not affected by underhood temperatures.

Order your Tiger SST today. It's the latest, most advanced C. D. System available. And, if you do an average amount

of driving, it should pay for itself in less than two months. You'll be satisfied. Guaranteed. Money back.

Dealer/Distributor inquiries invited.

Special free offer!

Order now and receive a convenient to have, ruggedly built rechargeable flashlight **free**. It's a \$4.95 value that can put an end to the annoyance of dead batteries. Your order must be received within 30 days from date of this publication.

Delta International, Ltd.

Box 1946D, Grand Junction, Colo. 81501

Enclosed is my check (or money order) for \$_____

Please send prepaid:

- Simpli-Kit Tiger SST @ \$28.95
- Assembled Tiger SST unit @ \$39.95

Make of car: _____ Year: _____

Name: _____

Address: _____

City/State: _____ Zip: _____

NEW FINCO®

HOME ENTERTAINMENT DISTRIBUTION WIRING SYSTEM FOR DO-IT-YOURSELFERS



HWK-75 75 ohm
HWK-300 300 ohm

Everything needed to wire
your home for multiple set re-
ception – in easy-to-handle kit form.

● For Color TV – UHF/VHF ● Black & White TV ● FM/FM Stereo

Turn your whole house into a home entertainment center. Operate up to four sets, or be able to move your entertainment equipment from room to room. Kit includes all necessary parts, fittings and instructions.



THE FINNEY COMPANY

34 W. Interstate Street, Dept. 410-7
Bedford, Ohio 44146

Please send free brochure 20-520 on FINCO HOME TV
DISTRIBUTION KIT.

Name _____

Address _____

City _____ State _____ Zip _____

Reflections on the news

Collision-Avoidance Systems for Planes

Three collision-avoidance systems getting tryout; *Martin-Marietta* is making tests, with major airlines paying bill; main element of systems is time-diversity transmission from planes in flight, giving altimeter, speed, direction, master timing pulse, and other info; on-board computer detects danger and shows pilot correct avoidance maneuver; computer can handle as many as three planes in dangerous proximity to its aircraft. . . . Federal Aviation Administration reveals ten-year plan to spend \$2-billion on enroute automation (alphanumeric radar/computer is going in already), new communications equipment, added terminal and enroute navigation aids, more and updated terminal (landing) aids and control-tower facilities, and master collision-avoidance systems in congested terminal areas. . . . Expected yearly air-passenger traffic by 1980 almost 500 million. . . . Supersonic transport (SST) plans keep getting setbacks; Great Britain withdrew from Concorde program, leaving France and West Germany to go it alone; U.S. project, by *Boeing*, may not make 1976 target date (could be scuttled altogether by a cost-conscious Congress).

Electronics in Medicine

All radiating medical equipment coming under fire from Congress; medical-safety bills also include standards for electronic devices going inside body and for diagnostic and therapy machines. . . . Needed to complete artificial heart, which kept patient alive for many hours recently, is dependable in-body power source and computer-like system to control heart activity on oxygen demand of blood stream. . . . Psychiatric and neurological responses are run into *IBM* 1800 data system at Lafayette Clinic in Detroit; data includes electroencephalographic responses to psychological tests, emotional or neurological responses to external stimuli, effects of certain drugs on brain's responses. . . . Ultrasonic breath tester using piezoelectric crystal helps diagnose lung ailments at University of California School of Medicine. . . . Device called Tactile Vision Substitutor, built at San Francisco's University of the Pacific, has 100 tiny vibrating plungers that touch back of blind person sitting in barber-style chair; plungers are activated by digital pulses developed from signal of a closed circuit television camera; blind person thus "sees" image camera picks up.

Computers in the News

RCA Information Systems is teaming Spectra 70/45 computer with *Teletype* electronic readout machine to deliver news stories from press services to newspapers at extremely high speed—up to 60,000 words per minute in some cases. . . . Music taught by computer is goal of feasibility study by *Wurlitzer* and *System Development Corp.*, with Wichita, Kans. schools. . . . Lawyers can quickly search statutes of all 50 states and U.S. Code for laws relating to any key subject; all is stored on discs and tapes, using *IBM* 360/40 equipment, by *Aspen Systems Corp.* . . . Scoreboard at Philadelphia's new sports stadium will be computer-operated. . . . Computer-operated traffic signals are slated for use on a couple of main thoroughfares in Queens, N.Y.C.

Of Weather and Radar

Project BOMEX (Barbados Oceanographic and Meteorological Experiment) is in first phases; ultimately will use almost a dozen ships, two dozen planes, seven satellites, several ocean buoys, sea-going lab called FLIP, Omega navigation system, land-based computers, hundreds of people; goal is understanding of environment—and interfaces—from 100,000-foot altitude to 13,000-foot depth in 90,000-square-mile area of Atlantic Ocean near West Indies. . . . Advances in long-range (monthly) weather forecasting are expected from Nibus B2 satellite launches lately, and from improved tracking of weather balloons with system combining loran and Omega navigation aids. . . . Side-looking Ka-band radar from *Westinghouse* Aerospace Division is great at aerial mapping; its services can now be bought commercially. . . . Army has radar that sees underground; it's reported helping locate enemy tunnel networks in Vietnam. ▲

With his NRI home training

as a solid base for success, graduate W. Gerald Kallies of Elliott Lake, Ontario, Canada, has branched into three different areas of Electronics. He is in charge of the complete Electronic automatic control system at Rio Algom Nordic, Ltd., a uranium mining company. Also, he handles operations at CKSO-TV, a satellite station in Elliott Lake, and he owns Gerol TV Sales & Service, which grosses \$60,000 a year.

How did Gerald Kallies launch his career? While a high school senior, he faced the fact that college was beyond his financial reach. So he wrote to ten Electronics training schools. He chose NRI. Why? Because, he says, it appeared to be complete training with no short cuts . . . because courses were offered at very reasonable prices . . . and because he was convinced NRI would take a personal interest in him. The results of his training speak for themselves.

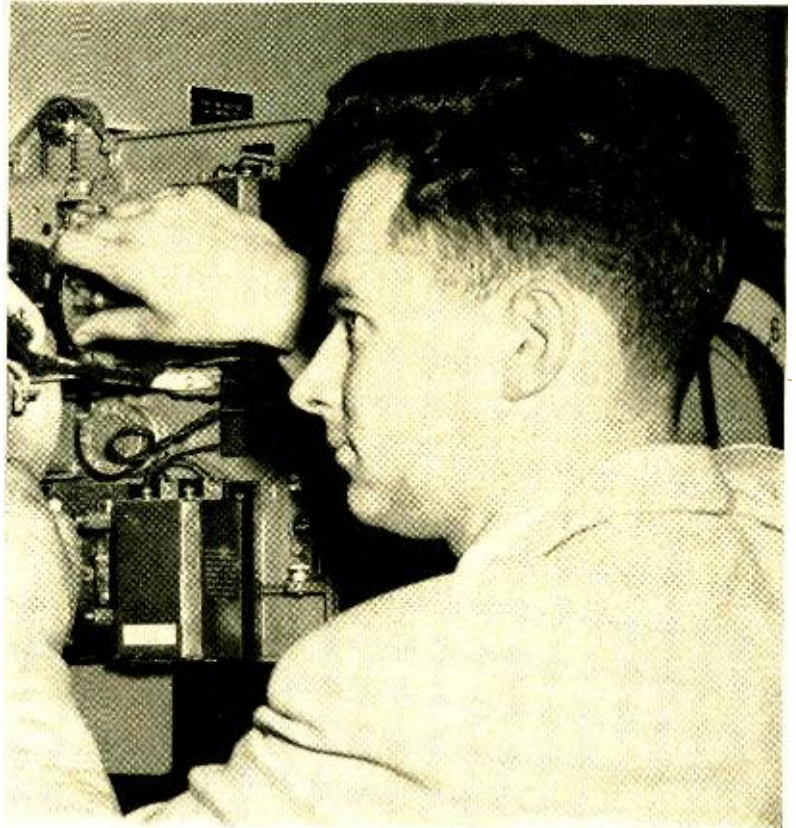

Experience Most in Color TV Communications Electronics

Designed-for-training equipment makes learning at home fast and fascinating—builds priceless confidence—as theory you learn comes alive.

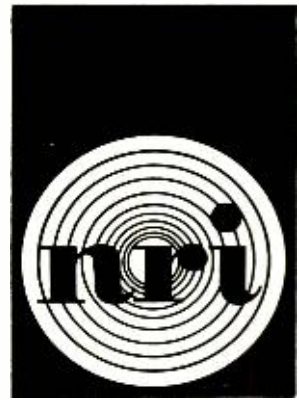

There is an all-important reason why NRI has invested so heavily in the development of equipment for learning Electronics at home. With more than 55 years of home education experience, NRI is convinced that theory alone is not enough. Your hands must be trained as well as your head. To get ahead fast you must have "hands-on" experience as well as "book" knowledge . . . and, you get *both* in NRI home training programs.

Learning becomes an absorbing adventure as you get your hands on professional parts and demonstrate theory you read in "bite-size" texts carefully programmed with NRI designed-for-learning equipment. You'll *prove* theory by

launch your own full-time business. Many NRI graduates start earning \$5 to \$7 an hour extra soon after they enroll, fixing home Electronics equipment for friends and neighbors in spare time. NRI's remarkable teaching method simplifies, organizes, dramatizes subject matter so that any ambitious man—regardless of his education—can effectively learn and profit from the Electronics course of his choice.

You get your FCC License or your money back

NRI is so confident of the effectiveness of its training programs that all Communications courses include a special money-back agreement. You *must* qualify for a Commercial Radiotelephone License issued by the FCC, after successfully completing your training program, or NRI refunds your tuition in full. Here is just one more example of the value you get when you choose NRI for your Electronics training . . . one more example of why NRI continues to be the country's leading Electronics home-study school. Over three-quarters of a million have enrolled since 1914. Discover for yourself how easy it is to move into Electronics—America's fastest growing industry—with NRI home training. Mail the postage-free card for the new NRI Catalog. There is no obligation. No salesman will call. NRI does not employ salesmen. NATIONAL RADIO INSTITUTE, Washington, D.C. 20016.

Counts

experimentation with the type of solid-state, transistorized and tube circuits you'll find on the job today—not hardware or breadboard hobby kits. Almost without realizing it, the NRI discovery method prepares you for your choice of careers in Color TV Servicing, Communications, Industrial Electronics. With your NRI diploma, you can confidently fill full-time openings in the TV-Radio Servicing business; become a part of the glamorous communication industry; have an important role in business, military or space Electronics or even

Approved under GI Bill

If you have served since January 31, 1955, or are in service now, check GI line on postage-free card.



Color TV circuitry is easy

to learn as you build the only Color TV set custom-designed for training purposes. The result is your own high-quality set you keep for years of viewing pleasure. NRI TV-Radio Servicing course includes your choice of color or black-and-white training equipment.



Communications experience

equal to as much as two years of on-the-job training is yours as you build and use equipment like this phone-cw transmitter suitable for the 80-meter amateur band. You also perform experiments on transmission lines and antenna systems. No other home-study school offers this equipment.



Competent technical ability

so necessary for careers in Industrial Electronics is easily acquired through NRI training. As you learn, you actually build and use your own motor control circuits, telemetering devices and even digital computer circuits. All major NRI courses include transistors, solid-state devices, printed circuits.

9 Exciting New Kits

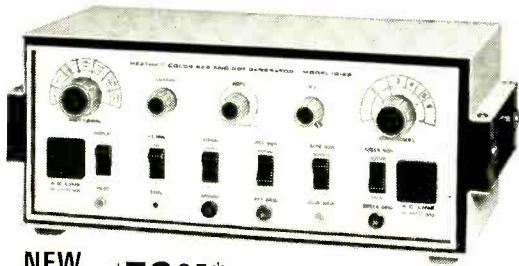

NEW
Kit IG-28 \$79.95*

Standard 9 x 9 Display **OR** Exclusive Heath "3 x 3" Display

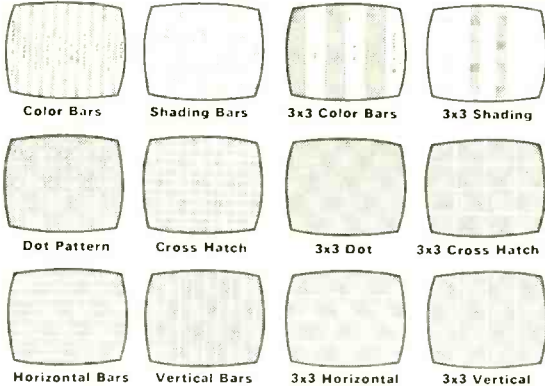

NEW Heathkit Color Bar-Dot Generator ... Advanced Integrated Circuitry Produces 12 Patterns Plus Clear Raster, Eliminates Divider Chain Instability Forever

The new IG-28 is the signal source for all color and B&W TV servicing. No other instrument at any price will give as much stable, versatile TV servicing capability. Its solid-state circuitry produces dots, cross hatch, vertical and horizontal bars, color bars, and shading bars in the familiar 9x9 display ... plus exclusive Heath 3x3 display of all these patterns ... plus a clear raster that lets you adjust purity without upsetting AGC adjustment. Fifteen J-K Flip-Flops and associated gates count down from a crystal controlled oscillator, eliminating divider chain instability and adjustments. And for time-saving convenience the IG-28 has variable front panel tuning for channels 2 through 6. Plus & minus going video signals at the turn of a front panel control ... for sync, in-circuit video or chroma problems, use the front panel sync output. Two front panel AC outlets for test gear, TV set, etc. Built-in gun shorting circuits and grid jacks too. Add any service-type scope with horizontal input and you have vectorscope display capability as well. Fast, enjoyable circuit board-wiring harness construction. You can't beat the Heathkit IG-28 for versatility or value ... put it on your bench now. 8 lbs.

NEW Heathkit 1-30 VDC Solid-State Regulated Power Supply

The new modestly priced IP-28 is an excellent power supply for anyone working with transistors. Compact Heathkit instrument styling with large, easy-to-read meter ... two voltage ranges — 10 V., 30 V. ... two current ranges — 100 mA, 1 A. External sensing permits regulation of load voltage rather than terminal voltage. Adjustable current limiting prevents supply overloads and excessive load current. Convenient standby switch. Fast, easy assembly with one circuit board and wiring harness. Order yours today! 9 lbs.

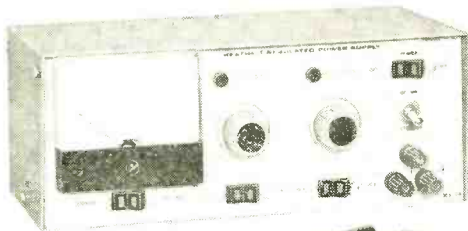

NEW
Kit IP-28
\$47.50*

NEW
Kit ID-29
\$29.95*



NEW Heathkit Solid-State Auto Tune-Up Meter ... Measures Dwell, RPM And DC Voltage

The new Heathkit ID-29 is most versatile ... really three automotive test instruments in one. Measures Dwell on all 4-cycle, 3, 4, 6, or 8 cylinder engines ... measures RPM in two ranges, 0-1500 and 0-4500 ... measures DC voltage from 0 to 15 volts. And no batteries are needed ... running engine provides both signal and power. Easy to use ... on both 6 and 12 volt system without changing leads. Lightweight and easy to carry ... its black polypropylene case has a built-in lead storage compartment and is resistant to virtually everything. Fast, simple assembly ... only about 5 hours. The perfect accessory for the handyman, emergency road service personnel or shop mechanics ... order your ID-29 now. 4 lbs.

NEW GR-88 Solid-State Portable VHF-FM Monitor Receiver

Tunes both narrow and wide band signals between 154-174 MHz ... for police, fire, most any emergency service. Exceptional sensitivity and selectivity, will outperform other portable receivers. Smart compact styling, portable or fixed station capability with accessory AC power supply, variable tuning plus single channel crystal control, collapsible whip antenna, adjustable squelch control, easy circuit board construction. The new GR-88 receiver is an added safety precaution every family should have ... get yours today! 5 lbs.

NEW GR-98 Solid-State Portable Aircraft Monitor Receiver

Tunes 108 through 136 MHz for monitoring commercial and private aircraft broadcasts, airport control towers, and many other aircraft related signals. Same exceptional features as the GR-88 above. The perfect receiver for aviation enthusiasts. 5 lbs. GRA-88-1, Accessory AC Power Supply ... \$7.95*

NEW GD-48 Solid-State Metal Locator

A low cost, versatile, professional metal detector at one-third the cost of comparable detectors. Packed with features for long life, rugged reliability, and dozens of uses ... battery operated, completely portable, weighs only 3 lbs. ... highly sensitive, probes down to 7' depth ... built-in speaker signals presence of metal, front panel meter gives visual indication, built-in headphone jack, telescoping shaft for height adjustment, easy-to-use and easy-to-assemble. Whether you're an amateur weekend hobbyist or a professional treasure hunter, the GD-48 is for you ... also a great help to contractors, surveyors, Gas, Electric, Telephone and other public Utility Companies. 4 lbs. GD-396, Headphones, 2000 ohm (Superex) ... \$3.50*



NEW
Kit GR-98
\$49.95*

NEW
Kit GR-88
\$49.95*

NEW
Kit GD-48
\$59.95*

From The Leader



NEW Heathkit Ultra-Deluxe "681" Color TV With AFT ... Power Channel Selection & Built-In Cable-Type Remote Control

The new Heathkit GR-681 is the world's most advanced Color TV with more built-in features than any other set on the market. Automatic Fine Tuning on all 83 channels ... eliminates touchy fine tuning forever, power push button VHF channel selection, built-in cable-type remote control ... or you can add the optional GRA-681-6 Wireless Remote Control any time you wish ... plus the built-in self-servicing aids that are standard on all Heathkit color TV's but can't be bought on any other set at any price. Other features include a bridge-type low voltage power supply for superior regulation; high & low AC taps to insure that the picture transmitted exactly fits the "681" screen. Automatic degaussing, 2-speed transistor UHF tuner, hi-fi sound output, two VHF antenna inputs, top quality American brand color tube with 2-year warranty.

GRA-295-4, Mediterranean Cabinet shown \$119.50*

Heathkit "295" Color TV

Big, Bold, Beautiful ... with the same high performance features and built-in servicing facilities as the GR-681 above ... but less the Automatic Fine Tuning, push button VHF power tuning and built-in cable-type remote control. You can add the optional GRA-295-6 Wireless Remote Control at any time.

GRA-295-1, Contemporary Walnut Cabinet shown \$62.95*

Both the GR-681 and GR-295 fit into the same Heath factory assembled cabinets; not shown, Early American style at \$99.95.*

NEW Deluxe Heathkit "581" Color TV With AFT

The new Heathkit GR-581 will add a new dimension to your TV viewing. Brings you color pictures so beautiful, so natural, so real ... puts professional motion picture quality right into your living room. Has the same high performance features and exclusive self-servicing facilities as the GR-681, except with 227 sq. inch viewing area, and without power VHF tuning or built-in cable-type remote control. The optional GRA-227-6 Wireless Remote Control can be added any time you wish. And like all Heathkit Color TV's you have a choice of different installations ... mount it in a wall, your own custom cabinet, your favorite B&W TV cabinet, or any one of the Heath factory assembled cabinets.

GRA-227-2, Mediterranean Oak Cabinet shown \$99.50*

Heathkit "227" Color TV

Same as the GR-581 above, but without Automatic Fine Tuning ... same superlative performance, same remarkable color picture quality, same built-in servicing aids. Like all Heathkit Color TV's you can add optional Wireless Remote Control at any time (GRA-227-6). And the new Table Model TV Cabinet and roll around Cart is an economical way to house your "227" ... just roll it anywhere, its rich appearance will enhance any room decor.

GRS-227-6, New Cart and Cabinet combo shown \$49.95*

Both the GR-581 and GR-227 fit into the same Heath factory assembled cabinets; not shown, Contemporary cabinet \$59.95.*

NEW Heathkit Deluxe "481" Color TV With AFT

The new Heathkit GR-481 has all the same high performance features and exclusive self-servicing aids as the new GR-581, but with a smaller tube size ... 180 sq. inches. And like all Heathkit Color TV's it's easy to assemble ... no experience needed. The famous Heathkit Color TV Manual guides you every step of the way with simple to understand instructions, giant fold-out pictorials ... even lets you do your own servicing for savings of over \$200 throughout the life of your set. If you want a deluxe color TV at a budget price the new Heathkit GR-481 is for you.

GRA-180-1, Contemporary Walnut Cabinet shown \$49.95*

Heathkit "180" Color TV

Feature for feature the Heathkit "180" is your best buy in color TV viewing ... has all the superlative performance characteristics of the GR-481, but less Automatic Fine Tuning. For extra savings, extra beauty and convenience, add the table model cabinet and mobile cart. Get the value-packed GR-180 today.

GRS-180-5, Table Model Cabinet & Cart combo \$39.95*

Both the GR-481 and GR-180 fit the same Heath factory assembled cabinets; GRA-180-2, Early American Cabinet \$75.00.*

Add the Comfort And Convenience Of Full Color Wireless Remote Control To Any Rectangular Tube Heathkit Color TV ... New Or Old!

Kit GRA-681-6, for Heathkit GR-681 Color TV's \$59.95*

Kit GRA-295-6, for Heathkit GR-295 & GR-25 TV's \$69.95*

Kit GRA-227-6, for Heathkit GR-581; GR-481 & GR-180 Color TV's \$69.95*

Now There Are 6 Heathkit® Color TV's To Choose From

2 Models In 295 Sq. Inch Size



NEW
Kit GR-681
With AFT
\$499.95*
(less cabinet)

Kit GR-295
\$449.95*
(less cabinet)

2 Models In 227 Sq. Inch Size



NEW
Kit GR-581
with AFT
\$419.95*
(less cabinet)

Kit GR-227
NOW ONLY
\$379.95*
(less cabinet
& cart)

2 Models In 180 Sq. Inch Size

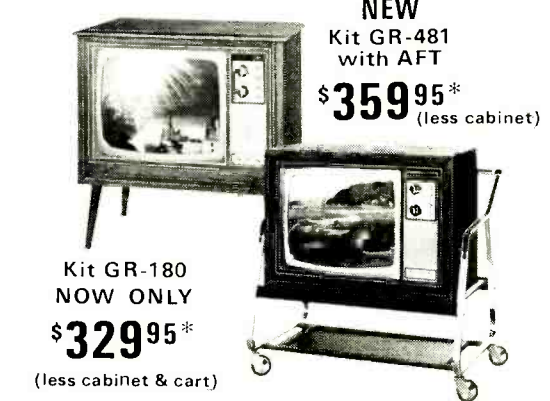

NEW
Kit GR-481
with AFT
\$359.95*
(less cabinet)

Kit GR-180
NOW ONLY
\$329.95*
(less cabinet & cart)



NEW

FREE 1969 CATALOG!

Now with more kits, more color. Fully describes these along with over 300 kits for stereo/hi-fi, color TV, electronic organs, electric guitar & amplifier, amateur radio, marine, educational, CB, home & hobby. Mail coupon or write Heath Company, Benton Harbor, Michigan 49022.

HEATH COMPANY, Dept. 15-7
Benton Harbor, Michigan 49022

Enclosed is \$ _____, plus shipping. *a Schlumberger company*

Please send model(s)
 Please send FREE Heathkit Catalog. Please send Credit Application.

Name _____

Address _____

City _____ State _____ Zip _____

*Mail order prices; F.O.B. factory. Prices & specifications subject to change without notice. CL-357

CIRCLE NO. 132 ON READER SERVICE CARD



DROP BY DROP

JOHN R. GILLIOM
Chief Engineer,
Loudspeakers

Reducing spurious resonances in a moving diaphragm is one of the most persistent and challenging problems facing speaker engineers. And in small cone tweeters, success in solving the problem dictates not only the ability of the speaker to provide smooth response over its effective range, but also strongly influences transient response capabilities.

In designing the current E-V 2½" cone tweeter, much of the development effort went into control of unwanted resonances, not only at the upper end of the spectrum, but also at the crossover point—a range often slighted but of more than casual significance to overall system response.

Investigation indicated that in addition to the fundamental resonance near the crossover frequency a 1st-order circular break-up mode of 6 kHz caused the edge of the cone to vibrate at excessive amplitudes. The solution was classical: addition of a controlled viscosity plasticized polyvinyl chloride compound to the compliance roll.

This material, commonly called damping compound, permeates the cone material, and when dry its high internal friction provides the desired control of rim resonances. But laboratory tests indicated that the quantity of damping compound to be added was most critical. Since the total cone mass was only 0.5 grams, even minor variations in damping compound characteristics and volume could lead to gross over-or under-damping.

The solution was fully automatic application of the compound. It was achieved by mounting the cone on a small turntable whose speed is precisely controlled. A carefully metered dispenser automatically flows exactly 200 milligrams of damping compound on the cone during a single rotation, with a tolerance of ± 30 mg. (0.001 oz.). After the compound dries, each cone is then weighed before acceptance for final assembly.

In addition to the application of metered amounts of damping compound, other efforts to control cone motion have proved successful. Behind each cone is placed a glass fiber pad that fills the space between the cone and the frame behind it. Precisely controlled in both consistency and quantity, this pad adds mechanical and acoustic damping to the cone to reduce unwanted cone breakup, while contributing little to the mass of the moving system, so that extended high frequency response may be maintained.

The result of these and other design characteristics that control resonances has been response that is relatively peak-free without excessive loss of efficiency.

For reprints of other discussions in this series,
or technical data on E-V products, write:
ELECTRO-VOICE, INC., Dept. 793N
629 Cecil St., Buchanan, Michigan 49107



CIRCLE NO. 136 ON READER SERVICE CARD
18

LETTERS FROM OUR READERS

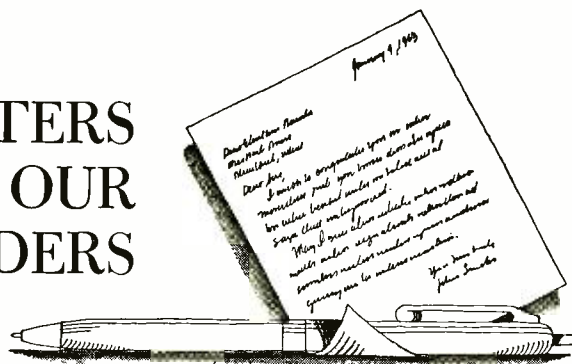

STEREO VS CONCERT HALL

To the Editors:

In "Stereo versus the Concert Hall" (April, 1969) the authors point out several factors which keep even the best stereo system from achieving concert-hall realism; yet they completely overlook the most obvious problem.

As a symphony musician I necessarily accept tympani, bassoon, cello, and trumpet sounds impinging on me from four directions; as a symphony listener I prefer the middle or back of the concert hall, please! There the total orchestra is heard more as a single composite entity—the point source concept. As a Dixieland musician and a jazz listener I bear similar feelings. No truly serious listener I know sits "down front."

I suggest that the authors convert to a full mono system and thus take one giant step toward that concert-hall realism they desire.

T. F. O'DONNELL
Lakewood, Cal.

The sophisticated stereo listener is not as interested in the ping-pong effect and the directivity of the sound sources, as he is in realism and "aliveness." The fact is that a good stereo system is far more able to recreate this realism than the best mono systems we have heard.—Editors

* * *

YOUR FRIENDLY, FADING TECHNICIAN

To the Editors:

The present situation relative to TV shops closing down ("Radio & Television News" items in Feb. issue on "Old Service Shops Just Fade Away" and "Who Cares About Customers?") is attributable to too much work and too little pay. TV technicians earning \$550.00 a month for a 44-hour week know they are underpaid. Increasing the work output is not the answer, for it cannot be increased beyond its prevailing level without lowering the quality and incurring the penalty of callbacks and the like. In short, only a given amount of work can be produced in a given period of time.

The handwriting is in the plaster. The consumer has to face the moment of truth that if he is to obtain the services of competent TV technicians he must pay what they are really worth.

This can be implemented only by a rate increase sufficient to pay shop owners a reasonable return for their efforts; and they will, in turn, pay their TV technicians more than \$3.00 per hour, which is what the above figure of \$550.00 per month reflects.

I could not agree more with Mr. Belt's view that the customer likes a friendly technician. This is as it should be. The present climate militates against this however; the scene is hardly pacifistic. Only a fellow technician can know the outrages suffered almost daily by other technicians dealing with the rank and file customer. This alone has driven the TV shop off the scene, for the pay is too little, and the attrition too great. Until the pay is increased substantially, and a new sense of pride is restored, the forces of attrition will continue to drive the cream of the TV servicing profession to other industries. This, Mr. Belt, is a fact to be reckoned with by all parties. Big shops will not ameliorate it—they will only perpetuate it on a larger corporate level.

VINCENT L. IRVAN
Pacific Grove, Cal.

* * *

STOP-ACTION EXPLOSION

To the Editors:

Refer to Fig. 1 on p. 47 of your March issue ("Stop-Action Photos"). Pictures can be deceiving—but didn't that balloon just *implode* and not *explode* as the caption states?

ROBERT K. ODOM
Carmichael, Cal.

Actually, we've always considered that a cathode-ray tube implodes since the pressure inside the bulb is less than atmospheric. On the other hand, a balloon explodes since the pressure within the balloon is higher than atmospheric. Perhaps we simply should have stuck to the word "collapsed."—Editors

* * *

SURPLUS TAPE FOR VTR

To the Editors:

We have read with great interest the recent article in the January ELECTRONICS WORLD pertaining to "TV Systems for Teacher Education." We find it particularly interesting inasmuch as approximately 45% of our sales are to educational institutions. Of these pur-

chases, the major application for both our ½" and 1" Videocorders is for teacher training.

Our experience over the past three years, however, has indicated that the use of surplus computer tape with any helical-scan recorder has developed into serious grief for the user. Video tape for use on slant/track VTR's requires special fabrication with most of the rotating heads moving at a speed of anywhere from 1800 r/s to 3600 r/s. Oxide-shed can be a serious deterrent to quality performance. Surplus computer tape in shedding has a tendency to seriously "gum" the heads. This results in either poor pictures or no pictures. In many instances, it results in serious damage to the video heads. We strongly advise all of our customers to shy away from being "penny-wise and pound-foolish." I hope that your readers will recognize the inherent dangers in the use of such surplus computer tapes.

R. F. O'BRIEN, Nat'l. Mktg. Mgr.
Video Products, *Sony Corp.*
Long Island City, N. Y.

SCOPE & V.T.V.M. CALIBRATOR

To the Editors:

In the article entitled "Low-Cost Precision Scope & V.T.V.M. Calibrator" (p. 80, March issue), it should be noted that if low-stability components are used for R8 and R9, the long-term stability will be inconsistent with the design goals. A wirewound, low-temperature compensation potentiometer and a precision resistor should be selected for R9 and R8 respectively.

In addition, the short-term stability can be enhanced if the 1% resistors are chosen from the same manufacturer and line, and then physically mounted as close to each other as practical. This will keep the ratios of output voltages nearly constant with temperature changes.

MICHAEL NEIDICH
Bethpage, N. Y.

FOT OR OTF

To the Editors:

Optimum Traffic Frequency is always referred to as FOT as was indicated in my original manuscript for the article "Ionospheric-Propagation Predictions" in your April issue, and not OTF as you have edited. The international abbreviation FOT is formed from the initial letters of the French words for optimum traffic frequency "Frequence Optimum de Travail."

H. C. WOOD
Costa Mesa, Cal.

We did Americanize the abbreviation, as many American engineers use the abbreviation OTF. In most texts and research reports, however, the abbreviation for the French wording, FOT, is used.—Editors ▲

the new SANSUI 350



46 watts of music power at 8Ω...FET FM Front End...exclusive Stereo Only circuit...outputs for 2 pair of stereo speaker systems, headphones, tape recording, monitoring and play-back... double protection for power transistors...plus many other exclusive features, that you expect from Sansui and only Sansui. Visit your franchised Sansui dealer for a demonstration of the exciting new Sansui 350 AM/FM Stereo Receiver...do it today for a truly memorable experience...\$199.95.

Sansui®

SANSUI ELECTRONICS CORPORATION, 34-43 56th ST., WOODSIDE, NEW YORK 11377
SANSUI Electric Co., Ltd., Tokyo, Japan • European Office Frankfurt a.M., West Germany

CIRCLE NO. 117 ON READER SERVICE CARD

**Build this magnificent
Schober Theatre
Organ for
only \$1550!***



*Includes finished walnut console. Amplifier, speaker system, optional accessories extra. Only \$1150.50 if you build your own console.

You couldn't touch an organ like this in a store for less than \$3500—and there hasn't been a musical instrument with this vast variety of genuine Theatre Organ voices since the days of the silent movies! Haunting tibias, biting strings, blaring reeds—the whole A to Z gamut of real pipe sounds that make the simplest playing a thrilling experience and give the professional organist everything he needs. If you've dreamed of the grandeur of authentic big-organ sound in your own home, you won't find a more satisfying instrument anywhere—kit or no kit.

The Schober Organ Corp., Dept. RN-67
43 West 61st Street, New York, N.Y. 10023

- Please send me Schober Organ Catalog and free 7-inch "sample" record.
- Enclosed please find \$1.00 for 12-inch L.P. record of Schober Organ music.

NAME _____
ADDRESS _____
CITY _____ STATE _____ ZIP _____

You can learn to play it. And you can build it, from Schober Kits, world famous for ease of assembly without the slightest knowledge of electronics or music, for design and parts quality from the ground up, and—above all—for the highest praise from musicians everywhere.

Send right now for your copy of the full-color Schober catalog, containing specifications of the five Schober Organ models, beginning at \$599.50. No charge, no obligation—but lots of food for a healthy musical appetite!

CIRCLE NO. 116 ON READER SERVICE CARD

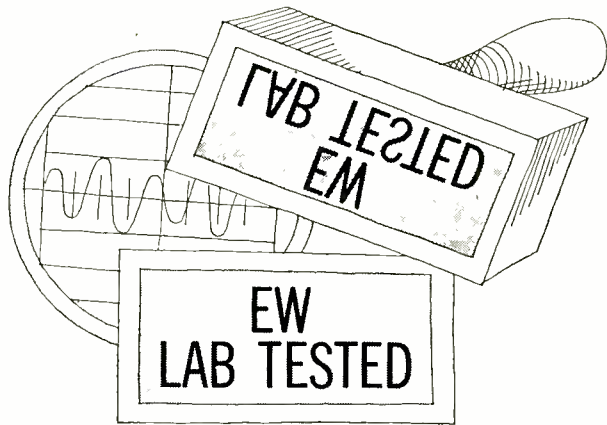

HI-FI PRODUCT REPORT

TESTED BY HIRSCH-HOUCK LABS

**Tannoy "Monitor Gold" Speaker System
Garrard SL 95 Automatic Turntable**

Tannoy "Monitor Gold" Speaker System

For copy of manufacturer's brochure, circle No. 24 on Reader Service Card.



It was with more than casual interest that we approached this test of the Tannoy Monitor Gold. This elite British-made speaker is a descendent of the coaxial speakers, which were so popular in the early days of high fidelity. With all the intervening advances in the loudspeaker art, such as acoustic suspension, high-energy magnets, and electrostatic elements, could the venerable coaxial Tannoy design compete effectively in today's market?

While the basic structure of the present-day Monitor Gold series of drivers (made in 10-, 12-, and 15-inch sizes) is

similar to that of the company's 1945 Dual Concentric, there have been many changes that may not be immediately obvious to the eye, but that are certainly audible to the ear. The multiple-throat, horn-loaded tweeter diaphragm is still located at the rear of the magnet structure, its flared horn tapering smoothly into the curved woofer cone, which serves as an extension of the high-frequency horn.

An acoustically transparent dome over the opening of the tweeter horn seals it against dust and foreign particles. The high-frequency driver's voice coil, 2 inches in diameter, is wound with aluminum wire for low mass. The 12-inch model, which is the one we tested, has a 7½-pound magnet structure. The woofer cone, also driven by a 2-inch voice coil, has a high-compliance, large-excursion plastic surround that results in a 28-Hz free-air resonance. Crossover frequency is 1000 Hz.

An integral part of the speaker is the physically separate crossover network and the two high-frequency controls usually mounted on the rear of the cabinet. One control, labeled Energy, is designed to raise or lower the relative output of the system above about 1000 Hz by about 2.5 dB, without changing the slope of the curve. The other control, Roll-off, is a four-position switch that

affects the slope and frequency response above 2000 Hz, with a total reduction of about 5 or 6 dB above 10,000 Hz. These relatively subtle controls permit the speaker's response to be trimmed over a moderate range.

To make the Monitor Gold speaker compatible with modern solid-state amplifiers, the nominal impedance has been reduced to 8 ohms from its former value of 16 ohms, and it is held to a minimum of 5 ohms throughout the audio-frequency range.

The speaker was supplied for testing installed in Tannoy's Stuart enclosure. This is a floor-standing lowboy with exceptionally attractive styling, and a black wooden filigree covering the grille cloth. The finish is a light-grained walnut, resembling teak, and it is one of the handsomest pieces of loudspeaker furniture we have seen in years. The Stuart is a ducted-port bass-reflex enclosure, standing 24½ inches high, 24¾ inches wide, and 16¾ inches deep.

The averaged frequency response from ten microphone positions, with the "normal" setting of the Energy control and maximum setting of the Roll-off control, was ±4.5 dB from 65 to 15,000 Hz. Between 1000 and 9000 Hz the response was extremely smooth, varying only ±1.5 dB. The low-frequency response was very uniform down to 70 Hz, but fell off rapidly below that frequency.

The harmonic distortion at 1-watt input was less than 2.5 percent down to 50 Hz, rising smoothly to 5 percent at 40 Hz and 10 percent at 35 Hz. The low-bass distortion suggests that the effective lower limit of the speaker's response in the Stuart enclosure might be in the 40-Hz region if the enclosure is situated properly in the listening room.

The tone-burst response was generally good, although we observed a secondary burst, or echo, about 0.5 to 1 millisecond after the cessation of the main burst. This appeared to be a property of the system (although not necessarily of the speaker itself); however, its amplitude was sufficiently low so that the effect was not audible.

The sound of the speaker system was
(Continued on page 60)

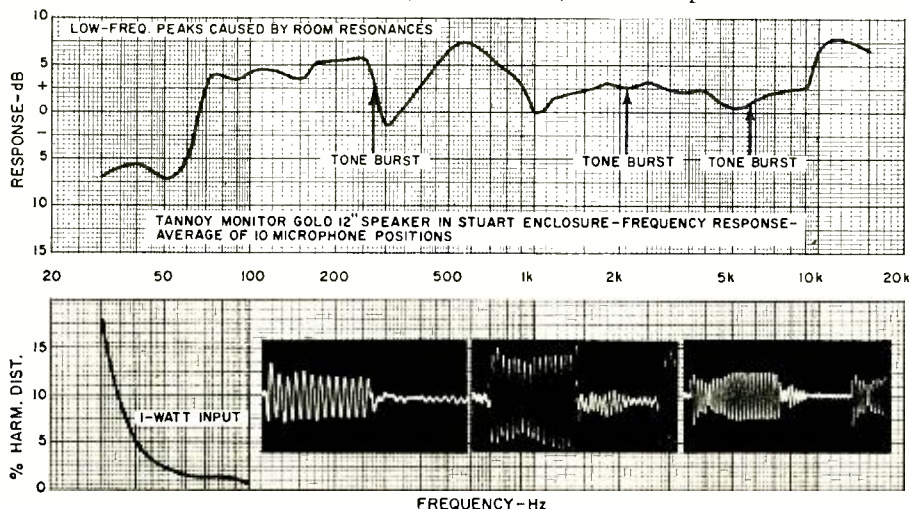

Here's More Alarming News From The Alarmists!

Dialtronic Automatic Telephone Communicator Model DT-1000



Radarsentry Alarm announces a new powerful way to stop crime . . . "Dialtronic"

Radarsentry Alarm announces a new powerful way to fight crime. Imagine a security system that automatically and silently delivers any emergency message for which it is programmed. Dialtronic adds a new dimension to your security needs. Advanced concepts in technology and design bring you a new level of security. Providing unlimited application, the Dialtronic uses solid state circuitry to bring help immediately. Use it with existing alarm systems or any other sensing device. Dialtronic is the ideal personal protection for anyone who is vulnerable to intruders. Dialtronic will perform with never a lapse in security . . . You are assured of highly reliable protection.

Also used to protect premises while they are being occupied, the Radar Dialtronic gives push button protection to businesses and home owners alike. This system is triggered by a hidden push button or portable transmitter. Once set into action, it automatically dials the phone—delivering any pre-recorded message for which it is programmed without the would-be-thiefs' knowledge. In effect, the Dialtronic gives you a direct line to police, fire departments, in-plant security, key personnel . . . whoever you designate.

Dialtronic's built-in programmer lets you magnetically store "error free" messages on cassette type tape cartridges. Stored information is instantly available to notify proper officials, delivering correct message in each case.

Advantages of Dialtronic Telephone Communicator

- Eliminates costly leased telephone lines.
- Simultaneously stores up to ten separate messages on magnetic tape.
- Automatically dials the right people and delivers the correct message in each case.
- Battery operated (optional) Rechargeable "Nic/Cad" batteries with built-in charger.
- Converts existing local alarm to central station system. Easily and quickly installed.
- Silent "on premises hold up alarm with the ability to get the facts out" instantly.
- Can be used with optional wireless control.
- Home prowler alarm, fire alarm, emergency alarm for invalids. Can be programmed for any emergency.

The Crimebusters Want You! . . . Now!

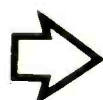

. . . To make the biggest profits of your career—filling ready-made demand for the dramatic new RADAR SENTRY ALARM systems. Get started NOW as dealer or distributor—step into five-figure income at once, with unlimited potential and wide-open opportunity to grow as you go! MAIL COUPON AT ONCE!

RADAR DEVICES MFG. CORP.
22003 Harper Avenue
St. Clair Shores, Michigan 48080

EW-79

- Send me the alarming details.
- Also send me booklet outlining available dealerships.

Name

Address

CityStateZip

There's a reward

on their heads.

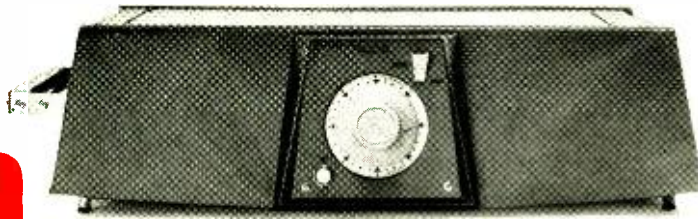

FREE:
The Copymate Dry Copier, with 20 sheets of copymate paper, with your purchase of the RCA WR-52A Stereo FM Signal Simulator or WO-91C oscilloscope!

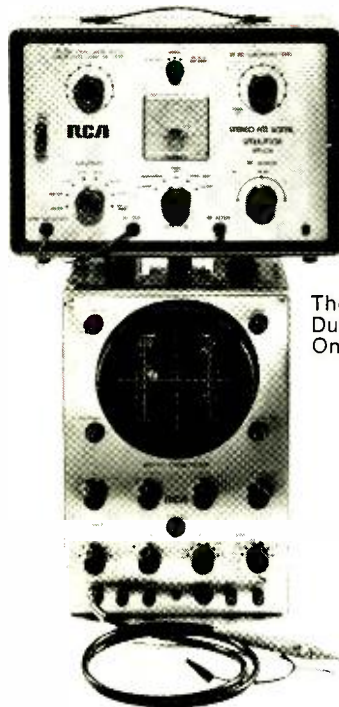

The WR-52A Stereo FM Signal Simulator only \$248.00*

The WO-91C 5-Inch Dual Band Oscilloscope Only \$269.00*

Now you can own one of the fastest, most accurate trouble-shooters in the East (West, North and South), and receive, absolutely free, the new all-electric Copymate!

Copymate is the portable dry copier that copies anything — ... checks, invoices, schematics, photos, your children's drawings and school work — without liquids, chemicals or sprays!

The Copymate, with paper, has a retail value of \$31.94, but you can get it free ... Here's how.

Buy the WR-52A or WO-91C between April 15 and July 15. Mail us your warranty card and the blue label on the outside of the carton no later than July 31st and we'll ship the Copymate to you at once, freight prepaid!

Good deal? You know it is.

Mail your card and label to: RCA Electronic Components, Test Equipment Headquarters, Bldg 17-2, Harrison, N.J. 07029.

*Optional distributor resale price.

RCA

CIRCLE NO. 119 ON READER SERVICE CARD

Communications Satellites — Success in Space

Part 1: From Score to Intelsat II

More than any other development in space, these successful satellites have had the greatest impact on our daily lives. Early problems and achievements are covered and descriptions of early satellites and their operating capabilities are included.

On December 18, 1958 an Atlas-B boosted the tenth satellite in history into orbit. It contained a tape-recorded Christmas greeting from President Eisenhower and for 13 days this message was broadcast from the world's first communications satellite. A decade after this simple experiment on Project Score, it is clear that communications satellites have had more of an impact on our daily lives than any other development in space.

The growth of this infant technology has been truly phenomenal; seven years after Score, the first international satellite (Early Bird) went into commercial service only to be replaced three years later by today's Intelsat III with five times more capacity. In the last three years six commercial comsats* have been orbited (see Fig. 1), representing an evolution of three generations of communications-satellite technology. Furthermore, this rapid progress shows no signs of slowing and by 1970 the fourth generation satellites will begin service with over twenty times more capacity than Early Bird.

Of course, this explosion in satellite technology would mean little to us if the development of earth stations to communicate with the satellites had not kept pace. When Telstar was launched in 1962 there existed three experimental earth stations (in England, France, and the United States) that could use the satellite. By the end of 1968, the number of stations had risen to nearly 25 devoted exclusively to communicating with commercial satellites. By 1972 it is estimated that over 85 earth stations in 61 countries will be operational and over 5000 international telephone calls will be carried by these stations. This is about five times our current submarine cable and h.f. radiotelephone capacity.

Impressive as these telephony figures are, the use of satellites for live international telecasts has been dramatic. Satellites brought us the 1964 Olympics from Japan, the 1968 Winter Olympics from Grenoble, several public debates between national leaders, Pope Paul's Christmas message, news events, and Apollo telecasts received from the moon by overseas tracking stations. Pope Paul's 1965 visit to the U.N. was the first major event telecast from the U.S. to European audiences by Early Bird. Other overseas transmissions have included news events, such as the Johnson-Kosygin meeting in Glassboro, and the 1968 Mexican Olympics which were telecast to 400 million viewers around the world. Doctors in Geneva have observed open-heart surgery in Houston, asking questions on technique during the operation. An experimental international exchange of data and photos on wanted criminals resulted in the arrest of a thief a few days later. Clearly, communications satellites are having a major impact on our lives.

Early Achievements

When Score was launched in 1958 (see Table 1), it was not clear that satellites could be justified economically. Only two years earlier the first transatlantic cable had been completed, providing the first reliable overseas telephone service.

*Throughout this 2-part series we will use this term for "communications satellites." It should not be confused with the capitalized term Comsat, which stands for the Communications Satellite Corp.

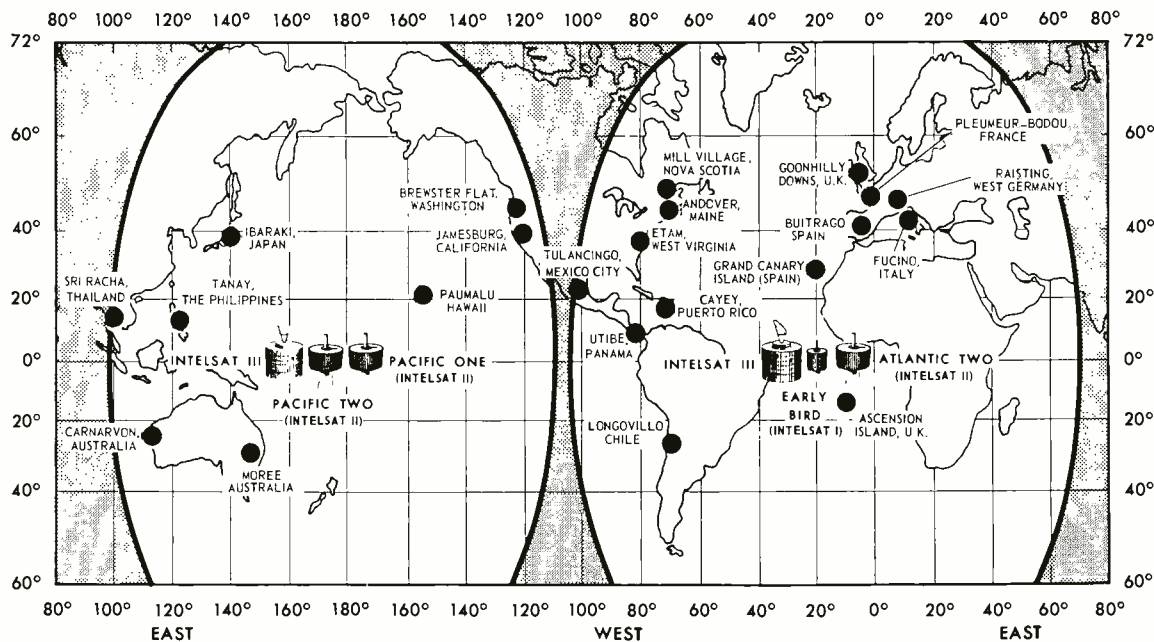

Fig. 1. Operational communications satellites, earth stations, and coverage areas. Not shown here are two additional NASA communications satellites, ATS-1 and ATS-3, located over Pacific and Atlantic Oceans. All satellites are in stationary synchronous orbits, although ATS-1 and -3 are moved occasionally.

Many did not believe that expensive and unreliable satellites could compete effectively with terrestrial facilities. It was also not clear how to design such satellites. Should a communications satellite be a passive reflector, like Echo, or employ the amplification of an active repeater? What orbital altitude would be best? Should the satellites be stabilized, and if so, how? The early experimental satellites were designed to answer these questions and to provide practical operating experience.

Echo demonstrated the feasibility of using a passive reflecting balloon, but for the transmission losses to be small the balloon had to be both large and orbit at low altitude. At low altitudes a satellite completes an orbit quickly and so moves rapidly from horizon to horizon. This, in turn, requires a large progression of satellites simply to assure that one is always in view of the pair of communicating earth stations. Also, the diffuse characteristics of the reflected Echo signal were not appropriate for wide-band communications, and so quality was poor.

Two months after Echo I, the Army's Courier satellite provided our first medium-altitude (675 miles) active repeater. The conclusion of this experiment was clear: amplifying active repeaters offer the most promise for high-quality communications. This led in 1962 to the significant Telstar experiments by the Bell System and NASA's Relay, both employing medium-altitude active repeaters. These satellites gave us our first TV transmissions by satellite and proved that excellent quality could be practically achieved. But, again, the relatively swift progression of satellites across the sky meant many expensive satellites and complicated earth tracking stations would be required.

A solution to this problem was suggested by, among others, science-fiction writer Arthur C. Clarke many years ago: Place the satellite in a stationary orbit. At the Courier altitude of 675 miles, an orbit is completed in 107 minutes; at the moon's distance of 239,000 miles, a revolution takes about 27 days; and at the "geo-stationary" synchronous altitude of 22,300 miles, the orbital period is just 24 hours.

If a satellite at this altitude is placed over the equator, it completes an orbit in just the time it takes for the earth to complete a revolution below. Thus, as seen from the earth, the satellite appears to stand still. This means that a satellite could be stationed over the Atlantic and permanently link Europe and the U.S.

Although it was apparent that the synchronous approach would greatly simplify ground tracking and reduce the number of satellites needed, there were several major unanswered questions. First, the path loss at 22,300 miles would be 30 dB

higher than at the Courier altitude, requiring 1000 times more ground and satellite radiated power for the same performance. Secondly, the two-way transit time is about 0.27 second and it wasn't clear that telephone conversations could tolerate such a delay. Finally, it wasn't clear that a stabilization system could be developed which would keep the satellite firmly in place ("station keeping").

Intelsat is Formed

Hence, in 1962 it appeared that only medium-altitude comsats would be practical. Such satellites would progressively orbit over all countries of the world. Unless international action were taken, it appeared likely that many nations would build their own systems, resulting in a multiplicity of different satellites, each capable of providing global communication services.

The Communications Satellite Act of 1962 established the *Communications Satellite Corporation (Comsat)* and charged it with the responsibility of representing the United States in international efforts to develop a single global satellite system. Under the auspices of the United Nations, nineteen nations agreed in 1964 to form the *International Telecommunications Satellite Consortium (Intelsat)*, affirming that through the cooperative efforts of its members it would be possible to realize the full benefits of communications-satellite technology. On August 20, 1964, the United States and thirteen other nations signed the *Intelsat Interim Agreement* establishing the Consortium.

The Interim Communications Satellite Committee (ICSC), governing body of *Intelsat*, was then charged with developing the first commercial global satellite system and drafting a suitable permanent set of working agreements to be adopted by 1970. *Comsat* acts as the U.S. representative to the ICSC and, under terms of the Interim Agreement, has also acted as *Intelsat's* manager for the space segment of the global system.

Membership in *Intelsat* is open to any nation which is a member of the International Telecommunication Union (ITU) and participation in the organization is based on a quota system which is related to each nation's potential use of the satellites. What began as a Consortium of nineteen nations in 1964 has grown to over 63 today and the ICSC is represented by delegates from eighteen nations or groups of nations.

It is significant that the Soviet-bloc countries are not members of *Intelsat*. Since the amount of external telephone traffic from the Soviet bloc is very small, they have had little need for international satellites. This also means that the Soviet quota would be small and Russia would have virtually no voice in *Intelsat*. Since the U.S. has traffic-related voting

SATELLITE	AGENCY	LAUNCHED	FUNCTION	SATELLITE	AGENCY	LAUNCHED	FUNCTION
Score	ARPA	12-18-58	First comsat. Transmitted taped messages.	Molniya 1-D	USSR	10-20-66	Fourth Soviet comsat. Elliptic orbit.
Echo I	NASA	8-12-60	First passive reflector. Relayed voice and crude TV.	Intelsat II-A	COMSAT	10-26-66	Commercial comsat. Not in planned orbit.
Courier I-B	ARMY	10-4-60	First active satellite. Functioned for 17 days.	ATS-1	NASA	12-6-66	Microwave and v.h.f. test-bed experimental comsat. Stationary.
Telstar I	AT&T	7-10-62	Private medium-altitude active comsat. Transmitted until 2-63.	Intelsat II-B	COMSAT	1-11-67	Commercial comsat. (in service over Pacific)
Relay I	NASA	12-13-62	Medium-altitude active comsat. Transmitted until 2-65.	Intelsat II-C	COMSAT	3-22-67	Commercial comsat. (in service over Atlantic)
Telstar II	AT&T	5-7-63	Private medium-altitude active comsat. Transmitted until 6-65.	Molniya 1-E	USSR	4-12-67	Fifth Soviet comsat. Elliptic orbit.
West Ford	USAF	5-10-63	Experimental ring of passive wire dipoles.	IDCSP	DOD	6-29-67	Second Initial Defense Communication Satellites (8).
Syncom II	NASA	7-26-63	First successful stationary-orbit comsat; being used by military.	LES-5	USAF	6-29-67	U.h.f. radio propagation experimental comsat. Repeater.
Relay II	NASA	1-21-64	Medium-altitude active comsat; repeater experiment.	Intelsat II-D	COMSAT	9-27-67	Commercial comsat. (in service over Pacific)
Echo II	NASA	1-25-64	Second passive-reflector comsat. Largest reflector in orbit.	Molniya 1-F	USSR	10-3-67	Sixth Soviet comsat. 12-hour orbit.
Syncom III	NASA	8-19-64	Second stationary synchronous-orbit comsat; being used by military.	Molniya 1-G	USSR	10-22-67	Seventh Soviet comsat. 12-hour orbit.
LES-1	USAF	2-11-65	First all solid-state experimental comsat; first de-spun antenna.	ATS-3	NASA	11-5-67	Microwave and v.h.f. test-bed experimental comsat. Stationary.
Intelsat I "Early Bird"	COMSAT	4-6-65	First commercial comsat; stationary-orbit active repeater. (in service over Atlantic)	Molniya 1-H	USSR	4-21-68	Eighth Soviet comsat. 12-hour orbit.
Molniya	USSR	4-23-65	First Russian comsat. Highly elliptic orbit.	IDCSP	DOD	6-13-68	Third Initial Defense Communication Satellites (8).
LES-2	USAF	5-6-65	Second all solid-state experimental comsat.	Molniya 1-I	USSR	7-5-68	Ninth Soviet comsat. 12-hour orbit.
Molniya 1-B	USSR	10-14-65	Second Soviet comsat. Soviet/France link. Elliptic orbit.	ATS-4	NASA	8-10-68	Experimental comsat. Not in planned orbit.
LES-3	USAF	12-21-65	U.h.f. radio propagation experimental comsat. Beacon.	Intelsat III-A	COMSAT	9-18-68	First global-system comsat. Failed to achieve orbit.
LES-4	USAF	12-21-65	Third solid-state microwave experimental comsat.	Intelsat III-B	COMSAT	12-18-68	First global-system comsat. (in service over Atlantic)
Molniya 1-C	USSR	4-25-66	Third Soviet comsat, plus cloud-cover photos. Elliptic orbit.	Intelsat III-C	COMSAT	2-5-69	First global-system comsat. (in service over Pacific)
IDCSP	DOD	6-16-66	First Initial Defense Communication Satellites (8).	Tacsat-I	USAF	2-9-69	Experimental military tactical comsat.

Table 1. A complete listing of United States and USSR communications satellites.

power in excess of fifty percent, this situation is politically unacceptable to Russia. As a result, Russia developed its own system for internal Soviet-bloc communications (Molniya) and has offered these satellites to other countries (Intelsput). Since, until recently, different earth-station frequencies were used, few non-Soviet countries have participated (principally France).

Impact of Syncom

The comsat economic revolution began on July 26, 1963 when a Delta launch vehicle successfully boosted a 150-pound Syncom into geo-stationary synchronous orbit. This launch achieved a number of firsts: It proved that a launch vehicle could perform the complex maneuvers needed to achieve synchronous orbit. Not only was this the first stationary orbit satellite to be launched, but it was also the first comsat to be spun for gyroscopic stability. But most important of all, it finally dispelled all doubts about this orbit for comsats.

Although the 0.27-second delay was noticeable in telephone conversations, test panelists judged the effect not objectionable. Although the higher path losses were certainly present, other

financial considerations more than compensated for this disadvantage. Earth stations could be greatly simplified since they did not have to track a moving satellite. Previous plans that required two tracking antennas at each site (one following the comsat being used, the other acquiring the next satellite) could be dropped. These major cost savings could be applied to larger antennas with higher gain, higher transmit-

Fig. 2. Orbital dynamics of Early Bird (which was later renamed Intelsat I), the first of the commercial communications satellites.

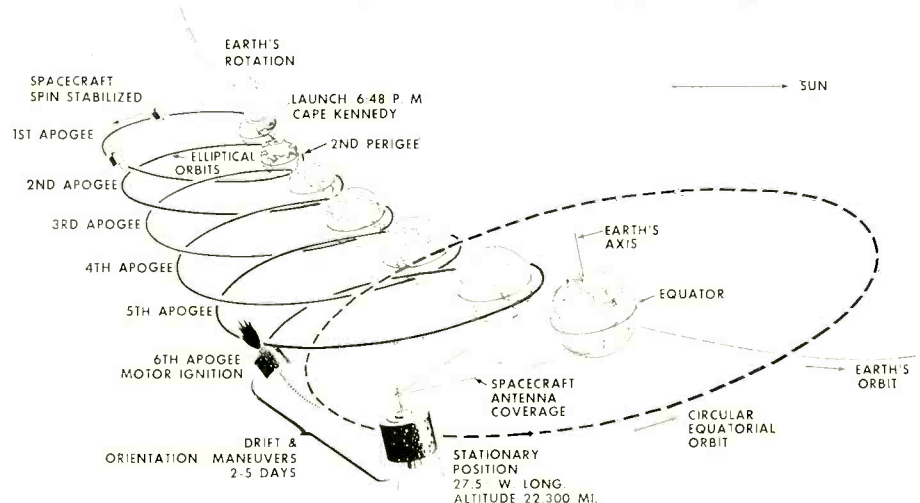

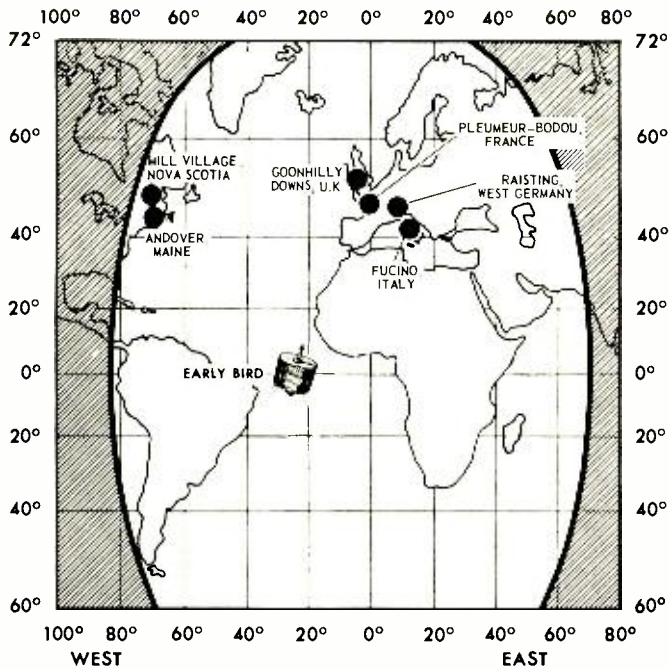

Fig. 3. The Early Bird communications system in June, 1965. The earth station at Mill Village was just being completed.

ter powers, and more sensitive receivers. In addition, the elimination of tracking would produce large operating savings. The result of these comparisons was heavily in favor of the synchronous satellite.

In the space segment, great savings were also evident. Syncom proved that a simple station-keeping system could be used to keep the satellite fixed as a stable platform over the earth. Three satellites, rather than 20 to 50, would cover the entire world. It was clear that these platforms could use antennas that radiated power only at the earth disc in view (about 17°) and that narrow-spot beams could be used and directed at high traffic points.

As a result of these considerations, *Intelsat* decided to perform a synchronous experiment to aid it in deciding between medium and stationary altitudes. The experimental satellite

was to be twice as heavy as Syncom (utilizing an improved Delta), transmit more power, and employ wider bandwidths. It was also expected that this satellite would provide service urgently needed by NASA for Apollo. A contract for this satellite (which was later named *Intelsat II*) was awarded to *Hughes Aircraft*, developer of Syncom, and the first launch of four experimental satellites was scheduled for late in the year 1966.

Concurrently, *Hughes* proposed that a slightly modified Syncom be orbited early in 1965 to provide early operational experience. This proposal was accepted and at 7:02 p. m. April 6, 1965 *Early Bird* (later renamed *Intelsat I*) was ejected into a synchronous elliptic transfer orbit (perigee 195 miles, apogee 23,000 miles) by the third-stage of a thrust-augmented Delta launch vehicle. See Fig. 2.

For three days the satellite was tracked to determine its orbital parameters and on the sixth apogee a command was sent from the *Comsat* earth station at Andover, Maine to fire the apogee motor. This circularized the orbit at synchronous altitude and the first commercial *comsat* was in a stationary orbit. For the next few days the attitude control gas jets were fired occasionally to further refine the orbit and position *Early Bird* at 27.5° West longitude over the Atlantic (east of Brazil).

At this time there were only five earth stations in operation that could utilize *Early Bird*. These were the *Comsat* station at Andover, Maine (then leased from AT&T which had developed it for Telstar), the British GPO station at Goonhilly Downs, the French research station at Pleumeur-Bodou, the German Bundespost station at Raisting, and the Italian Telespazio station at Fucino (see Fig. 3). Under completion was the Canadian station at Mill Village in Nova Scotia. New *Comsat* Pacific gateway stations were under construction at Brewster Flat, Washington and Paumalu, Hawaii.

Although only few earth stations were in operation, *Early Bird* proved its value early in June, 1965 when it provided emergency commercial service for eight days while an Atlantic cable break was being repaired. This was prior to formal inauguration of *Early Bird* TV service on June 28, 1965 in a transatlantic dedication ceremony by British and Canadian Prime Ministers Wilson and Pearson, West German Chancellor Erhard, and President Johnson.

Although *Early Bird* proved to be quite successful, it was

Table 2. Important characteristics of a number of experimental communications satellites.

Satellite	Launch Year	Comsat Weight (lbs)	Orbit ¹ Weight (lbs)	No. of Repeaters	Repeater ² Bandwidth (MHz)	Total Radiated Power (watts)	Antenna Type	Design ³ Capacity (circuits)
Telstar	1962	175	175	1	50	2	Omni	300
Relay	1962	172	172	1	23	6	Omni	150
Syncom	1963	150	75	2	5/10	16	Cloverleaf	Limited
Intelsat I (Early Bird)	1965	150	75	2	25	20	Cloverleaf	240
Intelsat II	1966	358	190	1	126	25-35 ⁴	Cloverleaf	240-480 ⁴
IDCSP (Military)	1966	100	100	1	20	2	Omni	23
ATS-1	1966	1616	775	2	25	330	Electronic de-spun	600
ATS-3	1967	1616	775	2	30	850	Mechanical de-spun	600
ATS-E	1969	1625	670	2	30	590	Planar array	600

NOTES: 1. After firing apogee motor (if any); 2. Nominal bandwidth of each independent repeater; 3. Two-way telephone calls ("circuits"); 4. Depending on satellite antenna pattern.

limited in power, capacity, and multiple-access capability (see Table 2). In this tabulation of experimental comsat characteristics, the orbital weight of the synchronous satellites is lower because of the loss of apogee motor propellants. The number of repeaters listed is the number of active repeaters and does not include standby redundant repeaters.

Early Bird's two 25-MHz bandwidth hard-limiting repeaters each provide 10 watts of effective isotropically radiated power (EIRP) through a cloverleaf antenna pattern which was squinted to favor the Northern hemisphere. Since the repeaters are not linear, only a single FM-modulated carrier can be handled by each (with up to 240 voice channels or one TV channel). This means that only one earth station on each side of the Atlantic can simultaneously use each of the repeaters. Of course, these two stations are required to complete both ends of two-way telephone conversations ("circuits"). As a result, all Early Bird telephone traffic must first be routed to a single gateway earth station. Four stations in Europe and two in North America have taken turns in using Early Bird and multiple-access (the more desirable multiple use of the satellite by many stations) has not been possible. Multiple access would have to wait for the 1967 launch of Intelsat II.

Aside from its technical limitations, Early Bird conclusively proved the many advantages of stationary satellites and

so, in February 1966, Intelsat formally voted to develop synchronous satellites exclusively. Today Russia is the only country still retaining non-synchronous comsats. This is partially because much of Russia is north of the 60° latitude where low earth-station elevation angles are required to reach a synchronous equatorial satellite. Low grazing angles require earth-station locations without obstructions on the southern horizon and are more subject to atmospheric propagation effects. Canada, however, which also has much land area above 60°, has chosen synchronous satellites as the method it will use to reach its northern cities. This suggests that Russia's continued use of its 12-hour elliptic-orbit Molniya system is for largely military and financial reasons; the satellites are hard to view from other countries and investment in the system has been too great to warrant a change.

Intelsat II

Like Early Bird, Intelsat II was to be experimental and was to help decide between synchronous and medium altitudes. As it turned out, this decision was reached well before the first Intelsat II (called Lani Bird by the Hawaiian press) was launched on October 26, 1966. Unfortunately, the satellite's apogee motor did not fire properly and so the comsat remained in its elliptical transfer orbit. Lani Bird did, however, provide limited commercial (Continued on page 66)



Launched on Jan. 24, 1965 Echo II is still the largest satellite in orbit. Measuring 135-ft in diameter, the 547-lb reflecting sphere is made of aluminum-coated Mylar. Seventy-two envelopes of pyrazole crystals released gas in sunlight to inflate sphere. This particular satellite, of course, was not an active repeater, but merely served as a reflector of radio signals.

The world's first stationary-orbit satellite, Syncom, revolutionized satellite communications. This 75-lb satellite proved that the geo-stationary synchronous orbit is the best for communications.



Telstar, launched July 10, 1962, was the second medium-altitude comsat to use active repeater. Developed by Bell System and launched by NASA, the 175-lb satellite provided the first transatlantic TV and telephone transmissions. Spiral antenna at top was for telemetry and command, while communications signals were handled by phased array around the middle.

Early Bird (later called Intelsat I) is the world's first commercial communications satellite. Weighing 75 lbs, this synchronous-orbit satellite provides 240 2-way voice channels between U.S. and Europe.

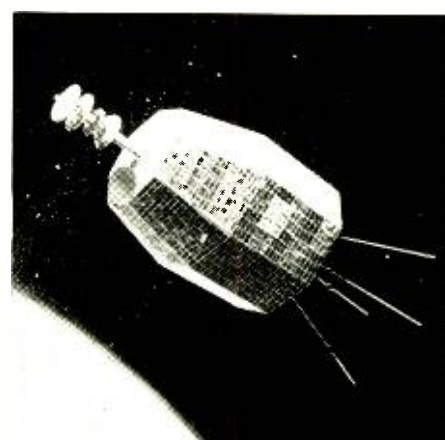

NASA's experimental medium-altitude active repeater satellite, Relay, provided over 3 years of test transmissions. The 172-lb satellite received at 1725 MHz and transmitted at 4170 MHz using the two disccone antennas at top. Dipoles at the bottom are for telemetry and command. Relay was visible between U.S. and Europe for as long as 70 minutes at a time.

Successor to Early Bird, Intelsat II is more than twice as large. Three of these satellites are providing communications to both northern and southern hemispheres in the Atlantic and the Pacific basins.

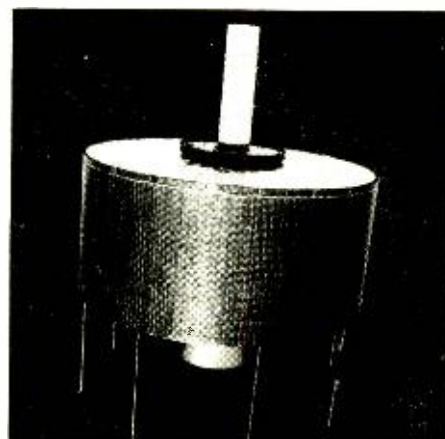
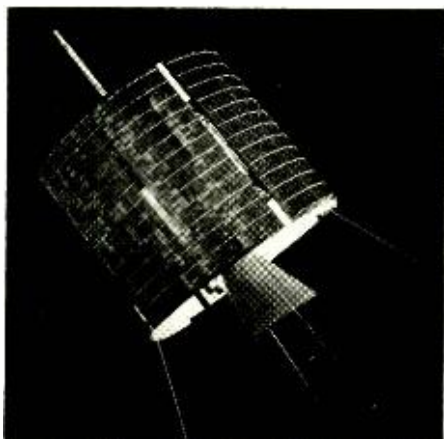
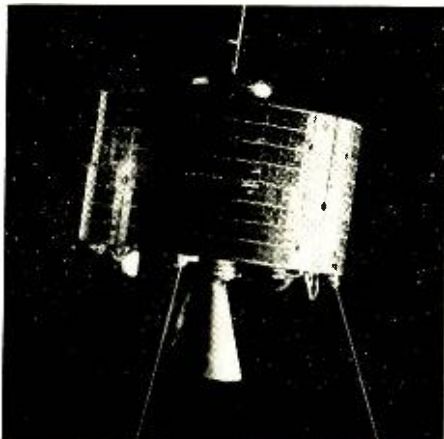

ATOMIC RADIATION: Measuring Techniques

By JOSEPH H. WUJEK, Jr.

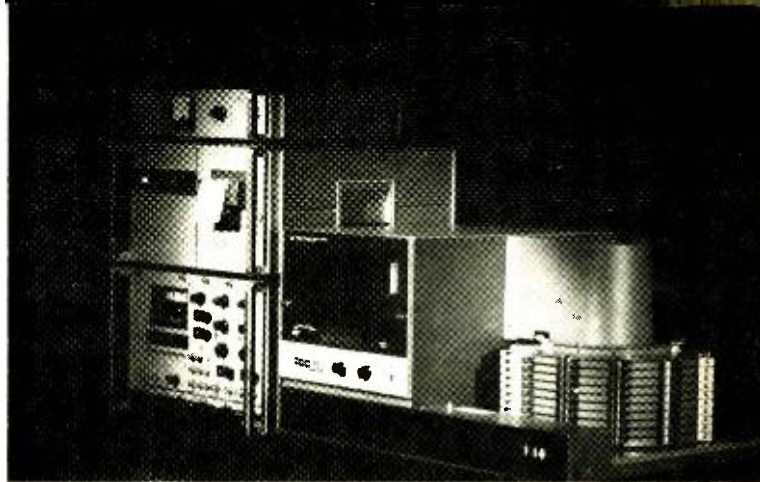

Hewlett-Packard developed this nuclear counting system. Radioactive samples in trays (right) are automatically selected and monitored. The level of radiation is shown by lighted numbers on the scaler console and by punched paper tape.

Part 3. An examination of the basic circuits that are used in spectroscopy to measure accurately the amount of radiation.

BEFORE examining some of the circuits and systems used in radiation measurement, we should state the design goal of an ideal radiation measurement system. Ideally, a radiation measuring system should detect the presence of radiation, identify the types of radioactive particles, and measure the flux level (number of particles per unit area in a given time period). The last function—sorting out the number of particles of a particular energy over a given time interval, is called “obtaining a spectrum” of the radiation, or “performing pulse-height analysis.” Of course, there may be additional design goals. We may require that the system perform calculations, such as averaging particle counts over a given time period and to display and/or print out these results. We may also require

the system to sound an audible and/or visual alarm when the radiation level exceeds some predetermined level. Too, we may require a very high resolution system, so that small energy differences between particles can be realized. There may also be a requirement to measure very low energy particles existing in the presence of high “natural” or “background” radiation, thus demanding a low-noise system with good background rejection. And, finally, the system may require a high degree of measurement precision, that is, a system which remains stable over a long time period regardless of use, variations in ambient temperature, or power-supply voltages. Clearly, every measurement system does not require all of these refinements. But most systems encountered in nuclear spectroscopy are designed with these considerations in mind.

Language of Nuclear Instrumentation

Unfortunately, many engineers in the nuclear instrumentation field use jargon or some words which are completely foreign to other areas of electronics. A good example is found in the expression “full-width at half-maximum.” This rather verbose statement is simply a measure of the sharpness of a spectral line and hence is not very different from the “ Q ” used elsewhere in electronics. Other examples of this unique and sometimes cumbersome language is the scalar (flip-flop or bistable multivibrator) and the coincidence gate (*and* gate). Because workers in the industry persist in using this terminology, we offer a short glossary in Table 1 to aid the newcomer to the field. More formal and extensive definitions may be found in the “Standards of the Institute of Electrical and Electronics Engineers for Nuclear Science.”

Radiation Detector Circuits

All radiation detectors used in spectroscopy require some kind of amplifier. Fig. 1 is a simple amplifier used to provide “charge” amplification. In Part 2 (“Atomic Radiation: Detection Methods”), we showed why the capacitance of some detectors is dependent upon certain bias conditions and why it is advantageous to measure the charge deposited by an incident particle rather than to measure a voltage change.

If the circuit in Fig. 1 is treated as an operational amplifier, certain simplifying assumptions can be made. They are: the amplifier has high open-loop input impedance and high open-loop voltage gain. Thus, $e_o = Q/C_f$. This same circuit is used to perform the integration operation in analog signal processing. Again, if we assume the feedback

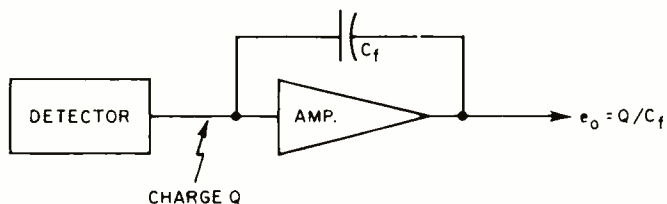
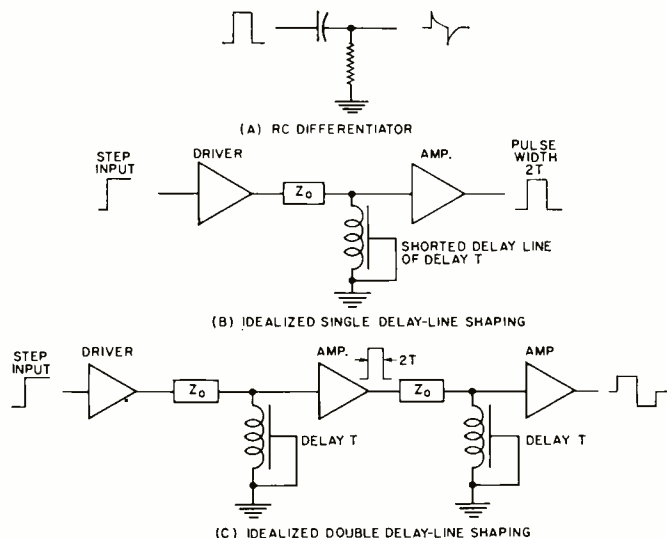

Fig. 1. Charge amplifier circuits must have high open-loop gain.

Fig. 2. Some common pulse-shaping networks. (A) is a simple RC differentiator, while (B) and (C) are idealized single and double delay-line shapers. (Z_o is characteristic impedance.)



capacitor C_f is a stable element, the output voltage is proportional to the charge generated by the detector. In most commercially available systems, temperature stabilities of better than 0.01% per degree C and voltage gains of 10 to 100 are common.

Resolution and threshold is detector limited, not electronically limited. In fact, circuit development has kept pace with detectors. Preamplifiers using FET input stages and solid-state detectors can be operated at very low temperatures, thus reducing system noise. (Most noise sources are strongly temperature dependent.) Bipolar transistors used in earlier systems exhibited considerable gain degradation at low temperature but FET devices do not, thus the FET system also improves over-all performance.

Systems have been operated at temperatures near liquid nitrogen with good results. The boiling point of liquid nitrogen is about 320° below zero F. At these temperatures there is relatively little thermal energy in the atoms within the crystal lattices, hence, little noise.

In addition, amplifiers used in radiation detecting instruments must be capable of fast recovery. Often, input signals several hundred times the input pulse amplitude occur, sufficient to saturate the output. These pulses severely overload the output. But, a recovery time of several microseconds is indicative of the state-of-the-art.

Pulse-shaping is an important consideration in establishing over-all system performance. Linearity, time-resolution, noise, overload recovery, and over-all precision are affected by the pulse-shaping network.

Perhaps the most commonly employed pulse-shaper is the simple RC-differentiator, often used in pulse work as well as linear circuits. Fig. 2 shows the RC pulse-shaper along with two of the more common schemes for shaping which employ delay lines. The various trade-off's, which determine which scheme is "best" for a given application, will not be discussed here, except to note that the choice is often dictated by system restraints.

Discriminators find widespread use in nuclear systems. Within the context of the present discussion, a discriminator is a circuit which changes its output state when prescribed conditions are fulfilled at the input. An integral discriminator is a circuit which changes state and remains in that state as long as the input is above (or below) a given voltage. A differential discriminator changes output state as long as the input remains between two given voltage levels. This voltage difference between these levels is commonly called the "window." In the more descriptive language of digital circuits, the integral and differential discriminators are, respectively, termed single-ended and double-ended differential voltage comparators.

The discriminator finds use in pulse-height analysis of the output of detector amplifiers. An array of these circuits can be used to route an output pulse to a particular counting channel, as shown in Fig. 3. Scalars, or other means, are used to count the number of pulses of each particular energy band (energy is proportional to pulse height), thus generating a spectrum (Fig. 4). Commercial pulse-height analyzers are avail-

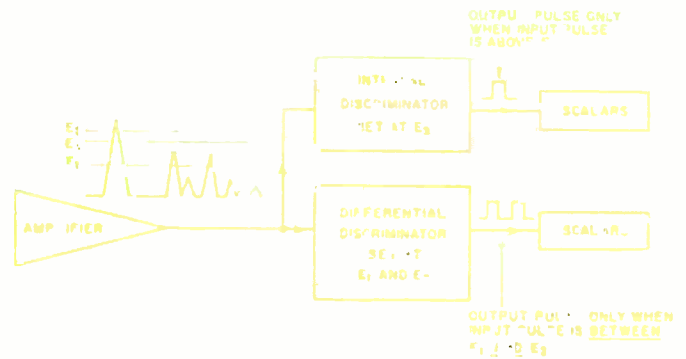

Fig. 3. Block diagram of a simple pulse-height analyzer.

able which show the spectrum on a CRT face, print out the number of counts in a given energy channel (band), and otherwise gather data from a pulse-height source. Systems of 1024 channels and more are available "off-the-shelf."

Coincidence and anticoincidence circuits (Fig. 5) form another basic building block in nuclear detection systems. A coincidence circuit yields an output, if and only if, two or more inputs signals are simultaneously present. The familiar *and* gate is an example of a coincidence circuit. The anticoincidence circuit provides an output whenever signals are not present at the same instant. This function is also

Table 1. A glossary of terms used in nuclear electronics system technology.

NUCLEAR TERMINOLOGY	ELECTRONICS EQUIVALENT	DEFINITION
Anticoincidence circuit	"Nand" gate	A circuit which provides an output only when all inputs are absent
Baseline	Reference level	The d.c. level from which all pulse signals are referenced
Bipolar pulse	---	A pulse which has appreciable amplitude in both directions from the baseline
Coincidence circuit	"And" gate	A circuit which produces an output only when all inputs are present
Detector	Transducer, sensor	A device which produces an electronic signal in response to atomic radiation stimulation
Discriminator (Differential)	Double-ended comparator	A circuit which produces a pulse output only when the input pulse is between two preset levels
Discriminator (Integral)	Single-ended comparator	A circuit which produces a pulse output when the input pulse is outside of a given level
FWHM (Full-width at half maximum)	---	The width of a signal or spectral line at half-amplitude
Overshoot	---	The spike which exceeds the smooth portion of a pulse
Pile-up	Bias shift	A departure from the baseline caused by rapid accumulation of pulses
Scalar	Binary, flip-flop, bistable multivibrator, toggle, etc.	A circuit with two stable states which can be triggered to the opposite state by appropriate means
Spectrum	---	A portrayal of pulse-height (amplitude) and number of counts of a particular amplitude
Standing current	Quiescent current, bias current	The current which flows in a circuit in the absence of signal
Tail-pulse	---	A pulse with decay time much longer than rise-time
Undershoot	---	The crossing of the baseline in opposition to the principal pulse, but of insufficient amplitude to be considered a bipolar pulse
Unipolar pulse	---	A pulse which has appreciable amplitude in one direction only

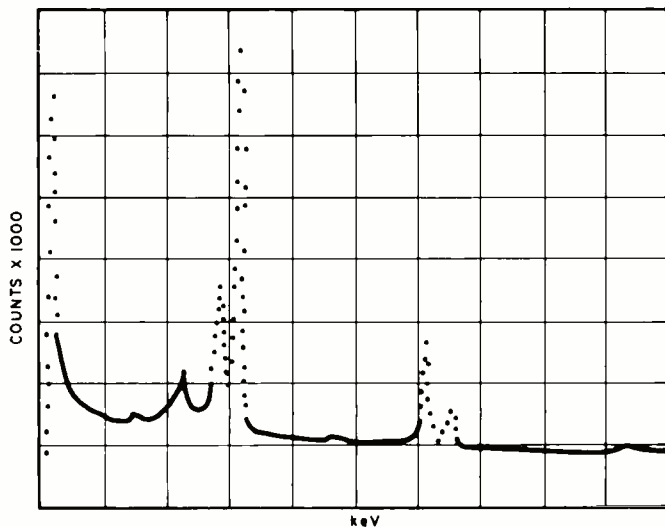

Fig. 4. Spectrum of selenium-75 (Se-75). Spectrum is shown peaking at 66, 81, 97, 121, 136, 199, 265, 280, 305, and 402 keV.

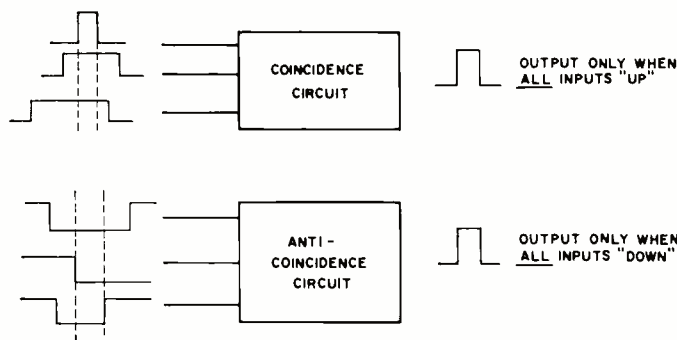

Fig. 5. Similar to an "and" gate, circuits like these are used to resolve events occurring a fraction of a nanosecond apart.

readily implemented with familiar digital circuits. Sophisticated coincidence and anticoincidence systems have been built which can resolve events occurring fractions of a nanosecond apart. Since many atomic reactions occur in sub-nanosecond times, these systems are extremely useful to the nuclear physicist.

The *count-rate meter* (CRM), which may or may not have a meter associated with it, is another useful circuit. The CRM, by the nature of its design, is at best a 1% instrument in terms of precision. In many applications, however, 1% is more than adequate.

The CRM is primarily an integrator and produces a voltage (or current) proportional to the rate at which pulses are applied at its input. In performing this function, the CRM is not unlike the pulse demodulator or the amplitude detector in an AM radio. Fig. 6 shows the principles involved in CRM circuitry.

So-called logarithmic count-rate meters have been built in a variety of configurations. One type employs a logarithmic ("log") amplifier as a stage. Others feature "scale change" circuits which automatically sense and change scale when the count rate goes outside the limits of the CRM scale in use at the time interval in question. Dynamic ranges of 10^5 and more can be fashioned in this way.

The availability and low cost of digital integrated circuits and associated readouts have tended to displace the CRM. However, narrow bandwidth requirements, small size, low power requirements, and circuit simplicity considerations tend to offset the digital circuit advantages in favor of the CRM. Remote sensing, as in space experiments, may impose severe restrictions on the number of available data lines, again favoring the CRM. In field instruments and certain special applications, the count-rate meter remains an important design.

One other system is worth noting because of its widespread use in nuclear instrumentation. The *analog-to-digital converter* (ADC), long used in computers, is used extensively in counting systems. Many varieties of ADC's exist, but most have in common the gating of a precision frequency. Fig. 7 shows the elements of a simple ADC. An integral discriminator compares the amplitude of the incoming pulse (stretched for a time period compatible with the conversion time) with a ramp voltage of precisely controlled length and amplitude. When the ramp begins, pulses of known frequency are gated into a scalar chain. When the ramp voltage reaches the voltage of the pulse, the pulses are gated off by the action of the discriminator (comparator). The number of pulses stored in the scalar chain is thus proportional to the amplitude of the signal. The ADC is then reset and awaits the next incoming signal for a repeat of the cycle.

In practice, ADC's have been built with clock rates of 100 MHz and more, and conversion times of fractions of a microsecond. The precision of the conversion is proportional to the number of digital bits (flip-flops used) and hence, in the scheme just outlined, the time of conversion. Thus, if we had six scalars and a 10-MHz clock, conversion could take as long as $6.3 \mu\text{s}$. This is found by taking $2^6 - 1 = 63$, the bit storage and multiplying by the clock rate of 100 ns. Other schemes, some rather elaborate, improve upon this basic time conversion and precision limitation.

In addition, the somewhat unique (unique to nuclear work) applications of the circuits already described, nuclear instrumentation systems make use of a variety of hardware common to the electronic art. Core memories, X-Y plotters, CRT outputs, digital printers, to name just a few, are often an integral part of a nuclear counting system. Direct interfacing with computers is becoming commonplace, enabling the scientist to escape much of the routine work of experimentation and data reduction. Improvements in detectors, especially in low-noise detectors, enable the experimenter to perform measurements which were beyond the state-of-the-art only months earlier. As with so much in modern science and technology, electronics holds the key to new discoveries. ▲

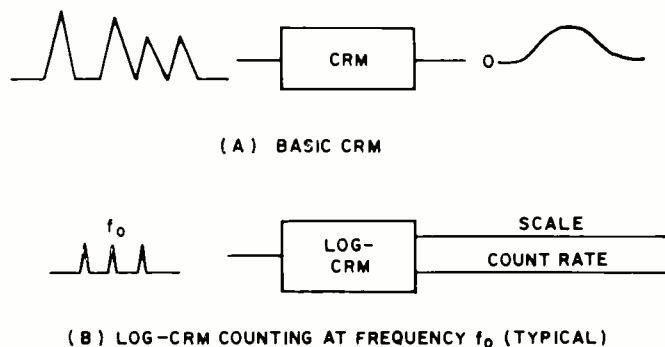
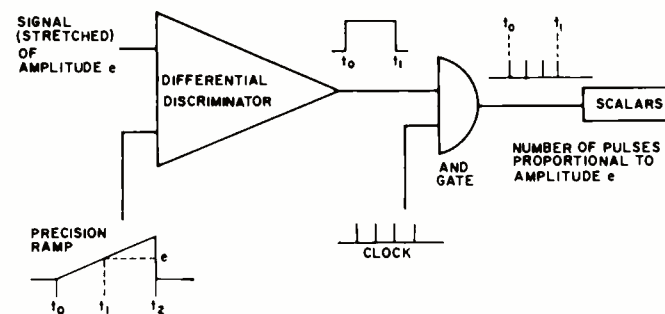

Fig. 6. In the basic CRM (A), the output voltage is proportional to the input pulse frequency. In the log CRM (B), the average signal rate f_0 is represented at the output by a count rate voltage (0.5 V d.c.) and a scale voltage (1.0 V d.c.). If the input rate is doubled, the scale voltage rises to 2 volts d.c.

Fig. 7. Elementary analog-to-digital converter is shown below.



RECENT DEVELOPMENTS IN ELECTRONICS

Disposable Electronic Thermometer. (Top right) The nurse is inserting a disposable plastic rod with a tiny metal slug imbedded at one end into a heat-sensor device that will register its temperature to within a tenth of a degree. The system is being hospital-tested as a possible substitute for conventional glass thermometers, which are often read incorrectly and may carry infection. A semiconductor sensor connected to a dual op amp performs the temperature measurement in this system that Computer Diode Corporation wants to lease to hospitals.



Electronic Abacus Uses LSI. (Center) The very small size of this new desk calculator (only $4\frac{5}{8}$ " by $9\frac{1}{2}$ " by $2\frac{1}{4}$ ") was made possible by using four large-scale integrated circuits and eight compact segmented readout tubes. This $3\frac{1}{8}$ -pound machine is completely silent and performs all the usual functions. Although prices were not available when we saw the machine, Sharp Electronics Corporation officials stated that it would be priced appreciably below other electronic desk-top calculators.

High-speed Laser-beam Deflector. (Below left) This experimental light deflector switches a laser beam from one spot to another in $35\mu\text{s}$ by moving a glass plate in and out of contact with a prism. The plate is driven by means of a ceramic piezoelectric disc bonded to the plate, across which 300 V are applied. Devices of this type may be used in future optical memories to position a laser beam for high-speed data recording and reading. The laser-beam deflector was developed by IBM.

Mobile Radar System for Army. (Below right) This radar system, used by the Army for re-entry vehicle and missile measurements, consists of a 30-ft dish antenna, a mobile electronic van, and a microwave communications system. Sylvania has just received a \$768,000 contract to operate and maintain the system (which they also developed and produced) for one year, and to install additional microwave links for communications over mountainous terrain at White Sands Missile Range.

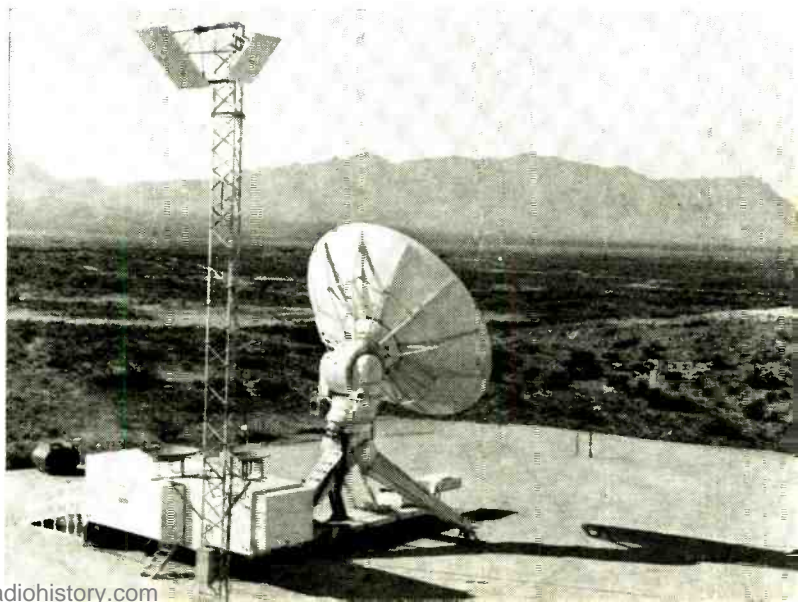
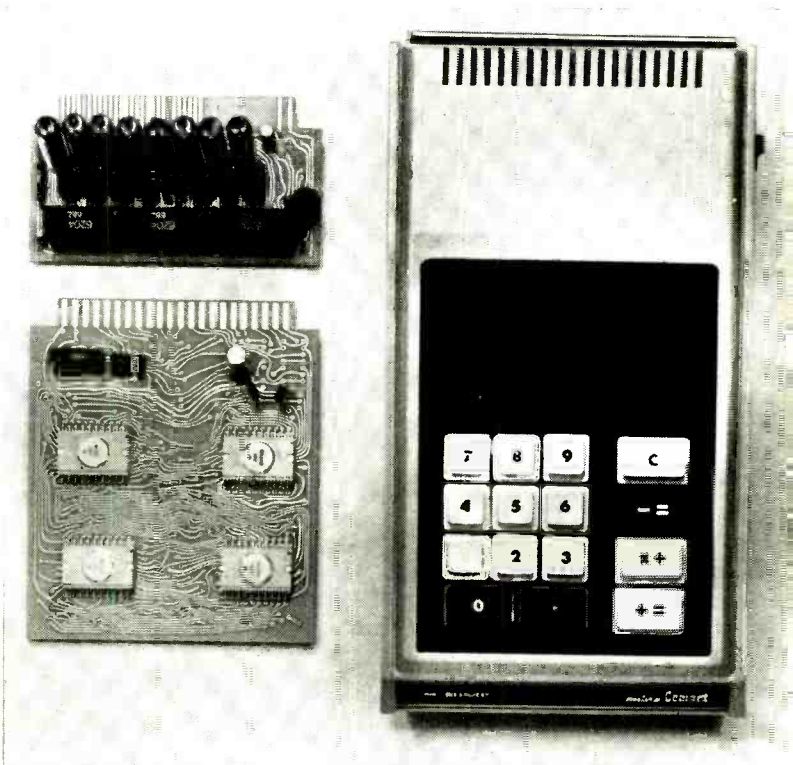

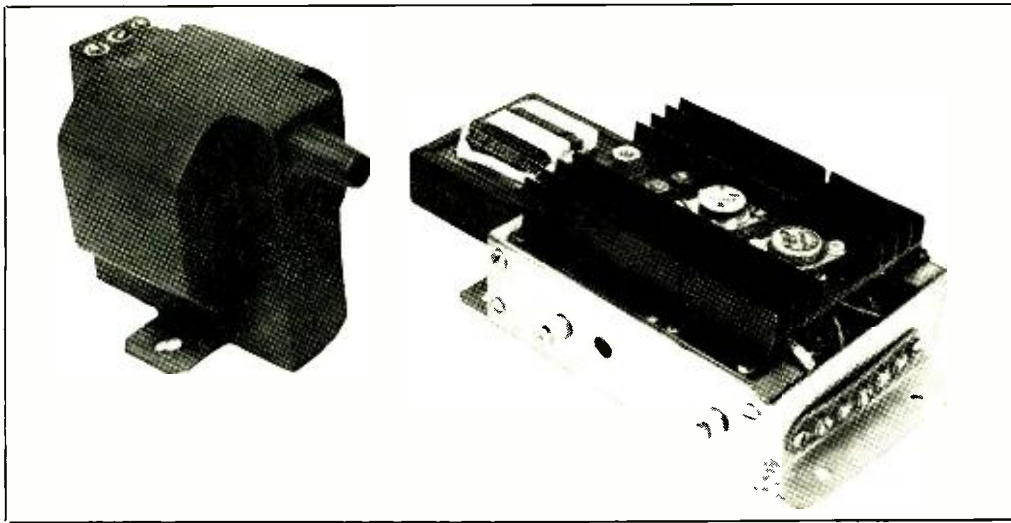

Circuit is built into a 6 by 4 by 2-in chassis box. Smaller heat sink at right has the driver transistor mounted on it, while larger heat sink has main switching transistor, zener diode, and output coupling diode. The choke is at one end and terminal strip at the other. The special high-voltage pulse transformer is shown at the left in the photo.

High-“Q” Inductive Electronic Ignition System

By HERBERT I. KEROES / President, Quaker City Transformer Co.

Maintaining good performance at high engine speeds, this highly efficient transistor system employs a special storage choke coil and pulse transformer to generate the high spark-plug voltage.

FROM the time of their inception transistor ignition systems have changed but little in form or design. It has become standard practice to use either a single or pair of switching transistors to make or break the current in an ignition coil. The coil is usually of conventional design but modified with an increased turns ratio. The idea is to increase the amount of coil current, reduce its inductance, and thus obtain a smaller time constant that is more favorable for rapid buildup in the primary. From a performance standpoint, some improvement is effected in obtaining a hotter spark at high engine speeds, but the relatively slow acceptance of the system by the public and even by automotive enthusiasts indicates that the amount of improvement in performance is not great. (Not to be overlooked with transistor ignition systems is reduced maintenance and increased life for the breaker points which carry much less current.—Editor)

Electronic ignition diehards remain convinced, and for good reason, that a great deal of improvement is possible with a good ignition system. Early in the development of the present system the author, an engineer, did not believe that performance could be greatly improved over that of a con-

ventional system in good repair. This assumption has since been thoroughly disproved, since performance with the system to be described has been startlingly better in areas that will be discussed later.

Clearly, what is required is a system that will take care of engine requirements in a more sophisticated way than the simple switched-coil method. The concept behind the development of the present system was that an ignition system is actually a type of high-voltage pulse generator, hence an improved system should result if developed along these lines. By using pulse methods a great improvement in efficiency is possible, and the power recovered from the portion normally lost can be put into the spark discharge.

The objective of any ignition system is to put the right amount of spark power in the right place at the right time. The last two requirements depend on proper engine timing, good wiring, and reasonably good plugs. Plugs may be fouled or poorly gapped, but a good spark generator will soon burn away dirt and oil, and will provide sufficient voltage to jump a worn gap.

At this point it is reasonable to inquire how much voltage and spark power the ignition system should provide. The voltage is about 20 kV with little spark advance. At high speeds the advance may be as much as 40 degrees before dead center, and less voltage will be needed. With regard to power, one authority states that as little as 0.002 joule (watt-second) of energy is needed to start combustion. It is reasonable to multiply this figure by a factor of 10 to account for losses due to leakage across fouled plugs and loading due to wiring capacitance. The actual spark power developed by the system described is 0.05 joule as measured across a one-megohm load.

Further considerations regarding ignition requirements, and taking into account factors of spark advance, fouled plugs, and ignition capacitance, leads to the following set of desirable objectives. These figures are representative of a

Fig. 1. Block diagram of inductive electronic ignition system.

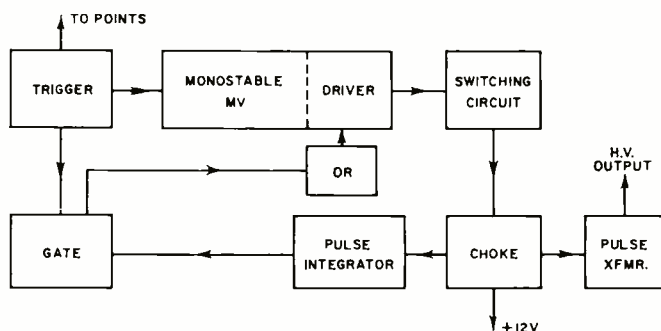

typical high-compression eight-cylinder automobile engine.

1. Voltage in excess of 22 kV across a 50-pF load below 2000 r/min.
2. Voltage in excess of 17 kV across 1 megohm and 50 pF at 2000 r/min.
3. Voltage in excess of 15 kV across 1 megohm and 50 pF at 5000 r/min.
4. An open-circuit voltage not exceeding 30 kV to prevent insulation breakdown.

These requirements are similar to those outlined by others and form a reasonable estimate of what an ignition system should provide. They are not easily met and among the systems tested by the author, other than the one described, all have failed to meet the third requirement and many the second.

To these requirements the author wishes to add another factor that seems desirable. The arc period should be sufficiently long to assure complete ignition of the explosive charge in the cylinder. This is another way of saying that the spark should be "hot" and have high energy content.

Description of System

This system differs in many ways from others previously covered in the literature. It may best be understood by referring to the block diagram of Fig. 1. Ignoring for the moment the drive circuit, the energy that ultimately goes into the spark is first stored in a choke coil that is supplied by current from a transistor switch. When the transistor switch is shut off, the inductive energy of the choke is transferred to the primary of a pulse transformer that steps up the voltage to ignition potential.

The combination of storage choke and pulse transformer constitutes an efficient form of pulse generator, in fact far more efficient than the conventional induction-type ignition coil. These coils are made with essentially an open magnetic circuit which is neither an efficient energy-storage device nor

a good pulse transformer. Separating the functions permits the use of closed magnetic circuits that allow for an optimum design.

The use of a separate pulse transformer provides another improvement. The discharge of an induction coil is oscillatory and takes considerable time to damp out. Ignition may occur in the first few oscillations; the balance of the discharge then represents wasted energy. In contrast, the discharge of this system is of typical pulse form and mainly rectangular in shape. Energy is thus concentrated during the firing interval.

The balance of the system consists of a drive circuit and a programming circuit that controls the transistor switch. The action of the circuit is as follows. When the ignition points open, a positive voltage is delivered to the input trigger circuit. The trigger, in turn, delivers a negative pulse to the input of a monostable multivibrator which develops a rectangular output pulse of short duration. This pulse is directly applied to the main transistor switch turning it "off." The choke and pulse transformer then "fire."

It will be noted that in the absence of the firing pulse delivered by the multivibrator the transistor switch is always "on." Therefore, the choke is always energized except for the firing interval. This has the advantage of providing more time to achieve a maximum buildup of current in the choke. By contrast, other systems switch the ignition coil "on" and "off" in unison with the points. The points are usually closed only about 60% of the time, and much less than that at high speeds due to inertia and contact bounce. Because of the effects of the time constant of the ignition coil, maximum current is severely limited.

This allowance of additional time is of importance only at high speeds where the firing interval, cylinder to cylinder, is of the same order of magnitude as the time constant of the choke. At low or moderate speeds it is relatively unimportant, hence a programming circuit has been added that defeats the multivibrator drive in this speed range. In the

Fig. 2. Complete schematic of unit. Ballast resistor R17 and high-voltage pulse transformer are externally mounted.

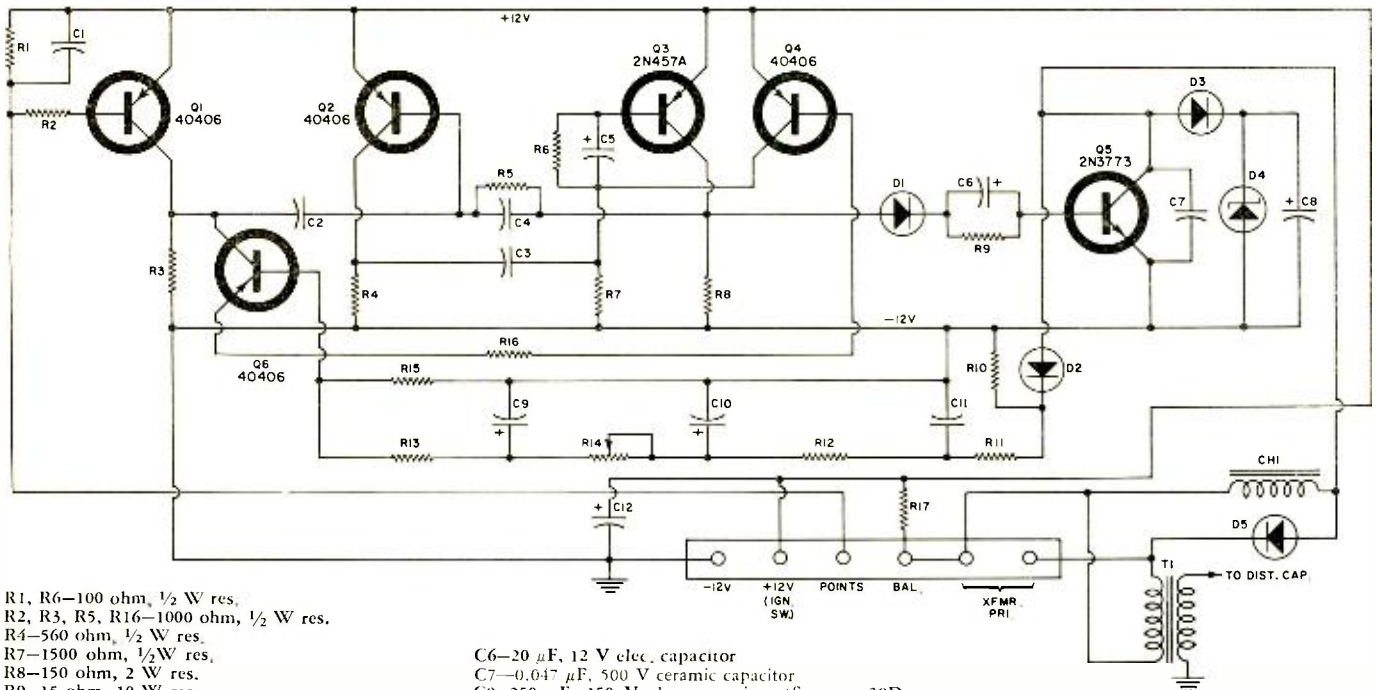

- R1, R6—100 ohm, 1/2 W res.
- R2, R3, R5, R16—1000 ohm, 1/2 W res.
- R4—560 ohm, 1/2 W res.
- R7—1500 ohm, 1/2 W res.
- R8—150 ohm, 2 W res.
- R9—15 ohm, 10 W res.
- R10—33,000 ohm, 1/2 W res.
- R11—56 ohm, 1/2 W res.
- R12, R13—15,000 ohm, 1/2 W res.
- R14—50,000 ohm pot
- R15—56,000 ohm, 1/2 W res.
- R17—1/4 ohm, 25 W ballast res. (Use four 1-ohm, 7 W res. in parallel.)
- C1, C11—0.1 μF, 100 V paper capacitor
- C2, C4—0.01 μF, 100 V paper or ceramic capacitor
- C3—0.25 μF, 100 V paper capacitor
- C5—250 μF, 6 V elec. capacitor

- C6—20 μF, 12 V elec. capacitor
- C7—0.047 μF, 500 V ceramic capacitor
- C8—250 μF, 150 V elec. capacitor (Sprague 39D-257F150HP4 or equiv.)
- C9, C10—1 μF, 50 V elec. capacitor
- C12—20 μF, 12 V elec. capacitor
- D1, D2—1 A, 200 p. i. v. diode (IR 10C2 or equiv.)
- D3—3 A, 200 p. i. v. diode (IR 3F20 or equiv.)
- D4—10 W, 120 V zener diode (1N3008 or equiv.)
- D5—15 A, 100 p. i. v. diode (IR 16F10 or equiv.)
- *CH1—5 mH, 10 A choke (Quaker City Type 703-5059, \$4.75)
- *T1—Pulse ignition trans. (Quaker City Type 506-5060, \$22.50)

- Q1, Q2, Q4, Q6—Silicon p-n-p transistor (RCA Type 40406)
 - Q3—Germanium p-n-p transistor (Delco Type 2N457A)
 - Q5—Silicon n-p-n transistor (Westinghouse Type 2N3773)
- Note: Heat sinks may be made using Delco Type 7270606 blanks.
- *CH1 and T1 can be ordered direct from Quaker City Transformer Co., 369 Shurs Lane, Philadelphia, Pa. 19128.

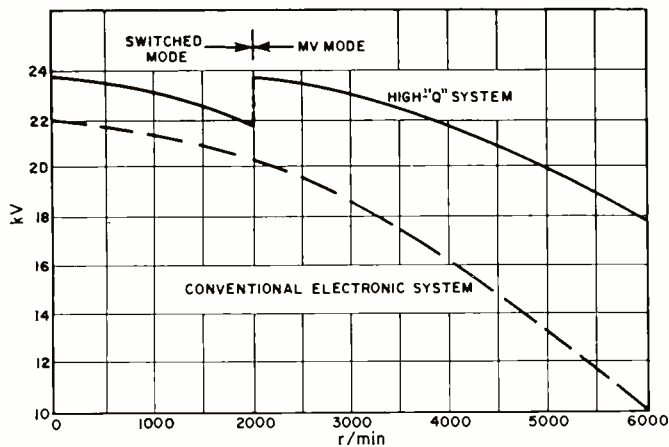

Fig. 3. Voltage measurements on high-"Q" system described compared to conventional transistor ignition system are shown here.

absence of a positive voltage delivered by the pulse-integrating circuit, the trigger circuit also provides a negative replica of the positive waveform generated by the points. This signal is transmitted through a gate and energizes the drive circuit through an "or" transistor. The driver then operates in unison with the points. With an increase of speed, the pulse integrator builds up a positive signal that at some preset speed disables the gate. The multivibrator then takes over. Actually, the multivibrator is never really shut off, so that the transition from one mode to the other is continuous and has no effect on ignition during the transition period.

This control feature has several advantages. At normal driving speed the battery drain is nominal and only slightly more than that of a conventional point and coil system. Thus, the battery is not subjected to an excessive load which might occur under adverse conditions, such as starting in cold weather. Moreover, heating in the critical transistor, the main switch, is much reduced, and it does not run hot even in crawling city traffic during hot weather. At high speeds the transistor does not run hot because maximum current is reduced due to the influence of the time constant of the choke and also because of the greater cooling draft in the engine compartment.

Practical Circuit Arrangement

The circuit of the system is shown in Fig. 2, and the transistors and associated circuits can be readily identified with the elements in the block diagram. The trigger is Q1, the multivibrator Q2 and Q3, the latter also being the driver. The main switching transistor is Q5, and the pulse integrator is formed by D2 and its associated RC filter network. The gate is Q6 and the "or" transistor Q4.

In the base circuit of Q1 it will be noted that there is a 0.1- μ F capacitor (C1) across resistor R1. Its purpose is to suppress a spurious trigger signal due to point bounce, and its effectiveness has been proven.

The main switching transistor is given somewhat more-than-usual zener-diode protection. Zener diodes have a certain impedance and, at the current levels in the circuit, the V_{CE0} rating of Q5 might be exceeded. Therefore, D3 and C8 have been added. Any voltage surge is now absorbed by C8 and it, in turn, is effectively clamped to the potential of the zener diode. The 0.047- μ F capacitor (C7) across Q5 is for the purpose of correcting the load line, thus preventing the excursion of voltage and current into the region of high dissipation where secondary breakdown might occur.

The choke (CH1) is of high-"Q" construction, rated at 5 mH, and is fed from an external ballast resistor of 0.25 ohm. This limits the collector current to 10 A maximum with Q5 continuously "on," and also limits the transistor dissipation to 22 watts. Therefore, no damage can occur if the ignition key is left on when the car is idle, other than the possi-

bility of finding a dead battery when you try to start.

The choke is diode-coupled via D5 to the primary of the pulse transformer (T1). The purpose of this arrangement is to block d.c. out of the primary where its presence would reduce the total inductive energy storage around the discharge loop. A 15-A diode is used because the instantaneous current flowing into the primary is 10 A and under pulse conditions there is some heating.

All transistors are p-n-p units except for the main switching unit. This selection was made to facilitate the use of the drive circuit shown. This has the advantage of driving Q5 more readily into saturation thereby minimizing heating. The driver transistor, Q3, is a germanium unit. At this time a complementary low-priced silicon unit does not seem to be available, however the germanium unit, provided with its own heat sink, has not caused any problems.

Control of transition speed in the switching mode is effected by adjusting the 50,000-ohm pot (R14) shown in the filter circuit of the pulse integrator. The usual setting is near maximum resistance and, at this point, switching occurs at about 2000 r/min. Switching occurs with a trigger-like action since output voltage increases as speed increases and *vice versa*. Hence there is no hunting in the selection of mode as engine speed changes.

Layout and Installation

The layout of the system is perfectly straightforward. The circuit is contained in a 6" x 4" x 2" high chassis. Two heat sinks are mounted side by side on the top, one about double the area of the other. The driver transistor is mounted to the smaller heat sink. The larger heat sink carries the main switching transistor, the zener diode, and the output coupling diode. All other parts of the circuit are mounted on a printed-circuit board housed inside the chassis. The choke is mounted at one end of the chassis and since it develops a considerable amount of heat its base is offset from the chassis by spacers of low thermal conductivity. The ballast resistor is a separate item mounted away from the chassis.

This particular arrangement of parts makes it possible to locate each item in the most favorable position. Placement of the chassis should be studied carefully. The ideal location is in a fairly cool spot, away from the direct heat of the engine. An unobstructed draft from the fan is beneficial. Usually the choice resolves itself to a location either on the inside fender wall or on the firewall. Another location worth considering is in back of and to one side of the radiator. The ballast resistor may be mounted in any convenient spot, usually next to the old one.

The distributor point-to-coil connection is reconnected to the input trigger terminal of the control box. It is advisable, but not essential, to remove the capacitor from the distributor. Its presence affects performance at high speeds, and it will result in some voltage being lost due to point bounce. The filter in the control box normally deals with this; however, its operation is affected by the presence of the distributor capacitor.

The pulse transformer should be mounted close to the distributor so that the lead from the transformer to the distributor cap is short and direct. There is no heating in the pulse transformer and heat can do it no damage, so it may be mounted near the engine.

One should make certain that ignition wiring is in good condition, and semi-rotted or oil-softened lines should be replaced with cable of good quality. Plugs should be properly gapped with a 0.030-in or recommended gap. It is not required that they be cleaned, since the system will do that in short order. Some maintain that gap spacing may be increased to 0.050 in with beneficial results. The author's experience does not confirm this, and all that really seems to happen is that the ignition voltage increases to a point which puts undue stress on the distributor wiring.

There seems to be little infor- (Continued on page 61)



The author, Assoc. Professor of Electrical Engineering at Pratt Institute, received his B.E.E. cum laude from CCNY in 1951 and attended Columbia and Hofstra Universities (M.A. in Physics, 1958). His areas of interest are solid-state electronics and computer logic. He is the co-author of "Semiconductor Fundamentals: Devices and Circuits" and is currently at work on a new book, "Electronic Circuit Analysis" which will be published very soon.

A SURVEY OF

Silicon Junction Diodes

By A. H. SEIDMAN / Contributing Editor

Notable progress has been made in developing higher-power rectifying, regulating, and switching diodes. Examples of what's available, their characteristics and cost, are given.

IN the past decade silicon junction diodes for rectification, regulation, switching, and r.f. applications have moved to the forefront in the hierarchy of electronic devices. The technology has progressed to a point where the manufacturer has more control over his process, ensuring greater yields, increased reliability, and lower device costs. For example, applications specialists have available today solid-state rectifier assemblies with peak reverse (inverse) voltage (p.r.v.) ratings of up to 50 kV and zener diodes that can dissipate as much as 300 watts of power. A variety of package types and diode arrays offer challenging design opportunities to the engineer.

There are more than a hundred firms manufacturing silicon junction diodes. Total sales in 1968 reached some \$170 million. Rectifier diodes accounted for approximately \$95 million of this sum; by 1972 this is expected to rise to \$120 million. Rectifier assemblies, enjoying a \$12 million volume in 1968, will probably reach \$20 million in 1972.

Selenium and copper-oxide rectifiers represented sales of \$15 million in 1968 but this figure is expected to drop to under \$10 million by 1972. Although selenium rectifiers have self-healing properties and exhibit good surge suppression, the superior characteristics of silicon devices have resulted in their gradually replacing seleniums in most applications. Copper-oxide rectifiers, because of their small forward-voltage drop, find their greatest use as instrument rectifiers like those used in average-reading a.c. voltmeters. With the greater use of electronic and digital instrumentation, though, this picture can change drastically in the future.

About \$56 million was spent for regulator (zener) diodes in 1968. According to experts in this field, this will drop to \$16 million by 1972. Reasons advanced for the decline are a saturated market for regulator diodes and the greater availability of integrated-circuit regulators. Low-level switching and r.f. diodes accounted for not more than \$10 million in sales in 1968. This market will probably taper off considerably owing to the wider use of integrated circuits in digital and communications circuits. High-power switching and zener diodes, however, should exhibit a steady growth in sales.

Rectifier Diodes

"Silicon rectifiers as a class used for bridges, full-wave rectification, single and polyphase, are essentially going through process refinement, product improvement, and cost

reduction," according to Rein Rist, Marketing Manager for Thyristors and Rectifiers at RCA. This assessment of the rectifier industry is also shared by many knowledgeable individuals in the field. What are some of the "process refinements" and "product improvements" worthy of our attention?

Since 1957 virtually all silicon rectifier diodes have been either of diffused or epitaxial type construction. The alloy junction as well as germanium devices are virtually things of the past in this area. To ensure high reliability, diodes are passivated by a silicon-dioxide coating that surrounds the structure, or the chip is enclosed in glass (glass passivation). The latter process permits greater stability and improved hermetic sealing, producing better performance and allowing the low-cost plastic encapsulation to be employed with a high degree of reliability.

Present device technology forces the manufacturer to make trade-offs; in general, the greater the p.r.v. the lower the average current rating. Single junction diodes are commonly available with p.r.v. ratings as high as 1000 volts. A representative example is Solitron's glass passivated chip (BF6-100C) with a p.r.v. of 1000 volts at 3 amperes. The device measures 0.09 inch in diameter, making it especially suited for hybrid integrated circuits. Many manufacturers are now providing small-size diode chips, having various characteristics and ratings, for the hybrid market.

To obtain greater inverse voltage ratings for silicon rectifiers than are available from a single chip, individual diodes with highly uniform breakdown characteristics are strung in series. This procedure results in rectifiers with p.r.v. ratings of 50 kV and higher. Because of their variable reverse leakage current ratings, in the past it was necessary to shunt each diode in a string with an RC network to ensure that every diode would take its share of reverse voltage. This is not required today owing to the uniform diode characteristics obtained in manufacturing.

Some representative examples include Semtech's "Minisitic" (SCMS 40K) where a number of junctions are metallurgically bonded at high temperature to provide p.r.v. ratings of 40 kV at 5-mA current. Solitron's "Solidpak" devices are rated up to 50 kV at 2.25 amperes. Motorola has a new sub-miniature series, the "Surnetic," with p.r.v. ratings of 5 kV at 250 mA. The field of applications for high-voltage silicon rectifiers is growing and includes power supplies for electrostatic equipment, high-energy capacitor-discharge systems,

Structure of Motorola multi-cell high-current rectifier. Each cell operates at 75% maximum current capability.

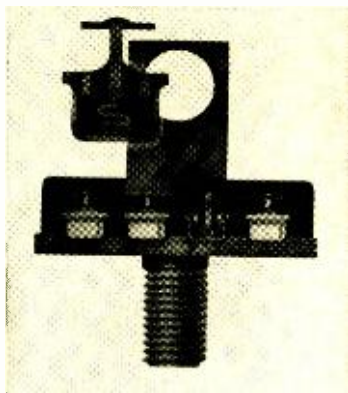

cathode-ray tubes, as well as some types of x-ray equipment.

High-current rectifiers, like the *Motorola* MR 1219, rated at 100 amperes d.c. and a p.r.v. of 600 volts, make use of multi-cell construction (see photo). In this configuration, a number of matched single diodes are connected in parallel and housed in a single package.

Many diode manufacturers have available multiple matched diode assemblies for a variety of applications. In the power-supply field, examples include single-phase center-tap, single-phase bridge, three-phase bridge, and six-phase star. Typical of what can be obtained is *Tung-Sol's* rectifier stack (16F611S23-2UV2) for a six-phase star rated at 600 volts p.r.v. and 290 amperes d.c. under forced-air cooling.

Sylvania has available epoxy packages containing matched quads (M9316) rated at 150 volts p.r.v. and 200 mA and a ring modulator (M9330) rated at 50 mA. Other examples are *Texas Instruments'* (TID 25) 16-diode core drivers. Housed in a JEDEC TO-89 package, the diodes are epitaxial planar and are designed to drive magnetic cores, drums, tapes, and discs.

Zener Diodes

Zener diodes, a term used to designate regulator and reference diodes, are offered in a large variety of ratings. The regulator diode, which enjoys the greatest application in power supplies, is available in zener voltage from approxi-

mately 2 to 200 volts with dissipation ratings as high as 300 watts. The regulator diode is, however, temperature-sensitive. In applications where the output voltage must be confined to narrow limits as temperature or current varies, temperature-compensated diodes, called reference diodes, are used.

A forward-biased junction has a negative temperature coefficient of 2 mV/°C at 5.5 volts d.c. and 6 mV/°C at 10 volts d.c. By a careful combination of junctions it is possible to fabricate reference diodes with stable zener voltages. For example, *Motorola's* 1N946B reference diode, rated at a zener voltage of 11.7 volts $\pm 5\%$ at 7.5 mA, has a maximum voltage change of 0.005 volt over a temperature range of -55°C to $+150^{\circ}\text{C}$.

High-power zener diodes find wide application in transient suppression, such as required for tactical radio equipment. Dr. J. Reynolds of *Delco Radio* has developed a zener diode capable of dissipating 300 watts of power in a single chip at a case temperature of 100°C ; the zener voltage rating is between 30 and 50 volts. The transient peak power dissipated for a pulse width of 0.1 ms can be as high as 100 kW. Eventually, zener voltage values greater than 200 volts at 300 watts dissipation may be realized.

According to Dr. Reynolds, a major problem in attaining high dissipation ratings in zener devices is a nonuniform microplasma distribution in the junction. A microplasma is a unit of avalanche current equal to 100 μA . Segregation of microplasmas leads to hot spots and the ultimate degradation of the junction. This phenomenon has limited the dissipation ratings of single-chip devices in the past. Dr. Reynolds has licked the problem by careful processing and bonding techniques. A special *p*-type silicon element of 0.1 ohm-cm resistivity with 1000-2000 dislocations/cm² is phosphorus-diffused. No enhancement layer is used and the silicon is alloyed between tungsten plates. The junction is tapered by approximately 10 degrees.

Other manufacturers use stacks of zener diodes to obtain greater dissipation ratings. Typical of this approach is *Motorola's* series of MPZ5 transient suppressors. Using six matched zener diodes, ratings of 350 watts dissipation at 25°C at minimum zener voltages of 16 to 180 volts are avail-

Table 1. Summary of some representative rectifiers, zeners, and switching diodes, along with costs.

DEVICE	I _{D.C.}	P.R.V.	ZENER VOLTAGE	DISS.	RECOVERY TIME	COST (QUANTITY)
RECTIFIERS						
Motorola MR 966A	0.25 A	5 kV	---	---	---	\$0.90 (1-99)
Motorola MR 1219	100 A	600 V	---	---	---	\$11.90 (25-99)
Semtech SCMS 40 K	5 mA	40 kV	---	---	---	\$11.50 (1-99)
Solitron BF6-100C	3 A	1 kV	---	---	---	\$13.30 (25-99)
ASSEMBLIES AND ARRAYS						
Sylvania M9316 Quad	200 mA	200 V	---	---	---	\$11.40 (25-99)
Sylvania M9330 Ring Mod.	50 mA	---	---	---	---	\$17.00 (25-99)
Tung-Sol 16F611S23-2UV2 6-phase Star	290 A*	600 V	---	---	---	\$71.38 (more than 25)
Texas Instruments TID 25 16-diode Core Driver	100 mA	60 V	---	---	20 ns	\$12.70 (10-99)
ZENER DIODES						
Motorola 1N946B Reference Diode	---	---	11.7 V	0.5 W	---	\$2.95 (1-99)
Motorola MPZ5-180 C Transient Suppressor	---	---	180 V	350 W	---	\$42.00 (25-99)
SWITCHING DIODES						
Unitrode UTX 4120	4 A	200 V	---	---	100 ns	\$8.50 (1-99)

*Under forced-air cooling

Motorola Semiconductor Products Inc., P.O. Box 20912, Phoenix, Arizona 85036

Semtech Corporation, 652 Mitchell Road, Newbury Park, California

Solitron Devices, 1177 Blue Heron Blvd., Riviera Beach, Florida 33404

Sylvania Electronic Components, Semiconductor Div., 100 Sylvan Rd., Woburn, Mass. 01801

Texas Instruments Incorporated, Box 5474, Dallas, Texas 75222

Tung-Sol Division/Wagner Electric Corp., Newark, New Jersey 07104

Unitrode Corporation, 580 Pleasant Street, Watertown, Mass. 02172

able. The transient peak power rating is 40 kW for a pulse width of 0.1 ms.

Switching and R. F. Diodes

Because of the increasing use of integrated circuits, the market for low-level discrete switching and r.f. diodes is dwindling. Exceptions to this trend are special arrays for functions such as ring modulators and core drivers, and microwave diodes. The latter enjoyed a market of \$24 million in 1968 and is on the ascent. High-power discrete switching diodes also find a viable market. An example is *Unitrode's* UTX-4120 miniature fast-recovery diode. Rated for a p.r.v. of 200 volts, the device switches 4 amperes with a recovery time (turn-off time) of less than 100 nanoseconds.

A new development, intended to replace the hydrogen thyatron in such applications as line-type modulators, is *Westinghouse's* Type 423 reverse-switching rectifier (r.s.r.). When reverse-biased, the device initially blocks and is non-conducting. At a critical voltage and current, the switch begins to conduct, rapidly reaching a low-impedance level. It remains conducting until the voltage or current is reduced

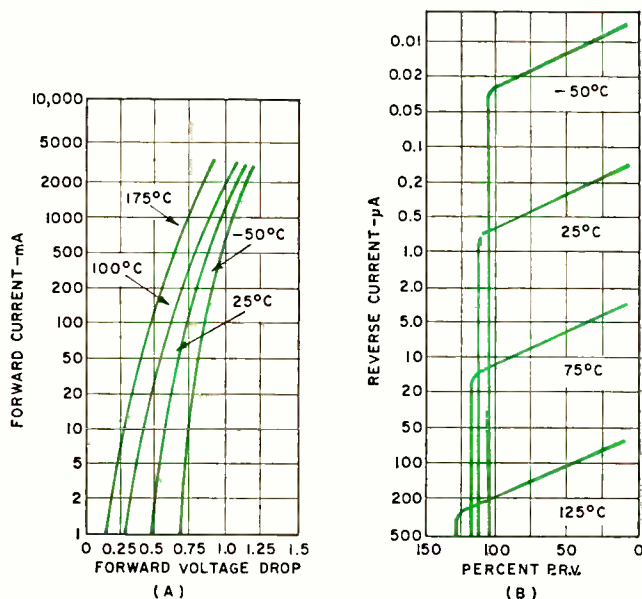

Typical (A) forward and (B) reverse characteristics of a representative rectifier diode at various operating temperatures. Device is one of Solitron's EF6 series.

essentially to zero. The minimum energy required to switch the device is 150 microjoules in the form of a high-voltage, fast-rising pulse.

The switch is capable of handling a maximum peak pulse current up to 2000 amperes with a typical di/dt rating of 10,000 amperes per microsecond. The switching voltage rating is as high as 1200 volts. In low-power (50 kW) applications, the device will replace the 5C22 thyatron. For higher switching powers, series-parallel strings of r.s.r. devices are employed.

Selecting Diodes

In selecting high-power diodes, the current-temperature derating curve is of paramount importance. The temperature scale for the curve can either be designated as case or ambient temperature and should be noted when calculating heat-sink requirements. Another item to consider is surge current; the manufacturer normally furnishes plots showing allowable peak surge current as a function of pulse width or frequency.

Because of the cost of many high-voltage stacks and high-current diodes of multi-cell construction, the engineer may be tempted to string individual diodes in series or parallel to achieve the higher ratings. Extreme care must be exercised.

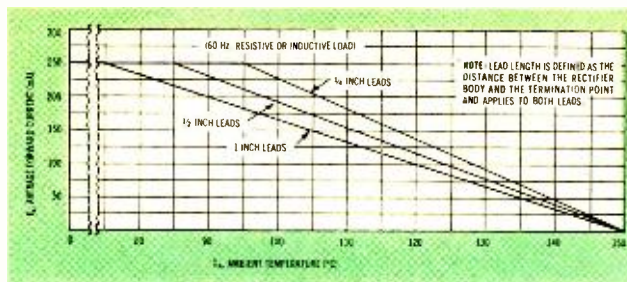

Example of a representative temperature-derating curve for h-v rectifier diode. Unit is a Motorola Type MR990.

In series stringing of diodes, parallel RC combinations across each diode are generally required to ensure equal distribution of voltage drops across the diodes when they are exposed to a reverse voltage. One technique used in paralleling diodes is to derate the current rating of each device by approximately 25 percent.

For most applications requiring zener-type diodes, the regulating diode will suffice. In critical applications, however, the reference diode must be considered. Device dissipation is an important factor in all cases. If the zener diode is used for transient suppression, a common application for a high-wattage device, the surge-power rating becomes especially important.

The reverse recovery time is the significant parameter for switching diodes. Forward recovery time, which is a function of the driving current and its waveform, is generally not of concern in the majority of applications. Peak reverse voltage and maximum switching current are other parameters to consider in selecting switching diodes.

The Future

A real challenge facing the solid-state diode manufacturer is the development of single-chip devices with greater voltage, current, and power-dissipation ratings. Instead of using a string of diodes to provide a high p.r.v. rating or a number of diode cells in parallel to achieve current ratings in the hundreds of amperes, there are advantages to having this accomplished on a single chip. Undoubtedly costs would be reduced and greater reliability realized.

Integrated circuits will have an ever-increasing impact on small-signal, low-level discrete components, like switching diodes. This segment of the industry will concentrate on the development of high-power switches with faster recovery times. Single chips with high power ratings should become more plentiful for application in hybrid circuits.

Over-all, the junction-diode industry appears to be in a healthy condition and likely to remain so for many years to come.

Performance of a typical reference diode over a wide temperature range. This particular diode is Motorola 1N946B.

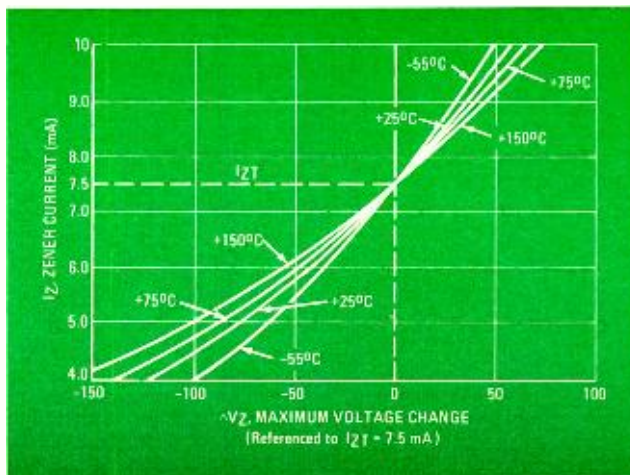



For the past three years the author has been responsible for disseminating technical information about Motorola products and developments. In this capacity he has worked with research engineers, production engineers, application groups, and product marketing personnel. Prior to joining the company, he worked for Ameco, Inc., preparing training material on use and maintenance of CATV equipment.

Variable-Capacitance Diodes

By IRWIN CARROLL / Supervisor

Technical Communications, Motorola Semiconductor Products Inc.

Diodes whose junction capacitance is variable with voltage are beginning to replace large bulky tuning capacitors. Here are the operating principles and important parameters.

VARACTOR diodes, or variable-capacitance diodes, are semiconductor diodes that have been optimized for the capacitance effect under reverse-bias conditions. Basically, they can be divided into two main applications categories: *tuning* and *harmonic generation*. As might be expected, they have different characteristic requirements, but do share the common trait of having a junction capacitance that is variable with voltage.

The capacitance effect in a varactor arises from the depletion region separating the *p* and *n* material in a diode. Recalling simple junction physics, the depletion region has a high resistivity because of the lack of mobile carriers and, as such, makes a good dielectric. When a reverse bias is applied to the diode, the depletion region is widened and if slightly forward-biased (not enough to cause forward conduction), the depletion region narrows. Fig. 1 is a simplified diagram of how bias affects the junction. The *p*- and *n*-doped regions are the "conductive plates" and, of course, the closer the plates of a capacitor, the higher the capacitance value, so that at zero, or slightly forward bias, the maximum capacitance value is reached. The minimum capacitance occurs when the depletion region is widest—at reverse breakdown voltage.

Used as a tuning diode, a varactor is biased between zero voltage and reverse breakdown voltage. (Actually paramet-

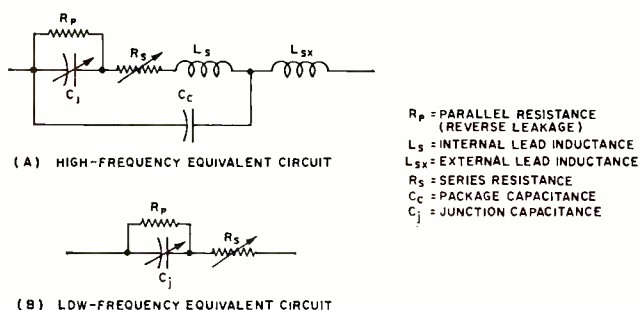

Fig. 2. Equivalent circuits for a varactor diode.

ric amplifiers would also fall into this category but will not be discussed in this article.) The equivalent circuit for a varactor diode is given in Fig. 2A. For low-frequency operation, the circuit reduces to that of Fig. 2B.

Doping profiles of varactors vary according to their intended use. Fig. 3 shows the four most common types encountered. The abrupt and hyper-abrupt junctions are used for tuning while the linearly graded and step-recovery junctions are used for harmonic generation. The abrupt junction can also be used for harmonic generation, but because the second harmonic predominates, it is impractical for high harmonics.

The step-recovery diode is a departure from the normal varactor since the capacitance change is quite small and occurs mostly near zero bias. Also, the step-recovery device makes use of forward bias and charge storage. The phenomenon that occurs is not too different from the reverse-recovery action of a common rectifier diode. Simply stated, when the junction is slightly forward biased, charge carriers from one region are injected into the other to form minority carriers in that area. If the lifetime of the carriers is longer than the period of the applied forward voltage, when the reverse voltage is impressed across the junction, most of the carriers are

Fig. 1. Behavior of depletion region under various bias conditions. The most commonly used symbols are shown.

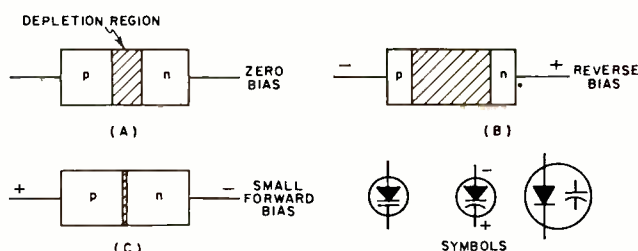

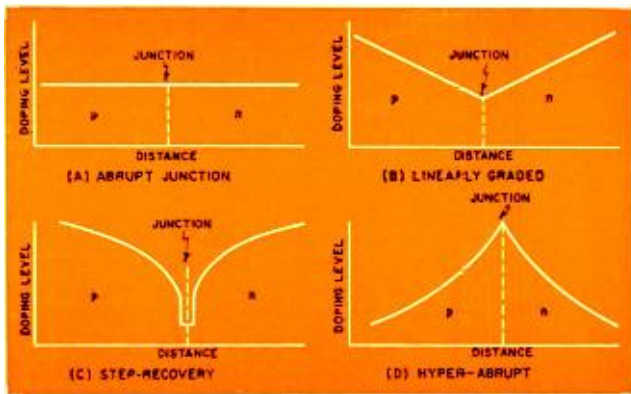

Fig. 3. Doping profiles for various varactor diodes.

returned to their point of origin in a compact bunch. While the carriers are returning, there is a high reverse current flowing; when they reach their point of origin, the current flow ceases abruptly.

The steep current waveform generated is rich in harmonics and when added to the other non-linearities of the varactor enhances its multiplier function. Step-recovery varactors have been used to obtain useful output levels for frequencies as high as the 25th harmonic of the input. Such devices are very economical when it is necessary to obtain crystal-controlled frequencies in the microwave region. Other devices can produce as much as a watt of power in the 12-GHz region (doubling from 6 GHz).

Tuning Applications

As a variable capacitor, the varactor is rugged and small, is not affected by dust or moisture, and is ideal for remote control and precision fine tuning. The current uses of tuning diodes span the spectrum from AM radio to the microwave region. Presently the cost of varactor tuning is a little higher than conventional methods but the cost is coming down quite rapidly as sales volume increases.

The most significant parameters of a tuning diode are the capacitance ratio, "Q", series resistance, nominal capacitance, leakage current, and breakdown voltage. For high-frequency operation, the package parasitics are also important considerations.

The capacitance ratio, which defines the tuning range, is the amount of capacitance variation over the bias voltage range. It is normally expressed as the ratio of the low-voltage capacitance divided by the high-voltage capacitance. For example, a typical spec which reads $C_4/C_{60} = 3$ indicates that the capacitance value at 4 volts is 3 times the capacitance value at 60 volts. The high voltage in the ratio is usually the minimum breakdown voltage specification. A 4-volt lower limit is quite common since it describes the approximate lower limit of linear operation for most abrupt-junction devices.

The curve in Fig. 4A is a normalized bias vs capacitance relationship for abrupt junctions and if the capacitance at a given reverse bias is known, the capacitance at other voltages can be determined. This curve follows the relationship:

$$C_T = C_c + \frac{C_0}{(1 + V_R/\phi)^\gamma} \dots (1) \dots$$

where: C_T = total capacitance, C_c = case capacitance (about 0.17 pF for glass diodes), C_0 = junction capacitance at zero bias, V_R = reverse bias voltage, ϕ = contact potential (about 0.6 V for silicon), and γ = power law of the junction (determined by doping gradient and is approximately 0.45 for abrupt junctions).

The capacitance ratio of tuning diodes varies in accordance with construction. Diffused tuning diodes are usually limited to a 4:1 capacitance ratio; alloy types, 5:1; and hyper-abrupt junctions can have ratios of 20:1 and higher.

The hyper-abrupt diode, because of its doping gradient (see Fig. 3D), has a $\gamma \approx 2$. A typical bias vs capacitance curve for this type of diode is shown in Fig. 4B. Particular effort has been devoted to this type of diode because of its high capacitance ratio potential. Indeed, it is the only type suitable for tuning the AM broadcast band, which requires a minimum tuning ratio of 10:1.

Temperature Stability & Figure of Merit

The temperature stability of a tuning diode is related to contact potential, ϕ . As shown in Eq. (1), temperature effects will be greatest at low values of reverse bias and will become minimal for high values of V_R . Changes in ϕ of 1.5 to 2.7 mV/°C are typical. This variation can be compensated, if necessary, by using a silicon diode with the same temperature coefficient in the bias supply, as shown in Fig. 5A.

The figure of merit or "Q" of a tuning diode should be specified at a given reverse bias and frequency. However, rather than stating "Q", series resistance at a given bias might be more practical. As shown previously in Fig. 2, R_S is in series with C_J but R_S is also variable with bias, decreasing in value as bias voltage increases. The "Q" for a capacitor with a series resistance is given by:

$$Q = 1 / (2\pi f C R_S) \dots (2)$$

where: f = frequency in Hz, C = capacitance in farads, and R_S = series resistance in ohms.

As reverse bias increases, both C and R_S decrease, so that

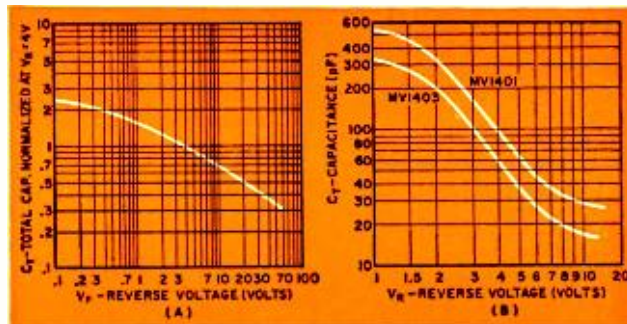
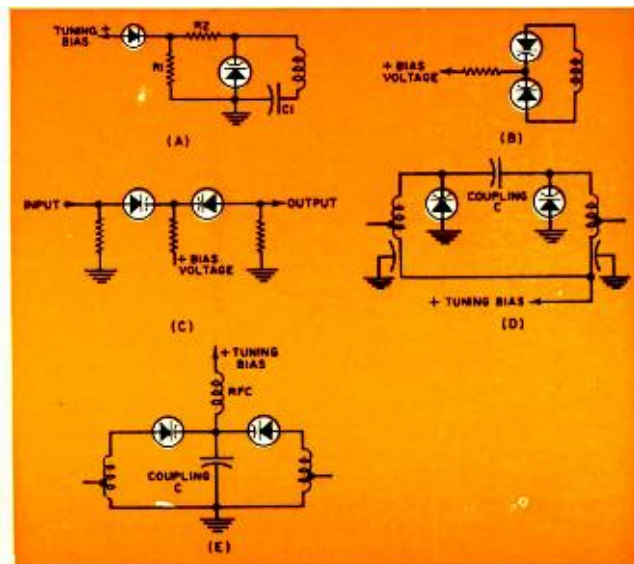

Fig. 4. (A) Normalized curve of capacitance vs reverse voltage for abrupt-junction diode. (B) Typical capacitance vs reverse voltage for the hyper-abrupt diodes.

Fig. 5. (A) Varactor-tuned circuit with diode for temperature compensation. (B) Using diodes back-to-back to reduce intermodulation distortion. (C) Varactors used as variable coupler. (D) Double-tuned circuit using parallel resonance. (E) Same but using series resonance.



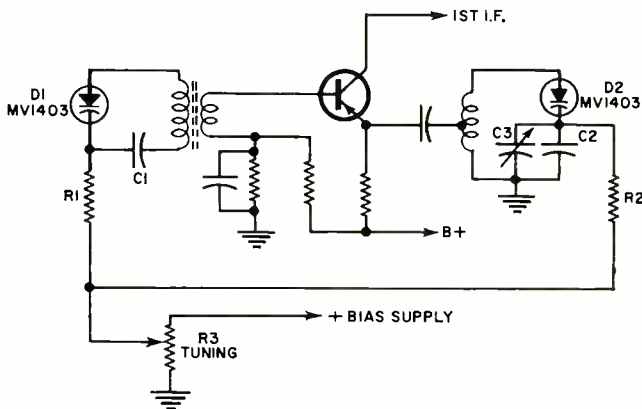

Fig. 6. AM radio front-end using varactor-diode tuning.

at a given frequency, "Q" is greatest at the highest reverse bias. For example, a diode that has a "Q" of 500 at 50 MHz and 2 volts reverse bias could have a "Q" of 2000 at the same frequency and 20 volts reverse bias. With this relationship in mind, if a tuned circuit is designed so that the highest frequency corresponds with a bias voltage that is at or near the maximum operating point, "Q" will be greatest at the highest frequency. Since selectivity is a function of "Q", selectivity will also be highest at the high end of the operating band.

Ideally, tuning diodes should have high "Q", low series resistance, low reverse leakage, and high breakdown voltage at any desired capacitance ratio; however, as might be expected, these parameters are not unrelated and improving one degrades another so that often a compromise must be reached. As a rule, diodes with low capacitance values have the highest "Q" and where this is the most important parameter, as in the high-selectivity tuners, the smallest possible capacitance value should be used. If large variations in operating temperature are expected, and temperature stability is the greatest need, large capacitance values should be chosen so that bias voltage can be kept at a high level.

Circuit Considerations

One of the simplest forms of varactor-tuned circuit was shown in Fig. 5A (with the compensating diode and R1 removed). Capacitor C1 is used for d.c. blocking and R2 (several hundred kilohms) provides isolation. However, in some applications the a.c. swing in the circuit might cause intermodulation distortion. Two things can be done to minimize this effect: (1) the a.c. signal should be as small as possible, and (2) a back-to-back pair of tuning diodes can be employed.

In the first case, for a given power level, low-impedance circuits have lower voltage swings—and voltage is the tuning mechanism; however, to maintain high "Q", the L/C ratio should be as small as possible. Fig. 5B is an example of the back-to-back diode method of reducing intermodulation. Note that the d.c. blocking capacitor is no longer necessary. This particular configuration is also useful as a variable coupling capacitor, as shown in Fig. 5C.

When operating at very high frequencies, the diode inductance, which has been ignored thus far, must be taken into account. As an example, the double-tuned, parallel-resonant circuit shown in Fig. 5D is useful at relatively low frequencies but has serious limitations at frequencies high enough for the diode inductance to become effective. Fig. 5E shows a double-tuned, series-resonant circuit where the diode inductances simply add to the circuit inductances and so do not degrade performance. By using series-resonant techniques, varactors have been successfully applied to the tuning of microwave cavities.

The development of hyper-abrupt junction diodes, with their high tuning ratios suitable for AM radio tuning, has stimulated a new and higher interest in such devices. This is

particularly true because of the many advantages they present for car radios which can be unhitched from their normal dash-mounted positions and placed in more easily accessible locations.

Fig. 6 shows the front-end of an AM radio modified for electronic tuning by means of varactor diodes. In this application, or any other where two or more stages are tuned simultaneously, matching of the diodes is important if the stages are to track one another. This means that the voltage vs capacitance curve for the diodes must be nearly the same. For the circuit in Fig. 6, a tracking error of up to 2 percent provided good results. By adding a ramp-voltage circuit and search oscillator to the circuit, search-tuning becomes a compact possibility. The frequency can be monitored by a voltmeter (measuring the bias voltage) calibrated in terms of frequency. Precision tuning can be achieved by using a multi-turn potentiometer in the bias supply.

Another obvious application for tuning diodes is for frequency modulation. The circuit of Fig. 7 has a center frequency of 52 MHz with a frequency deviation of ± 75 kHz. Voltage input, ΔV , is limited to ± 200 mV with the polarity chosen so that a positive ΔV corresponds to an increase in the diode reverse-bias voltage.

Other Circuit Applications

Step-recovery varactors are commonly used for high-order harmonic generation. Typical efficiencies may run around 30 percent for an 8 \times multiplication down to around 10 percent for a 25 \times multiplication.

The step-recovery diode can be used to great advantage as a duplexer, permitting a single antenna to be used for both transmitting and receiving. Normally, p-i-n varactors are used for this application but have the disadvantage of requiring an external bias circuit.

In multiplier applications, the power dissipation of the varactor becomes an important consideration. Also, the efficiency, η , defined as P_{out}/P_{in} is important. The latter is highly dependent on the multiplying factor, being as high as 75 percent for doubling and dropping to 10 percent for $\times 25$.

Future Growth

Although the cost of varactor tuning is slightly higher than mechanical methods, the advantages gained are usually well worth the difference. Compact, reliable, and what would be otherwise impractical circuits have been developed with tuning diodes. Gallium-arsenide tuning diodes for parametric

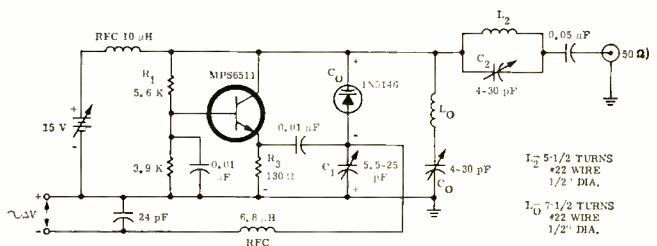

Fig. 7. A frequency modulator using a varactor diode.

amplification cost as much as \$400, silicon devices for u.h.f. and microwave tuning, \$12; matched sets of hyper-abrupt junction diodes for AM tuning, less than \$3 each, and plastic encapsulated diodes for tuning and a.f.c. applications in the v.h.f. TV and FM areas, less than \$0.40 each. (These are all small-quantity prices; however, as usage, hence volume, increases the price will drop to very competitive levels.)

Varactors for harmonic generation can cost from \$20 to \$150 with several high-quality units (up to 12-GHz operation) costing less than \$50. New devices such as Gunn-effect and IMPATT diodes and higher frequency transistors are reducing the need for some types of varactors but usage continues to grow. Two important areas of this growth are duplexing and digital phase shifting. ▲



Mr. Myers is an Applications Engineer with the responsibility for evaluating, rating, and supplying technical information on RCA LED's and related products. He has been an Applications Engineer with the company for 6 years.

Mr. O'Brien has been an RCA Product Development Engineer for seven years and has worked on a number of semiconductor programs, including thermoelectric power generation and IC's. He is currently responsible for process development and device design on commercial LED's.

Light-Emitting Diodes

By R. S. MYERS and J. O'BRIEN
RCA Electronic Components

These significant new solid-state devices can be used for indication and display, replacing incandescent lamps in a good many applications.

THE light-emitting diode, LED, a light source that can be used for indication and display wherever tungsten-filament, incandescent lamps are used, is among the most significant new semiconductor devices. Although it is still not fully developed, it is clearly destined to become one of the most commonly used semiconductors in military, industrial, and commercial electronics, as well as in consumer products, such as electrical appliances and automobiles. The LED will, by its nature, be more evident and have a greater direct effect on the consumer than the integrated circuit. In short, the LED will be seen everywhere; a bold prediction based on its usefulness, founded on the LED's inherent properties and advantages over other light sources.

The significance of the LED lies in the fact that it helps to fill a pressing need for a simple, trouble-free means of displaying information obtained by electronic equipment. At present, the output of such equipment is interpreted through pilot lamps, neon-glow readout tubes, cathode-ray tubes, and mechanical printers. Some of these devices

Fig. 1. (A) Arrows show light produced in a flat-geometry gallium-arsenide diode. At an incident angle greater than 15° there is a total internal reflection and re-absorption. (B) Hemispheric-geometry LED overcomes this limitation.

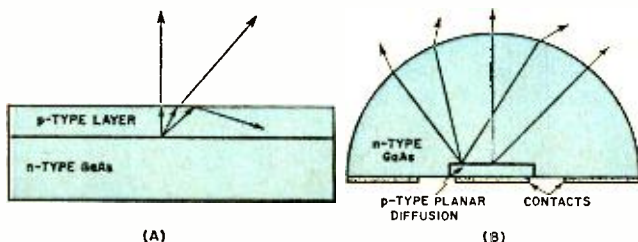
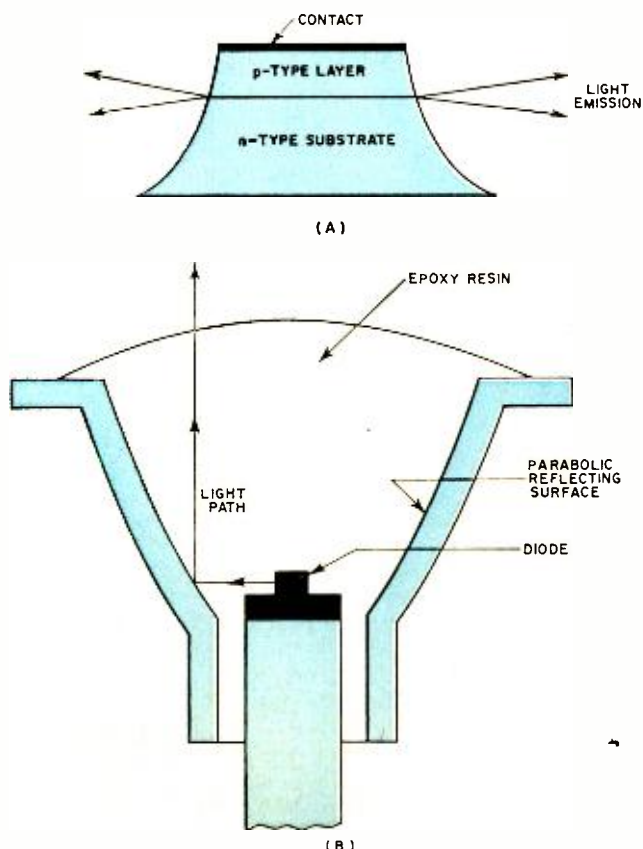

Fig. 2. (A) Construction of LED using edge emission of light. (B) Schematic of the RCA Type 40598A LED.



cost more than the equipment with which they are used. The limitations of these devices are overcome by the reliable, low-power, light-emitting diode.

The solid-state construction of this diode makes it a light source virtually immune to catastrophic failure and mechanical breakdown. It eliminates the need for sockets, special power circuits, and the additional operating tests necessary to check tungsten-filament indicator lamps. LED's can be used as reliable fault or warning indicators in power-supply monitors, blown-fuse indicators, logic-circuit status indicators, battery-charge indicators, and failed-car-light indicators, to name a few applications.

Beyond these simple "on-off" indicators are the display applications: alphanumeric outputs from computers and memory systems, and various pattern readouts from such diverse devices as watches, calculators, and measuring instruments. The use of LED's in digital instruments has already been demonstrated by three firms. The future growth of these displays will be accelerated by the simple IC driver circuits already being designed.

The LED's characteristics are best demonstrated by a comparison with a tungsten-filament incandescent lamp (see Table 1). Table 2 shows the wide range of LED's that can be manufactured within the present technology.

LED Operation

Some semiconductor materials can be made to emit light when excited in such a manner that recombination of an electron and a hole results in the emission of a photon. Although a *p-n* junction is not essential for electrolumines-

cence, since bulk materials have been made to emit light, it is still the most efficient means of generating large numbers of holes and electrons and exciting them into the energy levels needed for radiative recombination.

When a junction is forward-biased, electrons from the *n* region are injected into the *p* region where they recombine with excess holes. In the radiative process, the energy given up in a recombination is in the form of a photon whose wavelength corresponds approximately to the band-gap energy of the semiconductor. The generated photon then travels through the lattice until it is either re-absorbed by the crystal or escapes from the surface as light.

The wavelength of the emitted light is a function of the band gap of the material used for forming the junction. Pure gallium arsenide with a band gap of 1.4 electron volts emits in the near infrared region, while visible wavelengths may be obtained by using materials with larger band gaps, such as gallium phosphide (2.26 electron volts), which produces green light. When gallium phosphide is doped with zinc and oxygen, it produces red light and certain alloys of gallium arsenide emit reddish light with the actual wavelength dependent on the composition of the alloy used.

The optical power output of a device is determined, in general, by the internal geometry of the gallium-arsenide pellet and the type of package used. The simplest type of geometry is the planar or flat-geometry device in which a shallow *p*-type diffusion is made into an *n*-type substrate. Small-area contacts are applied to the *p* surface of the device, on a standard TO-18 header; light is generated in the *p-n* junction area and exits through the chip surface.

Table 1. Comparative characteristics of light-emitting diodes and conventional tungsten-filament lamps.

LIGHT-EMITTING DIODE	TUNGSTEN-FILAMENT LAMP
Relatively pure; single-color light	White light; output spread over visible and infrared spectra
Spectrum very stable and material-dependent but independent of drive	Spectrum stable and dependent on filament temperature; changes with drive
Minor thermal effects	Thermally activated
Solid construction	Vacuum-tight container and supports necessary to minimize thermal losses
Output changes with drive; delays in microseconds or less	Output depends on temperature; delays in tenths of seconds
Output varies with technology	Output very predictable
Up to 10 percent efficient over-all for infrared devices	30 percent efficient to eye; 80 percent efficient over-all
No wear-out mechanism	Thermal wear-out mechanism
D.c. power only; current can vary	A.c. or d.c. power; almost any voltage-current combination
More IC compatible	Less IC compatible
Inherently small	Always larger than LED
Easily focused to increase output	Generally too large for efficient focusing
Rugged construction	Subject to shock failure
Less light output	Greater light output
More expensive	Less expensive
Expanding technology	Fully developed technology

There are several limitations to the approach just described. As shown in Fig. 1A, the very high index of refraction of gallium arsenide results in a very low critical angle (15°) at the gallium-arsenide-air interface. Thus, any photons generated within the crystal which arrive at the surface with an incident angle greater than 15° are subject to total internal reflection and are usually re-absorbed within the crystal.

A structure which overcomes this limitation is shown in Fig. 1B. The gallium-arsenide crystal has been ground and polished into a hemisphere and a planar p region diffused into the base. By proper choice of crystal diameter, all light originating from the region of the junction can be made to arrive at the surface of the hemisphere with an angle of incidence less than the critical angle. Thus total internal reflection is virtually eliminated. Devices fabricated by this technique exhibit efficiencies about ten times greater than planar and flat-geometry devices.

Performance similar to, but less efficient than, that of the hemispheric crystal can be obtained by covering a flat-emission chip with a dome of some material, such as epoxy, that has a high index of refraction. An epoxy with an index of refraction of about 1.5 improves the performance of uncoated devices by about 2 to 3 times.

Another method of utilizing the light generated within a crystal takes advantage of edge emission, a mode in which light is emitted from the perimeter of the device, as shown in Fig. 2A. The Type 40598A infrared emitter uses edge emission; in this device light is emitted from the perimeter of a square-mesa-type diode that is mounted in a parabolic

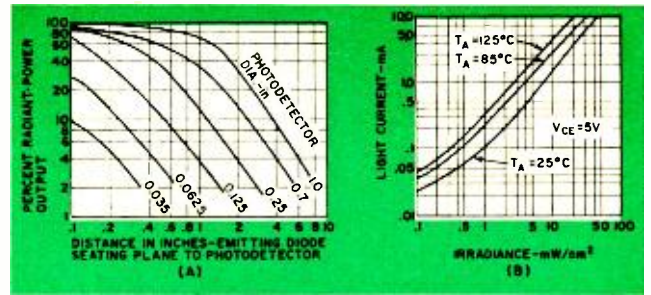

Fig. 3. (A) Performance curve for 40598A LED having a nominal output of 1.6 mW at 50 mA. (B) Performance curve for FPM-100 detector is used next to obtain light current.

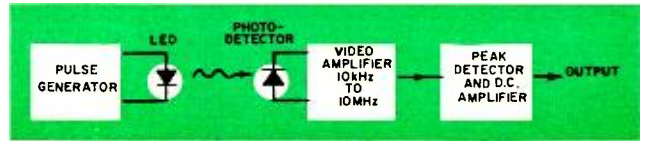

Fig. 4. Block diagram of a pulse light system with LED

reflecting surface, as shown in Fig. 2B. The emitting area of the diode falls within the focal plane of the parabola. An epoxy lens forms the optical window and aids in collimating the light to within 15° of the optical axis.

In the past, high costs have hindered the development of a market for devices like this. However, because costs have been steadily decreasing, the future appears promising. The fifteen-dollar-per-gram cost of gallium-arsenide wafers

Table 2. This listing shows the wide range of light-emitting diodes that are now being manufactured.

CATEGORY	EMISSION TYPE	CHARACTERISTICS	RANGE OF PERFORMANCE					
Indicator LED	Visible	Low current	Red light 1 to 100 fL* at 5 mA					
		Maximized output	<table border="0"> <tr> <td rowspan="3" style="font-size: 2em; vertical-align: middle;">}</td> <td>Green light</td> <td>80 fL</td> </tr> <tr> <td>Yellow light</td> <td>65 fL</td> </tr> <tr> <td>Red light</td> <td>500 fL</td> </tr> </table>	}	Green light	80 fL	Yellow light	65 fL
}	Green light	80 fL						
	Yellow light	65 fL						
	Red light	500 fL						
Display LED	Visible	Maximized output	Red light up to 500 fL					
		Thin edge	Yellow light up to 160 fL					
Film-recording LED	Visible		Yellow light 600 lm/W**					
Room-temperature emitter	Infrared	Special size	Line sources available					
		Secure illumination	8000 Å to 9000 Å sources available					
		Maximum performance	Up to 10 percent efficient					
		Used as isolators & couplers	Up to 0.002 current-coupling ratio					
Cryogenic-temperature emitter	Infrared	Maximized output	Up to 30 watts average					
Special-wavelength emitters	Infrared		8300 Å to 3600 Å to match photocathodes					

*fL = footlamberts; **lm/W = lumens per watt

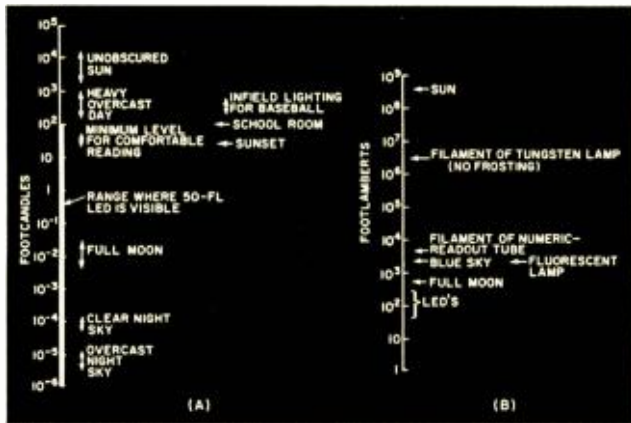

Fig. 5. (A) Representative light intensities falling on a surface along with (B) brightness of the various sources.

is still a problem, but refinements in crystal growth and better control of device fabrication processes promise to lower costs even further as a volume market begins to open up for light-emitting diodes.

LED Optical Systems

The performance of an optical system incorporating an LED is difficult to describe primarily because there are so many variables, including LED output, alignment of LED and detector, beam spread of LED output, required detector output current, range of radiation, and ambient light level.

In a given application, many performance factors are fixed. Manufacturers of LED's and detectors provide data which makes it easy to predict the performance of an optical system when these fixed values are known. The following paragraphs describe several applications of LED's and show how their performance may be predicted. For the purposes of this article, certain assumptions will be understood; namely, that all of the output of an LED is at one wavelength, that the emitted beam of light has uniform intensity, and that all parts of the system operate at nominal values and ratings.

Optical System with Maximum LED-to-Detector Coupling and No Lens. An optical system of this type is referred to as an *optical coupler*. It is used to provide voltage isolation and direct coupling of input and output; the isolation may be several thousand volts. The method of predicting the performance of such a system is as follows:

1. Look up total power received by the detector in data provided by the LED manufacturer.
2. Calculate power density on detector. Power density = [total power received (mW)]/[detector area (cm²)].
3. Obtain expected output from detector from data supplied by the detector manufacturer. Correct data for wavelength of LED, if necessary, by using data supplied for this purpose by the manufacturer.

As an example of the use of this method in actual practice, consider the performance of an optical coupler composed of an RCA 40598A LED and a Fairchild 0.06-inch-diameter detector (Type FPM-100) separated by a distance of 0.1 inch. The steps to be followed correspond to those outlined above in the general-method description and are as follows:

1. Total power received by the detector from the manufacturer's data given in Fig. 3A is $28\% \times 1.6 \text{ mW} = 0.45 \text{ mW}$.
2. Power density = $0.45 \text{ mW} / \pi (0.03 \text{ in})^2 = 159 \text{ mW/in}^2$ or 25 mW/cm^2 .

3. Detector output current from manufacturer's data in Fig. 3B is about 4 milliamperes at 5 volts unadjusted for wavelength, and, applying a correction recommended by the detector manufacturer, approximately 12 milliamperes at 5 volts adjusted for wavelength.

Optical System with Separated LED and Detector and No

Lens. A system with a separation between emitter and detector and no lens is needed for applications such as card readers, tape readers, object counters on production lines, and for simple intrusion alarms. The procedure for predicting the performance of this system is the same as for the optical coupler if a performance curve for the LED is available. For the important applications of card and tape readers, the information called for in steps 1 and 2 is available directly from the LED manufacturer.

For applications in which there is a large separation between the LED and the detector, the detector output is very small. Such a system becomes unusable when the ambient light produces more detector output than the LED. Intrusion alarms, photoelectric controls for production lines, and long-range signaling systems are plagued by ambient-light problems. Ambient light varies more than 100 million times from the dark of a movie theater to a bright sunny day and its exact level is not easily determined. Even indoors, the ambient-light level varies greatly because of window light, reflections, and shadows. Systems using LED's can be made independent of ambient light by taking advantage of the LED's high-speed pulse or high-frequency-modulation capabilities.

Pulsed and Modulated Light Systems

Pulsed or modulated light systems use detectors which respond to the pulse rise time or high-frequency modulation of the light emitted by an LED and ignore the absolute light level of the device. Tungsten lamps cannot produce high-speed pulses and therefore must be used with absolute-value detectors which require that the light of the emitting lamp be much greater than the highest ambient light expected. LED's can be used even if the ambient light is stronger than that emitted by the LED, as the following example demonstrates.

The 1 milliwatt of absolute light produced by the 40598A LED is detectable, under room-lighting conditions, at a maximum distance of 2 inches, by a detector with an area of 1 square centimeter. However, the pulsed light produced by the same device is detectable at 2 feet under room-lighting conditions even with a 10-watt tungsten lamp focused on a 5-square-millimeter detector to simulate the maximum ambient lighting conditions. A 1-microsecond pulse with a repetition rate of from 100 to 5000 Hz and a pulse power output of 6-milliwatts peak is used. A block diagram of the pulsed system is shown in Fig. 4. By comparison with the absolute method, the pulsed method shows an improvement in excess of 10 to 1 in working separation and in excess of 100 to 1 in sensitivity, and displays a far greater improvement in immunity to ambient light.

Systems with Lens

A lens placed between the LED and detector, but close to the LED, can be used to direct uselessly diverging light toward the detector and thereby increase the output of the system. Similarly, a lens placed between the LED and detector, but close to the detector, focuses divergent light on the detector and effectively increases detector size to that of the lens.

Because lenses greatly increase the output of a system, they allow greater LED-to-detector separation; theoretically miles, and quite practically many yards. Clearly, the use of a lens requires that the LED and detector be precisely positioned. Positioning is often the factor which limits the effectiveness of an optical system and thereby limits the separation of LED and detector.

LED's as Indicator Lights

The human eye responds to the difference in brightness (brightness ratio) between the LED and the background. The total output and size of the LED are important in that they affect the brightness of the LED: to be seen, an LED

must be noticeably brighter than its background. How much brighter depends upon the LED's color and the brightness of the actual surroundings; *i.e.*, the amount of ambient light, a quantity that varies over a very wide range, as indicated in Fig. 5.

The range of illumination in which a 50-footlambert LED can be seen extends from approximately 100 footcandles to total darkness. A tungsten lamp with a clear bulb yields about 3×10^6 footlamberts and is therefore visible under higher ambient light levels. Fig. 5 puts these ranges and levels in perspective.

The growth of the LED will be paced in the next three to five years by the development of new semiconductor materials and the refinement of processing techniques. This developmental sequence is completely analogous to the develop-

ment problems and growth cycle of other semiconductor devices which used new materials and therefore new processing techniques. Perhaps the best analogy is the silicon transistor; however, the silicon transistor is a great deal more complex than the LED.

At this time, comparatively few LED's are available. Technological problems and high individual device costs related to unfinished engineering on these devices are the most important limiting factors. However, present costs cannot be related to costs five years or even one year from now. Both costs and performance will change greatly for the better in the next few years as the technology advances. Future products will include a large percentage of visible emitters, and larger, more powerful devices that will be used in a greater number of larger, brighter, and more complex displays. ▲

LIGHT-SENSITIVE PHOTODIODES

THE solid-state photodiode industry, enjoying some \$6-million sales in 1968, is expected to reach \$10 million by 1972. Photodiodes find wide application in many sectors of the industrial, consumer, and military markets; examples include light dimmers, alarms, card readers, detectors, and counters. There are two basic kinds of photodiodes: *photovoltaic* and *photoconductive* devices. In quantities less than one hundred, prices range typically from \$2 to \$15. Compared to the vacuum phototube, semiconductor photodiodes have greater sensitivity, are much smaller in size and weight, and can be operated in short-circuit and open-circuit modes. Limitations include drift with age, temperature sensitivity, and a poorer frequency response than the vacuum phototube.

The photovoltaic diode consists of a relatively large silicon *p-n* junction that is exposed to light. Light photons impinging on the junction have sufficient energy to rupture a number of covalent bonds in the junction, thereby producing electron-hole pairs. No external bias source is required for operating the photovoltaic diode. If the device is short-circuited the current generated is directly proportional to the radiation. For open-circuit operation, the voltage developed across the diode varies logarithmically with radiation.

Practically, if the load resistance across the diode is less than 800 ohms, short-circuit operation is generally realized. Open-circuit operation is obtained if the load resistance is greater than 10k ohms. An example of a photovoltaic diode operating in the short-circuit mode is a photodiode used in the sound system of a movie projector. Because a linear response of the photodiode is essential to avoid audio distortion, the effective input resistance of the preamp is kept below 800 ohms.

Common to other solid-state devices, the electrical characteristics of photodiodes are temperature-sensitive. The rate of change (with respect to room temperature) of the open-circuit voltage is approximately $-0.004 \text{ V}/^\circ\text{C}$. Short-circuit current remains nearly constant with temperature. Typical operating temperature range for silicon photodiodes is from -55°C to $+125^\circ\text{C}$.

The reverse-biased photoconductive diode, for a given junction area, can generally be made more sensitive than the photovoltaic device. Without exposure to light and with a reverse bias as little as a few tenths of a volt, reverse current (due to thermal generation of electron-hole pairs), called the dark current, flows. When light falls on the junction, additional electron-hole pairs are released and the diode current increases. Typical *V-I* characteristic curves for a photoconductive diode are shown in Fig. 1 (1 footcandle = 1 lumen of radiation per ft² of exposed surface).

Increased output, as a result of the multiplication of light

current, can be obtained in semiconductors by what is referred to as the *hook collector* mechanism. The mechanism is realized by having two junctions in the same device separated by a wide base region. The resultant *n-p-n* structure is called a photo-duo-diode (see Fig. 2). Commonly used symbols for this as well as other photodiodes are illustrated in Fig. 3.

Junction J1 is slightly forward-biased; junction J2 is reverse-biased. Light photons striking the *p* region liberate electron-hole pairs. The released electrons diffuse out of the *p* region toward the junctions; the holes, however, are trapped in the *p* region and form a positive surface charge which increases the forward bias of junction J1. The increased bias produces an increase in current *I*. Typical characteristics of a photo-duo-diode are shown in Fig. 4.

An improved version of the duo-diode, the planar photodiode, is illustrated in Fig. 5. The difference between these two devices is that the *n-p-n* planar structure operates as a high-gain transistor, the base current being a function of radiation. There is no circuit connection to the base (*p* region), the device operating basically as a diode.

The spectral response of a photodiode is determined primarily by the energy gap of the semiconductor material used in fabricating the device. Changing such parameters as junction location and material resistivity have a minor effect on the spectral response.

In bandwidth-modulated light communications systems, the response of the photodiode becomes significant. Turn-on times on the order of 25 ns and turn-off times on the order of 250 ns are possible under certain conditions. It seems reasonable to expect that the switching time response of photodiodes will improve in the future.

A typical set of characteristics supplied by the manufacturer will include dark current, light current, rise and fall times, and light current sensitivity (microamperes per footcandle). These characteristics have meaning only if the test conditions, such as temperature, radiation wavelength, and diode voltage are specified.

One of the leading innovators in the photodiode development has been *Texas Instruments*. Other companies offering a variety of photodiodes include *Fairchild Semiconductor*, *G-E*, *Philco-Ford*, *RCA*, *Raytheon*, and *Solid State Products*. Aimed for the ever-growing computer industry, arrays of photodiodes used for such applications as reading paper tape, are being manufactured. A recent example is an array that uses thick-film technology containing from five to twelve photodiodes. This component is offered by *HEI Inc.* of Chaska, Minnesota. Others making photodiode arrays include *Fairchild Semiconductor* and *Motorola*. ▲

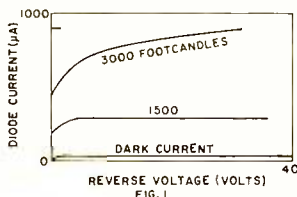

FIG. 1

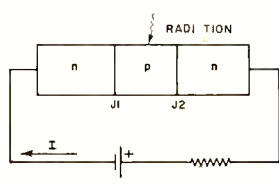

FIG. 2

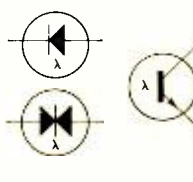

FIG. 3

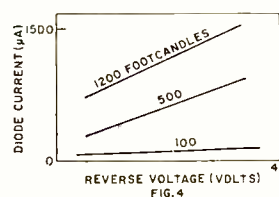

FIG. 4

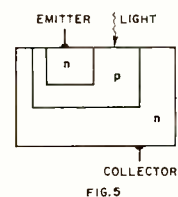

FIG. 5



The author received his mechanical and electrical engineering training in Budapest, Hungary and holds the equivalent of an M.S.E.E. He holds several patents covering microwave devices and has three more pending. He has published several articles in this field and is the author of a textbook on "Microwave Theory and Measurements" to be published this year. Since 1961 he has been teaching his specialty at Foothill College in California. He is president of the Bay Area Council for Electronics Education, Inc. and is a member of the IEEE.

Hot-Carrier Diodes

By STEPHEN F. ADAM/ Engineering Group Leader, Microwave Division, Hewlett-Packard Co.

These Schottky-barrier diodes, with their metal-semiconductor junctions, are used as high-frequency mixers and detectors and for very high speed switching.

SEMICONDUCTORS have been used in electronic equipment for decades. Point-contact diodes were the first ones to be used in radio receivers and they are still widely used, in high-frequency applications, for detecting and mixing r.f. signals. The development of *p-n* junction diodes made possible improvements in many applications at sub-microwave frequencies. Application of the Schottky theory to the metal-semiconductor junction produced the hot-carrier diode, which became one of the most versatile, highly dependable semiconductor devices used in modern electronics.

The hot-carrier (Schottky-barrier) diode features: non-linear resistance, no stored charge, very short recovery time, ideal *V-I* characteristics, low barrier potential, low flicker noise, high pulse power capability, good mechanical stability,

and high breakdown voltage. These features allow the hot-carrier diode to be used at microwave frequencies and for very fast pulse switching. Picosecond switching is now possible. As microwave detectors, hot-carrier diodes surpass other diodes in sensitivity and square-law characteristics and unprecedented mixing characteristics have been reported. Greatly improved microwave modulators and samplers have

Fig. 1. Switching characteristics of hot-carrier and "p-n" junction diode with 1-ns recovery time. Signal is 30 MHz.

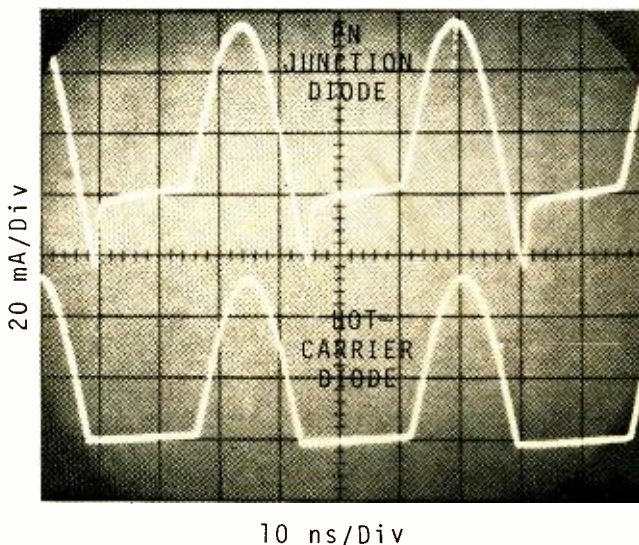
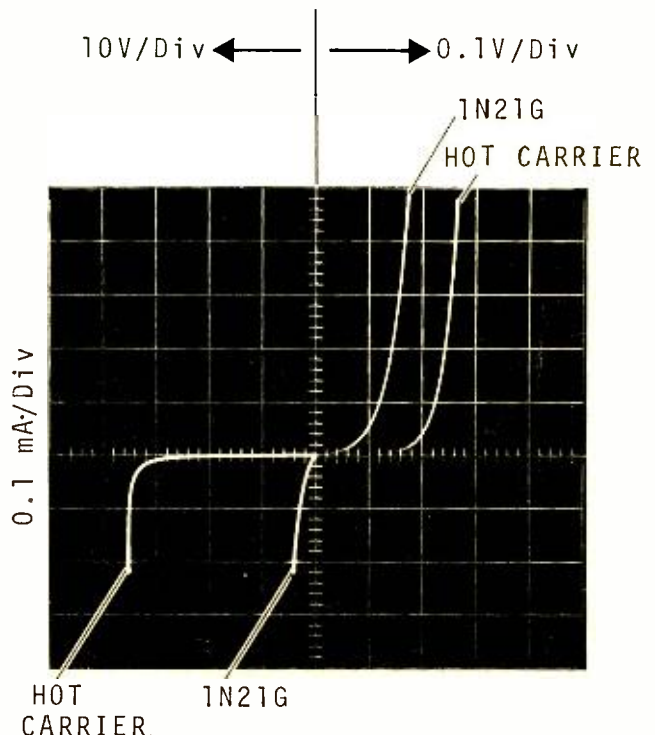

Fig. 2. *V-I* characteristics of hot-carrier diode compared with the 1N21G point-contact microwave diode.











CART-RIDGE	MINI GLASS	KOVAR-CERAMIC-KOVAR	FLANGE PILL	PILL	LEADLESS INVERTED DEVICE	MINI-STRIP	BEAM LEAD	CHIP
								
REXOLITE	GLASS	CERAMIC						
ADVANTAGES								
HERMETIC	LOW CAPACITANCE LOW COST HERMETIC	LOW CAPACITANCE HERMETIC BONDED CONTACT SYMMETRICAL	LOW INDUCTANCE HERMETIC BONDED CONTACT	LOW INDUCTANCE HERMETIC BONDED CONTACT SYMMETRICAL	LOW HANDLING COST BONDED CONTACT	BONDED CONTACT	SYMMETRICAL MONOLITHIC CONTACT	LOW PARASITICS DIRECTLY BONDABLE TO SUBSTRATE
DISADVANTAGES								
LOW TEMP. NOT RF TESTED	WHISKER CONTACT HIGH INDUCTANCE		NOT SYMMETRICAL			NOT HERMETIC HIGH HANDLING COST		

Fig. 3. Various packaging and encapsulating arrangements that are used for presently available hot-carrier diodes.

also been designed and constructed by using such diodes.

Essentially, the hot-carrier diode is a rectifying junction diode, where the junction is formed by a metal and a semiconductor. Either *n*- or *p*-type silicon is used for the semiconductor in junction with a variety of metals, such as gold, silver, platinum, or palladium.

The operation of the hot-carrier diode, in contrast to the *p-n* junction diode, is dependent on majority carrier conduction with virtually no storage of minority carriers. Fig. 1 compares the switching characteristics of a hot-carrier diode and a high-speed *p-n* diode having 1-ns recovery time. This illustrates the hot-carrier diode's superior rectification efficiency at very high frequencies. Microwave point-contact diodes exhibit similarly efficient rectification since at their point contact a sharp metal whisker provides the rectifying junction, which is essentially a Schottky barrier.

A comparison of the *V-I* characteristics of a point-contact microwave diode with a hot-carrier diode clearly shows the superiority of the hot-carrier diode (Fig. 2). In the point-contact diode, the metal-semiconductor junction is localized to a very small point, which is like a hemispherical junction. The hot-carrier diode has a true planar junction which provides uniform, repeatable contact potential and current

distribution. This structure gives a rugged, lower noise diode, with lower series resistance, which is capable of handling higher power levels and is capable of withstanding larger transient pulses. With forward bias, the electrons in the semiconductor override the barrier potential and with great kinetic energy, or temperature, plunge into the metal, hence the name "hot-carrier diode." As the barrier is reduced, then the amount of current flow in the device increases from

Fig. 4. The noise characteristics of a typical hot-carrier diode is compared here with a typical point-contact diode at various operating currents.

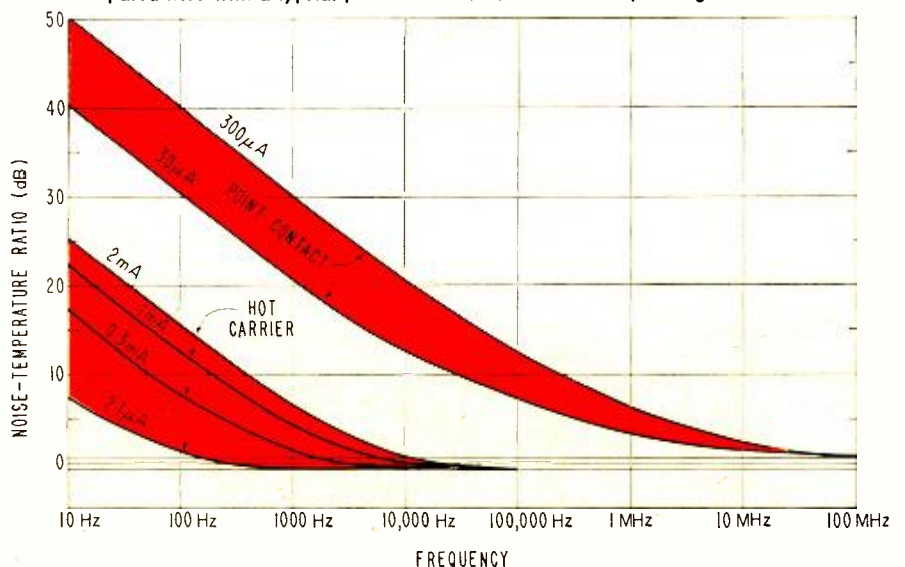

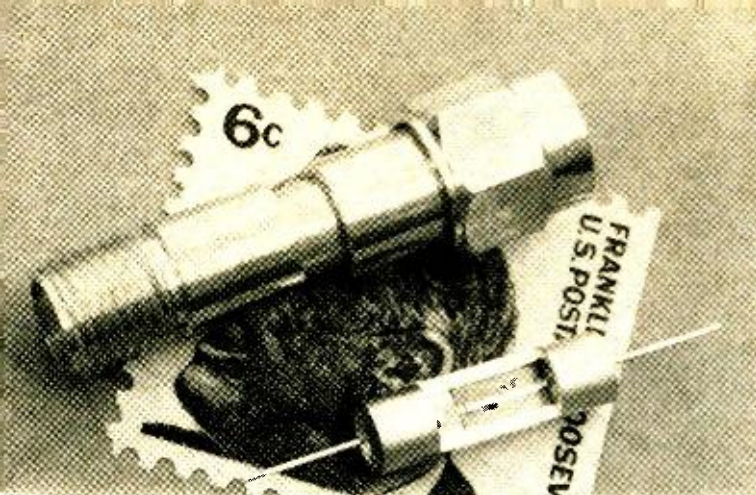

The HP 33801 series hot-carrier diode is shown here in a cutaway view along with its mixer/detector mounting.

the semiconductor to the metal in an exponential manner.

If reverse bias is applied to the hot-carrier diode, only a few tenths of a millivolt is sufficient to reduce current flow to a negligible value. The reverse current leakage is constant until fairly large reverse voltages are applied, at which time, due to breakdown, the current rises very rapidly. Avalanche multiplication causes this phenomenon.

A hot-carrier diode is made from a $0.020'' \times 0.020''$ heavily doped n^+ silicon substrate. An n^- -type epitaxial layer is grown on one side to a specific resistivity; on the other side a metallic ohmic contact is provided. After thorough cleaning, metal dots are deposited on the epitaxial surface to form a diode barrier. The size of dots and their material is dependent upon the required electrical characteristics.

These clips are then mounted into their casings, the type depending upon the application. Sometimes, for very critical applications, the chips themselves are bonded directly into devices to minimize the effects of the casing at very high frequency or with very fast pulses. Lately, a beam-lead configuration has been found to have excellent high-frequency characteristics.

Great care has to be taken with these non-hermetically sealed diodes so as not to damage them before they are placed into their mounts and then hermetically sealed. Furthermore, special transmission-line-mounted diodes are available in stripline configurations. Many types of encapsulation and packaging have been devised to enable the user to mount the diodes in the most desirable fashion. Some of the typical forms are shown in Fig. 3.

In addition to single diodes, matched pairs and quads are also available. Quads are marketed in pre-assembled, encapsulated form in bridge and ring configurations, or in matched individual diode form to enable the user to verify the electrical characteristics of the separate diodes.

Applications

Because of the nearly ideal electrical characteristics of hot-carrier diodes, a great variety of applications is open for them. Extremely fast turn-on and turn-off characteristics in the picosecond region, no charge storage, majority carrier conduction, low noise, and uniform forward and reverse characteristics make them useful even at microwave frequencies. Among the many uses of hot-carrier diodes, probably the most useful is for high-frequency mixer and detector applications.

In most cases, a *mixer* is used for frequency translation to a lower frequency while maintaining the information delivered by the high-frequency carrier. This is accomplished by applying the r.f. input signal with the local oscillator's signal, to a nonlinear resistor (the diode). Due to the high level of the local oscillator signal, the nonlinear element becomes a time-varying resistance. As a result, the difference of the two signals will appear as an intermediate frequency which is proportional to the input r.f. signal level and independent of the local oscillator signal level. In addition,

the sum of the signals will also appear if the mixer's bandwidth is able to carry it. The i.f. can range anywhere up to several hundred MHz, or even a few GHz, depending upon the application. The choice of the i.f. frequency and the mixer diode are basic contributions to the sensitivity of the receiving system.

Typically, noise figures of hot-carrier diodes used as mixers are on the order of 6 to 6.5 with an impedance mismatch of 1.5:1 v.s.w.r. on the r.f. side. Fig. 4 shows the noise characteristics of a hot-carrier diode. The reason for this lower noise behavior of the hot-carrier diode is that it has a planar junction in contrast to the point-contact diode's quasi-hemispherical junction, thereby providing a uniform contact potential.

Detectors are essentially low-sensitivity receivers, rectifying the r.f. signal through a nonlinear resistor, a diode. Two kinds of detectors can be considered; small-signal, low-level ones relying on the square-law characteristics of the $V-I$ curve, and the high-level, large-signal, or linear, peak detectors.

The small-signal detector operates near the bias point; the output signal voltage is proportional to the input power, that is, the square of the input voltage. One of the most important characteristics of such a detector is sensitivity. Sensitivity depends upon how well both the r.f. input and the video output are matched. Rectification efficiency, noise properties of the diode, and of course the noise figure, input impedance, and bandwidth of the following amplifiers are also important contributing factors in determining over-all sensitivity.

Conversion efficiency of hot-carrier diodes is quite small, consequently the sensitivity of these diodes can be vastly improved by biasing them. Bias limitations are set by the i.f. noise characteristics of the diode and by the amplifier's noise properties. A trade-off has to be reached when no more useful sensitivity can be obtained, due to increasing noise generation.

Large-signal detection with diodes is dependent upon the slope of the $V-I$ characteristic in the linear portion of the curve. The diode conducts only over a portion of the input cycle, consequently the output current follows only the peaks of the input signal, with a linear relationship between input and output voltages.

Limiter-detectors built with hot-carrier diodes provide such features as: high sensitivity, high burnout energy, low reflection, hybrid integrated-circuit structure, hermetically sealed diode construction, and ultra-miniature size, making them useful for space applications.

Prices Now and in Future

Schottky's original work on metal-semiconductor junctions opened the door to many experiments. In the early 1960's the "hot hole," "hot electron," "unipolar," and finally the uniformly named "hot-carrier diode," made its debut. Although these diodes have only been in use for the past 5 or 6 years, their desirable characteristics have led to a great many applications.

Single diodes with extremely good characteristics can now be purchased for under \$2.00. Matched pairs cost less than \$4.00 when purchased in small quantities. Matched quads, unconnected, cost around \$10.00. The ever-increasing usage and future technological advances promise more price reductions for microwave hot-carrier diodes.

One of the most recent developments has been the hybrid hot-carrier diode, where the $p-n$ junction technology is combined with Schottky-barrier techniques. This device offers higher reverse breakdown voltage and even higher speed operation.

Future applications in many areas, such as fast switching, sampling, waveform generation, logarithmic conversion in the picosecond region, and modulation, are expected to increase the usefulness of the hot-carrier diode. ▲



Dr. Niblack received his B.A. from the University of Buffalo, his A.M. in Physics from Harvard, and his Ph.D. from State University of New York. He joined Sylvania in 1961 and for three years carried out analysis of antennas and receiver systems for high frequency, microwave, and optical use and worked on the effects of radiation in semi-conductors. From 1965 to 1967 he was with Motorola where he developed designs and processing for advanced MOS devices in power transistors. He rejoined Sylvania in the Semiconductor Division in 1967. He taught physics at two universities.

Mr. Levi holds a B.A. in chemistry from University of Southern California. After two years of graduate work in chemistry, he joined Pacific Semiconductor. He has also been associated with Clevite Transistor Co. and Raytheon. He joined the staff of the Microwave Division of Sylvania in 1967. He holds several patents in the field.

Microwave Power Diodes

By WALTER K. NIBLACK and CLIFFORD A. LEVI
Microwave Dept., Semiconductor Div., Sylvania Electric Products

New avalanche and transferred-electron (bulk) devices, such as Read-effect or IMPATT, TRAPATT, Gunn-effect, and LSA diodes, are making possible the production of microwave power output at frequencies above 50,000 MHz.

EVER since the invention of the transistor, people in the microwave-systems business have dreamed of being able to produce and modulate microwave power without the use of vacuum tubes such as klystrons, magnetrons, and traveling-wave amplifiers. A solid-state transmitter, which shared the advantages of solid-state circuitry at lower frequencies—chiefly small size, high reliability, high efficiency, and the elimination of multiple power supplies—was the goal.

The first practical solid-state microwave sources appeared about ten years ago and, typically, consisted of a v.h.f. transistor oscillator whose output was fed into several stages of frequency doublers using the nonlinear capacitance of varactor diodes. At first, these sources were quite inefficient and very complicated, but had good reliability. Improvements in transistor and varactor design allowed the use of one v.h.f. power transistor, together with a high-order varactor multiplier (*e.g.*, one whose output frequency is 5 to 15 times the input frequency). This simplified the circuit considerably, but usually reduced efficiency.

It was recognized that what was really needed was a device which, like a klystron or magnetron, would produce output at some microwave frequency with only d.c. input power, just as a transistor oscillator does at lower frequencies. Transistors have improved considerably in the past ten years and now there are some capable of producing 5 watts at 2 GHz; but, at present, these are hard to make and thus expensive. It appears to be nearly impossible in the foreseeable future to make transistors that oscillate well above 8 GHz because of basic limitations.

In the past two years, however, two new classes of diode devices have emerged which make it unnecessary to use transistors at all in many oscillator and amplifier applications above 1 GHz. These are the *avalanche-type devices* which may be used either as oscillators or as negative-resistance amplifiers; and the *transferred-electron devices* which so far have found practical application only as os-

illators. Within each class there are a number of different "modes" or types of operation possible. Although it is usually necessary to optimize a given device design according to the intended mode and frequency desired, a particular device can often be operated in several different modes as circuit conditions and d.c. input are varied.

Devices in both these classes have produced power at frequencies above 50 GHz, far above the probable upper limit for transistors. Being two-terminal devices, they require only very simple d.c. power supplies and no bias on a third terminal. Also, both types will oscillate in the transit-time mode in almost any high-"Q" cavity if efficiency is not important.

There is some confusion about the modes since various manufacturers have given different names to the same mode. For the avalanche devices, there are three recognized modes: (1) the Read-effect, or transit time, or IMPATT (IMPact ionization And Transit Time) mode; (2) the "anomalous," or subharmonic, or TRAPATT (TRAPPED Plasma And Transit Time) mode; and (3) the self-pumped parametric mode. There are four clearly recognized modes for transferred-electron (bulk) devices: (1) the Gunn-effect, or transit-time mode, (2) the delayed-domain mode, (3) the LSA (Limited Space-charge Accumulation) mode, and (4) the quenched multiple-domain mode. Since both types of device exhibit complicated behavior, it is possible that other modes will be identified in the future.

With solid-state sources available to convert d.c. directly to microwave r.f., some means is required to modulate the output. Simply varying the d.c. input will do the trick, but in optimized circuits this results in simultaneous changes in both frequency and amplitude, so other means are desirable. If frequency modulation is desired, the best solution is to apply the modulating voltage to a tuning varactor coupled to the oscillator circuit. (These diodes are covered in another article in this Special Section.)

If amplitude modulation or pulse modulation is desired, it has been the practice for a number of years to use *p-i-n*

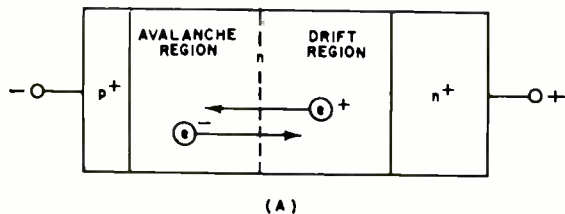

Fig. 1. (A) Cross-section schematic diagram and (B) typical impurity profile of an avalanche-type diode.

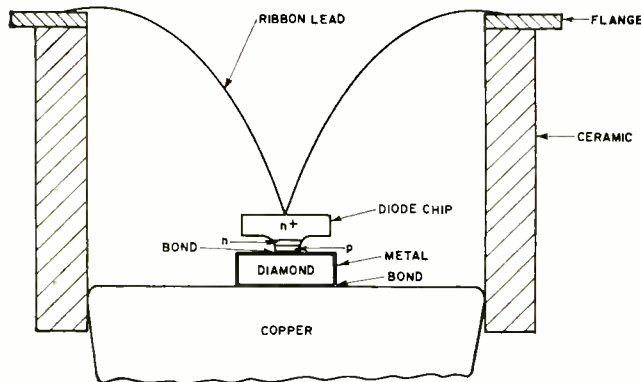

Fig. 2. By using diamond as part of the heat sink, the thermal performance of avalanche diode is improved.

Table 1. Partial listing of some available IMPATT diodes.

SOURCE	FREQ. BAND	MAX. PWR.	OSC. CKT.?
Cayuga Associates Cornell Research Park Ithaca, New York	Ku	80 mW	Yes
Hughes Aircraft Research 3011 Malibu Canyon Malibu Beach, Calif. 90265	X	up to 1 W	No
Microwave Associates Northwest Industrial Park Burlington, Mass. 01803	X, K, Ku	300 mW	Yes
Philco-Ford Microelectronics 2920 San Ysidro Way Santa Clara, Calif.	X	100 mW	Yes
Sylvania Electric Products 100 Sylvan Road Woburn, Mass. 01901	C, X, Ku	up to 1 W	Yes
Varian Associates 611 Hansen Way Palo Alto, Calif. 94303	Y, Ku	500 mW, 300 mW	Yes

NOTE: Because of the rapidity with which this field is moving, this table may indicate less capability than is presently available. Consult the manufacturer for most recent developments.

diodes. These diodes can be used as current-variable attenuators in forward bias, but their primary use is as switches for pulse modulation and phase shifting. As high-speed switches, they can also handle very large amounts of incident power (up to 10 kW pulsed power and hundreds of watts c.w.) because of their low loss in both the "on" and "off" states, and high breakdown voltage.

Avalanche Diodes

The avalanche IMPATT diode is a two-terminal negative-resistance device which can be fabricated of silicon, germanium, or gallium arsenide and is shown in Fig. 1A. The indicated p^+ region may be formed by diffusion, epitaxial growth, or ion implantation; the first being most common.

When the diode is reverse-biased into breakdown, the depleted n zone is functionally divided into two regions; an avalanche region and a drift region. In the avalanche region, the field is high enough to cause impact ionization, which causes continual production of free electrons and holes. This is strongly dependent on the field within the region. An increase in field causes an increase in the rate of change in the number of electron-hole pairs, and thus the current. There is a phase shift between the voltage and current so the avalanche current acts inductively. A further phase shift occurs across the drift region. If at some frequency the total phase shift for the two regions is greater than 90° , the diode exhibits a negative resistance at that frequency. This picture is complicated by the fact that capacitive (displacement) current also flows in the avalanche and drift regions causing a resonance.

The n^+ region serves as a contact for the active region of the diode and as a support during fabrication of the slice.

Typically, these diodes are mesa structures. An X-band diode might have a mesa diameter of 3-5 mils and an impurity distribution as shown in Fig. 1B.

Since typical efficiencies in the IMPATT mode are on the order of 10% or less, an input power of over 10 watts is required for 1-watt output, at say 10 GHz. At least 9 watts must therefore be dissipated. Hence, the thermal design is extremely important. For this reason, avalanche diodes are mounted with the anode bonded to a diamond heat sink to reduce the distance from the junction to the heat sink.

Fig. 2 is a drawing of a diode bonded to a diamond heat sink. Diamond is a better heat conductor than copper by a factor of four and advantage is taken of this in the critical spreading region of the heat path. Proper thermal design can permit thermal resistances of less than $6^\circ\text{C}/\text{W}$ for a junction diameter of 5 mils, as opposed to typically $15^\circ\text{C}/\text{W}$ for the chip mounted directly on copper.

In operation, as current is increased, a threshold current is reached, the value of which depends on diode area, frequency, and doping of the avalanche region. For a diode which is not thermally limited, the output power then increases with input power to a saturation value. The efficiency also increases with input power to near the saturation point. Hence, for maximum efficiency, a diode must be designed to operate optimally at its design power level.

The performance of an IMPATT diode depends critically upon the design of the circuit in which it is operated. Efficient operation has been achieved in waveguide cavities, coaxial cavities, stripline, and microstrip circuits. In the design of a circuit, attention must not only be given to the impedance presented to the diode at the fundamental frequency, but, in oscillator applications, to the proper terminations of the harmonics.

In the laboratory, power output at X-band of approximately 2 watts c.w. has been obtained in a single-chip device operating as an oscillator in the IMPATT mode. Similarly, multiple-chip devices have been built which generate as much as 5 watts c.w. Frequencies covered have ranged from 500 MHz to 70 GHz with 100-mW output being achieved in the laboratory at 50 GHz.

Transferred-Electron (Bulk) Devices

The transferred-electron effect is an effect which occurs because of peculiarities of the conduction band in certain semiconductors such as gallium arsenide. It does not occur in semiconductors such as silicon and germanium. The effect occurs when the field in an *n*-type sample exceeds a certain threshold, giving the electrons enough energy to transfer to another conduction band with higher energy and lower mobility. This results in a decrease of average mobility, and thus a decrease in conductivity, as the field increases. In simple terms, bulk gallium arsenide exhibits a negative small-signal resistance above a certain voltage. A typical *I-V* curve is shown in Fig 4.

At first it might seem that a slab of gallium arsenide could be made to amplify, just as a tunnel diode does, simply by connecting it to a positive-resistance load nearly equal in magnitude to the negative resistance and applying voltage, and that the frequency of operation would be determined entirely by a cavity or a tuned circuit. However, if an excess of electrons is created somewhere, instead of diffusing away from each other as usual, they diffuse toward each other leaving behind positively charged donor atoms. This segregation of positive and negative charges is a "dipole domain."

As soon as ohmic contacts are made to a piece of gallium arsenide, and sufficient field is applied, electrons are injected at the negative end and a domain immediately forms.

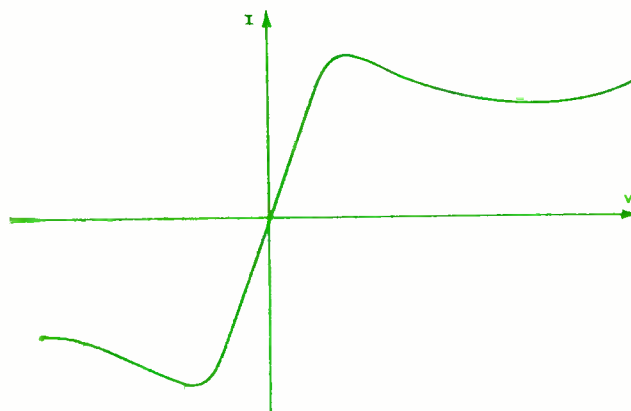

Fig. 4. Typical *I-V* curve for bulk gallium arsenide showing the negative resistance above certain voltage.



Fig. 3. Three-stage avalanche-diode amplifier package.

In the TRAPATT mode, much higher powers and efficiencies have been achieved. Five watts c.w. at 40% efficiency has been reported for a single chip. In pulsed operation, much higher powers, on the order of a hundred watts at 40% or higher efficiency, have been reported. These results are generally at frequencies below X-band but, in principle, similar efficiencies could be achieved at X-band. There is little doubt that performance such as that just cited will move out of the lab and into the market place in the near future.

For the present, both IMPATT diodes and complete oscillator circuits are commercially available from a number of sources and at power levels up to 1 watt at X-band. Table 1 is a partial listing of available diodes and oscillators. Since the field is moving so rapidly, it is difficult to prepare an exhaustive list. In addition to oscillator circuits, a 3-stage amplifier is available from *Sylvania*. This device, shown in the photograph, Fig. 3, provides 40-dB gain with up to 200-mW output.

Single diode circulator-coupled avalanche amplifiers have been built with outputs over one watt in the X-band, and bandwidths over 2.5 GHz reported, using commercial diodes.

Three circuit configurations that have been used for avalanche and transferred-electron device oscillators. The d.c. power supply should be of the regulated-current type with avalanche diodes. Voltage, current, and polarity depend on device.

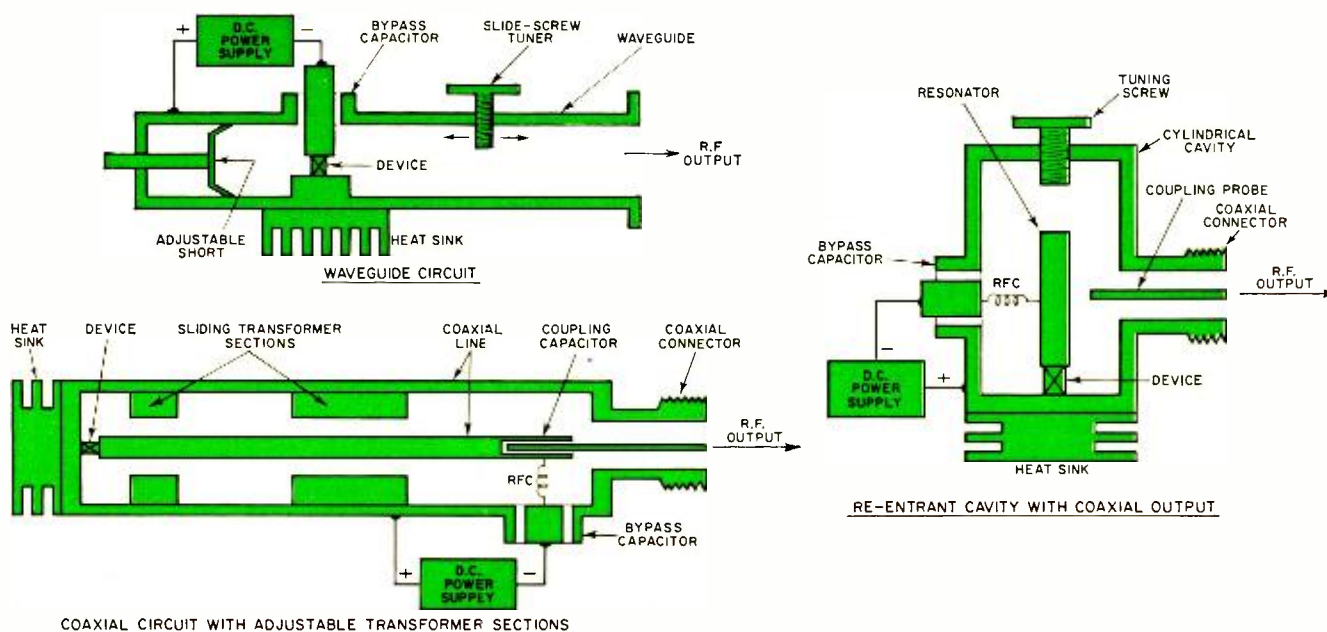

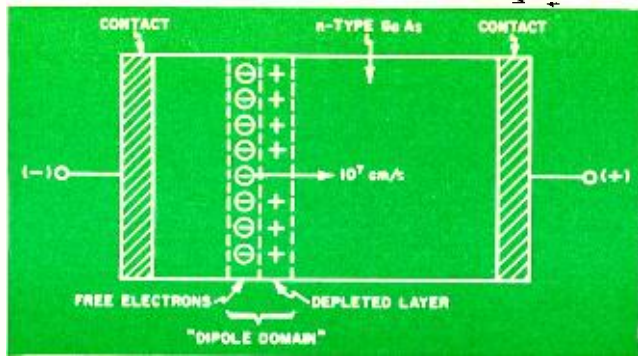

Fig. 5. Gunn diode showing the traveling domain produced.

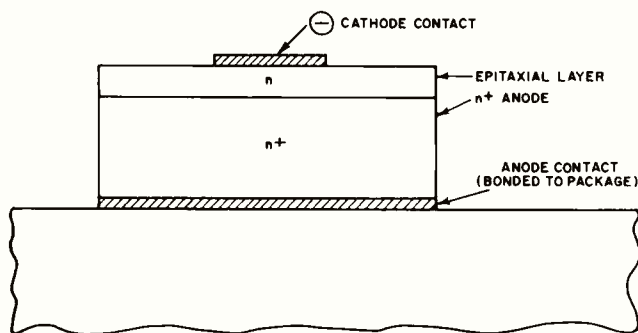

Fig. 6. A practical Gunn diode structure is shown here.

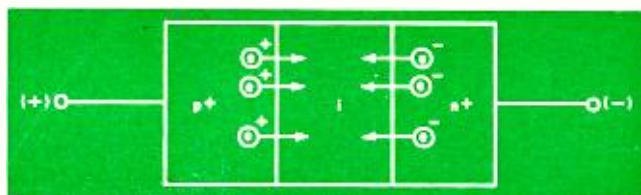

Fig. 7. Operation of "p-i-n" diode with forward-bias.

The electrons in the domain are free to move toward the anode so the whole domain drifts toward the anode at a velocity of about 10^7 cm/second. This is shown in Fig. 5. Since most of the voltage drop is taken up by the domain, no new domain can form until the existing one is destroyed at the anode, allowing the bulk field to rise into the negative-resistance region again.

For this reason, the sample oscillates at a natural frequency (f_0) close to $10^7/L$ (where L is the cathode-anode spacing in centimeters), regardless of circuit conditions. In practice, it is possible to "pull" the oscillation frequency from its natural value, f_0 , by $\pm 10\%$ by coupling to an external high-"Q" cavity.

Fabrication of practical Gunn diodes is complicated by the fact that the value of L must be small (about 10 microns for $f_0 = 10$ GHz) so that the device cannot be made by the obvious procedure of putting ohmic contacts on opposite sides of a single crystal slab of thickness L . Epitaxial layers of lightly doped gallium arsenide on heavily doped substrates must be used. In addition, the doping must be very light and very uniform if high conversion efficiency is desired. It is very difficult to meet these conditions, hence Gunn diodes are expensive to make. The structure of a practical Gunn device is shown in Fig. 6.

In modes other than the Gunn mode, the creation and annihilation of domains is controlled by material properties or circuit waveforms. In the LSA mode, domains are virtually completely suppressed by increasing crystal thickness and reducing doping level, while improving uniformity (very difficult). Because gallium arsenide is a poor heat conductor, and high input powers must be used, LSA devices must be pulsed.

Operating a Gunn diode is extremely simple. The diode is placed in a circuit that resonates near f_0 and d.c. voltage from a low-impedance source is applied until the field exceeds the critical field, causing domain formation. As the voltage is increased, the power output increases rapidly until the efficiency reaches a maximum of 2 to 5 percent. Power output usually continues to increase with increasing voltage until the device burns out.

A typical X-band Gunn diode might produce 20 to 50 mW output at 10 volts and 100 mA. The threshold would be about 5 volts, and burnout might occur due to overheating at as low as 12 volts.

P-I-N Diodes

The *p-i-n* diode, which can be made only in silicon, is basically an electronically controllable variable resistance. In some applications (switching, phase shifting) only two of its states are used, that is, "on" and "off." In others, such as attenuator or modulator, the continuous variation of resistance with forward current is utilized.

The operation of this diode depends upon the modulation of the conductivity of an intrinsic (very high resistivity) region by injection of holes and electrons under forward bias. Fig. 7 is a schematic of a *p-i-n* diode under forward bias. At low current levels or at zero or negative bias very few carriers exist in the *i* region. Since the conductivity is directly proportional to the number of carriers, the resistance of this region is high. As the current is increased, however, the conductivity increases as injected carriers from the p^+ and n^+ regions dope the *i* region. This effect is called conductivity modulation and is exhibited to some extent in all forward-biased *p-n* junctions when the injected carrier density becomes comparable to or exceeds the background doping. Fig. 8 is a plot of resistance vs forward current for a typical *p-i-n* diode. Operating bias levels for switches or phase shifters might be in the 10-150 mA range.

In the reverse direction, mobile charge is swept out of the *i* region and it becomes an insulating dielectric. The diode behaves as a typical reverse-biased junction with two exceptions. Since the *i* region has few carriers to be removed, it is swept out at low voltage and, in a good diode, punches through at a few volts or occasionally at zero bias. Since the *i* region is typically fairly thick, the capacitance per unit area at lower reverse voltages is less than for a comparable *p-n* junction.

In summary, then, a *p-i-n* diode can be represented as a current-variable resistance in the forward direction and as a constant capacitance in the reverse direction.

In microwave applications, the time during which the ap-

Fig. 8. Forward-bias characteristics of the "p-i-n" diode.

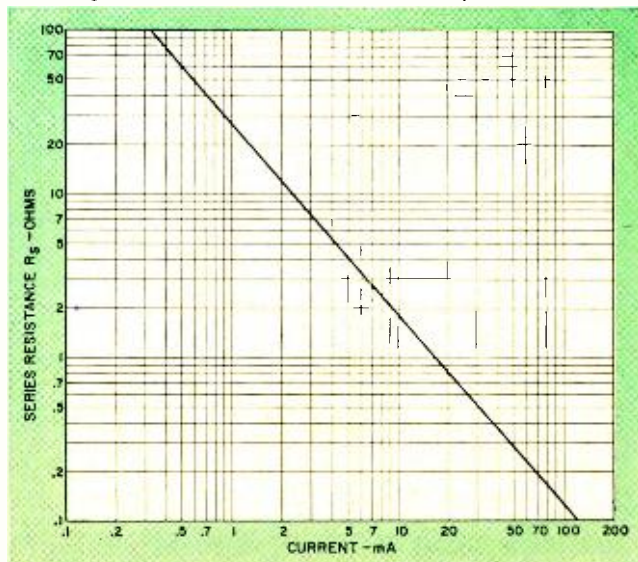

plied signal exceeds the breakdown voltage of the diode is too short for buildup of avalanche current to occur. A *p-i-n* diode, may, therefore, control peak r.f. voltage greater than the breakdown voltage of the diode.

In the forward-biased state, the r.f. current swing can exceed the d.c. bias without causing much rectification. Since the diode has a finite series resistance, power is dissipated and, therefore, the thermal design of the diode is important when appreciable powers are to be handled. This is particularly important in applications when the diode may not be fully conductivity modulated. Diodes should be selected with low thermal resistance as one of the criteria.

Diodes are currently available from many manufacturers in a variety of packages. Table 2 gives a partial listing of suppliers along with typical ranges for various parameters of interest. Note, however, that not all parameters can be selected independently. For example, an increase in series resistance accompanies a decrease in capacitance, other parameters being held constant. ▲

Alpha Industries, 381 Elliot Street, Newton Upper Falls, Mass. 02164
 Hewlett-Packard, 1501 Page Mill Road, Palo Alto, Calif. 94304
 Micro-State Electronics, 152 Floral Ave., Murray Hill, N.J. 07971
 Microwave Associates, Burlington, Mass. 01803
 Parametric Industries, 63 Swanton St., Winchester, Mass. 01890
 Sylvania Electric Products, 100 Sylvan Road, Woburn, Mass. 01901
 Unitrode Corp., 580 Pleasant St., Watertown, Mass. 02172

PARAMETER	TYPICAL RANGE
Breakdown Voltage	200-1500 V
Series Resistance at 100 mA	0.25-10 ohms
Capacitance at -50 V	0.01 pF up
Thermal Resistance	5° C/W up

Consult the individual manufacturer for specific data and packaging information.

Table 2. Partial list of suppliers of microwave "p-i-n" diodes along with typical range of operating parameters.

TUNNEL DIODES

FOLLOWING Esaki's announcement of the tunnel diode in 1958, expectations ran high for its potential use in a wide variety of applications. Many people thought that the tunnel diode would replace all magnetic cores and transistors in the digital computer. Because of the rapid progress made in conventional discrete diodes and transistors and the phenomenal development of integrated circuits, most of the early hopes never materialized. Taking advantage of its good frequency response and low noise characteristics, the greatest application of the tunnel diode today is for oscillators and amplifiers operating at video and microwave frequencies.

The volume of sales for tunnel diodes was \$4.5 million in 1968; by 1972 it is expected to reach close to \$7 million. Leading manufacturers of tunnel diodes include *Centralab, G-E, Motorola, Philco-Ford, RCA, Raytheon, Sylvania,* and *Texas Instruments*. In quantities from 1 to 99, prices range from \$1 to \$15, depending on device characteristics.

A typical tunnel diode characteristic curve and schematic symbol are shown in Fig. 1. Between peak and valley voltages V_P and V_V , respectively (corresponding to peak and valley currents I_P and I_V), diode current decreases with increasing diode voltage. This behavior results in the region of negative resistance $-R_N$, which permits the tunnel diode to be used as a switch, oscillator, or amplifier.

Conventional diodes, having a relatively wide depletion region, require the current carriers (electrons and holes) to overcome a potential hill in traveling from the valence band to the conduction band of energies. Since high doping levels are used in the tunnel diode, a narrow depletion region is formed at the junction. This allows electrons to "tunnel" directly through from the valence to the conduction bands. It is this mechanism which gives rise to the tunnel-diode characteristics, including the negative-resistance region. For voltages exceeding the valley voltage, the tunnel diode assumes the characteristics of the conventional *p-n* junction diode.

A small-signal model of the device is shown in Fig. 2. Capacitance C_j represents junction capacitance; C_p is the package capacitance. Series resistance R_S is ohmic and L_S is the lead inductance. The negative resistance is denoted by $-R_N$. Typical values of these parameters for a tunnel diode with a peak current rating of 10 mA are: $L_S \approx 5$ nH, $R_S \approx 1$ ohm, $-R_N \approx -25$ ohms, and $C_j \approx 10-20$ pF. C_p depends on the mounting and packaging.

Four basic materials used for fabricating tunnel diodes are: germanium (Ge), silicon (Si), gallium arsenide (GaAs), and gallium antimonide (GaSb). Typical values of significant tunnel-diode

parameters are listed in the table. Besides the peak-to-valley current ratio I_P/I_V and the peak and valley voltages V_P and V_V , two other parameters of interest are included: the peak current-to-capacitance ratio I_P/C (where C is the sum of the junction and package capacitance) and the resistive cut-off frequency f_{R0} (the frequency at which the net negative resistance reduces to zero). These two parameters serve as figures of merit for tunnel diodes.

Tunnel diodes exhibit good resistance to radiation. The valley current is most sensitive, with significant changes in its value occurring in the vicinity of an integrated flux density of 10^{16} neutrons/cm². The peak and valley voltages have negative temperature coefficients of 0.1 and 0.8 mV/°C, respectively. Typical variation of I_P and V_P over a temperature range of -55°C to 150°C is 10 percent. The valley current is temperature sensitive; its value at 150°C may be 3 times as great as at -55°C.

Because of their low noise, gallium antimonide and germanium diodes are generally employed for amplifiers. Although germanium exhibits somewhat greater noise than gallium antimonide, germanium tunnel diodes are more stable with respect to temperature. Gallium arsenide diodes exhibit the greatest power-output capabilities and are therefore invariably used for oscillators. For high-speed switching, gallium arsenide and germanium tunnel diodes are best. Silicon, however, would be required at elevated temperatures (up to 150°C).

Referring to Fig. 1A, if the forward characteristic is altered to appear as shown in Fig. 3A, the characteristics of the back diode are obtained. Interchanging the first and third quadrants results in Fig. 3B. An examination of the "forward" characteristics in quadrant I of Fig. 3B reveals that the cut-in or threshold voltage is approximately zero volts. The new reverse characteristic is not too different from that of ordinary diodes. At room temperature, the cut-in voltage is 0.6 and 0.2 V for silicon and germanium *p-n* junction diodes, respectively. Therefore, back diodes are well suited for rectifying very low-amplitude signals; they are also used as video detectors in microwave applications.

Some companies making back diodes are *G-E, Sylvania,* and *Transitron*. In small quantities prices are about \$3 and up. ▲

Parameter	Ge	Si	GaAs	GaSb
I_P/I_V	8	3.5	15	12
V_P (volts)	0.06	0.07	0.15	≈ 0.1
V_V (volts)	0.35	0.40	0.50	≈ 0.45
I_P/C (mA/pF)*	25	0.02	16	50
f_{R0} (GHz)*	50	1	20	50

*Maximum values quoted.

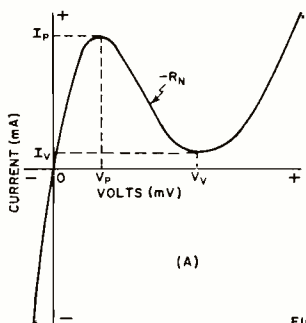

FIG. 1

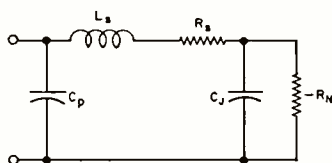

FIG. 2

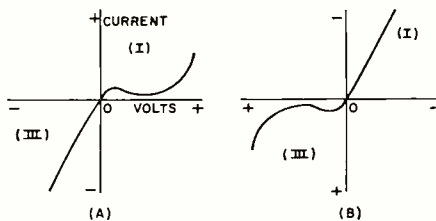

FIG. 3

**“He’s a good worker.
I’d promote him
right now if he had
more education
in electronics.”**



Could they be talking about you?

You'll miss a lot of opportunities if you try to get along in the electronics industry without an advanced education. Many doors will be closed to you, and no amount of hard work will open them.

But you can build a rewarding career if you supplement your experience with specialized knowledge of one of the key areas of electronics. As a specialist, you will enjoy security, excellent pay, and the kind of future you want for yourself and your family.

Going back to school isn't easy for a man with a

full-time job and family obligations. But CREI Home Study Programs make it possible for you to get the additional education you need without attending classes. You study at home, at your own pace, on your own schedule. You study with the assurance that what you learn can be applied to the job immediately.

CREI Programs cover all important areas of electronics including communications, radar and sonar, even missile and spacecraft guidance. You're sure to find a program that fits your career objectives.



NEW!
Expanded coverage of solid state electronics including integrated circuits!

You're eligible for a CREI Program if you work in electronics and have a high school education. Our FREE book gives complete information. Mail postpaid card for your copy. If card is detached, use coupon at right or write: CREI, Dept. 1107H, 3224 16th St., N.W., Washington, D.C. 20010.

Founded 1927



CREI, Home Study Division
McGraw-Hill Book Company
Dept. 1107H, 3224 Sixteenth Street, N.W.
Washington, D.C. 20010

Please send me FREE book describing CREI Programs. I am employed in electronics and have a high school education.

NAME _____ AGE _____

ADDRESS _____

CITY _____ STATE _____ ZIP CODE _____

EMPLOYED BY _____

TYPE OF PRESENT WORK _____ G.I. BILL

- I am interested in Electronic Engineering Technology
 Space Electronics Nuclear Engineering Technology
 NEW! Digital Communications

APPROVED FOR TRAINING UNDER NEW G.I. BILL



J OHN FRYE

Increased use of electronic equipment in medicine is creating a demand for meaningful safety standards.

SAFETY IN MEDICAL ELECTRONICS

“MAC,” Barney said to his employer, “did you see that story a while back claiming that some 1200 hospital patients were accidentally electrocuted every year?” “Yes,” the older man replied, taking a final swipe with the cleaning cloth at the face of the portable TV he had just serviced.

“As I remember, the story first appeared in the January 27th issue of *Electronic News*. The figure was given by John A. Hopps, Radio & Electrical Engineering Division, National Research Council, Canada, at the Reliability Symposium held in Chicago the week before. He was quoting Dr. Carl W. Walter, surgeon at the Peter Bent Brigham Hospital in Boston, who said he received the figures from an actuary of an insurance company who had made a computer study of the situation.”

“Ask for a slice of bread and you get a bakery!” Barney exclaimed. “You know more about it than I do. I was talking about a *Time* story that ran in the April 18th issue. Anyway, can you believe that ‘shocking’ figure? A guy goes to the hospital to get well, not electrocuted.”

“One more bad pun like that and you may go to the hospital yourself,” Mac growled. “I, of course, have no way of judging the validity of the figure, but the original story concluded with the comment that throughout the survey conducted by the newspaper ‘no one denied the figure of 1200 deaths or made a lower estimate.’ Dr. Walter, who is recognized as a man of stature in the medical field, sticks with the figure and contends it would be a lot higher if it included patients who suffered cardiac arrest from shock but were resuscitated.”

“The *Time* story says a spokesman for the AMA claims the figure is exaggerated by about 1175 cases,” Barney offered.

“On the other hand,” Mac countered, “Richard Merris, sales manager for *Dallons Instruments* is quoted as saying the figure sounds about right to him. As Dr. Walter points out, many hospitals are unaware of the cause of death in these electrocution cases. Death is attributed to other causes, and that is why it is difficult to get hard figures regarding these electrocution deaths.”

“I got the idea most of the deaths were caused by incompatible grounding systems used on different kinds of complex equipment and on such simple things as frayed cords or broken plugs,” Barney said.

“That’s partly oversimplification,” Mac answered. “Leakage of any sort between two different pieces of electrical equipment with which the patient is in contact could produce death, especially when the attachments of the instrument bypass the skin resistance by being inserted in a vein or artery or deliberately reduce the skin resistance through the use of moisture or conducting paste.”

“Know what you mean,” Barney offered. “I read an article in the September, 1968, issue of *QST* written by Melville M. Zemek of the *Associated Factory Mutual Fire Insurance Companies* in which he said the resistance of the human body varies from 100,000 ohms down to 1000 ohms or less, and most of this is made up of contact resistance. A value of approximately 500 ohms is usually accepted as the average

resistance of the human body between the major extremities.

“He went on to point out that while high voltage produces severe surface tissue destruction at high resistance contact points, it’s the current flowing through the body that kills you. Danger of electrocution depends on the magnitude, duration, and path of this current through the body.

“The most dangerous path is through the chest, for this is likely to cause the heart to lose its life-sustaining rhythm and to go into a condition of ineffective quivering called *ventricular fibrillation* in which the heart feels, in the almost-too-graphic words of a surgeon, ‘like a handful of worms, just squirming.’ Experiments on animals to determine the amount of current through the chest to produce usually fatal fibrillation have been projected into a theoretical criterion of danger for man in terms of current and time duration. This data produces a straight line graph on log-log paper from 400 mA for .005 second down to 75 mA for 5.0 seconds.”

“Electricity can produce death in other ways, can’t it?”

“Oh sure. Shocks can cause respiratory inhibition, heart block, and severe damage to the nervous system. These other mechanisms of death, however, ordinarily require a lot more current than that needed to initiate the deadly ventricular fibrillation; and that’s why the latter is more likely to be cause of death in a hospital electrocution. A current that only tickles the hands of a doctor or technician may be more than enough to bring death to a weakened patient when the electrodes are applied in such a manner as to bypass his protective skin resistance.”

“Let’s see if we can figure out for ourselves how some of these deaths might occur,” Mac suggested. “In older hospitals or hospitals that have added wings at different periods, there may not be a common ground for all outlets. If two pieces of equipment are plugged into receptacles with different grounds, there may be a ‘ground-loop current’ flowing from one instrument to the other through the patient.”

“Yeah, and suppose the grounded lead in the line cord is broken loose from the plug prong, leaving the case ungrounded. Suppose further that a capacitor from the hot side of the line to the case is leaky or has been actually shorted by a lightning surge. Now if the patient touches the case or anything connected to the case and also touches with his other hand a grounded object such as a radiator, water pipe, or wall plate, the current flows to ground right through his chest.”

“These are pretty obvious examples,” Mac admitted. “Quite likely the more subtle leakages are the ones that cause the most trouble. We both know that the primary or secondary of a power transformer can short to the core and thence to the case. An arc-over can establish a carbonized path that can carry enough current to produce fibrillation and still be high enough in resistance, especially when the instrument is not operating, to be hard to detect by a casual examination.

“Dr. Leon Porly, Assistant Professor of Medicine, Mount Sinai School of Medicine, points out that patients in an operating room are often wired up for sixteen different things. Every precaution is taken to avoid accidents, and the first consideration is to make sure the patient is not grounded. Ac-

tually the patient is safer in the operating room, even with all this equipment, because it is being used by experts. He is in more danger from more ordinary equipment carelessly used by hospital personnel with no training in electronics, equipment that is less rigorously examined. Few hospitals in the country use expert electronics technicians to operate complicated instruments. They usually scout around for some doctor with a smattering of electronics and turn the job over to him."

"Hey, that's about as smart as finding a janitor with a first aid course and turning the emergency ward over to him!" Barney exclaimed. "As I get it, there is at present no pre-marketing clearance of medical electronic equipment such as the UL tag on household equipment. How come?"

"There are a couple of reasons. For one thing, the doctors and the equipment manufacturers can't agree on what is necessary. The doctors want foolproof equipment that requires a minimum of maintenance and that can be operated by untrained personnel. The equipment manufacturers want the medical profession to set up some standards as to what constitutes safe leakage currents. But no doctor is willing to stick out his neck and say this is x number of microamperes. Doctors say the fibrillation level varies from individual to individual. They would prefer, of course, an impossible leakage level of zero.

"The second reason for a lack of safety standards is that Congress will not pass same. Starting in 1962, bills have been introduced every year requiring approval of electrical medical equipment by some federal agency, and every year these bills have died in committee. Two more bills were introduced in the House and Senate at the present session, but no one will wager they will ever get out of committee. However, the chance that some sort of legislation will be passed eventually is improving as a result of the present publicity regarding the hospital electrocutions—especially since Ralph Nader brought this subject up in testimony before the Product Safety Commission in Washington last February. The pity is that several hundred—or perhaps thousand—patients will die of electrocution while undergoing routine diagnostic tests or treatment before that takes place."

"That reminds me that Professor Paul E. Stanley, a Purdue University professor of aeronautical, aerospace, and engineering sciences, has spent the last few years in researching the causes and prevention of these hospital electrocutions. He has come up with both a long-range and a short-range plan for correcting the condition. His long-range plan is a typical engineering approach: 1. Define the problem and collect facts about the hazards of medical instrumentation. 2. Do

research to determine more precisely the maximum nonfibrillating current. 3. Expand the study to include such things as electrically operated beds, heating pads, TV sets, etc. 4. Set up design standards and procedures that will reduce the accidental electrocution rate in hospitals to zero.

"All this, he admits, will take time, precious time in which other lives will be lost needlessly. To reduce this loss, he recommends that in the meantime all personnel using electrically operated equipment in hospitals be trained in the fundamentals of safety, that a positive earth ground and a single ground reference be used for all equipment connected to one patient, that isolated and monitored ungrounded power be provided for all hospital rooms where patient monitors are used or where cardiac catheterization is performed, and that adequately trained personnel be employed to provide specifications for the purchase of equipment and to provide preventive maintenance on same."

"Makes sense," Mac observed. "The important thing is to fix the responsibilities. Dr. Pordy said it well: 'Suppliers of electronic equipment have the first responsibility to make sure their equipment is safe. Doctors have the second responsibility to make sure the equipment is properly used.' If both groups accept their responsibility, we should be able to bring a halt to this needless loss of life." ▲

EIA VERSUS NOISE

AN EIA committee on industrial safety and health has suggested a new approach to alleviating dangers caused by exposure to occupational noise.

The committee recommends that, when noise exposure criteria have been established, they be related to audiometric examination requirements for employees exposed to various dB levels for varying periods of time. The EIA also recommends adequate personal protective equipment be mandatory. ▲



"Bessie's Go-Go Club wants to talk to the cute bug-eyed kid that left his tools and tube caddy behind yesterday!"

For
**RELIABLE
PERFORMANCE**

the
LONG

and

SHORT
of **CRYSTEK**
is

QUALITY

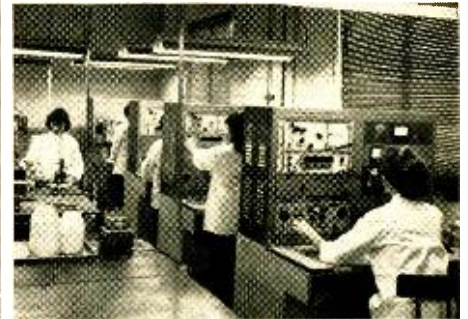

Our control of quality throughout precision manufacturing gives you crystals produced for your operating requirements that assure exact frequency control.

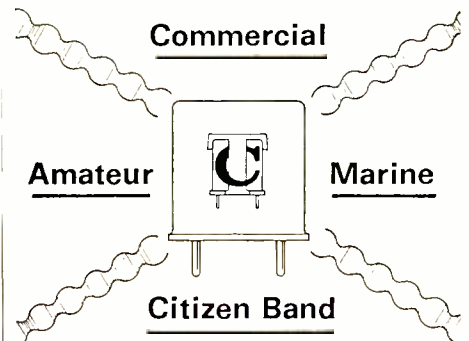

Whatever Your Application
Tell Us Your Needs

CRYSTEK

Formerly Texas Crystals Div.
of Whitehall Electronics Corp.
1000 Crystal Drive

Fort Myers, Florida 33901
Telephone Area 813 - WE 6-2100
Plants in Fort Myers and Los Angeles

CIRCLE NO. 141 ON READER SERVICE CARD

**WORLD'S
FINEST
5-CORE
SOLDER**



**ERSIN
MULTICORE**

**NEW EASY
DISPENSER
PAK ONLY 69¢**

BUY IT AT RADIO-TV PARTS STORES
CIRCLE NO. 124 ON READER SERVICE CARD

BUILD YOUR OWN HI-Q* INDUCTIVE IGNITION SYSTEM

First computerized ignition system. Automatically programs itself for optimum performance at all speeds.

- Fires even wet plugs
- Complete combustion
- No maintenance
- Fits all 12 volt systems

Order the heart and lungs of the system and build the brains now. Pulse transformer \$22.50, HI-Q choke \$4.75.

Dealers inquiries invited.

Send check or money order to
QUAKER CITY TRANSFORMER COMPANY
369 Shurs Lane, Phila., Pa. 19128

* Pat. Pending

CIRCLE NO. 120 ON READER SERVICE CARD

EW Lab Tested (Continued from page 20)

very sweet, smooth, and balanced. It had a strong lower midrange response that imparted warmth and body to the sound without ever becoming boomy or unnatural. To our ears, the over-all sound was best with both high-frequency controls at maximum. The speaker never spits or screams, and even at the highest volume levels showed no trace of break-up or harshness.

We must emphasize that the speaker

system is a truly contemporary one, both sonically and aesthetically, and it compares favorably with any other speaker in its price class.

The *Tannoy* Monitor Gold 12-inch speaker alone, complete with crossover network and level controls, sells for \$147. The Stuart enclosure is available separately at \$125, and the two combined as a system are \$272. The similarly designed 10-inch and 15-inch coaxial speakers are priced at \$127 and \$195, respectively. A variety of enclosures, in different styles, is offered for all of the speaker models. ▲

Garrard SL 95 Automatic Turntable

For copy of manufacturer's brochure, circle No. 25 on Reader Service Card.

THE Model SL 95 is the latest and most advanced automatic turntable in the *Garrard* line. It has a unique motor, which combines the high starting torque and low rumble of a good induction motor with the constant operating speed of a synchronous motor. The latter assures correct and constant turntable speed over a very wide range of line-voltage variations. We checked and verified this over a range from 30 to 135 volts, which should satisfy any practical requirements.

The rotating platter of the turntable is a balanced 3-pound nonferrous casting, 11½ inches in diameter, driven through an idler wheel at 33⅓, 45, or 78 r/min. The speed-selector knob also indexes the arm for 7-inch discs when set to 45 r/min, for 12-inch discs at 78 r/min, and it has three positions for 33⅓ r/min, corresponding to record sizes of 7, 10, and 12 inches.

The tonearm is of extruded aluminum, with afrormosia wood inserts which provide mechanical damping as well as decoration. The arm is balanced by an adjustable counterweight, isolated in rubber, and the tracking force is applied by a spring through a small wheel with click stops at ¼-gram intervals. Anti-skating correction is applied through a sliding weight on a small lever at the base of the arm pivot. The cartridge mounts in a slide that is easily removed from and reinstalled in the arm.

The automatic record-changer spindle supports the records at their centers and contains the dropping-release mechanism. Unlike other changers whose spindles control the record drop, the SL 95 also supports the record stack at its edge. The rear record-support platform retracts to the level of the motorboard for manual operation and springs to its operating height at the touch of a button. For single-disc manual play, the changer spindle is removed and a short rotating spindle is inserted.

In addition to the speed/arm-index selector, the SL 95 has two other operating controls. The Auto lever institutes the automatic playing cycle, and it is



used to stop play at any time or to reject or repeat a record. When the Manual lever is set to Play, the turntable starts and the arm must be positioned manually. At the end of the record the arm returns to the rest by itself, and the motor shuts off. A further rotation of the Manual lever, to the Lift position, raises the pickup gently from the record; returning the lever to the center Play position lowers the pickup slowly back into the groove. This function is also usable during automatic play. The arm lift and lowering action was very smooth, although the lever must be handled gently to avoid jarring the turntable.

The automatic turntable can be mounted on an optional molded black plastic base of unusual design. The base contains concealed compartments for storing spindles and other accessories. The optional smoky plastic dust cover slides off or hinges upward for access to the turntable.

In our laboratory tests, the rumble of the SL 95 was -32 dB by NAB standards. Excluding vertical rumble components, it was -35 dB. Wow was 0.08 percent at 33⅓ r/min, 0.04 percent at 45 r/min, and 0.03 percent at 78 r/min. Flutter was an excellent 0.025 percent (the residual of our test equipment) at all three speeds. The arm-tracking error was exceptionally low: zero near the center of the record and less than 0.6 degree per inch of radius at the outside of the disc.

The tracking-force dial calibration was quite accurate, being exact at 1 and

2 grams and about 0.2 gram in error at higher settings. This required balancing the arm at slightly above the horizontal. The anti-skating correction worked well, although we found that best results were obtained using a marked setting one or two grams higher than the tracking-force setting.

In use tests, the changer performed flawlessly. From the standpoint of mechanical operation and listening quality, it left nothing to be desired. The *Carrard* SL 95 sells for \$129.50. The optional base is \$5.95, as is the plastic dust cover. ▲

Electronic Ignition System

(Continued from page 34)

mation available regarding test methods, apparatus, and procedure, and the author had to more or less feel his way along and improvise.

Testing & Bench Performance

One essential item of equipment is a peak-reading electrostatic voltmeter. Although simple in principle, it is a costly item to purchase, and the author got around this problem by constructing and calibrating his own. At first, measurements were made using a variable ball-electrode spark gap with published tables to convert from gap spacing to voltage. It was soon discovered that these tables are grossly inaccurate, since they do not take into account the surface condition of the balls and the material of which they are made. For a given voltage, the gap spacing is also greatly affected by the incidence of ultraviolet light. However, a simple fixed gap is a useful loading device in testing.

The 1-megohm load resistor is constructed from nine individual 2-watt resistors of 1 megohm each, arranged in a series-parallel configuration. They are immersed in a jar filled with mineral oil. The addition of an aquarium-type thermometer to the oil bath also permits the load resistor to serve as a calorimeter for use in measuring efficiency. The 50-pF load capacitor is of Leyden-jar construction using a small pickle jar. To reduce corona, it is also filled with oil. Capacitance is adjusted to value with the aid of a bridge.

The input driving signal is obtained in either of two ways. In normal testing, a variable-frequency square-wave generator is used. A graph permits rapid conversion of hertz to r/min. A distributor driven from a variable-speed motor is also available, and is useful in evaluating the effects of point bounce and dwell.

Results are shown in Fig. 3 and it can be seen that the high-voltage objectives are more than adequately met. In fact, 18.5 kV is available at 5000 r/min under conditions of combined resistive and

LOOK! A NEW ELECTRONICS SLIDE RULE

with complete instruction program



Here's a great *new* way to solve electronic problems accurately, easily . . . a useful tool for technicians, engineers, students, radio-TV servicemen and hobbyists. The Cleveland Institute Electronics Slide Rule is the only rule designed *specifically* for the exacting requirements of electronics computation. It comes complete with an illustrated Instruction Course. You get four AUTO-PROGRAMMED lessons . . . each with a short quiz you can send in for grading and consultation by CIE's expert instructors.

See for yourself. Learn how to whip through

all kinds of reactance, resonance, inductance, AC and DC circuitry problems in seconds . . . become a whiz at conventional computations too!

This all-metal 10" rule is made to our rigid specs by Pickett, Inc. . . . comes complete with top grain leather carrying case *and* Instruction Course. A \$50 value for less than \$25. Send coupon for FREE illustrated booklet *and* FREE Pocket Electronics Data Guide, without obligation. Cleveland Institute of Electronics, 1776 E. 17th St., Dept. FW-165, Cleveland, Ohio 44114. *TRADEMARK

GET BOTH FREE!



Send coupon today →

Cleveland Institute of Electronics

1776 E. 17th St., Dept. EW-165, Cleveland, Ohio 44114

Send FREE Electronics Slide Rule Booklet. Special Bonus: Mail promptly and get FREE Pocket Electronics Data Guide too!

NAME _____ (Please Print)

ADDRESS _____ COUNTY _____

CITY _____ STATE _____ ZIP _____

A leader in Electronics Training . . . since 1934

CIRCLE NO. 144 ON READER SERVICE CARD

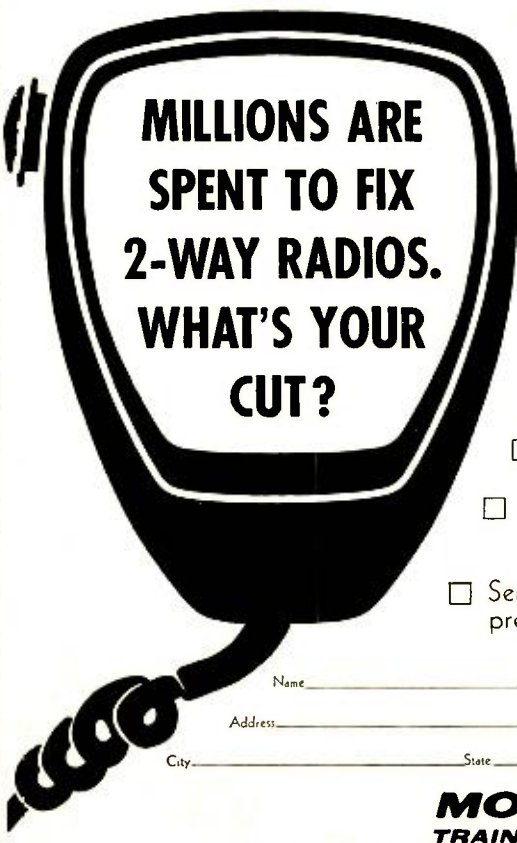

MILLIONS ARE SPENT TO FIX 2-WAY RADIOS. WHAT'S YOUR CUT?

If you'd like to get into a top-paying job, maybe FM 2-way radio is for you. Each year, more and more businesses are buying 2-way. That means service. And service means money. We can train you to get in on the action. Our special home study course is the place to start. We teach you FM 2-way radio servicing, and prepare you for an FCC license.

Send me FREE Evaluation Examination

Send details on Home Study Course on FM 2-way radio servicing.

Send details on how you can prepare me for an FCC license.

Name _____ Occupation _____

Address _____

City _____ State _____ Zip _____

MOTOROLA TRAINING INSTITUTE

1301 Algonquin Road, Schaumburg, Ill. 60172



CIRCLE NO. 126 ON READER SERVICE CARD

LIKE MUSIC WITHOUT COMMERCIALS?

The SCA-2B Sub-Carrier Adapter makes it possible for you to enjoy the background music transmitted on a 67KHz sub-carrier on many FM stations. (These programs cannot be heard on a FM set without an adapter) In the US there are approximately 400 FM stations authorized by the FCC to transmit the 67KHz programs. If you are within 50 miles of a city of 100,000 or more, it is probable that you are within the satisfactory reception range of one or more of these stations. If in doubt write for a list of such stations in your area.

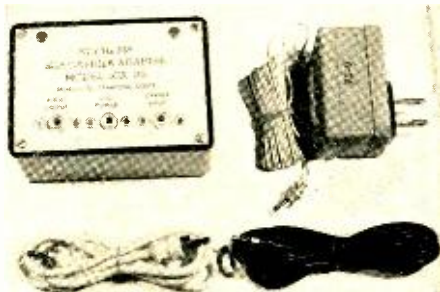

Patent Pending

Sub-Carrier Adapter, Model SCA-2B with two 36" shielded cables, Price \$39.95.
117 Volt AC Operated Power Supply, PS-9, Price \$4.95.

SCA-2B FEATURES

SIZE: 4" x 2 7/8" x 1 1/2". • Simple plug-in connections to your FM tuner/amplifier. (If your FM tuner does not have a multiplex output jack, we supply hook-up information). • No installation adjustments • All silicon transistors • Operates from our PS-9 Power Supply or 6 to 12 volts D.C. One Year Factory Guarantee

For Custom Installations: Completely Wired SCA-2 PC card (size: 2 1/2" x 3" x 3/4") with installation instructions for \$34.95. Also available SCA-2 installed in AC operated Panasonic 7-Transistor AM-FM Radio Model R-E6137 \$61.95.

Write for Dealer Quantity Discounts.

Commercial use of these units is not advised, unless the consent of the originating station is obtained.

Send order to JANZAC CO.

P.O. Box 177, Stamford, Conn. 06904
or KENZAC CO.

P.O. Box 66251, Houston, Tex. 77006

CIRCLE NO. 131 ON READER SERVICE CARD

Cut The Cost Of Printed Circuits



Our new production techniques and rapid service saves you delay time and research cost.

We can produce single and small quantity orders extremely economically. Our quality is unsurpassed, and orders are usually processed within three days from receipt of the order. Large quantity orders receive the same fast service.

HOW TO ORDER

Layout your circuit board to scale in exact proportion to the size you desire. We can enlarge or reduce the copy to your specifications. Copy can be an ink drawing or laid out with the new circuit tapes. NOTE: The board we produce can only be as accurate as the copy we receive; so be sure to double check. Specify rigid or flexible board.

SEND FOR FREE SAMPLE OR QUOTATIONS TODAY - NO OBLIGATION

American Engraving Inc.

MANGUM, OKLAHOMA 73554

CIRCLE NO. 149 ON READER SERVICE CARD

capacitive loading. When a spark gap is added to this, for some reason not yet clear, there is an additional 1500 volts developed, bringing the total to 20 kV.

The author has not run tests on all other systems available at this time; however typical results for one of the better grade transistor ignition systems are shown in the dashed curve of Fig. 3. This system develops a maximum of 13.5 kV at 5000 r/min and the waveform of the discharge is of the unfavorable oscillatory type.

Performance in the Car

The author's car is a 1966 *Jeep Wagoneer* which has a six-cylinder overhead-cam engine. The engine is rated at only 135 hp, and it is anything but a "hot" car. It is, however, a pleasant car to drive at moderate and high speeds.

Since the car weighs 4000 lbs, it is a little sluggish at low speeds, and if ignition is not just right it becomes difficult to handle. It was in one of these difficult periods when the car was in real need of a tune-up that the high-"Q" electronic-ignition system was installed. Prior to installation timing appeared to be off, since the engine knocked and balked during acceleration. Hill climbing was very poor, and the gears had to be shifted frequently. It also appeared that a carburetor adjustment was required since the exhaust was excessively smoky. The plugs were not removed for inspection but it is a fair guess that they were partially fouled and misgapped.

When the system was installed, the first thing immediately apparent was much better acceleration through the gears—and with no knock. Balkiness had disappeared, and although it is hard to believe, performance seemed as good or better than when the car was new. In addition, the smokiness of the exhaust was greatly reduced.

The author cannot altogether account for this vivid improvement in performance. Engine experts claim that knock is caused by predetonation of the mixture, and that this is controlled by engine timing. In this case, engine timing was unchanged so that the knock should still have been present. One can, however, conjecture that under conditions of pre-ignition, combustion is not complete, and that enough of the mixture is still available to produce power if the spark is of sufficient duration. The reduction of smoky exhaust would confirm this, since a good portion of the smoke consists of unburned mixture.

The most interesting test of the system has been in the area of drag racing. Here, engine speeds of 8500 r/min are common, not only at high speeds, but also during periods of acceleration and shifting of gears. The transmission is almost always a four-speed box. The engines contain special high-rise cams and are stiff and difficult to start. With

the very high speed of the engine and with starting difficulties, adequate ignition has long been a problem. Many drag-racing enthusiasts have tried and abandoned electronic systems and have instead favored the use of extra-hot coils drawing a primary current of 10 amps or better. They are used with a special set of dual points. Despite this brute-force approach, plugs must be removed and cleaned between runs.

At a recent meet the system was installed in a V-8 *Chevrolet* that had, on a previous run, turned up a top speed of 114 mi/h. This was a stock car with engine and exhaust system modifications. An extra-hot coil and dual points were used for ignition. Direct substitution of ignition systems resulted in an increase of speed to 116 mi/h. There was an increase of torque during pickup that at first caught the driver by surprise. Its effect was to break the force of traction of the driving wheels, causing them to spit. However, most surprising, when the plugs were removed at the end of the run, they were perfectly clean. It seems clear that the increase in torque and speed were due to complete ignition as evidenced by the lack of unburned residue on the plugs.

Further tests are planned of a more precise nature, using dynamometer equipment. However, the results to date have been so encouraging that it is planned to market the system shortly. It will be manufactured under the name "High-Q" to denote high efficiency and low loss. ▲

TINY HEART TRANSDUCER

BASIC research on electronics materials by NASA's Electronics Research Center, Cambridge, Mass., has led to the development of a rugged, tiny device that may eventually be implanted in the human body to measure blood pressure.

A simple semiconductor transducer, it is believed to be the smallest of its kind ever fabricated. About 2/100th of an inch thick, the new device uses less than 500 millionths of a watt of power. It is capable of transmitting pressure variations which provide the medical researcher with information about heart and blood circulation.

The medical importance of the device, which is called a cardiovascular pressure transducer, was established by a medical team headed by Dr. Bernard Lown of Harvard's School of Public Health. The device has been tested by the team.

According to Dr. Lown, the development is a significant advance in monitoring blood flow changes, which is especially important in cardiac patients, particularly those with coronary occlusions. He expects the first clinical application will be at the Levine Cardiac unit, Peter Bent Brigham Hospital, Boston.

A similar device, the Ames transducer, developed at NASA's Ames Research Center, Moffett Field, Calif., has been used successfully on heart patients at Stanford University Medical Center. ▲

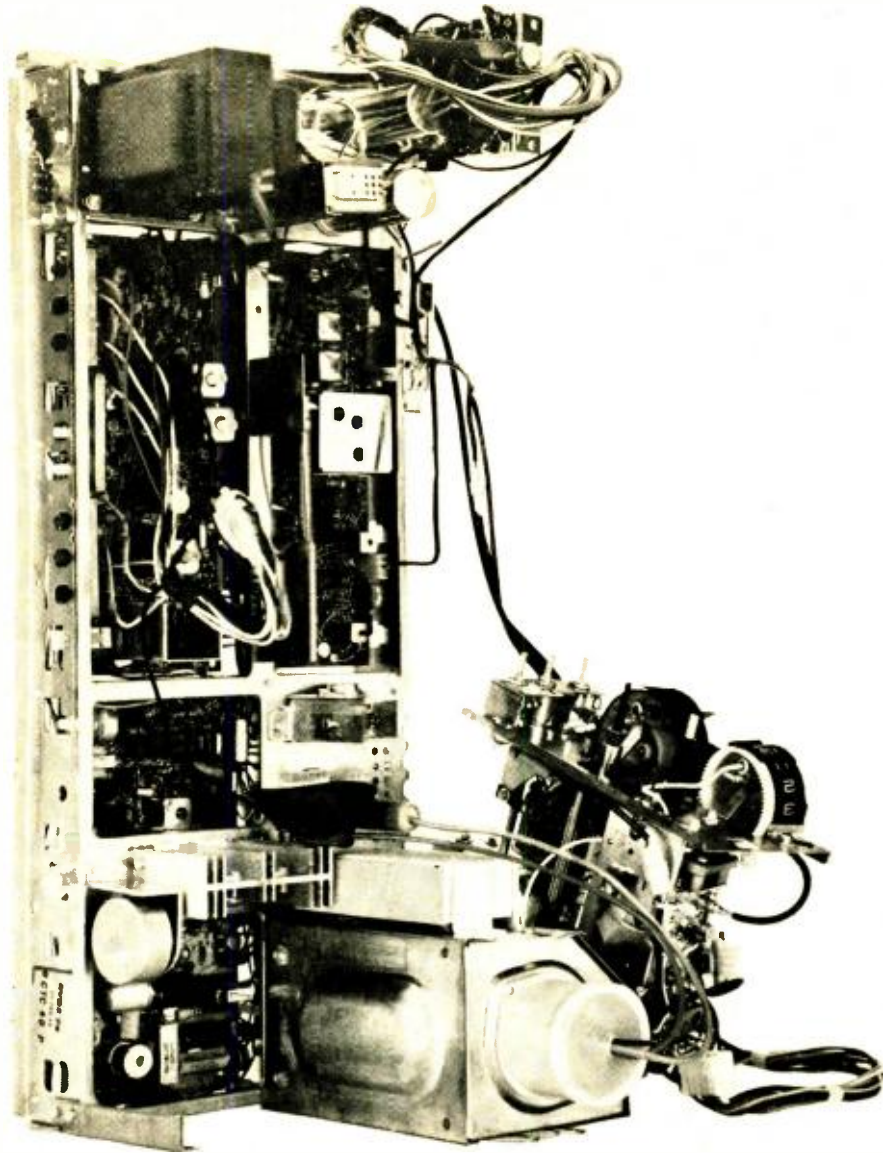

There's more here than meets the eye.

What you are looking at is RCA's solid-state* color chassis—the CTC-40. A whole lot went into that chassis. Like fifteen years of technical research. Pioneering in the development of Solid State. And the backing of a national workshop program like nobody else's.

That's where you come in.

We've written a technical manual on the CTC-40 especially for Electronic Service Technicians. It has color

diagrams, pictures, and everything there is to know about our CTC-40.

You can buy it from your RCA Consumer Electronics Distributor, but there's a better way.

Attend the next RCA Consumer Electronics Distributor CTC-40 Workshop and get the manual free. Our distributor can tell you when it will be held next in your area. See you there.

*one tube rectifier

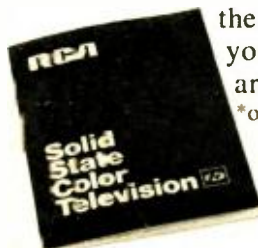

**This is 30,000
solid state replacement parts.**



So is this.



It used to be if you wanted to satisfy everyone, you had to stock over 30,000 different solid state replacement parts.

Well, everyone realized that was ridiculous. So some enterprising people came up with a bunch of universal replacements.

Then you only had to stock about eleven or twelve hundred.

That was a lot better, but we still thought it was a little ridiculous.

So two years ago (when we went into this business), we figured out how to replace all 30,000 with only 60.

Now all you have to do is stock 60 of our diodes, transistors, integrated circuits, etc., and you can replace any of the 30,000 JEDEC types manufacturer's

part numbers, foreign types, etc., now in use.

That means you invest less money.

You don't tie up valuable space.

You do away with complicated inventory control.

And you operate more efficiently.

To make life even easier, we've got a new book that gives you all the cross references you need to figure out which part replaces which.

It's available from your nearest Sylvania distributor.

If the whole thing sounds rather incredible, you're right. But why not give your distributor a call and let him narrow the incredibility gap.

SYLVANIA
GENERAL TELEPHONE & ELECTRONICS

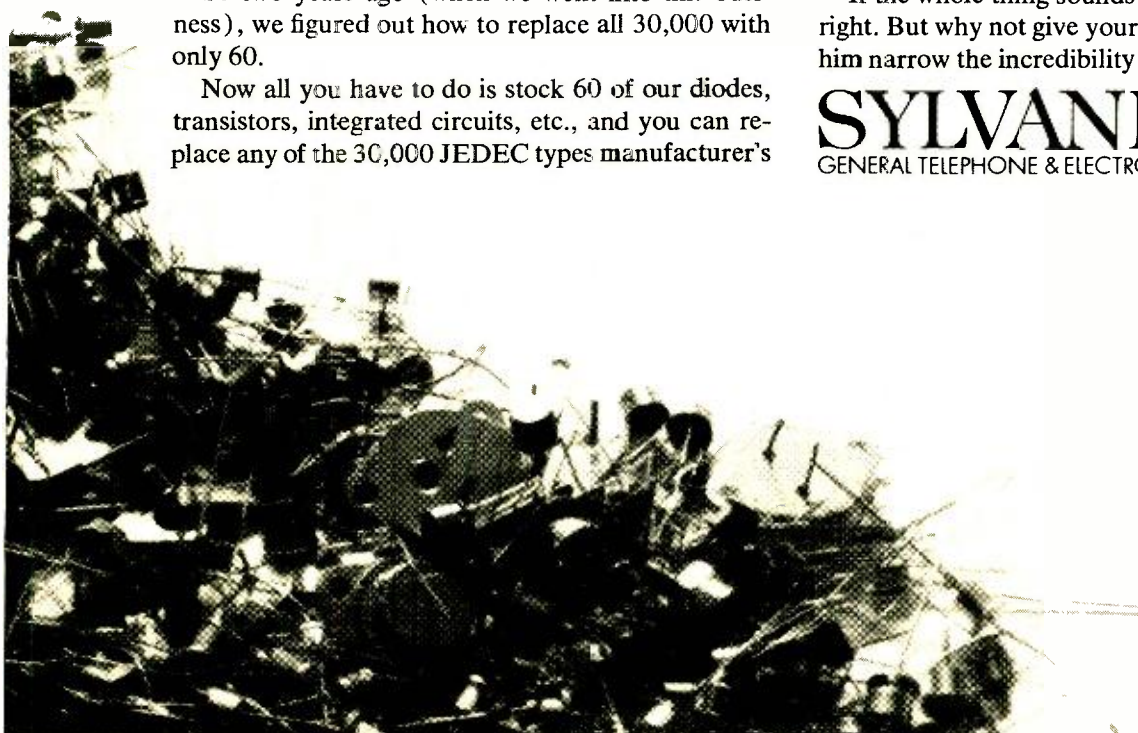

SERVICE MASTER HANDIEST HANDFUL of service tools



23 essential tools at your fingertips in this light-weight (only 2¾ lbs.), compact, easy-to-carry, roll-up kit. Contains long nose plier, diagonal plier, adjustable wrench, regular and stubby plastic handles with these interchangeable blades: 9 regular and 3 stubby nutdriver, 2 slotted and 1 Phillips screwdriver, 2 reamer, 1 extension. Eyelets in plastic-coated canvas case permit wall hanging. New elastic loop secures roll, eliminates need for tying.

many optional accessories:

Junior and Tee handles... Additional nutdriver, Phillips & slotted screwdriver, and extension blade sizes... Allen hex type, Bristol multiple spline, Frearson, Scrulox, and clutch head blades... Awl/Scraper... Chuck adaptors to use blades in spiral ratchet drivers.

WRITE FOR CATALOG 166



XCELITE, INC., 12 Bank St., Orchard Park, N. Y. 14127

In Canada contact Charles W. Pointon, Ltd.

CIRCLE NO. 105 ON READER SERVICE CARD
66

Communications Satellites (Continued from page 27)

service and inaugurated live television between Hawaii and the U.S. mainland on November 18, 1967.

The second Intelsat II series satellite, launched on January 11, 1967, was successfully emplaced in synchronous orbit and provided the first full-time service over the Pacific. More than twice as heavy as Early Bird (see Table 2), Intelsat II is higher-powered, its antenna can be squinted on command (doubling its capacity), and it provides a wide-band linear repeater for multiple access (see Fig. 4).

Intelsat II transmitter power is provided by four 6-watt travelling-wave tubes (TWT's) in parallel, any three of which can be operated at a time. When carrying a single message or TV-loaded FM carrier, the repeater TWT's are driven to saturation to provide the maximum possible satellite EIRP. If two or more FM carriers are to be amplified (the multiple-access case), drive power must be reduced (or backed-off) so that the TWT's operate linearly. Unless this is done, the non-linear limiting characteristics of the saturated TWT's would produce intermodulation distortion products among the various carriers. These products interfere with the desired signals, creating unacceptable distortion and also robbing useful power from the TWT's. Unfortunately, making the TWT linear requires a significant back-off from saturation thereby reducing both the maximum EIRP available and the total capacity of the satellite. Thus, FM multiple access causes reduced total capacity and requires accurate earth-station power control to proportion TWT power among all users.

The answer to these problems will be in the use of digital time-division multiple access (TDMA). Each earth station would transmit a burst of digital messages to the satellite within an allocated time slot and stations would then sequentially utilize the full power of the

satellite. TDMA experimental equipment is current being tested by Comsat with Intelsat II and it is probable that this access technique will be eventually adopted by Intelsat.

Three Intelsat II satellites have been successfully launched, two providing service over the Pacific and the third over the Atlantic. For satellites not intended to produce revenue for Intelsat, they have been unexpectedly successful. In 1967, Comsat reported that almost \$155-million of capital funds had not been used because system costs were running well below estimates.

Military Communications Satellites

The Department of Defense has also been actively developing its own private system of military communications satellites. On June 16, 1966 a Titan III-C launched the first eight satellites in the Initial Defense Communications Satellite Program (IDCSP) into sub-synchronous orbit (about 100 miles below synchronous). At this altitude the satellites slowly drift easterly at about 24° a day. To date 26 of these 100-pound IDCPS satellites have been placed into orbit. Their principal objective has been to establish an initial experimental military comsat network.

Each IDCSP satellite is designed to operate with a variety of terminals from fixed 60-foot-antenna earth stations, to 18-foot transportable stations, down to 6-foot shipboard terminals. The satellite can handle up to eight simultaneous carriers. Because of the low radiated power (2 watts), non-directive antenna, and small earth stations, the largest capacity per carrier is only eleven voice channels. (There are a total of eight carriers used, and the total number of voice channels is limited to 23.) Also, since the ring of slowly moving satellites occasionally bunches together, coverage gaps are left between tracking earth stations.

Partially because of these limitations, the Defense Department announced in June, 1968 its decision to proceed with an advanced Phase II Defense Satellite Communications System that would em-

Fig. 4. Arrangement of the components contained inside of Intelsat II.

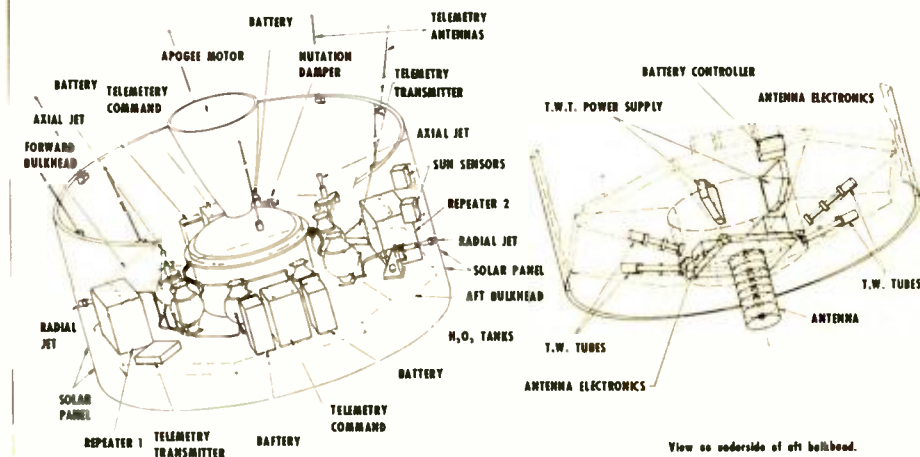

View on underside of aft bulkhead.

ploy large stationary satellites with directed antennas. Since the IDCSP satellites incorporate six-year timers to turn the satellite off, the advanced system (DSCS-II) must go into service by late-1971. In sharp contrast to IDCSP, DSCS-II will have a capacity of several thousand voice channels.

The MIT Lincoln Laboratories, under Air Force contract, developed a series of Lincoln Experimental Satellites (LES). The first two satellites of this series contained solid-state microwave repeaters and provided the Air Force with experience with medium-altitude comsats prior to IDCSP. LES-1 included the first attempt to direct an antenna so as to keep it pointed at the earth. LES-3 contained a u.h.f. beacon and LES-5 a u.h.f. repeater in the military aeronautical band (225-400 MHz) and performed mobile communications tests. These tests led to the decision to develop Tacsat-I, an experimental s.h.f./u.h.f. tactical satellite launched early this year. This large satellite is being used to perform military tactical experiments with mobile terminals developed for this program.

Applications Technology Satellites

One final series of experiments deserves mention; the NASA Applications Technology Satellites (ATS). This series of test-bed satellites was designed to perform several experiments, including communications, at synchronous altitude.

ATS-1 employs an antenna beam which is counter-rotated from the spin-stabilized satellite, thereby fixing the beam at the earth. ATS-1 utilizes a phased array that is electrically de-spun. While this involves no moving parts, the difficulty with this approach is that the array is inefficient and several complex arrays are needed if several beams are required.

ATS-3 de-spins its beams mechanically by rotating the antenna structure so that it remains aimed at the earth. Although this approach involves a moving structure, the earth coverage gain is significantly higher than for a phased array (18 dB vs 7-14 dB).

ATS-1 (Pacific) and ATS-3 (Atlantic) have served as emergency back-ups for the *Intelsat* satellites; ATS-3 transmitted the 1968 Mexican Olympics to Europe and ATS-1 relayed the recovery of Apollo 8 from the carrier Yorktown. They have also performed a series of multiple-access experiments comparing FM and SSB access. Both satellites also contain 40-watt v.h.f. repeaters which have been used for experimental aircraft communications.

ATS-E will be the final satellite in the current series. It will attempt to use the force of gravity to keep the vehicle stable and pointed at earth from synchronous altitude. A planar array will

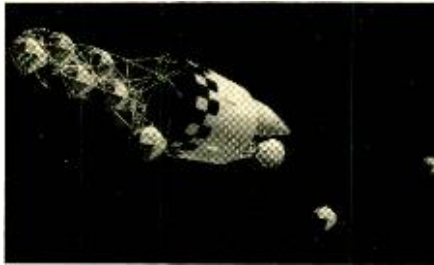

The trans-stage of a Titan III-C is depicted here ejecting IDCSP satellite into sub-synchronous orbit. Each launch contains 8 of these 100-lb military satellites.



This 85-ft antenna at the earth station at Paumalu, Hawaii has served as gateway station to the mainland. The facility has been recently expanded with an additional 96-ft antenna for Pacific traffic.

be used to beam communications signals at the earth from this stable platform. Since the force of gravity is so small at synchronous altitude, there is some question whether it can keep the vehicle stably pointed at earth. ATS-E will also perform the first millimeter space-to-earth communications experiments at 15.30 and 31.65 GHz.

Almost ten years to the day after Score, a long-tank Delta lifted the first operational communications satellite into orbit. Part 2 of this article will examine the operational satellites of today and tomorrow.

(Concluded Next Month)

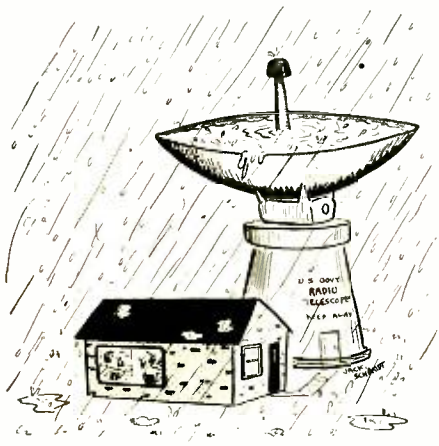

"It sounds like water on Mars!"



1969—WINTER \$1.25
ELECTRONIC EXPERIMENTER'S HANDBOOK

148 pages of the most fascinating and challenging construction projects for the electronics hobbyists. All with complete schematics, illustrations, parts list, and easy-to-follow instructions that guarantee you perfect finished products.



1969—SPRING \$1.25
ELECTRONIC EXPERIMENTER'S HANDBOOK

Another big package containing the most challenging, fun-to-build electronics projects ever! Be sure to order this one today!



1969 \$1.25
STEREO/HI-FI DIRECTORY

Giant 180 page buyer's guide listing more than 1,600 individual Stereo/Hi-Fi components by 176 manufacturers. Nine individual sections complete with specs, photos, prices—the works!

6 Vital Components
For Knowledge...
For Profit... For Sheer
Electronics Enjoyment!



1969 \$1.35
TAPE RECORDER ANNUAL

Over 130 pages covering every aspect of tape recording. Complete buyer's guide to the brands and models on the market. Expert tips on equipment — making better tapes — editing — copying — everything you want and need to know about tape recording.

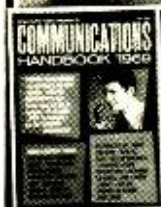

1969 \$1.35
COMMUNICATIONS HANDBOOK

148 fact packed pages for the CB, SWL or HAM. Equipment buyer's guide — photos — tables — charts — getting a license — everything to make this the world's most complete guide to communications.



1969 \$1.35
ELECTRONICS INSTALLATION & SERVICING HANDBOOK

For the serviceman who is also a businessman — the hobbyist who is also a perfectionist! Covers all 8 areas of consumer electronics servicing — all the tricks of the trade — in one complete, up-to-date guide. This is the industry's "how-to" book for installing and servicing consumer electronics equipment.

ZIFF-DAVIS SERVICE DIVISION • Dept. W
595 Broadway, New York, N.Y. 10012

Please send me the annuals I've checked below:

- 1969 Electronic Experimenter's Handbook - Winter
- 1969 Electronic Experimenter's Handbook - Spring
- 1969 Stereo/Hi-Fi Directory
- 1969 Tape Recorder Annual
- 1969 Communications Handbook
- 1969 Elect. Installation & Servicing Handbook

I am enclosing \$_____ My remittance includes an additional 25¢ per copy for shipping and handling (Outside U.S.A. all magazines are \$2.00 per copy, postpaid.)

print name _____ EW-79

address _____

city _____

state _____ zip _____

— PAYMENT MUST BE ENCLOSED WITH ORDER —

How to become a “Non-Degree Engineer”



In today's electronics boom the demand for men with technical education is far greater than the supply of graduate engineers. Thousands of real engineering jobs are being filled by men without engineering degrees—provided they are thoroughly trained in basic electronic theory and modern application. The pay is good, the future is bright... and the training can now be acquired at home—on your own time.

THE ELECTRONICS BOOM has created a new breed of professional man—the non-degree engineer. Depending on the branch of electronics he's in, he may "ride herd" over a flock of computers, run a powerful TV transmitter, supervise a service or maintenance department, or work side by side with distinguished scientists on a new discovery.

But you do need to know more than soldering connections, testing circuits and replacing components. You need to really know the fundamentals of electronics.

How can you pick up this necessary knowledge? Many of today's non-degree engineers learned their electronics at home. In fact, some authorities feel that a home study course is the *best* way. *Popular Electronics* said:

"By its very nature, home study develops your ability to analyze and extract information as well as to strengthen your sense of responsibility and initiative."

Cleveland Method Makes It Easy

If you do decide to advance your career through home study, it's best to pick a school that *specializes* in the home study method. Electronics is complicated enough without trying to learn it from texts and lessons that were designed for the classroom instead of the home.

Cleveland Institute of Electronics concentrates on home study exclusively. Over the last 30 years it has developed tech-

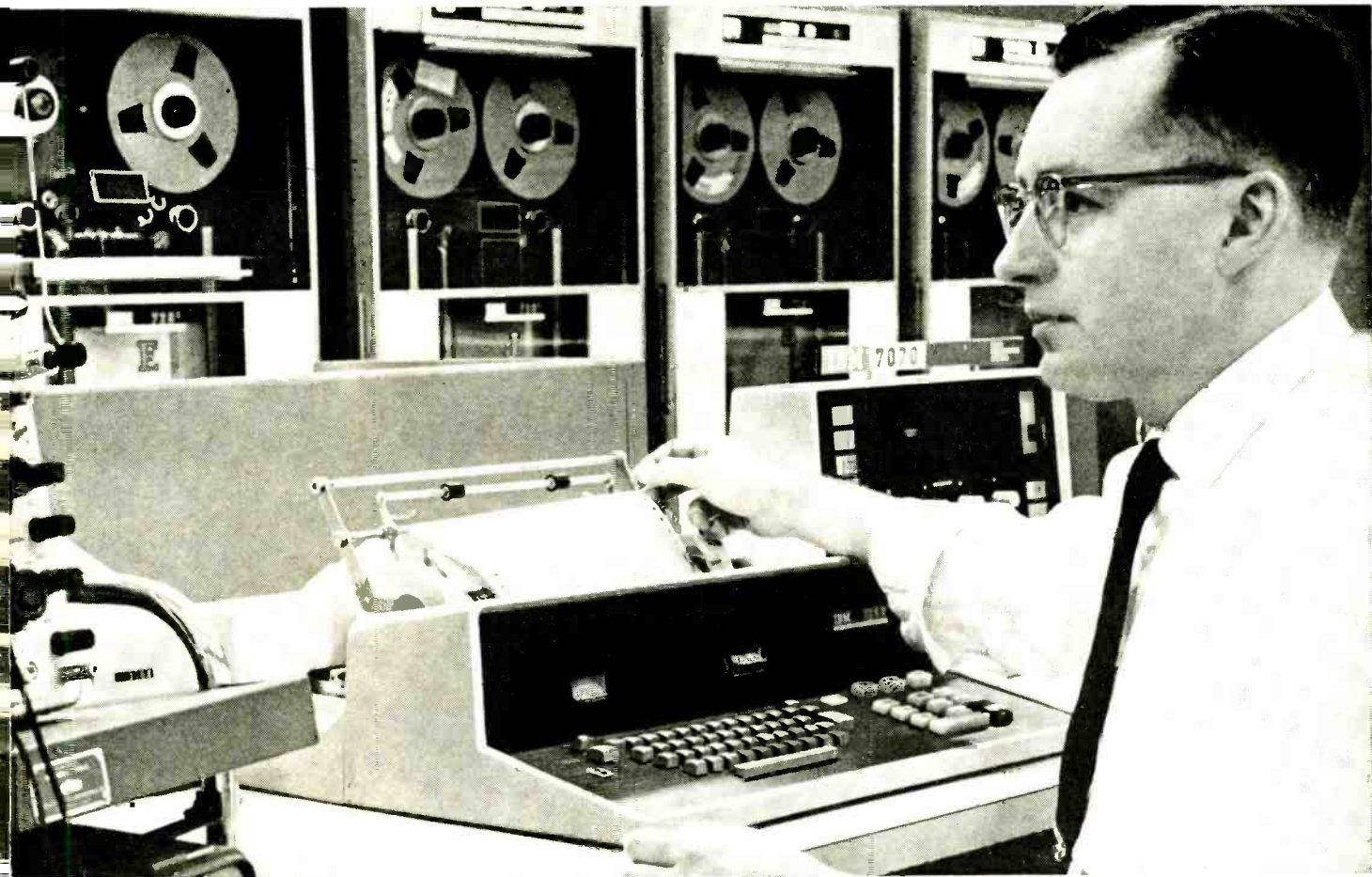

niques that make learning at home easy, even if you once had trouble studying. Your instructor gives the lessons and questions you send in his undivided personal attention—it's like being the only student in his "class." He not only grades your work, he analyzes it. And he mails back his corrections and comments the same day he gets your lessons, so you read his notations while everything is still fresh in your mind.

Students who have taken other courses often comment on how much more they learn from CIE. Says Mark E. Newland of Santa Maria, Calif.:

"Of 11 different correspondence courses I've taken, CIE's was the best prepared, most interesting, and easiest to understand. I passed my 1st Class FCC exam after completing my course, and have increased my earnings by \$120 a month."

Always Up-to-Date

Because of rapid developments in electronics, CIE courses are constantly being revised. This year's courses include up-to-the-minute lessons in Microminiaturization, Laser Theory and Application, Suppressed Carrier Modulation, Single Sideband Techniques, Logical Troubleshooting, Boolean Algebra, Pulse Theory, Timebase Generators...and many more.

CIE Assures You an FCC License

The Cleveland method of training is so successful that better than 9 out of 10 CIE

graduates who take the FCC exam pass it. This is despite the fact that, among non-CIE men, 2 out of every 3 who take the exam fail! That's why CIE can promise in writing to refund your tuition in full if you complete one of its FCC courses and fail to pass the licensing exam.

This Book Can Help You

Thousands who are advancing their electronics careers started by reading our famous book, "How To Succeed in Electronics." It tells of many non-degree engineering jobs and other electronics careers open to men with the proper training. And it tells which courses of study best prepare you for the work you want.

If you would like to cash in on the electronics boom, let us send you this 40-page book free.

Just fill out and mail the attached post-paid card. Or, if the card is missing, mail the coupon at right.

NEW COLLEGE-LEVEL CAREER COURSE FOR MEN WITH PRIOR EXPERIENCE IN ELECTRONICS

ELECTRONICS ENGINEERING... covers steady-state and transient network theory, solid state physics and circuitry, pulse techniques, computer logic and mathematics through calculus. A college-level course for men already working in Electronics.

CIE Cleveland Institute of Electronics

1776 East 17th Street
Cleveland, Ohio 44114

Please send me without cost or obligation:

Your 40-page book "How To Succeed In Electronics" describing the job opportunities in Electronics today, and how your courses can prepare me for them.

Your book on "How To Get A Commercial FCC License."

I am especially interested in:

- Electronics Technology
- Broadcast Engineering
- First Class FCC License
- Electronic Communications
- Industrial Electronics
- Electronics Engineering

Name _____ (PLEASE PRINT)

City _____

Address _____

State _____

Zip _____ Age _____

ENROLL UNDER NEW G.I. BILL. All CIE courses are available under the new G.I. Bill. If you served on active duty since January 31, 1955, or are in service now, check box on card or in this coupon for G. I. bill information.

EW-63

NEW PRODUCTS & LITERATURE

For additional information on items identified by a code number, simply fill in coupon on Reader Service Card. In those cases where code numbers are not given, may we suggest you write direct to the manufacturer.

COMPONENTS • TOOLS • TEST EQUIPMENT • HI-FI • AUDIO • CB • HAM • COMMUNICATIONS

CHART RECORDER

Simpson Electric Co., 5200 W. Kinzie Street, Chicago, Ill. 60644, has announced the availability of its new Model 2741 chart recorder which has eleven switch-selected d.c. voltage ranges, any of which can be set with front-panel controls



to become segmental scale or zero-center scale ranges. This allows the operator to custom-make the recording range for his specific needs.

For example, a 0-2 millivolt range can become a 1-2 millivolt range to use with a thermocouple for 50-100° F recordings; or a voltage which is expected to vary from about 12 to 18 volts can be recorded on a 10-20 volt range instead of a standard 0-20 volt range. The result is better resolution and an easier-to-read recording.

For short-duration pulses, resolution is assured by the recorder's fast response which reacts to a 10% change in just 200 ms. A complete 0 to full-scale change, across the entire 200-mm wide chart, requires no more than one second.

A six-page data sheet with complete specifications and information on these new recorders will be forwarded to those making letterhead request direct to the company.

V.H.F. DISTRIBUTION AMPLIFIER

Two solid-state, deluxe v.h.f. distribution amplifiers, designed for use in large hotel and apartment installations, have been introduced as the Models M-108 and M-109.

These high-output, broadband amplifiers offer a minimum gain of 40 dB on both high and low bands with individual gain control on both bands. Silicon overlay transistors in the driver and output stage provide a high level output with very low intermodulation.

A variable slope control with a range of 6 dB is fitted in each band to compensate for the very long cable runs which the amplifiers can handle. Silicon transistors are used to eliminate temperature problems.

In addition, a test point at -20 dB is provided at the amplifier output and the chassis slides easily from the case for inspection when in service. Electrical specifications are the same for both models with the exception that M-109 has separate low-band and high-band inputs at 75 ohms. Both come with all matching connectors. Finney

Circle No. 1 on Reader Service Card

CB BASE-STATION ANTENNA

A half-wave, 4-dB gain, omnidirectional base-station antenna with a new configuration and electrical characteristics has been announced as the Model M-227 "Mighty Magnum III."

The over-all configuration of the new unit is similar to previous versions, but with differences in the loading static arrester assembly at the top of the five-section aluminum dipole, and radical new "Power-Tip" radials. The static arrester is a

diamond-shaped double loop designed to improve static drain-off, reduce noise, and lower radiation angle.

The radials are substantially shorter than on previous models and are, therefore, more rugged. This is accomplished by means of four small loading coils which lengthen the radials electrically to full quarter-wavelength, thus producing an extremely low radiation angle and 4-dB omnidirectional gain.

Other features include a waterproof coax connector jacket, chemically welded dual-phasing coil jackets and double-interlock dipole joints. The v.s.w.r. is rated at 1.05 to 1 at center band and 1.4 to 1 at the band edges. Antenna Specialists

Circle No. 2 on Reader Service Card

ULTRASONIC CLEANER

A portable ultrasonic cleaner designed especially for home and shop applications is now on the market. It consists of three parts: a generator, transducer, and a cleaning tank.

Two models are being offered. The standard model can be used for cleaning jewelry, small electrical parts, etc. while the deluxe model has two insertable cleaning tanks to increase volume and two bottled cleaning solutions. Both units are moderately priced. Branson Instruments

Circle No. 3 on Reader Service Card

ACCESSORY TIP ASSEMBLY

Weller Electric Corp., 100 Welco Road, Easton, Pa. 18042 is now offering a low-cost accessory tip for the removal and resoldering of flat packs from printed-circuit boards. The new tip assembly, identified as the ESK-50, fits the company's standard Model W-TCP soldering tool.

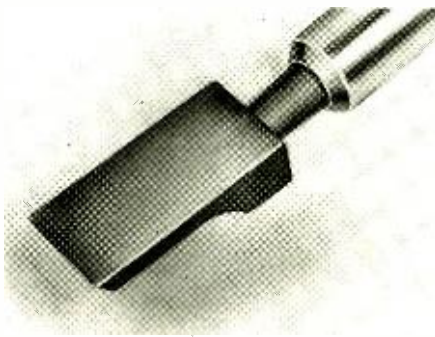

Conversion from standard soldering capability to the flat-pack assembly takes less than a minute.

Since the basic tool is a thermo-magnetically temperature-controlled device, any danger of component damage or board mealing is greatly reduced. The tip spans all seven leads at once and is non-wettable, thereby eliminating bridging of circuit lands.

Those writing on their company letterheads can obtain full details from the manufacturer.

SPECIAL-EFFECTS GENERATOR

A special-effects generator with facilities for switching, fading, superimposing, and wiping two video signals is now available as the Model SEC-1. The generator can accept inputs of up to four video cameras and can monitor the output of each camera. One channel may be inverted, if desired, to yield a negative picture. In addition, an internal sync generator supplies 2:1 interlace sync, or sync may be supplied with an external source.

The SEG-1 weighs 8½ pounds and measures 5¼" high x 15½" wide x 10" deep. Power consumption is 7 watts. It may be used with any of the firm's video cameras or any other video camera with external sync input, any monitor, or video tape recorder. Sony Corp.

Circle No. 4 on Reader Service Card

COAXIAL CONNECTORS

A new group of coaxial connectors that can be attached to cable without soldering or special tools is now on the market. The connectors are



designed to firmly, mechanically clamp the wire and braid when assembled. Wire impedance is maintained.

Three connectors are currently available: No. 6-80-2 is a splicer for RG-58 cable; No. 6-80-8 is a plug for RG-8 cable; and No. 6-80-58 is a plug for RG-58 cable. The connectors are made of silver-plated brass with Delrin insulators. NT-T Sales

Circle No. 5 on Reader Service Card

HIGH-POWER CASSETTE SYSTEM

A cassette stereo system, rated at 20 watts peak music power, has been added to the Micro series of cassette player/recorders.

Designated the Micro 86 system, the new unit includes individual stereo playback volume controls, illuminated vu meter, separate record-level dial, push-button cassette function controls, and a pair of matched stereo speaker systems and stereo microphones.

Styled in oiled walnut, the system weighs approximately nine pounds. The unit measures 14¾" x 8¾" x 3¾". Ampex

Circle No. 6 on Reader Service Card

AM-FM-STEREO SYSTEM

A three-piece AM-FM-stereo radio, designed especially for apartments and other locations where space is at a premium, has been introduced as the Model A-2690.

The receiver delivers 25 watts peak music power to two speakers. The solid-state circuit of the receiver uses 20 transistors, 17 diodes, and 4 thermistors. Push-buttons are used for "on-off" switching and for a.f.c. to lock in FM stations. A five-position mode switch selects AM, FM, stereo, phono, or auxiliary (tape). A balance control plus ganged bass and treble controls permits adjustment to suit room acoustics. There are inputs for ceramic phono and tape and outputs for tape recording. AM and FM antennas are built-in and terminals are provided for an ex-

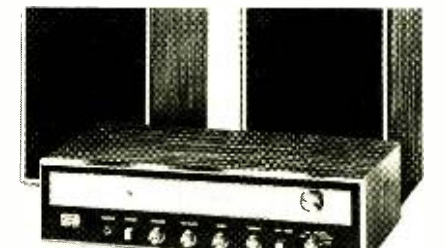

ELECTRONICS WORLD

ternal antenna if required. There is a front-panel stereo headphone jack and an FM-stereo indicator light.

Two speakers, a 6½" woofer and 2" tweeter, are mounted in each of the all-wood speaker enclosures. The speakers may be positioned up to 14 feet apart to meet individual space requirements.

An optional 4-speed record changer with cartridge, base, and dust cover is available for use with this system. Allied Radio

Circle No. 7 on Reader Service Card

VIDEO TAPE RECORDERS

The Model 1000 video tape recorder is a combination stereo and video machine that can play back pictures and sound on quarter-inch tape of the type used with audio tape recorders. The machine can also be used to record and play back conventional four-track stereo tapes.

The unit will operate in either a horizontal or vertical position, thus offering flexibility in use. It uses a helical scan rotating head system and tape speed, in the video tape mode, is 11.25 inches per second. A 17-inch reel of ¼-inch magnetic tape will record more than an entire half-hour TV program. In the four-track stereo mode, the equipment offers both 3¾ and 7½ in/s speeds, plus automatic reverse.

TV cameras and television screen monitors designed to be used with the Model 1000 are also available. Califone-Roberts

Circle No. 8 on Reader Service Card

FOUR-CHANNEL COLOR ORGAN

A new color organ control box which uses tunable active RC filters for frequency separation and all silicon solid-state construction is now on the market.

This four-channel unit is capable of operating up to 250 watts of incandescent lighting per channel. The unit is connected across the speaker terminals of any audio amplifier by means of clip leads.

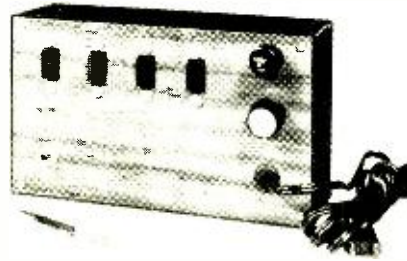

The color organ is housed in a compact Bakelite case with a walnut wood-grain front panel measuring 7¾" x 4½" x 2½" deep. Its small size makes it feasible to build it directly into the lighting display. A three-channel unit with the same wattage rating per channel is also available. Edison Instruments

Circle No. 9 on Reader Service Card

DIGITAL PANEL METER

Instrument Displays, Inc., 18-36 Granite Street, Haverhill, Mass. 01830 has announced the availability of its "Mini-Diget" series of MDPM digital panel meters.

According to the company, the new series are high-accuracy, low-cost, single-range digital volt, current, or ohm meters. They can be used for



production-line testing, process control, quality control, incoming inspection, as well as in display and data logging applications.

Standard features of the series include 8-4-2-1 BCD output to provide systems capability, latching memory circuits, trigger input for remote-control applications, and automatic ± polarity indication.

For complete information write the firm at the above address on your company letterhead.

TELEPHONE AMPLIFIER

An all-transistor telephone amplifier, designed to increase the usefulness of any phone, is now available as the Model KG-205.

No electrical connection is required to the telephone. A suction-cup mount on the pickup permits instant attachment to any phone. The solid-state circuit amplifies the sound to room level for hands-free phone conversation and group listening. It is also useful for the hard-of-hearing.

The amplifier is supplied in kit form and can be assembled using basic tools. It is equipped with a volume control and "on-off" switch. A 9-volt battery and step-by-step instructions are included. Allied Radio

Circle No. 10 on Reader Service Card

SOLID-STATE STEREO AMP

The LA-125TA is a 125-watt solid-state integrated stereo amplifier featuring a "Computer-Matic" circuit for instant protection of output transistors in the event of short-circuits or overloads.

Frequency response is 22-20,000 Hz ±1 dB at 1 watt and power bandwidth is 20-40,000 Hz. Harmonic distortion is less than 1% at rated power at 1000 Hz. The amplifier has front- and rear-panel tape outputs, front-panel headphone output jack and a microphone musical input, low- and high-frequency filters, plus eight additional controls for optimum performance: speaker mode, amplifier mode, program source selector,

This round surround is revolutionizing the speaker industry.

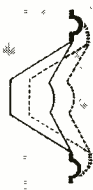
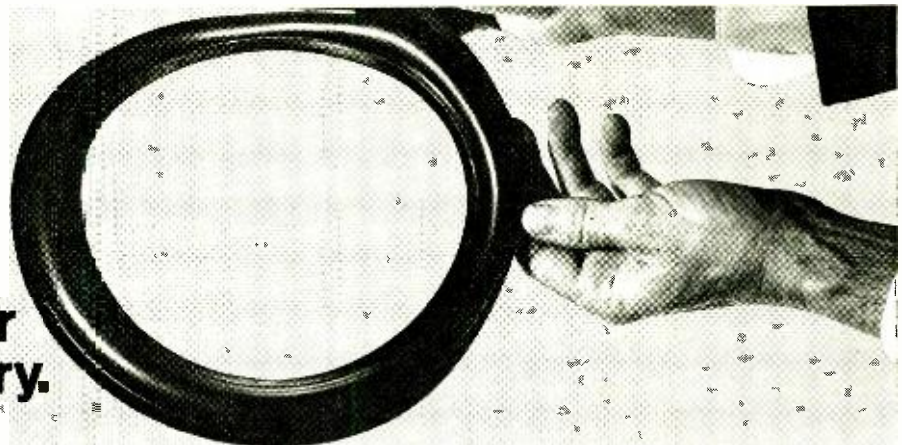

It suspends the woofer cone in University Sound's newest speaker system — the Project M. It allows the cone to make inch-long excursions and still maintain linearity accurate to within .001%. Try that on your woofer.

What does it mean?

For the first time, a compact speaker system that can match

specifications with the finest amplifiers and receivers. It means rich, uncluttered, accurate sound nearly a full octave below every other comparably priced speaker system on the market. Coupled with the Project M's exceptionally

clean tweeter, it means a fully balanced range of sound from 30 to more than 20,000 Hz, with no mid-range regeneration gaps.

See your University dealer and hear the difference.

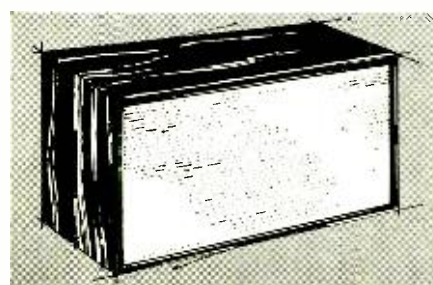

CIRCLE NO. 106 ON READER SERVICE CARD

SPECIFICATIONS: Acoustic Suspension System • Frequency Response: 30 to 20,000 Hz • Power Handling Capacity: 60 watts • Recommended Amplifier Power: 30 watts 1PM • Impedance: 8 ohms • Finished on four sides in oiled walnut • Dimensions: 23½" x 12¾" x 11⅞" • Shipping Weight: 30 lbs.

Listen . . . University Sounds Better

UNIVERSITY SOUND
A DIVISION OF UNIVERSITY ELECTRIC, INC.
P.O. Box 26105, Oklahoma City, Oklahoma 73126



FREE!

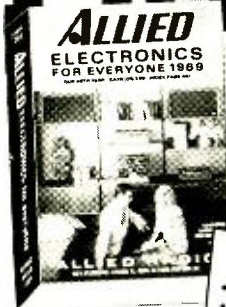

**NEW 1969
ALLIED
CATALOG**
**536
PAGES**

SAVE ON:

- Electronic & Hobby Kits
- Stereo Hi-Fi
- Tape Recorders, Tape
- CB 2-Way Radios
- Walkie Talkies
- FM-AM & AM Radios
- Shortwave Receivers
- Portable TV
- Phonographs
- Amateur Gear
- Intercoms & PA
- Automotive Electronics
- Test Instruments
- TV Antennas & Tubes
- Power Tools, Hardware
- Tubes, Transistors
- Parts, Batteries, Books

**TOP SAVINGS ON
THE BEST IN
ELECTRONICS
FOR EVERYONE**

Shop by mail and save at Allied, world's largest electronics headquarters. Hundreds of money-saving values. **NO MONEY DOWN.** Up to 2 years to pay!

**MAIL COUPON
BELOW**

ALLIED RADIO, Dept. 035
P.O. Box 4398, Chicago, Ill. 60680

NAME _____ Please Print
First Middle Last
ADDRESS _____
CITY _____
STATE _____ ZIP _____

CIRCLE NO. 150 ON READER SERVICE CARD

Olson



FREE

Fill in coupon for a **FREE** One Year Subscription to **OLSON ELECTRONICS' Fantastic Value Packed Catalog**—Unheard of **LOW, LOW PRICES** on Brand Name Speakers, Changers, Tubes, Tools, Stereo Amps, Tuners, CB, Hi-Fi's, and thousands of other Electronic Values. Credit plan available.

NAME _____
ADDRESS _____
CITY _____ STATE _____
GIVE ZIP CODE _____

If you have a friend interested in electronics send his name and address for a **FREE** subscription also.

OLSON ELECTRONICS

421 S. Forge Street Akron, Ohio 44308

CIRCLE NO. 123 ON READER SERVICE CARD

concentric balance/volume, treble, bass, loudness, and tape monitor. Speaker outputs are 4, 8, and 16 ohms. There are two a.c. outlets, one switched and one unswitched.

The unit is housed in a simulated walnut-grained metal enclosure measuring 13" x 3 3/8" x 10" deep. Lafayette

Circle No. 11 on Reader Service Card

PC WAFER SWITCHES

A new molded-design approach to wafer switches for PC board applications has been developed by Standard Grigsby Company, 920 Rathbone Ave., Aurora, Ill. 60507.

According to the company, the new design eliminates the often faulty mechanical pressure linkage between the stator and switch contact paths and uses a snap-lock rotor construction.

The rugged 8-terminal molded switch wafer has a one-piece metal stator contact path from

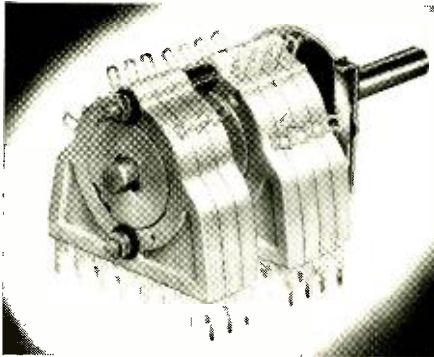

the PC termination to the switching point. Eight rigid PC terminals in the switch wafer can be used to make connections with the board terminations. Six auxiliary, solder-lug terminals may also be supplied. The metal inner stator contact structure can be divided at any 30° point with either a shorting division or a pair of cuts which make a non-shorting division. The snap-lock construction of the rotor lets the circuit engineer assemble and disassemble the switch wafer to make his own prototypes.

For complete information on these new SKPC switches, write on your company letterhead, to the above address.

TELEPHONE-ANSWERING MACHINE

An inexpensive phone-answering instrument designed for small businesses, home owners, and apartment dwellers has just been introduced as the "Phone-Mate 500."

The instrument will automatically answer the phone on any ring the user selects, broadcasts a pre-recorded message to the caller, records the incoming message, and hangs up, ready for the next call.

One special feature is the machine's ability to monitor and screen incoming calls. The user can set the unit so that he can hear who is calling and "be out" if he doesn't wish to talk or can



pick up the phone and override the answering machine.

The compact, all-transistor unit can be set to record both sides of a telephone conversation and it can amplify calls so that all persons in a large room can hear. Tron-Tech

Circle No. 12 on Reader Service Card

AUTOMATIC TURNTABLE

The new Model 600 automatic turntable includes a Decor-Matic base which incorporates an illuminated power switch that permits the complete receiver system to be shut off automatically by the turntable after the last record has been played. In addition to the base, the Model 600 includes a deluxe dust cover and a cartridge. The unit comes completely assembled and wired ready to be plugged into a system.

The unit has a cast turntable and an adjustable dynamic anti-skate control, which applies a continuously corrected degree of compensation, as required, at all groove diameters to neutralize inward skating force and eliminate distortion caused by unequal side wall pressure on the stylus.

The turntable also features a micrometer stylus pressure adjustment which permits 1/3 gram settings from 0 to 6 grams, a stereo muting switch for complete silence during the record-changing cycle, and a cueing and pause control lever which permits the listener to raise or lower the pickup arm at any time and then return it to the same groove. BSR McDonald

Circle No. 13 on Reader Service Card

REFLECTIVE "SKANNER"

The S-322-36 reflective "Skanner" is available for use with either infrared or visible light. It uses fiber optics to transmit light coaxially around a light sensor.

Reflective light provides a 1-V swing in the



sensor from black to white. The sharpest focus and minimum field of view is 0.100". Object definitions of 0.003" can be obtained. Over-all size of the unit is 1 7/8" x 3/8" x 5/8". Scan-A-Matic

Circle No. 14 on Reader Service Card

STEREO MUSIC SYSTEM

A compact stereo music system which combines an AM-FM-stereo receiver with an automatic changer and two matched speaker systems is now available as the #35-140.

The system provides 40 watts of music power at 8 ohms at less than 1% HD at listening levels; 40 dB channel separation; frequency response 25-25,000 Hz; separate bass and treble controls; built-in overload protection; stereo headphone jack; and tape-in/tape-out jacks. Sensitivity is 3.5 µV for 20 dB S/N on FM. There is a 300-ohm FM antenna and a built-in ferrite loop for AM.

The turntable is a Garrard unit with 4-pole shaded induction-surge motor equipped with a magnetic cartridge and diamond stylus. The speakers are acoustic suspension types housed in oiled walnut cabinets. Each loudspeaker enclosure in the system measures 17 7/8" x 10" x 5 1/2" deep. Claricon

Circle No. 15 on Reader Service Card

MOBILE CB UNIT

The new solid-state "Corsair" CB unit has been designed primarily for mobile use. It features complete AM capability plus a single-sideband receiver and a double-sideband suppressed-carrier transmitter.

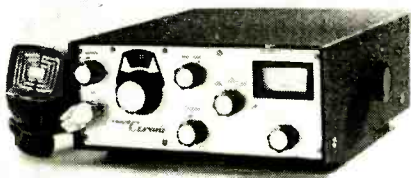

The new unit is completely compatible with any unit now on the market, whether standard AM, single- or double-sideband. The receiver uses a Collins mechanical filter which cuts interference from adjacent channels to 90 dB down or better. The transmitter provides above average power output, with 100% modulation assured by keyed audio compression. A unique noise blanker backed up by a noise limiter reduces ignition interference.

The "Corsair" is 4" x 9" x 8" and is designed to be installed in cars, boats, or aircraft. The unit draws a maximum of 1.5 amps on transmit and 300 mA on receive. Tram Corp.

Circle No. 16 on Reader Service Card

AUTOMATIC TURNTABLE

A pre-wired automatic turntable module designed to plug into and play through table radios, FM-stereo receivers, component stereo systems, TV sets, and tape machines has been introduced as the X-10.

The unit comes with a pre-installed stereo ceramic cartridge with diamond stylus and is pre-mounted on a base with the company's three-way dust cover.

The X-10 Module features single-lever cueing and pause control, an ultra-low-mass tubular



tonearm, interchangeable spindles for manual and automatic play, and an oversize turntable. Garrard

Circle No. 17 on Reader Service Card

DIGITAL PANEL-METER LINE

The Triplett Electrical Instrument Company of Bluffton, Ohio 45817 has announced the development of a new digital panel meter of "Total Capability" design that provides the user with a number of sophisticated features, built into a single package, without having to purchase added options to perform ultra-sensitive, highly accurate ($\pm 0.1\%$) readings.

The Model 5000, 3 1/2-digit meter with non-blinking display and movable decimal point, automatic polarity, and over-range indicator, has a sensitivity of 100 millivolts d.c., 100 μ V resolution, and an accuracy of $\pm 0.1\%$ full-range ± 1 digit. Dual-slope integration for greater stability and longer life is also provided.



July, 1969

The brand for all reasons

BSR McDONALD 600



Every BSR McDonald automatic turntable is precision made in Great Britain to the most exacting specifications. Upon their arrival in the U.S., every model is unpacked and re-tested under actual playing conditions. That's why ESR service calls are the lowest in the industry—and perhaps that also explains why ESR sells more turntables than anyone else in the world.



McDONALD

E
BSR (USA) LTD.
BLAUVELT, N.Y. 10913
Please send FREE detailed literature
on all BSR McDonald automatic turntables.

Name _____

Address _____

City _____

State _____

Zip _____

CIRCLE NO. 147 ON READER SERVICE CARD

SONARCOM

FOR FIRE, POLICE, SECURITY, BUSINESS
AND INDUSTRIAL APPLICATIONS
SONAR VHF-FM TRANSCEIVER

(132-174 MHz)

YOU ALWAYS GET THROUGH... OPERATES ANYWHERE!
INDOORS, OUTDOORS, IN STEEL BUILDINGS

More performance and features than much higher priced units. Engineered with space age techniques and military type components for high reliability.

- Provides instant voice contact with base stations, mobile units and other portable transceivers
- Compatible with all VHF narrow band systems
- Full frequency range for all public safety, industrial and land transportation services
- Exclusive "Push-to-Talk" microphone for easy to use action
- Electronic mode switching, no relays
- Receiver and transmitter can be operated on independent frequencies
- External connections for antenna, earphone and battery charger
- Sensitive, noise immune squelch
- Single or split channel operation
- 1.6 watt output

\$37500

with 1 pair of crystals
and penlite batteries

Sonar Radio Corporation
73 Wortman Avenue, Brooklyn, N.Y. 11207

Please send information on Model 2301—the SONARCOM.
Dept. 201

Firm Name _____ Title _____

Address _____ Phone _____

City _____ State _____ Zip _____

FCC TYPE
ACCEPTED for parts 89,91,93
and part 21
telephone use



CIRCLE NO. 109 ON READER SERVICE CARD

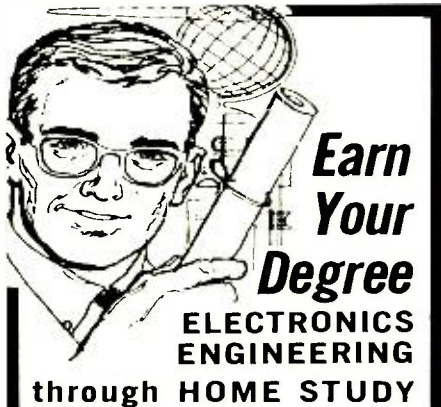

**Earn
Your
Degree**

**ELECTRONICS
ENGINEERING**

through HOME STUDY

**HIGHLY EFFECTIVE
HOME STUDY COURSES IN:**
 • Electronics Engineering Technology
 • Electronics Engineering Mathematics

Earn your Associate in Science Degree in Electronics Engineering and upgrade your status and pay to the engineering level. Complete college level courses in Electronics Engineering. We're a forward looking school. Outstanding lesson material—thorough and easy to understand. Engineering taught on the basis of application and understanding rather than on the basis of memorization. Up to date in every respect. Acquire the knowledge and ability that means the difference between a low paying technician job and a high paying engineering position. Low tuition cost with low monthly payments. Free engineering placement service for our graduates. Write for free descriptive literature. Ask for bulletin H, no salesman will call on you.

COOK'S INSTITUTE
of Electronics Engineering

Forest Hill Road
P. O. Box 10634
Jackson, Miss. 39209

Established 1945
Formerly Cook's School of Electronics

CIRCLE NO. 143 ON READER SERVICE CARD

**COOPERATE WITH THE
ZIP CODE PROGRAM
OF THE POST OFFICE
DEPARTMENT.
USE ZIP CODE
IN ALL ADDRESSES**

GET INTO ELECTRONICS



V.T.I. training leads to success as technicians, field engineers, specialists in communications, guided missiles, computers, radar and automation. Basic & advanced courses in theory & laboratory. Electronic Engineering Technology and Electronic Technology curricula both available. Assoc. degree in 29 mos. B. S. also obtainable. G.I. approved. Graduates in all branches of electronics with major companies. Start September. February. Dorms. campus. High school graduate or equivalent. Write for catalog.

VALPARAISO TECHNICAL INSTITUTE
Dept. RD, Valparaiso, Indiana 46383

For complete information on the Model 5000 and data about available options, write on your company letterhead to the above address.

MANUFACTURERS' LITERATURE

REED-RELAY CATALOGUE

Wheelock Signals, Inc. has made available a 24-page catalogue covering over 160 relays from its complete family of reed relays.

The catalogue contains detailed information on life and reliability characteristics of the relays. Also included are the firm's line of ultraminiature reed relays, microminiature types, miniatures, standard, and mercury-wetted types. Detailed electrical, mechanical, and environmental specifications; dimensional drawings; photographs; applications; and ordering information are also included.

Write on your company letterhead for a copy of this catalogue. The address is 273 Branchport Ave., Long Branch, New Jersey.

ANTENNA BROCHURE

A colorful 6-page brochure describing an extensive line of "Color Spectrum" antennas is now available for distribution.

Included in the line are v.h.f./u.h.f./FM models, v.h.f./FM types, and u.h.f. models. Each unit is pictured and technical specs provided. Information on how these frequency-dependent antennas operate and perform is also included, along with data on the hardware which is a part of each antenna. Finney

Circle No. 18 on Reader Service Card

MICROPHONE CATALOGUE

A 20-page catalogue describing an extensive line of microphones, including several recently developed models, is now available.

Included in the catalogue are professional cardioid dynamic, mobile and transistorized mobile, base station, paging, public address and tape recording microphones, plus microphone cartridges, stands, and accessories. The publication includes technical sections and product descriptions, specifications, photographs, and list prices on each microphone. A copy of catalogue No. 2520 will be forwarded on request. Turner

Circle No. 19 on Reader Service Card

AUDIO CONNECTORS

Catalogue C-502b describes a complete line of audio connectors, standard microphone connectors, adapters, r.f. connectors, Y connectors, a.c. receptacles, and phone jacks.

The 12-page catalogue includes specifications, detailed drawings, application hints, and prices for single- and multiple-conductor models. It provides engineers and designers with an up-to-the-minute guide to the latest in audio connectors and related components. Switchcraft

Circle No. 20 on Reader Service Card

POWER SUPPLIES

An 8-page, 2-color catalogue which introduces and discusses a unique design concept in power supplies is now available.

The catalogue describes the line of UniPower supplies which combine the advantages of a single all-purpose, wide-range supply with the compact size of a narrow-range slot supply. The units are available in current outputs up to 24 amperes.

The publication covers electrical specifications, mechanical data, and prices. A description of building-block modules, rack adapters, and a full line of accessories is also included. Power/Mate

Circle No. 21 on Reader Service Card

RELAY HANDBOOK

Hart/Advance Relay Division, Crystal Lake, Ill. 60014 has published a 36-page combination catalogue/engineering handbook covering a broad line of power, r.f., and signal relays now available in over 40 basic design types with dozens of operational features.

The four-color publication contains photographs, line drawings, scope patterns, electrical characteristics, and mechanical specifications for all configurations. Relay types included are tele-

phone, general-purpose, power, coaxial-antenna switches, polarized telegraphic, thermal time-delay, standard time-delay, sensitive and d.c., ultra-sensitive signal, solenoids, crystal can, microminiature, and military.

Those wishing a copy of this handbook may obtain one by requesting it on their company letterhead.

INDUCTANCE BULLETIN

James Millen Manufacturing Company, Inc., 150 Exchange St., Malden, Mass. 02148 has just issued a 16-page booklet covering its line of standard and special inductances.

Included in the bulletin are complete technical details on an extensive line of inductors, coils, r.f. chokes, and coil forms.

Copies of this publication are available on letterhead request direct to the manufacturer.

PLUG-IN POWER SUPPLIES

A 24-page catalogue that lists over 82,000 a.c.-to-d.c. all-silicon plug-in power supplies is now available from Acopian Corporation, Easton, Pa. 18042.

The catalogue describes and gives prices of regulated single and dual supplies, unregulated supplies, and high isolation units for strain-gage applications. Also included is a guide to power-supply selection.

Also shown are rack-mounted power-supply assemblies and crowbar d.c. overvoltage protectors.

Write on your business letterhead for a copy of this catalogue.

IC LOGIC HANDBOOK

Datascan, Inc., 1111 Paulison Ave., Clifton, N.J. 07013 has just published a 208-page "Integrated Circuit Logic Handbook," No. 101.

Included are complete descriptions of each standard module plus circuit operation, part lists, specifications, outline drawings, and prices. The company's power supplies, hardware, and accessories are also presented in detail.

Write on your business letterhead, direct to the company, for a copy of the Handbook.

MAGNETIC SHIELDING

Copies of the publication, "Helpful Information for Designing a Magnetic Shield", are now available for distribution. Written in no-nonsense style, the material is presented to engineers for maximum usefulness in minimum reading time. The article contains hundreds of actual measurements and, for the first time, measured shielding ratios are published.

Tabular data on shields for cathode-ray tubes and photomultiplier tubes constitutes over half of the booklet. James Millen

Circle No. 22 on Reader Service Card

SOUND PRODUCTS BROCHURE

A new pocket-size folder which illustrates and describes the company's full line of sound entertainment products—reel-to-reel portable and stereo tape recorders, portable and stereo cassette recorders, mobile stereo cartridge systems, home stereo cartridge players, and tape recording accessories—is now available for distribution. Craig Corp.

Circle No. 23 on Reader Service Card

PHOTO CREDITS

Page	Credit
20	Tannoy (America) Limited
27, 67	NASA
28	Hewlett-Packard
31 (top)	Computer Diode Corp.
31 (center)	Sharp Electronics Corp.
31 (bottom left)	IBM
31 (bottom right), 51	Sylvania Electric Products
36	Motorola Semiconductor
60	Garrard

HIGH-GAIN AUDIO INPUT STAGE

By FRANK H. TOOKER

Using an FET as the bias resistor for a bipolar transistor results in high gain.

THE distinct advantage of the field-effect transistor is its high input resistance. Generally, bipolar transistors can provide greater gain. Thus, an FET is often used as the first transistor in an audio amplifier, while the following stages employ bipolar types. The question is, how to get the FET into the first stage while using a minimum number of other components, in order to keep the cost down.

The circuit below is most often used by the author when high audio voltage gain is needed and the frequency response of the amplifier need not be quite up to hi-fi quality. The setup requires no additional components, other than the FET itself. In fact, the FET, Q1, takes the place of the bias resistor for the following stage transistor, Q2. This arrangement takes advantage of a fact which is apparently not realized by a number of circuit designers, i.e., many an FET can be operated effectively with a source current of only a few microamperes. The author's preferred transistors for this application, at the present time, are *Texas Instruments' 2N3819* or *Motorola's 2N5457* or MPF103 (2N5457 is the recently introduced JEDEC designation for the popular MPF103). A secondary advantage of using either of these FET's in this way is that the relatively high automatic gate bias keeps the transistor's input capacitance at a minimum value.

The circuit provides a signal voltage gain of 120. An input of 10 mV r.m.s. produces an output of 1.2 volts r.m.s. at 400 Hz. Frequency response is down 2 dB at 30 Hz and 10 kHz. This is actually quite good, considering the gain figure and the simplicity of the circuit. However, even though the output waveform is acceptably clean, the bandwidth is not quite up to hi-fi standards—although it would take an expert to detect the difference in a listening test. In any event, the circuit is well adapted for use in conventional radio receivers, phonographs, and speech amplifiers.

The d.c. bias for both Q1 and Q2 is established and controlled by the voltage drop across Q2's emitter resistor, R2. This biasing scheme is simple yet it provides good d.c. stabilization. The value of R2 should be selected to produce a d.c. stage current of 0.9 to 1.0 mA at 20 volts. The exact value for any individual setup will be somewhere between 560 and 1200 ohms. Too high a value for R2 reduces stage gain. R2 is bypassed with capacitor C2, to prevent audio signal degeneration. ▲

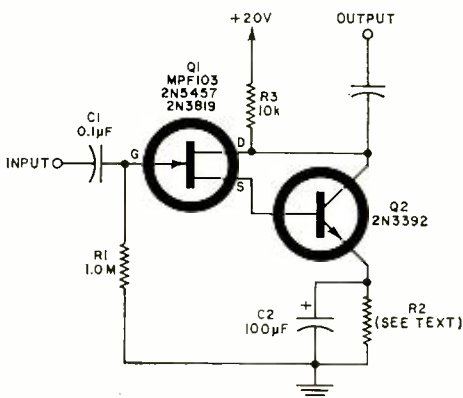

Schematic of circuit which provides high audio voltage gain in applications not requiring hi-fi frequency response.

COLOR ORGAN ONE KILOWATT-FOUR CHANNELS ULTRA - COMPACT - LOW COST



Build Dancing Colored Lighting Displays That Leap And Sparkle In Ever Changing Color Combinations Of Red, Blue, Green And Yellow. Displays Which Dance In Rhythm And Intensity According To The Frequency Content Of The Musical Input Taken From The Loudspeaker Terminals Of Any Audio Amplifier.

YEAR ROUND ENJOYMENT

Hi-Fi Enhancement — Lawn Parties — Musical Groups — Display Advertising — Spectacular Christmas Displays.

Features: Tunable Active R-C Filters For Frequency Separation
• All Silicon Solid State Design
• Walnut Wood Grain Panel — Compact Bakelite Case That Measures Only 7 3/4" x 4 1/2" x 2 1/2" Deep.

Easy to Assemble Printed Circuit Board Kit — \$49.95
Factory Assembled — \$65.00

Add \$2.00 For Handling And Shipping Costs
N. J. Residents Add 3% Sales Tax
(Payment Must Accompany Order)

EDISON INSTRUMENTS, INC.

54 West Cherry Street • Rahway, N. J. 07065

(201) 381-0140

CIRCLE NO. 138 ON READER SERVICE CARD

FREE



GIANT 1969 RADIO-TV ELECTRONICS CATALOG

228 GIANT VALUE-
PACKED PAGES

YOUR BUYING GUIDE FOR . . .
TV's, Radios, Recorders, Phonos,
Amateur and CB equipment, elec-
tronic parts, tubes and test equip-
ment . . . plus featuring B-A's
famous bargain packed section!

WRITE FOR YOUR FREE CATALOG TODAY!

BURSTEIN-APPLEBEE CO., DEPT. EW-G
3199 MERCIER ST., KANSAS CITY, MO. 64111

Name _____

Address _____

City _____

State _____ Zip Code _____

CIRCLE NO. 146 ON READER SERVICE CARD

Can you solve these two basic problems in electronics?

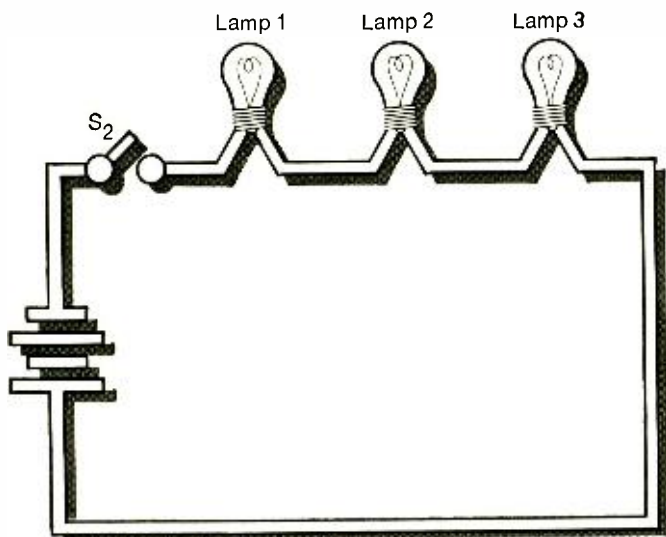

This one is relatively simple:

When Switch S_2 is closed, which lamp bulbs light up?

Note: If you had completed only the first lesson of any of the RCA Institutes Home Study programs, you could have solved this problem.

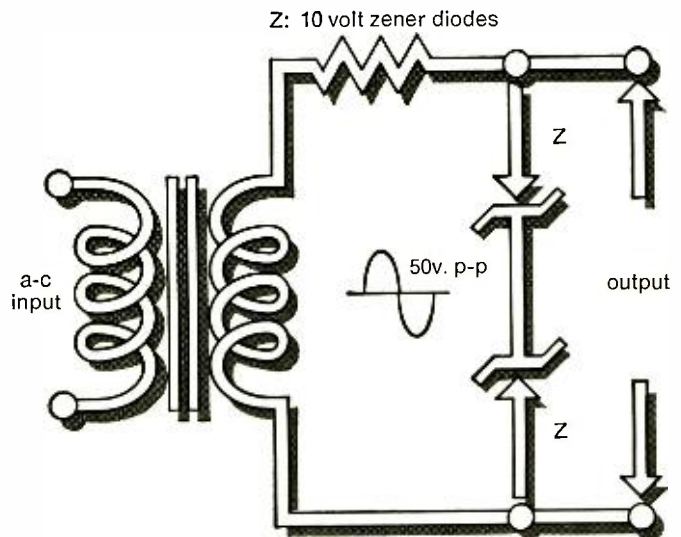

This one's a little more difficult:

What is the output voltage (p-p)?

Note: If you had completed the first lesson in the new courses in Solid State Electronics, you could have easily solved this problem.

These new courses include the latest findings and techniques in this field. *Information you must have if you are to service today's expanding multitude of solid state instruments and devices used in Television, Digital, and Communications Equipment.*

If you had completed an entire RCA Institutes Home Study Course in Semiconductor Electronics, Digital Electronics, or Solid State Electronics, you should now be qualified for a good paying position in the field you choose. Send for complete information. Take that first essential step now by mailing the attached card.

ANSWERS: Problem 1—they all light up
Problem 2—20 Volts (p-p)

RCA Institutes Autotext learning method makes problem-solving easier... gets you started faster towards a good-paying career in electronics

Are you just a beginner with an interest in electronics? Or, are you already making a living in electronics, and want to brush-up or expand your knowledge? In either case, RCA has the training you need. And Autotext, RCA Institutes' own method of Home Training will help you learn more quickly and with less effort.

Wide Range of Courses

Select from a wide range of courses. Pick the one that suits you best and check it off on the attached card. Courses are available for beginners and advanced technicians.

Electronics Fundamentals
Black & White Television Servicing
(Transistorized TV Kit Available)
Color Television Servicing (Color TV Kit Available)
FCC License Preparation
Automatic Controls
Automation Electronics
Industrial Electronics
Nuclear Instrumentation
Electronics Drafting
Computer Programming

Plus these new up-to-the-minute courses

Semiconductor Electronics
Digital Electronics
Solid State Electronics
Communications Electronics

Prepare for good paying positions in fields like these

Television Servicing
Telecommunications
Mobile Communications
CATV
Broadcasting
Marine Communications
Nuclear Instrumentation
Industrial Electronics
Automation
Computer Programming
Solid State
Electronics Drafting



Build and keep this valuable oscilloscope.

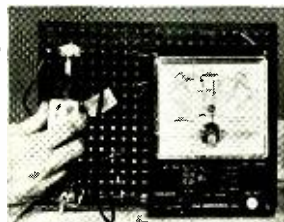

In the new program on Solid State Electronics you will study the effects of temperature and leakage characteristics of transistors.

RCA

Valuable Equipment—Yours To Keep

A variety of RCA Institutes engineered kits are included in your program of study. Each kit is yours to keep when you've completed the course. Among the kits you construct and keep is a working signal generator, a multimeter, a fully transistorized breadboard superheterodyne AM receiver, and the all-important oscilloscope. These kits are at no extra cost. Compare this selection with other home study schools.

Convenient Payment Plans

RCA Institutes offers liberal monthly payment plans to suit your budget.

Classroom Training Also Available

RCA Institutes operates one of the largest technical schools of its kind. Day and evening classes. No previous training is required. Preparatory courses are available. Classes start four times a year.

Job Placement Service, Too!

Companies like Bell Telephone Labs, GE, Honeywell, IBM, RCA, Westinghouse, Xerox, and major radio and TV networks have regularly employed graduates through RCA Institutes' own placement service.

All RCA Institutes courses and programs are approved for veterans under the new G.I. Bill.

Send Attached Postage Paid Card Today. Check Home Study or Classroom Training.

Accredited Member National Home Study Council.

IF REPLY CARD IS DETACHED, SEND THIS COUPON

RCA Institutes Inc.

Home Study Dept. EW-79
320 West 31 Street
New York, N.Y. 10001

Please send me FREE illustrated career catalog.

Name _____ Age _____
(please print)

Address _____

City _____ State _____ Zip _____

ActionLITE PUSHPINS LIGHT UP...

ACTUAL SIZE



GET YOUR MESSAGE ACROSS IN A FLASH!

Versatile NEW visual display system features **pushpins that light** . . . even **flash**. Your overlays of sales maps, production charts etc. mount easily on special cork-board surface backed with conducting Plasticon. (Board uses ordinary electric current.) Use ActionLITE pushpins to focus attention. The special surface is Magnetic too, to insure dramatic visual impact. ActionLITE pushpins and magnetic markers come in many sizes, shapes, colors. Boards range in size from 2'x3' to 4'x8'.

METHODS RESEARCH

200 Willow Ave., Staten Island, N.Y. 10305
CIRCLE NO. 127 ON READER SERVICE CARD

NEW! . . . from Lampkin Laboratories TYPE 107 DIGITAL FREQUENCY METER FAST - ACCURATE - PORTABLE

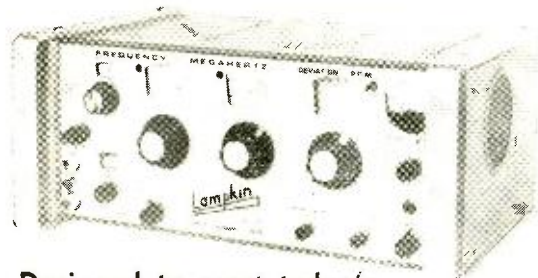

Designed to meet today's
mobile-radio service needs -

- ★ ONE PART PER MILLION ACCURACY!
- ★ ALL-CHANNEL COVERAGE - TO 500 MHZ
- ★ READ FREQUENCY DIRECT - NO CHARTS!
- ★ EASIER - MORE FLEXIBLE - FASTER!

\$2,390 F.O.B. Bradenton, Florida

For complete specifications - Mail coupon today

Name _____
Address _____
City _____ State _____ Zip _____

LAMPKIN LABORATORIES, INC.
MFM Div., Bradenton, Fla. 33505

SIMPLE FREQUENCY COUNTER

By RONALD L. CARROLL

If your scope lacks a calibrated time base, use this device for frequency measurement.

SINCE most of us can't afford expensive laboratory quality scopes for our home or shop workbenches, we must make do with the less expensive, kit variety. These do well enough for waveform presentation and it is fairly easy to calibrate the vertical deflection controls.

However, since only the more costly instruments have a calibrated time base (*i.e.*, time/in or time/cm) of horizontal deflection, it is difficult to make accurate frequency measurements. A frequency meter which will complement your scope and make such frequency measurements possible can be built at reasonable cost.

The circuit of Fig. 1 is basically a Schmitt trigger and monostable multivibrator with Q2 common to both. Once an input signal exceeds a certain voltage for a certain minimum time, a constant voltage and pulse-width output is produced. With the Schmitt trigger as the input stage, the input rise time has no effect. The triggering level may be adjusted by varying R1.

As shown, the circuit triggers at about 2 volts. In order not to affect the counting accuracy, the input must remain above 2 volts for a time equal to the output pulse width. This is set by C. This has been kept as short as practicable since the meter must respond and average these pulses. This results in a nice low-duty-cycle requirement.

This particular circuit offers several advantages over similar circuits. D1 provides a high input impedance and does away with the practice of capacitively coupling the input. This further eliminates errors induced by slow rise-time pulses. Diodes D2-D7 do two things: protect the vulnerable emitter-base junctions and provide a high impedance to negative inputs, such as the negative half of a sine wave.

Using a Simpson 25-microampere panel meter, the following values gave satisfactory results. Calibration is performed by adjusting R2 at a known frequency. High-frequency switching transistors must be used above 50,000 Hz if 2N744's are not available.

Frequency Range	C	R2
0-250 Hz	0.0072 μ F	15,000
0-2500 Hz	0.001 μ F	8000
0-25,000 Hz	300 pF	1000
0-250,000 Hz	150 pF	200

Fig. 1. Schmitt/multivibrator for use with service-type oscilloscope to allow making accurate frequency measurements.

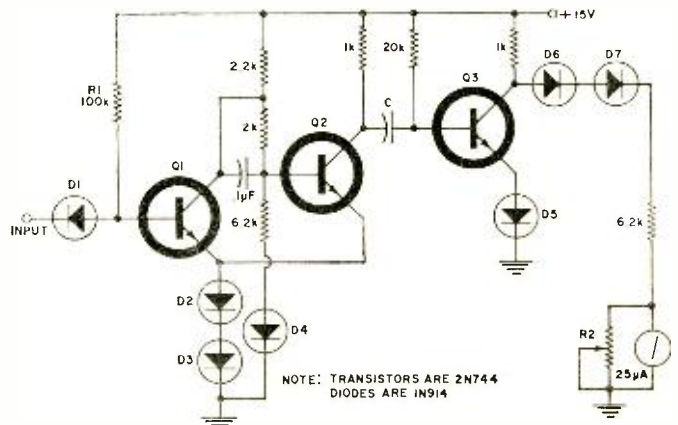

ELECTRONICS MARKET PLACE

COMMERCIAL RATE: For firms or individuals offering commercial products or services. 85¢ per word (including name and address). Minimum order \$8.50. Payment must accompany copy except when ads are placed by accredited advertising agencies. Frequency discount: 5% for 6 months; 10% for 12 months paid in advance.

READER RATE: For individuals with a personal item to buy or sell. 50¢ per word (including name and address). No minimum! Payment must accompany copy.

GENERAL INFORMATION: First word in all ads set in bold caps at no extra charge. Additional words may be set in bold caps at 10¢ extra per word. All copy subject to publisher's approval. **Closing Date:** 1st of the 2nd preceding month (for example, March issue closes January 1st). **Send order and remittance to:** Hal Cymes, **ELECTRONICS WORLD**, One Park Avenue, New York, New York 10016.

FOR SALE

JUST starting in TV service? Write for free 32 page catalog of service order books, invoices, job tickets, phone message books, statements and file systems. Oelrich Publications, 4040 North Nashville Avenue, Chicago, Ill. 60634.

GOVERNMENT Surplus Receivers, Transmitters, Sniperscopes, Radios, Parts, Picture Catalog 25¢. Meshna, Nahant, Mass. 01908.

METERS Surplus, new, used, panel or portable. Send for list. Hanchett, Box 5577, Riverside, Calif. 92507.

CONVERT any television to sensitive big-screen oscilloscope. Only minor changes required. No electronic experience necessary. Illustrated plans, \$2.00. Relco-A22, Box 10563, Houston, Texas 77018.

MUSIC LOVERS, CONTINUOUS, UNINTERRUPTED BACKGROUND MUSIC FROM YOUR FM RADIO, USING NEW INEXPENSIVE ADAPTER. FREE LITERATURE, ELECTRONICS, 11500-Z NW 7th AVE., MIAMI, FLORIDA 33168.

ELECTRONIC ignition, various types. Free literature. Anderson Engineering, Epsom, N.H. 03239.

TREASURE HUNTERS! Prospectors! Relco's new instruments detect buried gold, silver, coins. Kits, assembled models, Transistorized. Weighs 3 pounds. \$19.95 up. Free catalog. Relco-A22, Box 10839, Houston, Texas 77018.

WHOLESALE components: Manufacturers and distributors only. Request free catalog on business letterhead. **WESCOM**, Box 2536, El Cajon, California 92021.

INVESTIGATORS, LATEST ELECTRONIC AIDS. FREE LITERATURE. CLIFTON, 11500-J NW 7th AVE., MIAMI, FLORIDA 33168.

FREE ELECTRONICS PARTS FLYER. Large catalog \$1.00 deposit. **BIGELOW ELECTRONICS, BLUFFTON, OHIO 45817.**

ELECTRONIC bargain catalog on unusual kits, parts, do-it-yourself, stereo, intercom. Alcon, P. O. Box 1348 W. Lawrence, Mass. 01843.

EUROPEAN wholesale new products catalog. \$1.00 refundable. Deecow, 10639 Riverside, North Hollywood, Calif. 91602.

JAPAN & HONG KONG DIRECTORY. Electronics, all merchandise. World trade information. \$1.00 today. Ippano Kaisha Ltd., Box 6266, Spokane, Washington 99207.

RECTIFIERS, transistors, other components. Free Catalog. Lowest Prices. Electronic Components Co., Box 2902E, Baton Rouge, La. 70821.

FREE Catalog low priced, high performance sub-miniature listening devices direct from manufacturer. Dealers welcome. Emery W-7, 156 Fifth Avenue, New York, N.Y. 10010.

ULTRA-SENSITIVE AND POWERFUL METAL DETECTORS—join the many who are finding buried coins, minerals, relics and artifacts. Don't buy till you see our **FREE** catalog of new models. Write Jetco, Box 132-EW, Huntsville, Texas 77340.

ANSWERING ADS? GUARANTEE REPLIES! Use your own personalized correspondence cards. Name, address and zip printed on 100 cards, \$1.95. Meshna, North Reading, Mass. 01864.

SAVE direct from Japan, **KITS, PARTS, COMPONENTS.** Catalog \$2.00. International Hobbyist, 1-27 Miharucho, Yokosuka 238, Japan.

REPAIR YOUR OWN T.V. TUNERS—Color—Transistor—VHF—UHF. Earn to \$1,700 monthly. No customer headaches. Simple, complete course. First of its kind. Copyrighted. Years in preparation. Six sections, 33 chapters. All field-tested. Jigs, fixtures, adapters, "setting-up." Special probes. Quick-checks. How alter and use test sets. Repairs without equipment. Unique power supplies. Fast-fix luxuries. Equipment you can build. Professional tricks. Illustrated schematics, pictures, drawings, sketches. Plans for all items. Troubleshooting. Alignment. All tests and adjustments. Common mistakes. How and where to buy parts. Specific repairs common problems. Index of all tuners. Much, much more. Programmed teaching. Major course: Details. Introduction, plus two sample lessons \$1. Optional condensed courses (Complete in themselves): VHF \$9.50, UHF \$4.50, Transistor Tuners \$4.50. **TV TUNER SERVICE**, Frank Bocek, Box 3236W, Redding, Calif. 96001.

CATHODIC protection instructions \$1.00. F.F. KNAPP, P.O. Box 854, Scottsdale, Arizona 85252.

MODULES: Treasure detector \$3.50. Free catalog. BAC Electronics, 1707 San Bruno, Fairfield, Calif. 94533.

PLANS AND KITS

OSCILLOSCOPE improvement kits. High speed triggersweep eliminates sync problems. Dual trace FET switch displays two waveforms together. Solid-State Services, P.O. Box 901, Cupertino, California 95014.

PLANS. Analog computer programmed to make optimal strategy decisions in Blackjack. \$5.00. D. Tweedy, Box 11282, Santa Ana, Calif. 92711.

INTEGRATED CIRCUIT KITS: COMPUTER, AUDIO, Others. New catalog free. **KAYE ENGINEERING**, Box 3932-B, Long Beach, California 90803.

ARCTURUS SALE

- 1700 transistor types at 39¢ each.
 - 40 watt germanium power transistor, same as Delco 501, 2N278 (etc), cat. #349, 59¢ each.
 - Color TV cartridge focus rectifier 6.5 kv. Used in every color TV. Cat. #CFR-20, 79¢ each.
 - Motorola 2500 ma. at 1000 piv, high voltage/current epoxy silicon rectifier, axial leads. Cat. #HEP-170, 49¢ each.
 - 2 Printed circuit I.F. transformers, 4 lug. 455 kc input and output, cat. #1909P4, 99¢ each.
 - RCA UHF transistor type TV tuners, KRK-120 (long-shaft) cat. #UHF-20; KRK-120 (short-shaft), cat. #UHF-21, each \$4.98.
 - RCA VHF transistor type TV tuners, KRK-146, cat. #VHF-74, \$9.99 each.
 - Transistorized U.H.F. tuners used in 1965 to 1967 TV sets made by Admiral, RCA, Motorola, etc. Removable gearing may vary from one make to another. Need only 12 volts d.c. to function. No filament voltage needed. Easy replacement units. Cat. #UHF-567, \$4.95.
 - U.H.F. Tuner-original units as used in TV sets such as RCA, Admiral, etc. covering channels 14 through 82, as part #94D173-2. Complete with tube. Drive gearing is removable. Can be used in most sets. Cat. #UHF-3, \$4.95.
 - Color yokes. 70° for all round color CRT's. Cat. #XRC-70, \$12.95. 90° for all rectangular 19 to 25" color CRT's. Cat. #XRC-90, \$12.95.
 - Kit of 30 tested germanium diodes. Cat. #100, 99¢.
 - Silicon rectifier, octal based replacement for 5U4, 5Y3, 5A54, 5AW4, 5T4, 5V4, 5Z4. With diagram. Cat. #Rect-1, 99¢ each.
 - 7", 90° TV bench test picture tube with adapter. No ion trap needed. Cat. #7BP7, \$7.99.
 - Tube cartons 6AU6 etc. size, \$2.15 per 100. 6SN7 etc. size, \$2.55 per 100. 5U4GB size, \$2.95 per 100. 5U4 G size, 4¢ each.
- Send for complete free catalog. Include 4% of dollar value of order for postage. \$5 MINIMUM ORDER. Canadian check, 8% dollar differential.

ARCTURUS ELECTRONICS CORP.

502-22nd. St., Union City, N.J. 07087 Dept. MEW
Phone: 201-864-5568

CIRCLE NO. 148 ON READER SERVICE CARD
July, 1969

ADVERTISING SHORTHAND IN THIS AD:

A: As is, as received from a large volume; C: Overhauled, new parts & tubes as needed, then calibrated by Secondary Standards Lab; with dated sticker, grid good as new.

NEW LOW DIGITAL-COUNTER PRICES:

C: 8-digit 10 Hz-200 mhz. HP 521B 525A&B	895.00
C: Same. 1-4 Hz base counter is N.E. #1430	835.00
C: Same. 1-4 Hz base counter is H.P. #7310	950.00
C: Same. but base counter is H.P. #3241	995.00
C: 10 Hz-200 mhz. H.P. solid-state 5235H	850.00
C: 10 Hz-1 mhz. & period. CMC #203A	165.00
C: 1 Hz-1 mhz. Universal. CMC #226A	195.00
Best DC volts as 4-digit Dec. 0-999	295.00
Solid state 5-digit V to freq. converter	395.00

NEW LOW OSCILLOSCOPE PRICES:

Tek #321A 14 in solid-state 0-6 mhz. C	550.00
#317A w/over spy. Pulse extender. A	275.00
#331: 0-12 mhz. A	350.00
#335: Calibrated delay. A	450.00
#336: 4th Time Base. C	550.00
#445: 0-30 mhz. C	525.00
#445: Calib. delay. A	525.00
#581 with 281 Adapter. 0-100 mhz. C	750.00
B: oscin. 5 mv/cm. A	75.00
#538: 5 mv/cm. A	45.00
#542: 4-400 Hz. A	135.00
#546: 2-trace. A	100.00
#53C: 2-trace. A	65.00
#53: 0-30 mhz. 50 mv/cm. A	65.00
#53: 0-40 mhz. 50 mv/cm. A	45.00
#53: 0-30 mhz. 5 mv/cm. C	110.00
Fairchild solid-state 0-35 mhz. dual-trace. delay	825.00
sw. ch. w/hooks. C	825.00
Same but calibrated delay. C	895.00
Calib. delay. 0-50 mhz. C	995.00
Dumont 304A audioman's favorite. C	129.50
Dumont 401: 16 mv/cm. A	175.00
Hewlett-Packard 0-1000 mhz Sampler = 185A,	
w/ = 187B 2-trace & Delayer. A	495.00. C 595.00

A FEW SIGNAL GENERATORS FROM OUR LIST:

Meas. Corp. #82: 20 Hz to 50 MHz CW or AM up to	
1000. Output calib. to 1 v into 50 ohms. It is the	
only LP Gen. with Distn Attenuator, easy to use, no	
resistor burnouts. Like new. w/book &	450.00
NBS-traceable calib.	
Marconi TF-801D/1: 10 to 470 MHz CW & AM up to	
1000. XU-calib each 5 MHz and resettable dial	
pairing. AGC keeps level constant. 0-1 v to 1 v	
from 50 ohms into Type N. Cop-coupled turret	
switch on rubbing contacts. Practically zero leakage	
& FM. Like brand new. w/NBS-traceable	595.00
calib & book	
H.P. #608A: 10-500 MHz CW or AM up to 90%. 0.1	
v to over 1.0 v into 50 ohms. Like new.	395.00
NBS-traceable calib. & book	
H.P. #608B: Similar above. 10-400 MHz	375.00
H.P. #608D: 10-420 MHz. Like new. with	
NBS-traceable calib. & book	950.00

L&N Bridges & Pots at Low Prices ASK!
Automatic Line Voltage Regulators ASK!

WE PROBABLY HAVE THE BEST INVENTORY OF
GOOD LAB TEST EQUIPMENT IN THE COUNTRY.
BUT PLEASE DO NOT ASK FOR CATALOG! ASK FOR
SPECIFIC ITEMS OR KINDS OF ITEMS YOU NEED!
WE ALSO BUY! WHAT DO YOU HAVE?

R. E. GOODHEART CO. INC.

Box 1220-A, Beverly Hills, Calif. 90213
Phone: Area 213, office 272-5707, messages 275-5342

GARDNER-DENVER

14F-15 x 15x.125-A&C

AUTO. "Wire-Wrap" MACHINES

At 10% Of Original Cost - 4 Each

DENVER ELECTRONIC SURPLUS

1333 11th St. • Denver, Colorado 80204

(303) 222-0677

CIRCLE NO. 84 ON READER SERVICE CARD

ABOUT YOUR SUBSCRIPTION

Your subscription to **ELECTRONICS WORLD** is maintained on one of the world's most modern, efficient computer systems, and if you're like 99% of our subscribers, you'll never have any reason to complain about your subscription service.

We have found that when complaints do arise, the majority of them occur because people have written their names or addresses differently at different times. For example, if your subscription were listed under "William Jones, Cedar Lane, Middletown, Arizona," and you were to renew it as "Bill Jones, Cedar Lane, Middletown, Arizona," our computer would think that two separate subscriptions were involved, and it would start sending

you two copies of **ELECTRONICS WORLD** each month. Other examples of combinations of names that would confuse the computer would include: John Henry Smith and Henry Smith; and Mrs. Joseph Jones and Mary Jones. Minor differences in addresses can also lead to difficulties. For example, to the computer, 100 Second St. is not the same as 100 2nd St.

So, please, when you write us about your subscription, be sure to enclose the mailing label from the cover of the magazine—or else copy your name and address exactly as they appear on the mailing label. This will greatly reduce any chance of error, and we will be able to service your request much more quickly.

ELECTRONICS ENGINEERING AND INSTRUCTION

LEARN ELECTRONIC ORGAN SERVICING at home. All Makes including transistors. Experimental kit—troubleshooting. Accredited NHSC. Free Booklet. **NILES BRYANT SCHOOL**, 3631 Stockton, Dept. A, Sacramento, Calif. 95820.

DEGREE in Electronics Engineering earned mostly by correspondence. Free brochure. Dept. G-9, Grantham School of Engineering, 1505 N. Western Ave., Hollywood, California 90027.

R.E.I.'s famous (5) week course for the First Class Radio Telephone License is the shortest, most effective course in the nation. Over 98% of R.E.I. graduates pass F.C.C. exams for 1st class license. Total tuition \$360.00. Job placement free. Write for brochure Radio Engineering Incorporated Schools, 1336 Main Street, Sarasota, Florida 33577—or 3123 Gillham Road, Kansas City, Missouri 64109—or 809 Caroline Street, Fredericksburg, Virginia 22401—or 625 E. Colorado Street, Glendale, California 91205.

ELECTRONICS! Associate degree—29 months. Technicians, field engineers, specialists in communications, missiles, computers, radar, automation. Start September, February. Valparaiso Technical Institute, Dept. N, Valparaiso, Indiana 46383.

FCC First Class License in six weeks—nation's highest success rate—approved for Veterans Training. Schools in Dallas, Atlanta, Chicago, New Orleans, Minneapolis and Houston. Write Elkins Institute, 2603C Inwood Road, Dallas, Texas 75235.

TUBES

TUBES—33¢ each. Year guarantee. Tuner Cleaner \$1.00. Free catalog. Cornell, 4213-W University, San Diego, Calif. 92105.

TUBES, SEMICONDUCTORS, ELECTRONIC EQUIPMENT & COMPONENTS. Quality merchandise only! Serving engineers, Purchasing Agents, TV/HiFi Servicemen and Hams for 20 years. Write for Catalog or call 212-WA 5-7000. **BARRY ELECTRONICS**, 512 Broadway, New York, N.Y. 10012.

RECEIVING & INDUSTRIAL TUBES, TRANSISTORS, All Brands—Biggest Discounts. Technicians, Hobbyists, Experimenters—Request **FREE** Giant Catalog and **SAVE! ZALYTRON**, 569 Jericho Turnpike, Mineola, N.Y. 11501.

TUBES—lowest prices in the world. Hard to get British, German, foreign and American obsolete and present day special purpose transmitting tubes. Send for giant tube and parts catalog. United Radio Co., Dept. W-56 Ferry St., Newark, N.J. 07105.

JOBBER boxed tubes, top brands at 75% off mfg. list prices. Free catalog. **CECO**, 120 West 18th Street, N.Y.C. 10011.

WANTED

QUICKSILVER, Platinum, Silver, Gold. Ores Analyzed. Free Circular. Mercury Terminal, Norwood, Mass. 02062.

QUICK CASH . . . for Electronic Tubes, Semiconductors, Equipment (Receivers, Transmitters, Scopes, Vacuum Variables, etc.) Send lists now! Write: **BARRY ELECTRONICS**, 512 Broadway, New York, N.Y. 10012 (212-WA 5-7000).

DO-IT-YOURSELF

PROFESSIONAL ELECTRONICS PROJECTS—\$1.00 up. Catalog 25¢. **PARKS**, Box 25655A, Seattle, Wash. 98125.



FREE Catalog of The WORLD'S FINEST GOV'T SURPLUS ELECTRONIC BARGAINS

Now BIGGER and BETTER Than Ever!

MAIL COUPON TODAY

NAME: _____
ADDRESS: _____
CITY: _____ STATE: _____ ZIP NO.: _____

FAIR RADIO SALES Dept. EW • BOX 1105
LIMA, OHIO 45802

CIRCLE NO. 135 ON READER SERVICE CARD

TAPE RECORDERS

BEFORE renting stereo Tapes, try us. Postpaid both ways — no deposit — immediate delivery. Quality — Dependability — Service — Satisfaction — prevail here. If you've been dissatisfied in the past, your initial order will prove this is no idle boast. Free Catalog, Gold Coast Tape Library, Box 2262, Palm Village Station, Hialeah, Fla. 33012.

TAPEMATES make available to you **ALL 4-TRACK STEREO TAPES—ALL LABELS**—postpaid to your door—at tremendous savings. For free brochure write: **TAPEMATES**, 5727 W. Jefferson Blvd., Los Angeles, California 90016.

RENT 4-track open reel tapes—all major labels—8,000 different—free brochure. Stereo-Parti, 55 St. James Drive, Santa Rosa, Calif. 95401.

TAPE RECORDER SALE. Brand new nationally advertised brands, \$10.00 above cost. Amazing discounts on stereo components. Arkay Electronics, 1028-B Commonwealth Ave., Boston, Mass. 02215.

HI-FI Components, Tape Recorders at guaranteed "We Will Not Be Undersold" prices. 15-day money-back guarantee. Two-year warranty. No Catalog. Quotations Free. Hi-Fidelity Center, 239 (L) East 149th Street, New York 10451.

STEREO Tapes. Save 30% and up; no membership or fees required; postpaid anywhere U.S.A. Free 70-page catalog. We discount batteries, recorders, tape/cassettes. Beware of slogans, "not undersold," as the discount information you supply our competitor is invariably reported to the factory. **SAXITONE**, 1776 Columbia Road, N. W., Washington, D. C. 20009.

SCOTCH Recording Tapes. Wollensak Recorders. Catalog 6¢. Tower, Lafayette Hill, Pa. 19444.

STEREO TAPES: CARTRIDGES, CASSETTES, REELS, 33% DISCOUNT. LARGEST SELECTIONS, UNAVAILABLE ELSEWHERE. MAIL 20¢—CATALOGS, STAR RECORDINGS-ZD, BOX 1055, EL PASO, TEXAS 79946.

CASSETTE blanks, also educational and language, accessories and recorders. Literature—write **CASSETTES UNLIMITED**, P.O. Box 13119, W. Pittsburgh, Pa. 15243.

RECORDS

SPECIAL INTEREST RECORDS AVAILABLE, PRODUCED BY THE EDITORS OF THE WORLD'S LEADING SPECIAL INTEREST MAGAZINES. SEND FOR FREE CATALOG. RECORD CATALOG—EW, ZIFF-DAVIS PUBLISHING COMPANY, ONE PARK AVENUE, NEW YORK, N.Y. 10016.

PROTECT your LPs. Heavy poly sleeves for jackets 5¢, poly lined paper sleeves for records 10¢. House of Records, Box 323B, Hillburn, New York 10931.

OLDIES—45 RPM—original hits. Over 4000 available. C & S Record Sales, Box 197, Wampsville, N.Y. 13163.

HIGH FIDELITY

FREE! Send for money saving stereo catalog #E7W and lowest quotations on your individual component, tape recorder or system requirements. Electronic Values, Inc., 200 West 20th Street, N.Y., N.Y. 10011.

HI-FI Components, Tape Recorders at guaranteed "We Will Not Be Undersold" prices. 15-day money-back guarantee. Two-year warranty. No Catalog. Quotations Free. Hi-Fidelity Center, 239 (L) East 149th Street, New York 10451.

DON'T THROW YOUR OLD CARTRIDGE AWAY. Send us \$50.00 and any old used cartridge and we will ship you via air Prepaid anywhere any one of the following Top Stereo Cartridges: Shure V-15 Type II, Empire 999VE, ADC 10EMK II, Stanton 681EE. Write for lowest quotations all stereo components. **DEFA ELECTRONICS**, 2207 Broadway, New York, N.Y. 10024.

HI-FI components, tape recorders, sleep learning equipment, tapes. Unusual Values. Free catalog. Dressner, 1523 R Jericho Turnpike, New Hyde Park, N.Y. 11040.

HI-FI EQUIPMENT—GET Our "ROCK BOTTOM" prices on **NAME BRAND** amplifiers—tuners—tape-recorders — speakers **FRANCHISED — 60 YEARS IN BUSINESS.** Write for this month's specials—**NOW!** Rabson's 57th St., Inc., Dept. 569, 119 W. 57th St., New York, New York 10019.

INTEGRATED CIRCUITS / RECTIFIERS SEMICONDUCTORS / TRIACS

TRIACS

PRV	5 AMP	10A
100	.30	1.20
200	1.40	1.75
300	1.75	2.25
400	2.25	2.75
500	2.80	3.25

ER900 TRIGGER DIODES. These bidirectional trigger diodes are one of the best and cheapest methods to trigger SCR's and triacs **3/\$1.00**

MOUNTING HDWE KITS These kits are used to mount our SCR's, zeners, & rectifiers etc.
6 x 32 (3, 12 Amp rectifiers, 7 Amp SCR's) 6 sets/\$1.00
1/4 x 28 (20, 40 Amp rectifiers, 20 Amp SCR's) 4 sets/\$1.00

SQ-10A DISCRETE OPER. AMPL. MODULE
Voltage Gain 60,000 Min. **\$4.95 each**

N-CHANNEL FET'S TO-18 plastic units. low noise, low leakage, 25 volts source to gate. 50 ma gate current Gain to 9000 umho's. . . . \$.80

NEON LIGHT OR NIXIE TUBE DRIVERS. An NPN, TO-18, SI Transistor. With a VCBO of 120 3/\$1.00

Silicon Power Rectifiers

PRV	3A	12A	40A
100	.09	.30	.75
200	.16	.50	1.25
400	.20	.70	1.50
600	.30	1.00	1.80
800	.40	1.25	
1000	.55	1.50	

Terms: FOB Cambridge, Mass. Send check or Money Order. Include Postage. Average Wt. per package 1/2 lb. No C.O.D.'s. Minimum Order \$3.00

Rated companies 30 days net

LINEAR CIRCUITS

FM IF AMPLIFIERS \$.90
702C WIDE BAND DC AMPL. \$2.75
709C OPERATIONAL AMPL. \$2.75
710C HI SPEED DIFF. AMP. \$2.75
711C DUAL COMPARATOR \$2.75

DIGITAL RTL CIRCUITS
2-914 QUAD 2 input gates \$1.25
2-923 Dual JK flip flops \$1.50

PRV		Controlled Avalanche or Epoxy Rectifiers 1 AMP.
100	.07	
200	.09	
400	.12	
600	.18	
800	.22	
1000	.35	

Silicon Control Rectifiers

PRV	3A	7A	20A	70A
50	.35	.45	.70	
100	.50	.65	1.00	4.00
200	.70	.85	1.30	8.00
300	.90	1.25	1.70	
400	1.20	1.60	2.10	12.00
500	1.50	2.00	2.50	
600	1.80	2.40	3.00	16.00
700	2.20	2.80		
1000			5.00	24.00

Send for our latest catalog featuring Transistors and Rectifiers; 325 Elm St., Cambridge, Mass.

OLD

TATE

SALES

Post Office Box 74B

Somerville, Mass. 02143

Tel. (617) 547-4005

CIRCLE NO. 110 ON READER SERVICE CARD

LOW, LOW quotes: all components and recorders. Hi-Fi, Roslyn, Penn. 19001.

DON'T THROW YOUR OLD CARTRIDGE AWAY. Send us \$19.95 and any old cartridge. We will ship **PREPAID** any one of the following top rated elliptical diamond stereo cartridges **NEW:** Shure M75E, M91E, M92E, Empire 888E, Pickering V15AME3, XV15 ATE, ADC 660E, 550E. Write for lowest quotations all stereo components. **DEFA ELECTRONICS**, 2207 Broadway, New York, N.Y. 10024.

GOVERNMENT SURPLUS

JEEPS Typically From \$53.90 . . . Trucks From \$78.40 . . . Boats, Typewriters, Airplanes, Multimeters, Oscilloscopes, Transceivers, Electronics Equipment. Wide Variety, Condition, 100,000 Bid Bargains Direct From Government Nationwide. Complete Sales Directory and Surplus Catalog \$1.00 (Deductible First \$10.00 Order). Surplus Service, Box 820-K, Holland, Michigan 49423.

UNUSUAL BARGAINS BY MAIL

SHOPPING MART

GIANT FREE CATALOG! 148—PAGES

A selection of products available by mail for readers of Electronics World. All merchandise sold on a money-back guarantee. Order direct by Stock No. Send check or M. O.



3" Astronomical Telescope

See the stars, moon, phases of Venus, planets close up, 60 to 180 power. Aluminized and overcoated 3" diameter 7/16 primary mirror, ventilated cell. Equatorial mount with locks on both axes. Equipped with 60x eyepiece and mounted Barlow lens. 3x finder telescope, hardwood tripod. Included **FREE:** "STAR CHART"; 222-page "HANDBOOK OF HEAVENS"; "HOW TO USE YOUR TELESCOPE." **Stock No. 85,050AK \$29.95 Ppd**

4 1/2" REFLECTOR Stock No. 85,105AK \$ 84.50 FOB
6" REFLECTOR Stock No. 85,086AK \$199.50 FOB



Tune In and Turn On Your Own Psychedelic Light Show

Take one bookshelf sized conservative looking oiled walnut finished light box—With its built-in kicker, an independently controlled 3-channel color organ. Activate by attaching to Hi-Fi or stereo speaker. Plug in and switch on. Music fills the room and the prismatic screen leaps into pulsating life. Patterns are wild and wonderful, or soft and soothing—responding directly in time and intensity to music. Perfect home entertainment, little theater or casino. House current.
(18"Wx12"Hx9"D)
Stock No. 80,126AK \$49.95 Ppd.



World's Smallest Bible

See entire Holy Bible—all 773,744 words on 1,243 pages—reduced to size of 1 1/2" x 1 1/2" square. Incredible 48,400 to 1 reduction by new photochromic dye, micro-image technique that begins where microfilm leaves off. Needs 100X microscope to read. Astound your friends! Carry in your wallet or purse. Protect it on wall with "Scope and Prism." Real conversation piece.
Stock No. 41,191AK. \$2.00 Ppd.
50X, 150X, 300X MICROSCOPE
Stock No. 70,008AK \$16.50 Ppd.



SEE MUSIC IN DAZZLING ACTION

MUSIC VISION **DRAMATIC BREAKTHROUGH IN AUDIO-VISUAL ENJOYMENT**
Actually see favorite musical selections translated into fantastic patterns of beautiful colors—each individual note creating its own unique, twisting, radiating shape . . . each shape dancing and branching, whirling and swirling in perfect time with the music. Easily attached to stereo, radio, tape recorder. Send 25¢ in coin for 16-page booklet #2008AK.
BOY'S STARTER KIT No. 2,055AK \$6.00 Ppd.
DO-IT-YOURSELF KIT No. 71,009AK \$22.50 Ppd.
WALNUT CABINET MODEL No. 85,181AK \$95.50 F.O.B.



"Fish" With a Magnet

Go treasure hunting on the bottom! Fascinating fun & sometimes profitable. Tie a line to our 3-lb. Magnet—drop it overboard in bay, river, lake or ocean. Trawl it along bottom—your "treasure" haul can be outboard motors, anchors, other metal valuables. 3-lb. Magnet is war surplus—Abico. (U.S. Gov't cost \$50. Lifts over 150 lbs.)
Stock No. 70,571AK \$12.50 Ppd.
3 1/2-lbs (40 lbs.) Stock No. 70,570AK \$8.75 Ppd.
7 1/2-lbs (175 lbs.) Stock No. 70,572AK \$18.75

GIANT FREE CATALOG 148 Pages—1000's of Bargains

Completed new 1966 edition. New items, categories, illustrations. Dozens of electrical and electromagnetic parts, accessories. Enormous selection of Astronomical Telescopes, Microscopes, Binoculars, Magnifiers, Magnets, Lenses, Prisms, Many war surplus items: for hobbyists, experimenters, workshop, factory. Mail coupon for catalog "AK".
EDMUND SCIENTIFIC CO.
300 EDSCORP BUILDING, BARRINGTON, N.J. 08007

NAME _____
ADDRESS _____
CITY _____
STATE _____ ZIP _____

ORDER BY STOCK NUMBER • SEND CHECK OR MONEY ORDER • MONEY-BACK GUARANTEE

EDMUND SCIENTIFIC CO. BARRINGTON, NEW JERSEY 08007

CIRCLE NO. 137 ON READER SERVICE CARD

GREGORY ELECTRONICS

HERE NOW!
An Extensive Selection of
General-Electric
Progress Line 2-Way
Mobile Equipment

- 30-50 MHz Vibrator Power
14" Case Complete Access.
Fully narrow-band (Tx & Rx)
MA/E 13 6/12v, 30w **\$178.**
- MA/E 16 6/12v, 60w **\$198.**
- MD/Y 16N 6/12v, 60w
Dynamotor Power Supply **\$138.**
- 148-174 MHz Vibrator Power
14" Case Complete Access.
Fully narrow-band
MA/E 33 6/12v, 30w **\$198.**
- FA/E 33 6/12v, 30w **\$188.**
- 450-470 MHz 15w Vibrator
Power Supply MA/E 42,
with accessories **\$148.**

**450-470 MHz General-Electric
Progress Line Accents**

- 10 watts, 12 volts/transistor power supply; front or rear mount. Complete accessories.
Model No. EG48S
- Wide Band **\$168**
- Narrow Band **\$188**
- EG 48CT (Trunk) EG 48CF (Front)

"T" Powered Units Expected Soon . . .
Make your inquiries now!

Voice Commander II

Fully transistorized, 148-170 MHz, portable, 1-Watt, complete with nicad batteries.
1 unit \$148.

- 3 units—15% discount.....ea. **\$125.80**
- 6 units—30% discount.....ea. **\$103.60**
- Crystals & tuning if desired, add \$45.

BATTERY CHARGERS

1 unit **\$16.**

- 3 units—15% discount.....ea. **\$13.60**
- 6 units—30% discount.....ea. **\$11.20**

Reconditioned & Used FM 2-Way Radio Equipment
most enlarged inventory now on hand for practically everything you need—at savings!

We Buy Late Model Equipment for Cash
Send For '69 Catalog—



**GREGORY
ELECTRONICS
CORPORATION**

249 RT. 46, Saddle Brook, N.J. 07662
Phone: (201) 489-9000

CIRCLE NO. 133 ON READER SERVICE CARD

AUTHORS' SERVICES

AUTHORS! Learn how to have your book published, promoted, distributed. FREE booklet "ZD," Vantage, 120 West 31 St., New York 10001.

PERSONALS

MAKE FRIENDS WORLDWIDE through international correspondence. Illustrated brochure free. Hermes, Berlin 11, Germany.

SECRET LOANS BY MAIL. Borrow \$100 to \$1500 for any good reason in absolute privacy. No interviews, no endorsers, no co-signers. Fast service. Write Dial Finance Co., Dept. G-594, 410 Kilpatrick Bldg., Omaha, Nebraska 68102.

**PHOTOGRAPHY—FILM,
EQUIPMENT, SERVICES**

MEDICAL FILM—Adults only—"Childbirth" one reel, 8mm \$7.50; 16mm \$14.95. International W. Greenvale, Long Island, New York 11548.

SCIENCE Bargains—Request Free Giant Catalog "CJ"—148 pages—Astronomical Telescopes, Microscopes, Lenses, Binoculars, Kits, Parts, War Surplus bargains. Edmund Scientific Co., 300 Edscorp Bldg., Barrington, New Jersey 08007.

HYPNOTISM

FREE Hypnotism. Self-Hypnosis, Sleep Learning. Catalog! Drawer H400, Ruidoso, N.M. 88345.

HYPNOTIC Sleep Learning recordings produce fabulous results. Details free. ASR Foundation, Box 7021eg Henry Clay Station, Lexington, Kentucky 40502.

HYPNOTIZE MALES, FEMALES!—Unnoticed! Quickly! Nerves! Exciting! \$2.25. Research Enterprises, 29-SN21 Samoset, Woburn, Mass. 01801.

EMPLOYMENT OPPORTUNITIES

TWO-WAY RADIO TECHS for positions in the U.S. Virgin Island, 3 hours from New York in the Caribbean Playground. Send resume to: Electronics Unlimited, P.O. Box 2326, St. Thomas, U.S. Virgin Islands 00801.

EMPLOYMENT INFORMATION

FOREIGN and USA job opportunities available now. Construction, all trades. Earnings to \$3,000.00 monthly. Paid overtime, travel, bonuses. Write: Universal Employment, Woodbridge, Conn. 06525.

DIRECTORY OF ELECTRONIC TECHNICIAN EMPLOYERS. Over 250 listings \$2.00. Research, Box 542, Provo, Utah 84601.

EDUCATIONAL OPPORTUNITIES

USED Correspondence Courses and Books sold and rented. Money back guarantee. Catalog free (Courses Bought). Lee Mountain, Pisgah, Alabama 35765.

LEARN WHILE ASLEEP, Hypnotize! Strange catalog free. Autosuggestion, Box 24-ZD, Olympia, Washington 98501.

INVENTIONS WANTED

PATENT Searches including maximum speed, full airmail report and closest patent copies, \$6.00. Quality searches expertly administered. Complete secrecy guaranteed. Free Invention Protection forms and "Patent Information." Write Dept. 23, Washington Patent Office Search Bureau, 711 14th Street, N.W., Washington, D.C. 20005.

NEW G & G CATALOG

24 PAGES, crammed with Gov't Surplus Electronic Gear. Biggest Bargain Buys in America! It will pay you to **SEND 25c** for your copy—Refunded with First Order!



**LORAN APN-4
FINE QUALITY
NAVIGATIONAL
EQUIPMENT**

4-Channel long range dual units, will determine exact geographic position of your boat or plane. Indicator and receiver complete with all tubes and crystal. **INDICATOR ID-6B/APN-4, and RECEIVER R-9B/APN-4, complete with tubes, Exc. Used \$86.50**

LORAN R-6S/APN-9 RECEIVER & INDICATOR

4-Channel single unit system, used in ships and aircraft. Determines position by radio signals from known transmitters accurate to within 1% of distance. Complete with tubes and crystal. IN LIKE NEW Condition. **\$88.50**



All accessories for Loran Equipment in stock.



BC-645 TRANSMITTER, 15 tubes. 435 to 500 Mc. Easily adapted for 2-way voice or code on Ham, Mobile, Television Experimental and Citizens' Bands. With tubes, less power supply in factory carton. **\$16.95**

SPECIAL PACKAGE OFFER: BC-645 Transmitter, dynamotor and all accessories, including mounting, UHF Antenna Assembly, control box complete set of connectors, plus, BRAND NEW **\$26.95**

AN/APR-4Y FM & AM RECEIVER "FB" FOR SATELLITE TRACKING!

High precision lab instrument, for monitoring and measuring frequency and relative signal strength, 35 to 4000 Mc. in 5 tuning ranges. For 110 V 60 cycle AC. Built-in power supply. Original circuit diagram included. Checked out, perfect. **\$88.50**

ALL Tuning Units Available for Above

SCR-274-N, ARC-5 COMMAND SET HQ!

Freq. Range	Type	Exc. Used	Like New	BRAND NEW
RECEIVERS, Complete with Tubes				
190-550 Kc.	BC-453	\$18.95	\$23.50	\$27.50
3.6 Mc.	BC-454	\$16.50	\$19.50	\$22.50
6-9.1 Mc.	BC-455	\$14.95	\$17.95	\$21.50
1.5-3 Mc.	R-25		\$19.50	\$21.50
TRANSMITTERS, Complete with Tubes				
4-5.3 Mc.	BC-457	\$8.95	\$8.95	\$11.95
4-5.7 Mc.	BC-458	\$8.95	\$8.95	\$12.95
7-9.1 Mc.	BC-459	\$17.95	\$19.50	\$23.50
2.1 Mc.	T-18	\$3.95	\$3.95	\$11.95
4.4 Mc.	T-19	\$10.50	\$12.50	\$16.95

TERMS: Either 25% deposit with order, balance C.O.D., OR Remittance in Full. Minimum Order \$5.00. All shipments F.O.B. our warehouse, NYC. All merchandise subject to prior sale and price change.

G & G RADIO SUPPLY COMPANY

Telephone: (212) CO 7-4605
75-77 Leonard St., New York, N.Y. 10013

\$1 PEP \$1
1 Dollar Sale
EACH PACKAGE
MONEY BACK GUARANTEE

1 AMP Silicon Rectifier Choice of Package Built-Glass-Metal <input type="checkbox"/> 20-50V <input type="checkbox"/> 6-800V <input type="checkbox"/> 17-100V <input type="checkbox"/> 4-1000V <input type="checkbox"/> 12-200V <input type="checkbox"/> 3-1200V	ZENER-DIODES 250-400 MW 1 EA 4V-6V-8V-10V
1.5 AMP <input type="checkbox"/> 18-50V <input type="checkbox"/> 5-800V <input type="checkbox"/> 15-100V <input type="checkbox"/> 4-1000V <input type="checkbox"/> 10-200V <input type="checkbox"/> 2-1200V	2 WATT 12 to 60V CHOICE OF THREE
3 AMP <input type="checkbox"/> 15-50V <input type="checkbox"/> 4-600V <input type="checkbox"/> 10-100V <input type="checkbox"/> 3-800V <input type="checkbox"/> 8-20-1000V <input type="checkbox"/> 1-1200V <input type="checkbox"/> 5-400V	10 WATT 1 EA 6V-8V-10V
5 AMP <input type="checkbox"/> 10-50V <input type="checkbox"/> 4-400V <input type="checkbox"/> 8-100V <input type="checkbox"/> 3-800V <input type="checkbox"/> 6-200V <input type="checkbox"/> 2-1000V <input type="checkbox"/> 5-300V <input type="checkbox"/> 1-1200V	10 WATT 12 to 60V THREE
8 AMP STUD <input type="checkbox"/> 6-10-50V <input type="checkbox"/> 3-400V <input type="checkbox"/> 4-200V <input type="checkbox"/> 2-800V	SILICON-CONTROLLED RECTIFIER TO-5 PACKAGE <input type="checkbox"/> 4-5-200V <input type="checkbox"/> 4-100V <input type="checkbox"/> 3-400V
12 AMP STUD <input type="checkbox"/> 5-100V <input type="checkbox"/> 3-800V <input type="checkbox"/> 3-500V <input type="checkbox"/> 1-1000V	7 AMP <input type="checkbox"/> 4-50V <input type="checkbox"/> 2-200V <input type="checkbox"/> 3-100V <input type="checkbox"/> 1-1000V
20 AMP STUD <input type="checkbox"/> 4-50V <input type="checkbox"/> 2-500V <input type="checkbox"/> 3-100V <input type="checkbox"/> 1-1000V	20 AMP <input type="checkbox"/> 2-50V <input type="checkbox"/> 1-300V
40 AMP STUD <input type="checkbox"/> 3-50V <input type="checkbox"/> 1-300V <input type="checkbox"/> 2-100V	GENERAL PURPOSE GERMANIUM TRANSISTOR SIMILAR to 2N404 8 UNITS
60 AMP STUD <input type="checkbox"/> 2-50V <input type="checkbox"/> 1-1000V	

\$1 HOBBY CORNER SPECIALS \$1

SILICON RECT LOW V 1 AMP <input type="checkbox"/> 50 units \$1.00	COMPUTER DIODES FAST SWITCHING NO TEST <input type="checkbox"/> 100 units \$1.00
3 AMP LOW VOLTAGE <input type="checkbox"/> 35 units \$1.00	HALF POUND Rect. Diodes, Transistors Etc. Each different \$1.00
STUD MOUNT 5 AMP <input type="checkbox"/> 25 units \$1.00	

NO SALES TAX—WE PAY POSTAGE
OTHER PRODUCTS ON REQUEST

PARK ELECTRONIC PRODUCTS
P.O. Box 78 N. Salem, N.H. 03073

LET US TRY TO HELP YOU WITH YOUR ENG PROBLEMS
CIRCLE NO. 122 ON READER SERVICE CARD
ELECTRONICS WORLD

33¢
TUBES
1 YR. GUARANTEED
MILITARY MANUFACTURE—EXCEPTIONAL QUALITY
ELECTRONIC TUBES
30¢ PER TUBE

- Don't confuse our 1st quality tubes with seconds & factory rejects.
- If not shipped in 24 hrs. your order free!
- Free! New catalog write today!

CORNELL ELECTRONICS
DEPT. EW-7
4217 University Ave.
San Diego, Calif. 92105

INVENTORS! Receive free invention analysis at no risk to you. Send for FREE disclosure form today. New York Invention Service, Dept. 19, 160 Broadway, New York, N.Y. 14438.

INVENTORS! Sell your invention for cash or royalties! Our client manufacturers eagerly seek new items. Patented. Unpatented. Financial assistance if needed. 25 years proven performance. For free information, write Dept. 25, Gilbert Adams, Invention Broker, 80 Wall St., New York, N.Y. 10005.

MAGAZINES

BACK DATE MAGAZINES! Send needs. Midtown, Box 917-EW, Maywood, N.J. 07607.

MAGIC MAGAZINE—Monthly since 1936. 44 pages. All phases. 3 month trial \$1.00. Genii, P.O. Box 36068, Los Angeles, CA 90036.

REPAIRS AND SERVICES

PHOTO etched XXXP from ink drawing. 5x7" maximum \$2.50. Hornung, 1751 Creek Drive, San Jose, California 95125.

BUSINESS OPPORTUNITIES

INVESTIGATE ACCIDENTS: Earn to \$1000 monthly. Men urgently needed. Car furnished. Business expenses paid. No selling. No college education necessary. Pick own job location. Investigate full time or earn to \$8 hour spare time. Write for FREE information. No obligation. Universal Schools, CZ-7, 6801 Hillcrest, Dallas, Texas 75205.

FREE CATALOGS. Repair air conditioning, refrigeration. Tools, supplies, full instructions. Doolin, 2016 Canton, Dallas, Texas 75201.

I MADE \$40,000.00 YEAR by mailorder! Helped others make money! Start with \$10.00—Free proof. Torrey, Box 318-N, Ypsilanti, Mich. 48197.

JAPANESE Electronics New Products Monthly! Specimen copy \$1, deductible. Dee, 10639-W Riverside, North Hollywood, Calif. 91602.

FREE BOOK "990 Successful Little-Known Businesses." Work home! Plymouth 345-G, Brooklyn, New York 11218.

MAILORDER . . . Stop Looking! Start Your Own Business! Methods, 1416 F.D., Lafayette Hill, Pennsylvania 19444.

CHEMICALS

CHEMICAL Lists \$1.00. Deductible First Order Spectro, 1354 Ellison, Louisville, Ky. 40204.

MAGNETS

MAGNETS. 101 uses. 30 ozs. assembly lifts 75 lbs. \$5.85; 10 one inch bars \$1.00. Guaranteed! Calvin's, Box 774B, Temple City, CA. 91780.

MAGNETS. All types. Specials—20 disc magnets, or 2 stick magnets, or 10 small bar magnets, or 8 assorted magnets, \$1.00. Maryland Magnet Company, 5412-E Gist, Baltimore, Maryland 21215.

MISCELLANEOUS

WINEMAKERS: Free illustrated catalog of yeasts, equipment. Semplex, Box 122-76, Minneapolis, Minn. 55412.

AS YOU SCAN THESE COLUMNS, more than 170,000 monthly buyers of **ELECTRONICS WORLD** are doing the same. These men—all involved actively in electronics from a business or hobby viewpoint—are doubly interested in those ads which offer them opportunities to enhance their careers or their leisure hours. They look to the **ELECTRONICS MARKET PLACE** for prime sources of products and services of interest to them. They'll buy from you if your advertising appears regularly. Send copy and payment now if you want to be in the very next issue.

\$100.00 "EYE SEE" INTEGRATED CIRCUIT BONANZA BY POLY PAK



PENNY SALE!

By far the biggest Integrated Circuit Sale in our history. NOBODY! That's right NOBODY under-sells Poly Paks. Imagine — buy 1 Integrated Circuit at our bargain price and get the 2nd one for ONLY 1c . . . that's right ONE CENT! NO LIMIT PER ITEM! Every item guaranteed as advertised. All include data on Integrated Circuits.

Fairchild No.	* Two identical IC's in one package	EACH	1c MORE
900	Buffer	1 for 1.49	2 for 1.50
902	R-S Flip Flop	1 for 1.49	2 for 1.50
903	3 In. Gate Nand/Nor	1 for 1.49	2 for 1.50
904-904*	Dual Half adder	1 for 1.49	2 for 1.50
910	Dual Two Input Gate	1 for 1.29	2 for 1.30
914	Dual Two Input Gate	1 for 1.29	2 for 1.30
915	Dual 3 Input Gate Nand/Nor	1 for 1.49	2 for 1.50
923	JK-Flip Flop	1 for 1.49	2 for 1.50
923-923*	Dual JK Flip Flop	1 for 1.98	2 for 1.99
925	Dual 2 Input Gate, Expander	1 for 1.49	2 for 1.50
927	Quad Inverter	1 for 1.98	2 for 1.99
930	Dual 4 Input Gate Nand/Nor	1 for 1.49	2 for 1.50
933	Dual Input Gate, Expander	1 for 1.49	2 for 1.50
944	Dual 4 Input Power Gate	1 for 1.49	2 for 1.50
946	Quad 2 Input Gate Nand/Nor	1 for 1.49	2 for 1.50
952	Dual 2 Input Inverter Gate	1 for 1.29	2 for 1.30
953	2-2-3-Input and Gate	1 for 1.29	2 for 1.30
954	Dual 4 Input and Gate	1 for 1.29	2 for 1.30
955	8 Input and Gate w 2 output	1 for 1.29	2 for 1.30
961	Dual 4 Input Gate w/expander	1 for 1.49	2 for 1.50
962	Triple Gate	1 for 1.49	2 for 1.50

EPOXY SILICON TRANSISTORS
5 for \$1

Type	Sale
2N706	5 for \$1
2N2222	5 for \$1
2N2368	5 for \$1
2N2711	5 for \$1
2N3396	5 for \$1
2N3565	5 for \$1
2N3568	5 for \$1
2N3638	5 for \$1
2N3641-3	5 for \$1
2N3645	5 for \$1
2N3662	5 for \$1
2N3683	5 for \$1
2N3692	5 for \$1
2N3793	5 for \$1
2N4140-1	5 for \$1
2N4248-9	5 for \$1
2N4284-5	5 for \$1
2N4288-9	5 for \$1
2N4290-1	5 for \$1

LOWEST PRICES ON LINEAR AMPLIFIERS

Guaranteed! With Spec. Sheets!

\$2.22 EACH 3 for \$6

Type	Use
702	D.C. Amplifier
709	Operational Amp
710	Differential Comparator
711	Sense Amplifier

DIGITAL COUNTING
8 Bit memory cell
TO-5 case
With Spec. Sheets! **\$2.95**

Operational AMPLIFIERS
709 no test \$1
With Spec. Sheets!

Terms: add postage. Rated: net 30, coll's 25%
Phone Orders: Wakefield, Mass. (617) 245-3829
Retail: 211 Albion, St., Wakefield, Mass.

GIANT "SUMMERCATALOG ON: Parts, Rectifiers, Transistors, SCRs, I.C.'s, Equipment. 10c

POLY PAKS P.O. BOX 942W LYNNFIELD, MASS 01940

CIRCLE NO. 121 ON READER SERVICE CARD

Electronics World SUBSCRIBER SERVICE

Please include an address label when writing about your subscription to help us serve you promptly. Write to: Portland Place, Boulder, Colo. 80302

CHANGE OF ADDRESS:

Please let us know you are moving at least four to six weeks in advance. Affix magazine address label in space to the right and print new address below. If you have a question about your subscription, attach address label to your letter.

TO SUBSCRIBE:

Check boxes below.

- New Renewal
- 5 years \$21
- 3 years \$15
- 1 year \$6

SPECIFY:

- Payment enclosed—
You get 1 extra issue per year as a BONUS!
- Bill me later.

— AFFIX LABEL —

state | city | address | name | zip-code

If you have no label handy, print OLD address here.

please print

[Add'l postage: \$1 per year outside U.S., its possessions & Canada.]

name _____ please print _____ 0289

address _____

city _____

state _____ zip-code _____

LIBERTY PAYS MORE! WILL BUY FOR CASH

ALL TYPES:

- ★ ELECTRON TUBES
 - ★ SEMICONDUCTORS
 - ★ TEST EQUIPMENT
 - ★ Military Electronic Equipment
- WIRE—WRITE—PHONE COLLECT!
We pay freight on all purchases—

LIBERTY OFFERS MORE! PRESTEL FIELD STRENGTH METER

(Model 6T4G)

Only **\$120.00**
F.O.B. New York

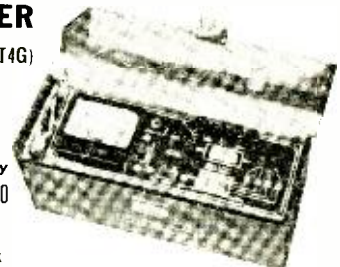

Calibrated from 40 to 230, and 470 to 860 in 4 Bands Megahertz, from 10 to 50,000 Microvolts. Nothing makes it easier to properly and speedily find the correct place to install TV, FM and Communication Antennas. You can measure and hear the signals with this 4½ volt battery economically powered unit. There is nothing else like it!

LIBERTY ELECTRONICS, Inc.
548 Broadway, New York, New York 10012
Phone (212) 925-6000

CIRCLE NO. 129 ON READER SERVICE CARD

U.S. GOV'T ELECTRONIC SURPLUS

Nationally Known - World Famous SURPLUS CENTER offers finest, most expensive, Government Surplus electronic units and components at a fraction of their original acquisition cost.

ORDER DIRECT FROM AD or WRITE FOR CATALOGS

COMPUTER TRANSISTORS ON HEAT SINKS

IBM Computer Quality Units

(#22-928) -- Unit consists of one 150-watt power transistor on heavy ribbed, aluminum heat sink. Many experimental uses. (1 lb.)
Cost Gov't Over \$10.00 **\$1.99**



(#22-915) -- Unit consists of two 150-watt power transistors, 1 p-n-p, several diodes, capacitors, resistors, etc. on heavy, ribbed aluminum heat sinks. Ideal for use as motor speed control. (4 lbs.)
Cost Gov't Over \$15.00 **\$4.91**



RUNNING TIME METER

(#DX-104) -- Use to record number of operating hours of electric lights and electrical devices such as refrigerators, furnaces, etc. Records total hours, trips and hours-to-day up to 9,999.99 hours. For 115-volt, 60-cycles. Size 4 1/2" x 3 1/2" x 2 1/2". Shipping weight 2 lbs.
\$5.69 Cost Over \$29.00



12 and 24-VOLT TRANSFORMER

(#15-920) -- General Electric 115-volt, 60-cycle to 12 and 24-volts - 330-watts. Capacity: 42-amps. = 24-volts 64-amps. at 12-volts. Useful for battery chargers, running DC motors, etc. 7" x 5" x 3". (18 lbs.)
Cost Gov't Over \$35.00 **\$16.72**



EXPANDED SCALE 0 - 15 DCVM

(#21-900) -- Brand new, expensive voltmeter reads 0.5 to 16-volts DC and 0 to 8-volts. Very useful for automotive and aircraft battery charge indicator, etc. D'Arsonval movement, black phenolic case. 7" x 5" x 2 1/2". (3 lbs.)
List \$32.50 **\$12.95**



SURPLUS TELETYPEWRITERS

Orig. Cost Over \$1500.00

SPECIAL \$249.50

(ITEM #22-936) -- 1-wd. Int. excellent teletypewriters. Model 15 complete with 31.4-c. Data-Com. Permits using teletypewriter over regular long distance connection. Complete with AC power supply, control telephone, etc. Ht. 160 lbs. Size 22" x 22" x 42".
• Also have limited number Model 19 Teletypewriters with perforator, Data-Com, etc. Write for sale price.



SEND 25c COIN OR STAMPS FOR CATALOGS

All Items FOB

Money Back Guarantee

SURPLUS CENTER

DEPT. EW-079 LINCOLN, NEBR. 68501

CIRCLE NO. 108 ON READER SERVICE CARD

DRAKE RF Wattmeters



W-4 \$49.50 **WV-4 \$73.50**
1.8-54 MHz 20-200 MHz

Reads forward and reflected power directly in watts (VSWR from nomogram). Two scales in each direction. Size: 5 1/2" H x 3 3/4" W x 4" D.

Full Scale | Calibration Accuracy

Model W-4

200 watts | ±(5% of reading + 2 watts)
2000 watts | ±(5% of reading + 20 watts)

Model WV-4

100 watts | ±(5% of reading + 1 watt)
1000 watts | ±(5% of reading + 10 watts)

Write for FREE Brochure EW9

R. L. DRAKE COMPANY

540 Richard Street,
Miamisburg, Ohio 45342

CIRCLE NO. 103 ON READER SERVICE CARD
88

ELECTRONICS WORLD JULY 1969

ADVERTISERS INDEX

READER SERVICE NO.	ADVERTISER	PAGE NO.	READER SERVICE NO.	ADVERTISER	PAGE NO.
150	Allied Radio	74		Lampkin Laboratories, Inc.	82
149	American Engraving, Inc.	62	129	Liberty Electronics, Inc.	87
148	Arcturus Electronics Corporation	83	128	Mallory & Co., Inc., P.R.	2
147	BSR (USA) Ltd., MacDonald Division	75	127	Methods Research	82
146	Burstein-Applebee Co.	77	126	Motorola Communications & Electronics	61
	CREI, Home Study Division, McGraw-Hill Book Company	54, 55, 56, 57	124	Multicore Sales Corporation	60
145	Cleveland Institute of Electronics	68, 69, 70, 71		National Radio Institute 12, 13, 14, 15	
144	Cleveland Institute of Electronics	61	123	Olson Electronics, Inc.	74
143	Cook's Institute of Electronics	76	122	Park Electronics Products	86
	Cornell Electronics Co.	86	121	Poly Paks	87
141	Crystek	59	120	Quaker City Transformer Co.	60
140	Delta International Ltd.	9		RCA Electronic Components & Devices	FOURTH COVER
139	Delta Products, Inc.	5	119	RCA Electronic Components & Devices	22
104	Denver Electronic Surplus	84		RCA Institutes, Inc.	78, 79, 80, 81
103	Drake Company, R.L.	88		RCA Sales Corp.	63
138	Edison Instrument	77	118	Radar Devices Mfg. Co.	21
137	Edmund Scientific Co.	85	117	Sansui Electric Co., Ltd.	19
136	Electro-Voice, Inc.	18	116	Schober Organ Corporation	19
135	Fair Radio Sales	84	115	Sencore, Inc.	1
134	Finney Company, The	10	110	Solid State Sales	85
125	G C Calectro	SECOND COVER	109	Sonar Radio Corp.	75
	G & G Radio Supply Company	86	108	Surplus Center	88
	Goodheart Company, Inc., R.E.	83	107	Sylvania Electric	64, 65
	Grantham School of Electronics	4	89	Triplett Electrical Instrument Co.	THIRD COVER
133	Gregory Electronics Corporation	86	106	University Sound	73
132	Heath Company	16, 17		Valparaiso Technical Institute	76
130	Kenwood Electronics	6	105	Xcelite, Inc.	66
131	Kenzac	62			

CLASSIFIED ADVERTISING 83, 84, 85, 86, 87

\$44,000,000

WILL BUY 1,000,000 TRIPLETT 310 VOM'S
 BUT YOU ONLY NEED ONE...AT \$44⁰⁰ THAT'S A BARGAIN



MODEL 310
 World's Largest Selling
 Volt-Ohm-Milliammeter
 (SHOWN ACTUAL SIZE)



MODEL 310-C
 Volt-Ohm-Milliammeter

- 1** HAND SIZE V-O-M WITH PROVISION FOR ATTACHING AC CLAMP-ON AMMETER.
- 2** 20,000 OHMS PER VOLT DC SENSITIVITY; 5,000 AC.
- 3** ONE SELECTOR SWITCH MINIMIZES CHANCE OF INCORRECT SETTINGS AND BURNOUTS.

310-C PLUS FEATURES

- 1** Hand size V-O-M with provision for attaching AC Clamp-on Ammeter.
- 2** 15,000 OHMS per volt AC sensitivity; (20,000 DC same as 310).
- 3** Single fully enclosed Lever Range Switch, plus DC Polarity Reversing.

MODELS 100 AND 100-C

Comprehensive test sets. Model 100 includes: Model 310 V-O-M, Model 10 Clamp-on Ammeter Adapter; Model 101 Line Separator; Model 379 Leather Case; Model 311 leads. (\$83.20 Value Separate Unit Purchase Price.)



MODEL 100 — U.S.A. User Net.....\$78.00
 MODEL 100-C — Same as above, but with Model 310-C, Net.....\$88.00

SELF-SHIELDED Bar-Ring instrument; permits checking in strong magnetic fields. FITTING INTERCHANGEABLE test prod tip into top of tester makes it the common probe, thereby freeing one hand. UNBREAKABLE plastic meter window. BANANA-TYPE JACKS—positive connection and long life.

Model 310—\$44.00 Model 310-C—\$56.00 Model 369 Leather Case—\$4.20
 All Prices are Suggested U.S.A. User Net, Subject to Change

THE WORLD'S MOST COMPLETE LINE OF V-O-M's • AVAILABLE FROM YOUR TRIPLETT DISTRIBUTOR'S STOCK



TRIPLETT ELECTRICAL INSTRUMENT COMPANY, BLUFFTON, OHIO 45817

IRCLE NO. 89 ON READER SERVICE CARD



On a color TV Service Call... GO BY THE BOOK!

Speed up your trouble-shooting and routine service adjustments on 15 makes of 1967 and 1968 model color TV sets with this remarkable book. All the data you usually need on a color service call is right here. Just look up the chassis number of the

set you're working on in the Chassis Index and you'll be guided to the proper sections of the Handbook. Chassis layouts...purity and convergence adjustments...and so much more...you'll find it indispensable for servicing color sets of

recent make. The RCA Color TV Service Handbook (1A1759) is available from your local RCA Tube Distributor. RCA Electronic Components, Harrison, N. J.