

Electronics World

OCTOBER, 1968
60 CENTS

AIRPORT GROUND CONTROL

A new system that could reduce much of today's airport traffic congestion.

VIDEO TAPE RECORDER DIRECTORY ELECTRONIC INTRUSION ALARMS (PART 2)

SPECIAL ISSUE

SHIELDED CABLES AND CONNECTORS



M0471 351528BDM013040MK
M BROWN
130 SM 48TH CT
MIAMI FL 33134



**“Get more
education
or
get out of
electronics**

...that’s my advice.”





Ask any man who really knows the electronics industry.

Opportunities are few for men without advanced technical education. If you stay on that level, you'll never make much money. And you'll be among the first to go in a layoff.

But, if you supplement your experience with more education in electronics, you can become a specialist. You'll enjoy good income and excellent security. You won't have to worry about automation or advances in technology putting you out of a job.

How can you get the additional education you must have to protect your future—and the future of those who depend on you? Going back to school isn't easy for a man with a job and family obligations.

CREI Home Study Programs offer you a practical way to get more education without going back to school. You study at home, at your own pace, on your own schedule. And you study with the assurance that what you learn can be applied on the job immediately to make you worth more money to your employer.

You're eligible for a CREI Program if you work in electronics and have a high school education. Our FREE book gives complete information. Airmail postpaid card for your copy. If card is detached, use coupon below or write: CREI, Dept. 1110G, 3224 Sixteenth Street, N.W., Washington, D.C. 20010.

Founded 1927



Accredited Member of the National Home Study Council



**CREI, Home Study Division
McGraw-Hill Book Company
Dept. 1110G, 3224 Sixteenth Street, N.W.
Washington, D.C. 20010**

Please send me FREE book describing CREI Programs. I am employed in electronics and have a high school education.

NAME _____ AGE _____

ADDRESS _____

CITY _____ STATE _____ ZIP CODE _____

EMPLOYED BY _____

TYPE OF PRESENT WORK _____ G.I. BILL

- I am interested in Electronic Engineering Technology
- Space Electronics Nuclear Engineering Technology
- Industrial Electronics for Automation
- Computer Systems Technology

APPROVED FOR TRAINING UNDER NEW G.I. BILL



Tips on selling batteries



Just about every customer who walks into your shop, or whom you see on a service call, is a prospect for batteries. You can get yourself more sales and profits from battery business, by recommending Mercury Duracell® and Alkaline Duracell batteries—the different high energy batteries made by Mallory.

Here are some facts about batteries that can help you trade customers up to today's best values in portable power.

Which batteries are best for transistor radios? At the relatively low drain service in most radios, Mercury Duracell batteries are generally the best buy. They actually cost about 15% less per hour of service than ordinary zinc-carbon types. And they give you better listening; their output voltage stays constant throughout life, so you don't drop into the high distortion part of the transistor characteristic. Next best are Alkaline Duracell batteries. Both Duracell types have the further advantage of extremely long shelf life—no appreciable drop in power even after two years. So they can sit idle in a radio instead of dying even when not used, like ordinary batteries.

How about cameras? For the electric eye devices which automatically adjust exposure, there's nothing like Mercury Duracell batteries. They last over a year, and produce highly accurate voltage required for this job. For built-in flash and for electric drive of movie cameras, Alkaline Duracell batteries are far superior to ordinary types. They drive 4 to 5 times more movie footage, and fire about three times more flashes.

What's good for tape recorders? Motor drive is a fairly heavy drain job . . . ideal for Alkaline Duracell batteries. These outlast zinc-carbon by 2 to 5 times in portable recorders.

Flashlights? Toys? For ordinary flashlight duty, the old zinc-carbon is hard to beat. But if you're apt to use a light continuously for long periods, Alkaline Duracell batteries can give steady lighting for up to 10 times longer than zinc-carbon. And they're much safer for emergency use, because they don't die in a few months on the shelf. Toys are real high drain duty; here Alkaline Duracell batteries are a real bargain, for they outlast zinc-carbon types by 5 to 8 times.

Sell your customer on the greater value of Duracell batteries, and you'll make twice as much profit per sale. Get the story on the new Mallory battery merchandise displays from your nearby Mallory distributor. Or write Mallory Distributor Products Company, a division of P. R. Mallory & Co. Inc., Indianapolis, Indiana 46206.

®DURACELL is a registered trademark of P. R. Mallory & Co. Inc.

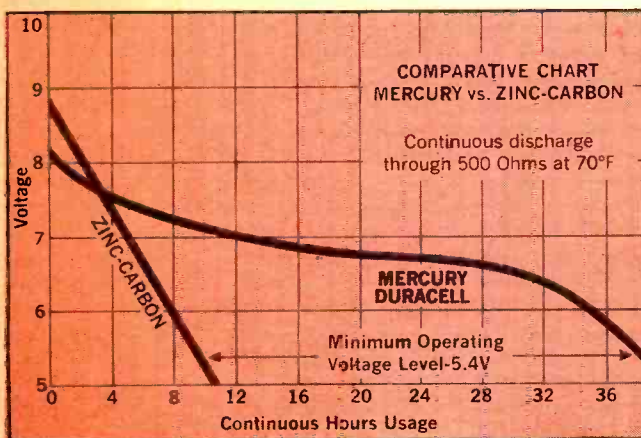
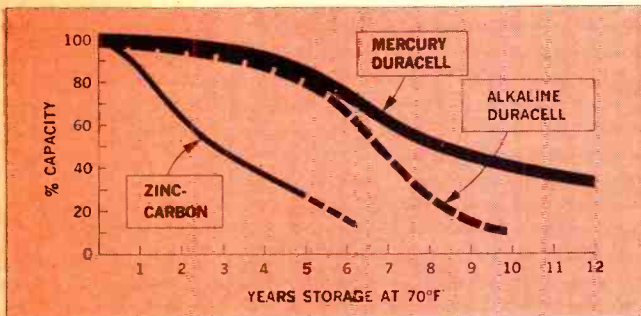

DON'T FORGET TO ASK 'EM "What else needs fixing?"

CIRCLE NO. 96 ON READER SERVICE CARD



THIS MONTH'S COVER shows a few of the many types of shielded cables and connectors and ties in with our Special Section on this oft-neglected topic. The radio-frequency, audio, microphone, and chassis connectors in the background were supplied by Amphenol. They illustrate the broad range of connectors which are used with shielded wire. The low-loss 50-ohm coax and 125-ohm RG-63B/U (top and lower left) were provided by Times Wire. Belden's multi-conductor cable, Type 8751 (center) contains 51 wire pairs covered by vinyl insulation and aluminum-polyester shielding. The three 75-ohm cables (right) were developed for TV work. Often tubular aluminum coax is packed with sand for "forming," then fitted to the airframe of planes that carry TV and radar. Photo: Leonard Heicklen Studios.



Publisher
PHILLIP T. HEFFERNAN

Editor
WM. A. STOCKLIN

Technical Editor
MILTON S. SNITZER

Associate Editors
W. J. EVANZIA
P. B. HOEFER

Contributing Editors
WALTER H. BUCHSBAUM
Prof. ARTHUR H. SEIDMAN
FOREST H. BELT

Art Editor
EUGENE F. LANDINO

Art and Drafting
J. A. GOLANEK

Advertising Manager
JOSEPH E. HALLORAN

Advertising Service Manager
ARDYS C. MORAN

Associate Publisher
LARRY SPORN

October, 1968

Electronics World

OCTOBER 1968

VOL. 80, No. 4

CONTENTS

- 27** Airport Ground Control *O. S. Willey*
- 30** Recent Developments in Electronics
- 32** Directory of Video Tape Recorders
- 34** Electronic Intrusion Alarms (Part 2) *Lon Cantor*

- SPECIAL SECTION: SHIELDED CABLES AND CONNECTORS**
- 37** New Directions in Cable Standardization *John W. Holland*
- 38** Coaxial Connectors *Tore N. Anderson*
- 43** Grounding Techniques *Saul Bernstein & Martin Mirsky*
- 46** Shielded Cable at Audio Frequencies *Robert E. Sharp*
- 49** A New Type of Shield
- 50** Connectors for Audio-Frequency Applications *J. H. Gove & L. J. Kehl*
- 52** Flexible Filters
- 53** Characteristics of RG/U Transmission Cables
- 54** Characteristics of Coaxial Transmission Lines *Allen M. Kushner*

- 62** Steerable Antenna
- 67** Tape Recorder Maintenance Program *Leonard Kubiak*
- 70** Hi-Fi Show Seminars Program
- 76** Shunt Switching *Melvin Chan & Robert Brock*
- 82** Electronic Dice *Arthur L. Plevy*
- 92** Tone Booster Circuit *Hugh L. Moore*

-
- 6** For the Record
The New York Hi-Fi Show
 - 7** EW Lab Tested
Sony Model TC-560 Tape Recorder
 - 59** The Laser: Toy or Tool? *John Frye*
 - 72** Test Equipment Product Report
Heathkit Model 10-17 Oscilloscope
Fairchild Model 8040 Digital Frequency Meter
Sencore Model MU150 Tube Tester

MONTHLY FEATURES

-
- 4** Coming Next Month
 - 13** Reflections on the News
 - 16** Letters from Our Readers
 - 18** Radio & Television News
 - 64** Book Reviews
 - 94** New Products & Literature

Electronics World: Published monthly by Ziff-Davis Publishing Company at 307 North Michigan Ave., Chicago, Illinois 60601. One year subscription \$6.00. Second Class Postage paid at Chicago, Illinois and at additional mailing offices. Subscription service and Forms 3579: Portland Place, Boulder, Colorado 80302. Copyright © 1968 by Ziff-Davis Publishing Company. All rights reserved.

new SAMS books

Practical Design with Transistors

by *Mannie Herowitz*. This book provides the circuit designer with a clear and practical approach to the design of a wide variety of solid-state circuits. Covers biasing, feedback, and high-frequency considerations, as well as various methods of coupling. Includes latest semiconductor developments, with emphasis on new applications of FET's. 288 pages. Order 20659, only.....\$5.95

Using Scopes in Transistor Circuits

by *Robert G. Middleton*. The leading authority on test equipment tells when and how to use oscilloscopes to analyze and/or troubleshoot transistor circuits; major emphasis is on scope waveform analysis. The book is intended primarily for the electronic technician. It includes detailed treatment of waveforms and circuit theory in transistor oscillators, amplifiers, waveshaping circuits, monochrome and color TV, and computers. 192 pages. Order 20662, only.....\$4.50

101 Easy CB Projects

by *Robert H. Brown*. Here are fascinating do-it-yourself projects for a wide variety of simple, inexpensive, yet practical citizens band radio equipment and accessories. Each easy-to-build device, designed to be a useful addition to any CB radio operator's gear, is covered by a description and complete parts list, with full instructions for its construction. 128 pages. Order 20663, only.....\$3.25

IMPORTANT RECENT BOOKS

Transistor TV Training Course

by *Robert G. Middleton*. Provides a complete understanding of modern transistor television circuitry. Progresses functionally through a typical receiver from signal input or tuner stages, through video and audio i-f and detector stages, picture and sound amplifier stages, vertical and horizontal deflection and synchronizing systems; concludes with analysis of power supply circuits. Includes review questions. 128 pages. Order 20619, only.....\$3.95

Know Your Tube and Transistor Testers

by *Robert G. Middleton*. Explains principles and circuits used in tube and transistor testers. Includes schematics, specifications, and analysis of typical service and lab-type instruments. Packed with troubleshooting and repair data for various instruments. 144 pages. Order 20630, only.....\$3.50

North American Radio-TV Station Guide

by *Vane A. Jones*. NEW 5th EDITION. Completely updated, listing frequencies, call letters, locations, etc., for all a-m, f-m, and tv stations in the U.S. and possessions, Canada, Cuba, Mexico, and the West Indies. Includes over 5,000 a-m stations, over 2,200 f-m stations, and nearly 1,100 vhf and uhf tv stations. 144 pages. Order 20635, only.....\$2.95

FET Principles, Experiments & Projects

by *Edward M. Noll*. Explains in detail the theory and use of field-effect transistors. Black-box equivalent circuits are developed for the various modes of operation. Experiments involving the measurement of parameters and projects using FET's in practical circuits are included. 272 pages. Order 20594, only.....\$4.95

These and over 300 other SAMS Books are available from your local Electronics Parts Distributor . . .

Howard W. Sams & Co., Inc.

Order from your Sams Distributor today, or mail to Howard W. Sams & Co., Inc., Dept. EW-10 4300 W. 62nd Street, Indianapolis, Ind. 46268

Send me the following books:

20659 20663 20630 20594
 20662 20619 20635

\$_____enclosed

Name _____

Address _____

City _____ State _____ Zip _____

My Distributor is _____

COMING NEXT MONTH

SPECIAL FEATURE ARTICLES:

SWEEP GENERATORS

For some time, sweep generators have been used to set up and test microwave and other high-frequency equipment in the laboratory. In next month's feature articles, Hewlett-Packard's David L. Widman gives an in-depth analysis of swept-frequency techniques and uses H-P, Kruse-Storke, and Alfred generators as examples. Dale Baldrige of Heath tells how sweep generators can help TV technicians in servicing black-and-white and color receivers.

NONDESTRUCTIVE TESTING

The use of ultrasonic techniques to detect flaws in metal parts, plywood, and containers as well as airplane wings and submarine hulls is on the increase. Test methods and equipment used by Grumman, American Oil, and Ford are covered.

LONG-LIVED BATTERIES

This state-of-the-art story discusses the development and advantages of using the silver chloride-magnesium battery in electronics equipment. Long shelf life makes it a favorite with the military.

All these and many more interesting and informative articles will be yours in the November issue of ELECTRONICS WORLD . . . on sale October 17th.

4-TUBE TV SET

Even though you can't buy this little set, it shows what can be done with ingenuity, four compactron tubes, a tuner, rectifier, and 12-inch picture tube—in a circuit developed by General Electric.

NEW WORLD OF ELECTRO-OPTICS

Infrared devices, lasers, photomultipliers, and the development of other similar equipment have opened up a number of new professional and vocational possibilities for both engineers and technicians.

ZIFF-DAVIS PUBLISHING COMPANY

William B. Ziff, Chairman of the Board (1946-1953)

William Ziff
President

W. Eradford Briggs
Executive Vice President

Hershel B. Sarbin
Senior Vice President

Philip Sine
Financial Vice President

Walter S. Mills, Jr.
Vice President, Circulation

Stanley R. Greenfield
Vice President, Marketing

Phillip T. Heffernan
Vice President, Electronics Division

Frank Pomerantz
Vice President, Creative Services

Arthur W. Butzow
Vice President, Production

Edward D. Muhlfeld
Vice President, Aviation Division

Irwin Robinson
Vice President, Travel Division

Furman Hebb
Administrative Vice President

George Morrissey
Vice President

Sydney H. Rogers
Vice President

Editorial and Executive Offices
One Park Avenue
New York, New York 10016 212 679-7200

NEW YORK OFFICE 212 679-7200
Joseph E. Halloran

MIDWESTERN OFFICE
307 North Michigan Avenue
Chicago, Illinois 60601 312 726-0892
Midwestern Advertising Manager, Robert J. Ur

WESTERN OFFICE
9025 Wilshire Boulevard
Beverly Hills, California 90211
213 CRestview 4-0265; BRadshaw 2-1161
Western Advertising Manager, Bud Dean

JAPAN: James Yagi Ishikawa Mansion,
#4, Sakuragaoka Shibuya-ku, Tokyo 462-2911-8

CIRCULATION OFFICE
Portland Place, Boulder, Colorado 80302



Member
Audit Bureau of
Circulations

Radio & TV News • Radio News • Radio-Electronic Engineering Trademarks Reg. U.S. Pat. Off.
SUBSCRIPTION SERVICE: Forms 3579 and all subscription correspondence should be addressed to Electronics World, Circulation Department, Portland Place, Boulder, Colorado 80302. Please allow at least six weeks for change of address. Include your old address, as well as new—enclosing if possible an address label from a recent issue.
EDITORIAL CONTRIBUTIONS must be accompanied by return postage and will be handled with reasonable care; however publisher assumes no responsibility for return or safety of art work, photographs, or manuscripts.
ELECTRONICS WORLD (October, 1968, Vol. 80, No. 4). Published monthly at 307 North Michigan Avenue, Chicago, Illinois 60601, by Ziff-Davis Publishing Company—also the publishers of Airline Management and Marketing, Boating, Business & Commercial Aviation, Car and Driver, Cycle, Flying, HiFi/Stereo Review, Modern Bride, Popular Electronics, Popular Photography, Skiing, Skiing Area News, and Skiing Trade News. (Travel Weekly is published by Robinson Publications, Inc., a subsidiary of Ziff-Davis Publishing Company.) One year subscription rate for U.S., U.S. Possessions, and Canada, \$6.00; all other countries, \$7.00. Second Class postage paid at Chicago, Illinois and at additional mailing offices. Authorized as second class mail by the Post Office Department, Ottawa, Canada and for payment of postage in cash.

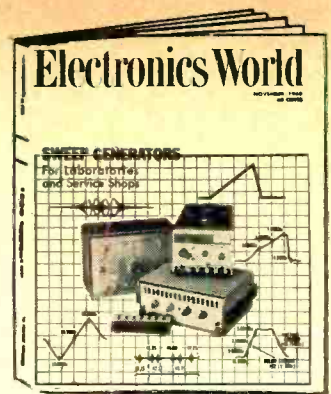

Success in Electronics Comes as Naturally as

1-2-3

through Education

There they are — three big steps — three deliberate steps which lead directly to success in electronics. Your future is shaped by the moves *you* make — by the steps *you* take. Begin now with Step #1.

STEP #1 is a simple request for full information on the Grantham Associate Degree Program in Electronics. You take this step by filling out and mailing the coupon. We mail our catalog to you; we do not send a salesman.

STEP #2 is earning your FCC first class radiotelephone LICENSE and radar endorsement. You complete this step in the first two semesters of the Grantham educational program (by correspondence or in residence). Train with the school which gives associate-degree credits for your license training, offering you the opportunity to advance beyond the FCC license level to a college degree in electronics.

STEP #3 is earning your ASEE DEGREE. This degree is conferred when you have earned credit for all six semesters of the Grantham curriculum.

The Grantham Associate Degree Program offers in-depth technical education, and prepares you for employment as an *engineering technician*—a big step above an ordinary technician. (Most of our students are already technicians when they begin the course.) Engineering technicians usually work directly with scientists and engineers, analyzing and solving engineering problems. *You can make more money as an engineering technician!*

Accreditation, and G.I. Bill Approval

Grantham School of Electronics is *accredited* by the Accrediting Commission of the National Home Study Council, and is *approved* for both correspondence and resident training under the G.I. Bill. Just mail the coupon, or write or telephone us for full information without obligation.

Grantham School of Electronics

1505 N. Western Ave.
Hollywood, Calif. 90027

or 818 18th Street, N.W.
Washington, D.C. 20006

Telephone:
(213) 469-7878

Telephone:
(202) 298-7460

October, 1968

①

Grantham School of Electronics ew 10-68
1505 N. Western Ave., Hollywood, Calif. 90027

Please mail me your free catalog, which explains how Grantham training can prepare me for my FCC License and Associate Degree, in electronics. I understand no salesman will call.

Name _____ Age _____

Address _____

City _____ State _____ Zip _____

②



③

Grantham School of Electronics

has conferred on
John Doe
the degree of
Associate in Science in Electronics Engineering

with all the rights and privileges thereunto appertaining. In witness thereof this diploma duly signed has been issued by the School Administration upon recommendation of the faculty at the School on this
first day of October, 1965.

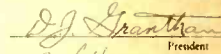
 
President

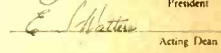
Acting Dean

FIRST WITH

- Digital Integrated Circuits
- 4 Crystal-Controlled Oscillators
- Battery & AC Operation Standard



The New Pace-Setting
CONAR Model 680

COLOR GENERATOR

KIT \$83.50 WIRED \$114.50

Until now, no commercially available color generator has offered so many quality features in a single instrument at such a low price. Only the CONAR COLOR GENERATOR has all these features at any price: exclusive digital integrated circuits; exclusive 4 crystal-controlled oscillators; exclusive AC or battery operation standard; completely solid state; color amplitude control; color phase adjustment; regulated power supply; stability control; TV station sync and blanking pulses; nine patterns; red, blue and green gun killers; compact; lightweight; portable.

For details write Dept. KB8C

CONAR instruments

DIVISION OF NATIONAL
RADIO INSTITUTE
3939 Wisconsin Ave.,
Washington, D.C. 20016

WRITE FOR
FREE CONAR CATALOG



GET INTO ELECTRONICS



V.T.I. training leads to success as technicians, field engineers, specialists in communications, guided missiles, computers, radar and automation. Basic & advanced courses in theory & laboratory. Electronic Engineering Technology and Electronic Technology curricula both available. Assoc. degree in 29 mos. B. S. also obtainable. G.I. approved. Graduates in all branches of electronics with major companies. Start February, September. Dorms, campus. High school graduate or equivalent. Write for catalog.

VALPARAISO TECHNICAL INSTITUTE
Dept. RD, Valparaiso, Indiana 46383



For the record

WM. A. STOCKLIN, EDITOR

NEW YORK HI-FI SHOW

WHAT started out to be an interesting experiment in 1964 continues to be quite an exciting annual event for us. The Institute of High Fidelity has again asked us to plan semi-technical symposiums for the forthcoming New York Hi-Fi Show. This is to be held at the Statler Hilton here in New York from September 19 through 22. Our particular work involves not only planning the sessions but selecting the most authoritative group of panelists for the various programs.

This will be the fifth consecutive year we have been directly involved with these sessions and each year turns out to be more interesting than the last. For complete schedule of subjects and speakers, see page 70.

The Institute (through John Koss, its new president) has been so well pleased with past results that they have asked us to prepare similar presentations for the forthcoming San Francisco Hi-Fi Show. This will be held at the Civic Auditorium from October 31 to November 3.

The symposiums for this year's New York Show will be somewhat different from those held last year. They will be fewer in number but those that are planned will be more exciting. We will have many new participants, along with those who did such an outstanding job in previous years that we have asked them to return.

One of the most interesting aspects of working on these symposiums is the enthusiasm of those in attendance. Len Feldman, who has been doing an outstanding job, has been presenting the novice sessions for the past five years, repeating the same performance four times throughout each show. Yet the attendance is just as high as it was the first time. Each program brings a new group with questions that need answering. The question and answer session which is part of each presentation kindles as much excitement as the presentation itself.

Questions, questions, questions . . . it seems everyone attending the show is there to learn more. They want to know everything they can, and if these symposiums serve no other purpose than to answer these questions, then they are successfully filling an important need.

Some of the newcomers you will meet at this year's seminars are John Bubbers of *Pickering* who will talk about phono cartridges; Ted Jensen of *British Industries*, whom we've not yet met but who comes highly recommended as an authority on turntables and changers; and Russ Molloy, of *Telex Communications Division*, whom we also look forward to meeting. His firm makes *Viking* and *Magnecord* tape machines and Russ will be there to answer questions in this area.

Joe Kemper (*Audio Devices*) is back with us again, and he will bring us up to date on magnetic recording tape. Larry Fish (*H. H. Scott*) will be with us for his second year, discussing solid-state developments in hi-fi amplifiers and receivers. He will team up with George Augs-

purger (*James B. Lansing Sound*) who is another newcomer to our technical sessions but well-known in his field. In fact, he has written many articles for this and other publications over the years, and is an authority on speakers. Adding speakers to solid-state amplifiers is much more critical in view of impedance limitations than was the case with vacuum-tube designs. We expect George will enlighten us on the proper procedure.

A new program (actually a combination of several we had last year) will cover "The Jazz and Classical Recording Scenes." Jim Lyons, editor, *American Record Guide*, will discuss classical music, while Fr. Norman O'Connor will cover the jazz scene. Fr. O'Connor is president of the N.Y. Chapter of NARAS but perhaps better known for his Channel 2 "Dial M for Music" program. Phil Ramone, of *A & R Recording Studios*, will round out the panel, and George Simon, executive secretary of NARAS, will moderate for us. George has just written a new book, "The Big Bands," which has received an enthusiastic reception.

We've asked two oldtimers back—Vic Brociner of *Scott* and Abe Cohen of *Instrument Systems Corp./Telephonics*. These two have been teaming up on our panel for a discussion of loudspeakers and room acoustics for some years now and theirs have always been one of the high-lights of the seminars.

We have a new session this year—"The Listening Faculty." We feel there should be tremendous interest in knowing about the ear itself, how it works, frequency and attenuation characteristics, what the "stereo effect" actually is, and why ear-phones make it so dramatic. Abe Cohen will also participate in this program, along with Ed Villehur, who is, of course, well-known as the developer of the AR speaker. Not too long ago, Ed sold *Acoustic Research* and started a non-profit research organization on hearing problems.

Since both Abe and Ed are vocationally involved with studies relating to the ear, their presentation should prove quite informative.

Another possibility (we're not quite sure about yet and therefore have omitted from the program schedule) is that Bob Moog, of *R. A. Moog & Co.*, will give an hour-long demonstration of electronic music. Bob will be remembered by many for his articles in this publication on the Theremin. In recent years he has become quite an authority on electronic music and we understand his presentations get an enthusiastic reception.

We hope that those of our readers who may be in the New York area from September 19-22 will drop in to say hello; and that those who are in San Francisco from October 31 to November 3 will visit us at the West Coast Show. Although the program has not been completely finalized for the West Coast, basically the subjects will be quite similar but with a different roster of guest speakers. The final program should appear in next month's issue. ▲

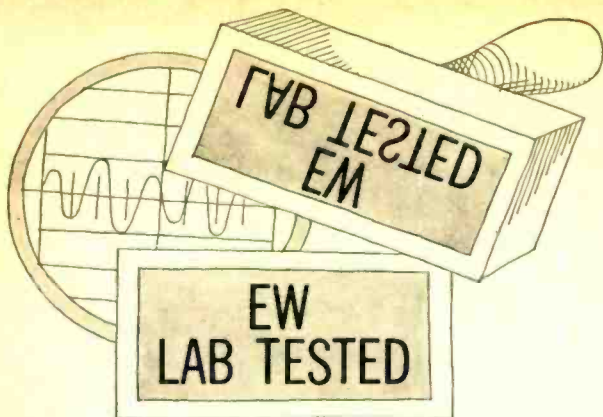

HI-FI PRODUCT REPORT

TESTED BY HIRSCH-HOUCK LABS

Sony Model TC-560 Tape Recorder

Sony Model TC-560 Tape Recorder

For copy of manufacturer's brochure, circle No. 1 on Reader Service Card.



THE Sony TC-560 is not only a high-quality solid-state portable tape recorder, but it can also serve as the heart of a stereo music system. It contains a stereo amplifier with equalization for a magnetic-phonograph cartridge, bass and treble tone controls, and a high-frequency noise filter. Push-buttons select the input signal source: tape, microphones, high-level auxiliary, stereo tuner, or phono.

The TC-560 has two detachable speaker systems (they can be set up 15 feet apart) which serve as covers in

portable use. The speaker units also contain storage space for the microphones, their desk stands, and cables. (Two of the excellent Sony F-96 low-impedance dynamic microphones are included.) The speakers as well as the recorder itself are covered with a grained vinyl and fitted with plastic feet to protect furniture.

The three-speed tape transport is driven by a servo-controlled d.c. motor. The speed of this electrically stabilized motor can be switched instantly without physical movement of belts or cap-

stans, and the speed can also be adjusted over a small range (in playback only) by means of an optional accessory. The motor can be switched off when the 560 is used as an amplifier only.

The d.c. motor also makes it possible to operate the recorder from a 12-volt automobile or boat battery, using a special line cord that plugs into the cigarette-lighter outlet of a car. Pitch and timing are not affected by variations in battery or line voltage.

The TC-560 features the Sony ESP (Electronic Sensory Perception) system of automatic tape reversal. The program level on all four tracks is monitored continuously by the control circuit. When all tracks have been blank for about 8 seconds, it is assumed that the tape has been fully played in the left-to-right direction. The tape direction is instantly reversed (using a second counter-rotating capstan driven by the single motor) and a second playback head is switched in. This permits playing a four-track stereo tape in both directions without any action by the user. The recorder shuts off automatically when the second pair of tracks has been played. The ESP circuit can be switched out if desired.

The function knob controls tape motion, at normal or fast speeds, in either direction. It also switches in the appropriate head for the selected direction. The tape can be recorded or played

(Continued on page 74)

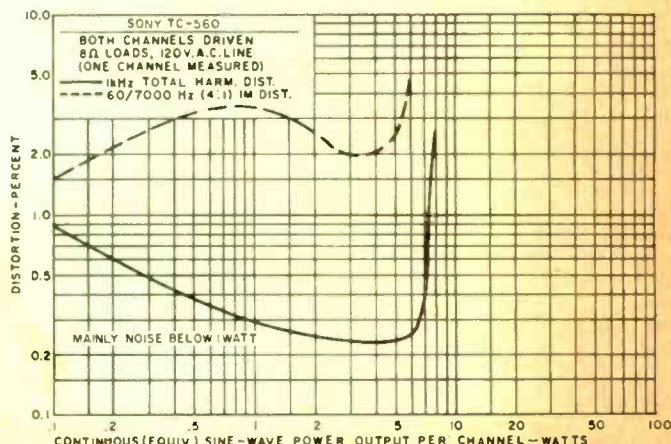
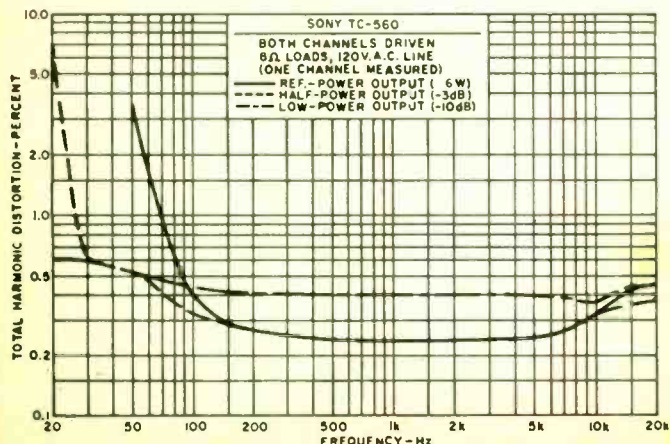



firsts

make learning
Electronics at home
fast and fascinating—
give you priceless
confidence.

Some NRI **firsts** in training equipment

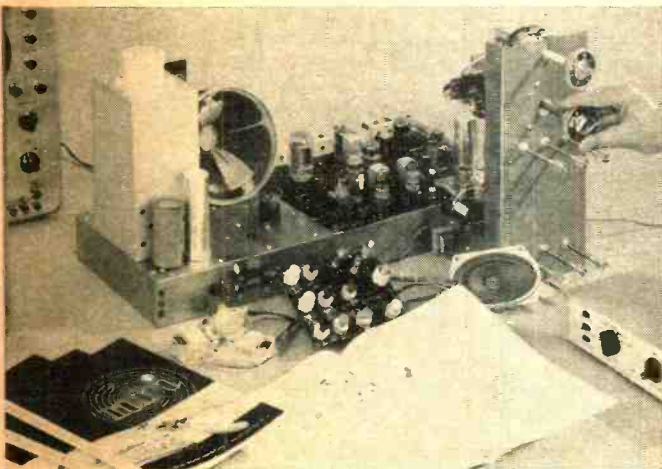

first to give you Color Television training equipment engineered specifically for education—built to fit NRI instructional material, *not* a do-it-yourself hobby kit. The end product is a superb Color TV receiver that will give you and your family years of pleasure. You “open up and explore” the functions of each color circuit as you build.

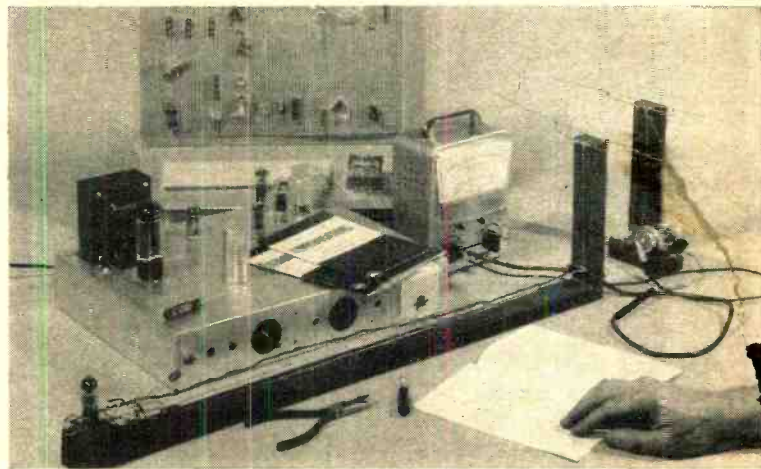

first to give you transmission lines and antenna systems that include experiments not otherwise attempted outside of college physics laboratories. The experience gained with this kind of Communications training equipment is matched only by months—sometimes years—of on-the-job experience.

NRI's "discovery" method is the result of over half a century of leadership simplifying and dramatizing training at home

The FIRSTS described below are typical of NRI's half century of leadership in Electronics home training. When you enroll as an NRI student, you can be sure of gaining the in-demand technical knowledge and the priceless confidence of "hands-on" experience sought by employers in Communications, Television-Radio Servicing and Industrial and Military Electronics. Everything about NRI training is designed for your education . . . from the much-copied, educator-acclaimed Achievement Kit sent the day you enroll, to "bite-size" well-illustrated, easy to read texts programmed with designed-for-learning training equipment.

YOU GET YOUR FCC LICENSE OR YOUR MONEY BACK

There is no end of opportunity for the trained man in Electronics. You can earn \$6 or more an hour in spare time, have a business of your own or qualify quickly for career positions in business, industry, government. And if you enroll for any of five NRI courses in Communications, NRI prepares you for your FCC License exams. *You must pass* or NRI refunds your tuition in full. No school offers a more liberal money-back agreement. The full story about NRI leadership in Electronics training is in the new NRI Catalog. Mail postage-free card today. No salesman is going to call.

NATIONAL RADIO INSTITUTE, Washington, D.C. 20016

APPROVED UNDER NEW GI BILL If you have served since January 31, 1955, or are in service, check GI line on postage-free card.

designed from chassis up for your education



first to give you true-to-life experiences as a communications technician. Every fascinating step you take in NRI Communications training, including circuit analysis of your own 25-watt, phone/cw transmitter, is engineered to help you prove theory and later apply it on the job. Studio equipment operation and troubleshooting become a matter of easily remembered logic.



first to give you completely specialized training kits engineered for business, industrial and military Electronics. Shown above is your own training center in solid state motor control and analog computer servo-mechanisms. Telemetering circuits, solid-state multi-vibrators, and problem-solving digital computer circuits are also included in your course.

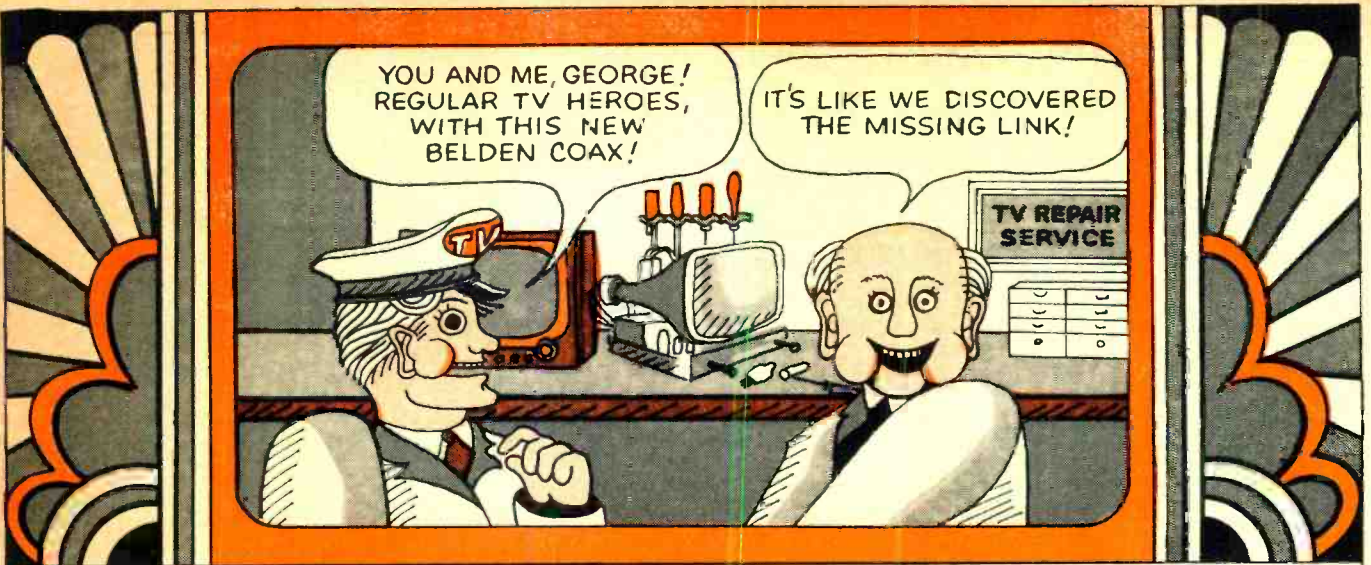

Jacket
Black all-weather PVC .030 nominal wall with a .242" nominal O.D.

Dielectric
Low loss cellular polyethylene, .180" nominal O.D.

Conductor
18 AWG solid, annealed, bare copper.

8228 BELDEN DUOFOIL

Drain Wires
4-28 AWG solid tinned copperweld conductors applied spirally and positioned uniformly around the circumference of the shield.

Shield
Belden DUOFOIL 100% shield is a polyester film with aluminum lamination on both outside surfaces.

THE MISSING LINK TO PERFECT VHF AND UHF COLOR AND B/W RECEPTION

BELDEN 8228 DUOFOIL®

75 OHM COAXIAL CABLE • 100% SHIELDED • 100% SWEEP TESTED

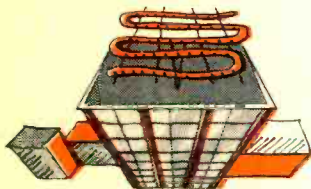

For MATV distribution systems, DUOFOIL is the finest coax yet. Its low loss, 100% shielding keeps B/W and color VHF and UHF signals pure. Apartment dwellers, hotel and motel tenants, etc.—even in congested areas—get sharp, clear reception. Its small diameter provides extra space savings in conduit installations.

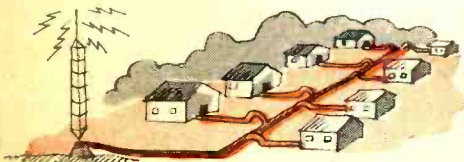

Is CATV coming into your area? DUOFOIL is the perfect underground drop cable. Its exceptional flexibility and moisture resistance assures extra-long service life, and preserves the impedance values of the cable design.

LOW, LOW ATTENUATION

Nom. Attenuation per 100'	
mc	db
50	1.5
100	2.1
200	3.1
300	3.8
400	4.5
500	5.0
600	5.5
700	6.0
800	6.5
900	6.9

Available in 100, 500 and 1000 ft. spools. See your local Belden Distributor for full details or to order. For a copy of the reprint article, "Electronic Cable," write: Belden Corporation, P.O. Box 5070-A, Chicago, Illinois 60680.

Don't forget to ask them what else needs fixing?

BELDEN

8-5-8

CIRCLE NO. 121 ON READER SERVICE CARD

Reflections on the **news**

Air Traffic Control . . .

has disintegrated. Unreasonable air-traffic delays continue to plague metropolitan areas, New York in particular. Recently, air traffic around New York has been so heavy that planes at Los Angeles' International Airport destined for this area have been prohibited from taking off. In one documented case, an *Air France* jet took so long to reach the flight line that it had to return to the terminal. It seems the crew's flight time (counted from the moment the plane starts to taxi on the runway) had run out. The Professional Air Traffic Controllers Association (PATCO) alleges the delays are in the interest of safety and blames the Federal Aviation Administration (FAA) for lack of sufficient controllers and antiquated equipment. The FAA, on the other hand, blames everybody—the Government for cutting funds, the controllers for their apparent over-sensitivity to an ever-worsening condition and their methods of forcing changes, and the airlines for their scheduling practices.

Recently, the newest and most elaborate air-traffic control center, the Common Instrument Flight Rules Room (CIFRR) went into operation at New York's Kennedy International Airport. From this facility, aircraft arriving and departing the Newark, N. J. airport, and the LaGuardia and Kennedy terminals in New York are controlled. The room contains the latest (not necessarily the best) in terminal ATC equipment—two giant *Eidophor* large-screen displays on which Newark, Kennedy, and LaGuardia air traffic is displayed, newly designed controller consoles and bright displays, alphanumeric generators to write aircraft identity, beacon code, altitude, etc. on the controller's scope, and two *Univac* 1219 computers to process radar and beacon tracking data and control scope information. The tragedy of the CIFRR is that it's already out of date. The FAA admits the \$7-million facility doesn't speed up traffic flow; however, they claim the controller's job is somewhat easier.

Even more advanced semi-automated metropolitan traffic control centers will be needed if the national ATC picture is to be improved. But, more importantly, an entire new concept of air-traffic control is a must. In addition, the FAA will have to face up to its responsibilities squarely, they will have to admit they cannot do a modern control job with an antiquated traffic-control system, Congress will have to stop its game of false economics and provide the necessary funds for new controllers, new equipment and new developments, and the Authorities who operate the airports will have to speed up construction and planning, and local politicians will have to stop wrangling and approve the necessary new jetports. Finally, the question of segregated air space will have to be resolved. For it is obvious that if the present air-transport growth rate continues, commercial and general aviation aircraft (business and private planes) will not be able to operate out of the same airports safely.

On page 27 of this issue, an article entitled "Airport Ground Control: The Problems and a Solution" discusses a method which can substantially reduce ground traffic congestion. Don't miss it.

End of an Era? . . .

Sperry Gyroscope's recently announced plans to "consolidate" its Lake Success operations continues to stir up rumors that the plant is being phased out. Company officials are attempting to push these mutterings aside as idle gossip while proclaiming loudly, "that's what we're trying to avoid." "The consolidation", they say, "will increase profit margins and keep the plant going." It's doubtful the hundreds of laid-off technicians and assembly workers can be convinced of this.

Meanwhile, the *Sperry Systems Management Division* is trying (again) to develop an electronic traffic control system. This time it's for the Bureau of Public Roads of the Department of Transportation. The contract is for a highway control test site which will be used in the Federal Highway Administration's Urban Traffic Control System (UTCS) project for on-street testing of advanced traffic control techniques. *Sperry's* previous traffic control system contract was with New York City. It flubbed when New York Traffic Commissioner Henry Barnes indicated the *Sperry* system just couldn't meet the city's over-all requirements.

The Navy's New Nuclear Sub . . .

may prove to be a boon to the electronics industry. The Department of Defense has formed a special management group to study systems for the super-speed attack boat. The new underseas craft, which is

supposed to be operational in the mid-1970's, opens up an entire new electronics and weapons market.

Sonar systems remain one of the Navy's biggest headaches. The boat's higher submerged speeds and greater operating depths are expected to generate new problems for detection-by-sound engineers. In addition, the Navy wants better closed-circuit sonar displays and computerized data-processing systems which could cut down human error in hostile submarine detection by operators. A truly secure underwater communications system has been a high priority item for some time. None of the supposedly secure communications systems tested thus far has proved satisfactory.

A "Home-Brew" Laser . . .

which can be built for about \$50 in anyone's basement, has been developed by *International Business Machines Corp.* scientists at the Watson Research Center. The inventor, Dr. Peter P. Sorokin, says the device uses ordinary commercial liquid dyes, such as those found in clothes whiteners and lipsticks, to produce a 100-kilowatt burst of light energy.

The laser consists of two glass tubes, one inside the other. The inner tube contains the dye and the outer tube contains air and has electrodes at each end. The electrodes are, in turn, connected to a capacitor which has been charged to 12 kilovolts. When the capacitor's voltage is discharged through the outer tube, an arc is created which excites some of the dye's molecules and causes them to give off photons of energy or packets of light. These light waves are reflected back and forth by mirrors at each end of the tubes, exciting other dye molecules and building the beam up to a very high intensity.

According to Dr. Sorokin, any bright high-school science student can build the laser. A word of caution, however; laser beams can be dangerous and can cause irreparable damage, especially to the eyes. No student should attempt to build one unless he is properly supervised.

Emergency Communications Networks . . .

are being considered by several of the larger metropolitan areas in the country, notably those cities where large minority groups are congregated. One of the cities concerned is Los Angeles which has a large Mexican-American as well as Negro population. The Mayor of Los Angeles, Sam Yorty, has asked executives from 21 of the nation's top electronics firms for help in setting up an emergency data and information transmission system. The coordinating agency for the high-level city-industry group denies that the sole purpose of the communications net is the possibility of riots, but points out that Los Angeles County has been plagued by forest fires and landslides and that an emergency net would help in these situations.

Acting as liaison between Los Angeles and the electronics companies is the Los Angeles Technical Services Corp., an agency set up expressly for this purpose. All of the interested companies are expected to take part in the system definition work. However, it's too early in the game to determine when, or even if, the hardware contract will be let.

Some Thoughts . . .

about things going on. Credit cards may soon give way to a new electronic memory "key" that does its own accounting work right at the retail counter. The device, called "Uni-Key", is made by *Diginetics, Inc.* When slipped into a counter-top reader, it will identify the purchaser, reveal his credit rating, subtract his purchase, and retain his credit balance in its memory for future use. . . . *Consolidated Edison of N.Y.* gets the go-ahead to build a new atomic electric generating plant at Fort Stocum, N. Y. It's not supposed to pollute the air or Long Island Sound, but city officials and sportsmen are fearful. . . . *Comsat (Communications Satellite Corp.)* pushing development of a domestic satellite system, for educational purposes, they say. . . . Computers are moving into automobile diagnostic centers. *IBM* has installed a modified 1130 in the *Mobil* center in East Meadow, New York. It checks the ratings on about 115 systems and components in approximately 25 minutes. . . . *Westinghouse's* Molecular Electronics Division has started a do-it-yourself design program, called "U-design," which enables engineers to tailor IC's to their needs. . . . The *Singer Co.* is trying to buy Cornell Aeronautical Laboratory from Cornell University. Possible acquisition of the Lab by the billion-dollar conglomerate is very unpopular with the Lab's scientific personnel, and many of them may defect if it occurs. *Singer* recently acquired *General Precision*. . . . "Flying saucers" are back in the news. Six prominent scientists, who insist that unidentified flying objects are fitting subjects for serious investigation, have asked the House Committee on Space and Astronautics for Federal support for an information collection program aimed at settling the question. It is almost certain that if such a report-gathering center is set up, they will have no difficulty in obtaining plenty of data on which to start an investigation. . . . Parallel contract awards for the *Lockheed-California Co.'s* L-1011 and the *McDonnell-Douglas Airbus* pushing avionics stocks to a new high. ▲

Everybody bulls, bluffs and brags about their tape recorders.

This new Ampex will clear the air.

It seems like there are an awful lot of claims flying around. Higher this, better that, lower something else.

It makes the mind boggle.

We can't speak for other manufacturers, but we sure can for ourselves. Every single Ampex spec you ever see will always be accurately and conservatively stated. We go by the toughest standards in the world. Our own. In fact, reproducer test tapes, used by professional recording studios, are produced in our own laboratories to N.A.B.* standards.

Our new model 761 is made for those who demand professional performance in a portable tape system. It has sound-with-sound, sound-on-sound, three exclusive deep gap heads and a built-in variable echo effect. *Minimum* overall record/play response is from 50 to 15,000 Hz \pm 4 db. Signal-to-noise ratio is

46 db at 7 1/2 ips (at peak record level).

And lots more. Like a pair of acoustic suspension cube speakers that nest conveniently inside the unit. Automatic shut-off.

Sure, you can find some of these features on other machines. But not all on *one* machine. Except ours. No brag. Just fact.

And to learn more about other professional quality home recorders from Ampex, see an Ampex Sound Idea Dealer or write to Department 540.



AMPEX:
The
Sound
Idea
People.

AMPEX

AMPEX CORPORATION
CONSUMER & EDUCATIONAL PRODUCTS DIVISION
2201 LUNT AVENUE
ELK GROVE, ILLINOIS 60007

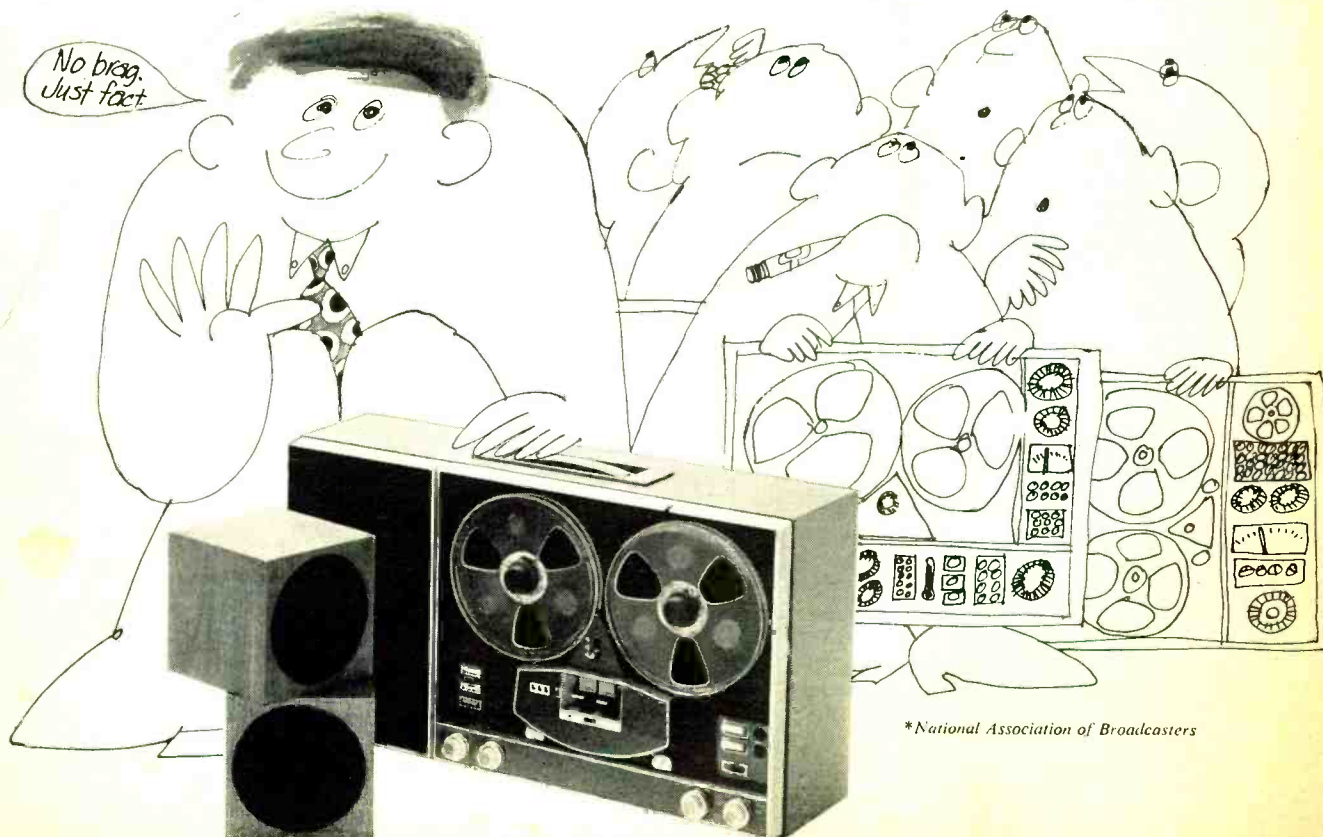

*National Association of Broadcasters

Build this exciting Schober Console Organ for only \$925!*



*Includes finished walnut console. (Only \$716 if you build your own console.) Amplifier, speaker system, optional accessories extra.

You couldn't touch an organ like this in a store for less than \$1800—and there never has been an organ of the Console II's graceful small size with 22 such pipelike, versatile voices, five-octave big-organ keyboards, and 17 pedals! It sings and schmaltzes for standards, pops, old-time favorites, speaks with authority for hymns and the lighter classics, all with a range of variety and satisfying authenticity you've never found before in an instrument under church or theatre size. If you've dreamed of an organ of your own, to make your own beautiful music, even if your home or budget is limited, you'll get more joy from a Schober Console II than any other "home size" organ—kit or no kit.

You can learn to play it. And you can build it, from Schober Kits, world famous for ease of assembly without the slightest knowledge of electronics or music, for design and parts quality from the ground up, and—above all—for the highest praise from musicians everywhere.

Send right now for the full-color Schober catalog, containing specifications of all five Schober Organ models, beginning at \$599.50. No charge, no obligation. If you like music, you owe yourself a Schober Organ!

The **Schober** Organ Corp., Dept. RN-58
43 West 61st Street, New York, N.Y. 10023

- Please send me Schober Organ Catalog and free 7-inch "sample" record.
- Enclosed please find \$1.00 for 12-inch L.P. record of Schober Organ music.

NAME _____
ADDRESS _____
CITY _____ STATE _____ ZIP _____

CIRCLE NO. 85 ON READER SERVICE CARD
16

LETTERS FROM OUR READERS

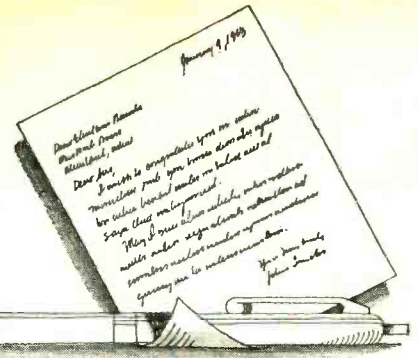

TAUT-BAND METERS

To the Editors:

I notice that in your test equipment product reports covering some of the new volt-ohm-milliammeters you talk about taut-band meter movements. I can't imagine just what such a meter movement looks like and what advantages it has over the conventional movements. The term brings visions of stretched bands someplace in the meter, but I don't know where.

JOHN McDERMOTT
Montreal, P.Q.

In conventional meter movements, a coil carrying the meter pointer rotates in the field of a permanent magnet. This coil is wound on a form that is held between two bearings. When a voltage or current is being measured, the current is made to flow through the coil and a magnetic field is set up. When this field interacts with the field from the permanent magnet, the coil and the meter pointer are caused to rotate by an amount depending upon the amount of current. When the current is removed, the coil and pointer would stay where they are if it were not for one or two miniature coil springs that look like the hairsprings of a watch. The springs pull the coil and pointer back to their original zero position. The springs also serve as conductors to lead the current from the meter terminals to the moving coil.

In the taut-band movement, the bearings and coil springs are removed and a straight, flat, thin metal band is substituted. This band is stretched and clamped at both ends, and it serves to support the moving coil and carry current to it. Now, when current flows in the coil and the coil turns, it twists the stretched or taut band. When current is removed, the band untwists and returns the coil to zero.

By doing away with the pivots and hairsprings, this movement (when it is well-made) is less subject to severe mechanical shocks and is more rugged. Also, the movement will have better repeatability of readings over very long periods of time. Finally, smaller currents may be measured because of the absence of bearing friction. (With a conventional jeweled pivot and bear-

ing, about 2 to 3 microwatts of energy are needed to move the meter coil and pointer compared with less than 0.5 microwatt for the taut-band movement.)—Editors

3-D TELEVISION

To the Editors:

Recently, a certain "Radio & Television News" item on the status of 3-D television stirred some memories of work I did on stereoscopic projection long before TV was even in sight.

No matter how the subject is divided into two displaced images, the problem resolves into that of providing some means of preventing the left eye from seeing that intended for viewing by the right eye. If no control of the viewer's position is had, he will, by moving alternately, get his left and right images mixed.

The flyback circuit can be used to alternately close the right and left eyes of the viewer who wears a very light-weight clip-on reed shutter connected to a transistorized receiver fed from his TV set. Of course the two TV cameras placed reasonably close (not necessarily 3 or 4 inches but a foot or more apart as required) are simply switched alternately in sync with the flyback circuit without even modifying existing equipment. This system is obviously compatible with either black-and-white or color.

Other means of switching left and right eye images are as follows:

1. A horizontally vibrating moiré grid placed before the screen synced with the flyback or by the 60-Hz supply.
 2. Rotating cylinder with alternating horizontal slots worn as glasses and synced as above.
 3. Rotating single or pair of alternately slotted discs.
 4. Piezo-optical filters. Miniature Kerr cells and polarizers.
 5. Visual cut-off by physio-optical stimulus (with electrodes placed just beyond the eyes with the nose grounded). This is shocking but not necessarily painful.
 6. Use two miniature picture tubes as in a 2x2 slide viewer for individual viewing, or two large sets and mirrors.
- Thus we see that existing studio equipment could be used to provide

stereo visual information, and the problems could be solved at the viewing end.

WM. E. BROWN
Pewaukee, Wisc.

Our own feeling is that if 3-D TV ever comes, it will not involve any special glasses or other apparatus worn by the viewer. Instead, the image itself will have to contain the 3-D information, much as would be produced by a laser hologram display.—Editors

* * *

AMPEX AG-500 RECORDER

To the Editors:

I wish to take *Hirsch-Houck Labs* to task for some erroneous statements made in the June, 1968 *ELECTRONICS WORLD* review of the *Ampex AG-500-4* tape recorder.

Hirsch-Houck states "The transport is a massive three-motor system on a milled die-cast plate . . . A tape lifter holds the tape clear of the heads during fast forward or rewind . . . Although the recorder has several equalization adjustments, as well as bias frequency and symmetry adjustments, there is no provision for adjusting bias current."

If *Hirsch-Houck* had read the ". . . large loose-leaf binder, containing detailed performance specifications and maintenance instructions" which they mentioned in the review, they would have noted that the AG-500 series is *not* a 3-motor system, but really a single-motor transport utilizing an ingenious *eddy-current clutch* for transmitting motion to feed and take up turntables. This feature, as far as I am aware, is unique in a single-motor transport.

The tape lifters (there are two) are manually operated and do not necessarily hold the tape clear of the heads in rewind or fast-forward modes—a very important point for cueing or editing.

Finally, the Bias Adjust control, which *does* exist, is located behind a small rectangular cover secured to the front panel of the electronics chassis by 2 flat head Allen socket screws, as pointed out on page 5-7 of the *Ampex AR-500* manual under Reproduce/Record Alignment.

It is interesting to note that located along with the bias adjust control are the record calibration and equalization adjustments; all very important that easy access be maintained for the professional recording engineer.

L. G. NEWTON
Toronto, Ont.

Reader Newton is correct about the motor system. The eddy-current clutches look like two additional motors, but they are not. Sorry we overlooked the bias adjustment. This was not mentioned in the maintenance instructions which our lab used during the test, although it was covered in the "large loose-leaf binder."—Editors ▲

October, 1968

Crisp Bacon in 90 Seconds

with INTERNATIONAL'S
MICROWAVE OVEN



The culinary wonder of space age cooking moves to your kitchen with this new International countertop oven that cooks with radar-spawned microwave power.

People on the go will welcome an oven that makes cooking chores a pleasure. Imagine a "piping hot" TV dinner (frozen) in 3½ minutes* instead of 20 to 50 minutes. Bake a potato in 5 minutes instead of 60 minutes. Warm a chilled baby bottle in 60 seconds. Fry crisp bacon in 90 seconds on a paper plate. Great for those leftovers.

International Microwave Oven is truly remarkable. No more waiting for the oven to reach cooking temperature.

Countertop designed for the home, mobile home, or the galley on your boat. No special wiring required. Works on 115 vac house circuit. Comes in baked vinyl white with attractive trim. **\$545.00**

Available direct from International or through your local appliance dealer.

*Times listed are approximate and vary with size of item.

Write for folder



CRYSTAL MFG. CO., INC.

10 NO. LEE • OKLA. CITY, OKLA. 73102
CIRCLE NO. 102 ON READER SERVICE CARD

Radio & Television news

By FOREST H. BELT /Contributing Editor

Satellite Telecasting

Amidst clamor over the future of television in the United States comes word that the most advanced means could be a reality elsewhere before it gets a chance here. Satellite telecasting is being examined as a practical way to bring mass TV to India. However, the plan is not for a direct satellite-to-receiver system, but for ground pickup stations. How signals will be distributed to receivers isn't laid out yet, but conjecture is that a wired system seems practical.

So far, only one ground station has been built, experimentally; trouble is, no present satellite is within its reach. Another ground terminal, to be built in Bombay, will have access to Intelsat 3, which will be placed in stationary orbit over the Indian Ocean next April. The satellite TV system should start serving about 50,000 receivers in 1972.

"Mr. Nice-Guy" Technicians

The attitudes of service technicians could be improved, say many customers. The scarcity of good servicers has made some of the good ones (and some not-so-good ones) smugly independent. With so much home-entertainment gear, customers are at the mercy of the whims of shops or technicians that have more work than they can do.

Short-sighted servicers are taking a "don't care" attitude toward many jobs. We've heard otherwise friendly guys boast about how they tell this or that customer where to get off. The same guy, when business wasn't so good, used to brag how he could "tame" customers who were hard to get along with. During the years when sets were simpler, and moonlighters and drugstore tube testers were everywhere, the serious technician had a tough time finding enough customers. Now, with color-TV and transistor sets making TV servicing a specialization again, the tables are turned. There's an undercurrent of "vengeance" noticeable in some shops—a feeling of "let's treat them like they treated us."

Therein lies a danger for the servicing industry. A pendulum, having swung in one direction, always swings back. The huge training efforts now going on will sooner or later satisfy the demand for technicians. What then? Will television set owners patronize shops that gave them a very difficult time? It's not too likely.

What servicers should be doing, instead of pressing their advantage negatively, is educating the now-receptive TV user to the facts of servicing—to the need for technicians to make a fair living—for a shop to make a fair profit—for a set to be fixed completely instead of partially and cheaply—for an expert to be treated like an expert. Wise technicians are using this chance to improve their image.

On a Safety Kick

If home-entertainment equipment is unsafe, the new National Commission of Product Safety is going to find it out. At least, it plans to, as soon as Congress approves a \$2-million appropriation. The commission will even publicize unsafe brands, if that's necessary to stop hazardous practices.

A list of devices slated for attention includes: audio and video recorders, motion-picture projectors, electronic musical instruments, radios, TV sets, and outdoor and indoor antennas. A spokesman for the commission says the list doesn't imply that these items are hazardous, or even under suspicion, it merely enumerates equipment that will be investigated.

Sales Are Better With Service

Most home-entertainment equipment is easier to sell if you can offer service afterward, a good many retailers are discovering. Fear of expensive service bills is one deterrent to color-TV sales, as several manufacturers have recognized—witness the long-term warranties now in vogue.

Potential buyers are extremely service-conscious. Furthermore, when they have a choice, they are picky about who will do the service. And they certainly have a choice when they're shopping. A retailer or dealer that has a well-staffed service department with a clean service reputation has a definite edge in the competition for sales.

Hi-fi, color-TV, and other expensive items are the chief concern. Buyers seem to be in lower income

Shocked? Don't be. Does this man *look* like a criminal? He's not. This man is in the business of *preventing* crime. (One of the fastest growing industries today.) He's a Radar Sentry Alarm dealer representative.

What could this possibly mean to you? Perhaps nothing. On the other hand, it could change your entire life.

As a Radar representative, you could make \$1,200 a month if you sold only one system each week. Most of our dealers make much more. Two sales a week would net you \$28,000 a year; five a week, \$46,000 a year. We make the finest solid state microwave burglar alarm system available; one that's easy to install and easy to service...for both home & business. We're presently expanding our organization of dealer representatives. We'll train you, provide you with leads and offer continuing counsel. You can operate full-time or part-time. Later, you may want to expand and organize your own sales staff.

But for now, let's get better acquainted. Fill out the coupon. In a few days, you'll receive complete details about how you can live a life of crime-and make it pay, *handsomely*.



Radar Sentry Alarm. The Crimebuster.

RADAR DEVICES MFG. CORP.
22003 Harper Ave., St. Clair Shores, Michigan 48080
Rush me RSA Distributor Info.
I understand there is no obligation. EW-10A

Name _____
Address _____
City _____ State _____ Zip _____

Live a life of crime, honestly.



brackets than you might expect. With credit reasonably easy, it only takes a down payment; the rest can be handled weekly. The rub comes when that same \$5000-\$10,000 family is hit with a sizable repair bill—say \$100 or so. That's not easy to absorb, with other costs of living climbing like they have been in the past several months; little wonder that service is one of their first thoughts before they buy. That's why dealers with the best-rated service facilities are now getting an outside share of the business.

Another Solid-State Color-TV

Not to the surprise of the industry, but ahead of projections, *RCA* just introduced the CTC-40 chassis—a transistor color set. Surprisingly, the only IC's are for automatic fine tuning (a.f.t.) and the sound section; both were used before. The new sound-section IC has a driver stage which will eliminate another transistor.

Horizontal sweep is with silicon controlled rectifiers, driven by a transistor blocking oscillator. The KRK-142 v.h.f. tuner has a MOSFET r.f. amplifier, with a stacked-transistor mixer stage that resembles the old cascode tube configuration.

A vague surprise is the use of a tube for high-voltage rectification. Several solid-state rectifiers are now available, at what seems reasonable cost, with inverse ratings up to 45,000 volts. *Motorola* includes a solid-state h.v. rectifier in its 1969 Quasar color chassis. *RCA* engineers express a preference for tubes in this spot "because they're more reliable." Tubes are less expensive, too—but then, any transistor color design is likely to be more expensive than a tube version right now.

Nine-Tube Color Receiver

It's just a prototype, but there's a color-TV now that uses only nine tubes and the CRT. Built by the Tube Division of *General Electric*, the design is reminiscent of the "4+1" monochrome set with only four special compactrons, a high-voltage rectifier (the "+1"), and the picture tube. (See full details on this set in next month's issue.—Editor)

The "8+1" is full of innovations to keep cost down; the 10-inch color set should sell for under \$150, says *G-E*. The vertical deflection stage doesn't need a matching transformer for the yoke; horizontal deflection is synchronized directly by incoming sync pulses, eliminating an a.f.c. stage; 600-mA tube heaters are series-wired in conventional hot-chassis design; color demodulation is by solid-state diodes.

Considering that a good many set makers are already replacing tubes with transistors wherever they think it feasible (without raising cost too much), it's anyone's guess whether *G-E's* new tube design will find any takers. However, that selling price seems bound to stir interest somewhere.

Public School for Training Technicians

Relief is on its way for the scarcity of service technicians around Louisville, Ky. The Louisville Electronic Technicians Association and the U.S. Department of Labor worked out a special training program with Ahrens Trade High School. Students who choose electronics training and maintain a "B" average in their first two years of high school become eligible for the program.

Every school day during their junior and senior years, they go to school 4 hours and work 4 hours in local shops. Some work Saturdays for extra pay. They also attend two years of summer school on the same schedule, and must maintain "B" grade average. Once they graduate, they become registered apprentices with the U.S. Department of Labor. A usual apprenticeship is 4 years, but this time can be reduced by students showing exceptional ability and performance. One recent graduate of the LETA-Ahrens program, Bernard Osborne, was allowed a 1-year advancement, which gave him an automatic raise in pay.

LETA has 16 boys in the program this school year, and the shop owners who employ them rate them very highly. Any other technicians' associations wanting to set up such a program can get details from the Apprenticeship Committee, LETA, 2343 Frankfort Ave., Louisville, Ky. 40206.

Flashes in the Big Picture

Better hope there's enough AM radio stations in your town, because there'll be no more for awhile; FCC stopped accepting applications until it examines policy. . . . There are about 4500 on the air now. . . . Little 6-transistor radio from *Majima Co.* includes siren that can be heard about a block; can be set off by hand or by 135-degree temperature. . . . New battery concept takes form of "energy paper", activated by soaking in water; still experimental, but could be developed to power transistor radios, small appliances; conceived by a *Norelco* affiliate. . . . Trouble brewing in complaints by dealers that 10% of new TV sets won't work when unpacked; dealers resent bearing expense of repairing them for delivery. ▲

The Alarmists.



Radarsentry Alarm supervises security from every angle.

Radarsentry Alarm covers every angle. It works on the same principle used by the U.S. government to protect our borders. Microwaves beamed by an installation of modular units are foolproof.

Any human movement, even the slightest gesture, sets off the alarm. And what an alarm! An ear-splitting blast that would frighten anything. You can't beat it.

And there's no way to escape detection... whether the intruder comes in from the wall, window, door or ceiling. Even if he shuts off the power, the alarm sounds.

This is the newest and completely proven system that everyone's talking about.

Take any of the set-ups pictured here.

The smallest is our model 301: its remote detector unit covers up to 5,000 square feet. Can set off an alarm that's heard half a mile away. Add up to 3 antennas for a coverage of up to 15,000 square feet. Model 5006 modular unit is 6 units in one. It will cover up to 90,000 square feet. The big one on the right, 5010, will give customized coverage of up to 150,000 square feet.

Take any of these solid state numbers, add Dialtronic automatic telephone dialer, programmed to phone the police or direct-hook-up or, in case of fire, the fire department. Or add the special Radarsentry Alarm holdup and prowler alarm. It can be used in combination with any of these set-ups, plus the telephone alarm, without the thief's knowledge.

There's no hiding place. These units are considered the best burglar traps in the world. Solid state circuitry gives effective performance, means a minimum of false alarms and reliable operation. And the heart of the electronic system is printed on one single printed circuit module. To replace, just pull out the old one, plug in the new one, no lapse in security.

Design your own inviolable customized system with Radarsentry Alarm and accessories. You won't be able to find a more versatile, more adaptable system...nor one that is more tamper-proof against burglars.

Get the full story on Radarsentry Alarms. Write now for our new booklet covering all the facts.

RADAR DEVICES MFG. CORP.
22003 Harper Avenue
St. Clair Shores, Michigan 48080

EW-10B

- Send me the alarming details.
 Also send me booklet outlining available dealerships.

Name

Address

City State Zip

How to become a “Non-Degree Engineer”



In today's electronics boom the demand for men with technical education is far greater than the supply of graduate engineers. Thousands of real engineering jobs are being filled by men without engineering degrees—provided they are thoroughly trained in basic electronic theory and modern application. The pay is good, the future is bright... and the training can now be acquired at home—on your own time.

THE ELECTRONICS BOOM has created a new breed of professional man—the non-degree engineer. Depending on the branch of electronics he's in, he may “ride herd” over a flock of computers, run a powerful TV transmitter, supervise a service or maintenance department, or work side by side with distinguished scientists on a new discovery.

But you do need to know more than soldering connections, testing circuits and replacing components. You need to really know the fundamentals of electronics.

How can you pick up this necessary knowledge? Many of today's non-degree engineers learned their electronics at home. In fact, some authorities feel that a home study course is the *best* way. *Popular Electronics* said:

“By its very nature, home study develops your ability to analyze and extract information as well as to strengthen your sense of responsibility and initiative.”

Cleveland Method Makes It Easy

If you do decide to advance your career through home study, it's best to pick a school that *specializes* in the home study method. Electronics is complicated enough without trying to learn it from texts and lessons that were designed for the classroom instead of the home.

Cleveland Institute of Electronics concentrates on home study exclusively. Over the last 30 years it has developed tech-



niques that make learning at home easy, even if you once had trouble studying. Your instructor gives the lessons and questions you send in his undivided personal attention—it's like being the only student in his "class." He not only grades your work, he analyzes it. And he mails back his corrections and comments the same day he gets your lessons, so you read his notations while everything is still fresh in your mind.

Students who have taken other courses often comment on how much more they learn from CIE. Says Mark E. Newland of Santa Maria, Calif.:

"Of 11 different correspondence courses I've taken, CIE's was the best prepared, most interesting, and easiest to understand. I passed my 1st Class FCC exam after completing my course, and have increased my earnings by \$120 a month."

Always Up-to-Date

Because of rapid developments in electronics, CIE courses are constantly being revised. This year's courses include up-to-the-minute lessons in Microminiaturization, Laser Theory and Application, Suppressed Carrier Modulation, Single Sideband Techniques, Logical Troubleshooting, Boolean Algebra, Pulse Theory, Timebase Generators...and many more.

CIE Assures You an FCC License

The Cleveland method of training is so successful that better than 9 out of 10 CIE

graduates who take the FCC exam pass it. This is despite the fact that, among non-CIE men, 2 out of every 3 who take the exam fail! That's why CIE can promise in writing to refund your tuition in full if you complete one of its FCC courses and fail to pass the licensing exam.

This Book Can Help You

Thousands who are advancing their electronics careers started by reading our famous book, "How To Succeed in Electronics." It tells of many non-degree engineering jobs and other electronics careers open to men with the proper training. And it tells which courses of study best prepare you for the work you want.

If you would like to cash in on the electronics boom, let us send you this 40-page book free.

Just fill out and mail the attached post-paid card. Or, if the card is missing, mail the coupon at right.

NEW COLLEGE-LEVEL CAREER COURSE FOR MEN WITH PRIOR EXPERIENCE IN ELECTRONICS

ELECTRONICS ENGINEERING... covers steady-state and transient network theory, solid state physics and circuitry, pulse techniques, computer logic and mathematics through calculus. A college-level course for men already working in Electronics.

CIE Cleveland Institute of Electronics

1776 East 17th Street
Cleveland, Ohio 44114

Please send me without cost or obligation:

Your 40-page book "How To Succeed In Electronics" describing the job opportunities in Electronics today, and how your courses can prepare me for them.

Your book on "How To Get A Commercial FCC License."

I am especially interested in:

- Electronics Technology
- Broadcast Engineering
- First Class FCC License
- Electronic Communications
- Industrial Electronics
- Electronics Engineering

Name _____ (PLEASE PRINT)

City _____

Address _____

State _____

Zip _____ Age _____

ENROLL UNDER NEW G.I. BILL. All CIE courses are available under the new G.I. Bill. If you served on active duty since January 31, 1955, or are in service now, check box on card or in this coupon for G. I. bill information.

EW-50

Scott's new LR-88 receiver takes the

! # @ * ☆ out of kit building

Building a kit used to be something you couldn't do with ladies and children present, but Scott's new LR-88 AM/FM stereo receiver kit has changed all that. First, there's the instruction manual. In clear and simple language, it leads you, step-by-step, through every stage of the assembly process. And each stage is illustrated . . . full-size, full-color. Next, there's Scott's ingenious new Kit-Pak®. The parts for each assembly stage are in individual compartments, keyed to the instructions. All wires are color-coded, and pre-cut and pre-stripped to the proper sizes. Difficult or critical sections are pre-wired, pre-aligned, pre-tested, and factory-mounted on printed circuit boards. Is soldering your bugaboo? Scott has provided push-on solderless connectors for the hard-to-get-at spots.

About thirty painless hours after you've started, you've completed one great receiver. The LR-88 is the 100-Watt kit brother to Scott's finest factory-wired beauties. It includes the famous Scott silverplated Field Effect Transistor front end, Integrated Circuit IF strip, all-silicon output circuitry . . . in fact, all the goodies that would cost you over a hundred dollars more if Scott did all the assembling. Performance? Just check the specs below . . . and you'll be amazed at how great a receiver sounds after you've built it yourself. Treat yourself to a weekend of fun and years of enjoyment . . . see the Scott LR-88 at your dealer's today.

LR-88 Control Features: Dual Bass and Treble; Loudness; Balance; Volume compensation; Tape monitor; Mono/stereo control; Noise filter; Interstation muting; Dual speaker switches; Stereo microphone inputs; Front panel headphone output; Input selector; Signal strength meter; Zero-center meter; Stereo threshold control; Remote speaker mono/stereo control; Tuning control; Stereo indicator light.

LR-88 Specifications: Music Power rating (IHF), 100 Watts @ 4 Ohms; Usable sensitivity, 2.0 μ V; Harmonic distortion, 0.6%; Frequency response, 15-25,000 Hz \pm 1.5 dB; Cross modulation rejection, 80 dB; Selectivity, 45 dB; Capture ratio, 2.5 dB; Signal/noise ratio, 65 dB; Price, \$334.95.

You'll swear by it



SCOTT®

Write for complete information on the new Scott components and kits.

H.H. Scott, Inc., Dept. 160-10,
Maynard, Mass. 01754

Export: Scott International,
P.O. Box 277, Maynard, Mass. 01754

Walnut case optional extra © 1968, H.H. Scott, Inc.

CIRCLE NO. 84 ON READER SERVICE CARD

the problems and a solution to AIRPORT GROUND CONTROL



While one Boeing 727 lands (background) and another prepares to take off, three other commercial jets and two General Aviation aircraft jockey for position. Each of the commercial planes had to cross landing runway to reach departure point.

By O. S. WILLEY/ Technical Liaison Representative, E. W. Bliss Company

Major airports are becoming so large and busy that it is possible for the ground controller to lose track of a large jet right on the taxiway.

THE day the first giant 747 jet rolls out of Boeing Co.'s Seattle plant, the control tower at Kennedy Airport in New York will be obsolete. And, paradoxically, the serious and growing problem of ground control may be on its way to being solved.

The proposed 747's are big—so big that the airplane load-gates will have to be built bigger and higher. This, quite naturally, contradicts one of the Federal Aviation Administration's most cherished axioms—tower personnel must be able to see all operating areas on the field.

Consequently, the coming of the 747's means either a higher tower to see over the terminals or, more likely, an automated ground-control system whereby the tower observes the field electronically, much as it does the planes in the air.

The ground controller is a man, or men, in the tower who is responsible for the location and movement of all vehicles on the field with the exception of those on the take-off and landing runways. At a busy airport such as Kennedy, 120 to 130 planes an hour may be taking off or landing, using two sets of parallel runways. This means that a ground controller may have to handle 20 to 30 aircraft simultaneously. He has to keep track of each one—where it is, where it is going—and, at the same time, keep his eye on all other vehicles on the taxi strips.

The Problem

A controller's biggest problem is voice communications. All vehicles are on the same v.h.f. or u.h.f. radio frequency (121.9 or 348.6 MHz), so there is competition for time on

the air. His job is to direct each pilot to or from the terminal areas, but the route may be complex and he must remember each plane's location and possibly give new directions at several points along the way.

In poor weather, spotting aircraft visually is, at best, difficult. And at night, it is often impossible. There is an additional problem, if the pilot is unfamiliar with the field, the taxiways can be a confusing "sea of blue lights."

Despite all these difficulties, ground control usually functions smoothly. In fact, most experienced air travelers are unaware that such a thing as ground control exists, much less that there is a problem. Only if something goes wrong does the passenger become concerned.

For example, he was concerned if he happened to be aboard a large jet that landed recently at one of our busiest airports during the rush hour. While taxiing toward the terminal, the pilot received instructions to turn right instead of left. One hour later (after the plane had circled the airport on the taxiway and returned to the right intersection), it reached its terminal. Cost to the passengers: one hour delay, missed connections, and aggravation. Cost to the airline: about \$300 in fuel plus the loss of revenue for an hour's operation.

This simple error by an overburdened ground controller points up the need for automated equipment.

The New Urgency

The coming of the 747's merely adds one more problem to existing ground control techniques, but this problem takes on the aspect of the "last straw." It is forcing all involved

parties—FAA, airport management, and the airlines—to re-examine ground control. For example, under the existing regulations, the Port of New York Authority, which runs Kennedy Airport, should either raise their tower (or build a new one) from its present height of 150 to about 250 feet. A quick “guesstimate” of the cost is somewhere between 5 and 10 million dollars. However, a higher tower may not be the answer, because in poor weather a low ceiling could hide the whole airport.

Besides elevating the control tower, the Port Authority has considered two other possibilities: 1. Ignore the effect on tower visibility, and 2. require the airlines to meet sight-line criteria—which, in effect, means somehow raise the landing gates to the needed 30 feet height (they are now 20 feet high) without blocking the tower’s view of the taxiways.

All three proposals are being considered. Meantime, the Port Authority has come up with a proposal which might satisfy the FAA from a traffic-control safety point of view, and still permit adequate airline terminal expansion for the 747. (If, of course, the FAA is willing to reexamine its line-of-sight regulation and bring it in line with the opportunities now available through modern technology.)

The plan requires that all runways, outer taxiways, and radial taxiways be fully visible to the traffic controller. But except for the tails of almost all aircraft, portions of the inner taxiways between radials would not be fully visible from the control tower. In addition, an automated ground control system would be installed that would: 1. Indicate to the ground controller all vehicles on all portions of the taxiways; 2. automatically prevent collisions at intersections by providing visual signals to the pilots; 3. provide complete taxiing routes to and from the runways, thereby reducing voice communications, and improve the ability to maintain a smooth flow of traffic to and from runways in the face of new ground-control problems resulting from increased length of aircraft.

An added bonus with such an automated system could be the location of a receiver in the emergency vehicles’ headquarters so that the crew can locate any accident immediately.

Solutions

Any solution to ground-control problems should be opened. It should be designed in building-block style, so that as new technological developments come along, they can be incorporated into the system rather than obsoleting it.

A system designated “Arrow”® (for Aircraft Routing Right-Of-Way) by its developers, the *E. W. Bliss Company*, meets these requirements. It is a traffic signal system with a memory that is operated by the ground controller. It eliminates neither the controller’s nor the pilot’s responsibilities, but it does eliminate confusion and a large percentage of verbal communications. Arrow, by means of a series of lights, automatically tells the pilot where to proceed, and automatically tells the controller where the aircraft is, as well as where every other vehicle on the taxiway is.

The Arrow ground traffic control system is composed of vehicle detectors imbedded in the runways, a cable or microwave system for data transmission, and a logic system and master control panel (a table-sized duplicate of the airport with all runways, taxiways, intersections, and terminals identified) located in the tower.

As an airplane lands, a magnetic inductor loop (similar to those manufactured for automobile traffic control) senses its presence. This information is sent as a pulse input to the logic box which interprets the sensor data and lights a lamp on the control panel to show the plane’s location. When the pilot identifies himself by radio and requests instructions, the ground controller takes a magnetic stylus and draws on the control panel a path from the plane’s present location to the appropriate terminal (Fig. 1). Once again

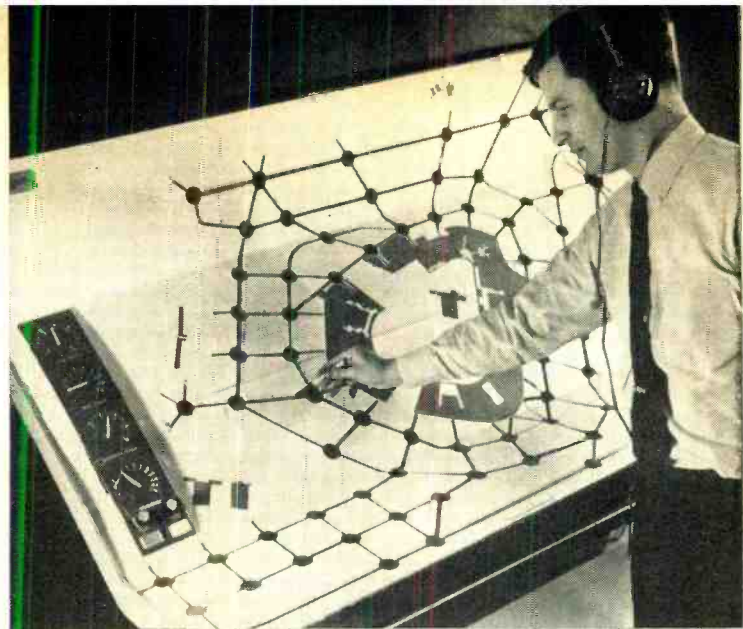

Fig. 1. Control panel mock-up of J. F. Kennedy Airport, New York City. The controller, using a magnetic stylus, is simulating programming a route for an airplane from a runway to its appropriate terminal. On the field, lights direct the craft.

the logic networks go into action and send control commands out to the plane. The pilot sees these commands as directional signals from lights imbedded in the center of the taxiways or at the approach to each intersection. Thus, as the aircraft approaches an intersection, the signals will be either a yellow directional command or a red to stop.

This is how the control panel works. As the metal stylus moves down the simulated runways, it actuates three magnetic switches located at the entrance of the intersection’s arm. The first switch is a detection erase switch which automatically turns off the lights which indicate previous movements of aircraft through that intersection. The next switch is a program erase switch which deletes previously programmed information from the Arrow system’s control logic. The third switch enters the new program into the control logic. When the program is entered, a light in the shape of an arrowhead appears on the panel’s taxiway and points in the direction which the controller desires the plane to move. Simultaneously, lights are illuminated on the actual airport taxiways, guiding the plane into the terminal.

The arrowheads which show the direction in which the aircraft is supposed to move are lit in accordance with the activating sequence of the program switches. For example, if in the diagram of Fig. 2 the magnetic stylus is moved from the lower arm of the intersection through and out the top, directional indicators A, B, and C would light. If the program were entered from the top, indicators B, A, and D would show the desired direction. The remaining indicators in the panel’s simulated taxiway are lit by the movement of the airplane on the field and thus show its progress through the intersection.

There is a fourth switch associated with the panel’s simulated intersection. It’s called the Intersection Occupied Erase Switch which, when armed, erases the aircraft presence light. For example, when an airplane enters an intersection on the field, its movement is sensed by detectors which light the presence light in the representative intersection on the control panel. This light is extinguished automatically by the movement of the plane through the intersection. However, if the light is lit and there is no aircraft in the intersection, the Intersection Occupied Erase Switch can be used to extinguish the light.

If the controller makes an error in programming, the presence light flashes red regardless of whether or not an aircraft is in the intersection involved. For example, if the controller programs a path from intersection 1 to intersection 2 while a program already exists in the opposite direction

(from intersection 2 to 1) the red flasher tells him to reprogram.

A second type of alarm, a flasher and a buzzer, warns of trouble on the field, such as when an airplane runs through a red signal; or it makes a wrong turn (leaves an intersection by a route other than that indicated by the lights); or if a program entered by the controller creates the possibility of a collision with another aircraft approaching the intersection from a different direction.

Under any alarm situation (whenever a flashing red light is observed on the control panel), the signals at the intersections involved immediately go red, stopping all vehicles. But the control panel maintains its program lights to help the controller locate the problem. After the situation is remedied, the controller resets the alarm and the control program is reinstated.

Arrow is designated to be completely flexible. It can be limited to just signals and control console; or it may consist of signals, aircraft taxiway sensors, centerline lights, control console, logic console, emergency vehicle override panel, and override panel for ATC (Air Traffic Control). Also, it can be connected to a computer which, once the pilot identifies himself, can automatically program the aircraft to the proper terminal.

Taxi Guidance

A further sophistication of the automatic ground-control technique is the *Bliss* taxi guidance system. Originally, this system was developed for the U. S. Navy for use on aircraft carriers to rapidly and precisely spot aircraft in position for catapult launch; but it can be used in modern airports as well, to guide any aircraft from touch down to its terminal. The system guides the aircraft, taxiing under its own power, along a predetermined path to the final deplaning spot.

Unlike Arrow, the taxi guidance system requires that several components be mounted on the aircraft. The additional weight, however, is less than 10 pounds. Essentially, the system consists of a ground reference path, with a position error transducer, a control box, a hydraulic steering control manifold, and a hydraulic brake manifold in the airplane (Fig. 3).

The reference path is two parallel wires embedded in the taxiways a minimum of six feet apart. They can be installed right from the runway to the park position at the terminal. A single-phase alternating generator energizes the

Fig. 2. The reed switches shown in this diagram are mounted on a printed-circuit board beneath the control panel. As the controller passes a magnetic stylus over them, they activate and turn on indicators which show desired program direction.

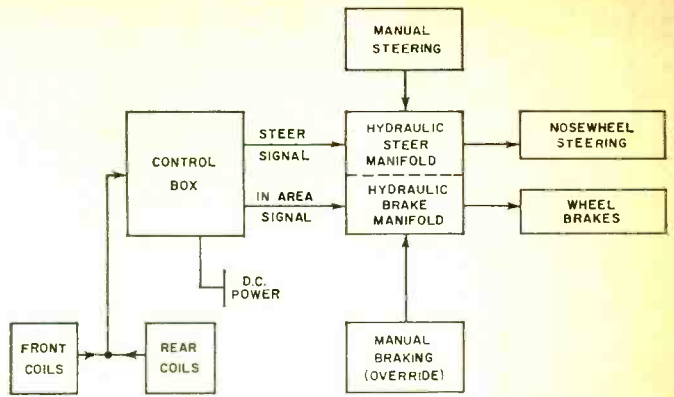
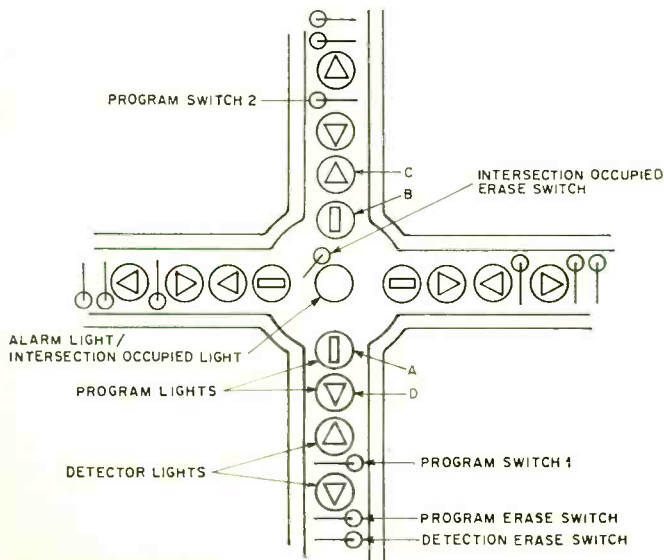

Fig. 3. Automatic taxi guidance system control diagram.

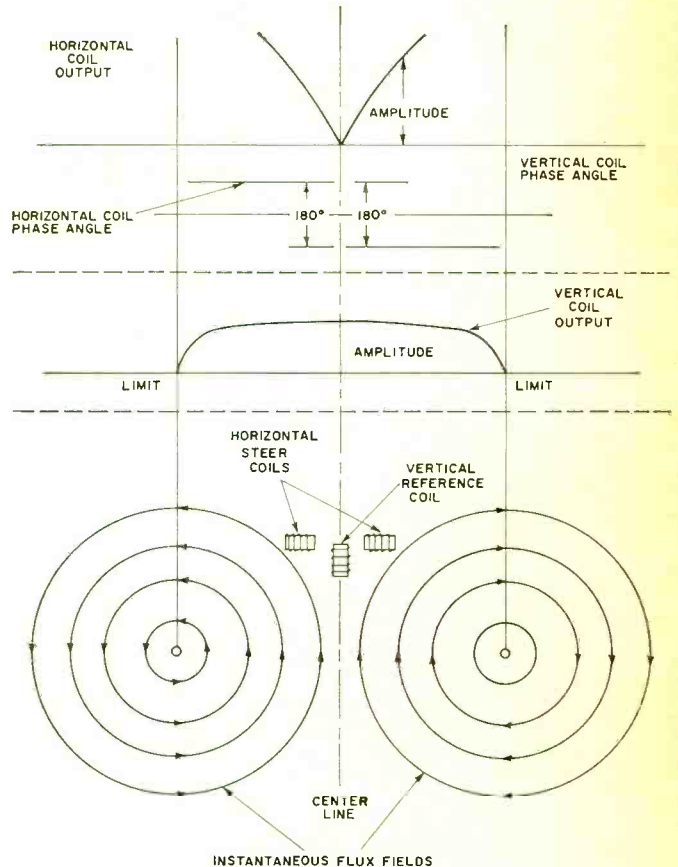
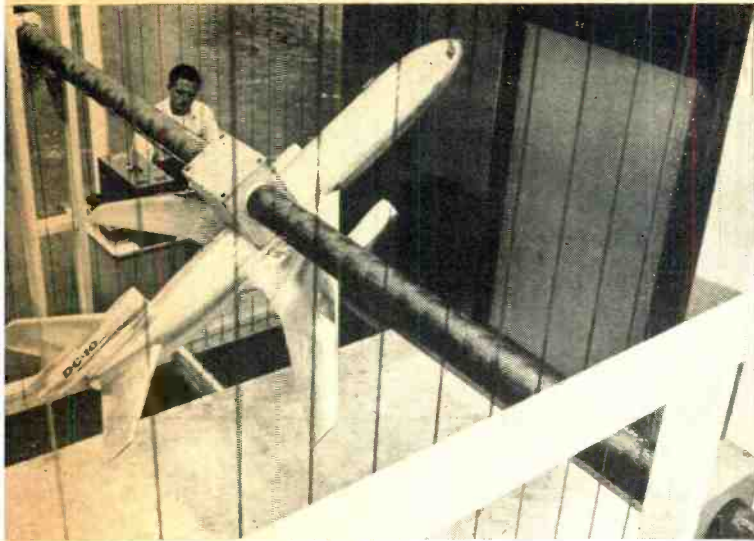

Fig. 4. A pair of horizontal coils and a vertical coil translates the aircraft's nose-wheel position into finite electrical signals. The coil senses the field around the guide wires and, by nulling the signals, directs the airplane between them.

conductors with a 5 to 15 amp signal depending upon distance between conductors. This path current creates a flux field, proportional to the distance from and perpendicular to the conductors, which is picked up by sensors on the nose wheel, amplified, and used to steer (Fig. 4).

In operation, the path is energized and as the aircraft approaches its entrance, the pilot turns the system on by means of a switch on his control panel. When the nose wheel of the aircraft enters the area between the path wires, an indicator on the control panel lights up. This tells the pilot that he is inside the path and automatic steering is available. The system is then switched to an "automatic" mode. The nose wheel is electronically guided down the center of the path while the pilot controls the speed. At the end of the run, or if the aircraft leaves the path for any reason, the brakes are automatically applied. Of course, the pilot can override the automatic steering commands at any time.



RECENT DEVELOPMENTS IN ELECTRONICS

Jet Antennas Under Test. (Top left) A six-foot-long model of the new McDonnell-Douglas DC-10 commercial jet transport is mounted inside a wire enclosure for tests of its communications and navigation systems. Wires that form the cage are charged to generate a controlled electromagnetic field around the model. Technicians then run experiments with the plane tilted in various flight attitudes to check performance of different antenna installations. The tri-jet plane, with a fuselage nearly 20 feet in diameter and 179 feet long, will carry up to 330 passengers and will operate over ranges from 300 to 3200 miles. Both American and United Air Lines have ordered and optioned a total of 110 of these new jet craft.



Bright Air Traffic Radar Display. (Center) Improved air-traffic control, so badly needed at our overcrowded jetports, is the goal of the new bright display radar system shown here. This compact, all-solid-state system is scheduled for installation at New York's John F. Kennedy and LaGuardia Airports, Newark Airport, Dallas-Love Field, and at the Houston International air terminal. While conventional radar scopes require the use of a special hood for viewing or conditions of semi- or complete darkness, this system can be used under high ambient lighting conditions. FAA representatives at Baer Field in Fort Wayne, Ind. feel the system will permit tower controllers to monitor more closely, spot potential traffic conflicts, and greatly expedite air traffic flow. The bright radar display was designed and developed by ITT Industrial Laboratories.

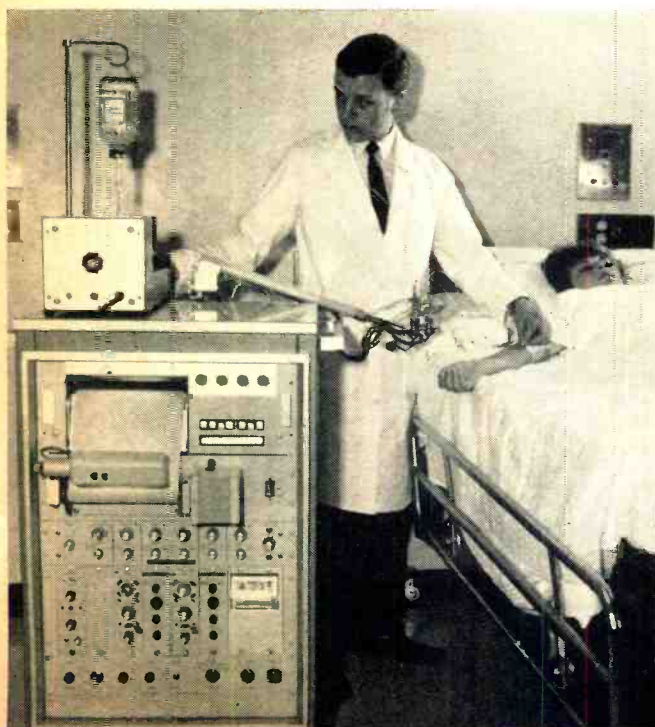

Electronic Patient Monitor. (Left) With the tremendous shortage of nurses in our hospitals, the importance of a patient monitor is obvious. The mobile unit shown here is a "shock cart" that contains electronic monitoring and measuring equipment designed to gather information vital to the treatment of patients suffering from shock. Electronic equipment built into the unit consists of: multiple transducers to measure blood flow, intravascular blood pressure, electrocardiogram, and other parameters associated with shock; a special retractable mounting arm for positioning the transducers near the patient; a multichannel oscillograph for immediate and permanent recording of the physiological information; and a variety of signal conditioning equipment required for measuring critical data. All components are in a 40-in high cart with large, quiet casters intended for easy movement to and from the patient's bed. The mobile console was designed and developed by the Cardiology Division of Stanford University School of Medicine and was built by Honeywell's Test Instruments Division.

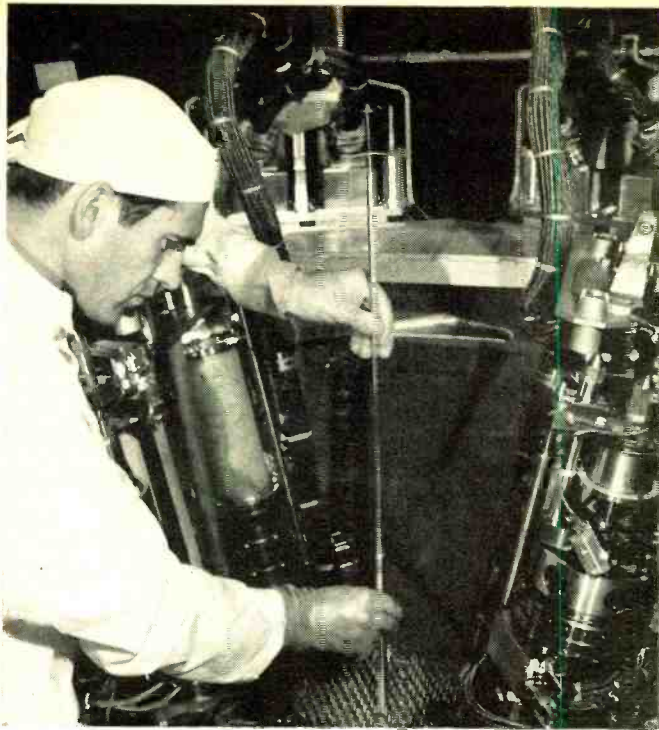

Nuclear Power for Space. (Above) Technician is inserting fuel element into core vessel of SNAP 8DR, compact nuclear reactor system being developed to supply power on the moon or for orbiting spacecraft. With most of its 211 fuel elements now loaded, criticality (sustained nuclear reaction) has now been attained. This system, designed by Atomics International, produces 600 kW of thermal energy. The heat may be converted to electricity by either a mercury rankine or thermoelectric converter. The flight-configured reactor weighs 66 lbs.



Color-TV at the Races. (Top right) The racing industry's first use of color television to record and play back races for fans and stewards is shown being tested at Monmouth Park (N.J.) race track. The unique RCA color video tape system also provides for instant replay, and makes Monmouth Park the only track in the nation with built-in capability for making color tapes of feature races for rebroadcast over commercial TV.

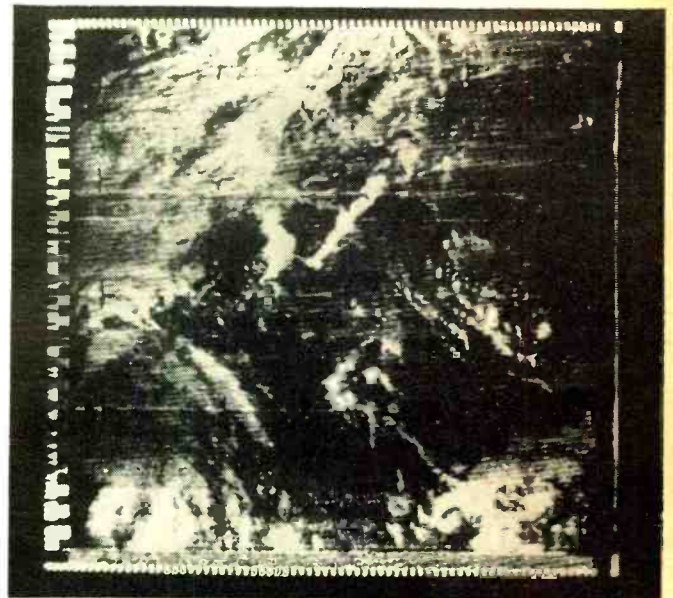

Amateur Weather Satellite Pix. (Center) The cloud cover over an area 1200 miles square in southeastern United States is shown in this photograph made by Rex L. Smith, senior technician at Westinghouse Electronic Tube Division. Using second-hand electronic equipment he put together himself, Rex tunes in on the government's Nimbus weather satellites. He records the picture signals on tape, reconstructs them line by line on an electronic storage tube, and takes pictures of the cloud formations the tube displays. A home-built high-frequency antenna leaning against the workshop wall picks up the signals.



Electronic Typing Teacher. (Right) A new electronic system is being used to teach typing to more than 100 junior-high school students in Waltham, Massachusetts. The system is unique in that it provides computer-assisted instruction in manual skills rather than mental skills entirely. The student's console shown is similar to that of a standard electric typewriter. The front panel consists of a display of colored lights, each light corresponding to a key on the keyboard. The bottom portion of the panel includes a letter and number unit that can display numbers, letters, or words. In an advanced stage of instruction, the display presents phrases and sentences. The system was developed by Sylvania Electric Products Incorporated.

DIRECTORY OF MOST POPULAR, LOW-PRICED



PHOTO	Model	Number of Heads	Tape Size Used (in)	Reel Size (in)	Tape Speed (in/s)	Record-Playback Time (min)	VIDEO					
							Input (V)	Level (±)	Output (V)	Level (±)	Response (MHz)	Horiz. Resolution (lines)
AMERICAN PHOTOCOPY EQUIPMENT CO., 2100 West Dempster Street, Evanston, Ill. 60204												
	SV-700	2	1/2	7	7.5	60	1	75	1	75	3.0	300
AMPEX CORP., 2201 Lunt Ave., Elk Grove Village, Ill. 60007												
A	VR-5100	1	1	9 3/4	9.6	60	1	75	1.3	75	3.0	250
	VR-6000	1	1	9 3/4	9.6	60	1	75	1	75	2.5	250
	VR-7000	1	1	9 3/4	9.6	60	1	75	1	75	3.5	350
	VR-7100	1	1	9 3/4	9.6	60	1	75	1	75	3.5	350
	VR-7500	1	1	9 3/4	9.6	60	1	75	1	75	3.5/4.2	350
	VR-7500C	1	1	9 3/4	9.6	60	1	75	1	75	3.5/4.2	350
B	VR-7800	1	1	9 3/4	9.6	60	1	75	1	75	4.2	350
BELL & HOWELL, 7100 McCormick Rd., Chicago, Ill. 60645												
C	2920	1	1	8	6.9	60	0.5-2	75	1	75	3.5/4.2	-
CONCORD ELECTRONICS CORP., 1935 Armacost Ave., Los Angeles, Calif. 90025												
D	VTR-600	2	1/2	7	12	60	1	75	1	75	2.5	250
	VTR-620	2	1/2	7	12	60	1	75	1	75	2.5	250
E	VTR-700	2	1/2	7	12	60	1	75	1	75	2.5	250
	VTR-900	2	1/2	7	12	60	1	75	1	75	2.5	250
CRAIG CORP., 2302 E. 15th St., Los Angeles, Calif. 90021												
	6402	2	1/2	7-8 1/4	9 1/2	50	0.5	75	1.3	75	-	250
GENERAL ELECTRIC CCTV Business Section, 600 Old Liverpool Rd., Liverpool, N.Y. 13088												
G	PT-4	2	1/2	5	7 1/2	20	1	75	1.4	75	-	200+
	PT-5A	2	1/2	7	7 1/2	64	1	75	1.4	75	-	200+
	PT-5B	2	1/2	7	7 1/2	64	1	75	1.4	75	-	200+
	PT-5C	2	1/2	7	7 1/2	64	1	75	1.4	75	-	200+
	PT-5D	2	1/2	7	7 1/2	64	1	75	1.4	75	-	200+
MATSUSHITA ELECTRIC CORP. OF AMERICA, 200 Park Ave., N.Y., N.Y. 10017												
F	NV-8000	2	1/2	7	12	40	0.4	75	1	75	2	200+
	NV-8100D	2	1/2	7	12	40	0.5	75	1	75	2	220+
	NV-204C	2	1	8.5	8.57	67	0.5	75	1	75	3	250+
PHILIPS BROADCAST EQUIPMENT CORP., PO Box 426, Paramus, N.J. 07652												
H	EL3401A/54	4	1	8.9	9	60	1	75	1.4	75	2.5	250
	EL3401B/54	4	1	8.9	9	60	1	75	1.4	75	3.2	280
I	EL3403A/52	5	1	8	7+	60	1	75	2	75	3.8	320
REVERE-MINCOM DIV., 3-M CO. 3-M Center, St. Paul, Minn. 55101												
	VTR-150	1	1/2	8	7 1/2	60	1	75	1	75	2	-
	VTR-150/MC	1	1/2	8	7 1/2	60	1	75	1	75	2	-
SHIBADEN CORP. OF AMERICA, 58-25 Brooklyn-Queens Expressway, Woodside, N.Y. 11377												
	SV-727U	2	1	10	8	90	1	-	1	-	-	450
	SV-727E	2	1	10	7.9	90	1	-	1	-	-	450
	SV-800U	2	1/2	-	7.5	60+	1	75	1	-	3+	300+
SONY CORP. OF AMERICA, 47-47 Van Dam Street, Long Island City, N.Y. 11101												
K	PV-120U	2	2	7	4 1/2	90	-	75	0.5	75	3.3	-
	EV-210	2	1	8	7.8	63	0.5	75	1	75	-	320
	CV-2100	2	1/2	7	7 1/2	60	1	-	1.4	-	-	220
J	CV-2200	2	1/2	7	7 1/2	60	1	-	1.4	-	-	220
	TCV-2110	2	1/2	7	7 1/2	60	1	-	1.4	-	-	220

a. recorder; monitor as package; b. camera; c. monitor; d. tripod; e. audio mixer; f. video switcher; g. microphone; h. v.h.f. converter; i. remote control; j. connector panel; k. mixer/fader; l. superimposer; m. special-effects generator; n. sync generator; o. two audio

VIDEO TAPE RECORDERS



AUDIO							Dimensions (in)			Weight (lb)	Price (\$)	Special Video	Notes
Micro (dB)	Line (Ω)	Output (dB)	Response (Hz)	W	H	D							
-60	10k	-14	10k	-14	-	60-10,000	18 3/8	10 1/16	15 1/16	52.8	995	D	b,c,d,e,f,g,h
1.8mV	80k	96mV	47k	8dBm	-	90-9,000	23 1/4	18 1/4	12 1/2	62	1600	-	b,c,d,r,s
-	50k	.5V	-	6dBm	-	90-9,000	29	15	18	100	1600	-	
-	-	-	-	-	-	-	29	15	18	100	2500	-	
-	-	-	-	-	-	-	45	44 1/8	23 1/2	-	5945	-	
-	-	-	-	-	-	-	29 3/4	13 1/4	20 1/2	100	4350	-	
-	-	-	-	-	-	-	29 3/4	13 1/4	20 1/2	100	4850	A	
-	-	-	-	-	-	-	34	15	19	140	9500	A,C	16,500
.2mV	200	-	-	4dBm	600	80-10,000	19	11 3/8	13 1/2	65	4200	NTSC color	b
1mV	20k	1V	1meg	1V	600	50-12,000	17	10	16 1/2	52	1150	-	i, j
1mV	20k	1V	1meg	1V	600	50-12,000	17	10	16 1/2	52	1050	-	
1mV	20k	1V	1meg	1V	600	50-12,000	17	10	16 1/2	60	1495	-	
1mV	20k	1V	1meg	1V	600	50-12,000	17	10	16 1/2	52	995	-	
-60	10k	-10	30k	-	-	70-10,000	18 1/2	10 1/4	17 1/2	59	1200	-	k,l,m,n
.775mV	600	-	-	-	-	80-10,000	11 1/4	4 7/8	11 1/16	15	1295	-	p, batt.
.775mV	600	-	-	-2	10k	80-10,000	15 1/2	9 3/4	16 1/2	62	1348	-	b,c,g,p
.775mV	600	-	-	-2	10k	80-10,000	15 1/2	9 3/4	16 1/2	62	1374	-	b,c,g,p
.775mV	600	-	-	-2	10k	80-10,000	14 3/4	9 1/2	16 1/2	58	950	-	c
.775mV	600	-	-	-2	10k	80-10,000	14 3/4	9 1/2	16 1/2	58	975	-	c
-60	20k	0	1meg	-20	600	80-10,000	16 3/8	9 3/8	16 3/8	54 1/2	800	-	h
-20	20k	-	-	-20	600	80-10,000	17 1/4	10 3/8	17 1/2	52	1050	-	h
-65	600	-	-	0	600	80-8,000	24 3/8	12 1/2	16 1/16	97	4250	A	i
1mV	1k	200mV	500k	1V	20k	120-12,000	24 3/4	16 1/2	15 1/4	100	1295	D	European std
1mV	1k	200mV	500k	1V	20k	120-10,000	24 3/4	16 1/2	15 1/4	100	1395	E	
.2mV	1k	200mV	6k	2V	600k	120-10,000	19 1/4	9 1/2	15 1/2	145	-	F,G	
.2V	10k	.2V	10k	.5V	10k	50-10,000	20	9 1/2	14	50	995	-	u
.2V	10k	.2V	10k	.5V	10k	50-10,000	20	9 1/2	14	275	2495	-	v
-	-	-	600	-	-	50-10,000	21 3/8	21 3/8	13 3/8	120	4995	-	European std
-	-	-	600	-	-	50-10,000	21 3/8	21 3/8	13 3/8	120	-	-	
-60	10k	-14	10k	-14	-	60-10,000	30	11	17 1/2	136	1295	-	
-	600	-	10k	4dBm	600	50-10,000	17 1/2	25	16 3/4	145	8950	D,E	b,c,i
-70dBm	500	-	-	4dBm	10k	50-12,000	26	11 1/8	17 3/8	88	3750	B	b,c,i
-60	-	-	-	0	-	80-10,000	18 1/8	11 7/8	15 3/4	49	795	-	c
-60	-	-	-	0	-	80-10,000	18 1/8	11 7/8	15 3/4	49	850	-	c,q
-60	-	-	-	0	-	80-10,000	27 1/2	16 1/4	11	70	1050	-	c

channels; p, special lens; q, video duplicating adapter; r, test tape; s, mounted in cart; t, battery-powered; u, 1-year warranty on head; v, completely mobile; A, color; B, adaptable for color; C, electronic editing; D, stop motion; E, slow motion; F, a.g.c.; G, dubbing.

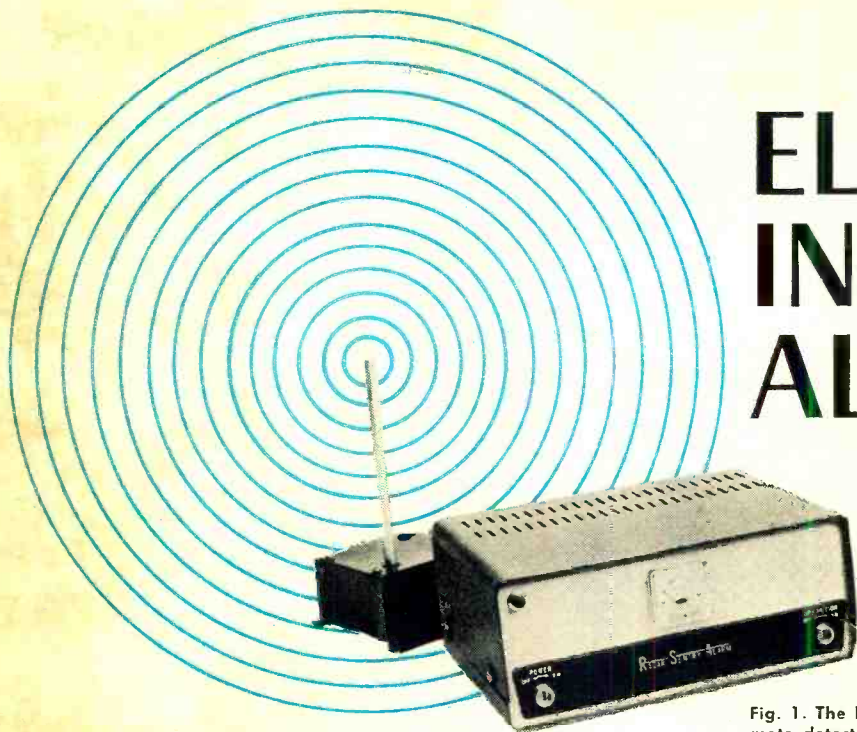

ELECTRONIC INTRUSION ALARMS

PART 2

Fig. 1. The Radar Sentry microwave alarm consists of remote detector with its antenna (left) and a control unit.

By LON CANTOR

Operating principles and design of equipment that is helping industry to combat a \$1 billion annual loss due to burglaries.

THE INCIDENCE of burglaries is rising rapidly. During the past decade, the number of burglaries committed each year has nearly doubled. Unfortunately, most burglaries—over 70%—are never cleared by arrest and conviction.

Not unexpectedly, 95% of all burglaries take place at night. What is surprising is that 20% of the time, the burglars enter without resorting to forcible means. In many cases, they simply stay behind, hiding out until the store or bank is locked up, do their work, and then leave.

The intrusion alarms discussed last month in Part 1 of this series were mainly audio sonic and ultrasonic types. This month, we will cover the microwave r.f. type of intrusion alarm. This type of alarm provides excellent protection against the stay-behind burglar. As soon as he moves he is detected and the alarm sounds.

The most obvious difference between the microwave and the sonic types of intrusion alarms is frequency. The difference in frequency, however, causes a basic difference in operation. While the sonic detectors are usually confined to a single room, and a relatively small area, the microwave units radiate right through non-metallic walls and each remote detector can cover up to 5000 square feet.

Microwave intrusion alarms are made by a number of companies including *Radar Devices* (Figs. 1, and 3) and the *Pinkerton Detective Agency*.

Microwave Alarm

Let's take a close look at a typical microwave r.f. alarm to see what makes it tick. Fig. 2 shows a combination schematic and block diagram of the Radar Sentry alarm (*Radar Devices Mfg. Corp.*) said to be the first solid-state unit of its type.

The remote detector is the sensing device. It puts out a 400-MHz signal which saturates the area from floor to ceiling of up to about 5000 square feet or a circular area with a radius of 35 to 40 feet.

The heart of the remote detector is a resonant-line oscillator built around a pair of transistors. Two links are employed and these are coupled to the oscillator tank circuit. The antenna rod is connected to one end of one of the coupling links.

Normally, we take pains to isolate the oscillator from the antenna. In this case, we deliberately make the "mistake" of connecting the oscillator directly to the antenna. Thus, any change in the antenna load is reflected back into the oscillator as a slight change in frequency.

When the Radar Sentry is set up in a given location, the entire area saturated by the remote detector becomes, in effect, part of the tank circuit. The outputs of the two coupling links are sent through diodes and then balanced by an adjustment potentiometer. This balance makes the detector very sensitive to any change.

According to the doppler principle, a signal reflected from a moving object is changed in frequency. If the object is moving toward the oscillator, the frequency increases. If it is moving away, the frequency decreases. The amount of change is dependent on the speed of the object. A train moving 100 miles an hour would change the frequency by about 50 Hz.

Human movement within the area saturated by the remote detector actually causes only a very slight change in frequency, from 2 to 8 Hz. But the oscillator is stable enough so that even this slight change can be detected and used as an alarm signal.

The alarm signal, at an amplitude of just a couple of

millivolts, is coupled into a series of amplifiers and then fed through a Schmitt trigger circuit to close the alarm relay.

The power supply is highly regulated so that the unit can be used at line voltages between 90 and 130 V a.c. By changing the transformer tap, you can use it on 230-V lines, and it operates effectively on either 50- or 60-Hz a.c.

The alarm actually occurs in two steps. The first alarm is generally used to turn on the lights. This in itself generally frightens the burglar. If the motion were just caused by a falling box or some other non-recurring motion, the siren connected to the unit never sounds. However, if a second motion occurs, the siren sounds, either on the premises or at police headquarters.

Timing between the two alarms is controlled by the setting of a cam. You can set the delay between alarms from 2 to 30 seconds.

The unit is turned on from a remote location, using a remote key switch. The remote key switch uses a resistor in parallel with the switch. This resistor makes the line tamper-proof. If you cut the line between the remote key switch and the control unit, you change the bias on the internal transistor circuit, causing conduction and activating the tamper horn. The unit is also protected against any other attempts to thwart it by this tamper circuit. Pull out the remote detector, the remote key switch, or the a.c. line cord, and the tamper horn will sound.

If a natural power failure occurs, a changeover relay immediately switches the unit over to built-in rechargeable nickel-cadmium battery operation. During the changeover, the tamper horn sounds for about five seconds.

Most of the intrusion alarm systems discussed in this two-part series can be made more versatile by the use of accessories.

For example, it is easy to add fire detection, simply by plugging in a suitable sensor. These sensors are actually small thermostats which close whenever the temperature rises rapidly or reaches a pre-set level. Most fires will trigger the sensor by rate-of-rise, but slow-starting combustion may gradually build ambient room temperature up to the alarm level.

Telephone & Prowler Alarms

Often, you want to frighten the burglar away before he gets anything. The combination of lights followed by an

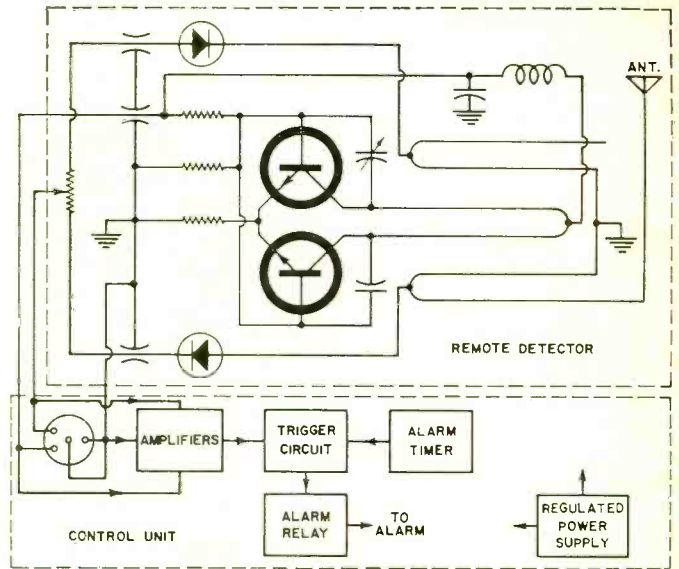

Fig. 2. Partial schematic and block diagram of r.f. alarm

ear-piercing police-type siren or alarm bell generally does this.

But sometimes, you want to trap the burglar and arrest him. In this case, you sound no alarm on the premises, but hook your system into police headquarters or some other central monitoring location. The burglar goes on with his work, unaware that the alarm has been sounded, and he often gets caught in the act.

Frequently, for double protection, you may use a sonic alarm along with an r.f. or ultrasonic type. If the burglar succeeds in defeating the sonic type, which he can hear, he may gain enough confidence to go on with his burglary. The silent ultrasonic or r.f. type will then come into play and sound the alarm or notify police headquarters.

Two basic types of systems are used to connect an alarm to police headquarters. The first uses a rented telephone line, providing a direct, permanent connection. Rented phone lines are expensive, however, so that they are generally not practical for installations more than a few miles from police headquarters.

The second type requires no rented phone lines. It sim-

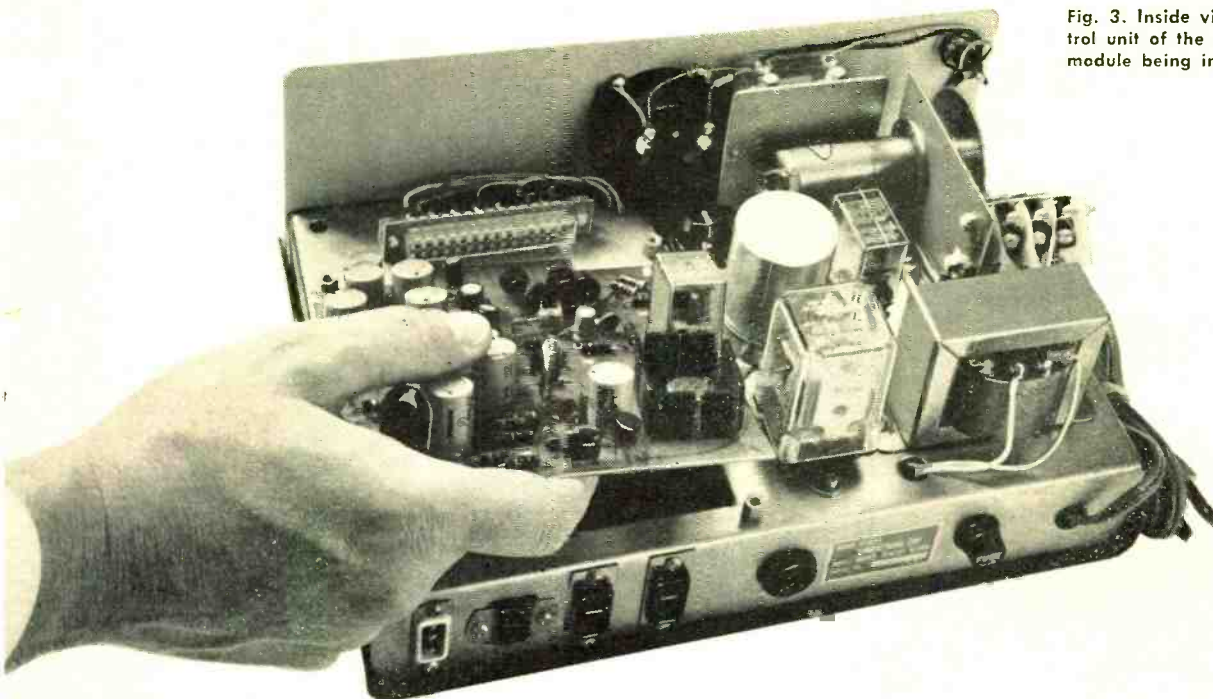

Fig. 3. Inside view of the solid-state control unit of the microwave alarm shows a module being inserted in its proper place.

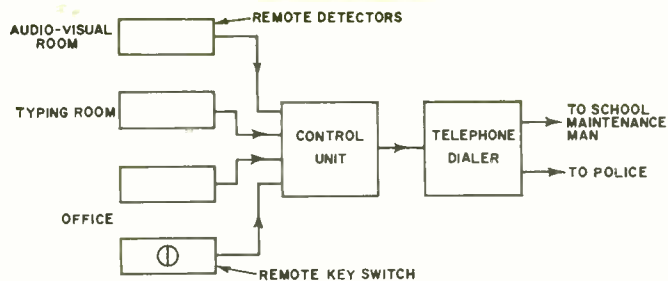

Fig. 4. Typical system to prevent vandalism in schools.

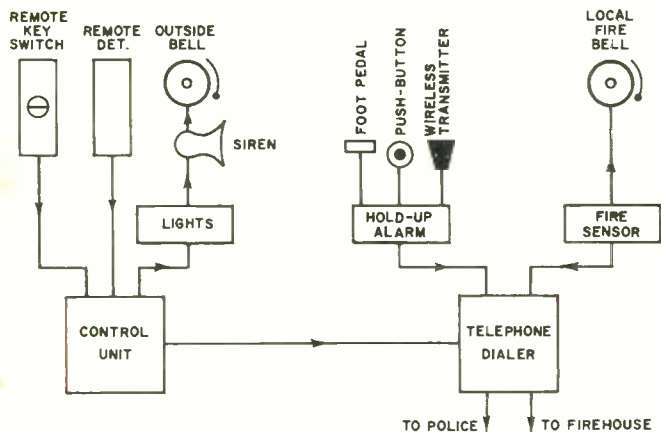

Fig. 5. Complete system for fire, holdup, intruder protection.

ply dials the phone and delivers a pre-recorded message. Most units can be connected to two locations simultaneously. They call fire alarms into the firehouse and burglar alarms into the police station. Then, they are programmed to make an automatic follow-up call to a company official or a guard service.

What does a woman do if she hears a window open in the rear of the house and she is all alone? That is where the prowler alarm comes in handy. The prowler alarm can be nothing more than a loud siren activated by a foot pedal, a push-button, or a tiny portable transmitter. Used in this way, it generally frightens intruders away. Or, it can be

tied into a central alarm system and used to summon police.

In stores and businesses, the same type of equipment used for burglary protection can be used as a hold-up alarm. Generally, the hold-up alarm protects the premises during the day, while the intrusion alarm provides protection after the place has been closed for the night.

Typical Applications

Fig. 4 shows a typical school system, using three remote detectors to cover up to 15,000 square feet, plus a telephone dialer. Generally speaking, it is neither possible nor necessary to protect the entire school. Instead, you protect only key areas—rooms most likely to appeal to most burglars and thieves. In this case, we've located our remote detectors in the office, the audio-visual room, and the typing classroom. The remote key switch is also located in the school office.

The telephone dialer notifies both the police and the school maintenance man in case of break-in.

This relatively simple system would cost the school about \$1500. Additional remote detectors (up to 20) could be added at a cost of \$500 each. Fire sensors could be added in key areas at nominal cost.

Fig. 5 shows a very elaborate system, using the most common accessories. This system provides hold-up, fire, and intrusion protection. Not only do local alarms go off, but police and firemen are notified in case of emergency.

If this is an industrial plant, sensors can easily be added to monitor equipment and processes. Sensors are available to detect increases in heat, pressure drops or increases, changes in freezer temperatures, failure of air compressors, changes in liquid levels, gage-levels changes, etc.

Many electronically trained men are finding that it is profitable to enlist in the war against crime. With the type of equipment described in these articles, you can offer customers low-cost, almost foolproof protection, and save them many thousands of dollars.

Electronics may never eliminate illegal entry and burglary entirely, but the widespread use of electronic intrusion alarms can reduce significantly the number of burglars and the number of burglaries committed. ▲

MANUFACTURERS OF INTRUSION ALARMS

Ademco
100 Voice Rd., Carle Place, N. Y. 11514

American Electronics, Inc.
14851 NW 27th Ave., Opa-Locka, Fla. 33054

American District Telegraph Co.
155 6th Ave., New York, N. Y. 10013

Alarmtronics Engineering, Inc.
154 California St., Newton, Mass.

Ballistics Control Corp.
3950 Crescent St., Long Island City, N. Y. 11101

Continental Instrument Corp.
110 Atlantic Ave., Lynbrook, N. Y. 11563

Continental Telephone Supply
17 W. 46th St., New York, N. Y.

Dadco
2018 Hillside Ave., New Hyde Park, N. Y.

Electro-Guard
P.O. Box 633, Hazelton, Pa. 18201

Euphonics
202 Park St., Miami Springs, Fla.

The Heath Company
Benton Harbor, Mich. 49002

Honeywell
2727 S. 4th Ave., Minneapolis, Minn. 55408

Johnson Service Co.
507 E. Michigan, Milwaukee, Wis. 53201

Walter Kidde & Co., Inc.
675 Main St., Belleville, N. J. 07109

Mosler Safe Co.
320 Park Ave., New York, N. Y. 10022

Minilert Co.
P.O. Box 446, Buena Vista Station, Miami, Fla. 33137

Notifier Co. (Emhart Corp.)
3700 No. 56th St., Lincoln, Neb. 68504

Pinkerton Detective Agency
61 Sutton Rd., Webster, Mass. 01570

Radar Detection Systems, Inc.
East Norwich, N. Y.

Radar Devices Mfg. Corp.
22003 Harper Ave., St. Clair Shores, Mich. 48080

Selectron Products, Inc.
10401 Decatur Road, Philadelphia, Pa. 19154

Solid State Research Corp.
640 Coors Rd. SW, Albuquerque, N. M. 87105



The author is chairman of the wire and cable engineering group of the Electronic Industries Association and serves on similar committees in NEMA and USASI. Mr. Holland joined Amphenol in 1961. Prior to that he was vice-president, engineering for Cable Designs, Inc, chief engineer for Hi-Temp Wires, Inc., and a standards engineer for Sperry Gyroscope Co. in New York. He is a graduate of Pratt Institute and a veteran of the Coast Guard.

New Directions in Cable Standardization

By JOHN W. HOLLAND/Vice-President, Engineering
Amphenol Cable Division, Bunker-Ramo Corp.

Two groups are coordinating their efforts to derive cable criteria.

FOR THE FIRST time communications cable standardization is now moving rapidly in two directions. Parallel efforts are under way by the U.S.A. Standards Institute (USASI) in the military coaxial cable area, and by the National Electrical Manufacturers Association (NEMA) in commercial communications cables, including coax, microphone, multi-conductor, and hook-up wire. The ultimate result will be an easier job of specification and selection for both commercial and military cable users.

Until recently, no formal commercial cable standards existed, and the only military standardization effort centered around just one old spec. (ELECTRONICS WORLD, June 1968, p. 22)

USASI Committee Goal: New Spec

Last March a meeting was held at the Defense Electronics Supply Center to study the possible revision of MIL-C-17D, which covers the popular "RG" types of coax cable. To handle the job, an industry-government standards subcommittee—USASI C-83.3—was organized.

The new unit's principal purpose will be to re-write MIL-C-17D into basically a design/performance type spec, similar to MIL-C-39012, the new coaxial connector specification which was prepared by USASI Committee C-83.2 under the chairmanship of Tore N. Anderson, vice-president, engineering, of the *Amphenol RF Division*.

The committee will establish performance levels for certain groups of cable types and thoroughly investigate new methods of r.f. measurement. Future cable buyers using the re-written spec will have a far better idea of how the cable they select will perform. The planned new spec will include complete information on v.s.w.r. and shielding effectiveness of standard cables. It will also recommend compatible connectors for each cable type and size covered. This effort will be closely coordinated with the C-83.2 connector committee.

Our new coax cable spec is long overdue. MIL-C-17D is one of the oldest Mil-Specs in existence and, although it's been amended from time to time, a complete overhaul has not been done.

As chairman of the C-83.3 committee, I have divided up our tasks into three groups and appointed group

leaders: Morton Pomerantz (U.S. Army Electronics Command) will have charge of spec format, selection of cables to be included and recommendation of each type's performance requirements; Dr. Bruno Weinschel (*Weinschel Engineering*) will head a group investigating r.f. measuring procedures and new techniques; David Peterson (*Times Wire & Cable*) will take charge of establishing environmental conditioning, mechanical testing and non-r.f. electrical measurements. Ronald A. Kunihiro of DESC is the committee secretary.

NEMA Task Group

Just last Spring NEMA formed a new section that will, as its charter states, be concerned with "wire, cables, and cords, whose primary use is on devices which produce, transmit, receive, detect, distribute, control, record or modify electrical impulses principally conveying information rather than power."

In short, the new Electronic Wire and Cable Section's main concern is communications cabling and wire. All cabling and wire included in this new section's scope are rated up to 150°C. Cabling and wire designed for higher temperature applications are presently covered by NEMA's High Temperature Wire Section.

As now organized, the section, chairmanned by Fred O. Weirich of *Belden Manufacturing*, has two subcommittees: a statistical group headed by Airy Mossiman of *Anaconda* and a technical group headed by myself. Our tech subcommittee's main task will be to develop standards for communications cables that will be useful to both commercial and military equipment designers.

Coordinated Committees

The cable industry's two new committees will not be working on divergent paths. Just the opposite is our plan of action. Since both the USASI C-83.3 committee and NEMA's new section have many common members, the groups will be fully aware of each other's progress and will assist each other technically.

Military and commercial cables users will definitely derive untold benefits from this bi-directional standardization effort. ▲

The author joined Amphenol in late 1965. He formerly served as vice-president, engineering of Airtron Inc. He is a graduate of Cooper Union, he has served as a consultant to the DOD Advisory Group on Electronic Parts, as a delegate to the international Electrotechnical Commission for Waveguide and Flange Standardization, and is chairman of the USA Standards Institute C83.2 working group on r.f. connector standardization.



Coaxial Connectors

By TORE N. ANDERSON / Vice-President, Engineering, Amphenol RF Division, Bunker-Ramo Corp.

Proper selection of coaxial connectors is as important as the cable on which they are to be used. Sometimes engineers overlook application for convenience. The result is system degradation caused by using adapters with high v.s.w.r.

PROPER coaxial connector selection is second only to accurate cable specification in insuring optimum performance of a radio-frequency transmission system. The right connector maintains a constant impedance throughout the unit, regardless of the fact that a drastic transition from solid-dielectric coaxial line to air-dielectric line (in the connector) has taken place. And it can withstand the r.f. power levels employed without significantly affecting this delicate balance, measured in terms of standing wave ratio (s.w.r.).

The first step in selecting the right r.f. connector for a given application is to narrow down the choice to a specific coaxial "series." Interestingly, however, this is frequently overlooked by the user intent on staying with a familiar-type connector for the sake of convenience. The result is often severe system degradation caused by the use of adapters and high v.s.w.r. Incidentally, several manufacturers have been known to make this same mistake. Some have used inexpensive phono-type connectors for r.f. applications exceeding 200 watts. Accidental damage to the fitting and dielectric occurs easily and tends to culminate in a blown final transmitter tube or power transistor due to shorted output.

When classifying connectors into their respective series, there are three main defining characteristics. The first is

by the size of cable for which they are designed, that is, they can be classified as small, medium, or large. Cables whose dimensions, for example, exceed 1/4-in diameter are generally well suited to connectors of the UHF and type N style; below 1/4 in, BNC and TNC are popular. For tiny miniature cables, the subminiature connector types such as the Amphenol 27 series (MIL-C-22557) or new SMA microwave subminiatures should be used. See Table 1.

The second criterion of classification is the method of coupling or mating. See Fig. 1. This, in turn, can be broken down into three sub-categories. The first method of coupling is the bayonet-coupling method. The jacks and receptacles have two or three circular protrusions on the exterior of the body which are referred to as bayonet ears. The plugs have internal slanted slots on the internal portion of the coupling nut. The next method of coupling is by the use of threads. The jacks and receptacles have the external body threaded and the plugs have the internal thread on the coupling nut. The last comes with numerous "aliases," such as push-on, plug-in, and quick disconnect. But the principle is always the same; simply push to mate, pull to unmate. The connectors are held together during mating by a press fit, retaining springs, or, in some cases, by spring-loaded ball bearings. Each of the three basic methods has advantages and disadvantages. Some are apparent, like the ease of connecting a push-on coupling type over a threaded coupling type; some are not so apparent, like the noise generated in the circuit by the two-ear bayonet-locking type when subjected to vibration.

The third criterion when classifying connectors is electrical or application, such as high voltage, close impedance matching, and d.c. pulse circuits, to name a few.

Classification by Series

"UHF" Series. Now that we have covered the basic parts and the rules of classification, the series themselves fall right into line. Of course, the first one we come to is the exception that proves the rule. The UHF series was the first real coax connector. It is designed for use with small diameter cables (0.185 in) to large diameter cables (0.630 in), and also cables having single and twin center conductors. The insulation materials of the UHF are the mica-filled Bakelite, Rexolite, polystyrene, and Teflon.

Fig. 1. Mating characteristics of three connector types.

BAYONET COUPLING



THREADED COUPLING



QUICK DISCONNECT COUPLING



The connector is not designed for impedance matching but it can be used at frequencies up to 200 MHz and peak voltages of 500 V. The twin-contact UHF connectors are manufactured in accordance with the applicable portions of the MIL-C-3655A specification.

"LC" Series. The largest cable connector in common usage is the LC series. It is designed for cables of the 0.870-in diameter range. It has screw-thread coupling and is designed especially for the transmission of large amounts of r.f. energy. The LC's are made to match 50-ohm impedance cables and can withstand a peak voltage of 5000 V. The receptacle has a dielectric material of either Teflon or polystyrene. The plug, however, has the unique feature of using the cable dielectric and core as its insulator and contact. This series is covered by MIL-C-3650.

"LT" Series. One of the other large series of connectors is the LT series. This series differs from the LC series in cable size, being 0.730-in diameter cable. The LT cable series is generally aluminum in order to reduce its weight. The LT Mil-Spec is MIL-C-26637.

"LN" Series. The LN series is the next large connector group. The LN is used with only three cables: the RG-14/U, RG-74/U, and RG-94/U. It has a threaded coupling connector. Peak voltage for the LN is 1000 V. There is no Mil-Spec for this series.

"N" Series. The N series is by far the most popular of the medium-size connectors. The average cable diameter for the N connector is 0.100 in, but due to its popularity, the diameter ranges from around 0.200 in to 0.900 in for special applications. Some threaded N connectors are designed to match 50-ohm cables and others to match 70-ohm cables. Type N is covered by MIL-C-39012.

"C" Series. The C connectors are used with the same cables as the N. The C connector is a bayonet-locking connector which has been electrically improved to afford better matches for 50-ohm cables. It works well at frequencies up to 10,000 MHz. Teflon is used exclusively as the insulation material; so is the improved cable-clamping mechanism. The C can be used with peak voltages of 1000 V. Original connectors were made in accordance with MIL-C-3989, new units are made to MIL-C-39012.

"HN" Series. For high-voltage use with medium-size cables, there are the HN connectors which can withstand maximum voltage of 5000 V peak. The HN is a screw-threaded coupling type with insulators of either polystyrene or Teflon. This is a 50-ohm constant-impedance connector, giving low v.s.w.r. values up to the 10,000 MHz limit. The specification of HN connectors is MIL-C-3643.

"BNC" Series. The BNC connector is the most popular connector for small-size cables, having an average outer diameter of 0.250-in. The BNC is a bayonet-coupling type. The newer units incorporate improved clamping and use Teflon as the predominant insulation material. They are also constant 50-ohm impedance connectors with low v.s.w.r. values throughout the frequency range. Due to the smaller size, they are good only up to 500 V peak. The old BNC specification is MIL-C-3608, the new designs are covered by MIL-C-39012 specification.

"TNC" Series. Since the two-ear bayonet-locking device tends to rock during vibration, setting up r.f. noise in the circuit, manufacturers developed the TNC connector which is a threaded-coupling BNC connector.

"MHV" Series. The high-voltage (5000 V peak) version of the small-size connector is the MHV series. The

Table 1. Useful electrical and mechanical specifications for a number of popular coax connector types.

TYPE	COUPLING	MATCHED IMPD. OHMS	TERMINATION			MIL SPEC		VOLTAGE			Weather-proof Availability	Maximum Freq.	Typical RG Cables
			Solder	Crimp Cable Braid, Solder Ctr. Contact	100% Crimp	Mechanical	Electrical	Max. VSWR to 1	Peak	Hi Potential 60V RMS			
SUBMINIATURE RF CONNECTORS—FOR CABLE UP TO .150 O.D.													
SUBMinax 27	Threaded, Push-on	50, 70	No	Yes	No	No	No	1.2	500	1500	No	4Gc	174, A21-597
SUBMinax 27 Quick-Crimp	Threaded, Push-on	50, 70	No	Yes	No	Yes	Yes	1.2	500	1500	No	4Gc	161, 174, 187, 188
SUBMinax 27 Field Serviceable	Threaded, Push-on	50	Yes	No	No	No	No	1.2	500	1500	No	4Gc	196
SUBMinax 5116	Threaded, Push-on	50, 75, 95	No	Yes	No	No	No	1.2	500	1500	Yes	4Gc	174, 180, 187, 188, 195, 196, 316
MINIATURE RF CONNECTORS—NORMALLY USED WITH CABLE UP TO .350 O.D.													
BN	Threaded	No	Yes	No	No	Yes	No	—	250	—	Yes	200Mc	55, 58, 59
BNC	Bayonet	50	Yes	No	No	Yes	No	—	500	1500	Yes	10Gc	55, 58, 59, 62
Quick Crimp BNC	Bayonet	50	No	Yes	Yes	No	No	1.25	500	1500	Yes	10Gc	55, 58, 59, 62
Mil Crimp BNC	Bayonet	50	No	Yes	Yes	Yes	Yes	1.25	500	1500	Yes	10Gc	55, 58, 59, 62
Original BNC Quick Crimp	Bayonet	No	No	Yes	No	No	No	—	500	—	Yes	—	55, 58, 59, 62
MB	Bayonet	No	Yes	No	No	No	No	—	500	—	No	500Mc	55, 58, 59, 178, 188
MC	Threaded	50, 75	Yes	No	No	No	No	—	500	—	No	500Mc	11, 58, 59
MHV	Bayonet	No	Yes	Yes	No	Yes	No	—	5,000	—	Yes	50Mc	54, 55, 58, 59, 62, 71
PLUG-IN	Plug-in	No	Yes	No	No	Yes	No	—	500	—	No	200Mc	58, 59, 62
SM	Threaded	No	Yes	Yes	No	Yes	No	—	500	—	No	200Mc	58, 59, 174, 187, 188
TNC	Threaded	50	Yes	No	No	No	No	—	500	1500	Yes	10Gc	55, 58, 59, 62, 180, 195
Quick Crimp TNC	Threaded	50	No	Yes	Yes	No	No	1.25	500	1500	Yes	10Gc	55, 58, 59, 62, 180, 195
Mil Crimp TNC	Threaded	50	No	Yes	Yes	Yes	Yes	1.25	500	1500	Yes	10Gc	55, 58, 59, 62, 180, 195
Original TNC Quick Crimp	Threaded	50	No	Yes	No	No	No	—	500	—	—	10Gc	55, 58, 59, 62, 180, 195
MEDIUM SIZE RF CONNECTORS—NORMALLY USED WITH CABLE UP TO .600 O.D.													
C	Bayonet	50, 70	Yes	No	No	Yes	No	—	1.5-4Kv	—	Yes	2Gc-10Gc	8, 9, 10, 11, 58, 59
HN	Threaded	50	Yes	No	No	Yes	No	—	1,500	5000	All	10Gc	8, 9, 10, 11, 17
N	Threaded	50, 70	Yes	No	No	Yes	No	—	500	1500	Yes	10Gc	8, 9, 10, 17, 58, 59, 62
TRIAx	Threaded	50	Yes	No	No	No	No	—	1.9-5Kv	—	Yes	10Gc	Triax
TWIN	Threaded	78, 95	Yes	No	No	Yes	No	—	100-500v	—	Yes	100-500Mc	22
	Bayonet	78, 95	Yes	No	No	Yes	No	—	100-500v	—	Yes	100-500Mc	108
UHF	Threaded	No	Yes	Yes	No	Yes	No	—	500	—	Yes	200-500Mc	8, 9, 10, 11
LARGE RF CONNECTORS													
LC	Threaded	50	Yes	No	No	Yes	No	—	5-10Kv	—	All	1Gc	17, 18
LN	Threaded	50	Yes	No	No	Yes	No	—	1,000	—	All	10Gc	14
LT	Threaded	50	Yes	No	No	Yes	No	—	5,000	—	All	1Gc	117, 118
PULSE	Threaded	48	Yes	No	No	Yes	No	—	5-15Kv	—	All	Pulse or DC	25, 26, 27, 28

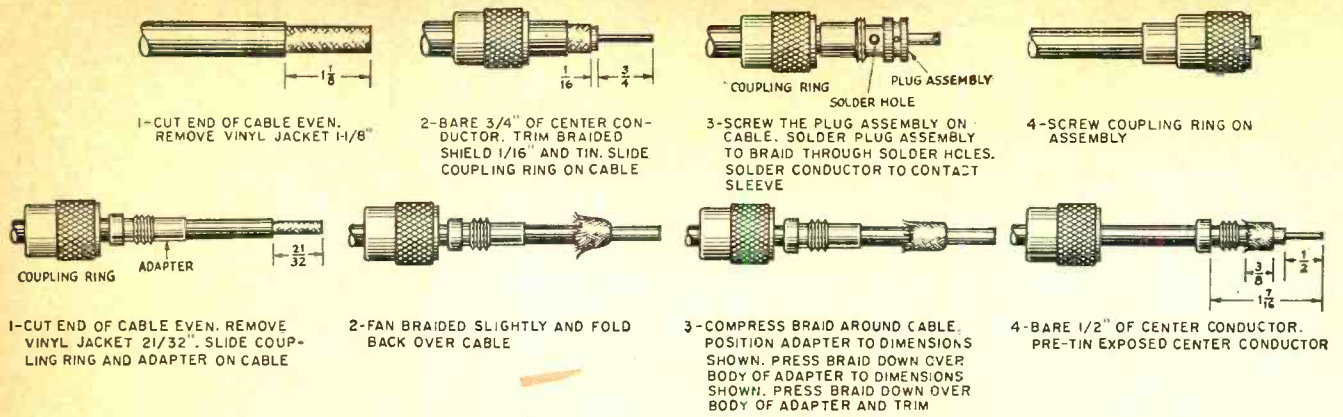

Fig. 2. The assembly method covering the 83-15P plug and adapter. See text for details.

MHV uses bayonet-type coupling and the cable-clamping method for the same cables as the BNC connectors.

"BN" and "MC" Series. The BN and MC series are also for use with small-size cables. These screw-threaded couplings are low-cost items designed for low-power r.f. applications.

"Subminax 27" and "5116" Series, "SM" and "MB" Series. There is another group of connectors for the sub-miniature size cables with 0.100-in diameters. These are the constant-impedance, 50-ohm and 75-ohm 27 series; 50-ohm, 75-ohm, and 93-ohm matched 5116 series; and the non-constant impedance SM and MB series. They are push-on, screw-on, and bayonet-coupling, respectively.

"Twinax" Series. This is a special application series for twin-conductor coax. They match the 95-ohm impedance of RG-22/U.

"Triax" Series. Triax connectors electrically connect the Triax cable's two braids separately when the threaded coupling connection is made.

"Pulse" Series. Pulse connectors are rubber or ceramic insulated connectors rated to handle a 15,000-V pulse at sea level or a 5000-V one at 50,000 feet with no corona effect.

Application Requirements

Considerable misunderstanding exists in the field concerning the impedance match of connectors and cables. Most UG-type connectors, for example, are designed for an impedance match with 50-ohm cables. In the case of type N connectors there is a group with smaller center contacts to provide a 70-ohm impedance. These are old designs, covered by military drawings, which do not include newer design features such as reactive cancellation characteristics. In the new miniature connectors there are 75- and 93-ohm versions, but in many cases they have not been completely checked with regard to v.s.w.r. Most applications for higher impedance cables are at relatively low frequencies such as encountered in video and pulse circuitry. For such low-frequency applications, the electrical length of the connector is a small fraction of a wavelength and appears as a small shunt capacitance in the circuit. Generally speaking, where the electrical length of the connector does not exceed 1/50 wavelength, a mismatch between cable and connector has negligible effect. With a mated BNC plug and jack this would correspond to a frequency of 140 MHz.

In many cases, connectors that are mechanically designed for 75- and 93-ohm cables require some form of shouldered contact because the cable conductor is too small to position the contact properly. This tends to make the impedance lower than the 50-ohm nominal. The BNC connectors for use with RG-9/U and RG-62/U are examples of this construction. To increase the impedance of a connector from 50-ohm nominal requires a smaller center contact or a larger outer conductor. In most cases,

it is not feasible to reduce the diameter of the center contact without introducing fabrication and assembly problems. To increase the outer conductor means an increase in the shell size and basically a completely new connector design. Whenever the application requires the use of higher impedance cables, and there is no standard matched-impedance connector available, the possible use of a 50-ohm connector should be carefully considered. Demanding a 75- or 93-ohm connector may result in an expensive item which offers little improvement in performance. Additional problems are created when it is necessary to mate these special impedance connectors with standard test equipment. The latter generally has 50-ohm connectors and very few inter-impedance adapters are available.

Understand Assembly Techniques

Assuming a connector is properly designed and manufactured to the required tolerances, the most important contributions to high v.s.w.r. are those variables associated with the assembly of the connector to the cable. See Fig. 2. The importance of this operation cannot be overemphasized. Any air gap between the cable core and the connector insulator introduces an impedance discontinuity that can greatly increase the s.w.r. of the assembly. Similar effects are present when the connector contact is not butted against a square cut of the cable dielectric. For best results, special fixtures and tools should be used to accurately cut the cable dielectric and position the contact. This procedure is recommended whenever a precision assembly is required.

Check Frequency, Power Needs

Next to impedance matching, the electrical characteristic of most importance is voltage rating. In general, r.f. connectors are a compromise type of design wherein one desirable characteristic is sacrificed to some extent in order to obtain other characteristics. This is especially true with regard to impedance matching and high-voltage characteristics. The two are not compatible. To obtain a high-voltage rating, especially at the junction of the cable core and connector insulator, requires a long overlap of the cable core. This presents an inductive discontinuity. It can be compensated to some extent by an adjacent section of low-impedance line which generally takes the form of an oversize center contact. These two sections comprise a line which is an appreciable portion of a wavelength at the higher frequencies and always limits the connector to usage at something less than the 10-GHz range of the standard connector. The HN series and high-voltage C connectors are examples of this construction. For a 1.5 maximum s.w.r. these connectors can be used up to 4 GHz.

Attenuation in an r.f. transmission line is a paramount design consideration. In practice, the loss in connecting

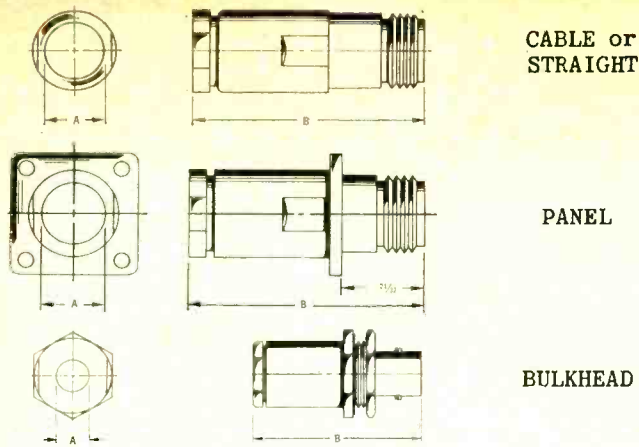

Fig. 3. Jacks tie cables to each other or to panels. Dimension A is the cable o.d.; Dimension B is jack length.

cables is large in comparison with that of the connectors. Therefore, in most cases, the latter can be disregarded. A type N connector, for example, has a dissipative loss of approximately 0.03 dB at 10 GHz, but the reflective loss in a system with various combinations of cable and connectors can be much higher. Consequently, a careful selection of well-designed, properly assembled connectors is the only available solution to this problem.

There is some small r.f. leakage from coaxial connectors. The slotted outer contacts are a contributing factor although leakage through the slots is reduced by the shielding of the coupling mechanism. Threaded-coupling types of connectors are better in this respect than the bayonet-lock type. When properly tightened, they form a low-resistance contact which effectively suppresses any leakage from the slots. Even with the bayonet-lock connectors, the leakage is small provided the cable support is such that the spring loading of the bayonet coupling mechanism permits a full bottoming of the outer contact. All of the recently designed connectors use positive metal-to-metal clamping of the braid wires to insure a consistent low-resistance connection at this point.

Coax-Connector Construction

As in the construction of a cable, let's start in the center and work out. There are two types of center contacts (male and female) which are terminated in the center conductor of the cable. The male contact, sometimes referred to as the male pin, almost always has a solder pocket in one end and is tapered at the other. The female or socket contact may have a variety of terminations such as a solder, flattened and pierced, or turret, but the front end is always hollow, slotted, and set. The male contact is made from 1/2-in hard brass for ease in machining and is plated with gold or silver. The trend seems to be toward gold plating because it doesn't tarnish and because of the increase in solderability. The female contacts are either brass or beryllium copper; the majority being beryllium copper because of its good spring action even after many insertions and withdrawals. Again, the platings are gold or silver, with gold becoming more popular. Both male and female may be what we call captivated or a captive contact. This is done by adding a shoulder of some type on the contact and then physically holding it in the connector. It is usually held stationary by placing it between two insulators which are, in turn, held stationary by a clamp nut or staking operation.

As in the cable, we come next to the dielectric or, as it is referred to in the connector, the insulator. The insulator varies in configuration depending upon the connector style and type. The materials also vary with the applications. The major insulation materials are poly-

styrene, Rexolite, polyfluoron (tradenamed Kel-F), polytetrafluoroethylene (Teflon), glass, and mica-filled Bakelite.

Next, is the outer contact. It is this portion of the connector that is electrically connected to the outer shield of the cable and serves the same purpose, that is, to carry a signal, to act as a shield, or as a grounding member of the circuit. In the case of jacks and receptacles, the body of the connector is the outer contact. The plug may have an outer contact and a coupling nut or just a coupling nut which acts as the outer contact. The term, "outer contact" is used only when referring to the tined portion of the body and is generally made out of silver-plated beryllium copper, again because of its good spring action and good electrical characteristics.

Still working outward, the coupling nut is encountered. This nut is that portion of the connector that mechanically joins two connectors. In the case of bayonet coupling, it is sometimes referred to as the bayonet sleeve. The coupling nut material is 1/2-hard brass with either a gold or silver plating. Most of the UG items are silver plated.

Connector bodies, last on our inside-looking-out list, are also silver-plated or gold-plated brass. Their configuration depends on the type of connector.

Cable-Retention Methods

Now let's take a quick look at the back of the connectors and the methods of attaching the cable to the connectors themselves. There are three basic methods of doing this: (1) soldering, (2) clamping, and (3) crimping. In UHF series, the cable braid is soldered to the connector. The second method of attachment is by clamping and is by far the most popular. In order to accomplish this, it is necessary to use additional piece parts. The first of these is the braid clamp and has two basic forms: one a tapered clamp or old style, the other an improved braid clamp. Both are silver-plated brass material. The second piece part is the sealing gasket. Originally the gasket was a flat rubber gasket. The improved type is a V-grooved gasket or chevron seal. Next comes flat washer, either of brass or phosphorous bronze with silver plate. The last part is the clamp nut. The inside diameter of the clamp nut is equal to the outside diameter of the cable and the o.d. is threaded to screw into the body of the connector. It is this part that holds the cable into the connector. The old-style clamping parts accomplished the sealing and clamping by compressing the flat gasket between the clamping nut and the braid clamp. This gave a fairly adequate seal but the cable retention, being dependent upon the rubber member, was rather weak. The last form of cable retention is by the use of a crimp. In this type, the braid clamp, gasket, washer, and clamp nut are replaced by a ferrule clamp nut assembly which is an extension of the body. The cable dielectric and center conductor are put inside the ferrule and the cable braid, and compressed by means of a crimping tool. The inner ferrule assembly is of silver- or gold-plated brass but the outer ferrule must be a softer alloy because it must be deformed. We can use the crimp in this application because it is outside of the electrically critical area of the connector. The biggest advantage to the crimping assembly method is that it is easier. The cable stripping dimensions are not as critical and there is no braid combing and no torque tightening problem to interfere with satisfactory cable retention. Its main disadvantage is the need for special tools.

Basic Coax Connector Terms

Plugs. The term "plug" defines the mating characteristics and can be broadly stated as that unit, when mated, which encompasses or fits over its mate. The two main types are the straight plug and the right-angle plug.

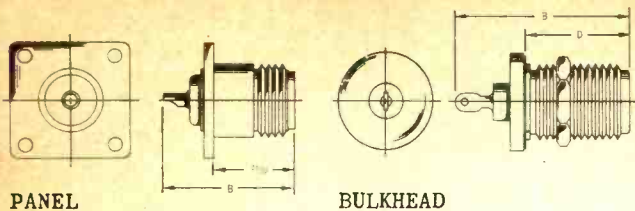

Fig. 4. Typical receptacle configuration. Dimension B is receptacle length; Dimension D projects through panel.

The right-angle can be of two types. The first is where the body of the unit is made from a block of brass with the circular mating units and cable-clamping portions brazed or threaded into it. This form is termed "cubic construction." The second is made by brazing the two circular portions directly together. This is usually referred to as mitred construction.

Jacks. There are two principles that define a jack. First, a jack is the mating unit to the plug and all mating features fit inside the plug during mating. Also, it must have a means for securing it to the end of a cable. There are three types of jacks. See Fig. 3. The first is only secured to the end of a cable and is referred to as a cable jack; the second is secured to the cable but is mounted to a panel by means of a square flange, this is called a panel jack; the last unit is mounted to the panel by a shoulder and hex nut and is called a bulkhead jack.

Receptacles. The receptacle has the same mating characteristics as the jack but has no cable-clamping parts. See Fig. 4. The receptacle is open-wired with the center conductor soldered on to the unit and the cable braid sometimes soldered to a grounding lug nut.

Adapters. An adapter takes two or more incompatible items and joins them together. The names applied to the adapters depend on their functions. See Fig. 5. The straight adapter joins two like units of the same series. These are also called feedthrough adapters when mounted to a panel. The angle adapter usually has a plug, or male end, and a receptacle, or female end, and is used where an angle connection is needed and an angle plug cannot be used. The "T" adapter joins three units together and can be any combination of ends, such as three-receptacle ends, two-receptacle ends, and one plug or possibly one cable-clamp end, and so on. There are also between-series adapters which give us a transition from one series to another. A note of caution should be interjected here. When referring to adapters of all types, it is necessary to be explicit as to the ends of the adapter. Some people describe an adapter by designating the unit with which it is to mate, such as an adapter for two plugs. This is not an adapter with two male or plug ends, but just the opposite; an adapter with two female or receptacle ends. The other method of describing an adapter is to discuss its own construction. The use of both methods is recommended when describing

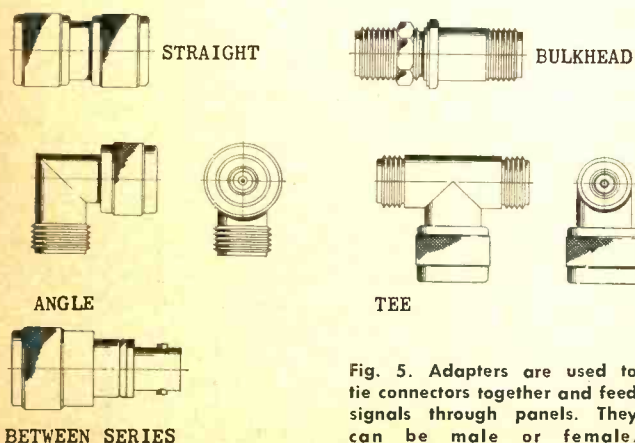

Fig. 5. Adapters are used to tie connectors together and feed signals through panels. They can be male or female.

adapters. Also, when calling out a between-series adapter, it is necessary to indicate the specific series involved, such as an adapter with a BNC female end and a series N male end.

Cable terminations. Cable terminations are used when a complete cable connector is not required. Basically, it is a means of clamping the cable braid and jack while allowing the core to pass through. Cable terminations can be supplied with various methods of mounting from square-flange mounting to strap mountings.

Resistor terminations. This is an electrical termination rather than mechanical. Generally, it takes the form of plugs with built-in resistors that close and load the circuit when mated.

Caps: Shorting and non-shorting. This same principle is used in shorting caps. The shorting cap is nothing more than a unit having the mating features of a plug or a receptacle, except that it shorts out the center contact to the cap body.

Hoods. Since receptacles are open-wired, covering the open end by means of a hood reduces noise pickup. The hood is either attached to the flange or screwed onto the threaded portion of the bulkhead connector.

Pressurized connectors. Another general term that requires clarification is pressurized connectors. There are two methods of pressurizing connectors. The most effective means being the use of a glass bead which is soldered into the connector body itself. The other method of pressurizing is by means of a rubber seal gasket compressed between two insulators. This is not a hermetically sealed connector and should not be referred to as such. Its sealing effectiveness varies greatly and, in general, should be used only where low pressure differentials exist.

A Look at Mil-Spec Connectors

Since the majority of r.f. connectors find their way into military applications, let's briefly review the military terminology associated with r.f. connectors.

The UG portion of the number has been assigned the meaning "Connector, R.F." The "/U" indicates that it is for general usage and officially defined as "used in two or more general installation classes such as airborne, shipboard, or ground." The number assigned to the connector is the identifying number and is assigned on a first-come, first-served basis. There is no correlation between this number and the type or series of the connector.

Provisions are made in the military nomenclature to reflect changes. This is the function of the letter inserted after the number and before the /U. The higher the letter, the later the revision. On some connectors, use revisions are as high as "E" indicating a fifth revision of the original design. A revision number is assigned when the detail parts and subassemblies therein are no longer interchangeable, but the component itself is interchangeable physically, electrically, and mechanically. If the change is of such a nature that the connector is not interchangeable with its forerunners, it will be assigned a new nomenclature.

There are two other identification symbols used in connection with r.f. lines. These are CW and MX. The MX denotes a miscellaneous category and covers such things as caps, hoods, and armor clamps. The CW designates a cover and is used with caps exclusively.

It can be seen, then, that proper selection of coaxial connectors depends upon several factors. For a quick recap, the following should be evaluated on a step-by-step basis:

1. Determine coaxial cable—cable should be chosen on the basis of impedance, temperature, attenuation or power capacity.
2. Determine possible connector series.
3. Constant or non-constant impedance.
4. Coupling.
5. Cost and availability.
6. Shell style.
7. Solder or crimp terminations.



Saul Bernstein received his BS degree from Hofstra University in 1957. Until 1959 he was employed by General Electric Co. as an EMI specialist in radar and guidance systems. Since then he has been manager of the Filtron Company's Test Div.



Martin Mirsky received his BEE degree from Pratt Institute in 1957 and attended Ohio State University Graduate School. In 1961 he joined Filtron and is presently associate director of the Interference Laboratory. Prior to that he was employed by the Wright-Patterson Air Development Center as an RFI/EMC specialist. He has published several papers on interference.

Grounding Techniques

By SAUL BERNSTEIN, Manager, Test Division
& MARTIN MIRSKY, Associate Director, Interference Laboratory/Filtron Co.

Improperly grounded shields can cause coupling and interference problems in sensitive electronic circuits. Shields can be single- or multi-point grounded.

THE problem of electrical compatibility in a complex electrical or electronics system is, in many cases, dependent on the treatment of the shielding and the grounding of the wire shields. Injudicious application of a grounded shield to a wire may cause coupling problems that otherwise would not exist. Grounding of the shields may be accomplished as single-point or multi-point grounding. Factors that influence the selection of single-point or multi-point grounding include the interference signal frequencies involved, the length of the transmission line, and the relative sensitivity of the circuit to high- or low-impedance fields.

The two grounding methods are more completely defined as follows:

Single-point shield grounding. For multi-lead systems, each shield may be grounded at a different physical point as long as individual shields are insulated from each other. Single-point grounding is more effective than multi-point shield grounding only for short shield lengths. Single-point grounding is ineffective in reducing magnetic or electrostatic coupling when conductor length-to-wavelength (L/λ) ratios are greater than 0.15; where the wavelength is that of the highest frequency to be used (or the highest frequency

interference to be expected) on the wire or on the system.

Multi-point shield grounding. For L/λ ratios greater than 0.15, multi-point grounding at intervals of 0.15λ is recommended, for the shield can act as an antenna that is relatively efficient at $L/4\lambda$ when one end is grounded. When grounding the shield at intervals of 0.15 is impractical, shields should be grounded at each end. Multi-point shield grounding is effective in reducing all types of electrostatic coupling, but is subject to failure if large ground currents exist. In general, multi-point shield grounding solves most problems, but in audio circuits single-point grounding may be more effective because of a ground-current problem.

General Considerations

Proper cable installation is essential if interference difficulties are to be avoided. Assuming proper grounding techniques have been employed, the following guidelines for good signal cable practice should be observed:

1. Shields should not be used for signal returns.
2. All signal circuits, including signal ground returns, should be individually shielded and have insulating sleeves or coverings over the shields. Balanced signal circuits should use twisted pairs or a balanced coaxial line with a common shield. Where multi-conductor twisted-pair cables that have individual shields as well as a common shield are used, all shields should be insulated from one another within the cable.
3. Coaxial cables should, in all cases, be terminated in their characteristic impedance.
4. On shielded cables in harnesses, where a common shield ground must be utilized, a clamp or shielded and grounded backshell should be used to ground all shields to the connector body. This should be done in addition to connecting the shields to ground through one or more connector pins.
5. Coaxial cables carrying high-level energy should not be bundled with unshielded cables or with shielded cables carrying low-level signals. Although the characteristic impedance of the cable or signal circuit will normally be quite low, the shield-circuit impedance may become appreciable if the shield becomes open-ended or electrically long. This reduces shield effectiveness.
6. Shields should be grounded on both sides of a connector

Fig. 1. Connector with pins enclosed by shielding shell.

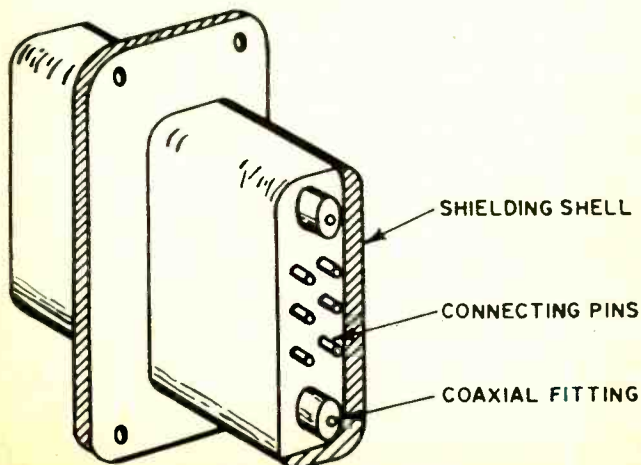

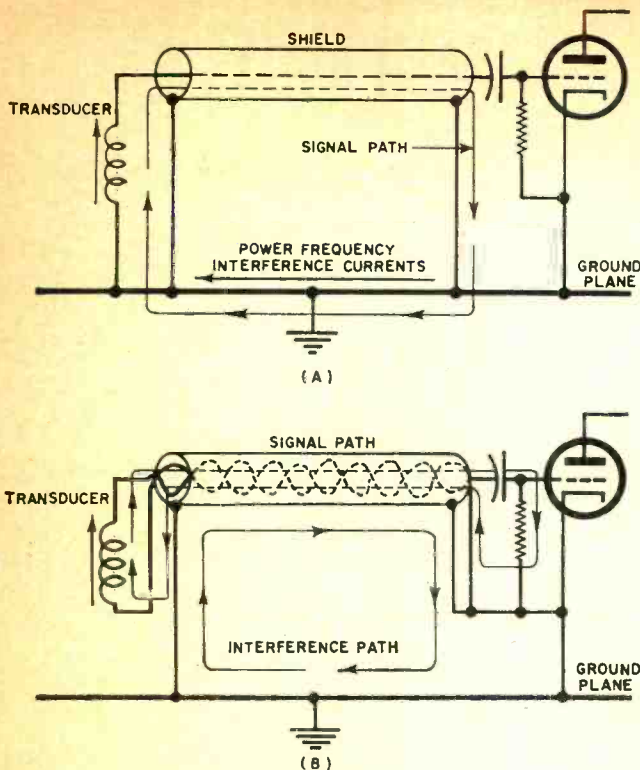

Fig. 2 (A) Multipoint shield grounds couple noise into signal circuits; twisted pair (B) reduces interference.

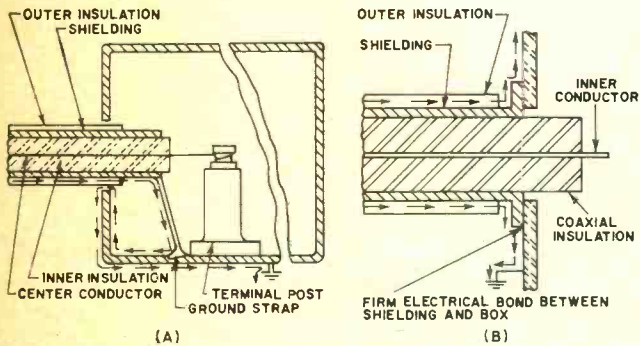

Fig. 3. (A) Shows the incorrect method of introducing shielded cable into junction box, (B) is the right way.

to avoid discontinuity; if not possible, the shield should be carried across the connector through a connector pin.

7. Grounding a number of conductor shields by means of a single wire to a connector ground pin should be avoided, particularly if the shield-to-connector or connector-to-ground lead length exceeds one inch, or where different circuits that may interact are involved. Such a ground lead is a common-

impedance element across which interference voltages can be developed and transferred from one circuit to another.

Connectors

Great care must be taken at connectors if impedance characteristics and shielding integrity are to be maintained. A shielding shell should be used to shield the individual pins of a connector. A well-designed connector has a shielding shell enclosing its connecting points (Fig. 1). The shells of multi-pin connectors should be connected to the shield. Coaxial lines should be terminated in shielded pins. Pigtail connections for coaxial lines are undesirable since they permit r.f. leakage.

Cable Shield Grounding

Each shield circuit should be carried individually; each should be electrically continuous and grounded at both ends. In the case of long cable shield runs, bonding of shields at intermediate terminals or locations will reduce impedance of the shields to ground, rendering the shielded circuits less susceptible to radiated or induced interference. Individual shields should not be electrically joined together so that one shield carries the r.f. currents of another. To obtain minimum r.f. shielding from shielded wires or coaxial lines, it is necessary to bond them effectively to the ground plane. For a low-impedance r.f. connection, the shortest length of connecting strap or jumper that is mechanically practical should be used. If coaxial cables are used to transmit r.f. signals, they should be grounded at both the sending and receiving ends. Normal coaxial connectors are adequate for this purpose; pigtail connections should be avoided. In applications where twisted-pair cables are used, the shield should be grounded at each end and the circuit return path should be floating (single-point grounding). Bonding and grounding techniques employed should comply with standard good installation practice.

Both multi-point and single-point ground systems offer singular design features. For electronic and electrical systems distributed over a large area, multi-point shield grounding for interference control is superior. The multi-point approach allows short ground connections, provides a low-impedance ground-return circuit, and improves the effectiveness of filter installations. While multiple-ground circuits are recommended for r.f. applications, there are some circumstances, primarily in low-frequency, low-level work with audio or servo amplifiers, in which single-point grounding is necessary. When a shielded cable in a sensitive circuit is grounded at both ends for the return circuit, power-frequency currents in the ground plane can induce audio-frequency interference (Fig. 2A). Therefore, single-point grounding may be the best approach where large a.c. currents flowing in the ground plane may couple into very sensitive low-frequency circuits. To provide extra protection, a shielded twisted pair should be used (Fig. 2B).

Fig. 4. Cable shield bonding for chassis connectors (A) when receptacles are on front panel, and (B) are on rear of chassis.

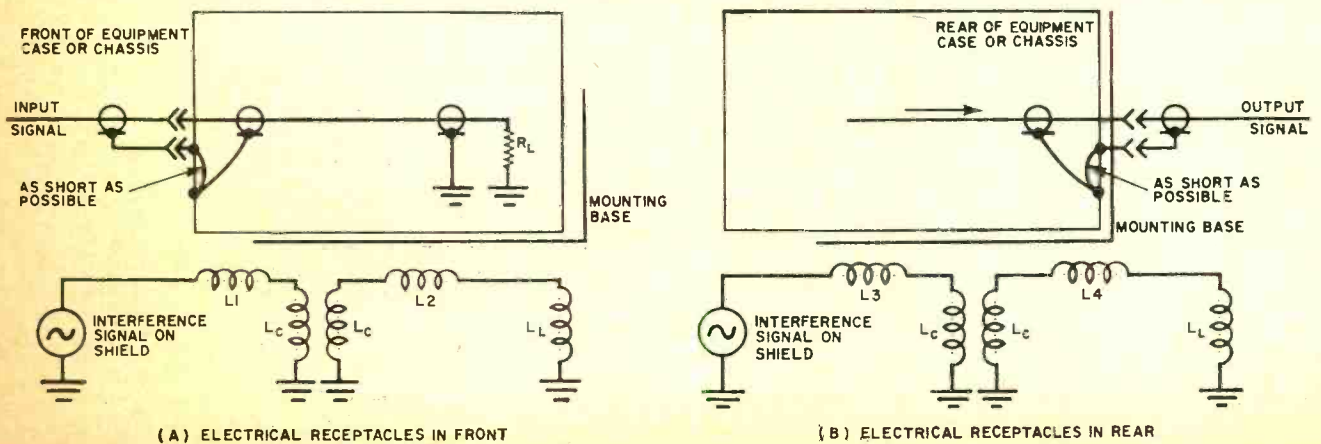

(A) ELECTRICAL RECEPTACLES IN FRONT

(B) ELECTRICAL RECEPTACLES IN REAR

The shield should be grounded at both ends; the signal return lead only at one end. Because of multiple grounding of the shield, magnetic fields may be coupled into the shield by conduction or induction. The twisted leads reduce magnetic susceptibility because of field cancellation.

Reducing Interference

Serious interference problems arise when shielded wires or coaxial cables are not properly terminated at the connector. It is important that the connector be properly grounded. The direct bond for this ground can be achieved by maintaining clean metal-to-metal contact between the connector and equipment housing. In those cases where a large number of individual shields from shielded wires must be connected to ground, it is recommended that the halo or shielded backshell technique be used. The exposed unshielded leads should be as short as possible to reduce electrical coupling between conductors. Interference is caused when a shielded cable is run into a completely sealed box, but is grounded internally. The correct way to install a shielded r.f. cable is to run the shield well inside the connector and bond it around the connector shell. The arrows in Fig. 3A show the path that any signal or interference that is picked up on the outer surface of the shielding must follow to return to ground. The currents around the loop generate a field in the enclosed box, as do coupling loops used with resonant cavities. Fig. 3B shows the correct method of introducing shielded cables into a box where shielding must be maintained. Interference currents may be carried when a shielded r.f. cable entering an enclosure has its shield stripped back to form a grounding pigtail. Such pigtails should therefore be avoided. If it is absolutely necessary to use a pigtail it should be kept as short as possible and soldered to provide a ground without breaking the shield. The pigtail should also maintain continuity of the shield (through a pin in the connector) to a continuation of the shield inside the enclosure. The cable r.f. shield is a part of the complete shielding enclosure. Care should be taken to insure there are no openings through which airborne noise can enter.

Electric plugs and receptacles are usually mounted on the front and/or rear of the equipment chassis or on the mounting base. If electrical receptacles are on the front of the case, the plugs should be separate units. Shield grounds should be made in accordance with Fig. 4A. If electric plugs and receptacles are placed at the rear of the case one unit should at least be securely attached to the case or chassis; the other separate or securely attached to the mounting base. Shield grounds should be made in accordance with Fig. 4B. Two poor methods of grounding cable shields are shown in Fig. 5. These methods are not recommended because their use permits interfering signals to enter the equipment. In cases where a common shield-ground must be employed, such as on multi-shielded cables or harnesses having a large number of individually shielded circuits, a clamp, bus, or shielded backshell should be used to ground all shields to the connector body; this in addition to grounding them through one or more of the connector pins. The common ground should be avoided when the shield-to-connector or connector-to-ground lead length exceeds one inch, or when current circuits that may interact are involved. To prevent discontinuity of the shield because of possible disconnect at intermediate connectors, shields should be grounded to the structure on both sides of the connector. If this isn't possible, the ground should be carried across the connector or through a conductor pin.

Cable Shield Bonding

Shields should be terminated no further than 0.25 inch from the ends of the lines they are shielding. Bonding halos, shielded backshells, or interlacing straps should be used to terminate the shields and to minimize the impedance

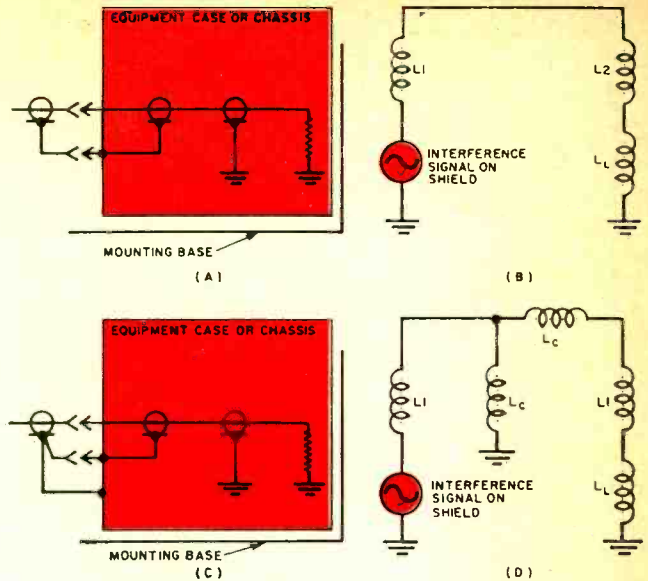

Fig. 5. Poor bonds permit noise to enter equipment.

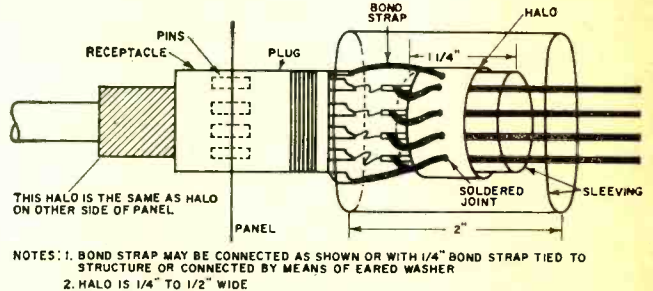
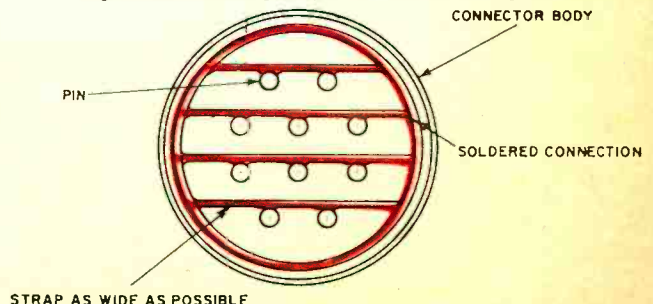

Fig. 6. When bonding halos are used to terminate shields in a harness, they minimize the termination's impedance.

of the shield termination (Fig. 6). Shields should be connected to the ground plane by 1.5 inches or less of 0.25- or 0.5-inch wide tin-plated copper strap. The halo technique is acceptable only when a few wires are involved. The interlacing strap or shielded backshell method should be used for a common shield ground in multi-shielded cables and in harnesses that have a large number of individual shields. The interlacing strap should be at least 0.25-inch wide by 0.012-inch thick and be bonded securely to the connector. This is shown in (Fig. 7).

Coaxial fittings should be kept tight at all times not only to provide a good impedance match but to eliminate loose connections that may result in rectification of interference energy at the fittings. Again, the resulting d.c. voltage may interfere with circuit operation by imposing an undesired bias signal at the circuit's input; or, in the case of power measurements, cause an erroneous wattmeter reading. For these same reasons, shielding or bonding clamps that may be part of the fittings should also be kept tight. Soldered fittings are recommended, particularly at terminations of shielding and braid. ▲

Fig. 7. An interlacing strap is the best common ground.



The author has held his present position for the past 11 years. Prior to that he was engaged in the design of power transformers for electronic applications. He has a BSEE from Illinois Institute of Technology.

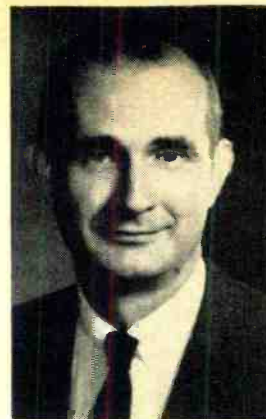

Shielded Cable at Audio Frequencies

By ROBERT E. SHARP/Product Development Engr., Belden Corp.

"Audio" frequencies range from d.c. to 100 kHz. Shielding cables which carry these signals presents engineers with some very special problems.

WHEN it comes to choosing a properly shielded cable for an audio-frequency application, many engineers are baffled. "Audio" may mean an electrical signal whose frequency is too low to be distinguishable, but one that nevertheless conveys information; or it may mean a signal which contains frequencies up to 100 kilohertz, or higher. For purposes of this discussion, we will define "audio" as d.c. to 100 kHz.

In audio circuits, as in radio-frequency circuits, the primary reason for shielding a cable is to keep external noise or electrical energy from disturbing the signal within the cable. The type of shield needed, and indeed, whether a shield is needed at all, depends on the nature of the signal and on the electrical and physical environment in which the cable will be used.

Fig. 1 shows the six most popular types of flexible shields. They are: braided wire, spirally wrapped wire, plastic-supported metallic foil, self-supporting metal foil, conductive textiles, and conductive plastic or rubber-type sheaths. Of course, some cable types have combinations of these basic shield configurations.

Shield quality is described by one or both of two terms; percent shield coverage—which is the percentage of the surface of the shielded element physically covered by the shielding material, and shield effectiveness—which indicates how well the shield is doing its job.

Shield effectiveness is the ratio of signal leakage with the shield in place to signal leakage if no shield is present, and is usually expressed in decibels. In the case of cross-talk measurements on a multi-pair cable, isolation between the pairs is given in terms of the ratio of the voltage picked up on one pair to the voltage which is applied to another pair, and is also expressed in decibels. Some isolation between the pairs may be the result of uniform twisting of each pair and, of course, isolation can be improved by shielding each wire-pair individually.

Normally, the higher the percent coverage, the more effective the shield. However, a shield made of high-resistance material such as carbonized yarn (used to give 100% coverage) may not be as effective as a copper-wire shield having only 85% coverage.

Braided Shields

For quite some time braided-wire shields were considered the industry standard and, although they have

been replaced by more efficient foil shields in many applications, they are still best for some uses. For most audio applications these shields are made of tinned copper wire for high conductivity, ease of soldering, and good flexibility. Braided-wire shields are recommended in other applications where the cable will be subjected to a great amount of flexing.

Sometimes a compromise must be made between shield coverage and flexibility. It's easy to see that the more complete the coverage, the stiffer the cable. For example, most microphone cables are not near sources of severe interference, so exceptionally good shielding is not required and shield coverage as low as 70% is frequently used with good results. In addition, braided-wire shields are frequently used on cables for strain-gage instrumentation, especially where the part under test is in motion and the cable must be extremely flexible.

In practice, the maximum wire-braid coverage is approximately 98%. This is because openings are required to pass shield strands over and under one another during the braiding operation.

Spirally Wrapped Wire Shields

Braided-wire shields are expensive to manufacture and assemble in a finished product. For that reason, spirally wrapped wire shields, frequently called *served shields*, are used. They are less expensive because the manufacturing process is simpler, and because they use less copper—approximately one-half the copper of an equivalent length of braided shield. Theoretically, a spirally wrapped shield can cover a cable completely because no holes are required as in braiding. In practice, however, coverage is kept below 100% to keep the wire strands from piling up.

Spirally wrapped shields are easy to terminate. The user merely unwinds a few wraps of the shield, twists it into a pigtail, and makes his connection either by soldering or clamping to a terminal.

Spirally wrapped shields are found in many home-entertainment systems such as tape recorder mikes, electronic guitars, and high-fidelity sound equipment. Fig. 2 shows a spirally wrapped shielded cable used with stereo sets. The two insulated wires which have spirally wrapped shields covered by a plastic jacket, resemble the familiar "zip cord." When it is necessary to split the cable for the two channels, the web between the wires is cut and the

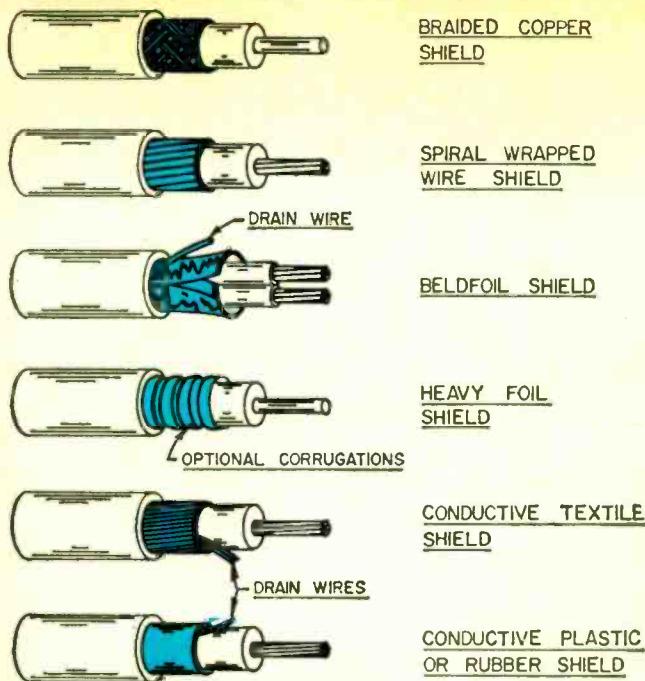

Fig. 1. Six popular types of flexible audio cable shields.

user then has two individually shielded and jacketed cables.

Inductance is the major disadvantage of spirally wrapped shields. Sometimes when a microphone cable is connected to a transmitter, the inductance causes it to resonate at the transmitted frequency—creating interference. Normally, spirally wrapped wire shield is satisfactory for audio use, but when it is necessary to overcome the inductive effect of the spiral, some cables use an uninsulated wire running lengthwise under the shield to short the turns of the shield coil.

Plastic-Supported Metallic-Foil Shields

While most wire shields are adequate for cables which carry audio signals that are to be interpreted by the human ear and brain, better shielding is needed for cables that carry information between machines. For example, digital data (in the form of pulses) can be erroneously interpreted if some noise pulses get through the cable shield. Then, too, the demand for more cables in less space has made shielding more difficult. This is true even when cables carry only speech or music. Why? Because

the closer together you have two cables, the more coupling you will have between them.

Clearly better shielding had to be developed. A thin aluminum foil tape wrapped around a cable makes a good shield; but most foils which are strong enough to withstand the manufacturing processes are so thick that they make the cable too stiff.

A few years ago the introduction by *Du Pont* of Mylar plastic film made possible the development of a shield consisting of Mylar laminated to thin aluminum foil by means of a suitable adhesive and wrapped around the cable. An uninsulated wire, called a "drain wire", is in contact with the aluminum foil for the entire length of the cable and is used for making connections to the shield.

From the basic concept, plastic-reinforced aluminum foil shields have been developed into many forms for specific applications, so that such shields can be much more than just a Mylar-backed aluminum tape wrapped around a cable. The excellent insulating properties of Mylar are used to provide a "bonus insulation" between the shield of a cable having a single shield and the conductors.

In cables having several shields, such as a 27-pair cable in which each pair is individually shielded, it is frequently important to keep the shields insulated from each other except at the grounded end to avoid "ground loops" which reduce the effectiveness of the shield. Here, the shield is used with the Mylar outward to provide insulation between the shields.

The inductive effect of a spirally applied foil tape can be a problem, just as it is with a spirally wrapped wire shield. To overcome this, it is necessary to "short-circuit" the turns of the spiral in some manner resulting in the electrical equivalent of a continuous metal tube.

Belden has a patent which pertains to folding back a

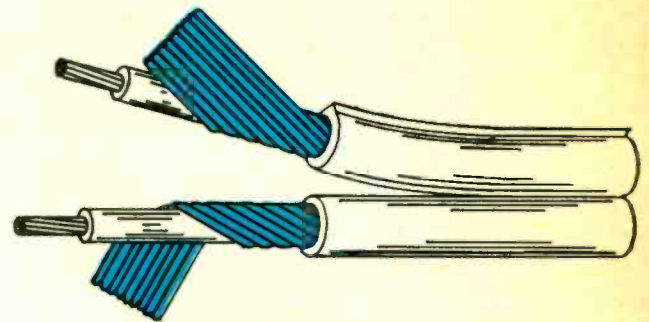
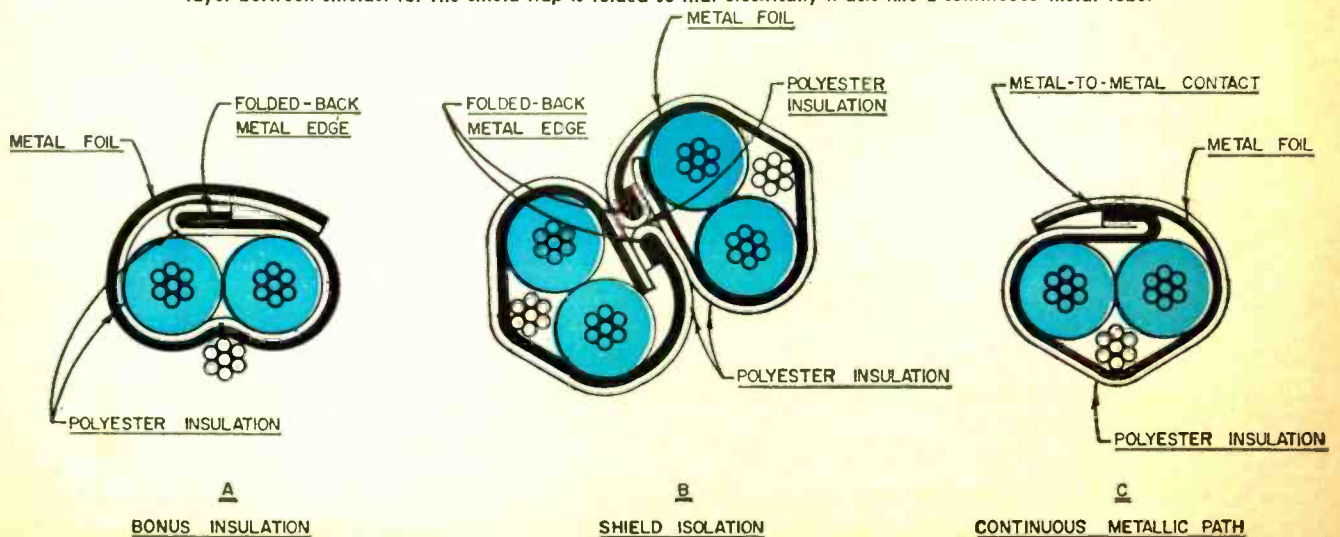

Fig. 2. Stereo cable with separately wrapped shields.

Fig. 3. (A) Patented fold keeps shield foil away from the conductors. (B) Mylar provides an insulating layer between shields. (C) The shield flap is folded so that electrically it acts like a continuous metal tube.



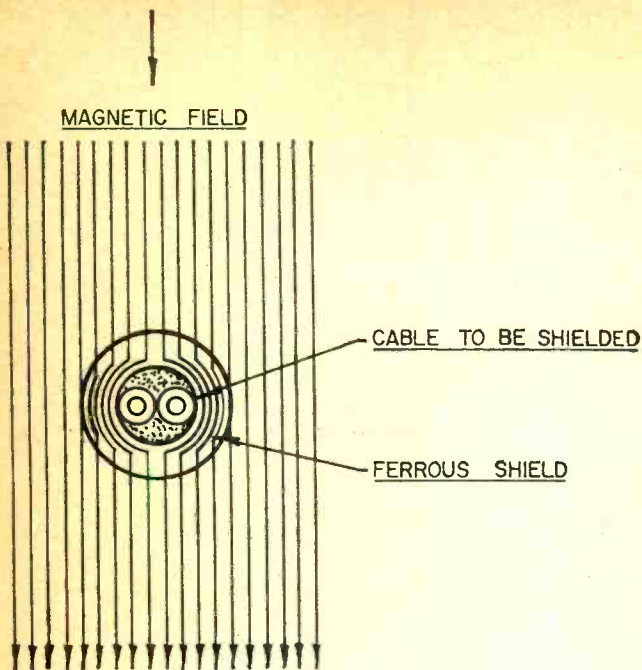

Fig. 4. Ferrous materials repel external lines of flux.

narrow edge of the plastic-supported foil tape used in its Beldfoil shielding. The folded edge is used to tuck the exposed edge of foil in such a manner that it is prevented from touching a conductor or another shield. Thus it enhances the "bonus insulation" and improves the reliability of shield isolation (depending on the type of cable). Folding one edge of the tape in the other direction permits metal-to-metal contact, effectively eliminating the added inductance of the helically applied shield. The various folds are shown in Fig. 3. The foil-to-foil fold is shown separately for clarity, but is actually used together with the other folds.

Plastic-supported foil-shielded cables are being specified instead of braid-shielded cables in nearly all new radio and TV studio installations because they give better shielding, take up less space, are easier to terminate, and are lower in cost than the old-style braided shields.

In addition, plastic-supported foil-shielded cables are being used in all sorts of applications where the best in electrostatic shielding is required. They are used in intensive care equipment in hospitals; with huge parabolic antennas used to track space probes; and with data collection instrumentation, especially at underground nuclear test sites.

It was at first felt that plastic-supported foil shields should not be used where they would be subject to flexing. However, exhaustive laboratory tests by the Belden Co., backed by experience in the field, have shown that foil shields will withstand continuous flexing as long as the cable is not bent sharply, and sharp bends will reduce the life of any cable.

It was found that after many thousands of bending cycles there will be some hairline cracks in the aluminum. However, the Mylar remains undamaged and the cracks in the foil are bridged by the drain wire, so the effectiveness of the shield remains better than that of a braided-wire shield.

(Editor's Note: Most of the major cable companies have developed and manufacture Mylar-backed aluminum-foil shielded coaxial and multiconductor cables. Apparently the big difference between the Belden cable and those of the other manufacturers is the method of wrap, and the fold on which Belden has a patent. The other companies use a short spiral wrap where Belden uses a long wrap in which the spirally wrapped shield turns slowly around the

cable insulation. According to some cable makers, the short wrap is equally effective as the long wrap; however, users should test each cable type to see which best meets their needs.)

Self-Supporting Metallic-Foil Shields

For mechanical strength it is necessary to use a relatively thick foil in unsupported metallic-foil shielded cables. Because of this, unsupported foil tapes are rarely used when individual cable elements must be shielded. However, they are frequently used as an over-all shield under the final outer jacket. While they have excellent shielding properties, they are also used to give the interior of a cable a certain degree of mechanical protection.

Heavy foil shields are usually made of copper or aluminum, and may be wrapped spirally or laid parallel to the axis of the cable. In general, spirally wrapped shields are more flexible, although the necessity for overlapping the tapes may cause some roughness in appearance. Heavy tapes applied parallel to the axis of the cable tend to collapse when the cable is bent. Two methods have been devised to overcome this problem. One method is to corrugate the tape so that it will bend easily at each corrugation. This results in many small bends rather than one large, single bend which could collapse the shield. The other method is to use a foil tape which is coated with a material which melts and bonds to the plastic jacket. This causes the jacket to support the foil, and thus helps to prevent its collapse.

Conductive Textile Shields

Textiles may be made conductive by impregnating them with carbon. When used as shields, conductive textiles are spirally wrapped around the cables to obtain 100% shield coverage. Usually a metallic drain wire running the full length of the cable is used as a shield termination, however, conductive textiles may be used in concert with a braided-wire shield and, in this case, the termination is made to the wire braid.

Conductive textiles are effective against 60-Hz hum and low-frequency noise caused by mechanical impact. However, effectiveness decreases significantly as frequency increases, therefore they are not used in high-frequency applications, especially when many cables are bundled together.

Plastics and rubber-like materials may also be made conductive by the addition of carbon or similar metals. When conductive plastics are used as shields, they are extruded over the cable and a drain wire is used for the termination. These shields are usually effective against low-frequency noise and 60-Hz hum but tend to be less effective at high frequencies. Effectiveness also decreases with the age of the material and also varies from one production lot to the next.

Table 1. Summary of audio cable shield characteristics.

	Copper Braid	Copper Serve	Foil/Plastic	Heavy Foil	Conductive Textile	Conductive Extrusion
Shield Effectiveness	Good	Good	Excel.	Excel.	Fair	Fair
Limpness	Good	Good	Fair	Poor	Excel.	Good
Fatigue Life	Good	Fair	Good	Poor	Excel.	Good
Relative Cost	High	Med.	Low	High	Med.	Med.
Tensile Strength	Good	Fair	Poor	Good	Poor	Poor
Termination Methods	Pigtail, crimp ring	Pigtail	Drain wire	Direct connection	Drain wire	Drain wire

Is it Just a Shield?

We have discussed the basic shield types without regard to what is underneath them. Sometimes we find that a shield is more than a "shield" and this has a bearing on the type of cable chosen and how it's used.

In the ideal case, a shield has no function beyond intercepting undesired energy and carrying it to ground. However, we frequently encounter a system in which the shield is a signal return path. A typical example is the mike cable on a tape recorder. Here the shield has two jobs, carrying the signal and protecting it from interference, but since the shielding is not too critical, it does both jobs satisfactorily. However, consider a long run of shielded single-conductor microphone cable between two metal chassis, and assume the connectors ground the shield to both chassis. Neither chassis is directly grounded but each has different capacitance to ground through its power supply. The result is dissimilar voltages at the two shield ends. This causes current in the shield and hum in the input.

Of course, the problem can be eliminated by installing a low-impedance bonding wire between the two chassis, and insulating the connectors from the chassis. A better way is to use a balanced input and output and a twisted-pair cable. Then the shield can be grounded at only one point and no current will flow through it to introduce interference.

Shields are sometimes used as one side of a push-to-talk circuit or buzzer system. In this case, the user must be sure the shield can carry the current. In the case of Beldfoil shields the drain wire is rarely more than 2 AWG sizes smaller than the conductors in the cable and is usually adequate for use as an auxiliary conductor, al-

though the user should satisfy himself that voltage drops will not be excessive.

Magnetic Shielding

So far, we have concentrated on electrostatic shielding, or the prevention of capacitive coupling. One other way in which interference occurs is by magnetic coupling, or "transformer action." Whenever a wire crosses a varying magnetic field a voltage will be induced in the wire.

Reduction of magnetic interference may be accomplished in several ways:

1. Route the cable away from the source of interference.
2. Use a balanced twisted-pair so that equal voltages of opposite polarity are induced in the conductors.
3. Use a magnetic shield. The first two methods, proper cable routing and a balanced pair, should be used whenever possible because an effective, flexible magnetic shield is extremely difficult to achieve. The object of a magnetic shield is to divert the magnetic field by providing a low-reluctance path which bypasses the magnetic flux around the cable (See Fig. 4.)

The best magnetic shield for cables is an ordinary soft-iron water pipe, but it can hardly be called flexible. Flexible cables may achieve some degree of magnet shielding by wrapping soft iron tape or high-permeability alloy tape around them.

Cable manufacturers constantly strive to develop more effective shields for the newer, more critical applications. New materials, new combinations of materials, and new methods of applying them are under evaluation, and vast amounts of test data is on file. Engineers with unusual cable applications may find this information helpful. Test data can be obtained by writing to the cable manufacturer direct. ▲

A NEW TYPE OF SHIELD

THE best way to shield a wire is to surround it with a continuous metal tube. In effect, this is what the Plaxial Cable group of United-Carr did when they developed what they claim is the first fully shielded, flexible coaxial cable. Tradenamed Plaxial Cable, the coaxial line is made by plating a ductile copper onto flexible Teflon or polyethylene dielectric.

Actually, the desire to miniaturize as much electronic equipment as possible has made large, rigid coax line obsolete. Therefore, the tendency is to replace rigid lines with miniature semi-rigid cables or with conventional single- or double-braided shielded cable. Both of these conductor types have serious shortcomings, however.

Plaxial cable offers a third choice. It is flexible like braided cable, but without the losses, and it is fully shielded like semi-rigid cable but there is no need for the accurate cutting and bending that limits semi-rigid cable use.

Plaxial cable is flexible because a continuous helical groove is scored in the polystyrene or Teflon dielectric to permit the outer copper sheath to flex without cracking or degrading the cable's v.s.w.r. or other characteristics. Bends as small as $\frac{1}{8}$ " radius can be made with the standard 50-ohm cable, which is 0.145-inch o.d.

As engineers know, semi-rigid cable does provide complete shielding of high-frequency signals but it must be accurately cut to length and bent to fit, so it is difficult to install in the field; it is heavy; and it is subject to damage by vibration. The fitting problem generates engineering drawings for every piece of harness yet the major variations aren't electrical but physical.

Fig. 1. In straight or right-angle connectors, Plaxial cable makes contact by screwing into connector body.

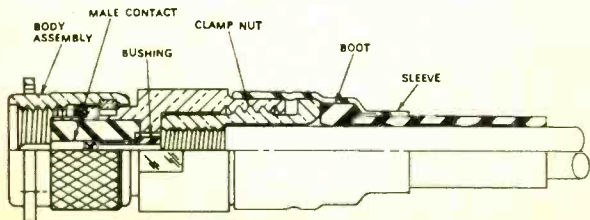

Braided cables cannot be used at the higher radio frequencies—above 6 GHz—because of high signal loss through the braid. And when the braid is flexed, the attenuation varies widely, indicating unstable shielding effectiveness. A flexed braid is also a noise source.

The Plaxial cable design provides a unique advantage for right-angle connectors. Rather than the lossy pin-to-pin contact used in conventional connectors, the Plaxial connector has no more degradation or v.s.w.r. than the straight connector. The cable itself makes the right-angle turn and thus avoids the additional signal loss.

Because this cable's construction is unlike any other, special connectors are required. At this time, Plaxial cable connectors are made only by United-Carr. They also make adapters which will mate with other type connectors made by Cinch and other companies.

In special situations where the Plaxial cable's shield must be externally grounded, a special conductive epoxy should be used to bond a drain wire to the corrugated copper shield since heating can deform the cable and change its characteristics.

Plaxial cable harnesses are being used on the Apollo spacecraft, the Sparrow missile system, and on Army combat helicopters.

Fig. 2. Diagram shows effectiveness of Plaxial cable.

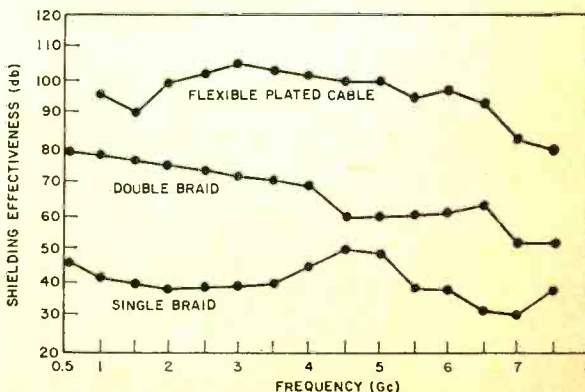



John H. Gove is a product specialist for Amphenol Industrial Division of the Bunker-Ramo Corp., Chicago. With a varied educational background that includes studies at the College of Advanced Traffic, General Motors Institute, and Northwestern University, he is known throughout the Amphenol organization ← for his expertise on a broad range of connector products.

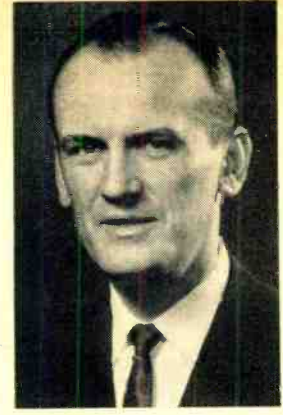

Lawrence J. Kehl is engineering product manager, Industrial Interconnecting Components, for the newly formed (Jan. 1968) Amphenol Industrial Division of the Bunker-Ramo Corp. He received his BS in mechanical engineering from the University of Illinois and is a Registered Professional Engineer. →

Connectors For Audio-Frequency Applications

By JOHN H. GOVE, Product Specialist
and LAWRENCE J. KEHL, Engineering Project Manager
Amphenol Industrial Division, The Bunker-Ramo Corporation

Most engineers choose the right connectors but put them together improperly. This article shows the correct method of assembling audio cable connectors.

TO SAY that the most serious problems in audio-frequency termination are the direct result of improper connector selection would be a mistake. Most users appear well schooled in what connector should be employed for a given application—thanks in part to a substantial degree of connector standardization on commercial audio equipment. Perhaps because of significantly simplified connector selection, however, some users often make hasty cable installations without regard to line attenuation, impedance characteristics, cable length, etc. Worse, actual wire and shield termination is far from consistent and often incredibly crude. Frequently the result is the right audio connector badly terminated to the wrong shielded cable.

For these reasons an over-all evaluation of the basic compositions of both shielded and coaxial cables can be important. Shielded audio lines typically contain one or more inner conductors covered by an outer conductive shielding. Coax, on the other hand, consists of two conductors having a single, common axis. Radio-frequency cable line inner conductors are covered with a low-loss dielectric material; the typical interwoven metal braiding tightly wound over the dielectric forms the outer (or second) conductor.

Outer conductors of both r.f. and audio cable types come in many forms. They can be composed of a conductive plastic jacket, a metallic tube, a spirally wound metallized film, or, more commonly, a braid of finely interwoven metal wires. In addition to serving as a return conductor or ground, the outer conductor may "float" and is, therefore, often referred to as the cable shield.

Although application (a.f. or r.f.) clearly dictates which cable to choose, theoretically, at least, all coaxial lines can be referred to as shielded types. The reverse is not true. Coaxial feedlines, for example, exhibit a uniform

cross-section at any point along their length. In addition, accurate calculation and measurement of such constants as capacitance per foot, nominal impedance, and attenuation at a specific operating frequency—critical to transmission of r.f. signals—is impossible with conventional shielded audio cables.

Electrical Rating

Microphone connectors, as well as phone or phono plugs and jacks, are generally capable of carrying considerably more power than most applications require. As an example: a typical six-contact microphone connector exhibits the following rating: (1) voltage, 600 V r.m.s. (sea level); (2) current, 3 amperes; and (3) voltage breakdown, 2000 V r.m.s. (sea level). In a typical actual application, though, the applied voltage is below one millivolt and the current flow below 0.1 milliamperes. Operational frequency is 10,000 Hz.

Electrical ratings of audio-type connectors are usually based on sea level, room temperature, and non-environmental conditions. Where more critical conditions prevail, standard connectors should be replaced with special environmental-type connectors.

In certain low-impedance circuit networks, connector power ratings of less than one microwatt may be required. It is here that gold plating over highly finished screw-machine, male and female contacts can frequently be recommended. The low ohmic resistance of gold-plated contacts enhances reliability of the circuit and, indirectly, the entire system.

Most audio and microphone connectors are manufactured with metal contacts for soldering wire leads as opposed to crimp (or other mechanical termination) frequently encountered in r.f. applications. Instead of simplifying the process, however, solder techniques appear

to vary considerably from one user to the next. It is rare indeed even to find professional service technicians following any "standard" assembly procedure. In spite of this, however, there are several recommended methods which have been developed within the audio connector industry to insure against broken connections, shorts, and a.c. hum induction. And it's interesting that they have proven themselves admirably in a wide variety of demanding environments over the years.

Single-conductor microphone connectors, for example, use eyelet-type contacts which butt together during mating. The recommended termination procedure is shown in Fig. 1. Note particularly the cutback dimensions, critical when assembly is complete and solder operations are ready to begin. Care should be exercised to prevent accidental nicking or cutting of the braid. Also, excess solder should be avoided; this one tendency among assemblers is easily the key to most termination problems. Heat, too, should be minimized to prevent deformation of the cable core. Once the solder operation is complete, the leads should be trimmed and smoothed into button shapes.

Terminating Multi-Contact Connectors

Shielded audio lines containing more than one connector—such as in push-to-talk microphone installations, some remote p.a. systems, etc.—become somewhat more difficult to terminate. Basically, these should be approached with an eye to the type of individual connector contact employed.

The step-by-step technique illustrated in Fig. 2, for example, demonstrates the recommended method for terminating to connectors of three or more contacts which employ screw-machine contacts with solder-cup tails. Note that when the wire is inserted to its full depth, the conductor should be exposed to the length shown, bringing the insulation to—but not into—the solder cup. All conductors and pigtailed leads should, of course, be pretinned before they are soldered to the contacts; this permits easy entrance to the solder cup and tends to eliminate the possibility of loose strands.

With screw-machine, solder-cup contacts it is essential that both braids and conductor leads be of equal length. Too long a lead will result in buckling and (if assembly is subject to flexing) can cause insulation abrasion resulting in an eventual short circuit. A lead that is too short, or one without adequate slack can be difficult to solder and will have a tendency to tear from the contact as the assembly is flexed.

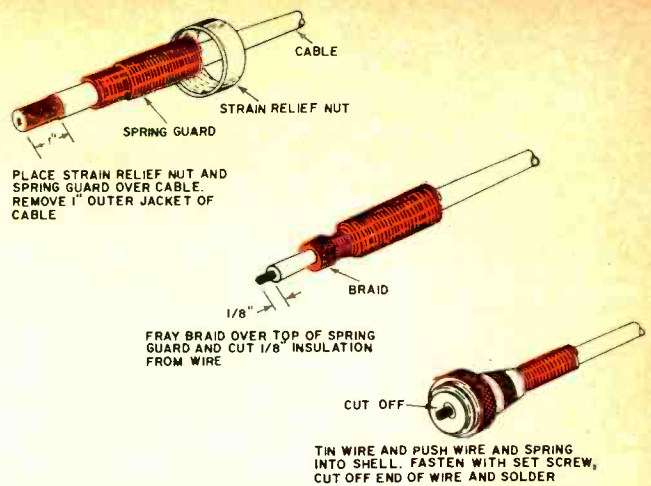

Fig. 1. Assembly procedure for microphone connector.

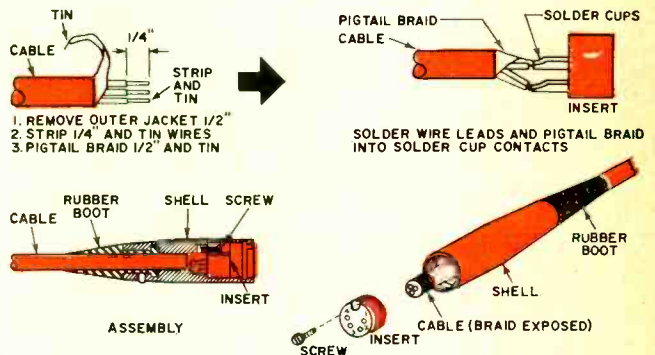
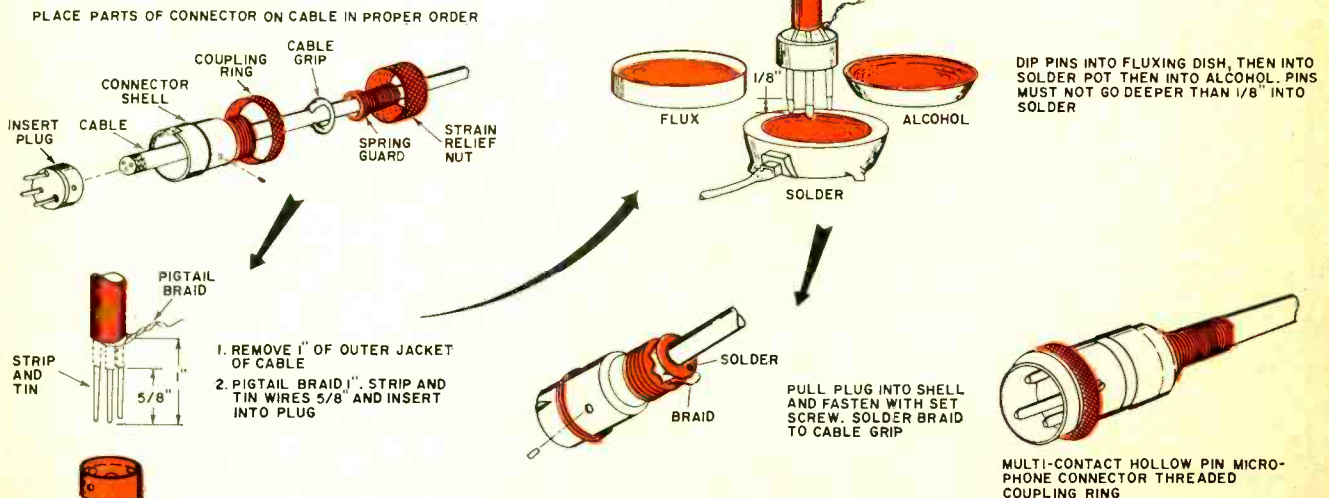

Fig. 2. When assembling multi-contact connectors, the insulation should butt the pins, and the conductors and pigtails be pretinned before placing in the solder cups.

Terminating Hollow-Pin Mike Connectors

Users of the hollow-pin and female sheet-metal-type contact microphone connectors often experience difficulty both in soldering leads and in making a suitable braid ground connection. Use of proper termination techniques, however, can overcome these problems. Before attempting connector assembly work, it is essential to select the most satisfactory materials to do the job. What follows is a description of required materials plus recommended solder-

Fig. 3. Step-by-step method for terminating to a multi-contact hollow-pin transceiver microphone connector.



ing techniques that have been based upon proven results.

For all termination work of this kind, coil and bar solder (for solder pot) should be of 60/40 consistency, indicating 60% tin and 40% lead composition. This formula provides easy flow and strong solder bond. Since the male connector pins have little or no plating on their interior surfaces, it is necessary to use a flux other than rosin and alcohol to get the cleaning action required prior to soldering. A non-corrosive flux offering good wetting action is most often preferred. (We use that supplied by *London Chemical Co.*, Melrose Park, Illinois.) In some cases it is advisable to clean pin interiors with a solution of Copperbrite; this not only cleans but also acts to produce a mild etching on the pin interior, significantly improving solder adhesion. Fluxes are also available in a water soluble formula for easier clean up after assembly.

Refer to Fig. 3. In preparing the conductors for pin plugs, all leads should be stripped back $\frac{3}{8}$ inch. This is necessary because adequate space must be provided to allow for escape of air from the pin top. In addition, the bare wire should be pretinned prior to inserting into the pins. Following the sequence shown in Fig. 3, the next operation is that of placing the insert plug's mating face down and inserting the wires. Now actual soldering begins. When using a dish to contain the flux, a felt pad or sponge should be placed on the bottom of the dish to both hold the flux and prevent excessive deposits. With the conductor wires in position, the pins should just touch the saturated pad; only the ends should be fluxed.

After fluxing, pins and leads should be immersed in a solder pot preset for operation at 550°F. The pins should be dipped no more than $\frac{1}{8}$ " into the molten solder, held for a few seconds and then quickly transferred to a dish of alcohol. Alcohol provides a cooling action and also acts to remove flux residue from the pins.

After pigtailling, the braid may be grounded to the cable grip or terminated to a hollow-pin contact.

How Braiding is Connected

There are a number of recommended methods for terminating a cable shield, some of which have been mentioned earlier in the article. Unfortunately, braid connections seem to cause the most problems. For this reason, what follows are several additional techniques that can be safely employed.

One of the most common methods for terminating shields is to comb the interwoven braid wire and then

twist to form a pigtail. The pigtail, which can also be a "drain wire" from a foil-wound shield, is then soldered or crimped to the contact. If this method is employed, the shield should be grounded at one circuit end to prevent an objectionable ground-loop effect. A slight variation would be to solder the pigtailed braid directly to the connector's cable-grip or shell.

Another method frequently employed is to comb the interwoven braid wire, wrap with a bare wire and solder to the shell or spring guard. A fourth technique is where the interwoven braid wire is combed over an auxiliary shell part, a ferrule is pushed over the braid, and the result crimped.

The last method involves the outside metal covering of a metal-jacketed cable (or the outside jacket of a conductive plastic-covered cable). Here, the covering can be mechanically terminated by means of a cable grip.

Power/Shielded-Contact Connectors

In certain applications, both power and signal circuits are combined in a single cable or cable assembly. The cable carrying this combination usually has several insulated power conductors and one more coaxial cable in its bundle. This cable is then terminated to a combination power and shielded contact connector. A typical example of this would be a rack-and-panel connector with 25 power contacts and two coaxial-type shielded contacts.

With this configuration a slightly modified termination procedure should be employed. First, the individual insulated conductors should be stripped and crimped to the connector contacts.

Next, the coaxial cables should be properly stripped and crimped to the center conductor; the braid should be combed and crimped to the shield. At this point all contacts can be inserted into the connector dielectric material. This entire procedure is repeated for the mating connector. (It is important to note that contact termination can be either by crimp or solder, depending upon connector type used.)

With both connector halves securely mated, power contacts are capable of carrying the rated current and voltage values specified. The signals carried in the coaxial lines now have an uninterrupted shield, eliminating the possibility of electrical noise or crosstalk pick-up being induced through the connector. This shield, in most cases, is grounded at one end of its length while the other end is left floating. ▲

FLEXIBLE FILTERS

IN increasing numbers of aircraft, space vehicles, and commercial applications, extremely tight limitations on space and weight make it virtually impossible to package electromagnetic interference suppression filters into all vital circuits. The "LossyLine" flexible filter was developed by Lundy Electronics & Systems, Inc. as one solution to the space and weight problem.

Typically, flexible filters can be made in several configurations to meet various attenuation and power requirements. For example, in the single-conductor configuration, a low-"Q" r.f. dissipative, flexible, lossy magnetic medium (a high permeability ferrite compound containing alloys of copper, silver, and iron to increase conduction at high and low frequencies) is placed around the conductor. Therefore, all magnetic lines of force pass through the lossy material. In conventional filters, the conductor is wound around the medium.

Some LossyLine filters have helical conductors. In this configuration, a coil of wire is embedded in a cylindrical mold of lossy magnetic material which is isolated and shielded. This form of construction provides higher attenuation per unit length as compared to the single-conductor configuration. In both designs, the shields around the lossy material protect the filter from external interference.

According to the manufacturer, a 1-inch piece of LossyLine has about 100-dB attenuation at 5 GHz. The filter is usable from 10 MHz to 100 GHz; v.s.w.r. is about 1.3-1.4.

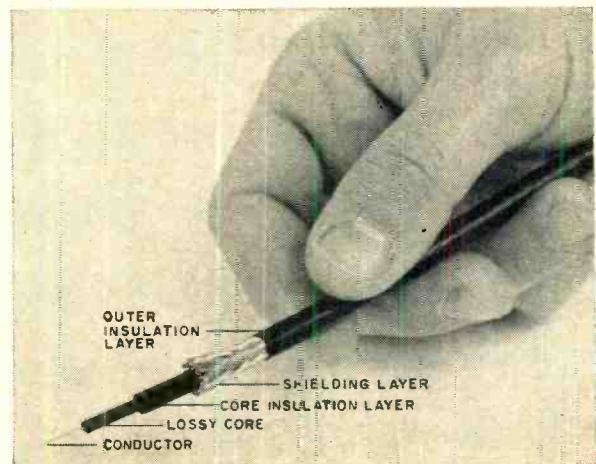

CHARACTERISTICS of RG/U TRANSMISSION CABLES

Type	Inner Conductor	Die. Material	Nominal Diameter of Dielectric	No. & Type of Shielding Material	Protective Covering	Nom. O.D. (inches)	Nom. Imp. (ohms)	Nom. Cap. (pF/ft)	Nom. ATT. per 100 ft	dB	Max. Oper. Volts (r.m.s.)
5A	16AWG, A-4	B-1	0.181	C-2	D-1	0.328	50	28.5	400	5.25	3000
58C	19/0.0071, A-2	B-1	0.116	C-3	D-2	0.195	50	28.5	400	12.60	1900
94A	19/0.0254, A-1	B-4	0.370	C-4	D-4	0.500	50	27.0	400	3.8	7000
115A	7/28 AWG, A-4	B-4	0.255	C-2	D-4	0.415	50	29.5	400	5.2	4000
141A	0.039 in. A-4, A-5	B-3	0.116	C-1	D-4	0.190	50	28.5	400	9.0	1900
142B	0.039 in. A-4, A-5	B-3	0.116	C-2	FEP	0.195	50	26.5	400	9.0	1900
143A	0.059 in. A-4, A-5	B-3	0.185	C-2	D-4	0.325	50	28.5	400	6.0	3000
178B	7/0.004, A-4, A-5	B-3	0.034	C-1	brown FEP	0.075	50	29.0	400	29.0	1000
188 A/U	7/0.004, A-4, A-5	B-3	0.060	C-1	white TFE	0.110	50	29.0	400	20.0	1200
196 A/U	7/0.004, A-4, A-5	B-3	0.034	C-1	TFE	0.080	50	29.0	400	29.0	1000
212	0.0556 in. A-4	B-1	0.185	C-2	D-2	0.332	50	—	—	—	3000
213	7/0.0296 in. A-1	B-1	0.285	C-3	D-2	0.405	50	30.8	400	4.5	5000
214	7/0.0296 in. A-4	B-1	0.285	C-2	D-2	0.425	50	30.8	400	4.5	5000
215	7/0.0296 in. A-1	B-1	0.285	C-3	armored, D-2	0.475	50	—	—	—	5000
217	0.106 in. A-1	B-1	0.370	C-4	D-2	0.545	50	—	—	—	7000
218	0.195 in. A-1	B-1	0.680	C-3	D-2	0.870	50	—	—	—	11,000
223	0.035 in. A-4	B-1	0.116	C-2	D-2	0.216	50	—	—	—	1900
225	7/0.0312 in. A-4	B-3	0.285	C-2	D-4	0.430	50	—	—	—	5000
226	19/0.0254 in. A-4	B-4	0.370	C-4	D-4	0.500	50	—	—	—	7000
280/U	.1144 in. A-1	B-4	0.327	C-2	D-2	0.480	50	27.5	400	3.5	4000
281/U	19/.0378, A-4	B-4	0.500	C-2	D-4	0.750	50	29.0	4000	12.5	4000
9A	7/0.0285, A-1	B-1	0.280	C-2	D-1	0.420	51	30.0	1000	8.6	4000
147	0.250, A-1	B-3	—	C-3	armored PVC	1.937	52	29.5	3000	7.7	4000
58	20 AWG, A-1	B-1	0.178	C-3	D-2	0.195	53.5	28.5	400	9.5	1900
54 A/U	7/0.152, A-1	B-1	0.178	C-3	polyethylene	0.245	58	26.5	400	6.7	2500
59	22 AWG, A-3	B-1	0.146	C-3	PVC	0.242	73	21.0	400	8.3	2300
124	22 AWG, A-2, A-5	B-4	0.135	C-5	D-4	0.240	73	20.3	—	—	2300
11A	7/0.0159, A-2	B-1	0.285	C-3	PVC	0.405	75	20.5	400	4.35	5000
12/A	7/0.0159 in. A-2	B-1	0.285	C-3	black PVC	0.475	75	20.5	3000	16.0	5000
59B	0.0230 in. A-5	B-1	0.146	C-3	D-2	0.242	75	21.0	400	—	2300
85/A	0.1045 in. A-1	B-1	0.680	C-3	D-2	1.000	75	21.5	400	2.8	10,000
140	0.025 in. A-4, A-5	B-3	0.146	C-1	D-4	0.233	75	21.0	400	8.0	2300
179B	7/0.004, A-4, A-5	B-3	0.063	C-2	brown FEP	0.105	75	—	400	21.0	1200
187 A/U	7/0.004, A-4, A-5	B-3	0.060	C-1	TFE	0.110	75	—	400	21.0	1200
216	7/0.0159 in. A-2	B-1	0.285	C-4	D-2	0.425	75	—	—	—	5000
302	0.025 in. A-4, A-5	B-3	0.146	C-1	D-4	0.233	75	21.0	400	8.0	2300
108	2-Conductor 7/28, A-2	B-1	0.079 over each conductor	C-5	D-1	0.235	78	24.5	—	—	1000
62	22 AWG, A-3	B-2	0.146	C-3	PVC	0.242	93	13.3	400	6.3	750
62B	24 AWG, A-3	B-2	0.146	C-3	D-2	0.242	93	14.5	400	6.3	750
71B	0.0253 in. A-5	B-2	0.146	C-6	black PVC	0.250	93	44.5	400	6.3	750
210	0.0253 in. A-4, A-5	TFE	0.146	C-1	D-4	0.242	93	14.5	—	—	750
22B	2-Conductor 7/0.0285 in. A-1	B-1	0.285	C-6	black PVC	0.420	95	16.0	400	10.5	1000
111/A	2-Conductor 7/0.0152 in. A-1	B-1	0.285	C-6	armored, D-4	0.490	95	16.0	400	10.5	1000
133	21 AWG, A-1	B-1	—	C-3	black PVC	0.405	95	16.2	—	—	4000
180B	7/0.004, A-4, A-5	B-3	0.102	C-1	brown FEP	0.145	95	15.0	400	17.0	1500
195 A/U	7/0.004, A-4, A-5 (Annealed)	B-3	0.102	C-1 ind. inner common outer	TFE	0.155	95	—	400	17.0	1500
24A	2-Conductor 7/0.0285 in. A-1	2-cores B-1	0.380	C-1 ind. inner common outer	armored PVC	1.034x0 .735	125	12.0	300	3.5	3000
63B	0.0250 in. A-5	B-2	0.285	C-3	D-2	0.405	125	10.0	400	5.5	1000
114 U	33 AWG, A-3	B-2	0.285	C-3	black PVC	0.405	185	8.5	—	—	1000
144/U	.007, A-3	B-2	0.285	C-3	D-2	0.405	185	8.5	—	—	1000

A-1 copper; A-2 tinned copper; A-3 copperweld; A-4 silver-covered copper; A-5 copper-covered steel, B-1 solid polyethylene; B-2 air space polyethylene; B-3 solid tetrafluorethylene; B-4 taped tetrafluorethylene. C-1 silver-covered copper, single braid; C-2 silver-covered copper, double braid; C-3 copper, single braid; C-4 copper, double braid; C-5 tinned-copper, single braid; C-6 tinned-copper, double braid. D-1 grey non-contaminating polyvinylchloride; D-2 black non-contaminating polyvinylchloride; D-3 armored polyvinylchloride; D-4 lacquer impregnated fiberglass.

Characteristics & Parameters of Coaxial Transmission Lines

By ALLEN M. KUSHNER* / Manager, Engineering Services, Times Wire and Cable Co.

Coaxial cables are in every sense microwave components. They have an impedance characteristic, power capability, and a distortion requirement.

A COAXIAL transmission line is not just a piece of hardware; in reality it is a microwave component. It's not merely a cable which links two black boxes but a device with an impedance characteristic, a power-handling capability, an attenuation or distortion requirement, a time-delay characteristic, and a specific ability to provide electromagnetic shielding. In addition, coaxial cable must demonstrate these properties over wide frequency and temperature ranges without significant degradation due to exposure to moisture, corrosive environments, and mechanical abuse. Coax is not always the most efficient means of power transfer; but it is easy to handle and is effective over wide bandwidths. A valuable feature of coax is that the outer conductor also acts as a shield.

To achieve maximum efficiency from coaxial cable transmission lines, the engineer must concern himself with: impedance—matching cables to the system or systems to assure maximum energy transfer; energy—loss or gain by radiation or pickup; insertion losses; and time delays. Mechanical considerations enter into his deliberations since tension and frequent flexing cause insertion losses, voltage standing-wave-ratios (v.s.w.r.), and time delays to vary. Temperature and pressure in high altitude and underseas applications also affect insertion loss and power-handling capability; while exposure to moisture and chemicals influence cable life.

Dielectrics

The dielectric is normally a polyolefin, polytetrafluoroethylene, air, or some other substance. While air has excellent electrical characteristics, it is adversely affected by moisture and it does not provide the necessary support to maintain the center conductor in place with respect to the outer conductor. For a cable to have stable electrical characteristics, both factors must be kept constant. Solid dielectrics are not affected by moisture, they are easily bent without changing conductor spacing, and they are not affected by changes in ambient pressure. Offsetting these advantages, however, is the fact that solid dielectrics have the highest electrical losses (Fig. 1). Foamed-plastic dielectric is an effort at compromise between the solid-dielectric approach and the air-spaced cable. In foam-plastic dielectrics, a great many small, individual air spaces are obtained by releasing gas in the molten plastic during the extrusion process. But foamed dielectrics can absorb moisture and cause an increase in attenuation. This can be prevented by encasing the cable in a seamless aluminum tube. By doing so, a 20% or greater reduction

in attenuation is achieved over ordinary solid-dielectric cables. It is apparent that we can reduce the attenuation even further by removing as much solid-dielectric material as possible, leaving only the amount needed to support and protect the center conductor. Cables housed in a seamless tubular aluminum sheath with the center conductor supported by minimum solid dielectric have the lowest possible losses for a given cable size. These sheathed cables are classified as semi-flexible since they may be easily bent for installation but not flexed in use.

Electrical Length

Usually electrical length is not a crucial dimension but there are applications where the length of a coaxial cable is critically related to other elements and to the system as a whole. Phased array antennas, for example, are functionally dependent on the electrical lengths of their various electrical members.

Time-delay and electrical length are closely related and for many applications the engineer must know the mechanical length of the cable and the velocity of propagation of an electromagnetic wave through the cable (Fig. 2). Velocity is a function of the dielectric material. For example, solid polyethylene dielectric propagates at 66% of the velocity of light, solid Teflon 69.4%, and foamed dielectrics at 81%. Air-spaced cables vary somewhat with velocities of propagation from production run to production run. In solid-dielectric cables, variances of $\pm 1\%$ are usual; foamed dielectrics $\pm 2\%$, and air-spaced cables $\pm 2\%$.

Electrical length also changes with cable flexing and frequency. The variation from a normal linear response can be $\pm 1^\circ$ in short cable lengths, but significantly higher where electrical-length spikes (variations at specific frequencies) occur in long cable runs.

Fig. 1. Cable losses due to dielectric configurations.

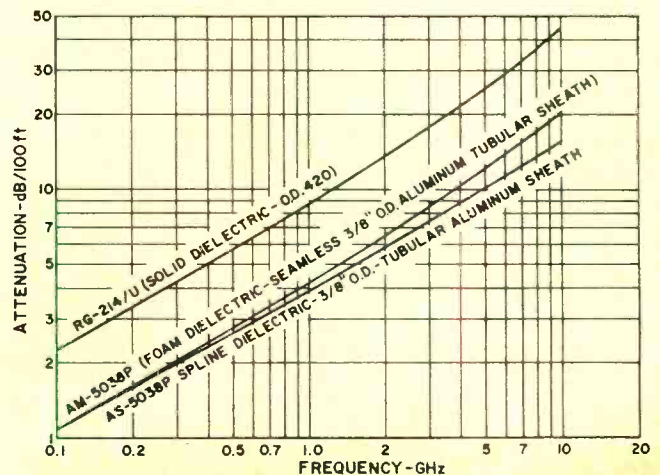

*The author holds a Bachelor of Mechanical Engineering degree from Rensselaer Polytechnic Institute and a Master of Science degree from the University of Connecticut. He is a former research worker for General Motors and also served with the U.S. Air Force as an Electronics Officer.

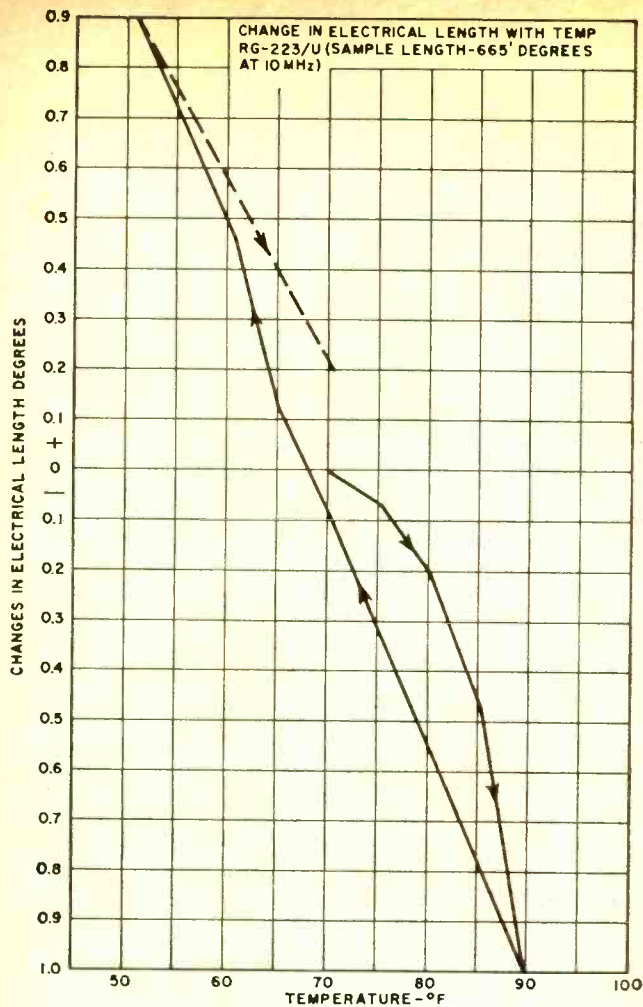

Fig. 2. In coax cables, electrical length changes with temperature. Some cable lengths will vary as much as 1°.

Shielding

Energy pickup and leakage relate to the quality of the cable's shielding. It is important that engineers know how much energy is lost through radiation and how much is picked up from outside sources (interference). The specific application will, of course, spell out tolerances. For example, consider two 20-foot lengths of single-shielded coax cable side by side. A one-volt input to one cable will result in approximately 10^{-4} volt induced in the second cable. This represents an over-all attenuation from cable to cable of 80 dB. This is only an approximation since much depends on the type of installation and surrounding conditions. But it is certainly a correct order of magnitude. In many systems, this much pickup is considered intolerable. Sensitive systems, therefore, use a second shield, triaxial cable, or a semi-flexible cable (aluminum sheath).

Double-shielded cable generally adds about 15 dB more isolation; and triaxial cable about 15 dB more than the double shielded. Cables encased in seamless aluminum sheath are at least 80 dB better than the single-shielded flexible variety. The seamless metal sheath effectively stops energy from escaping or being picked up, except at the connector interface (Fig. 3).

Cables must also match the impedances of the "black boxes" they connect. Compatible characteristic impedances mean efficient transfer of power, no overheating, and no voltage breakdown. Characteristic impedance is a function of conductor size, dielectric material, and form (solid, foam, air); and uniformity of dimensions and velocity of propagation. A 0.1% impedance variation every 3 inches

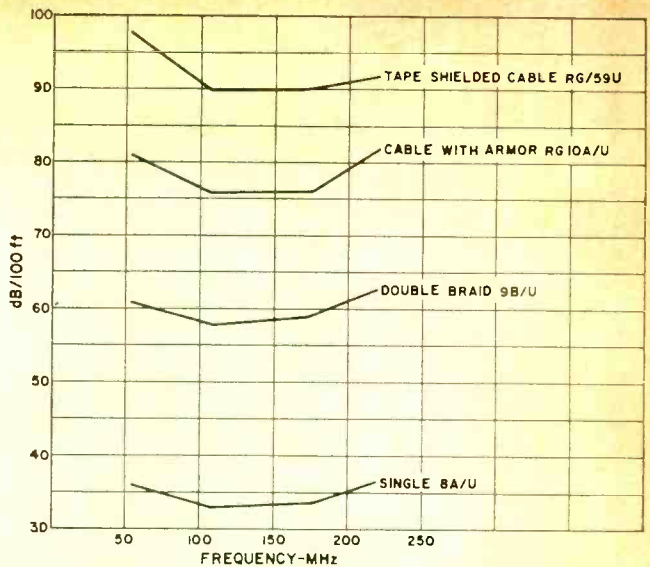

Fig. 3 Relative shielding efficiencies for various cables.

may cause a serious total input impedance variation. Further, these impedance variations occur at discrete frequencies and have bandwidths of approximately 1% (Figs. 4 and 5).

The Mechanical Environment

The mechanical environment in which a cable must work is also important in its selection by the designer. A cable chosen solely for electrical characteristics may be highly unsuited for its intended environment; and one picked for environment may have poor electrical characteristics. As it is with most engineering solutions, the result must be a judicious compromise between function and cost. For example, when a flexible cable with a solid conductor is attached to a shock-mounted piece of equipment or otherwise exposed to frequent motion. A stranded center conductor could be substituted. Characteristically, the stranded conductor will have a much longer flex-life than the solid, but the stranded conductor will have a 20% higher attenuation characteristic. The stranded conductor, however, is obviously the only practical approach and represents good engineering compromise.

Tension

Past installation practices generally account for cable design characteristics such as tensile strength. Cables of less than $\frac{1}{8}$ -inch diameter will usually break at about 100 pounds. Sometimes coaxial cables are used to support a component, in which case a strength member, such as a reinforced center conductor, a rated metallic, Dacron, or fiberglass member, is added. Usually, the limitation in cables over $\frac{1}{8}$ -inch diameter is the method of cable termination.

Moisture and Temperature

Moisture affects the attenuation stability of cables. In

Fig. 4. Variation of v.s.w.r. with frequency. Narrow v.s.w.r. spike (2.1) was caused by bending the cable.

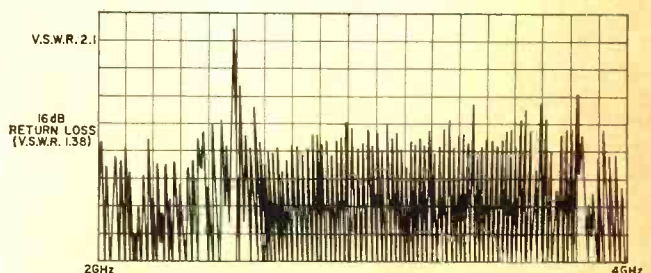

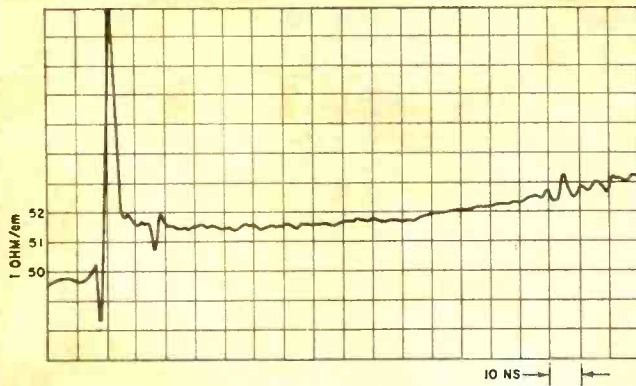

Fig. 5. Impedance changes along the length of a cable.

a 1000-foot cable run it is reasonable to expect one or more pinholes which admit water vapor. Even if there were no pinholes, water vapor might enter the cable through the connector and condense. In the ground, borers or worms may attack the cable jacketing and thus permit water to be admitted. If the dielectric is foam, water vapor will cause an attenuation increase; and if it is solid, the water will eventually corrode the braid or short the connector. Underwater, the problem is even more severe because pressure can push the water through the entire cable length.

Cables sheathed with seamless aluminum are less affected. Sheathed cables that use an air dielectric and a spline construction to protect the center conductor may be pressurized to prevent moisture entry. As long as the cable pressure is higher than the ambient pressure, the conductors will be immune to moisture and corrosion. New techniques developed for flexible and semi-flexible cables permit flooding the outer conductor with a corrosion prevention compound which does not affect the loss-characteristics of the cable. Since flexible cable jackets are not absolutely impervious to ambient moisture, corrosive vapors may also penetrate them and cause an increase in electrical losses with time. Flooding the outer conductor with a moisture-proofing compound is a good solution to this problem. Even aluminum-sheathed cables buried in the earth or otherwise subjected to corrosive ambients must be protected. Standard practice has been to extrude polyethylene jackets onto the aluminum sheaths. In a new manufacturing technique, an additional corrosion preventative layer is added between the sheath and the polyethylene jacket.

Elevated ambient temperatures may cause a permanent change in loss-characteristics by oxidizing the outer conductor. Therefore, attenuation in cables using bare copper and tinned copper conductors increase appreciably at frequencies above 1 GHz. Silver cladding of conductors brings attenuations down to acceptable levels (Fig. 6).

Impedance and Mechanical Environment

Even when the environment does not affect the cable proper, it may affect the cable-to-connector junction. The cable must at all times remain in intimate contact with the connector interface. Tension, flexure, temperature variations—all tend to destroy the contact. Temperature variations often cause some motion or shrinkage of the dielectric. Any such internal motions cause the cable-connector impedance and losses to vary. Sometimes, this kind of situation can go to extremes. A slight motion can, in certain cases, cause a v.s.w.r. of 3.0 and an increase in attenuation of 6 dB. These effects are most pronounced at the higher frequencies where a few thousandths of an inch of motion can mean significant alterations of cable characteristics and therefore significant changes in system performance.

Cable Terminations

All cables must be terminated in some manner. But the manner of termination becomes extremely important and relevant to system operation at frequencies about 1 GHz. Above this frequency, connectors of some kind are employed. But all the factors previously outlined or mentioned as leading to effective, efficient, and economic cable operation may be lost by use of an improper connector or by an improper termination procedure.

Center conductors are normally soldered and sometimes, depending on application, crimped. The UG V-type of braid clamp is usually a part of the outer conductor; or it may be crimped or restrained between the two surfaces of a friction clamp. When using the UG-type clamp, care must be taken to form the outer braid over the clamping ring and to torque the back nut up snugly. With crimp-type devices, the crimp ring location is critical to both the attenuation and v.s.w.r. stabilities of the cable. Center conductor soldering is not really desirable because low temperature dielectrics (such as polyethylene) can overheat and alter the relationship between inner and outer conductor at the connector interface. The cable must seat perfectly in the connector to achieve the designed electrical characteristics. If seating is off by as little as 20 to 30 thousandths, v.s.w.r. at high frequencies may increase. Also, above 1 GHz, cold-solder joints wreak havoc with cable parameters.

There is increasing recognition of the importance and critical character of the interconnecting cable and its termination. The sophistication of the "black boxes" of today is too high to be sacrificed by an inadequate means of energy transfer. There is a trend, therefore, to purchase cable assemblies which have been fully tested for insertion loss and v.s.w.r. over the usable frequency range. Cable manufacturers have developed semi-automated techniques that replace the normal soldering processes as well as the UG-type of clamp and hand tools used in crimping operations. Many types of connectors are now being assembled to cables in a true precision machining process and, in most cases, each and every complete assembly is evaluated by vigorous tests over its entire specified performance range.

Like so many other engineering areas, the design, manufacture, and application of coaxial cables has risen to the level of an independent technology. Nevertheless, it is still difficult to obtain enough cable design information to fully satisfy design needs. One of the best sources is MIL-Handbook-216, available to companies working on military contracts. Manufacturers catalogues are also excellent sources. Some cable fabricators issue technical memoranda from time to time which amplify specific topics of interest to cable users. ▲

Fig. 6. A stability test of RG-214/U with silver-clad outer conductor and bare copper-covered RG-217/U.

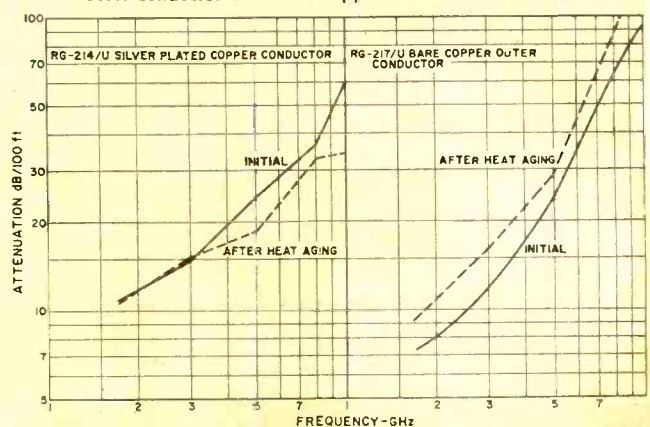



JOHN FRYE

The laser promises to exceed even the cathode ray scope in terms of usefulness and versatility.

THE LASER: TOY OR TOOL?

“MAC.” Barney said to his boss, “what’s all this big deal about lasers? Seems as though I can’t pick up a magazine these days that doesn’t mention them. Last night I suddenly realized that I’ve only a very vague idea of what a laser is or what it can do. Do you suppose you can help clear away any of the smog?”

“I can try,” Mac replied, taking his pipe from his pocket and loading it. “How far back do I have to start?”

“Better just start at the beginning,” Barney answered. “Just assume I’m a complete idiot about lasers and you won’t be far wrong.”

“Okay. In that case we may as well begin with 1917 when Albert Einstein observed that an atom or molecule stimulated by an electromagnetic wave should temporarily absorb energy that would be given off subsequently as light when the particle returned to its unexcited state. Experiments proved him right, and in 1958 Charles Townes and Arthur Schawlow dreamed up a device they thought could be made to produce an intense stream of photons—the basic units of light—by stimulating molecules of gas confined in a cylinder.

“Since the device was actually a variation of Townes’ Nobel Prize-winning invention, the maser, which produced microwaves by a process called ‘microwave amplification by stimulated emission of radiation,’ they called their invention an ‘optical maser.’ In 1960, T. H. Maiman, researcher for the *Hughes Aircraft Company*, used their theory to build the world’s first working laser that emitted bursts of intense red light.

“Instead of a gas, Maiman used a synthetic ruby crystal grown in molten aluminum oxide to which a pinch of chromium had been added to provide the crystals with a chromium atom for every 5000 aluminum atoms. The resulting crystal, in the form of a slender ruby-red rod, had both ends highly polished and silvered to form mirrors. One end was heavily silvered to make it highly reflective, while the other was silvered more lightly to cause it to be partially transparent. A flash tube, similar to that used in strobe lights, was wrapped around the rod in the form of a coil.

“When the flash tube was fired, the intense light it gave off excited the chromium atoms of the crystal, and their electrons shifted to paths farther from their nuclei than normal. When these electrons fell back into place, photons of light were emitted. Some escaped through the transparent walls of the rod, but others hit the mirrors at either end and were reflected back towards the other end. In their ping-pong excursions, the photons stimulated other chromium atoms into emitting photons, and finally the gathering, surging stampede burst through the partially silvered end of the rod in an intense pulse of red light. Since this light was tremendously more powerful than the light from the flash tube that triggered it, we had ‘light amplification by stimulated emission of radiation,’ or a *laser*.

“Laser light differs in important ways from ordinary light. For one thing, it has a very narrow frequency range, and it is *coherent*.”

“Hold it!” Barney interrupted. “That’s the word I keep stumbling across in all laser articles. What does it mean?”

“It means the resonant cavity action of the space between the mirrored surfaces of the crystal has marshalled the photons into plane wavefronts before they escaped. They are working together like oarsmen in a racing shell. Not only does this greatly intensify their collective strength, but it also keeps their parallel rays from diverging. The beam that emerges from the end of the ¼” rod spreads to a width of only 200 feet at a distance of twenty-five miles. Maiman says, in principle, the laser can generate a beam less than a hundredth of a degree of arc.”

“Modern laser light isn’t always red, is it?”

“No. Using different techniques and materials, scientists can produce laser beams in a spectrum of wavelengths all the way from infrared to blue. They can also be produced continuously or in pulses. While that synthetic ruby was the first substance to ‘lase,’ over a hundred different gases, glasses, plastics, semiconductors, and liquids have now been teased into producing laser beams by ‘pumping’ them with flashes of light, high-voltage discharges, the injection of a stream of electrons, or even through the use of chemical agents.”

“I still can’t see why a laser is so super,” Barney complained. “It makes a pretty bright light, and the way it’s produced is pretty neat, but what’s it good for?”

“The raw power that can be packed into a beam of light, the fact the light beam contains a very narrow band of frequencies that permit it to be precisely focused and used in making precise measurements, and the ability to maintain a very narrow beam over great distances—these are the important properties of the laser,” Mac replied.

A laser beam can be focused into a spot only 1/10,000th of a centimeter wide, and that tiny spot burns billions of times brighter than the sun’s surface. It can punch holes through steel plates, can ‘weld’ a detached retina in a human eye, and can cut through flesh like a surgeon’s scalpel and cauterize the smaller severed blood vessels as it goes. Since the beam actually exerts pressure on a surface on which it impinges, it has been proposed that powerful laser beams be used to push back into orbit satellites that have begun to fall toward the earth, or even to generate enough heat to melt an incoming ICBM before it can reach its target.

“Keep in mind that a laser wavelength is only about 1/1000th as long as the microwaves used in conventional radar. This makes laser altimeters, range finders, and aerial mappers extremely accurate. *Honeywell* recently developed a laser gyroscope that employs laser beams instead of a spinning rotor to sense rotation, thus doing away with the friction and drift of conventional gyros. Explorer 22 carried aloft a 10-lb array of fused silica glass mirrors that reflected back to earth a tracking laser beam. With this device it was possible to locate the satellite within ten feet at a distance of 600 miles. Two Japanese firms, *Hitachi Ltd.* and the *Mitsubishi Electric Corp.*, are exploiting at shorter ranges this ability of a laser beam to resolve linear measurements accurately. The equipment translates the contours of clay automobile models into digital dimensional data. Changes in contours detected by the laser are recorded on tape that

Deluxe ELECTRONICS WORLD MAGAZINE CASES

DESIGNED TO HOLD A FULL YEAR'S COPIES



These decorative, yet sturdily constructed cases are just what you've been looking for to keep your copies of Electronics World Magazine in easy-to-find order.

Constructed of reinforced fiberboard and covered in rich leatherette, these durable cases guard against soiling and tearing of your magazines while lending themselves handsomely to the decor of any room, whether it be a library, study, den, music room or pine-paneled garage. The magazine cases are available with embossed gold lettering in either all black or attractive maroon back with black sides.

Specially designed to hold a full year's copies of Electronics World Magazine, the cases are only

\$3.50 ea., 3 for \$10, 6 for \$19
FULLY GUARANTEED

NOTE: Magazine cases are also available for other of your favorite titles. For prompt shipment, use the coupon below.

Ziff-Davis Publishing Company, Dept. SD
One Park Avenue, New York, N.Y. 10016

Please send _____ Electronics World Magazine Cases. Also send cases for the magazine titles indicated below:

TITLE	QUANTITY
_____	_____
_____	_____
_____	_____

- All black, gold embossed
 Maroon back, gold embossed/black sides

Enclosed is \$_____ at \$3.50 per case, 3 for \$10, 6 for \$19 (Quantity prices apply for combination orders of more than one title). Orders outside U. S. A. \$4.50 ea., 3 for \$13, 6 for \$25.

Name _____ EW-108
Address _____
City _____
State _____ Zip Code _____

Payment must accompany order.

can be processed by a computer to generate control programs for the automatic milling of stamping dies. This materially reduces the time needed for new auto designs to get from the styling studio to the production line.

"The rare-earth gallium-arsenide semiconductor laser devised by R. N. Hall of *General Electric Company* is especially interesting. It is easily excited to laser action with efficiencies up to 75% and is responsive to simple caloric, magnetic, or electric-potential control of modulation and frequency. That makes it ideal for use in communications, and desert distances up to 118 miles have been spanned by communication over such a laser beam. The Air Force Avionics Laboratory at Wright-Patterson AFB has developed a single-laser communications system that can carry ten TV channels simultaneously.

"The use of the beam as an illuminant also has some interesting possibilities. For example, a laser beam in combination with a spinning mirror camera and a Kerr-cell shutter has produced framing rates exceeding one million per second and individual exposure times of less than 30 nanoseconds. And very recently it has been discovered that if an object is illuminated with two lasers of different colors and a holographic picture is taken of the object, a full-color three-dimensional picture can be reproduced with ordinary light shining through the film. The reproduced image seems to float in space, and if the observer moves, he changes his field of view just as if he were observing a real object. This may well be the forerunner of 3D color-TV.

"Physicist Schawlow insists lasers are still very primitive devices. 'They're still about at the crystal stage of radios, or airplanes around 1910,' he says and goes on: 'Laser technology has come a long way, but it still has a hell of a long way to go.'

"He thinks that in no more than twenty years the laser will be a common tool in the office, the factory, and in the home, where it may be used to peel potatoes and as a pilot light for kitchen stoves. To make his point, he has built and will soon market a laser eraser, a model of which he has already attached to his typewriter. When Schawlow makes a mistake, he pushes a button and the laser beam vaporizes the dark energy-absorbing typed letters and leaves the energy-reflecting white paper unscarred with no eraser rubbings to be brushed away.

"The thin, perfectly-straight beam of a laser makes a wonderful 'chalk-line' for tunnel builders and other construction workers. It can even remove a tattoo design from human skin. The laser ray penetrates the translucent white skin with little harm but vaporizes the

darker dye pigment beneath. In the same manner a laser beam can weld a broken lead inside a vacuum tube without damaging the glass envelope."

"Okay, okay! I'm convinced a laser is a perfect chalk line, an extremely accurate micrometer, a welder, a punch press, a radar, a gyroscope, a high-speed camera, a super-duper coaxial cable, a bloodless surgical knife, an eraser, a potato peeler, and a producer of optical illusions," Barney exclaimed. "That thing has more uses than a zipper!"

"You'll get no argument out of me about that," Mac said. "It reminds me very much of the cathode-ray oscilloscope. When that first came out, it seemed little more than a laboratory toy; but it soon moved on to the production line as a test instrument, went to war as a radar display device, came into the home as the heart of black-and-white TV and then color-TV, and proliferated into dozens of different versions.

"The laser seems destined to follow in its footsteps. At first, as Maiman put it, the new light source seemed 'a solution seeking a problem,' but it is finding those problems with ever-increasing frequency and is solving them. Even now lasers are a \$300 million a year business, and this is expected to grow to a billion-dollar-a-year business by 1975."

"I'd like to make a final small contribution to this discussion," Barney declared. "I read recently that several authorities are calling for stricter safety around lasers. Split-second exposure of the eye to a laser beam is all it takes to cause permanent burns to the retina or even blindness. In the laboratory lasers have produced fatal hemorrhages in the brains of mice. Several agencies are investigating hazards that may threaten workers around lasers. That pretty pencil of colored light is like the pretty little coral snake: it's nothing to fool around with!" ▲



"You're always blaming it on calories . . . scientists say it's gravity."

NEW

FINCO®

COLOR SPECTRUM™ ANTENNAS

are "signal customized"
for better color reception...



"the ANTENNA that captures the RAINBOW"

FINCO has developed the Color Spectrum Series of antennas — "Signal Customized" — to exactly fit the requirements of any given area.

There is a model scientifically designed and engineered for your area.

Check this chart for the FINCO "Signal Customized" Antenna best suited for your area.

STRENGTH OF UHF SIGNAL AT RECEIVING ANTENNA LOCATION ▼	Strength of VHF Signal at Receiving Antenna Location				
	NO VHF ▼	VHF SIGNAL STRONG ▼	VHF SIGNAL MODERATE ▼	VHF SIGNAL WEAK ▼	VHF SIGNAL VERY WEAK ▼
NO UHF →		 CS-V3 \$11.50	 CS-V5 CS-V7 \$18.50 \$25.95	 CS-V10 \$37.95	 CS-V15 CS-V18 \$50.95 \$59.50
UHF SIGNAL STRONG →	 CS-U1 \$10.50	 CS-A1 \$19.95	 CS-B1 \$31.50	 CS-C1 \$45.95	 CS-C1 \$45.95
UHF SIGNAL WEAK →	 CS-U2 \$15.95	 CS-A2 \$23.95	 CS-B2 \$41.95	 CS-C2 \$54.50	 CS-D3 \$73.50
UHF SIGNAL VERY WEAK →	 CS-U3 \$22.95	 CS-A3 \$32.50	 CS-B3 \$52.50	 CS-C3 \$62.95	 CS-D3 \$73.50



NOTE: In addition to the regular 300 ohm models (above), each model is available in a 75 ohm coaxial cable download where this type of installation is preferable. These models, designated "XCS", each come complete with a compact behind-the-set 75 ohm to 300 ohm balun-splitter to match the antenna system to the proper set terminals.

All Prices Subject to Change

THE FINNEY COMPANY

34 West Interstate Street • Dept. 410 • Bedford, Ohio 44146

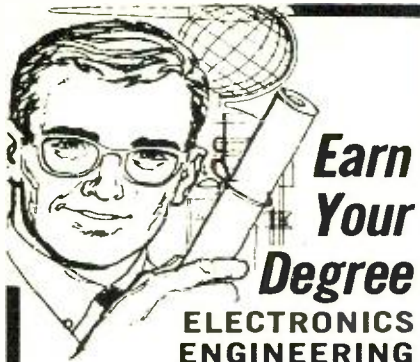

Earn Your Degree

ELECTRONICS ENGINEERING

through HOME STUDY

HIGHLY EFFECTIVE HOME STUDY COURSES IN:

- Electronics Engineering Technology
- Electronics Engineering Mathematics

Earn your Associate in Science Degree in Electronics Engineering and upgrade your status and pay to the engineering level. Complete college level courses in Electronics Engineering. We're a forward looking school. Outstanding lesson material—thorough and easy to understand. Engineering taught on the basis of application and understanding rather than on the basis of memorization. Up to date in every respect. Acquire the knowledge and ability that means the difference between a low paying technician job and a high paying engineering position. Low tuition cost with low monthly payments. Free engineering placement service for our graduates. Write for free descriptive literature. Ask for bulletin E, no salesman will call on you.



COOK'S INSTITUTE of Electronics Engineering

Forest Hill Road
P. O. Box 10634
Jackson, Miss. 39209
Established 1945
Formerly Cook's School of Electronics

CIRCLE NO. 114 ON READER SERVICE CARD

the new ELPA PE-2020 Automatic Turntable lets you escape from the ordinary

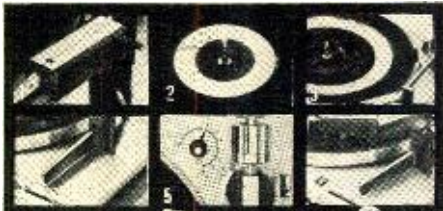

Here's why:

(1) The exclusive 15° vertical tracking angle adjustment — permits the precision tracking of a manual transcription turntable. (2) Stylus protection — tonearm never lowers on an empty platter. (3) Automatic scanning — automatically determines size of record on platter and adjusts tonearm accordingly . . . automatically. (4) Simplicity of operation — one lever for all modes of operation. (5) Anti-skating — the finest of any automatic turntable. (6) Motor driven cueing — never any damage to record grooves or stylus.

AND THERE ARE MANY, MANY MORE SUPERLATIVE FEATURES ON THE NEW ELPA PE-2020

Don't make a buying decision on an automatic turntable without seeing the finest . . . the new ELPA PE-2020. See it at your hi-fi retailer, or write for full literature and name of nearest franchised dealer.

ELPA MARKETING INDUSTRIES, INC. New Hyde Park, N.Y. 11040
CIRCLE NO. 108 ON READER SERVICE CARD

STEERABLE ANTENNA

AN electronically steerable antenna has an important advantage over other antenna types; it can pinpoint its beam at a single target. Steerability and high performance are features of a truly unique antenna design developed by *E.M.I.-Cossor Electronics Ltd.*

This aperiodic loop antenna is a high-gain steerable system designed to provide the maximum directive gain in the smallest possible amount of space. The basic beam pattern is optimized for the reception of high-frequency signals (2 MHz to 32 MHz) propagated *via* the ionosphere, in the same manner as the aperiodic linear arrays.

The antenna consists of 36 loop elements arranged around the perimeter of a 150-foot circle. By appropriate phase shifts, the loop outputs are combined to provide simultaneous beams every 10 through 360 degrees. Alternatively,

voltage (at a constant 50-ohm impedance) is constant over the complete frequency range for fixed incident field strength. Because of the flat frequency response, the antenna has a well-defined phase characteristic and is, therefore, particularly suited for a phased antenna system. The aperiodic configuration comprises loop/preamplifier elements in an "end fire" array with interconnecting transmission lines coupling each element. Outputs are available at both ends so that the array can look both ways simultaneously if required or can be switched rapidly through 180° with a coaxial relay.

The aperiodic loop array antenna is available in at least three different models whose principal differences lie in the number of loops employed. A typical 50-meter (diameter), 36-loop array would have directional characteristics

Freq. (MHz)	Front-to-Back Ratio (dB)	Azimuth Beam-width (-3 dB) (degrees)	Elevation Beam-width (-3 dB) (degrees)	Approx. Directional Gain dB (relative to isotropic)
30	16	9(±4.5)	22	19
12	14	20(±10)	35	15
6	11	38(±19)	51	12
3	11	64(±32)	78	9

Table 1. Directional characteristics of aperiodic loop antennas.

with a commutator switch, the beam can be made to scan at a fixed rate. This latter capability is especially valuable when the antenna system is used as a direction finder, while the former arrangement provides directional gain characteristics equivalent to 18 rhombic antennas inclined at 10° to one another.

The basic antenna element is an untuned balanced loop whose dimensions are small compared to the wavelength. A transistorized preamplifier, fitted at the antenna base, exactly complements the loop characteristics. This combination results in a constant effective height over the full four-octave frequency range, that is, the preamplifier output

such as those listed in Table 1. The loop in a basic element assembly is about 1 meter in diameter. Including the support tripod and preamplifier, the element weighs about 12 pounds. When rigidly bolted to the ground, the vertically polarized individual antenna elements are capable of withstanding winds up to 100 miles-per-hour.

Several government agencies and institutions have begun to use aperiodic loop antennas as part of their national and international communications systems. The array is being used by Diplomatic Wireless Service in Buckingham, England; Department of Transport, Ottawa, Canada; U.S. Navy; and University of Denver. ▲

Fig. 1. Typical aperiodic loop antenna array has 36 elements in 50-meter circle.

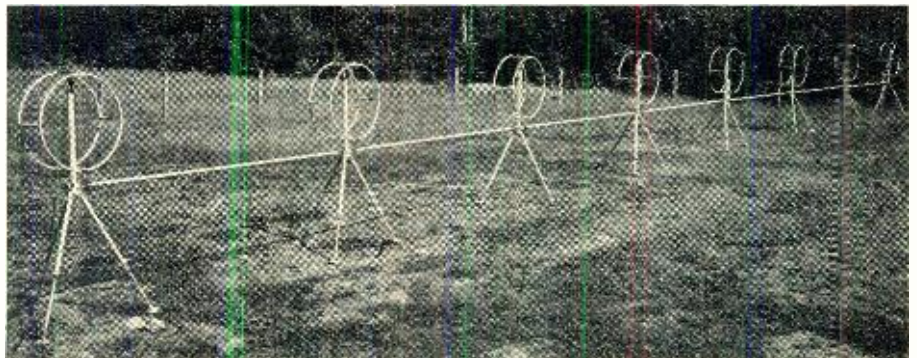

Technical Series HM-90

\$1.75

Suggested Price

RCA SOLID-STATE Hobby Circuits Manual

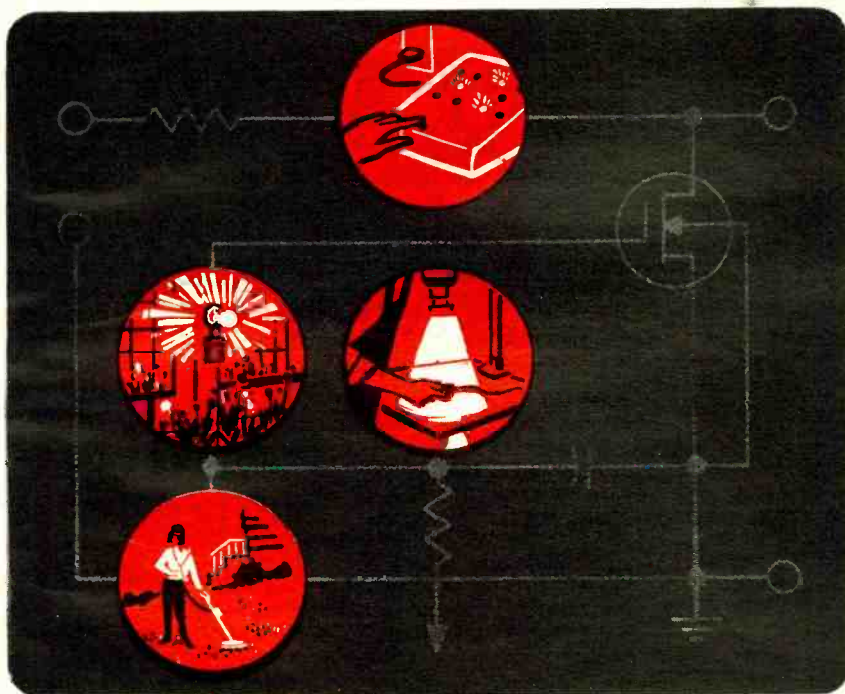

RCA

Novice or expert...

Here are many new, exciting solid-state hobby projects

For you, in this new manual from RCA, are 35 construction projects to satisfy your hobby interests for the coming months.

This newest addition to the expanding RCA technical library, the RCA Solid-State HOBBY CIRCUITS MANUAL, HM-90, has "something for everyone"—from beginner to expert. The 35 circuits are of interest to electronic experimenters including hams, motorists, photographers, home owners, and music and hi-fi buffs. Circuits are described in detail with circuit schematics, layouts, templates, parts lists and photographs. In addition, there are sections on theory and practical applications of solid-state devices—including integrated circuits and MOS/FET units as well as a section on trouble shooting and testing.

Typical circuits include:
electronic slot machine •
electronic dice • metal detector •
single-voice organ • electronic
metronome • code-practice
oscillator • automatic keyer •
enlarger exposure meter • lamp
dimmer • electronic "fuzz" box •
audio amplifier • automobile
tachometer • motor speed
control • electronic flasher •
light minder for automobiles, and
twenty other interesting circuits.

See your RCA Distributor today for your copy of HM-90, published by RCA Electronic Components, Harrison, N. J. 07029

RCA

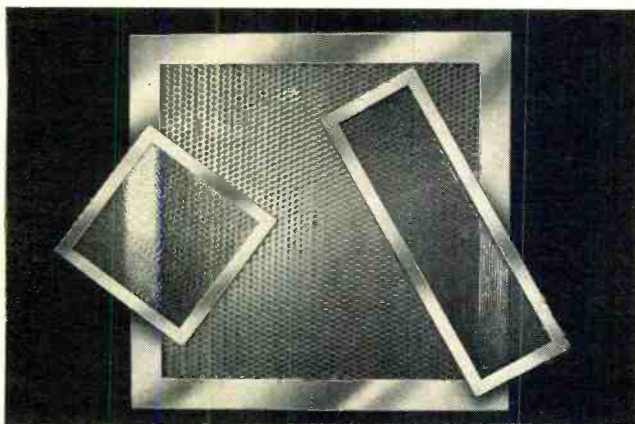

Shield-Cell®

... removable shielded cooling cells that install quickly, economically.

Shield-Cell is available in 3 unique frame designs for quick, low-cost installation. Provides attenuation of up to 100 db. Its metal-to-metal permeated aluminum honey-comb panels can be removed from frames, reducing

replacement costs up to 75%. High-reliability design includes METEX electronic weatherstrip RFI gasket. Shield-Cell mounts inside enclosure for extra protection. Write for prices and literature.

METEX Corporation

970 New Durham Road, Edison, N. J. 08817
(201) 287-0800 • TWX 710-998-0578
West Coast: Cal-Metex Corp., 509 Hindry Ave. Inglewood, Calif. 90301
(213) 674-0650 • TWX 910-328-6100



CIRCLE NO. 200 ON READER SERVICE CARD

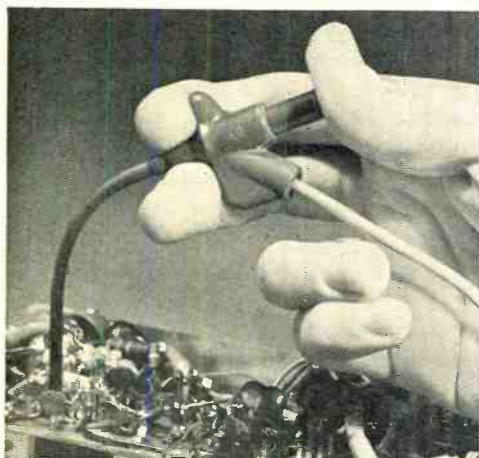

Clever Kleps 30

Push the plunger. A spring-steel forked tongue spreads out. Like this  Hang it onto a wire or terminal, let go the plunger, and Kleps 30 holds tight. Bend it, pull it, let it carry dc, sine waves, pulses to 5,000 volts peak. Not a chance of a short. The other end takes a banana plug or a bare wire test lead. Slip on a bit of shield braid to make a shielded probe. What more could you want in a test probe?

Available through your local distributor, or write to: **\$147**



RYE INDUSTRIES INC.

127 Spencer Place, Mamaroneck, N.Y. 10543

CIRCLE NO. 87 ON READER SERVICE CARD

BOOK REVIEWS

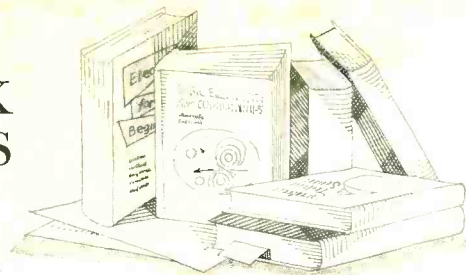

"WAVEFORM MEASUREMENTS" by Rufus P. Turner. Published by *Hayden Book Company, Inc.*, New York. 84 pages. Price \$2.95. Soft cover.

It is a wonder someone didn't think of compiling information on waveform measurements in a single book before. This is a how-to approach ranging from troubleshooting to signal synthesis. Presented in concise, no-nonsense format, this little reference work should be very useful to electronics personnel in their day-to-day operations.

Equal attention is given to the instrument measurement of frequency components which determine the particular shape of a wave as well as those which influence circuit behavior. Step-by-step procedures show the proper use of various instruments including scopes, wave analyzers, distortion meters, and recorders. The text is illustrated throughout.

"ELECTRONIC ENGINEERING NOMOGRAMS" by Max H. Applebaum. Published by *Tab Books*, Blue Ridge Summit, Pa. 17214. 175 pages. Price \$9.95. Spiral bound.

Readers of this magazine have long been familiar with nomograms bearing the Applebaum byline. Here is a compilation of over 100 nomograms designed to provide quick solutions to a wide variety of complicated electronic problems. There is explanatory material accompanying each nomogram. The subject matter covers conversion charts, attenuators and filters, transmission lines, passive components, vacuum tubes, transistors, etc.

Presented in a hard-cover, spiral binding, this 8½ x 11 inch format is designed for easy use on the service bench or desk. The type and nomograms are large and clear for quick reading.

"WORKING WITH THE OSCILLOSCOPE" by A.C.W. Saunders. Published by *Tab Books*, Blue Ridge Summit, Pa. 17214. 104 pages. \$6.95 hard cover, \$4.95 soft cover.

This is a workbook for students learning how to operate today's scopes. The first lesson is devoted to the scope itself—its component parts and the various controls. Lesson two describes the various patterns, while lessons three and four cover time-base oscillators and v.t. time-base generators. Lesson five covers the vertical-deflection amplifier.

The balance of the book is given over to twenty-six projects for the students to work. The projects get progressively more difficult and complicated and if the student completes all 26 successfully, he should have a better-than-average grasp of scope fundamentals.

The text is lavishly illustrated and the large type and generous page size makes the manual easy to consult while the experiments are being performed.

"INTRODUCTION TO THE BASIC COMPUTER" by Donald Eadie. Published by *Prentice-Hall, Inc.*, Englewood Cliffs, N.J. 423 pages. Price \$11.50.

This volume had its beginnings as class notes for an in-company course the author taught at *Honeywell* and has been expanded to include most of the fundamentals of digital computers.

The first five chapters cover the basic theory required for the study of digital devices in general and digital processes in particular. The later chapters describe how a computer

YOU'RE LOOKING AT THE BANK ACCOUNT OF A \$25,000 ENGINEER

IT'S HIS INFORMATION BANK

(You can open an account today)

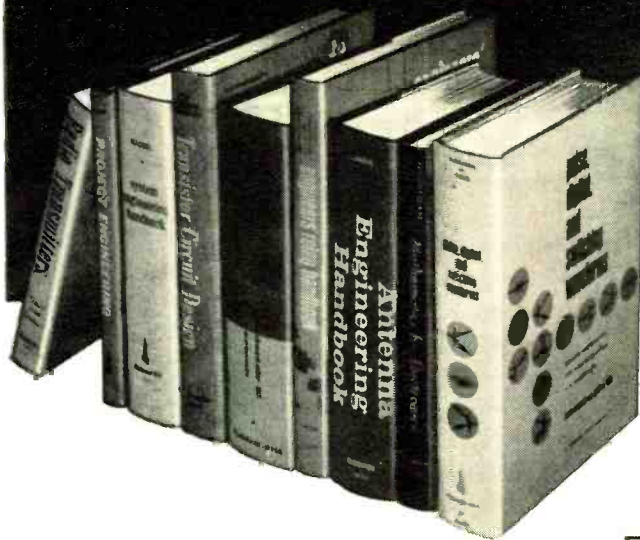

Further your own career by joining the Electronics and Control Engineers' Book Club... and save money on every book you buy!

TAKE ANY ONE FOR ONLY \$1
with your first club selection

Values from \$8.00 to \$29.50

#171. **Engineers' Relay Handbook** by the National Association of Relay Manufacturers. Comprehensive information on operating principles, properties, performance characteristics, application requirements, specifications, and testing.
Pub. Price, \$11.95 **Club Price, \$10.15**

#381. **Pulse, Digital, and Switching Waveforms** by J. Millman and H. Taub. Working descriptions of active and passive devices and circuit configurations for the generation and processing of pulse-type signals.
Pub. Price, \$18.00 **Club Price, \$15.30**

#290. **Antenna Engineering Handbook** by Henry Jasik. Provides a vast storehouse of data on antenna design for commercial and military applications.
Pub. Price, \$26.50 **Club Price, \$18.95**

#850. **Mathematics for Electronics with Applications** by H. M. Nodelman. Offers the working engineer practical, time-saving mathematical techniques.
Pub. Price, \$8.00 **Club Price, \$6.80**

#509. **Electronic and Radio Engineering** by F. E. Terman. Helps you solve problems in FM, TV, pulse techniques, and higher parts of the radio spectrum.
Pub. Price, \$17.50 **Club Price, \$14.95**

#737. **Transistor Circuit Design** by the Engineering Staff of Texas Instruments, Inc. Tested solutions to a wide range of today's basic circuit problems.
Pub. Price, \$15.00 **Club Price, \$12.75**

#371. **System Engineering Handbook** edited by R. E. Machol. Covers system environments, system components, theory, techniques, and useful mathematics associated with system engineering.
Pub. Price, \$29.50 **Club Price, \$25.00**

#240. **Radio Transmitters** by L. Gray and R. Graham. Gives a detailed analysis of transmitter components with design information on amplifiers, coupling circuits, frequency control units, power supplies, cooling equipment, and control circuits.
Pub. Price, \$14.00 **Club Price, \$11.90**

#530. **Project Engineering** by Victor Hajek. How to plan and execute a technical program efficiently and profitably, with recent advances in project monitoring, including PERT.
Pub. Price, \$8.50 **Club Price, \$7.25**

There are no more powerful tools than *books* in building a successful engineering career. Here's a professional Club Plan that assures you of getting the most needed and practical books in your field—at an average savings of 15% from publishers' prices.

HOW THE CLUB OPERATES. Basic to the Club's service is its publication, the *Electronics and Control Engineers' Book Club Bulletin*, which brings you news of books in your field. Sent to members without cost, it announces and describes in detail the Club's featured book of the month as well as alternate selections which are available at special members' prices.

When you want to examine the Club's feature of the month, you do nothing. The book will be mailed to you as a regular part of your Club service. If you prefer one of the alternate selections—or if you want no book at all for that month—you notify the Club by returning the convenient card enclosed with each *Bulletin*.

As a Club member, you agree only to the purchase of four books over a two-year period. Considering the many books published annually in your field, there will surely be at least four that you would want to own anyway. By joining the Club, you save both money and the trouble of searching for the best books.

MAIL THIS COUPON TODAY

electronics and control engineers' book club
582 PRINCETON ROAD, HIGHTSTOWN, N. J. 08520

Please enroll me as a member of the Electronics and Control Engineers' Book Club and send me the two books indicated below. You will bill me for my first selection at the special Club price and \$1 for my new membership book, plus local tax where applicable, and a few additional cents for delivery costs. These books are to be shipped on approval, and I may return them both without cost or further obligation. If I decide to keep the books, I agree to purchase as few as four additional books during the next two years at special Club prices (approximately 15% below list).

Write Code # of your \$1 bonus book

Write Code # of your first selection

NAME _____

ADDRESS _____

CITY _____ STATE _____ ZIP _____

COMPANY _____

(This offer good in United States and Canada)

E33066

Weller®

**makes first class
soldering the easiest
part of any job**



The original Dual Heat Soldering Guns

Preferred by technicians for their fast heating copper tips, exclusive trigger-controlled dual heat, and high soldering efficiency. Available in 3 wattage sizes, each with spotlight.

100/140-watt Model 8200, 145/210-watt Model D-440, and 240/325-watt Model D-550. Also in complete kits.

Dependable MARKSMAN Irons in a size for every job



Ideal for deep chassis work and continuous-duty soldering, Marksman irons outperform others of comparable size and weight. All five feature long-reach stainless steel barrels and replaceable tips.

- 25-watt, 1¾-oz. Model SP-23 with 1/8" tip (In kit with extra tips, soldering aid, solder—Model SP-23K)
- 40-watt, 2-oz. Model SP-40 with 1/4" tip
- 80-watt, 4-oz. Model SP-80 with 3/8" tip
- 120-watt, 10-oz. Model SP-120 with 1/2" tip
- 175-watt, 16-oz. Model SP-175 with 5/8" tip

25-watt Technician's Iron for intricate circuit work



Industrial rated pencil iron weighs only 1¾ ounces, yet delivers tip temperatures to 860°F. Cool, impact-resistant handle. All parts readily replaceable. Model W-PS with 1/8-inch tapered tip.

Also available: A new Battery Operated Iron for use with 12 volt battery or 12-24 volt AC/DC source. Complete with 12 ft. cord and battery clips. Model TCP-12.

Complete Weller Line at your Electronic Parts Distributor.

WELLER ELECTRIC CORPORATION, Easton, Pa.

WORLD LEADER IN SOLDERING TOOLS

CIRCLE NO. 80 ON READER SERVICE CARD

performs arithmetic operations, how a modern memory operates, how a program controls the computer, and how the computer adapts to various peripheral devices.

This text could be used as a 40-hour junior college, technical institute, or undergraduate course or as an orientation course for technicians and engineers in the digital field.

Three helpful appendices are included, covering logic symbols, a selected bibliography, and a comprehensive glossary of terms.

* * *

"HI-FI LOUDSPEAKERS AND ENCLOSURES" by Abraham B. Cohen. Published by *Hayden Book Company, Inc.*, New York. 427 pages. Price \$5.95. Soft cover.

This is a revised second edition of a volume which has already won a wide audience among audiophiles—professional and lay alike. The subject matter has been expanded, however, to include the listening room as part of the total environment.

The first part of the book is devoted to the loudspeaker itself: the basic types; the mechanics of good speaker design; speaker resonance, impedance, and damping; speaker system design; and networks in multi-speaker systems.

Part two deals with the various types of enclosures and how to choose them for specific speakers and specific applications. Part three, on the room, treats the environment as part of the over-all acoustic circuit and also discusses placement and various adjustments. Basic stereo practice is dealt with in the fourth part, while the concluding part covers acoustic measurements and provides extensive information on the construction of various types of enclosures.

The book is lavishly illustrated, clear and concise in its presentation, and a worthwhile source book for anyone who cares enough about the high-fidelity reproduction of his favorite programs or records.

* * *

"FUNDAMENTALS OF INTEGRATED CIRCUITS" by Lothar Stern. Published by *Hayden Book Company, Inc.*, New York. 195 pages. Price \$8.95.

Here is a welcome addition to the *Motorola* series covering solid-state electronics and one that will be helpful to all segments of the industry.

This volume provides the basic information needed to apply IC's to all areas of electronics and bridges the gap between the design and marketing concepts associated with discrete-component equipment and the integrated-systems approach.

The author has covered every phase of the industry from engineering to servicing and from equipment to product marketing. Management personnel will find the volume useful as will engineers and technicians. Separate sections cover semiconductor principles, IC's and their components, compatible circuits, circuit design latitude and limitations, and packaging.

Mathematics has been kept to a minimum and only a basic knowledge of electronics and semiconductor principles is prerequisite.

* * *

"COLOR TV SERVICING" by Walter H. Buchsbaum. Published by *Prentice-Hall, Inc.*, Englewood Cliffs, N.J. 262 pages. Price \$9.95.

This is a second edition of this basic servicing handbook which has been updated to include solid-state circuitry in the sets and the introduction of numerous items of service test equipment.

Written for the busy technician, the text provides a basic grounding in the why's and how's of color-TV, and then concentrates on specific servicing problems—from installation of the receiver, setup, to troubleshooting various color faults. In addition to the lavish use of schematics, block diagrams, and photographs, there are color sections in the book to help the technician pinpoint service faults accurately and quickly. ▲

Tape-Recorder Maintenance Program

By LEONARD KUBIAK

Whether your recorder is operated 4 to 8 hours a day, as is the author's, or less frequently, a regular program of care and maintenance will go far in assuring you top-notch recorded tapes.



IF YOUR tape recordings are plagued by poor frequency response, excessive flutter or wow, or a noticeable slow-down in tape speed toward the end of the reel, and your tape recorder is a good one, then you may not be keeping the recorder in top operating condition. A preventive-maintenance program will go far in keeping the performance high. Let's take a look at some of the problems and see how they can affect the performance of your tape recorder.

The Main Problems

Poor Frequency Response: This results in a "down-in-the-barrel" sound or loss of presence. Since the playback head is an electromagnet with a very narrow gap width, it is extremely sensitive to iron-oxide deposits. Only a few grains of iron-oxide rub-off from one of the tapes can effectively short out the higher frequencies.

A second cause of high-frequency loss can be traced to magnetized heads and tape guides. After running several miles of recorded tape through the recorder, all of the metal surfaces which come in contact with the tape become partially magnetized. When this happens, the magnetized surfaces actually erase the higher frequencies on pre-recorded tapes. A magnetized playback head also results in increased background noise level, which is particularly annoying during the lower passages of classical music.

The third major reason for poor frequency response is improper azimuth head alignment. Unless the playback and record heads are perfectly aligned, the higher frequencies will be greatly attenuated. Azimuth alignment should be performed periodically to compensate for uneven head wear and other factors which may have caused the heads to become slightly out of alignment.

Flutter and Wow: These are undesirable variations which occur in the pitch of sound, particularly noticeable in musical tapes. This type of distortion is generated by unsteady tape movement across the heads due to slippage somewhere between the drive motor and the tape. Generally this is caused by an oily drive belt, a dirty or misadjusted capstan pressure roller, dirty pressure pads, or other factors which produce excessive hold-back tension.

Tape Speed Slow-Down: Tape speed slow-down toward the end of a tape is a fairly common problem. As the amount

of tape on the supply reel decreases, the hold-back tension increases. Any tendency to slippage between the capstan roller and the tape shows up at this point on the tape. The problem is aggravated if thin tape (one mil) is being used.

Preventive-Maintenance Program

Let's see what can be done to keep the recorder in top operating condition. First of all, use only good-quality tape. Avoid tapes which are noticeably deteriorating or improperly lubricated. Second, set up a preventive-maintenance program such as the one to be described.

Daily Cleaning Schedule: The tape guides, pressure pads, and pressure roller should be cleaned daily with isopropyl or denatured alcohol. The heads should also be scrubbed at this time with a special head cleaner solution, such as the *Ampex 4010823* head cleaner. To prevent accidental damage to the heads, use a non-metallic cotton swab such as a "Q Tip" and discard after use to prevent contamination of the cleaning solution remaining in the container. When using head-cleaner solutions, avoid spilling the solution on any of the plastic surfaces as damage may result.

Weekly Demagnetization: Approximately once a week, the capstan, tape guides, and record and playback heads should be demagnetized, using a standard head demagnetizer. Proper demagnetization involves bringing the tip of the demagnetizer in slowly to the head gaps and gently moving it up and down the head gaps. Then slowly remove the demagnetizer to at least three feet away before turning off the power. The same demagnetization procedure should be followed for each of the metallic surfaces which come in contact with the tape during normal operation.

Semi-annual Check and Alignment: Approximately every six months the tape recorder should undergo a complete checkup. The record and playback heads should be aligned, the tape speed checked, record bias adjusted, and a complete record and playback frequency test performed. In addition, the six-month checkup should include a thorough cleaning of the interior of the recorder with denatured alcohol. Make certain the drive belts, idler wheel, and fly-wheel assembly are absolutely free of oil or other forms of contamination. Check the belts for signs of wear (replace if stretched or cracked). Oil the machine lightly according

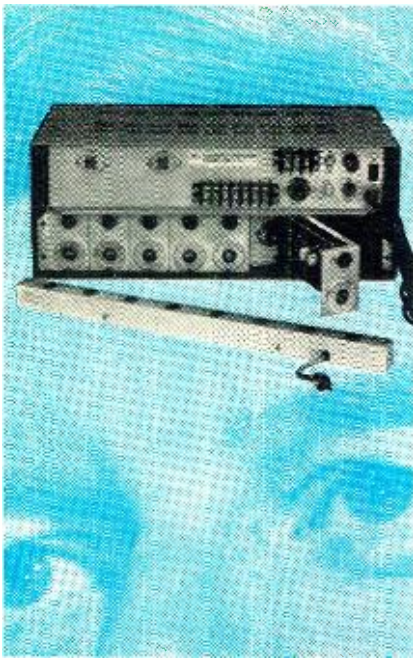

dream
factory!

"Invent" a whole new sound system . . . fast 'n easy . . . with new BELL P/A MODULAR AMPS

Bell P/A's "stacking" principle gives you *unusual design flexibility*. Place up to 8 input modules in different positions . . . get thousands of possible input configurations.

FET's are located up front for true Hi Z input (or bal. lo Z with trans.). Units have 20, 45, 90 or 200-watt output (RMS ratings)! All silicon solid state design.

Exclusive, fully automatic output circuit protection (with signal light) saves time, labor, components . . . eliminates guesswork. See your local electronics distributor, or send for full specs.

BELL P/A
professional appeal

BELL P/A PRODUCTS CORPORATION
1209 North Fifth St., Columbus, Ohio 43201

to the instruction manual which accompanies the recorder. Avoid over-oiling as the excess oil may collect on the drive belts or other critical points.

Tests and Adjustments

Playback Frequency Test and Azimuth Head Alignment: Before beginning the frequency-response test, carefully clean and demagnetize the heads and tape guides. If the recorder is not equipped with an accurate vu meter, connect a v.t.v.m. or external vu meter to the preamp output jacks.

Play a standard alignment test tape, such as the *Ampex 01-31321-01*, on the recorder. (Alignment tapes are available for full-track, half-track, and quarter-track recorders at 3¾ or 7½ in/s speeds.) Record the output readings.

The first tone on the tape (as identified by a narrator's voice) is a 700-Hz tone used to adjust the playback volume to a convenient and easy-to-read point on the vu meter. Since all of the tones on the test tape are recorded at the same level, the recorder should play back each of the tones on the test tape at the same level as the 700-Hz tone.

The next frequency tone is 15,000 Hz, which is used to adjust the playback head azimuth. With a small screwdriver (or Allen wrench, if this is required) rotate the azimuth screw until the highest possible reading is obtained on the output meter. At this point the playback head is in proper azimuth alignment.

Continue playing the tape through the remainder of the test frequencies. A good recorder will reproduce the entire range of frequencies from 50 to 15,000 Hz at a level of ± 4 dB of the original reference level.

Record Adjustments: After the playback section of the recorder is known to be in satisfactory operating condition, the record section can then be aligned. Never attempt to make any of the record adjustments without first aligning the playback section. Note that all record indications are dependent upon the playback circuitry.

The first step in the record alignment procedure is the selection of a blank tape which represents the type of tape most often used for recording on your machine. If a wide assortment of tapes will be used in recording, the *Scotch 111* may be used as a standard. The selection of an average tape is important as the optimum record bias setting varies from one brand and type of tape to another. Record bias, in turn, affects the record frequency response.

The next step consists of connecting an audio generator to the line input of the recorder. Use the same vu meter connections as were used in servicing the playback section. You are now ready for the record alignment procedure.

Record Bias Adjustment: Set the audio generator to a frequency of 400 Hz and place the machine in the record position. Set the bias oscillator adjustment to the point which produces a maximum output reading on the vu meter.

Record Head Alignment: Set the generator to a frequency of 10,000 Hz and continue recording on the blank tape. Adjust the record head azimuth or tilt for maximum output on the vu meter. If the recorder has a combination record/playback head, this step can be omitted.

Record Frequency Response Check: Set the generator to a frequency of 700 Hz and adjust the record output level to the same point on the vu meter as was selected earlier for the playback frequency test. Note the audio generator level and hold it at that level throughout the record frequency test. Go through the same audio frequencies as were contained on the frequency alignment tape. Compare the record output readings with those obtained in the playback frequency response test. The record and playback readings should be within 2 dB of each other.

Recorder Speed Test: For best performance using pre-recorded tapes, the machine should be within 2% of standard speed. Improper speed alters the pitch of the recorded sound.

In order to test the speed of the recorder, construct a timing tape by accurately measuring off a 150-foot length of tape and marking the beginning and end points with white leader tape.

Set the recorder to a speed of 7½ in/s and carefully time how long it takes to play the tape. An elapsed time of less than four minutes indicates your recorder is slightly fast. More than four minutes reveals a slower-than-normal tape speed.

The following formula can be used to determine the exact percentage of error at 7½ in/s:

$$\% \text{ of speed error} = \frac{\text{No. of seconds slow or fast}}{240} \times 100$$

At 3¾ in/s, it should take exactly eight minutes to play the timing tape. To determine the percentage of error, substitute 480 for 240 and use the above formula.

An error of 2% or less indicates the recorder is in satisfactory operating condition.

The maintenance schedule described in this article is based on a recorder being operated from four to eight hours daily. This schedule can be scaled up or down proportionally depending on the amount of use. A good maintenance program can keep your recorder operating at peak performance and greatly extend its useful life. ▲

The New 1968 Improved Model 257 **A REVOLUTIONARY NEW TUBE TESTING OUTFIT**

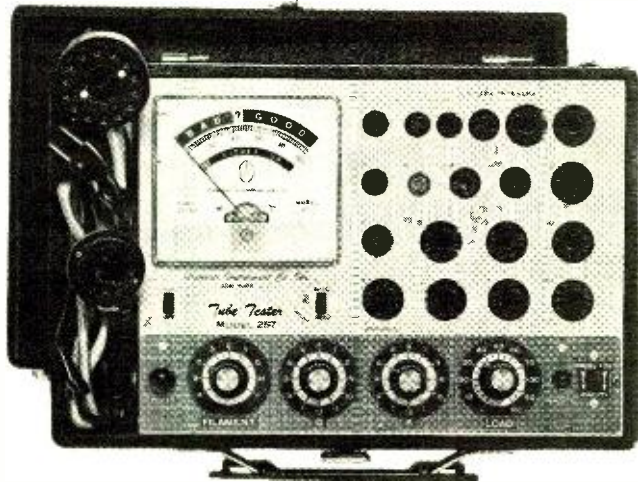

COMPLETE WITH ALL ADAPTERS AND ACCESSORIES, NO "EXTRAS"

STANDARD TUBES:

- ✓ Tests the new Novars, Nuvistors, 10 Pins, Magnovals, Compactrons and Decals.
- ✓ More than 2,500 tube listings.
- ✓ Tests each section of multi-section tubes individually for shorts, leakage and Cathode emission.
- ✓ Ultra sensitive circuit will indicate leakage up to 5 Megohms.
- ✓ Employs new improved 4½" dual scale meter with a unique sealed damping chamber to assure accurate, vibration-less readings.
- ✓ Complete set of tube straighteners mounted on front panel.

The Model 257 is housed in a handsome, sturdy, portable case. Comes complete with all adapters and accessories, ready to plug in and use. No "extras" to buy. Only

- Tests all modern tubes including Novars, Nuvistors, Compactrons and Decals.

- All Picture Tubes, Black and White and Color

ANNOUNCING...for the first time

A complete TV Tube Testing Outfit designed specifically to test all TV tubes, color as well as standard. Don't confuse the Model 257 picture tube accessory components with mass produced "picture tube adapters" designed to work in conjunction with all competitive tube testers. The basic Model 257 circuit was modified to work **compatibly** with our picture tube accessories and those components are not sold by us to be used with other competitive tube testers or even tube testers previously produced by us. They were custom designed and produced to work specifically in conjunction with the Model 257.

BLACK AND WHITE PICTURE TUBES:

- ✓ Single cable used for testing all Black and White Picture Tubes with deflection angles 50 to 114 degrees.
- ✓ The Model 257 tests all Black and White Picture Tubes for emission, inter-element shorts and leakage.

COLOR PICTURE TUBES:

- ✓ The Red, Green and Blue Color guns are tested individually for cathode emission quality, and each gun is tested separately for shorts or leakage between control grid, cathode and heater. Employment of a newly perfected dual socket cable enables accomplishments of all tests in the shortest possible time.

\$47⁵⁰

NOTICE

We have been producing radio, TV and electronic test equipment since 1935, which means we were making Tube Testers at a time when there were relatively few tubes on the market, way before the advent of TV. The model 257 employs every design improvement and every technique we have learned over an uninterrupted production period of 32 years.

Accurate Instrument Co., Inc.

SEND NO MONEY WITH ORDER
PAY POSTMAN NOTHING ON DELIVERY

Try it for 10 days before you buy. If completely satisfied then send \$10.00 and pay the balance at the rate of \$10.00 per month until the total price of \$47.50 (plus P.P., handling and budget charge) is paid. If not completely satisfied, return to us, no explanation necessary.

ACCURATE INSTRUMENT CO., INC.

Dept. 573 2435 White Plains Road, Bronx, N. Y. 10467

Please rush me one Model 257. If satisfactory I agree to pay \$10.00 within 10 days and balance at rate of \$10.00 per month until total price of \$47.50 (plus P.P., handling and budget charge) is paid. If not satisfactory, I may return for cancellation of account.

Name _____

Address _____

City _____ Zone _____ State _____

Save Money! Check here and enclose \$47.50 with this coupon and we will pay all shipping charges. You still retain the privilege of returning after 10 day trial for full refund.

FREE



GIANT 1969 RADIO-TV ELECTRONICS CATALOG

228 GIANT VALUE-
PACKED PAGES



YOUR BUYING GUIDE FOR . . .
TV's, Radios, Recorders, Phonos,
Amateur and CB equipment, elec-
tronic parts, tubes and test equip-
ment . . . plus featuring B-A's
famous bargain packed section!

WRITE FOR YOUR FREE CATALOG TODAY!

BURSTEIN-APPLEBEE CO., DEPT. EWV
3199 MERCIER ST., KANSAS CITY, MO. 64111

Name _____
Address _____
City _____
State _____ Zip Code _____

CIRCLE NO. 119 ON READER SERVICE CARD

Need high temperatures in tiny places?

The amazing Little Torch is so tiny it can throw a flame of 6300°F. through the eye of a needle. It solders, brazes, welds and heats with exacting precision in the smallest places; uses oxygen and acetylene, hydrogen, propane, natural gas or Mapp. It's available with five tips ranging in size from one large enough to weld 16 ga. steel to one small enough to weld .002" copper wire. For free brochure write to:



Dept. 1033-8, 2633 S.E. 4th St., Minneapolis, Minnesota 55441
CIRCLE NO. 82 ON READER SERVICE CARD

70

HI-FI SHOW SEMINARS PROGRAM

Sept. 19-22, 1968

Statler-Hilton Hotel

7th Ave. & 32nd St., New York, N.Y.

THURSDAY, SEPT. 19, 1968

6:30-7:30 p.m. (Novice Symposium)

"INTRODUCTION TO HI-FI COMPONENTS"

LEONARD FELDMAN, Engineering Vice-President
Crestmark Electronics

7:45-8:45 p.m.

"CHANGERS, TURNTABLES & CARTRIDGES"

Moderator: **MILT SNITZER**, Tech. Editor, Electronics World
Panelists: **JOHN BUBBERS**, Vice-President, Field Eng'g.
Pickering & Co., Inc.
TED JENSEN, Engineering Liaison Director,
Garrard Div., British Industries Corp.

FRIDAY, SEPT. 20, 1968

6:30-7:30 p.m. (Novice Symposium) As above.

"INTRODUCTION TO HI-FI COMPONENTS"

7:45-8:45 p.m.

"THE JAZZ & CLASSICAL RECORDING SCENES"

Moderator: **GEORGE SIMON**, Executive Director,
N.Y. Chapter, NARAS
Panelists: **JIM LYONS**, Editor, American Record Guide
PHIL RAMONE, President,
A & R Recording Studio
FR. NORMAN O'CONNOR, President, N.Y.
Chapter/NARAS; Host "Dial M for Music" (Ch. 2)

SATURDAY, SEPT. 21, 1968

2:00-3:00 p.m.

"TAPE & TAPE RECORDERS"

Moderator: **BILL STOCKLIN**, Editor, Electronics World
Panelists: **JOE KEMPLER**, Technical Services Dept. Mgr.,
Audio Devices, Inc.
RUSS MALLOY, National Sales Manager,
Telex Communications Division

3:15-4:15 p.m.

"STEREO & THE LISTENER"

Moderator: **BILL STOCKLIN**, Editor, Electronics World
Panelists: **VIC BROGINER**, Assist to the President,
H. H. Scott, Inc.
ABE COHEN, Manager, Acoustics Div.
Instrument Systems Corp./Telephonics (Benjamin)

6:30-7:30 p.m. (Novice Symposium) As above.

"INTRODUCTION TO HI-FI COMPONENTS"

7:45-8:45 p.m.

"THE LISTENING FACULTY"

Moderator: **BILL STOCKLIN**, Editor, Electronics World
Panelists: **ABE COHEN**, Manager, Acoustics Div.
Instrument Systems Corp./Telephonics (Benjamin)
ED VILLCHUR, President
Foundation for Hearing Aid Research

SUNDAY, SEPT. 22, 1968

1:30-2:30 p.m.

"SPEAKERS & AMPLIFIERS"

Moderator: **BILL STOCKLIN**, Editor, Electronics World
Panelists: **GEORGE AUGSPURGER**, Professional Products
Mgr., James B. Lansing Sound, Inc.
LARRY FISH, Chief Eng., Advanced Development
H. H. Scott, Inc.

2:45-3:45 p.m. (Novice Symposium) As above.

"INTRODUCTION TO HI-FI COMPONENTS"

ELECTRONICS WORLD

We've rectified high-voltage rectifiers.

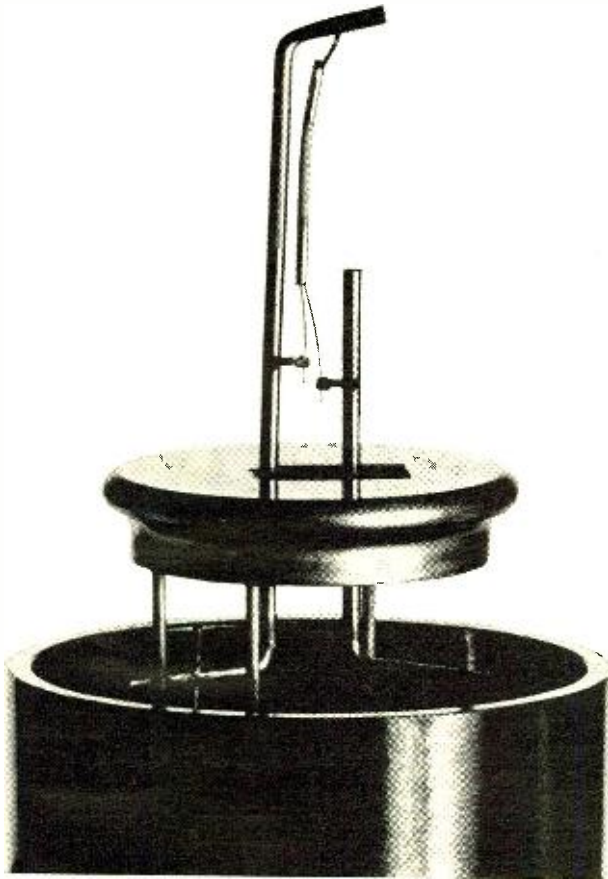

How it used to be.

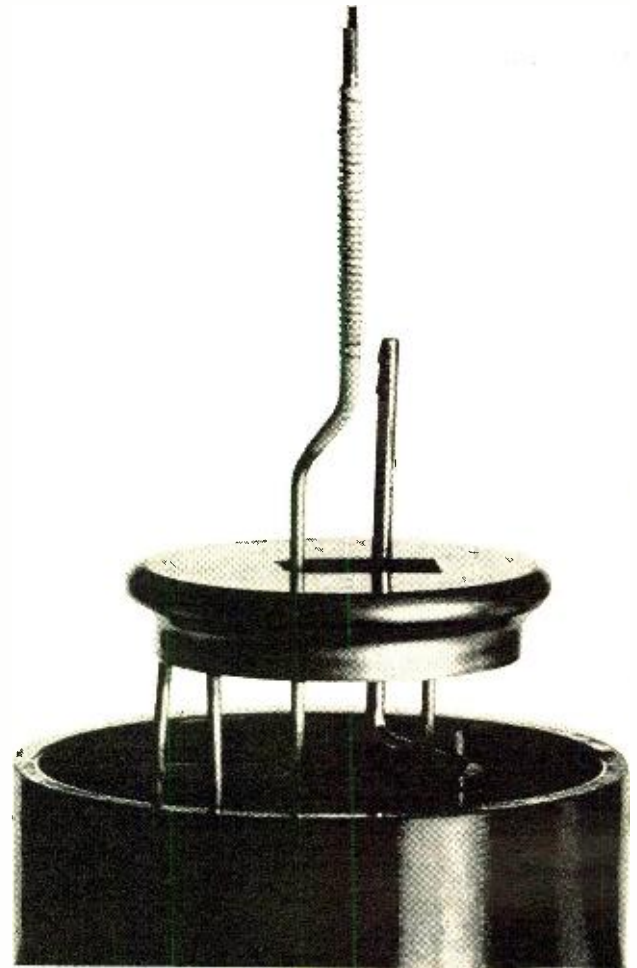

Our new 3CU3

Take a look at our new "Posted filament" design. There's no delicately suspended heater-cathode system. There's no need to heat up a metal sleeve and then an oxide coating.

It takes less than a second for the 3CU3 to start rectifying full swing.

In case of a break, there's no way for the 3CU3's filament to fall against the anode, creating a short and knocking out other components in the circuit.

The 3CU3's filament is always perfectly centered. It emits electrons uniformly in every direction. From a much larger surface than in the old design. There's no suspension post in the way to create an "electron shadow" that cuts down the plate current.

The uniform electric field around the rigid support reduces high voltage stresses. Arcing and its resulting troubles are eliminated.

The 3CU3 is interchangeable with 3A3 and 3A3A

high voltage rectifiers. And it's made exclusively by Sylvania.

The 3CU3 is just one of a new "posted filament" family which includes the new 3BL2 and 3BM2. They're designed for use in new color TV sets. These tubes are especially good for transistorized TV where their fast warm-up fits in with the "instant on" feature of solid state circuitry.

The new construction has higher reliability and longer life and should give you fewer and less troublesome callbacks.



From the outside you can hardly tell it's changed.

SYLVANIA
A DIVISION OF
GENERAL TELEPHONE & ELECTRONICS

Delta Launches the
COMPUTACH*

The
Great
One!



*An exclusive computer-tachometer for precise RPM measurement in easy-to-build Kit form!



ONLY
\$2995
ppd.

Delta, pioneers in CD ignition who produced the fabulous MARK TEN®, now offer a precise computer-tachometer which obsoletes any type tachometer on the market today! You achieve unbelievable accuracy in RPM readings due to the advanced, solid-state electronic matched components used in the computer, coupled with the finest precision meter in the world. Works on all 2, 3, 4, and 6 cylinder 2 cycle and with 4-6-8 cylinder—4 cycle 12 volt engines.

- ▲ 0-8000 RPM range
- ▲ Perfect linearity — zero parallax
- ▲ Adjustable set pointer
- ▲ Wide angle needle sweep
- ▲ Translucent illuminated dial
- ▲ Chrome plated die-cast housing
- ▲ All-angle ball & socket mounting
- ▲ Use it with ANY ignition system
- ▲ Meter: 3 1/8" dia. X 3 3/8" deep
- ▲ Calibration kit included, no test eqpt. needed.

Orders shipped promptly.
Satisfaction guaranteed.

DELTA PRODUCTS, INC.
Send check today!

P.O. Box 1147 EW / Grand Junction, Colo. 81501
Enclosed is \$ _____ Ship ppd. Ship C.O.D.
Please send:

COMPUTACH® Kits @ \$29.95 ppd
Sold in Kit Form ONLY!

Name _____
Address _____
City, State _____ Zip _____

CIRCLE NO. 113 ON READER SERVICE CARD
72

TEST
EQUIPMENT
PRODUCT REPORT

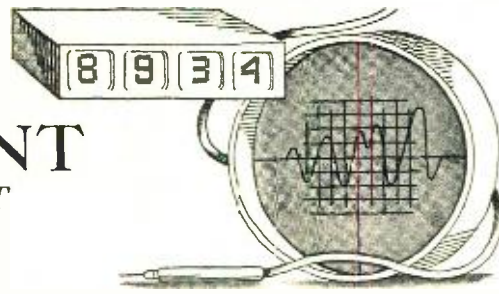

Heathkit Model IO-17 Oscilloscope

For copy of manufacturer's brochure, circle No. 2 on Reader Service Card.

A LITTLE over 20 years ago, the Heath Company began to sell oscilloscopes in kit form. These were simple scopes with surplus 5-inch cathode-ray tubes. Since that time, Heathkit has become a popular name in the test equipment kit field.

The newest scope in the company's line is a 3-inch utility model that is just right for the hobbyist and experimenter. Its professional features, compactness, and low cost make it perfect for general industrial work too. And schools should find the scope a valuable tool in physics and electronics laboratories. The scope's 5 Hz to 5 MHz frequency response and 30 millivolt peak-to-peak sensitivity make it especially valuable to TV service technicians.

The Model IO-17 measures only 9 1/2" h. x 5 1/4" w. x 14 1/2" d. and weighs 12 pounds. Most of the circuit's components, including the scope's seven tubes, are mounted on a printed-circuit board so wiring of the kit is minimized. The completely shielded 3RP1 medium-persistence CRT is mounted on a special bracket which hinges from the transformer well. Circuit power is provided by a conventional zener-regulated voltage doubler with silicon diode rectifiers. The scope's integrated chassis and its panel design permit removal of the left and right cabinet halves for servicing without impairing scope operation. All tubes, resistors, and capacitors are completely exposed and easily accessible.

A minimum of adjustments was all that was required to make the scope ready for use. The focus and astigmatism controls worked perfectly, forming the beam into a tiny round spot. The horizontal sweep was aligned with the graticule by simply loosening two hold-

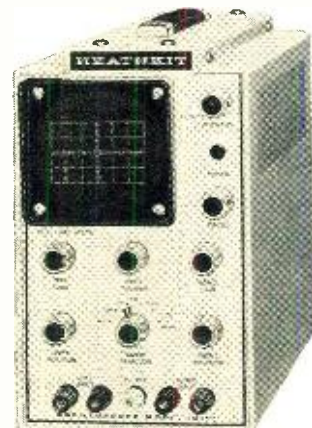

down screws and rotating the CRT. The attenuator adjustment was the only other circuit correction necessary. For this we used a square-wave generator although the adjustment would have been adequate using an internally generated signal.

To examine the scope's operating capabilities, we went through several alignment checks on a television receiver. We looked at the composite video signal, the vertical sync pulse, and the horizontal sawtooth waveform. All of the waveforms were adequately displayed. Finally, we put a Lissajous pattern on the screen and observed it over a four-hour period. The display remained rock-steady, and no noise, amplitude, or phase changes were noted.

Construction of the scope is simple. Our construction time was about nine hours. Set up and adjustments took another half hour. For those who are looking for a good, inexpensive utility instrument, the Heath IO-17 shouldn't be overlooked. It sells for \$79.95 in kit form. ▲

Fairchild Model 8040 Digital Frequency Meter

For copy of manufacturer's brochure, circle No. 3 on Reader Service Card.

THE new Fairchild Model 8040 is a four-digit, 2-MHz digital frequency-measurement instrument. It is packaged in the same compact one-piece case so well accepted with the introduction of the company's Model 7050 digital multimeter last year. The 8040 counter is, without options, the only four-digit,

low-cost counter which is capable of measuring from 10 Hz to 2 MHz. The counter offers self-check and totalizing modes and storage for non-blinking display.

Applications of a counter such as the 8040 in low-frequency communications would be for measuring transmitter out-

put and checking i.f. frequencies. In industrial situations, counting and totalizing of bulk and item production runs are easily achieved with the appropriate transducer. Use of an electronic counter eliminates the risk of failure that may occur with mechanical units, particularly in applications where high rate of count is necessary.

In order to realize the meter's capability, a unique logic sequence is utilized. This sequence prescales the input signal by a factor of 100 or 10 to yield effective gate times of 1 millisecond and 10 milliseconds respectively. This produces an important result; the most significant digits may be observed even at the highest frequencies. Efficient use of the same two decade scalers also allows division of the basic 0.1 second line time base to provide a 1 second and 10 second gate length. Equally important for space and cost considerations, this additional use eliminates unnecessary extra components in the unit.

The input circuitry of the Model 8040 offers three positions of desirable fixed attenuation rather than a variable sensitivity control. A unique feature of the input circuitry is that it will accept, without damage, 260 V r.m.s. at either 50 or 60 Hz at any position of attenua-

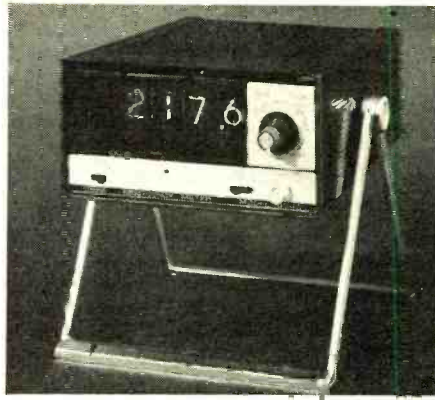

tion. This is of obvious advantage in industrial situations where the user may not be completely aware of the significance or value of the input. The amplifier used is a two-stage differential amplifier with a conventional Schmitt trigger circuit. The use of IC's, combined with plated-through printed-circuit cards, and high-quality components results in a low-cost unit without infringement of quality or reliability.

Standard version of the 8040 is for 117 V a.c., 60 Hz. Models are also available for 50 Hz and for other voltages. The unit measures 3 1/4" h. x 6 3/8" w. x 8 1/4" d. and weighs approximately 3 1/2 pounds. Price is \$349.00. ▲

Sencore Model MU150 Tube Tester

For copy of manufacturer's brochure, circle No. 4 on Reader Service Card.

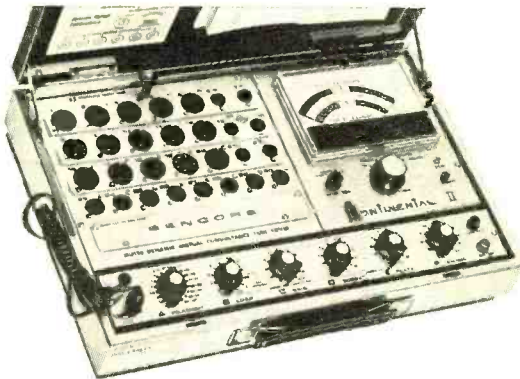

A NEW dynamic mutual conductance tube tester, the Model MU150 "Continental II," has just been introduced by Sencore. The tester is not only designed for fast and accurate field service, but also for precise lab work, and production testing in quality control. Able to check more than 3000 domestic and foreign tubes, the MU150 tests for mutual conductance, cathode emission, 100-megohm grid leakage, and internal shorts.

For mutual-conductance tests, the MU150 features an automatic biasing system and uses a 5000-Hz square wave for complete analysis of the tube being checked. Meter readings are in micromhos. In cathode-emission tests, the instrument draws near full rated cathode current as an extra test on power and rectifier tubes to measure their

emission capabilities. Grid leakage is measured with a high sensitivity of 100 megohms to find troublesome grid-contamination defects. In checking for shorts, each element in the tube is checked against all the others.

As protection against obsolescence, the MU150 provides space for additional sockets to accommodate new tubes that may have different base arrangements. A new simplified setup book is included. Tubes are listed in the center of each page for easy reading of setup numbers; emission on the left and mutual conductance on the right.

The unit is professionally styled and is housed in a handsome attaché-type case with brushed chrome center section and black vinyl-clad steel cover and base. The complete price for the tester is \$219.50. ▲

The TRUE electronic solution to a major problem of engine operation!

DELTA'S FABULOUS MARK TEN®



Only \$44.95 ppd.
In easy-to-build Deltakit®
Only \$29.95 ppd.

CAPACITIVE DISCHARGE IGNITION SYSTEM

You've read about The Mark Ten in *Mechanix Illustrated*, *Popular Mechanics*, *Electronics* and other publications!

Now discover for yourself the dramatic improvement in performance of your car, camper, jeep, truck, boat—any vehicle! Delta's remarkable electronic achievement saves on gas, promotes better acceleration, gives your car that zip you've always wanted. Find out why even Detroit has finally come around. In four years of proven reliability, Delta's Mark Ten has set new records of ignition benefits. No re-wiring! Works on literally any type of gasoline engine.

Why settle for less when you can buy the original DELTA Mark Ten, never excelled and so unique that a U.S. Patent has been granted.

READY FOR THESE BENEFITS?

- ▲ Dramatic Increase in Performance and in Fast Acceleration
- ▲ Promotes more Complete Combustion
- ▲ Points and Plugs last 3 to 10 Times Longer
- ▲ Up to 20% Mileage Increase (saves gas)

LITERATURE SENT BY RETURN MAIL
BETTER YET—ORDER TODAY!



DELTA PRODUCTS, INC. DP 7-17

P.O. Box 1147 EW • Grand Junction, Colo. 81501

Enclosed is \$_____ Ship ppd. Ship C.O.D.
Please send:

- Mark Tens (Deltakit®) @ \$29.95
(12 VOLT POSITIVE OR NEGATIVE GROUND ONLY)
- Mark Tens (Assembled) @ \$44.95
- 6 Volt: Negative Ground only.
- 12 Volt: Specify Positive Ground Negative Ground

Car Year _____ Make _____

Name _____

Address _____

City/State _____ Zip _____

CIRCLE NO. 111 ON READER SERVICE CARD

**cut holes
fast!**

Round—inches and mm

“Key”

“D”

Double “D”

Square

**with
Greenlee
punches**



Here's the simple speedy way to cut smooth, accurate holes in metal, hard rubber, plastics, epoxy, etc.

Save hours of hard work . . . punch clean, true holes in seconds for sockets, controls, meters, and other components. Easy to operate. Simply insert punch in a small drilled hole and turn with a wrench. For use in up to 16-gauge metal. Available at leading radio and electronic parts dealers.

GREENLEE TOOL CO
DIVISION OF GREENLEE BROS. & CO.

1866 Columbia Avenue, Rockford, Ill. 61101
CIRCLE NO. 105 ON READER SERVICE CARD

ENJOY THE "MUSIC ONLY" FM PROGRAMS

M. A. D.

MUSIC ASSOCIATED'S DETECTOR
NO COMMERCIALS—NO INTERRUPTIONS



It's easy! Just plug Music Associated's Sub Carrier Detector into multiplex jack of your FM tuner or easily wire into discriminator. Tune through your FM dial and hear programs of continuous commercial-free music you are now missing. The Detector, self-powered and with electronic mute for quieting between selections, permits reception of popular background music programs no longer sent by wire but transmitted as hidden programs on the FM broadcast band from coast to coast. Use with any FM tuner. Size: 5½" x 9". Shipping weight approx. 7 lbs.

KIT \$4950
(with pre-tuned coils, no alignment necessary)

WIRED \$7500

COVER \$4.95 EXTRA

Current List of FM Broadcast Stations with SCA authorization \$1.00

MUSIC ASSOCIATED

65 Glenwood Road, Upper Montclair, N.J. 07043
Phone: (201)-744-3337

CIRCLE NO. 93 ON READER SERVICE CARD

EW Lab Tested
(Continued from page 7)

back in either direction, although the automatic reversal system works only during playback in the left-to-right direction. There is an instant stop (pause) lever, as well as the tape-speed controls and a push-button four-digit index counter, on the panel of the transport. Tape threading is a simple wrap-around procedure because of Sony's retractable pinch roller which drops flush with the surface of the deck when the machine is to be threaded.

Twin vu meters monitor both recording and playback levels. The manufacturer states that these are true vu meters, meeting NAB standards. All recording controls are concealed behind a sliding metal panel which minimizes the possibility of accidental tape erasure. Two red recording-interlock buttons make it possible to record on either track alone or on both together. Separate left- and right-channel recording-level controls are used for the combined Mic/Aux inputs. Two more knobs under the cover panel control the recording levels for the tuner and phono inputs, affecting both channels simultaneously.

At the right side of the recorder are the amplifier controls. In addition to the push-button input selector, these include a speaker "on-off" switch, mode selector (L, R, Stereo), a high-frequency noise filter, bass and treble tone controls, concentric playback volume controls, power switch, and a stereo headphone jack.

All inputs and outputs are at the rear of the unit (or at its top, if it is installed vertically). These include signal-input jacks, speaker-output terminals, line-output jacks for driving external amplifiers, power and remote-control cable sockets, and two a.c. accessory outlets, one of them switched.

Although our prime interest in the TC-560 lay in its tape-recording functions, we also used and evaluated it as the center of a modest high-fidelity system. Within its design limits, it performed very well in both roles.

The tape recorder had the very fine performance that we have come to expect from Sony products. At 7½ in/s

its record-playback frequency response was +1, -3 dB from 42 to 17,500 Hz, referred to the 1000-Hz level. The playback equalization, as verified with the Ampex 31321-04 test tape, resulted in an exceptional over-all flatness of +0.5 dB from 50 to 15,000 Hz.

At 3¾ in/s, the TC-560 was still very much a high-fidelity recorder. Its frequency response was +2, -3 dB from 78 to 13,000 Hz. At 1⅞ in/s, where many tape recorders produce little more than a muffled travesty of the recorded program, this unit was highly listenable, even on music. Its response was +0, -3 dB from 85 to 5600 Hz, which is distinctly better than the usual quality of AM broadcasts.

Wow and flutter, measured with Ampex test tapes, were very low. At 7½ in/s, they were, respectively, 0.04 and 0.06 percent; at 3¾ in/s, they were 0.06 and 0.09 percent. The tape speed was exact at 3¾ in/s and very slightly slow at 7½ in/s. We did not attempt to adjust the playback speed with the internal control. In the fast speed (either direction) 1200 feet of tape was wound or rewound in 144 seconds. Two unusual features built into the deck are a special idler to minimize scrape flutter and a circuit that minimizes build-up of head magnetism.

The amplifier gains at the various inputs were quite high. Only 0.2 millivolt from a microphone, 1.6 millivolts from a phono cartridge, or 50 millivolts from the Aux inputs were needed for a 0-vu recording level. The signal-to-noise ratio was 48 dB, referred to the 0-vu recording level. Distortion in the record/playback process was exceptionally low—only 0.7% at 0 vu and 1% at +5 vu.

As an amplifier, Sony rates the TC-560 at 10 watts (per channel) dynamic power output into 8 ohms, which is the impedance of its speakers. We measured about 6.7 watts (continuous power) at the clipping level, with both channels driven. This is consistent with the dynamic power rating. Considering 6 watts per channel as the reference power output, the distortion at full power was under 0.5% from 90 to 20,000 Hz, rising to 1% at 70 Hz. At half power, the low-frequency "break point" was at about 30 Hz, with 1%

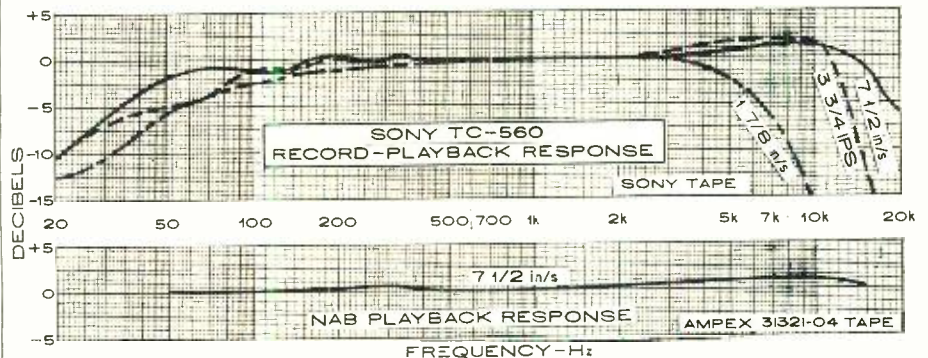

distortion occurring at 27 Hz. At 0.6 watt output (a reasonable listening level with the *Sony* speakers), the distortion was less than 0.6% from 20 to 20,000 Hz.

The 1000-Hz total harmonic distortion fell from about 0.5% at a few tenths of a watt to less than 0.25% in the 2- to 6-watt region. The IM distortion was between 1.5 and 3.5% in the range between 0.1 watt and 5.5 watts. The signal level required for 6 watts output was about 15% less than needed for 0-vu when recording. Hum and noise were extremely low, -79 dB to -83 dB on the high-level inputs and -68 dB on the phono input (all figures referred to 6-watts output).

The tone controls were of the conventional type found on most component amplifiers, with independent boost or cut of high and low frequencies. The noise filter was excellent, flat to about 6000 Hz and falling at 12-dB-per-octave above 9000 Hz. The RIAA magnetic-phono cartridge equalization was virtually flat from 30 to 15,000 Hz.

Considering the unit as a tape recorder and as a low-power amplifying system it proved to be excellent in every respect. The power is more than adequate for use with its own speakers. In respect to low distortion and noise, it is difficult to fault. The tape handling was gentle, and the ESP auto-reversal system worked perfectly.

Although we did not measure the speakers' performance, they sounded fine. With the help of a little bass boost, they delivered an impressive low-frequency output, and were well balanced over the full spectrum. We would rate them as sonically equivalent to many \$40 to \$50 bookshelf systems, and far better than the usual tape-recorder speaker.

The *Sony* TC-560 sells for less than \$449.50. If it is to be used only with an external amplifier and speakers, it can be purchased as a deck (TC-560-D), less power amplifiers and speakers, mounted on a walnut base, for less than \$349.50. ▲

TRIMMER-POT ADJUSTMENTS

By CHARLES ERWIN COHN

IT is frequently necessary to perform adjustments on instruments or equipment having screwdriver-adjust potentiometers. If these have not been moved for a long time (a year or so), the resistance element could become oxidized. An adjustment could then move the slider to an oxidized portion of the element, resulting in erratic adjustment and an unstable setting.

Therefore, such potentiometers should be turned back and forth over their range a few times before attempting adjustment, in order to scrape off the oxide. This should suffice for wirewound pots, but carbon pots could probably use a bit of control cleaner as well. ▲

NOW! Solve Electronics Problems fast with New Patented Slide Rule.



That's right! This amazing new Electronics Slide Rule will save you time the very first day you use it. It's a patented, all-metal 10" rule that features special scales for solving reactance, resonance, inductance and circuitry problems . . . an exclusive "fast-finder" decimal point locator . . . widely-used formulas and conversion factors for instant reference. And there's all the standard scales you need to do multiplication, division, square roots, logs, etc.

Best of all, the CIE Electronics Slide Rule comes complete with an Instruction Course

of four **AUTO-PROGRAMMED** lessons. You'll quickly learn how to whip through tough problems in a jiffy while others plod along the old-fashioned "pad and pencil" way.

Electronics Slide Rule, Instruction Course, and handsome, top-grain leather carrying case . . . a \$50 value for less than \$25. Send coupon for **FREE** illustrated booklet describing this Electronics Slide Rule and Instruction Course and **FREE** Pocket Electronics Data Guide. Cleveland Institute of Electronics, 1776 E. 17th St., Dept. EW-156, Cleveland, Ohio 44114.

*TRADEMARK

GET BOTH FREE!



Send coupon today →

Cleveland Institute of Electronics
1776 E. 17th St., Dept. EW-156, Cleveland, Ohio 44114

Send **FREE** Electronics Slide Rule Booklet. Special Bonus: Mail promptly and get **FREE** Pocket Electronics Data Guide too!

NAME _____ (Please Print)

ADDRESS _____ COUNTY _____

CITY _____ STATE _____ ZIP _____

A leader in Electronics Training... since 1934

CIRCLE NO. 117 ON READER SERVICE CARD

**WE DON'T CLAIM
OUR ELECTRONIC
IGNITION SYSTEM
IS BEST . . .**



OUR CUSTOMERS DO!

WRITE TODAY FOR FREE LITERATURE

JUDSON

RESEARCH AND MFG. CO.
ODNSHOCKEN PA. U.S.A.

CIRCLE NO. 101 ON READER SERVICE CARD

WAVE FORM ANALYSIS & PEAK FM MODULATION



all for LESS MONEY!

The Lampkin 205A FM Modulation Meter accurately indicates PEAK modulation on mobile transmitters. To shoot trouble visually, use your own general-purpose oscilloscope at the 205A rear jack output. This makes a low-cost, highly effective test combo — and a well-rounded shop — all for less money.

Lampkin pioneered the PEAK voltmeter for FM modulation indication.

Like to see the complete specs? Mail coupon today!

Use this coupon for **FREE** booklet "How To Make Money in Mobile-Radio Maintenance" and information on Lampkin meters.

Name _____
Address _____
City _____ State _____ Zip _____

LAMPKIN LABORATORIES, INC.
MFM Div., Bradenton, Fla. 33505

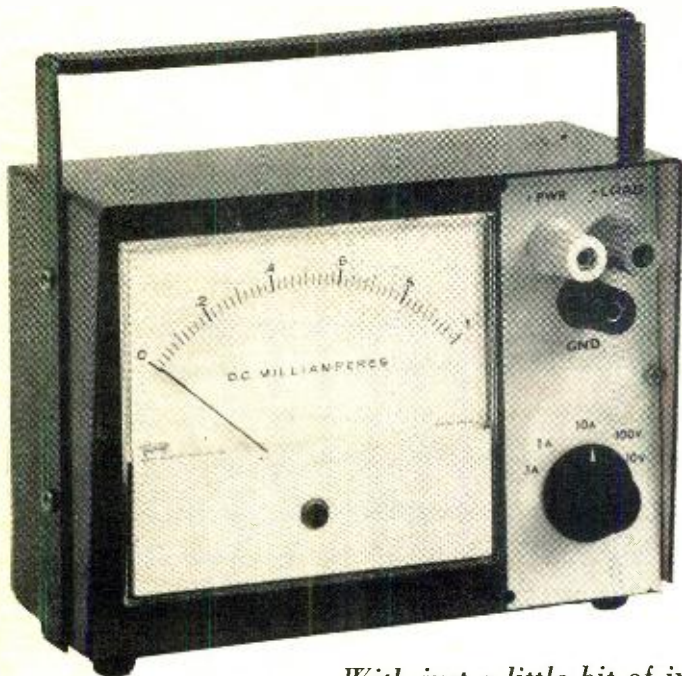

SHUNT SWITCHING METHOD REDUCES METER ERRORS

By MELVIN CHAN & ROBERT BROCK/Ampex Corp.

With just a little bit of ingenuity and care, engineers can design an accurate, reliable, low-cost d.c. volt-ammeter.

MANY engineers and lab technicians need an accurate and reliable low-cost ammeter. A meter that could selectively monitor currents between 0 and 100 milliamperes, 1 ampere, or 10 amperes for long periods without overheating would fill most needs. A d.c. unit whose accuracy is ± 2 to 3 percent costs about \$60; however one can easily design an instrument that has d.c. voltage ranges of 0 to 10 and 100 volts in addition to the previously mentioned current ranges, and find that the parts cost less than 30 dollars.

The most serious problem encountered in this particular meter design is the basic current-range selection circuit in which the switch contact is in series with the shunt resistor (Fig. 1A). As most engineers know, switch contacts have a small resistance (contact resistance will vary through a narrow range every time a switch is activated). In some switch applications, the variations in contact resistance (which can be as much as 0.00025 ohm) can be ignored. However, in a d.c. ammeter, the shunt resistor for the 10-ampere range is approximately 0.005 ohm; this is only 20 times the expected contact resistance. If this condition is not corrected, there could be unpredictable meter-deflection errors as large as 5 percent.

Fig. 1B illustrates the case in point. When a 10-A current flows through the 0.005-ohm shunt resistor, a 0.05-V voltage drop is produced across it. Neglecting variations in contact resistance, this voltage drop causes a full-scale deflection of the 1-mA meter. But, if the contact resistance is 0.00025 ohm, the total shunt resistance is 0.00525 ohm, and the voltage drop is 0.0525 volt. The meter would swing be-

yond full-scale. Or, if the meter reads exactly full-scale (for example, when the voltage drop is 0.05 volt), the current flow is only 9.5 amperes, a 5-percent meter error.

Fig. 1C shows how the problem is solved. The current-sensing shunt resistance is increased to 0.007 ohm and the switch contact is placed in series with the meter instead of the shunt resistor; and a variable resistor is inserted in this series circuit. The variable resistance reduces the voltage (0.07 volt when 10 A of current flows) applied to the meter to the 0.05-volt level. Now, because the total resistance of the meter plus the series resistance is approximately 70 ohms, the switch contact resistance has a negligible effect on the accuracy of the meter movement.

The circuit of the d.c. volt-ammeter (rear view, Fig. 2) is shown in Fig. 3. Note that current-sensing shunt resistors R_1 , R_2 , and R_3 are connected in series between the power input and the power output. In the 0.1-A position, R_1 , R_2 , and R_3 are all in circuit. At the 1-A setting, S_1B shorts R_3 ; at the 10-A setting it shorts R_2 and R_3 ; and at both voltage-range settings it shorts R_1 , R_2 , and R_3 . Switch S_1A selects range calibration potentiometers R_7 , R_8 , R_9 , R_{10} , and R_{11} . At the 100-volt setting, R_5 and R_{10} and R_4 and the rotor convert the meter to a voltage-measuring device having a sensitivity of 1000 ohms-per-volt. At the 10-volt setting, R_4 , R_6 , and R_{11} make this conversion.

When monitoring current, the meter movement is protected from overload by R_4 , diodes D_1 and D_2 , and the associated calibrating potentiometer. As mentioned earlier, the meter pointer swings full-scale with an applied voltage of approximately 0.05 volt. Thus both diodes remain cut off during normal voltage and current measurements and do not affect the meter indication. In the event of a severe overload (such as that resulting from the selection of a wrong scale) the forward-biased diode provides a shunt path around the meter. The other diode protects the meter from signals of wrong polarity.

Resistors R_1 , R_2 , and R_3 are made of plain enameled copper wire, wound on 2-watt fixed resistors (of any value) as a coil form. The lengths of the wire, the sizes used, and their calculated resistances are as follows:

R_1 is 18 inches of #16 AWG plain enameled wire to give 0.00692 ohm; R_2 is 20 inches of #26 AWG plain enameled wire for 0.06798 ohm; and R_3 is 48 inches of #32 AWG

Fig. 1. In many ammeter circuits, switch contact is in series with the shunt resistor (A). Normally, current flowing through R_1 (B) should cause 1-mA meter movement to deflect fully. In (C), R_2 compensates for unknown variations in contact resistance.

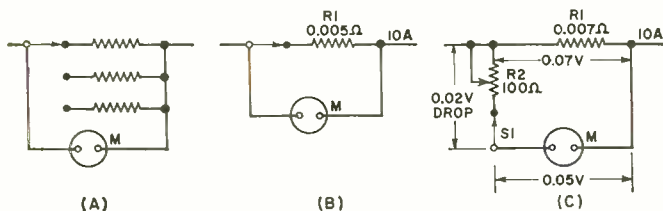

plain enameled wire for 0.6564 ohm. Potentiometers R7, R8, R9, R10, and R11 are for individual calibration of current and voltage ranges.

Calibration

The accuracy of the d.c. volt-ammeter depends upon the care with which it is calibrated, the availability of d.c. power sources suited to each range, and, of course, upon the availability of an accurate reference meter. If these are unavailable, another procedure must be used for calibration.

If a reference d.c. voltmeter and ammeter is available, the procedure is simply to adjust the appropriate calibrating potentiometer until the two meters agree. The setup required for current and voltage calibration ranges is shown in Fig. 4.

To calibrate the current ranges, use the circuit of Fig. 4A and the load resistor as follows: For the 0.1-A range, use four 620-ohm, 1/2-W (or larger) 10% fixed composition resistors connected in parallel, adjust R9; for the 1-A range, use a 25-ohm, 12-W, 10% wirewound power resistor (e.g., an IRC Type 1-3/4A), adjust R8; for the 10-A range, use 42 feet of #24 AWG bare copper wire airwound on any wooden skeleton frame 12" x 12" or larger, adjust R7.

To adjust the voltage ranges, use the circuit of Fig. 4B. The potentiometer shown limits the current flow to approximately 10 mA. For the 10-V range, turn the wiper of the pot to the 0-volts position before connecting the meters. Then connect the meters and adjust the pot until the reference voltmeter indicates exactly 10 volts. Finally, adjust R11 until the d.c. volt-ammeter indicates exactly 10 volts. On the 100-V range, adjust the pot until the reference voltmeter indicates 100 volts (or less, if the maximum available is less), adjust R10 until the d.c. volt-ammeter indication is identical with that of the reference voltmeter.

An Alternate Technique

A 12-volt storage battery can be used as a current source, but the engineer must be careful to monitor the output voltage under load. For example, each cell of a fully charged battery (under no load) produces 2.2 volts, or a total of 13.2 volts for the six cells. When a load is applied, the battery voltage drops and changes as the load resistance heats up.

During the calibration of each current range, allow the load resistor to heat up, then quickly disconnect it, and measure its hot resistance. The circuit shown in Fig. 4C will permit transfer of the load resistor from the power source to the v.o.m. quickly.

To calibrate the 0.1-A range, use two 560-ohm, 1/2-watt, 10% fixed composition resistors connected in parallel. Measure the battery voltage and the hot resistance, then calculate the current flow. Connect the d.c. volt-ammeter to the power source and to the load resistor and adjust R9 until the meter indicates the calculated current.

Similarly, to calibrate the 10-A range, use a 25-ohm, 12-watt, 10% wirewound power resistor (IRC Type 1-3/4A or equivalent) as the load resistor. Measure the battery voltage and the hot resistance as above. Calculate the current flow and connect the d.c. volt-ammeter as before, adjusting R8 until the meter indicates the calculated current.

On the 10-A range, 130 feet of #24 AWG bare copper wire wound on a 12" x 12" wooden frame may be used as the load resistance. R7 is the calibration adjustment.

The 12-volt storage battery may also be used to calibrate the meter's 10-volt range. To do this, connect a 1000-ohm, 2-watt wirewound potentiometer across the battery terminals; connect its wiper to the positive terminals of the reference voltmeter and the d.c. volt-ammeter; and connect the negative terminal of the battery to the negative terminal of both meters. Adjust the pot until the reference meter indicates exactly 10 volts; then adjust R11 until the meter indicates 10 volts. R10 calibrates the 100-volt scale. ▲

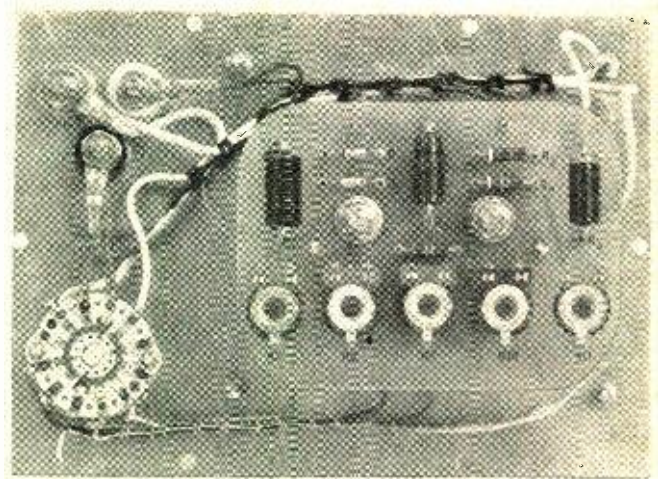
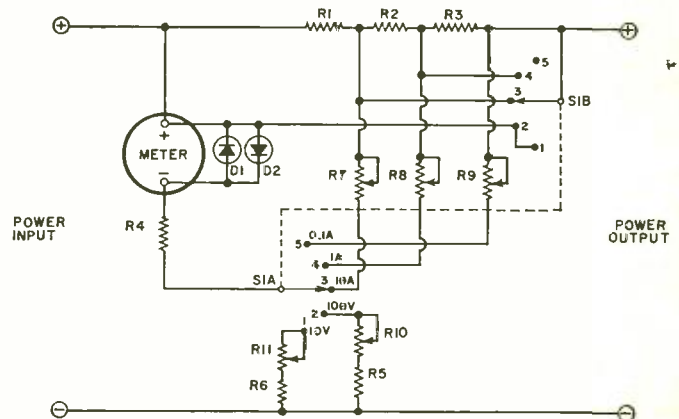

Fig. 2. All of the instrument's components other than the meter, connection terminals, and switch are mounted on phenolic board.



- R1, R2, R3—Shunt res. (see text)
- R4—8.2-ohm, 1/2 W res. ±10%
- R5—91,000 ohm, 1/2 W res. ±10%
- R6—9100 ohm, 1/2 W res. ±10%
- R7, R8, R9—100 ohm miniature pot (Mallory MTS series or equiv.)
- R10—20,000 ohm miniature pot (Mallory MTS series or equiv.)
- R11—2000 ohm miniature pot (Mallory MTS series or equiv.)
- S1—D. p. 5-pos. shorting rotary sw. (Centralab Type PA6002 or equiv.)
- Meter—0.1 mA meter (Triplet Series 420-G)
- D1, D2—1N34A or 1N96A germanium diode
- 3—Six-way binding posts (one each red, black, green)

Fig. 3. This meter's circuit measures voltage as well as current.

Fig. 4. A 12-volt battery (A) or a variable d.c. power supply (B) may be used to calibrate d.c. volt-ammeter. A load switching scheme for calibration purposes is shown in the diagram at (C).

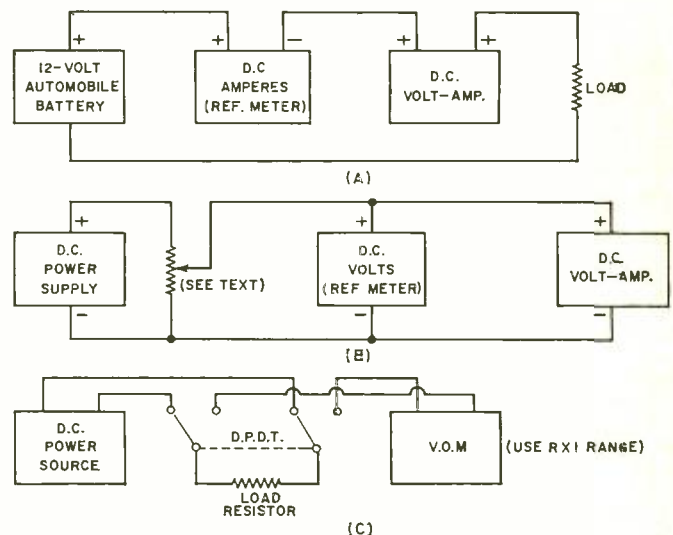

Two more examples of how RCA Institutes provides up-to-the-minute Home Training in all phases of electronics:

NEW CATV LESSONS

The demand is heavy for technicians in the booming field of CATV (Community Antenna Television Systems).

CATV was initially used to make it possible for large numbers of television receiver users to get good reception in remote areas through the use of a common antenna. It now brings to more people more programs than are available from local stations. It also improves reception where multipath signal transmission exists.

RCA Institutes includes two comprehensive lessons, covering the practical phases of CATV systems and servicing in Television Servicing and Communications courses and programs at no additional total tuition cost. Get in on the ground floor of this rewarding and expanding field. Send for full information today!

Prepare yourself for a career in the expanding field of CATV.

NEW COLOR TV KIT

To make courses even more practical and to better prepare you for a more rewarding future, RCA Institutes now includes an exciting Color TV Kit in both the beginner's program and the advanced course in color TV servicing. The cost of the kit is included in the tuition—nothing extra to pay. You also get five construction/experiment manuals plus a comprehensive service manual.

You'll receive all the materials and components to perform over 50 information-packed experiments. When you finish you'll have constructed an 18" (measured diagonally) high quality, color TV set, complete with rich cabinet in wood grain design.

Get all the details on RCA Institutes' valuable new Color TV Kit!

SEND THE ATTACHED CARD TODAY!

This is the high quality color TV set you'll construct, complete with rich cabinet in wood grain design.

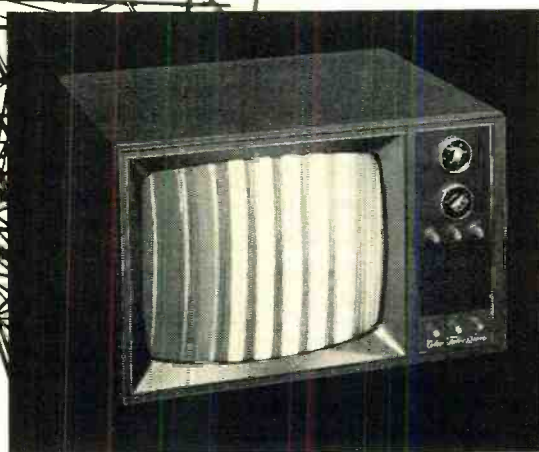

Learn electronics at home faster, easier, almost automatically—with RCA AUTOTEXT

Are you just a beginner with an interest in the exciting field of electronics? Or, are you already earning a living in electronics and want to brush-up or expand your knowledge in a more rewarding field of electronics? In either case, AUTOTEXT, RCA Institutes' own method of Home Training will help you learn electronics more quickly and with less effort, even if you've had trouble with conventional learning methods in the past.

THOUSANDS OF WELL PAID JOBS ARE OPEN NOW TO MEN SKILLED IN ELECTRONICS!

Thousands of well paid jobs in electronics go unfilled every year because not enough men have taken the opportunity to train themselves for these openings. RCA Institutes has done something positive to help men with an aptitude and interest in electronics to qualify for these jobs.

HOME STUDY CAN TRAIN YOU FOR REWARDING CAREER OPPORTUNITIES

To help fill the "manpower gap" in the electronics field, RCA Institutes has developed a broad scope of Home Training courses, all designed to lead to a well paying career in electronics in the least possible time. You also have the opportunity to enroll in an RCA "Career Program" exclusively created to train you quickly for the job you want! Each "Career Program" starts with the amazing AUTOTEXT Programmed Instruction Method. And, all along the way, your program is supervised by RCA Institutes experts who become personally involved in your training and help you over any "rough spots" that may develop.

VARIETY OF KITS ARE YOURS TO KEEP

To give practical application to your studies, a variety of valuable RCA Institutes engineered kits are included in your program. Each kit is complete in itself, and yours to keep at no extra cost. You get the new Programmed Electronics Breadboard for limitless experiments, including building a working signal generator, multimeter, and a fully transistorized superheterodyne AM receiver.

ONLY FROM RCA INSTITUTES— TRANSISTORIZED TV KIT— VALUABLE OSCILLOSCOPE

All students receive a valuable oscilloscope. Those enrolled in the Television program receive the all-new transistorized TV Kit. Both at no extra cost and only from RCA Institutes.

CHOOSE THE "CAREER PROGRAM" THAT APPEALS MOST TO YOU

Start today on the electronics career of your choice. Pick the one that suits you best and mark it off on the attached card.

- Television Servicing
- Telecommunications
- FCC License Preparation
- Automation Electronics
- Automatic Controls
- Digital Techniques
- Industrial Electronics
- Nuclear Instrumentation
- Solid State Electronics
- Electronics Drafting

ADVANCED TRAINING

For those already working in electronics, RCA Institutes offers advanced courses. You can start on a higher level without wasting time on work you already know.

2 CONVENIENT PAYMENT PLANS

RCA Institutes offers a unique tuition plan that lets you progress at your own pace. You only pay for lessons as you order them. You don't sign a contract obligating you to continue the course.

There's no large down-payment to lose if you decide not to continue.

However, if you desire, RCA Institutes also offers a convenient monthly payment plan.

CLASSROOM TRAINING ALSO AVAILABLE

If you prefer, you can attend classes at RCA Institutes Resident School, one of the largest of its kind in New York City. Coeducational classroom and laboratory training, day and evening sessions, start four times a year. Simply check "Classroom Training" on the attached card for full information.

JOB PLACEMENT SERVICE, TOO!

Companies like IBM, Bell Telephone Labs, GE, RCA, Xerox, Honeywell, Grumman, Westinghouse, and major Radio and TV Networks have regularly employed graduates through RCA Institutes' own placement service.

SEND ATTACHED POSTAGE PAID CARD TODAY. FREE DESCRIPTIVE BOOK YOURS WITHOUT OBLIGATION. NO SALESMAN WILL CALL.

All RCA Institutes courses and programs are approved for veterans under the new G.I. Bill.

Accredited Member
National Home Study Council

IF REPLY CARD IS DETACHED—SEND THIS COUPON TODAY

RCA INSTITUTES, Inc., Dept. EWQ-08
320 West 31st Street, N.Y., N.Y. 10001

Please rush me FREE illustrated catalog. I understand that I am under no obligation, and that no salesman will call.

Name _____ Age _____
(please print)

Address _____

City _____

State _____ Zip _____



ELECTRONIC DICE



By ARTHUR L. PLEVY

Electronics invades fun and games. A three-stage binary counter and lights can show a natural just like the hand-thrown cubes.

LAS VEGAS gamblers may never adopt electronics on their dice tables, but those who like games of chance may find rolling electronic dice enjoyable. The electronic die is a three-stage binary counter. It has a set of seven pilot lamps which light to simulate the dots on the side of an ordinary die.

These die dots are really decimal numbers; they indicate whether the die's value is 1, 2, 3, 4, 5, or 6. However, since the counter's number values are in a binary code, they must be converted to decimal equivalents.

The following example illustrates the conversion process. Suppose the binary number 101 is given; the decimal equivalent can be found by utilizing the following equation: decimal number = $(A)2^0 + (B)2^1 + (C)2^2 + \dots + (X)2^N$ where 2^0 is equal to 1, 2^1 is equal to 2, and 2^2 is equal to 4. By adding the appropriate powers of two, the same approach can be used to obtain the decimal equivalent of any binary number.

A three-stage binary counter without feedback will have eight unique states when triggered by a repetitive clock in-

put signal. A true die, however, has only six sides and six possible states. The three-stage binary counter, therefore, has two stages which must be inhibited. These states, which represent the binary numbers 000 and 111 (equivalent to the decimal numbers 0 and 7, respectively) do not appear on an ordinary die.

The inhibition function is performed by the *and* gate 111 shown in Fig. 1. It operates as follows. The *and* gate produces an output only when one side of each flip-flop is at 1 or -9 volts. Under these conditions, the counter would normally indicate binary 111. However, the *and* gate output immediately resets the flip-flops and the counter to the binary 001 state. Consequently, once the counter starts running, it continuously cycles from binary 001 to binary 110, or from decimal 1 to 6. The only time the binary 000 state can appear is when the unit is first turned on.

Each flip-flop has a bulb or a series of bulbs connected to its 1 output. Bulb *PL1* will light when flip-flop #1 is in the 1 state. Bulbs *PL2* and *PL3* will light when flip-flop #2 is in the 1 state, and bulbs *PL4* through *PL7* will light when flip-flop #3 is in the 1 state. Fig. 2 shows how bulbs *PL1* through *PL7* would look mounted on a panel. The panel lights are in the same positions as the dots on a true die, the only exception being that the number 3 (011) appears horizontally instead of diagonally.

Random Rolls

The electronic counter must be operated so that the number or state at which it stops is as random as the roll of a true die. To accomplish this, the counter is driven by an astable or free-running multivibrator. This circuit, unlike a flip-flop, oscillates from one state to another. Its frequency is controlled by a resistor-capacitor circuit.

The astable multivibrator in Fig. 3 is turned on by a single-pole momentary throw switch. Its frequency is designed to be fairly high (above 60,000 Hz). Therefore, if the switch were depressed for 1 second, the counter would recirculate approximately 60,000 divided by six or about 10,000 times. Opening the switch causes the counter to stop at any one of its six states. The exact state at which the counter stops is completely arbitrary. For example, assume a

Fig. 1. A multivibrator drives three flip-flops plus an "and" gate to turn on pilot lights that simulate the dots on a die.

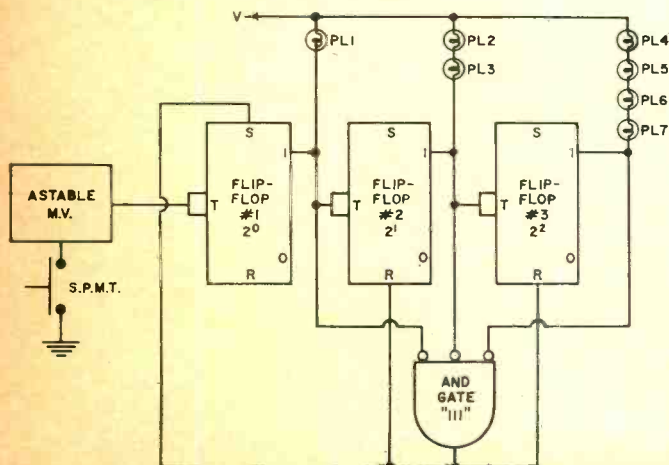

player quickly depresses and releases the start switch. A typical response time might be two to three milliseconds. During this time, the counter may receive anywhere from 120 to 130 pulses and recirculate between 20 and 22 times. If it recirculated 20 times, it would stop at position 010; if 22 times, then position 100; if 21 times, then 011; and so on. To change counts, the switch has to be depressed for $1/60,000$ or approximately 16×10^{-6} second or 16 microseconds. Certainly no one has good enough muscular control or reflexes to regulate the counter's stopping point.

Transistors Q1 and Q2 are the active devices comprising the astable multivibrator. Specifically, its circuit is designed to operate at a frequency equal to:

$$f = \frac{1}{2(0.7)RC}$$

where R is equal to 12,000 ohms and C equals 680 picofarads.

In this unit, the design frequency is 80 kHz. The astable multivibrator produces a square wave at its output (the collectors of either Q1 or Q2) that has a peak value approximately equal to the supply voltage (-9 volts). The emitters of Q1 and Q2 are returned to ground through the s.p.m.t. switch. If a switch were not available, an alligator clip could be used. When the switch connects the emitters of Q1 and Q2 to ground, power is applied to the astable circuit. Even though the circuit is balanced, it is unlikely that the current flow through the components is the same. One transistor will conduct more than the other. If the current through Q1 increases, the collector voltage at Q1 decreases. This positive transition (from -9 volts towards ground) is coupled to the base of Q2 by the discharge of the 680-pF capacitor. The positive transistor also serves to decrease the current in Q2 and forces Q1 to conduct harder. As a result of this regenerative action, transistor Q2 is cut off for a period determined by R and C . When the discharge current becomes small, Q2 is no longer held off and Q2's collector voltage starts to rise (from -9 volts to ground). This positive transition is coupled back to Q1 and causes it to turn off, thus repeating the action.

In contrast to the astable multivibrator, the flip-flop or bistable multivibrator has two stable states: the circuit is stable when either transistor is conducting and the other is cut off. The states of the transistors can be changed by the

C=2 ²	B=2 ¹	A=2 ⁰	DECIMAL NO.
0	0	0	0
0	0	1	1
0	1	0	2
0	1	1	3
1	0	0	4
1	0	1	5
1	1	0	6
1	1	1	7

Fig. 2. Decimal numbers 0 and 7 shown in the table are not used in dice games so that the first and eighth states of the three-stage binary counter are inhibited. When the pilot lights are inhibited, they count like the dots of a conventional die. However, the number three is horizontal instead of vertical.

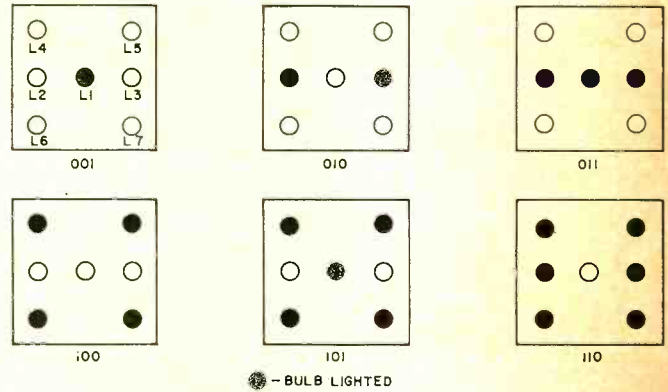

application of a proper trigger input. Assume that right-hand transistor Q4 of flip-flop #1 is on; then the collector is approximately at ground. This collector is coupled to the base of left-hand transistor Q3 by the 15,000-ohm resistor. The base of Q3 is at ground and the transistor is not conducting. Therefore, the voltage at its collector is -9 volts. A portion of this voltage is coupled back to Q4 through the voltage divider consisting of the 6800 and 15,000-ohm resistors. Hence, the voltage at the base of

Q3 is approximately $\frac{6800}{21,800} (-9 \text{ volts})$ or about -3 volts.

The base current is approximately $-3 / \frac{6.8(15)}{21}$ or about 0.6 milliampere. Assuming a minimum d.c. beta of 25 for the 2N404 transistors, then the collector current is about

Fig. 3. Transistors, diodes, pilot lights, and other components are all low-cost items. Alligator clip may be used instead of single-pole momentary-throw push-button switch. All flip-flops employ components having identical values.

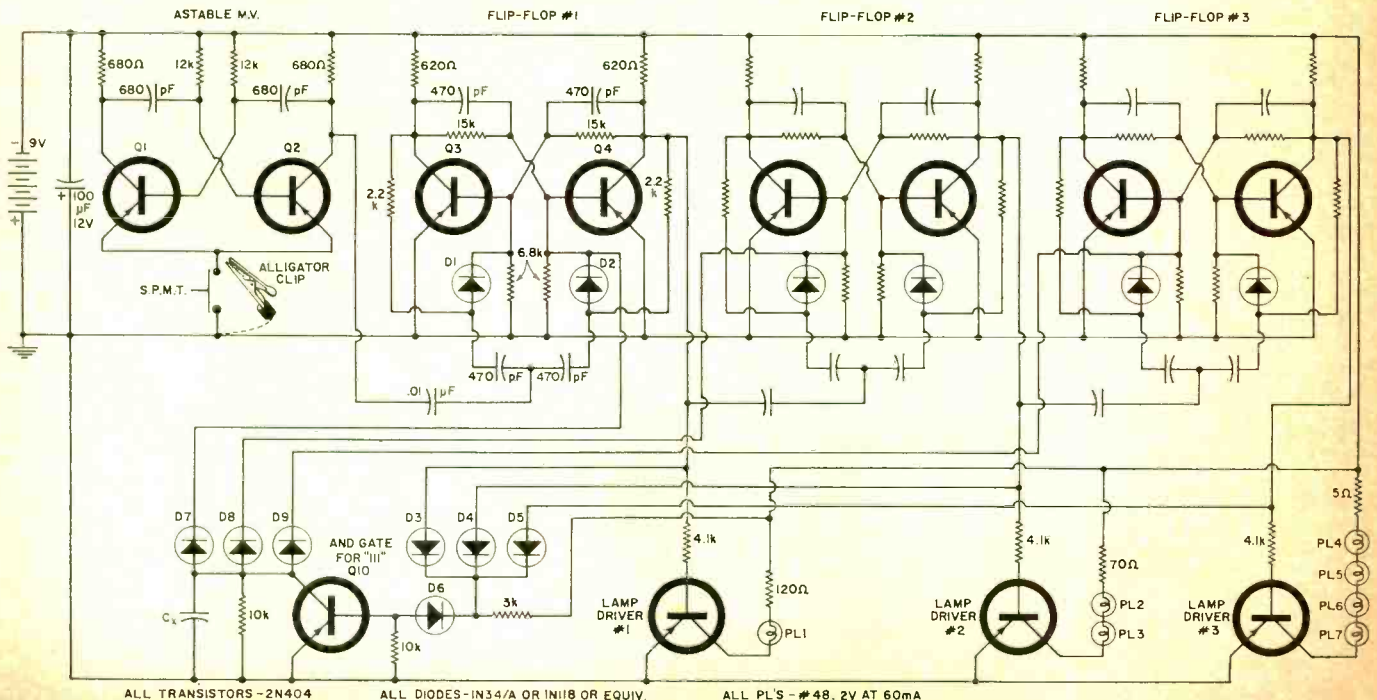

Focus

ON THE WORLD'S MOST WIDELY READ PHOTO YEARBOOKS!



PHOTOGRAPHY DIRECTORY BUYING GUIDE



Popular Photography's WOMAN 1968

First time ever published! A dramatic, sophisticated, colorful tribute to the loveliest subject in the world; 128 pages of the woman as girl next door, temptress, movie queen, fashion model, mother. Including a 20-page Playboy portfolio... an analysis of the movie, *Blow-Up*... plus a valuable tech data section. A must for every creative photographer!

1968 Photography Annual

Your private gallery of the year's most stimulating photographs by the world's most gifted photographers. Over 200 pages of superb, provocative photos—all magnificently reproduced in stunning color and dramatic black and white. Complete with "how it was done" tech section to help you improve your photographic skills. Acclaimed as the best edition yet!

Invitation to Photography

A unique 124-page "course" in better picture taking. Over 20 complete sections in all—on equipment, film, lighting, creativity, composition, portraits, glamor, color, processing—each written by an expert to help you progress quickly, easily, confidently. Includes a special 28-page bonus section on motion picture equipment and techniques!

1968 Photography Directory & Buying Guide

180-page "shop at home" directory of over 3000 photographic items! Provides every vital statistic you need to compare all the latest equipment—in virtually every category—and select the best in your price range. Lists complete specs, model numbers, special features, manufacturers along with hundreds of photos plus exclusive, money-saving "BUYPOINTS"!

GET THE DELUXE LEATHERFLEX-BOUND EDITIONS FOR JUST \$3 — POSTPAID! (Please allow three additional weeks for delivery.)

COMPLETE YOUR PHOTOGRAPHIC LIBRARY TODAY — Mail the Coupon Below!

ZIFF-DAVIS SERVICE DIVISION • DEPT. W
595 Broadway, New York, N.Y. 10012

Please send me the annuals I've checked below:

- WOMAN 1968, \$1.25
 Deluxe Edition, \$3.00
- INVITATION TO PHOTOGRAPHY, \$1.25
 Deluxe Edition, \$3.00
- 1968 PHOTOGRAPHY ANNUAL, \$1.50
 Deluxe Edition, \$3.00
- 1968 PHOTO DIRECTORY & BUYING GUIDE, \$1.25
 Deluxe Edition, \$3.00

In U.S.A., add 15¢ for shipping and handling for each Regular Edition; Deluxe Editions are postpaid.

Outside U.S.A., add 50¢ for each Regular Edition; 75¢ for each Deluxe Edition.

TOTAL ENCLOSED \$ _____

print name _____

address _____ EW-108

city _____

state _____ ZIP _____

— PAYMENT MUST BE ENCLOSED WITH ORDER —

$(\beta_{dc})I_b = 25 \times (0.6)$ or 15 milliamperes, and the voltage across the 620-ohm resistor is $620 \times .015$ or about 9 volts. Hence, the collector of Q4 is at ground. Then the assumption that Q4 was on and Q3 off is correct, and this is one stable state.

If the original assumption were reversed, the above analysis would show that this was the second stable state. The voltage drop in Q3's 620-ohm collector resistor due to Q4's base current of 0.62 milliamperes was deliberately neglected. The calculations, in any case, are rough and not intended to be fully accurate but simply to explain the circuit operation.

If a sufficiently large positive pulse were applied to the base of the on transistor, it would be switched off and regeneration would cause the state of the flip-flop to reverse. Hence, the circuit consisting of diodes D1, D2, the two 470-pF capacitors C1 and C2, and the 2200-ohm steering resistors enable positive pulses from the astable multivibrator to change the state of flip-flop #1. The other flip-flops (#2 and #3) are triggered by coupling their input circuits to the collectors of flip-flops #1 and #2, respectively. The diodes (labeled D3 through D5) are shown connected to the collector of the right-hand transistor in each flip-flop. These diodes form *and* gate 111 and in conjunction with transistor Q10 reset the counter to 001. In addition, a lamp driver circuit is coupled to the right-hand collector of each flip-flop. These circuits turn on bulbs PL1 through PL7 according to the binary number present in the counter.

From One Stage to the Other

Assume that the counter has been running and is at the count of 001. In this case, the right-hand transistor of each flip-flop is at -9 volts. Either a value of -9 volts or ground potential can determine a 1 or 0 state in the counter. Consequently, if the count is 001, the right-hand collector of stage #1 is at -9 volts and the right-hand collectors of stages #2 and #3 are at ground. The 0.01- μ F capacitor in the output of the astable multivibrator couples a positive pulse to the trigger circuit of flip-flop #1 through capacitors C1 and C2 (470 pF). Since Q4 is off, the collector of Q3 is at ground. This means that the anode of diode D1 is at ground. Hence D1 is conducting and diode D2 is reversed-biased. A positive-going signal from the astable multivibrator turns Q3 off and the collector of Q4 rises from -9 volts to ground. The positive pulse at the collector of Q4 turns the on transistor in stage #2 off. In this case, the right-hand transistor of flip-flop #2 goes from 0 to -9 volts. Flip-flop #3 is not affected by this pulse because its col-

lector is already at a negative potential. Therefore, after the first positive oscillator pulse, the counter is set at 010. From the above discussion, one can see that the polarity of the steering diodes inhibits the flip-flop circuits from responding to negative-going signals.

At the second positive transition of the astable multivibrator, flip-flop #1 again changes state and the collector of Q4 goes from ground to -9 volts or back to the 1 state. This negative transition does not trigger flip-flop #2, which stays in the 1 state, and hence flip-flop #3 receiving no pulse remains in the 0 state.

The third positive transition of the astable causes flip-flop #1 to go back to the 0 state, and Q4's collector goes from -9 volts to ground. This positive transition triggers flip-flop #2, and flip-flop #3, receiving a positive transition, now goes from the 0 to the 1 state. Therefore, at the end of the third positive transition of the astable multivibrator, the counter reads 100 or binary 4.

The fourth positive transition of the astable multivibrator just serves to trigger flip-flop #1 again and hence the counter is at the 101 or binary 5 state. The fifth transition puts the counter in the 110 or binary 6 state. The next transition or the sixth results in the following sequence. The sixth transition again triggers flip-flop #1 whose right-hand collector (that of Q4) goes back to the 1 state. At this instant, all the flip-flops are in the 1 state.

Many different types of flip-flops and gates can be used in the circuit. However, this design uses somewhat inexpensive components. If a higher voltage source is available, the flip-flop can be designed so that the bulbs are coupled in series with the collector resistors, and the lamp drivers can be eliminated. ▲

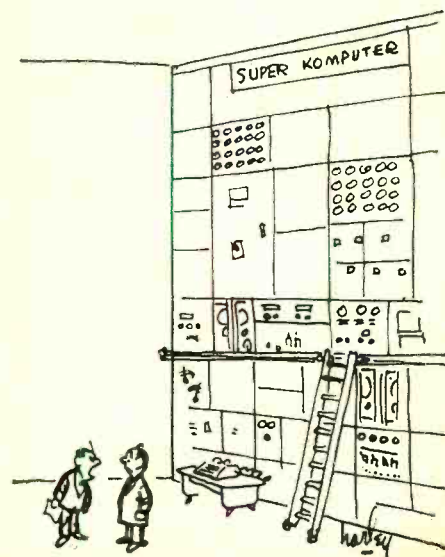

"How dare you think!"

Know why RCA's color chassis are so easy to service?

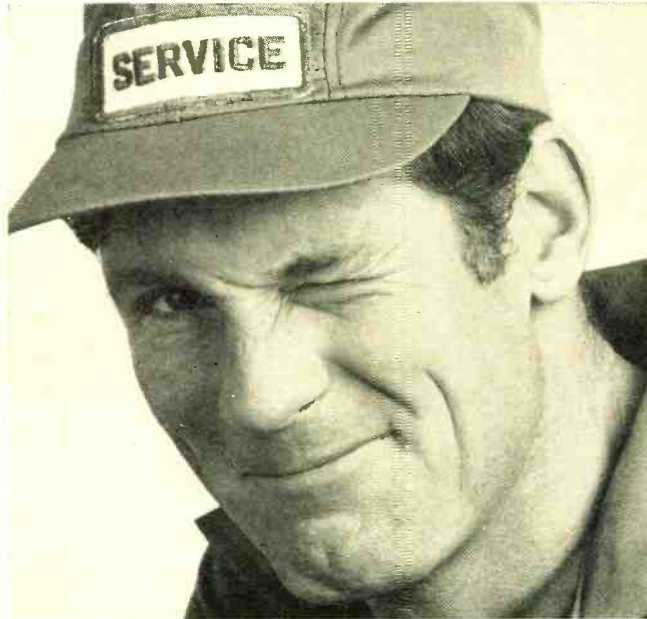

Because service men like you helped us design them.

First we got their advice, then we designed the whole assembly for easy servicing. For example, the chassis give you easy access. You don't have to pull out the chassis to get at the high-line voltage connection. Circuits and components on the circuit board are clearly marked so you can easily service them. The tuner assemblies are simplified for your convenience. And, we set up more test points. They're the kind of chassis we think you'd design yourself. Fact is, all our chassis designs are reviewed by a representative group of servicemen. And we appreciate their advice. We think you will, too—every time you service sets by RCA.

RCA

The New Look And New Values In

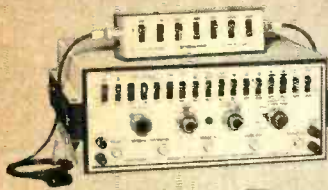

kit IG-57
\$135⁰⁰

wired IGW-57
\$199⁰⁰

kit IG-37
\$79⁹⁵



kit IT-18
\$24⁹⁵

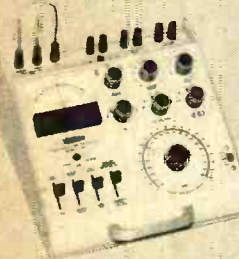

kit IM-36
\$60⁰⁰
wired IMW-36
\$90⁰⁰

kit IP-18
\$19⁹⁵



kit IP-17
\$59⁹⁵

wired IPW-17
\$89⁹⁵



kit IP-27
\$76⁹⁵
wired IPW-27
\$119⁹⁵



kit IO-18
\$84⁹⁵

wired IOW-18
\$139⁹⁵

kit IO-17
\$79⁹⁵



New Designs, New Features, New Styling . . . And Many Available, Kit or Assembled

HEATHKIT IG-57 Solid-State Post Marker/Sweep Generator

The new IG-57 plus a 'scope is all you need . . . no external sweep generator required. Switch selection of any of 15 crystal-controlled marker frequencies (you can view up to six different frequencies on one 'scope trace). Select the sweep range and you are ready to instantly see the results of any changes you make. Four markers for setting color bandpass, one for TV sound, eight at IF frequencies between 39.75 & 47.25 MHz plus picture and sound carrier markers for channels 4 & 10. Three sweep oscillators produce the 5 most-used ranges . . . color bandpass, FM IF, color & B&W IF and VHF channels 4 & 10. Save hundreds of dollars and put full alignment facilities in your shop too — order your IG-57 now. 14 lbs. Kit IG-14, same as IG-57 w/o the sweep, 11 lbs., \$99.95.

HEATHKIT IG-37 FM Stereo Generator

The IG-37 fills every need for alignment & trouble shooting of multiplex adapters, FM tuners & receivers. Generates mono or composite stereo FM signals. Crystal-controlled 19 kHz pilot signal, adjustable in level. Switch select 400 Hz, 1 kHz, 5 kHz, 19 kHz, 38 kHz & 65 kHz or 67 kHz SCA signals for total alignment capability. 100 MHz sweep signal (adjustable ± 2 MHz). Crystal-controlled marker oscillator for IF & dial tracking. Phase test for adjusting subcarrier transformers. 12 lbs.

HEATHKIT IT-18 In-Circuit Transistor Tester

In-Circuit transistor testers don't have to be expensive, and the IT-18 is proof of that . . . tests DC Beta 2-1000, in or out-of-circuit . . . leakage I_{ebo} and I_{ceo} current 0-5000 uA out-of-circuit . . . identifies NPN or PNP devices . . . tests diodes in or out-of-circuit for opens & shorts . . . identifies unknown diode leads . . . matches PNP & NPN transistors. The IT-18 is completely portable — runs on just one "D" cell. Easy to use too . . . rugged polypropylene case, attached 3' test leads, big 4½" 200 uA meter, all front panel controls, 10-turn calibrate control. 4 lbs.

HEATHKIT IM-36 Laboratory Transistor Tester

An essential instrument for solid-state circuitry design applications, the IM-37 allows you to read the results of varying parameters. Measures DC Beta to 400 on calibrated scales. Variable bias permits collector currents up to 15 amps . . . internal power to 9 volts in 1.5 v. steps . . . separate voltage & current range switches for both Gain & Leakage settings. External power supply connections for Gain, Leak & Bias supplies too. Four lever switches for fast test selection. 9 lbs.

HEATHKIT IP-18 1-15 VDC Power Supply

If you work with transistors, this is the power supply for you. All solid-state circuitry provides 1-15 VDC at up to 500 mA continuous. Features adjustable current limiting, voltage regulation, floating output for either + or — ground, AC or DC programming, circuit board construction, and small, compact size. Operates on either 110 or 220 VAC. A remarkable value at a remarkable price. 5 lbs.

HEATHKIT IP-17 Regulated High Voltage Power Supply

A good-looking, compact & versatile instrument for any workshop or lab. Supplies B+ from 0-400 VDC at 0-100 mA continuous with less than 1% variation, bias voltage 0 to —100 VDC at 1 mA and 6.3 & 12.6 AC filament voltages. Separate meters for B+ output voltages and current; voltmeter switched to read C-volts. Repeated tube warmup is eliminated by the use of separate filament & HV transformers and a "DC ON/Standby" switch. For a value-packed HV supply, order the IP-17. 21 lbs.

HEATHKIT IP-27 Regulated Low Voltage Power Supply

Here's a low voltage supply that has all the features of more expensive units and Heathkit styling too . . . Zener reference-voltage power supply, "outside" mounted calibration controls, solid-state circuitry that's virtually immune to overload from transients, and relay protection against shorts & overloads. Supplies 0.5-50 VDC with better than ± 15 mV regulation at 50 mA, 150 mA, 500 mA & 1.5 A. Adjustable current limiting, a panel meter that reads output voltage or current & a "DC ON/Standby" switch that eliminates warmup delays. 16 lbs.

HEATHKIT IO-18 Wide-Band 5" Scope

The New Heathkit IO-18 is destined to be the world's most popular 'scope, just as its predecessor, the IO-12 was. Features 5 MHz bandwidth, the famous Heath patented sweep circuit — 10 Hz to 500 kHz in 5 ranges, two extra sweep positions which can be preset to often-used rates, frequency compensated vertical attenuation, built-in P-P calibration reference, Z-axis input, retrace blanking, wiring options for 120 or 240 VAC operation and new Heathkit instrumentation styling in beige and brown. Circuit board-wiring harness assembly speeds construction. 24 lbs.

HEATHKIT IO-17 3" General Purpose Scope

The "just right" 'scope for thousands of applications . . . schools, hobbyists, shops, labs & servicemen all appreciate features like these: 5 MHz bandwidth . . . 30 mV P-P sensitivity . . . recurrent sweep generator, 20 Hz to 200 kHz in 4 ranges . . . x50 pullout frequency compensated vertical attenuator . . . front panel 1 v. P-P reference voltage . . . horizontal sweep from internal generator, 60 Hz line or external source . . . wide range automatic sync . . . shielded CRT . . . all front-mounted controls (except astigmatism) . . . solid-state high & low voltage power supplies . . . new Heathkit instrumentation styling in beige and brown . . . circuit board construction . . . dual primary power transformer for 120 or 240 VAC operation. 16 lbs.

Heathkit® Test Instruments

HEATHKIT IM-25 High Impedance Volt-Ohm-Milliammeter

Now you can buy the performance & features of a \$200 instrument for only \$80! Here's what the IM-25 has: 9 DC voltage ranges, 150 mV full scale to 1500 v. full scale . . . 9 AC voltage ranges, 150 mV full scale to 1500 v. full scale . . . 7 resistance ranges, 1 ohm to 1000 megohms . . . 11 current ranges, 15 uA full scale to 1.5 A full scale. 11 megohm input impedance on DC, 10 megohms on AC . . . AC response to 100 kHz . . . 6" 200 uA meter with zero center scale for + and - voltage measurements without switching. 1% precision resistors . . . all solid-state circuitry . . . precision ten-turn thumbwheel zero adjust . . . portable or line operation. 10 lbs.

HEATHKIT IM-16 Solid-State VOM

The value leader in its class, and no wonder . . . 8 DC voltage ranges, 8 AC voltage ranges, 7 ohmmeter ranges . . . 11 megohm input impedance on DC, 1 megohm on AC . . . internal battery or 120/240 50-60 Hz line operation at the flick of a switch with minimal zero adjustment . . . virtually drift-free zero . . . a single probe with fingertip flip switch makes all measurements — permits "hands-free" operation . . . separate switches for individual functions for much less knob twisting . . . wiring harness and circuit board construction . . . new Heathkit styling. 10 lbs.

HEATHKIT IM-17 Solid-State VOM

Another very popular VOM from Heathkit engineering and it's easy to see why — all solid-state circuitry . . . high impedance FET input, 11 megohms on DC, 1 megohm on AC . . . 4 AC voltage ranges . . . 4 DC voltage ranges . . . 4 ohm ranges . . . 4½" 200 uA meter . . . 3 built-in test leads . . . DC polarity reversing switch . . . zero-adjust & ohms-adjust controls . . . continuous 12-position function switch. And that's not all — the IM-17 is battery powered for complete portability and comes in a rugged polypropylene case with built-in handle. Simple circuit board assembly, rugged reliability and famous Heath engineering make the IM-17 the best value going. 4 lbs.

HEATHKIT IM-38 Laboratory AC VTVM

For general service work, audio design or lab analysis, you can't buy a better value than the IM-38 AC VTVM. Here's why — 10 voltage ranges — from 0.01 to 300 volts RMS full scale . . . extended frequency response, ±1 dB from 10 Hz to 500 kHz . . . 10 megohm input on all ranges for high accuracy, low circuit loading . . . wide dB range from -52 to +58 dB . . . VU-type ballistic meter damping . . . amplifier brown instrument styling . . . 120/240 50-60 Hz AC wiring options. 5 lbs.

HEATHKIT IT-28 Capacitor Checker

Provides complete analysis of all capacitor types at low cost. Features direct reading scales to eliminate involved calculations. Measures capacitance from 10 pF to 1000 uF and resistance from 5 ohms to 50 megohms. 16 leakage voltage positions, 3-600 VDC. Comparator circuit measures "L", "C" and "R" with external standard. Calibrated power factor control. Low bridge voltage for safe testing of miniature electrolytics. Determine transformer turns ratios quickly and read directly on the dial. External generator provisions included for measurements at frequencies up to 10 kHz. 120/240 VAC operation. New Heathkit beige and brown styling. 7 lbs.

HEATHKIT IM-48 Audio IM Analyzer

Three audio test instruments in one . . . combines the functions of an AC VTVM, Wattmeter and IM Analyzer. Built-in 60 Hz and 6 kHz signal sources for IM tests. Built-in non-inductive load resistors for 4, 8, 16 and 600 ohms. Wide frequency response: AC VTVM 10 Hz to 100 kHz; Wattmeter 10 Hz to 50 kHz. Ten AC voltage ranges .01 to 300 volts RMS. dBm range reads from -65 to +52 dBm. Wattmeter ranges 0.15 mW to 150 W. IM analyzer reads from 1% to 100% full scale. New Heathkit beige and brown instrument styling, 120/240 50-60 Hz wiring options, and a top performing instrument that's actually three in one. 13 lbs.

HEATHKIT IM-58 Harmonic Distortion Meter

An accurate measurement of harmonic distortion between 20 Hz and 20 kHz. Five distortion ranges — 1, 3, 10, 30 and 100% full scale. Large, easy to read meter calibrated in volts RMS, % distortion and dB. Measures noise levels down to -60 dB, voltage from 1 to 30 in four ranges. The high input impedance and the use of 1% precision resistors in the VTVM voltage divider assure accurate, repeatable results. New Heathkit beige and brown styling; easier to read settings; 120/240 VAC wiring options. Your best buy in a harmonic distortion meter is the Heathkit IM-58. 13 lbs.

HEATHKIT IB-28 Impedance Bridge

Laboratory accuracy in a versatile, easy to use instrument. Combines four popular bridge circuits for precision testing of components — a Wheatstone bridge for resistance, Capacitance Comparison for capacitance, Maxwell bridge for low Q inductance and a Hay bridge for high Q inductance. Built-in power supply and external binding posts for DC measurements; built-in 1 kHz generator and terminals for external generator. Internal vacuum tube detector & amplifier and terminals for external detector. Measures resistance 0.1 to 10 megohms, capacitance 100 pF to 100 uF, inductance 0.1 mH to 100 H, dissipation factor 0.002 to 1 and storage factor 0.1 to 1000. New Heathkit beige and brown instrument styling. 11 lbs.

kit IM-25

\$80⁰⁰



wired IMW-25

\$115⁰⁰

kit IM-16

\$44⁹⁵



wired IMW-16

\$64⁹⁵

kit IM-17

\$21⁹⁵



kit IM-38

\$39⁵⁰



wired IMW-38

\$54⁹⁵

kit IT-28

\$31⁹⁵



kit IM-48

\$69⁰⁰



kit IM-58

\$65⁰⁰



kit IB-28

\$85⁰⁰

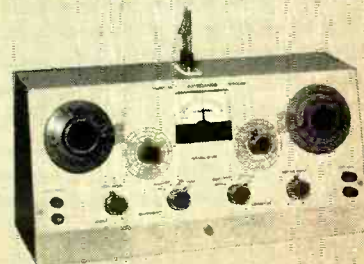

More New Heath Products On Next Pages

CIRCLE NO. 103 ON READER SERVICE CARD

Look What's New In Your



NEW kit MI-18-1

\$29⁹⁵

NEW kit MI-18-2

\$32⁹⁵



NEW kit GR-17

\$43⁹⁵



NEW kit AD-27

\$169⁹⁵

NOW, THE TUNER AND AMPLIFIER OF THE FAMOUS HEATH AR-15 RECEIVER ARE AVAILABLE AS SEPARATE COMPONENTS



NEW kit AJ-15

\$189^{95*}



NEW kit AA-15

\$169^{95*}

Heathkit Solid-State Tachometer

The Professional Tach. That's the new Heathkit MI-18. In Design: breaker point, "tach" lead or unique inductive pickup connection; use it with any spark-type engine and any ignition system, 2 cycle 1-6 cyl. engines or 4 cycle, 2-8 cyl. engines . . . all electronics are in the tach itself. In Performance: 0-6000 & 0-9000 RPM ranges . . . 250° edge-lighted dial . . . temperature-compensated, $\pm 4\%$ accuracy from 0° —120° . . . adjustable red line pointer . . . 10.5 to 17.5 VDC operation. In Styling: stainless steel hardware, splash-proof black & chrome case and scratch-proof glass face for use in rugged conditions. The MI-18-1 mounts in your dash — requires only a 3¼" hole & 2¼" depth. The MI-18-2 comes with mounting case & hardware. Put a Professional Tach in your car, boat, dune-buggy, or bike now — the Heathkit MI-18! Shpg. wt. 3 lbs.

Heathkit AM-FM Portable Radio

Here's performance others can't match. The new Heathkit GR-17 portable has 12 transistor, 7 diode circuit with the same front end as Heathkit hi-fi tuners; 3-stage IF; big 4" x 6" speaker; tone control; AFC on FM and amplified AGC on AM; built-in AM rod antenna plus telescoping 34" FM antenna; 350 milliwatt output; and 200-300 hour battery life. Shpg. wt. 5 lbs.

Heathkit FM Stereo COMPONENT-COMPACT

This new Heathkit AD-27 stereo compact has features not found in other units costing twice as much for one very simple reason. It wasn't engineered to meet the usual level of compact performance. Instead, Heath took one of its standard stereo/hi-fi receivers, the AR-14, and re-arranged it physically to fit a compact configuration. The result is performance that is truly high fidelity without compromise. It features 31 transistor, 10 diode circuitry with 15 watts per channel dynamic music power (enough to let you choose most any speaker systems you prefer), full-range tone controls, less than 1% distortion, and 12 to 60,000 Hz response. The pre-assembled FM stereo tuner section with 4-stage IF offers 5 μ V sensitivity, excellent selectivity, AFC, and the smoothest inertia tuning. The BSR McDonald "500" turntable offers features usually found only in more expensive units . . . like low mass tubular aluminum tone arm, anti-skate control, cueing and pause control, plus a Shure magnetic cartridge with diamond stylus. It's all housed in a smart oiled walnut cabinet with sliding tambour door that disappears inside the cabinet. For value and performance choose the AD-27, the new leader in stereo compacts. Shpg. wt. 41 lbs.

HEATHKIT AJ-15 Deluxe Stereo Tuner

For the man who already owns a fine stereo amplifier, and in response to many requests, Heath now offers the superb FM stereo tuner section of the renowned AR-15 receiver as a separate unit. The new AJ-15 FM Stereo Tuner has the exclusive design FET FM tuner for remarkable sensitivity, the exclusive Crystal Filters in the IF strip for perfect response curve and no alignment; Integrated Circuits in the IF for high gain, best limiting; elaborate Noise-Operated Squelch; Stereo-Threshold Switch; Stereo-Only Switch; Adjustable Multiplex Phase, two Tuning Meters; two variable output Stereo Phone jacks; one pair variable outputs plus two fixed outputs for amps., recorders, etc.; front panel mounted controls; "Black Magic" panel lighting; 120/240 VAC operation. 18 lbs. *Walnut cabinet AE-18, \$19.95.

HEATHKIT AA-15 Deluxe Stereo Amplifier

For the man who already owns a fine stereo tuner, Heath now offers the famous amplifier section of the AR-15 receiver as a separate unit. The new AA-15 Stereo Amplifier has the same superb features: 150 watts Music Power; Ultra-Low Harmonic & IM Distortion (less than 0.5% at full output); Ultra-Wide Frequency Response (± 1 dB, 8 to 40,000 Hz at 1 watt); Ultra-Wide Dynamic Range Preamp (98 dB); Tone-Flat Switch; Front Panel Input Level Controls; Transformerless Amplifier; Capacitor Coupled Outputs; Massive Power Supply; All-Silicon Transistor Circuit; Positive Circuit Protection; "Black Magic" Panel Lighting; new second system Remote Speaker Switch; 120/240 VAC. 26 lbs. *Walnut cabinet AE-18, \$19.95.

Free 1969 Heathkit® Catalog

**New Lower Prices On Heathkit Color TV
Make Them A Better Buy Than Ever!**

Deluxe "295" Color TV... Model GR-295 **now only \$449.95**
(less cabinet)

New improved phosphors and low voltage supply with boosted B+ for maximum color fidelity and operation • automatic degaussing • exclusive Heath Magna-Shield • ACC and AGC assures color purity, flutter-free pictures under all conditions • preassembled IF with 3 stages instead of the usual 2 • deluxe VHF turret tuner with "memory" fine tuning • choice of installation—wall, custom or optional Heath factory assembled cabinets • Easy to assemble.

Big, Bold, Beautiful... With Advanced Features and Exclusive Heathkit Self-Servicing. Top quality, American brand color tube... 295 sq. inch viewing area. The built-in dot generator and full color photos and simple instructions let you set-up, converge and maintain the best color pictures at all times. Add to this the detailed trouble-shooting chart in the manual and you put an end to costly TV service calls for periodic picture convergence and minor repairs.

GRA-295-4, Mediterranean cabinet shown... \$119.50
Other cabinets from \$62.95

Deluxe "227" Color TV... Model GR-227 **now only \$399.95**
(less cabinet)

Has same high performance features and built-in servicing facilities as the GR-295, except for 227 sq. inch viewing area. The vertical swing-out chassis makes for fast, easy servicing and installation. The dynamic convergence control board can be placed so that it is easily accessible anytime you wish to "touch-up" the picture.

GRA-227-1, Walnut cabinet shown... \$59.95
Mediterranean style also available at \$99.50

Deluxe "180" Color TV... Model GR-180 **now only \$349.95**
(less cabinet)

Same high performance features and exclusive self-servicing facilities as the GR-295 except for 180 sq. inch viewing area. Feature for feature the Heathkit "180" is your best buy in deluxe color TV viewing... tubes alone list for over \$245. For extra savings, extra beauty and convenience, add the table model cabinet and mobile cart.

GRA-180-5, table model cabinet and cart... \$39.95
Other cabinets from \$24.95

Now, Wireless Remote Control For Heathkit Color TV's

Control your Heathkit Color TV from your easy chair, turn it on and off, change VHF channels, volume, color and tint, all by sonic remote control. No cables cluttering the room... the handheld transmitter is all electronic, powered by a small 9 v. battery, housed in a small, smartly styled beige plastic case... feather-light and contoured to fit comfortably in your hand for easy pushbutton operation. The receiver contains an integrated circuit (15 resistors, 10 transistors, 1 diode) and a meter for adjustment ease. Circuit board construction and plug-in wire harness make installation of receiver and control motors easy. For greater TV enjoyment, order yours now.

kit GRA-295-6, 9 lbs., for Heathkit GR-295 and GR-25 Color TV's... \$69.95
kit GRA-227-6, 9 lbs., for Heathkit GR-227 and GR-180 Color TV's... \$69.95

**3 HEATHKIT® COLOR TV'S
NOW! ALL WITH 2-YEAR
WARRANTY ON PICTURE TUBE**



kit GR-295



kit GR-227



kit GR-180



**NEW Wireless
TV Remote Control**

\$69.95

FREE 1969 Heathkit Catalog

Shows these and over 300 other easy-to-build kits that save up to 50%... Electronic Organs, Stereo, Marine, CB, Ham Radio, Test, Photography, Educational for home & hobby. No skills or experience needed. Send for your free copy today. Mail coupon or write Heath Co., Benton Harbor, Michigan 49022.

HEATH COMPANY, Dept. 15-10
Benton Harbor, Michigan 49022
In Canada, Daystrom Ltd.

Enclosed is \$ _____, plus shipping.

Please send model (s) _____
 Please send FREE Heathkit Catalog.
 Please send Credit Application.

Name _____

Address _____

City _____

State _____

Zip _____

Prices & specifications subject to change without notice.

CL-341

Olson



FREE

Fill in coupon for a **FREE** One Year Subscription to **OLSON ELECTRONICS' Fantastic Value Packed Catalog** — Unheard of **LOW, LOW PRICES** on Brand Name Speakers, Changers, Tubes, Tools, Stereo Amps, Tuners, CB, Hi-Fi's, and thousands of other Electronic Values. Credit plan available.

NAME _____
 ADDRESS _____
 CITY _____ STATE _____
 GIVE ZIP CODE _____

If you have a friend interested in electronics send his name and address for a **FREE** subscription also.

OLSON ELECTRONICS

962 S. Forge Street Akron, Ohio 44308

CIRCLE NO. 92 ON READER SERVICE CARD

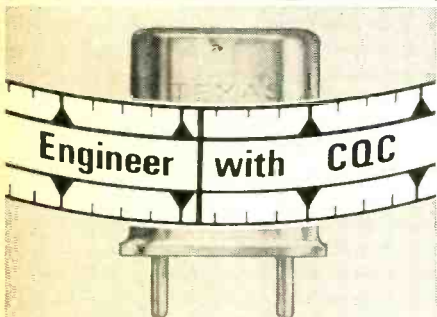

MORE CONTROL

Control of quality throughout precision manufacturing gives you crystals that assure exact frequency control.

MORE RELIABILITY

You'll stay on frequency better with CQC. And, you can rely on your CQC dealer to fill your needs promptly.

See your dealer for prices and data on CQC



TEXAS CRYSTALS

Division of Whitehall Electronics Corp.

1000 CRYSTAL DRIVE

FORT MYERS, FLORIDA 33901

Plants in Fort Myers and Los Angeles, Calif.

CIRCLE NO. 199 ON READER SERVICE CARD

TONE BOOSTER CIRCUIT

By HUGH L. MOORE

Electronics Education, Los Angeles Colleges

Here is a simple circuit that may be inserted between mike and speech amplifier to improve the sound. At a small cost in mid-band response, bass/treble frequencies are boosted.

YOU may want to customize the frequency response of your speech amplifier. This simple circuit requires only four inexpensive, non-critical components. It may be inserted between mike and amplifier as a removable option, or it may be permanently built into the amplifier. It offers about 18 dB relative bass and treble boost, which will greatly improve the sound of many common public-address systems.

Basically, this circuit is a voltage divider (R_1 and R_2) with high-frequency bypass C_1 , and low-frequency block C_2 . See Fig. 1. Bypass C_1 allows the high frequencies to go directly to the output and C_2 prevents loss of low frequencies to ground.

Frequency response of this circuit for a load of 1 megohm or greater is

shown in Fig. 2. For lower resistance loads, the load appearing across R_2 and C_2 upsets the ideal conditions assumed in calculating the network.

To reduce the effects of low load resistance, the booster circuit can be recalculated to use smaller resistors and larger capacitors. The easiest way to find new values is to simply multiply all resistor values and divide all capacitor values by a factor equal to the ratio of 1 megohm to the actual resistance.

For example, if the amplifier input resistance were 10,000 ohms (100 times smaller than 1 megohm), new values would be $R_1 = 2200$ ohms, $R_2 = 220$ ohms, $C_1 = 0.03 \mu\text{F}$, and $C_2 = 2 \mu\text{F}$. These values are appropriate for many of the small transistor audio amplifiers now available.

To prevent excessive loss of volume, the emphasis circuit must be driven from a relatively low-resistance source. A resistance of one-tenth the value of R_1 is a suitable maximum. The circuit of Fig. 1 could be driven from any mike up to 22,000 ohms output resistance. But the revised low-resistance circuit might require a matching transformer, and would do very well with a speaker serving as mike in an intercom system. ▲

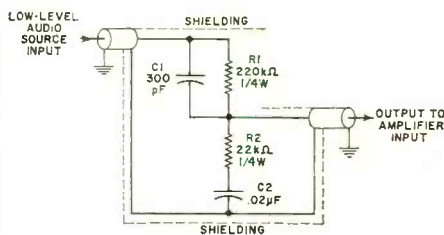
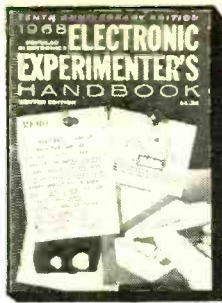

Fig. 1. Four inexpensive components offer bass and treble boost for a slight loss in mid-band response. At low signal levels, shielding and grounding control hum.

Fig. 2. Measured performance of the circuit of Fig. 1. Since this circuit has no voltage gain, higher amplifier gain settings are required to maintain volume at its previous levels.





Winter 1968 ELECTRONIC EXPERIMENTER'S HANDBOOK

Special 10th Anniversary Issue! You'll build such valuable units as . . . a solid-state CD ignition system . . . a sequence-operated lock . . . a metal locator . . . a 70 watt per channel hi-fi amplifier . . . an IC binary counter . . . and Tesla's thermo-magnetic motor! Each has complete schematics, illustrations, parts lists and easy-to-follow instructions that guarantee you perfect finished products.



Spring 1967 ELECTRONIC EXPERIMENTER'S HANDBOOK

Another big package containing 35 of the most challenging, fun-to-build electronics projects ever! Including . . . a transistorized auto-light minder . . . a \$2 intrusion alarm . . . a tape recorder echo chamber (for under \$10!) . . . a powerhouse 2-tube SW receiver . . . a solid-state scope calibrator . . . even a super-charged salt shaker! Be sure to order this one today!



1968 STEREO/HI-FI DIRECTORY

A giant 182-page buyer's guide to virtually every new audio component on the market today. Over 1600 products in all! From amplifiers to complete hi-fi systems to tape cartridge machines—all the latest offerings from 176 manufacturers are fully detailed and illustrated for your shop-at-home convenience. Also includes valuable "what to look for—how to buy" advice!

SIX VITAL COMPONENTS

For Knowledge... For Profit... For Sheer Electronics Enjoyment!

ONLY \$1.25 EACH

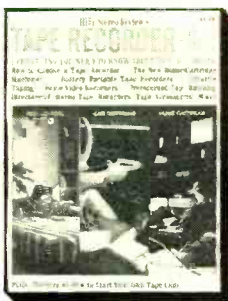

1968 TAPE RECORDER ANNUAL

Now it's easy to be an authority on tape recording. This fact-filled volume contains over 130 pages, 19 complete features, covering every aspect of the recording. You get expert tips by the dozens, on selecting the right equipment—creative taping—editing—copying—on everything you want and need to know. PLUS complete directories of machines and accessories!

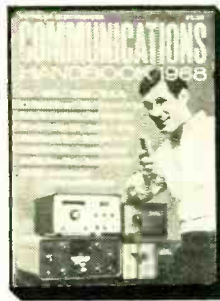

1968 COMMUNICATIONS HANDBOOK

For the ham, short wave listener, CB'er or business radio operator . . . here's 150 pages of "how to do it—how to do it better" information. From choosing your field . . . to learning the code . . . to getting your license . . . to selecting your equipment . . . to setting up your own station . . . to winning awards! Includes directories of the latest ham and CB gear!

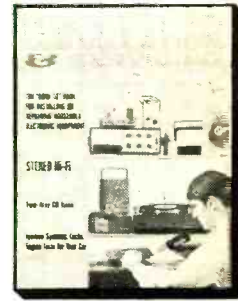

1968 ELECTRONICS INSTALLATION & SERVICING HANDBOOK

Now, get the tricks of the trade for servicing everything. For TV, AM/FM, CB, PA, transistor radios, stereo hi-fi, home intercoms—even automotive electronics—you'll find the latest technique advice, equipment and parts information and step-by-step "how to do it" hints. A 140-page "encyclopedia" that's a must for every serviceman and serious hobbyist!



GET THE DELUXE LEATHERFLEX-BOUND EDITIONS FOR JUST \$3—POSTPAID!

These valuable annuals are also available in handsome DELUXE EDITIONS. Each volume is bound in superb leatherflex—a softly textured, gold-embossed cover which also provides rugged, lasting protection. They are truly collector's items . . . prized additions to your electronics bookshelf. And they're yours, for just \$3 each postpaid. (Please allow three additional weeks for delivery.)

USE THIS COUPON TO ORDER YOUR COPIES TODAY!

ZIFF-DAVIS SERVICE DIVISION • Dept. W • 595 Broadway, New York, N.Y. 10012

Please send me the annuals I've checked below:

- | | |
|---|---|
| <input type="checkbox"/> Winter 1968 Electronic Experimenter's Handbook, \$1.25 | <input type="checkbox"/> 1968 Stereo/Hi-Fi Directory, \$1.25 |
| <input type="checkbox"/> Deluxe Edition, \$3.00 | <input type="checkbox"/> Deluxe Edition, \$3.00 |
| <input type="checkbox"/> Spring 1967 Electronic Experimenter's Handbook, \$1.25 | <input type="checkbox"/> 1968 Tape Recorder Annual, \$1.25 |
| <input type="checkbox"/> Deluxe Edition, \$3.00 | <input type="checkbox"/> Deluxe Edition, \$3.00 |
| <input type="checkbox"/> 1968 Electronics Installation & Servicing Handbook, \$1.25 | <input type="checkbox"/> 1968 Communications Handbook, \$1.25 |
| <input type="checkbox"/> Deluxe Edition, \$3.00 | <input type="checkbox"/> Deluxe Edition, \$3.00 |

In U.S.A., add 15c for shipping and handling for each Regular Edition; Deluxe Editions are postpaid. Outside U.S.A., add 50c for each Regular Edition; 75c for each Deluxe Edition. **TOTAL ENCLOSED \$** _____

print name _____

address _____ EW-108

city _____ state _____ zip code _____

PAYMENT MUST BE ENCLOSED WITH ORDER

NEW PRODUCTS & LITERATURE

Additional information on the items covered in this section is available from the manufacturers. Each item is identified by a code number. To obtain further details, fill in coupon on the Reader Service Card.

COMPONENTS • TOOLS • TEST EQUIPMENT • HI-FI • AUDIO • CB • HAM • COMMUNICATIONS

SCR-REGULATED SUPPLIES

A complete off-the-shelf line of SCR-regulated d.c. power supplies which combine 3% line/load regulation with other performance

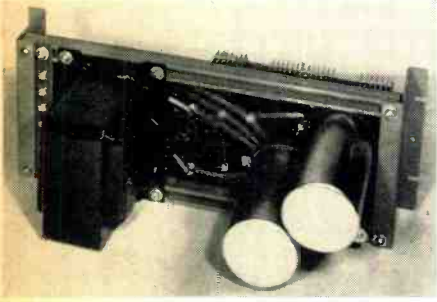

features, has just been announced as the SCRDC series.

There are five standard supplies in the line, in 4.5, 6, 12, 24, and 48-volt models, each available at 10, 20, and 40 amperes. These supplies are adjustable at the factory, however, so that the user can specify different voltages if his application requires. For example, the 6-volt unit can be adjusted down to the 3-volt level and still provide $\pm 3\%$ regulation. Automatic current limiting is another feature of the new line. No matter what happens, including shorting of its output, the supply will automatically limit the amount of current, protecting itself and the circuits which it powers.

The new supplies are designed for standard 24-inch rack mounting. Full details will be supplied on request. Sola

Circle No. 5 on Reader Service Card

ENGINEERING DESIGN KIT

An engineering design kit for its Kemet E-series dipped solid tantalum capacitors is now available. Each kit contains an assortment of 152 capacitors in 24 values in four case sizes. Included with each design kit is an engineering application note containing performance characteristics and typical circuit applications where E-Series tantalum capacitors can be designed in for improved electrical performance and reliability.

Additional information on the kit or E-Series capacitors is available on request. Union Carbide

Circle No. 126 on Reader Service Card

MINIATURE COAX COUPLER

A miniature 3-dB coaxial coupler utilizing a unique internal construction is being marketed as the Model AM7403. Weighing only 0.6 ounce and measuring 1.22" x 1" x 0.45", the device is ideal for system requirements where compactness and reliability are required. Frequency range

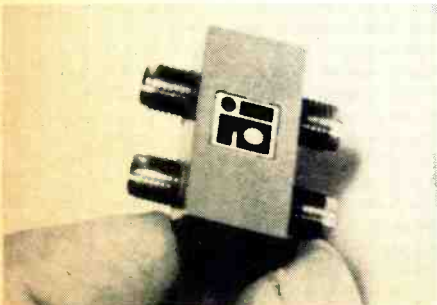

is 2600 to 5500 MHz, coupling is 3 ± 0.5 dB, isolation is 20 dB minimum, and v.s.w.r. is 1.3 max. Alpha Industries

Circle No. 127 on Reader Service Card

SQUARE TRIMMERS

Infinite resolution Metal Glaze resistance elements have been added to the new line of $\frac{5}{16}$ " square trimmers, Type 850. According to the company, improved moisture sealing methods make the unit impervious to common industrial solvents used in printed-circuit assembly.

The trimmer meets severe military environments. It features a rugged metal shaft that drives a precious metal contact over a resistance element of the glaze, a proprietary thick film. A multi-point center terminal contact minimizes electrical noise and contact resistance.

Resistance values from 100 ohms to 1 megohm $\pm 10\%$ are available. Power rating is 0.3 watt at 70° C. IRC

Circle No. 128 on Reader Service Card

DIGITAL PANEL METER

The Model 1280 digital panel meter is designed with a full four nines presentation with high accuracy and solid-state reliability, according to its maker. It is available in choice of ten voltage and current ranges, from 100 mV and 10 μ A up. Accuracy is 0.05% ± 1 digit. Resolution is 1 part in 10,000 (10 μ V on 100-mV range). Sample rate is one per second. BCD is 1-2-4-8 (4 decades).

The front panel measures $3\frac{3}{16}$ " x $4\frac{1}{8}$ " x $1\frac{1}{8}$ " while the case behind the panel is $4\frac{1}{2}$ " x $6\frac{1}{4}$ " x $4\frac{1}{2}$ ". Weston

Circle No. 129 on Reader Service Card

RESISTANCE DECADE BOXES

The series 1300 decade boxes are said to combine high stability, accuracy, and versatility plus unique advantages as secondary standards, resistance substitution units (variable and direct

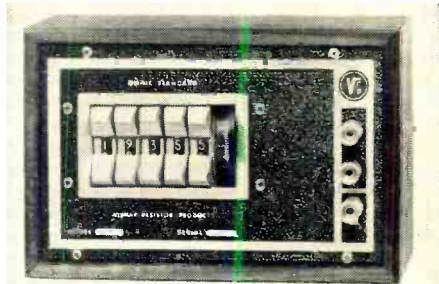

reading), components of bridges, attenuators and multipliers, adjustable feedback units for use with op amps, and other applications. Frequency range is d.c. to 100 MHz.

Two basic styles are offered: 5-digit and 7-digit. Both provide at-the-terminal accuracy to $\pm 0.005\%$, 20 ppm stability, ± 2 ppm/°C TC, constant-zero resistance, and 5-pF shunt capacitance at all values.

Complete specifications, delivery, and price information will be forwarded on request. Vishay

Circle No. 130 on Reader Service Card

AUTO ALARM

A pressure-sensitive device which protects automobiles from theft or tampering is now available as the Police Auto Alarm. The alarm switch is activated when the driver leaves the

car and any subsequent vibration causes the alarm to sound for about 15 seconds. If the tampering is halted, the alarm is silenced automatically. The device incorporates horizontal and vertical vibrators that react to any type of pressure. No batteries are required. J. Ross

Circle No. 6 on Reader Service Card

IN-CIRCUIT TRANSISTOR TESTER

The Model IT-18 in-circuit transistor checker measures d. c. beta in or out of circuit in two ranges from 2 to 1000 and also tests diodes in or out of circuit for forward and reverse current to indicate opens or shorts.

In addition, the new tester measures transis-



tors out of circuit for I_{CBO} and I_{CEO} leakage, provides positive identification of "p-n-p" and "n-p-n" devices, and anode or cathode of unmarked diodes. It permits matching of transistors of the same or opposite type. The checker has a $\frac{1}{2}$ ", 200- μ A meter, a 10-turn calibrate control, and is powered by a single "D" cell. Heath

Circle No. 7 on Reader Service Card

R.F. SHIELDING FABRIC

Eccoshield MNF is a series of woven fabrics that are highly conductive electrically. Each fiber is conductive continuously along its length so that the fabric retains its conductivity even after prolonged mechanical action or outdoor exposure. The fabric weighs approximately 3 ounces per square yard. It can be cut or sewn and drapes readily.

It is an r.f. shield and can be draped over equipment to give a measure of shielding. Clothing for the protection of personnel can be made from the fabric. MNF exhibits a high level of r.f. and microwave reflectivity, making it useful as the reflector in antennas or as the primary radiating element. Emerson & Cuming

Circle No. 131 on Reader Service Card

SPIRAL SLIDE RULE

A new slide rule which the company claims has a working accuracy several times greater than that provided by a conventional rule is now available as the No. 23C620.

Scales on the slide rule are wound in a spiral, 66" long. Thus many more graduations are provided for extended accuracy. A double scale (with unity at the center) reduces the number of



settings in a series of calculations. The rule is constructed principally of metal, and there are no delicate parts which can be readily damaged. The rule is just 6" long when stored and comes with a leather case. Jensen Tools

Circle No. 8 on Reader Service Card

SOLID-STATE POWER SUPPLIES

A new line consisting of nine low-cost, solid-state power supplies is now being offered in three basic sizes: 5 1/4" x 8" x 8", 5 1/4" x 8" x 9",

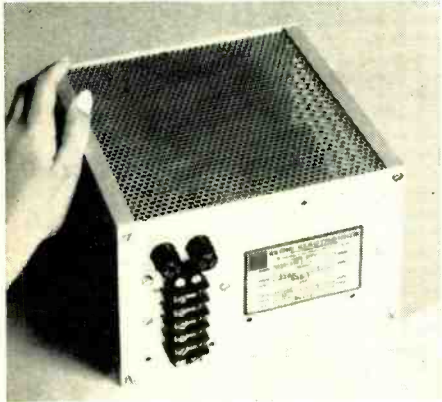

and 5 1/4" x 8" x 12". Standard output currents of 4, 8, and 16 amps are offered for each input of 115, 208, and 230 volts $\pm 10\%$. The supplies have an adjustable output voltage of 4.5-5.5 volts. Elgin Electronics

Circle No. 132 on Reader Service Card

FIELD-EFFECT METER

The Model FE149 field-effect meter features push-button design and simplified operation. By pushing one button in the top row to select the function, and one button in the bottom row for range, any circuit test can be made quickly and accurately, according to the manufacturer.

Designed for bench and laboratory work as well as service calls, the instrument operates on a.c., on its self-contained batteries, or on a.c. with batteries plugged in. With an accuracy of 1.5% on d.c. and 3% on a.c., plus a 7-inch meter with mirrored scale, more accurate tests are assured. The FE149 has eight d.c. voltage ranges to 1500 volts, a special 0.5-V low scale with 0.25 volt either side to assure accurate measurements to less than 1/10th volt for transistor bias measurements, and eight a.c. ranges to 1500 volts r.m.s. and 4500 volts peak-to-peak. Sencore

Circle No. 9 on Reader Service Card

PRECISION WIREWOUNDS

A new family of low-cost precision wirewound resistors, featuring accuracies of $\pm 0.1\%$, 0.025%, 0.01%, and 0.005%, is now available as the "Econistor" Series 8E16.

This new series has typical temperature coefficients of ± 3 ppm/ $^{\circ}\text{C}$ with a 3-year stability of better than 50 ppm. Other features include qualification to MIL-R-93D (type RB55), maximum voltage 200 V d.c. or peak a.c., and power rating of 1/4 watt at $+125^{\circ}\text{C}$ and 1/3 watt at 85°C . General Resistance

Circle No. 133 on Reader Service Card

SWEEP GENERATOR

The Model HS-86 sweep generator is a high-power, wide-tuning-range unit which provides 8 watts peak r.f. output and 4 watts c.w. into

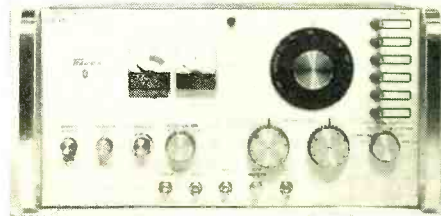

a 50-ohm load. It covers a frequency range of 500 MHz to 1000 MHz.

Four modes of operation are available: swept r.f., modulated swept r.f., continuous wave, and modulated continuous wave. The instrument contains built-in attenuators which enable the user to adjust the output signal from 0 to 80 dB in 1 dB steps plus a 0 to 6 dB vernier.

Particular applications include test and alignment of high-power r.f. amplifiers, v.h.f. and u.h.f. TV transmitters, and varactor multipliers. Texscan

Circle No. 134 on Reader Service Card

MODULAR POWER SUPPLIES

A new series of high-power, half-rack modular power supplies is now available in ratings up to 150 volts at 22 amps with current up to 33 amps at 3 volts.

The new EE package is 4 3/16" x 7 1/2" x 17" and with a new rack adapter, Model LRA-7, mounts up to two EE modules or up to eight smaller LM-A or LM-B modules. The power package is all-silicon, programmable, and convection-cooled. There is no heat sinking or forced air required. The unit meets military specs.

Complete specifications on the EE package are available on request. Lambda

Circle No. 135 on Reader Service Card

POWER FACTOR METER

A clip-on meter designed and built for measuring power factor in 3-phase distribution systems is now available. The power factor is read directly on the scale and reading is independent of the magnitude of voltage applied or of the current in the conductor, provided that current is between 1 and 1500 A and voltage between 150 and 600 volts.

Frequency range is 40-60 Hz. Accuracy of measurement is ± 0.05 referred to the numerical value of the power factor reading. The range is from capacitive 0 to 1 to 0 inductive. It can be used on round conductors up to 2 3/16" diam-

Zenith Tubes...

life-tested for greater dependability!



Exciting Surprises
for You—
and Your Family!
Fun for all!
Get the details
at your Zenith
Distributor's
Parts Department.

ZENITH TV PICTURE TUBES are rigorously tested at elevated line voltages for lengthy periods. Zenith's great reliability and long life satisfies your customers better. There are more than 200 Zenith quality tubes for color TV, black-and-white TV, or special purposes.

ZENITH "ROYAL CREST" CIRCUIT TUBES undergo over 1 1/2 million hours of life-testing every month. You can count on them for the same unrivaled dependability as Zenith original parts. Choose from a full line of over 900 tubes.

Zenith B&W replacement picture tubes are made only from new parts and materials except for the glass envelope in some tubes which, prior to reuse, is inspected and tested to the same high standard as a new envelope. Some color picture tubes contain used material which, prior to reuse, is carefully inspected to meet Zenith's high quality standards.

Order genuine Zenith tubes from your Zenith distributor

BEST YEAR YET TO SELL THE BEST



ZENITH

® The quality goes in
before the name goes on

CIRCLE NO. 79 ON READER SERVICE CARD

cter and on busbars with dimensions of up to 2 3/8" x 1 3/8". Epic

Circle No. 136 on Reader Service Card

VARIABLE-VOLTAGE SUPPLY

The Model PS-30 regulated IC power supply provides a highly regulated (0.01%) continuously adjustable output covering the range from



0 to 30 volts at currents from 0 to 1 ampere. Ripple level is below 1 millivolt. Output voltage and current are monitored by a front-panel meter and are isolated so that either terminal may be grounded. Short-circuit protection and provision for remote sensing and programming are provided.

The supply measures 3 1/2" high x 5 1/4" wide x 9" deep, sized for one-third rack mount. Aul Instruments

Circle No. 137 on Reader Service Card

METAL DETECTOR

The "Beachcomber II" is a transistorized metal detector designed specifically for locating small metal objects at appreciable depths. The lightweight unit operates on inexpensive, low-voltage batteries that provide over 100 hours of service. Designed for varied usage in unusual positions, the angle of the search head at the end of the

telescoping handle can be adjusted through 180 degrees by means of a swivel joint. Concealed and buried metallic objects are revealed visually by deflection of the meter needle and aurally from the speaker or earphones. Radiac

Circle No. 10 on Reader Service Card

CAPACITANCE DIODES

Twenty new "Varactron" voltage-variable capacitance diodes in the 1N5139-39A through 1N5148-48A series are now available. Diodes in this series provide a "Q" ranging from 200 to 350 at -4 V d.c., tuning ratios from 2.7 to 3.4, and center capacitance values from 6.1 to 51.7 pF. Maximum working voltage rating is 60 V d.c. for all diodes in the series.

A data sheet providing detailed specifications on these new units will be forwarded on request. Crystals

Circle No. 138 on Reader Service Card

HI-FI—AUDIO PRODUCTS

TAPE-RECORDER SPEAKERS

A new high-performance speaker system designed especially for use with stereo tape recorders has been introduced as the Model 715. Each speaker contains two 6" woofers with long-throw voice coils and high-compliance edge suspension, and one 3 1/2" wide-dispersion tweeter. The crossover network is a two-way LC high-pass/low-pass design. Frequency response is 40-20,000 Hz ±6 dB.

Sold in pairs, the oiled-walnut cabinets with dark brown grille cloths measure 19" x 13" x 9 1/4" and weigh 20 pounds each. Ampex

Circle No. 11 on Reader Service Card

STEREO TAPE DECK

A new open-reel, four-track stereo deck designed for the serious home recordist is now being marketed. It is the first consumer product to incorporate the Dolby audio noise re-



duction system. The Dolby system is used primarily to help optimize the 3 3/4 in/s tape speed, allowing the recorder to be designed for very wide frequency and dynamic range at that speed without background noise. It also provides small reductions in crosstalk and print-through. A single band version of the system is used, beginning operation at about 1700 Hz. The effective audible reduction of noise at 3 3/4 in/s is 10 dB. The system can be switched out if desired.

The new deck also provides 7 1/2 in/s for compatibility with older tapes and editing of "live", on-location recordings, but in this deck provides no practical advantage over the 3 3/4 in/s speed for musical recording.

The three-motor transport is solenoid-operated and the capstan is driven by a precision belt. The mechanical operation is fail-safe and there is high-speed rewind and fast-forward operation. Complete specifications on this new stereo deck will be forwarded on request. KLH.

Circle No. 12 on Reader Service Card

STEREO/MONO MIXING XFORMER

The Models STR-5 (5 watts r.m.s.) and STR-10 (10 watts r.m.s.) transformers permit the mixing of left and right stereo channels to provide a mono output, without upsetting the origi-

ARE YOU CASHING-IN ON THE PROFITABLE 2-WAY RADIO SERVICE BUSINESS?

- ★ Motorola will train you for this rewarding, elite profession
- ★ Send for our FREE EVALUATION EXAM. Prove to yourself that you are ready to learn FM 2-way radio servicing.

Opportunities in 2-way radio servicing are virtually unlimited. ■ Just one of the hundreds of successful Motorola Service Stations writes, "we would be pleased to interview any graduate of your school that has received some training in 2-way radio maintenance. We are an established firm, 10 years old, with a promise of expansion governed by our ability to obtain competent technicians." ■ Get all the facts today. There is no obligation and no salesman will call.



MOTOROLA TRAINING INSTITUTE

4545 West Augusta Blvd. • Chicago 51, Illinois • Dept. AEW 821

- Send me FREE entrance exam.
- Send full details on Home Study Course on FM 2-way Radio Servicing.
- Send me details on how you can help me prepare for an FCC License.

Name _____ Occupation _____

Address _____

City _____ Zone _____ State _____

CIRCLE NO. 94 ON READER SERVICE CARD

all kinds of COILED CORDS!

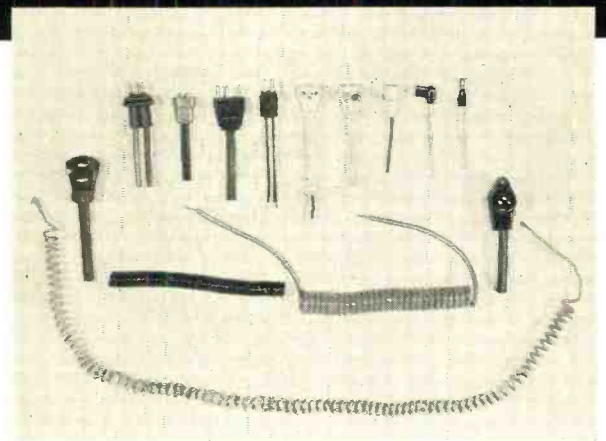

For EVERY Electronic Application

MOST STANDARD AND MANY SPECIAL PLUGS (Male and Female) ALREADY TOOLED.

TOOLING AND MOLDING OF OTHER SPECIAL PLUGS AT MINIMUM COST.

- Variety of Insulations: Shielded . . . PVC . . . Rubber . . . Neoprene.
- All Gauges Available.
- Single and Multiple Conductors.



YOUR COMPLETE SOURCE FOR COILED CORDS

Con-trx, Inc.

Albion, Indiana 46701 • Telephone (219) 636-2302

CIRCLE NO. 115 ON READER SERVICE CARD

ELECTRONICS WORLD

nal stereo separation. The balanced mono signal can then be distributed to individual extension speakers located throughout the house.

They can also be used for adding a center channel to an existing stereo system or for providing mono sound to any outside location where stereo sound is not effective. Frequency response is 10-30,000 Hz (-3 dB), impedance is 8 ohms, and the ratio is 1:1:1. Also

Circle No. 13 on Reader Service Card

PORTABLE TAPE RECORDER

The Model 11 is a professional-type portable tape recorder which is offered in two versions. This solid-state recorder has three separate heads, a 7" reel capacity, and measures 13" x 10" x 4". Both models operate on ten "D" cells or nickel-cadmium rechargeable batteries.

The Model 11-2 is a half-track unit and is



suited for music, technical, and broadcast applications. Model 11-1 is a full-track unit which is designed for audio-visual, journalism, and business uses.

Frequency response is 40-16,000 Hz ± 2 dB at 7 1/2 in/s; signal-to-noise ratio is better than 56 dB; and distortion is less than 0.5%. Both models include servo-type speed control, built-in mixer and limiter, Cannon microphone input, and three-speed d.c. motor. Tandberg

Circle No. 14 on Reader Service Card

AM-FM STEREO RECEIVER

The Model 36-240 AM-FM stereo receiver provides 30 watts dynamic power at 1% HD, frequency response from 25-25,000 Hz, and over 40-dB channel separation. The tuner section features illuminated slide-rule tuning and a stereo indicator light.

The receiver is housed in an oiled-walnut finished cabinet which measures 13 3/8" x 5 1/2" x 8 3/8". Claricon

Circle No. 15 on Reader Service Card

CONTROLLED-DISPERSION SPEAKERS

The newly developed UH Series of speakers and drivers feature an exclusive "Sound Deflector" which permits control of the dispersion pattern of paging/talkback speakers. This new feature makes the series especially suited for overhead factory installations which are frequently plagued by problems of sound dissipation in rafter areas. It is also useful in situations where a microphone must be located in close proximity to a speaker. The deflector is adjustable 360 degrees around the face of the speaker bell and can also be adjusted between 0 and 20 degrees off the center axis of the horn in 10-degree increments.

Three models are available: The UH-8 is an 8-ohm type, UH-45 has a 45-ohm impedance, while the UHT comes with a built-in line matching transformer and switch-selectable wattage and impedance taps on both 70.7- and 25-volt lines. Frequency response is 220-16,000 Hz and power handling capacity is 32 watts program and 45 watts when input is adjusted to frequencies above horn cut-off. University Sound

Circle No. 16 on Reader Service Card

SOUND-LEVEL METER

The Type 1561 precision sound-level meter uses a new ceramic microphone and meets specifications defined by the International Electrotechnical Commission (IEC 179, 1965) for such a unit. It is also a general-purpose sound-level meter as defined by USASI S1.4-1961, and International (IEC 123, 1961) standards by pro-

We took our WA-44C Audio Generator, transistorized it, made it smaller, lighter, more portable, made it easier to use...

and lowered the price! RCA WA-504A only \$95*.

The RCA WA-504A Sine/Square Wave Audio Generator—transistorized for stability and dependability—provides a tuneable AF signal that's ideally-suited for service, industrial, laboratory, education and hobby use. Frequency range extends from 20 Hz to 200 kHz. New solid state circuit design uses 6 transistors—including MOS FET oscillator circuit—and 2 diodes... assures stability (Amplitude variation ± 1.5 dB, total harmonic distortion of sine wave less than 0.25%).

The WA-504A is useful in a wide range of applications, including direct measurement of frequency response characteristics of audio amplifiers; testing speakers and enclosures; finding impedance of LC combinations; determining frequency of vibrating or rotating bodies, etc.

Ask to see WA-504A at your Authorized RCA Test Equipment Distributor, or write RCA Electronic Components, Commercial Engineering Department J-41W, 415 South Fifth Street, Harrison, N.J.

*Optional Distributor resale price. Prices may be slightly higher in Alaska, Hawaii and the West.

RCA

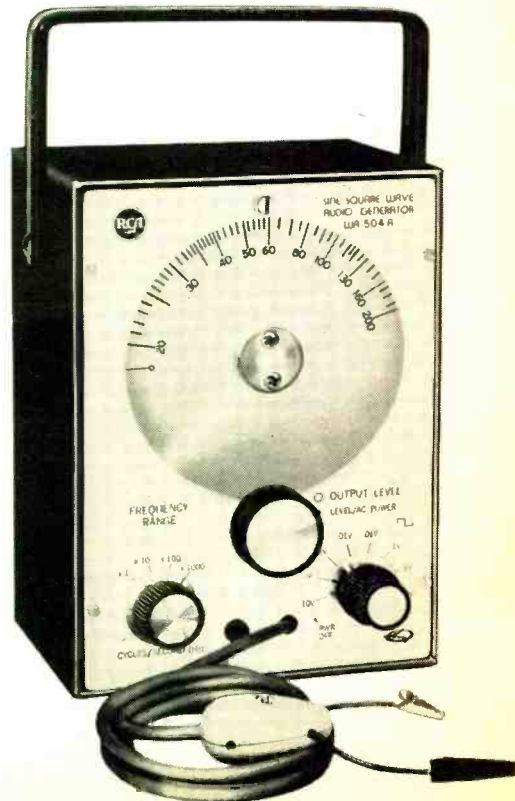

CIRCLE NO. 89 ON READER SERVICE CARD

ABOUT YOUR SUBSCRIPTION

Your subscription to **ELECTRONICS WORLD** is maintained on one of the world's most modern, efficient computer systems, and if you're like 99% of our subscribers, you'll never have any reason to complain about your subscription service.

We have found that when complaints do arise, the majority of them occur because people have written their names or addresses differently at different times. For example, if your subscription were listed under "William Jones, Cedar Lane, Middletown, Arizona," and you were to renew it as "Bill Jones, Cedar Lane, Middletown, Arizona," our computer would think that two separate subscriptions were involved, and it would start sending you two copies of **ELECTRONICS WORLD** each month. Other examples of combinations of names that would confuse the computer would include: John Henry Smith and Henry Smith, and Mrs. Joseph Jones and Mary Jones. Minor differences in addresses can also lead to difficulties. For example, to the computer, 100 Second St. is not the same as 100 2nd St.

So, please, when you write us about your subscription, be sure to enclose the mailing label from the cover of the magazine—or else copy your name and address exactly as they appear on the mailing label. This will greatly reduce any chance of error, and we will be able to service your request much more quickly.

CAR AND DRIVER YEARBOOK

The most exciting, most comprehensive automotive fact book available. A complete buyers guide for domestic and imported models—road tests, accessories, and performance equipment buying guide.
1968...\$1.50...#51
1967...\$1.50...#40

CAR AND DRIVER RACING ANNUAL

An almanac of competition information covering the entire racing year. Feature stories of individual races, personality wrap-up on top drivers, box scores on every major event throughout the world plus many dramatic photos.
1967...\$1.25...#63

Order by number from
Ziff-Davis Service Div., 595 Broadway • New York, N.Y. 10012. Enclose add'l 15¢ per copy for shipping and handling (50¢ for orders outside U.S.A.)
PAYMENT MUST BE ENCLOSED WITH ORDER

Just Published

How 88,648 Heavy Smokers Stopped Smoking

NEW YORK — The Anti-Tobacco Center of America has just published a booklet which explains how 88,648 heavy smokers (of whom many are physicians) have stopped smoking without straining their will power. This booklet is available free of charge to smokers. All you need to do, to obtain it, is to send your name and address to The Anti-Tobacco Center of America, Dept. A-348-B, 276 Park Avenue South, New York City, 10010. This offer is open while the supply of these booklets lasts.



viding A, B, and C weighting scales. Complete frequency-response measurements are made on each instrument before shipping, and microphone response and sensitivity are compared with a WE640AA laboratory-standard microphone.

This all-solid-state instrument has an "external filter" jack which permits connection of an external filter to shape the frequency response as desired. It is available as a battery-operated portable or as a relay-rack instrument operating on a.c. It provides flat response from 20 to 20,000 Hz to permit measurement of sound-pressure level. General Radio

Circle No. 139 on Reader Service Card

TAPE RECORDER

The new Uher "Royal Deluxe" Model 10,000 offers four speeds, a built-in circuit for sound/slide synchronization, sound-on-sound, sound-with-sound, echo effect, and two- and four-track head assembly modules which can be interchanged in minutes.

Output power rating is 10 watts per channel r.m.s. and the recorder can be used as a separate hi-fi amplifier. There are separate treble and bass controls, A-B monitoring facilities with lock switch, built-in single channel and stereo mixer for professional effects, and built-in reel locks.

The recorder will operate in any position and delivers a response of 20-20,000 Hz ± 2 dB at $7\frac{1}{2}$ in/s. Martel

Circle No. 17 on Reader Service Card

150-WATT AM-FM RECEIVER

The new Model 395 AM-FM receiver is all-solid-state and uses both integrated circuits and FET's. It features between-station muting, illuminated tuning meter, automatic stereo/mono switching, solid-state protection circuits for out-

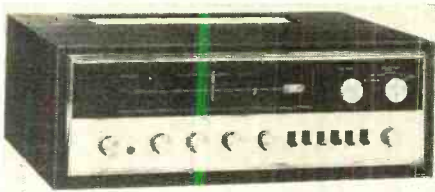

put transistors, flywheel tuning, headphone jack for private listening in stereo or mono, AM and FM antennas, and an amplifier frequency response of 30-50,000 Hz ± 3 dB. Power output is 150 watts (IHF) at 4 ohms or 50 watts r.m.s. per channel at 4 ohms.

Inputs for magnetic or ceramic phono cartridges, tape deck, tape transport, and TV are provided along with two a.c. outlets. The Model 395 measures $5\frac{1}{2}$ " high x 16" wide x $13\frac{1}{2}$ " deep. Allied Radio

Circle No. 18 on Reader Service Card

CB-HAM-COMMUNICATIONS

BROADBAND ANTENNA

A bi-conical antenna designed to measure electromagnetic radiation over a frequency range from 20 to 200 MHz is now available as the Model 7825. According to the company, it provides rapid measurement of signal strength and field intensity when used with scanning receivers or analyzer equipment. Broadband characteristics

of the antenna permit either wideband or automatic scanning without the need for dipole adjustment.

The Model 7825 can be used with any receiver, noise or field-intensity instrument having a 50-ohm unbalanced impedance load. Its maximum field intensity is rated at 10 volts/meter. Honeywell Test Instruments

Circle No. 140 on Reader Service Card

TUNABLE BANDPASS FILTERS

The VF series of tunable bandpass filters is being offered in a frequency range of 50 to 4000 MHz with a single model covering more than one octave.

The series is available with either a three- or five-section response and has a 3 dB bandwidth of 5%, insertion loss from 0.2 to 1.5 dB, and v.s.w.r. of less than 1.5:1.

The tunable bandpass filter is housed in an



aluminum case. An engraved dial calibrated in frequency indicates the center frequency of each filter response with resetability to within $\pm 1/2\%$. Texscan

Circle No. 141 on Reader Service Card

MANUFACTURERS' LITERATURE

MICROWAVE CATALOGUE

A new 16-page catalogue (No. 68a) describing an extensive line of microwave transmitters, receivers, and components is now available. There are detailed specifications on over 240 individual models of mixer preamps, receivers, linear i.f. amplifiers, logarithmic i.f. amplifiers, discriminators, power amps, preamps, transmitter components, and pulse-r.f. and octave amplifiers.

Two pages describe and illustrate FM microwave relay equipment. RHG

Circle No. 142 on Reader Service Card

COLOR VIDEOTAPE RECORDER

A brochure describing specifications and uses of the VR-7800 solid-state portable closed-circuit color videotape recorder is now available. The recorder features electronic editing, color recording and playback, and meets FCC specifications for monochrome broadcasting. Brochure V67-14. Ampex

Circle No. 19 on Reader Service Card

SWEEP GENERATOR DATA

A six-page brochure describing the new Model 5000 microwave sweep generator is now available. It contains charts, photo illustrations, and specifications covering the performance and applications of the instrument. Information on various oscillator plug-ins to be used with the basic instrument is also included. Kruse-Storke

Circle No. 143 on Reader Service Card

PC COATING BROCHURE

A new brochure, PC1, describes epoxy and urethane printed-circuit coatings that meet the requirements of MIL and NASA specs, as well as commercial grades of coatings. The brochure includes a selector chart that compares eight of the company's coatings. Hysol Division

Circle No. 144 on Reader Service Card

CATHODE-RAY TUBE GUIDE

A new 16-page quick reference guide which describes over 100 different cathode-ray tubes for industrial and military display applications has been issued as B-9473.

The guide contains sections describing high-

CIRCLE NO. 99 ON READER SERVICE CARD →

resolution CRT's; ruggedized, tube, yoke, and shield packages; electrostatic focus and deflection CRT's; round and rectangular magnetic deflection CRT's; and special tube and component assemblies. It also gives tube base diagrams and a list of pertinent literature that is available from the Division. Westinghouse Electronic Tube
Circle No. 145 on Reader Service Card

SELECTING RECORDING TAPE

A 24-page catalogue entitled "How to Select a Recording Tape" is now available without charge. The catalogue includes a chart which illustrates the variety of types, lengths, and reel sizes available in each of the company's five tape formulations. There is also a table of recording time for various tape lengths and speeds, for both one- and two-direction recording. An additional chart matches types of tapes with their uses to help in selecting the correct tape for a specific recording application. Audio Devices
Circle No. 20 on Reader Service Card

STEREO CONSOLE BROCHURE

A lavishly illustrated, full-color, 20-page brochure entitled "At Home with Stereo" is just off the press and available for distribution. The publication features an expanded line of stereo consoles in an exclusive collection of decorator-styled room settings. Included are many informative articles on high fidelity, the role of music in the home, choosing the correct console to match individual room decor, and complete explanations, in non-technical terms, of the more technical aspects of stereo consoles. H.H. Scott
Circle No. 21 on Reader Service Card

ELECTRONIC INSTRUMENTS

A 16-page brochure covering a "fourth generation" of electronic instruments is now available. Included in the line are counter/timers, frequency counters, pulse generators, frequency synthesizers, and digital clocks—all of which use IC's extensively.

In addition to listing specifications on the products, the brochure describes the company's facilities and production, quality, warranty, and service policies. Copies of catalogue #4200 are available without charge. Monsanto
Circle No. 146 on Reader Service Card

WIRING DEVICES

A full line of wiring devices is included in a new 148-page, fully illustrated catalogue which lists over 1700 products, 85 of which are new items developed since the last catalogue was issued in 1966.

The catalogue includes product and price information on solid-state and remote-control devices, switches, receptacles, plugs, connectors, wall plates, starters, lampholders, and other specialty wiring devices. The products are indexed for convenience in locating the needed product. G-E Wiring Device
Circle No. 147 on Reader Service Card

SWITCH TIPS

A four-page booklet, "Micro Tips No. 46", containing solutions to seven varied manufacturing problems through the applications of industrial switches in parts testing, conveyor belt control, plastic molding, package labeling, automatic reamer feeding, assembling, and parts stacking, is now available. Micro Switch
Circle No. 148 on Reader Service Card

SOUND/COMMUNICATION PRODUCTS

A 16-page composite product catalogue covering sound and communications equipment for all types of installations, ranging from military complexes to convention centers, from hospitals to factories, offices, hotels, theaters, churches, etc. is now available as AL-1712.

The publication includes technical information, photographs of products, and major installations. Equipment covered includes microphones, speakers, amplifiers and speech input equipment,

audio controls and consoles, high-level military and civil defense warning systems, telephone transmission equipment, intercoms, and call systems. Altec Lansing
Circle No. 22 on Reader Service Card

AUDIOVISUAL PRODUCTS

A newly revised catalogue of audiovisual equipment and film containing over 1000 items is now available. The publication is fully indexed, illustrated, and cross-referenced and covers products, auxiliary equipment, photo aids, film, etc.

The 68-page publication is of particular interest to educators and training supervisors. Eastman Kodak
Circle No. 23 on Reader Service Card

POWER-SUPPLY DATA

Two new data sheets describing two series of high-current d.c. power supplies are now available. One data sheet describes the 28G5P series which converts 50-60 Hz, 120/208 volts to 28 volts, 25, 50, 100, and 200 amps d.c. The second publication describes the 28GP series which converts 400-Hz, 120/208 volts to 28 volts, 100, 200, 300, and 400 amps d.c. Each data sheet contains photos, descriptions, physical characteristics, outline drawings, schematics, and complete specs. Tung-Sol
Circle No. 149 on Reader Service Card

BATTERY-OPERATED V.O.M.

A two-color, two-page data sheet giving complete mechanical and electrical characteristics on the Model 601 portable, battery-operated v.o.m. is now available. Data sheet 42068 will be forwarded on request. Triplet
Circle No. 24 on Reader Service Card

RELAY BOOKLET

A 12-page brochure covering a line of solid-state, electronic, and thermal time-delay relays



STEREO/HI-FI DIRECTORY

Giant 180 page buyers guide to virtually every new audio component on the market — amplifiers • changers and turn tables • receivers • tuners • tape machines • speakers, etc.

1968.....#56
 1967.....#45

TAPE RECORDER ANNUAL

The only buyers guide of its kind available to the brands and models on the market. Over 132 pages of full information on over 250 models plus articles covering every aspect of tape recording.

1968.....#59
 1967.....#42

Ziff-Davis Service Division—Dept. W • 595 B'way, New York, N.Y. 10012

I am enclosing \$_____ for the annuals circled below. My remittance includes an additional 15¢ per copy for shipping and handling (50¢ for orders outside U.S.A.). I understand quantities are limited and orders will be filled on a first come-first served basis.

\$1.25 each 42 45 56 59

Print Name _____

Address _____ EW-108

City _____ State _____ Zip _____

PAYMENT MUST BE ENCLOSED WITH ORDER

NEW UNIVERSAL ROOF-THRU/WALL-THRU

for Color TV



Mosley's new weatherproof M-60 lead-in entrance accessory accepts all types of antenna and rotor cable lead-in. Mounts on any sloped roof - or the wall of any structure. Unequaled in strength, weather protection, and versatility of application.

Write Dept. 161A for FREE detailed brochure.

Mosley Electronics, Inc. 4610 N. Lindbergh Blvd.,
Bridgeton Missouri 63042

CIRCLE NO. 95 ON READER SERVICE CARD

has just been issued. It includes information useful to both commercial and military users. Descriptions, modes of application, base diagrams, and dimensional drawings are given along with detailed specifications. Relay Specialties

Circle No. 150 on Reader Service Card

H. V. POWER SUPPLIES

Complete details on a line of high-voltage power supplies and accessories are provided in a new six-page, two-color short-form catalogue just issued. The line includes power supplies providing voltages up to 90 kV, regulated or unregulated, fixed or adjustable outputs; positive, negative, or reversible polarity; and other variations in module, rack, cabinet, or portable configurations—a total of several thousand variations. Spellman

Circle No. 151 on Reader Service Card

MINIATURE ROTARY SWITCHES

An engineering catalogue which features two new series of miniature rotary switches is now available for distribution. Included are complete general, electrical, and mechanical specifications for six series of switches, ranging in size from 1/2" to 1 3/8" body diameter, and allowing up to 12 poles per deck. RCL Electronics

Circle No. 152 on Reader Service Card

TORQUE-MEASURING TRANSDUCERS

A 17-page application note which describes and compares four major torque measuring principles now in use is available without charge. Advantages and disadvantages of each type are explored and then details are given on how the recently developed optical torque transducer provides improvements in response speed, cost, and over-all simplicity compared with more conventional versions. Vibrac

Circle No. 153 on Reader Service Card

INDUCTOR DATA

Five types of panel-mount and printed-circuit

mount types of inductors are described in a new two-page, two-color illustrated data sheet. Each type is pictured and then mechanical specifications and electrical parameters covered. LRC Electronics

Circle No. 154 on Reader Service Card

SNAP-ACTION SWITCHES

A complete line of light-force miniature snap-action switches is described in a new 4-page brochure now available. Included in the publication are specifications, operating characteristics, and prices for all versions in the line. Cherry

Circle No. 155 on Reader Service Card

SCR SHORT-FORM CATALOGUE

A 6-page short-form catalogue listing seven different series of SCR's in table form is now available on request. Attractively presented for easy readability, the catalogue has been prepared with design engineers in mind. Performance characteristics on a wide-range of SCR types are included. SSPI

Circle No. 156 on Reader Service Card

REPLACEMENT RECTIFIERS

A new catalogue describing a complete line of replacement rectifiers has just been published. The 4-page data sheet lists replacements for mono and color-TV, rectifier tube replacements, and special selenium rectifier replacements for a broad range of applications.

Copies of Catalogue 68-DL-5 will be forwarded without charge on request. Sarkes Tarzian

Circle No. 25 on Reader Service Card

VIDEOTAPE EQUIPMENT

A 16-page brochure which answers many commonly asked questions about non-commercial videotape recorders is now available as Bulletin V67-11.

In addition to exploring many of the considerations of cost, interchangeability, and reliability,

ty, the brochure provides a glossary of videotape recording terms. Ampex

Circle No. 26 on Reader Service Card

TANTALUM CAPACITORS

A new brochure entitled "Established Reliability Solid Electrolyte Tantalum Capacitors, Type CSR13" is now available for distribution. It describes a full line of capacitors in 140 standard ratings (6 to 50 volts), with type designations and standard dimensions. Nytronics

Circle No. 157 on Reader Service Card

METAL FILM RESISTORS

A data sheet on a family of four miniature high-value metal film resistors is now available. The resistors, which cover the range from 25 ohms to 100 megohms, are described in detail as to both physical and electrical characteristics. Pyrofilm

Circle No. 158 on Reader Service Card

PHOTO CREDITS

Page	Credit
7	Superscope, Inc.
27, 28	E. W. Bliss Company
30 (top)	McDonnell Douglas
30 (center)	ITT Industrial Laboratories
30 (bottom)	Honeywell Test Instruments Div.
31 (top left)	Atomics International
31 (top right)	Radio Corporation of America
31 (center)	Westinghouse
31 (bottom)	Sylvania Electric Products Inc.
34, 35	Radar Devices Mfg. Corp.
52	Lundy Electronics & Systems, Inc.
62	E.M.I.-Cossor Electronics Ltd.
72	Heath Company
73 (top)	Fairchild
73 (bottom)	Sencore, Inc.

A NEW DIMENSION IN HI-FI
SOUND PERFORMANCE
FROM KENWOOD
... PENETRATING THE
OUTER LIMITS OF
SOUND REPRODUCTION

165 watt 3 CHANNEL STEREO AMPLIFIER with ELECTRONIC CROSSOVER NETWORK

FEATURING:
the finest sound reproduction by driving
the woofer, mid-range and tweeter speakers
separately through a multi-channel amplifier.
Priced at \$695. Write for particulars.

the sound approach to quality



3700 South Broadway Place, Los Angeles, Calif. 90007
69-41 Calamus Avenue, Woodside, New York 11377



KENWOOD SUPREME 1

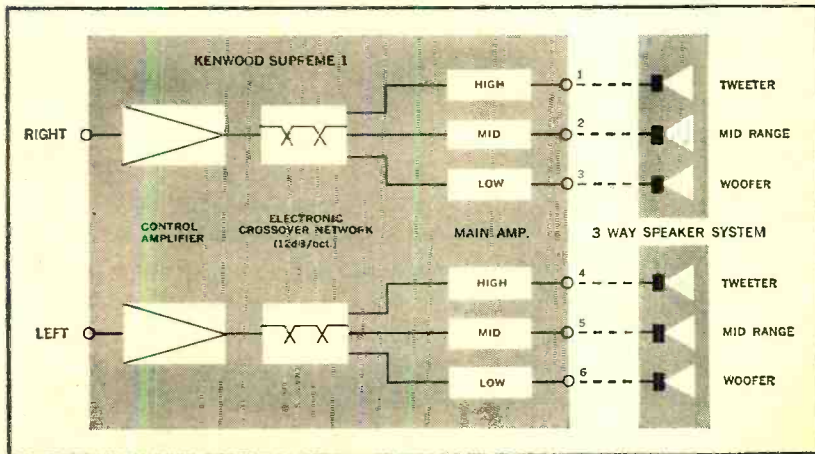

CIRCLE NO. 100 ON READER SERVICE CARD

ELECTRONICS MARKET PLACE

COMMERCIAL RATE: For firms or individuals offering commercial products or services. 85¢ per word (including name and address). Minimum order \$8.50. Payment must accompany copy except when ads are placed by accredited advertising agencies. Frequency discount: 5% for 6 months; 10% for 12 months paid in advance.

READER RATE: For individuals with a personal item to buy or sell. 50¢ per word (including name and address). No minimum! Payment must accompany copy.

GENERAL INFORMATION: First word in all ads set in bold caps at no extra charge. Additional words may be set in bold caps at 10¢ extra per word. All copy subject to publisher's approval. Closing Date: 1st of the 2nd preceding month (for example, March issue closes January 1st). Send order and remittance to: Hal Cymes, ELECTRONICS WORLD, One Park Avenue, New York, New York 10016.

FOR SALE

JUST starting in TV service? Write for free 32 page catalog of service order books, invoices, job tickets, phone message books, statements and file systems. Oelrich Publications, 6556 W. Higgins Rd., Chicago, Ill. 60656.

GOVERNMENT Surplus Receivers, Transmitters, Snooperscopes, Radios, Parts, Picture Catalog 25¢. Meshna, Nahant, Mass. 01908.

METERS—Surplus, new, used, panel and portable. Send for list. Hanchett, Box 5577, Riverside, Calif. 92507.

CONVERT any television to sensitive big-screen oscilloscope. Only minor changes required. No electronic experience necessary. Illustrated plans, \$2.00. Relco-A22, Box 10563, Houston, Texas 77018.

MUSIC LOVERS, CONTINUOUS, UNINTERRUPTED BACKGROUND MUSIC FROM YOUR FM RADIO, USING NEW INEXPENSIVE ADAPTER. FREE LITERATURE, ELECTRONICS, 11500-Z NW 7th AVE., MIAMI, FLORIDA 33168.

R.F. CONVERTERS World's largest selection. Also CCTV cameras, etc. Lowest factory prices. Catalog 10¢. Vanguard, 196-23 Jamaica Ave., Hollis, N.Y. 11423.

SECURITY AND PRIVACY PROTECTION DEVICES. FREE DATA: SECURITY ELECTRONICS EW, 15 EAST 43RD STREET, NEW YORK, N.Y. 10017.

CRYSTALS . . . largest selection in United States at lowest prices. 48 Hr. delivery. Thousands of frequencies in stock. Types include HC6/U, HC18/U, FT-241, FT-243, FT-171, etc. Send 10¢ for catalog with oscillator circuits. Refunded on first order. Jan Crystals, 2400E Crystal Dr., Fort Myers, Fla. 33901.

TREASURE HUNTERS! Prospectors! Relco's new instruments detect buried gold, silver, coins. Kits, assembled models. Transistorized. Weighs 3 pounds. \$19.95 up. Free catalog. Relco-A22, Box 10839, Houston, Texas 77018.

SURVEILLANCE COUNTERMEASURES BROCHURE \$1.00. ENGINEERING LABORATORIES, BOX 1036, ANDERSON, INDIANA 46015.

PROXIMITY switch detects nearness of human body! Free information. Claremont Products, 860 Reed, Claremont North, Calif. 91711.

NEW Sensitive Treasure Metal Detectors. New low prices. Professional models from \$29.95 to \$129.50. Write for free catalog today. Jetco Electronics, Box 132-E, Huntsville, Texas 77340.

WHOLESALE components: Manufacturers and distributors only. Request free catalog on business letterhead. WESCOM, Box 2536, El Cajon, California 92021.

NEW BSR record changers—\$13. Garrards—\$22. Radio-phono stereo receivers—\$15. "Changers EW", 2737 3rd Ave., Bronx, N.Y.

BARGAIN FLYER AND SIX NEW RESISTORS—25¢ (stamps or coin) **BIGELOW ELECTRONICS, Bluffton, Ohio 45817.**

LAW ENFORCEMENT AGENTS AND LEGAL INVESTIGATORS ONLY. FREE LITERATURE, LATEST ELECTRONIC AIDS. REQUEST MUST BE ON YOUR OFFICIAL LETTERHEAD. R. CLIFTON, 11500-J NW 7th AVE., MIAMI, FLORIDA 33168.

189 NEW WESTERN ELECTRIC J68602C1 1 SIGNAL FREQUENCY GENERATOR \$10.00 each. BRADS, Klatt Box 10000, Anchorage, Alaska.

RESISTORS . . . Technical bulletin #2550 free on request. Factory price sheet included. Kimberly-James, Inc., 1422 Chestnut St., Phila., Pa. 19102.

ELECTRONIC ignition, various types. Free literature. Anderson Engineering, Epsom, N.H. 03239.

WRITE now for free 1969 catalog McGee Radio Company. 1001 bargains. Speakers — Parts — Tubes — High Fidelity Components — Record Changers—Tape Recorders—Kits. Everything in Electronics. 1901 McGee Street, Kansas City (GE), Missouri 64108.

BARGAINS in Surplus Electronic Parts, Semiconductors, Tubes, Etc., **DISCOUNT PRICES, FREE CATALOG. REDCO SALES CO.,** Box 294, Needham, Mass. 02194.

STATE government purchasing offices. Send \$1.95. Leonard, 5789 S.W. 62nd Ave., Miami, Florida 33143.

ELECTRONICS ENGINEERING AND INSTRUCTION

ASSOCIATE Degree in Electronics Engineering earned through combination correspondence-classroom educational program. Free brochure. Grantham Technical Institute, 1505 N. Western Ave., Hollywood, Calif. 90027.

LEARN ELECTRONIC ORGAN SERVICING at home. All Makes including transistors. Experimental kit—troubleshooting. Accredited, NHSC. Free Booklet. **NILES BRYANT SCHOOL,** 3631 Stockton, Dept. A, Sacramento, Calif. 95820.

HIGHLY effective home study course in Electronics Engineering Mathematics with circuit applications. Earn your Associate in Science Degree. Free literature. **COOK'S INSTITUTE OF ELECTRONICS ENGINEERING,** P.O. Box 36185, Houston, Texas 77036.

ELECTRONICS! Associate degree—29 months Technicians, field engineers, specialists in communications, missiles, computers, radar, automation. Start February, September. Valparaiso Technical Institute, Dept. N, Valparaiso, Indiana 46383.

R.E.I.'s famous (5) week course for the First Class Radio Telephone License is the shortest, most effective course in the nation. Over 98% of R.E.I. graduates pass F.C.C. exams for 1st class license. Total tuition \$350.00. Job placement free. Write for brochure Radio Engineering Incorporated Schools, 1336 Main Street, Sarasota, Florida 33577—or 3123 Gillham Road, Kansas City, Missouri 64109—or 809 Caroline Street, Fredericksburg, Virginia 22401.

RADIO AND TELEVISION REPAIR COURSE, BASIC TEST EQUIPMENT AND INSTRUCTION NECESSARY FOR STARTING PROFITABLE BUSINESS. WRITE HOOSIER TECHNICAL INSTITUTE, BOX 88401, INDIANAPOLIS, INDIANA 46208.

RFI & FIELD STRENGTH METER BARGAINS:

(Add \$200 for fresh NBS-Traceable Calib.)
AN/URM-6A (Stoddard NM-10A): 14 to 250 KHz. In transit cases, almost every accessory. **650.00**
 book, 1000 small & large loops.
 (Add \$200 for the later model URM-6B)
AN/URM-6A missing the pwr sply case . . . **350.00**
Stoddard NM-20B: 150-23,000 KHz commercial model. In 2 transit cases, with NBS-traceable **995.00**
 Calib. June 8, 1968
AN/PRM-1B: Navy procurement from Espsey, exact imitation of Stoddard NM-20A, like brand new, in 2 transit cases . . . **695.00**
AN/PRM-1(*) Stoddard, incomplete sets; ask **275.00**
 for list, as low as . . .
AN/URM-47 (Stoddard NM-30A): 20-1000 MHz. Complete and like new in cases . . . **950.00**
AN/URM-47 Receiver only, no pwr sply . . . **650.00**
AN/URM-17 (Stoddard NM-50A): 375-1000 MHz. Practically 100% complete, exc. cond. **695.00**
Ferris #32A: 0.15-20 MHz; works on batteries with case provided, or a 6 v. Albrapack also provided. Checked 100% OK. W/book . . . **250.00**

SPECTRUM ANALYZER BARGAINS

Panoramic LP-1: 20 Hz to 22.5 KHz. In cabinet with pwr sply which is also an IM analyzer. Response on 5" CR tube, linear or logarithmic. Feed white noise to your amplifier, photograph the complete response curve; or feed a single freq. and see all the harmonics and IM components. Exc. with book . . . **495.00**
LP-1ABZM: Later model of above; has markers. With pwr sply in same cabinet. With book. **695.00**
\$2200.00 value only
Gen. Radio 1390A White Noise Generator. Use with above . . . **125.00**
Panalyzer SE-8B 110,000: Put signal to be observed into input A; put your signal generator tuned 30 mc higher into B. Analyzer sweeps thru your signal, with 0-10 MHz. See output on 5" CR tube. Lower limit: Common sense. Upper limit: 1000 MHz. With pwr sply & line CV strim. **350.00**
TSAW (Polaroid) with **STU-1** Head: 10 to 1000 MHz. Wide dispersion (25 to 80,000 KHz). Works fine. \$435.00 value! Only **175.00**
TSA with **STU-2A** head: 950-4500 MHz. 450.00
 Narrower dispersion setup . . .
STU-1WA Head 10-1000 MHz (\$1750.) . . . **175.00**
STU-3A Head 4.37 to 22 GHz (\$2250.) . . . **175.00**
STU-3W (Wd Dispersion) (\$2300.00) . . . **195.00**
STU-4 (21-33 GHz) (\$2750.) . . . **175.00**
STU-5 (33-44 GHz) (\$2750.) . . . **175.00**
SD-1 Multipulse Spectrum Selector: \$1890.00
 accessory for any Polaroid Spectrum Analyzer; displays noise trains gated so that only desired section presented . . . **175.00**
SA-84W Polaroid. No plug-in heads; late model uses fine switching. 10 MHz to 40,850 MHz. Wide dispersion (25 KHz to 80 MHz). A \$6290.00 quite-late model! Only **1495.00**

WE PROBABLY HAVE THE BEST INVENTORY OF GOOD LAB TEST EQUIPMENT IN THE COUNTRY. BUT PLEASE DO NOT ASK FOR CATALOG! ASK FOR SPECIFIC ITEMS OR KINDS OF ITEMS YOU NEED! WE ALSO BUY! WHAT DO YOU HAVE?

R. E. GOODHEART CO. INC.
 Box 1220-A, Beverly Hills, Calif. 90213
 Phones: Area 213, office 272-5707, messages 275-5342

LIBERTY PAYS MORE! WILL BUY FOR CASH

ALL TYPES:

- ★ ELECTRON TUBES
- ★ SEMICONDUCTORS
- ★ TEST EQUIPMENT
- ★ Military Electronic Equipment

WIRE—WRITE—PHONE COLLECT!

We pay freight on all purchases—

PRESTEL FIELD STRENGTH METER

(Model 6T4G)

Only
\$120.00

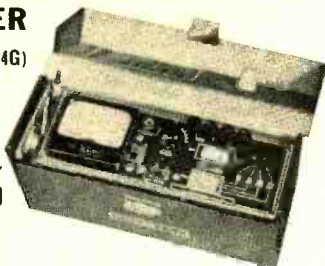

Calibrated from 40 to 230, and 470 to 860 in 4 Bands Megahertz, from 10 to 50,000 Microvolts. Nothing makes it easier to properly and speedily find the correct place to install TV, FM and Communication Antennas. You can measure and hear the signals with this 4 1/2 volt battery economically powered unit. There is nothing else like it!

LIBERTY ELECTRONICS, Inc.

548 Broadway, New York, New York 10012
 Phone (212) 925-6000

CIRCLE NO. 98 ON READER SERVICE CARD
 October, 1968

FCC First Class License in six weeks—nation's highest success rate—approved for Veterans Training. Write Elkins Institute, 2603C Inwood Road, Dallas, Texas 75235.

FCC First Class Phone License in six weeks. \$333.00 complete tuition. Guaranteed. Write Electronics Institute, 2202 West Erwin, Tyler, Texas 75701.

DRAFTING—home courses \$25.00. Send \$2.00 first lesson. Prior, Inc., 23-09 169th Street, Whitestone, New York 11357.

PLANS AND KITS

BUILD-IT-YOURSELF. Save big dollars. Transistor stereo amplifiers. Color organs. Speakers. Write Workshop, Box 393, Bethpage, NY, 11714.

INTEGRATED CIRCUIT KITS; COMPUTER CIRCUIT KITS: Others. New catalog free. **KAYE ENGINEERING,** Box 3932-B, Long Beach, California 90803.

WANTED

QUICK CASH . . . for Electronic Tubes, Semiconductors, Equipment (Receivers, Transmitters, Scopes, Vacuum Variables, etc.) Send lists now! Write: **BARRY ELECTRONICS,** 512 Broadway, New York, N.Y. 10012 (212-WA 5-7000).

QUICKSILVER, Platinum, Silver, Gold. Ores Analyzed. Free Circular. Mercury Terminal, Norwood, Mass. 02062.

DO-IT-YOURSELF

PROFESSIONAL ELECTRONICS PROJECTS—\$1.00 up. Catalog 25¢. **PARKS,** Box 25665A, Seattle, Wash. 98125.

TUBES

TUBES, SEMICONDUCTORS, ELECTRONIC EQUIPMENT & COMPONENTS. Quality merchandise only! Serving engineers, Purchasing Agents, TV/HiFi Servicemen and Hams for 20 years. Write for Catalog or call 212-WA 5-7000. **BARRY ELECTRONICS,** 512 Broadway, New York, N.Y. 10012.

RECTIFIERS & TRANSISTORS

Silicon Rectifiers

PIV	25	50	100	200	400	600	800	1000	1200
1A*	—	.04	.05	.07	.09	.12	.16	.20	.35
3A	.05	.06	.07	.09	.12	.16	.24	.32	.46
18A**	.10	.16	.20	.30	.40	.50	—	—	—
20A	.15	.20	.25	.39	.50	.75	.90	1.15	1.40
40A	.25	.35	.60	.90	1.20	1.50	1.80	2.10	2.40

*Tophat. **Flangeless **Pressfit 3, 20, 40 studs

Silicon Controlled Rectifiers

1500 PIV Stud	PRV	25	50	100	200	400	600
200 MA.	1A*	.10	.14	.22	.35	.60	.90
50¢ ea.	7A	.18	.25	.40	.70	1.25	1.60
	18A**	.18	.25	.40	.70	1.25	1.60
	20A	.25	.40	.55	.85	1.45	1.95

*Tophat. **Pressfit 7, 20 amp—stud

Germanium Power Transistors

20W-TO-5-3A	150W-TO-3-7A
2N1038—40V—4/1.00	2N456A—40V—35
2N1039—60V—3/1.00	2N457A—60V—50
2N1040—80V—2/1.00	2N458A—80V—65
2N1041—100V—70	2N1021A—100V—80
	150W-TO-3-25A
2N511, 40V—50; 2N511A, 60V—70;	
2N511B, 80V—1.00	

Silicon Power Transistors

2N 389A 85W, 60V 1.25	2N1048A 40W 120V 1.25
2N 424A 85W, 80V 1.49	2N1718 10W 60V .30
2N 497 4W, 60V .20	2N1719 10W 100V .40
2N 498 4W, 100V .28	2N1724 50W 80V 1.49
2N1047A 40W, 80V 1.00	2N2151 30W 80V .50

Silicon Small Signal NPN, TO-5

2N696 5/\$1.00, 2N697 4/\$1.00, 2698 3/\$1.00, 2N699 2/1.00
3N34 Tetrode —\$1.00; 1N34A Diodes 100/\$2.98; 2N1142 Ger. Hi-Freq. Amplifier—2/\$1.00; Thermistors Beads, 900 ohm or 1200 ohm—\$.50; Varicaps—27, 47, or 100 pf, 4V, 4:1—\$1.25; P.C. Board, 8"x8"x1/16", 1 oz. copper—2/98¢; Photo Cells, Herm Glass, 4 diff. for \$1.00; 2N1300 Series, To-5, assorted—10/\$1.00; I.C. dual-in-line—20/\$1.00; To-5 15/\$1.00.

Assortments

Precision resistors film	50/\$1.00
Ceramic capacitors	70/\$1.00
Electronic Hardware	2lbs/\$1.00
7 pin connector set M & F	3 sets/\$1.00
Free \$1.00 pack with \$10 order. Min. order \$3.00 plus postage. Guaranteed Prompt service.	

ELECTRONIC COMPONENTS CO.

Box 2902 Baton Rouge, La. 70821

CIRCLE NO. 109 ON READER SERVICE CARD
104

YOUR SERVICE AND QUALITY LEADER

We promise to supply you with the highest quality products at the most attractive prices with the fastest service in the industry.

TRIACS

TO-66
5 AMP

PRV	100	200	300	400	500
	.90	1.40	1.75	2.25	2.60

AVALANCHE MODE TRANSISTORS, used for TRIGGERING SCR's & TRIACS, with diagrams \$3/\$1.00

ZENERS 1 watt 7-33V \$.40
10 Watt 7-200V \$.75

MOUNTING HARDWARE KITS.

These kits are used to mount our SCR's, zenoro + rectifiers etc.
6x32 stud, 6 sets for \$1.00
1/4x28 stud, 4 sets for \$1.00



**POST OFFICE BOX 74B
SOMERVILLE, MASS. 02143**

featuring transistors & rectifiers
SEND FOR OUR FALL CATALOG

Business Address: 325 Elm St., Cambridge, Mass.

INTEGRATED CIRCUITS



LINEAR CIRCUITS

FM IF AMPLIFIERS	\$.90
702C WIDE BAND DC AMPL.	\$3.50
709C OPERATIONAL AMPL.	\$4.50
710C HI SPEED DIFF. AMP.	\$5.00
711C DUAL COMPARATOR	\$5.50

DIGITAL RTL CIRCUITS

2-914 QUAD 2 input gates	\$1.00
900 Buffer	\$1.25
925 Dual 2 input gate expander	\$1.25
923 JK flip flop	\$1.25

Controlled Avalanche Rectifiers (Top Hat + Epoxy replacements) 1 AMP.

PRV	100	200	400	600	800	1000
	.07	.09	.12	.18	.22	.35

UNIUNCTIONS!

Similar to 2N2419. RBB of 5-7 stand off ratio of .6 and Ip of 12, with data sheet. \$1.50

Silicon Control Rectifiers

PRV	3A	7A	20A	70A
50	.35	.45	.70	
100	.50	.65	1.00	4.00
200	.70	.95	1.30	8.00
300	.90	1.25	1.70	
400	1.20	1.60	2.10	12.00
500	1.50	2.00	2.50	
600	1.80	2.40	3.00	16.00
700	2.20	2.80		
1000			5.00	24.00

CIRCLE NO. 83 ON READER SERVICE CARD

CLASSIFIED ADVERTISING ORDER FORM

Please refer to heading on first page of this section for complete data concerning terms, frequency discounts, closing dates, etc.

1	2	3	4	5
6	7	8	9	10
11	12	13	14	15
16	17	18	19	20
21	22	23	24	25
26	27	28	29	30
31	32	33	34	35

Words { @ .50 Reader Rate } = \$ _____
 { @ .85 Commercial Rate } = \$ _____

Insert _____ time(s) Total Enclosed \$ _____

NAME _____

ADDRESS _____

CITY _____ STATE _____ ZIP _____

SIGNATURE _____

WORD COUNT: Include name and address. Name of city (Des Moines) or of state (New York) counts as one word each. Zip Code numbers not counted. (Publisher reserves right to omit Zip Code if space does not permit.) Count each abbreviation, initial, single figure or group of figures or letters as a word. Symbols such as 35mm, COD, PO, AC, etc., count as one word. Hyphenated words count as two words. EW-1068

TUBES—33¢ each. Year guarantee. Tuner Cleaner \$1.09. Free catalog, Cornell, 4213-W University, San Diego, Calif. 92105.

RECEIVING & INDUSTRIAL TUBES, TRANSISTORS, All Brands—Biggest Discounts. Technicians, Hobbyists, Experimenters—Request FREE Giant Catalog and SAVE! ZALYTRON, 469 Jericho Turnpike, Mineola, N.Y. 11501.

DON'T BUY TUBES—Radio, TV-Xmitting, special-purpose types until you get our price list! Lowest prices in U.S.A. 5,000 types—Guaranteed Brand New. Send postcard for TV-Special Purpose Price List, UNITED RADIO COMPANY, P.O. BOX 1000, NEWARK, N.J. 07101.

TAPE AND RECORDERS

BEFORE renting Stereo Tapes, try us. Postpaid both ways — no deposit — immediate delivery. Quality — Dependability — Service — Satisfaction — prevail here. If you've been dissatisfied in the past, your initial order will prove this is no idle boast. Free Catalog, Gold Coast Tape Library, Box 2262, Palm Village Station, Hialeah, Fla. 33012.

TAPEMATES make available to you ALL 4-TRACK STEREO TAPES—ALL LABELS—postpaid to your door—at tremendous savings. For free brochure write: TAPEMATES, 5727 W. Jefferson Blvd., Los Angeles, California 90016.

RENT 4-track open reel tapes—all major labels—3,000 different—free brochure. Stereo-Parti, 55 St. James Drive, Santa Rosa, CA. 95401.

TAPE RECORDER SALE. Brand new nationally advertised brands, \$10.00 above cost. Amazing discounts on stereo components. Arkay Electronics, 1028-B Commonwealth Ave., Boston, Mass. 02215.

WHOLESALE — 4-8-track STEREOTAPES — Car, Home PLAYERS—CB, Recorders, MUSICO, Box 11045, Montgomery, Alabama 36105.

STEREO Tapes, Save 30% and up; no membership or fees required; postpaid anywhere U.S.A. Free 70-page catalog. We discount batteries, recorders, tape/accessories. Beware of slogans, "not undersold," as the discount information you supply our competitor is invariably reported to the factory. SAXITONE, 1776 Columbia Road, N. W., Washington, D. C. 20009.

HI-FI Components, Tape Recorders at guaranteed "We Will Not Be Undersold" prices. 15-day money-back guarantee. Two-year warranty. No Catalog. Quotations Free. Hi-Fidelity Center, 239 (LT) East 149th Street, New York 10451.

STEREO Tape Club: Average cost \$3.78—\$4.20. Cartridges, Cassettes, Reels. No minimum monthly purchases. Free brochure—catalog. Star Recordings, Box 1055, El Paso, Tex. 79946.

RECORDS

SPECIAL INTEREST RECORDS AVAILABLE, PRODUCED BY THE EDITORS OF THE WORLD'S LEADING SPECIAL INTEREST MAGAZINES. SEND FOR FREE CATALOG. RECORD CATALOGUE, ZIFF-DAVIS PUBLISHING COMPANY, ONE PARK AVENUE, NEW YORK, N.Y. 10016.

OLDIES—45RPM. Original hits. Over 1500 available. Catalog 25¢. C & S Record Sales, Box 197, Wampsville, N.Y. 13163.

HIGH FIDELITY

FREE! Send for money saving stereo catalog #E10W and lowest quotations on your individual component, tape recorder or system requirements. Electronic Values Inc., 200 West 20th Street, N.Y., N.Y. 10011.

HI-FI Components, Tape Recorders at guaranteed "We Will Not Be Undersold" prices. 15-day money-back guarantee. Two-year warranty. No Catalog. Quotations Free. Hi-Fidelity Center, 239 (L) East 149th Street, New York 10451.

HIFI EQUIPMENT—GET Our "ROCK BOTTOM" prices on NAME BRAND amplifiers—tuners—tape-recorders — speakers FRANCHISED — 59 YEARS IN BUSINESS. Write for this month's specials—NOW! Rabson's 57th St., Inc., Dept. 569, 119 W. 57th St., New York, New York 10019.

LOW, LOW quotes: all components and recorders. Hi-Fi, Roslyn, Penn. 19001.

HI-FI components, tape recorders, sleep learn equipment, tapes. Unusual Values. Free catalog. Dressner, 1523 R Jericho Turnpike, New Hyde Park, N.Y. 11040.

ACOUSTIC RESEARCH, Dyna, Koss, Shure discount specialists. Write for free catalog. Stereo Component Systems Corp., 95 Vassar Street, Cambridge, Mass. 02139.

STEREO Components, tape recorders, tapes, citizen band transceivers, brand names, free catalog, free quotations. GLOBE ELECTRONICS SALES INC., 1160 Globe Avenue, Mountainside, New Jersey 07092.

GOVERNMENT SURPLUS

GOVERNMENT Surplus How and Where to Buy in Your Area. Send \$1.00 to: Surplus Information EW, Headquarters building, Washington, D.C. 20036.

JEEPS Typically From \$53.90 . . . Trucks From \$78.40 . . . Boats, Typewriters, Airplanes, Multi-meters, Oscilloscopes, Transceivers, Electronics Equipment, Used. 100,000 Big Bargains Direct From Government Nationwide. Complete Sales Directory and Surplus Catalog \$1.00 (Deductible First \$10.00 Order). Surplus Service, Box 820-K, Holland, Michigan 49423.

G & G SURPLUS SPECIALS!

BC-645 TRANSCEIVER. 15 tubes. 435 to 500 Mc. Easily adapted for 2 way voice or code on Ham, Mobile, Television Experimental and Citizens' Bands. With tubes, less power supply in factory carton. **\$16.95**
SPECIAL PACKAGE OFFER: BC-645 Transceiver, Dynamotor and all accessories, including mounting, UHF antennas, control box, complete, BRAND NEW **\$26.95**

AN/APR-4Y FM & AM RECEIVER "FB" FOR SATELLITE TRACKING! HIGH precision lab instrument, for monitoring and measuring frequency and relative signal strength, 38 to 4000 Mc, in 5 tuning ranges. For 110 V 60 cycle AC. Built-in power supply. Original circuit diagram included. Checked out, perfect. **\$88.50**
LIKE NEW
 All Tuning Units Available for Above

LORAN APN-4 FINE QUALITY NAVIGATIONAL EQUIPMENT
 4-Channel long range dual units, will determine exact geographic position of your boat or plane. Indicator and receiver complete with all tubes and crystal. **INDICATOR ID-6B/APN-4, and RECEIVER R-9B/APN-4, complete with tubes, Exc. Used \$86.50**

LORAN R-65/APN-9 RECEIVER & INDICATOR
 4-Channel single unit system, used in ships and aircraft, determines position by radio signals from known xmitters. Accurate to within 1% of distance. Complete with all tubes and crystals. Catalog IN LIKE NEW Condition. **\$88.50**
 All accessories for Loran Equipment in stock.

BC-929 3-inch Scope, with all tubes, EXC. USED, Like new Conversion instructions, with diagram, for 110 V AC operation **\$16.95**

TG-34A CODE KEYS, self-contained, automatic, reproduces code practice signals from paper tape, 5 to 25 WPM. Built-in speaker. Brand new with technical manual, take-up reel **\$24.50**
 Code practice tapes for above P.U.R.

BC-603 FM RECEIVER, 20 to 37 Mc 10 preset push-button channels or manual tuning. Complete with 10 tubes, checked out, exc. Used condition. **\$37.50**

BC-603 FM RECEIVER converted for operation on 35 to 50 Mc. Checked out, guaranteed Exc. Used Cond. **\$52.50**

AN/ART-13 TRANSMITTER makes fine Ham transmitter for 80, 40, 20 and 10 meters. Power output 100 Watts on AM, CW, MCW. 10 preset channels. Complete with all tubes, crystals, exc. Used, clean. **\$69.50**
Low-Frequency Oscillator Coil for above, 200-1500 Kc. Exc. Used **\$7.95**

ARC-5 VHF RECEIVER, TRANSMITTER, MODULATOR 100-156 MC. R-28 Receiver, with tubes and crystal, exc. Used Cond, like new **\$24.50**

T-23 Transmitter with tubes and crystals. Complete with original carton **\$24.50**
MD-7 Modulator, with tubes, exc. used **\$10.50**

APN-1 TRANSMITTER-RECEIVER FM 400-150 Mc. Exc. Used, with all tubes, dynamotor & wobbulator **\$8.95**

SCR-274-N, ARC-5 COMMAND SET HQ!

Freq. Range	Type	Exc. Used	BRAND NEW
RECEIVERS, Complete with Tubes			
190-550 Kc.	BC-453	\$18.95	\$23.50
1.6 Mc	BC-454	\$16.50	\$21.50
6-9.1 Mc.	BC-455	\$14.95	\$19.95
1.5-3 Mc.	R-25		\$21.50
TRANSMITTERS, Complete with Tubes			
4.3-3 Mc.	BC-457	\$ 6.95	\$11.95
5.3-7 Mc.	BC-458	\$ 6.95	\$12.95
7-9.1 Mc.	BC-459	\$17.95	\$22.50
2.1-3 Mc.	T-18	\$10.50	\$16.95
3-4 Mc.	T-15	\$10.50	\$14.95

NEW G&G CATALOG 24 Pages Terrific Buys in Military Electronic Gear. SEND 25¢—Refunded with First Order.

TERMS: Either 25% Deposit with order, balance C.O.D. \$5.00. —OR—Remittance in Full. Minimum Order \$5.00. All shipments F.O.B. our warehouse, NYC. All merchandise subject to prior sale and price change.

G & G RADIO SUPPLY COMPANY
 Telephone: (212) CO 7-4605
 75-77 Leonard St., New York, N.Y. 10013

U.S. GOV'T ELECTRONIC SURPLUS

• Nationally Known-World Famous SURPLUS CENTER offers finest, most expensive, Government Surplus electronic units and components at a fraction of their original acquisition cost.

ORDER DIRECT FROM AD or WRITE FOR CATALOGS

STANDARD DIAL TELEPHONE

• (ITEM #715) — Standard, commercial telephone same as used throughout U.S.A. Attractive polished black, like new condition. Use as extension phone to private systems or connect several phones together for local intercom system. Full instructions are furnished. Wt. 3 lbs. Original Cost \$24.50. **F.O.B. \$7.50**

STEP-BY-STEP AUTOMATIC SWITCH

• (ITEM #738) — Amazing "up-and-around" electro-magnetic telephone switch. Dial any bank pair from 1 to 100. Make your own telephone system. Can also be used to remotely control up to 100 circuits over a single pair of wires.
 • One of our FOUR STAR bargains. Comes complete with data, one dial and one bank. Size, 5" x 7" x 1 1/2". Wt. 16 lbs. Cost Gov't Over \$75.00.
 Complete Switch cover, dial, line bank, instructions..... **F.O.B. \$9.95**

TYPICAL BUYS FROM OUR 1968 CATALOGS

- \$ 350.00 - Geared 2-hp Battery Golf Car Motor **\$26.95**
- \$ 15.00 - Westinghouse DC Ammeter, 0 to 300 **\$ 7.11**
- \$ 40.00 - Vacuum/Pressure Pump, 12-VDC **\$11.95**
- - - 80-MW Walkie-Talkies, Per Pair **\$19.60**
- - - Deluxe, Multi-Range, AC/DC Tester **\$ 8.98**

SPECIAL SALE

Correspondence Course In ELECTRICAL ENGINEERING



Sells For \$10.79 Outside U.S.A. **\$8.79** Postpaid in U.S.A.
 • (ITEM #A181) — Wonderful chance to obtain technical training at Amazing Low Cost! Lincoln Engineering School has suspended its Correspondence Courses because of increased operating costs. We offer a limited number of the school's complete Electrical Engineering Course but without the examination paper grading service. The course consists of 14 lesson unit books. Each book has the regular exams, and in a separate section, "Standard Answers" to each exam question.
 • Course is well written, easy to understand, profusely illustrated. Reader's Digest size, easy to carry and study in spare time. Many Lincoln Engineering School students holding excellent jobs as a result of E.E. training. Course contains latest information on transistors, silicon diodes, etc. Additional book on how to build and operate a "Home Laboratory and Experimental Bench" furnished with each course.

SEND 25¢ COIN OR STAMPS FOR CATALOGS
 All Items FOB Lincoln Money Back Guarantee

SURPLUS CENTER

DEPT. EW-108 LINCOLN, NEBR. 68501

FREE Catalog of The WORLD'S FINEST GOV'T SURPLUS ELECTRONIC BARGAINS



Now BIGGER and BETTER than Ever!

MAIL COUPON TODAY

NAME:
 ADDRESS:
 CITY: STATE: ZIP NO.:

FAIR RADIO SALES Dept. EW • BOX 1105 LIMA, OHIO 45802

CIRCLE NO. 107 ON READER SERVICE CARD

AUTHORS' SERVICES

AUTHORS! Learn how to have your book published, promoted, distributed. **FREE** booklet "ZD," Vantage, 120 West 31 St., New York 10001.

PERSONALS

MAKE FRIENDS WORLDWIDE through international correspondence. Illustrated brochure free. Hermes, Berlin 11, Germany.

FREE Catalog low priced, high performance sub-miniature listen-in devices direct from manufacturer. Dealers welcome. Auditorium-W, 156 Fifth Avenue, New York, N.Y. 10010.

LEMURIAN VIEWPOINT—Meaningful discussions of Cosmic Truth: the purpose of human life, reincarnation, man's place in a Higher Plan, and subjects from the Lemurian Philosophy. Send for **FREE** copy. Lemurian Fellowship, Dept. 810, Box 397, Ramona, Calif. 92065.

HYPNOTISM

FREE Hypnotism, Self-Hypnosis, Sleep Learning. Catalog! Drawer H400, Ruidoso, N.M. 88345.

AMAZING HYPNOTIC record kit releases fantastic mental power! Free offer expires soon. Write: Forum, Studio AA10, 333 North Michigan, Chicago 60601.

FEMALE, MALE HYPNOTISM!! Easily! Instantly! Secret Nerve Centers! \$2.20. Brugeneheimer, Box 158-E30, Lexington, Mass. 02173.

HYPNOTIZE MALES, FEMALES! — Unnoticed! Quickly! Nerves! Exciting! \$2.25. Research Enterprises, 29-SN21 Samoset, Woburn, Mass. 01801.

PHOTOGRAPHY—FILM, EQUIPMENT, SERVICES

MEDICAL FILM—Adults only—"Childbirth" one reel, 8mm \$7.50; 16mm \$14.95. International W. Greenvale, Long Island, New York 11548.

SCIENCE Bargains—Request Free Giant Catalog "CJ"—148 pages—Astronomical Telescopes, Microscopes, Lenses, Binoculars, Kits, Parts, War Surplus bargains. Edmund Scientific Co., Barrington, New Jersey 08007.

WE ARE TOPS IN OUR FIELD: THE LEAST EXPENSIVE IN THE COUNTRY!

RUBBER STAMPS

RUBBER ADDRESS STAMP \$1.50. **SIGNATURE** \$3.50. **FREE** CATALOG. JACKSON, BOX 443-G, FRANKLIN PARK, ILL. 60131.

RUBBER STAMPS for special needs. (Signature, Emblems, etc.) \$2.50—UP. **Address Stamp**—\$1.35. Frost, 17639—67CT, Tinley Park, Ill. 60477.

STAMPS

RUSSIA HIGH-VALUE COLLECTION. 32 different Russia—some over 50 years old! Commemoratives. Czarist Issues, Airmails. Catalog price \$2.99. Special Get-Acquainted Offer—all for only 10¢. H. E. Harris, Dept. GG-13, Boston, Mass. 02117.

EMPLOYMENT INFORMATION

AUSTRALIA • Opportunity. Adventure. Jobs. New Life. Government Shares Passage. Information \$1. Pacifico, Box 43485-R, Los Angeles, Calif. 90043.

INVENTIONS WANTED

INVENTORS We will develop, help sell your idea or invention, patented or unpatented. Our national manufacturer clients are urgently seeking new items for outright cash sale or royalties. Financial assistance available. 10 years proven performance. For free information, write Dept. 42, Wall Street Invention Brokerage, 79 Wall Street, New York, N.Y. 10005.

INVENTORS! Receive free invention analysis at no risk to you. Send for **FREE** disclosure form today. New York Invention Service, Dept. 19, 160 Broadway, New York, N.Y. 10038.

PATENT Searches including maximum speed, full airmail report and closest patent copies, \$6.00. Quality searches expertly administered. Complete secrecy guaranteed. Free Invention Protection forms and "Patent Information." Write Dept. 23, Washington Patent Office Search Bureau, 711 14th Street, N. W., Washington, D.C. 20005.

GREGORY ELECTRONICS

New! Exciting!

LOW-PRICED!



FM POCKET RECEIVER
\$59⁹⁵

WITH DRY BATTERY

Add \$7.50 for nickel-cadmium battery. Add \$20 for crystals and tuning to your frequency.

- 30 to 50 MC or 150 to 170 MC.
- all units new.
- Completely solid state, with modular-assembly construction.
- 17 transistors.
- adjustable squelch.
- Sensitivity 0.3 microvolts to break squelch.
- Dual conversion crystal controlled.
- Designed for use with conventional dry cell or rechargeable nickel-cadmium battery. (Battery can even be charged without removing it from unit.)
- Easily set up on the desired operating channel.
- Compact—unit weighs less than 1 lb. and measures 6 5/8" x 2 1/2" x 1 1/4".
- Unit comes equipped with leather carrying case, earphone and shoulder strap.

Reconditioned & Used FM 2-WAY RADIO EQUIPMENT

We have a most enlarged inventory now on hand for practically everything you need—at savings! Buy now!

We Buy Late Model Equipment for Cash
Send For '68 Catalog—Write; Wire or Phone!



249 RT. 46, Saddle Brook, N.J. 07662
Phone: (201) 489-9000

CIRCLE NO. 104 ON READER SERVICE CARD

EDUCATIONAL OPPORTUNITIES

LEARN While Asleep, hypnotize with your recorder, phonograph. Astonishing details, sensational catalog free! Sleep-Learning Association, Box 24-ZD, Olympia, Washington 98501.

LEARN WHILE ASLEEP Miraculously build Mind Power, achieve Self-Confidence, improve Health, gain Success. Method 92% effective. Details free. ASR Foundation, Box 7021EG Henry Clay Station, Lexington, Kentucky 40502.

USED Correspondence Courses and Books sold and rented. Money back guarantee. Catalog free (Courses Bought). Lee Mountain, Pisgah, Alabama 35765.

PRINTING

MIMEO OWNERS: turn your mimeograph into a printing press with electronic stencils. Free instructions, samples, introductory offer. Seaview-W, 212-26 48th Avenue, Bayside, N.Y. 11364.

WPE—HAM—CB QSL'S samples 25¢. Dick, W8VXX, Gladwin, Mich. 48624.

All Tubes Guaranteed One Year!

To the thousands of friends who have used our Electron tubes over the past 17 years and to the many new prospective customers

Welcome To

VIDEO ELECTRIC CO.

For new, factory seconds and used Electron tubes, you can't lose!

ALL OUR EXPERIENCE AND KNOWLEDGE IS YOURS FOR ONLY

32¢ per tube

\$29.00 per 100 (Any Mixture)

ANY TYPE TUBE NOT LISTED ALSO AVAILABLE AT THE SAME LOW PRICE!

PARTIAL LISTING ONLY. ALL TYPES OF TUBES IN STOCK!

- | | | |
|---------|------|-------|
| 1B3 | 6CE5 | 7CS |
| 1J3/1K3 | 6CC7 | 7F8 |
| 1P5 | 6CG8 | 7N7 |
| 154 | 6CM7 | 8AW8 |
| 155 | 6CR6 | 8FQ7 |
| 2C45 | 6CY5 | 101F8 |
| 2F55 | 6D5 | 11CY7 |
| 3AT2 | 6DA4 | 12AD6 |
| 3BZ6 | 6DE4 | 12AU7 |
| 354 | 6DK6 | 12AV6 |
| 4BZ6 | 6DQ6 | 12AX4 |
| 5CC8 | 6DR7 | 12AX7 |
| 5R4 | 6DW4 | 12BA6 |
| 5U4 | 6EA7 | 12BE6 |
| 5V4 | 6E45 | 12BH7 |
| 6AC7 | 6EM7 | 12BK5 |
| 6AG5 | 6EW6 | 12BQ6 |
| 6AH4 | 6F5 | 12BY7 |
| 6AL5 | 6FV8 | 12C5 |
| 6AQ5 | 6GH8 | 12CA5 |
| 6AT6 | 6GK5 | 12CN5 |
| 6AU4 | 6GM6 | 12DQ6 |
| 6AU6 | 6H6 | 12HC7 |
| 6AV6 | 6H5 | 12JA7 |
| 6AW8 | 6J5 | 12KA7 |
| 6AX4 | 6J6 | 12SQ7 |
| 6AY3 | 6JZ8 | 12W6 |
| 6B4C | 6K6 | 13DR7 |
| 6BA6 | 6KA8 | 15KY8 |
| 6BA11 | 6L6 | 17AX4 |
| 6BC5 | 6L8 | 17BE3 |
| 6BD6 | 6LE8 | 17GQ6 |
| 6BE6 | 6MD8 | 17JZ8 |
| 6BG6 | 6N7 | 19BG6 |
| 6BH6 | 6Q7 | 22BW3 |
| 6BL7 | 6S4 | 24A |
| 6BN6 | 6S8 | 25C06 |
| 6BQ6 | 6SA7 | 25L6 |
| 6BQ7 | 6SB7 | 25P6 |
| 6BZ6 | 6SQ7 | 27 |
| 6C4 | 6T8 | 33CY7 |
| 6C5 | 6U8 | 33W4 |
| 6CC | 6V6 | 38HE7 |
| 6CC6 | 6W4 | 41 |
| 6CA4 | 6W5 | 50C5 |
| 6CB6 | 6X8 | 50L6 |
| 6CD6 | 6Y6 | 59S8 |
| | 6A7 | 72S8 |

Above Listed Tubes Are New!
Factory Seconds! Used! And Are So Marked!

Each tube shipped is mutual conductance checked on late model Hickok Tube Checkers or set checked in our fully equipped lab.

SEND FOR OUR FREE GIANT COMPLETE TUBE LIST

FREE TUBE CADDY

With the purchase of every order of \$100.00 or more of receiving tubes only. This sturdy caddy holds over 300 tubes & has a compartment for every tool you'll need on your house calls. (Only 1 **FREE** Caddy with Each Order of \$100.00 or More). Caddy May Be Purchased Outright For Only \$24.95 plus \$1.00 Shipping Charge!
(**FREE TUBE CADDY DOES NOT APPLY TO DUMONT PICTURE TUBES!**)

GET ON OUR MAILING LIST FOR MONTHLY TUBE & PARTS SPECIALS!

SPECIAL
While they last J.A.N. boxed 7H7
Excellent sub for 7A7, 7AH7, 7B7
19¢ each
plus 3¢ per tube shipping!

BRAND NEW
Radio & TV knobs 100 Assorted!
\$4.95 Plus 50¢ Handling!

ALL TUBES INDIVIDUALLY BOXED! BRANDED! CODE DATED!

DUMONT PICTURE TUBE SPECIALS NO DUD REQUIRED		Color	
Black & White	24.95	19EXP22	89.95
19X P4	17.95	21FJP22	74.95
21ALP4	19.95	23EGP22	149.95
21CBP4	23.95	25AP22A	95.95
23CBP4	33.95	25BP22	94.95
23FV4			

All Pix Tubes Shipped F.O.B. Union, N.J.

YOU MUST BE SATISFIED OR YOUR MONEY REFUNDED IN 5 DAYS!

WRITE! WIRE! PHONE!
VIDEO ELECTRIC CO.
795 Colonial Arms Road
Union, N. J. 07083 (201) 688-1414
Warehouse At Union Center, N.J.

CIRCLE NO. 81 ON READER SERVICE CARD

"ARCTURUS SALE"

- Tube cartons 6A6 etc. size, \$2.15 per 100. 6SN7 etc. size, \$2.55 per 100. 5U4GB size, \$2.95 per 100. 5U4G size, .03¢ each.
- 7" 90° TV bench test picture tube with adapter. No ion trap needed. Cat. # 7BP7, \$7.99.
- Silicon rectifier, octal-based replacement for 5U4, 5Y3, 5A5A, 5AW4, 5T4, 5V4, 5Z4. With diagram. Cat. # Rect 1, 99¢ each.
- 5 transistor circuit boards containing up to 6 transistors, plus diodes, resistors, capacitors, etc. Cat. # TB10. 99¢.
- Kit of 30 tested germanium diodes. Cat. #100, 99¢.
- RCA-110° flyback transformer, latest type, includes schematic diagram. Applicable to any TV. Cat. # BR-1, \$2.99.
- Color yokes. 70° for all round color CRT's. Cat. # KR70, \$12.95. 90° for all rectangular 19 to 25" color CRT's. Cat. #KRC90, \$12.95.
- Transistorized U.H.F. tuners used in 1965 to 1967 TV sets made by Admiral, RCA, Motorola, etc. Removable gearing may vary from one make to another. Need only 12 volts d.c. to function. No filament voltage needed. Easy replacement units. Cat. # U.H.F.—567, \$4.95.
- U.H.F. Tuner—original units as used in TV sets such as RCA, Admiral, etc. covering channels 14 through 82, as part #94D173-2. Complete with tube. Drive gearing is removable. Can be used in most sets. Cat. # U.H.F.—3, \$4.95.
- F.M. tuner-Hi-Fi amplifier tuning unit. Tunes from 88 to 108 mc. Contains two 10.7 Mc. I.F. transformers, one 10.7 sound discriminator, R.F. oscillator and mixer stages and 12DT8 tube. I.F.'s are standard "K" type. Circuit diagram for building F.M. radio included. Also plan for building F.M. tuner. Sam's photofact #620 shows 2 applications, 1 for radio, 1 for Hi-Fidelity tuner and amplifier. Cat. #FM-20, \$4.95.

Send for our free catalog listing thousands of similar best buys in tubes, parts, kits, transistors, rectifiers, etc. Orders under \$5.00, add \$1.00 handling charge. Include 4% of dollar value of order for postage. Canadian postage \$1.00 extra.

ARCTURUS ELECTRONICS CORP.
502-22nd St., Union City, N.J. 07087 Dept. MEW
Phone: 201-UN 4-5568

CIRCLE NO. 122 ON READER SERVICE CARD

MAIL
ORDER

SHOPPING MART UNUSUAL VALUES

A selection of products available by mail for readers of Electronics World.
All merchandise sold on a money-back guarantee. Order direct by Stock No. Send check or M.O.

SEE YOUR MUSIC IN DAZZLING ACTION with



Dramatic New Breakthrough
In Audio-Visual Enjoyment

Now you can have a thrilling psychedelic "see-in" right in your own home, club, school or business—in fact—anywhere you want to add sensational "mood" effects. Colored light beams dance and prance, whirl and swirl in perfect time with the music—each individual note creating its own unique twisting, radiating shape. Adds a spectacularly wild, new dimension to the world of music and entertainment. Combines electronics science and art with dramatic results. Attaches in seconds to your radio, tape recorder, hi-fi or stereo with two alligator clips. Can be used on small screens, large walls, stages and whole auditoriums. Build your own Music-Vision* with low-cost Do-It-Yourself Kit. Loads of fun! Fast! Easy! All you need is a light source. If you don't have one, the versatile Edmund 35mm 500 Watt Projector is a terrific bargain. All kinds of other uses which include crossed 8" or 12" Motorlizer, Color Wheel and set of apertures for use with your own 35mm projector. Large 12" set provides fabulous effects for commercial applications. Order by stock number listed below. Money-back guarantee. Complete information in new catalog. Send 25¢ in coin for fully illustrated, 16-page booklet No. 3666AK Introduction to MusicVision*
*Patent pending.

8" DO-IT-YOURSELF KIT
Stock No. 71.009AK\$22.00 Postpaid
8" SET (Motorlizer, color wheel, apertures)\$45.00 Postpaid
Stock No. 71.030AK
EDMUND 500 WATT 35MM PROJECTOR Stock No. 71.057AK

12" SET (Same as above w/large Motorlizer)
Stock No. 71.022AK\$57.50 Postpaid
12" SET (Same as above w/large CABINET MODEL)\$99.50 P.O.B.
Stock No. 85.181AK\$24.50 Postpaid



3" ASTRONOMICAL TELESCOPE

See the stars, moon, phases of Venus, planets close up, 60 to 180 power. Aluminized and overcoated 3" diameter f7D mirror, windowed cell. Equatorial mount with locks on both axes. Equipped with 60x eyepiece and mounted barlow lens. 8x finder telescope, hardwood tripod. Included FREE: "STAR CHART", 272-page "HANDBOOK OF HEAVENS"; "HOW TO USE YOUR TELESCOPE".
Stock No. 85.050AK ...\$29.95 Ppd

Stock No. 85.105AK
4 1/2" REFLECTOR ...\$ 84.50 FOB

Stock No. 85.086AK
6" REFLECTOR\$199.50 FOB



WAR SURPLUS! AMERICAN-MADE 7x50 BINOCULARS

Big savings! Brand new! Crystal-clear viewing—7 power. Every optical element is coated. An excellent night glass—the size recommended for satellite viewing. Individual eye focus. Exit pupil 7mm. Amphib. field at 1,000 yds. is 376 ft. Carrying Case included. American 7 x 50's normally cost \$274.50. Our war surplus price saves you real money.
Stock No. 1544AK
\$74.80 Pstd. (tax included)

GET FREE CATALOG

148 Pages—1000's of Bargains!



EDMUND SCIENTIFIC CO. 809
BARRINGTON BUILDING, BARRINGTON, N.J. 08007

Completely new 1969 edition. New items, categories, illustrations. Dozens of electrical and electronic parts, accessories. Enormous selection of Astronomical Telescopes, Microscopes, Binoculars, Magnifiers, Loupes. Prisms. Many war surplus items for hobbyists, experimenters, workshop, factory. Mail coupon for catalog "AKK".

NAME _____
ADDRESS _____
CITY _____
STATE _____ ZIP _____

ORDER BY STOCK NUMBER • SEND CHECK OR MONEY ORDER • MONEY-BACK GUARANTEE
EDMUND SCIENTIFIC CO. 300 EDCORP BUILDING
October, 1968 CIRCLE NO. 110 ON READER SERVICE CARD

BUSINESS OPPORTUNITIES

INVESTIGATE ACCIDENTS: Earn to \$1000 monthly. Men urgently needed. Car furnished. Business expenses paid. No selling. No college education necessary. Pick own job location. Investigate full time or earn to \$8 hour spare time. Write for FREE information. No obligation. Universal School, CZ-10, 6801 Hillcrest, Dallas, Texas 75205.

\$200.00 DAILY in Your Mailbox! Your Opportunity To Do What Mailorder Experts Do. Free Details. Associates, Box 136-K, Holland, Michigan 49423.

FREE CATALOGS. Repair air conditioning, refrigeration. Tools, supplies, full instructions. Doolin, 2016 Canton, Dallas, Texas 75201.

I MADE \$40,000.00 YEAR by mailorder! Helped others make money! Start with \$10.00—Free proof. Torrey, Box 318-N, Ypsilanti, Mich. 48197.

JAPANESE Electronics New Products Monthly! Specimen copy \$1, deductible. Dee, 10639-W Riverside, North Hollywood, Calif. 91602.

FREE BOOK "990 Successful Little-Known Businesses." Work home! Plymouth 245-M, Brooklyn, New York 11218.

SPECTACULAR INCOME POSSIBILITIES! Addressers, Mailers Wanted. Your name placed directly with companies wanting mailers, rush \$1.00. H. Distributing, Box 25, Norman, Ark. 71960.

MAILORDER . . . Stop Looking! Start Your own Business! Methods, 1407 F.D., Lafayette Hill, Pennsylvania 19444.

ADDRESSERS, MAILERS WANTED. Rush 12¢ postage for details. Smyre's, 953-ZD, Newark, N.J. 07101.

OPPORTUNITY UNLIMITED—T.V. stores, main business locations, established 17 years. Quality T.V. repair service—test equipment, Sams—package or separate terms. Gene Hofrock, Potter, Nebr. 879-4336.

REPAIRS AND SERVICES

SPEAKER REPAIR. Hi-Fi, guitar, organ speakers recond good as new at fraction of new speaker price. For details and Reconding Center in your area write: Waldom Electronics, Inc., Dept. EW, 4625 W. 53rd St., Chicago, Ill. 60632.

Buy 10 PAKS & CHOOSE 1 FREE

<input type="checkbox"/>	\$25 SURPRISE PAK: Transistors, rect. diodes, etc.	\$1
<input type="checkbox"/>	6 ONE AMP 800 PIV RECTIFIERS, silicon top hat	\$1
<input type="checkbox"/>	2—CLAIREX PHOTO ELECTRIC CELL, Hobby must	\$1
<input type="checkbox"/>	50 GERMANIUM GLASS DIODES, 1N34, 1N48 no test	\$1
<input type="checkbox"/>	40 TOP HAT SILICON RECTIFIERS, no test—ast values	\$1
<input type="checkbox"/>	25 EPOXY RECTIFIERS, silicon asst. no test	\$1
<input type="checkbox"/>	40 PRECISION RESISTORS, 1/2-W, 1/4-W asst values	\$1
<input type="checkbox"/>	30 TRANSISTORS, pf, ff, audio, asst. no test	\$1
<input type="checkbox"/>	60 TUBULAR CONDENSERS, to .5mf to 1K V, asst	\$1
<input type="checkbox"/>	50 DISC CONDENSERS, to .6mf npo, temp coef, asst	\$1
<input type="checkbox"/>	60 TUBE SOCKETS, receptacles, plus, audio, etc	\$1
<input type="checkbox"/>	30 POWER RESISTORS, to 25 watts, to 24K Ohms	\$1
<input type="checkbox"/>	3 2N356 NPN TRANSISTORS, 200me, 200 V, 200hf, 50	\$1
<input type="checkbox"/>	3 2N356 TRANSISTORS, min. 600me, 100hf, epoxy	\$1
<input type="checkbox"/>	10 VOLUME CONTROLS, to 1 meg, switch too!	\$1
<input type="checkbox"/>	10 ELECTROLYTICS, to 100mf, tubular, too, asst	\$1
<input type="checkbox"/>	50 RADIO & TV KNOBS, asst colors & styles	\$1
<input type="checkbox"/>	10 TRANS-TOR ELECTROLYTICS to 100mf, asst values	\$1
<input type="checkbox"/>	50 COILS AND CHOKES, if, rf, ant, ose, peaking, etc	\$1
<input type="checkbox"/>	65 HALF WATERS, to 1 meg, 5% popular values too	\$1
<input type="checkbox"/>	60 HI-QUALITY RESISTORS, 1/2, 1, 2W asst values	\$1
<input type="checkbox"/>	10 RCA PHONO PLUGS & JACK SETS, tuners, etc	\$1
<input type="checkbox"/>	4 INTEGRATED CIRCUITS, gates, etc, no test	\$1
<input type="checkbox"/>	2-PC INFRA-RED DETECTOR & FILTER SET—science proj	\$1
<input type="checkbox"/>	2 FIELD EFFECT TRANSISTORS, n channel, hobby	\$1
<input type="checkbox"/>	50 TERMINAL STRIPS, 1 to 8 lug types	\$1
<input type="checkbox"/>	3 PHOTO ELECTRIC CELLS, hi. imp., schematic	\$1
<input type="checkbox"/>	3 TRANS-TOR AMPLIFIER, WIRED, 3x2x3, schematic	\$1
<input type="checkbox"/>	10 PRINTED CIRCUIT BOARDS, copper clad, 100 uses	\$1
<input type="checkbox"/>	10 TRANSISTOR SOCKETS, for pnp & npn types	\$1
<input type="checkbox"/>	10 PANEL SWITCHES, toggle, slide, micro, rotary	\$1
<input type="checkbox"/>	4 TRANSISTOR TRANSFORMERS, asst. watt \$25	\$1
<input type="checkbox"/>	5 RAYTHEON CK-72 TRANSISTORS, pnp, must pop	\$1
<input type="checkbox"/>	5 G.E. 2N107 TRANSISTORS, pnp, audio ekt	\$1
<input type="checkbox"/>	10 "MICRO" COMPUTER BOARDS, many trans, diodes	\$1
<input type="checkbox"/>	40 "MICRO" CONDENSERS, for transistor circuitry	\$1
<input type="checkbox"/>	3 14W. EPOXY TRANSISTORS, npn, silicon, 8-5000, 10	\$1
<input type="checkbox"/>	15 3 to 12 AMP STD RECTIFIERS, up to 600 PIV	\$1

FAIRCHILD BRAND NEW! "FLAT PAK" RTL

INTEGRATED CIRCUITS

<input type="checkbox"/>	900 Buffer	\$1.49
<input type="checkbox"/>	903-903* 3 Input Gate	\$1.69
<input type="checkbox"/>	904-904* Half Adder	\$1.69
<input type="checkbox"/>	914-914* Dual 2 Input Gate	\$1.49
<input type="checkbox"/>	923 JK Flip Flop	\$1.69
<input type="checkbox"/>	923-923* JK Flip Flop	\$1.98
<input type="checkbox"/>	927 Quad Inverter	\$1.49

*First time anywhere two identical IC's in one package, example 923-923 contains two separate JK flip-flops in one package. 914's and 923's. We include 50 uses. * Licensed 1/4" x 1/4"

LINEAR AMPLIFIERS with circuits & data

<input type="checkbox"/>	702C WIDE BAND DC	\$3.98
<input type="checkbox"/>	703H RF-IF-FM	\$1.49
<input type="checkbox"/>	709C HI-GAIN OPERATIONAL	\$3.98
<input type="checkbox"/>	710C HI-SPEED DIFF. COMP.	\$3.98
<input type="checkbox"/>	711C DUAL COMPARATOR	\$4.98

1 AMP TOP HAT AND EPOXIES

PIV	SALE	PIV	SALE
50	.05	800	.19
100	.07	1000	.31
200	.08	1200	.44
400	.11	1400	.62
600	.16	1600	.72

Terms: add postage. Rated: net 30, coll's 25%
Phone Orders: Wakefield, Mass. (617) 245-3829
Retail: 211 Albion, St., Wakefield, Mass.

GIANT 'XMAS' CATALOG ON: Parts, Rectifiers, 10¢
 Transistors, SCRs, I.C.'s, Equipment, Etc.

POLY PAKS

P.O. BOX 942W
LYNNFIELD, MASS. 01940
CIRCLE NO. 91 ON READER SERVICE CARD

MAGAZINES

FACTS on vintage car values. Unique magazine for vintage car enthusiasts listing thousands of Classic, Antique, & Special interest cars with photographs. (Compiled from actual sales.) Used by Banks & Insurance Companies. Informative restoration hints. Vintage cars for investment. Classified, listing vintage cars for sale. Listing all American cars since 1895. Published semi-annually, New Fall Edition now available. One copy \$3.00. One Year \$5.00; three years \$12.00. Send cash, Check or M.O. to Old Car Value Guide, P.O. Box 105, Prescott, Ariz. 86301.

BACK DATE MAGAZINES! Send Needs. Midtown, Box 934-EW, Maywood, New Jersey 07607.

MISCELLANEOUS

WINEMAKERS: Free illustrated catalog of yeasts, equipment. Semplex, Box 7208, Minneapolis, Minn. 55412.

TEN Winemaking Recipes and Winemaking Supplies catalog 10¢. Country Winemaker, Box 191E, RFD 1, Mattapoisett, Mass. 02739.

Electronics World SUBSCRIBER SERVICE

Please include an address label when writing about your subscription to help us serve you promptly. Write to: Portland Place, Boulder, Colo. 80302

CHANGE OF ADDRESS:

Please let us know you are moving at least four to six weeks in advance. Affix magazine address label in space to the right and print new address below. If you have a question about your subscription, attach address label to your letter.

TO SUBSCRIBE:

Check boxes below.

- New Renewal
 5 years \$21
 3 years \$15
 1 year \$6

SPECIFY:

- Payment enclosed—
 You get 1 extra issue
 per year as a BONUS!
 Bill me later.

AFFIX LABEL

If you have no label handy, print OLD address here.

state city address name please print zip-code

[Add'l postage: \$1 per year outside U.S., its possessions & Canada.]

name 0234 please print

address

city

state zip-code



not by a long shot it isn't !!

There's certainly nothing top secret about the classified pages in Electronics World Magazine. They're wide open to the searching eyes of every buyer who's in the market for the product or service that he knows can be found in Electronics World's Electronics Market Place.

The more than 191,000 buyers of Electronics World, largest readership of any magazine for electronics professionals in the world, are your guarantee of knowing that your ad is being read by people who are constantly looking for and buying electronics products. It is these people to whom you MUST direct YOUR advertising as do the many key advertisers appearing in this issue and in each issue throughout the year.

No doubt about it—there's a vast market of buyers searching the classified advertising pages of Electronics World and it's important that your ad be exposed to this prime buying audience. Prove to yourself that the leading magazine for electronics professionals MUST ALSO be the leader in sales responses to the many classified ads presently enhancing its pages—it makes a great deal of sense—give it a try.

See classified section for rate information or write to
HAL CYMES, Classified Advertising Mgr.
ZIFF-DAVIS PUBLISHING COMPANY
 One Park Avenue, New York, N. Y. 10016

ELECTRONICS WORLD OCTOBER 1968

ADVERTISERS INDEX

READER SERVICE NO.	ADVERTISER	PAGE NO.	READER SERVICE NO.	ADVERTISER	PAGE NO.
125	Accurate Instrument Co., Inc	69	101	Judson Research and Mfg. Co	75
124	Allied Radio	57, 58	100	Kenwood	102
123	Ampex Corporation	15	99	Lafayette Radio Electronics	99, 100
	Anti-Tobacco Center of America, The	98		Lampkin Laboratories, Inc	75
122	Arcturus Electronics Corp	107	98	Liberty Electronics, Inc	103
121	Belden Corporation	12	96	Mallory & Co. Inc., P.R.	2
120	Bell P/A Products Corporation	68	200	Metex Corporation	84
119	Burstein-Applebee Co	70	95	Mosley Electronics, Inc	101
	CREI, Home Study Division, McGraw-Hill Book Company	SECOND COVER, 1	94	Motorola Training Institute	96
118	Cleveland Institute of Electronics	22, 23, 24, 25	93	Music Associated	74
				National Radio Institute	8, 9, 10, 11
117	Cleveland Institute of Electronics	75	92	Olson Electronics	92
115	Con-trx, Inc	96	97	Pioneer Electronics U.S.A. Corp	THIRD COVER
	Conar Instruments	6	91	Poly Paks	107
114	Cook's Institute of Electronics Engineering..	62	90	RCA Electronic Components and Devices	63
113	Delta Products, Inc	72	89	RCA Electronic Components and Devices	97
111	Delta Products, Inc	73		RCA Institutes, Inc	78, 79, 80, 81
110	Edmund Scientific Co	107		RCA Sales Corp	85
112	Electro-Voice, Inc	FOURTH COVER	88	Radar Devices Mfg. Corp	19
109	Electronic Components Co	104	78	Radar Devices Mfg. Corp	21
	Electronics and Control Engineers' Book Club	65	87	Rye Industries Inc	64
108	Elpa Marketing Industries, Inc	62	86	Sams & Co., Inc., Howard W	4
107	Fair Radio Sales	105	85	Scheber Organ Corp., The	16
106	Finney Company, The	61	84	Scott, Inc., H.H.	26
	G & G Radio Supply Company	105	83	Solid State Sales	104
	Goodheart Co. Inc., R.E.	103		Surplus Center	105
	Grantham School of Electronics	5		Sylvania	71
105	Greenlee Tool Co	74	82	Tescom Corporation	70
104	Gregory Electronics Corporation	106	199	Texas Crystals	92
103	Heath Company 86, 87, 88, 89, 90, 91			Valparaiso Technical Institute	6
102	International Crystal Mfg. Co., Inc	17	81	Video Electric Co	106
			80	Weller Electric Corporation	66
			79	Zenith	95

CLASSIFIED ADVERTISING 103, 104, 105, 106, 107

a few new reasons you should see the Pioneer line now!

In every area of high fidelity, new components by Pioneer are making listening more enjoyable... a richer experience. Although these components represent the newest and most advanced technology in audio electronics, each is backed by the 30 years' experience of the world's largest manufacturer devoted solely to high fidelity and audio components. Here is a sampling of some of the things to come in the next few months.

SX-1000TD-130-watt AM-FM Stereo Receiver with an FET front end and 4 IC's

A powerful 130-watt (8 ohms, IHF) receiver with most advanced circuitry, boasts 1.7 uv FM sensitivity (IHF), excellent selectivity, capture ratio of 1 dB (at 98 mHz), and S/N ratio of 65 dB (IHF). Automatic stereo switching, frequency response: 20 to 50,000 Hz \pm 1 dB.

CS-52T-Compact 2-way Speaker System

Brilliant sound reproduction from a

very small enclosure (13 $\frac{3}{8}$ "H x 8 $\frac{1}{2}$ "W x 8 $\frac{5}{8}$ "D). Driven by a 6 $\frac{1}{2}$ -inch woofer with extra large and heavy magnet, and 2 $\frac{1}{2}$ -inch cone-type tweeter. Excellent transient response and sparkling highs with very wide dispersion.

IS-31-Basic Music Programmer for Integrated Systems

Pioneer has led the way in advanced concepts of bi-amplification and electronic crossovers — the Pioneer Integrated Systems. Hailed as the ultimate approach to perfect sound reproduction, Pioneer introduces for 1969 (available now!) this basic music programmer — an AM-FM stereo tuner, a transcription turntable, and preamplifier, in one integrated module to couple with bi-amplified speaker systems such as the IS-80. Beautifully designed in walnut, charcoal, and white gold, with smoked acrylic cover.

PL-25-Semi-automatic Transcription Turntable

The turntable perfectionists have been waiting for — the precision of

a manual transcription turntable with automatic cueing, automatic shut-off, and automatic arm return. The turntable with the conveniences people want.

CS-5-Intermediate-sized, Budget priced Speaker System

An intermediate-sized speaker system at the lowest possible price from the world's largest manufacturer of loudspeakers. The CS-5 is a convenient bookshelf-size system, using the most advanced transducers for full range reproduction to fit anyone's budget. Measurements: 21 $\frac{1}{4}$ "H x 11 $\frac{7}{16}$ "W x 8 $\frac{13}{16}$ "D.

See these and other fine components by Pioneer at your nearest Pioneer franchised dealer. Or write directly to Pioneer for free literature. PIONEER ELECTRONICS U.S.A. CORP., 140 Smith Street, Farmingdale, L.I., New York 11735.

PIONEER 
... More Value All-Ways!





**Further proof...
sound has never
been in better shape!**

RE55 OMNIDIRECTIONAL DYNAMIC MICROPHONE

 There are plenty of good, functional reasons behind the new look of Electro-Voice professional microphones. Reasons dramatically proved by the rapid success of the Model 635A and the RE15. Now we've added the RE55 to this handsome group.

The RE55, like its predecessor the 655C, is an extremely wide-range omnidirectional dynamic. And in most electrical particulars it is not greatly different. RE55 frequency response is a bit wider, and perhaps a trifle flatter. An impressive achievement when you consider that the 655C has been extensively used as a secondary frequency response standard. Output level is 2 db hotter, and the exclusive E-V Acoustalloy® diaphragm of the RE55 can provide undistorted output in sound fields so intense as to cause ear damage.

The biggest changes in the RE55 are mechanical. For this microphone is even more rugged than the 655... long known as one of the toughest in the business. There's a solid steel case and new, improved internal shock mounting for the RE55. Plus a satin nickel finish that looks great on TV long after most microphones have been scarred and scratched almost beyond recognition.

For convenience we've made the barrel of the RE55 just 3/4" in diameter. It fits modern 3/4" accessories. It also fits the hand (and its length makes the RE55 perfect for hand-held interviews). We also provide XLR-3 Cannon-type connectors to help you standardize your audio wiring. Detail refinements that make the RE55 more dependable, easier to use.

Finally, the RE55 has the exclusive Electro-Voice 2-year *unconditional* guarantee. No matter what happens, if an RE55 fails to perform during the first two years — for any reason — we'll repair it at no charge.

Try the Electro-Voice RE55 today. The more you listen, the better it looks!

ELECTRO-VOICE, INC., Dept. 1081N, 629 Cecil Street, Buchanan, Michigan 49091

• high fidelity speakers and systems • tuners, amplifiers, receivers • public address loudspeakers
• microphones • phonograph needles and cartridges • organs • space and defense electronics

Electro-Voice®

A SUBSIDIARY OF GULTON INDUSTRIES, INC.

CIRCLE NO. 112 ON READER SERVICE CARD