

Electronics World

JUNE, 1968
60 CENTS

ELECTRONIC IMPLANTS IN LIVING TISSUE
DIAGNOSTIC CENTERS— New Approach to TV Servicing
REPORT ON 1968 FM-STEREO CAR RADIOS

EW LAB TESTS

**SOLID-STATE
STEREO
AMPLIFIERS**

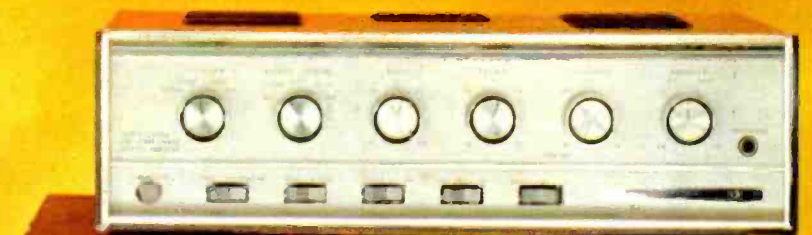
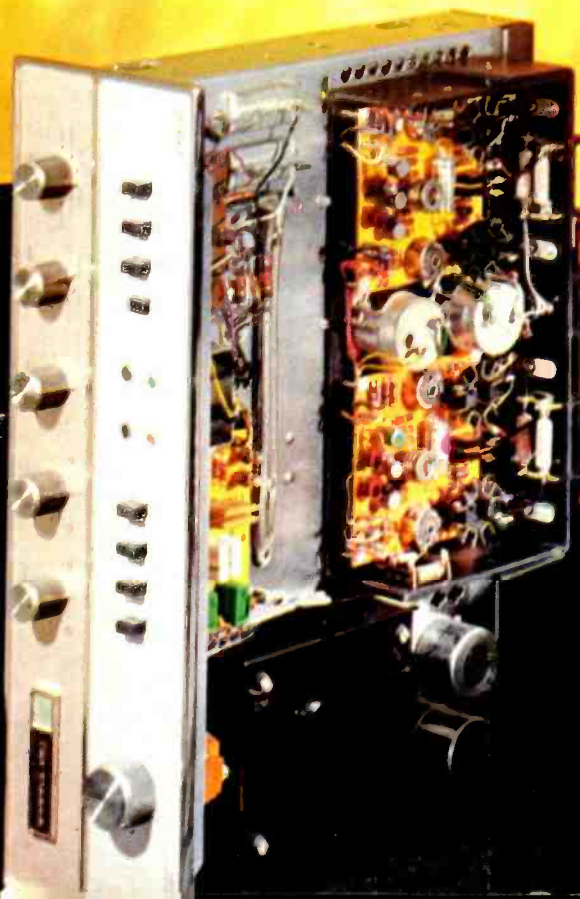

**“Get more
education
or
get out of
electronics**

...that's my advice.”



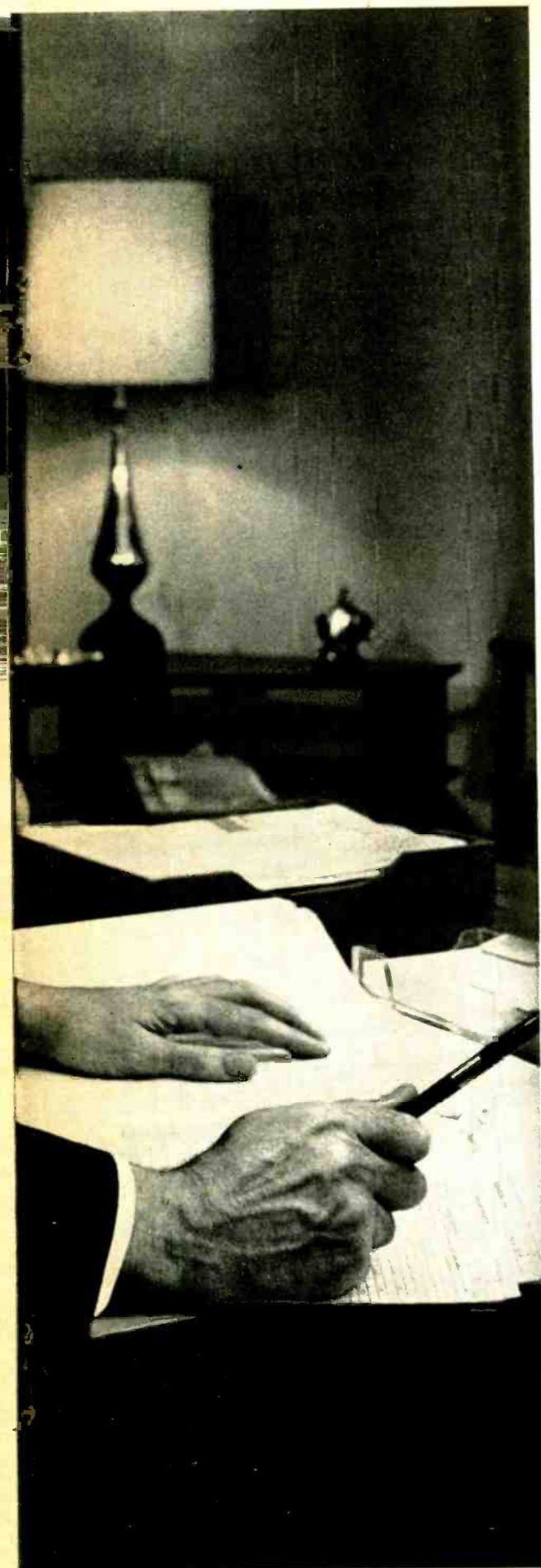

Ask any man who really knows the electronics industry.

Opportunities are few for men without advanced technical education. If you stay on that level, you'll never make much money. And you'll be among the first to go in a layoff.

But, if you supplement your experience with more education in electronics, you can become a specialist. You'll enjoy good income and excellent security. You won't have to worry about automation or advances in technology putting you out of a job.

How can you get the additional education you must have to protect your future—and the future of those who depend on you? Going back to school isn't easy for a man with a job and family obligations.

CREI Home Study Programs offer you a practical way to get more education without going back to school. You study at home, at your own pace, on your own schedule. And you study with the assurance that what you learn can be applied on the job immediately to make you worth more money to your employer.

You're eligible for a CREI Program if you work in electronics and have a high school education. Our FREE book gives complete information. Airmail postpaid card for your copy. If card is detached, use coupon below or write: CREI, Dept. 1106G, 3224 Sixteenth Street, N.W., Washington, D.C. 20010.

Founded 1927



Accredited Member of the National Home Study Council



**CREI, Home Study Division
McGraw-Hill Book Company
Dept. 1106G, 3224 Sixteenth Street, N.W.
Washington, D.C. 20010**

Please send me FREE book describing CREI Programs. I am employed in electronics and have a high school education.

NAME _____ AGE _____

ADDRESS _____

CITY _____ STATE _____ ZIP CODE _____

EMPLOYED BY _____

TYPE OF PRESENT WORK _____ G.I. BILL

- I am interested in Electronic Engineering Technology
 Space Electronics Nuclear Engineering Technology
 Industrial Electronics for Automation
 Computer Systems Technology

APPROVED FOR TRAINING UNDER NEW G.I. BILL

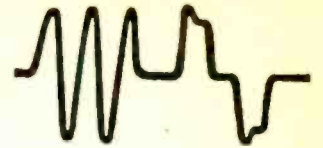

Low-drain Sonalert® signal has dozens of uses

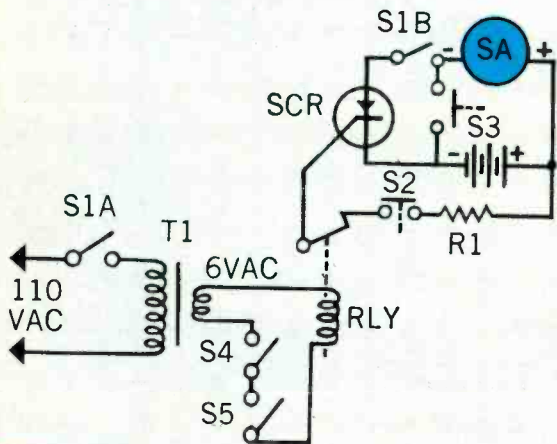

Most audible signals take considerable power to operate. But here's a *different* one... the Sonalert... that is completely solid state and works on a few milliamps. And because of this characteristic, it can be used in signalling, warning and testing arrangements that would otherwise be impractical, complicated or costly.

Here's an intrusion alarm circuit using the Sonalert (SA in the diagram). Switches S4 and S5 are control line contacts in a low-voltage AC circuit... which, when opened, will cause the relay contacts to open, gate the SCR and the Sonalert will immediately sound off. S4 and S5 can be door or window contacts, for example. This is a "fail safe" circuit. The Sonalert is powered by a battery (a 9-volt Mercury Duracell® battery TR-146X is ideal). Any loss of AC power will sound the alarm. S2 is an "arming" switch, and S3 lets you test battery condition.

By using fusible links in the S4 and S5 positions, you can convert this to a fire alarm.

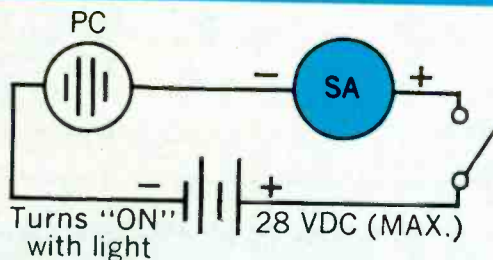
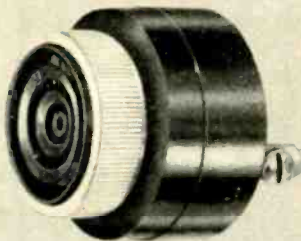

In conjunction with photo cells, Sonalert can be arranged to do all sorts of tricks. Its drain is so low that it can be coupled directly to low-cost cadmium sulfide cells. Two simple circuits are illustrated; one turns the Sonalert on when illuminated, the other turns the Sonalert on when light goes off.

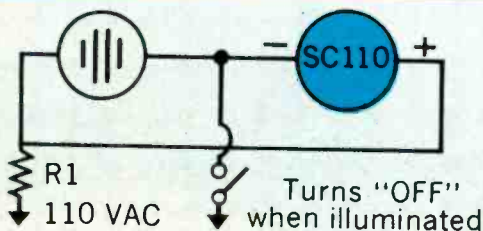

Other uses? Sonalert works great as a continuity checker, code practice oscillator, swimming pool splash alarm. In your automobile it can be hooked up as a water temperature or oil pressure signal, or as a "headlights on" alarm. We've published a booklet that describes how to make many different circuits. Ask your Mallory Distributor for a copy of Folder 9-406, or write to Mallory Distributor Products Company, a division of P. R. Mallory & Co. Inc., Indianapolis, Indiana 46206.

©Duracell is a registered trademark of P. R. Mallory & Co. Inc.

DON'T FORGET TO ASK 'EM — *What else needs fixing?*



Electronics World

JUNE 1968

VOL. 79, No. 6

CONTENTS

THIS MONTH'S COVER shows a half dozen representative examples of new solid-state integrated stereo amplifiers. These units, along with nine others, were subjected to a large number of tests and measurements by Hirsch-Houck Laboratories. For a complete run-down on the test results and methods of measurement, see our lead story on page 25. The amplifiers in our cover photograph are the following: The upright unit at left, shown with its case removed, is the Fisher TX-1000. The stack of amplifiers at the right are, from top to bottom: Sherwood S-9900a, Scott 260-B, Sony TA-1120, Heath AA-15, and Eico 3070. For complete details on these and many other such amplifiers, refer to our lead story. . . . Photo by Dirone-Denner.

- 20** GI Engineers
- 25** EW Lab Tests New Solid-State Stereo Amplifiers *Julian D. Hirsch*
- 29** Photometry Nomograph
- 30** Recent Developments in Electronics
- 32** Ceramic Phono Cartridge Loading & Equalization *John C. Rankin*
- 33** 1968 FM-Stereo Car Radios *Forest H. Belt*
Here are the most important circuit features and troubleshooting information on Bendix, Delco, and Motorola stereo receivers used in the 1968 model cars.
- 37** Early Warning Systems for Earthquakes *L. George Lawrence*
- 40** Trade Secrets: The Courts and You *Maurice J. Hindin*
Technical personnel on the move from one job to another should be especially careful to protect their former employer's rights as well as their own. Court calendars are crowded with damage suits against employees and their employers.
- 42** Diagnostic Clinics for TV Sets *John T. Frye*
Diagnostic centers have been used in the medical field for some time, more recently in the auto service area, and now have reached TV servicing. Here's a description of the franchised "Tele-Quick" operation which is beginning to spread over the U.S.
- 44** IC Op-Amp Hi-Fi Preamplifier *Daniel R. von Recklinghausen*
- 46** Electronic Implants *John T. Prenlice*
Pacemakers and other electronic implants are changing the pulse of medicine. They are more than an attachment; they act as data gatherers that measure and transmit physiological information for external evaluation and control.
- 49** Electronic Measurements Using Statistical Techniques *Sidney L. Silver*
When you have to study stray or random signals that are produced by many physical phenomena, you must use statistics to describe their average characteristics. Thermal and shot noise, static interference, irregular mechanical stresses and vibration must be handled this way.

- 11** EW Lab Tested
Electro-Voice "Sentry II" Speaker
Ampex AG-500-4 Tape Recorder
- 58** Solid-State Service Instruments *John Frye*
- 62** Test Equipment Product Report
Amphenol Model 857 CRT Tester-Rejuvenator
Sencore Model FE14 Field-Effect Meter
Millen 90651-A Grid-Dip Meter

MONTHLY FEATURES

- 4** Coming Next Month
- 5** Letters from Our Readers
- 17** Radio & Television News
- 21** Reflections on the News
- 73** Book Reviews
- 78** New Products & Literature

Electronics World: Published monthly by Ziff-Davis Publishing Company at 307 North Michigan Ave., Chicago, Illinois 60601. One year subscription \$6.00. Second Class Postage paid at Chicago, Illinois and at additional mailing offices. Subscription service and Forms 3579: Portland Place, Boulder, Colorado 80302. Copyright © 1968 by Ziff-Davis Publishing Company. All rights reserved.

Publisher
PHILLIP T. HEFFERNAN
Editor
WM. A. STOCKLIN
Technical Editor
MILTON S. SNITZER
Associate Editors
W. J. EVANZIA
P. B. HOEFER
Contributing Editors
WALTER H. BUCHSBAUM
Prof. ARTHUR H. SEIDMAN
FOREST H. BELT
Art Editor
EUGENE F. LANDINO
Art and Drafting
J. A. GOLANEK
Advertising Sales Manager
LAWRENCE SPORN
Advertising Service Manager
ARDYS C. MORAN

The Grantham Educational Program

BY CORRESPONDENCE

prepares you for your

A. S. E. E.

(Associate in Science in Electronics Engineering)

DEGREE

In today's world of electronics employment, an FCC license is important — sometimes essential but it's not enough! Without further education, you can't make it to the top. Get your FCC license without fail, but don't stop there. To prepare for the best jobs, continue your electronics education and get your Associate Degree in Electronics Engineering.

This is good common sense for those who want to make more money in electronics. It also makes sense to prepare for your FCC license with the School that gives degree credit for your license training — and with the School that can then take you from the FCC license level to the Degree level.

Accreditation, and G.I. Bill Approval

Grantham School of Electronics is accredited by the Accrediting Commission of the National Home Study Council, and is approved for both correspondence and resident training under the G.I. Bill. Just mail the coupon, or write or telephone us for full information without obligation.

It's Your Move

The move you make today can shape your future. Begin now with a step in the right direction — Step #1 — and then follow through with Steps #2, #3, and #4.

Step #1 is a simple request for full information on the Grantham Associate Degree Program in Electronics. You take this step by filling out and mailing the coupon shown below. We'll send full information by return mail. No salesman will call.

Step #2 is earning your FCC first class radiotelephone LICENSE and radar endorsement. You complete this step in the first two semesters of the Grantham educational program (by correspondence, or Washington resident classes).

Step #3 is earning your ASEE DEGREE. This degree is conferred when you have earned credit for the Grantham course, one semester of which must be taken in residence if you have less than one year of practical experience in electronics.

Step #4 is getting a better job, greater prestige, higher pay on the basis of your extensive knowledge of electronics.

It's your move! Why not begin now with Step #1.

Grantham School of Electronics

• Established in 1951 •

1505 N. Western Ave. or 818 18th Street, N.W.
Hollywood, Calif. 90027 or Washington, D.C. 20006

Grantham School of Electronics EW 6-69
1505 N. Western Ave., Hollywood, Calif. 90027

Please mail me your free catalog, which explains how Grantham training can prepare me for my FCC License and Associate Degree in electronics. I understand no salesman will call.

Name _____ Age _____
Address _____
City _____ State _____ Zip _____

**COMING
NEXT MONTH**

**SPECIAL ISSUE:
Linear Integrated Circuits**



A big 20 pages chock full of technical know-how about linear integrated circuits. There are six articles, each written by an expert in his field. Brent Welling, Manager, Signal Processing Applications at Motorola Semiconductor Products Inc., shows engineers how **Monolithic Operational Amplifiers** can be used in hundreds of new applications . . . Sometimes **The Hybrid LIC** is a better component selection than the monolithic LIC. Darnell Burks of Sprague Electric Co. gives examples of high-performance hybrid units. . . . Thinking about going from discrete to LIC's? Ken Blair, Supervisory Engineer at Westinghouse Electric Corp., explains how LIC's match or exceed the performance of discrete devices. . . . There are two articles from RCA experts. Engineer Stan Katz examines the concept of **Large-Scale Integration** while H. M. Kleinman, Engineer Leader, discusses **I. F. and R. F. IC Amplifiers**. . . . **Monolithic IC Audio Amps**, the newest component in the IC marketplace, are examined by Dwight Jones, an Applications Engineer from General Electric's Semiconductor Products Division.

**PARTICLE ACCELERATORS
FIND A NEW WORLD**

In the past, particle accelerators have been used almost exclusively for theoretical studies. Now they are moving out of the labs into industrial work.

**SYLVANIA
COLOR-TV SLIDE THEATER**

A new combination color-TV receiver and flying-spot scanner enables amateur photographers to see their color slides on their picture tubes.

**INTEGRATED CIRCUIT
EQUALIZED PREAMPLIFIER**

The Amperex TAA-293 IC is well suited for low-level audio applications. In this article, a high-gain, low-impedance output circuit is shown and its operation discussed.

VR'S FOR CAMERA TUBES

Television camera systems are becoming smaller but their requirements for circuit stability are still high. A new, inexpensive voltage regulator does the job easily.

All these and many more interesting and informative articles will be yours in the July issue of **ELECTRONICS WORLD** . . . on sale June 18th.

ZIFF-DAVIS PUBLISHING COMPANY

- William B. Ziff**
Chairman of the Board (1946-1953)
- William Ziff**
President
- W. Bradford Briggs**
Executive Vice President
- Hershel B. Sarbin**
Senior Vice President
- Philip Sine**
Financial Vice President
- Walter S. Mills, Jr.**
Vice President, Circulation
- Stanley R. Greenfield**
Vice President, Marketing
- Phillip T. Heffernan**
Vice President, Electronics Division
- Frank Pomerantz**
Vice President, Creative Services
- Arthur W. Butzow**
Vice President, Production
- Edward D. Muhlfeld**
Vice President, Aviation Division
- Irwin Robinson**
Vice President, Travel Division

Editorial and Executive Offices
One Park Avenue
New York, New York 10016 212 679-7200

NEW YORK OFFICE 212 679-7200
Joseph E. Halloran

MIDWESTERN OFFICE
307 North Michigan Avenue
Chicago, Illinois 60601 312 726-0892
Midwestern Advertising Manager, Robert J. Ur

WESTERN OFFICE
9025 Wilshire Boulevard
Beverly Hills, California 90211
213 CRestview 4-0265; Bradshaw 2-1161
Western Advertising Manager, Bud Dean

JAPAN
James Yagi
Ishikawa Mansion
#4, Sakuragaoka
Shibuya-ku, Tokyo
462-2911-3

CIRCULATION OFFICE
Portland Place, Boulder, Colorado 80302



Member
Audit Bureau of
Circulations

Radio & TV News • Radio News • Radio-Electronic Engineering Trademarks Reg. U.S. Pat. Off.
SUBSCRIPTION SERVICE: Forms 3579 and all subscription correspondence should be addressed to Electronics World, Circulation Department, Portland Place, Boulder, Colorado 80302. Please allow at least six weeks for change of address. Include your old address, as well as new—enclosing if possible an address label from a recent issue.
EDITORIAL CONTRIBUTIONS must be accompanied by return postage and will be handled with reasonable care; however publisher assumes no responsibility for return or safety of art work, photographs, or manuscripts.
ELECTRONICS WORLD (June, 1968, Vol. 79, No. 6). Published monthly at 307 North Michigan Avenue, Chicago, Illinois 60601, by Ziff-Davis Publishing Company—also the publishers of Airline Management and Marketing, Boating, Business & Commercial Aviation, Car and Driver, Cycle, Flying, HiFi/Stereo Review, Modern Bride, Popular Electronics, Popular Photography, Skiing, Skiing Area News, and Skiing Trade Review. (Travel Weekly is published by Robinson Publications, Inc., a subsidiary of Ziff-Davis Publishing Company.) One year subscription rate for U.S., U.S. Possessions, and Canada, \$6.00; all other countries, \$7.00. Second Class postage paid at Chicago, Illinois, and at additional mailing offices. Authorized as second class mail by the Post Office Department, Ottawa, Canada and for payment of postage in cash.

LETTERS FROM OUR READERS

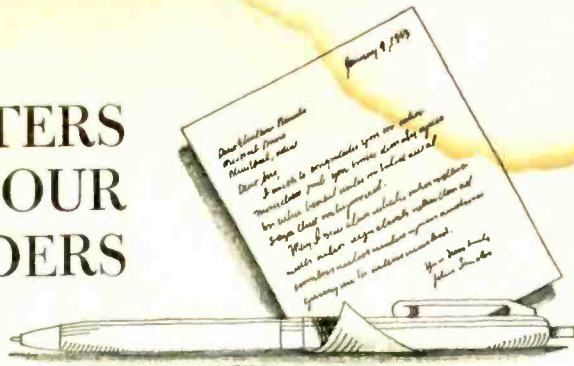

TRANSISTOR CURVE TRACER

To the Editors:

I have been overwhelmed by the caliber and number of people who have inquired about my "Transistor Curve Tracer" article appeared in your January issue (page 55).

The following information may be passed on to future inquirers:

1. No printed-circuit boards are available.
2. Transistors Q2, Q6, and Q13 (2N699 in article) can be 2N2102 or 40327 (RCA).
3. Some people are having difficulty in obtaining MPS2894 (Motorola) transistors. I suggest that they try any small-signal switching silicon units that are handy.

I would like to express my gratitude to Mr. Robert E. Brock of our technical writing staff. Mr. Brock had graciously deleted his name from the article and refused the credit he richly deserves.

MELVIN CHAN
 Ampex Corp.
 Redwood City, Cal.

DIFFERENTIAL AMPLIFIER

To the Editors:

The input-impedance expression and curve (Fig. 3) in my article "The Differential Amplifier" (Feb. '68, p. 54) are off by a factor of 2. Correct values are *double* those read off the graph. My thanks to Mr. Winfield Hill of Harvard University for pointing out this error.

Several other readers have questioned just where the curves and equations come from. They follow directly from the basic diode equation and some simple algebra.

If you treat the differential amplifier as an emitter-follower driving a grounded-base stage, the input impedance to the grounded-base stage is simply the diode equation, or at room temperature: $Z_{in} = 26/I$, where Z_{in} is in ohms and I is in milliamperes. The output impedance is R_L and the gain is R_L/Z_{in} . But I is half I_E and there is a 2:1 voltage loss when the emitter-follower drives the common-base stage due to their identical input and output impedances. Putting this all together results in an equation of: $E_{out}/E_{in} = I_E R_L / 104$, as shown in Fig. 2 of my article.

The input impedance is double the

input impedance of the common-base stage times the current gain, or $Z_{in} = 104 \beta / I_E$.

The maximum peak-to-peak output voltage is determined by how much voltage drop you can possibly get across R_L . This is simply $I_E R_L$ when all the current is routed to one side.

One reader also questioned whether we could talk about voltage gain without reference to input and output impedances. While some purists still protest this usage, a glance at any linear IC manufacturer's data sheet or any new book on operational amplifiers will show that this is an industry-wide practice, and that decibels of voltage gain are simply $20 \log_{10} E_{out}/E_{in}$ regardless of impedance.

Strictly speaking, you cannot have a "D" battery for your flashlight or a gasoline outboard motor for your boat either. They started out as cells and engines, but usage has forced acceptance of these "wrong" definitions.

DONALD E. LANCASTER
 Goodyear, Ariz.

ARTISAN ELECTRONIC ORGANS

To the Editors:

Your article "A New Electronic Organ Kit" in the January issue indicates that there are only two manufacturers of electronic organ kits—*Heath* and *Schober*. What about *Artisan*?

ALEX J. TRENTON
 Denver, Colo.

We are sorry for omitting Artisan. When the article was written, we didn't realize how extensive the company's line of organs was. Actually, the company has 12 kit models available. For further information, write to Artisan Organs, 1372 E. Walnut St., Pasadena, Calif. 91106.—Editors

FET VOLTMETER TUNING INDICATOR

To the Editors:

In your November, 1967 "Letters from Our Readers" column, you published a letter from Dewey W. Eppley describing an inexpensive FET voltmeter design using an *n*-channel FET and an epoxy *n-p-n* silicon transistor. The circuit looked like (and was) the answer to adding a sensitive "zero-cen-

(Continued on page 10)

The next four pages contain one of the most important messages you will read during 1968. It tells you how you can increase your income, protect the homes, lives and businesses of people in your community, and make money doing it with the finest security alarm system available today.

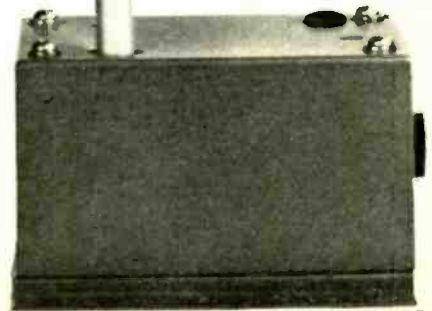

CIRCLE NO. 97 ON READER SERVICE CARD

Break into the bu

A career in crime

What's a bigger business than banking? Robbing banks. And stores and factories, and warehouses, etc.

Are we suggesting you embark on a life of crime? Not exactly. What we have in mind is a career in crime prevention.

A burglary will take place approximately every 20 seconds in 1968. Not to mention vandalism, fire, malicious mischief, and other crimes against property. People want and need maximum protection.

And we've got just the product that provides it.

Radarsentry Alarms. They work on foolproof micro-waves, and they're selling at an unprecedented rate because businessmen are demanding defense against crime.

Two hundred million customers

With constant news stories about crime waves, national and state campaigns against violence, people are attuned to thinking about protection. Your prospects are every person who has been hit by a crime, and everyone else who's worried that the next burglary may be at his business. In a way, that's almost everyone in the country!

Or as one new Radar Sentry Alarm dealer puts it, "...the market is like the boom days of early TV—only better. I never believed a product could sell itself like this one."

"It's like getting in on the ground floor of IBM," writes another Radar Sentry Alarm dealer. "When crime is on the mind of everyone in the country, and you're selling the best burglar trap in the business, you can't miss!"

Because the crime rate is mounting so rapidly, you can get into the crime prevention business **now**, with no experience, and less than \$500 of capital. You can even sell Radar Sentry Alarm in your spare time, out of your home. There's no franchising fee—no overhead!

Plus, your electronics background is a decided asset. Though you need no technical knowledge to install and maintain Radar Sentry Alarms, your electronics expertise is bound to instill the type of customer confidence that helps build sales and prestige.

Whether you're just out of school, or presently in another business—whatever your position—Radar

Sentry Alarms will improve it. Selling Radar Sentry Alarms is the most profitable opportunity to come along in years. Read what other Radar Sentry Alarm dealers in your exact situation have said:

Part Time: "I've earned more in three months part time as a Radar Sentry Alarm dealer, than my job paid all last year. Gave notice on my job today." Sewarren, New Jersey.

TV Business: "I've been trying to get out of the TV business for the last two years. Your product and program enabled me to do this and double my income at the same time." Detroit, Michigan.

Full time from home: "Working out of my home for the last year enabled me to pay cash for a new sales office. We now have four salesmen on the road..." Winnetka, Illinois.

Thousands of Radar Sentry Alarms are already protecting offices, factories and homes across the country. Radar Devices has been in business long enough to establish a reputation for quality. But a short enough time to allow you to get in on the ground floor of a booming business! For instance, you can make as much as \$1200 profit a month, by selling only **one** Radar Sentry Alarm a week!

The amazing facts and figures

IF YOU SELL	Gross Monthly Income from Sales Based on average selling price of \$795 each	Typical Monthly Expense and Cost of Equipment	Your Net Profit per Month	Your Net Profit per Year approximate
1 per week	\$3,180.00	\$1860	\$1,320.00	\$16,000.00
2 per week	\$6,260.00	\$3920 (also includes Installation/ serviceman's salary)	\$2,340.00	\$28,000.00
5 per week	\$15,900.00	\$12,080 (also includes a Salesmen's Commissions, 3 Servicemen)	\$3,820.00	\$46,000.00

Profitable business.

We back you all the way

Our dealer plan is a get-rich-quick scheme that really works. But is selling one unit a week easy? Like taking candy from a baby. Only more gentlemanly—and a lot more valuable to society. Because our dealership program backs you all the way. We develop leads for you, we help you get your own leads, and then we show you how to close the sale.

Leads: Our national advertising campaign nets hundreds of replies from businessmen interested in protecting their premises. Often the orders are for several Radar Sentry units at a time—detective agencies or insurance companies may order as many as a dozen units!

Dealer Manual: The heart of the Radar Sentry Alarm Dealer Plan is a complete dealer manual. It tells you how to start as a part-timer, grow to a full time business, and organize and train people for future growth. It even tells you how to find your own customers right in your own backyard.

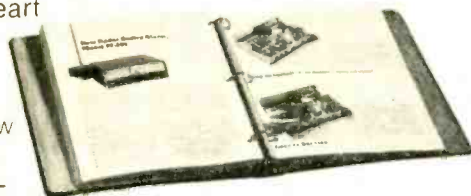

For instance, here are five inexhaustible sources of personal leads you'll find right in the dealer manual.

Newspapers: With crime rates galloping, your daily paper can furnish many leads each day!

Police: Precincts compile lists of recent burglary victims. Usually, the police are more than willing to make names available to you since the Radar Sentry Alarm helps curb crime.

Insurance Agents: Independent insurance agents are not only a good source of leads, but many will sell for you to supplement their incomes.

New Buildings: Many owners can be sold a Radar Sentry Alarm as part of the plans of a new building. A list of buildings under construction is available in all municipalities.

Police Band Radio: As a Radar Sentry Alarm distributor, you can listen to police band (with permission from your police department). You're entitled legally to know if one of the buildings you protect comes in on call. If you obtain new leads through the radio (and,

of course, you will), we suggest you wait at least two days, and follow up with a direct mail first. That's a lead a minute—and it's only one example of how our comprehensive dealer manual supports you.

Demonstration kit: Once you have your leads, our demonstration kit helps you clinch your sales on the spot.

Sales Aids: We give you a complete arsenal of proven sales aids to help you explain to prospects precisely how Radar Sentry Alarm protects them.

Advertising/Direct Mail/Public Relations: As your business grows, you will want to invest money in advertising and direct mail, and time in public relations. The Radar Sentry Alarm Dealer Plan gives you proven ad mats for newspapers to customize with your own name, tells you how to mount a direct mail campaign, and explains how to plan and execute a long-term public relations program.

Bank Financing: We help you get local bank financing for your retail sales contracts, using our bank as a reference.

Our dealership program offers you all these sales aids practically on a silver platter—WITH NO FRANCHISING FEE.

This is about one quarter of what you'll need to make your business grow. Why one quarter? Because three quarters of the selling job is done by our product. The Radar Sentry Alarm is in such demand, and is so ingeniously engineered it almost sells itself!

Turn the page and read about the best sales aid of all:

Radar Sentry Alarms



Radar Sentry Alarm

The best burglar trap

The Radar Sentry Alarm is simple, yet foolproof. It radiates microwaves in a circle of about 35 feet. *Any human movement* within this area will set the alarm off. There is simply no way a burglar can outwit the Radar Sentry, whether he comes thru the window, breaks thru the ceiling or wall, or hides on the premises. If he shuts off the power, the alarm will sound. If he tampers with the unit during the day, it sounds a fail-safe alarm. And if there's a power failure, the unit's built-in rechargeable nickel-cadmium batteries take over.

For the technical minded, here's how it works: a very stable oscillator generates microwaves which are radiated by a remote detector—actually an antenna. Each detector saturates a 5000 square foot area, floor to ceiling. Because the oscillator is connected directly to the antenna, it is very sensitive to changes in load. Human movement changes this load, which, in turn, changes the frequency. This change is amplified by a series of ultra-stable, transistor stages, detected, and used to close the alarm relay.

Radar Sentry Alarms can be used with on-location police-type sirens to frighten burglars off, or as silent alarm with direct connection to police headquarters.

Versatile Accessories for a complete protection system.

Fire Sensors—with this accessory, you can provide protection against fire, as well as burglary. It senses fire quickly by rate of temperature rise, and by absolute temperature.

Telephone Alarms—two types are available. One uses a rented phone line direct to police headquarters. The other automatically dials the police and the firehouse, delivering prerecorded messages.

Hold-up or Prowler Alarm—protects promises while they are occupied. Can be triggered by hidden button or tiny, portable activator.

As a Radar Sentry Alarm dealer, you can offer your customers these and many other useful accessories. Thus you provide your customer with total electronic security, tailored to their specific needs.

Foolproof installation and maintenance

Your technical know-how will instill confidence in your customers, and makes it easy to install and maintain Radar Sentry Alarm systems.

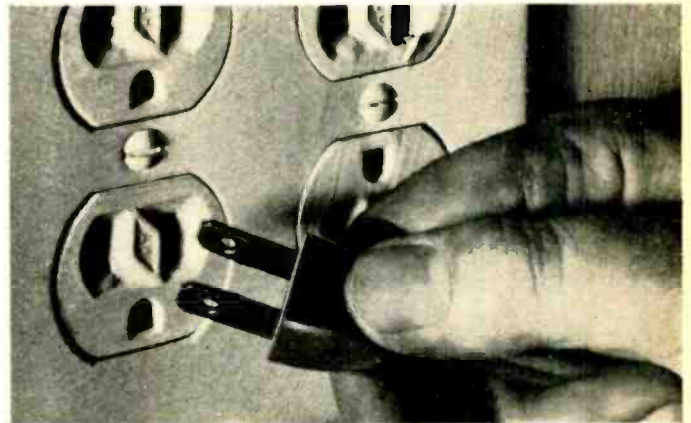

EASY TO INSTALL—No test equipment or special tools required.

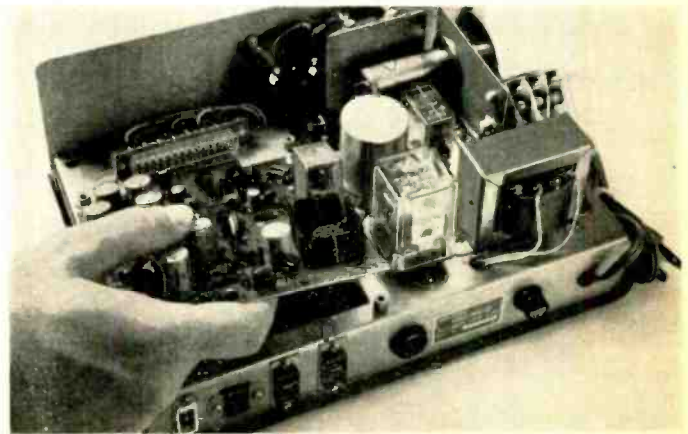

EASY TO SERVICE—The heart of Radar Sentry's electronics is on a single printed circuit module. If there's a problem, the complete module is simply pulled out and a new one plugged in. Instant repair, no lapse in security.

ms make crime pay.

NEW SOLID STATE MODELS—The newest Radar Sentry Alarms feature solid-state circuitry throughout. This means they are more sensitive, more reliable virtually impregnable to false alarms. Model SS-101 is the basic unit with a single remote detector. Its handsome, wood-grained cabinet, gold-anodized front panel make it ideal for home and office. The SS-301, for home, office and industrial installation, is furnished with a remote key switch, siren and detector unit. It has a handsome wood-grained cabinet with a gold-anodized front panel. It is for home and office use.

The SS-303 is specially designed for commercial and industrial installations. Capable of handling up to 3 remote detectors, covering an area of up to 15,000 square feet, it is furnished with remote detector, remote key switch, outside bell and weather-proof cabinet, and an inside siren.

Ride the crime wave today

Remember these 10 reasons for getting into the Radar Sentry Alarm business today:

- customers who need your product because burglary is the biggest crime category in the country.
- customers that never run out—because the crime rate is rising astronomically.
- a line of the best burglar alarm products available today
- competition that's still minimal.
- an immediate profit of 100 per cent with your first sale.
- no franchising fees.
- a full dealership program that supports you.
- minimal overhead.
- an initial investment of about \$500.
- easy installation and maintenance.

But you must act fast. Radar Sentry territories are running out.

Send no money, just fill out this coupon NOW. YOU'LL BE BUILDING YOUR OWN FUTURE, WHILE PROTECTING EVERYONE ELSE'S.

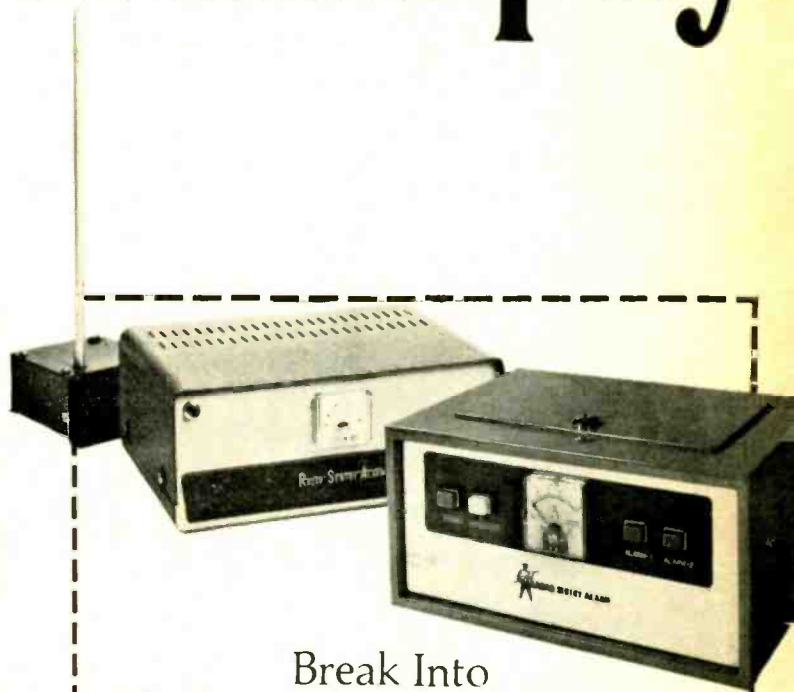

Break Into
The Burglary Business Today

Act Now

RADAR DEVICES MFG. CORP. EW-6
22003 Harper Avenue
St. Clair Shores, Michigan 48080

Gentlemen:

Please rush me your dealer prospectus outlining the Radar Sentry program.

I want to launch my career in crime prevention now—while there are still choice territories available.

Name _____

Street _____

City _____, State _____ Zip _____

Please state your current occupation: _____



LAB STANDARD AMPLIFIER



DELIVERS ONE HORSEPOWER



800 (IHF) Watts

WIDE BAND

± 0.5 db. ZERO—100,000 Hz (l.w.).

CLEAN

99 and 95/100% PURE POWER at ANY level.

QUIET

Less than 5 billionths of a watt total hum and noise.

RELIABLE

Short- and mismatch-Proof. Made in America.

STABLE

TRUE DC circuit design—patents pending.

MODEL
DC 300
DUAL CHANNEL
ONLY
\$575

WRITE NOW
FOR FULL DETAILS TO
DEPT. EW-6



Box 1000, Elkhart, Indiana 46514

CIRCLE NO. 88 ON READER SERVICE CARD

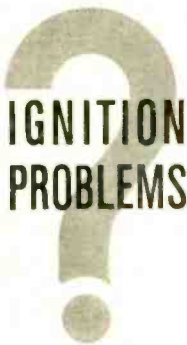

IGNITION PROBLEMS

Like a high speed miss — plug fouling—stumbles when you floor it? Maybe it just won't go, I mean go. You need a Judson Electronic Magneto, the most advanced ignition system on the market and the accepted standard in electronic ignition. Costs only \$49.50 — easily installed. You'll feel the difference right from the start.

Write today for free literature.

JUDSON
RESEARCH & MFG. CO.
CONSHOHOCKEN, PA. 19428

CIRCLE NO. 108 ON READER SERVICE CARD

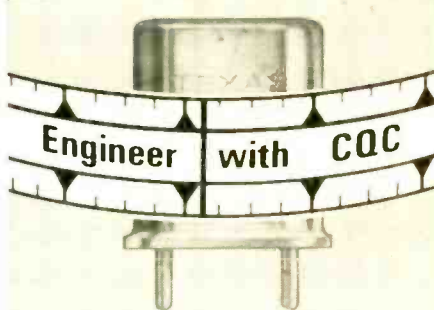

MORE CONTROL

Control of quality throughout precision manufacturing gives you crystals that assure exact frequency control.

MORE RELIABILITY

You'll stay on frequency better with CQC. And, you can rely on your CQC dealer to fill your needs promptly.

See your dealer for prices and data on CQC



TEXAS CRYSTALS

Division of Whitehall Electronics Corp.
1000 CRYSTAL DRIVE
FORT MYERS, FLORIDA 33901

Plants in Fort Myers and Los Angeles, Calif.

CIRCLE NO. 199 ON READER SERVICE CARD

(Continued from page 5)

ter" FM-tuning meter to my stereo FM receiver.

The attached schematic diagram shows the modified circuit suitable for use with an inexpensive imported "FM-tuning" or "Bal" meter of ±100 μA or better typical sensitivity. The only major change involved increasing the *n-p-n* emitter resistor to 27,000 ohms to provide optimum bias and linearity for the FET transistor over the desired ±0.5 volt input range.

This simple d.c. amplifier is ideally suited to modern solid-state FM tuners and receivers which use wide-band FM detectors of 500 kHz peak-to-peak or greater bandwidth. Such wide-band de-

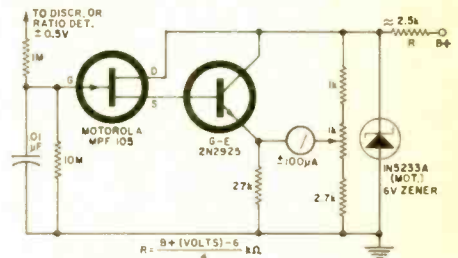

tectors provide insufficient d.c. volts/kHz output to deflect available inexpensive miniature meters connected to the detector through a 10,000- to 20,000-ohm isolation resistor.

One final comment. The trend in most popular-priced solid-state FM tuners and receivers is toward "tune for maximum" or "signal-strength" type tuning meters. As anyone familiar with FM-receiver circuitry will attest, these are of questionable value unless combined with a zero-center meter. Receivers tend to saturate on strong locals. Even on weaker signals, only a perfectly aligned receiver will provide maximum quieting and minimum distortion at maximum signal-strength reading. In any event, a zero-center meter can be used for signal strength and antenna alignment by "detuning" and observing the deflection obtained.

I hope other readers and perhaps even the manufacturers will be stimulated to provide this most useful FM-tuning aid for the very modest cost of \$4.10 for transistors and a meter.

J. B. BERRY, JR.
Southern Bell Tel. & Tel. Co.
Atlanta, Ga.

FIRE AND SMOKE DETECTORS

To the Editors:

We have read the article in your February 1968 issue relating to electronic fire and smoke detectors and we feel it appropriate to record how much we enjoyed this article and the excellent manner it dealt with the subject.

P. C. C. BROWN
Vice President Engineering
Graviner Inc.
Mountainside, N. J. ▲

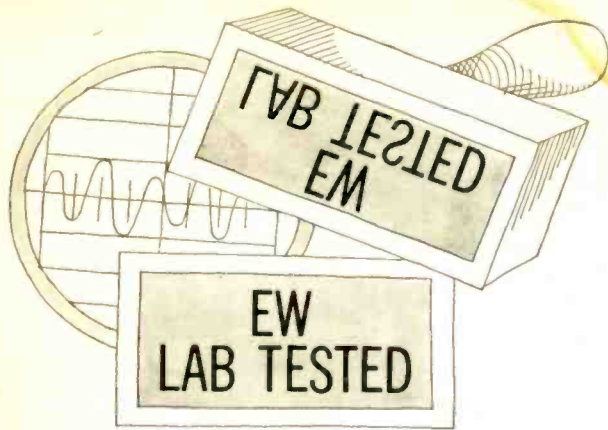

HI-FI PRODUCT REPORT

TESTED BY HIRSCH-HOUCK LABS

**Electro-Voice "Sentry II" Speaker
Amplex AG-500-4 Tape Recorder**

Electro-Voice "Sentry II" Speaker

For copy of manufacturer's brochure, circle No. 19 on Reader Service Card.

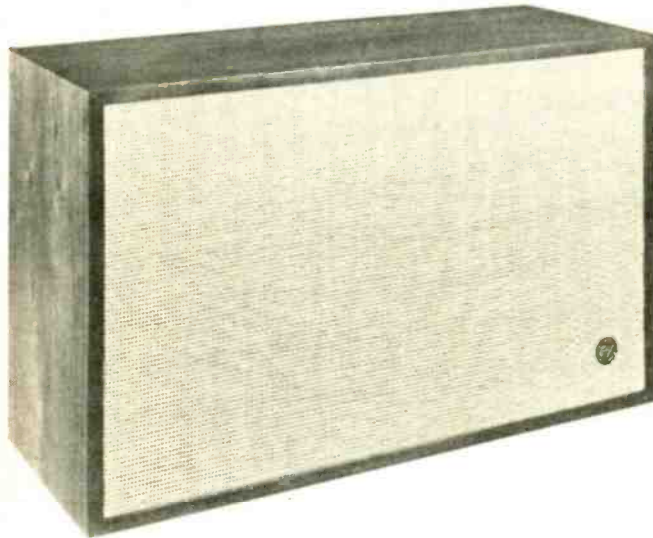

THE Electro-Voice "Sentry" speaker systems are offered as studio-monitor speakers for professional use in recording studios, control rooms, or listening rooms. The question naturally arises as to just what a studio-monitor speaker is expected to do, as compared to other good-quality speakers offered for home use.

There is probably no clear distinction between the two types. As we see it, a good monitor speaker should be as free

from coloration as possible. This implies a broad, flat frequency response, low distortion, good transient response, and wide polar dispersion. It should not require critical positioning in the room, nor should it be too large. Fairly high efficiency is desirable, since studio-monitor amplifiers usually are not of the super-powered variety found in many home music systems, and it may be necessary to reproduce music at very nearly its original volume levels. Furniture styling

is of secondary importance, and performance takes precedence over the price considerations which often prevail in the consumer market.

Obviously, from a listening standpoint at least, a good monitor speaker should be equally effective for home music applications. In any event, our evaluation of such a speaker must be from the standpoint of the high-fidelity hobbyist rather than from that of the professional user.

The E-V Sentry is available in two configurations. Sentry I is designed to be mounted at a wall-ceiling junction, while Sentry II, which we tested, is a conventional enclosure for floor mounting.

It is a fairly large enclosure, 32 inches high by 20 inches wide by 13 inches deep, and weighs 63 pounds. It is finished in sanded and sealed natural birch and may be used in that form or finished as desired. (The manufacturer is currently changing over to a walnut hand-rubbed finish enclosure, making the speaker system more desirable for home use.—Editor) Both systems use the same drivers. The woofer is a 12-inch cone speaker and the tweeter is a horn-loaded driver. The built-in crossover network (the frequency is not specified) has 12 dB/octave slopes. A matching transformer is built into the system, providing 150-ohm and 600-ohm impedances in addition to the normal 16-ohm impedance. The speaker levels are balanced and no adjustment is provided.

The manufacturer rates the frequency response of the speaker system as ± 3 dB from 30 to 20,000 Hz, which is flat enough to qualify the speaker as a reference standard. In contrast to many home-music-system speakers, the unit is rated at 20 watts continuous power, or 40 watts on momentary peaks. Because of its relatively high efficiency, this is no limitation on its sonic output in its intended applications. No details of the enclosure construction are supplied, but our examination shows that it is a ported (bass-reflex) enclosure.

The frequency response was measured with the speaker floor-mounted against the shorter wall of a 12 foot by
(Continued on page 65)

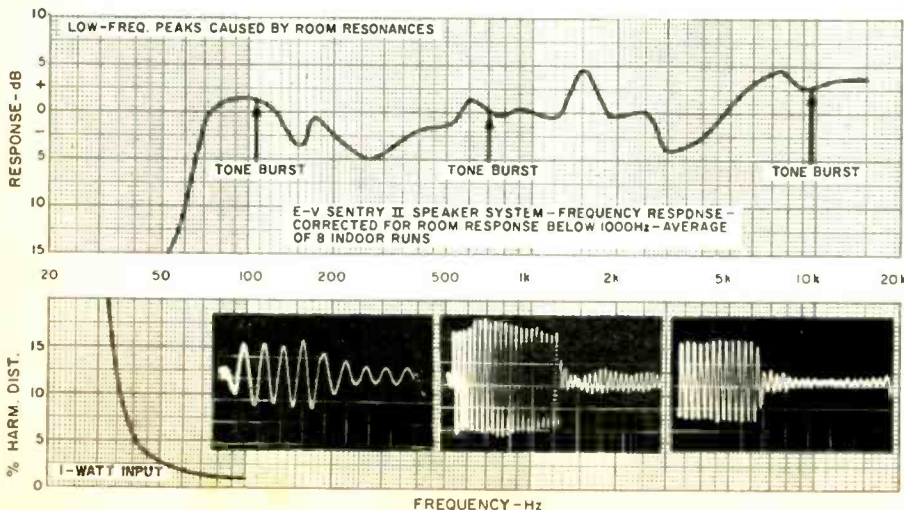

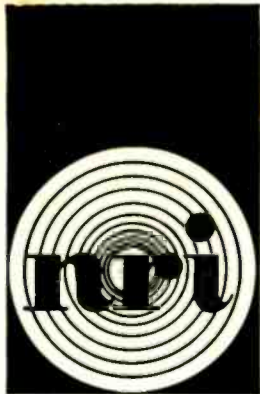

***Learning
electronics
at home
is faster,
easier, more
interesting with new achievement kit***

**GET A FASTER START IN THE
COURSE YOU CHOOSE WITH NRI'S
REMARKABLE ACHIEVEMENT KIT**

When you enroll with NRI we deliver to your door everything you need to make a significant start in the Electronics field of your choice. This remarkable, new starter kit is worth many times the small down payment required to start your training. And it is only the start . . . only the first example of NRI's unique ability to apply 50 years of home-study experience to the challenges of this Electronics Age. Start your training this exciting, rewarding way. No other school has anything like it. What do you get? The NRI Achievement Kit includes: your first set of easy-to-understand "bite-size" texts; a rich, vinyl desk folder to hold your training material in orderly fashion; the valuable NRI Radio-TV Electronics Dictionary; important reference texts; classroom tools like pencils, a ball-point pen, an engineer's ruler; special printed sheets for your lesson answers—even a supply of pre-addressed envelopes and your first postage stamp.

Only NRI offers you this pioneering method of "3 Dimensional" home-study training in Electronics, TV-Radio . . . a remarkable teaching idea unlike anything you have ever encountered. Founded more than half a century ago—in the days of wireless—NRI pioneered the "learn-by-doing" method of home-study. Today, NRI is the oldest, largest home-study Electronics school. The NRI staff of more than 150 dedicated people has made course material entertaining and easy to grasp. NRI has simplified, organized and dramatized subject matter so that any ambitious man—regardless of his education—can effectively learn the Electronics course of his choice.

**DISCOVER THE EXCITEMENT
OF NRI TRAINING**

Whatever your reason for wanting knowledge of Electronics, you'll find the NRI "3 Dimensional" method makes learning exciting, fast. You build, test, experiment, explore. Investigate NRI training plans, find out about the NRI Achievement Kit. Fill in and mail the postage-free card. No salesman will call. NATIONAL RADIO INSTITUTE, Electronics Division, Washington, D. C. 20016

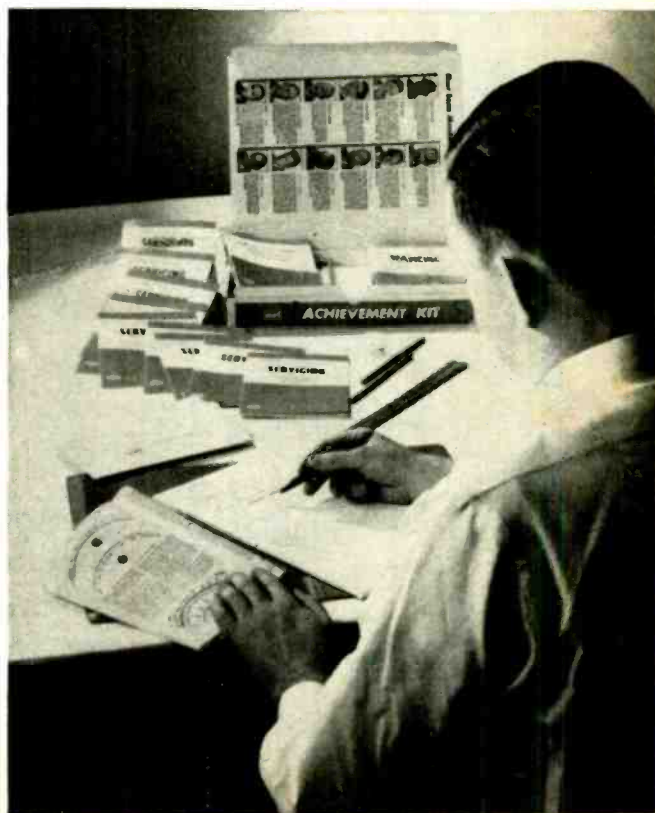

ELECTRONICS COMES ALIVE AS YOU LEARN BY DOING WITH CUSTOM TRAINING EQUIPMENT

Nothing is as effective as learning by doing. That's why NRI puts so much emphasis on equipment, and why NRI invites comparison with equipment offered by any other school, at any price. NRI pioneered and perfected the use of special training kits to aid learning at home. You get your hands on actual parts like resistors, capacitors, tubes, condensers, wire, transistors and diodes. You build, experiment, explore, discover. You start right out building your own professional vacuum tube voltmeter with which you learn to measure voltage and current. You learn how to mount and solder parts, how to read schematic diagrams. Then, you progress to other experimental equipment until you ultimately build a TV set, an actual transmitter or a functioning computer unit (depending on the course you select). It's the practical, easy way to learn at home — the priceless "third dimension" in NRI's exclusive Electronic TV-Radio training method.

SIMPLIFIED, WELL-ILLUSTRATED "BITE-SIZE" LESSON TEXTS PROGRAM YOUR TRAINING

Lesson texts are a necessary part of training, but only a part. NRI's "bite-size" texts are as simplified, direct and well-illustrated as half a century of teaching experience can make them. The amount of material in each text, the length and design, is precisely right for home-study. NRI texts are programmed with NRI training kits to make things you read come alive. As you learn, you'll experience all the excitement of original discovery. Texts and equipment vary with the course. Choose from major training programs in TV-Radio Servicing, Industrial Electronics and Complete Communications. Or select one of seven special courses to meet specific needs. Check the courses of most interest to you on the postage-free card and mail it today for your free catalog.

Available Under
**NEW
GI BILL**

If you served since
January 31, 1955, or
are in service, check GI
line in postage-free card.

custom training kits "bite-size" texts



Gavin gives you more gain per dollar!

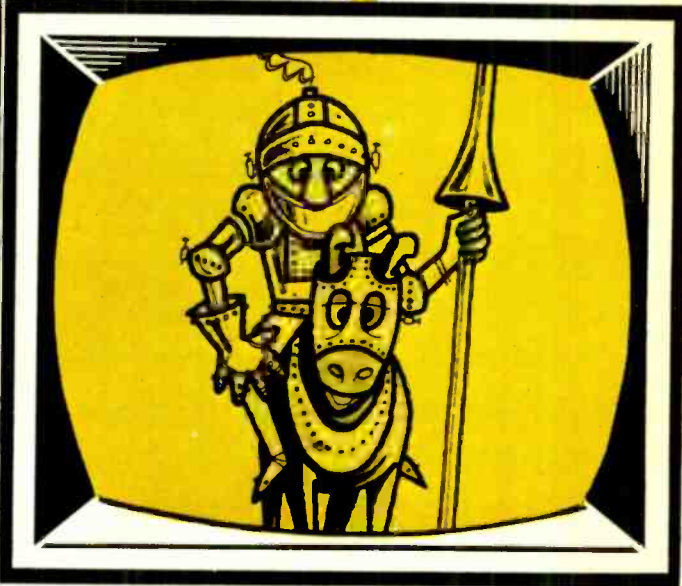
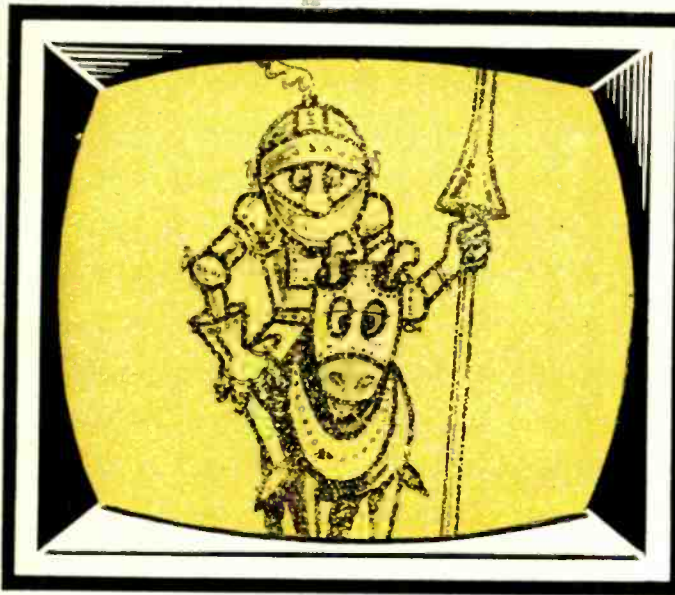

Side By Side Tests Prove...

...that model for model, dollar for dollar, the new Gavin V-Yagi design outperforms any other type of antenna you can buy.

Here's how the test works: We hoist your favorite antenna up on our specially equipped van. We check the signal pick-up on a field strength meter and a color receiver simultaneously. Then, we replace your antenna with a Gavin antenna costing the same or less. The results are eye opening.

Ask us to set up a side-by-side test for you. Invite a representative of the antennas you now handle to observe the demonstration—or set it up himself if he likes. The field strength meter tells the truth no matter who's asking the questions.

Once you see this test, you'll probably switch to Gavin. What are you waiting for?



GAVIN INSTRUMENTS, INC.
Subsidiary of ADVANCE ROSS CORP.
Somerville, N. J. 08876 U. S. A.

CIRCLE NO. 112 ON READER SERVICE CARD

ELECTRONICS WORLD

Radio & Television news

By FOREST H. BELT /Contributing Editor

Extended Color-CRT Warranties

More color-TV manufacturers have joined the trend to longer warranty periods for color picture tubes. *Admiral* announced a 3-year warranty on its color tubes, *Magnavox* and *Westinghouse* now guarantee their color CRT's for 2 years. Some smaller manufacturers do the same. *Curtes Mathes* sells an 8-year color-CRT warranty for \$12, but makes an additional pro-rated charge after the first year. Labor of replacement is not included in any of the warranties, and that may be a hang-up. Customers are likely to squawk at an expensive repair bill for replacing a "free" picture tube. Other manufacturers, who haven't yet gotten into this particular swing, contend that such warranties may force prices upward again. This doesn't seem too likely in view of last year's drop of \$9 in the "average" color-set price. However, extended warranties on CRT's and other components may well delay price reductions for color sets.

Cash or Charge?

Collecting for services rendered is always a problem. Many service shops work on a strictly cash-on-delivery basis. And no wonder. In 1966, when all businesses had collection problems, 44% of service businesses reported a large proportion of delinquent accounts. Now, a survey by the National Federation of Independent Business shows only 76% of service businesses extend any credit at all. Only 50% do, in some localities. Those that do are picky about credit risks.

One solution uncovered by the survey is the use of bank credit cards. The only credit allowed is to holders of the credit card of a local bank. The service-shop owner gets his money immediately; the burden of collection is on the bank. Worth looking into.

Youth Electronics

The 1969 lines of home-entertainment equipment are being shown to distributors and dealers. The public will get a glimpse of them at the Consumer Electronics Show in New York June 23-26. This is the second year for the Show, which will occupy the Americana, New York Hilton, and Warwick hotels.

One product grouping that is growing this year is for young people. *RCA* has already announced theirs, which includes tape recorder, battery phono, clock radio, CB transceiver, and cassette cartridge player. All are low-priced and dressed up in bright colors. *G-E* and *Philco* both already have youth-oriented lines.

Sickening X-Ray Situation

X-rays are a subject we can't seem to get away from. A technician in California recently told us about a customer of his. A distraught elderly man met him at the door of his shop at opening time one Monday morning. Someone had to come to his house right away, he said. "Our TV set blew up Saturday night. It has a hole in the front and the x-rays are leaking out. They got to my wife and made her awfully ill—vomiting and dizzy. We had to move out of the house for the weekend." The technician took 30 minutes explaining (even then the man was not convinced) there was no danger from x-rays in his dead TV set.

The CRT had imploded, but hadn't hit anyone. The woman's symptoms were entirely psychosomatic. As any technician knows, x-rays can occur—if at all—only while the set is operating. Even then, it must be operating improperly. Further, and most important, the x-rays emitted by a color set are soft x-rays which have very limited penetrating power.

The long-awaited x-ray report from the Public Health Service said 75% of the sets tested produced *no measurable x-rays*. Of those giving off *some x-rays*, only 6% exceeded the 0.5 mR/hr maximum set by the National Council on Radiation Protection and Measurement (NCRP). All of those 6% were *cured* of x-radiation by replacement of the regulator tube and proper adjustment of the high voltage.

Public TV

The Corporation for Public Broadcasting (CPB) has been taking a beating. Seems no one can decide where to get the money to carry it on. They can't even get the \$9 million that was authorized by Congress; only \$4 million was appropriated to keep it running until the end of June. For fiscal 1968-1969, the Presi-

dent only plans to ask for \$20 million. The way Congress has been slashing funds, CPB will be fortunate to get authorization for half that amount. Then, if appropriations are as scanty as they have been, the project is in trouble.

CBS President Frank Stanton came across with the \$1 million he had pledged. But that's only a drop in the financial bucket. Permanent financing is needed. One scheme being considered is an excise tax on new TV sets at the factory. Manufacturers oppose this, saying they'll have to pass the cost along to consumers ultimately. Broadcast-station operators were startled to hear that *they* are being considered as a source of the money, through a tax on station revenues. That's an engaging paradox: commercials paying for programs without commercials. It has even been suggested that pay-TV might provide an answer. It would work like this: The public would pay to watch TV programs without commercials. A tax on what they pay, collected of course by the pay-TV operators but paid by the public, would then be used to provide free TV programs without commercials.

Statistics for 1967

For you who like to know how many of what, here are last year's numbers, recently released, for consumer electronic products. There were 20 million AM radios sold, nearly 75% of which were imported. Of 11.6 million FM and AM-FM receivers, 65% were imports. There were 9.5 million auto radios sold, most AM (only 911,000 with FM). That makes a total of 41 million radios sold; 12.5 million of those could receive FM.

Phonographs did okay, with 6.6 million being sold. Tape recorders did pretty well, too: 4.6 million. There is no way of knowing how many of those were cartridge machines, but the ratio is rising.

The year 1967 was when many industry trend watchers expected sales of color receivers to outdo those of black-and-white. It didn't work out quite that way, although it came close. Just over 5.2 million color sets were sold, compared to over 5.4 million monochrome. Color manufacturers said, "Wait till next year!" That's *this* year and they may be right. Sales are strong and color could finally top monochrome.

Transistor Color-TV and the Computer

The first solid-state color-TV was introduced by *Motorola* nearly a year ago. This year, with the same basic model, the company initiated a saturation advertising campaign in certain markets to see how well the sets would sell if really promoted. According to dealers, the campaign was a success. One reported that transistor color-TV outsold others by 30%, despite a significant price difference.

All has not been roses, though. *Motorola's* plug-in modules gave some trouble. There were bugs to iron out, as there is with any innovation. An interesting sidelight is the use of a computer to aid in pinning down the most recurrent bugs, and to develop a way to combat them. Reports from field engineers, dealers, and distributors were put into the computer's memory. There they were compared, correlated, counted, and classified. Regular reports showed up trouble spots, and engineers designed improvements. Sets this year have improved modules, and growing pains have been alleviated. Solid-state color-TV owes a debt for the speed in this stage of its growth to its complex cousin—the computer.

Management Training for Service-Shop Owners

Poor management generates TV-shop failures, and contributes to poor wages and low profit. Texas Electronic Association (TEA) joins every year with the University of Texas in sponsoring a Management Institute. The 1968 Institute, held at Bandera, Texas, in March, drew 57 registrants—all shop owners and managers. Topics covered were: TV Service Pricing, Service-Shop Efficiency, Wages vs Profits, Retail Management Techniques, and Measuring Technicians' Performance. We conducted some of the classes. The interest, enthusiasm, and enterprise shown by attendees was out of the ordinary. Each of them had paid TEA \$80-\$100 to attend the sessions, held at Lost Valley Ranch. Every "student" worked hard (in sessions from 8 a.m. to 10 p.m.) to absorb the techniques of management being suggested and discussed.

Flashes in the Big Picture

Sylvania will introduce a new home-entertainment center that combines a color-TV set, a slide projector, and tape recorder. The slides are displayed on the picture tube by means of a flying-spot scanner, while the recorder can be used to synchronize the slides along with a spoken commentary. Price will be around \$1000. Complete technical details will be disclosed in a feature story in next month's issue. . . . Consumer electronic products are a bargain. Consumer Price Index puts all items at 118.2 average. However: TV sets, 80; radios, 77.3; tape recorders, 93.6. . . . While U.S. color-CRT makers cut back because some had over-produced. Japanese are boosting output; not all are for export, however. ▲



Step up...Lead-in Loud and Clear with Belden

TV lead-in. Belden makes all kinds. Indoor, outdoor, for color and black and white reception. All have one thing in common: for price and performance you won't find better lead-in anywhere. They provide a picture-perfect link between antenna and set. Since no two installations are alike, Belden gives the right choice for every situation. But don't skimp on your lead-in. Step up... choose one that gets the most out of the cus-

tomers overall investment. One that will delight the eye and ear with quality reception. For the absolute best, check out 8285 and 8290: the Color Twins. You won't find anything comparable for all-channel black and white as well as living color. Your Belden Distributor has all the facts. Talk to him today. Belden Corporation, P.O. Box 5070-A, Chicago, Illinois 60680.

*Belden Trademark, and Belden U.S. Pat. 2,814,666

don't forget to ask them what else needs fixing!

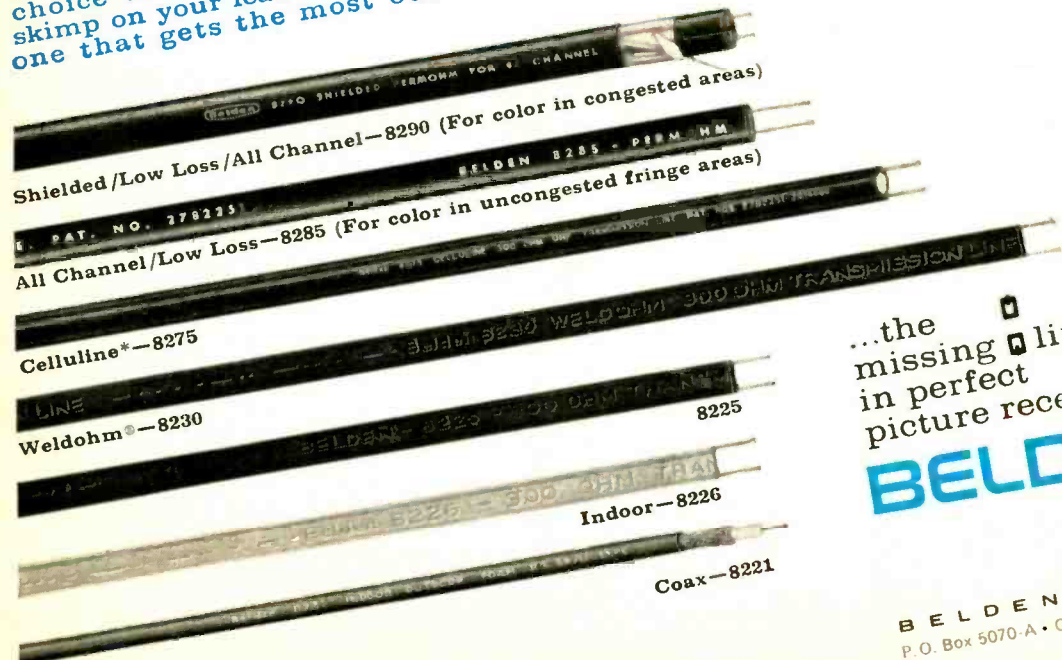

Shielded/Low Loss/All Channel—8290 (For color in congested areas)

All Channel/Low Loss—8285 (For color in uncongested fringe areas)

Cellulose*—8275

Weldohm®—8230

Indoor—8226

Coax—8221

...the missing link in perfect picture reception

BELDEN



BELDEN CORPORATION
P.O. Box 5070-A • Chicago, Ill. 60680 • Phone 312-378-1000

new Sams books



101 Questions and Answers About CATV and MATV

by Robert E. Baum and Theodore B. Baum. This book covers the growing applications of catv (community antenna television) and matv (master antenna television). Fully covers a variety of cable amplifier designs and installations, distribution systems, main trunk lines, subscriber equipment and service, and the future of community antenna systems. An informative and practical book for technicians, students, and others who want to know the facts about catv and matv. 96 pages; 5 1/2 x 8 1/2". Order 20655, only... \$2.50

Transistor Specifications Manual

NEW THIRD EDITION. Gives the electrical and physical parameters for virtually all transistors now in use. Electrical parameters include collector-to-base, emitter-to-base, and collector-to-emitter voltages; maximum collector current; power dissipation; and maximum operating temperature. Also lists frequency gain and leakage parameters. A physical outlines section provides dimensions and other physical data required for installation. Another section identifies leads and terminals for each transistor listed. An invaluable reference for anyone working with semiconductors. 272 pages; 5 1/2 x 8 1/2"; comb-bound. \$3.25 Order 20631, only.....

CURRENT BESTSELLERS

Modern Dictionary of Electronics, New 3rd Ed. Now defines more than 16,500 terms; includes special pronunciation guide, most widely used symbols and abbreviations, new terms in latest specialized fields. The most complete authoritative electronics dictionary available. Order 20600, only..... \$9.95

Tube Substitution Handbook, 11th Ed. List over 10,000 direct substitutions. A complete guide to substitutions for receiving, picture tube, miniature, industrial and communications types; includes foreign tubes. Tells when and how to make proper substitutions. Order 20614, only..... \$1.75

Transistor Substitution Handbook, 8th Ed. Now lists over 1000 additional substitutions; covers manufacturers of all transistor types. Includes thousands of direct substitutions for U.S. and foreign (including Japanese) home-entertainment, industrial, and military types; with basing diagrams and polarity indications. Tells when and how to make proper substitutions. Order 20625, only..... \$1.95

These and over 300 other SAMS Books are available from your local Electronics Parts Distributor . . .

HOWARD W. SAMS & CO., INC.
4300 WEST 62nd ST. INDIANAPOLIS, INDIANA 46268
CIRCLE NO. 96 ON READER SERVICE CARD

GI ENGINEERS

About 6% of the nation's engineers form a technological corps without which the Armed Forces could not function.

COMPARED to World War II and Korea, the Armed Forces and the men in them are more technically skilled today. There are about 38,000 engineers serving in the military (excluding the Coast Guard, Coast and Geodetic Survey, and Public Health Services). And while some have accused these engineers-in-uniform of doing second-rate engineering at best, new weapon technology and aerospace and undersea developments for war and peace are requiring more scientists with advanced technical degrees.

The status of the serviceman-engineer is equivocal because the manner in which he is utilized varies from service branch to service branch. The common denominator, however, is the identification of engineering requirements at the advanced degree level only.

According to a report by the Engineering Manpower Commission of the Engineers Joint Council, a Bachelor's degree is a preferred qualification for all commissioned officers, and all three branches of the service expect to use engineering students from the Reserve Officers Training Corps (ROTC) programs. Thus, with many engineers serving in general line posts, there is an apparent surplus of engineers when compared to published requirements. The Army says it has 1700 (advanced degree) engineering positions with more than 9000 engineers in service. The Navy lists requirements for 10,900 engineers and scientists, but has nearly 9000 engineers and 11,000 science graduates available to fill them. The Air Force reports that most of its 14,000 engineers are assigned to jobs that make use of their knowledge, but lists only 5000 advanced degree requirements in these areas. Only 171 of the 1668 engineering graduates in the Marine Corps have engineering as a primary occupational specialty.

With all this available brainpower, the services are still short-handed. There are more than 15,500 Master and Doctorate positions open, but fewer than 8500 men with these qualifications are on active duty. This means that half of the jobs must be filled by people with less than a Master's degree.

This poses something of a problem for the engineer with a Bachelor's degree. He has the alternative of filling a specialists job that normally requires an advanced degree or serving in a general line position with little or no engineering responsibilities.

Of the 14,000 engineering graduates

serving as Air Force officers, most are used in research and development management, development engineering, system program management, and civil engineering. There are also a good number of them assigned to the electronics and maintenance engineering centers. This year the Air Force will attempt to recruit at least 1241 new development and civil engineers. About half will come from ROTC programs in civilian colleges and the remainder from Air Force officer training schools.

By 1971, the Air Force says it will need about 9200 engineers with Master's degrees and about 800 PhD's.

The Army Corps of Engineers has about 7000 officers, many of whom hold engineering degrees. Many of these officers direct construction projects, both military and civilian as well as river, harbor, and water-control projects.

Advanced degrees in engineering or related disciplines are required by the Army Officer Special Career Programs for service as an atomic energy, research and development, operations research and systems analysis, and automatic data-processing specialists. In 1967, 1116 men were employed in these posts.

Although engineering degrees are not specifically required, they are considered a "must" for officers in the Signal Corps, Ordnance, Chemical, Transportation, and Artillery branches.

Engineers who are drafted into the Army as enlisted men have limited opportunities for serving in engineering-related capacities unless they go to officer candidate school.

The Navy has a number of "specialist" programs in which degree officers can expect to serve throughout their naval careers. Ship engineering officers or "restricted line" specialists work for the Naval Ship Systems Command or the Naval Electronics Systems Command. This group encompasses the broadest range of engineering disciplines. Ordnance and Aeronautical Engineering specialists are responsible for Navy weapons systems and aircraft. The Civil Engineer Corps, which includes the Seabees, is responsible for the design and construction of Navy shore bases at home and abroad.

Marine Corps engineers are also eligible for assignment to specialized career fields; these include engineering, communications, and others. About 532 of the 1668 engineers in the Marine Corps work in naval aviation and in air control, anti-aircraft operations. ▲

Reflections on the **news**

Is Industry Doing Enough. . . .

to alleviate the shortage of trained technicians? A number of companies in the New York area were surveyed and none had a program specifically designed to teach technical skills to untrained personnel. Most of the companies continue to rely on technical schools such as *RCA Institutes*, *CREI*, *NRI*, and *Cleveland Institute of Electronics* for technicians. However, all of the companies have programs to upgrade the skills of technical people already on the payroll. One company, *Sperry Gyroscope Division of Remington Rand Corp.*, actually has three programs—a tuition refund program for engineers and technicians taking approved courses at accredited colleges and universities, and two in-house technician training programs.

Meanwhile some companies have started to build a group of technically adept personnel from among all types of jobless people across the country. Utilizing the poverty program, *Packard Bell Electronics Corp.*, *Philco-Ford Corp.*, *RCA Service Co.*, *Burroughs Corp.*, *Westinghouse Electric Corp.*, *Thiokol Chemical Corp.*, *Litton Syste.ms, Inc.*, and *Federal Electric Corp.* have been training people by providing guidance, technical material, and in some cases personnel to Job Corps centers. Unfortunately, 16 of these centers were closed this spring for "economic reasons".

Two other companies, *Fairchild Hiller Corp.* and *RFL Industries Inc.*, have moved ahead on another tack. *Fairchild* and the Model Inner City Community Organization (MICCO) have formed *Fairmicco, Inc.*, a District of Columbia corporation located in the Shaw area, which will teach hard-core jobless how to get—and hold—a job. *Fairmicco* will receive financial and technical support from the Department of Labor to train so-called unemployables in woodworking, sheet metal, and electrical trades. After the trainees have reached a specific level of ability, they will produce, under government contract, shipping containers, furniture, lighting fixtures, harness and cable assemblies, junction boxes, and PC boards.

RFL is providing technical support to *James Jenkins and Fred Walden Enterprises*, an electronic subcontracting outfit formed by two young men who lived in the Newark, New Jersey ghetto. On their own initiative, Jenkins and Walden asked *RFL* to train them to make cable harnesses. The result was a \$5000 contract for cables for *RFL's* a.c.-d.c. instrument calibration standard, Model 300, and jobs for five other people besides themselves. Jenkins and Walden received no Federal aid.

"Our equipment is too complex," was the excuse most companies gave for not hiring untrained personnel. Yet *Control Data Corp.*, which will operate a computer parts factory in a Minneapolis, Minn. ghetto that eventually will employ 275 people, foresees no problem in training unskilled personnel to manufacture and service precision computer parts. The name of the game is "involvement" and the company that becomes involved may solve some of its own manpower problems as well as lessen a national dilemma.

Electronics Markets. . . .

continue their dizzy upward spiral to reach a peak that is, as yet, unknown. This year, the world's electronics production should total more than \$35 billion. Next year, the climb upward should continue with no slowdown in sight. Every day new applications of electronics to industry, the consumer, research, and the military rush upon the scene. For example, lasers—a laboratory toy only a short while ago—are being used in industry to make precision measurements, in medicine to perform eye operations, in space as a gyro component, and for three-dimensional movies. By the early 1970's, many business experts expect the laser industry alone to be a billion-dollar business.

The United States is the world's largest exporter of electronics equipment as well as the biggest importer. According to a report by the EIA, "U.S. exports of selected electronic and related products totaled \$1.1 billion during the first eight months of 1967". This represented an increase of 28.9 percent over the same period in 1966. It is interesting to note that during the same eight months of 1967, imports rose 18.4 percent to reach a total of \$490 million. Japan was the leading supplier, with Canada, the United Kingdom, West Germany, and the Netherlands following in that order.

Perhaps the spotlight shines more brilliantly on computers than any other segment of the electronics industry. This year, with a national growth rate of about 20%, computer manufacturers are hard pressed to serve their customers. Outside of the United States, the computer market is growing at a 30% yearly clip. In an attempt to cut into U.S. domination of this market, some governments are subsidizing their computer industries. Communications and navigation equipment are the second most important growth area of the broad category of industrial electronics.

Taking a close look at components, these trends are already evident. Expect component sales to increase about 6 to 7 percent over last year; look for a slight increase in tube sales (last year tube sales fell about 4 percent); and capacitors, relays, panel instruments, and power sources should all show a modest increase in sales. Like tubes, component sales dropped as much as 12% during the first nine months of 1967.

Will Electronic Cables and Wires. . . .

be manufactured to a standard? Surprised at the question? Don't be. The words "national standard" do not exist in the vocabulary of the nation's cable and wire makers. True, coaxial cables manufactured for the military meet MIL-C-17E specifications and some hookup wire is also made to MIL Specs; but by and large, companies set their own standards and the result is a potpourri of conductors—some bearing the label MIL-C-17E type or RG 58/U type, but each made to satisfy a particular requirement.

Another surprise, the National Electrical Manufacturers Association (NEMA) has taken on the job of developing the national standards. On March 13, NEMA's Electronic and Wire Section was formed to develop acceptance criteria for "wire, cable, and cords whose primary use is on devices which produce, transmit, receive, detect, distribute, record, or modify electrical impulses principally conveying information rather than power". Three *ad hoc* subcommittees were created within the section. A Planning Committee made up of industry leaders will set the scope of the section and define the areas of prime interest. A second technical committee will formulate the standards while the third committee will concern itself with developing industry statistics and other marketing-type information.

The Electronic Industries Association (EIA) has tried for past seven or eight years to get a section like this off the ground, with no success. One NEMA spokesman (who is also a member of EIA) said, "when we would call a meeting it would end up with one or two cable manufacturers and a user sitting there facing each other. EIA didn't have the membership or enough industry interest to make a go of it".

In Ocean Sciences. . . .

as well as aerospace, the U.S. and Russia are out to beat each other. Unfortunately, unlike the space race, the U.S. may finish lower than second. . . . perhaps as far back as fifth or sixth. It has taken the Russians less than 20 years to catch up and pass us in marine sciences—a fact which some top government researchers find hard to believe even when presented with evidence of Russian technological advances. The U.S. has been content to drag its feet. In 1963, President Kennedy proposed a \$2 billion 10-year program to develop and explore the ocean. By the end of 1967, the government had spent less than 1/6th that amount. As with other government-backed scientific programs, many attempt to blame the Vietnamese war for the lack of progress. In our opinion, however, it's government red tape, interagency rivalry, and a lack of long-range planning which have a strangle hold on the program.

In last month's column we mentioned that President Johnson had placed special emphasis on oceanography in his State-of-the-Union message. Yet, if he's going to get the program moving, he has got to get rid of those bureaucratic practices which have mired it for so long in a bog of confusion.

With the President, the Army, Navy, and Air Force (through the Department of Defense) involved in aerospace, what's the market potential? Well, depending on whom you talk to, total market estimates range from \$2 billion to \$50 billion. No one really knows for sure. The government has spent most of the money so far, but look for more and more industry participation in underseas programs.

Some Thoughts About. . . .

things going on. The biomedical engineering profession got a boost up the ladder of recognition when the National Academy of Engineering granted \$110,285 to six universities to help them (the National Academy) find ways of enhancing biomedical research and health care. . . . Continuing engineering education is an Achilles heel in many companies. "Technology is moving so fast that many engineers become obsolete almost as quickly as the components they are accustomed to use", say many educators and industry leaders. The road to survival for company and engineer is continuing education and it's questionable whether they, or the schools have planned for it properly. . . . Radar displays in airport control towers have always been relegated to the "useless category". Bright sunlight washed out the images. But the FAA is finally getting around to installing units that have a symbol intensity of 1000 footcandles. Doesn't it make you feel safe to know that the controller can, at last, see where your plane is going? Incidentally, the new display was developed over two years ago at the FAA's National Aviation Facilities Experimental Center (NAFEC). . . . Did you know that *Texas Instruments* has established a testing service division at Lake Success, New York? They say they will test all makes of IC's and semiconductors, not just TI's, as well as act a supplier for small-lot shipments. The service should be a big help to the small manufacturer. ▲

The replacement business, of course! Six new silicon power transistors can put you immediately into the expanding hi-fi and stereo solid-state replacement business. And, the addition of four new silicon rectifiers equip you with a full line of 1 A units with PRV ratings ranging from 200 V to 1,000 V—ideal for servicing radio and television.

RCA's SK-Series Transistors, Rectifiers, and Integrated Circuits now total 31 individual units. They can replace approximately 10,000 solid-state devices. This quality line is manufactured specifically for replacement use. There are no castoffs. No factory seconds. No unbranded culls. These are truly "Top-Of-The-Line" replacements!

See your RCA Distributor today about your supply of RCA SK-Series replacements. Ask about RCA's Replacement Catalog, SPG-202E (a complete cross-reference of foreign and domestic types), and the RCA Transistor Servicing Guide. RCA Electronic Components, Harrison, N. J. 07029

RCA

These 10 SK devices can bring you added business





**If you don't mind paying a lot less
for a lot more,
try the new University deceiver**

If we had priced our new Studio Pro-120 Solid-State FM/Stereo Receiver at half again more than its \$379.50, the whole thing would have been deceptively simple. Then no one, not even the most spend-thrifty status seeker, could question its modest price versus its immodest quality.

If the thought of paying a lot less to get a lot more bothers you, we'll tell you why the Studio Pro-120 is such a value. For over 35 years, we've built some of the world's finest speakers and sold them at prices lower than anything comparable. We're famous for that. But who ever heard of a University receiver?

The Studio Pro-120 is our first, so we put everything we could into it, including our many years of experience in designing sophisticated audio electronics for the military.

The results turned out to be so fantastic, we had every spec certified by a leading independent testing lab. That way, when you compare our middle-of-the-line price with quality that's quite comparable to the top-of-the-line of the Big 5, you'll know both are for real. And if that isn't enough, how about asking your dealer for a re-print of the three-page article on the Studio Pro-120 from the January, 1968, issue of *Audio Magazine*.

Better yet, play with the Pro-120. Listen to it. And by all means compare it to any much higher-priced receiver in the store. We'll bet you'll wind up with our magnificent deceiver, as long as you don't mind paying a lot less while getting a lot more.

 **UNIVERSITY[®] SOUND**
A DIVISION OF LTV LING ALTEC, INC.
9500 West Reno • Oklahoma City, Oklahoma 73126

AMPLIFIER SECTION: IHF Power Output: 120 watts total, IHF Standard at 0.8% THD, 4 ohms (60 watts per channel). RMS Power Output: 8 ohms: 30 watts per channel at 0.3% THD. Frequency Response: ± 0.3 dB from 10 Hz to 100 kHz. Power Bandwidth: 10 Hz to 40 kHz, IHF Standard. Intermodulation Distortion: Less than 0.5% at any combination of frequencies up to rated output. Tone Control Range: ± 18 dB at 20 Hz and 20 kHz. Damping Factor: 50 to 1. Noise Level: (Below rated output) Tape monitor: -83 dB—Auxiliary: -80 dB—Phono: -60 dB—Tape Head: -63 dB. Input Sensitivity: (For rated output) Tape Monitor: 0.4 Volts—Auxiliary: 0.4 Volts—Tape Head: 1 mV at 500 Hz—Phono: 4 mV at 1 kHz. Input Impedance: Phono and Tape Head: 47,000 ohms—Tape Monitor: 250,000 ohms—Auxiliary: 10,000 ohms. Load Impedance: 4 to 16 ohms. **FM TUNER SECTION:** Sensitivity: 1.6 μ V for 20 dB of quieting, 2.3 μ V for 30 dB of quieting, IHF. Frequency Response: $\pm 1/2$ dB from 20 to 20,000 Hz. Capture Ratio: Less than 1 dB. Image Rejection: Greater than 90 dB. IF Rejection: Greater than 90 dB. Separation: 40 dB at 1 kHz. Selectivity, Alternate Channel: 55 dB. Drift: .01%. Distortion: Less than 0.5% at 100% modulation ± 75 kHz deviation. Multiplex Switching: Fully automatic logic circuit. **GENERAL:** Dimensions: 4 1/2" H x 16 3/4" W x 12" D (including knobs). Weight: 17 lbs. Amplifier Protection: Three 1-ampere circuit breakers. Complement: 31 Silicon & MOSFET transistors, 21 Diodes, 2 Integrated circuits (each containing 10 transistors, 7 diodes, 11 resistors).

UNIVERSITY saving money never sounded better

EW Lab Tests NEW SOLID-STATE STEREO AMPLIFIERS

By JULIAN D. HIRSCH / Hirsch-Houck Laboratories

Test results on presently available integrated amplifiers show most of them to be clearly superior to the finest vacuum-tube models of five or ten years ago. Audible differences at moderate listening levels are very small, but one still pays more for higher power, unmeasurable distortion, rugged construction, conservative design.

MANY people consider the amplifier to be the keystone of a high-fidelity music system. This concept seems rather at odds with the unarguable fact that amplifiers, like small children, should be seen and not heard. Why, then, this concern with an inaudible component?

In the past, amplifiers were not always what they should have been. It was not uncommon for them to impose their own coloration on the reproduced sound. Power and frequency response limitations, as well as distortions both gross and subtle, made it possible for a careful listener to distinguish one amplifier from another, and obviously required some serious listening before making a purchase.

Today's solid-state amplifiers are, almost without exception, superior to the finest vacuum-tube models of five or ten years ago. From a listening standpoint, the differences among them are miniscule at moderate listening levels. In spite of this fact, the models covered in this report span an extremely wide price range. One pays a price for higher power capability over the full audible range, unmeasurable

distortion, conservation design, and rugged construction.

At one time it was common practice to use separate preamplifiers and power amplifiers. The cool-running solid-state amplifier has made this approach unnecessary although a few such components are still available. Most amplifiers, including all those covered in this report, are of the *integrated* type, combining stereo preamplifier, power amplifier, and power supply on a single chassis.

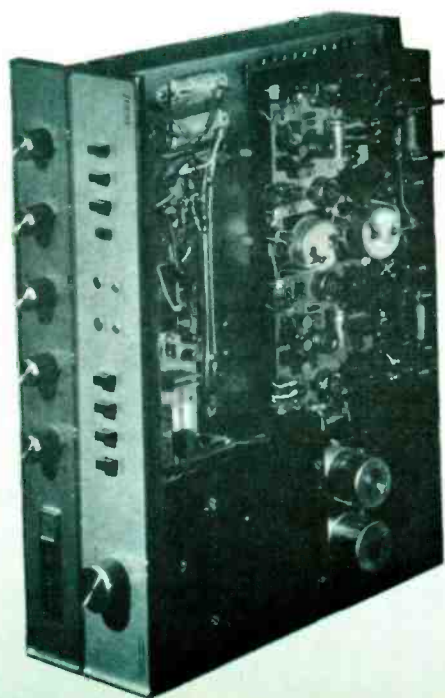

AMPLIFIER	CONT. POWER OUT. PER CHAN. (into 8 ohms)			0.1 W (%)	THD @ 1 kHz		MAX POWER RE 8-ohm LEVEL	AUDIO SENS. FOR 10-W OUT			HUM & NOISE RE 10 W			RIAA EQUALIZ. ERROR 50-15,000 Hz (dB)	NAB TAPE EQUALIZ. ERROR 50-15,000 Hz (dB)	
	30 Hz (W)	@ 2% THD 1 kHz (W)	20 kHz (W)		1.0 W (%)	10 W (%)		4 OHMS (%)	16 OHMS (%)	AUX (mV)	PHONO (mV)	TAPE HEAD (mV)	AUX (dB)			PHONO (dB)
ADC 60	18.5	74.5	3.7	0.18	0.14	0.13	136	76.5	78	1.9	NA	-65	-53	NA	+1.2, -6.5	NA
AR	20.0	70	5.0	0.17	0.18	0.08	156	64	84	1.2	NA	-75	-68	NA	+1.0, -1.0	NA
C/M Labs CC-505	63.5	72.0		0.17	0.10	0.085	117	27	68	0.8H 4L	1.6H 8.0L	-65	-66	-46	+1.5, -1.5	+3.0, -1.5
Eico 3070	14.0 ^a	13.0	15.0 ^a	0.15	0.11	0.12	166	56.5	110	1.6	NA	-76	-73	NA	+1.5, -1.5	NA
Fisher TX-1000	15.5	50.0	45.5	0.18	0.19 ^b	0.15 ^c	147	58	100	5.5H 1L	0.8	-73	-65H -70L	-59	+0.5, -0.0	+0.3, -0.8
Heath AA-15	69.0	73.0	75.0	0.20	0.15	0.12	95	61	80	0.9	NA	-93	-61	NA	+2.2, -1.2	NA
J.B.Lansing SA-600	66.5	74.0	43.0	0.13	0.095	0.11	155	58.5	87	7.5H 3.8H 1.8L	NA	-85	-71	NA	+4.0, -0.0	NA
Kenwood KA-2000	7.6	13.8	14.5	0.22	0.09	0.55	122	63.5	820	1.4	NA	-73	-64	NA	+0.5, -4.0	NA
Knight KG-865	15.3	18.7	23.8	0.52	0.18 ^a	0.13	152	57	200	3.7	NA	-74.5	-62	NA	+1.0, -1.5	NA
Lafayette LA-125T	25.2	34.0	37.0	0.45	0.16 ^b	0.18	144	59	200	1.4H 4.8L	1.6	-78	-66H -59L	-57.5	+0.5, -2.0	+0.5, -6.5
McIntosh MA-5100	64.0	69.0	78.0	0.25	0.13	0.11	161	57	160	1.2	2.0	-72	-71	-61	+0.8, -0.3	+1.0, -1.0
Sansui AU-777	32.0	38.0	45.0	0.40	0.20 ^d	0.15	77.5	78	74	1	0.8	-70	-67	-51	+0.0, -1.2	+0.4, -0.2
Scott 2608	28.0	50.0	52.5	0.29	0.17	0.09	137	71	33	1.4H 2.5H 4.5L	NA	-73	-67	NA	+2.0, -2.0	NA
Sherwood S-9900a	38.0	56.0	69.0	0.22	0.08	0.10	160	55	85	0.55H 3.4L	0.35H 2.2L	-85	-68H -63L	-49L	+1.5, -0.0	+8.0, -1.0
Sony TA-1120	58.0	66.0	79.0	0.25	0.12 ^e	0.14	124	65.5	72	1.5	1.0	-78	-71	-60	+0.2, -0.2	+1.5, -0.5

Notes: Appearance, operating convenience, serviceability, and reliability cannot be tabulated here. These factors are also important in determining price. (1) Power limitation not originally measured at 30 Hz. (2) 100-ohm or 100-ohm. (3) Correct contours obtained with

Tests and Measurements

The current Institute of High Fidelity (IHF) Standard (IHF-A-201) on audio amplifier measurement serves as a general guide for our own test program. Since the complete test series defined by this Standard is very lengthy, we have selected portions of it to provide the basis for a meaningful tabulation of amplifier performance specifications. For a more complete description of the IHF test procedures, see "EW Lab Tests of New Solid-State Stereo Receivers" in the December 1967 issue of *ELECTRONICS WORLD*.

For defining maximum power output, a reference distortion level of 2% was chosen. We made our measurements with both channels driven simultaneously, using 8-ohm loads and at a standard line voltage of 120 V. In some cases, our measured power outputs differ from the manufacturer's ratings. One reason for this is difference in test conditions. For example, the rated distortion is often less than 2%, power ratings are frequently in terms of *dynamic* or *music power* instead of continuous power output, and in many cases 4-ohm loads are specified, since the available

EICO is using the Model 3070 amplifier listed in our table as the amplifier section of the company's Model 3570 receiver, priced at \$170 as a kit or \$260 factory-wired.

power is usually higher into 4 ohms than into 8 ohms. What is more, our power figures represent the output *per channel* rather than the total output of the amplifier.

Nevertheless, we have provided sufficient information in our tabular summary so that a careful comparison will bring out most of the true differences among the various amplifiers. We measured maximum power output per channel at three frequencies—30 Hz, 1 kHz, and 20 kHz. Normally, an amplifier will deliver its greatest power at mid-frequencies, such as 1 kHz. Sometimes, due to the type of output transistors used, high-power frequency is limited by increased distortion, and the output measured at 20 kHz is correspondingly low. It is common for low-frequency power output to be limited by increasing power-supply impedance as the frequency is lowered. The ratio of an amplifier's power at 30 Hz to its power at 1 kHz is therefore related to its power-supply design.

Although most speakers are nominally 8-ohm types, there are some 4-ohm and 16-ohm speakers. We have expressed the maximum power into each of these load impedances as

ADC is using its Model 60 amplifier listed in our table as the amplifier section of its Model 600 receiver. This receiver is priced at \$200.



AR Amplifier

ADC 60

C/M Labs CC-505

ADDITIONAL INPUTS	LOW FILTER	HIGH FILTER	LOUDNESS COMP.	REMOTE SPRKR. SWITCH	PHONE JACK	TAPE MONITOR	A.C. OUTLETS	BALANCE CONTROL	TONE CONT. GANG. OR SEP.	SIZE (in)			PRICE (\$)	CABINET	COMMENTS AND SPECIAL FEATURES
										W	H	D			
None				X	X	X	2 Sw	X	Ganged	14 1/4	3 1/4	8 1/2	130	Includes metal cab.	
1 high						X	1 Sw 1 Unsw	X	Sep	15 1/4	4 1/4	10	205	Wood 115	Null circuit for channel balancing
2 high	X	X	X				1 Sw 1 Unsw	X	Ganged	17	6	13	187		Tone control bypass switches
1 high	X	X	X			X	2 Sw 1 Unsw	X	Ganged	12	3 1/4	7 1/4	90 (kit) 130 (wired)	Includes metal cab.	
2 high 1 aux	X	X	X			X	2 Sw	X	Sep	15 1/4	4 1/4	12 1/4	150	Wood 125	Two-pos. phono sens. sw. Extra front-panel Tape Out jack
1 high			X			X	1 Sw 1 Unsw	X	Ganged	16 1/4	4 1/4	12 1/2	170 (buff)	Wood 120	Tone control bypass sw. Individual input level controls behind front panel door
1 high (5 phono)			X				3 Sw 1 Unsw	X	Ganged	16 1/4	5 1/4	13 1/4	175	Wood and plastic w/uff	Three-pos. phono sens. sw. Aural null balance
1 high			X			X	1 Sw		Ganged	10 1/4	4 1/2	9 3/4	85	Includes metal cab.	Concentric volume controls for channel balance
1 high						X	1 Sw 1 Unsw	X	Ganged	13	3 1/4	10	75 (kit)	Wood 115	Tape recorder outputs
1 aux 2 high 1 phono	X	X	X			X	1 Sw 1 Unsw		Sep	13	3 1/4	9 1/4	130	Includes metal cab.	Extra front-panel Tape Out jack
2 high 1 phono	X	X	X			X	1 Sw 1 Unsw	X	Sep	16	5 1/2	14 1/2	445	Wood 130	Spkr. phase sw. Center channel output with separate level control
2 high 1 phono	X	X	X			X	1 Sw 1 Unsw	X	Sep	17 1/4	6 1/4	13 1/4	280		Sw. type tone controls. 20 dB Muting sw. 50-Hz boost Presence sw. 3 1/4 & 7 1/2 in/stape-head equal
2 high 1 aux	X	X	X			X	2 Sw	X	Sep	15	4 3/4	12 1/2	295	Wood 125 Metal 114	Tone control bypass sw. Three-pos. phono sens. sw.
2 high		X	X			X	1 Sw	X	Ganged	14	4	10 1/2	210	Metal 119	Front-panel preamp level control
1 aux 1 phono 1 high	X	X				X	2 Sw 1 Unsw	X	Ganged	15 1/4	5 1/4	12 1/4	400	Wood 125	Step-type tone controls. Defeat sw. for tone controls and limiters. Preamp and power amp. separable.

tone controls: (A) Two 10-Hz filter cut-off frequencies; (B) Loudness only effective near minimum volume setting. Not measurable at normal levels; (C) Not measurable due to low tape biasing; (D) Not available.

a percentage of the 8-ohm power output, at 1 kHz. Most amplifiers deliver 20% to 60% more power into 4 ohms and 25% to 50% less into 16 ohms, than into 8 ohms. There are exceptions, as our test results show.

Since an amplifier is usually rated for a certain maximum distortion at its maximum power output, and this power varies from model to model, we have chosen to measure the 1-kHz total harmonic distortion (THD) at standardized power levels of 0.1, 1.0, and 10 watts. The lowest figure is typical of power levels used in casual listening, while 1 watt corresponds to moderately high listening levels. Few am-

HEATH uses the Model AA-15 covered in our table as the amplifier portion of the manufacturer's Model AR-15 receiver, which is priced at \$330 in kit form, or at \$500, factory-wired. Other integrated stereo amplifiers in the company's line include: Model AA-22, rated at 20 W/ch (cont.) into 8 ohms and priced at \$100 as a kit; Model AA-14, rated at 10 W/ch (cont.) into 8 ohms and priced at \$63 as a kit; and Model AA-21D, rated at 35 W/ch (cont.) into 8 ohms and priced at \$140 as a kit.

FISHER employs the Model TX-1000 amplifier covered in our table as the amplifier section in their Model 700-T receiver, available at \$500. Other integrated stereo amplifiers in the company's line include: Model TX-100, which produces 20 W/ch, cont. (watts per channel, continuous power) into 8 ohms and is priced at \$190; Model KX-200, a 40 W/ch (dynamic power) kit priced at \$170; Model KX-100, a 25 W/ch (dynamic) kit priced at \$130; and Model KX-90, a 20 W/ch (dynamic) kit priced at \$100. Continuous power ratings on these kits is about 15% lower than the dynamic power ratings.

plifiers will be called upon to deliver more than 10 watts, even on peaks, unless one operates low-efficiency speakers in a large room at very high volume levels. In the latter case, the maximum power output of an amplifier becomes a vital consideration; otherwise it is of secondary importance.

The distortion figures measured at 0.1 watt are not really distortion at all. They represent residual hum or hiss, which in every case exceeded the actual harmonic distortion. In three cases, the minute distortion at 1-watt output was still masked by noise. It is noteworthy that at 10-watts output, practically all the amplifiers had nearly unmeasurable or negligible distortion.

We also measured hum and noise under standardized conditions, since amplifier gains differ widely and the common

J. B. Lansing SA-600

Knight KG-865



Kenwood KA-2000

KENWOOD, in addition to the Model KA-2000 listed in our table, also has available the Supreme 1 stereo amplifier. This unit includes an electronic crossover whose output feeds separate low-, mid- and high-frequency sections of the main amplifier. Continuous power output from these three sections is 33 W/ch, 23 W/ch, and 15 W/ch, respectively. Price of the amplifier is \$695.

practice of using either maximum or minimum gain would be either unfair or unrealistic. We set the gain of the amplifier so that 10-watts output at 1 kHz was produced by an input of 1.0 volt (high level), 10 millivolts (phono), or 3 millivolts (tape head). Then, with the signal removed and the input terminated by a 2200-ohm resistor, the output noise was measured and expressed in decibels relative to 10 watts. Where several phono sensitivities were provided, the measurement was made at each setting. Sometimes the less sensitive condition resulted in more hum, since the gain control had to be set higher to obtain standard gain.

From a listening standpoint, none of the amplifiers tested had audible noise levels under any practical listening condition. Noise which is 60 dB or more below 10 watts is usually inaudible unless one's ear is placed against the speaker. Below -70 dB, one is hard put to find noise even in that unconventional posture.

With all level controls at maximum, we measured the 1-kHz voltage required at each input to develop 10-watts output. Since most tuners or tape amplifiers produce at least 1-volt output, and most of the amplifiers can develop an earsplitting 10 watts from 0.1 volt or less, the sensitivity of high-level inputs is not a problem. Typical phono cartridges deliver several millivolts, more than sufficient to drive any of these amplifiers. The reduced phono sensitivity offered by some amplifiers serves two purposes. It enables the playing level from a phono cartridge to be roughly matched to that from a tuner which may have no level control, and it reduces the possibility of overdriving the phono preamplifier with a high-output cartridge. An interesting variation of this technique is offered in the *Heath AA-15*, whose phono level control follows the preamplifier and therefore could not prevent overdriving. Although it has one of the highest phono sensitivities (0.9 millivolt), its preamplifier is designed to handle signals in excess of 150 millivolts without distortion.

The RIAA phono equalization standard allows a variation

KNIGHT is using their Model KG-865 covered in our table as the amplifier portion of the Model KG-980 receiver, which is priced at \$150 in kit form. The company also has the following integrated amplifiers: Model KG-870, rated at 28 W/ch (cont.) into 8 ohms and priced at \$100 in kit form; and Model KG-854, rated at 17 W/ch (cont.) into 8 ohms and priced at \$80 in kit form.

of ± 2 dB around a specified frequency response curve, from 50 to 15,000 Hz. We measured the equalization of each amplifier, and have tabulated the maximum deviations from the ideal curve, referred to the 1-kHz level. Even with those amplifiers that exceeded the ± 2 dB limits, the errors were not objectionable or even audible without direct comparison to an ideally equalized amplifier. What is more, slight adjustment of the tone controls is all that is necessary to produce closer equalization, if desired.

A similar procedure was followed with respect to the NAB tape-equalization characteristic, on the amplifiers which offered tape-head inputs. Few audio systems use the main amplifier for tape equalization, so this feature is rarely offered.

For convenience in evaluating these amplifiers, we have also listed the presence or absence of such features as filters, remote-speaker switching, additional inputs, a.c. convenience outlets, availability of cabinets, and certain special or unusual features of individual amplifiers.

Comparison of Performance and Features

The one central fact emerging from this survey is that there is no "perfect" amplifier. In other words, none has *all*

LAFAYETTE uses the Model LA-125T covered in our table as the amplifier section of the Model LR-1000T receiver, priced at \$220. In addition, the company has the following integrated amplifiers: Model LA-224T, rated at 15 W/ch (dynamic) into 8 ohms and priced at \$60; Model LA-85T, rated at 30 W/ch (dynamic) into 8 ohms and priced at \$100; the Stereo 20, rated at 10 W/ch (dynamic) into 8 ohms and priced at \$40; and the Stereo 10, rated at 5 W/ch (dynamic) into 8 ohms and priced at \$23.

the features possessed by some of these represented, *plus* a clear superiority in electrical performance.

In their power outputs, they tend to fit into three groups: 25 watts and under, about 50 watts, and over 70 watts. Since all of them have entirely negligible distortion and noise levels, as they are used in most home listening environments, the choice of a particular power rating must be influenced by the efficiency of the speakers, the size of the room, and one's listening volume preferences. It should be clearly understood that, while a 20-watt and a 70-watt amplifier may sound alike at a 1-watt level, the differences may become very audible when one turns up the volume "just a little".

Obviously, if one wishes to operate remote speakers as well as the main speaker systems, a few amplifiers are ruled out. Interestingly enough, they include two of the least expensive and two of the most expensive models. This lack need not be a serious drawback, since the necessary switching can be added externally, but it is nonetheless a factor to consider.

All but one of the amplifiers (*Continued on page 77*)



Lafayette LA-125T

McIntosh MA-5100

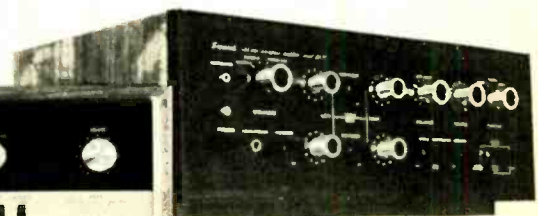

Sansui AU-777

PHOTOMETRY NOMOGRAPH

Simplified method of determining the amount of light falling on a photocell or other surface when the light originates from other than a point source.

THERE are occasions when foot-candle measurements are not applicable and brightness measurements are required, for example, if light reflected from a secondary surface causes it to be not a point source but an area source. The common unit used to express brightness is the foot lambert. A foot lambert is the brightness of a uniformly diffusing surface reflecting 100% of the light falling on it when illuminated with one foot candle. Therefore, if one foot candle illuminates a surface which had a reflectance of 80%, the surface brightness would be 0.8 foot lambert.

The nomograph solves the light intensity equation for both feet and inches. Results are obtained on similar sets of scales, i.e., either use all A scales for a calculation or use B or C as required for the solution.

For example, a 20-candlepower lamp is 5 feet from a photocell. What is the light intensity at the cell? A line drawn from 20 on the Candlepower scale through the 5 on the B Distance scale, intersects the B Foot candle scale at 0.80 foot candle.

Unfortunately, most lamps are classified according to wattage rather than candlepower. The following approximate relationships are useful:

1. Depending on the application for which they are designed, lamps are rated for lifetimes of seconds to near infinite life. The shorter the rated life, the higher the efficiency (cp/W), and the higher the color temperature of the light.

2. If we restrict ourselves to standard voltage (120 V), inside-frosted incandescent lamps rated for 1000 hours; we find that efficiency increases with increasing wattage; a 25 W lamp is near 19 cp, a 60 W lamp is near 60 cp, and a 250 W lamp is near 200 cp; color temperature increases with increasing wattage; color temperature of a 150 W lamp is near 2900° K; light output varies at approximately the 3½ power of the supply voltage (near rated voltage); lamp life is approximately proportional inversely to the 13th power of the supply voltage (near rated voltage); when lamps are operated at constant voltage, light output falls with time rapidly during the first 50 hours, more slowly thereafter; and when lamps are operated at constant current, the light output rises with time, slowly at first, then accelerating to catastrophic destruction.

Definitions

A foot candle is the illumination produced when the light from one candle falls normally on a surface at a distance of one foot. A lux (commonly used in Europe), is the illumination

produced when the light from one candle falls normally on a surface at a distance of one meter from the source.

A point source emitting light uniformly in all directions radiates 4π lumens per candle.

A lambert is the brightness of a perfectly diffusing surface emitting or reflecting one lumen per square centimeter. A foot lambert equals $1/\pi$ candles per square foot.

The information included in this article and the nomograph are extracted from the *Clairex Corporation's* new publication "Photoconductive Cell Design Manual."

Our thanks to the company for permitting us to pass along this information for the benefit of our readers. ▲

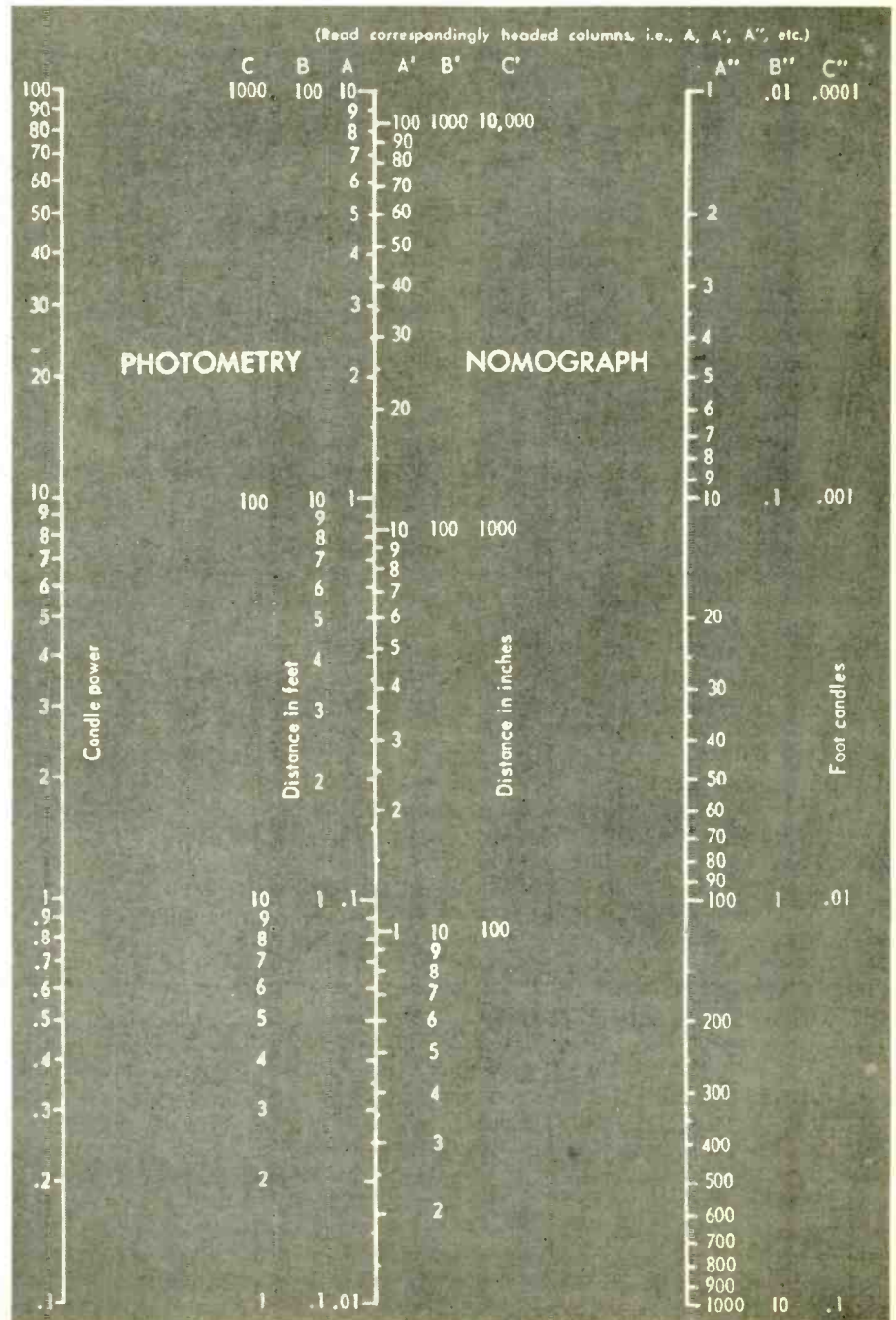

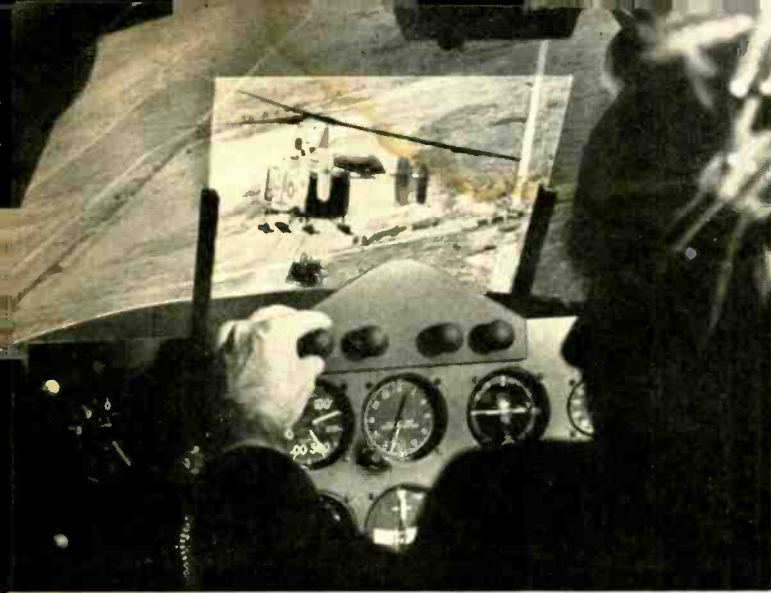

RECENT DEVELOPMENTS IN ELECTRONICS

Electro-optical Night Window for Pilots. (Top left) A foot-square transparent screen mounted behind the aircraft window is giving the pilot a clear, realistic view of night-darkened terrain. Called "Night Window", it uses advanced electro-optical techniques to display an enhanced image of the real world with the same apparent depth, size, and realism a pilot would see if he looked at the scene during daylight. Unlike previous systems, which also use highly sensitive image-intensifying devices, the new system does not display the viewed scene as an image on a small picture tube below pilot eye level. Night Window projects its images so that they appear to the eye like real objects in their true positions. Unlike radar and infrared equipment, this system is completely passive and emits no visible or invisible radiation that an enemy could detect or jam. It can see in darkness as dim as an indoor sports arena lit only with a pocket flashlight, or a landscape lit only by overcast starlight. A laboratory model of the new electro-optical system, which was developed by Kollsman Instrument Corp., has already undergone U. S. Army helicopter field trials.



Brighter Color Picture Tube. (Center) Improved phosphors, a new electron gun, a temperature-compensated mask, and a new method of dusting the phosphors onto the faceplate have resulted in a color-TV picture tube that is claimed by its manufacturer to be "the brightest tube in the history of color television". The engineer in the photo is shown measuring the tube's brightness with a photoelectric cell. The brightness level is displayed on the monitor atop the color set by means of closed-circuit TV. The tube is said to be 23 to 69 percent brighter than other currently available tubes. The new tube, which has been developed by Sylvania, will be employed in this manufacturer's new line of color-television receivers.



Dancing Rods Used in Computer Memory. (Bottom left) These tiny metal rods are the heart of a sophisticated new computer memory which is made by a fully automated manufacturing technique. The rods, only a tenth of an inch long, replace conventional magnetic cores which must be strung together by costly hand operations to form the more conventional memory unit. The rods are literally "danced" into the centers of minute solenoids when placed in a pulsating magnetic field. The tiny rods are made by electrodeposition of a thin magnetic film on a beryllium copper wire substrate 6 mils in diameter. A completely automatic process is capable of producing miles of such wire in a single working shift. The plating process as well as the cutting of the wire into rods requires no hand operation at all. After the rods have been properly inserted into the solenoids, they are then plastic-sealed and tested—again all automatically. The new device, called a "thin-film memory", is used in recent National Cash Register Co. computers.



New Powerhouse SCR. (Top left) This SCR has a 5000-ampere surge current rating making it suitable for use in heavy-duty applications such as motor control, starters, primary controlled power systems, and inverters where high inrush currents are encountered. The thyristor passes a forward current of 475 amperes r.m.s. with forward and reverse blocking voltages of up to 1500 volts. With such high ratings it is unnecessary to connect many smaller devices in series or parallel. Forced-air, water, or oil cooling is usually used with the new Westinghouse SCR which costs \$440 in 25 quantities.

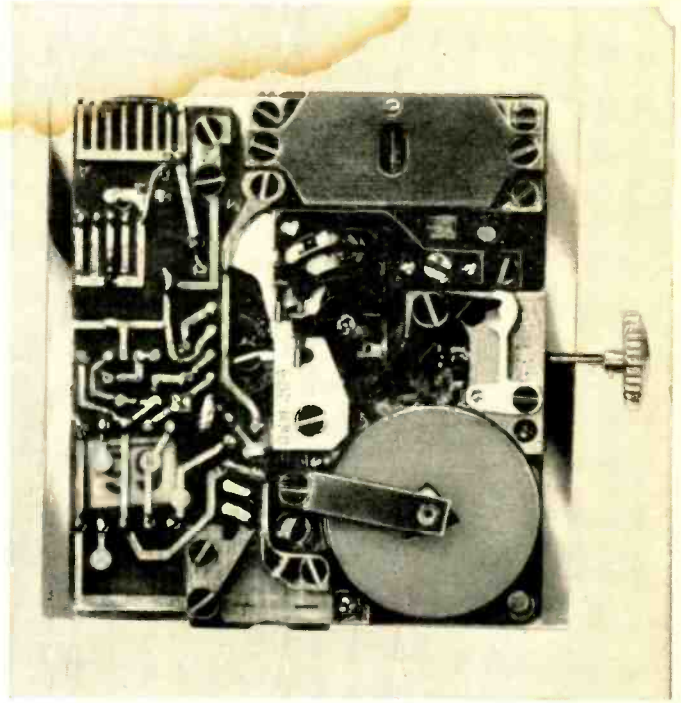

Quartz-crystal Wrist Watch. (Top right) A new electronic watch developed by the Swiss watch industry recently set new records for accuracy, showing a timing variation of only a few tenths of a second per day during the testing period of 45 days. A tiny, vacuum-sealed quartz crystal is used in an oscillator circuit operating at 10 kHz. The output is then frequency-divided by means of an integrated circuit (at left in photo) whose output operates a small drive motor (top right) that turns the hands. A small battery (bottom right) powers the watch. Work still remains, however, before this highly accurate watch reaches the commercial market and appears at your local jeweler.



Mobile Radar System. (Center) This highly mobile radar system can detect high-speed aircraft at tree-top levels and relay target information to nearby anti-aircraft sites. Called the Forward Area Alerting Radar (FAAR), it will serve as the early warning "eye" for the Army's Chaparral Vulcan, a 20-mm gun, and the Redeye heat-seeking missile. An engineering model of the L-band radar, developed by Sanders Associates, is housed in a 2½-ton truck to facilitate storage of test equipment and permit testing room. Actual system will be much smaller.

Driving Simulator Helps Develop Safer Cars. (Below right) A simulator which can impart the sensation of driving motion is helping GM engineers to evaluate driver-car relationships in the laboratory. Electronically controlled and hydraulically actuated pitch and roll equipment is tied in with visual and audio information from a stereo sound system in order to make the driver really experience the effects of an emergency. Instrumentation of the steering wheel, brake, and accelerator provides feedback of driver response to simulated accidents.



CERAMIC PHONO CARTRIDGE LOADING & EQUALIZATION

By JOHN C. RANKIN

The effect of the load resistor on cartridge response is covered along with the design of a FET source-follower stage that can be used to load the cartridge properly.

DESPITE the excellent capabilities of ceramic cartridges they are giving very poor results in some installations due to improper loading and equalization. The output of a ceramic cartridge is proportional to the amplitude of the stylus motion; hence, it is termed an *amplitude device*. The magnetic cartridge, on the other hand, has an output that is proportional to the velocity of the stylus motion. For this reason the ceramic phono cartridge requires a different type of compensation.

Fig. 1 shows the compensation required for a ceramic cartridge in playing back a record with an RIAA recording curve. It is necessary to decrease the low frequencies and increase the high frequencies, as shown. The high-frequency portion of the curve is shown dotted because the cartridge manufacturer takes care of this by controlled stylus resonance at the high frequencies so no electrical boost is necessary here.

The proper low-frequency cut is taken care of by the ceramic element itself if it is supplied with the correct load. The cartridge is effectively a ceramic capacitor, C , which is used in conjunction with a loading resistor, R , as shown in Fig. 2A. In such a circuit the capacitance will provide a decrease in the low frequencies appearing across the load resistor. If the capacitance of the cartridge is known, the low-frequency voltage appearing across R may be made to follow any curve approximately, including Fig. 1.

With a known capacitance, the resistor value to provide

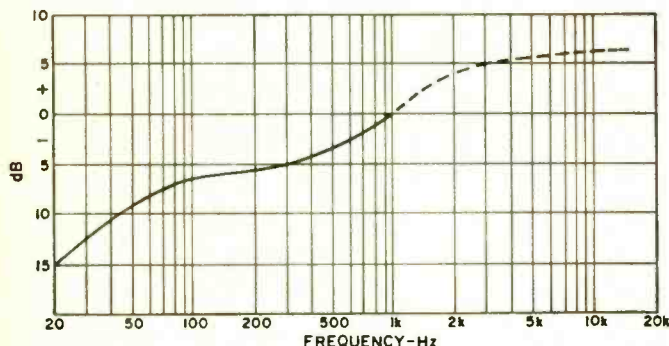
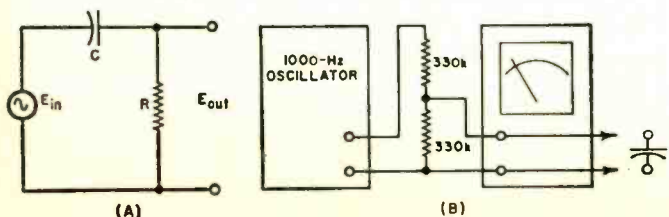

Fig. 1. Compensation required for ceramic phono cartridge.

Fig. 2. (A) Equivalent circuit of the cartridge. (B) Setup to be employed to determine the capacitance of cartridge.



correct RIAA compensation is: R (megohm) = $1300/C$ (picofarads).

In the days of tube amplifiers, some ceramic stereo cartridges had a capacitance of approximately 600 pF. The correct loading resistor would be: R (megohms) = $1300/600 = 2.2$ megohms. A 2-megohm resistor would be close enough and enables later calculations to be kept simple.

With the arrival of transistors, a 2-megohm input was difficult to achieve and a 1-megohm input was about the limit. It can be seen from the equation that it would be necessary to have a cartridge with a capacitance of 1300 picofarads to operate into 1 megohm and produce the desired curve. The cartridge manufacturers went further than this; they produced ceramic cartridges with capacitances of 4000 pF and over, which meant that the cartridges could operate into load resistances of 330,000 ohms and less.

It might be interesting to see what happens to cartridges with different loading resistances. The matching will be based on the curve of Fig. 1 where the required bass attenuation is 12 dB at 30 Hz. In the case of the 600-pF cartridge mentioned earlier, where the load is 2 megohms, the ratio of output to input voltage at 30 Hz is:

$$\begin{aligned} \frac{E_{out}}{E_{in}} &= \frac{R}{\sqrt{R^2 + X_c^2}} = \frac{2 \text{ M}\Omega}{\sqrt{(2 \text{ M}\Omega)^2 + (9 \text{ M}\Omega)^2}} \\ &= \frac{2}{\sqrt{4 + 81}} = 0.22 = -13 \text{ dB} \end{aligned}$$

Since this is very close to the 12 dB required, the equalization is suitable for an RIAA recording but a 2.2-megohm resistor would be better.

What happens when a 4500-pF cartridge is connected to a 3-megohm load?

$$\begin{aligned} \frac{E_{out}}{E_{in}} &= \frac{R}{\sqrt{R^2 + X_c^2}} = \frac{3 \text{ M}\Omega}{\sqrt{(3 \text{ M}\Omega)^2 + (1.2 \text{ M}\Omega)^2}} \\ &= \frac{3}{\sqrt{9 + 1.44}} = 0.93 = -0.6 \text{ dB} \end{aligned}$$

This means that the bass control would have to provide an additional 11.4 dB cut which may be beyond the capability of some bass controls. If the additional cut is not provided, the result would be *excessive bass*. The correct load for the cartridge is $1300/4500 = 288,000$ ohms, and a 270,000-ohm resistor would be suitable.

If a 433-pF cartridge meant for a 3-megohm load is connected to a 300,000-ohm load, the low frequencies will be lost.

$$\begin{aligned} \frac{E_{out}}{E_{in}} &= \frac{R}{\sqrt{R^2 + X_c^2}} = \frac{0.3 \text{ M}\Omega}{\sqrt{(0.3 \text{ M}\Omega)^2 + (12 \text{ M}\Omega)^2}} \\ &= \frac{0.3}{\sqrt{0.09 + 144}} = 0.025 = -32 \text{ dB} \end{aligned}$$

This is 20 dB too much low-frequency attenuation and very few amplifiers could com- (Continued on page 72)



1968 FM-STEREO CAR RADIOS

This AM-FM-FM-stereo car radio by Delco uses a separate stereo multiplex unit shown here mounted below the dash.

By FOREST H. BELT/Contributing Editor

Circuit features and troubleshooting information on the Bendix, Delco, and Motorola stereo receivers that are used in 1968 model automobiles.

WHEN warranties begin expiring on the accessories in 1968 cars, a good share of the FM-stereo radios that are so popular this year will find their way to independent service shops around the country. It's important, then, to know what's in them. In many ways, the multiplex sections are similar, and yet there are enough differences to make them worth studying if you expect to work on them.

The one circuit they have all standardized is the balanced detector for re-mixing the 38-kHz subcarrier with the L - R sideband signal. The most important difference is in the way the 38-kHz subcarrier is developed. Another is the way the stereo-indicator light operates. There are other small differences, and we'll touch on some of them later.

Most of the FM-stereo units in 1968 automobiles are made by just three companies: *Bendix, Delco, and Motorola*. In all, the job of the FM-multiplex circuitry is to recover—separately—the left and right stereo signals that originate at the FM station.

As you probably recall, the signal is made up of three main parts: the ordinary monophonic modulation, which is the

sum of the left- and right-channel signals (L + R) that is frequency-modulated directly on the station carrier; a double-sideband suppressed-carrier signal, made by amplitude-modulating a 38-kHz subcarrier with the difference between the left- and right-channel signal (L - R) and putting only the resulting sidebands on the FM station carrier; and a 19-kHz pilot carrier that synchronizes or produces a 38-kHz subcarrier in the receiver, so the L - R signal can be recovered accurately from the sidebands. The spectrum graph of Fig. 1 shows the signals that are frequency-modulated on the FM

Fig. 1. The FM-stereo signal spectrum, as it is modulated on the station carrier. The L-R signal is amplitude-modulated on a 38-kHz subcarrier, and the subcarrier then removed, which leaves only the sidebands. These frequency-modulate the main station carrier along with the monophonic L+R FM signal.

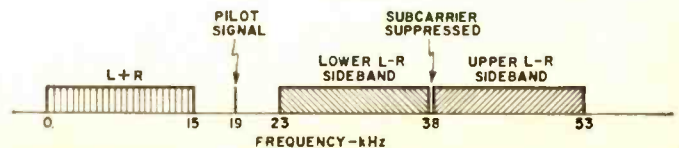

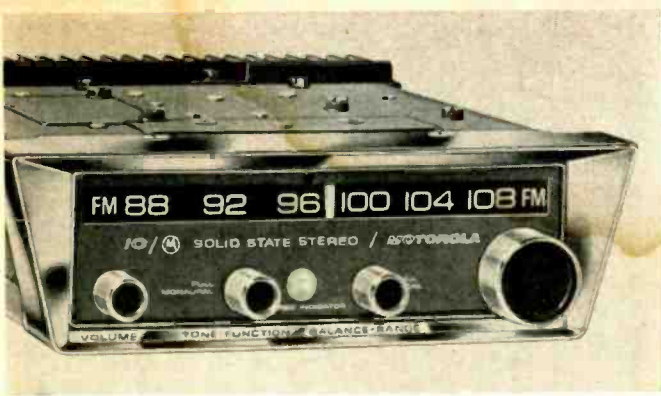

The latest model Motorola FM-stereo radio uses four IC's.

station carrier. The 38-kHz subcarrier is, of course, suppressed.

The Balanced Stereo Detector

With only minor differences, the circuit shown in Fig. 2 is the balanced stereo detector used in all 1968 car radios. Because it is so popular (it is also used in many home receivers), you need to know how it works so you can troubleshoot it intelligently.

First notice that the secondary winding of transformer T1 is in series with diodes D1 and D2, which are in series with each other. When a 38-kHz signal is present (from the primary of T1), the diodes are switched on and off (conducting and non-conducting) 38,000 times each second. That is the frequency of the subcarrier that needs to be mixed with the L - R sidebands to recover the original L - R signal. It is sometimes called the *switching rate* of the detector. Note that the switching signal is fed to both diodes but from opposite ends of T1 secondary resulting in equal-amplitude but opposite-polarity switching signals.

Next, note that the L - R sidebands and the L + R audio signals are fed to the center tap of the secondary winding of T1, and then fed equally to each diode. However, only one diode conducts at any given instant, and they take turns—alternating 38,000 times each second. The 38-kHz switching signal is carefully phase-locked to the transmitter pilot signal. The L + R signal is merely conducted to the output, first through D1 and then through D2. The sidebands, though, because of the phase relationship between them and the subcarrier, are demodulated. That produces a combination of the L + R and the L - R signals at the output of the diodes.

The nature of a balanced detector is such that the reinserted 38-kHz subcarrier is virtually canceled in the demodulating process. The two 220-pF capacitors finish the job by shunting to ground whatever 38-kHz signal is left. The 100k resistors and the 0.002-μF capacitor complete the job, at the same time providing whatever audio de-emphasis is necessary. The output is a left-only signal.

Fig. 2. Balanced detector used in all major auto FM-stereo receivers and in some home sets. Diode pairs are matched.

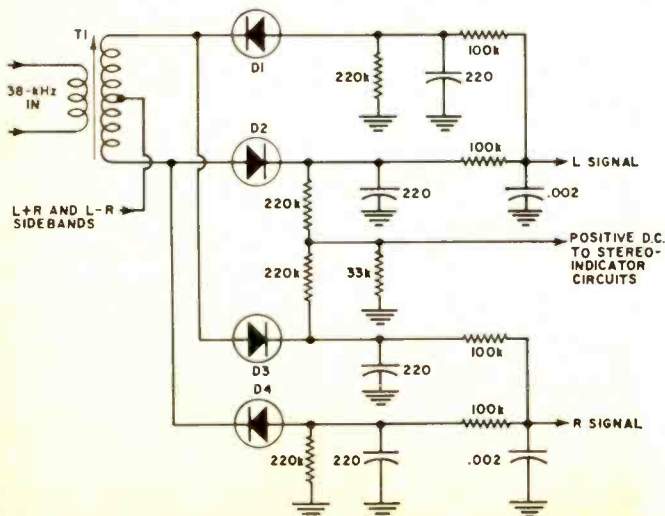

But why do we have a left-only signal? That's because of the direction of diodes D1 and D2. D3 and D4 are hooked up just the opposite. L + R and L - R signals are *added* in the D1-D2 circuit and they are *subtracted* in the D3-D4 circuit. When you add L + R and L - R algebraically, the result is $(L+R) + (L-R) = L+R+L-R = 2L$. When you subtract the two signals, you get $(L+R) - (L-R) = L+R-L+R = 2R$.

The balanced detector shown in Fig. 2 has an auxiliary purpose, too. The 220k resistors that follow D1 and D4 are grounded, while those following D2 and D3 are not. As long as the latter are returned to the same point, the detector remains balanced. So, they are returned to ground together, through the 33k resistor. Both are at the cathode ends of their respective diodes, and a small positive d.c. voltage appears there by normal rectifier action whenever a 38-kHz signal is present. That d.c. makes a handy trigger voltage to actuate the stereo-indicator lamp, and it is used for that in Motorola sets. The voltage is small and can't be used directly to light the lamp, but it activates transistor circuits which, in turn, operate the lamp. This function is handled differently in all three brands of sets and we will point out the method used in each of them, later.

Each output of the balanced detector is usually followed by a buffer amplifier of some sort, sometimes an emitter-follower to match the high impedance of the balanced detector to the low input impedance of the audio amplifier or driver transistors. The buffer amplifiers are not included in Fig. 2, since they are just ordinary transistor audio stages and familiar to most technicians.

Processing the Pilot Signal

The reinserted subcarrier in the balanced detector has to be in very precise synchronization with the original subcarrier at the transmitter. Otherwise the L-R sidebands would not be properly demodulated and would not produce the correct audio signals at the receiver. The station broadcasts a 19-kHz pilot signal that is recovered in the receiver and is used to keep the 38-kHz reinsertion subcarrier exactly in phase. As mentioned earlier, one of the greatest differences among the three major models of automobile stereo units is in the manner by which the 19-kHz pilot carrier controls the phase of the receiver's 38-kHz subcarrier.

All three systems are shown in Fig. 3. The simplest is the Motorola unit in Fig. 3A. The incoming 19-kHz pilot carrier signal is amplified in a transistor stage (input amplifier) and then fed to a frequency doubler. A diode in the input circuit serves two purposes in the doubler stage: it keeps the 19-kHz signal that is fed to the doubler at a constant level; and it clips the sine wave, making harmonics for the doubler. An output tank, tuned to 38 kHz, feeds the signal to the balanced detector.

Next, in order of complexity, is the Bendix system of processing the 19-kHz pilot carrier (Fig. 3B). From the input amplifier, the 19-kHz signal is amplified by one transistor stage (19-kHz amplifier) and then fed to a frequency doubler, which uses two diodes to clip and level the signal and to make the second harmonic readily available. The new 38-kHz signal goes through one stage of amplification, and is passed along to the balanced detector.

As you can see, neither the Motorola nor the Bendix system uses an oscillator to supply the 38-kHz subcarrier in the receiver. Both merely amplify the 19-kHz pilot signal itself, and use a frequency-multiplier stage to raise it to 38-kHz. With enough amplification, this is a good way to get the job done, for it avoids the complication of trying to lock an oscillator precisely in phase. However, there is always the danger that signal-fading and multipath cancellation could make the pilot carrier so weak that true stereo reception would be impossible. In that respect, the locked oscillator is sometimes more reliable.

Fig. 3C shows the Delco arrangement, which uses a phase-

locked oscillator. From the input preamp, the 19-kHz signal is fed through a cascaded group of high-*Q* tuned circuits. Then it is amplified. A Hartley-type locked oscillator, operating at 38 kHz, produces the subcarrier for the balanced detector. The 19-kHz signal holds this 38-kHz oscillator precisely on frequency and in phase.

Stereo Indicators

Again, each of the three major stereo units differ in the circuits which make the lamp glow when stereo is being received. In this case, *Bendix* has the least complicated arrangement, with *Motorola* next, and *Delco* again being the most detailed. All of them have one thing in common: they are activated by reception of the 19-kHz pilot signal. If that signal is missing, either because the program is not stereo or because the signal is too weak, the lamp fails to glow and it is useless to expect stereo reception.

The block diagram of Fig. 4A shows how simple the indicator circuit is in the *Bendix* stereo unit. A d.c. voltage developed in the base circuit of the 38-kHz amplifier activates a switching transistor, called the *lamp amplifier*, which causes the incandescent lamp to glow when a stereo signal is present.

The *Motorola* system (Fig. 4B) is the same, except that it gets its d.c. from the balanced detector, as already described. A d.c. amplifier stage, called the *indicator amplifier*, is used between the balanced detector and the switching transistor. It turns on the switching transistor to light the lamp. Notice also that the incandescent lamp in the *Bendix* unit is between the switching transistor and ground, while in the *Motorola* circuit it is between the switcher and "B+".

As you can see from Fig. 4C, the *Delco* unit has a special detector for stereo indication. The 38-kHz oscillator, when it is triggered by an incoming pilot signal, feeds a voltage-doubler rectifier circuit. The d.c. voltage that is developed is fed to a *lamp preamp* stage. The preamplified d.c. voltage is coupled to the *lamp amplifier*, which gives it another big boost—making it large enough to trigger the switching transistor which actually makes the lamps glow. All three stages—the lamp preamp, the lamp amplifier, and the indicator switch—are d.c.-coupled to pass along the voltage that originates in the voltage doubler. To simplify this kind of coupling arrangement, the first two transistors are *n-p-n* types, while the switching transistor is a *p-n-p*. The lamps are between the switch transistor and ground.

Other Special Circuits

When the FM signal gets weak in any FM receiver, stereo reception becomes noisy. This is particularly noticeable in an automobile stereo receiver because the moving car is continually changing the location of its antenna, and multipath and other signal effects may become quite annoying. *Motorola* includes a muting system that automatically switches the stereo section to mono reception whenever the main station signal is reduced below a certain level. Fig. 5 shows how this works.

A sample of the i.f. signal is picked off at the third i.f. transistor in the FM receiver. This 10.7-MHz signal is fed to the detector diode, which is the signal-strength-sensing circuit. The amount of i.f. signal determines how much d.c. voltage is developed by the diode rectifier. That d.c. voltage is applied to a switching transistor, the *muting switch*.

In normal operation, when signal strength is adequate for good reception, the voltage developed by the diode is high, and the muting transistor is kept biased off; that is, it does not conduct. When signal strength drops below the desired level, the d.c. voltage developed by the diode drops off. When it gets low enough, it allows the normal bias of the switching transistor to take over and the muting switch is turned on—the transistor conducts. Its conduction grounds one side of the capacitor and that capacitor bypasses to

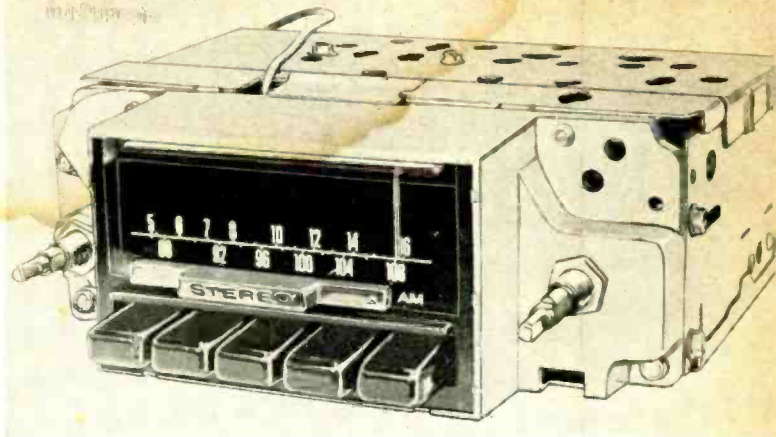

This Bendix AM-FM-FM-stereo radio includes push-button operation.

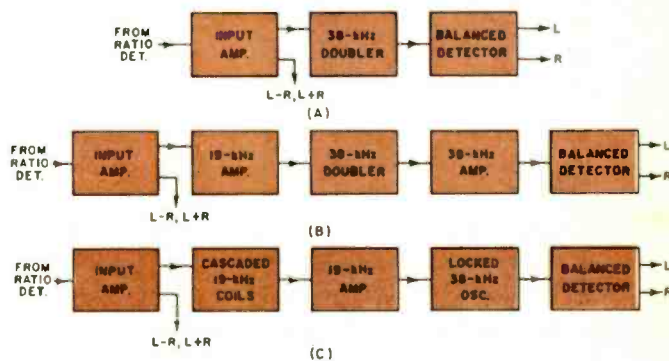

Fig. 3. Handling the 19-kHz pilot signal in (A) *Motorola*, (B) *Bendix*, and (C) *Delco* sets. The sum and difference sideband signals are eventually applied to the balanced detectors.

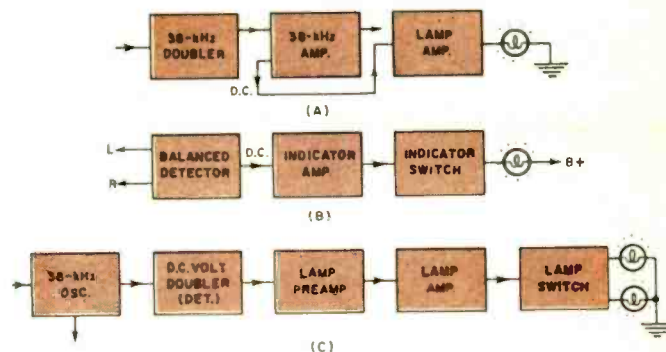

Fig. 4. Stereo indicator-lamp circuit arrangements as employed in the (A) *Bendix*, (B) *Motorola*, and (C) *Delco* sets.

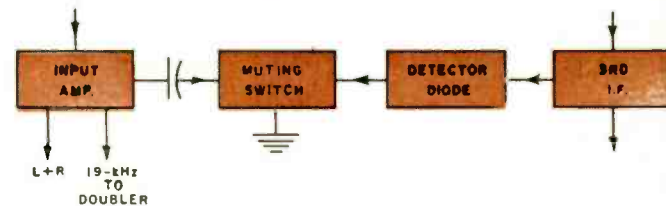

Fig. 5. Muting circuit in *Motorola* switches to mono if the incoming stereo signal becomes too weak for good reception.

ground the 19-kHz pilot-signal output of the input amplifier. This takes all 38-kHz signal away from the balanced detector, and the only signals that can get through it are the $L + R$ signals. The $L - R$ sidebands become just so much r.f. noise that is ignored by the sound stages that follow. By thus eliminating the $L - R$ signal, the muting circuit has effectively switched reception to mono, thus avoiding much of the noise that is inherent in stereo reception with a weak or fading signal.

Something different in the *Delco* set is the use of 38-kHz filters that follow the balanced detector. They are merely a circuit refinement, but should be kept in mind whenever it is necessary to service one of these receivers. They

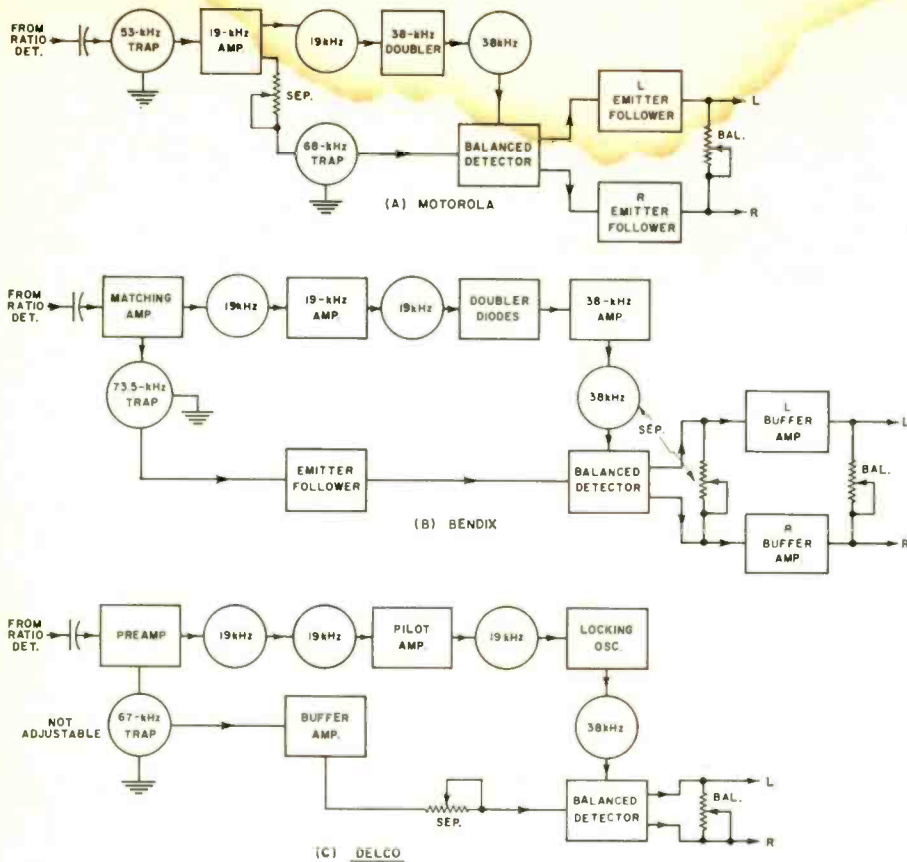

Fig. 6. Block diagrams that include the coil adjustments (the circles) and balance and separation potentiometers. Alignment can be developed from diagrams.

are not adjustable, and are a problem only if one of the internal components becomes defective.

Troubleshooting Auto Stereos

One of the most effective ways to pin down trouble in the stereo section of an auto FM-stereo receiver is to run through a quick alignment, using the signal from an FM-stereo signal generator. First, be very sure that the r.f. and i.f. circuits of the receiver itself are in perfect alignment, because it is impossible to get good stereo reception from a receiver that is improperly aligned.

As you go through the alignment steps, take careful note of any adjustments that don't react properly. They are a clue to trouble. A coil may be shorted if it won't cause a peak on your indicator as you tune the core; an open coil usually disrupts some d.c. supply route and is discovered by the missing operating voltage on its associated transistor. Or, a coil that tunes too broadly or not at all may be a clue to a fault in some associated part. Be alert for signs like these; they can save you a lot of time and hunting.

The essential stages and adjustments in all three major brands have been put in block form in Fig. 6 to make it easy for you to compare them. The circles represent coil adjustments; the variable resistors are the potentiometer adjustments for balance and separation. If you don't happen to have the manufacturer's alignment instructions for the stereo set, you can figure out a pretty competent alignment just from these diagrams. You need only know the best place to connect your meter for indicating the results of the various adjustments.

For example, suppose you want to adjust balance. Use a monophonic audio signal, fed into the input (the capacitor). This should produce equal outputs in the left and right channels. Connect the v.t.v.m., set for a.c. volts, across first one speaker output and then the other, meanwhile adjusting the balance control until both are equal.

The 19-kHz and 38-kHz coils can be peaked for maxi-

mum d.c. indication on a v.t.v.m. connected to the output side of any one of the diodes in the balanced detector. Choose one whose cathode is on the output side, and you'll get a positive d.c. reading. Feed a 19-kHz signal (extremely accurate—crystal-controlled if possible) into the stereo unit at the input capacitor. You can peak all the coil adjustments that are marked 19 kHz or 38 kHz.

For traps, use the same method, but feed in a signal at the trap frequency and then tune the coils for *minimum* d.c. indication on the v.t.v.m. An r.f. generator without modulation can furnish the signal for this and for the 19- and 38-kHz adjustments, in case you don't have an FM-stereo generator handy.

For separation, however, you can't make the adjustment correctly without a stereo-signal generator. Some technicians try to do it with a station signal, but you can never be sure just how much audio signal is supposed to be in each channel. With a stereo generator, the quickest method of adjusting separation is the single-channel maximum-minimum method. Modulate only one channel of the generator—say, the left. Apply the signal to the stereo unit, being sure the generator is supplying the pilot signal. Use the v.t.v.m. across the speaker outputs just as you did

when you checked balance. Adjust the separation control until you get the least signal from the right-channel output. In the *Bendix*, and to a lesser degree in the others, the 38-kHz coil preceding the balanced detector has an effect on separation. In the *Bendix*, it must be adjusted in conjunction with the potentiometer in the input circuit of the buffer amplifiers. Adjust both until signal is maximum in the left channel and minimum in the right.

Although each manufacturer has a set procedure for alignment, you can get by as described here. If you do have the manufacturer's instructions, by all means follow them; the job will be easier and the results better in most cases.

Once you have isolated the trouble to a particular stage or circuit, you can use your d.c. voltmeter to pin down the trouble to a particular transistor or d.c. supply component. Probably the fastest way to check the balanced detector is with an ohmmeter. Unsolder one end of each diode and measure the forward and backward resistances. The ratio of forward resistance to backward resistance should be several-thousand-to-one. Furthermore, *D1* and *D2* (see Fig. 2) should have approximately the same resistances both forward and backward—in other words, they should be closely matched. The same is true of *D3* and *D4*. It is well if all four are closely matched, but that's not imperative.

While the diodes are thus disconnected, it is easy to check the values of each resistor in the circuit without the effects of the diodes making readings difficult to interpret. Just like the rest of the stereo receiver, the balanced detector isn't hard to troubleshoot as long as you understand it and use sensible and logical troubleshooting procedures.

No doubt readers may encounter other FM-stereo radios in automobiles that are different from the ones that were covered in this article. However, by using the same basic troubleshooting and alignment techniques, it should be possible to handle these as well. In any case, a set of service data on the particular radio involved will usually give you all the detailed servicing information you need. ▲

EARLY WARNING SYSTEMS FOR EARTHQUAKES



The tilt in the Cajon Beds near State Highway 138 north of San Bernardino was caused by the San Andreas Fault.

By L. GEORGE LAWRENCE

Seismology is most recent of the geophysical sciences to make extensive use of electronic aids in forecasting earth tremors.

OVER 50,000 quakes shake the earth each year, and almost any one of them can release up to 28×10^{10} kilowatt hours (10^{25} ergs) of destructive power. This is many times the energy of the atom bomb which smashed Hiroshima. Seismology (the scientific study of earthquakes) alone cannot predict earthquakes; even using computers to calculate the probability of quakes from past seismic activity helps little. It is only in recent years, notably since 1965, that parallel advances in electronics and geophysical exploratory techniques have led to the development of a forecasting system. In general, emphasis is being placed on the detection of certain phenomena which occur in rocks prior to an earthquake.

Triggering Mechanism of Quakes

All great earthquakes and the vast majority of small ones are generated by release or decrease of elastic strain in rock. Quakes of this type are called *tectonic* earthquakes. In some of these shocks, there may be as much as two million cubic miles of earth in motion at one time.

Large faults are assumed to have caused one or more past earthquakes, especially those of the tectonic type. Fig. 1 shows how faults generate earthquakes. There are two opposing masses of earth, A and B. Initially, they are pressed together and held in place by friction. However, if one of the regions is strained beyond limits by excessive weight or high pressure, the frictional bond is broken and the mass lets go. In nature, physical forces tend to balance one another. Thus the energy released by the earth's activity will spread rapidly throughout the region—causing additional earth movement as it propagates—until a new state of rest is attained. The largest slip ever measured was in Yakutat, Alaska; it had a displacement of 47 feet. In 1857, lesser slips occurred in the southern segment of the San Andreas Fault system from San Bernardino northward. The

photograph at the top of this page shows the Cajon Beds which were tilted near vertical by fault movements, then eroded into hogbacks.

Quake Prediction Methods

Several countries, notably the United States and Japan, have worked out a plan of earthquake prediction studies. Included are the following categories of investigation: tide movements, geodetic work, tectonics, seismic activity, crustal deformation, geomagnetic work, laboratory research, and computerized data processing. These will be complemented by field patrols and specially equipped survey parties. The electronics phase of the prediction program involves the study of electrical conductivity and piezomagnetism in stressed rock.

In decades past, tedious repetitive use of triangulation and leveling instruments and a multitude of observations

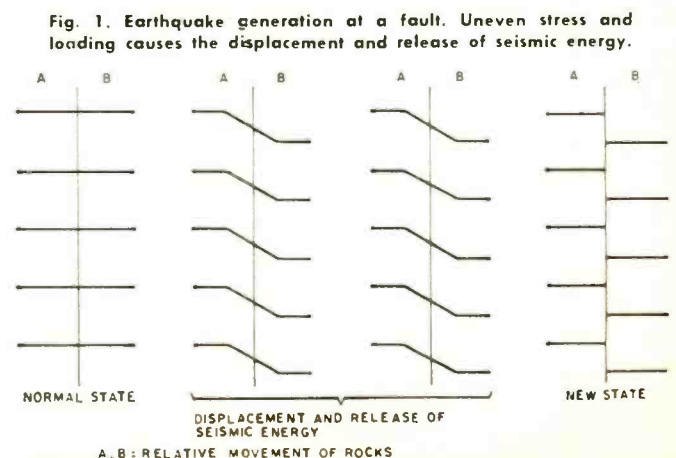

by tiltmeters and extensometers were needed to note changes in earth stress. Until recently, electrical methods were used little, if at all.

Attempts to use "straight" ohmmeters for strain investigations were unsuccessful because natural (telluric) earth currents caused erroneous readings. It wasn't until the development of a.c.-powered ratiometers that it was possible to effectively isolate the instrument.

A Lundberg-type ratiometer is shown in Fig. 2. The unit has a variable ratio-arm a.c. bridge with a provision for phase adjustment. A 500-Hz a.c. signal is injected into the ground between two line electrodes (C1 and C2) a mile or more apart. Three "search" electrodes, P1, P2, P3, are spotted between C1 and C2 to measure potential differences. During the initial set-up, the spacing between electrodes is varied so that the fixed a.c. detector can be balanced and nulled. When the earth's impedance—mainly the resistivity component—changes, the equilibrium breaks

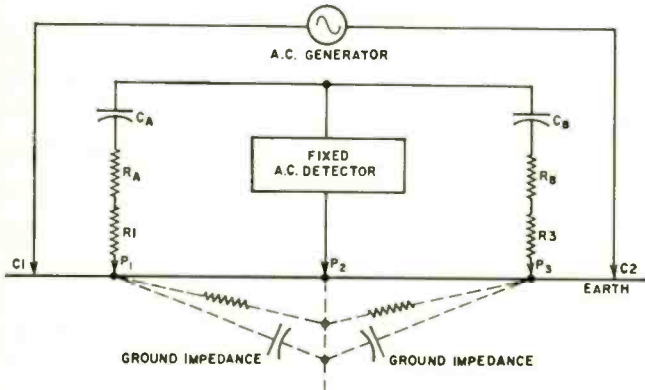

Fig. 2. A Lundberg ratiometer for earth resistivity tests.

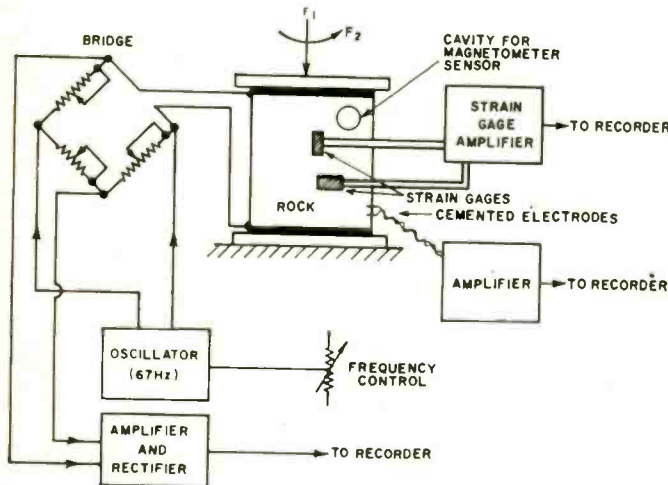
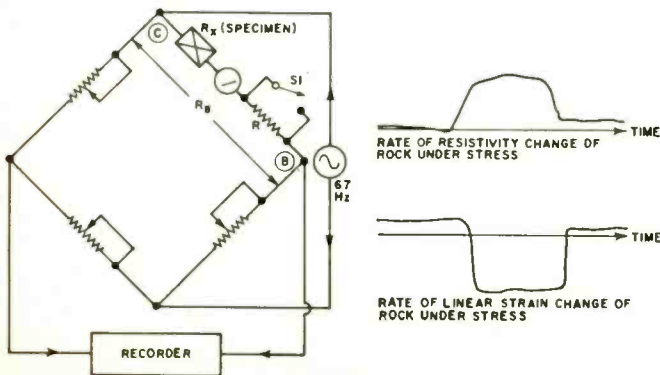

Fig. 3. Equipment for detecting electrical behavior of rocks under compression and torsion. Refer to text for the details.

Fig. 4. Details of the bridge circuit discussed in text. System was developed by Y. Yamazaki of the University of Tokyo.



down and, if an appropriate sensing circuit is employed, the readout can be made proportional to changes in the earth's effective resistance.

I. Yokoyama of the University of Tokyo reported that this method is especially useful in an arid climate. Using this method, he was able to measure earth resistance changes at various phases of the lunar cycle.

Fig. 3 shows the basic equipment needed for simultaneous mechanical and electrical testing of rock. The rock specimen is supported by two iron prisms which are placed on a heavy platform and a compressive force, F_1 , and torsional force, F_2 , applied at the top. Since the specimen is excited by an a.c. signal and equipped with strain gages and contact electrodes, changes in strain patterns and electrical conduction can be recorded.

In a typical laboratory set-up, the rock is a piece about $40 \times 40 \times 65$ millimeters and is excited by a voltage up to 450 V a.c. at 67 Hz. This frequency is chosen to reduce interference from 60-Hz power lines.

In Fig. 4, the bridge circuit is shown in greater detail. The drawing includes the electrical and mechanical profiles of the rock under stress.

A simplified form of resistivity measurement is made possible by assuming that the recorder's pen will deflect a distance D (in millimeters) when the calibration resistance, R , in the previously balanced bridge is shunted by switch, S_1 . Thus the change in resistance required for 1 mm deflection of the recorder's pen is: $(R/R_B) = (1/D)$ where R_B is the resistance between points B and C on the schematic. (R_B is approximately equal to R_X , the resistance of the rock specimen.)

To a large degree, the rate of change of resistivity depends on the rock's water content. In the case of a pumice-tuff specimen, the rate of change of resistivity is from -0.9 to -1.7×10^{-4} ohm per 10^{-4} in strain values for the same sample. These values change from one type of rock to another.

Probably the most promising instrument for earthquake forecasting is the magnetometer. Its purpose is to detect the presence of piezomagnetism in rocks under pre-quake stress.

It is well known that negative and positive charges are balanced in an electrically charged body, and that solid matter consists of arrays of electrically charged particles. When the sample is mechanically deformed, changes occur in the line up of charges at the surface. Certain combinations of symmetry planes and axes, which are characteristic of the various crystal classes, determine the components of applied stress and piezoelectric polarization.

The rock's stress-dependent behavior is known as inverse magnetostriction or piezomagnetism. It arises from the magneto-crystalline anisotropy (the definite polarity) of magnetic minerals, chiefly magnetite, which are present in rocks. A change in stress beneath the earth should, therefore, by virtue of the piezomagnetic effect cause a change in observed geomagnetic field intensities at the surface. Since the intensity is a function of the rock's magnetic susceptibility and remnant magnetization near the earth's Curie point isotherm, it is logical to assume that definite geomagnetic changes should occur in seismically active zones.

Several optically pumped rubidium-vapor magnetometers were installed in the San Andreas Fault in 1965 by Stanford University. On five occasions, from December 1965 to October 1966, small changes in the geomagnetic field were observed. In each case, the changes were followed by creep, or slight dislocations of the fault, and occasionally by earthquakes.

This prompted the installation of other magnetometers south of Hollister, California in late 1966. On April 18, 1967, a decrease in the local magnetic field was observed simultaneously on four instruments positioned over a 16-mile span along the fault. Creep displacement of 4 millimeters occurred 16 hours after the magnetic event; and a series of local earthquakes, the heaviest not exceeding

Richter scale magnitude 3.6, followed on April 20-22, 1967.

Earthquake Magnetometry

The magnitudes of piezomagnetic effects are determined by the magnitudes of stress change, principally the unstressed value and stress dependence of the susceptibility of rock, and other magnetic anomalies.

Usually quake-connected stress changes occur at random. Further, the piezomagnetic effect is small—usually 0.001 to 10 *gammas* (1 *gamma*, γ , equals 1/100,000 oersted/gauss; a common horseshoe magnet, by comparison, has a field intensity of about 1000 oersted/gauss). Therefore, to detect such exceedingly small increments one must use sensitive, high-quality magnetometer instrumentation and be exceedingly careful in making the tests. Further, to make the data meaningful, it is also necessary for the magnetometer operator to maintain contact with one or more of the official geomagnetic observatories operated by the U.S. Coast and Geodetic Survey. This helps prevent erroneous interpretations of data in the case of magnetic storms and/or changes in ionospheric conditions.

The rubidium-vapor magnetometer, together with other types of atomic magnetometers, has the necessary sensitivity for earthquake work. The instrument shown in use in Fig. 5 is diagrammed in Fig. 6.

The sensor head contains a monochromatic rubidium lamp which is focused upon a sample of rubidium in a vapor cell. External magnetic fields, such as the earth's, invoke a change, called the Zeeman effect, in the characteristic absorption frequency of the rubidium vapor. The changes in frequency are proportional to external magnetic-field changes—for rubidium-85, the value is 4.67 Hz per *gamma*.

If a weak r.f. field is applied to the vapor cell perpendicular to an external magnetic field (under measurement), the exciter lamp's light becomes intensity modulated and flickers. The flickering signal is fed back from the photocell to the vapor cell's r.f. coil and the process becomes self-sustaining. Thus detected field intensities may be read as a vapor-cell frequency and transferred as a Larmor frequency (one-half the cyclotron frequency for electron motion in a steady magnetic field)—to a calibrated readout. This particular magnetometer, a *Varian Associates* instrument, is powered from 28 volts d.c. and can use rechargeable storage cells for extended periods of operation.

In-Field Interference

If magnetometers are operated near occupied or abandoned buildings, all ferromagnetic objects, visible or buried, must be removed. As an alternative, the instrument can be removed from the site to avoid "lock-on" to man-made magnetic fields. If the interferences are high, the magnetometer will give only one continuous reading.

Other interferences are anomalous magnetizations in igneous rocks caused by lightning. Sometimes, when a magnetometer is positioned between two different rock specimens in the same outcrop, a scatter in their direction of magnetization can be noted. Investigators should conduct preliminary surveys of the area to be sure the site is suitable for fixed or semi-fixed magnetometer operations. ▲

REFERENCES

- Richter, C. F.: "Elementary Seismology," Freeman, San Francisco, 1958.
 Benioff, H.; Ewing, M.; Howell, B. F., Jr.; and Press, F.: "Contributions in Geophysics", Pergamon Press, London, 1958.
 Breiner, S.: Science, 150, 185 (1965).
 Bullen, K. E.: "An Introduction to the Theory of Seismology", Cambridge University Press, London, 1963.
 Bates, D. R.: "The Planet Earth", 2nd Edition, Pergamon Press, London, 1963.
 Bulletin of the Earthquake Research Institute, University of Tokyo, Maruzen Co., Ltd., Tokyo.
 Eiby, G. A.: "About Earthquakes", Harper & Row, New York, 1957.

Fig. 5. A scientist uses a Varian Assoc. rubidium-vapor magnetometer to make tests of the earth's magnetic field.



Fig. 6. External magnetic fields cause a change of 4.67 Hz per gamma in the absorption frequency of the rubidium vapor. The oscillator's flicker frequency, once begun, is self-sustaining throughout.

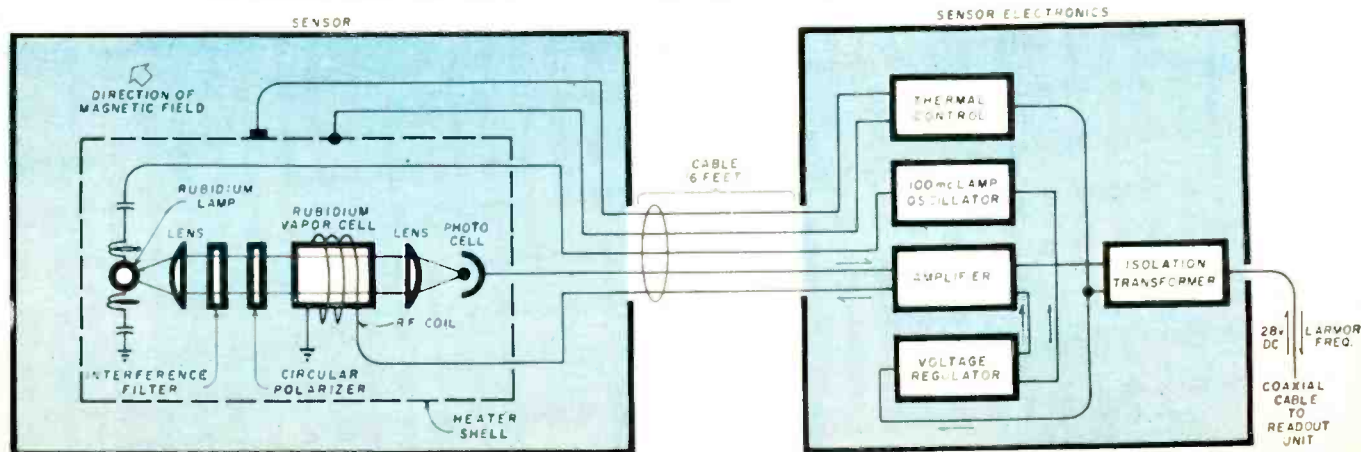



TRADE SECRETS

PICK up almost any Sunday paper and you'll find the classified sections weigh almost half as much as the entire issue. Prominent among the want ads are calls for scientists, engineers, and technicians. Not so evident are the problems these men face when they change jobs.

Job jumping, job stealing, and indeed trade-secret stealing have become almost a way of life in the professional world. Most companies hire personnel because they have need for that person's professional competence. But sometimes the employee's new company is a direct competitor of the organization he is leaving and sometimes it is the possibility that the employee has certain proprietary knowledge (other than his professional skills) which makes him valuable to the new company.

The professional man should know his responsibilities—but often he doesn't, and perhaps an employer should protect his employee—but usually he doesn't. Most employees do not know how to protect themselves. The problem is that when an employee learns his employer's trade secrets, he may, quite innocently, carry these secrets with him to his new job. This frequently results in litigation between the former employer, the employee, and the new employer. The number of legal suits is rising, and more and more employees are being enjoined in the litigation with their corporate employers.

A Matter of Law

The law is very clear. Everyone, be he an engineer or technician, who learns trade secrets from his employer, is legally bound not to disclose such secrets to anyone, including his new employer. Likewise, the new employer is not bound to protect his employee unless there is a contract between them in which the employer agrees to protect, indemnify, and defend the employee against his former employer's charges. Also, the new employer becomes personally liable if he knowingly uses trade secrets brought to him by his new employee. These are matters of law which have been established by legal precedents.

The principle of law can be stated simply: *Every employee is under a legal obligation to preserve his employer's trade secrets learned by him in the course of his employment and not to disclose or divulge them to anyone, including his new employer.* If the employee, innocently or through intent or design, discloses to his new employer the former employer's trade secrets, the former employer has available to him a number of legal remedies. One type of action is a suit by the former employer against the new employer as well as a suit against his former employee for an injunction. In this type of case, the court is empowered to issue an injunction against

use of the trade secrets. Another type of action is against the new employer and the former employee for damages (if the former employer can establish damages). The same liability exists if the former employee goes into business for himself. Since the employer is often well aware of his legal rights and since the employee seldom has a clear idea of what is involved, this article is limited to an analysis of the problem from the standpoint of the employee.

Any analysis of the problem of trade secrets should consider some of the more fundamental questions presented by the subject. These are: (1) What is a trade secret? (2) What are some defenses available to the employee? (3) What can the employee do to protect himself?

The problem is further accentuated by the very widespread belief held by many employers that in hiring a man they are entitled to all of the knowledge acquired by the employee while working for a former employer. Therefore, it is not difficult to see how an employee may, in good faith, be induced to overstep the limits and subject himself to liability.

In recent years a large number of employers, especially in fields of engineering research, have required employees to sign so-called secrecy agreements. These agreements normally refer to patent rights relating to discoveries or inventions developed by the employee in the course of his employment. In this article, no attempt is made to analyze or discuss the legal effect of such agreements insofar as they relate to patents. Many of these agreements, however, also purport to cover trade secrets. The agreement is not a solution because the real problem involved is not whether or not the employee has executed an agreement to preserve trade secrets, but what are the trade secrets which he has agreed to protect. The law imposes upon the employee the same duty of preservation of his employer's trade secrets whether or not he has signed a secrecy agreement. If he has signed such an agreement, it simply gives the employer an added ground for legal action, namely a cause of action based on breach of contract.

What is a Trade Secret?

The Restatement of the law of Torts, *Section 757, Comment b*, defines a trade secret as follows: "A trade secret may consist of any formula, pattern, device or compilation of information which is used in one's business and which gives him an opportunity to obtain an advantage over competitors who do not know or use it." The problem of definition is further accentuated by the language of the courts in dealing with trade secret cases. For example, the courts exclude from protectable trade secrets matters of public knowledge or matters of general knowledge. In an industry where an idea is well

The COURTS and YOU

By MAURICE J. HINDIN / Hindin, McKittrick & Powsner, Attorneys at Law

Scientific and technical personnel moving from one job to another should take particular care to protect their employer's trade secrets. The number of legal suits is rising and more and more employees find themselves caught up in litigation with their corporate employers.



known or readily ascertainable, courts have held that there is no legally recognizable trade secret. Likewise, it is not necessary that a trade secret be a novelty or invention. A good statement of one of the problems is found in the court's opinion in the case of *A.O. Smith Corp. vs Petroleum Iron Works* [73 F. 2d 531 (CA 6)]. In that case the court used the following language:

"A process may, however, be maintained in secrecy and be entitled to equitable protection even though invention is not present. . . . The mere fact that the means by which a discovery is made are obvious, that experimentation which leads from known factors to an ascertainable but presently unknown result may be simple, we think cannot destroy the value of the discovery to one who makes it, or advantage that competitor who by unfair means, or as the beneficiary of a broken faith, obtains the desired knowledge without himself paying the price in labor, money, or machines expended by the discoverer."

The Restatement of the Law of Torts comments on six criteria which may be used to determine whether certain information amounts to a trade secret. In effect, the Restatement says:

" . . . Some factors to be considered in determining whether given information is one's trade secrets are: (1) the extent to which the information is known outside of his business; (2) the extent to which it is known by employees and others involved in his business; (3) the extent of measures taken by him to guard the secrecy of the information; (4) the value of the information to him and to his competitors; (5) the amount of effort or money expended by him in developing the information; (6) the ease or difficulty with which the information could be properly acquired by others."

It's easy to see that it is extremely difficult to establish whether particular information obtained by an employee during the course of his employment does, in fact, encompass his employer's trade secrets. It can require weeks or months of technical expert testimony.

When the cases are analyzed, however, we see that the conduct of the employee has much to do with the relief which the former employer may obtain. Where there is evidence of an employee's bad faith, that is, where there is an apparent desire to take unfair advantage of knowledge he gained from a former employer, the courts have said trade secrets exist. On the other hand, in similar cases the courts have been unwilling to find the existence of a trade secret where the evidence showed the employee has attempted to act fairly and honorably and tried to preserve his former employer's confidences. Two examples of unfair dealings or unfair con-

duct by a former employee are: where an employee has made an exact duplication of his former employer's product or process, or where an employee has taken without permission his former employer's papers or records. Likewise there are cases of an employee being held equally responsible with his new employer because the new employer actively induced the employee to breach his former employer's confidences. (*B.F. Goodrich vs Wohlgenuth*, 192 N.E. 2d 99; *Minnesota Mining & Manufacturing Co. vs Technical Tape Corp.*, 192 N.Y.S. 2d 102.)

Consequently, whenever an engineer or technician moves from one job to another he must in all respects deal with honesty and fairness toward both his old and new employers. Sometimes this is difficult because the new employer is in direct competition with his old boss.

Some Defenses for the Employee

Just because an employee knows his former employer's trade secrets, it does not mean he is automatically in danger. Other factors must be analyzed. The employee is also entitled to the protection of the courts. The principle of law which protects the employer and his trade secrets also has another equally well established concept, that is, an employee may freely compete with his former employer. An additional problem is presented where the former employer has obtained a non-competition agreement with the employee. No attempt is made here to discuss the limitations of such non-competition agreements. The courts have imposed severe limitations and restrictions on the enforceability of such agreements, but they nevertheless do represent a problem of concern and require independent legal analysis. There is usually a limit to the time that the employee can be prevented from competing and generally limit the area of his competitive activities. A good legal discussion about competition and its philosophy can be found in the opinion of the court in the ruling on the *Continental Car-Na-Var Corp. vs Moseley* case (24 Cal. 2d 104, 148 P. 2d 9).

Again, the key to the conflict between the two opposing theories of law is very often the element of the good faith of the employee. To be protected, the competition must be fair competition, and fairness, although often a question of fact, determines whether or not the employee will be enjoined from his new activity or not.

Also, an employer must have considered the item or process a secret before his employee left him. If he did not previously consider the information which his employee acquired a secret, or if he took no reasonable steps to guard it as a secret, then the employee (*Continued on page 74*)

DIAGNOSTIC CLINICS FOR TV SETS

By JOHN T. FRYE

READERS of last month's "Radio & Television News" column learned about a new wrinkle in the TV-service field. They were told that TV owners in some cities can now take their black-and-white or color sets to a diagnostic clinic to get a detailed report on what's wrong and an estimate of the repair costs. Repairs may be done at the diagnostic center or elsewhere, in which case the only charge would be a basic diagnostic fee. The *Tele-Quick Corp.* is now franchising these centers all over the country. Since there are several unusual features about this innovation in TV service, the writer will outline those that may interest a customer, a service technician, or a person interested in acquiring a *Tele-Quick* franchise.

The first thing a customer notices is that, while the owners of the diagnostic centers may be local men, the shops all have the same distinctive sign, their physical arrangements are similar, and their methods of operation are the same. This is true of centers located in New Haven and Indianapolis, Indiana; Clearwater, Florida; Nashville, Tenn.; Gulfport, Miss.; Denver, Colorado; Columbus, Ohio; Baltimore, Maryland; or in probably a half-dozen other cities by the time this article sees print.

Investigation reveals other ways in which a diagnostic center differs from the usual radio and TV service shop. For example, only TV service—no radio or hi-fi work—is performed at a center. Neither is any work done in the customer's home. You bring your set to the center; or, in the case of some centers, a truck will pick up and deliver your television receiver for an additional charge.

Typical Operation

The quickest way to grasp how the centers operate is to take a typical case. Suppose you take your ailing portable TV receiver to the first center that opened. This was on Washington's Birthday, 1967 at 359 Lincoln Highway West,

New Haven, Indiana, just outside Fort Wayne. This is the headquarters of the *Tele-Quick Corporation*.

An attendant carries your receiver inside while you are questioned by the person at the desk regarding the complaint. This information is taken down on a form called a *Tele-Log*. If you have trouble describing the symptoms, you may be shown helpful pictures portraying typical video difficulties. The form is placed in a plastic satchel and this is attached to the set and remains with it during ensuing operations. Your receiver is placed on a wheeled cart and you are invited into a comfortable, carpeted waiting room to watch through a glass partition while your set is checked; or, if you prefer, you can call back for it later. If you do stay, one portion of the service area you will be watching will look like Fig. 2.

Your set is pushed to diagnostic island #1, where an operator removes the back and gives the interior a quick vacuuming to remove loose dust and dirt. Later the set will come back to him for a thorough cleaning and reassembly. Next it goes to island #2. The operator here does not even plug the set in, but he removes and checks every tube. Any bad tubes are placed in the plastic bag and new ones are installed in their place.

The next stop is island #3, shown in Fig. 1. Here is where most of the actual troubleshooting is done by the top man in the shop, called the Coordinating Technician. The island consists of a compact array of service equipment rising above the center of a revolving Lazy Susan type of bench. A TV-carrying cart can be locked to each of the four ports of this bench. This means while one receiver is being checked, three others can be "cooking" as they are monitored for any intermittent irregularities in performance. If something shows up in one of these, that receiver can be immediately turned in front of the technician for intensive testing.

Service equipment at the diagnostic island consists both of instruments of special patented design and of other more or less standard instruments that have been modified. The present version of the diagnostic island—and its design has been an evolutionary process—contains, among other instruments, sweep and marker generators, resistor and capacitor substitution banks, a line monitor, a v.t.v.m., a transistor tester, a color bar and dot generator, a substitute speaker, a flyback checker, an analyst, and a scope of special design. Labeled retractable test prods keep the working area neat.

The coordinating technician follows a prescribed testing procedure outlined in an operations manual. Some *Tele-Quick* advertising claims 67 separate tests are made on every receiver. This thorough procedure is designed to locate not only the primary difficulty about which the cus-



←
Fig. 1. Bench and equipment used by the coordinating technician at one of the troubleshooting islands. In addition to the tools, phone, variable autotransformer for line-voltage adjustment, and special test panel at the lower right, the following pieces of test equipment are installed: resistor decade, capacitor decade, transistor tester, v.t.v.m., monitor speaker, line-voltage meter, TV analyst, oscilloscope, color-bar generator, CRT tester, marker and sweep generators.

Diagnostic centers have been used in medical field for some time, in the auto service area more recently, and are now being introduced to TV service. Here is how such a franchised service operation functions in certain locales.

tomer complained but also any unnoticed secondary troubles that may exist—and to do it in a minimum amount of time.

When the coordinating technician is satisfied he has uncovered all the troubles with the receiver, he writes up an estimate and gives it to the attendant at the desk. The customer is contacted and told what it will cost to repair the receiver if the work is done at the diagnostic center. The estimate is a hard one and will not be exceeded. The customer then has the option of giving the center an okay to repair the set or to pay a diagnostic fee and take the receiver elsewhere to be repaired. Diagnostic fees at the New Haven shop are \$3.50 for a portable, \$4.50 for a console, and \$5.50 for a color set.

If an okay is given, the set goes to the service department that has two islands. One is a duplicate of the diagnostic island. This serves two purposes: the effect of repairs can be immediately checked; and during heavy work loads or in case of difficulty with the equipment at the diagnostic island, this service department island serves as a back-up. The other service department island is manned by a parts-installer who simply removes indicated defective parts and replaces them with new ones.

When the coordinating technician is satisfied proper repairs have been made, the set returns to island #1 for a thorough cleaning, replacement of the back, and a heat run. All defective parts that have been removed are in the plastic satchel for the customer's inspection.

The Franchise Idea

Tele-Quick is chiefly the brainchild of 31-year-old electronic engineer Royce Evans, a graduate of Indiana Tech. While operating his own service shop in New Haven for nine years, he worked out details of the operation and shop-tested his ideas. At first he planned merely to open a chain of service shops, but gradually the franchise idea evolved. The company is incorporated with Royce as president. Pat Boone, the popular television and movie star, is on the board of directors and is a principal in the franchise for the state of Tennessee.

It is not necessary to be a technical person to obtain a franchise. Business management ability is more important. The corporation will help the franchisee (who is granted the franchise) obtain competent technicians, train them in the procedure, and get production going. The company sells him a total equipment package and a parts inventory. They study the floor plan of his building—he must have a minimum of 3000 square feet of floor space—and aid him in fitting their standard setup into this space. They also offer him replacement parts at attractive prices made possible by their volume buying, but he can buy elsewhere if he so chooses.

The franchisee files a weekly report with the parent company and pays a percentage of his gross business to them. They check these reports and make recommendations for increasing their mutual income. A fifteen-page contract clearly sets forth the responsibilities of both corporation and the franchisee. While the company does not undertake to exercise undue control over the franchisee, he is expected to conduct his business so as not to detract from the national

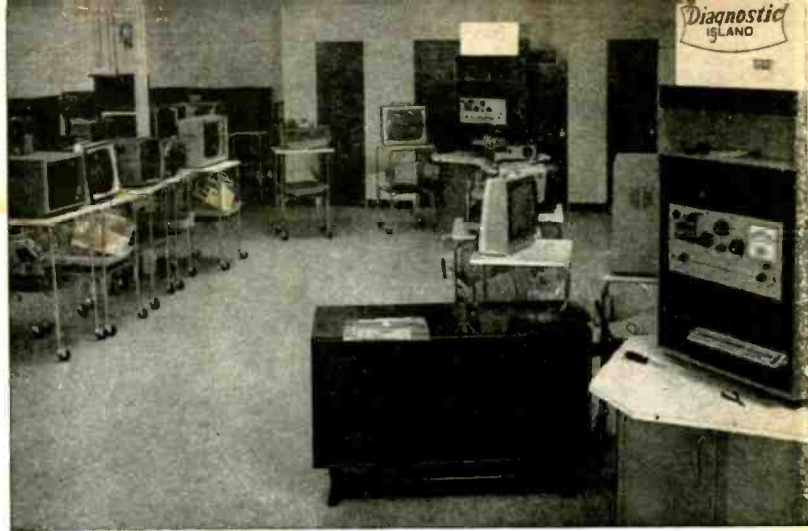

Fig. 2. Partial interior of diagnostic center showing carts that are used to move the portables from island to island.

image of the *Tele-Quick* name. In return, he can expect to receive substantial benefit from national promotion and from the good will engendered by other diagnostic centers. People are expected to seek out the franchised shops in the same way they hunt for *McDonald* hamburger stands, *Dairy Queen* confections, or *Kentucky Fried Chicken*.

Advantages & Personnel

The company claims several advantages for the customer: he knows precisely what it will cost to find what is wrong with his receiver; he does not have to wait several days for service; he is permitted to watch the work being done; and he saves money on service charges because of the reduced overhead and high efficiency of the diagnostic center. Quite obviously this operation is tailored to take advantage of the growing popularity of portable TV receivers. The customer can easily carry these to the shop; they fit neatly on the carts; and most of the troubles they develop yield to a comparatively quick solution.

The service technician reader will understand that the operators of most of the service islands need not be highly trained. Cleaning, checking tubes, and installing parts do not require a great deal of experience or technical background. Only the service coordinator need be a top-flight technician, and the quality of the work turned out by a center will depend in a large degree on the proficiency of this man. The company claims, however, that if the technician will master the step-by-step procedure outlined in its operations manual and follows this faithfully, he will not be nearly so dependent on his experience and technical background as would be the case if he were working in a shop without such guidance.

Royce Evans and Robert Miller, the executive vice-president, impressed the writer with their enthusiasm and ambitious plans. These men see their organization solving many of the problems of the TV service industry. They believe it can relieve the shortage of technicians, upgrade service, and do much to correct the bad image the industry has acquired in some quarters. They hope to see at least a thousand diagnostic centers spread across the United States, taking care of warranty service for big department stores and entering into service contracts with such large-scale TV users as hotels, motels, and hospitals.

As far as can be determined, there has not been any concerted opposition to this operation by individuals or service organizations. In fact, I am told that some service shop owners like to put their "dogs" through the diagnostic centers to find out what is wrong with them in a hurry. They find this cheaper than paying for long-drawn-out troubleshooting by their own technicians.

Be that as it may, *Tele-Quick* is interesting as representing a serious attempt to apply big business organization to the TV service industry. It will bear watching. ▲

IC OP-AMP HI-FI Preamplifier

By DANIEL R. von RECKLINGHAUSEN/Chief Research Engineer, H. H. Scott, Inc.

Technical details on integrated-circuit operational amplifier that is incorporated in the new Scott compact stereo system.

Editor's Note: The operational amplifier is a very high gain direct-coupled circuit using external feedback for control of its response. It commonly uses cascaded differential-amplifier stages around which the compensation or feedback is applied. Following these is a single-ended output section. This particular circuit arrangement is very readily adapted to integrated-circuit construction techniques. For further details, see our articles: "The Operational Amplifier" (August, 1967) and "The Differential Amplifier" (February, 1968).

ONE of the latest devices starting to make inroads in high-fidelity equipment is the operational amplifier. An integrated-circuit version of such a unit is used as the equalized preamp section of the H.H. Scott Series 2500 AM-FM compact stereo system.

Fig. 1. Terminal connections and circuit diagram of a two-channel operational amplifier, all on a single silicon chip.

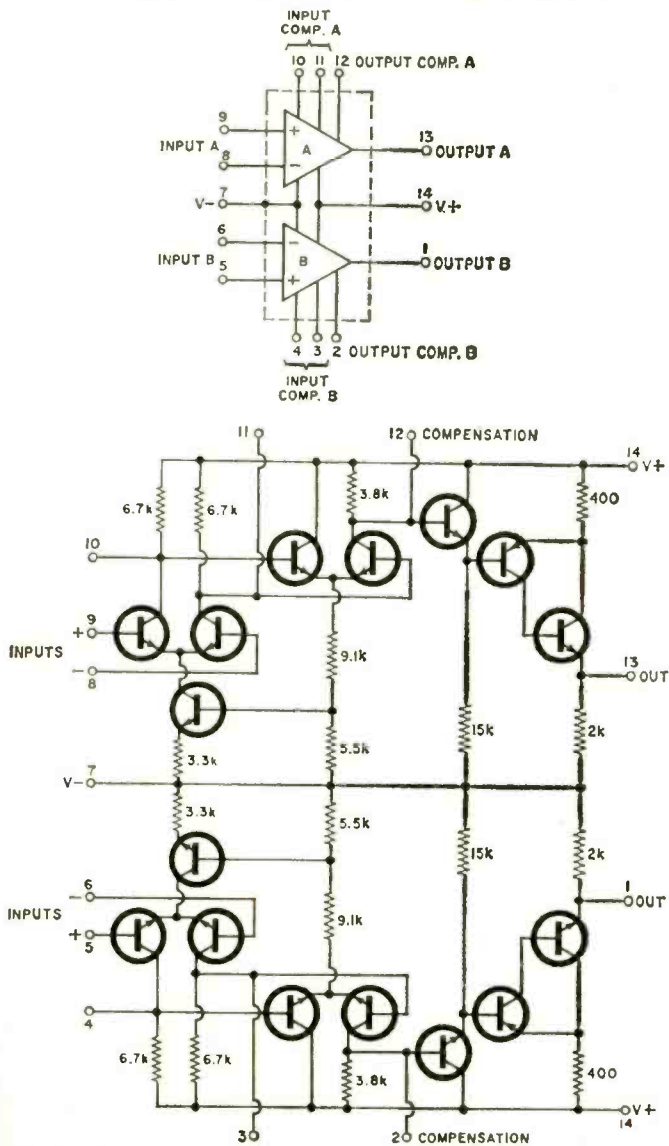

An operational amplifier is really a block of electronic amplification which, with the addition of resistors, capacitors, and perhaps diodes, is used to perform mathematical operations on signals. These operations may be integration, addition, differentiation, subtraction, and level sensing of various analog signals. For these purposes, operational amplifiers have been used extensively in computers and in laboratory and industrial control and measuring equipment where precise measurement and processing of signals are required.

Operational amplifiers may be constructed from a number of matched transistors and resistors. More recently, operational amplifiers have been made as monolithic integrated circuits where the matched transistors and resistors were constructed by the use of transistor and IC manufacturing techniques.

An operational amplifier has a high voltage gain, with 500 to more than 50,000 times amplification depending on the model, and has two inputs and at least one output. One input signal, the one connected to "+" (plus or non-inverting) input terminal will appear as an amplified signal at the output without phase inversion, and the signal applied to the "-" (minus or inverting) input terminal will be amplified exactly as much but with the opposite phase. Furthermore, both inputs have the same impedance. Operational amplifiers are basically d.c. amplifiers with an upper useful frequency limit from 1 to more than 100 MHz depending on the model.

Since both inputs of an operational amplifier have equal gain but result in opposite-phase outputs, the output signal will be the amplified difference of the two input signals. If one of the input signals that is connected to the "-" input is a fixed portion of the output signal (as established with a voltage divider) and the other signal is a normal input, the difference between the two inputs must be equal to the output signal divided by the gain of the operational amplifier. Since the gain of the amplifier is quite large, the two inputs will be almost equal in amplitude and the normal input voltage will be almost equal to the voltage obtained from the voltage divider. Therefore, the gain of this circuit is almost equal to the loss of the voltage divider.

The amplification and frequency response of an operational amplifier circuit is determined primarily by the losses of passive attenuator networks and only secondarily by the characteristics of the amplifier. Since the portion of the output signal fed to the minus input can also be thought of as a feedback signal, any amplifier distortion will be reduced by the amount of feedback used.

All operational amplifiers are subject to certain limitations. For example, the maximum peak-to-peak output voltage swing (at clipping) will be somewhat less than the total power-supply voltage, and the input bias should be adjusted so that symmetrical clipping occurs. Usually, but not necessarily, the d.c. output voltage of the operational amplifier without input signal will be at the midpoint of the power-supply voltage. For this reason, operational amplifiers are often operated from equal "+" and "-" power supplies.

Fig. 1 shows a circuit diagram of an operational ampli-

fier. The two input transistors are connected as an emitter-coupled differential amplifier. Base current of a few microamperes must be supplied externally to produce a bias voltage equal to approximately the midpoint of the power-supply voltage.

The Biasing Problem

Adjustment of bias voltage can be a problem if certain characteristics of operational amplifiers are not recognized. As stated previously, operational amplifiers have a high voltage gain for any difference in voltage between the two inputs. This is the differential-mode voltage gain. If, for example, the differential-mode voltage gain is 10,000 and an output offset voltage of 1 volt is tolerable, the differential input voltage must be kept constant to less than $1/10,000$ of 1 volt or 100 microvolts. In addition, a fixed differential voltage, the input offset voltage, will exist between the two inputs when the output voltage is at its normal midpoint. In an operational amplifier using discrete transistors and resistors, the differential input offset voltage may be as high as 100 millivolts and this will vary with temperature. In monolithic integrated-circuit operational amplifiers, the differential offset voltage is reduced, typically, to 2 millivolts because of very close transistor matching. Even this voltage is larger than tolerable. Therefore, the two inputs of an operational amplifier should never be supplied from one common or two separate bias supplies.

Fortunately, operational amplifiers have much lower amplification for equal signals into both inputs, or common-mode signals. The reduction in gain between differential signals and common-mode signals is the *common-mode rejection*. This is usually between $1/1,000$ and $1/1,000,000$ or less of the differential gain. Consequently, the bias voltage at the inputs may vary more than one volt for an output offset voltage of one volt for this type of operation.

The solution to the biasing problem is to supply the bias voltage and current to the "+" input from a voltage divider between the power-supply terminals, and the bias for the "-" input from the output of the operational amplifier. In this fashion, any bias offset voltage will be amplified and fed back to the "-" input as a correction factor. The more d.c. feedback there is in the bias circuit, the more stable will be the operating point of the amplifier.

One further biasing precaution must be taken. Both inputs of the operational amplifier require bias currents, which are the base currents of the input transistors. Since these transistors are matched, but may require different bias currents from unit to unit, any unequal voltage drop in the bias networks to the two inputs due to the bias currents will cause an undesired input offset voltage. Consequently, it is desirable to keep the d.c. impedance of the bias networks, as measured from the two input terminals, as nearly equal as practical. By doing this, only the differential input offset current (less than $1/2$ the bias current) will cause an input offset voltage.

Use in Audio Circuits

All of these precautions have to be taken into account when using an operational amplifier in audio circuits. Since only audio frequencies and not direct current or voltage need be amplified, full d.c. feedback can be used to stabilize all operating points. However, the filtering time constants of the bias network must be sufficiently long so as not to attenuate the low-frequency response of the amplifier circuit.

Fig. 2 shows these biasing methods in use in a stereo preamplifier circuit. This is a circuit section where large amplification, low noise and distortion, and good gain stability are required. The dual operational amplifier used is similar to the *Motorola MC 1302P* and is enclosed in the 14-lead, dual in-line plastic package—such as typically used in computer circuits.

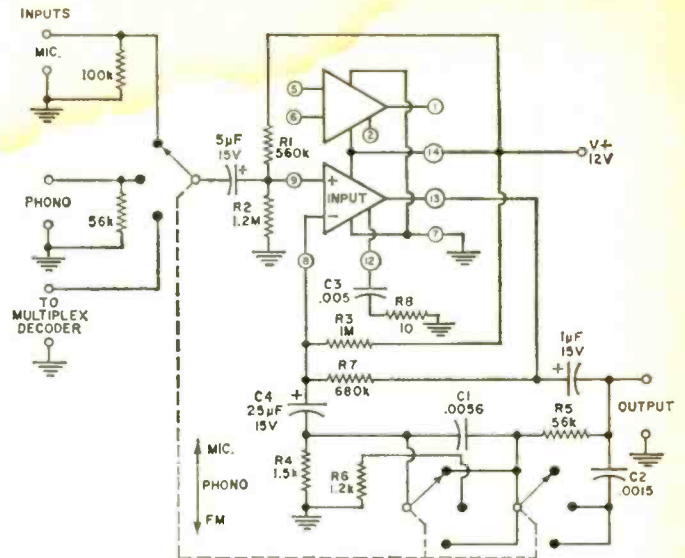

Fig. 2. Use of dual-channel IC operational amplifier as stereo preamp. Although only one channel is shown wired in here, terminals 1, 2, 5, and 6 are hooked up just exactly the same way for the other stereo channel. Note that a single IC is used to handle both stereo channels.

Although operational amplifiers are usually supplied from equal "+" and "-" supplies, a single +12-volt source supplies both amplifiers, used here as stereo preamps. Bias is supplied to the "+" input from a voltage divider ($R1$ and $R2$) which furnishes the typical 1.6-microampere bias current. The d.c. feedback to the "-" input is taken directly from the output through $R7$ and bias current is supplied through $R3$. The d.c. impedance seen by both inputs is approximately 390,000 ohms.

Resistors $R4$ and $R5$ form the voltage divider which determines the low-frequency audio gain of approximately 30 dB in the "Microphone" and "FM" positions of the selector switch. With $R6$ connected in the "Phono" mode, the mid-frequency audio gain becomes 40 dB. Resistors $R4$, $R6$, and $R7$, aside from setting mid-frequency gain and bias, also determine the low-frequency gain with the RIAA equalization curve in the "Phono" mode. Capacitor $C1$ determines the 500-Hz turnover frequency and capacitor $C2$ (together with resistor $R5$), the 75-microsecond roll-off.

Capacitor $C3$ and resistor $R8$ insure that the high-frequency loop gain of the operational amplifier rolls off smoothly in the radio-frequency range for good amplifier stability. Capacitor $C4$ causes a low-frequency roll-off below 8 Hz.

It may be noted that all input and feedback switching is done at d.c. ground level only. This minimizes clicks and transients when switching from one mode to another.

The performance of this monolithic operational amplifier circuit, as used in the audio preamplifier section of the *H.H. Scott Series 2500 AM-FM compact stereo radio-phonographs*, has met all expectations. The gain and frequency response in all modes is limited only by the accuracy of the feedback-network components. The complete preamplifier is capable of producing a maximum output voltage between 2.5 and 3.0 volts r.m.s., which compares well with a calculated value of 2.8 volts. Below clipping, distortion is very low, limited only by test-equipment accuracy. When equalized for RIAA, the equivalent input noise is less than 2 microvolts referred to 1 kHz or 0.2 microvolt at low frequencies. This is comparable to low-noise transistor performance.

The dual operational amplifier and the preamplifier circuit are joint developments of the engineering staffs of *H.H. Scott, Inc.* and *Motorola Semiconductor*. The author wishes to thank all of the individuals involved for their efforts and cooperation.

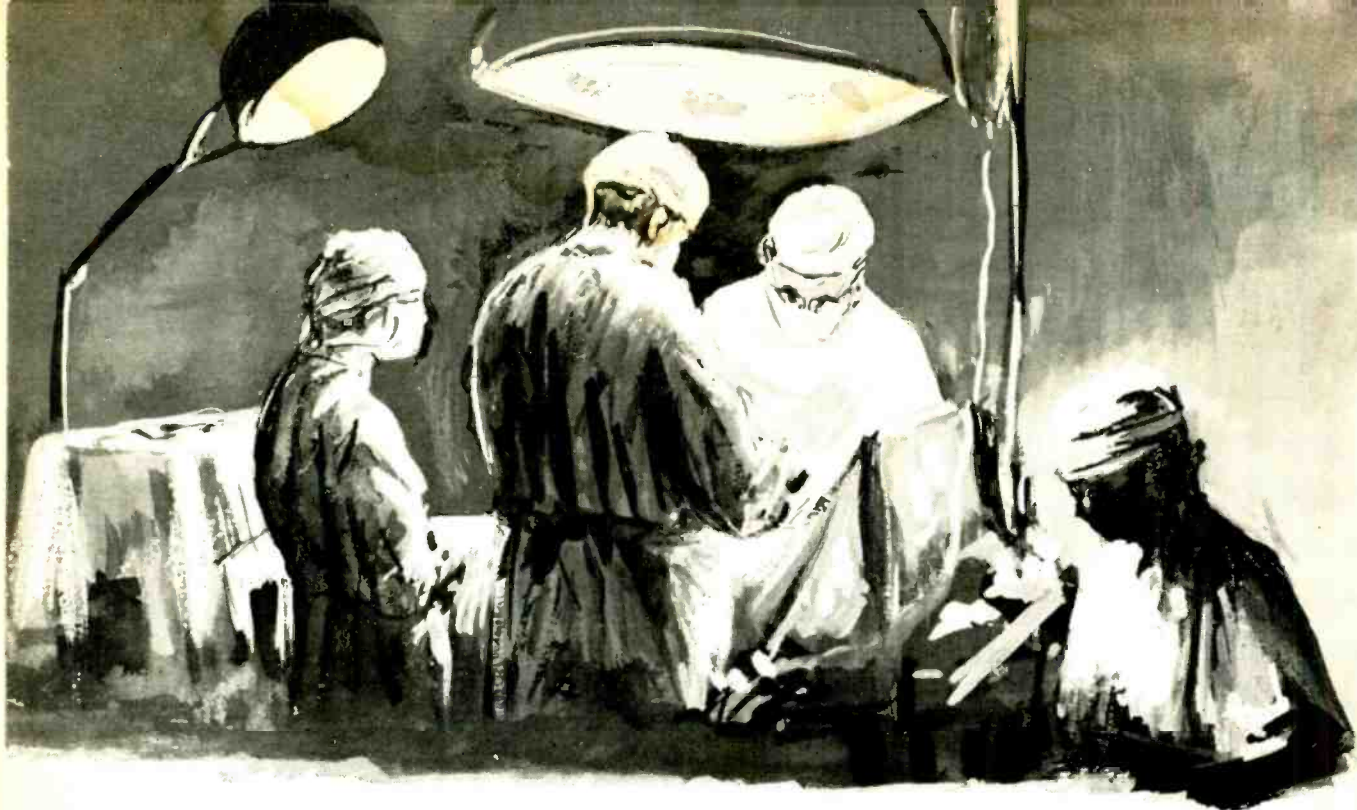

Electronic Implants

By JOHN T. PRENTICE

A new family of devices, medical electronic implants, are helping thousands of people crippled with heart diseases to find a new life.

LIKE a bright sun that suddenly, and without warning, bursts through heavy black clouds, the news that Dr. Christiaan Barnard of South Africa had successfully performed a human heart transplant brought shining new hope to countless thousands of people who suffer crippling heart diseases. But, almost overshadowed by the glow of Dr. Barnard's success, is the new family of devices—the electronic implants—which carry a promise of continued life and health to many thousands of patients who are now disabled or dying.

These medical electronic implants are divided into two groups. In the first group are dynamic devices, that is, those which are designed to become an intrinsic part of a living biological system by assisting or replacing malfunctioning natural organs.

The second group of devices are passive systems which gather, measure, and transmit physiological information for external evaluation and control. Readout systems are an important part of this group.

Dynamic Systems

Medical electronic implants have, without doubt, proven exceptionally helpful to the human heart. In healthy individuals, heart action is fully automatic and does not depend on the nervous system or mechanical implements. However, should the organ's natural electric pacing be impaired, a condition known as *heart block* might occur. This, in turn, can cause Stokes-Adams disease, a condition characterized by decreased cardiac output and increased venous pressure. Dizziness, unconsciousness, convulsions, or death might result if immediate aid is not given.

The best substitute for a failing human heart is an auto-sustaining, self-contained prime mover—such as a fish. Fig. 1 shows a fish harnessed within a cylinder which, theoretically, can be inserted in place of the natural heart. Blood would

start to move through the arterial system once the fish began to swim. (Human blood contains enough oxygen and nutrients to sustain a fish.) Provided the fish maintains an average "speed" of 9 miles per hour, a blood pressure of 150 millimeters of mercury, mandatory for humans, could be realized. *Maximum* blood velocity is 56 milliliters per second or about 11 miles per hour. A nuclear-type pumping mechanism, free from external feeders and requirements, could do the same job. But these and related schemes, while not utterly absurd, are impractical.

A discussion of both "fixed" and "on-demand" electronics-based pacemakers necessarily involves an understanding of electrical events and pulse trains which occur during normal heart action. Fig. 2 shows an electrocardiogram (ECG) and the human heart.

Every time the heart beats, electrical potential changes occur within it. These potentials spread to the surface of the body, and a pair of electrodes positioned almost anywhere on the skin will show potential differences related in *time* to the heartbeat. The electrocardiogram always looks like Fig. 2A. Other potentials, primarily d.c. skin potentials and action potentials of nerves and muscle fibers, can be eliminated by suitable canceling circuits incorporated in the electrocardiograph's circuitry. Specific data, normal to human electrocardiogram patterns, is given in Table 1. Thus, the ECG helps determine the heart's dynamic functions with considerable precision and is a major aid in designing electronic pacing devices.

When conditions indicate a need for artificial pacing, a suitable implant is prepared and readied for use. The surgeon performs a *thoracotomy* and the heart is exposed. The pacemaker is then implanted beneath the skin in the lower abdomen or left chest and the electrodes are tunneled, inside the body, up to the thorax where they are passed into the thoracic cavity and carefully sutured into the heart.

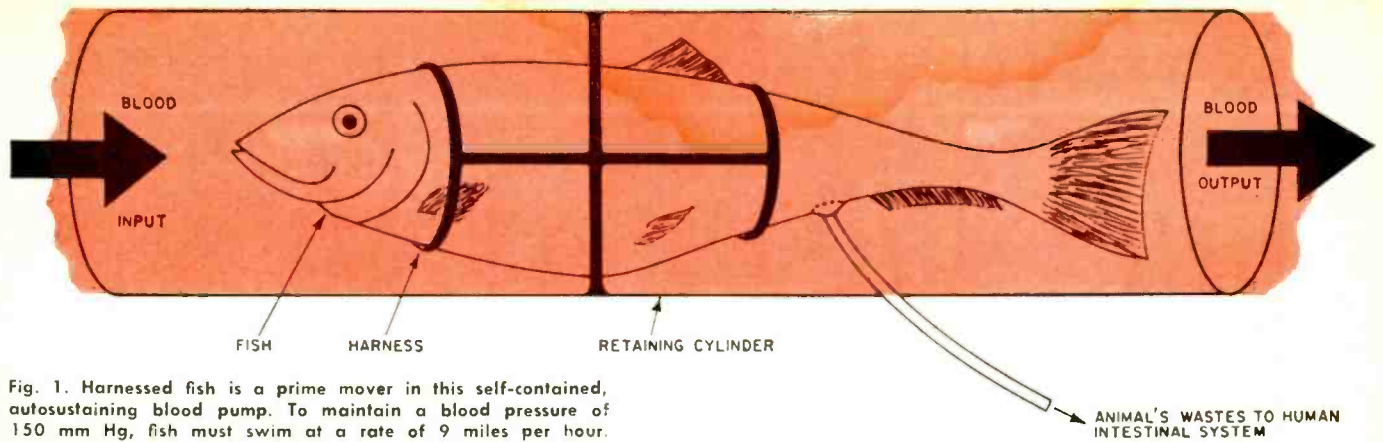

Fig. 1. Harnessed fish is a prime mover in this self-contained, autosustaining blood pump. To maintain a blood pressure of 150 mm Hg, fish must swim at a rate of 9 miles per hour.

Figs. 3 and 4 show pacemakers with fixed pacing rates. Due to the sensing of reference signals, the "on-demand" pacemakers, described below, are more complex.

A typical pacemaker has these characteristics: constant amplitude of 4-V peak-to-peak independent of changes in muscle impedance; constant 1.6-ms pulse; controlled pulse rate (60 ppm, ± 6 ppm/ $^{\circ}$ C). It might weigh about 30 grams and measure $40 \times 25 \times 13$ millimeters and have an effective service life of five years.

The circuit of Fig. 3 is an adjustable-speed, free-running relaxation oscillator. Prior to implantation the speed is controlled by means of potentiometer R1. Effective pulse length is determined by C1-R2-R5. The unit shown in Fig. 4 contains only eight discrete components and features a simple blocking oscillator which generates a very low-power pulse for triggering transistor Q2. The latter acts as a switch to short out a capacitor charged by the 8-volt power supply. The capacitor, C2, delivers a 1-ms pulse to the output electrode.

The wave and shape of the pulse are *biphasic*, that is, the pulse has positive and negative peaks. The peaks are not symmetrical, but the areas under both curves are of equal size. The net result is that electrons are not transferred from the electrode into the tissue. This reduces the possibility of tissue injury from overstimulation.

Slow impulse rates, rather than high- and slow-speed pacing, are preferred. The slower rate provides for longer coronary filling periods, which is an advantage to patients with coronary artery disease. Further, in case of pacemaker failure, ventricular recovery is more rapid.

Piezoelectric Pacemakers

Since traditional pacemakers get their energy from chemical-type power sources (batteries), efforts are being made to eliminate this highly critical component. An experimental design, already tested on dogs, features a *piezoelectric* generator which can be started by massage.

The circuit is shown in Fig. 5. The power source is a lead-zirconate-titanate crystal mechanically tied to the heart to convert muscular contractions into electricity. The pulsating current is rectified, stored, zener-regulated, and fed to a unijunction transistor and amplifier. C1 determines the UJT's pulse rate. The final pacing pulse is taken off across Q2's collector resistor and fed to the left ventricle.

"On-Demand" Pacemakers

From a technical point of view, the advantages of fixed-rate electronic pacing systems are considerable. Simplicity and long-term reliability are outstanding features. However, problems arise if an ailing heart, normally aided by a fixed-rate pacemaker, suddenly returns to a normal sinus rhythm. This return is not usually permanent and the patient continues to need his implanted aid because the possibility of an Adams-Stokes attack is still an ever-present threat.

The design of "on-demand" pacemakers is best understood,

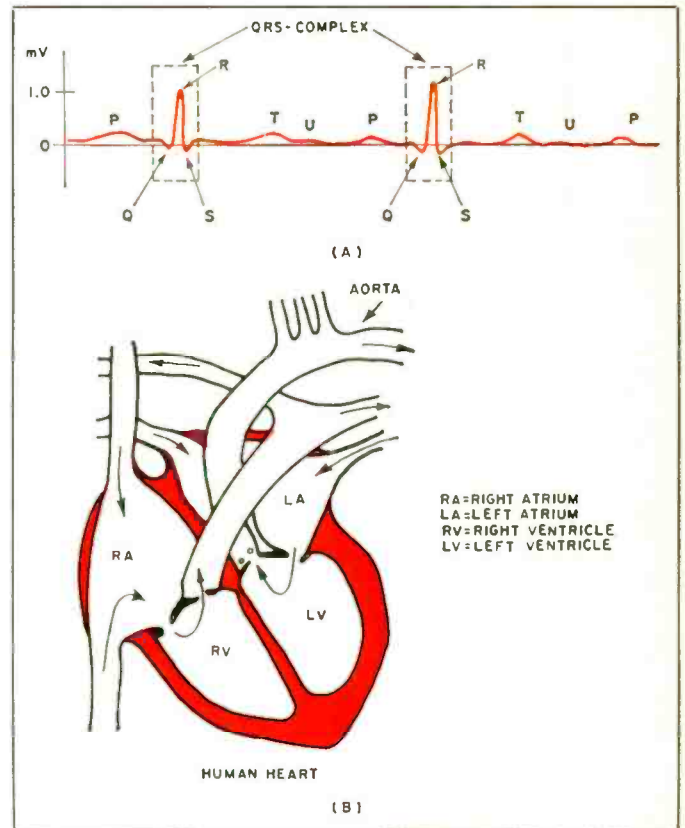

Fig. 2. In a typical electrocardiogram (A), P-wave occurs just before the heart's auricular contraction. The QRS-complex is at the start and the T-wave follows ventricular contraction. Lower drawing (B) illustrates the heart's physical characteristics.

Table 1. Potentials and intervals of an electrocardiogram pattern.

ECG Interval	Millivolts	Duration (seconds)	Relationship to Heart Cycle
P	0.1	0.008	Precedes auricular contraction by about 0.02 sec.
P-Q	0.0	0.15-0.20	Auriculoventricular delay time
Q	0.1	0.04-0.08	—
R	1.0	0.04-0.08	Precedes ventricular contraction
S	0.1	—	—
S-T	0.0	0.1-0.25	Ventricular ejection
T	0.1	0.1	Follows ventricular relaxation
T-P	0.0	0.3	Diastole (chambers fill with blood)

perhaps, by referring back to Fig. 2 and the QRS-complex. The illustration shows a specific power peak. Between these peak times, the heart is particularly vulnerable and artificial triggering (with an electronic pacemaker) can provoke repetitive firings and/or ventricular fibrillation. This is a very dangerous condition and can be lethal if not remedied at once. It is to this end, then, that the pacemaker is inhibited from emitting a pacing pulse during the vulnerable period. The vulnerable period starts about 250-300 ms ahead of the QRS-complex and lasts for 20 to 40 ms. ECG potentials must be carefully evaluated before installing an "on-demand" pacemaker.

Fig. 6 shows the "on-demand" pacing profiles. The instrument's basic circuitry is diagrammed in Fig. 7.

A reference potential, principally R-waves, is picked up in the abdominal region. Their potential causes the switching amplifier to clamp capacitor C to the potential E1 (Fig. 6) for about 30 ms. The value of E1 is established by po-

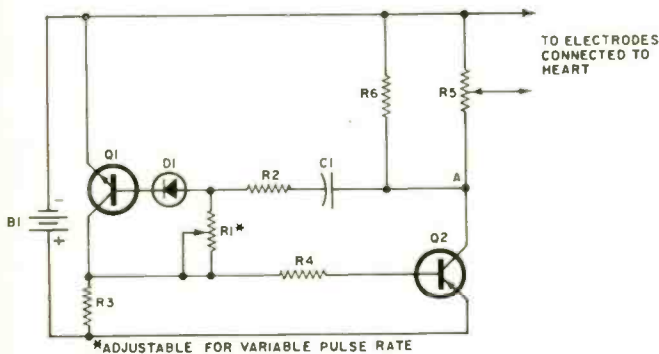

Fig. 3. The frequency of the free-running cardiac pacemaker can be manually adjusted by potentiometer R1. R5 controls pulse length.

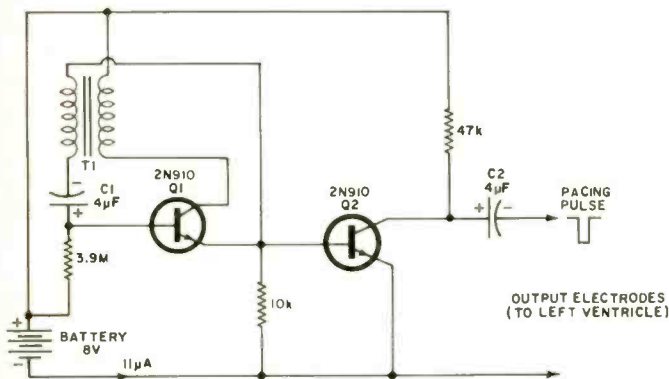

Fig. 4. Simple 8-component pacemaker features TV-type blocking oscillator. Q2 acts as the discharge switch for capacitor C2.

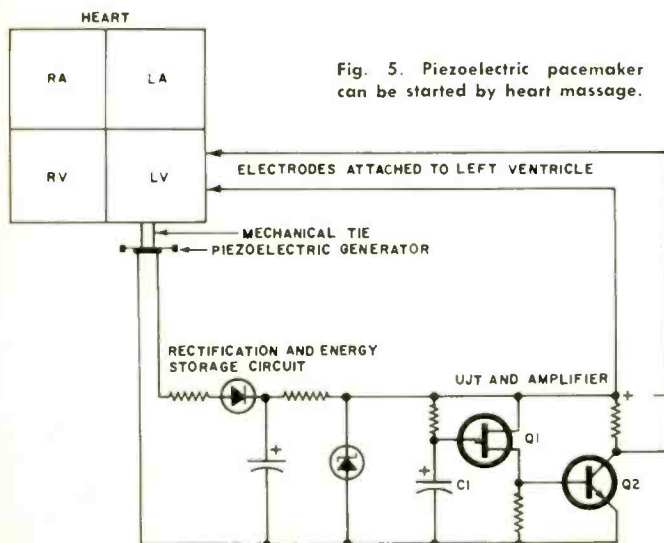

Fig. 5. Piezoelectric pacemaker can be started by heart massage.

tentiometer P. The refractory (or "break-away") time of the pacemaker, measured from R-wave to the stimulating pulse, can be fixed independently of the generator's frequency by varying potential E2.

Circuits like that of Fig. 7 are usually proprietary because of the costly research involved. But in these and similar designs artificial pacing starts immediately after the disappearance of the heart's spontaneous activity, but stops once the activity resumes. Usually the circuit is inhibited from generating pacing pulses earlier than 0.5 second after the QRS-complex. Devices of this type are not small, and improvements in both electronics and packaging are needed to make them clinically acceptable.

Quasi-Dynamic & Passive Implants

Electronic implants can also help people with urinary weakness, particularly incontinence. Unfortunately, the mechanism governing micturition in normal individuals is not fully understood.

Experimental implants, designed to overcome this very embarrassing physiological handicap, consist of stainless-steel electrodes inserted beneath the skin on each side of the bladder-urethra junction. A coil, also implanted, is energized by a 1-MHz signal from an external coil connected to the r.f. generator. Working at an energy level of about 400 µW, the stimulus takes the form of pulses of 1 to 3 ms duration, and a 4-volt monophasic pulse with a repetition frequency of 10 pulses per second. In many cases, the treatment has been effective and has significantly strengthened the weakened physiological mechanism.

The previously mentioned implants can be supplemented to some degree by relatively passive devices.

Medical electronic implants of the passive variety have, by and large, measurement (Continued on page 75)

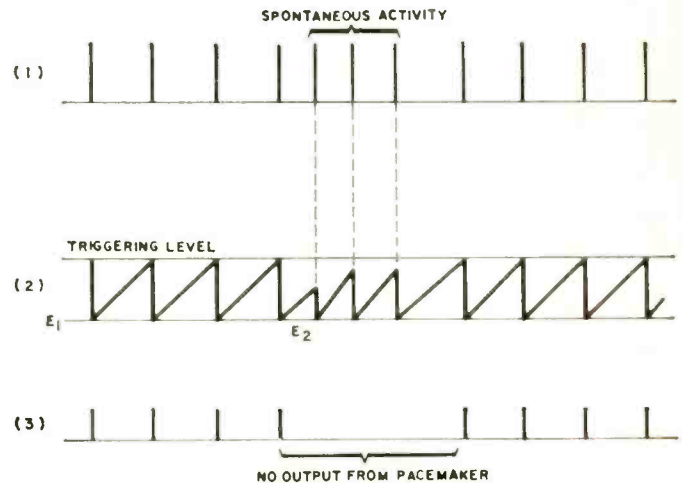
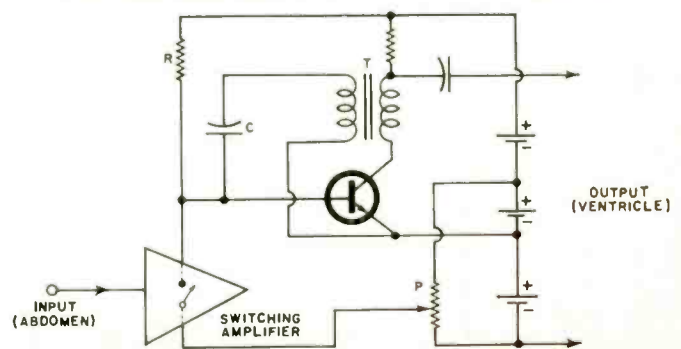

Fig. 6. Refer back to Fig. 2. Line 1 is the evaluated potential from the ECG. In line 2, the "on-demand" pacing profile is related to the QRS complex. Notice during periods of spontaneous heart activity, pacemaker output (line 3) is silent.

Fig. 7. R-waves during QRS complex energize switching amplifier and clamp capacitor C to a predetermined potential.



ELECTRONIC MEASUREMENTS USING STATISTICAL TECHNIQUES

By SIDNEY L. SILVER

Many physical phenomena produce nonperiodic, random signals that must be analyzed by a statistical study of their average characteristics. Examples include thermal and shot noise, static interference, irregular mechanical stresses, or vibration. Techniques used are probability density, distribution correlation, spectral analysis.

IN many branches of applied science and engineering, there occur problems involving the measurement of physical quantities whose solution depends upon the proper interpretation of the relative amplitude, phase, and frequency characteristics of complex waveforms. Harmonic functions, for example, produce data which may be separated into simple periodic waveshapes in order to determine the various frequency components and their energy distribution. Such quantities are said to be "deterministic" since their instantaneous values can easily be predicted as a function of time.

In practice, however, many physical phenomena produce non-periodic or random information, which can best be defined in statistical terms. These quantities are described as "probabilistic" since their instantaneous amplitudes cannot be predicted with complete certainty at any future period of time. Instead, they must be analyzed by making a statistical study of their average characteristics over a specific time interval.

Typical examples of measurable quantities which produce random data are temperature fluctuations in an industrial control process, noise and vibration from high-power jet and rocket engines, buffeting forces on an aircraft at gust wind velocities, acoustic pressures generated by turbulent air, motion of a structure caused by seismic excitation, stresses of a stabilized ship exposed to rough ocean waves, static interference in communications systems due to atmospheric disturbances, shot noise in a vacuum tube, and thermal noise in a resistor.

Characteristics of Random Waveforms

To demonstrate the nature of a random process, the voltage-time history of a number of random-noise generators of identical design and construction is plotted on a chart recorder (Fig. 1). For convenience, the mean value of each waveform is arbitrarily chosen to be zero. By operating all generators simultaneously the collection, or ensemble, of sample records is observed to fluctuate erratically, each waveform representing only one of many possible occurrences. Clearly each observation of the instantaneous magnitudes is a unique phenomenon, since the waveshapes never exactly recur in a finite time period. Any attempt to make a precise, detailed analysis of the fluctuations by observing previous values would be meaningless.

Theoretically a thoroughly accurate implementation of the random process would involve an infinite number of sample records over an infinite time period. In practice, however, only a finite number of noise generators need be considered, since the long-term average characteristics of the amplitude values remain unchanged by any additional noise sources. By applying statistical concepts to the measurement of these random signals, it is possible to quantitatively describe them by computing the integrated values

of the waveforms over a predetermined interval of time. Some of the apparent statistical variations can then be determined and a reasonably accurate estimate of the future values easily obtained.

If the statistical properties of an ensemble (of sufficient length) do not vary with time, the ensemble is said to be stationary. This implies that the mean value, the ampli-

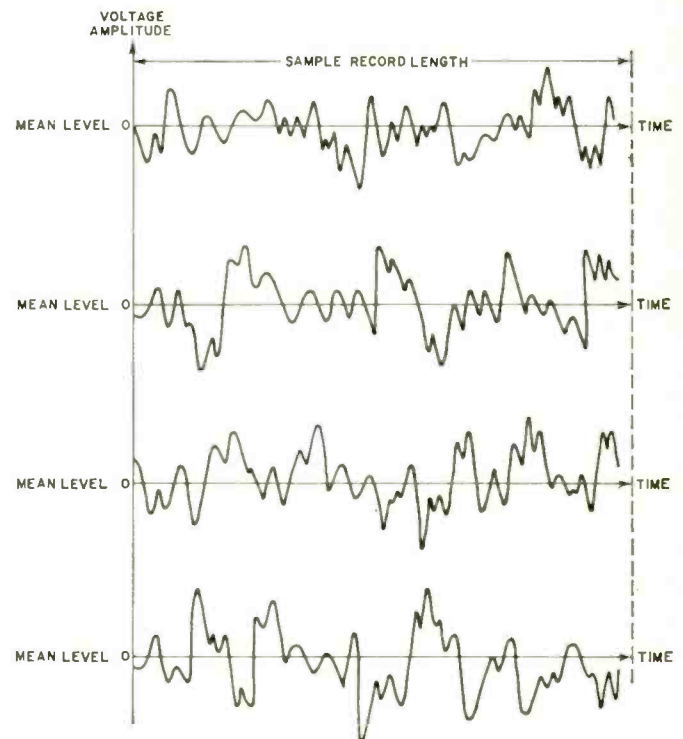
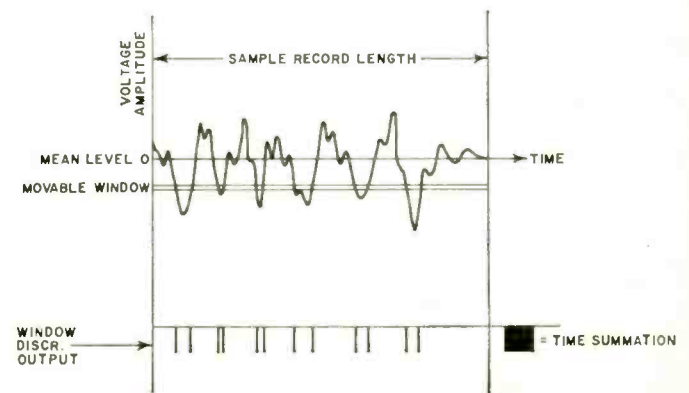

Fig. 1. Volts-time history of random data from 4 noise generators.

Fig. 2. A graphic determination of probability density function.



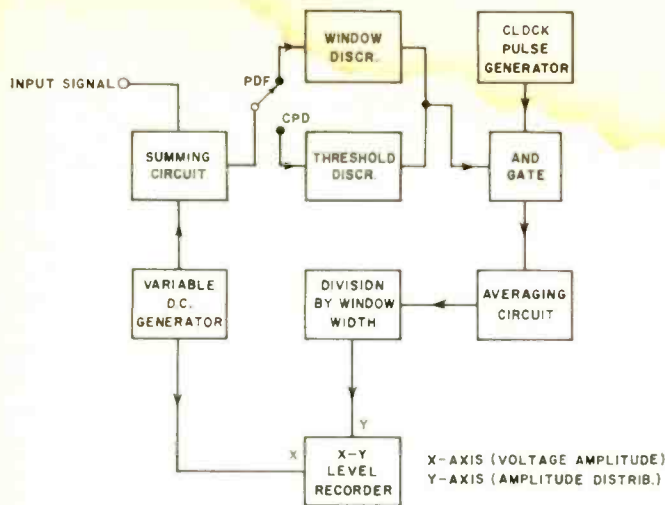

Fig. 3. Amplitude distribution analyzer measures the probability density and cumulative probability distribution

tude distribution about the mean value, the number of peaks per unit time, and the predominant frequencies, if any, of the collection of sample records is the same. In this article, reference will be made only to those stationary random phenomena with *ergodic* properties, *i.e.*, where the time average of a single sample record is equal to the corresponding ensemble average value, thus leading to the same statistical results. Fortunately, most statistical phenomena are generally ergodic so that such random data can be properly measured from a single sample record.

In the electronic measurement of random information, there are three domains in which the statistical parameters may be processed: amplitude domain (probability density and distribution), time domain (correlation), and frequency domain (spectral analysis). Any of these can be implemented through analog or digital techniques.

Amplitude Domain Measurement

An important means of characterizing random data in the amplitude domain is the probability density function (PDF), which describes the probability that the waveform amplitude will assume a value within some specified range of values at any interval of time.

Initially, the quantity to be analyzed is picked up by a suitable transducer which converts the original signal into electrical form. The computation of the PDF is most conveniently accomplished by recording a sample of the signal on a magnetic tape loop. During the playback mode, the signal is continuously compared with a reference level, or "window", discriminator which "slices" the sample record into a very narrow amplitude range (Fig. 2), thus allowing only that portion of the signal to pass through the system. The signal waveform is then integrated over the time the signal spends within the amplitude window. At the end of each tape revolution, the integrated signal is plotted and the window voltage is moved one incremental step before the next integration cycle begins. This process continues until the scanning band sweeps the entire amplitude range of the input signal, producing a graphic representation of the amplitude distribution curve.

A functional block diagram of a typical amplitude distribution analyzer is shown in Fig. 3. In the PDF mode of operation, the input signal is mixed with a variable d.c. potential. This provides a bias voltage which allows different levels of the waveform to be sampled by the window discriminator, and simultaneously shifts the X-axis of the graphic recorder. Each time the instantaneous value of the signal falls within the limits of the window, the *and* gate opens and passes 1-MHz clock pulses to the averaging circuit. By this means, a measure of the total number of pulses passed by the window circuit is obtained, expressed as a percentage of the total number of pulses generated.

The time average may be obtained either by a true integrator (consisting of an operational amplifier with feedback capacitor), or by a low-pass RC filter which continuously smoothes the amplitude fluctuations. In general, true averaging is employed when the scanning process is accomplished in discrete steps (stepped scan), and RC averaging employed when a continuous scan sweeps the window. Finally, the required division of the average sampling time by the window width (fixed amplitude window voltage) yields the probability density function. Applying this parameter to the Y-axis of the level recorder produces a plot of PDF vs voltage amplitude.

Fig. 4 shows a normal, or "Gaussian", PDF curve which is frequently encountered in random data measurement. Here the higher portions of the symmetrical curve correspond to the region where most of the input signal values occur, while the lower sections indicate values which rarely occur. The area of the curve is based on a scale of unity (or 100%), so that any given area under the curve may be expressed in terms of a percentage of all values represented

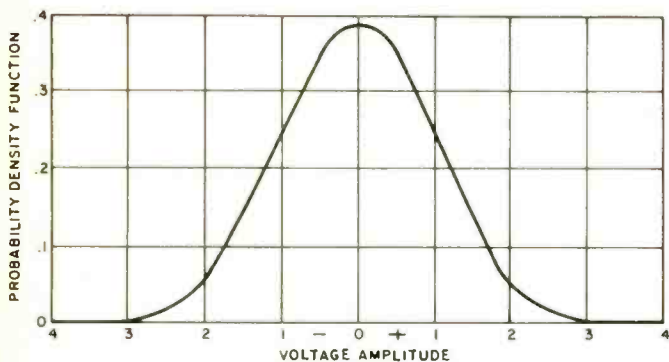

Fig. 4. A normal probability density function curve.

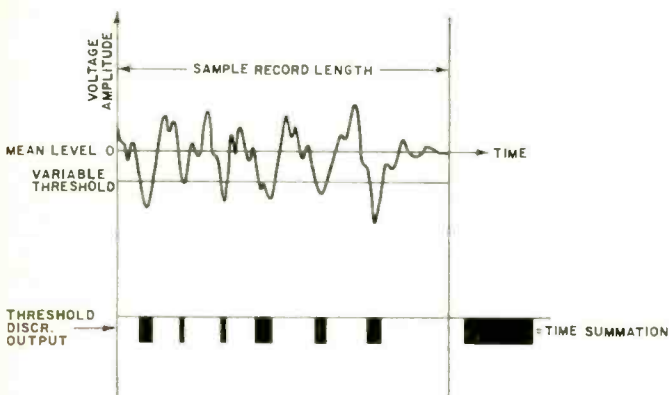

Fig. 5. Evaluation of cumulative probability distribution.

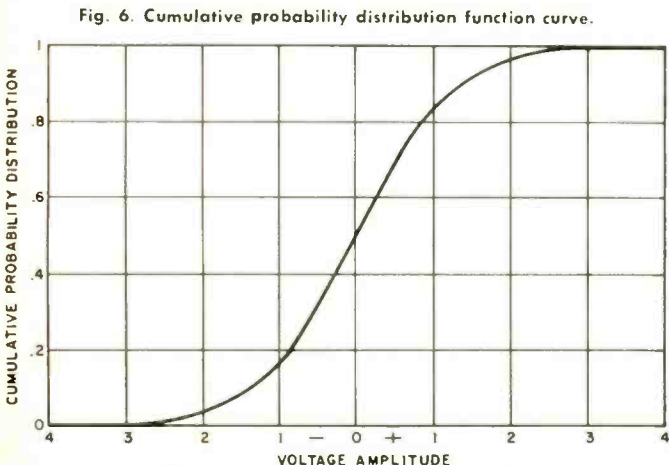

Fig. 6. Cumulative probability distribution function curve.

by the entire curve. Thus, for example, the probability that the instantaneous amplitude values of the input lie within a range bounded by zero and +3 volts, is 50%.

An alternate method of evaluating the amplitude distribution of a random waveform is a measure of the "cumulative probability distribution" (CPD), which contains the same information as the density function but presents it in a different form. The value of the CPD function is defined as the probability that the input signal is equal to, or below, a given amplitude.

In this mode of operation, one of the two thresholds of the window discriminator shown in Fig. 3 is eliminated, thus extending the amplitude slice to include all of the magnitudes that are less than, or equal to, the remaining threshold. Initially, the reference level is set below the maximum negative value of the sample record to be examined. As the threshold voltage sweeps upward from negative to positive values (Fig. 5), an increasing portion of the input signal will lie below the reference level. By comparing the proportion of time that the signal falls below the threshold to the total sampling time, a plot of the CPD-function vs voltage amplitude is automatically produced (Fig. 6). At the completion of the scanning process, the entire signal waveform lies below the reference level and the integrated output is considered to be 100%.

The principal applications for amplitude distribution measurements include the determination of threshold levels in mechanical stress analysis, detection of non-linear structural characteristics, surface and thickness instrumentation, and testing for normality of random data.

The Domain Measurement

One of the most powerful techniques used to describe the properties of random fluctuations in the time domain is the correlation function. The correlation concept determines the extent to which a future value of a random quantity will be the same as preset value of that quantity. By establishing a measure of similarity between two waveforms, or by determining the influence of one signal upon another, a quantitative analysis of the degree of randomness may be obtained.

An important parameter employed in the computation of random data is the "autocorrelation function" (ACF). This quantity refers to the dependency of a random signal upon a time-shifted version of itself, and provides a convenient means of determining the presence of a periodic signal obscured in a background of random noise. To implement this process, it is necessary to delay the random signal by a variable time displacement, multiply the signal value at any instant by the value preceding the delay time, and finally average the instantaneous product value over the total time of the sample record.

Fig. 7 shows a typical ACF analyzer which operates in conjunction with a special-purpose instrumentation tape recorder. In this arrangement, a time sample of the signal to be analyzed is recorded on a magnetic tape loop, and fed to a time-delay generator to provide the necessary lag time. The variable time displacement is obtained by means of a movable playback head which automatically advances one small step for each revolution of the tape loop. Both the input and the output of the delay generator are then multiplied and time-averaged so that at the end of each integration cycle, the output appears as a series of discrete points on the curve. In some instruments, correlation values are measured while the delay time is continuously varied through the time displacement of interest, so that a continuous output curve is obtained. The sample record is recirculated until the information at each time delay is completely scanned and a graph of ACF vs time displacement is plotted on the X-Y recorder.

Fig. 8 shows an ACF plot, called an "autocorrelogram", which is typical of wide-band random noise. Assuming that

the curve is plotted on positive and negative delay values, the graph is observed to be a sharply peaked symmetrical pulse which reaches a maximum value at zero time delay. The pulse then diminished to very low values until the correlation function reaches zero at large time delays.

In order to interpret the form of the ACF curve, the relationship among the time-displaced versions of the input waveform is given in Fig. 9. At zero delay time, the random fluctuations applied to each input of the multiplier are in-phase. Since each positive and negative ordinate in

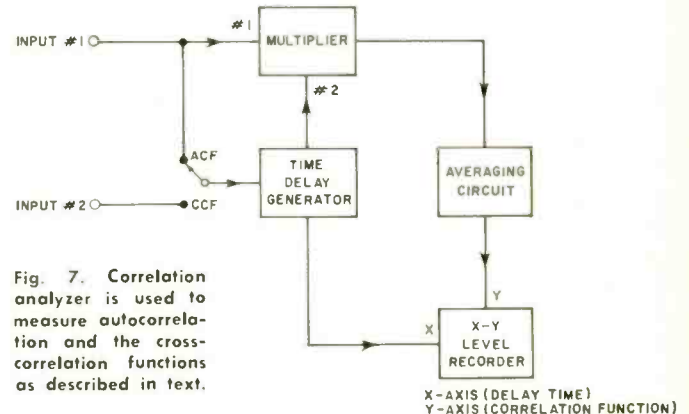

Fig. 7. Correlation analyzer is used to measure autocorrelation and the cross-correlation functions as described in text.

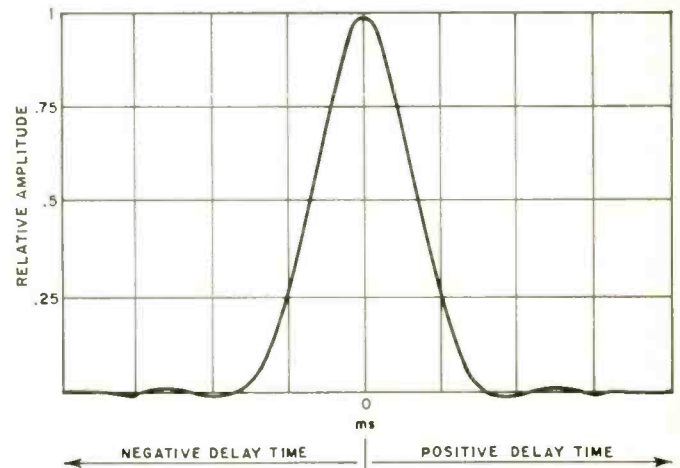
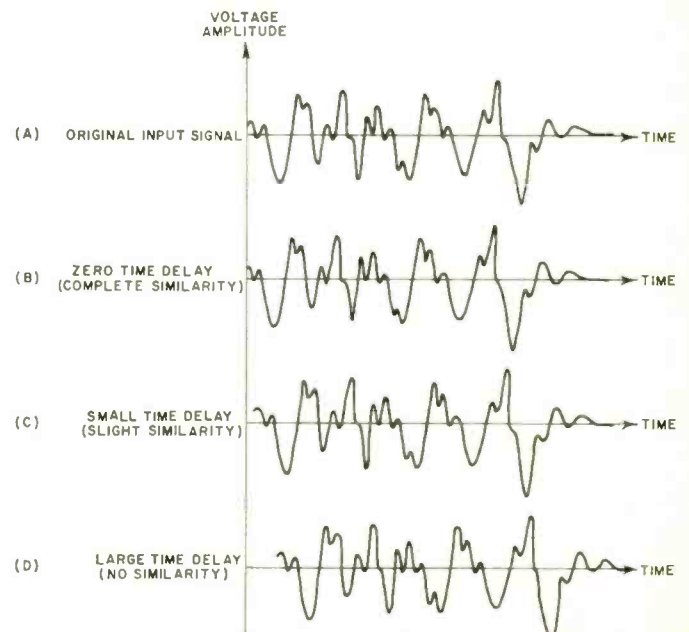

Fig. 8. Autocorrelation function of wide-band random noise.

Fig. 9. Time-shifting of the sample record during autocorrelation scanning process to assess degree of similarity.



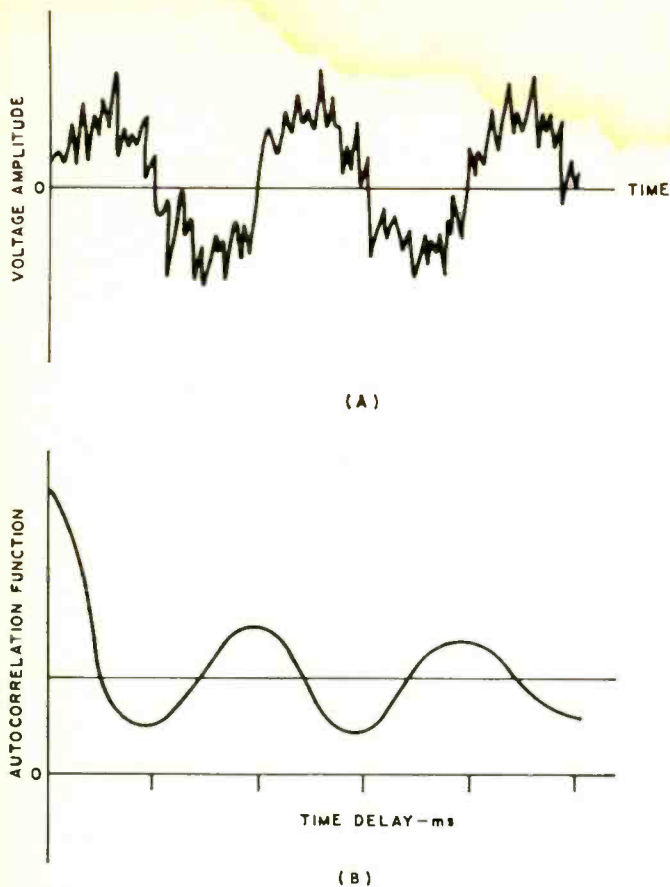

Fig. 10. (A) Voltage-time plot of sine wave immersed in noise. (B) Resulting autocorrelation function extracts the periodic component.

(A) is identical to its counterpart in (B), the product of both values contributes a positive term to the sum. As the delay time increases during the scanning process, the waveform becomes less and less related to itself in (C), until the point is reached in (D) where the similarity is completely destroyed. Now that each positive product value is offset by another negative product, the sums rapidly decrease and the ACF reading falls effectively to zero.

If a sine wave were fed to the ACF analyzer, the autocorrelation would also be sinusoidal, having the same frequency and harmonic content as the input signal but dropping all phase information. It is reasonable to expect, therefore, that an ACF measurement of a wide-band noise record containing a hidden sine-wave component (Fig. 10A) would have some of the characteristics of both the random noise and the periodic signal. The resulting autocorrelation in Fig. 10B indicates the peaked curve at zero delay, with the sinusoidal component persisting over all time displacements. Clearly the correlation technique makes it possible to detect and recover periodic information by greatly improving the signal-to-noise ratio (as much as 40 dB) of an incoming signal.

Now that the frequency of the periodic signal to be extracted from the random noise is known, a more powerful technique, called the "cross-correlation function" (CCF), may be applied. This is accomplished by switching the

ACF analyzer, shown in Fig. 7, to the CCF mode of operation. In this arrangement, the random signal fed to the direct input of multiplier #1 is independent of an external periodic waveform applied to the time-delay generator. Since the delayed input to the instrument is now a pure sine wave of the same frequency as the hidden periodic signal, the CCF analyzer produces a still greater improvement in signal-to-noise ratio and, in the ideal case, reduces the noise components of the signal to zero. An important advantage of this method over autocorrelation is that phase information is preserved, so that the resultant cross-correlogram is a proportional reproduction of the original time function.

Another method of detecting a signal masked by extraneous noise is indicated in Fig. 11. This technique consists of cross-correlating the obscured signal (Fig. 11A) with a series of narrow pulses (Fig. 11B) which have the same fundamental frequency as the obscured signal. The resultant CCF curve (Fig. 11C) reveals the hidden signal to be a triangular wave.

The cross-correlation technique may be employed to establish a possible "cause and effect" relationship between a disturbing sound source and a reverberant condition. In acoustic vibration problems, for example, cross-correlation is useful in determining the transmission paths and propagation velocities of a random vibration source. By placing one microphone close to the source of the disturbance and moving another microphone to different locations in sequence, a CCF computation is performed for each point. If multiple sound paths exist the cross-correlogram will contain one peak for each sound path, while unrelated disturbances will rapidly correlate to zero. The delay value at each peak corresponds to the transmit time of the transmission path, and the ordinate of each peak indicates the relative contribution of each sound source.

Frequency Domain Measurement

Since random waveforms are characterized by the relative distribution of their frequency content, the analysis of non-periodic signals may be obtained in terms of the "power spectral density" (PSD) function. This parameter describes the harmonic composition of random data in terms of the mean square, or average power distribution over the frequency spectrum. To make an analysis, it is necessary to filter the input signal and average the squared instantaneous value over the total sampling time.

In the PSD analyzer shown in Fig. 12, the data stored on a magnetic tape loop is heterodyned in the modulator by the output of a swept local oscillator. The modulator output is then fed to a highly sensitive narrow bandpass filter (with a fixed center frequency), which extracts that portion of the signal whose frequency range lies within its passband. The frequency components are detected by the squaring circuit and averaged by an RC filter whose time constant is set equal to the sample record length. Where a true integrator is used for averaging, the transient produced by the tape splice is used to derive a trigger pulse in order to reset the integrator at the end of each tape loop period. The required division of the mean square value of the averaging network by the filter bandwidth may be obtained by a proper scale calibration. As the sweeping oscillator scans the frequency range of interest, the center frequency of the

Fig. 11. (A) Time plot of sawtooth wave in noise. (B) Time function of reference pulses. (C) Cross-correlogram.

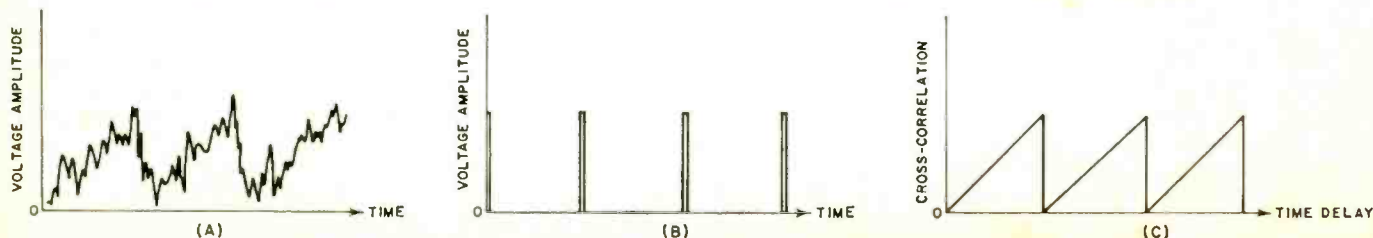

bandpass filter is progressively moved, and output of the analyzer is displayed as a continuous plot of PSD function vs frequency.

In Fig. 13A, a sample voltage-time history record is shown of an undesirable random vibration, such as that produced by industrial machinery. By feeding this data into the PSD analyzer, the resultant power spectral density curve (Fig. 13B) shows how each peak level represents the signal contribution within the sample bandwidth. Since the total power distribution is equal to the entire area under the curve, the power in each of the peaks can be calculated from their individual areas. Now that the hidden components in the frequency domain are easily identified, and knowing the rotational speed of the machine parts, the disturbing vibration source can be located and eliminated.

Where the phenomena being investigated involve the analysis of two related random processes, some knowledge of the phase relationship between the two quantities is sometimes required. For example it may be necessary to determine to what degree an acoustic source of vibration is responsible for the mechanical vibration in a metallic structure. This can be accomplished by means of a "cross-spectral density" (CSD) analyzer which measures the linear relationship between the power spectral density data represented by the two sample records.

The statistical concepts discussed have been restricted to the analog measurement of stationary random data. Since the processing techniques do not, for the most part, apply to the analysis of non-stationary random waveforms (whose statistical properties change with time), more sophisticated methods must be developed to handle such data. ▲

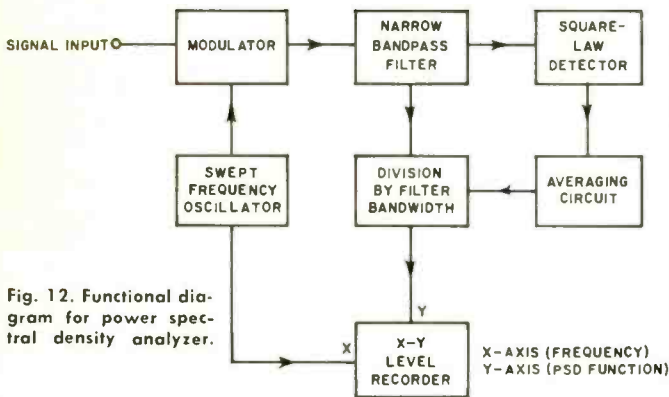
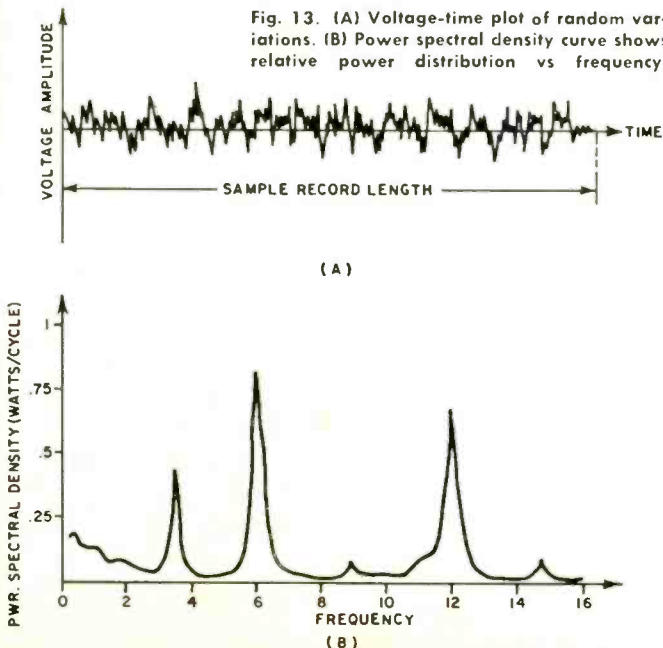

Fig. 12. Functional diagram for power spectral density analyzer.

Fig. 13. (A) Voltage-time plot of random variations. (B) Power spectral density curve shows relative power distribution vs frequency.







**it Pays
to go
with
the Guy
that
brought
You!**



Let's face it! Oxford pioneered this speaker business—to coin a phrase—this "sound" business of speakers you're in. The fact that we were first in the making, and still first in selling, ought to tell you something. We've got the name—the quality—the value that sells.

Take Oxford's new "TEMPO" High-Fidelity speaker line. No one can touch it. Their exclusive "Floating Suspension Surround" extends the low frequency spectrum without "hangover", provides clean, transient response with smooth mid-range and brilliant high frequency response. You don't need to talk this one up... the unsurpassed brilliance and clarity of sound sells itself.

For replacement or new installations, it pays to go with "the guy that brought you", That way, you know you're home safe.

	"TEMPO" Hi-Fi Speakers
	Public Address Speakers
	Paging and Talk Back Speakers
	All Weather Speakers
	Replacement Speakers
	Professional Musical Instrument Speakers
	MEMBER ALMA

OXFORD TRANSDUCER COMPANY

A Division of Oxford Electric Corporation

3911 S. Michigan Ave.
Chicago, Ill. 60653

CIRCLE NO. 100 ON READER SERVICE CARD

Join "THE TROUBLESHOOTERS"

They get paid top salaries
for keeping today's
electronic world running

Suddenly the whole world is going electronic! And behind the microwave towers, push-button phones, computers, mobile radio, television equipment, guided missiles, etc., stand

THE TROUBLESHOOTERS
—the men needed to inspect, install, and service these modern miracles. They enjoy their work, and get well paid for it. Here's how you can join their privileged ranks—without having to quit your job or go to college in order to get the necessary training.

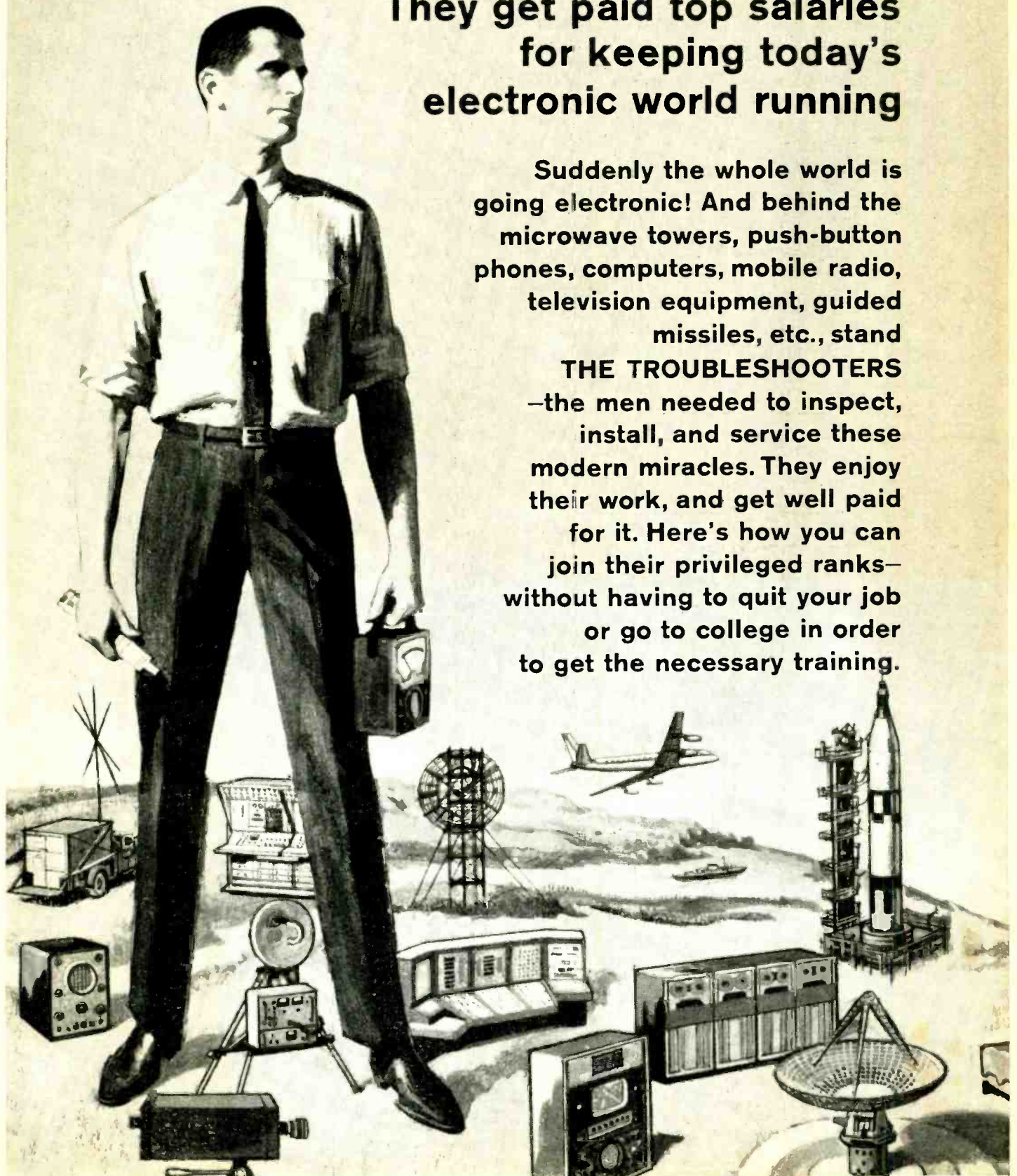

JUST THINK HOW MUCH in demand you would be if you could prevent a TV station from going off the air by repairing a transmitter...keep a whole assembly line moving by fixing automated production controls...prevent a bank, an airline, or your government from making serious mistakes by repairing a computer.

Today, whole industries depend on electronics. When breakdowns or emergencies occur, someone has got to move in, take over, and keep things running. That calls for one of a new breed of technicians—The Troubleshooters.

Because they prevent expensive mistakes or delays, they get top pay—and a title to match. At Xerox and Philco, they're called Technical Representatives. At IBM they're Customer Engineers. In radio or TV, they're the Broadcast Engineers.

What do you need to break into the ranks of The Troubleshooters? You might think you need a college diploma, but you don't. What you need is know-how—the kind a good TV service technician has—only lots more.

Think With Your Head, Not Your Hands

The service technician, you see, "thinks with his hands." He learns his trade by taking apart and putting together, and often can only fix things he's already familiar with.

But as one of The Troubleshooters, you may be called upon to service complicated equipment that you've never seen before or *can't* take apart. This means you have to be able to take things apart "in your head." You have to know enough electronics to understand the engineering specs, read the wiring diagrams, and calculate how a circuit should test at any given point.

Now learning all this can be much simpler than you think. In fact, you can master it without setting foot in a classroom and without giving up your job!

AUTO-PROGRAMMED™ Lessons Show You How

For over 30 years, the Cleveland Institute of Electronics has specialized in teaching electronics at home. We've developed special techniques that make learning easy, even if you've had trouble studying before.

For one thing, our AUTO-PROGRAMMED™ lessons build your knowledge as you'd build a brick wall—one brick at a time. Each piece rests securely on the one that came before it.

ENROLL UNDER NEW G.I. BILL

All CIE courses are available under the new G.I. Bill. If you served on active duty since January 31, 1955, or are in service now, check box on reply card for G.I. Bill information.

In addition, our instruction is personal. When your teacher goes over your assignment, no one else competes for his attention. You are the only person in his class. He not only grades your work, he analyzes it to make sure you are thinking correctly. And he returns it the day it's received so that you can read his comments and corrections while everything is fresh in your mind.

Always Up-To-Date

To keep up with the latest developments, our courses are constantly being revised. This year CIE students are getting new lessons in Laser Theory and Application, Microminiaturization, Single Sideband Techniques, Pulse Theory and Application, and Boolean Algebra.

In addition, there is complete material on the latest troubleshooting techniques including Tandem System, Localizing through Bracketing, Equal Likelihood and Half-Split Division, and In-circuit Transistor Checking. There are special lessons on servicing two-way mobile equipment, a lucrative field in which many of our students have set up their own businesses.

Your FCC License—or Your Money Back!

Two-way mobile work and many other types of troubleshooting call for a Government FCC License, and our training is designed to get it for you. But even if your work doesn't require a license, it's a good idea to get one. Your FCC License will be accepted anywhere as proof of good electronics training.

And no wonder. The licensing exam is so tough that two out of three non-CIE men who take it fail. But CIE training is so effective that 9 out of 10 of our graduates pass. That's why we can offer this warranty with confidence: *If you complete one of our license preparation courses, you'll get your license—or your money back.*

Mail Card for 2 Free Books

Want to know more? Mail the postage-paid reply card bound here. We'll send our 40-page catalog describing our courses and the latest opportunities in Electronics. We'll also send a special book on how to get a Commercial FCC License. Both are free. If the card is missing, just send us your name and address.



CIE

Cleveland Institute of Electronics

1776 E. 17th St., Dept. EW-46, Cleveland, Ohio 44114

Accredited Member National Home Study Council
A Leader in Electronics Training . . . Since 1934





J OHN FRYE

New solid-state service equipment presents several advantages—and a few disadvantages

SOLID-STATE SERVICE INSTRUMENTS

"HEY, BOSS," Barney said to Mac, his employer, "you've been mooning over that catalogue for a good half hour. Sure and I know your name's McGregor, but is the prospect of having to turn loose of a few bucks all that painful to a Scotsman?"

"Keep a civil tongue in your head, you Black Irishman!" Mac retorted with a fierce scowl. "It's not giving up the money that hurts; it's just that we canny Scots like to do the best we can. I want to order some new service equipment, and I find there are a lot of ways to go. Solid-state devices have invaded the service instrument field, just as they have done in almost every other electronics field; and this has sort of muddled the water. I used to know the specs of most popular service instruments by heart, but now I find it's a whole new horse race—if you don't mind my mixing a few metaphors!"

"I don't mind; I'm used to it; but what kind of instruments are you thinking of buying?"

"Well, for one thing, we need a new v.t.v.m., or equivalent, for use in making outside calls. I'm wondering if one of those new solid-state v.o.m.'s might not be a better buy. Thanks to the use of FET's, such a v.o.m. achieves an input resistance at least as high as the 11-megohm input of a conventional v.t.v.m. One of those I've been looking at has a built-in power supply for working off the line or it can be switched to self-contained batteries. That would make it handy for working on equipment where there's no convenient a.c. outlet for plugging in the instrument; yet we could conserve the batteries when this feature isn't needed."

"How about accuracy?"

"It is rated just as good as the tube-type instruments. In fact, I should imagine the long-time accuracy might be better because you wouldn't have the tube-aging factor to contend with. Also, since other components of the instrument will not be subjected to self-generated heat, as they are in a v.t.v.m., these components should last longer. All in all, I shouldn't be at all surprised if this new type of v.o.m. might not eventually put the v.t.v.m., that faithful old work horse of the service technician, out to pasture."

"Kind of sad, ain't it?" Barney mused. "But I guess that's progress. What other goodies are you contemplating buying?"

"I'd like to have a really good square-wave generator that will have a fast enough rise time to let us take full advantage of the capabilities of our new wide-band, driven-sweep scope. I want something that will produce a good clean square wave up to at least 1 MHz. The *Hewlett-Packard Model 217A* I've been looking at is typical of a new breed of fully transistorized generators that will easily satisfy such demands. In fact, it will produce square waves from 1 Hz to 10 MHz with a rise time of 5 nanoseconds or better. The 'on' time of the square wave—or the relative length of the 'bottom' horizontal portion of the square wave compared with the 'top' horizontal portion—can be varied between 25% and 75%. A triggering source for the scope's driven sweep is also provided.

"The \$300-\$400 price tags on these instruments sound

salty when compared with the cost of the usual service-type square-wave generator whose rise time is measured in microseconds or even milliseconds, but the price is still a lot lower than it was before fast-acting solid-state switching devices got into the picture.

"If we're willing to settle for a rise time of ten nanoseconds and dispense with some of the other features, we can get the price down below \$200; but I'm inclined to go whole-hog and get the better instrument. Admittedly, that rise time is better than we need with our present scope; but in square-wave testing, if you have to make allowance for the limitations of the scope amplifier and for the limitations of your generator, you end up feeling quite unsure about what you are *really* seeing on the tube face. How much of the distortion seen there is produced by the amplifier or device being tested, and how much is produced by your equipment? It seems to me the logical place to start upgrading is with the signal source. If you can be certain your generator is producing a clean, fast-rise square wave at a repetition rate in the MHz, you are in a position to evaluate the contribution the scope amplifier makes to the distortion seen. Knowing this, you can then proceed to check the amplifier or delay line with confidence."

"Sounds logical," Barney agreed. "Does that wind up your buying spree, Diamond Jim?"

"Not quite. For a long, long time I've wanted an electronic counter to measure frequency, and it looks as though the use of transistors and integrated circuits may eventually enable me to satisfy my wish. In fact, I can buy one right now that will count from 5 Hz to 10 MHz for only \$350 if I am willing to accept a four-figure readout and a gate based on the power-line frequency. This basic model has gate periods of 1 second and 0.1 second. For \$125 more, you get a six-figure readout, which, of course, would be much better for high-frequency measurement."

"How about the accuracy? Doesn't that gate's being keyed to the line frequency impair the accuracy a great deal?"

"Depends on what you mean by 'a great deal'. The accuracy of the count is the usual plus-or-minus one Hz plus-or-minus the accuracy of the line frequency. In the United States, this accuracy is typically better than 0.1% for commercial power. But if you need greater accuracy, you can get it for about double the money in a counter whose gate is operated by a stable 1-MHz crystal oscillator. This model has gate periods of .01, 0.1, 1, and 10 seconds with a five-figure readout. A six-figure readout is an option. And, of course the counter can be used to measure time intervals from 1 microsecond to 1 second.

"The point I want to stress is that these and similar counters coming on the market from the development labs make extensive use of IC's. This leads to a reduction in size and cost and an improvement in reliability."

"Hey, do I get to say anything in this dialogue, or do I have to content myself with being your straight man?" Barney demanded.

"If you really have anything to contribute—which I doubt—I might be persuaded to listen," Mac answered.

"Thanks a great big heap!" Barney retorted. "I was just going to mention that *International Crystal* has just come out with a Model 1110 transistorized secondary frequency standard with outputs at 1 MHz, 100 kHz, and 10 kHz. Used in conjunction with a general coverage communications receiver, this standard can be calibrated against WWV to provide an accuracy of one part in 10^6 . The long-term stability of the 1-MHz oscillator is claimed to be plus or minus 10 Hz over a range of 40°F to 100°F. While this is not in the league with the counters you were discussing and would require the use of an external receiver and some operating skill to read frequencies accurately, it only costs \$125 and would be plenty good enough for most amateur radio or service technician measurements."

"That is interesting, and I'm going to look into it," Mac promised. "But in our discussion we've just scratched the surface of solid-state applications to service instruments. Digital voltmeters; transistorized scopes; signal, sweep, and marker generators; dot and color bar generators—well, you just name it, and solid-state versions are either on the market or are in R & D laboratories."

"I'm all for it," Barney offered. "For one thing, the use of transistors and IC's produce instruments that are smaller, easier to carry, and that take up less bench room. What's more, they are rugged and not easily damaged by jars or vibration. These things are important in portable instruments you have to lug along on house calls. Finally, from our own experience, we know solid-state devices fail much more rarely than do tubes; so it would seem safe to assume these new instruments will last longer and require less service."

"I agree with everything you say, but that last point brings up one disadvantage of the new instruments: they are not going to be so easy to repair when something *does* go wrong with them. IC's are not readily tested with the equipment and know-how found in the average service shop. Furthermore, changing a critical IC or even a transistor in a service instrument may make recalibration necessary."

"Another thing: there's not as much standardization and stability in the stocking of transistors and IC's as there is in tube stocks. By the time one of these solid-state devices hits the market it may be already obsolete because a new and improved type is emerging from its own lab or the labs of competitors. We both know instrument manufacturers stuck pretty close to well-established and popular tubes, avoiding the new and the esoteric; so getting replacement tubes was never a problem. I can't help wondering how true this will be of IC's and transistors. Will we be able to get replacements in five or ten years?"

"You've got a point," Barney said; "but I still like transistorized service equipment. Surely the instrument manufacturers will keep a goodly stock of replacement IC's and transistors on hand—or at least the reputable manufacturers will."

"Okay, okay!" Mac said. "I'm not arguing with you. I just wanted to mention what might be a couple of small drawbacks to transistorized service equipment. Like you, I'm still for it because the advantages far outweigh the disadvantages. At any rate, I'm resigned to having everything transistorized. Any day now I expect someone to come out with a transistorized coat-hanger. But now suppose we get busy and see if we can fix some TV sets with our out-of-date tube-type service equipment!" ▲

METER SAFETY BOX

By ROBERT E. BROCK
Amplex Corp.

WHEN one uses a volt-ohmmeter to measure alternately voltage and current, the meter leads must be switched repeatedly from a parallel to a series position. This also requires a constant resetting of the meter's function switch. If these actions are done carelessly, the v.o.m. can be damaged or ruined.

Fig. 1 is a schematic of a meter safety box which disconnects the v.o.m. from the power circuit automatically when its function switch is reset. When the d.p. 3-position switch is in the Off position, the meter is disconnected from the power source but the power remains connected to the load. When the meter is turned to the Volts setting, it shunts the load and the power source; and at the switch's Current setting, the meter is placed in series with the load. The load is momentarily disconnected when the switch is reset.

The box itself should be larger than 2" x 3" x 1½". The type whose top, front, and rear surfaces are formed from a single piece of metal is best. The latter allows the switch to be mounted on the top, and the input and outputs of the box to be mounted on the front and rear surfaces, respectively.

The input and load receptacles may be color-coded banana jacks, while the meter receptacles may be color-coded tip jacks. The total cost of parts is less than \$5.00. When building the box, be sure to electrically isolate the circuits. ▲

Fig. 1. During switching, the meter is disconnected from the load for safety.

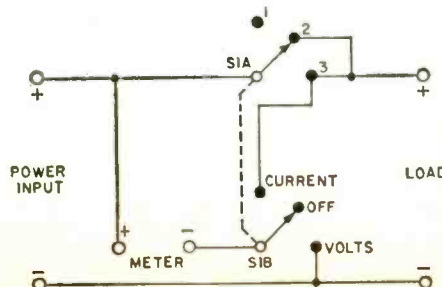

When you write
for our condensed
high fidelity
SPEAKER,
ELECTRONICS or
MICROPHONE
catalogs...



you really get
a brief progress
report on the
state of the art
in sound.

Both **FREE** for the
asking, of course.

Electro-Voice
SETTING NEW STANDARDS IN SOUND

ELECTRO-VOICE, INC., Dept. 683N
629 Cecil Street, Buchanan, Michigan 49107

Please send me the latest word on

E-V high fidelity E-V microphones

I am particularly interested in E-V Model _____

Name _____

Address _____

City _____ State _____ Zip _____

CIRCLE NO. 115 ON READER SERVICE CARD

Look What's New

NEW HEATHKIT In-Circuit Transistor Tester

At last, a realistic price for in-circuit testing of transistors! The new Heathkit IT-18 Tester has the facilities you need and it costs a lot less. It measures DC Beta in-or-out-of-circuit in 2 ranges from 2 to 1000 (the spec. commonly used by mfrs. and schematics to determine transistor gain). It tests diodes in-or-out-of-circuit for forward and reverse current to indicate opens or shorts. Measures transistors out-of-circuit for ICEO and ICBO leakage on leakage current scale of 0 to 5,000 uA. Identifies NPN or PNP devices, anode and cathode of unmarked diodes; matches transistors of the same type or opposite types. Cannot damage device or circuit even if connected incorrectly. Big 4½" 200 uA meter. 10-turn calibrate control. Completely portable, powered by "D" cell (long battery life). Front panel socket for lower power devices. Attached 3' test leads. Rugged polypropylene case with attached cover. Build in 2 hours. 4 lbs.



NEW
Kit
IT-18
\$24⁹⁵

NEW HEATHKIT 1-15 VDC Regulated Power Supply

Labs, service shops, hams, home experimenters . . . anybody working with transistor circuitry can use this handy new Heathkit All-Silicon Transistor Power Supply. Voltage regulated (less than 40 mV variation no-load to full-load; less than .004% change in output with input change from 105-125 VAC). Current limiting; adjustable from 10-500 mA. Ripple and noise less than 0.1 mV. Transient response 25 uS. Output impedance 0.5 ohm or less to 100 kHz. AC or DC programming (3 mA driving current on DC). Circuit board construction. Operates 105-125 or 210-250 VAC, 50/60 Hz. 6 lbs.



NEW
Kit
IP-18
\$19⁹⁵

NEW HEATHKIT Crystal-Controlled Post Marker Gen.

Fast, accurate color TV and FM alignment at the touch of a switch! 15 crystal-controlled marker frequencies. Select picture and sound IF's, color bandpass and trap freqs., 6 dB points. FM IF center freq. and 100 kHz points. Use up to six markers simultaneously. Birdie-type markers. Trace and marker amplitude controls permit using regular 'scope. 400 Hz modulator. Variable bias supply. Input and output connectors for use with any sweep generator. Also has external marker input. BNC connectors. Solid-state circuit uses 22 transistors, 4 diodes. Two circuit boards. Handsome new Heathkit instrument styling of beige and black in stackable design. Until now, an instrument of this capability cost hundreds of dollars more. Order your IG-14 now, it's the best investment in alignment facilities you can make. 8 lbs.

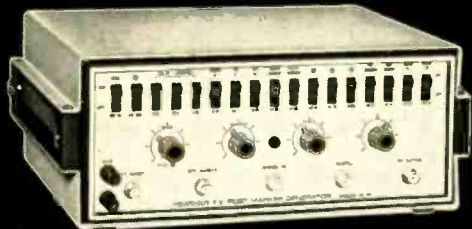

NEW
Kit
IG-14
\$99⁹⁵

NEW HEATHKIT Low-Cost 5 MHz 3" 'Scope

Here is the wideband response, extra sensitivity and utility you need, all at low cost. The Heathkit IO-17 features vertical response of 5 Hz to 5 MHz; 30 mv Peak-to-Peak sensitivity; vertical gain control with pull-out X50 attenuator; front panel 1 volt Peak-to-Peak reference voltage; horizontal sweep from internal generator, 60 Hz line, or external source; wide range automatic sync; plastic graticle with 4 major vertical divisions & 6 major horizontal; front mounted controls; completely nickel-alloy shielded 3" CRT; solid-state high & low voltage power supplies for 115/230 VAC, 50-60 Hz; Zener diode regulators minimize trace bounce from line voltage variations; new professional Heath instrument styling with removable cabinet shells; beige & black color; just 9½" H. x 5½" W. x 14½" L.; circuit board construction, shipping wt. 17 lbs.

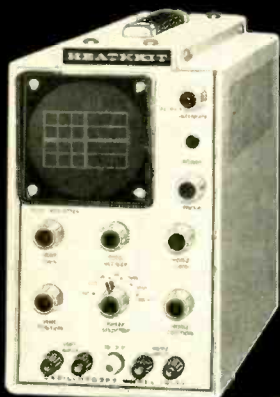

NEW
Kit
IO-17
\$79⁹⁵

NEW HEATHKIT Solid-State Portable Volt-Ohm Meter

There's never been a better buy in meters. Solid-state circuit has FET input, 4 silicon transistors, and 1 diode. 11 megohm input on DC, 1 megohm on AC. 4 DC volt ranges, 0-1000 v. with ±3% accuracy; 4 AC volt ranges, 0-1000 v. with ±5% accuracy. 4 resistance ranges, 10 ohms center scale x1, x100, x10K, x1M, measures from 0.1 ohm to 1000 megohms. 4½", 200 uA meter with multicolored scales. Operates on "C" cell and 8.4 v. mercury cell (not included). Housed in rugged black polypropylene case with molded-in cover and handle and plenty of space for the three built-in test leads. An extra jack is provided for connecting accessory probes to extend basic ranges. Controls include zero-adjust, ohms-adjust, DC polarity reversing switch, continuous rotation 12-position function switch. Easy-to-build circuit board construction completes in 3-4 hours. 4 lbs.



NEW
Kit
IM-17
\$21⁹⁵

From Heath

NEW HEATHKIT AA-15 Deluxe Stereo Amplifier

For the man who already owns a fine stereo tuner, Heath now offers the famous amplifier section of the AR-15 receiver as a separate unit. The new AA-15 Stereo Amplifier has the same superb features: 150 watts Music Power; Ultra-Low Harmonic & IM Distortion (less than 0.5% at full output); Ultra-Wide Frequency Response (± 1 dB, 8 to 40,000 Hz at 1 watt); Ultra-Wide Dynamic Range Preamp (98 dB); Tone-Flat Switch; Front Panel Input Level Controls; Transformerless Amplifier; Capacitor Coupled Outputs; Massive Power Supply; All-Silicon Transistor Circuit; Positive Circuit Protection; "Black Magic" Panel Lighting; new second system Remote Speaker Switch; 120/240 VAC. 26 lbs. *Walnut cabinet AE-18, \$19.95.

NEW HEATHKIT AJ-15 Deluxe Stereo Tuner

For the man who already owns a fine stereo amplifier, and in response to many requests, Heath now offers the superb FM stereo tuner section of the renowned AR-15 receiver as a separate unit. The new AJ-15 FM Stereo Tuner has the exclusive design FET FM tuner for remarkable sensitivity, the exclusive Crystal Filters in the IF strip for perfect response curve and no alignment; Integrated Circuits in the IF for high gain, best limiting; elaborate Noise-Operated Squelch; Stereo-Threshold Switch; Stereo-Only Switch; Adjustable Multiplex Phase, two Tuning Meters; two variable output Stereo Phone jacks; one pair variable outputs plus two fixed outputs for amps., recorders, etc.; front panel mounted controls; "Black Magic" panel lighting; 120/240 VAC operation. 18 lbs. *Walnut cabinet AE-18, \$19.95.

NEW HEATHKIT 2-Meter AM Amateur Transceiver

2-Meters at low cost. And the HW-17 Transceiver has 143.2 to 148.2 MHz extended coverage to include MARS, CAP, and Coast Guard Auxiliary operation. Output power of tube-type transmitter is 8 to 10 watts, AM. 4 crystal sockets plus VFO input. Relayless PTT operation. Double conversion solid-state superhet. Receiver has 1 μ V sensitivity with prebuilt, aligned FET tuner, ANL, Squelch, "Spot" function, and lighted dial. Signal-strength/relative power-output meter. Battery saver switch for low current drain during receiving only. 15 transistor, 18 diode, 3 tube circuit on two boards builds in about 20 hours. Built-in 120/240 VAC, 50-60 Hz power supply and 3" x 5" speaker; low profile aluminum cabinet in Heath gray-green; ceramic mic. and gimbal mount included. 17 lbs. *Optional DC mobile supply, HWA-17-1, \$24.95.

NEW HEATHKIT Home Protection System

Customize your own system with these new Heathkit units to guard the safety of your home and family. Warns of smoke, fire, intruders, freezing, cooling, thawing, pressure, water, almost any change you want to be warned about. Your house is already wired for this system, just plug units into AC outlets. Exclusive "loading" design of transmitters generates unusual signal which is detected by the Receiver/Alarm. Solid-state circuitry with fail-safe features warns if components of system have failed. Any number of units may be used in system. Receiver/Alarm has built-in 2800 Hz alarm and rechargeable battery to signal if power line fails (built-in charger keeps battery in peak condition). Receiver accepts external 117 VAC bells or horns. Smoke/Heat Detector-Transmitter senses smoke and 133°F. heat (extra heat sensors may be added to it). Utility Transmitter has several contacts to accept any type switch or thermostat to guard against any hazard except smoke. All units feature circuit board construction and each builds in 3-4 hours. All are small and finished in beige and brown velvet finish. Operating cost similar to that of electric clocks. Invest in safety now with this unique new low-cost Heathkit system.

NOW, THE TUNER AND AMPLIFIER OF THE FAMOUS HEATH AR-15 RECEIVER ARE AVAILABLE AS SEPARATE COMPONENTS



NEW Kit AA-15 \$169⁹⁵*



NEW Kit AJ-15 \$189⁹⁵*



NEW Kit HW-17 \$129⁹⁵*



GD-77 Receiver / Alarm \$39⁹⁵



NEW GD-87 Smoke/Heat Detector-Transmitter \$49⁹⁵



GD-97 Utility Transmitter \$34⁹⁵



NEW

FREE 1968 CATALOG!

Now with more kits, more color. Fully describes these along with over 300 kits for stereo/hi-fi, color TV, electronic organs, electric guitar & amplifier, amateur radio, marine, educational, CB, home & hobby. Mail coupon or write Heath Company, Benton Harbor, Michigan 49022.

HEATH COMPANY, Dept. 15-6
Benton Harbor, Michigan 49022
In Canada, Daystrom Ltd.

Enclosed is \$ _____ plus shipping.

Please send model (s)
 Please send FREE Heathkit Catalog.
 Please send Credit Application.

Name _____

Address _____

City _____

State _____

Zip _____

Prices & specifications subject to change without notice.

CL-327

CIRCLE NO. 109 ON READER SERVICE CARD

Olson



FREE

Fill in coupon for a FREE One Year Subscription to OLSON ELECTRONICS' Fantastic Value Packed Catalog—Unheard of LOW, LOW PRICES on Brand Name Speakers, Changers, Tubes, Tools, Stereo Amps, Tuners, CB, Hi-Fi's, and thousands of other Electronic Values. Credit plan available.

NAME _____

ADDRESS _____

CITY _____ STATE _____

GIVE ZIP CODE _____

If you have a friend interested in electronics send his name and address for a FREE subscription also.

OLSON ELECTRONICS, INC.

880 S. Forge Street Akron, Ohio 44308

CIRCLE NO. 101 ON READER SERVICE CARD

WORKMAN *Electronic*
P.O. BOX 3828 SARASOTA, FLORIDA 33578 PRODUCTS, INC.

MANUFACTURES A COMPLETE LINE OF

FAIL SAFE IN MOLDED BLACK PLASTIC CASE
CIRCUIT BREAKERS

CUT AWAY MODEL



Model Numbers FA1.5 to FA7

When Red Button is depressed, contacts remain open, circuit is refused **ONLY** after Red Button is released.

RECOGNIZED UNDER THE COMPONENT PROGRAM OF
UNDERWRITERS' LABORATORIES, INC.

CIRCLE NO. 90 ON READER SERVICE CARD

TEST EQUIPMENT PRODUCT REPORT

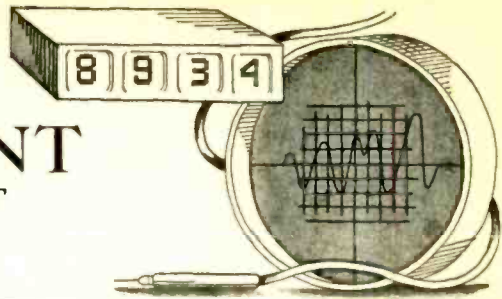

Amphenol Model 857 CRT Tester-Rejuvenator

For copy of manufacturer's brochure, circle No. 21 on Reader Service Card.

THIS new lightweight tester-rejuvenator, called "CRT Commander" by Amphenol, permits the service technician to tell his customer, in his home or at the shop, whether his picture tube needs replacement. The unit can be used with almost all black-and-white and color picture tubes. The Model 857 also permits technicians to rejuvenate CRT's by applying high voltage to grids 1 and 2 of the tube, while elevating the heater voltage to 35% or 85% of the normal value.

The voltages applied to the tube electrodes are all variable, with up to 100 volts available for grid 1 and up to 300 volts for grid 2. Heater voltage, also adjustable, is monitored on the built-in voltmeter. This meter, incidentally, can also be used as a 0-1000 and 0-5000-volt instrument for checking all "B+" test points on the TV chassis. It can also be used with an optional h.v. probe for checking second-anode voltage on a range from 0 to 50,000 volts. This feature means that the technician often does not have to carry or use his v.o.m.

Besides checking the emission of a picture tube, the CRT Commander includes tests for shorts (using three separate shorts-indicating neon lamps, along with a handy indicator chart on the panel), for gas, and for tube life. Also, a second-anode leakage test is included to enable the technician to detect leakage and breakdowns occurring in the picture tube when high voltage is present.

The three guns of a color tube must balance within 200 μ A of each other, relative to identical cut-off characteristics of each gun. The new tester indicates if these guns are properly balanced, providing a fast, accurate read-out of gray-scale tracking.

The sensitive 50- μ A basic meter move-



ment used permits direct meter reading of low values of grid current which is required for making gas checks of picture tubes.

Three different socket assemblies are provided to plug into the socket wired to the end of a long interconnecting cable. Each assembly consists of two picture-tube sockets, permitting direct mating with most CRT types. Other adapters will be available for future tube types. A large storage area is included for housing cables and probes when the instrument is not in use.

The tester is professionally styled in a smart, black luggage-type case. It weighs less than 6 lbs and is priced at \$99.50. An up-to-date picture-tube chart is included, listing over 1000 CRT types. Purchasers are automatically sent the new tube listings free as they are issued. ▲

Sencore Model FE14 Field-Effect Meter

For copy of manufacturer's brochure, circle No. 22 on Reader Service Card.

THE new Sencore FE14 is a battery-operated portable volt-ohm-milliammeter that uses a pair of field-effect transistors in a balanced differential amplifier. Such transistors have very high input impedance so they make admira-

ble substitutes for the twin-triode electron tube usually used in such a circuit in the conventional v.t.v.m. The transistors are operated from a single 9-volt transistor-radio battery and, since they operate cool in the circuit, they should

last indefinitely and result in a very stable instrument requiring no warm-up time. Another battery, a 1½-V "C" cell, is used in the ohmmeter circuit.

With 15-megohm input resistance on d.c. and 10-megohm input impedance on a.c., the FE14 accurately measures voltages with a minimum of circuit loading. Seven a.c. and d.c. voltage ranges are provided, from 1V full-scale to 1000 V full-scale. Peak-to-peak measurements of complex waveforms are also possible on seven ranges, with frequency response up to 10 MHz. In addition, a zero-center scale of 0.5 volt simplifies testing of transistor circuits, eliminating the need to determine polarity.

D.c. current measurements are also possible with the new instrument on five ranges from 100 μA full-scale to 1



A full-scale. For current measurements, the transistors are not used; instead shunt resistors are employed along with the basic 100-μA meter movement.

A mirrored scale prevents reading errors due to parallax. Protection is provided by a pair of back-to-back diodes connected directly across the movement and by the use of a neon lamp at the input circuit. The lamp fires in the event that excessive voltage is applied.

The meter is housed in a non-breakable vinyl-clad steel case. It is priced at \$59.95. ▲

Millen 90651-A Grid-Dip Meter
For copy of manufacturer's brochure, circle No. 23 on Reader Service Card.

THE new Millen 90651-A grid-dip meter is a calibrated stable r.f. oscillator unit with a voltmeter to indicate



A tuner for the connoisseur...
thanks to SCOTTKIT® packaging
and exceptionally clear instructions
it can be put together
in about eight hours time...



pulled in
more stations,
more clearly,
than we thought
could be logged
in our fringe area.

HIGH FIDELITY
MAGAZINE

See your
Scott dealer
and review the
new LT-112B-1 for yourself.
Only \$199.95. Matching
120-Watt LK-60B amplifier
kit, only \$199.95.

SCOTT

© 1968, H.H. Scott, Inc.

H.H. Scott, Inc., Maynard, Mass. 01754 Dept. 160-06

CIRCLE NO. 94 ON READER SERVICE CARD

NOW! Solve Electronics Problems fast with New Patented Slide Rule.

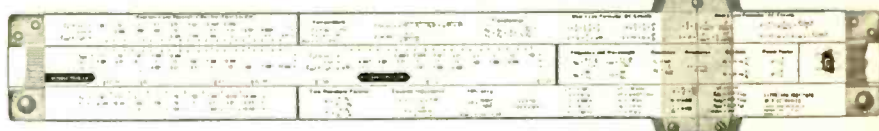

That's right! This amazing new Electronics Slide Rule will save you time the very first day you use it. It's a patented, all-metal 10" rule that features special scales for solving reactance, resonance, inductance and circuitry problems . . . an exclusive "fast-finder" decimal point locator . . . widely-used formulas and conversion factors for instant reference. And there's all the standard scales you need to do multiplication, division, square roots, logs, etc.

Best of all, the CIE Electronics Slide Rule comes complete with an Instruction Course

of four AUTO-PROGRAMMED* lessons. You'll quickly learn how to whip through tough problems in a jiffy while others plod along the old-fashioned "pad and pencil" way.

Electronics Slide Rule, Instruction Course, and handsome, top-grain leather carrying case . . . a \$50 value for less than \$25. Send coupon for FREE illustrated booklet describing this Electronics Slide Rule and Instruction Course and FREE Pocket Electronics Data Guide. Cleveland Institute of Electronics, 1776 E. 17th St., Dept. EW-152, Cleveland, Ohio 44114.

*TRADEMARK

GET BOTH FREE!



Send
coupon
today →

**Cleveland Institute
of Electronics**

1776 E. 17th St., Dept. EW-152, Cleveland, Ohio 44114

Send FREE Electronics Slide Rule Booklet. Special Bonus: Mail promptly and get FREE Pocket Electronics Data Guide too!

NAME _____ (Please Print)

ADDRESS _____ COUNTY _____

CITY _____ STATE _____ ZIP _____

A leader in Electronics Training... since 1934

CIRCLE NO. 120 ON READER SERVICE CARD

ENJOY THE "MUSIC ONLY" FM PROGRAMS

M. A. D.

MUSIC ASSOCIATED'S DETECTOR
NO COMMERCIALS—NO INTERRUPTIONS



It's easy! Just plug Music Associated's Sub Carrier Detector into multiplex jack of your FM tuner or easily wire into discriminator. Tune through your FM dial and hear programs of continuous commercial-free music you are now missing. The Detector, self-powered and with electronic mute for quieting between selections, permits reception of popular background music programs no longer sent by wire but transmitted as hidden programs on the FM broadcast band from coast to coast. Use with any FM tuner. Size: 5½" x 9". Shipping weight approx. 7 lbs.

KIT \$49.50
(with pre-tuned coils, no alignment necessary)

WIRED \$75.00

COVER \$4.95 EXTRA

Current List of FM Broadcast Stations with SCA authorization \$1.00

MUSIC ASSOCIATED

65 Glenwood Road, Upper Montclair, N.J. 07043
Phone: (201) 744-3387

CIRCLE NO. 102 ON READER SERVICE CARD

cut holes
fast!

Round—inches and mm

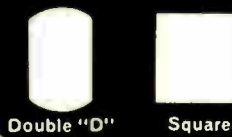

with
**Greenlee
punches**

Here's the simple speedy way to cut smooth, accurate holes in metal, hard rubber, plastics, epoxy, etc.

Save hours of hard work . . . punch clean, true holes in seconds for sockets, controls, meters, and other components. Easy to operate. Simply insert punch in a small drilled hole and turn with a wrench. For use in up to 16-gauge metal. Available at leading radio and electronic parts dealers.



GREENLEE TOOL CO
DIVISION OF GREENLEE BROS. & CO.

1866 Columbia Avenue, Rockford, Ill. 61101
CIRCLE NO. 111 ON READER SERVICE CARD



the amplitude of the output. The frequency-determining coil is plugged into the unit so that it may be used as a probe.

The meter incorporates many improvements over the company's previous model, which for years has been widely used as the standard of the industry. These include a transistor d.c. amplifier to increase sensitivity and provide full-scale meter reading at all frequencies, and the use of a taut-band meter to avoid the possibility of ever having a "sticky" meter. The grid-dip meter may be employed for any of the following purposes:

1. A *grid-dip oscillator* for use as an oscillating frequency meter to determine the resonant frequency of de-energized r.f. circuits. With the function selector set to "Osc", the grid-dip meter becomes an r.f. oscillator. When an external circuit, resonant at the oscillator frequency, is coupled to the "probe" inductance, power is absorbed from the oscillator and this is indicated by a dip (decrease) in the transistorized electronic voltmeter reading. Used in this manner, the meter may then be used to check the resonant frequency of a circuit without the application of power to the circuit in question. This results in a considerable saving of time; and a definite assurance of correct frequency adjustment of a circuit is obtained without the danger of working in the presence of high-voltage d.c. or r.f.

2. An *oscillating detector* for determining the fundamental or harmonic frequencies of energized r.f. circuits.

With a pair of headphones plugged into the phone jack, an audible beat note may be heard when the instrument is tuned to the fundamental or harmonic frequency of a source of r.f. The frequency in question, or its harmonics (and sub-harmonics), may be read directly from the calibrated dial to an accuracy of $\pm 2\%$.

3. A *signal generator* for use as a source of r.f. frequencies between 165 kHz and 300 MHz. The instrument may be employed in place of a standard signal generator, except in those cases where special shielding or a known amount of radio-frequency voltage is required.

4. A *tuned r.f. diode detector* for use as an absorption frequency meter. To use the grid-dip meter for this purpose, set the function selector to "Diode". The meter reading will now increase when the probe is brought into the presence of an r.f. field of the same frequency as that to which the dial is tuned. The frequency may be read directly from the dial if between 1.7 MHz and 300 MHz or from the logging scale and calibration curve if between 165 kHz and 1.7 MHz.

The a.c.-operated instrument is supplied in a convenient polypropylene carrying case which keeps the coil/probes with the grid-dip meter and protects both. Five additional coils are available for extending the range to 165 kHz.

The meter, less the coil/probe, measures 7" x 3½" x 3½"; it is available at \$90, including 7 coils and carrying case. ▲

60-Hz SCOPE TERMINAL

By CHARLES ERWIN COHN

A useful feature for an oscilloscope, if it is not already so equipped, is a source of low-voltage 60-hertz a.c. available at the front panel. This has two uses. First, it can be connected to the external synchronization terminal to lock the sweep to the line frequency when troubleshooting equipment for hum. In this way, hum components will remain stationary on the screen while other signal components will move. Second, the 60-

hertz signal is a convenient signal source for a quick check of the scope's vertical amplifier.

This feature can easily be provided by mounting a binding post in a convenient place on the front panel and connecting it to the hot side of the filament circuit. If the oscilloscope has a 60-hertz phasing control, the binding post being installed should be connected to the output of that circuit. ▲

EW Lab Tested
(Continued from page 11)

30 foot room. The outputs of eight microphones positioned throughout the room were averaged to obtain a composite response curve. Low-frequency harmonic distortion and tone-burst response were measured with a single microphone close to the speaker grille, to minimize the effects of room reflections.

In spite of the rather different room environments used in our measurements and in the E-V test chamber, we obtained a remarkably close agreement with their published figures. The response was relatively smooth and flat, within ± 4.5 dB from 65 to 15,000 Hz, which is the upper limit of our microphone's calibration. Below 65 Hz the output fell off rapidly in our test room. The harmonic distortion was extremely low (about 1%) down to 70 Hz, increasing to 5% at 40 Hz and 10% at 35 Hz. This is a clear indication that the speaker is coupling to the room down to 35 Hz and in other test locations or listening environments might have a substantial output down to that frequency. The distortion figures, taken at a 1-watt drive level, were actually measured at a rather high acoustic output level, since this speaker is considerably more efficient than most home speaker systems.

The tone-burst response was good, although not exceptional. There were no frequencies at which break-up occurred, and the only point where we found serious alteration of the burst shape was at 105 Hz which corresponded to a speaker and/or room resonance.

After listening to the speaker system for some time, we were convinced that our original premise was correct. A good monitor speaker can be a highly satisfactory home music system speaker. This was certainly the case with the Sentry II. It has a very smooth balanced sound, without any undue emphasis on any part of the frequency spectrum. The low bass was not overly obvious as is the case with some acoustic-suspension speakers, but we never felt any lack of the lower registers. The middles and highs were audibly smooth, to the point where we soon ceased to be aware of them as special features to be listened for, and simply sat back to enjoy the music.

The 16-ohm impedance of the system makes it less suitable for most transistor amplifiers than most speaker systems, since the typical transistor amplifier can only deliver about half as much power into 16 ohms as into 8 ohms. With a high-powered amplifier, this is of little consequence, but the easy sound of this speaker invited playing at a healthy volume, and many popular receivers can only deliver 8 to 10 watts into 16-ohm

People who built their own Schober Organs wrote this ad

Here's what they say about the pleasure of assembling the Schober Electronic Organ from kits . . . and enjoying the magnificent sound of an instrument they've created in their spare time.

Building was fun
"Building it was at least as much fun as playing it!"
Mr. Lester F. Schwartz,
Somerset, N. J.

So proud I could pop
"I've done over 90 per cent of the work on this organ myself—and I'm so proud I could about pop!"
Mrs. V. P. Allbert,
Topeka, Kansas

Nothing as fine under \$5,000
". . . I could not find any organ that sounded as fine as the Schober under \$5,000."
Mr. Jerome J. Fraenkel,
Franklin Square, N. Y.

Proud to own
"I am proud to own such a valuable instrument."
Mr. Jean J. Juteau,
Montreal, Canada



The new Schober THEATRE ORGAN— one of four models available

Most cherished possession
"My spinet has become the most cherished possession in our home—fabulous, indeed."
Mr. Frank J. Marion,
North Bergen, N. J.

Tremendous sound
"The sound is conservatively, tremendous."
Mr. Paul DeForest Wren,
Westbrook, Conn.

Unbelievably easy to build
"When we ran out of instruction, the organ was finished . . . To me it was unbelievable!"
Mr. Ted Sowinski,
Chicago, Illinois

Thousands of music lovers in every walk of life—from teen-agers to grandmothers, from people who are "all thumbs" to electronic engineers—have enjoyed the pleasure of assembling, playing and hearing the magnificent sound of the Schober organ. Whether you favor Bach or Bop, there is a Schober organ that gives you full range of expressional and tonal quality—so like a fine pipe organ that many listeners can't tell the difference. You can build a Schober organ for as little as \$645. And—even if you've never played a note before—Schober's self-teaching courses give you immediate musical results.

Over 50% of Schober Organ owners never handled an electronic job before and didn't play a note, yet assembled some of the best organs ever designed and get a daily thrill from making their own music. Isn't it time for you to take this cost-saving road to greater musical

pleasure—and enjoy the satisfaction of doing it yourself?

Free Information and Demonstration Recording
Send today for your free copy of Schober's 16-page, full color booklet, plus 7" free recording.

The Schober Organ Corp., Dept. RN-56
43 West 61st Street, New York, N. Y. 10023

- Please send me Schober Organ Catalog and free 7-inch "sample" record.
- Enclosed please find \$1.00 for 12-inch L.P. record of Schober Organ music.

NAME _____
ADDRESS _____
CITY _____ STATE _____ ZIP _____

CIRCLE NO. 95 ON READER SERVICE CARD

FREE!

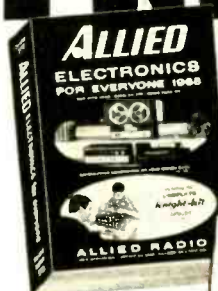

ALLIED
NEW 1968
CATALOG
518
PAGES

SAVE ON:

- Famous Knight-Kits®
- Stereo Hi-Fi
- Tape Recorders, Tape
- CB 2-Way Radios
- Walkie-Talkies
- FM-AM & AM Radios
- Shortwave Receivers
- Portable TV
- Phonographs
- Amateur Gear
- Intercoms & PA
- Automotive Electronics
- Test Instruments
- TV Antennas & Tubes
- Power Tools, Hardware
- Tubes, Transistors
- Parts, Batteries, Books

TOP SAVINGS ON THE BEST IN ELECTRONICS FOR EVERYONE

Shop by mail and save at Allied, world's largest electronics headquarters. Hundreds of money-saving values. NO MONEY DOWN. Up to 2 years to pay!

MAIL COUPON BELOW

ALLIED RADIO, Dept. 1F
P.O. Box 4398, Chicago, Ill. 60680

NAME (Please Print) _____
ADDRESS _____
CITY _____
STATE _____ ZIP _____

CIRCLE NO. 125 ON READER SERVICE CARD

WAVE FORM ANALYSIS & PEAK FM MODULATION



all for LESS MONEY!

The Lampkin 205A FM Modulation Meter accurately indicates PEAK modulation on mobile transmitters. To shoot trouble visually, use your own general-purpose oscilloscope at the 205A rear jack output. This makes a low-cost, highly effective test combo—and a well-rounded shop—all for less money.

Lampkin pioneered the PEAK voltmeter for FM modulation indication.

Like to see the complete specs? Mail coupon today!

Use this coupon for FREE booklet "How To Make Money in Mobile-Radio Maintenance" and information on Lampkin meters.

Name _____
Address _____
City _____ State _____ Zip _____

LAMPKIN LABORATORIES, INC.
MFM Div., Bradenton, Fla. 33505

CIRCLE NO. 107 ON READER SERVICE CARD

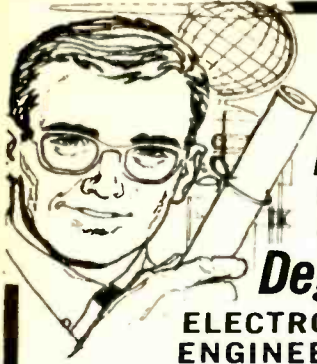

Earn Your Degree

ELECTRONICS ENGINEERING

through HOME STUDY

HIGHLY EFFECTIVE HOME STUDY COURSES IN:

- Electronics Engineering Technology
- Electronics Engineering Mathematics

Earn your Associate in Science Degree in Electronics Engineering and upgrade your status and pay to the engineering level. Complete college level courses in Electronics Engineering. We're a forward looking school. Outstanding lesson material—thorough and easy to understand. Engineering taught on the basis of application and understanding rather than on the basis of memorization. Up to date in every respect. Acquire the knowledge and ability that means the difference between a low paying technician job and a high paying engineering position. Low tuition cost with low monthly payments. Free engineering placement service for our graduates. Write for free descriptive literature. Ask for bulletin D, no salesman will call on you.



COOK'S INSTITUTE

of Electronics Engineering

Forest Hill Road

P. O. Box 10634

Jackson, Miss. 39209

Established 1945

Formerly Cook's School of Electronics

CIRCLE NO. 119 ON READER SERVICE CARD



STEREO/HI-FI DIRECTORY

1968... \$1.25... #56
1967... \$1.25... #45

Giant 180 page buyers guide to virtually every new audio component on

the market—amplifiers • changers and turn tables • receivers • tuners • tape machines • speakers, etc.

Order by number from

Ziff-Davis Service Div., 595 Broadway • New York, N.Y. 10012. Enclose add'l 15¢ per copy for shipping and handling (50¢ for orders outside U.S.A.)

GET INTO ELECTRONICS



V.T.I. training leads to success as technicians, field engineers, specialists in communications, guided missiles, computers, radar and automation. Basic & advanced courses in theory & laboratory. Electronic Engineering Technology and Electronic Technology curricula both available. Assoc. degree in 29 mos. B. S. also obtainable. G.I. approved. Graduates in all branches of electronics with major companies. Start September, February. Dorms, campus. High school graduate or equivalent. Write for catalog.

VALPARAISO TECHNICAL INSTITUTE
Dept. RD, Valparaiso, Indiana 46383

loads. Since most monitor amplifiers are probably tube types, with output transformers matching 16-ohm loads, this compromise does not exist in professional applications. (What is more, the higher efficiency of this system results in

considerable acoustic output with only a rather modest electrical input power. —Editor)

The Electro-Voice Sentry I is priced at \$165 while the Sentry II is priced at \$174 for the audiophile. ▲

Ampex AG-500-4 Tape Recorder

For copy of manufacturer's brochure, circle No. 20 on Reader Service Card.

WE recently had the opportunity to use and test a professional recorder rather than the home recorders we usually check. The unit in question is the Ampex AG-500-4, a portable stereo/mono four-track, two-speed (7½ and 3¾ in/s) recorder. The same basic instrument is available strictly for mono and with other speeds, various head configurations, and provision for rack mounting. The stereo unit we tested, however, would probably come nearest to satisfying the needs of a critical hobbyist who could afford this machine.

The AG-500-4 is a large, heavy recorder which weighs 52 pounds. It measures about 20" x 17" x 9½". The transport is a massive, three-motor system on a milled die-cast plate. All functions are solenoid-controlled and operate by a row of push-buttons or by an optional remote-control unit. The tape speeds are changed by pulling out or pushing in a button located between the tape reels. The recorder is intended to accommodate 7-inch or smaller reels.

Tape threading is simplified by a hinged head cover that swings out of the way to give a clear view of the full tape path. A tension arm shuts off the tape transport if the tape runs out or breaks. A tape lifter holds the tape clear of the heads during fast-forward or rewind. There is no index counter.

The fully solid-state electronics are contained in two identical rack-panel units mounted below the transport. Each channel has two recording inputs, with separate level controls. The playback amplifier, which operates from the monitor head, is separate and has its own level controls. Each channel's illuminated vu meter can be switched to read either the input signal or the monitor-head signal, and the selected signal



can be monitored with headphones plugged into a front-panel jack.

The playback equalization is switched to correspond to the tape speed by a separate control. Each channel has a record-safety switch (in addition to a Record button) which prevents recording when in the Safe position. A red light indicates that the channel is in the Record mode. The inputs and outputs are accessible through a sliding panel beneath the case. The connectors are standard three-pin locking types, commonly used in recording and broadcast studios.

Operation is simple and uncomplicated. The transport buttons are clearly marked for their functions (Reverse, Fast-Forward, Play, Stop, and Record). All-in-all, this is about as foolproof as a machine of its flexibility can be.

The instruction book for the recorder is a large, loose-leaf binder, containing detailed performance specifications and maintenance instructions. Examination of the specifications reveals the great conservatism which sets this machine apart from even the finest home recorders. For example, the nominal output is 1.25 volts (+4 dBm) into 600 ohms. However, it can deliver up to 12.5 volts

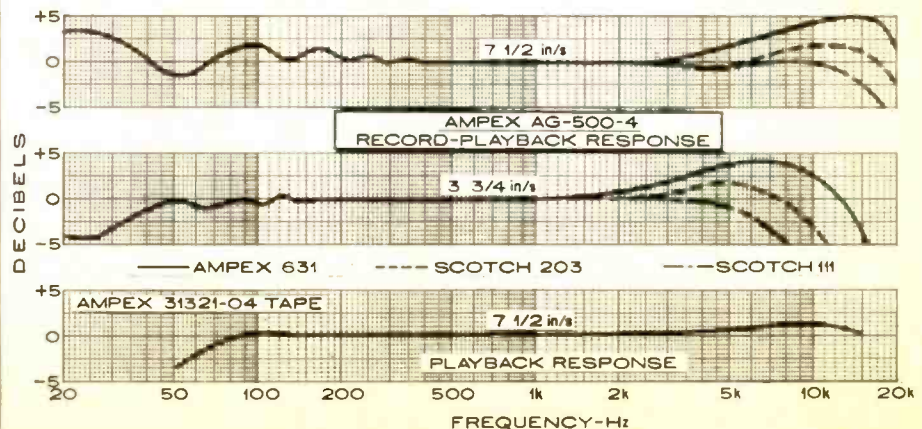

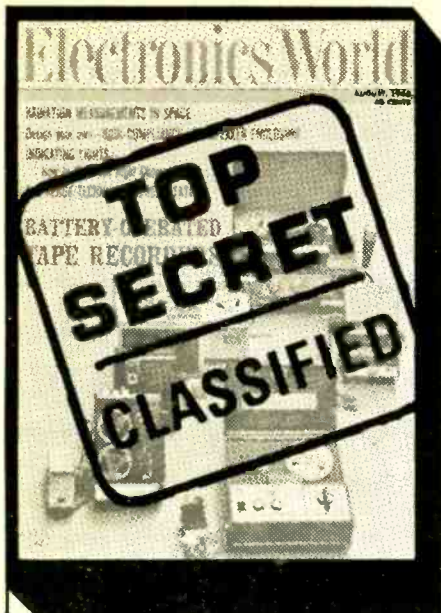

*...not by
a long shot
it isn't !!*

There's certainly nothing top secret about the classified pages in Electronics World Magazine. They're wide open to the searching eyes of every buyer who's in the market for the product or service that he knows can be found in Electronics World's Electronics Market Place.

The more than 191,000 buyers of Electronics World, largest readership of any magazine for electronics professionals in the world, are your guarantee of knowing that your ads are being read by people who are constantly looking for and buying electronics products. It is these people to whom you MUST direct YOUR advertising as do the many key advertisers appearing in this issue and in each issue throughout the year.

No doubt about it—there's a vast market of buyers searching the classified advertising pages of Electronics World and it's important that your ad be exposed to this prime buying audience. Prove to yourself that the leading magazine for electronics professionals MUST ALSO be the leader in sales responses to the many classified ads presently enhancing its pages—it makes a great deal of sense—give it a try.

There's complete rate information for your convenience in the classified section of this issue. Or, if you'd like a little personal service, it's right up our alley. Just write to

HAL CYMES
Classified Advertising Manager
ZIFF-DAVIS PUBLISHING COMPANY
One Park Avenue
New York, New York 10016

(+24 dBm) before clipping occurs. Peak recording levels, 6 dB above zero, will not cause significant distortion. The second harmonic distortion is rated at less than 0.4 percent at normal recording.

Although the recorder has several equalization adjustments, as well as bias frequency and symmetry adjustments, there is no provision for adjusting bias current. We made several frequency-response measurements with various tape types. At 7½ in/s using Ampex 631 tape for which the manufacturer states the machine was adjusted, the record-playback frequency response was +5, -1.5 dB from 20 to 20,000 Hz, with a rising characteristic at both ends of the spectrum. At 3¾ in/s, the response was ±4 dB from 20 to 15,500 Hz. As evident from our curves, a somewhat more even response was obtained with another tape type. In any case, it was obvious from these measurements that the Ampex AG-500-4 at 3¾ in/s would satisfy the most critical home-recording needs, as well as most professional requirements.

The playback frequency response, with the Ampex 31321-04 test tape, was +1, -3.5 dB from 50 to 15,000 Hz. The signal-to-noise ratio, referred to normal recording level, was 48.5 dB at 7½ in/s and 47 dB at 3¾ in/s. Ampex specifies signal-to-noise ratio with respect to a peak recording level 6 dB above normal, which would increase these figures to 54.5 dB and 53 dB respectively. Either way, the AG-500-4 was one of the quietest tape recorders we have used.

The recording inputs required only 0.043 volt for normal recording level. Wow and flutter were each 0.05 percent at 3¾ in/s, and 0.03% and 0.045% respectively at 7½ in/s. The normal tape speeds were slightly slow, with an error of about 30 seconds in 30 minutes of playing time. In the fast speeds, 1200 feet of tape were handled in 72 seconds.

We could not find fault with the sonic performance of the recorder. As we expected, FM broadcasts recorded at 3¾ in/s could rarely be distinguished from the original program. The 7½ in/s speed offered little audible improvement, although it was necessary for compatibility with tapes recorded elsewhere.

Being accustomed to home tape recorders, we felt the lack of an index counter on several occasions, but aside from this minor inconvenience, the AG-500-4 was a delight to use. We felt that its ruggedness and conservative design would insure long and reliable service even under rough handling in the field. That, after all, is one of the basic differences between home and professional machines. The former may initially match the performance of the latter, but are less likely to maintain their full performance under adverse conditions and after long service. The Ampex AG-500-4, in the form we tested, is priced at \$1524. The mono model, the AG-500-1, is priced at \$1202.

Ziff-Davis Service Division, Dept. ISH
595 Broadway, New York, N. Y. 10012

Please send my copy of the 1968 ELECTRONICS INSTALLATION & SERVICING HANDBOOK as checked below:

- I am enclosing \$1.25 plus 15c for shipping and handling for the Regular Edition. (\$1.75 for orders outside U.S.A.)
- I am enclosing \$3.00. Please send me, postpaid the Leatherflex-covered Deluxe Edition, (\$3.75 for orders outside U.S.A.) (Please allow 3 additional weeks for delivery of the Deluxe Edition.)

print name _____

address _____

EW 68

city _____

state _____

zip code _____

**HERE'S
THE MOST IMPORTANT
JOB TICKET YOU'LL
WRITE UP THIS YEAR!**

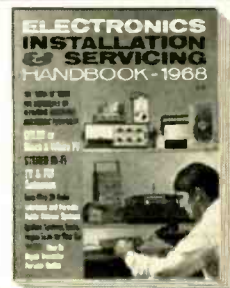

NOW—GET THE TRICKS OF THE TRADE FOR SERVICING EVERYTHING . . . FROM TV TO AM/FM . . . FROM CITIZEN'S BAND TO PUBLIC ADDRESS . . . FROM HOME INTERCOM TO TAPE CARTRIDGE UNITS. THEY'RE ALL IN THE NEW, 1968 ELECTRONICS INSTALLATION AND SERVICING HANDBOOK.

You'll find the latest, most comprehensive technique advice, equipment information and step-by-step "how-to-do-it" hints that will aid you in your servicing (or save you costly outside repairs).

This 140-page "encyclopedia" of electronics servicing knowledge contains a special, full-color section on color TV maintenance . . . model numbers and prices of replacement parts . . . recommended tools for every operation . . . accessory information to help you turn an extra dollar. Plus up-to-the-minute reports from hundreds of manufacturers.

Whether you're a professional serviceman, weekend home hobbyist or spare time "Mr. Fixit," the 1968 ELECTRONICS INSTALLATION AND SERVICING HANDBOOK is essential for you. Essential for your profit, fun or both.

GET THE HANDSOME LEATHERFLEX COVERED EDITION FOR \$3 POSTPAID!

The 1968 ELECTRONICS INSTALLATION & SERVICING HANDBOOK is also available in a splendid deluxe edition. Rugged Leatherflex cover provides lasting protection yet is softly textured and gold-embossed for the look of elegance. A collector's item—a superb addition to your electronics library. And it's yours, for just \$3 postpaid, when you check the appropriate box on the order form.

1968
ELECTRONICS
INSTALLATION
& SERVICING
HANDBOOK

ORDER YOUR COPY TODAY!

**Confused by all the ads for
home training in electronics?**

**find out what it's really
all about from the leader...**

With RCA Institutes Home Training Programs you get:

- As many as 24 valuable kits at no extra cost.
- The AUTOTEXT programmed method of learning electronics faster, easier, almost automatically.
- A unique easy-pay Tuition Plan.

CLASSROOM TRAINING ALSO AVAILABLE. For special catalog and full information, simply check the appropriate box on the attached card.

All courses approved under the new G.I. Bill.
Accredited Member National Home Study Council.

RCA INSTITUTES, DEPT. **EW-68**
320 West 31st Street, New York, N.Y. 10001

RCA



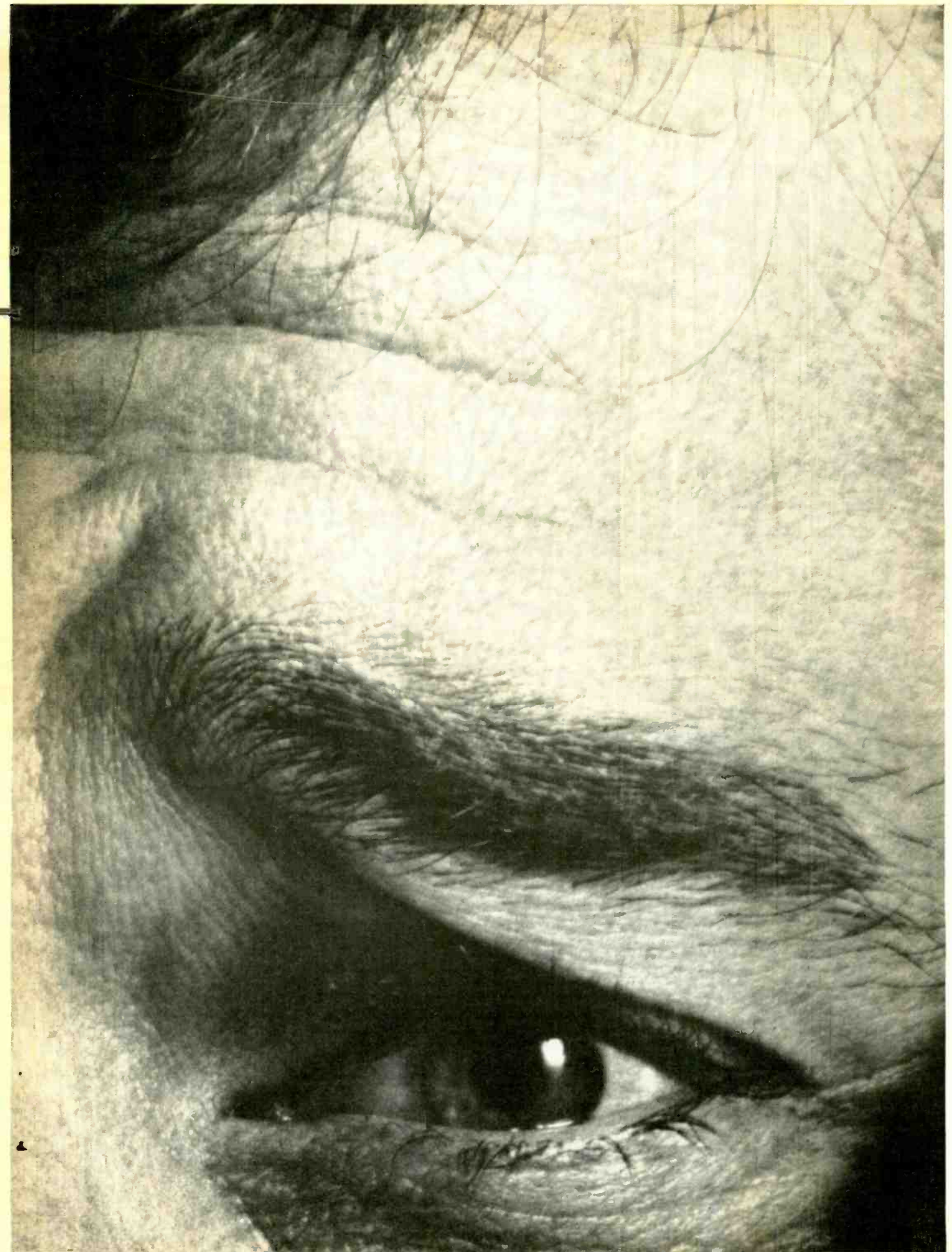

Electronics World SUBSCRIBER SERVICE

Please include an address label when writing about your subscription to help us serve you promptly. Write to: Portland Place, Boulder, Colo. 80302

CHANGE OF ADDRESS:

Please let us know you are moving at least four to six weeks in advance. Affix magazine address label in space to the right and print new address below. If you have a question about your subscription, attach address label to your letter.

TO SUBSCRIBE:

Check boxes below.
 New Renewal
 5 years \$21
 3 years \$15
 1 year \$6

SPECIFY:

Payment enclosed—
 You get 1 extra issue per year as a BONUS!
 Bill me later.

← AFFIX LABEL →

state	city	address	name	If you have no label handy, print OLD address here.
zip-code	please print			

[Add'l postage: \$1 per year outside U.S., Its possessions & Canada.]

name 0227

address

city

state zip-code

CAR AND DRIVER YEARBOOK

The most exciting, most comprehensive automotive fact book available. A complete buyers guide for domestic and imported models—road tests, accessories, and performance equipment buying guide.

1968 ... \$1.50 ... #51
 1967 ... \$1.50 ... #40

CAR AND DRIVER RACING ANNUAL

An almanac of competition information covering the entire racing year. Feature stories of individual races, personality wrap-up on top drivers, box scores on every major event throughout the world plus many dramatic photos.

1967 ... \$1.25 ... #63

Order by number from
 Ziff-Davis Service Div., 595 Broadway • New York, N.Y. 10012. Enclose add'l 15¢ per copy for shipping and handling (50¢ for orders outside U.S.A.)

PAYMENT MUST BE ENCLOSED WITH ORDER

LONG RANGE RADAR DETECTOR

Only
\$39.95

to protect
 yourself
 against
 speeding

tickets ... Be a safe driver

Amazing new transistorized receiver warns ... with buzzing sound ... far in advance of clocked radar zone area. Pays for itself over and over again by preventing loss of points and driver's license. Avoid insurance increases. Clips on car visor. Users agree they drive more efficiently and safely. Ten day money back guarantee. Reg. \$44.95. For limited time send check or money order for \$39.95 to ...

VAL PRODUCTS

Dept. W
 3040 SOUTH MONROE STREET
 DENVER, COLO. 80210 Phone 757-6767

Cartridge Loading (Continued from page 32)

compensate for this excessive loss by means of the bass control.

Measuring Capacitance of Cartridge

If a 1000-Hz oscillator and a high-impedance a.c. voltmeter are available, it is possible to find the approximate capacitance of a ceramic cartridge. Two 330,000-ohm resistors are connected in series across the oscillator, as shown in Fig. 2B, with the meter between the junction and ground. The oscillator is adjusted for about 2 volts on the meter. The cartridge is then connected across the meter and the meter reading is noted. A 300-, 500-, 1000-, or 4000-pF capacitor is then connected in place of the cartridge until the same meter reading is obtained. The capacitance of the cartridge is the same as that of the capacitor which produces the same voltage reading. A 300-pF capacitor will produce a change of only about 0.1 volt so a low range should be used on the meter.

FET Source-Follower Stage

If it is found that a change is necessary to provide a correct match, making this change may be inconvenient. It was then decided that it would be better to have something which could be simply plugged in to provide the proper equalization. Such a unit was constructed, using a pair of inexpensive FET's which would provide high input impedance. See Fig. 3. It is battery-operated to eliminate the added bulk and weight of a power transformer and filter. The total current is only 50 microamperes so that the life of the battery would be practically equal to the shelf life, which would be over a year. For this reason the unit has no switch and is left on continuously.

Transistors Q1 and Q2 are FET

source-followers, one for each channel. Resistors R3 and R4 are the feedback resistors. Resistors R1 and R2 are the cartridge loading resistors and may be conveniently changed to any value to match a cartridge. Because the FET source-followers have an extremely high input impedance, resistors R1 and R2 may be made high enough to match the lowest capacitance cartridges available.

There is no limit to the low value of R1 and R2 if it is required to match a high-capacitance cartridge. Each channel will handle a 0.75-volt input signal and, since most stereo cartridges have outputs of under 0.5 volt, the circuit will not be overloaded in any normal use.

Operating a FET at a low current of 25 μ A reduces the transconductance but it is still adequate and the output impedance in this circuit is around 2000 ohms. This is low enough so that the shunt capacitance of standard audio shielded cables should have little effect on the high-frequency response. The source-follower should not be terminated in a load less than 100 times its output impedance. This would make the minimum load resistance 200,000 ohms, which fits in with the following amplifier's input resistances, discussed previously.

With a 200,000-ohm termination and 0.75-volt input, the output is 0.7 volt at 0.65% harmonic distortion. With a 100,000-ohm termination and 0.75-volt input, the output is 0.68 volt at 1.6% harmonic distortion. These checks were made both with a new battery which read 9.5 volts and an old one reading 6 volts. Due to the large amount of feedback from the unbypassed source resistors, the readings were identical. With a 200,000-ohm termination, the response of the source-follower stage is within 0.5 dB of flat from 20 to 15,000 Hz. With a 100,000-ohm termination, the output is within 1 dB of the desired flat response. ▲

Fig. 3. Stereo FET source-follower stage in which the values of the cartridge-loading resistors may be readily changed to match any ceramic cartridge. Battery drain is so low that no power switch is used. The output of this stage is fed to any flat-response channel of a preamplifier or amplifier unit.

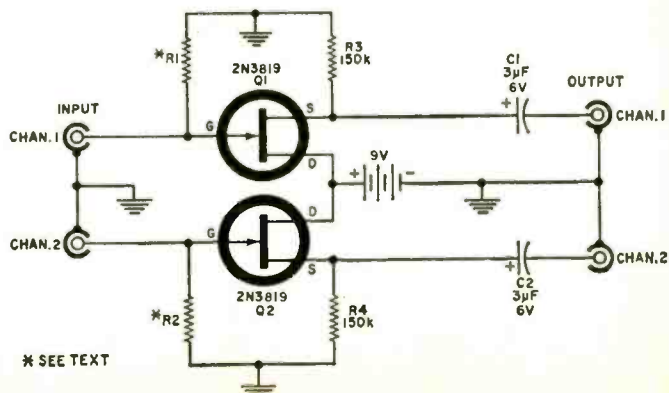

"RCA PHOTOMULTIPLIER TUBES" compiled and published by RCA Electronic Components and Devices, Harrison, New Jersey. 16 pages. Price \$0.35. Soft cover.

This compact booklet (PIT-703) is designed to present a full line of photomultipliers in an easy-to-select form. The tubes listed range from detectors for very low levels of visible and near-visible radiation to sophisticated types for research and space exploration. Detailed characteristics are listed for each type.

"APPLIED MATHEMATICS FOR ELECTRONICS" by J.H. Westlake & G. E. Noden. Published by Prentice-Hall, Inc., Englewood Cliffs, New Jersey. 600 pages. Price \$12.25.

This book, written by two members of the electronics department at Southern Alberta Institute of Technology, is geared to the technician and technical institute student. It can be used as a classroom text or as a home-study manual. In keeping with the authors' dictum that pure mathematics is wasted on engineering students unless they are able to relate the information to applications, this is a carefully integrated treatment of theory and practice.

Prerequisite is a knowledge of elementary electricity and electronics as well as a background in high school mathematics. The text is divided into fourteen chapters covering basic opera-

BOOK REVIEWS

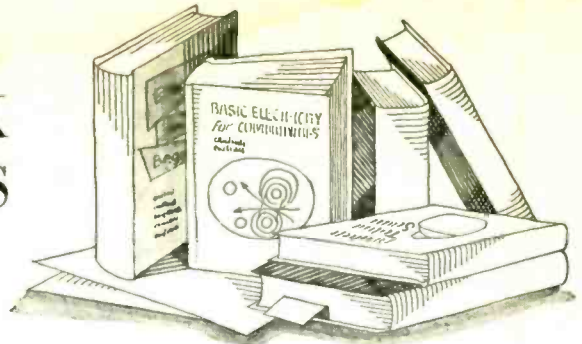

tions, algebraic equations, systems of linear equations, mathematics of resistive networks, trigonometry, complex algebra, logarithms and exponentials, matrix algebra, mathematics of two-port networks, calculus, digital machine languages, symbolic logic and Boolean algebra, and the mechanization of logic. Answers to the odd-numbered problems appended to each chapter are provided as are a series of appendices to make the text a complete source book for the subject.

"THE RADIO AMATEUR'S HANDBOOK" compiled and published by the American Radio Relay League, Newington, Conn. 610 pages plus tube, transistor, and catalogue sections. \$4.00 (in U.S.). Soft cover.

This is the Forty-Fifth Edition of this standard manual of hamdom and it has reached "middle age" very gracefully. A

completely redesigned cover, clearer and sharper type and diagrams inside contribute to a very welcome "new look".

Many of the chapters on theory have been revised to reflect current state-of-the-art; greater emphasis has been placed on solid-state devices; and renewed emphasis has been placed on using such devices in the construction of equipment.

New construction projects have been introduced, in many cases replacing dated circuits. Information on how to fabricate etched-circuit boards, build transistor heatsinks, and assemble an SCR-operated motor-speed control is also included.

As always, the tube and transistor data sections are worth the price of admission since they represent a compilation of material from the data books of many different manufacturers. They provide a ready reference. ▲

THE ELECTRONIC INDUSTRY'S MOST CURRENT 1968 CATALOG

FREE!



ALL NEW...
SPRING AND SUMMER
ELECTRONICS CATALOG



YOUR BUYING
GUIDE FOR:

- Stereo & Hi-Fi Systems & Components
- Tape Recorders
- Phonos, Radios, & TVs
- Cameras & Film
- PA
- Ham Gear
- Test Instruments & Kits
- Citizens Band
- Electronic Parts, Tubes & Tools!

MAIL TODAY TO...

BURSTEIN-APPLEBEE

DEPT. EWR, 3199 MERCIER STREET KANSAS CITY, MO. 64111

Name _____
Address _____
City _____ State _____ Zip Code _____

DO YOUR FRIEND A FAVOR... ALSO INCLUDE HIS NAME AND ADDRESS IN ENVELOPE WHEN MAILING YOUR REQUEST

CIRCLE NO. 122 ON READER SERVICE CARD

NEW COAX UHF & VHF MATCHING TRANSFORMER INPUT-SPLITTER

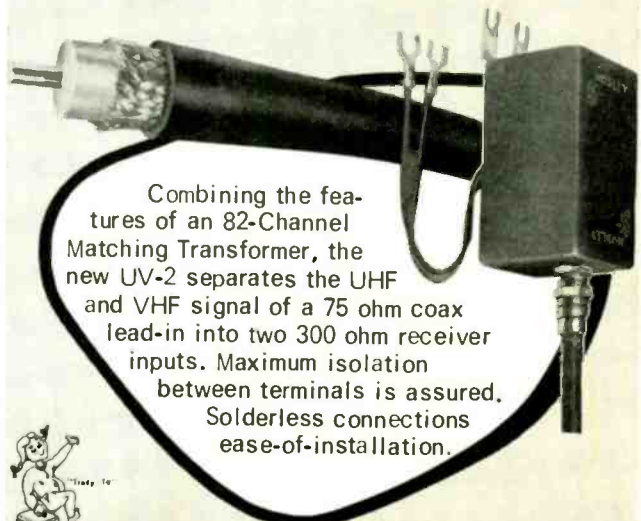

Combining the features of an 82-Channel Matching Transformer, the new UV-2 separates the UHF and VHF signal of a 75 ohm coax lead-in into two 300 ohm receiver inputs. Maximum isolation between terminals is assured. Solderless connections ease-of-installation.



Write Dept. 168 for FREE detailed brochure

Mosley Electronics, Inc. 4610 N. Lindbergh Blvd.,
Bridgeton Missouri 63042

CIRCLE NO. 104 ON READER SERVICE CARD

Trade Secrets (Continued from page 41)

Now it's easy
to be an authority on
tape recording— with
HiFi/STEREO REVIEW'S
all-new
1968 TAPE RECORDER
ANNUAL

TAPE RECORDER ANNUAL 1968

How to Choose a Tape Recorder • The New Home Cartridge
Markings • Battery-Portable Tape Recorders • Creative
Taping • Home Video Recorders • Pre-recorded Tape Roundup
Directory of Stereo Tape Recorders, Tape Accessories, Blank



This fact-filled volume contains over 130 pages, 19 complete features, covering every aspect of tape recording. You get expert tips by the dozens, on equipment—making better tapes—editing—copying—on everything you want and need to know about tape recording.

Featuring a complete directory of the latest monaural and stereo recorders, players and transports—the only complete buyer's guide available in the tape recorder field! Hundreds of photos—full data on hundreds of models from portable units to professional rigs. All the model numbers, specifications, dimensions and prices... every vital statistic you need to compare the newest machines and select the finest one in your price range.

Plus—Complete Directories of cartridge machines... microphones... headphones... raw and pre-recorded tapes... accessories. **How-To** Articles on selecting the right recorder... recording off the air... editing... creative taping... starting your own tape club. **Special Reports** on taping and the law... new self-reversing tape recorders... having fun with home VTRs... home cartridge players... buying a battery portable.

The 1968 TAPE RECORDER ANNUAL is an indispensable guide for everyone who wants better performance, greater versatility and a lot more fun from his tape recorder... month after month... tape after tape. Order your copy today!

GET THE DELUXE LEATHERFLEX-COVERED EDITION FOR \$3 POSTPAID! THE 1968 TAPE RECORDER ANNUAL is also available in a splendid deluxe edition. Rugged Leatherflex covers provide lasting protection yet are softly textured and gold-embossed for the look of elegance. A collector's item—a superb addition to your permanent reference library. And it's yours, for just \$3 postpaid.

Ziff-Davis Service Division, Dept. TRA
595 Broadway, New York, N.Y. 10012

Please send my copy of the 1968 TAPE RECORDER ANNUAL as checked below:

- \$1.25 enclosed, plus 15c for shipping and handling for the Regular Edition. (\$1.75 for orders outside U.S.A.)
- \$3.00 enclosed. Please send me, postpaid, the Leatherflex-covered Deluxe Edition. (\$3.75 for orders outside U.S.A.) (Please allow 3 additional weeks for delivery of the Deluxe Edition).

print name _____ EW-68

address _____

city _____

state _____ zip code _____

■ PAYMENT MUST BE ENCLOSED WITH ORDER ■

need not treat it as a secret. There is also a difference between matters of public knowledge and matters which are peculiarly within the knowledge of the employer. A frequent defense raised by employees when they are charged with unauthorized disclosure of their employer's trade secrets is that what they learned from the employer was only general knowledge which anyone skilled in his work could gain from similar employment. When this is established, it is a valid defense. According to the Supreme Court of Indiana in the case of *Donahue vs Permacel Tape Corp.* [234 Ind. 398; 127 NE (2) 241]:

"... Knowledge, skill and information (except trade secrets and confidential information) become a part of the employee's personal equipment. They belong to him as an individual for the transaction of any business in which he may engage, just the same as any part of the skill, knowledge, information or education that was received by him before entering the employment. Therefore, on terminating his employment he has a right to take them with him."

It is difficult for the courts to determine what is general knowledge or what is specific knowledge. Consequently, the concept has been the subject of many lawsuits.

To ask an employee to make such a judgment is to ask him to determine something which, for the most part, he will be unable to answer.

Employee Protection?

The purpose of this article is not only to alert the reader to the existence of the problems, but to offer some concrete suggestions which he can use to minimize his risk. The following questions can be utilized as a check list to assist the engineer or technician changing jobs or contemplating going into business for himself in determining if there is a real risk involved.

1. Will I be doing the same kind of work in my new job as I did in my last position?

2. Will I be required to use the same techniques for my new employer as I used for my former employer?

3. Did my old employer have a proprietary product or service which is in competition with products or services of my new employer?

4. What has been the attitude of my former employer with respect to the subsequent employment of his employees?

5. Did I learn something of a proprietary nature while working for my former employer, either as to research, production techniques, or processes

which I will be called upon to use for the benefit of my new employer?

6. Is my new employer in direct competition with my former employer?

7. If I were my former employer, would I feel imposed upon by what I intend to do in connection with my new employment?

If the answer to any of these questions is "yes", then there is a potential legal problem. And if the answer is "yes", there are several things that can be done to protect yourself and your new position. Some of these are:

1. Have a frank discussion with your new employer. Point out that in the course of your former employment you may have learned of your former employer's trade secrets. Point out that in fairness to him and to yourself you want to be assigned to work in which you will not be required to reveal trade secrets of your former employer.

2. Obtain from your new employer an indemnification agreement. This agreement should say that in the event you are accused of unauthorized use of your former employer's trade secrets, the new employer will defend you in any law suit and pay your attorney fees and court costs and satisfy any judgment that may be rendered against you.

3. If requested to reveal anything which in good conscience you believe to be a trade secret, ask to discuss the problem with your new employer's attorney. You will find that top management will appreciate your concern since the new employer will not want to get involved in unfair trade litigation, and second, it stamps you as an honorable person in whom the new employer may repose trust and confidence.

4. If your new employer does not respond favorably to your suggestions, you should take a further hard look at your over-all exposure. Perhaps you should consult an attorney of your own choosing, state fully the facts and circumstances and obtain from him a written opinion as to your exposure to liability.

As in most cases where there is danger of legal complications, the cost of prevention is much less than the cost of defense. This is especially true in matters affecting the commercial aspects of the law. The incidence of litigation with former employers seems to be increasing and with the pressures of competition on the increase, there is little prospect that such problems will decrease in the future.

(EDITOR'S NOTE: The author is very much aware of the legal problems of technicians and engineers. Recently he was involved in a six-month court battle in which half-a-dozen technical personnel were enjoined with their corporate employer in a case alleging that they misappropriated the trade secrets of a former employer.)

Electronic Implants

(Continued from page 48)

functions. Orthodoxy, both in design and application, are basic characteristics. For example, the design might employ strain gages to measure femoral forces in a hip-bone, notably the components X, Y, and Z as shown in Fig. 8. Rather than a direct cable, a simple r.f. transmitter may be used to send data so that the patient's movements are not restricted. Or, a radio tooth may be implanted in the jaw to transmit data to an external receiver. These are relatively simple devices, but the development of a multi-channel system is a common engineering goal. Six or more channels are necessary to obtain a reasonably good set of behavioral profiles.

Experience gained with passive implants has helped in the development of special, implantable synthetics and metals, since replacements for natural bone structures must follow the original's characteristics as closely as possible.

Implantable Materials

Any discussion of medical electronic implants must, of necessity, involve consideration of characteristics common to implantable materials. The defense mechanism of the body must be kept in mind at all times.

The human body's defense mechanism is, in many ways, unpredictable and unique. In the case of implanted natural tissues, if there is a genetic disparity between donor and recipient, the body attempts to throw it off. The body makes a powerful effort to preserve what is termed "self". Once the body has been made aware of "self", any further attempt to reintroduce more of the identical foreign antigens is met with an even faster and more explosive rejection.

The development of materials suitable for implantation was neither swift nor painless; and electronic devices, as they were to emerge later on, posed a special set of problems.

Current techniques may be traced to two men. During the period 1860 to 1880, Baron Joseph Lister introduced rigid antiseptic surgical techniques. Later, in 1894, Sir William Arbuthnot Lane stated that large metal implants could block the healing action of the body and insisted that strict aseptic control was a foremost consideration in surgery. His technique, which bears his name, is still practiced today all over the world.

According to M. T. Edgerton, the ideal properties of implanted materials are these: the implant must be chemically stable; it must not excite an inflammatory response in tissues; it must be non-carcinogenic (that is, not cause cancer); it must not produce a state of allergy or hypersensitivity; it

Fig. 8. Passive electronic implant uses strain-gage type sensors to detect and relay femoral force data (bending moments) from the hip to the readouts.

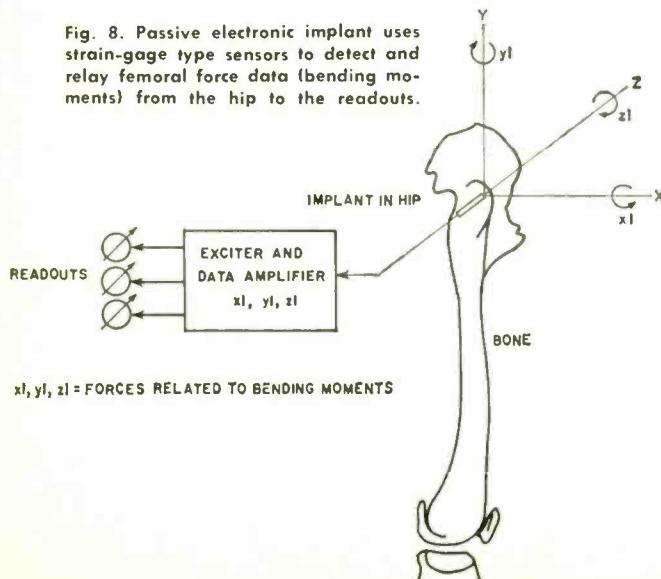

Weller®

...the soldering tools professionals depend on



The original Dual Heat Soldering Guns

Preferred by technicians for their fast heating copper tips, exclusive trigger-controlled dual heat, and high soldering efficiency. Available in 3 watt-age sizes, each with spotlight.

100/140-watt Model 8200, 145/210-watt Model D-440, and 240/325-watt Model D-550. Also in complete kits:

- Model 8200PK includes 100/140 watt gun, extra tips, tip-changing wrench, flux brush, soldering aid and solder
- Model D-550PK heavy-duty 240/325 watt gun kit with soldering, cutting and smoothing tips, wrench and solder

Dependable MARKSMAN Irons in a size for every job



Ideal for deep chassis work and continuous-duty soldering, Marksman irons outperform others of comparable size and weight. All five feature long-reach stainless steel barrels and replaceable tips.

- 25-watt, 1¼-oz. Model SP-23 with 1/8" tip (In kit with extra tips, soldering aid, solder—Model SP-23K)
- 40-watt, 2-oz. Model SP-40 with 1/4" tip
- 80-watt, 4-oz. Model SP-80 with 3/8" tip
- 120-watt, 10-oz. Model SP-120 with 1/2" tip
- 175-watt, 16-oz. Model SP-175 with 5/8" tip

NOW a BATTERY OPERATED IRON for field servicing

Use this lightweight service tool for automotive wiring, model planes, or mobile communications. Works from any 12 volt battery or 12-14 volt AC/DC supply. Supplied complete with long-life patented "Temperature Sensing" tip, 12-ft. power cord and terminal clips. Model TCP-12—12 volt; Model TCP-24—24-28 volts.



Complete Weller Line includes replacement tips and solder at your Electronic Parts Distributor

WELLER ELECTRIC CORPORATION, Easton, Pa.

CIRCLE NO. 91 ON READER SERVICE CARD

Delta Launches the COMPUTACH®*



The
Great
One!

*An exclusive computer-tachometer for precise RPM measurement in easy-to-build Kit form!



ONLY
\$29.95
ppd.

Delta, pioneers in CD ignition who produced the fabulous MARK TEN®, now offer a precise computer-tachometer which obsoletes any type tachometer on the market today! You achieve unbelievable accuracy in RPM readings due to the advanced, solid-state electronic matched components used in the computer, coupled with the finest precision meter in the world. Works on all 2, 3, 4, and 6 cylinder 2 cycle and with 4-6-8 cylinder—4 cycle 12 volt engines.

- ▲ 0-8000 RPM range
- ▲ Perfect linearity — zero parallax
- ▲ Adjustable set pointer
- ▲ Wide angle needle sweep
- ▲ Translucent illuminated dial
- ▲ Chrome plated die-cast housing
- ▲ All-angle ball & socket mounting
- ▲ Use it with ANY ignition system
- ▲ Meter: 3 1/8" dia. X 3 3/8" deep
- ▲ Calibration kit included, no test eqpt. needed.

Orders shipped promptly.
Satisfaction guaranteed.

DP 8-2

DELTA PRODUCTS, INC.

Send check today!

P.O. Box 1147 EW / Grand Junction, Colo. 81501

Enclosed is \$_____ Ship ppd. Ship C.O.D.

Please send:

COMPUTACH® Kits @ \$29.95 ppd
Sold in Kit Form ONLY!

Name _____

Address _____

City/State _____ Zip _____

must be physically stable in tissue fluids; it must be able to stand any physical strains that may be imposed; it must possess qualities within the tissues, such as elasticity or rigidity; and the material must be capable of being manufactured in the desired form at reasonable cost.

Various metallic and synthetic materials which meet these requirements have evolved.

Vitalium, a cobalt chrome-base alloy originally designed for dental use has found wide application. Other metals are stainless steel BS-58-G, AISI 316 and 317. Tantalum, elgiloy, titanium, ticonium, and zirconium have come into vogue in recent years.

Of synthetics, commonly used substances are "Silastic" medical grade silicone rubber made by *Dow Corning*; "Marlex 50" made by *Phillips Petroleum Co.*; "Palacos R" and "Palacos K" made by the *Kulzer Co.* of West Germany. "Cerosium," a ceramic principally composed of Alcoalumina, is a rather new substance which shows great promise as a bone replacement. Its porosity attracts tissue growth and features excellent tissue adherence.

A typical electronic implant may be potted in epoxy resin (such as "Scotch Cast" No. 5) and encapsulated in a second thin shell of *Dow-Corning* silicone rubber Type RTV-502. From experience, the author found that this material also performs well in both space and oceanographic applications. Supplementary coating techniques can be used and give excellent results.

Perhaps both groups of electronic implants herald an era of "rebuilt man". And, within a very short time, many new devices may take a preeminent position in the medical arts and in medically oriented electronics engineering as well. New miniaturization techniques will stimulate development of this important technology.

This article discusses just one of the many areas in which electronics has proved to be a powerful tool for life sciences. Through it, new and startling advances have been made in research into the nature of life and the measurement and study of all living processes. Thanks to electronics, biomedical engineering, electron microscopes, computerized nursing, have become almost household words. ▲

REFERENCES

Stephenson, S. E., et al: "Physiologic P-Wave Cardiac Stimulator", *Journal Thoracic and Cardiovascular Surgery*, 38:607, 1959

Zoll, P. M.: "Long-Term Electric Stimulation of the Heart for Stokes-Adams Disease", *Ann. Surg.*, 154:330, 1961

Lillehei, C. W., et al: "Transistor Pacemaker for Treatment of Complete Atrioventricular Dissociation", *Journal American Medical Association*, 172:2006, 1960

Edgerton, M. T.: "Prosthetic Surgery, Modern Trends in Plastic Surgery", *Butterworth Ltd.*, London, 1964.

Focus

ON THE WORLD'S
MOST WIDELY READ
PHOTO YEARBOOKS!

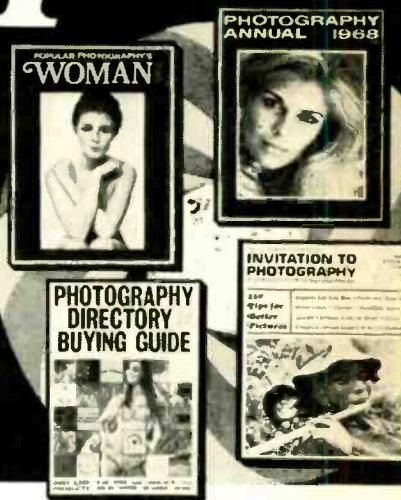

Popular Photography's WOMAN 1968

First time ever published! A dramatic, sophisticated, colorful tribute to the loveliest subject in the world; 128 pages of the woman as girl next door, temptress, movie queen, fashion model, mother. Including a 20-page Playboy portfolio... an analysis of the movie, *Blow-Up*... plus a valuable tech data section. A must for every creative photographer!

1968 Photography Annual

Your private gallery of the year's most stimulating photographs by the world's most gifted photographers. Over 200 pages of superb, provocative photos — all magnificently reproduced in stunning color and dramatic black and white. Complete with "how it was done" tech section to help you improve your photographic skills. Acclaimed as the best edition yet!

Invitation To Photography

A unique 124-page "course" in better picture taking. Over 20 complete sections in all—on equipment, film, lighting, creativity, composition, portraits, glamor, color, processing—each written by an expert to help you progress quickly, easily, confidently. Includes a special 28-page bonus section on motion picture equipment and techniques!

1968 Photography Directory & Buying Guide

180-page "shop at home" directory of over 3000 photographic items! Provides every vital statistic you need to compare all the latest equipment—in virtually every category—and select the best in your price range. Lists complete specs, model numbers, special features, manufacturers along with hundreds of photos plus exclusive, money-saving "BUYPOINTS"!

GET THE DELUXE LEATHERFLEX-BOUND EDITIONS FOR JUST \$3 — POSTPAID!
(Please allow three additional weeks for delivery.)

COMPLETE YOUR PHOTOGRAPHIC LIBRARY TODAY — Mail the Coupon Below!

ZIFF-DAVIS SERVICE DIVISION • DEPT. W
595 Broadway, New York, N.Y. 10012

Please send me the annuals I've checked below:

- WOMAN 1968, \$1.25
 Deluxe Edition, \$3.00
- INVITATION TO PHOTOGRAPHY, \$1.25
 Deluxe Edition, \$3.00
- 1968 PHOTOGRAPHY ANNUAL, \$1.50
 Deluxe Edition, \$3.00
- 1968 PHOTO DIRECTORY & BUYING GUIDE, \$1.25
 Deluxe Edition, \$3.00

In U.S.A., add 15¢ for shipping and handling for each Regular Edition; Deluxe Editions are postpaid.

Outside U.S.A., add 50¢ for each Regular Edition; 75¢ for each Deluxe Edition.

TOTAL ENCLOSED \$ _____

print name _____

address _____ EW-68

city _____

state _____ zip _____

■ PAYMENT MUST BE ENCLOSED WITH ORDER ■

New Stereo Amplifiers

(Continued from page 28)

SCOTT uses Model 260-B covered in our table as the amplifier portion of the company's Model 348-B receiver, which sells for \$500. Other integrated stereo amplifiers in the manufacturer's line include: Model 299F, rated at 18 W/ch (cont.) into 8 ohms and priced at \$200; and the Model LK-60B, rated at 40 W/ch (cont.) into 8 ohms and priced at \$200 in kit form.

can be used to monitor from a tape recorder while recording. Separate volume and balance controls are offered on all but one, whose concentric volume controls perform the same function.

Low- and high-cut filters are presumably most useful when listening to inferior program sources. Many of them have slopes and cut-off frequencies which are far from ideal, and actually are of limited value. There is no correlation between the price of an amplifier and whether or not it has filters.

One rarely thinks of the auxiliary a.c. outlets in the rear of an amplifier until the system is being installed, at which time it may be too late. Some amplifiers have only a single switched outlet (what about the tuner, turntable, and tape recorder?). At the other extreme are two top-priced models, with three switched outlets plus an unswitched outlet for a record player.

With most stereo systems now using matched speaker systems, the need for separate tone controls for the two channels has diminished. Several of the units tested offer separate tone controls (usually concentric, with slip clutches). The others have ganged controls. Several amplifiers have a means for bypassing the tone-control circuits entirely, insuring flat response.

These amplifiers vary widely in size and weight. The *ADC*, *Eico*, *Kenwood*, and *Knight* units are among those that are small and light, posing no installation problems. The *Fisher*, *Scott*, and *Sherwood* units are slightly larger, still suitable for bookshelf mounting. The *AR* amplifier is still larger, and the *C/M*, *Heath*, *JBL*, and *Sansui* units are in the heavyweight class.

Transistor Protection

One of the most important characteristics of a solid-state amplifier is its immunity to damage from overdriving or shorted outputs. At one time it was commonplace for a transistor output stage to be destroyed when operated at full power for more than a few moments, or if the speaker terminals were shorted while the amplifier was driven. All

but one of the present group of amplifiers has one or more protective devices to prevent damage to the output transistors. The exception (*Knight*) was among the least expensive of the group, yet it delivered a lot of performance for its price. It was not damaged by our tests, which suggests a conservative design in spite of the omission of speaker fuses or obvious protective circuitry.

Transistor protection systems generally fall into one of two categories. In one, each speaker line is protected by a fuse or circuit breaker, which keeps the transistors from delivering excessive current to the load. In the other, electronic circuits sense excessive current in the transistor circuits and operate a fast-acting "crowbar" circuit which either removes the driving signal from the output stage, removes its supply voltage, or both. Some of the latter type require that the amplifier be shut off for a few seconds to restore operation. In addition, the most powerful units often have thermal cut-out switches which shut off the power if the transistors become too hot.

Among the amplifiers tested, the following had speaker fuses: *ADC*, *AR*, *Eico*, *JBL* (self re-setting breakers), and *Scott*. In all cases, the internal circuits limit the current through the output transistors to prevent their destruc-

SHERWOOD employs the Model S-9900a listed in our table as amplifier section of the company's Model S-8800-FET receiver, which is available at \$370. This manufacturer also has the following additional integrated amplifiers: Model S-9000a, rated at 65 W/ch (cont.) into 8 ohms and priced at \$310; and the Model S-9500b, rated at 20 W/ch (cont.) into 8 ohms at \$190.

tion by transients too brief to blow the fuses. The following amplifiers use electronic circuits to protect the output stages: *C/M*, *Fisher*, *Heath*, *Kenwood*, *Sansui*, and *Sherwood*. No amplifiers were damaged during our tests.

Each of the amplifiers tested for this report is capable of delivering excellent sound quality in an appropriate home environment. Most of them are far superior to the top-quality vacuum-tube amplifiers of a few years ago. Careful consideration of their features and prices should enable anyone to make the best choice for his particular needs. ▲

SONY also has, in addition to the Model TA-1120 covered in our table, a Model TA-1080 integrated amplifier. This is rated at 30 W/ch (cont.) into 8 ohms and is available at a price of \$300.

The TRUE electronic solution to a major problem of engine operation!

DELTA'S FABULOUS MARK TEN®



Only \$44.95 ppd.
In easy-to-build Deltakit®
Only \$29.95 ppd.

CAPACITIVE DISCHARGE IGNITION SYSTEM

You've read about The Mark Ten in *Mechanix Illustrated*, *Popular Mechanics*, *Electronics* and other publications!

Now discover for yourself the dramatic improvement in performance of your car, camper, jeep, truck, boat — any vehicle! Delta's remarkable electronic achievement saves on gas, promotes better acceleration, gives your car that zip you've always wanted. Find out why even Detroit has finally come around. In four years of proven reliability, Delta's Mark Ten has set new records of ignition benefits. No re-wiring! Works on literally any type of gasoline engine.

Why settle for less when you can buy the original DELTA Mark Ten, never excelled and so unique that a U.S. Patent has been granted.

READY FOR THESE BENEFITS?

- ▲ Dramatic Increase in Performance and in Fast Acceleration
- ▲ Promotes more Complete Combustion
- ▲ Points and Plugs last 3 to 10 Times Longer
- ▲ Up to 20% Mileage Increase (saves gas)

LITERATURE SENT BY RETURN MAIL
BETTER YET — ORDER TODAY!



DELTA PRODUCTS, INC. DP 7-17

P.O. Box 1147 EW • Grand Junction, Colo. 81501

Enclosed is \$_____ Ship ppd. Ship C.O.D.

Please send:

- Mark Tens (Deltakit®) @ \$29.95
- (12 VOLT POSITIVE OR NEGATIVE GROUND ONLY)
- Mark Tens (Assembled) @ \$44.95
- 6 Volt: Negative Ground only.
- 12 Volt: Specify Positive Ground Negative Ground

Car Year _____ Make _____

Name _____

Address _____

City State _____ Zip _____

CIRCLE NO. 117 ON READER SERVICE CARD

NEW PRODUCTS & LITERATURE

Additional information on the items covered in this section is available from the manufacturers. Each item is identified by a code number. To obtain further details, fill in coupon on the Reader Service Card.

COMPONENTS • TOOLS • TEST EQUIPMENT • HI-FI • AUDIO • CB • HAM • COMMUNICATIONS

DIGITAL SYSTEM USING IC'S

Two new IC main-frame units, designated DMS3200A and DMS3200P, have been added to the company's existing digital measuring system. The DMS3200A main frame uses IC's predomi-



nantly and incorporates a higher capacity power supply with additional output voltages for use with special custom plug-ins of the future. Counting response has been increased to 5 MHz, short-circuit-proof power-supply protection has been added, and display tubes have been changed from biquinary type to "Nixies."

The DMS3200P main frame uses IC's throughout but provides, in addition, ten-line decimal output signals (all individually buffered) to drive the firm's new PR4900 digital printer or other interface equipment. Numeric data, print command, decimal point position, and polarity indication are provided as outputs at the rear connector. Buffer storage has also been added to this model, with a rear-panel switch selecting either buffered or non-buffered operation. Hickok

Circle No. 1 on Reader Service Card

HUMIDITY-PROOF TRIMMER

A humidity-proof $\frac{3}{4}$ " rectangular, wirewound trimmer, performing to the requirements of MIL-STD 202B, is now on the market as the 3810.

Each trimmer is immersion-tested for leakage. A silicon "O"-ring seal permanently shuts out dust and humidity, and the lid and case are permanently weld-fastened. The trimmers are 100% automatically checked for 11 electrical and mechanical parameters. This automatic checking of noise level, insulation resistance, dielectric strength, continuity, and various measurements of resistance eliminates all possibility of human error.

The solvent-resistant case is impervious to freons, ketones, esters, and chlorinated hydrocarbons. They can be used in all applications employing dip and flow soldering.

Resistance values are available from 10 to 20,000 ohms. Power rating is 1 watt at 40°C. The new trimmer features silver welded terminations and gold-plated terminals and operates in a temperatures range of -65°C to +125°C. Amphenol Controls

Circle No. 126 on Reader Service Card

CERAMIC & QUARTZ FILTERS

Two new standard lines of filters, the TCF ceramics and the Uni-Wafer quartz units, are now available. The TCF ceramic filters provide tuned transformers at input terminals and stop-band rejection up to 90 dB in a package measuring only $\frac{1}{2}$ cubic inch. Skirt ratios for 60/6 dB are from 1.5 to 3.0, with bandwidths from 1% to 10% of center frequency (455 kHz).

Applications include c.w., AM and FM radio for mobile, aircraft, marine, or stationary equipment operation.

The quartz units are four-poled crystal filters with center frequencies of 10 MHz, 15 MHz, 30 MHz, and 45 MHz. Except for termination, they are contained in the standard HC-6/U crystal can. Applications include communications receivers operating in the v.h.f. and u.h.f. frequency ranges, and telemetry, radar, and aerospace systems. Clevite

Circle No. 127 on Reader Service Card

BATTERY-OPERATED VTR

A battery-operated video tape recording system whose closed-circuit camera is just a little larger than a home movie camera has been put on the market for use by law enforcement officers, fire fighters, coaches, investigators, teachers, and product service or field maintenance men.

Known as "Porta-Pack", the half-inch tape system records both sight and sound and permits instant playback on any of the firm's half-inch VTR recorder decks. The hand-held camera weighs less than five pounds and has a small removable microphone mounted on top to record voices or background sounds.

A one-inch viewfinder on the camera also serves as a postage-stamp-size TV screen to show cameramen the action being recorded. The zoom lens permits users to zoom in for greater detail on distant subjects.

The video tape recorder, about the size of a woman's large handbag, is carried over the shoulder. It is linked to the hand-held camera by a single cable. The recorder weighs about 10 pounds including the two rechargeable batteries. A battery charger is included with the system. General Electric

Circle No. 2 on Reader Service Card

READOUT TUBE

A new form of "Nixie" tube is now available as the Type B-5750. Designed for new applications such as low-cost digital voltmeters, calculators, and counting instruments, the design of the tube specifically incorporates features which makes it compatible with the latest integrated circuits for digital instrumentation.

The tube measures 0.530" diameter by 1.5". The numeral height is 0.5" with an aspect ratio which provides the optimum in readability and viewing distance. The narrow diameter is compatible with IC's.

The tube operates in time-sharing applications where higher than normal current is needed. This time-sharing operation permits all like numerals to be driven in parallel while the tube

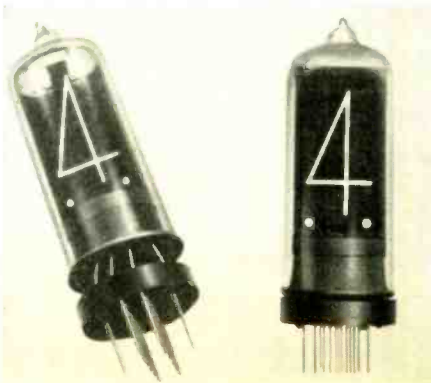

anode is strobed. Substantial reduction in driver costs for many multi-digit display applications can be achieved.

A pin-spacer stand-off, which is used to align the tube pins for ease of PC layout and insertion, is part of the tube assembly and permits any gas formed during soldering operations to escape. Burroughs

Circle No. 128 on Reader Service Card

STABLE RESISTORS

The HA Series resistors are hermetically sealed, oil-filled, and axial-lead units which the company claims can be used at virtually any frequency (d.c. to 100 MHz and above) with absolute tolerances to 0.001%, and shelf stability of ± 5 ppm/yr (guaranteed).

The resistance elements use proprietary thick-film alloys on which resistance patterns are photo-

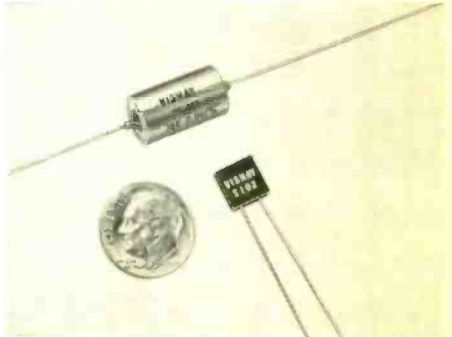

etched by company-developed techniques. Depending on resistance values desired (30 ohms to 200,000 ohms), the HA Series units are available in two basic diameters ($\frac{3}{8}$ " and $\frac{1}{2}$ "") and lengths from $\frac{7}{16}$ " to $1\frac{1}{4}$ ". Maximum power, without derating, ranges from $\frac{1}{2}$ watt to 1.25 watts.

Applications for the new resistors include secondary resistance standards, feedback devices for operational amplifiers, precision voltage dividers, meter multipliers, precision bridge resistors, and decade voltage dividers. Vishay

Circle No. 129 on Reader Service Card

PORTABLE INVERTER

The Model 12T-RME-1 portable inverter operates from 12 volts d.c. and delivers 117-volt, 60-Hz a.c. at 140 watts maximum. The output is frequency stable and automatically controlled, thus making the inverter suitable for operating 11" to 13" portable TV sets, test equipment, power tools, soldering irons, record players, and tape recorders. ATR

Circle No. 3 on Reader Service Card

ALL-CHANNEL TV TUNER

The new "Mark IV" TV tuner is designed to eliminate differences in tuning u.h.f. and v.h.f. channels. The innovation has been made possible by a unique, low-loss v.h.f./u.h.f. switch scheme and unusual circuitry. Inside the all-channel tuner, stator lines from the u.h.f. tuner section pass through an opening in a separating metallic shield wall and enter the v.h.f. circuit area. Physically, this wall—electrically grounded to the chassis—acts to divide the rectangular tuner into two sections. When the tuner is switched to the u.h.f. position, a plastic cam spreads apart two flexible leaves of each stator line until positive contact is made with the chassis-ground wall section. This converts the tuning capacitor stator

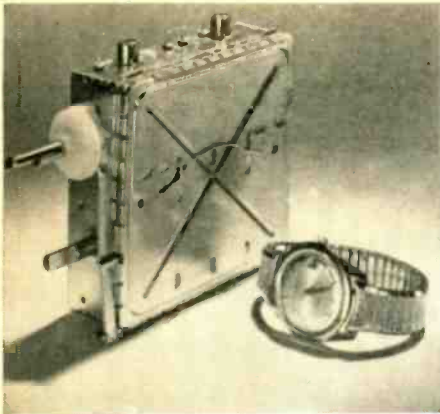

to a tuned quarter-wave u.h.f. transmission line. Four connecting points serve as contacts and are effectively in shunt, assuring low signal loss and high operational reliability.

When switched into v.h.f., the stator's flexible switching leaves are trapped between the rotor blades of the switch section and this converts the previous u.h.f. transmission line elements into a low-loss capacitor which, in turn, tunes v.h.f. coils located on the rotary switch section.

All of these new design features make it possible for a drastic size reduction in the tuner. The Mark IV measures 1 1/8" x 3 1/2" x 4". Oak Manufacturing

Circle No. 4 on Reader Service Card

R.F. TEST PROBE

A new miniature r.f. test probe designed for use by radio and TV technicians, instrument test lab technicians, and transmitter station engineers, is now on the market as the Model 79B-264.

The new unit permits d.c. measurements of r.f. signals, extends the frequency response for a.c. voltage measurements to 250 MHz, and is de-

signed to be used with the company's Model 600, an 11-megohm input impedance transistorized v.o.m.

The probe consists of a germanium rectifier and a 3.9-megohm resistor coupled to the probe tip with a 500-pF capacitor. The extension of the frequency response for a.c. voltage measurements to 250 MHz is accomplished by placing the rectifier in the probe tip and reducing the input capacitance of the probe. The d.c. output of the rectifier is then fed to the instrument through the probe lead. Triplett

Circle No. 5 on Reader Service Card

HI-FI—AUDIO PRODUCTS

TELEPHONE ANSWERING DEVICE

A new, low-cost, all-purpose cartridge telephone answering machine is now available as the Model 520.

Featuring an endless tape which is contained in an easy-to-use, snap-in cartridge, virtually any outgoing message may be recorded. Since no solenoids are used, cartridges with almost any length of recording time can be used. The unit operates independent of the telephone company equipment thus eliminating monthly rental and installation charges.

The basic "answer only" device may be con-



verted to allow for recording messages into any transistorized a.c. tape recorder or dictating machine. No current flows into the external recorder until it is actually needed for recording. Details on the various options will be supplied on request. Minatronics

Circle No. 6 on Reader Service Card

1-WATT IC AUDIO AMP

A low-cost, one-watt monolithic integrated-circuit audio amplifier has just been introduced as the PA234.

A key feature of the new unit is that it requires fewer external components for the circuit to operate than previously available IC audio amplifiers. The unit will operate with only four external components: three resistors, one capacitor, plus any capacitors required for coupling to the source or load. The new amp will deliver one watt of continuous power to either a 16 or a 22 ohm speaker. Frequency response extends from 30 to 100,000 Hz and the noise output is typically —80 dB relative to one watt.

Designed for various consumer and industrial applications—including driving headphones in school language labs and commercial airline headphones, with phonographs, dictating equipment, tape players, recorders, TV and FM receivers, the PA234 has a sensitivity of 600 mV of input signal to drive the audio amplifier to one watt output with 2-3% total harmonic distortion at 1 kHz. General Electric

Circle No. 7 on Reader Service Card

RECEIVER WITH IC'S

The Model 5000 180-watt AM-FM stereo receiver includes four IC's in the i.f. section plus a specially selected FET FM front-end. Specifications include 180 watts of IHF dynamic power, providing 75 watts per channel of continuous power at 4 ohms. FM tuner sensitivity is 1.8 μ V (IHF); selectivity is better than 50 dB at 98 MHz; and stereo separation is better than 35 dB. The amplifier section provides a flat frequency response from 10 to 50,000 Hz.

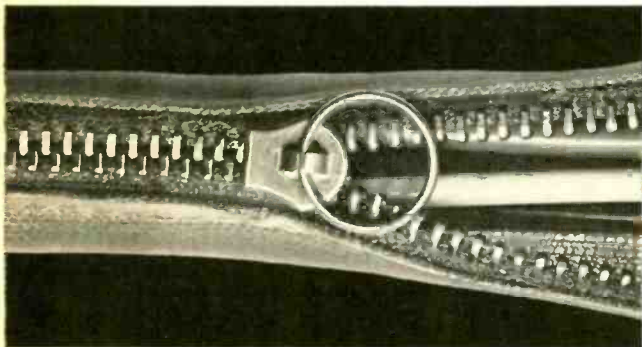

ZIP-EX®

... first all-metal RF shield that zips on—or off.

ZIP-EX all-metal knitted mesh shielding jacket zips around any shape, before or after installation. Its unique loop structure ensures high attenuation and flexure... no wire break. All-metal zipper has low

closing force, high resistance to lateral opening, and provides shielding continually around the cable. ZIP-EX comes with terminations to ensure continuous shielding. Write for prices and literature.

METEX Corporation

970 New Durham Road, Edison, N. J. 08817
(201) 287-0800 • TWX 710-998-0578
West Coast: Cal-Metex Corp., 509 Mindry Ave., Inglewood, Calif. 90301
(213) 674-0650 • TWX 910-328-6100



94



ARE YOU CASHING-IN ON THE PROFITABLE 2-WAY RADIO SERVICE BUSINESS?

- ★ Motorola will train you for this rewarding, elite profession
- ★ Send for our FREE EVALUATION EXAM. Prove to yourself that you are ready to learn FM 2-way radio servicing.

Opportunities in 2-way radio servicing are virtually unlimited. ■ Just one of the hundreds of successful Motorola Service Stations writes, "we would be pleased to interview any graduate of your school that has received some training in 2-way radio maintenance. We are an established firm, 10 years old, with a promise of expansion governed by our ability to obtain competent technicians." ■ Get all the facts today. There is no obligation and no salesman will call.



MOTOROLA TRAINING INSTITUTE

4545 West Augusta Blvd. • Chicago 51, Illinois • Dept. AEW 821

- Send me FREE entrance exam.
- Send full details on Home Study Course on FM 2-way Radio Servicing.
- Send me details on how you can help me prepare for an FCC License.

Name _____ Occupation _____

Address _____

City _____ Zone _____ State _____

CIRCLE NO. 103 ON READER SERVICE CARD

CIRCLE NO. 200 ON READER SERVICE CARD



Among the features of this new receiver are outputs for three separate stereo speaker systems which may be selected to play individually or in pairs. In addition to inputs for tape, phono, and auxiliaries, the unit provides extra input and output connections for recording or playback using two tape recorders. Tape machine #1 or #2 may be monitored from a jack on the front panel.

The receiver also has a push-button, stereo-only switch which blocks out mono reception so that only stereo broadcasts come through. The dial face has an exclusive "black-out" design in which the dial, signal, and tuning meters light up only when the broadcast function is selected. When other functions are selected, the identification lights up in color on the dial. Sansui

Circle No. 8 on Reader Service Card

CARDIOID DYNAMIC MICROPHONES

Two new cardioid dynamic microphones, designed for nightclub singers, musicians, entertainers, tape recording, and interview work, have been introduced as the Models 650A and 651AH.

Both microphones feature an "on-off" switch which can be locked in the "on" position when required and a bass roll-off switch (on the 650A only) which allows the performer to reduce feedback, subdue excess instrumental bass tones from 400 Hz down, and reduce rumble. The 650A has an easily changeable output impedance of 150/250 or 20,000 ohms and an output level of -56 dBm/10 dynes/cm². Average front-to-back ratio is 20 dB. The standard high-impedance 651AH has an output impedance of 20,000 ohms and an output level of -57 dBm/10 dynes/cm². Average front-to-back discrimination is 15 dB. Altec Lansing

Circle No. 9 on Reader Service Card

COMPACT MUSIC SYSTEM

The new SC 740 compact music system combines a 60-watt solid-state AM-FM-stereo receiver, a Dual 1009SK turntable, and two HK-40 air-suspension speakers with 10-inch high-compliance woofer and a 3 1/2-inch curvilinear tweeter.

Although measuring only 18" x 18", the control center will drive any speaker. Wideband response assures full harmonic content within the audible range, according to the company. There is a new MOSFET front-end for FM reception and newly designed integrated circuits in the i.f. strip.

There is a stereo indicator light, a tape monitor switch, automatic shut-off at the conclusion of the last record, stereo headphone jack, separate bass and treble controls, and a contour switch for listening at low volume level. Frequency response is 8-45,000 Hz ± 1.5 dB at 1 watt. Harmonic distortion is less than 1%. Harman-Kardon

Circle No. 10 on Reader Service Card

SOLID-STATE STEREO RECEIVER

A new 65-watt solid-state AM-FM stereo receiver is now on the market as the Model 365. The receiver uses 65 semiconductors in its circuit. Designed on a single chassis, 5" high x 16" wide x 12" deep, the receiver requires only the addition of two speakers, a phono turntable, or



tape deck to make a complete hi-fi system.

Response is 20-50,000 Hz ± 1 dB and power bandwidth is 15-30,000 Hz. IM distortion is 1% and hum and noise is -60 dB magnetic phono and -75 dB auxiliary. There are outputs for 4-16 ohm speakers, headphones, and recorder.

Controls include clutch-type bass and treble, balance, volume, program selector, mode, and tape monitor.

The receiver comes with a metal case, but a wooden cabinet is available at extra cost. Allied Radio

Circle No. 11 on Reader Service Card

CB-HAM-COMMUNICATIONS

23-CHANNEL TRANSCEIVER

A new 23-channel, solid-state CB transceiver is now available as the "Messenger 320". Incorporating 23 transistors and 15 diodes, the new unit measures only 2 1/2" high x 8" wide x 9" deep. Accessories include a.c. and portable power supplies and a Tone Alert selective calling system.

The transceiver features a double-conversion superhet receiver with a sensitivity of 0.5 microvolt for a 10 dB signal-to-noise ratio. The transmitter section features a full 5-watt r.f. input.

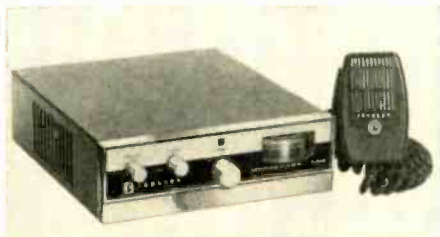

Built-in speech compression provides more audio for greater range without distortion or splatter, according to the maker.

The unit is furnished with a universal mobile mounting bracket ready for 12-volt d.c. operation on all 23 channels and can be removed in seconds for base or portable use. Plug-in power supplies for a.c. operation require no wiring. The rechargeable power pack furnishes power for up to 8 hours of operation.

Other features include a built-in combination "S" and r.f. power output meter, squelch and volume controls, a built-in 3-watt p.a. system that only requires an external speaker for operation, and a rugged ceramic microphone. E.F. Johnson

Circle No. 12 on Reader Service Card

TWO-WAY BUSINESS RADIO

The MOCOM-10 is a two-way radio designed for small business with as few as one or two mobile units and a base station. The circuit is fully transistorized for instant full-power trans-



mission. The receiver draws less than 1/10 A on standby.

The system uses FM which reduces interference from vehicle ignitions and power lines. Audio output is a full 3 watts to override background noise. Transmitter power is 10 watts input and 5 watts output. Units are available on frequencies from 25 to 50 MHz. The mobile units operate on 12 volts d.c., negative ground, while the base stations operate on 117-volt, 60-Hz a.c.

An optional "Automute" tone squelch circuit is available. Picking up the microphone unmutes the speaker, automatically monitoring the channel before transmission. Pushing the mike button

automatically transmits a tone that unmutes the speakers in all radios in the system. The tone is not transmitted during subsequent transmissions. No special manual operations are necessary. Motorola

Circle No. 13 on Reader Service Card

SOLID-STATE CB KIT

A two-way CB radio in kit form has just been put on the market as the "Safari IV". Designed for base, mobile, or portable use, the new trans-



ceiver is a 12-channel, 5-watt unit featuring a sensitive superhet receiver with adjustable squelch, all-silicon transistors, and built-in series gate noise limiter to overcome ignition and pulse-type interference.

The kit is easy to build and comes with a factory assembled and aligned transmitter section and step-by-step instructions. Available accessories include a factory assembled a.c. power supply and charger for mobile use, a lightweight assembled battery pack for portable use, a mobile mounting bracket, and extra crystals.

The completed unit measures 2 1/8" high x 6 7/8" wide x 8 1/2" deep and weighs 4 pounds. Allied Radio

Circle No. 14 on Reader Service Card

MANUFACTURERS' LITERATURE

PRESSURE-SENSITIVE TRANSISTORS

An 8-page brochure describing the "Pitran" pressure-sensitive transistor is now available for distribution. The brochure includes complete operating instructions and specifications as well as application data on this state-of-the-art device. Stow Laboratories

Circle No. 130 on Reader Service Card

ICE-DETECTION REPORTING

A four-page brochure, No. E-765, has been issued telling how an automatically operated alarm transmitter reports icing conditions from key highway locations, thus eliminating the requirement for 24-hour maintenance patrol of highways.

The alarm reporting system can constantly monitor all critical areas and this brochure describes the transmitter and monitoring station in some detail. Motorola Communications

Circle No. 15 on Reader Service Card

VARIABLE VOLTAGE XFORMERS

A four-page report, GER-2020, describes how to select the right variable-voltage transformer for a given voltage-control application.

Electrical, physical, and economic considerations are covered, along with current ratings, mechanical variations, and operational limitations of variable-voltage transformers. Normally designed for single-phase applications, the report explains the use of the variable voltage transformer in a three-phase circuit and how voltage and frequency limitations can be extended.

Included are photographs, performance curves, and circuit diagrams. General Electric

Circle No. 16 on Reader Service Card

CIRCUITRY DESIGN HANDBOOK

Electrical characteristics, design information, and a variety of applications of "Flexprint" circuitry, which permits greater design flexibility and increases circuit reliability, according to the company, are described in a new 14-page handbook now available.

The handbook includes current applications, a table of insulation material characteristics, and a conductor design chart which compares electrical characteristics of flat conductors with AWG round wire sizes. Methods of attaching Flexprint circuitry to various types of connectors are described along with instructions for low-cost design. The handbook also features standard specifications and tolerances for commonly used insulation materials. Sanders Associates

Circle No. 131 on Reader Service Card

KNOB LINE

A four-page, two-color brochure listing a complete line of knobs for military and commercial applications is now available. Included in the publication are tactile shape control knobs, pointer knobs, crank knobs, safety crank knobs, slip-clutch knobs, and spinner knobs. The individual types are illustrated and the available specifications tabulated for easy ordering. Russell Industries

Circle No. 132 on Reader Service Card

POWER SUPPLIES

Catalogue 503A, a two-page, short-form brochure, describes the 1412 models of power supplies in ten product lines now available from the company. There are three laboratory lines, two card module series, four modular lines, and 720 models in the system rack lines, plus accessories for all lines. The brochure is illustrated. Deltron

Circle No. 133 on Reader Service Card

PILOT-LIGHT DATA

A six-page catalogue which details an expanded line of "Mini-Slide" high-intensity, easy-to-install, long-lived pilot lights has just been issued.

Included in the brochure is a new pilot-light assembly Model 2801 which comes with a stainless steel bezel. Also new is the legend light series 3130 and the series 3000 assemblies which are available in round, square, or angle lens options.

Each unit is illustrated and full specification data provided. Typical installation diagrams are also included. Industrial Devices

Circle No. 134 on Reader Service Card

STOCK RELAY CATALOGUE

Catalogue 269, a 16-page publication, contains information on a full line of stock relays. Included are telephone type, general purpose, power, hermetically sealed, coaxial, latching, time delay, high voltage, as well as 195 mercury-wetted and dry-reed relays. Besides price, the catalogue gives complete mechanical and electrical specifications. Magnecraft

Circle No. 135 on Reader Service Card

MUSICAL SOUND PRODUCTS

A new brochure on musical sound products has just been issued. Included are technical specifications and descriptions of the firm's guitar speakers, cardioid microphones, and speaker systems.

Copies of brochure AL-1370 will be forwarded on request. Altec Lansing

Circle No. 17 on Reader Service Card

MODULAR POWER SUPPLIES

A 16-page, 2-color catalogue listing thousands of all-silicon, regulated slot supplies with voltage outputs from 0 to 400 volts and output currents to 25 amperes is now available.

The modular supplies covered are short-circuit-proof and are designed for laboratory use or permanent installation. All meet specifications of MIL-E-5272. Power/Mate

Circle No. 136 on Reader Service Card

PRODUCT LINE CHART

A new chart listing product lines and specifications is available as #PLL-1. The products are listed in three groups: wire, cable, tubing; electronic hardware and switches; and radio-TV accessories and components. There is also a

military switch cross reference, military and commercial specification charts for tubing products, hardware, and wire and cable. There is also a listing of UL and CSA specifications. Birnbach

Circle No. 137 on Reader Service Card

SPEAKER ENCLOSURE PLANS

A 20-page manual, CF802, is now available for distribution. It contains complete instructions for building loudspeaker enclosures for various sizes of the company's hi-fi speakers. Information on cabinet construction, joints, glue-block construction, terminal pads, baffling, cabinet bracing, grille frames, and finishing techniques is included. The manual is lavishly illustrated and the text material is clear and concise. JBL

Circle No. 18 on Reader Service Card

ELECTRICALLY CONDUCTIVE TAPES

Information on "Scotch" brand electrically conductive tapes is included in a new four-color brochure now available on request.

The 8-page foldout brochure lists properties and application data on X-1170 and X-1181 conductive tapes. Both tapes are designed for EMI/RFI shielding applications. 3M

Circle No. 138 on Reader Service Card

PHOTO CREDITS

Page	Credit
11	Electro-Voice
33	Delco Radio
34	Motorola Inc.
35	Bendix Corp.
39	Varian Associates
42, 43	Tele-Quick Corp.
62	Amphenol Corporation
63	Sencore, Inc.
64	James Millen Mfg. Co., Inc.
66	Ampex Corporation

The best TV deserves the best antenna!

Install a Zenith Quality-Engineered Antenna!

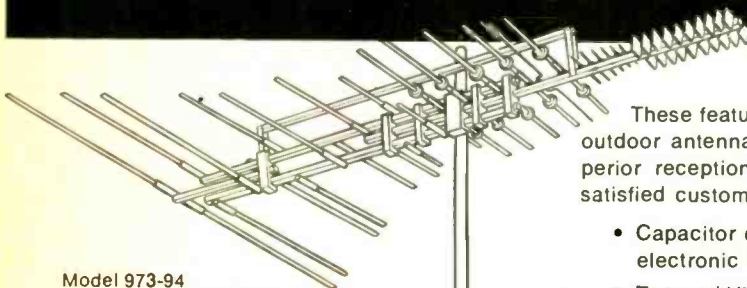

Model 973-94
designed for far fringe areas

Exciting Surprises
for You—
and Your Family!
Fun for all!
Get the details
at your Zenith
Distributor's
Parts Department.

These features help a Zenith outdoor antenna provide the superior reception that makes for satisfied customers:

- Capacitor coupled cap-electronic VHF dipoles.
- Tapered UHF grid driver.
- Staggered square UHF directors.
- Low-impedance, triple boom construction.

You can choose from 12 all-new Zenith VHF/UHF/FM or VHF/FM antennas. All are gold color alodized aluminum for better conductivity, greater corrosion resistance and longer service.

Ask your Zenith distributor for a free technical manual. He has charted the reception characteristics of your area, so he can recommend the best antenna for each installation.



BEST YEAR YET TO SELL THE BEST



The quality goes in
before the name goes on

ELECTRONICS MARKET PLACE

COMMERCIAL RATE: For firms or individuals offering commercial products or services. 70¢ per word (including name and address). Minimum order \$7.00. Payment must accompany copy except when ads are placed by accredited advertising agencies. Frequency discount: 5% for 6 months; 10% for 12 months paid in advance.

READER RATE: For individuals with a personal item to buy or sell. 40¢ per word (including name and address). No Minimum Payment must accompany copy.

GENERAL INFORMATION: First word in all ads set in bold caps at no extra charge. Additional words may be set in bold caps at 10¢ extra per word. All copy subject to publisher's approval. Closing Date: 1st of the 2nd preceding month (for example, March issue closes January 1st). Send order and remittance to: Hal Cymes, **ELECTRONICS WORLD**, One Park Avenue, New York, New York 10016

FOR SALE

JUST starting in TV service? Write for free 32 page catalog of service order books, invoices, job tickets, phone message books, statements and file systems. Oelrich Publications, 6556 W. Higgins Rd., Chicago, Ill. 60656.

GOVERNMENT Surplus Receivers, Transmitters, Snooperscopes, Radlos, Parts, Picture Catalog 25¢. Meshna, Nahant, Mass. 01908.

METERS—Surplus, new, used, panel and portable. Send for list. Hanchett, Box 5577, Riverside, Calif. 92507.

INVESTIGATORS, FREE BROCHURE, LATEST SUBMINIATURE ELECTRONIC SURVEILLANCE EQUIPMENT. ACE ELECTRONICS, 11500-J NW 7TH AVE., MIAMI, FLA. 33168.

CONVERT any television to sensitive big-screen oscilloscope. Only minor changes required. No electronic experience necessary. Illustrated plans, \$2.00. Relco-A22, Box 10563, Houston, Texas 77018.

R.F. CONVERTERS World's largest selection. Also CCTV cameras, etc. Lowest factory prices. Catalog 10¢. Vanguard, 196-23 Jamaica Ave., Hollis, N.Y. 11423.

MUSIC LOVERS, CONTINUOUS, UNINTER- RUPTED BACKGROUND MUSIC FROM YOUR FM RADIO, USING NEW INEXPENSIVE ADAPTER. FREE LITERATURE, ELECTRONICS, 11500-Z NW 7th AVE., MIAMI, FLORIDA 33168.

FREE ELECTRONICS (new and surplus) parts catalog. We repair multimeters. Bigelow Electronics, Bluffton, Ohio 45817.

SURVEILLANCE EQUIPMENT—NEW HIGH PERFORMANCE SUBMINIATURE MODELS. ELECTRONIC COUNTERMEASURE DEVICES TO PROTECT PRIVACY. FREE DATA: SECURITY ELECTRONICS-EW, 15 EAST 43RD STREET, NEW YORK, N.Y. 10017.

JAPANESE PRODUCTS CATALOG by air mail \$5, sea \$3. Intercontinental, CPO 1717, Tokyo, Japan.

CRYSTALS . . . largest selection in United States at lowest prices. 48 Hr. delivery. Thousands of frequencies in stock. Types include HC6/U, HC18/U, FT-241, FT-243, FT-171, etc. Send 10¢ for catalog with oscillator circuits. Refunded on first order. Jan Crystals, 2400E Crystal Dr., Fort Myers, Fla. 33901.

TREASURE HUNTERS! Prospectors! Relco's new instruments detect buried gold, silver, coins. Kits, assembled models. Transistorized. Weighs 3 pounds. \$19.95 up. Free catalog. Relco-A22, Box 10839, Houston, Texas 77018.

SURVEILLANCE COUNTERMEASURES BROCHURE \$1.00. ENGINEERING LABORATORIES, BOX 1036, ANDERSON, INDIANA 46015.

TRANSISTOR-Tube-Radio-Television-Phono, SIGNAL GENERATOR, \$4.00. Takoma Servicing School, 11808 Pittston Road, Wheaton, Maryland 20906.

ELECTRONIC Ignition, various types. Free literature. Anderson Engineering, Epsom, N.H. 03239.

PROXIMITY switch detects nearness of human body! Free information. Claremont Products, 860 Reed, Claremont North, Calif. 91711.

WORN shafts repaired economically with steel or stainless; motors, pumps, machinery, patented process introductory offer \$10.00 gives you 2 yr license, 30 day money back guarantee. Watson, 772 Hastings Ave., Salinas, Cal. 93901.

SURVEILLANCE EQUIPMENT, latest devices, also construction plans, free catalog, FISHER ELECTRONICS, Box 350, N. Miami Beach, Florida 33160.

SOLID-STATE 50 Watt RMS plug-in D.C. thru 25KC, \$30.00. OPAMP LABS., 172 So. Alta Vista Blvd., Los Angeles, California 90036.

GR 805C signal generator, \$485.00. GR 1021A, 118 136MC only, \$360.00. Lampkin 205-A, \$150.00. Keys Radio, Box 99, Abingdon, Va.

RADIO-Television Diagrams, fifty pound carton, \$29.00, postpaid. Ninety different electronic magazines, \$19. Hartford, 1760 Balsam, Highland Park, Ill. 60035.

TEST Equipment—Used—All types. Send 25¢ for large list. Palen Electronics, Box 1536, San Mateo, California 94401.

DETECTIVES! Precision Surveillance Devices. New Catalog. Free when writing on letterhead. Otherwise \$1.00 refundable with first purchase. **SILMAR ELECTRONICS, 3476 N. W. 7th Street, Miami, Florida 33125.**

CONTROL Panel with electronic counter, reset wheel, six different pilot lights with miniature bulbs, four assorted switches mounted and wired. New, original factory sealed carton. \$10.00 postpaid. Lillian's, Box 17165EC, Chicago, Illinois 60617.

DISPOSAL—\$80,000.00 hi-fidelity retail store inventory. New/used equipment: Ampex, Marantz, Fisher, others. Hewlett-Packard test equipment. Free-list—Marco Electronics, Box 336-D, Winter Park, Fla. 32789.

NEW Sensitive Treasure Metal Detectors. New low prices. Professional models from \$29.95 to \$129.50. Write for free catalog today. Jetco Electronics, Box 132-E, Huntsville, Texas 77340.

PRINTED Circuit Board—single or double sided. 9 x 12—75 cents; 6 x 9—40 cents; 4 1/2 x 6—20 cents. minimum order \$1.00. No C.O.D. Star Sales, 404 West 38 St., Wilmington, Del. 19802.

WANTED

QUICKSILVER, Platinum, Silver, Gold, Ores Analyzed. Free Circular. Mercury Terminal, Norwood, Mass. 02062.

QUICK CASH . . . for Electronic Tubes, Semiconductors, Equipment (Receivers, Transmitters, Scopes, Vacuum Variables, etc.) Send lists now! Write: **BARRY ELECTRONICS, 512 Broadway, New York, N.Y. 10012 (212-WA 5-7000).**

BIG CATALOG

World's "BEST BUYS" in GOV'T. SURPLUS Electronic Equipment

TELEVISION TELEMETER

TELEMETER PAY TELEVISION PROGRAM

SELECTOR—Choice of 3 programs that are tone operated in the VHF band, with provisions for detuning the amount of money required for each program as indicated on the coin register, and that also shows a credit balance when an over-payment is made. A pre-recorded tape will drive program information when desired. With Tubes: 1/12BH7, 1/6BE6, 1/6BA6, 2/6U8; 4" speaker, coin mechanism, tape magazine, etc. Size: 15 x 7 x 7 1/2". Wt.: 25 lbs. #100135 **\$14.95**

LM FREQUENCY METER

LM NAVY TYPE FREQ. METER: 125—20,000
KC crystal calibrated indicating equipment, heterodyne type; accuracy .01 to .02 depending on frequency. With modulation 500 cycle. Voltage required 12/24 for Fil. and 180 @ 5 MA/475 VDC @ 20 MA. With 1000 KC crystal & tubes. Also calibration book. Units have been used and may need replacement of some switches or minor parts. Otherwise guaranteed serviceable. Size: 7 1/2" x 7 1/2" x 8". Wt.: 15 lbs. Price—(As described above) **\$24.95**
Or: With All Parts: \$29.50

RADIATION DETECTOR

AN/PDR-27 RADIAC SET
Is a portable, water-tight, battery operated radiation detector and indicator. It is capable of detecting and measuring Beta and Gamma radiations together—or Gamma radiation alone. The test unit can be carried by hand or by the shoulder strap. The probe is attached to the main unit by a coiled cord. Visual indication is provided by the radium meter, aural indication is provided by the headphones. Battery voltage required: 135 VDC & 1.5 VDC. Also 22.5 —DCV. With Tubes: 3/502AX, 1/3VA, 2 GM tubes RS-1 & 2. Headset and Manual contained in metal carrying case: 9 1/2 x 15 x 10 3/4". **\$19.95**
Wt.: 28 lbs. Price—Used

BIG FREE CATALOG—Send for your copy today!
Address Dept. EW • Prices F.O.B. Lima, O. • 25% Deposit on C.O.D.'s

FAIR RADIO SALES
1016 E. EUREKA • Box 1105 • LIMA, OHIO • 45802

RECTIFIERS & TRANSISTORS

Silicon Rectifiers

PIV	25	50	100	200	400	600	800	1000	1200
1A*	—	.04	.05	.07	.09	.12	.16	.20	.35
3A	.05	.06	.07	.09	.12	.16	.24	.32	.46
18A**	.10	.16	.20	.30	.40	.50	—	—	—
20A	.15	.20	.25	.39	.50	.75	.90	1.15	1.40
40A	.25	.35	.60	.90	1.20	1.50	1.80	2.10	2.40

*Tophat, Flangeless **Preset 3, 20, 40 studs

Silicon Controlled Rectifiers

1500 PIV Stud	PRV	25	50	100	200	400	600
1A*	.10	.14	.22	.35	.60	.90	
200 MA.	7A	.18	.25	.40	.70	1.25	1.60
50¢ ea.	18A**	.18	.25	.40	.70	1.25	1.60
	20A	.25	.40	.55	.85	1.45	1.95

*Tophat, **Preset 7, 20 amp—stud

Germanium Power Transistors

20W-TO-5-3A	150W-TO-3-7A
2N1038—40V—4/1.00	2N456A—40V—35
2N1039—60V—3/1.00	2N457A—60V—50
2N1040—80V—2/1.00	2N458A—80V—65
2N1041—100V—70	2N1021A—100V—80
150W-TO-3-25A	
2N511, 40V—50; 2N511A, 60V—70;	
2N511B, 80V—11.00	

Silicon Power Transistors

2N 389A 85W, 60V 1.25	2N1048A 40W 120V 1.25
2N 424A 85W, 80V 1.49	2N1718 10W 60V .30
2N 497 4W, 60V .20	2N1719 10W 100V .40
2N 498 4W, 100V .28	2N1724 50W 80V 1.49
2N1047A 40W, 80V 1.00	2N1251 30W 80V .50

Silicon Small Signal NPN, TO-5

2N696 5/1.00, 2N697 4/1.00, 2N698 3/1.00, 2N699 2/1.00
3N34 Tetrode—\$1.00; 1N34A Diodes 100/\$2.98; 2N1142 Ger. Hi-Freq. Amplifier—2/\$1.00; Thermistors Beads, 900 ohm or 1200 ohm—\$.50; Varicaps—27, 47, or 100 pf, 4V, 4.1—\$1.25; P.C. Board, 8"x8"x1/16", 1 oz. copper—2/98¢; Photo Cells, Herm Glass, 4 diff. for \$1.00; 2N1300 Series, To-5, as-sorted—10/\$1.00; I.C. dual-in-line—20/\$1.00; To-5 15/\$1.00.

Assortments

Precision resistors firm	50/\$1.00
Ceramic capacitors	70/\$1.00
Electronic Hardware	2lbs/\$1.00
7 pin connector set M & F	3 sets/\$1.00
Free \$1.00 pack with \$10 order. Min. order \$3.00 plus postage. Guaranteed Prompt service.	

ELECTRONIC COMPONENTS CO.

Box 2902 Baton Rouge, La. 70821

CIRCLE NO. 113 ON READER SERVICE CARD
ELECTRONICS WORLD

YOUR SERVICE AND QUALITY LEADER

We promise to supply you with the highest quality products at the most attractive prices with the fastest service in the industry.

TRIACS

TO-66
5 AMP

PRV	
100	.90
200	1.40
300	1.75
400	2.25
500	2.60

ZENERS 1 Watt 7-33V \$.50
10 Watt 7-200V \$.75
50 Watt 7-200V \$1.75

P-CHANNEL TO-18 FET'S plastic units. Vds-40V. -20 ma drain current, gain to 5000 $\mu\text{mho's}$. With data sheet. \$1.75

N-CHANNEL FET'S TO-18 plastic units, low noise, low leakage, 25 volts source to gate, 50 ma gate current Gain to 9000 $\mu\text{mho's}$. \$1.00



POST OFFICE BOX 74B
SOMERVILLE, MASS. 02143
featuring transistors & rectifiers
SEND FOR OUR SPRING CATALOG
Business Address: 325 Elm St., Cambridge, Mass.

CIRCLE NO. 93 ON READER SERVICE CARD

PLANS AND KITS

INTEGRATED CIRCUIT KITS; COMPUTER LOG-IC, IC's; others. Catalog free. Kaye Engineering, Box 3932-B, Long Beach, California 90803.

ELECTRONICS ENGINEERING AND INSTRUCTION

ASSOCIATE Degree in Electronics Engineering earned through combination correspondence-classroom educational program. Free brochure. Grantham Technical Institute, 1505 N. Western Ave., Hollywood, Calif. 90027.

LEARN ELECTRONIC ORGAN SERVICING at home. All Makes including transistors. Experimental kit-troubleshooting. Accredited NHSC. Free Booklet. NILES BRYANT SCHOOL, 3631 Stockton, Dept. A, Sacramento, Calif. 95820.

FCC First Class License in six weeks—nation's highest success rate—approved for Veterans Training. Write Elkins Institute, 2603C Inwood Road, Dallas, Texas 75235.

HIGHLY effective home study course in Electronics Engineering Mathematics with circuit applications. Earn your Associate in Science Degree. Free literature. **COOK'S INSTITUTE OF ELECTRONICS ENGINEERING**, P.O. Box 36185, Houston, Texas 77036.

ELECTRONICS! Associate degree—29 months. Technicians, field engineers, specialists in communications, missiles, computers, radar, automation. Start September, February. Valparaiso Technical Institute, Dept. N, Valparaiso, Indiana 46383.

R.E.I.'s famous (5) week course for the First Class Radio Telephone License is the shortest, most effective course in the nation. Over 98% of R.E.I. graduates pass F.C.C. exams for 1st class license. Total tuition \$350.00. Job placement free. Write for brochure Radio Engineering Institute of Electronics, 1336 Main Street, Sarasota, Florida 33577—or 3123 Gillham Road, Kansas City, Missouri 64109—or 809 Caroline Street, Fredericksburg, Virginia 22401.

INTEGRATED CIRCUITS



FM IF AMPLIFIERS TO-5 pack \$2.00

JK & SRT flip flop dual in-line pack \$1.40
SR Flip Flops \$.90
SR Clocked Flip Flops \$1.15
Dual Nand Nor Gates \$1.00
8 Input Nand Nor Gates \$1.00
Dual and Gates \$1.00
Quad Nand Nor Gates \$1.00
OR Expander \$1.00
TO-85 flat pack with holder. Guaranteed to work. They come complete with schematic and elect. characteristic sheet.

Top Hat & Epoxy 1 AMP

PRV				
100	.07	1000	.35	
200	.09	1200	.50	
400	.12	1400	.65	
600	.18	1600	.80	
800	.22	1800	.90	

UNIUNCTIONS!

Similar to 2N2419. RBB of 5-7 stand off ratio of .6 and Ip of 12, with data sheet. \$1.50

Silicon Control Rectifiers

PRV	3A	7A	20A	70A
50	.35	.45	.70	
100	.50	.65	1.00	4.00
200	.70	.95	1.30	8.00
300	.90	1.25	1.70	
400	1.20	1.60	2.10	12.00
500	1.50	2.00	2.50	
600	1.80	2.40	3.00	16.00
700	2.20	2.80		
1000			5.00	124.00

- SIM** to 2N3429 (NPN). Si 1/4" stud, min HFE of 30, 7.5 Amps. 175 watts, V_{CE} of 75 \$1.75
- SILICON BILATERAL SWITCH.** Replaces two SCR's by firing in either direction when breakdown voltage is exceeded. Used in light dimmers, etc. 2/\$1.00
- NEON LIGHT OR NIXIE TUBE DRIVERS.** An NPN, TO-18, Si Transistor. With a VCBO of 120 3/\$1.00
- SIM.** to 2N2875 (PNP). Silicon 20 watts with 30 MHz cut off \$.75
- 500 Hfe plastic transistors.** NPN. TO-18, Si unit similar to 2N3565 4/\$1.00

Silicon Power Rectifiers

PRV	3A	12A	20A	40A
100	.09	.30	.40	.75
200	.15	.50	.60	1.25
400	.20	.70	.80	1.50
600	.30	1.00	1.20	1.80
800	.40	1.25	1.50	
1000	.55	1.50	1.80	

Terms: FOB Cambridge, Mass. Send check or Money Order. Include Postage. Average Wt. per package 1/2 lb. No C.O.D.'s. Minimum Order \$3.00
Rated companies 30 days net
TELEPHONE (617) 547-4005

G & G SURPLUS SPECIALS!

BC-645 TRANSCEIVER, 15 tubes. 435 to 500 Mc. Easily adapted for 2 way voice or code on Ham, Mobile, Television, Experimental and Citizens' Bands. With tubes, less power supply in factory carton. Brand new. \$16.95



Dynamotor. Antenna. All Plugs. Accessories available.

TS-175/U FREQUENCY METER Crystal-controlled. 85 to 1000 Mc Complete with tubes, crystal, calibration hook. Checked out. Exc. Used \$124.95



TG-34A CODE KEYSER, self-contained, automatic, reproduces code practice signals from paper tape. 5 to 25 WPM. Built-in speaker. Brand new with tech manual, take-up reel, \$24.50 and AC line cord. \$24.50
Code practice tapes for above P.U.R.



BC-603 FM RECEIVER, 20 to 27 Mc 10 preset push-button channels or manual tuning. Complete with 10 tubes; checked out. Exc. Used condition \$37.50

BC-603 FM RECEIVER converted for operation on 35 to 50 Mc. Checked out. Guaranteed Exc. Used Cond. \$52.50

AN/ART-13 TRANSMITTER 300 watt line Ham transmitter for 80, 40, 20 and 10 meters. Power output 100 Watts on AM, CW, MCV. 10 preset channels. Complete with all tubes, crystal. exc. Used \$49.50



Low-Frequency Oscillator Coil for above, 200-1500 Kc. Exc. Used. \$7.95

ARC-5 VHF RECEIVER, TRANSMITTER, MODULATOR 100-156 Mc.

R-28 Receiver, with tubes and crystal, exc. Used Cond. \$19.50

T-23 Transmitter with tubes and crystals. Brand New in original carton \$21.50
M-D 7 Modulator, with tubes, exc. used \$10.50

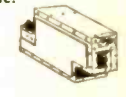

ARB RECEIVER, 200-500 Kc & 1.5-18 Mc. 8 tube, 8 band. Complete with tubes and dyn. Exc. Used Cond. \$34.50

TS-34 PORTABLE TEST SCOPE, complete with 2A1P CR tube, Exc. Used. Condition \$49.50

APX-6 TRANSMITTER-RECEIVER TRANSDUCER, 950-1150 Mc. (convertible to 1215-1290 Mc.) With 30 tubes, Exc. Used. P.U.R.

APN-1 TRANSMITTER-RECEIVER FM 400-450 Mc. Exc. Used with all tubes, dynamotor & wobulator \$8.95

VISIT OUR NEW SHOWROOM
AT 45 WARREN STREET, N.Y.C.

WILLARD 2-VOLT STORAGE BATTERY Model 20-2 rated at 20 Amp. Hours. Rechargeable. 3x4x5 1/2". Shipped dry. Uses standard electrolyte, see below. NEW \$2.79



1-Qt. Acid for above, 1280 Specific Gravity.....\$1.25

HEADSETS

HS-33 Type, Dynamic, Lo-Imp. NEW \$5.45
CD-307 Extension Cord for above, NEW \$1.35
Chamois Ear Cushions for above, Per Pair \$1.50

T-17 MICROPHONE, NEW \$8.50; Exc. Used \$4.75

NEW G&G CATALOG 24 Pages Terrific Buys in Military Electronic Gear. SEND 25¢—Refunded with First Order.

TERMS: Either 25% Deposit with order, balance C.O.D.—OR—Remittance in Full. Minimum Order \$5.00. All shipments F.O.B. our Warehouse, NYC. All merchandise subject to prior sale and price change.

G & G RADIO SUPPLY COMPANY
Telephone: (212) CO 7-4605
75-77 Leonard St., New York, N.Y. 10013

STEREO Tapes, Save 30% and up; no membership or fees required; postpaid anywhere U.S.A. Free 70-page catalog. We discount batteries, recorders, tape/accessories. Beware of slogans, "not undersold," as the discount information you supply our competitor is invariably reported to the factory. **SAXITONE**, 1776 Columbia Road, N. W., Washington, D. C. 20009.

Hi-Fi Components, Tape Recorders at guaranteed "We Will Not Be Undersold" prices. 15-day money-back guarantee. Two-year warranty. No Catalog. Quotations Free. Hi-Fidelity Center, 239 (LT) East 149th Street, New York 10451.

RENT 4-track open reel tapes—all major labels—3,000 different—free brochure. Stereo-Parti, 55 St. James Drive, Santa Rosa, CA. 95401.

RENT Tapes—No dues. Scotch Tape Discounted—catalog. The Tape Library, Box 8146, D.C. 20024.

SCOTCH RECORDING TAPE, lowest prices. **TAPE CENTER,** Box 4305, Washington, D.C. 20012.

GET IT from GOODHEART!

0.01% SORENSEN Line Voltage Regulator

#1001 regul. against load changes 0-1 kva & line changes 95-130 v. 1 ph 55/85 cy; adj. output 110-120 v. holds to 0.01%. Distortion max. 3%. Response 0.1 sec. Regularly \$370.00. From us, OK Grid, **\$275.00**

#5005 is same, 0.5 kva, 0.1% **\$89.50**

#10005 is same, 1 kva, 0.1% **\$99.50**

#20005 is same, 1 kva, 0.1% **\$179.50**

Sup. Electric IE-5102 is same spec. electronic regul., but 2 1/2 kva, 0.1% **\$199.50**



Sup. Elect. IE-20060: Same specs as above but MIL-spec built, all potted xfrms, etc. Behind rack panel 21" h, 14 1/2" dp. No cabinet. Regular \$500. BRAND NEW, export boxed, 310# for **\$279.50** Utica, N.Y.

(Catalog for above \$30 job Utica.) Sorensen R5010 all-solid-state, zero reference, 0.5 kva, 90% efficient. Regular \$79.25. With cabinet, **\$450.00**

Sup. Elect. IE-5105: Same specs as Sorensen "N" series, 0.5 kva, regularly \$655.00. **\$349.50**

Only Sorensen 10,0005: Same specs as all above, but 0-10 kva. Regular \$1272. With spares, **\$695.00** (job San Diego)

ALL ABOVE are 110-130 v. Two below are 1 ph 190-250 v in. adj. 220-240 v out, 0.5 kva. Same specs, choose Sorensen 5000-28 or Sup. IE-5200P. **\$349.50**

(Picture is #5000-28.)

Above are electronic. Following are electromech. A servo system senses output, turns a Variac or Powerstat, corrects to 1% very fast. Life tested 99 years. 47-69 cy OK. AND NO DISTORTION!

Gen. Radio #1570AL: 0-6 kva, regular \$330. From us only, **\$199.50**

Sup. Elect. EM-4106 in upright metered cabinet, 0-6 kva, **\$199.50**

Sup. Elect. EM-4115 in metered cabinet, 1 ph 0-15 kva, **\$295.00**

Sup. Elect. EM-4228 0-27.5 kva 1 ph. Above are all 95-130 v. 190-240 v follows: **\$495.00**

Sup. Elect. EM-4228, 1 ph, 0-27 1/2 kva, regular \$750. New, **\$495.00**

EMT 6220Y (transformerized 3 ph 20 kva, \$1200 value, only **\$450.00**)

PLEASE DON'T ASK FOR CATALOG! Tell us what you need! We have: Aer. amp. Amplifiers/Antennators. Audio. Bridges (includes pots, gals, Dividers, etc.). Communic. Counters/Freq. Meters/Freq. Standards. Motors of all kinds. Microwave. Oscilloscopes. Pwr. splitters (regulated, precision, freq. changers). Pulse Generators. Recorders (graphic). Semiconductor/Servo/Tube Testers. 5 pieces of Signal Generators. Spectrum Analyzers. Wattmeters, etc. Etc. WE ALSO BUY! What have you?

R. E. GOODHEART CO. INC.

Box 1220-A, Beverly Hills, Calif. 90213

Phones: Area 213, office 272-5707, messages 275-5342

"ARCTURUS" SALE

• Tube bargains, to name just a few:

#6146...\$2.95 #5725/6AS6 79c; #6AQ5 61c
 #6360...3.50 #5842/417A...2.50 #6BQ7 94c
 #6688...3.50 #5847/404A...2.50 #6CG7 99c
 #6939...3.50 #1AX2 49c; 5 for 2.00 #6J6...49c
 #7025...59 #6K7...39c; 3 for 1.00 #6T8...88c
 #7288...3.75 #12BN6 59c; 3 for 1.49 #6U8...78c
 #7212...49 #25L6 59c; 3 for 1.49 #12AU7 59c

• Tube cartons: 6AU6 etc. size, \$1.95 per 100. 6SN7 etc. size, \$2.35 per 100. 5U4GB size, \$2.75 per 100. 5U4G size, .03c each.

• Obsolete tubes: #UX200, \$1.69; #80, \$1.20; #10Y, 69c.

• 7 inch 90 degree TV bench test picture tube with adapter. No ion trap needed. Cat. #7BP7, \$7.99.

• Silicon rectifier octal-based long-range replacement for 5U4, 5Y3, 5AS4, 5AW4, 5T4, 5V4, 5Z4. With diagram. Cat. # Rect 1, 99c each.

• Silicon rectifier replacement, octal based, for 024. Cat. # Rect 2, 99c each.

• 10 silicon rectifiers, 750 MA., 50 to 300 p.i.v. Cat. # 330F, 99c each.

• RCA-110 degree flyback transformer, latest type. Produces 10 KV. Includes schematic diagram application for any TV. Cat. # BR-1 \$2.99.

• Transistor circuit boards containing up to 6 transistors, plus diodes, resistors, capacitors, etc. Cat. # TB10, 99c.

• Needles; values such as # AS22 sapphire, 39c; diamond, 99c.

• Color yokes, 70 degree for all around color CRT's. Cat. # XRC70, \$12.95, 90 degree for all rectangular 19 to 25 inch color CRT's. Cat. # XRC90, \$12.95.

• Transistorized U.H.F. tuners used in 1965 to 1967 TV sets made by Admiral, RCA, Motorola, etc. Removable gearing may vary from one make to another. Need only 12 volts d.c. to function. No filament voltage needed. Easy replacement units. Cat. # U.H.F. 567, \$4.95.

• Flyback transformer in original carton. Made by Merit or Todd. Most with schematic drawing of unit. Please do not request specific type. Cat. # 506, 99c each.

• Kit of 30 tested germanium diodes. Cat. # 100, 99c.

Send for our free catalog listing thousands of similar best buys in tubes, parts, kits, transistors, rectifiers, etc. Orders under \$5.00, add 50c handling charge. Include 4% of dollar value of order for postage. Canadian postage \$1.00 extra.

ARCTURUS ELECTRONICS CORP.

502-22nd St., Union City, N.J. 07087 Dept. MEW

Phone: 201-UN 5568

CIRCLE NO. 124 ON READER SERVICE CARD

DO-IT-YOURSELF

PROFESSIONAL ELECTRONICS PROJECTS--\$1.00 up. Catalog 25c. PARKS, Box 25665A, Seattle, Wash. 98125.

RECORDS

SPECIAL INTEREST RECORDS AVAILABLE, PRODUCED BY THE EDITORS OF THE WORLD'S LEADING SPECIAL INTEREST MAGAZINES. SEND FOR FREE CATALOG. RECORD CATALOGUE, ZIFF-DAVIS PUBLISHING COMPANY, ONE PARK AVENUE, NEW YORK, N.Y. 10016.

!!!RECORDS!!! Assorted, \$25.00, 20 LP's, \$5.00, 30, 45RPM. 129 Carol Avenue, Aberdeen, Maryland 21001.

HIGH FIDELITY

FREE! Send for money saving stereo catalog #E6W and lowest quotations on your individual component, tape recorder or system requirements. Electronic Values Inc., 200 West 20th Street, N.Y., N.Y. 10011.

HI-FI Components, Tape Recorders at guaranteed "We Will Not Be Undersold" prices. 15-day money-back guarantee. Two-year warranty. No Catalog. Quotations Free. Hi-Fidelity Center, 239 (L) East 149th Street, New York 10451.

HIFI EQUIPMENT—Get Our "ROCK BOTTOM" prices on NAME BRAND amplifiers—tuners—tape-recorders—speakers FRANCHISED—59 YEARS IN BUSINESS. Write for this month's specials—NOW! Rabson's 57th St., Inc., Dept. 569, 119 W. 57th St., New York, New York 10019.

LOW, LOW quotes: all components and recorders. Hi-Fi, Roslyn, Penn. 19001.

HI-FI components, tape recorders, sleep learn equipment, tapes. Unusual Values. Free catalog. Dressner, 1523 R Jericho Turnpike, New Hyde Park, N.Y. 11040.

GOVERNMENT SURPLUS

JEEPS Typically From \$53.90 . . . Trucks From \$78.40 . . . Boats, Typewriters, Airplanes, Electronics Equipment, Photographic Equipment, used. 100,000 Bargains Direct From Government. Complete Sales Directory and Surplus Catalog \$1.00 (Deductible First \$10.00 Order). Surplus Service, Box 820-K, Holland, Michigan 49423.

GOVERNMENT Surplus How and Where to Buy in Your Area. Send \$1.00 to: Surplus Information EW, Headquarters building, Washington, D.C. 20036.

INSTRUMENTATION & COMPUTER TAPE. 500 Reel lot in good condition. Excellent investment opportunity. Write for description. Lingenfelder, 5640 Bradley Road, Santa Maria, CA. 93454.

AUTHORS' SERVICES

AUTHORS! Learn how to have your book published, promoted, distributed. FREE booklet "ZD," Vantage, 120 West 31 St., New York 10001.

PERSONALS

MAKE FRIENDS WORLDWIDE through international correspondence. Illustrated brochure free. Hermes, Berlin 11, Germany.

HYPNOTISM

FREE Hypnotism, Self-Hypnosis, Sleep Learning. Catalog! Drawer H400, Ruidoso, N.M. 88345.

HYPNOTIZE SUCCESSFULLY—or money refunded! Complete illustrated course—including Self-Hypnosis \$1.00. Arthur Fowler, Box 4396, Woodbury, New Jersey 08096.

AMAZING HYPNOTIC record kit releases fantastic mental power! Free offer expires soon. Write: Forum, Studio AA6, 333 North Michigan, Chicago 60601.

HYPNOTIZE Females, Males! Unnoticed! Quickly! Quietly! Thrilling secret methods! Rush \$3.00. Smith's, Box 2469-E1, Newark, New Jersey 07112.

HYPNOTIZE FEMALES, MALES!—Unnoticed! Instantly! Nerves! Exciting! Send \$2.25. Research Enterprises, 29-SN21 Samoset, Woburn, Mass. 01801.

GREGORY ELECTRONICS

Reconditioned & Used FM 2-WAY RADIO EQUIPMENT

Here's a small part of enlarged inventory now on hand for practically everything you need—at savings! Buy now!

450 MHz USERS

Gregory Electronics offers you a large selection of Motorola T-44 Series U.H.F. equipment. Complete with cables, control head, speaker, microphone, control relay and fuse block. All units are 15-18 watts in 15" cases.

T-44 A-6 or 12 volts
—vibrator supply **\$48.**

T-44A6-6/12 volt
—vibrator supply **\$58.**

T-44A6A-6/12 volt
—vibrator supply **\$68.**

T-44AAV-6/12 volt
—vibrator supply **\$88.**

With the conversion data in the schematic digest, you can be on 432 MHz in no time!

6 METERS F.M. MOTOROLA X-51GGS SPECIALS . . . VERY CLEAN!

3 frequency dual front end receiver
2 frequency transmitter. Receiver has a transistorized power supply
Transmitter uses a dynamotor.
12 watts/50 watts/wide band in 15" cases. Units complete with cables, multi-freq. control head, speaker, microphone, **\$128.**

Multi-Freq. Specials Very Clean

2 Meters T-43GGV Specials
In 15" cases 6/12 volts 30 watts—vibrator power supply. Unit has two dual freq. transmitter strips and a dual freq. receiver. With cables, control head, speaker, microphone, **\$178.**

General Electric Schematic Outline and Interconnection

Diagrams for General Electric Two-Way FM Radios

\$4.50 per volume

Volume I—Pre Progress Line—25-50 MHz 72-76 MHz
Volume II—Pre Progress Line—150-170 MHz

We Buy Late Model Equipment for Cash Send For '68 Catalog—Write; Wire or Phone!



GREGORY ELECTRONICS CORPORATION

249 RT. 46, Saddle Brook, N.J. 07662
Phone: (201) 489-9000

CIRCLE NO. 110 ON READER SERVICE CARD

HYPNOTIZE Others—Unnoticed. Quietly, Quickly, Safely, Instruction \$1.00. Anderson, 32AA, Randallstown, Maryland 21133.

MALE, FEMALE HYPNOTISM! Easily! Instantly! Secret Nerve Centers! \$2.20. Brugenheimer Publishers, Box 158-E30, Lexington, Mass. 02173.

PHOTOGRAPHY—FILM, EQUIPMENT, SERVICES

MEDICAL FILM—Adults only—"Childbirth" one reel, 8mm \$7.50; 16mm \$14.95. International W. Greenvale, Long Island, New York 11548.

SCIENCE Bargains—Request Free Giant Catalog "CJ"—148 pages—Astronomical Telescopes, Microscopes, Lenses, Binoculars, Kits, Parts, War Surplus bargains. Edmund Scientific Co., Barrington, New Jersey 08007.

RUBBER STAMPS

RUBBER ADDRESS STAMP \$1.50. SIGNATURE \$3.50. FREE CATALOG. JACKSON, BOX 443-G, FRANKLIN PARK, ILL. 60131.

PRINTING

LOW Cost Offset, Mimeographing, Business Cards, Envelopes. Free Brochures, Introductory offer. Seaview, 8115-R Avenue "L", Brooklyn, N. Y. 11236.

EDUCATIONAL OPPORTUNITIES

LEARN While Asleep, hypnotize with your recorder, phonograph. Astonishing details, sensational catalog free! Sleep-Learning Association, Box 24-ZD, Olympia, Washington 98501.

LEARN WHILE ASLEEP. Miraculously build Mind Power, achieve Self Confidence, improve Health, gain Success. Method 92% effective. Details free. ASR Foundation, Box 7021EG Henry Clay Station, Lexington, Kentucky 40502.

USED Correspondence Courses and Books sold and rented. Money back guarantee. Catalog free (Courses Bought). Lee Mountain, Pisgah, Alabama 35765.

INVENTIONS WANTED

PATENT SEARCHES, \$6.00! FREE "Invention Record"/Information. Miss Hayward, 1029HE Vermont, District of Columbia 20005.

INVENTIONS - IDEAS developed Cash/Royalty Sales. Member: United States Chamber Commerce. Raymond Lee, 230-GE Park Avenue, New York City 10017.

INVENTORS We will develop, help sell your idea or invention, patented or unpatented. Our national manufacturer clients are urgently seeking new items for outright cash sale or royalties. Financial assistance available. 10 years proven performance. For free information, write Dept. 42, Wall Street Invention Brokerage, 79 Wall Street, New York, N.Y. 10005.

INVENTORS! Receive free invention analysis at no risk to you. Send for FREE disclosure form today. New York Invention Service, Dept. 19, 160 Broadway, New York, N.Y. 10038.

U.S. GOV'T ELECTRONIC SURPLUS

Nationally Known-World Famous SURPLUS CENTER offers finest, most expensive, Government Surplus electronic units and components at a fraction of their original acquisition cost.

ORDER DIRECT FROM AD OR WRITE FOR CATALOGS

STANDARD DIAL TELEPHONE

(ITEM #715) - Standard, commercial telephone same as used throughout U.S.A. Attractive polished black, like new condition. Use as extension phone to private systems or connect several phones together for local internal systems. Full instructions are furnished. Wt. 9 lbs. Original cost \$24.30. F.O.B. \$7.50

STEP-BY-STEP AUTOMATIC SWITCH

(ITEM #738) - Amazing "up-and-around", electro-magnetic telephone switch. Dial any bank pair from 1 to 100. Make your own telephone system. Can also be used to remotely control up to 100 circuits over a single pair of wires.
One of our F.O.B. STAR bargains. Comes complete with data, one dial and one line bank. Size, 2" x 3" x 1 1/2". Wt. 1/2 lb. Cost Gov't Over \$15.00. Complete; switch, cover, dial, line bank, instructions..... F.O.B. \$9.95

TYPICAL BUYS FROM OUR 1968 CATALOGS

- \$ 350.00 - Geared 2-hp Battery Golf Car Motor \$26.95
- \$ 15.00 - Westinghouse DC Ammeter, 0 to 300 \$ 7.11
- \$ 40.00 - Vacuum/Pressure Pump, 12-VDC \$11.95
- - - 80-MW Walkie-Talkies, Per Pair \$19.60
- - - Deluxe, Multi-Range, AC/DC Tester \$ 8.98

SPECIAL SALE Correspondence Course in ELECTRICAL ENGINEERING

Sells For \$10.79 Outside U.S.A. **\$8.79** Postpaid in U.S.A.
(ITEM #A181) - Wonderful chance to obtain technical training at Amazing Low Cost! Lincoln Engineering School has suspended its Correspondence Courses because of increased operating costs. We offer a limited number of the school's complete Electrical Engineering Course but without the examination paper grading service. The course consists of 14 lesson unit books. Each book has the regular exams, and in a separate section, "Standard Answers" to each exam question.
Course is well written, easy to understand, profusely illustrated. Reader's digest size, easy to carry and study in spare time. Many Lincoln Engineering School students holding excellent jobs as a result of E.E.S. training. Course contains latest information on transistors, silicon diodes, etc. Additional book on how to build and operate a "Home Laboratory and Experimental Bench" furnished with each course.

SEND 25c COIN OR STAMPS FOR 3 MAIN CATALOGS All Items FOB Lincoln Money Back Guarantee

SURPLUS CENTER
DEPT. EW-068 LINCOLN, NEBR. 68501

Sale

709C OPERATIONAL AMPLIFIER High Gain **\$4.88**
Fairchild, Motorola, Etc.

TYPICAL USES: AC AMPLIFIER, AVERAGING AMPLIFIER, BI-STABLE MULTIVIBRATOR, PIAA PHONO PREAMP, DIFFERENTIATOR, DC AMPLIFIER, INTEGRATOR, MULTIPLIER, SWEEP GENERATOR, POWER SUPPLY

703H RF LINEAR AMP \$1.97

TYPICAL CIRCUIT APPLICATIONS: 30 MHz IF STRIP, 10 MHz-200MHz RF AMP, COLOR TV SOUND-IF AMPLIFIER, 10MHz OSCILLATOR, 30MHz LIMITING RF AMP

EPOXY TRANSISTORS & IC's

Fairchild, Motorola, Texas, Bendix

- 2N3563 NPN, 600MC, 200MW \$1
- 2N3643 NPN, 250MC, 350MW \$1
- 3-5000 SW, 3Amp, PNP \$1
- 2N4313 PNP, 600MC, 200MW \$1
- 2N3565, 500MFE, NPN, 200MC \$1
- 2N4265, 400MFE, NPN, 350MC \$1

100 MICROAMP PANEL METER

Made in U.S.A. D'Arsonval Meter Movement! **2.99 ea.**

New! Originally designed to be used with radio tube detectors. Now, metric movement, 100µA. 2 mounting holes for easy installation in panel. Size: 2 1/2" x 1 1/2". Mounting centers: 1 1/2". Ideal for builders, hobbyists, labs, etc. Heavy, at this fantastic price they won't last long!

HAM SILICON TUBE SPECIALS
(Replaces) Sale
1N1238 5U4GB 2.39
1N1239 5R4I 4.39
1N1237 0Z4I 2.39
1N1262 6AU4GTAI 2.39
1N2637 866A 9.99
3DG4I 2.39

3** 5*
PRV AMPS AMPS
50 .35 .85
100 .75 1.35
200 1.50 2.60
400 3.00 5.20
600 4.50 7.80

Actual Size →
1 AMP 4000 PIV MICRO SILICON RECTIFIERS **\$1.49**

Actual Size →
1.5 AMP 2000 PIV SILICON RECTIFIERS **\$1**

2 AMP 800 PIV SILICON RECTIFIERS **4 for \$1**

-FREE-
"HAM SHACK PAK"
\$25 WORTH OF TRANSISTORS, RECTIFIERS, RESISTORS, CONDENSERS, DIODES, ETC.
Add 25c for handling
BOTH FREE WITH ANY \$10 ORDER

PLUS ANY **\$1.00*** ITEM FREE
*or items totaling \$1.00.

STEREO PREAMP **400 mc**
NPN SILICON **5 for \$1**
Similar to 2N706
★ 8 TRANSISTORS
★ Ready to Play thru tape Amplifier, radio, TV
★ Volume, Tone, Controls sw

1 AMP TOP HAT AND EPOXIES
PIV Sale PIV Sale PIV Sale
50 5c 800 19c 1800 82c
100 7c 1000 29c 2000 1.25
200 8c 1200 42c 3000 1.50
400 10c 1400 55c 4000 1.95
600 15c 1600 69c

Actual Size →
1 AMP MICROMINIATURE SILICON RECTIFIERS
PIV Sale PIV Sale
50 7c 600 20c
100 10c 800 25c
200 12c 1000 39c
400 17c

2 AMP SILICON RECTIFIERS
PIV Sale PIV Sale
200 12c 1000 45c
400 16c 1200 59c
600 19c 1400 69c
800 22c 1600 89c

SILICON POWER STUD RECTIFIERS
PIV 3A 6A 12A 55A
50 .06 .16 .20 .50
100 .07 .22 .25 .75
200 .09 .30 .39 1.25
400 .16 .40 .50 1.50
600 .20 .55 .75 1.80
800 .30 .75 .90 2.30
1000 .40 .90 1.15 2.70

SOLITRON DEVICES. 5 AMP Epoxy Rectifiers
PIV Sale PIV Sale
50 19c 600 59c
100 25c 800 69c
200 39c 1000 89c
400 45c

'GLASS AMP' ONE AMP SILICON RECTIFIERS
PIV Sale PIV Sale
50 5c 600 19c
100 7c 800 21c
200 9c 1000 32c
400 12c 1200 45c

AS ADVERTISED OR YOUR MONEY BACK

GIANT SUMMER CATALOG ON: Parts, Rectifiers, Transistors, SCRs, I.C.'s, Equipment, Etc. 10p

TERMS: Include postage. Rated, net 30 days. COD 25%

POLY PAKS P.O. BOX 942 W
Lynnfield, Mass. 01940

CIRCLE NO. 99 ON READER SERVICE CARD

INVENTORS—Turn your ideas into cash. Manufacturer of electronic equipment is looking for new products. Write: Electronic Traffic Control, 4331 Elston, Chicago, Illinois 60641.

PATENT Searches including maximum speed, full airmail report and closest patent copies, \$6.00. Quality searches expertly administered. Complete secrecy guaranteed. Free Invention Protection forms and "Patent Information." Write Dept 23, Washington Patent Office Search Bureau, 711 14th Street, N. W., Washington, D.C. 20005.

BUSINESS OPPORTUNITIES

INVESTIGATE ACCIDENTS: Earn to \$1000 monthly. Men urgently needed. Car furnished. Business expenses paid. No selling. No college education necessary. Pick own job location. Investigate full time or earn to \$8 hour spare time. Write for FREE information. No obligation. Universal Schools, C2-6, 6801 Hillcrest, Dallas, Texas 75205.

FREE CATALOGS. Repair air conditioning, refrigeration. Tools, supplies, full instructions. Doolin, 2016 Canton, Dallas, Texas 75201.

I MADE \$40,000.00 YEAR by mailorder! Helped others make money! Start with \$10.00—Free proof. Torrey, Box 318-N, Ypsilanti, Mich. 48197. \$200.00 DAILY In Your Mailbox! Your Opportunity To Do What Mailorder Experts Do. Free Details. Associates, Box 136-K, Holland, Michigan 49423.

INCREASE your Business Opportunities by placing your classified advertising in these columns. Each month, more than 172,000 electronics professionals turn to these pages. They'll turn to you if your ad is here, too!

REPAIRS AND SERVICES

SPEAKER REPAIR. Hi-Fi, guitar, organ speakers reconed good as new at fraction of new speaker price. For details and Reconing Center in your area write: Waldom Electronics, Inc., Dept. EW, 4625 W. 53rd St., Chicago, Ill. 60632.

EMPLOYMENT OPPORTUNITIES

POSITIONS OPEN: ELECTRONIC PARTS SPECIALIST—Responsible for establishing effective procedure insure supply electronic parts, home entertainment product line. Duties include assigning company part numbers, maintaining parts list, recommending inventory levels, supervising warranty fund. Location: New York City. High School Graduate some electronic technical training. Salary: \$8,000.00 range. **ASSISTANT PRODUCT MANAGER**—Electronic home entertainment—TV, Radio, Phonograph. Prepare comparison reports, analyze field sales reports and plan corrective action. Analyze sales trends. Background and education in marketing and business. Salary: \$12,000.00 range. **ELECTRONICS WORLD, Classified, Box 588, 1 Park Avenue, New York, N.Y. 10016.**

MISCELLANEOUS

WINEMAKERS: Free illustrated catalog of yeasts, equipment. Semplex, Box 7208, Minneapolis, Minn. 55412.

WATCHES AND CHRONOGRAPHS—Import from Switzerland, save 50%. Color catalog. DFI, West Dennis, Massachusetts 02670.

EMPLOYMENT Resumes. Get a better job & earn more! Send only \$2.00 for expert, complete Resume Writing Instructions. J. Ross, 80-34 Kent St., Jamaica, N.Y. 11432 Dept. EW.

STOP BURGLARS THE EASY WAY!! Affix authentic "Protected by Electronic Sentry Alarm" Decals to auto windows, doors & windows of home, retail stores; vending machines, etc. Whether you have an alarm or not—thieves stay away! Only \$1.00 for each set of two. J. Ross, 80-34 Kent St., Jamaica, N.Y. 11432. Dept. EW.

YOUR CLASSIFIED AD IN THESE COLUMNS WILL PRODUCE RESULTS. Read by more than 172,000 electronics professionals each month, your ad will "pull" on these pages as it will nowhere else. For just 70¢ a word, additional sales responses will more than pay for your advertising costs. Send copy and payment today to **ELECTRONICS WORLD Classified, One Park Avenue, New York, N.Y. 10016.**

UNUSUAL BARGAINS

... MANY U.S. GOV'T SURPLUS

NICKEL-CADMIUM BATTERY BARGAIN!

Terrific value—slightly used gov't surplus. Lightweight 5 cell, 8 volt, 4 Amp-hour battery with almost unlimited life. Extremely high current output. Recharges in 1 hour with Edmund kit. Won't deteriorate when left discharged. Minimum maintenance—few drops of water per year. Rugged, shock and vibration resistant nylon case. Delivered partially charged. Filled with electrolyte. 1 1/2" x 2 1/2" x 2 1/2".
Stock No. 70.942AK. (battery) \$15.00 Ppd.
Stock No. 70.807AK. (charger kit) \$ 8.00 Ppd.

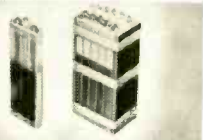

NEW SURPLUS NI-CD BATTERIES



Save more than 50%! Long life—accept 300 charge and discharge cycles. 1.25 Volts per cell—750 milliamper hour capacity. Excellent charge retention. Hermetically sealed. Indefinite storage life. Multiple cells welded in series—easily combined in form factor—charger separate.

Order #	Cells	DC Volt.	Price Ppd.
40.986AK	1	1.25	\$ 1.50
40.987AK	2	2.50	2.75
60.633AK	3	3.75	3.60
60.634AK	4	5.00	4.80
60.703AK		(Charger)	\$3.25 Ppd.

Order by Stock No.—Check or M.O.—Money-Back Guarantee

EDMUND SCIENTIFIC CO., 300 EDCORP BUILDING BARRINGTON, NEW JERSEY 08007

MAIL COUPON for FREE CATALOG

148 Pages—1000's of Bargains!

EDMUND SCIENTIFIC CO. 300 EDCORP BUILDING, BARRINGTON, N.J. 08007

Completely new 1968 edition. New items, categories, illustrations. Dozens of electrical and electromechanical parts, accessories. Enormous selection of Astronomical Telescopes, Microscopes, Binoculars, Magnifiers, Magnets, Lenses, Prisms. Many war surplus items for hobbyists, experimenters, workshop. factory. Mail coupon for catalog "AK".



NAME _____
ADDRESS _____
CITY _____ STATE _____ ZIP _____

ELECTRONICS WORLD JUNE 1968

ADVERTISERS INDEX

READER	SERVICE NO.	ADVERTISER	PAGE NO.	READER	SERVICE NO.	ADVERTISER	PAGE NO.
	125	Allied Radio	65	106	Kenwood	THIRD COVER	
	124	Arcturus Electronics Corp	84	107	Lampkin Laboratories, Inc	65	
	123	Belden Corporation	19	105	Mallory & Co. Inc., P.R.	2	
	122	Burstein-Applebee	73	200	Metex Corporation	79	
		CREI, Home Study Division, McGraw-Hill Book Company	SECOND COVER	104	Mosley Electronics, Inc	73	
	121	Cleveland Institute of Electronics	54, 55, 56, 57	103	Motorola Training Institute	79	
	120	Cleveland Institute of Electronics....	63	102	Music Associated	64	
	119	Cooks Institute of Electronics Engineering	66		National Radio Institute	12, 13, 14, 15	
	88	Crown International	10	101	Olson Electronics, Inc	62	
	118	Delta Products, Inc	76	100	Oxford Transducer Company	53	
	117	Delta Products, Inc	77	99	Poly Paks	85	
	116	Edmund Scientific Co	86	98	RCA Electronic Components and Devices	23	
	115	Electro-Voice, Inc	59		RCA Institutes, Inc	68, 69, 70, 71	
	113	Electronic Components Co	82	97	Radar Devices Mfg. Corp	5, 6, 7, 8, 9	
		Fair Radio Sales	82	96	Sams & Co., Inc., Howard W	20	
	114	Finney Company, The	FOURTH COVER	95	Schober Organ Corp., The	65	
		G & G Radio Supply Company	83	94	Scott, Inc., H.H.	63	
	112	Gavin Instruments, Inc	16	93	Solid State Sales	83	
		Goodheart Co. Inc., R.E.	84		Surplus Center	85	
		Grantham School of Electronics	4	199	Texas Crystals	10	
	111	Greenlee Tool Co	64	92	University Sound	24	
	110	Gregory Electronics Corporation	84		Val Products	72	
	109	Heath Company	60, 61		Valparaiso Technical Institute	66	
	108	Judson Research & Mfg. Co	10	91	Weller Electric Corporation	75	
				90	Workman Electronic Products, Inc ..	62	
				89	Zenith	81	

CLASSIFIED ADVERTISING 82, 83, 84, 85, 86

FREE

INFORMATION

SERVICE



a/ Here's an easy and convenient way for you to get additional information about products advertised or mentioned editorially in this issue. Just follow the directions below...and the material will be sent to you promptly and free of charge.

b/ Tear out one of the perforated postage-free cards. Please print or type your name and address where indicated.

c/ Circle the number on the card that corresponds to the key number at the bottom of the advertisement or editorial mention that interests you. (Key numbers for advertised products also appear in the Advertisers' Index.)

d/ Simply mail the card. No postage is required.

e/ Inquiries for information other than "Free Information Service" are to be directed to Electronics World, One Park Avenue, New York, N.Y. 10016.

f/ The "Free Information Service" is available to all readers of Electronics World. If your copy is passed along, the next reader can also take advantage of this service. All he has to do is tear out the remaining card and follow the same directions.

g/ Electronics World's Free Information Service lets you "shop by mail".



Important: BLACK numbers are of general interest and you do not have to include your company name and address to receive the information requested.

BLUE numbers correspond to an ad or editorial mention of professional interest. Manufacturers will honor your request **only** if it is to be mailed direct to your company—so be sure to include your company's name and address.

I AM EMPLOYED IN: INDUSTRY -1 COMMERCIAL -2
COMMUNICATIONS -3 MILITARY/GOVERNMENT -4 OTHER -5

NAME (Print Clearly) _____ TITLE _____

ADDRESS _____

CITY _____ STATE _____ ZIP CODE _____

(Fill in the following only if you circle any BLUE numbers below)

NAME (Print Clearly) _____ TITLE _____

COMPANY NAME _____

COMPANY ADDRESS _____

CITY _____ STATE _____ ZIP CODE _____

(Zip Code must be included to insure delivery.) (Void 60 days after date of issue.)

Please send me additional information on products I have circled.
(Key numbers for advertised products also appear in Advertisers Index.)

NB 668

1	2	3	4	5	6	7	8	9	10	11	12	13	14	15	16	17	18	19	20	21	22	23	24	25
26	27	28	29	30	31	32	33	34	35	36	37	38	39	40	41	42	43	44	45	46	47	48	49	50
51	52	53	54	55	56	57	58	59	60	61	62	63	64	65	66	67	68	69	70	71	72	73	74	75
76	77	78	79	80	81	82	83	84	85	86	87	88	89	90	91	92	93	94	95	96	97	98	99	100
101	102	103	104	105	106	107	108	109	110	111	112	113	114	115	116	117	118	119	120	121	122	123	124	125
126	127	128	129	130	131	132	133	134	135	136	137	138	139	140	141	142	143	144	145	146	147	148	149	150
151	152	153	154	155	156	157	158	159	160	161	162	163	164	165	166	167	168	169	170	171	172	173	174	175
176	177	178	179	180	181	182	183	184	185	186	187	188	189	190	191	192	193	194	195	196	197	198	199	200

I AM EMPLOYED IN: INDUSTRY -1 COMMERCIAL -2
COMMUNICATIONS -3 MILITARY/GOVERNMENT -4 OTHER -5

NAME (Print Clearly) _____ TITLE _____

ADDRESS _____

CITY _____ STATE _____ ZIP CODE _____

(Fill in the following only if you circle any BLUE numbers below)

NAME (Print Clearly) _____ TITLE _____

COMPANY NAME _____

COMPANY ADDRESS _____

CITY _____ STATE _____ ZIP CODE _____

(Zip Code must be included to insure delivery.) (Void 60 days after date of issue.)

Please send me additional information on products I have circled.
(Key numbers for advertised products also appear in Advertisers Index.)

NA 668

1	2	3	4	5	6	7	8	9	10	11	12	13	14	15	16	17	18	19	20	21	22	23	24	25
26	27	28	29	30	31	32	33	34	35	36	37	38	39	40	41	42	43	44	45	46	47	48	49	50
51	52	53	54	55	56	57	58	59	60	61	62	63	64	65	66	67	68	69	70	71	72	73	74	75
76	77	78	79	80	81	82	83	84	85	86	87	88	89	90	91	92	93	94	95	96	97	98	99	100
101	102	103	104	105	106	107	108	109	110	111	112	113	114	115	116	117	118	119	120	121	122	123	124	125
126	127	128	129	130	131	132	133	134	135	136	137	138	139	140	141	142	143	144	145	146	147	148	149	150
151	152	153	154	155	156	157	158	159	160	161	162	163	164	165	166	167	168	169	170	171	172	173	174	175
176	177	178	179	180	181	182	183	184	185	186	187	188	189	190	191	192	193	194	195	196	197	198	199	200

FREE
INFORMATION
SERVICE



FIRST CLASS
PERMIT NO. 25682
PHILADELPHIA, PA.

BUSINESS REPLY MAIL
NO POSTAGE NECESSARY IF MAILED IN U. S. A.

POSTAGE WILL BE PAID BY

Electronics World

P.O. BOX 7842

PHILADELPHIA, PA. 19101



FIRST CLASS
PERMIT NO. 25682
PHILADELPHIA, PA.

BUSINESS REPLY MAIL
NO POSTAGE NECESSARY IF MAILED IN U. S. A.

POSTAGE WILL BE PAID BY

Electronics World

P.O. BOX 7842

PHILADELPHIA, PA. 19101

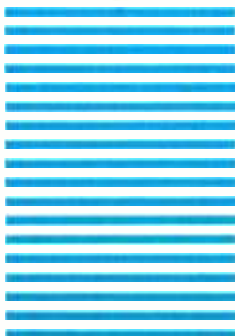

**Read
each
month
by the
world's
largest
audience
of
electronics
professionals**

Both KENWOOD amplifiers sound like a million dollars. Read why one is less than \$90... while the other is \$700.

THE NEW
KENWOOD KA-2000
 IS THE BEST BUY
 FOR THE MONEY.....SO IS THE NEW **SUPREME 1.**



The KA-2000 solid state stereo amplifier is modestly priced at \$89.95, including cabinet. Inputs for tuner, record player, tape recorder and aux. It offers 40 watts of music power and ultra-wide frequency response to let you enjoy fine sound reproduction.



The 165-watt SUPREME 1 three-channel stereo amplifier offers the ultimate in sound reproduction. An electronic crossover network drives the woofer, mid-range and tweeter speakers separately thru multi-channel amplifiers. Priced at \$695, it is designed for the discriminating (and technically-oriented) professional audiophile.

Listen to both. Whichever you choose,
KENWOOD is your assurance of superior quality and dependability. Either one is a sound value.

KA-2000 specifications:

Total Music Power: 40 watts (IHF Standard 4 ohms)
 35 watts (IHF Standard 8 ohms)
 Continuous Power: 13 watts per channel (0.5% T.H.D.)
 IM Distortion: 0.5% (-3dB of rated power)
 Frequency Response: 20 Hz - 50,000 Hz (±1 dB)
 Input Sensitivity: Phono 2.1 mV, Aux 130 mV,
 Tape play 130 mV
 Damping Factor: 40 (at 16 ohms), 20 (at 8 ohms)
 Bass Control: ±11 dB (at 100 Hz)
 Treble Control: ±11 dB (at 10,000 Hz)
 Speaker Impedance: 4 to 16 ohms
 Built-in Circuits: Tape Monitor Switch, Loudness Control
 Bass and Treble control,
 Stereo Headphone Jack,
 U.S. Patented Protection Circuit
 Dimension: 10 1/4" W x 4 1/8" H x 9 3/8" D
 Weight: 10 Lbs.

Supreme 1 specifications:

MAIN AMPLIFIER SECTION		RMS (.5% THD)	Music
OUTPUT POWER:	Low range amplifier	33/33 watts	80 watts
	Mid range amplifier	23/23 watts	50 watts
	High range amplifier	15/15 watts	35 watts
	Total	142 watts	165 watts
FREQUENCY RESPONSE:	Low range amplifier	10-100,000 Hz ±1dB	
	Mid range amplifier	100-100,000 Hz ±1dB	
	High range amplifier	1,000-100,000 Hz ±1dB	
DAMPING FACTOR:	(each channel)	80 (16 ohms)	
		40 (8 ohms)	
		90 dB	
SIGNAL TO NOISE RATIO:		1% at -3dB rated output	
IM DISTORTION:	(60 Hz and 7,000 Hz, 4:1)		
CONTROL AMPLIFIER SECTION			
BASS CONTROL:			±12dB at 100 Hz
TREBLE CONTROL:			±12dB at 10,000 Hz (2KHz, 5KHz Turnover roll-off changeable)
EQUALIZATION:			RIAA 20-20,000 Hz ±1dB NAB 20-20,000 Hz ±1dB
SIGNAL TO NOISE RATIO:	Phono 60dB, Phono (Low) 50dB, Tape HD 60dB, Tuner 90dB, Aux 90dB		
FREQUENCY RESPONSE:			20-50,000 Hz ±1dB
FILTER SECTION			
LOW FILTER:		12dB/oct	40 Hz, 80 Hz changeable
HIGH FILTER:		12dB/oct	6,000 Hz, 9,000 Hz changeable
DIVIDING FILTER:		12dB/oct	400 Hz, 800 Hz changeable
LOW CROSS OVER:		12dB/oct	2,500 Hz, 5,000 Hz changeable
HIGH CROSS OVER:			
POWER CONSUMPTION	117V 50/60 Hz, 45 watts (No Signal), 200 watts (Full Power)		
DIMENSIONS:			W 16 3/4", H 6 1/2", D 12"

the sound approach to quality



3700 South Broadway Place, Los Angeles, Calif. 90007
 69-41 Calamus Avenue, Woodside, New York 11377

CIRCLE NO. 106 ON READER SERVICE CARD

NEW

FINCO®

COLOR SPECTRUM™ ANTENNAS

are "signal customized"
for better color reception...

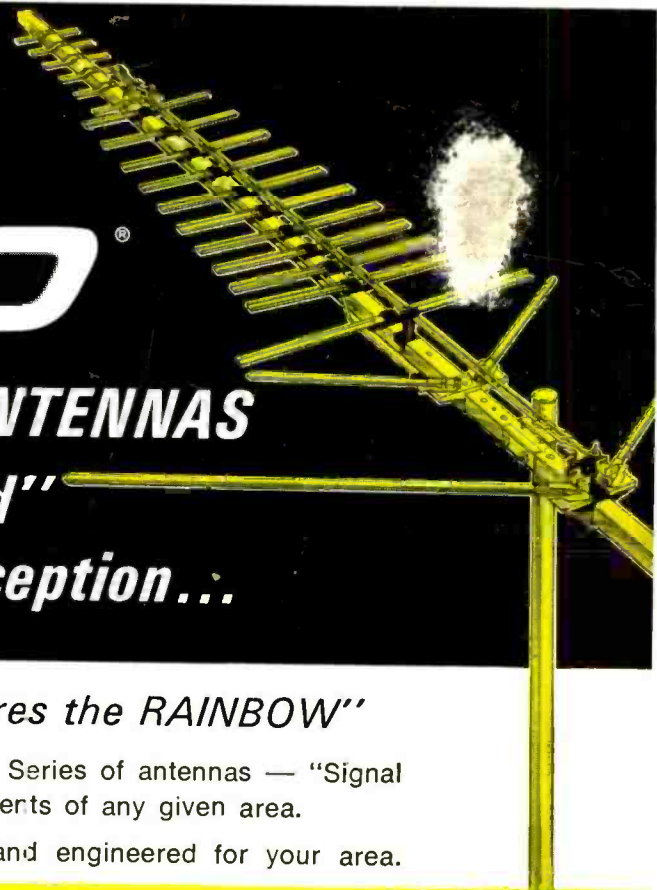

"the ANTENNA that captures the RAINBOW"

FINCO has developed the Color Spectrum Series of antennas — "Signal Customized" — to exactly fit the requirements of any given area.

There is a model scientifically designed and engineered for your area.

Check this chart for the FINCO "Signal Customized" Antenna best suited for your area.

STRENGTH OF UHF SIGNAL AT RECEIVING ANTENNA LOCATION ▼	Strength of VHF Signal at Receiving Antenna Location				
	NO VHF ▼	VHF SIGNAL STRONG ▼	VHF SIGNAL MODERATE ▼	VHF SIGNAL WEAK ▼	VHF SIGNAL VERY WEAK ▼
NO UHF →→		 CS-V3 \$10.95	 CS-V5 CS-V7 \$17.50 \$24.95	 CS-V10 \$35.95	 CS-V15 CS-V18 \$48.50 \$56.50
UHF SIGNAL STRONG →→→	 CS-U1 \$9.95	 CS-A1 \$18.95	 CS-B1 \$29.95	 CS-C1 \$43.95	 CS-C1 \$43.95
UHF SIGNAL WEAK →→→→	 CS-U2 \$14.95	 CS-A2 \$22.95	 CS-B3 \$49.95	 CS-C3 \$59.95	 CS-D3 \$69.95
UHF SIGNAL VERY WEAK →→→→→	 CS-U3 \$21.95	 CS-A3 \$30.95	 CS-B3 \$49.95	 CS-C3 \$59.95	 CS-D3 \$69.95



NOTE: In addition to the regular 300 ohm models (above), each model is available in a 75 ohm coaxial cable downlead where this type of installation is preferable. These models, designated "XCS", each come complete with a compact behind-the-set 75 ohm to 300 ohm balun-splitter to match the antenna system to the proper set terminals.

Prices and specifications subject to change.

THE FINNEY COMPANY

34 West Interstate Street • Dept. 410 • Bedford, Ohio 44146