

# Electronics World

MARCH, 1968  
60 CENTS

HOW BELL LABS' NEW PICTURE TELEPHONE WILL WORK  
LATEST REPORT ON SUBMINIATURE INTEGRATED ANTENNAS  
RADIC—THE WORLD'S MOST ELABORATE INTERCOM?

## LASERS



## HOLOGRA

M0371 490684LNE108820K43  
K J LYNES  
1088 22ND AV SE  
MINNEAPOLIS MN 55414



The closer you get...  
the better you like  
the new  
E-V Model 631  
dynamic  
microphone!



 There's just one way to learn how good—or how bad—a microphone really is. Try it. So let's put the new Electro-Voice Model 631 omnidirectional dynamic microphone through its paces.

#### Based on Broadcast Design

The shape of the new 631 may seem familiar—for good reason. This unique microphone is a direct descendant of the E-V 635A seen often on every major TV network, and fast becoming radio and TV's most popular microphone. Recording and film studios also found that the 635A could replace microphones costing hundreds of dollars more. But it was performance, not price, that convinced them. The 631 enjoys the same basic advantages, especially tailored to general purpose applications.

#### Top Performance Sealed In

Listen critically to the 631. Smooth, flat response with plenty of output (it wouldn't be an E-V microphone otherwise). But unlike any other microphone with a switch in the body, this performance is sealed in. There are no openings of any kind to leak and degrade bass response. It's an entirely new concept of microphone switching. We call it Uniseal™. It guarantees that every 631 will maintain its like-new performance for years.

#### Ends Switching Problems Forever

Don't try this on any other microphone, but you can peel off the 631 switch actuator. Underneath that smooth, solid case is a magnetically operated reed relay, forever safe from dirt and corrosion. The magnet is in the removable actuator. In the "Off" position, the magnet closes the switch contacts, shorting the 631 output. In the "On" position, the contacts open. And when the actuator is removed, the microphone stays on. There is nothing more versatile or dependable. The Uniseal switch is exclusive with Electro-Voice.

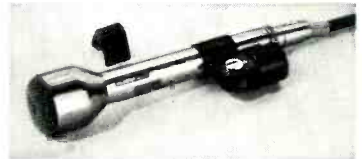

#### Protected Four Ways

Pick up the 631. Light, but not flimsy. Good balance. A joy to use in handheld applications, and easy to mount anywhere. If you could look inside the 631 you would find a 4-stage acoustic filter that traps dirt and magnetic particles before they can get to the element. And the same filter makes it almost impossible to blast or "pop" the 631—even when performers work ultra-close.



#### Unique "Nesting" Construction

Behind the filter is a most sophisticated dynamic element. The diaphragm is made of E-V Acoustalloy® and just about indestructible. The entire element is designed so that internal parts "nest" inside each other, making a solid assembly almost impervious to shock. To cut down on mechanical noise, the complete assembly is cushioned by viscous vinyl.

#### Easy to Install

To install a 631, just slip it into the 3/4" stand clamp provided (it also fits all other 3/4" accessory mounts). Next, plug in the cable. Note the sturdy pin-type connectors for more positive contact, especially on the high impedance model. Note also the heavy broadcast-type cable that withstands heaviest abuse.

The 631 is available in satin chrome or matte satin nickel finish for just \$60.00 list (less normal trade discounts). Or you can buy it in your choice of custom carrying cases, complete with standard phone plug for slightly more. Want more details? Just write. Or better yet, inspect the 631 first hand at your E-V microphone headquarters. The closer you look, the better you like it!

**ELECTRO-VOICE, INC.**, Dept. 382N,  
629 Cecil Street, Buchanan, Michigan 49107

**Electro-Voice**®  
SETTING NEW STANDARDS IN SOUND

high fidelity systems and speakers • tuners, amplifiers, receivers  
• public address loudspeakers • microphones • phono needles  
and cartridges • organs • space and defense electronics

**CIRCLE NO. 108 ON READER SERVICE CARD**



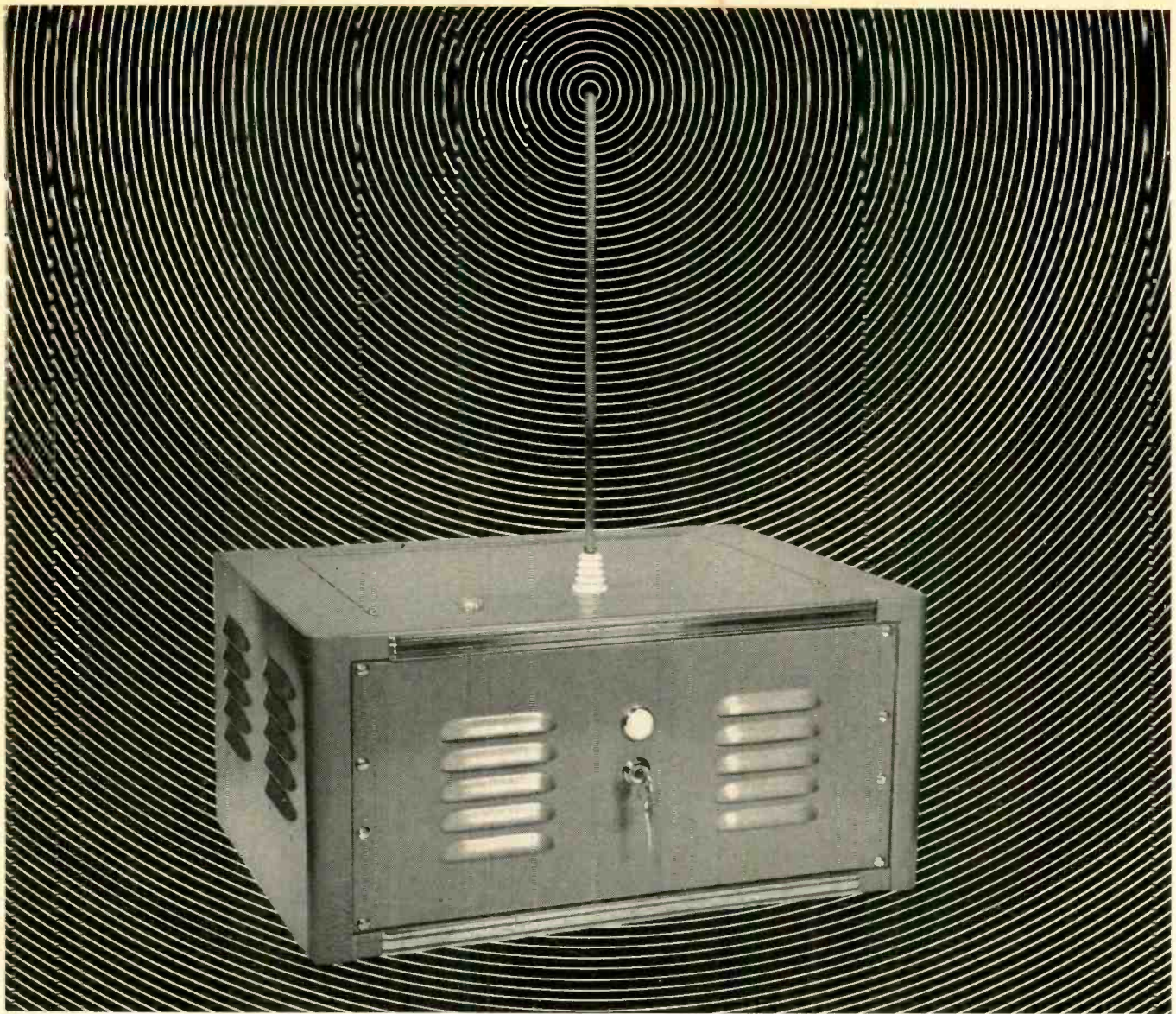

## You are now in Radar Sentry Alarm's r.f. microwave field. Don't move a muscle!

This security system is so sensitive, it can be adjusted to detect the motion of your arm turning this page.

And if this Portable Model Unit were within 35 feet of you and you moved . . . people up to a half-mile away could hear the siren. Plus with optional equipment, it can detect fire . . . turn on lights . . . even notify police.

What does a burglar alarm have to do with you?

Just this: Radar Sentry is no ordinary alarm. It is the most modern and effective security system available. And it's also electronic.

That's why we need you. We need Dealers with technical knowledge. For the most successful Dealers for Radar Sentry Alarm are men who know electronics. This is a product that sells itself when demonstrated properly.

It's been proven time after time. In fact, many of the more than one thousand readers of electronics magazines who became Dealers in the past year — sold a system on their *first* demonstration.

And that's why we need men with technical knowledge and experience.

Men like you.

### How about it?

Do you want to start a business of your own . . . or expand your present business with a product that in 8 years has become the world-wide leader in its field?

Do you want to earn up to \$5,000 a year in your spare time?

Do you want to earn \$20,000 and more full time?

We'll show you how.

O.K., now you can move.

Fill out the coupon and get complete Dealer/Distributor information . . . free.

Mail to: RADAR DEVICES MANUFACTURING CORP.  
22003 Harper Ave., St. Clair Shores, Michigan 48080



Please tell me how I can have a business of my own distributing Radar Sentry Alarm Systems. I understand there is no obligation.

Name \_\_\_\_\_

Address \_\_\_\_\_

City \_\_\_\_\_ State & Code \_\_\_\_\_

EW 3



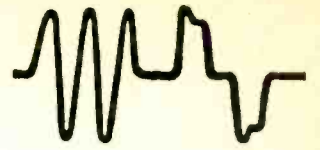

## Sonalert<sup>®</sup> versatile signal for service shops

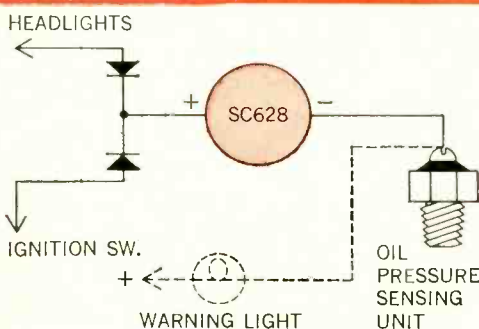
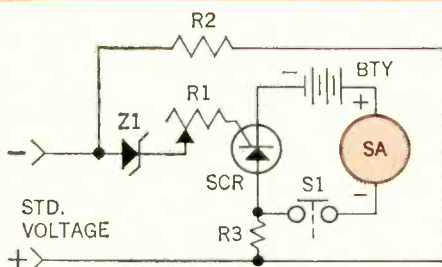
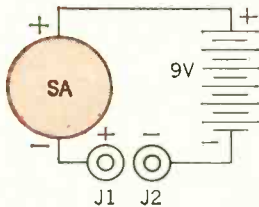
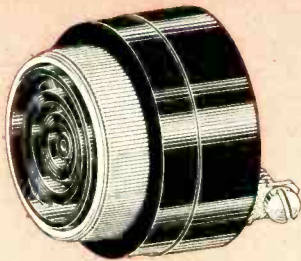

Ever hear of the audible signal that works on only a few milliamps? We have one. It's called the Sonalert, and it's a solid-state tone device that you can find lots of uses for in your shop, your car and your home.

For instance, it makes a wonderful continuity checker. Just hook it to a 9-volt battery . . . a Duracell<sup>®</sup> TR-146X mercury battery is ideal. You can test circuits having resistance up to about 1000 ohms, with complete safety against accidental burn-out of fine-wire components such as coils and transformers. At 9 volts, Sonalert draws only 3 milliamps. Its distinctive 2800 Hz tone helps make circuit tracing easy. A convenient way to put this useful gadget together is described in our booklet "How to Use Sonalert".

Or maybe you'd like an alarm that will sound when voltage gets too low or too high. If your equipment already has an over- or under-voltage signal light, it's easy to convert a Sonalert in parallel to give you a tone alarm that can't be ignored. Just make sure to choose a Sonalert with the right voltage rating. You can also rig a high or low voltage alarm circuit using a zener diode as the reference. The signal circuit illustrated here will keep sounding once an overvoltage has happened, until you open the switch.

And here's an idea for your service truck. A guy in a hurry will sometimes forget to turn off the headlights when he leaves the truck . . . and find the battery dead when he returns. It's easy to connect a Sonalert to sound a warning when headlights are left on when the engine is turned off. One side of the Sonalert goes to the oil pressure sensing unit, which actuates the low pressure warning light. The other goes to both the headlights and the ignition switch, through a pair of silicon rectifiers which prevent coupling those two circuits (two Mallory Type A50 silicon rectifiers fit this job ideally).

If you'd like some more tips on how to use Sonalert, ask your Mallory Distributor for "idea folder" No. 9-406. Or write Mallory Distributor Products Company, a division of P. R. Mallory & Co. Inc., Indianapolis, Indiana 46206.

DON'T FORGET TO ASK 'EM — *"What else needs fixing?"*



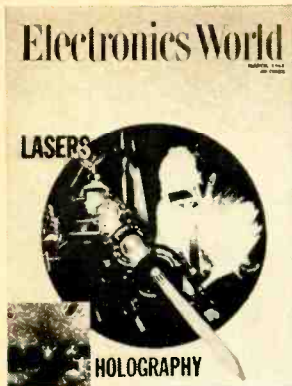

ON THIS MONTH'S COVER, Dr. R. A. Myers of the International Business Machines Corp. Research Division, observes a "scanlaser," a new device that utilizes the electric beam in a special cathode-ray tube to control the direction of a laser scan. In the scanlaser, the red-orange light from a mercury vapor gas discharge tube is not deflected; but under electronic control, a beam is generated in the desired direction in just a fraction of a millionth of a second. In its present form, the scanlaser can produce about 15,000 separate beam directions. Eventually IBM scientists expect to achieve several million beam directions. The hologram on our cover was provided by the Grumman Aircraft Engineering Corp. When laser light is shown through the photographic plate, a three-dimensional scene like the one that produced the hologram is created. Lasers have made holography one of the exciting new technologies.



*Publisher*  
**PHILLIP T. HEFFERNAN**  
*Editor*  
**WM. A. STOCKLIN**  
*Technical Editor*  
**MILTON S. SNITZER**  
*Associate Editors*  
**W. J. EVANZIA**  
**P. B. HOEFER**  
*Assistant Editor*  
**MARSHA JACOBS**  
*Contributing Editors*  
**WALTER H. BUCHSBAUM**  
**Prof. ARTHUR H. SEIDMAN**  
**FOREST H. BELT**  
*Art Editor*  
**HERBERT L. SILBERMANN**  
*Art and Drafting*  
**J. A. GOLANEK**  
*Advertising Sales Manager*  
**LAWRENCE SPORN**  
*Advertising Service Manager*  
**ARDYS C. MORAN**

March, 1968

# Electronics World

MARCH 1968 VOL. 79, No. 3

## CONTENTS

- 27 Lasers: Multi-Million Dollar Market** *E. Alan Haley*
- 31 RADIC—Low-Frequency Multiplex Intercom** *Jack Malmin*  
This may well be the world's most elaborate intercom with its 112 channels. It is used at the Kennedy Space Flight Center to link hundreds of technicians during pre-launch assembly operations and during missile countdowns.
- 34 Recent Developments in Electronics**
- 36 Coil Tuning Range Nomogram** *Donald W. Moffat*
- 38 New Picture Telephone Goes Commercial** *Milton S. Snitzer*
- 40 Holograms, Pictures in Depth** *Benjamin J. Pernick*  
The development of lasers as practical devices has enabled holography to become an exciting new technology. Born as an aid to electron microscopy, it is being used in many new applications.
- 44 Transistor's 20th Anniversary**
- 46 Linear Pots and Straight Lines** *John Doering*  
Engineers who select and specify precision potentiometers should understand the complexities of linearity definitions. This knowledge can save money, expedite delivery, and reduce confusion.
- 49 Tiny Antennas Push State-of-Art** *Paul E. Mayes*  
Subminiature integrated antennas are being used experimentally at frequencies below 30 MHz, but TV, FM radio, and other v.h.f. services have not been able to use them. The biggest problem is noise.
- 53 Transistor Curve Tracer** *Hugh L. Moore*
- 85 SCR Color Organ** *W. S. Reynolds*

**6 For the Record (Editorial)**  
1967—Another Banner Year

**7 EW Lab Tested**  
Ampex "Micro 85" Tape Recorder  
Eico Model 3200 FM Stereo Tuner

**58 Silence Pollution** *John Frye*

**67 Test Equipment Product Report**  
Conar Model 680 Color-Bar Generator  
Pomona Model 2900 High-Voltage Tester  
Hewlett-Packard Model 4328A Milliohmmeter

## MONTHLY FEATURES

- |           |                                    |           |                                      |
|-----------|------------------------------------|-----------|--------------------------------------|
| <b>4</b>  | <b>Coming Next Month</b>           | <b>23</b> | <b>Reflections on the News</b>       |
| <b>13</b> | <b>Radio &amp; Television News</b> | <b>78</b> | <b>Book Reviews</b>                  |
| <b>16</b> | <b>Letters from Our Readers</b>    | <b>86</b> | <b>New Products &amp; Literature</b> |

Electronics World: Published monthly by Ziff-Davis Publishing Company at 307 North Michigan Ave., Chicago, Illinois 60601. One year subscription \$6.00. Second Class Postage paid at Chicago, Illinois and at additional mailing offices. Subscription service and Forms 3579; Portland Place, Boulder, Colorado 80302.  
Copyright © 1968 by Ziff-Davis Publishing Company. All rights reserved.



The Grantham Educational Program  
BY CORRESPONDENCE

prepares you for your

**A. S. E. E.**  
(Associate in Science in Electronics Engineering)  
**DEGREE**

In today's world of electronics employment, an FCC license is important — sometimes essential but it's not enough! Without further education, you can't make it to the top. Get your FCC license without fail, but don't stop there. To prepare for the best jobs, continue your electronics education and get your Associate Degree in Electronics Engineering.

This is good common sense for those who want to make more money in electronics. It also makes sense to prepare for your FCC license with the School that gives degree credit for your license training — and with the School that can then take you from the FCC license level to the Degree level.

**Accreditation, and G.I. Bill Approval**

Grantham School of Electronics is *accredited* by the Accrediting Commission of the National Home Study Council, and is *approved* for both correspondence and resident training under the G.I. Bill. Just mail the coupon, or write or telephone us for full information without obligation.

**It's Your Move**

The move you make today can shape your future. Begin now with a step in the right direction — Step #1 — and then follow through with Steps #2, #3, and #4.

**Step #1** is a simple request for full information on the Grantham Associate Degree Program in Electronics. You take this step by filling out and mailing the coupon shown below. We'll send full information by return *mail*. No salesman will call.

**Step #2** is earning your FCC first class radiotelephone LICENSE and radar endorsement. You complete this step in the first two semesters of the Grantham educational program (by correspondence, or Washington resident classes).

**Step #3** is earning your ASEE DEGREE. This degree is conferred when you have earned credit for the Grantham course, one semester of which must be taken in residence if you have less than one year of practical experience in electronics.

**Step #4** is getting a better job, greater prestige, higher pay on the basis of your extensive knowledge of electronics.

It's your move! Why not begin now with Step #1.

**Grantham School of Electronics**

• Established in 1951 •

1505 N. Western Ave. 818 18th Street, N.W.  
Hollywood, Calif. 90027 or Washington, D.C. 20006

**Grantham School of Electronics** EW-3-68  
1505 N. Western Ave., Hollywood, Calif. 90027

Please mail me your free catalog, which explains how Grantham training can prepare me for my FCC License and Associate Degree in electronics. I understand no salesman will call.

Name \_\_\_\_\_ Age \_\_\_\_\_

Address \_\_\_\_\_

City \_\_\_\_\_ State \_\_\_\_\_ Zip \_\_\_\_\_

**COMING  
NEXT MONTH**

**SPECIAL ISSUE:  
POWER SUPPLIES**

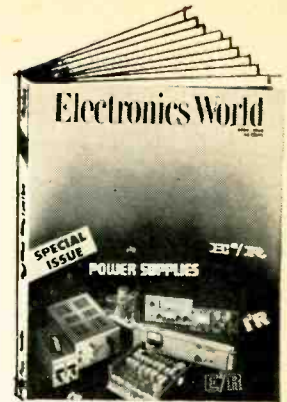

This big 24-page section carries eight feature stories devoted to power supplies and power-supply problems. Edward Brenner of the Lambda Electronics Corp. will discuss **Power Supply Principles** and how designers control ripple and regulation, and the effects of output impedance, recovery time, and inductive and capacitive loads on such power supplies. B.C. Biega, Director of Engineering of the Sola Electric Co. will tell **How to Measure Power Supply Performance** and will illustrate some techniques that help in avoiding measurement errors. Paul Birman, Applications Engineer for Kepco, Inc. covers **Power-Supply Programming**. Some **Constant-Current Power Supplies** are discussed by Sid Oakleaf, Executive Vice-President of Dynage, Inc. while Paul Muchnick of Raytheon's Sorensen Operation will discuss **A.C. Regulated Power Supplies** and what to look for when choosing a super-stable unit. A multitude of new needs and requirements have made **Power Inverters and Converters** perhaps the fastest growing and most important area of the power-supply industry. Some tips on selecting and designing efficient inverter and converter units are given by Ben Barron, former Vice-President of Lear Siegler's Data and Controls Div. Some **Protection Circuits for Solid-State Power Supplies** will be examined by Art Darbie, Marketing Manager of the Hewlett-Packard Co. Plus . . . a description of the newest **Integrated Circuit Voltage Regulators** by EW's Contributing Editor, Arthur H. Seidman.

**THE TECH INSTITUTE GRADUATE—  
HOW DOES HE COMPARE?**

*Despite a shortage of qualified engineers and engineering technicians, technical school graduates with ASEE degrees or equivalents are not being utilized effectively. Many concerned observers are asking why.*

*All these and many more interesting and informative articles will be yours in the April issue of ELECTRONICS WORLD . . . on sale March 19th.*

**TUNING IN ON COLOR**

*Some 1968 color-TV sets utilize IC's and a.f.t. circuits to improve performance. Many of the controls have also moved around to the front. Use this article for that extra "know-how" that gets you bluer blues and redder reds on your color-TV receiver.*

**ZIFF-DAVIS PUBLISHING COMPANY**

**William B. Ziff**  
*Chairman of the Board (1946-1953)*

**William Ziff**  
*President*

**W. Bradford Briggs**  
*Executive Vice President*

**Hershel B. Sarbin**  
*Senior Vice President*

**Philip Sine**  
*Financial Vice President*

**Walter S. Mills, Jr.**  
*Vice President, Circulation*

**Stanley R. Greenfield**  
*Vice President, Marketing*

**Phillip T. Heffernan**  
*Vice President, Electronics Division*

**Frank Pomerantz**  
*Vice President, Creative Services*

**Arthur W. Butzow**  
*Vice President, Production*

**Edward D. Muhlfeld**  
*Vice President, Aviation Division*

**Irwin Robinson**  
*Vice President, Travel Division*

Editorial and Executive Offices  
One Park Avenue  
New York, New York 10016 212 679-7200

NEW YORK OFFICE 212 679-7200  
Joseph E. Halloran

MIDWESTERN OFFICE  
307 North Michigan Avenue  
Chicago, Illinois 60601 312 726-0892  
Midwestern Advertising Manager, Royce Richard

WESTERN OFFICE  
9025 Wilshire Boulevard  
Beverly Hills, California 90211  
213 CRestview 4-0265; BRadshaw 2-1161  
Western Advertising Manager, Bud Dean

JAPAN  
James Yagi  
Ishikawa Mansion  
#4, Sakuragaoka  
Shibuya-ku, Tokyo  
462-2911-3

CIRCULATION OFFICE  
Portland Place, Boulder, Colorado 80302



Member  
Audit Bureau of  
Circulations

Radio & TV News • Radio News • Radio-Electronic Engineering Trademarks Reg. U.S. Pat. Off.  
**SUBSCRIPTION SERVICE:** Forms 3579 and all subscription correspondence should be addressed to Electronics World, Circulation Department, Portland Place, Boulder, Colorado 80302. Please allow at least six weeks for change of address. Include your old address, as well as new—enclosing if possible an address label from a recent issue.

**EDITORIAL CONTRIBUTIONS** must be accompanied by return postage and will be handled with reasonable care; however publisher assumes no responsibility for return or safety of art work, photographs, or manuscripts.

**ELECTRONICS WORLD** (March, 1968, Vol. 79, No. 3). Published monthly at 307 North Michigan Avenue, Chicago, Illinois 60601, by Ziff-Davis Publishing Company—also the publishers of Airline Management and Marketing, Boating, Business & Commercial Aviation, Car and Driver, Cycle, Flying, HiFi/Stereo Review, Modern Bride, Popular Electronics, Popular Photography, Skiing, Skiing Area News, and Skiing Trade News. (Travel Weekly is published by Robinson Publications, Inc., a subsidiary of Ziff-Davis Publishing Company.) One year subscription rate for U.S., U.S. Possessions, and Canada, \$6.00; all other countries, \$7.00. Second Class postage paid at Chicago, Illinois and at additional mailing offices. Authorized as second class mail by the Post Office Department, Ottawa, Canada and for payment of postage in cash.



# LOOK!

## A New Electronics Slide Rule with Instruction Course

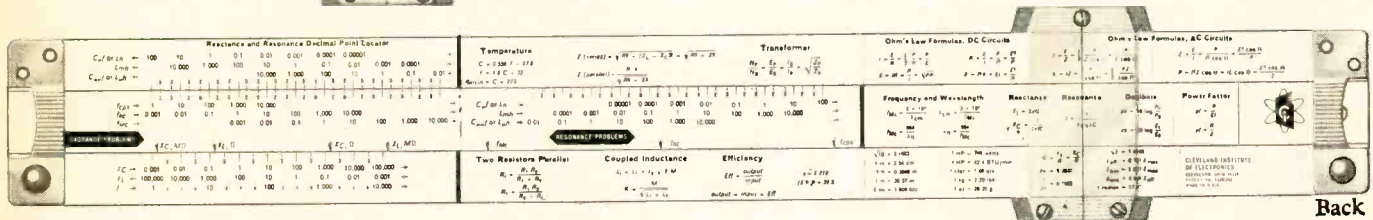
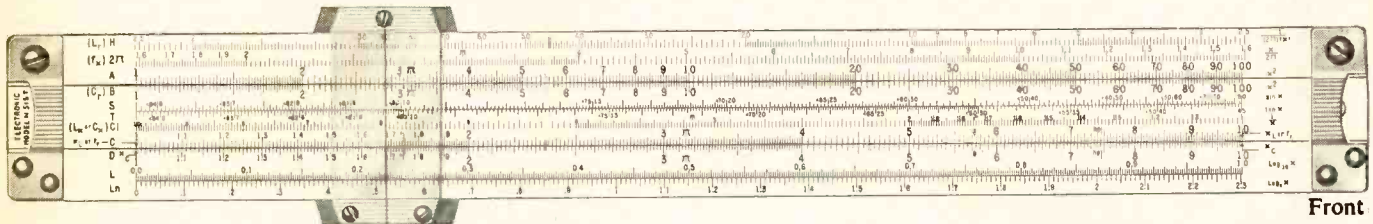

This amazing new "computer in a case" will save you time the very first day. CIE's patented, all-metal 10" electronics slide rule was designed *specifically* for electronic engineers, technicians, students, radio-TV servicemen and hobbyists. It features special scales for solving reactance, resonance, inductance and AC-DC circuitry problems . . . an exclusive "fast-finder" decimal point locator . . . widely-used formulas and conversion factors for instant reference. And there's all the standard scales you need to do multiplication, division, square roots, logs, etc.

Best of all, the CIE Slide Rule comes complete with an Instruction Course of four **AUTO-PROGRAMMED** lessons. It includes hundreds of illustrations, diagrams and practice problems. You'll learn ingenious short cuts . . . whip through exacting electronics problems quickly and accurately. This course alone is worth far more than the price of the entire package!

Electronics Slide Rule, Instruction Course, *and* handsome, top-grain leather carrying case . . . a \$50 value for less than \$25. Send coupon for **FREE** illustrated booklet and **FREE** heavy vinyl Pocket Electronics Data Guide. Cleveland Institute of Electronics, 1776 E. 17th St., Dept. EW-149, Cleveland, Ohio 44114.

\*TRADEMARK

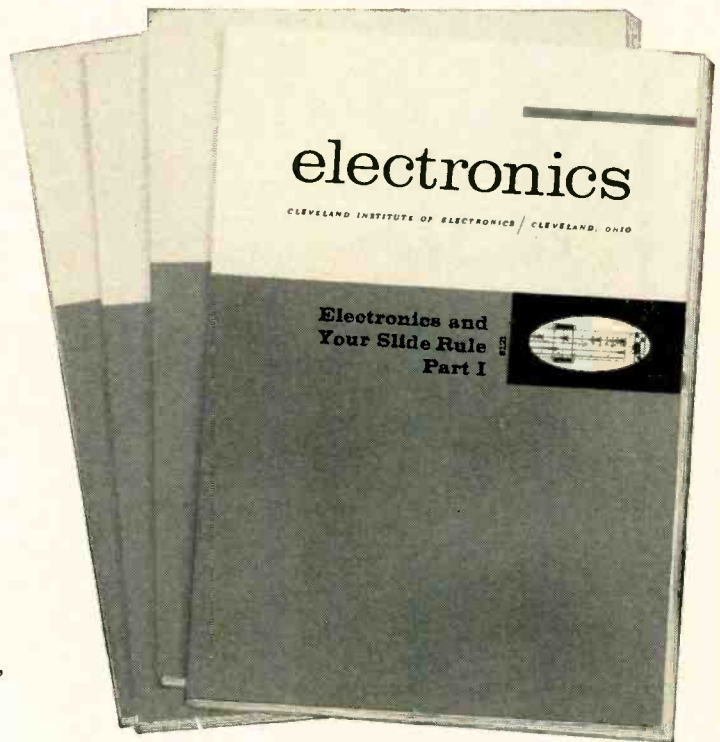

**GET BOTH FREE!**

**ELECTRONICS**

**SLIDE RULE**

**Send coupon today →**



**Cleveland Institute of Electronics**

1776 E. 17th St., Dept. EW-149, Cleveland, Ohio 44114

Please send **FREE** illustrated Booklet describing your Electronics Slide Rule and Instruction Course.

**SPECIAL BONUS!** Mail coupon promptly . . . get **FREE** Pocket Electronics Data Guide too!

Name \_\_\_\_\_

Address \_\_\_\_\_ (PLEASE PRINT) County \_\_\_\_\_

City \_\_\_\_\_ State \_\_\_\_\_ Zip \_\_\_\_\_

A leader in Electronics Training . . . since 1934.

CIRCLE NO. 122 ON READER SERVICE CARD



## MAGNECORD LEADS THE FIELD

with six different  
professional quality  
portable  
rack mounted  
tape recorders

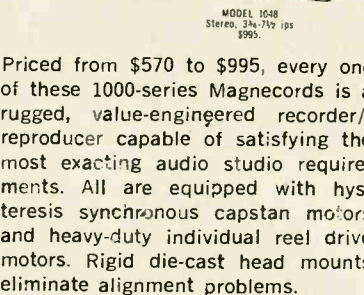
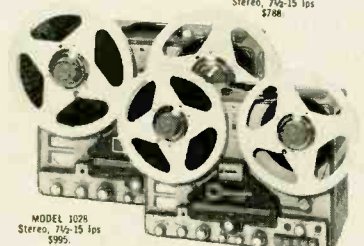
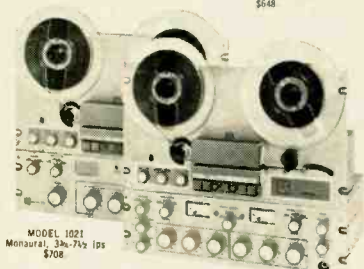
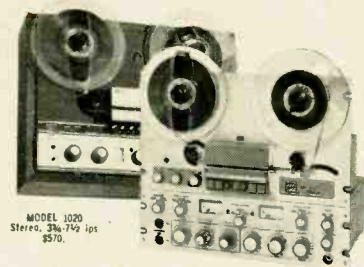

Priced from \$570 to \$995, every one of these 1000-series MagneCORDs is a rugged, value-engineered recorder/reproducer capable of satisfying the most exacting audio studio requirements. All are equipped with hysteresis synchronous capstan motors and heavy-duty individual reel drive motors. Rigid die-cast head mounts eliminate alignment problems.

For complete characteristics and specifications, write:

**MAGNECORD**  
tape recorders  
DIVISION OF THE TELEGRAPH COMPANY  
9600 ALDRICH AVENUE, SOUTH, MINNEAPOLIS, MINNESOTA 55420



# For the record

W.M. A. STOCKLIN, EDITOR

## 1967—Another Banner Year

**A**LTHOUGH not all the sales figures are in for 1967—it is apparent from those we do have that 1967 was another record year with factory sales of consumer electronics products reaching \$5 billion. This compares with \$4.7 billion in 1966 and less than \$1.5 billion just over a decade ago, in 1957.

While some of the product lines, such as black-and-white television and console stereo phonographs, will not top 1966 figures—the industry dollar volume was spurred by record sales of color-TV receivers and FM radios.

Color-TV sales, which have about doubled each year since 1964, will most likely exceed 5.3 million units for 1967. This is a 10-15% increase over 1966.

From about 85,000 units (worth \$37 million) sold in 1957, color television this year will contribute over \$2 billion to the market value of the major consumer electronics products. It is estimated that black-and-white and color-TV unit sales will be about equal—slightly over the 5 million level.

Television today has attained 95 percent saturation in American homes, which sets all records for growth ever achieved by any popular consumer item. Color-TV itself has a saturation of about 20 percent. It is estimated that 93.6 million television receivers, both color and black-and-white, are currently in use in American homes, and that 25 percent of U.S. homes now have two or more sets—double that of only five years ago.

Radio's rebirth continues to astound everyone. The total U.S. home radio market in 1947—which, admittedly, was boosted by the pent-up post-war demand—reached 16.5 million units. In 1954, as television entered the marketplace, radio sales dropped to 6.7 million. Many at that time felt that the downtrend would continue; but much to our surprise, sales of home radios reached 37.8 million units in 1966. Including auto radios, the total figure reached 47 million units. 1967 sales performance will be slightly below but very near this all-time record.

The most significant development has been the growth of FM. While FM radios accounted for only 2 percent of radio sales 10 years ago, they are responsible for at least 40 percent of today's sales. The number of FM broadcasting stations has kept pace with

this growth, increasing from 530 stations in 1957 to some 1700 this year. As a result, it is estimated that over 270 million radios are now in use—almost 1 3/4 sets for every U.S. citizen.

Both price and technological advances can be given credit for radio's success. The transistor freed radio from confinement in the home, and drastic price slashes made it the least expensive means of mass communications. Today's \$5 to \$10 shirt-pocket transistor set retailed for about \$30 in 1960.

The growth of the consumer electronics industry is really astounding, particularly when one considers that while the cost of living has been rising steadily over the past ten years, the prices for consumer products, such as television sets, radios, tape recorders, and hi-fi, have continuously dropped. The latest Bureau of Labor Statistics consumer price index (Sept. 1967) shows all consumer items to be at 117.1 (1957-1959 base of 100). It's also significant that for 1965 this figure stood at 109.9. In astonishing contrast, TV sets stand at 79.5 today, down from the 86.3 average of 1965. Radios measured on the same scale stand at 77.3, down from the 83.9 index for 1965. Even tape recorders now read 94.6, based on the December 1963 scale—down from the 1965 average of 97.2.

Price reductions have been prevalent in many areas of our industry. Outstanding examples are the receiving tube and transistor. While the receiving tube had a selling price of 85 cents in 1959, the average price in 1966 dropped to 68 cents for a product that was significantly superior in terms of multi-function capabilities and over-all quality. The germanium transistor which sold for \$1.96 in 1959 now averages about 43 cents per unit.

This ten-year success story of the consumer electronics industry, astonishing as it is, may appear in the future to have been no more than a preliminary stage in the electronics revolution that will profoundly alter the processes of human communications and the structure of the family and society. The 520 million consumer electronic units in use today may appear antiquated in another two decades as products of revolutionary new design and performance proceed from laboratory to product line and then into the home. ▲



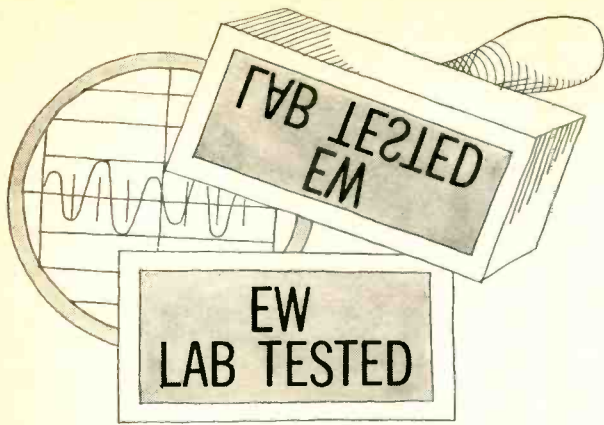

# HI-FI PRODUCT REPORT

TESTED BY HIRSCH-HOUCK LABS

**Ampex "Micro 85" Tape Recorder  
Eico Model 3200 FM Stereo Tuner**

## Ampex "Micro 85" Cassette Tape Recorder System

For copy of manufacturer's brochure, circle No. 20 on Reader Service Card.



ONE of the major drawbacks to the widespread use of tape recorders and players in home music systems is the awkwardness of handling and loading tape reels. An obvious solution to the problem is to use some form of cartridge which contains the tape and both supply and take-up reels. Several such systems have been devised and marketed, but at present there are two rather different systems competing for public acceptance.

The eight-track continuous-loop cartridge, widely used in automobile tape players, is designed primarily for playback systems, but is rarely employed where the user wishes to make his own recordings, *per se*, but that the tape cannot be reversed or moved at faster than its normal playing speed. On the other hand, the *cassette* is a miniature reel-to-reel tape cartridge, capable of high-speed operation in both directions. The

150-mil-wide tape accommodates four tracks, each 24-mils wide. The cassette can be handled with less care than phonograph records, to say nothing of ordinary reel-wound tape, and is available with sufficient tape for 60 minutes, 90 minutes, or even 120 minutes of recording at 1 1/2 in/s.

Ampex has decided to cast its lot with the cassette and has introduced the "Micro 85" recorder system. This diminutive unit, measuring 14 1/2" wide, 8 1/2" deep, and 3 1/2" high, weighs only 7 1/2 pounds. It contains the transport mechanism, controlled by a row of piano key buttons, all electronics (solid-state), and a pair of nominally 1-watt playback amplifiers. It is supplied with a pair of small speakers, whose walnut cabinets measure 14 1/2" x 9" x 7 1/2" deep.

To load a cassette, the key marked "Cassette" is pressed. A cover pops open, and the cassette is inserted in the opening. Pressing down the cover locks

it in place and the unit is ready for use. The playback volume control also operates the "on-off" switch. Other knobs control recording volume, balance, and tone. A meter monitors recording volume (of both channels combined). The usual recording interlock is incorporated, requiring that the red "Record" key be held down while the "Play" key is operated. Other keys control fast-forward, rewind, pause, and stop functions. There is a resettable index counter.

The ends of the tape in the cassette are fastened to the hubs with strong leaders so that when the tape is finished, the mechanism is stalled without damage to itself or to the tape. Being a four-track system, the cassette can be turned over after playing and played for an equal time on the second pair of tracks. An ingenious feature of the cassette is the two knock-out tabs, one for each side. When these are removed, the record button cannot be depressed when the cassette is installed. They can be removed individually for each side, and it is possible to restore the record function by placing a small piece of tape over the hole left by the tab. This is a remarkably simple, yet foolproof, system for preventing accidental erasure of recorded tapes.

In the rear of the deck are jacks for the two speaker outputs, and a pair of DIN (European) jacks. One serves as a radio/phono input jack, and the other is used for line output or microphone input. Adapter cables fitted with standard American phono jacks are supplied. Also included is a stereo microphone, consisting of two small microphone units mounted at right angles on a small stand.

We measured the record/playback frequency response of the "Micro 85" through the line outputs, which deliver a minimum of 500 millivolts into a 100,000-ohm load. The results were nothing less than remarkable for a 1 1/2 in/s recorder. The response was +0, -3 dB from about 85 Hz to 9500 Hz, and quite smooth throughout the range. It fell off rapidly above 9500 Hz.

(Continued on page 64)

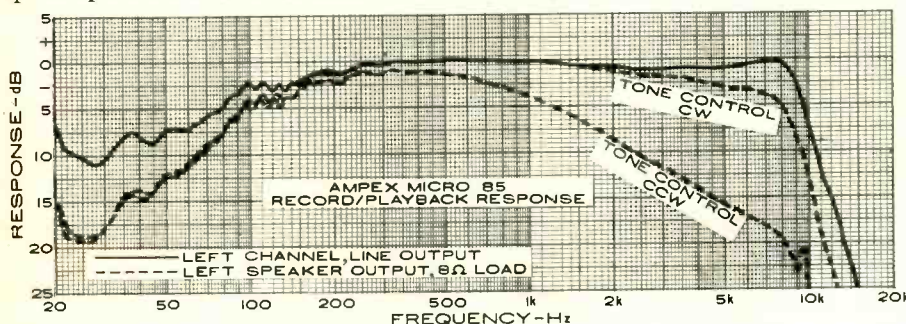

# Electronics comes alive with NRI Training Kits

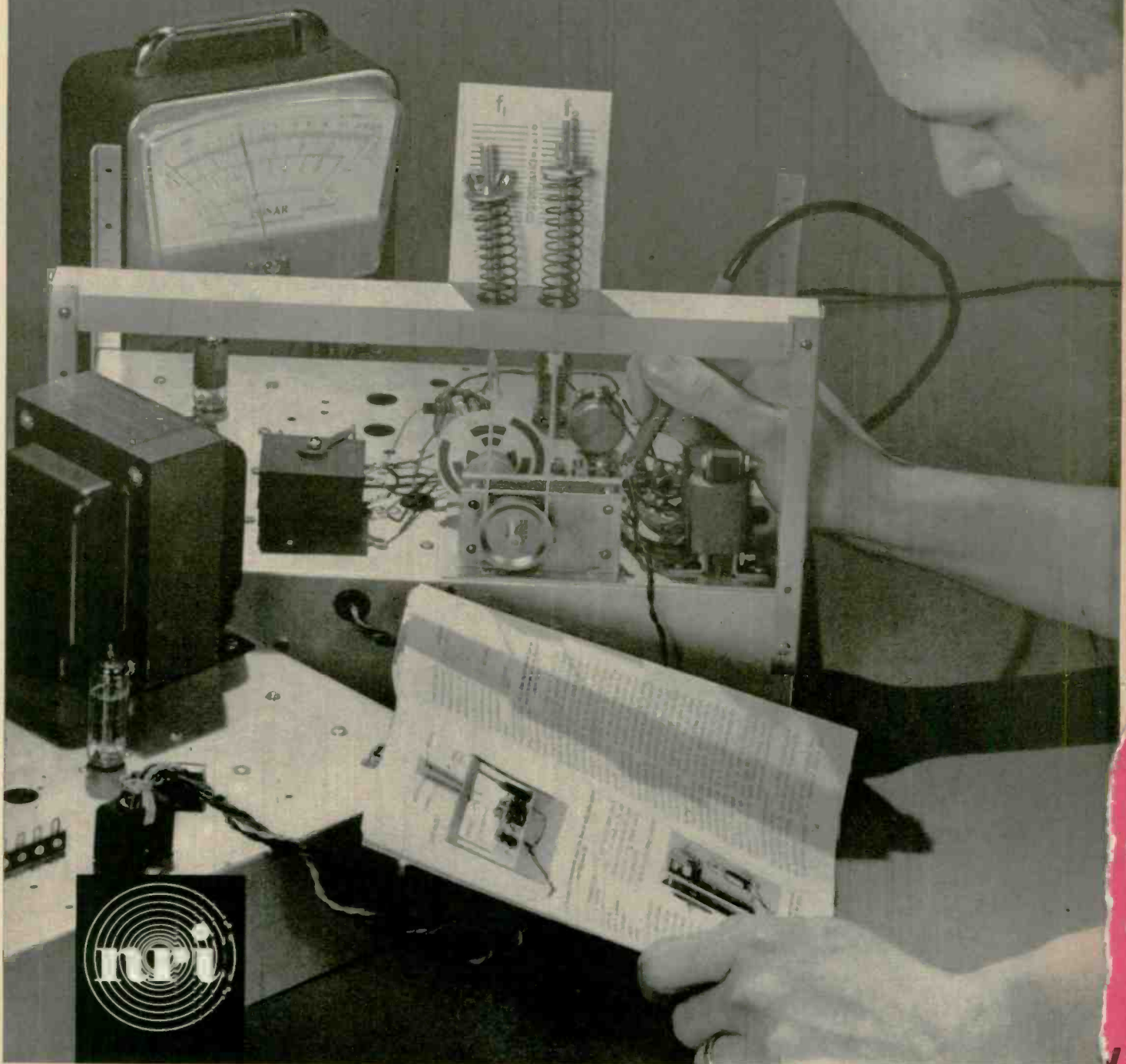



# DISCOVER THE EASE AND EXCITEMENT OF TRAINING AT HOME THE NRI WAY

## New Achievement Kit—Custom Training Kits—"Bite Size" Texts

Only NRI offers you this pioneering method of simplified "3 Dimensional" home-study training in Electronics, TV/Radio and Broadcasting/Communications. It's a remarkable teaching idea unlike anything you have ever encountered, the result of more than half a century of simplifying, organizing and dramatizing learning-at-home techniques. If you are an ambitious man—regardless of your education—you can effectively learn the Electronics field of your choice the NRI way.

NRI has *simplified* Electronics by producing "bite size" lesson texts averaging only 40 pages each. Dozens of illustrations open wide a picture window through which you'll see and understand practical uses of Electronics. You start out with NRI's exclusive Achievement Kit, containing everything you need to get started fast. (Illustrated at right.)

NRI has *organized* Electronics training to take you step-by-step from the first stages into more intriguing areas. Once you know the fundamentals thoroughly, it's easy to grasp more advanced theory and techniques. You move with confidence and enthusiasm into a new adventure filled with the excitement of discovery.

NRI has *dramatized* Electronics through the careful development of special training equipment that is *programmed* into your training systematically . . . beginning with your first group of lessons. Things you read about come alive in your hands as you build, experiment, purposely cause "problems" in circuits—and solve them. You learn to use test equipment, to build radios and TV sets, transmitter, or computer circuits. It's the priceless "third dimension" in NRI training . . . practical experience.



## YOU GET MORE FOR YOUR MONEY FROM NRI

Mail postage-free card now for your free NRI catalog. Then, compare. You'll find—as have thousands of others—NRI training can't be beat. Read about the new Achievement Kit sent the day you enroll; about "bite-size" texts and custom designed training equipment. See why NRI gives you more value. Whatever your reason for wanting more knowledge of Electronics, NRI has an instruction plan for you. Choose from major programs in TV/Radio Servicing, Industrial Electronics and Complete Communications. Or select from special courses to meet specific needs. Check the course of interest to you on postage-free card and mail today for free NRI catalog. No salesman will call. NATIONAL RADIO INSTITUTE, Electronics Div., Washington, D.C. 20016.

### Available Under NEW GI BILL

If you served since January 31, 1955, or are in service, check GI line in postage-free card.

More than 50 years of leadership  
in Electronics Training



## Career? Part-Time Earnings? Hobby? Choose From 12 Training Plans

**1. TELEVISION-RADIO SERVICING** — Learn to fix all TV sets, including Color. Includes your choice of NRI Color Kit or 19" black-white TV Kit. Also covers radios, stereo hi-fi, etc. Profitable field spare or full-time.

**2. INDUSTRIAL-MILITARY ELECTRONICS** — Basics to computers. Starts with fundamentals, covers servos, telemetry, multiplexing, phase circuitry, other subjects.

**3. COMPLETE COMMUNICATIONS\*** — Operation, service, maintenance of AM, FM and TV broadcasting stations. Also covers marine, aviation, mobile radio, facsimile, radar, microwave.

**4. FCC LICENSE\*** — Prepares you for 1st Class FCC License exams. Begin with fundamentals, advance to required subjects in equipment and procedures.

**5. MATH FOR ELECTRONICS** — Brief course for engineers, technicians seeking quick review of essential math: basic arithmetic, short-cut formulas, digital systems, etc.

**6. BASIC ELECTRONICS** — For anyone wanting a basic understanding of Radio-TV Electronics terminology and components, and a better understanding of the field.

**7. ELECTRONICS FOR AUTOMATION** — Not for beginners. Covers process control, ultrasonics, telemetering and remote control, electromechanical measurements, other subjects.

**8. AVIATION COMMUNICATIONS\*** — Prepares you to install, maintain, service aircraft in-flight and landing systems. Earn your FCC License with Radar Endorsement.

**9. MARINE COMMUNICATIONS\*** — Covers electronic equipment used on commercial ships, pleasure boats. Prepares for FCC License with Radar Endorsement.

**10. MOBILE COMMUNICATIONS\*** — Learn to install, maintain mobile transmitters and receivers. Prepares for FCC License exams.

**11. ELECTRICAL APPLIANCE REPAIR** — Learn to repair all appliances, including air conditioning, refrigeration, small gas engines. Leads to profitable part or full-time business.

**12. ELECTRONICS FOR PRINTERS** — Operation and maintenance of Electronic equipment used in graphic arts industry. From basics to computer circuits. Approved by major manufacturers.

\* You must pass your FCC License exams (any Communications course) or NRI refunds in full the tuition you have paid.

# NEW

# FINCO®

## COLOR SPECTRUM™ ANTENNAS

are "signal customized"  
for better color reception...



*"the ANTENNA that captures the RAINBOW"*

FINCO has developed the Color Spectrum Series of antennas — "Signal Customized" — to exactly fit the requirements of any given area.

There is a model scientifically designed and engineered for your area.

Check this chart for the FINCO "Signal Customized" Antenna best suited for your area.

STRENGTH OF UHF SIGNAL AT RECEIVING ANTENNA LOCATION ▼	Strength of VHF Signal at Receiving Antenna Location				
	NO VHF ▼	VHF SIGNAL STRONG ▼	VHF SIGNAL MODERATE ▼	VHF SIGNAL WEAK ▼	VHF SIGNAL VERY WEAK ▼
NO UHF →		 CS-V3 \$10.95	 CS-V5 \$17.50   CS-V7 \$24.95	 CS-V10 \$35.95	 CS-V15 \$48.50   CS-V18 \$56.50
UHF SIGNAL STRONG →	 CS-U1 \$9.95	 CS-A1 \$18.95	 CS-B1 \$29.95	 CS-C1 \$43.95	 CS-C1 \$43.95
UHF SIGNAL WEAK →	 CS-U2 \$14.95	 CS-A2 \$22.95	 CS-B3 \$49.95	 CS-C3 \$59.95	 CS-D3 \$69.95
UHF SIGNAL VERY WEAK →	 CS-U3 \$21.95	 CS-A3 \$30.95	 CS-B3 \$49.95	 CS-C3 \$59.95	 CS-D3 \$69.95



NOTE: In addition to the regular 300 ohm models (above), each model is available in a 75 ohm coaxial cable downlead where this type of installation is preferable. These models, designated "XCS", each come complete with a compact behind-the-set 75 ohm to 300 ohm balun-splitter to match the antenna system to the proper set terminals.

## THE FINNEY COMPANY

34 West Interstate Street • Dept. 410 • Bedford, Ohio 44146

CIRCLE NO. 114 ON READER SERVICE CARD



By FOREST H. BELT / Contributing Editor

## Testing System for the Future

The Air Force is rapidly expanding its use of troubleshooting instruments called "general-purpose automated testing systems" (GPATS). The impact of the change could make itself felt before long in home-electronics equipment, too. The use of GPATS instruments to speed pinpointing the location of faulty parts demands a new design philosophy in the equipment to be tested. *Motorola* has already made a move in that direction in designing its transistor color-TV set in modules.

There are two approaches to "automatic" testing. In one, probably visualized by *Motorola* with its color set, equipment modules can be taken out of the unit and plugged in (or otherwise connected) to a GPATS instrument, which then applies power and monitors key points; a conclusion is drawn about the fault and displayed on a readout device or indicator. In the other approach, which has been used in a less sophisticated way in communications equipment for some years, the equipment has monitoring points brought to a connector; a GPATS instrument is plugged into the connector and an indicator points out the trouble.

The Air Force hopes to have 80% of its electronics testing thus automated within the next four years. The makers of home-electronics equipment could do the same within a similar period. Standardization would be an important factor, something that could probably be coordinated by organizations such as the Electronic Industries Association (EIA) and the Institute of Electrical and Electronics Engineers (IEEE). With a little imagination and planning, a single GPATS instrument could be designed to cover practically all present home-entertainment gear. Automated troubleshooting might prove a quicker answer to service shop owners' manpower problems than the constant search for competent technicians.

## The Self-Made Technician

There's always some discussion whether formal schooling with lab training makes better service technicians than at-home study combined with on-the-job apprenticeship. Most agree, however, that practical experience alone is not sufficient, and neither is study of theory alone; the best technicians have had both. It remains a fact, nevertheless, that a good portion of the men now in the home-electronics servicing field get their training at home by correspondence.

A survey among students of *International Correspondence Schools (ICS)* sheds some interesting light on these self-made technicians. In the first place, "Radio-TV Servicing with Equipment Training" is one of the ten most popular courses in the entire school (225 courses are listed in the *ICS* catalogue). About half of *ICS* enrollees are high-school graduates, 15% have some college training, and a few are Ph.D's. The "average" *ICS* student is 29 and married. He is already employed in a skilled occupation and is studying a course related to his present job. Among electronics students, this suggests that many present technicians are upgrading their knowledge and skills. This is good, in the light of recent complaints from the public and shop owners of the incompetence of many who call themselves technicians.

This advanced study has practical benefits. Another survey of students two years after they completed their *ICS* course revealed salary increases averaging \$500 a year. For those already earning over \$10,000 increases ranged up to \$1000. We can paraphrase an old cliché: Additional training doesn't cost, it pays.

## In-Line Color-Tube Guns Again

Ever since *General Electric* brought out the 10-inch Porta-Color receiver more than 2 years ago, it contained the only shadow-mask picture tube in the industry that varied from the triangular arrangement of the electron guns. The guns in the *G-E* tube were arranged in a single line. (See "G-E 11-inch color TV" in our March, 1966 issue.) Now that tube has a companion—also from *G-E*. This one is a 14-incher to be used in a new 35-lb portable color set that will retail between \$300 and \$350. There is still another color-TV picture tube with in-line guns: the 7-inch three-gun Chromatron *Sony* will use in its tiny color portable later this year.

## 800 TV Stations Soon

There isn't and likely won't ever be the boom in u.h.f. television station starts hoped for by the Federal Communications Commission when they convinced Congress in 1964 to pass the All-Channel Law. Nevertheless, the mandatory inclusion of u.h.f. tuners in all new TV receivers since then has generated a pretty good penetration by u.h.f. throughout the country. As a result, most of the new stations that do go on the air are u.h.f. With a total of 785 TV stations on the air at the end of 1967, the magic number 800 is expected to be reached shortly. New sign-ons have been occurring at the rate of 2 or 3 a month, and may well

pick up during the summer months. When the 800 total is reached, u.h.f. among them will amount to about 225 (they numbered 210 at the end of 1967).

The increase in educational stations is slow but steady. There are presently just over 150 in operation, about half of which are on u.h.f. However, the next few months should see a rise in ETV starts, as there are a good many in construction with federal money granted last year. By the end of this year, there should be over 100 u.h.f. ETV stations, and a total (u.h.f. and v.h.f.) nearing 200.

## Public Broadcasting Laboratory

Speaking of ETV, over 100 educational stations carried the first programs of the Public Broadcast Laboratory (PBL). Dreamed up by Fred W. Friendly, formerly of *CBS-TV*, and financed by a grant from the Ford Foundation, the PBL is a 2-year experiment in freeing television programming from the fetters of commercial sponsorship.

The content of the early programs was sufficiently controversial to scare off some of the more faint hearted educational stations. Some programs dealt with civil rights and were blacked out by ETV stations in race-hyperconscious states. Further stir was caused by programs critical of the Administration.

The future of this kind of broadcasting seems to lie in a new government-created corporation called the Corporation for Public Broadcasting (CPB). The new CPB awaits President Johnson's list of nominees to its board, and Congressional approval of its first \$9 million appropriation. Considering all the furor over the initial broadcasts of PBL, its creators and proponents fear the spectre of Congressional Administration censorship; a lot of thought and activity are going into plans for averting that possibility.

So far, it looks as if the very life of national educational and noncommercial television is in the hands of the federal government, since money in the proportions needed on a long-term basis appears unavailable otherwise. All parties that are interested—CPB, PBL, the Ford Foundation, the National Association of Educational Broadcasters (NAEB), the National Education Association (NEA), National Educational Television (NET), and any others—had better get their heads together before the end of 1968 and work out whatever proposals and suggestions they have to offer. Once the November elections are out of the way, recommendations will be going to Congress on how to finance and administer educational television for years to come. If new ideas are evolving from the PBL experiments, now is the time to get them solidified and organized for presentation to the powers that will be.

## Book-Sized TV

For years the search has continued for a practical picture-frame TV set, one that could hang on the wall. Integrated circuits and pencil-eraser-size transistors have solved all the dimensional problems except that of the picture tube. Past schemes have generally concentrated on unusual deflection designs. *Toshiba* now has a picture-tube design that comes close, yet uses fairly standard deflection. Instead of having the neck, with the electron gun, extending straight backwards from the screen, the neck extends out sideways. The tube looks almost like a fat ping-pong paddle. The electrons approach the screen from a very acute angle. That creates slight deflection-correction problems, but is all-in-all a blessing in disguise. Coming in at such an angle, the electronic beam needs much less horizontal deflection than in an ordinary picture tube—only 22°. Think of the saving in horizontal sweep power. Vertical deflection is a normal 90°. The screen is a mere 6 inches diagonal, large enough to view easily if you aren't too far away, enough anyway for a "personal" set. Once the new tube gets into production and is surrounded by solid-state electronics, a receiver no larger than a large book is possible.

## Home Video Tape Recorders

There are dozens of comparatively low-priced video tape recorders around now, but more keep appearing. Latest are from *G-E* and *Toshiba*. The *G-E*—with transistorized camera, record/playback deck, and monitor receiver—sells for \$1350 and up. It is a monochrome system, using half-inch tape, actually intended for business and educational use. Priced closer to the home market is a color VTR by *Toshiba*: under \$750. No camera, of course, but the machine records and plays back color programs through any color set that has been modified for use with it. Distribution in this country will be in cooperation with *Ampex*.

## An Electronics Memo Pad

For the peripatetic businessman, a pocket dictating machine is a boon. We feel this is a very important market and we know of at least one manufacturer in this country considering the development of such an electronic memo pad. We have just learned that one already exists, however, in West Germany. Called the Mini-Memo and manufactured by *Grundig*, the playing-card-size unit weighs only 10 oz. It holds a tiny tape cartridge (which is even smaller than the *Philips* cassette) that records two tracks for 10 minutes each. It operates from a small battery inside, and uses integrated circuits to help attain this extreme degree of miniaturization. Prices are not available yet for units to be distributed in this country. ▲





# get the service data you need in PHOTOFACT® COMPLETE COLOR TV COVERAGE

283 Here are the PHOTOFACT sets with Color TV coverage from the beginning in 1954 through 1967:

1	31	61	91	121	151	181	211	241	271	301	331	361	391	421	451	481	511	541	571	601	631	661	691	721	751	781	811	841	871	901
2	32	62	92	122	152	182	212	242	272	302	332	362	392	422	452	482	512	542	572	602	632	662	692	722	752	782	812	842	872	902
3	33	63	93	123	153	183	213	243	273	303	333	363	393	423	453	483	513	543	573	603	633	663	693	723	753	783	813	843	873	903
4	34	64	94	124	154	184	214	244	274	304	334	364	394	424	454	484	514	544	574	604	634	664	694	724	754	784	814	844	874	904
5	35	65	95	125	155	185	215	245	275	305	335	365	395	425	455	485	515	545	575	605	635	665	695	725	755	785	815	845	875	905
6	36	66	96	126	156	186	216	246	276	306	336	366	396	426	456	486	516	546	576	606	636	666	696	726	756	786	816	846	876	906
7	37	67	97	127	157	187	217	247	277	307	337	367	397	427	457	487	517	547	577	607	637	667	697	727	757	787	817	847	877	907
8	38	68	98	128	158	188	218	248	278	308	338	368	398	428	458	488	518	548	578	608	638	668	698	728	758	788	818	848	878	908
9	39	69	99	129	159	189	219	249	279	309	339	369	399	429	459	489	519	549	579	609	639	669	699	729	759	789	819	849	879	909
10	40	70	100	130	160	190	220	250	280	310	340	370	400	430	460	490	520	550	580	610	640	670	700	730	760	790	820	850	880	910
11	41	71	101	131	161	191	221	251	281	311	341	371	401	431	461	491	521	551	581	611	641	671	701	731	761	791	821	851	881	911
12	42	72	102	132	162	192	222	252	282	312	342	372	402	432	462	492	522	552	582	612	642	672	702	732	762	792	822	852	882	912
13	43	73	103	133	163	193	223	253	283	313	343	373	403	433	463	493	523	553	583	613	643	673	703	733	763	793	823	853	883	913
14	44	74	104	134	164	194	224	254	284	314	344	374	404	434	464	494	524	554	584	614	644	674	704	734	764	794	824	854	884	914
15	45	75	105	135	165	195	225	255	285	315	345	375	405	435	465	495	525	555	585	615	645	675	705	735	765	795	825	855	885	915
16	46	76	106	136	166	196	226	256	286	316	346	376	406	436	466	496	526	556	586	616	646	676	706	736	766	796	826	856	886	916
17	47	77	107	137	167	197	227	257	287	317	347	377	407	437	467	497	527	557	587	617	647	677	707	737	767	797	827	857	887	917
18	48	78	108	138	168	198	228	258	288	318	348	378	408	438	468	498	528	558	588	618	648	678	708	738	768	798	828	858	888	918
19	49	79	109	139	169	199	229	259	289	319	349	379	409	439	469	499	529	559	589	619	649	679	709	739	769	799	829	859	889	919
20	50	80	110	140	170	200	230	260	290	320	350	380	410	440	470	500	530	560	590	620	650	680	710	740	770	800	830	860	890	920
21	51	81	111	141	171	201	231	261	291	321	351	381	411	441	471	501	531	561	591	621	651	681	711	741	771	801	831	861	891	921
22	52	82	112	142	172	202	232	262	292	322	352	382	412	442	472	502	532	562	592	622	652	682	712	742	772	802	832	862	892	922
23	53	83	113	143	173	203	233	263	293	323	353	383	413	443	473	503	533	563	593	623	653	683	713	743	773	803	833	863	893	923
24	54	84	114	144	174	204	234	264	294	324	354	384	414	444	474	504	534	564	594	624	654	684	714	744	774	804	834	864	894	924
25	55	85	115	145	175	205	235	265	295	325	355	385	415	445	475	505	535	565	595	625	655	685	715	745	775	805	835	865	895	925
26	56	86	116	146	176	206	236	266	296	326	356	386	416	446	476	506	536	566	596	626	656	686	716	746	776	806	836	866	896	926
27	57	87	117	147	177	207	237	267	297	327	357	387	417	447	477	507	537	567	597	627	657	687	717	747	777	807	837	867	897	927
28	58	88	118	148	178	208	238	268	298	328	358	388	418	448	478	508	538	568	598	628	658	688	718	748	778	808	838	868	898	928
29	59	89	119	149	179	209	239	269	299	329	359	389	419	449	479	509	539	569	599	629	659	689	719	749	779	809	839	869	899	929
30	60	90	120	150	180	210	240	270	300	330	360	390	420	450	480	510	540	570	600	630	660	690	720	750	780	810	840	870	900	930

STAY AHEAD IN COLOR TV SERVICING—

## JOIN the P.O.M. (Photofact-of-the-Month) CLUB!

AND OWN THE COMPLETE PHOTOFACT COLOR TV LIBRARY

NOW! Only \$10 per month brings you 20% MORE PHOTOFACT coverage to keep you current—and you save more than \$60 per year!

- Get 6 new Photofact Sets each month
- 6 to 9 Color TV Folders monthly
- Covers at least 50 new chassis
- Includes b & w TV, FM-AM, AC-DC, Stereo Hi-Fi, Phonograph, and Record Changer models

GET GOING IN  
COLOR TV!

GET THIS BIG "BONUS"! Now exclusively for P.O.M. Club members—a minimum of 10 "advance" TV schematics (mostly color) with each month's issue! Keeps you ahead on new model releases. Extra: Special File Cabinet deal with trial 6-month subscription to the P.O.M. Club.



JOIN  
P.O.M.

SEE YOUR SAMS DISTRIBUTOR FOR FULL INFORMATION, OR MAIL THE COUPON TODAY.

HOWARD W. SAMS & CO., Dept. EWF-3  
4300 W. 62nd St., Indianapolis, Indiana 46206

- Send Photofact-of-the-Month Club details
- Send full details on Library Offer and Easy-Buy Plan
- Send FREE 1968 PHOTOFACT Cumulative Index

My Distributor is \_\_\_\_\_

Shop Name \_\_\_\_\_

Attn.: \_\_\_\_\_

Address \_\_\_\_\_

City \_\_\_\_\_ State \_\_\_\_\_ Zip \_\_\_\_\_



# ENGINEERED FOR EXCELLENCE: TOP-QUALITY TELEX HEADSETS

Ham operators, hi-fi fans and audio engineers all endorse famous TELEX headsets; known for top grade performance for more than 25 years.



**MAGNA-TWIN**—Typifies the quality standards which have made Telex a favorite of hams. Delivers absolute maximum intelligibility under difficult QRM conditions; equipped with super-comfort foam cushions. Rugged, moisture-proof magnetic drivers give excellent sensitivity. Made of tough, high-impact plastic for outstanding durability under hard usage.



**COMBO**—Brand new, high quality stereo headphones for the lively set. Big 3½" reproducers deliver deep rich bass and pure sweet highs. Exciting new styling has deluxe foam-filled vinyl earcushions. Designed for comfort, adaptability and concert-quality sound—anytime, anywhere.



**TELESET**—Lightweight, economy version of the famous Magna-Twin; designed especially for ham requirements. High performance, shock-proof Magna-Twin drivers at a low, low price.

MORE THAN 50 DIFFERENT MODELS TO CHOOSE FROM, PRICED TO \$59.95

PRODUCTS OF SOUND RESEARCH

**TELEX**  
acoustics  
A DIVISION OF THE  
TELEX CORPORATION  
3054 EXCELSIOR BOULEVARD  
MINNEAPOLIS, MINN. 55416

## LETTERS FROM OUR READERS

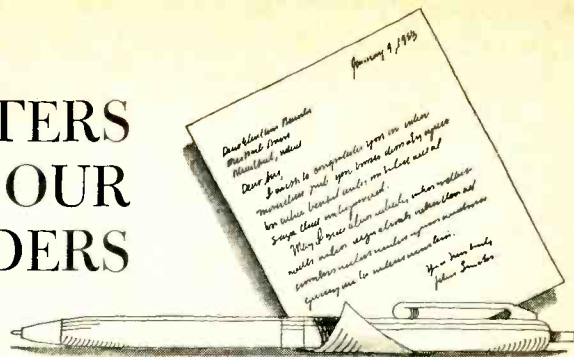

### INCENTIVE LICENSING FOR HAMS To the Editors:

It is unfortunate that what started out as an objective exposition of the new incentive licensing program (Robert M. Brown, December, 1967 *ELECTRONICS WORLD*, page 32) degenerated into a subjective, rumor-generating article.

1. While the American Radio Relay League (ARRL) did bring the incentive licensing problem into the open (*QST*, February, 1963), the FCC's proposal (April, 1965) was in response to eleven petitions from individuals and organizations, each petition in some way related to incentive licensing. Whether orchids or tomatoes be called for, the ARRL cannot take full responsibility for originating the incentive licensing program.

2. To say that thousands of amateurs resigned from the ARRL over the incentive licensing program is open to question. Net losses in full memberships for 1965 and 1966 are given below:

Year	Net Loss	% Loss
1965	680	0.8
1966	345	0.4

Clearly, if it can be said that thousands resigned over the proposal, it would be equally fair to state that thousands joined in agreement with the proposal, the net effect being an almost constant membership figure.

3. Mr. Brown does the ham an injustice in saying that radio amateurs are commonly viewed as "non-contributing hangers-on". Perhaps Mr. Brown has not heard of, or prefers to ignore, amateur contributions and investigations in the fields of automatic picture transmissions for weather satellites; amateur television, both conventional and sub-carrier FM slow-scan; Project OSCAR; Project Moonray; Military Affiliate Radio System communications (MARS); Med-Aid (medical aid via amateur radio); and meteor-shower and aurora communications.

4. As an active ham for over 15 years, I can definitely state that the average ham *does not* tinker just with vacuum tubes and World War II devices, though occasionally, but infrequently, one does see WW II gear.

5. U.S. amateurs do outnumber all

other nations' hams combined (total U.S. hams: 280,000). They are authorized to use, and do use, high-power transmitters. The American amateur does spend considerable time on the air. The results? "... the highest rate of return in functions performed per kilocycle of allocation of any existing radio service" (Stanford Research Institute, "Amateur Radio—An International Resource", 1967).

THEODORE J. COHEN, W9VZL/3  
Rockville, Md.

*Space prevents us from publishing more than a portion of Reader Cohen's long and interesting defense of the ham. As a long-time radio amateur, we are quite familiar with the technical contributions made by this group. However, we have also witnessed a change in the level and technical interest of a good many hams over the years so that there seems to be a much greater proportion today who do not build their own equipment and who couldn't care less about what's inside it and how it works.*

*Actually, most of the article involved a factual description of the new rules, and we felt there was very little editorializing by Author Brown.—Editor*

### C-D IGNITION SYSTEM

To the Editors:

The capacitive-discharge ignition system on page 30 of your November issue works just as described on 12 volts. The system will also work on 6 volts provided the following changes are made:

1. Increase C2 from 1  $\mu$ F to 2  $\mu$ F.
2. Reduce R2 and R4 from 250 ohms, 5 watts to 80 ohms, 5 watts.
3. Reduce R8 from 50 ohms, 5 watts to 25 ohms, 5 watts.

Substitutions may also be made for the various semiconductors used as follows: *Motorola* 2N174's or 2N442's can be used as Q1 and Q2, and the *Motorola* 2N4172 can be used as SCR1 in the circuit.

BYRON D. LOTT  
Sunnyvale, Calif.

*Both TI and Motorola semiconductors indicated are readily available. Also, on the matter of a positive-ground system, if all ground connections are*



elevated and if insulated breaker points can be found for the car in question, readers should be able to use the circuit as shown.—Editors

**ELECTRONICS TRAINING EDITORIAL**

To the Editors:

Regarding your December editorial (page 6), I agree entirely with the philosophy of Prof. Howard Malmstadt that "... irrespective of your profession, electronics will be playing a major role in your vocational life and becoming of even greater importance as time goes on."

However, the fact that Dr. Malmstadt's program is reaching only 72 individuals a year—after 7 years—would seem to indicate that some new approach is needed.

A line or two of your editorial might have indicated that some National Home Study Council accredited electronics home-study schools provide training equipment in courses with experimental work approximating that of the finest resident-school electronics labs. As for actual numbers, *National Radio Institute* enrolls literally hundreds of "professionally oriented individuals" a year for this lab training. Needless to say, we're proud indeed of the NRI "VIP" file which reads something like an electronics Who's Who.

For the 928 individuals who are not selected for Dr. Malmstadt's unique program, there is still hope!

J. F. THOMPSON  
National Radio Institute  
Washington, D.C.

**EMERGENCY BROADCAST SYSTEM**

To the Editors:

In the "New Emergency Warning System" item in your "Reflections on the News" column appearing in January (p. 15), you indicated that the old Conelrad system was still being used up until the development of the new "two-tone" emergency signal described. Well, I think Author Buchsbaum must have fallen asleep while reflecting since Conelrad hasn't been used since '63.

JOHN T. MITCHUM  
Louisville, Ky.

*At least the Washington office of the FCC was not asleep, for as soon as they saw our January issue, they pointed out this blooper to us. The emergency broadcast system in effect when the item was written involved a number of 24-hour-a-day broadcast stations. In an emergency, these stations are to remain on their own frequencies but are to alert their listeners and other monitoring stations by breaking their carriers and transmitting an alerting tone. The development discussed in our column involves a new type of alerting signal consisting of two different audio tones.*

—Editors ▲

March, 1968

2

**ALIGNMENT OSCILLATORS  
DESIGNED TO MAKE SERVICING EASIER  
BOTH NEW FROM INTERNATIONAL**

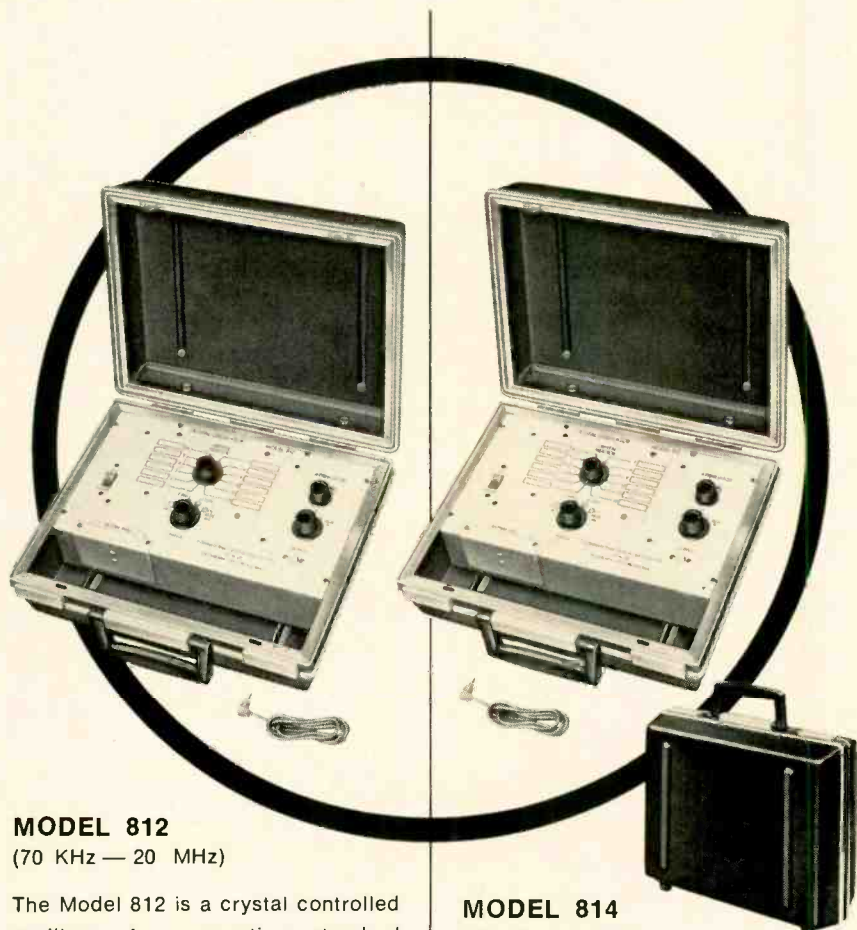

**MODEL 812**  
(70 KHz — 20 MHz)

The Model 812 is a crystal controlled oscillator for generating standard signals in the alignment of IF and RF circuits. The portable design is ideal for servicing two-way radios, TV color sets, etc. This model can be zeroed and certified for frequency comparison on special order. Individual trimmers are provided for each crystal. Tolerance .001%. Output attenuators provided. Battery operated. Bench mount available.

Complete (less crystals) \$125.00

**MODEL 814**  
(70 KHz — 20 MHz)

The Model 814 is identical in size to the 812. It does not have individual trimmers for crystals. Tolerance is .01%. Battery operated. Bench mount available.

Complete (less crystals) \$95.00

*Both the Model 812 and Model 814 have positions for 12 crystals and the entire frequency range is covered in four steps.*

Write for catalog



**CRYSTAL MFG. CO., INC.**  
10 NO. LEE • OKLA. CITY, OKLA. 73102  
CIRCLE NO. 109 ON READER SERVICE CARD

**“He’s a good worker.  
I’d promote him  
right now if he had  
more education  
in electronics.”**

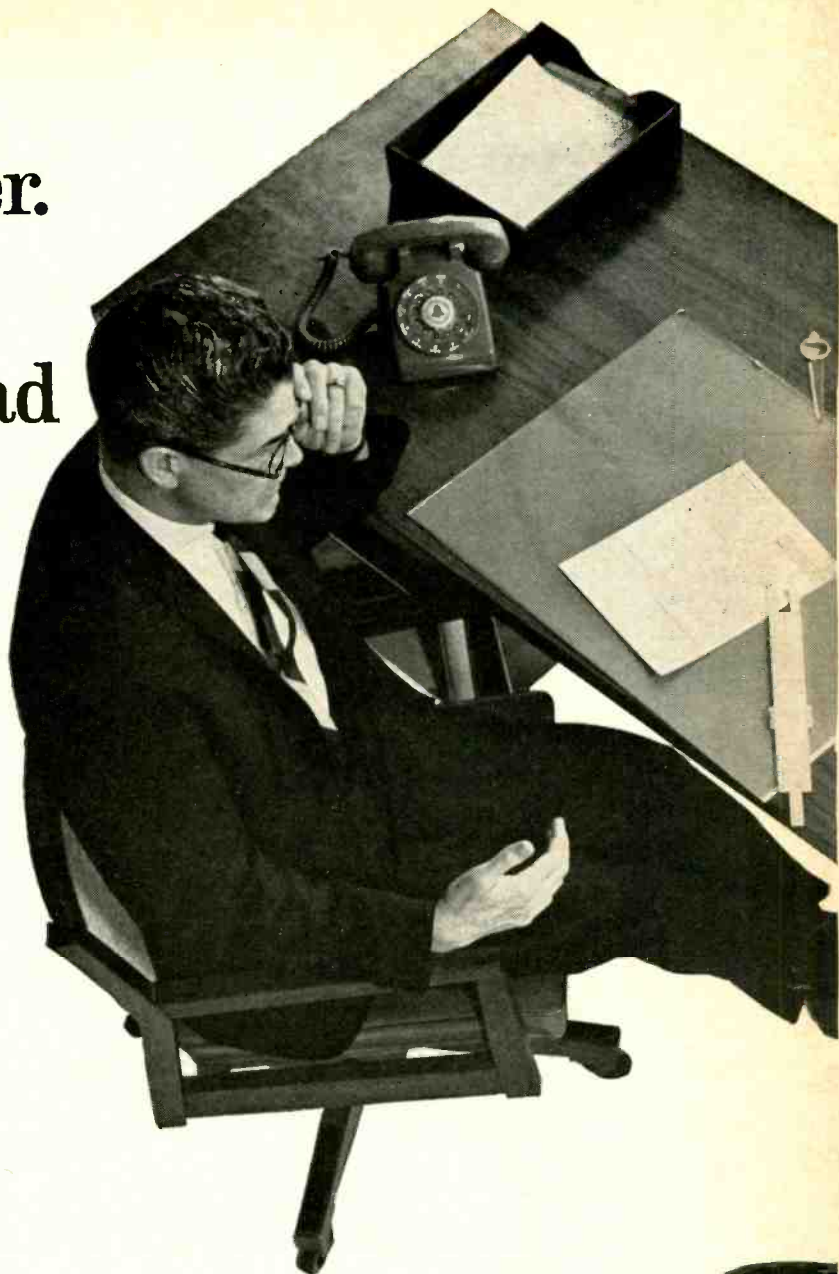

## **Could they be talking about you?**

You'll miss a lot of opportunities if you try to get along in the electronics industry without an advanced education. Many doors will be closed to you, and no amount of hard work will open them.

But you can build a rewarding career if you supplement your experience with specialized knowledge of one of the key areas of electronics. As a specialist, you will enjoy security, excellent pay, and the kind of future you want for yourself and your family.

Going back to school isn't easy for a man with a

full-time job and family obligations. But CREI Home Study Programs make it possible for you to get the additional education you need without attending classes. You study at home, at your own pace, on your own schedule. You study with the assurance that what you learn can be applied to the job immediately.

CREI Programs cover all important areas of electronics including communications, radar and sonar, even missile and spacecraft guidance. You're sure to find a program that fits your career objectives.





You're eligible for a CREI Program if you work in electronics and have a high school education. Our FREE book gives complete information. Airmail post-paid card for your copy. If card is detached, use coupon at right or write: CREI, Dept. 1103G, 3224 16th St., N.W., Washington, D.C. 20010.

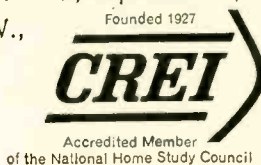

**The Capitol Radio Engineering Institute**

*A Division of McGraw-Hill, Inc.*

**Dept. 1103G, 3224 Sixteenth Street, N.W.  
Washington, D.C. 20010**

Please send me FREE book describing CREI Programs. I am employed in electronics and have a high school education.

NAME \_\_\_\_\_ AGE \_\_\_\_\_

ADDRESS \_\_\_\_\_

CITY \_\_\_\_\_ STATE \_\_\_\_\_ ZIP CODE \_\_\_\_\_

EMPLOYED BY \_\_\_\_\_

TYPE OF PRESENT WORK \_\_\_\_\_  G.I. BILL

- I am interested in  Electronic Engineering Technology  
 Space Electronics  Nuclear Engineering Technology  
 Industrial Electronics for Automation  
 Computer Systems Technology

**APPROVED FOR TRAINING UNDER NEW G.I. BILL**

# The cool new "C." It has more life.

When the horizontal deflection tube in a color TV set goes dead, chances are you've been replacing it with our 6JE6-A.

(You learn by hard experience what's best. Who needs callbacks?)

But this doesn't mean that what's best can't be made even better. At least it doesn't to Sylvania electronic engineers.

That's the reason for our third-

generation 6JE6-C. (We skipped "B" altogether.)

The "C" is the new workhorse of color television.

We've given the plate wings.

It's been so designed that it acts as a superior heat sink. It holds more heat. Radiates it out from a larger surface. Dissipates it more quickly.

The new tube runs

cooler and has longer life.

And it still costs the same as the "A"

It should mean fewer replacement calls.

Try the "C" and see.

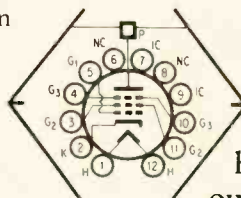

**SYLVANIA**  
A DIVISION OF  
GENERAL TELEPHONE & ELECTRONICS

Big plate fins absorb heat and radiate it out of the tube.





# Reflections on the news

By WALTER H. BUCHSBAUM/Contributing Editor

## Another Anti-Collision System

Private industry continues to develop equipment for the prevention of aircraft collisions, whether or not the Federal Aviation Administration takes a lead in this vital field. The most recent entry is from the *Weston Instrument's Garwin Division* in Wichita, Kansas. According to a company spokesman, the new system surrounds an aircraft with almost a 360° detection envelope, and from closing rate and azimuth information, will display collision information to the pilot in time for him to take evasive action. The system, which the company refuses to identify other than to say it is lightweight and uses r.f. techniques, can detect closing aircraft five miles away and will work at closing rates up to 1200 miles an hour. It was developed especially for General Aviation (business and private aircraft) and will sell for about \$1000. Feasibility flight tests have already been made but the system will not be ready for production for another year or two.

Independent of *Weston* and *McDonnell-Douglas* (see page 35, December, 1967 issue), the Air Transport Association, a private organization to which most airlines belong, has initiated the first phase of a test program to determine what the best displays and controls of any future collision-avoidance scheme will be. This program is a joint venture of the airlines (acting through the ATA) and the equipment suppliers, among whom *McDonnell-Douglas*, *Collins*, and *Bendix* seem to be the most active. Although technical details have not been worked out as yet, actual flight tests with three jet aircraft and two ground stations are scheduled to begin in 1969. Meanwhile the FAA seems to continue as "innocent bystander", supplying neither initiative nor leadership.

## Parking Space Assigned by Radio

Parking lots at major airports have been a particular problem because of their size and the amount of traffic they are required to handle, but the Los Angeles Airport Administration is trying to do something about it. They plan to use buried cables and a low-power AM radio signal to broadcast a continuous report of parking-space locations. At the parking-lot entrance, signs will advise drivers to which radio frequency to tune their car radios. The radio tells them in which section of the field spaces are available. The Los Angeles Airport already has an electronic control system which counts the number of cars entering and leaving the automatic gates of each parking lot and this information is displayed in a central control room. Based on this data, a controller can direct incoming cars by radio. In the future, individual sensors may be placed in each parking space. Sensor information would be fed to a central computer which would determine if the space were occupied. The computer could, by means of a visual display or a prerecorded voice message, direct drivers to the nearest parking space.

Any improvement in the chaotic parking situation is worthwhile, but a number of non-electronic improvements are also urgently needed. Foremost among them is a means of rapid and weather-protected transportation from the parked car to the airline terminal. It seems that the automatic underground train installed at Houston Airport, combined with a scheme which advises motorists where to park, could provide a really good solution to the airport parking problem.

## A New Bio-Electric Power Scheme

In the January issue of *EW* we discussed a fuel cell that used chemical power from inside the human body and some possible uses of thermoelectric generating cells on the outside of the body. Now a team of researchers at the University of Maryland has come up with still another source of electric power. Potential differences exist in a number of portions of the human body and animal experiments show that the largest amount of power, 114 microwatts, can be obtained inside the heart. Using platinum electrodes, these researchers have measured 0.26 volt at 440 microamps between the inside and the outside of the right ventricle of a dog's heart. Apparently, the power source is quite stable regardless of heart rates or a variety of metabolic differences. According to the researchers, the aim of this study is to provide a reliable internal power source for cardiac Pacemakers and other heart-assist devices. Most modern Pacemakers require about 30 microwatts for operation.

In the near future either a biological fuel cell or the biological internal battery described above may make it possible to implant a Pacemaker and leave it there without the worry of battery replacement. Further investigations along these lines may reveal other power sources within the human body which will be

able to power prosthetic devices. Organ transplants have recently made headlines, but the lack of suitable organs and the problems of tissue rejection point strongly toward the use of artificial organs whose most serious limitation has been the lack of adequate power source. The fruits of bio-medical research and the combination of engineering and medicine are already apparent and if more trained personnel and more research funds were made available, the benefits to mankind might easily exceed those derived from the "miracle drugs."

## Electronic Shark Repeller

Apparently, sharks and electric fields don't mix; at least that's the principle of *Electromagnetic Industries'* electronic shark repeller. One version of the device, which is designed to keep sharks away from the shrimp trawlers, uses two trailing electrodes connected to a pulse generator. These produce a 10-millisecond pulse every second. Because of the low duty cycle, relatively large peak powers can be generated from a moderate size power supply.

Another, smaller version is intended for divers and has the electrodes mounted right in the wet-suit. It can be powered by "D" cells or a rechargeable battery and because pulsed power is used, the batteries are good for 8 to 10 hours of service. Actual sea trials have shown that sharks never approach closer than 6 feet to the active electrodes. Both versions of the electronic shark repeller are completely solid-state and sealed in epoxy.

With skin diving becoming an increasingly popular sport, a good repellent will be welcome news. However, there is one small flaw; skin divers who want to go spear fishing may find that the shark-repelling electric fields will also prevent them from getting close enough to the game fish, and if the device is turned on only when sharks are in the vicinity, he may not notice them in time. But for commercial fishing, for protecting swimming areas, and for military work, the electronic shark repeller should prove a real boon.

## Open Flame Loudspeaker

Interaction between flames and sound waves was first observed by John Leconte, in England, in 1858 when he noticed that gas flames at a concert responded to certain musical beats. In 1952, at a symposium of the Combustion Institute, several experiments were described in which diaphragms driven by audio signals modulated gas flow and caused a flame to act as a loudspeaker. A radically new method was discovered recently by scientists of the United Technology Center (*United Aircraft Corp.*) in California. Using a small flame from an ordinary acetylene torch, scientists were able to produce omnidirectional sound, with good fidelity, at sound pressures of 90-95 dB. High-frequency response was excellent, but the bass response dropped off below 2000 Hz at the rate of 6 dB per octave. Larger flames, much like larger speakers, have better low-frequency response.

The method of coupling the audio signal to the flame is quite unique. One tungsten electrode is inserted into the flame close to the orifice and another electrode is placed in the center of the flame about 1 to 2 inches above the orifice. A d.c. bias of 500 volts at 200 to 300 mA is maintained between the electrodes and the audio is coupled to the electrodes through a regular audio transformer.

But before you think of buying acetylene torches to replace the speakers in your hi-fi system, check on whether you have space for all the oxygen and acetylene tanks you'll need to keep the system going. And remember what a hot open fire can do to your furniture. We do not foresee any immediate application for the flame loudspeaker, though one might eventually think of such gimmicks as a musical fireplace, "electronic candles" for dinner entertainment, and possibly, acetylene musical torches for welders to work by. However, one practical application of the audio-modulated flame phenomenon may be the monitoring of rocket flames by their response to various test tones.

## X-Ray Exposure Reduction

A new combination of magnetic recording and TV displays designed by *Westinghouse Electric Corp.* reduces patient exposure during x-ray fluoroscopy more than 100 to 1. In addition, it enables doctors to utilize many advantageous and novel displays that aid in diagnosing and displaying the patient's condition. This month, Chicago's Presbyterian Hospital began evaluating the system and expects to provide a preliminary report later this spring.

The heart of this system is a memory disc recorder which stores the video data obtained from the image amplifier that takes the place of the fluoroscope viewing screen. The x-ray exposure time need only be long enough for one TV frame. By using a number of recordings and playing them back in sequence, the movement of x-ray dye through the organs can be displayed. The system uses a vidicon pickup tube and an 875-line scan for a very high resolution picture but can be adapted to the commercial 525-line system. Naturally, the TV picture can be displayed on a number of monitors, enabling a number of doctors or medical students to participate in an analysis. ▲





## Why We Make the Model 211 Available Now

Although there are many stereo test records on the market today, most critical checks on existing test records have to be made with expensive test equipment.

Realizing this, HiFi/STEREO REVIEW decided to produce a record that allows you to check your stereo rig, accurately and completely, just by listening! A record that would be precise enough for technicians to use in the laboratory—and versatile enough for you to use in your home.

The result: the HiFi/STEREO REVIEW Model 211 Stereo Test Record!

## Stereo Checks That Can Be Made With the Model 211

- ✓ Frequency response—a direct check of eighteen sections of the frequency spectrum, from 20 to 20,000 cps.
- ✓ Pickup tracking—the most sensitive tests ever available on disc for checking cartridge, stylus, and tone arm.
- ✓ Hum and rumble—foolproof tests that help you evaluate the actual audible levels of rumble and hum in your system.
- ✓ Flutter—a test to check whether your turntable's flutter is low, moderate, or high.
- ✓ Channel balance—two white-noise signals that allow you to match your system's stereo channels for level and tonal characteristics.
- ✓ Separation—an ingenious means of checking the stereo separation at seven different parts of the musical spectrum—from mid-bass to high treble.

ALSO: ✓

Stereo Spread  
Speaker Phasing  
Channel Identification

## PLUS SUPER FIDELITY MUSIC!

The non-test side of this record consists of music recorded directly on the master disc, without going through the usual tape process. It's a superb demonstration of flawless recording technique. A demonstration that will amaze and entertain you and your friends.

# NOW...GET THE FINEST STEREO TEST RECORD ever produced

for just...\$4.98

Featuring Tests Never Before Available Outside Of The Laboratory

### UNIQUE FEATURES OF HiFi/STEREO REVIEW'S MODEL 211 STEREO TEST RECORD

- Warble tones to minimize the distorting effects of room acoustics when making frequency-response checks.

*Warble tones used are recorded to the same level within  $\pm 1$  db from 40 to 20,000 cps, and within  $\pm 3$  db to 20 cps. For the first time you can measure the frequency response of a system without an anechoic chamber. The frequency limits of each warble are within 5% accuracy.*

- White-noise signals to allow the stereo channels to be matched in level and in tonal characteristics.
- Four specially designed tests to check distortion in stereo cartridges.
- Open-air recording of moving snare drums to minimize reverberation when checking stereo spread.

## All Tests Can Be Made By Ear

HiFi/STEREO REVIEW's Model 211 Stereo Test Record will give you immediate answers to all of the questions you have about your stereo system. It's the most complete test record of its kind—contains the widest range of check-points ever included on one test disc! And you need no expensive test equipment. All checks can be made by ear!

*Note to professionals: The Model 211 can be used as a highly efficient design and measurement tool. Recorded levels, frequencies, etc. have been controlled to very close tolerances—affording accurate numerical evaluation when used with test instruments.*

### DON'T MISS OUT—ORDER NOW

The Model 211 Stereo Test Record is a disc that has set the new standard for stereo test recording. There is an overwhelming demand for this record and orders will be filled by ELECTRONICS WORLD promptly upon receipt. At the low price of \$4.98, this is a value you won't want to miss. Make sure you fill in and mail the coupon together with your check (\$4.98 per record) today.

### FILL IN AND MAIL TODAY!

Stereo Test Record

P. O. Box 3110  
Church St. Station, New York, N.Y. 10008

Please send \_\_\_\_\_ test records at \$4.98 each, **postpaid**.

My check (or money order) for \$\_\_\_\_\_ is enclosed.  
(Outside U.S.A. please send \$7.00 per record ordered.) N. Y. State residents please add local sales tax.

Name \_\_\_\_\_ (PLEASE PRINT)

Address \_\_\_\_\_

City \_\_\_\_\_ EW-38

State \_\_\_\_\_ Zip Code \_\_\_\_\_

**PAYMENT MUST BE ENCLOSED WITH ORDER**



**"For my money, the best antenna for Color TV  
is the JFD Color Laser,"...**

**says Ronnie Morgan of Best Antenna Service, Arlington, Va.**

"When we install a JFD Color Laser or Log Periodic, we *know* we can guarantee better *color* pictures than the customer ever had before. We get sharp directivity and high front-to-back ratios that clean up ghosts. And the JFD's wide bandwidth and flat gain give us good color registration on all VHF and UHF stations in the area. JFD's are well constructed and easy to install... They go up fast and stay up for good."

Mr. Morgan (who has been installing antennas for twenty years and counts his installations in the hundred of thousands) does most of his work in metropolitan areas where that extra sharp, ghost-chasing directivity is mighty welcome. His opinion of the JFD is typical of professional an-

tenna installers from coast to coast. And it's only natural because the Color Laser offers:

**BRILLIANT COLOR**—flat (frequency independent) response across each channel, free from suck-outs or roll-offs. Keeps color vivid and alive.

**PATENTED W-I-D-E BAND LOG PERIODIC DESIGN**—the most efficient ever developed—provides higher gain, better signal-to-noise ratios, needle-sharp directivity. Eleven patents cover its revolutionary space-age design.

**MORE DRIVEN ELEMENTS.** Harmonically resonant capacitor coupled design makes dual-function elements work on both VHF and UHF

frequencies. **Entire** antenna (not just part of it as in other log periodic imitations) responds on every channel.

**LUSTROUS, ELECTRICALLY CONDUCTIVE GOLD ALODIZING** promotes signal transfer, protects against corrosion, enhances appearance.

**PROFESSIONAL ANTENNA INSTALLERS KNOW**—The Best Antenna for Color TV is The Color Laser by

**JFD<sup>®</sup>**

Now at your JFD distributor!

**JFD ELECTRONICS CO.**

15th Avenue at 62nd Street, Brooklyn, N.Y. 11219

JFD International, 64-14 Woodside Ave., Woodside, N.Y. 11377 JFD Canada, Ltd., Ontario, Canada

JFD de Venezuela, S.A., Avenida Los Haticos 125-97, Maracaibo, Venezuela

1. LICENSED UNDER ONE OR MORE OF U.S. PATENTS 2,958,081; 2,985,879; 3,011,168; 3,108,280; 3,150,376; 3,210,767; RE. 25,740 AND ADDITIONAL PATENTS PENDING IN U.S.A. AND CANADA. PRODUCED BY JFD ELECTRONICS CO. UNDER EXCLUSIVE LICENSE FROM THE UNIVERSITY OF ILLINOIS FOUNDATION. LICENSED UNDER ONE OR MORE OF U.S. PATENTS 2,955,287 AND 3,015,821 AND ADDITIONAL PATENTS PENDING.

**CIRCLE NO. 107 ON READER SERVICE CARD**



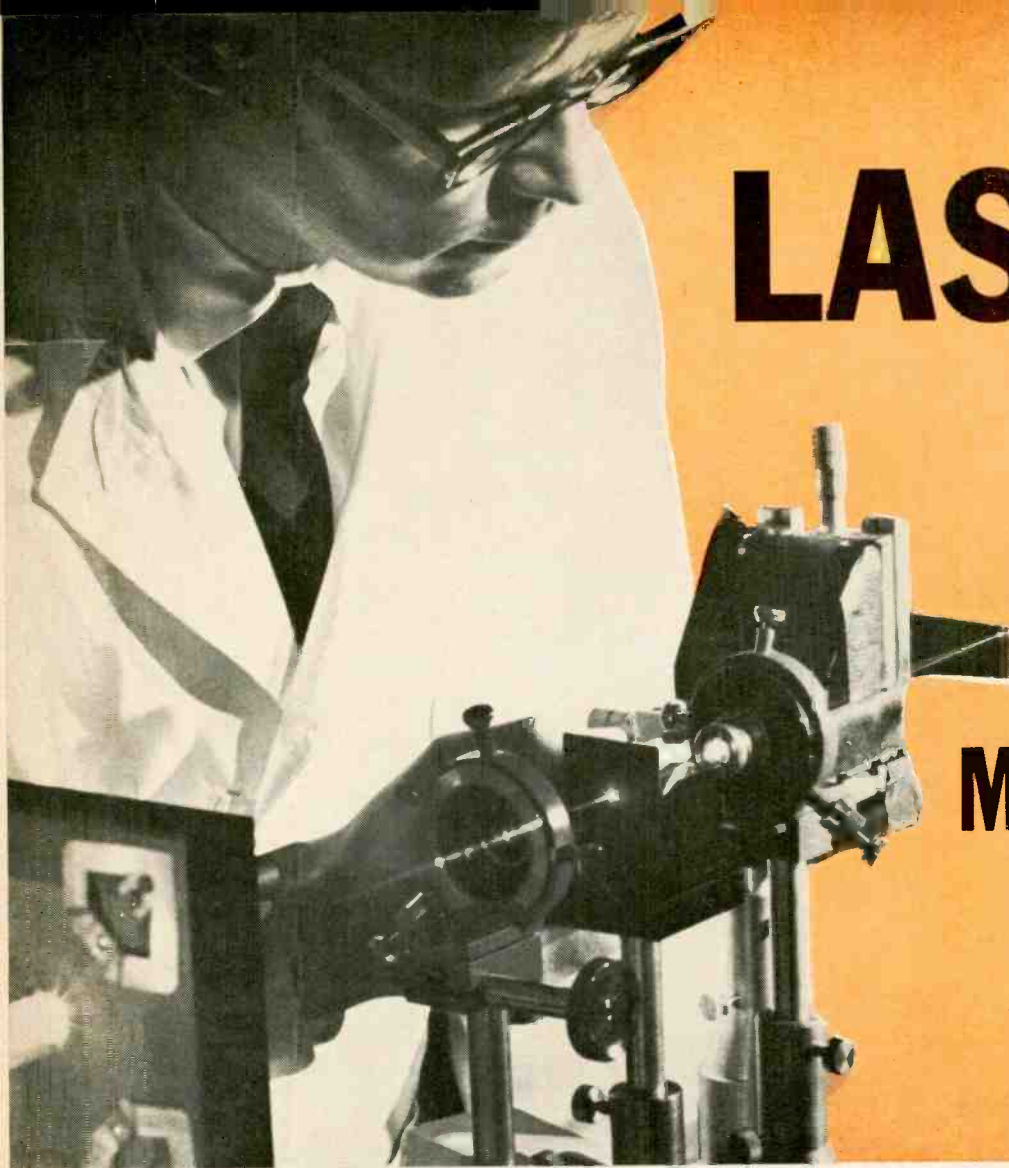

# LASERS:



## Multi-Million Dollar Market

Scientist Philip E. Norgren uses laser to find blood cells in process of splitting; at mitosis the determinants of heredity are visible.

By E. ALAN HALEY/Laser Applications Engineer, The Perkin-Elmer Corp.

*Not yet the mature, big-systems market that optimists predicted, lasers have, nevertheless, reached a practical stage. Continuing new developments insure their future as a useful tool. \$500 million sales are expected in 1970.*

**W**HEN the laser was introduced in 1960, bright-eyed marketers predicted that by 1970 it would be a billion-dollar industry. Today, most sources close to the laser industry claim that by the end of 1967 the worldwide market for laser-related goods and services was close to \$300 million while estimates for 1970 are in the range of \$500 million. These estimates are understandably vague since, for competitive and military reasons, full disclosure of laser usage is lacking.

The United States Government is the largest customer for lasers and laser research projects. According to one analysis of government contracts, government agencies spent nearly \$30 million on lasers and laser systems last year. Experts say that this figure could reach \$70 million by 1970 and should continue to accelerate in the '70's.

Today there are about 800 organizations engaged in laser work compared to the less than 300 in 1965. These figures include industrial and commercial companies, universities, institutes and foundations, and military and civilian governmental agencies. But no more than seventeen, according to the trade journal *Laser Focus*, can be labeled as principal manufacturers of lasers and laser systems.

At the end of the calendar year 1967, about \$22-million worth of gas-laser systems was expected to have been sold.

This is followed by solid-state lasers, with projected sales of \$15 million. Significantly, laser components and accessories will have combined sales of \$34 million.

While lasers have not come up to the heady predictions made for them, there are a number of significant areas in which lasers have made their mark. In eye surgery, solid-state lasers are being used to weld and stitch retinas. Gas lasers are saving time and money in alignment, surveying, and metrology systems.

*NASA Facts*, a publication of the National Aeronautics and Space Administration, says that lasers may be used for clear-air turbulence warning systems, drilling and welding of machine and electric parts, erasure of typewritten letters, and for brain and nerve operations. In chemistry, the laser may be used to manipulate a single atom within a molecule; in metallurgy to cut, weld, and pierce materials such as tungsten, diamonds, and steel; in space, for communications, tracking and navigation, and to detect and measure high-altitude cosmic dust; and as gyroscopes for rocket-launch guidance systems.

Military applications for the laser are equally exotic. There are artillery laser range finders, visual airborne target locating systems, vehicular target locating/distance-measuring systems, laser illuminators, laser seekers and sur-





The straight, narrow beam of laser light is used to align tool jigs for the Boeing 747 transport. Accuracy is 0.01" in 200 ft.

veillance equipment (both ground-based and airborne), and laser guidance systems for anti-tank missiles and rockets.

The applications in which the laser replaces other light sources are the most developed. Roman spectroscopy, for example, (a type of fluorescence developed thirty or forty years ago) is enhanced by the laser, especially with the advent of the argon laser and its visible green light. In transit instrument applications, too, the laser allows the user to replace an imaginary line-of-sight with a visible one, increasing the measurement accuracy tenfold.

### How Lasers Work

Laser (an acronym for *Light Amplification by Stimulated Emission of Radiation*) action is the process of externally exciting atoms in certain materials, as by shining intense light upon them. The electrons in the atoms are raised to energy levels higher than those they normally occupy. Because the electrons are unstable at their new, higher energy levels, they immediately begin to return to their lowest energy level while pausing, for an instant, at an intermediate level. As they return, each electron gives off a basic unit of light—a photon. Mirrors within the tube in which the laser

Comparative specs for gas, solid-state, and semiconductor lasers.

	POWER RATING (watts)	EFFICIENCY	MODE OF OPERATION	PRICE RANGE
<b>GAS LASERS</b>				
1. Helium-neon	0.001-0.1	0.1%	C.W. or Pulse	\$300 to \$55,000
2. Argon	0.001-1	0.01%	C.W. or Pulse	
3. Carbon dioxide	10-1000(avg.)	up to 15%	C.W. or Pulse	
<b>SOLID-STATE LASERS</b>				
Using doped synthetic crystals	up to and beyond 10 <sup>9</sup> (peak)	up to 0.6%	C.W. or Pulse	\$1000 to \$100,000
Using rare-earth doped glass				
<b>SEMICONDUCTOR LASERS</b>				
	1-10 (peak)	+20% at cryogenic temp.	C.W. or Repetitively pulsed	\$20 to \$20,000

action takes place move the photons back and forth. This stimulates other excited electrons and causes them to give off light. This cascading action results in a unidirectional beam of coherent laser light.

Remember light travels in waves, like ripples in water; the frequency of light is determined by the number of waves passing a given point in a second; and wavelength is the distance from crest to crest. Ordinary incandescent light is a blend of many wavelengths (or colors), mixed together and traveling in every conceivable direction. On the other hand, laser light is coherent, that is, it is of one wavelength (monochromatic), with the waves moving in one direction. The waves are in-phase, or in step, and thus can move in a straight, narrow beam for incredibly long distances instead of diverging like an ordinary light beam.

### Three Types of Lasers

There are only three basic types of lasers but they are used in more than 200 different kinds of instruments. There are: gas lasers—which have a variety of wavelengths and are excited by an electrical discharge; solid-state lasers; and semiconductor or injection lasers.

Although it is more than two years old, the carbon dioxide (CO<sub>2</sub>) laser is the newest and most powerful gas laser developed to date.

The Army at Redstone Arsenal, Alabama, recently announced that the longest, most powerful continuous-wave gas laser in existence is operational. It is a nitrogen-carbon dioxide-helium laser 178 feet long that generates an output power of 2.3 kilowatts and operates at an efficiency of 10 to 14 percent. According to the Army, some planned modifications will increase the power to 4 to 5 kilowatts with a corresponding increase in efficiency to 20 to 28%.

Gas lasers usually operate in a continuous-wave mode and produce a great variety of wavelengths. But they can be made to pulse by adding a switch. Although many different gases and combinations of gases have been lased, most practical gas lasers use helium-neon, carbon dioxide, and argon. Helium-neon is used in low-power (0.001 to 0.1 watt) and low-efficiency (0.1 percent) lasers. Argon is utilized in medium-power devices (from a milliwatt to a watt), but has a lower efficiency than helium-neon (0.01 percent). Carbon dioxide is used in high-power (10 watts to 1 kilowatt) lasers and has efficiencies as high as 15 percent. Krypton and nitrogen are used in other gas lasers which offer additional wavelengths, including ultraviolet. Gas lasers are especially valuable for studying various optical phenomena like interference, diffraction, and aberrations. Gas lasers range in price from \$300 to \$55,000.

Solid-state lasers are descendants of the original ruby laser. Their lasing action is produced by bathing the laser rod in light from a high-intensity lamp called a pump. (The light from the pump stimulates the electrons in the laser rod, causing them to change energy levels and emit photons of coherent light.)

Solid-state lasers are generally pulse lasers, using doped synthetic crystals or rare-earth-doped crystals and glass. They give high, almost instantaneous, pulses of energy and are frequently combined with a "Q" switch (a switch made of Kerr cells with rotating reflecting prisms and thin gold foil between the laser crystal and a high-reflectivity end plate). The switch keeps the "Q" of the laser cavity low while the ion population inversion is building up, and high just before instability occurs. This technique gives a very high rate of stimulated emission.

As is the case with all lasers, they must be cooled, by water, air, or cryogenics. Efficiency is usually low because of the method by which energy is transferred in the laser and because of the losses in energy through physio-chemical reactions and the laser's mirror-like ends and sides. A good solid-state laser, such as the neodymium-doped glass type, has an efficiency of 0.6 percent. Ruby and glass lasers



can produce short peak pulses of about  $10^9$  watts or more.

Prices of pulse lasers range from \$1000 to \$100,000, including the power supply.

Recently, *Bell Telephone Laboratories* announced the use of a new non-linear material—barium-sodium niobate—which permits the conversion of infrared radiation at 1.06 microns to visible green light. Some solid-state lasers are continuous wave. In fact, the experiment just described used a yttrium-garnet (YAG) c.w. laser to produce 1.06-microns radiation which was then doubled in the barium-sodium niobate.

The third type of laser—semiconductor or injection—represents an important development which will find future widespread usage, especially in communications. Excitation is provided by electron flow across a semiconductor junction. Semiconductor lasers are small, relatively inexpensive, and reliable. However, the fact that they can have more than one frequency is somewhat of a disadvantage.

Semiconductor lasers are also made from a number of materials and cover a wide range of wavelengths. The leading type uses gallium arsenide. This kind of laser can be operated continuously or be repetitively pulsed. Typical power output is in the 1 to 10-watt range. Efficiency, when operated at cryogenic temperatures, is better than 20 percent. When used as a pulse laser, at room temperatures, it can reach peak powers up to 30 watts. These lasers cost from \$20 to \$20,000.

A fourth type of laser, the liquid laser, is still in the preliminary investigatory stages and, when compared to other lasers, serves no useful purpose as yet. It uses europium in a benzoyl-acetate chelate, dissolved in methyl alcohol.

### Laser Applications

It is difficult to judge the superiority of the laser over traditional components in any one application area, but again, the best applications are those in which the laser replaces other light sources.

In medicine, for example, the laser is still in its infancy. But one application is retina welding or stitching, also known as photocoagulation, in which the laser replaces the carbon or mercury arc lamp and the surgeon's needle.

Every year thousands of people develop holes or tears in their retinas (the membrane of nerve cells which lines the back of the eye and which detects light and sends visual messages to the brain). If left untreated, the holes will eventually cause separation of the membrane and, ultimately, blindness. Before the laser was developed, such retinal detachment meant long, difficult, and painful surgery, followed by an extremely long period of convalescence. With the laser photocoagulator's tiny point of weak, pulsed light, the stitch distance is greatly reduced. The operation is painless and can be done in one, or a series of short visits to the doctor's office. In most instances, recuperation is immediate.

Other bio-medical and surgical applications include using lasers to remove birthmarks and tattoos, and to selectively alter and destroy cells. At the University of Pittsburgh, researchers use a laser system for genetic studies. The laser locates and identifies human blood cells in their mitotic stage, that is, when chromosomes are visible. Dentists are also experimenting with the laser as a weapon against cavities. However, much of the medical research is still in the hypothetical and theoretical stages.

Optical and radar simulation studies have been greatly enhanced by the addition of coherent, monochromatic laser light. Laser light has short wavelengths so large scale factors between radio waves and optical waves are possible. For example, by means of a laser, a 50-mile radar antenna array can be tested and its expected performance 9000 miles away in space simulated on a lab bench 3 feet long.

Interferometers, complex instruments which measure great distances accurately, have benefited considerably from the extreme coherence of lasers. Previously, such measure-

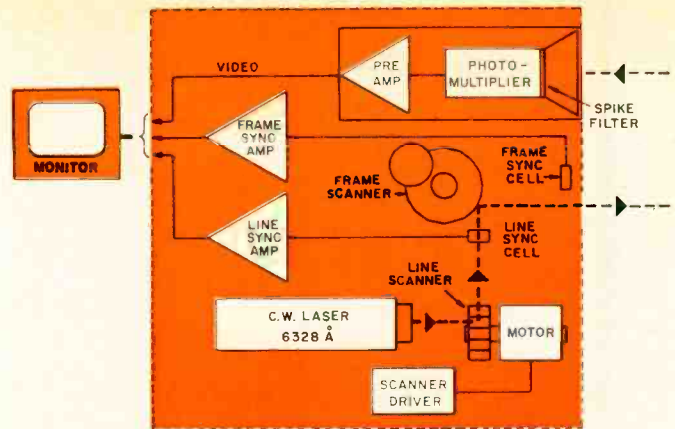

A very low intensity laser beam scan enables the Perkin-Elmer laser TV system to "see" images in virtually total darkness.

ments depended on micrometers and glass scales and accuracy was limited. The laser interferometer makes it possible to make linear measurements with a precision of one-hundred millionth of an inch—an accuracy impossible to obtain before. These instruments are used for extremely accurate surveying and for guiding machine tools.

Other laser alignment devices are saving time and money, and producing new standards of accuracy. They align turbines, particle accelerators, bridges, and pipelines. A standard *Perkin-Elmer* helium-neon laser was used as part of a guidance system in a tunnel project in New Mexico. It had to maintain a runout accuracy of  $\frac{1}{8}$  of an inch over a mile and a half in the boring operation. Without the laser, countless surveys would have been needed. Another *Perkin-Elmer* laser, in conjunction with a centering detector, is used to align wing panel jigs and other manufacturing fixtures for the *Boeing 747*. According to *Boeing* engineers, the laser provides ten times the accuracy of conventional optical systems and has greater accuracy at 200 feet (within  $\pm$

High-intensity laser beams are being used to weld metals and drill tiny holes in glass, ceramics, and in precious stones.

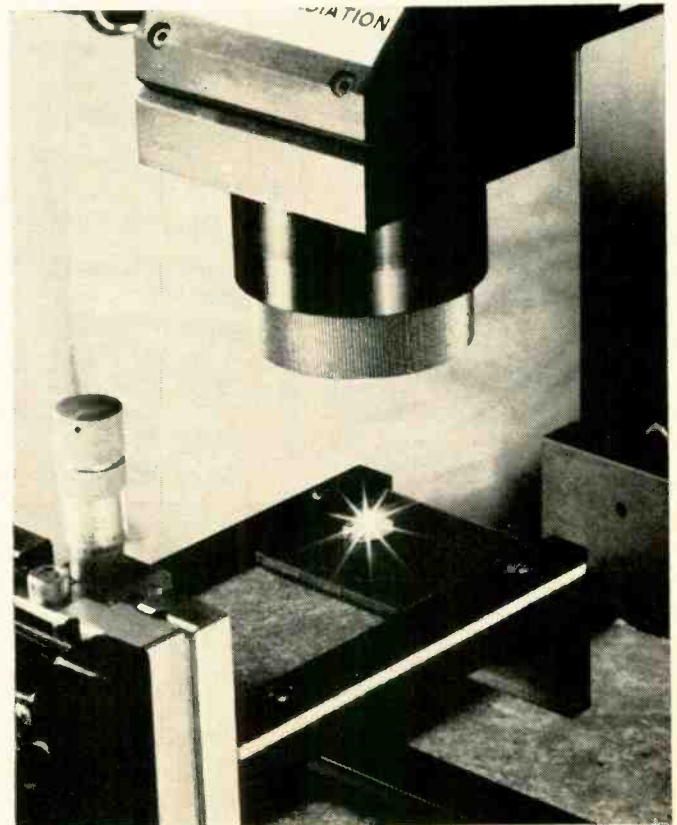



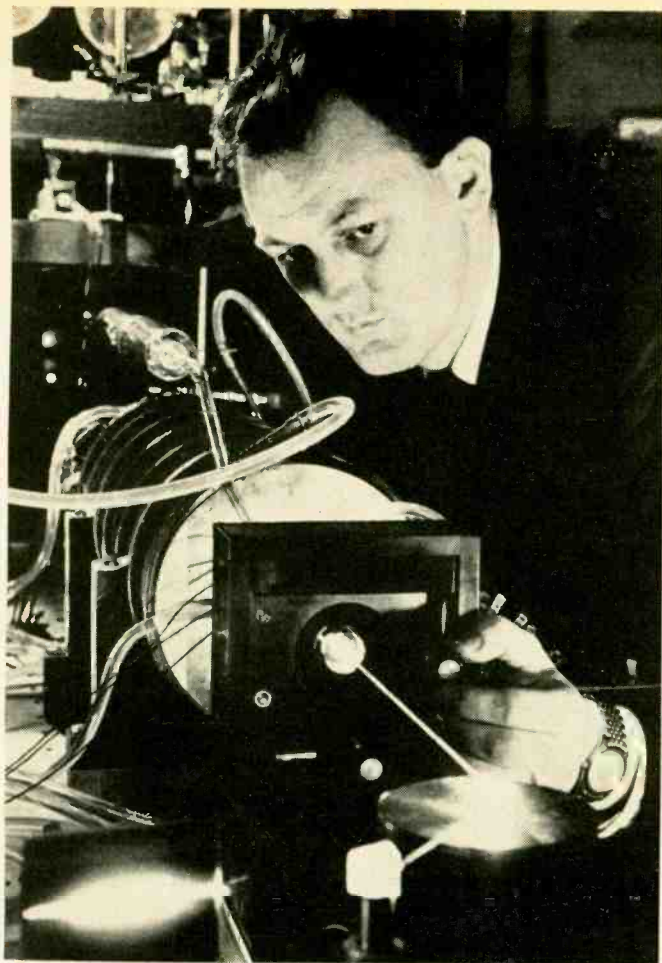

Lasers are used for communications and spectroscopy. Scientist J. Dane Rigden splits argon laser light into discrete wavelengths.

0.0015 inch) than the best alignment telescopes have at 70 feet.

There are countless other industrial applications of the laser. For example, optical alignment and optical testing by lasers have provided accuracies only dreamed of in the past. Lasers are used for welding because of their high intensity and precise direction. Drilling materials such as glass, ceramics, precious stones, and hardened metals is currently being done. For example, a minute hole can be drilled through a diamond by a laser in ten minutes. By conventional methods, such a procedure would take 24 hours. Lasers are used as velocimeters—measuring flow rates of liquids or gases; as autocollimators—for stress analysis; in photography; and, of course, holography. Many of these applications, however, are still in the experimental stage.

In communications, television, and oceanography, the laser is still in the research laboratory. Some experts contend that the laser will eventually replace microwave systems that carry simultaneous voice transmissions. While a microwave system can presently carry more than 16,000 conversations cross country, the laser, they contend, is theoretically capable of carrying hundreds of millions. Deep space communications is also being considered. Already a part of laser history is the Gemini mission in which the astronauts communicated by an argon laser beam to a ground station in Hawaii.

Television applications of the laser are still confined to the research laboratory. At *Perkin-Elmer*, a laser television camera, which takes pictures in the dark, has been developed. It is a scanner whose beam moves so quickly the spot of red light is virtually invisible. The camera needs no other illumination. While it may be valuable as a securi-

ty camera for unlighted warehouses or as a remote camera for photographing news events, its practicality is still to be determined.

Oceanography applications, too, are in the laboratory stage, but under consideration is the use of a laser system for the short-range, precise navigation needed for hydrographic and oceanographic studies.

The laser movement into the analytical instrument field is evidenced by the laser-excited Raman spectrometer. Ordinary light sources take hours of exposure to reproduce Raman spectra on film. Using the visible green light of an argon laser as the source, Raman spectra can be done in seconds or fractions of a second. In some instances weak Raman lines that could not be observed previously have been seen with a laser. The addition of the laser to the Raman spectrometer might allow the instrument to be competitive with existing infrared and emission spectrometers.

A laboratory tool that is slowly reaching practicality because of the laser is the optical computer and, although the computer device has existed for some time, the laser is speeding its development. In combining the laser and precise optical elements, the optical computer, or correlator as it is also known, processes electronic signals differently than before. It can handle three to four times as much data as electronic computers. And real time optical correlators can convert electronic signals like those of a reconnaissance radar into recognizable visual images, or unscramble a communications signal from jamming or background noise. Eventually, they may assist the development of commercial hybrid computers which handle graphic information.

### The Future of the Laser

While a number of applications presently attributable to the laser insure its future as a useful tool, there are even greater hopes. Although no truly spectacular developments are expected in laser technology, lasers will exert a steady and increasing influence. And by the same, steady rate, they will gain in importance.

In seven short years lasers have enabled scientists to demonstrate more easily than before classical optical theories. Surgery has yet to tap the true potential of the coherent light. Photography, laser instrumentation based on Doppler shift, holography, welding, machining, drilling, and communications are understandably part of the laser system.

The potentialities of future laser systems are being demonstrated by a project now under way at the Massachusetts Institute of Technology. Scientists are attempting to measure the speed of light more accurately than ever before. And, by measuring reflected laser light from a falling mirror, scientists should be able to measure gravity ten times more accurately than previously. Indirectly, these measurements may lead to tests of the theory of relativity.

The international standard of length may also change within the next five or ten years as an extremely accurate helium-neon laser replaces the krypton 86 that is being used now.

As with most technical items, the cost of lasers should decline. The commercial laser market should easily exceed \$500 million by 1970 and indications are that the rate of growth will enable the industry to pass the \$1-billion mark in total world-wide volume of laser-related goods and services in the early 1970's.

A mass market for laser systems still does not exist since the most money is earmarked for research and development. The most significant deterrent to laser growth at present is ignorance of the laser's tremendous potential. ▲

*Editor's Note: Recently scientists at Bell Labs were able to shift the frequency of a helium-neon laser over a range of 45 GHz. Previous electro-optic frequency shifts were less than 2 kHz. The ability to tune lasers over a wide range of optical frequencies may one day be useful in a multiplexing system for laser communications.*



# RADIC—Low-Frequency Multiplex Intercom

By JACK MALMIN

*Technical description of multichannel, high-density intercom system currently in use at the Kennedy Space Flight Center. Links hundreds of technicians with reliable voice channels during pre-launch assembly operations and during countdowns.*

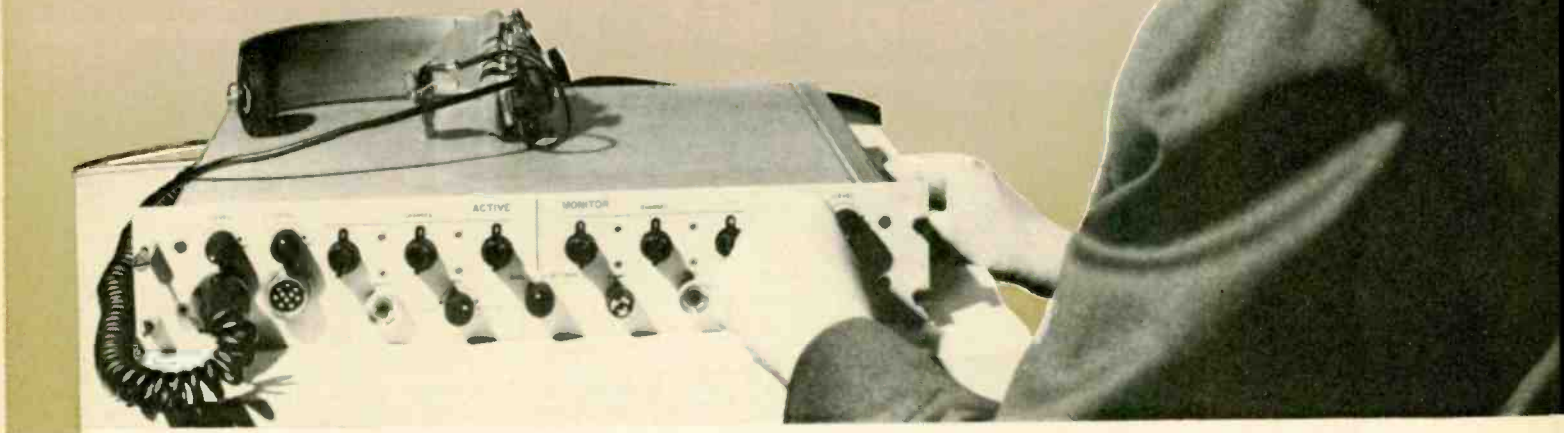

This rack-mounted RADIC station offers a maximum of 112-channel capability to each of two operating technicians.

**B**ACK in 1963, when the gigantic Merritt Island space operations center was still on the drawing boards, development engineers at *Collins Radio Company* in Dallas were putting the finishing touches on a unique interior communications system for the U.S. Navy. Called RADIC, short for *RADio Interior Communication*, that early carrier multiplex system proved its worth and caught the eye of NASA planners. Now being installed at key operational points in both the Manned Spacecraft Operations Building (MSOB) and the colossal Vehicle Assembly Building (VAB), the RADIC intercommunications system will link hundreds of technicians with reliable voice channels during the pre-launch assembly operations and throughout the countdown on Apollo launch missions. At the Cape, this system is known as the Operational Intercommunication System (OIS).

## System Description

NASA's choice of an r.f. carrier intercom system in lieu of a more conventional central dialing exchange was based on the basic system simplicity of the RADIC approach. Multi-channel operation on a single trunk line to distances of many miles is possible because of the refined method of signal propagation. Using conventional single-sideband, suppressed-carrier, frequency-division multiplexing techniques, the system allows one hundred or more stations "random" access (on an assigned channel basis), *all-call*, or paging operation on a dual-coax trunk line (which includes d.c. power transmission lines) on any of 112 channels. Groups of such branch systems, operating in tandem through a central Communications Control Room (CCR), provide the required system density to service the entire spaceflight center.

To date, over a thousand stations have been installed at the center; 2300 dual-operator stations have been purchased

and will be installed in the near future. The system includes 60 special-purpose stations and additional control and interface equipment, which is being installed in cooperation with the U.S. Army Corps of Engineers, Canaveral District, the executive construction agent for the complex.

Feedback amplifiers, reference oscillators, line amplifiers, and fault-sensing equipment at the CCR installation combine the branches to form a unified system. All amplifiers employ feedback circuitry which yields a flat response to 3 MHz, plus low-noise characteristics; amplifiers at the CCR and Local Communications Areas (LCA's) perform the function of summing coaxial branch lines at the input and driving each coaxial branch with the combined signal.

The CCR also contains float-charged battery banks to enhance system reliability and interface modems (modulator/demodulator terminals) for linking RADIC equipment with associated quick-access channels, test conductor stations, test supervisor stations, or commercial wire lines. The interface equipment permits direct tie-in with NASA facilities at Houston, Huntsville, or elsewhere in the world tracking network. (See Fig. 1.)

Certain areas at LC-39 require extensive communications capability. Such an area is the pad, where cameras, mobile launcher teams, the mobile service structure, and other key areas must be linked directly with a Launch Control Center (LCC) firing room. Rather than extend all such coaxial pairs back to the CCR, a small remote central, called the Local Communication Area (LCA), is installed. The LCA combines all stations and routes them to the correct LCC-CCR on one coaxial pair. LCC firing room branches are patched into a mission at the CCR. Branches at an LCA, such as a pad, are combined as an independent RADIC system and may be patched into a mission by a trunk line extended to the CCR.

The savings in system wiring using the RADIC approach



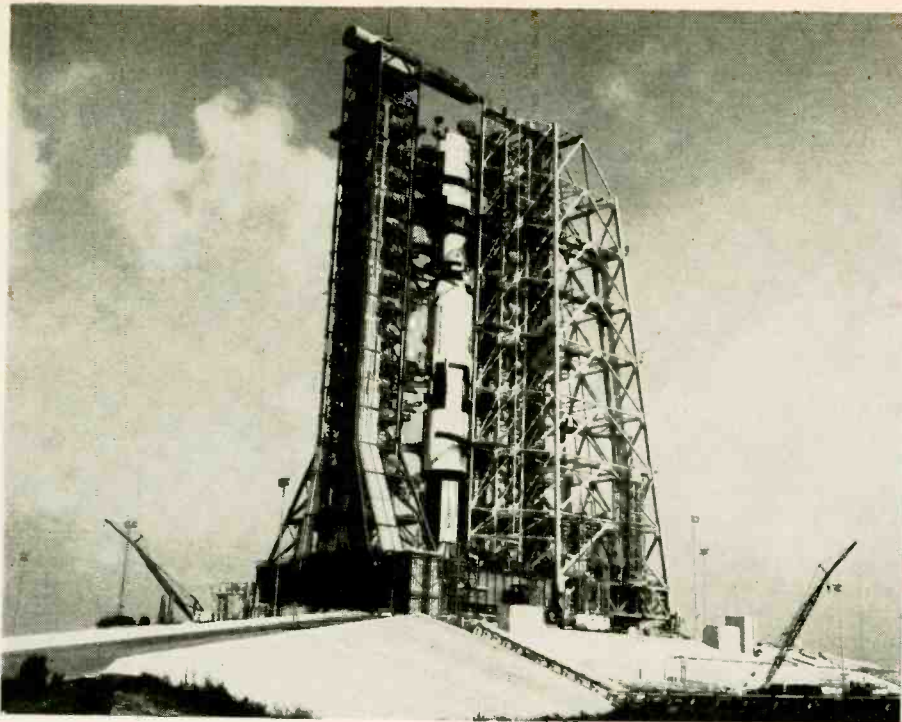

A Saturn V missile is shown at Pad A, LC-39, with the Mobile Launcher at the left and the Mobile Service Structure at the right. RADIC stations link assembly levels at the pad with the Vehicle Assembly Building and the Operations Building.

is enormous. Even if a conventional wireline system had been practicable for a system of this size, it would have been operationally unsound. Voice quality would have been unsatisfactory because of the sound degradation inherent in such a system. With the RADIC system, signal attenuation is held to 3.5 dB for 100-station loading; 2.0 dB for 50-station loading; and less than  $\pm 1$  dB for insertion or removal of a single dual-operator station. An additional advantage is the elimination of a complex central dial exchange.

Technicians at the Merritt Island installation will be equipped with headsets for hands-free operation and the RADIC station, being dual in nature, will permit individual communications for two persons on different channels from a single location. This feature also permits an operator to talk on the active channel and continue to monitor both the active and monitor channels. The completed system will include several thousand such stations.

Differing from conventional intercoms, which normally use a master station and several slave stations, the RADIC

Dual RADIC station is shown here in rack-mounted configuration (left) and redesigned for hazardous-location duty (at right).

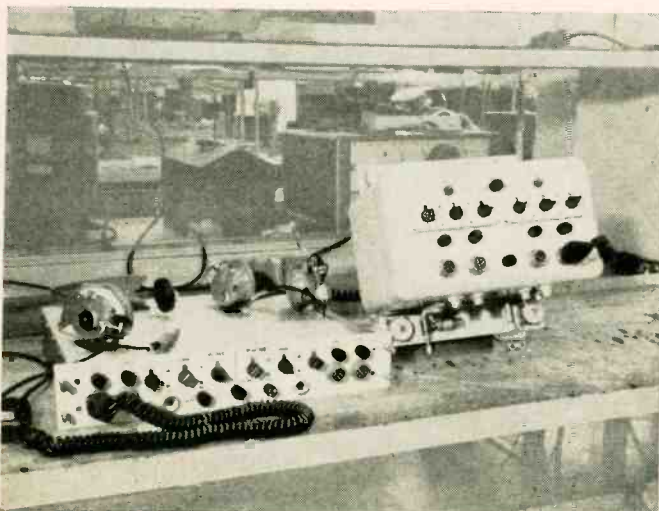

system uses master stations at each intercom site. Call origination can be made from all locations and a constant monitor capability is maintained on at least one channel. (Normal practice at Merritt Island requires no-call constant monitor operation at each one of the stations.)

Reserved channels, linked with public-address equipment, provide a paging capability at each station. Master stations use the paging system to help issue instructions and re-assign channels. Similarly, each station can be interrupted by another calling station by merely switching to the desired channel and commencing conversation. Channel lockout is possible, by local option, via an included lockout matrix. Master stations can talk simultaneously to all stations on a branch by switching to the *all-call* mode. Conversation in this mode is transmitted direct on the i.f. frequency (500 kHz) which effectively overrides all conversation on all channels in the branch.

Spectrum conservation is realized, since the same channel is used for both transmission and reception, just as with any conventional SSB radio conversation. Signals are spaced at 4-kHz intervals in the 13- to 500-kHz range. Only the lower sideband is transmitted on each channel—a combination of the i.f. and frequency synthesizer signals. This method of channelization, quite similar in nature to methods used for high-density telephone carrier multiplex systems, results in a decrease in signal loading and neutralizes crosstalk effects.

The digital frequency synthesizer provides carrier generation for the system. Using a single 4-kHz reference generator to supply a pilot signal to phase-lock all stations and determine channel spacing, the frequency synthesizer generates signals in the 516- to 960-kHz region in 4-kHz steps to be used for carrier injection. Signals are counted down to 4 kHz, then compared with the 4-kHz reference signal for phase lock and oscillator control.

Voice signals are amplified and modulated with 500 kHz (the i.f. and an exact controlled harmonic of the 4-kHz reference). The modulated output yields sum and difference sidebands and a mechanical filter then rejects the lower sideband component. The resultant signal is the i.f. and, in the instance of all-call, is transmitted at the r.f. output. The i.f. signal is modulated with any of the selectable frequency synthesizer signals to produce the desired lower sideband output channel.

For example, to generate the lowest channel signal, an injection signal of 516 kHz is mixed with the i.f., resulting in the lowest channel, which lies between 13 and 15.7 kHz. (The suppressed-carrier frequency is 16 kHz.) This process is repeated for all channels up to 460 kHz, where a 40-kHz segment is retained as a guard channel below the 500-kHz i.f.

The r.f. output impedance is 75 ohms, which is matched to the transmission line by a line-tap circuit, providing a constant 5000-ohm bridging connection to the line. A unique pressure tap junction box facilitates quick connection or removal of stations—a practical necessity on the gantry platform. The line tap probes pierce the RG-213 coaxial cable without severing either the conductor or the shield, making a good electrical connection when the line tap is tightened. The tap is left in the line when a station is temporarily removed. Multiple line taps that serve up to five dual-operator stations are in use at LC-39.

Computer-designed equalization networks at the CCR



equalize the LC-39 cable plant through 3 MHz, permitting eventual expansion of system density to 600 channels. The highest frequency transmitted at the present time is the 500-kHz i.f. Equalization is provided on all cables of over 600 feet in length.

RADIC reception is the exact reverse of the transmission process. An incoming signal at 13 to 15.7 kHz is picked up at the line tap and modulated with a 516-kHz injection signal to produce two sidebands. The 500.3- to 503-kHz sideband is passed by a mechanical filter and again modulated by the i.f. to reproduce the original 300- to 3000-Hz audio signal.

Under no-signal, or idle-circuit, conditions, the receiver headset is electrically disconnected, eliminating background noise. Incoming calls automatically activate the receiver, while the transmitter is activated by internal VOX circuits when the operator speaks. Audio sidetone is provided by constant r.f. transmission throughout a branch with demodulation within each receiver, permitting self-check at each station. The sidetone (100 percent) is heard in the headset at a constant, reduced level when the station is operating properly. (See Fig. 2.)

The regulator/4-500-kHz generator and transmit/receive r.f. amplifiers are common at all dual stations, resulting in circuit conservation; however, digital frequency synthesizers and audio i.f. amplifiers are redundant. (One synthesizer and one audio i.f. circuit are provided in each section of the dual-operator station.) To enhance system reliability, fault-sensing networks are provided at the RADIC system center which automatically switch to back-up facilities in the event of malfunction. All faults also activate visual and aural alarms to speed corrective maintenance. Faults at the remote LCA are indicated both at the LCA and the LCC-CCR.

A typical launch mission may require that the vehicle unload area, instrumentation facility, high-pressure gas converter, VAB low bay and high bay, firing room, mobile launcher, and LC-39 pad be interconnected. This is accomplished in the CCR by r.f. patching all areas into one mission amplifier. Patched in this manner, any dual-operator station in the mission area can communicate with any other station on one of the 112 available channels. During a launch, typically, many or all of the stations may be switched to a common channel for full party-line operation. Mission amplifier capacity is great enough to permit such operation throughout the entire launch complex.

Two electrically identical station configurations are provided at LC-39. One is a 19-inch rack-mounted station for console areas. The other is a quick-disconnect, wall-mounted, hermetically sealed and gas-pressurized unit. The latter is safe for use in hazardous areas.

### Other Applications

Design conventions incorporated in the RADIC system make the concept adaptable to other applications. The RADIC system can be used for transmission of data, telemetry, telegraph, or audio signals. System interface poses no problem and the system can be linked with u.h.f. nets or wide-band video links. Since the system uses solid-state construction throughout, it could be miniaturized, using exclusive integrated-circuit techniques. (The present system includes one such circuit.) Nickel cadmium battery packs could be adapted to such units for powering portable systems. Within the current state of the art, portable units could be produced with 600-channel capability and adapted for wire-

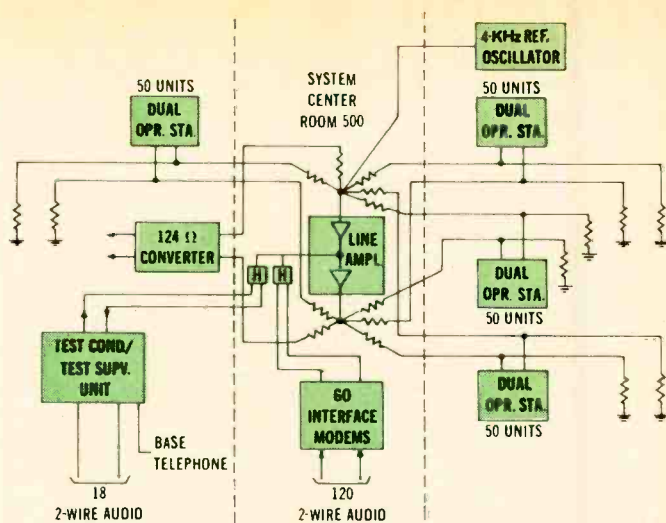

Fig. 1. Block diagram of the basic RADIC system described.

less communications, using u.h.f. front-ends and central repeater stations.

The portable feature could make this system a logical choice for space exploration team communications, such as the lunar excursion mission. Space scientists could keep in touch with base stations by a combination of RADIC-type intercoms and short-haul radio or laser links. A permanent installation of such hybrids could adequately handle moon-base operations on a permanent basis, assuming dark-surface temperature limitations can be surmounted.

Other potential applications include manufacturing plant coordination, temporary construction site links, spot direction of large-scale film productions, convention news coverage, or even many military operations.

The RADIC system, like its contemporary h.f., microwave, and laser cousins, is pointing the way toward more sophisticated, highly reliable, space-age communications. ▲

This is one of the coax line tap assemblies used in system.

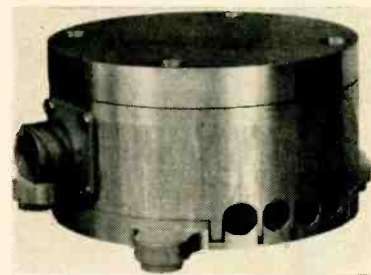
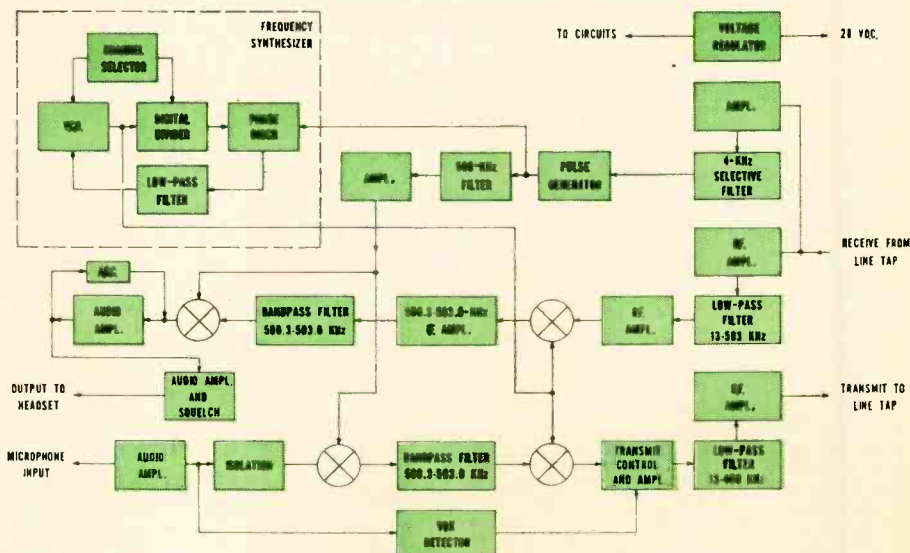
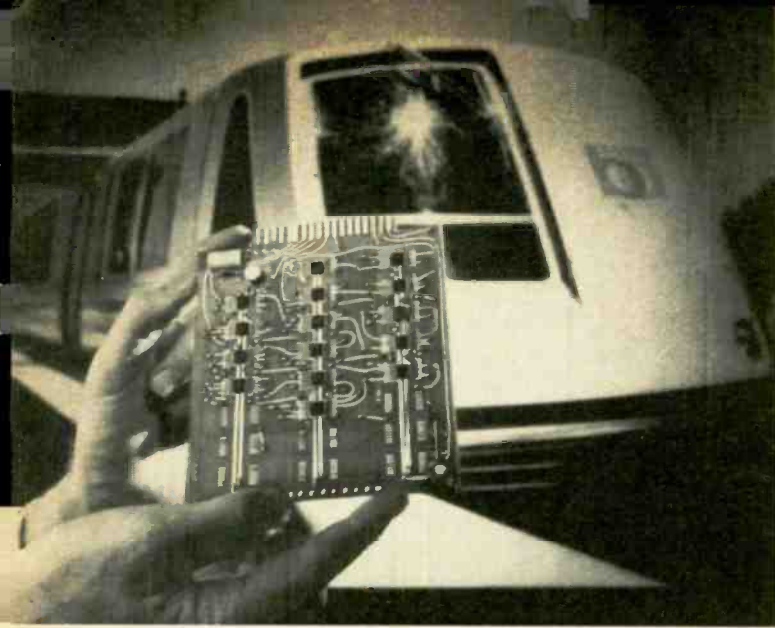

Fig. 2. The basic operator station block diagram shows frequencies that are used.







# RECENT DEVELOPMENTS IN ELECTRONICS

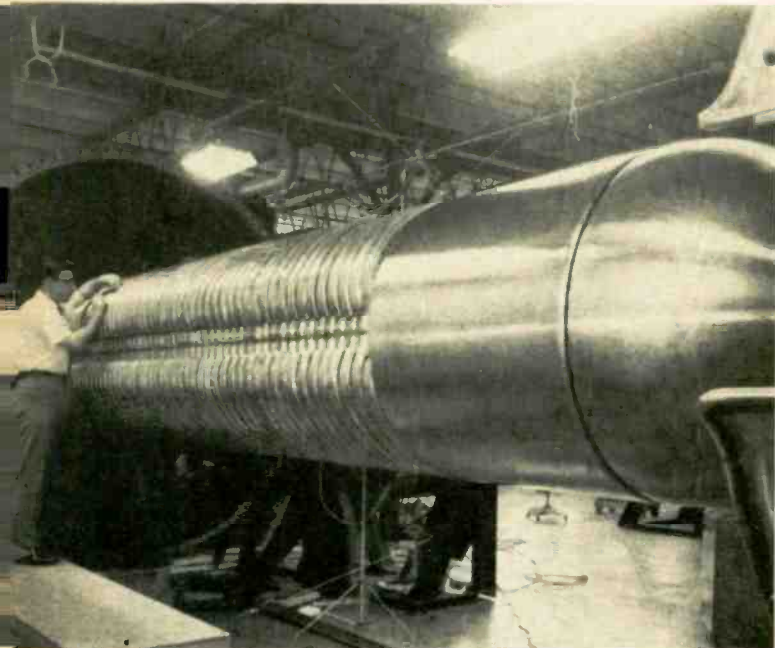

**Train Brain Uses IC's.** (Top left) This integrated-circuit logic board is one of hundreds to be used in an automatic control system that will direct trains like the one in the background along the 75-mile rapid transit system being built for San Francisco. The trains will be capable of speeds of 80 miles an hour and be as frequent as every 90 seconds. Although one attendant will be on each train to observe its operation, the train will be run by its own computer. Detection and separation of trains, as well as operating speed control, are accomplished by use of audio signals transmitted through the rails and picked up by car-mounted antennas connected to digital control equipment. When a station stop is called for, train control will be transferred from the wired-logic speed control equipment to a small digital computer. This computer will use signals from a wire laid between the tracks to bring the train to a precise stop at the platforms. Computers and control equipment are designed and manufactured by Westinghouse.

**Giant Electron Accelerator for Auto Industry.** (Center) The large high-voltage column shown here is a part of a 1.5 million volt electron accelerator recently ordered by General Motors. The accelerator, which costs over \$171,000, releases a beam of charged particles that travel at an extremely high velocity. The particles possess energy of such intensity that materials placed in their path undergo atomic rearrangement and are fundamentally changed. There is no residual radiation. GM will probably use the accelerator, which is manufactured by Radiation Dynamics, Inc., as a research tool. One use for an instrument of this type is in manufacturing and process control for curing plastic parts and coatings.

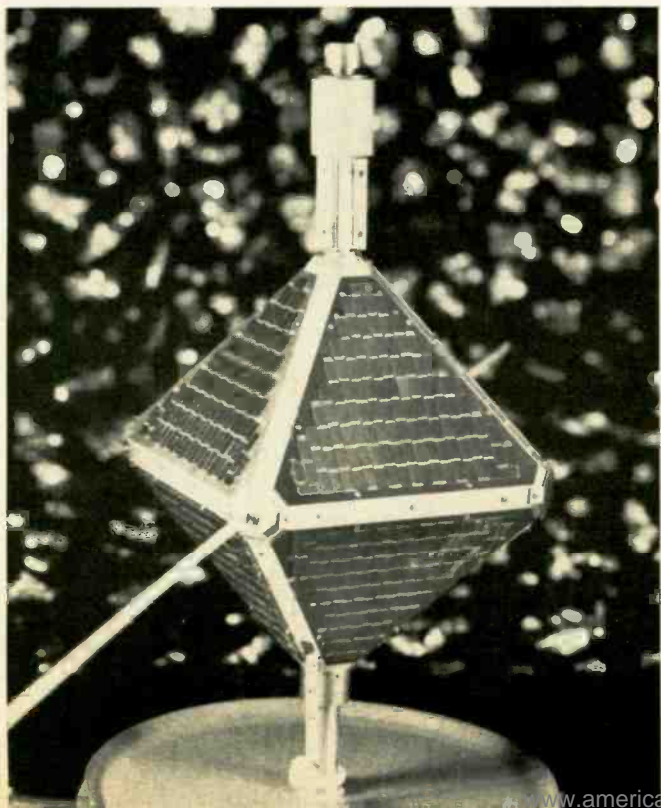

**Test and Training Satellite.** (Left) This is the 40-pound Test and Training Satellite (TTS) slated to orbit the Earth in order to exercise NASA's Apollo Communications and tracking network stations. Built by TRW Inc., the satellite contains an S-band transponder especially made for the mission. The transponder receives a signal sent from the ground on a frequency of 2282.5 MHz. These signals will simulate those to be used during manned orbital flights of the Apollo spacecraft. The TTS and its transponder give ground stations and shipboard crews an economic way of practicing acquisition of the spacecraft and the reception of its complex telemetry signals. The simulated data includes "normal" voice (1.25 MHz subcarrier frequency modulated by voice or test tone); PCM telemetry (1.024 MHz bi-phase modulated subcarrier for biomedical data); "emergency" voice (direct phase modulation of the r.f. carrier); and emergency AM key (using 512 MHz subcarrier).



**Laser Hologram Shows Larger Depth of Field.** (Right) The hologram being inspected at the right provides three-dimensional views of scenes up to six feet deep when illuminated by laser light. A new technique which enables gas lasers to emit light of greater purity and uniformity than ever before was used to make the hologram. Heretofore, most holograms have been limited to objects and depths of field measured in inches. This is because the lack of perfect coherence of the laser beam, which doesn't show up in short distances, becomes more evident at the greater distances needed to illuminate large objects or large depths of field. With the new ultra-pure argon laser, developed by RCA, the only limit is the size of the vibration-free platforms required to make the holograms. If laser or object moves as little as 1/100,000 inch, the optical interference patterns become blurred, ruining the hologram.

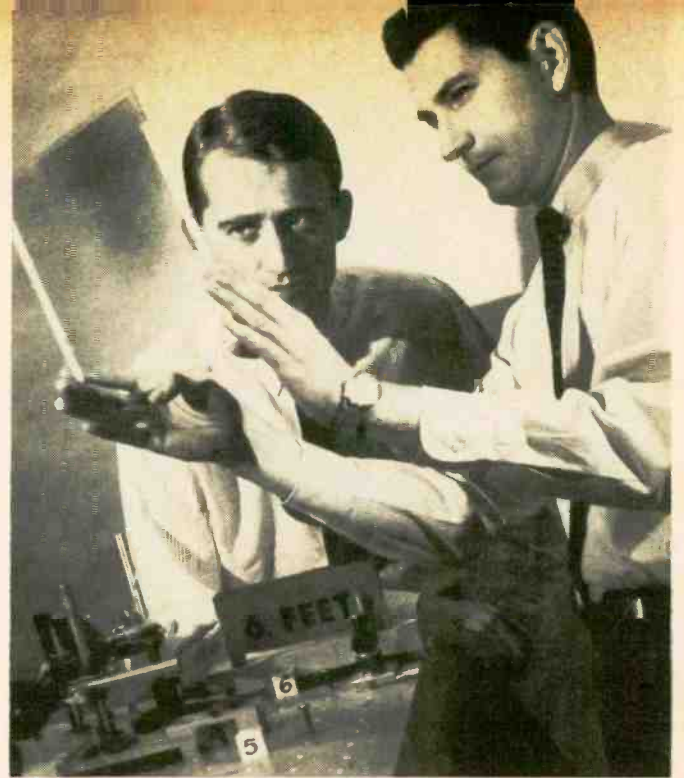

**First Computer-Operated Oil Rig.** (Center) A submersible drilling barge, operated by Humble Oil in marshlands of Louisiana, is using a high-speed digital computer to control oil-drilling operations. The computer scans and analyzes electrical signals from sensing devices on the rig floor. The signals provide a measure of the weight on the drilling bit and the speed at which the drill pipe is turning. The rate of penetration through the underground formations is automatically tested at different bit weights and speeds, and the computer determines combination which will result in lowest drilling cost.

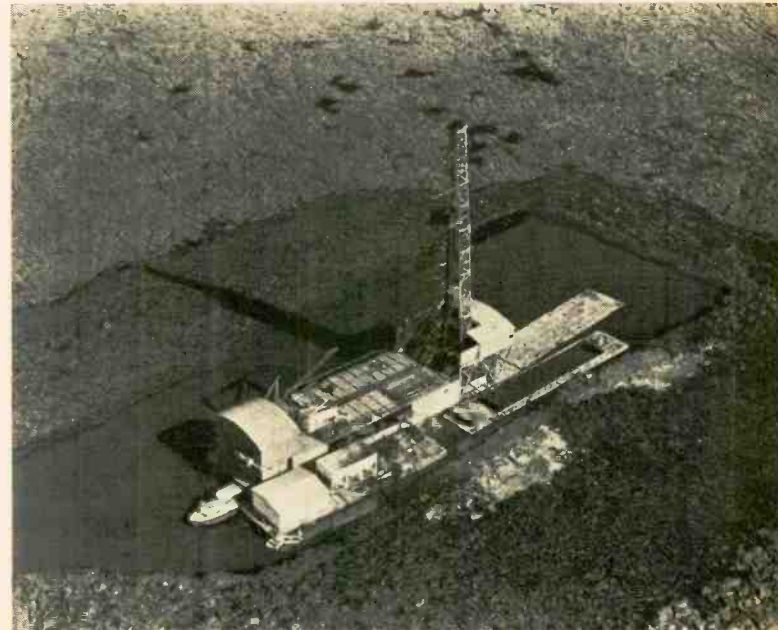

**Color TV of the Human Stomach.** (Below right) Recently, in West Germany, a color-TV camera transmitted pictures of the human stomach onto a screen for medical diagnosis and examination. A flexible fiber-optic tube, consisting of 150,000 fibers about 40 inches long and about as thick as a finger, transmitted light and picked up the image that was applied to the lens of the camera. To keep the color camera small, three parallel one-inch vidicon pickup tubes were used, one for each of the primary colors. The camera was made by Siemens.

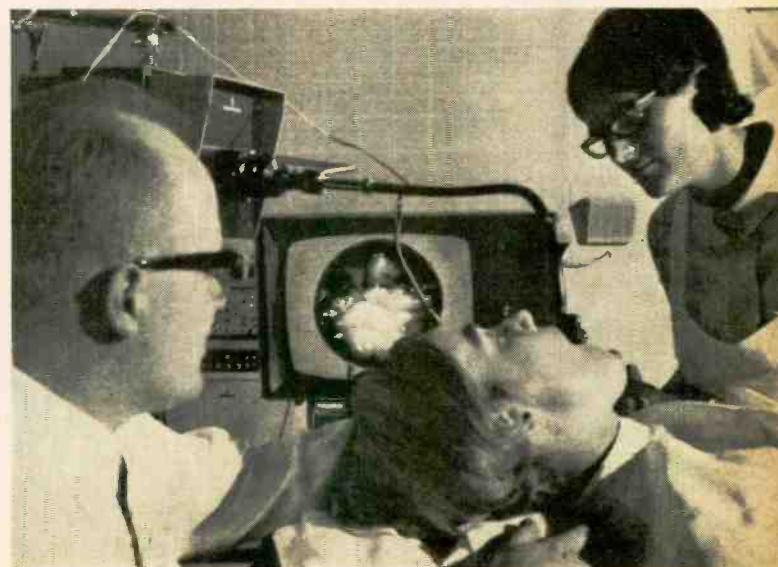

**Picosecond Laser Pulses Measured Directly.** (Below left) Single laser pulses lasting about a trillionth of a second—one picosecond—can now be measured accurately for the first time using a technique devised by Bell Labs. It may now be possible to observe picosecond events occurring in atoms and molecules or to develop new pulse-coding methods for future laser communications systems. The pulse is reflected at a mirror immersed in a clear organic solution, whose molecules fluoresce where the pulse is reflected back onto itself. The pulse is then recorded photographically. By measuring the fluorescent region and relating its length to the speed of light, it is possible to find the duration of the extremely brief pulse.

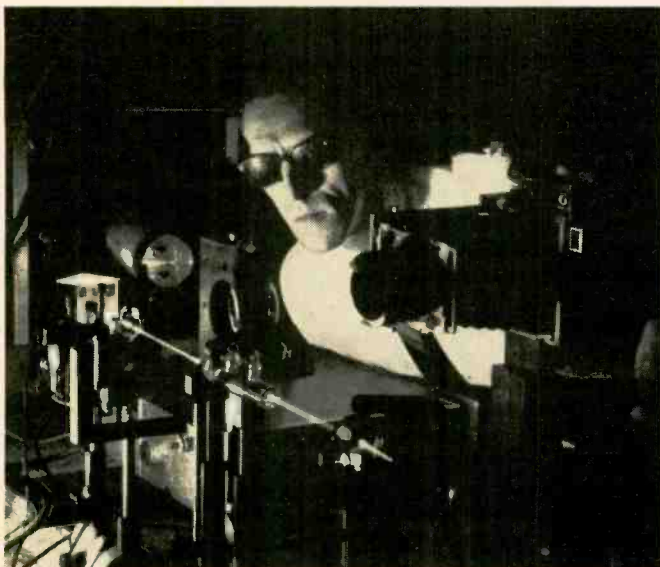



# COIL TUNING RANGE NOMOGRAM

By DONALD W. MOFFAT

*An accurate calculation of the amount of capacitance required to resonate a coil to a given frequency, taking into account the distributed capacitance and the value of the true inductance.*

WHEN a variable capacitor is used to tune a coil to resonance over a selected range of frequencies, the actual tuning range usually measures lower than the calculated values. The difficulty arises when the standard resonance formula is applied to calculate inductance by using a known external capacitor and the measured frequency at which they resonate. Then, attempting to calculate the capacitance which would be required to resonate at other frequencies leads to trouble because the inductance value found in that manner is the *apparent* inductance, a value that varies with frequency. Dependable answers are obtained only if *true* inductance is used.

This nomogram allows an accurate calculation of the conditions at various frequencies, automatically correcting for true inductance, although it does not require that true inductance actually be determined.

A quick look at the meaning of the two kinds of inductance should give an appreciation of the reasons why idealized coils cannot be assumed. Because a coil in a circuit represents an impedance, there will be an over-all voltage drop and a resultant turn-to-turn voltage difference appears to the designer in the form of a distributed capacitance. Therefore, a practical coil must be analyzed as an ideal inductance in parallel with a capacitor, causing a coil by itself to have a self-resonant frequency,  $f_0$ .

When a known capacitor is connected across a coil to find a resonant frequency with which to calculate inductance, the calculation will therefore yield a value of inductance which is too high because of the effect of the distributed capacitance. Such calculations will yield a different value of inductance at every frequency, making it difficult to design a circuit which will tune over a specified frequency range.

This nomogram permits a quick calculation of actual tuning conditions, using a value of distributed capacitance which can be determined by any of several means. (See instructions and Manual of Radio Frequency Measurements, *Boonton Radio Corporation*.) Or, the nomogram can be worked twice: once to determine distributed capacitance and the second time to evaluate the frequency and capacitance for the selected resonance.

First, it will be assumed that the coil's distributed capacitance has already been determined. Find the coil's self-resonant frequency,  $f_0$ , with an instrument such as a grid-dip meter, and locate this value on the horizontal scale at the bottom of the nomogram. Next, locate on the  $f_1$  scale, the frequency at which it is desired to resonate the circuit. Draw a straight line through these two points. From the point where this line intersects the horizontal axis of the curve, proceed straight up to the curve, using the dashed lines as guides. At the curve, turn and proceed straight out to the vertical axis, again using the dashed lines as guides. Draw the final straight line from the vertical axis to the correct value of distributed capacitance,  $C_0$ , and this line will cross the  $C_1$  scale at the correct external capacitance which will tune the circuit to frequency  $f_1$ .

If distributed capacitance has not been found by other means, the first step will be to work the nomogram in a different sequence so as to evaluate  $C_0$ . Find the self-

resonant frequency of the coil alone and then connect a capacitance,  $C_1$ , across the coil and find a new resonant frequency,  $f_1$ . Locate these two frequencies on the appropriate scales of the nomogram, draw a straight line through them, and proceed straight up to the curve as in the preceding instructions. Turn at the curve and go straight out to the vertical axis. The final line is then drawn through the known value of  $C_1$ . Distributed capacitance is read where this line crosses the  $C_0$  scale. This value of the coil's distributed capacitance is then used in working the nomogram, as first described, to calculate external capacitances which will cause resonance at given frequencies.

It is not necessary to perform the steps in the sequence described. For instance, this procedure has assumed that a capacitance is to be found which will cause resonance at a given frequency. The nomogram can be worked in the other direction if it is desired to determine the frequency at which a circuit will resonate when a given capacitor is connected across the coil. Let us now consider an example of how the nomogram is used.

## Example of Using Nomogram

This will be a complex example, showing how distributed capacitance can be determined first. Then the nomogram will be worked through again to calculate a tuning condition. The objective is to predict accurately the capacitance required to resonate a given coil to one megahertz. Three quantities are considered "knowns" at the start: self-resonant frequency ( $f_0$ ) of the coil is 8 MHz and when a 47-pF capacitor ( $C_1$ ) is connected across the coil, resonance moves to 3 MHz ( $f_1$ ).

The nomogram will be worked first to determine distributed capacitance of the coil, using these given numbers, and then it will be reworked, using distributed capacitance as a known quantity, to find an external capacitor which will cause resonance at 1 MHz.

Locate 8 on the  $f_0$  scale and 3 on the  $f_1$  scale and draw a straight line (solid) through these two points. At the intersection of this straight line and the horizontal axis of the curve, proceed straight up (parallel to the nearby dashed line which serves as a guide) to the curve and then turn and proceed straight out to the vertical axis. The last line of this part of the calculation is drawn from the vertical axis, through 47 pF on the  $C_1$  scale, to the  $C_0$  scale. At this intersection, read a distributed capacitance of 6.5 pF.

Now that the coil's distributed capacitance has been determined, the nomogram can be worked in a different sequence to find a  $C_1$  which will tune the coil to 1 MHz. Draw a line (dashed) through 8 on the  $f_0$  scale (self-resonance of a coil is not affected by external connections) and 1 on the  $f_1$  scale. This line crosses the curve's horizontal axis very near one of the dashed guide lines. Proceed straight up next to the guide line, to the curve, and then straight out to the vertical axis. Draw the last line from that point to 6.5 on the  $C_0$  scale (distributed capacitance of this coil remains at 6.5 pF). This line crosses the  $C_1$  scale at a little less than 600 pF, the capacitance which will tune with this coil to 1 megahertz. ▲



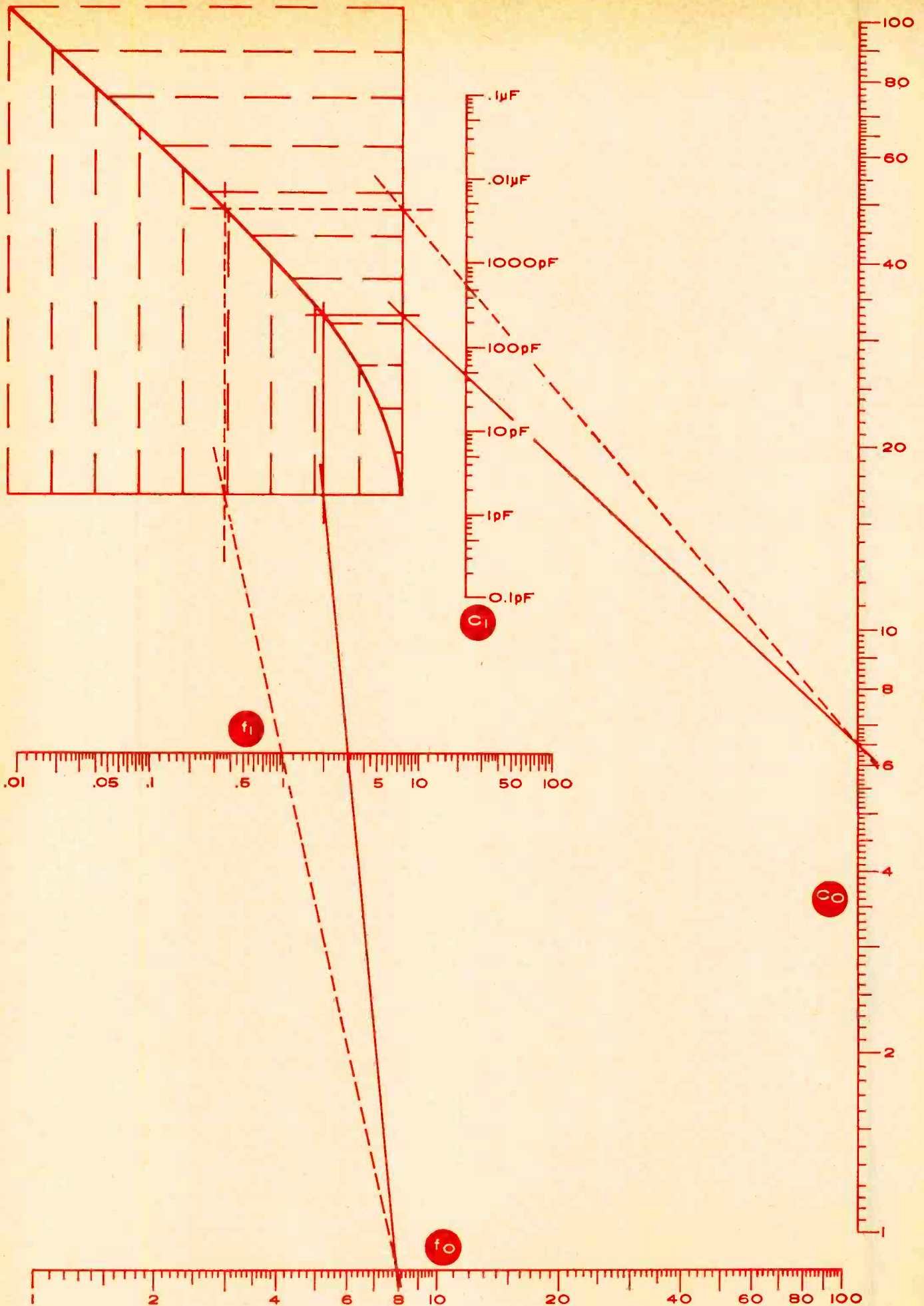

# NEW PICTURE TELEPHONE GOES COMMERCIAL

By MILTON S. SNITZER / Technical Editor

*An improved model of Bell's Picturephone is slated for commercial trial later this year. Here are some of the technical details on this new see-while-you-talk instrument.*



The new Picturephone can transmit drawings or charts which are placed on the desk before it. The "self-view" feature is being used so that the operator can locate his chart properly and see what he is transmitting. Note the small mirror above the lens opening to reflect image into lens.

**I**N last month's article "Ring Two—For Tomorrow" we introduced our readers to the new model of the Bell Picturephone, a video telephone that permits person-to-person communications. Since that article was received by us, we have had a chance to see and use the new instrument. We were so impressed with the picture quality and versatility of the new Picturephone, that we felt it important to bring our readers further technical details.

The occasion of the demonstration was to announce that a

new model of the see-while-you-talk set would be put to use by Westinghouse starting in September. Forty such sets—28 in Pittsburgh and 12 in New York—will be used for at least several months to gauge the usefulness and performance of the system. An earlier model of the picture telephone is now providing limited commercial service between New York, Chicago, and Washington, but these are installed in public places rather than in business offices where they can be used on a day-to-day basis.

## One Megahertz on a Phone Pair

The new model of video telephone not only looks better than the old one, but it represents a real improvement in many areas. For example, it contains a new TV camera tube that provides a better picture under both normal and poor lighting conditions and makes it possible to alter the field of vision for close-up or wide-angle viewing. The screen of the set is 5½ inches wide by 5 inches high, which is larger than that used in the early model. This feature, along with a new camera lens centered over the screen, gives the user more freedom to move from side to side. Although some discrete components are employed, production models of the new set will use many integrated circuits. Video bandwidth has been doubled from the previous value of 500 kHz to the present 1 MHz.

The use of this fairly high video frequency may bring visions of coax cable installations. But the new instrument sends its 1-MHz video signal out over conventional twisted-pair telephone lines. True, an installation requires three phone lines rather than just one, but these are still conventional phone lines. One of the three is used for the voice

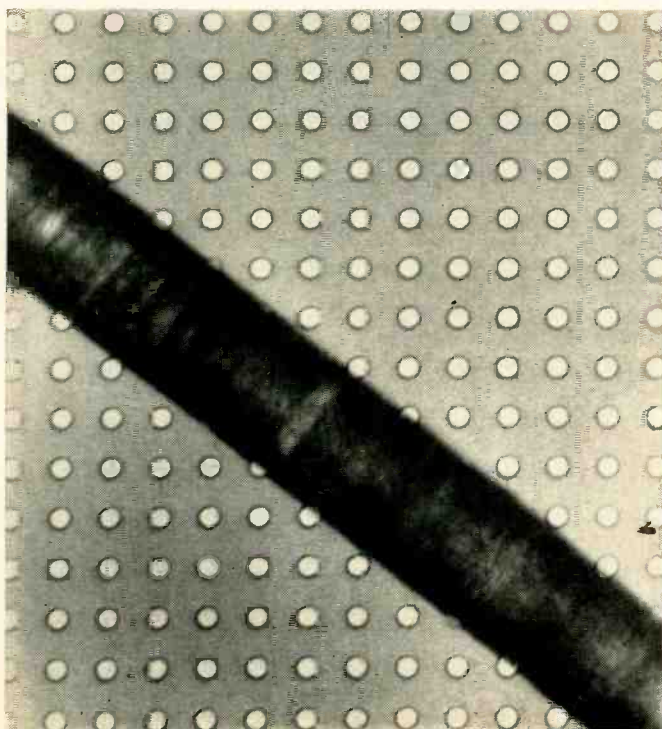

← Here is a magnified portion of target structure of the new camera tube. The entire silicon substrate is about the size of a nickel while the maximum target area measures a half inch on a side. In this area there are about 700,000 silicon photodiodes, each one of which is about 0.3 mil (0.0003 in) in diameter, spaced about 0.8 mil apart. The human hair, shown here for comparison, is about 2 mils thick.



signal, a second is used to transmit the video, and the third to receive the video.

The secret of handling such a wide-band signal over a line that normally carries only 300 to 3000 Hz is the use of closely spaced repeaters. These repeaters, which must be located at 1-mile intervals, employ a brute-force technique for overcoming the rather large amount of attenuation of the phone lines for higher video frequencies. They are highly equalized to restore the reduced high frequencies and they have considerable gain to overcome the losses. Just as long as there are no interference problems, the open lines do a very fine job in handling the video signals that they must transmit.

Once the analog video signals reach a switching terminal, they can be converted into pulse signals that can then be handled over wide-band long-distance microwave, cable, or satellite links.

The scanning rates used in the new set are the same as those used for commercial TV. Interlaced scanning at a frame rate of 30 per second and a field rate of 60 per second is employed. The number of visible lines on the displayed picture, however, is only about half that used for TV, or about 250. Because of the fairly small picture area, though, resolution is excellent.

### New Camera Tube Uses IC Techniques

Getting the credit for most of the improvements in the new Picturephone is its unique TV camera tube that is way ahead of the usual vidicon in many ways. It's this tube that makes the electronic zooming possible without a zoom lens. And it's this tube that allows operation in a very dimly lighted room with an  $f2.8$  lens. Even with all its improved linearity and sensitivity, the new tube is not damaged by excessive light, such as from very brightly lighted offices, or even photoflash lamps. As a matter of fact, laser beams have been shined into the camera tube without any permanent damage.

The new pickup tube looks very much like a conventional 1-inch vidicon. There is one very important difference, however, and that is the nature of the target used. The vidicon has a target, on which the image is focused, made of a thin film of photoconductive antimony trisulfide with a transparent tin oxide backing. The film is fairly touchy in that it must not be subjected to very bright light or very high temperature. The vidicon will have "burn-in" damage if the tube is focused on a bright light for a long time and there will be a permanent reduction of target sensitivity where the light struck. What is more, the electron scanning beam may cause a similar type of damage called "raster burn-in". Hence, if we try to change the size or position of the raster, then the edges of the previous raster will show up clearly in the displayed picture. Therefore, although we can readily make the picture appear to change size and position by merely changing the beam focusing voltage and deflection currents, the nature of the vidicon target keeps us from doing this. In addition to these faults, the vidicon is not fast (you'll see a smear if the displayed object moves rapidly), is not linear, and is not very efficient.

By simply changing the nature of the target, we can with one stroke wipe out all these drawbacks. The target in the new pickup tube is an array of reverse-biased silicon photodiodes. There are no less than 700,000 of them in an area measuring only one-half inch on a side. The entire array is made by the same kind of diffusion techniques that are used to make integrated circuits. The diodes are extremely uniform with practically no defects. Since the scanning electron beam is larger than the spacing between the diodes, the discrete nature of the array does not limit the resolution of the tube.

The photodiodes face the electron beam being emitted from the tube's cathode. When an image is formed on the opposite surface of the target, light penetrates the silicon

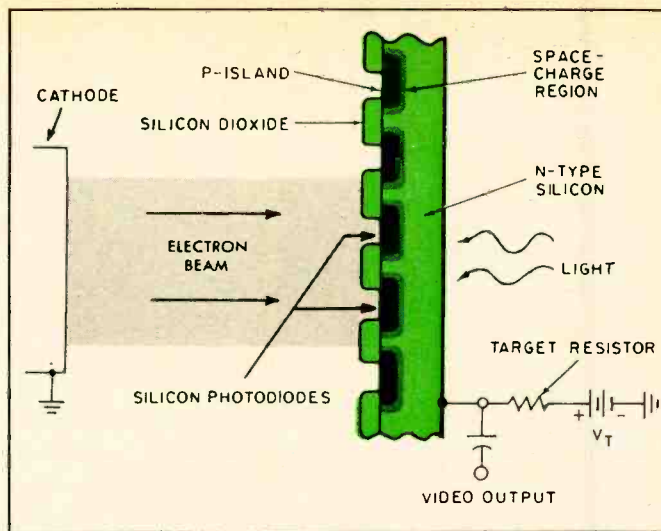
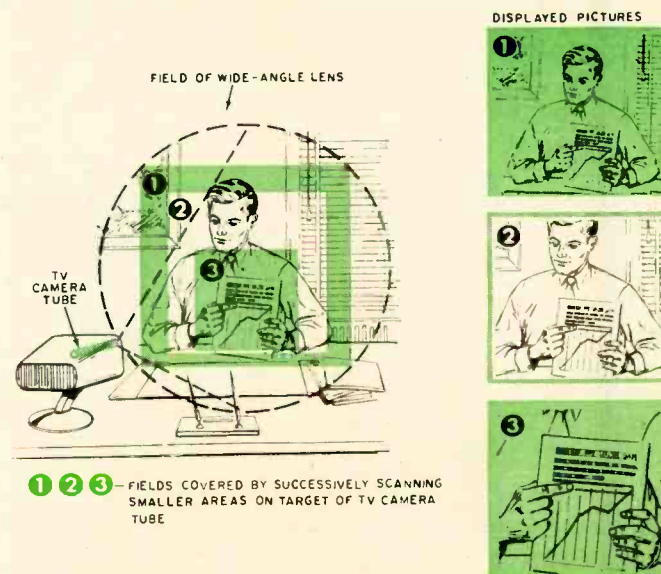

Fig. 1. Cross-section of target of new camera tube. Electron beam scans the diode array and charges "P" islands, reverse-biasing diodes. Holes are created when light strikes silicon substrate, partially discharging diodes. At next scanning, electron beam replaces lost charge and, in so doing, produces an output voltage drop across target resistor which varies in proportion to light. Coupling capacitor picks up output.

substrate and creates hole-electron pairs. The holes sweep across the diode junctions, thereby discharging the photodiodes that were previously charged by the scanning beam of electrons. This discharge occurs between successive scans. The video signal is created as the scanning beam recharges successive diodes. The output signal is directly proportional to the number of holes discharging the diodes and this depends directly on the light intensity (Fig. 1).

The new tube is linear and requires only about one-fifth the illumination needed for the vidicon. It has little or no time lag and is completely free from "burn-in" problems. Hence, electronically controlled zooming and centering may be used (Fig. 2). The silicon target is rugged enough to be baked at high temperatures, so that contaminants are eliminated from the tube while it is being evacuated. This results in a cathode that has a longer life and is more reliable. So, it seems that the new tube is better in every way; it is more sensitive and it should last longer. (Continued on page 74)

Fig. 2. This is how electronic zooming works. The wide-angle lens produces a fixed-size image, a portion of which is scanned from the target of camera tube. By varying the beam accelerating voltage or bias current in the deflection coils the raster position and size is varied to produce displays shown.



# H O L O G R A M S

PICTURES  
IN  
DEPTH

By BENJAMIN J. PERNICK  
Grumman Aircraft Engineering Corporation

*Developed as a technique to correct spherical aberration in electron microscopes, holography has become a new and exciting technology. The bright-ordered beams of laser light help make 3-D holograms of virtually any subject matter.*

**W**ITHIN the past few years laser technology has revolutionized a number of scientific and technical areas. In particular, its application to the development of holography has been most spectacular. Holography was first proposed as a technique for reducing spherical aberration in high-magnification electron microscopes. More recently, holography has achieved a reputation as a dramatic and exciting technology. Originally, holography generated little interest, but the advent of the laser completely reversed the situation. This was due to the practical techniques made possible by special properties of laser light.

A hologram is made by exposing a photographic plate to laser light that has, in part, been reflected or transmitted by a subject. When viewed in ordinary light, the photograph looks smudged and bears no resemblance to the original scene. However, when the hologram is illuminated by the same laser light that made the photograph, one sees a reproduction of the original scene with full perspective and depth.

The word hologram comes from the Greek root "holos" which means complete, whole, or entire record. That is, the hologram contains sufficient detail needed to recreate a realistic object scene in depth. This ability to see an object in three dimensions without optical elements has led to such descriptive names as *lens-less* or *3-D photography*.

## Principles of Holography

Fig. 1 is an experimental arrangement used to generate what is called a Fresnel hologram. In the drawing, a collimated beam of light is intercepted by a beam splitter. A portion of the beam, called the reference beam, is reflected from a good quality first-surface mirror (a mirror with the silver coating on top of the glass instead of between glass layers. This helps minimize interference patterns.) to a photographic plate. The other part of the beam, the object beam, is not diverted by the beam-splitter and passes on to the subject being photographed. The curved and irregular wave fronts of light, scattered and reflected by the subject, are coincident with the plane waves of the reference beam at the surface of the photographic plate.

If an ordinary white light source is used for illumination, rays from the subject and mirror at the plate will not be in-phase or maintain a constant phase difference for any length of time. In other words, the reflected light rays would not be coherent since an incoherent source was used. As a result, the photographic plate would record useless light intensities. A meaningful record can only be obtained if coherent light sources are used.

Naturally coherent light sources were not available prior to the development of the laser. In order to obtain a coherent beam from a conventional light (a high-intensity mercury arc, for example), one had to first select an extremely narrow wavelength or color region. Second, it was necessary to set up an optical system such that the monochromatic light used to make and reconstruct a hologram came from a very small region (ideally a point source, in practice a small pin-hole). With this system, the necessary degree of temporal coherence (monochromatic light) and spatial coherence (point-source approximation) could be achieved. Unfortunately, most of the light was lost trying



to make the source coherent and even with extremely bright sources, the light intensities were too low for use with opaque, scattering objects. Consequently, successful holograms were made only from semi-transparent, two-dimensional objects. Furthermore, long exposure times were needed for photographic recordings. This is a disadvantage because mechanical vibrations alter the relative phase or coherence of the objective and reference beams at the photographic plate. The effect is to destroy spatial coherence.

The laser was the answer because it provided, simultaneously, an extremely high light intensity and very sharp wavelength selection and hence temporal coherence and spatial coherence. Thus the cumbersome procedure for obtaining an appropriate light source was effectively eliminated. A simple discussion of the laser mechanism will suffice to illustrate why a laser is a source of coherent light. In a helium-neon gas laser, for example, an electrical discharge excites a number of atoms of both helium and neon. Some of the excited helium atoms collide with unexcited neon atoms and give excitation energy to the neon atoms. Thus the number of neon atoms in an excited energy state is greater than if no helium atoms were present. These excited neon atoms fall to a lower energy state or excitation level and, in doing so, radiate light (monochromatic light whose frequency is just the energy difference between higher and lower levels). Under these conditions, the excited atoms relax and release their stored energy in unison, that is, coherently. Since this resonant radiation passes through the gas in essentially one dimension, a laser produces an intense, directional beam of coherent light.

When a laser is used as a coherent, monochromatic light source for a hologram, the light striking the plate in Fig. 1 has four components. The first two are the reference and object beams which comprise the light which bathes the surface of the subject and which acts as a bias or d.c. component. They influence the exposure level and time.

The remaining two light intensity components are instrumental in producing the hologram images. They represent a mixing of the reference and object beams (more accurately, a product of the amplitude of both beams). The light intensity distribution or interference pattern is photographed and then developed to form the line images on the photographic plate. The developed hologram is illuminated by the reference beam only. This is shown in Fig. 2.

### Adaptation of the Techniques

Multiple scenes can be recorded on the same holographic plate. During the first exposure, the reference beam and object beam are coherently mixed and recorded. The combined beam light intensity of the first scene is recorded on the film as an amplitude transmittance,  $\sqrt{T_1}$ . A second exposure is made with a different object and its light intensity distribution is recorded. The total intensity on the plate is the sum of all the intensities and the resulting amplitude transmittance is  $\sqrt{T_1} + \sqrt{T_2} + \dots + \sqrt{T_N}$ . Reconstruction will yield distinct virtual and real images of each individual scene.

Each image can be readily seen by changing the direction of view. A multiple-scene hologram can be made with one exposure. However, due to mixing of the reconstructed beams, the image quality is degraded. Reasonable quality reconstruction can be obtained if the object beams are well separated.

An interesting extension of this technique is to record a subject with laser light of different colors, for example, blue and green from an argon laser or red from a helium-neon laser. Since blue, green, and red are primary colors, a hologram viewed with multi-colored beams yields a virtual image seen in its original coloring. Other colors can be generated by appropriate mixing. Image quality degradation can also be controlled by proper orientation of the multi-color beams.

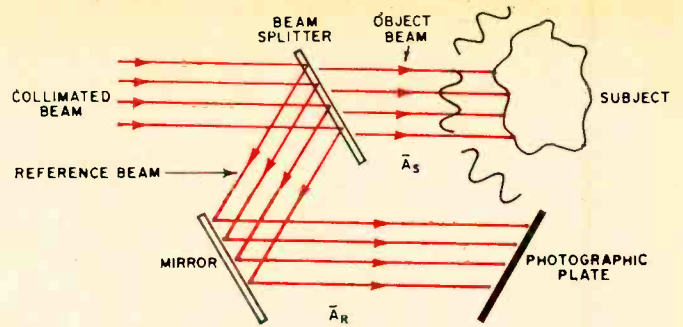

Fig. 1. An experimental setup used to make Fresnel holograms. A beam splitter divides collimated light into the object and reference beams,  $\bar{A}_s$  and  $\bar{A}_r$ , that serve to compose the picture.

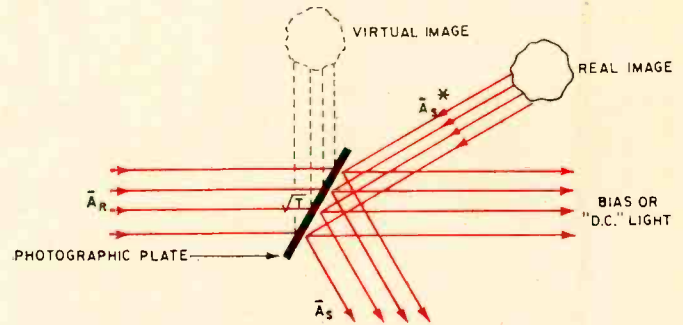

Fig. 2. Developed hologram is illuminated by reference beam. Lenses are not needed to project a real image onto a screen and the naked eye sees the virtual image in three dimensions.

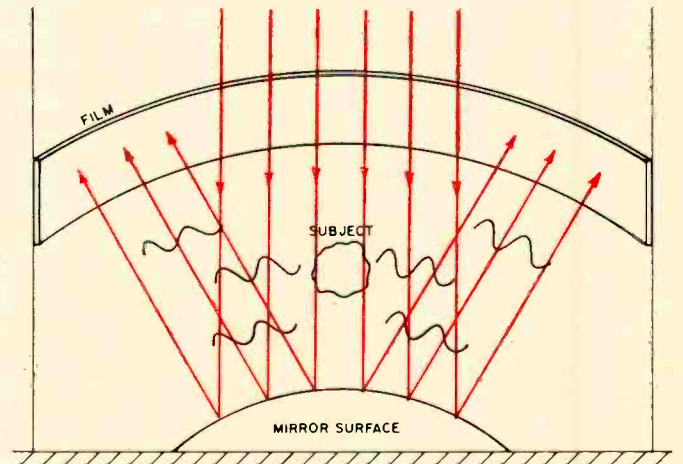

Fig. 3. A 360° hologram can be made by wrapping film around the inside of a cylindrical support in such a way that it picks up light reflected from the subject and curved mirror.

A different approach to color holography has recently been investigated. This technique utilizes the thickness of the photographic emulsion rather than the surface. In essence, a three-dimensional recording is generated throughout the emulsion. This is possible because of the extremely sharp color selectivity of the three-dimensional grating. To generate a volume hologram, multi-color reference and object beams strike on opposite sides of the film emulsion and color-selective interference patterns are generated throughout the emulsion. The hologram images can then be reconstructed with the multi-color beams, or more dramatically, with a white light point source. Both colored virtual and real images are obtained. More recent work has led to color holograms using sunlight as a reconstruction source. This is a most interesting development since it eliminates the laser as a source of light for image reconstruction.

Another interesting technique designed to produce a 360°



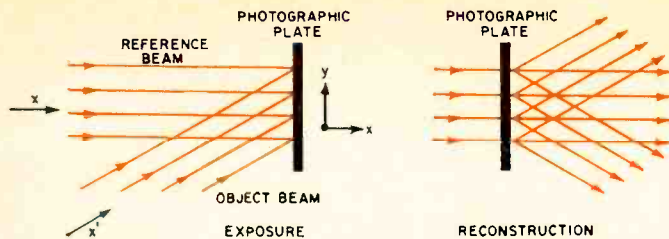

Fig. 4. The original electric field distribution is recreated during the reconstruction process. Here  $\theta$  is the angle between object and reference beams at photographic plate surface.

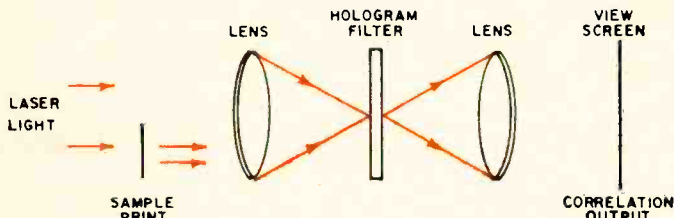

Fig. 5. Holography can aid in fingerprint identification. A number of prints can be stored on film. Correlation is made by observing the light intensity pattern on the hologram.

hologram has been attempted. With a  $360^\circ$  hologram, one can see completely around an object by rotating the film record. An experimental set-up used to record a  $360^\circ$  hologram is shown in Fig. 3. The object is mounted on top of a curved mirror and both the object and mirror are illuminated from above by a laser. A strip of film is wrapped completely around the inside of a cylindrical support. Light is scattered in all directions by the object and mixes coherently at all points along the film strip with the reference beam reflected upward by the mirror. To view the reconstructed hologram all that is required is to place the film back in position, remove the object, and illuminate the mirror. By walking around or rotating the film strip, one will see the hologram image turn completely around. The image can also be viewed by holding the film flat in the illuminating beam. However, it will be distorted. Because good-quality curved mirrors of large diameter are expensive, this technique is usually limited to small objects.

### Experimental Problems

The ability to record good-quality holograms depends upon several factors. One of the most important is film resolution. An interference pattern is made up of a large number of closely spaced lines that form a grating-like structure. The line separation depends upon the angle between beams. However, large angles are needed to physically separate real and virtual images upon reconstruction. On the other hand, large angle-beam separation results in extremely small line spacing. Therefore, the recording film must be capable of responding to a close-spaced line structure. Since film grain size determines the ultimate line spacing, extremely fine-grain emulsions must be used to record and yield a crisp, clear hologram image. Type 649 high-resolution film has been used extensively. It is capable of resolving lines that are spaced on the order of  $1/2000$  mm apart.

Since this film is extremely slow (ASA approximately 0.05), long time exposures or high light intensities are required. Both are undesirable features from an experimental point of view. A high-intensity laser, on the other hand, is not the ultimate answer since the spatial coherence of such a laser is usually less than that of a weaker counterpart and spatial coherence must be considered when objects of relatively large dimensions are to be photographed holographically. If the object size exceeds the inherent coherence length of the laser, the reconstructed image will appear fuzzy and washed out at its edges.

Field of view is also a consideration. The photographic plate acts like a window and when looking at the hologram images, the smaller the window of film size, the smaller the field of view. To record a large film format, the reference beam must also be large. This results in a decreased light intensity level.

Distortions are also present when the hologram is not reconstructed in a manner similar to the way it was made. If the original exposure was taken with a parallel beam and the reconstructed images viewed with a diverging (or converging) beam, aberrations similar to those in ordinary lenses are introduced. (The idea behind using different beam shapes for production and for viewing is to obtain image magnification. This is one of three ways to magnify a scene, and by far the most convenient. Alternate ways are, first to reconstruct at a higher wavelength and then magnify the image by the ratio of the two wavelengths, or to copy the hologram with reduction. The latter method is least desirable since fine details in the interference patterns are lost in copying.)

### Applications

One of the significant uses for holography has been in the study of small-scale static deflections and deformations. Since the hologram is a record of an interference pattern, slight alterations of an object will produce changes in the record. This property has led to the development of holography as a tool for measuring extremely small dimension changes (on the order of one wavelength of light). It can also be used for strain measurements of delicate mechanical devices, precision alignment, and testing of optical equipment. The procedure is straightforward but requires great alignment precision. After the hologram plate has been exposed and developed, it is returned to place in the original set-up. If changes have occurred in the object and if the object and hologram are illuminated and viewed simultaneously, the changes will be evident by the presence of light and dark fringes. Since each fringe corresponds to a dimensional change of one wavelength, object deformations can be determined by fringe counts.

Vibration patterns in mechanical structures can also be studied as long as they are steady and kept reasonably small during the exposure time. The hologram is made while the object is in motion. Sections of the hologram image that represent stationary parts of the object appear bright, whereas portions in motion are indicated by dark fringes or fuzzy areas. This application is indeed very promising. It offers a complete vibration study of complicated structures (or models if size is a problem), and eliminates the need for tedious and costly point-by-point measurements that cannot give an over-all picture. Sensitivities are again on the order of one wavelength.

High-resolution microscopy, ostensibly the reason for holography, has not been neglected. The promise of magnifications of  $10^6$  are very appealing, but two major problems must be overcome. First, coherent beams of electrons or x-rays (for an x-ray microscope) are hard to come by and difficult to deflect because good reflectors do not exist at this radiation frequency. Second, since the interference fringe spacing is determined by the wavelength of the illuminating light, such a hologram would require spatial resolution far beyond the capability of photographic emulsions. Some progress has been reported by several investigators. A modified holographic technique, called the *lensless Fourier transform* method has been proposed whereby one can record these extremely fine fringes as broader fringes on photographic film. This is a major step towards the goal of ultra-high magnification.

The hologram as a memory storage device has received much attention. Because of the high resolution (and convenience) of photographic film, high information-storage capabilities are available. Investigations concerning applica-



# Mathematics of Holography Process

THE manner in which a hologram recording process produces 3-D images can best be described mathematically. In the experimental set-up of Fig. 1, the light source is now a laser and  $\bar{A}_R(r,t)$  represents the reference beam's electric field vector, and  $A_S(r,t)$  the object field vector. The resultant electric field vector  $A_T(r,t)$  is in the plane of the hologram plate and is the sum of the two vector amplitudes, or:

$$A_T(r,t) = \bar{A}_R(r,t) + \bar{A}_S(r,t) \quad (1)$$

These field vectors are functions of time,  $t$ , and space coordinate,  $\bar{r}$ , and are generally expressed as complex quantities. The time dependence for each vector can be written explicitly as  $A_R(r,t)$  equals  $A_{R\text{exp}}(i\omega t)$ , etc. Since  $\omega$  is constant for monochromatic light, Eq. (1) becomes:

$$\bar{A}_T = \bar{A}_R + \bar{A}_S \quad (2)$$

At any point in space, the light intensity of coherently mixed beams is the product of  $A_T^*$  and its complex conjugate  $A_T$ . Therefore:

$$I = A_R^2 + A_S^2 + \bar{A}_S \cdot \bar{A}_R + \bar{A}_S^* \cdot \bar{A}_R \quad (3)$$

Light intensity distribution does not depend on time, and the quantities  $A_R^2$  and  $A_S^2$  represent the light intensity of reference and object beams separately. These quantities are not directly involved in image reconstruction but act as a light intensity bias or d.c. component. The bias light level influences film exposure level and time.

The light intensity distribution or interference pattern given by Eq. (3) can be photographed and developed. But the development process must be tightly controlled so that the film's transmission characteristics are proportional to light intensity at the plate over as wide a range as possible. If  $D$  represents film darkening or density and  $T$  the film transmission, then  $D$  is equal to  $-\log T$ . However, the square root of transmission or amplitude transmittance,  $\sqrt{T}$ , is the important film characteristic. The  $\sqrt{T}$  and  $I$  must be linear. For a given film emulsion,  $\sqrt{T}$  versus  $I$  curves depend on development time and temperature.

Let the light intensity levels, exposure time, and development time be correct. The developed hologram plate is only illuminated by the reference beam. Fig. 2 shows this arrangement. If  $\bar{A}$  represents the electric field vector of the light after it has passed through the hologram and  $\sqrt{T}$  equals  $kI$  (where  $k$  is a constant), then:

$$\bar{A} = kI \bar{A}_R \quad (4)$$

For the case where the reference beam is a plane wave,  $\bar{A}_R$  has a simple form, namely  $A_R = C_{\text{exp}}(i\varphi)$ . Here  $C$  is a constant vector and  $\varphi$  is a phase angle. For simplicity, take  $k$  and  $C$  equal to 1. Then combining Eqs. (3) and (4), the electric field vector is:

$$\bar{A} = I_{\text{exp}}(i\varphi) = \{1 + A_S^2\}_{\text{exp}}(i\varphi) + A_S + A_S^*_{\text{exp}}(i,2\varphi) \quad (5)$$

The electric field transmitted by the hologram is made up of three components: a d.c. or bias term, the reconstructed field, and a conjugate field  $A_S^*_{\text{exp}}(i,2\varphi)$ . The reconstructed field  $A_S$  is a three-dimensional view of the subject that one sees if looking in the direction indicated in Fig. 2. This is the virtual image. Since the

original field distribution  $\bar{A}_S$  is regenerated during reconstruction, one can think of a hologram as capturing light rays from a subject, and then releasing the rays upon reconstruction. The conjugate field produces a real image that can be projected on a screen for viewing.

## A Simple Example

To illustrate these results, let the object be another mirror reflecting plane waves in the direction of the hologram plate. The angle between the direction of propagation of this object beam and reference beam is  $\theta$  (see Fig. 4). Establish an x,y,z coordinate system with an origin at the hologram, and whose x-direction is in line with the reference beam path. The electric field vectors are:

$$\begin{aligned} \bar{A}_R &= \hat{z}_{\text{exp}}(i2\pi x/\lambda) \\ \bar{A}_S &= \hat{z}_{\text{exp}}(i2\pi x'/\lambda) \end{aligned} \quad (6)$$

where  $x' = x \cos \theta + y \sin \theta$ ,  $\lambda$  is the laser wavelength and  $\hat{z}$  is a unit vector in the z-direction (out of the page). Equal reference and object beam intensities are assumed. The light intensity exposing the hologram, given by Eqs. (3) and (6), is:

$$I = 2 + 2 \cos [2\pi (x - x')/\lambda] \quad (7)$$

Now  $(x - x')$  equals  $x - (x \cos \theta + y \sin \theta)$ . At the plane of the hologram,  $x = 0$  and  $(x - x')$  is equal to  $-y \sin \theta$ , so

$$I = 2 + 2 \cos [2\pi y \sin \theta/\lambda] \quad (8)$$

The intensity distribution illuminating the film is composed of a constant bias level plus an oscillating term which depends upon position. The points at which the intensity is a maximum occur when  $2\pi y \sin \theta/\lambda = 0, \pm 2\pi, \pm 4\pi$ , etc. Minimum points are found when  $2\pi y \sin \theta/\lambda$  equals  $\pm \pi, \pm 3\pi, \pm 5\pi$ , and so on.

The transmission variations across the hologram which are similar in shape to the intensity distribution, resemble a line grating. Peaks and valleys are separated by a distance:

$$d = \lambda / 2 \sin \theta \quad (9)$$

Illuminating the developed hologram with the reference beam alone results in an electric field transmitted by the plate, and neglecting the constant factors:

$$\bar{A} = \hat{z}_{\text{exp}} [i2\pi x/\lambda] \{1 + \cos [2\pi y \sin \theta/\lambda]\}$$

Writing the cosine term in exponential form and combining, one has finally:

$$\bar{A} = \hat{z} \{ \text{exp}(i2\pi x/\lambda) + \text{exp}[i2\pi (x + y \sin \theta)/\lambda] + \text{exp}[i2\pi (x - y \sin \theta)/\lambda] \}$$

The first term corresponds to the d.c. plane wave component, propagated in the x-direction. The second and third terms also correspond to plane waves but these waves travel in directions determined by:  $x + y \sin \theta = \text{constant}$  and  $x - y \sin \theta = \text{constant}$ . These equations define the planes of constant phase or wavefronts for the outgoing signal beams. Ray directions are perpendicular to these wavefronts.

tions to character recognition and matched filtering, where large capacity is required, have been carried out. One such area where holographic techniques have proven successful is in fingerprint recognition (Fig. 5). A quantity of prints can be stored on film by holographic means and handled at one time. If a stored print matches a sample print, the correlation is indicated by a light intensity pattern. An optical system for fingerprint identification has recently appeared on the market. High speed and convenience of operation are outstanding features of this device.

Holograms have been used to correct lens aberrations in optical systems. Since a hologram changes the wavefront of a coherent light beam, wavefront distortions can be reduced

by using a special hologram to correct or compensate for the aberrations. The hologram is constructed using the lens system to be corrected.

Three-dimensional movies and television are applications that have been proposed for some time. Short film strips have been made with small animated subjects. The primary obstacle has been that the hologram movie must be made at a slow rate with a small field of view (due to low light intensity levels). And, aside from large-scale movie projection problems or difficulties in reconstructing the 3-D image in home TV sets, the project is costly. On the other hand, limited 3-D movies or TV displays for use in simulation programs or to train personnel in (Continued on page 75)

# TRANSISTOR'S

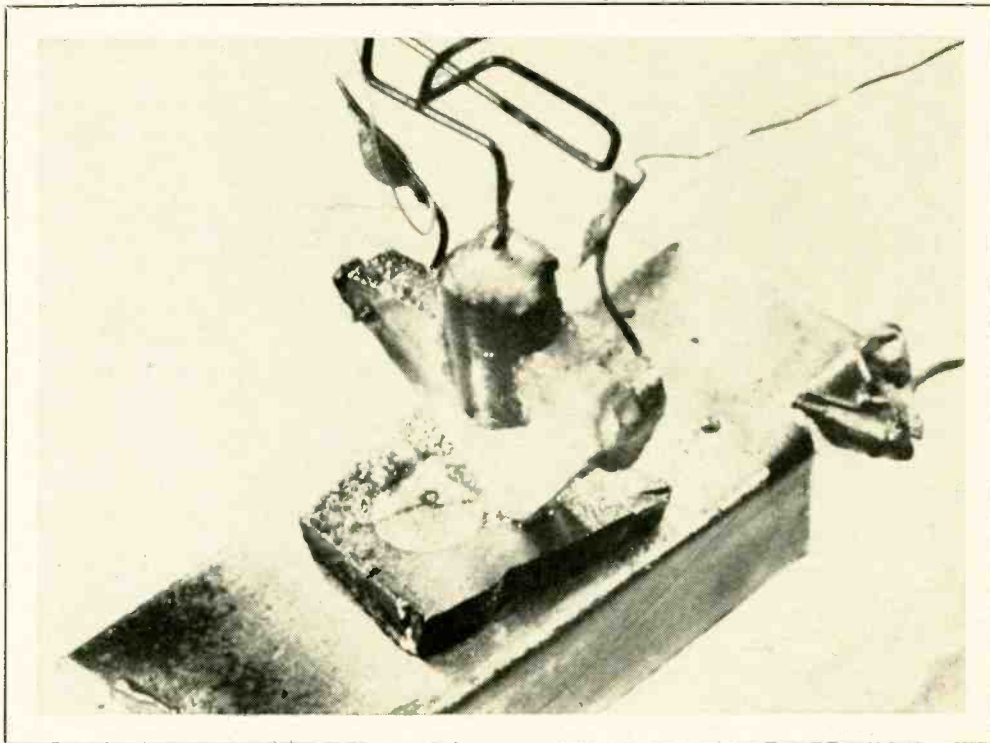

This first transistor consisted of a small bit of germanium along with two closely spaced "cat-whisker" contacts. The device actually produced a power gain of 40 in an audio circuit that was diagrammed in the inventor's notebook. During the following year, 1948, the junction transistor was patented.

## 20th Anniversary

*Just over two decades ago, scientists showed that a small piece of germanium could amplify speech signals. The invention, for which a Nobel Prize was later awarded, has given rise to what is now a multibillion-dollar industry.*

**O**N December 23, 1947, a little more than 20 years ago, *Bell Labs* scientists John Bardeen, Walter Brattain, and William Shockley showed that a small piece of the element germanium could be made to amplify a speech signal about forty times. Later, in 1956, the trio was given the Nobel Prize for discovery of the transistor effect.

The invention has resulted in the growth of the multibillion-dollar transistor industry, with scores of companies employing hundreds of thousands of people. Transistors are everywhere—in homes, banks, automobiles, factories—even on the ocean floor and in outer space. They activate radios, TV sets, hearing aids, and telephones. They control industrial equipment. They drive wristwatches, power tools; big ones even drive locomotives. They make complex calculations in giant computers, and process TV pictures from the moon. They even prolong life in "Pacemakers" that stimulate heartbeats.

Transistors have played a vital role in communications and information processing. In telephony; the underseas cables, new central offices, and radio transmission are made possible or greatly improved by transistors. Today's giant computers contain over 100,000 transistors, connected to-

gether to enable the machine to make millions of calculations per second.

Transistors are able to perform all of the functions of vacuum tubes. They can amplify electrical signals, act as oscillators, or control and combine pulses of current. For practically every application they are less expensive, more reliable, smaller, and they consume less power than vacuum tubes.

The transistor is not only one of the great inventions of the twentieth century, it has also led to a host of advances in other scientific fields. For instance, zone refining, invented at *Bell Labs* by William Pfann to purify transistor materials, has made ultra-pure materials available for all sorts of technical and scientific purposes. The increased interest in the properties of solids has led to other "quantum electronic" devices, such as lasers, light amplifiers, and light modulators. The study of surface properties of materials, vital to transistor technology, has progressed to a point where active atoms can be detected in single layers in one-in-a-million concentrations.

Recently, transistor technology has been applied to making integrated circuits—complete electronic circuits fabri-



cated on one paper-thin wafer of material. An integrated circuit containing 50 to 100 transistors and other circuit elements can fit on the head of a pin.

This miniaturization is important for compact equipment; moreover, along with size, it means reduction in cost and increase in operating speeds. Today, tiny transistors and other components in an integrated circuit can perform a function at 100 times less cost and with 1000 times the reliability of doing the same job with vacuum tubes and with vacuum-tube circuits.

### Significant Events in Development

Right after World War II, physicists John Bardeen, Walter Brattain, and William Shockley, and many other scientists, turned full time to semiconductor research. Research was centered on the two simplest semiconductors—germanium and silicon. Experiments led to new theories. For example, Shockley proposed an idea for a semiconductor amplifier that would critically test the theory. The actual device proved to have far less amplification than predicted. Bardeen then suggested a revision of the theory that would explain why the device would not work and why previous experiments had not been accurately foretold by the older theory. In new experiments designed to test the new theory, Bardeen and Brattain discovered an entirely new physical phenomenon—the transistor effect.

The initial patent on the transistor was held by W. Brattain and J. Bardeen. This transistor was called the “point-contact” type because the transistor effect was produced by two pointed metal contacts on the surface of a germanium semiconductor material. When a small positive potential was applied to one of the contacts, holes flowed into the germanium surface, greatly increasing the flow of current from the germanium to the other point which was negatively biased.

W. Shockley patented the junction transistor in 1948. Nearly all transistors today are classed as junction transis-

tors. They are essentially solid-state devices having three layers of alternately negative or positive type semiconductor material.

Through the years, there were developed new types of junction transistors that performed better and were easier to construct. In the early 1950's work at G-E, RCA, and Bell Labs led to a commercial process for making germanium transistors by alloying techniques. Further impetus was given to the transistor industry in 1954 by the Bell Labs development of diffusion or oxide-masking techniques for making p-n junctions. Earlier, development of the revolutionary zone-refining technique made available ultra-pure semiconductor crystals. The immediate product of these two advances was the diffused-base, high-frequency transistor that was mass-produced at a reduced cost. In the same year, 1954, Texas Instruments was the first manufacturer to devise a method for making silicon transistors on a commercial scale.

Another important innovation, made by Fairchild Semiconductor in 1960, was a new type of planar geometry for the junction transistor based on the earlier oxide masking and diffusion techniques. During the same year the epitaxial transistor was developed at Bell Labs, further improving performance and lowering costs.

Many other devices have been derived from the transistor which have their own unique capabilities. Among these are devices for handling high power, generating microwaves, and detecting extremely weak signals at optical and microwave frequencies. The basic transistor technology also led to the development of integrated circuits in which arrays of circuit elements are manufactured simultaneously rather than singly.

Through the invention of the transistor and its resulting development, the future of our society has been profoundly affected. Better world-wide communications, automatic control equipment, and the ability to process large amounts of information are vitally necessary to modern life. ▲

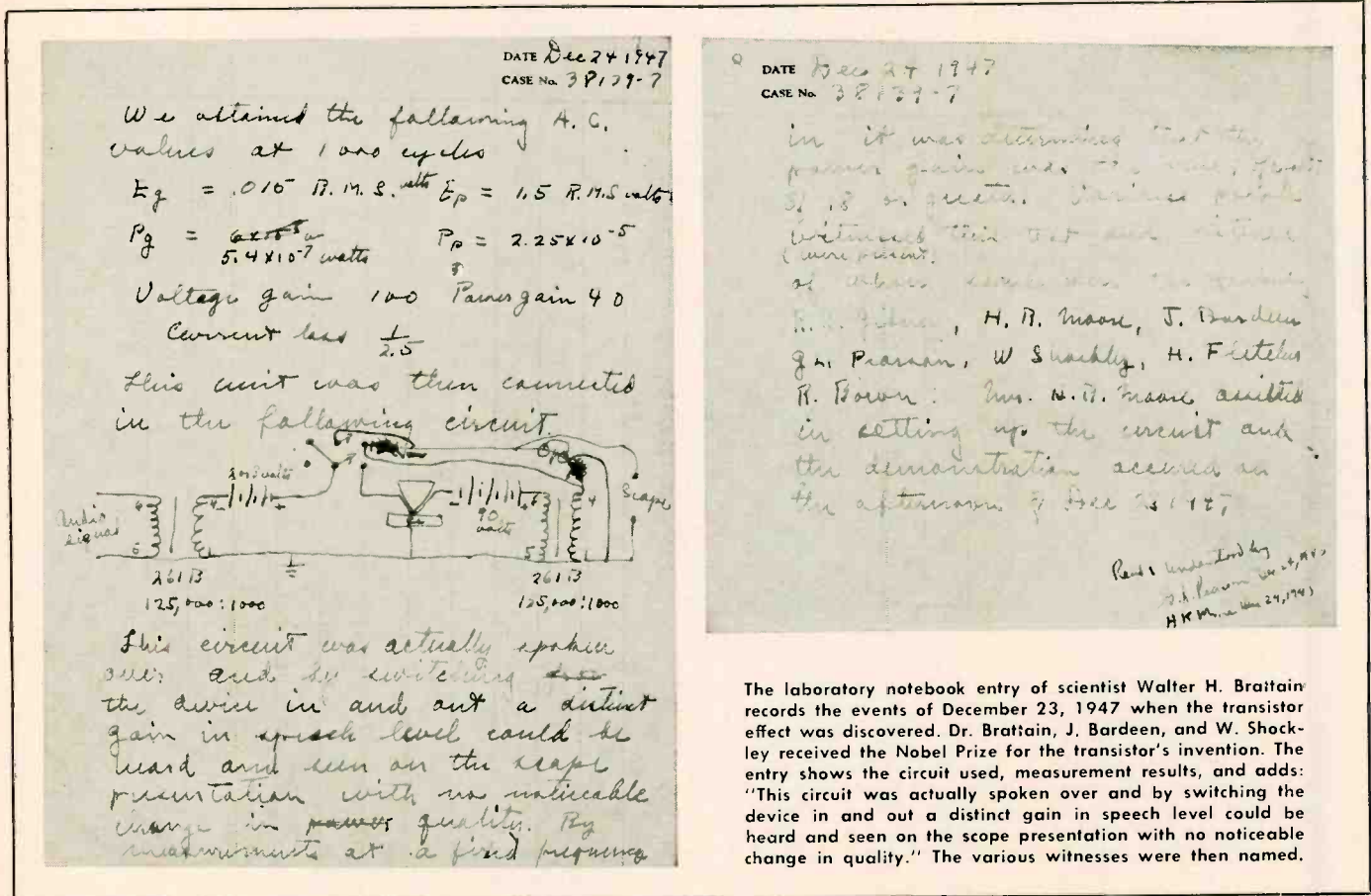

# Linear Pots and



## STRAIGHT LINES

By JOHN DOERING/Chief Engineer, Product Design  
Helipot Div., Beckman Instruments, Inc.

*If engineers understood the terms which describe a precision potentiometer's linearity, they would save time and money and get the best part for the job.*

**L**INEARITY is perhaps a precision potentiometer's most important characteristic—and also one of the most confusing. There are a number of basic types of linearity and this frequently causes misunderstandings between designers on a project or between designers and manufacturers. Such confusion can result in poor circuit performance, extra costs, unnecessary component rejections, and frustrating delays. A thorough knowledge of the various types of linearity—and the correct usage and terminology for each—can help engineers avoid such problems. But first, what types of linearity are we concerned with?

### What is Linearity?

Any discussion of linearity requires an understanding of the three basic elements illustrated in Fig. 1. First, the engineer must have a picture of the potentiometer's output(s). This is obtained by connecting the potentiometer as shown and recording the output voltage while rotating the shaft. (In actual practice only the output voltage deviations from a theoretically perfect master are of interest.) Next, he must establish a straight line from which to measure deviations (b) and then he must have a means of expressing linear errors that does not depend on rotation, resistance, or test voltage (c). This is accomplished by expressing the maximum deviation of the output curve (in

volts) as a percentage of the applied voltage. Errors in linearity are always understood to be plus or minus even though the maximum deviation may not occur in both directions.

In other words, no matter how linearity is defined, it is always a measure of the deviation of the potentiometer's actual output voltage from some straight reference line and is always expressed as a percentage of the applied voltage.

The only difference among the various definitions of

Fig. 1. Potentiometers are called linear when their outputs follow a straight line. Linearity errors can be plus or minus.

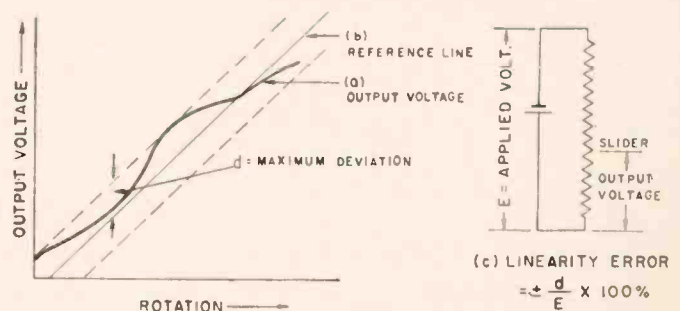



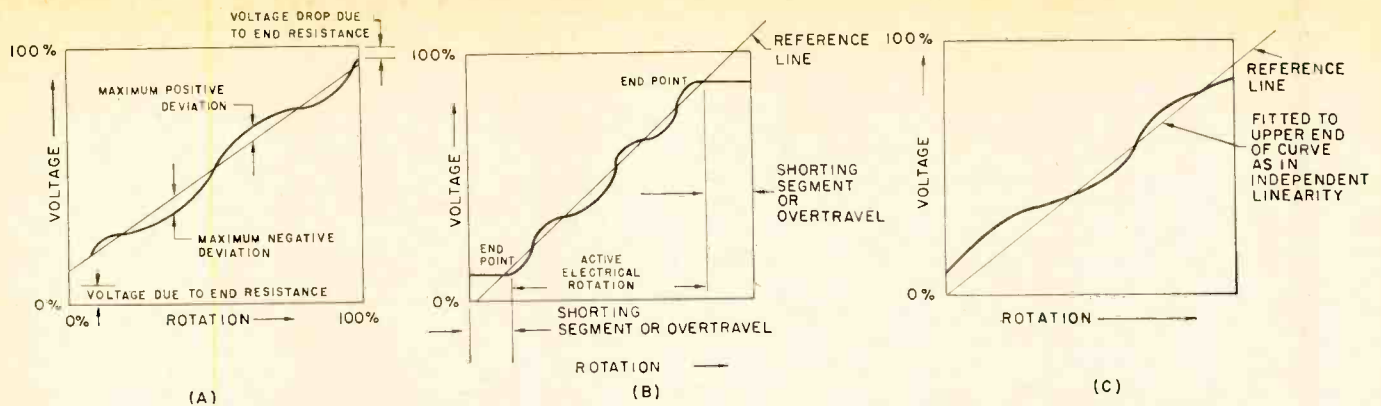

Fig. 2. (A) A potentiometer whose deviation is measured over its "active electrical length", or "end points" (B), is independently linear. The reference line of a zero-based linear pot (C) passes through 0% voltage point at 0% rotation.

linearity is in the position of the reference line. There can be just as many definitions as there are ways of drawing reference lines on an output *versus* rotation chart. However, there are only four generally accepted definitions: independent, zero-based, terminal-based, and absolute linearity.

### Independent Linearity

In independent linearity, voltage deviations are measured from a reference line placed to minimize the maximum excursions. By definition, then, a potentiometer can have no lower linearity value than its independent linearity figure. In this case, the positive and negative errors are equal.

The significant feature of this measurement is that the reference line's slope and position are determined only by the output curve and thus may assume any value (Fig. 2A). In actual practice, they are held within reasonable limits by specifying the maximum end resistance. However, it

is important to remember that independent linearity is a measure of the "straightness" of the potentiometer output. Other types of linearity measurements relate the potentiometer's output to some other factor, such as an index point or rotation.

Independent linearity is nearly always defined as being measured over the "active electrical rotation" or between the "end points". These are equivalent expressions and are illustrated in Fig. 2B. Only that part of the output curve between the end points was considered in determining the position of the reference line. Engineers often specify this type of linearity when trimmers are available to adjust end voltages, as for example, in XY plotters. However, independent linearity is not used when maximum accuracy is required.

In spite of this limitation, independent linearity is the most commonly used type, since it is adequate for most applications and is the least expensive.

### Zero-Based Linearity

In zero-based linearity, the reference line passes through the zero voltage point at 0% potentiometer rotation (Fig. 2C). The potentiometer's upper end is adjusted to minimize deviations. In this type of linearity, the reference line's position is specified, but the slope is unrestricted except, as in independent linearity, by the actual output curve of the potentiometer. Standard practice is to consider the counterclockwise end point as the 0% rotation point.

Engineers specify zero-based linearity when the linearity at the beginning end point must be held within a certain tolerance. If the tolerance were not held, a voltage of opposite polarity would be required to compensate for the beginning-end voltage error and a trimmer to compensate for errors at the other end. This could be an expensive technique and should be avoided if possible.

### Terminal-Based Linearity

In terminal-based linearity, the reference line must pass through the 0% voltage point at 0% rotation and the 100% voltage point at 100% of the active rotation.

In Fig. 3A, it is obvious that the slope of the reference line is much more restricted than when using zero-based linearity. Figs. 3B and 3C, however, show that the slope (in terms of voltage change per degree) can still vary within certain limits. The limits are determined by the tolerance on electrical rotation.

In many applications, a particular potentiometer is picked to match a circuit and if the potentiometer is replaced, the entire circuit or system must be recalibrated. Therefore, circuits that utilize this type of linear potentiometer are more expensive. For this reason, this definition is almost never used today. It has been superseded by the specification "absolute linearity".

## STANDARD LINEARITY DEFINITIONS

(Revised Standard Terms and Definitions, July 1964. Precision Potentiometer Manufacturers Association—now Variable Resistive Components Institute.)

**Independent Linearity:** The maximum deviation of a potentiometer output from a straight reference line whose slope and position was chosen to minimize error. It is expressed as a percent of the total applied voltage.

**Zero-Based Linearity:** The maximum deviation of a potentiometer output from a straight reference line drawn through a specified minimum output ratio and extended over the component's actual electrical travel and rotated to minimize deviations. Unless otherwise specified, the minimum output ratio is zero.

**Terminal-Based Linearity:** The maximum deviation of a potentiometer output from a straight reference line drawn through specified minimum and maximum output voltage ratios which are separated by the component's actual electrical travel. Unless otherwise specified, minimum and maximum output ratios are zero and 100% of applied voltage.

**Absolute Linearity:** The maximum deviation of a potentiometer output from a straight reference line drawn through the specified minimum and maximum output ratios which are separated by the theoretical electrical travel. An index point on the actual output is required.

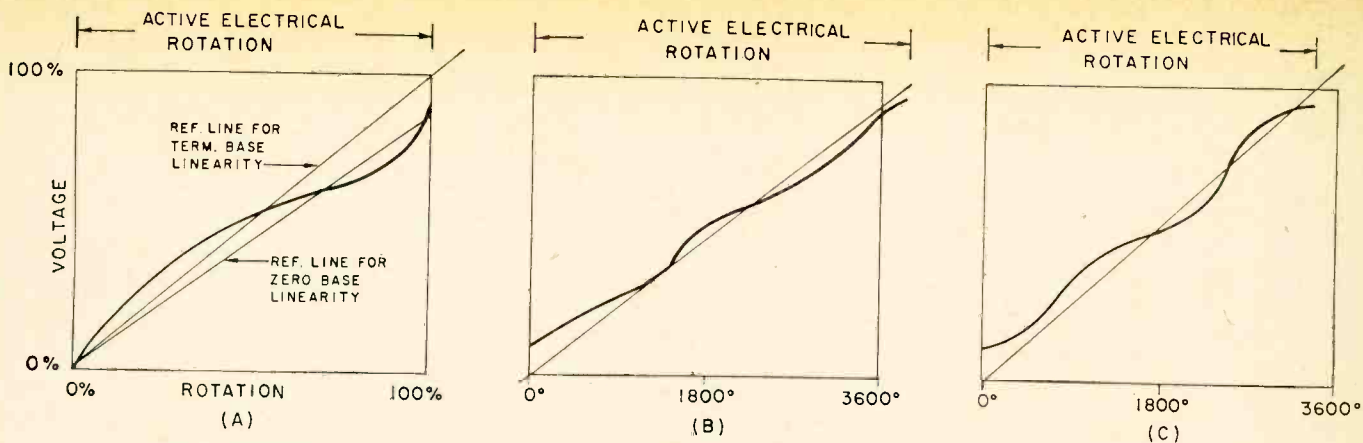

Fig. 3. Although the reference lines of terminal-based potentiometers pass through zero voltage at 0% rotation and maximum voltage at 100% rotation, slope can vary within certain limits as indicated by linearity graphs.

### Absolute Linearity

In absolute linearity, the reference line is drawn from the 0% voltage point at 0% rotation to the 100% voltage point at some fixed angle. Thus, both the voltage reference and the angle which determines the slope of the reference are independent of the potentiometer being tested. This means the reference line of all potentiometers (measured over the same angle) have a constant slope in terms of voltage change per degree. The angle which determines the slope is called the "theoretical angle". While it is standard practice to do so, it is not necessary that this be the same as the angle over which the linearity is measured.

A potentiometer compared to this fixed reference line is being compared to an absolutely perfect or ideal potentiometer. Consequently, one potentiometer can be replaced by another without mechanical or electrical adjustment or trimming.

The difference between a terminal-based linearity reference line and an absolute-linearity reference line is shown in Fig. 4A. Here the actual active electrical rotation is shown greater than the nominal or theoretical rotation. This is usually the case in multi-turn potentiometers where the tolerance is positive.

### Using Absolute Linearity

The designer must know what position of the potentiometer shaft represents 0% rotation before he can properly phase the component into his system. If the end point is chosen, the installation is simplified. However, one reason this is not a standard practice is because it limits the potentiometer's accuracy. This is illustrated in Fig. 4B. Here the output curve lies mostly below the reference line AA.

If the reference line were moved over to BB, the output curve would not have as much deviation, but the reference line would not pass through zero at the end point.

End resistance is another reason the end point is not used. Again, the average slope of the output line is different from the reference line. It starts higher at one end and finishes lower at the other. By moving the end points slightly, the output curve can be made to follow the reference more closely. This is shown in Fig. 4C.

To avoid these restrictions, an "index point" is used and it is standard industry practice to specify the voltage at 50% of the nominal angle. Such a potentiometer carries a label which might read "1800° = 49.937%  $E_{in}$ ". This enables a technician to find a point on the actual output curve and identify it as a particular angle.

Potentiometers that have absolute linearity are commonly used in precision servo systems or in any circuit where extreme accuracy is desired. Their big advantage is that no trimming is required either at initial installation or when they are replaced.

### Summary

As a quick recap, the identifying characteristics of the reference line for the various linearity types are as follows: independent—slope and position determined by the output curve and can have any value; zero-based—position determined by an end point and slope determined by output curve; terminal-based—slope and position determined by end points (This definition of linearity is obsolete.); and absolute—slope is constant and determined by some given angle between the zero and one hundred percent voltage points. The position is determined by an index point. No mechanical or electrical trimming is necessary. ▲

Fig. 4. In graph (A) absolute and terminal-based linearity reference lines are compared. The other curves demonstrate how linearity is improved by (B) moving the reference line, and (C) by moving the end taps.

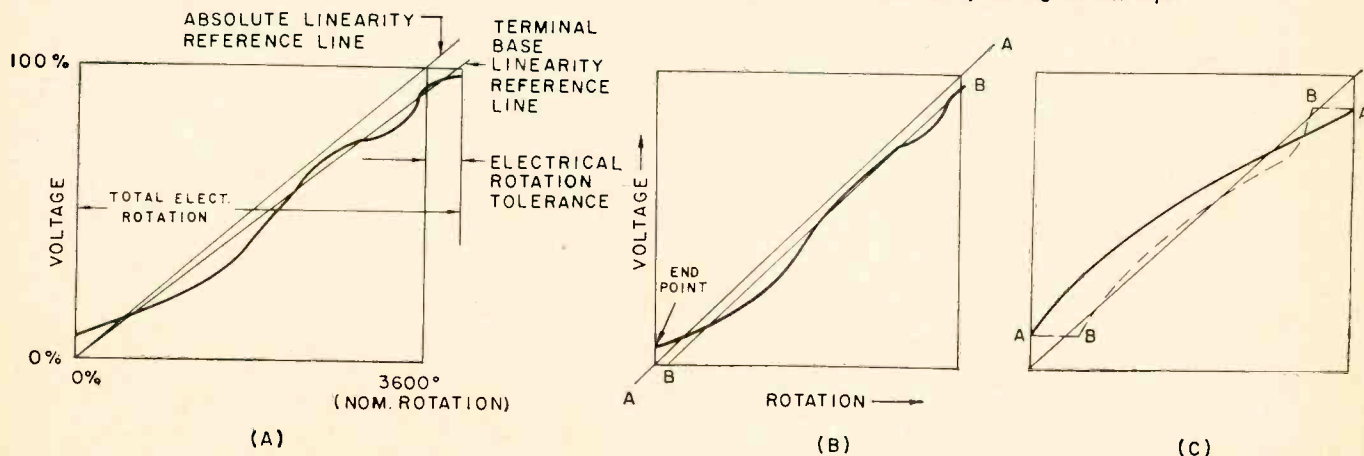



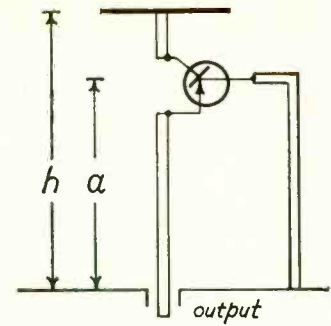
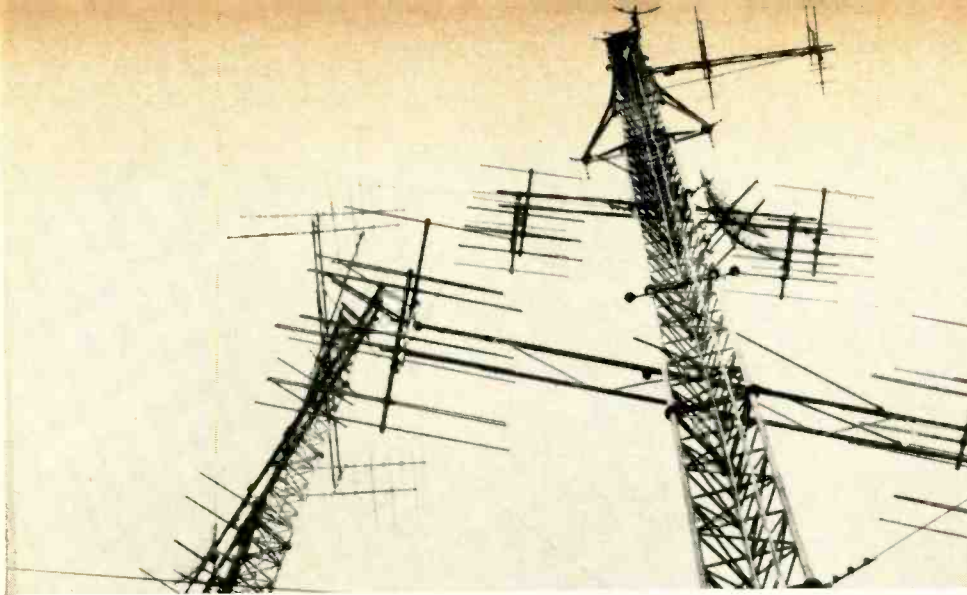

Subminiature integrated antennas (inset) less than 20-in tall may eventually replace huge arrays on steel structures across the country. A top-loaded 20-in SIA whose capacitance is 10 pF, will resonate at frequencies from 10 to 80 MHz. The exact frequency is controlled by the ratio of the dimensions "a" and "h" but the SIA works best at communications frequencies below 30 MHz.

# Tiny antennas push state-of-art

By PAUL E. MAYES / Technical Consultant, JFD Electronics Co.

*Subminiature integrated antennas are being used at frequencies below 30 MHz, but it may be some time before the roof-top TV antenna disappears.*

**T**HERE has been a lot of talk in the industry about eliminating outdoor television antennas, but until recently, the basis for this conjecture was the analogy to AM radio receivers in which ferrite loops have replaced long-wire antennas. Of course, television is not the only communications medium in which engineers would like to get rid of the large and bulky receiving antennas. Furthermore, interest has been stimulated by recent publicity disclosing the development (under Air Force sponsorship) of a subminiature integrated antenna (SIA). Because of this antenna development's widespread implications to the communications industry, the problems bearing on replacing large antennas with small ones and the current status of research in this area are reviewed.

Several years ago, E.M. Turner of the Air Force Avionics Laboratory in Dayton, Ohio, suggested that the performance of small antennas might be improved if active elements were placed in the antenna rather than at the junction of the antenna and input line. The suggestion was taken up by Professor H. Meinke and his colleagues at the Technische Hochschule in Munich, West Germany. They utilized transistors in single and dual monopole configurations to match tiny antennas to the input lines of radio sets.

In general, the miniature antenna performed well because the transistor saw a very low source resistance and thus provided a good match. However, the technique worked best at frequencies below 30 MHz. Antenna line reactance, antenna directivity, balancing, and suitable transistor characteristics are all problems which haven't been licked and which limit applications of SIA antennas at v.h.f.

## The Match's the Thing

The principal task of any receiving antenna is to extract energy from a passing electromagnetic wave and produce

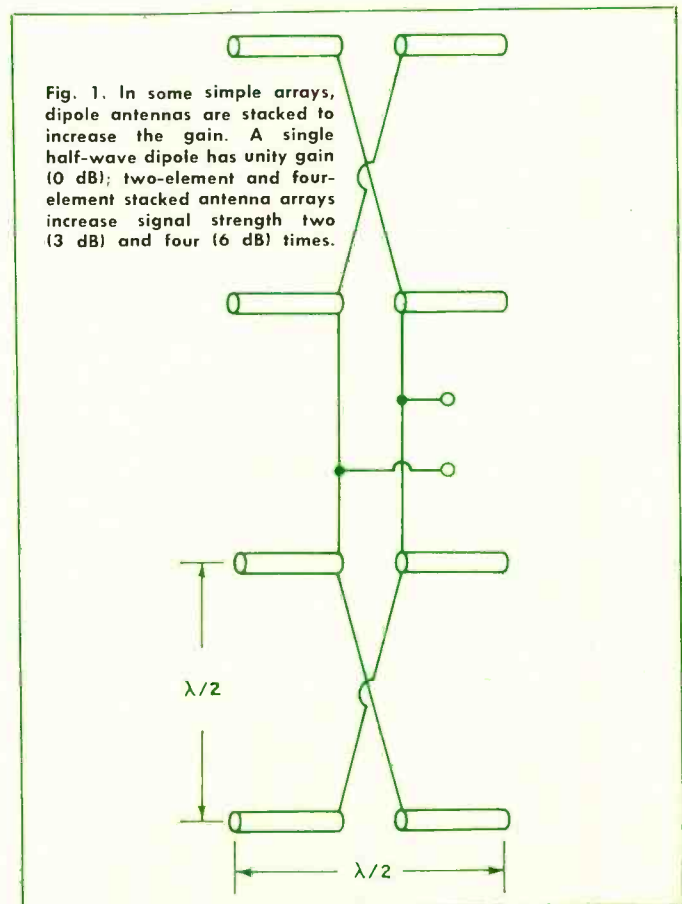

Fig. 1. In some simple arrays, dipole antennas are stacked to increase the gain. A single half-wave dipole has unity gain (0 dB); two-element and four-element stacked antenna arrays increase signal strength two (3 dB) and four (6 dB) times.

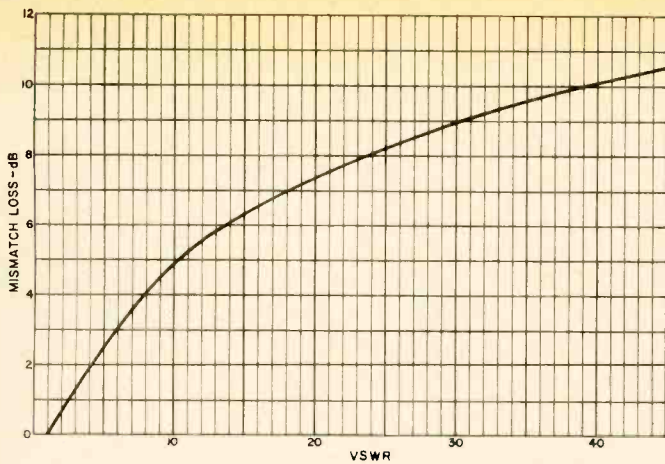

Fig. 2. This graph is used to relate v.s.w.r. and mismatch loss.

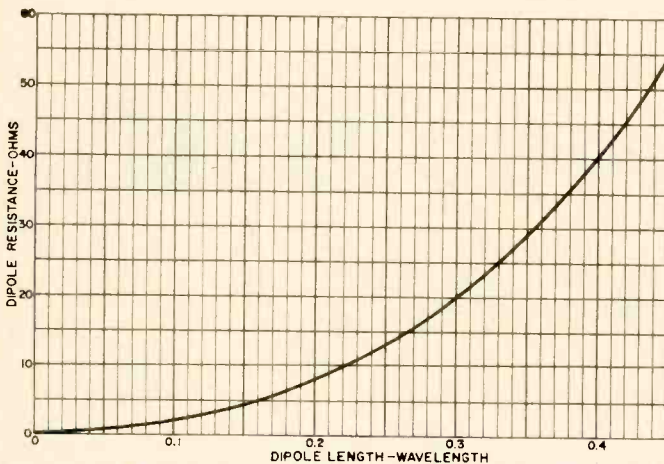

Fig. 3. Dipole resistance is not a linear function of length.

at its terminals a usable r.f. voltage that represents a signal. If the electromagnetic wave carrying the signal were the only field present at the antenna, then the evaluation of performance would be a relatively easy task. But man-made and terrestrial noise make the evaluation difficult.

Antenna gain, a figure of merit, is the result of comparing a normal antenna with an ideal antenna, usually a half-wave dipole. Engineers are interested in the power available at the antenna's terminals. The ratio of the antenna power is the relative gain and is usually expressed in decibels.

One method of increasing the gain of an antenna system is to use several elements as dipoles, in an array like the system shown in Fig. 1. Here the elements are stacked vertically (placed one above the other with approximately one-half wavelength spacing) and connected so that the antenna currents are all of the same phase. This array is called a broad-side configuration since the direction of maximum response is perpendicular to the plane of the dipoles. Each time the number of elements is doubled, or the antenna size increased by a factor of two, the gain increases by two, or approximately 3 dB. It should be emphasized, however, that this relationship between gain and size holds only for antennas which are one-half wavelength or larger in dimensions. The difference in gain between a half-wave dipole and one which is very small (in terms of wavelength) is only 0.4 dB. Hence, a small antenna is almost as good as a half-wave dipole when judged on the basis of gain alone.

Another commonly used term and one which is closely related to gain is the effective area or as it is sometimes called, the capture area. When used to describe receiving antennas, the effective area is defined as the ratio of power available at the antenna terminals to the power per unit area of an incident wave. The link between effective area,

$A$ , and the gain,  $g$ , is given by the following formula:

$$A = (\lambda^2/4\pi) g \dots \dots \dots (1)$$

where  $\lambda$  is the wavelength and  $g$  is the gain relative to a hypothetical omnidirectional antenna. The effective area of a half-wave dipole is approximately 0.13 square wavelength and that of a very small dipole is about 0.12 square wavelength. Since the gains are almost equal, there is little difference between the effective areas of a small dipole and a half-wave dipole.

However, in order to utilize fully the effective area of an antenna, it is necessary that the impedance of the antenna be matched to that of the load. An imperfect impedance match causes power loss. Actual antenna gain is the ideal gain minus the mismatch loss (in decibels).

A widely used method of evaluating the impedance match is to observe the voltage standing wave ratio (v.s.w.r.) on a transmission line. The line is terminated by an antenna at one end and excited by a generator at the other end. Fig. 2 shows the relationship between the v.s.w.r. and mismatch loss in decibels.

Fig. 3 shows the resistive part of  $Z_{in}$  and dipole length. Suppose a dipole which is  $1/10$  wavelength were made to resonate by adding a lossless coil at its base. The resistance of the dipole is approximately two ohms. On a 75-ohm line, this load would produce a v.s.w.r. of 37.5 and cause a mismatch loss of about 10 dB. In this case, the actual antenna's gain is about -8.64 dB and there is a loss factor of 0.0915 when compared to an ideal half-wave dipole. Less than one-tenth of the available power is being delivered to the line. In addition, this figure is reduced by resistive losses in the tuning coil.

### Noise

Why is it important that a receiving antenna deliver a high signal level to the receiver or that the antenna have a high gain and be properly matched? If the receiver were perfect, it could be designed with enough amplification stages to raise the signal to any desired level. However, no receiver is perfect and several factors prevent amplified signals from being exact duplicates of the input. One of these is internally generated receiver noise. The perturbation of a signal due to noise voltages can be kept negligible only if the signal voltage is much larger than the noise levels. Consequently, the most crucial point in a receiver is the input stage because it is here that the signal is at its lowest strength. To reproduce a signal faithfully, the ratio of signal power  $S$  to noise power  $N$  must be large.

Since noise is random, noise voltages must be averaged over a long time period to yield a time-independent measurement. Thus, mean-square voltages are used in computing signal-to-noise ratios. The ratio of the mean-square voltages is also the ratio of powers since both voltages appear across the same impedances.

In most electronic circuitry noise is caused by resistances. When molecules are thermally agitated, they generate a noise voltage across the resistor terminals. The equation for noise power is:

$$N = kTB \dots \dots \dots (2)$$

where  $k$  is Boltzmann's constant ( $1.372 \times 10^{-23}$  joule per degree Kelvin),  $T$  is the temperature of the resistance in degrees Kelvin, and  $B$  is the bandwidth of succeeding circuitry, in hertz. Since resistance in transmission lines and input and output circuits of amplifiers is unavoidable, the signal-to-noise ratio at the output of a two-port network is always less than at the input. Active elements, such as transistors and tubes, add more noise to the circuits.

If the only noise sources were internal to the receiver, the signal-to-noise ratio at the input would be infinite. However, there are many external noise sources which induce noise voltages in the antenna. One way to increase the antenna's signal-to-noise ratio is to make it absolutely unidirectional. But, since it is not practical to build an antenna



which receives in one direction only, the desired result must be approximated. This can be done by designing the antenna to receive electromagnetic waves arriving in a small cone of angles near the antenna's center. Thus, in this circumstance, an antenna's response decreases as the radio wave's angle of arrival moves away from the cone. The angle at which the received signal power drops to one-half of its maximum value is called the half-power beamwidth and is generally governed by the size of the antenna as measured in wavelengths. The beamwidth of a small dipole is about the same as that for a half-wave dipole—approximately 80 degrees.

In addition, the ratio of the maximum response in one hemisphere (where the response is greatest) to the response in the opposite hemisphere is called the front-to-back ratio and is, in fact, a measure of the effectiveness of an antenna in discriminating against extraneous radio waves. Like gain, the front-to-back ratio is usually expressed in dB. High front-to-back ratios can be obtained by combining the output signals of two closely spaced small antennas. A small antenna system is capable of a front-to-back ratio and directivity almost equal to that of a two-element half-wave dipole array. In practice, high directivity is achieved by increasing the antenna size.

Although most noise sources are external to the antenna terminals, it is still convenient to use equation (2) to represent the noise power. External noise is often expressed as a noise temperature,  $T_a$ , which is greater than the ambient temperature. Increasing the antenna directivity by decreasing the beamwidth and/or increasing the front-to-back ratio, is the only effective means of reducing antenna noise temperature.

The level of most external noise changes with frequency as noise temperature changes. This is shown in Fig. 4. Time variations are indicated by the shaded area. Thus, high signal-to-noise ratios often depend upon the operating frequency. For example, below 30 MHz, external noise strength is quite high and increasing the actual antenna gain does very little, if anything, to raise signal-to-noise ratio. The point of diminishing return is reached when the external noise delivered to the receiver by the antenna is larger than the receiver's internal noise. Sometimes this happens just above 30 MHz, and often above 100 MHz. Then the only way to improve the signal-to-noise ratio is to increase the effective area and reduce the mismatch losses.

A figure of merit for the noise performance of two-port networks is the noise factor:

$$F = (S_i/N_i) / (S_o/N_o) \dots (3)$$

where  $S_i/N_i$  is the signal-to-noise ratio at the input and  $S_o/N_o$  is the signal-to-noise ratio at the output. More frequently used is the noise figure  $f$  which is  $10 \log_{10} F$ . For a television receiver, the noise figure in the v.h.f. band is typically between 3 and 6 dB and in the u.h.f. band between 5 and 10 dB. Radar receivers in the 1-GHz range have noise figures ranging from 10 to 15 dB and communications receivers in the h.f. band have noise figures of from 8 to 12 dB. Parametric amplifiers, on the other hand, may have noise figures as low as 1 to 2 dB.

From the foregoing discussion, it is clear that the antenna must be able to develop a signal voltage which is greater than the noise voltage level of the receiver's input stage. However, an antenna with a high enough actual gain

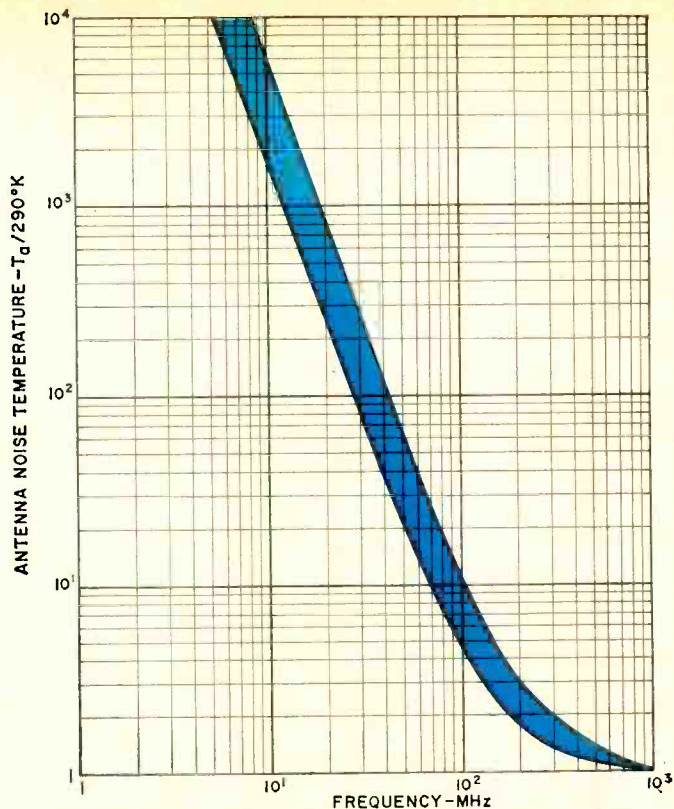

Fig. 4. External noise amplitude depends on frequency and temperature. Time variations are shown by the shaded area.

may be of little advantage below 30 MHz because the signal-to-noise ratio is determined by external noise. At these frequencies, a small antenna may be quite adequate. At higher frequencies, the situation is quite different. Here an antenna with high actual gain can be utilized to increase the signal-to-noise ratio since the principal noise source is the receiver.

### Improving Noise Figure with Pre-amplification

In conventional small antenna systems, mismatch occurs

Fig. 5. Active transistor monopoles broaden the antenna bandwidth.

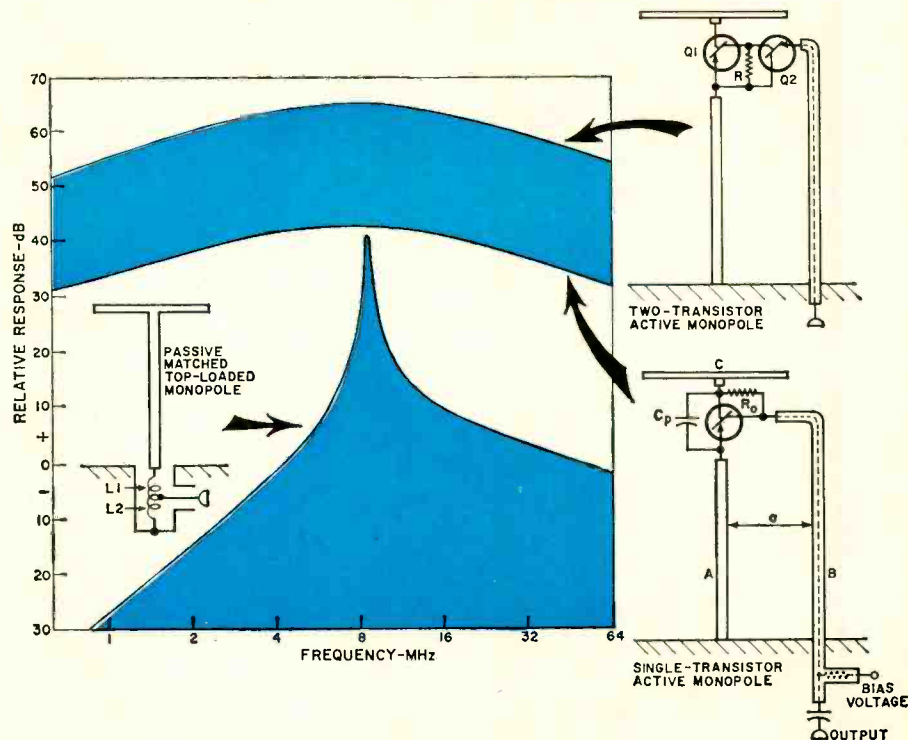



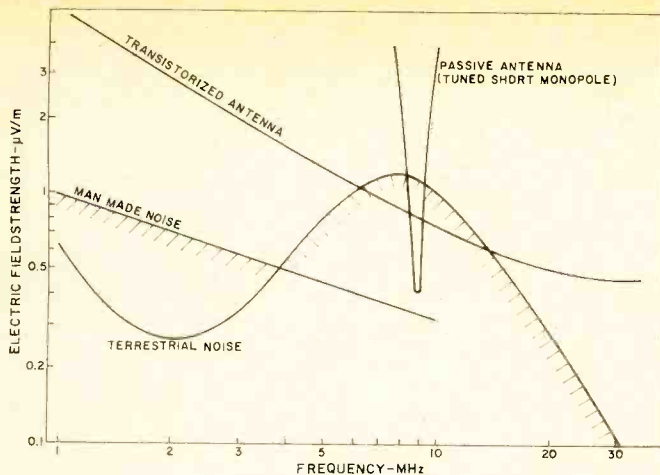

Fig. 6. Small antennas have good S/N ratios, but high fields are needed to overcome terrestrial and man-made noise sources.

between the antenna and the transmission line which leads to the receiver. In some systems, a matching circuit is placed between the antenna and the transmission line. However, the matching circuit and the line degrade the signal-to-noise ratio at the antenna since the circuit element's resistive components add noise.

Since the signal-to-noise ratio at the receiver input may be considerably less than that at the antenna, some engineers place an amplifier at the antenna to compensate for the mismatch loss. This does not raise the amplifier's signal-to-noise ratio, but it does improve the signal-to noise ratio at the receiver input.

The noise factor of a transmission line with loss factor  $K$  (power gain less than unity) is:

$$F = (1/K) \dots \dots \dots (4)$$

Since the line is lossy, the noise factor of the line is greater than one.

The noise factor of two cascaded stages is given by:

$$F = F_1 + (F_2 - 1)/G_1 \dots \dots \dots (5)$$

where  $F_1$  and  $G_1$  are the noise factor and power gain of the first stage and  $F_2$  is the noise factor of the second stage. In the case where the matching circuit and line are the first stage, the gain is less than one and the over-all noise factor is degraded. The amplifier's noise factor then becomes:

$$F_{1a} = (1/K) + (F_2 - 1)/K \dots \dots \dots (6)$$

If the amplifier is placed between the antenna and the transmission line, the over-all noise factor is nearly that of the amplifier, or

$$F_{a1} = F_2 + [(1-K)/K/G_2] \dots \dots \dots (7)$$

and the amplifier gain  $G_2$  reduces the effect of noise added by the transmission line.

As an example, suppose the loss factor of the line is 0.5 (-3 dB), the amplifier noise factor is 4 (6 dB), and the amplifier gain 10 (10 dB). The noise factor of the combination when the line is first is:  $F_{1a} = 2.0 + (4 - 1)/0.5 = 8$ . When the amplifier is first, the noise factor is  $F_{a1} = 4 + (2 - 1)/10 = 4.1$ , which is almost the same as that for the amplifier alone. Obviously, an amplifier stage at the antenna is a good idea when the losses in matching circuits and lines are high. However, this still does not solve the basic problem of the small antenna, namely, the small resistive and large reactive components in the antenna impedance.

Prof. H. Meinke and his colleagues attempted to solve this problem by placing solid-state active elements in the antenna. They pointed out that although a transistor at the base of a short monopole will indeed see a very small source resistance, the resistance at a gap some distance above the base is much greater and, as a consequence, an improved match is obtained. However, this technique

does not do anything to solve the problem of high reactance.

An indication that the mismatch problem has not been eliminated is given in the relative response curve published in a paper "Active Antennas with Transistors," (International Electronics Conference, Toronto, 1967) by Meinke and reproduced in Fig. 5. Although the signal is amplified many times by a transistor at the gap of the monopole, the output power of a single transistor circuit is about the same as that of a matched lossless antenna of the same height. To increase the signal level significantly above that of a matched passive monopole, a two-transistor circuit was employed. In both instances the bandwidth of the active antennas were much broader than those of the passive antennas. A small active antenna operates far from the resonant point of the input circuit and the mismatch loss remains nearly constant over a wide frequency band.

The noise performance of some of Meinke's antennas is reproduced in Fig. 6. The vertical scale is the field strength necessary to achieve a unity signal-to-noise ratio at the antenna output. Also indicated is a predicted curve of noise from terrestrial and man-made sources. Although better signal-to-noise ratio is obtained by a small matched passive antenna over a narrow band, the active antenna noise performance is better over a much wider bandwidth. Between 6 and 15 MHz, high electromagnetic fields are needed to overcome external noise and achieve a unity S/N ratio. Above 30 MHz, however, the external noise has dropped to such low values that an antenna with a noise output less than that of the subminiature integrated antenna could be used to advantage.

### Cross-Modulation and Intermodulation

The nonlinear characteristic of an overloaded transistor also causes noise. For example, when a strong modulated carrier at a frequency different from the frequency of a second carrier is impressed across a slightly nonlinear transistor element, each carrier will have the modulation of the other on it. No amount of selectivity in succeeding circuits will remove the interference. Also, a signal at the correct frequency can be produced when two off-frequency carriers or harmonics combine in the nonlinear element. The evaluation of these effects in transistorized antennas is just beginning. To date, circuits have been deliberately mismatched to keep off-carrier signal levels low and reduce cross-modulation and intermodulation effects. However, as progress is made on lowering mismatch loss and improving signal-to-noise ratios, the interference caused by cross-modulation and intermodulation will become more severe. Elimination of these undesirable sources of noise must depend upon suitable preselectivity and/or the use of transistors with improved linearity over a much wider dynamic range.

### For the Future

The outlook for the very small antenna for communications services below 30 MHz has been enhanced by the work of Meinke and his group. Indeed, a number of small antennas with low-noise preamplifiers in or near the antenna are being used. But television, FM radio, and other services which operate above 30 MHz, have not been able to utilize small antennas. Techniques for improving the noise performance of the SIA's must be developed and balanced antennas with directivity, rather than omnidirectional monopoles, are needed for best results. It is also difficult to obtain perfectly matched transistor circuits for balanced dipoles.

Thus considerable work remains to be done before the conventional roof-top antenna (which has high gain and high directivity, and very low mismatch loss) can be eliminated for either television or FM reception. It seems likely, however, that the use of antennas which are small in wavelengths will grow in popularity. ▲



Motor-driven version of curve tracer shown here connected to scope.



# TRANSISTOR CURVE TRACER

By HUGH L. MOORE  
Electronic Education  
Los Angeles City Schools

*Design of a simple tester that will show the characteristics of junction and field-effect transistors on an oscilloscope.*

WHEN transistors began replacing vacuum tubes in electronic circuits, designers and technicians all hoped that somehow transistors would be the panacea for all circuit problems. Besides lasting virtually forever, maybe they would simplify power-supply needs, ease circuit-design difficulties, and cure that blight on all circuit operation—*distortion*. But, alas, we couldn't have everything. Transistors are dependable, within reason; they have reduced power-supply needs; and they have made some circuits easier to design and lay out. But everyone soon found that distortion was still with us.

Stated briefly, *distortion* describes what happens when a signal of specific characteristics is fed into an amplifying stage and something different comes out. Carried further, the term also applies to signal-generating stages in which the output waveshape differs from what the circuit design would lead you to expect. Distortion, then, leads to undesirable and—what's worse—unpredictable circuit operation.

The three- or four-terminal simplicity of transistors offers an advantage that can be used to at least *reduce* the inconvenience that transistor distortion causes. A relatively simple tester can be built which enables the circuit designer to select junction and field-effect transistors that will work predictably in his latest brainchild, enables the service technician to choose from a batch of new transistors the one best suited for important or critical replacement situations, and enables the experimenter to pick out a transistor suitable for his purposes from among the hundreds of fractional-cost surplus transistors that are now available. A tester like this one can show up trouble spots at a glance and can help spot the cause of distortion in ordinary and field-effect transistors—even before the transistor is put into a circuit.

Ordinary transistor testers that simply measure gain or *beta* are all right for some purposes, but they don't tell the whole story. Graphs could be compiled from the measurements taken with such testers, but to put together a set of operating curves for a single transistor would take hours. More practical is an instrument that plots an entire group of operating-characteristics curves at once. A properly designed instrument can show quickly and graphically how

a particular transistor would function under various operating voltages and current. An experienced operator of such an instrument can recognize the characteristics that cause a transistor to introduce distortion into its operating circuit. All the clues are included in the group of curves plotted by the instrument.

## Transistor Curves

The transistor characteristics most useful for analyzing probability of distortion are based on curves of collector voltage *vs* collector current. If this curve can be plotted for several values of base bias, the resulting graph is a *family* of curves from which a great amount of information can be derived.

Fig. 1 is an example of such a graph. Collector current is plotted on the Y or vertical axis, with collector voltage on the X axis. Each curve shows the rate at which collector current increases as collector voltage goes up. By itself, this curve doesn't tell you much about the operation of a transistor in a circuit, but when a family of such curves is plotted, you can project a *load line* that represents what effect any changes in base bias will have. Each curve in the family represents the collector characteristic for one value of base bias. Six values are plotted in Fig. 1, representing bias from zero to 5 mA.

The *operating load line* is drawn in parallel with the test load line, which is along the right-hand edge of the family of curves. The operating load line begins on the bottom line of the graph, at the point of rated operating voltage for the transistor and continues upward through the various curves until it reaches a point of minimum collector volts (the left-hand knee of the curves in Fig. 1).

For analyzing the probability of distortion, it is *gain* or amplification along the load line that is most important. If gain is the same all the way up the load line, amplification is linear. You judge this from the spacing of the curves. The farther apart they are, the greater the change in collector current for a change in base bias—which means more gain or *beta*. If the transistor is perfectly linear, all six curves will be spaced equally along the operating load line. If the curves are spaced wide at the bottom and close to-



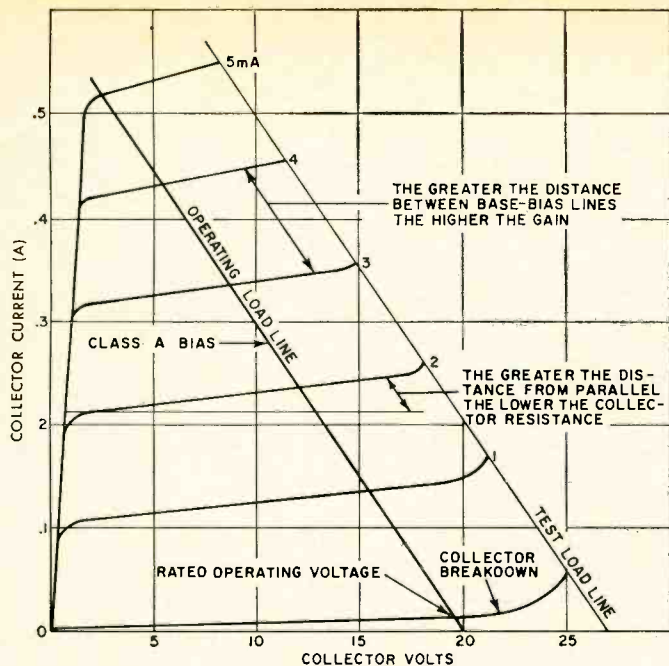

Fig. 1. Graph of voltage versus current curves for collector.

gether near the top of the load line, or *vice versa*, the amplification of the transistor is not linear and distortion can result.

There is more to be learned quickly about a transistor from the family of curves in Fig. 1. For example, you can gauge collector resistance. The more the collector current changes during a change in collector voltage, the greater the slope of the curve (more vertical). The less the change in collector current, the higher the collector resistance and the more nearly horizontal the curves appear. It is quite possible to have two transistors with the same gain but different collector resistances. In a class-B push-pull stage, this would result in imbalance between the two halves of the wave and thus create distortion.

The linearity and distortion problems that occur in ordinary transistors also apply to FET's. The FET gate is comparable to the transistor base, and gate voltage takes the place of base current. The FET drain and source compare with the transistor collector and emitter, respectively. Throughout our discussion of these operating curves, the principles will apply to FET's if the terminology is changed to conform.

### What Curves Means

It will help you understand how much information you can get from a family of characteristic curves if you examine several. Since developing and plotting a family of curves is a time-consuming job if done with an ordinary tester, the faster way is with a curve tracer. This instrument can display the important parameters of a transistor in one quick view. An experienced operator can easily spot breakdown voltage, gain, linearity of amplification, collector resistance, and thermal runaway in a transistor or FET. A curve tracer also shows a great deal of useful information about zener and standard diodes.

Fig. 2 shows the first of several curve families, plotted on an oscilloscope with the curve tracer to be described later. They will familiarize you with how to interpret such displays. The display in Fig. 2 is a family of curves for a "textbook" transistor—a nearly perfect example of ideal characteristics in a transistor. This particular transistor happened to be an expensive one rescued from a piece of surplus equipment. The curves show that it would do quite well as a large-signal audio amplifier. Even with transistors as good as this, it must be remembered that when two transistors

are used in class-B push-pull, both transistors must have the same gain or half of the output wave will be larger and the output distorted.

Notice how flat (horizontal) the curves are in Fig. 2. Since collector resistance equals the change in collector voltage divided by the change in collector current, a wide change of voltage without more than a small change in current means a transistor has high collector resistance. All the curves in Fig. 2 change very little in current (Y axis) over the entire range of collector voltage (X axis); therefore, you know this particular transistor has an extremely high collector resistance.

Notice also that the spacing of the curves is relatively constant. They spread only slightly farther apart up to the top pair. The transistor will be virtually linear in operation, then, until a very high value of base bias is reached. Also notice that the gain (*beta*) goes higher with an increase in base bias, which is usual with transistors.

The transistor whose curve family is shown in Fig. 3 would be good for use in a small-signal stage that is biased by automatic gain control. As greater amounts of bias are applied to this stage, the gain becomes less and less (the opposite of most transistors). However, the signal must be so small that it is always operating within an area of the same gain—between any two curves. If this transistor were used in the large-signal stages of an audio amplifier, the output would be distorted. The part of each cycle near zero bias would be greatly amplified (wide spacing at the bottom). The high-bias areas (top) have very low gain, and that part of the cycle would be compressed. The audio signal would have its shape altered drastically and sound terrible.

Fig. 4 shows a transistor with a low gain characteristic (narrow spacing) in the low-bias condition, and high gain in the high-bias condition. This transistor is either defective or made for special applications.

The curves in Fig. 5 are important to remember because they show collector breakdown. The upward hook at the extreme right of the base line is where the collector is drawing reverse current due to junction breakdown. Notice also that the other lines curve upward at their limit. This transistor is definitely operating beyond its rated maximum collector voltage. If the amount of voltage applied under operating conditions were the same as in this test situation, this transistor would cause distortion due to collector-voltage breakdown. Always operate well below breakdown voltage. You can estimate from these curves what that voltage is, at low bias values; just check the X-axis reading (calibration) at the point to the left of where the curves turn upward.

The transistor in Fig. 6 is also being driven beyond its maximum rated voltage at low bias values, note the hook at the right of the base line. This transistor is also a good example of one with low collector resistance. Notice how sharply upward each curve slopes.

Fig. 7 shows a transistor with considerable leakage between collector and emitter. Note that even with zero bias the collector is drawing high current. The first curve is well above zero. This transistor will amplify and will give an acceptable reading on most d.c.-type transistor testers, yet it will consume excessive current and run hot. The high operating current of this transistor could cause transformer saturation, power-supply problems, or short battery life.

In this display, although you can't see it in the still photo, the entire family of curves is slowly moving upward on the scope screen. When the pattern moves gradually upward with an *n-p-n* transistor (downward with a *p-n-p*), the transistor is generating heat within itself and changing characteristics. This condition is called thermal runaway and, if allowed to persist, will destroy the transistor. Lowering the transistor collector voltage or utilizing heat sinks will prevent this.



Figs. 8 and 9 are curves of two different zener diodes. The diode in Fig. 8 will immediately draw lots of current when its rated voltage is exceeded and will hold an applied voltage constant. The zener in Fig. 9 has a gradual curve at the right end of the line. The applied voltage will be allowed to shift along this curve, resulting in poor stability of the output voltage.

### A Simple Curve Tracer

It isn't too difficult to build an instrument that will display the families of curves shown in Figs. 2 through 9. The schematic diagram of one built by the author is shown in Fig. 10. The instrument consists of two parts, a circuit to sweep the collector voltage and a stepper for the base current. Each of these units works independently of the other and are not synchronized.

The sweep voltage for the collector circuit comes from an adjustable full-wave unfiltered supply. This voltage sweeps the collector from zero to the calibrated voltage 60 times each second. The dial of adjustable transformer T3 is calibrated in peak volts so the operator can know at a glance the total length of his oscilloscope base line (X axis on the graph). A bridge rectifier (D5, D6, D7, D8) is connected in series with the transformer to prevent the incorrect half of the a.c. sine wave from being applied to the collector. Diode D9 and resistor R23 prevent transient responses from interfering with the zero base. Low and high

scales (30 and 150 volts maximum) are controlled by switch S6. A 20-volt transformer (T2), connected ahead of the variable transformer, provides the low scale.

The base-current stepper circuit is fed by a 100-volt, 0.2-amp d.c. supply, consisting of T1, D1, D2, D3, and D4. This d.c. current is filtered through CH1, C1, and C2 and then applied to voltage dividers R1 through R5. A fast-turning rotary switch develops the sequential steps of voltage—or rather, current—that are applied to the transistor base. The sequence of steps is fed through one of the step-size resistors R6 through R16. The combination of the large supply voltage and the high values of the step-size resistances make this a constant-current supply. The variations in base resistance are small by comparison, and the base current is therefore determined mostly by the step-size resistor.

The taps between the step-sequence voltage-divider resistors are connected to a rotary switch which is driven either by a slow-speed motor or with a hand crank. The latter works quite well and allows the operator to stop at any desired base-bias step for detailed study of its curve.

To adapt the curve tracer for FET's, the step current must be changed into a step voltage, and the base-current supply (which becomes a gate-voltage supply) must be reversed in polarity. This is accomplished by switch S8 which grounds one end of the sequence-stepping divider. S8 also allows a choice between one step or no steps of reverse

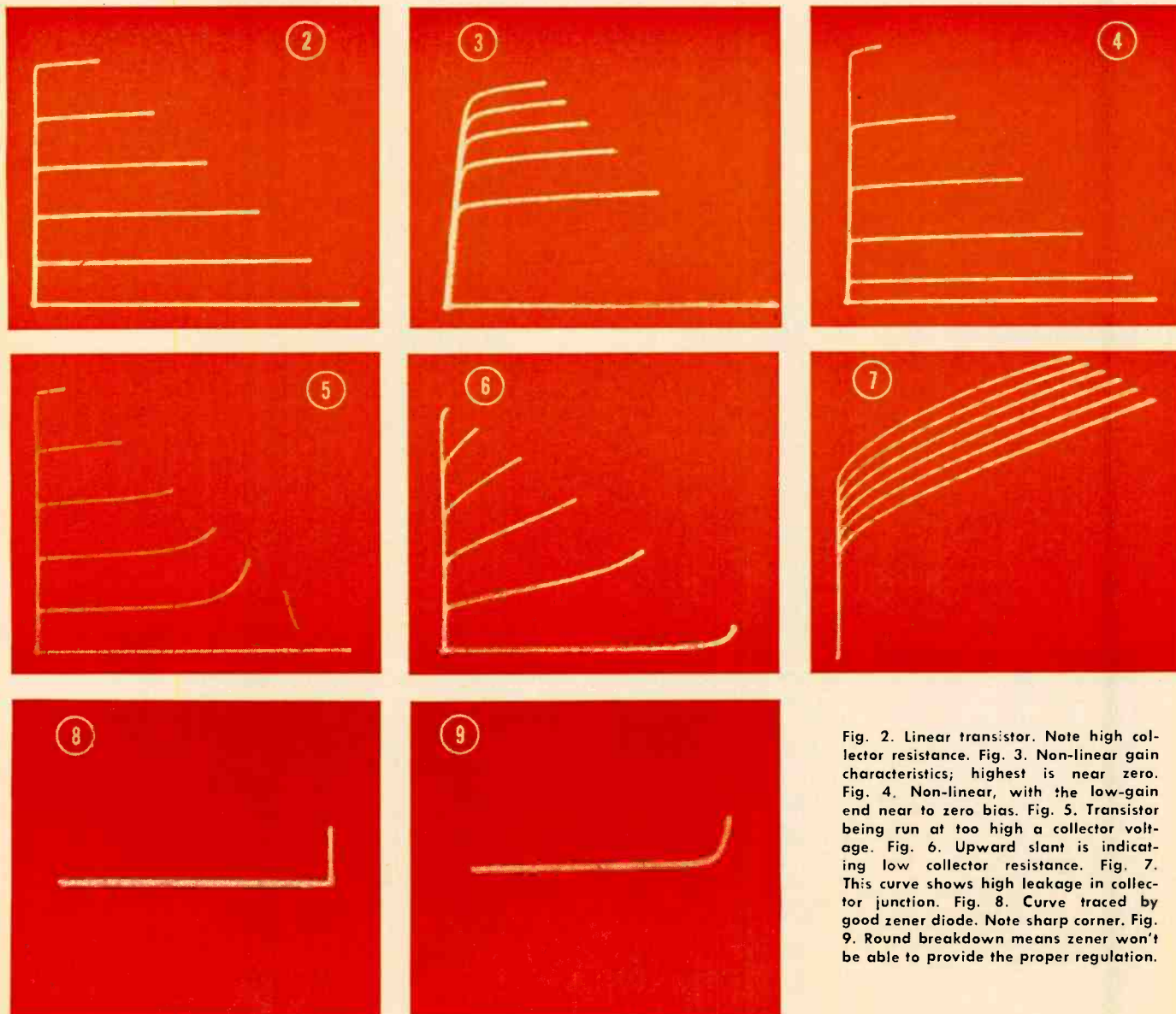
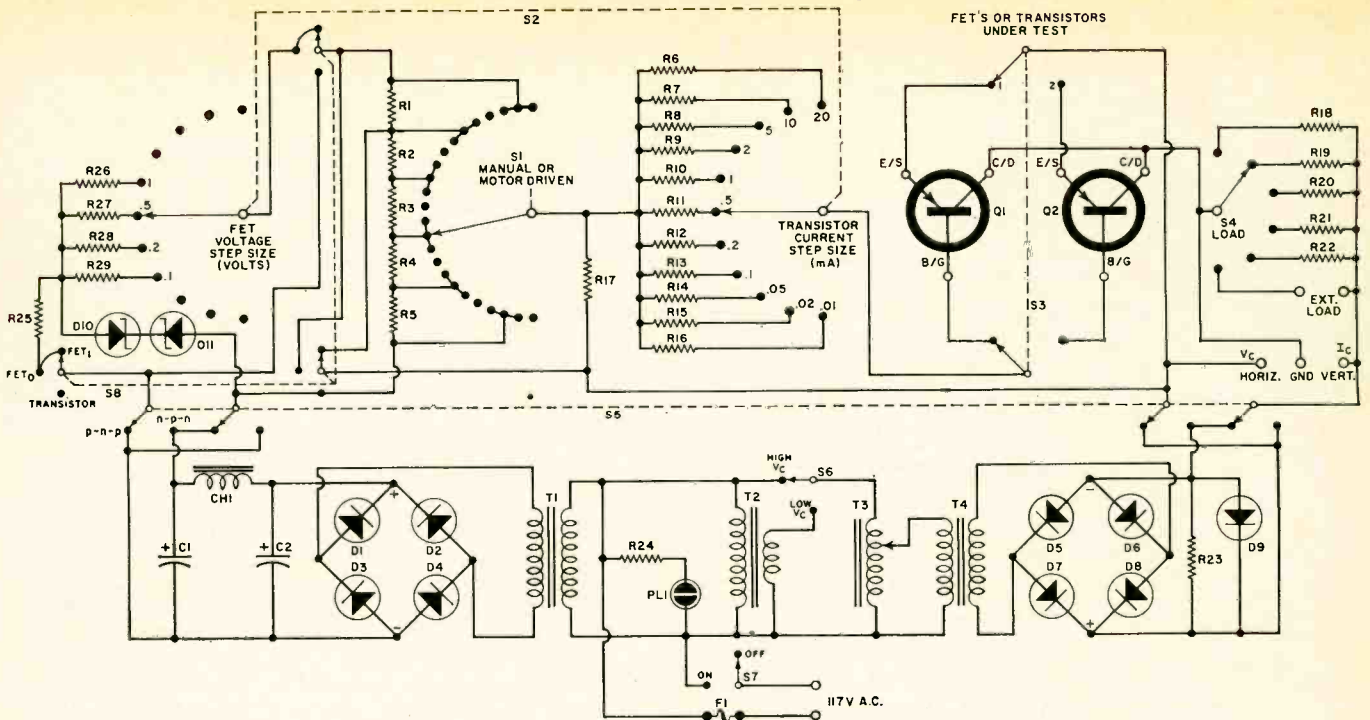

Fig. 2. Linear transistor. Note high collector resistance. Fig. 3. Non-linear gain characteristics; highest is near zero. Fig. 4. Non-linear, with the low-gain end near to zero bias. Fig. 5. Transistor being run at too high a collector voltage. Fig. 6. Upward slant is indicating low collector resistance. Fig. 7. This curve shows high leakage in collector junction. Fig. 8. Curve traced by good zener diode. Note sharp corner. Fig. 9. Round breakdown means zener won't be able to provide the proper regulation.



- R1, R2, R3, R4, R5—100 ohm, 5 W wirewound res.
- R6—1000 ohm, 2 W res.  $\pm 5\%$
- R7—2000 ohm, 2 W res.  $\pm 5\%$
- R8—3900 ohm, 1 W res.  $\pm 5\%$
- R9—10,000 ohm,  $\frac{1}{2}$  W res.  $\pm 5\%$
- R10—20,000 ohm,  $\frac{1}{2}$  W res.  $\pm 5\%$
- R11—39,000 ohm,  $\frac{1}{2}$  W res.  $\pm 5\%$
- R12—100,000 ohm,  $\frac{1}{2}$  W res.  $\pm 5\%$
- R13, R24—200,000 ohm,  $\frac{1}{2}$  W res.  $\pm 5\%$
- R14—390,000 ohm,  $\frac{1}{2}$  W res.  $\pm 5\%$
- R15—1 megohm,  $\frac{1}{2}$  W res.  $\pm 5\%$
- R16—2 megohm,  $\frac{1}{2}$  W res.  $\pm 5\%$
- R17—56,000 ohm,  $\frac{1}{2}$  W res.  $\pm 10\%$
- R18—1 ohm, 20 W wirewound res.
- R19—10 ohm, 20 W wirewound res.
- R20—100 ohm, 20 W wirewound res.
- R21, R23—1000 ohm, 20 W wirewound res.
- R22—10,000 ohm, 5 W wirewound res.
- R25—10,000 ohm, 5 W wirewound res.  $\pm 10\%$
- R26—1300 ohm,  $\frac{1}{2}$  W res.  $\pm 5\%$
- R27—3300 ohm,  $\frac{1}{2}$  W res.  $\pm 5\%$
- R28—9100 ohm,  $\frac{1}{2}$  W res.  $\pm 5\%$
- R29—18,000 ohm,  $\frac{1}{2}$  W res.  $\pm 5\%$
- C1—300  $\mu$ F, 150 V elec. capacitor
- C2—200  $\mu$ F, 200 V elec. capacitor
- S1—S.p. 24-pos. shorting rotary sw. Terminals are wired together in groups of three with one contact between each group. See text.
- S2—D.p. 11-pos. non-shorting rotary sw.
- S3—D.p. 2-pos. non-shorting lever sw.
- S4—S.p. 6-pos. non-shorting rotary sw.
- S5—4 p.d.t. non-shorting lever sw.
- S6—S.p.d.t. toggle sw.
- S7—S.p.s.t. toggle sw.
- S8—3 p. 3-pos. non-shorting rotary sw.
- F1—3 A fuse
- PL1—NE51 neon pilot light
- CH1—10 henry, 200 mA, 150 ohm choke (Triad C-16A)
- T1, T4—Isolation trans., 115 V: 115 V, 0.3 A (Triad N-51X)
- T2—Power trans. 115 V: 20 V @ 1.25 A (Chicago-Stancor RE-201)
- T3—Variable trans. 0-120 V, .3 kVA (Superior 10B)
- D1, D2, D3, D4, D5, D6, D7, D8, D9—1N4383 diode
- D10, D11—1N3026 18 V, 1 W zener diode
- Q1, Q2—Transistors or FET's under test

Fig. 10. Simple curve tracer that can be driven by hand to display entire families of transistor characteristic curves.

bias applied to the field-effect transistor being tested.

Zeners D10 and D11 regulate the voltage applied to the gate-voltage step-size switch. These two diodes are back to back so that the voltage will be a constant 18 volts regardless of polarity. The voltage is then dropped through R26 for 1-volt steps, R27 for 0.5-volt steps, R28 for 0.2-volt steps, or R29 for 0.1-volt steps. It is then applied to the sequencing divider. The voltage is commutated off through S1 to the gate of the FET. FET's must not be tested with switch S8 in the transistor position or the FET's will be permanently damaged.

The initial letter *p* or *n* on switch S5 represents the FET channel type. Thus, the *n-p-n* marking indicates the setting of S5 for testing an *n*-channel FET.

The collector is the common point for all measurements. Power-supply common is above ground, but no difficulty was encountered because most transformer insulation is thick enough to have no capacitive effect at the sweep frequency of 60 Hz. The scope actually looks at the emitter voltage, which is the reverse of the collector voltage. A

polarity-reversing switch can be added to the oscilloscope horizontal-amplifier grids (see Fig. 11); otherwise curves will be reversed left-to-right.

Lever switch S3 permits a quick change from one transistor to another, for matching. When two transistors have the same spacing between curves, they have the same gain characteristic and are therefore a balanced pair.

Because a *p-n-p* transistor has negative collector voltage and current, the display of curves will be upside down. This image is mathematically correct. With a little experience, you can read these families of curves as easily as you can the *n-p-n* curves.

### Construction

Subminiature transistor sockets accommodate the TO-5 or TO-40 case. Banana jacks and short clip leads are provided for eye-type terminals used on the TO-36 and TO-61. These short leads also allow reasonable connection to diodes or transistors. A TO-3 socket is mounted between the banana plugs in such a way that it can be plugged into the three banana jacks on the front panel.

The dial of the variable-voltage transformer is calibrated by connecting the vertical amplifier of an oscilloscope to the emitter terminal of one test socket and then grounding the scope to the collector or common terminal. There should be no transistor in the tester. The peak-to-peak readings indicated on the scope are recorded on the variable-voltage dial.

Load resistors are included, in values from 1 to 10,000 ohms. Any other size may be used by inserting it in the external terminals and turning (Continued on page 84)

Fig. 11. Polarity-reversal switch for scope horizontal amp.

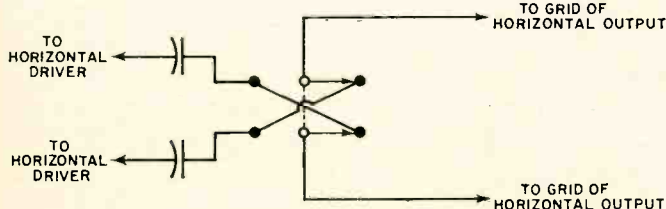



# VOTE ANY ROW...THEY'RE ALL WINNERS!

A COMPLETE SELECTION OF ANNUALS, YEARBOOKS, DIRECTORIES AND HANDBOOKS from the world's largest publisher of special interest magazines.

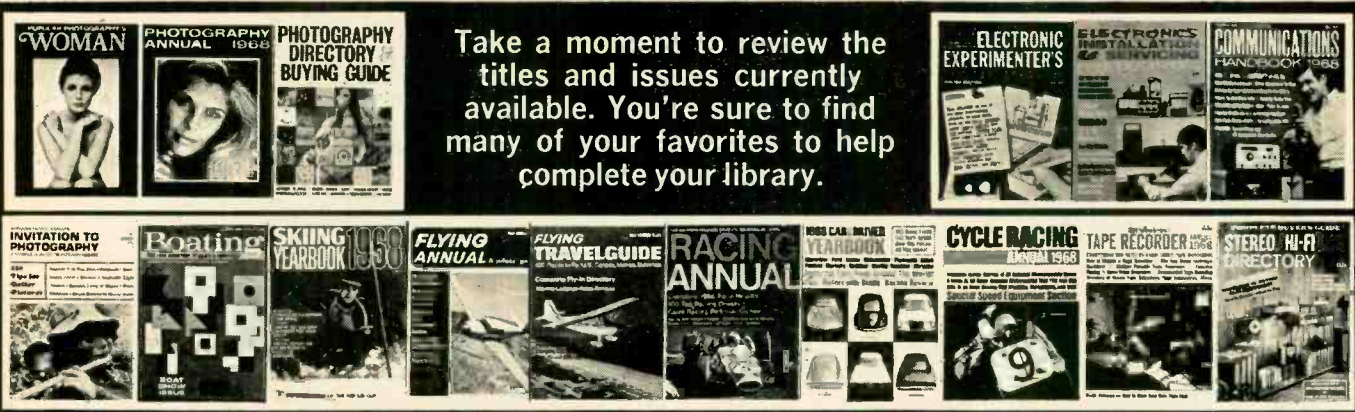

Take a moment to review the titles and issues currently available. You're sure to find many of your favorites to help complete your library.

## POPULAR PHOTOGRAPHY'S WOMAN

An exciting insight into the world of beautiful women by the great photographers of our time! This 128 page collection of superb photographs includes complete technical data and technique used for each photo.

1968 ..... #62

## PHOTOGRAPHY ANNUAL

The world's most distinguished photographic annual and largest selling publication of its kind. A brilliant collection of the year's most stimulating photos—212 pages—24 in full color.

1968 ..... #61  
1967 ..... #38  
1966 ..... #1

## PHOTOGRAPHY DIRECTORY

Lists over 5,000 photographic items with complete information on manufacturers, model numbers, special characteristics and prices. Compiled by the editors of Popular Photography.

1968 ..... #60

## INVITATION TO PHOTOGRAPHY

A unique guide to better picture taking by the editors of Popular Photography. Basic down to earth advice that helps you eliminate costly trial and error, time-consuming guess work. 20 complete, fact-and-photo packed articles in all.

1967 ..... #52  
1966 ..... #35

## BOATING Jan. 1968 Ann. Dir. Issue

Annual Directory of Boating including over 6,000 listings of boats, engines and equipment; prices and specifications for comparison; plus special articles and features.

1968 ..... #65

## SKIING YEARBOOK

Provides you with the most authoritative and detailed compendium of facts, figures and faces that made skiing news in the past 12 months. Over 164 pages.

1968 ..... #55  
1967 ..... #48

## FLYING ANNUAL

Most complete, most valuable aviation yearbook ever compiled. Over 164 pages of timely features, vivid facts and figures specifically designed to upgrade your pilot proficiency—and the equipment you buy.

1968 ..... #57  
1967 ..... #44

## FLYING TRAVELGUIDE

Only complete useful fly-in directory assembled exclusively for pilots. Includes data on airport facilities, lodgings, prices, restaurants, resorts, sightseeing, recreation, sports activities and children's fun.

1967 ..... #54  
1966 ..... #34

## CAR AND DRIVER RACING ANNUAL

An almanac of competition information covering the entire racing year. Feature stories of individual races, personality wrap-up on top drivers, box scores on every major event throughout the world plus many dramatic photos.

1967 ..... #63

## CAR AND DRIVER YEARBOOK

The most exciting, most comprehensive automotive fact book available. A complete buyers guide for domestic and imported models—road tests, accessories, and performance equipment buying guide.

1968 ..... #51  
1967 ..... #40

## CYCLE RACING ANNUAL

Action photos—Race Results—Facts on equipment to use, clothes to wear—previews of next year's racing scene—in fact, everything you need to keep track of today's fast-breaking racing happenings.

1968 ..... #64

## TAPE RECORDER ANNUAL

The only buyers guide of its kind available to the brands and models on the market. Over 132 pages of full information on over 250 models plus articles covering every aspect of tape recording.

1968 ..... #59  
1967 ..... #42

## STEREO/HI-FI DIRECTORY

Giant 180 page buyers guide to virtually every new audio component on the market—amplifiers • changers and turn tables • receivers • tuners • tape machines • speakers, etc.

1968 ..... #56  
1967 ..... #45

## ELECTRONIC EXPERIMENTER'S HANDBOOK

The most fascinating and challenging construction projects for the electronics hobbyist. Over 148 pages.

1968 Winter Edition ..... #50  
1967 Spring Edition ..... #49  
1966 Fall Edition ..... #39  
1966 Spring Edition ..... #36  
1965 Fall Edition ..... #9

## ELECTRONICS INSTALLATION & SERVICING HANDBOOK

The only complete guide for servicemen and hobbyists to every major phase of consumer electronics servicing. Over 132 pages of the latest electronics information.

1968 ..... #58  
1967 ..... #43  
1966 ..... #32

## COMMUNICATIONS HANDBOOK

World's most complete guide to communications. 148 fact packed pages of features by experts in each category.

1968 ..... #53  
1967 ..... #47

TO PLACE YOUR ORDER, circle the numbers of the annuals you wish to receive on the coupon, clearly print your name and address and enclose your remittance. Please be sure to enclose an additional 15¢ shipping and handling for each copy ordered. Add 50¢ per copy for orders outside U.S.A.

Ziff-Davis Service Division—Department W • 595 Broadway, New York, N. Y. 10012

I am enclosing \$\_\_\_\_\_ for the annuals circled below. My remittance includes an additional 15¢ per copy for shipping and handling (50¢ for orders outside U.S.A.). I understand quantities are limited and orders will be filled on a first come-first served basis.

\$1.25 EACH 1 9 32 34 35 36 39 42 43 45 47 48 49  
50 52 53 54 55 56 58 59 60 62 63 64 65

\$1.50 EACH 38 40 44  
51 57 61

PRINT NAME \_\_\_\_\_

ADDRESS \_\_\_\_\_

CITY \_\_\_\_\_

STATE \_\_\_\_\_

ZIP \_\_\_\_\_

EW-38

PAYMENT MUST BE ENCLOSED WITH ORDER





# J OHN FRYE

*Aroused awareness of the damage done to humans by civilization's racket has increased interest in nature and measurement of noise.*

## SILENCE POLLUTION

Mac, returning from lunch, stepped through the door of the service department only to have his ears assaulted by a blast of sound. Both a radio and a portable TV receiver were blaring away on the "intermittent bench" while Barney snapped his fingers and twisted his body in rhythm to the music of a *Tiajuana Brass* record revolving on the turntable of a portable hi-fi resting on the main service bench.

Mac walked over and turned down the volume controls of the radio and TV receiver and then threw the bench switch that cut off power to the record player. The ensuing sudden silence was deafening.

"Hey! What did you do that for?" Barney demanded.

"So I could hear myself think," Mac retorted. "What are you trying to do, ruin your hearing?"

"Of course not. Those two jobbies on the intermittent bench both have complaints of intermittent loss of sound; so I was keeping an ear on them while I worked on this hi-fi player that is supposed to lose one of its stereo channels every now and then. Being a man who likes to combine pleasure and work, I was just shagging along with Herb Alpert while I listened. Anything wrong with that?"

"Quite a bit. In the first place, nine out of ten intermittent audio failures will show up more quickly at a low signal level than at a high one, especially if the fault lies in a coupling capacitor. Furthermore, I wasn't kidding about damaging your hearing. The October, 1967 issue of *Today's Health*, published by the AMA, carried an article by Drs. John A. Garrett and Charles P. Lebo, ear specialists at the University of California, reporting their findings on deliberately exposing their hearing to lengthy sessions of rock and roll music. After one three-hour session Dr. Garrett reported, 'I couldn't hear my watch tick for three hours afterwards.'

"Dr. Samuel Rosen, another ear specialist, calls noise 'a molestor.' He describes 'a chronic noise syndrome' this way: 'At an unexpected or unwanted noise, the pupils dilate, the skin pales, mucous membranes dry up, there are intestinal spasms, and the adrenals explode secretions. The biological organism, in a word, is disturbed.' Dr. Rosen says our loss of hearing in later years is most likely related to accumulated noise exposure in our urban environment rather than age. A 70-year-old Meban tribesman in the Sudan, where average environmental noise is less than the hum of a refrigerator, has the hearing acuity of a 20-year-old New Yorker.

"It has been established by a number of authorities in continuous noise environments that a sound level of 85 dB has a damage potential. Yet you are making 10 dB of sound just breathing. Matilda's quiet typewriter is producing 65 dB, and I am producing 60-70 dB talking. A New York subway train rounding a curve produces 104 dB of noise; a loud power lawn mower, 107 dB; a jet plane at takeoff, 150 dB.

"Before you crank up the volume next time, remember this warning from the American Academy of Ophthalmology & Otolaryngology in its *Guide for Conservation of Hearing in Noise*: 'Prolonged exposure to the noises encountered in

many industrial environments can produce a permanent hearing loss. This hearing loss is not amenable to treatment. Once a noise-induced loss has been acquired, normal hearing cannot be restored.'

"I will, I will!" Barney promised with a grin. "But tell me how you define 'noise.'"

"You've touched a nerve there," Mac admitted. "Sometimes it's hard to tell what *is* noise. Probably the best definition is that noise is unwanted sound. Another definition says noise is sound that does not convey information or produce pleasure. Any sound can, under certain conditions become noise. Take the case of an auto mechanic tuning up a motor in a garage where a radio service technician is repairing a radio. The sound of the jazzing motor will be noise to the radio man trying to listen to the sound from the speaker; yet it is not noise to the mechanic because it conveys information to him. At the same time the music from the radio is noise to the mechanic because it masks informative sounds of the engine's response to acceleration he needs to hear."

"Is anybody doing anything about noise abatement?"

"You bet. A year ago New York formed the Mayor's Task Force on Noise Abatement to: (1) identify noise sources, (2) find resources that can minimize noise, and (3) educate New Yorkers to the problem so they will support abatement measures. In Congress, Representative Theodore R. Kupferman of New York is a kind of Paul Revere trying to arouse his fellow Congressmen to the dangers and evils of noise. He has done so much research on the subject that he is recognized as a lay authority on noise. He placed a bill before the House Interstate Commerce Committee that would create an office of noise control within the Office of the Surgeon General. Last June the Health, Education, and Welfare Department decided noise was one of the most unpleasant forms of pollution confronting Americans today and decided that by no later than 1973 it must have all data necessary to set human levels of tolerance for noise."

"That means we must have some way to measure noise accurately, I suppose," Barney observed.

"Right, but this is a lot more difficult than a person might think," Mac replied. "An excellent discussion of the problems involved is contained in several articles in the November, 1967 issue of the *Hewlett-Packard Journal*. As pointed out therein, if we are going to reduce noise, we must have instruments to measure loudness; but loudness is subjective. It is the way things sound to the human ear, and no instrument yet devised is a complete model of the human ear. In fact, we do not have a very good understanding of the complicated physiological and psychological mechanisms involved in the sensation of loudness. However, even though our knowledge of many unique properties of the human ear is only empirical, we are still able to make instruments that do a fair job of duplicating the loudness-sensing function of the ear."

"Are two different but equally loud sounds equally disturbing?"

"Not necessarily, and this has caused some scientists to



try to define a better measure of noise-sound called 'annoyance.' But this is difficult to pin down because of the large number of unknown psychological factors that contribute to the effect of a sound on an individual at a given time. These include such things as the listener's history, his present state of mind, what he is trying to do at the moment, etc. Mothers know they can easily tolerate the din produced by their children at one time and scarcely bear it at another. Kryter's 'perceived noise' concept, which arrives at annoyance measured in PNdB by a computing method, has found some acceptance; but until we know more about the psychological effects of sound, the only reasonable objective measure of the disturbing effect of a sound seems to be its loudness.

"To get down to basics, sound at a particular point is a rapid variation in the pressure at that point around the steady-state atmospheric pressure value. It is measured in the same units as atmospheric pressure, but because of its alternating nature 'sound pressure' refers to its r.m.s. value. At a frequency of 1 kHz, sound with an r.m.s. value of  $2 \times 10^{-4}$   $\mu$ bar, or about  $2 \times 10^{-10}$  atmosphere, is just below the level of audibility for good ears. (One  $\mu$ bar represents one dyne per square centimeter, about the sound pressure produced by a human speaker at a distance of one meter.) This means the sensitive ear responds to variations in atmospheric pressure of only a few parts in  $10^{10}$ .

"But the ear can also accommodate sound pressures as high as 200  $\mu$ bars without becoming overloaded. Because of this tremendous dynamic range of the ear, a logarithmic scale is used for sound pressure. The reference value is the threshold of hearing level of  $2 \times 10^{-4}$   $\mu$ bar, and sound pressure level is indicated in dB above this value. On this scale the ear has a dynamic range of about 120 dB—a range matched by only a few of the more sophisticated instruments.

"Because loudness is subjective, the primary instrument for measuring it must be a human observer. To determine how loud a sound is, we must have a significant number of people compare its apparent loudness with that of a standard sound, the accepted standard being a pure 1-kHz tone or narrow-band noise centered at 1 kHz. When a significant number of observers say the two sounds are equal in loudness, we define the loudness level of the measured sound as being equal to the sound pressure level of our standard sound. Loudness level is measured in phons. The level of any sound in phons is equal to the sound pressure level in dB of an equally loud standard sound. Thus a noise judged to be

as loud as a 40-dB, 1-kHz tone has a loudness level  $L = 40$  phons.

"But the phon scale does not fit a subjective loudness scale. Doubling the loudness doesn't double the number of phons. In fact, for 40 phons or greater, the corresponding increment is 10 phons. Why loudness should be different from physical quantities like voltage, for which a factor of two corresponds to 6 dB, is not fully understood; but in an effort to obtain a quantity proportional to the intensity of the loudness sensation, a loudness scale was defined with a unit called a *son*. One son corresponds to a loudness level of 40 phons, and the numerical value equivalents for loudness levels of 40 phons or greater are given by the formula  $S = 2(L-40)/10$ , in which  $S$  is in sons and  $L$  in phons.

"There remain many other difficulties in measuring noise. Broad-band sounds seem louder to human ears than pure tones or narrow-band noise having the same sound pressure level, and I'm sure you know loudness is a function of frequency. A 40-phon, 100-Hz tone has a sound pressure level of 50 dB, while a 40-phon, 1-kHz tone has a sound pressure level of only 40 dB. I'm sure you've seen the Fletcher-Munson equal loudness level curves published in 1933 showing the response of normal ears with varying frequency. These curves are made for pure tones and relate feeling to sound level. They show the average sound intensity needed to produce a given loudness level throughout the audio-frequency spectrum.

"Zwicker worked out a procedure in which the frequency range between 45 Hz and 14 kHz is divided into bands by pass-band filters and the level of each band measured. Then these are combined by computation to produce a total loudness level comparing closely to that of the human ear. *Hewlett-Packard's* new Model 8051A Loudness Analyzer is designed to measure loudness by the Zwicker method automatically. Sound is fed into the instrument from a microphone or tape recorder and the levels of all the outputs of the 20 pass-band filters are displayed simultaneously on a CRT, while the total loudness is shown on a meter. The displays can be frozen for several minutes for leisurely analysis, and the instrument also has X and Y recorder outputs. There's lots more dope on the theory back of this instrument and its performance and application in the *H-P Journal* that I recommend you read."

"Okay, but I was just thinking: we've had the Lost Generation and the Angry Generation; but now, what with air pollution, water pollution, radioactive pollution, and now silence pollution, do you suppose I belong to the Polluted Generation?" ▲

## LAFAYETTE Power Packed DYNA-COM 6



**5 WATTS**  
Hand Held Power

**6 CHANNELS**  
Switchable Crystal  
Control For All 23 Channels

Plus New Revolutionary

99-3150L\*  
**9995**

With Leather  
Shoulder Strap



- ★ Integrated Circuit (IC) plus 12 Transistors and 5 Diodes for Super Performance
- ★ Superheterodyne Receiver with Less Than  $1 \mu$ V Sensitivity for 10 db S + N/N Ratio
- ★ Mechanical Filter for Superior Selectivity
- ★ Automatic Compressor Range Boost
- ★ Variable Squelch and ANL
- ★ Public Address External Speaker Jack with PA Switch and PA Volume Control
- ★ Mobile Operation with Cigarette Lighter Plug-in Adapter
- ★ Jacks for External Battery Pack, Mobile Battery and Battery/Charger Eliminator \*Imported

**FREE** 1968  
CATALOG  
NO. 680



512 Pages

Everything in Electronics  
for Home and Industry  
from the "World's Hi-Fi  
Electronics Center"

LAFAYETTE Radio Electronics  
Dept. RK-7, P.O. Box 10  
Syosset, L. I., N. Y. 11791

Send me the FREE 1968  
LAFAYETTE Catalog 680

RC-8

Name \_\_\_\_\_

Address \_\_\_\_\_

City \_\_\_\_\_

State \_\_\_\_\_

Zip \_\_\_\_\_

CIRCLE NO. 106 ON READER SERVICE CARD

GET  
INTO

## ELECTRONICS



V.T.I. training leads to success as technicians, field engineers, specialists in communications, guided missiles, computers, radar and automation. Basic & advanced courses in theory & laboratory. Electronic Engineering Technology and Electronic Technology curricula both available. Assoc. degree in 29 mos. B. S. also obtainable. G.I. approved. Graduates in all branches of electronics with major companies. Start September. February. Dorms. campus. High school graduate or equivalent. Write for catalog.

VALPARAISO TECHNICAL INSTITUTE  
Dept. RD, Valparaiso, Indiana 46383



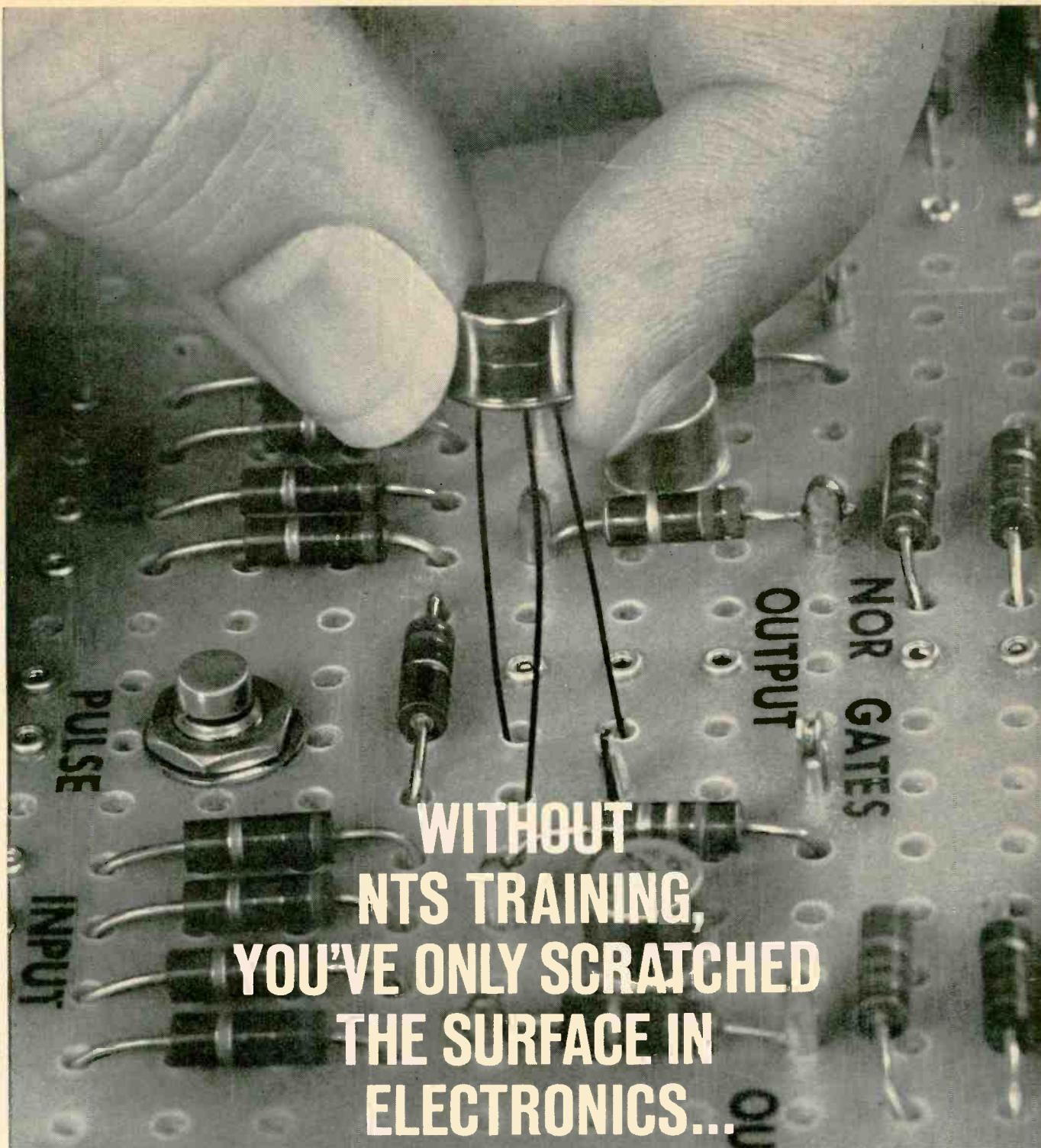

Only NTS penetrates below the surface. Digs deeper. Example? Take the above close-up of the first transistorized digital computer trainer ever offered by a home study school.

It's called The Compu-Trainer®—an NTS exclusive. Fascinating to assemble, it introduces you to the exciting world of computer electronics. Its design includes advanced solid-state NOR circuitry,

flip-flops, astable multivibrators and reset circuits. Plus two zener and transistorized voltage-regulated power supplies. The NTS Compu-Trainer® is capable of performing 50,000 operations per second.

Sound fantastic? *It is!* And at that, it's only one of many *ultra-advanced* kits that National Technical Schools offers to give you incomparable, in-depth career training.

**PROVE IT YOURSELF. SEND FOR OUR NEW CATALOG. SEE THE LATEST, MOST ADVANCED KITS AND COURSES EVER OFFERED BY A HOME STUDY SCHOOL.**



## NTS...THE FIRST HOME STUDY SCHOOL TO OFFER LIVE EXPERIMENTS WITH INTEGRATED CIRCUIT KITS

You build a computer sub-system using the new, revolutionary integrated circuits. Each one, smaller than a dime, contains the equivalent of 15 resistors and 27 transistors.

And your kits come to you at no extra cost. These kits are the foundation of the exclusive *Project-Method* home study system...developed in our giant resident school and proven effective for thousands of men like yourself.

With Project-Method, all your kits are carefully integrated with lesson material. Our servicing and communication kits are *real* equipment—not school-designed versions for training only. As you work on each of the projects, you soon realize that even the most complicated circuits and components are easy to understand. You learn *how* they work. You learn *why* they work.

NTS Project-Method is a practical-experience approach to learning. The approach that works *best!* An all-theory training program can be hard to understand — difficult to remember. More than ever before you need the practical experience that comes from working with real circuits and components to make your training stick.

### NTS SENDS YOU KITS TO BUILD THESE IMPORTANT ELECTRONICS UNITS!

- ◆ 25" COLOR TV
- ◆ 21" BLACK & WHITE TV
- ◆ SOLID-STATE RADIO
- ◆ AM-SW TWIN-SPEAKER RADIO
- ◆ TUBE-TESTER
- ◆ TRANSCEIVER
- ◆ COMPU-TRAINER®
- ◆ VTVM
- ◆ SIGNAL GENERATOR

See them all illustrated in  
the new NTS Color Catalog.

**CLASSROOM TRAINING AT LOS ANGELES:** You can take classroom training at Los Angeles in sunny California. NTS occupies a city block with over a million dollars in facilities devoted exclusively to technical training. Check box in coupon.

## NATIONAL TECHNICAL SCHOOLS

WORLD-WIDE TRAINING SINCE 1905

4000 So. Figueroa Street, Los Angeles, Calif. 90037

### APPROVED FOR VETERANS



Accredited Member: National Home Study Council  
Accredited Member: National Association of  
Trade and Technical Schools

March, 1968



### COMMUNICATIONS

This transceiver is included in Communications courses. You build it. With it, you easily prepare for the F.C.C. license exam. You become a fully-trained man in communications, where career opportunities are unlimited.

### 25" COLOR TV ▼

Included in Color TV Servicing Courses. With it you advance yourself into this profitable field of servicing work. Color is the future of television, you can be in on it with NTS training.

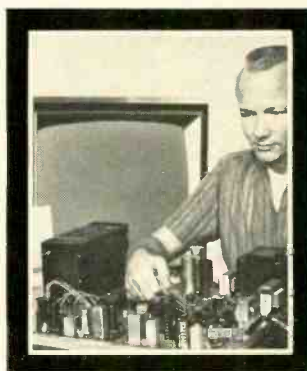

### YOUR OPPORTUNITY IS NOW

New ideas, new inventions, are opening whole new fields of opportunity. The electronic industry is still the fastest growing field in the U.S. There's a bigger, better place in it for the man who trains today. So, whatever your goals are — advanced color TV servicing, broadcasting, F.C.C. license, computers, or industrial controls, NTS has a highly professional course to meet your needs.

GET THE FACTS! SEE ALL NEW COURSES AND KITS OFFERED IN THE NEW NTS COLOR CATALOG. SEND THE CARD OR COUPON TODAY!

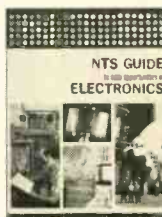

There's no obligation. You enroll by mail only. No salesman will call.

DEPT. 240-38

### NATIONAL TECHNICAL SCHOOLS

4000 S. Figueroa St., Los Angeles, Calif. 90037

Please rush Free Color Catalog and Sample Lesson, plus information on field checked below. No obligation.

- |   |  |
|---|--|
| <input type="checkbox"/> MASTER COURSE IN COLOR TV SERVICING        | <input type="checkbox"/> PRACTICAL TV & RADIO SERVICING    |
| <input type="checkbox"/> COLOR TV SERVICING                         | <input type="checkbox"/> FCC LICENSE COURSE                |
| <input type="checkbox"/> MASTER COURSE IN TV & RADIO SERVICING      | <input type="checkbox"/> INDUSTRIAL & COMPUTER ELECTRONICS |
| <input type="checkbox"/> MASTER COURSE IN ELECTRONIC COMMUNICATIONS | <input type="checkbox"/> STEREO, HI FI & SOUND SYSTEMS     |
|   | <input type="checkbox"/> BASIC ELECTRONICS                 |

NAME \_\_\_\_\_ AGE \_\_\_\_\_

ADDRESS \_\_\_\_\_

CITY \_\_\_\_\_ STATE \_\_\_\_\_ ZIP \_\_\_\_\_

Check if interested in Veteran Training under new G. I. Bill.

Check if interested ONLY in Classroom Training at Los Angeles.





... AS  
EASILY AND  
COMPETENTLY AS  
ONE  
MICROPHONE

The Shure M68 Microphone Mixer enables you to teach inexperienced users how to operate a multiple-microphone sound system in seconds! It is your best tool for selling Total Communications\*.  
(\* A superior sound system in which everybody who needs a microphone has one at his fingertips.)

# SHURE MICROPHONE MIXER

...YOUR KEY TO TOTAL COMMUNICATIONS  
© 1967 Shure Brothers, Inc.  
CIRCLE NO. 93 ON READER SERVICE CARD  
64

## EW Lab Tested (Continued from page 7)

Through the speaker outputs, terminated in 8-ohm loads, the response was not quite as good. Relative to the mid-range level, it was down 6.5 dB at 9000 Hz and at 80 Hz with the tone control at maximum treble. At its counterclockwise limit, the tone control rolled off the highs at about 6 dB/octave, to about -22 dB at 10,000 Hz. The low frequencies also fell off more rapidly at the speaker outputs than at the line outputs.

Only 0.13 volt was needed at the radio/phono input for maximum recording level. At the maximum level, the distortion was less than 2.5% in the total record/playback process. The 60-minute cassette was passed through at fast speeds in about 50 seconds. Wow and flutter were 0.08% and 0.36% respectively, well within the rated 0.4%. The amplifiers delivered 1 watt into 8 ohms with less than 2% distortion at 1000 Hz.

We did not make any measurements on the small *Ampex* 515 speaker systems supplied with the "Micro 85". Each appears to contain an oval speaker of approximately 6" x 9". They sound pleasant and complement the frequency response of the recorder quite well. Due to the lack of low bass when using these

speakers, we found the sound to be best with the tone control considerably down from its maximum treble setting.

We listened to the sampler tape included with the recorder, and made numerous recordings off the air and with the microphones. The sound was at all times clean and listenable, and often unbelievably good from such small speakers, 1-watt amplifiers, and a 1½ in/s tape recorder. At present, the cassette system, as exemplified by the "Micro 85", is not what can be termed "high fidelity". When played through a good external amplifier and speakers, it comes quite close to meeting present standards for moderately good high-fidelity sound. Certainly it is competitive in quality with many phonograph-playing systems in the same price class, and has the advantage of being able to make records. Furthermore, the cassette is by far the easiest device to handle, not requiring the care demanded by phonograph records.

This unit was our first close contact with the cassette tape system. We feel strongly that this is the natural direction for development of tape cartridges and have no doubt that ultimately cassette systems will be high fidelity in every sense of the word.

The *Ampex* "Micro 85" system, complete with speakers and microphones, sells for \$199.50. ▲

### Eico Model 3200 FM Stereo Tuner

For copy of manufacturer's brochure, circle No. 21 on Reader Service Card.

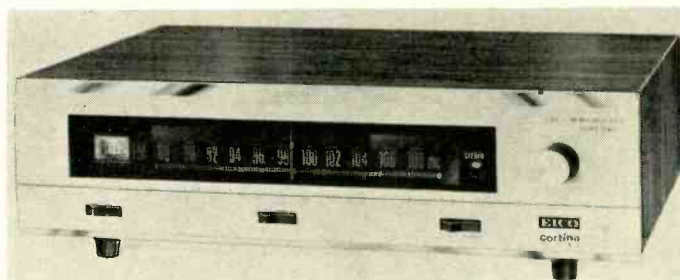

**T**HE *Eico* Model 3200 ("Cortina") FM tuner is a companion to the Model 3070 amplifier recently reviewed in *ELECTRONICS WORLD*. It is similar in size and styling to the Model 3070 and

is probably the most compact FM stereo tuner presently available.

The Model 3200 is an all-solid-state unit employing 13 transistors and 11 diodes. It has automatic mono/stereo

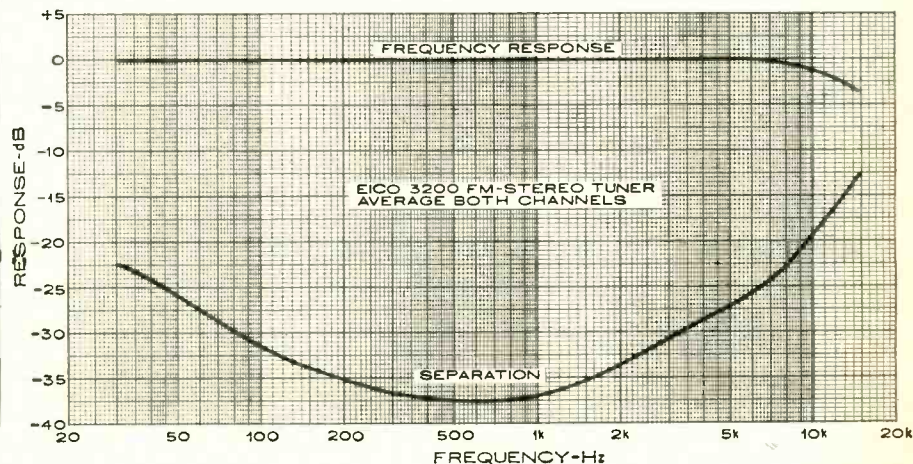



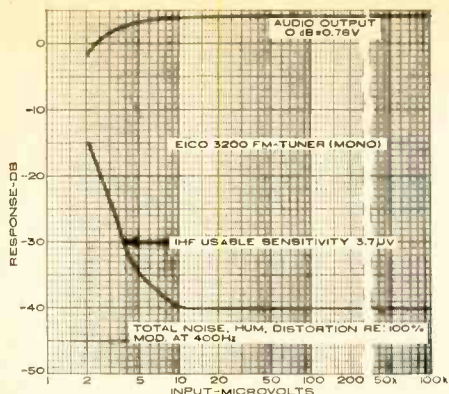

switching, with a manual override to convert to mono reception of weak stereo signals. Switchable a.f.c. is also provided, although like most transistorized tuners, the 3200 has negligible drift. The only other operating controls are the power switch and the tuning knob, indicating the simplicity of operation of this tuner.

The unit is available in kit form or factory-wired. The task of the kit builder is greatly simplified by the fact that all critical subassemblies (front end, i.f., and multiplex section) are supplied fully wired and aligned. The kit construction consists of mechanically mounting and interwiring these sections, wiring the power supply, and stringing the dial cord. Unusual among kits, the 3200 does not require any touch-up alignment by the builder; in fact, the instruction manual cautions against such attempts to align the tuner, since they would void the warranty.

The front end of the tuner has a grounded-base r.f. amplifier, mixer, and oscillator. A.f.c. is applied to the oscillator by a voltage-variable capacitor. The i.f. amplifier, on its own printed board, has four stages of double-tuned amplification followed by a ratio detector. A separate detector diode operating from the third i.f. stage supplies a.g.c. voltage to the first i.f. stage. This stage serves as a d.c. amplifier for a.g.c., with its amplified emitter current operating the tuning meter and supplying a.g.c. to the r.f. stage.

The multiplex board is simple yet highly effective. Following a 67-kHz SCA trap, a single transistor stage separates the 19-kHz pilot carrier from the composite signal. The pilot signal is amplified and drives a harmonic generator stage with a 38-kHz tuned transformer in its collector circuit. A separate transistor is also driven by the amplified pilot carrier, which increases its collector current and causes a bulb in its collector circuit to glow when a stereo broadcast is received.

The 38-kHz carrier drives a four-diode balanced modulator which is supplied with the composite signal from the stage of the multiplex unit. The outputs are the left- and right-channel programs which are de-emphasized and

March, 1968

# Important New SAMS BOOKS

**THE BOOK YOU NEED**

## NEW 11th Edition of the famous HOWARD W. SAMS Tube Substitution Handbook

**TWIN PAK: 2 Books in 1 Package!**

Regular size for your bench  
Pocket-size for your tube caddy

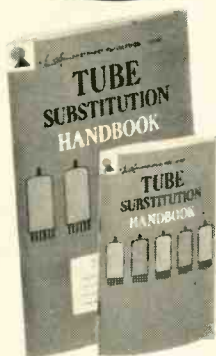

Completely revised, each book contains identical up-to-date listings of over 10,000 direct substitutes for all types of American and foreign receiving and picture tubes. The most complete and updated direct tube substitution guide available. Includes cross reference for all American receiving tubes, list of picture tubes and substitutions, cross reference for miniature tubes, industrial substitutions for receiving tubes, substitutions for communications and special-purpose tubes, cross reference for American and foreign tubes. Instructions tell you when and how to make proper substitutions. You get *two* books, each with exactly the same information—the full-sized book for your bench or reference library, the pocket-size for your tube caddy. \$2.25 Order 20615, both books for only... \$2.25 Shop edition only (5 1/2 x 8 1/2", 96 pages). Order 20614, only... \$1.75

### ABC's of Ham Radio, 3rd Ed.

by Howard S. Pyle, W70E. Newly revised to contain all the information you need to get your novice-class amateur license. Covers all the latest FCC regulations, including the new incentive licensing program. Explains how to apply for a license and what to expect in the FCC exam. Shows you how to learn the code, and how to set up your station and operate it; provides a world of helpful hints to get you into ham radio in the shortest time. \$2.50 144 pages; 5 1/2 x 8 1/2". Order 20638, only...

### Understanding Electronic Test Equip.

by Joseph A. Risse. Explains the operating principles, functions, and applications of the test equipment most commonly used in electronic testing and troubleshooting. Clear, in-depth explanations help you to better understand and make more effective use of test instruments; also shows you how to repair and even calibrate them. Includes data on the latest solid-state instruments. Fully illustrated with schematics, drawings, and photographs. \$4.25 192 pages; 5 1/2 x 8 1/2". Order 20613, only...

### 101 Easy Audio Projects

by Robert M. Brown and Tom Kneitel. Includes complete instructions for building 101 simple, low-cost audio projects using parts salvaged from discarded radio and television receivers. Projects include a-m and f-m tuners, reverb units, eavesdropping amplifiers, time-delay control boxes, hearing aids, and test equipment. Many can be completed in just one evening. Construction is enjoyable, and at the same time you will also learn the basics of electronics. \$3.25 168 pages; 5 1/2 x 8 1/2". Order 20608, only...

### ABC's of Transformers and Coils, 2nd Ed.

by Edward J. Bukstein. Because transformers and coils are a part of almost all electronic equipment, you must know how they work in order to understand how circuits operate. This book explains the basic principles of inductance, transformer and coil construction, inductor applications, and how to test and measure inductance components. Includes computer developments (magnetic-core memory and logic circuits, and toroidal and ferrite-head inductors). 96 pages; 5 1/2 x 8 1/2". Order 20612, only... \$2.25

These and over 300 other SAMS Books are available from your local Electronics Parts Distributor.

COMING NEXT MONTH

49 EASY TRANSISTOR PROJECTS  
SERVICING DIGITAL DEVICES  
101 QUESTIONS & ANSWERS ABOUT COLOR TV



**HOWARD W. SAMS & CO., INC.**

4300 W. 62nd St., Indianapolis, Ind. 46268

CIRCLE NO. 94 ON READER SERVICE CARD

## Electronics World SUBSCRIBER SERVICE

Please include an address label when writing about your subscription to help us serve you promptly. Write to: Portland Place, Boulder, Colorado 80302

### CHANGE OF ADDRESS:

Please let us know you are moving at least 4 to 6 weeks in advance. Affix magazine address label in space to the right and print new address below. If you have a question about your subscription, attach address label to your letter.

**TO SUBSCRIBE:** Check boxes below.

New  Renewal  
 5 years \$21  3 years \$15  1 year \$6

**SPECIFY:**  Payment enclosed—You get 1 extra issue per year as a bonus!  Bill me later.

If you have no label handy, print OLD address here.

name \_\_\_\_\_ please print  
address \_\_\_\_\_  
city \_\_\_\_\_  
state \_\_\_\_\_ zip-code \_\_\_\_\_

← AFFIX LABEL HERE →

(Add'l postage: \$1 per year outside U.S., its possessions & Canada.)

name \_\_\_\_\_ please print 0200

address \_\_\_\_\_

city \_\_\_\_\_

state \_\_\_\_\_ zip-code \_\_\_\_\_



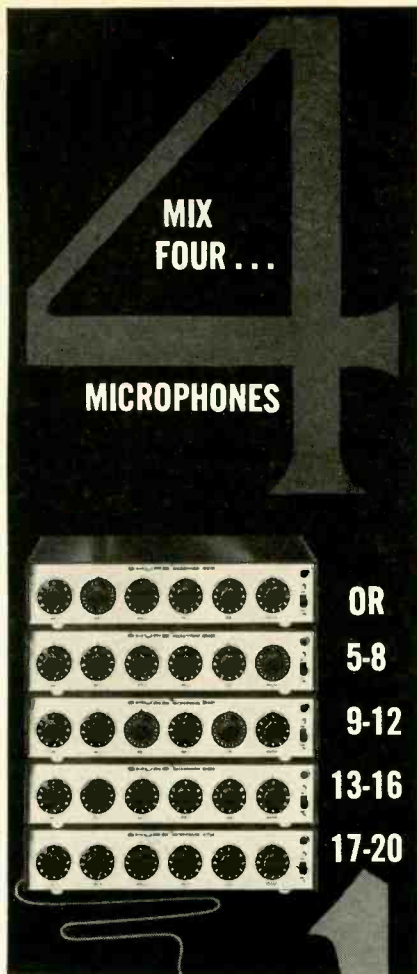

... WITH ONE  
VOLUME CONTROL  
FOR EACH  
MICROPHONE AND  
ONE MASTER  
VOLUME CONTROL

Shure M68 Microphone Mixers can be stacked and interconnected to accommodate virtually any number of microphones regardless of impedance. They are unusually compact, singularly flexible, and modest in cost. They make Total Communications a practical reality.

## SHURE MICROPHONE MIXER

...YOUR KEY TO TOTAL COMMUNICATIONS  
SHURE BROTHERS, INC., 222 HARTREY AVE.  
EVANSTON, ILL. 60204

© 1967 Shure Brothers, Inc.

CIRCLE NO. 93 ON READER SERVICE CARD

filtered to remove 19 kHz and higher frequencies. Each channel is amplified and fed to its output jack in the rear of the tuner. There is no volume control, that function being relegated to the amplifier.

We measured the IHF usable sensitivity of the *Eico* 3200 tuner as 3.7 microvolts, slightly less than its rated 2.4 microvolts. The distortion at 100% modulation was 1% (-40 dB). Limiting was complete at 10 microvolts. The stereo separation was excellent, about 37.5 dB at middle frequencies, 22.5 dB at 30 Hz, and 20 dB at 10,000 Hz. The frequency response was almost perfectly flat from 30 to 7000 Hz and was down only 1 dB at 10,000 Hz and 3.5 dB at 15,000 Hz. This negligible rolloff is the result of the post-detection filtering which is almost totally effective in removing pilot carrier and other ultrasonic frequencies from the audio output.

We attempted to improve the performance of the tuner by means of instrument alignment (although this is specifically not recommended in the manual) but were only able to increase the sensitivity to 3.3 microvolts and reduce the distortion to 0.9%. This is a negligible improvement, and we strongly concur in the manufacturer's suggestion that the builder not disturb any adjustments.

The tuner sounded fine in on-the-air testing. Its quality was indistinguishable from that of several far more expensive tuners, and it pulled in a full complement of stations with quiet backgrounds, low distortion, and non-critical tuning. This compact, straightforward tuner is a fitting companion for the excellent 3070 amplifier and its construction should pose no problems even for the neophyte kit builder.

The *Eico* 3200 sells for \$89.95 in kit form or \$129.95 factory-wired. The price includes an attractive walnut-finished vinyl-clad steel cabinet. ▲

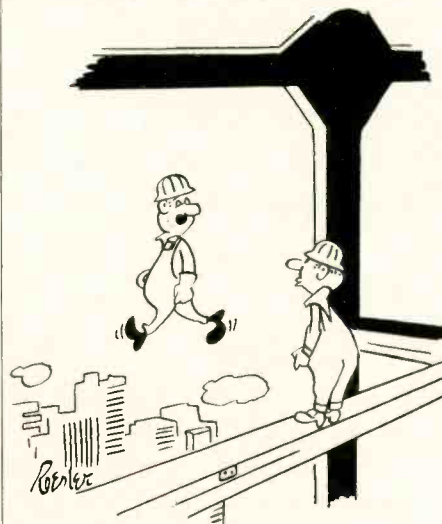

"Don't worry. I'm walking on a laser beam."

*This Space Reserved for You!*

**FIRST PRIZE**

**Dreaming about winning first prize in a photo contest?**

Well, whether you're a perplexed beginner, a serious hobbyist—or someone who just likes to take pictures—everything you need to know about getting the best out of your camera is now clearly defined in one concise, easy-to-understand guidebook.

### The all-new 1967 INVITATION TO PHOTOGRAPHY!

Produced by the editors of *POPULAR PHOTOGRAPHY*, *INVITATION* is a unique 124 page "course" in better picture taking.

#### Including:

- a primer of photographic terms
- color wizardry
- choosing the equipment you really need
- girls and glamor
- suiting the film to the occasion
- creative composition
- using the right light
- which lens for you
- starring the kids
- darkroom procedure simplified
- not-so-simple-pictures from simple cameras
- eliminating the focus-focus from portrait, action and night shots.

#### Plus an extra BONUS—

Lights, camera, action! A complete 28 page section on movie making... movie cameras... creative and technical filming procedures.

Over 20 complete sections in all! Each written by an expert to help you progress quickly, easily, *confidently*. So whether you're aiming at professional blue ribbons, or professional-quality photos for your family album—take the first important step now. By ordering *your INVITATION TO PHOTOGRAPHY!* **Only \$1.25**

*INVITATION TO PHOTOGRAPHY* is also available in a handsome deluxe edition. Rugged Leatherflex cover provides lasting protection yet is softly textured and gold-embossed for the look of elegance. A collector's item—a superb addition to your permanent photo reference library. And it's yours, for just \$3 postpaid, when you check the appropriate box on the order form.

ZIFF-DAVIS SERVICE DIVISION • DEPT. IP  
595 BROADWAY • NEW YORK, N. Y. 10012

YES! Please send my copy of the 1967 *INVITATION TO PHOTOGRAPHY* as checked below:

- \$1.25 enclosed, plus 15¢ for shipping and handling. Send me the regular edition. (\$1.75 for orders outside the U.S.A.)
- \$3.00 enclosed. Send me the Deluxe Leatherflex-bound edition, postpaid. (\$3.75 for orders outside the U.S.A.) Allow three additional weeks for delivery.

Print Name \_\_\_\_\_ E.W.-38

Address \_\_\_\_\_

City \_\_\_\_\_

State \_\_\_\_\_ Zip Code \_\_\_\_\_

**PAYMENT MUST BE ENCLOSED WITH ORDER**

ELECTRONICS WORLD







# Space age minded ?

Look ahead to an exciting career in engineering. Start now. At

## MSOE

Residence study at the Milwaukee School of Engineering leads to B.S. degrees in Electrical and Mechanical Engineering and Engineering Technologies. Other courses lead to Associate in Applied Science degrees in these engineering technologies: computer... electrical power... electronic communications... air conditioning... fluid power... internal combustion engines... metallurgy... welding... chemical... architectural and building construction. Find out about financial aids, and job placements. Approved for G.I. Bill. Send for Your Career Booklet today.

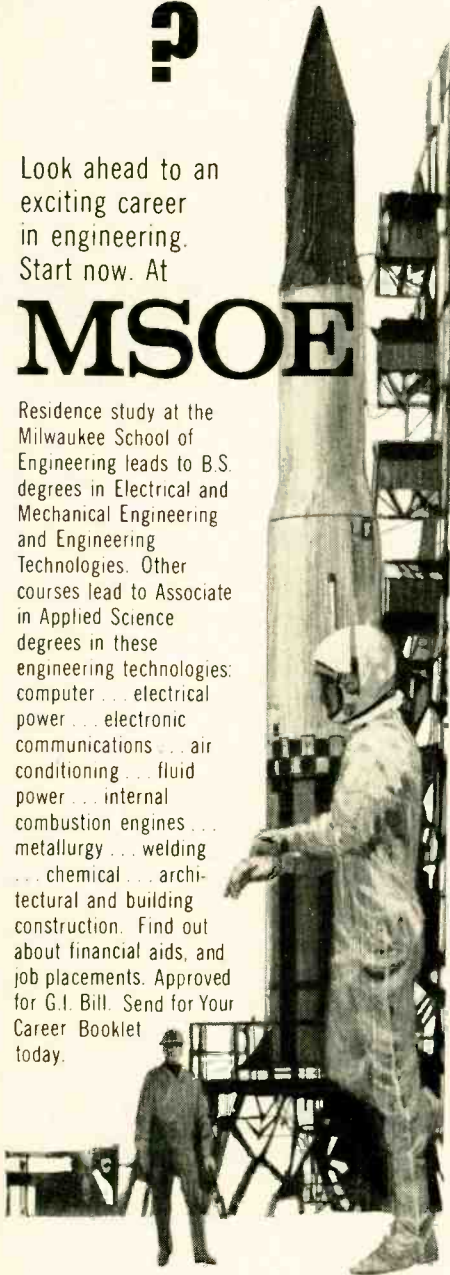

MILWAUKEE SCHOOL OF ENGINEERING  
Dept. EW-368, 1025 N. Milwaukee Street  
Milwaukee, Wisconsin 53201  
Please send the "Your Career" booklet.  
I'm interested in  
 Electrical fields     Mechanical fields

NAME \_\_\_\_\_ AGE \_\_\_\_\_  
ADDRESS \_\_\_\_\_  
CITY \_\_\_\_\_ STATE \_\_\_\_\_ ZIP \_\_\_\_\_

**CIRCLE NO. 101 ON READER SERVICE CARD 68**

### Pomona Model 2900 High-Voltage Tester

For copy of manufacturer's brochure, circle No. 23 on Reader Service Card

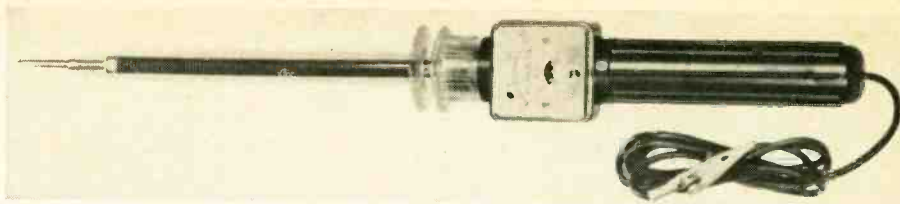

ALONG with his color-bar generator, the TV service technician should have a simple means of measuring the high voltage at the color picture tube (usually about 25 kV). This assures the proper setting of the high-voltage regulator and horizontal-output stage so that the voltage is high enough to produce a bright color picture but not too high, which would result in voltage breakdown and the possible generation of x-rays. Incorrect high voltage can also cause picture blooming, improper focus, and changes in raster size. It is also important to be able to measure the high voltage of black-and-white picture tubes, too, since improper operation may result from insufficient or excessive high voltage.

The usual way of making this measurement is by means of a high-voltage probe connected to a v.o.m. or v.t.v.m. The use of the new *Pomona Electronics*

Model 2900 h.v. tester is a much more convenient method.

This tester is actually built like a h.v. probe, except that it not only contains the high-value multiplier resistor but also the meter itself. The resistor has a value of 600 megohms ( $\pm 2\%$ ), while the meter movement is rated at 50 microamperes. The meter face is calibrated to read 0 to 30,000 volts d.c. at 20,000 ohms/volt. Over-all accuracy of the tester is within 3%.

The probe is designed mechanically to be light in weight and yet rugged enough to withstand an extensive amount of use. The probe handle is high-impact thermoplastic while the probe body is clear polystyrene. The tester is just under 15 inches long and weighs 8 ounces. It is priced at \$19.95 and is available from the manufacturer's local electronics distribution outlets. ▲

### Hewlett-Packard Model 4328A Milliohmmeter

For copy of manufacturer's brochure, circle No. 24 on Reader Service Card



THIS new milliohmmeter needs only two probe connections to make four-terminal resistance measurements. One jaw of each of the probes supplies the stimulus current to the measured device, while the other jaw returns the resulting voltage to the ohmmeter for measurement. This simplifies measurements by reducing by half the number of connections that must be made.

The milliohmmeter also provides protection to sensitive devices being measured. The oscillator, which supplies the stimulating current, functions only when a resistance is connected to the probes. Hence, there is no large transient when connections are made, thus

protecting semiconductors or other sensitive devices. Furthermore, sensing circuits limit the applied voltage to 20 millivolts r.m.s. regardless of the measurement range. If the correct range has already been chosen, the applied voltage is no more than 200 microvolts.

The new milliohmmeter (*Hewlett-Packard Model 4328A*) has 11 measurement ranges from 1 milliohm full-scale to 100 ohms full-scale in a 1, 3, 10 sequence. To preserve accuracy when measurements are made in magnetic circuits, the instrument is able to read the resistance of circuits or devices that have a reactive impedance equal to twice the full-scale resistance range with no loss in accuracy. The milliohmmeter can also read resistance when there is up to 150 volts d.c. across the tested circuit or device.

For situations where there is no room to use the alligator clip probes, a pair of test prods is provided. The four-terminal measurement is preserved by running the voltage leads coaxially with the current leads to the probe tip. For those cases where four separate connections are absolutely required, a third set of probes, with four alligator clips, is provided.

The milliohmmeter consists of an oscillator that supplies a constant-level alternating current to the tested device along with a phase-sensitive voltmeter



**WORLD'S  
FINEST  
5-CORE  
SOLDER**



**ERSIN  
MULTICORE**

**NEW EASY  
DISPENSER  
PAK ONLY 69¢**

BUY IT AT RADIO-TV PARTS STORES  
MULTICORE SALES CORP., WESTBURY, N.Y. 11590  
CIRCLE NO. 100 ON READER SERVICE CARD

**FREE!**



**ALLIED  
NEW 1968  
CATALOG**

**518  
PAGES**

**SAVE ON:**

- Famous Knight-Kits Ⓢ
- Stereo Hi-Fi
- Tape Recorders, Tape
- CB 2-Way Radios
- Walkie-Talkies
- FM-AM & AM Radios
- Shortwave Receivers
- Portable TV
- Phonographs
- Amateur Gear
- Intercoms & PA
- Automotive Electronics
- Test Instruments
- TV Antennas & Tubes
- Power Tools, Hardware
- Tubes, Transistors
- Parts, Batteries, Books

**TOP SAVINGS ON  
THE BEST IN  
ELECTRONICS  
FOR EVERYONE**

Shop by mail and save at Allied, world's largest electronics headquarters. Hundreds of money-saving values. NO MONEY DOWN. Up to 2 years to pay!

**MAIL COUPON  
BELOW**

**ALLIED RADIO, Dept. 1C**  
P.O. Box 4398, Chicago, Ill. 60680

NAME (Please Print) \_\_\_\_\_

ADDRESS \_\_\_\_\_

CITY \_\_\_\_\_

STATE \_\_\_\_\_ ZIP \_\_\_\_\_

CIRCLE NO. 125 ON READER SERVICE CARD  
March, 1968

that reads the resulting voltage. The oscillator operates at 1 kHz when connected to a test sample, the use of an a.c. sine wave eliminating errors that might be caused by thermal e.m.f. electrolytic polarization, or contact potential difference. The applied current ranges from 150 milliamperes r.m.s. on the 0.001-ohm range to 1.5 microamperes on the 100-ohm range. Maximum power dissipation in the sample during a measurement ranges from 23 microwatts on the 0.001-ohm range to 0.23 nanowatts on the 100-ohm range.

Typical applications for the milliohm-meter include the measurement of contact resistance in relays, switches, and connectors. Also, it is used for measuring waveguide joint resistance in corrosion tests and for making resistivity contours in semiconductor devices. The low-power dissipation of this instrument also makes it possible to measure fuses and explosive squibs.

The Hewlett-Packard Model 4328A milliohm-meter costs \$450. An optional version (at \$475) includes a rechargeable battery supply. ▲

**IC EMERGENCY BOX**

**A** NEW radio emergency call box that utilizes integrated circuits and digital logic to take the "false" out of alarms has been developed by the *Gamewell Division of the E. W. Bliss Co.* According to *Gamewell*, the box transmits a three-round message in two seconds—faster than any other emergency call box system now available.

The new call box, designated the SST (solid-state transmitter), will be available in a number of models for fire, police, ambulance, and highway emergencies.

American Insurance Association rules require that emergency boxes transmit three or four consecutive alarm signals. If one round of a signal differs from the others, both signals represent separate box locations and two responses instead of one would have to be made. But in the SST, digital logic circuits automatically compare the three message rounds and only the majority signal is transmitted. At the central control station, the transmitted signals are again examined by logic circuits and the majority signal passed to an IC decoder and alphanumeric printer.

All of the call box electronics are solid-state. The transmitter has a power output of more than one watt and operates in the 72- to 76-megahertz band. Frequency shift keying is employed in the modulator. The transmitter is exceptionally stable (0.005%) and the signal can be heard 25 miles away. Long-life batteries supply power for the electronics.

One version of the new radio box has four call buttons labeled "fire", "police", "ambulance", and "service". The user merely pushes the appropriate button to indicate the kind of help needed. In every case three consecutive rounds are transmitted to the central station, identifying the location of the box and the type of aid required. ▲

The TRUE electronic solution to a major problem of engine operation!

**DELTA'S FABULOUS  
MARK TEN®**



Only \$44.95 ppd.  
In easy-to-build Deltakit®  
Only \$29.95 ppd.

**CAPACITIVE DISCHARGE  
IGNITION SYSTEM**

You've read about The Mark Ten in *Mechanix Illustrated*, *Popular Mechanics*, *Electronics* and other publications!

Now discover for yourself the dramatic improvement in performance of your car, camper, jeep, truck, boat—any vehicle! Delta's remarkable electronic achievement saves on gas, promotes better acceleration, gives your car that zip you've always wanted. Find out why even Detroit has finally come around. In four years of proven reliability, Delta's Mark Ten has set new records of ignition benefits. No re-wiring! Works on literally any type of gasoline engine. Why settle for less when you can buy the original DELTA Mark Ten, never excelled and so unique that a U.S. Patent has been granted.

**READY FOR THESE BENEFITS?**

- ▲ Dramatic Increase in Performance and in Fast Acceleration
- ▲ Promotes more Complete Combustion
- ▲ Points and Plugs last 3 to 10 Times Longer
- ▲ Up to 20% Mileage Increase (saves gas)

LITERATURE SENT BY RETURN MAIL  
BETTER YET—ORDER TODAY!

**DELTA PRODUCTS, INC.** DP 7-17

P.O. Box 1147 EW • Grand Junction, Colo. 81501

Enclosed is \$ \_\_\_\_\_  Ship ppd.  Ship C.O.D.

Please send:

Mark Tens (Deltakit®) @ \$29.95  
(12 VOLT POSITIVE OR NEGATIVE GROUND ONLY)

Mark Tens (Assembled) @ \$44.95

6 Volt: Negative Ground only  Positive Ground

12 Volt: Specify  Negative Ground

Car Year \_\_\_\_\_ Make \_\_\_\_\_

Name \_\_\_\_\_

Address \_\_\_\_\_

City/State \_\_\_\_\_ Zip \_\_\_\_\_

CIRCLE NO. 118 ON READER SERVICE CARD

# There's more than one road to success.

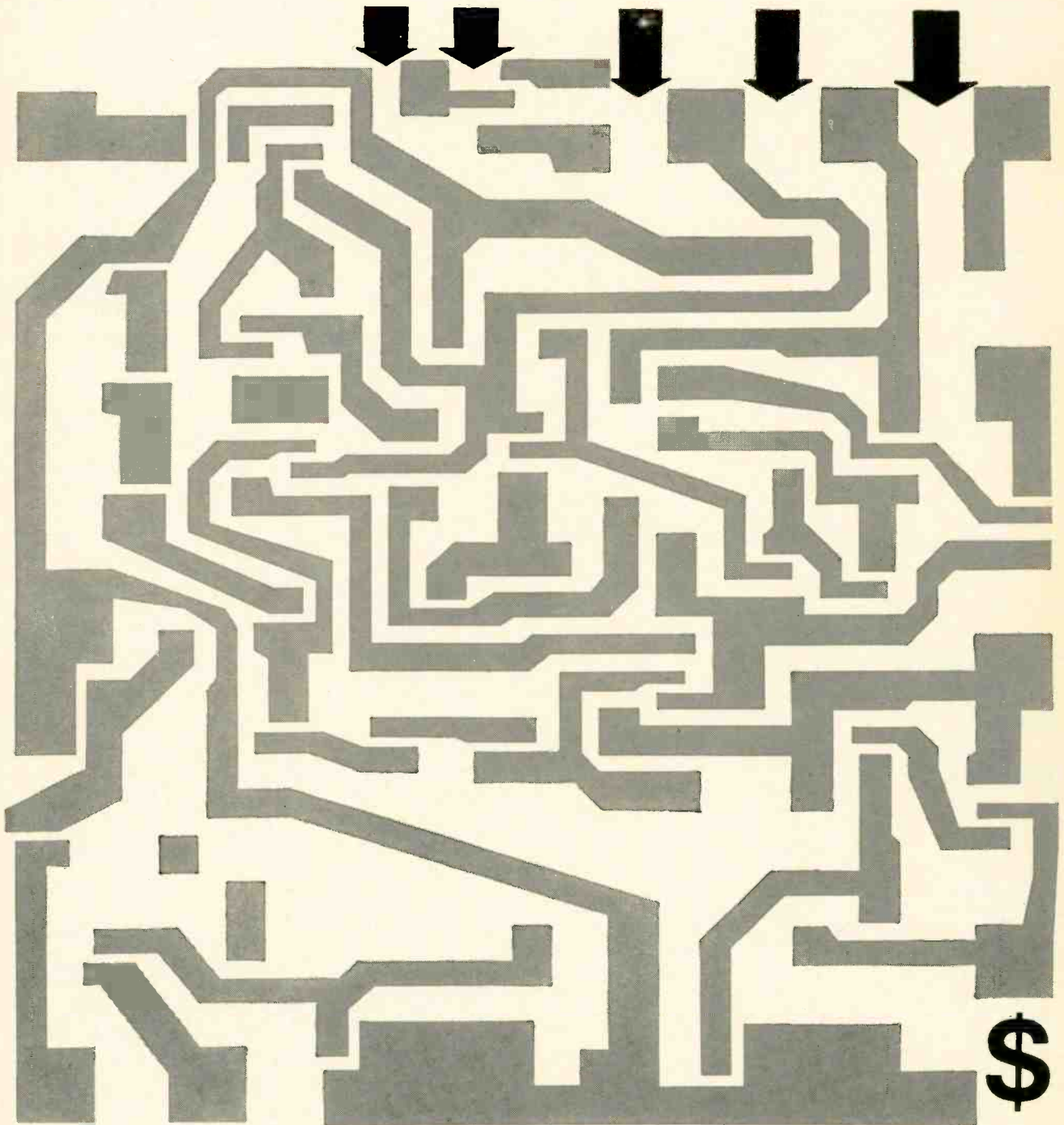

An integrated circuit enlarged several thousand times

**RCA Institutes can help find the one best for you!**

Are you trying to find your way through a maze of career possibilities? Find out how RCA Institutes can start you on your way toward a well paying job in electronics. Send the attached card today!



# Learn electronics at home faster, easier, almost automatically— with RCA AUTOTEXT

Are you just a beginner with an interest in the exciting field of electronics? Or, are you already earning a living in electronics and want to brush-up or expand your knowledge in a more rewarding field of electronics? In either case, AUTOTEXT, RCA Institutes' own method of Home Training will help you learn electronics more quickly and with less effort, even if you've had trouble with conventional learning methods in the past.

## THOUSANDS OF WELL PAID JOBS ARE OPEN NOW TO MEN SKILLED IN ELECTRONICS!

Thousands of well paid jobs in electronics go unfilled every year because not enough men have taken the opportunity to train themselves for these openings. RCA Institutes has done something positive to help men with an aptitude and interest in electronics to qualify for these jobs.

## HOME STUDY CAN TRAIN YOU FOR REWARDING CAREER OPPORTUNITIES

To help fill the "manpower gap" in the electronics field, RCA Institutes has developed a broad scope of Home Training courses, all designed to lead to a well paying career in electronics in the least possible time. You also have the opportunity to enroll in an RCA "Career Program" exclusively created to train you quickly for the job you want! Each "Career Program" starts with the amazing AUTOTEXT Programmed Instruction Method. And, all along the way, your program is supervised by RCA Institutes experts who become personally involved in your training and help you over any "rough spots" that may develop.

## VARIETY OF KITS ARE YOURS TO KEEP

To give practical application to your studies, a variety of valuable RCA Institutes engineered kits are included in your program. Each kit is complete in itself, and yours to keep at no extra cost. You get the new Programmed Electronics Breadboard for limitless experiments, including building a work-

ing signal generator, multimeter, and a fully transistorized superheterodyne AM receiver.

## ONLY FROM RCA INSTITUTES— TRANSISTORIZED TV KIT— VALUABLE OSCILLOSCOPE

All students receive a valuable oscilloscope. Those enrolled in the Television program receive the all-new transistorized TV Kit. Both at no extra cost and only from RCA Institutes.

## CHOOSE THE "CAREER PROGRAM" THAT APPEALS MOST TO YOU

Start today on the electronics career of your choice. Pick the one that suits you best and mark it off on the attached card.

- Television Servicing
- Telecommunications
- FCC License Preparation
- Automation Electronics
- Automatic Controls
- Digital Techniques
- Industrial Electronics
- Nuclear Instrumentation
- Solid State Electronics
- Electronics Drafting

## ADVANCED TRAINING

For those already working in electronics, RCA Institutes offers advanced courses. You can start on a higher level without wasting time on work you already know.

## UNIQUE TUITION PLAN

With RCA Institutes Training, you progress at your own pace. You only pay for lessons as you order them. You don't sign a long-term contract. There's

no large down-payment to lose if you decide not to continue. You're never badgered for monthly payments. Even if you decide to interrupt your training at any time, you don't pay a single cent more.

## CLASSROOM TRAINING ALSO AVAILABLE

If you prefer, you can attend classes at RCA Institutes Resident School, one of the largest of its kind in New York City. Coeducational classroom and laboratory training, day and evening sessions, start four times a year. Simply check "Classroom Training" on the attached card for full information.

## JOB PLACEMENT SERVICE, TOO!

Companies like IBM, Bell Telephone Labs, GE, RCA, Xerox, Honeywell, Grumman, Westinghouse, and major Radio and TV Networks have regularly employed graduates through RCA Institutes' own placement service.

**SEND ATTACHED POSTAGE PAID  
CARD TODAY. FREE DESCRIPTIVE  
BOOK YOURS WITHOUT OBLIGATION.  
NO SALESMAN WILL CALL.**

All RCA Institutes courses and programs are approved for veterans under the New G.I. Bill.

RCA INSTITUTES, DEPT. EW-38  
320 West 31st Street,  
New York, N. Y. 10001

Accredited Member National Home Study Council

# RCA

# VIKING VERSATILITY MEANS EXTRA VALUE

Viking's versatile Model 230 transports are especially designed for continuous operation in a variety of commercial and industrial uses. Sophisticated installations in electronic teaching and dial access information retrieval systems, radio broadcast monitors, flight communications, law enforcement agencies, delayed broadcasting and background music centers all attest to their rugged reliability.

A two speed, three-motor tape transport, the Model 230 is equipped with momentary push-button controls and is ideally suited

for remote controlled and automatic applications. Various head configurations and interchangeable, plug-in head block assemblies, plus other optional features, make it a highly versatile unit. And Viking solid state modular amplifiers, single channel RP110 or dual channel RP120, match the 230 transports in dependability and design. For complete information write to Viking.

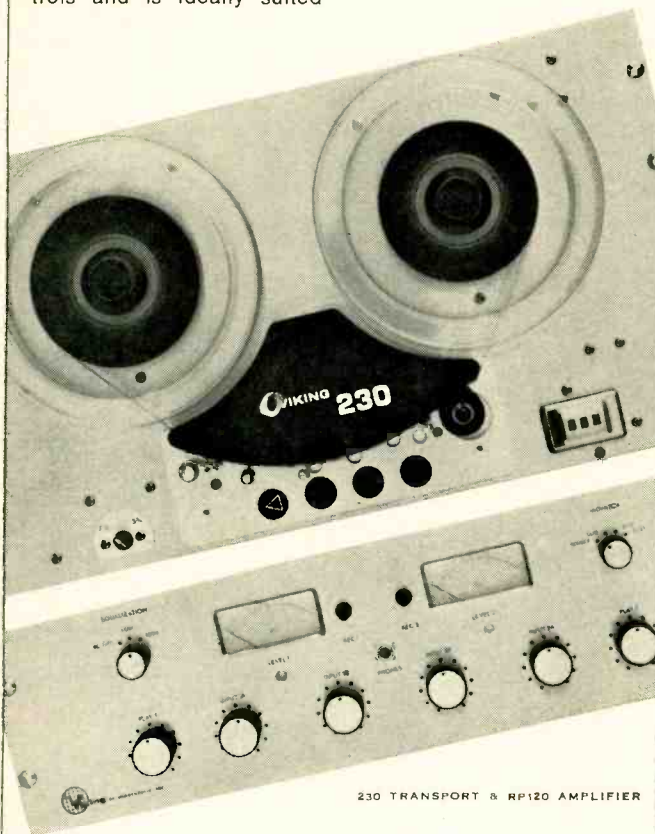

230 TRANSPORT & RP120 AMPLIFIER

PRODUCTS OF SOUND RESEARCH

**VIKING**  
tape recorders

A DIVISION OF THE  
TELEX CORPORATION  
9600 ALDRICH AVENUE SOUTH  
MINNEAPOLIS, MINNESOTA 55420

CIRCLE NO. 88 ON READER SERVICE CARD

## New Picture Telephone (Continued from page 39)

When the tube is picking up a dimly lighted scene, its electrically operated lens iris is wide open. As the illumination is increased, the video output signal is averaged to develop a controlling voltage that is employed in order to operate a solenoid to reduce the iris opening. Hence, the iris opening is controlled automatically by the light level just as is done in an automatic-exposure camera that sets its own lens opening. In the case of the Picturephone tube, however, the signal is derived only from the video output produced during the middle half of the picture. This means that very bright office light near the top of the picture, or a subject's white shirt near the bottom of the picture will not fool the camera into "thinking" that the subject in the center of the screen is adequately lighted.

The picture display uses a conventional type of black-and-white TV tube. It produces an image with a highlight brightness of 80 foot-lamberts and employs an ultor voltage of 14 kV developed from a flyback power supply.

### The "Graphics Mode"

For normal operation the Picturephone camera is focused at about three feet. Because of the tube sensitivity, a fairly small lens opening is used so that the depth of field is great (from about 24 to 40 inches). The user can also adjust the focus for 20 feet in order to transmit a picture of a distant chart, blackboard, or group of people. A third possibility is the use of the "graphics mode" in which the camera is focused to one foot and a small 45-degree angle mirror pops out in front of the lens opening. Now a small drawing or object can be placed on the desk and a picture of this can be transmitted. The maximum size of the drawing or photo is the same as the viewing area, or 5" x 5½". Because the mirror reverses the image from right to left, it is necessary to reverse the polarity of the display's scanning lines in order to make any lettering "read right".

In all cases, it is possible to self-monitor the picture being transmitted in order to be assured of proper centering and adequate coverage.

### Some Problems

The idea of being able to communicate face-to-face is certainly an attractive one. Even more important, however, will be the transmission of graphic material. Banks and libraries, for example, are just two organizations that would find it useful to show their customers what they are talking about.

But what about the person who doesn't want his picture transmitted? There is a control button on the new set that cuts off the camera tube and the Picturephone transmits instead a pattern of three horizontal bars (just to show the person at the receiving end that everything is still working). However, no doubt the same sort of person who bugs phone lines today will find a way to disable this switch.

What about cost? Because the Picturephone is still in an early stage of development, *Bell* officials refused to answer any questions about the price of the service. Our own guess is that it won't be cheap. Certainly the first users will be business concerns who may find that it cuts travel costs for their employees. After all, if a salesman can see as well as talk to a prospect, why should he have to make a personal call? Later, libraries and schools will probably begin installing Picturephones. And, finally, individuals may begin to have them in their own homes so that Grandma can see the children or so that daughter Jane can see her boyfriend while she is talking to him. Or perhaps the housewife will be able to call the department store and see the item she wants to order. But we wonder if she will also like the idea of changing her dress, taking out her curlers, and putting on makeup before she answers a Picturephone call? ▲



# Audio-Color

Lets you see your music

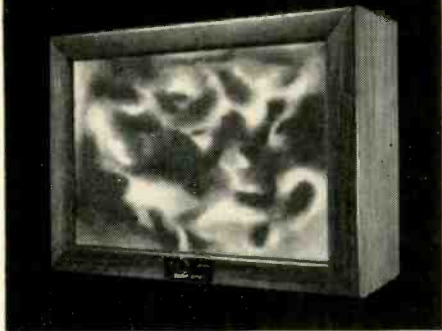

**ASSEMBLED**      **KIT FORM**  
**\$54.95**            **\$44.95**  
**\$5 DOWN — \$5 MONTH**

Walnut finished cabinet included  
 Shipped REA Collect

Easy to build, easy to install. All transistor AUDIO-COLOR adds a visual dimension to musical enjoyment. A brilliantly moving panorama of color casts dancing images on a soft frosted screen, reflecting rising and falling volume with each beat of the music. Here's a truly unique and exciting new musical experience. Make check or money order to CONAR.

SEND FOR FREE CONAR CATALOG

**CONAR** Division of National Radio Institute  
 Dept. CB8C2, 3939 Wisconsin Avenue, Washington, D.C. 20016

# Olson



\*

FREE

Fill in coupon for a FREE One Year Subscription to OLSON ELECTRONICS' Fantastic Value Packed Catalog — Unheard of LOW, LOW PRICES on Brand Name Speakers, Changers, Tubes, Tools, Stereo Amps, Tuners, CB, Hi-Fi's, and thousands of other Electronic Values. Credit plan available.

NAME \_\_\_\_\_

ADDRESS \_\_\_\_\_

CITY \_\_\_\_\_ STATE \_\_\_\_\_

GIVE ZIP CODE \_\_\_\_\_

If you have a friend interested in electronics send his name and address for a FREE subscription also.

OLSON ELECTRONICS, INC.

822 S. Forge Street Akron, Ohio 44308

CIRCLE NO. 98 ON READER SERVICE CARD  
 March, 1968

## Holography

(Continued from page 43)

the operation of complex equipment are of value. They introduce an element of realism. This is a distinct advantage over analog training devices.

Holographic recording is not limited to the use of light beams. Ultrasonic waves have been used to generate 3-D pictures of objects. One important application is the detection of underwater objects. A surface ship directs an ultrasonic beam in a scanning or search mode. Return echoes from an underwater target are detected by a moving microphone which acts as the hologram plane as it moves back and forth. By mixing the transmitted signal and return echo, an interference pattern is generated. The mixed electrical signals are recorded on photographic film from a CRT display. When this film is illuminated by a laser, an image of the underwater target is reconstructed.

Various organs and structures of the human body also reflect ultrasonic waves. This technique can, in principle, be adopted for medical use. Conceptually, an ultrasonic hologram of a portion of a patient's body can be generated, photographically stored, and reconstructed for study by the physician.

### Future Outlook

The financial status of holography from the standpoint of how much manpower, materials, equipment, time, and effort being expended, is hard to estimate. Recent figures span the range from \$10-\$20 million per year. Judged by the increasing laser market, film sales, rise of speciality companies in allied areas, and employment ads seeking trained personnel, the immediate outlook appears healthy. However, a "mild" note of caution. As with most new technological developments, efforts will settle down as potential gains and limitations are uncovered and evaluated.

To date, holography has not ventured far from the R & D environment. Its impact and contribution to pure scientific development has not extended to engineering technology to any great extent. This is, in part, due to unfamiliarity with fundamental details but most of all because of the practical difficulties mentioned previously.

However, interest in holography has mushroomed. In England, Dr. D. Gabor helped develop some of the basic techniques; in Russia, Y.N. Denisuk has been studying color holography; and in Japan, Takeomi Suzuki and Ryuichi Hiocoki are developing 360° holography.

The author wishes to express his gratitude to his associates C. Bartolotta and D. Yustein for their assistance in the preparation of this article. ▲

## Delta Launches the **COMPUTACH**\*



The  
 Great  
 One!

\*An exclusive computer-tachometer for precise RPM measurement in easy-to-build Kit form!



ONLY  
**\$29.95**  
 ppd.

Delta, pioneers in CD ignition who produced the fabulous MARK TEN®, now offer a precise computer-tachometer which obsoletes any type tachometer on the market today! You achieve unbelievable accuracy in RPM readings due to the advanced, solid-state electronic matched components used in the computer, coupled with the finest precision meter in the world. In kit only for all 12V, 8 cyl. cars.

### Check these Deltafeatures:

- ▲ 0-8000 RPM range
- ▲ Perfect linearity — zero parallax
- ▲ Adjustable set pointer
- ▲ Wide angle needle sweep
- ▲ Translucent illuminated dial
- ▲ Chrome plated die-cast housing
- ▲ All-angle ball & socket mounting
- ▲ Use it with any ignition system
- ▲ Meter: 3 1/8" dia. X 3 3/8" deep
- ▲ Kit complete, no extras to buy

Orders shipped promptly.  
 Satisfaction guaranteed.  
 Send check today!



DELTA PRODUCTS, INC.

DP 8-2

P.O. Box 1147 EW / Grand Junction, Colo. 81501  
 Enclosed is \$ \_\_\_\_\_  Ship ppd.  Ship C.O.D.  
 Please send:

**COMPUTACH® Kits @ \$29.95 ppd**  
 (12 VOLT 8 CYLINDER VEHICLES ONLY)

Name \_\_\_\_\_

Address \_\_\_\_\_

City/State \_\_\_\_\_ Zip \_\_\_\_\_

CIRCLE NO. 117 ON READER SERVICE CARD  
 75



# 11 New Kits From Heath...

## New Deluxe Heathkit "227" Color TV

**Exclusive Heathkit Self-Servicing Features.** Like the famous Heathkit "295" and "180" color TV's, the new Heathkit "227" features a built-in dot generator plus full color photos and simple instructions so you can set-up, converge and maintain the best color pictures at all times. Add to this the detailed trouble-shooting charts in the manual, and you put an end to costly TV service calls for periodic picture convergence and minor repairs. No other brand of color TV has this money-saving self-servicing feature.

**Advanced Features.** Top quality American brand color tube . . . 227 sq. in. rectangular viewing area . . . 24,000 v. regulated picture power . . . improved phosphors for brilliant, livelier colors . . . new improved low voltage power supply with boosted B+ for best operation . . . automatic degaussing . . . exclusive Heath Magna-Shield to protect against stray magnetic fields and maintain color purity . . . ACC and AGC to reduce color fade and insure steady, flutter-free pictures under all conditions . . . preassembled & aligned IF with 3 stages instead of the usual 2 . . . preassembled & aligned 2-speed transistor UHF tuner . . . deluxe VHF turret tuner with "memory" fine tuning . . . 300 & 75 ohm VHF antenna inputs . . . two hi-fi sound outputs . . . 4" x 6" 8 ohm speaker . . . choice of installation — wall, custom or optional Heath factory assembled cabinets. Build in 25 hours.

**Kit GR-227**, (everything except cabinet) . . . 114 lbs. . . \$42 dn., as low as \$25 mo. . . . . **\$419.95**

**GRA-227-1**, Walnut cabinet 54 lbs. no money dn., \$6 mo. . . **\$59.95**

**GRA-227-2**, Mediterranean Oak cabinet (shown above) 70 lbs. . . no money dn., \$10 mo. . . . . **\$94.50**



**Kit GR-227**  
**\$419.95** (less cabinet)  
\$25 mo.

## New Remote Control For Heathkit Color TV

Now change channels and turn your Heathkit color TV off and on from the comfort of your armchair with this new remote control kit. Use with Heathkit GR-227, GR-295 and GR-180 color TV's. Includes 20' cable.

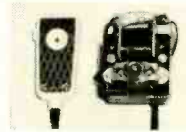

**Kit GRA-27**  
**\$19.95**



**Kit GR-295**  
**\$479.95**  
(less cabinet)  
\$42 mo.

## Deluxe Heathkit "295" Color TV

Color TV's largest picture . . . 295 sq. in. viewing area. Same features and built-in servicing facilities as new GR-227. Universal main control panel for versatile in-wall installation. 6" x 9" speaker.

**Kit GR-295**, (everything except cabinet), 131 lbs. . . \$48 dn., \$42 mo. . . . . **\$479.95**

**GRA-295-4**, Mediterranean cabinet (shown above), 90 lbs. . . no money dn., \$11 mo. . . . . **\$112.50**  
Other cabinets from \$62.95.



**Kit GR-180**  
**\$359.95**  
(less cabinet & cart)  
\$22 mo.

## Deluxe Heathkit "180" Color TV

Same high performance features and exclusive self-servicing facilities as new GR-227 (above) except for 180 sq. in. viewing area.

**Kit GR-180**, (everything except cabinet), 102 lbs. \$36 dn., as low as \$22 mo. . . . . **\$359.95**

**GRS-180-5**, table model cabinet & mobile cart (shown above), 57 lbs. . . no money dn., \$5 mo. . . . . **\$39.95**  
Other cabinets from \$24.95.

## New! Heathkit Crystal-Controlled Post Marker Generator

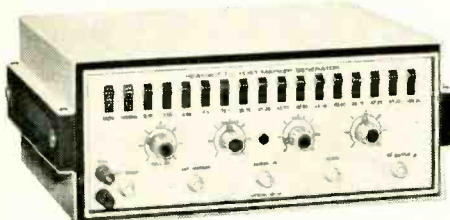

**Kit IG-14**  
**\$99.95**  
\$10 mo.

Fast, accurate color TV and FM alignment at the touch of a switch! 15 crystal-controlled marker frequencies. Select picture and sound IF's, color bandpass and trap freqs., 6 dB points, FM IF center freq. and 100 kHz points. Use up to six markers simultaneously. Birdie-type markers. Trace and marker amplitude controls permit using regular 'scope. 400 Hz modulator. Variable bias supply. Input and output connectors for use with any sweep generator. Also has external marker input. BNC connectors. Solid-state circuit uses 22 transistors, 4 diodes. Two circuit boards. Handsome new Heathkit instrument styling of beige and black in stackable design. Until now, an instrument of this capability cost hundreds of dollars more. Order your IG-14 now, it's the best investment in alignment facilities you can make.

**Kit IG-14**, 8 lbs., no money dn., \$10 mo. . . . . **\$99.95**

## New! Low Cost Heathkit 5 MHz 3" Scope

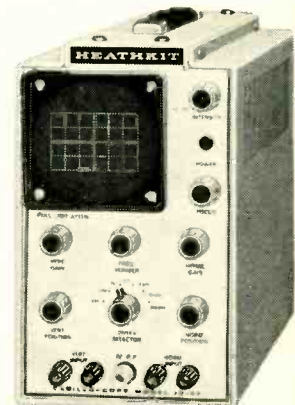

**Kit IO-17**  
**\$79.95**

Here is the wideband response, extra sensitivity and utility you need, all at low cost. The Heathkit IO-17 features vertical response of 5 Hz to 5 MHz; 30 mv Peak-to-Peak sensitivity; vertical gain control with pull-out X50 attenuator; front panel 1 volt Peak-to-Peak reference voltage; horizontal sweep from internal generator, 60 Hz line, or external source; wide range automatic sync; plastic graticule with 4 major vertical divisions & 6 major horizontal; front mounted controls; completely nickel-alloy shielded 3" CRT; solid-state high & low voltage power supplies for 115/230 VAC, 50-60 Hz; Zener diode regulators minimize trace bounce from line voltage variations; new professional Heath instrument styling with removable cabinet shells; beige & black color; just 9 1/2" H. x 5 1/2" W. x 14 1/2" L.; circuit board construction, shipping wt. 17 lbs.



# See 300 More in FREE Catalog

## New! Heathkit/Kraft 5-Channel Digital Proportional System with Variable Capacitor Servos

System Kit GD-47  
**\$219.95**  
 \$21 mo.

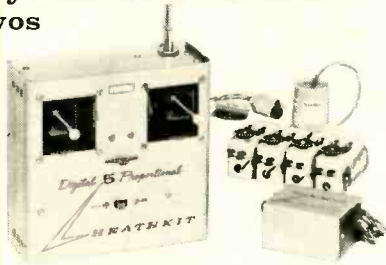

This Heathkit version of the internationally famous Kraft system saves you over \$200. The system includes solid-state transmitter with built-in charger and rechargeable battery, solid-state receiver, receiver rechargeable battery, four variable capacitor servos, and all cables. Servos feature sealed variable capacitor feedback to eliminate failure due to dirty contacts, vibration, etc.; three outputs: two linear shafts travel 1/2" in simultaneous opposite directions plus rotary wheel. Specify freq.: 26.995, 27.045, 27.145, 27.195 MHz.

- System Kit GD-47, all of above, 5 lbs. . . . . \$219.95
- Kit GDA-47-1, transmitter, battery, cable, 3 lbs. . . . . \$86.50
- Kit GDA-47-2, receiver, 3 lbs. . . . . \$49.95
- GDA-47-3, receiver rechargeable battery, 1 lb. . . . . \$9.95
- Kit GDA-47-4, one servo only, 1 lb. . . . . \$21.50

## World's Most Advanced Stereo Receiver



Kit AR-15  
**\$329.95**  
 (less cabinet)  
 \$28 mo.

Acclaimed by owners & experts for features like integrated circuits & crystal filters in IF amplifier; FET FM tuner; 150 watts music power; AM/FM and FM stereo; positive circuit protection; all-silicon transistors; "black magic" panel lighting; and more. Wrap-around walnut cabinet \$19.95.

- Kit AR-15 (less cab.), 34 lbs. . . \$33 dn., \$28 mo. . . . . \$329.95
- Assembled ARW-15, (less cab.), 34 lbs. . . \$50 dn., \$43 mo. . . . . \$499.50

## New! Solid-State Portable

So Handy, So Low Cost we call it "every man's" meter. Just right for homeowners, hobbyists, boatowners, CBer's, hams . . . it's even sophisticated enough for radio & TV servicing! Features 12 ranges . . . 4 AC & 4 DC volt ranges, 4 ohm ranges; 11 megohm input on DC, 1 megohm input on AC; 4 1/2" 200 uA meter; battery power; rugged polypropylene case and more. Easy 3 or 4 hour kit assembly. Ideal gift for any man! 4 lbs.

## Volt-Ohm-Meter

Kit IM-17  
**\$19.95**



## What would you expect to pay for a Vox "Jaguar" Combo organ with a 180-watt 3-channel amp?

\$1000? \$1250?  
 \$1500? More?



Kit TOS-1  
 Organ, Amplifier  
 & Speaker Kits  
 (240 lbs.)  
**\$598.00**

Kit TOS-2  
 Organ Kit,  
 Assembled  
 Amplifier &  
 Speaker (240 lbs.)  
**\$698.00**

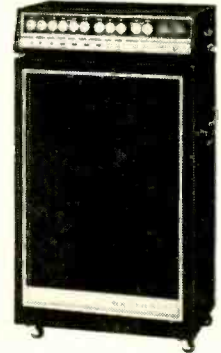

## You can get both for only \$598 during this Special Heathkit Offer!

Now you can get this famous professional combo organ with a versatile high-power piggy-back amp. and matching speaker system for just a little more than you'd expect to pay for the "Jaguar" alone! The Heathkit/Vox "Jaguar" is solid-state; two outputs for mixed or separated bass and treble; reversible bass keys for full 49 key range or separate bass notes; bass volume control; vibrato tab; bass chord tab; four voice tabs (flute, bright, brass, mellow); keyboard range C<sub>2</sub> to C<sub>6</sub> in four octaves; factory assembled keyboard, organ case with cover, and stand with case. Also available separately; you'll still save \$150 (order Kit TO-68, \$349.95).

The Heathkit TA-17 Deluxe Super-Power Amplifier & Speaker has 180 watts peak power into one speaker (240 watts peak into a pair); 3-channels with 2 inputs each; "fuzz", brightness switch; bass boost; tremolo, reverb; complete controls for each channel; foot switch; 2 heavy duty 12" speakers plus horn driver. Also available separately kit or factory assembled (Kit Amplifier TA-17, \$175; Assembled \$275; Kit Speaker TA-17-1 \$120; Assembled \$150; Kit TAS-17-2, amp. & two speakers \$395; Assembled TAW-17-2, amp. & two speakers \$545).

## New! Heath/Mitchell COLORVAL Dark-room Computer . . . Kit or Assembled

Kit PM-17  
**\$89.95**  
 \$9 mo.



Colorval takes the work out of color printing, leaves the creativity to you. Colorval is easy to set up . . . you "program" the scan filter pack for the type of film, paper, and equipment you use . . . we show you how. Unique Color Probe allows visual determination of ideal enlarger filter combination. Color Wheel and table shows what filter changes are needed. Exposure Probe scans shadows and highlights; exposure scale on Computer indicates proper contrast for color and b/w printing. Get started in color the right way, quickly, easily.

- Kit PM-17, 6 lbs., no money dn., \$9 mo. . . . . \$89.95
- Assembled PMW-17, 6 lbs. . . no money dn., \$13 mo. . . \$125.00



## NEW FREE 1968 CATALOG!

Now with more kits, more color. Fully describes these along with over 300 kits for stereo/hi-fi, color TV, electronic organs, electric guitar & amplifier, amateur radio, marine, educational, CB, home & hobby. Mail coupon or write Heath Company, Benton Harbor, Michigan 49022.

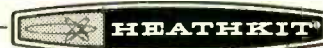

HEATH COMPANY, Dept. 15-3  
 Benton Harbor, Michigan 49022  
 In Canada, Daystrom Ltd.

- Enclosed is \$ \_\_\_\_\_, including shipping.
- Please send model (s) \_\_\_\_\_
- Please send FREE Heathkit Catalog.
- Please send Credit Application.

Name \_\_\_\_\_  
 Address \_\_\_\_\_  
 City \_\_\_\_\_ State \_\_\_\_\_ Zip \_\_\_\_\_

Prices & specifications subject to change without notice.

CL-318



**NEW CONAR**  
All-Channel  
**COLOR TV KIT**  
**\$366.00**  
Model 600UK



- Easier to build because it's designed for learning
- Complete with cabinet—nothing else to buy!

Tops for quality, simplicity of design, ease of building, the new CONAR 600 gives you the latest advances in the art of color TV receiver construction. In addition to 21 tubes, this all-channel receiver incorporates a transistor UHF tuner, transistor noise cancellation circuit and 16 solid-state diodes. Separate gun killer switches and a cross hatch generator are built in. All hardware is engineered for accessibility. Attractive bronze-tone steel cabinet with durable wood-grained vinyl covering.

For information write Dept. CB8C

**CONAR instruments**

DIVISION OF NATIONAL RADIO INSTITUTE  
3939 Wisconsin Ave., Washington, D.C. 20016

WRITE FOR FREE  
CONAR CATALOG



**PHOTOGRAPHY ANNUAL**

A selection of the World's finest photographs compiled by the editors of Popular Photography. All editions \$1.25 each:

1966 — \$1.25	#1
1964 — \$1.25	#3
1967 — \$1.50	#38

Order by number from Ziff-Davis Service Div., 595 Broadway • New York, N. Y. 10012. Enclose add'l 15¢ per copy for shipping and handling (50¢ for orders outside U.S.A.)

**LEARN Electronics Engineering AT HOME**

Fix TV, design automation systems, learn transistors, complete electronics. College level Home Study courses taught so you can understand them. Earn more in the highly paid electronics industry. Computers, Missiles, theory and practical. Kits furnished. Over 30,000 graduates now employed. Resident classes at our Chicago campus if desired. Founded 1934. Catalog. \*Vets—write for information about G I Bill Training.

American Institute of Engineering & Technology  
1141 West Fullerton Parkway Chicago, Ill. 60614

**BOOK REVIEWS**

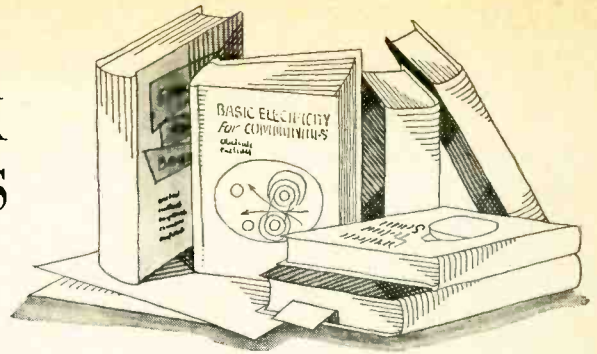

**"ELECTRONICS MATHEMATICS"** by G.J. Nunz & W.L. Shaw. Published by McGraw-Hill Book Company, New York. 775 pages. Price \$9.95.

This book consists of two volumes in a single binding, Volume 1 covering arithmetic and algebra and Volume 2 dealing with algebra, trigonometry, and calculus.

The authors, who are members of the electronics department at Los Angeles Pierce College, are thoroughly familiar with the mathematical strengths and weaknesses of the average student enrolled in electronics courses and have designed this book for such embryo engineers and technicians.

The first volume involves no prerequisites since it is a review of basic mathematical techniques, continuing on to powers and roots, physical quantities, the slide-rule, beginning algebra, equations and formulas, and introduction to the mathematics of the d.c. circuit, algebraic fractions, parallel and series-parallel d.c. circuits, linear functions and graphs, simultaneous equations and Kirchhoff's laws.

After mastering this material, the student is ready to tackle Volume 2 covering elementary trigonometry; exponents, radicals, and logarithms; imaginary and complex numbers; the quadratic equation; vectors and phasors; periodic functions and elementary a.c. theory; the solution of a.c. circuits; limits and the derivative; higher derivatives and differentials; the integral; and an introduction to nondecimal number systems.

Although designed for the classroom, there is no reason why the ambitious student couldn't use this as a self-help text to improve his mathematical skills.

\* \* \*

**"WALKIE-TALKIE HANDBOOK"** by Leo G. Sands. Published by Howard W. Sams & Co., Inc., Indianapolis. 172 pages. Price \$3.95. Soft cover.

The author has addressed this book to users, prospective users, students, and service technicians. The text is divided into eight chapters covering applications, Part 15 walkie-talkies, CB walkie-talkies, FM units, accessories, specifications, maintenance, and licensing and operation.

The book includes technical specifications on available commercial units, schematics and partial schematics, and photographs of all types of commercial portables for the various radio bands on which their use is authorized.

\* \* \*

**"ENGINEERING MANUAL"** edited by Robert H. Perry. Published by McGraw-Hill Book Company, New York, N.Y. 770 pages. Price \$11.75.

This is the second edition of a compact reference source which includes all of the essential working concepts, tables, formulas, and facts needed in day-to-day engineering assignments.

Designed for architects, chemical, civil, electrical, mechanical, and nuclear engineers, the sections of greatest interest to our readers are the ones on math (section 1) and electrical engineering (section 7). The convenience of having all this basic information readily available at one's fingertips is well worth the modest price for this goldmine of data.

\* \* \*

**"UNDERSTANDING SCHEMATIC DIAGRAMS"** and **"ENCYCLOPEDIA ELECTRONICS COMPONENTS"** compiled and published by Allied Radio Corp., 100 N. Western Ave., Chicago, Ill. 60680. 108 pages, 75 cents and 112 pages, \$1.00, respectively.

These are two of the newest volumes in Allied's line of practical manuals for those in the electronics field. As with all of the offerings in this series, emphasis is on the practical and usable, with the exposition clear and down-to-earth.

It has been our experience that there are many persons buying electronics magazines these days who are unable to work from schematics—to judge from the numbers of requests for pictorial and wiring diagrams of construction projects. The "schematic" book is just the sort of volume such persons need. It is complete, concise, and lavishly illustrated. Anyone with "schematic trouble" is urged to investigate this volume.

The "encyclopedia" consists of short, informative paragraphs (some with illustrations) about various components. The material is presented in alphabetical order, making it easy to locate the



item of interest. There has been no attempt to present an "in depth" analysis of each component, but as a capsule commentary, the definitions and descriptions are entirely adequate for the purpose.

\* \* \*

"UNDERSTANDING AND USING YOUR OSCILLOSCOPE" edited and published by Allied Radio Corporation, Chicago, Ill. 60680. 124 pages. Price \$0.75. Soft cover.

The increasing sophistication of electronic equipment has brought the scope to the forefront among instruments needed for troubleshooting and servicing such equipment. No longer can the technician relegate his scope to a post of "window dressing to impress the customers". Now he must reach for the scope probes as often, if not oftener, than he reaches for his solder gun or the v.t.v.m. leads.

The text is divided into seven chapters covering the history of the CRT, basic oscilloscope principles, scope applications, scope tests and measurements, the types of scopes needed for various applications, auxiliary equipment, and how to assemble an oscilloscope from available kits. The text is lavishly illustrated with photos and diagrams that clarify the many points made.

\* \* \*

"TRANSISTOR CIRCUIT HANDBOOK" and "TRANSISTOREN" compiled and published by De Muiderkring N.V., Bussum, Netherlands. Available in the U.S. from Gilfer Associates, Inc., P.O. Box 239, Park Ridge, N.J. 07656. 172 pages, \$4.50 and 191 pages, \$1.95, respectively.

The "Handbook" is a bilingual run-down on a number of commercial transistor circuits as developed and used by such European manufacturers as Siemens, Intermetall, Philips, Telefunken, etc. The compilers offer circuits and parts lists for building audio amplifiers, receivers, hearing aids, power supplies, preselectors, etc. Most of the circuits are carefully analyzed as to operating characteristics and circuit design parameters.

The second volume is a pocket-sized interchangeability guide for transistors from U.S., European, and Japanese sources. The transistors for which a substitute is desired are listed alphabetically and numerically, then identified as to source and, finally, European, American, and/or Japanese substitutes are given. Hundreds of transistors have counterparts from all three sources, making the job of repairing all types of transistorized equipment easier for the technician.

Both of these books have flexible plastic covers and are sturdily bound to withstand even heavy day-to-day usage.



# Crown

## LAB STANDARD AMPLIFIER



**DELIVERS ONE HORSEPOWER**

800 (IHF) Watts

MODEL  
**DC 300**  
DUAL CHANNEL  
ONLY  
**\$575**

**WRITE NOW**  
FOR FULL DETAILS TO  
DEPT. EW-3

**WIDE BAND**  
± 0.5 db. ZERO—100,000 Hz (1w.).

**CLEAN**  
99 and 95/100% PURE POWER at ANY level.

**QUIET**  
Less than 5 billionths of a watt total hum and noise.

**RELIABLE**  
Short- and mismatch-Proof. Made in America.

**STABLE**  
TRUE DC circuit design—patents pending.



# Crown

Box 1000, Elkhart, Indiana 46514

CIRCLE NO. 119 ON READER SERVICE CARD

Enjoy the "music-only" programs now available on the FM broadcast band from coast to coast.

- NO COMMERCIALS •
- NO INTERRUPTIONS •



It's easy! Just plug Music Associated's Sub Carrier Detector into multiplex jack of your FM tuner or easily wire into discriminator. Tune through your FM dial and hear programs of continuous, commercial-free music you are now missing. The Detector, self-powered and with electronic mute for quieting between selections, permits reception of popular background music programs no longer sent by wire but transmitted as hidden programs on the FM broadcast band from coast to coast. Use with any FM tuner. Size 5½" x 9". Shipping weight approx. 7 lbs.

**KIT \$49.50**  
(with pre-tuned coils, no alignment necessary)

**WIRED \$75.00**

**COVER \$4.95 EXTRA**  
Current List of FM Broadcast Stations with SCA authorization \$1.00

**MUSIC ASSOCIATED**

65 Glenwood Road, Upper Montclair, New Jersey  
Phone: (201) 744-3387

CIRCLE NO. 99 ON READER SERVICE CARD

## MAKE MONEY ON FREQUENCY CHECKS FOR OTHERS



**TYPE 105-B**  
**Micrometer Frequency Meter**

**GUARANTEED ACCURACY .001% ONLY \$295**

The going rate for frequency checks on Commercial radio transmitters is \$5 to \$10 per measurement. Most commercials need periodic checks.

Buy an MFM for your own ham or CB rig — then amortize the cost by measuring others—on the bench, on the ramp, or (with a receiver) on the air.

Remember — ANYONE can measure frequency, but only FCC 2nd commercial licensees or higher can adjust frequency.

---

Use coupon below to send for our FREE booklet "How To Make Money in Mobile-Radio Maintenance" and information on Lampkin meters.

Name \_\_\_\_\_  
Address \_\_\_\_\_  
City \_\_\_\_\_ State \_\_\_\_\_ Zip \_\_\_\_\_

**LAMPKIN LABORATORIES, INC.**  
**MFM Div., Bradenton, Fla. 33505**

CIRCLE NO. 105 ON READER SERVICE CARD





**This important job (and its big salary)  
is reserved for a qualified  
electronics technician. It can be you!**

It's a fact. There are *many thousands* of jobs like this available *right now* for skilled electronics technicians. What's more, these men are going to be in even *greater* demand in the years ahead. But how about you? Where do *you* fit into the picture? Your opportunity will never be greater... so act *now* to take advantage of it. The first step? Learn electronics fundamentals... develop a practical understanding of transistors, troubleshooting techniques, pulse circuitry, micro-electronics, computers and many other exciting new developments in this booming field. Prepare yourself now for a job with a bright future

...unlimited opportunity...lasting security...prestige... and a steadily-increasing salary.

Thousands of ambitious men are using Cleveland Institute of Electronics Training Programs as a stepping stone to the good jobs in Electronics. Why not join them? You will learn at home, in your spare time, and tuition is remarkably low. Read the important information on the facing page. Then fill out the postage-free reply card and drop it in the mail today. Without obligation we'll send you all the details. But act now... and get *your* high-paying job just that much sooner.



# How You Can Succeed In Electronics

## . . . Select Your Future From Five Career Programs

### The "right" course for your career

Cleveland Institute offers not one, but five different and up-to-date Electronics Home Study Programs. Look them over. Pick the one that is "right" for you. Then mark your selection on the reply card and send it to us. In a few days you will have complete details . . . without obligation.

#### 1. Electronics Technology

A comprehensive program covering Automation, Communications, Computers, Industrial Controls, Television, Transistors, and preparation for a 1st Class FCC License.



#### 2. First Class FCC License

If you want a 1st Class FCC ticket *quickly*, this streamlined program will do the trick and enable you to maintain and service all types of transmitting equipment.



#### 3. Broadcast Engineering

Here's an excellent studio engineering program which will get you a 1st Class FCC License and teach you all about Program Transmission and Broadcast Transmitters.



#### 4. Electronic Communications

Mobile Radio, Microwave, and 2nd Class FCC preparation are just a few of the topics covered in this "compact" program . . . Carrier Telephony too, if you so desire.

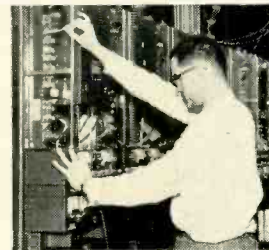

#### 5. Industrial Electronics & Automation

This exciting program includes many important subjects such as Computers, Electronic Heating and Welding, Industrial Controls, Servomechanisms, and Solid State Devices.



### An FCC License . . . or your money back!

In addition to providing you with comprehensive training in the area indicated, programs 1, 2, 3, and 4 will prepare you for a Commercial FCC License. In fact, we're so certain of their effectiveness, we make this *exclusive* offer:

The training programs described will prepare you for the FCC License specified. Should you fail to pass the FCC examination after completing the course, we will refund *all* tuition payments. You get an FCC License . . . or your money back!

### CIE's **AUTO-PROGRAMMED**™ lessons help you learn faster and easier

Cleveland Institute uses the new programmed learning approach. Our **AUTO-PROGRAMMED**™ lessons present facts and concepts in small, easy-to-understand bits . . . reinforce them with clear explanations and examples. Students learn more thoroughly and faster through this modern, simplified method. You, too, will absorb . . . retain . . . advance *at your own pace*.

### Lifetime job placement service for every CIE graduate . . . at no extra cost

Once enrolled with CIE, you will get a bi-monthly listing of the many high-paying interesting jobs available with top companies throughout the country. Many Cleveland Institute students and graduates hold such jobs with leading companies like these: American Airlines, American Telephone and Telegraph, General Electric, General Telephone and Electronics, IBM, Motorola, North American Aviation, New York Central Railroad, Raytheon, RCA and Westinghouse.

### CIE lessons are always up-to-date

Only CIE offers new, up-to-the-minute lessons in all of these subjects: Logical Troubleshooting, Laser Theory and Application, Microminiaturization, Single Sideband Techniques, Pulse Theory and Application, Boolean Algebra.



### Full accreditation . . . your assurance of competence and integrity

Cleveland Institute of Electronics is accredited by the Accrediting Commission of the National Home Study Council. You can be assured of competent electronics training by a staff of skilled electronics instructors.

**ENROLL UNDER NEW G.I. BILL.** All CIE courses are available under the new G.I. Bill. If you served on active duty since January 31, 1955, or are in service now, check box on reply card for G.I. Bill Information.

**CIE**

**Cleveland Institute of Electronics**

1776 E. 17th St., Dept. EW-43, Cleveland, Ohio 44114

CIRCLE NO. 121 ON READER SERVICE CARD



PROGRESS IN AN EXPLODING TECHNOLOGY  
 PROGRESS IN AN EXPLODING TECHNOLOGY  
 PROGRESS IN AN EXPLODING TECHNOLOGY  
 PROGRESS IN AN EXPLODING TECHNOLOGY  
 PROGRESS IN AN EXPLODING TECHNOLOGY  
 PROGRESS IN AN EXPLODING TECHNOLOGY

**EXHIBITS**  
 NEW YORK COLISEUM

**TECHNICAL SESSIONS**  
 NEW YORK HILTON

Monday through Thursday

- 48 GENERAL SESSIONS at the New York Hilton. Hours: 10:00-12:30; 2:00-4:30.
- FOUR FLOORS OF EXHIBITS at the N. Y. Coliseum including over 750 firms. Hours: 10 a.m.-8 p.m. 4 Days.
- GALA ANNUAL BANQUET—Wednesday 7:15 p.m. N. Y. Hilton Grand Ballroom—\$16.00.
- FREE SHUTTLE BUSES between the Hilton and the Coliseum—every few minutes.

- REGISTRATION—Good all days—General Sessions and exhibits. In and out privileges.—IEEE Members \$3.00. Non-members \$6.00. Ladies \$1.00. High School Students \$3.00 if accompanied by an adult—One student per adult; Thursday only—limit of 3 students per adult.
- REG-IDENT CARD speeds request for exhibitors' literature. Ask for one when registering.
- ESCALATORS/EXPRESS ELEVATORS to the Fourth Floor.

**IEEE Exhibition MARCH 18-21, 1968**

CIRCLE NO. 110 ON READER SERVICE CARD

**CONQUER NEW HORIZONS**

WITH  
**CONTROLLED QUALITY CRYSTALS**



- *Tried and True*
- **Complete Range**
- *Guaranteed*
- **Ready for you at your dealer**



Division of Whitehall Electronics

**TEXAS CRYSTALS**

1000 Crystal Drive • Fort Myers, Fla. 33901  
 Plants in Fort Myers and Los Angeles

CIRCLE NO. 199 ON READER SERVICE CARD

**Transistor Curve Tracer**  
 (Continued from page 56)

switch S4 to "Ext. Load". The 1- and 10-ohm resistors are used for power transistors. These low values should not be used on low-power transistors because thermal runaway will cause permanent damage to the transistor. Instead, use 1000- or 10,000-ohm load.

The step generator that drives the transistor base produces five steps and a zero base line. For the author's unit, a motor-driven, shorting-type, 36-contact switch was obtained from surplus. The motor speed was about 300 r/min. Five consecutive contacts were tied together and used as one tap. One contact was left open between wired-together groups to prevent shorting.

A manually cranked switch can be used. The detent and stops are removed from a 24-position shorting-type switch. Terminals are tied together in groups of three with one open contact left between each group. A crank-type knob may be attached to this switch or a belt drive from a slow-speed motor.

**How to Connect the Scope**

The vertical and horizontal connections are standard. The oscilloscope is switched from internal sweep to "Ext. Horiz." The collector sweep of the tracer is adjusted to about 15 volts. The scope's horizontal gain is set so that the base-line voltage fills three-quarters of the scope screen. Select the 1000-ohm load resistor; it will give a reasonable current maximum at 15 volts. Throw the *n-p-n/p-n-p* switch to the correct type. Place a transistor in the socket and adjust the scope's vertical gain to give a display three-quarters of full height.

The vertical amplifier of the oscilloscope must be calibrated if you want to read current. Since the peak-to-peak voltage divided by the resistance equals the peak current, the voltage calibration may be divided into the 1000-ohm load resistance to obtain the value of maximum current.

Certain scopes show a tendency to make the vertical lines jitter. This is due to poor low-frequency response in the scope's horizontal amplifier. By increasing the coupling capacitance by ten times, the problem can be reduced.

Occasional faint lines will be seen between the curves, due to lack of synchronization between collector sweep and base-current steps. These lines can be disregarded.

(Editor's Note: Readers who are interested in a somewhat more elaborate transistor curve tracer in which the stepping is performed completely automatically are referred to the article by Melvin Chan on p. 55 of our January issue.)



# SCR COLOR ORGAN

By W. S. REYNOLDS/Design Engineer, General Electric Co.

*Unijunction transistors cut response times and improve the stability of a solid-state, 3-channel color organ.*

A few years ago, Donald Lancaster wrote an article in this publication ("Simplified Solid-State Color Organ," January, 1964) which described a novel method of firing silicon controlled rectifiers to improve his original color-organ circuit of April 1963.

Now the firing circuits have been improved again by adapting them to unijunction oscillators. This was done to establish a very stable bias and to make the color organ more sensitive.

The three input circuits were retained because of their low cost and good performance. The three large-value capacitors, C1, C2, and C3, have to be non-polar types. If these are not available, then two polarized units with double the capacitance value can be connected back-to-back.

The unijunction firing circuit is an a.c. line-synchronized type which is described in *General Electric's SCR Manual*. The bias potentiometer sets the

unijunction firing time to a point where the SCR fires just far enough into the conduction angle to dimly light the bulbs. When a peak from the audio crossovers comes into the unijunction's emitter, the unijunction fires earlier in the a.c. cycle and more current is passed through the bulb, raising the color level.

The circuit components are not critical, and many substitutions can be made. The bias circuit has enough range so that any unijunction may be used. The size of the SCR's and the diodes in the bridge circuit can be chosen to fit almost any load, but keep in mind that their p.r.v. must be 200 volts or better.

*Editor's Note: We are sorry but we are no longer able to supply copies of Mr. Lancaster's original articles. Those who have built his original color organs or still have the January 1964 and April 1963 issues in their files should refer to the original schematics.* ▲

Fig. 1. Color organ's SCR's are fired by unijunction oscillators.

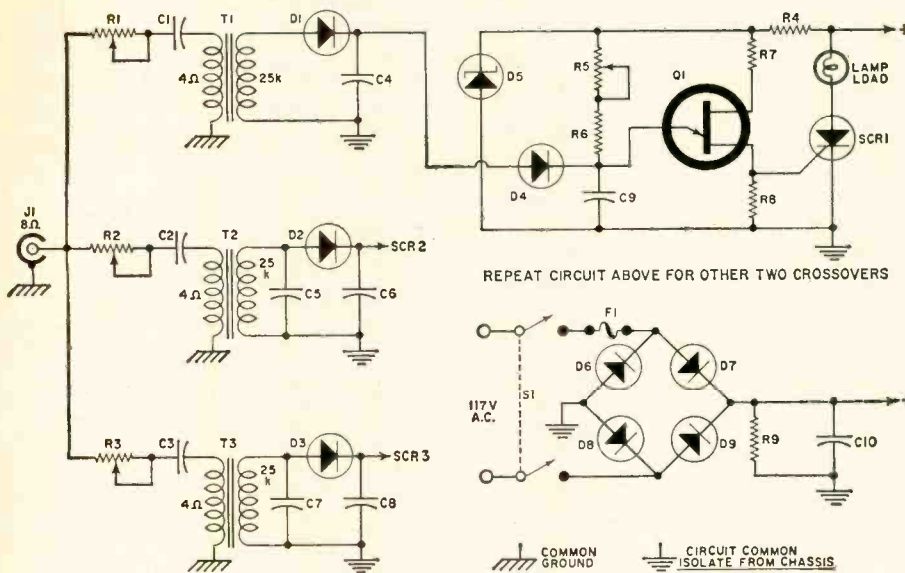

- R1, R2, R3—50 ohm pot ("Level")
- \*R4—5000 ohm, 10 W res.
- \*R5—10,000 ohm pot ("Bias")
- \*R6—10,000 ohm, 1/2 W res.
- \*R7—180 ohm, 1/2 W res.
- \*R8—47 ohm, 1/2 W res.
- R9—4000 ohm, 5 W res.
- C1—10 μF, 25 V non-polarized capacitor
- C2—25 μF, 25 V non-polarized capacitor
- C3—100 μF, 25 V non-polarized capacitor
- C4, C7—0.047 μF, 100 V capacitor
- C5—0.01 μF, 100 V capacitor
- C6—0.1 μF, 100 V capacitor
- C8—0.25 μF, 100 V capacitor
- \*C9—0.47 μF, 50 V capacitor

- C10—0.01 μF, 200 V capacitor
- D1, D2, D3—1N1693 or A13B
- \*D4—1N1693 or A13B
- \*D5—14 V, 1 W zener diode (Z4X14B)
- D6, D7, D8, D9—G-E-X4 diode
- \*SCR1—G-E X1 silicon controlled rectifier
- F1—5A fuse
- S1—D.p.d.t. switch
- T1, T2, T3—Audio output trans. 25,000 ohms: 3.2-4 ohms
- \*Q1—2N1671B or equiv.
- \*One crossover only: three are required.
- Values for D6, D7, D8, D9, SCR1, and F1 can be varied, depending on load. The listed parts run cool at 300 W load.

March, 1968

have you any idea  
how many ways  
you can use this  
handle?



as a screwdriver...



for slotted, Allen hex, Phillips, Frearson, Bristol, Clutch Head, Scrulox® screws

as a nutdriver...



for hex nuts, screws, and bolts

as an awl/scriber and reamer



It accommodates 49 interchangeable blades of various types and sizes.

Its patented spring device permits quick blade insertion and removal.

It's shockproof, breakproof (UL) plastic. Comes in three sizes—regular, junior, stubby—also Tee type.

It's available in a great variety of sets from 39-piece roll kits to compact, pocket cases.

For information on time-saving, space-saving Xcelite "99" tool kits and sets, request Catalog 166.



## XCELITE

XCELITE, INC., 12 Bank St., Orchard Park, N. Y. 14127  
In Canada contact Charles W. Pointon, Ltd.  
CIRCLE NO. 87 ON READER SERVICE CARD

85



# NEW PRODUCTS & LITERATURE

COMPONENTS • TOOLS • TEST EQUIPMENT • HI-FI • AUDIO • CB • HAM • COMMUNICATIONS

## OPERATIONAL FILTER

The Model 1000F operational filter functions as a variable filter and low-noise amplifier or as a sine-wave oscillator over the frequency range from 0.001 Hz to 11.1 kHz.

Filter modes include low pass, high pass, band pass, and band reject. Corner frequencies are selectable in discrete steps to 2% accuracy. Con-

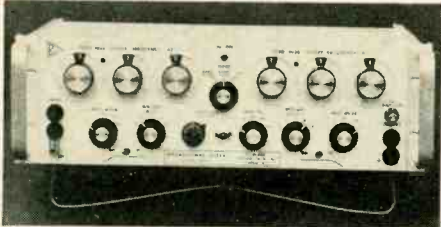

tinuous amplitude control is provided in the "Oscillator" mode of operation. The over-all gain is adjustable to 40 dB maximum. The high-pass and low-pass roll-offs are separately adjustable to a maximum of 24 dB/octave. Butterworth or simple RC response is selectable by means of a front-panel switch. Input is single-ended or differential. Input impedance is 1 megohm.

The unit will operate from either a.c. or d.c. power sources. A brochure giving complete specifications on the Model 1000F will be forwarded on request. Rockland Laboratories

Circle No. 126 on Reader Service Card

## PROGRAM TIMERS

A new line of program timers capable of controlling up to 288 program operations per day is now available. No tools are required for program setting. Small spring brass clips are easily inserted and held securely in numbered slots according to the required schedule. Signals can be set at any 5 minute period of a 24-hour schedule.

The clocks are driven by a synchronous motor for split-second accuracy. All adjustments and settings are made from the front of the timer. All units are supplied with a push-button for non-scheduled operation and a day selector device to automatically eliminate signaling on non-working days.

The line is available in six model variations for single-, two-, or three-circuit systems, 117 or 230 volt, 60 Hz. Zenith Controls

Circle No. 127 on Reader Service Card

## SWITCHES FOR PC BOARDS

The new 513 series momentary action switches are available for direct connection to printed-circuit boards. The light source is the incandescent T-1 1/4 bulb with midjet flanged base in a range of voltages from 1.35 to 28 volts.

Three types of switches are available: s.p.s.t., normally open; s.p.s.t., normally closed; and s.p.d.t., two circuit (one normally open, one normally closed). The break occurs before make.

Switch ratings are 3 A, 125 V a.c.; 3 A, 30 V d.c. (resistive load). Operating force is approximately 20 ounces n.o. and 10 ounces n.c. Button travel is 3/32".

Complete details on the 513 series is available on request. Dialight

Circle No. 128 on Reader Service Card

## REGULATED D.C. SUPPLY

Designed to meet the needs of modern labs and sophisticated systems, the new Model SVC-40-5 all-silicon, high-temperature, voltage/current regulated d.c. power supply is housed in an 8" x 5" x 14" enclosure.

Output rating is 0-40 volts and 0-5 amps. When used as a constant voltage source, regulation for load and line changes is 0.01% or 1 mV, respectively. Current regulation is 0.2 mA/V change in output and 1 mA in constant-current mode. The operating mode is indicated by a pair of front-panel signal lamps. One lamp is lighted during voltage-regulated operation, the other during current-regulated operation. NJE Corp.

Circle No. 1 on Reader Service Card

## RFI/EMI DESIGNER KIT

A special designer's kit is now available to assist engineers in selecting the proper RFI, EMI and magnetic shielding materials. The kit contains samples of a wide variety of such materials.

Information regarding availability will be supplied on request. Primec Corp.

Circle No. 129 on Reader Service Card

## HIGH-TEMPERATURE TAPE

Type CC is a double-faced, epoxy-impregnated, adhesive tape for use in maintenance, assembly work, and for making repairs. When this new tape is cured under high temperatures, it signals by changing color from yellow to dark red. Curing may be done with a hot air gun, blow torch, oven air dryer, or soldering iron.

The tape comes in rolls 2" wide x 10 or 25 yards in length. It is available in other widths and lengths on special order. The CC adhesive is also available in other forms such as aerosol spray, solid stick, or liquid. Leal

Circle No. 130 on Reader Service Card

## SOLID-STATE INVERTER/CHARGER

The Model KG-666, a solid-state inverter/charger, has just been added to the "Knight-Kit" line. This compact unit permits operation of standard a.c. appliances from 12-volt batteries. It converts 12 volts d.c. to 110-130 volts a.c., with a maximum load of 200 watts.

Square-wave output is 55-65 Hz at 200 watts continuous power rating. The d.c. output will



provide full starting torque for universal motor loads. There is a silicon-diode starting network.

The kit is designed for easy assembly and is supplied with complete step-by-step wiring instructions and solder. It measures 4 3/4" x 8" x 8 1/4". Two or more units may be stacked to provide added power in the d.c. mode if required. Allied Radio

Circle No. 2 on Reader Service Card

## ULTRAMINIATURE CAPACITORS

A new line of ultraminiature capacitors, the Series 317-318, has just been introduced. The new units use a thin-film metallized polycarbonate dielectric which the company claims makes

Additional information on the items covered in this section is available from the manufacturers. Each item is identified by a code number. To obtain further details, fill in coupon on the Reader Service Card.

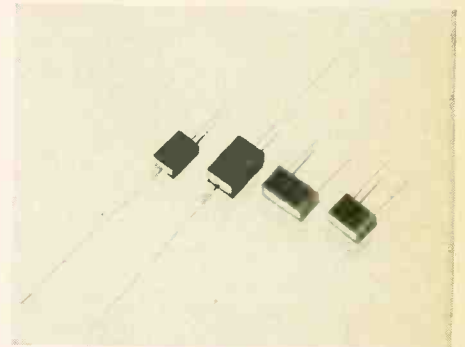

them especially adaptable where size, high insulation resistance, minimum capacity change with temperature, and low dissipation are of vital importance.

The capacitors are designed to operate within a temperature range of -55°C to +125°C. The low-loss characteristic makes the series suitable for tuned circuits, audio filters, and both power and high-frequency a.c. circuits. The Type 317 is furnished with axial leads, the Type 318 with radial leads. The latter have premolded stand-offs to permit cleaning agents to pass under the unit.

Both series are available in 100 and 200 volt d.c. ratings. The 317 series has capacitance values from 0.001 to 5 µF at 100, and 0.001 to 3.0 µF at 200 volts. The range for the 318 is 0.001 to 5.6 µF at 100 and 0.001 to 3.0 µF at 200 volts. Gudeman

Circle No. 131 on Reader Service Card

## SOLDERING FLUX FOR ALUMINUM

The new fluoride flux SF-60 has been developed especially for soldering aluminum metal with tin-lead solders. The fluxing action of the new product is based on a special fluoride compound which dissolves aluminum oxide.

The SF-60 occurs as an anhydrous system in the form of a liquid suspension, applied by brushing or dipping. Oxides occurring on the aluminum metal are readily dissolved by the new flux at the temperature of soldering with tin-lead solders. Tin-zinc solder may also be used. The action of the special flux also aids in soldering by preventing re-oxidation of aluminum during the soldering operation, according to its maker.

The flux is marketed in quart and gallon containers. Transene

Circle No. 132 on Reader Service Card

## PHOTODETECTOR AND LIGHT SOURCE

A new line of subminiature photodetectors and light sources has just been put on the market. The photodetectors include types for use with incident and reflected light. Light transmission is accomplished by fiber optic and lens systems which combine to derive object definition approaching 0.005 inch. Standard detectors use light-sensitive photodiodes. Other light-activated semiconductor devices can be packaged with response times from 1 nanosecond and in wavelengths from the visible to the infrared spectrum.

The light sources are long life, 40,000 hours at





rated voltage, according to the company. Indexing is accurate at a distance sensing to 0.005 inch, with repeatability to 0.001 inch. Skan-A-Matic  
**Circle No. 133 on Reader Service Card**

#### SOLID-STATE SWEEP GENERATOR

The VS-50 solid-state sweep generator is designed as a laboratory and production instrument to provide multiple octave coverage, variable sweep rates, internal and external marker capability, and complete control of r.f. output level.

The r.f. output is extremely flat and is specified for a flatness of  $\pm 0.25$  dB at maximum sweep width with an output of 1 V r.m.s. into 50 ohms. Provisions for accepting up to eight single-frequency or harmonic plug-in crystal-controlled markers are included.

Four sweep rate modes are also provided: vari-

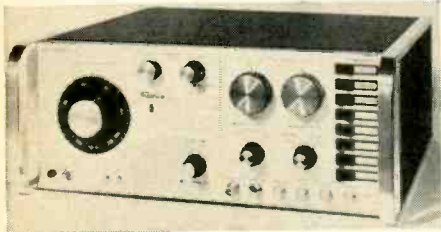

able from 5 to 60 Hz, 50/60 Hz line rate, manual sweep, and external sweep.

Complete specifications on the VS-50 will be forwarded on request. Texscan

**Circle No. 134 on Reader Service Card**

## HI-FI—AUDIO PRODUCTS

#### AM-FM STEREO RECEIVER

The new "Stereofidelity 400" AM-FM stereo receiver has an output of 60 watts at 4 ohms and is rated 25 watts per channel continuous. The all-solid-state receiver incorporates a special amplifier circuit which the company claims virtually eliminates distortion even at full power



levels. The power transformer has been designed to decrease the difference between maximum music power (IHF) and the continuous power. An exclusive SCR protection circuit eliminates the danger of short-circuit damage to transistors.

The tuner section has a silicon-transistor front-end plus a 3-gang variable capacitor that minimizes cross-modulation, background noise, and other interference which occurs in areas subject to strong local signals. Switching from mono to stereo is automatic. A stereo indicator changes color if a stereo station is dialed.

A two-color data sheet giving complete specs on this receiver will be forwarded on request. Sansui

**Circle No. 3 on Reader Service Card**

#### AUTOMATIC TURNTABLES

Two new automatic push-button Elac/Miracord turntables have just been introduced as the Models 620 and 630.

Incorporating many of the features of the Miracord 50H, including single-action push-button controls, similar electro-mechanical components such as anti-skate system, precision cueing, and dynamically balanced tonearm, the new units will play single records manually or up to ten in automatic sequence. No switching or pre-setting is required to go from manual to automatic play, or vice versa.

The 630 has all of these features plus a dynamically balanced turntable, lathe-turned from a single non-ferrous metal casting, stroboscopically tested and corrected. It also has lead-screw ad-

justment for location of the stylus at the exact distance from the pivot.

Additional information and prices on these new models are available on request. Benjamin  
**Circle No. 4 on Reader Service Card**

#### 4-WAY SPEAKER SYSTEM

The "Laredo" is a four-way hi-fi speaker system which incorporates the company's Mustang M-12 woofer and M-8 mid-range speaker, and the MS Sphericon tweeter with variable brilliance control.

The system covers the range from 30-40,000 Hz and is housed in a hand-rubbed walnut



cabinet measuring 27" x 19" x 13". The speaker will handle 30 watts. University Sound

**Circle No. 5 on Reader Service Card**

#### FLUSH-MOUNTING P.A. AMP

A fully transistorized p.a. amplifier designed so that it can be mounted flush in a wall has been introduced as the Model DWA60.

The amplifier features all-silicon circuitry and has an r.m.s. power output of 60 watts, with a 110-watt peak. The unit is intended for use in churches, schools, ballrooms, or wherever a continuous-duty, tamperproof amplifier is required.

Only 14 1/4" wide x 3 3/4" deep, the mounting

# ZENITH TUBES built to the quality standards of Zenith original parts

#### "Royal Crest" Circuit Tubes

More than 875 tubes—a full line with the same quality as original Zenith equipment. Get Zenith tubes for greater dependability and finer performance.

Order all genuine Zenith replacement parts and accessories from your Zenith distributor.

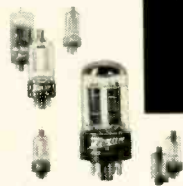

#### TV Picture Tubes

For color TV, B&W TV or special purposes. A complete Zenith line of more than 200 tubes built for greater reliability, longer life.

Zenith B&W replacement picture tubes are made only from new parts and materials except for the glass envelope in some tubes which, prior to reuse, is inspected and tested to the same high standard as a new envelope. Some color picture tubes contain used material which, prior to reuse, is carefully inspected to meet Zenith's high quality standards.

BEST YEAR YET



TO SELL THE BEST

# ZENITH

The quality goes in before the name goes on.

CIRCLE NO. 86 ON READER SERVICE CARD

box for the DWA60 fits into any wall with standard 16" center or wider spacing. Five low-impedance microphone and two auxiliary inputs are mounted on the rear bottom of the chassis, with one microphone and one auxiliary input duplicated on the front panel.

Other front-panel facilities include five microphone volume controls with push-pull low-frequency speech filter switches, a fader control for the two auxiliary inputs, master volume control, bass and treble controls for tonal balancing, tape in/out jack, a circuit breaker reset, and an a.c. convenience outlet. Locking doors cover the front panel when not in use. Bogen

Circle No. 6 on Reader Service Card

#### MINIATURE CASSETTE RECORDER

A cassette tape recorder which is small enough to fit into a jacket pocket has been introduced by Sony as the TC-50 "Easy-matic".

The new recorder incorporates many of the firm's regular features such as a built-in micro-



phone and speaker, as well as push-button rewind or back-up and push-button fast-forward. The unit also incorporates a.r.c. (automatic recording control) which automatically adjusts recording levels to insure a well-balanced recording every time.

A meter is used to show battery level and recording modulation. A handy snap-in battery pack contains four type "AA" batteries. The TC-50 comes complete with leather carrying case and one 60-minute tape cassette. Superscope

Circle No. 7 on Reader Service Card

#### COMPACT STEREO SYSTEM

The Model 1040 stereo component compact is a complete home music system in the moderate



price class. Embodying many of the features of the firm's deluxe Model 1050, this new system is available with or without speakers.

The Model 1040 provides power output of 50 watts (IHF) at 8 ohms. The record changer used in the system is the Miracord Model 40A. There is an AM-FM-stereo receiver, and an optional Philips-type cassette recorder, which is designed to mount on drawer slides under the cabinet, available at extra cost.

Complete specifications on the Model 1040 will be forwarded on request. Benjamin

Circle No. 8 on Reader Service Card

#### ELECTRONIC ORGAN KIT

A transistorized theater-type organ is being offered in kit form as the "Imperial".

According to the company, by using transistor oscillators and special voicing filters, the instrument is able to approximate the actual tone of theater pipes. No previous kit building experience is required to assemble this instrument.

The console is available in several woods and optional finishes. Complete details will be supplied on request. Artisan Organs

Circle No. 9 on Reader Service Card

#### CB-HAM-COMMUNICATIONS

##### STANDARDS RECEIVER

The Model RLF-1 receiver is a complete 1-MHz calibrating system, providing a means for referencing frequency standards and 1-MHz oscillators against the standards broadcast of WWVB, and for comparing oscillators and other 1-MHz frequency devices against available, in-house 1-MHz standards.

According to the company, calibration and comparison are fast and accurate. All controls and indicators are front-panel mounted for simple operation and easy reading. A resolution switch provides for selection of high and low modes of operation. A front-panel meter provides a means for visually monitoring the phase differences between signals being compared and to observe the results of phase corrections quickly, without the need for external phase measuring equipment. Auxiliary outputs are provided at the front of the receiver for connection to an external recorder.

The two resolution modes are: low resolution for rapid analysis of oscillators with gross errors as high as parts in 10<sup>3</sup>, or where corrections in the range of parts in 10<sup>3</sup> to 10<sup>4</sup> are satisfactory; and high resolution for calibration of more precise oscillators and standards to parts in 10<sup>5</sup>, using the receiver front-panel meter, or to parts in 10<sup>6</sup>, using an external recorder connected to the receiver output.

# FREE!



**BRAND NEW  
SPRING & SUMMER  
RADIO-TV  
ELECTRONICS  
CATALOG**



**YOUR BUYING GUIDE  
FOR:** • Stereo & Hi-Fi  
Systems & Components  
• Tape Recorders • Elec-  
tronic Parts, Tubes, Tools  
• Phonos & Records  
• Ham Gear • Test In-  
struments & Kits • Cam-  
eras & Film • PA • Cit-  
izens Band • Radio & TV  
Sets • Musical Instru-  
ments

**MAIL TODAY TO:**

**BURSTEIN-APPLEBEE**

Dept. EWO 1012 McGee, Kansas City, Mo. 64106

Name \_\_\_\_\_  
Address \_\_\_\_\_  
City \_\_\_\_\_  
State \_\_\_\_\_ Zip Code \_\_\_\_\_

CIRCLE NO. 123 ON READER SERVICE CARD

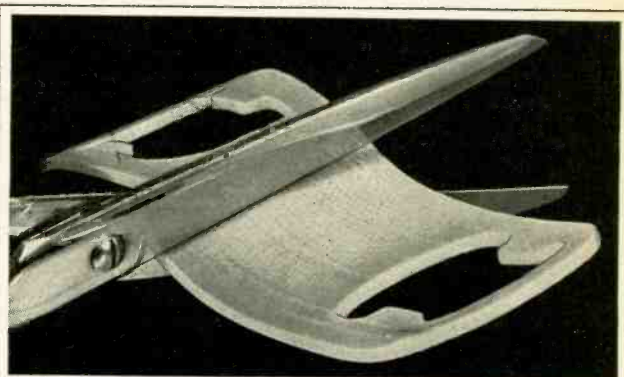

U.S. Patent No. 3,126,440

## POLASHEET II

**flexible, compressible, cuttable  
pressure and RFI connector seal**

With sealing pressures up to 30 psi, Polasheet II yields overall system attenuation of 125-135 db. Polasheet is oriented wire imbedded in silicone rubber sheets from .062" that can be cut or

stamped into resilient, flexible gaskets of any shape. Requires no machined surfaces because it's compressible. About 12¢ per sq. in. Free samples, prices, literature. Write today.

### METEX Corporation

970 New Durham Road, Edison, N.J. 08817  
(201) 287-0800 • TWX 710-998-0578  
West Coast: Cal-Metex Corp., 509 Hindry Ave., Inglewood, Calif.



53A

CIRCLE NO. 200 ON READER SERVICE CARD





The Model RLF-1 is a completely integrated package and includes the v.l.f. receiver, loop antenna, and a 100-foot cable. Gertsch  
Circle No. 135 on Reader Service Card

#### CB UNIT FOR MOBILE USE

The "Commodore" is a 23-channel, all-solid-state CB transceiver designed specifically for mobile applications.

It incorporates a unique and patented "Pulse Eliminator" to provide good performance in situations where there is extremely bad interference from engine ignition, electric motors, appliances, or fluorescent lights. According to the company, the circuit permits the reception of the weakest signals clearly and without distortion. Reception of signals as weak as  $\frac{1}{2}$   $\mu$ V are claimed for the receiver.

The full 5-watt transmitter is 100% modulated, with crisp audio to provide a maximum of intelligible power.

The transceiver is housed in a beige enclosure with a natural walnut wood panel and gold trim. A high-output ceramic-cartridge, push-to-talk microphone, housed in a high-impact plastic case, is included. Squires-Sanders

Circle No. 10 on Reader Service Card

#### MARINE RADIOPHONES

A new line of marine radiotelephones has just been introduced, ranging from a 55-watt (photo) transmitter to a 150-watt unit to meet the communications requirements of all types of boats and yachts.

The Model 55 is a four-channel marine unit with a 55-watt transmitter and broadcast-band reception. It is encased in a vinyl-clad aluminum



cabinet and comes with mounting cradle, crystals for four channels, and a 13-foot fiberglass antenna with chrome lay-down mount.

A six-channel radiotelephone, the Model 85, features an 85-watt transmitter, broadcast-band coverage and comes with the same housing and accessories as the Model 55. The Models 130 and 150 provide the same features at high power ratings, 130 watts and 150 watts, respectively. Simpson

Circle No. 11 on Reader Service Card

#### CB TRANSCEIVER

The 23-channel solid-state CB transceiver, the "Traveller", measures a compact  $5\frac{3}{4}$ " w. x  $6\frac{1}{4}$ " d. x  $1\frac{7}{8}$ " h.

Adjacent-channel selectivity is better than 50 dB while the super-efficient transmitter is designed to help pierce skip, according to its maker. A new type of incoming signal indicator activates when receiving signals of 10 microvolts or more.

The transceiver has an illuminated channel selector, auxiliary speaker jack, single-knob tuning, a modulation indicator, d.c. cord, and a noise-cancelling microphone wired into the front

March, 1968



LET'S FACE IT . . . TWIST-PRONG CAPACITORS JUST DON'T HAVE THE "FITS-ALL" ABILITY OF STRETCH SOCKS

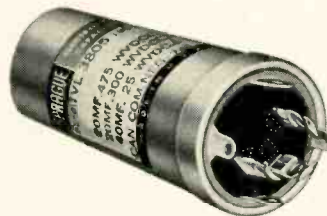

. . . THERE'S NO NEED TO STRETCH ANYTHING WITH A SPRAGUE TWIST-LOK®

they come in 2,365 ratings and sizes so you can make EXACT replacements

Some people claim that you can use multi-rating twist-prong capacitors to make replacements "as exact as they need be." Putting it another way, some other people say that you can take "a certain amount of leeway in the matching of ratings and sizes."

BUT—there is nothing exactly like an exact replacement, particularly when working with the exacting requirements of Color TV circuitry.

Yes, you can replace one twist-prong capacitor with another that has a higher voltage rating and everything's OK. That is, everything except the cost. You have to pay for the extra voltage.

True, too: Circuit tolerances may allow you to make successful replacements without matching original

capacitance values exactly. However, if you pick a replacement that's at the high end of the circuit's tolerance, its own manufacturing tolerance may throw it out of the ball park. For example, you pull out a 100  $\mu$ F @ 350 V unit and figure that the 150  $\mu$ F capacitor on your shelf is a close enough replacement. But the standard industry tolerance on this part is +50%, -10%. Therefore, it may actually have a capacitance of 225  $\mu$ F —more than double the value your circuit calls for. And probably will get you called back.

We repeat: There is nothing exactly like an exact replacement.

And . . . we make Twist-Lok Capacitors in 2,365 ratings and sizes so you can make exact replacements.

You can get a copy of Sprague's comprehensive Electrolytic Capacitor Replacement Manual K-109 from your Sprague Distributor or by writing to Sprague Products Company, 51 Marshall Street, North Adams, Massachusetts 01247.

DON'T FORGET TO ASK YOUR CUSTOMERS  
"WHAT ELSE NEEDS FIXING?"

68-7145

CIRCLE NO. 90 ON READER SERVICE CARD







**DUAL CONVERSION  
SMALL SIZE • LOW POWER DRAIN  
• HIGH STABILITY • CRYSTAL CONTROLLED**

Specifically designed for simplicity of operation... efficiently engineered to give you years of service. Fits the smallest auto yet powerful enough to deliver a clear signal. Operates on 6 crystal controlled frequencies. Dual limiter & Foster Seeley discriminator. Quadruple tuned RF stage for greater image rejection. Noise Free squelch, PLUG IN crystals for instant frequency change. Compatible with major continuous tone systems. Operates on 117VAC and 12VDC. Size: 6 7/8" x 2 5/8" x 8 1/2". Wt. 3 lbs. 8 oz.

**FR-104**  
(25-50 MHz)

**\$140.00**

Complete with AC and DC power cables, mounting bracket, less crystals. Crystals \$5.00 ea.

**FR-105**  
(150-175 MHz)

**SONAR RADIO CORPORATION**  
73 Wortman Ave., Bklyn, N. Y. 11207 Dept. 601  
Please send me information on Model FR-104/105 FM Monitor Receivers.

Name \_\_\_\_\_  
Address \_\_\_\_\_  
City \_\_\_\_\_ Zone \_\_\_\_\_ State \_\_\_\_\_

**LISTEN TO:  
POLICE, FIRE and  
WEATHER REPORTS!**



Perfect for Industrial, Commercial, Utility and Government Use  
**SONAR SENTRY  
VHF MONITOR  
RECEIVERS**

Designed and engineered for simplicity of operation, compact enough to fit a shirt pocket yet powerful enough to deliver a clear clean signal—it's dependable. Operates on two crystal controlled VHF channels plus broadcast band. Completely solid state for long life use. Visible battery indicator to show battery condition at all times. Built in antenna. 5 7/8" H x 2 1/2" W x 1 3/8" D. Wt. 11 oz.

**FR-103**  
150-175 MHz

**\$39.95**

With Battery, Earphone, & less Crystals  
Crystals \$5.00 ea.

**FR-106**  
25-50 MHz

**SONAR RADIO CORPORATION**  
73 Wortman Ave., Bklyn, N. Y. 11207 Dept. 601  
Please send me information on Model VHF Monitor Receivers.

Name \_\_\_\_\_  
Address \_\_\_\_\_  
City \_\_\_\_\_ Zone \_\_\_\_\_ State \_\_\_\_\_

**CIRCLE NO. 91 ON READER SERVICE CARD 90**

panel. It comes with crystals for all 23 channels. Courier

Circle No. 12 on Reader Service Card

## MANUFACTURERS' LITERATURE

### HI-FI CATALOGUE

A new 12-page illustrated catalogue (No. 546) describing the company's latest stereo high-fidelity components and compact music systems has been issued.

Among the products shown are speaker systems, receivers, and turntables as well as a tuner and an amplifier. Also included is a handy 2-page chart outlining the specifications, features, and prices of the components described. Bogen

Circle No. 13 on Reader Service Card

### PRODUCTS CATALOGUE

A full line of electronic products is described and illustrated in a 28-page condensed catalogue. Listed in the booklet are small-signal diodes, power rectifiers, temperature-compensated zeners, solid-state replacements for vacuum tubes, test equipment, random white-noise generators, and high-voltage assemblies. Solitron

Circle No. 14 on Reader Service Card

### NEW TRANSISTORS

The second edition of the "New Product Review", a quarterly publication providing detailed information on the company's latest semiconductor devices, is now available.

Covering products introduced during the second quarter of 1967, the review describes a wide range of transistors and linear IC's. Fairchild Semiconductor

Circle No. 136 on Reader Service Card

### SEMICONDUCTOR CATALOGUE

A new 16-page 1968 condensed catalogue (No. B-9418) describing the company's line of semiconductor devices has been issued. Included in the illustrated booklet are silicon power transistors, thyristors, rectifiers, and assemblies. Westinghouse

Circle No. 137 on Reader Service Card

### MUSICAL-INSTRUMENT SPEAKERS

A new 4-page illustrated brochure on a line of power columns, power modules, and high-frequency power multihorns for electronic musical instruments has been issued. Designed for use with bass or lead guitars, the units come with retractable handles for easy portability and are stackable. Jensen

Circle No. 15 on Reader Service Card

### ELECTRONIC KITS

More than 300 electronic kits are described and illustrated in a new 108-page 1968 catalogue (No. 810/68). Featured are complete lines of stereo/hi-fi components, ham radio equipment, test and lab instruments, and electric guitars and amplifiers.

Several new kits are introduced in the catalogue, including a solid-state v.o.m., an FM-stereo generator for r.f., i.f., and FM-stereo alignment, and a professional 10-band short-wave receiver. Heath

Circle No. 16 on Reader Service Card

### COILS AND CHOKES

A new 156-page combination general catalogue and coil-replacement guide (No. 167) has been published. More than 2800 coils and coil-related components are listed in the general catalogue, while the replacement guide contains cross references to over 50,000 exact and general replacement parts. J. W. Miller

Circle No. 138 on Reader Service Card

### NOISE POWER DENSITY

A straightforward technique for measuring noise power density with the company's Model H10-851B/8551B spectrum analyzer is described and illustrated in a new 6-page application note (No. 63C).

Instructions are given for calibrating the analyzer's noise bandwidth, making the power-

density calibration, and performing the actual power-density measurement. Theoretical material is covered in an appendix. Hewlett-Packard

Circle No. 139 on Reader Service Card

### OIL-TIGHT PUSH-BUTTONS

Complete information on the type PT line of heavy-duty oil-tight push-button switches is contained in a new 24-page illustrated catalogue (No. 71a). Included are lighted and unlighted push-buttons, contact blocks, lighted push-pull devices, indicator lights, legend plates, potentiometers, assembled stations, and accessories. Micro Switch

Circle No. 140 on Reader Service Card

### SOLDERING EQUIPMENT

A new 24-page catalogue of soldering irons, accessories, service parts, and tips has been issued. More than 450 items are listed, including tip-temperature control systems, small solder pots, safety stands, and tip cleaners. American Beauty

Circle No. 141 on Reader Service Card

### STEREO COMPONENTS

A complete line of stereo hi-fi components is described and illustrated in a new 22-page brochure. Included are receivers, speaker systems and speaker-system components, duplex and full-range loudspeakers, and equipment cabinets. Altec Lansing

Circle No. 17 on Reader Service Card

### TEST EQUIPMENT

Described and illustrated in a new 32-page catalogue is a complete line of r.f. test instruments. Included are sweep and marker generators, radio and TV generators, noise generators, amplifiers, a pulsed carrier generator, and various sweep aids. Kay Electric

Circle No. 18 on Reader Service Card

### METER-RELAY FOLDER

A six-page folder on "contactless" meter relays has just been published as folder C-1200A. The meter relays covered in the folder are intended for control, alarm, and limit applications and are dependable enough to use for unattended operation.

The folder provides complete circuit and dimensional details for stock models and additional information on special order models. Sizes covered are 3 1/2", 4 1/2", and 4" x 6". Simpson Electric

Circle No. 19 on Reader Service Card

### MINIATURE ELECTRONIC SWITCHES

The recently published G-304A general catalogue provides 52 pages of information on a wide range of momentary contact push-button switches, up to 12-position multi-deck rotary switches, test clips, binding posts, plastic cases and header boards, stand-off insulators, and printed-circuit test jacks.

Detailed drawings, product photographs, electrical ratings, and materials give design engineers necessary specifying data. Grayhill

Circle No. 142 on Reader Service Card

### TRANSISTOR SELECTION GUIDE

A complete selection guide for plastic transistors, covering the company's "Unibloc" silicon annular types, has just been issued.

The publication includes such useful information as all major device parameters, complete voltage vs current selection information, a replacement table listing current industrial plastic transistors and their nearest company equivalent, and a parameter interrelationship table.

This 6-page, fold-out guide can be mounted on the wall, table, or desk top or inserted in a 3-ring binder for ready referral. A copy of the guide will be forwarded on request. Motorola Semiconductor

Circle No. 143 on Reader Service Card

### BRIGHT INDICATING LIGHTS

An illustrated, four-page bulletin (GEA-8119A) provides descriptions, features, outline drawings with dimensions, and complete order-



ing information on four lines of the company's CR103 Type H indicating lights.

Used in such applications as panels, electronic equipment, laboratory and test equipment, business machines, material handling systems, hospital equipment, and commercial cooking equipment, the booklet also provides information on lenses and lamps to fit the proper CR103 unit. General Electric  
Circle No. 144 on Reader Service Card

#### ZENER DIODE GUIDES

Easy, quick identification and selection of virtually any zener or temperature-compensated reference diode is possible with the two publications just announced.

The 40-page cross-reference guide is a complete 24-page listing of all EIA registered zener and temperature-compensated reference devices (in numerical sequence) with their nearest company equivalent and/or recommended industry-preferred replacement types with major parameters shown for each unit, a selection guide section, a "special selections" section, and a part devoted to dimensional diagrams.

The condensed selector guide provides a handy wall or desk-mounted key to more than 6000 standard, industrial, and military devices made by the company, listed by nominal voltage and wattage. Case dimensions, reverse information on various tolerances, and reverse polarities are included. Motorola Semiconductor  
Circle No. 145 on Reader Service Card

#### TIMING EQUIPMENT CATALOGUE

A comprehensive, full-color 1968-1969 catalogue which covers a wide range of timing equipment, has just been released.

The new publication includes such technical information as a guide to the selection of stopwatch dial divisions, a section on the various operating actions and functions, and recommendations for selection of timepieces depending upon the timing purpose.

In the field of electronic timing, the catalogue lists an automatic stopwatch actuator; a 1/1000 second BCD timer; a direct digital readout giving time in minutes, seconds, and milliseconds; and a timer which prints time to 1/100 second on paper tape. Heuer Time  
Circle No. 146 on Reader Service Card

#### RELAY/SWITCH CATALOGUE

A new 26-page comprehensive catalogue covering a line of relays, switches, push-button stations, and reversing-drum controls is now available for distribution.

The new publication provides complete electrical and mechanical specifications and features for each product line.

Also available at this time is a pocket-size replacement guide for potential motor-start relays, which contains over 1400 listings. Relay and Control  
Circle No. 147 on Reader Service Card

#### R.F. POWER INSTRUMENTS

A v.s.w.r. nomograph and other helpful radio-frequency measurement data is included in the new 60-page catalogue of coax load resistors and attenuators, absorption wattmeters, directional peak and average wattmeters, r.f. filters, and power sensors just issued.

This comprehensive reference of r.f. measurement instrumentation from 25 mW to 250 kW in the frequency range of 0.45 to 2300 MHz features over thirty new listings. Catalogue GC-68 will be forwarded on request. Bird Electronic  
Circle No. 148 on Reader Service Card

#### THYRISTOR SELECTOR GUIDE

A handy thyristor selector guide provides an easy-to-use key to more than 300 of the company's devices currently available for use with modern stepless power control circuits.

The guide profiles an SCR line available in ten current choices from 800 mW to 35 amperes and voltage categories from 25 to 1000 volts, includ-

ing the new low-cost 8-ampere Triacs and "Thermopad" plastic SCR's.

Also included is data on plastic and metal uni-junction transistors, plastic bilateral triggers, fast-switching SCR's, four-layer diodes, case dimensions on all units, and a practical how-to-do-it thyristor applications guide. Motorola Semiconductor  
Circle No. 149 on Reader Service Card

#### NEMA STANDARDS

The 19th biennial guide to current standards for a wide variety of electrical products has recently been published by the National Electrical Manufacturers Association (NEMA).

Produced by the organization's Engineering and Safety Regulations Dept., the booklet includes standards covering most of the products in the Association's seven major divisions: building equipment, power equipment, industrial electronics and communications equipment, electrical insulating materials, lighting equipment, and wire and cable.

Copies of the guide are available without charge from NEMA, 155 E. 44th St., New York, N.Y. 10017. ▲

#### PHOTO CREDITS

Page	Credit
7	Amplex Corporation
27, 28, 29, 30	Perkin-Elmer Corp.
31, 32 (bottom), 33	Collins Radio
32 (top)	Kennedy Space Flight Center
38, 44, 45	Bell Telephone Laboratories
46	Helipot Div., Beckman Instruments, Inc.
49	Jerrold Electronics
64	Eico Electronic Instrument Co., Inc.
67	National Radio Institute
68 (top)	Pomona Electronics
68 (bottom)	Hewlett-Packard

## A SELECTION OF ANNUALS STILL AVAILABLE

FROM THE WORLD'S LARGEST PUBLISHER OF SPECIAL INTEREST MAGAZINES



#### CAR & DRIVER YEARBOOK

A complete buyers guide covering virtually every car available in the United States... Road tests... Technical specifications... Accessories and performance equipment buying guide... Guide to racing with action-packed photos.

1967 — \$1.50... #40  
1966 — \$1.25... #15  
1965 — \$1.25... #17

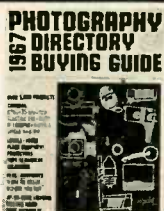

#### PHOTOGRAPHY DIRECTORY

World's most complete photographic buying guide  
1967 — \$1.25... #41  
1966 — \$1.25... #22



#### TAPE RECORDER ANNUAL

Everything you need to know about tape recording including a complete directory of mono and stereo recorders.

1967 — \$1.25... #42  
1966 — \$1.25... #30  
1965 — \$1.00... #31



#### STEREO/HI FI DIRECTORY

Complete buyers guide for virtually every Hi Fi component manufactured.

1967 — \$1.25... #45  
1966 — \$1.25... #29

Order by number from Ziff-Davis Service Division, 595 Broadway, N.Y., N.Y. 10012. Enclose add'l 15¢ per copy for shipping & handling (50¢ for orders outside U.S.A.)

# GAS WELDING TORCH



Uses OXYGEN and LP GAS

- Completely self-contained.
- Produces 5000° pin-point flame.
- Welds, brazes, solders.
- Hundreds of lightweight uses.
- Suggested list — \$19.95.

GET COMPLETE DETAILS AT MOST INDUSTRIAL DISTRIBUTORS, OR WRITE TO MICROFLAME, INC.



## MICROFLAME, INC.

7800 COMPUTER AVENUE  
MINNEAPOLIS, MINNESOTA 55424

CIRCLE NO. 102 ON READER SERVICE CARD





# ELECTRONICS MARKET PLACE

**COMMERCIAL RATE:** For firms or individuals offering commercial products or services. 70¢ per word (including name and address). Minimum order \$7.00. Payment must accompany copy except when ads are placed by accredited advertising agencies. Frequency discount: 5% for 6 months; 10% for 12 months paid in advance.

**READER RATE:** For individuals with a personal item to buy or sell. 40¢ per word (including name and address). No Minimum! Payment must accompany copy.

**GENERAL INFORMATION:** First word in all ads set in bold caps at no extra charge. Additional words may be set in bold caps at 10¢ extra per word. All copy subject to publisher's approval. **Closing Date:** 1st of the 2nd preceding month (for example, March issue closes January 1st). Send order and remittance to: Hal Cymes, **ELECTRONICS WORLD**, One Park Avenue, New York, New York 10016

## FOR SALE

**JUST starting in TV service?** Write for free 32 page catalog of service order books, invoices, job tickets, phone message books, statements and file systems. Oelrich Publications, 6556 W. Higgins Rd., Chicago, Ill. 60656.

**GOVERNMENT Surplus Receivers, Transmitters, Snooperscopes, Radios, Parts, Picture Catalog 25¢.** Meshna, Nahant, Mass. 01908.

**METERS—Surplus, new, used, panel and portable.** Send for list. Hanchett, Box 5577, Riverside, Calif. 92507.

**INVESTIGATORS, FREE BROCHURE, LATEST SUBMINIATURE ELECTRONIC SURVEILLANCE EQUIPMENT.** ACE ELECTRONICS, 11500-J NW 7TH AVE., MIAMI, FLA. 33168.

**CONVERT any television to sensitive big-screen oscilloscope.** Only minor changes required. No electronic experience necessary. Illustrated plans, \$2.00. Relco-A22, Box 10563, Houston, Texas 77018.

**R.F. CONVERTERS** World's largest selection. Also CCTV cameras, etc. Lowest factory prices. Catalog 10¢. Vanguard, 196-23 Jamaica Ave., Hollis, N.Y. 11423.

## U.S. GOV'T ELECTRONIC SURPLUS

• Nationally Known-World Famous SURPLUS CENTER offers finest, most expensive, Government surplus electronic units and components at a fraction of their original acquisition cost.

ORDER DIRECT FROM AD OR WRITE FOR CATALOGS

### STANDARD DIAL TELEPHONE

• (ITEM #715) - Standard, commercial telephone same as used throughout U.S.A. Attractive polished black, like new condition. Use as extension phone to private systems or connect several phones together for local intercom system. Full instructions are furnished, Wt. 9 lbs. Original Cost \$24.50.



F.O.B. \$7.50

### STEP-BY-STEP AUTOMATIC SWITCH

• (ITEM #738) - Amazing "up-and-around", electro-magnetic telephone switch. Dial any bank pair from 1 to 100. Make your own telephone system. Can also be used to remotely control up to 100 circuits over a single pair of wires.



• One of our FOUR STAR bargains. Comes complete with data, one dial and one line bank. Size 5" x 7" x 15". Wt. 16 lbs. Cost Gov't Over \$75.00. Complete; Switch, cover, dial, line bank, instructions..... F.O.B. \$9.95

### TYPICAL BUYS FROM OUR 1968 CATALOGS

- \$ 350.00 - Geared 2-hp Battery Golf Car Motor ..... \$26.95
- \$ 15.00 - Westinghouse DC Ammeter, 0 to 300 ..... \$ 7.11
- \$ 40.00 - Vacuum/Pressure Pump, 12-VDC ..... \$11.95
- - - 80-MW Walkie-Talkies, Per Pair ..... \$19.60
- - - Deluxe, Multi-Range, AC/DC Tester ..... \$ 8.98

### SPECIAL SALE Correspondence Course in ELECTRICAL ENGINEERING



Sells For \$10.79  
Outside U.S.A. \$8.79

Postpaid  
in U.S.A.

• (ITEM #A181) - Wonderful chance to obtain technical training at Amazing Low Cost! Lincoln Engineering School has suspended its Correspondence Course because of increased operating costs. We offer a limited number of the school's complete Electrical Engineering Course but without the examination paper grading service. The course consists of 14 lesson unit books, Each book has the regular exams, and in a separate section, "Standard Answers" to each exam question.

• Course is well written, easy to understand, profusely illustrated. Reader's Digest size, easy to carry and study in spare time. Many Lincoln Engineering School students holding excellent jobs as a result of L.E.S. training. Course contains latest information on transistors, silicon diodes, etc. Additional book on how to build and operate a "Home Laboratory and Experimental Bench" furnished with each course.

SEND 25¢ COIN OR STAMPS FOR 3 MAIN CATALOGS  
All Items FOB Lincoln Money Back Guarantee

**SURPLUS CENTER**

DEPT. EW-038 LINCOLN, NEBR. 68501

**MUSIC LOVERS, CONTINUOUS, UNINTERRUPTED BACKGROUND MUSIC FROM YOUR FM RADIO, USING NEW INEXPENSIVE ADAPTER. FREE LITERATURE.** ELECTRONICS, 11500-Z NW 7th AVE., MIAMI, FLORIDA 33168.

**FREE ELECTRONICS (new and surplus) parts catalog.** We repair multimeters. Bigelow Electronics, Bluffton, Ohio 45817.

**DETECTIVES!** Free brochures! Electronic Surveillance devices. SILMAR ELECTRONICS, 3476 N.W. 7th Street, Miami, Florida 33125.

**SURVEILLANCE EQUIPMENT—NEW HIGH PERFORMANCE SUBMINIATURE MODELS. ELECTRONIC COUNTERMEASURE DEVICES TO PROTECT PRIVACY. FREE DATA: SECURITY ELECTRONICS-EW, 15 EAST 43RD STREET, NEW YORK, N.Y. 10017.**

**CRYSTALS** - largest selection in United States at lowest prices. 48 Hr. delivery. Thousands of frequencies in stock. Types include HC6/U, HC18/U, FT-241, FT-243, FT-171, etc. Send 10¢ for catalog with oscillator circuits. Refunded on first order. Jan Crystals, 2400E Crystal Dr., Fort Myers, Fla. 33901.

**JAPANESE PRODUCTS CATALOG** by air mail \$5, sea \$3. Intercontinental, CPO 1717, Tokyo, Japan.

**TREASURE HUNTERS!** Prospectors! Relco's new instruments detect buried gold, silver, coins. Kits, assembled models. Transistorized. Weighs 3 pounds. \$19.95 up. Free catalog. Relco-A22, Box 10839, Houston, Texas 77018.

**METAL—Treasure Detectors, most sensitive.** Lowest priced. Free catalog. Jetco Instruments, Box 2880-E, Huntsville, Texas 77340.

**PROXIMITY switch.** Detects nearness of human body! Free information. Claremont Products, 860 Reed, Claremont North, Calif. 91711.

**LOOKING FOR SURVEILLANCE EQUIPMENT?** Write for information about Directory of Manufacturers and Distributors. T & G Publications, Box 28658, Memphis, Tenn. 38128.

**SURVEILLANCE COUNTERMEASURES BROCHURE \$1.00. ENGINEERING LABORATORIES, BOX 1036, ANDERSON, INDIANA 46015.**

**SONIPROBE, New penlite audio signal injector.** Ideal for transistor radios and stereos. Two transistor circuitry generates a signal that penetrates I.F. strips. Guaranteed satisfaction. Send \$4.95 to: Hickory Electronics, Box 12, Worth, Illinois 60482.

**DIAGRAMS, service information, Radio \$1.00, Television \$1.50. HARTFORD, 1760 Balsam, Highland Park, Illinois 60035.**

**TRANSISTOR-Tube-Radio-Television-Phono, SIGNAL GENERATOR, \$4.00.** Takoma Servicing School, 11808 Pittson Road, Wheaton, Maryland 20906.

**SCHOBER spinet organ tone generator, complete, assembled and tuned. 50% off.** Dale Peter, Randolph, Kansas 66554.

**DISPOSAL—\$80,000.00 hi-fidelity retail store inventory.** New/used equipment: Ampex, Marantz, Fisher, others. Hewlett Packard test equipment. Free list—Marco Electronics, Box 336 D, Winter Park, Fla. 32789.

**NEW VOLTMETER 20,000 ohms/volt with case. "Perfect" MONEY BACK GUARANTEE. \$10.95.** United, Dept. EW4, Box 8690 Brightwood, Washington, D. C. 20011.

**PSYCHEDELIC Strobe Lights, Stops Motion, simulated Psychedelic trip.** Terrific for bands, Go-Go girls, Night club owners. For literature. R & R Electronics Mfg., P. O. Box 526, Niles, Ohio 44446.

## ELECTRONICS ENGINEERING AND INSTRUCTION

**WANTED! TV—Radiomen to learn aircraft electronics servicing.** Numerous job openings everywhere. Write: **ACADEMY AVIONICS, Reno/Stead Airport, Reno, Nevada 89500.**

**ASSOCIATE Degree in Electronics Engineering earned through combination correspondence-classroom educational program.** Free brochure. Grantham Technical Institute, 1505 N. Western Ave., Hollywood, Calif. 90027.

**LEARN ELECTRONIC ORGAN SERVICING at home.** All Makes including transistors. Experimental kit—troubleshooting. Accredited NHSC. Free Booklet. **NILES BRYANT SCHOOL, 3631 Stockton, Dept. A, Sacramento, Calif. 95820.**

**FCC First Class License in six weeks—nation's highest success rate—approved for Veterans Training.** Write Elkins Institute, 2603C Inwood Road, Dallas, Texas 75235.

**HIGHLY effective home study course in Electronics Engineering Mathematics with circuit applications.** Earn your Associate In Science Degree. Free literature. **COOK'S INSTITUTE OF ELECTRONICS ENGINEERING, P.O. Box 36185, Houston, Texas 77036.**

**ELECTRONICS! Associate degree—29 months.** Technicians, field engineers, specialists in communications, missiles, computers, radar, automation. Start September, February. Valparaiso Technical Institute, Dept. N, Valparaiso, Indiana 46383.

**R.E.I.'s famous (5) week course for the First Class Radio Telephone License is the shortest, most effective course in the nation.** Over 98% of R.E.I. graduates pass F.C.C. exams for 1st class license. Total tuition \$350.00. Job placement free. Write for brochure Radio Engineering Institute of Electronics, 1336 Main Street, Sarasota, Florida 33577—or 3123 Gillham Road, Kansas City, Missouri 64109—or 809 Caroline Street, Fredericksburg, Virginia 22401.

**HOME Electronics Course only \$26.95.** Free literature. Edu-Kits, Department 115E, Hewlett, New York 11557.

## TUBES

**TUBES, SEMICONDUCTORS, ELECTRONIC EQUIPMENT & COMPONENTS.** Quality merchandise only! Servicing engineers, Purchasing Agents, TV/HiFi Servicemen and Hams for 20 years. Write for Catalog or call 212-WA 5-7000. **BARRY ELECTRONICS, 512 Broadway, New York, N.Y. 10012.**

**RECEIVING & INDUSTRIAL TUBES, TRANSISTORS, All Brands—Biggest Discounts.** Technicians, Hobbyists, Experimenters—Request FREE Giant Catalog and SAVE! **ZALYTRON 469 Jericho Turnpike, Mineola, N.Y. 11501.**

**TUBES—33¢ each.** Year guarantee. Tuner Cleaner \$1.09. Free catalog. Cornell, 4213-W University, San Diego, Calif. 92105.

**DON'T BUY TUBES—Radio, TV-Xmitting, special-purpose types until you get our price list!** Lowest prices in U.S.A. 5,000 types—Guaranteed Brand New. Send postcard for TV—Special Purpose Price List. **UNITED RADIO COMPANY, P.O. BOX 1000, NEWARK, N.J. 07101.**

## STAMPS

**SURPRISE COLLECTION! Exotic mint British Colonials, absolutely free with approvals.** **VIKING, Great Neck 50, N. Y.**



# "ARCTURUS" SALE

• Tube Bargains, to name just a few:

#6146 ..\$2.95	=5725/6AS6 ..59c	=6AQ5 ..56c
#6360 ..3.50	=5842/417A ..\$2.50	=6BQ7 ..94c
#6688 ..3.50	=5847/404A ..2.50	=6CG7 ..59c
#6839 ..3.50	=1AX2 ..49c; 5 for ..2.00	=6L6 ..49c
#7025 ..5.00	=6BQ7 ..39c; 3 for ..1.00	=6T3 ..84c
#7788 ..3.75	=12BN6 ..39c; 3 for ..1.00	=6U8 ..77c
#2D21 ..1.49	=25L6 ..59c; 3 for ..1.49	=12AU7 ..59c

Any unlisted receiving tube, 75% discount off current list prices

• Tube Carbons: 6AU6 etc. size, \$1.75 per 100. 6SN7 etc. size, \$2.10 per 100. 5U4GB size, \$2.50 per 100. 5U4G size, 03c each.

• Obsolete Tubes: =UX200, \$1.69; =80, \$1.20; =10Y, 69c; etc.

• 7 inch 90 degree TV bench test Picture Tube with adapter. No ion trap needed. Cat. =7BP7, \$6.99.

• Silicon Rectifier octal-based long-life replacement for =5U4, 5Y3, 5AS4, 5AW4, 5T4, 5V4, 5Z4. With diagram. Cat. =Rect 1, 99c each.

• OZ4 Silicon Rectifier replacement, octal based. Cat. =Rect 2, 99c each.

• 10 Flangeless rectifiers, 1 amp, 400 to 1000 p.i.v. Cat. =RS10, \$2.98.

• 10 Silicon Rectifiers, 750 MA., 50 to 300 p.i.v. Cat. =330F, 99c each.

• Condensers: 50-30 MFG at 150 v., .39¢ each. 3 for \$1.00. Cat. =80: 850-400-100-15 MFD at 16-16-4-115 v., 3 for 79¢. Cat. =82V.

• 2 Silicon Controlled Rectifiers, 1 amp, general purpose units with instructions. Cat. =SCR 1, \$1.00.

• 5 Transistor Circuit Boards containing up to 6 transistors, plus diodes, resistors, capacitors, etc. Cat. =TB10, 99c.

• Needles: values such as #AS22 Sapphire, 39c; Diamond, 99c.

• Color Yokes, 70 degree for all round color CRT's. Cat. =XRC70, \$12.95. 90 degree for all rectangular 19 to 25 inch color CRT's. Cat. =XRC90, \$12.95.

• Transistorized U.H.F. Tuners used in 1965 to 1967 TV sets, made by Admiral, RCA, Motorola, etc. Removable gearing may vary from one make to another. Need only 15 volts d.c. to function. No filament voltage needed. Easy replacement units. Cat. =U.H.F. 567, \$4.95.

• General Electric U.H.F. miniature Transistorized Tuner. G.E. Part =ET85X-33. Cat. =GE85, \$4.95.

• F.M. Tuner, Hi-Fi amplifier tuning unit complete with diagram, 2 tubes. Sams' Photofacts #620 lists 2 applications. Cat. =FM20, \$3.98.

• Flyback Transformer in original carton. Made by Merit or Todd. Most with schematic drawing of unit. Please do not request specific type. Cat. =506, 99c each.

• Flyback Transformer Kits, 2 flybacks per kit. #502E. Emerson. =502Y. Silvertone. =502W. Westinghouse. =507. Philco. =502. RCA. Any kit \$2.99.

• Kit of 30 tested Germanium Diodes. Cat. #100. 99c.

• Kit of 10 NPN Transistors. Cat. #371, 99c. 10 PNP Transistors. Cat. #370. 99c. All tested.

Send for our Free Catalog listing thousands of similar best buys in tubes, parts, kits, transistors, rectifiers, etc. (prices under \$5.00, add 5¢ handling charge. Include 4¢ of dollar value of order for postage.)

**ARCTURUS ELECTRONICS CORP.**  
502 - 22nd St., Union City, N.J. 07087 Dept. MEW  
Phone: 201 - UN 4 - 5568  
CIRCLE NO. 124 ON READER SERVICE CARD

## WANTED

**QUICKSILVER**, Platinum, Silver, Gold. Ores Analyzed. Free Circular. Mercury Terminal, Norwood, Mass. 02062.

**QUICK CASH** . . . for Electronic Tubes, Semiconductors, Equipment (Receivers, Transmitters, Scopes, Vacuum Variables, etc.) Send lists now! Write: **BARRY ELECTRONICS**, 512 Broadway, New York, N.Y. 10012 (212-WA 5-7000).

**TECH MANUALS, SOLD ON MILITARY SURPLUS AND CIVILIAN ELECTRONIC EQUIPMENT. GIVE MAKE, MODEL FOR MANUAL QUOTE. SLEP ELECTRONICS, DRAWER 178EW, ELLENTON, FLORIDA 33532.**

## DO-IT-YOURSELF

**PROFESSIONAL ELECTRONICS PROJECTS** - \$1.00 up. Catalog 25¢. **PARKS**, Box 15265B, Seattle, Wash. 98115.

**URETHANE** Foam. Direct from factory. Free catalog. Lists foam for cushions, mattresses, boats, upholstery—any home project. Perma-Foam, Inc., 605-H South 21st Street, Irvington, New Jersey 07111.

## TAPE AND RECORDERS

**BEFORE** renting Stereo Tapes, try us. Postpaid both ways - no deposit - immediate delivery. Quality - Dependability - Service - Satisfaction - prevail here. If you've been dissatisfied in the past, your initial order will prove this is no idle boast. Free Catalog. Gold Coast Tape Library, Box 2262, Palm Village Station, Hialeah, Fla. 33012.

**SCOTCH** Recording Tapes. Tape Recorders. Catalog 10¢. Tower, Lafayette Hill, Pa. 19444.

**RENT** Stereo Tapes—Over 2,500 Different—all major labels—free brochure. Stereo-Parti, 1616 -E. W. Terrace Way, Santa Rosa, California 95404.

**TAPEMATES** make available to you ALL 4-TRACK STEREO TAPES—ALL LABELS—postpaid to your door—at tremendous savings. For free brochure write: **TAPEMATES**, 5727 W. Jefferson Blvd., Los Angeles, California 90016.

## GREGORY ELECTRONICS

### Reconditioned & Used FM 2-WAY RADIO EQUIPMENT

Here's a small part of enlarged inventory now on hand for practically everything you need—at savings!



### Voice Commander

132 to 172 MC, 1W 9.5" x 5.3" x 1.7" Lowest price ever, including brand New Rechargeable Nickel Cadmium Battery Pack

**\$148**

If crystal & tuning is desired add \$45.00  
Battery charger for these units \$16.00  
Write for Quantity Prices

**VOICE COMMANDER**  
Monitor Receiver only—\$78  
Tuned & Crystalled with dry Batteries

**GE RECEIVER**  
4ER6 30-40 MC, 40-50 MC, 6 or 12 Volts  
3 Coil I. F. . . . . \$28  
4 Coil I. F. . . . . \$34

**MOTOROLA T41GGV 30-50mc 6/12 V**, 30 watt vibrator power supply fully narrow banded complete with accessories less crystals and antenna . . . . . **\$148**  
Add \$45.00 for tuning to desired frequency and new antenna

**MOTOROLA 30-50mc 6/12 V**, T51GGV vibrator power supply. Fully narrow banded (TX & RX) . . . . . **\$198**  
Above price includes accessories less crystals and antenna (less accessories, deduct \$30.00)  
To tune unit to desired frequency including new antenna add \$45.00

**GE 2-Piece unit—6 volt or 12 volt 4ER6—4ET5**, 30w 30-40, mc.—40-50 mc. Wide Band . . . . . **\$48**  
Fully narrow band (TX+RX) . . . . . **\$68**  
Complete Accessories  
**4ER6—4ET6**, 60w 30-40 mc.—40-50 mc. Wide Band . . . . . **\$68**  
Fully Narrow Band . . . . . **\$88**  
Complete Accessories  
Add \$45.00 for tuning and crystals to desired frequency, including new antenna.

**RCA—CMCT 30 148-172 mc.** transistorized power supply fully narrow banded complete with accessories . . . . . **\$198**  
Add \$40.00 for crystals and tuning and new antenna.

**G.E. PACERS—EG43SA6 150-170 mc** Transistorized Power Supply 13-15 watts, 12 v Front Mount (Complete accessories, less crystals and antenna) . . . . . **\$108.00**

We Buy Late Model Equipment for Cash  
Send For '68 Catalog—Write: Wire or Phone!

**GREGORY ELECTRONICS CORPORATION**  
249 RT. 46, Saddle Brook, N.J. 07662  
Phone: (201) 489-9000

CIRCLE NO. 112 ON READER SERVICE PAGE

**RENT STEREO TAPES**—75¢ week. Catalog. Art's Tape Service, 1613 1/2 North Mariposa Ave., Hollywood, Calif. 90027.

**TAPE RECORDER SALE.** Brand new, nationally advertised brands, \$10.00 above cost. Special prices on Hi-Fi Components and color television. Arkay Sales, 1028-B Commonwealth Avenue, Boston, Mass. 02215.

**STEREO Tapes.** Save 30% and up; no membership or fees required; postpaid anywhere U.S.A. Free 70-page catalog. We discount batteries, recorders, tape/accessories. Beware of slogans, "not undersold," as the discount information you supply our competitor is invariably reported to the factory. **SAXITONE**, 1776 Columbia Road, N. W., Washington, D. C. 20009.

**BLANK CARTRIDGE TAPES**—34 minute 4 or 8 track—60 minute cassette—\$1.50 each. Douglas Sales, Dept. R, P. O. Box 5909, Chicago, Illinois 60605.

**BELTS** for Grundig, Akai, Telefunken. Give model number. Public Sound, 9385 Bird Road, Miami, Florida.

## YOUR SERVICE AND QUALITY LEADER

We promise to supply you with the highest quality products at the most attractive prices with the fastest service in the industry.

### TRIACS

TO-66  
5 AMP

PRV		
100		.90
200		1.40
300		1.75
400		2.25
500		2.60

**ZENERS**  
1 Watt 6-33V \$ .50  
10 Watt 6-200V \$ .75  
50 Watt 7-200V \$1.75

- SIM** to 2N3429 (NPN), SI 7/8" stud, min HFE of 30, 7.5 Amps, 175 watts, Vce of 75 . . . . . \$1.75
- SILICON BILATERAL SWITCH.** Replaces two SCR's by firing in either direction when breakdown voltage is exceeded. Used in light dimmers, etc. . . . . 2/\$1.00

- CADMIUM SELENIDE PHOTO-CONDUCTIVE CELLS.** Dark resistance of 500 megohms. Sensitivity of 1.4-99 Na/Ft candle with data sheet . . . . . \$1.25
- NEON LIGHT OR NIXIE TUBE DRIVERS.** An NPN, TO-18, SI Transistor. With a VCBO of 120 3/\$1.00
- SIM.** to 2N2875 (PNP). Silicon 20 watts with 30 MHz cut off . . . . . \$ .75
- High Voltage NPN 150V.** VCBO at 2.5A., High HFE in TO-66 pack . . . . . \$ .75
- 500 Hfe plastic transistors.** NPN, TO-18, SI unit similar to 2N3565 . . . . . 3/\$1.00

**Silicon Power Rectifiers**

PRV	3A	12A	20A	40A
100	.09	.30	.40	.75
200	.16	.50	.60	1.25
400	.20	.70	.80	1.50
600	.30	1.00	1.20	1.80
800	.40	1.25	1.50	2.30
1000	.55	1.50	1.80	2.70

Terms: FOB Cambridge, Mass.  
Send check or Money Order. Include Postage, Average Wt. per package 1/2 lb. Allow for C.O.D. Minimum Order \$3.00  
Rated companies 30 days net  
TELEPHONE (617) 547-4005

**POST OFFICE BOX 74B  
SOMERVILLE, MASS. 02143**  
featuring transistors, rectifiers and components  
**SEND FOR OUR SPRING CATALOG**  
Business Address: 325 Elm St., Cambridge, Mass.

CIRCLE NO. 92 ON READER SERVICE CARD

## INTEGRATED CIRCUITS



- SR Flip Flops . . . . . \$ .90
- SR Clocked Flip Flops . . . . . \$1.15
- SRT Flip Flops . . . . . \$1.15
- JK Flip Flops . . . . . \$1.15
- Dual Nand Nor Gates . . . . . \$1.00
- 8 Input Nand Nor Gates . . . . . \$1.00
- Dual and Gates . . . . . \$1.00
- Quad Nand Nor Gates . . . . . \$1.00
- TO-85 flat pack with holder. Guaranteed to work. They come complete with schematic, elect. characteristic sheet & some typical applications.

**Top Hat & Epoxy 1 AMP**

PRV		
100	.07	1000 .-35
200	.09	1200 .-50
400	.12	1400 .-65
600	.18	1600 .-80
800	.22	1800 .-90



**Silicon Control Rectifiers**

PRV	3A	7A	20A
50	.35	.45	.70
100	.50	.65	1.00
200	.70	.95	1.30
300	.90	1.25	1.70
400	1.20	1.60	2.10
500	1.50	2.00	2.50
600	1.80	2.40	
700	2.20	2.80	





## RECTIFIERS & TRANSISTORS

### Silicon Diodes

Amps	50 PIV	100 PIV	150 PIV	200 PIV
.75*	.03	.04	.05	.07
3	.04	.06	.10	.13
15	.15	.23	.32	.40
18**	.09	.20	.30	.35

Amps	300 PIV	400 PIV	500 PIV	600 PIV
.75*	.08	.09	.11	.14
3	.15	.18	.20	.22
15	.35	.45	.50	.55
18**	.43	.75	.90	1.10
35	.85	1.15	1.35	1.60

Amps	700 PIV	800 PIV	900 PIV	1000 PIV
.75*	.16	.18	.22	.26
3	.28	.34	.36	.40
15	1.19	1.23	1.29	1.35
35	1.70	1.80	1.90	2.10

**\*\*Press Flt Pkg., \*Top Hat or Flangless**

**10 WATT SIL. ZENER STUD 20% 12-200 V. 60c ea.**  
**1 WATT ZENER DIODE, axial leads 20%**

8-300V SIL. DIODE 1500 PIV 300 ma. 25c ea.  
 HI-VOLTAGE Silicon Epoxy Diodes 2 1/2" x 3/4" x 1 1/2"  
 HOFFMAN 3000 PIV 200 ma. 75c ea.  
 HOFFMAN 6000 PIV 200 ma. 1.50 ea.  
 SILICON POWER TRANSISTORS 80V 2N1724 1.50 ea.

Varicap—Voltage Variable Capacitor  
 27, 47, or 100 pf at 4V, 4:1 new. 1.25 ea.

SIL. DIODES, 1N200 series sil. new. 25/1.00  
 GER. DIODES, glass, new exceeds 1N34. 25/1.00  
 2N 1047B Sil. Pow. 80V TO57. 50c ea.  
 2N 1050 Sil. Pow. 120V TO57. 65c ea.  
 2N 456A 7A. 40V 150W Ger. Pow. TO3. 35c ea.  
 2N 1021 Ger. Pow. 7A, 100V, TO3. 60c ea.  
 2N 1300 Series NPN or PNP. 10/1.00

2N 2151 Sil. Pow. 80V NPN. 50c ea.  
 2N 118 Sil. Pow. NPN 45V. 1.00 ea.  
 3N 34 Silicon Tetrode. 1.00 ea.  
 SIL. POW. TRANSISTOR 40V TO57 NPN. 40c ea.  
 SIL. POW. TRANSISTOR 40V TO53 NPN. 40c ea.  
 SIL. POW. TRANSISTOR 60V TO57 NPN. 60c ea.  
 2N 1142 Ger. Small Signal Hi-Freq. TO5 30V 3/1.00  
 INTEGRATED CIRCUITS TO5. 20/1.00  
 INTEGRATED CIRCUITS Dual In Line. 20/1.00  
 2N 2553 GER. MED. POW. HEATSINK TRANSISTOR  
 PNP. 60c ea.

**SILICON CONTROLLED RECTIFIERS**

PRV	75A*	7A	15A	PRV	75A*	7A	16A
25	.07	.14	.24	300	.40	.55	.85
50	.14	.24	.35	400	.75	1.70	2.20
100	.20	.35	.60	500	1.25	1.15	2.50
150	.30	.45	.75	600	1.50	1.60	1.85
200	.40	.55	.85				

ALL MERCHANDISE UNCONDITIONALLY GUARANTEED OR REFUND. \$3.00 MINIMUM ORDER PLUS POSTAGE. FREE \$1.00 IN MERCHANDISE WITH EACH \$10.00 ORDER. ORDERS FILLED PROMPTLY.

**ELECTRONIC COMPONENTS CO.**  
 BOX 2902, BATON ROUGE, LA. 70821

CIRCLE NO. 115 ON READER SERVICE CARD

WHOLESALE — 4-8-track STEREOTAPES — Car, Home PLAYERS—CB, Recorders. MUSICO, Box 2705, Montgomery, Alabama 36105.

### PLANS AND KITS

INTEGRATED CIRCUIT KITS; COMPUTER LOG-IC, IC's; others. Catalogue free. Kaye Engineering, Box 3932-B, Long Beach, California 90803.

### HIGH FIDELITY

FREE! Send for money saving stereo catalog #E3W and lowest quotations on your individual component, tape recorder or system requirements. Electronic Values Inc., 200 West 20th Street, N.Y., N.Y. 10011.

Hi-Fi Components, Tape Recorders at guaranteed "We Will Not Be Undersold" prices. 15-day money-back guarantee. Two-year warranty. No Catalog. Quotations Free. Hi-Fidelity Center, 239 (L) East 149th Street, New York 10451.

HIFI EQUIPMENT—Get Our "ROCK BOTTOM" prices on NAME BRAND amplifiers—tuners—tape-recorders — speakers FRANCHISED — 59 YEARS IN BUSINESS. Write for this month's specials—NOW! Rabson's 57th St., Inc., Dept. 569, 119 W. 57th St., New York, New York 10019.

LOW, LOW quotes: all components and recorders. Hi-Fi, Roslyn, Penn. 19001.

Hi-Fi components, tape recorders, sleep learn equipment, tapes. Unusual Values. Free catalog. Dressner, 1523 R Jericho Turnpike, New Hyde Park, N.Y. 11040.

### GOVERNMENT SURPLUS

JEEPS Typically From \$53.90. . . Trucks From \$78.40. . . Boats, Typewriters, Airplanes, Electronics Equipment, Photographic Equipment, used. 100,000 Bargains Direct From Government. Complete Sales Directory and Surplus Catalog \$1.00 (Deductible First \$10.00 Order). Surplus Service, Box 820-K, Holland, Michigan 49423.

MANUALS for surplus electronics. List 20¢. Books, Box 804, Adelphi, Maryland 20783.

SURPLUS ELECTRONICS BONANZA. Buy directly from Government. Don't Miss Out! All necessary information: \$2.00. Pacifico, Box 43485-F, Los Angeles, California 90043.

### AUTHORS' SERVICES

AUTHORS! Learn how to have your book published, promoted, distributed. FREE booklet "ZD," Vantage, 120 West 31 St., New York 10001.

POEMS WANTED for new song hits and recordings by America's most popular studio. Tin Pan Alley, 1650-ZD Broadway, New York 10019.

### PERSONALS

MAKE FRIENDS WORLDWIDE, promote international understanding, join Europe's leading correspondence club. Illustrated brochure free. HERMES, Box 17/33, 1 Berlin 11, Germany.

### HYPNOTISM

FREE Hypnotism, Self-Hypnosis, Sleep Learning. Catalog! Drawer H400, Ruidoso, N.M. 88345.

SELF-HYPNOSIS for self-improvement. Safe, effective! Free literature. McKinley, Dept. T-3, Box 3038, San Bernardino, California 92404.

HYPNOTIZE SUCCESSFULLY — or money refunded! Complete illustrated course—including Self-Hypnosis \$1.00. Arthur Fowler, Box 4396, Woodbury, New Jersey 08096.

FREE!! AMAZING hypnotic record-kit releases fantastic mental power. Trial offer expires soon. Write: Forum, AA3, 333 North Michigan, Chicago 60601.

FEMALE HYPNOTISM! Easily! Instantly! Secret Nerve Centers! \$2.20. Brugenheimer Publishers. Box 158-E30, Lexington, Mass.

HYPNOTIZE FEMALES!—Unnoticed! Instantly! Nerves! Exciting! Send \$2.25. Research Enterprises, 29-SN21 Samoset, Woburn, Mass. 01801.

### RUBBER STAMPS

RUBBER ADDRESS STAMP \$1.50. SIGNATURE \$3.50. FREE CATALOG. JACKSON, P.O. BOX 443-G, FRANKLIN PARK, ILL. 60131.

FINEST quality stamps, three lines, \$1.50. Dee's, Box 14004, Phoenix, Arizona 85031.

## G & G CATALOG!

**NEW** 24 Pages Military Electronic Gear  
 SEND 25¢ - Refunded with first order

### AN/APR-4Y FM & AM RECEIVER "FB" FOR SATELLITE TRACKING!

High precision lab instrument, for monitoring and measuring frequency and relative signal strength. 38 to 4000 Mc. in 5 tuning ranges. For 110 V 60 cycle AC. Built-in power supply. Original circuit diagram included. Checked out, perfect, LIKE NEW. **\$88.50**  
 All Tuning Units Available for Above



### LORAN APN-4 FINE QUALITY NAVIGATIONAL EQUIPMENT

4-Channel long range dual units. will determine exact geographic position of your boat or plane. Indicator and receiver complete with all tubes and crystal. INDICATOR ID-6B/APN-4, and RECEIVER \$88.50 R-9B/APN-4, complete with tubes, Exc. Used

### LORAN R-65/APN-9 RECEIVER & INDICATOR

4-Channel single unit system. used in ships and aircraft. Determines position by radio signals from known transmitters. Accurate to within 1% of distance. Complete with tubes and crystals. LIKE NEW Condition **\$88.50**  
 All Accessories for Loran Equipment in stock.



BC-929 3-Inch Scope, with all tubes. LIKE NEW. \$16.95

Conversion instructions, with diagram, for 110 V AC operation. \$ .65

R-4/ARR-2 RECEIVER, 234-258 Mc, Tunable. Complete with 11 tubes, NEW. \$11.95  
 Dynamotor (24VDC) for ARR2. \$2.45

BC-645 TRANSCIVER 435 to 500 Mc, convertible for Ham or Citizens' bands, Voice or Code. Brand new, with 15 tubes. \$16.95  
 Dynamotor, Antenna, Plugs, All accessories available.

**VISIT OUR NEW SHOWROOM  
 AT 45 WARREN STREET, N.Y.C.**

### SCR-274-N, ARC-5 COMMAND SET HQ!

Freq. Range	Type	Exc. Used	BRAND NEW
<b>RECEIVERS, Complete with Tubes</b>			
190-550 Kc.	BC-453	\$18.95	\$23.50
3-6 Mc.	BC-454	\$16.95	\$21.50
6-9.1 Mc.	BC-455	\$14.95	\$19.95
1.5-3 Mc.	R-25		\$21.50
<b>TRANSMITTERS, Complete with Tubes</b>			
4-5.3 Mc.	BC-457	\$ 6.95	\$11.95
5-7 Mc.	BC-458	\$ 6.95	\$12.95
7-9.1 Mc.	BC-459	\$17.95	\$22.50
2-1.3 Mc.	T-18		\$10.95
3-4 Mc.	T-19	\$10.50	\$14.95
<b>MODULATOR, Complete with 3 Tubes</b>			
Voice	BC-456	\$ 2.75	\$ 4.95
All Command Set Accessories in Stock			

SCR-625 MINE DETECTOR \$32.50  
 BC-1206-C Beacon Recvr, 200-400 Kc. NEW. \$12.95  
 BC-1206-C as above, used \$ 9.95  
 SCR-522 Transmitter-Receiver, Like New \$39.50

**EE-8 FIELD PHONES**

Checked out, perfect working order. Complete with all parts. Excellent Condition. LIKE NEW! \$16.95  
 Each

Please include 25% Deposit with order—Balance C.O.D. or Remittance in Full. 50¢ Handling Charges on all orders under \$5.00. All shipments F.O.B. Our Warehouse, N.Y.C. All Merchandise subject to Prior Sale and Price Change.

### G & G RADIO SUPPLY COMPANY

Telephone: (212) CO 7-4605  
 75-77 Leonard St., New York, N.Y. 10013

### EDUCATIONAL OPPORTUNITIES

LEARN While Asleep, hypnotize with your recorder, phonograph. Astonishing details, sensational catalog free! Sleep-Learning Association, Box 24-ZD, Olympia, Washington 98501.

LEARN WHILE ASLEEP. Miraculously build Mind Power, achieve Self Confidence, improve Health, gain Success. Method 92% effective. Details free. ASR Foundation, Box 7021EG Henry Clay Station, Lexington, Kentucky 40502.

USED Correspondence Courses and Books sold and rented. Money back guarantee. Catalog free (Courses Bought). Lee Mountain, Pisgah, Alabama 35765.

### REPAIRS AND SERVICES

SPEAKER REPAIR. Hi-Fi, guitar, organ speakers reconed good as new at fraction of new speaker price. For details write: Waldom Electronics, Inc., Dept. EW, 4625 W. 53rd. St., Chicago, Ill. 60632.

## TAPE RECORDER ANNUAL

Everything you need to know about tape recording including a complete directory of mono and stereo recorders.

1967 — \$1.25 #42  
 1966 — \$1.25 #30  
 1965 — \$1.00 #31

Order by number from Ziff-Davis Service Division, 595 Broadway • New York, N.Y. 10012 Enclose an additional 15¢ per copy for shipping and handling (50¢ for orders outside U.S.A.)

## CHEMTRONICS TUN-O-LUBE®

SPECIALLY FORMULATED  
 FOR ALL TV TUNERS

- SAFE FOR ALL PLASTICS
- WILL NOT DETUNE TUNERS



# CLASSIFIED ADVERTISING ORDER FORM

Please refer to heading on first page of this section for complete data concerning terms, frequency discounts, closing dates, etc.

1	2	3	4	5
6	7	8	9	10
11	12	13	14	15
16	17	18	19	20
21	22	23	24	25
26	27	28	29	30
31	32	33	34	35

Words { @ .40 Reader Rate } = \$ \_\_\_\_\_  
 { @ .70 Commercial Rate }

Insert \_\_\_\_\_ time(s) Total Enclosed \$ \_\_\_\_\_

NAME \_\_\_\_\_

ADDRESS \_\_\_\_\_

CITY \_\_\_\_\_ STATE \_\_\_\_\_ ZIP \_\_\_\_\_

SIGNATURE \_\_\_\_\_

WORD COUNT: Include name and address. Name of city (Des Moines) or of state (New York) counts as one word each. Zip Code numbers not counted. (Publisher reserves right to omit Zip Code if space does not permit.) Count each abbreviation, initial, single figure or group of figures or letters as a word. Symbols such as 35mm, COD, PO, AC, etc., count as one word. Hyphenated words count as two words. EW-368

## RECORDS

SPECIAL INTEREST RECORDS AVAILABLE, PRODUCED BY THE EDITORS OF THE WORLD'S LEADING SPECIAL INTEREST MAGAZINES. SEND FOR FREE CATALOG, RECORD CATALOG-EW, ZIFF-DAVIS PUBLISHING COMPANY, ONE PARK AVENUE, NEW YORK, N.Y. 10016.

## PRINTING

OFFSET PRINTING—8 HOUR SERVICE. 25 to 5,000 copies. Nationwide Printing, Atlanta, Illinois 61723.

LOW Cost Printing, Mimeographing, Business Cards, Envelopes, Free Brochures, Introductory offer. Seaview, 8115-R Avenue "L", Brooklyn, N. Y. 11236.

# BIG CATALOG

World's "BEST BUYS" in GOV'T. SURPLUS Electronic Equipment

## COMMUNICATION RECEIVER



RCAF GR-10 COMMUNICATION RECEIVER—115 Volt 25-60 cye., 6 Bands; 195 to 410 KC & 1400 to 31000 KC., electric band spread, var. selectivity, adj. crystal filters, noise limiter, AVC, carrier control on any one freq. to 6.8 MC., temp. & voltage reg. of oscillator, sensitivity better than 5 Mic. V. 2:1 sig. to noise ratio. Max. undistorted output 3 watts. With Tubes: 3/6SK7, 1/6K8, 1/6SJ7, 1/6H6, 1/6SQ7, 1/6F6G, 1/5Y3G, & 1/VR-105. Beat freq. osc. control & prov for speaker & headset. Size: 10 1/2" x 20 x 11 1/2"; Wt.: 85 lbs. (Cabinet design may vary.)

Prices: USED—Not Checked ..... \$89.95  
 USED—Checked ..... \$99.95

## TRANSMITTER—RECEIVER W/S CDN No. 29 "B" SET

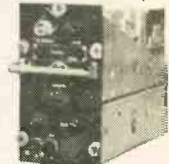

Approx. 230 to 240 MC. with 12/24 VDC Power Supply self contained, and Tubes: 4/6AG5, 2/6AK6, 2/6C4, & 3/6J6. Two preset channels in the freq. range. (Ideal set for local netting on 1 1/4 meters.)

Size: 4 1/2 x 8 x 11"; Wt.: 18 lbs. Price: Used ..... \$18.95  
 NAVY TCS RECEIVER AM—1.5 to 12 MC in 2 bands. For details see our ad in the January, '68 issue ..... Used: \$44.95  
 NAVY TCS TRANSMITTER AM—1.5 to 12 MC in 3 bands. See detailed description in Jan. '68 issue ad. .... Used: \$34.50

Both above items—Checked for Operation—\$10.00 additional.  
**BIG FREE CATALOG**—Send for your FREE copy now. New edition just off the press!  
 Address Dept. EW • Prices F.O.B. Lima, O. • 25% Deposit on C.O.D.'s

**FAIR RADIO SALES**  
 1016 E. EUREKA • Box 1105 • LIMA, OHIO • 45802

# CORNELL

33¢

PER TUBE

100 TUBES OR MORE:  
30¢ PER TUBE

Special!

With every \$10 Order

25¢

per tube

(No Limit) from this list.

6AG5	6SN7
6AQ5	6CB6
6AU6	6J6
6S4	6W4

# One Year TUBES Guaranteed

Tubes are new or used and so marked

OZ4	3BZ6	6AB4	6AT6	6BA6	6BQ6	6CG7	6EA7	6K7	6SN7	6X4	12AD6	12BE6	12SQ7	77
1B3	3DG4	6AC7	6AT8	6BC5	6BQ7	6CG8	6EM5	6Q7	6SQ7	6X8	12AE6	12BF6	25L6	78
1J3/1K3	5U4	6AG5	6AU4	6BD6	6BZ6	6CM7	6F6	6S4	6SR7	7A7	12AF6	12BH7	25Z6	84/6Z4
1H5	5U8	6AK5	6AU5	6BG6	6C4	6CZ5	6GH8	6SA7	6U7	7A8	12AT7	12BL6	35W4	5687
1L4	5V4	6AL5	6AU6	6BJ6	6C6	6D6	6H6	6SH7	6U8	7B6	12AU7	12BY7	35Z3	6350
1T4	5Y3	6AN8	6AV6	6BL7	6CB6	6DA4	6J6	6SJ7	6V6	7C5	12AX7	12C5	50L6	6463
1U4	6A6	6AQ5	6AW8	6BN4	6CD6	6DE6	6J6	6SK7	6W4	7N7	12BA6	12CA5	24	7044
1X2	6A8	6AS5	6AX4	6BN6	6CF6	6DQ6	6K6	6SL7	6W4	7Y4	12BD6	12SN7	27	

Other tubes and CRT's at low prices—send for free list

NO SUBSTITUTIONS WITHOUT YOUR PERMISSION • YOUR ORDER FREE IF NOT SHIPPED IN 24 HRS.

### TRANSISTORS

FAIRCHILD SEMICONDUCTOR

FOR—RADIO—TV—HI-FI—REPAIRS

ORDER CORNELL PART NO	PNP	NPN	MIXED USE (COM)	IF	AF DRIVER
ET-12	ET-13	ET-1	ET-8	ET-2	ET-9
AK3	GE-11	ET-2	ET-9	ET-2	ET-9
	GE-11	GE-1	GE-8	AK3	AK3

79 79 69 69 69 69 79 79

Prestige & Success are yours as an ELECTRONIC EXPERT

COMPLETE RADIO SERVICING AND BASIC ELECTRONICS COURSE ONLY \$3.00 (30 to 40 working hours)

NEW PRACTICAL TV TRAINING COURSE ONLY \$2.50 (15 to 20 working hours)

Both above courses \$6.00

### TUBE CARTONS

HIGH GLOSS RED & BLACK CLAY COATED With Built in Diagonal Partitions

SIZE	FOR TUBE SIZE	PRICE PER 10 CARTONS	PRICE PER 100 CARTONS
MIN.	6AU6	.29	2.59
GT.	6SN7	.39	3.49
LG. GT	5U46B	.59	5.29
G.	5U4G	.89	7.99

FREE

Send for CORNELL'S NEW 1968 CATALOG!!!

PICTURE TUBES!

MANY NEW ITEMS!!!

FREE

all purpose ELECTRONIC CLEANER

89¢

plus 70¢ shipping

# CORNELL

Dept. EW-3—4217 UNIVERSITY AVE.  
 SAN DIEGO, CALIFORNIA 92105

TERMS: ORDERS OVER \$5.00: Add 3¢ per tube shipping. Prepay in full and avoid C.O.D. charges. Send \$3.00 deposit on C.O.D. orders. No 24 hr. free offer on personal checks orders.

ORDERS UNDER \$5.00: Add 3¢ per tube shipping plus 50¢ handling.

CANADIAN AND FOREIGN ORDERS: Add approximate postage. No C.O.D. orders.

COMBINE VARIED ITEMS TO BRING YOUR ORDER OVER \$5.00



# Sale

**- FREE**

**\$25** WORTH OF  
 TRANSISTORS  
 RECTIFIERS  
 RESISTORS  
 CONDENSERS  
 DIODES ETC.

PLUS ANY **\$100\*** ITEM FREE  
 \* or items totalling \$100.)

Add 25¢ for handling

**BOTH FREE WITH ANY \$10 ORDER**

**2 AMP**  
**800 PIV**  
**SILICON**  
**RECTIFIERS**

**LOOK SPECIAL!**

**500 PRV**

MIL	Sale
50 10 for 25¢	
100 10 for 35¢	
All Tests	
150 10 for 40¢	
200 10 for 45¢	
250 10 for 50¢	
TOP	
300 10 for 55¢	

**4 for \$1**

**HATS**

**EPOXY TRANSISTORS & IC's**  
 Fairchild, Motorola, Texas, Bendix

4-2N3563 NPN, 600MC, 200MW	\$1
4-2N3643 NPN, 250MC, 350MW	\$1
3-8-5000 SW, 3Amp, PNP	\$1
4-2N4313 PNP 600MC, 200MW	\$1
3-2N3565, 500HFE, NPN, 200MC	\$1
3-2N4265, 400HFE, NPN, 350MC	\$1
1-DUAL 4 IN. GATE, EXPANDER	\$1
1-QUAD 2 IN. NAND/NOR GATE	\$1
1-703 LINEAR RF AMP, Fairchild	\$2.49

**FIELD EFFECT TRANSISTORS**

**RAYTHEON 2N3608**  
 "MOST" p-channel  
 IGFET  
 Input 10 million meg-

**2.99 ea.**

**100 MICROAMP PANEL METER**  
 2.99 ea.

• Made in USA!  
 • D'Arsonval  
 • Meter Movement!

New! Originally designed to be used with radio tube detector. Basic meter movement 100µA. 2 mounting holes for easy installation in panel. Size: 2 1/2" x 1 1/4". Mounting centers: 1-1/2" / 1". Ideal for builders, hobbyists, labs, etc. Hurry, at this fantastic price they won't last long!

**1 AMP TOP HAT AND EPOXIES**

PIV	Sale	PIV	Sale	PIV	Sale
50	5¢	800	21¢	1800	90¢
100	7¢	1000	32¢	2000	1.25
200	9¢	1200	45¢	3000	1.50
400	11¢	1400	65¢	4000	1.95
600	17¢	1600	75¢		

Actual Size →

**1 AMP MICROMINIATURE SILICON RECTIFIERS**

PIV	Sale	PIV	Sale
50	7¢	600	20¢
100	9¢	800	25¢
200	12¢	1000	39¢
400	17¢		

**2 AMP SILICON RECTIFIERS**

PIV	Sale	PIV	Sale
200	12¢	1000	45¢
400	16¢	1200	59¢
600	19¢	1400	69¢
800	29¢	1600	89¢

**STEREO PREAMP 4.95**

★ 8 TRANSISTORS  
 ★ Ready to Play thru Tape Amplifier, radio, TV  
 ★ Volume, Tone, Controls sw

**3 for \$1**

HIPower  
 PNP, 100Watt/15 Amp  
 TOS6 Case! 2N441, 442, 278, DSS01 up to 50 V

**SILICON POWER STUD RECTIFIERS**

PIV	3A	6A	12A	55A
50	.06	.16	.20	.50
100	.07	.22	.25	.75
200	.09	.30	.39	1.25
400	.16	.40	.50	1.50
600	.20	.55	.75	1.80
800	.30	.75	.90	2.30
1000	.40	.90	1.15	2.70

**SOLITRON DEVICES**

**5 AMP Epoxy Rectifiers**

PIV	Sale	PIV	Sale
50	19¢	600	59¢
100	25¢	800	69¢
200	39¢	1000	79¢
400	45¢		

**GIANT SPRING CATALOG ON: Parts, Rectifiers, Transistors, SCRs, I.C.'s, Equipment, Etc. 10¢**

TERMS: include postage. Rated, net 30 days. COD 25%

**POLY PAKS** P.O. BOX 942W  
 Lynnfield, Mass. 01940

AS ADVERTISED OR YOUR MONEY BACK  
 CIRCLE NO. 97 ON READER SERVICE CARD

**'GLASS AMP' SILICON RECTIFIERS**

PIV	Sale	PIV	Sale
50	5¢	600	19¢
100	7¢	800	21¢
200	9¢	1000	32¢
400	13¢	1200	45¢

PRV may be exceeded without the risk of breaking down.

**PHOTOGRAPHY—FILM, EQUIPMENT, SERVICES**

**MEDICAL FILM—Adults only—"Childbirth"** one reel, 8mm \$7.50; 16mm \$14.95. International V. Greenvale, Long Island, New York 11548.

**SCIENCE Bargains—Request Free Giant Catalog "CJ"**—148 pages—Astronomical Telescopes, Microscopes, Lenses, Binoculars, Kits, Parts, War Surplus bargains. Edmund Scientific Co., Barrington, New Jersey 08007.

**INVENTIONS WANTED**

**INVENTORS.** We will develop, help sell your idea or invention, patented or unpatented. Our national manufacturer clients are urgently seeking new items for outright cash sale or royalties. Financial assistance available. 10 years proven performance. For free information, write Dept. 42, Wall Street Invention Brokerage, 79 Wall Street, New York, N.Y. 10005.

**PATENT SEARCHES, \$6.00! FREE "Invention Record"/Information.** Miss Hayward, 1029H Vermont, District of Columbia 20005.

**INVENTIONS — IDEAS** developed Cash/Royalty Sales. Member: United States Chamber Commerce. Raymond Lee, 230-GE Park Avenue, New York City 10017.

**INVENTORS!** Receive free invention analysis at no risk to you. Send for FREE disclosure form today. New York Invention Service, Dept. 19, 160 Broadway, New York, N.Y. 10038.

**INVENTOR** or any person with normal education, invincible imagination is eligible to join HIP-Club, which pays its members plus promoting their invention. HIP-Club, 2020 N. 8th Street, Phila., Pa. 19122.

**EMPLOYMENT INFORMATION**

**FOREIGN** and USA job opportunities available now. Construction, all trades. Earnings to \$2,000.00 monthly. Paid overtime, travel, bonuses. Write: Universal Employment, Woodbridge, Connecticut 06525.

**AUSTRALIA.** New Life. Jobs. Opportunity. Government Shares Fare. Information \$1. Pacifico, Box 43485-R, Los Angeles, Calif. 90043.

**BUSINESS OPPORTUNITIES**

**INVESTIGATE ACCIDENTS:** Earn to \$1000 monthly. Men urgently needed. Car furnished. Business expenses paid. No selling. No college education necessary. Pick own job location. Investigate full time or earn to \$8 hour spare time. Write for FREE information. No obligation. Universal Schools, CZ-3, 6801 Hillcrest, Dallas, Texas 75205.

**FREE CATALOGS.** Repair air conditioning, refrigeration. Tools, supplies, full instructions. Doolin, 2016 Canton, Dallas, Texas 75201.

**I MADE \$40,000.00 YEAR** by mailorder! Helped others make money! Start with \$10.00—Free proof. Torrey, Box 318-N, Ypsilanti, Mich. 48197.

**FREE BOOK "990 Successful, Little-Known Businesses."** Work home! Plymouth-245W, Brooklyn, New York 11218.

**PIANO TUNING** learned at home quickly. Tremendous field! Musical knowledge unnecessary. GI approved. Information free. Empire School, Dept. E, Miami, FL 33145.

**MISCELLANEOUS**

**WINEMAKERS:** Free illustrated catalog of yeasts, equipment. Semplex, Box 7208, Minneapolis, Minn. 55412.

**EMPLOYMENT Resumes.** Get a better job & earn more! Send only \$2.00 for expert, complete Resume Writing Instructions. J. Ross, 80-34 Kent St., Jamaica, N.Y. 11432 Dept. EW.

**SPARE TIME OPPORTUNITY—MONEY. WE PAY** at the rate of \$10 hr. for NOTHING but your opinions, written from home about our clients' products and publications, sent you free. Nothing to buy, sell, canvass, or learn. NO SKILL, NO GIMMICKS. Just honesty. Details from RESEARCH, ZD-3, Box 669, Mineola, N.Y. 11501.

**VENTRILOQUISM!** Information free! Dummy catalog, 25¢. State age. Maher, Studio ZD3, Box 8536, Kensington Station, Detroit, Michigan 48224.

**GET IT from GOODHEART!**

**EVERYTHING UNCONDITIONALLY GUARANTEED!**

**MARCONI FM DEVIATION METER TF-934,** regularly \$890. Reads dev. w/ranges 5, 25, 75 kc. Has audio monitor. Made for MIL. 20-100 mc. easily reaches 1000 mc on harmonics; we include all instructions. Checked out, ready to use..... \$249.50

**TEKTRONIX #531 15 mc scope w/dual-trace plugin, w/NBS-traceable Certif., books, probes.....775.00**  
 Other Tekt., Hewl-Pack, DuMont scopes.....ASK!

**COUNT FREQ. DIGITALLY** 10 cy to 220 mc with crystal accuracy, at the lowest price available anywhere; and each set has been completely checked and comes with a dated CERTIFICATE OF CALIBRATION (and stickers) traceable to the National Bureau of Standards. You get Hewl-Pack #524B with #525A & #525B plug-ins, and complete set of books.....1275.00

**Brand New VHF rcvrs** look like BC-453 Command but are 9-tube 100-155 mc. 2 uv sens; 2 rf's, 3 IF's; noise limr; avc, w/schem., instruct., spine knob, & graph to set freq. by counting turns. A.R.C. Type 13B, 28V htr wiring; 7" ship wt. .... \$22.50  
 R32 is same but w/squelch; 14V htr wiring...\$27.50

**R-23/ARC-5 Command revr** 190-550 kc. .... 14.95  
**A.R.C. 12 #22 Command revr** 540-1600 kc. .... 17.95  
**L.N.-14 freq. meter,** .01% 125 kc-20 mc. .... 57.50  
**TS-325/UR freq. meter** 20-480 mc., .001%..... 169.50  
**BC-221's DK**.....\$67.50 **TS-175 OK**..... 127.50  
**CLOSING OUT Radio Receivers** 38-4000 mc at CRAZY LOW PRICES! Ask for APR-4/4Y/4V-253 sheet.

**ALL-BAND SSB RCVR BARGAIN:** Hallicrafters R-45/Alt-7., 550 kc to 43 mc continuous. Voice, CW, MCW, aligned, grtd, w/book; 2-RF, 2-IF's, 8-meters; noise limr; 3 xtl, 3 non-xtl selector. 149.50  
 60 cy pwr aply; \$30. SSB product detect: \$20

**SP-600-JX Revr** .54-54 mc. Exc. Cond. w/book.....325.00

**Super. EMT 6220V** 3 ph 20 kva Line V Regulator..... 450.00  
**Sorens. 10000S 10 kva Line V Regulator**.....695.00  
 And others from 250 VA up. Ask for Regulator List. Autoclheron Cesium-Beam Freq. Standard.....ASK!  
 Regulated Power Supplies, Meter Calibrators.....ASK!  
 All kinds of AUDIO Test Equipment.....ASK!  
 Standard Signal Generators CW/AM/FM/Sweep ASK!  
 Bridges, Potentiometers, other Lab Standards.....ASK!  
 Electronic & Rotary Frequency Converters.....ASK!  
 Noise & Field Strength Meters.....ASK!

**TIME PAY PLAN:** Any purchase totalling \$100.00 or more, down payment only. 10%

Above is a small sampling of our terrific inventory. **WE ALSO BUY!** We want Tektronix scopes, Hewlett-Packard equip., Aeronaut. radio-shop equip., etc. . . . AND Military Communications of all kinds.

**DO NOT ASK FOR CATALOG! ASK FOR SPECIFIC ITEMS OR KINDS OF ITEMS YOU NEED!**

**R. E. GOODHEART CO. INC.**  
 Box 1220-A, Beverly Hills, Calif. 90213  
 Phones: Area 213, office 272-3707, messages 275-3342

**CIRCLE NO. 113 ON READER SERVICE CARD**



**ELECTRONICS WORLD MARCH 1968**  
**ADVERTISERS INDEX**

READER SERVICE NO.	ADVERTISER	PAGE NO.	READER SERVICE NO.	ADVERTISER	PAGE NO.
125	Allied Radio .....	69	103	Mallory & Co. Inc., P.R. ....	2
	American Institute of Engineering & Technology .....	78	200	Metex Corporation .....	88
124	Arcturus Electronics Corp. ....	93	102	Microflame, Inc. ....	91
123	Burstein-Applebee .....	88	101	Milwaukee School of Engineering ..	68
	Capitol Radio Engineering Institute, The .....	18, 19, 20, 21	100	Multicore Sales Corp. ....	69
	Chemtronics .....	94	99	Music Associated .....	79
122	Cleveland Institute of Electronics ....	5		National Radio Institute ....	8, 9, 10, 11
121	Cleveland Institute of Electronics .....	80, 81, 82, 83		National Technical Schools .....	60, 61, 62, 63
	Conar .....	75, 78	98	Olson Electronics, Inc. ....	75
120	Cornell .....	95	97	Poly Paks .....	96
119	Crown .....	79		RCA Electronic Components and Devices .....	FOURTH COVER
118	Delta Products, Inc. ....	69		RCA Institutes, Inc. ....	70, 71, 72, 73
117	Delta Products, Inc. ....	75	96	Radar Devices Manufacturing Corp. ....	1
116	Edmund Scientific Co. ....	98	95	Sams & Co., Inc., Howard W. ....	15
108	Electro-Voice, Inc. ....	SECOND COVER	94	Sams & Co., Inc., Howard W. ....	65
115	Electronic Components Co. ....	94	93	Shure Brothers, Inc. ....	64, 66
	Fair Radio Sales .....	95	92	Solid State Sales .....	93
114	Finney Company, The .....	12	91	Sonar Radio Corporation .....	90
	G & G Radio Supply Company .....	94	90	Sprague Products Company .....	89
113	Goodheart Co. Inc., R.E. ....	96		Surplus Center .....	92
	Grantham School of Electronics .....	4		Sylvania .....	22
112	Gregory Electronics Corporation ....	93	89	Telex Acoustics .....	16
111	Heath Company .....	76, 77	199	Texas Crystals .....	84
110	IEEE .....	84	84	Triplett Electrical Instrument Company .....	THIRD COVER
109	International Crystal Mfg. Co., Inc. ..	17		Valparaiso Technical Institute .....	59
107	JFD Electronics Company .....	26	88	Viking Tape Recorders .....	74
106	Lafayette Radio Electronics .....	59	87	Xcelite, Inc. ....	85
105	Lampkin Laboratories, Inc. ....	79	86	Zenith .....	87
104	Magnecord Tape Recorders .....	6			

CLASSIFIED ADVERTISING 92, 93, 94, 95, 96

**THE ONLY COMPLETE  
AND UP-TO-DATE GUIDE TO  
THE EXCITING WORLD OF  
SPECIALIZED  
RADIO COMMUNICATIONS!**

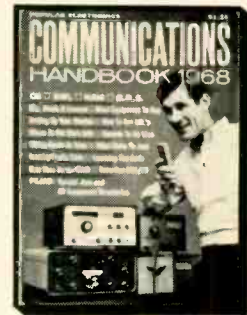

Whether you're a ham, short wave listener, CB'er or business radio operator . . . a newcomer to the fascinating world of radio communications or an oldtimer who cut his teeth on crystal sets . . .

**You need a copy of the new 1968  
COMMUNICATIONS  
HANDBOOK!**

It's packed with over 150 pages of "how to do it—how to do it better" features written by the experts in each category. From choosing your field . . . to learning the code . . . to getting your license . . . to setting up your own station . . . to winning awards!

**And note this:**

You also get valuable directories of the latest ham and CB equipment for both novice and technician class — PLUS hundreds of photos, charts, lists and tables . . . everything you need to get the most enjoyment from your hours on the air!

**THE 1968 COMMUNICATIONS HANDBOOK IS READY RIGHT NOW. Use the coupon below to order your copy TODAY! It's just \$1.25.**

**GET THE HANDSOME LEATHERFLEX-BOUND EDITION for just \$3 POSTPAID! The 1968 COMMUNICATIONS HANDBOOK is also available in a splendid deluxe edition. Rugged Leatherflex cover provides lasting protection yet is softly textured and gold-embossed for the look of elegance. A collector's item—a superb addition to your permanent reference library. And it's yours, for just \$3 postpaid, when you check the appropriate box on the order form.**

**ZIFF-DAVIS SERVICE DIVISION • DEPT. CH  
595 Broadway • New York, N.Y. 10012**

**OK! Send me the new 1968 COMMUNICATIONS HANDBOOK.**

\$1.25 enclosed, plus 15c for shipping and handling. Send me the regular edition. (\$1.75 for orders outside the U.S.A.)

\$3.00 enclosed. Send me the Deluxe Leatherflex-bound edition, postpaid. (\$3.75 for orders outside the U.S.A.) Allow three additional weeks for delivery.

print name \_\_\_\_\_

address \_\_\_\_\_

E.W. 38

city \_\_\_\_\_

state \_\_\_\_\_

zip code \_\_\_\_\_

**— PAYMENT MUST BE ENCLOSED WITH ORDER —**



**MAIL  
ORDER**

# SHOPPING MART

**UNUSUAL  
VALUES**

A selection of products, many war surplus, available by mail for readers of Electronics World  
All merchandise sold on a money-back guarantee. Order direct by Stock No. Send check or M. O.

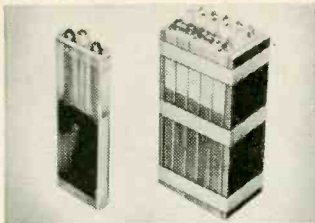

### NI-CD BATTERY BARGAINS

Terrific value—used government surplus. Quick-charge, lightweight 6-volt nickel-cadmium battery. 4-amp. hour capacity. Almost unlimited life. Charges in 1 hr. w/Edmund Charger Kit. Hundreds of uses. Few drops of water yearly for full maintenance. Minimum of electrolyte-sealed to prevent loss. Five vented 1.2 volt cells. 3 1/2" x 2" x 6"

No. 70,942AK (Battery) ..... \$15.00 Ppd.  
No. 41,109AK (1.2 V.) ..... \$ 3.95 Ppd.  
No. 70,807AK (Charger) ..... \$ 8.00 Ppd.

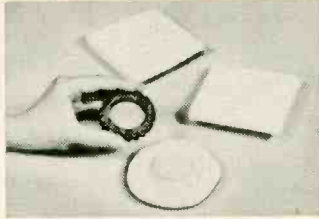

### WHITE MODELING PLASTIC

Perfect for figures, forms, shapes, product & tool designs, negative molds, model making, etc. Easily shaped by hand, tools. Can be rolled flat, built up into figures. Permanently pliable until baked at 300° F. for 15-30 minutes in oven—no kiln nor plaster molds needed. Acquires permanent, non-brittle hardness. Can then be cut, sawed, drilled, sanded, painted, embossed. Smooth and harmless.

Stock No. 60,656AK ..... 3 lbs. \$ 4.50 Ppd.  
Stock No. 70,909AK ..... 10 lbs. \$11.50 Ppd.

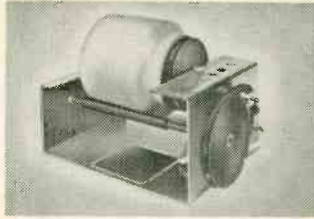

### NEW, LOW-COST GEM TUMBLER

Become a rockhound! Fascinating hobby! Loads of fun, inexpensive, easy. Make jewelry of all kinds—decorative bookends, table tops, etc. Simply tumble-finish readily available gemstones. . . . then polish to high lustre . . . brings out beautiful colors. Rugged 3-lb. capacity tumbler w/continuous duty motor compares to units selling for many times its price.

Stock No. 70,874AK ..... \$10.75 Ppd.  
6-LB. ROCK ASSORTMENT (10 TYPES)  
Stock No. 70,868AK ..... \$ 9.00 Ppd.

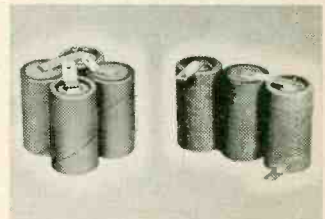

### NEW SURPLUS Ni-Cd BATTERIES

Save more than 50%! Long life—accept 300 charge and discharge cycles. 1.25 Volts per cell—750 milliampere hours capacity. Excel. charge retention. Hermetically sealed. Indefinite storage life. Combine to form btry. 7/8" dia. x 1 1/2" high.

Order No. Cells DC Volt Price Ppd.  
40,986AK 1 1.25 \$ 1.50  
40,987AK 2 2.50 2.75  
60,634AK 4 5.00 4.80  
70,812AK Trickle Charger (1-10 cells) 10.95

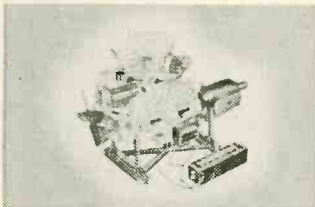

### PLASTIC MODEL V-8 ENGINE

Hours of fun! Get thrill of building easily assembled engine from over 350 parts. Push starter and watch it run. Crankshaft revolves, pistons move, valves open and close in sequence with spark plugs. 1/4 scale, molded in 4 colors. Same motor used in many auto-mechanic courses. Excellent, simple "tech manual"

Stock No. 70,448AK ..... \$10.95 Ppd.

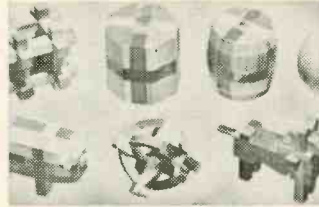

### WOODEN SOLID PUZZLES

Here's a fascinating assortment of 12 different puzzles to provide hours of pleasure and stimulate ability to think and reason. Animals and geometric forms. Take them apart and reassemble them. Lots of fun for the whole family—young and old. Will test skill, patience and ability to solve problems. Order yours now.

Stock No. 70,205AK ..... \$3.50 Ppd.

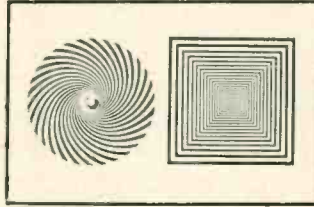

### FASCINATING MOIRÉ PATTERN KITS

Now explore the world of "Op Photography". Fantastic visual effects. Limitless applications. 1,000's of uses for hobbyists, photographers, home experimenters. Fun! Profitable! Contains 8 basic patterns on both clear acetate and white Krome-kote, 150 dot screen on film, book.

Stock No. 70,719AK ..... \$8.50 PPD.  
SAME KIT IN FULL COLOR  
Stock No. 60,530AK ..... \$12.50 Ppd.

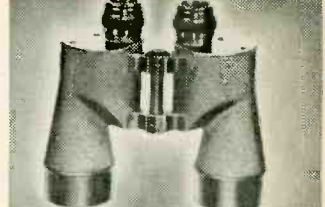

### AMER. MADE 7x50 BINOCULARS

Big savings! Brand new! Crystal-clear viewing—7 power. Every optical element is coated. An excellent night glass—the size recommended for satellite viewing. Individual eye focus. Approx. field at 1,000 yds. is 376 ft. Carrying Case included. American 7 x 50's normally cost \$274.50. Our war surplus price saves you real money.

Stock No. 1544AK ..... \$74.80 Ppd.

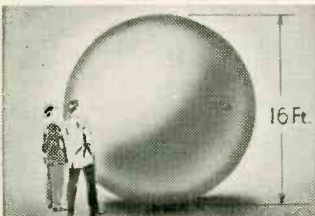

### GIANT WEATHER BALLOONS

Big 8' and 16' diameter. Create neighborhood sensations. Great backyard fun. Blow up with vacuum cleaner or auto air hose. With helium use in sky to attract crowds, advertise store sales, etc. Amateur meteorologists use balloons to measure cloud heights, wind speeds, temperature pressure, humidity at various heights. Heavy duty neoprene.

Stock No. 60,568AK ..... 8' ..... \$2.00 Ppd.  
Stock No. 60,632AK ..... 16' ..... \$7.00 Ppd.

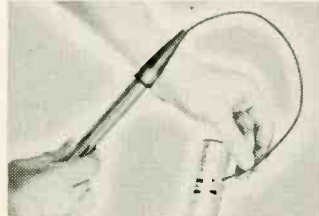

### 'PIPE' LIGHT INTO REMOTE AREAS

New, low-cost Flex-I-Light "pipes" light around corners, thru small holes, into other areas previously inaccessible. Utilizes new 2' long flexible plastic light guide with .130" O.D. attached to 5 1/2" long rotary switch penlight. Perfect for technicians, electricians, mechanics, T.V., radio & appliance repairmen, hobbyists, etc. Easily converts to regular penlight.

Stock No. 60,648AK ..... \$2.75 Ppd.

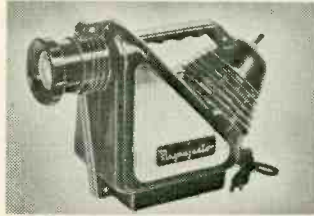

### AMER. MADE OPAQUE PROJECTOR

Projects illustrations up to 3" x 3 1/2" —enlarges them to 35" x 30" if screen is 6 1/2 ft. from projector, larger pictures if screen further away. No film or negatives needed. Projects charts, diagrams, color or black-and-white. Operates on 115 volts A.C. current. 6 ft. cord & plug included. Uses 60 watt bulb, not included. Size 12" x 8" x 4 1/2" wide. Plastic case.

Stock No. 70,199AK ..... \$7.95 Postpaid

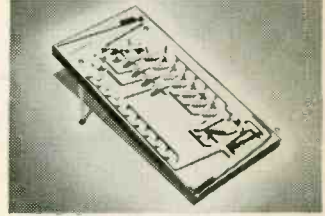

### IT'S HERE—BIG, NEW DIGICOMP II!

If you think DIGICOMP I was something—wait 'til you use DIGICOMP II! Loads of fun! Terrific challenge! Actually works like electronic digital computer but needs no power. Adds, subtracts, multiplies, divides, memorizes. 1st mechanical computer w/ auto. switch action. 1st model designed for programming. Speed reduced by factor of million to 1—you can see what's happening. Demonstrates computer tech.

Stock No. 70,946AK ..... \$16.00 Ppd.



### GIANT FREE CATALOG

Completely new 1968 edition. New items, categories, illustrations. Dozens of electrical and electromagnetic parts, accessories. Enormous selection of Astronomical Telescopes, Microscopes, Binoculars, Magnifiers, Magnets, Prisms. Many war surplus items: for experimenters, workshop, factory. Send for catalog "AK".



### ASTRONOMICAL TELESCOPE KITS

Grind your own mirror for powerful telescope. Kit contains fine annealed pyrex mirror blank, tool, abrasives, diagonal mirror, and eyepiece lenses. You build instruments valued from \$75.00 up

Stock # Diam. Thickness Price  
70,003AK 4 1/4" 3/4" \$7.50 Ppd.  
70,004AK 6" 1" 11.95 Ppd.  
70,005AK 8" 1 1/4" 19.50 Ppd.  
70,006AK 10" 1 3/4" 30.75 f.o.b.

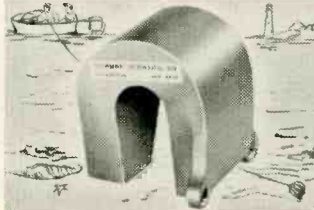

### "FISH" WITH A MAGNET

Go treasure hunting on the bottom! Fascinating & sometimes profitable! Tie a 11lb to 5-lb. Magnet—drop it overboard in bay, river, lake or ocean—your "treasure" haul can be outboard motors, anchors, other valuables. Magnet is war surplus—Alnico V Type—Gov't cost \$50. Lifts over 150 lb. under water.

Stock No. 70,571AK ..... \$12.50 Ppd.

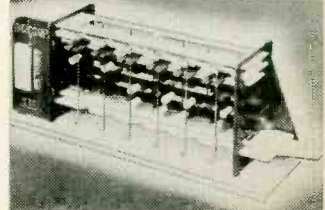

### NEW MODEL DIGITAL COMPUTER

Solve problems, teach logic, play games with miniature version of giant electronic brain! Adds, subtracts, multiplies, shifts, complements, carries, memorizes. 12" x 3 1/2" x 4 3/4". Step-by-step assembly diagrams, 32-p. instruction book covering operation, computer language (binary system) programming problems & 15 experiments.

Stock No. 70,683AK ..... \$5.98 Ppd.

ORDER BY STOCK NUMBER • SEND CHECK OR MONEY ORDER • MONEY-BACK GUARANTEE

## EDMUND SCIENTIFIC CO. 300 EDCORP BUILDING BARRINGTON, NEW JERSEY 08007

CIRCLE NO. 116 ON READER SERVICE CARD

Printed in U.S.A.

ELECTRONICS WORLD



# TRIPLET

## EXTRA QUALITY IS HIDDEN\*

### MODEL 630 V-O-M PRICE † \$61.00

### Standard Of The Industry

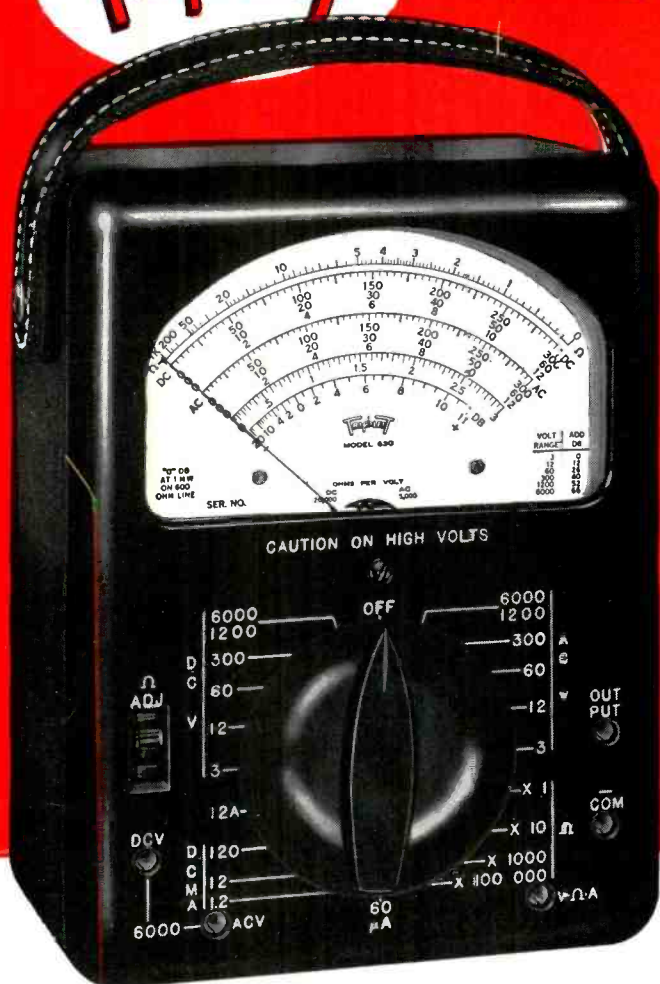

#### USES UNLIMITED:

- Field Engineers
- Application Engineers
- Electrical, Radio, TV, and Appliance Servicemen
- Electrical Contractors
- Factory Maintenance Men
- Industrial Electronic Maintenance Technicians
- Home Owners, Hobbyists,

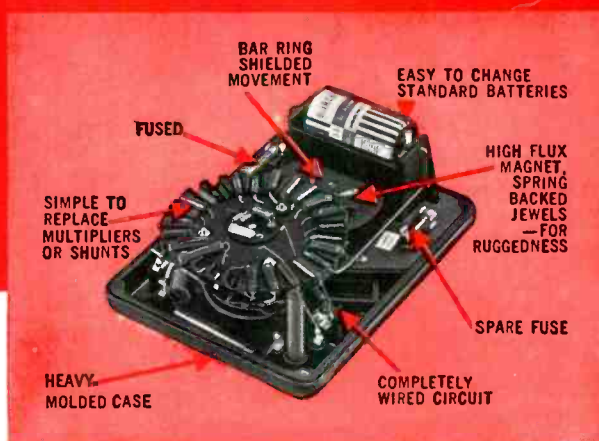

#### FACTS MAKE FEATURES:

- 1** One selector switch minimizes chance of incorrect settings and burnouts.
- 2** 4.4 ohm center scale, reads from 0.1 ohm up to 100 megohms resistance in 4 ranges.
- 3** 20,000 ohms per volt DC sensitivity; 5,000 AC.

Attention to detail makes the Triplet Model 630 V-O-M a lifetime investment. It has an outstanding ohm scale; four ranges—low readings .1 ohm, high 100 megs. Fuse affords extra protection to the resistors in the ohmmeter circuit, especially the X1 setting, should too high a voltage be applied. Accuracy 2% DC to 1200V. Heavy molded case.

†630A same as 630 plus 1½% accuracy and mirror scale only \$71.00

**TRIPLET ELECTRICAL INSTRUMENT COMPANY, BLUFFTON, OHIO**

#### RANGES

DC VOLTS	0-3-12-60-300-1,200-6,000 at 20,000 ohms per volt.
AC VOLTS	0-3-12-60-300-1,200-6,000 at 5,000 ohms per volt.
OHMS	0-1,000-10,000.
MEGOHMS	0-1-100.
DC MICRO-AMPERES	0-60 at 250 millivolts.
DC MILLI-AMPERES	0-1.2-12-120 at 250 millivolts.
DC AMPERES	0-12.

DB: -20 to +77 (600 ohm line at 1 MW).

OUTPUT VOLTS: 0-3-12-60-300-1,200; jack with condenser in series with AC ranges.

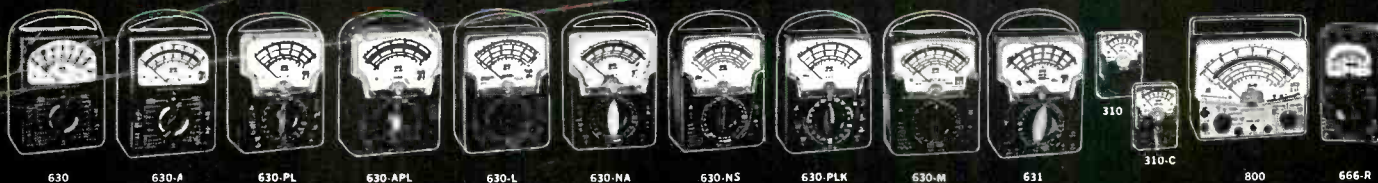

THE WORLD'S MOST COMPLETE LINE OF V-O-M'S. AVAILABLE FROM YOUR TRIPLET DISTRIBUTOR'S STOCK.

CIRCLE NO. 84 ON READER SERVICE CARD



## We can't leave well enough alone...

...so we redesigned the RCA-6BK4A to improve its capability in shunt regulator circuits of high voltage power supplies in color TV receivers. Always the best tube to do the job, the RCA-6BK4B is now even better.

An improved plate provides highly efficient heat radiation and uniform temperature distribution...and permits a 40 W max. plate dissipation rating. This rating is especially important in present-day color receivers. An increased peak

negative heater-cathode voltage capability of 450 V max. results from better heater insulation and tighter processing controls. A redesigned top cap reduces strain on dome of the glass envelope for greater strength and reliability.

Innovations and improvements that make your service operation more reliable, efficient and profitable are our constant aim. So see your local Authorized RCA Tube Distributor for quality RCA receiving tubes.



# RCA