

Electronics World

DECEMBER, 1967
60 CENTS

NEW INCENTIVE REGULATIONS FOR HAMS—What Happens Now?

SELECTING THE RIGHT CONSTANT-VOLTAGE TRANSFORMER

DESIGNS FOR LOG-PERIODIC FM & TV ANTENNAS

ADVANCES IN MAGNETIC MATERIALS



M0568 514700HND2724L0M8M
M J HINDMAN
2724 E LINWOOD
SPRINGFIELD MO 65804

EW LAB TESTS

SOLID-STATE STEREO RECEIVERS

Take a long look... at the new shape of progress from Electro-Voice.

E-V At E-V we'll go to unusual lengths to make better sound products. For instance, we created a microphone seven feet long. It solves long distance sound pickup problems for radio and TV. On the other hand, we needed less than 3-1/2" of height to design a 65 watt FM stereo receiver. And we keep putting bigger and bigger sound in smaller and smaller speaker systems.

And even the products that don't look radically different, sound different. That difference is what high fidelity is all about. Hear it today at leading soundrooms everywhere. Or send coupon below for free literature. It's full of progressive sound ideas for you.

A. Model 643 highly directional "shotgun" microphone. Widely used at football games, news conferences, motion pictures. \$1,560.00 list.

B. Model E-V 1277 65-watt* FM stereo receiver, complete with cabinet, yet just 3-3/8" high. Solid state, of course. \$280.00

C. Model E-V 1179 55-watt* FM stereo receiver. Tuning meter, full-time stereo light, many extras. Just \$210.00.

D. Model E-V FIVE-A two-way speaker system. With four-layer voice coil for better bass at lower cost. \$88.00.

E. Model E-V SEVEN-A two-way speaker system. Takes up just 19" of shelf space, yet delivers sound rivaling a much larger system. \$66.50.

F. Model SP12B An old favorite that has been kept up to date with scores of detail changes through the years. \$39.00

G. Model LT8 3-way speaker. The modern way to provide full-range sound in every room of your house. \$33.00.

*IHF output at 4 ohms.



Electro-Voice®

high fidelity speakers and systems • tuners, amplifiers, receivers • public address loudspeakers
• microphones • phonograph needles and cartridges • organs • space and defense electronics

CIRCLE NO. 116 ON READER SERVICE CARD

ELECTRO-VOICE, INC., Dept. 1174N

629 Cecil Street, Buchanan, Michigan 49107

Please send free high fidelity literature.

Please send free microphone literature.

Name _____

Address _____

City _____ State _____ Zip _____

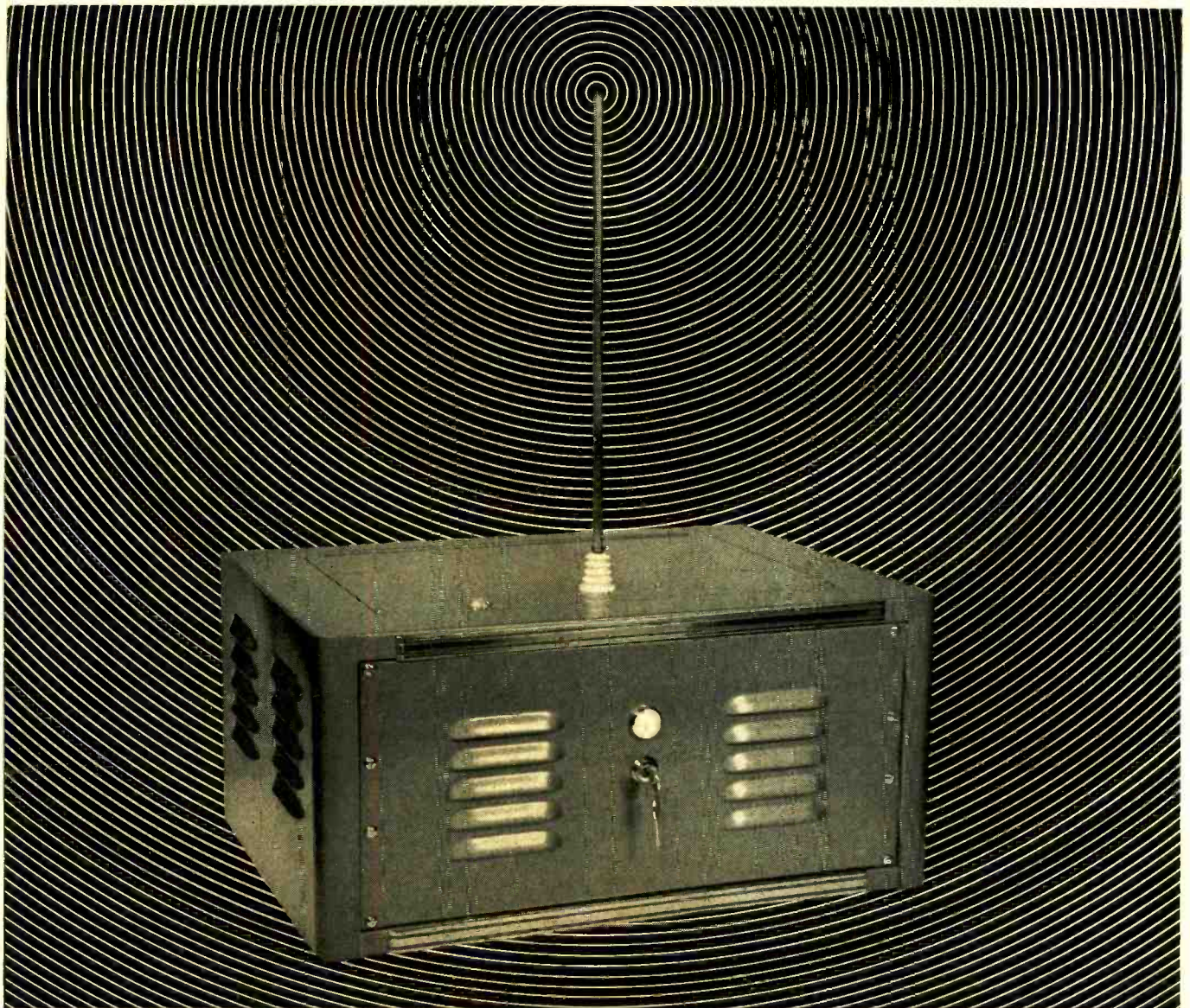

You are now in Radar Sentry Alarm's r.f. microwave field. Don't move a muscle!

This security system is so sensitive, it can be adjusted to detect the motion of your arm turning this page.

And if this Portable Model Unit were within 35 feet of you and you moved . . . people up to a half-mile away could hear the siren. Plus with optional equipment, it can detect fire . . . turn on lights . . . even notify police.

What does a burglar alarm have to do with you?

Just this: Radar Sentry is no ordinary alarm. It is the most modern and effective security system available. And it's also electronic.

That's why we need you. We need Dealers with technical knowledge. For the most successful Dealers for Radar Sentry Alarm are men who know electronics. This is a product that sells itself when demonstrated properly.

It's been proven time after time. In fact, many of the more than one thousand readers of electronics magazines who became Dealers in the past year—sold a system on their *first* demonstration.

And that's why we need men with technical knowledge and experience.

Men like you.

How about it?

Do you want to start a business of your own . . . or expand your present business with a product that in 8 years has become the world-wide leader in its field?

Do you want to earn up to \$5,000 a year in your spare time?

Do you want to earn \$20,000 and more full time? We'll show you how.

O.K., now you can move.

Fill out the coupon and get complete Dealer/Distributor information . . . free.

Mail to: RADAR DEVICES MANUFACTURING CORP.
22003 Harper Ave., St. Clair Shores, Michigan 48080



Please tell me how I can have a business of my own distributing Radar Sentry Alarm Systems. I understand there is no obligation.

Name _____

Address _____

City _____ State & Code _____

EW-12

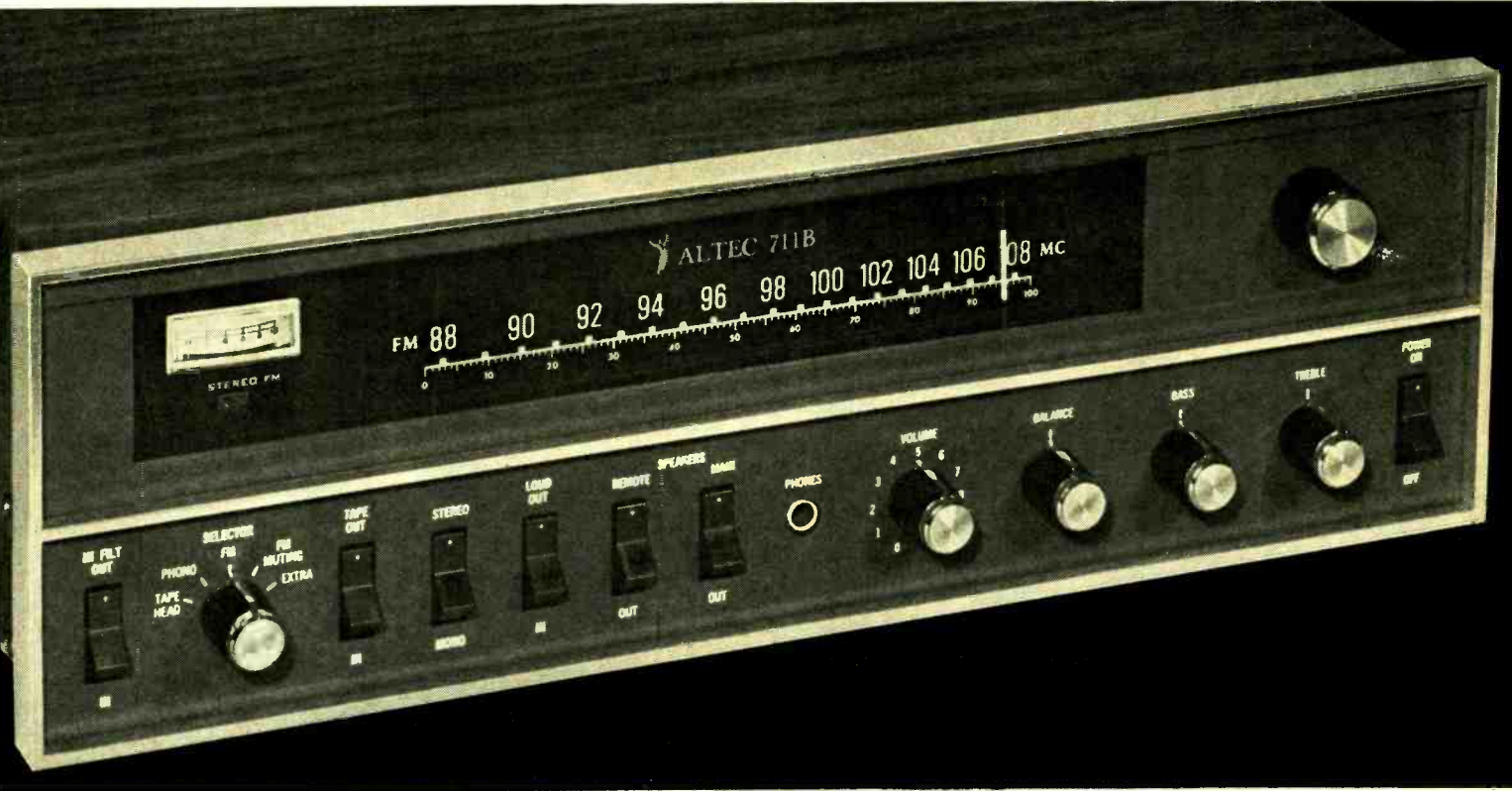

Our new 711B has been influenced by the company it keeps.

Never underestimate the importance of good heredity. Or of good environment. Our 711B Stereo FM Receiver has both going for it.

From concept to production line, it's shared the attention and concern of the same hands and minds that produced other fine Altec audio equipment. Equipment which has already made its mark in the world, in professional recording studios such as Paramount Pictures, ABC-TV, Disney Studios, and others. As well as in entertainment centers like the Los Angeles Music Center, Lincoln Center's Philharmonic Hall, Dallas Music Hall, the Houston Astrodome.

Matter of fact, Altec probably supplies more professional audio equipment for recording and broadcast studios, concert halls, stadiums and similar centers, than any other manufacturer in the field.

As a result, what's new to others is pretty old hat to us. Solid state, for example. We pioneered in the use of transistors for audio circuits over 10 years ago, developing special amplifiers that are used by telephone companies throughout the country, to give you better service.

With a background like this, it stands to reason the 711B would be something special. That it would have an FET front end and integrated circuits as a matter of course. (Fact is, there are two of them in the IF strip, each replacing 10 transistors for outstanding selectivity.) And the capture

ratio is an impressive 2.5 dB.

In the amplifier section, the 711B provides 100 watts of all-silicon transistor power with a frequency response of ± 1 dB, 15-25,000 Hz. Automatically resetting circuit breakers protect the components, and a built-in FM muting circuit provides noise-free tuning.

Obviously, the 711B has the latest of everything. We wouldn't consider anything less.

Take a look at it soon, at your Altec dealer's. And while you're there, ask for your copy of our new 24-page folder on stereo components and systems. Or write directly to us.

The 711B is yours for \$399.50. And if you want to hear it at its best, choose a pair of matching Altec speaker systems. That way, you'll all be in good company.



A Division of
Ling Altec, Inc.,
Anaheim, Calif. 92803

CIRCLE NO. 86 ON READER SERVICE CARD



THIS MONTH'S COVER shows a grouping of some of the new solid-state stereo receivers that we Lab-Tested for this issue. For a full report on our test results, specifications, and prices of these as well as other new receivers, refer to the article by Julian Hirsch on page 25. The stack of five receivers at the center of the photo are: from top to bottom, Electro-Voice 1277, Sherwood S-8800FET, Eico 3570, Heath AR-15, and Marantz 18. The stack of two receivers at the right are: top, Kenwood TK-88, and bottom, Scott 344-C. We removed the cases of three of the receivers. The one in the left foreground is the Pioneer SC-1000TA, in the right foreground is the Fisher 700T, and the Sansui TR-700 is at the top right. Cover photograph by Dirone-Denner.



Publisher
PHILLIP T. HEFFERNAN
Editor
WM. A. STOCKLIN
Technical Editor
MILTON S. SNITZER
Associate Editor
P. B. HOEFER
Assistant Editor
MARSHA JACOBS
Contributing Editors
WALTER H. BUCHSBAUM
Prof. ARTHUR H. SEIDMAN
Art Editor
HERBERT L. SILBERMANN
Art and Drafting Dept.
J. A. GOLANEK
Advertising Sales Manager
LAWRENCE SPORN
Advertising Service Manager
ARDYS C. MORAN

December, 1967

Electronics World

DECEMBER 1967 VOL. 78, No. 6

CONTENTS

- 25 EW Lab Tests of New Solid-State Stereo Receivers** *Julian D. Hirsch*
Here is an in-depth rundown on industry standards for testing hi-fi receivers, along with our Lab-Test measurements of 14 of the newest models. Also included is information on all the major manufacturers' complete line of sets.
- 30 Recent Developments in Electronics**
- 32 New Incentive Regulations for Hams: What Happens Now?** *Robert M. Brown*
There have been sweeping changes made recently by the FCC which will affect all radio amateurs. Incentive licensing is provided that will make available a number of exclusive frequencies for Advanced and Extra Class hams. Here are details.
- 35 EROS, An Airborne Collision Avoidance System** *Joseph H. Wujek, Jr.*
Collision avoidance systems for aircraft are very much in the news these days. Here is information on one such system that has been used in test aircraft and that may be the basis for future commercial use in supersonic jet transports.
- 39 Stable, Low-Cost Reference Power Supplies** *Carl David Todd*
- 42 Selecting the Right Constant-Voltage Transformer** *B. C. Biega*
These ferroresonant devices are widely used to maintain the voltage level of the a.c. line at a constant value. Important factors to consider in choosing the proper transformer for your job are given.
- 44 The Instrumentation Tape Recorder (Part 2)** *Ray A. Shiver*
- 46 Designs for Log-Periodic FM & TV Antennas** *Harold D. Pruett*
- 49 Advances in Magnetic Materials** *John R. Collins*
Details on grain-oriented materials, new magnetic alloys, ceramic and ferrite magnets, and superconducting cryogenic magnets, and other new developments that are advancing magnetic technology.
- 68 New Color-TV Tuning Indicator** *Walter H. Buchsbaum*
- 89 Electronics World 1967 Index (Vols. 77-78)**

-
- 6 For the Record (Editorial)**
Electronics Training for All
 - 22 EW Lab Tested**
Eico Model 3070 "Cortina" Amplifier
 - 54 Electronics and Aphasia** *John Frye*
 - 64 Test Equipment Product Report**
Heath Model IM-25 Solid-State V.O.M.
Jackson Model 806 V.T.V.M.
Lectrotech TT-250 Transistor Tester

MONTHLY FEATURES

- 4** Coming Next Month
- 12** Letters from Our Readers
- 15** Reflections on the News
- 74** Radio & TV News
- 82** New Products & Literature

Electronics World: Published monthly by Ziff-Davis Publishing Company at 307 North Michigan Ave., Chicago, Illinois 60601. One year subscription \$6.00. Second Class Postage paid at Chicago, Illinois and at additional mailing offices. Subscription service: Portland Place, Boulder, Colorado 80302.
Copyright © 1967 by Ziff-Davis Publishing Company. All rights reserved.

ENGINEERED FOR EXCELLENCE: TOP-QUALITY TELEX HEADSETS

Ham operators, hi-fi fans and audio engineers all endorse famous TELEX headsets; known for top grade performance for more than 25 years.



MAGNA-TWIN—Typifies the quality standards which have made Telex a favorite of hams. Delivers absolute maximum intelligibility under difficult QRM conditions; equipped with super-comfort foam cushions. Rugged, moisture-proof magnetic drivers give excellent sensitivity. Made of tough, high-impact plastic for outstanding durability under hard usage.



COMBO—Brand new, high quality stereo headphones for the lively set. Big 3 1/2" reproducers deliver deep rich bass and pure sweet highs. Exciting new styling has deluxe foam-filled vinyl earcushions. Designed for comfort, adaptability and concert-quality sound—anytime, anywhere.



TELESET—Lightweight, economy version of the famous Magna-Twin; designed especially for ham requirements. High performance, shock-proof Magna-Twin drivers at a low, low price.

MORE THAN 50 DIFFERENT MODELS TO CHOOSE FROM, PRICED TO \$59.95

PRODUCTS OF SOUND RESEARCH

TELEX
acoustics
A DIVISION OF THE
TELEX CORPORATION
3054 EXCELSIOR BOULEVARD
MINNEAPOLIS, MINN. 55416

COMING NEXT MONTH

SPECIAL FEATURE ARTICLES ON: COLOR TELEVISION



Don't miss the three important and timely articles on color television coming in the next issue. **Color-TV in the Marketplace** provides information on color sales—both in the past and as projected for the next few years; **Troubleshooting New Color Chassis**—with their many new features that add to the complexity but, strangely enough, make the sets easier to service and adjust; and **Inside the 1968 Color Sets**—a rundown on the principal innovations in the new models including transistors and IC's, modular design, new a.f.t. circuits and remote controls, and a 3-gun Chromatron color tube.

LIGHT-EMITTING DIODES

These new semiconductors emit light directly from their "p-n" junctions and are finding their way into photoelectric circuits because of their long life, resistance to shock and vibration, and transistor compatibility.

AMPLITUDE MODULATION TESTER

A novel instrument, that operates directly off the transmitter and produces an unusual CRT display of percentage of modulation, is described by D. Stephani of Brookhaven National Laboratory. This tester will be of particular interest to those involved in servicing commercial communications equipment.

HIGH-VOLTAGE, HIGH-POWER SEMICONDUCTORS

A description of some of the new solid-state devices having breakdown voltages above 100 volts with power ratings in tens of watts and current ratings in excess of tens of amperes.

TRANSISTOR CURVE TRACER

The design of an instrument which produces on a scope a definitive family of characteristic curves that can be measured as well as interpreted to derive the principal parameters for most transistors. Melvin Chan of Ampex describes the circuit features of the curve tracer and its operation.

All these and many more interesting and informative articles will be yours in the January issue of **ELECTRONICS WORLD** . . . on sale December 19th.

ZIFF-DAVIS PUBLISHING COMPANY

William B. Ziff
Chairman of the Board (1946-1953)

William Ziff
President

W. Bradford Briggs
Executive Vice President

Hershel B. Sarbin
Senior Vice President

Philip Sine
Financial Vice President

Walter S. Mills, Jr.
Vice President, Circulation

Stanley R. Greenfield
Vice President, Marketing

Phillip T. Heffernan
Vice President, Electronics Division

Frank Pomerantz
Vice President, Creative Services

Arthur W. Butzow
Vice President, Production

Edward D. Muhlfeld
Vice President, Aviation Division

Irwin Robinson
Vice President, Travel Division

Editorial and Executive Offices
One Park Avenue
New York, New York 10016 212 679-7200

NEW YORK OFFICE 212 679-7200
James J. Sullivan
Joseph E. Halloran

MIDWESTERN OFFICE
307 North Michigan Avenue
Chicago, Illinois 60601 312 726-0892
Midwestern Advertising Manager, Royce Richard

WESTERN OFFICE
9025 Wilshire Boulevard
Beverly Hills, California 90211
213 CRestview 4-0265; BRAdshaw 2-1161
Western Advertising Manager, Bud Dean

JAPAN
James Yagi
Ishikawa Mansion
4-4, Sakuragaoka
Shibuya-ku, Tokyo
462-2911-3

CIRCULATION OFFICE
Portland Place, Boulder, Colorado 80302



Member
Audit Bureau of
Circulations

Radio & TV News • Radio News • Radio-Electronic Engineering Trademarks Reg. U.S. Pat. Off.
SUBSCRIPTION SERVICE: All subscription correspondence should be addressed to Electronics World, Circulation Department, Portland Place, Boulder, Colorado 80302. Please allow at least six weeks for change of address. Include your old address, as well as new—enclosing if possible an address label from a recent issue.

EDITORIAL CONTRIBUTIONS must be accompanied by return postage and will be handled with reasonable care; however publisher assumes no responsibility for return or safety of art work, photographs, or manuscripts.

ELECTRONICS WORLD (December, 1967, Vol. 78, No. 6). Published monthly at 307 North Michigan Avenue, Chicago, Illinois 60601, by Ziff-Davis Publishing Company—also the publishers of Airline Management and Marketing, Boating, Business & Commercial Aviation, Car and Driver, Cycle, Flying, HiFi/Stereo Review, Modern Bride, Popular Aviation, Popular Electronics, Skiing, Skiing Area News, and Skiing Trade News. (Travel Weekly is published by Robinson Publications, Inc., a subsidiary of Ziff-Davis Publishing Company.) One year subscription rate for U.S., U.S. Possessions, and Canada. \$6.00; all other countries, \$7.00. Second Class postage paid at Chicago, Illinois and at additional mailing offices. Authorized as second class mail by the Post Office Department, Ottawa, Canada and for payment of postage in cash.

NEW!
MASTER COURSE
IN COLOR TV...

WITH NTS COLOR KITS

Big 25" Color TV kits included in new Master Color TV Home Study program. Learn Color TV; keep the new 25" color TV receiver you build with exciting kits we send you. 10 million homes in this country will have color TV by the end of 1967. This industry needs technicians as never before, and NTS-trained men can move quickly into the big money.

COLOR TV SERVICING BRINGS HIGH PROFITS

New color sets need careful installation, precision tuning and skilled servicing. NTS home training can put you in this profit picture—prepare you for big pay, security, or start a business of your own.

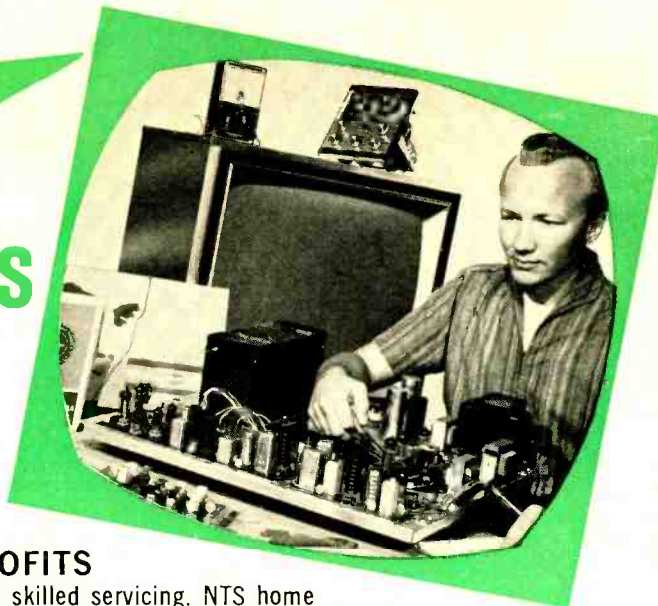

LIFT OFF...TO
A "SPACE AGE"
CAREER IN
ELECTRONICS

This is the "space age". It offers new opportunities in communications, industrial electronics, computer technology, and many others. Automation has increased the need for skilled electronics technicians in thousands of manufacturing plants. Only the well trained man makes it big. Industry wants and demands this kind of man... the NTS man. Pick your field. Let an NTS Project Method Program help you toward a well-paid career in Electronics wherever you travel.

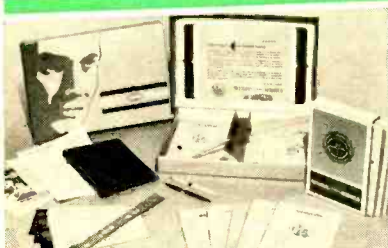
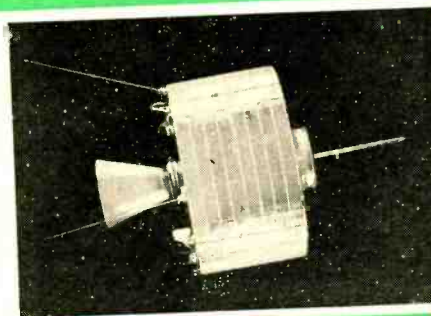

NEW CAREER KIT... FAST, EASY START TO NTS HOME TRAINING

The exclusive Project Method Career Kit helps you move quickly into your training program. Earn while you learn as you progress with your shop-tested Project Method lessons and kits.

Send for the New illustrated NTS Color Catalog. It shows the equipment and kits you work with and keep. Describes in detail the advantages of NTS Project Method Home Training. Tells you everything you need to know about starting your career in electronics.



HIGH SCHOOL AT HOME

National offers accredited high school programs. Take only subjects you need. Study at your own pace. Everything included at one low tuition. Check special High-School box in coupon for full information & FREE catalog.

CLASSROOM TRAINING AT LOS ANGELES

You can take Classroom Training at Los Angeles in Sunny Southern California. NTS occupies a city block with over a million dollars in facilities devoted exclusively to technical training.

MAIL REPLY CARD OR COUPON FOR NEW, FREE COLOR CATALOG AND SAMPLE LESSON.



NATIONAL TECHNICAL SCHOOLS

World Wide Training Since 1905
 4000 S. Figueroa St., Los Angeles, Calif. 90037
 You enroll by mail

We have no salesmen: This means lower tuition for you.
 Accredited Member National Home Study Council. Accredited Member: National Association of Trade & Technical Schools

NATIONAL TECHNICAL SCHOOLS

4000 S. Figueroa St., Los Angeles, California 90037

APPROVED FOR VETERANS



Please rush Free Color Catalog and Sample Lesson, plus detailed information on field checked below. No obligation. Dept. 240-127

- MASTER COURSE IN COLOR TV SERVICING
- COLOR TV SERVICING
- MASTER COURSE IN TV & RADIO SERVICING
- PRACTICAL TV & RADIO SERVICING
- MASTER COURSE IN ELECTRONIC COMMUNICATIONS
- FCC LICENSE COURSE
- INDUSTRIAL & COMPUTER ELECTRONICS
- STEREO, HI FI & SOUND SYSTEMS
- BASIC ELECTRONICS HIGH SCHOOL AT HOME

Name _____ Age _____

Address _____

City _____ State _____ Zip _____

- Check if interested in Veteran Training under new G.I. Bill.
- Check if interested ONLY in Classroom Training at Los Angeles.





For the record

WM. A. STOCKLIN, EDITOR

ELECTRONICS TRAINING FOR ALL

I HAVE always been critical of our educational system, probably more vocally than in print. It is common knowledge that there is not only a critical shortage of instructors at all educational levels, but that those directly involved with teaching any of our sciences find it quite difficult to keep abreast of industry developments.

There is, in a way, a great awareness of these problems since Federal and state governments, private foundations, and even industries are funding billions of dollars per year in the hope of improving this situation. Yet their efforts have been basically directed toward material things such as new schools and new equipment. There has also been an over-emphasis on research grants, often at the expense of developing good teaching methods and new curricula. We cannot deny this need but we do feel much of the money is not being used effectively. There are many instances where these funds are being spent simply because they are available and not because of real need.

Why not draft teachers—much like our military ROTC program—and subsidize their educations with a promise on the part of the student to devote 2 or 3 years after graduation to serving the educational institution of his choice? Why not set up funds to reward good teaching practices? Why shouldn't some of the funds be directed to sponsoring special post-graduate-type programs for teachers, professors, and even engineers and scientists in industry—not just tuition-free courses for our educators, but subsidize them with a sum equivalent to their salaries to encourage this type of self-improvement?

We have had an opportunity of meeting Prof. Howard Malmstadt of the University of Illinois at Urbana. He has been a one-man crusader in promoting the philosophy that electronics should be taught all science students and should be extended as a post-graduate course to men in all industries. One cannot disagree with the philosophy that, irrespective of your profession, electronics will be playing a major role in your vocational life and becoming of even greater importance as time goes on. He believes that not only should everyone have a basic knowledge of electronics but, much to our surprise, he even advocates that everybody be taught elementary servicing and maintenance techniques.

Servicing and maintenance of electronic equipment will continue to plague the industry and, as a result, much time and effort are wasted in simply waiting for repairs. Since much electronic equipment is being modularized, Dr. Malmstadt believes any man working with such equipment should be capable of isolating most problems and replacing the modular unit involved.

As a result of his efforts, his program has become a standard course for all science-oriented students at the University of Illinois. In addition, he has, for the past seven years, offered a special summer course which is partly sponsored (tuition free only for teachers and professors) by the National Science Foundation.

Some 72 professionally oriented individuals from all walks of life are selected each year. These men and women are scientists, doctors, professors, chemical and mechanical engineers of all ages—the oldest to date being 64. The course runs 22 days and the students literally put in a 12-hour day, 6 days a week—evenly divided among study periods, lectures, and lab work.

The laboratory is set up with individual test positions and we have never seen as much *Heath* equipment in one place as we did in this lab. Each of the 24 benches has about a dozen different types of instruments ranging from v.t.v.m.'s to scopes to recorders and operational amplifiers. The most recent addition—and we feel the most important one—was a modularized digital system so designed that it could be used as a counter, digital voltmeter, frequency meter, etc. The students learn the basic digital circuits and eventually are able to develop sophisticated integrated-circuit digital instrumentation.

The true significance of this, though, is the fact that only 72 individuals are selected to take the course out of some 500 to 1000 who apply each year. Much to our surprise, we learned that some individuals have applied in each of the past four years and have not as yet been able to take the course, for no other reason than lack of time and space. The laboratory is in use every day of the normal college year and it is only through the summer months that a special program such as this can be conducted. This is unfortunate, but it is a good example of the lack of facilities and instructors for such programs. There are great numbers of individuals throughout the country that not only have the need for such training but the desire. Yet, unfortunately, such training is not available to the masses.

It is Prof. Malmstadt's hope that many of the students taking this course—those who teach at other educational institutions—will return to their own schools and initiate similar programs for those in their area. It is also his hope that this philosophy will spread across the nation.

Similarly, and much to our surprise, the *Heath Co.* hopes that other manufacturers will follow its example in developing this type of equipment that is especially useful in educational labs across the country. Funds, too, are required and in recent years there has arisen an awareness of the need for this post-graduate-type of education with particular emphasis on college and high school teachers.

The National Science Foundation sponsors quite a few courses ranging from chemistry, physics, mathematics, biology and the social sciences—to engineering and all branches of engineering technology. Not only are the courses themselves tuition-free to the selected participants, but the National Science Foundation offers additional payment to some participants to make such study economically feasible for the student. The usual reimbursement is around \$100 per week. The trend is toward this type of endowment yet there is much more that remains to be done. ▲



LR-500T 60 WATT AM/FM MULTIPLEX STEREO/RECEIVER/FM USEABLE
SENSITIVITY: 1.8 μ v (IHF)—179.95

WITH NEW
REVOLUTIONARY



ELECTRONIC
MARVEL OF THE
SPACE AGE

LAFAYETTE
Stereo Receivers

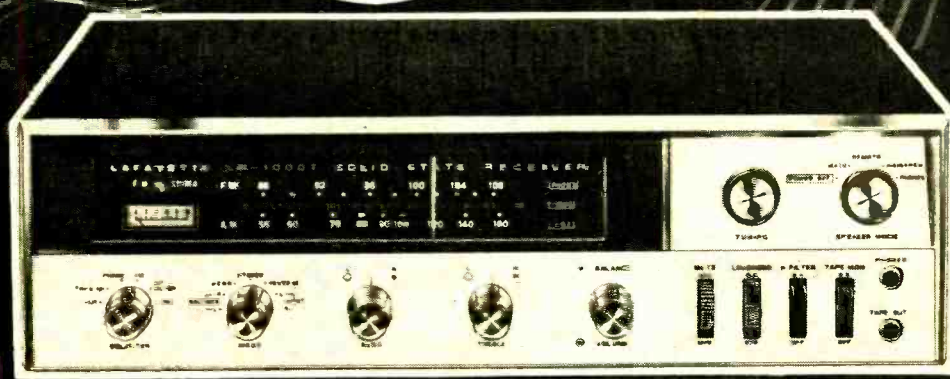
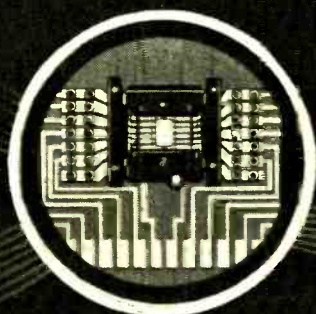

LR-1000T 120 WATT AM/FM MULTIPLEX STEREO/RECEIVER/FM USEABLE
SENSITIVITY: 1.65 μ v (IHF)—219.95

Dealerships Available
in Selected Areas.
For Details Write:
Lafayette Radio
Electronics
Dept. R...
Box L., Syosset,
L. I., N. Y. 11791



LR-1500T 150 WATT AM/FM MULTIPLEX STEREO/RECEIVER/FM USEABLE
SENSITIVITY: 1.5 μ v (IHF)—279.95

4 INTEGRATED
CIRCUITS
plus
2 FIELD EFFECT
TRANSISTORS

LAFAYETTE 'New Era' Stereo Super-Receivers

Only Lafayette ingenuity could give you a new experience in stereo listening! For all the features that make Hi-Fi stereo receivers truly magnificent—Integrated Circuits ("IC's"), Field-Effect-Transistors (FET's), direct coupled silicon transistor circuitry, automatic stereo/mono switching, 4-gang FM tuning condenser, 5 i.f. stages, wide-band ratio detector, fused output transistors, center channel output, built-in AM/FM antennas, dual system speaker control, **exclusive front and rear panel tape output jacks**, plus all controls to obtain the quality of sound which suits your personal taste—Lafayette offers the sound approach to superior performance. Except for power, and sensitivity all Lafayette receivers perform to the same standards. You get the kind of over-all quality, reliability, and performance that you cannot find in most expensive units.

60 WATTS.
Model LR-500T. Captures every trace of a signal and converts it to "Live Performance"...a degree of quality that far exceeds the price. **179.95**
120 WATTS.
Model LR-1000T. Exceptional component quality offering virtually flawless performance...enormous power meets the most demanding stereo Hi-Fi applications. **219.95**
150 WATTS.
Model LR-1500T. Lafayette's finest receiver, specifically designed for the audiophile who demands every performance extra that you'd find on only the finest separate tuners and amplifiers. **279.95**

Send For Your **FREE** 512 page 1968 Catalog No. 680 Dept. RK-7 111 Jericho Turnpike, Syosset, L. I., N. Y.

Lafayette Radio Electronics
CIRCLE NO. 109 ON READER SERVICE CARD

Electronics comes alive with NRI Training Kits

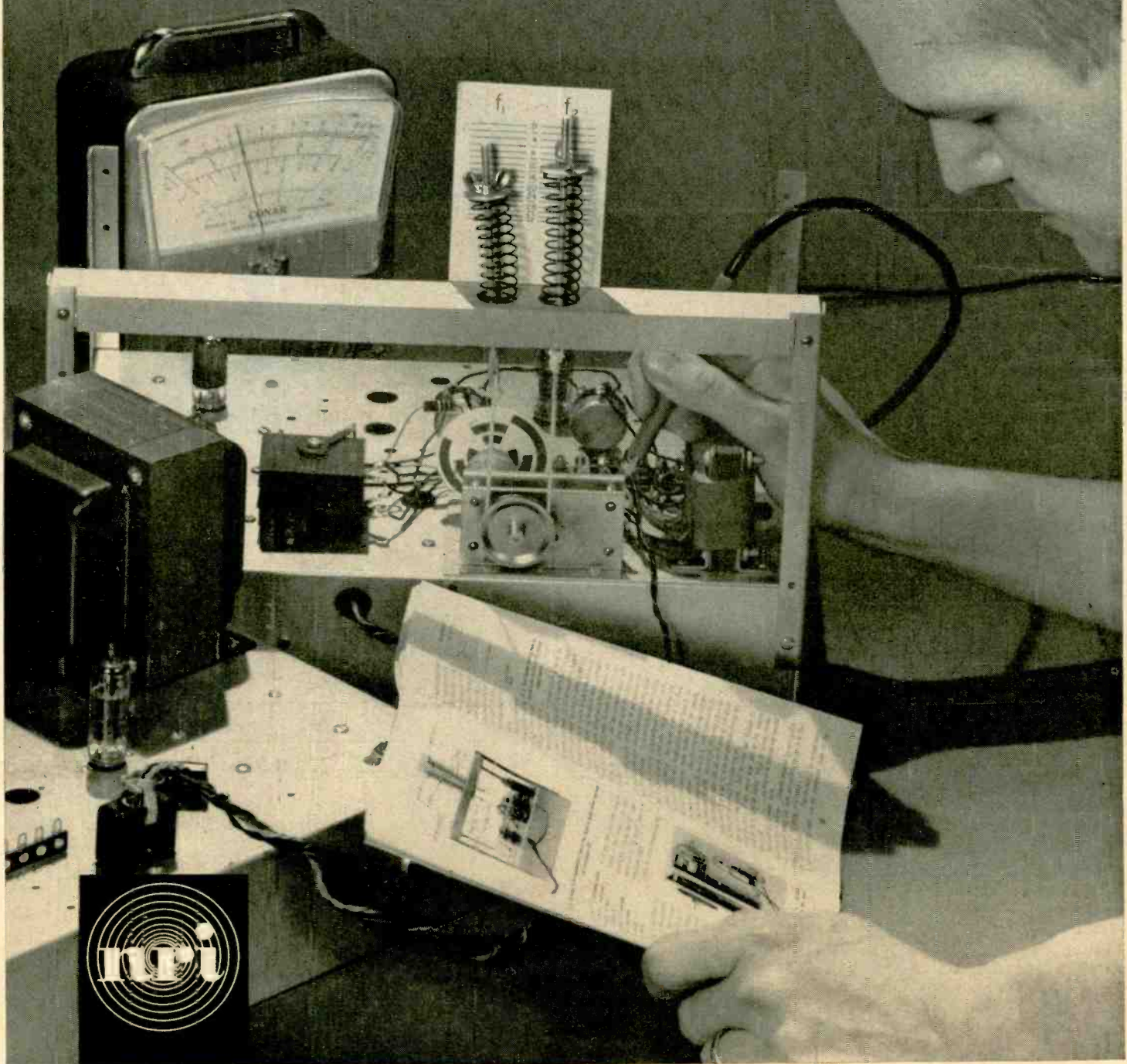

DISCOVER THE EASE AND EXCITEMENT OF TRAINING AT HOME THE NRI WAY

New Achievement Kit—Custom Training Kits—"Bite Size" Texts

Only NRI offers you this pioneering method of simplified "3 Dimensional" home-study training in Electronics, TV/Radio and Broadcasting/Communications. It's a remarkable teaching idea unlike anything you have ever encountered, the result of more than half a century of simplifying, organizing and dramatizing learning-at-home techniques. If you are an ambitious man—regardless of your education—you can effectively learn the Electronics field of your choice the NRI way.

NRI has *simplified* Electronics by producing "bite size" lesson texts averaging only 40 pages each. Dozens of illustrations open wide a picture window through which you'll see and understand practical uses of Electronics. You start out with NRI's exclusive Achievement Kit, containing everything you need to get started fast. (Illustrated at right.)

NRI has *organized* Electronics training to take you step-by-step from the first stages into more intriguing areas. Once you know the fundamentals thoroughly, it's easy to grasp more advanced theory and techniques. You move with confidence and enthusiasm into a new adventure filled with the excitement of discovery.

NRI has *dramatized* Electronics through the careful development of special training equipment that is *programmed* into your training systematically... beginning with your first group of lessons. Things you read about come alive in your hands as you build, experiment, purposely cause "problems" in circuits—and solve them. You learn to use test equipment, to build radios and TV sets, transmitter, or computer circuits. It's the priceless "third dimension" in NRI training... practical experience.



YOU GET MORE FOR YOUR MONEY FROM NRI

Mail postage-free card now for your free NRI catalog. Then, compare. You'll find—as have thousands of others—NRI training can't be beat. Read about the new Achievement Kit sent the day you enroll; about "bite-size" texts and custom designed training equipment. See why NRI gives you more value. Whatever your reason for wanting more knowledge of Electronics, NRI has an instruction plan for you. Choose from major programs in TV/Radio Servicing, Industrial Electronics and Complete Communications. Or select from special courses to meet specific needs. Check the course of interest to you on postage-free card and mail today for free NRI catalog. No salesman will call. NATIONAL RADIO INSTITUTE, Electronics Div., Washington, D.C. 20016.

Available Under NEW GI BILL

If you served since January 31, 1955, or are in service, check GI line in postage-free card.

More than 50 years of leadership
in Electronics Training



Career? Part-Time Earnings? Hobby? Choose From 12 Training Plans

1. TELEVISION-RADIO SERVICING — Learn to fix all TV sets, including Color. Includes your choice of NRI Color Kit or 19" black-white TV Kit. Also covers radios, stereo hi-fi, etc. Profitable field spare or full-time.

2. INDUSTRIAL-MILITARY ELECTRONICS — Basics to computers. Starts with fundamentals, covers servos, telemetry, multiplexing, phase circuitry, other subjects.

3. COMPLETE COMMUNICATIONS* — Operation, service, maintenance of AM, FM and TV broadcasting stations. Also covers marine, aviation, mobile radio, facsimile, radar, microwave.

4. FCC LICENSE* — Prepares you for 1st Class FCC License exams. Begin with fundamentals, advance to required subjects in equipment and procedures.

5. MATH FOR ELECTRONICS — Brief course for engineers, technicians seeking quick review of essential math: basic arithmetic, short-cut formulas, digital systems, etc.

6. BASIC ELECTRONICS — For anyone wanting a basic understanding of Radio-TV Electronics terminology and components, and a better understanding of the field.

7. ELECTRONICS FOR AUTOMATION — Not for beginners. Covers process control, ultrasonics, telemetering and remote control, electromechanical measurements, other subjects.

8. AVIATION COMMUNICATIONS* — Prepares you to install, maintain, service aircraft in-flight and landing systems. Earn your FCC License with Radar Endorsement.

9. MARINE COMMUNICATIONS* — Covers electronic equipment used on commercial ships, pleasure boats. Prepares for FCC License with Radar Endorsement.

10. MOBILE COMMUNICATIONS* — Learn to install, maintain mobile transmitters and receivers. Prepares for FCC License exams.

11. ELECTRICAL APPLIANCE REPAIR — Learn to repair all appliances, including air conditioning, refrigeration, small gas engines. Leads to profitable part or full-time business.

12. ELECTRONICS FOR PRINTERS — Operation and maintenance of Electronic equipment used in graphic arts industry. From basics to computer circuits. Approved by major manufacturers.

* You must pass your FCC License exams (any Communications course) or NRI refunds in full the tuition you have paid.

Enjoy the "music-only" programs now available on the FM broadcast band from coast to coast.

- NO COMMERCIALS •
- NO INTERRUPTIONS •

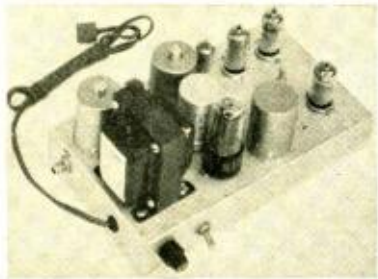

It's easy! Just plug Music Associated's Sub Carrier Detector into multiplex jack of your FM tuner or easily wire into discriminator. Tune through your FM dial and hear programs of continuous, commercial-free music you are now missing. The Detector, self-powered and with electronic mute for quieting between selections, permits reception of popular background music programs no longer sent by wire but transmitted as hidden programs on the FM broadcast band from coast to coast. Use with any FM tuner. Size 5½" x 9". Shipping weight approx. 7 lbs.

KIT \$49.50

(with pre-tuned coils, no alignment necessary)

WIRED \$75.00

COVER \$4.95 EXTRA

Current List of FM Broadcast Stations with SCA authorization \$1.00

MUSIC ASSOCIATED

65 Glenwood Road, Upper Montclair, New Jersey
Phone: (201)-744-3387

CIRCLE NO. 105 ON READER SERVICE CARD

Olson



FREE

Fill in coupon for a FREE One Year Subscription to OLSON ELECTRONICS' Fantastic Value Packed Catalog - Unheard of LOW, LOW PRICES on Brand Name Speakers, Changers, Tubes, Tools, Stereo Amps, Tuners, CB, Hi-Fi's, and thousands of other Electronic Values. Credit plan available.

NAME _____

ADDRESS _____

CITY _____ STATE _____

GIVE ZIP CODE _____

If you have a friend interested in electronics send his name and address for a FREE subscription also.

OLSON ELECTRONICS, INC.

763 S. Forge Street Akron, Ohio 44308

CIRCLE NO. 103 ON READER SERVICE CARD
12

LETTERS FROM OUR READERS



R.F. HEARING AID

To the Editors:

I was surprised to see my invention, the "r.f. hearing aid", described in your September issue in the article "Electronics for Speech and Hearing Therapy" by L. George Lawrence. My patent on the device, which I have named the "Neurophone", was granted on July 27 of this year after pending for more than five years. The patent has been assigned to *Listening, Inc.*, Arlington, Mass., of which company I am Vice President.

I would like to caution your readers against experimenting with the device. The power at the electrodes should *not* exceed 150 mW. Avoid the area over the eyes, as this region is *very* sensitive to the r.f. field and is quite painful if a high level of r.f. is applied.

Listening, Inc. has been doing Neurophone research for some time, and we lease and sell a model, the GPF-1, as a research instrument to qualified institutions. The GPF-1 is transistorized, it operates at 100 kHz (crystal-controlled), and the modulation and r.f. power levels are independently adjustable from zero to maximum.

G. PAT FLANAGAN
Listening, Inc.
6 Garden St.
Arlington, Mass.

ANNUAL ASSEMBLY OF RTCM

To the Editors:

In the article "Report on Annual Assembly of RTCM" in your September issue, Mr. Humphrey mentions that "discontinuance of installation" (of double-sideband equipment) has been "already implemented" by Canada.

This is not so. Although the Department of Transportation does its best to persuade radio users to employ SSB equipment on new installations, SSB equipment has not been made mandatory.

Mr. Humphrey's statement that satellite communication could end the usefulness of v.h.f./FM as a highly efficient local-range tool is very, very true. As the spectrum becomes more and more crowded, the biggest problem today is interference, not coverage.

It is true that reliability of communication would be much higher, but what is the use of knowing that you would

have been able to talk well if only you could have found a channel not fully occupied by a few hundred other users sailing the same ocean? On m.f. and h.f. you can at least choose a frequency which eliminates some sections of the ocean because of known propagation effects.

R. C. ELDRIDGE
Vancouver, B.C.

VERSATILE TRANSISTOR TESTER

To the Editors:

Would you please thank Mr. M. J. Moss for a very excellent article on the "Versatile Transistor Tester" in the August issue? The article inspired me to construct the tester, and because it was so clearly drawn and explained I felt no qualms about changing a few things. (Doesn't everyone?)

I appreciate your running Mr. Moss' article at this time for a special reason. I tried to cross-check some transistors on the school's transistor tester and found that it did not function at all. With all the projects I have planned for the students using transistors, I sure appreciate this fine unit.

DON WARNER
Electronics Instructor
Cooper High School
Abilene, Texas

HOLES IN MICROPHONES

To the Editors:

I have just purchased a professional-quality microphone for my tape recorder in order to improve the quality of some of my tapes. Upon examining the mike (which was fairly expensive, by the way), I noticed a number of large and small holes along the sides and rear of the microphone housing. I'm sure the holes are intentional and have something to do with the sound pickup, but there is nothing in the accompanying literature to give me a hint as to their function. Do you have any ideas about my "holey" microphone?

BERNARD KAPLAN
Chicago, Ill.

Yes, the holes are intentional and they form part of the microphone design. A number of fairly large openings along the side of the mike body located very close to but behind the dia-

CIRCLE NO. 104 ON READER SERVICE CARD →

\$695.00
 (and at last)
No Needless
~~Needles~~



WHY?

Because Non-Linear Systems introduces (X-3), a solid-state integrated circuit DVM "(VTVM)" with extras for \$695.

DC Volts:

10 mv to 10K v
 .1% ± 1 digit
 100 Megohm input impedance, entire range
 10 Microvolts resolution

AC Volts:

200 Millivolts to 300 volts

10 Millivolts resolution

3% Accuracy

20 Hz to 500 MHz

10 Megohms Input Impedance

Resistance:

10 Ohms to

2000 Megohms

.1% ± 1 digit to 200K

Current:

10 Nano Amps to

200 Milliamps

.1% ± 1 digit

Yes, all these extras for \$695 (including probes)

LOOK AT THESE EXTRAS

100% Over-range Digit

Over-load Indicator

Over-load Protection

Automatic Polarity

Display Storage

High CMR

Unique Low, Medium, and

High Range Selector



Originator of the Digital Voltmeter
NON-LINEAR SYSTEMS, INC.
 DEL MAR, CALIFORNIA 92014
 (714) 755-1134/TWX: 910-322-1132

Reward

for the recovery of each of these shunt regulator tubes



General Electric has discovered that certain of its large screen color TV sets containing these high voltage regulator tubes could emit soft X-radiation in excess of desirable levels.

Almost all of the sets which might have this potential X-ray emission have been found and modified with a new regulator tube specially designed for the purpose. We are now conducting a nationwide search for the remaining obsolete regulator tubes.

We are looking for these tubes in two ways. **Those in use** in any model General Electric color television set. **And new tubes in cartons**, on shop shelves, in trucks and kits.

Now here's how you can help us and pick up your reward.

First, look for the above tube types of any brand in every large screen GE color set you service. If you find one, remove it and return it to this address:

General Electric Product Service Section
Northern Concourse Building
North Syracuse, New York 13212

For every one you turn in, you will receive a check for \$5.00 plus a new replacement tube at no extra charge. To qualify, you need only to provide the customer's name and address and the model and serial number of the TV set serviced.

Second, should you have unused tubes bearing these numbers in your shop or truck, send them to the following address, and you will receive a check in the amount of 50% of list price (plus transportation expense) for each and every tube returned:

General Electric Company
Building #12, Old Hartford Road
P.O. Box 1008
Owensboro, Kentucky 42301

Remember, every used tube will get you \$5.00 when mailed to Syracuse. And every new, cartoned tube when mailed to Owensboro will bring you a check worth 50% of the list price.

If you haven't seen it, we recommend you ask your GE Distributor for a copy of GE's recent "Service Talk" on X-ray precautions in servicing color TV receivers.

GENERAL  **ELECTRIC**

phragm are used to transmit the higher frequencies. These high frequencies arriving from the sides and rear of the mike would ordinarily be diffracted around the mike body and would act on the diaphragm at the front of the mike, producing a useful output well off the axis of main response. This would have the effect of reducing or destroying the directivity of the mike at these high frequencies. By leading this energy to the rear of the diaphragm, the highs are reduced very substantially in volume. Hence, the unit retains its directivity over a wider frequency range.

In addition to holes for the highs, some mikes have several other openings along the mike body at a greater distance back from the rear of the diaphragm. These have the same effect for the middle and low frequencies. The holes, of course, should be kept open and not covered by the hand when using the microphone, otherwise directivity will suffer.—Editors

OPERATIONAL AMPLIFIERS

To the Editors:

I enjoyed very much the article on operational amplifiers in your August issue. However, Author Lancaster apparently overlooked the extremely high impedances obtainable with electrometer vacuum tubes in operational amps.

In particular, I have personally used the *Keithley* Model 300 electrometer operational amplifier in applications requiring input impedances of a million megohms. Operation at 100 million megohms is practical (without chopper stabilization) and with far fewer problems with low-frequency noise and danger of burnout from input-voltage transients than with either MOS transistors or varactor diode parametric amplifiers. In terms of cost (less than \$200), ruggedness (it can take 400-volt overloads), and even temperature dependence, the vacuum-tube electrometer operational amplifier still has a lot going for it.

CHARLES D. GEILKER, Research Asst.
Warner & Swasey Observatory
Case Institute of Technology
East Cleveland, Ohio

INFORMATIVE ARTICLES

To the Editors:

I find *ELECTRONICS WORLD* very helpful in my efforts to keep abreast of the state of the electronics art. I appreciate particularly your straightforward and relatively simplified technical articles on new devices and techniques such as FET's and IC's. Articles on this level often prove more valuable to me than those which I read in the more sophisticated engineering journals.

CYRUS ROHRER, JR., Instructor
Institute of Aviation
Univ. of Illinois
Urbana, Ill.

Electronic Fuel-Injection System

Volkswagen's new electronic fuel-injection system will be used in its 1968 Model 1600's and promises not only fuel economy and engine efficiency but also greatly reduced air pollution. The heart of the system is a small "black box" electronic control unit, containing about 25 transistors and assorted diodes and other components. This unit controls the fuel injection to each of the four cylinders through solenoid-operated fuel-injector valves. Pulse width determines the "open" time of each fuel injector and both the start and duration of each pulse are continuously adjusted for optimum performance. The control unit receives electrical signals from a pressure sensor in the air intake manifold and from a pressure switch which determines the differential between the air intake manifold and the ambient air pressure. These signals indicate engine loading. Temperature sensors at the crankcase and the cylinder heads signal the control unit to provide the optimum fuel injection for cold starting. A special throttle valve switch signals whenever deceleration occurs and permits cutting off the fuel accordingly. On the distributor, an extra set of contacts generates timing pulses which indicate engine speed and synchronize the opening of each injector valve.

Present service instructions of *VW of America* do not permit the automobile mechanic to service the electronic control unit, except for a few simple tests to assure that the connections are not loose. In our opinion the continuing pressure toward anti-pollution devices on automobiles may well force American manufacturers to resort to a similar electronic approach in future designs. Within a few years cars may have electronic ignition, fuel injection, and even automatic transmission systems, all controlled by a small central computer. This will bring electronics people into the automotive business on a large scale and will provide still another diversification of the electronics industry.

Hip-Pocket Records

In recognition of the huge teenage music market *Philco-Ford* has announced the HP—Hip Pocket—record series. Selling for 69 cents each, and containing one hit song on each side, these records are of durable flexible, wafer-thin plastic, measuring only $3\frac{3}{8}$ " in diameter and can be played on a 45 r/min machine. A special, miniaturized record player is also available. This unit, sold together with a starter pack of records, is fully transistorized and operates on penlite batteries, with an a.c. adapter available for home use. Weighing less than two pounds and equipped with a carrying handle, this rugged new phonograph can also play existing 45 r/min (7-inch diameter) and 33 r/min records. A six-transistor radio is also built into this \$25 phonograph.

Because of the specialized market, the new HP's will contain only well-established hit tunes. Arrangements are under way with a number of record companies to obtain the originals of their best sellers to serve as masters for the new discs.

Letter Writing Obsolete?

Mailing tape back and forth is old hat for tape-recorder buffs, but now *Smith-Corona Marchant* has introduced a special tape-recorder package that will put tape correspondence into the hands of the general public. Sold in sets of two under the name "Mail Call", priced at \$69.95 a set, each tape recorder weighs 2 pounds and is $10\frac{1}{4}$ " long x $4\frac{1}{8}$ " wide x $3\frac{3}{8}$ " deep. Powered by four "C" batteries, the tape transport contains an automatic speed control which assures correct record and playback speed. The tape is contained in a continuous-loop cartridge, called the "Letterpack", and is available in three-, six-, and ten-minute lengths. A "Letterpack" can be mailed in a standard envelope for ten cents as first-class mail. Each tape cartridge can be played, erased, and rerecorded just as any standard magnetic tape.

The availability of a standard-speed, inexpensive tape recorder and a small, continuous-loop cartridge will certainly not hurt the Post Office and will mean additional business to the electronics servicing industry. We can foresee a host of other applications for this system, such as taped greeting cards, birth announcements, taped instruction manuals for home appliances, and even advertising messages which use music and well-known entertainers. The real impact of "Mail Call" will come, however, when video tape recording becomes available to the general public. Correspondence on video tape may not be as far away as it seems if we remember that tape recording is not much more than 20 years old.

Picture-Tube as Fine-Tuning Indicator

While other manufacturers have attempted to eliminate the need for fine tuning their color sets, *Westinghouse* attacked the problem by providing the fine-tuning indication right on the picture tube. A separate PC board, containing 9 transistors, 7 diodes, and associated components, is activated when the "Tuning Bar" is depressed. This superimposes two black vertical lines over the picture. The center line is stationary and the other line moves as the fine-tuning control is rotated. When both lines coincide, the fine-tuning control is set correctly and depressing the "Tuning Bar" the second time removes the vertical line.

Technically, the *Westinghouse* innovation seems great. The big question is whether the customer, barely able to follow the operating instructions for his color-TV set, will take the time and trouble to use the tuning bar each time he switches channels, once the novelty of its appearance has worn off. We suggest that *Westinghouse* eliminate the tuning-bar control and simply let two vertical lines appear for one or two minutes whenever the set is turned on or whenever a new channel is selected. This will either show correct tuning or else remind the viewer that the fine-tuning control needs adjustment. A disable switch can also be incorporated for those viewers who do not care to use this feature. For a detailed description of this circuit, see page 68 of this issue.

Automatic Gas-Meter Reader

If the Illinois Institute of Technology Research Institute has its way, the gas-meter reader will soon join the lamplighter and the iceman as a legendary figure of early Americana. Earlier systems have added reading devices to the gas meter which could transmit data over the telephone. A new system, developed by ITTRI together with the *Northern Illinois Gas Company*, is different in that the device attached to the meter will transmit its information by radio.

While still in the early stages of development, this system uses individual r.f. transponders, located in the basement, or wherever the meter is. Each transponder will be able to "read" the gas consumption and transmit it, but only when its assigned address is received. A specially equipped truck will contain the interrogation transmitter, the receiver, and the digital equipment to generate the correct addresses. Each address and the corresponding reply are then recorded on tape which allows the gas company's central computer to prepare the individual gas bills automatically. Details of the operation will be established after the field tests, scheduled to start the first part of 1968.

Eventually the computer may be housed in the truck, or a direct radio link may eliminate the tape. The use of an airplane in place of the truck is also under consideration. If the transponders can be made inexpensive enough, we can foresee widespread applications of this technique by utilities, irrigation projects, and all sorts of field operations where monitoring of data is required.

High-Power Semiconductors

Having all but conquered the entire field of small-signal devices, semiconductors are now invading high-power areas, the remaining domain of tubes. As pointed out before, *VW* already uses semiconductors for its electronic carburetors and other auto manufacturers are planning various solid-state schemes. Silicon diodes have replaced ignitrons, thyratrons, and other tubes on electric and diesel locomotives and SCR's, SCS's, triacs, and other thyristors are replacing relays and other mechanical controls in many industrial applications.

A recent breakthrough in the high-power semiconductor area is *International Rectifier Corp.*'s announcement of a 200-ampere device which can control either a.c. or d.c. from 400 to 1000 volts. This unit includes a logic circuit as part of the assembly so that, depending on the gate voltage, current flow can be controlled in either direction. This permits speed control of a.c. or d.c. motors and the new "Logic Triac" can also be used as inverter or chopper. (For additional devices, see also the article "High Voltage, High-Power Semiconductors" in next month's issue.—Editor)

One of the most novel applications of high-voltage, high-current semiconductors will be the projected use of extremely high-voltage d.c. power transmission lines. Because inductance of the wire and its capacitance to ground cause inevitable losses in a.c. transmission lines, d.c. systems are theoretically superior. Recent tests of an EAV d.c. system by the Bonneville Power Authority in Utah and the work done by Columbia University at its Hastings-on-Hudson Labs, confirm the superiority of d.c. transmission. The main problem of converting high-voltage d.c. to low-voltage a.c. and *vice versa* can be solved economically by high-power semiconductors operating as chopper-inverters and as rectifiers.

In the realm of the 117-volt a.c. power-line system, power semiconductors are already appearing in light dimmers and power-tool speed controls. This trend is bound to continue at an ever-increasing rate as the prices of the semiconductors drop below the prices of the switches and relays they replace. ▲

Be the man who's always
first to say: "I've got
the answer right here!"



START USING THIS REMARKABLE

ELECTRONICS SLIDE RULE

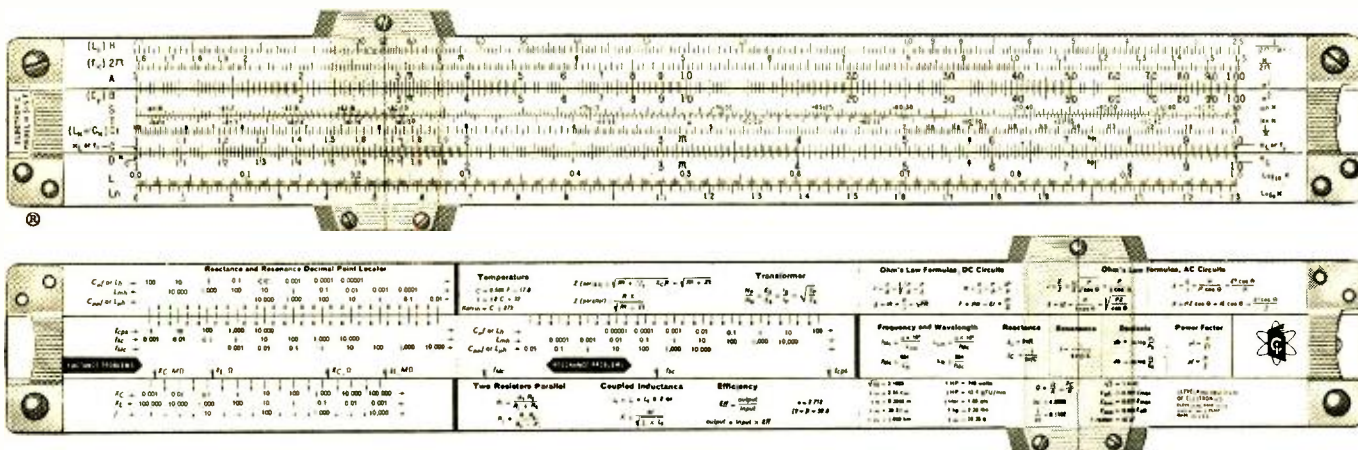

SOME DAY EVERYONE in electronics may have a slide rule like this. Till then, the man who uses one will seem like a wizard as he solves reactance and resonance problems in 12 to 20 seconds—without pencil and paper.

This is a professional slide rule in every detail, a full 10" long, made exclusively for Cleveland Institute of Electronics, to our rigid specifications, by Pickett, Inc. It can be used for conventional computation as well as special electronics calculations. All-metal construction assures smooth operation regardless of climate.

Handsome top-grain leather carrying case has heavy-duty plastic liner to protect slide rule; removable belt loop for convenient carrying. "Quick-flip" cover makes it easy to get rule in and out of case.

You also get four full-length AUTO-PROGRAMMED™ Lessons, which teach you how to use the special electronics scales on the slide rule. These lessons have been carefully designed to meet the same high educational standards as the electronics career courses for which our school is famous. Even if you've never used a slide rule before, you'll soon whiz through the toughest problems with this CIE rule.

Deliberately underpriced. Many men in electronics have told us that this unique slide rule, leather case, and 4-lesson course easily add up to a \$50 value. But we have deliberately underpriced it at less than \$25. Why? Our reason is simple: we are looking for men in electronics who are ambitious to improve their skills...who know that this will require more training. If we can attract you with the low price of our slide rule and course—and impress you with its quality—you are more

likely to consider CIE when you decide you could use more electronics training.

Send for free booklet. See for yourself why this amazing slide rule and course have made such a big hit with busy electronics men everywhere. No obligation, of course—just an opportunity to get in on the best offer ever made to people in electronics. Just mail coupon, or write Cleveland Institute of Electronics, Dept. EW-146, 1776 East 17th St., Cleveland, Ohio 44114.

CIE Cleveland Institute of Electronics
1776 East 17th Street, Cleveland, Ohio 44114

MAIL THIS COUPON FOR **FREE BOOKLET**

Cleveland Institute of Electronics
1776 East 17th Street Cleveland, Ohio 44114

Please send me without charge or obligation your booklet describing CIE Electronics Slide Rule and Instruction Course. **ALSO FREE** if I act at once: a handy pocket-size Electronics Data Guide.



Name _____ (please print)

Address _____

City _____ State _____ Zip _____



Accredited Member National Home Study Council
A Leader in Electronics Training... Since 1934

EW-146

CIRCLE NO. 122 ON READER SERVICE CARD

TAKE THE FIRST BIG STEP TOWARD A REWARDING CAREER IN ELECTRONICS

Mail card to RCA Institutes today

Thousands of well paid jobs for
Electronics Technicians are
unfilled now

*RCA Institutes Can Train You —
At Home — And Help You Qualify
For This Work*

It's a sad, but true, fact that today, with so many men yearning for better jobs and better incomes, thousands of well paid jobs are unfilled in the vast electronics industry.

Many of the men who could fill these jobs — that is, men with the aptitude and native interest to enjoy a career in electronics—are handicapped because for one reason or another they have not had the opportunity to train themselves for these lucrative positions.

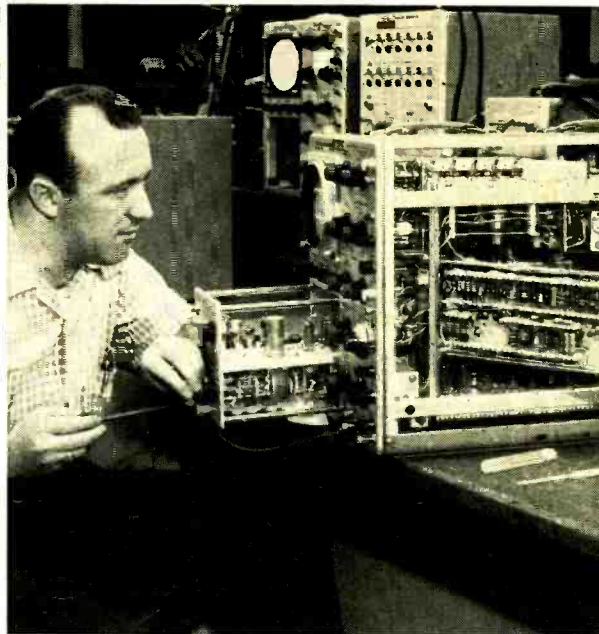

NOW— THANKS TO RCA INSTITUTES HOME STUDY— YOU CAN TRAIN FOR A CAREER IN ELECTRONICS

Realizing that thousands of technical jobs—well paid jobs—in electronics are going unfilled each week, RCA Institutes has done something positive about the problem. To benefit the electronics industry, with its crying need for trained men . . . and to help men who really want to move into a well paid electronics job, RCA Institutes offers an ideal home training program!

HOME STUDY CAN PROVIDE CAREER OPPORTUNITIES!

To help meet the need for qualified men in the electronics field, RCA Institutes has created a wide variety of Home Training Courses, all aimed toward a profitable, exciting electronics career in the shortest possible time. Included are exclusive "Career Programs" designed to train you quickly for the job you want! Your study program is supervised by RCA Institutes experts who work with you, help guide you over any "rough spots" that may develop along the way.

OFF TO A FLYING START WITH AMAZING RCA "AUTOTEXT" METHOD

Each "Career Program" starts with the amazing "AUTOTEXT" Programmed Instruction Method — the new, faster way that's almost automatic! "AUTOTEXT" helps even those who have had trouble with conventional learning methods in the

past. It is truly the "Space Age" way to learn everything you need to know with the least amount of time and effort.

RCA INSTITUTES ENGINEERED KITS SPEED YOUR PROGRESS

To speed you on your way to a successful electronics career, your "Career Program" will include a variety of RCA Institutes engineered kits at no extra cost—each complete in itself. As a bonus, you will also receive and build a valuable Oscilloscope. You'll get the new Programmed Electronics Breadboard for limitless experiments, including building a working signal generator and a fully transistorized superheterodyne AM receiver and Multimeter.

CHOOSE YOUR CAREER PROGRAM NOW

To get a head start today on the electronics career of your choice, look over this list of RCA Institutes "Career Programs", pick the one that appeals most to you, and check it off on the attached card:

- Television Servicing
- Telecommunications
- FCC License Preparation
- Automation Electronics
- Automatic Controls
- Digital Techniques
- Industrial Electronics
- Nuclear Instrumentation
- Solid State Electronics
- Electronics Drafting

To meet other specific needs, RCA Institutes also offers a wide variety of separate courses which may be taken separately from the "Career Programs". These range from Electronics Fundamentals to Computer Programming. They are described in the material you receive.

ACCREDITED MEMBER
National Home Study Council



The Most Trusted Name in Electronics

ADVANCED TRAINING TOO

If you are already working in electronics or have some experience but want to move on up, you may start RCA Institutes training at an advanced level. No tedious repetition of work you already know!

UNIQUE TUITION PLAN

With RCA Institutes, you learn *at your own pace*, and you pay only as you learn. There are no long term contracts to sign . . . no staggering down-payments to lose if you decide to stop . . . no badgering bills. You pay for lessons only as you order them, and should you decide to interrupt your training at any point, you may do so and not owe one cent.

CLASSROOM TRAINING AVAILABLE

RCA Institutes Resident School is one of the largest schools of its kind in New York City with classroom and laboratory training available in day or evening sessions. Coeducational classes start four times a year. Just check "Classroom Training" on the attached card for more details.

JOB PLACEMENT SERVICE, TOO!

Companies like IBM, Bell Telephone Labs, GE, RCA, Xerox, Honeywell, Grumman, Westinghouse, and major Radio and TV Networks have regularly employed graduates through RCA Institutes' own placement service.

**ALL RCA INSTITUTES COURSES
AVAILABLE UNDER NEW GI BILL.**

**SEND ATTACHED POSTAGE PAID
CARD TODAY FOR COMPLETE
INFORMATION. NO OBLIGATION.
NO SALESMAN WILL CALL.**

RCA INSTITUTES Inc. Dept. EW-D7
320 West 31st Street
New York, N.Y. 10001

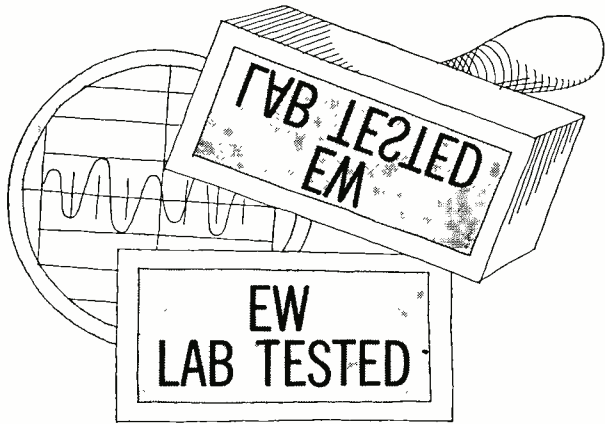

HI-FI PRODUCT REPORT

TESTED BY HIRSCH-HOUCK LABS

Eico Model 3070 "Cortina" Amplifier

For copy of manufacturer's brochure circle No. 33 on Reader Service Card.

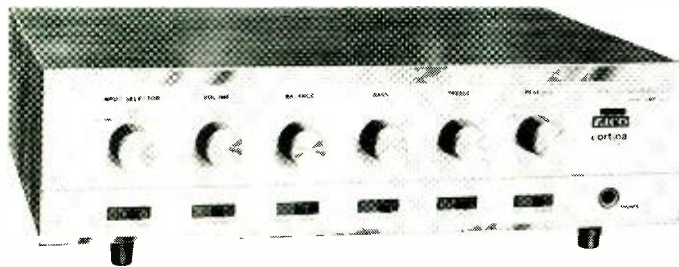

AMONG the growing number of large, heavy, powerful, and expensive amplifiers, the new Eico Model 3070 "Cortina" stands out, almost in a class by itself. The 3070 is small (3½" high x 12" wide x 7¾" deep), weighs only 7½ pounds, and sells at an attractively low price. It is an all-silicon transistor amplifier, with a complement of 18 transistors and 12 diodes.

The listening habits of many music lovers can be catered to quite well by a good 15-watt (per channel) amplifier. Speakers of moderately high efficiency, played at reasonable volume levels in an average sized room do not require a super-powered amplifier. The problem lies in the fact that so many low-powered amplifiers are lacking in the basic qualities of a good high-fidelity amplifier—low distortion at all power levels, low hum and noise, and complete control flexibility.

The 3070 meets the needs of this large group of users in a very satisfactory manner. It has virtually every operating feature found in the most expensive amplifiers. These include selec-

tion of either or both of two pairs of speakers, headphone listening through a front-panel jack, tape-monitoring facilities, high- and low-cut filters, switchable loudness compensation, mono/sterco selection, and separate volume and balance controls. It has inputs for magnetic phono cartridge, tuner, and another high-level (Aux.) source.

The IHF dynamic power rating of the amplifier is 70 watts into 4-ohm loads. As we rate amplifiers, driving both channels continuously into 8-ohm loads, it is rated at 15 watts per channel. Our laboratory measurements confirmed this rating, with less than 2% distortion at 15 watts output between 80 and 16,000 Hz. At half power, the distortion was less than 0.5% between 30 and 8000 Hz, and only 0.7% at 20,000 Hz. At 1.5 watts, a typical level for fairly loud listening in the home, the distortion was only about 0.15% over most of the frequency range, reaching 0.2% at 20 Hz and 0.3% at 20,000 Hz.

The RIAA phono equalization was accurate to within ±1.5 dB from 30 to 15,000 Hz. The basic frequency response

was ±1 dB from 20 to 20,000 Hz and the tone controls had more than enough range for any situation. At the extremes of the tone-control settings, the mid-range level and frequency response were affected appreciably.

The loudness contours were well chosen, boosting lows considerably and the uppermost octave slightly at lowered volume control settings. The filters had 6 dB/octave slopes, too gradual to be very effective, but also too mild to remove appreciable program content.

The available continuous power into 4-ohm loads was 25 watts per channel, exactly as rated. Into 16 ohms it was 9 watts per channel. Hum and noise were exceptionally low, -77 dB on high-level inputs and -73 dB on phono input; referred to 10 watts. The two sections of the volume control tracked within 1 dB over a 40-dB range.

The amplifier performed beautifully. It is a high-fidelity amplifier in every sense of the term and, with all but the least efficient speaker systems, should never be overtaxed.

The unit is constructed for the most part on four printed-circuit boards and assembly from the kit would seem to be a simple and uncomplicated matter. For those who would prefer not to "roll their own", it is also available factory-wired. The Eico 3070, complete with an attractive walnut-finished, vinyl-clad steel cover, costs \$89.95 in kit form and \$129.95 factory-wired. This is certainly an excellent value in high-fidelity amplifiers. ▲

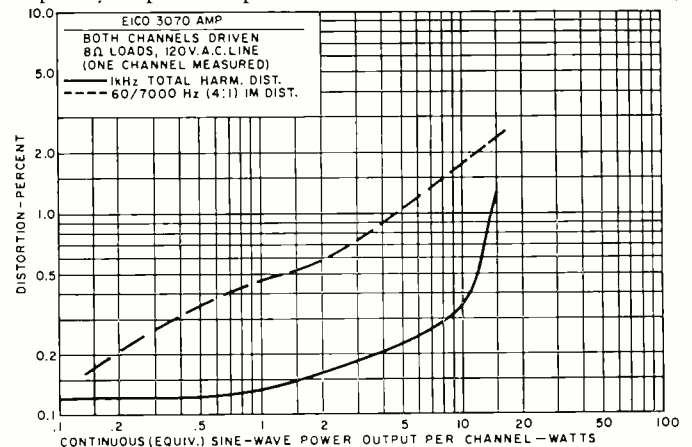
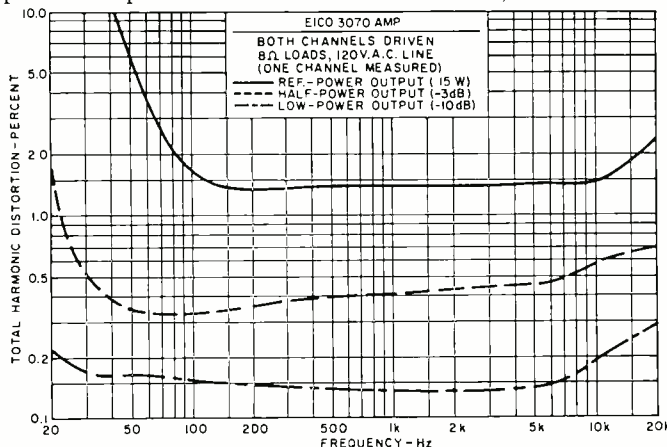

Only **Solitron**

offers
 250v
 400v
 500v
 600v
 700v
 High Voltage
 NPN Silicon Power
 Transistors

in 3 Packages!

CHARACTERIZATION CURRENT LEVEL			
	$I_C = 1.0A$	$I_C = 2.0A$	$I_C = 3.0A$
V_{CEX}	$h_{FE} = 15 \text{ Min}$ $V_{CE(sat)} = 0.5V$ $V_{BE(sat)} = 1.0V$	$h_{FE} = 10-50$ $V_{CE(sat)} = 0.5V$ $V_{BE(sat)} = 1.5V$	$h_{FE} = 10 \text{ Min}$ $V_{CE(sat)} = 0.5V$ $V_{BE(sat)} = 1.5V$
250V	SDT1050 SDT1150 SDT1250	SDT1055 SDT1155 SDT1255	SDT1060 SDT1160 SDT1260
400V	SDT1051 SDT1151 SDT1251	SDT1056 SDT1156 SDT1256	SDT1061 SDT1161 SDT1261
500V	SDT1052 SDT1152 SDT1252	SDT1057 SDT1157 SDT1257	SDT1062 SDT1162 SDT1262
600V	SDT1053 SDT1153 SDT1253	SDT1058 SDT1158 SDT1258	SDT1063 SDT1163 SDT1263
700V	SDT1054 SDT1154 SDT1254	SDT1059 SDT1159 SDT1259	SDT1064 SDT1164 SDT1264

SDT1050 · SDT1064



T0-3
100W @ 75°C

SDT1150 · SDT1164



T0-66
50W @ 75°C

SDT1250 · SDT1264



T0-61
100W @ 75°C

Solitron now offers silicon power transistors, with V_{CEX} up to 700 Volts, in three different packages: T0-3, T0-61 and T0-66. These high reliability devices, priced low, have many applications including vertical and horizontal TV circuits, audio amplifiers, inverters, converters and relay drivers. They replace similar higher priced units now on the market.

To obtain additional information on these devices,
 Dial 1-800-327-3243 for a no charge telephone call.

*When you think of semiconductors...
 think Solitron!*

Solitron DEVICES, INC.

1177 BLUE HERON BLVD. / RIVIERA BEACH, FLA / (305) 848-4311 / TWX: (510) 952-6676

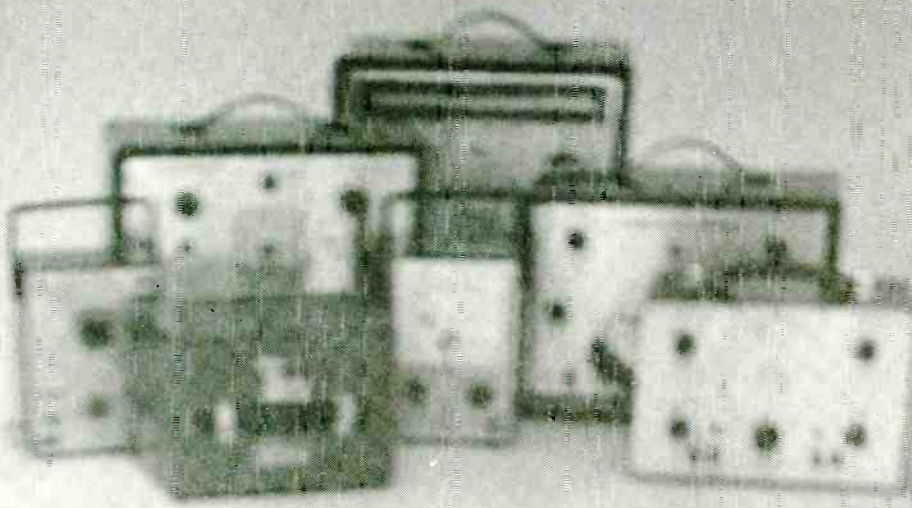

For \$1100, you can buy these seven pieces of stereo testing equipment. Together they do what Amphenol's new Stereo Commander does alone...for \$329.95.

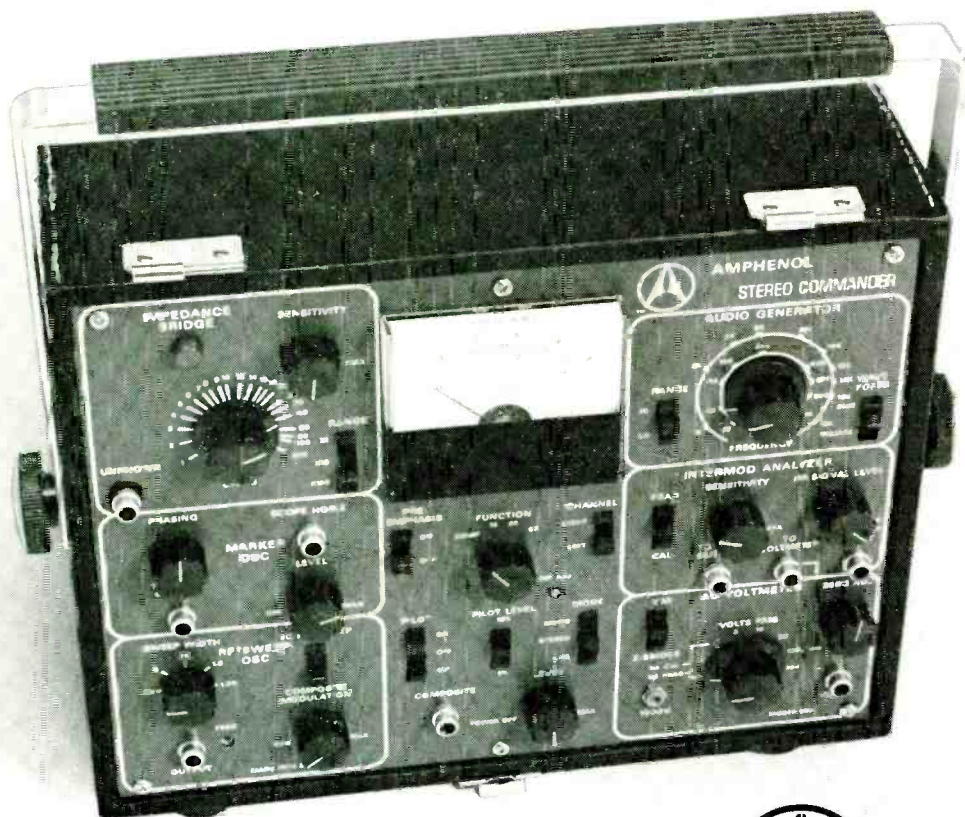

Now you can have a profitable stereo repair business without a huge investment.

The Stereo Commander Model 880 lets you test and adjust stereo and monaural FM tuners, Multiplex adaptors and amplifiers.

The Stereo Commander is easy to use. It operates on 117 volts AC. All the connecting leads necessary are provided. And, to top it all off, the operating manual included with each unit is really a short course in stereo servicing.

See your local Amphenol distributor. Find out why you don't need seven separate pieces of stereo test equipment to go into business for yourself . . . or write us direct for more facts about the Stereo Commander Model 880. Amphenol Corporation, 2875 South 25th Avenue, Broadview, Illinois 60153.



AMPHENOL

EW Lab Tests of NEW SOLID-STATE STEREO RECEIVERS

By JULIAN D. HIRSCH /Hirsch-Houck Laboratories

An in-depth rundown on industry standards for testing hi-fi receivers, including actual EW Lab Test measurements of many of the newest models.

THE stereo receiver, one of the most popular high-fidelity components, combines tuner and amplifier in one compact, easy-to-operate unit. Most of the necessary system interconnections are internal, reducing the installation process to one of connecting the antenna and loudspeakers (plus the phono cartridge if record-playing facilities are desired). The elimination of many connectors and cables, as compared to an equivalent system made up of separate components, is a positive contribution to reliability, to say nothing of the elimination of hard-to-trace hum-producing ground loops.

The advantages of a receiver are obvious—reduction in size and cost due to the use of a common chassis and power supply, elimination of duplicated control functions, simplified installation, and often a less formidable appearance to the non-technical user.

What about the disadvantages? Perhaps the most serious one is the inability to up-grade the system by changing to a better tuner or amplifier without obsoleting the other component. Fortunately, most modern receivers perform so well that the average user will have no reason to make changes during the normal lifetime of the instrument, which should be many years. The components which are most likely to be replaced in the up-grading process are the phono cartridge and the speakers, both external to the receiver.

Are receivers inferior in perform-

ance to comparably priced separate components? No, not at all. Just as with individual components, receivers differ in sensitivity, power output, distortion, and operating conveniences. Dollar for dollar, a receiver will usually equal or surpass the performance of equivalent tuner and amplifier combinations.

Practically any receiver has sufficient sensitivity for all but extreme fringe-area FM reception, and some can match the sensitivity of the finest separate component tuners. Just about any receiver delivers enough audio power to drive moderately efficient speakers. Low-efficiency speakers

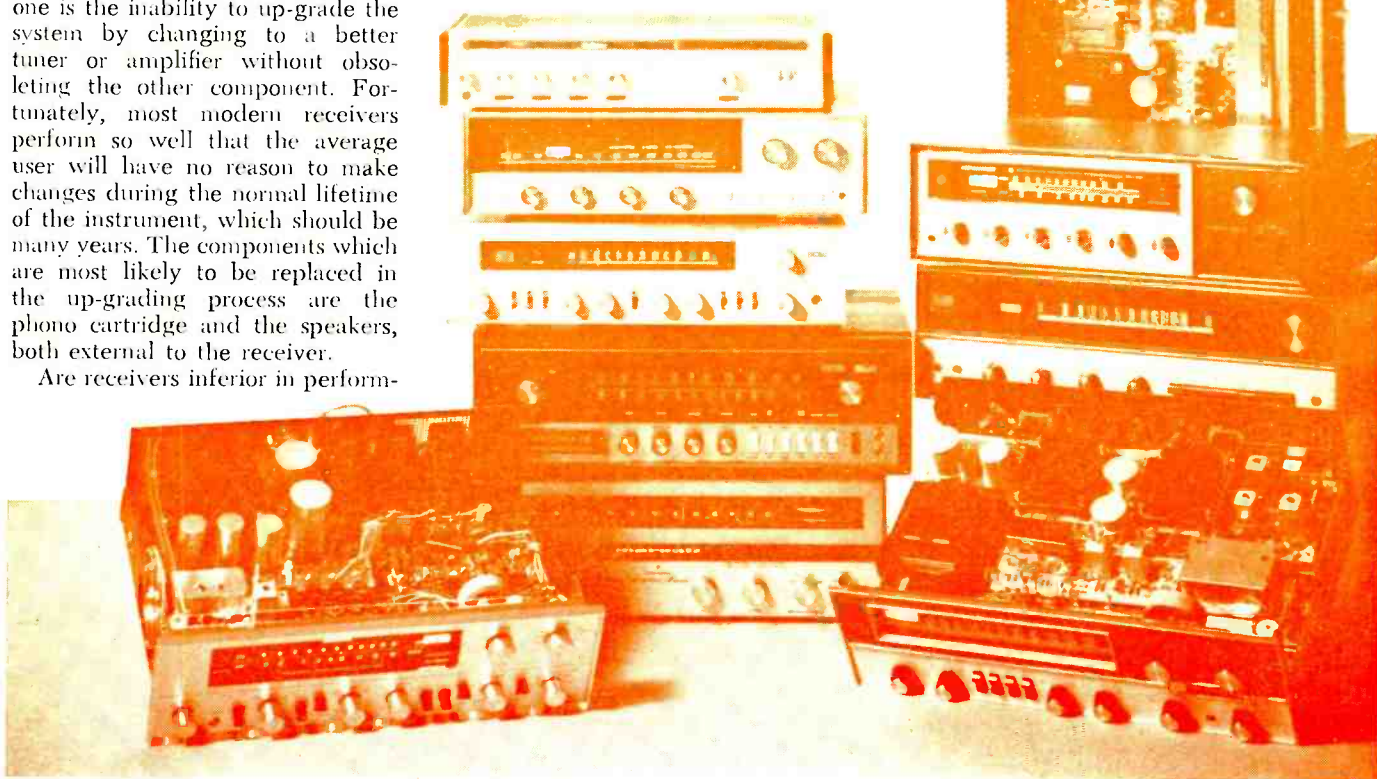

Receiver	Cont. Power Out. per Chan. (into 8 ohms) @ 2% THD			THD @ 1 kHz			Audio Sens. for 10-W Out.		Hum and Noise re 10 W		RIAA Equaliz. Error		Max. Power re 8-ohm Level		IHF Usable Sens. (μ V)	FM Distortion at 75-kHz Dev. (%)	FM Freq. Resp. 30-15,000 Hz (dB)
	30 Hz (W)	1 kHz (W)	20 kHz (W)	0.1 W (%)	1 W (%)	10 W (%)	Aux (mV)	Phono (mV)	Aux (dB)	Phono (dB)	50-15,000 Hz (dB)	4 ohm (%)	16 ohm (%)				
Allied 399	33	47	55	0.12 ²	0.08	0.095	110	1.2	-73	-63	+0 -1	90	67	2.1	1.5	+2.2 -5.8	
Altec 711B	27.9	30	28.7	0.35	0.26	0.15	290/600	4.5/9.5	-80	-61.3/	-57.3 +4.5, -0	164	54	2.0	1.2	+0.8 -2.7	
Bogen TR-100X	16	19	19	0.15 ²	0.15	0.63	140	2.0	-76	-57	+4 -1	120	50	2.9	1.1	-2 -2.5	
Eico 3570	12.8	19	19.3	0.25	0.14	0.18	200	3.5	-70	-62.8	+0.5, -0.5	150	54	3.4	1.0	+1, -0.9	
Electro-Voice EV-1277	3.1	18	7.1	1.9 ²	1.0 ²	0.8	130	3.5	-53	-38	+3.5, -1.5	159	68	3.4	1.7	+0.1 -2.6	
Fisher 700T	35	41	41	0.2 ²	0.2 ²	0.18 ²	360	9/2	-65	-53	+0 -4.5	156	61	1.8	0.45	+0.6 -2.8	
Heath AR-15	60+	70	60+	0.2 ²	0.11	0.12	110	1.6	-70	-51	+1 -1	120	60	1.45	0.55	+0.3 -3.9	
Kenwood TR-88	20	32	35.8	0.4 ²	0.24	0.18	830	2.5	-85	-54.5	+0.5, -2	116	69	3.1	0.9	+2 -1.7	
Lafayette LR-1000T	18.3	30.5	18.9	0.38 ²	0.27	0.26	250	1.9/6.8	-74.5	-59/	53.5 +0.5, -0.5	146	60	1.75	0.39	+0.8, -5.2	
Pioneer SX-1000TA	29.3	41	45	0.11	0.08	0.10	122	1.5	-75	-69	+0 -1.3	103	68	2.4	1.25	+0.8 -6	
Sansui TR-700	13.8	30	21.7	0.22	0.12	0.26	140	4.0	-75.5	-56.5	+6.5, -1.5	53	2.5	1.0	+0.1, -2.4		
Scott 344C	17.5	35.5	39.3	0.2 ²	0.11 ²	0.25	240	3.5	-73	-59	+0.5, -0.5	140	57	2.0	0.58	+0 -3	
Sherwood S-8800FET	31.3	45	3	1.0 ²	0.34 ²	0.34 ²	130	5.1/1.4	-60	-50	+1 -0	159	60	2.1	0.48	+0.1 -0.8	
University 120	30	35.8	44.5	0.17 ²	0.21	0.09	250	2.2	-80	-67	+0.7, -3.8	150	57	2.5	0.75	+0.4 -2.9	

¹Actual distortion @ 60 W = 0.3%. Not measured at 2% THD. ²Distortion masked by hum or noise. ³Overload trips—not measurable. ⁴Unless indicated, price excludes cabinet.

should be driven by amplifiers capable of at least 30 watts output per channel. A number of the receivers we tested can do as well, or better.

Testing the performance of a receiver is the same as testing separate tuners and amplifiers and, in fact, we consider these portions of a receiver as though they had nothing in common. By measuring the tuner output at the tape recorder output jacks, the amplifier's frequency response and distortion cannot affect the test results. The amplifier is tested with signals applied to the auxiliary, or high-level input jacks, and the tuner is not used.

The current hi-fi industry standard for tuner measurements is IHFM-T-100, December, 1958, issued by the Institute of High Fidelity, Inc. Although it is now nine years old and pre-dates FM-stereo, it is still a valid and useful standard for defining the performance of FM and AM tuners.

A complete IHF tuner rating involves 11 specifications,

ALLIED is offering other sets in its line of AM-FM solid-state receivers. They are: Model 365, rated at 25 W/ch (cont.) at 8 ohms and priced at \$230; and Model 355, rated at 17.6 W/ch (cont.) at 4 ohms and priced at \$180. Prices include metal case. In addition, the company has a line of "Knight" and "Knight-Kit" receivers in factory-assembled or kit form.

listed below in order of their importance (as determined by the IHF). 1. IHF Sensitivity, 2. Signal-to-Noise Ratio, 3. Harmonic Distortion, 4. Drift, 5. Frequency Response, 6. Capture Ratio, 7. Selectivity, 8. Spurious Responses, 9. IM Distortion, 10. Audio Hum, and 11. AM Suppression.

The first five must be presented as *minimum published specifications* by manufacturers using IHF Standard.

IHF Usable Sensitivity is the least signal input, modulated 100% at 400 Hz, which results in a total noise and distortion level in the tuner output 30 dB below the 400-Hz audio output (30 dB corresponds to 3% distortion). Usually, the residual output is almost entirely harmonic distortion, but some tuners have an appreciable amount of noise present in their output at the IHF Usable Sensitivity signal level. The signal generator is connected to the receiver antenna terminals through a standard dummy antenna which presents a 300-ohm source impedance to the receiver and correctly terminates the signal-generator output. The standard measurement frequency is 98 MHz (90 MHz and 106 MHz may also be employed, if desired).

We conform to this procedure in our tuner measure-

BOGEN also has a Model TF-100 which is similar to the receiver in our table except it is FM-only and is priced at \$235. The FM tuner is available as a separate component as the TT-100 at \$150. In addition, the company has an RT-8000 AM-FM receiver with 18 W/ch (cont.) at 8 ohms, priced at \$320. Prices exclude cabinets. Newly introduced is the Model RX-200 AM-FM receiver, rated at 32 W/ch (cont.) at 8 ohms. Price of this new model has not been established at the time of this writing.

ments, using 98 MHz and a null-type distortion analyzer to measure noise and distortion.

The IHF Usable Sensitivity is convenient for comparing one receiver with another. However, a sensitivity figure of 3 microvolts does not mean that a 3-microvolt signal will produce a usable program output from the receiver. The 30-dB signal-to-noise ratio at which sensitivity is defined is too noisy for enjoyable listening. In general, however, a receiver with a sensitivity of better than 4 μ V will be adequate for any normal listening situation. A more sensitive receiver *may* pick up a few more stations, but they are not likely to be of entertainment quality. A sensitivity figure larger than 4 μ V is not inherently serious, but in practice is usually associated with poor limiting, high distortion, and other defects. In other words, skimping on tuner sensitivity is usually accompanied by poor design in other, more important, areas.

Signal-to-Noise Ratio of an FM tuner is defined by the IHF as the ratio of the tuner output from a 100% modulated signal at 98 MHz, at a level of 1000 μ V, to the output when the modulation is removed. Before transistorized FM tuners were available, it was not uncommon to find a hum output due to frequency modulation of the receiver's local oscillator by heater-cathode leakage or other sources. Not surprisingly, hum in transistorized tuners is extremely rare, and this measurement often amounts to little more than a check of the residual FM hum of the test signal generator (in our case about -60 dB). We do not ordinarily

EICO has available as separate components the two main portions of the receiver listed in our table. These are the 3200 FM-only tuner at \$90 in kit form or \$130 wired, with cabinet, and the 3070 amplifier at \$90 in kit form or \$130 wired, with cabinet.

FM Stereo Separation 50 Hz 400 Hz 10 kHz (dB) (dB) (dB)			Tuning Indicator	AM	FM Muting	Noise or Scratch Filter	Rumble Filter	A.F.C.	Center-Chan. Out.	Tape-Out. Jack	Tape-Mon. Switch	Size (in) W H D			Price ^a (\$)	Comments
25.5	34.5	23.7	Meter	Yes	Yes	Yes	Yes	Yes	No	Yes	Yes	16	5	12	300	Includes case; tube front end
24.8	34.8	11.1	Meter	No	Yes	Yes	No	No	Yes	Yes	Yes	16¾	5	11¾	400	IC i.f.; FET front end
24	33	19.5	Meter	Yes	No	No	No	No	No	Yes	No	16	4½	11¾	250	
25	29	16.4	Meter	No	No	Yes	Yes	Yes	No	Yes	Yes	16	4½	9	160 (kit) 240 (wired)	
20.3	21.7	12.3	Meter	No	No	No	No	Yes	No	Yes	Yes	15¾	5½	10¼	280	Includes case
31.7	35	23.2	Meter	No	Yes	Yes	Yes	No	Yes	Yes	Yes	16¾	5½	11¾	300	FET front end
28.8	39	23.3	Meters	Yes	Yes	Yes	No	No	No	Yes	Yes	16¾	4¾	14½	330 (kit) 500 (wired)	Crystal filter; IC i.f. amp.; FET front end
22	25	20.8	Meter	Yes	Yes	Yes	Yes	No	Yes	Yes	Yes	16½	5	12¼	290	Includes case; FET front end
27.2	32.5	19	Meter	Yes	Yes	Yes	No	No	Yes	Yes	Yes	15¾	4¾	11¾	220	Includes case; FET front end IC i.f.
21.9	25.3	18.5	Meter	No	Yes	Yes	Yes	Yes	No	Yes	Yes	16	5½	13¾	360	Includes wooden cabinet; tube front end
16.3	17.8	18.4	Meter	No	Yes	Yes	Yes	Yes	Yes	Yes	Yes	18¾	6	15	240	Tube front end
26.1	30.2	13.5	Meter	No	Yes	Yes	No	No	Yes	Yes	Yes	18¼	6¼	11¾	400	FET front end; IC i.f.
38.6	30.5	14.2	Meter	No	Yes	Yes	No	No	Yes	Yes	Yes	16½	4½	14	370	FET front end
23.5	29.1	16	Meter	No	Yes	Yes	Yes	No	Yes	Yes	Yes	16¾	4½	12	380	FET front end; IC i.f.

NOTE: Appearance, operating convenience, serviceability, and reliability cannot, of course, be tabulated here. These factors are also important in determining price.

report on tuner hum unless it is much greater than -60 dB.

Harmonic Distortion is measured at the tuner output, using a 98-MHz test signal of 1000 μ V, modulated 100% at 400 Hz. The tuner is tuned for minimum distortion (not always exactly at the optimum tuning point shown on the receiver's tuning meter). This measurement shows up misalignment in the i.f. or detector circuits, inadequate i.f. bandwidth, or other deficiencies. Normally, a distortion level of -40 dB (1%) or less is indicative of satisfactory performance, since the distortion is likely to be much less at the smaller deviations prevalent during normal broadcasting. Some tuner manufacturers claim very low distortion levels, which require specially modified low-distortion signal generators for their measurement. The residual distortion of our signal generator, typical of most laboratory-grade instruments, is in the vicinity of 0.4%

ELECTRO-VOICE is offering an AM-FM version of the receiver listed in our table as the Model 1278 at \$315. Also, there is the Model 1179 FM-only receiver, rated at 15 W/ch (cont.) at 8 ohms, priced at \$210, as well as the Model 1180 FM-only receiver rated at 10 W/ch (cont.) at 8 ohms, priced at \$176. In addition, the various sections of the EV-1277 are available as separate components as follows: EV-1255 FM-only tuner at \$160, EV-1256 AM-FM tuner at \$195, and EV-1244 amplifier at \$140. Prices include cabinets.

to 0.5% (-46 to -48 dB). Tuners which measure in that region almost certainly have much lower distortion.

Harmonic distortion is as serious a problem in a tuner as in an amplifier. Since it is measured at 75-kHz deviation, equivalent to 100% modulation, it can be expected to be smaller at lower modulation levels. The average modulation level of an FM station is far below 100%, although peaks may reach or exceed that figure. One is unlikely to hear much difference between a tuner with a distortion rating of 1% and one with 0.5% distortion. At higher percentages, more data is needed to decide whether a tuner is adequate. We have heard tuners with measured distortion of 1.5% which sound excellent, and others with similar performance specifications which are unpleasantly fuzzy.

Drift is a measure of the change in a receiver's oscillator frequency from any or all of three causes: warmup (thermal) drift, line-voltage variation, and signal-level variation (acting through the a.g.c. circuitry).

Solid-state receivers have, in our experience, negligible

FISHER has a number of other solid-state stereo receivers in its line. The Model 200-T is an FM-only receiver with 25 W/ch dynamic power at 8 ohms, priced at \$300. The 220-T is an AM-FM set, rated at 16 W/ch (cont.) at 8 ohms, priced at \$330. The 500-T is an FM receiver rated at 26 W/ch (cont.) at 8 ohms, priced at \$400. The 550-T is a receiver which is similar except for the addition of an AM tuner; it is priced at \$450. Also, the amplifier portion of the Model 700-T, which is covered in our table, is available as a separate component as the Model TX-1000 at \$350. All prices quoted are less cabinet.

drift from the first two sources. The third is not readily measurable without the use of an expensive high-frequency counter capable of measuring the local oscillator frequency directly (98 to 118 MHz). It is possible to experience detuning effects with varying signal level, not related to the actual oscillator frequency shift, which makes measurements by other means unreliable. We do not consider drift to be a significant factor in modern receivers.

Frequency Response is measured between 30 and 15,000 Hz, with respect to the 400-Hz output level. The results are compared to the response of a standard 75- μ s de-emphasis network. A 1000- μ V test signal at 98 MHz is used, modulated either 100% or 30%. We use 30% modulation, which is more typical of average program levels.

Many FM tuners have low-pass filters in their outputs, in order to sharply attenuate any 19-kHz or 38-kHz multiplex components which might cause "birdies" in tape recording by beating with the recorder's bias oscillator. Most of these filters have an appreciable effect at 15,000 Hz, accounting for the 4 to 6 dB loss exhibited by many receivers at that frequency. As a rule, the attenuation at 12,000 Hz or lower is negligible, and we found no audible loss of brilliance in any of the tuners tested.

HEATH offers two other solid-state receivers. One is the AR-13A, which is an AM-FM set with a continuous output power of 20 W/ch at 8 ohms, priced at \$184 in kit form. The other is the AR-14, an FM-only receiver rated at 10 W/ch (cont.) at 8 ohms, priced at \$100 in kit form, less cabinet. A newly introduced FM-only model is the AR-17, with an output of 5 W/ch (cont.) at 8 ohms, priced at \$73 in kit form, less cabinet.



The Allied Model 399 solid-state stereo receiver.

Frequency response is perhaps the least important characteristic of a tuner or amplifier—simply because all we have tested in recent years are so nearly flat that this parameter loses much of its significance. In most tuners, any significant departure from flatness occurs below 50 Hz or above 10,000 Hz, and is unlikely to be heard in either case.

We did not perform the six optional tests. *Capture Ratio* is a measure of the tuner's ability to reject the weaker of two signals on the same frequency. The lower the capture ratio, in dB, the better the rejection. It is difficult to measure low capture ratios (less than 3 dB) with repeatability, let alone accuracy, and there is no accepted maximum value for good performance. Based on use tests, we consider all the tested receivers to have adequately low capture ratios.

Capture ratio in most cases is not too important from the standpoint of rejecting an interfering station on the

KENWOOD offers a TK-140 receiver which is similar to the TK-88 listed in our table except for a higher output power of 50 W/ch (cont.) at 8 ohms. This unit is priced at \$340, less cabinet. The company also has a TK-40 AM-FM receiver with an output power of 10 W/ch (cont.) at 8 ohms, priced at \$190 with cabinet. In addition, there is the FM-only TK-55, rated 20 W/ch (cont.) at 8 ohms and priced at \$200 with cabinet. The TK-66 is the same except it also has AM and is priced at \$240.

same frequency. A 3-dB capture ratio means that if one signal is stronger than another on the same channel by 3 dB, only the stronger one will be heard. In the rare case where two nearly equal signals are received on the same channel, they are normally from different directions and either can be selected by a rotatable directional antenna.

It does assume a much greater significance in stereo reception. *Multipath* reception is quite common, where signals will arrive over different path lengths from the same station. Because of the differing transmission times over several paths, the effect is similar to that of receiving several stations on the same frequency. If one of the received signal components is only 2 dB weaker than the main signal, and a tuner with a capture ratio of 3 dB is used, the result will be severe distortion in either mono or stereo modes, and probable loss of stereo separation.

The Altec Model 711B solid-state stereo receiver.

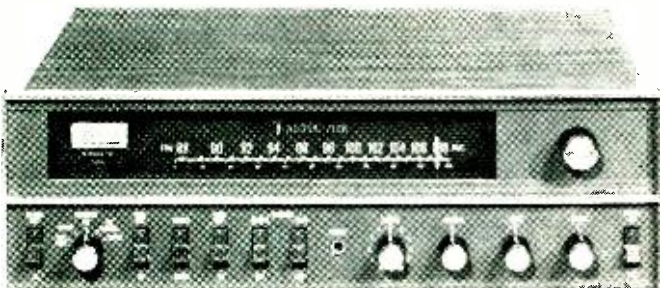

Most tuners have a capture ratio from 2 dB to perhaps 6 dB. Although the lower figure is preferable, there will be many cases where no practically attainable capture ratio will completely eliminate the distortions of multipath reception. The most effective solution in any case is to use a good directional antenna and orient it to reject the strongest reflected signal. Discriminations of 10 or 20 dB are often possible by this method, far more efficacious than improving the tuner capture ratio from 6 dB to 2 dB. Naturally, the combination of good tuner capture ratio and a good antenna is ideal.

Selectivity, the ability of a tuner to reject a strong sig-

LAFAYETTE, in addition to the unit described in our table, has the following AM-FM stereo receivers in its line. Model LR-99 is a 15 W/ch (dynamic) at 8 ohms unit priced at \$120. Model LR-500T is a 25 W/ch (dynamic) at 8 ohms unit priced at \$180. Model LR-1500T is a 60 W/ch (dynamic) at 8 ohms unit priced at \$280. All receivers are supplied with cases.

nal 200 kHz or 400 kHz removed from the desired signal, was not measured quantitatively. However, we make an aural appraisal of *cross-modulation* which is a more important consideration in urban and suburban areas. A strong off-channel signal may be heard in the background of the desired program, due to overload of the r.f. or mixer stages of the receiver. We have several stations in our vicinity which provide an excellent test of the tuner's cross-modulation.

Selectivity is quite important in urban and suburban areas where strong signals may be found with only 400-kHz separation. Cross-modulation is even more serious here.

IM Distortion is another measure of the non-linearities which are checked by a harmonic-distortion measurement. *Audio Hum* is, like FM hum, essentially absent from solid-state tuners. *AM Suppression* is more than adequate on any tuner we have tested in recent years. All of the tested receivers have sufficient limiting, usually combined with self-limiting ratio detectors, to make an AM suppression test unnecessary.

We make one test not called for in IHFM-T-100. The preceding tests were all made in the monophonic mode of operation. To check stereo channel separation, the signal generator is modulated by a multiplex generator, which simulates the output of a standard FM-stereo broadcast station. With only the left channel modulated with a 400-Hz tone, reference output level is established from the

MARANTZ is offering the Model 18 FM-only stereo receiver. Although the unit is shown on our cover, we did not Lab-Test it since the model we photographed was an engineering prototype rather than a production model. The receiver is rated at 40 W/ch (cont.) at 8 ohms and is said to have under 0.2% distortion over the entire audio range. The receiver portion uses a passive front end and incorporates a scope for tuning. The solid-state receiver sells for \$595, less cabinet.

tuner. The modulation is then switched to the right channel and the output from the left channel (crosstalk) is measured. The difference between the two readings represents the *separation* between the two channels. The measurement is repeated for the right channel and the results averaged, since there are often slight differences between channels.

Separation is usually greatest at mid-frequencies, such as 400 Hz. We repeat this measurement at 50 Hz and at 10,000 Hz to indicate the over-all stereo performance of the tuner. A separation of 15 dB or more over this range is

adequate for satisfactory stereo performance, and most tuners exceed this by a wide margin, particularly in the important mid-range.

Similar tests are defined for AM tuners, covering sensitivity, frequency response, distortion, selectivity, etc. We do not make any AM tuner measurements, preferring to judge them by listening. Meaningful AM measurements require the use of a completely shielded room to exclude noise and interfering signals. Lacking such a facility, we find that critical listening comparison between AM and FM program quality is an effective and valid technique. What is more, most hi-fi listening and, of course, all tuner stereo listening is done on the FM band.

In general, AM tuners sound much inferior to the FM sections of the same receivers. In our summary of receiver

PIONEER has additional solid-state AM-FM receivers in its line. One of these is the SX-300T which has a continuous power output of 12½ W/ch at 8 ohms and is priced at \$200, less cabinet. There is also the SX-800A, which uses a solid-state switching circuit in an otherwise tube design. This unit is rated at 38 W/ch (cont.) and is priced at \$270. Scheduled for introduction is the SX-700T, an all solid-state receiver rated at 30 W/ch (dynamic) into 8 ohms and selling for \$250.

performance data we have merely noted the presence of AM facilities where they are provided in the receiver.

Amplifier Tests & Measurements

The current IIF Standard on measurement of audio amplifiers, IIF-A-201, was released in 1966 and is both up-to-date and comprehensive. It provides for certain additional tests to be made on multi-channel (stereo) amplifiers. These include measurement of power and distortion with both channels driven, a procedure which has been followed by Hirsch-Houck Laboratories since the introduction of stereo amplifiers. IIF-A-201 lists 10 specifications in order of importance: 1. Dynamic Output and Distortion; 2. Continuous Output and Distortion; 3. Power Bandwidth; 4. Sensitivity at highest-gain and lowest-gain inputs; 5. Hum

SANSUI has two other stereo receivers in its line, both including AM. One is the Model 400, rated at 25 W/ch dynamic power at 8 ohms and priced at \$240, less cabinet. The other is the Model 3000A, rated at 48 W/ch continuous power (8 ohms) and priced at \$380. In addition, newly introduced is an AM-FM receiver, the Model 2000, rated at 26 W/ch (cont.) at 8 ohms and selling for \$300.

and Noise at highest-gain and lowest-gain inputs, 6. Frequency Response at highest-gain and lowest-gain inputs, 7. Maximum Input Signal at highest-gain and lowest-gain inputs, 8. Stability, 9. Input Impedance at highest-gain and lowest-gain inputs, and 10. Damping Factor.

Additional tests are prescribed for stereo amplifiers, as follows: 11. Difference of Frequency Response, 12. Tracking Error, and 13. Separation and Crosstalk.

A minimum published specification for an amplifier according to IIF Standards requires the listing of items 1, 2, 3, 4, and 5 above. In the case of stereo, both channels must be driven for the Power Bandwidth measurements.

Dynamic Output is the largest power output obtainable with a sine-wave signal for a short period of time at reference distortion. Two methods of measurement are defined. One uses a transient signal (similar to a tone burst) whose distortion is measured on a calibrated oscilloscope connected to the output of a null-type distortion analyzer. The other is essentially the old "music-power" technique,

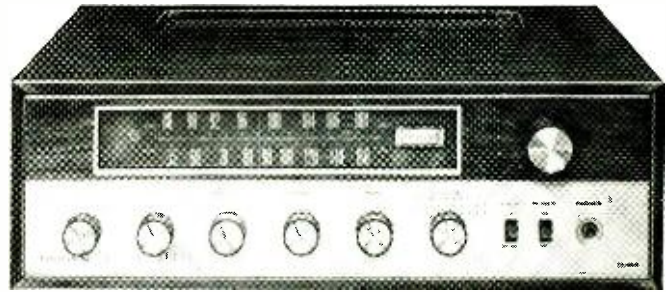

The Bogen Model TR-100X solid-state stereo receiver.

in which the normal power supplies are replaced by regulated supplies and a continuous input signal is applied.

The transient-distortion test requires a rather specialized test set-up. The regulated-power-supply method is impractical for anyone but a manufacturer, since it requires extensive modification of the amplifier wiring. There is

SCOTT offers an AM-FM version of the receiver listed in our table as Model 384 at \$440. Also, the FM tuner portion of the 344C is available as a separate component at \$200. Other receivers in the line are the following: Model 342B FM-only receiver, rated at 18 W/ch (cont.) at 8 ohms, priced at \$300. Model 382B is an AM-FM version of this receiver priced at \$340. Model 348B is an FM-only receiver rated at 40 W/ch (cont.) at 8 ohms and priced at \$500. Model 388B is an AM-FM version of this unit priced at \$540. All prices exclude case. In addition, there is the LR-88 AM-FM receiver kit, rated at 32 W/ch (cont.) at 8 ohms and priced at \$335.

also a high probability of damaging the output transistors during such a test.

We do not consider either of these tests to be really significant in defining the performance of an amplifier for music reproduction. The Continuous Power performance of an amplifier is more indicative of its true quality and capability, and we always measure amplifier power and distortion under conditions of continuous drive, with both channels driven. The measured power in such a test is almost always appreciably lower than the Dynamic Power output. Differences between our test figures and a manufacturer's ratings are usually attributable to the difference in measurement technique.

Continuous Output is the largest single frequency power output obtainable with a sine-wave signal for at least 30 seconds at reference distortion. All tests are made with a line voltage of 120 ±1 volt, using 8 ohm ±1% loads connected to the "8-ohm" output terminals of the amplifier. Figures given are the power output per channel. The total amount of power output for both channels of the receiver would be twice the values shown. (Continued on page 77)

SHERWOOD, in addition to the receiver in our table, has the following solid-state models. The S-7800 is similar to the model listed except that it includes an AM tuner; price is \$410. The S-8600 uses the same tuner design but the amplifier is rated at 20 W/ch (cont.) at 8 ohms and is priced at \$290. The S-7600 is similar except it has an AM tuner; price is \$340. In addition, the FM-only tuner portion is available as a separate component as the S-3300 at \$178. The AM-FM tuner is available separately as the S-2300 at \$210. Also, the higher-power amplifier section is available separately as the S-9900A at \$230; while the lower-power amplifier section is available as a separate component as the S-9500A at \$180. All prices are less cases.

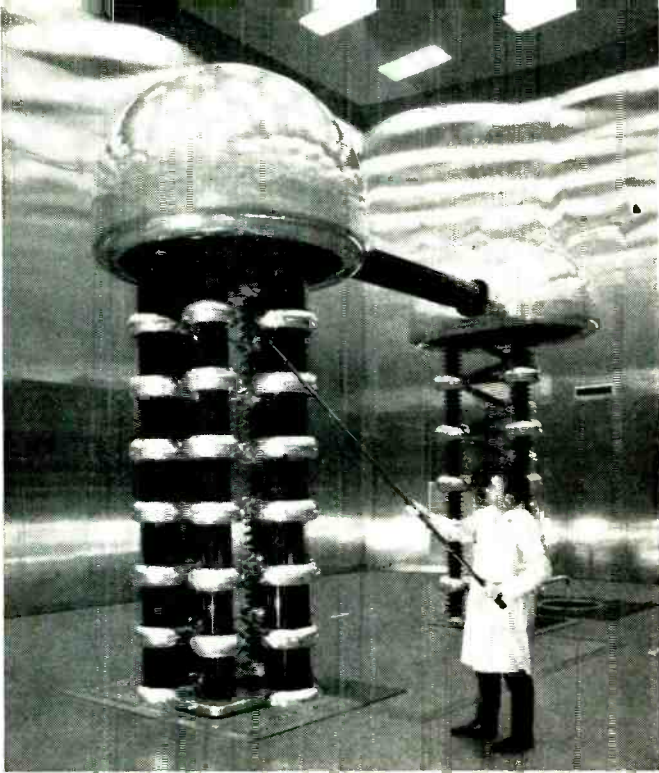

RECENT DEVELOPMENTS IN ELECTRONICS

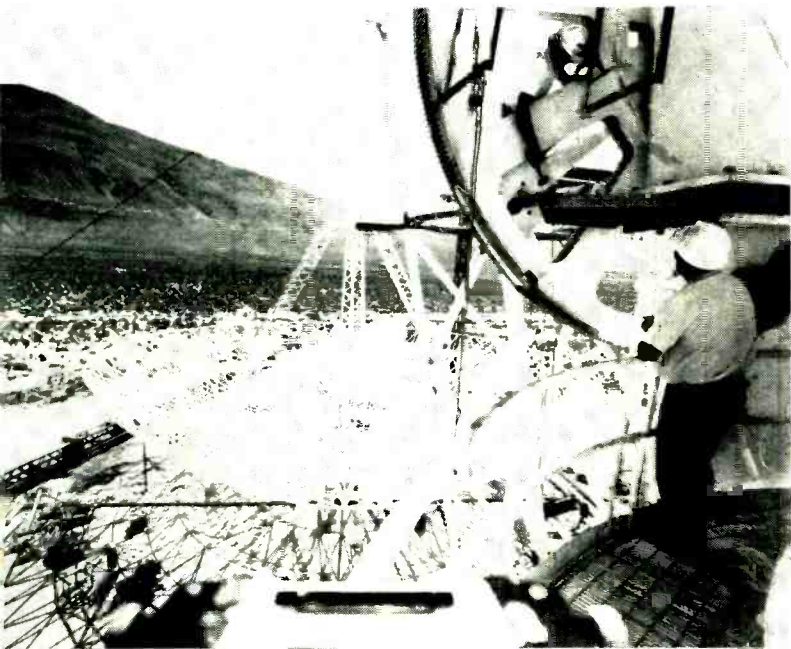

Million-Volt Electron Microscope. (Top left) The technician in the photo is shown removing the latent charge from the 17-foot-high accelerators used with a new one-million-volt electron microscope. The microscope, designed by RCA for the U. S. Steel Research Center in Monroeville, Penna., is the largest in the western hemisphere. It will be used to probe for new and valuable information about metal structures. The instrument's higher resolving power will permit closer study of the microstructural components of steels, some of which contain only a few atoms. The accelerator which powers the microscope speeds a stream of electrons through the instrument's magnetic lenses at 94% the speed of light. This velocity gives the electrons a penetrating power of up to 10 times that of beams used in standard electron microscopes and makes it possible to examine much thicker specimens of material. Increasing the accelerating voltage reduces the wavelength of the electron beam, hence improving the resolving power. The microscopist expects to "see" features 2 angstroms (8 billionth of an inch) apart, which is the theoretical limit.

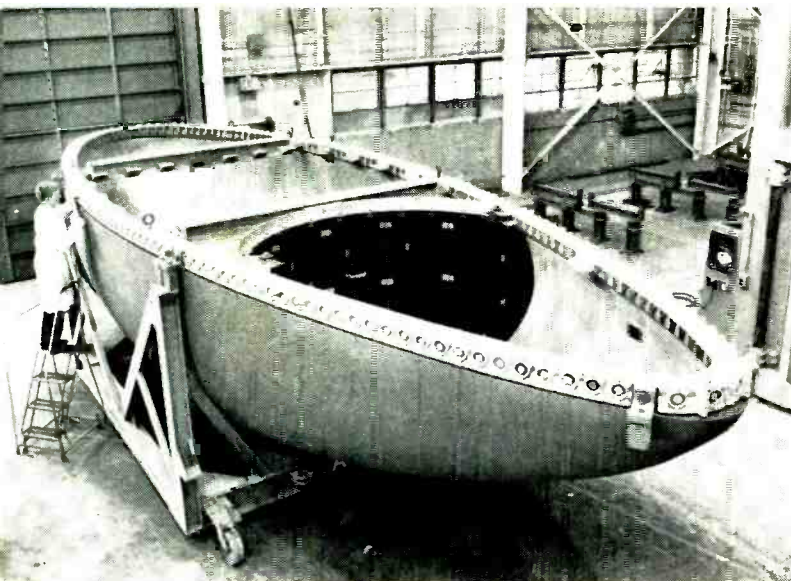

New Radio Telescope. (Center) The first of eight proposed antennas that will tune in radio sources coming from billions of light years out in space nears completion at California Institute of Technology's Owen Valley Radio Observatory. The 130-foot steel-rib dish was delicately placed on its pedestal recently. Moving on rails, this dish along with seven others will be used together to form an antenna system whose equivalent size will be far greater than the total area of the eight individual dishes. The antenna, gears, drives, and the associated equipment were all manufactured by Westinghouse.

Giant Sonar Dome for Destroyer. (Bottom left) The largest rubber product ever molded in one piece—a sonar dome 34 feet long, 11 feet wide, and 8 feet high—is readied for its trip to the Navy for extensive testing. The dome is to be installed beneath a destroyer. The keel dome is made of specially developed "sound transparent" rubber which possesses acoustical properties similar to sea water, enabling water-borne sound waves to pass through the dome with minimum distortion and attenuation. After installation, the sonar dome will be pressurized internally with sea water to resist battering from high speeds and the hydrodynamic forces of the sea.

Digital Readout Police Radar. (Top right) A new Doppler radar for police use has been introduced that has a readout in digital form rather than the old swinging needle. The radar timer registers speeds up to 199 mi/h and is said to be accurate to within 1 mi/h. The radar system uses modular construction, printed circuits, transistors, and integrated circuits. The indicator is small enough so that it can be located anywhere in the police car. The transmitter and antenna portion of the system are usually located outside the vehicle. Range is up to 1500 feet. An optional unit is a compact ticket printer that prints out the speed being indicated. The tuning fork shown in the photo is used for calibration purposes. The new police radar equipment is being made by the Mini Quip Corporation.

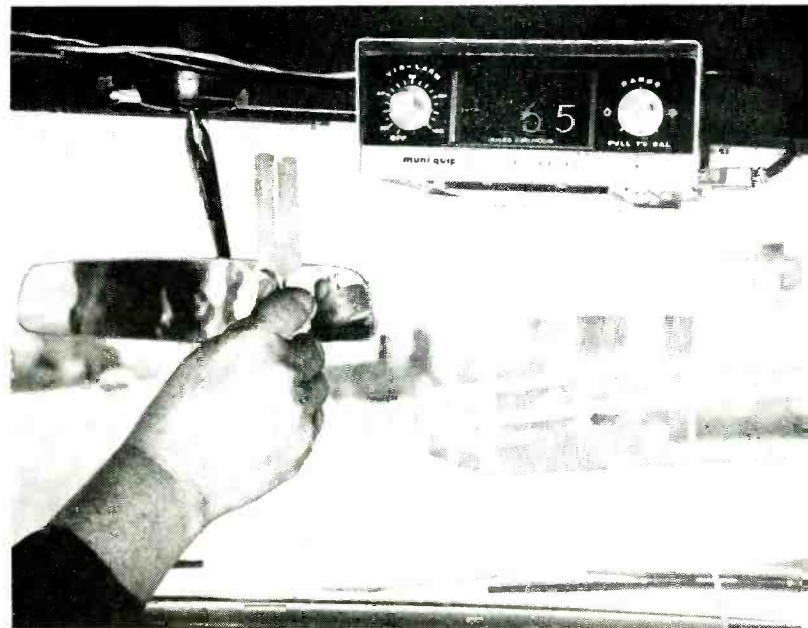

Computer Diagnoses Cars. (Center) A service technician is shown running a sequence of automobile engine and electrical system tests on a new automotive computer. An individual program card with performance standards for the model being tested is fed into the slot visible in the upper left of the computer console. Computerized results are transmitted to a printer readout in the customer lounge. The entire process is completed in seven to fifteen minutes. The computer, which employs integrated circuits, is produced by Allen Electric for use in car-care centers, service stations, or auto garages.

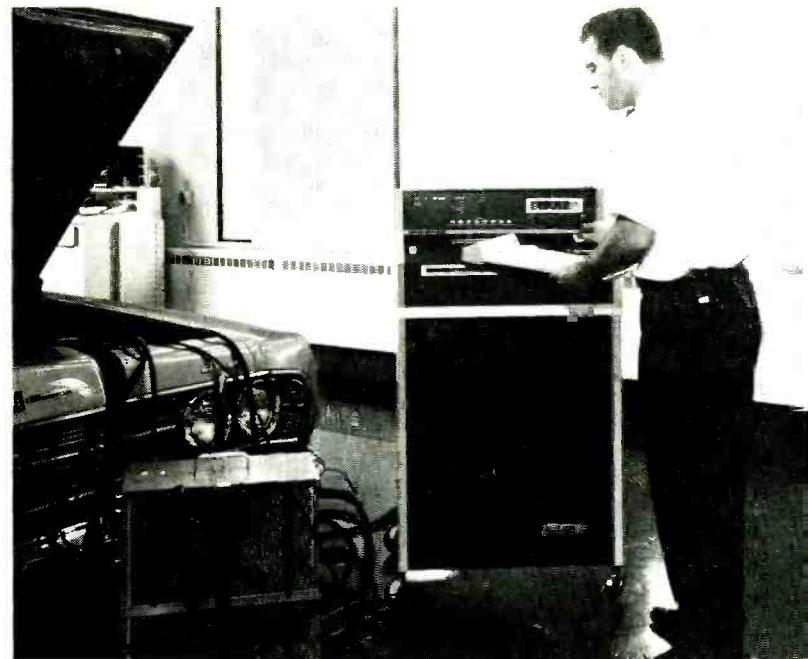

Jeep-Mounted Video Tape Recorder. (Below right) Closed-circuit video tape recording, plus an unmanned radio-controlled helicopter are making possible remote recording and immediate replay of televised aerial surveillance. The system, developed by Gyrodyne Co. for military use, employs a TV camera in the helicopter which beams pictures to an Ampex video recorder, shown here mounted in the jeep. In addition, to TV surveillance, the system can be used in forward area cargo delivery, smoke screening, battlefield illumination, artillery spotting, and rescue. Commanders can then make evaluations on the spot without waiting for film processing.

Ultra-Compact Solid-State Antenna Array. (Below left) This experimental array shows four rows of 25 dipoles each making a total of 100 closely spaced radiating elements in the space normally occupied by a single half-wave radiating element. The array is actually a wave-front amplifier with back-to-back receiving and transmitting elements connected by solid-state stripline circuitry. Operating frequency is 410 MHz. The elements in the array are typically 1/40 wavelength long with a 1/6 to 1/40 wavelength spacing. The antennas are being developed by RCA for military radar use where it is desired to parallel many low-powered devices for high power output.

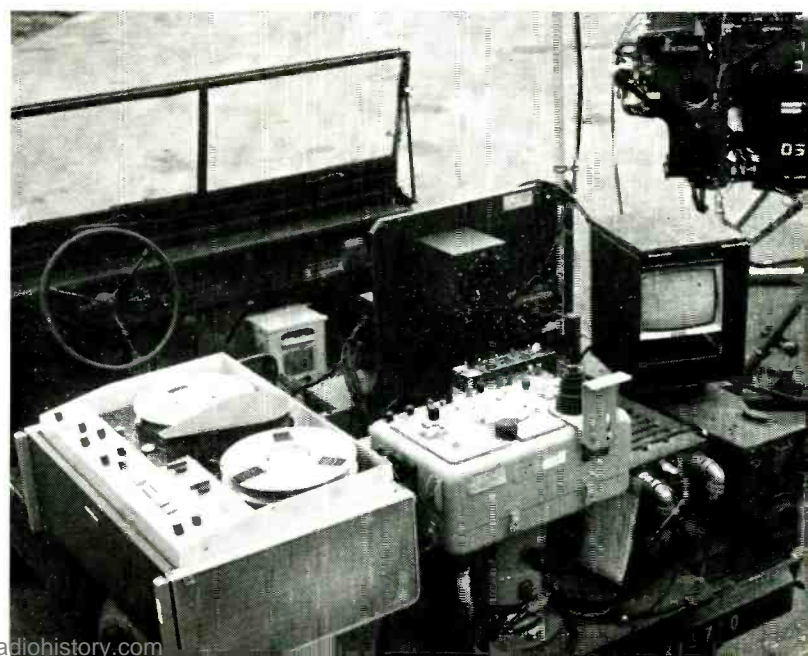
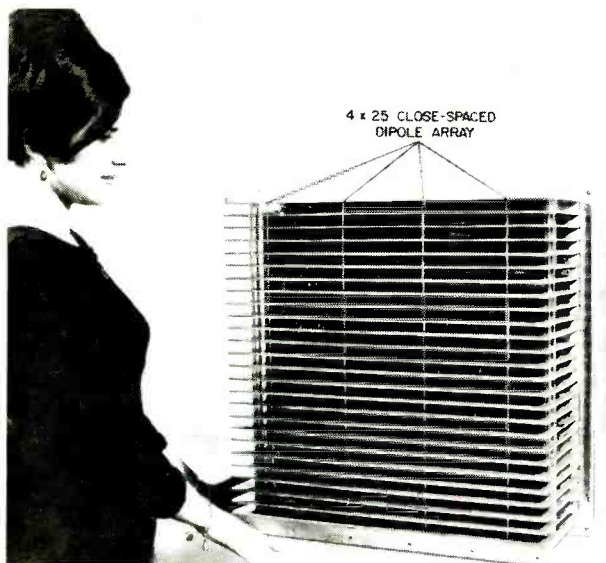

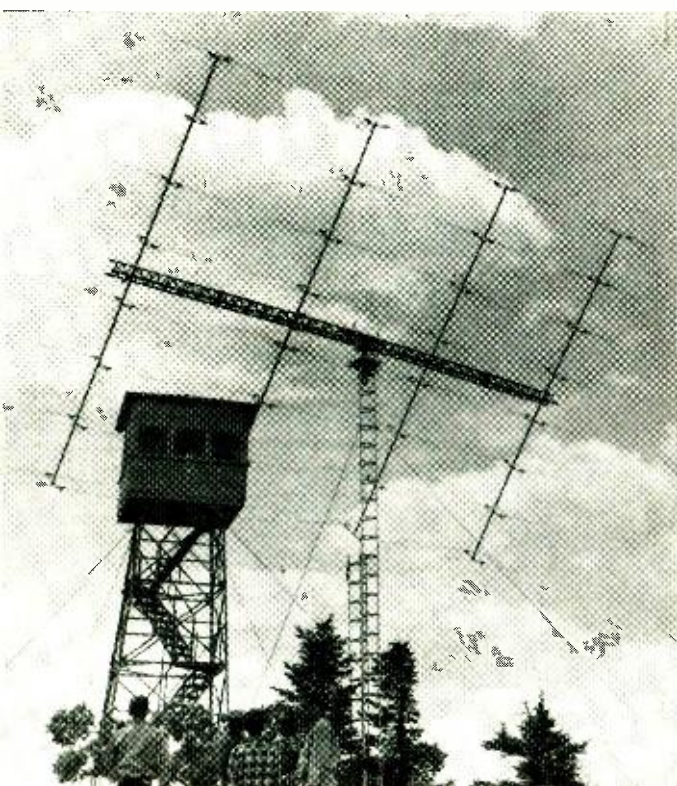

Incentive licensing may stimulate experimental work by American hams, like this antenna and moon-bounce communications installation operating on 144 MHz.

NEW INCENTIVE REGULATIONS FOR HAMS

What Happens Now?

By ROBERT M. BROWN

Sweeping changes provide incentives for amateurs to develop their technical skills and increase their prestige. Exclusive frequencies will be available for all Advanced and Extra Class License holders.

CLIMAXING nearly five years of heated argument and internal controversy in the Amateur Radio Service, the Federal Communications Commission has adopted new regulations. On November 22, 1967 the first part of a three-phase incentive licensing program goes into effect, a plan which is said to provide "for the remodeling and revitalization of the Amateur Radio Service without changing its basic character and spirit and without depriving any amateur licensee of the major portion of his present operating privileges."

The new rules re-establish the Advanced Class ham license, which has not been available since 1951. (Extra Class exams are still available to General Class operators "or higher" who have at least 2 years status as such.) Novice tickets issued after this date are for two years. Radio amateurs with at least 25 years of amateur standing may apply (\$20 fee) for two-letter calls.

In its new form, the Advanced Class ticket will be at a difficulty level between the current General Class (50 multiple-choice questions) and the Extra Class (100 harder multiple-choice questions) licenses. Code speed requirements are the same 13 wpm required for the General ticket. Actual Advanced Class questions and answers were not available as this was written, but the Commission has stated that these will be made public along with availability of the actual FCC-administered exams as soon as possible.

To provide motivation for up-grading the approximately 100,000 General Class ticket holders, the Commission is introducing "reserved frequencies", which will be phone and c.w. frequency blocks available only to Advanced and Extra Class licensees. These new reserved bands represent the "incentive" behind the entire program and will be implemented on the installment plan: approximately half made available in 1968 and the remainder in 1969. There will be no frequency cuts or changes during the rest of 1967.

All General Class amateurs will immediately qualify for the new Advanced examination. Since code proficiency requirements are identical, the prospective Advanced ticket-holder can proceed directly into the written portion of his

test—providing he brings proof of his General amateur status.

On November 22, 1967, all the new Novice licensees receive two-year operating privileges. According to Washington, "Extension of the 1-year Novice Class term is intended to afford licensees an additional period for the development of their proficiency and knowledge before attempting to advance to higher classes of licenses."

Many persons have felt that the present one-year non-renewable restriction inhibits growth of the hobby from the standpoint of youngsters who are unable to master so much in such a short period of time. Proposal RM-775, a formal petition submitted by Joseph L. Kofron of Las Vegas, requested that the "Novice Class license be made renewable by licensees 12 years of age or younger" to facilitate their gaining the required operating experience. The Commission pointed out this request in explaining why it is extending the term of the beginner's license.

Next in line of things happening in 1967 comes the availability of 2-letter (W2AA-type) call signs for Extra Class amateurs who have been active in the hobby for 25 years or more. Although no choice of call letters will be possible, a check for \$20 and a suitable request is all that will be required of these "old timers". This highest grade of license holder will be the only one with any kind of distinctive call-sign. An earlier proposal to issue calls according to license status has been abandoned.

In a statement released on August 24, 1967, the FCC said that "means of identification now in use are satisfactory. Automatic data processing now makes available listings of amateur licensees with their classes of operator licenses which can be utilized by monitoring personnel for reasonably prompt identification purposes. . . ." Additionally, it has been reported that the publishers of "The Radio Amateur's Callbook" will begin immediately to print the class of license held by every ham listed in the directory. Enforcement of the new regulations, however, still rests upon the hams themselves who must be counted upon not to bootleg higher-license-class call signs.

For the 40,000-odd hams who still hold the pre-1951 Ad-

vanced Class tickets, the Commission has good news. These amateurs will be grouped with the new incentive-program Advanced Class-ers. This "grandfather clause" was adopted after floods of mail called the Commissioners' attention to the fact that at one time these people had passed a far more difficult examination than is now required of most hams. "Rather than have amateurs think we are losing faith with these licensees", the FCC added, "no further demands will be made upon them."

New Rules in 1968

On November 22, 1968, holders of the Extra Class ham ticket will get "reserved" frequencies on the h.f. bands. On this date the Commission is opening a 25-kHz c.w. section at the lower edges of the 80-, 40-, 20-, and 15-meter bands for Extras only. A special phone band will be reserved in the first 25 kHz of the 75- and 15-meter bands; this is felt to be the choicest allocation of them all and one which may ultimately spur other licensees to graduate to Extra Class. With Extra licensees truly the rarest of all those now in the hobby, these sub-bands should be relatively free from interference—at least for a while.

The Extra Class is the only license that stands to lose nothing under the incentive licensing provisions. Extra Class operators will continue to be able to operate anywhere they choose within the U.S. Amateur bands.

Novice licensees will lose their 2-meter phone privileges permanently on November 22, 1968, although they may operate c.w. in the 145-147-MHz range if they desire. In explaining this move, the Commission mentioned certain petitions by amateurs in addition to reiterating that "one of the prime purposes of the Novice license is to prepare for the higher classes of licenses which require increased code proficiency." Those individuals, however, who feel that the code barrier is too much to handle can still elect to pass the Technician Class examination and operate on all modes in the 6-meter band and up.

While the original proposal called for setting aside reserved frequencies in much the same manner as will soon be implemented on the h.f. bands up on 144 MHz, in the final version this concept was dropped entirely. With the exception of the deletion of phone privileges for Novices, 2-meter privileges will be unchanged. Opponents of the original proposal petitioned Washington that "since this band is very useful for experimental operations, it should continue to be available to all licensees". In an order released in late August the following remark was made: "The Commission agrees and will delete reservations of the proposed 144-145-MHz segment." What is left, then, is only the loss of the first 100 kHz of 6 meters in the v.h.f. spectrum, a segment now allocated exclusively for c.w. and one which will revert to the Extra Class and Advanced amateurs on November 22 of next year.

Final Implementation: 1969

The third phase of the three-part program also concerns frequency assignments and goes into effect on November 22, 1969. No new reserved blocks will be created but, with the exception of the 75- and 15-meter Extra phone segments, all "incentive attraction frequencies" will undergo final expansion. Nearly all reserved blocks will become twice as large, cutting down the size of the remaining General frequencies proportionally.

For the most part, this will mark the date when the General Class hams will have only half the usable phone privileges they had prior to 1968. And with just over 100,000 licensees so affected, it isn't difficult to understand, at this point, where the "incentive" lies.

Interestingly, the 160- and 10-meter low-frequency bands have come out of this unscathed, as have all bands above 2 meters. These frequencies represent bands not utilized by the majority of the country's radio amateurs. And frequency

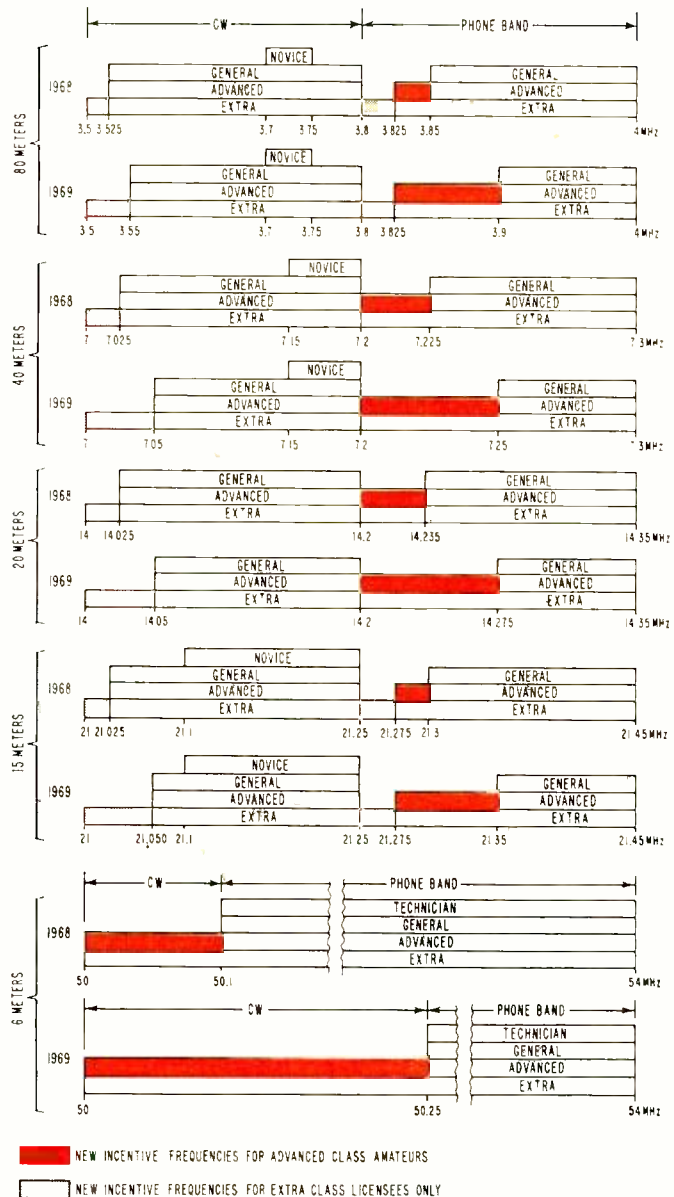

NOTE 1: NOVICES LOSE 2 METER PHONE PRIVILEGES NOV. 22, 1968
 2: THE FOLLOWING BANDS REMAIN UNAFFECTED BY THE NEW REGULATIONS—160, 10, 11/4 AND UP (METERS)

The new FCC rulings provide that certain amateur frequency bands will be open exclusively to advanced license holders. Chart shows status effective as of November 22, 1968 and 1969.

demands from emerging nations (largely African) have increased in recent years to a point where the next Geneva Frequency Allocation Conference is expected to review all sparsely populated amateur bands carefully. According to many sources, 160 and 10 meters may be lost at this time for these reasons.

However, with the results of the incentive program still undetermined, it is entirely possible that many amateurs not desiring to compete with others for the remaining DX band space (and not electing to up-grade themselves out of it) may begin to fill these two h.f. bands. Should the over-all program not pan out, it is conceivable that 160 and 10 meters might wind up as extremely active frequency blocks—thereby redeeming themselves perhaps just in time for Geneva. However, this opinion is the author's and is not official thinking now.

This same concern for Geneva apparently has motivated a great deal of what is illustrated on the accompanying chart. With the exception of a final 250 kHz reserved block at the bottom of the 6-meter band, the v.h.f.-v.h.f. spectrum has come out largely unaffected by the new program. It should be noted that these frequencies are not "mutual in-

INCENTIVE PROGRAM TIMETABLE

November 22, 1967

Advanced Class tests become available with 13 wpm code exam or General c.w. endorsement.

New Novices will receive 2-year operational term, retain 2-meter phone until next year.

Two-letter calls available upon request (\$20 fee) for Extra Class ticketholders with at least 25 years of ham status. No choice of 2-letter call.

"The Radio Amateur's Callbook" to begin identifying the class of license held in future U.S. listings.

Present Advanced licensees awarded identical status with new Advanced (incentive program) licensees.

November 22, 1968

All Novices lose 2-meter phone privileges.
First phase of incentive frequencies program goes into effect.

November 22, 1969

Final phase of frequencies program goes into effect.

THE NEW ADVANCED CLASS EXAM

(according to the FCC)

C.W. Proficiency: will consist of a "General code test of thirteen (13) words per minute."

Written Test: "Intermediate amateur practice involving intermediate-level radio theory and operation as applicable to modern amateur techniques, including, but not limited to, radiotelephony and radiotelegraphy."

Grading: "Seventy-four percent (74%) is the passing grade for the written examination. For the purpose of grading, each element (code and written) will be considered as a separate examination. All written examinations will be graded only by Commission personnel."

Reason for Re-establishment of this License: "The Commission . . . has made every reasonable effort to provide an opportunity for the remodeling and revitalization of the Amateur Radio Service without changing its basic character and spirit and without depriving any amateur licensee of the major portion of his present operating privileges.

It remains only for the licensee to prove himself and to improve the Amateur Radio Service by voluntarily upgrading his license. . . ."

terference" bands normally of concern to other countries, primarily because of their range limitations. Further, it appears the Commission has concentrated on the most occupied bands where congestion was a serious problem from the very beginning—dating back to 1963.

How It All Began

While this has been the subject of the most intense internal controversy that has hit the U.S. Amateur Radio Service, the idea of an "incentive" program did not originate with the FCC. It was introduced in an early 1963 issue of *QST*, the official journal of the American Radio Relay League: "Should we return to an incentive system of licensing whereby an amateur must demonstrate increased technical proficiency in order to increase his operating privileges?" This gave rise to confused reactions in ham circles, with the number of proponents and opponents, in itself, the subject of a great deal of mystery. Thousands of ARRL members resigned when the organization formally petitioned the FCC for such a program. Other amateurs fervently supported the move as a much-needed "clean-up" procedure, and one that was long overdue. *CQ*, an independent ham magazine, appeared to support the effort and published a controversial article "The Swans of Abbotsbury" by a British observer who noted that a swan population can only survive when limited to a given number of birds. Reason: the available food was the same from year to year; a corollary to the international problem of just so many available frequencies for purposes of amateur radio operation. And *73 Magazine*, vehemently denouncing both ARRL and *CQ* for "selling the hobby down the river", organized its own national club known as the Institute of Amateur Radio (IoAR). For a while it appeared that IoAR was getting most of its members from the disgruntled ex-ARRL block, but eventually the Institute was dissolved. According to *73's* editor-publisher and IoAR founder, Wayne Green, his organization lacked required "support from the concerned amateurs".

The ham world was split right down the middle over the original FCC proposal as announced in *QST* in May, 1965. One of the most controversial segments of that version of the incentive program called for the establishment of "distinctive call signs" and the down-grading of present old-timer Advanced Class-ers to General status. These provisions and some others were omitted from the final rule-making—a move which may act to reunite forces in the hobby and strengthen its primary spokesman—the ARRL.

Reports continue to circulate that the ARRL was pressured into suggesting the program in the first place by the FCC—which is normally hard put to do much more than react to formal petitions. This rumor has at last been officially denied by all concerned. Whether the story (now about five years old) contained any element of truth may never be known.

But it appears that credit for the idea now being turned into Amateur Radio Service law rests primarily with the League. After the League petitioned the Commission for some kind of incentive program, the FCC issued the Notice of Proposed Rulemaking (in 1965) incorporating concepts from a wide number of sources. In reply, the ARRL and many individual hams undertook to issue formal (petitioned) comments calling for modifications and rule clarifications. In the words of the Commission, the rule proposal had "generated . . . formal comments by some 4000 licensees" and that "two-thirds of the comments supported an incentive licensing program".

The Disadvantages

Although the primary portions of the original plan which seemed to alienate many hams from the ARRL have been deleted in the new rulemaking, there still remains substantial numbers of U.S. amateurs who sense impending doom for the hobby. Many of their arguments are worth examining.

The big question seems to be: "Where will the new hams come from?". Since the inception of the Citizens Radio Service on 27 MHz in 1958, amateur radio has been less and less attractive to the aspiring enthusiast. Applications for new Novice licenses have dwindled and from a purely economic standpoint the news is bad. Since word first came that handom might undergo severe changes, annual equipment sales have tended to settle around \$16 million. It is expected that year-end analysis for 1967 will reveal actual sales of equipment and accessories near \$13-\$14 million, reflecting the uncertainty over the future. (These figures compare with roughly \$60 million for CB in 1966—excluding the unlicensed Part 15 walkie-talkies.) The Novice Class license, which did much to revitalize the hobby by bringing in hordes of newcomers, has become unappealing to many because of its 5-wpm code requirement.

Even with the new 2-year license for Novices, as provided in the incentive program, the 5-wpm requirement remains. But worse still, all phone privileges have been withdrawn. Hence, a youngster trying to de- (Continued on page 60)

EROS, An Airborne Collision Avoidance System

By JOSEPH H. WUJEK, Jr.

Description of an airborne transmitter-receiver-computer system, now being used in test aircraft, that may be the basis for future commercial use in supersonic jet planes.

SINCE the development of the jet-powered commercial airliner in the latter half of the 1950's, civil air transport has enjoyed a phenomenal growth. Not only in the United States, but in most of the countries of the world, airline traffic is on the increase. Projections call for a five-fold growth in world air passenger traffic from 1966 to 1980. Coupled with this rise in airline mileage has come a significant increase in private and business flying, as well as the usual military training and exercise flights.

With more and more aircraft occupying the skies at any given time, the risk of aircraft collision has become a growing problem, particularly in the dense traffic patterns surrounding major terminals. In the first seven months of 1967 there were two mid-air collisions between private planes and commercial jets and one ground collision between a private plane and scheduled commercial liner. It is in the terminal area that the routes of many aircraft converge. Unlike auto traffic which is confined to two-dimensional patterns, aircraft move with three degrees of freedom; both geographic coordinates as well as altitude.

The problem is compounded in the vicinity of terminals where the crew is busily engaged in preparing for takeoff or landing and must, in addition, scan the skies for other aircraft. While it is true that ground-based and airborne radars assist the crew in surveillance of the region near their aircraft, the extra burden of this task diverts the crew's attention from other duties.

Clearly, some means of assistance in monitoring the volume of air space surrounding the aircraft is desirable, if not mandatory. Beyond the hazard of air collision is the risk of near-collision. Documented cases have shown that in some instances a pilot's severe corrective action to avoid collision has resulted in loss of control, leading to a crash, or at the least, severely shaking the passengers. In order to minimize and, ideally, remove these risks from air travel, an aircraft collision avoidance system is required. As is so often the case with problems which can be solved by technology, electronics shows promise of providing the solution.

In general, two types of aircraft collision avoidance systems (CAS) are under consideration by the aerospace industry: the so-called *active* system, one type of which we shall discuss in this article, and the *passive* system. The active system requires that the observer *and* the observed carry the working equipment. The passive system requires only that the observer carry the instrumentation, independent of the observed.

An example of the active system, which is used along with radar, is the transponder. When a properly coded message is received by the transponder, this *interrogation* signal triggers a responding signal to the interrogating signal source. An example of a passive radar is the ordinary military or weather radars that are capable of detecting radar targets without the target's cooperation. A cloud formation obviously does not carry electronic systems, but its presence may be detected by the radar system.



An EROS ground station operator locates an aircraft by pressing button and watching radar blip "bloom" on screen.

The EROS System

The EROS, or *Eliminate Range zero (O)* System, is an active, airborne, aircraft collision avoidance system. Developed by *McDonnell Douglas* to fill a particular need, the system illustrates what can be done to provide collision-free airspace.

Company engineers were required to develop a system which would insure air safety for the relatively fixed area where a high density of their own aircraft were undergoing test. Since this region was well above the altitudes used by private airplanes, and because the area was removed from commercial air routes, the greatest hazard to such aircraft was other *McDonnell Douglas* aircraft. Hence, an active system was both feasible and practical as a solution, since all the manufacturer's test aircraft would be so instrumented. As the aircraft under test are primarily production planes, it was desirable to equip the planes with a system that could be easily installed and easily removed.

Requirements of CAS

Any CAS can be considered a computer which makes decisions based on the information received. These decisions may be summarized, relative to the proximity of another aircraft, into four separate items: 1) range, 2) time, 3) altitude, and 4) corrective action.

The first of these, *range*, simply tells the computer how far the approaching collision hazard is away. Certainly range is a fundamental measurement. But range alone is not sufficient as a measure of collision hazard. An aircraft moving at 300 miles per hour approaching head-on another aircraft flying at the same speed is closing the gap at 600 mi/h, or 10 miles per minute. Thus, to be warned when the oncoming

THE AIRLINE SEARCH FOR A COLLISION AVOIDANCE SYSTEM

(Editor's Note: The following material was supplied by the Air Transport Association of America.)

What is a collision avoidance system? A collision avoidance system, commonly called CAS, is a device that can be carried aboard an aircraft to assess the probability of collision with another aircraft in flight. This device analyzes collision threats to determine potential collision hazards, calls the pilot's attention to them, tells him what evasive action to take, and when, to avoid the hazard.

Why do the airlines want CAS? The airlines want a system that will function independently of any visual assessment of collision risk by the pilot. Since the system is intended to supplement the ground-based air traffic control (ATC) system, CAS should be independent of the ATC system.

Why don't we have CAS now? An active airline industry search for a suitable CAS has been underway for 12 years. Ten of these years were marked by disappointment and a few false hopes. Then two years ago, pessimism gave way to optimism. Three things happened: (1) Collins Radio completed FAA-funded simulation studies of various possible techniques to use for CAS; (2) McDonnell Douglas displayed hardware built to use the technique found best by Collins' studies, and (3) solid-state electronic technology developed to the point where a practical CAS could be built. When CAS equipment enters airline service, it will be the first equipment aboard an airliner using integrated solid-state construction.

When will operational equipment be available? This is difficult to say

because there are so many unknowns. We can expect three to five years will be needed for completion of the evaluation, for FAA to prepare a U.S. common system standard, and to secure agreement in ICAO to an international standard. It is possible that some airlines may begin fitting CAS to the aircraft once the outlines of probable international agreement are clear. So some time between 1970 and 1974 you can expect to begin seeing CAS in routine operation.

Will CAS be included in new aircraft now on order? The production line of the U.S. SST will be the first to incorporate CAS from the very beginning. Other production line aircraft now on order will require some degree of retrofit because the point where production line decisions must be made will be reached before firm orders for CAS can be made.

Will CAS be retrofitted to existing airline aircraft? Yes, if they are intended to be kept in the fleet long enough to justify its installation.

What will the equipment include? An airborne digital computer, transmitting and receiving equipment, enough antennas to provide spherical coverage, and a timekeeping device. How much will it cost? Present estimates range from \$30,000 to \$50,000 per unit.

Is CAS the only answer to preventing mid-air collisions? Definitely not, the CAS is only one of many avenues that the airlines are exploring, all at the same time, to reduce the risk of mid-air collisions. The other avenues involve changes in air traffic control procedures and better, more wide-spread, use of new air traffic control facilities.

aircraft is ten miles away is probably enough advanced notice.

But now suppose the two aircraft in question are flying at 1200 mi/h, with a resultant closing speed of 2400 mi/h or a closing rate of 40 miles per minute. A warning of 10 miles gives each pilot only 15 seconds to react to the oncoming hazard.

From this example it should be clear that another parameter must be provided as input to the computer. The second parameter, *time*, is thus required. This time is usually designated by the Greek letter *tau* (τ). τ is simply the range divided by the range rate, or in more familiar terms, distance divided by closure speed.

Range and τ alone do not provide all the information required since we are, after all, dealing with aircraft. *Altitude* thus becomes the third parameter of interest. Aircraft separated in bearing by 180° are not headed for collision unless they are at, or nearly at, the same altitude.

With these three measurements—range, range rate, and altitude—the computer can now indicate a course of corrective action.

If the airplane is in level flight, the computer can indicate that a climb or descent is required. If the plane is climbing or descending, a level-off maneuver may be signalled. Obviously, the collision course aircraft must be ordered into a compatible maneuver. To instruct both aircraft on a head-on bearing and common altitude to "climb" merely results in a collision at higher altitude than originally in store.

From our discussion thus far, we might guess that the more input information provided for the computer, the "better" the system performance. In general, this is true. In the case of range information only, for example, an overly conservative safety zone must be maintained. If we insisted on a 10-mile separation, as in our previous example, then no distinction would be made between an aircraft approaching us

Collision avoidance pod with access doors removed to show packaging of electronic components in Sparrow III guided-missile shape.

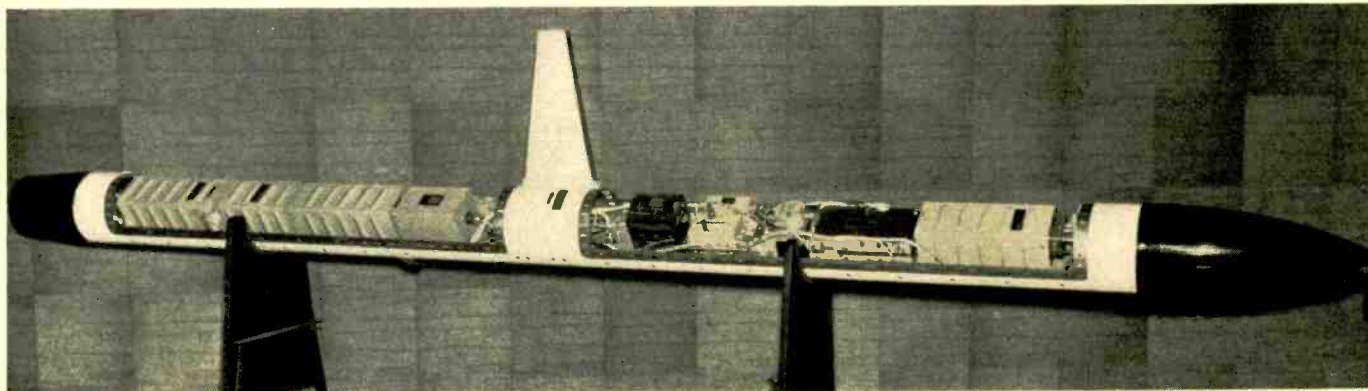

head-on and one that is flying on our bearing and 10 miles above us. Such a system would not be useful, especially in terminal areas. As additional information is supplied to the computer, such as bearing and altitude changes, the safety zone can be narrowed *while maintaining the same degree of safety.*

Now that we have examined some of the system requirements and considered some of the problems inherent in the design of a feasible CAS, we can proceed to the hardware stage. Since we know that we will need a precise method of time measurement, we might guess that somewhere in the system a stable electronic clock will be required, with a means for synchronizing clocks or clock receivers. Such is indeed the case with EROS. This technique, called the "time-frequency" method, was endorsed by the Air Transport Association (ATA) as the most feasible solution to the problem.

The ATA, made up of commercial air line companies, made their recommendation in response to an inquiry by the Federal Aviation Agency (FAA). A committee of the FAA, the Collision Prevention Advisory Group (Copag), had long studied the collision problem and asked the various airspace users to furnish information as to their CAS needs. Hopefully, a standard system or compatible systems will soon become standard equipment on all military and commercial aircraft. Private airplanes may some day also carry the equipment, although that day is much farther in the future. Until costs are substantially reduced, few private operators will be in a position to install such a collision avoidance system.

How EROS Works

The basic cycle time for EROS is a two-second interval divided into 1000 equal segments, called *message slots*. Thus, each message slot is 2 milliseconds in length. Since a master station provides synchronization of the frame, we consider the master station as message slot "000". For the EROS, the master station is on the ground. Each aircraft is then assigned a unique message slot, ranging from "001" through "999". Hence, 999 aircraft can be accommodated within the range of the EROS ground station.

As shown in Fig. 1, each station transmits during one, and only one, message slot during each two-second cycle. When not transmitting, the station is receiving. Each station, now in sync with the master station, keeps track of message slots by counting 10,000 oscillations from a highly stable 5-MHz crystal oscillator, contained in each station. The 10,000 oscillations thus correspond to one message slot length of 2 milliseconds. The counter is advanced each time 10,000 counts are accumulated. When the counter has advanced to the appropriate message slot for the particular station, a transmission is made.

Coarse synchronization by the master station occurs once each 2-second cycle. A pair of pulses, each 1.6 microseconds wide, and separated by 9.6 μ s, is transmitted by the master station at the start of message slot "000". The first pulse is transmitted precisely at the start of the message slot. Each slave station "001" through "999" contains logic circuits which sense the duration and separation of this pulse doublet. If the received pulses satisfy the duration and separation requirements, coarse sync is established. Once sync is thus established, no repetition of the sync is required, unless a momentary power loss occurs in one of the stations, causing a sync loss. In this event, coarse sync is re-established within the two-second interval.

Fine synchronization is required because of the non-zero wave propagation time between master and slave stations. As an example, consider a slave station situated 30 miles from the master station. Since an electromagnetic wave travels at a speed of about 186,000 miles per second, 30 miles / 186,000 miles per second = 161 microseconds. Hence, the slave station will "think" the start of a message slot occurs 161 microsecond later than the true instant. In order to bring the slave station into sync within the resolving limits of the

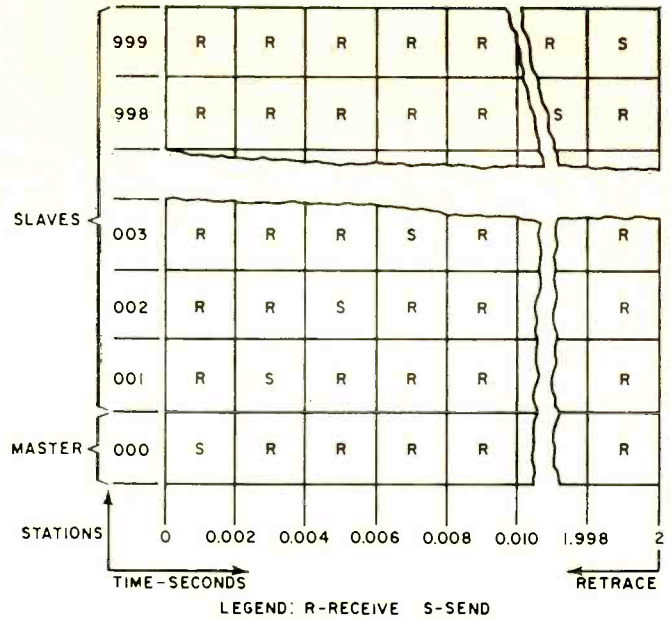
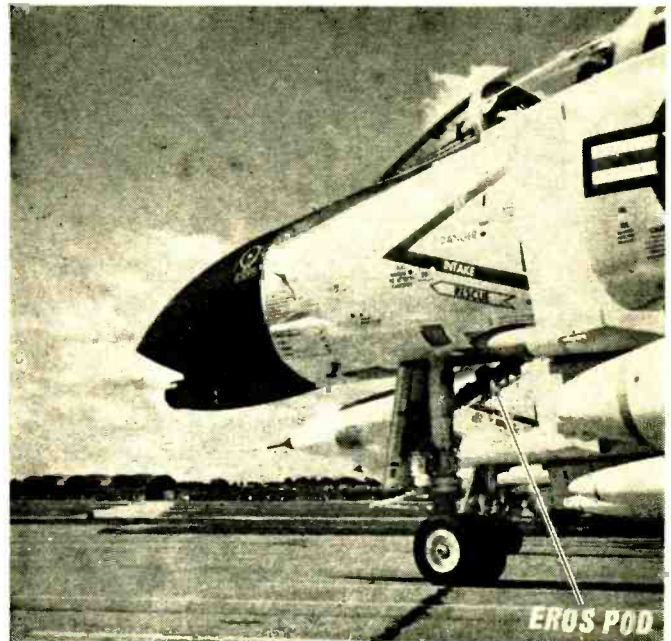
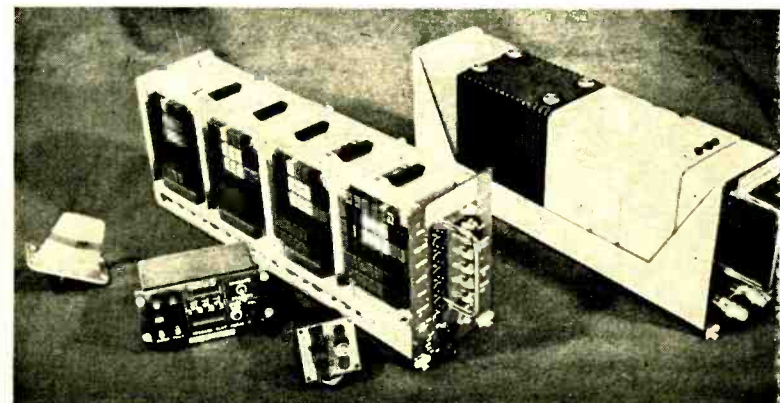

Fig. 1. The EROS message format uses 1000 2-MS message slots.



McDonnell Douglas "Phantom" jet with CAS equipment indicated.

Mockups of EROS II equipment shown for commercial installation with an air transport rack, instrument and control panel form factors. Control unit has been changed. Development program objectives include increased range and range rate measuring capacity to provide coverage of the supersonic transport.



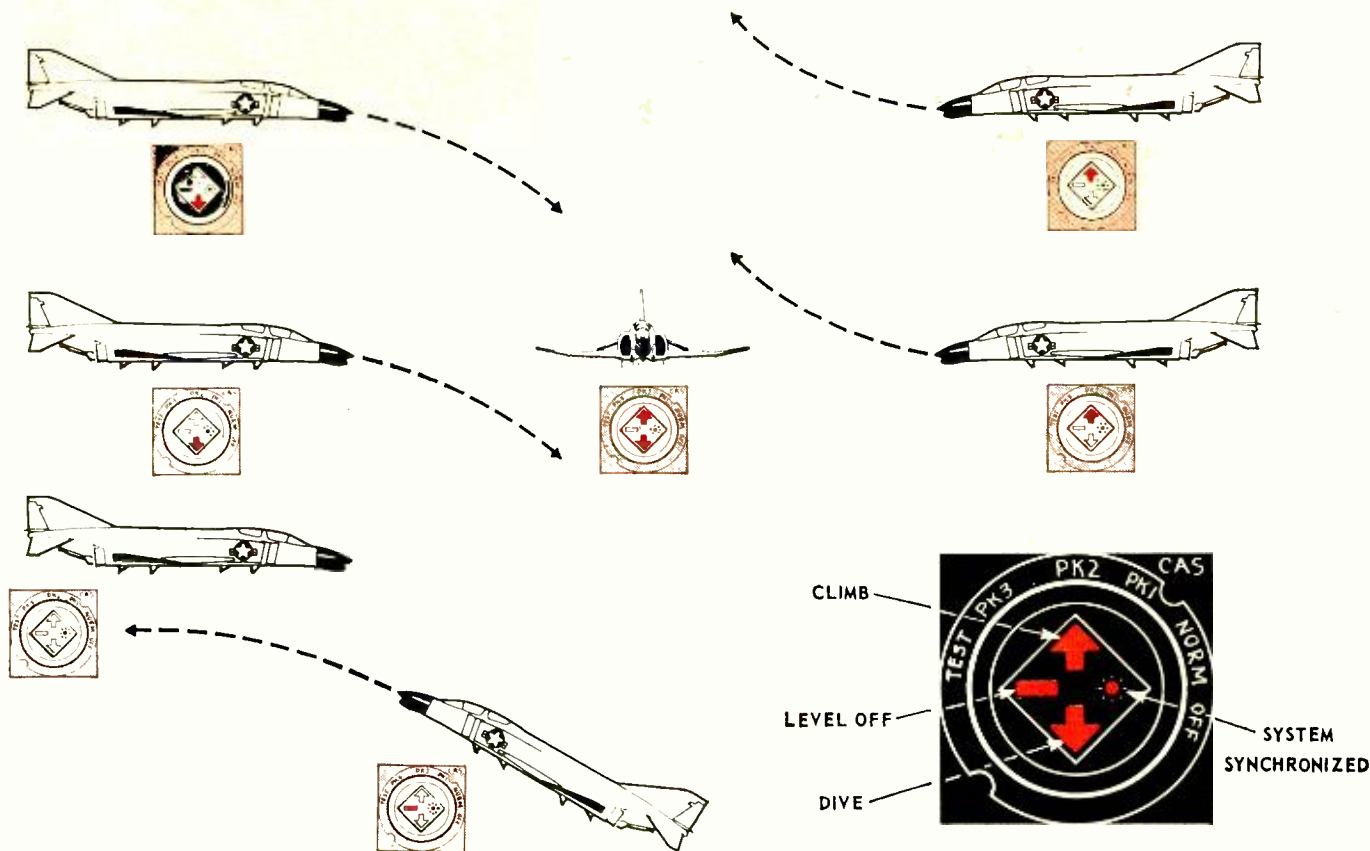

Fig. 2. Three cases of alarm maneuvers are indicated here along with the visual cockpit indications shown.

Range	40 miles air/air; 120 miles air/ground/air
Number of Message Slots	1000
Cycle Time	One signal from each aircraft every 2 sec.
Message Slot Length	2000 μ s
Altitude Range	-1000 to +60,000 feet
Doppler (Range Rate) Range	0-3000 knots, \pm 50 knots
Transmitter Power	300 watts air; 1000 watts ground
Frequency	1545 Megahertz

Table 1. Summary of EROS system specifications (F-4 installation).

on-board oscillator (1/5 MHz or 0.2 microsecond), a fine sync technique is used.

The master station "waits" until it receives a transmission from the slave. This signal is received at the master station at a time later than the transmission from the slave by an amount equal to the propagation time \pm time error. The time error includes drift in the station oscillator from the 5-MHz standard frequency. At the time of the start of the particular message slot at the master station, an auxiliary counter in the master station is started. The counter is stopped when the signal from the slave is received, and this interval measured. This interval then gives the total time error between master and slave.

A time, late in each message slot, is reserved for fine sync. This fine sync consists of three pulses, each 1.6 μ s long, separated by 6.4 microseconds, and is transmitted by the master. The time at which this fine sync signal is transmitted is determined by the error measurement mentioned before. The sync signal is transmitted at a time such that the propagation delay time will cause the sync signal to arrive at the slave at a time differing from the proper sync time by the error time. The slave counter then switches from the normal rate to a double rate for a time determined by the difference (error) between the slave apparent sync time and true (master station) sync time. When fine sync is attained, the counter that is employed

in the system switches back to the normal counting mode.

The information transmitted by each slave station during its message slot is at a frequency of 1545 MHz. Other stations reference this signal to the start of the message slot and thus compute the range of the sender. By measuring the frequency change, or Doppler, the range rate is known. In addition, altitude is coded into the transmission to give all the required decision-making information.

The logic of the slave station is such that a warning is given if either of the following conditions exist at a slave station: 1. Aircraft within 1 1/2 miles, regardless of range rate, flying at the same altitude, and 2. Aircraft within 60 seconds, or if climbing or descending, at an altitude it will pass through in 60 seconds.

The climb/descent feature is obtained by the slave station's observing of the change in altitude of other slaves.

If a possible collision condition exists, an aural signal tells the pilot to look at the EROS indicator. The cockpit indicator informs the pilot to "climb", "dive", or "level off". Fig. 2 illustrates three cases of alarm maneuvers, along with the cockpit indications. The alarm is set up so that compatible maneuvers always result. One aircraft is instructed to descend, while the other plane is told to climb.

In the event three aircraft are involved, the third plane would receive both the "climb" and "descend" instructions and would thus do neither. This indication would remain until one aircraft had cleared the zone, and the situation then reverts to the two-airplane case already explained.

If an airplane is climbing or diving into a collision situation, that aircraft is told to level off. For formation flying, blocks of message slots are made available by the "pack" switch positions on the EROS cockpit indicator. Specifications for the system are given in Table 1.

The EROS I system we have discussed was packaged to fit into a Sparrow III guided-missile pod. The pod allows easy installation and removal from production test aircraft.

The master ground station, in addition to the functions already discussed, can identify, locate, and obtain altitude information on each EROS-equipped (Continued on page 90)

STABLE, LOW-COST REFERENCE POWER SUPPLIES

By CARL DAVID TODD

Design of a "standard" voltage supply for small laboratories or shops, using economy-grade transistors as temperature-compensating diodes. May be used as a d.c. or a.c. calibrator to monitor small voltage changes.

A VERY stable voltage source of known value can be a useful addition to any lab or shop. It can help you calibrate instruments or serve as a comparison to monitor very small voltage changes. Imagine having your own complete reference supply with the following characteristics: 1. Temperature coefficient less than 0.002%/°C; 2. Operating stability better than 0.03% even with line-voltage fluctuations of ±15%; and 3. Warmup time less than two minutes.

The least expensive unit you could buy would cost far more than the components for the basic unit described here. Even if you buy all the parts new, you will spend less than \$10.00. The secret of its low cost is in utilizing one characteristic of some economy-grade transistors.

Basic VR Diode Regulation

Let's start by looking at the diode VR (voltage regulator) circuit of Fig. 1. Voltage supply V_1 and resistance R_1 establish bias current I_1 through the VR diode according to the operating load line drawn on the diode's characteristic curve.

We would like to obtain an output voltage, V_o , which remains constant. Two sources of output-voltage variation or error are input voltage and operating temperature. Let's see what we can do to reduce output error, even though input voltage or operating temperature may vary.

First, consider what happens as the value of unregulated input voltage V_1 is changed. If V_1 increases, the load line just assumes a new position—parallel to the former one and above it. The result is an increase in current flowing through the diode, which causes a slight increase in the voltage drop across it. The change in V_o will equal the product of the current change times r_d , the dynamic resistance of the diode.

To reduce the output-voltage variation, we might try reducing r_d . For a particular VR diode, we could increase bias current I_1 since r_d is somewhat a function of bias current. Unfortunately, this would just cause a larger variation in I_1 with any change in V_1 so we would gain very little improvement in the control of V_o . We might also try decreasing the slope of the load line. This would necessitate a higher value of R_1 and a higher value of V_1 . However, if the percentage of variation in V_1 remained the same, we would still gain little. We need a better way.

We can replace R_1 with a constant-current device such as the transistor circuit of Fig. 2. As long as we keep voltage V_2 constant, the emitter current of Q_1 stays at a fixed value. If the current gain of Q_1 is relatively high, collector current is just about equal to emitter current and also remains constant. In a practical circuit, V_2 can be developed by a second VR diode— D_2 in Fig. 2B.

The second source of output-voltage variation in the basic regulator circuit of Fig. 1 is the temperature co-

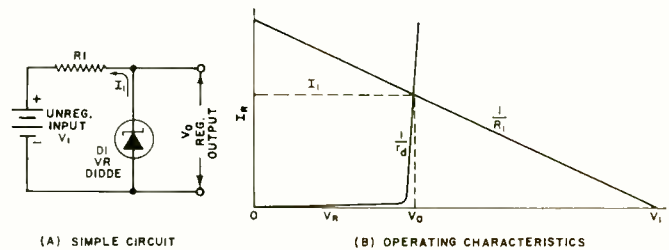

Fig. 1. The simplest diode-type voltage regulator circuit.

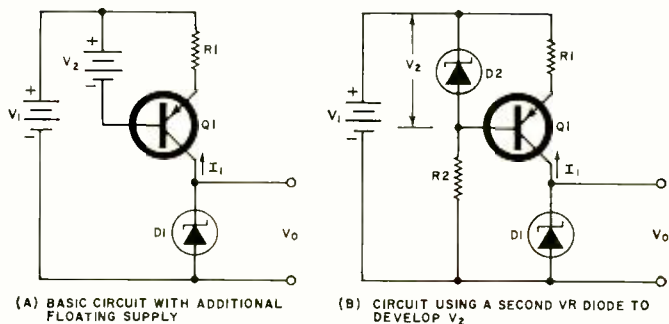
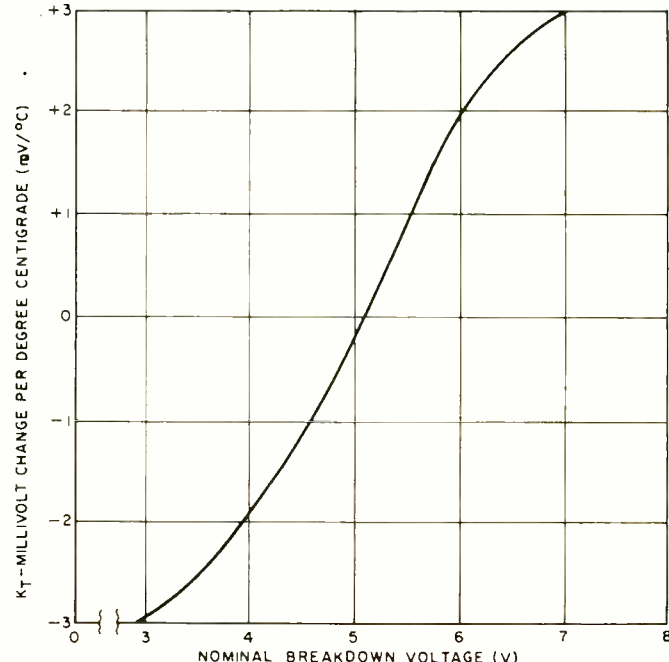

Fig. 2. Adding constant-current regulation for bias current.

Fig. 3. A graph of temperature coefficient versus breakdown voltage. This curve is typical of voltage-regulator diode.



which this approach is capable, it is also necessary to control the K_T of the bias current since this could create a temperature error greater than the one compensated for. To meet the 0.001%/°C performance stipulated above, we must keep the level of bias current within 0.1%/°C. If we carefully adjust the current through our homebrew compensated VR diode, we can produce an intentional temperature error which is equal in size but opposite in sign to the net sum of any other temperature errors. The result can be a very tight K_T for the package.

Operating Circuits

A practical circuit for a stable reference supply is shown in Fig. 6. Q1, Q2, Q3 and R1, R2, R3, R4 make up the constant-current bias source for Q4 which is the transistor being used as our temperature-compensated VR diode.

In order to produce a bias current that is stable with temperature, the E-B diode of Q1 (biased in a forward direction) and Q2 compensate for any change in V_{BE} for Q3. The net voltage across R2 therefore remains constant with temperature.

R4 provides a means of adjusting the temperature coefficient of the over-all supply by varying the bias current. A lower-than-optimum bias current gives a negative K_T while a higher value yields a net positive K_T .

Resistors R2 and R3 should be wirewounds to prevent temperature problems. They need not be precision units—in fact, Ohmite "Brown Devil" power resistors will work quite well.

Terminals A and B are provided to compensate for external loading. If, for example, a load resistance of 10,000 ohms is to be tied to the output, we can make the bias current through Q4 constant (and thus hold the output voltage) by increasing the current output from Q3. This is easily done by connecting a resistor, of the same type and value as the load, between A and B. This technique not only allows for correction of most output-voltage error which might result from loading, but also keeps the K_T of the output voltage constant. Load resistances down to about 2500 ohms are practical.

The basic reference supply in Fig. 6 provides a very stable voltage of approximately 6.7 volts at an output resistance of approximately 10 ohms. Adding one of the output circuits of Fig. 7 will permit an adjustable output voltage.

Using the simple potentiometer of Fig. 7A at the output gives us a way to vary the output voltage. We would need to compensate for the loading effects of R5 either by placing a 5000-ohm wirewound resistor between A and B or by changing R2 to 1000 ohms. The output voltage will not be calibrated but it will be very stable and thus may be used as a reference to measure small voltage changes, as will be discussed later.

By using the more elaborate output circuit of Fig. 7B, we can obtain output voltages that correspond to the readings of a multi-turn dial attached to the 10-turn potentiometer used for R7. (The open-circuit output voltage will be one-half the dial reading on a 0-10 basis.) Calibration potentiometer R5 permits us to adjust the full-scale voltage to exactly 5 volts. For the output voltage to be accurate, no appreciable loading of the output is permissible. Maximum output resistance is approximately 1700 ohms.

Fig. 8 shows a circuit that permits 0-10 volts output. The open-circuit output voltage corresponds exactly to the dial reading of the counter associated with R7. Two home-made temperature-compensated VR diodes are connected in series to permit the higher output voltage. The maximum output resistance is 3300 ohms.

Construction Hints

Before assembling your reference supply, measure the breakdown voltage of all the 2N3638 transistors. Use the circuit of Fig. 4 with $V_1 = 22\frac{1}{2}$ volts and $R_1 = 3300$ ohms.

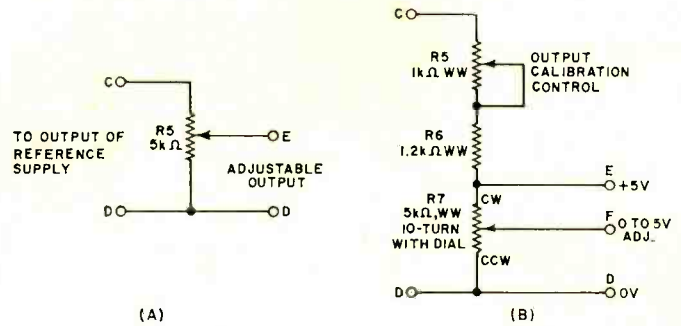

Fig. 7. Output circuits for reference supply. (A) Simplest version. (B) Precision-type output control with calibration.

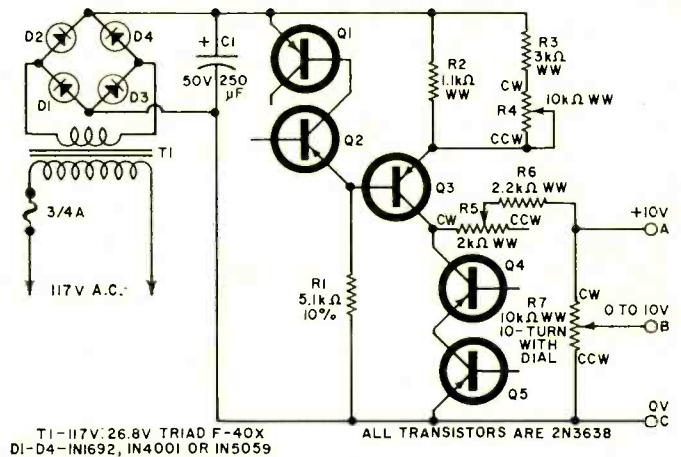

Fig. 8. Complete 10-volt constant-voltage reference supply is independent of temperature, due to low-cost transistors wired as temperature-compensated voltage regulator diodes. Parts for elaborate version cost under \$25, with a precision dial.

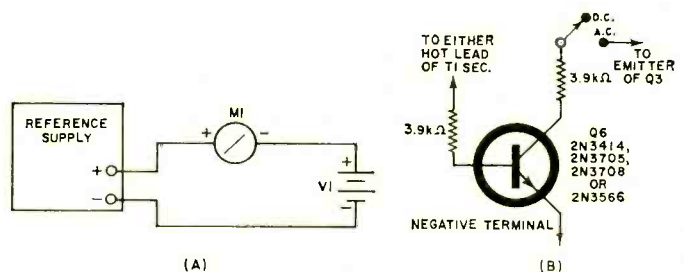

Fig. 9. Accessories. (A) Hookup to adjust temp-compensation pot. (B) Chopper circuit, so supply can make a.c. measurements.

This allows you to spot any maverick units by making sure the breakdown voltages of the transistors to be used as temperature-compensated VR diodes (Q4 in Fig. 6 and Q4 and Q5 in Fig. 8) are between 6.55 and 6.75 volts.

Circuit layout is not critical, although best performance is obtained when all the transistors are mounted close together so they operate at the same temperature.

Calibration and Adjustment

Precise adjustment of temperature coefficient can be accomplished while monitoring the output voltage as ambient temperature is varied. Fig. 9A shows a possible test arrangement. V_1 must be a relatively stable power source, at least during the test. M1 is a v.o.m. set for its lowest current range. Be sure to get the polarities of the meter and the supplies correct. The reference-supply output should be adjusted until the two values are exactly equal (no meter deflection) at room temperature.

Now place the power supply in an oven which has been heated to about 100°C (212°F on your wife's oven control) and allow it to stabilize for 5 to (Continued on page 79)

SELECTING THE RIGHT CONSTANT-VOLTAGE TRANSFORMER

By B. C. BIEGA / Director of Engineering, Sola Electric Div. (Sola Basic Industries)

Factors to consider include type of waveform required, capacity, range of regulation, temperature, and mechanical considerations.

MOST electronic and electrical devices, such as instruments, system controllers, amplifiers, and data-processing equipment, require a certain narrow range of input voltage to operate properly. But, since line voltage varies widely both above and below normal, some type of internal voltage regulation is almost always required.

One of the more widely used regulators is the constant-voltage transformer (CVT). But these ferroresonant devices must be applied correctly to produce maximum benefit. (For a description of their operating principles, refer to the article "Voltage-Regulating Transformers" by John Frye on page 62 of our July 1965 issue.—Editor)

CVT's vs Standard Transformers

Since virtually every application requires a transformer—usually a step-down type—designers should consider combining the voltage transformation operation with line-voltage correction. Although the cost of a CVT that does this would normally run about twice the price of a conventional transformer, this extra cost can be offset by a reduction in the number of components required if a CVT is used.

For example, let us assume a given solid-state device

must maintain an output of 0.01 percent and the line-voltage swing is $\pm 15\%$ for a total swing of 30%. If a CVT is used as a pre-regulator, with an output of only $\pm 1\%$, the solid-state regulating components need only handle that swing, not the total 30% variation. In this case, the saving in electronic components alone would be enough to pay for the extra cost of a CVT. Also, far less heat-sink capacity is required because solid-state regulators operate more efficiently with reduced voltage variation, thus dissipating less heat.

Specifying a constant-voltage transformer in the design also reduces the number of active circuit components required. One precision instrument manufacturer reports that use of a CVT provides the same degree of regulation accuracy with far fewer components than electronic regulation and at a lower cost. And fewer components in the instrument mean fewer chances of subsequent failure.

Sine-Wave Output or Not?

The designer's first choice rests between a standard CVT with a non-sine-wave output (Fig. 1A) and special CVT's with sinusoidal outputs (Fig. 1B). For a wide range of applications, the distorted sine wave of the standard CVT is no problem. In fact, if the application calls for rectifying the CVT output, the non-sinusoidal waveform is advantageous. Since the distorted waveform resembles a square wave, the amplitude of ripple in the rectified output is lower than when a pure sine wave is rectified. Consequently, less filtering is required.

However, in order that the right d.c. output may be provided, designers should take into account the lower d.c. output provided by the near square wave in comparison with a sine wave of the same r.m.s. voltage. Most CVT's have name-plate ratings in r.m.s. Therefore, for a rectification application, a standard CVT should be chosen with a slightly higher output voltage than normally required.

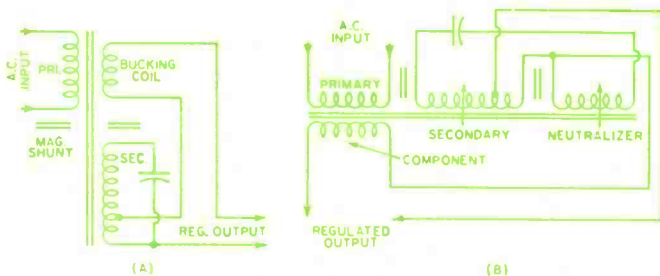
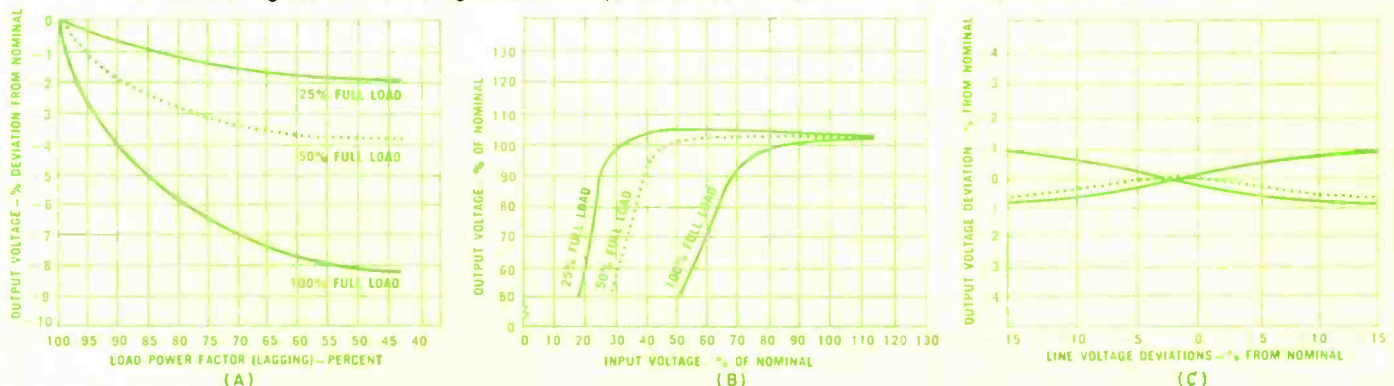
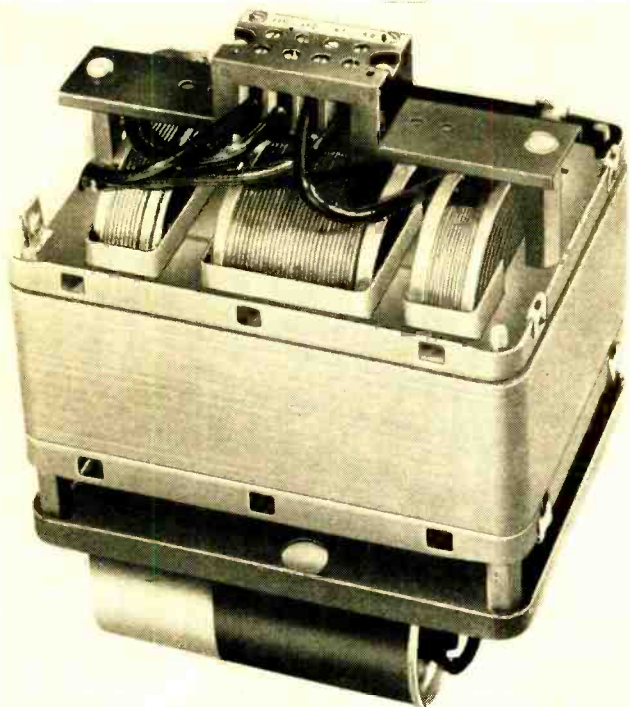

Fig. 1. (A) Normal CVT produces a non-sinusoidal output. (B) For sine-wave output more complex design is required as shown.

Fig. 2. (A) Changes in medium voltage level with changes in load and load power factor. (B) Extension of constant-voltage transformer regulation action at light loads. (C) Typical residual voltage variations within guarantee limits of $\pm 1\%$.





If a particular application requires almost pure sine-wave output to operate properly, a CVT that provides this type of waveform must be chosen. CVT's with sine-wave outputs generally cost about 10% more than standard CVT's.

Capacity Requirements Next

After selecting the right type of CVT, capacity of the unit should be the next consideration. Capacity should be at least equal to the total power requirement and, in some cases, higher. Thus, if the circuits draw a high momentary pulse current, the CVT must be rated high enough to allow for it. This is so because voltage output of a CVT falls off rapidly as load is increased beyond 150% of name-plate rating.

In many applications the current-limiting characteristic of the CVT is desirable and eliminates the need for special overload-sensing circuitry.

With low power factor loads, this sharp drop in output voltage occurs at smaller overload and even at less than name-plate rating (Fig. 2A). Increasing the CVT capacity to allow for pulse currents also reduces the effect of low power factor, thus eliminating the need for power factor correction capacitors or at least reducing their size. Another advantage of using a CVT larger than required for normal load current is that better line-voltage regulation and better load-voltage regulation are achieved (Fig. 2B).

Input Frequency & Regulation

Where the CVT and the device it is a part of are for use with normal utility-supplied power, there is no need to be concerned with frequency variation. The power grid system in the United States requires that frequency be controlled very accurately for correct operation. But, since a standard CVT is not insensitive to frequency changes, a special constant-voltage device should be specified for equipment to be used overseas and in areas where power sources are not reliable. Typically, the output voltage of the CVT will vary 1.6% for every 1% of frequency change.

The degree of output-voltage regulation should be considered carefully. Unnecessary reduction of the width of the regulation band can be very costly. Most standard constant-voltage transformers economically deliver an over-all output voltage regulation of $\pm 1\%$ for relatively fixed loads from nominal input lines (± 10 to 15% line variation and less than ± 0.5 Hz frequency variation). Detailed performance

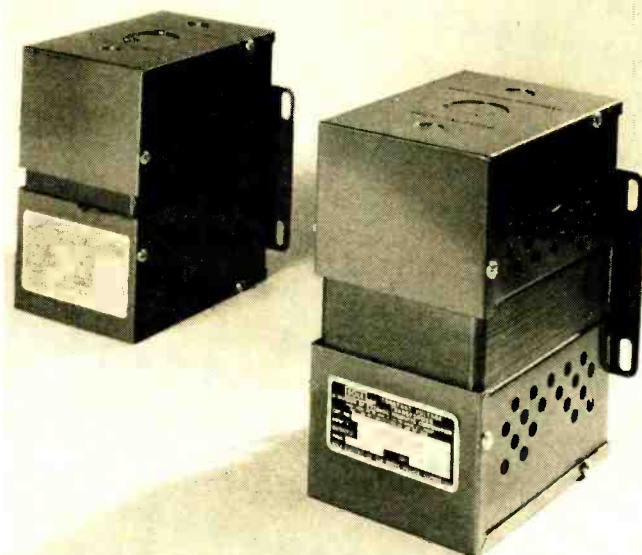

A pair of typical constant-voltage transformers are shown.

← Interior photo of coils and core assembly of constant-voltage transformer before end-bell housings are bolted in place.

of the CVT within these limits is an area of accuracy rather than a line or curve (Fig. 2C). Typical performances shown in this graph indicate most residual changes take place near the extremes of the input range. It is thus possible to obtain substantially better than 1% regulation if a.c. line variations remain within a tighter range from 105 to 125 V, for example.

If the application requires output voltage regulation of $\pm 0.5\%$, special CVT's can be designed and built, but obviously at far higher cost than a standard unit.

Another way of obtaining tighter output regulation is to operate two units in cascade, with the output of one CVT feeding the input of another. Regulation of $\pm 0.25\%$ is possible with such a system. The first, or "driver", unit should be a sinusoidal output type of the VA rating next larger than the second, which is rated for load requirements.

Combined Specs an Advantage

Probably the most efficient way of specifying a constant-voltage transformer is to lump all applicable design parameters into a single minimum/maximum worst-case combination. Specifying individual parameters and their individual tolerances may result in the CVT vendor being forced to design a unit more sophisticated and costly than actually required. The usual parameters that could be grouped in this maximum/minimum envelope include: input frequency, line regulation, load regulation, and load variation.

Here is a typical case: a nominal a.c. voltage of 120 V at 8 A is required. Input line voltage varies from 100 V to 130 V; frequency is 60 ± 0.5 Hz; load varies from 1 to 8 A with short-time overloads up to 12 A for not more than 5 minutes. Under the overload condition, output voltage may be permitted to drop to 115 V. Maximum output voltage permissible at no load is 125 V. Harmonic distortion up to 5% can be tolerated.

The CVT specification should be written as follows: input, 100 to 130 V at 60 ± 0.5 Hz; load, 1 A to 8 A at 0.8 power factor lagging with loads up to 12 A not more than 5 minutes duration; output, $120 \text{ V} \pm 5 \text{ V}$ for any input voltage, frequency, or load; ambient temperature, 15°C to 40°C ; harmonic distortion, 5% maximum.

If the specification had been written as directed by a manufacturer's standard catalogue, it would have appeared as follows: Output: $120 \text{ V} \pm 1\%$ at nominal line, $\pm 1\%$ output variation for line variation (Continued on page 69)

THE INSTRUMENTATION TAPE RECORDER PART 2.

By RAY A. SHIVER/AiResearch Mfg. Co.

Three basic systems for analog recording are covered, along with electronics used. Included are direct-record, FM, and PDM methods and their applications.

LAST month's article offered a brief history of the development of the magnetic tape machine and provided a detailed description of the construction of the modern tape transport and its mechanical and electrical features. This article will describe the three basic systems for analog recording and the electronics used. An analog system is any method whereby the output signal is a reproduction of the input system, that is, it is not converted to another form such as a coded format used in digital recording.

The Direct-Record System

As the name implies, direct recording is a method whereby the signal appearing at the record head is essentially the same as the input signal and does not undergo conversion. Fig. 1 shows the operational sequence as it occurs at each stage of the recording and reproduction process. The pre-amplifier section of the record amplifier is a straightforward RC-coupled circuit that produces enough voltage gain to drive the output stage. The output amplifier is a constant-impedance current amplifier with a low output impedance designed to work into the record head. This permits a fixed driving impedance over a wide frequency range. The bias oscillator signal is also inserted at this point. The two signals are mixed and applied to the record head as shown in the diagram.

The reproduce signal at the playback head is shown minus the bias oscillator signal. Most of this is lost due to the spacing of the reproduce head gap. It is not sufficiently small so as to reproduce the high-frequency bias signal. The remainder of the bias signal is usually removed by a simple RC filter.

From this point the signal is amplified through the pre-amplifier stage and applied to the equalizer network. This is shown in the diagram of Fig. 2. The frequency response curve as it would appear at the output of the record head is shown as Curve A. Since the driving source impedance remains constant at the record head, the output response curve is mainly a product of frequency vs the inductive reactance of the head assemblies. In order to produce a flat output response curve it is necessary to provide an equalizing network that produces a response as shown in Curve B. It will be recognized that this is a mirror image of Curve A and would, in effect, produce an output response like that of Curve C. This is a typical curve for a direct-record system and most instrumentation recorders will provide a response of ± 3 dB for the full recording range. In most portable-type recorders, the equalizers are plug-in units and must be changed for each tape speed. In the more sophisticated types of machines the equalizers are switched automatically each time that the tape speed is changed.

Applications for Direct Recording

Since it has been pointed out that the direct-record system has a response of ± 3 dB for full-range recording, this system does not lend itself to data that requires precise amplitude accuracies. For this reason, direct recording in instrumentation is generally limited to applications where frequency data rather than exact amplitude is important. In this respect, direct recording is as good as any system since frequency or timing accuracy is dependent on the stability of the tape transport.

One of the earliest and still most important uses for the direct-record system is the recording of telemetry signals from aircraft and missiles. The wide frequency response of the direct system lends itself to this application. A simplified diagram of such a system is shown in Fig. 3.

The output voltage from one of the transducers is used to modulate the subcarrier oscillator (s.c.o.). The s.c.o. is a voltage-controlled oscillator in which a change in the level of the input voltage will change the frequency of the oscillator proportionally. The resultant FM signal is mixed with the outputs of the other s.c.o. units and the composite signal is used to phase-modulate a crystal-controlled transmitter.

At the ground receiving station the signal is received on the FM receiver, demodulated, and applied to the instrumentation tape recorder. In this manner the individual s.c.o. frequencies are recorded on tape. To reproduce the original analog signals, the tape is played back into a bank of FM discriminators, each of which is tuned to its corresponding unit in the aircraft or missile. Such a system is called an FM/PM multiplex system after the modulation used.

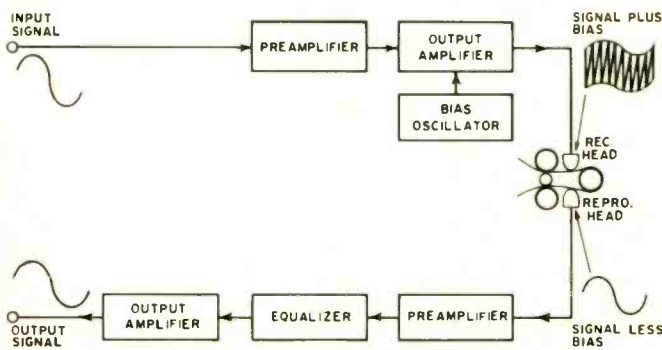
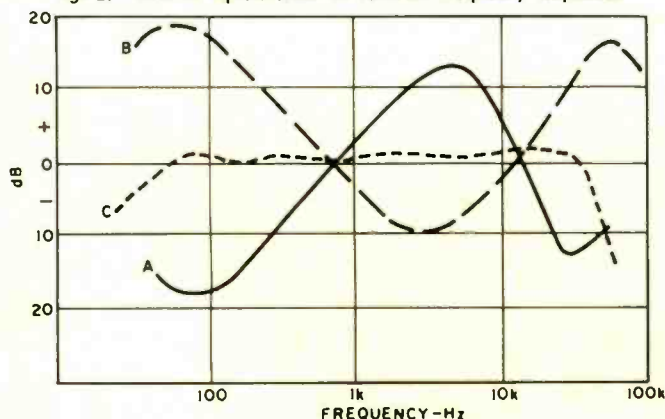

Fig. 1. Block diagram of the direct-record system described.

Fig. 2. Effect of equalization on recorder frequency response.



A system of multiplexed subcarrier frequencies necessarily limits the frequency range of each data channel. For example, on telemetry channel 18, the FM center frequency is 70 kHz and the nominal frequency response is 1050 Hz. This value may be doubled if the adjacent channels are omitted, with a corresponding decrease in the capacity of the system. The frequency response decreases as the channel number and channel 1 has a center frequency of 400 Hz with a range of only 6 Hz.

With this restricted frequency range it is important that transducers be assigned to channels that will adequately cover their frequency range. Referring to Fig. 3, it will be noted that the vibration transducer is assigned to channel 18 since a range of about 1 kHz is appropriate for this type of transducer. The magnetic flowmeter is a low-to-medium frequency device and channel 14 would be appropriate. Since the output of a thermocouple is a d.c. voltage with a slow rate of change (except for special high-response types), it is suitably covered by the limited response of channel 3.

From the above example, it can be seen that it is possible to record a large number of transducer outputs on one direct-record channel by using the appropriate telemetry equipment.

The FM System

The FM system of recording was developed primarily as a means of recording d.c. and extremely low frequencies. A great many of the transducers used in instrumentation provide output voltage of this type. A block diagram of a typical FM recording system is shown in Fig. 4.

The d.c. preamplifier will accept input signals from d.c. to 20 kHz. The signal is then applied to the v.c.o. which supplies an output signal whose frequency is proportional to the level and rate of change of the input. At this point the signal is FM and further d.c.-coupled stages are not needed. The output amplifier drives the record head to the point where the tape is near saturation at all times. This explains the excellent signal-to-noise ratio obtained with this system. There are no amplitude variations and the signal remains at a consistently high level which virtually eliminates tape noise. Also, since the amplitude is limited in FM recording, the effects of head inductance are of no consequence and the frequency response curve can be made quite flat, ± 0.5 dB for the full recording range being quite common.

The signal is recovered at the playback or reproduce head as shown in the diagram. Several stages of limiting are generally used in the input stages of the playback amplifier before the signal is applied to the discriminator. The discriminator is usually a phantastron or similar circuit which produces a linear output pulse each time the input is triggered. The pulse train is used to drive a charging circuit which produces an output voltage analogous to the input signal. A low-pass filter is included in the output circuit to remove the center carrier frequency.

Since the accuracy of FM recording is determined primarily by the stability of the tape transport system, it is important that a precision drive system be used if the benefits of this type of recording are to be realized.

Applications for FM Recording

Any transducer that produces a d.c. output voltage which is analogous to some function to be measured can be recorded by the FM method. This would include such devices as thermocouples, strain gages, pressure transducers, and potentiometers. Transducers of this type generally produce a slowly changing (quasi-static) d.c. output voltage which permits one of the slower tape speeds to be used with a corresponding saving in tape. Since the recording range for FM is very linear right down to d.c., many low-frequency transducers can be measured with this system. This would include flow meters, vibration pickups, and tachometers.

Also FM recording offers the most accurate means of reproducing data in the medium-to-high frequency range (up to 20 kHz at 60 in/s). Some transducers that operate in this particular range include accelerometers, speed pickups, dynamic strain gages, and capacitance probes.

Pulse Duration Modulation

PDM is a method whereby 30 or more channels of data can be recorded on one tape track. This is possible with rotating commutators used as a means of sampling many separate channels of data rapidly. A diagram of such a system is shown in Fig. 5. The commutators are essentially rotating switches with 60 or more segments driven by synchronous motors. The keyer unit converts the data samples into pulses of equal height but of varying duration, as shown in the diagram. The pulse duration (*Continued on page 63*)

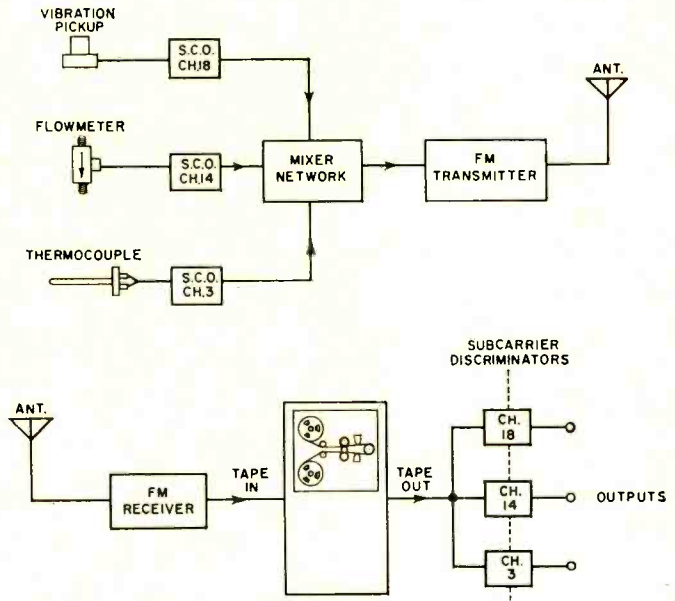

Fig. 3. A number of transducers may be multiplexed on signal.

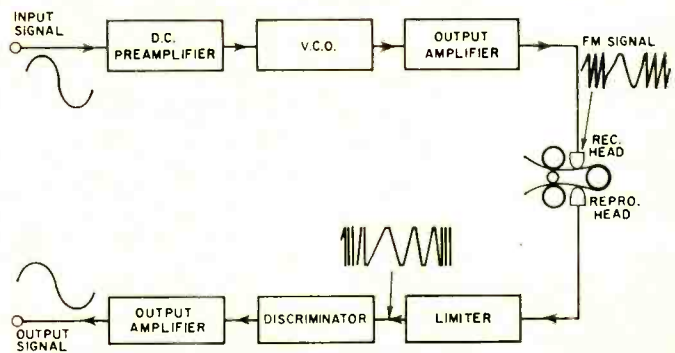

Fig. 4. Block diagram of FM system of recording described.

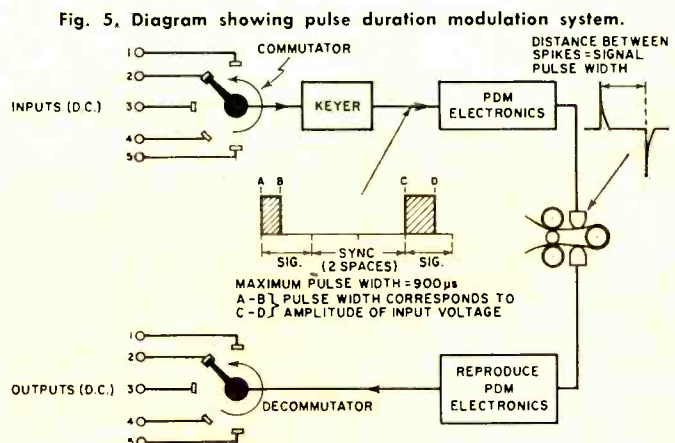

Fig. 5. Diagram showing pulse duration modulation system.

Designs For LOG-PERIODIC FM & TV ANTENNAS

By HAROLD D. PRUETT

Asst. Professor of Physics, Colorado State University

An FM-only and FM-TV antenna are described with gains of 10-12 dB, beamwidths of about 50°, and front-to-back ratios greater than 20 dB.

THE importance of a good antenna for satisfactory reception of FM-stereo or color-TV cannot be over-emphasized. Unsatisfactory reception is often blamed on the receiver but, in many cases, the difficulty is that the antenna is not providing a large enough signal or is picking up signals from undesired directions. Low signal levels result in a high background noise level in the case of FM-stereo or "snow" in the case of a TV picture. Signals from undesired directions produce multipath distortion or "ghosts" for the same two systems, respectively.

In this article the role of the antenna as well as some details on the log-periodic antenna will be discussed. Plans are included for constructing two such antennas, one for FM only and the other for both TV and FM. These antennas will provide both an adequate signal level and enough discrimination against signals from undesired directions for most reception areas. Cost of materials for constructing either of the two antennas is less than \$5.00, materials are readily available, and no special skills or tools are needed.

Role of the Antenna

A brief discussion of the role of an antenna in a receiving system seems appropriate before proceeding to consideration of the log-periodic antenna. In all imaginable situations where information is transmitted, achieving an acceptable signal-to-noise ratio is a primary consideration. A non-directional antenna can pick up and transfer signals to a receiver, but while it is picking up a desired signal from one direction, it is picking up undesired noise from all di-

rections. In contrast, a directional antenna achieves gain in one direction at the expense of gain in all other directions. Since only noise signals would be received from the other directions anyway, you "get something for nothing". Therefore, a directional antenna improves the signal-to-noise ratio in two ways: the signal level is increased and the noise level is reduced by directional discrimination.

A measure of the directive gain of a receiving antenna is twice the angular beamwidth, in degrees, at which the power received falls to one-half the maximum value that is obtained when the antenna is aimed directly at the transmitter. The smaller the half-power beamwidth, the higher the gain of the antenna and the more immune it is to reception of noise from directions outside the half-power beamwidth.

The similarity between the gain-beamwidth product of an antenna and the gain-bandwidth product of a feedback amplifier should be noted. However, an antenna is a completely passive device in that it cannot amplify a signal. An antenna with directive gain is an array of more elementary antennas, usually half-wave dipoles, phased in such a way that their individual gains *add* in essentially one direction and *cancel* in all other directions.

Geometric Relations in Log-periodic Antenna

Many readers may wonder why log-periodic dipole array (LPDA) antennas are being widely used in home installations. The primary reason is that an LPDA antenna will cover a wide range of frequencies with nearly constant directive gain and impedance. In addition, its directive gain for a given antenna length is greater than that of many other types of directional antennas. These factors, along with the ease and low cost of constructing LPDA antennas, should indicate the basis for their ever-increasing popularity.

The geometric configuration of an LPDA antenna is shown in Fig. 1. The antenna is an array of half-wave dipoles, each of which is formed by two quarter-wave dipoles that are connected alternately to the feeder line. When the length, l_n , of a dipole element is related to the frequency received by the equation $f = 5905/l_n$, the element will be a half-wave resonant dipole. In this equation, l_n must be expressed in inches and f in MHz. For example, a 59-inch half-wave dipole is resonant at 100 MHz, neglecting the relatively unimportant length-to-diameter and end effects. (These effects may combine to reduce the resonant length by about 2-5% or to a value of about 57 inches.—Editor)

Fig. 1. Schematic configuration of log-periodic antenna.

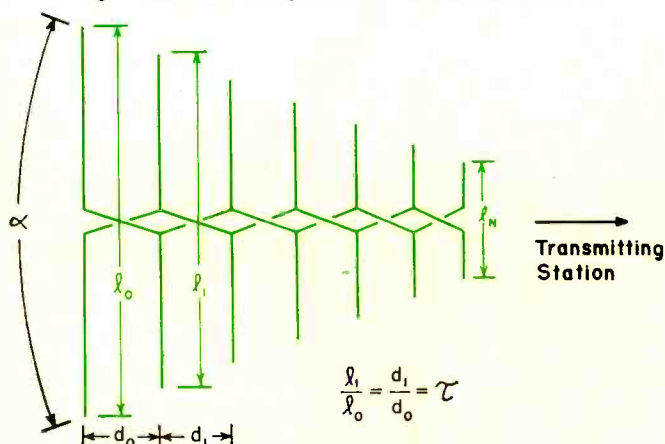

Frequency-independent operation of the LPDA antenna is achieved by imposing a condition on the ratio of successive dipole lengths and the spacing between them. As shown in Fig. 1, the ratio condition is $l_n/l_0 = d_n/d_0 = \tau$, where τ is a constant called the *scale factor*. The same condition is imposed on all other adjacent dipole lengths and spacings. If l_n is the length of an arbitrary dipole, its length is given by $l_n = l_0 \tau^n$. Similarly, $d_n = d_0 \tau^n$. If the above condition is met, and if the shortest element of the array is resonant at a frequency somewhat higher than the highest frequency to be received, the gain of the antenna will be constant and independent of frequency. This auxiliary condition is imposed to avoid another kind of end effect, the details of which need not concern us here.

As indicated earlier, an antenna with relatively high directive gain is usually an array of properly phased elementary dipoles. In the case of an LPDA antenna, which fits the above description, proper phasing is achieved by alternately connecting the quarter-wave dipoles to the feeder line as shown in Fig. 1, and by controlling the spacing d_n between adjacent dipoles in the manner described previously. Half-power beamwidths are approximately 50° for the antennas to be described, and front-to-back ratios are over 20 dB.

Frequency Considerations

The frequency band from 88 to 108 MHz is allotted to FM. On either side of this are the two v.h.f.-TV bands, one extending from 54 to 88 MHz and the other from 174 to 216 MHz. The u.h.f.-TV band, which is not yet as widely used, extends from 470 to 890 MHz. Television antennas designed prior to the discovery of the log-periodic principle were often made up of two sections, one to cover the lower frequency v.h.f. band and the other the higher frequency u.h.f. band. This is continued with LPDA antennas, but for entirely different reasons. An LPDA antenna could be designed to cover the entire range from 54 to 890 MHz, but the dipoles which resonate in the TV-frequency gaps from 88 to 174 and from 216 to 470 MHz would serve no useful function as far as TV reception is concerned. These dipoles can be omitted in an LPDA design without disturbing the response of the antenna in the frequency ranges of interest and, if this is done, a shorter, less expensive antenna can be manufactured.

If the dipoles which resonate in the FM band are omitted, the antenna will not be very satisfactory for FM reception. Anyone contemplating purchase, rather than construction, of an LPDA antenna for both TV and FM reception should examine the unit to see if these dipoles have been omitted. If so, any antenna designed for FM-only reception is likely to perform better than the so-called dual-purpose TV-FM unit. To illustrate this point, the author found one commercial LPDA antenna that was proclaimed by the manufacturer to be excellent for both TV and FM-stereo, but which had less gain on the FM band than a folded dipole!

Construction Details

There are several antenna configurations in which the dipole elements are located in accordance with the basic log-periodic principle. One such alternate configuration, which lends itself to simple construction, is the zig-zag antenna shown in Fig. 2. In this design, each linear quarter-wave dipole element shown in Fig. 1 is replaced by a "vee"-shaped element such that the perpendicular distance from the centerline of the antenna out to the point of the vee is equal to the quarter-wave length of the linear dipole it replaces.

Plans for the home-constructed zig-zag TV-FM antenna were first offered by George Monser in his article "Design for an All-Purpose TV-FM Antenna" in the November 1962 issue of this magazine. Although the antenna de-

scribed in his article is far from obsolete, the antennas to be described here have several advantages over this earlier one. First, the new TV-FM antenna has slightly higher and more uniform gain over the entire v.h.f. TV band, while the FM-only antenna has approximately twice as much gain on the FM band as the original antenna had. Next, the frame for the planar zig-zag configuration used in the present design is easier to construct than the frame used in the original design. The planar zig-zag also requires less

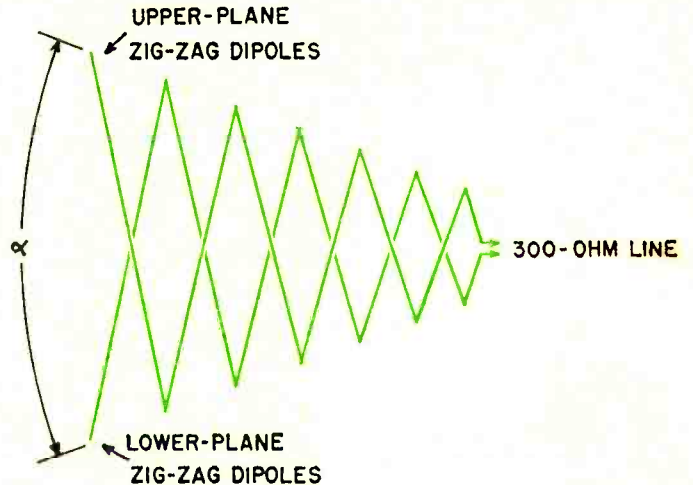

Fig. 2. Arrangement employed in the zig-zag LPDA antenna.

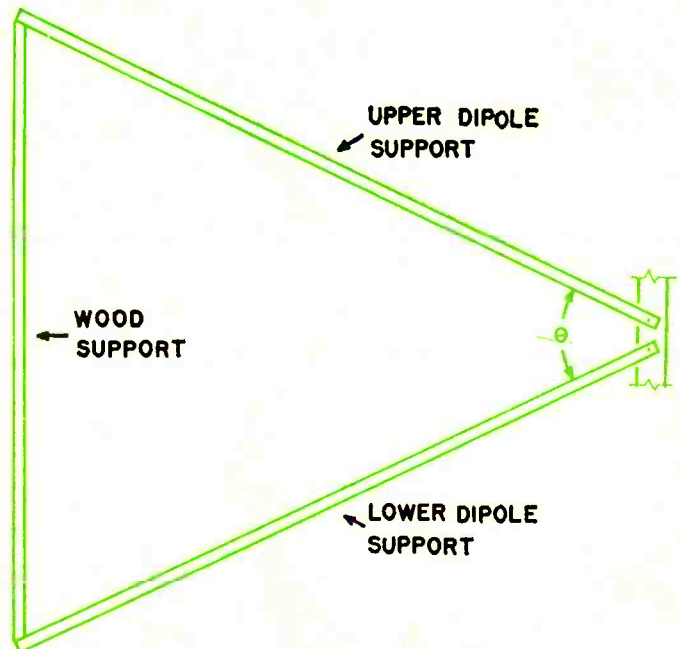
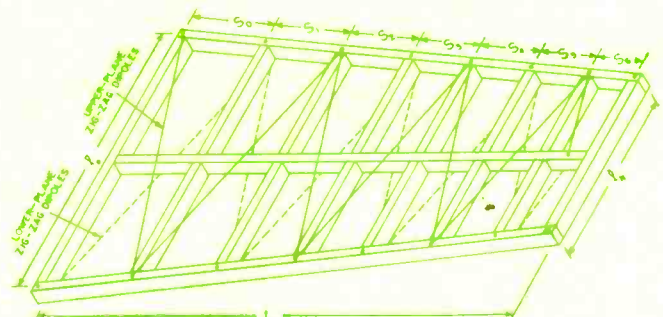

Fig. 3. Side view of the pyramidal log-periodic design shows how upper and lower dipole supports are oriented. The shortest dipole element is near apex which points to transmitter.

Fig. 4. Wood frame used to support wire zig-zag FM antenna.



vertical space for installation and can be used in an attic with an inexpensive rotor to provide multi-direction reception. Finally, the solder connections to the center feeder line used in the original design have been eliminated, resulting not only in less work, but also in a better impedance match to standard 300-ohm line.

The configuration used by Monser is called a pyramidal log-periodic design. When viewed from the side, the supports for the dipole elements are inclined at an angle θ as shown in Fig. 3. If the angle θ is reduced to zero so that the supports are parallel, but spaced a few inches apart,

n Element No.	τ^n	S_n Spacing (in inches)	ΣS_n (in inches)
0	1.0	21 $\frac{3}{8}$	21 $\frac{3}{8}$
1	.9255	19 $\frac{3}{4}$	41 $\frac{1}{8}$
2	.857	18 $\frac{3}{8}$	59 $\frac{1}{2}$
3	.793	17	76 $\frac{1}{2}$
4	.734	15 $\frac{3}{4}$	92 $\frac{1}{4}$
5	.680	14 $\frac{1}{2}$	106 $\frac{3}{4}$
6	.629	13 $\frac{1}{4}$	120

$l_0=67$ inches; $L=118.5$ inches; $l_N=39$ inches; $d_0=21.375$ inches; $\tau=0.9255$; $\alpha=13^\circ$.

Table 1. Dimensions to be used for the FM-only antenna.

n Element No.	τ^n	S_n Spacing (in inches)	ΣS_n (in inches)
0	1.000	16 $\frac{1}{8}$	16 $\frac{1}{8}$
1	.900	14 $\frac{1}{2}$	30 $\frac{5}{8}$
2	.810	13	43 $\frac{5}{8}$
3	.729	11 $\frac{3}{4}$	54 $\frac{3}{8}$
4	.656	10 $\frac{1}{2}$	65 $\frac{7}{8}$
5	.590	9 $\frac{1}{2}$	75 $\frac{3}{8}$
6	.531	8 $\frac{5}{8}$	84
7	.478	7 $\frac{5}{8}$	91 $\frac{5}{8}$
8	.430	7	98 $\frac{5}{8}$
9	.387	6 $\frac{1}{4}$	104 $\frac{7}{8}$
10	.349	5 $\frac{1}{2}$	110 $\frac{3}{8}$
11	.314	5 $\frac{1}{8}$	115 $\frac{1}{2}$
12	.282	4 $\frac{1}{2}$	120
13	.254	4 $\frac{1}{8}$	124 $\frac{1}{8}$
14	.229	3 $\frac{5}{8}$	127 $\frac{3}{4}$
15	.206	3 $\frac{3}{8}$	131 $\frac{1}{8}$

$l_0=111\frac{3}{8}$ inches; $L=123\frac{1}{8}$ inches; $l_N=21$ inches; $d_0=15.1$ inches; $\tau=0.90$; $\alpha=41^\circ$.

Table 2. Dimensions to be used for v.h.f. TV-FM antenna.

Fig. 5. Method of connecting the final zig-zag element to feeder.

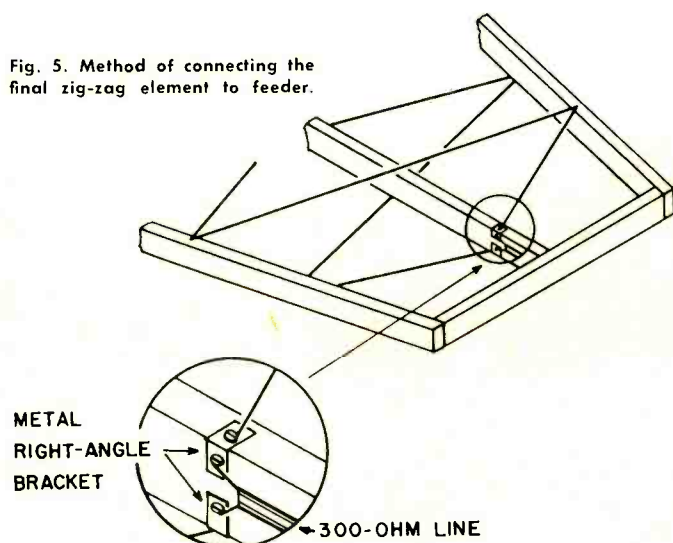

the antenna is called a *planar log-periodic* antenna. For either the pyramidal or planar configuration, the resonant elements may be linear dipoles, as in Fig. 1, or zig-zag elements as in Fig. 2. The only essential requirement for proper performance is that the inclination angle, θ , should not be larger than the angle α shown in Fig. 1.

Although used by Monser in his design, a zig-zag antenna does not require a conducting wire along the centerline when it is connected to a balanced transmission line such as 300-ohm twin-lead. By omitting the centerline wire, distributed capacitance is decreased and the antenna impedance is increased. For example, in a planar zig-zag where the planes of the upper and lower dipole elements are one inch apart, removal of the center wire will increase the impedance from less than 100 ohms to approximately 230 ohms. The 1 $\frac{1}{4}$ -inch spacing used in the present design results in an impedance slightly higher than that of a 1-inch spacing and an even closer impedance match to standard 300-ohm line.

The antennas to be described are intended primarily for mounting in the attic, although mast mounting is possible if the builder is willing to expend a little extra effort in constructing an all-metal version. Except in extreme-fringe reception areas, attic mounting is preferable for both aesthetic and practical reasons. It is doubtful that any rooftop antenna adds to the appearance of a house and, in addition, there are weather problems. Mast-mounted antennas are subject to wind damage and the useful lifetime of standard 300-ohm line is shorter when used outdoors rather than when sheltered by a roof.

A wooden frame, constructed from 1 x 2 inch firring strips (actual dimensions are $\frac{3}{4}$ x $1\frac{1}{2}$ ") is used to form and support the dipole elements for both the FM-only and the v.h.f. TV-FM antennas. The shape of the frame shown in Fig. 4 is that of the FM-only antenna; the shape of the TV-FM antenna is similar. Both frames should be constructed with the 2-inch sides of the firring strips oriented vertically. The spacing between the planes of the upper and lower dipole elements would then be 1 $\frac{1}{2}$ inches actual. Centerline-to-centerline dimensions indicated symbolically in Fig. 4 are given in tabular form in Tables 1 and 2. The column headed ΣS_n is the total distance from the large end to the n th element. The total length of the *outside* member of the frame is the last entry in the ΣS_n column. Details concerning the antenna frame supports are left to the discretion of the builder since their only purpose is to give structural rigidity.

It is best to cut and completely assemble the antenna framework in an open area to make sure that all the pieces fit together. Most attics are cramped for space and only final assembly should be undertaken there. When construction of the frame is complete, mark the positions of the dots shown in Fig. 4 by using the dimensions given in either Table 1 or 2, depending on which antenna is being built. There will be eight end-point positions for the FM-only antenna and seventeen for the TV-FM antenna. Standing at the rear (large end) of the antenna facing forward, drive nails in the first, third, fifth, etc. positions on the left side of the frame and leave about $\frac{1}{8}$ " of the nail protruding. On the right side, drive nails in the second, fourth, sixth, etc. positions. Turn the antenna frame over and then repeat the process.

After the frame has been reassembled in the attic, wire to form the dipole elements is strung between the nails. The author used aluminum clothesline wire because it is readily available, but any reasonable sized wire or tubing is satisfactory. Since a center feeder line is not required, the wire can even be covered with insulation except where it is connected to the 300-ohm line. To string the wire, connect one end to the left-rear nail on the top of the antenna, then run the wire over to and around the second nail on the right side, around the third (Continued on page 76)

ADVANCES IN Magnetic Materials

By JOHN R. COLLINS

Grain-oriented materials, new magnetic alloys, ceramic and ferrite magnets, and superconducting cryogenic magnets are just some of the new developments advancing magnetic technology.

ALTHOUGH much progress in magnetic materials can be ascribed to gradual refinements, the more important advances have come from technological breakthroughs—quantum jumps to new levels of capability. In the case of soft magnetic materials, the discovery of grain orientation was perhaps the greatest accomplishment, contributing both to economical power distribution and to important savings in size and weight for airborne apparatus. For permanent magnets, a significant milestone was the introduction of Alnico alloys which permitted, among other things, the manufacture of practical PM speakers to replace the cumbersome electro-magnetic speakers previously used. Ceramics, or ferrites, have vastly influenced both hard and soft magnetic materials. Their unusually high coercive force permits the design of relatively thin permanent magnets as compared with competitive materials; their nonconductive properties, coupled with high permeability, have revolutionized magnetics at radio and microwave frequencies. In addition, they are comparatively easy to form in irregular shapes and do not utilize critical materials.

Designing superconducting magnets for practical use has unquestionably been the greatest accomplishment in recent years. Such magnets support magnetic fields far stronger and more concentrated than any previously obtainable. They have added new dimensions to old techniques and hold the promise of solutions to problems that could not be tackled before because available magnetic fields were inadequate.

Grain-Oriented Steels

By far the greatest volume of magnetic material is used in the electric power industry for the generation and distribution of electricity. To minimize I^2R losses, voltage is stepped up for transmission of power over distances and stepped down to conventional levels before distribution to households. Large transformers are most efficient for such purposes. Doubling transformer dimensions will increase volume, weight, and losses by a factor of eight, but will increase power capacity by a factor of about sixteen. Therefore, 250,000-kilowatt transformers weighing more than $\frac{1}{2}$ million pounds are not unusual.

Transformer power loss is measured in watts per pound. Although this loss may be only a fraction of a watt per pound, the enormous amount of electrical power consumed in the world today makes even minor improvements in efficiency important. For many years transformers were made from hot-rolled iron sheet containing about 4 percent silicon to increase resistivity and thus reduce eddy currents. Typical good grade material of this kind exhibits losses of about 0.5 watt per pound at 10 kilogauss and 60 Hz. Cold rolling makes a slight improvement in the material.

Grain-oriented steels first came into production after World War II. As shown in Fig. 1A, crystals of silicon steel are magnetized most readily along their edges. It follows

that losses would be less if the crystals were aligned so that their edges were oriented in the direction of magnetization. This is accomplished by means of hot and cold rolling steps followed by recrystallization annealing. Individual grains of the alloy are aligned by this procedure so that magnetization is easy in the direction of rolling and losses are small, amounting to less than 0.3 watt per pound at 10 kilogauss and 60 Hz. Coercive force may be as low as 0.1 oersted, compared to 0.5 for ordinary silicon steel.

A further improvement in the past several years has produced magnetic steel oriented in such a manner that it has two directions of easy magnetization—in the direction of rolling and perpendicular to it. These steels make it possible to operate a transformer at 15 kilogauss instead of 10. Although losses rise to about 0.5 watt per pound at the higher flux density, the accompanying reduction in the amount of material needed more than compensates for the difference.

A parallel improvement has been an increase in maximum permeability—through refining the steel, removing impurities, and relieving strains—from about 5000 in early transformers to about 35,000 today. This represents an important increase in efficiency, since it permits transformers to be built with less material, and losses are proportional to

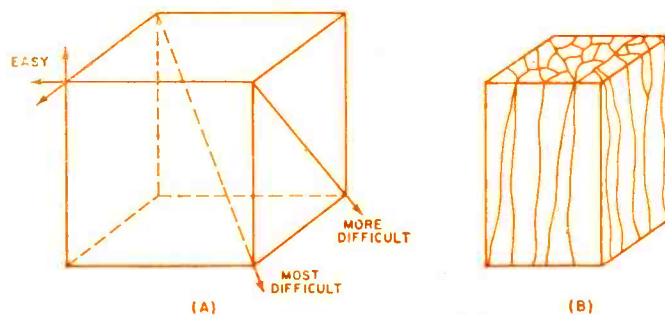

Fig. 1. (A) A crystal of silicon steel, showing relative difficulty of magnetizing along its various axes. (B) Grain structure of oriented Alnico magnetic material is shown here.

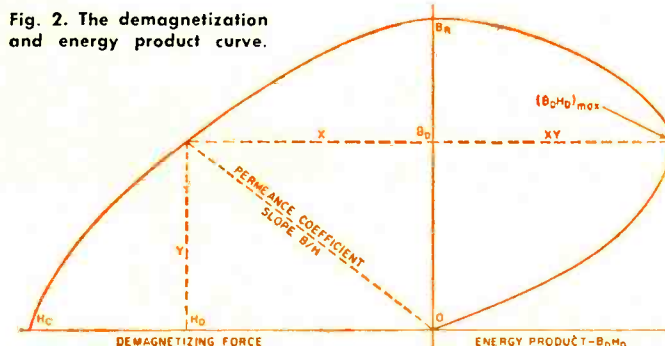

Fig. 2. The demagnetization and energy product curve.

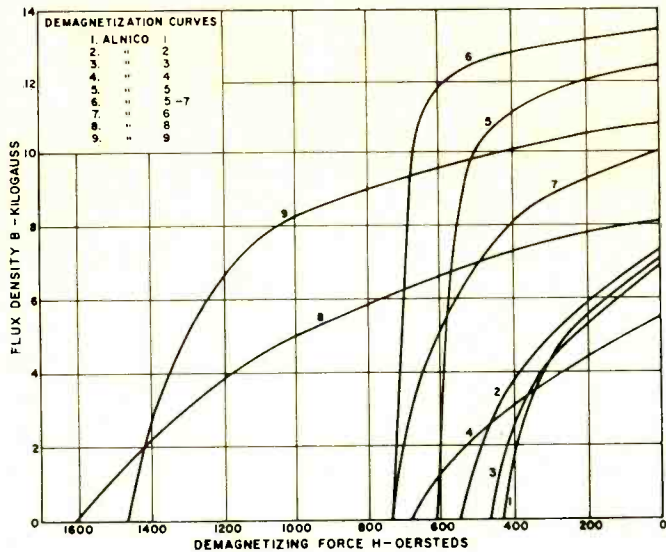

Fig. 3. Comparative demagnetization curves for various Alnicos.

weight. Far greater permeability can be achieved through further refinement, but the material is too delicate for use.

Permeability is also greatly enhanced through the use of nickel alloys. Permalloys, embodying 78 percent nickel and 22 percent iron have been quite successful, and alloys that include small quantities of chromium and molybdenum have been especially efficient, since those elements increase resistivity. A notable example is Supermalloy, which contains 70 percent nickel, 5 percent molybdenum, 15 percent iron, and 0.5 percent manganese, all of extremely high purity. When properly heat-treated, Supermalloy has maximum permeability of about 1,000,000 together with coercive force as low as 0.002 oersted. Alloys of this kind are useful for small transformers for communications equipment and specialized applications, but are far too expensive for large power types.

The Growing Alnico Family

A permanent magnet should have high residual induction to provide a strong magnetic field and high coercive force to resist demagnetization. These properties may be determined by plotting residual magnetism against the strength of the demagnetizing force, as at the left in Fig. 2. The figure of merit of a permanent magnet is its maximum energy product, measured in gauss-oersteds. This value may be determined by multiplying x and y coordinates of each point on the demagnetization curve and plotting the products as shown at the right of Fig. 2.

Early permanent magnets were made of hardened steel, usually with tungsten, chromium, or cobalt added. All had maximum energy products of less than 1 million gauss-oersteds. Carbon steel, for example, has a maximum energy product of 0.18; tungsten steel, of 0.32; 3½ percent chromium steel, of 0.29. By far the best material formerly available was 36 percent cobalt steel, with a maximum energy product of 0.94.

Because of the relatively low magnetic fields that could be obtained with permanent magnets, solenoid magnets were used almost exclusively for speakers in radio receivers and amplifiers. With the discovery of the first aluminum-nickel-cobalt alloy in 1938, however, the situation changed rapidly and permanent magnets have found increasing uses not only in speakers but in a multitude of other devices.

At the present time, there are nine such Alnico alloys in general use. The first five have been in existence for a number of years, but the latter four are relatively recent additions. There may be several variations of a single Alnico type, depending on the method of construction. Alnico 5, for example, may have a maximum energy product of 3.5, 5.5, or 6.25 million gauss-oersteds, depending on whether

it is formed by sintering, casting, or a special directional grain process.

In general, Alnicos are formed by conventional casting or powder metallurgical techniques and a special heat treating procedure. The heat treatment consists of heating the alloy to about 1300°C and holding it at that temperature until a homogeneous structure is achieved. This is followed by controlled cooling, then a period of aging in which the alloy is heated to about 600°C to increase coercive force and energy product. Variations in the composition of the alloy or the time and temperature of the heat treatment result in a variety of different magnetic properties. The goal, of course, is to maximize the desired properties.

Alnicos 1 through 4 are isotropic, which means that they have the same magnetic properties regardless of the direction of magnetization. Although they were considered quite advanced when first discovered, they have only limited application today. Anisotropic or directional magnets are made by applying a strong magnetic field to the magnet during cooling. The field must also be in the same direction during aging. Magnets having markedly superior properties are produced in this way.

More recently, Alnicos have been developed in which the crystal structure is oriented in the direction of magnetic orientation. This is accomplished by casting the molten metal against steel plates which chills the magnet and causes rapid cooling and growth of long grains in the preferred direction. With careful regulation of casting and heat treating, almost complete directional grain growth is achieved. (Fig. 1B). Alnico 5-7, a premium material for applications requiring superior performance, is a product of this kind. Typical applications include airborne and space instrumentation, where high magnetic fields are attained with magnets of reduced length and small cross-section. The possible configurations of such magnets are limited, since the direction of grain growth must correspond to the direction of the magnetic field, and this can be done only in pieces magnetized in straight paths.

Alnico 8 is remarkable for its unusually high coercive force. This property makes it especially valuable for circuits having large air gaps or involving large demagnetizing influences. The most recent addition to the family is Alnico 9, whose energy product is typically 8.5 but may be as high as 9.5 million gauss-oersteds in selected specimens, and a coercive force of 1450 oersteds. It is a hard, brittle alloy that cannot be machined easily except by grinding. Because orientation and magnetization must be straight, the most common magnet shapes are cylinders and rectangles. Like Alnico 5-7, it is used in critical applications where a reduced size and weight without sacrifice of energy is required. Comparative curves of these materials are shown in Fig. 3.

Magnetic Particles

A limitation of Alnico magnets is the fact that the high-temperature heat-treating processes that are involved make it difficult to hold close tolerances in physical dimensions. The magnetic materials thus produced are hard and brittle, making grinding difficult and expensive. This problem has been overcome in a family of magnets developed by *General Electric* under the tradename *Lodex*. *Lodex* magnets grew out of the knowledge that most permanent magnetic materials derive their magnetic properties from extremely small and discrete particles dispersed in a non-magnetic medium.

In Alnicos and most other magnetic materials, the fine particles are precipitated from the matrix as a result of high-temperature processing. In the manufacture of *Lodex*, however, the magnetic elements are prepared by the electro-deposition of iron-cobalt and are thermally treated to develop elongated shapes having superior magnetic properties. These single-domain particles are then physically dis-

persed in a non-magnetic matrix composed of lead and become the magnetic domains of this synthetic system. In practice, the fine particle magnets and the lead binder are mixed in powder form and then pressed into final shape. Properties can be regulated by maintaining uniform proportions of magnetic particles to non-magnetic matrix, and close tolerances can be obtained in the finished parts, since pressing of powders is the final operation.

Lodex magnets are less powerful than the best Alnico magnets, but they are available with energy product as high as 3.4 million gauss-oersteds and coercive force of 1250 oersteds. The ease with which they can be handled permits wide latitude in design and economies in manufacturing.

Rare Earth and Hard Ceramic Magnets

Although still in the research stage, there are indications that compounds of cobalt and rare earth elements, such as yttrium, cerium, praseodymium, and samarium, may eventually yield permanent magnets with characteristics vastly superior to Alnico alloys. Already experimental magnets have been produced of these materials which exhibit energy product exceeding 5 million gauss-oersteds, and coercive force in excess of 7000 oersteds. This is still a long way from the calculated theoretical energy products, which range as high as 31 million gauss-oersteds, so there is much room for development.

Rare earth mixtures are becoming commercially available at prices that compare favorably with other premium magnetic materials. There is reason to believe that fabrication will be easier than it now is with Alnico alloys.

Magnetic ceramics, or ferrites, are classified as "hard" if they exhibit high energy product and high coercive force, and "soft" if they combine high permeability with low loss in an a.c. field. The principal hard ceramic material is barium ferrite $BaO \cdot 6Fe_2O_3$. Crystals of the material have a hexagonal structure. The ferrite has a high degree of anisotropy and, therefore, a preferred direction of magnetization.

The basic ingredients are barium carbonate and iron oxide, both readily available, which are processed to obtain the desired characteristics. The resulting powder is formed under high pressure in the required shape in a die. This fragile compact is then sintered in a furnace at a high temperature. The magnet thus obtained can be finished by grinding if necessary but is extremely difficult to drill or machine.

Barium ferrites, some of which are produced by *Indiana General Corporation* under the tradename Indox, have the highest coercive force of any commercially available magnetic material, being exceeded only by platinum-cobalt (see Table 1) which is too costly for ordinary use. This characteristic makes it practical to use much shorter magnet lengths than is possible with other materials. Like other ceramics, barium ferrites have high electrical resistivity and are classed as non-conductors. This permits them to be used in places where other magnetic materials would create an undesired path for current or a short circuit. In addition, eddy current losses and associated heating effects are extremely low when barium ferrites are exposed to high-frequency alternating fields.

Because of their unusually high coercive force, barium ferrite magnets cannot be demagnetized with ordinary demagnetizing coils, since these are not sufficiently strong to overcome their field. For this reason, demagnetization is accomplished when necessary by heating the ferrite above its Curie temperature (about 450°C) and cooling it slowly to avoid damage from thermal shock.

The first barium ferrites were nonoriented types, consisting of aggregates of hexagonal crystals randomly arranged. Indox I is an example. It has a reasonably high energy product and coercive force that compares favorably with Alnicos. It is relatively inexpensive and thus finds extensive use.

MATERIAL ¹	PEAK ENERGY PRODUCT ($\times 10^6$)	RESIDUAL INDUCTANCE (KILOGAUSS)	COERCIVE FORCE (OERSTEDS)
Cast Alnico 1	1.4	7.0	440
Cast Alnico 2	1.6	7.2	560
Sintered Alnico 2	1.45	6.9	520
Cast Alnico 3	1.35	6.9	470
Cast Alnico 4	1.3	5.5	700
Sintered Alnico 4	1.2	5.2	700
Cast Alnico 5	5.25	12.5	600
Sintered Alnico 5	3.5	10.5	600
Oriented Alnico 5	6.25	12.6	670
Cast Alnico 5-7	7.5	13.4	730
Cast Alnico 6	3.5	10.1	750
Cast Alnico 8	5.0	8.0	1600
Cast Alnico 9	8.5	10.5	1450
Indox I (ceramic)	1.0	2.2	1825
Indox V (ceramic)	3.5	3.84	2200
Indox VI-A (ceramic)	2.6	3.3	3000
Lodex 30	1.68	4.0	1250
Lodex 31	3.4	6.25	1140
36% Cobalt Steel	0.94	9.6	228
5% Tungsten Steel	0.32	10.3	70
Platinum-Cobalt	7.5	6.0	4200

¹Slight differences may occur in products of various manufacturers.

Table 1. Characteristics of permanent magnet materials.

The characteristics can be remarkably improved, however, through partial orientation (as in the case of Indox II) or complete orientation (as in the case of Indox V and Indox VI-A). Orientation is accomplished by subjecting the magnet to a very strong magnetic field during the pressing operation and prior to final sintering.

Barium ferrite magnets are found in many common articles, such as cabinet latches, can openers, and door closers. Because of their extremely high coercive force they are especially useful in providing magnetic fields for motors and generators. In hand tools, such as electric drills, they permit smaller and lighter devices than is possible with conventional field coils. Their resistance to high-frequency field makes them excellent choices for focusing applications, such as the periodic focusing of traveling-wave tubes. They are also finding wide use in PM speakers, especially for unusually flat speaker designs which have been made possible through the use of relatively short magnets.

Soft Ceramic Materials

Because of the high conductivity of metallic cores, losses mount rapidly with frequency. For this reason, silicon steel is rarely used much above 400 Hz. Instead, soft ceramic materials which have relatively high resistance are used as cores in such devices as horizontal output transformers and deflection yokes for TV that operate at about 16 kHz. They are also used for recording heads where, in addition to their ability to handle high frequencies without significant loss, their mechanical hardness provides superior resistance to wear.

The most common soft ferrites are composed of oxides of nickel and zinc. High permeability material is made by sintering the oxides at high temperature until a dense formation is obtained. For the higher frequencies, losses may be reduced at the expense of permeability by increasing the ratio of nickel oxide to zinc oxide.

A superior soft material may be made from manganese oxide and zinc oxide, having generally higher flux density, lower loss, and higher Curie temperature than the nickel zinc types. The valence of manganese tends to vary, making manganese oxide ferrites more difficult to produce. However, modern furnaces permit careful control of firing conditions, so the problem is no longer as troublesome.

In recent years, ferrites have become important as cores for filter inductors, i.f. transformers, antenna coils, and wide-band transformers where frequencies from several hundred kHz to several hundred MHz may be encountered. The loss

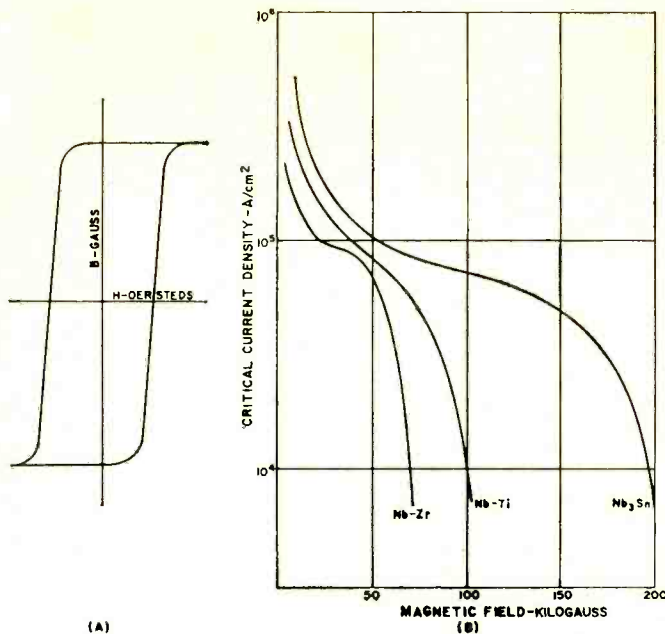

Fig. 4. (A) Rectangular hysteresis loop characteristic of materials used for magnetic amplifiers and memory cores. (B) Critical current density vs field for superconductors.

factor of ferrites, discussed above, is too high for these applications and so a special series of materials has been developed. These are characterized by unusually high resistance and high "Q". "Q" refers to the efficiency of the material for converting from electrical to magnetic energy and back again.

High-"Q" materials may be made from either oxides or nickel and zinc or oxides of manganese and zinc. The manufacturing process is quite similar to that described above except that the proportions of the compounds are not the same. In addition, high-"Q" materials are somewhat under-fired, leaving them slightly porous. As a result, their permeability is substantially less than ferrites' intended high-frequency use, but this factor is more than compensated by the reduction in losses at radio frequency.

A class of ferrites known as garnets has been developed for use at microwave frequencies. They have the general formula $3R_2O_3 \cdot 5Fe_2O_3$, where *R* is any rare earth element. Yttrium iron garnet is an example of the type. They have extremely high resistance and low loss. Typical applications include isolators, phase shifters, and rotation devices. Placed within a cavity, such a ferrite causes the plane of polarization of the microwave radiation to be rotated, thus permitting nonreciprocal or one-way electrical networks to be constructed.

Square-loop ferrites are usually made by combining oxides of magnesium and manganese. Other materials, such as nickel, copper, or calcium may be added to modify the properties. These materials have high remanence, approximately equal to saturation flux density, which gives the flatness at the top and bottom of their hysteresis loop (Fig. 4A). Initial permeability is characteristically low, as is coercive force. Square-loop ferrites are used for information storage and switching applications. One of their primary uses is for core memories in computers. Switching speed is a very important consideration, and this parameter has been reduced to a fraction of a microsecond in some types.

Superconducting Magnets

Although superconductivity was discovered more than half a century ago, it has been only in the past few years that the production of practical superconducting magnets has become possible. The phenomenon was first noted in relation to mercury, which was found to lose any measurable

resistance at about 4°K. Early experimentation demonstrated that tin and lead exhibit the same characteristic. As a result of concentrated research the list has continued to grow. There are now 26 known superconducting elements along with more than 1000 superconducting alloys and compounds.

The idea of winding magnet coils from superconducting materials is attractive for obvious reasons. Since superconductors have no resistance they consume no power. After a field has been established in such a coil, the terminals can be short-circuited and the current will continue to flow indefinitely. In the absence of resistance no heat is generated, and a much stronger field can be established in a small area than is possible with conventional equipment. It is thus feasible, in theory, to achieve extremely concentrated magnetic fields with lightweight apparatus.

Putting theory into practice was not easy. It was soon discovered that superconducting elements lose all trace of superconductivity when the magnetic field exceeds a certain critical value. This is attributed to the fact that the field is totally excluded from the interior of the conductor at the lower flux levels, and that loss of superconductivity occurs when the field penetrates the surface. Superconductors of this kind are called "soft". They are unsuited for sustaining magnetic fields exceeding about 1000 gauss.

So-called "hard" superconductors are alloys and compounds that will continue in the superconducting state despite partial penetration by the magnetic field. Although they also lose superconductivity when field penetration is complete, many of them are capable of sustaining quite concentrated fields before that transition occurs. Theoretical calculations indicate that fields as high as 300 kilogauss may be possible with hard superconductors, but this level has not yet been reached.

Superconducting alloys are usually quite ductile and easy to fabricate. The two most promising at the present time are *Nb-Zr*, containing approximately 75% niobium and 25% zirconium, and *Nb-Ti*, containing approximately 50% niobium and 50% titanium. Both alloys are made from fine powders that are sintered to form wires. *Nb-Zr* has a critical magnetic field of about 60 kilogauss; *Nb-Ti* of about 80 to 100 kilogauss (Fig. 4B).

Like most other superconducting compounds, niobium tin (*Nb₃Sn*) is extremely brittle and difficult to handle. However, it offers the greatest hope today of obtaining superconducting magnets with fields in the vicinity of 200 kilogauss. Several methods of forming niobium tin magnet coils have been devised. In one method, the tin is deposited on niobium wire. After the coil is wound it is heat treated, causing the tin to diffuse into the wire and react chemically to form niobium tin. A related process involves placing powdered tin and niobium into a niobium tube which is heated in order to form a compound after it has been coiled.

It is possible to wind a coil after the compound has been formed by coating a thin metallic ribbon with a very thin layer of niobium tin. With proper care, a ribbon of this kind can be wound into a coil no more than an inch in diameter without damaging the superconducting layer.

The highest magnetic field yet achieved with a superconducting magnet is about 140 kilogauss. This is still far short of the 250 kilogauss field that has been obtained with a conventional magnet. However, conventional magnets in that range required about 16 million watts to operate and huge quantities of water to dissipate heat, whereas the superconducting magnets are relatively compact and require virtually no power except the amount needed to refrigerate the superconducting coils.

A number of important uses are visualized for superconducting magnets. These include such projects as improved bubble chambers for atomic research, deflection systems for particle accelerators, plasma (Continued on page 88)

SYLVANIA INDUSTRIAL P

Your Sylvania distributor can give you a technical library. For fast answers to difficult electronic problems.

Nobody beats Sylvania when it comes to up-to-date technical information—for *your* applications. And your Sylvania distributor has it all for you.

You can get data sheets and catalogs on industrial receiving tubes, transmitting tubes, industrial control tubes, counter tubes, cathode ray tubes, flash tubes, gauge tubes, photosensitive devices, microwave devices and all semiconductors.

Your Sylvania man also has inventory programming forms—and many types of application information. Plus other kinds of free technical materials. And he's a tube expert. He can analyze your tube and semiconductor replacement needs. He can prevent emergencies, take an inventory and save you time and money.

Call him for these services—and for the best technical literature in the tube industry. And depend on him for fast delivery—in any quantity.

Sylvania Electronic Tube Division, Electronic Components Group, Seneca Falls, New York 13148.

SYLVANIA

SUBSIDIARY OF
GENERAL TELEPHONE & ELECTRONICS GTE

CATALOG/ Industrial Receiving Tube
Microwave Devices • Co

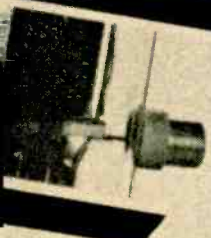

SYSTEM DESIGN
OF SYLVANIA INDUSTRIAL

SYLVANIA RECEIVING TUBES
Voltage Regulators
0A2, 0B2

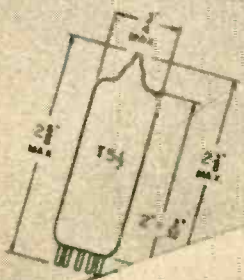

BOOK
MILITARY CRT'S

TECHNICAL DATA

1-455	0-2
1-456	0-2
1-457	0-2
1-458	0-2
1-459	0-2
1-460	0-2
1-461	0-2
1-462	0-2
1-463	0-2
1-464	0-2
1-465	0-2
1-466	0-2
1-467	0-2
1-468	0-2
1-469	0-2
1-470	0-2
1-471	0-2
1-472	0-2
1-473	0-2
1-474	0-2
1-475	0-2
1-476	0-2
1-477	0-2
1-478	0-2
1-479	0-2
1-480	0-2

SHIN GOLT ELECT

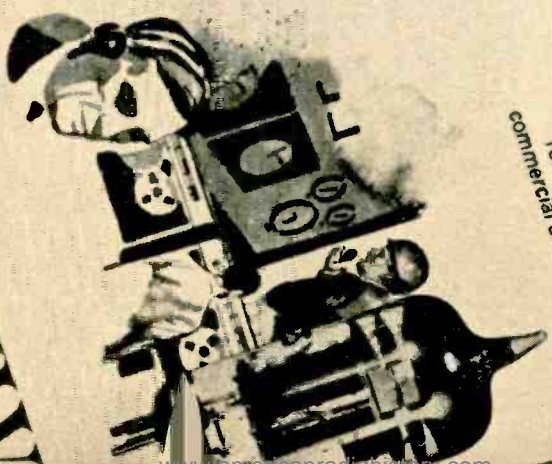

Unsurpassed quality for reliable performance in critical commercial and industrial applications.



J OHN FRYE

Electronics can play a vital role in understanding the effects of a stroke and in rehabilitating the victim.

ELECTRONICS AND APHASIA

WINTER, a little slow in coming, was definitely on the way; and Barney appreciated the cosy warmth of the service shop as he stepped inside out of the near-freezing rain that had been falling all morning. He found Mac, his employer, reading a blue paperbound book bearing the title *Care of the Patient with a Stroke*.

"How is your mother, Mac?" Barney asked.

"That's tougher to answer than you might suppose," Mac replied, putting the book aside. "She still can't move her right arm or leg, but the really rough thing is she still can't talk, even though it is now three months since she had her 'cerebral vascular accident,' as the doctors like to call a stroke. All she can do is nod or shake her head in answer to questions, and you can't put too much dependence on these responses because she sometimes becomes confused and nods her head when she actually means 'No'. With such sketchy, imperfect communication, it's very difficult to tell how she feels, what she wants, or if she is improving.

"It's especially frustrating to me," he went on sadly, "a communications expert of sorts who works constantly with communications media that easily span hundreds of miles with the speed of light, not to be able to communicate with my own mother when I am sitting right by her bed holding her hand. Above all else, I want to get her talking, for I know it must be doubly frustrating to her. That's why I've hired a trained speech therapist to work with us one day a week and why I'm studying the chapter on teaching stroke victims to talk in this excellent book written by Genevieve W. Smith and published by the Springer Publishing Company of New York City.

"The author is a registered nurse whose own husband suffered a stroke. Thus she is able to draw, not only on her contacts with the medical profession, but also on a wealth of both general and highly personalized experience in preparing this book designed for use both by the patient's family and the nurse. By explaining what you can expect in the way of patient behavior—and the reasons for that behavior—it saves tremendous wear and tear on the nervous system of the family; and, much more important, it enables you to give intelligent, meaningful help to the patient.

"The chapter I was reading is a good illustration. This business of a stroke victim's not being able to talk is a lot more complicated than most people believe. It is called *aphasia* and is defined as 'The loss or impairment of the ability to use words as symbols of ideas as the result of a brain lesion'.

"I'm sure you know the brain is divided into equal halves, or hemispheres, and that the left half controls the right side of the body and *vice versa*. As both sides of the brain are alike, there are actually two speech centers; but since speech is a single operation in which both sides participate, it's necessary that one center or the other be the leader. The dominant center is normally the one in the left side of the brain.

"As an electronics technician, I find it easy to think of the speech center as a computer that has a memory stored

with all the words a person knows. Some of these words are lightly linked to others. For example, the word 'ham' may be lightly linked to 'eggs' or to 'actor.' 'Tall' is often linked with 'dark' and 'handsome'.

"Information inputs to this speech center include data from the eyes, the ears, and the sense of touch. A pin-up is likely to evoke a 'Wow!' response from a male. 'Hi' produces a return greeting. Burning yourself on the soldering iron may well cause you to exclaim 'Ouch'—or something worse! The important point is that input information combines with material from the memory bank in the speech center and produces an output in the form of nerve messages sent to the lips, tongue, vocal cords, or fingers that result in the speaking or writing of word symbols for the ideas formed in the brain. And feedback circuits from the ears and eyes compare the sound or sight of the word thus formed with the memory of that word in the brain to insure it is spoken or written correctly.

"All the areas of the brain controlling sight, hearing, feeling, speech, etc., have nerve pathways connecting them with each other as well as pathways going to the organs performing particular functions. The brain hemorrhage blocks one or more of these paths either by cell destruction or pressure on the nerves. Which paths are blocked determine the nature of the aphasia. If the path from the hearing center to the speech center is blocked, the victim can hear but he cannot make sense out of the words heard. It is as though he were listening to an unknown language. This is called *auditory aphasia*.

"Perhaps another incoming path, that from the sight center, is impaired. In this case the patient cannot read and is said to suffer from *visual aphasia*, or *alexia*. All writing and print may appear like mysterious hieroglyphics so that he cannot read a word, or he may be able to decipher single words separately but still be unable to string them together so they make sense."

"How about the paths leading out from the speech center? What if they are injured?"

"If the ones going to the speech organs are injured, as is the case with my mother, the patient cannot utter the word symbols for the ideas formed in the mind. This is called *vocal aphasia*, or *aphemia*. And if the ones controlling precise movements of the fingers and arms are injured, the patient may be unable to write and so be said to suffer from *agraphia*. A stroke victim may have any combination of these four basic types of aphasia, depending on just where the hemorrhage occurs and how extensive it is."

"What can you do about correcting the damage?"

"Nature does her best to help. The blood clot that formed to plug the rupture in the blood vessel is gradually absorbed, and this may remove pressure that has been causing a temporary disruption of the signal path. Or, if the path is permanently destroyed, other nerve paths may be bridged around the break by constant repetition. It's like the way a sudden voltage surge will sometimes restore the broken connection inside an open coupling capacitor and allow it to carry the signal again. Finally, if the paralyzed person

is not too old, there is one other possibility: the other speech center, the one in the right half of the brain, may be taught to take over the communication leadership from the damaged left-side center.

"As might be suspected, the first signals to travel over these restored or substitute paths are likely to be erratic and unreliable. That's why the first words spoken by stroke victims are often swear words or obscenities, even though the victim previously never used such words. This is probably because these words in the memory bank may be weighted by emotions surrounding them and are easily triggered by a random stimulus."

"I certainly see how a technical electronics background makes it easier to understand the brain damage," Barney said. "We can really put cybernetics to work for us. But it sounds to me as though teaching an aphasia victim to talk or write would take an awful lot of patience."

"It does," Mac answered. "For one thing, the patient normally has a very short span of interest, and you *must* have his undivided attention while you are teaching. To batter your way through the blocked nerve paths, you try to make as strong a presentation as possible, appealing to every possible sense. For example, if you are trying to get him to say, "drink", you may show him a glass of water, point to the written word, guide his hand in the motion of taking a drink, and say the word aloud with exaggerated lip and tongue movements that he can watch and imitate in a mirror. And you do this over and over and over until he finally utters the word in recognizable fashion. Then you praise him warmly, for if ever he needed the encouragement of achievement and progress it is now."

"However, keep in mind the speech therapy must be fitted into the routine of his very essential and extensive nursing care and physiotherapy. Remember, too, it must compete for his attention against the aches and pains that accompany his condition and the spells of frustrated depression that are bound to plague him. If the person trying to teach him to talk is in constant attendance with the patient while he is awake, that person can take advantage of the most favorable times for giving instruction; but this is seldom the case. That's why I've been thinking what is needed is a highly specialized teaching machine specifically designed for aphasia victims. With such a tireless, ever-ready machine sitting by his bed, the nurses could urge him to use it during his most alert periods; and, even without their urging, he would be tempted to use it to relieve boredom."

"What sort of machine do you have in mind?"

"I've been thinking basically of a video tape recorder that would play back through any TV receiver. In the home the patient could use his own set or a rented portable. In the hospital, a set designed for patient use could be employed. The video tapes would be prepared by a speech therapist for the particular use of each patient. On the tape would be the words to be learned, with close-ups showing the position of the tongue and lips in articulating the words. The words could be shown in print or script at the same time. Concrete objects could be shown to illustrate nouns; actions, to illustrate verbs."

"After the patient was told to say the word, a pause would occur while he tried. This would be recorded on a separate sound track, possibly an endless loop of tape, so the patient could hear his own pronunciation. Quite possibly an attachment similar to the word-recognition devices being developed by several different laboratories could compare the word spoken by the therapist with that uttered by the patient and flash an approval signal when they were near enough alike. At any time the patient could 'back-space' the tape for a repeat of the word the therapist wanted him to say."

"Naturally I can't be too specific about the final form of the machine, but I am sure doctors, speech therapists, and electronic engineers, working closely together, could come up with something that would be of major help to victims of apoplexy. I *know* there is a need for such a device. Strokes bow only to heart disease and cancer as being a major cause of death in this country; and I am sure the number of stroke victims occupying beds in hospitals and nursing homes at any given time in this country must be staggering. Anything that speeds up their rehabilitation would go far toward relieving the shortage of doctors and nurses and hospital beds, not to mention the alleviation of anguish on the part of the victims and their families."

"You've got me sold," Barney said. "After all, electronics has shown what it can do time and again in the field of communication, and this *is* a communication problem in the final analysis."▲

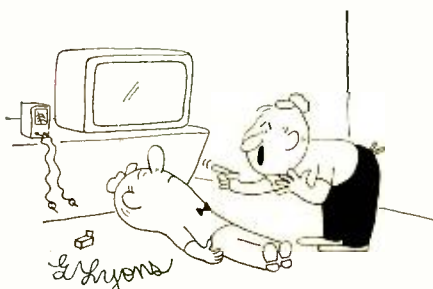

Come on, now. Let's not faint at the thought of troubleshooting your first 62-transistor color set!"

Our policies are your best insurance:



Sonotone has been the reliable, quality name in replacement phono cartridges since 1947. We've made and sold 20 million of them. When you service with Sonotone cartridges, you can be assured you are servicing with the best. *We'll stake our name on that.*

REPLACE WITH SONOTONE CARTRIDGES. There's a complete line for immediate replacement of virtually every cartridge in use today. Prove it to yourself — fill out and mail coupon TODAY for your free copy of Sonotone's 1967 "computer-programmed" cartridge replacement manual.

Send today for complete information:

**Sonotone Corporation, Dept. 107
Elmsford, New York 10523**

Just fill out and mail this coupon for your free copy of Sonotone's 1967 "computer-programmed" cartridge replacement manual.

YOUR NAME _____
ADDRESS _____
CITY _____
STATE _____ ZIP _____

CIRCLE NO. 94 ON READER SERVICE CARD

FREE!



**ALLIED
NEW 1968
CATALOG
518
PAGES**

SAVE ON:

- Famous Knight-Kits®
- Stereo Hi-Fi
- Tape Recorders, Tape
- CB 2-Way Radios
- Walkie-Talkies
- FM AM & AM Radios
- Shortwave Receivers
- Portable TV
- Phonographs
- Amateur Gear
- Intercoms & PA
- Automotive Electronics
- Test Instruments
- TV Antennas & Tubes
- Power Tools, Hardware
- Tubes, Transistors
- Parts, Batteries, Books

**TOP SAVINGS ON
THE BEST IN
ELECTRONICS
FOR EVERYONE**

Shop by mail and save at Allied, world's largest electronics headquarters. Hundreds of money-saving values. NO MONEY DOWN. Up to 2 years to pay!

**MAIL COUPON
BELOW**

**ALLIED RADIO, Dept. 1M
P.O. Box 4398, Chicago, Ill. 60680**

NAME (Please Print) _____

ADDRESS _____

CITY _____

STATE _____

ZIP _____

CIRCLE NO. 125 ON READER SERVICE CARD

**“Get more
education
or
get out of
electronics
...that’s my advice.”**



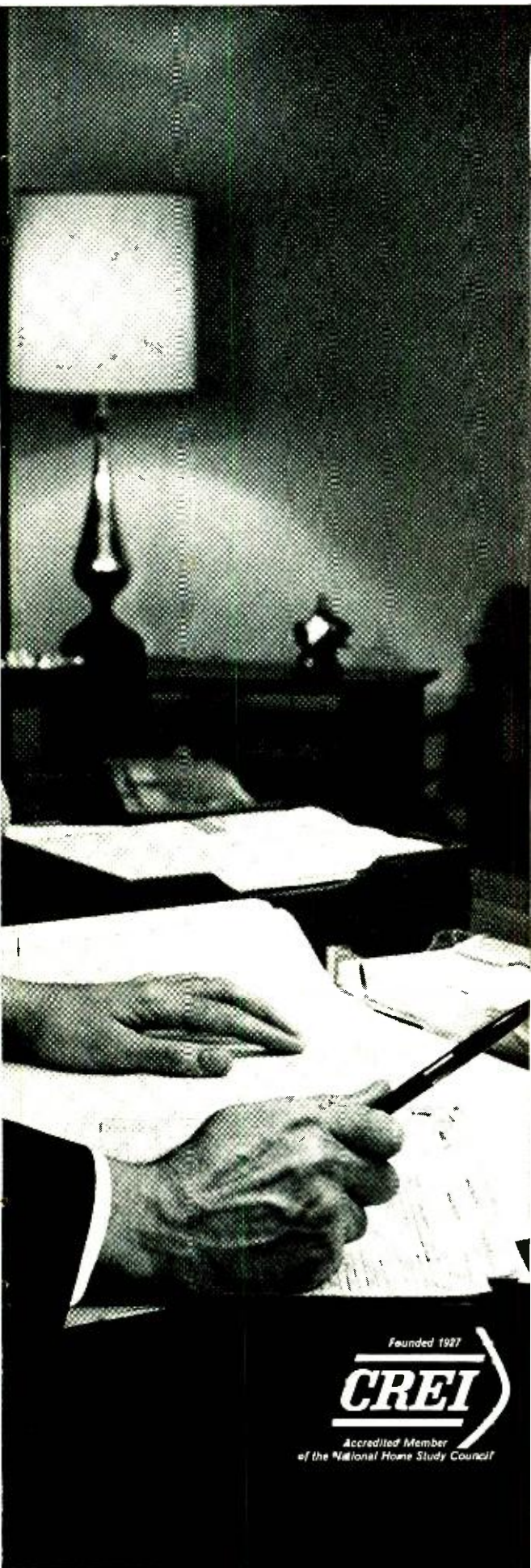

Ask any man who really knows the electronics industry.

Opportunities are few for men without advanced technical education. If you stay on that level, you'll never make much money. And you'll be among the first to go in a layoff.

But, if you supplement your experience with more education in electronics, you can become a specialist. You'll enjoy good income and excellent security. You won't have to worry about automation or advances in technology putting you out of a job.

How can you get the additional education you must have to protect your future—and the future of those who depend on you? Going back to school isn't easy for a man with a job and family obligations.

CREI Home Study Programs offer you a practical way to get more education without going back to school. You study at home, at your own pace, on your own schedule. And you study with the assurance that what you learn can be applied on the job immediately to make you worth more money to your employer.

You're eligible for a CREI Program if you work in electronics and have a high school education. Our FREE book gives complete information. Air-mail postpaid card for your copy. If card is detached, use coupon below or write: CREI, Dept. 1112E, 3224 Sixteenth Street, N.W., Washington, D.C. 20010.

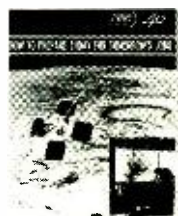

The Capitol Radio Engineering Institute
A Division of McGraw-Hill, Inc.
Dept. 1112E, 3224 Sixteenth Street, N.W.
Washington, D.C. 20010

Please send me FREE book describing CREI Programs. I am employed in electronics and have a high school education.

NAME _____ AGE _____

ADDRESS _____

CITY _____ STATE _____ ZIP CODE _____

EMPLOYED BY _____

TYPE OF PRESENT WORK _____ G.I. BILL

I am interested in Electronic Engineering Technology
 Space Electronics Nuclear Engineering Technology
 Industrial Electronics for Automation
 Computer Systems Technology

APPROVED FOR TRAINING UNDER NEW G.I. BILL

NEW! 10 Watt Power INTERCOM & PAGING SYSTEM



Master
\$69.95

Offers the latest in solid state and more features . . .

- Master & remotes originate calls by making use of "tone" calling.
- Indicators continue to display calls until contact is completed. 115 VAC.
- Simplified 2-wire installation.
- 8-Transistor 5-station master.

DEALER
INQUIRIES
INVITED

ALCO
ELECTRONIC PRODUCTS, INC.
LAWRENCE, MASSACHUSETTS

CIRCLE NO. 200 ON READER SERVICE CARD

cut holes
fast!

Round—Inches and mm

"Key"

"D"

Double "D"

Square



with
**Greenlee
punches**

Here's the simple speedy way to cut smooth, accurate holes in metal, hard rubber, plastics, epoxy, etc.

Save hours of hard work . . . punch clean, true holes in seconds for sockets, controls, meters, and other components. Easy to operate. Simply insert punch in a small drilled hole and turn with a wrench. For use in up to 16-gauge metal. Available at leading radio and electronic parts dealers.



GREENLEE TOOL CO
DIVISION OF GREENLEE BROS. & CO.

1866 Columbia Avenue, Rockford, Ill. 61101
CIRCLE NO. 113 ON READER SERVICE CARD
60

Incentive Licensing (Continued from page 34)

side between ham radio and CB will be faced with the hard fact that he'll need much more than a Novice ticket to enjoy phone operation *via* the amateur route. Opponents of the new program point out that without "young blood", any group or organization can only fade off into oblivion. They ask how the pro-incentive people propose to draw newcomers (especially teenagers) into the hobby. One New Jersey amateur, upon being told the news, wanted to know "if ARRL is planning a program of mass-brainwashing so as to prevent an enthusiast from ever hearing that CB exists?"

Along these same lines, opponents see amateur radio in the U.S. slowly fading away. Many feel that the number of hams will drop from 200,000 to just over 100,000 after the rules go into effect. They think the Commission will never be able to get the majority of General ticketholders to FCC examination offices for Advanced tests. The equipment industry, however, seems somewhat cheered by the over-all prospects, although they foresee dark days ahead for several months. There is some feeling that the Advanced exam may prove a major stumbling block and be primarily responsible for the almost-predestined disappearance of ham radio in this country.

If the number of licensees begins to dwindle, what will happen to the ham bands? The contention here is simply that if they are not utilized, they will be lost forever to other nations. And to many, this seems an ultimate certainty.

Finally, the quite-vocal opponents have come up with one constructive idea: lifting the antiquated eligibility requirements for the Novice Class license. As it now stands, no one can go for this test if he has ever before held radio amateur status in this country. Similarly, holders of 1st Class Commercial Radiotelephone licenses are now ineligible for this beginner's ticket. How about retired people who want to get back into amateur radio but who held licenses when in their late teens? Obviously, any one who's been away from electronics for any length of time cannot be expected to become an overnight expert in sophisticated communications technology. Many feel certain that if this restriction were lifted, it might offset some of the unattractive stumbling blocks Washington is putting in the way of the hobby, by replacing the youngsters with returnees.

The Advantages

The proponents of pro-incentive licensing are concerned over the low level of technical competence and the

rise in the number of "push-button" operators". By developing the knowledge and skills of the hams, it is said that America *might* be able to reach the degree of sophistication and ingenuity being demonstrated by the hams in Australia, Great Britain, and USSR.

Any honest observer must agree that ham radio has slipped badly in recent years due, in part, to the wide acceptance of CB communications and the great technological strides being made by the industry. In an age of solid-state computers, IC's, FET's, and microminiaturization, the average ham tinkers in his basement with vacuum tubes and World War II devices. Once largely responsible for major developments in communications, radio amateurs are commonly viewed as non-contributing hangers-on. With CB-ers capturing most newspaper publicity and outnumbering the hams 5 to 1, even the service aspect of ham radio has been largely forgotten by the general public. Prior to adoption of the new regulations, word was out that ARRL was looking for a NYC-based advertising PR agency to promote the hobby.

If the incentive program does what it is designed to do, it is possible that once again American industry will be relying on hams for fresh ideas and an amateur license will recapture its prestige among electronics buffs. Even if the ultimate goals are never fully realized, at least the FCC can show that it is attempting to improve conditions—something that may weigh quite heavily at the next Geneva conference.

From an international point of view, U.S. hams have come to be known as the "ugly Americans" on the air. They outnumber all other nations' hams combined. They saturate the airwaves with high-powered transmitters at levels far in excess of what is permitted in most of the other countries. And they spend more time *on the air* than their more technically inclined overseas counterparts. The result is that amateurs in other countries not desiring to contact Americans have no choice but to vacate the international frequencies in search of a band the U.S. hams can't congest. Many foreign observers feel that the incentive program was long overdue and can only improve the state of the art. In one respect, they are looking forward (hopefully) to seeing an end to American domination of the airwaves; on the other hand, they are also awaiting the time when the average U.S. ham will play an active role in complex semiconductor equipment design—a field now largely in the hands of the British, the Germans, and the Russians.

Finally, it is felt both internally and internationally, that this new move will remove the mail-order stigma that has characterized the U.S. ham since 1951.

Step up...Lead-in Loud and Clear with Belden

TV lead-in. Belden makes all kinds. Indoor, outdoor, for color and black and white reception. All have one thing in common: for price and performance you won't find better lead-in anywhere. They provide a picture-perfect link between antenna and set. Since no two installations are alike, Belden gives the right choice for every situation. But don't skimp on your lead-in. Step up... choose one that gets the most out of the cus-

tomers overall investment. One that will delight the eye and ear with quality reception. For the absolute best, check out 8285 and 8290: the Color Twins. You won't find anything comparable for all-color. Your Belden Distributor has all the facts. Talk to him today. Belden Corporation, P.O. Box 5070-A, Chicago, Illinois 60680.

*Belden Trademark, and Belden U.S. Pat. 2,814,666

don't forget to ask them what else needs fixing!



...the missing link in perfect picture reception

BELDEN 

BELDEN CORPORATION
P.O. Box 5070-A • Chicago, Ill. 60680

Get Top **PERFORMANCE** from
your Car! **Buy The Best!**



**DELTA'S Remarkable, Proven
MARK TEN CAPACITIVE DISCHARGE
IGNITION SYSTEM**

ONLY
\$44.95
ppd.

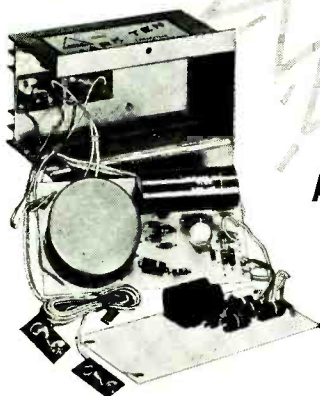
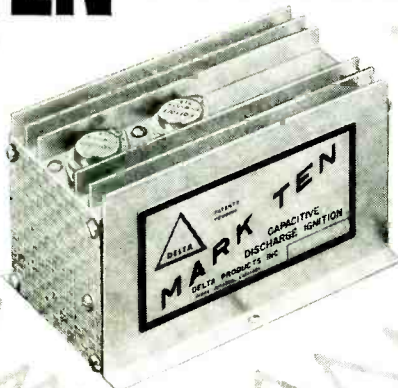

Available in Easy-to-Build

DELTAKIT®

ONLY

ASSEMBLE IT
YOURSELF!

\$29.95
ppd.

You've read about the Mark Ten in Radio Electronics, Electronics World, Mechanix Illustrated, Electronics, Popular Mechanics and other leading publications! Now discover what dramatic improvement in performance with capacitive discharge ignition is yours for your car, truck, jeep, boat—any vehicle! Delta's remarkable electronic achievement—on the market since 1963 and so unique that a patent has been granted—saves on gas, promotes better acceleration, gives your car that zip you've always wanted. Even Detroit has finally come around. Delta's Mark Ten, the original, the proven winner from Sebring to Suburbia, has set new records of ignition benefits attested to by thousands of satisfied purchasers. No re-wiring necessary. Works on literally any type of gasoline engine. Satisfaction guaranteed.

Order from coupon below, specifying car make, voltage and polarity. Like to build your own? Order a Deltakit® and save!

COMPARE THESE PROVEN BENEFITS!...

- ▲ DRAMATIC INCREASE IN ACCELERATION
- ▲ LONGER POINT AND PLUG LIFE
- ▲ IMPROVED GASOLINE MILEAGE
- ▲ MORE COMPLETE COMBUSTION
- ▲ SMOOTHER PERFORMANCE

Order Your Mark Ten Today! Shipped Postpaid at Once.



DELTA PRODUCTS, INC.

P.O. BOX 1147 EW — GRAND JUNCTION, COLORADO 81501

Enclosed is \$ _____ Ship prepaid. Ship C.O.D.
 Mark Tens (Assembled) @ \$44.95 Mark Tens (Deltakit®) @ \$29.95
(12 volt positive or negative ground only)

Specify 6 Volt: Negative Ground only.
 12 Volt: Specify Positive Ground Negative Ground

Car Year _____ Make _____

Name _____

Address _____

City/State _____ Zip _____

CIRCLE NO. 118 ON READER SERVICE CARD

With few exceptions, this has been the easiest country in the world to obtain an amateur license—and its recipients receive the most privileges and the least supervision. For instance, in Australia if any of their 6000 amateurs attempted to construct a tube-type converter or transmitter he would have a lot of official (and unofficial) explaining to do. In the U.S. it is commonplace and accepted without comment.

Will It Work?

Even the FCC isn't sure. While it has been decided that the concept of using "reserved frequency blocks" will be the incentive for ham upgrading, the Commission seems to be hedging a bit on what's going to happen. The following comment summarizes the feeling in Washington: "If it is determined that there is *insufficient occupancy of any part of the reserved frequency segments*, then the effective date of the implementation schedule will necessarily *be stayed in whole or in part.*" (italics ours)

Corroborating this, the FCC has stated that "it intends to make a careful review" of the ham frequencies as the new incentive program becomes effective. It is particularly interested in how many new signals will pop up on the "exclusive" Advanced and Extra Class DX-band segments—and when. ▲

CURE FOR COLOR BLINDNESS?

An electronic device that corrects color blindness in 3 to 6 months by wearing a pair of earphone-like stimulators for 20 minutes a day has been developed by Hayakawa Electric of Japan.

The unique apparatus, called "Sunvister", is based on the theory that visual sensitivity to color can be stimulated by electric current. Frequencies of 77 and 42.5 Hz were found to be the most effective for stimulating human sensitivity to red, green, and blue.

The Sunvister consists of two components: a compact, transistorized control and power supply measuring approximately 8" x 5½" x 2", and the stimulator headset, which plugs into the control and is worn over the temples. The unit is powered by a set of 9-volt batteries.

Work on the color-blindness corrector was done by Dr. Susumu Imamura of Kansai University and clinical test results were reported by Dr. Makoto Seki of Tokyo Medical University. ▲



Instrumentation Tape Recorder

(Continued from page 45)

is directly proportional to the amplitude of the data sample. The synchronization interval occupies two data spaces and is used to synchronize the commutator in the reproduce unit. The signal is differentiated by the PDM record electronics and appears at the record head as positive and negative spikes which correspond to the duration of the data sample. The playback signal is recovered as shown, converted once again to a pulse train analogous to the input signal, and finally demodulated and fed to the decommutator.

Since the commutator speed is usually 30 r/s, it would appear that 58 samples of data could be sampled 30 times a second (two segments are used for synchronization). However, in practice, alternate segments are generally used for calibration or zero-reference signals and ordinarily 30 is the maximum number of data channels per system. Accuracies for this method of recording are one percent of full-scale which makes it one of the better systems for the recording of quasi-static data.

Pulse duration modulation is widely used in the aircraft and missile industry where a large number of data channels must be recorded simultaneously. It can be combined with FM/PM telemetry to produce a very large number of data channels, 400 or more being possible with a 14-track instrumentation recorder. PDM is generally used when it is desired to record a large number of transducer outputs of one type on a test vehicle. This procedure is called surveying (or mapping) the test specimen and is commonly done for the measurement of such factors as temperature, stress, and vibration.

Once the signal has been reproduced on the tape recorder, some means must be provided for read-out. This requires an electronic or electro-mechanical system to provide a visual

display or a written record of the events that have been previously recorded.

The oscilloscope is useful as a "quick-look" approach since it can be used for any type of data. Very often the scope is sufficiently accurate for data reduction and photographs of the display can be taken with an oscilloscope camera.

Several methods are available for reducing d.c. or quasi-static type data. The photographic oscillograph is useful since 50 or more channels of data can be handled at one time and, with sufficiently sensitive galvanometers, the signals can be recorded directly from the tape outputs without further amplification. Direct-writing recorders have the advantage that the written record is available for immediate inspection although this type usually has a maximum of eight data channels.

Digital voltmeters can be used for d.c. type data. This can take the form of a visual display or, if a printer is also used, a written record can be obtained.

The first two methods just described are also suitable for reducing data in the mid-frequency range. Galvanometers with a good response up to 5 kHz are available for the photographic oscillograph. Direct-writing recorders are useful up to about 200 Hz. Some types of signals found in this recording range are quite complex and a frequency analyzer must be employed for best results. These instruments generally have an output jack for a recorder and the necessary electronic circuitry for signal conditioning.

The oscilloscope is about the only instrument capable of handling signals in the range of 5 kHz to 20 kHz directly without a conversion process. The variable time base of the instrumentation tape recorder is really a valuable feature in this case. The playback speed of the tape recorder can be reduced until the output frequency range is compatible with the data reduction equipment. For example, if a 10-kHz signal is recorded at 30 in/s and reproduced at 7½ in/s, the results will appear as a 2.5 kHz signal. ▲

A NEW DIMENSION IN HI-FI
SOUND PERFORMANCE
FROM KENWOOD

... PENETRATING THE
OUTER LIMITS OF
SOUND REPRODUCTION

165 watt 3 CHANNEL STEREO AMPLIFIER with ELECTRONIC CROSSOVER NETWORK

FEATURING:

the finest sound reproduction by driving
the woofer, mid-range and tweeter speakers
separately through a multi-channel amplifier.

Priced at \$695. Write for particulars.

the sound approach to quality



3700 South Broadway Place, Los Angeles, Calif. 90007
69-41 Calamus Avenue, Woodside, New York 11377

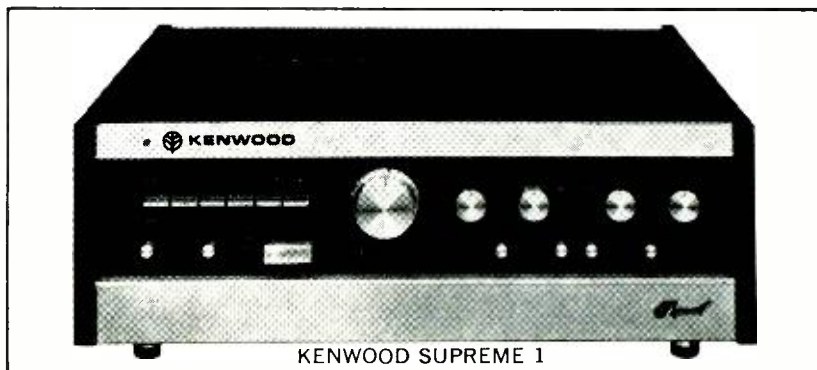

KENWOOD SUPREME 1

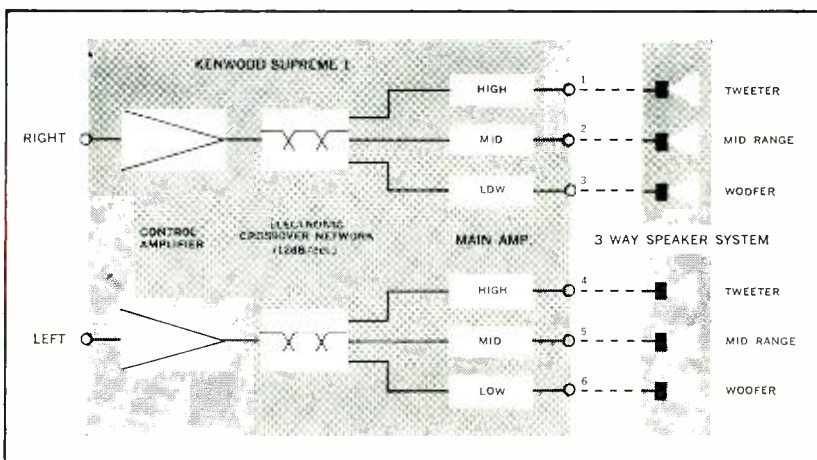

Thinking of college
and a
space age career in
electronics?

How to prepare for
YOUR CAREER
in Engineering Technology and Electronics

MSOE
MILWAUKEE SCHOOL OF ENGINEERING

Send for this booklet on
**ENGINEERING TECHNOLOGY
AND ENGINEERING**

Learn how you can prepare for a dynamic career as an electrical or mechanical engineering technician or engineer in such exciting, growing fields as avionics, missiles, reliability control, fluid mechanics, data processing, metallurgy, microelectronics, and advanced aerospace research.

MSOE offers residence study programs leading to these degrees in engineering technology and engineering:

2 years—Associate in Applied Science
4 years—Bachelor of Science

Also get facts about scholarships and financial aids, job placement and other student services, plus photographs of MSOE technical laboratories and student activities. For your copy, just mail the coupon — no obligation.

Programs approved for veteran training.

MSOE

Milwaukee School of Engineering
Dept. EW-1267, 1025 N. Milwaukee St.,
Milwaukee, Wisconsin 53201

Please send the "Your Career" booklet.
I'm interested in
 Electrical fields Mechanical fields

Name Age

Address

City State ZIP

MS-289

CIRCLE NO. 106 ON READER SERVICE CARD
64

TEST EQUIPMENT

PRODUCT REPORT

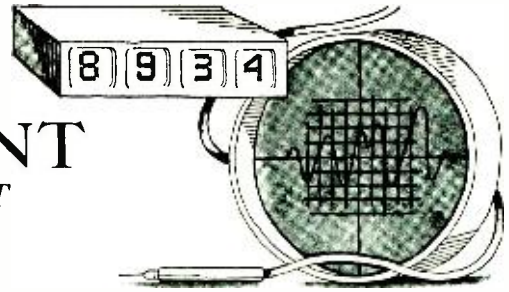

Heath Model IM-25 Solid-State V.O.M.

For copy of manufacturer's brochure, circle No. 34 on Reader Service Card.



THIS is no simple v.o.m. to which an FET has been added to give a high input impedance, but rather a full-fledged solid-state instrument using 2 FET's, 13 bipolar transistors, and 7 zener and other diodes. Six of the transistors are used as overload-protecting and temperature-compensating diodes. The specs are not too dissimilar from those of a conventional v.t.v.m. (11-megohm input impedance, 3% d.c. accuracy, etc.), but this unit has much more to offer. It has low-voltage a.c. and d.c. ranges (150 and 500 mV), high input impedance on a.c. (10 megohms), plus full facilities for measuring d.c. and a.c. currents in 11 ranges from 15 μ A to 1.5 A. Other ranges include 9 d.c. and a.c. voltage scales and 7 ohmmeter ranges. Accuracy is 3% on d.c. and 5% on a.c.

The front-panel layout of the IM-25 is quite functional. The main operating

switch, marked "Volts", "Ohms", and "MA", points to three separate range switches for each of these three measurements. The instrument has a low-profile appearance with recessed carrying handles at both sides, and the color is a handsome beige and black combination. The size and appearance match other new Heath solid-state instruments now being introduced.

The use of the solid-state components should result in long life, reliable operation, and stable adjustments. The meter is powered either from the a.c. line or by means of a built-in power supply consisting of 12 "C" cells. Two other "C" cells and a mercury cell provide voltage for the ohmmeter function.

The diagram of the metering circuit shown here indicates how some of the transistors are used. The d.c. input stage is an FET for high input impedance. Output from the source electrode is ap-

TO A.C. & D.C. INPUT ATTENS.

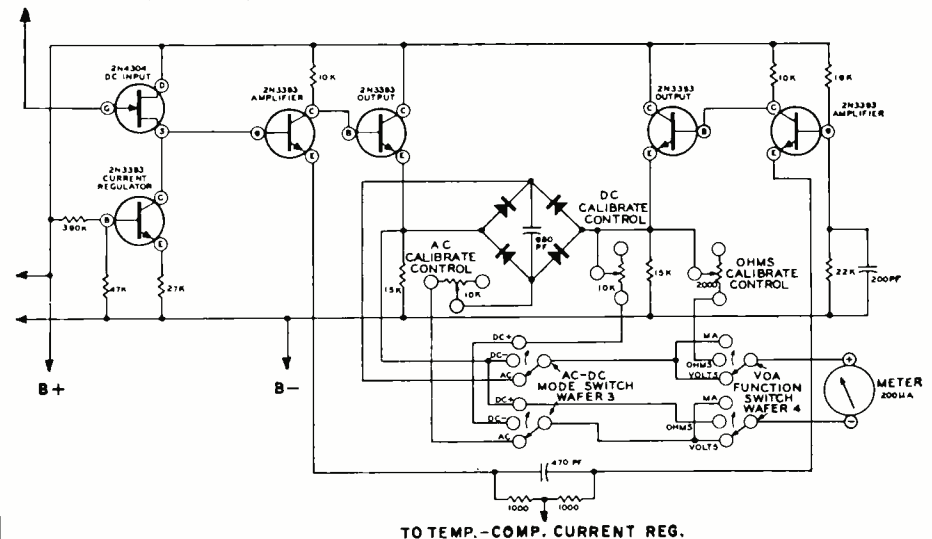

TO TEMP.-COMP. CURRENT REG.

THE COLOR TV SERVICING BOOM IS ON!

BE IN ON THE PROFIT PICTURE *with the know-how you get in*
COMPLETE PHOTOFACT® COLOR TV COVERAGE

283 Here are the PHOTOFACT sets with Color TV coverage from the beginning in 1954 through 1967:

1	31	61	91	121	151	181	211	241	271	301	331	361	391	421	451	481	511	541	571	601	631	661	691	721	751	781	811	841	871	901
2	32	62	92	122	152	182	212	242	272	302	332	362	392	422	452	482	512	542	572	602	632	662	692	722	752	782	812	842	872	902
3	33	63	93	123	153	183	213	243	273	303	333	363	393	423	453	483	513	543	573	603	633	663	693	723	753	783	813	843	873	903
4	34	64	94	124	154	184	214	244	274	304	334	364	394	424	454	484	514	544	574	604	634	664	694	724	754	784	814	844	874	904
5	35	65	95	125	155	185	215	245	275	305	335	365	395	425	455	485	515	545	575	605	635	665	695	725	755	785	815	845	875	905
6	36	66	96	126	156	186	216	246	276	306	336	366	396	426	456	486	516	546	576	606	636	666	696	726	756	786	816	846	876	906
7	37	67	97	127	157	187	217	247	277	307	337	367	397	427	457	487	517	547	577	607	637	667	697	727	757	787	817	847	877	907
8	38	68	98	128	158	188	218	248	278	308	338	367	398	428	458	488	518	548	578	608	638	668	698	728	758	788	818	848	878	908
9	39	69	99	129	159	189	219	249	279	309	339	369	399	429	459	489	519	549	579	609	639	669	699	729	759	789	819	849	879	909
10	40	70	100	130	160	190	220	250	280	310	340	370	400	430	460	490	520	550	580	610	640	670	700	730	760	790	820	850	880	910
11	41	71	101	131	161	191	221	251	281	311	341	371	401	431	461	491	521	551	581	611	641	671	701	731	761	791	821	851	881	911
12	42	72	102	132	162	192	222	252	282	312	342	372	402	432	462	492	522	552	582	612	642	672	702	732	762	792	822	852	882	912
13	43	73	103	133	163	193	223	253	283	313	343	373	403	433	463	493	523	553	583	613	643	673	703	733	763	793	823	853	883	913
14	44	74	104	134	164	194	224	254	284	314	344	374	404	434	464	494	524	554	584	614	644	674	704	734	764	794	824	854	884	914
15	45	75	105	135	165	195	225	255	285	315	345	375	405	435	465	495	525	555	585	615	645	675	705	735	765	795	825	855	885	915
16	46	76	106	136	166	196	226	256	286	316	346	376	406	436	466	496	526	556	586	616	646	676	706	736	766	796	826	856	886	916
17	47	77	107	137	167	197	227	257	287	317	347	377	407	437	467	497	527	557	587	617	647	677	707	737	767	797	827	857	887	917
18	48	78	108	138	168	198	228	258	288	318	348	378	408	438	468	498	528	558	588	618	648	678	708	738	768	798	828	858	888	918
19	49	79	109	139	169	199	229	259	289	319	349	379	409	439	469	499	529	559	589	619	649	679	709	739	769	799	829	859	889	919
20	50	80	110	140	170	200	230	260	290	320	350	380	410	440	470	500	530	560	590	620	650	680	710	740	770	800	830	860	890	920
21	51	81	111	141	171	201	231	261	291	321	351	381	411	441	471	501	531	561	591	621	651	681	711	741	771	801	831	861	891	921
22	52	82	112	142	172	202	232	262	292	322	352	382	412	442	472	502	532	562	592	622	652	682	712	742	772	802	832	862	892	922
23	53	83	113	143	173	203	233	263	293	323	353	383	413	443	473	503	533	563	593	623	653	683	713	743	773	803	833	863	893	923
24	54	84	114	144	174	204	234	264	294	324	354	384	414	444	474	504	534	564	594	624	654	684	714	744	774	804	834	864	894	924
25	55	85	115	145	175	205	235	265	295	325	355	385	415	445	475	505	535	565	595	625	655	685	715	745	775	805	835	865	895	925
26	56	86	116	146	176	206	236	266	296	326	356	386	416	446	476	506	536	566	596	626	656	686	716	746	776	806	836	866	896	926
27	57	87	117	147	177	207	237	267	297	327	357	387	417	447	477	507	537	567	597	627	657	687	717	747	777	807	837	867	897	927
28	58	88	118	148	178	208	238	268	298	328	358	388	418	448	478	508	538	568	598	628	658	688	718	748	778	808	838	868	898	928
29	59	89	119	149	179	209	239	269	299	329	359	389	419	449	479	509	539	569	599	629	659	689	719	749	779	809	839	869	899	929
30	60	90	120	150	180	210	240	270	300	330	360	390	420	450	480	510	540	570	600	630	660	690	720	750	780	810	840	870	900	930

Order Your PHOTOFACT COLOR TV LIBRARY Now!

3 SPECIAL OFFERS:

- ① 1954 up to 1964—full coverage in 60 PHOTOFACT Sets
- ② 1954 through 1966—full coverage in 180 PHOTOFACT Sets
- ③ 1954 through 1967—full coverage in 240 PHOTOFACT Sets

FREE 1-drawer file cabinet with 60 Set Offer; 4-drawer file cabinet with 180 Set Offer; 4-drawer cabinet plus 1-drawer cabinet with 240 Set Offer

USE THE SPECIAL EASY-PAY PLAN

- No interest or carrying charges
- Only \$20 down
- From 12-30 months to pay
- Prepaid transportation
- Save 25¢ per Set—special \$2.25 Set price applies on Easy-Buy (instead of the regular \$2.50 price)

ASK ABOUT THE PHOTOFACT "TRADE-IN" DEAL
(offer available through June 30, 1968)

SEE YOUR SAMS DISTRIBUTOR FOR FULL DETAILS OR MAIL COUPON BELOW TODAY

**GET GOING IN
 COLOR TV!**

JOIN THE PHOTOFACT-OF-THE-MONTH CLUB:



NOW! Only \$10 per month brings you 20% MORE Photofact coverage to keep you current—saves you over \$60 per year!

- Get 6 new Photofact Sets each month
- Covers at least 50 new chassis
- At least 6 Color TV Folders monthly

NEW BONUS: MINIMUM OF 10 "ADVANCE" TV SCHEMATICS (MOSTLY COLOR) WITH EACH MONTH'S ISSUE—PLUS GREAT FILE CABINET DEAL WITH TRIAL 6-MONTH SUBSCRIPTION TO P.O.M. (PHOTOFACT-OF-THE-MONTH CLUB).

HOWARD W. SAMS & CO., Dept. EWF-12
 4300 W. 62nd St., Indianapolis, Indiana 46206

- Send full details on Library Offer and Easy-Buy Plan
- Send Photofact-of-the-Month Club details
- Send FREE 1968 PHOTOFACT Cumulative Index

My Distributor is _____

Shop Name _____

Attn.: _____

Address _____

City _____ State _____ Zip _____

New COLOR-TV Tuning Indicator

By WALTER H. BUCHSBAUM/Contributing Editor

Westinghouse receiver uses on-screen tuning bar that moves with the fine-tuning control to indicate the proper setting.

MANY of the new *Westinghouse* color-TV receivers have a feature which is intended to help the user fine-tune his set more effectively. When the "Tuning Bar" push switch is depressed, two black vertical lines appear on the screen, superimposed on the picture. If the fine tuning is correct, the two lines will coincide at the center of the screen, as shown in the center of Fig. 1. As the fine-tuning control is adjusted, one line remains stationary at the center while the other line moves either to the left or the right. As indicated in Fig. 1, moving the fine-tuning control clockwise or counterclockwise brings the movable line to the center until the two coincide. At that point correct fine tuning is achieved, the tuning-bar control is depressed again and the display disappears. The circuitry for this feature is mounted on a separate printed-circuit board and consists of 9 transistors and 7 diodes. There are three service adjustments.

Circuit Functions

The block diagram of Fig. 2 illustrates the functions performed by the various circuits to generate the fine-tuning display. The actual selection of the correct fine-tuning point is accomplished by a slope detector. A resonant circuit receives a portion of the i.f. signal so that the 45.75-MHz video i.f. carrier frequency falls halfway on the slope of the i.f. response curve. When the fine-tuning control is set correctly, the 45.75-MHz signal falls at exactly the right spot and the slope detector, a simple diode video detector, produces a negative-going video signal of approximately 3 volts peak-to-peak. This signal will depend on the received signal strength and, to compensate for this variation, a portion of the video signal from the first video amplifier is peak-detected and the resulting d.c. is added in opposite polarity to the output of the slope detector.

If the received signal is very strong, the video signal will be correspondingly strong and the d.c. output of the peak

detector will act as bias for the buffer amplifier and second peak detector. The slope detector output is a video signal added to the d.c. level established by the first video peak detector. This is fed into a buffer amplifier and into another peak detector, which rectifies the video and produces the final d.c. control signal. It is this d.c. control signal, which now depends primarily on the fine tuning (the position of the 45.75-MHz carrier on the response curve slope) that determines the position of the movable vertical line on the picture-tube screen. The stationary line is positioned by an adjustable reference voltage.

The display on the picture tube is made possible by allowing the signals generating each vertical line to reach the last video amplifier on alternate vertical scans. To accomplish this, the vertical pulse (at 60 Hz) is fed into a bistable multivibrator which then controls a diode gate section, shown as a switch in Fig. 2. Operation is such as to connect either the d.c. from the peak detector or the d.c. from the reference source on alternate fields, at a 30-Hz rate.

To provide a vertical line on the picture tube, it is necessary to generate identical pulses during successive horizontal lines so that all pulses occur with the identical delay after the sync. This is accomplished by passing horizontal pulses through a variable delay, which is a circuit that compares the sawtooth component due to the horizontal pulse with a d.c. voltage, and then triggers a monostable multivibrator. By varying the d.c. voltage, the time delay between the horizontal pulse which corresponds to the start of a scanning line and the instant of triggering can be controlled. Depending upon the d.c. control voltage fed into the variable delay circuit, the monostable multivibrator will generate a pulse each time a horizontal pulse occurs but at a fixed time delay.

During one field of vertical scanning the d.c. reference voltage is connected to the variable delay and the monostable multivibrator will fire so that the resultant pulse appears in the center of the picture. A potentiometer in the delay circuit is used to set the d.c. reference voltage so that the stationary line appears in the center. During alternate vertical fields, when the output of the slope detector section is connected to the variable delay circuit, the position of the vertical line or the pulses generated by the monostable multivibrator depend on the d.c. voltage. When both d.c. voltages are identical the two lines will coincide.

Service Adjustments

From this description it is apparent that a number of adjustments must be made by the service technician to set up the system correctly. These adjustments are in addition to the customary r.f. and i.f. alignment procedures. The first adjustment concerns the tuning coil in the slope detector which must be adjusted so that the 45.75-MHz video i.f. carrier is centered on the slope of the response curve. Next, the reference voltage is adjusted so that the best fine tuning makes the lines coincide. Finally, there is a potentiometer adjustment in the variable delay circuit to center both lines on the screen.

The video gate output pulses from the monostable multivibrator are applied through a diode to the control grid of the second video amplifier. This means that the pulses will appear as a positive-going spike on the three cathodes of

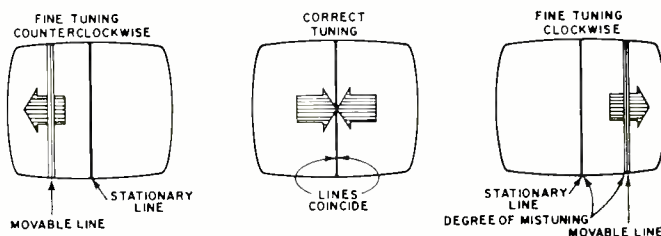
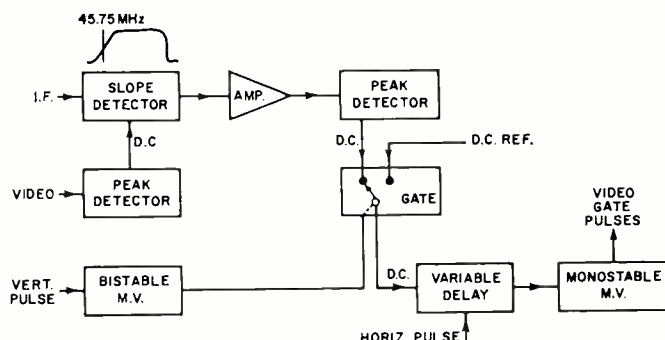

Fig. 1. Operating the fine-tuning control moves vertical line.

Fig. 2. Block diagram of circuit that provides the tuning bar.



the color picture tube and will therefore cut the electron beam off, generating a black vertical line on the screen.

Depressing the tuning bar itself merely connects +12 volts power from the audio amplifier cathode to the bistable multivibrator, the variable delay, and the monostable multivibrator. The slope detector, buffer amplifier, and the two peak detectors receive power at all times in order not to change the circuit loading in other portions of the color-TV set.

Westinghouse's service literature contains detailed oscilloscope waveforms and test points to facilitate troubleshooting of the printed-circuit board containing the on-screen tuning-bar circuitry. In the event of incorrect operation, the first steps would be to check the output of the video peak detector going to the slope detector, the output of the peak detector going to the gate, and the d.c. reference voltages since they are the critical elements in determining the over-all circuit operation. ▲

Constant-Voltage Xformers

(Continued from page 43)

from 100 V to 130 V, must be able to withstand 150% overload, continuous rating of 8 A, maximum harmonic 3%, load regulation to full load of 2%.

This specification would no doubt result in the ordering of a larger and more costly CVT than necessary.

Other Considerations

Ambient temperature and temperature variations, if any, should be considered. Normal maximum temperature rise of a constant-voltage transformer may fall anywhere in the range of 45°C to 115°C depending on type and rating. In any case, the maximum operating temperature at a 40°C ambient is always within safe operating limits for the class of insulating material used. Nominal design and ambient range is between -10°C and 40°C.

Many CVT's are built on magnetic cores specially proportioned to minimize external stray-field effects. With these designs, in the great majority of applications, stray-field effect from the CVT may be disregarded but, for critical applications, care should be taken in orienting the core with respect to critical circuits in the device to minimize field effect. Special units can be designed and built with shielding to further reduce stray-field effect.

The following basic mechanical requirements should also be specified: package size, type and location of mounting surfaces, input power termination and general location, output power termination and location. ▲

Popular Science Top-Rates Scott's Stereo Tuner Kit

(THERE'S A SOUND REASON.)



Popular Science magazine's reviewer said, "I rate the LT-112-B as one of the finest FM tuners available — in or out of kit form." All of this fabulous tuner's critical circuitry comes pre-wired, pre-tested, and pre-aligned . . . and the full-size, full-color instruction manual makes the rest simple. In just eight hours, you'll have it completed. Again, in the reviewer's words: "Stereo performance is superb, and the set's sensitivity will cope with the deepest fringe area reception conditions . . . drift is non-existent." See your Scott dealer and review the new LT-112B-1 for yourself. Only \$199.95.



©Copyright 1967, H.H. Scott, Inc.

H.H. Scott, Inc., Dept. 160-12, Maynard, Mass. 01754. Export: Scott International, Maynard, Mass. 01754
CIRCLE NO. 99 ON READER SERVICE CARD



LAB STANDARD AMPLIFIER



DELIVERS
ONE
HORSEPOWER

800 (1HF) Watts

WIDE BAND

± 0.5 db. ZERO—100,000 Hz (1w.).

CLEAN

99 and 95/100% PURE POWER at ANY level.

QUIET

Less than 5 billionths of a watt total hum and noise.

RELIABLE

Short- and mismatch-Proof. Made in America.

STABLE

TRUE DC circuit design—patents pending.

MODEL
DC 300
DUAL CHANNEL
ONLY
\$575

WRITE NOW

FOR FULL DETAILS TO
DEPT. EW-12



Box 1000, Elkhart, Indiana 46514

CIRCLE NO. 119 ON READER SERVICE CARD

In today's electronics boom, the demand for men with technical education is far greater than the supply of graduate engineers. Thousands of real engineering jobs are being filled by men without engineering degrees—provided they are thoroughly trained in basic electronic theory and modern application. The pay is good, the future is bright...and the training can now be acquired at home—on your own time.

How to become a “Non-Degree Engineer”



THE ELECTRONICS BOOM has created a new breed of professional man—the non-degree engineer. Depending on the branch of electronics he's in, he may "ride herd" over a flock of computers, run a powerful TV transmitter, supervise a service or maintenance department, or work side by side with distinguished scientists on a new discovery.

But you do need to know more than soldering connections, testing circuits and replacing components. You need to really know the fundamentals of electronics.

How can you pick up this necessary knowledge? Many of today's non-degree engineers learned their electronics at home. In fact, some authorities feel that a home study course is the *best* way. *Popular Electronics* said:

"By its very nature, home study develops your ability to analyze and extract information as well as to strengthen your sense of responsibility and initiative."

Cleveland Method Makes It Easy

If you do decide to advance your career through home study, it's best to pick a school that *specializes* in the home study method. Electronics is complicated enough without trying to learn it from texts and lessons that were designed for the classroom instead of the home.

Cleveland Institute of Electronics concentrates on home study exclusively. Over the last 30 years it has developed tech-

niques that make learning at home easy, even if you once had trouble studying. Your instructor gives the lessons and questions you send in his undivided personal attention—it's like being the only student in his "class." He not only grades your work, he analyzes it. And he mails back his corrections and comments the same day he gets your lessons, so you read his notations while everything is still fresh in your mind.

Students who have taken other courses often comment on how much more they learn from CIE. Says Mark E. Newland of Santa Maria, Calif.:

"Of 11 different correspondence courses I've taken, CIE's was the best prepared, most interesting, and easiest to understand. I passed my 1st Class FCC exam after completing my course, and have increased my earnings by \$120 a month."

Always Up-to-Date

Because of rapid developments in electronics, CIE courses are constantly being revised. This year's courses include up-to-the-minute lessons in Microminiaturization, Laser Theory and Application, Suppressed Carrier Modulation, Single Sideband Techniques, Logical Troubleshooting, Boolean Algebra, Pulse Theory, Timebase Generators...and many more.

CIE Assures You an FCC License

The Cleveland method of training is so successful that better than *9 out of 10 CIE*

men who take the FCC exam pass it—and on their first try. This is despite the fact that, among non-CIE men, 2 out of every 3 who take the exam fail! That's why CIE can promise in writing to refund your tuition in full if you complete one of its FCC courses and fail to pass the licensing exam.

This Book Can Help You

Thousands who are advancing their electronics career started by reading our famous book, "How To Succeed in Electronics." It tells of many non-degree engineering jobs and other electronics careers open to men with the proper training. And it tells which courses of study best prepare you for the work you want.

If you would like to cash in on the electronics boom, let us send you this 40-page book free.

Just fill out and mail the attached card. Or, if the card is missing, write to:

CIE Cleveland Institute of Electronics
1776 E. 17th St. Dept. EW-39,
Cleveland, Ohio 44114
Accredited Member National Home Study Council

ENROLL UNDER NEW G. I. BILL

All CIE courses are available under the new G.I. Bill. If you served on active duty since January 31, 1955, or are in service now, check box on reply card for G.I. Bill information.

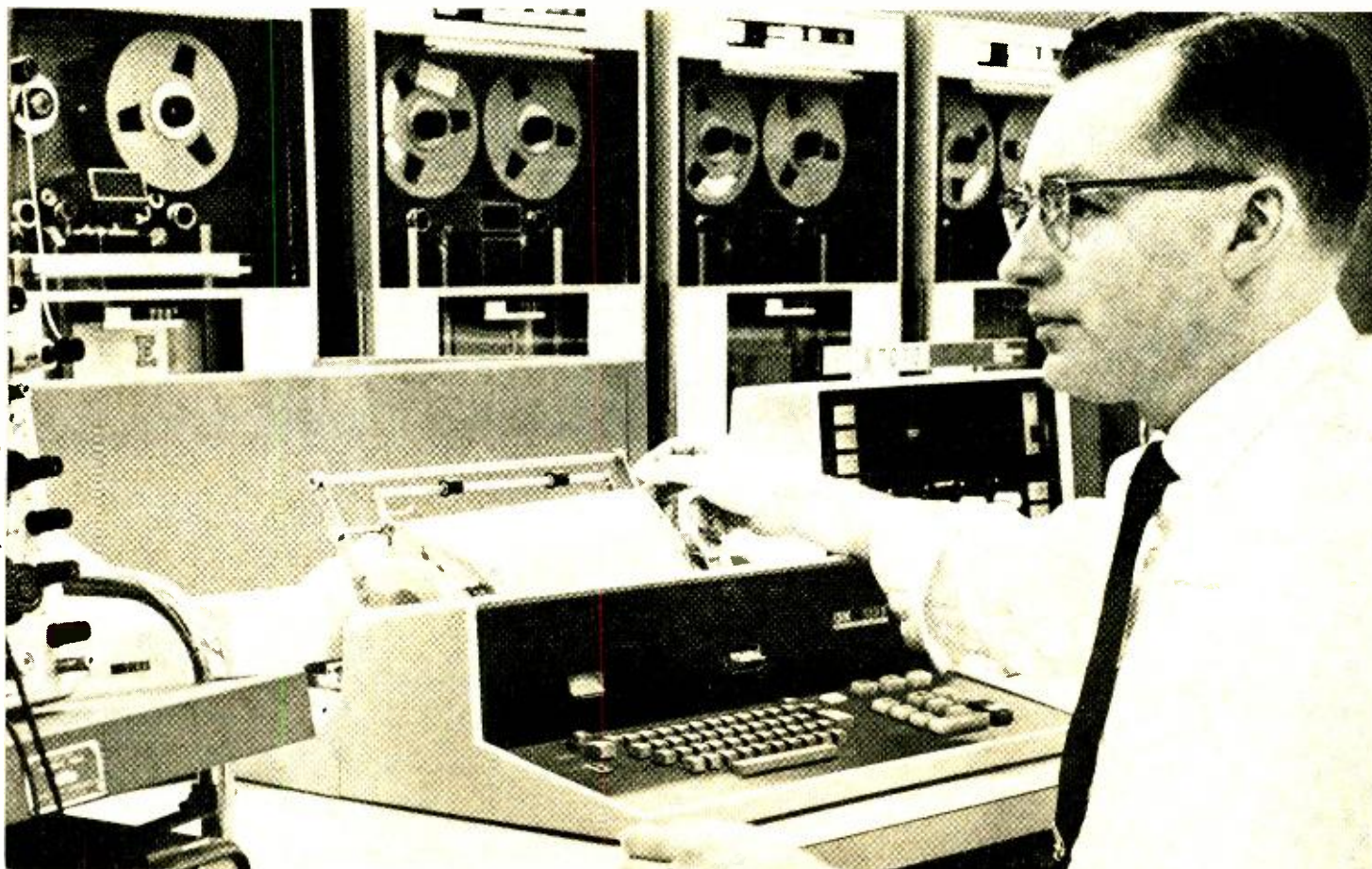

No dealer stocks everything.

No salesman knows everything.

But the 1968 STEREO/HI-FI DIRECTORY does!



It's a giant 182 page buyer's guide to virtually every new audio component on the market today. Over 1600 products in all! From amplifiers to complete hi-fi systems to tape cartridge recorders and players for your home, car and boat. All the latest offerings from 176 manufacturers are fully detailed and illustrated for your "shop-at-home" convenience.

Every technical specification, dimension, special feature, optional accessory, price and model number is at your fingertips—to help you compare similar items, feature for feature, dollar for dollar and decide which is best for you. Before you buy!

Forget the guesswork, costly mistakes, store-to-store treks and "after-you-get-it-home" disappointments. With the 1968 STEREO/HI-FI DIRECTORY as your guide, you'll zero-in on the equipment you want, buy it with confidence—and know you're getting the greatest value for your money.

The price for this valuable "encyclopedia" of hi-fi information? Just \$1.25. A small investment, indeed, for such an essential component of your listening enjoyment. So don't delay. Use the coupon below to order your copy of the 1968 STEREO/HI-FI DIRECTORY today!

CONTENTS INCLUDE
Special 8-page section on: • How to choose components • How to compare prices, features specifications • Exclusive state-of-the-art report on componentry • PLUS an incisive analysis of the controversial 8 track, 4 track and cassette tape cartridges. . . . Comments and clues on which design holds the most promise for the future.

Individual directories for amplifiers / changers / turntables / cartridges and tonearms / receivers/tuners/tape machines (including video recorders and cartridge units) / speakers / integrated systems / antennas / microphones / cabinets.

The 1968 STEREO/HI-FI DIRECTORY is available in a splendid deluxe edition. Rugged Leatherflex cover provides lasting protection yet is softly textured and gold-embossed for the look of elegance. A collector's item—a superb addition to your permanent reference library. Just \$3 postpaid.

ZIFF-DAVIS SERVICE DIVISION • DEPT. SD 595 Broadway • New York, N. Y. 10012

YES: Send me the new 1968 STEREO/HI-FI DIRECTORY as checked below:

- \$1.25 enclosed, plus 15c for shipping and handling. Send me the regular edition. (\$1.75 for orders outside the U.S.A.)
- \$3.00 enclosed. Send me the Deluxe Leatherflex-bound edition, postpaid. (\$3.75 for orders outside the U.S.A.) Allow three additional weeks for delivery.

print name EW-127
 address _____
 city _____
 state _____ zip code _____

PAYMENT MUST BE ENCLOSED WITH ORDER

RADIO & TV NEWS



LEANING heavily on all the old clichés, "sauce for the goose . . .", "all's fair in love and war", etc., the British are fighting back with a "Brain Gain" office in New York for the recruitment of top level management personnel and technical specialists.

Hoping to counteract the outflow of United Kingdom "brains" to the lush fields of American industry, new offices have been set up at Suite 301, 465 Park Ave., manned by personnel from *Management Selection International Inc.*, a subsidiary of a British recruitment and selection consultant firm.

MSL will also publish a regular newsletter highlighting current developments within British industry and technology and send it to North American talent.

Ideographic Composing Machine

The U.S. Army has taken delivery on a new electronic typesetting machine which is capable of composing Chinese, Japanese, and Korean written language directly from a keyboard.

Developed by RCA, the new Ideographic Composing Machine employs a technique that is the first practical departure from hand-set type in the 3000-year history of these written languages.

By combining the latest in computer, television, and optical techniques, the machine can set 60 to 100 characters a minute, each character representing a word, phrase, or a complete sentence from any of the three languages—from a storage bank of some 10,000 characters. The machine can be operated manually or automatically by means of paper tape punched in advance.

Tiny "Teacup" Computer

What is claimed to be the world's smallest operational data processing system, (4" x 4" x 9") *Control Data's* 449 computer has been demonstrated to those attending the 1967 Air Force Association Aerospace Development Briefings and Displays in Washington.

The "teacup" computer, itself, occupies only a four-inch cube within the outer case yet it contains all of the elements and computing power of a standard-size general-purpose computer system, including a 4096-word (24-bit) memory. Weighing less than four

pounds, the computer consumes just 4 watts of power. It has been specifically designed for aerospace applications, but who knows where this handy "pocket-sized" unit might pop up next!

Field-Testing Data

Miniature FM transmitters which were originally developed by NASA for broadcasting biomedical data from space capsules are finding down-to-earth application in broadcasting load data from industrial equipment under actual operating conditions.

Rex Chainbelt is using the units to gather information on the loads and stresses its machinery is subjected to in the field and are thus able to predict more accurately the service life of its products and help customers select those products which will provide the requisite service life.

The company is building its own units for this particular application, to its rather specialized specs.

Spectrochemical Analysis by Laser

The National Bureau of Standards has conducted a series of tests on the uses of lasers for spectrochemical analysis. In this application, a high-energy laser beam is focused on a specimen, vaporizing a small sample. By further exciting the vapor with a spark discharge, emission spectra may be obtained.

The wide range of laser-probe analytical applications includes analysis of microsamples, thin films, small wire, and particles embedded in specimens.

The apparatus used in the NBS study has as its main components a control console, a Q-switched ruby laser, a microscope, and an electrode system with separate spark power supply.

Master Antennas for S.A.

Siemens, the German firm, has installed master antennas in San Felipe, Peru's largest and most modern housing project, to bring radio and TV programs to some 1600 dwelling units. Since American TV standards prevail in Peru, seven TV programs can be transmitted. The subscriber network, totaling 26, is equipped with antenna socket outlets employing a directional coupler. ▲

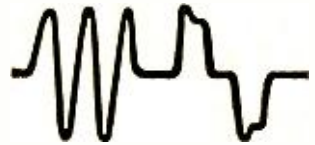

Remember to ask—"What else needs fixing?"



That's the question to ask to add extra profit to every service call. It makes sense. Just about every customer who calls you for TV repair owns other electronic products that are excellent prospects for service. You've already invested your time getting to his home. So why not see what further service you can render?

Does it work? You bet! On a test program sponsored by Electronic Industries Association, in which Mallory is an active member, service men got 6% more profit from business they added just by asking that simple question.

Here are some tips that you can use to cash in on this idea.

Portable radios, for instance. Most homes have at least one. Ask 'em, "How about fresh batteries?" And then sell Mallory Duracell® batteries . . . best buy in long life and fade-free power. And don't forget cameras, flashlights and toys. They need batteries, too, and there's a Duracell type for every job.

Ask to check table radios . . . then listen for hum as the set warms up. Many people put up with hum because they've forgotten how well the radio sounded when new. But hum may be a sign that a filter capacitor is near the end of its life. Replace with a Mallory FP, WP, TC or MTA. Your Mallory Distributor can supply the exact size and rating you need.

How about hi-fi and stereo? Ask to turn them on, and see if you detect anything that calls for service. You can suggest adding remote speakers for a porch or family room. Be sure to include a Mallory balance control and remote volume controls, to make the installation complete. Record changers and electronic organs are good service opportunities, too.

Try this profit-building "What else needs fixing?" idea on the next calls you make. And for the quality components that make every job sure, see your Mallory Distributor. Mallory Distributor Products Company, a division of P. R. Mallory & Co. Inc., Indianapolis, Indiana 46206.

©Duracell is a registered trademark of P. R. Mallory & Co. Inc.

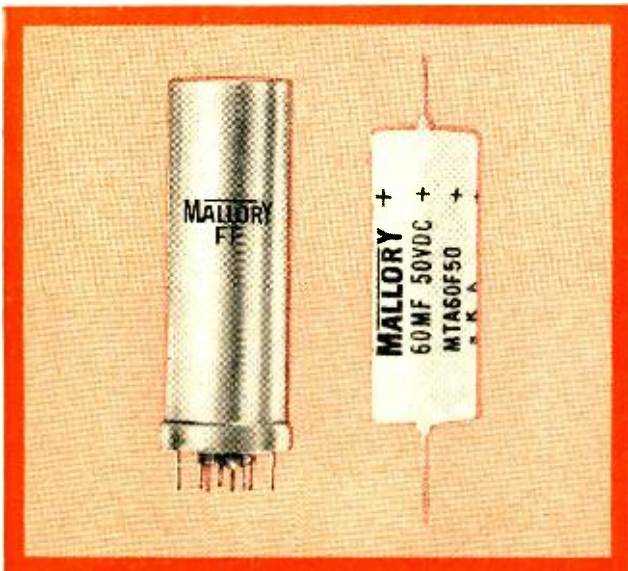

CIRCLE NO. 107 ON READER SERVICE CARD

Log-Periodic Antennas

(Continued from page 48)

nail on the left side, etc., in zig-zag fashion. The bottom wire is strung in a similar manner, starting with the first nail on the right-hand side. If small wire is used, it should be taut enough so that it doesn't sag, but not so taut that it bends the frame. Note that the connection to the 300-ohm line is made at the point where the top and bottom wires would otherwise cross the center line for the last time. A method for connecting the final zig-zag element to 300-ohm twin-lead is shown in Fig. 5.

As mentioned previously, the only difference between a pyramidal and planar log-periodic antenna is that in the former the dipole supports are inclined at an angle. Both of the antennas whose dimensions are given in Tables 1 and 2 can be constructed in pyramidal form. To do so, two identical frames must be built, one to support the upper dipole elements and the other to support the lower dipole elements. If sufficient attic space is available, the angular separation, θ , should be made equal to α for maximum gain. Approximately 2 dB additional gain can be obtained from the TV-FM antenna with $\theta = 41^\circ$ rather than zero. Additional gain can also be obtained from the FM-only antenna by making $\theta = 13^\circ$.

An all-metal antenna suitable for mast mounting can be constructed with a little additional work. In a sample model constructed to prove the feasibility of the idea, the author used 10-foot lengths of 1/2-inch diameter galvanized electrical conduit to serve both as the feeder line and as the structural support for the dipole elements. The wooden frame described earlier is recommended as a jig for locating and forming the dipole elements. Such a jig was used by the author to determine the lengths of the sides of the vees which constitute the dipole elements. Vees were formed from aluminum clothesline wire and the sides were cut about 2 inches longer than required to reach the centerline. Holes were drilled in the conduit where the vees were to be attached. The ends of the vees were inserted through the proper holes and the excess length was bent parallel to the length of the conduit. An eyelet was then formed with the excess length and a metal screw was placed through the eyelet and into a hole drilled in the conduit for anchoring.

Ordinary aluminum clothesline wire was used in the feasibility model because it can be easily bent to form the dipole vees. However, rigid aluminum rod is desirable for a mast-mounted antenna that is subject to wind forces. Also, aluminum tubing rather than galvanized conduit is preferable for use as the feeder line because of its lighter weight. As before, either a pyramidal or planar version of the two basic antennas can be constructed. The wooden support shown in Fig. 3, which is used to maintain the angle in a pyramidal version, can actually be metal, since either a short or open-circuit termination is satisfactory.

The directive gains of the planar TV-FM and FM-only antennas are 10 and 12 dB above isotropic.

Under favorable atmospheric conditions, the author is able to satisfactorily receive two FM stations 130 miles away using a 2.7-microvolt sensitivity (IHF standards) FM tuner and the FM-only antenna. One of the two stations has a radiated power output of only 23.5 kilowatts. FM-stereo stations 70 miles away which have radiated power outputs greater than 10 kilowatts are received satisfactorily all of the time. The FM-only antenna also provides snow-free reception of TV channels 4 through 9 even though the broadcast stations are 70 miles away and the antenna was not designed to cover TV-broadcast frequencies (except channel 6 which is received at 87.5 MHz).

As expected, TV reception with the TV-FM antenna is excellent. FM reception with this antenna is not quite as good as with the FM-only antenna, but is satisfactory. ▲

FREE!



**BRAND NEW
FALL AND WINTER
RADIO-TV
ELECTRONICS
CATALOG**



**YOUR BUYING GUIDE
FOR:** • Stereo & Hi-Fi
Systems & Components
• Tape Recorders • Elec-
tronic Parts, Tubes, Tools
• Phonos & Records
• Ham Gear • Test In-
struments & Kits • Cam-
eras & Film • PA • Cit-
izens Band • Radio & TV
Sets • Musical Instru-
ments

MAIL TODAY TO:

BURSTEIN-APPLEBEE

Dept. EWL 1012 McGee, Kansas City, Mo. 64106

Name _____
Address _____
City _____
State _____ Zip Code _____

CIRCLE NO. 123 ON READER SERVICE CARD

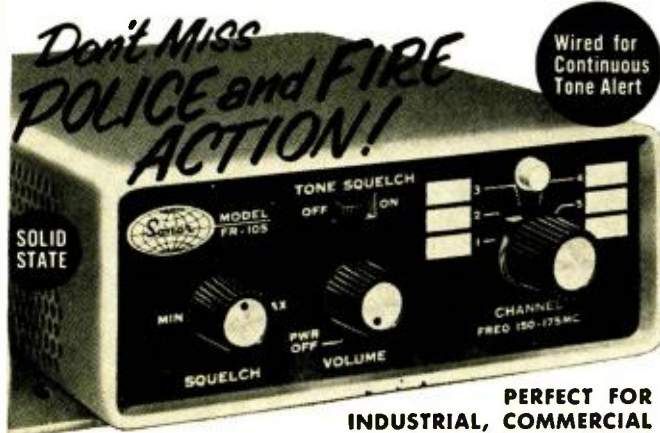

**PERFECT FOR
INDUSTRIAL, COMMERCIAL
and GOVERNMENT USE**

**DUAL CONVERSION
SMALL SIZE • LOW POWER DRAIN • HIGH STABILITY • CRYSTAL CONTROLLED**

Specifically designed for simplicity of operation... efficiently engineered to give you years of dependable service. Fits the smallest auto yet powerful enough to deliver a clean, clear signal. Operates on 6 crystal controlled frequencies. Features: Dual limiter & Foster Seeley discriminator. Quadruple tuned RF stage for greater image rejection. Noise Free squelch, PLUG IN crystals for instant frequency change. Compatible with major continuous tone systems. Operates on 117VAC and 12VDC. Size: 6 7/8" x 2 3/8" x 8 1/2". Wt. 3 lbs. 8 oz.

FR-104

(25-50 MHz)

FR-105

(150-175 MHz)

\$140⁰⁰

Complete with AC and DC power cables, mounting bracket, less crystals. Crystals \$5.00 ea.



SONAR RADIO CORPORATION
73 Wortman Ave., Bklyn, N.Y. 11207 Dept. 579
Please send me information on Model
FR-104/105 FM Monitor Receivers.

Name _____
Address _____
City _____ Zone _____ State _____

CIRCLE NO. 95 ON READER SERVICE CARD

New Stereo Receivers

(Continued from page 29)

As a rule, each manufacturer specifies the *reference distortion* level for his amplifier. We used a 2% distortion level for all units to permit comparisons among models on the same basis.

The power output of an amplifier is not too meaningful in itself. It must be considered in relation to the size of the room, the speaker efficiency, and one's listening habits. For most speakers used in average-sized living rooms, an output of 15 watts (continuous) per channel is adequate. Low-efficiency speakers require at least 30 watts per channel. In a very large room, this figure should be doubled.

Power output does not relate to how loud an amplifier can play in normal use. Average power levels, even with low-efficiency speakers, are rarely more than a watt or two. However, peaks of ten times the average power, or more, are often encountered in music. If the amplifier cannot deliver that power without distortion, it sounds fuzzy and strained when played at even moderate levels. A barely noticeable 3-dB increase in listening level calls for double the power from the amplifier, so it can be seen that the 20- to 40-watt capabilities of most receivers are not at all excessive.

Dynamic power output is a measure of the regulation of the amplifier's power supply. With a perfectly regulated power supply, the dynamic and continuous output ratings would be essentially the same. It is difficult to compare amplifiers by their dynamic power ratings, which may not relate too closely to their true output capabilities.

Power Bandwidth is measured by operating the amplifier at reference (rated) output and measuring harmonic distortion *versus* frequency between 20 and 20,000 Hz. Where the distortion is either much less than, or much more than 2% at the manufacturer's rated output, we establish a reference power level as close as possible to that which results in 2% distortion at 1000 Hz.

Similar measurements are made at -3 dB (half reference power) and -10 dB (one-tenth reference power). We do not normally express Power Bandwidth numerically, but it can be read from the published curves of dis-

ortion *versus* frequency. The frequencies at which the -3 dB curve intersects the reference distortion level (e.g., 2%) define the Power Bandwidth.

Power bandwidth is a measure of how much power an amplifier can deliver over the full audio frequency range. If two amplifiers can each deliver 30 watts at 1000 Hz, but at 30 Hz one can develop only 10 watts while the other produces 25 watts, it is obvious which is the better unit. Where the power bandwidth is limited, one can easily encounter distortion at moderate levels, due to overload of the amplifier at one or both of the frequency extremes. An amplifier is no better than its performance at the limits of the audible spectrum, regardless of what it can do at the middle frequencies.

Sensitivity is the 1000-Hz input voltage which will develop reference output from an amplifier, at maximum volume control setting. We modified this test slightly to use 10 watts as a reference level for all amplifiers, regardless of their power ratings. This simplifies comparison among amplifiers, indicating how much signal is required for a given listening volume, assuming the use of the same speakers in each case. We measure sensitivity at the high-level (auxiliary) and magnetic phono inputs.

Amplifier sensitivity is relatively unimportant. We know of no combinations of receiver and phono cartridge which would be incompatible from the standpoint of signal levels.

Hum and Noise are measured at the amplifier outputs in the absence of an input signal. According to IHF Standards, hum is measured at maximum gain settings, with inputs both open and shorted. The hum and noise output is expressed in decibels below reference output.

Amplifiers differ greatly in their sensitivities and sometimes have unrealistically high hum levels when operated at maximum gain. Our practice is to set the volume control so that 1 volt at the "Aux" input, or 10 mV at the phono input, will develop 10 watts output. The input being measured is terminated with 2.2 kohms, to simulate a driving source, not necessarily an open or short-circuited condition which is unlikely to be found in a real situation. Hum and noise are expressed in decibels below 10

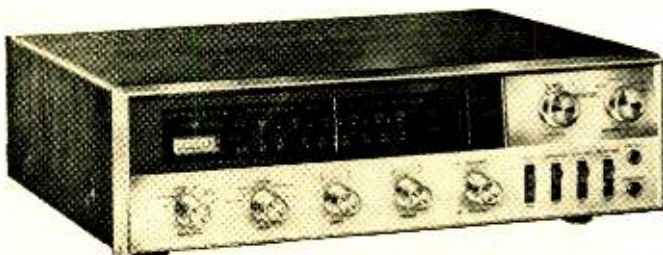

The Lafayette Model LR-1000T solid-state stereophonic receiver.

SPECIAL 10th ANNIVERSARY ISSUE—

All-new
Winter
1968
Edition!

Over 145
Pages!

28 New
Projects!

It's our anniversary . . . but you get the present: 250 fascinating, fun-filled hours with the all-new Winter 1968 ELECTRONIC EXPERIMENTER'S HANDBOOK! A big surprise package of 28 challenging do-it-yourself construction projects for • your home and auto • audio, stereo, hi-fi • SWL, CB and Ham • science fair projects • lab and test equipment.

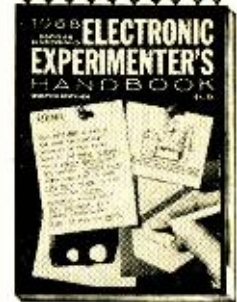

You'll build such valuable units as . . . a solid-state CD ignition system . . . a sequence-operated lock . . . a metal locator . . . a two-by-two stereo preamplifier . . . a 70 watt per channel hi-fi amplifier . . . a VOM range splitter . . . an IC binary counter . . . and Tesla's thermomagnetic motor!

Each has complete schematics, illustrations, parts lists and easy-to-follow instructions that guarantee you perfect finished products. PLUS expert tips 'n techniques designed to build your electronics skill. You'll keep up with the latest advances in the field, learn many professional methods and shortcuts . . . and develop that extra technical know-how you get only from practical, first hand experience.

In short, Happy Anniversary to us . . . means Happy Hobbying to you. For this big 10th Anniversary edition of the ELECTRONIC EXPERIMENTER'S HANDBOOK is the best yet—sure to be grabbed up by electronics enthusiasts everywhere. Use the coupon below to order your copy today!

GET THE
DELUXE
LEATHERFLEX
BOUND EDITION
for just \$3 POSTPAID!

The Winter 1968 ELECTRONIC EXPERIMENTER'S HANDBOOK is also available in a splendid deluxe edition. Rugged leatherflex cover provides lasting protection yet is softly textured and gold-embossed for the look of elegance. A collector's item—a superb addition to your electronics bookshelf. And it's yours, for just \$3 postpaid, when you check the appropriate box on the order form.

Only
\$125

OK! Send me the all-new Winter 1968 ELECTRONIC EXPERIMENTER'S HANDBOOK.

\$1.25 enclosed, plus 15c for shipping and handling. Send me the regular edition. (\$1.75 for orders outside the U.S.A.)

\$3.00 enclosed. Send me the Deluxe Leatherflex-bound edition, postpaid. (\$3.75 for orders outside the U.S.A.) Allow three additional weeks for delivery.

print name _____

address _____

EW-127

city _____

state _____

zip code _____

I missed the big Spring 1967 edition. Please send me the
 regular edition Deluxe Leatherflex-bound edition.
(Prices same as above.)

PAYMENT MUST BE ENCLOSED WITH ORDER

Electronics World SUBSCRIBER SERVICE

Please include an address label when writing about your subscription to help us serve you promptly. Write to: Portland Place, Boulder, Colo. 80302

CHANGE OF ADDRESS:

Please let us know you are moving at least four to six weeks in advance. Affix magazine address label in space to the right and print new address below. If you have a question about your subscription, attach address label to your letter.

TO SUBSCRIBE:

Check boxes below.

- New Renewal
 5 years \$21
 3 years \$15
 1 year \$6

SPECIFY:

- Payment enclosed—
 You get 1 extra issue
 per year as a BONUS!
 Bill me later.

← AFFIX LABEL →

If you have no label handy, print OLD address here.

name _____

address _____

city _____

state _____ zip code _____

please print

Add'l postage: \$1 per year outside U.S., its possessions & Canada.

name _____ please print _____ 0192

address _____

city _____

state _____ zip code _____



PHOTOGRAPHY ANNUAL

1967 — \$1.50#38
 1966 — \$1.25#1
 1964 — \$1.25#3

A selection of the World's finest photographs compiled by the editors of Popular Photography.

Order by number from
Ziff-Davis Service Div., 595 Broadway • New York, N.Y. 10012 Enclose add'l 15¢ per copy for shipping and handling (50¢ for orders outside U.S.A.)

THE NEW SCIENCE OF ASTRONICS FROM PROJECT TAMAROA

The Six Keys To The Universe

This compendium explains the electro-mechanics of planet earth, gyroscope action, spatial capacitors, gravity, rotating electric charges, unified field theory, the electronic spring, 5th dimension, instin postulate, the ferrette, light transmission, etc.

Price \$2.50

J. E. LEWIS

3219 N. Panama Ave. Chicago, Ill. 60634

LEARN Electronics Engineering AT HOME

Fix TV, design automation systems, learn transistors, complete electronics. College level Home Study courses taught so you can understand them. Earn more in the highly paid electronics industry. Computers, Missiles, theory and practical. Kits furnished. Over 30,000 graduates now employed. Resident classes at our Chicago campus if desired. Founded 1934. Catalog: "Vets—write for information about G. I. Bill Training."

American Institute of Engineering & Technology
 1141 West Fullerton Parkway Chicago, Ill. 60614

watts output, providing a measure of the audible effect with any given speaker system when comparing different amplifiers.

Hum and noise are normally significant only on the low-level inputs, for phono cartridge and tape heads. A noise level of -50 dB on a phono input is normally inaudible (related to 10 watts, which we have used as a reference level). On high-level inputs, -60 dB is a satisfactory figure. Most such inputs will be used with tape recorders or TV sound programs which have poorer signal-to-noise ratios than 60 dB.

The other IHF ratings are of lesser importance and are not required for the minimum published specification. *Frequency Response* is normally so nearly flat that measurement is pointless. In the case of the phono input, we do measure the response and compare it to the ideal RIAA equalization characteristic. According to the RIAA, it should fall within 2 dB of the standard curve from 50 to 15,000 Hz. Most amplifiers meet this requirement, but sometimes larger errors occur, particularly at frequencies below 100 Hz.

The *Maximum Input Signal* test reveals any tendency for early stages of an amplifier to overload if a large signal is applied with the volume turned down. Practically, this is only significant in the phono preamplifier stages where high output cartridges may overdrive the amplifier on loud passages. Almost all modern stereo cartridges have average outputs of less than 5 or 6 millivolts, making overload unlikely. We do not normally make this test.

Stability is a measure of an amplifier's ability to drive loads of high or low impedance or loads which contain large amounts of inductance or capacitance without spurious oscillations. We perform a limited form of this test, shunting capacitance across the 8-ohm load while observing the effect on a square-wave test signal. This test is particularly important when driving an electrostatic speaker. Most transistor amplifier manufacturers specifically caution against using full electrostatic speakers with their products, since the high current drawn by the speaker at high frequencies may damage the output transistors. In view of this situation, we feel that this test is academic for most transistor amplifiers.

Input Impedance is no longer the problem that it was in the early days of solid-state amplifiers. The lower input impedance of some of these units, compared to tube amplifiers, caused difficulties when they were driven from tube preamplifiers having a high output impedance. It is of no significance in receivers where the necessary interface problems are fully under the designer's control.

Damping Factor is a much over-rated performance parameter. It is a measure of the internal impedance, or regulation, of an amplifier. As long as this impedance is less than the speaker impedance by a factor of 5 to 10, no improvement in speaker damping results from a further reduction of driving impedance. Although the IHF Standard calls for Damping Factor to be measured from 20 to 20,000 Hz, and at various power levels, we do not make this measurement.

The *Difference of Frequency Response* (between channels) is solely a matter of component tolerances and, in practice, is negligible. We frequently measure both channels of a stereo amplifier and have yet to find a significant difference in their frequency response characteristics.

Volume control *Tracking Error* was a serious problem in the early days of stereo. Unequal attenuation in the two ganged volume-control sections caused the stereo balance to shift from side to side as the volume was varied. Control manufacturers have made great improvements in recent years and a tracking error of more than 2 dB is unusual. We still make this measurement, but rarely find anything out of the ordinary.

Separation and Crosstalk are not a real factor in most stereo amplifiers. It is unusual to find crosstalk between channels as great as -30 dB, which is better than most signal sources including records and FM-stereo. Since a 15-dB separation is sufficient for good stereo effect, this factor can be ignored.

Receiver Survey

In this comparative survey of stereo receivers, we performed the same basic measurements on all models tested. The tabular listing of test results allows the reader to make his own judgments.

We make no attempt to "rate" these receivers in any way. All of them are



The University Studio Pro 120 solid-state stereophonic receiver.

good—capable of excellent high-fidelity performance in home music systems. As we stated earlier, some are more sensitive or more powerful than others—and more expensive as well. Since the measurements were made under our standard conditions, although within the framework and spirit of the applicable IIF Standards, the actual numbers may differ in some cases from a manufacturer's published ratings.

In some cases, the harmonic distortion at low power levels was masked by noise or hum. The measured figures in each case were so low that the distortion was obviously negligible. Also, the hum and noise measurements show that these were not excessive when the receiver was operated at reference gain settings.

All power and distortion measurements were made with 8-ohm loads. A rough determination was made of the power available with 4-ohm and 16-ohm loads. These powers are expressed as percentages of the power into 8 ohms and were measured at the point of visual clipping of the output waveform. Sometimes the measurement could not be made at 4 ohms without blowing a speaker fuse or tripping an automatic protective circuit in the amplifier. This does not mean that a 4-ohm speaker cannot be used with the receiver but merely that it cannot operate at full power for a prolonged period into a low impedance.

It is quite common for receiver manufacturers to rate their products in terms of total (both channels) dynamic power output at 4-ohm output impedance. This practice accounts for the ratings of "90 watts", "120 watts", or "140 watts" which one sees in many receiver specifications. Our continuous power output measurements, made at 8 ohms, result in much less impressive figures, due to the measurement technique employed. Most receivers cannot deliver more than 80 to 90 watts total on a continuous basis, which should be ample for any home installation.

Electrical performance is not the only consideration in choosing a receiver. Obviously, price and size are factors to be considered as well. Even within a given price bracket, there are numerous details of styling and control features which make one receiver more appealing than another to a particular individual.

Specific circuit features, such as the use of integrated circuits (IC's) in i.f. amplifiers, usually have little to do with the final performance of the receiver. The end product is what matters and that is the cumulative result of many factors, rarely attributable to any single feature. One of the more meaningful recent innovations in FM tuners is the use of field-effect transistors (FET's) in the front-ends. ▲

Reference Power Supplies

(Continued from page 41)

10 minutes. Do not change the output voltage setting of the reference supply, and make sure the temperature of the V_1 supply hasn't varied much.

Note which direction the change in reference-supply voltage takes, if it changes, to determine which way you should adjust R_4 . If the output voltage increased in value, indicated by an upscale reading on M_1 , then you have a positive temperature coefficient which may be corrected by decreasing the bias current. This is done by turning R_4 counterclockwise.

The procedure is repeated until you obtain the desired K_T . The adjustment isn't critical unless you want the ultimate in temperature stability. In fact, you would probably get an K_T of less than $0.003\%/^{\circ}\text{C}$ by just setting R_4 to center position or replacing R_2 , R_3 , and R_4 by a single 1000-ohm wirewound resistor.

Precise voltage calibration requires an external voltmeter of adequate accuracy. If one is not available, you can obtain fairly good results by using three 1.345-volt mercury cells in series for V_1 . Set the reference-supply dial to 4.035 volts and adjust the calibration potentiometer for a zero reading on M_1 .

A typical application of this type of supply is to permit monitoring a small fluctuation in voltage. The arrangement used is the same as shown in Fig. 9A. Initially, the reference-supply output is adjusted to give a zero reading on M_1 . Now any variation in the M_1 reading indicates a change in voltage, V_1 . The value of the change will be indicated on M_1 directly. With my v.o.m. used for M_1 , I can see a change of less than 2 mV out of 10 volts; that's a 0.02% change!

With the voltage output calibrated, the arrangement may be used as a differential voltmeter to measure any unknown source under practically no-load conditions. Again the configuration of Fig. 9A is used. The output of the reference supply is adjusted until M_1 reads zero. The value of the unknown voltage is read from the dial of the reference supply.

Calibrating voltmeters, recorders, or d.c. oscilloscopes is a snap when the output voltage of the reference supply is accurately known. You can add the simple chopper circuit shown in Fig. 9B to your supply. It permits calibrating a.c. voltmeters or scopes with a peak-to-peak square-wave voltage whose value is equal to the output of the reference supply. If you include this feature in your packaged unit, provide a switch to remove the chopper when you use the supply as a d.c. reference. ▲

BACK ISSUES AVAILABLE

Use this coupon to order back issues of
ELECTRONICS WORLD

We have a limited supply of back issues that can be ordered on a first-come, first-served basis. Just fill in the coupon below, enclose your remittance in the amount of 75¢ for each copy ordered.

ZIFF-DAVIS SERVICE DIVISION
Dept. BCEW, 595 Broadway
New York, New York 10012

Please send the following back issues of
ELECTRONICS WORLD

I am enclosing to cover cost of the magazine, shipping and handling.

Month Year

Month Year

Month Year

Name

Address

City

State Zip

Payment must be enclosed with order

Our most honored receiver



The highly-rated Sherwood S-8800 now features Field Effect Transistors (FET's) in the RF and Mixer stages to prevent multiple responses when used with strong FM signals. Among the Model S-8800's many useful features are two front-panel switches for independent or simultaneous operation of main and remote stereo speaker systems. Visit your Sherwood dealer now for a demonstration of those features which make Sherwood's new Model S-8800-FET receiver so outstanding. With Sherwood, you also get the industry's longest warranty—3 years, including transistors.

In New York City at Airex Radio, Arrow Elect., Audio Exchange, Grand Central Radio, Sam Goody, Harvey Radio, Lafayette Radio, Leonard Radio, Liberty Music, Lyria Hi-Fi, Macy's, Packard Elect., Rabson's, G. Schirmer, Sonocraft and Terminal Hudson.

Sherwood

Sherwood Electronic Laboratories, Inc.
4300 North California Avenue
Chicago, Illinois 60618. Write Dept. 12EW

CIRCLE NO. 97 ON READER SERVICE CARD

14 KIT-GIVING IDEAS FROM HEATH...

For The Whole Family . . .

New Deluxe "227" Color TV

Exclusive Heathkit Self-Servicing Features. Like the famous Heathkit "295" and "180" color TV's, the new Heathkit "227" features a built-in dot generator plus full color photos and simple instructions so you can set-up, converge and maintain the best color pictures at all times. Add to this the detailed trouble-shooting charts in the manual, and you put an end to costly TV service calls for periodic picture convergence and minor repairs. No other brand of color TV has this money-saving self-servicing feature.

Advanced Features. Boasts new RCA Perma-Chrome picture tube for 38% brighter pictures . . . 227 sq. in. rectangular viewing area . . . 24,000 v. regulated picture power . . . improved phosphors for brilliant, livelier colors . . . new improved low voltage power supply with boosted B+ for best operation . . . automatic degaussing . . . exclusive Heath Magna-Shield to protect against stray magnetic fields and maintain color purity . . . ACC and AGC to reduce color fade and insure steady, flutter-free pictures under all conditions . . . preassembled & aligned IF with 3 stages instead of the usual 2 . . . preassembled & aligned 2-speed transistor UHF tuner . . . deluxe VHF turret tuner with "memory" fine tuning . . . 300 & 75 ohm VHF antenna inputs . . . two hi-fi sound outputs . . . 4" x 6" 8 ohm speaker . . . choice of installation — wall, custom or optional Heath factory assembled cabinets. Build in 25 hours.

Kit GR-227, (everything except cabinet) . . . \$42 dn., as low as \$25 mo. . . 114 lbs. **\$419.95**

GRA-227-1, Walnut cabinet . . . no money dn., \$6 mo. **\$59.95**

GRA-227-2, Mediterranean Oak cabinet (shown above) . . . no money dn., \$10 mo. **\$94.50**



Kit GR-227
\$419.95 (less cabinet)
\$25 mo.

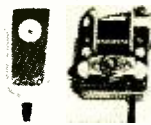

Kit GRA-27
\$19.95

New Remote Control For Heathkit Color TV

Now change channels and turn your Heathkit color TV off and on from the comfort of your armchair with this new remote control kit. Use with Heathkit GR-227, GR-295 and GR-180 color TV's. Includes 20' cable.



Kit GR-295
\$479.95 (less cabinet)
\$42 mo.

Deluxe Heathkit "295" Color TV

Color TV's largest picture . . . 295 sq. in. viewing area. Same features and built-in servicing facilities as new GR-227. Universal main control panel for versatile in-wall installation. 6" x 9" speaker.

Kit GR-295, (everything except cabinet), 131 lbs. . . . \$48 dn., \$42 mo. **\$479.95**

GRA-295-1, Walnut cabinet (shown above), 35 lbs. . . . no money dn., \$7 mo. **\$62.95**

Other cabinets from \$94.50



Kit GR-180
\$349.95 (less cabinet & cart)
\$30 mo.

Deluxe Heathkit "180" Color TV

Same high performance features and exclusive self-servicing facilities as new GR-227 (above) except for 180 sq. in. viewing area.

Kit GR-180, (everything except cabinet), 102 lbs. . . . \$35 dn., \$30 mo. **\$349.95**

GRS-180-5, table model cabinet & mobile cart (shown above), 57 lbs. . . . no money dn., \$5 mo. **\$39.95**

Other cabinets from \$24.95



FREE... 40-Lesson Record Course With Either Heathkit/Thomas Organ! A \$50 Value! Includes four 33 1/3 rpm records, music book & leatherette album.

Kit TO-67
\$995 (including bench)
\$200 dn., as low as \$29 mo.

Heathkit®/Thomas "Paramount" Theatre Organ

Save Up To \$500! Build in 80-100 hours. All Thomas factory-made parts . . . 15 manual, 4 pedal voices; instant-play Color-Glo; all-transistor circuit; 200 watts peak power; 2-speed rotating Leslie plus main speaker system with two 12" speakers; 44-note keyboards; horseshoe console with stop tablets; 28-note chimes; 13-note bass pedals; repeat & attack percussion; reverb; headset outlet; assembled walnut finish hardwood cabinet & bench; and more. 265 lbs. 7", 33 1/3 rpm demonstration record 50c.

America's Lowest Cost Solid-State Organ

Kit GD-325B
\$394.90
\$40 dn., \$34 mo.

Save Up To \$205! Instant-play Color-Glo; 10 voices; 13-note bass pedals; repeat percussion; 37-note keyboards; 75-watt peak power; vibrato; assembled walnut cabinet & bench. 172 lbs. 7", 33 1/3 rpm demonstration record 50c.



Exclusive Band Box Percussion

Automatically or manually adds 10 percussion voices to any Heathkit/Thomas organ. Build & install in 12 hours.

Kit TOA-67-1, no money dn., \$14 mo. **\$145.00**

Exclusive Playmate Rhythm Maker

Adds 15 fascinating rhythms to any Heathkit/Thomas Organ. Requires Band Box percussion (above) for operation.

Kit TOA-67-5, no money dn., \$18 mo. **\$189.90**



USE COUPON BELOW TO ORDER NOW

NEW! VOX "Jaguar" Transistor Combo Organ By Heathkit



Kit TO-68
\$349.95
\$35 dn., \$30 mo.

Save Up To \$150 on the world's most popular combo organ with this new Heathkit version. Features the most distinctive sound of any combo organ. Has a special bass output that gives a brilliant stereo bass effect when played through a separate or multi-channel amplifier, 4 complete octaves, vibrato, percussive effects and reversible bass keys. Includes hand crafted orange and black cabinet, fully plated heavy-duty stand, expression pedal and waterproof carrying cover and case for stand. Requires a bass or combo amplifier like Heathkit TA-17 (opposite page).

Kit TO-68, 80 lbs... \$35 dn., \$30 mo..... **\$349.95**

NEW! Deluxe Solid-State Combo Amplifier & Speaker System... Choose Kit Or Factory Assembled

Amplifier
Kit TA-17
\$175
\$17 mo.
(Assembled
TAW-17 \$275)

Speaker System
Kit TA-17-1
\$120
\$11 mo.
(Assembled
TAW-17-1 \$150)

Special
Combination Offer
Amplifier & Two
Speaker Systems
Save \$20
Kit TAS-17-2
\$395
\$40 dn.
\$34 mo.
(Assembled
TAW-17-2 \$545)

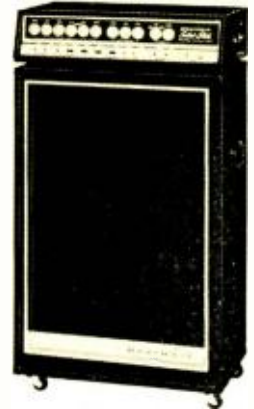

All the "big sound" features every combo wants... tremolo, built-in "fuzz", brightness, reverb, separate bass and treble boost and more. Delivers a shattering 120 watts EIA music power (240 watts peak power) through two TA-17-1 speakers... or 90 watts through one TA-17-1 speaker. Features 3 independent input channels, each with two inputs. Handles lead or bass guitars, combo organ, accordion, singer's mike, or even a record changer. All front panel controls keep you in full command of all the action.

Speaker system features two 12" woofers, special horn driver and matching black vinyl-covered wood cabinet with casters & handles for easy mobility.

NEW! Lowest Cost Solid-State Stereo Receiver

Kit AR-17
\$72.95
(less cabinet)
\$8 mo.



Features wide 18-60,000 Hz response @ ±1 db at full 5 watts RMS power per channel... 14 watts music power... inputs for phono and auxiliary... automatic stereo indicator... outputs for 4 thru 16 ohm speakers... adjustable phase for best stereo... flywheel tuning... and compact 9 1/4" D. x 2 7/8" H. x 11 1/4" W. size. 12 lbs. Optional factory assembled cabinets (walnut \$7.95, beige metal \$3.50).

Kit AR-17, (less cab.) 12 lbs... no money dn., \$8 mo... **\$72.95**

Kit AR-27, 7-Watt FM Mono Only Receiver (less cab.)
9 lbs... no money dn., \$5 mo..... **\$49.95**



Kit AR-15
\$329.95
(less cabinet)
\$28 mo.

Assembled
ARW-15 \$499.50
(less cabinet) \$43 mo.

World's Most Advanced Stereo Receiver

Acclaimed by owners & experts for features like integrated circuits & crystal filters in IF amplifier; FET FM tuner; 150 watts music power; AM/FM and FM stereo; positive circuit protection; all-silicium transistors; "black magic" panel lighting; and more. Wrap-around walnut cabinet \$19.95

Kit AR-15 (less cab.), 34 lbs... \$33 dn., \$28 mo..... **\$329.95**

Assembled ARW-15, (less cab.), 34 lbs... \$50 dn.,
\$43 mo..... **\$499.50**

Professional 10-Band Shortwave Receiver

Kit SB-310
\$249
\$23 mo.



Covers 49, 41, 31, 25, 19 & 16 meter shortwave... 80, 40 & 20 meter ham... 11 meter CB. Includes 5 kHz crystal filter for AM, SSB and CW listening. Features selectivity that slices stations down to last kHz; 11-tube circuit; crystal-controlled front-end and more. 20 lbs. SB-600 8 ohm 6" x 9" speaker in matching cabinet \$18.95.

NEW! Solid-State Portable Volt-Ohm-Meter

So Handy, So Low Cost we call it "every man's" meter. Just right for homeowners, hobbyists, boatowners, CBER's, hams... it's even sophisticated enough for radio & TV servicing! Features 12 ranges... 4 AC & 4 DC volt ranges, 4 ohm ranges; 11 megohm input on DC, 1 megohm input on AC; 4 1/2" 200 uA meter; battery power; rugged polypropylene case and more. Easy 3 or 4 hour kit assembly. Ideal gift for any man! 4 lbs.

Kit IM-17
\$19.95



NEW FREE 1968 CATALOG!

Now with more kits, more color. Fully describes these along with over 300 kits for stereo/hi-fi, color TV, electronic organs, electric guitar & amplifier, amateur radio, marine, educational, CB, home & hobby. Mail coupon or write Heath Company, Benton Harbor, Michigan 49022.

HEATH COMPANY, Dept. 15-12
Benton Harbor, Michigan 49022
In Canada, Daystrom Ltd.

Enclosed is \$ _____, including shipping.

Please send model (s) _____

Please send FREE Heathkit Catalog.

Please send Credit Application.

Name _____

Address _____

City _____

State _____

Zip _____

Prices & specifications subject to change without notice.

CL-310

NEW PRODUCTS & LITERATURE

Additional information on the items covered in this section is available from the manufacturers. Each item is identified by a code number. To obtain further details, fill in coupon on the Reader Service Card.

COMPONENTS • TOOLS • TEST EQUIPMENT • HI-FI • AUDIO • CB • HAM • COMMUNICATIONS

IC POWER SUPPLY

An integrated voltage regulator that contains the monolithic equivalent of one of the most popular and widely used discrete power-supply circuits is now being marketed in a space-saving, low-profile TO-3 case.

The new WM-110 and WM-330 units can

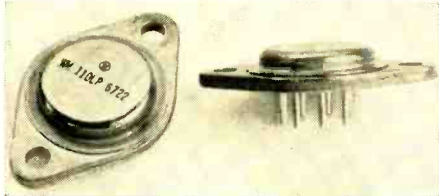

replace most present discrete power-supply regulators since these integrated circuits can deliver 0.2 ampere outputs at 8 to 48 volts. According to the company, they provide 2% or better regulation at 1 ampere.

The main difference between the two units is that the WM-330 has an additional lead brought out so that external discrete zener references may be used instead of an internal zener reference. This permits the WM-330 to be used for outputs of less than 8 volts.

Good regulation over the full -55 to $+125$ degree C military temperature range is provided by both units.

Complete details on the units and their applications will be supplied on request. Westinghouse
Circle No. 126 on Reader Service Card

PISTON TRIMMER

A new high r.f. voltage piston trimmer capacitor featuring high stability and small size is now available as the VCJ 1616D. Applicable in communications equipment and wherever a small trimmer capacitor is needed to handle large voltage peaks and high power at elevated temperature, the new unit operates over a frequency range of from 1 to 30 MHz.

The operating r.f. voltage level of this unit is 3100 volts peak at $+25^{\circ}\text{C}$ derated to 2500 volts peak at $+200^{\circ}\text{C}$. Its capacitance is variable from 0.5 to 5 pF and its operating temperature range is from -55° to $+200^{\circ}\text{C}$. Turning torque is 1-10 in./oz in accordance with the MIL-Spec.

The trimmer is furnished for panel mounting and is $1\frac{1}{8}$ " long x $\frac{3}{16}$ " in diameter. JFD

Circle No. 127 on Reader Service Card

OSCILLATOR FOR IC SYSTEMS

Operating from a 5-6 volt d.c. source for compatibility with integrated circuit systems, the Model CO-204-5 crystal oscillator provides a stability (aging rate) better than one part in 10^6 per day.

This 2" x 2" x 4" package employs an integrated circuit proportional oven control system to provide reliability and stable operation over the -20°C to $+70^{\circ}\text{C}$ temperature range with -54°C to $+75^{\circ}\text{C}$ operation optional. Despite low power drain, the CO-204-5 exhibits excellent

restabilization characteristics, achieving an accuracy better than five parts in 10^6 within 30

minutes after turn-on, according to the company. Electronic tuning is provided for remote frequency control or phase locking operation.

Other units in the series range in stability from one part in 10^8 per day through three parts in 10^6 per day. They have been designed to provide a high stability reference for frequency counters, time code generators, frequency synthesizers, communications receiver/transmitters, and similar equipment. Vectron

Circle No. 128 on Reader Service Card

TOROIDAL POWER TRANSFORMERS

A new line of 400-Hz toroidal power transformers is now available from stock. These units are designed for low-voltage silicon power supplies and isolation applications for transistorized equipment requiring low height and small package size.

Toroidal construction provides an inherently low radiation magnetic field. The transformers are available in 9 to 20 VA power ratings with center-tapped secondaries of 28, 56, or 115 volts. Primary ratings are 115 V at 400 Hz. Supplied with pins for printed-circuit applications, the transformers can also be mounted for point-to-point wiring if desired. The transformers are built to meet MIL-T-27 Grade 5 class S requirements. Microtran

Circle No. 129 on Reader Service Card

ALL-DIFFUSED SCR'S

A new line of high-current, high-voltage, all-diffused SCR's has just been introduced as the NL-C180 series.

These all-diffused, shorted emitter, 235-ampere units have a guaranteed d.v./d.t. rating of 200 volts/ μs . The series is offered in a voltage range from 100 volts to 1300 volts. Maximum d.i./d.t. ratings are available up to 100 A/ μs . Typical peak on-voltage is 1.8 volts. I_T rating is 49,000 A² and surge current rating is 3500 amperes.

Hard solder construction is used to give minimum thermal fatigue and thermal impedance. There is no peak forward voltage limitation. A data sheet on this new series will be forwarded on request. National Electronics

Circle No. 130 on Reader Service Card

NEW TV ANTENNA LINE

The "Color Spectrum" series of antennas is now available in 35 basic models and, with kit packs and special applications, a total of 45 models can be had.

The new models are the CS-B2, an 82-channel TV and FM combination 300-ohm antenna which is designed for those areas where the v.h.f. signal is of moderate strength and the u.h.f. signal is relatively weak. The Model XCS-B2 is a 75-ohm version where the same relative signal strengths are found, but interference conditions or the installation makes the use of coax preferable. The Model CS-C2 is also an all-channel TV plus FM 300-ohm design for reception areas where both the u.h.f. and v.h.f. signals are relatively weak. The XCS-C2 is the 75-ohm version of this model. Finney

Circle No. 1 on Reader Service Card

LOW-VOLTAGE SOLDERING STATION

A single heat capsule that delivers a tip temperature range of 370°F to 880°F is designed for use in prototype and production assembly of microelectronic flat and stack packs, hybrids, and discrete devices.

The complete low-voltage station consists of a specially engineered, featherlight, Princess sol-

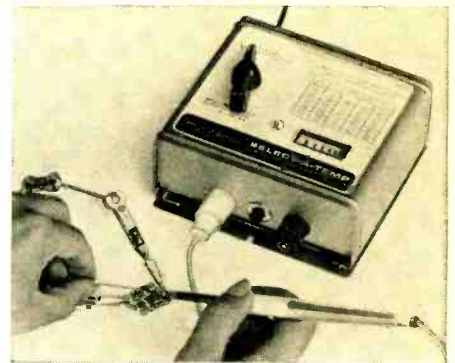

dering pen and heat capsule with coaxial connector, "Select-A-Temp" control unit, and three of the most widely used Princess threaded soldering nibs.

A 4-pin molded connector joins the isolated slim-line pen to the control unit which, operating on line current of 120 volts a.c., delivers 12 volts to the soldering pen. A fingertip control dial permits the operator to select the correct tip temperature required for a specific assembly. A visible meter registers line voltage so that a precise power setting can be dialed to achieve the desired temperature. Ungar

Circle No. 2 on Reader Service Card

"WRAP" FILM CAPACITORS

The new "Aerofilm" Type V170 capacitor offers excellent electrical characteristics in a miniature construction for upright mounting, according to the company. It has been constructed by wrapping the film dielectric section with a synthetic film and thermally sealing the end. It uses a welded lead construction and is said to exhibit its performance characteristics even at high frequencies and microvolts.

The V170 units, the largest of which measures 0.413" x 0.669", are available in six types with capacitances ranging from 0.01 to 0.1 μF and dissipation factor not exceeding 1% (at 25°C). Standard tolerance is $\pm 10\%$, although $\pm 5\%$ units can be supplied for special requirements. Aerovox.

Circle No. 131 on Reader Service Card

TEMPERATURE INDICATORS

A microminiature series of temperature indicators which permits the temperatures on small parts to be seen is now available with one, three, or four different temperature indications. Sizes range from $\frac{3}{16}$ " diameter with one indication to $\frac{3}{4}$ " diameter with up to four indications.

The series may be obtained in indicated values from 100 to 500°F, or the centigrade equivalents. Accuracy factor is $\pm 1\%$. When the indicator is exposed to its calibrated temperature it changes from a pastel to solid black. This change is irreversible and cannot be altered, serving as a positive record of temperature exposure. They may be used on such items as heat sinks, transistors, tube shields, and other critical components. Temp-Plate Div.

Circle No. 132 on Reader Service Card

TRANSISTORIZED INDICATING LIGHTS

New fixed neon and removable cartridge incandescent model transistorized indicating lights have been introduced. The CR103 Type G lights meet the application requirements for computers, data processing equipment, communications and

**HERE'S THE
MOST
IMPORTANT
JOB TICKET
YOU'LL
WRITE UP
THIS YEAR!**

Ziff-Davis Service Division, Dept. ISH • 595 Broadway, New York, N. Y. 10012

Please send my copy of the 1968 ELECTRONICS INSTALLATION & SERVICING HANDBOOK as checked below:

- I am enclosing \$1.25 plus 15c for shipping and handling for the Regular Edition. (\$1.75 for orders outside U.S.A.)
- I am enclosing \$3.00. Please send me, postpaid, the Leatherflex-covered Deluxe Edition, (\$3.75 for orders outside U.S.A.) (Please allow 3 additional weeks for delivery of the Deluxe Edition.)

print name _____

EW-12

address _____

city _____

state _____

zip _____

**NOW—GET THE TRICKS OF THE TRADE FOR SERVICING EVERYTHING . . .
FROM TV TO AM/FM . . . FROM CITIZEN'S BAND TO PUBLIC ADDRESS . . .
FROM HOME INTERCOM TO TAPE CARTRIDGE UNITS. THEY'RE ALL IN THE NEW,
1968 ELECTRONICS INSTALLATION AND SERVICING HANDBOOK.**

You'll find the latest, most comprehensive technique advice, equipment information and step-by-step "how-to-do-it" hints that will aid you in your servicing (or save you costly outside repairs).

This 140-page "encyclopedia" of electronics servicing knowledge contains a special, full-color section on color TV maintenance . . . model numbers and prices of replacement parts . . . recommended tools for every operation . . . accessory information to help you turn an extra dollar. Plus up-to-the-minute reports from hundreds of manufacturers.

Whether you're a professional serviceman, weekend home hobbyist or spare time "Mr. Fixit," the 1968 ELECTRONICS INSTALLATION AND SERVICING HANDBOOK is essential for you. Essential for your profit, fun or both.

1968
ELECTRONICS
INSTALLATION
AND SERVICING
HANDBOOK

GET THE HANDSOME LEATHERFLEX-COVERED EDITION FOR \$3 POSTPAID!

The 1968 ELECTRONICS INSTALLATION & SERVICING HANDBOOK is also available in a splendid deluxe edition. Rugged Leatherflex cover provides lasting protection yet is softly textured and gold-embossed for the look of elegance. A collector's item—a superb addition to your electronics library. And it's yours, for just \$3 postpaid, when you check the appropriate box on the order form.

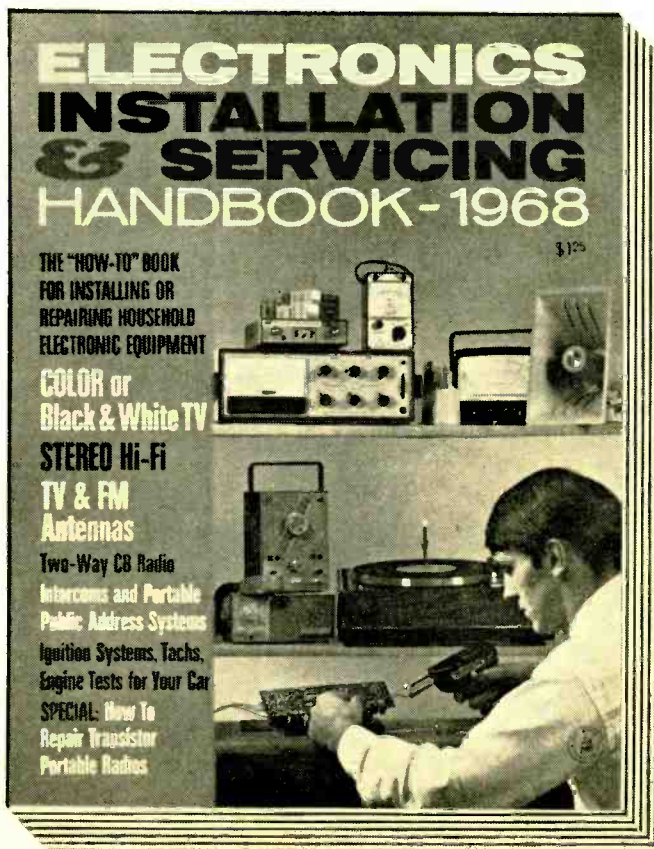

ORDER YOUR COPY TODAY!

control systems using printed or integrated circuits.

The new lights require very low input signal power to turn the indicator on or off. Input signals required to actuate the lights are: neon "on", 0-2 volts d.c., neon "off", 3.6 to 6 volts d.c.; incandescent "on", 0 volt d.c. at 1.4 mA, incandescent "off", 6 volts d.c.

Compact and easy to install, the new lights may be mounted from the rear of the panel with a single knurled nut and backwasher. Lights mount in a $\frac{3}{8}$ " diameter hole on centers as close as $\frac{1}{8}$ " and on panel thicknesses of from $\frac{1}{16}$ " to $\frac{3}{16}$ ". General Electric

Circle No. 133 on Reader Service Card

MINIATURE SOLDERING IRONS

A new line of miniature irons designed for soldering of miniature electronic assemblies has been put on the market as the "Slim-Line".

Ruggedly constructed to stand up under heavy production use without bending or loosening, the new irons weigh less than 2 ounces. The short slim $\frac{5}{16}$ " case diameters offer maximum visibility of work and directional control. White room handles are of small diameter, extra cool, and well balanced. A super flexible 2- or 3-wire grounded cord provides effortless handling, according to the company.

Long-life tips are available in a wide selection of shapes and are non-scaling and non-freezing for ease of maintenance. Tip diameters from $\frac{1}{16}$ " to $\frac{3}{8}$ " and wattages ranging from 15 to 60 watts are available. Hexacon

Circle No. 134 on Reader Service Card

LIGHTWEIGHT SHIELDED CABLE

The new BC6/U is a low-loss, solid-aluminum-sheath coaxial cable designed for applications where RFI may seriously affect transmission performance.

The dielectric is "Polyfoam", a patented cellular polyethylene core, which lowers attenuation by as much as 35 percent over solid dielectric cables of similar size and drastically reduces cable weight. Nominal o.d. of the BC6/U is 0.257 inch and it weighs only 32 pounds per 1000 feet.

Shielding tests rate the new cable at 80 to 80 dB down, making it suitable for both commercial and military-communications systems. Amphenol

Circle No. 3 on Reader Service Card

R.F. LEAK DETECTOR

An r.f. shielded-enclosure leak detection system is now available as the "RF Sniffer", Model 500.

The detector is portable, solid-state, and has a very high order of sensitivity. It can be used in conjunction with MIL-Spec methods to ensure continuous integrity of an enclosure and, in many applications, can replace the laborious conventional method for making this determination.

Use of the "RF Sniffer" can improve the attenuation of a shielded enclosure by 20 to 40 dB, by detecting seam leakage, poorly mating joints, minute construction flaws, and high-resistance regions. Even the very small perfora-

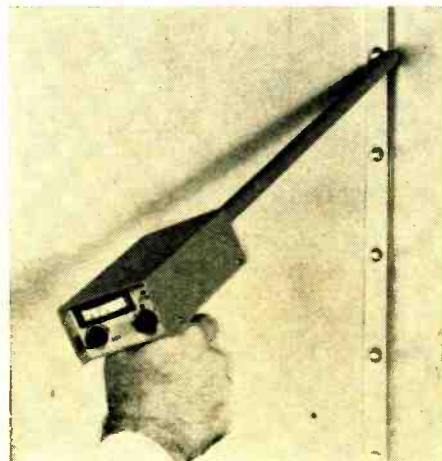

tions that can cause r.f. leakage at frequencies to 10 GHz and higher are readily detected.

The system is made up of two units, an exciter and a hand-held detector-indicator. The exciter couples a test signal to the outer surface of the enclosure at two diametrically opposite points. Where leaks exist, the electromagnetic field inside the enclosure will have a component perpendicular to the enclosure wall. This component is detected by the detector-indicator.

Full specifications on this instrument are available on request. Stoddart

Circle No. 135 on Reader Service Card

GERMANIUM POWER TRANSISTOR

A new 25-ampere "p-n-p" germanium power transistor, the SDT3080 series, is now available in a TO-3 or TO-41 package. It is a low-cost, high-current device capable of 106 watts. Typical



specifications include a minimum gain of 10 at 25 amps, V_{CE0} of 40-80 volts, V_{CEX} of 40-80 volts, and V_{CEO} of 30-50 volts.

This device is a general-purpose transistor for use in military and industrial inverters, converters, switches, regulators, control circuitry, and audio amplifier applications. Solitron

Circle No. 136 on Reader Service Card

INTEGRATED-CIRCUIT COUNTERS

Three new integrated-circuit counters have been introduced: the Model 8300, a 100-MHz universal counter-timer; the Model 8200, a 12.5-MHz universal counter; and the Model 8220, a 500-MHz digital frequency meter.

The Model 8300 is a versatile 8-digit instrument with 10 ns resolution, high input impedance, a.c. or d.c. input coupling, and many more features. By adding a plug-in module, the frequency range may be extended to 500 MHz.

The Model 8200 is an externally programmed instrument using the latest design concepts to provide a wide range of measurement flexibility. The unit includes measurement functions for frequency, period, multiple period averaging, frequency ratio, time interval, and totalizing.

The Model 8220 features direct frequency measurement to 500 MHz and 7-digit resolution. It is designed to meet the needs of the communications industry as well as other industry and laboratory applications. Fairchild Instrumentation

Circle No. 137 on Reader Service Card

CONTROLLED HEAT SOLDERING

Introduction of the new "V-3000" brings to three the number of systems now available for dealing with the problems of controlling soldering tip temperatures. Choice will depend on such factors of operation as degree of miniaturization, the importance of eliminating component damage from temperature overshoot, and demands for tool economy.

The V-3000 is the most advanced of the systems. It direct-dials and continuously controls any tip temperature from 350 to 750 degrees F. The soldering iron, usable only with the system, is a 40-watt unit with $\frac{3}{16}$ " diameter tip. The sensing mechanism is an integral part of the iron, not the tip, so regular, plug-type tips of any shape may be used.

The second is the V77 variable power control for use with any regular conduction-type soldering iron up to 125 watt size. Dial control is stepless, infinitely variable. The third system is the T-6. This 12-watt system is designed for use on delicate jobs. Tip temperature is dial controlled, in approximately 50° steps from 310 to

850 degrees F. The handpiece weighs $\frac{3}{4}$ oz and the tip element is a needlepoint. American Beauty

Circle No. 4 on Reader Service Card

SOLID TANTALUM CAPACITORS

Ratings of 1000 μ F, 6 volts d.c.; 560 μ F, 10 volts d.c.; 330 μ F, 15 volts d.c.; and other super ratings in standard military style, A, B, C, and D cases are now available in the A-series.

This new Kemet series meets or exceeds the environmental and mechanical requirements of MIL-C-39003A and exhibits the same superior electrical characteristics normally associated with solid tantalum capacitors, according to the company. In addition, the super capacitance devices display exceptionally low impedance characteristics from -55°C to +125°C and are ideal for d.c. power supply filtering and decoupling.

The new capacitors are available in values ranging from 0.82 μ F to 1000 μ F and in working voltages from 6 to 60 volts. Union Carbide

Circle No. 138 on Reader Service Card

LOW-LOSS 75-OHM COAX

No. 8221 is a new low-loss 75-ohm, #22 AWG solid, foam polyethylene vinyl-jacketed coax which is being offered in standard colors of white, gray, and black.

Easily installed with standard RG 59/U connectors, the new cable has been designed to meet the multiple requirements of MATV, CATV, CCTV, and indoor/outdoor applications.

The 100% sweep-tested cable also features a flexible all-weather jacket and is available in 100, 500, and 1000 foot put-ups as standard catalogue items. Belden

Circle No. 5 on Reader Service Card

RFI ADAPTERS

Designed to provide 360° shield termination for the "new breed" of high-density microminiature circular connectors, the new adapters are easy to assemble, convenient to repair, and meet the most restrictive weight limitations while maintaining connector performance and integrity, according to the manufacturer.

Available for over-all shielded cables and harnesses and for shielded and jacketed cables alike, the new connectors come in either environmental or non-environmental versions and in a choice of cable entry sizes for each size connector.

Shield termination is accomplished by the use of the exclusive single-ferrule "Wedge-Lok" and these adapters are available for all circular connectors including such microminiatures as Amphenol Astro 348, Bendix JT-JTRE, Cannon Centi-K, Deutsch STK, Matrix Mini-Mate, Microdot Marc 53, and others. Glenair

Circle No. 139 on Reader Service Card

WIRE/CABLE HARNESS KIT

A sample kit for evaluation of wire/cable harnesses and markers has been assembled for engineers. It includes the Cradleclip, Spiroband, strapping, cable tie, and adjustable P-clip harnessing systems; three different types of markers for indestructible coding of wires and cables; and grommet-strip, the snip-n-fit grommeting material. Electrovert

Circle No. 140 on Reader Service Card

LOG-PERIODIC ANTENNAS

Four new models in the "Color Ranger" line of log-periodic antennas provide for connection to either 300- or 75-ohm coax downlead. A mating male connector is supplied for the 75-ohm coax. Patented stainless steel stripless screws are provided for connecting the 300-ohm twin-lead.

The models with this new dual-connection facility include the 15-300/75, a 15-element fringe area model; the 10-300/75 designed for metropolitan and suburban areas with severe ghosting; 7-300/75 designed for metropolitan and suburban areas where ghosting is a problem, and the 5-300/75 designed for metropolitan and strong-signal suburban areas.

All of the antennas feature the patented spaced dual-boom log-periodic design for uniform gain across the entire bandwidth. The v.h.f. units are easily convertible to 300-ohm, channel 2-83 antennas with the addition of the "U-Ranger" u.h.f.

add-on log periodics. No couplers or extra downleads are required and a single downlead carries television channels 2-83 plus FM. Blonder-Tongue

Circle No. 6 on Reader Service Card

MINIATURE CERAMIC CAPACITORS

A complete line of miniature ceramic capacitors is now being offered as the "Red Cap" line. The line provides values ranging from 1 pF through 4.7 μ F in fourteen temperature compensating and seven Hi-K formulations in sizes as small as 0.1" square. They meet all applicable requirements of MIL-C-20 and MIL-C-11015. They are protected by a patented encapsulant to give maximum ruggedness and superior moisture protection. Eric Technological

Circle No. 141 on Reader Service Card

HI-FI—AUDIO PRODUCTS

ULTRA-MINIATURE RECORDER

An ultra-miniature tape recorder designed as a "talking note pad" is now available in two models. The Model M-75 is a mono unit while the M-75-B is stereo. The recorder measures 5" x 2 $\frac{3}{4}$ " x 1 $\frac{5}{16}$ ". It functions automatically and completely hands-free while worn on the person. A remote switch controls start or stop. It is

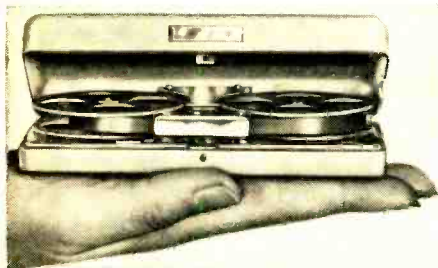

capable of taping voices up to a distance of 75 feet.

Both models have capstan-drive constant-speed at 1 $\frac{7}{8}$ in/s. The motor is governor controlled. Two inexpensive mercury batteries furnish power up to 50 hours of use. Long-play 1/4" tapes can be replayed directly from the unit or most standard recorders. The recorders come complete with twin earset. ElectroData

Circle No. 7 on Reader Service Card

INTEGRATED STEREO AMP

An all-silicon integrated stereo preamplifier/control and power amplifier has just been introduced providing 60 watts r.m.s./ch at 4 ohms,

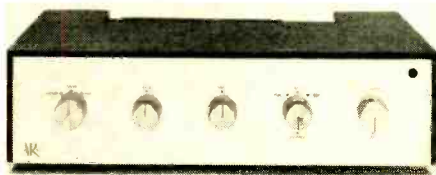

50 watts r.m.s./ch at 8 ohms, and 30 watts r.m.s./ch at 16 ohms.

Frequency response is 20-20,000 Hz \pm 1 dB at indicated flat tone-control settings at full power or below. Distortion at any power output level up to and including full rated power is IM (60 & 7000 Hz, 4:1) less than 0.25%, harmonic less than 0.5% from 20-20,000 Hz. These figures include the phono preamp stages.

Switched inputs are magnetic phono, tuner, and tape playback. Signal-to-noise ratio on the phono input is 65 dB unweighted and 76 dB unweighted for the tape playback and tuner inputs. Damping factor is 8 to 20 for 4-ohm speakers, 16-40 for 8-ohm speakers, and 32-80 for 16-ohm speakers.

Controls include an input selector switch, individual bass control for each channel, individual treble control for each channel, concentric balance control and mode switch, power "on-off" and

volume control. Rear panel controls include an individual phono input level control for each channel.

With the optional wood cover, the amplifier measures 15 $\frac{3}{4}$ " w. x 4 $\frac{1}{2}$ " h. x 10" d. Without the cover it is 15 $\frac{1}{8}$ " w. x 4 $\frac{3}{16}$ " h. x 10" d. Acoustic Research

Circle No. 8 on Reader Service Card

UNRECORDED CASSETTES

In response to the demand by those owning cartridge machines capable of recording as well as playing back, the company is now offering unrecorded cassettes. Irish

Circle No. 9 on Reader Service Card

AUTOMATIC TURNTABLE

The new Perpetuum-Ebner P.E. 2020 automatic turntable features an exclusive 15° tracking angle adjustment for all records, permitting perfect tracking even in the automatic play mode, according to the company.

The turntable also features an automatic anti-skating device combined with an exact adjustment dial to compensate for stylus shape and friction; a cartridge shell that accepts all cartridges with a foolproof, slide-fit mounting; a single lever command center which controls start, stop, repeat, cueing, and lift; automatic start and automatic shut-off in either single play or with a stack of



Why not sell the best

**3 ZENITH
WAVEMAGNET®
INDOOR TV ANTENNAS**
built to the quality
standards of Zenith
original parts

Zenith has designed these Wavemagnet antennas for sensitive reception in color or B/W. Fully adjustable telescopic dipoles. Six-position selector switch for top performance on each channel. Handsome molded base of high-impact styrene. Individually packaged for effective sales display. Order now from your Zenith distributor.

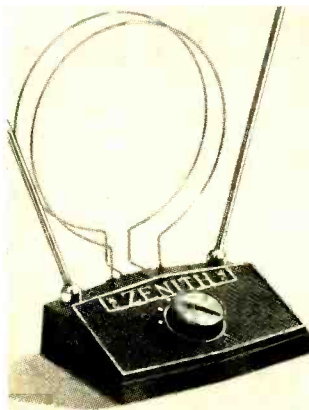

**DELUXE
ALL-CHANNEL**
Part No. 973-56
Two full-size UHF
loops develop high
front-to-back ratios
equal to many
outdoor antennas.



**ECONOMY
ALL-CHANNEL**
Part No. 973-55



VHF ONLY
Part No. 973-58

ZENITH®
The quality goes in before the name goes on

CIRCLE NO. 90 ON READER SERVICE CARD

records; and automatic scanning to determine the diameter of any record and adjust the tonearm accordingly.

The new unit plays records at all four speeds and has a four-pole, four-coil induction motor. It has a revolving spindle on single play to reduce center-hole wear. Elpa Marketing

Circle No. 10 on Reader Service Card

STEREO RECEIVER

The Model Eighteen stereo receiver provides 40 watts continuous watts per channel with less than 0.2% distortion across the entire audio frequency spectrum. It is designed to be used with speakers ranging from 4-ohm acoustic suspension types to 16-ohm electrostatic units.

The solid-state FM tuner section incorporates a passive front-end, representing the first use of a non-amplifying front-end in a hi-fi component,



according to the company. The receiver incorporates an oscilloscope for tuning, thus enabling the user to observe multipath reception and re-orient his antenna to eliminate it.

The tuning knob is actually a heavy flywheel turned so that its edge protrudes through the panel for smooth, easy tuning. An accessory walnut cabinet to house the receiver is available extra as the Model B18-0. Marantz

Circle No. 11 on Reader Service Card

TAPE PLAYING ADAPTER FOR CARS

The new CA-150 car adapter is a sliding tray with simple plug-in connections for playback of prerecorded tapes through any automobile radio speaker system using the F-100 cartridge "Sound Camera."

Used with the F-100, the adapter provides a complete automobile sound system with high-fidelity music reproduction. In addition to playing music tapes while traveling, the F-100 functions as a mobile dictation machine. The automobile electrical system provides the power source, saving the F-100 batteries for portable tape recording applications.

The CA-150 is bolted under the dash. Operation for tape playing is accomplished from the plug-in connections. An "on-off" switch on the adapter lets the listener select sound either from the car radio or from the tape recorder. Concord

Circle No. 12 on Reader Service Card

HIGH-POWER AMPLIFIERS

Two new high-power, all-silicon solid-state amplifiers are now available in the DX Series.

The DX250 with a 250-watt professional rating, 325-watt commercial rating and the DX125 with a 125-watt professional rating, 165-watt

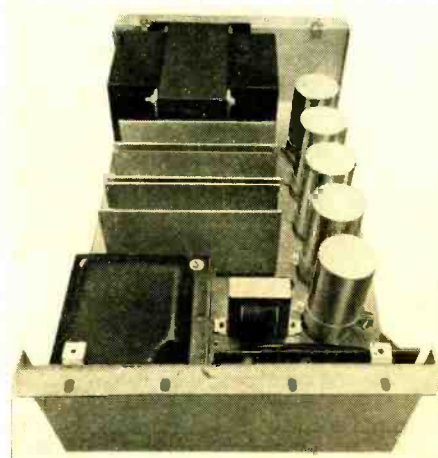

commercial rating carry a five-year warranty and come with individual registered certificates of performance.

The DX250 has an output of 325 watts r.m.s. (650 watts peak), thermostatically controlled protective relay, a back-up fast-acting overload protective relay, instant operation with no-warmup time, low power consumption, and a frequency response of 30-20,000 Hz $\pm 1\frac{1}{2}$ dB. Distortion is less than 2% at rated output and noise level is 85 dB below rated output.

Complete details on either or both of these professional amplifiers will be forwarded on request. Rauland-Borg

Circle No. 13 on Reader Service Card

PUSH-BUTTON RECORD PLAYER

An automatic push-button record player, styled for the home and equipped to provide push-button selection, change, and repeat of any one of 50 record sides automatically, is now available.

The "Radionette Multiplayer" features a 15-watt transistorized amplifier with a three-way speaker system, all housed in a bookshelf cabinet. The unit, which plays 45 r/min in records only, is designed for the young adult market. Tandberg

Circle No. 14 on Reader Service Card

STEREO CASSETTE DECK

A four-track stereo cassette deck has just been introduced as the Model F-105. Designed for use with a high-fidelity system (component, compact, or stereo console), the new deck permits recording of stereo or mono sources off-the-air, from records, or from another tape source. A standard size cassette snaps into place instantly. The cassettes can be erased for new recordings if desired.

The tape deck contains solid-state preamplifiers, precision tape-transport mechanism, flux-field heads, capstan driver, two vu meters and recording level controls, stereo auxiliary and microphone inputs, cassette ejector button, stereo

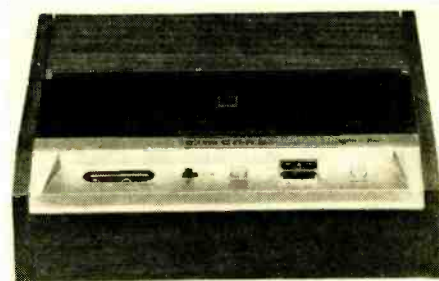

headphone jack, and instant fast-forward and reverse control.

The deck operates horizontally and measures 9 $\frac{3}{8}$ " w. x 2 $\frac{3}{4}$ " h. x 8 $\frac{3}{8}$ " d. It is housed in a teak cabinet with "black screen" dust cover. Concord

Circle No. 15 on Reader Service Card

SOLID-STATE TAPE RECORDER

The Model 1040 records and plays 4-track mono and stereo at speeds of 7 $\frac{1}{2}$, 3 $\frac{3}{4}$, and 1 $\frac{7}{8}$ in/s while an "instant stop" feature permits "edit-as-you-go" operation. The same single control is used for rewind, stop, play, and fast forward.

The recorder incorporates a digital counter and two professional-type vu meters. The stereo amplifier (10 watts peak) is of solid-state design. Two detachable speakers may be positioned for best stereo effect or a stereo headphone may be plugged into the front-panel headphone output.

A fold-down panel conceals the recording controls, record interlock, and inputs. The recorder and speakers fold into a compact portable case measuring 13 $\frac{3}{8}$ " h. x 18 $\frac{1}{2}$ " w. x 9 $\frac{7}{8}$ " d. Allied

Circle No. 16 on Reader Service Card

PHOTOELECTRIC CARTRIDGE

A photoelectric cartridge for professional and audiophile use incorporates a lamp, a screen (which is attached to the cantilever that works by the tracing operation of the stylus), photoelectric diodes, and a preamplifier.



Operational theory of the cartridge is as follows: 1. the movement of the screen controls the amount of light ray passing through the screen on to the diode; 2. the movement of the stylus on the record causes the screen to vibrate; 3. the amount of light ray passing through the screen on to the diodes changes the current of the diodes to sound current. The cartridge, according to its maker, can transform the most minute vibration to electricity. Kenwood

Circle No. 17 on Reader Service Card

SOLID-STATE MIXER

An economical mixer-preamplifier which greatly extends the performance capability of p.a. systems or tape recorders has just been introduced as the MX6A-T.

The new unit is an a.c. powered, all-silicon, solid-state unit which can be used singly to add four or more microphones or other signals to an existing system. Up to three units may also be paralleled to provide 12 individual inputs, with three mixers mounted "piggy-back" if this is desired.

Measuring just 9 $\frac{1}{4}$ " x 6" x 2 $\frac{3}{8}$ " and weighing less than five pounds, the new mixer only requires plugging in to existing equipment to be instantly operable. It has standard phone jacks for high-impedance microphones and guitars, screw terminals for low-impedance microphones, and RCA-type phono jacks for output to auxiliary input of public address amplifier or tape recorders. Bogen

Circle No. 18 on Reader Service Card

AM-FM-STEREO MUSIC CENTER

The LRC-60 is a 60-watt, solid-state AM-FM-stereo music center which provides complete tuner and phono-playing facilities in compact form.

The unit incorporates a new 60-watt stereo receiver with FET front-end and four IC's, plus a BSR McDonald 500 4-speed automatic stereo turntable with Pickering V15/AC-3 "Dustomatic" stereo cartridge. All components are mounted on an oiled walnut wood cabinet.

The turntable will handle 7", 10", or 12" records at 16 $\frac{2}{3}$, 33 $\frac{1}{3}$, 45, or 78 r/min. The amplifier delivers 60 watts (IHF) power. Impedance is 8-16 ohms. Frequency response is 20-20,000 Hz ± 1 dB. Tuner sensitivity is 1.8 μ V IHF and the capture ratio is 1.25 dB.

The music center includes a full set of audio controls: d'Arsonval tuning meter, automatic FM mono/stereo switching, stereo indicator light, stereo headphone jack, tape recorder jacks, and a precision vernier dial drive for accurate tuning.

The control center measures 16 $\frac{3}{8}$ " w. x 7" h. x 15 $\frac{7}{8}$ " d. It will operate at 117 volts, 50 or 60 Hz a.c. Lafayette

Circle No. 19 on Reader Service Card

AM-FM-STEREO RECEIVER

The Model AS-60 solid-state AM-FM-stereo tuner/amplifier has facilities for up to four tape-deck inputs to provide studio tape handling versatility, and serve as a central tuner and audio control component.

The power amplifier is rated at 100 W (IHF) dynamic power; 40 W ch r.m.s. power at 1% harmonic distortion. Power bandwidth is 30-

60,000 Hz \pm 1 dB, over-all frequency response of the receiver is 20-20,000 Hz. Channel separation at 1000 Hz is 50 dB.

Controls include bass, treble, loudness, low filter, high filter. Center channel output is 4.4 V at rated output. The source selector includes AM, FM, FM automatic, phono, tape player, and aux. The mode selector provides for stereo reverse, stereo, left, right, and L+R.

The FM tuner section provides a range of 88-108 MHz or 76-90 MHz. Sensitivity is 2.5 V (IHF), and i.f. selectivity is 3 dB at 250,000 Hz. Channel separation is 40 dB at 1000 Hz and stereo left, right, and L+R.

The unit will operate from 110/115 volt a.c.,



50/60 Hz. It measures 17 $\frac{7}{8}$ " w. x 5 $\frac{1}{2}$ " h. x 15 $\frac{1}{2}$ " d. Teac

Circle No. 20 on Reader Service Card

CB-HAM-COMMUNICATIONS

BATTERY PACK FOR CB RIGS

A self-contained battery pack designed to make most of the firm's solid-state CB rigs completely portable has been introduced as the "Port-A Pak" Model PAP-1.

It features a rechargeable nickel-cadmium battery which provides continuous operation in the "receive" position for up to 8 hours. It can be left on trickle-charge continuously or can be recharged while in "standby" position. Reliable operation is claimed over the temperature range from -30 to +140 degrees F.

Other features include a collapsible antenna,

rechargeable battery and battery meter, durable Texion case, charging connector, mounting hardware, shoulder strap, and microphone bracket. Courier

Circle No. 21 on Reader Service Card

ELECTROMECHANICAL RESONATOR

A tunable, low-cost electromechanical resonator suitable for use in a radio control for model aircraft and boats is on the market as the "Twintron". The unit can be used in audio oscillator circuits, as a narrow band reject or pass filter, and as a tone echo reflector.

The resonator is inherently immune to shock, vibration, and mounting position and is insensitive to harmonics. It is available in three types for the following frequency ranges: 100-700 Hz, 300-3000 Hz, and 700-8000 Hz. Each type is tunable to any frequency within its range. The "Q" can

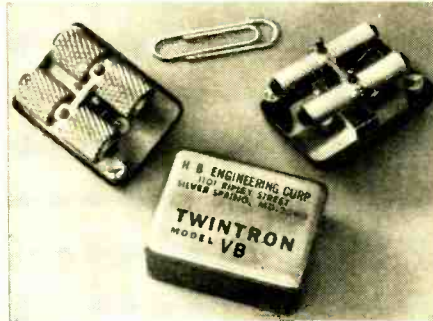

be adjusted from approximately 50 to higher than 200. Thermal stability is 0.05% from -30° to +60°C.

Complete specifications and application data are available on request. HB Engineering

Circle No. 22 on Reader Service Card

LAND/MARINE MONITOR RECEIVER

The HA-153/155 is a dual-conversion v.h.f./FM monitor receiver which may be operated on

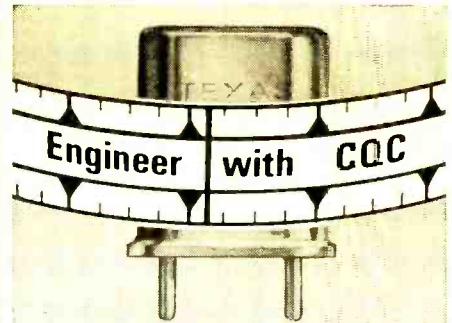

MORE CONTROL

Control of quality throughout precision manufacturing gives you crystals that assure exact frequency control.

MORE RELIABILITY

You'll stay on frequency better with CQC. And, you can rely on your CQC dealer to fill your needs promptly.

See your dealer for prices and data on CQC



TEXAS CRYSTALS

Div. of Whitehall Electronics

1000 Crystal Drive
Fort Myers, Fla. 33901

Plants in Fort Myers and Los Angeles

CIRCLE NO. 197 ON READER SERVICE CARD

THE MOST USEFUL GIFTS FOR CHRISTMAS ARE GIFT WRAPPED WHEN YOU BUY 'EM

With more hi-fi kits, TV's, ham radios and electrical appliances being sold this season than ever before, it's a sure thing your friends will be needing topnotch soldering tools. Give them the best—Weller guns or Marksman irons in colorful yuletide packages. Gun kit sleeves are perforated to fit inside the open case, will be a welcomed sight under the Christmas tree . . . a useful gift all year long.



Weller®

SOLDERING KITS

Dual heat soldering gun kit. Includes trigger-controlled 100/140 watt Weller gun with 3 soldering tips, tip-changing wrench, soldering aid, flux brush and solder in plastic utility case. Holiday wrapped Model 8200PK-X.

Heavy-duty dual heat gun kit. Features 240/325 watt Weller gun plus extra tips for smoothing and cutting, tip-changing wrench, and solder. Holiday wrapped Model D550PK-X.

MARKSMAN pencil iron kit by Weller. Featherweight 25-watt iron for outstanding continuous-duty soldering, two extra tips, soldering aid and solder. Holiday wrapped Model SP23K-X.

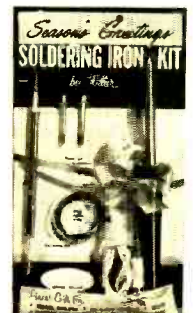

At Your Electronic Parts Distributor . . . Available in Canada

WELLER ELECTRIC CORP., Easton, Pa. World Leader in Soldering Technology
CIRCLE NO. 91 ON READER SERVICE CARD

up to six crystal-controlled channels in the 153-157 MHz FM land mobile and marine band. Sensitivity is 0.7 μ V for 20 dB quieting. Selectivity is 60 dB down at ± 30 kHz. Image rejection is 60 dB and audio output is 3 watts.

The six channels permit monitoring of fire, police, special emergency, Civil Defense, industrial, and business FM communications as well as radio paging and alerting stations and the v.h.f. marine band channels.

The receiver measures 6" w. x 8" d. x 2" h. and comes complete with all mounting hardware. It operates from an external 12-volt battery, drawing less than 0.7 amp, or with optional 117-volt a.c. power supply. Unimetrics

Circle No. 23 on Reader Service Card

TRANSISTORIZED DYNAMIC MIKE

A new transistorized dynamic microphone that will directly replace most carbon mobile mikes is now available as the "+350".

The new microphone contains a transistorized preamplifier which provides improved transmission quality compared to carbon microphones, according to the company. The greater intelligibility results from reduction of distortion and background noise. Output level of the "+350" is -38 dB below 1 volt/dyne cm^2 . Response is 350-4000 Hz. Turner

Circle No. 24 on Reader Service Card

MANUFACTURERS' LITERATURE

R.F. SPECTRUM ANALYSIS

A handy 30" x 40" three-color wall chart of engineering reference information for microwave and electronics engineers is now available. Covered on the wall chart are spectrum-analysis data, signal and transmission information, and receiver noise-figure data. Polarad

Circle No. 142 on Reader Service Card

NEW DIGITAL VOLTMETER

A new 4-page illustrated brochure describing the features and specifications of the new Model X-3 solid-state multipurpose digital voltmeter with v.t.v.m. capabilities has been released.

The instrument measures d.c. volts from 10 microvolts to 10,000 volts at 100 megohms input impedance; a.c. volts from 10 mV to 300 volts, 20 Hz to 500 MHz; ohms from 10 milli-ohms to 2000 megohms; and current from 10 picoamperes to 200 mA. Readout is a four-Nixie display with a fifth \pm overload indication. Nixie. Non-Linear Systems

Circle No. 25 on Reader Service Card

COLOR-TV ELECTROLYTICS

A new 6-page foldout brochure listing more than 250 replacement electrolytics for color-TV according to capacitance value is now available. Single-, dual-, triple-, and quadruple-section types are included. Cornell-Dubilier

Circle No. 26 on Reader Service Card

ELECTRONIC HARDWARE

A complete line of circuit boards, spacers, washers, leads, and cables is described in a new Summer 1967 catalogue. Intended for the specifying designer and engineer, the booklet contains technical specifications, dimensions, and prices. Technical Accessories

Circle No. 27 on Reader Service Card

SCR CATALOGUE

Condensed technical information on a complete line of silicon controlled rectifiers is contained in a new 8-page quick-reference catalogue (No. SB-57). The SCR's covered in the booklet range in current values from 16 to 235 amperes.

Featured in the catalogue is a 2-page glossary of symbols and definitions of terms. National Electronics

Circle No. 143 on Reader Service Card

TRANSISTOR SUPPLEMENT

Featured in a new 12-page supplement to the company's 1967 condensed catalogue of semiconductor products is a line of small-signal "n-p-n" and "p-n-p" transistors for military, in-

dustrial, and commercial applications. For speedy reference, each transistor listing is accompanied by a summary of primary specifications.

New small-signal devices recently introduced by the firm are also included in the booklet. Solitron

Circle No. 28 on Reader Service Card

MICROPHONE CATALOGUE

A new 14-page illustrated catalogue of microphones and public-address equipment has been issued. Included are professional broadcasting and recording microphones, general-purpose microphones, paging and two-way microphones, and accessories; sound reinforcement loudspeakers; p.a. transformers and accessories; and p.a. horns and drivers. Electro-Voice

Circle No. 29 on Reader Service Card

PRODUCTS CATALOGUE

A new 72-page illustrated catalogue of electromechanical components and equipment has been published for Fall 1967. Featured are accelerometers, counters, motors, precision potentiometers, test equipment, and timers. Special complete sections are included on relays, pressure transducers, and gyros. American Relays

Circle No. 144 on Reader Service Card

TAPE RECORDERS

A new 32-page illustrated brochure spotlighting a line of tape recorders and other audio products is now available. Included are portable tape recorders, solid-state stereo tape recorders and tape decks, portable cassette players, stereo tape players for automobiles, marine radios, and CB transceivers. Craig

Circle No. 30 on Reader Service Card

EDUCATIONAL AIDS

A new 4-page illustrated catalogue describing five training-aid kits designed to give students a basic foundation in elementary electronics and electricity is now available.

The kits utilize solderless connections and permit up to 20 different projects, including the construction of a transistor radio, microphones, amplifiers, oscillators, and intercoms. Each set contains a manual which discusses each project separately, includes some theory, and provides both the technical name and schematic symbol for each component. Marcon

Circle No. 31 on Reader Service Card

THERMAL RELAYS

A new literature package on a complete line of industrial thermal timing relays is now available. The folder supplies specifications, dimensional drawings, and typical application information on the Red Line DT Series of octal-base time-delay relays; the Type DM instant-reset thermal timing element used in communications systems and data-processing equipment; and the JT Series of thermal timing relays designed specifically for PC-board mountings. G-V Controls

Circle No. 145 on Reader Service Card

COAXIAL CABLES

A new 8-page catalogue describing the 9800 Series of coaxial cables is now available. Included in the booklet (No. C-7) are cables specially engineered for CATV, MATV, color, black and white, CCTV, educational TV, FM, CB, and amateur use. Alpha Wire

Circle No. 32 on Reader Service Card

PHOTO CREDITS

Page	Credit
22	Eico Electronic Instrument, Inc.
35, 36, 37	McDonnell Aircraft Corp.
43	Sola Electric Div.
88	Varian Associates

Magnetic Materials

(Continued from page 52)

containment for thermonuclear reactions, magnetohydrodynamic propulsion, and magnetic shielding and braking systems for space vehicles.

Although most of these applications are in the future, it is important to note that superconducting magnets are no longer laboratory curiosities but are becoming standard equipment. As a case in point, consider the nuclear magnetic resonance spectrometer manufactured by *Varian Associates*. This device requires a strong magnetic field for its operation, and was traditionally supplied with a huge iron-core magnet weighing 5000 pounds and capable of producing a 23-kilogauss field. Until quite recently, such magnets represented the state of the art for NMR use: it was not feasible to exceed that figure using conventional techniques. However, *Varian* now offers superconducting magnets for use with its NMR spectrometers which weigh only 100 pounds and produce a field of 50 to 60 kilogauss (Fig. 5).

Although it is necessary to refrigerate the coil with liquid helium, the dewar holding the liquid and minimizing evaporation adds only 200 pounds to the weight, so the total is still only a fraction of the weight of the conventional magnet. Operating cost per kilogauss is less and there is better stability in the magnetic field. Most important, however, is the fact that the markedly higher field has added another dimension to NMR spectroscopy. The chemical shift of NMR spectra is proportional to field strength, so results are clearer, more easily interpreted. ▲

Fig. 5. This superconducting magnet provides a field of 60 kilogauss.



COMMUNICATIONS

Antennas for CB and Business Radio... Mar. 38
 Business Radio Communications (Brown) ... Mar. 29
 CB and Integrated Circuits (Frye) ... Mar. 56
 "Eros"—An Airborne Collision Avoidance System (Wujek, Jr.) ... Dec. 35
 FCC Bears Down on CB ... May 6
 Ferrite Coil and Crystal Sideband Filter (Genaille) ... June 46
 Ham Radio and Semiconductors (Frye) July 62
 New Incentive Regulations for Hams: What Happens Now? (Brown) ... Dec. 32
 New Q-Band Marine Radar (Humphrey) Apr. 32
 New Radiotelephone Modulation Method (Halliday) ... Jan. 78
 One-Tube Low-Frequency Converter (Sueker, W3TLQ) ... July 28
 Pakistani Communications to be Upgraded ... Nov. 99
 Penultimate Automatic Keyer (Stark, Gordon & Manfredonia) ... June 36
 Portable Satellite Communications Link Feb. 69
 Radar Signature Analysis (Lacy) ... Feb. 23
 Radio Measurements in Space (Wujek, Jr.) ... May 46
 Report on Annual Assembly of RTCM (Humphrey) ... Sept. 46
 Selecting a CB Transceiver (Buckwalter) Mar. 40
 Tone-Selective Signaling. The New Look (Solomon) ... Sept. 88
 Walkie-Talkies to Move to 49.9 MHz ... Aug. 6
 Weather Surveillance by Satellite (Wujek, Jr.) ... Mar. 23

COMPONENTS

Advances in Magnetic Materials (Collins) ... Dec. 49
 Arc, Surge, and Noise Suppression (Rovnyak) ... Apr. 46
 Checklist for Ordering Relays (Underwood) ... Apr. 60
 Check List for Ordering Switches ... Oct. 56
 Electrical Contact Considerations (Capp, Jr.) ... Apr. 49
 Enclosed Rotary Switches (Tillack) ... Oct. 39
 Finding Relay Operate and Release Times (Ludwig) ... Apr. 48
 Lighted Switching Devices (W. Smith) ... Oct. 40
 Look at Relays (Frye) ... Apr. 62
 Mercury-Wetted Relay Contact Protection ... Apr. 43
 Mercury-Wetted Relays (Koda) ... Apr. 56
 Meter Relays ... Apr. 57
 Miniature Switches (Contarino) ... Oct. 37
 Open-Frame Rotary Switches (Sefton) ... Oct. 57
 Operate and Release Times of Relays (Wright) ... Apr. 54
 Popular Switch Contact Configurations & Circuit Terminology ... Oct. 49
 Precision Rotary Commutating Switches (Waznys) ... Oct. 43
 Pressure-Sensitive Switches ... Oct. 46
 Reed Relays (Rosenberg) ... Apr. 41
 Relay Coil Considerations (Steinback) ... Apr. 44
 Relay Terminology ... Apr. 53
 Resonant-Reed Relays ... Apr. 57
 Selecting the Right Constant-Voltage Transformer (Biega) ... Dec. 42
 Slide Switches and their Ganged Arrays (Golbeck) ... Oct. 44
 Snap-Action Switches and their Ganged Arrays (Meyer) ... Oct. 53
 Stacked Switches and their Ganged Arrays (Bailey) ... Oct. 50
 Stepping Relays ... Apr. 40
 Switches: A Guide to Selection & Application (Hackman) ... Sept. 47
 Switch Kits for Designers ... Oct. 60
 Time-Delay Relays (Elpers) ... Apr. 37
 Toggle Switches (Rezel) ... Oct. 47
 Trade-Offs in Relay Selection (Underwood) ... Apr. 58

HIGH FIDELITY & AUDIO

Aligning FM-Stereo Receivers without a Generator (Moore) ... Nov. 33

1967 INDEX

VOLUMES

77-78

As a service to our readers we are again presenting a complete listing of all feature articles which appeared in **ELECTRONICS WORLD** during 1967. We suggest you keep this for reference.

Audio Integrated Circuits—What's Available? (Lancaster) ... Oct. 34
 Bias Compensation for Transistor Output Stages (Halliday) ... Aug. 76
 Biasing in Magnetic Tape Recording (McKnight) ... Aug. 34
 Buying a Hi-Fi Tune? (Feldman) ... Mar. 34
 Characteristics of Limiter Amplifiers ... Mar. 86
 Common Sense Design of Transistor Amplifiers (Carlson) ... June 48
 Damping Factor Debate (Augsburger) ... Jan. 46
 Design of an Electronic Guitar System (Arndt) ... Feb. 26
 Electronic Guitars and Amplifiers (Queen) ... Feb. 38
 Electronic Music—Its Composition & Performance (Moog) ... Feb. 42
 Electronic Percussion Instruments (Muller) ... Feb. 36
 EW Lab Tests of Solid-State Stereo Receivers (Hirsch) ... Dec. 25
 Guitar-Organ ... Feb. 65
 Hi-Fi Amplifier Terms and Definitions (Feldman) ... Jan. 27
 Hi-Fi Show Seminars Program ... Sept. 94
 Hi-Fi Tuner and Receiver Directory ... Mar. 35
 How to Select Magnetic Sound Recording Tapes (Kempner) ... Aug. 27
 Independence Hall Reconstruction Sound System (Nelson) ... July 32
 Integrated-Circuit Used in New FM Receiver (von Recklinghausen) ... Apr. 34
 Integrated Circuits Used in New Hi-Fi AM/FM Receiver (Hannah) ... Jan. 34
 Loudspeakers for Electronic Musical Instruments (Kramer) ... June 32
 Measuring Tracking Ability of Phono Cartridges (Kogen) ... June 26
 Miniature Dictation Recorders (Frye) ... Aug. 64
 Musical Instrument Sound Chart ... Aug. 45
 N.Y. Hi-Fi Show ... Sept. 6
 Noiseless Switching for Hi-Fi (Neiger) ... Jan. 58
 Operational Amplifier Circuit for Hi-Fi (Locanthi) ... Jan. 39
 Power Output of Solid-State Receivers May 74
 Problems of Matching Speakers to Solid-State Amplifiers (Brociner) ... Jan. 23
 Pulse-Counting Detector for FM Tuners (Seidman) ... Jan. 36
 SCR Protective Circuit for Hi-Fi Amplifier ... Mar. 71
 Solid-State Hi-Fi Amplifier Directory ... Jan. 28
 Solid-State Microphone "Transformer" (Wood) ... Mar. 68
 "Varitone" Electronic Saxophone (Tomcik) ... Feb. 30
 Volume Unit ... Sept. 87

EW LAB TESTED

Ampex Model 1115 Speaker System ... Feb. 14
 Ampex Model 2161 Tape Recorder ... Oct. 14
 Bogen TR-100X Stereo Receiver ... July 14
 BSR McDonald 500 Automatic Turntable Jan. 14
 Dynaco Stereo 120 Power Amplifier ... June 14
 Eico Model 3070 "Cortina" Amplifier ... Dec. 22
 Empire 888 Phono Cartridge ... Aug. 16
 Heath AR-15 Stereo Receiver ... May 16
 Jensen X-40 and X-45 Speaker Systems June 14
 KLH Model 12 Speaker System ... Apr. 16
 "Knight-Kit" KG-790 AM-FM Stereo Tuner ... Sept. 16
 "Knight-Kit" KG-895 "Superba" Amplifier ... Aug. 16
 Ortofon S-15T Phono Cartridge ... Mar. 14
 PML EC-71 Capacitor Microphone ... Sept. 16
 Scott 342 FM-Stereo Receiver ... Mar. 14

Sherwood S-8800-FET Receiver ... Oct. 14
 Shure Model 565 "Unisphere I" Microphone ... May 16
 Shure Model M-68 Microphone Mixer ... Feb. 14
 Shure V-15 Type II Stereo Phono Cartridge ... Apr. 16
 Sonotone "Velocitone Mark V" Cartridge ... Feb. 14
 Sony TA-1120 Integrated Amplifier ... Jan. 14
 Sony TC-660 Tape Recorder ... Nov. 16
 Wharfedale W20 Speaker System ... July 14

INDUSTRIAL & GENERAL

A.C. Motor Drive for Electric Cars (Brown) ... May 28
 Automobile Diagnostic Center (Solomon) ... May 48
 Automotive Electronics (Brown) ... May 23
 Communicating with Computers (Kyle) ... Feb. 50
 D.C. Motor Drive for Electric Cars (Mungenast) ... May 25
 Digital Computer Logic: What the Symbols Mean (Bukstein) ... Aug. 46
 Digital Plotting Techniques (Frenzel, Jr.) ... Mar. 47
 Ecology and Electronics (Frye) ... May 60
 Electronic Audible Alarm (Frye) ... Jan. 56
 Electronic Challenges in the SST Program (Wujek, Jr.) ... July 26
 Electronic Eavesdropping (Brown) ... Apr. 23
 Electronic Ignition Systems (Carroll) ... Feb. 47
 Electronic Stethoscope & Cardiac Rate Meter (Dunn, Wilger & Myers) ... July 30
 Electronics and Aphasia (Frye) ... Dec. 54
 Electronics and the Handicapped (Frye) Feb. 60
 Electronics for Speech and Hearing Therapy (Lawrence) ... Sept. 44
 Electronics in Oceanography (Althouse) Mar. 44
 Fluidic Systems (Miller) ... June 23
 Frequency Measurements with the Electronic Counter (Edwards) ... Jan. 84
 Gunn Oscillators (Heiserman) ... Sept. 42
 High-Speed Punched-Card Readers (Barden) ... Jan. 42
 IC Engine Tachometer and "Red Line" Indicator (Hirschfeld) ... May 37
 Improper Grounding—The Subtle Troublespot (Burke) ... Nov. 82
 Infrared Radiometry (Collins) ... Oct. 23
 Integrated Circuits and the Automobile (Hirschfeld) ... Feb. 31
 Laser Interferometer (Engeman) ... June 43
 Laser Modulators ... Apr. 82
 Laser-Recorded Digital Memory ... Mar. 76
 Light Probe for the Blind ... Nov. 77
 Low-Cost Capacitive-Discharge Ignition System (Cawfield) ... Nov. 30
 Magnetic Shielding (Frye) ... June 54
 Measuring Missile Explosions (Lacy & Golub) ... Sept. 23
 Neutralizing the Cascode Amplifier (Bishop) ... July 66
 New Approach to Breadboarding (Harris) ... Jan. 82
 New Approach to Engine Tachometers (Carroll) ... Sept. 71
 New Developments in CRT Phosphors (Collins) ... Jan. 48
 Occupational Outlook for Electronics Technicians ... June 64
 Operational Amplifier: Circuits & Applications (Lancaster) ... Aug. 49
 Parametric Light Amplification ... Nov. 88
 Permanent Tinning of Soldering Irons (Profera) ... Sept. 60

Pipe and Leak Locating (Frye)	Oct.	63
Potentiometer Linearity & Power Dissipation (Heiserman)	Aug.	59
Radiation and the Technician (Frye) ..	Nov.	52
Reflections on the News (Buchsbau) ..	Nov.	18
Search for a Highway Emergency Radio Program (Brown)	June	39
Show Corporation Names New Board Members	Nov.	91
Solid-State Circuit Breaker Operates Within Microseconds (Thomas)	July	31
Solid-State Flashers for Light Displays (Adem)	Aug.	83
Solid-State Ring Counters & Chasers for Light Displays (Adem)	Sept.	84
Space Etch	Apr.	85
Stable, Low-Cost Reference Power Supplies (Todd)	Dec.	39
Static Electricity: The Space Age's Billion- Year-Old Gremlin (Lacy)	July	21
Sun and Space Solar Measurements (Wujek, Jr.)	Oct.	32
Surveyor—Mission to the Moon (Wujek, Jr.)	Nov.	41
Technical Writing (Frye)	Sept.	58
Temperature-Depth Measurements in the Ocean (Althouse)	Sept.	33
Universal Wiring for Automotive Ignition Systems (Morris)	Aug.	48
Value Engineering for the Electronics Industry (Posser)	Aug.	41
Variable Low-Voltage Power Supply (Rifkin)	Oct.	79

NOMOGRAMS & DESIGN CHARTS

Common Slide Rule for Reactance Calculations (Houck, Jr.)	Sept.	93
Extended Resonance Curves (Lancaster) ..	Nov.	36
Percent Modulation Nomogram (Appelbaum)	Jan.	31
Period-Frequency Graph (Bailey)	Sept.	27
Resistor-Selection Nomogram (Salva) ..	Apr.	29

SOLID-STATE

Alloy Transistors	July	44
Audio Integrated Circuits—What's Available? (Lancaster)	Oct.	34
Avalanche Transistor Circuits (Silver) ..	Sept.	30
Bias Compensation for Transistor Output Stages (Halliday)	Aug.	76
CB and Integrated Circuits (Frye)	Mar.	56
Common-Sense Design of Transistor Amplifiers (Carlson)	June	48
Diffused Transistors (Haenichen)	July	41
Field-Effect Transistors (Evans)	July	49
Field-Effect Transistor Circuits (Wujek, Jr. & McGee)	May	32
Ham Radio and Semiconductors (Frye) ..	July	62
Higher Gain Avalanche Photodiodes ..	Nov.	86
High-Voltage Transistors	July	60
How Many Transistors?	July	60
IC's Head for Industrial Market	May	42
Integrated-Circuit Used in New FM Receiver (von Recklinghausen)	Apr.	34
Integrated Circuits Used in New Hi-Fi AM/FM Receiver (Hannah)	Jan.	34
Low-Cost Semiconductors for the Consumer Market (MacDougall)	Sept.	37
LSA Diodes: New Source of Microwave Power	June	29
New Frontiers in Semiconductors	Mar.	78
New Tetrode Transistor (Tartas)	Feb.	34
Operational Amplifier Circuit for Hi-Fi (Locanthi)	Jan.	39
Power Output of Solid-State Receivers ..	May	74
Power Transistors (Vahle)	July	45
Pulse-Counting Detector for FM Tuners (Seidman)	Jan.	36
Resonant-Gate Transistor	July	56
SCR Protective Circuit for Hi-Fi Amplifier	Mar.	71
Selection of Transistors (Ryder)	July	37
Semiconductor Switching of Low-Power Circuits (Harris)	June	33
Silicon-Carbide Light Diode	Mar.	61
Small-Signal Low-Frequency Transistors (Stasiar)	July	53

Small-Signal High-Frequency Transistors (Robe)	July	38
Switching Transistors (Fierro)	July	57
Troubleshooting Integrated Circuits (Part 1) (Buchsbau & Henn)	July	34
Troubleshooting Integrated Circuits (Part 2) (Buchsbau & Henn)	Aug.	37
Unijunction Transistor	July	52
Using the New Constant-Current Diodes (Lancaster)	Oct.	30

TELEVISION & RADIO

Camera Tube Uses Solid-State Target Electrode	May	54
CATV: Past, Present & Future (Hastings) ..	Aug.	23
Computerized Servicing	Apr.	6
Design for Log-Periodic FM & TV Antennas (Pruett)	Dec.	46
Directory of Most Popular, Low-Priced Video Tape Recorders	Sept.	40
Earth's Magnetic Field & Color TV	Jan.	71
G-E Offers Bonus for H.V. Regulator Tubes	Oct.	88
IC Used in New TV Kit (Rupley)	Jan.	73
Microwave ETV—System Planning & Installation (Lawrence)	May	34
New Color-TV Tuning Indicator (Buchsbau)	Dec.	68
Philco-Ford Introduces IC Radio	Jan.	72
Radiation and the Technician (Frye) ..	Nov.	52
Solid-State Image Scanner	July	77
Troubleshooting Integrated Circuits (Part 1) (Buchsbau & Henn)	July	34
Troubleshooting Integrated Circuits (Part 2) (Buchsbau & Henn)	Aug.	37
Vista—A New Look at Satellite TV	Apr.	84

TEST EQUIPMENT & MEASUREMENTS

Digital U.H.F. Measurements (Barden) ..	Nov.	48
Digital Voltmeters (Lenk)	Nov.	37
FET Voltmeter (Randall)	Feb.	63
Instrumentation Tape Recorder (Part 1) (Shiver)	Nov.	44
Instrumentation Tape Recorder (Part 2) (Shiver)	Dec.	44
New Breed of Digital Voltmeter (Seidman)	Nov.	23
Scope Sweep Generator (Teeter)	Feb.	80
Selecting and Using Pulse Generators (Lenk)	May	43
Selecting Frequency and Time Standards (Math)	May	40
Semiconductor Test Set (Gross)	Nov.	74
Temperature Monitor (Horwitz)	Nov.	58
Test Equipment for CB and Business Radio (Walker)	Mar.	32
Versatile Transistor Tester (Moss)	Aug.	56
Wide-Range Electronic Timer (Jackson) ..	Nov.	56

PRODUCT REPORTS

Amphenol Model 670 Transistorized Volt-Ohmmeter	Sept.	66
Amphenol Model 880 Stereo Commander	Nov.	66
Aul Instruments Model TVM4 Transistor V.O.M.	Jan.	68
B&K Model 1242 Color Generator	Nov.	66
Basic Science Industries Model 100 Electronic Thermometer	May	64
Bird Model 6155 R.F. Wattmeter	July	72
Boonton Electronics Model 41A R.F. Microwatt Meter	Apr.	86
Dynamics Model 501 D.C.-A.C. Millivoltmeter	Feb.	74
Eico "Truvohm" Model 100A4 V.O.M. ..	Apr.	86
Fairchild Model 7050 Digital Voltmeter ..	July	72
Fairchild Model 7100A Digital Voltmeter ..	May	64
Fairlane Electronics Model LBO-55A Oscilloscope	Mar.	58
Heathkit Model IM-25 High-Impedance V.O.M.	Dec.	64
Hewlett-Packard Model 211B Square- Wave Generator	May	64
Hewlett-Packard Model 3430A Digital Voltmeter	Jan.	68
Hewlett-Packard Model 5221A Electronic Counter	Sept.	66

Hewlett-Packard Models 6215A and 6217A D.C. Power Supplies	Oct.	74
Hickok Model GC-660 Color-Bar Generator	June	76
Jackson Model 806 V.T.V.M.	Dec.	64
Jensen Tools Model SC-4 Transistor Tester	Feb.	74
Jerrold Model AIM-718 Signal-Strength Meter	Nov.	66
"Knight-Kit" Model KG-640 V.O.M.	Feb.	74
"Knight-Kit" Model KG-663 Regulated D.C. Power Supply	Aug.	74
"Knight-Kit" KG-2100 Laboratory Oscilloscope	June	76
Lafayette 99-5065 Volt-Ohm- Milliammeter	July	72
Lectrotech Model TT-250 Transistor Analyzer	Dec.	64
Seco Model 240 Thyristor (SCR) Analyzer	Sept.	66
Seco Model 260 Transistor Analyzer	Oct.	74
Semitronics Model 1000 Transistor Tester & Set Analyzer	Mar.	58
Sencore Model CR143 CRT Tester and Rejuvenator	Oct.	74
Sencore MU-140 Tube Tester	Aug.	74
Sencore TR-139 In-Circuit Transistor Tester	Apr.	86
Sensi-Tronics Model 200 Electronic Circuit Breaker	June	76
Triplett Model 600 Transistorized V.O.M.	Aug.	74
Vari-Tech Model VT-1160 Low-Resistance Tester	Jan.	68
Wahl Series HS-8 "Heat Spy" Electronic Thermometer	Mar.	58

PLEASE . . .

Save this Annual Index for future reference to all the feature material which has appeared during 1967.

EROS System

(Continued from 38)

aircraft. "Bogey" aircraft, planes not equipped with EROS, can also be detected and identified.

The Future of CAS

McDonnell Douglas engineers are already at work on an improved EROS. EROS II, as the new model is designated, will have increased range and range rate measurement capability. This improvement in performance will make EROS II suitable for use aboard the U.S. Supersonic Transport (see "Electronic Challenges in the SST Program" in the July 1967 issue).

With two SST's approaching one another at 1800 miles per hour each, the closure rate is 3600 miles per hour, or 60 miles a minute. The human eye could not resolve the hazard in time for corrective action to be taken. Hence a system such as EROS II will be mandatory if we are to traverse the skies of the world in safety. The history of aviation is marked by significant achievements made possible by the art of electronics. The CAS, of which EROS is a spectacular example, is yet another chapter in that saga. Other chapters are yet to be written. ▲

ELECTRONICS MARKET PLACE

COMMERCIAL RATE: For firms or individuals offering commercial products or services. 70¢ per word (including name and address). Minimum order \$7.00. Payment must accompany copy except when ads are placed by accredited advertising agencies. Frequency discount: 5% for 6 months; 10% for 12 months paid in advance.

READER RATE: For individuals with a personal item to buy or sell. 40¢ per word (including name and address). No Minimum! Payment must accompany copy.

GENERAL INFORMATION: First word in all ads set in bold caps at no extra charge. Additional words may be set in bold caps at 10¢ extra per word. All copy subject to publisher's approval. **Closing Date:** 1st of the 2nd preceding month (for example, March issue closes January 1st). Send order and remittance to: Hal Cymes, **ELECTRONICS WORLD**, One Park Avenue, New York, New York 10016

FOR SALE

JUST starting in TV service? Write for free 32 page catalog of service order books, invoices, job tickets, phone message books, statements and file systems. Oelrich Publications, 6556 W. Higgins Rd., Chicago, Ill. 60656.

GOVERNMENT Surplus Receivers, Transmitters, Snooperscopes, Radios, Parts, Picture Catalog 25¢. Meshna, Nahant, Mass. 01908.

METERS—Surplus, new, used, panel and portable. Send for list. Hanchett, Box 5577, Riverside, Calif. 92507.

INVESTIGATORS, FREE BROCHURE, LATEST SUBMINIATURE ELECTRONIC SURVEILLANCE EQUIPMENT. ACE ELECTRONICS, 11500-J NW 7TH AVE., MIAMI, FLA. 33168.

CONVERT any television to sensitive big-screen oscilloscope. Only minor changes required. No electronic experience necessary. Illustrated plans, \$2.00. Relco-A22, Box 10563, Houston, Texas 77018.

MUSIC LOVERS, CONTINUOUS, UNINTERRUPTED BACKGROUND MUSIC FROM YOUR FM RADIO, USING NEW INEXPENSIVE ADAPTOR. FREE LITERATURE. ELECTRONICS, 11500-Z NW 7TH AVE., MIAMI, FLORIDA 33168.

R.F. CONVERTERS World's largest selection. Also CCTV cameras, etc. Lowest factory prices. Catalog 10¢. Vanguard, 196-23 Jamaica Ave., Hollis, N.Y. 11423.

FREE ELECTRONICS (new and surplus) parts catalog. We repair multimeters. Bigelow Electronics, Bluffton, Ohio 45817.

DETECTIVES! Free brochures! Electronic Surveillance devices. **SILMAR ELECTRONICS**, 3476 N.W. 7th Street, Miami, Florida 33125.

SURVEILLANCE EQUIPMENT—NEW HIGH PERFORMANCE SUBMINIATURE MODELS. ELECTRONIC COUNTERMEASURE DEVICES TO PROTECT PRIVACY. FREE DATA: SECURITY ELECTRONICS-EW, 15 EAST 43RD STREET, NEW YORK, N.Y. 10017.

CRYSTALS . . . largest selection in United States at lowest prices. 48 Hr. delivery. Thousands of frequencies in stock. Types include HC6/U, HC18/U, FT-241, FT-243, FT-171, etc. Send 10¢ for catalog with oscillator circuits. Refunded on first order. Jan Crystals, 2400E Crystal Dr., Fort Myers, Fla. 33901.

JAPANESE PRODUCTS CATALOG by air mail \$5, sea \$3. Intercontinental, CPO 1717, Tokyo, Japan.

TREASURE HUNTERS! Prospectors! Relco's new instruments detect buried gold, silver, coins. Kits, assembled models. Transistorized. Weighs 3 pounds. \$19.95 up. Free catalog. Relco-A22, Box 10839, Houston, Texas 77018.

ELECTRONIC Ignition. Kits, components, systems. Diagrams. Anderson Engineering, Epsom, N.H. 03239.

CONTINUOUS commercial-free background music from your FM radio using new transistorized SCA converter, \$49.95 complete. Simple installation. LF Labs, P.O. Box 312, Lockport, Illinois 60441.

No telephone privacy? "Bug" on your line? Blow it off! **ENGINEERING LABORATORIES**, Box 1036, Anderson, Indiana 46015.

POLICE RADIO. Hear all police calls, fire departments, Sheriffs, taxis, ambulances. Highway Patrol. New 5 band portable radio and direction finder. Free Booklet. NovaTech, Dept 301, Redondo Beach, Calif. 90278.

FM Wireless MIC, Guitar pickup, bug in case \$9.85, board only with instruction, \$6.75 C.O.D. SCI Mfg Co., 3700 First Nat'l Bank, Dallas, Texas 75202.

METAL—Treasure Detectors, most sensitive. Lowest priced. Free catalog. Jetco Instruments, Box 2880-E, Huntsville, Texas 77340.

FAIRCHILD Scopes, Dumont line selector amplifier general radio. Frequency meter & standard UHF generator, H.P. pulse generator, distortion analyzer, Tektronix time mark generator, English insulation tester, Marconi radio tester, square wave generator, others. 212-781-8084.

MOS ICs, JFETS, MOSFETS—MOS NAND, NOR gates \$1, MOSFET 75¢, N JFET 75¢, P JFET 50¢. Minimum Order \$3.50. FET G6, Box 593, Cupertino, Calif. 95012.

COMPUTER FOR SALE—DIGITAL—AII Manufacturer. Modular. Write for details, photo, etc. \$125. J. Paul, 1370 St. Nicholas Avenue, New York, New York 10033.

SHORTWAVE RECEIVERS AND TRANSCEIVERS. "68" MODELS BY HAMMARLUND, NATIONAL, DRAKE, SWAN. TRADES ACCEPTED ON YOUR TUBES, TEST EQUIPMENT AND GOVERNMENT SURPLUS. WRITE: BILL SLEP, W4FHY, SLEP ELECTRONICS, DRAWER 178EW, ELLENTON, FLORIDA 33532.

TECH MANUALS, SOLD ON MILITARY SURPLUS AND CIVILIAN ELECTRONIC EQUIPMENT. GIVE MAKE, MODEL FOR MANUAL QUOTE. SLEP ELECTRONICS, DRAWER 178EW, ELLENTON, FLORIDA 33532.

BURGLAR, Fire Alarm supplies and information. Send \$1.00 (refundable) for catalog to: Protecto Alarm Sales, Box 357, Birch Run, Michigan 48415.

EDUCATIONAL OPPORTUNITIES

LEARN While Asleep, hypnotize with your recorder, phonograph. Astonishing details, sensational catalog free! Sleep-Learning Association, Box 24-ZD, Olympia, Washington 98501.

LEARN WHILE ASLEEP. Miraculously build Mind Power, achieve Self Confidence, improve Health, gain Success. Method 92% effective. Details free. ASR Foundation, Box 7021EG Henry Clay Station, Lexington, Kentucky 40502.

USED Correspondence Courses and Books sold and rented. Money back guarantee. Catalog free (Courses Bought). Lee Mountain, Pisgah, Alabama 35765.

GET IT from GOODHEART!

EVERYTHING UNCONDITIONALLY GUARANTEED!

Brand new VHF revs in original cartons; look exactly like the familiar BC-453 Command Revs but are 9-tube superhet 108-135 mc AM revs and very easy to power & control without touching anything inside. The unit, you can even connect an S-Meter externally. We furnish schematic and complete instructions on all pin connections and also a spline tuning knob. A.R.C. Type No. R13B. No tuning dial; we furnish graph of freq. vs knob turns. 2 uV sensitivity. 2 RF, 3 IF stages. Shpg wt 7 lbs (to Los Angeles). **BRAND NEW \$22.50** R32 is same but w/adjustable squelch \$27.50

R-23/ARC-5 Command revr 190-550 kc. 14.95
A.R.C. 12 ±22 Command revr 540-1600 kc. 17.95
ART-13 AC Power Supply, NEW 49.50
RA-62-B is AC pwr sply for SCR-522, only 17.95
TDQ smtr 45 W To A2, A3, 115-156 mc. 295.00
TDZ smtr 30 W To A2, A3, 225-400 mc. 495.00
LM-14 freq. meter, 0.1% 125 kc-20 mc. 57.50
TS-323/UR freq. meter 20-480 mc., 0.01% 169.50
BC-221's OK \$67.50 TS-175 OK 127.50
CLOSING OUT Radio Receivers 38-4000 mc at CRAZY LOW PRICES! Ask for APR-14/1Y/CV 254 sheet.

ALL-BAND SSB RCVR BARGAIN: Hallicrafters R-45/ARR-7, 550 kc to 43 mc continuous, Voice, CW, MCW, aligned, grd, w/book; 2-RF, 2-IF's, S-meter; noise filter & xfr, 3 non-adj. selectivity choices. Less pwr sply. **149.50**
60 cy pwr sply; \$30. SSB product detector; \$20

Collins R-390 Receiver, Exc. Cond. 750.00

NEW ARRIVALS IN GOOD SCOPES

Tek 531: 0-15 mc. On way in to us 695.00
Tek 541: 0-30 mc. Like new, rd corners 795.00
Tek 543: 0-30 mc. Like new, rd corners 895.00
Add \$25 for NBS-traceable calib. cert. Add for calibrated plug-ins: N \$500; CA \$175; 53C or K, \$100;
B \$95; 53B \$60, Cart \$50. Probes \$12.50.
MANY OTHER SCOPES! Tek. H.P., DntMnt. ASK!

Sorens. 10000S 10 kva Line V Regulator 695.00
And others from 250 VA up. Ask for Regulator List.
Gen. Radio 5765S Primary Freq. Standard, dual rack, 100AMP & 105A, exc. condition, both 756.50
Autonatron Cesium-Beam Freq. Standard ASK!
Regulated Power Supplies, Meter Calibrators ASK!
Electronic Freq. Converters to 1 KVA ASK!
All kinds of AUDIO Test Equipment ASK!
Standard Signal Generators CW/AM/FM/Sweep ASK!

TIME PAY PLAN: Any purchase totaling \$180.00 or more, down payment only. **10%**

Above is a small sampling of our terrific inventory. We **ALSO BUY!** We want Tektronix scopes, Hewlett-Packard equip., Aeromat, radio-shop equip., etc. . . . AND Military Communications of all kinds.

R. E. GOODHEART CO. INC.
Box 1220-A, Beverly Hills, Calif. 90213
Phones: Area 213, office 272-5707, messages 275-5342

CIRCLE NO. 88 ON READER SERVICE CARD

RECTIFIERS, TRANSISTORS & COMPONENTS

6 tube Amplifier, New 4 lbs. 2/\$1.98
1/4 Watt Resistors, asstd. 50/1.00
1/2 Watt Resistors, asstd. 60/1.00
2N4138 Sil. Chopper To-46 NPN 1.50
Precision Resistors, asstd. 50/1.00
Pots, 2-4 Watt, asstd. 15/1.00
2N1724 Sil. Pow. 50 W 80 V Stud. 1.50
2N1047B Sil. Pow. 80V To-5760
Tantalum Capacitors, asstd. 10/1.00
2N1722 Sil. Pow. 50W 80V To-53 1.45
2N2944 Sil. Chopper To-46 1.00
50W. Zeners 10 to 19 Volts 1.00
Thermistor head, 1200 ohm. 2/1.00
2N1021, Ger. Power, 7amp, 100V, To -360
2N456A, 7A, 40V, Ger. Power To -345
2N1718, Sil. Power, 10W, 60V, Heatsink 3/1.00
70 amp Stud. 50PIV—\$2.50; 100PIV \$3.50

SILICON CONTROLLED RECTIFIERS

AMPS.	300PRV.	400PRV.	500PRV.
7A.	1.50	2.05	2.75
10A.	2.15	2.65	3.25

Pots, 1W, 100K, or 1/2 W, 500K 5/1.00
Surprise Kit, 10 lbs. components 2.50
Epoxy Hi-Vol diode, 200ma, 3000PIV98
Computer Board, TO-3 Power, Heat Sink 1.00
I.C., TO-5, untested 5/1.00
I.C. Dual-inline, untested 10/1.00
2N389, 85W 60 V, TO5379
2N3707-11 Asstd. Plastic Silicon Xisters 20/1.00
2N3704-3706, Asstd. Plastic Sil. Xisters 10/1.00
2N2151, Sil. Power Xister65
2N1009 Ger. Min. Xister untested 30/1.00
3N35 Tetrode, NPN, untested 5/1.00
Ger. Diodes, Asstd. 15/1.00
2N458A, 7A, 80V, Ger. Power, TO -355
Sil. Diodes, Switching, Signal, Asst. 15/1.00
2N118, Silicon, NPN 10/1.00
2N1149, Silicon, NPN, untested 20/1.00
2N1300, Untest. PNP & NPN, 1/2" leads 25/1.00
2N1714, Silicon Power 10W, 60V 4/1.00
Computer Boards, Parts Free, per transistor05
Germanium Power, 2N457A, 7A, 60V50
Silicon Power 40 W, 2N1047, TO-57 2/1.00
Tophats 750 ma., 200PIV-8¢, 400, 12¢ 600 PIV 1.18
1N34A 100/2.98
Varicaps, 27, 47, or 100 pf 1.25
2N1038, Germanium 20 W, 40 V 4/1.00
With any \$10.00 Order any \$1.00 item Free. On \$25.00 order any (3) \$1.00 items Free. Catalog.

Minimum order \$3.00 plus postage, C.O.D.'s 25%
ELECTRONIC COMPONENTS
Post Office Box 2902 Baton Rouge, Louisiana 70821

CIRCLE NO. 115 ON READER SERVICE CARD
December, 1967

GREGORY ELECTRONICS
Reconditioned & Used FM
2-WAY RADIO SAVINGS

Partial list—Send for New '68 Catalog

Voice Commander



132 to 172 MC, 1W 9.5" x 5.3" x 1.7" Lowest price ever, including brand New Rechargeable Nickel Cadmium Battery Pack

\$148

If crystal & tuning is desired add \$45.00
 Battery charger for these units \$16.00

Write for Quantity Prices

VOICE COMMANDER

Monitor Receiver only—Tuned & Crystalled with dry Batteries **\$78**

GE RECEIVER

4ER6 30-40 MC, 40-50 MC, 6 or 12 Volts
 3 Coil I. F. **\$28**
 4 Coil I. F. **\$34**

GENERAL ELECTRIC 4ES14A1—450-470 MC
 6/12 volts, less accessories—12 to 15 Watts. **\$38**

MOTOROLA T41GGV 30-50mc 6/12 V,
 30 watt vibrator power supply fully narrow banded complete with accessories less crystals and antenna **\$148**
 Add \$45.00 for tuning to desired frequency and new antenna

MOTOROLA 30-50mc 6/12 V,
 T51GGV vibrator power supply. Fully narrow banded (TX & RX) **\$198**
 Above price includes accessories less crystals and antenna (less accessories, deduct \$30.00)
 To tune unit to desired frequency including new antenna add \$45.00

GE 2-Piece unit—6 volt or 12 volt 4ER6—4ET5, 30w 30-40, mc.—40-50 mc. Wide Band \$48
 Fully narrow band (TX+RX) **\$68**
 Complete Accessories
4ER6—4ET6, 60w 30-40 mc—40-50 mc. Wide Band \$68
 Fully Narrow Band **\$88**
 Complete Accessories
 Add \$45.00 for tuning and crystals to desired frequency, including new antenna.

RCA—CMCT 30 148-172 mc. Transistorized power supply fully narrow banded complete with accessories **\$198**
 Add \$40.00 for crystals and tuning and new antenna.

G.E. PACERS—EG43SA6 150-170 mc Transistorized Power Supply 13-15 watts, 12 v Front Mount (Complete accessories, less crystals and antenna) **\$108.00**

We Buy Late Model Equipment for Cash
 —Write; Wire or Phone!



GREGORY ELECTRONICS CORPORATION

249 RT. 46, Saddle Brook, N.J., 07662
 Phone: (201) 488-9000

CIRCLE NO. 112 ON READER SERVICE CARD

ELECTRONICS ENGINEERING AND INSTRUCTION

REI First Class Radio Telephone License in (5) weeks Guaranteed. Tuition \$295.00. Job placement free. (KANSAS CITY) R.E.I., 3123 Gillham Road, Kansas City, Missouri. Telephone WE1-5444. (SARASOTA) R.E.I., 1336 Main Street, Sarasota, Florida 33577, Telephone 955-6922.

WANTED! TV—Radiomen to learn aircraft electronics servicing. Numerous job openings everywhere. Write: **ACADEMY AVIONICS**, Reno/Stead Airport, Reno, Nevada 89500.

ASSOCIATE Degree in Electronics Engineering earned through combination correspondence-classroom educational program. Free brochure. Grantham Technical Institute, 1505 N. Westery Ave., Hollywood, Calif. 90027.

LEARN ELECTRONIC ORGAN SERVICING at home. All Makes including transistors. Experimental kit—troubleshooting. Accredited NHSC. Free Booklet. **NILES BRYANT SCHOOL**, 3631 Stockton, Dept. A, Sacramento, Calif. 95820.

FCC First Class License in six weeks—nation's highest success rate—approved for Veterans Training. Write Elkins Institute, 2603C Inwood Road, Dallas, Texas 75235.

HIGHLY effective home study course in Electronics Engineering Mathematics with circuit applications. Earn your Associate in Science Degree. Free literature. **COOK'S INSTITUTE OF ELECTRONICS ENGINEERING**, P.O. Box 36185, Houston, Texas 77036.

ELECTRONICS! Associate degree—29 months. Technicians, field engineers, specialists in communications, missiles, computers, radar, automation. Start February, September. Valparaiso Technical Institute, Dept. N, Valparaiso, Indiana 46383.

PLANS AND KITS

INTEGRATED CIRCUIT KITS; COMPUTER LOG-IC; parts: others. Catalogue free. Kaye Engineering, Box 3932, Long Beach, California 90803.

HIGH FIDELITY

FREE! Send for money saving stereo catalog ±E12W and lowest quotations on your individual component, tape recorder or system requirements. Electronic Values Inc., 200 West 20th Street, N.Y., N.Y. 10011.

HI-FI Components, Tape Recorders at guaranteed "We Will Not Be Undersold" prices. 15-day money-back guarantee. Two-year warranty. No Catalog. Quotations Free. Hi-Fidelity Center, 239 (L) East 149th Street, New York 10451.

HIFI EQUIPMENT—Get Our "ROCK BOTTOM" prices on NAME BRAND amplifiers—tuners—tape-recorders—speakers FRANCHISED—59 YEARS IN BUSINESS. Write for this month's specials—NOW! Rabson's 57th St., Inc., Dept. 569, 119 W. 57th St., New York, New York 10019.

LOW, LOW quotes: all components and recorders. Hi-Fi, Roslyn, Penn. 19001.

HI-FI components, tape recorders, sleep learn equipment, tapes. Unusual Values. Free catalog. Dressner, 1523 R Jericho Turnpike, New Hyde Park, N.Y. 11040.

BIG CATALOG
 World's "BEST BUYS" in GOV'T. SURPLUS
 Electronic Equipment

TCS EQUIPMENT

NAVY TCS RECEIVER AM



1.5 MC to 12 MC in two (2) bands. Variable freq. oscillator & crystal control on four (4) preset channels in the entire freq. range. Audio output 1.5 watts into 500 ohm load; uses tubes 12SK7 RF A., 12SA7 converter, 2/12SK7 IF A., 12SQ7 detector BFO, 12A6 oscillator, 12A6 audio amp. 456 KC 1F Freq. Large vernier & spin dial, audio gain, AVC, BFO and all controls on the front panel. Voltages required: 12 VDC & approx. 220 VDC 100 MA. Size: **\$44.95**
 11 3/4" x 11 3/4" x 1 3/4". Wt.: 37 lbs. USED:
 Checked for Operation—\$10.00 extra.

NAVY TCS TRANSMITTER AM

1.5 MC to 12 MC in three (3) bands. CW 40 watts, voice modulation 20 watts, master oscillator variable and crystal control on 4 preset channels in the entire freq. range. Uses 3/12A6 in oscillator & buffer-doubler; 4 16Z5 in modulator & power amplifier stages. 2 1/2" meters for PA Plate 0-200 DC RF meter 0-3, all tuning and operating controls on front panel. Voltages required: 12 VDC & 400-440 VDC 200 MA. W/tubes. Size: 11 3/4" x 11 3/4" x 1 3/4". **\$34.50**
 Wt.: 41 lbs. USED:
 Checked for Operation—\$10.00 extra.

Antenna Loading Coil #47205 Used: \$6.95
 Remote Control Box—w/Speaker #20270 Re-New: 9.95
 Dual Dynamotor Power Supply
 12 V. #21881 Re-New: 14.95
 D-401 Transmitter Dynamotor 12 V. New: 6.95
 D-402 Receiver Dynamotor 12 V. New: 4.95
 CABLE—Receiver to Power Supply New: 2.75
 CABLE—Transmitter to Power Supply New: 2.75
 Connector Plug; Remote Control Box New: 1.50
A C POWER SUPPLY—115 V. 60 cycle (Not Govt. Surplus)
 Receiver: \$20.00 — Transmitter: \$35.00
 Shock Mounting for Receiver or Transmitter Used: 2.95
 Noise Limiter Conversion Kit—W/6BE tubes 2.00
 PARTS available for Rec. & Trans. Advise us your needs!
BIG FREE CATALOG—Send for your FREE copy
 now. New edition just off the press!
 Address Dept. EW • Prices F.O.B. Lima, O. •
 25% Deposit on C.O.D.'s

FAIR RADIO SALES
 1016 E. EUREKA • Box 1105 • LIMA, OHIO • 45802

CLASSIFIED ADVERTISING ORDER FORM

Please refer to heading on first page of this section for complete data concerning terms, frequency discounts, closing dates, etc.

1	2	3	4	5
6	7	8	9	10
11	12	13	14	15
16	17	18	19	20
21	22	23	24	25
26	27	28	29	30
31	32	33	34	35

_____ Words { @ .40 Reader Rate } = \$ _____
 { @ .70 Commercial Rate }

Insert _____ time(s) Total Enclosed \$ _____

NAME _____

ADDRESS _____

CITY _____ STATE _____ ZIP _____

SIGNATURE _____

WORD COUNT: Include name and address. Name of city (Des Moines) or of state (New York) counts as one word each. Zip Code numbers not counted. (Publisher reserves right to omit Zip Code if space does not permit.) Count each abbreviation, initial, single figure or group of figures or letters as a word. Symbols such as 35mm, COD, PO, AC, etc., count as one word. Hyphenated words count as two words. EW-1267

TUBES

RECEIVING & INDUSTRIAL TUBES, TRANSISTORS. All Brands—Biggest Discounts. Technicians, Hobbyists, Experimenters—Request FREE Giant Catalog and **SAVE! ZALYTRON** 469 Jericho Turnpike, Mineola, N.Y. 11501.

TUBES, SEMICONDUCTORS, ELECTRONIC EQUIPMENT & COMPONENTS. Quality merchandise only! Serving engineers, Purchasing Agents, TV/HiFi Servicemen and Hams for 20 years. Write for Catalog or call 212-WA 5-7000. **BARRY ELECTRONICS**, 512 Broadway, New York, N.Y. 10012.

TUBES—33¢ each. Year guarantee. Tuner Cleaner \$1.09. Free catalog. Cornell, 4213-W University, San Diego, Calif. 92105.

DON'T BUY TUBES—Radio, TV-Xmitting, special-purpose types until you get our price list! Lowest prices in U.S.A. 5,000 types—Guaranteed Brand New. Send postcard for TV—Special Purpose Price List. **UNITED RADIO COMPANY, P.O. BOX 1000, NEWARK, N.J. 07101.**

FREE Catalog. Electronic parts, tubes. Wholesale. Thousands of items. Unbeatable prices. Arcturus Electronics ZD, 502-22 St., Union City, N.J. 07087.

WANTED

QUICKSILVER, Platinum, Silver, Gold. Ores Analyzed. Free Circular. Mercury Terminal, Norwood, Mass. 02062.

QUICK CASH . . . for Electronic Tubes, Semiconductors, Equipment (Receivers, Transmitters, Scopes, Vacuum Variables, etc.) Send lists now! Write: **BARRY ELECTRONICS**, 512 Broadway, New York, N.Y. 10012 (212-WA 5-7000).

DO-IT-YOURSELF

PROFESSIONAL ELECTRONICS PROJECTS — \$1.00 up. Catalog 25¢. **PARKS**, Box 15265B, Seattle, Wash. 98115.

TAPE AND RECORDERS

BEFORE renting Stereo Tapes, try us. Postpaid both ways — no deposit — immediate delivery. Quality—Dependability—Service—Satisfaction—prevail here. If you've been dissatisfied in the past, your initial order will prove this is no idle boast. Free Catalog. Gold Coast Tape Library, Box 2262, Palm Village Station, Hialeah, Fla. 33012.

SCOTCH Recording Tapes. Tape Recorders. Catalog 5¢. Tower, Lafayette Hill, Pa. 19444.

STEREO TAPES. Save up to 60% (no membership fees, postpaid anywhere USA). Free 60-page catalog. We discount batteries, recorders, tape accessories. Beware of slogans "not undersold," as the discount information you supply our competitor is usually reported to the factory. **SAXITONE**, 1776 Columbia Rd., Washington, D.C. 20009.

RENT Stereo Tapes—Over 2,500 Different—all major labels—free brochure. Stereo-Parti, 1616 —E. W. Terrace Way, Santa Rosa, California 95404.

TAPE RECORDER SALE. Brand new, nationally advertised brands, \$10.00 above cost. Arkay Sales, 1028-B Commonwealth Avenue, Boston, Mass. 02215.

HI-FI Components, Tape Recorders at guaranteed "We Will Not Be Undersold" prices. 15-day money-back guarantee. Two-year warranty. No Catalog. Quotations Free. Hi-Fidelity Center, 239 (LT) East 149th Street, New York 10451.

RENT STEREO TAPES—75¢ week. Catalog. Art's, 1442 Blaze, Simi, Calif. 93065.

TAPEMATES make available to you **ALL 4-TRACK STEREO TAPES—ALL LABELS**—postpaid to your door—at tremendous savings. For free brochure write: **TAPEMATES**, 5727 W. Jefferson Blvd., Los Angeles, California 90016.

RECORDS

SPECIAL INTEREST RECORDS AVAILABLE, PRODUCED BY THE EDITORS OF THE WORLD'S LEADING SPECIAL INTEREST MAGAZINES. SEND FOR FREE CATALOG. RECORD CATALOGUE, ZIFF-DAVIS PUBLISHING COMPANY, ONE PARK AVENUE, NEW YORK, N.Y. 10016.

WE WANT YOU TO MAKE THE SWITCH JOIN OUR GROWING LIST OF THOUSANDS OF SATISFIED CUSTOMERS.

Our semiconductors have full factory length leads, are American made, unused, and in good physical condition. Our technical descriptions and pictures are accurate.

TRIACS

TO-66 5 AMP

PRV	100	200	300	400	500
	.90	1.40	1.75	2.25	2.60

ZENERS 1 Watt 6-33V \$.50
10 Watt 6-200V \$.75
50 Watt 6-200V \$1.75



POST OFFICE BOX 74B SOMERVILLE, MASS. 02143
featuring transistors, rectifiers and components
SEND FOR OUR FALL CATALOG

- SIM** to 2N3429 (NPN). SI 7/8" stud, min HFE of 30, 7.5 Amps. 175 watts. VCe of 75 \$1.75
- SILICON BILATERAL SWITCH.** Replaces two SCR's by firing in either direction when breakdown voltage is exceeded. Used in light dimmers, etc. 2/\$1.00
- CADMIUM SELENIDE PHOTO-CONDUCTIVE CELLS.** Dark resistance of 500 megohms. Sensitivity of 1-4.99 Va/Ft candle. with data sheet \$1.25
- NEON LIGHT OR NIXIE TUBE DRIVERS.** An NPN, TO-18, SI Transistor. With a VCBO of 1.0 3/\$1.00
- SIM.** to 2N2875 (PNP). Silicon 20 watts with 30 Mhz cut off \$.75
- High Voltage NPN 150V.** VCBO at 2.5A., High HFE in TO-66 pack \$.75
- 500 Hfe plastic transistors** NPN, TO-18, SI unit similar to 2N3965 3/\$1.00

Silicon Power Rectifiers

PRV	3A	12A	20A	40A
100	.09	.30	.40	.75
200	.16	.50	.60	1.25
400	.20	.70	.80	1.50
600	.30	1.00	1.20	1.80
800	.40	1.25	1.50	2.30
1000	.55	1.50	1.80	2.70

Terms: FOB Cambridge, Mass. Send check or Money Order. Include Postage. Average Wt. per package 1/2 lb. Allow for C.O.D. Minimum Order \$3.00
Rated companies 30 days net
TELEPHONE (617) 547-4005

MORE INTEGRATED CIRCUITS

SR Flip Flops \$.90
SR Clocked Flip Flops \$1.15
SRT Flip Flops \$1.15
JK Flip Flops \$1.15
Dual Nand Nor Gates \$1.00
8 Input Nand Nor Gates \$1.00
Dual and Gates \$1.00
Quad Nand Nor Gates \$1.00
TO-85 flat pack with holder. Guaranteed to work.
They come complete with schematic, elect. characteristic sheet & some typical applications.

Top Hat & Epoxy 1 AMP

PRV	100	200	400	600	800
	.07	.09	.12	.18	.22
	1000	1700	1400	1600	1800
	.35	.50	.65	.80	.90



Silicon Control Rectifiers

PRV	3A	1A	20A
50	.35	.45	.70
100	.50	.65	1.00
200	.70	.95	1.30
300	.90	1.25	1.70
400	1.20	1.60	2.10
500	1.50	2.00	2.50
600	1.80	2.40	
700	2.20	2.80	
1000		4.00	

CIRCLE NO. 96 ON READER SERVICE CARD
ELECTRONIC COMPONENTS CO., 715 LATHAM SQUARE BLDG., OAKLAND, CALIFORNIA 94612

INTEGRATED CIRCUIT ASSORTMENTS
UNMARKED ASSORTED IC'S, TO-5 & TO-66, FLAT PACK, AND DUAL IN LINE UNITS. SPECIFY TYPE 50/\$5.95 100/\$9.95. INCLUDES SCHEMATIC FOR SIMPLE TESTER, AND SCHEMATICS FOR IDENTIFYING THE UNITS. FLAT PACK TEST SOCKETS \$1.00 MATCHING CONNECTOR \$.95
SPECIAL DUAL IN LINE ASSORTMENTS—ALL UNITS FULLY IDENTIFIED

THESE UNITS ARE MECHANICAL DROP OUTS AND HAVE NEVER BEEN TESTED ELECTRICALLY. SAMPLE TESTS INDICATE BETTER THAN 75% MEET MANUFACTURERS ELECTRICAL PARAMETERS. ASSORTMENT CONTAINS THE FOLLOWING:

	25 PACK	50 PACK	100 PACK
944 DUAL POWER GATE	2	4	8
945 R S Clocked FLIP FLOP	2	4	8
946 QJAD 2 INPUT GATE	1	3	6
948 R S Clocked FLIP FLOP	1	1	2
952 DUAL 2 INVERTER	3	6	12
953 TRIPLE 2-2-3 GATE	5	9	18
954 DUAL 4 INPUT GATE	2	5	10
955 SINGLE 8 INPUT GATE	2	5	10
956 DUAL 2 INPUT BUFFER	2	5	10
957 BINARY	2	5	10
OUR OPTION	3	3	6

25/\$7.95 50/\$13.95 100/\$24.95

COPPER CLAD GLASS EPOXY BOARD 1/16"

SIZE	CLAD ONE SIDE		CLAD BOTH SIDES		PRODUCTION QUANTITIES AVAILABLE. WRITE FOR QUOTATION—SPECIFY SIZE.
	1 ONLY	5 PACK	1 ONLY	5 PACK	
3"X6"	.40	1.88	.45	2.10	ETCHANT CRYSTALS: 2 QT. SIZE \$1.15 4 QT. SIZE \$2.00
4"X6"	.50	2.25	.55	2.50	
4"X8"	.66	3.00	.70	3.20	
5"X6"	.62	2.80	.67	3.20	
6"X8"	1.00	4.50	1.10	5.00	
12"X12"	3.00	13.00	3.20	14.00	

DAYSTROM 316-00 TRIMMERS 3/\$1.95
TRANSISTORS AND DIODES
ASSORTED TO-5, TO-18, TO-46 100/\$1.95
UNMARKED NPN-PNP
ASSORTED DO-7 DIODES 100/\$1.95
UNMARKED SILICON
MINIATURE DIODES 50 PIV 100/\$1.95
G.I. 2N1393 PHOTO TRAN. \$1.95
J.T.C. 2N1307 10/\$1.00
F.S.C. 2N1132 2/\$1.95
FPR-300 CADMIUM SULFIDE CELL 2/\$1.95

NEW FAIRCHILD EPOXY TRANSISTORS
2N3565 2N3567 2N3638 2N3643 2N3566
2N3568 any 6 FOR \$1.95

8 AMP SCRS TO-59 CASE
1COPIV .60 200PIV .90 300PIV 1.40

WE ARE INTERESTED IN PURCHASING YOUR NEW, UNUSED ELECTRONIC PARTS.
TERMS: COD 25% WITH ORDER, F.O.B. OAKLAND CASH WITH ORDER SHIPPED P.P. PREPAID ALL ORDERS SHIPPED DAY RECEIVED.

ASSORTED DUAL TRANSISTORS TO-5, TO-18 UNMARKED 25/\$1.95
ELECTRONIC COMPONENTS CO., 715 LATHAM SQUARE BLDG., OAKLAND, CALIF. 94612 (415) 836-3180

CIRCLE NO. 110 ON READER SERVICE CARD

G&G CATALOG!

NEW

24 Pages Military Electronic Gear
SEND 25¢ - Refunded with first order

AN/APR-4Y FM & AM RECEIVER "FB" FOR SATELLITE TRACKING!

High precision lab instrument, for monitoring and measuring frequency and relative signal strength. 38 to 4000 Mc. in 5 tuning ranges. For 110 V 60 cycle AC. Built-in power supply. Original circuit diagram included. Checked out, perfect.
LIKE NEW **\$89.50**
All Tuning Units Available for Above



BC-929 3-Inch Scope, with all tubes, LIKE NEW **\$16.95**

Conversion instructions, with diagram, for 110 V AC operation **\$.65**

BC-221 FREQ. METER. Accurate, reliable crystal calibrated, for 125 to 20,000 KC range. Complete with tubes, calibration book. Checked out. Exc. Used, unmodulated **\$79.50**
Exc. Used, Modulated **\$129.50**
1000 Kc crystal for above **\$5.50**

LM FREQ. METER, Modulated, 125 to 20,000 Kc. With calibration book, like new **\$79.50**

T-23/ARC-5 TRANSMITTER, 100 to 156 Mc. Less tubes and crystals, Used **\$5.95**

R-4/ARR-2 RECEIVER, 234-258 Mc, Tunable. Complete with 11 tubes, NEW **\$11.95**
Dynamotor (24VDC) for ARR2 **\$2.45**

BC-645 TRANSCEIVER 435 to 500 Mc, convertible for Ham or Citizens' bands, Voice or Code. Brand new, with 15 tubes **\$16.95**
Dynamotor, Antenna, Plugs, All accessories available.

SCR-274-N, ARC-5 COMMAND SET HQ!



Freq. Range	Type	Exc. Used	BRAND NEW
RECEIVERS, Complete with Tubes			
190-550 Kc.	BC-453	\$18.95	\$23.50
3-6 Mc.	BC-454	\$16.50	\$21.50
6-9.1 Mc.	BC-455	\$14.95	\$19.95
1.5-3 Mc.	R-25		\$21.50
TRANSMITTERS, Complete with Tubes			
4-5.3 Mc.	BC-457	\$ 6.95	\$11.95
5-3.7 Mc.	BC-458	\$ 6.95	\$12.95
7-9.1 Mc.	BC-459	\$17.95	\$22.50
2.1-3 Mc.	T-18		\$10.95
3-4 Mc.	T-19	\$10.50	\$14.95
MODULATOR, Complete with 3 Tubes			
Voice	BC-456	\$ 2.75	\$ 4.95
All Command Set Accessories in Stock			

SCR-625 MINE DETECTOR **\$32.50**
EE-8 FIELD PHONES, Exc. Used, Each **\$16.95**
BC-1206-C Beacon Recvr, 200-400 Kc. NEW **\$12.95**
BC-1206-C as above, used **\$ 9.95**
SCR-522 Transmitter-Receiver, Like New **\$39.50**

TG-34A CODE KEYS **\$24.50**
Brand New in original carton
Exc. Used **\$18.95**
Practice Tapes available, with Keyer P.U.R.

VISIT OUR NEW SHOWROOM
AT 45 WARREN STREET, N.Y.C.

Please include 25% Deposit with order—Balance C.O.D., or Remittance in Full. 50¢ Handling Charges on all orders under \$5.00. All shipments F.O.B. Our Warehouse, N.Y.C. All Merchandise subject to Prior Sale and Price Change.

G & G RADIO SUPPLY COMPANY
Telephone: (212) CO 7-4605
75-77 Leonard St., New York, N.Y. 10013

CUSTOM RECORDING

L.P. HiFi Records made from any speed tape. Plan sixteen minutes per side. Three identical copies \$19.95. "RECORDS", Box 206, N. Wales, Penna. 19454.

MAGNETS

MAGNETS. All types. Specials—20 disc magnets, or 2 stick magnets, or 10 small bar magnets, or 8 assorted magnets, \$1.00. Maryland Magnet Company, 5412-E Gist, Baltimore, Maryland 21215.

AUTHORS' SERVICES

AUTHORS! Learn how to have your book published, promoted, distributed. FREE booklet "ZD," Vantage, 120 West 31 St., New York 10001.

POEMS WANTED for new song hits and recordings by America's most popular studio. Tin Pan Alley, 1650-ZD Broadway, New York 10019.

PRINTING

PRINTING Presses, Type, Supplies, Lists 5¢. Turnbaugh Service, Mechanicsburg, Pa. 17055.
OFFSET PRINTING—8 HOUR SERVICE—LOW PRICES 25 to 5,000 copies. Nationwide Printing, Atlanta, Illinois 61723.

GOVERNMENT SURPLUS

JEEPS Typically From \$53.90. . . Trucks From \$78.40. . . Boats, Typewriters, Airplanes, Electronics Equipment, Photographic Equipment, used, 100,000 Bargains Direct From Government. Complete Sales Directory and Surplus Catalog \$1.00 (Deductible First \$10.00 Order). Surplus Service, Box 820-K, Holland, Michigan 49423.

PERSONALS

LEMURIAN VIEWPOINT—Meaningful discussions of Cosmic Truth: the purpose of human life, reincarnation, man's place in a Higher Plan, and subjects from the Lemurian Philosophy. Send for FREE copy. Lemurian Fellowship, Dept. 764, Box 397, Ramona, Calif. 92065.

MAKE FRIENDS WORLDWIDE, promote international understanding, join Europe's leading correspondence club, illustrated brochure free. HERMES, Box 17/33, 1 Berlin 11, Germany.

MUSICAL INSTRUMENTS

GUITAR Amplifiers—Solid State custom built powerful with reverb tremelo piggyback, one piece cabinets with Lansings or Jensens also assembled Heathkits all models (For Sale) new. Write for free price list. Rivera Industries, 615 Warburton Ave., Yonkers, New York 10701.

HYPNOTISM

FREE Hypnotism, Self-Hypnosis, Sleep Learning. Catalog! Drawer H400, Ruidoso, N.M. 88345.

AMAZING HYPNOTIC record kit releases fantastic mental power! Free offer expires soon. Write: Forum, Studio AA12, 333 North Michigan, Chicago 60601.

SELF-HYPNOSIS for self-improvement. Safe, effective! Free literature. McKinley, Dept. T-3, Box 3038, San Bernardino, California 92404.

COMPLETE Illustrated Hypnotism course—"Instantaneous"—"One Word"—"Against Will"—"Secret Nerve Pressure" Methods Revealed! RESULTS ABSOLUTELY GUARANTEED! \$1.00. Arthur Fowler, Box 4396, Woodbury, New Jersey 08096.

HYPNOTIZE FEMALES!—Unnoticed! Instantly! Nerves! Exciting! Send \$2.25. Research Enterprises, 29-SN21 Samoset, Woburn, Mass. 01801.

PHOTOGRAPHY—FILM, EQUIPMENT, SERVICES

MEDICAL FILM—Adults only—"Childbirth" one reel, 8mm \$7.50; 16mm \$14.95. International W. Greenvale, Long Island, New York 11548.

SCIENCE Bargains—Request Free Giant Catalog "CJ"—148 pages—Astronomical Telescopes, Microscopes, Lenses, Binoculars, Kits, Parts, War Surplus bargains. Edmund Scientific Co., Barrington, New Jersey 08007.

RUBBER STAMPS

RUBBER ADDRESS STAMP \$1.50. SIGNATURE \$3.50. FREE CATALOG. JACKSON, P.O. BOX 443-G, FRANKLIN PARK, ILL. 60131.

STAMPS

WHITE ACE Historical Stamp Albums. Write for catalog. Washington Press, Maplewood, N.J. 07040.

EMPLOYMENT INFORMATION

FOREIGN and USA job opportunities available now. Construction, all trades. Earnings to \$2,000.00 monthly. Paid overtime, travel, bonuses. Write: Universal Employment, Woodbridge, Connecticut 06525.

UNUSUAL BARGAINS EXCELLENT XMAS GIFTS!

NICKEL-CADMIUM BATTERY BARGAINS



Terrific value—used government surplus. Quick-charge, lightweight 6-volt nickel-cadmium battery. 4-amp hour capacity. Almost unlimited life—thousands of discharge-charge cycles with minute deterioration. Charges fully in approx. 1 hr. with Edmund Charger Kit. Hundreds of uses for hobby, photography, model building, industry, etc. Only few drops of water yearly for full maintenance. Req. minimum of electrolyte-sealed to prevent loss. Delivers nearly 100% output at below freezing. Maintains constant voltage through major portion of capacity. Five vented 1.2 volt cells strapped in 3 polypropylene bands, 3 1/2" x 2" x 6" (10 & 1/2 Jumbo 275 Ampere Hour Batteries also available. Write for info.)
Stock No. 70,942AK **\$15.00 Ppd.**
ONE NEW 1.2 VOLT NICKEL-CADMIUM CELL
Stock No. 40,798AK **\$3.95 Ppd.**
CHARGER KIT FOR 6-VOLT BATTERY
Stock No. 70,807AK **\$8.00 Ppd.**

GIANT WEATHER BALLOONS



"Balls of fun" for kids, traffic stoppers for stores, terrific for amateur meteorologists, create a neighborhood sensation. Great backyard fun. Exciting beach attraction. Made of heavy duty neoprene. Inflate with vacuum cleaner or auto air hose; or locally available helium for high rise.

Stock No. 60,568AK (8' diam.) **\$2.00 Ppd.**
Stock No. 60,632AK (16' diam.) **\$7.00 Ppd.**

Order by Stock No.—Check or M.O.—Money-Back Guarantee
EDMUND SCIENTIFIC CO., 300 EDSORP BUILDING BARRINGTON, NEW JERSEY 08007

MAIL COUPON for FREE CATALOG

SEND FOR FREE CATALOG "AK"

EDMUND SCIENTIFIC CO., 300 EDSORP BUILDING BARRINGTON, N.J. 08007. Completely new 1968 edition. New items, categories, illustrations, dozens of electrical and electromagnetism parts, accessories. Enormous selection of Astronomical Telescopes, Microscopes, Binoculars, Magnifiers, Magnets, Lenses, Prisms. Many war surplus items; for hobbyists, experimenters, workshop, factory. Mail coupon for catalog "AK".



NAME _____
ADDRESS _____
CITY _____ STATE _____ ZIP _____

CIRCLE NO. 117 ON READER SERVICE CARD

Deluxe ELECTRONICS WORLD MAGAZINE CASES

DESIGNED TO HOLD A FULL YEAR'S COPIES



Constructed of reinforced fibreboard and covered in rich leatherette, these durable cases guard against soiling and tearing of your magazines while lending themselves handsomely to the decor of any room. The magazine cases are available with embossed gold lettering in either all black or attractive maroon back with black sides.

These decorative cases are just what you've been looking for to keep your copies of Electronics World Magazine in easy-to-find order.

\$3.50 ea., 3 for \$10, 6 for \$19
FULLY GUARANTEED

Ziff-Davis Publishing Co., Dept. SD
1 Park Ave., N.Y., N.Y. 10016

Please send _____ Electronics World Magazine Cases. Also send cases for the magazine titles indicated below:

- All black, gold embossed
 Maroon back, gold embossed/black sides

NAME _____ EW-12

ADDRESS _____

CITY _____

STATE _____ ZIP _____

Enclosed is \$ _____ at \$3.50 per case, 3 for \$10, 6 for \$19 (Quantity prices apply for combination orders of more than one title). Orders outside U.S.A. \$4.50 ea., 3 for \$13, 6 for \$25.

(Payment must accompany order)

U.S. GOV'T ELECTRONIC SURPLUS

Nationally Known-World Famous SURPLUS CENTER offers finest, most expensive, Government Surplus electronic units and components at a fraction of their original acquisition cost.

ORDER DIRECT FROM AD OR WRITE FOR CATALOGS

LABORATORY EXPERIMENTAL KIT

PERFORM 100'S OF FASCINATING ELECTRICAL EXPERIMENTS

Gov't Acquisition Cost Of Parts Over \$50.00

\$14.85

F.O.B.



(ITEM #A222) -- Amazing Value! Valuable gift for son or husband. Hundreds of fascinating experiments. Teaches modern electronic theory and practice. Easy, interesting way to learn.

Experiments with electro-plating, electro-magnetic phenomena, resonance, burglar alarm, relay circuits, identification, test circuits, gas-discharging, motor experiments, transformer phenomena, etc.

Kit Contains: 100 miniaturized electronic components, ac and dc relays, 500 ohm lab capacitors, compass, test bulbs, plating chemicals, silicon diodes, germanium diode, burglar alarm actuator, carbon microphone, gas-discharging element, ac test sockets, permanent magnets, telephone handset, leads, test clips, wire and other items, plus 25 pieces, 400-odd files, 100 component manual with drawings, procedures, etc., written by professional engineers.

Also furnished with each kit our popular book Home Laboratory Bench and Experimental Procedures, Reg. \$1.00, shows how to build wonderful home laboratory test bench, and how to get the most out of your experimental work. 112 lbs. 1 Paris Post only \$10.00

AC PROGRAM TIMING CLOCK

(ITEM #158) -- Zenith 115-AC program timer. Use for portable signaling, work benches, school classes, time in radio, etc. Features: Adjustable clips permit switching on or off any time during 24 hour period, built-in clips for multiple programming. Also has "skip-days" feature. Controls can handle 100 to 150amps, 115V, 60 Hz, 4 1/2" x 8 1/2" x 1 1/2" deep. Cost \$39.00. Instructions furnished. F.O.B. **\$9.49**



AUTO-PILOT GYROSCOPE



(ITEM #115) -- In motor driven, gimbal mounted gyroscope. Utilizes positive action unit used in "steer" large, multi-engine planes. Distraction from established plane sends governor controlled signals to bring about change in other motors. Unit can be used as auto-pilot for boats, model planes, etc. Also used to demonstrate and study gyro action. Missiles, planes, boats all use gyro. Size 3 1/2" x 3 1/2" x 1 1/2". Cost Gov't over \$500.00.

STANDARD DIAL TELEPHONE

(ITEM #715) -- standard, commercial telephone same as used throughout U.S.A. Mirrored polished black, like new condition. Use as extension phone to private systems or connect several phones together for local intercom system. Full instructions are furnished. 9 lbs. Original cost \$4.50. F.O.B. **\$5.95**



STEP-BY-STEP AUTOMATIC SWITCH

(ITEM #738) -- Amazing "up-and-around" electro-magnetic telephone switch. Dial any bank part from 1 to 100. Make your own telephone system. Can also be used as remotely controlled up to 100 circuits over a single pair of wires. One of our EARLY NFR bargains. Comes complete with data, coin dial and one bank. Size 3 1/2" x 4 1/2" x 1 1/2". Wt. 1 1/2 lbs. Cost Gov't \$10.00. Complete. Switch, cover, dial, line bank, instructions. F.O.B. **\$9.95**



STEP UP/DOWN TRANSFORMER

(ITEM #1543) -- Step up/step down transformer with data. Full step 115 volts up to 230, 115 down to 115. Also transform 115 volts to 75 volts. Rated 1.5 amps. Output 115 volt capacity. Size 3 1/2" x 3 1/2" x 1 1/2". Wt. 4 lbs. Cost \$12.75. F.O.B. **\$4.99**

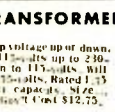

TYPICAL BUYS FROM OUR 1967 CATALOGS

- \$ 350.00 - Geared 2-hp Battery Golf Car Motor **\$24.95**
- \$ 15.00 - Westinghouse DC Ammeter, 0 to 300 **\$ 7.11**
- \$ 40.00 - Vacuum Pressure Pump, 12-VDC **\$11.95**
- 80-MW Walkie-Talkies, Per Pair **\$19.60**
- Deluxe, Multi-Range, AC DC Tester **\$ 8.98**
- \$4000.00 - Carrier Telephone Amplifier System **\$13.91**

SPECIAL SALE

Correspondence Course In ELECTRICAL ENGINEERING



Sells For \$10.79 Outside U.S.A. **\$8.79** Postpaid

(ITEM #A18) -- Wonderful chance to obtain technical training at Amazing Low Cost! Lincoln Engineering School has suspended its Correspondence Courses because of increased operating costs. We offer a limited number of the school's complete Electrical Engineering course but without the examination paper grading services. The course consists of 14 lesson unit books. Each book has the regular exams, and in a separate section, "Standard Answers" to each exam question.

Course is well written, easy to understand, profusely illustrated. Reader's Digest size, easy to carry and study in spare time. Many Lincoln Engineering school students holding excellent jobs as a result of E.E. training. Course contains latest information on transistors, silicon diodes, etc. Additional book on how to build and operate a "Home Laboratory and Experimental Bench" furnished with each course.

SEND 25c COIN OR STAMPS FOR 3 MAIN CATALOGS All Items FOB Lincoln Money Back Guarantee

SURPLUS CENTER
DEPT. EW-127 LINCOLN, NEBR. 68501

INVENTIONS WANTED

INVENTORS. We will develop, help sell your idea or invention, patented or unpatented. Our national manufacturer clients are urgently seeking new items for outright cash sale or royalties. Financial assistance available. 10 years proven performance. For free information, write Dept. 42, Wall Street Invention Brokerage, 79 Wall Street, New York, N.Y. 10005.

PATENT SEARCHES, \$6.00! FREE "Invention Record"/Information. Miss Hayward, 1029HE Vermont, District of Columbia 20005.

INVENTIONS - IDEAS developed Cash/Royalty Sales. Member: United States Chamber Commerce. Raymond Lee, 230-GE Park Avenue, New York City 10017.

INVENTORS! Receive free invention analysis at no risk to you. Send for FREE disclosure form today. New York Invention Service, Dept. 19, 160 Broadway, New York, N.Y. 10038.

BUSINESS OPPORTUNITIES

INVESTIGATE ACCIDENTS: Earn up to \$1,000 and more a month in your own business. Work spare time with average earnings of \$5 to \$8 per hour. No selling. Send for FREE booklet. No obligation. No salesman will call. Write: Universal Schools, CZ-12, 6801 Hillcrest, Dallas, Texas 75205.

FREE CATALOGS. Repair air conditioning, refrigeration. Tools, supplies, full instructions. Doolin, 2016 Canton, Dallas, Texas 75201.

I MADE \$40,000.00 YEAR by mailorder! Helped others make money! Start with \$10.00-Free proof. Torrey, Box 318-N, Ypsilanti, Michigan 48197.

FREE BOOK "990 Successful, Little-Known Businesses." Work home! Plymouth-145P, Brooklyn, New York 11218.

100,000 PRODUCTS Wholesale! Terrific bargains! Wholesalers, 1265-PP Broadway, New York, N.Y. 10001.

FREE "Franchise Profit Letter" tells how unique NFR service is helping thousands seeking profitable businesses. Write today. National Franchise Reports, EW-528, 333 North Michigan, Chicago 60601.

PIANO TUNING learned at home quickly. Tremendous field! Musical knowledge unnecessary. GI approved. Information free. Empire School of Piano Tuning, Dept. E, Miami, FL 33145.

MISCELLANEOUS

WINEMAKERS: Free illustrated catalog of yeasts, equipment. Semplex, Box 7208, Minneapolis, Minn. 55412.

EMPLOYMENT Resumes. Get a better job & earn more! Send only \$2.00 for expert, complete Resume Writing Instructions. J. Ross, 80-34 Kent St., Jamaica, N.Y. 11432 Dept. EW.

SPARE TIME OPPORTUNITY-MONEY WE PAY at the rate of \$10 hr. for NOTHING but your opinions, written from home about our clients' products and publications, sent you free. Nothing to buy, sell, canvass, or learn. NO SKILL. NO GIMMICKS. Just honesty. Details from RESEARCH, ZD-3, Box 669, Mineola, N.Y. 11501.

STOP BURGLARS THE EASY WAY!! Affix authentic "Protected by Electronic Sentry Alarm" Decals to auto windows, doors & windows of home, retail stores; vending machines, etc. Whether you have an alarm or not--thieves stay away! Only \$1.00 for each set of two. J. Ross, 80-34 Kent St., Jamaica, N.Y. 11432. Dept. EV. STOP read and act now! Don't wait until it's too late, it costs too much. Diabetes, do you or don't you have it? Send \$2.00 for test yourself kit. Savlife Enterprises, 1302 1st St., Brookings, South Dakota 57006.

BE YOUR OWN INSTALLMENT BANKER. Description, Forms--\$2.00. Berwin, Box 141, Raritan, N.J. 08869.

TEN Winemaking Recipes and Winemaking Supplies catalog. 10¢. Country Winemaker, Box 243EGA, Lexington, Massachusetts 02173.

REACH YOUR LARGEST AUDIENCE of Electronics Professionals with your low cost ad in these columns. Your investment of 70¢ per word (minimum \$7.00) virtually guarantees a profitable return in additional mail order sales responses. Use the handy coupon printed in this section. Mail today to: Hal Cymes, Classified Ad Mgr., ELECTRONICS WORLD, 1 Park Ave., New York, N. Y. 10016.



DOUBLE BONUS SALE!

\$25 FREE WORTH OF Transistors, Rectifiers, Condensers, Diodes, Knobs, Coils, etc. PLUS ANY **\$1 ITEM FREE**

Both FREE WITH ANY \$10 ORDER

Actual Size

1 AMP MICROMINIATURE SILICON RECTIFIERS	PIV	Sale	PIV	Sale
	50	7¢	600	20¢
	100	9¢	800	25¢
	200	12¢	1000	45¢
	400	17¢		

6 amp TRIACS

SALE

PRV	100	200	300	400	600
Sale	.90	1.40	1.75	2.25	2.60

6-MONTHS' GUARANTEE

Poly Paks, the only company of its kind in the world due to its tremendous purchasing power, quality and factory testing procedures, GUARANTEES all items AS ADVERTISED for 6 months or your money back. A 'FIRST' ANYWHERE

SILICON POWER RECTIFIERS

PIV	3A	6A	12A	45A
50	.07	.18	.22	.50
100	.09	.25	.30	.75
200	.16	.39	.50	1.25
400	.20	.50	.70	1.50
600	.30	.75	1.00	1.80
800	.40	1.00	1.25	2.30
1000	.55	1.15	1.50	2.70

FACTORY TESTED \$1 SEMI-KON-DUCTORS

- 2-85 WATT 2N424 PLANAR, silicon, TO-53 npn \$1
- 3-40W NPN SILICON MESA, 2N1648, transistor \$1
- 4 2N170 TRANSISTORS, by GE, npn for gen'l rf. \$1
- 15 3 Amp RECT's, studs, silicon, to 800V no test \$1
- 4-2N255 POWER TRANSISTOR EQUALS \$1
- 10 PNP SWITCHING TRANSISTRS, 2N104, no test \$1
- 2N3088 "N" Channel FET'S Very High Input Z. \$1
- 5 2N107 TRANSISTRS, by GE, npn, pop. audio pak \$1
- 4-2N1613 NPN SIL. 120 mc, by "Rheem" TO-18 \$1
- 3-45 AMP POWER RECTIFIERS, stud, silicon \$1
- 5 2N706 500MW, 300 MC NPN transistors, TO-18 \$1
- 10PNP SWITCHING TRANSISTORS, no test, TO-5 \$1
- 25 TOP HAT RECTIFIERS, silicon, 750 ma, no test \$1
- 4 BIDIRECTIONAL TRANSISTORS, 2N1641 \$1
- 10 NPN SWITCHING TRANSISTRS, 2N335, 107, no test \$1
- 15 NPN TRANSISTORS, 2N355, 170, 440, no test \$1
- 30 TRANSISTORS, rf, if, audio use-ifs, TO5 no test \$1
- 4 "EPOXY" TRANSISTORS 2N3563, 600 MC \$1
- 4 "EPOXY" TRANSISTORS 2N3643 by Fairchild \$1
- 3 EPOXY TRANSISTORS 2N4265 by Motorola \$1
- 4 EPOXY TRANSISTORS 400 HFE by Fairchild \$1
- 5-1 AMP 800 PIV EPOXYS, submini \$1
- 2 2N918 TRANSISTORS 1000MC npn TO18 \$1
- 3-5-WATT EPOXY B-5000 Bendix transistors \$1
- 2 PHOTO ELECTRIC CELLS by GE Very High Z. \$1
- 2 FETS FOR HOBBYIST, EXPERIMENTERS \$1
- 3-2 AMP 1000 PIV, axial leads silicon \$1
- 10-10-AMP SILICON RECTIFIERS, studs, asst \$1
- 4 GE 2N43 OUTPUT TRANSISTORS pnp, TO5 \$1
- 25 GERMANIUM DIODES, glass asst \$1

1 AMP TOP HAT AND EPOXIES

PIV	Sale	PIV	Sale	PIV	Sale
50	5¢	800	2¢	1800	90¢
100	7¢	1000	3¢	2000	1.50
200	9¢	1200	4¢	3000	1.90
400	11¢	1400	6¢	4000	2.50
600	17¢	1600	7¢		

"GLASS" ONE AMP RECTIFIERS

PIV	Sale	PIV	Sale
50	5¢	600	17¢
100	7¢	800	19¢
200	9¢	1000	29¢
400	13¢		

RETAIL STORE: 211 Albion St. Wakefield

10c FOR OUR 1968 BARGAIN CATALOG ON:

Semiconductors ICs Parts

POLY PAKS TERMS: send check, money order, include postage-avg. wt. per pak 1 lb. Rated, net 30 days. COD's 25% **01940**

P.O. BOX 942W SO. LYNNFIELD, MASS.

ADVERTISERS INDEX

READER			READER		
SERVICE NO.	ADVERTISER	PAGE NO.	SERVICE NO.	ADVERTISER	PAGE NO.
200	Alco Electronic Products, Inc.	60	111	Kenwood	63
125	Allied Radio	55	109	Lafayette Radio Electronics	7
86	Allec Lansing	2	108	Lampkin Laboratories, Inc.	66
	American Institute of Engineering & Technology	78	107	Mallory & Co. Inc., P.R.	75
87	Amphenol Corporation	24	106	Milwaukee School of Engineering	64
	Anti-Tobacco Center of America, The	66	105	Music Associated	12
124	Belden Corporation	61		National Radio Institute	8, 9, 10, 11
123	Burstein-Applebee	76		National Technical Schools	5
	Capitol Radio Engineering Institute, The	56, 57, 58, 59	104	Non-Linear Systems, Inc.	13
122	Cleveland Institute of Electronics	17	103	Olson Electronics, Inc.	12
121	Cleveland Institute of Electronics	70, 71, 72, 73	102	Poly Paks	95
119	Crown International	69		Project Tamora	78
118	Delta Products, Inc.	62		RCA Electronic Components and Devices	FOURTH COVER
120	EICO Electronic Instrument Co., Inc.	THIRD COVER		RCA Institutes, Inc.	18, 19, 20, 21
117	Edmund Scientific Co.	94	101	Radar Devices Manufacturing Corp	1
116	Electro-Voice, Inc.	SECOND COVER	100	Sams & Co., Howard W.	65
115	Electronic Components	91	99	Scott, Inc., H.H.	69
110	Electronic Components Co.	93	97	Sherwood Electronic Laboratories, Inc.	79
	Fair Radio Sales	92	96	Solid State Sales	93
114	Finney Company, The	67	199	Soliton Devices, Inc.	23
	G & G Radio Supply Company	94	95	Sonar Radio Corporation	76
	General Electric	14	94	Sonotone Corporation	55
88	Goodheart Co. Inc., R.E.	91	93	Surplus Center	95
113	Greenlee Tool Co.	60	198	Sylvania	53
112	Gregory Electronics Corporation	92	92	Telex Acoustics	4
89	Heath Company	80, 81	197	Texas Crystals	87
				Valparaiso Technical Institute	66
			91	Weller Electric Corp.	87
			90	Zenith	85

CLASSIFIED ADVERTISING 91, 92, 93, 94, 95

Printed in U.S.A.

Now it's easy to be an authority on tape recording- with HiFi/STEREO REVIEW'S all-new 1968 TAPE RECORDER ANNUAL

1968 TAPE RECORDER ANNUAL

How to Choose a Tape Recorder • The New Home Cartridge Machines • Battery Portable Tape Recorders • Transport Tapes • Home Video Recorders • Specialized Tape Recorders • Directory of Stereo Tape Recorders, Tape Accessories, Plans



PLUS: Posters on How to Start Your Own Tape Club

This fact-filled volume contains over 130 pages, 19 complete features, covering every aspect of tape recording. You get expert tips by the dozens, on equipment—making better tapes—editing—copying—on everything you want and need to know about tape recording.

Featuring a complete directory of the latest monaural and stereo recorders, players and transports—the only complete buyer's guide available in the tape recorder field! Hundreds of photos—full data on hundreds of models from portable units to professional rigs. All the model numbers, specifications, dimensions and prices—every vital statistic you need to compare the newest machines and select the finest one in your price range.

Plus—Complete Directories of cartridge machines . . . microphones . . . headphones . . . raw and pre-recorded tapes . . . accessories. **How-To Articles** on selecting the right recorder . . . recording off the air . . . editing . . . creative taping . . . starting your own tape club. **Special Reports** on taping and the law . . . new self-reversing tape recorders . . . having fun with home VTRs . . . home cartridge players . . . buying a battery portable.

The 1968 TAPE RECORDER ANNUAL is an indispensable guide for everyone who wants better performance, greater versatility and a lot more fun from his tape recorder . . . month after month . . . tape after tape. Order your copy today!

GET THE DELUXE LEATHERFLEX-COVERED EDITION FOR \$3 POSTPAID! THE 1968 TAPE RECORDER ANNUAL is also available in a splendid deluxe edition. Rugged Leatherflex covers provide lasting protection yet are softly textured and gold-embossed for the look of elegance. A collector's item—a superb addition to your permanent reference library. And it's yours, for just \$3 postpaid.

Ziff-Davis Service Division, Dept. TRA
595 Broadway, New York, N.Y. 10012
Please send my copy of the 1968 TAPE RECORDER ANNUAL as checked below:
 \$1.25 enclosed, plus 15c for shipping and handling for the Regular Edition. (\$1.75 for orders outside U.S.A.)
 \$3.00 enclosed. Please send me, postpaid, the Leatherflex-covered Deluxe Edition. (\$3.75 for orders outside U.S.A.) (Please allow 3 additional weeks for delivery of the Deluxe Edition).

print name _____ EW-12
address _____
city _____
state _____ zip code _____
PAYMENT MUST BE ENCLOSED WITH ORDER

Electronics World

APRIL 1987
60 CENTS

ELECTRONIC EAVESDROPPING — How "Bugging" Devices Work
What's Available • How They Are Planted • How They Are Detected

MICROWAVE EDUCATIONAL TV — System Planning & Installation

**SPECIAL
ISSUE**

RELAYS

Read each month by
the world's largest audience
of electronics professionals.



FIRST CLASS
PERMIT NO. 25682
PHILADELPHIA, PA.

BUSINESS REPLY MAIL

NO POSTAGE NECESSARY IF MAILED IN U. S. A.

Postage will be Paid by

Electronics World

P. O. Box 7842

Philadelphia, Pa. 19101



FIRST CLASS
PERMIT NO. 25682
PHILADELPHIA, PA.

BUSINESS REPLY MAIL

NO POSTAGE NECESSARY IF MAILED IN U. S. A.

Postage will be Paid by

Electronics World

P. O. Box 7842

Philadelphia, Pa. 19101



READER SERVICE CARD

To get more information, promptly, about products or services mentioned in this issue, simply circle the number corresponding to the ad or editorial mention and send us the card.

IMPORTANT

BLACK numbers are of general interest and you do not have to include your company name and address to receive the information requested.

BLUE numbers below correspond to an ad or editorial mention of professional interest. Manufacturers will honor your request *only* if it is to be mailed direct to your company—so be sure to include your company's name and address.

Use only one card to obtain the information you want.

(Void 60 days after date of issue)

I AM EMPLOYED IN: INDUSTRY .1 COMMERCIAL .2
 COMMUNICATIONS .3 MILITARY/GOVERNMENT .4 OTHER .5

NAME (Print Clearly) _____ TITLE _____

ADDRESS _____

CITY _____ STATE _____ ZIP CODE _____

(Fill in the following only if you circle any **BLUE** numbers below) SB 1267

NAME (Print Clearly) _____ TITLE _____

COMPANY NAME _____

COMPANY ADDRESS _____

CITY _____ STATE _____ ZIP CODE _____

(ZIP CODE MUST BE INCLUDED TO INSURE DELIVERY)

Please send me additional information on products I have circled.

(Key numbers for advertised products also appear in Advertisers Index.)

- | | | | | | | | | | | | | | | | | | | | | | | | | |
|-----|-----|-----|-----|-----|-----|-----|-----|-----|-----|-----|-----|-----|-----|-----|-----|-----|-----|-----|-----|-----|-----|-----|-----|-----|
| 1 | 2 | 3 | 4 | 5 | 6 | 7 | 8 | 9 | 10 | 11 | 12 | 13 | 14 | 15 | 16 | 17 | 18 | 19 | 20 | 21 | 22 | 23 | 24 | 25 |
| 26 | 27 | 28 | 29 | 30 | 31 | 32 | 33 | 34 | 35 | 36 | 37 | 38 | 39 | 40 | 41 | 42 | 43 | 44 | 45 | 46 | 47 | 48 | 49 | 50 |
| 51 | 52 | 53 | 54 | 55 | 56 | 57 | 58 | 59 | 60 | 61 | 62 | 63 | 64 | 65 | 66 | 67 | 68 | 69 | 70 | 71 | 72 | 73 | 74 | 75 |
| 76 | 77 | 78 | 79 | 80 | 81 | 82 | 83 | 84 | 85 | 86 | 87 | 88 | 89 | 90 | 91 | 92 | 93 | 94 | 95 | 96 | 97 | 98 | 99 | 100 |
| 101 | 102 | 103 | 104 | 105 | 106 | 107 | 108 | 109 | 110 | 111 | 112 | 113 | 114 | 115 | 116 | 117 | 118 | 119 | 120 | 121 | 122 | 123 | 124 | 125 |
| 126 | 127 | 128 | 129 | 130 | 131 | 132 | 133 | 134 | 135 | 136 | 137 | 138 | 139 | 140 | 141 | 142 | 143 | 144 | 145 | 146 | 147 | 148 | 149 | 150 |
| 151 | 152 | 153 | 154 | 155 | 156 | 157 | 158 | 159 | 160 | 161 | 162 | 163 | 164 | 165 | 166 | 167 | 168 | 169 | 170 | 171 | 172 | 173 | 174 | 175 |
| 176 | 177 | 178 | 179 | 180 | 181 | 182 | 183 | 184 | 185 | 186 | 187 | 188 | 189 | 190 | 191 | 192 | 193 | 194 | 195 | 196 | 197 | 198 | 199 | 200 |

I AM EMPLOYED IN: INDUSTRY .1 COMMERCIAL .2
 COMMUNICATIONS .3 MILITARY/GOVERNMENT .4 OTHER .5

NAME (Print Clearly) _____ TITLE _____

ADDRESS _____

CITY _____ STATE _____ ZIP CODE _____

(Fill in the following only if you circle any **BLUE** numbers below) SA 1267

NAME (Print Clearly) _____ TITLE _____

COMPANY NAME _____

COMPANY ADDRESS _____

CITY _____ STATE _____ ZIP CODE _____

(ZIP CODE MUST BE INCLUDED TO INSURE DELIVERY)

Please send me additional information on products I have circled.

(Key numbers for advertised products also appear in Advertisers Index.)

- | | | | | | | | | | | | | | | | | | | | | | | | | |
|-----|-----|-----|-----|-----|-----|-----|-----|-----|-----|-----|-----|-----|-----|-----|-----|-----|-----|-----|-----|-----|-----|-----|-----|-----|
| 1 | 2 | 3 | 4 | 5 | 6 | 7 | 8 | 9 | 10 | 11 | 12 | 13 | 14 | 15 | 16 | 17 | 18 | 19 | 20 | 21 | 22 | 23 | 24 | 25 |
| 26 | 27 | 28 | 29 | 30 | 31 | 32 | 33 | 34 | 35 | 36 | 37 | 38 | 39 | 40 | 41 | 42 | 43 | 44 | 45 | 46 | 47 | 48 | 49 | 50 |
| 51 | 52 | 53 | 54 | 55 | 56 | 57 | 58 | 59 | 60 | 61 | 62 | 63 | 64 | 65 | 66 | 67 | 68 | 69 | 70 | 71 | 72 | 73 | 74 | 75 |
| 76 | 77 | 78 | 79 | 80 | 81 | 82 | 83 | 84 | 85 | 86 | 87 | 88 | 89 | 90 | 91 | 92 | 93 | 94 | 95 | 96 | 97 | 98 | 99 | 100 |
| 101 | 102 | 103 | 104 | 105 | 106 | 107 | 108 | 109 | 110 | 111 | 112 | 113 | 114 | 115 | 116 | 117 | 118 | 119 | 120 | 121 | 122 | 123 | 124 | 125 |
| 126 | 127 | 128 | 129 | 130 | 131 | 132 | 133 | 134 | 135 | 136 | 137 | 138 | 139 | 140 | 141 | 142 | 143 | 144 | 145 | 146 | 147 | 148 | 149 | 150 |
| 151 | 152 | 153 | 154 | 155 | 156 | 157 | 158 | 159 | 160 | 161 | 162 | 163 | 164 | 165 | 166 | 167 | 168 | 169 | 170 | 171 | 172 | 173 | 174 | 175 |
| 176 | 177 | 178 | 179 | 180 | 181 | 182 | 183 | 184 | 185 | 186 | 187 | 188 | 189 | 190 | 191 | 192 | 193 | 194 | 195 | 196 | 197 | 198 | 199 | 200 |

EICO Makes It Possible

Uncompromising engineering—for value does it!
You save up to 50% with Eico Kits and Wired Equipment.

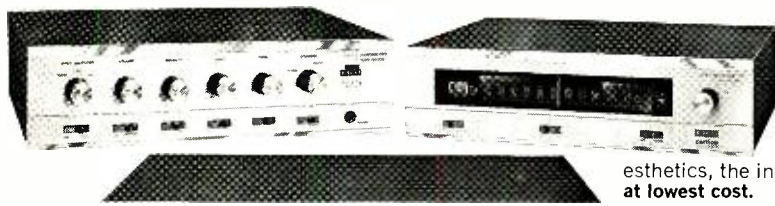

Cortina Stereo

Engineering excellence, 100% capability, striking esthetics, the industry's only **TOTAL PERFORMANCE STEREO at lowest cost.**

A Silicon Solid-State 70 Watt Stereo Amplifier for \$89.95 kit, \$129.95 wired, including cabinet. Cortina 3070.

A Solid-State FM Stereo Tuner for \$89.95 kit, \$129.95 wired, including cabinet. Cortina 3200.

A 70-Watt Solid-State FM Stereo Receiver for \$159.95 kit, \$239.95 wired, including cabinet. Cortina 3570.



Eicocraft

The newest excitement in kits.

100% solid-state and professional. Fun to build and use. Expandable, interconnectable. Great as "jiffy" projects and as introductions to electronics. No technical experience needed. Finest parts, pre-drilled etched printed circuit boards, step-by-step instructions.



Electronic Siren \$4.95, Burglar Alarm \$6.95, Fire Alarm \$6.95, Intercom \$3.95, Audio Power Amplifier \$4.95, Metronome \$3.95, Tremolo \$8.95, Light Flasher \$3.95, Electronic "Mystifier" \$4.95, Photo Cell Nite Lite \$4.95, Power Supply \$7.95, Code Oscillator \$2.50, FM Wireless Mike \$9.95, AM Wireless Mike \$9.95, Electronic VOX \$7.95, FM Radio \$9.95, AM Radio \$7.95, Electronic Bongos \$7.95.



Citizen's Band

Two years ahead! Model 7923
All Solid-State 23-Channel 5W Transceiver. 4 exclusives: dual-crystal lattice filter for razor-sharp selectivity; efficient up-converter frequency synthesizer for advanced stability; precision series-mode fundamental crystals; Small: only 3"H, 8"W, 8 1/4"D. \$189.95 wired only.

The best buy in tube-type CB—"Sentinel-Pro" 23-channel dual conversion 5W Transceiver \$169.95 wired only.

EICO Trans/Match (Model 715) is a professional test set designed for complete checking of ham and CB equipment. Kit \$34.95; Wired \$49.95.

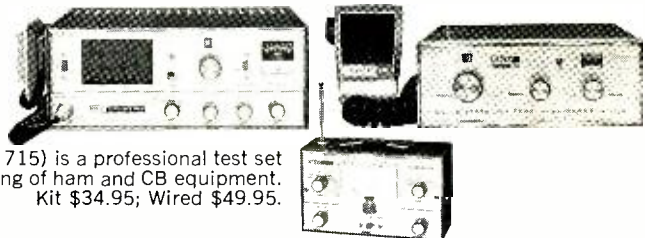

Truvohm

Professional Portable Multimeters by EICO.
The industry's greatest V-O-M values. Designed, made to Eico's high standards of professionalism. Each complete with batteries & test leads. Backed 100% by famous EICO warranty.

- Model 100A4, 100,000Ω/V, \$34.95.
- Model 30A4, 30,000Ω/V, \$19.95.
- Model 30A3, 30,000Ω/V, \$15.95.
- Model 20A3, 20,000Ω/V, \$12.95.
- Model 4A3, 4000Ω/V, \$8.95.
- Model 1A1, 1000Ω/V, \$5.95.



Automotive

EICO 888—Car/Boat Engine Analyzer.
For all 6V/12V systems; 4, 6, 8-cyl. engines.

Now you can keep your car or boat engine in tip-top shape with this solid-state, portable, self-powered universal engine analyzer. Completely tests your total ignition/electrical system.

Complete with a Tune-up & Trouble-shooting Manual. Model 888; \$44.95 kit, \$69.95 wired.

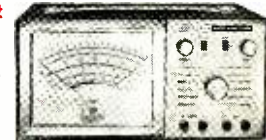

Model 232 Peak-to-Peak VTVM. A must for color or B&W TV and industrial use. 7 non-skip ranges on all 4 functions. With exclusive Uni-Probe.® \$29.95 kit, \$49.95 wired.

Test Equipment **EICO**®

100 best buys to choose from.

"The Professionals"
—laboratory precision at lowest cost.

Model 460 Wideband Direct-Coupled 5" Oscilloscope. DC-4.5mc for color and B&W TV service and lab use. Push-pull DC vertical amp., bal. or unbal. input. Automatic sync limiter and amp. \$109.95 kit, \$149.95 wired.

FREE 1968 CATALOG

EW-12

EICO Electronic Instrument Co., Inc.
131-01 39th Ave., Flushing, N.Y. 11352

Send me **FREE** catalog describing the full EICO line of 200 best buys, and name of nearest dealer.

Name _____
Address _____
City _____
State _____ Zip _____

RCA Announces two important new test instruments for service, industrial and lab applications.



All solid-state battery operated VOLTOHMYST® WV-500A

Eliminate warm-up time! Eliminate zero-shift that can occur in tube-operated voltmeters! RCA's new WV-500A VoltOhmyst is an all solid-state, battery operated, completely portable voltmeter that is ideal for service, industrial and lab applications. Seven overlapping resistance ranges measure from 0.2 ohm to 1000 megohms. Eight overlapping dc-voltage ranges measure from 0.02 volt to 1500 volts (including special 0.5 dc volt range), ac peak-to-peak voltages of complex waveforms from 0.5 volts to 4200 volts, and ac (rms) voltages from 0.1 to 1500 volts. Input impedance of all dc ranges is 11 megohms.

All measurements are made with a sturdy, wired-in single-unit probe with fully shielded input cable. The probe is quickly adapted to either dc measurement or ac and resistance measurement by a convenient built-in switch. *And an accessory slip-on high-voltage probe is also available to make possible measurements up to 50,000 dc volts.*

Solid-state reliability and convenience for only \$75.00*

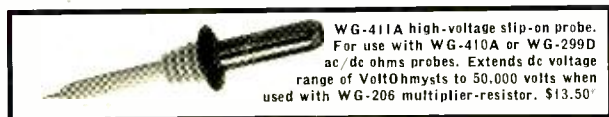

WG-411A high-voltage slip-on probe. For use with WG-410A or WG-299D ac/dc ohms probes. Extends dc voltage range of VoltOhmysts to 50,000 volts when used with WG-206 multiplier-resistor. \$13.50*



In-circuit/ out-of-circuit TRANSISTOR TESTER WT-501A

Completely portable and requiring no external power source, RCA's new WT-501A tests transistors both in-circuit and out-of-circuit, tests both low and high power transistors, and has both NPN and PNP sockets to allow convenient transistor matching for complementary symmetry applications. The instrument tests out-of-circuit transistors for dc beta from 1 to 1000, collector-to-base leakage as low as 2 microamperes, and collector-to-emitter leakage from 20 microamperes to 1 ampere. Special low impedance circuitry assures reliable in-circuit testing.

Collector current is adjustable from 20 microamperes to 1 ampere in four ranges, permitting most transistors to be tested at rated current level. A complete DC Forward Current Transfer Ratio Curve can be plotted. The three color-coded test leads are provided for in-circuit testing, and for out-of-circuit testing of those transistors that will not fit into the panel socket.

Extra features... RCA reliability... for only \$66.75*

*Optional Distributor resale price. All prices subject to change without notice. Prices may be slightly higher in Alaska, Hawaii and the West.

Ask to see them at your Authorized RCA Test Equipment Distributor, or write RCA Commercial Engineering Department L41W, 415 South Fifth Street, Harrison, N. J.



RCA Electronic Components and Devices, Harrison, N. J.

The Most Trusted Name in Electronics