

Electronics World

NOVEMBER, 1967
60 CENTS

THE NEW BREED OF DIGITAL VOLTMETERS

DIGITAL VOLTMETER CIRCUITS

DIGITAL U.H.F. FREQUENCY MEASUREMENTS

ALIGNING FM-STEREO RECEIVERS
WITHOUT A GENERATOR

LOW-COST CAPACITIVE-DISCHARGE
IGNITION SYSTEM



DIGITAL
V M ERS
40859 0W
4 00
M J HINDMAN
M 0568 514700HND2724L 0M8L



Something For Every Interest... Save Up To 50%!



NEW! Deluxe Heathkit Contemporary Walnut Hi-Fi Furniture ... \$244.00



NEW! Deluxe Heathkit Mediterranean Pecan Hi-Fi Furniture ... \$299.00



NEW! Deluxe Heathkit Early American Hi-Fi Furniture ... \$264.00



NEW! Heathkit 4-Speed Solid-State Stereo Portable Phonograph ... \$49.95



Heathkit 4-Speed Solid-State Mono Portable Phonograph ... \$39.95



NEW! Heathkit Jr. Children's Portable Phonograph ... \$19.95



NEW! Professional Heathkit 10-Band Shortwave Receiver ... \$249.00



Deluxe Heathkit 10-Band AM/FM/Shortwave Portable ... \$139.95

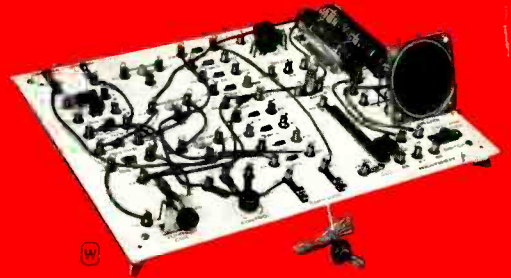

Heathkit Jr. Experimenter "19" Electronic Workshop ... \$13.95

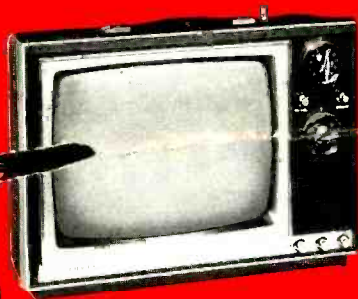

Heathkit 12" Solid-State Black & White TV Portable ... \$119.95



NEW! Heathkit Amateur Radio Novice CW Transceiver ... \$99.50



Deluxe Heathkit SB-101 80-10 Meter SSB/CW Transceiver ... Kit \$370.00
Wired \$540.00



NEW! Headphone Control Unit For Private Listening Of Any Audio System ... \$7.95



NEW! Heathkit 3-Heat Soldering Iron ... \$14.95



NEW! Deluxe Heathkit Solid-State Volt-Ohm Meter ... Kit \$44.95
Wired \$64.95

Gift Shop The Easy Heathkit® Way... Some



A

NEW! Deluxe Heathkit "227" Color TV ... \$419.95*



B

Deluxe Heathkit "295" Color TV ... Industry's Largest Picture ... \$479.95*



C

Deluxe Heathkit "180" Color TV ... Now Only \$349.95*



NEW! Heathkit Color TV Remote Control ... \$19.95



D

Deluxe Heathkit Solid-State 150-Watt AM/FM Stereo Receiver ... Kit \$329.95*, Wired \$499.50*



E

NEW! Low Cost Heathkit Solid-State FM Stereo Receiver ... Only \$72.95*



F

NEW! Low Cost Heathkit Solid-State FM Mono Receiver ... Only \$49.95*

*Less Cabinet



G

Harmony®-By-Heathkit® Electric Guitars ... 3 Models



H

Heathkit 120 Watt Music Power Combo Amplifier & Matching 2-Way Speaker Systems, Amplifier Kit ... \$175.00, Wired ... \$275.00, Speaker Kit ... \$120.00, Wired ... \$150.00

Deluxe Solid-State Guitar Amplifiers Choice Of Kit Or Assembled



I

Heathkit Dual Channel 25-Watt Music Power "Starmaker" Amplifier ... Kit \$134.95, Wired \$199.95



J

Heathkit Single Channel 20-Watt Music Power Amplifier ... Kit \$89.95, Wired \$134.95



K

Deluxe Heathkit®/Thomas® Paramount Theatre Organ ... \$995.00



L

Heathkit®/Thomas® "Artiste" Transistor Organ ... \$394.90



M

NEW! Band Box Percussion Accessory To Heathkit®/Thomas® Organs ... \$145.00



N

NEW! "Playmate" Rhythm Accessory To Heathkit®/Thomas® Organs ... \$189.90

**The World's Most Wanted
Christmas Gifts Come In
These Boxes...**



Armchair Shopping Guide From Heath Widest Kit Selection — Liberal Credit

- (A) Deluxe "227" Color TV Kit**
227 sq. in. rect. view. area. Exclusive self-servicing facilities. RCA Perma-Chrome tube & new "rare earth" phosphors for 38% brighter pictures. Automatic degaussing. 24,000 v. power. 3-stage IF. Mediterranean Oak cab. (illust.) \$94.50. Other cab. from \$59.95.
Kit GR-227, (less cab.) \$42 dn.
as low as \$25 mo. . . . \$419.95
- (B) Deluxe "295" Color TV Kit**
295 sq. in. rect. view. area. Exclusive self-servicing. Automatic degaussing. ACC & AGC. 3-stage IF. 25,000 v. power. RCA Perma-Chrome tube for 38% brighter pictures. Walnut cab. (illust.) \$94.50. Other cab. from \$62.95.
Kit GR-295, (less cab.) 131 lbs. . . . \$48 dn.
\$42 mo. . . . \$479.95
- (C) Deluxe "180" Color TV Kit**
180 sq. in. rect. view. area. Exclusive self-servicing. Automatic degaussing. 3-stage IF. 24,000 v. power. ACC & AGC. Extra B+ boost for best definition. Walnut cab. (illust.) \$49.95. Other cab. from \$24.95.
Kit GR-180, 102 lbs. (less cab.) \$35 dn.
\$30 mo. . . . \$349.95
- Color TV Remote Control**
Change channels and turn your Heathkit color TV off and on from the comfort of your armchair. 20' cable.
Kit GRA-27 \$19.95
- (D) 150-Watt AM/FM Stereo Receiver**
World's most advanced! All silicon transistor circuit. IC's and crystal filters in IF amp. FET FM tuner. Positive circuit protection. ± 1 db, 6 to 50,000 Hz. Walnut cab. \$19.95
Kit AR-15, 34 lbs. . . . \$33 dn., \$28 mo. . . . \$329.95
Wired ARW-15, 34 lbs. . . . \$50 dn. . . . \$499.50
- (E) Transistor FM Stereo Receiver**
FM/FM stereo. 14 watts music power, 10 watts RMS, ± 1 db 18-60,000 Hz. Adjustable phase for best stereo. Automatic stereo indicator. Optional cab. (Walnut veneer \$7.95, beige metal \$3.50)
Kit AR-17, 12 lbs. . . . (less cab.) no money dn., \$8 mo. . . . \$72.95
- (F) Transistor FM Mono Receiver**
7 watts music power, 5 watts RMS, ± 1 db 18-60,000 Hz. Flywheel tuning. Prebuilt & aligned "front-end". 9 $\frac{3}{4}$ " D. x 2 $\frac{7}{8}$ " H. x 1 $\frac{1}{4}$ " W. Optional cab. (walnut \$7.95, beige metal \$3.50)
Kit AR-27, 9 lbs. . . . (less cab.) no money dn., \$5 mo. . . . \$49.95
- (G) Electric Guitar Kits**
3 famous Harmony models in money-saving Heathkit form from \$88.50 to \$189.95. Details in FREE Heathkit catalog.
- (H) 120-Watt Guitar Amp & Speaker**
All solid-state. All the "pro" features every combo wants . . . tremolo, "fuzz", brightness, reverb. 3 channels with 2 inputs each. Speaker has two 12" woofers, horn driver.
Kit TA-17, amp, 40 lbs. . . . no money dn., \$17 mo. . . . \$175.00
Wired TAW-17, 40 lbs. . . . no money dn., \$26 mo. . . . \$275.00
Kit TA-17-1, speaker, 100 lbs. . . . no money dn., \$12 mo. . . . \$120.00
Wired TAW-17-1, 100 lbs. . . . no money dn., \$14 mo. . . . \$150.00
Kit TAS-17-2, amp & 2 speaker systems, 240 lbs. . . . \$40 dn., \$34 mo. . . . \$395.00
Wired TAW-17-2, 240 lbs. . . . write for credit details. . . . \$595.00
- (I) Dual Channel 25-Watt Guitar Amp**
60 watts peak power. All solid-state. 2 inputs

- per channel. Two 12" speakers. Variable tremolo & reverb. Foot switches. Front panel controls.
Kit TA-16, 52 lbs. . . . no money dn., \$13 mo. . . . \$134.95
Wired TAW-16, 52 lbs. . . . no money dn., \$19 mo. . . . \$199.95
- (J) Single-Channel 20-Watt Guitar Amp**
All solid-state. 40 watts peak power. Two inputs. Variable tremolo & reverb. 12" speaker. Foot switches. Handles lead guitars, mike.
Kit TA-27, 35 lbs. . . . no money dn., \$9 mo. . . . \$89.95
Wired TAW-27, 35 lbs. . . . no money dn., \$13 mo. . . . \$134.95
- (K) Heathkit/Thomas Theatre Organ**
Save up to \$500. All Thomas factory parts. Professional features like 15 manual voices, 4 pedal voices, 200 watts peak power, chimes, Leslie speaker, instant-play Color-Glo, all solid-state, 44-note keyboards.
Kit TO-67, organ & bench, 265 lbs. . . . \$200 dn., as low as \$29 mo. . . . \$995.00
- (L) Heathkit/Thomas Color-Glo Organ**
Save up to \$205. All Thomas factory parts. 10 organ voices, 37-note keyboards, repeat percussion, 13-note bass pedals, 75-watt peak power, instant-play Color-Glo, solid-state.
Kit GD-325B, organ & bench, 172 lbs. . . . \$40 dn., \$34 mo. . . . \$394.90
- (M) Band Box Percussion**
Automatically or manually adds 10 exciting percussion voices to any Heathkit/Thomas Organ.
Kit TOA-67-1, 8 lbs. . . . no money dn., \$14 mo. . . . \$145.00
- (N) Playmate Rhythm Maker**
Adds 15 fascinating rhythms to any Heathkit/Thomas organ. Requires Band Box percussion (above) for operation.
Kit TOA-67-5 no money dn., \$18 mo. . . . \$189.90
- (O) Contemporary Hi-Fi Cabinet Ensemble**
Fully assembled & finished in walnut. Adjustable shelves accommodate most hi-fi components. Speaker cabinet can be matched to 8" or 12" speakers, has slot for tweeter.
AE-37, equip. cab. . . . no money dn., \$12 mo. . . . \$125.00
AEA-37-1, speaker cab., no money dn., \$6 mo. . . . each \$59.50
- (P) Mediterranean Hi-Fi Cabinet Ensemble**
Factory assembled and finished in Pecan. Adjustable shelves accommodate most hi-fi components. Speaker cabinet matches to any 8" or 12" speaker, has slot for tweeter.
AE-57, equip. cab., no money dn., \$14 mo. . . . \$150.00
AEA-57-1, speaker cab., no money dn., \$8 mo. . . . each \$74.50
- (Q) Early American Hi-Fi Cabinet Ensemble**
Factory assembled and finished in Salem-Maple. Adjustable shelves accommodate most hi-fi components. Speaker cabinet matches to any 8" or 12" speaker, has slot for tweeter.
AE-47, equip. cab., no money dn., \$13 mo. . . . \$135.00
AEA-47-1, speaker cab., no money dn., \$7 mo. . . . each \$64.50
- (R) 4-Speed Stereo Phonograph**
All solid-state. Automatic changer folds up for easy carrying. Ceramic cart. w/dual diamond-sapphire styli. Twin 4" x 6" speakers. 45 rpm adaptor. Build in 4 hours.
Kit GD-107, 24 lbs. . . . no money dn., \$5 mo. . . . \$49.95
- (S) 4-Speed Mono Phonograph**
All solid-state. Automatic changer folds up for portability. Ceramic cart. w/dual sapphire

- styli. 4" x 6" speaker. 45 rpm adaptor. Build in only 2 hours.
Kit GD-16, 25 lbs. . . . no money dn., \$5 mo. . . . \$39.95
- (T) Children's Portable Phonograph**
Plays all 4 speeds, all size mono records. Crystal cart. w/universal sapphire stylus for all types of records. Detachable lid. All solid-state. Pre-assembled turntable & cab.
Kit JK-17, 11 lbs. \$19.95
- (U) 10-Band Shortwave Receiver**
Professional quality . . . slices stations down to last kHz! Covers 49, 41, 31, 25, 19 & 16 meter shortwave . . . 80, 40 & 20 meter ham . . . 11 meter CB. Crystal-controlled front-end. Tunes AM, CW, SSB.
Kit SB-310, (less speaker), 20 lbs. . . . no money dn., \$23 mo. . . . \$249.00
- (V) 10-Band AM/FM/Shortwave Portable**
Tunes longwave, AM, FM, and 2 MHz — 22.5 MHz shortwave. All solid-state. Separate AM & FM tuners & IF strips. 44 factory-built & tuned RF circuits. 4" x 6" speaker. 2 built-in antennas. Converter/charger for AC \$6.95
Kit GR-43, 19 lbs. . . . no money dn., \$13 mo. . . . \$139.95
- (W) Experimenter "19" Workshop**
Perfect for any youngster who wants to explore the mysteries of electronics. Contains all materials & instructions for building 19 electronic items that really work. Safe flashlight battery operation. Solderless connectors.
Kit JK-27, 4 lbs. \$13.95
- (X) 12" Black & White TV Portable**
All solid-state plus integrated sound circuit. Runs on AC, 12 v. DC or plays anywhere on optional battery pack @ \$39.95. 3-stage IF. AGC. 110° shell bond picture tube with 20 mm neck. Durable plastic cab.
Kit GR-104, 27 lbs. . . . no money dn., \$11 mo. . . . \$119.95
- (Y) Amateur Novice CW Transceiver**
Optimum CW on first 250 kHz of 80, 40 & 15 meter bands. True "break-in" CW. 75-watt input power, up to 90 watts for general class. Built-in sidetone. Crystal lattice filter for high selectivity. Easy to build.
Kit HW-16, 25 lbs. . . . no money dn., \$10 mo. . . . \$99.50
- (Z) Amateur SSB/CW Transceiver**
180 watts input P.E.P. SSB — 170 watts input CW on 5 bands, 80-10 meters. Switch selection of USB & LSB or CW. Built-in CW sidetone. Operates PTT or VOX.
Kit SB-101, 23 lbs. . . . \$37 dn., \$32 mo. . . . \$370.00
Wired SBW-101, 23 lbs. . . . \$54 dn., \$47 mo. . . . \$540.00
- (AA) Hi-Fi Headphone Control**
For private listening of any audio system. Accommodates any impedance, 3 or 4 connector stereo or mono headset. 20' cable.
Kit AC-17, 3 lbs. \$7.95
- (BB) 3-Heat Soldering Iron Kit**
25-watt iron with $\frac{1}{8}$ " chisel tip. 2-minute warm-up. Protective metal cage.
Kit GH-17, 5 lbs. \$14.95
- (CC) Solid-State Volt-Ohm-Meter**
High impedance input. Battery power, plus built-in AC supply. 8 AC & DC volt ranges from 0.5 v. to 1500 v., 7 ohmmeter ranges. Full scale. New unitized cabinet.
Kit IM-16, 10 lbs. . . . no money dn., \$5 mo. . . . \$44.95
Assembled IMW-16, 10 lbs. . . . no money dn., \$7 mo. . . . \$64.95



HEATHKIT 1968

FREE!

FREE 1968 CATALOG!

Now with more kits, more color. Fully describes these along with over 300 kits for stereo/hi-fi, color TV, electronic organs, electric guitar & amplifier, amateur radio, marine, educational, CB, home & hobby. Mail coupon or write Heath Company, Benton Harbor, Michigan 49022.

ORDER NOW! Use This Handy Form
HEATH COMPANY, Dept. 15-11
Benton Harbor, Michigan 49022

Enclosed is \$ _____, including shipping.

Please send model (s) _____

Please send FREE Heathkit Catalog.

Please send Easy-Credit Form.

Name _____

Address _____

City _____ State _____ Zip _____

Prices & specifications subject to change without notice. CL-303

November, 1967

CIRCLE NO. 114 ON READER SERVICE CARD

Advertising Service Manager
ARDYS C. MORAN

Illinois 60601. One year subscription \$6.00. Second Class Postage paid at Chicago, Illinois and at additional mailing offices. Subscription service: Portland Place, Boulder, Colorado 80302.
Copyright © 1967 by Ziff-Davis Publishing Company. All rights reserved.

November, 1967

Now...in every

One of a series of brief discussions
by Electro-Voice engineers



Most audio engineers are familiar with the basic mechanics of transducer testing using tone burst signal sources. In its most often used form, tone burst testing is used to compare the relative ability of loudspeakers or other transducers to respond to transient audio phenomena.

Generally, however, tone burst testing has been ignored in favor of more traditional testing techniques, such as steady-state sine wave testing, sweep frequency testing, etc. as a means of determining design parameters.

Recently, Electro-Voice instituted a program of design testing using tone burst signals, in association with more conventional techniques, in an effort to develop a correlation between deviations from optimum transient response as displayed in oscilloscope tracings of tone bursts, and data obtained by other techniques.

It was proven that there was indeed a proveable relationship between data displayed and faults determined by more conventional means. For instance, specific peaks and dips in response, shown in steady-state measurements, often were related to poor transient response as shown in tone burst testing. By varying each of the possible contributing causes while observing the oscilloscope tracings, it could be determined which changes improved both frequency response and transient characteristics.

It was also noted that subjective reaction to speaker systems could often be anticipated by careful examination of exhaustive tone burst data. If similar units were compared, trained listeners most often preferred the unit with better transient response as shown in tone burst testing.

Using tone bursts, design parameters such as cone shape and composition, speaker optimum damping, enclosure construction, etc., can be tested with greater precision, and changes in design can be made with greater effectiveness. While no consumer-oriented specification has yet been developed to express the ability of a specific product to respond to such a testing program, it should be noted that several testing organizations use tone burst data in confirming subjective responses to loudspeaker characteristics.

The current testing program at Electro-Voice differs not in kind, but in degree, from previous efforts, using this effective new tool to determine more closely the optimum design parameters of transducers for home and industry.

For technical data on any E-V product, write:
ELECTRO-VOICE, INC., Dept. 1173N
629 Cecil St., Buchanan, Michigan 49107



CIRCLE NO. 119 ON READER SERVICE CARD
4

COMING NEXT MONTH

SPECIAL FEATURE ARTICLE ON: SOLID-STATE STEREO RECEIVERS

An in-depth rundown on industry standards for testing hi-fi receivers, including actual E W Lab Test results on a number of the newest solid-state receivers on the market. Among the units Julian Hirsch will analyze are stereo receivers manufactured by Pioneer, Heath, Fisher, Sansui, Kenwood, Sherwood, Electro-Voice, Scott, Bogen, Eico, Allied, and Lafayette.

ADVANCES IN MAGNETIC MATERIALS

Grain-oriented materials, new magnetic alloys, ceramic and ferrite magnets, and superconducting cryogenic magnets are just some of the new developments which are advancing magnetic technology. John R. Collins provides a rundown on the new materials and their applications.

DESIGN FOR LOG-PERIODIC FM & TV ANTENNAS

Construction details on FM-only and FM-TV antennas which provide gains of 10 to 12 dB, beamwidths of about 50 degrees, and front-to-back ratios greater than 20 dB. Both antennas can be fabricated of readily available parts.

MEDICAL INSTRUMENTATION SYSTEMS

Up-to-the-minute information on how

electronics is helping doctors in the areas of diagnosis and patient monitoring; in therapeutic systems; and for important biomedical research.

STABLE, LOW-COST REFERENCE POWER SUPPLIES

Carl David Todd describes the design of a voltage supply to be used as a voltage standard in small labs or shops. Featuring compensating diodes, these supplies may be used as a d.c. or a.c. calibrator to check small voltage changes.

SELECTING THE RIGHT CONSTANT-VOLTAGE TRANSFORMER

B.C. Biega, Sol's Director of Engineering, outlines the factors to consider, including types of waveform required, capacity, range of regulation, temperature, and mechanical parameters.

All these and many more interesting and informative articles will be yours in the December issue of **ELECTRONICS WORLD** . . . on sale November 16th.

ZIFF-DAVIS PUBLISHING COMPANY

William B. Ziff
Chairman of the Board (1946-1953)

William Ziff
President

W. Bradford Briggs
Executive Vice President

Hershel B. Sarbin
Senior Vice President

Philip Sine
Financial Vice President

Walter S. Mills, Jr.
Vice President, Circulation

Stanley R. Greenfield
Vice President, Marketing

Phillip T. Heffernan
Vice President, Electronics Division

Frank Pomerantz
Vice President, Creative Services

Arthur W. Butzow
Vice President, Production

Edward D. Muhlfeld
Vice President, Aviation Division

Irwin Robinson
Vice President, Travel Division

Editorial and Executive Offices
One Park Avenue
New York, New York 10016 212 679-7200

NEW YORK OFFICE 212 679-7200
James J. Sullivan
Joseph E. Halloran

MIDWESTERN OFFICE
307 North Michigan Avenue
Chicago, Illinois 60601 312 726-0892
Midwestern Advertising Manager, Royce Richard

WESTERN OFFICE
9025 Wilshire Boulevard
Beverly Hills, California 90211
213 Crestview 4-0265; BRADshaw 2-1161
Western Advertising Manager, Bud Dean

JAPAN
James Yagi
Ishikawa Mansion
#4, Sakuragaoka
Shibuya-ku, Tokyo
462-2911-3

CIRCULATION OFFICE
Portland Place, Boulder, Colorado 80302



Member
Audit Bureau of
Circulations

Radio & TV News • Radio News • Radio-Electronic Engineering Trademarks Reg. U.S. Pat. Off.
SUBSCRIPTION SERVICE: All subscription correspondence should be addressed to Electronics World, Circulation Department, Portland Place, Boulder, Colorado 80302. Please allow at least six weeks for change of address. Include your old address, as well as new—enclosing if possible an address label from a recent issue.
EDITORIAL CONTRIBUTIONS must be accompanied by return postage and will be handled with reasonable care; however publisher assumes no responsibility for return or safety of art work, photographs, or manuscripts.

ELECTRONICS WORLD (November, 1967, Vol. 78, No. 5). Published monthly at 307 North Michigan Avenue, Chicago, Illinois 60601, by Ziff-Davis Publishing Company—also the publishers of Airline Management and Marketing, Boating, Business & Commercial Aviation, Car and Driver, Cycle, Flying, HiFi/Stereo Review, Modern Bride, Popular Aviation, Popular Electronics, Popular Photography, Skiing, Skiing Area News, and Skiing Trade News. (Travel Weekly is published by Robinson Publications, Inc., a subsidiary of Ziff-Davis Publishing Company.) One year subscription rate for U.S., U.S. Possessions, and Canada, \$6.00; all other countries, \$7.00. Second Class postage paid at Chicago, Illinois and at additional mailing offices. Authorized as second class mail by the Post Office Department, Ottawa, Canada and for payment of postage in cash.

ELECTRONICS WORLD

NEW!
MASTER COURSE
IN COLOR TV...

WITH NTS COLOR KITS

Big 25" Color TV kits included in new Master Color TV Home Study program. Learn Color TV; keep the new 25" color TV receiver you build with exciting kits we send you. 10 million homes in this country will have color TV by the end of 1967. This industry needs technicians as never before, and NTS-trained men can move quickly into the big money.

COLOR TV SERVICING BRINGS HIGH PROFITS

New color sets need careful installation, precision tuning and skilled servicing. NTS home training can put you in this profit picture—prepare you for big pay, security, or start a business of your own.

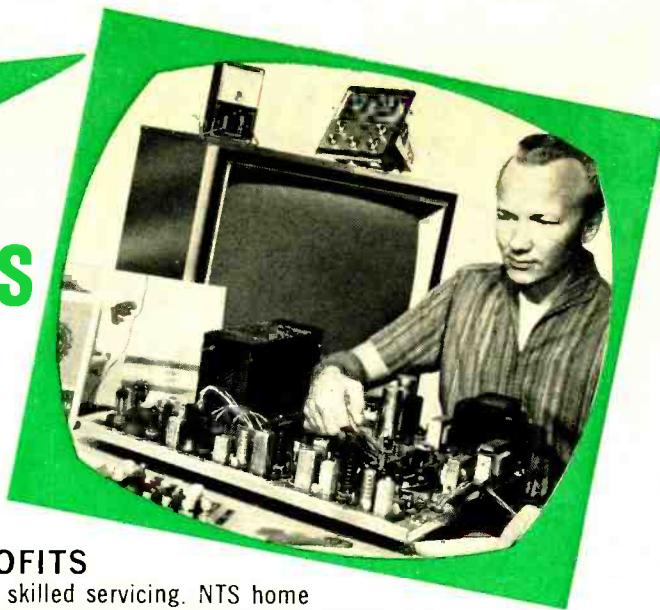

LIFT OFF... TO A "SPACE AGE" CAREER IN ELECTRONICS

This is the "space age". It offers new opportunities in communications, industrial electronics, computer technology, and many others. Automation has increased the need for skilled electronics technicians in thousands of manufacturing plants. Only the well trained man makes it big. Industry wants and demands this kind of man... the NTS man. Pick your field. Let an NTS Project Method Program help you toward a well-paid career in Electronics wherever you travel.

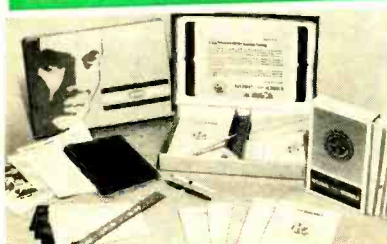
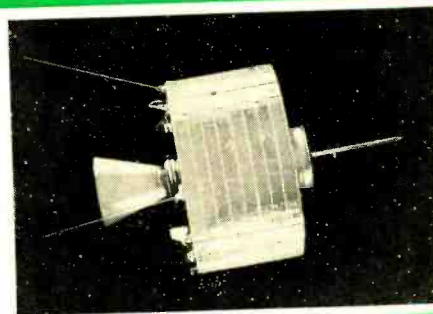

NEW CAREER KIT... FAST, EASY START TO NTS HOME TRAINING

The exclusive Project Method Career Kit helps you move quickly into your training program. Earn while you learn as you progress with your shop-tested Project Method lessons and kits.

Send for the New illustrated NTS Color Catalog. It shows the equipment and kits you work with and keep. Describes in detail the advantages of NTS Project Method Home Training. Tells you everything you need to know about starting your career in electronics.



HIGH SCHOOL AT HOME

National offers accredited high school programs. Take only subjects you need. Study at your own pace. Everything included at one low tuition. Check special High School box in coupon for full information & FREE catalog.

CLASSROOM TRAINING AT LOS ANGELES

You can take Classroom Training at Los Angeles in Sunny Southern California. NTS occupies a city block with over a million dollars in facilities devoted exclusively to technical training.

MAIL REPLY CARD OR
 COUPON FOR NEW, FREE
 COLOR CATALOG AND
 SAMPLE LESSON.



NATIONAL TECHNICAL SCHOOLS

World Wide Training Since 1905
 4000 S. Figueroa St., Los Angeles, Calif. 90037
 You enroll by mail

We have no salesmen: This means lower tuition for you.
 Accredited Member National Home Study Council
 Member: National Association of Trade & Technical Schools

NATIONAL TECHNICAL SCHOOLS

4000 S. Figueroa St., Los Angeles, California 90037

APPROVED
 FOR
 VETERANS



Please rush Free Color Catalog and Sample Lesson, plus detailed information on field checked below. No obligation.

Dept. 240-117

- MASTER COURSE IN COLOR TV SERVICING
- COLOR TV SERVICING
- MASTER COURSE IN TV & RADIO SERVICING
- PRACTICAL TV & RADIO SERVICING
- MASTER COURSE IN ELECTRONIC COMMUNICATIONS
- FCC LICENSE COURSE
- INDUSTRIAL & COMPUTER ELECTRONICS
- STEREO, HI FI & SOUND SYSTEMS
- BASIC ELECTRONICS HIGH SCHOOL AT HOME

Name _____ Age _____

Address _____

City _____ State _____ Zip _____

- Check if interested in Veteran Training under new G.I. Bill.
- Check if interested ONLY in Classroom Training at Los Angeles.



NRI GIVES YOU THE RIGHT BALANCE...

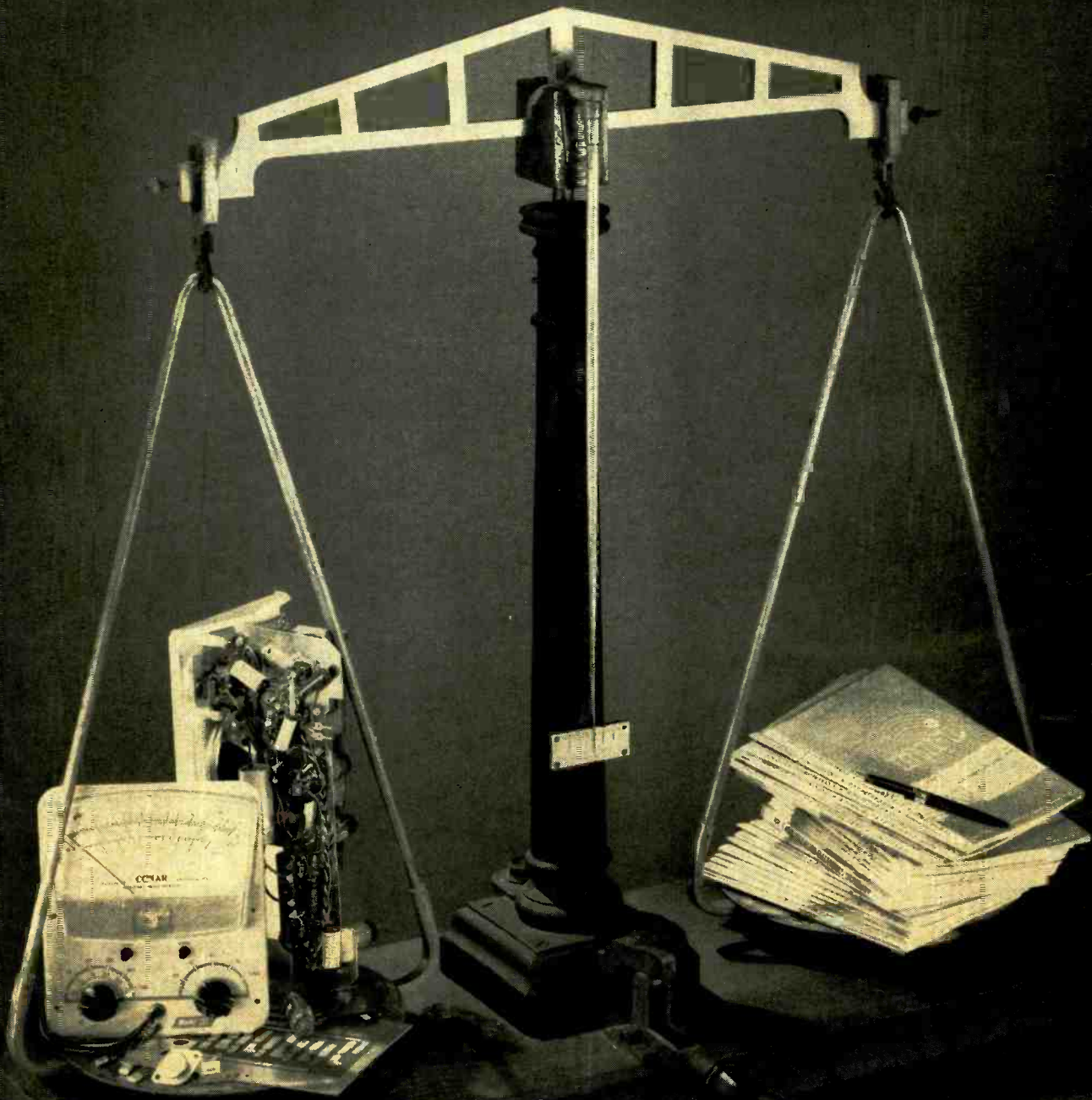

...for fast, fascinating
training at home in TV-RADIO,
COMMUNICATIONS, ELECTRONICS

Experience is still your best teacher

Here's how you get it with NRI job-simulated training

Ask any teacher, job counselor, engineer, technician or prospective employer about the need for practical application of theory in Electronics. He'll tell you Electronics is as much a "hands on" profession as dentistry or chemistry. That's the way you learn at home with NRI. You put to work the theory you read in "bite-size" texts, using designed-for-learning lab equipment you build with professional components. You introduce defects into circuits, do experiments, until the "why" of circuitry and equipment operation comes clear through demonstration. You gain experience with transistors and solid-state designs as well as conventional tube circuits.

NRI lab equipment is designed and engineered from chassis up for education through practical experience — not for entertainment. The fact that the end results of your projects are usable, quality products is a personal bonus for you. Everything about NRI training has but one ultimate goal — to make you employable in your chosen field of Electronics by preparing you to prove your practical understanding of actual equipment; by giving you the equivalent of months, even years, of on-the-job training. There is no end of oppor-

tunity for the trained man in Electronics. You can earn extra money in your spare time, have your own full-time business, or qualify quickly for career positions in business, industry, government. Discover for yourself the ease and excitement of NRI training. Mail the postage-free card today for the new NRI Color Catalog. No obligation. No salesman will call. NATIONAL RADIO INSTITUTE, Electronics Div., Washington, D. C. 20016.

NRI has trained thousands



L. V. Lynch, Louisville, Ky., was a factory worker with American Tobacco Co., now he's an Electronics Technician with the same firm.

He says, "I don't see how the NRI way of teaching could be improved."



G. L. Roberts, Champaign, Ill., is Senior Technician at the U. of Illinois Coordinated Science Laboratory. In two years he received five pay

raises. Says Roberts, "I attribute my present position to NRI training."



Ronald L. Ritter of Eatontown, N.J., received a promotion before even finishing the NRI Communications course, after scoring one of the

highest grades in Army proficiency tests. He works with the U. S. Army Electronics Lab. Ft. Monmouth, N.J. "Through NRI, I know I can handle a job of responsibility."



Don House, Lubbock, Tex., went into his own Servicing business six months after completing NRI training. This former

clothes salesman just bought a new house and reports, "I look forward to making twice as much money as I would have in my former work."

APPROVED UNDER NEW GI BILL. If you served since January 31, 1955, or are in service, check GI line on postage-free card.

Accredited by the Accrediting Commission of the National Home Study Council

Over 50 Years of Leadership



in Electronics Training



Everything you see here is included in one typical NRI home study course. Other courses are equally complete. Your training starts with the NRI Achievement Kit, sent the day you enroll. It contains the first of your "bite-size" texts which are programmed with

designed-for-learning professional lab equipment. Step-by-step, you learn with your hands as well as your head. You discover the "why" of circuitry as you acquire the professional's most valuable tool — practical experience in Electronics.

HICKOK

DMS-3200

DIGITAL MEASURING SYSTEM
(Fully transistorized)



DMS-3200 Main Frame \$320
(shown with DP-100)



- DP-100
DC Voltmeter
Plug-in
\$175
- DP-150
1 MC Counter
Plug-in
\$195
- DP-170
Ohmmeter
Plug-in
\$240
- DP-200
Capacity
Meter
Plug-in
\$240
- DP-140
Event Counter
and
Slave Plug-in
\$75

DESCRIPTION

The Hickok DMS-3200 Digital Measuring System is a precision electronic measuring device which displays readings in digital form instead of the relatively inaccurate and difficult-to-read moving-pointer meter display.

Because the DMS-3200 consists of a main frame which will accept a number of "plug-in" units, it can be used to measure a variety of electrical parameters. The main frame provides display of the reading; the plug-in determines the application.

The DMS-3200 is designed for rugged industrial and laboratory applications. Solid-state construction and conservative design ratings insure long, trouble-free life. By utilizing a design which has the optimum combination of accuracy capability and number of digit display, the DMS-3200 meets the general purpose measurement needs of industry for reliable digital measurement equipment in the \$400 - \$500 price range.

Ask Your HICKOK Distributor For A Demonstration!

THE HICKOK ELECTRICAL INSTRUMENT COMPANY
10514 Dupont Avenue • Cleveland, Ohio 44108
CIRCLE NO. 113 ON READER SERVICE CARD

LETTERS FROM OUR READERS

FET VOLTMETER

To the Editors:

In the February, 1967 issue of *ELECTRONICS WORLD* there appeared an FET voltmeter construction article by James Randall (p. 63). Mr. Randall stated that the choice of both the FET and the transistor was dictated by economy reasons.

With slight modifications, the original circuit can be adapted to use an even cheaper set of semiconductors. Please refer to the schematic diagram for the changes.

First, a *Motorola* MPF-105 FET is used. This is an *n*-channel unit and

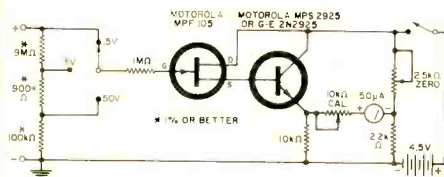

it requires that the battery polarity be reversed. The MPF-105 is currently listed at \$1.00 each in single-lot quantities.

Battery-polarity reversal permits the use of an economy-line transistor. This can be either the *G-E* 2N2925 listing at 60¢ or the *Motorola* MPS 2925 listing at 75¢ in single lots. The only real difference between the transistors is basing. The *G-E* unit is E-C-B, while the *Motorola* has the more standard E-B-C.

One additional change is the use of a 2500-ohm pot for the zero function. The 10,000-ohm pot specified did not provide as fine a resolution as was desired.

As an electronics engineer at *Bendix Corporation* (South Bend, Ind.), I have access to the lab standards. I was quite amazed at the high degree of linearity this circuit provides. I believe that use of quality resistors in the input network and accurate calibration would enable this device to come close to equaling lab standard equipment.

DEVEY W. EPPLEY
Nappanee, Ind.

* * *

MICROWAVE ETV ARTWORK

To the Editors:

I have a bone to pick with your artist for the lead artwork illustrating the article "Microwave ETV—System Plan-

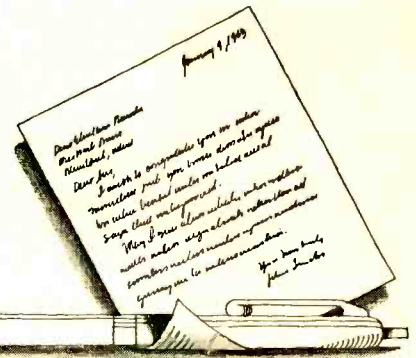

ning & Installation" on p. 34 of your May issue. The illustration shown at the top left is a receiving dish with a mast-mounted receiver. As a matter of fact, it is a drawing of the same equipment shown in the photo at the bottom of the page. Now, if it's a receiving antenna, how can it transmit a signal to the TV set that the two students are watching at the right?

MICHAEL T. CRAWFORD
Minneapolis, Minn.

Reader Crawford is right, strictly speaking. We did take a little artistic license with the illustration. However, parabolic dishes are used in the ETV system for transmission as well. These, of course, send their signals directly to the receiving antennas, thence to the receiver and TV monitors. In other cases, omnidirectional transmitting antennas are employed to radiate signals to a large number of widely separated receiving dishes.—Editors

* * *

LASER INTERFEROMETER

To the Editors:

In his article "The Laser Interferometer" in your June, 1967 issue, J. P. Engeman states (near the top of the right-hand column on p. 44), "Doubling the variable path length halves the resolution of the device, causing fringes to occur every 6.25 microinches."

As conventionally used in the field of optics, resolution is inversely proportional to the smallest distance that can be detected. Consequently, if the smallest distance that can be detected is halved, then the resolution is doubled. Therefore, the sentence in question should read, "Doubling the variable path length *doubles* the resolution of the device. . . ."

KENNETH D. POWELL, Jr.
Lindsey AS, W. Germany

Reader Powell's comment regarding the increased resolution of the "folded path" interferometer is quite correct. Decreasing the fringe value from 1/2 to 1/4 doubles the resolution.—Editors

WHITE NOISE

To the Editors:

First of all, I wish to comment on what a fine magazine you have. It never fails to be up-to-date and interesting.

LOOK!

A New Electronics Slide Rule with Instruction Course

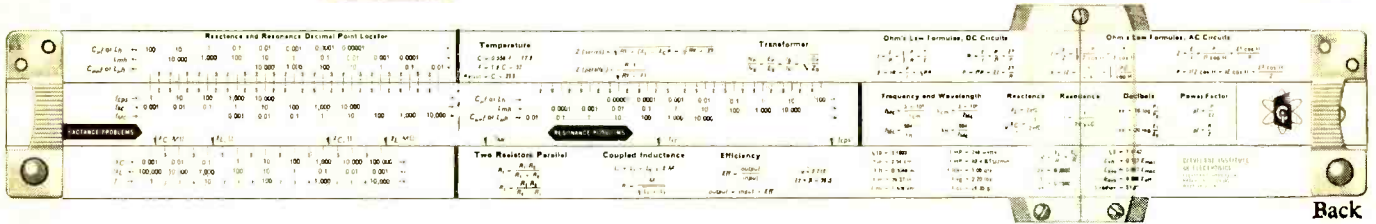
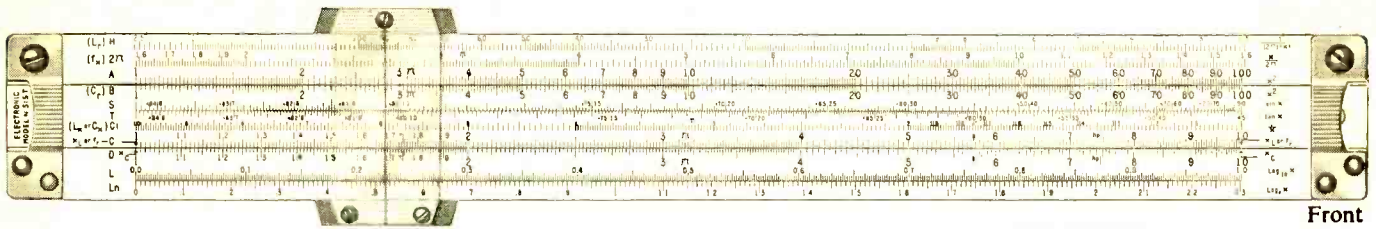

This amazing new "computer in a case" will save you time the very first day. CIE's patented, all-metal 10" electronics slide rule was designed *specifically* for electronic engineers, technicians, students, radio-TV servicemen and hobbyists. It features special scales for solving reactance, resonance, inductance and AC-DC circuitry problems . . . an exclusive "fast-finder" decimal point locator . . . widely-used formulas and conversion factors for instant reference. And there's all the standard scales you need to do multiplication, division, square roots, logs, etc.

Best of all, the CIE Slide Rule comes complete with an Instruction Course of four **AUTO-PROGRAMMED** lessons. It includes hundreds of illustrations, diagrams and practice problems. You'll learn ingenious short cuts . . . whip through exacting electronics problems quickly and accurately. This course alone is worth far more than the price of the entire package!

Electronics Slide Rule, Instruction Course, *and* handsome, top-grain leather carrying case . . . a \$50 value for less than \$25. Send coupon for **FREE** illustrated booklet and **FREE** heavy vinyl Pocket Electronics Data Guide. Cleveland Institute of Electronics, 1776 E. 17th St., Dept. EW-145, Cleveland, Ohio 44114.

*TRADEMARK

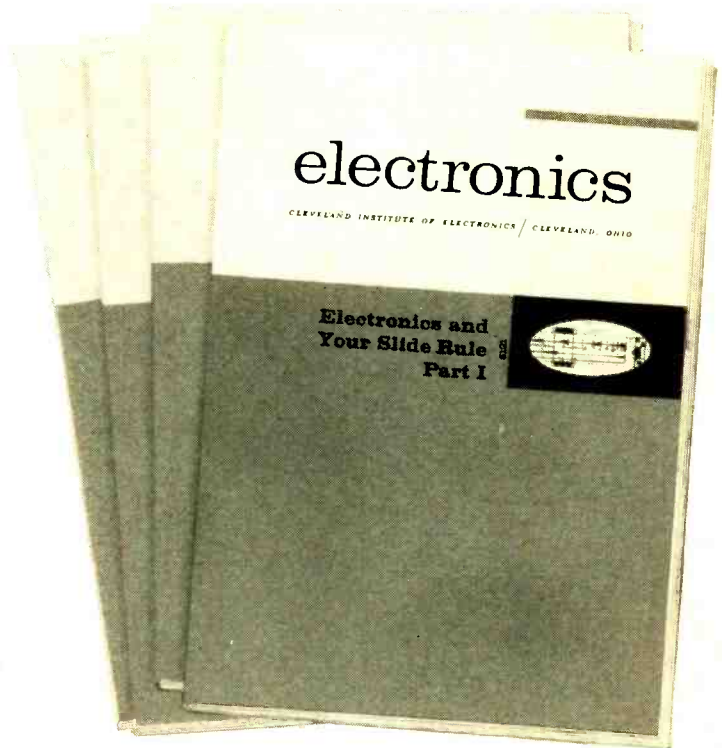

GET BOTH FREE!

ELECTRONICS SLIDE RULE

Send coupon today →

Cleveland Institute of Electronics

1776 E. 17th St., Dept. EW-145, Cleveland, Ohio 44114

Please send **FREE** Illustrated Booklet describing your Electronics Slide Rule and Instruction Course.

SPECIAL BONUS! Mail coupon promptly . . . get **FREE** Pocket Electronics Data Guide too!

Name _____ (PLEASE PRINT)

Address _____ County _____

City _____ State _____ Zip _____

A leader in Electronics Training . . . since 1934.

CIRCLE NO. 123 ON READER SERVICE CARD

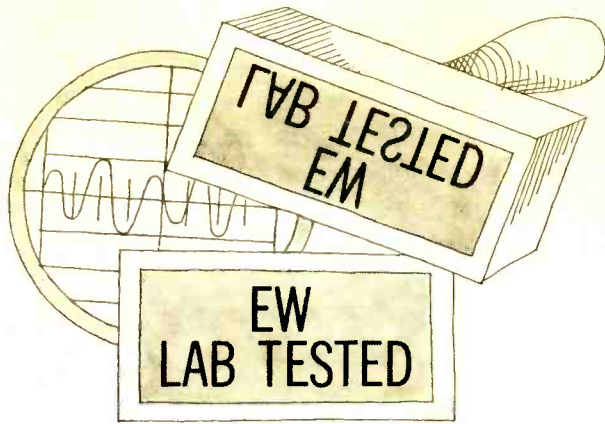

HI-FI PRODUCT REPORT

TESTED BY HIRSCH-HOUCK LABS

Sony TC-660 Tape Recorder

Sony TC-660 Tape Recorder

For copy of manufacturer's brochure, circle No. 35 on Reader Service Card.



USERS of two- or four-track reel-to-reel tape recorders have always had to remove and interchange the reels after each pass in order to cover all the recorded tracks. This is, at best, an annoyance, but in many cases it may have delayed acceptance of the tape recorder as a key part of the average home music system.

Considerable effort has been expended by tape recorder manufacturers in overcoming this problem. Automatic reversing systems have been devised which are actuated by a conducting metal foil spliced near the end of a tape or by tension sensors which are operated by an extra strong leader fastened to the supply reel hub. Both systems require physical modification of

previously recorded tapes, which is obviously undesirable.

Another technique uses a sub-sonic tone which the user records on the tape at the point where reversal is desired. Although no physical alteration of the tape or reels is required, this method nevertheless calls for a specific action on the user's part.

The Sony TC-660 tape recorder features what the manufacturer calls "ESP" (Electronic Sensory Perception). This is an ingenious solution to the automatic reversal problem. Like any automatic reversing recorder, the TC-660 has two playback heads, one for each direction of tape motion. The ESP circuitry, which uses 7 transistors and many other components, continuously

monitors the output from both heads. When no signal has been present on either set of tracks for 10 seconds, the tape reverses direction almost instantly and the second set of heads is connected to the playback amplifiers.

The ESP system operates only on playback in the normal (left-to-right) direction and can be switched off if conventional operation is desired. The tape can be reversed manually at any time and the appropriate heads are selected by this action. Unlike some auto-reverse recorders, the TC-660 has two sets of record and erase heads so that the tape can be fully recorded without removing or interchanging reels.

The ESP system worked flawlessly in our use tests and made it possible to enjoy up to three hours of recorded music without any attention to the recorder. There are two precautionary notes which are duly pointed out in the instruction manual. If a recorded tape does not have 10 seconds of silence at the end of the first side it is necessary to splice a few feet of leader to the tape. If recorded levels are exceptionally low, the ESP circuit may not function properly. However, these situations are uncommon and, for the most part, the ESP represents one of the most elegant and workable solutions to the tape reversal problem we have encountered.

The recorder is an all solid-state 7½ and 3¾ in/s quarter-track machine in an attractive portable case. Loading tape is simplified by straight-line threading. All transport functions, including the instant stop or "pause," are solenoid-operated through feather touch controls. The tape bounce and momentary "wow" which many recorders exhibit after release of the instantaneous stop are virtually absent from the TC-660.

The front of the recorder has two input jacks to accommodate the Sony F-96 dynamic microphones supplied and which are stored in the detachable speaker housings when not in use. Individual red "Record" interlock buttons for the two channels must be pressed

(Continued on page 85)

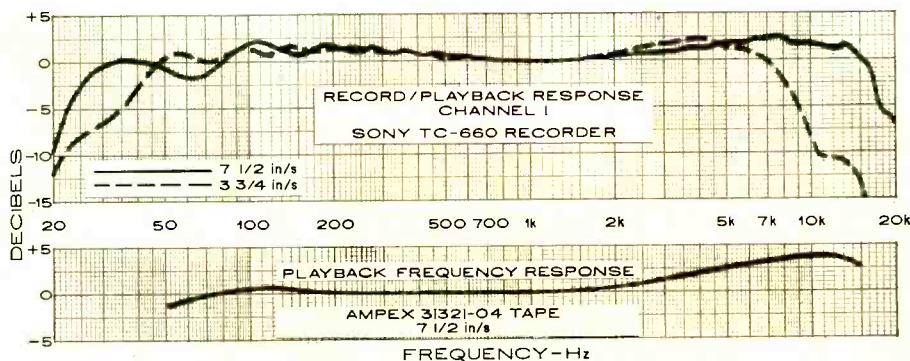



Tape it with a Sony Solid-State Stereo 560

There's a world of beautiful music waiting for you and it's yours for the taping. Let Sony-superb 4-track stereo capture every note faithfully while you relax in your easy chair. Simply connect your stereo tuner to the Sony Solid-State 560, "Stereo Compact Portable," and tape your favorites off the air. Here is the nucleus of a complete stereo sound system with an ESP automatic reversing stereo tape recorder as its main component. The Sony-unique Stereo Control Center permits four separate stereo components to be connected to its stereo preamplifier and 20-watt music power amplifier. Push buttons select your component source for listening or recording. Individual input level controls balance output whenever you switch between components. Sony's revolutionary ESP Reverse electronic brain constantly scans and automatically senses the voice of music modulations on your recorded tapes. When these modulations stop, the ESP (Electronic Sensory Perceptor) automatically reverses the tape direction in 10 seconds. The Sony Solid-State 560 incorporates the most advanced electronic developments for sound-quality control. The Sony-exclusive Servo-Control Motor provides, among other things, the flexibility of AC/DC operation and variable musical pitch tuning. Non-Magnetizing Heads eliminate the most common cause of tape hiss. The exclusive Scrape Flutter Filter eliminates tape modulation distortion providing the purest recordings ever. An exclusive Noise Suppressor Switch eliminates any undesirable hiss that may exist on older recorded tape without affecting the sound quality. All of this is yours, with two Sony F-98 cardioid dynamic microphones for less than \$499.50! Check these Sony-exclusive features for luxury listening: ■ ESP Automatic Tape Reverse ■ Stereo Control Center ■ Scrap Flutter Filter ■ ServoControl Motor ■ Noise Suppressor Switch ■ Non-magnetizing Heads.



SONY'S PROOF OF QUALITY — A FULL ONE YEAR WARRANTY

SONY **SUPERSCOPE** The Tapeway to Stereo.

8138 VINELAND AVENUE • SUN VALLEY, CALIFORNIA • 91352

Sony Solid-State 560D ESP Automatic Reverse Stereo Tape Deck Recorder. If you already have components or a package stereo system, simply connect the Sony Solid-State 560D Stereo Tape Deck Recorder and add the incomparable advantage of stereo tape to your present stereo sound system. Here is the same superb ESP Reverse stereo tape deck that is the main component of the Sony 560. You will find every feature and the same advanced electronic developments for sound-quality control less the Stereo Control Center and speakers. Yet, mounted in its own handsome, low-profile walnut cabinet with recording amplifiers and playback preamplifiers, the Sony 560D sells for less than \$349.50!

CIRCLE NO. 90 ON READER SERVICE CARD

Reflections on the NEWS

By WALTER H. BUCHSBAUM/Contributing Editor

We have selected a number of recent news items which we believe will be of interest to our readers and have some impact on our industry. In presenting this information, we have stressed hard facts and consulted specialists to bring you these new forecasts.

X-Ray Danger from Color-TV Sets

Following G-E's recent withdrawal and repair of a large number of color-TV sets because of the x-ray danger, politicians at all levels are uniting to extend protection of Federal legislation to the consumer already faced by so many dangers. (See John Frye's column "Radiation and the Technician" on page 52 of this issue.)

The National Council on Radiation Protection and Measurements (NCRPM) has recommended a maximum radiation level of 0.5 milliroentgen/hour measured about 2" from the surface of the TV receiver. Some of the TV sets withdrawn by G-E are said to have produced levels between 500 and 5000 milliroentgens, measured at a particular spot below the chassis of this set. X-ray emission is primarily due to high-voltage electrons striking the metal elements of the h.v. regulator tube. Radiation decreases as the square of the distance and this means that a 5000 mR level at 2" is reduced to 15 mR at 3 feet.

By comparison, during a chest x-ray, between 10 to 200 mR are actually absorbed by the body tissue. The average background radiation due to natural sources in the United States varies between 100 and 300 mR per year. Standard hospital practice in New York State allows workers in x-ray laboratories to absorb 100 mR per week of constant radiation and much larger amounts in brief doses.

All of the radiation levels measured for medical purposes are in the very short wavelength range and are considered "hard" x-rays. The type of x-rays which can be produced by color-TV sets at a voltage of approximately 25 kV, on a non-tungsten target, have a much greater wavelength and are generally called "soft" x-rays. This latter type of radiation is greatly attenuated by glass and many other materials. "Soft" x-rays penetrate only a few millimeters into the human skin, but very large doses will definitely injure the skin. If the eye is irradiated by "soft" x-rays in sufficient doses, serious injury may occur.

We reviewed these facts with a doctor who heads the radiology department in a famous hospital. He agreed with other radiologists that the radiation effects of a yearly chest x-ray and a yearly dental x-ray are far greater than anything that would be encountered while watching a color-TV set. Technicians working with exposed high-voltage circuits could be endangered, especially if the eyes are close to an unshielded source of h.v. electrons. Most manufacturers are now sending out warnings to their dealers concerning this hazard.

Miniature TV Antennas

Newspaper accounts have described a miniaturized antenna, a few inches long, housed inside the TV cabinet, which will replace present roof installations. Such an antenna was developed by E. Turner of the U.S. Air Force and H. Meinke of Munich, Germany. Their technique reduces the length of a whip or dipole antenna by substituting the electrical inductance or capacitance of a transistor circuit for physical length, similar to the loading coils used in mobile installations. These antennas are suitable for military applications where their omnidirectional characteristics can be tolerated and where the signal-to-noise ratio is not a critical parameter.

As anyone who has ever installed a TV antenna knows, the directivity is frequently of the greatest importance. Even simple rabbit-ear dipoles have some directivity, practically all outdoor antennas are designed to have far more. This directivity is generally obtained by use of reflectors, directors, and active antenna elements in the array. Even if the elements themselves could be made smaller by the use of transistor circuitry, the distance between the elements in the array would have to be several feet at v.h.f. Very little would then be gained because such an antenna, while narrower, would still be much too long to be housed in a TV receiver cabinet.

Some directivity is claimed for a loop configuration of the miniaturized antenna system. The front-to-back ratio in this particular configuration is only on the order of about 3 dB, hardly sufficient to eliminate ghosts.

The inventors readily admit that the use of the transistor contributes noise while use of the shorter antenna itself reduces the otherwise expected signal-to-noise ratio. The sum total of these two effects is a signal-to-noise ratio considerably worse than that of the standard dipole.

In our opinion the time to tear down the antenna installation from the various roofs in metropolitan, fringe, or far-fringe TV areas is not yet. Unless new principles of electromagnetic theory are discovered or unless the presently accepted principles can somehow be overthrown, it will be wise to rely on the commercially available "large" antennas for the next few years, at least.

CBS TV Film Device

The recent announcement by CBS Laboratories of a new TV recording system does not concern a new type of video tape recorder, but consists essentially of a "super 8" size movie film which is electronically scanned and converted into video signals. The master film can be prepared from video tape, movie film, or live pickups and a number of prints are then made which can be used for viewing on TV sets. The outstanding features of the CBS development are the use of new, strong, flexible and extremely thin film material, similar to magnetic tape, but containing movie pictures of great resolution. Unlike movie

Want a real man's job and pay?

Join "THE TROUBLESHOOTERS"

who get paid top salaries for keeping today's electronic world running

Behind today's microwave towers, computers, pushbutton phones, mobile radios, TV equipment, guided missiles, etc., stand THE TROUBLESHOOTERS — the men who inspect, install and service these modern miracles. Here's how you can join their privileged ranks — without having to quit your job or go to college to get the necessary training.

ARE YOU IN THE MARKET for a better job—a real man's job that will earn you a real man's pay? Your best bet is to join the ranks of today's Electronics Troubleshooters.

Just think how much in demand you would be if you could prevent a TV station from going off the air by repairing a transmitter... keep a whole assembly line moving by fixing automated production controls... prevent a bank or an airline or your Government from making serious mistakes by repairing a computer.

Today, whole industries depend on Electronics. When breakdowns or emergencies occur, someone has got to move in, take over, and keep things running. That calls for one of a new breed of technicians—The Troubleshooters.

Because they prevent expensive mistakes or delays, they get top pay—and a title to match. At Xerox and Philco, they're called Technical Representatives. At IBM, they're Customer Engineers. In radio or TV, they're the Broadcast Engineers.

What do you need to break into the ranks of The Troubleshooters? You might think you need a college diploma, but you don't. What you need is know-how—the kind a good TV serviceman has—only lots more.

The serviceman, you see, "thinks with his hands." He learns his trade by taking apart and putting together, and often can only fix things he's already familiar with. But as one of The Troubleshooters, you may be
(continued on next page)

Detach and mail postpaid card

FIRST CLASS
PERMIT NO. 8685
CLEVELAND, OHIO

BUSINESS REPLY MAIL
No postage stamp necessary if mailed in the United States

Postage will be paid by:

**Cleveland Institute
of Electronics**

1776 East 17th Street
Cleveland, Ohio 44114

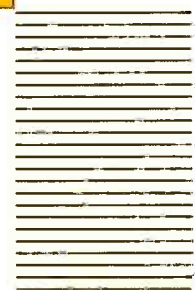

They're earning top pay as Electronics Troubleshooters —now you can do the same

Owns his own business

CIE graduate Ed Dulaney credits his training with helping him realize his highest ambition — owning his own two-way radio business. "Now," he writes, "I manufacture my own equipment, with dealers who sell it in seven states, and have seven full-time employees."



Troubleshooter for IBM

Raymond Ott trained with CIE while in the Air Force. "The day after leaving service," he says, "I passed my FCC exam—first try! Then I got my present job as Associate Customer Engineer with IBM, working on computers and related electronic equipment."



Wins Management Position

"Upon completion of my CIE course," writes Thomas E. Miller, Jr., "I was swamped with job offers. My only problem was to pick the best offer, and I did—engineer with Indiana Bell Telephone. CIE made the difference between just a job and a management position."



(continued from preceding page)

called upon to service complicated equipment that you've never seen before or can't take apart. This means you have to be able to take things apart "in your head." You have to know enough Electronics to understand the engineering specs, read the wiring diagrams, and calculate how a circuit should test at any given point.

Now learning all this can be much simpler than you think. In fact, you can master it without setting foot in a classroom and without giving up your job!

AUTO-PROGRAMMED® Lessons Show You How

For over 30 years, Cleveland Institute of Electronics has specialized in teaching Electronics at home. We've developed special techniques that make learning easy, even if you've had trouble studying before. Our AUTO-PROGRAMMED lessons build your knowledge as easily and solidly as you'd build a brick wall—one brick at a time. And our instruction is personal. Your teacher not only grades your work, he analyzes it to make sure you are thinking correctly. And he returns it the same day it's received.

Get FCC License—or Your Money Back!

Many types of troubleshooting call for a Government FCC License, and our training is designed to get it for you. But even if your work doesn't require a license, it's a good idea to get one. Your FCC License will be accepted anywhere as proof of good electronics training.

And no wonder. The licensing exam is so tough that two out of three non-CIE men who take it fail. But CIE training is so effective that 9 out of 10 of our graduates pass! That's why we can offer this Warranty with confidence: *If you complete one of our license-preparation courses, you'll get your license—or your money back.*

Mail Card for 2 Free Books

Want to know more? Mail the postage-paid reply card below. We'll send our 40-page book describing our courses and the latest opportunities in Electronics. We'll also send a special 24-page book on how to get a Commercial FCC License. Both are free. If the card has been detached, just send us your name and address.

ENROLL UNDER NEW G.I. BILL. All CIE courses are available under the new G.I. Bill. If you served on active duty since January 31, 1955, or are in service now, check box on card for G.I. Bill information.

CIE Cleveland Institute of Electronics

1776 East 17th Street, Dept. EW-38
Cleveland, Ohio 44114

Accredited Member National Home Study Council • A Leader in Electronics Training... Since 1934

CIE Cleveland Institute of Electronics

1776 East 17th Street, Cleveland, Ohio 44114

Please send me without cost or obligation:

- Your 40-page book "How To Succeed In Electronics" describing the job opportunities in Electronics today, and how your courses can prepare me for them.
- Your book on "How To Get A Commercial FCC License."

I am especially interested in:

- | | |
|--|--|
| <input type="checkbox"/> Electronics Technology | <input type="checkbox"/> Electronic Communications |
| <input type="checkbox"/> First Class FCC License | <input type="checkbox"/> Industrial Electronics |
| <input type="checkbox"/> Broadcast Engineering | <input type="checkbox"/> Advanced Engineering |

Name _____ Age _____
(please print)

Address _____

City _____ State _____ Zip _____

Check here for G.I. Bill information

Accredited Member National Home Study Council • A Leader in Electronics Training... Since 1934

EW-38

← JUST DETACH AND MAIL THIS POSTPAID CARD

GET 2 FREE BOOKS THAT CAN CHANGE YOUR LIFE



Find out how you can prepare for a high-pay job and how to get an FCC License or your money back

films, the new CBS film moves continuously, without the pull-down and shutter effect, and without sprocket holes. The optical transducer for the TV playback device apparently consists of a light source and a photo pickup. While CBS had not divulged the exact method of playback, a type of flying-spot scanner, such as used in TV studios, could provide the means of transducing the photographic picture into video signals. Synchronizing information, in the form of black-and-white markings along the edge of the film, can provide the frame-by-frame synchronization.

For the reproduction of color pictures, two separate frames, side by side on the film, are used. One frame contains the "black-and-white" picture content while the other frame provides the color information. This is compatible with the present color-TV system where the Y signal contains the brightness information and the color subcarrier contains all the color information. The actual pictures are much smaller than standard 8-mm movies. Good resolution is obtained by using microfilm techniques. An added feature of this new CBS development is provision for stereo sound, which is also recorded on the film, somewhat similar to the sound track used in 16- and 35-mm sound film systems.

The CBS system is intended primarily for educational TV systems where a film played at a central location can be viewed on TV monitors in different classrooms. For the home entertainment market, the attractions of this system appear somewhat limited. It is now possible to rent or purchase sound movies at relatively low cost. Even if the cost of the CBS playback device is brought down to the projected \$270, this is only barely competitive with film which can be viewed on a large screen, rather than from the face of a TV tube.

At the present time, CBS is still conducting tests, mostly in school situations in England and does not plan a full-scale demonstration of the system in this country until April of next year.

We can conclude that video tape recorders are here to stay and that their eventual application to the home market will not be impeded by the CBS Labs development. This development may, however, provide a valuable addition to educational TV and to some other applications where the use of microfilm techniques, combined with TV viewing, will offer a substantial advantage.

New Uses for the Telephone

In a little noticed FCC recommendation, the likelihood of increasing the scope of the electronic-minded individual has been greatly increased. In the past, AT&T has maintained control over any devices which might be connected to its telephones, but recently a number of small companies have tried to break this monopoly by the sale of special phones and such devices as telephone answering machines and telephones connected to fire and burglar alarm systems. As recently as a year ago, AT&T developed a new unit, the Alarm Coupler, which would permit "foreign" devices, i.e., those not made by AT&T, to be connected to the telephone line and transmit dial and alarm information. This device has not been widely marketed by AT&T.

The FCC Broadcast Bureau has now thrown its weight against AT&T. By interceding in the case of Carter Electronic Association vs AT&T, the Bureau has recommended that AT&T's monopoly on devices connected to telephone lines be broken. This would open a vast market for a wide variety of electronic devices ranging from the obvious connection of radio links to the telephone lines to automatic dialing alarm systems, and remote control devices for kitchen equipment, air conditioners, and many other appliances.

These new services will add greatly to the revenues of the telephone company. For these reasons and because of public pressure, it is a safe bet that AT&T will allow "foreign" devices to be connected to its lines—at least to some extent—for a nominal service charge. ▲

Weller®

...the soldering tools professionals depend on



The original Dual Heat Soldering Guns

Preferred by technicians for their fast heating copper tips, exclusive trigger-controlled dual heat, and high soldering efficiency. Available in 3 wattage sizes, each with spotlight.

100/140-watt Model 8200, 145/210-watt Model D-440, and 240/325-watt Model D-550. Also in complete kits:

- **Model 8200PK** includes 100/140 watt gun, extra tips, tip-changing wrench, flux brush, soldering aid and solder
- **Model D-550PK** heavy-duty 240/325 watt gun kit with soldering, cutting and smoothing tips, wrench and solder

Dependable MARKSMAN Irons in a size for every job



Ideal for deep chassis work and continuous-duty soldering, Marksman irons outperform others of comparable size and weight. All five feature long-reach stainless steel barrels and replaceable tips.

- 25-watt, 1 3/4-oz. Model SP-23 with 1/8" tip (In kit with extra tips, soldering aid, solder—Model SP-23K)
- 40-watt, 2-oz. Model SP-40 with 1/4" tip
- 80-watt, 4-oz. Model SP-80 with 3/8" tip
- 120-watt, 10-oz. Model SP-120 with 1/2" tip
- 175-watt, 16-oz. Model SP-175 with 5/8" tip

NOW a BATTERY OPERATED IRON for field servicing

Use this lightweight service tool for automotive wiring, model planes, or mobile communications. Works from any 12 volt battery or 12-14 volt AC/DC supply. Supplied complete with long-life patented "Temperature Sensing" tip, 12-ft. power cord and terminal clips. Model TCP-12—12 volt; Model TCP-24—24-28 volts.



Complete Weller Line includes replacement tips and solder at your Electronic Parts Distributor

WELLER ELECTRIC CORPORATION, Easton, Pa.

WORLD LEADER IN SOLDERING TECHNOLOGY
CIRCLE NO. 83 ON READER SERVICE CARD

\$695.00
 (and at last)
**No Needless
~~Needles~~**



WHY?

Because Non-Linear Systems introduces (X-3), a solid-state integrated circuit DVM "(VTVM)" with extras for \$695.

DC Volts:

- 10 mv to 10K v
- .1% ± 1 digit
- 100 Megohm input impedance, entire range
- 10 Microvolts resolution

AC Volts:

200 Millivolts to 300 volts

- 10 Millivolts resolution
- 3% Accuracy
- 20 Hz to 500 MHz
- 10 Megohms Input Impedance

Resistance:

- 10 Ohms to 2000 Megohms
- .1% ± 1 digit to 200K

Current:

- 10 Nano Amps to 200 Milliamps
- .1% ± 1 digit

Yes, all these extras for \$695 (including probes)

LOOK AT THESE EXTRAS

- 100% Over-range Digit
- Over-load Indicator
- Over-load Protection
- Automatic Polarity
- Display Storage
- High CMR
- Unique Low, Medium, and High Range Selector



Originator of the Digital Voltmeter
NON-LINEAR SYSTEMS, INC.
 DEL MAR, CALIFORNIA 92014
 (714) 755-1134/TWX: 910-322-1132

THE NEW BREED OF DIGITAL VOLTMETER

By A. H. SEIDMAN, Contributing Editor

Editor's Note: Thanks to the use of low-cost transistors and integrated circuits, prices and sizes of new d.v.m.'s have dropped. The introduction by Fairchild, during the March IEEE Show, of a 3½-digit digital vote-ohmmeter using IC's and selling for about \$250 in large quantities and just under \$300 in small quantities created quite a stir, to say the least. (See July 1967 "Test Equipment Product Report".) To meet this competition and what is felt to be an expanding instrumentation market, manufacturers are coming out with new moderately priced models and are finding it difficult to keep up with their orders. Because of the reduced cost, many manufacturers are considering building such instruments into their equipment. This article gives details on as many of these new under-\$600 instruments on which we were able to obtain information.

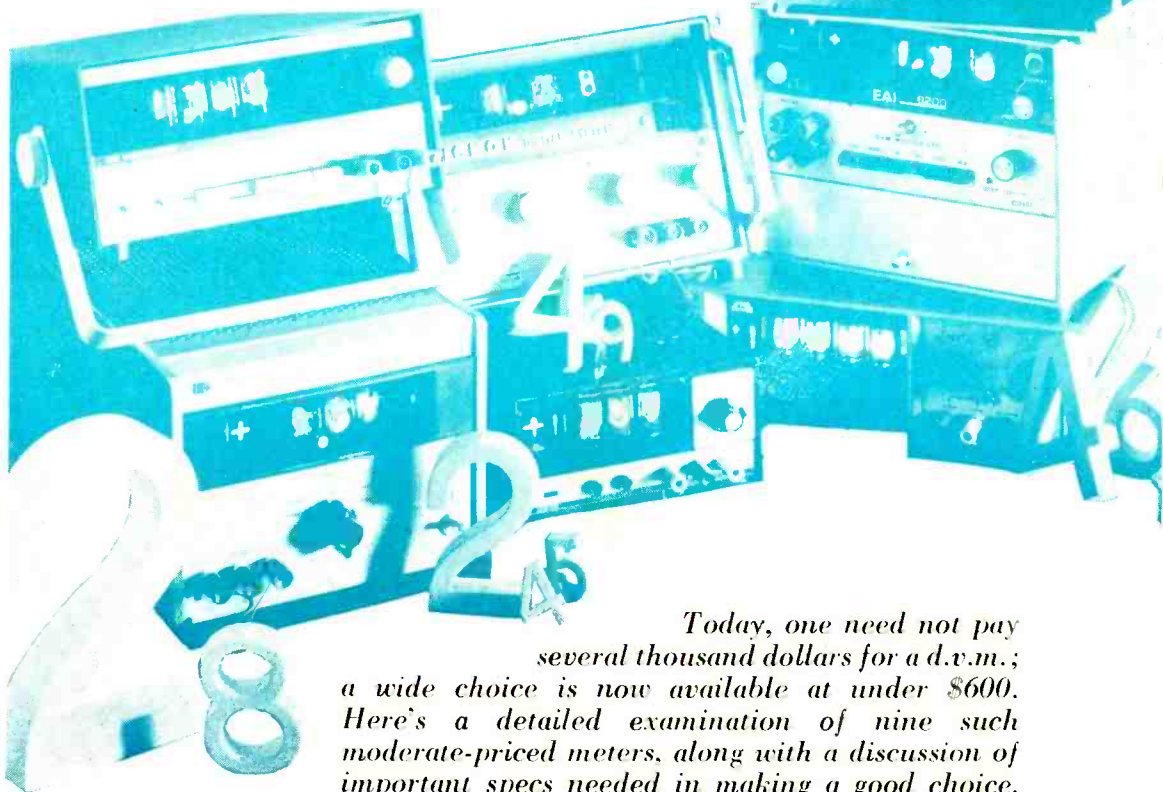

Today, one need not pay several thousand dollars for a d.v.m.; a wide choice is now available at under \$600. Here's a detailed examination of nine such moderate-priced meters, along with a discussion of important specs needed in making a good choice.

THE idea of reading an unknown voltage directly as a number (digital readout), instead of having to squint at a continuous meter scale, do some mental interpolation, and guard against parallax errors (analog readout), is irresistible. The advantages of digital over analog readout are accuracy, speed, and simplicity; guesswork is eliminated and the instrument can be used by unskilled personnel.

The first digital voltmeter (d.v.m.) was marketed by *Non-Linear Systems* in 1953. Since then, many companies have manufactured d.v.m.'s ranging in price from a few hundred dollars to several thousand dollars, with accuracies of 0.1 percent and better. The market for d.v.m.'s in 1967 is pegged by many at 30-million dollars; in the next year or two, it is estimated that the market will double to 60-million dollars. Because of current demand for d.v.m.'s, some companies queried have declared that they could not keep up with orders.

Undoubtedly the catalyst for the meteoric rise of digital-readout instruments has been the transistor and, more recently, the integrated circuit. The circuits of a d.v.m. are imposing and sophisticated, requiring many components in digital-type configurations. For example, a d.v.m. can use some 60 transistors. Just imagine if vacuum tubes were used; their heater power alone would come to 120 watts, not

to mention reliability and cooling problems, greater weight and larger size, and higher cost. Although there have been reports of reliability difficulties with some integrated circuits and small-size indicator tubes, these problems appear to be solved. In fact, future d.v.m.'s will use more integrated circuits than discrete components.

An early example of a digital-readout instrument is the frequency counter; the basic counting circuit of this instrument is also found in the d.v.m. *Tektronix* is marketing an oscilloscope that permits digital readout of voltage and time. Digital readout of time differences as small as 50 μ s, pulse rise times as fast as 0.4 μ s, and pulse amplitudes as small as 2 mV peak-to-peak are possible. Upper and lower limits for voltage and time can be preset for "go/no-go" indication, a valuable feature for production testing.

In this article, emphasis will be placed on d.v.m.'s in the \$600-and-under price range. Many of these units have plug-in modules that permit digital readout of current, a.c. voltage, resistance, capacitance, etc. In this price range, d.v.m.'s generally have 4-digit readout and full-scale accuracies of $\pm 0.1\%$. In the higher-bracket class, for example \$1440 buys *Dana's* Model 5400 d.v.m. having 5-digit readout and $\pm 0.01\%$ accuracy. *Fairchild's* Model 7200 multimeter provides a 6-digit display and $\pm 0.001\%$ accuracy; price is \$3500. For \$4250, *Hewlett-Packard* offers Model HO4-3460A

d.v.m. which features 7-digit readout and an accuracy of up to $\pm 0.0005\%$.

Applications

Digital voltmeters find wide application where there is a need for making rapid and accurate d.c. voltage measurements. With plug-ins, measurement of other quantities is possible with the same speed and good accuracy. Obvious areas where a d.v.m. is useful are on production lines, in quality control, in research and development, calibration, and OEM equipment.

Some digital voltmeters feature digital readout in binary-coded decimal (BCD) form of the voltage being measured. The d.v.m. thus behaves as an analog-to-digital voltmeter, converting an analog quantity (voltage) to a digital signal. With the growing importance of digital computers and systems, this is another area where the d.v.m. enjoys wide application.

Besides its usefulness for high-accuracy measurements, the simplicity of the d.v.m. makes it ideal for use by unskilled personnel. It is questionable, however, if the superior accuracy and simplicity of use of the d.v.m. over an analog

meter is worth the additional cost to the usual service technician; he seldom requires very high accuracy and he is used to using analog instruments.

Understanding the Specs

The purchaser of a d.v.m. is assailed by claims and specifications in advertisements and catalogues. He reads terms like "accuracy", "resolution", "overrange", and "common-mode rejection", and wonders what all this really means. In this section the more important specifications, especially those that often result in misunderstanding, will be explained.

Accuracy is a statement of the largest allowable error expressed as a percentage, an absolute value, or in digits of the reading. For example, if 0.1% total error on the 10-volt scale with a 3-digit readout is specified, the maximum deviation is 1 digit. If 0.1%, ± 1 digit is specified, this implies a 2-digit maximum error in the reading. It is important to note if the quoted accuracy figure applies to all ranges and at all input voltage levels, up to the overrange value (see below).

Overrange denotes by how much a selected voltage range can be exceeded and the instrument still maintain its speci-

Table 1. Specifications for digital voltmeters that are in the under-\$600 price range. (See cover for photo of instruments.)

INSTRUMENT	TYPE	DISPLAY (digits)	VOLTAGE RANGES	FULL-SCALE ACCURACY	OVER-RANGE	MEASUREMENT SPEED (samples/s)	NORMAL-MODE REJECTION (@ 60 Hz, in dB)	COMMON-MODE REJECTION (@ 60 Hz, in dB)	POWER (W) WEIGHT (lbs) DIM. (in.) (h, w, d)	PRICE*	ACCESSORIES
Digitec Model 252	Ramp	4	Four, 2-1000 V, 1-mV res.	$\pm 0.05\%$, ± 1 digit	50% low, 20% high range	2	75	80	25 10 4 1/4 x 8 5/8 x 11 1/2	\$585	None
Electrolab Model 100	Integrating	4	Four, 1-1000 V, 1-mV res.	$\pm 0.1\%$, ± 1 digit	50%	3	40	100	15 7 3 1/2 x 9 x 10 1/2	\$495	Autorange, \$50
EAI Series 6200	Integrating	4	Five, 0.1-1000 V, 0.1-mV res.	$\pm 0.1\%$, ± 1 digit	40% except on 1000 V	2	80	**	** 12 1/2 7 x 8 1/2 x 11	\$580	A.c. module (6203) \$250 Counter (6202) \$210
Fairchild Model 7050	Dual slope	4	Four, 1.5-1000 V, 1-mV res. (also measures res.)	$\pm 0.1\%$, ± 1 digit	50%	6	**	**	7 4 3 1/4 x 6 1/8 x 7 1/4	\$299	Set of five current shunts \$45
Hewlett-Packard Model 3430A	Staircase ramp	4	Five, 0.1-1000 V, 0.1-mV res.	$\pm 0.1\%$, ± 1 digit	60%	2	**	90	20 9 3/4 6 1/8 x 7 3/4 x 11	\$595	Voltage ratio option (01) \$675
Hickok Model DMS-3200	Integrating	3	Five, 0.1-1000 V, 0.1-mV res.	$\pm 0.1\%$, ± 1 digit	40%	10	80	**	14 13 1/2 6 3/8 x 9 1/2 x 12 3/8	\$495	Events counter (DP-140) \$75 1-MHz counter (DP-150) \$195 Ohmmeter (DP-170) \$240 Cap. meter (DP-200) \$240
Janus Model 404	Integrating	5	Four, 1-1000 V, 0.1 mV res. (also 10- μ A range)	$\pm 0.05\%$	30%	3	50 (@ 40 Hz)	120	15 10 3 7/8 x 10 1/2 x 10 5/8	\$495	None
Simpson Model 2700	Ramp	4	Four, 1-1000 V, 0.1-mV res.	$\pm 0.05\%$, ± 1 digit	20%	0.5	**	**	12 8 4 x 8 1/4 x 11	\$550 (approx)	BCD option, cost not available
Weston Panel Meter Model 1270	Dual slope	3	Five, 0.1-1000 V (also current 10 μ A-100 mA) res. is 1/1000	$\pm 0.1\%$, ± 1 digit	50%	2	35	100	** 3 3 1/2 x 4 1/8 x 1 1/8	\$312	None

*Where applicable, price includes frame plus d.c. voltage module. **Not specified by the manufacturer.

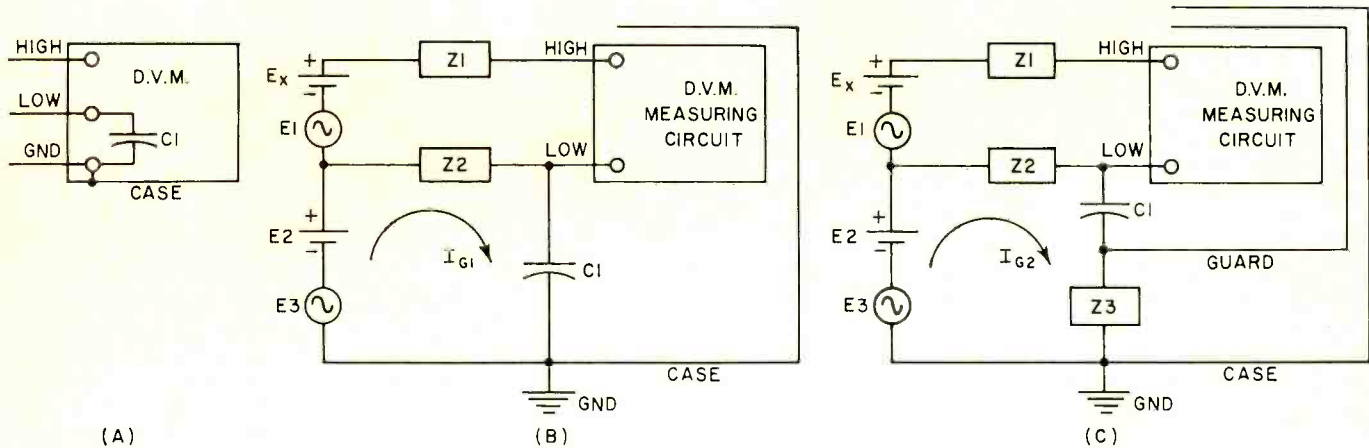

Fig. 1. (A) Typical floating voltmeter. (B) Conditions existing for measuring floating voltages. (C) Use of guard arrangement.

fied accuracy. Assume the instrument is on the 10-volt range with a full-scale accuracy of 0.1%. If the specified overrange is 60%, this means that on the 10-volt range an excess up to 60% of 10 volts (6 volts) can be applied to the meter and the reading will meet the 0.1% accuracy figure.

Resolution refers to the smallest change in input voltage that a d.v.m. can detect and indicate. It is the voltage represented by the least significant digit of the display, generally quoted for the smallest range of the instrument.

Floating voltmeters (Fig. 1A) are typical of low-priced instruments. Capacitor C1 is present to minimize hum originating in the instrument's power transformer. In making measurements with respect to ground, there are usually no problems with ground currents. Conditions existing for measuring floating voltages are shown in Fig. 1B. The d.c. voltage to be measured is E_x ; E1 is any a.c. that is in series with E_x ; voltages E2 and E3 are referred to as the *common-mode* voltages that exist above ground. The equivalent impedances of the circuit being measured are represented by Z1 and Z2. Neglecting E1, for the present, ground-loop current I_{G1} , resulting from E2 and E3, produces a voltage drop across Z2 that adds to or subtracts from E_x ; the voltage read by the meter is thus different from E_x .

In the guarded d.v.m. of Fig. 1C, the measuring circuit is enclosed in a shield or guard that isolates it from the rest of the instrument. Z3 represents the impedance (mainly stray capacitance) between the shield and instrument case. This impedance is now in series with C1; the resultant impedance is very high and the effective ground current I_{G2} is much less than I_{G1} for the floating meter. The voltage drop across Z2 is thereby greatly reduced and the voltage read by the meter is very close to the true value of E_x .

A.c. generator E1 in either Figs. 1B or 1C represents series, normal, or superimposed noise. Its rejection by the d.v.m., termed *normal-mode rejection*, is expressed in dB and relates the actual value of E1 to its value read on the meter. The larger the rejection figure, the better the meter rejects this type of noise.

The ability of the instrument to reject the d.c. common-mode source E2, is defined as the *d.c. common-mode rejection* and is expressed in dB as: $dB = 20 \log_{10} (E2/E_m)$ where E_m is the reading of the voltmeter. The *a.c. common-mode rejection* refers to the meter's ability to reject the a.c. common-mode signal, E3; it is defined by the above equation with E3 substituted for E2. In either case,

the higher the common-mode rejection figure, the less sensitive is the instrument to ground noise.

In discussing *stability*, one has to distinguish between short-term and long-term stability. The short-term variety refers to random variations in the meter reading in either the positive or negative direction. The effects of short-time stability should be included in the quoted accuracy figure for the meter.

Long-term stability refers to the inherent drift of the instrument and is equivalent to a calibration shift. For this reason, most d.v.m.'s have a front-panel calibration control. In specifying long-term stability, the degree of measurement repeatability and the length of time for which it holds should be mentioned.

Response time is the time it takes for a voltmeter to reach a reading (within its accuracy limit) to a transient input, like a step function. If the instrument uses a filter to minimize noise, the effect of the filter should be included in this specification. In an integrating-type d.v.m. without a filter, the response time is under 100 milliseconds; if a filter is used, the response time can be several hundred milliseconds.

Reading time is the time required for the d.v.m. to complete one encoding operation. The *sampling rate*, in samples per second, is the reciprocal of reading time.

Autorangeing permits the automatic selection of the appropriate input voltage range, no matter what the setting of the manual range voltage selector.

Not all manufacturers provide specifications as exactly defined as in the preceding discussion. Nevertheless, the purchaser should study the manufacturer's data and make certain the specifications are understood. If any item is not clear or is omitted, the manufacturer should be queried for the required information.

D.V.M. Types

Terms that described d.v.m. circuitry, like *ramp*, *integrating*, and *dual slope*, can be puzzling to the reader. John D. Lenk, in his article "Digital Voltmeters" in this issue, provides an explanation of the operation of various types of d.v.m.'s. Therefore, in this section only the operation of the d.v.m. types listed in Table I will be reviewed and the advantages and disadvantages of each type considered.

Perhaps the simplest and least expensive d.v.m. uses the *ramp* principle. In the voltage-to-time conversion ramp meter the length of time required for an internally generated linear ramp vol-

The Fairchild 7050 is one of the most compact of the d.v.m.'s.



tage, beginning from a known level, to become equal to the unknown voltage is measured. The internal oscillator frequency and ramp slope are adjusted to give a digital reading numerically equal to the unknown voltage. Accuracy is limited by the linearity of the ramp waveform and comparator circuits; accuracies of $\pm 0.1\%$ are typical.

A version of the ramp d.v.m. uses a staircase waveform for comparison. An oscillator is turned on at the beginning of the measuring cycle and generates a staircase waveform as well as counts. When the staircase reaches a value equal to the unknown, the oscillator turns off and the accumulated count is transferred to the display. Because the oscillator generates the staircase and counts, its stability does not affect the accuracy of the instrument. Both types of ramp generators are susceptible to input noise that may result in false triggering. A filter can be used to reject noise; however, the sampling rate of the d.v.m. is reduced.

The *integrating* d.v.m. rejects superimposed noise without an input filter. The meter measures the true average of the input voltage over a fixed encoding time and noise is thereby averaged out. In most units the unknown voltage is first converted to frequency by a voltage-to-frequency converter and counted over a fixed interval of time. In addition to noise rejection, the integrated d.v.m. is characterized by high accuracy, fast response time, and excellent resolution. Because of voltage-to-frequency conversion, problems with temperature, drift, and linearity can arise.

The *dual-slope* d.v.m. makes a two-step measurement that combines integration in the first step with automatic comparison of its internal standard in the second. The dual-slope technique rejects noise because of integration and achieves stability from comparison with its standard. The same integrator is used during both halves of the measurement cycle; therefore, the usual problems of integrators are minimized. It is only necessary for the integrator to retain the same characteristics for both halves of the measurement cycle. The dual-slope method does not lend itself to high-speed operation.

Making the Selection

There are a number of instruments available in the price range from 300 to 600 dollars (see Table 1). These instruments share many features: all-solid-state circuitry; minimum accuracy of $\pm 0.1\%$, ± 1 digit; the display is easy to read; overload protection; and fine workmanship and styl-

Not shown on the cover is this Electrolab Model 100.



Several of the instruments use plug-ins in order to increase their capabilities. Here are the plug-ins for the Hickok Model DMS-3200 digital measuring system.

ing. Their differences lie in such matters as overrange; calibration method; storage hold capability; and available accessories. The writer had a chance to check out many of the instruments listed in Table 1 and all performed to specifications.

With the exception of the *Hewlett-Packard* and *Fairchild* instruments, the units in Table 1 have front-panel calibration controls. In the *Fairchild* meter, automatic comparison of the unknown voltage to an internal reference is made during each measurement. *Hewlett-Packard* uses a zener diode with a well-defined drift characteristic that permits a guaranteed meter accuracy for a 90-day calibration cycle. At the end of this period the instrument may have to be calibrated, requiring a differential voltmeter and a d.c. standard. Although a front-panel calibration control is convenient, there is the tendency for the user to check the calibration continuously and waste time.

Storage hold permits the retention of a voltage reading on the display after the voltage has been removed from the instrument input terminals. This feature also eliminates possible blinking in the least significant digit. Storage hold is the limiting position of the front-panel variable display time control of some instruments. Variable display enables the user to adjust the rate the indica-

tors read voltage changes.

The *Digitec (United Systems) Model 252* d.v.m. comes with a carrying handle that also serves as a tilting stand. Using the ramp principle, four ranges (2 to 1000 volts) with a constant input impedance of 10 megohms are available. Resolution is 1 mV on the 2-volt range and full-scale accuracy is $\pm 0.05\%$, ± 1 digit. The unit features automatic polarity indication and selection, variable display time and storage hold, and BCD output. The voltage ranges are chosen by a push-bar switch; if the impressed voltage is greater than the overrange, the display is extinguished.

Electrolab's Model 100 d.v.m. is the only unit listed in Table 1 that has autoranging as an optional feature and a guarded circuit. Equipped with a handle that is also a stand, this instrument is an integrating-type meter. Four ranges from 1 to 1000 volts at a constant input impedance of 10 megohms can be selected. Resolution is 1 mV on the lowest scale; full-scale accuracy is quoted at $\pm 0.1\%$, ± 1 digit. Polarity selection and indication are fully automatic; overload is indicated by the flashing of the polarity symbol.

Electronic Associates Inc. (EAI), a manufacturer in the analog computer field, has made its debut in the low-priced meter field with its Series 6200 integrating-type d.v.m. The instrument has five voltage ranges from 100 mV to 1000 volts at 10-megohm constant input impedance. Full-scale accuracy is $\pm 0.1\%$, ± 1 digit; resolution is 0.1 mV. Available modules are a digital counter (measures frequency up to 10 MHz and time intervals of 1 μ s) and an a.c. module (four scales, 1 to 300 volts r.m.s., $\pm 0.2\%$, ± 1 digit accuracy from 20 to 20,000 Hz and $\pm 0.3\%$, ± 1 digit from 10,000 to 100,000 Hz). Because the unit holds any two modules at a time, the Series 6200 d.v.m. is the largest of the instruments listed in Table 1. Variable display time and storage hold, automatic polarity selection and indication, and an overload indicator light are other features found in the EAI unit.

Fairchild's Model 7050 digital multimeter permits d.c. voltage and resistance measurements. Optional low-cost shunts extend the instrument's capability to d.c. current mea-

surements. Using the dual-slope technique, four ranges from 1.5 to 1000 volts with 1-mV resolution can be selected; full-scale accuracy is $\pm 0.1\%$, ± 1 digit. The input impedance is greater than 1000 megohms on the 1.5-volt range and is 10 megohms on the other ranges. Resistance measurements can be made by selecting one of the five full-scale ranges from 1500 ohms (1-ohm resolution) to 15 megohms. On the kilohm ranges the accuracy is $\pm 0.2\%$, ± 1 digit; the accuracy for megohms is $\pm 1\%$, ± 1 digit. Using current shunts, full-scale readings of 150 μA to 1.5 A are possible; tolerance for the 1.5-A shunt is $\pm 0.3\%$, the others $\pm 0.1\%$. Storage hold is provided by a separate pair of terminals on the panel.

Using the staircase ramp method, *Hewlett-Packard's* Model 3430A d.v.m. offers full-scale accuracy of $\pm 0.1\%$, ± 1 digit on all five ranges from 100 mV to 1000 volts at 10-megohm input impedance. Resolution on the lowest scale is 0.1 mV. Polarity indication is automatic and overload is indicated by a blinking display. A precision 0.1% d.c. output amplifier at the rear panel can be used while making measurements or drive a d.c. recorder. An annunciator indicates if volts, millivolts, or ratios are being measured. Display time is fixed and no storage hold is provided. A voltage ratio option is available that permits the measurement of ratios of an unknown to a reference voltage from 0.0001:1 to 1000:1. The front panel is strikingly simple, having two controls—an "on-off" switch and range selector.

The digital instrument with the greatest number of available plug-in modules is *Hickok's* Model DMS-3200 digital measuring system. With appropriate modules, d.c. voltage, resistance, capacity, and frequency can be measured. It is expected that plug-ins for a.c. voltage and current will soon become available. The basic 3200 frame used with the integrating-type DP-100 plug-in becomes a digital voltmeter. Five scales from 0.1 volt (0.1-mV resolution) to 1000 volts at 10-megohm input impedance and $\pm 1\%$, ± 1 digit full-scale accuracy are available on a 3-digit display. Overload indication, variable display time and storage hold, automatic polarity indication, and wrong polarity indication are provided.

Using the DP-170 plug-in, resistance measurements from 10 ohms (0.05-ohm resolution) to 1000 megohms in nine ranges can be made. A Wheatstone bridge with internal automatic nulling is used; accuracy is $\pm 0.2\%$ of reading and $\pm 1\%$ above 10 megohms. Capacity measurements with the DP-200 module can be made in eight ranges from 1000 pF to 10,000 μF . A bridge compares the stored charge of the unknown capacitor with that of a precision internal standard capacitor. Accuracies are $\pm 0.1\%$ full scale ± 2 pF; for the highest range, accuracy is $\pm 0.5\%$ of reading.

The DP-150 plug-in provides numerical display of frequencies from 10 Hz to 1 MHz in five ranges; accuracy is $\pm 0.005\%$, ± 1 digit. Used singly in the main frame, the DP-140 plug-in permits straight counting of incoming pulses up to 1 MHz; operating as a slave, the DP-140 can be driven from the main frame and a DP-150 frequency counter is made to provide full 6-digit display.

Janus has brought out an integrating-type 5-digit d.v.m. (Model 404) with $\pm 0.05\%$ full-scale accuracy. Four voltage ranges from 1 to 1000 volts at an input impedance of 10 megohms with full-scale resolution of 0.01% and a 10- μA current range can be selected. The 10- μA range permits direct reading in engineering units, of temperature in degrees, pressure in psi, etc., of transducer outputs. Other features include variable display time, storage hold, and BCD output. *Janus* plans to add resistance, a.c. voltage, and other modules.

Simpson has recently unveiled its Model 2700 ramp-type d.v.m. which supersedes its Model 111 meter. Using 90% integrated circuits, the 4-digit instrument has $\pm 0.05\%$, ± 1 digit full-scale accuracy on all four ranges (1 to 1000 volts) at an input impedance in excess of 10 megohms; resolution

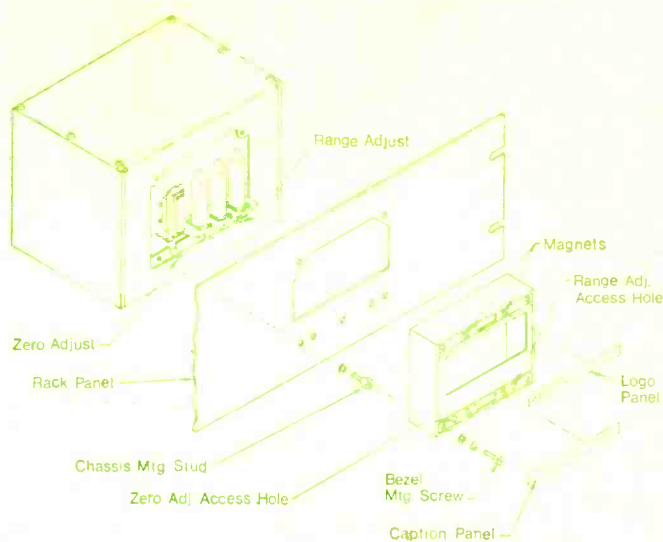

Fig. 2. Method of panel-mounting the Weston digital panel meter.

on the lowest scale is 0.1 mV. Automatic polarity and over-range indication, variable display time, and storage hold are supplied. As an option, BCD output at T²L logic levels is available. *Simpson* plans to make available plug-in modules for a.c. voltage and resistance measurements sometime early in 1968.

Aimed at the OEM market, *Weston* is offering a digital panel meter (Model 1270) that uses more than 50% integrated circuitry (Fig. 2). Standard d.c. ranges available are from 0.1 to 1000 volts and from 10 μA to 100 mA with an accuracy of $\pm 1\%$, ± 1 digit; resolution is 1 part in 1000. Input impedance on the 0.1- and 10-volt ranges is 10,000 ohms; on the other ranges it is 1 megohm. Dual-slope integration is used in this general-purpose 3-digit readout instrument. Other features include automatic indication for over or under range, slope adjustment for direct reading in engineering units, and BCD output.

Summary

The trend will be toward digital-readout instruments; their superior accuracy and simplicity of use surpass that of analog meters. With the increased use of integrated circuits and their declining cost and automatic manufacturing techniques, the cost of digital-readout instruments may become somewhat more comparable to analog meters in the not-too-distant future. ▲

Table 2. Listing of manufacturers' addresses for further details.

Electrolab Inc. 18271 Parthenia St. Northridge, Calif. 91324	The Hickok Electrical Instr. Co. 10514 Dupont Ave. Cleveland, Ohio 44108
Electronic Associates, Inc. Instrument Div. Long Branch, N.J. 07764	Janus Control Div. 296 Newton St. Waltham, Mass. 02154
Fairchild Instrumentation 475 Ellis Street Mountain View, Calif. 94040	Simpson Electric Co. 5200 W. Kinzie St. Chicago, Ill. 60644
Hewlett-Packard Loveland Div. P. O. Box 301 Loveland, Colo. 80537	United Systems Corp. (Digitec) 918 Woodley Rd. Dayton, Ohio 45403
	Weston Instruments, Inc. Weston-Newark Div. 614 Frelinghuysen Ave. Newark, N.J. 07114



RECENT DEVELOPMENTS IN ELECTRONICS

Long-Life Gas Laser. (Top left) Looking like a double-barreled ray gun, this is the first long-life gas laser to become commercially available for producing intense beams of ultraviolet light continuously. The device is water-cooled, d.c.-excited, and uses neon gas to produce an output of up to 10 milliwatts of UV power concentrated in a 1-mm diameter invisible beam. Up to 1000 hours of continuous operation are produced by the new RCA laser. It is expected to find important uses in the biomedical field, industrial and chemical processing, drug and pharmaceutical manufacture, and in the photographic and copying industries. Heart of the laser is a sealed quartz tube (at right in photograph), filled with the neon gas, from which the intense UV beam is emitted.

Helicopter Installs Communications Antenna. (Top right) Acting as an airborne crane, an S-58 helicopter solved a three-day lifting problem in approximately five minutes. The helicopter, owned by Keystone Helicopter Corp., was used to lift a 62-foot, 1-ton communications antenna and mast to the roof of a 20-story telephone company building in Newark, N.J. The antenna was lifted from a truck in an adjacent parking lot. The communications mast will be part of a unique telephone network that will provide telephone communication for the new high-speed, 150 mi/h trains which will be operating between New York and Washington, D.C. With this system, passengers will be able to push-button dial and make phone calls to any part of the U.S.

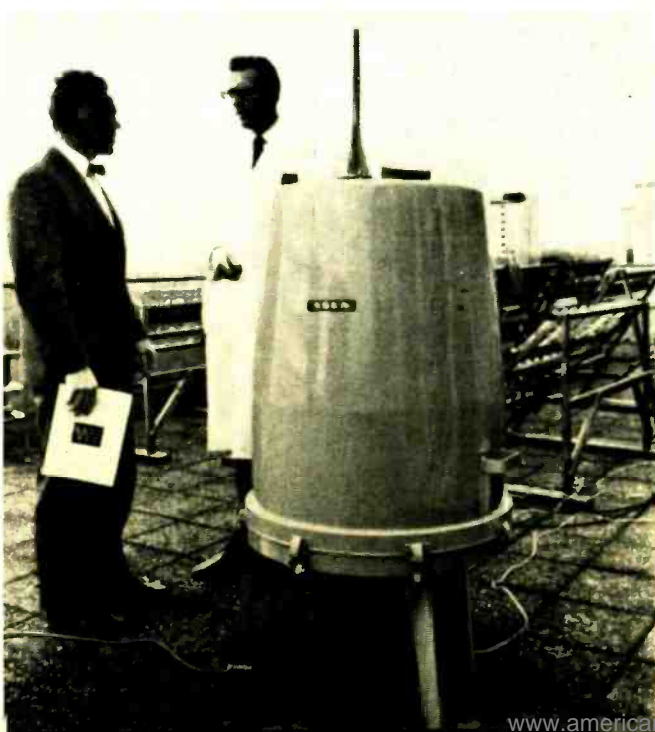

Laser Measures Airport "Ceilings." (Left) Completely automatic laser equipment for measuring the height of the "ceiling" at airports or other locations is being delivered by the Swedish firm ASEA to that nation's Board of Aviation. The equipment not only measures the distance from the ground to the cloud-base but also provides information about the thickness and structure of the clouds. The laser sends an ultra-short (25 ns) light pulse straight up and measures the elapsed time for the receipt of the echo from the cloud layers. Cloud ceilings of 5 miles or more can be measured. The mean height of the layers is registered every minute. Along with a recorder, a scope indicator shows received echo pulses.

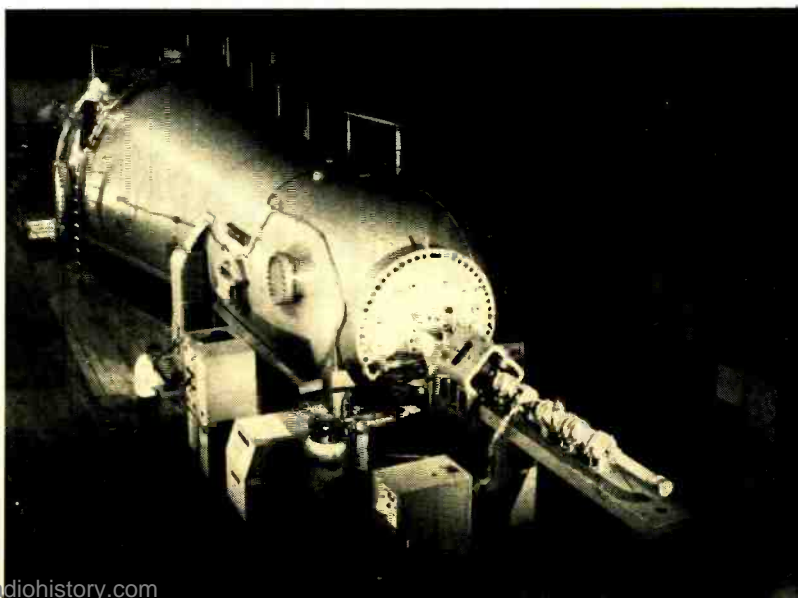
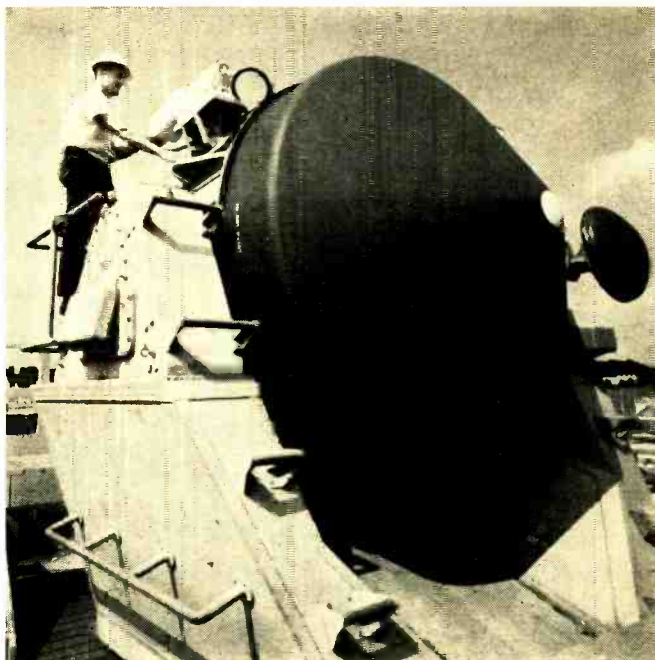
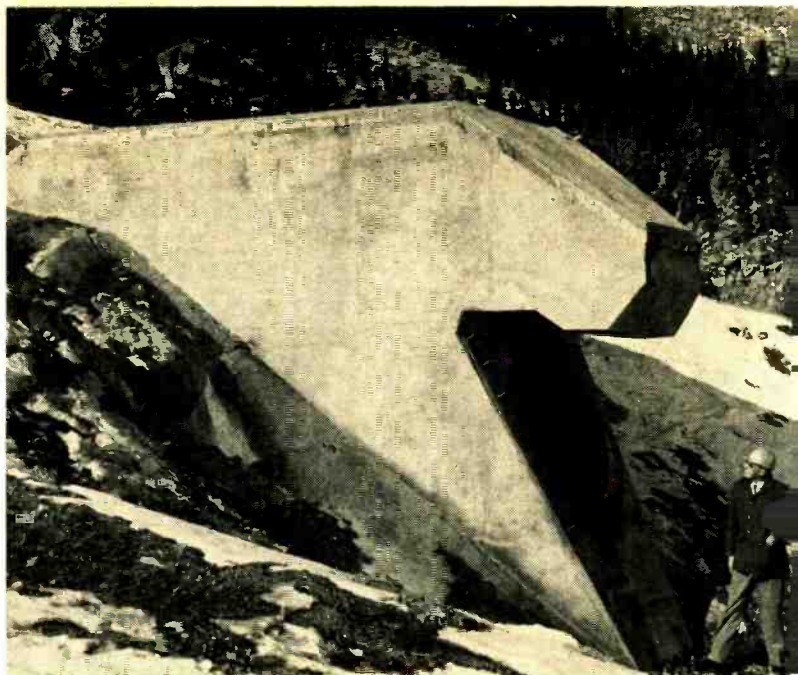

Scale-Model Radar Antenna Tests. (Top left) A one-seventh scale model of Boeing's design for the U.S. Air Force's Airborne Warning and Control System is shown here undergoing tests on the company's new 5000-foot antenna range at Kent, Wash. On the tower, the aircraft, a model of a long-range 707-320 Intercontinental, is moved through various attitudes while its extensive antenna array receives signal from a transmitter nearly a mile away. The model is rotated about its yaw and pitch axes and its yaw and roll axes. Precise measurements are made of the quality of antenna reception.

Blast-Proof Antenna. (Top right) This single-eyed structure, high on the steep slopes of Cheyenne Mountain near Colorado Springs, looks out over eastern Colorado plains. It is a blast-resistant radio antenna and the messages it picks up are channeled to the North American Air Defense Command's Combat Operations Center several hundred feet below and inside the mountain. There are two microwave antennas and they are part of the center's communications link with outside world. Building of the two structures used 12,000 hundred-pound bags of concrete and 60 tons of reinforced steel.

TV-Aided Fire-Control Radar. (Center) Technician is shown here checking the television camera during tests on one of the SPG-55B fire-control shipboard radars now being refurbished. The radars are being improved by installation of new computers. The fire-control radar, being updated by Sperry Rand, is a part of the Terrier surface-to-air missile system installed aboard two of the Navy's guided-missile frigates. The TV camera shows the radar operator the target being tracked.

Giant Van de Graaff Accelerators. (Below right) This is the first of two Van de Graaff accelerators that will make up High Voltage Corporation's nuclear physics research facility at Burlington, Mass. The machine is 81 feet long, 18 feet in diameter, and weighs 180 tons. A second, more powerful accelerator will be mated to this unit by 1970. The two machines, working in tandem, will then allow physicists to create elements that are far heavier than those occurring in nature. The experiments could lead to uranium fusion and firmly establish U.S. prominence in transuranium research.

low-cost Capacitive- Discharge Ignition System



By BILLY F. CAWLFIELD

Circuit details and performance of a simple, non-critical capacitive-discharge system that will cut ignition-system maintenance and give the old car new pep.

THE capacitive-discharge system seems to be well-established as a most satisfactory electronic ignition system. The CD type provides engine performance equal to or better than other systems and, in addition, requires less input current than a transistor switching system. One great advantage is that it uses the conventional coil and distributor so there is no need to buy a new, expensive ignition coil. Also, since all the components of a conventional ignition system are still installed in the car, a "back-up" system is available simply by reconnecting the coil and distributor in the conventional circuit. With a changeover plug, switching from capacitive discharge to standard ignition is as quick as raising the hood and closing it. With a changeover switch, you can go all the way and mount the switch inside the car where it can be reached while driving.

The electronic system should outlast several cars as it contains no tubes or electrolytic capacitors, and nothing to wear out, burn out, or ravel at the seams.

Basic Circuit Arrangement

The basic circuit of the system described here is not new nor novel, so its main claim to fame is its low cost and the use of common, readily available parts. Many of the parts will be found in the junk box and, even if all the parts are purchased new, the total cost will not be much more than about \$20 at mail-order prices. A big saving is effected by using a filament transformer in the d.c.-to-a.c. inverter circuit. This transformer is not as efficient as the special types designed for this application, but it performs satisfactorily and the cost is much lower. This system will draw slightly more primary current than a system using a specially de-

signed transformer, but this extra load is an insignificant portion of the total load on the automobile electrical system and the maximum current is still much lower than a transistor switching system.

With the ignition on and the engine not running, the primary current at 12 volts input is about 1.4 amperes, rising to about 3.6 amperes at 4500 r/min for an 8-cylinder engine. The exact current drawn will vary from one car to another, depending on the value of the ballast resistor, which is part of the original ignition system.

In the conventional ignition system, Fig. 1, the primary current flowing through the ignition coil and the distributor points stores energy in the inductance of the coil. When the points open, this stored energy is released into an oscillatory circuit formed by the coil inductance and the distributor capacitor. The peak voltage in this circuit rises to about 200 to 250 volts and, multiplied by the turns ratio of the ignition coil (actually it is a transformer), produces about 15 to 20 kilovolts to fire the spark plugs.

This system is delightfully simple and this simplicity is the main reason for its continued use for so many years. However, there are certain weaknesses as well. At high speeds there is not sufficient time between firings to store maximum energy in the inductance, so the high voltage begins to fall off as the speed is increased. Also there is a nice fat arc generated each time the points open so the contact surfaces are burned away and eventually must be replaced. Even a little burning of the contacts reduces the over-all efficiency of the ignition system and really top performance can be realized for only a short time after a tune-up.

The switching-transistor system operates on the same principle, with a transistor switching the primary current and the distributor contacts handling only the base current of the transistor. The distributor contacts are relieved of almost all load so the arcing problem is solved, but the transistor is subjected to the high voltage developed by the coil primary. So to reduce this voltage to a tolerable level, a new low-inductance coil is used, which causes the primary current to be greatly increased, which in turn creates other

Fig. 1. Circuit arrangement of conventional ignition system.

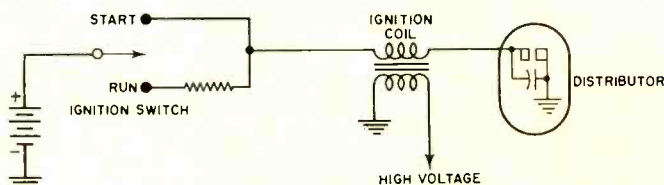

problems. In some cars the ignition switch cannot handle this heavier current so a bypass relay must be installed and, if the ignition is left on with the engine not running, the high-priced low-inductance coil may be scorched (unless some fancy protective circuitry is provided).

In the capacitive-discharge system, Fig. 2, energy is stored in a capacitor which is then discharged into the ignition coil through an SCR, now called a *thyristor*. The energy-storage capacitor and the coil form an oscillatory circuit in which the peak voltage is the voltage to which the capacitor was initially charged. Using the coil which is part of the conventional ignition system, a significant increase in spark-plug voltage can be realized if the capacitor is charged to about 350 to 400 volts. This voltage can be easily generated with a solid-state d.c.-to-d.c. converter. The thyristor is triggered by the distributor points which carry only about ¼ ampere at 12 volts.

Circuit Design & Operation

A complete schematic diagram and parts list are shown in Fig. 3. The two transistors, Q1 and Q2, and the transformer T1 comprise a d.c.-to-a.c. inverter, with a square-wave output of about 400 volts peak. This square wave is rectified by the bridge rectifier, D1, D2, D3, and D4, and charges capacitor C2 to about 400 volts d.c. The charge on C2 is the stored energy which is used to excite the ignition coil and fire the spark plugs. When C2 is charged to 400 volts, the energy stored is about 80 millijoules, which is more than twice the amount generally considered to be required for automotive ignition.

When the distributor points open, the thyristor, SCR1, is fired and becomes virtually a short circuit so C2 and the ignition coil are connected together. This oscillatory circuit is excited by the energy stored in C2 and the secondary of the ignition coil produces about 30 kilovolts. The thyristor also shorts the output of the power supply and stops the inverter. When the current in the oscillatory circuit reverses, the thyristor, SCR1, turns off and the diode bridge provides a path for this reverse current, which recharges C2 to about 200 volts. At this time the inverter restarts and continues charging C2 up to 400 volts, ready for the next firing.

Now let's take a closer look at the thyristor gate circuit. We need a short trigger pulse so it will be ended well before positive voltage is again applied to the anode of the thyristor. And we need some way to prevent point bounce from falsely triggering the thyristor. In Fig. 3, when the points are closed, about ¼ ampere flows through R8 and the points. This current is sufficient to keep the points clean but not burn them. The 50-ohm resistor also provides a relatively low impedance source for driving the thyristor gate.

When the points open, the voltage at the junction of R7 and R8 rises abruptly to +12 volts, diode D5 is forward-biased, and a trigger pulse is passed through capacitor C3 to the gate of the thyristor. Capacitor C3 is charged quickly through R8 and the parallel combination of R5 and the thyristor gate so the trigger pulse is very short. When the points close, diode D5 becomes reverse-biased and capacitor C3 discharges slowly through R7, a 3900-ohm resistor. Any point bounce occurs while C3 is still almost fully charged so these false pulses are not passed on to the thyristor.

Construction & Installation

Construction and installation of this system are not at all critical. Only one restriction needs to be mentioned: try to avoid mounting any parts near the exhaust manifold. Almost any other location under the hood will be satisfactory. The system has been tested in an environmental chamber to 160° F, which is representative of the maximum temperatures encountered under the hood.

The transistors require a heat sink and the maximum temperature to be expected will determine the size of this

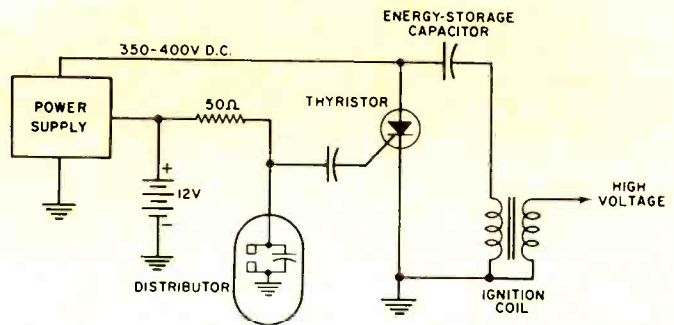
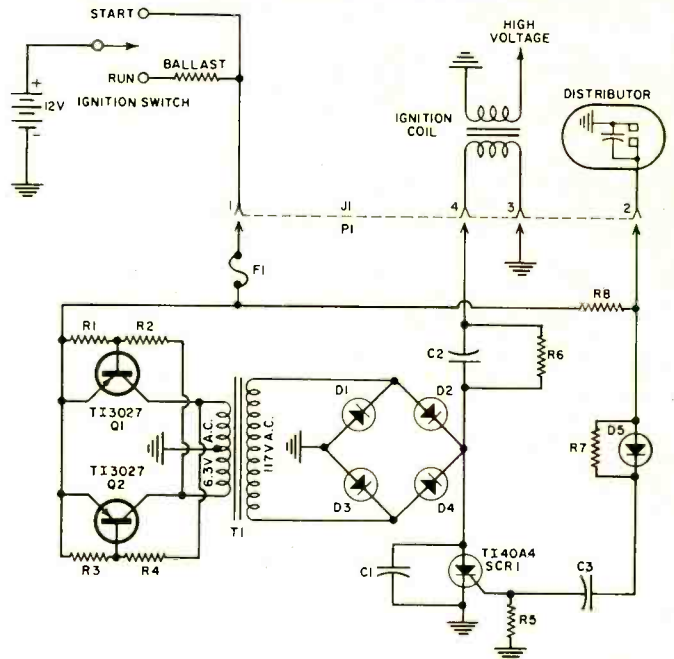

Fig. 2. Simplified diagram of capacitive-discharge system.



- | | |
|-------------------------------------|--------------------------------------|
| R1, R3—39 ohm, 2 W res. ±10% | no. 91-MPF4S) |
| R2, R4—250 ohm, 5 W res. (IRC PW-5) | P1, P2—4-pin male connector (Amphe- |
| R5—100 ohm, ½ W res. ±10% | no. 91-MPF4S) |
| R6—470,000 ohm, ½ W res. ±10% | T1—6.3 V filament trans. @ 6 A, c.t. |
| R7—3900 ohm, ½ W res. ±10% | (Stancor P6456) |
| R8—50 ohm, 5 W res. (IRC PW-5) | D1, D2, D3, D4—750 mA, 600 p.i.v. |
| C1—0.01 μF, 600 V capacitor | silicon diode (TI1N2071 or 1N4385) |
| C2—1.0 μF, 600 V capacitor | D5—1 A, 50 p.i.v. silicon diode (TI |
| C3—0.25 μF, 25 V capacitor | 1N4364 or 1N4001) |
| F1—6¼ A 3AG fuse ("slow blow") | SCR1—5A, 400 V thyristor (TI 40A4) |
| J1—4-pin female connector (Amphe- | Q1, Q2—7A, 45 V economy germa- |
| | nium power transistor (TI 3027) |

Fig. 3. Complete schematic and parts list for CD system. Parts above J1, P1 are those of the car's existing ignition system.

heat sink. If there is sufficient room in front of the radiator, the system can be mounted there where the cool air available will require only a ¼" aluminum flat plate of about 6 × 6 inches for the transistor heat sink. If space in front of the radiator is limited, the transistors can be mounted there on a flat plate and the remainder of the components mounted in the engine compartment. If it is absolutely necessary to mount the transistors in the engine compartment (or if you just want to), be sure to use a heavy finned heat sink of ample capacity, such as the *Thermalloy* 6123B. Whatever construction and mounting you use, it will be best to mount the transistor heat sink separately from the rest of the components so as not to pick up heat from the transformer and resistors.

As mentioned earlier, the transformer used here is not the most efficient type for this application and the excess power consumed shows up as heat in the core. After the ignition has been operating for a while, you will notice that the core is warmer than the winding. This type of core is not the best for saturating service in a d.c.-to-d.c. converter, but it is economical and that's a "plus."

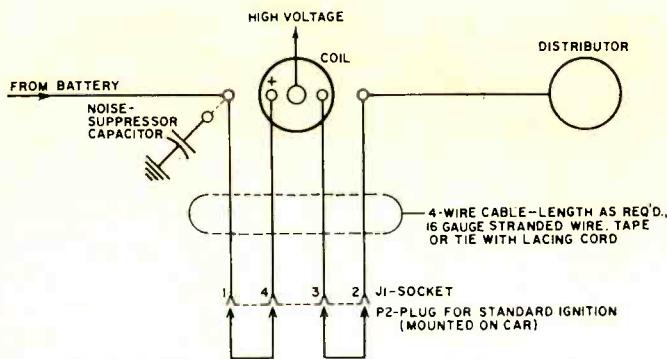

Fig. 4. Wiring for the changeover-to-standard-system plug.

Be sure to insulate the transistors and thyristor with the insulating hardware supplied with these devices. And if you have some silicone grease handy, smear a thin coat of it on both sides of the insulating washers. If you use a home-made transistor heat sink of plain aluminum, you can increase its heat radiation by spraying a *thin* coat of flat black paint on both sides. And a little extra spray around the transistor terminals will provide all the waterproofing necessary. Moisture on the transistor heat sink really is no problem because only low-voltage, low-impedance circuits are exposed.

All the other components can be mounted in whatever box or chassis is handy. The author's first unit was built in a 4" x 5" x 6" utility box, which proved to be considerably larger than necessary. The second unit was built in a 3" x 4" x 6" aluminum chassis and that is still quite roomy. Whether you use a printed-circuit board or point-to-point wiring, take time to mount all parts securely and to make good solder joints, because in an automobile there is plenty of vibration.

The thyristor stud will have about 400 volts on it so if you mount it through the side of the box or chassis with the stud exposed, insulate it in some way, such as with a plastic cap or a rubber grommet. That 400 volts could be dangerous, or at least if you bump into it you may make a dent in the fender with your elbow.

The parts specified in the parts list are intended only as a guide and any other manufacturer's parts of equal or higher rating will do just as well. Parts placement in the unit is not critical. Don't try to skimp by leaving the fuse and fuse holder out. Most cars have no fuse or other protection in the ignition circuit, so if a transistor should develop a short, something would be damaged.

After you have your box or chassis stuffed with all the components, make up a 4-wire cable, as shown in Fig. 4, long enough to reach from the ignition coil to the location you have selected for the electronic unit. Attach ring-type terminals to the wires at the coil end or form the bare end of each wire into a loop and tin with solder. Disconnect the existing wires from the coil, then connect the new cable to the coil and to the wires which you just removed from the coil. Use machine screws, flat washers, and nuts to connect the new cable to the old wires, then cover with electrical tape. If there is a noise-suppressor capacitor connected to the coil, connect it with the battery wire to the wire in the new cable going to pin 1 of J1.

The plug, P2, is wired with short jumpers to reconnect the wiring in the conventional ignition system and should be mounted on the car near the new electronic unit. A similar plug, P1, connects to the electronic unit and can be mounted directly on the unit or on the end of a short cable. If you prefer a 4-pole, double-throw switch instead of the changeover plug, it is a good idea to still use a plug and socket for connecting the electronic unit so it can be easily removed for testing. Make a good ground connection to the unit; if you mount it with self-tapping sheet metal screws that will take care of it.

The wiring shown in Fig. 4 results in high-voltage polarity the same as the original. If you want to check the polarity, disconnect the wire from one spark plug and place the wire terminal about 1/2" from the engine or chassis. With the engine running, hold the point of a wooden pencil in the path of the spark and note that on one side of the pencil point the spark has a more orange, flaring appearance. If the orange flare is between the pencil and the engine, the polarity is negative, which supposedly is correct. However, in the author's cars changing polarity makes no noticeable difference in performance. But watch out for that pencil; the high voltage tends to run up the pencil lead and grab you. It would be a better idea to hold it with a wooden clothespin or insulated pliers.

Performance

Ready to try it out? All connections checked and secure? Now turn on the ignition switch and listen for a singing sound in the electronic unit. That's the inverter making beautiful music. So hit the starter and you're in business. Now that you have satisfied yourself that it really works, go over the whole ignition system and prepare to forget it for a long time.

Clean up the points with a stone or point file and set them to the auto maker's specifications. The point gap for the capacitive discharge system is not critical, just so they open, and dwell really has no meaning now but just in case you want to go back to standard ignition for some reason, the points will be ready. Set the timing to the manufacturer's specification, running on standard ignition. Check the plugs and clean them or replace them if they are really fouled. Some "authorities" say to open up the plug gaps to 0.050" to 0.065", others say to set them to the usual 0.03". Both extremes were tried in the author's cars and both seemed to perform the same.

Now switch to the electronic ignition. With a timing light the timing will probably check the same, but the timing mark will appear much sharper and clearer because the high-voltage pulse is shorter and there is no jitter. The capacitive-discharge system fires slightly earlier because the voltage rises to a higher peak value and thus reaches the firing voltage of the plug sooner. This advance amounts to less than one degree of crankshaft rotation at idling speeds so it will not be noticeable with a timing light. At higher speeds this fixed time advance can amount to several degrees and, in some cars, may result in a little too much "knock" or "ping." If you don't like what you hear, just retard the distributor timing slightly.

The author's first unit has been running for over 17,000 miles with no malfunctions of any kind. The points appear clean and smooth as at the beginning and the gap has not changed any measurable amount. The rubbing block is nylon, as it is in most point sets now, so a set of points could be expected to last the life of the car. One or two gap adjustments during this life might be necessary, but point replacement appears to be a thing of the past. Spark plugs appear to last longer and certainly can be used longer since the higher voltage will fire plugs that would be completely unusable in a standard ignition system.

The top speed of this system is about 500 pulses per second, since it takes about 2 milliseconds to recharge the storage capacitor. That speed will get you 7500 r/min with an 8-cylinder engine and 10,000 r/min with a six. If that isn't fast enough, you'll have to get one of the special inverter transformers so that the inverter can run at a higher frequency.

The next logical evolutionary step is to replace the distributor points with a magnetic pulse generator and then there would be no maintenance except replacing plugs every 50,000 miles or so. But the magnetic pulse generator would require a major mechanical change in the distributor, so for now we'll have to settle for "halfway to heaven." ▲

Aligning FM-STEREO Receivers Without a Generator

By HUGH L. MOORE

District Coordinator of Electronic Education
Los Angeles City Schools

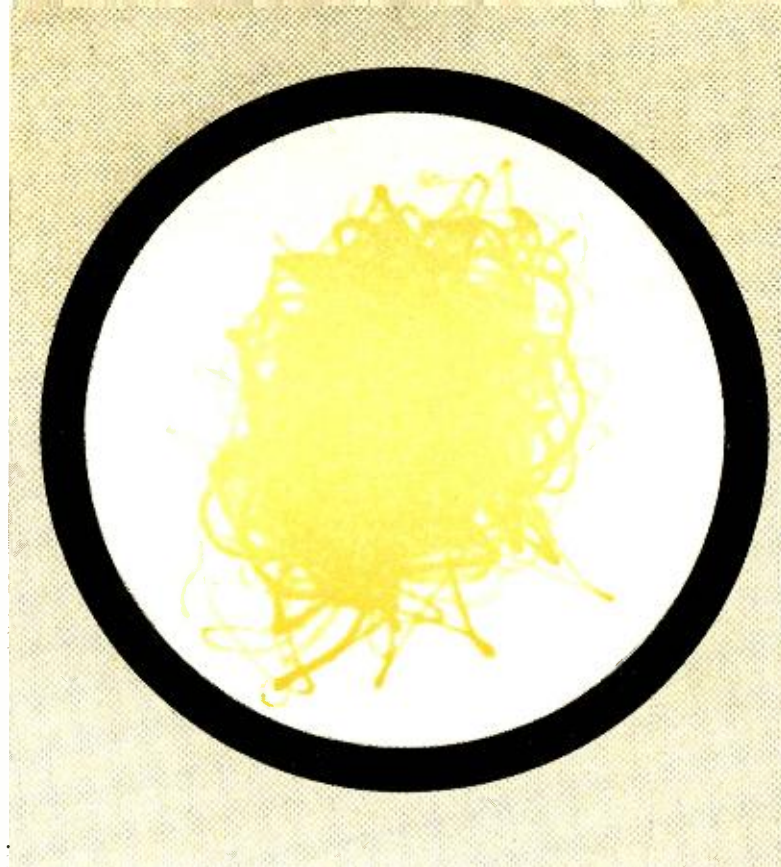

Well-balanced stereo scope pattern after a thorough alignment.

This method is fast, accurate, easy to learn, and requires only the use of an oscilloscope and received FM signals.

WE are all accustomed to judging stereo performance by ear, but viewing stereo on an oscilloscope can give us a great deal more information about the multiplex signal. If we connect the left (L) and right (R) signals to the Y (vertical) and X (horizontal) axes on the oscilloscope, we can examine balance, phase, and separation.

With a little practice, we can identify the multiplex sub-carrier and align and check the multiplex carrier amplifier. By aligning with the very accurate signals transmitted by an FM-stereo station, with its highly controlled level of modulation, we avoid the whole problem of an incorrectly calibrated multiplex signal generator. This technique has a number of important advantages.

Stereo is basically a system where two separated microphones are used to record or broadcast a program. Stereo music constantly reflects the difference in position of the two microphones. There is a volume and a phase difference between the two signals. Orchestral recordings have certain instruments audible on one channel and not the other. Some instruments will record on both channels equally, if they

are equidistant from both microphones. Still other instruments, at various locations throughout the orchestra, will be recorded on both channels, but with phase and volume differences. The extent of the ability of a stereo system to reproduce sound on one channel and not on the other is referred to as the stereo "separation."

"Watching" Stereo Sound

The following test setup will allow you to measure how well your stereo system is responding to a given recording. Adjust the scope so that both vertical and horizontal amplifiers are in a.c. position. Connect the left channel of your pickup or left preamp output to the vertical input and jumper the vertical and horizontal inputs together. Set the horizontal gain to maximum. Play a recording. Adjust the vertical gain until the line on the scope appears to be at a 45-degree angle. Remove the jumper between the two input connections. Connect the right channel of your pickup or preamp to the horizontal input. If you then play a mono record, the pattern on the scope should still be a 45-degree

Fig. 1 Mono music makes single 45-degree line.



Fig. 2. Stereo forms a more circular pattern.



Fig. 3. L-channel predominates in this trace.



Fig. 4. Mainly R-channel signal produces this.



line (Fig. 1). If the two outputs are unequal, the line will shift from the 45-degree angle. A slight adjustment in the balance control of your preamp will compensate for most minor imbalances.

When a stereo record is played, other patterns will appear on the scope screen. If the passage is of equal volume in both channels, the pattern will appear as in Fig. 2. Notice that the pattern is symmetrical around a center. If the record and the system have good separation and mainly the left channel is active, the pattern will look like Fig. 3—more height than width. Good separation with sound mainly in the right channel will make a pattern like Fig. 4—more width than height. These basic patterns can be used to align multiplex units and troubleshoot stereo equipment.

For example, suppose the complaint against a stereo unit is that left-right separation is poor. A signal in both channels produces an echo effect, but little or no sound distinctly from either speaker. Start by connecting the vertical input of the scope at the input of the left channel and the horizontal to the input of the right. One of the patterns showing phase difference will appear. Move the scope input connections on through subsequent stages until the point is found where stereo appears as mono on the scope (Fig. 1). This is where the two signals are combining into a common signal. The trouble could be caused by an open bypass capacitor which is common to both channels, or even a circuit board that is leaking between the two channels.

FM-Stereo Multiplex Alignment

When FM stations broadcast stereo multiplex, the left and right audio channels (L+R) are combined and modulated directly. A suppressed-carrier sideband signal is also modulated on the station signal; the sidebands contain a subtractive combination of the audio channels, called L-R. A 38-kHz carrier must be added at the receiver to reconstruct the L-R information. A 19-kHz pilot or control signal is transmitted by the FM station. The multiplex receiver doubles the pilot frequency to construct the 38-kHz carrier signal.

When the recovered L-R is properly combined with the L+R, the separate left- and right-channel sounds will be reconstructed. The correct amount and phase of each L-R and L+R signal is applied to a matrix which adds in-phase and cancels out-of-phase audio components. The result is that the R signal is canceled in the left channel and

the L signal canceled in the right. Reconstructed L and R signals are now available for the stereo audio amplifiers that are used.

The multiplex signal can be used to align the coils and controls of a multiplex receiver (Figs. 5 and 6). Since all stations do not broadcast stereo constantly, a check with your oscilloscope will tell you when you are receiving multiplex. The scope is adjusted for a low-frequency sweep and the vertical amplifier connected to the output of the ratio detector (points A on both schematics). When a station is tuned in which is not broadcasting multiplex, the audio will appear as a clean single line (Fig. 7). A multiplex broadcast will give a ribbon-like appearance to the line (Fig. 8), due to the 19-kHz and suppressed-carrier signals. (The 67-kHz signal for background music or SCA will also give this pattern. You can identify these signals by trial-aligning the 67-kHz trap.) Perform the alignment on a station without SCA.

In receivers, two types of multiplex carrier generators are used. The older type uses a 19-kHz oscillator; its output is synchronized with the station's pilot signal and then doubled to 38 kHz. This type produces a visible heterodyne beat when it is adjusted off frequency. The newer type merely amplifies the 19-kHz signal sent out by the FM station and doubles it.

The first step is to align the 19-kHz and 38-kHz coils. The results of alignment are observed with the scope adjusted for a 9.5-kHz sweep. The vertical amplifier is connected through a low-capacitance probe to the output of the 38-kHz amplifier (points B in Figs. 5 and 6).

Adjust all the coils, except the 67-kHz trap, for maximum output as indicated by the pattern height on the scope. If a low-frequency beat is noticeable, one of the 19-kHz coils must be readjusted for zero beat.

The 67-kHz trap is the one with the smallest coil (fewest turns) and should be adjusted for *minimum* output when the receiver is tuned to a station broadcasting SCA. This trap prevents a heterodyne squeal that can develop between harmonics of the 19-kHz receiver oscillator and the 67-kHz SCA subcarrier.

At this point make sure the doubler is not tripling. The scope is already connected to point B. Carefully adjust it to show a stable pattern of four sine waves with a low setting of the scope sync control. Then move the low-capacitance probe back to the output of the 19-kHz stage (points C). If

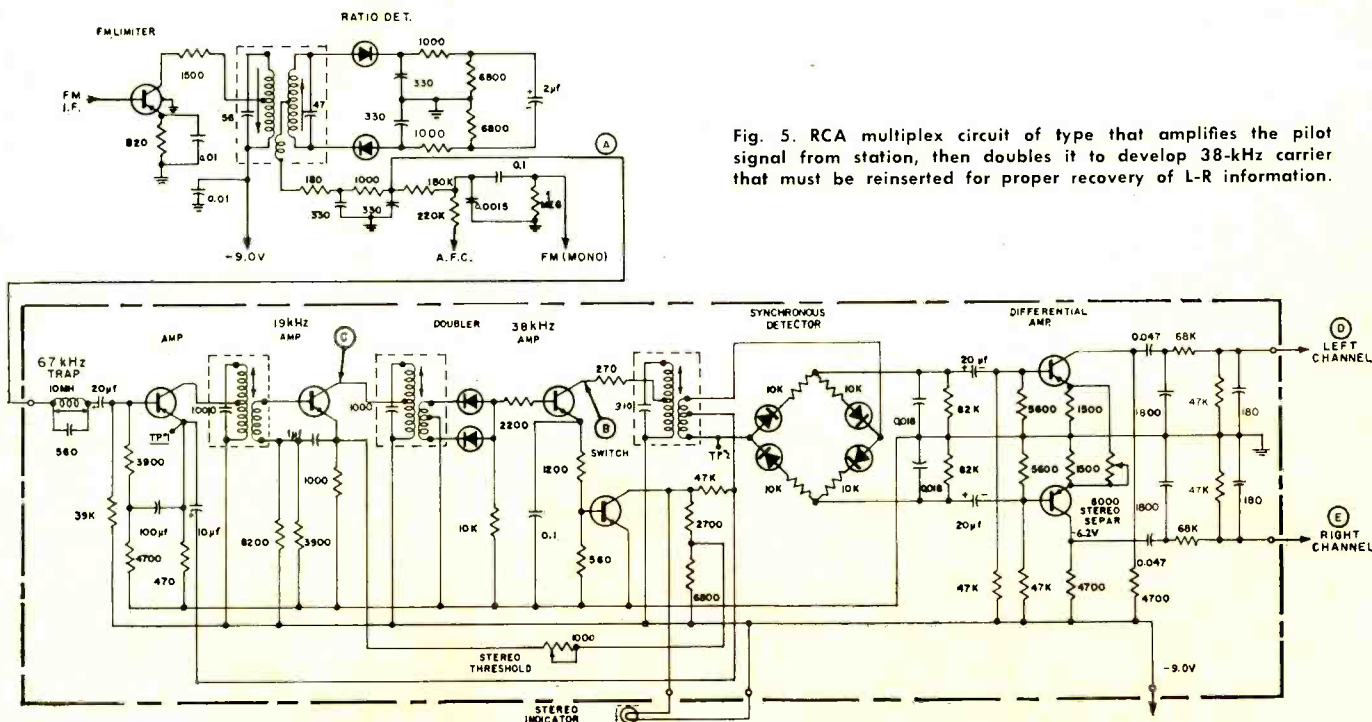

Fig. 5. RCA multiplex circuit of type that amplifies the pilot signal from station, then doubles it to develop 38-kHz carrier that must be reinserted for proper recovery of L-R information.

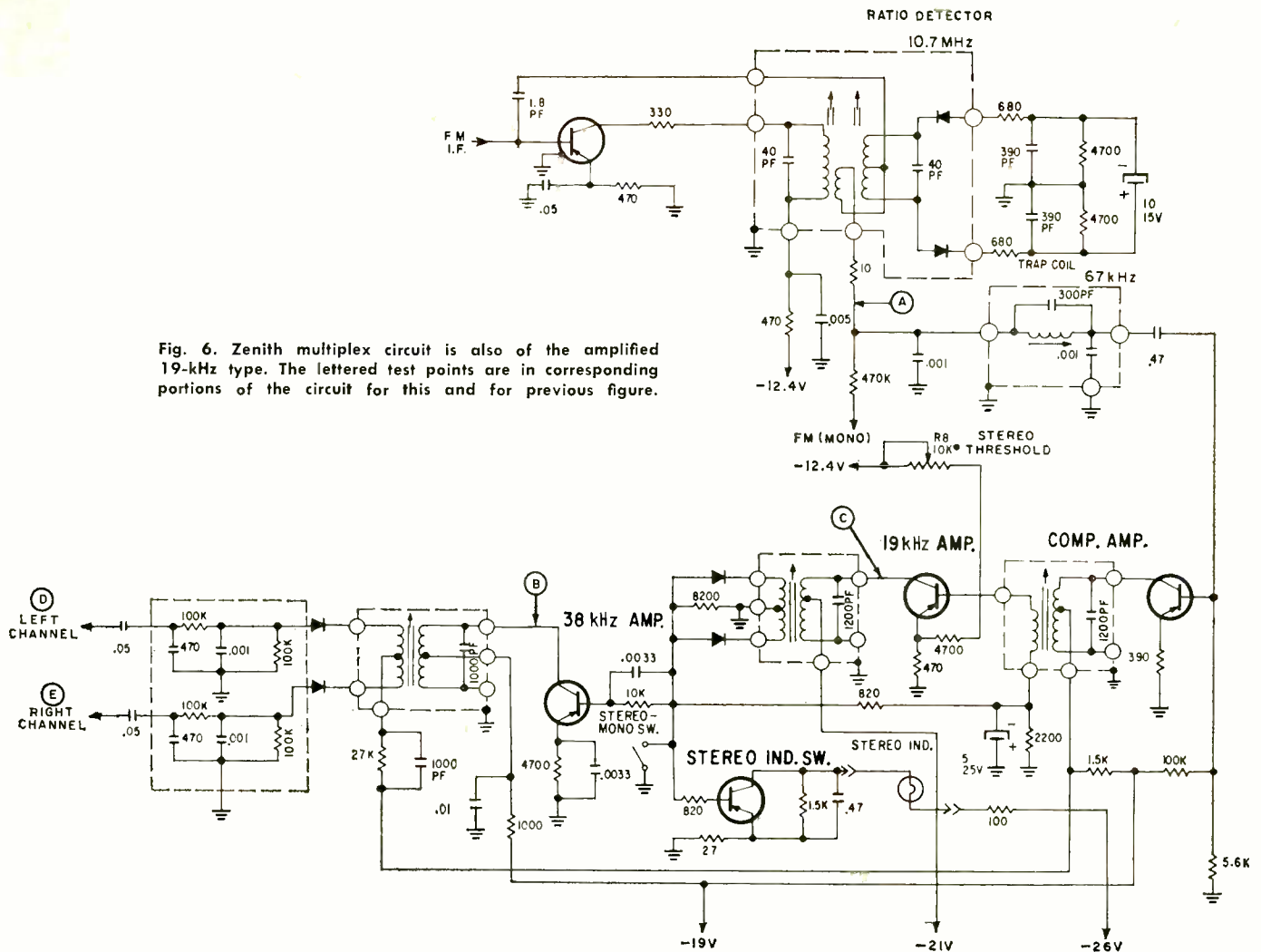

Fig. 6. Zenith multiplex circuit is also of the amplified 19-kHz type. The lettered test points are in corresponding portions of the circuit for this and for previous figure.

the stage is only doubling in frequency, there will be a stable presentation of two sine waves at points C.

Next, the coils are adjusted to produce exactly the correct phase of 38-kHz carrier. For this test, the scope is adjusted for external horizontal input at maximum gain. The horizontal and vertical inputs (no low-capacitance probe) are tied together and a single a.c. signal applied to both. The vertical gain is adjusted to produce a 45-degree line on the scope screen. Then the vertical and horizontal inputs are separated and the vertical input is connected to the output of the left preamplifier, points D. The horizontal input is connected to the output of the right preamplifier, point E.

If a monophonic signal is tuned in, the R and L signal are the same and a 45-degree line (Fig. 9) will appear on the scope, with occasional excursions from this line. The number of excursions away from the average signal line will depend on the phase shift at particular frequencies in each amplifier

stage and the number of stages between discriminator to the scope connection. If the average line is not exactly 45 degrees, the balance control on the receiver can compensate.

When a multiplex signal is tuned in, the oscilloscope pattern should appear as an expanding and contracting series of shapes. They start with a pinpoint on the screen during no-modulation periods, and expand to circles and ellipses that are sometimes vertical, sometimes horizontal, and many times working around to the 45-degree monophonic line (Fig. 10).

For this phase adjustment, a program with a full orchestra is desirable, which will produce a large circular pattern as shown next to title of article. If the phase of the 19-kHz or 38-kHz coil is not correct, the circle will be flat on one side of the 45-degree area. Adjust each coil slightly to fill out the pattern equally on either side.

Adjustment of the coils at (Continued on page 70)

Fig. 7. FM sound without multiplex signal.

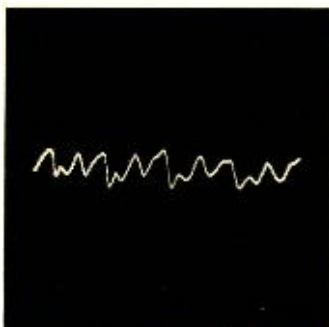

Fig. 8. FM sound with 19-kHz and sidebands.



Fig. 9. Mono, some phase shift in amps.



Fig. 10. Stereo, also with some phase shift.



Extended Resonance Curves

By DONALD E. LANCASTER

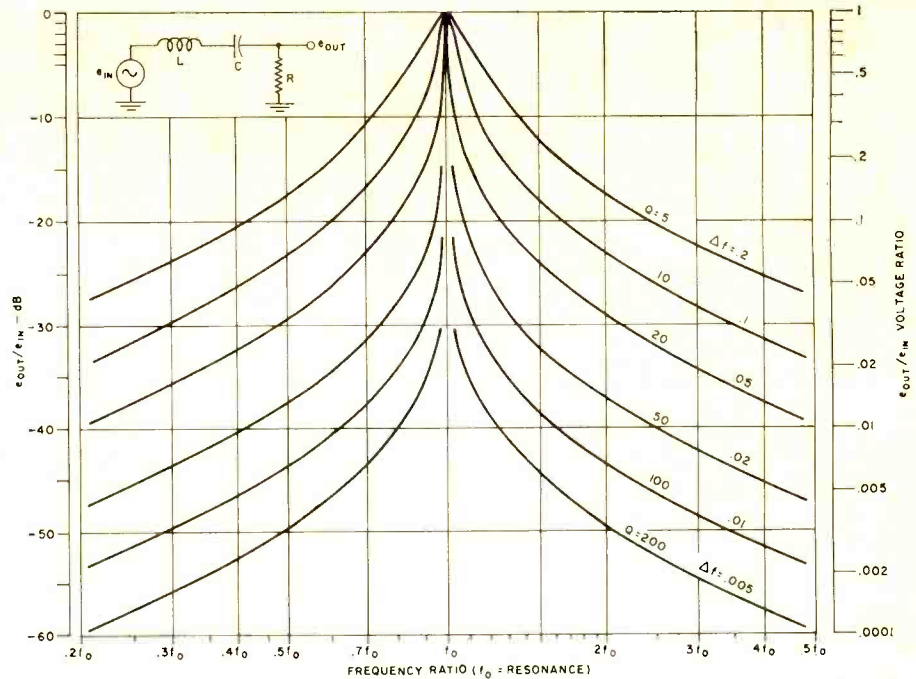

Fig. 1. These curves can be used to predict resonant circuit performance from one-fifth to five times resonant frequency.

Extension of universal resonance curves permits prediction of performance at frequencies well off the actual resonance.

THE universal resonance curves given in most circuit theory books are rather difficult to read when dealing with high- Q circuits or with frequencies well off resonance. Presented here is a family of extended resonance curves that accurately predict the performance of any series RLC resonant circuit or any high- Q parallel-resonant circuit for frequencies ranging from one-fifth to five times the resonant frequency.

The basic curves, which are constructed for various values of Q , are shown above. Although no actual frequency is indicated for horizontal scale, f_0 (scale center) is the center frequency selected.

The curves may be used to predict the harmonic rejection of a simple "one-pole" filter, as well as to indicate the selectivity that a tuned circuit can provide. The curves will also show whether a simple tuned trap will solve a given rejection or filter problem, or whether a more complex filter structure is called for.

The rejection of a series RLC circuit at any frequency is given by the formula: $insertion\ loss = 20\log_{10} \{1 + jQ [(\omega^2 - 1)/\omega]\}$ if the load resistance and angular resonant frequency are normalized to unity. The same relation also holds true for those parallel-resonant circuits having a Q that exceeds 10.

The extended resonance curves are simply a plot of this equation for various values of frequency, insertion loss, and Q , and they appear in Fig. 1. The frequency is shown on the horizontal scale and is given in terms of the ratio of the frequency in question to the resonant RLC frequency. Insertion loss is plotted vertically and is given both in decibels (on the left) and in output/input voltage ratios (on the right). Various values of Q appear as curve parameters. The Q specified is the loaded circuit Q that includes both the load resistance and any circuit losses associated either with the particular inductor or capacitor being used. The bandwidth of each Q curve is also given, expressed in terms of the frequency difference between the -3 dB points as a fraction of the center frequency. For high- Q circuits, the bandwidth is very nearly

centered about the resonant frequency of the tuned circuit.

Using the Curves

Some examples of actual use will demonstrate the value of these curves.

Example 1. What is the minimum Q required to guarantee a 40-dB rejection of the second harmonic of a 100-kHz signal? What will the filter bandwidth be?

Entering the frequency axis at $2f_0$ and the loss axis (left one) at -40 dB, note that a Q of approximately 60 is required. The bandwidth will equal $1/Q$, or 0.0167, which, when multiplied by the 100-kHz resonant frequency, will be 1.67 kHz, half on each side of 100 kHz. The -3 dB points will then be very close to 99.2 and 100.8 kHz. Any signals not between these two frequencies will be rejected by at least 3 dB. To realize this particular filter, 1% components will be required, unless a tuning provision is made.

Example 2. What rejection will a 2-MHz, $Q = 20$ parallel-tuned circuit give to 1.0, 2.0, 3.0, and 16.0 MHz?

1.0 MHz is $1.0/2.0$ or 0.5 times the resonant frequency. Entering the curves at $0.5f_0$ and $Q = 20$ produces 29 dB rejection. Since 2.0 MHz is the resonant frequency, the rejection will be zero at this frequency. 3.0 MHz is a frequency ratio of $3.0/2.0$ or $1.5f_0$, for which we read an insertion loss of 24 dB, or a voltage ratio of approximately 0.063.

16 MHz gives a normalized frequency of $8f_0$ which is beyond the range of the curves, but we can note that all the curves are smoothly falling at 6 dB per octave for frequencies well above, or well below, resonance. The loss at $8f_0$ will be 6 dB more than the loss at $4f_0$, or $37 + 6 = 43$ dB of insertion loss.

Actual values of inductance and capacitance required in a series filter are obtained by specifying the load resistance and then using the formulas $L = RQ/6.28f$ and $C = 0.0253/f^2L$. The unloaded Q of the inductor that is employed must be significantly higher than the loaded circuit Q . ▲

DIGITAL VOLTMETERS

By JOHN D. LENK

Principles of operation, comparative performance, along with the basic circuit arrangements that are employed in the various types of electromechanical and all-electronic d.v.m.'s.

TODAY'S laboratory engineer and technician must master a host of new meters. While the conventional v.o.m. and v.t.v.m. meet the needs of most shop technicians and home experimenters, industrial electronic measurements frequently require the convenience and precision offered by digital meters. Digital voltmeters, or d.v.m.'s, read out measurements in discrete numerals rather than as a pointer deflection on a continuous scale as is commonly done in analog devices.

Digital meters have several advantages over analog meters. The direct numerical readout in a d.v.m. reduces reading error, eliminates parallax, and increases reading speed. Automatic range-changing and polarity-changing features reduce operator training time, measurement error, and possible instrument damage through overload or reversed polarity. Measurement capabilities of a.c. voltage, d.c. currents, and resistance are available along with the basic d.c. voltage ranges. Permanent records of measurements are available with printers, card and tape punches, and magnetic tape equipment. With data in digital form, it may be further processed with no loss of accuracy.

Except for the readout method, operating limits for digital meters are essentially the same as for analog meters of corresponding type. The photographs accompanying this article show a few of the many digital meters available. (Additional meters in the under-\$600 range are shown on our cover and discussed in our lead article.—Editor)

There are two basic types of digital meter—the *electromechanical* and the *all-electronic*. We will discuss the electromechanical type of meter first.

Electromechanical Digital Meters

Electromechanical digital meters can be broken down into four general groups—*stepping switch*, *relay*, *analog servo*, and *stroboscopic* types.

Stepping-Switch Type. These instruments are comparison-type meters in which a stepping-switch-operated voltage divider creates a feedback voltage equal to the input voltage. As shown in Fig. 1, the comparison-type digital voltmeter measures by comparing the unknown voltage to a variable known voltage (feedback voltage) and then varying the feedback voltage until it equals the unknown, that is,

it creates discrete increments of voltage, adds and subtracts them in a prescribed sequence until a feedback voltage equal to the input is created, then displays the measurement on a digital readout which is connected to the same electronic switches which created the feedback voltage.

Stepping-switch type meters can be divided into two major groups by the sequence (logic) in which they develop the feedback voltage. The two major logic groups are "scan" and "tracking".

In a scan-logic meter (also known as "successive trial" logic), the output voltage of each decade is scanned, or sampled, in a definite sequence and the decade's switches are operated once per measurement, starting with the left-most digit and progressing to the right. Some digital meter manufacturers designate this type of logic as "no-needless-nines" logic when used in stepping-switch meters because it eliminates needless cycling of the switches through their nine and zero positions. Scan logic is also frequently used in relay and all-electronic digital meters.

There is also another version of scan logic, known as "double-duty no-needless-nines" logic, used in some stepping-switch meters. Such instruments have the ability to display a 1-digit increase in voltage very quickly. In ordinary scan logic, the positions of the polarity and range switches or circuits and all left-most decade switches must be sam-

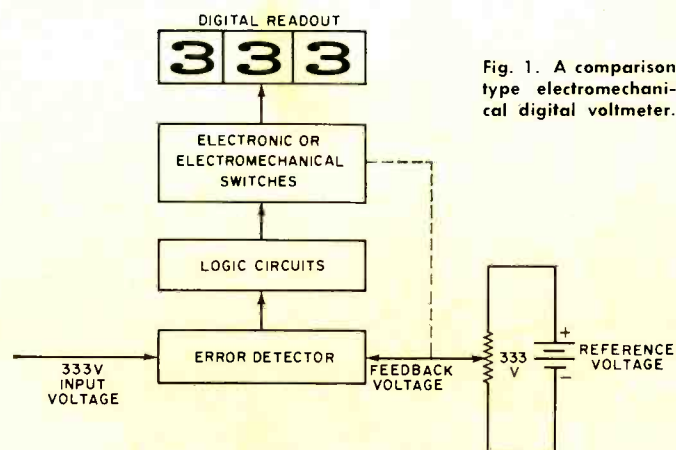

Fig. 1. A comparison type electromechanical digital voltmeter.

pled—but not changed—before the right-most decade switch position can be changed. In starting a measurement with a double-scan logic meter, the logic first determines (without moving stepping switches) which decade or decades must be changed. Then, numerical changes are made starting with the left-most decade which requires a change and progressing to the right. Each stepping switch cycles no more than once per reading—if a switch doesn't have to change, it doesn't.

In tracking logic, the decade switches are always free to follow any input signal change that occurs (unless the decade switches are turned off), and the readings are computed starting with the least significant (right-most) decade and progressing from right to left.

Relay Type. These instruments are also of the comparison type. However, the voltage divider that creates a feedback voltage equal to the input is relay operated. Relay-type digital meters are capable of higher speed than the stepping-switch type since the relays can be operated at a higher speed, for example, 100 steps per second rather than 30 steps per second. Also, the relays can be operated in any

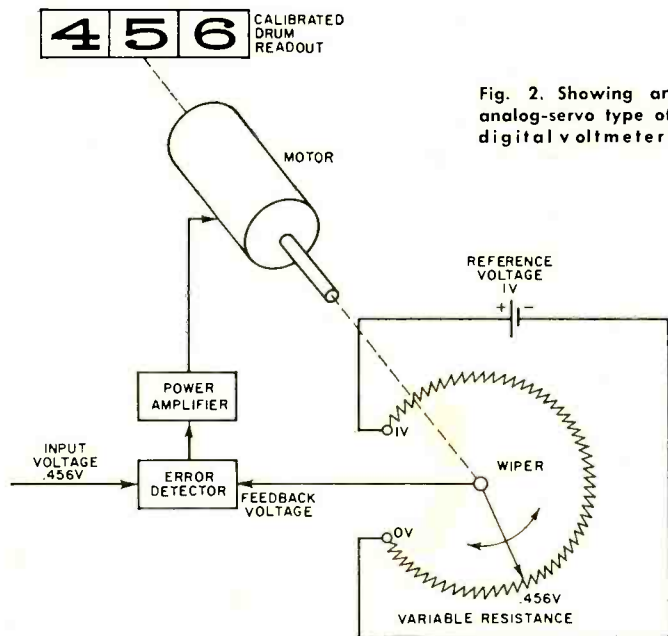

Fig. 2. Showing an analog-servo type of digital voltmeter.

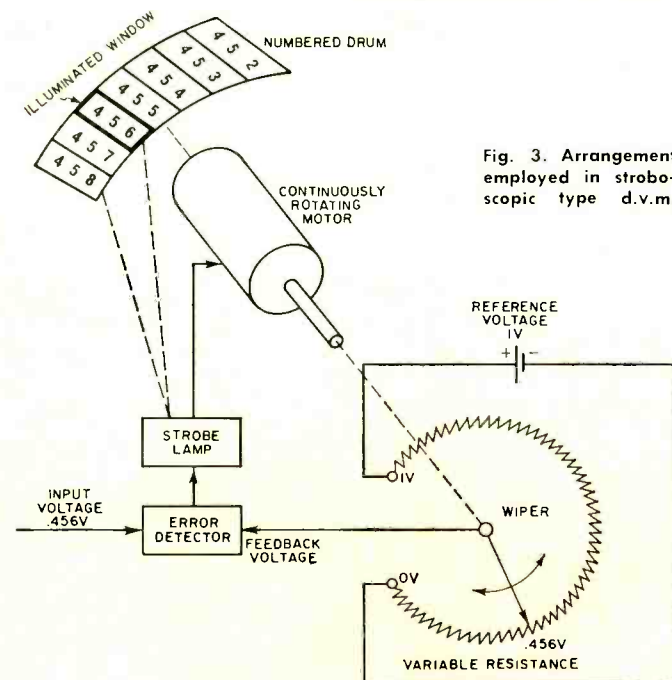

Fig. 3. Arrangement employed in stroboscopic type d.v.m.

sequence while in a stepping switch the switching sequence is fixed. Some relay-operated instruments make three measurements per second which compares favorably with the speed of some all-electronic instruments having automatic ranging.

Analog-Servo Type. This comparison-type instrument creates its feedback voltage by a motor-driven variable resistance (potentiometer). Its functional diagram (Fig. 2) resembles that of a servo system used for positioning an output shaft ("position servo"); that is, a balance detector compares the input and feedback voltages and issues commands which are amplified to energize the motor. The motor drives the variable resistance in the proper direction to make the feedback voltage equal to the input. When the feedback and input voltages are equal, the balance detector output voltage drops to zero and the motor stops. Voltage readout is in terms of motor-shaft position and is displayed by a calibrated drum or several numbered drums, each geared to the adjacent drum by a mechanical transmission having a ten-to-one drive ratio.

Stroboscopic Type. The stroboscopic-type meter generates a ramp voltage by continuously rotating the wiper of a d.c. reference voltage (Fig. 3). The ramp voltage is compared continuously to the input signal and each time the two voltages are equal, a lamp is flashed to illuminate a numbered drum coupled to the shaft of the rotating potentiometer. The numbers aligned with the small window in front of the drum are made visible by the flashing lamp at the time of voltage equality. Drum speed is high enough (1500 r/min, on the average) to produce numbers which appear to be stationary.

Electronic Digital Meters

The heart of an electronic digital meter is the circuitry which converts analog voltage to a digital form. This is known as analog-to-digital conversion or ADC. Most digital voltmeters on the market today fit into one of five categories: successive approximation, continuous balance, ramp (voltage-to-time interval), integrating, and integrating and potentiometric.

Successive Approximation. This type of instrument converts the input voltage into digital form by a series of approximations and decisions. The successive-approximation meter consists of a digital storage register (digital accumulator), a digital-to-analog converter, a comparison network (error detector), a precision voltage reference, and control circuitry. The input voltage is compared first with the

Fig. 4. Voltage-to-time conversion technique used in d.v.m.'s. Clock pulses are produced only during time of the count gate.

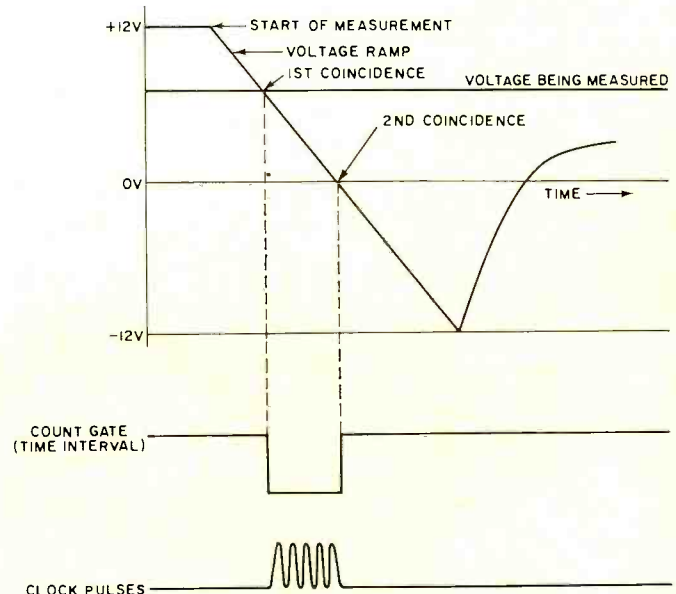



The Vidar 520 is an integrating digital voltmeter that also provides frequency counting, period measurements, and voltage-to-frequency conversion. Its range for voltage measurement is from 10 mV to 1000 V full-scale. The accuracy is $\pm 0.01\%$ of full-scale, $\pm 0.004\%$ of reading. Price is \$3925.



The Hickok DMS-3200 is a digital measuring system. It can be used to measure a variety of electrical parameters depending on the plug-in unit used. As a voltmeter, it measures up to 999 volts with a 0.1% accuracy. Other plug-ins convert unit to counter, ohmmeter, capacitor meter. Main frame: \$320.



Simpson Model 111 measures from 0 to 999 volts in four ranges. Display time is variable from 200 ms to 10 s. Accuracy is 0.1% of reading, ± 1 count. The readout is by means of a seven-bar numerical display that can be read out to about 20 feet even under high ambient lighting. Price of unit \$500.



Honeywell Model 620 guarded, differential-input d.v.m. measures d.c. voltages up to 750 V and d.c./d.c. ratios in the presence of high noise levels. Accuracy is $\pm 0.01\%$ of reading or of full-scale. Accessory unit at left is Model 623 converter which adds a.c., resistance, and low-level d.c. measurements. Price of the system begins at \$2080.



Non-Linear Systems Model X-2 is a small-size integrating d.v.m. with multimeter capabilities. A.c., resistance, and low-level d.c. measurements can be obtained by plugging in appropriate circuit boards. Full-scale d.c. ranges are up to 999.9 V with a rated accuracy of $\pm 0.01\%$ of full-scale and $\pm 0.05\%$ of the reading, ± 1 digit. Price: \$980.



The Cohu Electronics 530 Series digital voltmeter can be used to measure d.c. voltage from 10 mV to 1 kV (actually 999.99 V) with an accuracy of 0.005% of reading ± 1 digit and d.c./d.c. ratios up to 99.999 to 1. Additional functions, including d.c. current, resistance, and a.c. voltage, can also be provided at additional cost. The price is \$1495.

most significant bit. The actual comparisons are made successively in binary form. If the input voltage is less than the most significant bit of the reference, the most significant bit of the register is cleared and the next lower bit is switched in for comparison. The process of switching in the next lower significant bit is continued until a decision is made on all digits. At this point, the voltmeter has completed its measurement.

The accuracy of this technique is limited by the comparator sensitivity, reference supply, digital-to-analog converter, and the resolution of the instrument. Its advantages are speed, accuracy, and fixed encoding time. However, the successive-approximation method has sensitivity and noise problems and lacks the ability to make accurate measurements in the presence of noise unless filters are used.

Continuous Balance. The continuous-balance type of meter performs a digital measurement by comparing the unknown voltage against a voltage derived from a stable reference supply. At the beginning of a measurement, the unknown voltage is compared to the "full-scale" reference. If a null is not reached, a voltage derived from the reference is reached by an incremental value representing a unit of the least significant digit by automatically switching precision resistors. This process continues until a null is reached. However, when the input voltage varies because of superimposed noise, a null is never reached and the digital voltmeter hunts about the correct answer.

Ramp (Voltage-to-Time Conversion). This system is widely used in the lower priced digital meters. The ramp meter measures the length of time it takes for a linear ramp of voltage to become equal to the unknown input voltage after starting from a known level. This time period

is measured with an electronic time-interval counter and displayed on in-line indicating tubes. The advantages of this type of instrument are low price and simplicity. However, it requires an input noise filter if superimposed noise is present.

Conversion of a voltage to a time interval is shown in the timing diagram of Fig. 4. At the start of a measurement cycle, a ramp voltage is initiated. The ramp is compared continuously with the voltage being measured. At the instant the voltages become equal, a coincidence circuit generates a pulse which opens a gate. The ramp continues until a second comparator circuit senses that the ramp has reached zero volts. The comparator output pulse closes the gate.

The time duration of the gate opening and closing is proportional to the input voltage. The gate allows clock pulses to pass to totalizing circuits and the number of pulses counted during the gating interval is a measure of the voltage. Choice of ramp slope and clock rate enables the totalizing circuit readout to register directly in millivolts (for example, a slope of 300 volts/second and a clock rate of 300 kHz).

If the input were a negative voltage, coincidence with it would occur after zero coincidence. Circuitry senses which coincidence occurs first and switches the polarity indicator accordingly.

The main advantage of voltage-to-time conversion as a technique for d.v.m.'s is its simplicity. Also, slowly varying input voltages do not disturb the operation of the voltmeter, as often happens with null-seeking voltmeters which may continually hunt for, but never reach, a final balance.

A block diagram of a typical ramp-type d.v.m. is shown in Fig. 5. Here a voltage ramp is generated and compared with the unknown voltage and with zero voltage. Coinci-

dence with either voltage starts the oscillator and the electronic counter registers the cycles. Coincidence with the second comparator stops the oscillator. The elapsed time is proportional to the time the ramp takes to go between the unknown voltage and zero volts, or *vice versa*. The order in which the pulses come from the two comparators indicates the polarity of the unknown voltage. The accumulated reading in the counter can be used to control ranging circuits.

Integrating (Voltage-to-Frequency Conversion). This meter measures the true average of the input voltage over a fixed encoding time instead of measuring the voltage at the end of the encoding time as do ramp-type units and successive-approximation and continuous-balance meters. Measurement at the end of the encoding time could coincide with a burst of noise, thus creating an inaccuracy in the ramp-type meters.

Conversion of a voltage to a frequency is illustrated in the diagram of Fig. 6. The circuitry functions as a feedback control system which governs the rate of pulse generation, making the average voltage of the rectangular pulse train equal to the d.c. input voltage.

A positive voltage at the input results in a negative-going ramp at the output of the integrator. The ramp continues until it reaches a voltage level that fires the level detector which, in turn, triggers a pulse generator. The pulse generator produces a rectangular pulse with closely controlled width and amplitude, just sufficient to draw enough charge

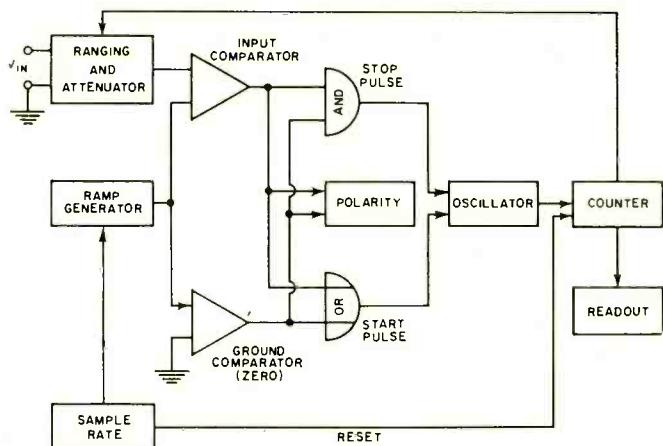

Fig. 5. Block diagram of typical ramp-type digital voltmeter.

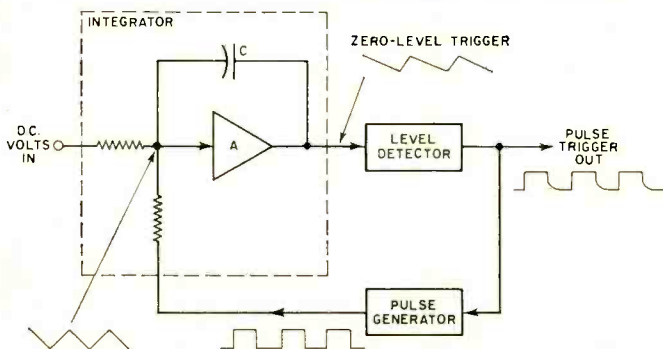
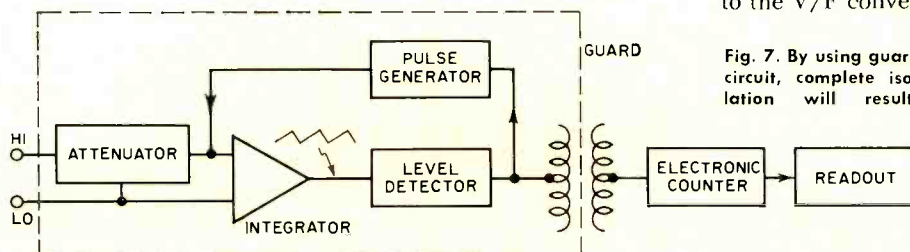

Fig. 6. Voltage-to-frequency conversion employing integrator.



from capacitor *C* to bring the input of the integrator back to the starting level. The entire cycle will then repeat.

The ramp slope is proportional to the input voltage. A higher voltage at the input results in a steeper slope, causing the ramp to have a shorter time duration, consequently, the pulse repetition rate would be higher. Since the pulse repetition rate is proportional to the input voltage, the pulses can be counted during a known time interval to obtain a digital measure of the input voltage. While a voltage ramp is generated in this type of d.v.m., the amplitude is only a fraction of a volt and the accuracy of the analog-to-digital conversion is determined not only by the characteristics of the ramp but also by the area of the feedback pulses.

The main advantage of this type of analog-to-digital conversion is that the input is "integrated" over the sampling interval and the reading represents the true average of the input voltage. The pulse repetition frequency "tracks" a slowly varying input voltage so closely that changes in the input voltage are accurately reflected as changes in the pulse repetition rate. Therefore, the total pulse count during a sampling interval represents the average frequency and, consequently, the average voltage. This is important when noisy signals are encountered during measurement. The noise is thereby averaged out during the measurement without requiring input filters which would slow the meter response time. Also, the meter achieves essentially infinite rejection of power-line hum, the most prevalent source of signal noise, when the measurement interval is an exact multiple of the hum waveform period.

Another advantage is that the pulse circuits provide a convenient means of coupling the information out of a guard circuit. Such guard circuits are used to isolate the measuring circuit from the remaining readout circuits. Fig. 7 shows a simplified block diagram of the guard circuit arrangement. Here the integrating digital voltmeter has a floating input and all of the voltage-to-frequency conversion circuitry is housed within a guard shield. As in the case of other integrating d.v.m.'s, the integrator, pulse generator, and level detector generate a train of pulses. The total number of pulses over a specified period is directly proportional to the integral of the input signal over this same period of time. This arrangement makes it possible to transformer-couple the signal to the digital circuits outside the guard, permitting complete isolation of the measuring circuit itself.

Potentiometric Integrating. This type of digital voltmeter combines the features of an integrating d.v.m. and a form of differential voltmeter.

A conventional integrating d.v.m. measures the true average of the input voltage over a fixed encoding time. A conventional differential voltmeter relies primarily on resistance ratios and a stable reference voltage to assure accuracy. It is possible to combine these two basic features. Such a voltmeter is divided into three sections: a voltage-to-frequency (V/F) converter, a counter, and a digital-to-analog (D/A) converter. Readings are taken in two steps. First, the voltage-to-frequency converter generates a pulse train with a rate proportional to the input voltage. This pulse train is gated for a precise time interval and is fed to the first four places of a six-digit counter. The stored (undisplayed) count is transferred to the D/A converter, which produces a highly accurate d.c. voltage proportional to the stored count. This voltage is subtracted from the unknown voltage at the input to the V/F converter.

The next step in operation occurs when the pulse train from the V/F converter is again gated—this time to the last two places in the six-digit counter. At the end of the second gate period the total count is transferred to the six display tubes. The counter display is indicative of the integral of the input voltage.

Fig. 7. By using guard circuit, complete isolation will result.

SURVEYOR— Mission to the Moon

By JOSEPH H. WUJEK, Jr.

Operation of TV camera system which soft-landed on moon, took high-quality pictures of the lunar surface, and then transmitted them back to earth.

Editor's Note: The system described in this article is used in our Surveyor spacecraft, which is designed to actually soft-land on the moon, sample, and take pictures of the lunar surface by means of the TV cameras discussed. It should not be confused with the system used in our Lunar Orbiter, which has taken many fine pictures of the moon's surface from an orbit around that satellite.

THE successful lunar soft landings by Surveyors 1 and 3 were the culmination of years of engineering effort. In many respects, the Surveyor series of space vehicles are perhaps the most sophisticated space systems yet devised. From a distance of nearly a quarter-million miles, photographs of the moon's surface were transmitted to a receiving station on earth. The majority of the received photographs were of commercial TV quality. This article will discuss the missions of Surveyors 1 and 3, with particular emphasis on the television camera systems employed.

The Surveyor spacecraft was built by the *Hughes Aircraft Company* for NASA under the direction of The Jet Propulsion Laboratory of The California Institute of Technology (Caltech). Seven Surveyors are to be built and launched on lunar soft-landing missions. Surveyor 3 differs from Surveyor 1 in that in addition to the TV camera, a surface-sampler device was incorporated in the design. Surveyor 3 also used two small, flat mirrors in order to extend the visual range of the TV camera. A third variation in Surveyor 3 was a small metal visor used to keep stray light from reflecting into the mirror of the TV camera.

Surveyor 3 weighed 2283 pounds at launch and after the retro-rocket, weighing 1444 pounds, was jettisoned, landing weight of the spacecraft on the moon was 666 pounds. The over-all height of Surveyor 3 was about 10 feet, with the extended tripod legs forming a circle 14 feet in diameter. The Atlas-Centaur launch vehicle, built by *General Dynamics/Convair*, develops 387,000 pounds of thrust in the first-stage Atlas, with the second-stage Centaur providing about 30,000 pounds more thrust. Surveyor 1 used a

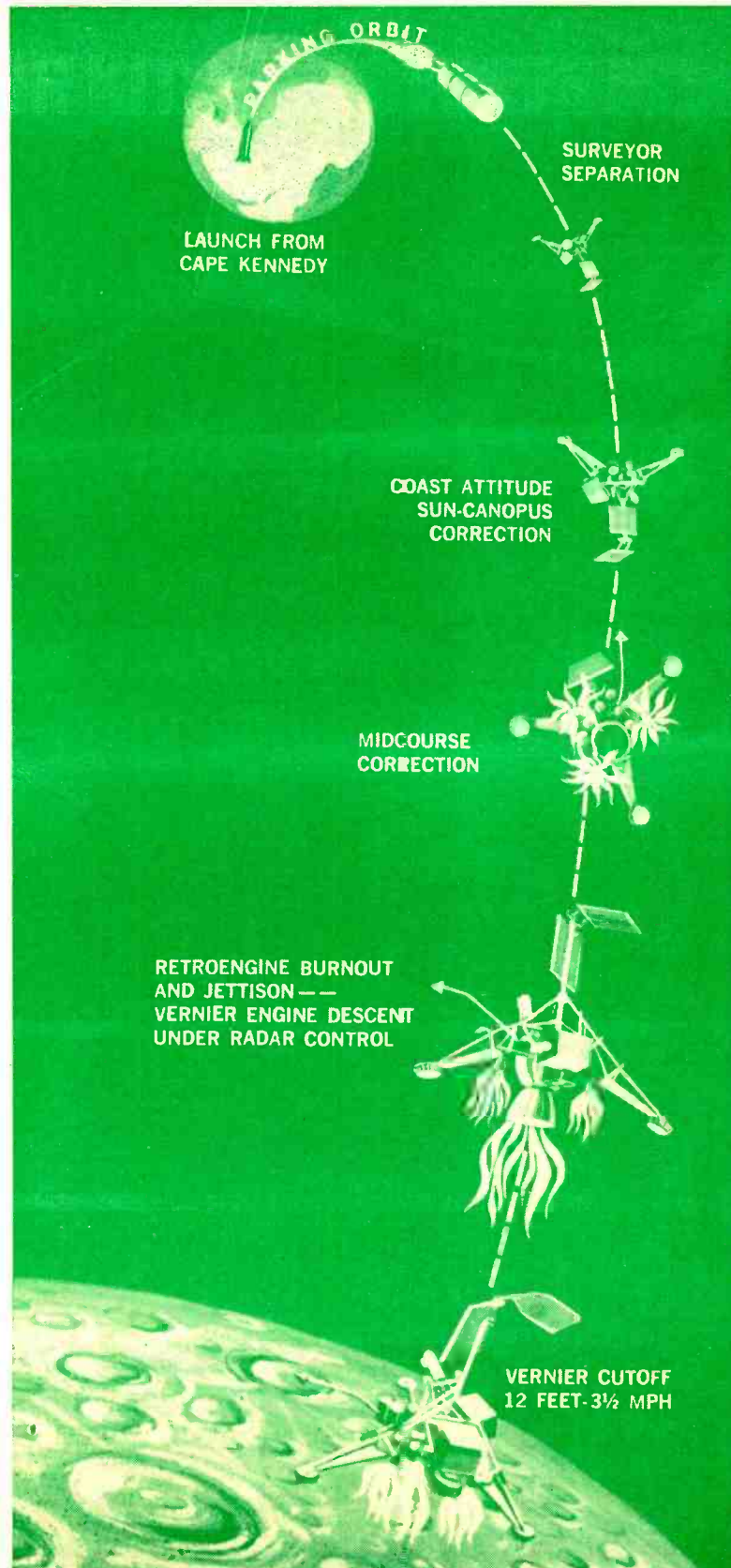

Fig. 1. Major maneuvers performed by Surveyor 3 after lift-off for the 240,000-mile journey to the moon. Earth-parking orbit was maintained about 20 minutes prior to 66-hr trip.

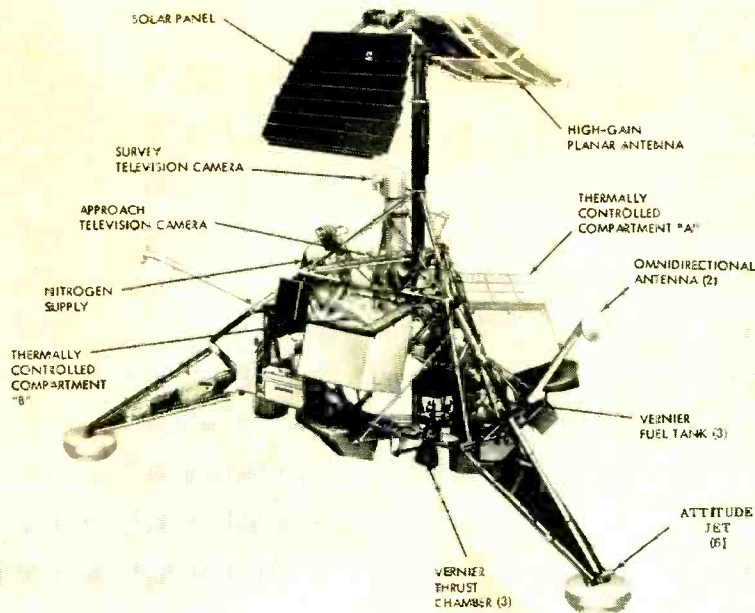
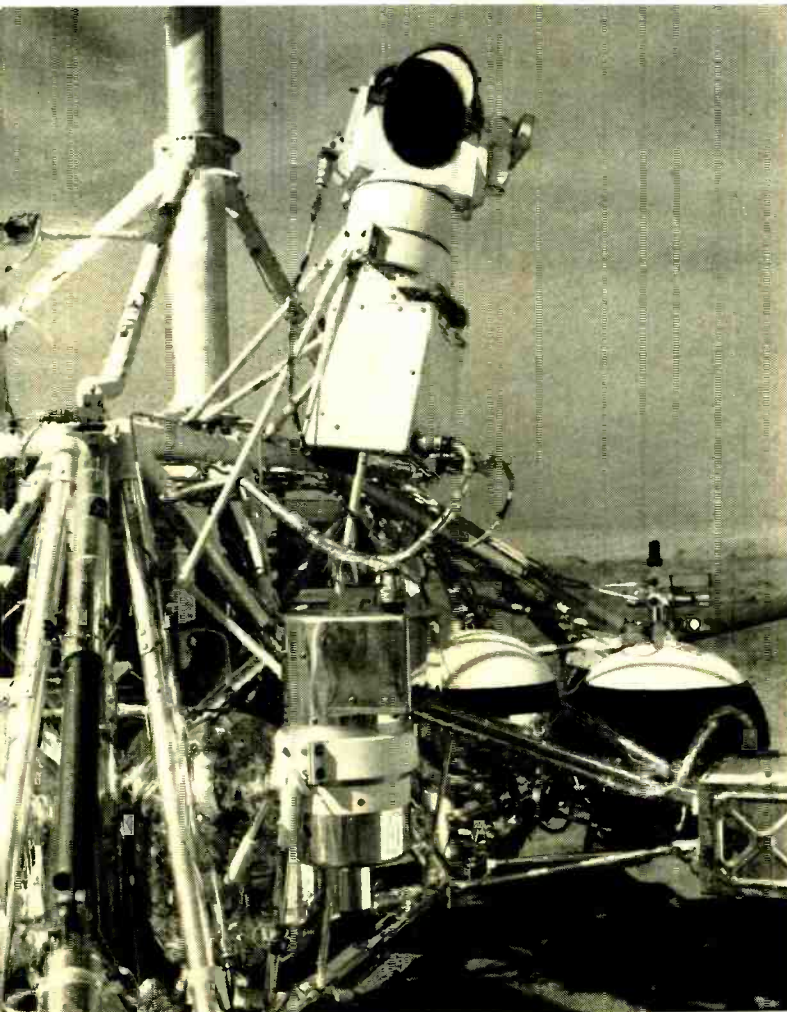

Fig. 2. The various components of the Surveyor spacecraft. Included are solar panels, a planar antenna, approach and survey TV cameras, two omnidirectional antennas, and a number of power sources and control devices for spacecraft functions.

Fig. 3. The survey TV camera is mounted atop the white turret, while the downward-looking camera is in the center foreground. The larger ball-shaped tank at the far right was filled with helium used for the vernier engines. The smaller tank next to it holds nitrogen used for small attitude jets.



direct approach to the moon, while Surveyor 3 used a parking orbit, requiring a second ignition of the rocket engine. Details of the Surveyor 3 maneuvers are shown in Fig. 1.

In the harsh environment of the moon, reliability becomes the prime consideration. The temperature of the lunar surface ranges from -250°F to $+250^{\circ}\text{F}$ during the lunar night and day, respectively, but since a lunar night or day stretches over 14 earth days, there are long periods of exposure to these temperature extremes. However, thermal control within the spacecraft maintains a temperature range of -20°F to $+165^{\circ}\text{F}$. The solar panel and planar array antenna also serve as a sun shield to protect the TV camera from direct solar heating. Since the moon is, practically speaking, without an atmosphere, heating is by radiation and conduction.

Fig. 2 shows the spacecraft configuration with the survey TV camera situated high atop the vehicle for maximum viewability. A close-up view and cut-away drawing of the camera are shown in Figs. 3 and 4. Since one requirement of the missions was to scan as much of the lunar surface as possible, a mechanical scanning arrangement was incorporated in the vehicle. Limits on power consumption and the thermal extremes made movement of the entire TV camera impractical. Instead, a mirror that could rotate vertically and horizontally was used. By ground command the mirror could be rotated horizontally in 3-degree increments and vertically in 5-degree increments.

The TV system was triggered into various modes by 27 different ground commands, yielding a high degree of scanning and photographic flexibility. Potentiometers were mechanically coupled to the scan mirror and the resultant signal used to determine mirror orientation relative to the spacecraft. Three color filters—red, green, and blue—were used to construct color photographs. Each filter was successively commanded to cover the camera lens and the photo then taken with each filter in place. A polarizing filter was also available by ground command. Potentiometers were used to indicate which filter was positioned before the camera. As with the mirror position data, this information was transmitted to earth via the telemetry (TM) link.

A photosensitive diode was used as a detector to prevent direct sunlight from entering the camera lens and damaging the vidicon tube. The presence of direct sunlight on the diode caused an inhibiting circuit to lock the shutter in a closed position. A photocell was used to adjust the camera aperture in much the same way as the automatic shutter control operates on some types of ordinary cameras.

Two modes of TV transmission are possible: 600 and 200 lines. The 600-line transmission, compared to the 525-line transmission of U. S. commercial broadcasting systems, can be transmitted at the rate of one complete picture every 3.6 seconds. The 600-line transmission can also be completed in 2.4 seconds. The faster transmission of 600-line pictures is achieved at some sacrifice of picture quality since less time is allowed for vidicon erasure. The 200-line mode requires 21 seconds to transmit and 41 seconds to erase the vidicon. The second mode was incorporated into the design as a safeguard in the event the array antenna were damaged or not alignable with the earth. The reduced bandwidth requirement of the 200-line system allows use of one of the two omnidirectional antennas.

The system may be operated at either 0.1 watt or 10 watts of radiated power. The relatively slow speed of transmission is due to bandwidth limitations, erasure time of the vidicon tube, and readout of the vidicon information. In addition, sync pulses and data regarding the camera position is transmitted with each picture.

The camera can resolve objects of 20/1000th inch (20 mils) diameter at a distance of four feet. A zoom lens is used to allow close-up photos as well as distance shots.

The surface sampler, a claw-like device that looks like a

toy shovel at the end of a scissors-like extension arm, was used by Surveyor 3 to dig a small furrow in the moon's surface. The sampler has a 2 to 5 foot reach over about a 10-foot arc and can penetrate the earth's crust to a depth of 18 inches. The mechanism and housing of the scoop weighs 8.4 pounds and the control electronics an additional 6.3 pounds. A channel of the TM link monitors the current drawn by the sampler mechanism motor, thus providing a measure of the force required to power the scraper. The force required tells something of the composition of the moon's crust, which in the vicinity of the Surveyor 3 touchdown is the consistency of wet sand.

The primary ground station for the Surveyor program is in the Mojave Desert at Goldstone, California. The site is an important station in many of the U.S. space programs and is operated by The Jet Propulsion Laboratory for NASA.

Results of Surveyor Missions

Surveyor 1 landed near Flamsteed Crater in *Oceanus Procellarum* (Ocean of Storms) at 0617 hours GMT, June 2, 1966. The landing was within one second of the target time and within nine miles of the selected landing point. In the six weeks which followed, Surveyor 1 transmitted 11,150 high-resolution pictures of the lunar surface. Communications with the spacecraft were established intermittently from July 1966 through January 1967, but photographs were not transmitted after July. However, important data on the motion of the moon was provided by observing the Doppler shift. Recall that the Doppler effect has to do with the increase or decrease in frequency of a wave (electromagnetic or sound, for example), as the wave emanates or is reflected from an object in motion relative to the observer.

Surveyor 2 was launched September 20, 1966 with an intended landing in the *Sinus Medii* (Central Bay) region at the center of the moon. As a result of a failure in one of the three vernier (maneuvering) rockets, the spacecraft began a tumbling motion during the mid-course maneuver phase. On September 22 the main retro was fired, but all signals from the spacecraft ceased one minute after firing. After an attempt to locate the spacecraft by receiver signals, the mission was officially terminated at 2:53 a.m. PDT, September 22, 1966.

Surveyor 3 was launched from Cape Kennedy at 11:05 p.m. (PST) on April 16, 1967. A parking orbit of nearly circular proportions was held for 24 minutes at an altitude of 103 miles. The Centaur stage was then re-ignited for the lunar flight. The landing at 4:04 p.m. (PST) on April 19 was in a crater in the Ocean of Storms. Because the landing was a bouncing touchdown, program personnel were fearful that the spacecraft had sustained damage. These fears vanished, however, when the vehicle responded to commands. Within 12 hours after landing nearly 400 photos had been transmitted. See Fig. 5.

The mechanical claw sampler was commanded into action about 24 hours after touchdown. Color photographs revealed the soil to be gray.

The remaining Surveyor missions will undoubtedly add to our knowledge of the moon. The Surveyor program thus forms an important link in the plan to land a manned vehicle on the moon. By supplying data on the terrain, soil consistency, and geology of the moon, Surveyor will provide astronauts with much information prior to their landing. ▲

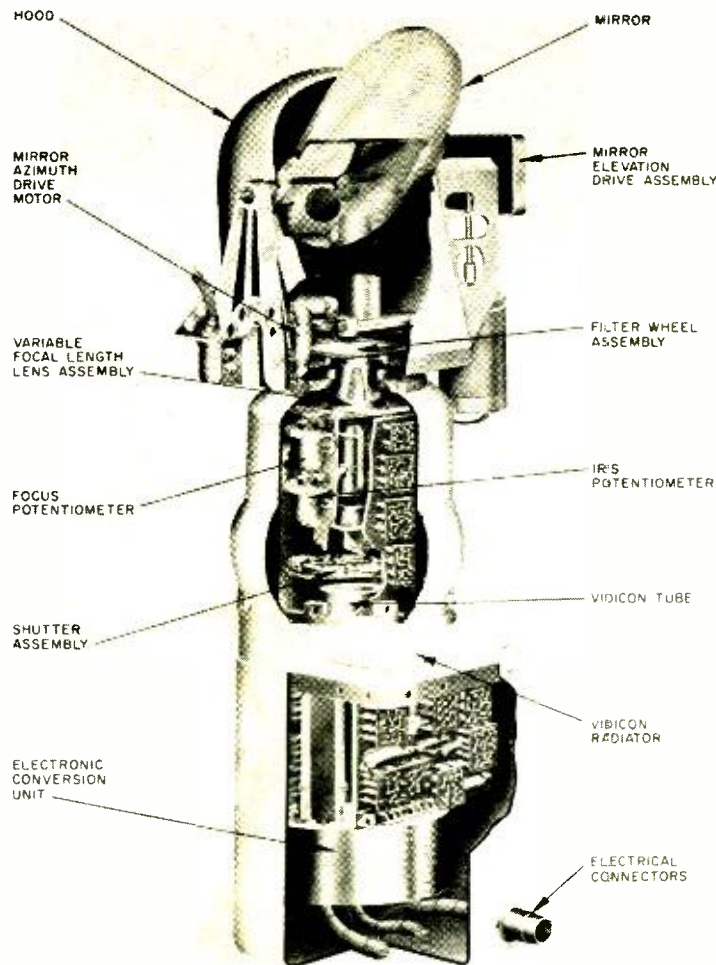

Fig. 4. Cutaway view of the survey television camera which is shown mounted in place in Fig. 3. Because of the high temperatures on the moon and a limitation on the amount of power which could be consumed, the camera was made stationary and the mirror was made movable on command from ground control.



Fig. 5. Sun shining from directly behind Surveyor 3 silhouettes shadow of spacecraft against interior of crater in which it landed on April 19, 1967. This photo, taken on May 2, is among the more than 6000 photos obtained by the spacecraft during its first lunar day (14 Earth days) operation. Surface sampler is seen in its final position at lower left, the arm almost fully extended about five feet from the spacecraft. Shadow at top is image of solar panel and the planar antenna array atop mast. Just to the left of the mast is the shadow of the television camera that took this picture.

THE INSTRUMENTATION TAPE RECORDER

PART 1

By RAY A. SHIVER / AiResearch Mfg. Co.

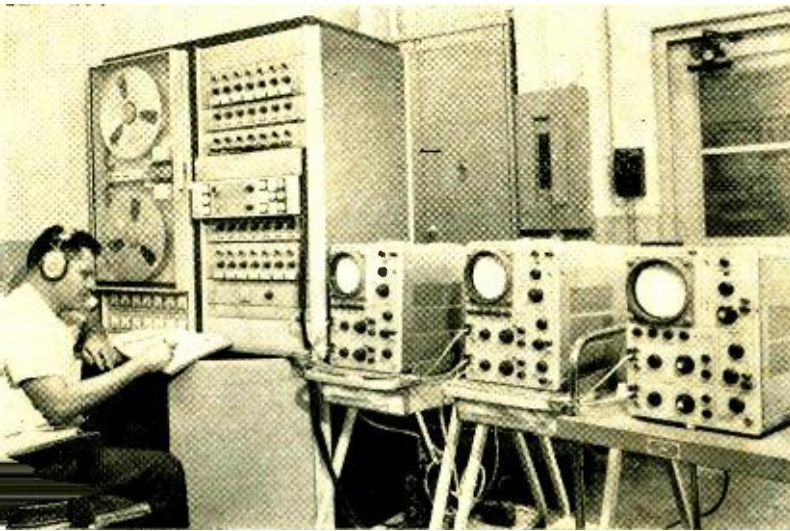

Photo shows a sophisticated 14-track instrumentation tape recorder. This instrument, an Ampex FR-600, can use any of the recording systems for analog recording—including direct record, FM, or PDM. It features automatic switching of tape speeds and electronics, a precision drive system with a frequency standard, a speed control servo system, air-lubricated tape guides, and other items described in the text. A recorder such as this is generally centrally located with all the lines from the various test locations being piped to a central patch board. Tape machine should be in air-conditioned environment.

THE technical principles involved in the audio tape recorder are well-known to many in the electronics industry but probably few are familiar with its big brother, the instrumentation tape recorder. This modern workhorse of the instrumentation industry owes its humble beginnings to the development of the audio tape recorder by a German, Fritz Pfleumer, during the early days of World War II. Pfleumer discovered that the addition of a high-frequency bias current to the recording process eliminated most of the distortion caused by the non-linear characteristics of magnetic tape. The machine soon ceased to be a laboratory novelty and was adopted for the recording of broadcast material and for other wartime purposes.

The design of the machine remained unchanged until several years after the war when technological advances triggered increasing interest in magnetic tape as a means of recording scientific data. From that time on the progress of instrumentation tape systems was very rapid until, by the 1950's, the machine was in widespread use throughout the industry in essentially its present form.

Head-Gap Size and Tape Speed

The recording range of the tape recorder when it was first adopted as an instrument of scientific research was about 100-13,000 Hz. This was recording by the so-called "direct-record" method, that is, the signal was amplified, mixed with a high-frequency bias current, and applied to the magnetic tape in basically the same form as it was received. This same method is used in present-day audio recorders.

A recording range of this bandwidth, although useful, provided rather limited scope in scientific research. Upon investigation, it was found that frequency response was essentially dependent on two factors: tape speed and the size of the head-gap in the reproduce head. This is because, as the wavelength of the recorded signal on the tape approaches the head-gap size, the output signal from the head decreases until it finally becomes zero when they are equal. This is shown in Fig. 1.

From this it becomes apparent that the frequency response of the recorder can be increased by one of two methods: increasing the tape speed or decreasing the reproduce head-gap size (gap length). Actually a compromise is made in the

Widely used to record data in lab and industry, this special purpose multi-channel magnetic recorder evolved from the simple audio machine. Part 1 covers the development of the recorder and describes the tape transport, along with the available mechanical and electrical features.

modern instrumentation recorder. For example, to reproduce a signal up to 250 kHz by this direct-record method a tape speed of 60 inches per second (in/s) is commonly used. This is equal to 4166 complete cycles per inch of tape or a wavelength on the tape which equals about 0.00024 inch. Thus, in order to insure adequate output from the reproduce head, a head gap size equal to half this value, or 0.00012 inch, would be needed. In practice, a gap of 0.0001 inch (or 100 μ in) is used.

This compromise between tape speed and reproduce head-gap size is necessary for several reasons. There is a direct relationship between tape speed and head wear. The higher the tape speed, the shorter the life of the head assemblies. Although the oxide particles on the tape surface are extremely small, their abrasive action on the head surfaces increases with tape speed. If the reproduce head-gap size is reduced in order to increase frequency response, the output voltage is reduced, with a corresponding decrease in the signal-to-noise ratio. A narrower head gap results in faster surface wear and shortened head life. Hence, it becomes apparent why most instrumentation recorders of the future will probably use rotating head assemblies as a solution to this problem. This is one way to effectively increase tape speed while maintaining practical head-gap sizes.

Construction of Heads

Since the heads are a very critical part of any tape system, a great deal of care goes into their design and construction.

Fig. 1. Head-gap spacing (gap length) determines the highest frequency that can be recovered from the magnetic tape used.

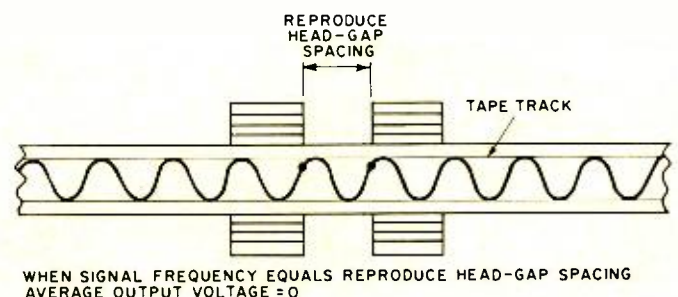

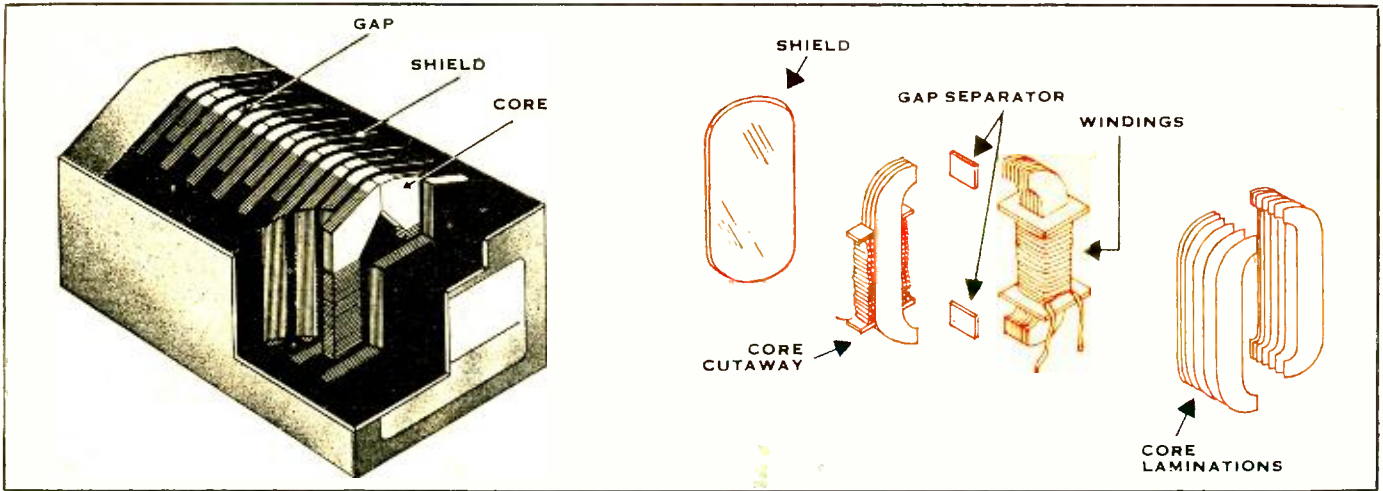

Fig. 2. Construction and the component parts of Ampex magnetic tape head that will produce seven tracks on instrumentation recorder.

Unlike audio recorders, head-stacks for the instrumentation recorder may produce up to 14 separate tracks. (Digital tape systems designed for use with computers may contain an even greater number.)

Construction details of such a head stack are shown in Fig. 2. It consists of a number of laminated core halves joined together with non-magnetic spacers to form a gap area. The flux path between core halves is completed when magnetic tape is drawn across the gap. The magnetic shields are designed to minimize coupling between adjacent core sections. In order to provide a rigid head assembly, the core sections and shields are sometimes cast into a solid mounting made of epoxy.

Important dimensions to be maintained in the construction and alignment of a head stack are shown in Fig. 3. Track spacing refers to the distance between tracks on a centerline while track width is the area of tape occupied by the width of the head gap. Gap scatter is any deviation from true center of any of the head gaps and is taken as the total distance encompassing the greatest point of deviation between two gaps. Gap azimuth is the perpendicular alignment of the gap centerline with reference to the base plate of the recorder.

Since variations in these dimensions must be kept to a minimum for the instrumentation recorders produced by various manufacturers, a set of standards has been adopted by IRIG (Inter-Range Instrumentation Group—a group of military testing centers that perform extensive tests using magnetic tape equipment) to insure the compatibility of all recorders in the instrumentation field. These dimensions are given in Fig. 3, along with the accuracy to be maintained.

Magnetic Recording Tape

Magnetic tape for instrumentation recorders must conform to many rigid specifications in order to produce the results for which the instruments are designed. Among the most important are uniformity of the oxide coating, a backing that possesses both high tensile strength and the ability to resist stretching, and a suitable binder for the oxide coating that will resist wear and prevent contamination of the gaps and other surfaces with oxide particles.

Two materials commonly used for backing on instrumentation tape are cellulose acetate and polyester. Since polyester has somewhat greater tensile strength, it is used more frequently. Standard widths of $\frac{1}{4}$, $\frac{1}{2}$, and 1 inch are provided to record four, seven, and fourteen channels of data, respectively. Tapes are available in either 1.5 or 1.0 mil thicknesses with the 1-mil tape offering twice the recording time.

The oxide coatings are generally designed for specific applications and the exact composition of oxide and binder depends on the ultimate use. Magnetic tape containing small impurities can cause dropouts (momentary loss or reduction of the signal) which could have an adverse effect on the data.

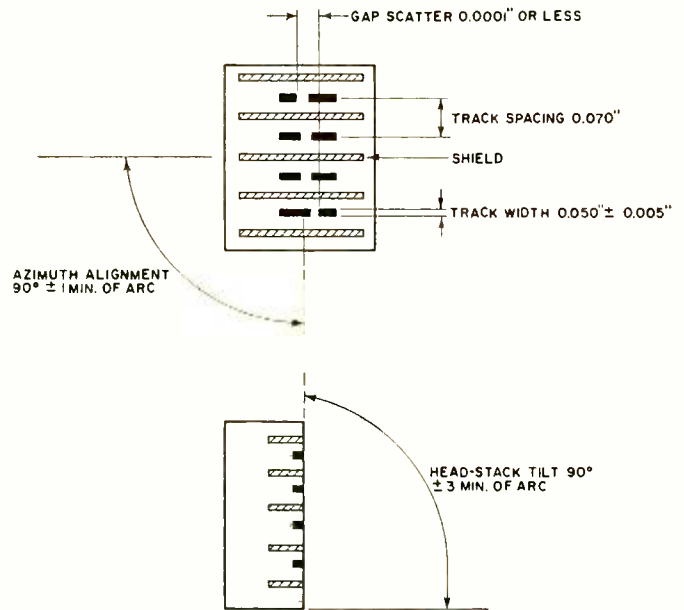
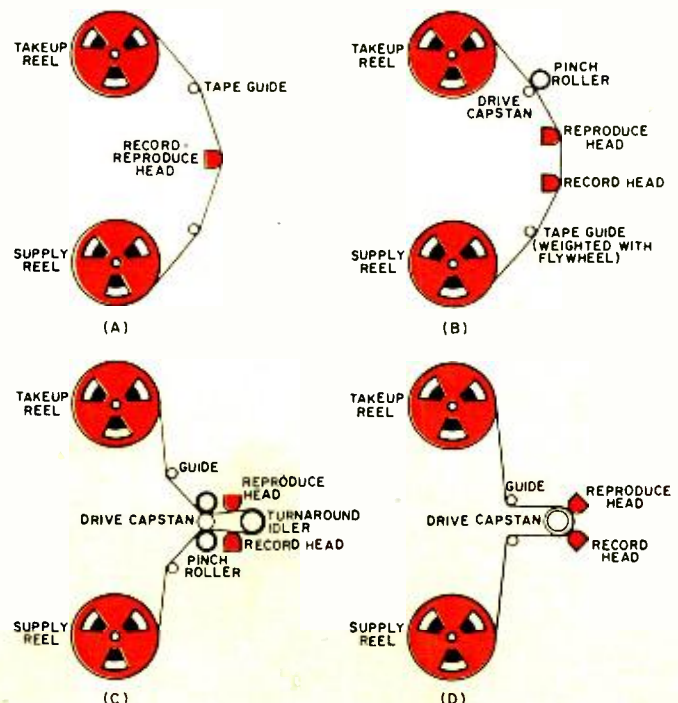

Fig. 3. Important dimensions that are to be maintained.

Fig. 4. Evolution of the tape-transport mechanism used.



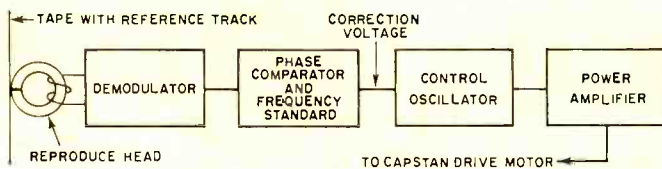

Fig. 5. Playback servo system is used to reduce timing error.

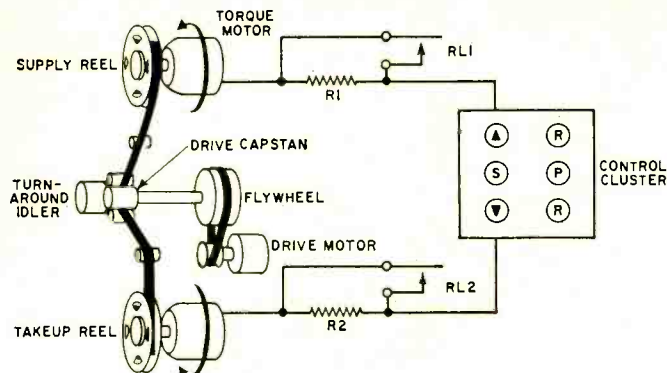

Fig. 6. A three-motor instrumentation tape transport system.

depending on the type of signal and recording method used. Special tapes are available with the oxide coating covered by a thin layer of plastic which prevents the head gap from making direct contact with the oxide surface. The plastic coating (50 μin or less) has the effect of increasing head life although there is a loss of the higher frequencies due to the separation of the oxide surface from the head gap. However, it is very useful for certain applications.

Tape-reel sizes for instrumentation recorders are available in standard NAB 7", 10½", and 14" diameters. When using a fast tape speed (30 or 60 in/s), it is convenient to use the larger reel size since tape is used quite rapidly at such recording rates. For example, a 14" reel containing 5000 feet of 1.5-mil tape will provide approximately 15 minutes of recording time at 60 in/s. Thus it is important to choose a tape speed that is consistent with the frequency range to be recorded if optimum tape usage is to be realized.

The Tape Transport

The evolution of the tape transport from the early audio recorder to the present-day instrumentation recorder is shown in Fig. 4. Fig. 4A shows the basic system of the original audio recorder. The tape was pulled from the supply reel by the take-up reel through a series of tape guides and past the record and reproduce heads or a single record-reproduce head. This long loop of uncontrolled tape led to undesirable oscillations in the system which are known as flutter or wow, depending on the frequency. Flutter usually refers to changes above 10 Hz while wow covers a frequency range from 0.1 to 10 Hz. Another drawback to this method is the large change in tape speed that results.

The open-loop drive system of Fig. 4B offers an improvement since now the tape movement is controlled by the drive capstan and pinch-roller assembly. This constant-speed system is used in most modern audio recorders. However, the need for a more precisely controlled system for instrumentation purposes led to the development of the closed-loop drive system of Fig. 4C. The use of the two pinch rollers and the turnaround idler controls the tape both as it enters and leaves the head assemblies and keeps the tape loop very short. Thus the tape is maintained at a constant tension which lessens the chance of flutter.

An ideal tape transport system would be the one of Fig. 4D. This is the zero-loop drive system which eliminates any tape loop between the record and reproduce heads. This requires extremely close tolerances for the manufacture of the drive capstan which doubles as a turnaround idler and associated parts. For this reason this particular type of tape-

transport system is not found in most production recorders.

Several additional features have been developed to help reduce flutter and wow to a minimum. One of these is the use of air-lubricated tape guides which virtually eliminates friction caused by the movement of tape over non-rotating members. This is accomplished by producing a film of air for the tape to ride on as it passes the tape guide. A small air compressor is included with this type of recorder to produce the air supply needed for the air lubrication system.

Another method used to combat flutter in tape systems is electronic flutter compensation. This is a system whereby a reference signal is recorded on the tape on a separate channel and later used in the playback process in order to cancel out the effects of flutter.

Precision Drive Systems

Besides the undesirable effects of flutter and wow, instrumentation tape systems are also subject to variations in tape speed known as drift. This is a much more gradual process but one that can produce serious errors in timing. Errors of this nature are generally caused by small variations in power line voltage and frequency, although mechanical imperfections can be a contributing factor. It is usually at its worst when a tape is recorded on one machine and reproduced on another. A highly regulated power supply for the tape transport serves to reduce this type of error to a minimum.

The heart of the power supply is a frequency standard containing a tuning fork that oscillates at a precise frequency. This signal is amplified until enough power output is obtained to drive the capstan motor. Thus a power source is provided which maintains a constant frequency and voltage no matter what the variations in the power-line source.

It can be seen from the above that a precision driving source will reduce timing errors caused by power-line variations. However, this will not correct for errors in timing caused by stretching or otherwise deforming of the tape itself. A playback servo system is very effective in reducing this. Referring to the diagram of Fig. 5, a separate 60-Hz oscillator is used to modulate a control reference signal for one of the recording channels. When played back in the reproduce mode, the signal is then demodulated and compared with the 60-Hz reference frequency in the phase comparator. Any error voltage present is used to shift the frequency of the control oscillator to either speed up or slow down the drive capstan. This, in effect, will cause the capstan to reproduce the original error in the same manner produced in the recording process, thereby canceling it out.

Tape Tension and Braking

From an examination of the various tape drive systems in Fig. 4, it can be seen that the tape must be kept under proper tension as it enters and leaves the drive capstan. Improper tension at either point can cause skewing, tape loops, or slippage at the drive capstan. In the normal mode of operation tape is drawn from the supply reel at a rate determined by the speed of the drive capstan. The tension on the takeup reel must be sufficient to prevent a tape loop from forming between the reel and the drive capstan but not so great as to cause slippage of the tape.

A block diagram of a typical tape transport containing three motors is shown in Fig. 6. The tape supply and takeup reels are driven by torque motors with torque output being a direct function of current input. The transport is shown in the normal record or playback mode. Resistors R1 and R2 are in series with the supply and takeup reel motors which thereby operate at reduced torque. Note that the arrow on the supply reel shows a force opposed to the direction of tape travel. This supplies the braking action necessary for proper tape tension between the supply reel and the drive capstan. The situation between the takeup reel and the drive capstan is just the reverse. Here the reduced torque in the direction of tape travel maintains just enough tension to

allow for a smooth winding operation without permitting a tape loop to form.

In the fast-forward position resistor R2 is shorted by relay contacts RL2 and full voltage is applied to the takeup reel motor. Relay contacts RL1 remain open, maintaining a reduced voltage at the supply-reel motor. This permits tape to be pulled rapidly from the supply reel to the takeup reel.

In the rewind process the conditions are reversed. RL1 is closed, providing full voltage to the supply-reel motor and RL2 remains open, maintaining a braking torque at the take-up reel.

The amount of torque required for the reel motors to perform their various functions is dependent on reel size and the thickness of the tape used. A separate switch (not shown) which presets the voltage range for the particular reel size and tape thickness is usually provided.

In addition to the functions given above, a means must be provided for braking both reels when the tape transport is placed in the "stop" position. This can be conveniently done by mechanical brake bands and drums attached to the shafts of the torque motors. Such a braking system can be actuated by an electrical solenoid or pneumatic piston in conjunction with the stop switch. The brake-tension adjustments are quite critical since broken tape or tape loops will result if they are incorrectly set.

Useful Operational Features

Several features usually found in a precision tape transport are worthy of mention since they contribute to operator convenience or speed up operation of the system considerably.

1. *End-of-reel sensing:* This is useful in preventing tape from running off the end of the reel in either direction. Probably the easiest way to accomplish this is to provide a section of foil leader spliced to both ends of the tape. When the foil leader comes up, an electrical path from an insulated guide post is completed through the metal, actuating the stop relay. In some of the more sophisticated machines this is accomplished with a differential pressure transducer which senses the air pressure between the tape and a small air jet. As the tape approaches the end of the reel in either direction, the pressure between the tape and the sensing transducer rises until, at a predetermined level, the stop circuit is actuated. This has the advantage of eliminating the foil leader.

2. *Tape-to-head disengaging system:* This provides automatic separation between the tape and heads in the fast-forward and rewind mode. This eliminates the tedious task of removing the tape from the drive loop each time the rewind or fast-forward mode is used. Leaving the tape in contact with the heads during the process would, of course, greatly accelerate head wear. One method of obtaining the necessary separation is to move the headstacks away from the tape surfaces during fast-forward or rewind. This involves the use of either a pneumatic or electric actuator. Either system works well, although precision machining is required for all moving parts since the head tolerances must be maintained within specs. Tape separation can also be accomplished by a system of movable tape guides with stationary heads. The guides act as "fingers" to lift the tape just clear of the head surfaces when fast cycling the tape. Both systems are provided with a manual override switch to disengage the circuit when necessary to monitor the tape when in the fast-forward or rewind mode.

3. *Single-switch speed control circuit:* This feature provides for the selection of any tape speed from a single switch. Some machines require the changing of belts or pulleys to accomplish this. In most four-speed recorders a drive motor is furnished which has four separate windings. To select a tape speed it is only necessary to select the appropriate winding. Transports that have six or more tape speeds usually require several belt and pulley changes in order to cover the complete speed range.

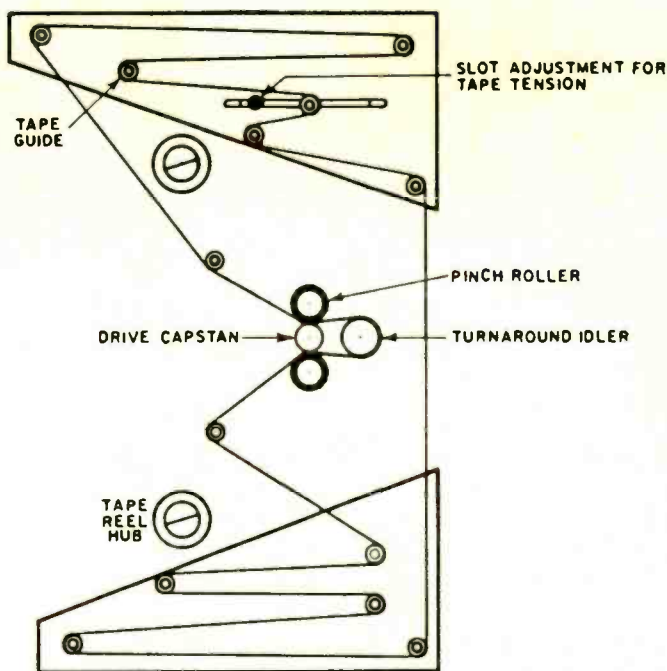

Fig. 7. Installation of a tape loop or "tail chaser."

4. *Automatic electronic switching:* This is usually operated in conjunction with the tape speed selector switch and, by means of relays, connects the various equalizers, filters, and oscillator center-frequency units necessary for each tape speed. Without this feature all the components (which may be plug-in types) must be changed by hand each time a different tape speed is used.

5. *Portability:* This feature is important in a machine that must be moved from one job to another. However, in order to produce a tape transport of small size and less weight, the manufacturer must frequently leave out many of the features desired by the operator.

6. *Remote control:* This feature is desirable when a large instrumentation recorder is centrally located. This permits an operator to start, stop, record, and perform various other operations while several hundred feet from the recorder. Transports having this feature generally require all the control functions to be operated electrically by a system of relays. Remote control then becomes a matter of extending the various switching leads.

7. *Turns counter:* This is practically a "must" for any machine that is to be used for data reduction. The counter does not necessarily indicate actual tape footage but is used in the data-reduction process to provide reference points.

8. *Edge-of-tape channel:* This is a direct-record channel that is used for commentary and is applied to the extreme edge of the recording tape. This is in addition to the regular recording channels.

9. *Tape-shuttle system:* Two turns counters are provided on a machine with this feature. These are electrically connected to the control system in such a way that the tape can be shuttled continuously between any two selected points. This permits any point desired to be repeated continuously in the reproduce mode.

10. *Tape-loop adapter:* Most tape transports can be readily adapted for a tape loop (or "tail chaser"). Fig. 7 shows the way this is done. The reels are removed from the transport and the tape loop adapter is installed. A section of tape is cut from the reel and spliced into a continuous loop. Threading the loop is simply a matter of placing the tape on the various idlers and adjusting the tape tension, as shown in the diagram. The data on the tape loop can now be repeated continuously for detailed analysis.

Next month we will go into the electronics circuitry used and discuss the various recording methods that are employed.

(Concluded Next Month)



Electronic counter having a 300 to 3000 MHz plug-in unit.

Digital U.H.F. Frequency Measurements

By WILLIAM BARDEN

Three basic techniques are used to make digital frequency measurements possible up to frequencies as high as 15,000 MHz. In one method, with transfer oscillator, an accuracy of 300 Hz in 1000 MHz is obtainable.

DIGITAL electronic counters are a must in every calibration lab, production line, and research and development laboratory in the electronics industry. They not only have the several parts-per-million accuracy necessary for precise frequency measurements, but provide an easy-to-read display of measurements taken at rapid sampling rates. Unfortunately in the past, their frequency limits have extended only up to 50 or 100 MHz at the most.

Recently, however, new techniques have been introduced that make digital frequency measurements possible to 15,000 MHz. One of these techniques divides the input frequency to be measured by two, four, or eight to produce a frequency low enough to be measured by conventional methods. Another activates the old principle of heterodyning with a new approach. In the third, a zero-beating technique is used. These new methods mean that engineers and technicians now have the direct-reading versatility and extreme accuracy of an electronic counter for frequencies widely used for communications and experimental purposes. Furthermore, as the state-of-the-art advances, one other important fact is noticeable. Prices are coming down, making u.h.f. counting equipment readily available.

Prices have decreased not only because of the availability of less expensive transistors and components but also because of current manufacturing philosophy. Most of the new u.h.f. equipment is built as plug-in units similar to those used with oscilloscopes. The plug-ins are used in a basic counter chassis that, by itself, is capable of counting up to 50 or 100 MHz. When installed in a counter chassis, the plug-ins use the power supply, oscillator, and functional switching of the counter. While the combined price of the plug-in and basic counter is not low, it is much less expensive to supplement the range of a low-frequency counter by adding a plug-in assembly than to replace the whole counter with a new one which covers all frequencies up to the u.h.f. range.

Since most u.h.f. counting equipment is of the plug-in type and is used in conjunction with a low-frequency counter chassis, an understanding of low-frequency electronic counting by direct methods is necessary in order to grasp the new higher frequency techniques.

Basically, most electronic counters are designed to provide two types of measurements; rate and time interval. The rate function measures the number of pulses in a selected time—the pulses do not have to be regularly spaced. Frequency measurement is a special case of rate measurement. The pulses in this case just happen to be regularly

spaced, but are still a rate function (cycles per second). The time interval function measures the time interval between two or more input pulses. Period measurement is another special case. The time interval in a period measurement is the same for any two input pulses selected. Because the time intervals between pulses of u.h.f. signals are smaller than the period of the signal used as a standard in most counters, time-interval measurements are not usable at u.h.f. frequencies. Almost all measurements of u.h.f. signals eventually involve frequency measurements by the basic counter.

A counter measures frequency (or rate) as shown in Fig. 1. The input frequency (f_{in}) is received by the input amplifier. The amplified signal is next squared by the shaper, a conventional Schmitt trigger whose triggering point may or may not be adjustable. The square-wave output of the Schmitt trigger is one of the inputs to an *and* signal gate. The signal gate is enabled (opened) when a gating signal is present. The gating signal is developed by the crystal oscillator/decade divider section of the counter. The oscillator is extremely stable, typically 10 parts in a billion per week, and operates at a 1- or 10-MHz frequency. The output of the oscillator is squared by another Schmitt trigger circuit (shaper) and then divided in steps of ten by a series of decade dividers. Each decade divider provides one output pulse for every ten input pulses. A 1-MHz oscillator frequency then becomes a precision 100-, 10-, 1-kHz and 100-, 10-, and 1-Hz time-base frequency. A time-base switch selects which of the time bases will be used for measurements. The control gate allows one time-base pulse to open the gate and the next to close it. The signal gate, then, allows the shaped input frequency pulses to pass through it only for the time interval between two pulses of the selected time base.

Assume the input frequency to be exactly 15 MHz. If a time-base frequency of 10 kHz is selected (the time-base frequency must always be lower than the input frequency for obvious reasons), the signal gate will be opened for the time interval between two 10-kHz pulses, or 0.1 millisecond. For every 10-kHz pulse there are 1500 15-MHz pulses. Consequently, 1500 pulses pass through the signal gate during the time it is open. The signal pulses passing through the gate are counted by decade counters. The decade counters are similar to the decade dividers used in time-base circuits in that they produce one output pulse for every ten input pulses. The decade counters, however, provide a visual display of the number of pulses each receives. An indicator

Bring your slides and movies to Life...

(and your audience, too!)

WITH VOLUME II

SOUND FOR A PICTURE EVENING

This superb 12-inch, 33 $\frac{1}{3}$ rpm record brings you 30 selections of sparkling, mood-setting off-beat music and hard-to-find, sound effects. For use "as is" by playing the appropriate tracks as your slide or movie show proceeds or for editing your selections and recording them on tape, "Sound For A Picture Evening" adds another dimension to your photography—high fidelity sound.

MADE WITH PHOTOGRAPHERS IN MIND

Photographers are travelers . . . are parents . . . are sportsmen . . . are restless experimenters with the unusual. And so the editors of POPULAR PHOTOGRAPHY have produced this second volume of unusual music and sound effects expressly to match the activities and moods in the most popular types of pictures shown in slide and home movie shows. These are melodies and sounds selected from the vast resources of the Capitol Record Hollywood Library to fit the special needs of photographers. The 30 bands of "Sound For A Picture Evening, Vol. II" supplement but do not duplicate any of those in the first edition of this popular record.

A POPULAR PHOTOGRAPHY EXCLUSIVE

The "Sound For A Picture Evening, Vol. II" album has been produced by the editors of POPULAR PHOTOGRAPHY exclusively for our readers and is prepared by the Custom Services Division of Capitol Records. This outstanding album, which cannot be purchased in any store, is available by mail only to the readers of Popular Photography and other Ziff-Davis magazines.

YOU GET 30 SPECIAL MUSIC AND SOUND TRACKS

There are 19 bands of mood and special-situation music . . . 11 bands of unusual, hard-to-find sound effects.

MOODS: Majestic, Backyard Nature, Experimental, Mysterious, Music of the Spheres • **NATIONAL PORTRAITS:** Vive la France, German Village Band, Soul of Spain, American West, English Countryside, Buon Giorno, Italia •

SOUND EFFECTS: Bass Drum, Bassoonery, Cathedral Bells, Galloping Horses, Zoo Noises, Children at Play, Cocktail Party, Birds on a Spring Morning, Outboard Motor, Oars in Water, Skis on Snow, Trumpet Fanfare, Solo Violin • **SPECIAL PURPOSE MUSIC:** Music From Silent Movies, Music for Slow-Motion Movies, Music for Speeded-Up Motion, Music for Stop-Motion Movies, Underwater Music, Music for Old-Time Footage.

For photographers with wanderlust, you'll find the "National Portraits" to be authentic melodies to go with your vacation pictures of England, France, Germany, Italy, Spain and the American West.

There are also those special bands to accompany the kind of pictures sportsmen take: The sound of galloping horses, of boat motors, of skis on snow, of oars in the water. You'll even find other-worldly mood-music chosen especially to go with underwater pictures.

Experimental photographers will find the electronic music ideal accompaniment for abstract pictures. The music for stop-motion, slow-motion and speeded-up-motion pictures is fanciful and imaginative in helping to present the unusual scenes being portrayed on your screen. And there is even mood music to convey the visual grandeur of ancient museum relics and photographs of the stars and planets.

To these add many other tracks of carefully selected music and sounds—and you have "Sound For A Picture Evening, Volume II."

November, 1967

PHOTOGRAPHY.

VOLUME II

SOUND FOR A PICTURE EVENING

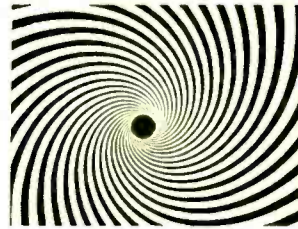
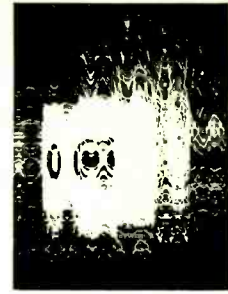

30 bands of unusual background music & sound effects specially chosen for slide shows & movies

*19 Bands of mood and special-situation music...
11 Bands of unusual, hard-to-find sound effects...*

COMPLETE WITH INSTRUCTIONS AND BAND POINTER

FREE!

A comprehensive instruction booklet comes with your record, showing you how to make a successful sound-and-music tape track for your slide or movie show, or to use the record alone as background, even if you're a rank beginner. An ingenious band pointer which fits on top of your record instantly locates any band you want. No guessing, no wasted motion, no false starts.

This 12" long playing vinyl album consisting of selections from the music masters of the Capitol Record Hollywood Library is available to you for

only \$3.⁹⁸ POSTPAID!

It's a must for every slide and film show impresario and an album you will enjoy for many years to come.

PLACE YOUR ORDER NOW

"Sound For A Picture Evening, Volume II"

P. O. Box 3118

Church Street Station, New York, N.Y. 10008

Please send _____ "Sound For A Picture Evening, Volume II" albums at \$3.98 each, postpaid.

My check (or money order) for \$_____ is enclosed.

(Outside U.S.A. please send \$6.00 per record ordered.)

N. Y. State residents please add local sales tax.

Name _____

Address _____ EW-117

City _____

State _____ Zip Code _____

PAYMENT MUST BE ENCLOSED WITH ORDER

"SOUND FOR A PICTURE EVENING, VOLUME I" still available

I missed this first release containing 17 specific mood music backgrounds and 8 tracks for special sound effects. Please send _____ "Sound For A Picture Evening, Volume I" albums at \$3.98 each, postpaid. (Outside U.S.A. send \$6.00 per record ordered.)



JOHN FRYE

Technicians working closely with radiation-emitting devices are exposed to far greater danger than the general public.

RADIATION AND THE TECHNICIAN

"HERE'S something to read and think about," Mac said, sliding a sheet of paper along the service bench to his assistant, Barney. "It's a 'Service News' sheet put out by RCA telling of the dangers of radiation from TV receivers and describing precautions that should be taken to protect the viewer and the technician from excessive radiation."

"I notice you emphasize 'and the technician,'" Barney observed. "Any particular reason?"

"Yes. You remember the hue and cry that took place this summer when it was found that certain color-TV sets were emitting radiation in excess of what is considered safe. This resulted in hearings in both the House and Senate aimed at determining what radiation hazards to the general public are contained in various kinds of electronic gear, especially TV receivers, and whether or not legislation was needed to afford protection to the public.

"That's all very fine, but, when you come to think of it, the service technician is likely to have much more exposure to this kind of equipment than is the user. While radiation falls off rapidly with distance from the source, we are usually working right on top of receivers. Total radiation dosage is a function of the length of exposure, and we often spend an eight-hour day with color sets working on all sides of us. To make matters worse, we often work on sets with some of the protective shielding removed or on sets in which the voltage regulation is malfunctioning and higher than normal accelerating voltages are present. Since the generation of x-rays is directly related to the accelerating potential, such sets often exude higher than normal radiation."

"See what you mean," Barney said; "and to add to the problem, many top-notch technicians, including your humble servant, are not too knowledgeable about radiation dangers."

"That's probably because low-level radiation is such an insidious menace. Unlike a jolting shock or a blistering burn from a hot tube, radiation damage cannot be detected by the senses and shows no immediate effect. In that regard it reminds me of the discovery a few years back of the damage to the liver and other organs resulting from the breathing of carbon tetrachloride fumes. Because of the time lag between exposure to the fumes and resulting illness, the two were not tied together, even by the medical profession; and we technicians in our ignorance blithely used gallons of the stuff to clean volume controls, wash off grease, etc., breathing in pure poison all the while."

"Where does most of a TV set's radiation come from?"

"From the picture tube, the high-voltage rectifier, and the high-voltage regulator tube."

"What's considered a safe level of radiation?"

"Actually, according to radiation experts, there's no such thing as a completely safe dose. Any exposure can harm man. However, man lives with a background level of bombardment from cosmic rays and natural radiation that results in an average dose of about 0.3 milliroentgen every twenty-four hours. This exposure is considerably greater at higher elevations where there is less atmospheric shielding

from cosmic rays. And, for medical reasons, individuals deliberately expose themselves to much greater radiation at times. A conventional chest x-ray represents a dose of 1 to 3 roentgens per film; a chest fluorogram, 5 to 10 R; and a full mouth x-ray, about 180 mR. It's interesting to note that the average annual exposure of all Hanford-Oak Ridge workers (0.2 R a year) is less than the normal exposure to cosmic rays in mile-high Denver (0.5 R a year). This proves that man can protect himself from even high-level radiation sources with proper precautions."

"What's the maximum radiation permitted a TV set?"

"Until recently, the *Underwriters' Laboratories* standard was a maximum of 2.5 mR per hour as measured at a point 5 cm from the receiver's surfaces. As of September 1st, this was lowered to 0.5 mR per hour, as has been recommended by the National Council on Radiation Protection and Measurements since 1960. This lower figure was also recommended by the International Commission on Radiation Protection at that time."

"What does RCA suggest the technician do to protect himself and the viewer?"

"First, don't modify the compartment and chassis enclosing the high-voltage circuit. Keep the compartment in place and the door closed when the set is operating. Make sure all metal shields are in place. If one is missing, replace it as a standard service procedure.

"Second, make it a standard operating practice on every chassis you work on to run the brightness level up and down with a meter on the high voltage to be certain that voltage is being regulated correctly. And make darned sure you use an accurate and reliable high-voltage meter. Since we normally make high-voltage measurements much more rarely than we do lower voltage measurements, the accuracy of the meter or probe being used for such measurements could drift off without our being aware of it.

"Third, do not adjust the high voltage beyond the rated value for the particular chassis at the recommended line voltage. As I said before, increasing this voltage increases the x-radiation output.

"Fourth, when replacing a color picture tube, be certain to replace the magnetic shield which fits on the funnel of some tube types."

"Those precautions all make sense, but aren't there other kinds of electronic equipment that put out dangerous radiation?"

"Yes indeed! James G. Terrill, Director, Public Health Service, National Center for Radiological Health, in giving testimony to a House committee listed many electronic components operating at high voltage which may have the potential to emit excessive radiation. His list included magnetrons and klystrons with common accelerating voltages between 20 and 50 kilovolts used in both industrial heating and radio transmission, projection TV tubes, cathode-ray tubes in oscilloscopes, Van de Graaff generators used commercially for polymerization of plastic, scientific toys that generate high voltages, and the CR tubes used in computers.

"He went on to mention other devices that emit electro-

tube for each decade counter indicates 0 to 9 pulses received; on the tenth pulse, a "carry" pulse is sent to the next decade counter, and the indicator tube starts over from 0. Therefore, at the end of the gate time, 1500 is displayed on the readout tubes of the counter. The time the display is held is usually variable; after the display period has ended, the control gate allows the next count sample to begin.

The maximum frequency that an electronic counter can measure by direct counting methods is limited, but this value is increasing. In the late 1940's, when the electronic counter was first developed, the upper frequency limit was 100 kHz. In the mid-fifties, 10-MHz counters became a reality. Advances in gating and steering circuits and transistor switching speeds have currently increased the frequency measuring capability of direct counting to 100 MHz. With this frequency as a practical and economical limit, for the time being at least, three other techniques have been devised to offer most of the advantages of electronic counting for u.h.f. work.

Fig. 2 shows prescaling, the oldest method of the three. Prescaling methods make measurement of up to 400 MHz possible by dividing the frequency to be measured by two, four, or other powers of two. Since the signal is not gated before or during the division, frequency limitations of a gating circuit are avoided. Another frequency limitation is bypassed since the prescaler uses binary division instead of decade division. Decade dividing utilizes internal feedback among four flip-flops to enable the divider assembly to divide-by-ten instead of a normal 2, or 16. This feedback, however, slows down the operation of the circuit and consequently lowers the frequency limit of the decade divider. Binary dividing circuits use no internal feedback, thus division by a binary circuit is much faster than the divide-by-ten action of a decade divider. The output of the prescaling divider circuits is within the range of direct counting capabilities.

Since prescaling divides the frequency to be measured by a power of two, the gate of the counter must be left open a longer time to maintain the ratio of input frequency to gate time. This is usually done automatically in the basic counter by dividing the time-base frequency by the same power of two by which the prescaler divides. The readout of the counter is still in frequency units when this is done.

Heterodyne Frequency Measurement

The counting frequency limit may be extended to 3000 MHz or more by employing heterodyning. This technique mixes the frequency to be measured with another known frequency to produce a difference frequency that lies within the measurement range of the basic counter. For example, if the input frequency is 358.583 MHz it cannot be measured by direct counting methods. If the input frequency is mixed with a precision 350-MHz signal, however, the difference frequency of 8.583 MHz may be measured by direct methods. The input frequency is then found by adding the known mixing frequency of 350 MHz to the counter display of 8.583 MHz.

The principles of heterodyning are illustrated in Fig. 3. The main counter supplies a reference frequency of 1 or 10 MHz from its internal oscillator. A multiplier increases the reference frequency by 100 or 10. Harmonics of this multiplied frequency are produced by a harmonic generator in the heterodyne unit. The output of the harmonic generator goes to a cavity tuning circuit which can be made to resonate at the harmonic frequencies. A typical cavity of this type produces an output of 100, 200, 300, 400, or 500 MHz from a 1-MHz reference frequency. The mixing-frequency (harmonic) frequency desired is selected by a mixing-frequency switch. The input frequency is then combined with the mixing frequency to produce a sum and difference frequency. The output of the mixer goes to a bandpass filter which attenuates the frequencies about 100 MHz. Thus, only a difference

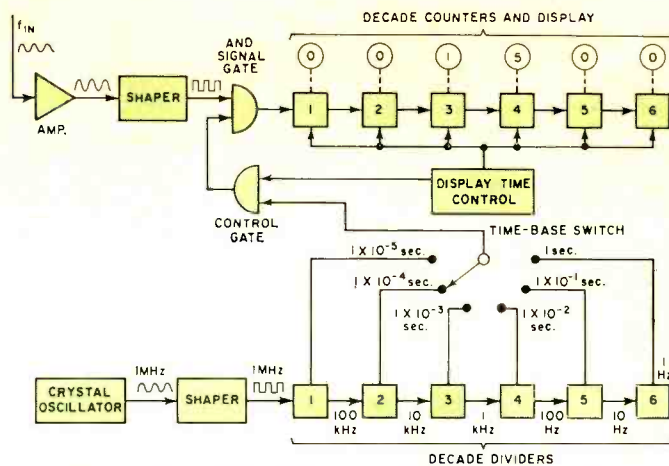

Fig. 1. Basic counter used to measure frequency or rate.

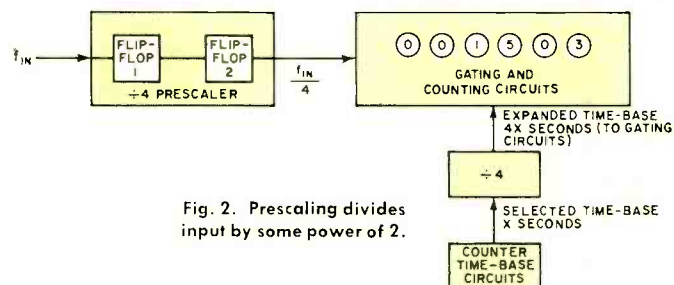

Fig. 2. Prescaling divides input by some power of 2.

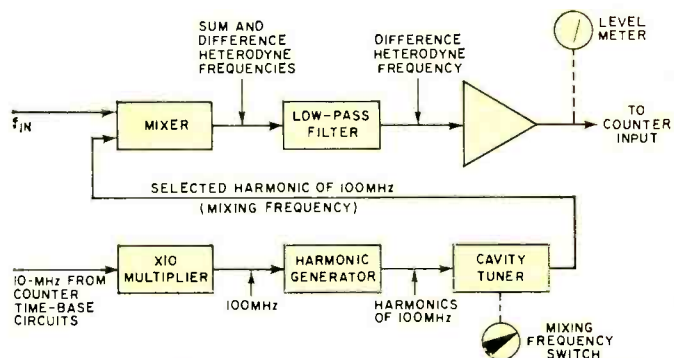

Fig. 3. Heterodyning extends frequency measurement to 3 GHz.

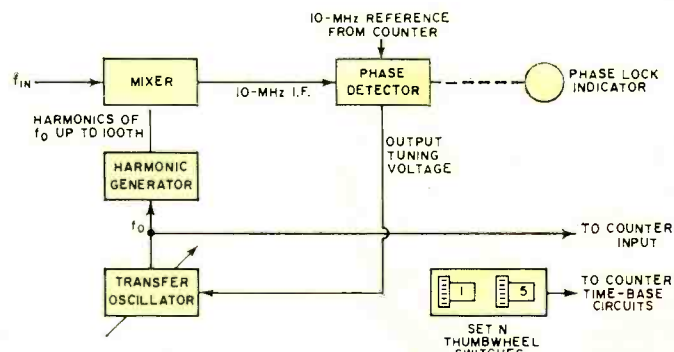

Fig. 4. Transfer oscillator uses phase-locking techniques.

frequency below 100 MHz is allowed to pass the filter without appreciable attenuation. The difference-frequency output is amplified and applied to the input of the basic counter to be measured by conventional methods. The presence of a usable output from the amplifier is detected by a level meter. The setting of the mixing-frequency switch and the counter display when added together give the actual input frequency.

One difficulty in the heterodyne method is that two frequencies produce the same heterodyne frequency. If the



Laboratory counter using a 15,000-MHz transfer oscillator plug-in unit. Other plug-ins cover different frequencies.

mixing frequency is 300 MHz, for example, input frequencies of 320 and 280 MHz both produce heterodyne difference frequencies of 20 MHz. It is not immediately obvious, then, whether the counter display should be added to, or subtracted from, the setting of the mixing-frequency switch.

When the approximate input frequency is not known, a technique called complementing must be used. Complementing requires that at least two measurements of an unknown frequency be taken to eliminate the ambiguous result. One measurement is made at the first mixing frequency which produces an appreciable output on the level meter. The mixing-frequency switch is then set to an adjacent setting and the heterodyne frequency is again measured. If the input frequency is between the two mixing frequencies, the sum of the two heterodyne frequencies will be the mixing frequency interval.

Assume that the input frequency is 320 MHz. Mixing frequencies of 300 and 400 MHz will produce heterodyne frequencies of 20 and 80 MHz, respectively. The two heterodyne frequencies add up to 100 MHz, the mixing frequency interval. Therefore, 20 MHz added to 300 MHz gives the correct input frequency (or 80 subtracted from 400 MHz).

The difficulties of a count ambiguity and the extra effort in measurements notwithstanding, heterodyne counting is reliable and covers a greatly extended frequency range compared to either direct counting or prescaling. The accuracy of the measurement remains as good as direct counting since the fundamental frequency used in generating the mixing frequencies is the precision oscillator frequency of the basic counter, and these are usually of very high quality.

Transfer Oscillators

The transfer oscillator method of u.h.f. frequency measurement is unlike either the prescaling or heterodyne methods. In the previous two, the input signal is converted to a signal that is within the range of the basic counter. The basic transfer oscillator technique uses a separate low-frequency oscillator to generate harmonics which are compared to the frequency to be measured. One of the harmonics is zero-beat with the input signal by use of a CRT phase pattern or audio beat note. The unknown input frequency is then found by measuring the oscillator frequency by direct methods and multiplying it by the harmonic number of the zero-beating harmonic.

In a more sophisticated version of the transfer oscillator principle, the difficulties in obtaining a precise zero-beat are avoided by mixing a harmonic with the input frequency to produce an intermediate frequency. The intermediate frequency is then used to lock the oscillator harmonic to the input, enabling a stable oscillator frequency.

Fig. 4 shows a typical transfer oscillator, usable from 100 MHz to 6 GHz. The oscillator in this case is variable from 40 to 60 MHz. The output of the oscillator goes to a harmonic generator. The harmonic generator produces harmonics

up to the 100th of the transfer oscillator fundamental frequency. These harmonics are mixed with the input frequency to produce various heterodyne frequencies. The oscillator has two tuning modes, automatic or manual. In the automatic mode, the oscillator is swept through its range by the voltage output of a phase detector. As the oscillator is tuned across its range, one of the harmonics will beat with the frequency to be measured to produce a 10-MHz intermediate frequency. This i.f. is then amplified and applied to one of the inputs of the phase detector. The other input to the phase detector is a precision 1-MHz signal from the oscillator of the basic counter.

Any difference in frequency between the two inputs is detected and produces a corresponding change in the voltage output of the phase detector. This voltage controls the frequency of the transfer oscillator. As long as the i.f. frequency and the 10-MHz reference are equal in frequency, the oscillator frequency does not vary. Should the i.f. deviate from 10 MHz, the transfer oscillator changes frequency to bring the i.f. back to 10 MHz. The phase detector "locks" one of the harmonics of the transfer oscillator to the input frequency. Phase lock is indicated by a light which illuminates when a lock condition exists. When a lock condition is established, the transfer oscillator frequency is measured by the basic counter. The input frequency is then determined by the counter display multiplied by the harmonic number N and added to or subtracted from 10 MHz.

If the approximate input frequency is not known, N may be found by applying a simple relationship. At a phase-lock condition, the input frequency is the oscillator frequency times N plus or minus 10 MHz.

If the oscillator frequency is increased so that another frequency causes phase lock, then the harmonic producing the second phase lock will have a harmonic number one less than the first, or $f_m = [f_o \times (N-1)] \pm 10$ MHz. By setting the terms on the right side of each equation equal to each other, N may be found to be $= f_o / (f_o - f_m)$.

For example, if the frequency to be measured is exactly 370 MHz, a phase lock will occur at a transfer oscillator frequency of 40 MHz, when its 360-MHz *ninth* harmonic beats with the input to produce the 10-MHz i.f. If the oscillator is then tuned to 45 MHz, a *eighth* harmonic (360 MHz) produces another phase lock. The harmonic number is found to be $N = 45 \text{ MHz} / (45 \text{ MHz} - 40 \text{ MHz}) = 9$. The input frequency is then 40 MHz times 9 plus 10 MHz or 370 MHz. In actual practice, calculation of this type is avoided by the use of a nomogram or table supplied with the transfer oscillator plug-in.

Most transfer oscillators also include a means of expanding the signal gate of the basic counter so that the input frequency will be indicated on the digital display of the counter directly, without conversion. When N is determined by nomogram, it is set on two thumbwheel switches on the face of the plug-in and control the time-base divider circuits. For a harmonic number of 9 and an input frequency of 370 MHz, for example, 09 is set on the thumbwheel switches and the divider circuits divide the basic counter time-base frequency (or increase the time base) by nine. This means that the signal gate of the counter will be open nine times as long as before the division. The counter then reads 360 MHz instead of 40 MHz, the transfer oscillator frequency. 10 MHz is added to the display as before to yield 370 MHz, the input frequency.

The transfer oscillator may include a second frequency range that makes measurements up to 15 GHz possible. In many cases the consequent increase in the transfer oscillator frequency range may necessitate using a combination of the transfer oscillator and heterodyne measurement techniques. The accuracy of the transfer oscillator method is dependent upon the stability of the oscillator in the assembly; with the phase-lock technique, however, an accuracy of 3 parts in 10^7 , or 300 Hz in 1000 MHz is possible. ▲

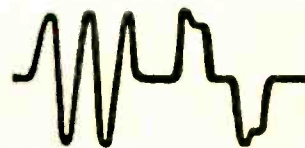

Which miniature electrolytics for transistorized AM-FM radios ?

**COMPARATIVE SIZES
OF CAPACITORS ALL RATED
10 MFD., @ 25 WVDC
(shown actual size)**



TT aluminum electrolytic



MTA aluminum electrolytic



TAS solid tantalum



TAP wet slug tantalum



TLS wet slug tantalum



MTP wet slug tantalum

The new portable AM-FM radios are so compact you wonder how they get all those components into that little box. You wonder even more when you have to replace some of the parts.

Electrolytic capacitors, for example. The original electrolytic usually turns out to be a tiny thing jammed in among a dozen other midget gadgets. Getting it out is a trick in itself. Getting a suitable replacement is even tougher! And unfortunately, you're apt to need replacements, because many of these tiny capacitors just aren't much good. They don't meet the quality specs of good domestic capacitor makers. But high quality domestic capacitors are often just a bit too big to fit in the space available.

What's the answer? Search the town for another "little-bitty" original capacitor? Tell your customer you can't finish the job?

Don't give up. We have a few suggestions.

First, try a Mallory TT aluminum electrolytic. This is a real quality capacitor, rated 85°C, and it's pretty doggone small. Or a Mallory MTA, a revolutionary molded case aluminum electrolytic with excellent quality at low-low price.

If neither of these will fit, try a Mallory tantalum capacitor. The TAS solid tantalum is about the same size as the TT, but it's rated 125°C. Need still smaller size? Take a look at the Mallory "wet slug" tantalum types TAP and TLS—and the super-miniature MTP, which gives you the most microfarads in the smallest size of anything on the market. The pictures at the left show you comparative sizes, all for a 10 mfd, 25 WVDC rating.

Sure, you'll pay a little more for the tantalum capacitor. But not as much as you might think. The TAP only costs 42c more than the TT, in the rating shown. And you get the utmost in reliability.

We certainly don't expect you to use a tantalum capacitor to replace every aluminum electrolytic. But they come in mighty handy sometimes. And you can get them when you need them from your Mallory Distributor. Ask him for our latest catalog, or write to Mallory Distributor Products Company, a division of P. R. Mallory & Co. Inc., Indianapolis, Indiana 46206.

DON'T FORGET TO ASK 'EM—*What else needs fixing?*

Thinking of college and a space age career in electronics?

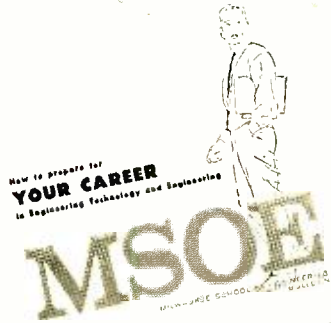

Send for this booklet on ENGINEERING TECHNOLOGY AND ENGINEERING

Learn how you can prepare for a dynamic career as an electrical or mechanical engineering technician or engineer in such exciting, growing fields as avionics, missiles, reliability control, fluid mechanics, data processing, metallurgy, microelectronics, and advanced aerospace research.

MSOE offers residence study programs leading to these degrees in engineering technology and engineering:

2 years—Associate in Applied Science
4 years—Bachelor of Science

Also get facts about scholarships and financial aids, job placement and other student services, plus photographs of MSOE technical laboratories and student activities. For your copy, just mail the coupon — no obligation.

Programs approved for veteran training.

MSOE

Milwaukee School of Engineering
Dept. EW-1167 1025 N. Milwaukee St.,
Milwaukee, Wisconsin 53201

Please send the "Your Career" booklet.
I'm interested in
 Electrical fields Mechanical fields

Name..... Age.....

Address.....

City..... State..... ZIP.....

MS-289

CIRCLE NO. 106 ON READER SERVICE CARD
54

magnetic radiation that might create biological effects: ovens producing microwaves for cooking; radar used in boat navigation and available for small boats; ultraviolet-light-producing lamps used in greenhouses, welding arcs, germicidal lamps, and sun lamps; infrared industrial drying lamps such as those used in the automobile industry; and infrared cooking grills. He stressed that there is too little known about possible radiation effects from these devices."

"Yeah, and many devices that can be used safely by someone who knows what he is doing can become dangerous in inexperienced hands," Barney added. "I remember reading recently that a 1961 survey of 3600 x-ray units in New York City found 92% defective. A 1963 study of x-ray machines by the Florida Board of Health found 42% below state standards. And it was said that many of the people who operate these machines are poorly trained. In many states, almost anyone can become an x-ray operator without formal preparation. Dr. Granville Larimore of New York's Health Department warns that an unskilled operator can expose a patient to as much as 100 to 200 times the necessary amount of radiation. This is true in spite of the fact that the Oak Ridge National Laboratory has proved conclusively that lower dosages result in better pictures."

"This is all part of man's growing uneasiness about the heedless way we've been fouling up our environment—water, air, and now our radiation background," Mac said thoughtfully. "We're bound to be hearing and reading much more about this in the future; so we may as well equip ourselves with the proper vocabulary. I've jotted down some of the words certain to crop up in any serious discussion of radiation," he said, pulling a slip of paper from his pocket.

"There are two kinds of radiation measurement: one a measure of the strength of the source and the other a measure of the dose received by an irradiated object or person," he went on. "The unit of activity of a radioactive source is the curie (Ci), and it indicates that the source is undergoing 3700×10^{10} disintegrations per second. This is about the activity of one gram of pure radium. Smaller units, of course, are the millicurie (mCi) and the microcurie (μ Ci).

"The roentgen (R) is the unit of dosage. It's defined as the quantity of x- or gamma radiation that produces under ideal conditions in one cm³ of air at 0°C and 760 mm of mercury pressure ionization of either sign equal to one electrostatic unit of charge. The roentgen is the unit of total dose in terms of energy and does not refer to the rate at which radiation is absorbed. But it's clear a dose that could be tol-

erated when spread over a lifetime might well be fatal if absorbed in a few seconds; so we need a concept of dose-rate, expressed as roentgens per week, milliroentgens per hour, etc. The number of ion pairs produced by one roentgen in air is given as 1.61×10^{12} . This is equivalent to 83.7 ergs or, if animal tissue is substituted for air, to 93.1 ergs.

"Another unit of dose, the rad, has recently been adopted. It's the amount of radiation which produces 100 ergs per gram of absorbing material and is the same for any radiation: alpha, beta, gamma, or x-rays, protons or neutrons; but the biological effect in man depends on the kind of radiation. Therefore, it's necessary in some cases to multiply the dose by the relative biological effectiveness (RBE) of the particular radiation. The RBE of gamma rays of radium, x-rays from 0.1 to 3.0 MeV, and beta rays is unity; that of fast protons and fast neutrons of energy not less than 2 MeV is 10; and that of alpha radiation is 20.

"The roentgen-equivalent-man, or rem, is the unit of dose of radiation absorbed by man. It is not a precise unit and is given by the relation: dose in rems = dose in rads \times RBE."

"Well," Barney said as he stood up and stretched lazily, "after hearing all this I shall not be at all surprised if I glow in the dark after I go home from a hard day here in the shop. Seriously, I'm taking this all to heart and fully intend to guard myself against unnecessary radiation to the best of my ability. I don't like that business about the experts revising downwards their idea of what constitutes a dose of harmful radiation. Maybe one of these days they'll be third-guessing that second-guess, and I want to be one jump ahead of them if I can!" ▲

(Editor's Note: For additional comments on this important topic, refer to "Reflections on the News" on page 18 of this issue.)



EXTRA POWER
with
FINCO
AMPLIFIERS
*For perfect color TV and
FM Stereo Reception*

FINCO MODEL #65-4
Antenna Amplifier
\$47.95 list VHF-TV
Two-transistor Antenna
Amplifier for 75 OHM
Downlead, and power
supply with built-in
single or dual 300 ohm
outputs. Provides 12
dB gain in the low band
and 14 dB gain in the
high band.



FINCO MODEL #65-1
Distribution Amplifier
\$29.95 list 2-tube 4-
output VHF-TV or FM
Distribution Amplifier
for 300 OHM Opera-
tion, providing 8 dB
gain at each 300 ohm
output to feed home or
commercial systems.

FINCO MODEL #65-5
Distribution Amplifier
\$44.95 list VHF-TV 75
OHM Single Outlet Dis-
tribution Amplified for
deluxe home or com-
mercial use to feed
multiple sets through
line tap offs or split-
ters. Delivers 17 dB
Low Band and 14 dB
High Band.



FINCO MODEL #65-2
Distribution Amplifier
\$39.95 list 2-tube 4-
output VHF-TV or FM
Distribution Amplifier
for 75 OHM CO-AX
Operation, providing 6
dB gain at each 75 ohm
output to feed deluxe
home or commercial
systems.

FINCO MODEL #65-6
Amplifiers \$79.95 list.
VHF-TV Antenna Moun-
ted two-transistor pre-
amplifier with 75 OHM
two-tube Single Output
Distribution Post-am-
plifier up to 30 dB gain
for improved reception.
Used in home or com-
mercial installations to
feed multiple sets.

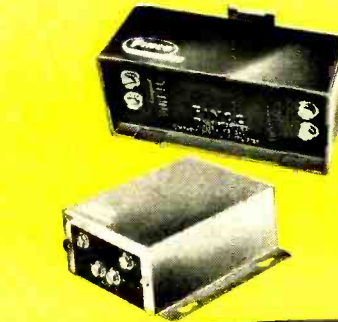

FINCO MODEL #65-3
Antenna Amplifier
\$44.95 list New VHF-
TV Antenna Amplifier
and Power Supply with
built in single or dual
outputs to improve re-
ception of weak signals
in fringe areas. Pro-
vides 12 dB gain in the
low band and 14 dB
gain in the high band.

FINCO MODEL #65-7
FM Signal Amplifier
\$24.95 list. One-trans-
istor Indoor Behind-
the-set FM amplifier
with a passive filter in-
put circuit to reject sig-
nals outside the FM
band which cause in-
terference. Delivers 20
dB Gain.



**Sets "COME ALIVE" with
Brilliant Sound and Color**
A Finco high-gain, low-noise amplifier
will bring in the sharpest **COLOR** or
B & W TV picture and the finest sound!
**All FINCO Products are Engineered
For Color!**



Write for Color Brochure #20-411.
THE FINNEY COMPANY

34 W. Interstate Street • Dept. 410 • Bedford, Ohio 44146

LAFAYETTE

Power Packed

DYNA-COM 6

5 WATTS
Hand Held Power

6 CHANNELS
Switchable Crystal
Control For All 23 Channels

Plus New Revolutionary

99-3150L*

9995

With Leather
Shoulder Strap



- ★ Integrated Circuit (IC) plus 12 Transistors and 5 Diodes for Super Performance
- ★ Superheterodyne Receiver with Less Than 1 μ V Sensitivity for 10 db S + N Ratio
- ★ Mechanical Filter for Superior Selectivity
- ★ Automatic Compressor Range Boost
- ★ Variable Squelch and ANL
- ★ Public Address External Speaker Jack with PA Switch and PA Volume Control
- ★ Mobile Operation with Cigarette Lighter Plug-in Adapter
- ★ Jacks for External Battery Pack, Mobile Battery and Battery/Charger Eliminator *Imported

FREE

1968
CATALOG
NO. 680

512 Pages

Everything in Electronics
for Home and Industry
from the "World's Hi-Fi
Electronics Center"

LAFAYETTE Radio Electronics
Dept. RK-7, P.O. Box 10
Syosset, L. I., N. Y. 11791

Send me the FREE 1968
LAFAYETTE Catalog 680

RK-7

Name _____

Address _____

City _____

State _____

Zip _____

CIRCLE NO. 109 ON READER SERVICE CARD

GET
INTO

ELECTRONICS



VALPARAISO TECHNICAL INSTITUTE
Dept. RD, Valparaiso, Indiana 46383

V.T.I. training leads to success as technicians, field engineers, specialists in communications, guided missiles, computers, radar and automation. Basic & advanced courses in theory & laboratory. Electronic Engineering Technology and Electronic Technology curricula both available. Assoc. degree in 29 mos. B. S. also obtainable. G.I. approved. Graduates in all branches of electronics with major companies. Start February September. Dorms. campus. High school graduate or equivalent. Write for catalog.

WIDE-RANGE ELECTRONIC TIMER

BY GENE L. JACKSON/Sr. Aerosystems Engr., General Dynamics

This junction FET device can provide accurately timed output periods from one second to over five minutes.

THE heart of most solid-state timers is an RC circuit. These timers operate on the principle that the time required for a charged capacitor to discharge depends directly upon the values of resistance and capacitance. The amplifier circuit in such a device should present as high an impedance as possible so that the discharge time of the circuit is not affected by the amplifier it controls. The FET with its very high input impedance is uniquely qualified for this application.

The basic principles of the timer described in this article are illustrated by the basic circuit of Fig. 1. With switch S1 in the "Set" position, the FET is in a conducting mode and the current through it is limited only by the characteristics of the device and the value of drain resistor R2. With normal component values, the output (drain) voltage will be approximately one volt above ground reference.

With switch S1 in the "Set" position, the capacitor will charge to the value of B1. When the switch is placed in the "Time" position, the capacitor will begin to discharge through resistor R1. The voltage drop across R1 causes a negative potential to be produced at the gate of Q1 that will cut off the FET. Because FET amplifiers are voltage-controlled, no current flows in the gate circuit, thus allowing the RC circuit to operate as though it were an isolated circuit. To cut off Q1, the potential of B1 must be larger than the pinch-off voltage of the FET. (The pinch-off voltage is that voltage necessary to stop conduction of Q1.) As soon as the voltage across the capacitor decreases to below the FET pinch-off voltage level, conduction will again occur in the drain circuit of the FET. The cycle can now be repeated by momentarily placing S1 in the "Set" position and then returning it to the "Time" position.

A second amplifier is usually necessary to provide sufficient power amplification to operate a relay or other control device. Referring to the circuit of Fig. 1, transistor Q2 will be at or near

cut-off when Q1 is conducting. When Q1 is cut off by the actuation of S1 as described in the preceding paragraphs, the drain of Q1 will move in a positive direction. This provides forward bias for Q2 and drives it into conduction with the resulting power and current amplification at the collector of Q2 (across resistor R4).

To provide additional power amplification and to ensure quick, positive action of the timer, the amplifier circuit shown in Fig. 2 may be used. Transistors Q2 and Q3 are employed in what is called a "compound"-connected amplifier or Darlington circuit. The two transistors function like a single transistor in that there is one external base, emitter, and collector connection. The main advantage of this type of circuit is an extremely high current gain. If the current gain of either Q2 or Q3 is denoted by h_{FE} (I_C/I_B), the current gain of this circuit is expressed as $h_{FE}^2 + 2h_{FE}$. When this circuit is used in place of Q2 in Fig. 1, a larger valued drain resistor can be employed, which results in more positive action of the timer relay.

Utilizing the features previously described, the complete timer circuit of Fig. 2 may be constructed. A one-megohm linear potentiometer is used in place of R1 in the previous circuit so that the RC time can be varied and thus the time interval of the device adjusted accordingly.

Resistor R4, a current limiter, is used

Fig. 1. The basic timing circuit uses a field-effect transistor. See text.

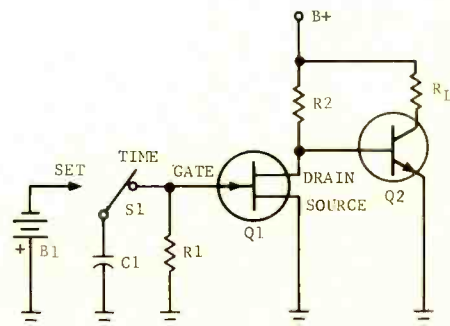

to prevent possible damage to the timing capacitor during its charge or discharge. Resistor R3 is also a current-limiting resistor that aids in protecting the transistor amplifiers or the relay against possible harm if one of these components should become damaged or inadvertently shorted. Diode D1 is an arc-suppressing diode across the relay which permits longer relay life and prevents relay "chatter" when the timer is used for longer time-intervals.

With S2 in the position shown and S1 at "Set", timing capacitor C1 will charge to 13.5 volts with the indicated polarity. FET Q1 is at saturation and its drain voltage is approximately one volt. This is less than the voltage required to turn on Q2 and Q3 (V_{BE} of Q2 plus V_{BE} of Q3). Therefore, Q1 is the only transistor drawing current until the timer is actuated.

In a manner similar to the action previously described, when S1 is placed in the "Time" position, C1 begins to discharge through R1, cutting off Q1. This turns the compound-connected amplifier on, and the resulting collector current energizes relay K1.

Variable resistor R1 allows the use of a pointer and calibrated scale so that this control may be set for any time-interval operation within the range of the components in the RC circuit. Using the parts listed in Fig. 2, time intervals up to and slightly above 30 seconds may be obtained with S2 in the $\times 1$ position.

The versatility of the device is greatly increased by the use of S2 and a second timing capacitor. With S2 in the $\times 10$ position, a 100- μ F capacitor is operating in the circuit in place of the 10- μ F capacitor. Because the time interval of the device is directly propor-

tional to the capacitance, using the 100- μ F capacitor will give time intervals that are ten times greater than those obtained with S2 in the $\times 1$ position. Therefore, the time scale of the dial (associated with R1) may be used for both positions of S2. It is not particularly important that the timing capacitors be exactly 10 and 100 μ F, but the larger capacitor must be precisely ten times the capacitance of the smaller capacitor (10:1 ratio) if the same dial scale is to be used for both ranges. Another possibility is to employ smaller capacitors in parallel with one of the timing capacitors and thus obtain the desired capacitance ratio in this way.

For best timer operation, it is important that the capacitors used have a very low leakage current. If electrolytic capacitors are employed, it may be desirable to "age" them by applying a voltage source across the terminals of the capacitor for a few hours. The voltage should be between the value used in the circuit and the voltage rating of the capacitor. Of course, the correct polarity must be maintained across the capacitors at all times.

There are many combinations of capacitance and resistance that may be used in the RC circuit. For particular applications, values other than those given might be more useful. It would also be practical to have more than two ranges if desired. Capacitor values above 100 μ F can be used if the leakage current is low. Relays other than the one shown could also be used.

The device draws approximately 75 mA during the actual timing interval, with the current dropping to 0.5 mA between the timing intervals. Because of this low current drain, the timer is well-suited for battery operation. ▲

Fig. 2. Schematic diagram and parts list for the electronic timer.

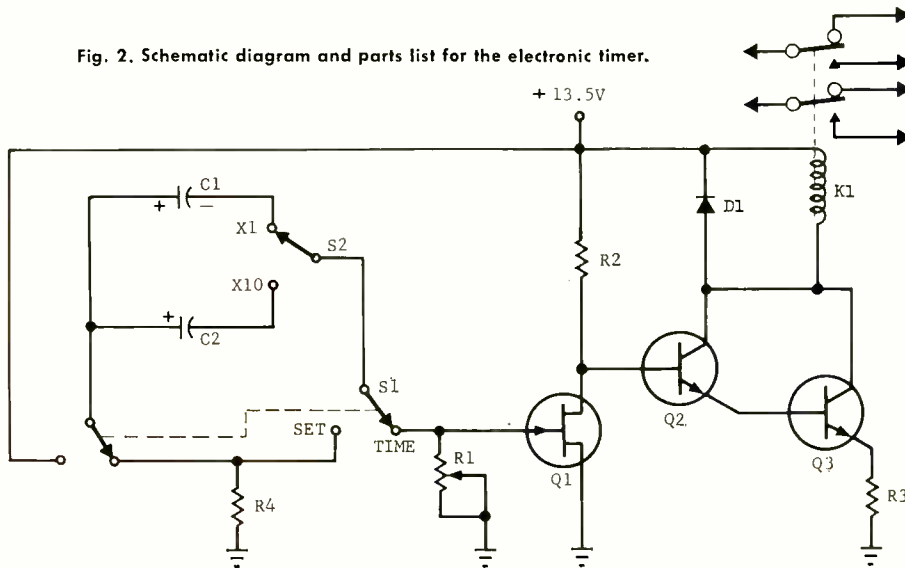

R1—1 megohm linear-taper pot
R2—27,000 ohm, 1/4 W res. $\pm 10\%$
R3—12 ohm, 1/4 W res. $\pm 10\%$
R4—100 ohm, 1/4 W res. $\pm 10\%$
C1—10 μ F, 15 V capacitor
C2—100 μ F, 15 V capacitor

S1—D.p.d.t. switch
S2—S.p.d.t. switch
D1—1N457 or equiv.
K1—D.p.d.t., 12 V d.c., 150 ohm relay
(Allied Radio #41A4658)
Q1—2N3819 FET
Q2, Q3—2N3704 transistor

new miniature electronic pliers

HOLD, BEND, CUT
ALL FINE WIRES
WITH EASE

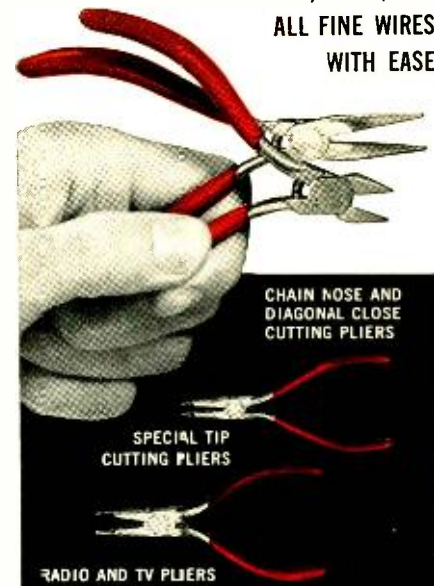

Ideal for electronic, radio/TV, electrical service and assembly. Forged alloy steel construction. Precision machined. All have polished heads and shoulders. Comfortable "Cushion Grip" handles and coil spring openers speed work, reduce hand fatigue. Miniature round and flat nose pliers also available.

a complete line of regular pliers and snips, too



Includes long nose pliers with and without cutters; diagonal, needle nose, chain nose, side cutting, and other pliers; electronic snips. Variety of sizes. All available with "Cushion Grip" handles. Professional quality.

XCELITE

XCELITE, INC., 12 Bank St., Orchard Park, N. Y. 14127
In Canada contact Charles W. Pointon, Ltd.
CIRCLE NO. 82 ON READER SERVICE CARD

Temperature Monitor

By SILOM HORWITZ

Complete design details for a general utility temperature indicator sensitive to one-half degree, and having very rapid response time.

THIS extremely accurate temperature indicator can be built for less than the cost of a conventional precision laboratory thermometer. Here, "extremely accurate" means not only sensitive to half-degree variations, but also having very rapid response time.

It is all possible with a low-cost thermistor coupled to a simple bridge circuit. The advantage of the bridge is that it is not affected by voltage variations so that an inexpensive unregulated power source (1½-volt flashlight battery) does the job.

Referring to Fig. 1, note that fixed resistors R2 and R5 make up the constant legs of the bridge, with R3 and R4 balancing out the changing resistance of the thermistor (R1) as it reacts to temperature variations. As all legs of the bridge will react identically regardless of voltage (at 1.5 volts, current through the device is approximately 400 microamperes), the voltage of the source does not affect the reading. As the battery ages, the swing of the meter becomes less and less until it is hard to read the zero, or null, position. Then it is about time to change the battery, which will restore the swing without affecting the calibration.

Construction

Building the temperature monitor is straightforward. For the highest accuracy, precision film resistors should be used for R2, R3, and R5, not because of circuit requirements but because they are not as temperature-sensitive as wire or carbon types. This is important only if the instrument will be located where there are wide variations in ambient temperature. Exact matching of R2 and R5 is not vital because of the manner in which R4 is connected. The switch (S) should be separate, as shown, and not included on R4 so that the current can be turned "on" and "off" to precisely locate the null for very accurate readings.

A "Minibox" or plastic instrument box just large enough to house the meter and permit sufficient separation of the calibration markings is all that is necessary (Fig. 2). Of course, for extreme precision, as large a panel and dial as required for the separation may be used.

Fig. 1. Schematic and parts list for the temperature monitor.

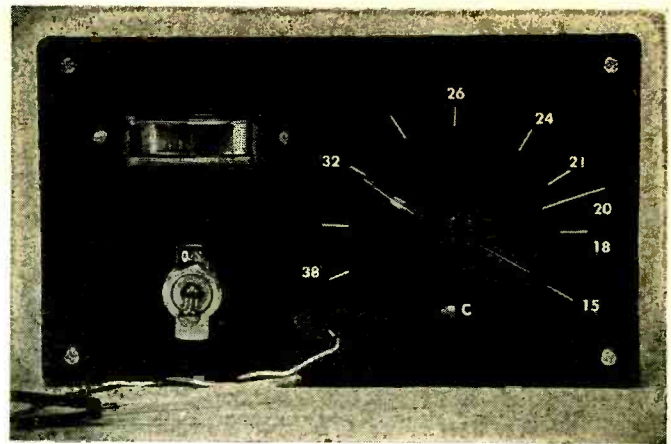
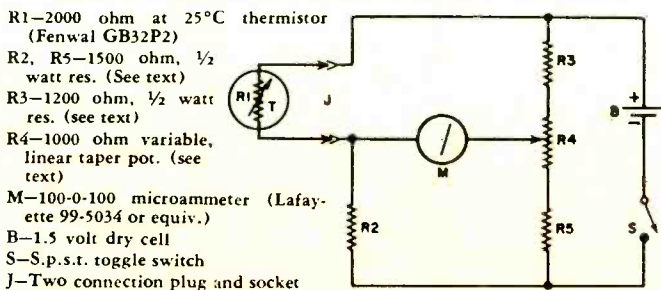

Fig. 2. Front view of the temperature monitor. To convert temperature in °C to °F, multiply by 9/5 and add 32 degrees.

The values given for the components are suitable for the thermistor recommended, to cover the range from 15° C (59° F) to 38° C (100° F). Modifications can easily be made to accommodate a thermistor of a different value or to read a different temperature range. The resistance of R3 should be about 10% less than the resistance of the thermistor (R1) at the highest temperature to be read. The total resistance of R3 and R4 should be slightly greater than the resistance of R1 at the lowest temperature to be read. Resistors R2 and R5 should be approximately the same value and, with the other legs of the bridge, should provide twice the current needed by the meter for full swing of the needle in both directions. Care must be taken, if the circuit is modified, not to increase the current to the point where the thermistor will produce heat rather than sense it.

Calibration

For calibration, a conventional thermometer equal to the precision desired for the temperature monitor must be used. Household thermometers are not satisfactory. A photographer friend may be able to provide a suitable one, or perhaps one may be borrowed from a scientific laboratory.

If no modifications have been made to the circuit, ordinary tap water may be used as the calibration medium. Fill a container with water of the lowest temperature (15° C or 59° F for the components given), carefully monitoring the temperature by means of the calibration thermometer. The calibration thermometer should be immersed at least two or three minutes to become stabilized. (The thermistor is almost instantaneously responsive in water, so it does not require time to stabilize.) Immerse the thermistor, being careful to keep the leads dry, and balance the meter to the null position by adjusting R4. Mark the position of the knob pointer with a decal line or piece of narrow plastic tape. Repeat for each temperature. After completing all the calibration points, recheck by repeating several temperatures.

Each thermistor has slightly different resistance vs temperature characteristics so that if accuracy is desired, the instrument must be specifically calibrated to the thermistor used. For interchangeability, the more expensive calibrated thermistors must be used.

The temperature monitor can be used like any thermometer, but the small size of the sensing element and possibility of remote operation makes it much more versatile.

The thermistor can be cemented within a plastic tube with just the tip protruding. This can be inserted into the mouth for instant indication of body temperature, or it can be mounted outside the house with the readout inside. Use is limited only by the imagination. Lead length is not critical up to 50 feet. However, in all applications, be sure to waterproof the leads (epoxy cement is ideal) as moisture will lower the resistance and produce false readings. ▲

1968

A Howard W. Sams PUBLICATION

Photofact® Annual Index

MASTER INDEX TO THE AUTHORITATIVE SERVICE DATA FOR THE ELECTRONICS INDUSTRY

COMPLETE PHOTOFACT COVERAGE

COVERS PHOTOFACT SETS 1 THROUGH 840 (All PHOTOFACT FOLDER releases from April 1, 1946 to January, 1968. All PHOTOFACT Specialized Series volumes released through Jan. 1968.)

IMPORTANT: Use this Master Annual Index with the latest current Supplement for complete up-to-date model coverage. Supplements are issued in February, May and September of each year.

See Complete Table of Contents on Page 1

Free Photofact® Annual Index

for your use throughout 1968

send today for your instant handy guide to the world's finest electronic service data!

COVERS OVER 75,000 LISTINGS:

Send today for this valuable 136-page guide covering virtually every model of home-entertainment electronic equipment produced since 1946! Helps you locate the proper PHOTOFACT Folder to quickly solve any service problem in any model. PHOTOFACT provides everything you need in complete, uniform style for quick, effective repairs: Famous Standard Notation Schematics packed with the service details you need; Full Photo Coverage of all chassis views; Complete Replacement Parts Lists; Tube Placement Diagrams; Alignment Instructions; CircuiTrace® for printed boards; Disassembly Instructions; Dial Cord Diagrams; Changer and Recorder "Exploded Views"—plus dozens of other great features. Send coupon for your FREE copy of the latest PHOTOFACT Index to the service data you need!

- Color and Black & White TV Receivers
- Home and Auto Radio Receivers
- Phonographs and High-Fidelity Sets
- CB Radios • Tape Recorders • Record Changers

YOUR COMPLETE REFERENCE TO PHOTOFACT COVERAGE FOR FASTEST REPAIR OF VIRTUALLY ANY MODEL!

Send for the Photofact Annual Index—your "master" reference throughout 1968. Once you are on our mailing list you will automatically receive Index Supplements to keep you up-to-the-minute on Photofact coverage of the latest equipment as it is released.



JOIN THE PHOTOFACT-OF-THE-MONTH CLUB:

NOW! Only \$10 per month brings you 20% MORE Photofact coverage to keep you current—saves you over \$60 per year!

- Get 6 new Photofact Sets each month
- Covers at least 50 new chassis
- At least 6 Color TV Folders monthly

NEW BONUS: MINIMUM OF 10 "ADVANCE" TV SCHEMATICS (MOSTLY COLOR) WITH EACH MONTH'S ISSUE—PLUS GREAT FILE CABINET DEAL WITH TRIAL 6-MONTH SUBSCRIPTION TO P.O.M. (PHOTOFACT-OF-THE-MONTH CLUB).



JOIN P.O.M.

For details, see your Sams Distributor, or send coupon

HOWARD W. SAMS & CO., Dept. EWF-11
4300 W. 62nd St., Indianapolis, Indiana 46206



Send FREE 1968 Photofact Annual Index and place my name on your mailing list to receive the Supplements

Send Photofact-of-the-Month Club details

My Distributor is _____

Shop Name _____

Attn.: _____

Address _____

City _____ State _____ Zip _____

CIRCLE NO. 98 ON READER SERVICE CARD

MALE

career opportunities with

Programmers SYSTEMS & APPLICATIONS

Professional programmers with college degrees and 2 or more years of experience on large-scale computer systems needed to participate in the specifications and implementation of new systems.

ELECTRONIC TECHNICIA

Permanent positions offering excellent working conditions and the latest equipment. Military An Equal Opportunity Employer

TECHNICIANS

FOR ANALOG, DIGITAL AND HYBRID COMPUTERS & CALIBRATION

We offer challenge, advancement potential and the opportunity to contribute to the latest advances in computer technology.

GOOD SALARY LIBERAL FRINGE BENEFITS

ELECTRONICS TECHNICIAN

With experience in transistor circuitry and electro-mechanical devices wanted as engineering assistant for development of data communication equipment. Experience in background with reference.

RADAR SYSTEMS

Long term programs in advanced tactical fire control systems and research for augmented systems capability and application.

More years radar system design and evaluation preferred. In one of the following areas desirable: Detection, data processing and tracking techniques; Mathematical investigation of radar system performance and operational environment; Video and display systems; Land based tactical weapons control system concepts.

MALE HELP WANTED

MAINTENANCE TECHNICIANS

Commercial communications Equipment

are immediate openings technical school graduates related experience, or with equivalent training experience. Must have class FCC radio tele-license and telecommunications experience. Actual experience in data communication systems and telephone systems and file transmission systems be helpful.

MALE HELP WANTED

FIELD ENGINEERS

Opportunity With Expand- Wide Organi-

DATA HANDLING AND TRANSMISSION

Requires minimum of 2 years' experience in maintenance of AN/FST-2

REPAIRMEN AND PME TECHNICIANS

Minimum of 4 years' experience in maintenance, repair & calibration of electronic equipment, at least of which must have been in a secondary category. Thorough knowledge of military and/or commercial procedures & techniques.

We're looking for the men who want these well paid jobs!

And RCA Home Training can help you qualify

Just mail card today for details

high school graduate with good technical ability and high intelligence. Must have resist application of precision patterns in ink and on glass.

Complete benefit program including profit sharing

ELECTRONIC TEST TECHNICIANS

Production testing and troubleshooting of VHF and UHF aviation radio equipment. Exceptional opportunity for permanent first and second shift positions with AAA non-military company having outstanding profit-sharing program. Male and female.

MECHANICAL DRAFTSMEN

Immediate openings for both experienced and high school graduates with advanced schooling in drafting design. The

DATA REDUCTION TECHNICIANS

Immediate Opening LOCAL
Duties involve scanning film records of radar and optical data, plus log and data sheets using voice recording, and processing of data to be with radar and/or optical data characteristics, operating procedures and signature

INSTRUMENTATION TECHNICIANS

Must be experienced in calibration, maintenance and repair of electronic equipment such as oscilloscopes, oscilloscopes, etc. Must also be able to trouble shoot test equipment and determine problem areas. Requires 2 to 3 years' related experience and Trade School background.

RESEARCH TECHNICIANS

Immediate opportunity for

Thousands of well paid jobs for men skilled in electronics are unfilled now

RCA INSTITUTES CAN TRAIN YOU —AT HOME—AND HELP YOU QUALIFY FOR JOBS LIKE THESE!

Every Sunday—and most week days—you will find *The New York Times*, *The Houston Chronicle*, *The Los Angeles Times* and many, many other newspapers cram-full of ads like these. Actively seeking qualified men for jobs in electronics and related fields.

Many of the men who *could* qualify for these jobs—well paid jobs—that is, men with the aptitude and native interest to enjoy a career in electronics—are handicapped because for one reason or another they have not had the opportunity to train themselves for jobs like these.

NOW—THANKS TO RCA INSTITUTES HOME STUDY— YOU CAN TRAIN FOR A CAREER IN ELECTRONICS

Realizing that thousands of technical jobs—well paid jobs—in electronics are or will be available, RCA Institutes has done something positive about the problem. To help sincerely interested men to get started toward a well-paid electronics job, RCA offers an ideal home training program!

HOME STUDY CAN PROVIDE CAREER OPPORTUNITIES!

To help meet the need for qualified men in the electronics field, RCA Institutes has created a wide variety of Home Training Courses, all geared to a profitable, exciting electronics career in the shortest possible time. Included are exclusive "Career Programs" designed to train you quickly for the job you want! Your study program is supervised by RCA Institutes experts who work with you, help

Accredited Member National Home Study Council

guide you over any "rough spots" that may develop along the way.

OFF TO A FLYING START WITH AMAZING RCA "AUTOTEXT" METHOD

Each "Career Program" starts with the amazing "AUTOTEXT" Programmed Instruction Method—the new, faster way that's almost automatic! "AUTOTEXT" helps even those who have had trouble with conventional learning methods in the past. It is truly the "Space Age" way to learn everything you need to know with the least amount of time and effort.

RCA INSTITUTES ENGINEERED KITS SPEED YOUR PROGRESS

To speed you on your way to a successful electronics career, your "Career Program" will include a variety of RCA Institutes engineered kits at no extra cost—each complete in itself. As a bonus, you will also receive and build a valuable Oscilloscope. You'll get the new Programmed Electronics Breadboard for limitless experiments, including building a working signal generator and a fully transistorized superheterodyne AM receiver and Multimeter.

CHOOSE YOUR CAREER PROGRAM NOW

To get started today on the electronics career of your choice, look over this list of RCA Institutes "Career Programs", pick the one that appeals most to you, and check it off on the attached card:

- Television Servicing
- Telecommunications
- FCC License Preparation
- Automation Electronics
- Automatic Controls
- Digital Techniques
- Industrial Electronics
- Nuclear Instrumentation
- Solid State Electronics
- Electronics Drafting

To meet other specific needs, RCA Institutes also offers a wide variety of separate courses which may be taken separately from the "Career Programs". Those range from Electronics Fundamentals to Computer Programming. They are described in the material you receive.

ADVANCED TRAINING TOO

If you are already working in electronics or have some experience but want to move on up, you may start RCA Institutes training at an advanced level. No tedious repetition of work you already know!

UNIQUE TUITION PLAN

With RCA Institutes, you learn *at your own pace*, and you pay only as you learn. There are no long term contracts to sign . . . no staggering down-payments to lose if you decide to stop . . . no badgering bills. You pay for lessons only as you order them, and should you decide to interrupt your training at any point, you may do so and not owe one cent.

CLASSROOM TRAINING AVAILABLE

RCA Institutes Resident School is one of the largest schools of its kind in New York City with classroom and laboratory training available in day or evening sessions. Coeducational classes start four times a year. Just check "Classroom Training" on the attached card for more details.

JOB PLACEMENT SERVICE, TOO!

Companies like IBM, Bell Telephone Labs, GE, RCA, Xerox, Honeywell, Grumman, Westinghouse, and major Radio & TV Networks have regularly employed graduates through RCA Institutes' own placement service.

SEND ATTACHED POSTAGE PAID CARD TODAY FOR COMPLETE INFORMATION. NO OBLIGATION

ALL RCA INSTITUTES COURSES AVAILABLE UNDER NEW GI BILL.

RCA INSTITUTES, Inc., Dept. EW-N7
350 West 4th Street,
New York, N. Y. 10014



The Most Trusted Name in Electronics

FROM HiFi STEREO REVIEW
**DELUXE
 PADDED
 DUST-PROOF RECORD
 AND TAPE CASES**
 plus FREE cataloging forms



These decorative, yet sturdily constructed cases are just what you've been looking for

to keep your records and tapes from getting tossed about and damaged, disappearing when you want them most and just generally getting the "worst of it" from constant handling. They're ideal too for those valuable old "78's" that always seem to get thrown about with no place to go.

Constructed of reinforced fiberboard and covered in rich leatherette in your choice of nine decorator colors, the HiFi/STEREO REVIEW Record and Tape Cases lend themselves handsomely to the decor of any room, whether it be your library, study, den, music room or pine-paneled garage. The padded leatherette back (in your color choice) is gold tooled in an exclusive design available only on HiFi/STEREO REVIEW Record and Tape Cases. The sides are in standard black leatherette to keep them looking new after constant use.

Extra With each Record and Tape Case you order you will receive, free of charge, a specially designed record and tape cataloging form with pressure-sensitive backing for affixing to the side of each case. It enables you to list the record names and artists and will prove an invaluable aid in helping you locate your albums. The catalog form can be removed from the side of the case at any time without damaging the leatherette.

Record Cases are available in three sizes: for 7", 10" and 12" records. Each case, with a center divider that separates your records for easy accessibility, holds an average of 20 records in their original jackets. The Recording Tape Case holds 6 tapes in their original boxes.

● The Tape Cases and the 7" Record Cases (with catalog forms) are only \$3.25 each; 3 for \$9; 6 for \$17.

● The 10" and 12" Record Cases (with catalog forms) are \$3.50 each; 3 for \$10; 6 for \$19.

Add an additional 75c per order (regardless of number of cases ordered) for shipping and handling.

Ziff-Davis Publishing Company, Dept. SD
 One Park Avenue, New York, N. Y. 10016

My remittance in the amount of \$_____ is enclosed for the Cases indicated below.

Quantity _____ Tape Case at \$3.25 each; 3 for \$9; 6 for \$17.
 _____ 7" Record Case at \$3.25 each; 3 for \$9; 6 for \$17.
 _____ 10" Record Case at \$3.50 each; 3 for \$10; 6 for \$19.
 _____ 12" Record Case at \$3.50 each; 3 for \$10; 6 for \$19.

Add 75c PER ORDER for SHIPPING and HANDLING
 Check color choice for back of case (sides in black only):

Midnight Blue Red Saddle Tan
 Pine Green Orange Yellow
 Grey Black Spice Brown

Name _____

Address _____ EW-117

City _____ State _____ Zip Code _____

PAYMENT MUST BE ENCLOSED WITH ORDER

RADIO & TV NEWS

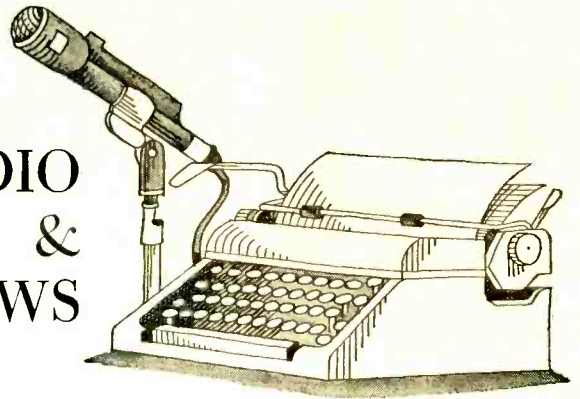

A series of laser tests with satellites has been started by NASA and the French space agency, Centre National Des Etudes Spatiales (CNES) which may lead to the location of points on earth to within 10 cm, 4 in.

Initial tests of laser trackers have been so successful that the scientists feel it may soon be possible to prove or disprove the theory of continental drift by using a triangulation technique to determine the movement of continents relative to one another. It is believed that Africa is moving a few inches a year away from South America.

European Color-TV Booms

With West Germany now in the ranks of color-TV-dom, *EMI Electronics* of England has announced that early in this year they had passed the million-pound mark for color-TV equipment and since that time have received additional orders bringing the present total value to over 2 million pounds. The orders have been coming in from Europe and the United Kingdom.

The company's transmitting equipment, designed to both American and European TV standards, includes cameras, slide scanners, video mixing and

switching equipment, encoders, decoders, vertical aperture correctors, and other equipment. The boom is on!

EIA Favors HELP Channel

The Electronic Industries Association has thrown its weight behind the current campaign to have the FCC designate CB channel 9 for highway assistance and information communications.

The FCC commended the EIA for "its constructive and cooperative attitude" but intimated that its decision is still in the future.

IC Unit Sales up 125%

In the first quarter of this year, U.S. manufacturers sold \$64.3 million worth of semiconductor integrated circuits, a 52% increase in dollar value from the same period last year but a 125% rise in volume, due to the 32% decline in average values.

Analog IC's amounted to nearly 2 million units in the first quarter while digital types reached 14.2 million.

Low-Cost Portable Computer

A.M. Lock and Co. of England recently unveiled a low-cost, portable computer designed for teaching.

As demonstrated at the ISA Instru-

DEATH OF TWO ELECTRONICS PUBLISHING PIONEERS

TWO of the electronics publishing industry's pioneers died within ten days of each other in August. **Hugo Gernsback, 83**, who founded this magazine in 1918 and was editor-in-chief of *Radio-Electronics* when he died, was also known as the "Father of Modern Science Fiction".

Dr. Orestes S. Caldwell, who was co-founder and editor of *Electronics*, *Radio Retailing*, and *Electrical Merchandising* during his association with McGraw-Hill, died at the age of 79. He and an associate, **Maurice Clements**, formed their own publishing company in 1935 and established the magazines *Electronic Industries* and *Electronic Technician*.

Both men made a far greater impact on the industry than just as publishers and editors. **Mr. Gernsback** was also an inventor and sponsored New York's first television broadcast in 1928. **Dr. Caldwell**, as member of President Coolidge's Radio Commission in 1927 (predecessor of the FCC), helped to assign frequencies in the radio spectrum and, as the only engineer on the Commission, was the target of a long and acrimonious campaign to have him unseated.

In the deaths of **Mr. Gernsback** and **Dr. Caldwell**, the electronics industry has lost two dedicated men who through the years have given much of themselves to advance the cause of scientific inquiry and progress. They will be sorely missed.

No dealer stocks everything.

No salesman knows everything.

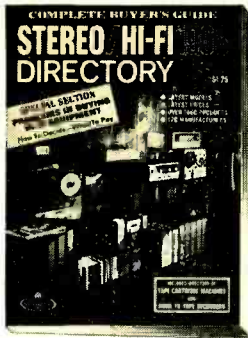

But the 1968 STEREO/HI-FI DIRECTORY does!

It's a giant 182 page buyer's guide to virtually every new audio component on the market today. Over 1600 products in all! From amplifiers to complete hi-fi systems to tape cartridge recorders and players for your home, car and boat. All the latest offerings from 176 manufacturers are fully detailed and illustrated for your "shop-at-home" convenience.

Every technical specification, dimension, special feature, optional accessory, price and model number is at your fingertips—to help you compare similar items, feature for feature, dollar for dollar and decide which is best for you. Before you buy!

Forget the guesswork, costly mistakes, store-to-store treks and "after-you-get-it-home" disappointments. With the 1968 STEREO/HI-FI DIRECTORY as your guide, you'll zero-in on the equipment you want, buy it with confidence—and know you're getting the greatest value for your money.

The price for this valuable "encyclopedia" of hi-fi information? Just \$1.25. A small investment, indeed, for such an essential component of your listening enjoyment. So don't delay. Use the coupon below to order your copy of the 1968 STEREO/HI-FI DIRECTORY today!

CONTENTS INCLUDE

Special 8-page section on: ● How to choose components ● How to compare prices, features specifications ● Exclusive state-of-the-art report on componentry ● PLUS an incisive analysis of the controversial 8 track, 4 track and cassette tape cartridges. . . . Comments and clues on which design holds the most promise for the future.

Individual directories for amplifiers / changers / turntables / cartridges and tonearms / receivers/tuners/tape machines (including video recorders and cartridge units) / speakers / integrated systems / antennas / microphones / cabinets.

The 1968 STEREO/HI-FI DIRECTORY is available in a splendid deluxe edition. Rugged Leatherflex cover provides lasting protection yet is softly textured and gold-embossed for the look of elegance. A collector's item—a superb addition to your permanent reference library. Just \$3 postpaid.

ZIFF-DAVIS SERVICE DIVISION • DEPT. SD
595 Broadway • New York, N. Y. 10012

YES: Send me the new 1968 STEREO/HI-FI DIRECTORY as checked below:

\$1.25 enclosed, plus 15c for shipping and handling. Send me the regular edition. (\$1.75 for orders outside the U.S.A.)

\$3.00 enclosed. Send me the Deluxe Leatherflex-bound edition, postpaid. (\$3.75 for orders outside the U.S.A.) Allow three additional weeks for delivery.

print name _____ EW-117

address _____

city _____

state _____ zip code _____

PAYMENT MUST BE ENCLOSED WITH ORDER

ment Automation Conference in Chicago, the "Teachaid" is capable of solving up to third-order differential equations. It can also tackle differential equations of a much higher order, when using more advanced techniques.

Transistorized and weighing less than 10 lbs., maximum voltage is a safe 12 volts.

Doubling Audio "Reading" Speed

According to the Medical Electronics Research Institute in Phoenix, blind people can be trained to understand tape recorded voices when played back at twice the recorded speed. Modifications of voice recorders offer promise of doubling the audio "reading" speed of the visually handicapped.

According to Dr. John W. Hudson, blind professor of sociology at Arizona State University who directed the recorder improvement, understanding the speeded-up speech can be frustrating to beginners. However, he claims that with continued training and experimentation with gradually increased voice playback speed, complete understanding can be achieved. The program is under the aegis of the Public Health Service's National Center for Chronic Disease Control.

Problem-Solving Made Easy

Dr. Donald Knuth, a 29-year-old associate professor of mathematics at Cal Tech, got tired of exploring fruitless avenues in problem-solving and trained an IBM 7094 computer to deduce the maximum number of consequences from any given set of algebraic axioms.

Although computers have been used in somewhat similar ways to study math logic and artificial intelligence in the past, Knuth is, as far as he knows, the only mathematician currently programming systematic procedures for efficiently dealing with algebraic axioms.

"For Internal Use Only"

CBS Labs has come up with an experimental color-TV camera which can be used for viewing the inside of the human body. This is the first time that color transmission could be made, and CBS has developed a means of doing it in almost virtual darkness.

Designed to be used as a teaching aid for medical students, no modification of existing operating room equipment and light sources is necessary with the new device.

The system consists of a 16-inch probe about the diameter of a pencil with a camera lens at one end surrounded by a fiber optic bundle. These plastic fibers are used to carry light into the area of the body to be viewed by the lens. The camera is able to operate virtually in the dark through a highly sensitive tube that will operate at levels approximating moonlight.

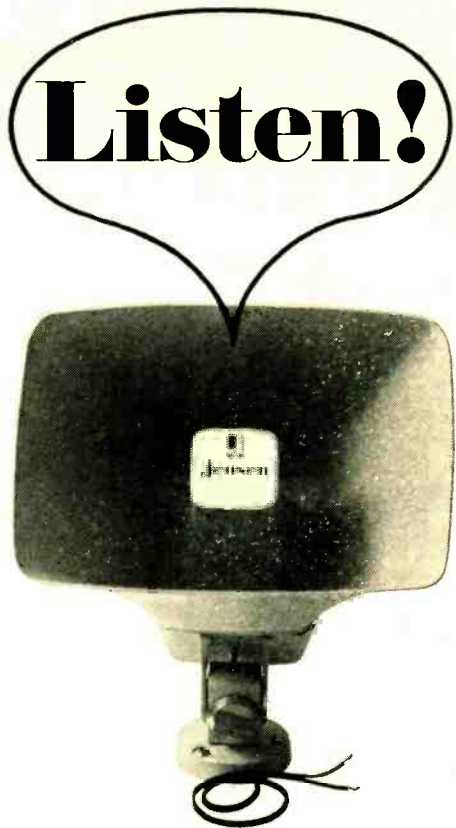

Hang it fast and easy then forget it!

The new Jensen VH-100 Series horn speakers were designed for fast installation and a lower installed cost. Their new and exclusive features let you install three VH-100's for the labor penalty previously charged for two.

KWIKON® connectors, an easily detached base, universal angle adjustment, accessible power control and an optional pre-integrated transformer are but a few of the many advantages of these rugged new weatherproof 32 watt speakers.

Our new brochure tells all.

Write Jensen Manufacturing Division, The Muter Company, 6601 South Laramie Avenue, Chicago, Illinois. 60638.

jensen

CIRCLE NO. 111 ON READER SERVICE CARD 65

TEST EQUIPMENT PRODUCT REPORT

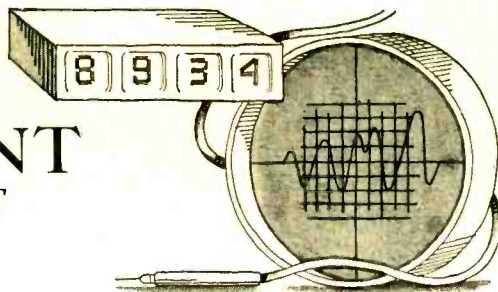

Amphenol Model 880 Stereo Commander

For copy of manufacturer's brochure, circle No. 36 on Reader Service Card.



THE new Amphenol Model 880 incorporates seven instruments in one compact package, providing a complete testing laboratory for audio amplifiers and FM-stereo tuners and receivers at a fraction of the cost of the seven individual instruments it replaces. It is a completely solid-state portable unit that can be used in the customer's

home as well as in the service shop.

Four signal sources and three measuring instruments are contained in the package. Signal sources include:

1. An audio generator that supplies either sine- or square-wave signals used by other sections of the instrument.

2. A multiplex simulator that generates or controls all signals necessary

for complete and accurate alignment of an FM multiplex receiver.

3. An r.f./sweep oscillator that may be used as an FM source modulated by the signal present at the composite jack (mono sine wave or square wave) or as a sweep generator with a 60-Hz sweep rate for FM tuner alignment.

4. An oscillator that generates a crystal-controlled 10.7-MHz signal for use as a marker for aligning FM receivers.

Measuring instruments include:

1. An intermodulation distortion analyzer which measures distortion to 100% using SMPTE standard signal.

2. An impedance bridge capable of measuring largely resistive unknowns from 1 ohm to 20,000 ohms. Since the audio generator provides the signal used to drive the bridge, an unknown impedance can be checked at any frequency within generator range. This section may also be used to determine resonant frequencies.

3. A high-impedance a.c. voltmeter with a sensitivity of 100 millivolts full scale. The unit measures from 0.1 volt full scale to 1000 volts full scale in nine increments. The voltmeter is also used as an indicator for the impedance bridge and intermodulation analyzer sections mentioned above.

The Model 880 Stereo Commander has a composite output of 5 volts (p-p) stereo, with 35 dB channel separation up to 10 kHz; 2.5 volts (p-p) L-R; and 3 volts (p-p) mono. Output at 19, 38, and 67 kHz is identical—5 volts (p-p), sine wave.

The mono audio output is 3 volts (p-p), sine wave and 10 volts (p-p), square wave. Both sine and square waves are variable from 35 Hz to 18 kHz in two ranges with less than 1% distortion.

The Stereo Commander is 11½" wide, 9¾" high, and 6" deep and weighs slightly over eight pounds. Price of the seven-in-one unit is \$329.95. ▲

Jerrold Model AIM-718 Signal-Strength Meter

For copy of manufacturer's brochure, circle No. 37 on Reader Service Card.



A NEW solid-state signal-strength meter has been introduced by Jerrold for use by professional antenna installers. The meter, Model AIM-718, is specifically designed for field use. It is portable, light in weight, battery-operated, and housed in a rugged case.

An instrument of this type can often convert a two-man antenna installation job into one requiring the services of only a single installer. The field-strength meter is simply connected to the antenna to be installed, and the optimum location for the antenna may be readily determined by observing the meter reading. Hence, it is not necessary to have a second man down with the set to observe for maximum signal strength.

A field-strength meter such as this one is especially useful for ultra-high-frequency antenna installations. With u.h.f. antennas, the shifting of position and orientation by only a slight amount often results in tremendous changes in signal strength at the associated television receiver.

The meter, which reads directly in dBmV and microvolts, shows exact antenna performance and requirements. It is equipped with separate v.h.f. and u.h.f. tuners, providing continuous coverage from 54 to 216 MHz (including the FM band) and from 470 to 890 MHz.

An audio output jack, crystal earphone, and two built-in dB attenuators

are provided. The basic range of the instrument is 500 to 2000 μ V, and this is increased to 20,000 μ V with one attenuator switched in or to 200,000 μ V with both attenuators inserted. These figures are for 300-ohm use. Values are one-half the scale readings for 75-ohm lines, in which case a special plug-in matching transformer is used.

Maximum sensitivity is 20 μ V at 75 ohms or 40 μ V at 300 ohms, while accuracy is 3 dB on the v.h.f. band and

6 dB on the ultra-high frequency band.

Powered by four 9-volt long-life batteries, the AIM-718 has a safety switch that turns off the power when the instrument cover is closed. The case has a large compartment in which accessories can be carried. Dimensions are 9" long by 6 $\frac{1}{2}$ " wide by 4" high. Weight of the instrument is a little over 4 pounds. Price of the meter is \$198.50, and it is available from the manufacturer's distributors. ▲

B & K Model 1242 Color Generator

For copy of manufacturer's brochure, circle No. 38 on Reader Service Card.

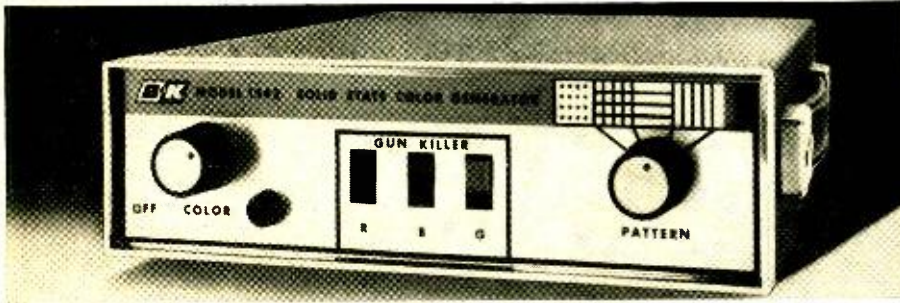

A NEW, low-cost solid-state color generator featuring complete stability in all service extremes is available from the B & K Division, Dynascan Corp.

The unit, Model 1242, is among the smallest, easiest-to-carry generators available. It measures only 2" high by 6 $\frac{3}{4}$ " wide by 9 $\frac{3}{4}$ " deep and weighs only 2 pounds complete with all cables. The generator gives the service technician instant performance without adjustments whether the unit is hot or cold. Ultrastable solid-state circuits using unijunction transistors and conservative design are largely responsible for this.

The instrument is designed to produce station-quality waveforms for quick, easy convergence and color adjustments of TV sets in the home or shop. The Model 1242 has only two

front-panel controls: an amplitude control and a pattern-selector switch for dot, crosshatch, horizontal line, vertical line, and color patterns. Other features include over 5000 microvolts r.f. output on channels 3 and 4, built-in gun killer with "miniclips" for easy connection, rugged vinyl-clad steel case with storage space for all leads, and a zener-diode-regulated transformer power supply.

A block diagram of the circuit used is shown here. The unit is basically a gated, rainbow generator. Transistors Q1 and Q7 are stable crystal oscillators, while the lower frequency oscillators serving as frequency dividers use unijunction transistors. These are Q3, Q4, Q5, and Q6.

Price of the compact Model 1242 is \$99.95 ▲

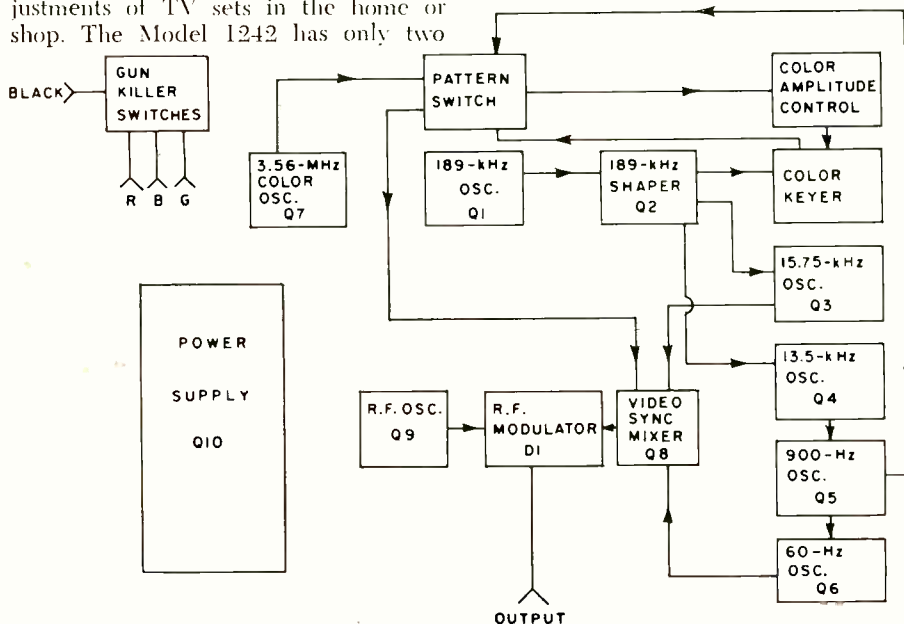

Start a Stereo System of Unparalleled Quality

For Solid State or Tube Amplifiers

...for less than \$40⁰⁰

FABULOUS MUSTANG M-12T

12" 3-WAY SPEAKER SYSTEM.
A new breed of high performance for whole house sound! With 35-40,000 Hz response; extra slim, thin profile; exclusive front or rear baffle mounting design; 12 15/16" dia. by 3 3/8" deep.



...for less than \$70⁰⁰

AWARD WINNING MODEL 6201

12" 2-WAY SPEAKER SYSTEM.
Updated version of the most popular true-coaxial speaker ever made! With axially mounted compression driven, wide-angle reciprocating flare horn tweeter; 28 to 18,500 Hz response; 13" dia. by 6 5/8" deep.



...for less than \$85⁰⁰

AWARD WINNING MODEL 312

12" 3-WAY DIFFAXIAL SYSTEM.
The only integrated single speaker assembly capable of response from 28 to 40,000 Hz! With high compliance woofer; Diffusicone mid-range; exclusive Sphericon tweeter; integral brilliance control; 15 1/2" dia. by 12" deep.



Listen to these and other fine University speakers at your dealers today! Ask about PSE —University's "master blue print" for goof-proof planning and building of your own speaker system. Includes many plans for speaker enclosures designed to deliver the very best in stereo sound. Address inquiries to desk L-75



LISTEN—UNIVERSITY®SOUNDS BETTER

UNIVERSITY SOUND



A DIVISION OF LTV LING ALTEC, INC.

9500 W. Reno Oklahoma City, Oklahoma 73101

CIRCLE NO. 85 ON READER SERVICE CARD

4 ways to increase your income

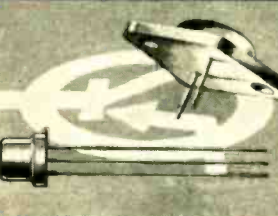
RCA Institutes, Inc. offers these four comprehensive home study courses especially designed to help build your income immediately!

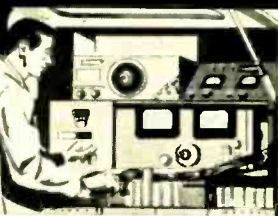
	
<p>COLOR TV Add profitable color TV to your skills with this home training course, newly revised to include information on the latest techniques, receiver circuitry and equipment. Train under the direction of RCA Institutes... experts in Color TV home study training.</p>	<p>TRANSISTORS You get the necessary background for semiconductor technology including characteristics of tunnel diodes, rectifiers and other solid state devices. Transistor trainer also available.</p>
	
<p>AUTOMATION ELECTRONICS Trains you for the many applications of automation electronics in industry and government including Photoelectronics, Digital Computer Techniques, Synchros and Servomechanisms, Automatic Control Systems, and many more!</p>	<p>MOBILE COMMUNICATIONS Trains you to service and maintain 2-way radio communications on land, sea, and air! Gives you the technical foundation for space communications!</p>

Take advantage of RCA's Liberal Tuition Plan. You only pay for lessons you order; and have no long-term obligations. Licensed by New York State Education Department. Approved for Veterans.

RCA INSTITUTES, INC.

A Service of Radio Corporation of America
350 West Fourth Street, New York, N. Y. 10014



The Most Trusted Name in Electronics

SEND THIS COUPON NOW FOR COMPLETE FREE INFORMATION

RCA INSTITUTES, INC. Home Study School, Dept. EWA-N7
350 West Fourth Street, N. Y., N. Y. 10014

Without obligation, rush me free information on the following RCA Home Training Course: COLOR TV TRANSISTORS MOBILE COMMUNICATIONS AUTOMATION ELECTRONICS

Name _____ Age _____

Address _____

City _____ Zone _____ State _____

ELECTRONIC CROSSWORDS

By JAMES R. KIMSEY

(Answer on page 98)

ACROSS

1. To increase the level of.
6. An impedance-matching device for antennas.
9. Fish eggs.
10. Unit of magnetomotive force.
11. Unit of resistance.
12. The oscillator that establishes the carrier frequency of a transmitter (abbr.).
13. Distribution of resistance over the range of rotation of the volume or tone control.
16. System of transmission (abbr.).
17. To consume food.
18. Light amplifier.
20. Lyric poem.
22. Sea eagle.
23. The unit of magnetic flux, equal to one magnetic line of force.
25. Battle condition (Navy abbr.).
27. Chemical abbreviation.
28. Organ of hearing.
29. Utilize.
30. _____ shield, a network of parallel wires all interconnected at the same end, like a comb, to provide electrostatic shielding.
33. A system for making yourself heard "loud and clear" (abbr.).
35. Staff.
36. A transformer whose output voltage can be varied over a wide range by means of a switch and a series of taps (a registered trademark).
37. A particular aircraft radar navigation system.
40. A means for radiating or receiving radio waves (abbr.).
41. A tube circuit arranged so that secondary emission from the plate causes plate current to decrease as plate voltage is increased.
42. _____ level, the reference level used when specifying a level in dB.

DOWN

1. _____ unit, a unit of wavelength measurement equal to one hundred-millionth of a centimeter.
2. In radar, equipment combining the function of duplexing and lobe switching.
3. Old name for IEEE (abbr.).
4. _____ factor, the ratio of the effective to the average current.
5. Still.
6. Increase in spot size in a cathode-ray tube resulting from abnormal brilliancy.
7. Unit of luminance.
8. _____ ghosts, duplicate images that appear on a television screen with intensity variations opposite to those of the picture.
12. Unit of current, one-thousandth of an ampere (abbr.).
14. Apiece (abbr.).
15. Indian coins (abbr.).
19. An electromechanical device.
21. Facts used in a logical process.
24. _____ cable, a navigational aid in which the path to be followed is defined by a magnetic field around a cable.
26. A natural crystalline material widely used as the source of piezoelectric crystals.
31. Region.
32. Accomplish.
33. To move a television camera vertically and/or horizontally to keep it trained on a moving object to secure a panoramic effect.
34. In radar, the portion of energy of the transmitted pulse which is reflected to a receiver.
36. Group in front.
37. A cable dimension (abbr.).
38. Next to.
39. Switch position.

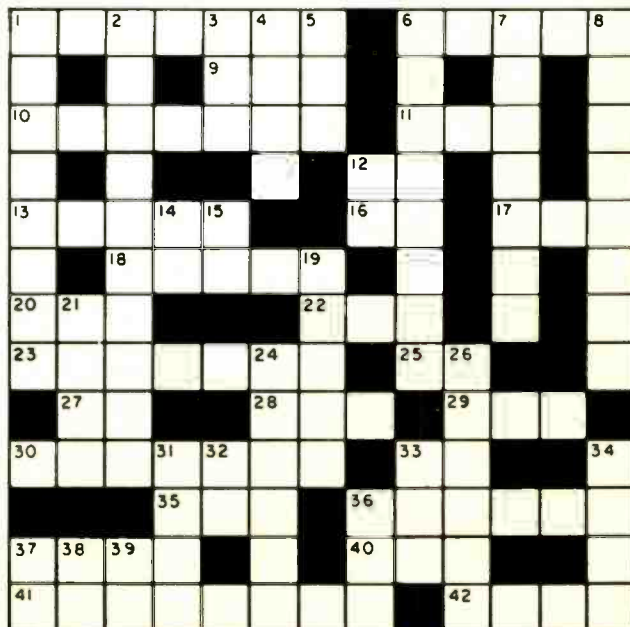

THE MOST SPECTACULAR SOUND EXHIBITION OF STEREO FIDELITY EVER AVAILABLE ON ONE DISC.

This record is the result of two years of intensive research in the sound libraries of several of the world's leading record companies. The Editors of HiFi/Stereo Review have selected and edited those excerpts that best demonstrate each of the many aspects of the stereo reproduction of music. The record offers you a greater variety of sound than has ever before been included on a single disc.

AN ELECTRIFYING EXPERIENCE IN LISTENING

The HiFi/Stereo Review Stereo Demonstration Record is a series of independent demonstrations, each designed to show off one or more aspects of musical sound and its reproduction. Entirely music, the Record has been edited to provide self-sufficient capsule presentations of an enormous variety of music arranged in a contrasting and pleasing order. It includes all the basic musical and acoustical sounds that you hear when you listen to records, isolated and pointed up to give you a basis for future critical listening.

WIDE RANGE OF DEMONSTRATIONS

- Techniques of Separation and Multiple Sound Sources • Acoustic Depth • The Ambiance of a Concert Hall • Sharp Contrasts of Dynamics • Crescendo and Diminuendo • Very High and Very Low Pitched Musical Sounds • Polyphony (two or more melodies going on at once) With Both Similar and Contrasting Instruments • Tonal Qualities of Wind, String and Percussion Instruments • Sounds of Ancient Instruments • Sounds of Oriental Instruments • Sound of the Singing Voice, Both Classically Trained and Untrained • Plus a Large Sampling of Finger Snapping, Hand Clapping, Foot Stamping and Other Musical and Percussive Sounds

13 SUPERB SELECTIONS

STRAUSS: Festive Prelude, Op. 61 (excerpt) Deutsche Grammophon Gesellschaft • Scored for full symphony orchestra plus organ with prominence to the brass instruments. Remarkable for the impressive sense of depth it reproduces.

DEBUSSY: Feux d'artifice (excerpt). Connoisseur Society • Virtually the entire range of the piano is used, including the full force of the bass notes. This is the sound of a piano in reverberant surroundings heard fairly close-up.

BEETHOVEN: Wellington's Victory (Battle Symphony) (excerpt from the first movement) Westminster • The recording emphasizes extreme directionality. It is a dramatic presentation engineered specifically for stereo reproduction.

MASSAINO: Canzona XXXV à 16 (complete) DGG Archive • Performed on old instruments, and recorded with techniques that combine directionality with depth and ambiance, this band reproduces the sound of the music in its original environment, a large and reverberant cathedral.

CORRETTE: Concerto Comique Op. 8, No. 6, "Le Plaisir des Dames" (third movement) Connoisseur Society • Recording demonstrates the

HiFi/Stereo Review **STEREO DEMONSTRATION RECORD**

A stunning series of demonstrations, each designed to show off one or more aspects of musical sound and its stereo reproduction.



sound and special layout of a small performing group (harpsichord, cello and flutes) in fairly resonant surroundings.

KHAN: Raga Chandranandan (excerpt) Connoisseur Society • This classical Indian music provides some of the most exciting musical experiences imaginable. Directionality between vastly different instruments is the point here, as well as the sheer sound of the instruments themselves.

RODRIGO: Concert—Serenade for Harp and Orchestra (excerpt from the first movement) Deutsche Grammophon Gesellschaft • This excerpt provides a wealth of instrumental color behind a harp solo. The music is clear, colorful, rather classical, and immensely entertaining.

MANITAS DE PLATA: Gypsy Rhumba (complete) Connoisseur Society • The recording puts the listener in the center of a flamenco party by precisely transmitting the directionality, depth and ambiance of this completely impromptu recording session.

MARCELLO: (arr. King): Psalm XVII "The Heaves are Telling" (complete) Connoisseur Society • This arrangement of the brief Marcello Psalm is for brass, choir and organ, who answer one another antiphonally.

PRAETORIUS: Terpsichore: La Bourrée XXXII (complete) DGG Archive • A musical gem played by a raft of renaissance instruments including recorders, viols, lutes, harpsichord, small kettle drums, chimes, bells, and triangle.

BERG: Wozzeck (excerpt from Act III) Deutsche Grammophon Gesellschaft • The acknowledged masterpieces of modern music incorporating the use of many unusual and extraordinary musical devices, including dramatic crescendos for full orchestra.

BARTOK: Sonata for two pianos and Percussion (excerpt from the first movement) Cambridge • The work is a stunning exploration of percussive sounds used as the basic material of the composition.

BEETHOVEN: Wellington's Victory (Battle Victory) (excerpt from the last movement) Westminster • A demonstration of one of stereo's greatest virtues, its unmatched ability to clarify separate contrapuntal voices being played by similar instruments.

Advanced New Anti-static Vinyl

Recorded with the cooperation of Deutsche Grammophon Gesellschaft, Connoisseur Society, Westminster Recording Company and Cambridge Records Incorporated, the Stereo Demonstration Record is processed and pressed on a newly developed, improved vinyl. It is permanently anti-static, repels dust and dirt and promotes longer stylus wear. The use of this material is conducive to low surface noise and contributes to the production of full dynamics and frequency range. The record continually looks new, sounds new and wears longer.

▶ **FREE** DESCRIPTIVE BOOKLET ENCLOSED WITH EACH ALBUM

Packed with valuable facts to give you a better understanding of the term "stereo high fidelity," including a discussion of the selections appearing on the record, plus a complete description of each selection performed and the purpose behind its demonstration.

▶ **12" STEREO RECORDING AVAILABLE IN YOUR CHOICE OF 33 1/3 RPM OR 45 RPM**

The 33 1/3 rpm is of the highest attainable quality at that speed. The higher speed of the 45 enables an even higher quality disc.

ORDER YOUR STEREO DEMONSTRATION RECORD TODAY

Only **\$4.98** Postpaid

Stereo Demonstration Record
P. O. Box 3463 • Church Street Station • New York, N.Y. 10008

Please send me _____ HiFi/Stereo Review Stereo Demonstration Record Albums at \$4.98 each, postpaid. My check (or money order) for \$ _____ is enclosed.

Check One: 33 1/3 rpm 45 rpm

(outside U.S.A. please send \$7.00 per album ordered.) New York State residents please add local sales tax.

Print Name _____ EW-117

Address _____

City _____ State _____ Zip Code _____

PAYMENT MUST BE ENCLOSED WITH ORDER

WHY bother with makeshift twist-prong capacitor replacements?

When you substitute capacitor sizes and ratings, you leave yourself wide open for criticism of your work . . . you risk your reputation . . . you stand to lose customers. It just doesn't pay to use makeshifts when it's so easy to get the exact replacement from your Sprague distributor!

Get the right SIZE,
right RATING every time
with improved



SPRAGUE TWIST-LOK® CAPACITORS!

2,365 different capacitors to choose from!

The industry's most complete selection of twist-prong capacitors, bar none. Greater reliability, too. Exclusive Sprague cover design provides a leak-proof seal which permits capacitors to withstand higher ripple currents.

GET YOUR COPY of Sprague's comprehensive Electrolytic Capacitor Replacement Manual K-109 from your Sprague Distributor, or write Sprague Products Co., 51 Marshall Street, North Adams, Mass.



WORLD'S LARGEST MANUFACTURER OF CAPACITORS

65-126-63R2

CIRCLE NO. 89 ON READER SERVICE CARD

Aligning FM-Stereo Sets (Continued from page 35)

this point is not just a simple tuning for maximum. The oscilloscope pattern is jumping wildly. You turn a slug slightly and watch for roundness. Too far one way, and the scope makes a straight 45-degree line. If the pattern goes to an ellipse, the change is in the right direction. You try to make the ellipse a little fatter. If you turn a little too much, the ellipse collapses again to a straight 45-degree line. Back up that last slug and open up the waveform as much as possible, and then move on to another coil. That one may have the pattern stretched out on the lower half. A slight turn of its slug makes the two halves balance.

At this point, tune in several multiplex stations and make sure the receiver is working equally well on all stations. This will insure that no control is set out of range for some stations and in range for others. Very slight compromise should bring in all stations equally.

Separation and Threshold

The next adjustment is for separation. In Fig. 5 the separation control is a 6000-ohm pot between emitters of the differential amplifier. Since vertical excursions of the scope trace represent the L signal and horizontal excursions the R, a vertical line represents an L signal with no R, which is ideal separation. A horizontal line represents ideal right-only separation. In actual practice, the pattern in Fig. 3 shows very good left-only separation. In Fig. 4 right-only separation is incomplete but acceptable.

The best music for separation tests features solos. The separation control is adjusted and the patterns observed as the music changes from an instrument on one side of the orchestra to a different instrument on the other. Adjusting slightly and watching the music over a period of time you will soon locate the spot where separation is best.

The threshold control is adjusted so that the stereo indicator does not flick on and off with weak signals or when someone moves about the room. The light should stay off on weak signals and turn on only when strong signals are received.

As is the case with alignment jobs on any equipment, the technician has to develop a "know-when" sense. The big "know-when" in this case is called "know-when-to-quit". Two more turns of the alignment tool after that and all is lost. As the signal shapes up, be more cautious. Make the adjustments smaller and smaller. Observe the waveforms for a longer period of time. And, if worst comes to worst, you can always start over. ▲

fill the gaps... WITH A COMPLETE SELECTION OF ANNUALS, YEARBOOKS, DIRECTORIES AND

HANDBOOKS from the world's largest publisher of special interest magazines. Take a moment to review the titles and issues currently available. You're sure to find many of your favorites to help complete your library and fill those wide open spaces on your bookshelves.

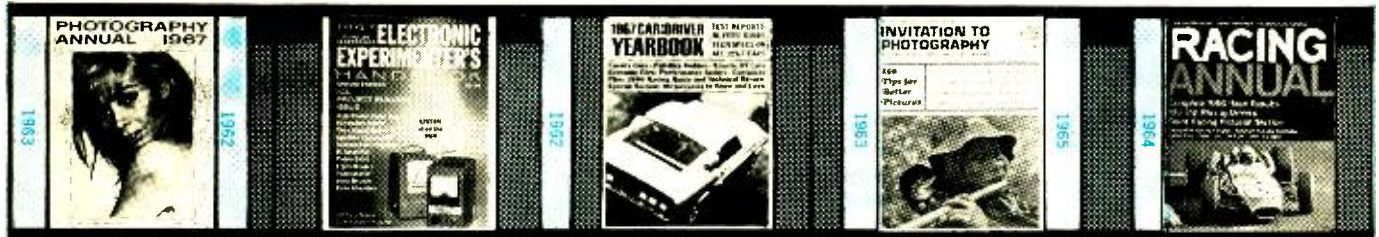

PHOTOGRAPHY ANNUAL

A selection of the World's finest photographs compiled by the editors of Popular Photography. 212 pages—24 in full color.

1967 — \$1.50 — #38
1966 — \$1.25 — #1
1964 — \$1.25 — #3

ELECTRONIC EXPERIMENTER'S HANDBOOK

Many challenging projects for the electronics hobbyist.

1966—Fall Edition—\$1.25 —#39
1966—Spring Ed.—\$1.25 —#36
1965—Fall Edition—\$1.25 —#9
1965—Spring Ed.—\$1.25 —#14
1967—Spring Ed.—\$1.25 —#49

CAR & DRIVER YEARBOOK

A complete buyers guide covering virtually every car available in the United States . . . Road tests . . . Technical specifications . . . Accessories and performance equipment buying guide . . . Guide to racing with action-packed photos.

1967 — \$1.50 — #40
1966 — \$1.25 — #15
1965 — \$1.25 — #17

INVITATION TO PHOTOGRAPHY

A unique 116 page guide to better picture taking by the Editors of Popular Photography. Basic down-to-earth advice that helps you eliminate costly trial and error. time-consuming guess work. 20 complete, fact-and-photo packed articles in all.

1966 — \$1.25 — #35
1967 — \$1.25 — #50

CAR AND DRIVER RACING ANNUAL

An almanac of competition information covering the entire year of 1966. It's the finest, most complete manual of its kind—it brings every suspenseful heat back to life with lavish use of dramatic photos, and words that spell "speed" from start to finish!

1967 — \$1.25 — #51



PHOTOGRAPHY DIRECTORY

World's most complete photographic buying guide.

1967 — \$1.25 — #41
1966 — \$1.25 — #22

TAPE RECORDER ANNUAL

Everything you need to know about tape recording including a complete directory of mono and stereo recorders.

1967 — \$1.25 — #42
1966 — \$1.25 — #30
1965 — \$1.00 — #31

ELECTRONICS INSTALLATION AND SERVICING HANDBOOK

The only complete guide for servicemen and hobbyists to every major phase of consumer electronics servicing.

1967 — \$1.25 — #43
1966 — \$1.25 — #32

FLYING ANNUAL

The most valuable aviation yearbook ever compiled . . . Pilot reports . . . Aircraft directory . . . How to buy a used airplane . . . Navcom directory . . . Learn to fly section.

1967 — \$1.50 — #44
1966 — \$1.25 — #27
1965 — \$1.25 — #28



STEREO/Hi Fi DIRECTORY

Complete buyers guide for virtually every Hi Fi component manufactured.

1967 — \$1.25 — #45
1966 — \$1.25 — #29

POLAROID LAND PHOTOGRAPHY

Complete guide and only comprehensive and up-to-date handbook on Polaroid Land Photography.

1966 — \$1.25 — #24
1963 — \$1.00 — #25

SKIING INTERNATIONAL YEARBOOK

A luxuriously illustrated compendium of 1966's important events. . . . A timely forecast of the excitement-packed 1967 season —by the editors of Skiing Magazine.

1967 — \$1.25 — #48
1966 — \$1.25 — #26

FLYING TRAVELGUIDE

Here's the first really useful guide to flying vacations. Everything you need to know about: lodgings, restaurants, resorts, sightseeing, recreation, sports activities, airport facilities, childrens fun, price information, special information for the gals —and much more.

1967 — \$1.25 — #46
1966 — \$1.25 — #34

COMMUNICATIONS HANDBOOK

The most complete and up-to-date guide to the exciting world of specialized radio communications.

1967 — \$1.25 — #47
1966 — \$1.25 — #18
1965 — \$1.00 — #19
1964 — \$1.00 — #20

TO PLACE YOUR ORDER, circle the numbers of the annuals you wish to receive on the coupon, clearly print your name and address and enclose your remittance. Please be sure to enclose an additional 15¢ shipping and handling for each copy ordered. Add 50¢ per copy for orders outside U.S.A.

Ziff-Davis Service Division—Department W 595 Broadway, New York, N. Y. 10012

I am enclosing \$_____ for the annuals circled below. My remittance includes an additional 15¢ per copy for shipping and handling (50¢ for orders outside U.S.A.). I understand quantities are limited and orders will be filled on a first come-first served basis.

1 3 9 14 15 17 18 19 20 22 24 25 26 27 28 29 30 31 32
34 35 36 38 39 40 41 42 43 44 45 46 47 48 49 50 51

Name _____

Address _____ EW-117

City _____ State _____ Zip Code _____

PAYMENT MUST BE ENCLOSED WITH ORDER

WORLD'S FINEST
5-CORE
SOLDER

ERSIN MULTICORE

NEW EASY DISPENSER
PACK

ONLY 69¢

BUY IT AT RADIO-TV PARTS STORES

MULTICORE SALES CORP., WESTBURY, N.Y. 11590
CIRCLE NO. 104 ON READER SERVICE CARD

**World's
Number
One
Trusted
Name
Brand**

"NO NOISE"

- VOLUME CONTROL & CONTACT RESTORER
- TUNER-TONIC with PERMA-FILM
- EC-44 FOR ELECTRICAL CONTACTS
- TAPE-RECO HEAD CLEANER
- FRIGID-AIR CIRCUIT COOLER

All Guaranteed Non-Flammable, No Carbon-Tet, Non-Toxic & Won't Affect Plastics

The Only Brand Perfect For Color TV and Black & White

FREE extender assembly for pin-point application supplied with ALL NO-NOISE PRODUCTS.

Electronic Chemical Corp.
813 Communipaw Ave. / Jersey City, N. J. 07304

CIRCLE NO. 118 ON READER SERVICE CARD

BOOK REVIEWS

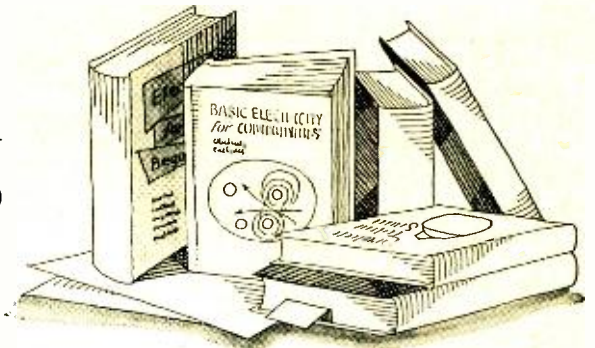

"MUSIC, PHYSICS AND ENGINEERING" by Harry F. Olson. Published by *Dover Publications, Inc.*, 180 Varick Street, New York, N. Y. 10014. 448 pages. Price \$2.75. Soft cover.

This book has long been familiar to audio engineers as "Musical Engineering" and has been revised and enlarged in this second edition to include new material on acoustics in all types of listening areas from cars to concert halls. There is new data on mono and stereo sound reproducing systems, on various types of tape systems, and even a chapter on the composition of music by computer.

The text is divided into ten chapters covering sound waves; musical terminology; musical scales; resonators and radiators; musical instruments; characteristics of musical instruments; properties of music; theater, studio, and room acoustics; sound-reproducing systems; and electronic music.

The book is lavishly illustrated, written in clear and concise style, and wherever possible has eschewed mathematics. Thus this volume can be used by teachers, by students, by musicians, by engineers, as well as by the intelligent layman.

* * *

"MUSIC, SOUND AND SENSATION—A MODERN EXPOSITION" by Fritz Winckel. Published by *Dover Publications, Inc.*, 180 Varick Street, New York, N. Y. 10014. 183 pages. Price \$2.25. Soft cover.

This is a translation from the 1960 German edition which has been updated and revised by the author. It is a book for the composer, the performer, and the sophisticated listener. The author has gone beyond the area of physical acoustics and music and delves into the realm of psychoacoustics from which results the subjective character of musical hearing.

In research conducted in psychoacoustics in the past few years music has been considered in many aspects; the evaluation of loudness and the dissolution power of the ear; the influence of the acoustical properties of the concert hall on the hearing process; the function of time variation and rhythm in musical perception; and the evaluation of the sound spectrum including the unharmonic components.

Thomas Binkley has given the work an excellent, idiomatic translation and the author has provided a bibliography embracing both American and European references. A generous sprinkling of line drawings, graphs, and photographs adds to the exposition.

* * *

"FIELD EFFECT TRANSISTOR PROJECTS" compiled and published by *Motorola Semiconductor Products, Inc.*, Box 955, Phoenix, Arizona 85001. 96 pages. Price \$1.00 plus 10 cents postage by mail. Soft cover.

Here is a chance for those who are interested in learning about FET's to build a number of pieces of equipment using field-effect transistors.

Following an introductory section which explains the construction, operation, and terminology of the FET, the book goes on to outline construction techniques and then continues with complete circuits and building hints on a vibrato, audio mixer, timer, crystal oscillator, preamplifier, and d.c. voltmeter.

Each piece of equipment has a schematic, pictorial, complete parts list, information on chassis layout, and even a step-by-step construction guide with boxes the builder can check off as he completes that step.

* * *

"RESEARCH ON THE LIGHTNING PHENOMENON" co-edited by Eugene W. Boehme & R. H. Golde. Published by the Journal of The Franklin Institute, Philadelphia, Pa. 19103. Price \$2.75. Soft cover.

This is a special issue of the Journal dealing with a single topic—the current aspects of lightning research. The co-editors have enlisted the services of five international experts from three continents to provide an up-to-date physical understanding of the nature and causes of lightning and the resulting advances in the science of lightning protection.

The article on The Lightning Conductor is by R. H. Golde of The Electrical Research Association of Leatherhead, England; Novel Observations on Lightning Discharges: Results of Research on Mount San Salvatore are described by K. Berger of the High Voltage Research Committee, Zurich; the Physics of Thunderstorm Electric

Circuit are discussed by D. J. Malan of the University of Witwatersrand, Johannesburg; The Production of Thunderstorm Electricity is covered by E. J. Workman of the University of Hawaii; and Lightning and Transmission Lines is handled by C. F. Wagner of Westinghouse.

Each article is complete in itself, well illustrated, and elaborately referenced. Almost anyone working in the electrical or electronic field could profit from a thoughtful study of this volume.

* * *

"INTEGRATED ELECTRONICS" by K. J. Dean. Published by *Chapman & Hall*, London. Distributed in the U. S. by *Barnes & Noble, Inc.*, 105 Fifth Ave., New York, N. Y. 10003. 130 pages. Price \$5.25.

This is another volume in this publisher's Modern Electrical Studies series which is designed to keep the practicing engineer or graduate student of engineering abreast of developments as they occur in the industry. The author has specified this readership since the prerequisite semiconductor and mathematical backgrounds are taken for granted.

The text is divided into eight chapters, two appendices, and a bibliography. After the preface and a glos-

sary of terms, the text covers the development of the alloy junction transistor, thin-film integrated circuits, diffusion techniques in silicon, field-effect transistors, logic circuits, bistable elements, linear amplifiers, and applications of bistable elements.

The author places particular emphasis on the digital applications of integrated electronics since, as he points out, it is the field in which the greatest advances have been made. The text has been elaborately illustrated throughout.

* * *

"DICTIONARY OF ELECTRONICS" by Harley Carter. Published by *Hart Publishing Company, Inc.*, New York. 410 pages. Price \$10.00.

The only difficulty in transporting an electronics dictionary which originated abroad to the United States is the inescapable fact that we "don't speak the same language" as our European neighbors, not excluding our British brethren.

While this is an excellent dictionary of its type, well illustrated and with copious explanations, most American users will find themselves a bit put off by the terminology and many of the definitions will have a decidedly foreign ring.

If the reader is accustomed to reading British engineering books and mag-

azines, this dictionary should prove both familiar and useful.

* * *

"THE MEANING OF SOUND" by Colin A. Ronan. Published by *Hart Publishing Co., Inc.*, New York. 118 pages. Price \$3.95.

The author of this volume is a familiar figure to British school children as he often appears on radio and television programs dealing with the sciences. He has successfully "popularized" the subjects of light, the universe, and the earth. With this book he performs a similar service for the subject of sound.

He has divided his subject matter into eight chapters covering the nature of sound, sound waves, musical sounds, noise, hearing and speech, broadcasting and recording sound, using sound, and ultrasonics. His style is informal and chatty and he has drawn little sketches to illustrate points which cannot be adequately demonstrated with photographs.

While this is not a book for the engineer or those involved in the design of audio equipment, there are bits of information which may be new even to the professional.

For those seeking a basic text on sound which can instruct but not bore, this volume should do the trick. ▲

A SELECTION OF ANNUALS STILL AVAILABLE

FROM THE WORLD'S LARGEST PUBLISHER OF SPECIAL INTEREST MAGAZINES

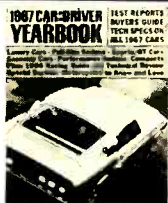

CAR & DRIVER YEARBOOK

A complete buyers guide covering virtually every car available in the United States . . . Road tests . . . Technical specifications . . . Accessories and performance equipment buying guide . . . Guide to racing with action-packed photos.

1967 — \$1.50 — #40
1966 — \$1.25 — #15
1965 — \$1.25 — #17



TAPE RECORDER ANNUAL

Everything you need to know about tape recording including a complete directory of mono and stereo recorders.

1967 — \$1.25 — #42
1966 — \$1.25 — #30
1965 — \$1.00 — #31

Order by number from Ziff-Davis Service Division, 595 Broadway, N.Y., N.Y. 10012. Enclose add'l 15¢ per copy for shipping & handling (50¢ for orders outside U.S.A.)

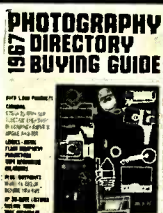

PHOTOGRAPHY DIRECTORY

World's most complete photographic buying guide.

1967 — \$1.25 — #41
1966 — \$1.25 — #22



STEREO/HI FI DIRECTORY

Complete buyers guide for virtually every Hi Fi component manufactured.

1967 — \$1.25 — #45
1966 — \$1.25 — #29

GAS WELDING TORCH



Uses **OXYGEN** and **LP GAS**

- Completely self-contained.
- Produces 5000° pin-point flame.
- Welds, brazes, solders.
- Hundreds of lightweight uses.
- Suggested list — \$19.95.

GET COMPLETE DETAILS AT MOST INDUSTRIAL DISTRIBUTORS, OR WRITE TO MICROFLAME, INC.



MICROFLAME, INC.

7800 COMPUTER AVENUE
MINNEAPOLIS, MINNESOTA 55424

CIRCLE NO. 80 ON READER SERVICE CARD

FREE!



**BRAND NEW
FALL AND WINTER
RADIO-TV
ELECTRONICS
CATALOG**



YOUR BUYING GUIDE
FOR: • Stereo & Hi-Fi
Systems & Components
• Tape Recorders • Elec-
tronic Parts, Tubes, Tools
• Phonos & Records
• Ham Gear • Test In-
struments & Kits • Cam-
eras & Film • PA • Cit-
izens Band • Radio & TV
Sets • Musical Instru-
ments

MAIL TODAY TO:

BURSTEIN-APPLEBEE

Dept. EWK 1012 McGee, Kansas City, Mo. 64106

Name _____
Address _____
City _____
State _____ Zip Code _____

CIRCLE NO. 124 ON READER SERVICE CARD



ARE YOU CASHING-IN ON THE PROFITABLE 2-WAY RADIO SERVICE BUSINESS?

- ★ Motorola will train you for this rewarding, elite profession
- ★ Send for our FREE EVALUATION EXAM. Prove to yourself that you are ready to learn FM 2-way radio servicing.

Opportunities in 2-way radio servicing are virtually unlimited. Just one of the hundreds of successful Motorola Service Stations writes, "we would be pleased to interview any graduate of your school that has received some training in 2-way radio maintenance. We are an established firm, 10 years old, with a promise of expansion governed by our ability to obtain competent technicians." Get all the facts today. There is no obligation and no salesman will call.



MOTOROLA TRAINING INSTITUTE

4545 West Augusta Blvd. • Chicago 51, Illinois • Dept. AEF 741

- Send me FREE entrance exam.
- Send full details on Home Study Course on FM 2-way Radio Servicing
- Send me details on how you can help me prepare for an FCC License.

Name _____ Occupation _____
Address _____
City _____ Zone _____ State _____

CIRCLE NO. 105 ON READER SERVICE CARD

SEMICONDUCTOR TEST SET

By M. GROSS

This easy-to-use test set measures leakage current and transistor beta and will also test diodes and SCR's.

THE semiconductor test set described in this article is designed to provide a great deal of information about the semiconductor device under test without requiring complex calibration or testing procedures. Most tests consist of inserting a semiconductor device into the test socket, pushing a button, and reading the results on a meter or short-circuit indicator lamp.

The test set can measure leakage current and d.c. current gain (*beta*) of transistors and indicate shorted or open junctions *via* the indicator lamp. It can also show shorts or open circuits in diodes and SCR's in both the forward- and reverse-biased conditions. In addition, the test set can demonstrate whether an SCR is functioning properly, that is, if the device will conduct when current is supplied to the gate and if it will turn off when the voltage is momentarily removed from the device.

Fig. 1. Parts list and schematic for semiconductor tester.

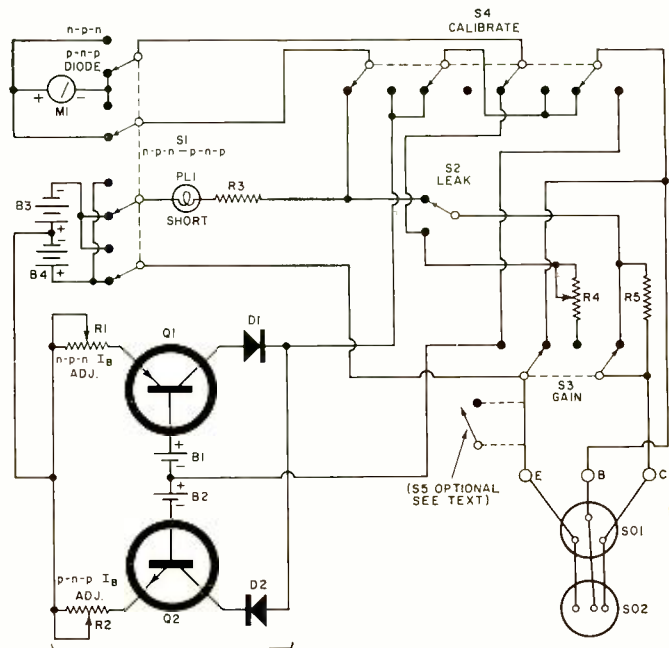

- CURRENT GENERATOR**
R1, R2—50,000 ohm pot
R3, R5—47 ohm, 1/2 W, res.
R4—5000 ohm pot
M1—0-100 μ A meter
S1—4 p.d.t. rotary sw.
S2—S.p.d.t. push-button sw.
S3—D.p.d.t. push-button sw.
S4—4 p.d.t. push-button sw.

- PL1—#49 pilot light
SO1, SO2—Transistor socket
D1, D2—1N100 or equiv.
B1, B2—1.35 V mercury battery
B3, B4—6 V battery
Q1—P-n-p transistor, beta more than 20
Q2—N-p-n transistor, beta more than 20

Tests Performed

The short test determines the existence of a shorted emitter-collector or base-collector junction; the presence of such a short is indicated when the front-panel indicator lamp glows.

The leak test measures the current flowing through the collector of the transistor under test. This test is similar to the short test except that the meter is connected in place of the lamp. When a transistor is inserted in the socket, the meter will indicate I_{cvs} (the amount of leakage current flowing from collector to emitter with the base connected to the emitter). To measure I_{cbo} (the current flowing from collector to base with the emitter open), the emitter lead is removed from the test socket. The meter then indicates the I_{cbo} current.

To perform the d.c. gain (*beta*) test, the transistor base is biased through a constant-current generator, and the ratio of collector current (I_c) to base current (I_b) represents the d.c. current gain (β). Since the current generator supplies a constant base drive of 100 μA and the meter is a 100- μA movement adjusted to read 10 mA full scale, the meter scale will indicate β directly from 0 to 100.

Test Set

A complete schematic for the test set is shown in Fig. 1. Switch S1 connects batteries B3 and B4 to the circuit so that the device under test is properly biased. This switch also connects the meter (M1) so that it always indicates up scale.

With switches S2, S3, and S4 in their normal (undepressed) condition, a device short circuit will be indicated. By depressing S2 ("Leak"), either I_{cvs} or I_{cbo} can be read.

To test gain, depress S3 ("Gain"). In this mode, resistor R5 is connected into the collector-emitter loop and the



meter is arranged to indicate the current flowing through this resistor. The meter is adjusted to indicate 10 mA (full scale) by R4. The current generator is connected to the base of the transistor under test and adjusted to provide 100 μA of base drive. If a transistor having a β of 100 were tested, the current through R5 would be $\beta (I_b)$ or 10 mA. This would produce a full-scale indication on the meter, representing a β of 100. Similarly, if a transistor having a β of 10 were tested, the current through R5 would be 1 mA, a deflection of one-tenth the meter scale. Thus, the meter is used to indicate β directly.

By releasing S3 and depressing S4 ("Calibrate"), the meter is then unshunted and connected in series with the

CARBON COMPOSITION AND WIRE-WOUND POTENTIOMETERS

FRACTIONAL HP ELECTRIC MOTORS

AC. AND D.C. OPERATED, WITH OR WITHOUT SPEED REGULATOR

LESER
LESER
LESER
LESER
LESER

OF AMERICA CORP, 521 FIFTH AVENUE, NEW YORK, N.Y. 10017, TEL. 212 697.5838

COSTRUZIONI ELETTROMECCANICHE S.p.A., VIA BERGAMO, 21, MILANO, ITALY

DEUTSCHLAND GMBH, 1 WIESENTALSTRASSE, FREIBURG i/Br. WEST-GERMANY

ELECTRA, S.A., VIALE PORTONE 27, BELLINZONA, SWITZERLAND

FRANCE S.A.R.L., 19 RUE DUHAMEL, LYON, FRANCE

LESER
LESER
LESER
LESER
LESER

CIRCLE NO. 200 ON READER SERVICE CARD

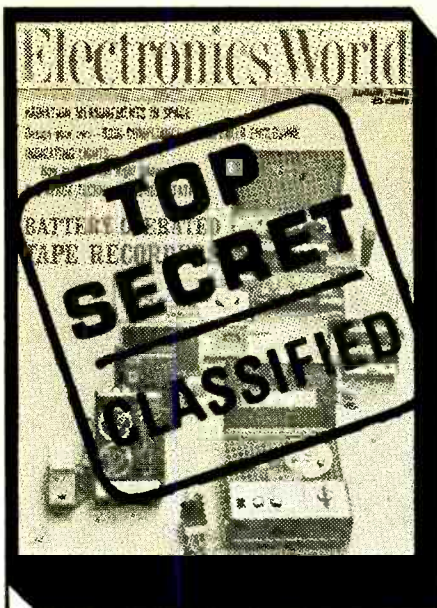

**...not by
a long shot
it isn't!!**

There's certainly nothing top secret about the classified pages in Electronics World Magazine. They're wide open to the searching eyes of every buyer who's in the market for the product or service that he knows can be found in Electronics World's Electronics Market Place.

The more than 191,000 buyers of Electronics World, largest readership of any magazine for electronics professionals in the world, are your guarantee of knowing that your ad is being read by people who are constantly looking for and buying electronics products. It is these people to whom you MUST direct YOUR advertising as do the many key advertisers appearing in this issue and in each issue throughout the year.

No doubt about it—there's a vast market of buyers searching the classified advertising pages of Electronics World and it's important that your ad be exposed to this prime buying audience. Prove to yourself that the leading magazine for electronics professionals **MUST ALSO** be the leader in sales responses to the many classified ads presently enhancing its pages—it makes a great deal of sense—give it a try.

There's complete rate information for your convenience in the classified section of this issue. Or, if you'd like a little personal service, it's right up our alley. Just write to

HAL CYMES
Classified Advertising Manager
ZIFF-DAVIS PUBLISHING COMPANY
One Park Avenue
New York, New York 10016

current generator and the base lead. Thus, the base drive in μA may be read. With S_4 depressed, base-current-adjusting resistors R_1 and R_2 may be set to provide 100 μA of base drive.

Current Generator

It is obvious from the preceding discussion that any change in the amount of base current supplied by the current generator will cause an erroneous β indication. It is desirable, therefore, to minimize the effects of emitter-base junction impedance changes on base current. Theoretically, this may be accomplished by using an "ideal" current generator, that is, a device which has an infinite input impedance and which can supply any desired current. In practice, however, this type of device may be a little difficult to create.

The current generator shown in Fig. 1 is really two generators connected in parallel. The first, consisting of R_1 , Q_1 , B_1 , and D_1 , is used to test $n-p-n$ transistors; the second, consisting of R_2 , Q_2 , B_2 , and D_2 , is used for $p-n-p$ transistors.

The current-generator circuit is a common-base configuration, with the emitter-base junction impedance R_{be} of the transistor under test as the collector load. This type of circuit is used to advantage since the impedance seen looking back into the generator collector is very high. Thus, changes in R_{be} have very little effect on the current flowing through the generator transistor and into the base of the transistor under test. R_{be} can vary from a short (zero ohms) to 8000 ohms and will result in only a 2% change in base drive.

Calibration

After the circuit is completed and inspected for wiring faults, the test circuits may be calibrated as follows:

1. Connect a 1000-ohm pot in series with an external 10-mA meter or v.o.m. between the test set "C" and "E" terminals. Adjust this pot for 10-mA deflection on the external meter. Press S_3 and adjust R_4 for full-scale deflection of test-set meter.

2. Short the test set "B" and "E" terminals with a clip lead. With S_1 in the "P-N-P" position, depress S_4 . Adjust R_2 to produce full-scale deflection on the test-set meter. Place S_1 in the "N-P-N" position. Depress S_4 and adjust R_1 for full-scale deflection. Both R_1 and R_2 may be adjusted with a transistor inserted in one of the test sockets and with the clip lead removed from the "B" and "E" terminals. This will ensure maximum accuracy for the β test.

Examples of Tests

Transistors. A transistor is inserted in the test socket with emitter, base, and

collector leads in their proper positions. Flipping S_1 back and forth between "N-P-N" and "P-N-P" should make lamp PL_1 light in one position and not in the other. The position of S_1 in which PL_1 does not light is the proper one for the transistor under test. In other words, if PL_1 does not light in the "N-P-N" position, the test transistor is $n-p-n$; if PL_1 does not light in the "P-N-P" position, the transistor is $p-n-p$.

If PL_1 does not light in either position of S_1 , the transistor is open; if PL_1 stays lit in both positions of S_1 , the transistor is shorted.

With S_1 in the proper position for the device under test, S_2 ("Leak") is depressed. The total leakage current I_{ces} (in μA) may be read on the meter. I_{cbo} may be read by removing the emitter lead of the transistor from the test socket and depressing S_2 . If the builder desires, another switch may be added (S_5 ; see schematic) which will effectively remove the emitter lead from the circuit for this test.

Diodes. The anode lead of the diode is connected to the "B" terminal of the test set and the cathode is connected to the "C" terminal. With S_1 in "Diode P-N-P" position, lamp PL_1 should light with S_1 in "N-P-N" position, the lamp should go out. If the light is off in the "P-N-P Diode" position but is lit in the "N-P-N" position, the diode is reversed. If the light stays on in both positions, the diode is shorted; if the light fails to go on in either position, the diode is open. With S_1 in the "N-P-N" position, S_2 is depressed and the reverse leakage current may be read on the front-panel meter.

SCR's. The stud of an SCR is usually the anode, the large terminal the cathode, and the small terminal the gate. Attach the anode to the "E" terminal of the test set, the cathode terminal to "C", and place S_1 in the "P-N-P Diode" position. The light should stay off. When a clip lead is attached to the "B" terminal of the test set and the other end of this clip lead touched to the gate lead of the SCR, the light should go on and stay lit even when the clip lead is removed from the gate. When S_2 is depressed, the light should go off and stay off and there should be no deflection observed on the meter.

When the clip lead is touched to the gate, current flows into the gate, turning the SCR on. When S_2 is depressed, in the time it takes this switch to go from its normally closed to normally open position (about 30 milliseconds), voltage is removed from the SCR. In this time the device should turn off. Any delay in turnoff of the SCR will be observed as a kick of the meter needle. If the SCR fails to turn off, the meter will be pegged so that S_2 should be released. ▲

LIGHT PROBE FOR THE BLIND

THE optical light probe to be discussed has been successfully used in teaching laboratory science to a blind student and enabled him to perform ordinary laboratory experiments, using conventional test equipment, without the aid of a sighted partner. The device was developed by Dr. Thomas R. Carver of Princeton University.

It was immediately obvious that most problems could be solved by a small photoelectric light sensor which could focus at short object distances as a microscope, at intermediate distances as a "flag" for moving objects, and at infinity for certain optical experiments. It was also obvious that the readout had to be an audio tone.

The basic circuit, shown in Fig. 1, consists of a two-transistor RC feedback oscillator in which photoresistor R1 acts as a bias resistor for transistor Q2. Variations in the light level reaching the photoresistor produces a broad range of frequency change. Audio output is *via* a small magnetic earphone.

Different optical functions are performed by a set of interchangeable lenses which can be attached to the main tube. One lens has a focal length of 2 inches and an object distance of infinity and is useful for general guidance and location functions. The second lens has a 1/2-inch diameter and an object distance of about 6 inches in front of the lens and is useful in timing a moving object passing in front of the lens, as well as "reading" the explanatory diagrams on the blackboard and tracing wiring on a benchtop.

The third lens has a short focal length and is used with a 5-power magnifier having an object distance only 3/8 inch from the first surface of the lens. This is used to scan an oscilloscope screen, locate fluid levels, and find punched holes in paper tape or cards. It is also useful in determining whether or not the equipment pilot lamps are lit.

The fourth lens is similar to the third lens except that it contains a semi-reflecting beamsplitter at 45°, between the lens and the photoresistor, in order to provide axial self-illumination from an internal light bulb. This last lens is useful for reading fluid level in a conventional thermometer, and sensing the location of meter pointers.

Because the oscillator operates reliably on 2.5 to 3 V, but the tiny grain-of-wheat lamp operates at 1.25 V, switch S2 is provided so as to connect only one cell to the lamp. With 225 mA/h batteries, operating life is about 12 hours with the lamp in use, and about 5 days when the lamp is not used. Switch S1 is provided to adjust the center frequency of the oscillator to the ambient light which happens to be present in any particular area. ▲

Fig. 1. Circuit and parts list for the audio/light probe.

R1—Photoresistor (Clairex CL904L or equiv.)
R2—150 ohm, 1/4-watt res.

R3—620 ohm, 1/4-watt res.

R4—16,000 ohm, 1/4-watt res.

C1—500 pF capacitor

C2—0.01 μF capacitor

C3—1 μF, 6-volt elec. capacitor

C4—0.1 μF capacitor

S1—S.p.d.t. switch

S2—S.p.3-pos. switch

PL1—1.25 V pilot lamp

J1—Phone jack (also "on/off" switch)

B1, B2—1.25 V rechargeable battery

Q1—2N207 transistor

Q2—2N706 transistor

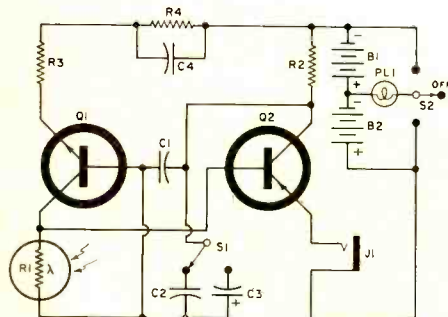

VIKING VERSATILITY MEANS EXTRA VALUE

Viking's versatile Model 230 transports are especially designed for continuous operation in a variety of commercial and industrial uses. Sophisticated installations in electronic teaching and dial access information retrieval systems, radio broadcast monitors, flight communications, law enforcement agencies, delayed broadcasting and background music centers all attest to their rugged reliability.

A two speed, three-motor tape transport, the Model 230 is equipped with momentary push-button controls and is ideally suited

for remote controlled and automatic applications. Various head configurations and interchangeable, plug-in head block assemblies, plus other optional features, make it a highly versatile unit. And Viking solid state modular amplifiers, single channel RP110 or dual channel RP120, match the 230 transports in dependability and design. For complete information write to Viking.

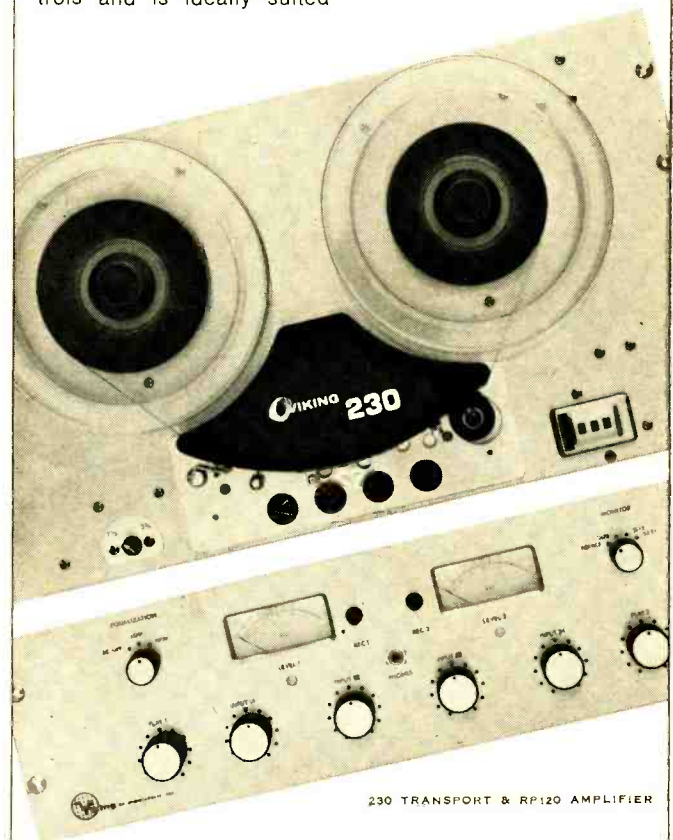

PRODUCTS OF SOUND RESEARCH

VIKING
tape recorders

A DIVISION OF THE
TELEX CORPORATION
9600 ALDRICH AVENUE SOUTH
MINNEAPOLIS, MINNESOTA 55420

CIRCLE NO. 84 ON READER SERVICE CARD

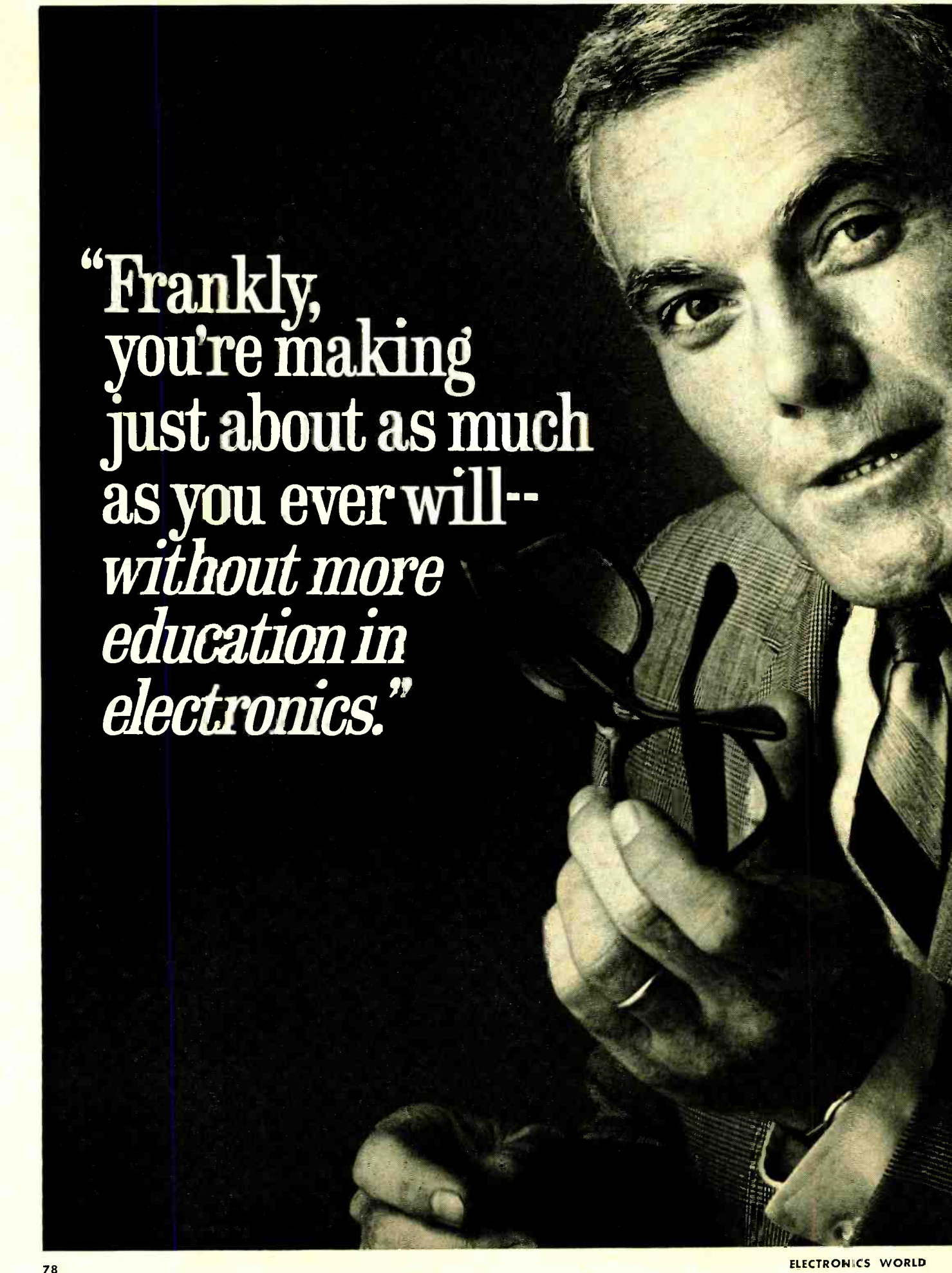

“Frankly,
you’re making
just about as much
as you ever will--
*without more
education in
electronics.*”



Ask any man who really knows the electronics industry.

Opportunities are few for men without advanced technical education. If you stay on that level, you'll never make much money. And you'll be among the first to go in a layoff.

But, if you supplement your experience with more education in electronics, you can become a specialist. You'll enjoy good income and excellent security. You won't have to worry about automation or advances in technology putting you out of a job.

How can you get the additional education you must have to protect your future—and the future of those who depend on you? Going back to school isn't easy for a man with a job and family obligations.

CREI Home Study Programs offer you a practical way to get more education without going back to school. You study at home, at your own pace, on your own schedule. And you study with the assurance that what you learn can be applied on the job immediately to make you worth more money to your employer.

You're eligible for a CREI Program if you work in electronics and have a high school education. Our FREE book gives complete information. Air-mail postpaid card for your copy. If card is detached, use coupon below or write: CREI, Dept. 1111E, 3224 Sixteenth Street, N.W., Washington, D.C. 20010.



The Capitol Radio Engineering Institute

A Division of McGraw-Hill, Inc.
Dept. 1111E 3224 Sixteenth Street, N.W.
Washington, D.C. 20010

Please send me FREE book describing CREI Programs. I am employed in electronics and have a high school education.

NAME _____ AGE _____

ADDRESS _____

CITY _____ STATE _____ ZIP CODE _____

EMPLOYED BY _____

TYPE OF PRESENT WORK _____ G.I. BILL

- I am interested in Electronic Engineering Technology
- Space Electronics Nuclear Engineering Technology
- Industrial Electronics for Automation
- Computer Systems Technology

APPROVED FOR TRAINING UNDER NEW G.I. BILL

IMPROPER GROUNDING— THE SUBTLE TROUBLESPOT

By MORTON H. BURKE

There is considerably more to a ground connection than a soldered joint. In fact, too many grounds or grounding in the wrong place can cause far more harm than good.

BECAUSE most modern design requirements demand that electronic equipment be free from unwanted signals, it is important that all precautions be taken to minimize hum and noise pickup from undesirable sources. It behooves the designer (he usually doesn't specify how ground returns should be run) and the technician (he actually does the wiring but may be unaware that certain grounding techniques exist) to avoid running ground wires incorrectly.

Hum in vacuum-tube circuits is usually caused by ripple from the main power supply, or a.c. from the filament circuits, getting into the grid or cathode circuits of an amplifier stage. It is especially important that ripple or hum not be introduced into stages that are amplifying low-level signals. In order to keep these hum levels low, it is important that the power-supply filter capacitors be grounded correctly and that separate leads are run from the filament trans-

formers. Fig. 1 shows a conventional tube amplifier and its power supply wired in accordance with an often-used technique.

Visualize the chassis spread out for five, six, or even twelve inches. By referring to Fig. 2 it can be seen that the mixture of filament currents and power-supply pulses with signal currents is inevitable. Each impedance, shown as R_{AB} , R_{BC} , R_{CD} , R_{DE} , R_{EF} , and R_{FG} , consists of the resistance of the chassis, plus wire resistance, plus solder-joint or mechanical-joint resistance. As shown in Fig. 2, $I_{FIL V1}$ and $I_{FIL V2}$ can develop a hum voltage across R_{DE} and R_{DE} which will mix with input voltage V_s in the grid circuit of V1. $I_{FIL V2}$ can induce hum voltage in the grid of V2 by way of R_{FG} . Charging pulses through filter capacitor C2 mix 120-Hz ripple with the input signal by way of common impedance R_{DE} . The addition of these currents within these common impedances causes a.c. from filament currents or power-supply pulses to be superimposed upon the signal, and, after being amplified with the signal, this hum appears as objectionable audible output that deteriorates the wanted signal.

To eliminate most of the interference, this circuit should be rewired on the chassis to conform with the method shown in Fig. 3. Here the filter capacitors' grounds are returned directly to the center tap of the transformer, thus preventing the capacitor charging-current pulses from mixing with the signal. Also, the filaments are shown fed by separate "twisted-pair" wires. Here again, there is no way for the filament currents to mix with the signal. (Twisting helps cancel the magnetic field around the wires, thus reducing interference from radiated fields.) The input jack has been moved physically closer to the amplifier input grid and the input ground is connected to the same point as the cathode resistor ground. This removes their common impedance.

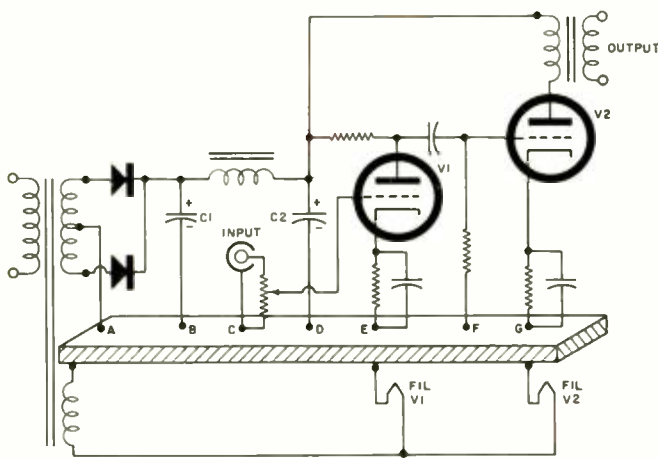

Fig. 1. Typical grounding method used by most constructors.

Fig. 2. How common impedances can interact when an indiscriminate amount of ground (mostly wrong) is used.

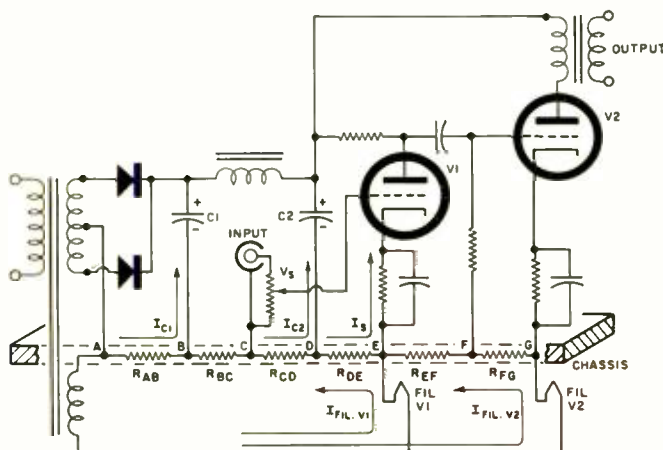
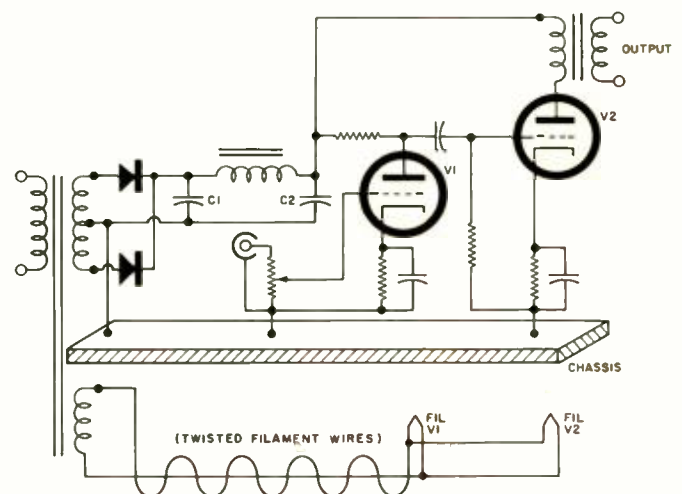
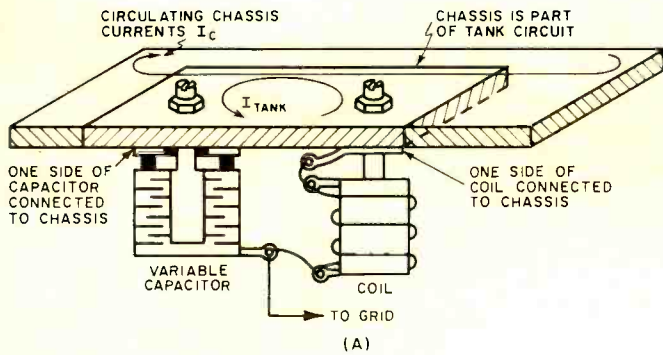

Fig. 3. The proper method of grounding reduces interference.





SINCE "Q" OF COIL IS $\frac{\omega L}{R_T}$
 $"Q" = \frac{\omega L}{R_L + R(\text{CHASSIS})}$
 THUS: ADDITIONAL $R(\text{CHASSIS})$
 LOWERS "Q" OF TANK
 COMBINATION.

Fig. 4. (A) Incorrect method of r.f. grounding uses chassis as part of tank circuit. (B) The equivalent electrical circuit.

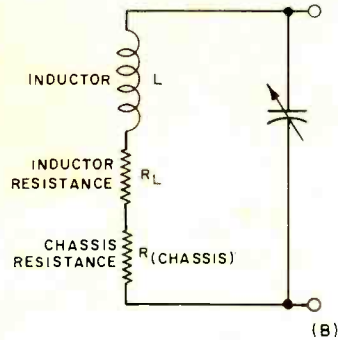
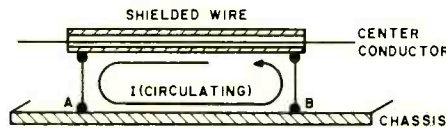

Fig. 5. Incorrect grounding of coax cable can produce extraneous noise due to the pickup from other circulating currents.



R.f. circuits also require that certain techniques be observed in "running" grounds. The methods shown in previous paragraphs concerning separate filament wires and the grounding of power-supply capacitors should be followed. In addition, where tank circuits are involved there is the possibility of incorrectly wiring the ground or "cold" side of the parallel inductor-capacitor combination.

Grounding R.F. Circuits

Fig. 4A shows a common method of grounding a capacitor and a coil in a tank circuit where the "cold" sides are connected to each other by way of the chassis. This method should be avoided for the following reasons: (1) The extra resistance introduced by the path through the chassis connections and the possibility of a poor connection to the chassis will lower the "Q" of the circuit. The equivalent circuit of this type of connection is shown in Fig. 4B. (2) The r.f. currents flowing through the chassis due to the tank circuit may induce undesirable coupling with other stages; and (3) if the tank circuit is located in the grid circuit of a tube, it is possible that spurious ground currents in the chassis might introduce unwanted signals into the tube through the tank circuit. These ground currents can exist in a metal chassis whenever several ground returns are tied to different locations on a chassis. Moreover, the usual electronic chassis, although a relatively large mass of low-resistance material like copper, aluminum, or steel, is not a perfect conductor. With the many current levels "running" through it due to the various grounded circuits, the chassis is no longer an equal-potential surface with zero volts between points on the surface. In fact, it is often possible to get readings of several millivolts between different points on a supposedly "grounded" chassis.

Therefore, every effort should be made to avoid tying additional grounds to chassis points that may already have an appreciable difference of potential between them.

Shielded Wires

In the general area of both direct and alternating current, shielded wire is an important way of providing a means of keeping a signal clean. Grid leads carrying low-

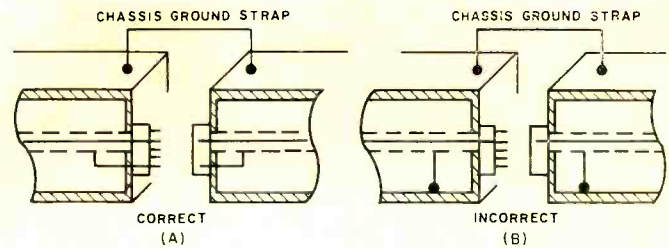
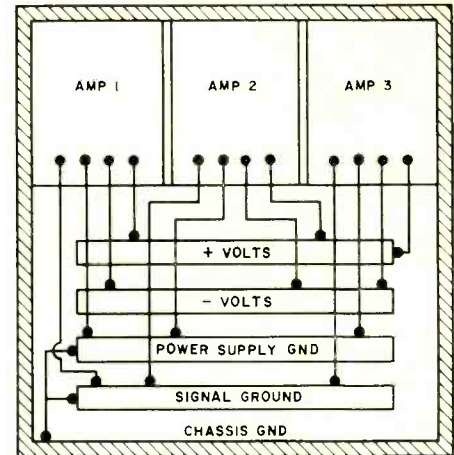

Fig. 6. (A) Correct method of interchassis ground connection. Center conductor and shield have separate pins. Shield ground does not carry chassis currents. (B) Incorrect method in which the shields carry circulating chassis currents induced in them.

Fig. 7. For multiplicity of chassis, power and signal grounds are connected to each chassis through bus at single spot.



level d.c. or a.c. voltages which are to be amplified should always be protected by shielded wire. This type of wire uses a center conductor which is insulated from its outer woven shield. The outer shield, usually made of copper mesh, will help prevent any electromagnetic coupling of unwanted signals into the low-level input circuits.

To be effective, this outer protective shield should be connected to chassis ground to allow any built-up potential to "leak off." In addition, it is important that this shield be grounded in only *one* place. The reason for this can be seen by referring to Fig. 5. Assume that the shield is connected to points A and B. If these points are at different potentials (the possibility of this was discussed previously), a current will flow using the shield as its conductive path. With this current flowing, the center conductor can still have unwanted signals coupled into it. Since capacitances of 30 pF-per-foot can be expected from coax, and even more from shielded wire, coupling would probably take place through the capacitance between the inner conductor and the shield. The best place to ground a shielded wire is not always apparent in a long run of cable. In most cases, this best spot will be found at a relatively "cool" (electrical speaking) location near the termination point of the inner conductor. In some tricky situations, it may be necessary to do some experimenting to determine the best grounding spot.

To prevent shielded wire from rubbing against the chassis and essentially grounding itself at more than one point, wire manufacturers are offering for sale shielded wire with clear vinyl covering throughout the length of the wire. This covered shielded wire should be used wherever runs of wire are over six inches long or pass near or through metal.

Wiring Between Chassis

Where a shielded wire or a coax cable is to be run between two independent chassis, care must be taken to continue the shield connections through the electrical connector linking the chassis. The shield should be assigned a pin in both male and female connectors; it should *not* be grounded to the chassis. A so-called ground strap should not be relied upon to supply a good interference-free connection. Figs. 6A and 6B show the correct and incorrect ways to

TELEX \$25,000 STEREO STAKES



WIN

one of five complete hi-fi component systems, made up of highest-quality components from the finest manufacturers in the field! Altec Lansing, Acoustic Research (AR), BASF, Dual, Electro-Voice, Fisher, J.F.D., Koss/Acoustech, Magnecord, Marantz, Pickering, Koss/Rek-O-Kut, Sherwood, Stanton, Telex, University and Viking . . . plus

FREE

Telex Serenata II Stereo Headphones to winners of special drawings from each participating dealer. A guaranteed winner from every store!



TELEX • MAGNECORD • VIKING
DIVISIONS OF THE TELEX CORPORATION
3000 ALIEN AVE., SOUTH • MINNEAPOLIS, MINN. 55120

Fill out coupon below and deposit in Stereo-Stakes Entry Box at hi-fi equipment dealer's

RULES:

1. Entries must be mailed to or deposited at official participating dealership.
2. No purchase required (however, if winner has purchased Magnecord or Viking tape recorder or Telex headphone during contest period, cash refund equivalent to retail price will be made.)
3. Contestants must be 18 years of age or older.
4. Employees of Telex, Magnecord, Viking, their advertising agencies, and families of same not eligible.
5. Winners to be selected by random drawing. All decisions of the judges will be final.
6. Contest void in states where prohibited by law.*
7. Entries must be postmarked or deposited at dealer's before midnight, November 30, 1967.
8. Winners will be notified by mail within 30 days of close of contest.

*Wisconsin residents mail entries to: Stereo-Stakes Contest, Box 7E26, Tulsa, Oklahoma 74105

OFFICIAL ENTRY FORM TELEX \$25,000. STEREO-STAKES

Name _____

Street Address _____

City _____ State _____ Zip _____

Area Code _____ Tel. No. _____

Hi-Fi Dealer _____

City _____

CIRCLE NO. 86 ON READER SERVICE CARD
84

run shielded wire between physically separated chassis.

Three-Ground System

Low-level d.c. and a.c. signals that require amplification must be protected from outside interference by the same grounding methods discussed in previous paragraphs. However, in many instances where measurements are to be taken, it is important that ground reference be preserved. In the case of d.c. recorders, d.c. voltmeters, and analog computers, accurate deviations or multiplications of the original signal must be measured. To preserve this reference point or plane, it has become necessary to create a physically separate reference line or bus called "signal" ground. Thus, in the sensitive instrument category, a three-ground system is utilized. The three-ground system consists of a power-supply ground, a chassis ground, and the previously mentioned signal ground. It is important that each ground return be kept independent of the others except where they are eventually tied together at one place on the chassis.

This serious attention to grounds is necessary in computers and other measuring circuits because these instruments must measure extremely low-level voltages with high accuracy. And because voltages on the order of 10 millivolts can be important, it is necessary that extraneous voltages from stray pickup, power-supply ripple, and pulses from relays be kept from mixing with the original signal. The use of three separate ground systems prevents chassis ground currents and power-supply ground currents from mixing with signal currents.

Ground Busses

In equipment where there is a multiplicity of separate amplifying devices sharing a common power supply, the use of ground busses should be considered. This bus method is widely used in analog computers, multi-channel recorders, and other sensitive read-out devices. The method illustrated in Fig. 7 will save time and wire and will also result in a neater assembly that will prevent the various ground currents from mixing with the signal. It is important that all ground busses be insulated from each other throughout their length. However, they must eventually be connected together at the chassis where the amplified voltage is to be measured. Thus, in computers, recorders, and voltmeters, the three busses will be tied together at one point on the chassis. Where an amplifier is working into a separate measuring device, the signal ground will be brought out separately.

In large systems it is often difficult to determine exactly where to tie the

grounds together, making it necessary to try many locations before optimum performance is obtained.

Transistor Operation

Since transistors have no filaments, the technician need not concern himself with running filament wires. However, the other comments concerning power-supply returns, signal returns, and chassis grounds still apply. Similarly, the method of interwiring of tuned-circuit elements previously described should be followed. Since capacitors of high microfarad capacitance are used in many transistor circuits, a problem might exist where ground wires are run a relatively long distance before they are terminated. In circuits where capacitors are carrying large bypass currents, the ground wire of the capacitor may radiate enough energy to interfere with other stages. Emitter bypass and collector bypass capacitors should be returned directly to the emitter return in as short a distance as possible.

Once the basics of proper grounding are understood and applied, the experimenter will be able to concentrate on the signal and not on the hum. ▲

USEFUL FORMULAS FOR COAXIAL LINES

THE following formulas are useful for calculating the pertinent characteristics of coaxial lines at high frequencies. If any doubt exists concerning the feasibility of using a coaxial cable, then the cable manufacturer should be consulted.

$$\text{Capacitance} = \text{Kr} / [59.1 \times \text{Ln} (d2/d1)] \times 10^{-9} \text{ farads/ft}$$

$$\text{Inductance} = 0.061 \text{ Ln} (d2/d1) \text{ microhenrys/ft}$$

$$\text{Impedance} = (60 / \sqrt{\text{Kr}}) \text{ Ln} (d2/d1) = \sqrt{L/C}$$

$$\text{Velocity of propagation} = 3 \times 10^{10} / \sqrt{\text{Kr}} \text{ cm/sec}$$

$$\text{Delay time} = 1.02 \sqrt{\text{Kr}} \times 10^{-9} \text{ sec/foot of cable}$$

$$\text{Cut-off frequency} = 6.75 \text{ GHz} / [\sqrt{\text{Kr}} (d1 + d2)] = 90\% \text{ F cut-off}$$

$$\text{Reflection coefficient } \Gamma = (Z1 - Z2) / (Z1 + Z2) = (v.s.w.r. - 1) / (v.s.w.r. + 1)$$

$$v.s.w.r. = (1 + \Gamma) / (1 - \Gamma)$$

$$\text{Peak voltage} = (G/S) \times 0.5 \times d1 \text{ Ln} (d2/d1)$$

where: d1 is the outer diameter of the inner conductor in inches, d2 is the inner diameter of the outer conductor in inches, C is the capacitance, G is the maximum voltage gradient of the cable insulation in volts per mil, Kr is the dielectric constant of the cable, L is the inductance, Ln is natural logarithmic base, S is a safety factor, and Z is impedance.

For pulse cable applications, the maximum voltage gradient will be based on the impulse strength of the insulation as long as the pulse does not reverse polarity.

This information was extracted from the *Phelps Dodge Technical Bulletin FF, Issue 4*. ▲

EW Lab Tested

(Continued from page 16)

before starting the tape when recording. Concentric recording level controls for both channels operate on microphone and high-level "Aux." inputs. Twin illuminated vu meters monitor both recording and playback levels. A "0 vu" recorded signal produces 0 dBm (0.78 volt) at the line outputs, unaffected by volume or tone controls.

The tape machine has built-in playback monitor amplifiers with their own volume and tone controls. A push-button switch disables the monitor speakers when using an external power amplifier. Stereo headphones may be plugged into a panel jack.

The built-in speakers are unique and among the best sounding we have heard on a portable machine. Two small high-compliance speakers facing out the sides of the recorder case may be used alone for monitoring or non-critical listening. Two removable satellite speakers which form the lid of the portable case may be removed up to seven feet from the recorder and plugged into jacks on the top of the case. This switches in a 350-Hz crossover network which converts the built-in speakers to woofers, with the lid speakers acting as tweeters. The maxi-

mum spacing of fifteen feet allows a full stereo effect to be obtained. In addition, there are jacks for connecting external speaker systems.

In our laboratory tests, the Sony TC-660 had an over-all record/playback frequency response of ± 2 dB from 25 to 17,000 Hz at $7\frac{1}{2}$ in/s and ± 2 dB from 42 to 7800 Hz at $3\frac{3}{4}$ in/s. Its playback response was +3.5 dB, -1 dB from 50 to 15,000 Hz, using the Ampex 31321-04 $7\frac{1}{2}$ in/s alignment tape. Wow was almost unmeasurable (about 0.01%) and flutter was 0.055% at $7\frac{1}{2}$ in/s. Tape speeds were exact and the exceptionally rapid fast-forward and rewind handled 1200 feet of tape in only 41 seconds. The signal-to-noise ratio was 48.5 dB at $7\frac{1}{2}$ in/s and 46 dB at $3\frac{3}{4}$ in/s. These are unweighted figures, referred to 0 vu recording level. The distortion at this level was only 1.3% and rose to only 1.6% at +3 vu, which pinned the vu meters.

In listening tests, the output of the recorder could not be distinguished from the input at $7\frac{1}{2}$ in/s. At $3\frac{3}{4}$ in/s the sound was slightly bright, with an accentuated hiss level, but of excellent quality nonetheless. The sound from the "Quadradiol" speaker system was remarkably good, hardly distinguishable from that of a pair of good-quality, full-sized external speakers, except for a lack of low bass, when played at

reasonable volume levels. Unlike most tape recorders with built-in playback amplifiers and speakers, the TC-660 can provide true high-fidelity sound without outside help. The F-96 microphones, while unable to exploit the full potential of the TC-660, sounded distinctly better than those supplied with other recorders we have tested.

Over-all operation of the recorder was highly satisfactory. The transport controls were effortless and foolproof while the sound left nothing to be desired. Despite its portable construction, we doubt that many people will wish to carry it far. The unit weighs almost 60 pounds with lid speakers mounted, attesting to its solid construction.

The Sony TC-660 sells for under \$575. ▲

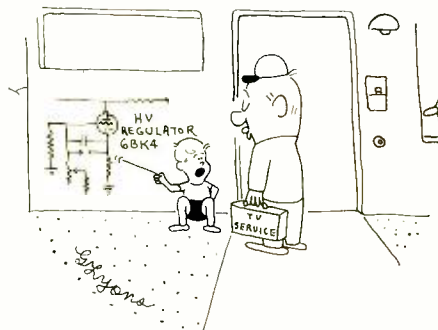

"Don't tell Pop I said so, but he put the wrong tube back in this circuit!"

Why not sell the best

Now...get genuine Zenith parts three ways faster—with ZIP!

Your Zenith Distributor has a revolutionary new system to speed your replacement parts ordering. Called "ZIP" (Zenith Instant Parts), it gives you much improved service.

1. Looking up parts numbers is 100% quicker than before. Because parts lists and schematics for the past ten years are now microfilmed on compact, easily-handled filmcards.

2. "Out-of-stocks" are cut down. The new ZIP program helps your Zenith distributor keep tighter inventory controls and maintain a more complete stock.

3. Factory special orders are shipped faster. Under the new ZIP program, the Zenith factory is geared to ship orders without delay.

Order from your Zenith Distributor for "Zenith Instant Parts" service on all genuine Zenith replacement parts and accessories.

ZENITH®

The quality goes in before the name goes on

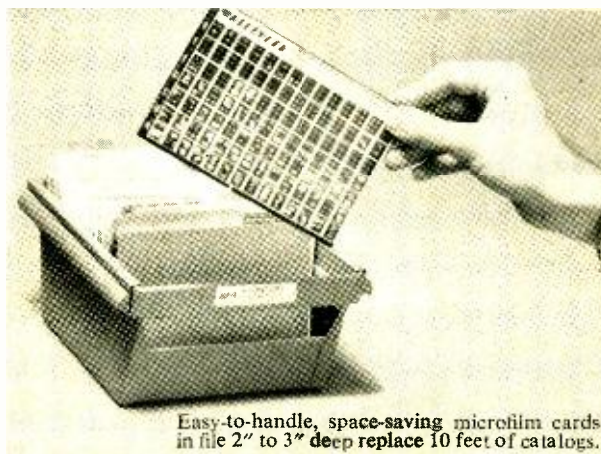

Easy-to-handle, space-saving microfilm cards in file 2" to 3" deep replace 10 feet of catalogs.

Get Top **PERFORMANCE** from
your Car! **Buy The Best!**



DELTA'S Remarkable, Proven

MARK TEN CAPACITIVE DISCHARGE IGNITION SYSTEM

ONLY
\$44.95
ppd.

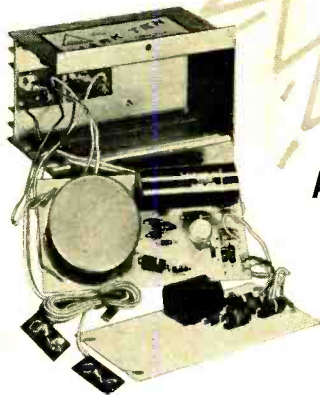

Available in Easy-to-Build

DELTAKIT® ONLY

ASSEMBLE IT YOURSELF! **\$29.95**
ppd.

You've read about the Mark Ten in Radio Electronics, Electronics World, Mechanix Illustrated, Electronics, Popular Mechanics and other leading publications! Now discover what dramatic improvement in performance with capacitive discharge ignition is yours for your car, truck, jeep, boat—any vehicle! Delta's remarkable electronic achievement—on the market since 1963 and so unique that a patent has been granted—saves on gas, promotes better acceleration, gives **your** car that zip you've always wanted. Even Detroit has finally come around. Delta's Mark Ten, the original, the proven winner from Sebring to Suburbia, has set new records of ignition benefits attested to by thousands of satisfied purchasers. No re-wiring necessary. Works on literally any type of gasoline engine. Satisfaction guaranteed.

Order from coupon below, specifying car make, voltage and polarity. Like to build your own? Order a Deltakit® and save!

COMPARE THESE PROVEN BENEFITS!...

- ▲ DRAMATIC INCREASE IN ACCELERATION
- ▲ LONGER POINT AND PLUG LIFE
- ▲ IMPROVED GASOLINE MILEAGE
- ▲ MORE COMPLETE COMBUSTION
- ▲ SMOOTHER PERFORMANCE

Order Your Mark Ten Today! Shipped Postpaid at Once.



DELTA PRODUCTS, INC.

P.O. BOX 1147 EW — GRAND JUNCTION, COLORADO 81501

Enclosed is \$ _____ Ship prepaid. Ship C.O.D.
 Mark Tens (Assembled) @ \$44.95 Mark Tens (Deltakit®) @ \$29.95
(12 volt positive or negative ground only)

Specify 6 Volt: Negative Ground only.
 12 Volt: Specify Positive Ground Negative Ground

Car Year _____ Make _____

Name _____

Address _____

City/State _____ Zip _____

CIRCLE NO. 121 ON READER SERVICE CARD

HIGHER GAIN AVALANCHE PHOTODIODES

New Bell Labs' technique ups multiplication factor to 2500.

GAIN in avalanche photodiodes, devices which combine the functions of both light detectors and microwave amplifiers, can be increased by factors of between 10 and 100 through a new operating method devised by *Bell Labs*. For example, current gain in a silicon photodiode previously limited to an avalanche multiplication factor of 50 was increased to 2500 by the new method.

Improved performance is obtained by sumperimposing an a.c. voltage on the d.c. voltage, which is the same or slightly higher than the normal d.c. voltage used to bias the diodes. The a.c. voltage prevents premature avalanches by quenching microplasmas (local flaws in the diode where small areas of intense ionization occur). Application of a.c. voltage to "uniform" diodes (those without microplasmas) has also produced a noticeable improvement in performance.

Gain is achieved in avalanche diodes by impact ionization of carriers; that is, under the influence of a high field the carriers acquire enough energy to knock valence electrons into the conduction band. This generates new carriers which by the same process create still more new carriers. The avalanche effect was first discovered at *Bell Labs*, where avalanche photodiodes are presently used in laser research studies.

Because microplasmas now can be quenched, the production yield of usable silicon and germanium photodiodes is expected to increase—especially for large-area diodes where microplasmas are more difficult to avoid. The new technique has been applied successfully to germanium, silicon, and gallium-arsenide diodes. It also should allow production of photodiodes from previously unusable semiconductor materials such as indium antimonide or gallium phosphide.

Microplasmas are undesirable in photodiodes because of the electrical noise they produce. The frequency selected for a small quenching signal (e.g. 10 to 1000 MHz, with an amplitude of 1 V) is high enough that the probability of "turning on" a microplasma during a cycle is small. Should one be turned on, it would immediately be turned off again because during each cycle the applied voltage drops below the breakdown voltage of the microplasmas and the ionization is not sustained. This quenching action eliminates the microplasmas. ▲

No dealer
stocks
everything.

No salesman
knows
everything.

**But the
1968 STEREO/HI-FI DIRECTORY does!**

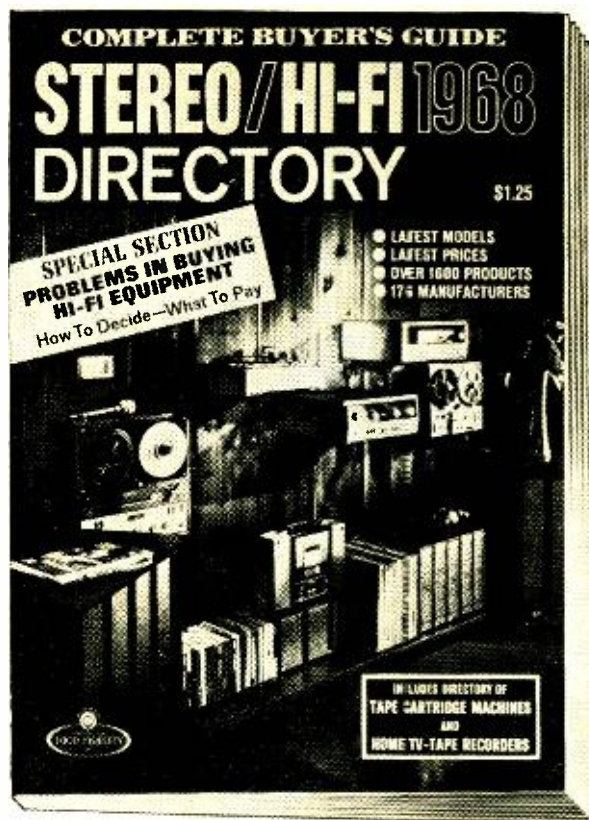

It's a giant 182-page buyer's guide to virtually every new audio component on the market today. Over 1600 products in all! From amplifiers to complete hi-fi systems to tape cartridge recorders and players for your home, car and boat. All the latest offerings from 176 manufacturers are fully detailed and illustrated for your "shop-at-home" convenience.

Every technical specification, dimension, special feature, optional accessory, price and model number is at your fingertips—to help you compare similar items, feature for feature, dollar for dollar and decide which is best

for you. Before you buy!

Forget the guesswork, costly mistakes, store-to-store treks and "after-you-get-it-home" disappointments. With the 1968 STEREO/HI-FI DIRECTORY as your guide, you'll zero-in on the equipment you want, buy it with confidence—and know you're getting the greatest value for your money.

The price for this valuable "encyclopedia" of hi-fi information? Just \$1.25. A small investment, indeed, for such an essential component of your listening enjoyment. So don't delay. Use the coupon below to order your copy of the 1968 STEREO/HI-FI DIRECTORY today!

CONTENTS INCLUDE

Special 8-page section on:

- How to choose components
- How to compare prices, features, specifications
- Exclusive state-of-the-art report on componentry
- PLUS an incisive analysis of the controversial 8 track, 4 track and cassette tape cartridges. . . . Comments and clues on which design holds the most promise for the future.

Individual directories for amplifiers / changers / turntables / cartridges and tonearms / receivers / tuners / tape machines (including video recorders and cartridge units) / speakers / integrated systems / antennas / microphones / cabinets.

GET THE DELUXE LEATHER-FLEX-BOUND EDITION for just \$3 POSTPAID!

The 1968 STEREO/HI-FI DIRECTORY is also available in a splendid deluxe edition. Rugged Leatherflex cover provides lasting protection yet is softly textured and gold-embossed for the look of elegance. A collector's item—a superb addition to your permanent hi-fi reference library. And it's yours, for just \$3 postpaid, when you check the appropriate box on the order form.



ZIFF-DAVIS SERVICE DIVISION • DEPT. SD • 595 Broadway • New York, N. Y. 10012

YES: Send me the new 1968 STEREO/HI-FI DIRECTORY as checked below:

- \$1.25 enclosed, plus 15c for shipping and handling. Send me the regular edition. (\$1.75 for orders outside the U.S.A.)
- \$3.00 enclosed. Send me the Deluxe Leatherflex-bound edition, postpaid. (\$3.75 for orders outside the U.S.A.) Allow three additional weeks for delivery.

name please print EW-117

address

city

state zip code

PAYMENT MUST BE ENCLOSED WITH ORDER

sonotone's dynamic cardioid mike for taping

Are unwanted sounds spoiling your home tape recordings? Has everyday household noise got you down? Sonotone has the unconditional answer: Our CDM30 dual impedance microphone.



This Sonotone microphone features the discriminating cardioid pattern that professional performers prefer. Captures every word, note and nuance directed into it, while suppressing extraneous, distracting noises, boominess and feedback.

Complete with on-off switch, 15-foot cable and shield. Impedances of 200 ohms and 50K ohms. Price: \$43.50



ELECTRONIC APPLICATIONS DIVISION
SONOTONE CORPORATION • Elmsford, N.Y. 10523
Exports: Singer Prods. Co., NYC. Cable: Exregis, N.Y.

PARAMETRIC LIGHT AMPLIFICATION

UNLIKE conventional amplifiers that convert d.c. into signal power, a parametric amplifier uses a non-linear circuit element that accepts an input signal at one frequency, mixes it with a so-called pump signal at another frequency, and produces an amplified, low-noise output of the original signal frequency. A third frequency output, called the "idler" is also produced, and as this is an unwanted by-product, it is dissipated into some form of load.

Until very recently, all parametric amplification has taken place at frequencies ranging from v.h.f. to the end of the microwave spectrum, and has made for some very sensitive low-noise receivers.

A scientist at *Bell Telephone Labs* has now achieved parametric amplification of light (albeit far infrared) by producing a 3-dB gain in the intensity of a laser light.

Operation of the light amplifier is shown in the diagram. The inputs to the 7-mm long tellurium crystal (an elemental semiconductor) are the signal frequency from a helium-neon c.w. laser and the pump frequency from a carbon-dioxide laser, pulsed at 160 pulses per second.

Although the two input waves in the illustration are shown as separate beams for clarity, they actually enter the tellurium crystal as colinear (superimposed) waves.

Tellurium has two properties which make it especially effective as a medium for parametric amplification. First, it is the most non-linear material known; that is, there is a non-linear relationship between the amount of electric polarization induced in the tellurium crystal and the electric field applied to the crystal by the laser light waves. Within a non-linear material, the only type suitable for parametric amplification, light waves of different frequencies can interact and the energy from one light wave can be transferred to the other. Because of tellu-

rium's high coefficient of nonlinearity, the energy transfer from the pump radiation of the signal frequency is very efficient.

Tellurium is also birefringent; that is, it has different optical properties in different directions. The velocity of light passing through a birefringent crystal depends on the direction of its path through the crystal. For example, when both laser beams pass through the tellurium crystal at an angle of 7 degrees from the optic axis, the interaction among the pump frequency, the signal frequency, and the idler frequency are phase matched. This matching strengthens the parametric amplification by lengthening the optical path along which the three light waves interact.

The light output from the crystal is passed through filters which block the pump and idler signals, yet allow the signal wave to pass through with minimum attenuation.

The signal radiation output showed a 3-dB gain at the output of the tellurium crystal and filter. The pulses of signal energy were coincident with the pump pulses of the carbon-dioxide pump laser, verifying that parametric amplification had occurred.

Once a means of modulating the signal laser has been developed, these optical parametric amplifiers will be of considerable interest for possible use in future laser communications systems.

This system of light amplification should not be confused with the older method of light amplification of a received light signal, in which the photoelectric effect is used. The system discussed in this article is a transmitter light amplifier that operates at the point of origin. It can be considered the optical equivalent of an r.f. parametric amplifier as commonly used. These experiments also showed that tunable optical parametric amplifiers could be constructed if suitable reflective coatings were added to the tellurium crystal. ▲

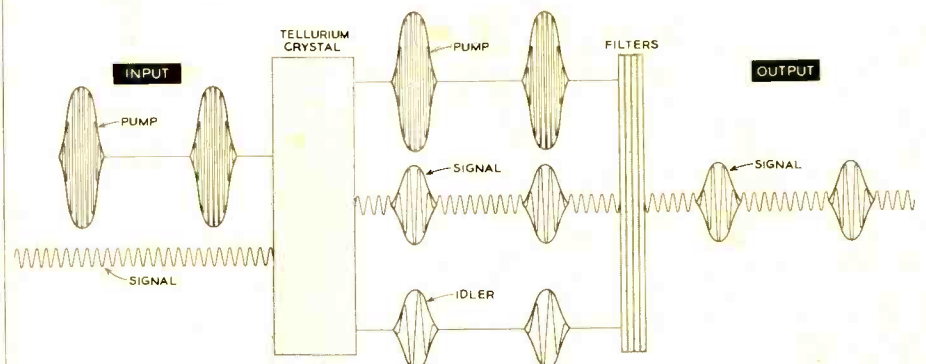

SHOW CORPORATION NAMES NEW BOARD MEMBERS

THE Electronic Industry Show Corporation has appointed ten new members to its Board of Directors. The new directors, representing five major electronic trade associations, will join the eight holdover directors in planning the 1968 National Electronics Week—the NEW Show—to be held at the New York Hilton between June 9-16, 1968 and the EISC-sponsored Upper Midwest Distributor-Manufacturer-Representative Conference, scheduled for April of next year.

Each Show Corporation director is selected by his own trade association to serve on the intra-industry panel.

Elected from NEDA are: Phillip Gustafson, *Hughes-Peters*, Cincinnati; R. C. Hewett, *R & R Electronics Supply*, Lubbock, Texas; John Knight, *Womack Electronics Supply Company, Inc.*, Durham, N. C.; Vernon Lampley, *Lampley Electronics*, Benton, Ill.; and Harold Powell, *Powell Electronics*, Philadelphia.

For the EIA, Milton Friedberg, *Antenna Specialists*, Cleveland, will serve. The Eastern Division of AEM has named Jack Kirschbaum, *Alpha Wire*, Elizabeth, N. J., while the Central Division will be represented by Dave M. Rice, *Electronic Publishing Co.*, Chicago.

WEMA has named R. H. Collier, *Collins Radio*, Newport Beach, California as its representative while Harry Estersohn, *Estersohn and Associates*, Philadelphia is the delegate for ERA.

Those continuing their terms include: Jay Greengard, *Waldom Electronics*; Arthur Rabb, *United Technical Publications*; J. Rudy Hummes, *J. W. Miller Co.*; J. L. Nichols, *Mallory Distributor Products*; F. W. Moulthrop, *F. W. Moulthrop and Associates*; Albert Kass, *Kass Electronic Distributors*; William A. Satterfield, *Satterfield Electronics*; and T. R. Waters, *Farwest Electronics, Inc.*

EISC board members who retired in September included: Jack Berman representing ERA, Don Chandler for WEMA, Norm Triplett for AEM-Central, Matthew Simon for AEM-Eastern, Bruce Vinkemulder for the EIA, and Alex Brodsky, Willis O. Jackson, James Neustadt, Michael Spolane, and John Viser, Jr., all representing NEDA. Each has completed a two-year term.

The general manager of the non-profit industry-sponsored Show, Kenneth G. Prince, administers all Show Corporation activities in accordance with established Board policies. ▲

Solid State Circuit Boards Featuring Professional Performance at Low-Budget Prices

Model AA-100
\$695

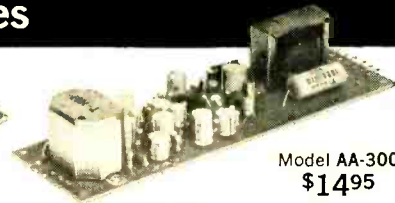
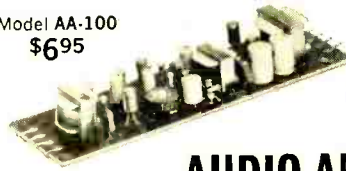

Model AA-300
\$1495

AUDIO AMPLIFIERS

Transistorized audio pre-amplifiers and amplifiers capable of delivering 200 MW of audio power, sufficient to drive a small speaker or a number of ear-phones. The AA-100, which includes a mounted volume control, is designed for general purpose audio applications and can also be used to modulate the TR-100 Transmitter (see below). The AA-300, a 200 MW amplifier, has excellent frequency response and low distortion characteristics which make it ideally suited for broadcast, recording, and TV applications. Either amplifier may be powered from a 9 volt source such as a battery or the PS-300 Power Supply. In applications where greater audio power is required, the AA-100 or the AA-300 may be used to drive the Model AA-400 Power Amplifier (see below).

	Model AA-100	Model AA-300
Frequency Response	±3 db, 100 to 12K cps	±1 db, 20 to 20K cps @ 200 MW ±2 db, 20 to 35K cps @ 100 MW
Harmonic Distortion	Less than 3%, 100 to 12K cps	Less than 1%, 20 to 20K cps @ 100 MW Less than 2%, 20 to 20K cps @ 200 MW
Input Impedance	150, 600, and 100K ohms (shielded transformer)	50 to 150 ohms, or 600 ohms, balanced (mu-metal shielded permalloy core transformer) 2K or 100K ohms unbalanced
Gain	70 db	80 db, 50 ohm input, 8 ohm load
Output Impedance	500 ohms and 8 ohms 200 MW	500 ohms and 8 ohms (grain oriented transformer)
Circuit	5 transistors, 1 thermistor	7 transistors, 1 thermistor
Power Supply	9 volts DC, 50 MA	9 volts DC, 100 MA
Size	5½" L x 1¾" W x 1" H	8" L x 2¼" W x 1½" H
Weight	3½ ounces	12 ounces

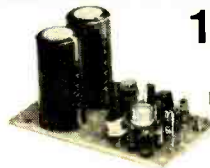

1-WATT AUDIO POWER AMPLIFIER

Model AA-400
\$995

A transistorized audio power amplifier that can be driven to a full 1-watt output by a 1.5 volt signal. When the AA-400 is used with the Round Hill AA-100 or AA-300 Amplifier, a complete high gain, 1-watt audio system is obtained. Power can be furnished by any stable DC source delivering 14 volts at 150 MA, such as the PS-300.

Frequency Response ±1 db, 20 to 20K cps @
1 watt
Harmonic Distortion..... Less than 1.5%, 20 to 20K
cps @ 1 watt
Input Impedance 500 ohms and 2,000 ohms

Output Impedance 4 to 16 ohms
Circuit 4 transistors
Power Supply 14 volts DC, 150 MA
Size 3½" L x 2" W x 2" H
Weight 3 ounces

REGULATED POWER SUPPLY

The PS-300 is a zener-referenced, voltage regulated power supply which delivers a highly stable, extremely low ripple DC output of 9 volts with loads up to 200 MA and an unregulated output of 14 volts DC. The PS-300 is ideally suited for transistor circuit applications requiring a well-filtered regulated DC source, and may be used to furnish power to all Round Hill circuit boards.

Input Voltage 105-120 volts AC, 60 cps, 5 watts
Regulation Line + load 5 MV
Ripple Under full load 10 MV, peak-to-peak
Maximum Load Current 200 MA



Model PS-300
\$1895

Output Voltage 9 volts DC fully regulated;
14 volts DC unregulated
Size 4½" L x 2" W x 1½" H
Weight 23 ounces (with transformer)

TRANSMITTER

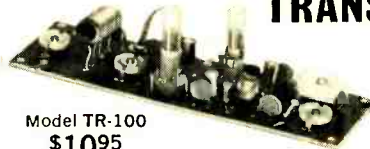

Model TR-100
\$1095

Circuit Crystal controlled, 3 transistors
Frequency Range..... Any CB channel (channel 10
crystal supplied)
Modulation..... CW or AM with external modulator
such as Round Hill AA-100

The TR-100 is a complete crystal controlled Transmitter for the Citizens' Band. It is factory pre-tuned and supplied with a channel 10 crystal. The Transmitter is capable of an RF output in excess of 100 MW and may be modulated with the Round Hill AA-100 Amplifier. Transmitter power supply requirements are 9 volts DC which can be obtained from the PS-300 Power Supply.

RF Output 100 MW, 50 ohm load
Power Supply 9 volts DC, 50 MA
Size 5½" L x 1¾" W x 2" H
Weight 3½ ounces
Additional CB Crystals \$3.00 each

ROUND HILL ASSOCIATES INC. A SUBSIDIARY OF MILO ELECTRONICS
434 Avenue of the Americas, New York, N.Y. 10011

PLEASE SEND ME THE FOLLOWING CIRCUIT BOARDS:

MODEL	QTY.	PRICE ea.	AMOUNT
AA-100 AUDIO AMPLIFIER		\$ 6.95	\$
AA-300 AUDIO AMPLIFIER		\$14.95	\$
AA-400 AUDIO POWER AMPLIFIER		\$ 9.95	\$
PS-300 POWER SUPPLY		\$18.95	\$
TR-100 TRANSMITTER		\$10.95	\$
CB CRYSTAL (channel:)		\$ 3.00	\$
TOTAL:			\$

Send postpaid—enclosed is full payment.
 Send C.O.D.

NAME _____
ADDRESS _____
CITY _____
STATE _____ ZIP _____

The editors of *Popular Photography* proudly present a dramatic, sophisticated and colorful tribute to the loveliest subject in the world...

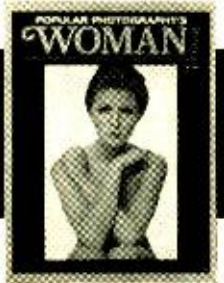

an exciting insight into the world of beautiful women by the great photographers of our time!

POPULAR PHOTOGRAPHY'S WOMAN 1968 is a collection of superb photographs—the finest, most searching works of leading professional photographers including Gowland, Steckler, Sokolsky and Lyon. They bring the woman into focus—her many moods, her countless expressions, her unpredictable reactions, as she plays her varied roles in modern life. From girl next door to girl friend. From movie queen to mother. From fashion model to temptress. And always—glamorous, subtle and enchanting.

Included in a 20-page *Playboy* feature section is a portfolio of never-before-published photos taken by 6 of *Playboy's* best photographers... another outstanding section analyzes *Blow-Up*—the motion picture that probes the relationships of a photographer with his cameras and models. To celebrate the 100th anniversary of *Harper's Bazaar*, a special photo album depicts *Harper's* stylish effects on the woman of today.

POPULAR PHOTOGRAPHY'S WOMAN 1968—a 128-page gallery of fine photography is essential as a reference work for every photographer. A section of the publication is devoted to technical data including camera, lighting, exposure time, film, filters and technique used for each photograph.

POPULAR PHOTOGRAPHY'S WOMAN 1968 is a masterful study of the loveliest subject in the world. It is destined to become a collector's item for every person who appreciates great photography. Order your copy today!

GET THE HANDSOME LEATHERFLEX-BOUND EDITION for just \$3 POSTPAID!

POPULAR PHOTOGRAPHY'S WOMAN 1968 is also available in a splendid deluxe edition. Rugged leatherflex cover provides lasting protection yet is softly textured and gold-embossed for the look of elegance. A collector's item—a superb addition to your permanent reference library.

ZIFF-DAVIS SERVICE DIVISION • DEPT. WO
595 Broadway • New York, N.Y. 10012

Please send me a copy of **POPULAR PHOTOGRAPHY'S WOMAN 1968** as checked below.

\$1.25 enclosed, plus 15c for shipping and handling. Send me the regular edition. (\$1.75 for orders outside the U.S.A.)

\$3.00 enclosed. Send me the Deluxe Leatherflex-bound edition, postpaid. (\$3.75 for orders outside the U.S.A.) Allow three additional weeks for delivery.

print name _____

address _____

E.W. 117

city _____

state _____

zip _____

PAYMENT MUST BE ENCLOSED WITH ORDER

ELECTRONICS WORLD NOVEMBER 1967

ADVERTISERS INDEX

READER SERVICE NO.	ADVERTISER	PAGE NO.	READER SERVICE NO.	ADVERTISER	PAGE NO.
125	Allied Radio	89, 90	103	Music Associated	97
	American Institute of Engineering & Technology	99		National Radio Institute	8, 9, 10, 11
124	Burstein-Applebee	74		National Technical Schools	5
	Capitol Radio Engineering Institute, The	78, 79, 80, 81	102	Non-Linear Systems, Inc.	22
123	Cleveland Institute of Electronics	13	101	Olson Electronics, Inc.	97
122	Cleveland Institute of Electronics	19, 20	100	Poly Paks	105
	Conar	98		RCA Electronic Components and Devices	FOURTH COVER
121	Delta Products, Inc.	86		RCA Institutes, Inc.	60, 61, 62, 63, 68
120	Edmund Scientific Co.	102	99	Radar Devices Manufacturing Corp.	7
119	Electro-Voice, Inc.	4		Round Hill Associates, Inc.	91
118	Electronics Chemical Corp.	72	98	Sams & Co., Inc., Howard W.	59
117	Electronic Components	103	96	Schober Organ Corp., The	97
	Fair Radio Sales	102	95	Sentry Manufacturing Company	95
116	Finney Company, The	55	94	Shure Brothers, Inc.	2
	G & G Radio Supply Company	103	93	Solid State Sales	101
115	Gregory Electronics Corporation	105	91	Sonotone Corporation	88
114	Heath Company	SECOND COVER, 1	90	Sony/Superscope, Inc.	17
113	Hickok Electrical Instrument Company, The	12	89	Sprague Products Co.	70
112	International Crystal Mfg. Co., Inc.	14	88	Surplus Center	104
111	Jensen Manufacturing Division	65	199	Switchcraft, Inc.	6
110	Judson Research and Mfg. Co.	98	198	Sylvania	15
109	Lafayette Radio Electronics	56	87	Sylvania	51
108	Lampkin Laboratories, Inc.	95	86	Telex-Magnecord-Viking Stereo Stakes	84
200	Lesca of America Corp.	75	197	Texas Crystals	99
107	Mallory & Co. Inc., P.R.	53	97	Triplett Electrical Instrument Company	THIRD COVER
	Micro Electron Tube Co.	105	85	University Sound	67
80	Microflame, Inc.	73		Valparaiso Technical Institute	56
106	Milwaukee School of Engineering	54	84	Wiking Tape Recorders	77
105	Motorola Training Institute	74	83	Weller Electric Corporation	21
104	Multicore Sales Corp.	72	82	Xcelite, Inc.	57
			81	Zenith	85

CLASSIFIED ADVERTISING 101, 102, 103, 104, 105

200,000 OHMS PER VOLT



Model 630-NS
VOLT-OHM-MICROAMMETER

TRIPLETT SUSPENSION MOVEMENT

*no pivots . . . no jewels . . .
no hair springs . . . thus NO FRICTION.*

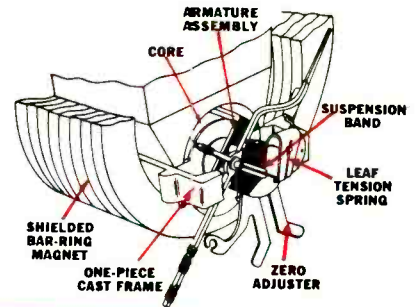

\$105.00
SUGGESTED
U.S.A. USER NET

FACTS MAKE FEATURES

- 1** 200,000 OHMS PER VOLT D.C. for greater accuracy on high resistance circuits. 20,000 OHMS PER VOLT A.C.
- 2** 5 μ a SUSPENSION METER MOVEMENT. No pivots, bearings, hair-springs, or rolling friction. Extremely RUGGED. Greater sensitivity and repeatability.
- 3** 62 Ranges, usable with frequencies through 100 Kc. Temperature compensated. 1½% D.C. ACCURACY, 3% A.C.

Low voltage ranges and high input impedance make the 630-NS especially useful in transistor circuit measurement and testing. Input impedance, at 55 volts D.C. and above, is *higher than most vacuum tube voltmeters.*

The unit is designed to withstand overloads and offers greater reading accuracy. Reads from 0.1 μ a on 5 μ a range. Special resistors are rigidly mounted and directly connected to the switch to form a simplified unit. Carrying cases with stands are priced from \$11.00.

TRIPLETT ELECTRICAL INSTRUMENT COMPANY, BLUFFTON, OHIO

CIRCLE NO. 97 ON READER SERVICE CARD

62 RANGES

D.C. VOLTS	0-0.6-3-12-60-300-1200 at 100,000 Ohms/Volt. 0-0.3-1.5-6-30-150-600 at 200,000 Ohms/Volt. 0-0.150 at 60 μ a
A.C. VOLTS	0-3-12-60-300-1200 at 10,000 Ohms/Volt. 0-1.5-6-30-150-600 at 20,000 Ohms/Volt.
DB	-20 to 77 in 10 ranges.
D.C. MICRO-AMPERES	0-5 at 300 MV. 0-60-600 at 150 MV. 0-120 at 300 MV.
D.C. MILLI-AMPERES	0-6-60-600 at 150 MV. 0-1.2-12-120-1200 at 300 MV.
D.C. AMPERES	0-6 at 150 MV. 0-12 at 300 MV.
OHMS	0-1K-10K-100K (4.4-44-440 at center scale)
MEG OHMS	0-1-10-100 (4400-44,000-440,000 Ohms center scale)

OUTPUT: Condenser in series with A.C. Volt ranges.

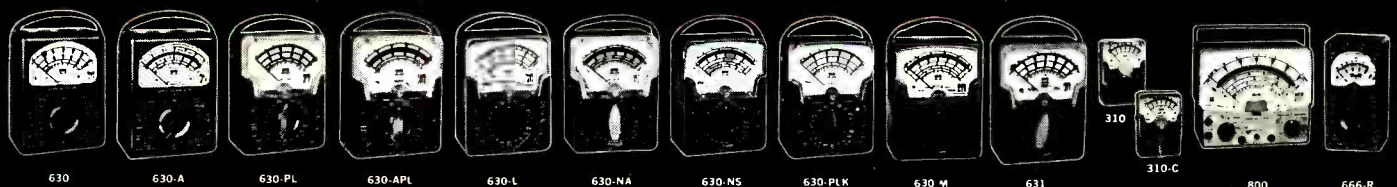

THE WORLD'S MOST COMPLETE LINE OF V-O-M'S. AVAILABLE FROM YOUR TRIPLETT DISTRIBUTOR'S STOCK.

Get on board RCA's Gift-Time Special for 71 valuable prizes

FREE with your purchases of
RCA receiving tubes

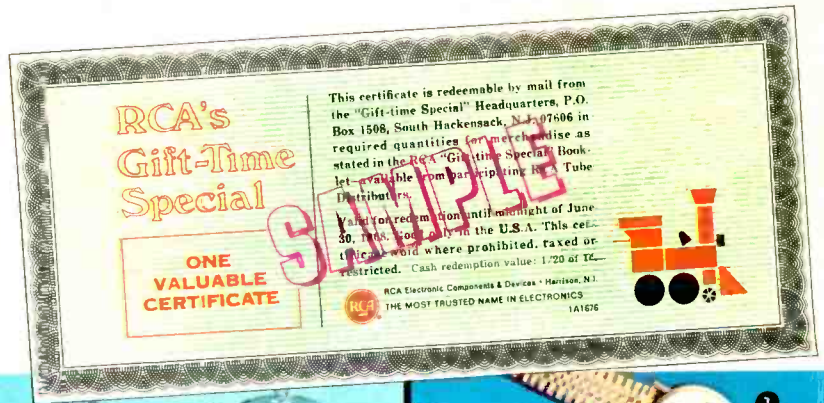

RCA's "Gift-time Special" certificates bring you great premiums for Christmas gift giving for the entire family. These valuable certificates are FREE WITH YOUR PURCHASES OF RCA RECEIVING TUBES from your participating RCA Tube Distributor. (Optional with RCA Tube Distributors.)

1. Argus Electromatic Slide Viewer. 51-126. 43 Cert. 2. Polaroid 215 Color-Pack Camera. 51-170. 155 Cert. 3. Polaroid Flash Gun Attachment. 51-174. 22 Cert. 4. Toastmaster "Sovereign" Automatic Toaster. 35-80. 51 Cert. 5. Rival Slimline Electric Knife. 35-141. 33 Cert. 6. West Bend 8-Cup Automatic Aluminum Perculator. 35-73. 27 Cert. 7. Man's Elgin "Armada" 17-jewel Watch. 53-80. 61 Cert. 8. Longines-Wittnauer Man's Watch. 53-11. 146 Cert. 9. Hiccock Man's Alligator Belt. 20-765. 36 Cert. 10. Sterling Silver Candlesticks. 52-25. 15 Cert. 11. Star Rogers and Bros. Silverplate "Starlight" by The International Silver Company. 52-45. 37 Cert. 12. Oneida 4 pc. "Paul Revere" Coffee Service. 52-46. 81 Cert. 13. Sterling Silver Salt and Pepper Shakers. 52-26. 15 Cert. 14. Sterling Silver and Crystal Cake Plate. 52-75. 17 Cert. 15. Reed and Barton Color-Glazed "Paul

Revere" Bowl. 52-96. 29 Cert. 16. Man's Alligator Raincoat. 20-568. 103 Cert. 17. Lady's Alligator Raincoat. 20-571. 103 Cert. 18. Lady's Twin-Pearl Ring. 49-147. 39 Cert. 19. Lady's Linde Star Ring. 49-149. 105 Cert. 20. Hamilton "Loralie" Lady's Watch. 53-65. 133 Cert. 21. "Buddy L" Aerial Ladder Fire Engine. 48-90. 18 Cert. 22. Toddler's "Tiger Trike". 47-51. 16 Cert. 23. "Buddy L" Sit N Ride Truck. 48-207. 19 Cert. 24. "Kiss Me" Doll. 48-137. 13 Cert. 25. Cosco Doll High Chair. 48-43. 10 Cert. 26. "Drink and Wet" Doll and Cradle. 48-139. 13 Cert.

AND THESE ARE JUST A FEW OF THE 71 EXCITING GIFT PREMIUMS AVAILABLE! Get RCA "Gift-time Special" certificates FREE with your purchases of RCA receiving tubes from your participating RCA Tube Distributor.

RCA Electronic Components and Devices, Harrison, N.J.



The Most Trusted Name in Electronics