

Electronics World

SEPTEMBER, 1967
60 CENTS

TEMPERATURE-DEPTH MEASUREMENTS IN THE OCEAN

NEW AVALANCHE TRANSISTOR CIRCUITS

LOW-COST SEMICONDUCTORS
FOR THE CONSUMER MARKET

DIRECTORY OF THE MOST POPULAR
LOW-PRICED VIDEO TAPE RECORDERS

**MEASURING
MISSILE
EXPLOSIONS**



M J HINDMAN
2724 E LINWOOD
4 SPRINGFIELD MO 65804
M0568 514700HIN2724LM059

Electro-Voice®
Stereo
STARTER SET



*sets the
 pace in
 component
 home music
 systems*

E-V Nowhere is the soundness of the component approach to home music better demonstrated than with the new Electro-Voice Starter Set.

The unique value of this system lies—in large part—in the modestly-priced E-V ELEVEN speaker systems. These compact basic starter units offer a most pleasant appearance and surprisingly robust performance... conclusive proof that the advantages of component reproduction need not be expensive.

But the principal unit of the Starter Set is the E-V 1177* FM Stereo receiver... and rightly so. For the future of your stereo system rests on the ability

of this receiver to meet tomorrow's needs. Right from the start you enjoy FM stereo with remarkable clarity. Yet you can expand your musical horizons as you wish, adding any component stereo record player or tape recorder at any time.

But the Starter Set goes further, providing all the power and quality needed to accommodate the very largest—and smallest—component speakers available. If you eventually desire even finer speaker systems, they're easily added. Your E-V ELEVEN's may then be moved to a second listening location where requirements are perhaps less

critical. Nothing has been lost—nothing made obsolete.

In essence, the E-V Starter Set offers you more than the initial pleasure of fine high fidelity. It is designed to grow and change with your personal needs—and without compromising your standards of musical reproduction.

You'll be surprised at the modest initial cost of the E-V Starter Set—and at how much it offers. Take the first step toward a lifetime of musical pleasure. Write today for full details, or listen to the Starter Set at fine high fidelity showrooms everywhere.

**Also available with E-V 1178 AM/FM Stereo Receiver*

high fidelity speakers and systems • tuners, amplifiers, receivers • public address loudspeakers • microphones • phonograph needles and cartridges • organs • space and defense electronics

ELECTRO-VOICE, INC., Dept. 974N, 629 Cecil Street, Buchanan, Michigan 49107

CIRCLE NO. 116 ON READER SERVICE CARD

Electro-Voice®

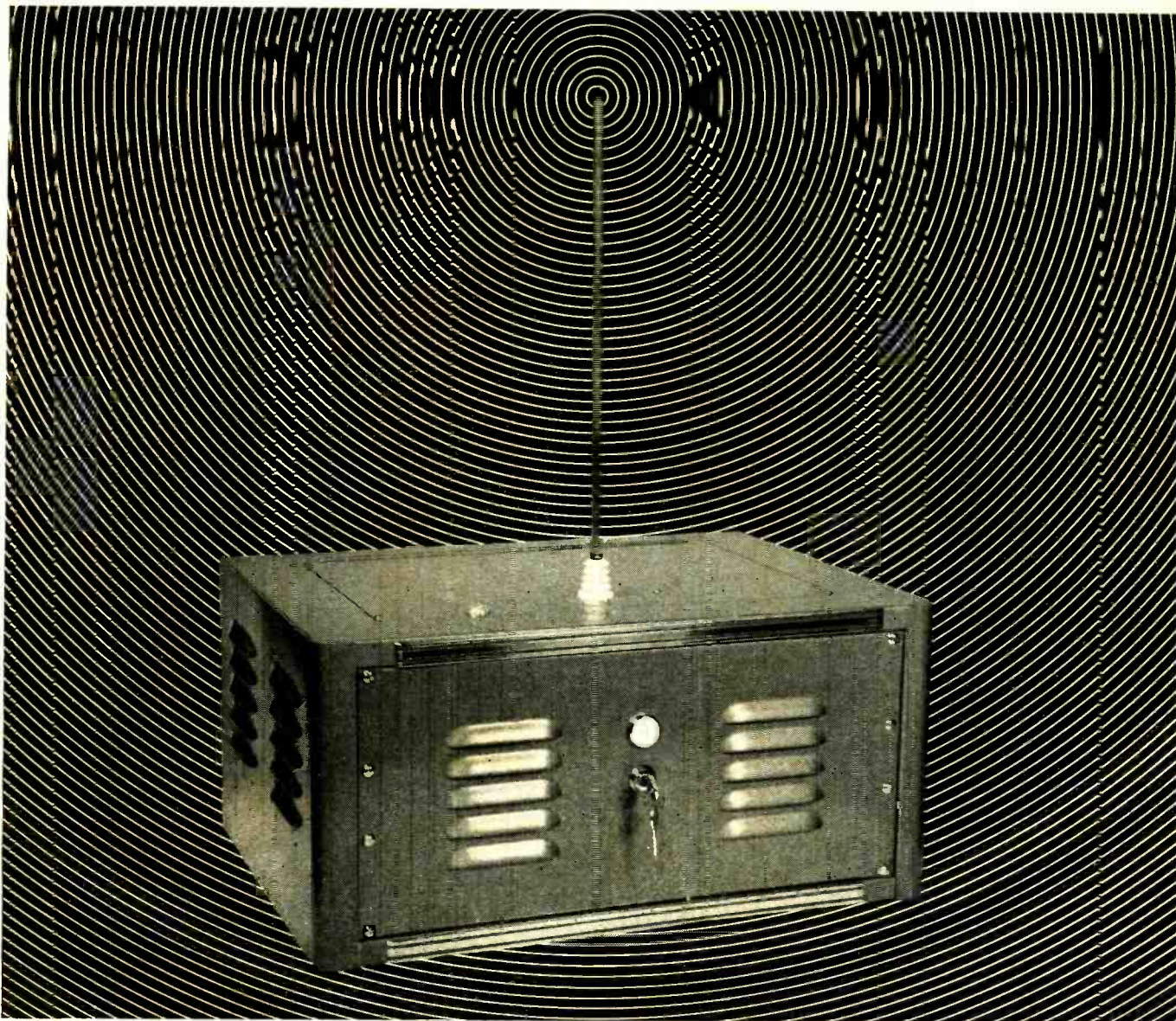

You are now in Radar Sentry Alarm's r.f. microwave field. Don't move a muscle!

This security system is so sensitive, it can be adjusted to detect the motion of your arm turning this page.

And if this Portable Model Unit were within 35 feet of you and you moved... people up to a half-mile away could hear the siren. Plus with optional equipment, it can detect fire... turn on lights... even notify police.

What does a burglar alarm have to do with you?

Just this: Radar Sentry is no ordinary alarm. It is the most modern and effective security system available. And it's also electronic.

That's why we need you. We need Dealers with technical knowledge. For the most successful Dealers for Radar Sentry Alarm are men who know electronics. This is a product that sells itself when demonstrated properly.

It's been proven time after time. In fact, many of the more than one thousand readers of electronics magazines who became Dealers in the past year — sold a system on their *first* demonstration.

And that's why we need men with technical knowledge and experience.

Men like *you*.

How about it?

Do you want to start a business of your own... or expand your present business with a product that in 8 years has become the world-wide leader in its field?

Do you want to earn up to \$5,000 a year in your spare time?

Do you want to earn \$20,000 and more full time?

We'll show you how.

O.K., now you can move.

Fill out the coupon and get complete Dealer/Distributor information... free.

Mail to: RADAR DEVICES MANUFACTURING CORP.
22003 Harper Ave., St. Clair Shores, Michigan 48080



Please tell me how I can have a business of my own distributing Radar Sentry Alarm Systems. I understand there is no obligation.

Name _____

Address _____

City _____ State & Code _____

EW-9



Using silicon rectifiers in horizontal AFC circuits

FIG. 1. 6AL5 AFC CIRCUITS

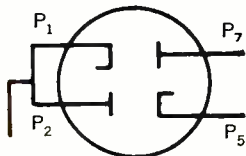

Series Connected

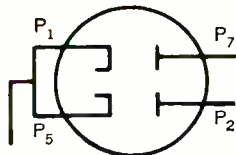

Common Cathode

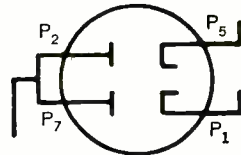

Common Anode

FIG. 2. SELENIUM RECTIFIER AFC CIRCUITS

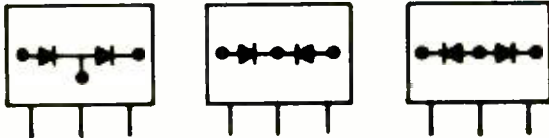

Selenium Stack

FIG. 3. MALLORY SILICON RECTIFIER REPLACEMENTS

Packaged Circuits

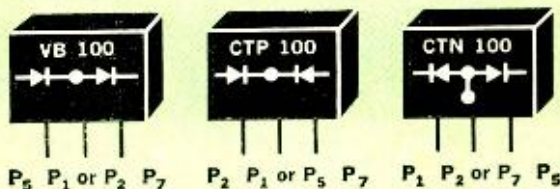

Type A Rectifiers

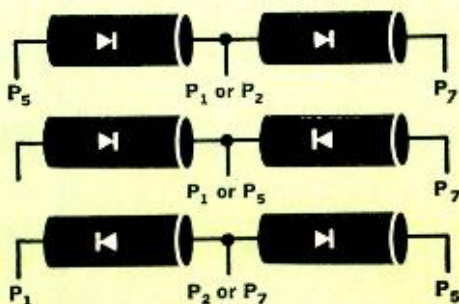

Many of the older TV sets you'll run into have a 6AL5 dual rectifier tube in the horizontal automatic frequency control circuit. Its function is to insure a stable horizontal frequency, by comparing the input signal from the sync separator with a feedback signal from the horizontal output. Three different circuits were used for this job, as shown in Figure 1.

In some later sets, selenium rectifiers took over the 6AL5 job for AFC. These were connected as shown in Figure 2.

When you run into one of these AFC circuits that needs fixing, you can do your customer a favor by switching to Mallory silicon rectifiers. You'll give him a repair job that will shape up this part of the set for all time, at no extra cost. You won't have to chase around finding a selenium stack with exactly the rating you need. And you're sure you won't ever have a call-back on the job.

You can go either of two ways with Mallory silicon replacements. Simplest is to use a Mallory packaged rectifier circuit—a pair of factory-connected rectifiers in a single compact plastic case. Cost is slightly less than two separate rectifiers, and installed reliability is better because you have fewer solder connections to make. The VB doubler is ideal for the series-connected AFC circuit; just get a Mallory VB100 and hook it to the tube socket. For the common cathode AFC circuit, use a Mallory CTP100 (full wave, center tap positive). And for the common anode circuit, use a Mallory CTN100 (full wave center tap negative).

Or if you prefer to work with separate rectifiers, get yourself a pair of Mallory Type A's. The A100 will work fine. Either way, just make your connections as shown in Figure 3.

For this service, 100 volt ratings are ample to give you full protection against transient "spikes" and assure long life. For other applications in TV sets, stereo, radios and industrial equipment, take a look at the complete line of Mallory power rectifiers, zener diodes and other semiconductors stocked by your Mallory Distributor. He's a good guy to know for everything you need for service, prototype building or experimental work. Mallory Distributor Products Company, a division of P. R. Mallory & Co. Inc., Indianapolis, Indiana 46206.

DON'T FORGET TO ASK 'EM—*What else needs fixing?*



THIS MONTH'S COVER shows an attempted launch of an Atlas-Centaur rocket in 1965. While these now rare explosions may seem wasteful, much needed information can be obtained from failures if proper instrumentation is on-site at the time. The Pad Abort Measuring System described in our lead article "Measuring Missile Explosions" received its first checkout at Cape Kennedy during this explosion. Information gathered by the system will enable aerospace engineers to reduce hazards to personnel and damage to structures from any future explosions..... Photo courtesy of NASA—Kennedy Space Center.



Publisher
PHILLIP T. HEFFERNAN
Editor
WM. A. STOCKLIN
Technical Editor
MILTON S. SNITZER
Associate Editor
P. B. HOEFER
Assistant Editor
MARSHA JACOBS
Contributing Editors
WALTER H. BUCHSBAUM
Prof. ARTHUR H. SEIDMAN
Art Editor
HERBERT L. SILBERMANN
Art and Drafting Dept.
J. A. GOLANEK
Advertising Sales Manager
LAWRENCE SPORN
Advertising Service Manager
ARDYS C. MORAN

September, 1967

Electronics World

SEPTEMBER 1967 VOL. 78, No. 3

CONTENTS

- 23** Measuring Missile Explosions *E.A. Lacy & C.N. Golub*
- 27** Period-Frequency Graph *R.W. Bailey*
- 28** Recent Developments in Electronics
- 30** Avalanche Transistor Circuits *Sidney L. Silver*
- 33** Temperature-Depth Measurements in the Ocean *John Althouse*
- 37** Low-Cost Semiconductors for the Consumer Market *John S. MacDougall*
- 40** Directory of Most Popular, Low-Priced Video Tape Recorders
- 42** Gunn Oscillators *David L. Heiserman*
- 44** Electronics for Speech and Hearing Therapy *L. George Lawrence*
- 46** Report on Annual Assembly of RTCM *Richard Humphrey*
- 47** Switches: A Guide to Selection & Application *Arthur F. Hackman*
- 60** Permanent Tinning of Soldering Irons *Peter J. Profera*
- 71** New Approach to Engine Tachometers *Ronald L. Carroll*
- 84** Solid-State Ring Counters & Chasers for Light Displays *A.A. Adem*
- 87** The Volume Unit
- 88** Tone-Selective Signaling: The New Look *Leslie Solomon*
- 93** The Common Slide Rule for Reactance Calculations *Gladden B. Houck, Jr.*
- 94** Hi-Fi Show Seminars Program

-
- 6** For the Record (Editorial)
N. Y. Hi-Fi Show
 - 16** EW Lab Tested
"Knight-Kit" KG-790 AM-FM Stereo Tuner
PML EC-71 Capacitor Microphone
 - 58** Technical Writing *John Frye*
 - 66** Test Equipment Product Report
Seco Model 240 Thyristor (SCR) Analyzer
Hewlett-Packard Model 5221A Electronic Counter
Amphenol Model 670 Transistorized Volt-Ohmmeter

MONTHLY FEATURES

- 4** Coming Next Month
- 12** Letters from Our Readers
- 70** Radio & TV News
- 80** Book Reviews
- 81** Electronic Crosswords
- 96** New Products & Literature

Electronics World: Published monthly by Ziff-Davis Publishing Company at 307 North Michigan Ave., Chicago, Illinois 60601. One year subscription \$6.00. Second Class Postage paid at Chicago, Illinois and at additional mailing offices. Subscription service: Portland Place, Boulder, Colorado 80302.
Copyright © 1967 by Ziff-Davis Publishing Company. All rights reserved.

color coded nutdriver sets

in new "keep and carry" cases

Sturdy plastic cases keep nutdrivers in order on the workbench. Tight fitting, snap-lock covers protect tools when not in use, permit carrying them on service calls without danger of spilling or becoming lost in tool box.



No. HS-6-18
HOLLOW SHAFT
NUTDRIVER SET

10 Hex Openings: $\frac{3}{16}$ ", $\frac{7}{32}$ ", $\frac{1}{4}$ ", $\frac{9}{32}$ ", $\frac{5}{16}$ ", $\frac{11}{32}$ ", $\frac{3}{8}$ ", $\frac{7}{16}$ ", $\frac{1}{2}$ ", $\frac{9}{16}$ ". Yellow, slipover cover case.



No. 77
DRILLED SHAFT
NUTDRIVER SET

7 Hex Openings: $\frac{3}{16}$ ", $\frac{7}{32}$ ", $\frac{1}{4}$ ", $\frac{9}{32}$ ", $\frac{5}{16}$ ", $\frac{11}{32}$ ", $\frac{3}{8}$ ". Hole depth $\frac{11}{4}$ ". Black, pebble grain, hinged cover case.

professional quality

Precision fit, case-hardened sockets, polished and plated steel shafts; shockproof, breakproof, color coded plastic (UL) handles.

WRITE FOR BULLETIN N567

XCELITE

XCELITE, INC., 12 Bank St., Orchard Park, N. Y. 14127
In Canada contact Charles W. Pointon, Ltd.

CIRCLE NO. 84 ON READER SERVICE CARD

COMING NEXT MONTH SPECIAL ISSUE: SWITCHES



A 24-page section devoted to all types of switches will include: **Open-Frame Rotary Switches** by William Sefton of Centralab; **Snap-Action Switches & Their Ganged Arrays** by Harry H. Meyer of Micro Switch; **Slide Switches & Their Ganged Arrays** by Bernard Golbeck of Oak; **Miniature Switches** by Al F. Contarino of Alcoswitch; **Toggle Switches** by Ronald G. Rezel of Cutler-Hammer; **Lighted Switching Devices** by Walker Smith of Micro Switch; and **Stacked Switches & Their Ganged Arrays** by James Bailey of Switchcraft. With the information provided, circuit designers and component engineers will have at their fingertips complete and up-to-the-minute data on all currently available types.

INFRARED RADIOMETRY

Since everything above Kelvin zero emits heat that can be converted into infrared photographs, by radiometers, industry is taking advantage of this technique to make mechanical inspections while the Armed Forces use it to locate camouflaged men and vehicles.

THE SUN AND SPACE SOLAR MEASUREMENTS

What types of radiation and what levels reach the earth from our sun? To answer

these important questions, the OSO series of advanced space explorers are orbiting space and sending back much valuable data.

AUDIO INTEGRATED CIRCUITS— WHAT'S AVAILABLE?

A wide range of low-cost IC's is now available for use in low-power audio circuits. Donald E. Lancaster provides a rundown on what is on the market now and what you can expect to find in the next few months.

All these and many more interesting and informative articles will be yours in the October issue of *ELECTRONICS WORLD* . . . on sale September 19th.

ZIFF-DAVIS PUBLISHING COMPANY

William B. Ziff
Chairman of the Board (1946-1953)

William Ziff
President

W. Bradford Briggs
Executive Vice President

Hershel B. Sarbin
Senior Vice President

Philip Sine
Financial Vice President

Walter S. Mills, Jr.
Vice President, Circulation

Stanley R. Greenfield
Vice President, Marketing

Phillip T. Heffernan
Vice President, Electronics Division

Frank Pomerantz
Vice President, Creative Services

Arthur W. Butzow
Vice President, Production

Edward D. Muhlfeld
Vice President, Aviation Division

Irwin Robinson
Vice President, Travel Division

Radio & TV News • Radio News • Radio-Electronic Engineering Trademarks Reg. U.S. Pat. Off.

SUBSCRIPTION SERVICE: All subscription correspondence should be addressed to Electronics World, Circulation Department, Portland Place, Boulder, Colorado 80302. Please allow at least six weeks for change of address. Include your old address, as well as new—enclosing if possible an address label from a recent issue.

EDITORIAL CONTRIBUTIONS must be accompanied by return postage and will be handled with reasonable care; however publisher assumes no responsibility for return or safety of art work, photographs, or manuscripts.

ELECTRONICS WORLD (September, 1967, Vol. 78, No. 3). Published monthly at 307 North Michigan Avenue, Chicago, Illinois 60601, by Ziff-Davis Publishing Company—also the publishers of Airline Management and Marketing, Boating, Business & Commercial Aviation, Car and Driver, Cycle, Flying, HiFi/Stereo Review, Modern Bride, Popular Aviation, Popular Electronics, Popular Photography, Skiing, Skiing Area News, and Skiing Trade News. (Travel Weekly is published by Robinson Publications, Inc., a subsidiary of Ziff-Davis Publishing Company.) One year subscription rate for U.S., U.S. Possessions, and Canada, \$6.00; all other countries, \$7.00. Second Class postage paid at Chicago, Illinois and at additional mailing offices. Authorized as second class mail by the Post Office Department, Ottawa, Canada and for payment of postage in cash.

Editorial and Executive Offices
One Park Avenue
New York, New York 10016 212 679-7200

NEW YORK OFFICE 212 679-7200
James J. Sullivan
Joseph E. Halloran

MIDWESTERN OFFICE
307 North Michigan Avenue
Chicago, Illinois 60601 312 726-0892
Midwestern Advertising Manager, Royce Richard

WESTERN OFFICE
9025 Wilshire Boulevard
Beverly Hills, California 90211
213 CRestview 4-0265; BRadshaw 2-1161
Western Advertising Manager, Bud Dean

JAPAN
James Yagi
Ishikawa Mansion
〒4, Sakuragaoka
Shibuya-ku, Tokyo
462-2911-3

CIRCULATION OFFICE
Portland Place, Boulder, Colorado 80302



Member
Audit Bureau of
Circulations

CIRCLE NO. 199 ON READER SERVICE CARD →

SYLVANIA INDUSTRIAL P

Your Sylvania distributor can give you a technical library. For fast answers to difficult electronic problems.

Nobody beats Sylvania when it comes to up-to-date technical information—for *your* applications. And your Sylvania distributor has it all for you.

You can get data sheets and catalogs on industrial receiving tubes, transmitting tubes, industrial control tubes, counter tubes, cathode ray tubes, flash tubes, gauge tubes, photosensitive devices, microwave devices and all semiconductors.

Your Sylvania man also has inventory programming forms—and many types of application information. Plus other kinds of free technical materials. And he's a tube expert. He can analyze your tube and semiconductor replacement needs. He can prevent emergencies, take an inventory and save you time and money.

Call him for these services—and for the best technical literature in the tube industry. And depend on him for fast delivery—in any quantity.

Sylvania Electronic Tube Division, Electronic Components Group, Seneca Falls, New York 13148.

SYLVANIA

SUBSIDIARY OF
GENERAL TELEPHONE & ELECTRONICS GTE

CATALOG/ Industrial Receiving Tub
Microwave Devices • Co

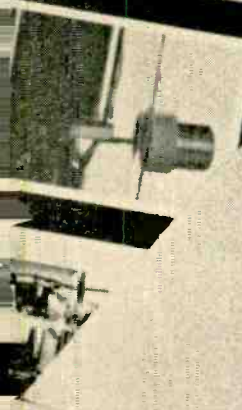

SYSTEM DESIGN
OF SYLVANIA INDUSTRIAL

SYLVANIA RECEIVING TUBES

Voltage Regulators
OA2, OB2



BOOK
MILITARY CRT'S

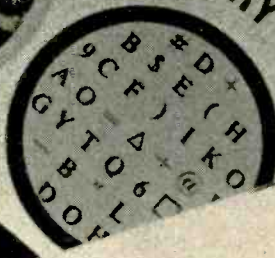

TECHNICAL DATA
E-1, Small Button, 9-Pin
6-2
1/2 inch
0.1
Control Unipotential
Any

6.3 Volt
100 Ma
100 Volt Max.
200 Volt Max.
ANCES
Pseudo
Section
000 of Max.
1.8 of
3.3 of
3.8 of

679/12AT7

VHF HIGH
D-TRIODE

SYNTH
GOLD
ELECTR

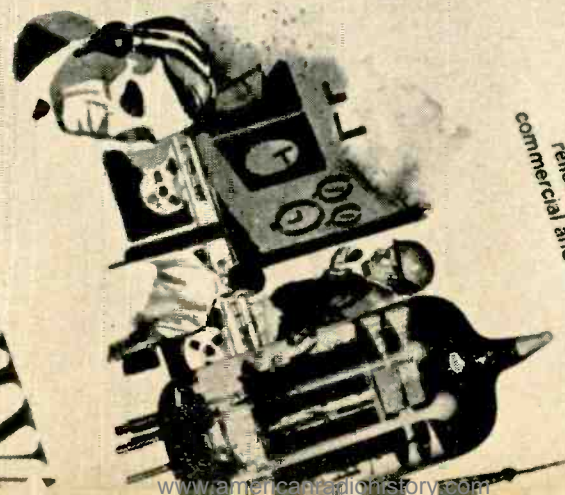

Unsurpassed quality for
reliable performance in critical
commercial and industrial applications

Listen!



Hang it fast
and easy
then forget it!

The new Jensen VH-100 Series horn speakers were designed for fast installation and a lower installed cost. Their new and exclusive features let you install three VH-100's for the labor penalty previously charged for two.

KWIKON® connectors, an easily detached base, universal angle adjustment, accessible power control and an optional pre-integrated transformer are but a few of the many advantages of these rugged new weatherproof 32 watt speakers.

Our new brochure tells all.

Write Jensen Manufacturing Division, The Muter Company, 6601 South Laramie Avenue, Chicago, Illinois. 60638.

jensen

CIRCLE NO. 109 ON READER SERVICE CARD

6



For the record

WM. A. STOCKLIN, EDITOR

N.Y. Hi-Fi Show*

AS chairman of a committee of one, we have again been asked by the Institute of High Fidelity to plan the various seminars to be run concurrently with the New York Hi-Fi Show at the Statler Hilton (Sept. 21-24).

This will be the fourth consecutive year in which these seminars have been held and, if past experience is any criterion, this forthcoming program should attract considerable interest. In fact, the Hi-Fi Show Committee, under the direction of its president, Walter Stanton, has been so encouraged by past attendance that almost double the number of seminars will be held this year.

In addition to the technical and semi-technical sessions, we will add three separate programs on the subject of applications of hi-fi equipment as part of "Room Decor". These sessions will be conducted by members of the Association of Interior Decorators and the National Association of Interior Design.

There will also be four additional symposia on "Musicology". These sessions will explore the theory and background of the most popular musical art forms, including "Jazz", "Popular Music", "Classical Music", and a special session on "The Successful Recording".

This year's sessions should prove to be most exciting. While many of our "regulars" will be back, for the most part, there will be new faces—new people with new ideas—engineers and executives—and when we get to the symposia on musicology many of the "experts" will be well-known radio-TV stars. For complete program details, see page 94 of this issue.

Technical Symposia

"Tape and Tape Recorders"

Many of you will remember Joe Kempler of *Audio Devices* who has been with us for the past two years. He has given us such thought-provoking presentations in the past that we have asked him to return. In addition to discussing raw tape—what to buy, how to store it, and what to expect—Joe will expand his talk to include raw tape as used in our many new tape cartridge systems. This is a new field and should prove an interesting subject for exploration.

Paul Bunker, product manager of the *Magnecord Div., Telex Corp.* is a new guest panelist and he will discuss tape recorders—not only what you should expect for what you spend—but review many of the technical characteristics, their meaning, and importance. Paul comes to us highly recommended and we look forward to an interesting session.

"Cartridges, Turntables, and Changers"

We couldn't help but ask Jim Kogen,

chief engineer, R&D, *Shure Brothers*, to return. Not only was his presentation enlightening, but Jim is the only one we know of who has a demonstration kit to illustrate the 45/45 degree operation of a disc recording. We are sure he will bring us up-to-date on the new developments in stereo cartridges, with particular emphasis on the elliptical stylus and the 15° tracking angle.

As a co-panelist, we have selected a newcomer to our group of guest speakers—a man well-known in our industry for many years. Bud Childs, president of *Elpa Marketing Industries (Thorens)*, is technically qualified to answer all questions about automatic turntables and changers.

"Amplifiers and Tuners"

This is a new program this year and our guest speakers, since their specialty is solid-state design, are relatively new to our industry. We will have with us George Meyer who is product manager of *Fisher Radio*, and Larry Fish, chief engineer of *H.H. Scott*. Both of these men will bring us up-to-date on solid-state applications to hi-fi equipment. They will go beyond the present and describe future trends in applying integrated circuits and pulse-counting detectors.

"Stereo and The Listener"

Abe Cohen, formerly with *University Sound* and now manager of acoustics at *Instrument Systems Corp.*, and Vic Brociner, assistant to the president of *H. H. Scott*, have been called back to repeat their performances of last year. Their presentations, and particularly their live demonstrations of the stereo effect, proved of such interest that we felt many of those who attended last year's program would repeat this year.

These are the four technical sessions and, of course, everyone is invited to attend. If anyone has any hi-fi questions, this is an ideal opportunity to come and ask the "pros".

It would be a grave error if we didn't mention the great presentations given the past three years by Len Feldman in a semi-technical talk covering all aspects of hi-fi. Leonard attracted capacity crowds at every session and we have asked him to be with us again this year. He will give four repeat performances during the Show.

My personal thanks, of course, to all of our old friends who are again devoting their time and effort to help make this year's program a success, and a hearty welcome to all of the newcomers who will assist us in broadening the scope of our coverage. ▲

* Plans are under way, but not finalized, for holding similar symposia at the Institute of High Fidelity's West Coast Show, Nov. 2-5, Ambassador Hotel, L.A.

**If you know everything
there is to know about the new
high fidelity components, about
decorating with music and
about musicology, stay out of
New York September 21, 22, 23, 24
and don't go anywhere near
Los Angeles November 2, 3, 4, 5.**

The 1967 IHF Shows will be in those cities on those days. And never before have so many experts been gathered to give so many talks about so many subjects related to music in the home.

Unless you know it all, there's sure to be something new you can find out at the biggest I-F High Fidelity Music Shows of all.

**1967 New York
High Fidelity Music Show**

Sept. 21—3:30 PM—10:00 PM
Sept. 22—3:30 PM—10:00 PM
Sept. 23—Noon—10:00 PM
Sept. 24—Noon—6:00 PM

**1967 Los Angeles
High Fidelity Music Show**

Nov 2—4:00 PM—10:30 PM
Nov 3—4:00 PM—10:30 PM
Nov 4—Noon—10:30 PM
Nov 5—Noon—6:00 PM

Schedule of N.Y. Show Seminar Events—Keep It Handy!

Los Angeles Seminar Schedule to be announced.

Thurs., Sept. 21, 5:30—7:30 PM—Novice Symposium—“Introduction to Hi-Fi Components” . . . 7:30—8:30 PM—“Tape and Tape Recorders” . . . 8:30—9:30 PM—“The Classical Recording Scene.”*

Fri., Sept. 22, 6:30—7:30 PM—Novice Symposium (same as Thurs.) . . . 7:30—8:30 PM—“Cartridges, Turntables, and Changers” . . . 8:30—9:30 PM—Decor Group—Albert Herbert.

Sat., Sept. 23, 2:00—3:00 PM—“The Pop Scene”* . . . 3:00—4:00 PM—“Amplifiers and Tuners” . . . 4:00—5:00 PM—Decor Group—Bill Leonard . . . 6:30—7:30 PM—Novice Symposium (same as Thurs.) . . . 7:30—8:30 PM—“Stereo and the Listener” . . . 8:30—9:30 PM—“The Successful Recordings.”*

Sun., Sept. 24, 2:00—3:00 PM—Decor Group—Vladimir Kagan . . . 3:00—4:00 PM—Novice Symposium (Same as Thurs.) . . . 4:00—5:00 PM—“The Jazz Recording Scene.”*

*Sponsored by the National Academy of Recording Arts & Sciences (NARAS).

Show Admission: \$2.00. See your high fidelity dealer for special discount tickets.

In New York—Statler Hilton Hotel.

In Los Angeles—Ambassador Hotel.





Learning electronics at home is faster, easier, more interesting with new achievement kit

GET A FASTER START IN THE COURSE YOU CHOOSE WITH NRI'S REMARKABLE ACHIEVEMENT KIT

When you enroll with NRI we deliver to your door everything you need to make a significant start in the Electronics field of your choice. This remarkable, new starter kit is worth many times the small down payment required to start your training. And it is only the start . . . only the first example of NRI's unique ability to apply 50 years of home-study experience to the challenges of this Electronics Age. Start your training this exciting, rewarding way. No other school has anything like it. What do you get? The NRI Achievement Kit includes: your first set of easy-to-understand "bite-size" texts; a rich, vinyl desk folder to hold your training material in orderly fashion; the valuable NRI Radio-TV Electronics Dictionary; important reference texts; classroom tools like pencils, a ball-point pen, an engineer's ruler; special printed sheets for your lesson answers—even a supply of pre-addressed envelopes and your first postage stamp.

Only NRI offers you this pioneering method of "3 Dimensional" home-study training in Electronics, TV-Radio . . . a remarkable teaching idea unlike anything you have ever encountered. Founded more than half a century ago—in the days of wireless—NRI pioneered the "learn-by-doing" method of home-study. Today, NRI is the oldest, largest home-study Electronics school. The NRI staff of more than 150 dedicated people has made course material entertaining and easy to grasp. NRI has simplified, organized and dramatized subject matter so that any ambitious man—regardless of his education—can effectively learn the Electronics course of his choice.

DISCOVER THE EXCITEMENT OF NRI TRAINING

Whatever your reason for wanting knowledge of Electronics, you'll find the NRI "3 Dimensional" method makes learning exciting, fast. You build, test, experiment, explore. Investigate NRI training plans, find out about the NRI Achievement Kit. Fill in and mail the postage-free card. No salesman will call. NATIONAL RADIO INSTITUTE, Electronics Division, Washington, D. C. 20016

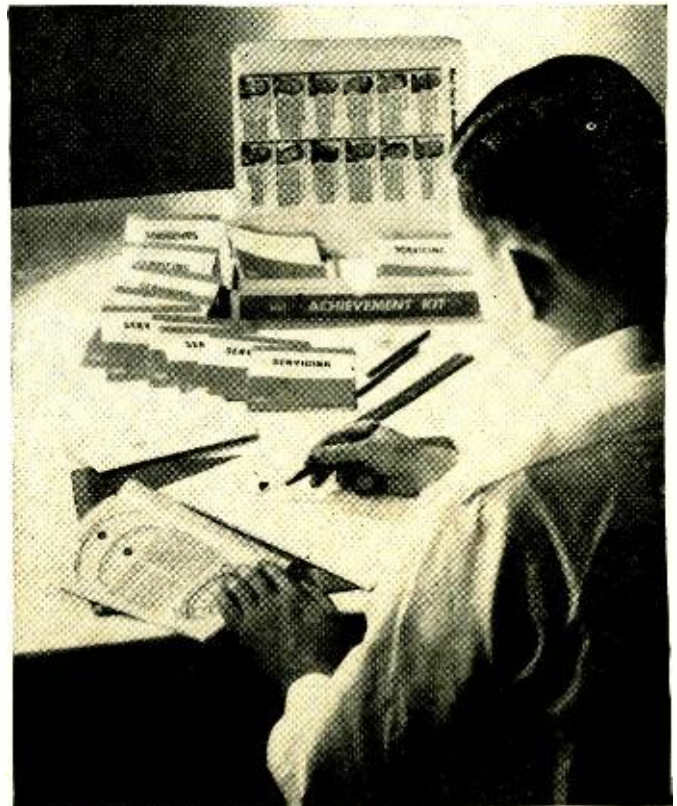

ELECTRONICS COMES ALIVE AS YOU LEARN BY DOING WITH CUSTOM TRAINING EQUIPMENT

Nothing is as effective as learning by doing. That's why NRI puts so much emphasis on equipment, and why NRI invites comparison with equipment offered by any other school, at any price. NRI pioneered and perfected the use of special training kits to aid learning at home. You get your hands on actual parts like resistors, capacitors, tubes, condensers, wire, transistors and diodes. You build, experiment, explore, discover. You start right out building your own professional vacuum tube voltmeter with which you learn to measure voltage and current. You learn how to mount and solder parts, how to read schematic diagrams. Then, you progress to other experimental equipment until you ultimately build a TV set, an actual transmitter or a functioning computer unit (depending on the course you select). It's the practical, easy way to learn at home—the priceless “third dimension” in NRI's exclusive Electronic TV-Radio training method.

SIMPLIFIED, WELL-ILLUSTRATED “BITE-SIZE” LESSON TEXTS PROGRAM YOUR TRAINING

Lesson texts are a necessary part of training, but only a part. NRI's “bite-size” texts are as simplified, direct and well-illustrated as half a century of teaching experience can make them. The amount of material in each text, the length and design, is precisely right for home-study. NRI texts are programmed with NRI training kits to make things you read come alive. As you learn, you'll experience all the excitement of original discovery. Texts and equipment vary with the course. Choose from major training programs in TV-Radio Servicing, Industrial Electronics and Complete Communications. Or select one of seven special courses to meet specific needs. Check the courses of most interest to you on the postage-free card and mail it today for your free catalog.

Available Under **NEW GI BILL**

If you served since January 31, 1955, or are in service, check GI line in postage-free card.

custom training kits “bite-size” texts

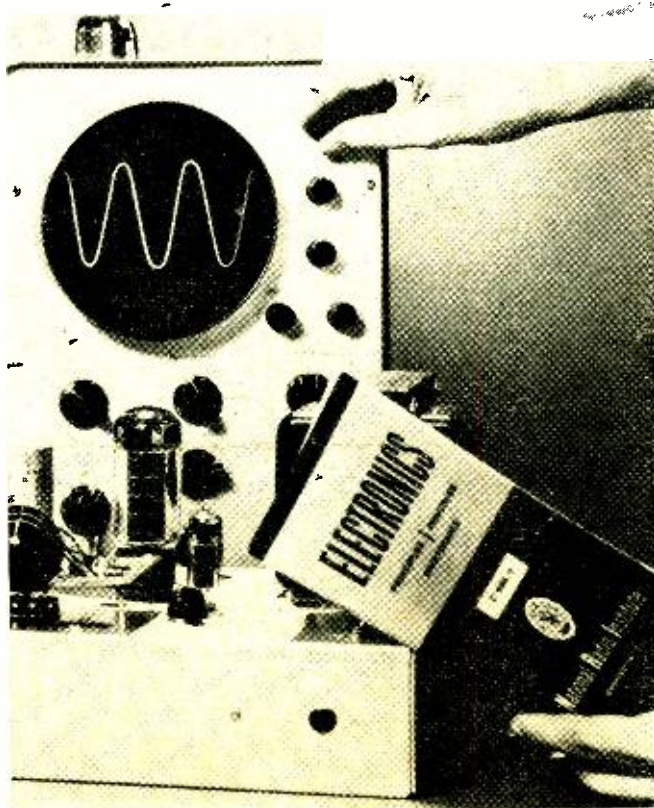
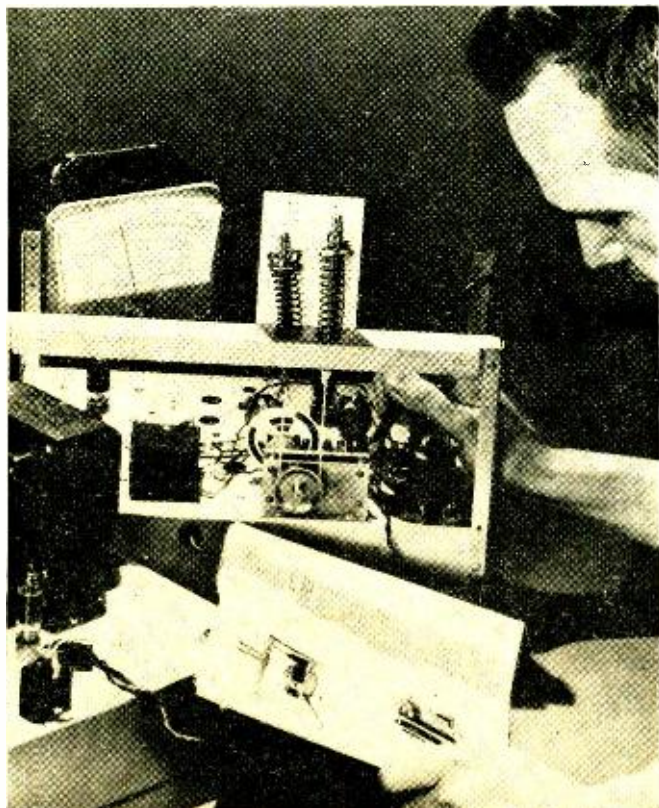

How to Read Schematic Diagrams (2nd Ed.)



by Donald E. Herrington. Enlarged, updated and more valuable than ever. Explains all types of schematics; shows symbols for all circuit components, and explains their functions. Describes how components are connected into circuits and gives symbols for these connections. With this background of understanding, a signal is traced through a typical superhet receiver. Explains in detail variations likely to be encountered in both symbols and designations. Includes review questions at end of each chapter. An invaluable reference for everyone in electronics. 160 pages; 5½ x 8½".

Order 20568, only \$295

Walkie-Talkie Handbook

by Leo G. Sands. Describes basic types of walkie-talkies (licensed and unlicensed) now on the market. An indispensable guide to the proper selection of a walkie-talkie for prospective buyers. Describes types of applications and circuitry used in various units; covers accessories, specifications, maintenance, and licensing requirements (Part 95 of FCC rules covering the citizens band in which most walkie-talkies operate is included). An extremely practical and helpful book. 176 pages; 5½ x 8½". Order 20572, only \$395



new Sams books



Transistorized Amateur Radio Projects

by Charles Caringella, W6NJV. Presents a broad range of transistorized ham radio construction projects for the beginner as well as the advanced amateur. Projects include: electronic c-w keyer, code-practice oscillator, VOX transmitter control, transistor tester, field-strength meter, regulated power supplies, 80- and 40-meter novice c-w transmitter, 2- and 6-meter voice transmitters, and low-noise converters. Provides full information and parts lists for each project; all projects have been designed, built, and carefully tested to insure trouble-free construction and operation. Several projects utilize printed-board construction; negatives are included for etching required boards. 138 pages; 5½ x 8½". Order 20570, only \$325

CB Radio Antennas (2nd Ed.)

by David E. Hicks. This updated edition is the most complete book on the subject; explains how to set up a CB antenna system to get maximum "reach" with CB units. A practical guide for those planning to get into CB operation, or for present operators who want to improve the performance of their present setup. Requires no prior knowledge of antenna design and installation. Explains radio wave characteristics as they affect antenna design, communicating ranges to be expected, base- and mobile-antenna installations, how to improve existing antenna systems, and antenna maintenance. 144 pages; 5½ x 8½". Order 20567, only \$325

Bridges and Other Null Devices

by Rufus P. Turner. Fills the "information gap" on bridge-type instruments—covering every present significant bridge design. Begins with an explanation of the null principle and basic theory of bridge circuits, then shows how design is applied to specific instruments for widely varying applications. Provides practical "know-how" in the proper use of bridge instruments and helps in the selection and purchase of the right bridge instruments to meet the reader's requirements. 144 pages; 5½ x 8½". Order 20564, only \$325

These and over 300 other SAMS Books are available from your local Electronics Parts Distributor . . .

HOWARD W. SAMS & CO., INC.
4300 WEST 62nd ST. INDIANAPOLIS, INDIANA 46286
CIRCLE NO. 97 ON READER SERVICE CARD

LETTERS FROM OUR READERS

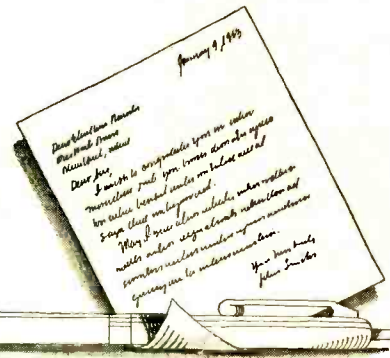

WEATHER SATELLITES GUIDE PILOTS To the Editors:

Two of the photos in your May "Recent Developments" department show a new ESSA 4 weather satellite along with an optical reader used by the U.S. Weather Bureau to read weather data from the satellites. Well, our weather bureau is not the only one using data from these satellites. According to a recent Associated Press newspaper story, the weather satellites are being monitored by our Air Force in South Vietnam and Thailand. It was reported that cloud-cover photos of all Southeast Asia had become a very valuable guide to United States bombing. By spotting breaks in the clouds, planes can be promptly diverted to clear areas.

BILL DONAHUE
St. Louis, Mo.

Also, because the wavelengths are not secret and the required receiving equipment is so simple, it's a good guess that North Vietnam is using the same information for air-defense operations as well. As a matter of fact, it is possible to buy commercial equipment for receiving as many as 15 high-resolution cloud-cover photos a day from these weather satellites. Cost of all the equipment required except for the receiving antenna is between \$3500 and \$5000.—Editors

AUTOMOTIVE ELECTRONICS

To the Editors:

The articles on electronics in automobiles in the May issue were quite interesting, especially those about new developments. However, I found two slight inaccuracies, both of which involve one company, American Motors.

First, at the bottom of p. 23, concerning transistorized voltage regulators, it is stated, ". . . Ford Motor Company has announced that it will be using some solid-state regulators in many of their 1968 models." Since this is the only mention of an automobile manufacturer in this section, the implication is that the 1968 Fords will be among the first to use solid-state voltage regulators. This is about two years behind the actual use of solid-state regulators by an automobile manufacturer. My 1966 Rambler Classic has as standard

factory equipment a Motorola alternator and Motorola solid-state voltage regulator. The regulator is in a sealed metal case about 1" x 1" x 2" in size. I understand that the solid-state regulators were adopted about the middle of the 1966 model year by American Motors for all Rambler models.

Second, on p. 28, you mention ". . . American Motors' announcement in February of its intention to market a small combustion-type passenger car which would openly compete with the Volkswagen." If I am not mistaken, the American Motors February announcement was not of a new model, but rather of a new pricing structure for the Rambler American, which has been in production for several years. This change involves the elimination of yearly model changes, with improvements in safety and other features being added as they are developed (as is done with Volkswagen). The elimination of yearly changes allowed a price reduction of about \$200.

W. J. STILES
Wentzville, Mo.

To the Editors:

I have just read the article called "Automotive Electronics" in the May issue. The article was great, as were the associated articles.

Naturally, it is impossible for you to cover every single development so this may be the reason why the item I enclose information on was not mentioned.

TOM SANCHEZ, SR.
Albany, N.Y.

Thanks to Reader Sanchez for sending us a description of a solid-state device that automatically raises the roof of a convertible in the event of rain, even though the driver is not in the car.—Editors

PHONO CARTRIDGES VS RECORDS

To the Editors:

I have read with interest the article in your June issue by Mr. J. H. Kogen on the tracking ability of phono cartridges. Apparently Mr. Kogen has adopted an "If you can't lick 'em, join 'em" philosophy with respect to the ridiculously wild modulation on some

of the current recordings. He even has the audacity to call them "high quality"! There can be no valid excuse for record manufacturers to produce recordings with such high modulation levels that many otherwise high-quality cartridges cannot track them. This sort of exercise evolves into a contest between the record manufacturers and the cartridge manufacturers, with the loser in this game being the poor consumer. It is high time that reasonable limits for peak modulation levels were established and adhered to.

Although he cited it as an example only, I don't believe that Mr. Kogen's selection of 10% distortion at the peak output of a cartridge is within reason. A better figure might be 1%, since the paper referred to by Mr. Kogen points out that a measured CCIF distortion of only 1% at 10 kHz becomes 7.5% after passage through the RIAA playback network.

J. E. DUPREE
San Antonio, Texas

To the Editors:

Mr. Dupree has misinterpreted our position on the subject of high recording levels. We are by no means trying to promote the concept of excessive modulation levels. We are simply recognizing the facts of life. We continually try to encourage the record companies to maintain reasonable levels, but we have a concurrent responsibility to our customers to provide a cartridge which will track existing records properly. Adequate tracking is essential not only to eliminate a source of severe distortion but also to protect records.

With regard to our calling records with high modulation levels "high quality," it should be emphasized that we are not referring to the program content or any esthetic aspect of the record. We refer only to the fact that these records do not have significant distortion when played with a suitable phonograph cartridge.

Mr. Dupree makes the statement that "There can be no valid excuse for record manufacturers to produce recordings with such high modulation levels that many otherwise high-quality cartridges cannot track them." Isn't there some question as to how one would then define a high-quality cartridge? We certainly wouldn't want to see a contest such as Mr. Dupree suggests, but, on the other hand, we would not want to see the progress of disk recording impeded by stagnation in the development of cartridges.

As to my selection of 10% distortion, this was chosen simply as a value for comparison. There was no intention of relating this to subjective reaction.

J. H. KOGEN, Chief Engr.
Shure Bros. Inc.
Evanston, Ill. ▲

Meet The Dividers!

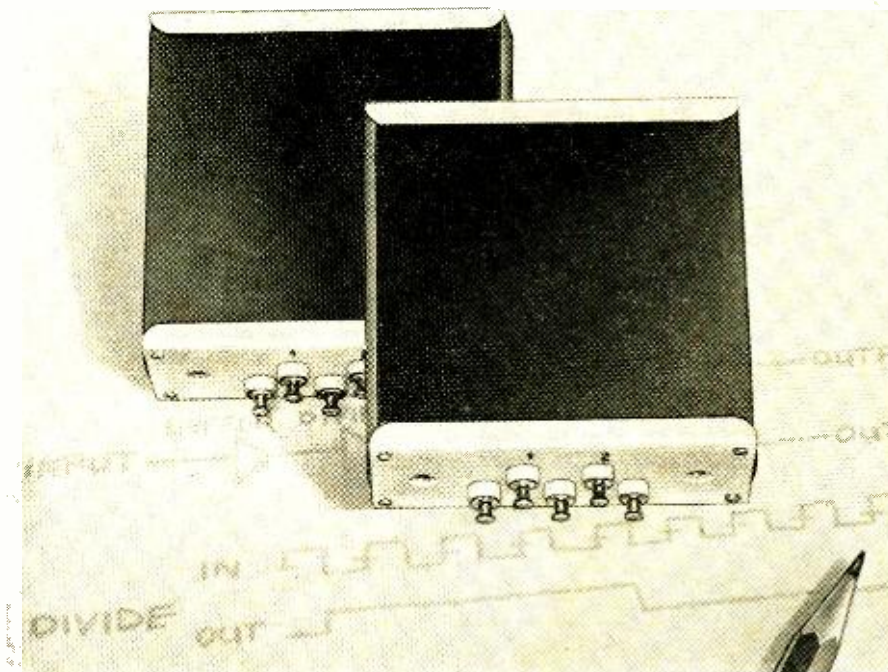

ICD SERIES INTEGRATED CIRCUIT DIVIDERS

They are new from International. Use them for crystal controlled time bases, scope calibrators, and clock sources.

International ICD units are totally integrated circuit frequency dividers. They are smaller than a pack of cigarettes (1" x 2¼" x 2⅜"). All have two separate outputs. They are packaged in nine types providing divide ratios 2 thru 10. No tuning or adjustment is required. The output pulse has the same stability as the driving pulse. Voltage required, 3.6 vdc ± 10%.

FREQUENCY RANGE

ICD-10 to 10 MHz.....\$19.95 ea.

ICD-2 thru ICD-9 to
2 MHz.....\$19.95 ea.

ICD Buffer (for feeding
more than one circuit)...\$ 9.95 ea.

WRITE FOR COMPLETE CATALOG.



CRYSTAL MFG. CO., INC.

10 NO. LEE • OKLA. CITY, OKLA. 73102

CIRCLE NO. 110 ON READER SERVICE CARD

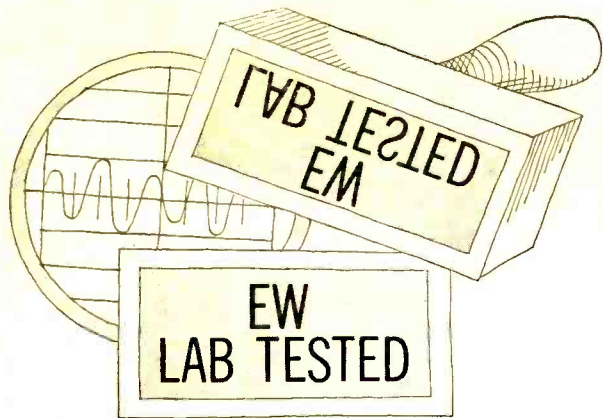

HI-FI PRODUCT REPORT

TESTED BY HIRSCH-HOUCK LABS

"Knight-Kit" KG-790 AM-FM Stereo Tuner
PML EC-71 Capacitor Microphone

"Knight-Kit" KG-790 AM-FM Stereo Tuner

For copy of manufacturer's brochure, circle No. 40 on Reader Service Card.



THE KG-790 ("Superba Series") stereo tuner is the finest tuner kit in the comprehensive line offered by Allied Radio under the "Knight-Kit" label. It is a companion, in style, size, and quality of performance, to the KG-895 amplifier reviewed in the August issue.

The panel of the tuner, handsomely finished in brushed gold, is 5" high and 16 3/4" wide, and it extends approximately 15" behind the panel. The multi-color edge-illuminated dial face has green calibrations for the FM band and orange for the AM band and the logging scale. The illuminated tuning meter is used for both AM and FM and a bright green light indicates FM-stereo reception.

The front panel contains three knobs and two rocker switches. The center knob, labeled "Selector", controls the power to the tuner and selects the mode of reception. Illuminated words appear

on the dial face to indicate "AM", "FM", or "Stereo" reception, in colors to match the corresponding dial calibrations. In the "Stereo" position, the automatic mono/stereo switching of the tuner is effective, but in case a stereo signal is marginal in strength, the stereo circuits may be disabled by selecting the "FM" position.

The left knob is the interstation muting control which is adjusted to suppress the hiss between FM stations. An "Off" position is provided on this control. The right knob is the tuning control. The tuning is very smooth, aided by a heavy flywheel. One rocker switch turns on the SCA filter which eliminates or greatly reduces the gurgling or whistling sounds often heard when a station is simultaneously broadcasting stereo and commercial SCA transmissions. It has no appreciable effect on the reception of normal stereo

broadcasts. The other rocker switch turns on the a.f.c. This is one of the few transistorized tuners we have seen with a.f.c., although it does not need this feature any more than most modern tuners do, having negligible drift.

In the rear of the chassis are the left and right channel outputs, with a second pair of output jacks in parallel for connecting a tape recorder. There are individual level adjustments for each channel to match the requirements of the associated amplifier, and one for the AM output which appears at both output jacks. There is a built-in ferrite AM antenna and a terminal for connecting an external AM antenna in weak-signal areas.

The "Knight-Kit" KG-790 circuits are assembled in several modules. The AM tuner is assembled on a printed board which is put together and aligned by the kit builder. The FM tuner is a pre-assembled and aligned unit, mounted on a metal plate sub-assembly with the i.f. circuit. The entire i.f. is pre-aligned and requires no touch-up by the builder. The multiplex printed board requires mounting of its parts but is pre-aligned and needs no more than a touch-up alignment without additional test equipment. The power supply, which has a zener-diode-regulated output for critical circuits, is assembled on the chassis.

The FM tuner section has a tuned r.f. stage, oscillator, and mixer. Four i.f. stages precede the ratio detector. The AM tuner also has a tuned r.f. stage and shares the first two i.f. amplifier stages with the FM tuner, using separate 455-kHz transformers in series with the 10.7-MHz FM i.f. transformers. The AM diode detector is followed by a 10-kHz whistle filter.

In the multiplex section, the 19-kHz pilot signal is amplified and doubled with a full-wave diode circuit to obtain the 38-kHz switching signal for the four-diode balanced modulator. The 19-kHz amplifier is controlled by the a.g.c. voltage developed from a diode at the output of the second i.f. stage. This

(Continued on page 76)

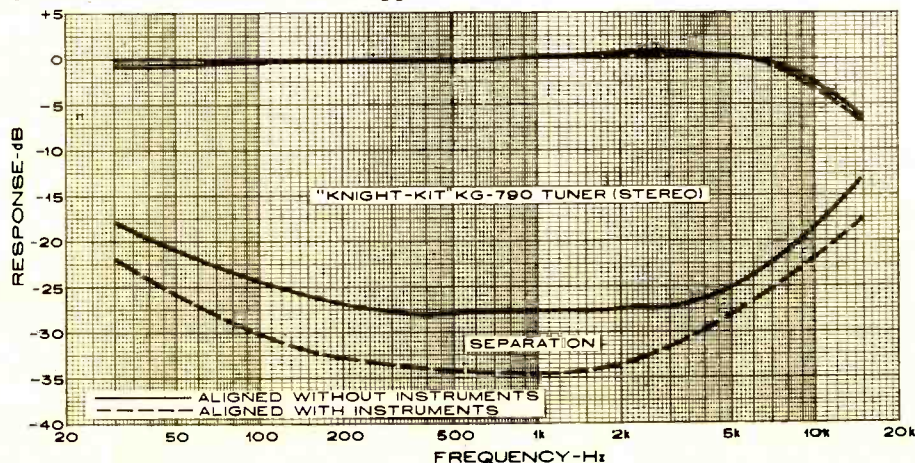

CONTROL
WIND NOISE,
"POP" & **FEEDBACK**

...PLUS:

VIBRATION PROBLEMS

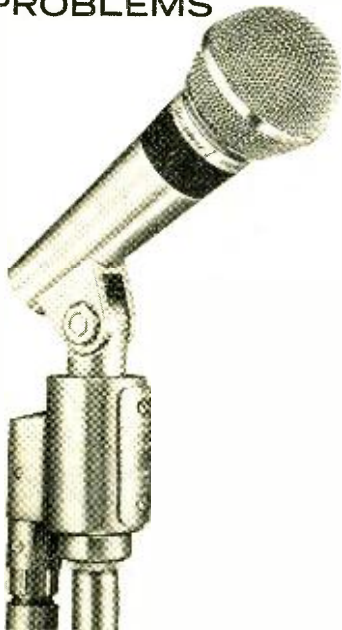

SHOCK-MOUNTED UNISPHERE™ I

Model 566. All the superb feedback and pop-control characteristics of the famed Shure Unisphere I, plus built-in vibration-isolation shock-mount which prevents pickup of mechanical vibrations and handling noise. \$140.00 List.

QUICK CUT-OFF PROBLEMS



SWITCH-MOUNTED UNISPHERE™ I

Model 565S. Now, a built-in on-off switch and permanent swivel mounting are added to the premium-quality Unisphere I—already famous for its uniform pick-up pattern at all frequencies, in all planes, and built-in wind-noise and explosive breath "pop" protection. \$100.00 List.

Model 565SC. \$102.00 List.*

OVERLOAD PROBLEMS



ADJUSTABLE VOLUME UNISPHERE™ A

Model 585SAV. One of the most ingenious microphones ever! Volume control right on the Unisphere enables the user to reduce output if audio break-up due to overload occurs. Also, enables a speaker or singer to control his own volume for dramatic effects. \$72.50 List.

3 NEW CARDIOIDS FROM



Write for Complete Data Sheets / Shure Brothers, Inc., 222 Hartrey Ave., Evanston, Illinois 60204

*Same as 565S, but with "C" series (3-in-1) connector attached.

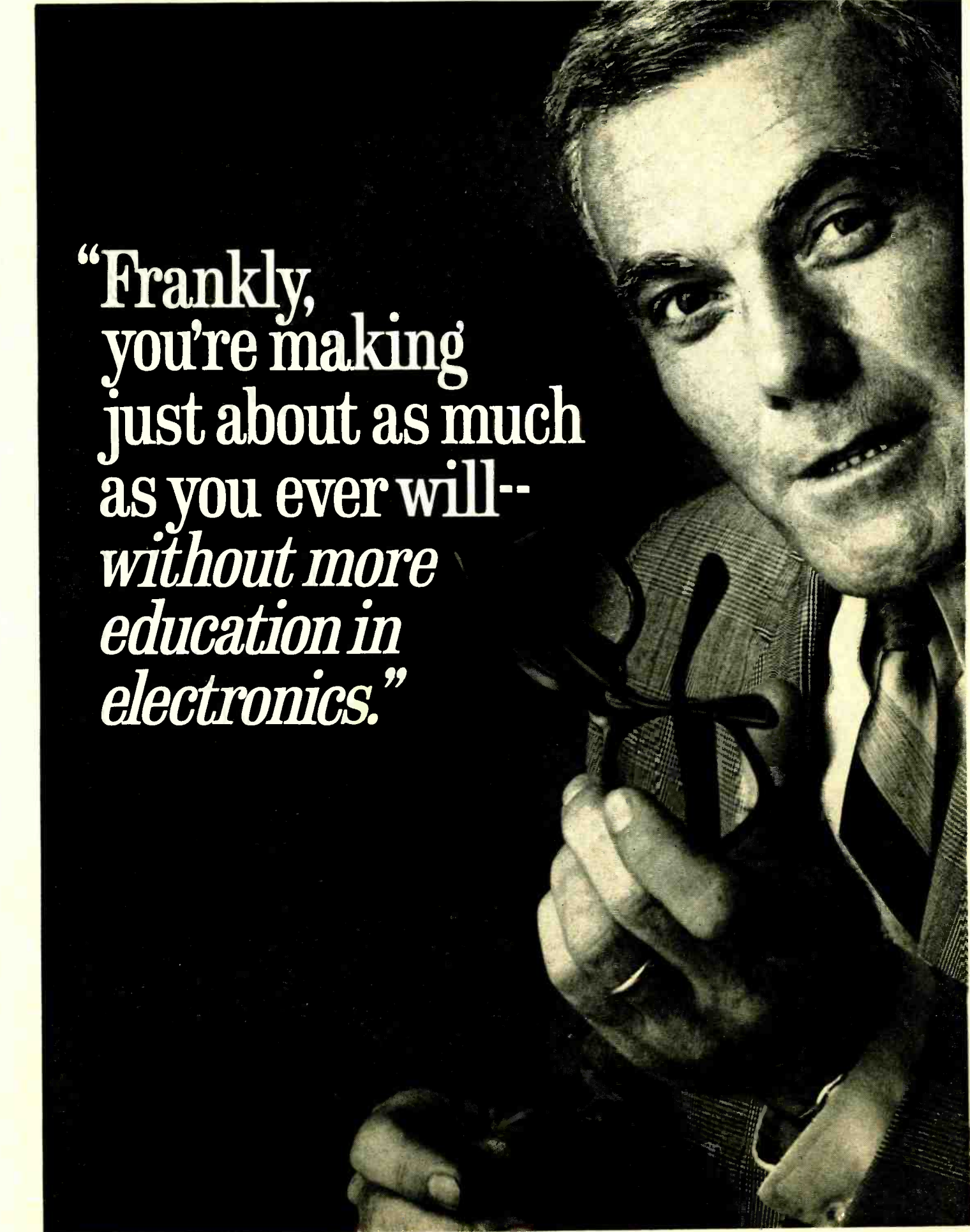

“Frankly,
you’re making
just about as much
as you ever will--
*without more
education in
electronics.*”

Ask any man who really knows the electronics industry.

Opportunities are few for men without advanced technical education. If you stay on that level, you'll never make much money. And you'll be among the first to go in a layoff.

But, if you supplement your experience with more education in electronics, you can become a specialist. You'll enjoy good income and excellent security. You won't have to worry about automation or advances in technology putting you out of a job.

How can you get the additional education you must have to protect your future—and the future of those who depend on you? Going back to school isn't easy for a man with a job and family obligations.

CREI Home Study Programs offer you a practical way to get more education without going back to school. You study at home, at your own pace, on your own schedule. And you study with the assurance that what you learn can be applied on the job immediately to make you worth more money to your employer.

You're eligible for a CREI Program if you work in electronics and have a high school education. Our FREE book gives complete information. Air-mail postpaid card for your copy. If card is detached, use coupon below or write: CREI, Dept. 1109E 3224 Sixteenth Street, N.W., Washington, D.C. 20010.



The Capitol Radio Engineering Institute

A Division of McGraw-Hill, Inc.

**Dept. 1109E 3224 Sixteenth Street, N.W.
Washington, D.C. 20010**

Please send me FREE book describing CREI Programs. I am employed in electronics and have a high school education.

NAME _____ AGE _____

ADDRESS _____

CITY _____ STATE _____ ZIP CODE _____

EMPLOYED BY _____

TYPE OF PRESENT WORK _____ G.I. BILL

- I am interested in Electronic Engineering Technology
- Space Electronics Nuclear Engineering Technology
- Industrial Electronics for Automation
- Computer Systems Technology

APPROVED FOR TRAINING UNDER NEW G.I. BILL



Now-it's easy to make recordings of children

WITH POPULAR PHOTOGRAPHY'S UNIQUE NEW RECORD ALBUM

"TONY SCHWARTZ ON HOW TO RECORD—THE SOUND OF CHILDREN"

To instruct you in the techniques of recording children's voices, the editors of Popular Photography asked famed sound authority Tony Schwartz to prepare this special record, available exclusively and by mail only through Popular Photography magazine and other Ziff-Davis publications. By listening to it you can quickly acquire the skills needed to make top-quality recordings of youngsters—thus preserving permanently the sound of their voices.

YOUR TEACHER: AN EXPERT'S EXPERT

You couldn't have a better instructor than Tony Schwartz. A pioneer in the use of portable tape recorders, he has been capturing the sounds of actuality for 23 years. You've read his monthly column in Popular Photography. Now hear him explain and illustrate in provocative recorded demonstrations the working methods that have helped him to become the world's No. 1 sound collector.

SIMPLE, COMPLETE INSTRUCTIONS

HEAR ACTUAL DEMONSTRATIONS OF

- A tape recording before and after editing.
- The sound of a battery-operated recorder at three tape speeds: 1½, 3¾, and 7½ inches per second.
- The improvement in fidelity when a quality microphone replaces the mike supplied as a recorder's standard equipment.
- How to reduce unwanted noise while recording.
- Acoustics: the sound of sound in the living room, kitchen, hallway, and street.
- Improving sound quality by re-recording a tape.

In addition to the tips on selecting and using equipment, you learn how to create complete sound stories with children—even recreate a situation that has already taken place! Actual sound demonstrations enable you to hear the effects of various tape speeds, microphones, and acoustical conditions. You also learn how to eliminate unwanted noise and to improve your tapes by re-recording them. In less than one hour, you get the benefit of years of experience and recording know-how!

EXTRA!

You'll be intrigued and thoroughly entertained by Side II of this superb new album. It's devoted entirely to three of Tony Schwartz's most famous sound essays, all acclaimed as "works of great artistry that will surely be enjoyed by anyone who enjoys and appreciates the sounds of children."

"CHILDREN AND GOD"—a fascinating composite of thoughts expressed by youngsters of various religious faiths. Their naively reverent concepts of God, heaven, good and bad, and prayer will be a revelation to you. This unique presentation is unlike anything you have ever heard before!

"NANCY GROWS UP"—a remarkable sound portrait of a girl's developing personality. In just two minutes, you hear her voice from 20 minutes after her birth, through the years until she's 13—when she reveals: "I've discovered boys!"

"SOUND SNAPSHOTS"—a potpourri of chuckles . . . once-in-a-lifetime sayings that could come only from the mouths of babes. These uproarious remarks, all said in the innocence of childhood, include delightfully ingenuous observations like these:

"I'm so hot I'd like to take my skin off!"

"I had growing pains yesterday."

"You go up in heaven when you die. You don't have to pay taxes, or anything—I'm positive."



A high-fidelity 12-inch, 33 $\frac{1}{3}$ RPM long-playing vinyl album manufactured by the Custom Services Division of Capitol Records.

. . . plus many more that will make you howl with laughter! You and your friends will enjoy listening to all of these entertaining essays in sound again and again.

Free INSTRUCTION BOOKLET WITH EACH RECORD ALBUM

Packed with valuable facts, it contains scores of helpful tips you can use to make better, more interesting recordings—information that supplements the instructions in the record. And it's yours if you place your order now for "Tony Schwartz on How To Record—The Sound Of Children."

Get the most out of your recording equipment by discovering the easy way to make tapes that you'll always treasure. This instructive and entertaining album should be owned by everyone within the sound of a child's voice and laughter. The special low price is:

only \$4.98 postpaid
ORDER YOUR ALBUM TODAY

"The Sound of Children"
P.O. Box 3112
Church Street Station, New York, N.Y. 10008

Please send _____ "Sound of Children" albums at \$4.98 each, **postpaid**.

My check (or money order) for \$ _____ is enclosed.

(Outside U.S.A. please send \$7.00 per record ordered.)
N.Y. State residents please add local sales tax.

Name _____

Address _____ EW-97

City _____

State _____ Zip Code _____

PAYMENT MUST BE ENCLOSED WITH ORDER

MEASURING MISSILE EXPLOSIONS



This early attempted Titan launch shows the need for explosion measurements to prevent future mishaps.

By EDWARD A. LACY and CYRIL N. GOLUB

Pan American World Airways, Inc., Guided Missiles Range Div., Patrick AFB, Florida

Using thermocouples, calorimeters, radiometers, pressure gauges, microphones, and tape recorders, engineers at Cape Kennedy stand ready to measure and to record a missile catastrophe. Armed with such knowledge, we should be able to prevent most future mishaps.

IT all starts with a malfunction in the missile or rocket—the result is an accidental abort or a deliberate destruct. In either case, within seconds the missile explodes, a gigantic ball of fire erupts, and shock waves bounce off nearby gantries.

With manned spacecraft or with nuclear payloads such disasters are not pleasant to contemplate. Can the escape system, for instance, outrun the fireball? Or can it withstand the tremendous heat and pressure if it does not outrun the fireball? Also, can the launch stands take this sort of punishment?

At Cape Kennedy the engineers have begun studying these problems in the most direct manner possible: by setting up their instruments and then waiting for an explosion to occur. With a group of thermocouples, calorimeters, radiometers, pressure gauges, and tape recorders they were ready to measure and record a missile catastrophe.

Then in March of 1965 came their big opportunity. At Complex 36 the countdown proceeded without interruption on a 2-stage liquid-propellant Atlas-Centaur rocket carrying a Surveyor for the moon. The rocket lifted off as scheduled but reached an altitude of only four feet when



Swing-out chassis on the PAMS console makes servicing easier.

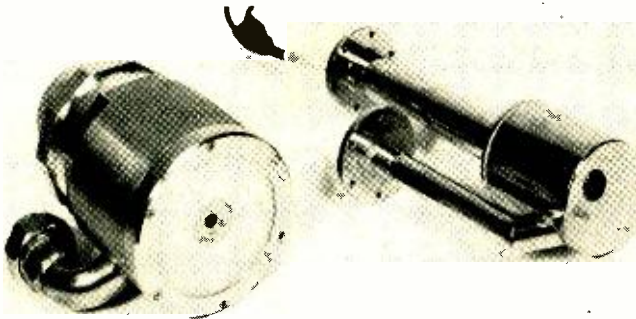

Quartz window radiometer receiver (left) and calorimeter.

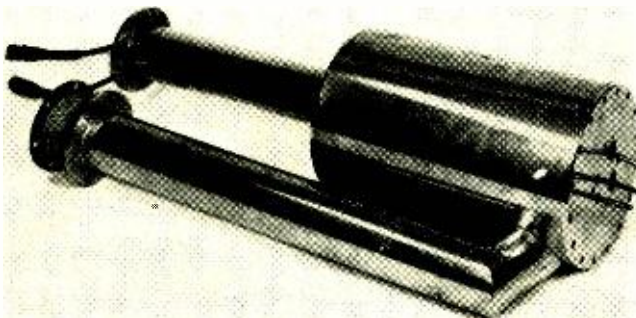

Close-up of one of the thermocouples used in the PAMS system.

the booster lost thrust. As it fell back and struck the launching stand, its thin metal skin ripped, spilling liquid oxygen, RP-1 fuel, and liquid hydrogen. Within seconds five explosions occurred, yielding a peak force equivalent to 25,000 pounds of TNT, and shattering glass 3000 feet away. The ellipsoidal fireball had a major axis of 800 feet; the temperature of the fireball was in excess of 5600° F, hot enough to melt tungsten.

Thus the Pad Abort Measuring System, PAMS for short, received its first checkout "under fire" and provided its designers much needed explosion measurements: temperatures inside and on the surface of the fireball, thermal energy generated by the fireball, blast pressures, and their history in time and space.

Although such parameters have generally been available for conventional and nuclear explosions, they have not been available for large chemical explosions. However, the need for such data becomes greater each day, not only for oil refiners and munitions manufacturers but particularly for the aerospace industry. For despite the fact that the abort rate has drastically decreased in 16 years of launches at

the Cape, the danger from an abort has increased—today's rockets are much bigger since they are required to have much greater thrust.

Obviously the rocket engineers cannot take chances with such danger. But on the other hand, when the rocket launch complexes and their associated safety zones begin to take up large amounts of real estate, the designers become cost-conscious. Cost also becomes a big problem in the construction of ground-support structures such as blockhouses—to overdesign or provide too much protection may take away funds from much needed rocket design and development.

To determine the damaging effects of missile explosions, it is essential to determine how fast the shock waves and fireballs occur, how long they take to subside, and how they are distributed in space. In the Atlas-Centaur explosion, for instance, it was learned that they occur much too fast for comfort: the expansion rate of one of the fireballs was 1600 feet/second. Thus an escape system for outrunning this fireball would have had to have a velocity greater than 1000 mi/h. To make matters even worse, such a system would have to get up to speed in 3 seconds.

The Atlas-Centaur explosion showed too that overpressures due to shock waves can be distributed quite unevenly in space: while the peak pressure in one direction was equivalent to 25,000 pounds of TNT, in other directions the pressure was as low as that created by 1100 pounds of TNT. The explosion caused overpressures (increases in atmospheric pressure) as high as 101 psi at 37 feet away. Since an overpressure of only 2 psi can shatter a concrete block wall, it was fortunate indeed that the peak overpressure subsided to 1 psi within a few hundred feet. As it was, the umbilical tower and the gantry (which was 300 feet from the launch pad) were not damaged.

Since that first rugged checkout, PAMS pressure transducers and thermal sensors have been placed on all major launch complexes at the Cape, including Titan, Saturn, and the old Gemini complexes, thereby allowing engineers and scientists to gain vital information about normal and aborted launches. More recently microphones have been installed to measure acoustic waves.

PAMS was built for the Air Force's Range Safety Division by the Sandia Corporation under the direction of Pan American World Airways' Guided Missiles Range Division which now operates and maintains the system.

Pressure Transducers

Twelve pressure transducers or gauges are laid out in a spiral pattern around each major launch complex to measure the shock waves formed during an explosion. The spiral pattern is based on lack of symmetry in the explosion. Thus, three high-pressure units are mounted on the launch deck, a sensitive low-pressure unit is installed just outside the complex perimeter, and the remainder of the gauges are located in between.

Overpressures from 0.025 to 10,000 psi can be measured with these gauges, and pressure risetimes as short as 100 microseconds can be detected.

The pressure gauges are bridge-type variable-reluctance transducers installed in removable canisters which are inserted in concrete slabs buried flush with the ground. The face of the canister serves as a reference for the side-on pressure measurements. Each gauge circuit is excited by a 10-volt, 3-kHz carrier signal received by an underground cable from a transportable recording console. (The console is usually located hundreds of feet away in a blockhouse where it is safe from blast forces.)

Normally the bridge is balanced and no output signal is produced. When a shock wave strikes the sensor, it causes a small diaphragm to move which unbalances the bridge circuit, thereby producing a modulated a.c. voltage.

The signals from the twelve transducers are amplified by twelve amplifiers in the recording console and then re-

corded on 14-track magnetic tape at a speed of 3¾ ips.

Since surface wind direction and velocity, temperature, surface pressure, and relative humidity can affect blast wave propagation, *Pan American* weathermen record these weather factors at the launch blockhouse during all tests involving the use of PAMS. With such measurements they can perform more accurate data analysis.

Thermal Sensors

Two sets of six thermal sensors are mounted on the umbilical tower and the launch deck for measuring temperature and heat energy. Each set consists of four different thermocouples, a calorimeter, and a radiometer. The radiometer senses radiant energy only since the receiver, a blackened silver foil, is protected from heat convection by a quartz window. The calorimeter measures total heat energy (radiant and convective thermal energy) which may approach that of a kiloton nuclear device for some of the larger launch vehicles.

Both the radiometer and the calorimeter provide a low-level d.c. signal which is calibrated in terms of Btu per square foot-second. The radiometer senses thermal radiant energy up to 1000 Btu/sq ft-s while the calorimeter senses radiant and convective energy up to 500 Btu/sq ft-s. The output of the radiometer is 16-18 millivolts and the output of the calorimeter is 8-10 millivolts.

The thermocouples measure from 150° to 5600° F in four overlapping ranges. With such an overlap, continuous coverage is insured since some of the fastest reacting thermocouples cannot survive the highest heat encountered.

For example, the most sensitive of these thermocouples is a tungsten/tungsten-rhenium couple in a thin tantalum case. Its time constant is 1 millisecond which means that it is the first unit to generate a signal when an abort occurs. Although it did not fail during the Centaur explosion, it is expected to disintegrate on future aborts before it can measure the decreasing side of the temperature curve. A similar thermocouple heavily sheathed in siliconized molybdenum for greater protection has a slower response but can survive and measure much of the temperature decrease. The other thermocouples are slow response but high survivability platinum/platinum-rhodium and chromel-alumel thermocouples housed in stainless steel cases.

With this multiple-element technique an accurate coverage of the complete temperature/time profile of the Atlas-Centaur explosion was obtained, as shown in Fig. 1. The solid lines represent recorded temperatures from each of two thermocouples and the dotted line represents the predicted temperature.

The signals from the thermocouples are amplified by a 12-channel d.c. amplifier located under the launch stand and then transmitted to the recording console.

Acoustic Measurements

At some of the largest launch complexes, such as for the Titan III, the noise generated during a normal launch is so great that it may set up undesirable vibrations in the ground-support structures and equipment, especially if the waves have a frequency near that of the resonant frequency of the structure.

Piezoelectric microphones and charge amplifiers which are part of the Launch Acoustic Measuring System (LAMS), are now being used to measure this acoustic noise. LAMS is an auxiliary unit to the Pad Abort Measuring System. LAMS can make sound power measurements from 80 to 200 dB (referred to 0.0002 dyne/cm²) at distances from the rocket exhaust of a few feet up to 20 miles.

Because of the hostile environment during launch, it is not possible to place preamplifiers near these microphones, some of which are located near the rocket exhaust. Since preamplifiers cannot be located far from the microphones



The Atlas Centaur explosion (see color photograph on the cover) caused this amount of damage to the doors on the launching pad.



The over-all view of Launch Complex 36 at Cape Kennedy with the location of the pressure gauges and thermal sensors indicated.

Pan American engineers removing a pressure gauge from its earth well to check it out prior to launch. Author Golub is at left.



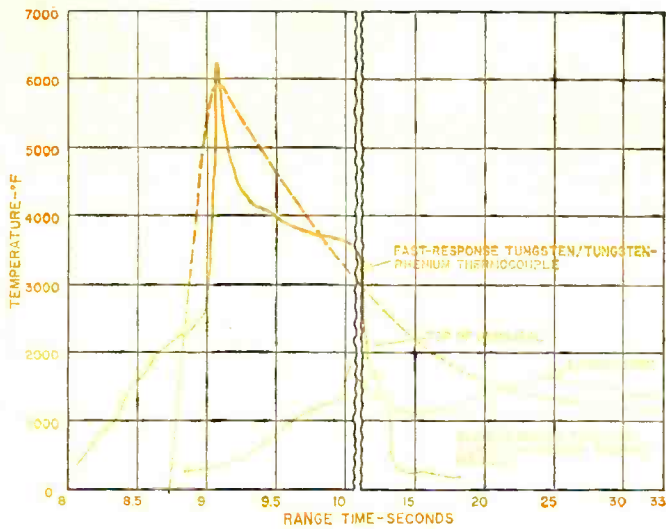

Fig. 1. Temperature measurements during Atlas Centaur explosion. The dotted line represents the temperature that was predicted.

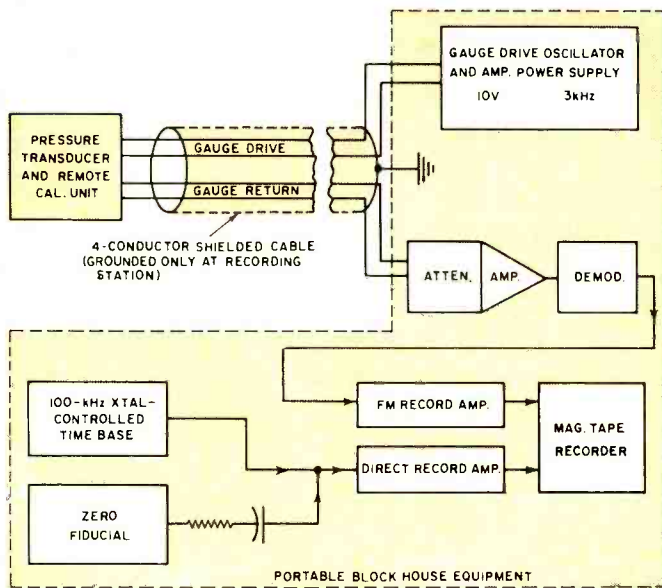

Fig. 2. Block diagram showing portable blockhouse equipment.

because of signal degradation due to long cable runs, charge amplification is used in preference to voltage amplification. In this method of signal conditioning, the charge from the microphone is sensed by an operational type amplifier and balanced by an equal charge of opposite sign provided by a feedback arrangement.

The controlling parameter is the total capacitance of the microphone and the feedback capacitor. Its value is much larger than the capacitance of the cable connecting the microphone to the charge amplifier. With this technique the microphone can be located up to 2 miles from the charge amplifier, and the charge amplifier can be located up to 5 miles from the recording equipment that is employed.

Once the output charge of the microphone has been converted into a voltage by the charge amplifier, it can be recorded directly on the magnetic tape or strip chart, or it can be multiplexed so that as many as ten data channels can be recorded on a single track of magnetic tape. The multiplexing process converts the analog voltage output that is produced into a frequency-modulated carrier which again lends itself to long-distance transmission that is carried over cable.

In a typical application where the tape recorder speed is 60 inches per second, the output of a charge amplifier can be directly recorded on tape with a frequency response

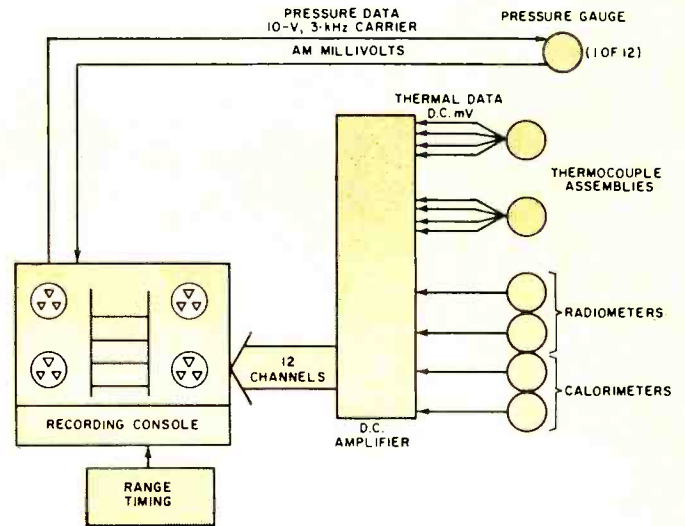

Fig. 3. Data flow in the PAMS system shown in block diagram.

from 0 to 10 kHz. A multiplexed signal can also be recorded with each channel having a frequency response from 0 to 2 kHz with constant-bandwidth multiplexing.

Recording Consoles

Recording consoles for PAMS and LAMS are mobile. One PAMS console and one LAMS console are housed in a self-contained air-conditioned instrumentation van. PAMS consoles can also be moved from the Launch Hazards Laboratory to the blockhouse for each test which requires PAMS coverage. See Fig. 2.

The PAMS console consists essentially of two tape recorders (one for the pressure data, one for the thermal data) and amplifiers for the pressure data. An oscillograph is used to transcribe the magnetic-tape analog data onto a visual record (Fig. 3).

The LAMS console includes among its electronic equipment charge amplifiers, multiplex and test equipment, and a tape recorder.

Because of the unpredictable nature of an abort or explosion, PAMS equipment is turned on before a hazardous sequence is started and is left on as long as necessary. After three hours the tapes on the recorder must be changed to give an additional three hours of recording time. In addition to covering the launches, PAMS covers dual tanking tests involving liquid propellants and solid propellant dry runs which go as far as arming the first-stage ignition system or the vehicle's destruct system.

Remote Abort Measuring System

If a rocket explodes or is aborted after it leaves the launch stand, the damage may be far different than what it would have been with the rocket on the launch stand. Most aborts in flight occur within a slant range of six miles of the launch stand. Ideally it might be possible to place survivable sensors on the rocket, but this cannot be done because of the fact that space on the rocket is so very valuable.

For this reason engineers at the Cape are now investigating techniques for measuring explosions remotely by ground-based equipment. These techniques include laser and r.f. ranging methods for plotting shock-wave position in time and space, and infrared television, interferometric, and spectrometric means for measuring thermal properties. The electromagnetic phenomena generated by a fireball are also being studied.

Under these conditions, the day is not far off when we will be able to measure and analyze every facet of missile and rocket operation "from the ground up" with a view toward avoiding future mishaps. ▲

PERIOD-FREQUENCY GRAPH

By R. W. BAILEY

A chart that makes it easy to convert a large number of period measurements to frequency or frequency to period.

THE electronics technician or engineer is frequently confronted with the task of converting period to frequency and *vice versa*. Although the relationship between frequency and period is expressed simply as $F=1/T$, the graph below can be useful when a large number of conversions is required. This is often the case, for example, when an oscilloscope with a time-calibrated sweep is used to make frequency measurements.

It should be noted that the graph is actually a log-log plot of the expression for an equilateral hyperbola ($XY=1$) with the restriction that (X) and (Y) must be positive or they must both be negative simultaneously. This graph, then, is nothing more than the reciprocal curve and thus can be used for a variety of parameters other than period and frequency.

Example No. 1: Suppose a period of 12 milliseconds is measured and the corresponding frequency is required. Note from the graph that the period must be written as a number between 0.1 and 1.0 multiplied by the quantity 10^{-n} . Since 12 milliseconds equal 0.12×10^{-1} second, n is equal

to 1. Locate 0.12 on the Period axis and follow it across to the graph; read the number 8.35 on the Frequency axis directly below the intersection. The actual frequency is found by multiplying 8.35 by the expression 10^n where n is the number 1 established above. Since 10^1 is equal to 10, the frequency is $8.35 \times 10 = 83.5$ Hz. (See point A.)

Example No. 2: Suppose a frequency of 2650 Hz is measured and the corresponding period is required. Note from the graph that the frequency must be written as a number between 1.0 and 10.0 multiplied by the quantity 10^n . Since $2650 \text{ Hz} = 2.65 \times 10^3 \text{ Hz}$, the value of n is 3. Locate 2.65 on the Frequency axis and follow it up to the graph. Directly to the left of the intersection of the 2.65 line and the graph, read the number 0.377 on the Period axis. The period is found by multiplying 0.377 by the quantity 10^{-n} where n is 3, as was established above. The correct multiplier is then 10^{-3} . The period is 0.377×10^{-3} second, or 377 microseconds.

It should be noted that any units of time may be used with the graph as long as consistency is maintained. ▲

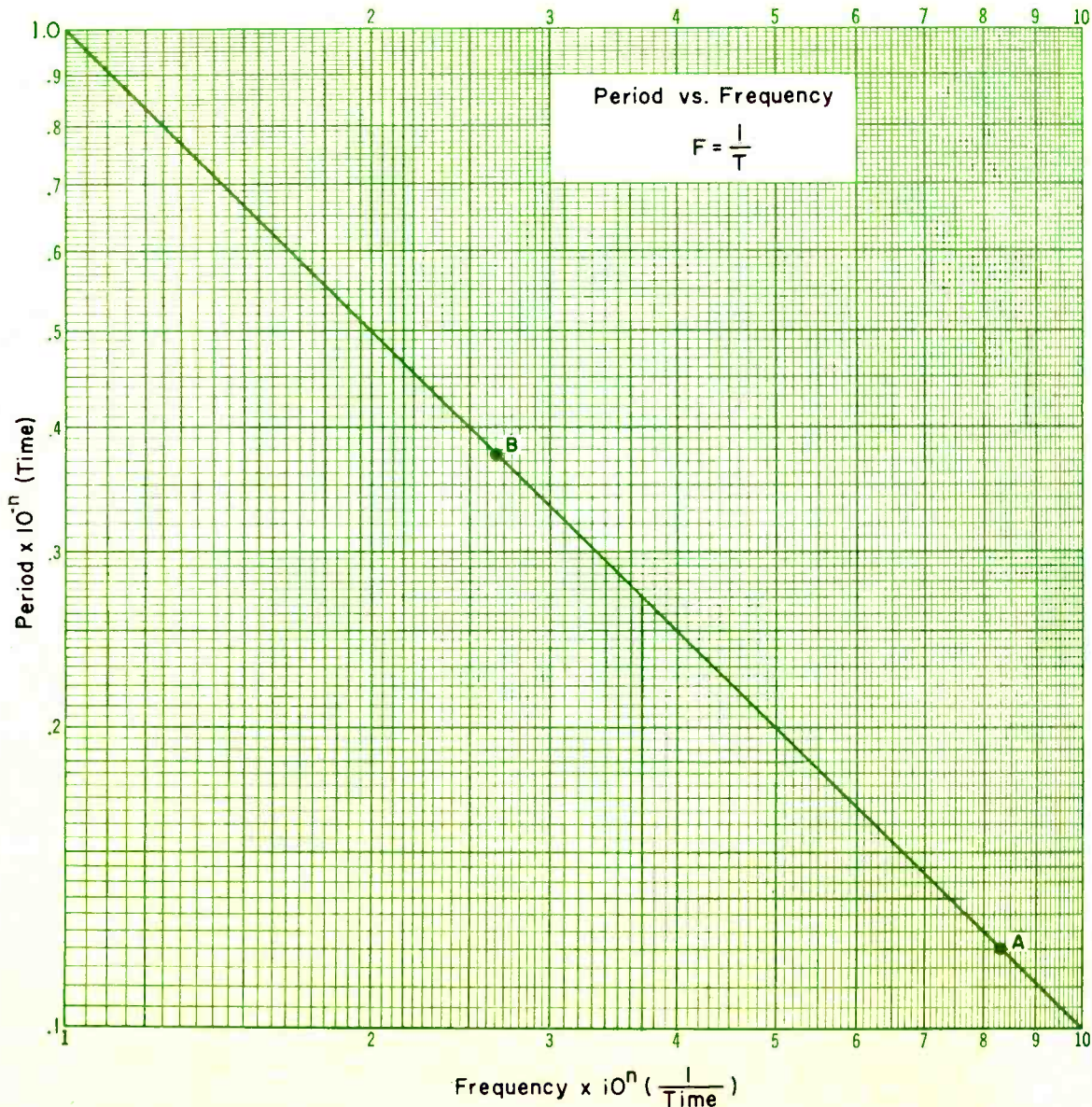

RECENT DEVELOPMENTS IN ELECTRONICS

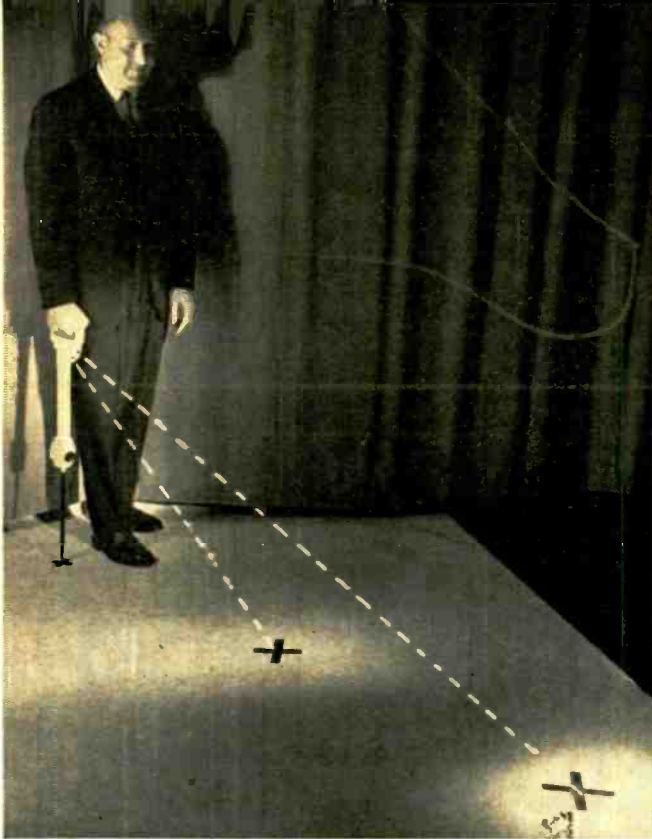

Laser "Seeing-Eye" Cane. (Top left) An experimental laser cane for the blind is shown being demonstrated here. The dotted lines show the paths of the two invisible infrared injection laser beams that strike the surface three and six feet ahead of the cane. If there are no obstacles at these two points, the laser beams are reflected back to optical detectors, midway down the cane. Blunt pins in the handle of the cane vibrate to tell its user that no large depression or raised surface is in front of him. If an obstacle is illuminated by either beam, it is not reflected back to the cane and the corresponding pin stops vibrating. The experimental cane weighs less than five pounds and can be operated for 10 hours before its four small batteries must be recharged. The inventor, Wm. J. Hannan of RCA Laboratories, is investigating the use of an array of laser diodes to generate a number of laser beams for an advanced model. This contemplated model would be able to provide cane user a contour map, which he would be able to feel with his thumb, of the area that is directly in front of him.



Computer-Drawn Graphs (Center) The closing prices of three stocks over a five-month period have been plotted on the screen of a display unit by a computer. Information was previously fed to the computer by means of the light pen and two keyboards. This is an experimental program which eliminates the painstaking manual plotting of points and lines usually required to draw graphs. Any numerical field can be plotted against any other numerical field, making the number of graphs which can be generated from the various combinations almost infinite. Scaling—making the graphs the right size for the variables being plotted—is done automatically by the IBM computer. Several plots can also be shown simultaneously on one graph, using either solid or dotted lines on CRT.

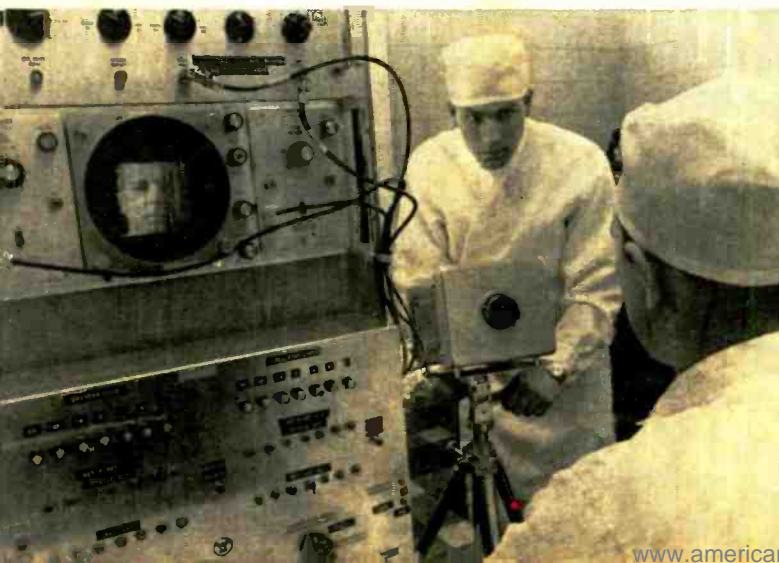

Solid-State TV Camera. (Left) The second in a family of solid-state image converters has been built for NASA by Westinghouse. The new converter is part of a long-range program to develop a solid-state TV camera with imaging characteristics equivalent to those of a conventional vidicon camera. Resolution of the new converter is 100 lines and it can "see" images in six shades of gray. The heart of the system is a monolithic 100-by-128 element array of phototransistors fabricated in a half-inch square silicon substrate. The 12,800 phototransistors of the mosaic are addressed sequentially in a row-column fashion at rates up to 60 frames per second to provide a standard TV-type raster. There is no need for high voltages, magnetic fields, vacuum envelopes, or filament power. Consequently, an imaging system using a solid-state sensor is smaller, lighter, and more rugged, uses less power, and is more compatible with integrated circuits than its vidicon counterpart. Because of the digital scanning, special scan processing for moving-target indication, pattern recognition, and random scan is obtained without digital-analog conversion.

Remote-Controlled Oceanographic Buoy. (Right) A large red 40-ft diameter steel sea buoy is scheduled to go on-station just outside the entrance to New York harbor for evaluation as a possible replacement for the Scotland lightship off Sandy Hook, N.J. Two 1-kW generators running on liquid propane supply charging current for a 21-cell nickel-cadmium battery comprising the power source for the 5000-candlepower light, foghorns, and on-board electronic equipment. The buoy can operate unattended for one year. On-board equipment is automatic but can be controlled by telemetry command from a shore station. Sensors on the buoy measure air speed and direction, temperature, barometric pressure, as well as sea-water temperature, pressure, salinity, speed, and direction. All data will be transmitted to shore. Antennas atop the buoy are for the v.l.f. radiobeacon and for v.h.f. command and telemetry.

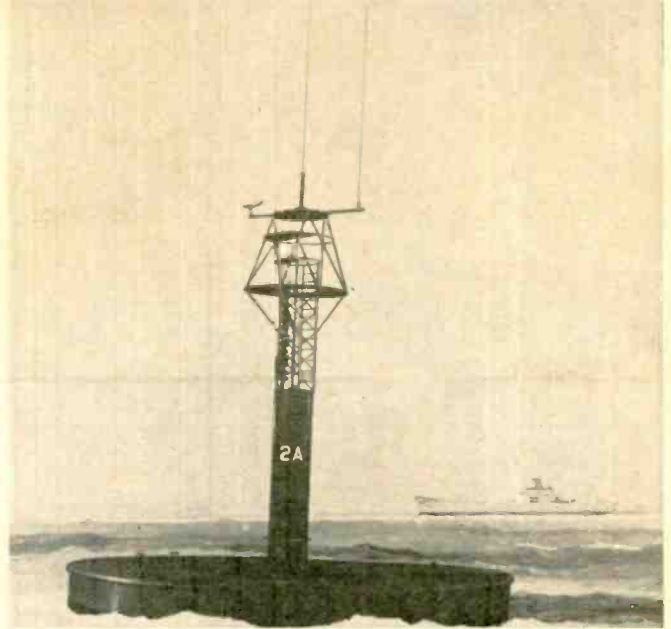

Portable Thermoelectric Generator. (Center) A new portable thermoelectric generator, weighing only 35 lbs with fuel, has been developed which can be carried about by a soldier to provide immediate, silent, and long-term power for military field equipment. The generator, produced by 3M Co., delivers 300 watts of electrical power, has an 8-hr fuel supply, and can operate on kerosene, jet fuel, or diesel fuel. Generators of this type can convert heat into electrical energy using a series of pellets of semiconductor material arranged in junctions.



One-Gun, Two-Color CRT. (Below right) The availability of what is said to be the first commercial high-resolution single-gun, two-color display tube has been announced by Sylvania. Designed for non-entertainment type applications, the new tube can be read under high ambient light. The CRT uses a 5-in round faceplate coated with two layers of phosphor—red and green. The two layers are separated by a barrier layer. By switching the final anode voltage, the electron beam is made to excite the first phosphor layer only, creating one color, or to penetrate the barrier and excite both phosphor layers, creating a second color. By high-speed voltage switching, the tube produces a two-color display that appears to be continuous to the viewer. No shadow mask or dot pattern is employed.

Facsimile Via TV. (Below left) An experimental system that can broadcast printed copy into the home along with standard TV programming is shown here. The image of a girl appears on the TV screen while a printed weather map and forecast emerge from the facsimile equipment below. RCA has requested FCC permission to make on-the-air tests of the system between New York City and Princeton, N.J. The facsimile signals which can now transmit four different printed messages at the same time, are sent out during TV vertical blanking intervals. A page of copy can be reproduced every ten seconds.

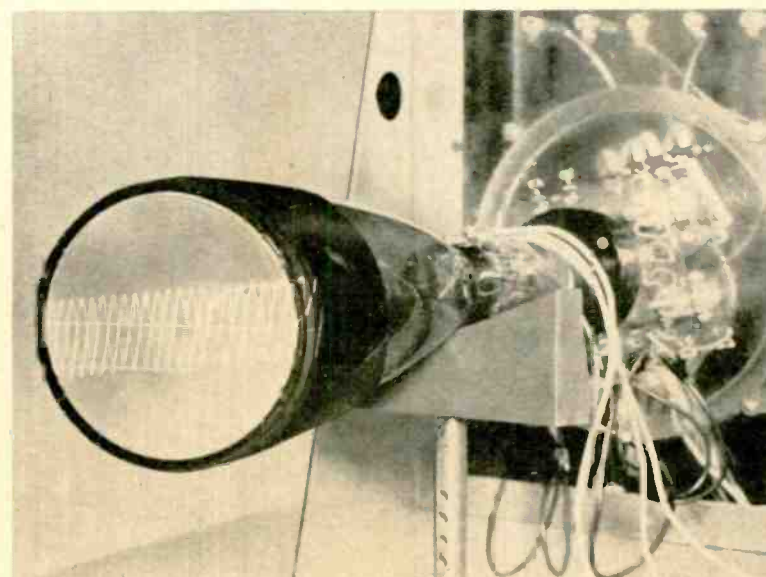

AVALANCHE TRANSISTOR CIRCUITS

By SIDNEY L. SILVER

These special switching transistors—made possible by improved fabricating techniques—can produce extremely fast pulses at high power output levels.

IN the early days of transistor development, avalanche breakdown was considered a troublesome phenomenon which imposed a limit on the useful life of a junction transistor. To offset this problem, collector voltages were restricted to values far below the actual breakdown rating in order to reduce surface leakage currents across the collector junction. Excessive leakage currents not only increased the power-dissipation level of the transistor, but also initiated thermal runaway and possible destruction of the device.

The avalanche effect was found to be nondestructive if the peak and average power dissipated at the collector junction were controlled by external circuitry. By operating ordinary high-frequency switching transistors in the avalanche mode, it was possible to generate extremely fast pulses (in the nanosecond range) in applications requiring high current outputs of short duration. Nevertheless, the avalanche process did not find wide acceptance since, in many cases, transistors of the same type did not always exhibit uniform avalanching properties. Consequently, it was necessary to carefully test and select these units for consistent breakdown characteristics, thus making it difficult to design stable, reliable pulse circuits.

As a result of recent improvements in fabrication technology (leading to, for example, the reduction of surface leakage currents), modern avalanche transistors are now capable of operating at relatively high collector voltages and of producing large current-voltage swings with subnanosecond rise times. Within the limits set by allowable power dissipation, pulse widths of 100 μ s are easily attained with repetition rates in the MHz region. In simple circuits, peak swings of 75 volts and 10 amps in less than 0.5 ns are obtainable with ultra-high-speed transistors whose geometry is optimized for avalanche switching. In more complex circuits, rise times of less than one ns can be generated at peak powers in excess of 500 watts across very low impedance loads.

Some of the important applications of avalanche transistors include the generation of fast-rising pulses employed in sampling oscilloscopes, decade ring counters, and high-speed nuclear instruments. For pulse power requirements in the milliwatt range, suitable avalanche devices are now being developed for low-level computer logic circuits. For higher pulse handling capacity, avalanchers are finding increasing use in strobe-pulse generators, pulse amplitude detectors, memory-core drivers, and voltage-comparators. With proper impedance-matching, avalanche pulse generators can be used for pulse modulation of injection lasers.

In normal transistor operation, a reverse bias is applied to the base-collector junction so that an electric field is produced within a space charge region, or depletion layer,

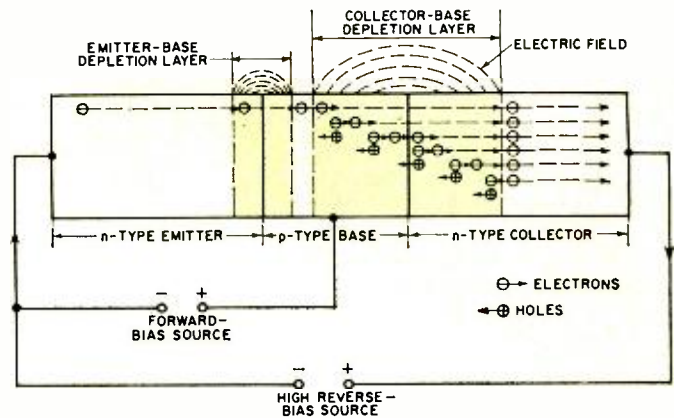

Fig. 1. Simplified current-flow diagram of an "n-p-n" transistor that is shown here operating in the avalanche mode.

of the junction. In the avalanche process, however, the reverse collector voltage is raised substantially above the normal operating value so that the depletion layer is considerably widened, and a large electric field extends over most of the base region.

As shown in Fig. 1, the strong electric field approaches the small field associated with the narrow emitter-base depletion layer thereby reducing the effective base width. As a result electrons diffuse across the base from the emitter region and accelerate to high velocities toward the collector. Upon entering the collector-base depletion layer, the fast-moving electrons excite additional carriers (hole-electron pairs) by impact ionization with atoms in the semiconductor material. Owing to the high field, the free electrons move rapidly toward the collector and the associated holes drift in the opposite direction across the base region. The new carriers, in turn, acquire sufficient energy to cause further ionization by collision with the other atoms in the material. Since the atoms in the lattice structure are closely spaced, the ionization process occurs many times, particularly at the collector-base junction which corresponds to maximum-field intensity.

The cumulative process, referred to as avalanche multipli-

Fig. 2. Relation between avalanche breakdown voltage and M .

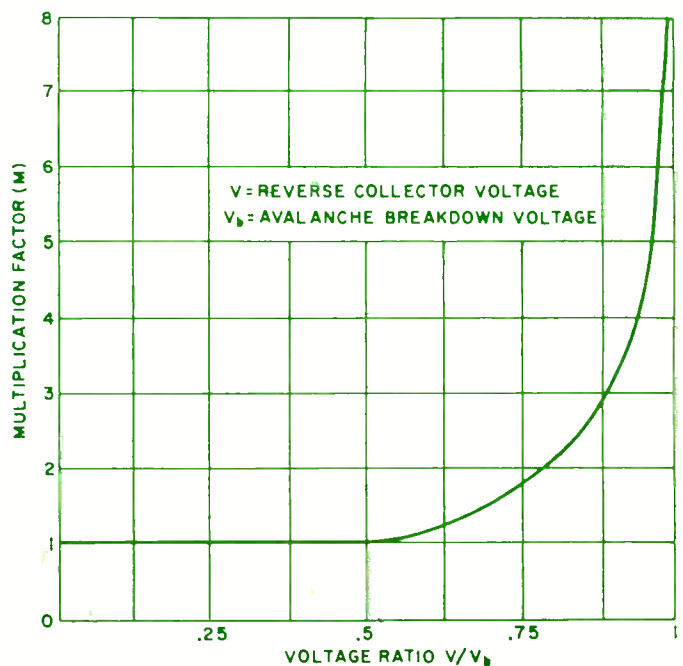

cation, results in a much larger number of electrons entering the collector region than cross the collector-base junction. When a critical point is reached, the current flowing across the collector-base junction rises abruptly as avalanche breakdown occurs and tremendously high values of reverse collector currents are attained. The breakdown condition is not a permanent effect since the junction will rapidly recover when the voltage is reduced again.

An important parameter used to designate the rise of collector current prior to breakdown is the multiplication factor (M), which is defined as the ratio of actual collector current to the current that would flow had there been no increase in current due to ionization. Fig. 2 shows a typical multiplication factor curve for an $n-p-n$ silicon transistor in which M values are plotted against collector voltage.

At low collector voltages, M is close to unity and no apparent multiplication effect is present. In avalanche, however, the emitter-to-collector gain is increased to a magnitude many times greater than unity, so that M approaches an infinitely high value. In practice, the multiplication factor can never be infinite, since this would imply an unlimited current flow and unlimited heat generation. To obtain a high value of M , it is desirable that the collector current be as large as possible; but a limit is set by the maximum allowable power dissipation of the transistor, which is controlled by external circuitry.

The multiplication factor is found to be related to the reverse bias across the collector junction by the formula: $M = 1/[1 - (V/V_b)^n]$ where V is the applied collector voltage, V_b is the avalanche breakdown voltage, and n is a parameter whose value depends upon the type and resistivity of the junction material, and ultimately determines the sharpness of the knee of the M curve. For silicon $n-p-n$ transistors, $n = 4$ and for germanium $n-p-n$ types, $n = 3$.

Basic Circuitry

The basic features of a single $n-p-n$ transistor operating in the avalanche mode are shown in the emitter-follower configuration of Fig. 3A. In the quiescent state, capacitor $C1$ charges toward the collector supply voltage, V_{cc} , which is adjusted to a value slightly less than that required to initiate avalanche breakdown. When a positive-going trigger pulse is applied to the base, the emitter-base junction becomes forward-biased, and the breakdown potential is effectively lowered. The emitter begins to inject electrons into the base, which are multiplied at the collector junctions, causing a regenerative current build-up to occur.

At breakdown, the heavy current flowing through the collector-emitter junction path rapidly discharges $C1$ and produces the leading edge of a positive pulse across load resistor R_L . The breakdown condition exists as long as there is stored energy in $C1$ to sustain it, since the alternate path (from V_{cc} via $R1$) is unable to supply sufficient current. After $C1$ has discharged, a small transient current flows through $R1$, which maintains the collector at a lower voltage and allows the transistor an interval of time to recover and revert back to its original quiescent state. Finally, capacitor $C1$ slowly recharges toward the collector supply source through $R1$ and upon arrival of the next trigger pulse, and the cycle is repeated.

The pulse repetition rate of the monostable circuit in Fig. 3A is determined by the time constant of $R1$ and $C1$, while the pulse width depends upon the values of R_L and $C1$. Resistor $R1$ can be made adjustable (within small limits) so that increased repetition rates are obtainable by decreasing its value. $C1$, which determines the avalanche turn-on transient, is usually fixed by pulse-width requirements.

If a negative output pulse is required, the emitter terminal may be grounded and the load resistor, R_L , is placed in series with the $C1$ -to-ground connection. To convert the generator into a self-running type, the collector supply voltage, V_{cc} , may be raised or the base resistor, $R2$, returned

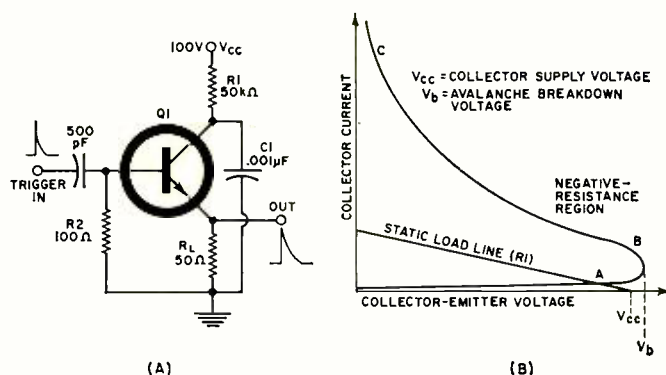

Fig. 3. (A) Avalanche switching circuit, and (B) the V-I curve.

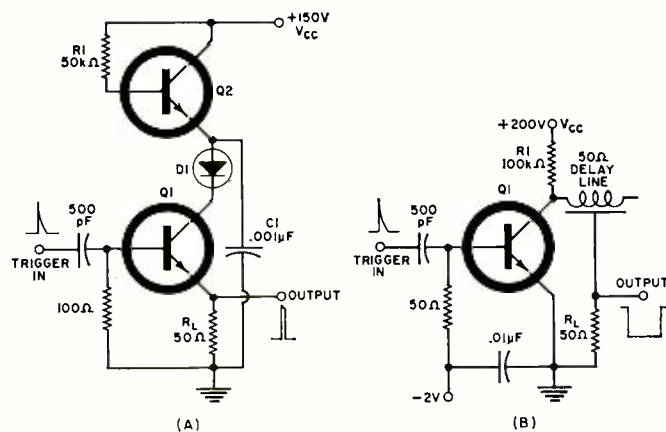

Fig. 4. (A) A narrow-pulse avalanche generator capable of high pulse repetition rates. (B) Delay-line avalanche-mode generator.

to a suitable bias voltage so that the avalanche breakdown is achieved without the need for an external trigger.

The sequence of events relating to the avalanche-switching mechanism is graphically illustrated by the volt-amp characteristic curve of Fig. 3B. Under quiescent conditions, a static load line is constructed to yield a single stable operating point (A), where it intersects the curve in the low-current region. When a trigger pulse appears, avalanching occurs between points A and B, where the transistor's operating point is shifted beyond its normal-region rating. Capacitor $C1$ supplies the surge of discharge current which builds up rapidly toward point C in the negative-resistance region. It is the low transit time with which the transistor switches from a low-current state to an avalanche discharge state in the negative-resistance area that leads to extremely fast rise times. When the trigger pulse has dissipated, the operating point moves back to point A as capacitor $C1$ recharges to the same point and the circuit is ready to accept another transient.

An important design consideration is that the load line must not intersect the transistor breakdown curve in the high-current region. This condition, referred to as "latch-up," would establish an undesirable stable operating point at the common intersection and prevent the normal shift to point A during the recovery period. If the product of current and voltage at the latching point were sufficiently high to exceed the maximum transistor power rating, circuit malfunction or thermal destruction would occur.

Narrow-Pulse Switching

The main disadvantage of the single-stage avalanche pulse generator is the relatively long recovery time after the avalanche transition period which sets a limit on the maximum pulse repetition rate. Fig. 4A shows an arrangement which incorporates a second transistor to dynamically reduce the charging time constant of the circuit without appreciably affecting the static load line during the pulse period. Initially, the base-emitter junction of transistor $Q2$ is forward-

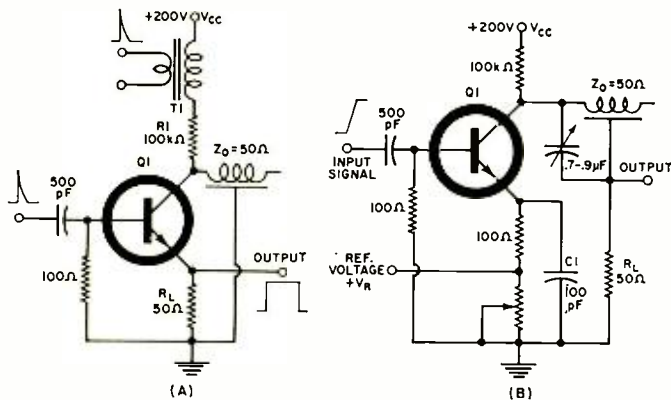

Fig. 5. (A) Pulse-coincidence detector. (B) Comparator circuit.

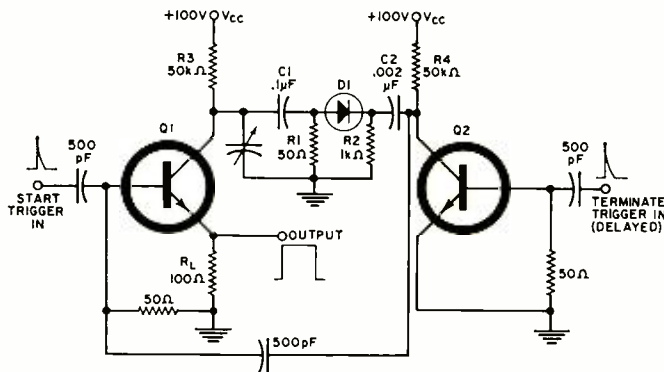

Fig. 6. Variable-width avalanche pulse generator circuit.

biased, and $C1$ is charged, *via* $Q2$, toward the collector supply voltage, V_{cc} . Transistor $Q1$ rests near its avalanche breakdown potential and V_{cc} is adjusted to a value slightly less than that which would start the $Q1$ circuit free-running.

When $Q1$ is triggered $C1$ discharges rapidly through the series path formed by load resistor R_L , transistor $Q1$, and diode $D1$. The resultant voltage drop across $D1$ reverse-biases the emitter-base junction of $Q2$, leaving only the limiting resistor $R1$ as the current path between V_{cc} and the collector of $Q1$. After $C1$ has discharged, $Q2$ turns "on" and $C1$ rapidly charges toward V_{cc} *via* the low-resistance path provided by $Q2$. By this means, very narrow pulses are easily generated which have fast fall times as well as fast rise times. Pulse repetition rates can thus be increased a hundredfold over the single-stage circuit, with obtainable repetition rates up to approximately 5 MHz.

Delay-Line Stabilization

In applications requiring flat-topped pulses, a transmission-line load provides greater control of pulse duration, amplitude, and phase of the output signal than does the use of a load capacitor. Fig. 4B shows a monostable pulse generator which employs an open-circuited delay line as a pulse-forming network in the collector circuit of transistor $Q1$. In this configuration, a hold-off bias is applied to the base to maintain $Q1$ in the nonconducting state. During the "off" cycle the delay line acts essentially as a capacitive load which is charged to the collector supply voltage, V_{cc} , in conjunction with resistor $R1$. The application of a trigger pulse forward biases the base-emitter junction and produces a positive regenerative avalanche transient across the transmission line and load resistor R_L .

At this point, the switching transient travels along the delay line (approximately 2 ns/ft), which now behaves as a resistive element equal to its characteristic impedance ($Z_0 = 50$ ohms). When the pulse reaches the open end of the line it is reflected back to the source (in phase) since there is no resistive termination at the load end to absorb the energy. Upon returning to the collector, the pulse increases the

voltage across the source end of the line and causes a reduction of the voltage across R_L . By this means the collector current is reduced to a sufficiently low value to turn off the transistor regeneratively, thus terminating the pulse.

In this circuit, the duration of the rectangular output pulse is equal to the two-way transit time of the delay line. Although small changes of pulse repetition rate can be produced by adjusting the values of V_{cc} and $R1$, the repetition rate is primarily determined by the value of the transmission-line capacitance. To prevent ringing and undesirable reflections, R_L must be equal to or slightly less than the characteristic impedance of the line.

Fig. 5A indicates how the avalanche process is applied to coincidence detection in high-speed nuclear instrumentation. In this arrangement, the two trigger pulses applied to the delay-line coincidence circuit are derived from a pair of nuclear scintillating counters. To detect the coincidence of both pulses, one half of the required pulse height is coupled to the collector of $Q1$ and the other half is fed to the base input circuit. The collector circuit parameters are selected so that the presence of both pulses is necessary in order to drive the transistor into avalanche and deliver an output.

In the voltage comparator circuit shown in Fig. 5B, the input level of a ramp signal is compared with an adjustable positive voltage reference source V_R , in the emitter circuit. When the applied voltage ramp exceeds the threshold trigger level, avalanche breakdown takes place and the collector-emitter path of $Q1$ conducts heavily. The delay line then discharges around the loop formed by load resistor R_L , emitter bypass capacitor $C1$, and $Q1$ so that a large nanosecond pulse is produced at the output.

Variable-Width Pulses

A convenient method of obtaining continuously variable pulse width is the complementary arrangement shown in Fig. 6. Here the fast rise time of avalanche transistor $Q1$ is utilized for the leading edge of the output pulse and that of $Q2$ for the trailing edge so that precise control of pulse duration is achieved. By varying the time delay between start and stop trigger signals, it is possible to continuously adjust the pulse width from a few nanoseconds to over one microsecond.

Initially, $C1$ and $C2$ are charged toward the V_{cc} source *via* resistors $R3$ and $R4$, respectively. To initiate the avalanche process, a start trigger pulse is applied to the base of $Q1$. A heavy current flows through the collector circuit which discharges $C1$ through the $R1$, R_L , and $Q1$ path so that the leading edge of the output pulse is formed. During this interval, diode $D1$ is reverse-biased to prevent interaction with the $Q2$ switching circuit.

After a predetermined period of time, a trigger pulse is applied to the base of $Q2$ in order to terminate the pulse. As $C2$ discharges through $R2$ and $Q2$ a large negative voltage is developed across $R2$ which overcomes the reverse bias on $D1$. As a result, the $R1$ - $C1$ junction is driven more negative so that the algebraic sum of the voltages between the $Q1$ collector and ground approaches zero. This bucking effect cancels the power that keeps $Q1$ in avalanche, thereby turning off $Q1$ and terminating the pulse. At this point $C1$ and $C2$ recharge to complete the cycle as the $Q1$ circuit awaits the arrival of a new start pulse.

At the present state of the art, the avalanche mechanism adds a new dimension to solid-state switching design which has not yet been fully explored. To meet the increasing demands for ultra-high-speed, high-current switching applications, a number of high-frequency transistors are now commercially available, *e.g.*, 2N3033, 2N3034, 2N3035, which are specifically tailored for avalanche-mode operation. As more avalanching transistors become available, circuit designs will reach farther into the picosecond region to solve some of the problems related to operation at very high repetition rates. ▲

Temperature- Depth Measurements in the Ocean

By JOHN ALTHOUSE

A description of the electronic instruments used to make these important oceanographic measurements. Included here are the various types of electronic bathythermographs, infrared and quartz thermometers, recording thermographs.

DID Benjamin Franklin measure temperature more accurately than oceanographers do today? It is quite possible that he did and here lies a challenge to the electronics industry. It was almost 200 years ago that Franklin developed his "thermometrical navigation". He was able to guide a ship along favorable currents by measuring the temperature of the surface water. His measurement method was simple. He dipped a bucket into the water, hauled his water sample aboard, and measured its temperature with an ordinary thermometer.

Today, temperatures taken by this method are called "bucket temperatures" and the technique is still the prime method of obtaining the temperature of ocean surface water. But it is likely that Ben Franklin used wooden buckets. Today's metal buckets are poor insulators and can allow water temperature to change before measuring.

Reversing Thermometer

In 1874 the English instrument firm of *Negretti and*

Zambra introduced the reversing thermometer, an instrument whose accuracy is a source of some embarrassment to the manufacturers of today's electronic instruments.

Ben Franklin's bucket was limited to measurements of surface temperature. The reversing thermometer can measure temperature from near the surface to as deep as 20,000 feet. It is a form of mercury-in-glass thermometer which is lowered to the depth at which a measurement is to be taken. A trigger mechanism then "locks" the thermometer reading so it can be brought back to the surface to be read. (See "Electronics in Oceanography" in the March, 1967 issue.)

The reversing thermometer is of particular interest because it uses techniques common to many oceanographic instrument designs:

1. It is pressure protected. An unprotected thermometer will change calibration at the high pressures of the deep ocean.
2. It measures pressure by use of an auxiliary thermometer. Pressure is not measured for its own sake but as a means

Fig. 1. The mechanical bathythermograph (shown here in its carrying case) makes a graph of temperature vs depth on a coated glass slide as it is lowered and raised in the water at end of wire rope. (Manufacturer: Kahl Scientific Instrument Corporation.)

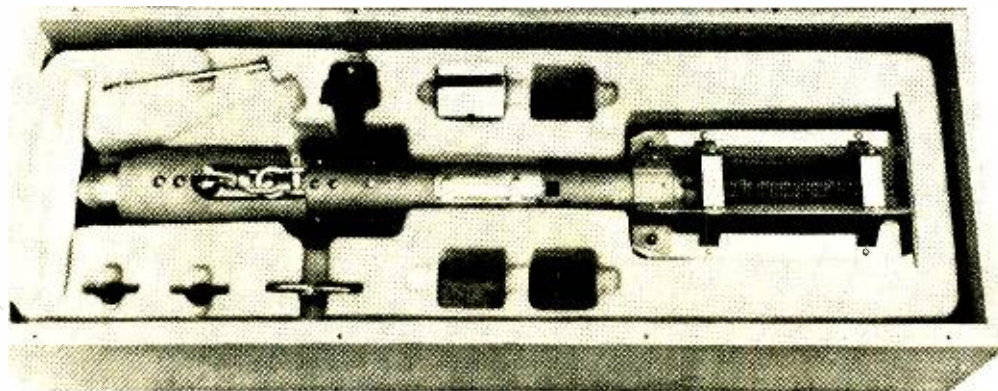

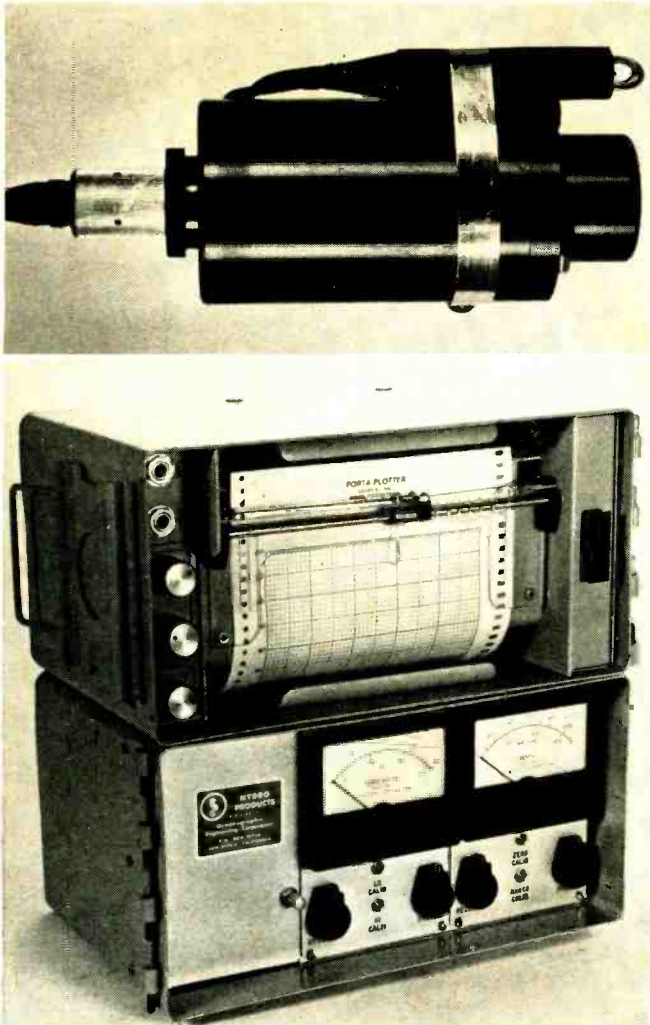

Fig. 2. Upper photo shows the underwater probe of the electronic B-T. It consists of a Bourdon tube potentiometer pressure transducer in an oil-filled aluminum housing and a neoprene-jacketed thermistor (top). The lower photo shows the deck unit, containing a power supply, a meter readout, along with a graphic recorder. (The manufacturer: Hydro Products)

of determining depth. To a good approximation, pressure in the ocean increases at the rate of 0.445 psi per foot of depth. Depth can be determined more accurately by pressure measurement than, for example, measuring the length of wire supporting the thermometer.

3. It is used with a water-sampling bottle so that chemical analysis of the water (at the place where temperature is measured) can be made. This is the "instrument-cluster" concept frequently used in oceanographic instrumentation.

Disadvantages of this instrument are:

1. It takes but one measurement per lowering.
2. Some time is required to make each measurement.

The Bathythermograph

In 1938 Prof. A. Spillhaus devised a mechanical temperature/depth instrument that probably has been used to take more oceanographic data than any other single device. A commercial version of this particular instrument is shown in Fig. 1.

Designed to be towed behind a ship, it contains a replaceable smoked glass slide. A temperature-sensitive element moves a stylus vertically across the slide. The slide itself is moved horizontally by a pressure-sensitive bellows assembly. As the instrument is lowered into the water and raised again, the stylus traces temperature vs pressure (depth).

The instrument is usable to a depth of about 1000 feet and gives an accuracy of approximately ± 10 feet in depth

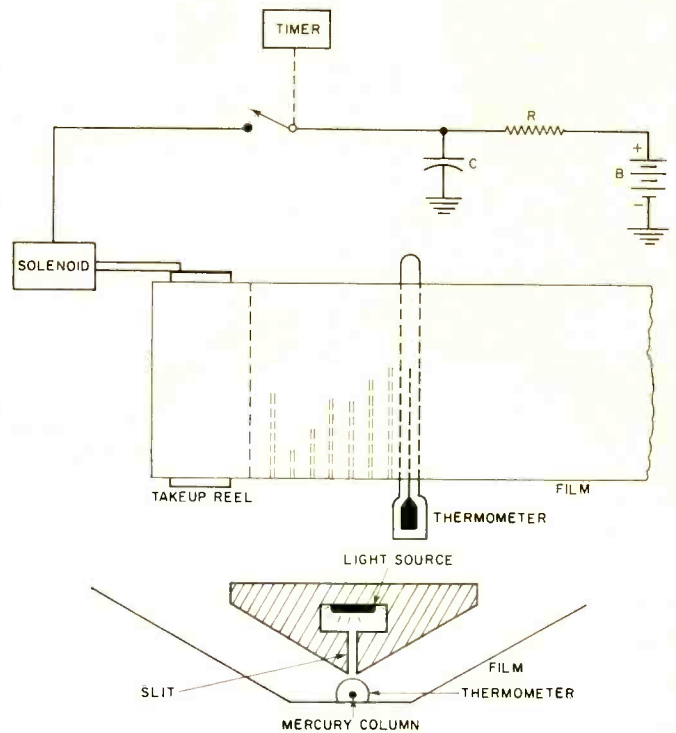

Fig. 3. Side and top views of the recording thermograph which makes hourly records of the temperature measured by a mercury thermometer. Photographic film is exposed by radioactive-phosphorescent light source. Film advance is controlled by clockwork timer and powered by capacitor discharge. (An instrument of this type is manufactured by Braincon Corp.)

and ± 0.1 degree centigrade in measured temperature.

Electronic Bathythermograph

A simple and inexpensive electrical analog of the mechanical B-T is shown in Fig. 2. The underwater assembly contains a thermistor to measure temperature and a potentiometer-type pressure transducer to determine the ocean depth.

A multi-wire cable connects to a power supply, recording and signal-conditioning assembly on shipboard.

Its great advantage is that, unlike the mechanical B-T whose glass slide must be recovered before the data can be read, the temperature and depth measurements are displayed in real time on shipboard. If an interesting anomaly appears it can be closely investigated while the sensor is still in place. Also, the electrical data is amenable to electronic data processing techniques.

This simple electronic B-T is best suited for use near the surface of the ocean. At great depths more elaborate pressure protection is required. Also, as the lead wire becomes longer, its resistance becomes significant and it becomes desirable to place the signal conditioner underwater and, if possible, to use a single-conductor wire.

Recording Thermograph

The device shown in Fig. 3 is a unique combination of old and new techniques. It illustrates several facets of oceanographic instrumentation:

1. Ingenuity in design
2. Simplicity of design—a quality that has been found to be of importance in equipment used in the ocean
3. Low power consumption (Unattended instruments frequently must be located where sources of commercial power are not available.)

The temperature measurement is made with a mercury-in-glass thermometer. A zinc-sulfide phosphorescent material, excited by a radioactive source, provides light. This exposes a strip of film behind the thermometer except where the light is blocked by means of the thermometer's mercury column.

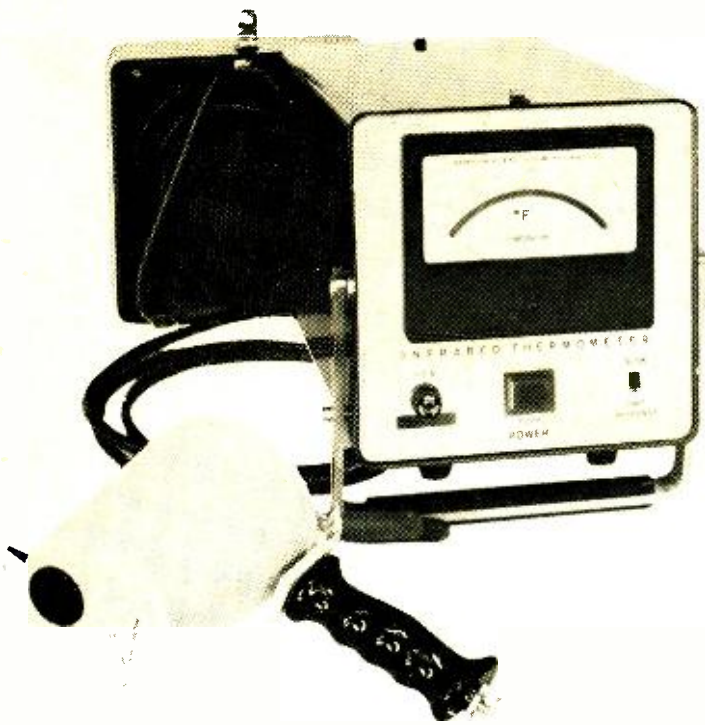

Fig. 4. The infrared thermometer consists of a hand-held or tripod-mounted sensing head (left) containing a thermistor bolometer detector, optical lenses and filters, controlled-temperature chamber, and mechanical chopper. The temperature of the ocean surface can be read directly on the meter located in the case of the instrument. (Barnes Engineering Co.)

The film advances periodically to give a record of temperature vs time. Power for the film advance comes from a battery that charges a capacitor through a large resistance. Once an hour a clock-controlled switch applies the capacitor charge to the solenoid-ratchet stepping mechanism.

The recording thermograph was designed to monitor temperature in harbors, bays, and estuaries where temperature changes are slow. Accuracy is on the order of $\pm 0.1^\circ \text{C}$.

Infrared Thermometer

The concept of measuring temperature at a distance by observing infrared radiation has been put to practical use in oceanography in recent years. The instrument shown in Fig. 4 can be used on shipboard or, more commonly, in a low-flying airplane. The probe, which has 3° field of view, is pointed at the surface of the water. The infrared radiation received is compared to that of a standard-temperature source within the probe to determine the water temperature. The temperature that is measured is that of the top few millimeters of the ocean surface.

The probe contains optical filters to restrict its passband to 8-14 microns. In this wavelength band the sea appears black (non-reflecting) and the atmosphere is nearly transparent. Thus interference from sun reflection is minimal and attenuation through the sea-to-aircraft path is small.

The basic sensor is a thermistor which, with the aid of a gold-plated mechanical chopper, alternately sees the ocean surface and a chamber of known temperature. The resulting square wave is processed to provide a d.c. signal for meter display and recording.

The absolute accuracy of the infrared thermometer is about $\pm 1.2^\circ \text{C}$. Most oceanographic temperature sensors are an order of magnitude better in this respect. But the ability of the infrared thermometer to operate from an airplane saves the high cost of a research ship and allows data to be collected over much larger areas of the sea.

The Deep-Sea Bathythermograph

Electronic methods have made practical continuous tem-

perature-pressure (depth) measurements from the ocean surface to the deep sea.

Using the "instrument-cluster" concept, a typical system also measures sound velocity, conductivity, and other parameters. The instrument, supported by its electrical cable, is lowered over the side of a ship. Data is recorded on deck as the probe is lowered to 10,000 feet or more below the surface. Another record is made as the probe is pulled back to the surface.

The design of the deep-sea B-T differs in several respects from that of instruments used closer to the ocean surface.

Supporting Wire The deep-sea B-T may require a supporting wire that is four miles long. Such a wire needs considerable strength just to support its own weight. The mechanical design usually dictates that the electrical conductors of a multi-wire cable be small, ≈ 24 gauge for example.

The resistance of the wire is significant and, for measurements of good accuracy, the wire usually is not placed in series with a resistive transducer. Instead, the sensor bridge and output amplifiers are placed in the underwater probe. The deep-sea instrument is typically more complex than its near-surface counterpart for this reason.

The twisted-armor construction of multi-wire cable restricts the speed at which it can be towed. Thus many deep-sea designs favor single-wire plastic-insulated cable. The plastic insulation, buoyant in the water, reduces the total immersed cable weight and presents a smooth surface to the water. The sea water serves as a return conductor.

Data signals, in this arrangement, must be multiplexed. Frequency multiplex is popular. Here, each measurement is converted to a frequency analog. The combined multi-frequency signal can then be sent up the single wire. At the same time d.c. to power the sensors can be sent down the wire.

Pressure Sensor. Pressure (depth) data from the bathythermograph varies slowly and the data-gathering time is

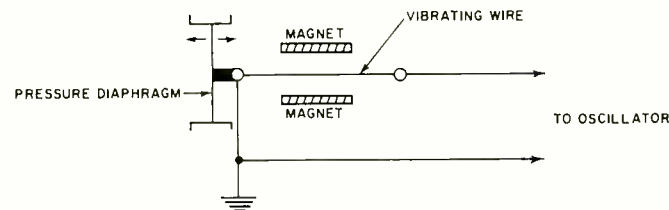

Fig. 5. The "Vibrotron" converts pressure into frequency through a vibrating wire. When excited electrically, the oscillation frequency is pressure dependent. (United Control)

long. The sensing system need not have wide data bandwidth. The prime requirement is for good long-term stability.

Thus, in preference to the v.c.o. approach widely used in missile telemetry, oceanographic frequency-multiplex systems favor more direct conversion from pressure to frequency.

A strain-gage-bridge transducer can be used directly as a feedback element to control an oscillator's frequency. Bridge-controlled oscillators (b.c.o.'s) using integrated-circuit amplifiers provide excellent long-term stability, are small in size, and use little d.c. power.

The "Vibrotron" is specifically designed to be used with a bridge oscillator. A tungsten wire (Fig. 5) in a magnetic field is stretched between a fixed anchor point and a pressure diaphragm. When the wire is connected in an oscillator circuit, it is excited to a sustained vibration at the natural frequency determined by the pressure on the diaphragm.

Accuracies on the order of $\pm 0.3\%$ of full scale are obtained with the sensor.

Temperature Sensor. The most popular temperature sensor is the thermistor. Platinum resistance sensors are also used for this application. Typically, they are connected as

feedback elements to control the frequency of an oscillator.

For deep-sea use the probe must be protected from mechanical deformation by the high pressure environment. The metal sheath usually used for this purpose increases the time constant of the probe. It is difficult to obtain a thermal time constant less than $\frac{1}{2}$ second in a pressure-protected probe.

The time constant limits the speed at which the probe can be lowered to obtain a temperature profile or, alternatively, it limits the accuracy and detail of the measurement.

Allyn Vine of Woods Hole Oceanographic Institution has described the time-constant problem in a pictorial manner with the "apparent probe size" concept.

Following a step change in temperature, a sensor approaches its final reading by 37% after one time constant, by 13% in two time constants, by 0.7% in five time constants.

If we want to read changes to 0.7% with a $\frac{1}{2}$ -second time-constant probe, a $2\frac{1}{2}$ -second wait is necessary. If the probe is moving at 5 feet/second it will move $12\frac{1}{2}$ feet during this time.

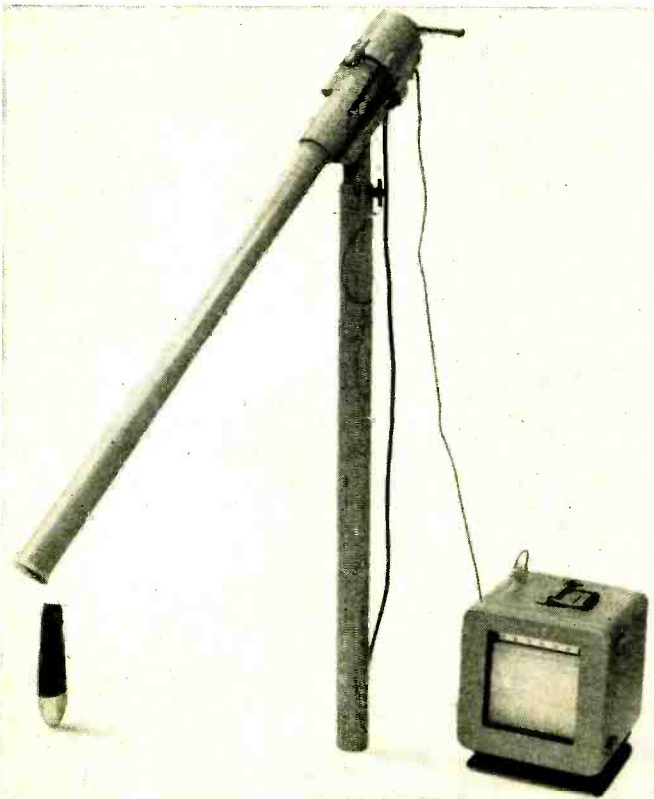
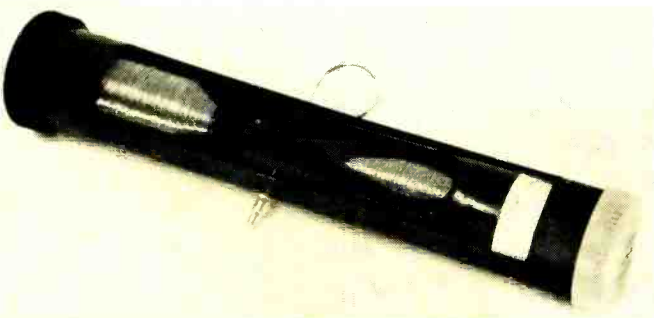

Fig. 6. The expendable B-T probe (lower left), its launcher, and recorder. The launcher, which extends over the side of the ship, ensures that the probe gets a good start on its journey to the bottom of the ocean. Temperature-depth recordings are made for the first 1500 feet. (Sippican Corp.)

Fig. 7. Cutaway view of expendable B-T probe and cannister. The wire coil at left remains in the launcher; its wire pays out as the ship moves. The wire coil in the probe (which is shown at the right in the photo) pays out as probe descends.



Thus, even though the probe may be small, it has an "apparent length" of $12\frac{1}{2}$ feet for this measurement precision.

The Expendable Bathythermograph

It takes time to lower an instrument to 1000 feet or more and to haul it back up. During this time the ship's operation is restricted. If the instrument is heavy, a winch is needed to raise and lower it and in rough weather it may not be possible to use the instrument at all.

The expendable B-T is a new concept in temperature-depth instrumentation that eliminates these problems. It uses a thermistor temperature sensor mounted in a ballistically shaped housing. When dropped into the water it falls at a known rate. Thus, a record of its temperature readings *vs* time can be displayed as temperature *vs* depth.

The key to the successful operation of the probe lies in the ingenious use of two spools of fine insulated wire. One coil of wire is inside the probe. The other remains on shipboard. The coils are connected together to form one continuous length of wire that carries the temperature signal from the probe to a shipboard recorder.

As the probe falls through the water wire pays off its coil. Wire that is already outside the probe does not move and so does not hold back the probe.

As the ship moves wire pays off the shipboard coil. The wire laying along the surface of the water does not move. Nothing is towed behind the ship. Readings can be taken when the ship is moving as fast as 30 knots.

The system is shown in Fig. 6. It consists of the expendable probe, a launcher, and a recorder. Initially, the probe and the coil of wire that will pay out from shipboard are held in a cannister (Fig. 7).

When the cannister is inserted into the launcher, electrical connection between probe and recorder is made. When the restraining pin is pulled the probe drops from the launcher. An electrical signal is generated when it hits the water and the recorder starts.

During the next 90 seconds the temperature-depth profile is recorded. When the probe reaches a depth of 1500 feet, it runs out of wire, the recorder stops, and the probe is expended.

The system gives accuracies of $\pm 0.2^\circ$ C in temperature and $\pm 2\%$ in depth. The expendable probe costs about \$20.

The Quartz Thermometer

The quartz crystal resonator, which has seen wide use as a stable controller of radio-frequency oscillators, has recently been introduced as an oceanographic temperature sensor.

The quartz thermometer uses two crystals. One is an AT-cut which is temperature insensitive. It controls a "reference" oscillator. The other crystal is an LC (Linear Coefficient of frequency with temperature) cut which is sensitive to temperature in a linear manner. It controls a "temperature" oscillator. At its operating frequency of 28 MHz it changes 1000 Hz per $^\circ$ C.

The outputs of the two oscillators are mixed. The crystal frequencies are selected so that the resulting difference frequency is zero at 0° C. The beat frequency increases 1000 Hz/ $^\circ$ C to 40 kHz at 40° C. This audio frequency signal is transmitted to an electronic counter that gives direct digital readout in $^\circ$ C.

The oceanographic temperature sensor was derived from the laboratory thermometer shown in Fig. 8. Here the reference oscillator and two temperature oscillators are built into the rack-mount assembly. The probes contain only the LC-cut crystals. Their cables are restricted to 12 feet in length. Probe diameter is $\frac{3}{8}$ inch and the small probe is less than an inch long. Their time constants are less than one second.

By contrast, Fig. 9 shows the oceanographic temperature probe. It is 10 inches long and $1\frac{1}{2}$ inches in diameter. Its time constant is three seconds. (Continued on page 95)

One of the new low-cost plastic-encapsulated epoxy transistors.

low-cost SEMICONDUCTORS FOR THE CONSUMER MARKET

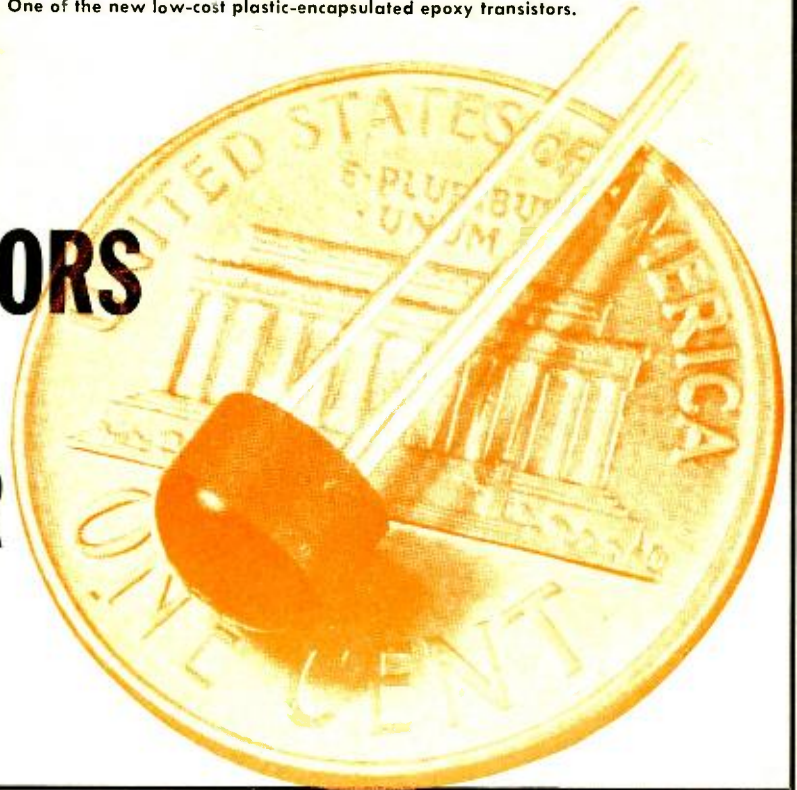

By JOHN S. MacDOUGALL

Consumer Applications Department, Fairchild Semiconductor

The availability of new plastic-cased IC's, transistors, and diodes is now opening up vast new home and auto markets. Here is what's happening to the semiconductors involved in this revolution along with a look into the future.

RECENT advances in semiconductor manufacturing technology have permitted drastic price reductions coupled with improved unit performance. These changes have alerted the consumer industry to the many advantages of using semiconductors. A quiet revolution is now taking place which will eventually trigger one of the greatest changes ever undergone by the consumer industry. In this age of space shots and moon landings the average housewife is probably unaware of the radical improvements which have been made in her household appliances. The purpose of this article is to examine what is happening to the components responsible for this revolution and from this to try and predict some of the future possibilities.

The Cost Picture

One of the primary reasons for the widespread acceptance of semiconductors in consumer products is price reduction. Transistors which once sold for \$60 (Fig. 1) now cost less than 20 cents while integrated circuits which once carried a \$200 price tag now sell for less than 60 cents. With these price reductions have come performance improvements so that in terms of price-performance the slope is really much steeper. When these changes are compared with the much smaller changes in the price of typical passive devices, such as resistors and capacitors, it is easy to see why manufacturers are interested. It should be noted that the prices shown for transistors are only for silicon devices since similar price reductions were made much earlier on germanium devices. However, it seems that silicon will dominate the

market in the long run and will ultimately yield the lowest price and the best performance.

Why have these drastic price reductions occurred and what basis is there for predicting that they will continue? In the first place, the application of sophisticated manufacturing techniques makes it possible to "make the device for the socket". In the early days transistors were made for the military or computer market and after the best units were supplied to these high-priced areas, an outlet was sought for the "fallout". When the "fallout" business started to dominate the market, the manufacturer had to decide whether to sell prime material in the low-cost market or lose present and future business. The decision, which was made for the

Fig. 1. Price declines for silicon semiconductor devices.

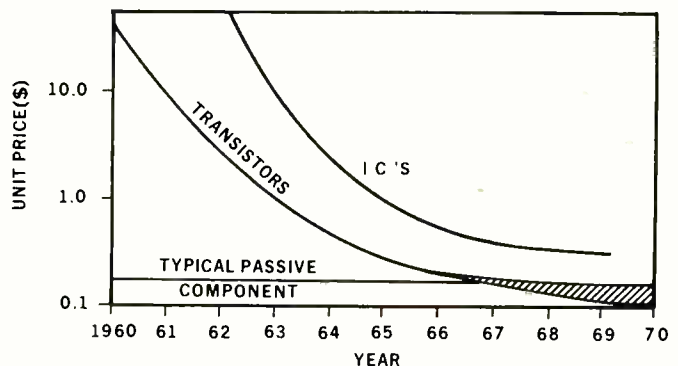

silicon market about five years ago, was to enter the low-cost market with products designed for that market with production rates geared to predicted volumes and costs.

The resulting industry buildup is now yielding high volume and low cost. For instance, in 1966 *Fairchild Semiconductor* conservatively estimated sales of over 100 million epoxy transistors with an expectation that the market will continue to grow at a similarly high rate for many years to come. Estimates of the total world-wide industry volume of epoxy devices is also growing (Fig. 2). It can be seen that in 1970 world consumption of epoxy transistors should reach about 1.5 billion units.

Full development of the low-cost semiconductor devices should be credited to a unique manufacturing process and the epoxy package. The former permitted high-yield volume production while the latter reduced the cost of the most expensive component in the assembly. A third factor, testing, has not been fully automated as yet. The process for fabricating silicon transistors has already been described extensively in the literature and will not be covered here. The die that results from this process contains a highly protective surface covering of silicon dioxide and can thus be handled by relatively crude techniques. However, the epoxy environment is a nasty one and, in addition to the surface treatment, it may be necessary to provide additional protection to the device depending on its circuit application and method of encapsulation.

There are two principal encapsulation techniques involving plastic materials: *pressure molding* and *casting*. Each technique has its advantages and disadvantages from a technical standpoint which more or less offset each other but the principal argument in favor of the casting method is its suitability in low-cost-labor areas. (How these techniques work and their differences are shown in Fig. 3.)

Although design engineers usually try to avoid them, there are instances where metal or non-epoxy packages must be specified. Prices on some form of metal packages have been drastically reduced in the past few years but one must still pay a premium. Metal packages provide true hermetic seal, high dissipation, and low interlead capacitance.

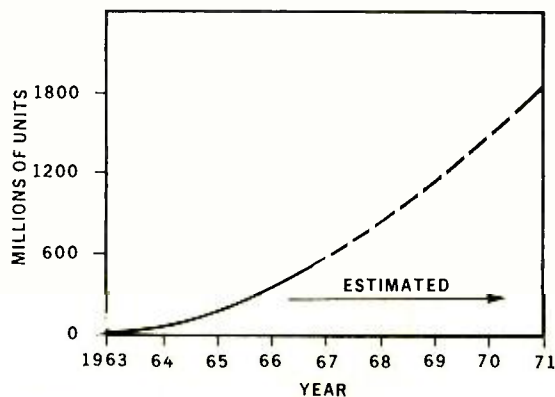
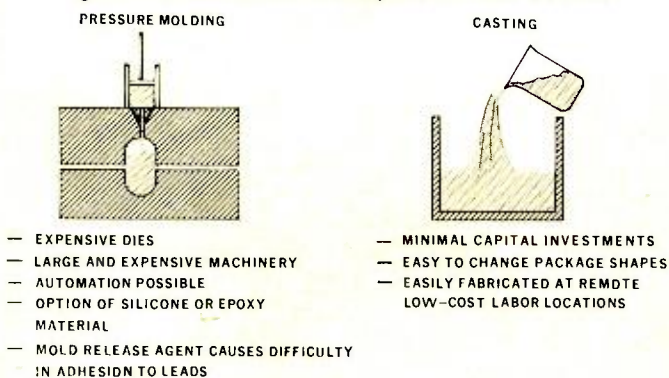

Fig. 2. Estimated world-wide usage of plastic transistors.

Fig. 3. Two main methods of encapsulation which are used.



If one assumes that the best device for a particular consumer application is one designed specifically for the socket, then it is obvious that the semiconductor manufacturer should be looking into all possible areas of semiconductor application to determine device requirements. Since the lead time from the conception of a new device specification to full production can be as long as two years, the semiconductor manufacturer must be at least two years ahead of his customers in order to be ready with the needed device. In looking for the technical and economic justification for making such a new device, he must consider the product for a particular application. It is only by operating in this way that a manufacturer can maintain his position in the market and continue to make a profit on high-volume, low-cost sales.

Another consideration that enters into the cost and price area is that of other possible methods of obtaining the same function. For instance, in the appliance field electromechanical switching functions can be taken over by equivalent SCR circuitry. However, relays, although inherently much less reliable, are still well entrenched in the industry and now sell at very low prices. In the radio and television industry, semiconductor components compete for the older vacuum-tube sockets on the basis of two factors—price of the total circuitry and performance.

What About Reliability?

The question most frequently asked by potential users of plastic-encapsulated devices concerns reliability. Reliability depends on the type of plastic used for encapsulation and on the environmental stresses.

In the early production runs of plastic devices reliability problems were encountered with both epoxy and silicone materials. At the present time technology has advanced to the point where both materials show exceptional resistance to environmental stresses.

The effects of environment are as follows:

1. *Humidity*: This great killer of all semiconductor devices can enter a plastic package *via* the lead-plastic interfaces, through the plastic interfaces, or *via* the absorption of the material itself. The interface route is by far the most common and problems in that area have now been eliminated. However, since the solution involves considerable plastic technology and know-how, it is still in the nature of a trade secret.

2. *Stray Ions*: The ion migration problem is of primary concern since undesirable ions are likely to be present in almost any environment under conditions of high-voltage back bias of the collector-base junction (a normal operating condition). These ions migrate to the semiconductor surface and form an electrostatic bias that tends to increase the leakage current of the device. The ions may be in the silicon dioxide itself or in the surrounding epoxy but wherever they occur the effect is readily apparent. Protection of the surface by metalization structures is almost essential for epoxy transistors operating above about 20 volts d.c.

3. *Shock*: Plastic-encapsulated transistors are especially resistant to mechanical shock.

Future of Integrated Circuits

In many digital applications in the industrial field, integrated circuits are now competitive with discrete devices in terms of total circuit cost. The systems designer gains a number of advantages by using integrated circuits:

1. If he has a minimum operating budget, he can avoid all of the design problems associated with the detailed circuit thus leaving his engineers free to concentrate on the system as a whole or additional performance features.

2. The system designer is buying a system component with guaranteed performance features.

3. Small size in large systems is of considerable help in terms of circuit boards to be assembled and handled.

4. Over-all cost of the product can be materially reduced.

In the consumer market, the use of integrated circuits is not as easy to justify since the systems are smaller yet still require the use of complex linear circuits. However, it seems that integrated circuits will ultimately enter the consumer area especially in radios, hi-fi equipment, TV sets, appliance controls, and automotive circuits. In all of these areas the circuit must offer equal or improved performance at an equal or better price as compared to discrete components in order to justify its use.

At present, it is technically feasible to make integrated circuits for the following portions of a color-TV receiver: the sound i.f., the video i.f., the sync-signal processing, the color amplification and processing, the color reference oscillator, vertical and horizontal scanning oscillators, the audio amplifier, and portions of the u.h.f. and v.h.f. tuners. If all of these circuits are integrated, the economics of IC manufacture will dictate that TV set makers have relatively little say in the design of the circuits or, on the other hand, the semiconductor manufacturer will function as a custom designer of IC's for the set maker. Obviously, some compromise between these two extremes will be required.

The Effect on the Consumer

The introduction of low-cost semiconductors will not offer the consumer any immediate price reduction in the equipment he is now buying. Rather, it is our feeling that the consumer will receive better performance from his present equipment and a chance to buy new kinds of equipment. For example, predictions of coming drops in the price of color-TV receivers are not based on the future trends of semiconductor pricing but on competitive factors. On the other hand it is certain that the consumer will be offered many extras which would not have been available to him except through the use of semiconductors.

Among the general features which low-cost semiconductors can provide are:

1. *Flexibility*: Changes in operating parameters of the device can be easily altered in the design phase, in production, or by the user.

2. *Remote Operation*: A timer or speed control need not be at the point of operation—the attic fan can be easily controlled from the bedroom via low-voltage signal circuitry.

3. *New Control Features*: SCR speed control of mixers is one example.

4. *Reliability*.

There are many new things that can be done with semiconductors in household equipment. What are these new areas of application and what features do they offer the consumer?

1. *Continuous Speed Control*: Better and more reliable hand mixers, sewing machine which operate smoothly, and quieter fans and air conditioners will result. A current application of an SCR control to a washing machine permits control of the machine agitator for delicate fabrics without compromising its ability to handle heavy loads.

2. *Continuous Power Control*: A light dimmer is a relatively low-cost and unsophisticated example of this. In the future one might expect electric ranges with heating elements offering continuous control such as is now possible with gas stoves. Coffee machines with reliable contactless operation and space heaters with continuous proportional heat are other examples.

3. *Flexibility of Timing*: In the future we may have a timer for the whole house which could be programmed to ring the morning alarm, turn on the coffee maker, start the lawn sprinklers, turn off the lights (or turn them on sequentially during vacation periods), and start the oven. With a mechanical timer, providing these functions would be very complicated, but with a solid-state electronic unit, it would be a fairly simple matter and certainly much more reliable.

With this increased capability made possible by the use

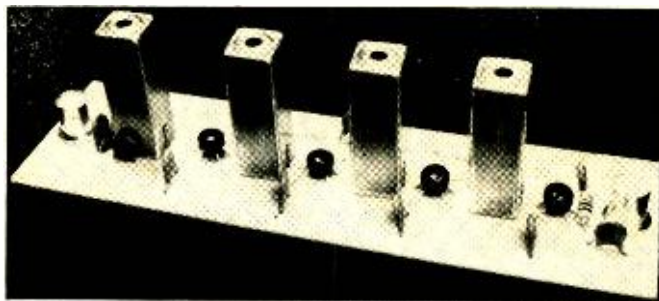

Here are four plastic IC's used in FM tuner i.f. strip. Note the absence of a large number of separate R and C components.

of semiconductors we can look forward to a host of new appliances and important changes made in older models.

The automotive field is another prime area for the application of low-cost semiconductor components. Two features can be offered which will make their use attractive to the car and truck buyer. The first of these is reliability. With the longer warranty periods and the new emphasis on safety, reliability is becoming both an economic and a performance sales tool. The second feature is added performance. The electronic ignition system is already available as an option for increased performance, however, it has not been widely accepted by the consumer since the improved performance is rarely obvious in everyday usage.

On the other hand, an electronic ignition system which would provide automatic timing adjustment would be very desirable and, at present, appears economically feasible.

In addition to improved radios, tape recorders, and back-seat TV receivers for the car, there are many areas where real performance features can be added. Some of these include anti-skid brake controls, computer-controlled automatic transmission systems, and automatic speed controls.

As to the future, production rates will continue to increase and epoxy devices will dominate the field. Integrated circuits will be introduced and used in conjunction with discrete circuits in the most economical arrangement. The appliance and automotive industries will certainly incorporate semiconductors in their products at an accelerated rate and this will create a booming new semiconductor market area. ▲

POSSIBLE USES FOR SEMICONDUCTORS IN THE HOME

- SCR control of electric range elements
- Capacitance burglar alarms or door openers
- Garage door openers using IC's
- SCR light dimmers
- IC temperature sensor for furnace control
- Digital electric clock using IC's
- A.c.-to-d.c. converter for electric razors to allow razor motor to deliver higher torque
- IC limit clocks for stop-start operation of electric ovens
- Ultrasonic power source for ultrasonic dishwasher and/or washing machine
- Solid conductivity detector to turn on sprinklers as the lawn dries out
- Water level cut-out switch for bath tubs and sinks to prevent overflow
- Automatic humidity control for dry air regions
- SCR control for electric blanket
- Electronic bathroom or food-weighing scale using strain gage coupled to counters
- Electronic metronomes for musical-instrument students
- Automatic electric timer-temperature computer for photography fans
- Timers for washers, dryers, ovens
- Speed controls for drills, saws, washers, furnace fans, air conditioners
- Digital coded or magnetically coded door locks
- Automatic focus control for projector
- Pollen/dust count detector and electronic filter control

DIRECTORY OF MOST POPULAR, LOW-PRICED



PHOTO	Model	Number of Heads	Tape Size Used (in)	Reel Size (in)	Tape Speed (ips)	Record-Playback Time (min.)	VIDEO					
							Input Level (V)	Output Level (V)	Response (MHz)	Horiz. Resolution (lines)		
AMPEX CORP., 401 Broadway, Redwood City, California 94063												
A	VR-6050	1	1	9¾	9.6	60	1	75	R.f. ^a 300	2.5	250	
	VR-7000	1	1	9¾	9.6	60	1	75	{ R.f. ^a 300 1 75	3.5	350	
	VR-7500	1	1	9¾	9.6	60	1	75	{ R.f. ^a 300 1 75	4.2	350	
CONCORD ELECTRONICS CORP., 1935 Armacost Ave., Los Angeles, Calif. 90025												
B	VTR-500	2	½	7	12	60	1	75	{ R.f. ^a 300 1 75	2.5	250	
CRAIG PANORAMA INC., 2302 15th St., Los Angeles, Calif. 90021												
	6401	2	½	7 or 8¼	9½	63	.5	75	1	75	—	200
GENERAL ELECTRIC CO., Audio Products Dept., Decatur, Illinois 62525												
C	VC-941	2	½	7	7½	90	1	75	1.4	75	—	200+
GENERAL ELECTRIC CCTV Business Section, Syracuse, N. Y. 13201												
D	2-30	2	1	8	7.8	63	.5	75	1	75	3	300+
	PT-3A	2	½	7	7½	64	1	75	1.4	75	—	200+
	PT-2A	2	½	7	7½	64	1	75	1.4	75	—	200+
MATSUSHITA ELECTRIC CORP. OF AMERICA, 200 Park Ave., N. Y., N. Y. 10017												
E	NV-8000	2	½	7	12	40	.4	75	1	75	2	200+
F	NV-204	2	1	8½	8.57	67	.5	75	2	75	3	340
PHILIPS BROADCAST EQUIP. CORP., 900 South Columbus Ave., Mt. Vernon, N. Y. 10550												
G	EL3400	1	1	8	9	40	1	75	1 R.f. ^a 75 300	3.2	285	
REVERE-MINCOM DIV., 3-M CO., 2501 Hudson Road, St. Paul, Minnesota 55119												
	Wollensak VTR-150	1	½	8	7½	60	1	75	1	75	2	—
SHIBADEN CORP. OF AMERICA, 58-25 Brooklyn-Queens Expressway, Woodside, N. Y. 11377												
I	SV-700U	2	½	7	7½	60	1	75	1	75	3.5	300
SONY CORP. OF AMERICA, 47-47 Van Dam St., Long Island City, N. Y. 11101												
	CV-2000D	2	½	7	7½	60	1	75	1	75	2.5	200
J	CV-2000	2	½	7	7½	60	1	75	1	75	2.5	200
	TCV-2010	2	½	7	7½	60	1	75	1	75	2.5	200
K	TCV-2020	2	½	7	7½	60	1	75	1	75	2.5	200
L	DV-2400	1	½	5	7½	20	1	75	—	75	2.5	200

a—VHF channels 2 through 5; b—camera; c—monitor; d—tripod; e—microphone; f—mono version \$3995; g—recorder, camera, monitor as package \$1509.50; h—TV101 school trainer including VTR, receiver, viewfinder camera, tripod, console \$5800; i—R.F. modulator; j—built-in monitor; k—built-in timer.

VIDEO TAPE RECORDERS



AUDIO						Dimensions (in)			Weight (lbs)	Price (\$)	Special Video	Notes	
Micro. (dB)	Line (Ω)	Line (dB)	Line (Ω)	Output (dB)	Output (Ω)	Response (Hz)	W	H					D
—	50K	—	100K	—	—	90—9,000	—	—	—	85	1195	—	b, c, d, e
.2 mV	200	.12 V	100K	{ 4 dBm 8Ω	600 6W	50—12,000	29 3/4	13 3/4	20 1/4	100	3450	—	b, c, d, e
.2 mV	200	.12 V	100K	{ 4 dBm 8Ω	600 6W	50—12,000	29 3/4	13 3/4	20 1/4	110	4495	color	b, c, d, e, f
1 mV	20K	1 V	1 meg.	1 V	600	60—12,000	17	10	16 1/2	52	1050	—	b, c, d, e, g
-60	10K	-10	10K	0	2K	70—10,000	21 3/4	13 3/4	17 3/4	65	1035	—	Accessories: camera, monitor, tripod, mike
-60	600	-20	high	0	high	80—10,000	18 1/2	10 1/2	16 5/8	—	1600	—	Includes cam- era, micro., monitor, cables
-70	600	-8	10K	+4	600/10K	—	26	11 1/2	17 7/8	88	3495	still, slow motion, color	two audio channels consists of VTR, cam- era, monitor console—VTR, camera, monitor
0.775 mV	600	—	—	-2	10K	80—10,000	15 1/2	9 3/4	16 1/2	62	1695	—	
0.775 mV	600	—	—	-2	10K	80—10,000	37 1/2	34 3/4	26	75	1995	—	
-60	20K	0	1 meg.	-20	600	80—10,000	16 5/8	9 7/8	16 3/8	54 1/2	1050	—	b, c, d, e, i
-65	600	-10	600	0	600	50—12,000	24 7/8	12 1/2	16 1/8	97	3750	still, color	b, c, d, e, i
1 mV	1K	200 mV	500K	1 V	20K	120—12,000	24 3/4	16 1/2	15 1/4	100	2495	—	b
.2 V	10K	—	—	.5 V	10K	50—10,000	20	9	14	50	1495	—	—
-60	10K	-14	10K	-14	Low	50—10,000	15 3/4	9 1/2	15 3/4	53	1295	still	b, c, d, i
-60	600	-2	high	0	high	80—10,000	19 3/4	9 7/8	15 1/4	42 1/2	695	—	b, c, d, e
-60	600	-2	high	0	high	80—10,000	18 1/2	11 7/8	13 3/4	46	730	—	b, c, d, e
-60	600	-2	high	0	high	80—10,000	27 1/2	11	16 1/4	66	995	—	b, c, d, e
-60	600	-2	high	0	high	80—10,000	29 1/2	11 7/8	11 7/8	70	1150	—	b, c, d, e, j, k
-60	600	—	—	—	—	—	10 1/2	9 3/4	12 1/4	12	1250	—	camera, view- finder, micro. battery powered

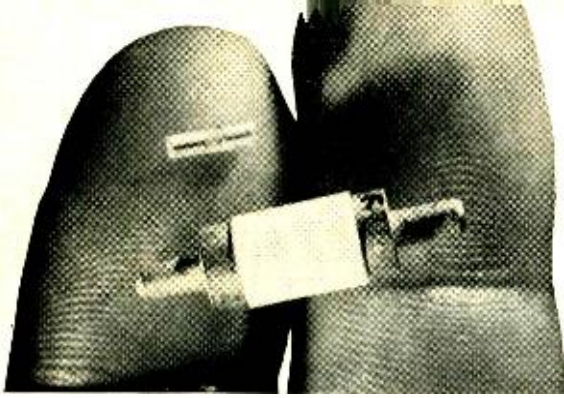

The larger device is intended for the Gunn bulk oscillator, while the smaller device houses a Read-type junction diode.

GUNN OSCILLATORS

By DAVID L. HEISERMAN

A new type of microwave semiconductor that may one day replace present complex and expensive sources, and create new consumer microwave communications and radar devices.

THERE is little doubt in the minds of semiconductor scientists and engineers that microwave technology is on the threshold of a miniaturization and cost revolution. A new breed of simple microwave semiconductors may one day replace our present complex and expensive microwave sources and create a whole new line of consumer microwave communications and radar devices.

The makers of the revolution will be the new transit-time semiconductors best represented by the Read p - n junction diode and the Gunn bulk gallium arsenide oscillator. (See "New Frontiers in Semiconductors" on page 78 of the March, 1967 issue.) At this stage of development, however, no one can say which device will eventually set the microwave revolution into motion—both have advantages and disadvantages, and both are plagued by production reliability problems.

The theories of operation of both devices are rather new. The Read-type device operates on the well-known principles of the zener and tunnel diodes with the new idea of semiconductor electron transit time tying the two effects together. The operation of the Gunn device, however, represents a radical departure from conventional semiconductor thinking. In this respect, the Gunn device is worthy of closer study.

Gunn's Discovery

Those of us who have been working in electronics for more than a few years associate semiconductor devices with one or more p - n junctions. We think in terms of holes and electrons, minority and majority carriers, junction potentials—always in terms of at least one pair of p and n semiconductor materials within one device. To think of an operational semiconductor made up of only one type of semicon-

ducting material (a bulk semiconductor) is, traditionally, to think of an impossibility. Despite conventional thinking, the "impossible" was accidentally discovered by Dr. J.B. Gunn at IBM's Watson Research Center.

In 1963, Gunn was running a series of routine experiments on a 0.005-inch thick slice of homogeneous n -type gallium arsenide when he noticed some unexpected coherent r.f. oscillations on his oscilloscope. Checking the set-up for possible stray reactance or faulty components, he discovered that the plain n -doped material was oscillating at slightly less than 1 GHz (1000 MHz) with nothing more than a 6-volt d.c. power supply connected to the terminals (Fig. 1).

What had been a purely theoretical possibility became a fact—Gunn found a semiconductor material that could oscillate in the microwave region without benefit of external tuned circuitry.

Gunn and his associates soon realized that they had uncovered a phenomenon that could not be explained in terms of the usual semiconductor theories, so they were forced to try new theories and experimental techniques. The theoretical model of the oscillator, as finally developed, represents one of the biggest sidesteps from the mainstream of semiconductor thinking since the introduction of the laser diode.

Negative Resistance in Bulk GaAs

Without the benefit of the usual p - n junction, the Gunn oscillator demonstrates negative resistance properties. The quantum energy diagram and corresponding I - V curve are shown in Fig. 2.

The diagram shows the usual forbidden gap between the valence and normal conduction bands. These regions in GaAs have the characteristics of any other n -type semicon-

Fig. 1. The current through bulk GaAs increases with an increasing amount of applied d.c. voltage until the conduction-band electrons gain enough energy to skip upward into high energy, low-mobility band. At this threshold voltage (about 3000 volts/cm or about 6 volts of applied voltage) the GaAs sample will oscillate without any external tuned circuitry.

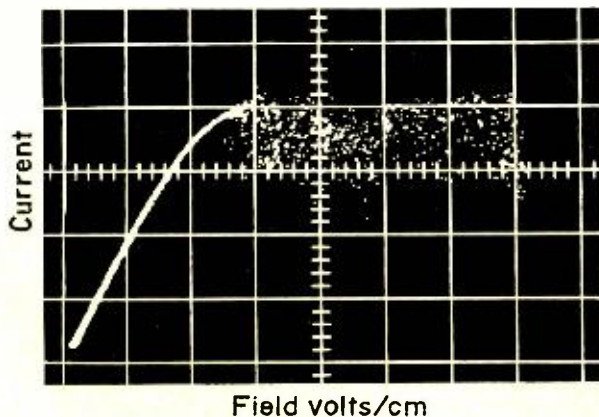
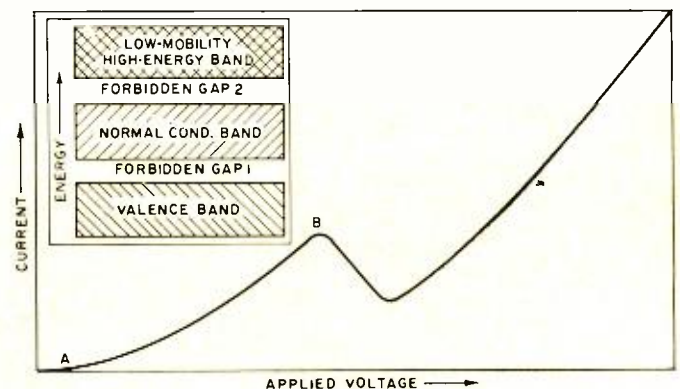

Fig. 2. The quantum-energy diagram (shown in the inset) along with a corresponding current-voltage curve for bulk gallium arsenide are illustrated below. The existence of the second forbidden gap and the low-mobility, high-energy conduction band gives GaAs quite different properties from the usual semiconductor, such as n -doped silicon, showing no negative R .



ductor such arsenic-doped silicon. The *GaAs*, however, has an additional forbidden gap and a special conduction band that differs from the first in two important respects. First, carriers (electrons in the case of *GaAs*) can cross the second forbidden gap only when the applied d.c. potential reaches an extraordinarily high value of 3000 volts per centimeter. Second, carriers that *do* gain enough energy to skip into the second conduction band effectively gain some mass and thus travel much more slowly through the semiconductor than their lower energy counterparts in the first conduction band.

The second conduction band is thus described as one containing only high-energy carriers which travel with unusual slowness through the semiconductor. It is this additional conduction band that makes it possible for an *n*-type bulk semiconductor to show negative resistance.

Referring to the *I-V* curve in Fig. 2, the non-linear slope between points A and B is due to the increasing fraction of valence electrons skipping upward into the high-mobility first (normal) conduction band under the influence of a small applied voltage.

As the applied e.m.f. is increased beyond point B, however, the current drops off sharply. It is at this point that some of the electrons in the low-energy, high-mobility first conduction band enter the high-energy, low-mobility second conduction band. If electrons move slower in the second conduction band than they can in the first, it follows that increasing the percentage of electrons in the second conduction band will cause a corresponding decrease in the net rate of electron flow through the material. As the applied voltage passes beyond point B, then, the current through the *GaAs* sample decreases. This, of course, is the general description of a negative-resistance effect.

The negative-resistance, junction-type semiconductors in use today require some capacitance or inductance to sustain oscillation while the Gunn device does not. So, negative resistance in bulk semiconductor theories are potentially useful, but cannot wholly account for the Gunn effect.

Electron Domain Transit Time

The theory that finally rounded out the explanation of the Gunn effect involves the new concept of slow-moving, high-energy packets or "domains" within a bulk semiconductor.

If a sufficient voltage (the threshold voltage) is applied to a thin slice of *n*-type *GaAs*, electrons skipping into the second conduction band tend to collect into discrete energy domains. Further, if the *GaAs* is of sufficient purity and the applied voltage is carefully regulated, one and only one domain can exist within the material at any one instant.

Since this one domain is made up of second conduction band electrons, the domain will behave exactly as the electrons described in connection with Fig. 2. The domain will drift with relative slowness from cathode to anode, holding the net current flow through the semiconductor to a minimum.

Once the domain reaches the anode, it disappears momentarily and current surges through the material *via* the first conduction band. This surge continues until another high-energy, low-mobility domain forms at the cathode. The current through the bulk semiconductor, then, is low during the electron domain transit time and relatively high during the brief period of time it takes to form another do-

main at the cathode. Thus, the Gunn device demonstrates current oscillations, the period of which depends on the rate of domain travel and the physical length of the bulk semiconductor material.

The oscillogram of Fig. 3 shows the high-energy domain passing through discrete points along the length of a thin slice of bulk *GaAs*. The trace at the top shows the domain leaving the cathode. In the following traces, the moving electron domain is shown at points progressively closer to the anode. If the frequency of oscillation is assumed to be about 1 GHz, the traces cover an interval of about 1 ns.

At the present stage of semiconductor technology, the Gunn device's advantages of small size, low cost, and simplicity must be weighed against the disadvantages of lower operating frequency and low c.w. output power. Placed beside the Read-type devices, the Gunn oscillator has about a 50 percent chance of becoming *the* microwave source of the future. See Table 1.

Regardless of the final outcome, the Gunn effect described in this article represents another opening to products and industrial equipment thought impossible a few years ago. ▲

Fig. 3. The low-mobility, high-energy electron domain passing through the Gunn device. The domain builds up near the cathode and moves with relative slowness to the anode, holding the current through the semiconductor to a minimum. Although the ordinate of the oscillogram is in terms of field strength, the downward progression of traces has no physical meaning except to display the chronology of the shock wave that is produced.

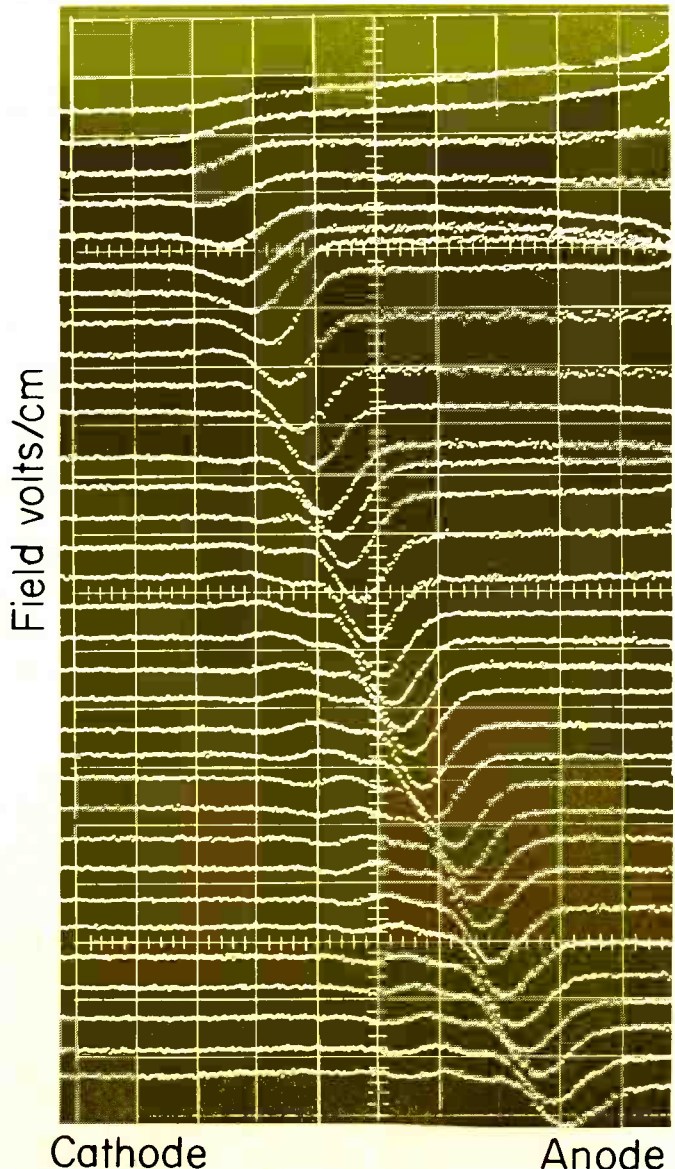

Table 1. Performance of Gunn and other microwave devices.

DEVICE	FREQ. RANGE	POWER OUTPUT	EFFICIENCY
Gunn oscillator	2-3 GHz	0.060 W (c.w.) 200 W (pulsed)	5-6% 14%
Read diode	5 GHz	0.019 W (c.w.)	0.5%
Small klystron	10 GHz	0.100 W (c.w.)	2%

Electronics For Speech and Hearing Therapy

By L. GEORGE LAWRENCE

Special techniques for detecting response to auditory stimuli, loop-type induction receivers, and unique neurological sound inducers are some of the many types of electronics used to help hearing-handicapped people.

THE creation of a normal educational profile for hearing-handicapped persons, especially children, is of interest to society at large. Today, with otologists, audiologists, and educators being supported with purpose-tailored electronic systems, good progress is being made in nearly all teaching situations.

Unlike "normal" children, young students afflicted with a hearing impairment are exposed to electronic devices at an early age. This exposure begins when the child is taken to a clinic for audiometry, to be tested for threshold levels and fitted with a suitable hearing aid. In many cases, this piece of equipment will be an indispensable companion throughout life. Unlike those who use electronic devices for purposes of entertainment and the like, a handicapped person depends upon electronics for his personal welfare.

Although his vocal cords may be intact, the hearing-impaired child might be unable to speak. Speech requires an inventory of auditory-type references, a set of "models" after which a speech pattern can be formed. But since the child cannot hear, he is unable to collect and vocalize these references in a distinct and comprehensive manner.

In traditional audiometry, the clinical worker tends to define hearing in terms of a raised finger or a pressed signal button after the patient has been verbally or otherwise instructed to respond to sounds directed to him *via* headphones connected to an audio generator (audiometer). One

might also say that a patient hears if his pupils contract or if his skin resistance decreases. And there also may be a "startle response" that follows a sudden intense stimulus. Unfortunately, the finger-raising and button-pressing type of auditory response indicators tend to fail if the patient is difficult to instruct or if he is unable to respond to verbal instructions due to too great a loss of hearing. It is under these and related conditions that quantitative information must be obtained by means of *galvanic skin response*.

Galvanic Skin Response

Two kinds of response are of interest: the *Tarchanow effect* and the *Féré effect*. The former is a change in electrical *potential* that exists between two points on the surface of the skin, while the latter is a change in electrical *resistance* between two such points. The Tarchanow effect, or galvanic skin response, can be elicited both by intense sounds and electric shocks—the magnitude being directly related to the intensity of the stimulus.

Fig. 1 illustrates the equipment used for measuring changes in skin resistance (*Féré effect*) in response to applied electric shock and conditioned auditory stimuli. The shock electrodes may be connected to the arm or leg, and the resistance-measuring electrodes may be placed either on the top and sole of the foot, or on the back and palm of the hand. In practice, the first tones as supplied *via* headphones have a relatively high intensity. After an interval of 4 or 5 seconds, each tone is followed by a mild shock. The pause between tone and shock is long enough for separate response data to be gathered. As the intensity of the tone is gradually reduced, a point will be reached where the patient gives no response to the tone alone. The process, repeated several times, makes it possible to calculate a definite threshold of auditory acuity.

Historically, these and related methods are traceable to the Russian Nobel Laureate I. P. Pavlov (1849-1936) who pioneered studies in conditioned reflexes. The American scientists J. E. Bordley, W. G. Hardy, and C. P. Richter, as a result of experiments published in 1949, brought this art to a high degree of perfection. Other workers, active both here and abroad, are in the process of adapting and redefining these principles for the purpose of creating *tactile* communication systems. Tactile data communicators are a must if, for example, one wishes to transmit a set of emergency instructions to an astronaut whose hearing has been impaired due to brief, accidental decompression of a space suit or vehicular system.

In alignment with Pavlovian theory and concepts developed by American psychologist B.F. Skinner, speech pathologists have long recognized the need for speech to be recorded and played back to a hearing-loss-afflicted individual. The "phonic mirror" is a modern example of an instrument that lets the student speak whenever ready; then, after a few seconds' delay, he hears his speech played back automatically. Since he can listen to the playback several times,

Fig. 1. When measuring changes in skin resistance in response to shock and auditory stimuli, instruments rather than the patient indicate the true hearing threshold.

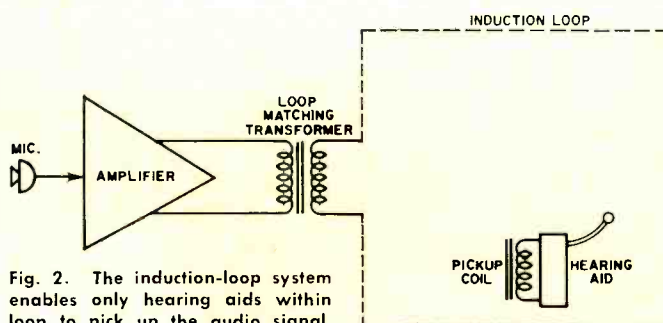
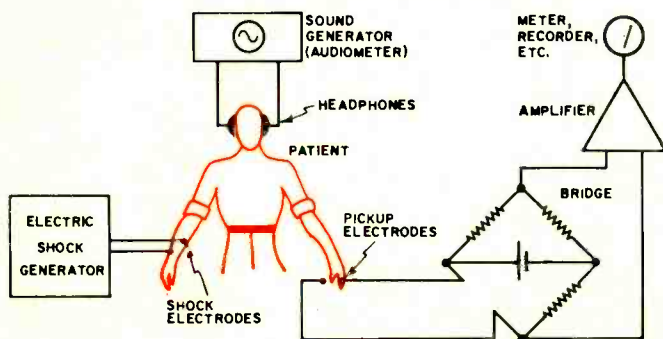

Fig. 2. The induction-loop system enables only hearing aids within loop to pick up the audio signal.

evaluation and correction processes become much more effective.

Most instruments of this type use a continuous-loop tape mechanism. Maximum sound-pressure levels are at 135 dB with a S/N ratio of 65 dB. The output amplifier develops 3 watts. In some designs, the student simultaneously hears the clinician's production in one ear and his own production in the other ear. By means of a binaural balance control, the clinician can vary sound intensities of the two stimuli, thereby creating a flutter effect that focuses attention. It is also possible to reverse the stimuli transmission between ears to emphasize speech discrimination and modification. The high sound pressure of 135 dB enhances the indication of sibilant disorders (lingual and lateral lisps) requiring correction.

Induction Loops

For many years, the two standard methods of amplifying speech for the deaf and hard of hearing have been the conventional hearing aid and the group amplification system. Unfortunately, in the case of group amplifiers, the presence of connecting cables tends to place a severe restriction upon the movements of students. To mitigate these disadvantages, a new kind of wireless classroom hearing aid has been introduced. The composite system is known under the name of "loop-induction trainer" and is shown in Fig. 2.

The generic term "induction" simply implies the transfer of electrical energy by wireless (non-galvanic) means. In the case at hand, loop-type communication systems were used during World War II aboard ship to enable the captain to speak to his crew while moving around. The present systems have been modified slightly, but the basic principle has been retained.

In operation, speech is picked up by the microphone. An amplifier magnifies the product and, *via* matching transformer, applies it to the loop. The loop itself consists of a thin wire strung around the interior of a given classroom. If a person having a hearing aid equipped with a telephone-type pickup coil moves within or close to the loop, he will hear the original audio information as picked up by the microphone feeding the power amplifier. Unfortunately, as experience has shown, the sound pattern often tends to be non-uniform at different places within the loop area. To mitigate this undesirable effect, efforts are being made to equip the receiving hearing aid with an a.g.c.-type amplifier such as shown schematically in Fig. 3. In this particular case, the a.g.c. voltage is derived from a voltage-doubler circuit having an a.c. supply winding of its own on the intermediate output transformer. The a.g.c.'s attack time is determined by the RC values in the a.g.c. line. The loop-feeding power amplifier might employ a similar form of volume gating to maintain the radiated electromagnetic loop energies at a predetermined level. Customarily, if sound pressure increases by 40 dB, the automatic gain control will hold the

Fig. 3. The use of a.g.c. helps to maintain a constant volume level.

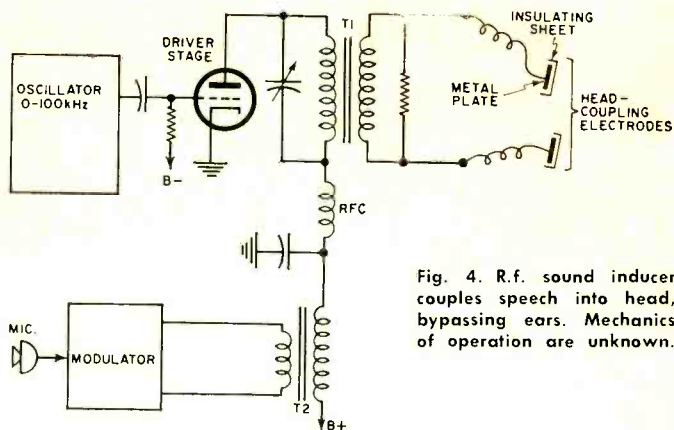
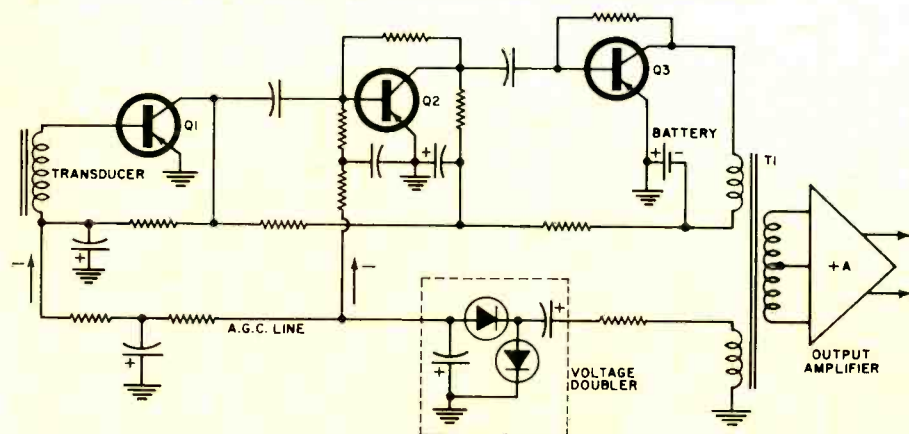

Fig. 4. R.f. sound inducer couples speech into head, bypassing ears. Mechanics of operation are unknown.

output stable within approximately 2 dB of the selected level.

A typical free-field speech trainer in the form of a standard hearing aid has a frequency response from 400 to 4000 Hz ± 5 dB with three separate internal adjustments. It may operate from the induction loop or from an individual program source with control by the teacher or student. A convenient shoulder harness adds comfort.

Generally speaking, loop-type induction trainers appear to work very well in most situations. However, an interference problem occurs if there are too many fluorescent lights or certain other electrical fixtures operating in the classroom adding electrical noise to the program. Another drawback is electromagnetic spillover into adjacent classrooms, but cloverleaf loop patterns mitigate these effects.

New Concepts

While no drastic changes in traditional techniques and implements can be expected in the immediate future, the supreme position held by acoustical-type hearing aids will be challenged once the intrinsic auditory mechanisms have been defined more clearly. It appears that r.f.-type hearing aids offer new promise; but, unfortunately, their method of operation is such that manufacturers would be reluctant to let the public at large "play" with these relatively potent devices.

An r.f.-type hearing aid is illustrated in Fig. 4. The apparatus takes the form of a Heising-modulated low-frequency transmitter operating at approximately 50 kHz. Insulated electrodes, connected to the output tank, are placed on facial areas (but not the region of the temples) and the system is then energized. The apparatus is unique in that it induces a clear, audible signal directly into the brain's neuron complex by bypassing the ears completely. The biological mechanism responsible for the phenomenon has not yet been defined, but it seems to lie *behind* the common auditory track. Since the effect does very much exist, scientists are forced to re-evaluate and, if possible, restate the

classic laws dealing with stimuli and experienced sensation. Since the respective findings are of importance to the character of this article, some of the more pertinent points are outlined below.

In 1860, the German physicist G. T. Fechner (1801-87) published his widely acclaimed book *Elemente der Psychophysik*. In it, Fechner presented a scheme whereby the magnitude of a sensation could be computed from objective measurements of various physical stimuli and responses. He seemingly made clear once and for all that stimuli and responses could be measured directly, whereas sensations could

(Continued on page 69)

Report on Annual Assembly of RADIO TECHNICAL COMMISSION for MARINE SERVICES

By RICHARD HUMPHREY

Most of this year's Washington RTCM meeting was devoted to the coming shift to single-sideband in the 2-3 MHz band and changes in new v.h.f. channels.

THE May 16-18 annual Assembly of the Radio Technical Commission for Marine Services in Washington, D.C. revolved around two centers: the coming shift from double-sideband to single-sideband emission in the 2-3-MHz marine band, and the extensive alterations in the new 18-channel v.h.f./FM marine frequencies.

The change in the v.h.f./FM band is in its final steps before becoming law. A Notice of Proposed Rule Making (issued March 15th) uses channel-splitting (going from 50-kHz to 25-kHz spacing) to create 38 transmit and receive channels and one receive-only "environmental" channel in the same spectrum spread presently occupied by 18.

Because of this doubling-up in the v.h.f./FM marine band, the first step under the FCC Notice (carrying an effective date of January 1, 1968) will be to go from wide-band FM (± 15 kHz) to narrow-band FM (± 5 kHz) to prevent adjacent-channel spill over. Our country's attitude, as expressed at the Assembly, is that the gain in the number of channels and new services included in the expansion plan (such as bringing the weather reports—now on 162.5 MHz—into the fold by including them in the 156.75-MHz "environmental" frequency) far outweigh the loss of capture effect and the possible incompatibility between foreign and U.S. ships.

J.C. Hillman of RCA cited the "good service provided at ± 5 kHz FM in the land service" but went on to point out that there might be problems in trying to dovetail an international wide-band FM system with an American narrow-band FM system.

The international wide-band signal would be received with a high degree of distortion on an American narrow-band receiver. On the other hand, reception of narrow-band FM on a wide-band receiver results in no distortion but there is a definite loss of recovered audio. Most probably this could be compensated in the majority of cases by advancing the volume control.

The unofficial consensus was that v.h.f./FM equipment in the U.S. could best be "converted" by merely decreasing the transmitter deviation since, as Hillman put it, "tighter tolerance and roll-off filters are not required until 1971". This solution should certainly please owners of existing v.h.f./FM installations who have been worried about the expense of narrow-banding their equipment. For a towing or shallow-draft tanker company with a number of vessels this would represent quite an outlay. Recreational boaters already committed to v.h.f./FM should be similarly relieved.

A good case for opposing views on the v.h.f./FM expansion was made by Colonel J.D. Parker (Secretary-General of the Committee-International Radio-Maritime) when he charged that the FCC's March 15 Notice "relies on the assumption that a large number of pleasure vessels are going to be forced to fit marine v.h.f."

This hopeful assumption has been implicit in FCC (and U.S. Coast Guard) thinking from the outset.

Referring to the pleasure boater, Colonel Parker doubted

that single-sideband equipment "need be so expensive as to preclude its use". A review of SSB marine radiotelephones presently on the market and small enough in size and voltage requirements, show the most inexpensive set to be well over \$1000. On the other hand, *Heath Company's* C.A. Robertson said (in his paper) "our SSB marine radiotelephone" should "cost the boat owner about \$720". The representative of another manufacturer suggested that his company is planning to sell an SSB marine radiotelephone in the \$600 range.

Clearly the equipment choice available to both commercial and recreational marine interests is already expanding. The decision may not be so single-ended, *i.e.*, "to go to the v.h.f. band", as it was before.

But the problem still remains: which marine band will give the recreational boatman more of the services and type of communications he might feel he needs? If you think the interference and congestion on the 2-3-MHz band during the summer boating months is bad *now*, wait until all those thousands of pleasure-boat radio licensees begin falling over each other's transmissions with highly efficient, greater-distance-capability SSB emission.

The single-sideband question was in the future when Lt. Cmdr. Walter Hamilton (then Chief of Communications, 3rd U.S. C. G. District) in speaking for the 3rd District said, in effect, that the average recreational boater should get rid of his 2-3-MHz equipment because he didn't need it. Neither was SSB in Victor B. Robinett's (AT&T Engineering Staff) mind when he told the author v.h.f./FM should be used *instead* of 2-3 MHz by the bulk of pleasure boaters. This attitude (echoed by FCC officials, other Coast Guard officers) that the v.h.f./FM marine band is *the* place for the great majority of pleasure-boat stations has been reported many times in the past.

The author contends that to deliberately "sell" single sideband to those recreational boat owners whose interests would the best served by v.h.f./FM and make it possible for them to cause interference *thousands* of miles away instead of *hundreds* of miles away is a monumental disservice to marine communications as a whole.

The Interference Problem

Interference on the v.h.f./FM frequencies presently is almost non-existent. The minimal number of users contributes of course, but the fact that the bulk of the transmissions are by commercial users who keep their talk short and to the point is also a factor. But one characteristic of v.h.f. is going to *keep* the interference factor below that of the 2-3-MHz band: the line-of-sight feature. With a thousand vessel-stations, including yours, in a two-hundred-mile area on 2-3 MHz it is entirely clear that the potential interference factor is 999, the number of vessel-stations who could interfere with you and *vice versa*. This interference factor would be diminished on v.h.f. by the (Continued on page 86)

SWITCHES

A Guide to Selection & Application

By ARTHUR F. HACKMAN

Component Specialist, Standards Engineering Dept., McDonnell Douglas Corp.

Important factors for mechanically and manually actuated switches are presented as a practical aid in choosing the best switch for the job.

WHEN trying to decide what switch to use, your first questions must be "What function do I want the switch to perform? Will it be used to switch one circuit, two circuits; to switch electrical power to one load, two loads, or to one of several loads?" The answer must include the number of poles and the number of throws which make up part of the switch description. The word "throw" is not to be confused with the word "position" since "position" includes any "off" position that may exist. Hence a simple single-pole, double-throw switch can switch the power of one circuit to either of two loads and may be equipped with two, or with an "off," three positions. If a switch is to be kept in some particular position, this too is reflected in the description, such as single-pole, single-throw, normally open. Standard terminology and circuit arrangements are illustrated in Fig. 1. Those for rotary and other types of switches will be covered later in this article.

Voltage and current ratings must also be considered. The electrical ratings of the switch should not be exceeded if satisfactory operation is expected. It is not necessary to derate or use a percentage of the rated current of the switch of a reputable manufacturer. However, if greater electrical life is desired, the manufacturer can probably recommend a reduced current that will increase switch life. Current overloads decrease switch life; sufficiently high or consistent overloads cause early switch failure by welding the contacts. Over-voltage also decreases switch life. Ultimate switch failure from overvoltage results because the switch is unable to interrupt current flow after the contacts have separated. Voltage or dielectric failures are usually catastrophic, sometimes resulting in an explosion.

Often, minimum levels of voltage-current are overlooked but when values are expressed in millivolts and microamperes it is wise to determine and specify the maximum acceptable voltage drop at the rated load across the contacts. Usually gold contacts are specified for such applications, but this should be checked with the manufacturer or your company's switch specialist, if there is one.

There are many advantages in using off-the-shelf switches. The fact is that the vast majority of applications can be handled without the need for a specially designed switch. Admittedly, the state of the art would never advance without new designs, nevertheless an attempt should be made to use existing switch designs whenever and wherever possible.

After determining what circuit configuration and electrical capacity is required, the next choice involves the method of actuation. This choice falls into two categories: 1. mechanically actuated, and 2. manually actuated switch.

Mechanically Actuated Switches

Very often an engineer will find that the mode of mechanical actuation is dictated by his design, that is, the medium sensed is also the actuating medium. The majority of these switches fit into the following categories: pressure sensitive switches, temperature-sensitive switches, and position-sensitive or limit switches.

Pressure-sensitive switches are used when specifications require changes in fluid pressure to be monitored or controlled. Switches are available to cover a wide range of pressures—from those of over 25,000 psi to pressures expressed in fractions of an inch of mercury. Generally speaking, the actuating mechanism of pressure switches

Fig. 1. Popular contact configurations and circuit terminology.

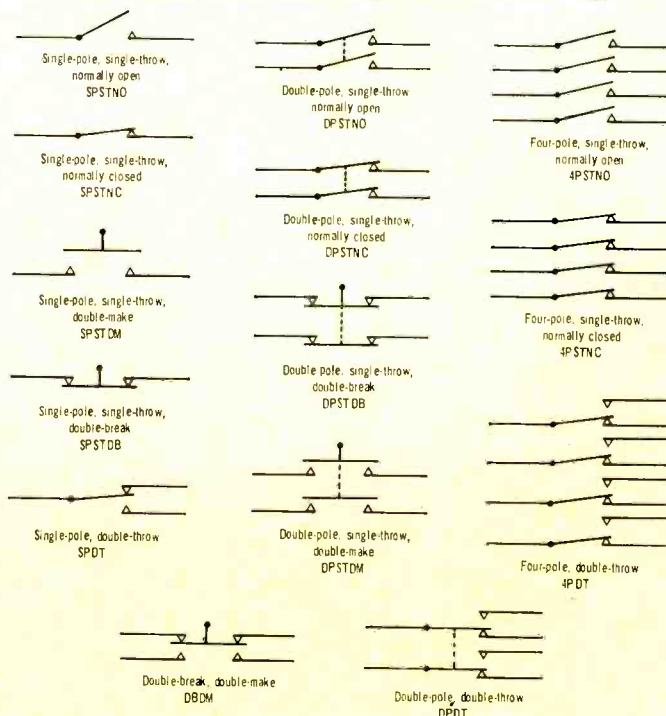

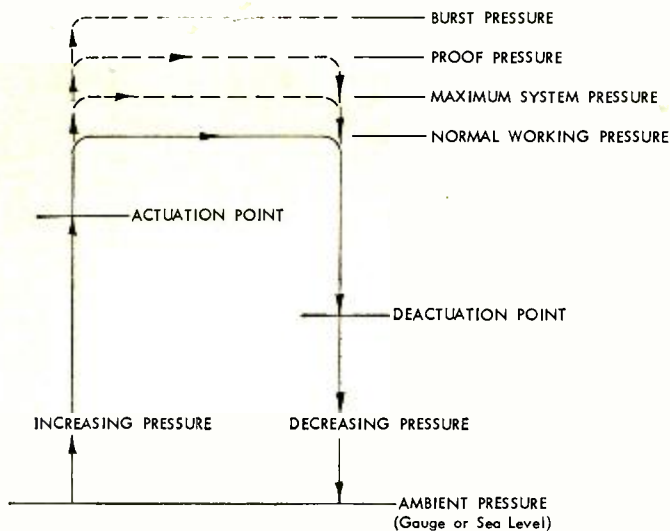

Fig. 2. Schematic operating cycle of a gauge pressure switch.

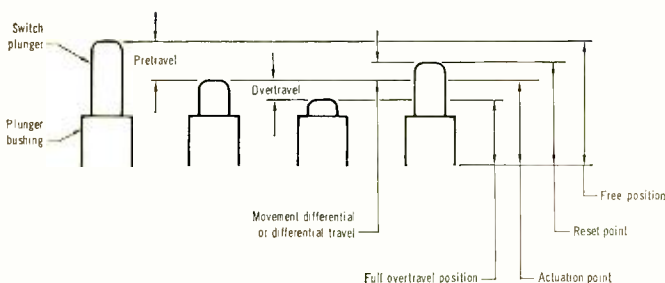

Fig. 3. Terms describing operation of limit switches are shown.

incorporates a pressure-sensitive diaphragm coupled to an electrical switch. Actuation of the switch occurs within a specified range of pressures. Similarly, deactuation occurs within a specified range of pressures. This range includes the actuation (or deactuation) point plus a tolerance which will vary widely, depending upon the accuracy required and the pressure range of the switch. Good engineering practice demands that only the required accuracy be specified as the tolerance, not the best available. The deactuation point is the pressure at which the switch mechanism resets and, as a general rule, occurs at a lower pressure than that which caused actuation. Sometimes, the terms of actuation and deactuation are interchanged, depending on the primary application of the switch in question.

The proof pressure is the maximum pressure that can be applied without a calibration shift in the actuation and deactuation points. Good design requires that the proof pressure of a switch be a minimum of one and a half times the maximum system pressure.

The burst pressure of a pressure switch is the maximum pressure to which the switch can be subjected without rupture or damage. Usually, burst pressure is two to two and a half times the pressure in the system under normal operating conditions.

Fig. 2 shows schematically an operating cycle of a gauge pressure switch and illustrates the terms just discussed. The different types of available pressure switches include: 1. altitude or

absolute pressure switches, 2. differential pressure switches, 3. vacuum switches, 4. altitude switches, and 5. absolute pressure ratio switches.

Temperature-sensitive switches are used to protect against over-temperature, indicate an extreme temperature, or control at a specified temperature. The characteristics and behavior of thermal switches are similar to those of simple pressure-sensitive switches except that they are operated by changes in temperature. Actuation and deactuation occur in a similar manner. They are available with ranges from -100°F to $+500^{\circ}\text{F}$. Switches with smaller ranges are also available with tolerances approaching $\frac{1}{2}^{\circ}\text{F}$. The range of the switch is a function of application, and tolerance or temperature differential will depend on the accuracy required.

Limit or position-sensitive switches are used to actuate or deactuate equipment relative to cam position or door location. Very often limit switches are multi-circuited to actuate signal lights to indicate the condition of the equipment. Types of limit switches vary according to the type of actuation, including lever, plunger, roller plunger, rotary roller-lever, and rotary linkage-lever, and non-contacting switches. Non-contacting or remote sensing switches perform the same function as other mechanically actuated switches but without physical contact. These include proximity, photovoltaic, photoelectric, or pneumatic devices acting as sensors coupled with amplifiers or relays to perform the switching functions. Since their use is largely confined to automated machinery, they will not be discussed here.

Plunger-actuated limit switches allow the greatest range of applications, but are restricted to in-line actuation with controlled overtravel. If the overtravel is not controlled, the switch may be damaged if the force is sufficient. (The actuation point of bushing-mounted plunger switches can be set by means of the two hex nuts supplied with the switch. Often, due to the normal build-up of tolerances, the exact position of actuation cannot be predetermined. It is then necessary to adjust the nuts by a cut-and-try technique to locate the exact actuation point of the switch.) Operating characteristics applying to limit switches are shown in Fig. 3.

The most popular mounting means are: 1. bolt or screw-mounted as in Fig. 4A or 2. bushing-mounted as in Fig. 4B through E. The bolt or screw-mounted limit switch is essentially restricted to basic switches, with most sealed limit switches being bushing-mounted.

Scaled limit switches can be designed to operate in almost

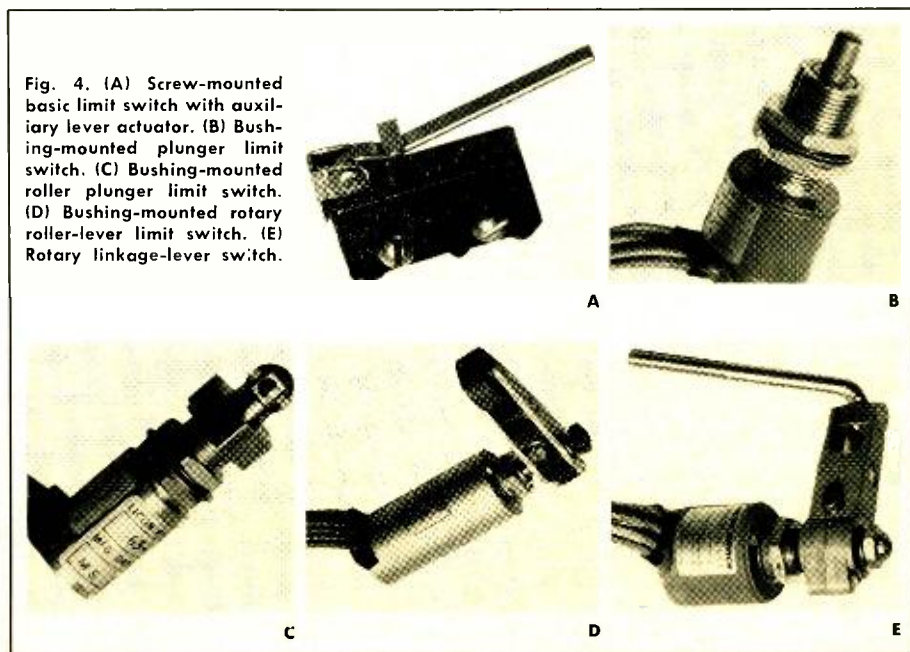

any environment. They are often watertight to the extent that moisture cannot be pumped into the switch through cycles of pressure or temperature with the resultant condensation. Some sealed switches, for example, are subjected to environments that build up ice on the actuating plunger. An integral part of the switch, called the "ice scraper," acts to clean the plunger upon actuation and free it of ice. If the switch has been held actuated and the actuating force is removed, the release force built into the switch acts to break the ice barrier.

Lever actuation is most often employed with a basic switch, as shown in Fig. 4A. Advantages include its compact size, ease of installation, general lack of tight tolerances, and its flexibility of application with additional actuators. Its main disadvantage is its vulnerability due to a lack of protection.

A roller-plunger limit switch is a slight modification of the plunger limit switch (Fig. 4B) for adaptation to cam or slide actuations which have an incline or rise of less than 30°. An example is shown in Fig. 4C. Often the roller plunger has an adjustment mechanism that allows locking the roller in 45° increments.

Cam or slide actuation with an incline of more than 30° requires a rotary roller-lever actuation, the type shown in Fig. 4D. This type of actuation usually operates in only one direction and is spring-loaded to return the lever to a neutral or deactuated position after the operating force is removed.

A modification of the rotary roller-lever switch is the rotary linkage-lever (Fig. 4E) which is used to physically connect the actuating device to the switch. This switch operates in both directions but has no return spring. The linkage-lever is threaded so it can be attached to the actuating device which must provide the deactuating as well as the actuating forces. The actuation point of both rotary lever

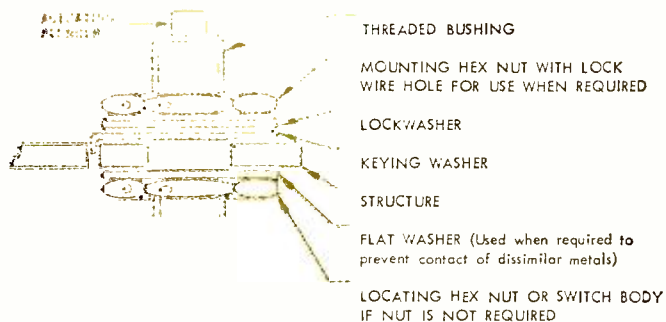

Fig. 5. Accepted installation of a bushing-mounted switch.

switches is positioned by a worm gear with a screw adjustment that locates the arm in any position through 360°.

Mounting of rotary-lever switches is often similar to that of plunger switches except the axial positioning of the switch is not as critical and, for this reason, only one hex nut is used. Fig. 5. shows an accepted method of installing a bushing-mounted switch. Note that the keying washer is placed on top of the structure to serve the dual purpose of keying the switch and protecting the structure from the lockwasher. An alternative to the keying washer, as used by some switch manufacturers, takes the form of two tabs projecting above the switch body which engage two mating holes in the mounting. In areas of extreme vibration, a lockwire is used to prevent loosening of the mounting nuts.

Manually Actuated Switches

A selection of manually actuated switches offers the designer a little more leeway in his circuit than mechanically actuated switches. Personal preferences may sometimes influence switch selection since a goodly number of applications can be handled by more than one type of switch. Table 1 compares applications while Table 2 compares parameters

Table 1. Comparison of manually actuated switches with their main advantages and limitations.

TYPE	ADVANTAGES	LIMITATIONS
Push-button	Short plunger travel and light actuating forces minimize operator fatigue when extended operation is required. Lighted switches add to the appearance of the panel and conserve panel space by combining switch and indicator. Lighted switches facilitate identification and provide rapid indication of switch or circuit condition.	Non-illuminated push-buttons often require an auxiliary indicator to signify actuation. The push-to-actuate motion can be conducive to accidental actuation. Care must be taken in their location. Often, guards that must be reached into or pushed aside must be used. Push-buttons are not readily adaptable to multi-position indication except when lighted.
Rotary	The most varied switching functions are available. Rotary switch knobs are very resistant to accidental actuation. The mode of actuation provides a natural habit reflex for "increase or decrease" functions.	Actuation of other circuits to reach the required position is often undesirable. The time required to find and select the desired position may cause considerable lost time.
Thumbwheel	The operator is required to reach into a recess to cause actuation. Switch and circuit condition is indicated by the thumbwheel position.	Visual identification of switch position is difficult when viewed from a distance or at an angle. Actuation is difficult if the operator wears gloves. The limitations of rotary switches also apply.
Toggle	A great number of switching functions are available. Toggles are easily and speedily actuated. Two-position switches require no additional judgement once the decision to actuate has been made. Lever-lock toggles cannot be accidentally actuated. The installation may allow for habit reflex actuation or de-actuation.	Toggle levers are prone to accidental actuation when poorly located. Guards or lever locks must be used if no suitable location is available. When more than one switching position is available, some time may be lost if an operator's decision must be made prior to actuation. Actuation of unusual toggle designs rely on operator's memory.
Slide & Knife	Two-position switches require no additional judgement once the decision to actuate has been made. The installation may allow for habit reflex actuation or de-actuation.	Visual identification of the switch position is difficult when viewed "head on". Actuation may be difficult if operator wears gloves. Knife switches may present a shock hazard to operating personnel.

TYPE	DIMENSIONAL COMPARISON OF SIZE BEHIND PANEL SURFACE (IN INCHES)		CURRENT CAPACITY (IN AMPERES AT (28 V d.c./117 V a.c.))		COST ² RANGE (\$)
	MINIMUM SIZE ¹	MAXIMUM SIZE ¹	MINIMUM SIZE ¹	MAXIMUM SIZE ¹	
Push-Button (Integral), SPST, Sealed	1 deep X 5/8 dia.	1 1/8 deep X 3/4 dia.	10/10	35/35	4.00 to 6.94
Push-Button (Assembly), SPDT, Unsealed	21/32 deep X 25/32 X 3/8	15/16 deep X 1 1/4 X 1 3/4	4/5	40/40	4.45 to 9.90
Rotary, Single- Pole, Eight- Throw, Explosion- Proof	.62 deep X .62 dia.	1.43 deep X 2.125 dia.	.25/.25	15/15	10.00 to 22.00
Rotary, Single- Pole, Eight- Throw, Open	.4 deep X 1 dia.	.95 deep X 2 13/16 dia.	.55/.15	12/10	1.50 to 4.50
Toggle, Single- Pole, Toggle- Sealed	1.1 deep X 1.12 X .62	3 3/16 deep X 2 1/8 X 1 1/2	25/10	80/30	2.50 to 20.00
Toggle, Single- Pole, Sealed	1.2 deep X 1.16 X .62	-----	20/15	-----	5.00 & up
Slide, Single- Pole, Double- Throw	.7 deep X .9 X .6	-----	1/3	-----	.10 & up
Knife, Single- Pole, Double- Throw	-----	2 5/8 X 1 (base dimensions)	-----	25/30	.25 & up

1. Some smaller minimums and larger maximums may be available. The switches chosen here were selected for their current capacity and size, consistent with high quality, competitive prices and is indicative of a cross-section of the industry.
2. The cost range is based on the purchase of a single unit qualified to Military Specifications. Procurements of large quantities often yield upward of a fifty-percent discount. Similar switches may carry smaller price tags; higher costs usually reflect an increased amount of testing and quality control.

Table 2. Characteristics of a cross-section of available manually actuated switches of various types.

of a number of different manually actuated switches.

The application of a manually actuated switch simply conveys a message from the man to the machine. The man/machine concept involves several considerations. Since the design of the machine interface is the more flexible, the switches involved must be selected and applied to fit the operator. The considerations involved are: 1. physical location, 2. mode of actuation, and 3. identification of the switch.

Actuating levers and knobs that are most often used should be in close proximity to the operator's normal position. The switch in the control panel should be positioned so that the operator's clothing won't accidentally cause actuation. The switch should also be located so that it is not inadvertently actuated. If this is not possible, protect the actuator with a guard. Ideally, if several switches are

mounted on a single panel, they should be spaced far enough apart to avoid accidental actuation of a switch due to its proximity to another.

Consideration should also be given to the environment in which the switch will operate. Even though performance, life, and reliability can almost always be increased by improved sealing, this often carries a prohibitive price tag. For this reason, economics usually dictates selection of the least amount of sealing that can do the job. In addition to the obvious case of selecting a sealed switch if water may drip or splash on it, a sealed switch should also be selected if it will be exposed to extremes of temperature or some other environment that might cause moisture to penetrate the switch when the environment is a non-operating one. Flexible rubber seals or boots are available to aid in sealing a switch between the actuator and mounting bushing and/or mounting panel.

The mode of actuation should be consistent with habit reflexes, e.g., actuate a toggle in the upward or forward direction to bring machinery up to full speed, or push a button to test for some condition. The effort required for actuation may sometimes be related to the switch application. For example, when switches will be actuated at high speeds and for long durations, a light actuating force is recommended. It is also desirable that some form a feedback, an indicating light for example, be designed into the circuit if the switch does not provide some audible or operational indication of actuation. Assuming the switch is in working order, the positive "snap" of actuation or sudden reduction of operating force will often be sufficient evidence of actuation.

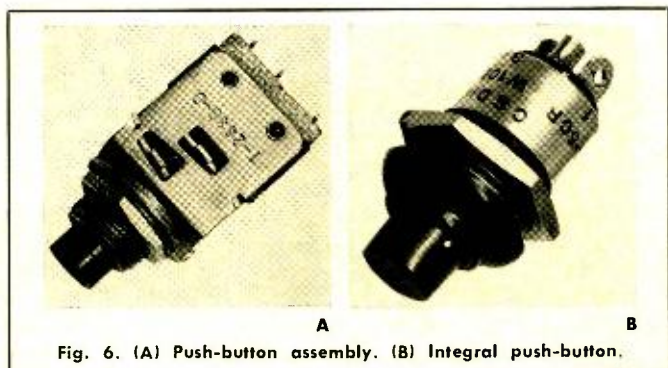
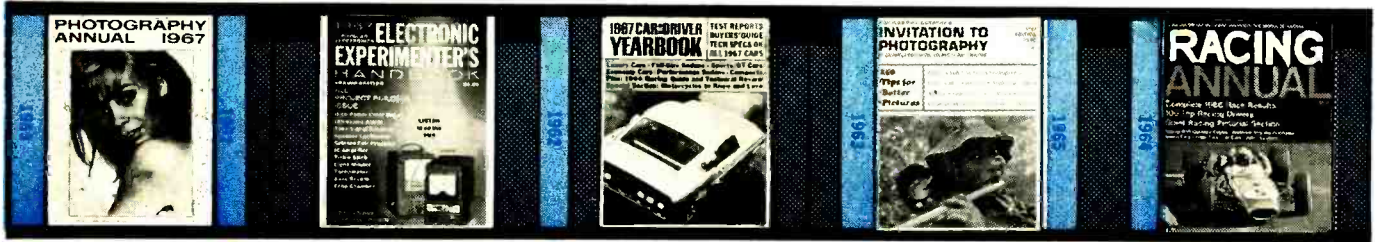

Fig. 6. (A) Push-button assembly. (B) Integral push-button.

fill the gaps... WITH A COMPLETE SELECTION OF ANNUALS, YEARBOOKS, DIRECTORIES AND HANDBOOKS

from the world's largest publisher of special interest magazines. Take a moment to review the titles and issues currently available. You're sure to find many of your favorites to help complete your library and fill those wide open spaces on your bookshelves.



PHOTOGRAPHY ANNUAL

A selection of the World's finest photographs compiled by the editors of Popular Photography. 212 pages—24 in full color.

- 1967 — \$1.50 — #38
- 1966 — \$1.25 — #1
- 1964 — \$1.25 — #3

ELECTRONIC EXPERIMENTER'S HANDBOOK

Many challenging projects for the electronics hobbyist.

- 1966—Fall Edition—\$1.25 — #39
- 1966—Spring Ed.—\$1.25 — #36
- 1965—Fall Edition—\$1.25 — #9
- 1965—Spring Ed.—\$1.25 — #14
- 1967—Spring Ed.—\$1.25 — #49

CAR & DRIVER YEARBOOK

A complete buyers guide covering virtually every car available in the United States... Road tests... Technical specifications... Accessories and performance... equipment buying guide... Guide to racing with action-packed photos.

- 1967 — \$1.50 — #40
- 1966 — \$1.25 — #15
- 1965 — \$1.25 — #17

INVITATION TO PHOTOGRAPHY

A unique 116 page guide to better picture taking by the Editors of Popular Photography. Basic down-to-earth advice that helps you eliminate costly trial and error, time-consuming guess work. 20 complete, fact-and-photo packed articles in all.

- 1966 — \$1.25 — #35
- 1967 — \$1.25 — #50

CAR AND DRIVER RACING ANNUAL

An almanac of competition information covering the entire year of 1966. It's the finest, most complete manual of its kind—it brings every suspenseful heat back to life with lavish use of dramatic photos, and words that spell "speed" from start to finish!

- 1967 — \$1.25 — #51



PHOTOGRAPHY DIRECTORY

World's most complete photographic buying guide.

- 1967 — \$1.25 — #41
- 1966 — \$1.25 — #22

TAPE RECORDER ANNUAL

Everything you need to know about tape recording including a complete directory of mono and stereo recorders.

- 1967 — \$1.25 — #42
- 1966 — \$1.25 — #30
- 1965 — \$1.00 — #31

ELECTRONICS INSTALLATION AND SERVICING HANDBOOK

The only complete guide for servicemen and hobbyists to every major phase of consumer electronics servicing.

- 1967 — \$1.25 — #43
- 1966 — \$1.25 — #32

FLYING ANNUAL

The most valuable aviation yearbook ever compiled... Pilot reports... Aircraft directory... How to buy a used airplane... Navcom directory... Learn to fly section.

- 1967 — \$1.50 — #44
- 1966 — \$1.25 — #27
- 1965 — \$1.25 — #28



STEREO/Hi Fi DIRECTORY

Complete buyers guide for virtually every Hi Fi component manufactured.

- 1967 — \$1.25 — #45
- 1966 — \$1.25 — #29

POLAROID LAND PHOTOGRAPHY

Complete guide and only comprehensive and up-to-date handbook on Polaroid Land Photography.

- 1966 — \$1.25 — #24
- 1963 — \$1.00 — #25

SKIING INTERNATIONAL YEARBOOK

A luxuriously illustrated compendium of 1966's important events... A timely forecast of the excitement-packed 1967 season—by the editors of Skiing Magazine.

- 1967 — \$1.25 — #48
- 1966 — \$1.25 — #26

FLYING TRAVELGUIDE

Here's the first really useful guide to flying vacations. Everything you need to know about: lodgings, restaurants, resorts, sightseeing, recreation, sports activities, airport facilities, children's fun, price information, special information for the gals—and much more.

- 1967 — \$1.25 — #46
- 1966 — \$1.25 — #34

COMMUNICATIONS HANDBOOK

The most complete and up-to-date guide to the exciting world of specialized radio communications.

- 1967 — \$1.25 — #47
- 1966 — \$1.25 — #18
- 1965 — \$1.00 — #19
- 1964 — \$1.00 — #20

TO PLACE YOUR ORDER, circle the numbers of the annuals you wish to receive on the coupon, clearly print your name and address and enclose your remittance. Please be sure to enclose an additional 15¢ shipping and handling for each copy ordered. Add 50¢ per copy for orders outside U.S.A.

Ziff-Davis Service Division—Department W 595 Broadway, New York, N. Y. 10012

I am enclosing \$_____ for the annuals circled below. My remittance includes an additional 15¢ per copy for shipping and handling (50¢ for orders outside U.S.A.). I understand quantities are limited and orders will be filled on a first come-first served basis.

- 1 3 9 14 15 17 18 19 20 22 24 25 26 27 28 29 30 31 32
34 35 36 38 39 40 41 42 43 44 45 46 47 48 49 50 51

Name _____

Address _____ E.W.-97

City _____ State _____ Zip Code _____

PAYMENT MUST BE ENCLOSED WITH ORDER

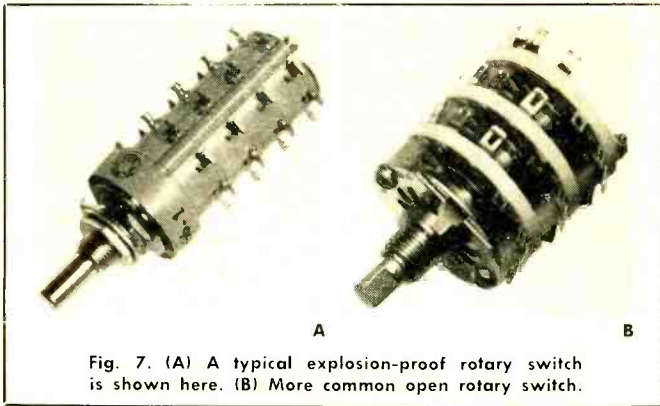

Fig. 7. (A) A typical explosion-proof rotary switch is shown here. (B) More common open rotary switch.

Printed or lettered identification of the switch should be within reading distance and numbers or letters associated with the switch should be located in such a way as to allow reading when the operator is in his normal position. Sometimes an unusual shape of a knob or handle may be employed to help the operator make the proper selection quickly, but this type of design is generally not recommended as it relies on the operator's memory.

The majority of manually actuated switches fit into the following four categories: push-button switches, rotary switches, toggle switches, and slide and knife switches.

Push-button switches are of two general designs: either a basic switch (or switches) mounted in a push-button housing, Fig. 6A, or an integral push-button switch, Fig. 6B. The switching chamber of the first design is simply that of the basic switch, often enclosed but unsealed. The integral push-button switch has a housing that is usually water-sealed at the plunger and environmentally sealed at the terminals. Both groups are further subdivided into lighted and unlighted push-buttons, with several possible identifying colors available. Unlighted push-buttons should be colored black. Lighted push-buttons should be red, green, amber, white, or blue. Requirements for the application of identifying colors as indicators are as follows:

Red: The circuit controlled by the switch requires immediate attention, e.g., a portion is inoperative or corrective action must be taken.

Green: The circuit controlled is in satisfactory condition, e.g., the equipment is within operating tolerance.

Amber: The circuit controlled is in a marginal operating condition, caution may be required.

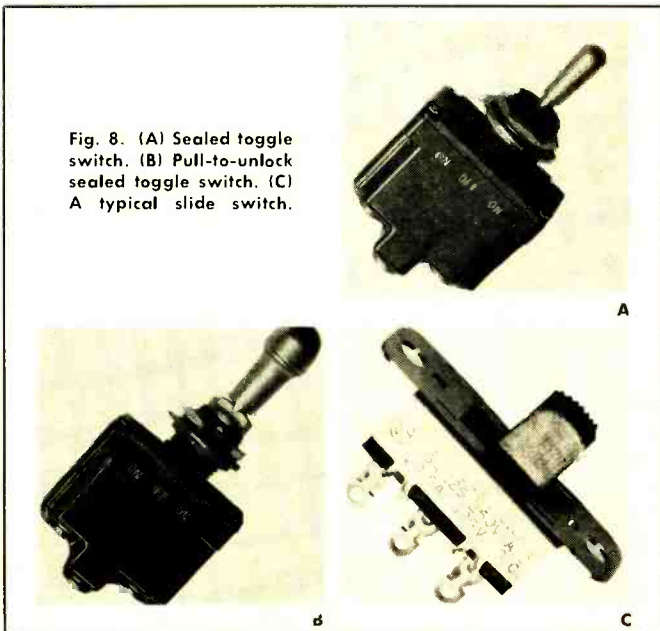

Fig. 8. (A) Sealed toggle switch. (B) Pull-to-unlock sealed toggle switch. (C) A typical slide switch.

White: The circuit is operating satisfactorily with no "right" or "wrong" implications. White is often used to convey some additional information to the operator.

Blue: Blue is used to indicate radiation hazards but is generally accepted as an alternative to white. Blue should be used only when absolutely necessary since it doesn't show up well.

Push-buttons are available with maintained actions and momentary actions, the former requiring a second plunger operation to complete the cycle. Push-button switches should be used when a control or array of controls is needed for momentary contact or for test functions or when used frequently. The push-button surface should be concave or designed so as to prevent the fingers from slipping off the control.

Since there is no knob or lever position to indicate a maintained push-button's actuation, lighted push-buttons are usually preferred. Non-illuminated push-buttons may be used with an auxiliary pilot light but this decreases system reliability and may cause the operator to search for the proper indicator light.

Rotary switches can be classified according to the type of sealing—closed or open, with further sealing classifications in the sealed category. The most popular sealing of a closed switch is explosion-proof, that is, the rated load can be switched in an explosive atmosphere without causing the switch to explode. See Fig. 7A. This enclosure is not water-tight to immersion, but is sufficiently tight to prevent water penetration in most applications. Often a rotary switch is made with a rubber "O" ring between the shaft and bushing to prevent moisture from entering the switch through the bushing. The advantage of a closed rotary switch, like that of other switches, is the protection afforded by its enclosure. However, open rotary switches offer an advantage, besides cost, that is very desirable in some applications. See Fig. 7B. The accessibility of the switching contacts allows visual inspection of their condition and even repair.

Rotary switches should be used when the circuitry involved requires more than three positions. They should not be used when only two positions are needed. Momentary actions are available in addition to maintained actions. Rotary switches can switch current to as many as 24 loads or with as many as 12 poles or circuits per deck. The number of poles can be increased by a factor of 3 or 4 by using several poles per deck at the expense of the number of loads. The common contacts (poles) of each circuit may be either shorting or non-shorting. A shorting contact activates the next circuit during each switching cycle before removing power from the last circuit. A non-shorting contact supplies power to only one circuit at a time.

Switches with concentric shafts are useful where a small package is essential. Two switches are combined into a single unit with two distinct shafts. Combinations of shorting and non-shorting contacts along with varied numbers of loads and poles are available. However, complex designs of this nature reduce system reliability, operator efficiency, and tend to degrade the over-all system effectiveness and should be avoided if possible.

Round black knobs are frequently specified. Consideration must also be given to the depth of the recess in the knob with the length of actuator shaft of the switch and any possible interference with the mounting panel (and face plate if one is used) or the switch identification.

Included in rotary switches are thumbwheel switches. These are rather specialized in their application and are usually used in conjunction with circuit boards. Most often the thumbwheel switch has ten position with the output digital or binary coded.

Toggle switches are classified according to their number of poles, with each group being further divided according to the sealing. Usually toggle switches have one, two, or four poles; three-pole switches are available but

FREE

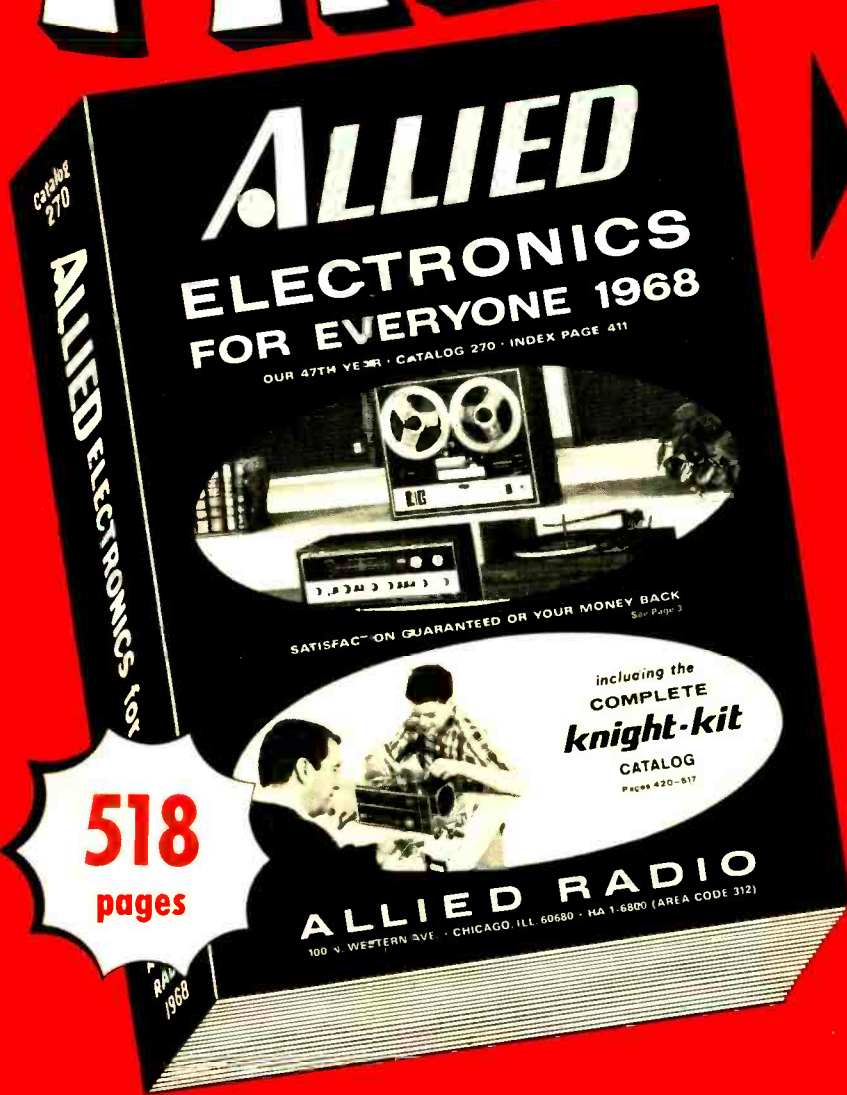

New 1968 Allied Catalog

Here it is! The brand-new 1968 edition of the world's most famous catalog of electronic equipment.

518 pages, including the complete Knight-Kit Catalog—picturing, describing and pricing thousands of items—the most complete inventory ever assembled of hi-fi, radios, tape recorders, CB, electronic equipment, parts and tools—all at money-saving low prices.

You'll want your own personal copy of the Allied Catalog. It's free. So tear off, fill out, and mail a card. Do it now!

NO MONEY DOWN—24 MONTHS TO PAY!
Low Monthly Payments to fit your budget.

DO A FRIEND A FAVOR—give him this card to send for his FREE ALLIED CATALOG

NAME—PLEASE PRINT

ADDRESS

CITY

STATE

IJ

ZIP

FILL THIS CARD OUT—MAIL IT NOW!

FREE
ALLIED
1968 CATALOG

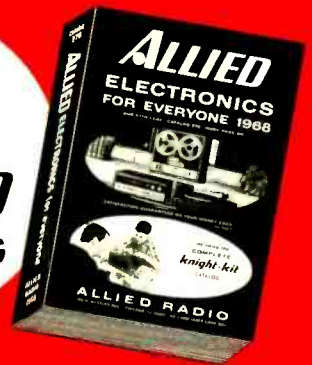

WORLD'S LARGEST SELECTIONS. SATISFACTION GUARANTEED OR YOUR MONEY BACK

NAME—PLEASE PRINT

ADDRESS

CITY

STATE

IJ

ZIP

FILL THIS CARD OUT—MAIL IT NOW!

FREE
ALLIED
1968 CATALOG

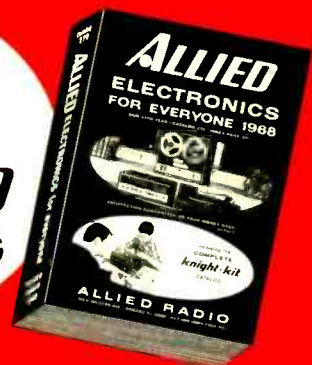

WORLD'S LARGEST SELECTIONS. SATISFACTION GUARANTEED OR YOUR MONEY BACK

RUSH THIS CARD TODAY!

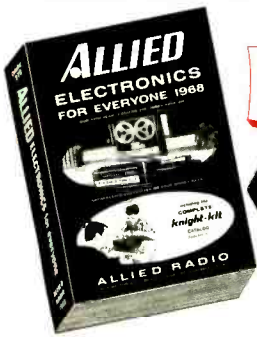

for your

FREE

**1968
ALLIED
CATALOG**

TO:

ALLIED RADIO
P.O. BOX 4398
CHICAGO, ILLINOIS 60680

PLACE
STAMP
HERE



Why Buy by Mail from **ALLIED?**

Each year Allied fills more than a million orders by mail. Only the complete facilities of the world's largest electronics supply house can satisfy all the needs of hi-fi enthusiasts, CB users, engineers, "Hams" and experimenters.

WORLD'S LARGEST SELECTIONS

Imagine shopping for hi-fi where you can select from every model of 15 major manufacturers of receivers, tuners and amplifiers, 14 brands of tape recorders, 7 makes of turntables, nearly 100 speakers from a dozen manufacturers. Plus similar choices in every area of electronics—CB and Ham, test equipment, kits (including Knight-Kits), parts, supplies . . . almost anything you want.

MANY PRODUCTS NOT AVAILABLE ANYWHERE ELSE

As the world's largest supplier of electronics, Allied can afford to stock thousands of items not available elsewhere. In addition, many products are specially-designed and built to our specifications.

FIRST WITH THE LATEST FOR 47 YEARS

We have always been the first to offer the latest developments in electronics, as you will see when you receive your new 1968 catalog from Allied.



RUSH THIS CARD TODAY!

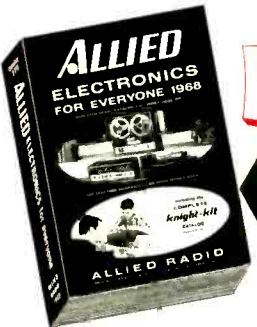

for your

FREE

**1968
ALLIED
CATALOG**

TO:

ALLIED RADIO
P.O. BOX 4398
CHICAGO, ILLINOIS 60680

PLACE
STAMP
HERE

WE QUALITY-TEST WHAT WE SELL

Among all electronics supply houses, only Allied has a continuous program of quality-testing to assure you that everything you buy meets the highest standards.

COUNT YOUR SAVINGS AT ALLIED

You always get the lowest prices at Allied. Check Allied prices and compare. Look for the special values—available only when you shop in the Allied catalog.

IMMEDIATE SHIPMENT

There's no delay when you deal with the world's largest electronics supply house. Orders are filled promptly—usually the day they're received.

NO MONEY DOWN — UP TO TWO YEARS TO PAY

You don't need cash at Allied. Make "add-on" purchases—even though you are already paying for something else. It's easy to be a credit customer at Allied.

SATISFACTION GUARANTEED OR YOUR MONEY BACK

You can buy with confidence from Allied. We guarantee satisfaction or your money back.

ENJOY "EASY-CHAIR" SHOPPING

Shopping's easy at Allied. More accurate, too! You always know exactly what you get. And *what a choice!* A selection of merchandise so vast that no store could ever assemble and stock it all.



do not enjoy the same usage and popularity. The sealing is: 1. unsealed with varying amounts of enclosure; 2. toggle-sealed, that is, when submerged with water one-half inch above the bushing, water will not enter the switch through the toggle seal; or 3. environmentally sealed, that is when submerged completely and subjected to pressure equivalent to 56,000 feet altitude for several hours, depressurized, and allowed to remain under water for several more hours, water will not be pumped into the switch. An environmentally sealed toggle switch is shown in the photograph of Fig. 8A.

Toggle switches should be used in applications requiring two or three positions. Generally, in a three-position toggle switch the center is the "off" position with the extremes representing circuitry "on" conditions. These switches are also available with "momentary-on" positions. Toggles with more than three positions should not be used. When more than three positions are required, a rotary switch should be specified.

A very popular safety feature, often selected as an alternative to a switch guard, is the "pull-to-unlock" toggle lever, Fig. 8B. A spring-loaded cap or knob on top of the lever requires the operator to lift it manually to allow movement to another position. Guards are available ranging from complete enclosures of the toggle to channel-shaped guards that require the operator to reach into the channel and actuate the switch.

Slide and knife switches are the most basic, simple, and reliable of the manually actuated switches. A slide switch is shown in Fig. 8C. Almost without exception they are unsealed. They are usually enclosed or provided with some form of housing to protect the operator. As with any switch, special functions, hybrids, and accessories are available. The most popular slide and knife switches are used where economy is a major consideration. Their application is limited to environments that do not require sealing, except those knife switches used in outdoor fuse boxes which are usually classified as rain-tight. Their function is similar to that of toggle switches.

Standard Switches

Almost any number of variations on the switches discussed here are available—unusual or untested parts should be avoided. Such a selection most often contributes little or nothing to the system effectiveness. A hard and fast rule which will enable a designer to determine if a switch will function properly in his application usually does not exist. The only criterion is the establishment of the application requirements and then the selection of a suitable switch which will meet those requirements. ▲

Why settle for less? Buy the Best!

THE FABULOUS

MARK TEN CAPACITIVE DISCHARGE IGNITION SYSTEM

Available in easy-to-build kit form at only

\$29.95 ppd.!



Only **\$44.95** ppd.!

Dramatically improve the performance of your car—or any vehicle. Racers and Pacers from Sebring to Suburbia by the thousands attest to the peerless performance of the Mark Ten. Delta's remarkable electronic achievement, proven for four years, is often copied, never excelled.

Ready for these?

- ▲ Dramatic increase in acceleration
- ▲ Longer point and plug life
- ▲ Improved gasoline mileage
- ▲ Complete combustion
- ▲ Smoother performance

Ready? Order today!

BE YOUR OWN MECHANIC



Tune-up

DWELL METER \$12.95 ppd.

A universal precision instrument for use in tuning all vehicles, regardless of the number of cylinders or battery polarity. Gives correct point dwell readings on vehicles equipped with capacitive discharge, transistor or conventional ignition. Precision accuracy at low cost.

- ▲ Portable, high-impact case for rugged work
- ▲ Large, easy-to-read 3 1/2 inch precision jeweled meter
- ▲ Wide scale — reads dwell angles in degrees
- ▲ All solid state



Tune-up

TACHOMETER \$14.95 ppd.

A universal precision instrument for making carburetor adjustments on all vehicles, regardless of the number of cylinders or battery polarity. Gives precise RPM readings on vehicles equipped with capacitive discharge, transistor or conventional ignition. Gives you better gas mileage, fuel savings and peak engine operation.

- ▲ Large, easy-to-read 3 1/2 inch precision jeweled meter
- ▲ Portable, high-impact case for rugged work
- ▲ Range: 0 to 1200 RPM
- ▲ All solid state



DELTA PRODUCTS, INC.

P.O. BOX 1147 EW • GRAND JUNCTION, COLORADO 81501

Enclosed is \$_____ Ship prepaid. Ship C.O.D.

Please send: Dwell Meters @ \$12.95 Mark Tens (Assembled) @ \$44.95
 Tach Meters @ \$14.95 Mark Tens (Delta Kit) @ \$29.95

Specify — Positive Ground Negative Ground 6 or 12 volt
(12 volt positive or negative ground only)

Car Year _____ Make _____

Name _____

Address _____

City State _____ Zip _____

CIRCLE NO. 119 ON READER SERVICE CARD

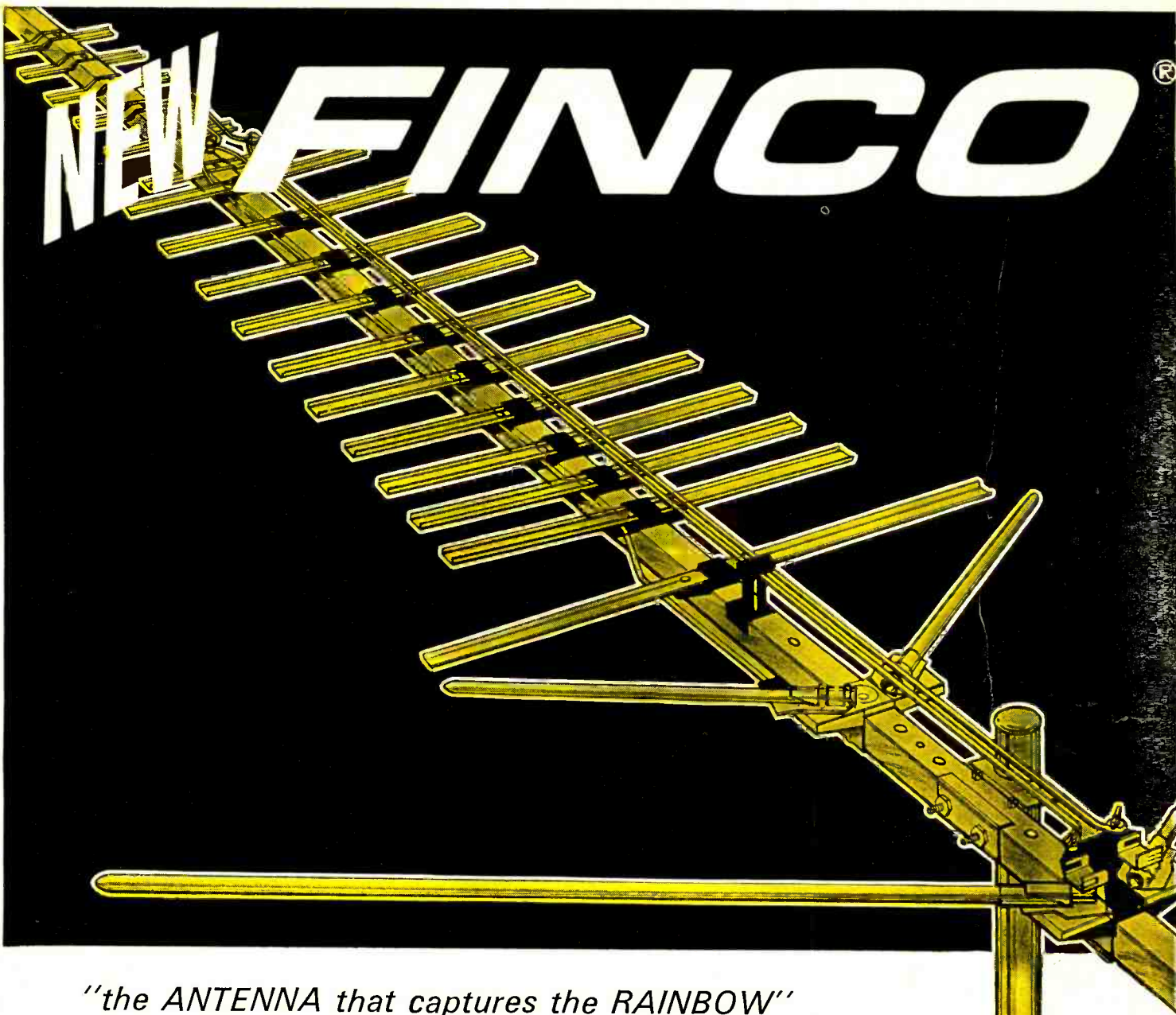

“the ANTENNA that captures the RAINBOW”

No two reception areas are alike in the number of stations, UHF and VHF, station channel frequencies, and signal strengths.

FINCO has developed the Color Spectrum Series of antennas – “Signal Customized” – to exactly fit the requirements of any given area. There is a model scientifically designed and engineered for every area, even the most troublesome, and for all combinations of signal conditions.

Engineering studies show that a receiving antenna should have more gain as channel frequency is increased – that is, channel 6 more than channel 2, channel 13 more than channel 7, and UHF from channel 14 on up...

- 1 – to compensate for signal strength loss
- 2 – to compensate for down-lead loss
- 3 – to meet receiver requirements for more signal to operate properly

FINCO Color Spectrum Antennas obtain this frequency dependent characteristic through a newly developed principle of spacing between elements. Gain increases as frequency increases. This new FINCO engineering break-through, combined with superior flat response patterns and unusually high front-to-back ratios, assure the finest COLOR and B & W reception possible... everywhere.

Write for full information on “Signal Customized” Antennas:



THE FINNEY COMPANY









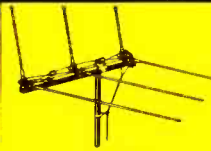
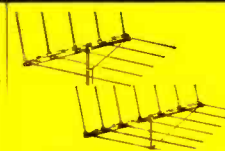
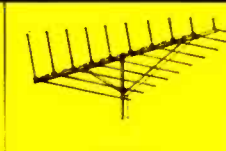

34 West Interstate Street • Dept. 410 • Bedford, Ohio 44146

COLOR SPECTRUM

T.M.

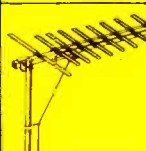
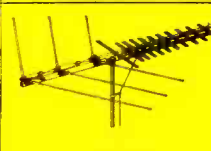
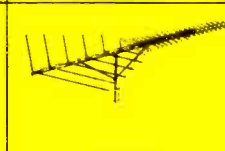
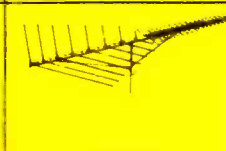
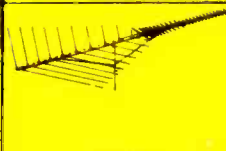
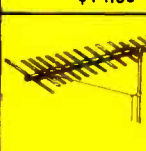
ANTENNAS are "signal customized" for better reception.

Check this chart for the FINCO "SIGNAL CUSTOMIZED" Antenna best suited for your area

STRENGTH OF UHF SIGNAL AT RECEIVING ANTENNA LOCATION ▼	Strength of VHF Signal at Receiving Antenna Location				
	NO VHF ▼	VHF SIGNAL STRONG ▼	VHF SIGNAL MODERATE ▼	VHF SIGNAL WEAK ▼	VHF SIGNAL VERY WEAK ▼
NO UHF →		 CS-V3 \$10.95	 CS-V5 \$17.50 CS-V7 \$24.95	 CS-V10 \$35.95	 CS-V15 \$48.50 CS-V18 \$56.50
UHF SIGNAL STRONG →	 CS-U1 \$9.95	 CS-A1 \$18.95	 CS-B1 \$29.95	 CS-C1 \$43.95	 CS-D1 \$43.95
UHF SIGNAL WEAK →	 CS-U2 \$14.95	 CS-A2 \$22.95	 CS-B3 \$49.95	 CS-C3 \$59.95	 CS-D3 \$69.95
UHF SIGNAL VERY WEAK →	 CS-U3 \$21.95	 CS-A3 \$30.95	 CS-B3 \$49.95	 CS-C3 \$59.95	 CS-D3 \$69.95

NOTE: In addition to the regular 300 ohm models (above), each model is available in a 75 ohm coaxial cable downlead where this type of installation is preferable. These models, designated "XCS", each come complete with a compact behind-the-set 75 ohm to 300 ohm balun-splitter to match the antenna system to the proper set terminals.

CIRCLE NO. 114 ON READER SERVICE CARD



J OHN FRYE

First-class technical journalism is a highly skilled art that effectively weds good writing and special knowledge.

TECHNICAL WRITING

EMITTING a sudden grunt of distaste, Barney hurled the electronics magazine he had been reading clear across the service shop. "I've had it with that so-called technical writer," he announced to Mac, his employer. "The joker is so busy demonstrating how devastatingly clever, witty, and cute he is that he has little time left for his subject. I couldn't care less about the car he drives or his opinion of miniskirts!"

Mac grinned sympathetically as he loaded his pipe, a sure sign he intended taking a break from the TV set he was aligning.

"He must belong to what my writing friend, Tom, calls 'the smart aleck cult,'" Mac observed. "These writers try to project an amusing, egocentric, mildly obnoxious personality as a substitute for hard work and research. They answer questions from readers flippantly, being more interested in securing laughs than in supplying useful information. These writers often make an amusing first impression on some readers, but they don't wear well with the majority."

"The sad thing is they have simply gone too far in trying to make their writing interesting for its own sake. Tom says all writing *should* be interesting in itself. He quotes: 'No man can read for profit what he cannot read for pleasure'. But good writing can be made highly readable and interesting through legitimate literary arts without becoming facetious, insulting, or downright silly. When a tech writer inserts his personality between the reader and the subject, he has gone too far in trying to hold the reader's interest. Means has become an end in itself."

"You seem to put considerable store by what Tom says."

"I do. He is a truly professional tech writer who makes a darned good living with his typewriter because he prepared himself to do just that. He made up his mind to write while still in high school and studied for his profession in the best university journalism schools in the country. He still reads constantly to improve his writing ability, and you will find almost as many books on English composition and effective writing on his shelves as you will technical electronics books. I know he has had several offers to write fiction and for TV, but he has stuck chiefly to electronics because of his long interest in this subject. He does occasionally do an article for a professional writer's magazine, though, and that in itself bears testimony to his recognized ability."

"For my part, I've been reading technical electronics articles and books for better than a third of a century, and I have pretty definite ideas about what does or does not constitute a good article."

"First, the subject matter should not be flyblown. It can present a new device, spotlight a novel application of an old device, or cast additional light into shadowed areas of electronics theory; but I don't want any tired old rehash of textbook material."

"Second, I expect the article to be well organized. I want a beginning that quickly outlines the subject to be covered and foreshadows the tone and depth of treatment so that I don't have to read the whole article to tell if I *want* to read it. The body of the article should develop the subject in an

orderly easy-to-follow manner without any confusing necessity for backtracking. The majority of the text and illustrations should be concentrated in the areas of greatest need: on the most important and hard-to-understand parts of the discussion. When the subject has been thoroughly covered, the article should come to a prompt and definite end—not just peter out. If the final sentence appears at the bottom of the page, I should know it is the final sentence without having to turn the page to see.

"The article should not read as though written by a high-school sophomore. I expect it to be cast in clear, vigorous English devoid of clichés and verbosity. Marks of punctuation should be used with the precision of an engineer designating components of a prototype device. The punctuation should clearly and consistently indicate the relationship of the various sentence elements. There should be no room for suspicion that the author has punctuated 'by ear'."

"The article need not sound as though written by Shakespeare, but it should have a definite literary quality. Figures of speech, analogies, careful choice of words, variation in sentence length, proper paragraphing—all these should be used to insure clarity and enhance the readability. What's more, the article should be complete. By that I mean a construction article should include all the information necessary for the reader to duplicate the described device exactly from readily available resources. Every statement or theory open to question should be backed up by quoted authority or experimental data carefully described so that it may be duplicated."

"Finally, a good technical article should leave the reader with an urge to action. A construction article should make him want to duplicate the device described. A description of an exciting new device should make him want to obtain one for his own use. Even a theory article should awaken a desire to perform experiments to confirm the theory or to do more extensive reading along the same line. I consider this evoking of enthusiasm the most important test of a technical article because, if you stop to think about it, it embraces all the other requirements."

"You certainly have definite ideas about what a good technical article should be—and I can't argue with any of your points—" Barney admitted; "but what does Tom have to say about the making of a good technical writer? What preparation does a writer need to turn out the kind of articles you have just described?"

"Tom is most eloquent on that subject. He says good technical writing is first 'good' and then 'technical'. By that he means the possession of technical knowledge is not enough to turn out first-class technical articles. Technical writing, he says, is actually communication, and it is more closely related to teaching than it is to engineering. A tech writer doesn't 'just happen' any more than an engineer 'just happens'."

"It follows, then, that the first thing a tech writer must do is learn to write good, clear, simple prose. This ability, acquired only through diligent study and constant practice, is not easy to come by. Many men never acquire it. The

turgid writing often seen in government releases bears proof. The authors of this tortured prose would do well to heed Hemingway's reminder: 'Good writing is architecture, not interior decorating'.

"Next the writer must acquire proficiency in handling the 'tools' of his profession. He must master not only the mechanical aids, such as the typewriter, tape recorder, and camera, but he must also learn to get the most out of an unabridged dictionary, a set of encyclopedias, a thesaurus, Fowler's *Modern English Usage*, and the public library. Knowing where and how to obtain needed information quickly and efficiently is absolutely essential.

"Tom says that ideally the tech writer's technical knowledge should be acquired through both study and experience. He must have—and use!—a good technical library and read most of the technical publications in his chosen field. Also, unless his writing is to take on a 'bookish' quality that will be immediately spotted and resented by a practicing technician, he must be constantly using and experimenting with actual equipment. Only this will give his writing that authentic 'this-guy-has-really-been-there' flavor.

"At the same time, he must have sufficient contact with various classes of readers to understand the technical limitations of each. Armed with this knowledge, he will be prepared to write articles that will successfully bridge from what those readers *do* know to what they *want* to know. In the writing trade, this matching of the writing of a magazine article to the sophistication of the magazine's average reader is called *slanting*, and it's done almost automatically by a good tech writer.

"Finally, the professional tech writer is a responsible person. He abhors publishing an error because he knows that the reputations of the editor who bought his article and the magazine that prints it are both being placed on the line right alongside his own reputation. That's why he checks and doublechecks every word he writes."

"Somehow I feel you don't think an engineer is a good technical writer."

"Not any more than I think a tech writer is a good engineer," Mac retorted with a grin. "Actually, both are professionals in different fields, and in this modern day of specialization it's rare to find a man who can master two professions. Some of the dullest technical writing I know is found in professional technical journals—the kind where the only reward received by the author is to see his article in print.

"On the other hand, some of the best-written technical articles published recently have appeared in such popular magazines as *Time* and *Life*. These articles, written by highly paid professional writers, often are more easily

understood by technician as well as layman than are articles on the same subjects appearing in many technical journals. Articles on laser beams, holographic photography, and fluidics come to mind. The popular articles were better, not because of any basically superior content, but because of smooth professional writing."

"I think one reason there is such a demand for good technical writing is that the present generation has been accustomed to receiving information in attractive, interesting form. The editor who thinks he can get by publishing dull, unimaginative articles had better take a good long look at modern high-school math and physics textbooks. They are a far cry from the dull, forbidding texts of yesteryear. In these modern books every literary art is used to present knowledge in an attractive, palatable form."

"Right you are, Barney," Mac said, knocking the dottle from his pipe and switching on the sweep and marker generators. "Modern man's knowledge of himself, his environment, and the physical laws controlling his universe has taken a tremendous spurt in the past half century. In that brief span, his technical knowledge has far more than doubled all he learned in the preceding centuries. In fact, this knowledge pouring down from every side threatens to swamp him.

"But the professional technical writer voraciously attacks this flood of information channeled to him through carefully cultivated contacts with R&D laboratories, military research centers, and our great colleges and universities. He predigests a tremendous amount of this raw information and then regurgitates the essence of it in a form easily assimilated by those with less technical knowledge.

"Doing this well is a true profession; and I, for one, am glad to see these specialized writers beginning to receive the recognition and reward they richly deserve." ▲



"How could the Post Office have broken up your radio like that?"

FROM HiFi STEREO REVIEW

DELUXE PADDED DUST-PROOF RECORD AND TAPE CASES

plus FREE cataloging forms



These decorative, yet sturdily constructed cases are just what you've been looking for

to keep your records and tapes from getting tossed about and damaged, disappearing when you want them most and just generally getting the "worst of it" from constant handling. They're ideal too for those valuable old "78's" that always seem to get thrown about with no place to go.

Constructed of reinforced fiberboard and covered in rich leatherette in your choice of nine decorator colors, the HiFi/STEREO REVIEW Record and Tape Cases lend themselves handsomely to the decor of any room, whether it be your library, study, den, music room or pine-paneled garage. The padded leatherette back (in your color choice) is gold tooled in an exclusive design available only on HiFi/STEREO REVIEW Record and Tape Cases. The sides are in standard black leatherette to keep them looking new after constant use.

Extra With each Record and Tape Case you order you will receive, free of charge, a specially designed record and tape cataloging form with pressure-sensitive backing for affixing to the side of each case. It enables you to list the record names and artists and will prove an invaluable aid in helping you locate your albums. The catalog form can be removed from the side of the case at any time without damaging the leatherette.

Record Cases are available in three sizes: for 7", 10" and 12" records. Each case, with a center divider that separates your records for easy accessibility, holds an average of 20 records in their original jackets. The Recording Tape Case holds 6 tapes in their original boxes.

● The Tape Cases and the 7" Record Cases (with catalog forms) are only \$3.25 each; 3 for \$9; 6 for \$17.

● The 10" and 12" Record Cases (with catalog forms) are \$3.50 each; 3 for \$10; 6 for \$19.

Add an additional 75c per order (regardless of number of cases ordered) for shipping and handling.

Ziff-Davis Publishing Company, Dept. SD
One Park Avenue, New York, N. Y. 10016

My remittance in the amount of \$_____ is enclosed for the Cases indicated below.

Quantity _____

_____ Tape Case at \$3.25 each; 3 for \$9; 6 for \$17.

_____ 7" Record Case at \$3.25 each; 3 for \$9; 6 for \$17.

_____ 10" Record Case at \$3.50 each; 3 for \$10; 6 for \$19.

_____ 12" Record Case at \$3.50 each; 3 for \$10; 6 for \$19.

Add 75c PER ORDER for SHIPPING and HANDLING
Check color choice for back of case (sides in black only):

Midnight Blue Red Saddle Tan
 Pine Green Orange Yellow
 Grey Black Spice Brown

Name _____

Address _____

City _____ State _____ Zip Code _____

PAYMENT MUST BE ENCLOSED WITH ORDER

VIKING

ADDS SOMETHING EXTRA TO EVERY STAGE OF YOUR SOUND SYSTEM

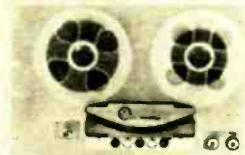

MODEL 225 SOLID STATE reel-to-reel back-ground music system. Plays 4 track monaural

tape in two directions, reversing automatically, to provide 16 hours of unrepeatd and unattended continuous audio programming. Contains built-in solid state playback preamplifier; connects to any existing sound system. \$500.00



MODEL 87 TAPE TRANSPORT

is a high quality, 2-motor tape deck ideally suited for fine music and recording systems, as well as electronic teaching applications. Two speed (3¾ and 7½ ips) unit has interlocked tape motion control and "Erase Protek" safety record interlock switch, plus pause control, cue control, head shifter, push-button counter and pilot light. Available in various head configurations for monaural and/or stereo applications. From \$138.00



RP 110 MONAURAL SOLID STATE tape record/playback amplifier incorporates latest

modular design concepts. Will record and play tapes of highest professional quality. Intended for use with electrically-controlled magnetic tape transports with separate erase, record and play heads, such as Viking models 230 and Studio 96. Performance exceeds NAB standards. \$299.00

Professional quality at popular prices — that's the virtue of VIKING. Latest design concepts and highest quality components are combined to produce functional excellence and flexibility equal to the highest requirements, yet costs are held down by the elimination of fancy frills and cabinetry. This is what makes VIKING equipment so perfectly suited to educational and industrial uses, in addition to custom applications in high fidelity systems. For further information, write:

VIKING
tape recorders
TELECOMMUNICATIONS
9600 ALDRICH AVENUE, SOUTH,
MINNEAPOLIS, MINNESOTA 55420

CIRCLE NO. 86 ON READER SERVICE CARD

FIELD SERVICE ENGINEERS MEDICAL X-RAY

Expanding division requires several field servicemen to locate in New York, Chicago, Milwaukee, Cleveland, Philadelphia & other metropolitan areas. Exp in the installation, service and repair of Medical X-Ray equipment is required.

LIBERAL STARTING SALARY . MANY COMPANY BENEFITS
Contact: MARTIN G. WOLFERT

North American Philips Co., Inc.

Norelco
An equal opportunity employer

Room 1027
100 East 42nd St.,
N.Y., N.Y. 10017

GET INTO ELECTRONICS



VALPARAISO TECHNICAL INSTITUTE
Dept. RD, Valparaiso, Indiana

V.T.I. training leads to success as technicians, field engineers, specialists in communications, guided missiles, computers, radar and automation. Basic & advanced courses in theory & laboratory. Electronic Engineering Technology and Electronic Technology curricula both available. Assoc. degree in 29 mos. B. S. also obtainable. G.I. approved. Graduates in all branches of electronics with major companies. Start September. February. Dorms. campus. High school graduate or equivalent. Write for catalog.

PERMANENT TINNING OF SOLDERING IRONS

By PETER J. PROFERA

THE corrosive action of some soldering fluxes, and the solvent action of molten solder on copper soldering iron tips combine to eat away the working surface of the tip until it finally becomes useless for further work. When this occurs, the tip has to be retinned.

Silver solder has a far higher melting point than tin-lead solder and can be used to make a permanently tinned tip. This solder is the type used for brazing, not the type intended for use in printed-circuit board repair, and can be obtained from either plumbing or jewelry supply dealers, or ordered from a metal and alloy supply house.

This permanent tinning operation is based on the fact that conventional tin-lead solders (the so-called soft solders), melt at temperatures between 360 and 750°F (depending on the ratio of tin to lead), while silver solder melts at about 1300°F.

The first step is to remove the tip from the iron and file its working faces until they are bright and shiny and free from pit marks. Wrap the tip shank in a piece of asbestos cloth (available at electrical supply houses) and fasten the combination in a vise. The asbestos wrapping acts as a heat insulator to prevent rapid dissipation of the heat applied to the tip during the tinning process, and to keep the temper of the vise jaws from being destroyed by the high temperature attained by the tip during the tinning process.

The flux to be used with the silver solder is ordinary borax, available in powdered form at any drugstore. Mix a little of the powder with water until it acquires the consistency of a paste, then brush some of the paste on the surfaces of the tip which are to be tinned.

Heat the tip with a blow torch until it becomes hot enough to melt the silver solder. Dip one end of a silver solder rod into the borax paste and then melt the solder onto the tip until a good coating covers the desired areas. After cooling, a few strokes of a file will render the coating smooth and uniform. Be careful that you don't file through the coating and expose any of the copper underneath. If you do, you will have to reheat the tip and recoat the exposed area.

To complete the job, replace the tip in the soldering iron, plug in the iron and when it has come up to operating temperature, tin the tip with conventional tin-lead solder. The tip is now permanently tinned and a wipe with a clean cloth is all that will ever be needed to make the tip ready for use. ▲

Bring your slides and movies to Life...

(and your audience, too!)

WITH VOLUME II

SOUND FOR A PICTURE EVENING

This superb 12-inch, 33 $\frac{1}{3}$ rpm record brings you 30 selections of sparkling, mood-setting off-beat music and hard-to-find, sound effects. For use "as is" by playing the appropriate tracks as your slide or movie show proceeds or for editing your selections and recording them on tape, "Sound For A Picture Evening" adds another dimension to your photography—high fidelity sound.

POPULAR PHOTOGRAPHY.

VOLUME II

SOUND FOR A PICTURE EVENING

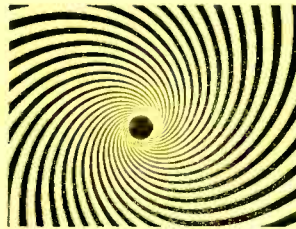

30 bands of unusual background music & sound effects specially chosen for slide shows & movies

*19 Bands of mood and special-situation music...
11 Bands of unusual, hard-to-find sound effects...*

MADE WITH PHOTOGRAPHERS IN MIND

Photographers are travelers . . . are parents . . . are sportsmen . . . are restless experimenters with the unusual. And so the editors of POPULAR PHOTOGRAPHY have produced this second volume of unusual music and sound effects expressly to match the activities and moods in the most popular types of pictures shown in slide and home movie shows. These are melodies and sounds selected from the vast resources of the Capitol Record Hollywood Library to fit the special needs of photographers. The 30 bands of "Sound For A Picture Evening, Vol. II" supplement but do not duplicate any of those in the first edition of this popular record.

A POPULAR PHOTOGRAPHY EXCLUSIVE

The "Sound For A Picture Evening, Vol. II" album has been produced by the editors of POPULAR PHOTOGRAPHY exclusively for our readers and is prepared by the Custom Services Division of Capitol Records. This outstanding album, which cannot be purchased in any store, is available by mail only to the readers of Popular Photography and other Ziff-Davis magazines.

YOU GET 30 SPECIAL MUSIC AND SOUND TRACKS

There are 19 bands of mood and special-situation music . . . 11 bands of unusual, hard-to-find sound effects.

MOODS: Majestic, Backyard Nature, Experimental, Mysterious, Music of the Spheres • **NATIONAL PORTRAITS:** Vive la France, German Village Band, Soul of Spain, American West, English Countryside, Buon Giorno, Italia •

SOUND EFFECTS: Bass Drum, Bassoonery, Cathedral Bells, Galloping Horses, Zoo Noises, Children at Play, Cocktail Party, Birds on a Spring Morning, Outboard Motor, Oars in Water, Skis on Snow, Trumpet Fanfare, Solo Violin • **SPECIAL PURPOSE MUSIC:** Music From Silent Movies, Music for Slow-Motion Movies, Music for Speeded-Up Motion, Music for Stop-Motion Movies, Underwater Music, Music for Old-Time Footage.

For photographers with wanderlust, you'll find the "National Portraits" to be authentic melodies to go with your vacation pictures of England, France, Germany, Italy, Spain and the American West.

There are also those special bands to accompany the kind of pictures sportsmen take: The sound of galloping horses, of boat motors, of skis on snow, of oars in the water. You'll even find other-worldly mood-music chosen especially to go with underwater pictures.

Experimental photographers will find the electronic music ideal accompaniment for abstract pictures. The music for stop-motion, slow-motion and speeded-up-motion pictures is fanciful and imaginative in helping to present the unusual scenes being portrayed on your screen. And there is even mood music to convey the visual grandeur of ancient museum relics and photographs of the stars and planets.

To these add many other tracks of carefully selected music and sounds—and you have "Sound For A Picture Evening, Volume II."

COMPLETE WITH INSTRUCTIONS AND BAND POINTER

FREE!

A comprehensive instruction booklet comes with your record, showing you how to make a successful sound-and-music tape track for your slide or movie show, or to use the record alone as background, even if you're a rank beginner. An ingenious band pointer which fits on top of your record instantly locates any band you want. No guessing, no wasted motion, no false starts.

This 12" long playing vinyl album consisting of selections from the music masters of the Capitol Record Hollywood Library is available to you for

only \$3.⁹⁸ POSTPAID!

It's a must for every slide and film show impresario and an album you will enjoy for many years to come.

PLACE YOUR ORDER NOW

"Sound For A Picture Evening, Volume II"
P. O. Box 3118
Church Street Station, New York, N.Y. 10008

Please send _____ "Sound For A Picture Evening, Volume II" albums at \$3.98 each, postpaid.

My check (or money order) for \$_____ is enclosed.

(Outside U.S.A. please send \$6.00 per record ordered.)
N. Y. State residents please add local sales tax.

Name _____

Address _____ EW-97

City _____

State _____ Zip Code _____

PAYMENT MUST BE ENCLOSED WITH ORDER

"SOUND FOR A PICTURE EVENING, VOLUME I" still available I missed this first release containing 17 specific mood music backgrounds and 8 tracks for special sound effects. Please send _____ "Sound For A Picture Evening, Volume I" albums at \$3.98 each, postpaid. (Outside U.S.A. send \$6.00 per record ordered.)

How to get into One of the hottest money-making fields in electronics today— servicing two-way radios!



HE'S FLYING HIGH. Before he got his CIE training and FCC License, Ed Dulaney's only professional skill was as a commercial pilot engaged in crop dusting. Today he has his own two-way radio company, with seven full-time employees. "I am much better off financially, and really enjoy my work," he says. Read here how you can break into this profitable field.

More than 5 million two-way transmitters have skyrocketed the demand for service men and field, system, and R&D engineers. Topnotch licensed experts can earn \$12,000 a year or more. You can be your own boss, build your own company. And you don't need a college education to break in.

HOW WOULD YOU LIKE to start collecting your share of the big money being made in electronics today? To start earning \$5 to \$7 an hour... \$200 to \$300 a week... \$10,000 to \$15,000 a year?

Your best bet today, especially if you

don't have a college education, is probably in the field of two-way radio.

Two-way radio is booming. Today there are more than *five million* two-way transmitters for police cars, fire department vehicles, taxis, trucks, boats, planes, etc. and Citizen's Band uses—

and the number is still growing at the rate of 80,000 new transmitters per month.

This wildfire boom presents a solid gold opportunity for trained two-way radio service experts. Many of them are earning \$5,000 to \$10,000 a year *more* than the average radio-TV repair man.

Why You'll Earn Top Pay

One reason is that the United States Government doesn't permit anyone to service two-way radio systems unless he is *licensed* by the Federal Communications Commission. And there simply aren't enough licensed electronics experts to go around.

Another reason two-way radio men earn so much more than radio-TV service men is that they are needed more often and more desperately. A home radio or television set may need repair only once every year or two, and there's no real emergency when it does. But a two-way radio user must keep those transmitters operating at all times, and *must* have their frequency modulation and plate power input checked at regular intervals by licensed personnel to meet FCC requirements.

This means that the available licensed experts can "write their own ticket" when it comes to earnings. Some work by the hour and usually charge at least \$5.00 per hour, \$7.50 on evenings and Sundays, plus travel expenses. A more common arrangement is to be paid a monthly retainer fee by each customer. Although rates vary widely, this fixed charge might be \$20 a month for the base station and \$7.50 for each mobile station. A survey showed that one man can easily maintain at least 100 stations, averaging 15 base stations and 85 mobiles. This would add up to at least \$12,000 a year.

Be Your Own Boss

There are other advantages too. You can become your own boss—work entirely by yourself or gradually build your own fully staffed service company. Instead of being chained to a workbench, machine, or desk all day, you'll move around, see lots of action, rub shoulders with important police and fire officials and business executives who depend on two-way radio for their daily operations. You may even be tapped for a big job working for one of the two-way radio manufacturers in field service, factory quality control, or laboratory research and development.

How To Get Started

How do you break into the ranks of the big-money earners in two-way radio? This is probably the best way:

1. Without quitting your present job, learn enough about electronics fundamentals to pass the Government FCC Exam and get your Commercial FCC License.
2. Then get a job in a two-way radio service shop and "learn the ropes" of the business.
3. As soon as you've earned a reputation as an expert, there are several ways you can go. You can move *out* and start signing up and servicing your own customers. You might become a franchised service representative of a big manufacturer and then start getting into two-way radio sales, where one sales contract might net you \$5,000. Or you may even be invited to move *up* into a high-prestige



THIS COULD BE YOUR "TICKET" TO A GOOD LIVING. You must have a Commercial FCC License to service two-way radios. Two out of three men who take the FCC exam flunk it... but nine out of ten CIE graduates pass it the first time they try!

salaried job with one of the major manufacturers either in the plant or out in the field.

The first step—mastering the fundamentals of Electronics in your spare time and getting your FCC License—can be easier than you think.

Cleveland Institute of Electronics has been successfully teaching electronics by mail for over thirty years. Right at home, in your spare time, you learn electronics step by step. Our AUTO-PROGRAMMED™ lessons and coaching by expert instructors make everything clear and easy, even for men who thought they were "poor learners." You'll learn not only the fundamentals that apply to all electronics design and servicing, but also the specific procedures for installing, troubleshooting, and maintaining two-way mobile equipment.

Get Your FCC License... or Your Money Back!

By the time you've finished your CIE course, you'll be able to pass the FCC License Exam with ease. Better than nine out of ten CIE-trained men pass the FCC Exam the first time they try, even though two out of three non-CIE men fail. This startling record of achievement makes possible the famous CIE

warranty: you'll pass the FCC Exam upon completion of your course or your tuition will be refunded in full.

Ed Dulaney is an outstanding example of the success possible through CIE training. Before he studied with CIE, Dulaney was a crop duster. Today he owns the Dulaney Communications Service, with seven people working for him repairing and manufacturing two-way equipment. Says Dulaney: "I found the CIE training thorough and the lessons easy to understand. No question about it—the CIE course was the best investment I ever made."

Find out more about how to get ahead in all fields of electronics, including two-way radio. Mail the bound-in postpaid reply card for two FREE books, "How To Get A Commercial FCC License" and "How To Succeed In Electronics." If card has been removed, just send us your name and address on a postcard.

ENROLL UNDER NEW G.I. BILL

All CIE courses are available under the new G.I. Bill. If you served on active duty since January 31, 1955, OR are in service now, check box on reply card for G.I. Bill information.

CIE Cleveland Institute of Electronics
1776 E. 17th St., Dept. EW-36, Cleveland, Ohio 44114

A Leader in Electronics Training... Since 1934 • Accredited Member National Home Study Council



CIRCLE NO. 122 ON READER SERVICE CARD

Earn Extra Income in MOBILE-RADIO MAINTENANCE!



CITIZENS BAND
AIRCRAFT... MARINE
... PUBLIC SAFETY...
BUSINESS AND INDUSTRIAL
RADIO
961,000 new transmitters added
last year, with the curve still
going upward!

MEASURE FREQUENCY with the LAMPKIN 105-B

- Just this ONE instrument... with no extra crystals or factory adjustments... will measure ALL channels from 100 KC to 175 MC. Only \$295.00.
- Ample accuracy for all mobile transmitters except for split-channels above 50 MC—for these use inexpensive accessory PPM Meter.
- Pin-point signal generator for receiver final alignment.
- Internal quartz crystal standard... correctable to WWV.

MEASURE FM DEVIATION with the LAMPKIN 205-A

- Just this ONE meter measures all mobile channels, 25 MC to 500 MC.
- Reads instantaneous true peak swing due to FM modulation.
- Set selective-calling tone signals using 0-1.25 KC or 0-2.5 KC ranges of 205-A Quad Scale, \$340.00. Dual Scale model, 12.5 KC and 25 KC ranges, only \$290.00.
- Oscilloscope jack for true wave form.
- 3-inch meter indicates directly in peak KC.

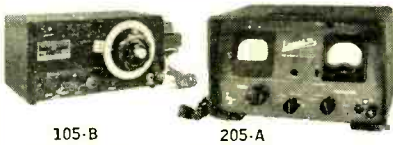

105-B 205-A

FREE BOOKLET!

Send for "HOW TO MAKE MONEY IN MOBILE-RADIO MAINTENANCE".

MAIL COUPON TODAY!

At no obligation to me, please send free booklet and information on Lampkin meters.

Name _____
Address _____
City _____ State _____ Zip _____

LAMPKIN LABORATORIES, INC.
MFM Div., Bradenton, Fla. 33505

CIRCLE NO. 107 ON READER SERVICE CARD

PHOTOGRAPHY ANNUAL

A selection of the World's finest photographs compiled by the editors of Popular Photography. All editions \$1.25 each:

1966 — \$1.25.....#1	1964 — \$1.25.....#3
1967 — \$1.50.....#38	

Order by number from Ziff-Davis Service Div., 595 Broadway • New York, N. Y. 10012. Enclose add'l 15¢ per copy for shipping and handling (50¢ for orders outside U.S.A.)

LEARN Electronics Engineering AT HOME

Fix TV, design automation systems, learn transistors, complete electronics. College level Home Study courses taught so you can understand them. Earn more in the highly paid electronics industry. Computers, Missiles, theory and practical. Kits furnished. Over 30,000 graduates now employed. Resident classes at our Chicago campus if desired. Founded 1934. Catalog, "Vets—write for information about G. I. Bill Training."

American Institute of Engineering & Technology
1141 West Fullerton Parkway Chicago, Ill. 60614

TEST EQUIPMENT PRODUCT REPORT

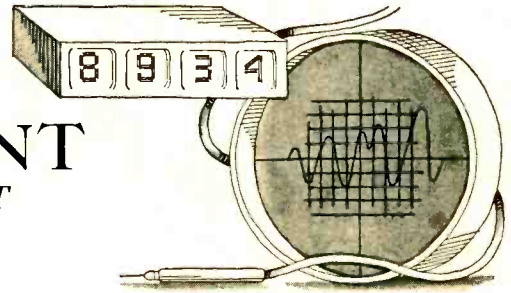

Seco Model 240 Thyristor (SCR) Analyzer

For copy of manufacturer's brochure, circle No. 153 on Reader Service Card.

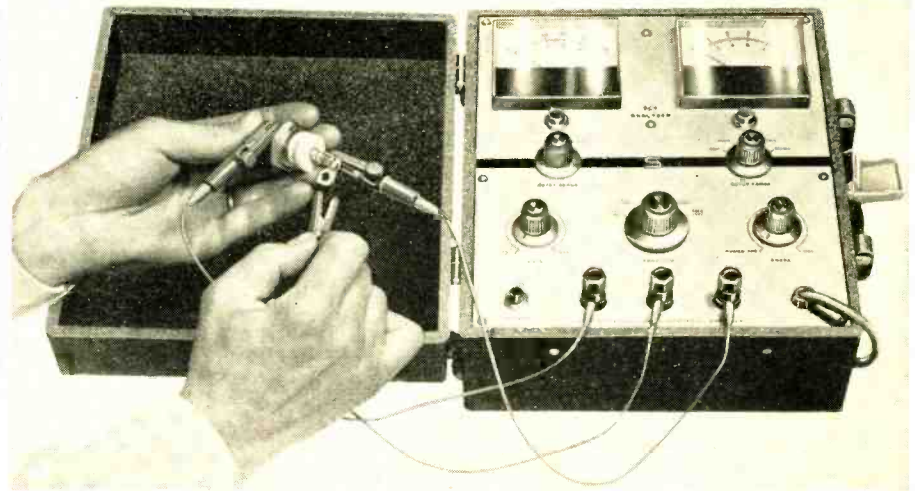

AS SCR's, triacs, breakdown diodes, and gate-controlled switches continue to gain in popularity in industrial equipment and home appliances, technicians have become aware of the need for a fast, accurate, modest-cost test unit for these thyristors. The Seco Model 240 was designed to meet this need. The instrument checks gate firing voltage and current as well as peak forward and peak reverse voltage and current. These parameters are indicated on two separate meters on the front panel of the tester.

When the function control is in the "PFV" position (see circuit diagram), the SCR gate is shorted to its cathode, and either 200 or 2000 volts d.c. are applied between anode and cathode to check the ability of the SCR to block

forward voltages with zero gate current. Two ranges of full-scale sensitivity are provided: 100 μ A and 1 mA. For the "PRV" test, the polarity of the anode-to-cathode voltage is reversed and the current is again measured on the two-scale current meter.

For the "Gate Test" position of the function switch, a 5-volt peak source (half-wave rectified a.c.) is connected to the SCR anode through an indicator lamp. With the SCR conducting an average current of 40 mA, the lamp is turned on. A 5-volt d.c. source is then connected between gate and cathode, and this source is made adjustable with

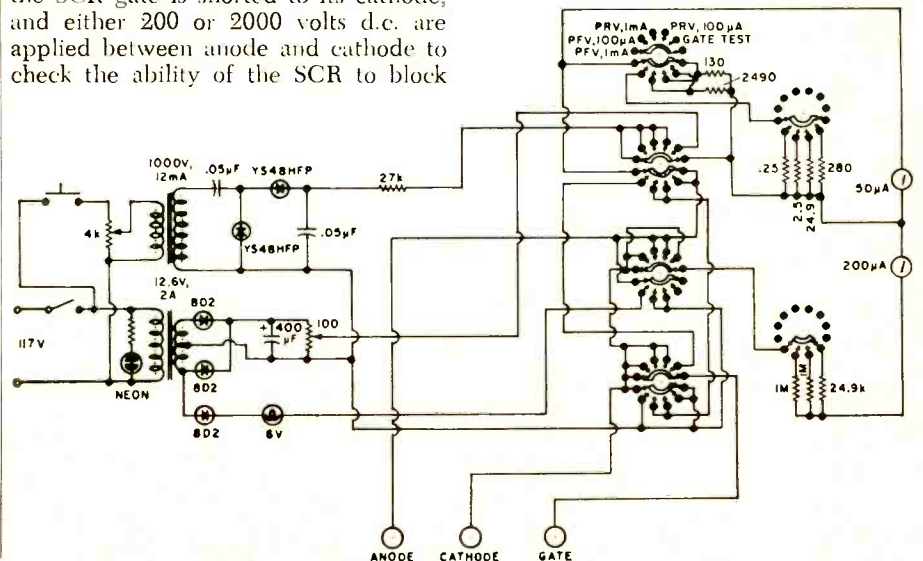

a front-panel control. As the voltage is varied, its value being monitored on the voltmeter, a point is reached when the SCR fires as indicated by the lamp. The values of gate current and voltage required are then indicated.

Because the tester is fast and easy to operate, it is useful in matching SCR's to particular voltage and current parameters, or for sorting SCR's into matched pairs or threes to share loads evenly in full-wave or three-phase circuits.

The instrument is housed in a durable vinyl-covered carrying case measuring 10½" x 9" x 5" deep. The Model 240 is priced at \$144.50. ▲

**Hewlett-Packard Model 5221A
Electronic Counter**

For copy of manufacturer's brochure, circle No. 154 on Reader Service Card.

SMALL size and low cost combined with high performance and ruggedness—this has been the promise of integrated circuits. We have already seen IC's used in a low-cost digital voltmeter, and now we have a new electronic counter from Hewlett-Packard which uses IC's.

The counter (Model 5221A) has a maximum counting rate of 10 MHz.



higher than any previous counter selling for less than \$1000. This one sells for only \$350.

Besides a significant reduction in price, a reduction in size was made possible by the use of integrated circuits. The instrument case is only one-third of a standard 19-inch rack module in width, a convenient size for carrying or for bench use. Case dimensions are 5½" wide by 6½" high by 11" deep. And the instrument weighs only 5 pounds.

The counter has a 4-digit readout using new miniature side-viewing Nixie tubes developed especially for H-P by the Burroughs Corp. The readout retains the most recent count until a new count is completed, then it changes to the new count, thereby providing a continuous, non-blinking display. A new

CONQUER NEW HORIZONS

WITH
CONTROLLED QUALITY CRYSTALS

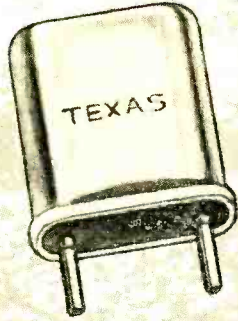

- **Tried and True**
- **Complete Range**
- **Guaranteed**
- **Ready for you at your dealer**



Division of Whitehall Electronics

TEXAS CRYSTALS

1000 Crystal Drive • Fort Myers, Fla. 33901
Plants in Fort Myers and Los Angeles

CIRCLE NO. 198 ON READER SERVICE CARD

World's
Number
One
Trusted
Name
Brand

"NO NOISE"

- VOLUME CONTROL & CONTACT RESTORER
- TUNER-TONIC with PERMA-FILM
- EC-44 FOR ELECTRICAL CONTACTS
- TAPE-RECO HEAD CLEANER
- FRIGID-AIR CIRCUIT COOLER

All Guaranteed Non-Flammable, No Carbon-Tet, Non-Toxic & Won't Affect Plastics

The Only Brand Perfect For Color TV and Black & White

FREE extender assembly for pin-point application supplied with ALL NO-NOISE PRODUCTS.

Electronic Chemical Corp.
813 Communipaw Ave. / Jersey City, N. J. 07304

CIRCLE NO. 116 ON READER SERVICE CARD



FREE Electronics Data Guide

Want help in working out those tricky electronics calculations? Send for our FREE Electronics Data Guide. This heavy-duty plastic guide fits right in your shirt pocket—gives you instant reference to over 40 indispensable electronics formulas...plus conversion factors, color codes and decibel table as well. Saves you time and the trouble of memorizing or "looking it up." A "must" for every man interested in electronics—provided as a service by CIE. Why not get your FREE Data Guide today? Just fill in your name and address below, then cut out this ad and mail it to:

Cleveland Institute of Electronics
1776 E. 17th St., Cleveland, Ohio 44114

Name _____ (Please Print)

Address _____

City _____

State _____ Zip _____

Accredited Member National Home Study Council. 907

CIRCLE NO. 121 ON READER SERVICE CARD

Rx
avoid
headaches

use Sony Tape

If you've been using any of the so-called bargain tapes, chances are you should have your heads examined. The odds are good that the heads are excessively worn and you're not getting the most out of your recorder. If you want to keep "factory-fresh" sound to your recorder—and avoid future "headaches" and keep it that way—Here's the prescription—buy Sony Professional-quality Recording Tape. Sony Tape is permanently lubricated by the exclusive Lubri-Cushion process. Sony's extra-heavy Oxi-Coating won't shed or sliver and is applied so evenly that recordings made on Sony Tape are not subject to sound dropouts. Sony Tape captures and reproduces the strength and delicacy of every sound—over and over again. There's a bonus, too, with every 5" and 7" reel of Sony Tape—a pair of Sony-exclusive "Easy Threader" tabs to make tape threading the easiest ever. And Sony reels are a sturdier, heavier gauge plastic for protection against possible warping. It's just what the "Doctor" ordered and yours for just pennies more than "bargain" tape.

SONY **SUPERSCOPE**
 SUN VALLEY, CALIFORNIA • 91352
 CIRCLE NO. 93 ON READER SERVICE CARD

blanking feature suppresses display of unneeded zeros to the left of the most significant digit, simplifying readout interpretation.

Counter functions are similar to previous basic counters. Frequency and rate measurements are made with either of two count times (gate times): 0.1 and 1 second. The time between counts is adjustable between 50 milliseconds and 5 seconds by a front-panel control, or a count may be retained indefinitely with the control in the "Hold" position.

The counter also totalizes input pulses during the time that the "Gate Selector" switch is in the "Open" position. The gate can be controlled manually with the switch or remotely by a simple contact closure to ground.

Input impedance is 1 megohm shunted by 30 pF. Input sensitivity is 0.1 volt r.m.s. between 5 Hz and 10 MHz. An internal control allows either positive or negative pulses to be counted. The time base is derived from the power line, typically accurate within 0.1%. ▲

Amphenol Model 670 Transistorized Volt-Ohmmeter

For copy of manufacturer's brochure, circle No. 42 on Reader Service Card.



FIELD-EFFECT transistors, already widely used in hi-fi tuners and receiver front-ends, are now beginning to appear in modestly priced test equipment for the service technician. The latest such instrument to come to our attention is *Amphenol's* Model 670, called the "Millivolt Commander." By using an FET as the front-end for volt-ohmmeter circuitry, we can have the advantages of a v.t.v.m. with its very high input impedance along with the portability of a v.o.m., since the FET

and other circuits within the instrument are completely battery-operated.

One other important feature of the new tester is its very low voltage d.c. and a.c. ranges. For example, it can measure voltages as low as one-tenth volt d.c. full scale and one-hundredth volt a.c. full scale. The measurement of such low voltages is very important to the technician who must work on new transistorized TV sets, radios, and audio equipment.

Nine d.c. ranges are provided, from

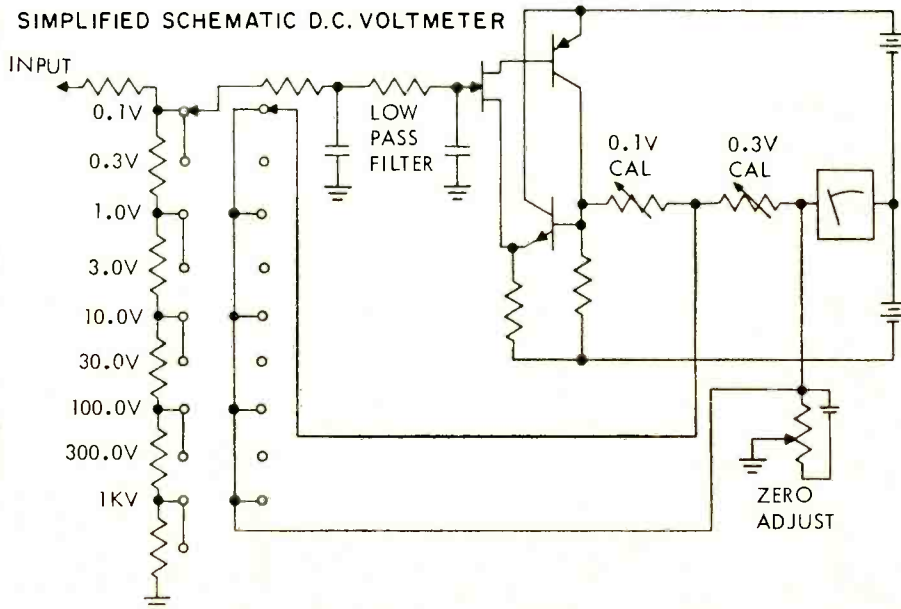

100 mV to 1000 V, along with ten a.c. ranges from 10 mV to 300 V. Input resistance of the unit is 11 megohms on d.c. and 10 megohms on a.c. In addition to voltage measurements, the instrument also has the usual resistance and decibel scales. Accuracy is somewhat better than the usual v.t.v.m., being $\pm 2\%$ of full scale on all d.c. ranges and $\pm 3\%$ of full scale on all a.c. and dB ranges. A single probe is used for all d.c. and a.c. measurements.

Power is supplied by two 1.4-volt mercury cells and eight 1.5-volt AA zinc-carbon cells, available in most stores. Because of the very low current drain from these batteries, life under normal eight-hour-per-day working conditions is expected to be the same as shelf life.

The meter is housed in a compact, luggage-like case with a pouch inside the cover for the probe. The instrument measures $9\frac{1}{4}$ " wide, $6\frac{3}{8}$ " high, and $5\frac{1}{2}$ " deep and it weighs about 4 pounds with batteries. The price of the v.o.m. is \$99.95. ▲

Electronics for Therapy

(Continued from page 45)

not. However, the foundation of Fechner's postulations was what is now known as Weber's Law. In 1834, E. H. Weber (1795-1878) had found that in order for a given stimulus to appear just noticeably different from a preceding stimulus, the necessary increment always had to be a constant fraction of the original stimulus. After some verifications, Fechner's Law started to emerge: $S = K \log I$, where S is the magnitude of sensation, I is a dimension of the stimulus, and K is a constant of proportionality that varies with sense modality. The \log is there since the responses of human organisms to stimuli vary as the logarithms of those stimuli. Fechner therefore proposed that we accumulate such "just noticeable differences" (jnd) to calculate a sensory magnitude. Today, one finds that this early work matches our decibels rather well.

But—and this is where the trouble starts—the mathematical tenets do not hold true when it comes to microphysical-type processes electromagnetically triggered within the neuron complex of the brain. In the case of r.f.-type audio inductions into the brain, the observer has the novel experience of "hearing a thought" rather than a sound, and current research tends to bog down on this because the phenomenon cannot be defined biophysically or mathematically. In spite of these current drawbacks, however, there can be no doubt that a new family of superior auditory implements will emerge once the attendant problems of clinical safety and packaging have been solved. ▲

Major Breakthrough in TV Accessories... NEW from Mosley!

In response to your requests, Mosley introduces a completely NEW 'profit building' line of TV accessories for use with shielded and other types of twin lead cables on the market!

These solderless receptacles, line splicers, 2 and 4 set couplers, clamp the line securely so it can't pull out! Assure peak performance, especially for color. Eliminate call backs. Help simplify the cable lead-in job... for a compact, time saving installation.

Stock up now and watch your sales climb! Send for complete details.

Write: Dept. 145

Mosley Electronics Inc.

4610 N. Lindbergh Blvd., Bridgeton, Mo. 63042

CIRCLE NO. 103 ON READER SERVICE CARD

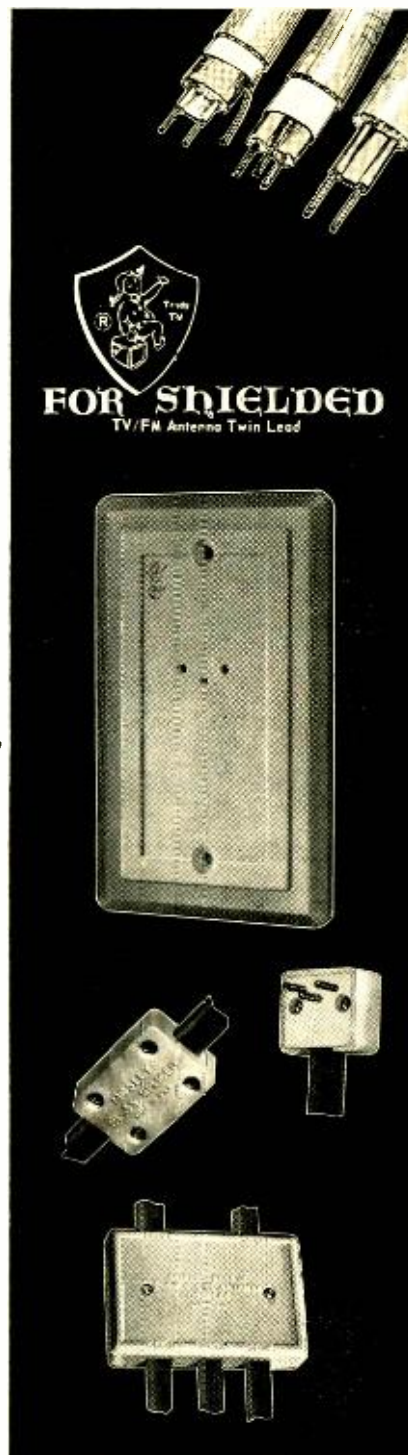

STEREO HI-FI DIRECTORY

1967 — \$1.25...#45
1966 — \$1.25...#29

Complete buyers guide for virtually every Hi Fi component manufactured.

Order by number from
Ziff-Davis Service Division,
595 Broadway, New York, N. Y. 10012.
Enclose an additional 15¢ per copy for shipping and handling (50¢ for orders outside U.S.A.)

You can't buy a better recording tape at any price

IRISH

IRISH MAGNETIC RECORDING TAPE
453 Broadway, New York, N. Y. 10013

Start a Stereo System of Unparalleled

Quality For Solid State
or Tube Amplifiers

...for less than \$40⁰⁰

FABULOUS MUSTANG M-12T

12" 3-WAY SPEAKER SYSTEM.

A new breed of high performance for whole house sound! With 35-40,000 Hz response; extra slim, thin profile; exclusive front or rear baffle mounting design; 12 15/16" dia. by 3 7/8" deep.



...for less than \$70⁰⁰

AWARD WINNING MODEL 6201

12" 2-WAY SPEAKER SYSTEM.

Updated version of the most popular true-coaxial speaker ever made! With axially mounted compression driven, wide-angle reciprocating flare horn tweeter; 28 to 18,500 Hz response; 13" dia. by 6 5/8" deep.



...for less than \$85⁰⁰

AWARD WINNING MODEL 312

12" 3-WAY DIFFAXIAL SYSTEM.

The only integrated single speaker assembly capable of response from 28 to 40,000 Hz! With high compliance woofer; Diffusicone mid-range; exclusive Sphericon tweeter; integral brilliance control; 15 1/2" dia. by 12" deep.

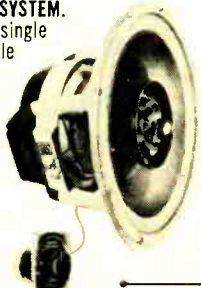

Listen to these and other fine University speakers at your dealers today! Ask about PSE—University's "master blue print" for goof-proof planning and building of your own speaker system. Includes many plans for speaker enclosures designed to deliver the very best in stereo sound. Address inquiries to desk J75



LISTEN—UNIVERSITY®SOUNDS BETTER

UNIVERSITY® SOUND

A DIVISION OF LTV LING ALTEC, INC.
9500 W. Reno Oklahoma City, Oklahoma 73101
CIRCLE NO. 87 ON READER SERVICE CARD

70

RADIO & TV NEWS

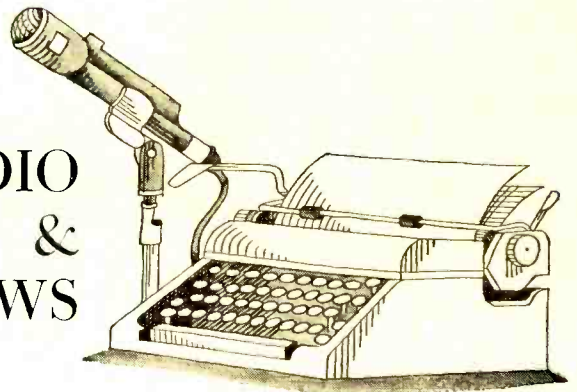

WHEN you subscribe to several technical magazines a month and you see things in some that you want to save, it often leads to voluminous files of odds and ends of information. Some people take to saving magazine indices just to find out what's where.

Take heart, all you paper savers, the U.S. Army Electronics Command has recently announced a new program in which a computer "browses" through the new technical literature of 7144 areas of interest (including technical reports, magazine articles, and translations) and prepares an individual listing of all pertinent material in accordance with the interests of each particular "subscriber."

The purpose of the new automated system, called Selective Dissemination of Information (SDI), is to ensure that each scientist is continuously aware of the latest technical publications in his field without having to spend many hours each week searching for it.

TV Planet Patrol

Long before man sets foot on other planets, robots with TV "eyes" far sharper than man's will have gone over almost all of the ground.

According to a spokesman from RCA's Astro-Electronics Division, these robot-like explorers of the 1980 to 2000 year period will have sensors far more advanced than those available today. Resolution of 20,000 to 30,000 lines is being discussed. Current space TV uses 600 to 800 line resolution, although RCA is presently working on systems using between 2000 and 8000 lines. As a reference, present commercial TV uses only 525 lines.

The significance of the 20,000 to 30,000 line systems is that they will be capable of producing visual data equivalent in quality to that offered by the finest photographic film. It is also expected that the robot TV system will also operate in color, although the technical operation may differ from today's version.

IR I See

It is an old adage in the military that you have to see the target before you can take a shot at it. But what do

you do in the dark? Up until now, we have been using an infrared Snooper-scope mounted on a rifle, a method which has been successfully used for many years by the military.

ITT now checks in with the Metascope, a binocular-like instrument for use by the troops. Essentially, it is intended for use by tank drivers, and the devices are mounted to the periscopes of their tanks.

The case of the Metascope contains a light source that resembles a flashlight with an infrared filter which only passes the light that is invisible to the human eye. The tank-mounted version uses an infrared searchlight.

An object hidden by darkness is illuminated by the invisible infrared beam. The night-vision equipment's infrared detection unit perceives the infrared images of the targets and converts them to visible images.

Reliability Personified

When we look at a large, complex electronic system having a vast number of transistors and other semiconductors, a large group of relays, switches, and power supplies, an optical system, a complex TV system, and a stack of other highly complex gear and then ponder over just what would happen to this mass of equipment if it were subjected to extremes of heat and cold, micrometeorite abrasion, and other assorted assaults that exist in outer space, we are right in wondering just how long it will work.

NASA, obviously proud, has just released some figures on Tiros VII, now in its fourth year in space (launched June 19, 1963). Although designed with an operational goal of three to six months, this weather satellite has completed 21,600 revolutions of the earth, travelling 594,000,000 miles in the process. It has also snapped over 124,500 pictures of the earth and its weather patterns. Areas covered by these pictures total over 50 billion square miles.

Although still capable of transmitting excellent weather pictures, Tiros VII is seldom used since it was joined in space by eight, more advanced Tiros and TOS weather satellites. Tiros VII is one of fifteen weather satellites. ▲

ELECTRONICS WORLD

NEW APPROACH TO ENGINE TACHOMETERS

By RONALD L. CARROLL / Texas Instruments

AUTOMOTIVE engine tachometers for both conventional and transistor ignition systems use the waveform at the distributor points for triggering. From an engineering point of view, this is the worst place to use.

Consider the entire ignition system as a pulse generator having a constant duty cycle and a mechanically determined frequency of operation. The properties of a good pulse generator are basically low output impedance and clean waveform: *i.e.*, an absence of transients superimposed on the desired output waveform. By taking the counting pulses from the distributor points, both these aforementioned points are directly violated. First, we are now harnessed to a pulse generator having a 12-volt output waveform plagued with voltage spikes that can reach 1 kV; and second, the impedance of the circuit ranges from 100 to 1000 megohms.

Every 12-volt ignition system uses a ballast resistor of about one-ohm resistance. On late model cars, this takes the form of a piece of resistance wire between the ignition switch and the positive terminal of the ignition coil. Depending on the type of ignition circuit, between 4 and 12 amperes can flow through this wire. This current gives rise to a fairly clean voltage pulse (4 to 12 volts) across an ideally low one-ohm resistance.

The circuit to the right of the ballast resistor (*R*) shown in Fig. 1 has been thoroughly tested and its linearity in all cases was limited only by the linearity of the meter movement itself. Calibration potentiometer *R2* must be selected for the meter used.

Calibration may be either with a known accurate engine tachometer or a good high-current pulse generator converting frequency to r/min as shown in Fig. 2. ▲

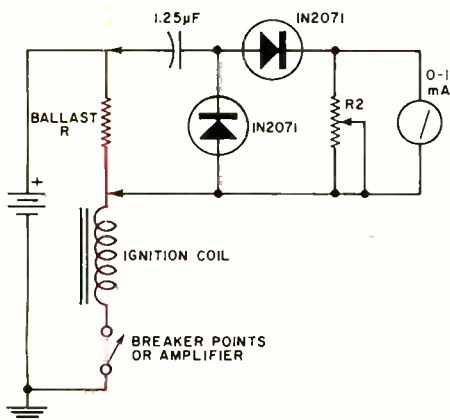
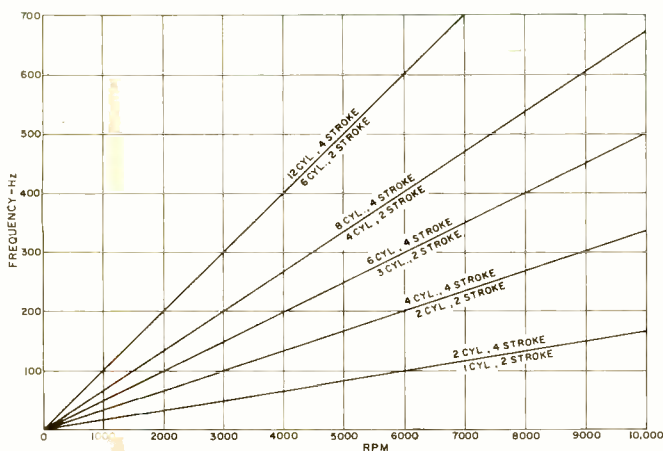

Fig. 1. Pulses are taken across ballast resistor.

Fig. 2. Converting frequency to engine r/min.



Weller®

...the soldering tools professionals depend on



The original Dual Heat Soldering Guns

Preferred by technicians for their fast heating copper tips, exclusive trigger-controlled dual heat, and high soldering efficiency. Available in 3 wattage sizes, each with spotlight.

100/140-watt Model 8200, 145/210-watt Model D-440, and 240/325-watt Model D-550. Also in complete kits:

- **Model 8200PK** includes 100/140 watt gun, extra tips, tip-changing wrench, flux brush, soldering aid and solder
- **Model D-550PK** heavy-duty 240/325 watt gun kit with soldering, cutting and smoothing tips, wrench and solder

Dependable MARKSMAN Irons in a size for every job



Ideal for deep chassis work and continuous-duty soldering, Marksman irons outperform others of comparable size and weight. All five feature long-reach stainless steel barrels and replaceable tips.

- 25-watt, 1 3/4-oz. Model SP-23 with 1/8" tip (In kit with extra tips, soldering aid, solder—Model SP-23K)
- 40-watt, 2-oz. Model SP-40 with 1/4" tip
- 80-watt, 4-oz. Model SP-80 with 3/8" tip
- 120-watt, 10-oz. Model SP-120 with 1/2" tip
- 175-watt, 16-oz. Model SP-175 with 5/8" tip

NOW a BATTERY OPERATED IRON for field servicing

Use this lightweight service tool for automotive wiring, model planes, or mobile communications. Works from any 12 volt battery or 12-14 volt AC/DC supply. Supplied complete with long-life patented "Temperature Sensing" tip, 12-ft. power cord and terminal clips. Model TCP-12—12 volt; Model TCP-24—24-28 volts.



Complete Weller Line includes replacement tips and solder at your Electronic Parts Distributor

WELLER ELECTRIC CORPORATION, Easton, Pa.

WORLD LEADER IN SOLDERING TECHNOLOGY
CIRCLE NO. 85 ON READER SERVICE CARD

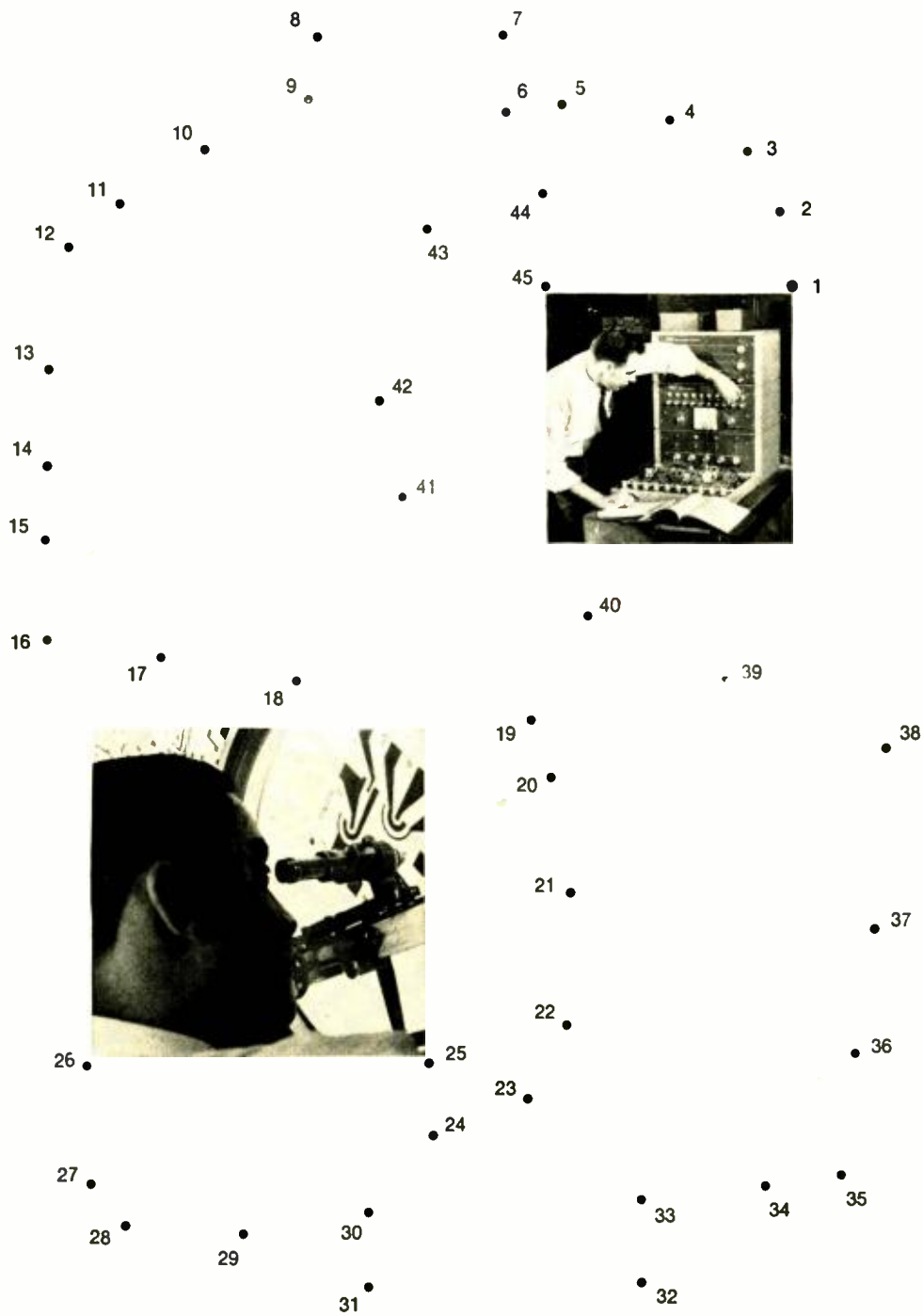

Connect the dots
and find out what RCA Institutes
Home Training in Electronics
can do for you!

Learn electronics at home faster, easier, almost automatically— with RCA AUTOTEXT

Are you just a beginner with an interest in the exciting field of electronics? Or, are you already earning a living in electronics and want to brush-up or expand your knowledge in a more rewarding field of electronics? In either case, AUTOTEXT, RCA Institutes' own method of Home Training will help you learn electronics more quickly and with less effort, even if you've had trouble with conventional learning methods in the past.

THOUSANDS OF WELL PAID JOBS ARE OPEN NOW TO MEN SKILLED IN ELECTRONICS!

Thousands of well paid jobs in electronics go unfilled every year because not enough men have taken the opportunity to train themselves for these openings. RCA Institutes has done something positive to help men with an aptitude and interest in electronics to qualify for these jobs.

HOME STUDY CAN TRAIN YOU FOR REWARDING CAREER OPPORTUNITIES

To help fill the "manpower gap" in the electronics field, RCA Institutes has developed a broad scope of Home Training courses, all designed to lead to a well paying career in electronics in the least possible time. You also have the opportunity to enroll in an RCA "Career Program" exclusively created to train you quickly for the job you want! Each "Career Program" starts with the amazing AUTOTEXT Programmed Instruction Method. And, all along the way, your program is supervised by RCA Institutes experts who become personally involved in your training and help you over any "rough spots" that may develop.

VARIETY OF KITS ARE YOURS TO KEEP

To give practical application to your studies, a variety of valuable RCA Institutes engineered kits are included in your program. Each kit is complete in itself, and yours to keep at no extra cost. You get the new Programmed Electronics Breadboard for limitless experiments, including building a work-

ing signal generator, multimeter, and a fully transistorized superheterodyne AM receiver.

ONLY FROM RCA INSTITUTES— TRANSISTORIZED TV KIT— VALUABLE OSCILLOSCOPE

All students receive a valuable oscilloscope. Those enrolled in the Television program receive the all-new transistorized TV Kit. Both at no extra cost and only from RCA Institutes.

CHOOSE THE "CAREER PROGRAM" THAT APPEALS MOST TO YOU

Start today on the electronics career of your choice. Pick the one that suits you best and mark it off on the attached card.

- Television Servicing
- Telecommunications
- FCC License Preparation
- Automation Electronics
- Automatic Controls
- Digital Techniques
- Industrial Electronics
- Nuclear Instrumentation
- Solid State Electronics
- Electronics Drafting

ADVANCED TRAINING

For those already working in electronics, RCA Institutes offers advanced courses. You can start on a higher level without wasting time on work you already know.

UNIQUE TUITION PLAN

With RCA Institutes Training, you progress at your own pace. You only pay for lessons as you order them. You don't sign a long-term contract. There's

no large down-payment to lose if you decide not to continue. You're never badgered for monthly payments. Even if you decide to interrupt your training at any time, you don't pay a single cent more.

CLASSROOM TRAINING ALSO AVAILABLE

If you prefer, you can attend classes at RCA Institutes Resident School, one of the largest of its kind in New York City. Coeducational classroom and laboratory training, day and evening sessions, start four times a year. Simply check "Classroom Training" on the attached card for full information.

FREE PLACEMENT SERVICE, TOO

In recent years, 9 out of 10 Resident School students who used the Free Placement Service have been placed before or shortly after graduation. This Service is available to Home Study students.

**SEND ATTACHED POSTAGE PAID
CARD TODAY. FREE DESCRIPTIVE
BOOK YOURS WITHOUT OBLIGATION.
NO SALESMAN WILL CALL.**

All RCA Institutes courses and programs are approved for veterans under the New G.I. Bill.

RCA INSTITUTES, INC. Dept. EW-97
350 West 4th Street
New York, N.Y. 10014



The Most Trusted Name In Electronics

MAGNECORD LEADS THE FIELD

with six different
professional quality
portable
rack mounted
tape recorders

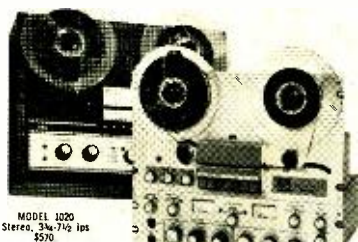

MODEL 1020
Stereo, 3 1/2-7 1/2 ips
\$570

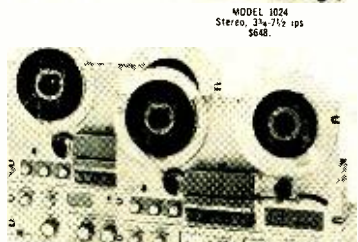

MODEL 1024
Stereo, 3 1/2-7 1/2 ips
\$648



MODEL 1021
Monaural, 3 1/2-7 1/2 ips
\$408

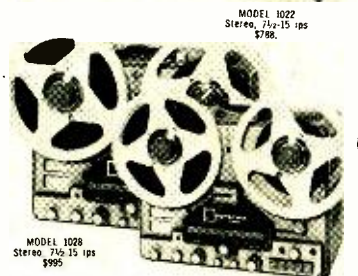

MODEL 1022
Stereo, 7 1/2-15 ips
\$788



MODEL 1028
Stereo, 7 1/2-15 ips
\$995

MODEL 1048
Stereo, 3 1/2-7 1/2 ips
\$995

Priced from \$570 to \$995, every one of these 1000-series MagneCORDs is a rugged, value-engineered recorder/reproducer capable of satisfying the most exacting audio studio requirements. All are equipped with hysteresis synchronous capstan motors and heavy-duty individual reel drive motors. Rigid die-cast head mounts eliminate alignment problems.

For complete characteristics and specifications, write:



EW Lab Tested (Continued from page 16)

prevents triggering of the multiplex circuit and the indicator light by weak signals or interstation noise. The a.g.c. voltage controls the gain of the first i.f. stage which also acts as a d.c. a.g.c. amplifier to control the FM r.f. stage and mixer. Another diode supplies a control voltage from the third i.f. stage to operate the muting circuits.

In our laboratory measurements, the tuner met or exceeded its salient specifications, within the limits of normal measurement error. The IHF usable sensitivity was 2.3 microvolts (rated 2.5 μ V), with virtually complete limiting by 4.5 microvolts. The distortion at 100% modulation was 0.8% (rated 0.75%). The frequency response of the FM tuner was within ± 1 dB from 30 to 8000 Hz, sloping off to -2.5 dB at 10,000 Hz, and -6.5 dB at 15,000 Hz. This was apparently the result of the filtering built into the deemphasis networks which are designed to eliminate 19-kHz and 38-kHz components from the tuner output where they might interfere with making tape recordings of stereo broadcasts. This filtering is quite effective and we were unable to hear any loss of highs resulting from the roll-off. In our view, this was a worthwhile exchange of performance parameters.

The stereo channel separation was about 27 dB at middle frequencies, reducing to 18 dB at 30 Hz and to 13 dB at 15,000 Hz. We attempted to improve the performance by instrument alignment, but were largely unsuccessful. The sensitivity and distortion, already equal to or better than rated values in the "as received" alignment condition, could not be improved at all. The multiplex circuits had been originally tested with no alignment since the coils are supplied pre-aligned. Using

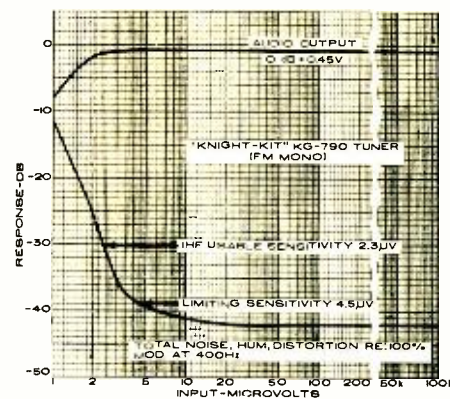

our multiplex signal generator we optimized the alignment and gained an improvement of 3 to 7 dB in stereo separation across the frequency range of 30 to 15,000 Hz. This is a negligible improvement, hardly worth the effort, so that we have no hesitation in recommending to the builder that he follow the instruction manual advice and not disturb the adjustments of the pre-aligned coils.

The AM tuner alignment is simple, using received signals. When this had been done, we found it to be one of the better AM tuners we have used in recent years. It is free from "birdies" and the 10-kHz whistle filter works well. The sensitivity and selectivity were more than adequate for our suburban location, using the built-in ferrite antenna. The quality, while perhaps not high fidelity, was clean and undistorted and probably the best that could be obtained from a relatively simple tuner.

The "Knight-Kit" KG-790 is clearly one of the better kit-type tuners to be had and its performance easily matches that of many more expensive factory-wired units. Anyone who wishes to include AM capability in his high-fidelity system could hardly do better than to build the KG-790 which sells for \$149.95. An oiled-walnut cabinet is available for \$19.95.

PML EC-71 Capacitor Microphone

For copy of manufacturer's brochure, circle No. 41 on Reader Service Card.

IN January, 1965 we reported on the PML EK-61 capacitor microphone, which brought professional sound quality within the reach of the serious home recordist. PML (a Swedish manufacturer) has brought out a new version of this microphone, quite similar in its electro-acoustic design, but with its vacuum tube and power supply replaced by a field-effect transistor and a new, highly compact power-supply.

The capacitor microphone, although capable of the highest quality, requires an extremely high load impedance for the tiny transducer element. Previous designs normally used a subminiature vacuum tube as a cathode follower to match the high microphone impedance to the common load impedances of 200

ohms or less. The tube was housed in the body of the microphone and tube replacement was usually difficult.

The FET, whose impedance is high-



er than most vacuum tubes, is ideally suited for this application. It should have an indefinitely long life and total freedom from hum and microphonics. In addition, the power-supply requirements are minimal. *PML* has an a.c. supply, measuring about 3" x 5" x 1½", which will accommodate two microphones. A similar battery-operated supply is available as well, with a 67.5-volt battery having a life of about 500 hours.

The microphone itself is housed in a small cylindrical case, 1¼" in diameter and 2¼" long, weighing only 1¼ oz.

The microphone comes in two versions, the omnidirectional EK-71 and cardioid EC-71. We tested the latter model by plotting the response of a speaker system with the EC-71 and with our calibrated capacitor microphone mounted in the same position relative to the speaker. When the two microphones have similar polar-response patterns, this permits an accurate measurement to be made, as we proved with the earlier model tested. However, the difference between the cardioid pattern of the EC-71 and the comparison microphone made this close correlation impossible. This is particularly true in view of the fact that our tests are done in a normal listening room rather than an anechoic chamber. Even so, it was obvious from the curve that the EC-71 has a smooth, uniform response over the full

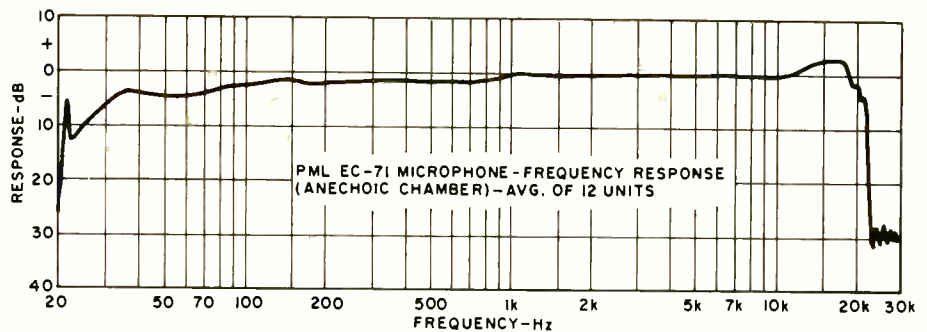

audio range, and we see no reason to question the manufacturer's published response curve, included here, which shows a very flat response from 30 to 20,000 Hz.

The EC-71 has a rather high output, about 25 dB higher than the comparison microphone. Evidently the electronic circuits of the EC-71 include amplification as well as impedance transformation. We made tape recordings with it and found it to have a smooth and natural sound consistent with its claimed response. We did, however, find a tendency to "blast" with close talking and found it necessary to stay at least 8 inches from the microphone. An accessory windscreen is available and might be helpful for close talking.

The power-supply unit contains impedance-matching transformers providing output impedances of 30-50 ohms,

200 ohms, 600 ohms (balanced), and a high-impedance unbalanced output. The output cable connection determines the impedance. Low-impedance cables are available in lengths of 25, 50, and 100 feet as well as the standard 12 feet.

We made a tape-recorded comparison between the *PML* EC-71 and a good-quality cardioid dynamic microphone. The EC-71 had a noticeably smoother and more natural sound on male voice, as well as far better highs.

The *PML* solid-state capacitor microphones continue to bring the finest sound quality into a price bracket within reach of many non-professional users. The EC-71, distributed in the U.S. by *Ercona Corp.*, sells for \$109.50 and the omnidirectional EK-71 is \$99.50. The power supplies for the microphone are \$69.50 for the a.c. and \$49.50 for battery-operated models. ▲

Why not sell the best

Now...get
genuine Zenith parts
three ways faster—
with ZIP!

Your Zenith Distributor has a revolutionary new system to speed your replacement parts ordering. Called "ZIP" (Zenith Instant Parts), it gives you much improved service.

1. Looking up parts numbers is 100% quicker than before. Because parts lists and schematics for the past ten years are now microfilmed on compact, easily-handled filmcards.

2. "Out-of-stocks" are cut down. The new ZIP program helps your Zenith distributor keep tighter inventory controls and maintain a more complete stock.

3. Factory special orders are shipped faster. Under the new ZIP program, the Zenith factory is geared to ship orders without delay.

Order from your Zenith Distributor for "Zenith Instant Parts" service on all genuine Zenith replacement parts and accessories.

ZENITH®
The quality goes in before the name goes on

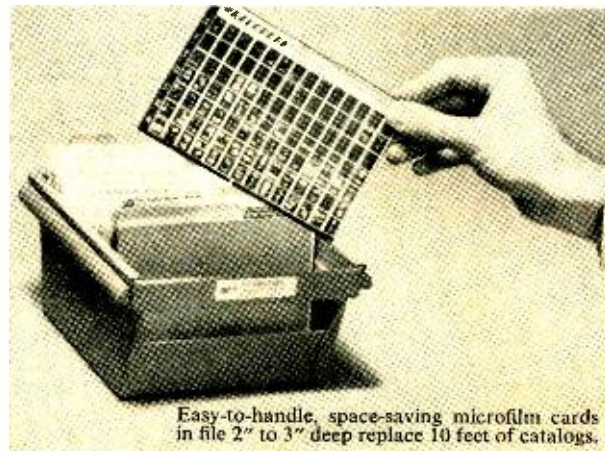

Easy-to-handle, space-saving microfilm cards in file 2" to 3" deep replace 10 feet of catalogs.

BOOK REVIEWS

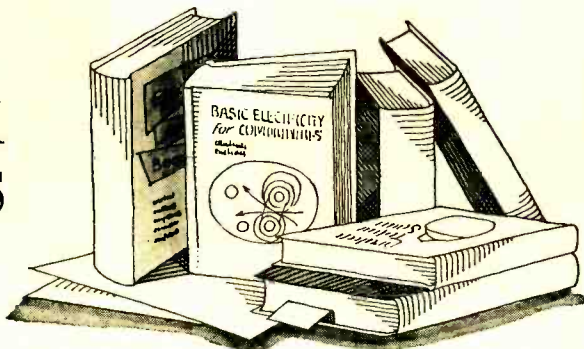

"SWITCHING CIRCUITS FOR ENGINEERS" by Mitchell P. Marcus. Published by *Prentice-Hall, Inc.*, Englewood Cliffs, N.J. 332 pages. Price \$12.00.

This is a second edition of a book which originally appeared in 1962. It has been expanded considerably and updated throughout. The emphasis on the practical rather than the abstract has been retained. The author, who is with the Systems Development Division of *IBM's* Endicott Laboratory, has worked with his subject, taught his subject, and written about it and what he has to say about switching circuits commands attention. He contends that while switching circuits can be designed intuitively, because of the tremendous growth of automatic digital computers and complex business machines, logic design requires a discipline in order to reduce designing time and the number of components needed.

The book is addressed to both the logic design engineer and the engineering student of switching circuits and presupposes an engineering background and a familiarity with the requisite mathematical procedures.

The text is divided into 19 chapters covering Boolean algebra; special forms of Boolean expressions; logic circuits; electronic logic blocks; contact networks; tabular method of simplification; map method of simplification; trees—relay and electronic; symmetric functions, reiterative networks; number systems, adders; codes, error detection, error correction; sequential circuits; and pulse-input sequential circuits. Answers and solutions to the problems appearing in the text are provided in the back of the book for self-checking or classroom assignment.

"TRANSISTOR CIRCUIT ENGINEERING" by Basil L. Cochran. Published by *The Macmillan Company*, New York. 437 pages. Price \$13.95.

This volume is designed as a textbook for undergraduates in electrical engineering courses who have had some previous experience with the physics of semiconductors and a knowledge of mathematical procedures.

The text is divided into eleven chapters covering semiconductor concepts, semiconductor junctions, transistor be-

havior and equivalent models, low-frequency characteristics of the basic configurations, biasing, low-frequency amplifiers and active filters, high-frequency amplifiers (wide-band and narrow-band), noise, feedback and stability, and FET's. Five appendices cover the black-box approach to equivalent circuits, the superposition concept of gain and impedance, signal flow graphs, useful physical constants, and the frequency characteristics from log-modulus plots.

Each chapter carries a series of problems, a list of references, and a bibliography for further study. The text is adequately illustrated.

"CIRCUIT PROBLEMS AND SOLUTIONS" by Gerald Lippin. Published by *Hayden Book Company, Inc.*, New York. 188 pages. Price \$3.95. Soft cover.

This is the first volume in a projected two-volume series and is subtitled "Elementary Methods". This book is a problem-oriented text which is designed to be used in conjunction with an a.c. and/or d.c. text.

Starting with Ohm's Law, progressing through meters, resistance, vectors, *RL* circuits, time constants, *RLC* circuits, and filter circuits, the author has first presented some circuit theory and then followed this with step-by-step problem solutions.

Written at the technical school or junior college level, the author has provided four appendices covering conversion factors, wire gauge tables, trigonometric tables, and log tables for the convenience of the student.

"INTRODUCTION TO RADIO ASTRONOMY" by Roger C. Jennison. Published by *Philosophical Library Inc.*, 15 East 40th St., New York, N.Y. 10016. 155 pages. Price \$4.75.

This book by a former Senior Lecturer in Radio Astronomy at Jodrell Bank in England falls somewhere between an engineering treatise and a popular exposé. It would be helpful if the reader had some familiarity with electronics even if he knows nothing of radio astronomy.

The text is divided into eight chapters covering an introduction to astronomy, the basic tools of the trade (the equip-

ment), the radio sun, the moon and planets, galactic radio emissions and the first radio stars, spectral measurements, the extra-galactic radio sources, and tricks of the trade. This final chapter covers the sophisticated techniques involved in radio astronomy and here the author has resorted to mathematical treatment which may be a little over the head of the average layman. The rest of the text is fairly easy to assimilate.

"APPLIED MATHEMATICS FOR ELECTRONICS" by L.J. Adams & R. Journigan. Published by *Holt, Rinehart and Winston, Inc.*, New York. 692 pages. Price \$10.95.

Although addressed specifically to the post-high-school technical institute student, this volume is equally well suited to engineering students and practicing engineering technicians who want to upgrade their everyday mathematical skills.

The text covers arithmetic, algebra, trigonometry, analytic geometry, and elementary calculus, with emphasis on areas of special interest—such as Boolean algebra.

After an introductory chapter, the book goes on to cover basic arithmetical techniques, fundamental algebraic operations, the metric system, basic concepts of electric circuits, systems of linear equations, quadratic equations, trigonometry, the slide rule, alternating current, analytic geometry, calculus, Boolean algebra, and matrices. The authors have provided 13 appendices to give the user access to all of the reference data he will require to work with the text material.

Problems are provided throughout the text with the answers given for the odd-numbered problems. The text is attractively presented in two colors, with items for particular emphasis printed in brown.

"POWER SUPPLIES FOR ELECTRONIC EQUIPMENT" by Leo G. Sands. Published by *John F. Rider Publisher, Inc.*, New York. 184 pages. Price \$6.25 (cloth) or \$4.25 (paperbound).

This book is addressed to engineers, technicians, and experimenters who are involved in buying, applying, or maintaining power supplies used with electronic equipment. It covers batteries as well as generators.

Divided into ten chapters, the author first discusses the power requirements of electronic equipment, then batteries, electromechanical generators, utility power, transformers, rectifiers, filters, regulators, converters and inverters, and power-supply specifications. Since commercial as well as theoretical circuits are presented, this volume can serve as a "buying guide" as well as a reference source. ▲

ELECTRONIC CROSSWORDS

By JAMES R. KIMSEY

(Answer on page 102)

ACROSS

1. Process by which an object is electrified or magnetized by exposure to a magnetic field.
6. An electro-acoustic unit of power ratio.
10. Type of current (abbr.).
11. Fuss.
12. Variation of a wave with time, serving to convey information in communications.
13. Skill in dealing with delicate situations.
15. Communications record of a station.
16. Consume.
17. Connecting wires.
19. Entrance.
20. Lubricate.
21. Stake.
22. Large plants.
25. Unit of relative power.
28. Distress signal.
30. Recording medium.
31. Resistor whose value may be changed by means of a control knob.
33. Designation for a widely used circuit.
35. Designating an oscilloscope (abbr.).
36. First man.
37. Negative.
38. Mechanism used on indexed rotary switches to hold switch firmly in position.
40. Part of a cylinder mechanism.
42. Long period of time.
44. A small current (abbr.).
45. Russian affirmative.
46. Electromagnetic unit of resistance.
48. A body that will attract iron and steel.
50. "For that reason".
52. Requires.

53. In a directional antenna system, the rear portion or element (usually not connected to the remainder of the antenna).

DOWN

1. An object that offers opposition to the movements of electrons: used for supporting or separating conductors.
2. Excavate.
3. Metal frame or base supporting an electronic circuit.
4. Ego.
5. Eight-element vacuum tube.
6. Lowest resonant frequency of an antenna or circuit.
7. Man with a blue pencil (colloq.).
8. Voltage.
9. Electromagnetic switch employing an armature to open or close the contacts.
14. Time past.
18. Female deer.
23. One of the plates of an electrolytic capacitor.
24. The power that a device delivers.
26. Organ of hearing.
27. Circuit that responds in accordance with oscillations produced in another circuit.
28. Commonwealth.
29. Discolor.
32. Unrefined metal.
34. Milieu.
37. Any point, line, or surface in a stationary wave system at which the amplitude of the waveshaping variable is zero.
38. Term used to indicate current being taken from a voltage source.
39. Titles.
41. Droop.
43. Finished.
47. Movie starring Paul Newman.
49. Remains after deductions.
51. In a superhet, a "combined" frequency (abbr.).

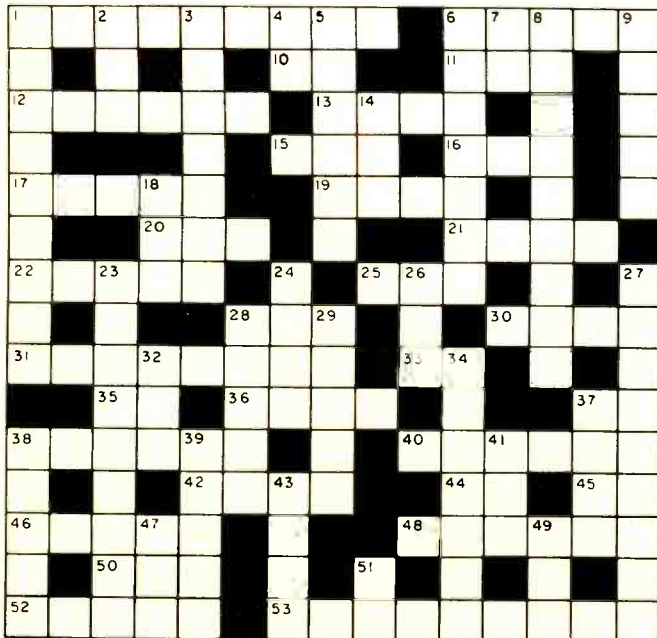

GAS WELDING TORCH



Uses **OXYGEN** and **LP GAS**

- Completely self-contained.
- Produces 5000° pin-point flame.
- Welds, brazes, solders.
- Hundreds of lightweight uses.
- Suggested list - \$19.95.

GET COMPLETE DETAILS AT MOST INDUSTRIAL DISTRIBUTORS. OR WRITE TO MICROFLAME, INC.



MICROFLAME, INC.

7800 COMPUTER AVENUE
MINNEAPOLIS, MINNESOTA 55424

CIRCLE NO. 104 ON READER SERVICE CARD

LISTEN TO: POLICE, FIRE, AIRCRAFT & WEATHER REPORTS!

Perfect for Industrial, Commercial, Utility and Government Use

SONAR SENTRY VHF MONITOR RECEIVERS

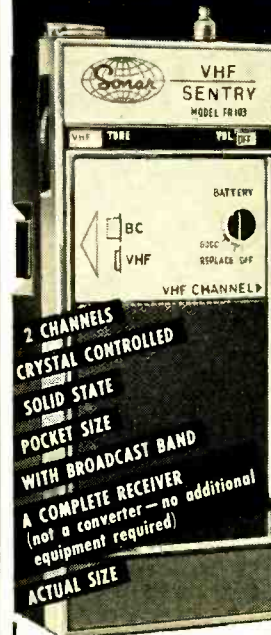

Designed and engineered for simplicity of operation, compact enough to fit a shirt pocket yet powerful enough to deliver a clear clean signal—it's dependable • Operates on two crystal controlled VHF channels plus broadcast band • Completely solid state for long life use • Visible battery indicator to show battery condition at all times • Built in antenna • 5 7/8" H x 2 1/2" W x 1 3/8" D. Wt. 11 oz.

\$39.95

With Battery, Earphone, & Carrying Strap
less Crystals. Crystals \$5.00 ea.



SONAR RADIO CORPORATION
73 Wortman Ave., Brooklyn, N. Y. 11207
Please send me information on VHF Monitor Receivers.

- MODELS**
- FR-103 150-175 MHz
 - FR-106 25-50 MHz
 - AR-107 Aircraft 108-136 MHz

Name.....
Address.....
City..... State.....

CIRCLE NO. 94 ON READER SERVICE CARD

Look What's NEW In The

NEW! Deluxe Solid-State Combo Amplifier & Speaker System!

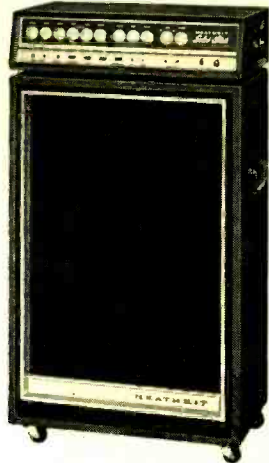

Special Combo Offer!

Kit TAS-17-2 Amplifier &
2 Speaker Systems
Save \$20.00

\$395⁰⁰
240 lbs.

All the "big sound" features every combo wants . . . tremolo, built-in "fuzz", brightness, reverb plus a shattering 120 watts of EIA music power. Has 3 independent input channels each with 2 input jacks. Handles lead or bass guitars, combo organ, singer's mike, even a record changer. Speaker system features two special 12" woofers, special horn driver and matching black vinyl-covered wood cabinet.

Kit TA-17
Amplifier
\$175⁰⁰

Kit TA-17-1
Speaker System
\$120⁰⁰

NEW! Low Cost Single-Channel Solid-State Guitar Amplifier



Kit TA-27
\$89⁹⁵

Boasts 20 watts EIA music power, 40 watts peak power; variable tremolo & reverb; two inputs that handle lead guitars; singer's mike; special heavy-duty 12" speaker; line bypass reversing switch that reduces hum; transformer-operated power supply; and handsome leather-textured, black vinyl covered wood cabinet with extruded aluminum front panel and chrome knobs. 35 lbs.

NOW Available Fully Assembled . . . Heathkit "Starmaker" Dual-Channel Guitar Amplifier



Assembled
TAW-16
\$199⁹⁵
(Kit TA-16
\$134.95)

Features all solid-state circuit; 25 watts EIA, 60 watts peak power; two channels, one for accompaniment, accordion or mike, the other for variable tremolo & reverb; two inputs each channel; two 12" heavy-duty speakers; line bypass reversing switch for hum reduction; leather-textured black vinyl covered wood cabinet with extruded aluminum front panel & chrome knobs. For extra savings, build the kit version in just 15 hours. 52 lbs.

NEW! Heathkit Soldering Iron



Kit GH-17
\$14⁹⁵

Ideal for kit-building or other electronic soldering jobs. Safe 6 volt, 25 watt GE midget iron with non-corroding tip. 3 heat ranges. Excellent heat recovery time. Quick warm-up . . . iron ready in 2 minutes. Protective metal cage. Build in an hour. 5 lbs.

NOW Available Fully Assembled . . . World's Most Advanced Stereo Receiver!



Assembled
ARW-15
\$499⁹⁵
(less cab.)
Kit AR-15,
\$329.95

Acclaimed by owners & audio experts for its advanced features like integrated circuits and crystal filters in the IF amplifier section; ultra-sensitive FET FM tuner; 150 watts dynamic music power; complete AM, FM and FM stereo listening; positive circuit protection; all-silicon transistors; "black magic" panel lighting; stereo only switch; adjustable phase control for best stereo and many more. 34 lbs. Optional wrap-around walnut cabinet \$19.95

NEW! Professional 10-Band Shortwave Listener's Receiver



Kit SB-310
\$249⁰⁰

Covers 6 shortwave bands (49, 41, 31, 25, 19 & 16 meters) . . . 80, 40 & 20 meter ham bands . . . 11 meter CB. Includes 5 kHz crystal filter for AM, SSB and CW listening. Features selectivity that slices stations down to last kHz . . . no more guessing station identities; 11-tube circuit; crystal-controlled front-end for same rate tuning on all bands; prebuilt & aligned LMO; tuning dial to knob ratio 4 to 1; and many more deluxe SWL features. 2-tone green metal cabinet included. Optional crystal filters for optimum CW & SSB available. 20 lbs.

'68 HEATHKIT® Catalog!

Introducing The Exciting New Look Of Heathkit Solid-State Instruments!

Now from Heath... the most exciting innovation in electronic instrumentation... new ultra-functional cabinet styling. These new Heathkit instruments feature a cabinet frame consisting of front and rear panels with side rails that completely support the component chassis independent of the top and bottom cabinet shells... allows complete freedom for assembly, checkout and calibration. You'll like the

clean bold panel & meter markings for easier reading... the easier-to-grasp knobs... the compact size... and the retractable carrying handles that are concealed in the side rails. The die-cast front panel bezel styled in chrome and black, the black side rails, and the special two-tone beige front panels and cabinet shells give these new instruments an appearance as up-to-date as their performance.

NEW! Deluxe Solid-State Volt-Ohm Meter... Battery Plus Built-In AC Power

Features 8 DC and 8 AC voltage ranges from 0.5v to 1500 v. full scale; 7 ohmmeter ranges x1 (10 ohms center scale), x10, x100, x1k, x10k, x100k and x1 megohm; 11 megohm input resistance on DC ranges; 1 megohm on AC ranges; internal battery or 120/240 v., 50/60 Hz AC power for portable or "in-shop" operation; large, easy-to-read 6" 100 uA meter; separate switches for individual functions; single test probe with finger-tip flip switch for all measurements; simple circuit board construction.

Solid-State High Impedance Volt-Ohm-Milliammeter

All silicon transistors plus FET's. Features 9 AC and 9 DC voltage full scale ranges down to 150 mv; 11 current ranges from 15 uA to 1.5A full scale; 7 resistance ranges (10 ohms center scale) measure one ohm to 1000 megohms; AC plus battery power for portability; 6" 200 uA meter with zero center scale for + & - voltage measurements without switching; accuracy of $\pm 3\%$ full scale on DC volts, $\pm 5\%$ on AC volts; separate range switches for each function; 1% precision resistors; 10-turn thumbwheel zero adjustment; fast circuit board construction. 10 lbs.

New FM Stereo Generator For RF, IF and FM Stereo Alignment

Produces virtually all signals for trouble-shooting & aligning multiplex adapters, FM tuners and receivers. Generates mono FM or composite stereo FM signals. Crystal-controlled 19 kHz (± 2 Hz) pilot signal, adjustable from 0 to 10% for checking tuner lock-in range. Switch-selection of 400 Hz, 1000 Hz, 5000 Hz, 19 kHz, and 65 kHz or 67 kHz SCA signals for complete alignment capability. 100 MHz sweep signal (adjustable ± 2 MHz) for overall RF and IF alignment. Built-in crystal controlled marker oscillator for IF and dial tracking checks. Phase test capability. No balance adjustment needed for equal right and left channel modulation levels.

New Variable Regulated High Voltage Power Supply

Features 6v. and 12 v. AC filament voltages; also furnishes B+ from 0 to 400 volts DC, bias from 0 to -100 volts DC; separate panel meters monitor B+ output voltage & current; voltmeter switched to read C- volts; output terminals isolated for safety; high voltage and bias may be switched "off" with filaments still "on" for maximum testing efficiency and safety.

New Solid-State Regulated Low Voltage Power Supply

New Zener reference-voltage power supply. New up-dated circuit that is virtually immune to overload from exotic transients. Relay-protected against short circuit & overload. Provides 0.5 to 50 volts DC with better than ± 15 millivolts regulation. 4 current ranges: 50 mA, 150 mA, 500 mA & 1.5 A. Adjustable current limiter: 30 to 100% on all ranges. Panel meter shows output voltage or current. Choice of kit or assembled versions.

Kit IM-16
\$44⁹⁵

Kit IM-25
\$80⁰⁰

Wired IMW-25
\$115.00

Kit IG-37
\$79⁹⁵

Kit IP-17
\$59⁹⁵

Kit IP-27
\$76⁹⁵

Wired IPW-27
\$119.95



NEW

FREE 1968 CATALOG!

Now with more kits, more color. Fully describes these along with over 300 kits for stereo/hi-fi, color TV, electronic organs, electric guitar & amplifier, amateur radio, marine, educational, CB, home & hobby. Mail coupon or write Heath Company, Benton Harbor, Michigan 49022.

HEATH COMPANY, Dept. 15-9
Benton Harbor, Michigan 49022
In Canada, Daystrom Ltd.

Enclosed is \$ _____, including shipping.

Please send model (s) _____

Please send FREE Heathkit Catalog.

Name _____

Address _____

City _____

State _____

Zip _____

Prices & specifications subject to change without notice.

CL-301

SOLID-STATE RING COUNTERS AND CHASERS FOR LIGHT DISPLAYS

By A. A. ADEM / Semiconductor Products Dept., General Electric Co.*

Basic semiconductor circuits for incandescent light displays, warning and traffic lights, and illuminated advertising signs.

THIS article describes some basic semiconductor circuits for incandescent light displays, warning and traffic lights, and illuminated advertising signs. The SCR and the Triac are ideal for this type of application to switch heavy loads on and off. These solid-state switches have no contacts to bounce, stick, or wear out; they are economical, explosion-proof, and reliable.

Ring counters are used for display purposes where, out of a string of several lights, only one light (sometimes more) is kept on at any one time. There is, however, a continuous and sequential transfer from the light that is on to the next one. This can be visualized by imagining a sixty-stage ring counter where sixty lights are arranged in a circle, six degrees apart. In such a ring counter, if the trigger pulses are maintained one second or one minute apart, the movement of the light would correspond to the numeral to which

the second or minute arm, respectively, points.

Chasers are similar to ring counters except that, once a light is turned on, it stays on until the rest of the lights are on, and then they all turn off and start with the first light again. In our imaginary clock, this type of operation would correspond to the hands "chasing" something, always beginning at one minute and losing it on the sixty-minute mark.

Ring Counters

A three-stage ring counter is shown in Fig. 1. More stages can be added to this circuit, as required, between the dotted lines. The component values as shown are for a load of 100 watts or less for each SCR. For heavier loads, diodes *D1* through *D4* would have to be changed to higher current diodes, such as the G-E A40B, and the value of the filter capacitor *C1* and the commutating capacitors *C2*, *C3*, and *C4*

would have to be increased. The value of the commutating capacitors can be determined in the manner explained in the author's previous article on solid-state flashers (August issue).

When power is first applied to the circuit, diodes *D1-D4* and capacitor *C1* supply 120 volts d.c. to the anodes of the SCR's through the loads, causing diodes *D6*, *D7*, and *D8* to be reverse-biased. Out of this d.c. supply, zener diode *D5* provides 18 volts to the free-running unijunction oscillator circuit. The trigger pulses from the UJT cannot turn any SCR on due to the reverse bias on the gate diodes.

To start the circuit, switch *S1* must be closed momentarily to provide a pulse to the gate of *SCR1* to turn it on. When *SCR1* turns on, the reverse bias on *D7* is removed and the next time the UJT supplies a pulse, *SCR2* turns on causing *SCR1* to turn off because of the commutating capacitor *C3*. Similarly, when *SCR2* turns on, the reverse bias on *D8* is removed and the next time the UJT fires, *SCR3* turns on, causing *SCR2* to turn off. Thus, every time a pulse appears at the common shift line, the power to the load transfers sequentially from one stage to the next, always in the same direction.

As the load of a ring counter is increased, the value of the commutating capacitors, (which incidentally are of the non-polarized type), the filter capacitor, and the current rating of the supply diodes must be increased. After a certain power output level, this circuit becomes impractical and uneconomical. If this is the case, a ring counter can be used to trigger Triacs much in the same way as described in the next section.

Fig. 2 shows a chaser circuit with three stages. Just like the circuit of Fig. 1, more stages may be added between the dotted lines. If in Fig. 1, the commutating capacitors were left out and some means were provided to turn all the SCR's off after *SCR3* had been turned on, the circuit would function as a chaser.

Fig. 1. Ring counter in which each SCR is triggered in turn to operate its load.

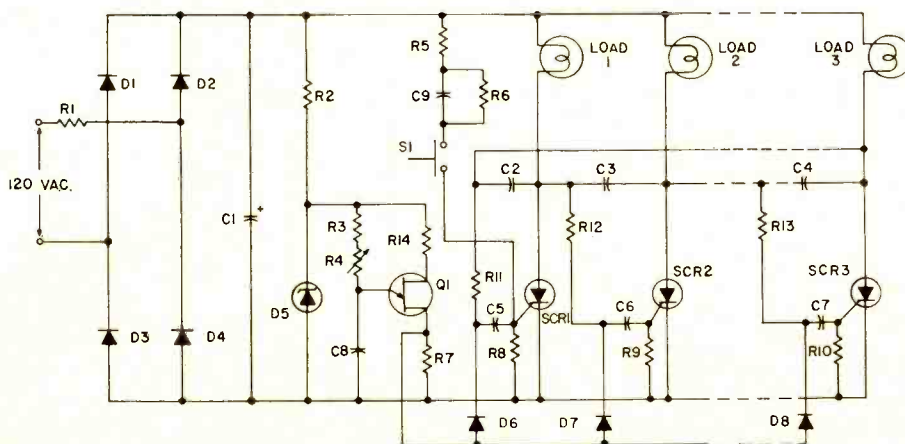

R1—Adjust to give 120 volts across C1 (depends on load)
 R2—4700 ohm, 2 W res.
 R3—10,000 ohm, 1/2 W res.
 R4—500,000 ohm linear pot
 R5—100 ohm, 1/2 W res.
 R6—1 megohm, 1/2 W res.
 R7—47 ohm, 1/2 W res.
 R8, R9, R10—1000 ohm, 1/2 W res.
 R11, R12, R13—33,000 ohm, 1/2 W res.
 R14—330 ohm, 1/2 W res.
 C1—100 μ F, 200 V capacitor
 C2, C3, C4—0.5 μ F, 200 V capacitor

C5, C6, C7—0.01 μ F, 200 V capacitor
 C8—1 μ F, 25 V capacitor
 C9—0.1 μ F, 200 V capacitor
 D1, D2, D3, D4—A10B diode (G-E)
 D5—Z4XL18 zener diode (G-E)
 D6, D7, D8—A13F diode (G-E)
 SCR1, SCR2, SCR3—Silicon controlled rectifier (G-E C20B)
 Q1—2N2646 unijunction transistor (G-E)
 Loads—100 W

Note: Additional stages may be inserted between dashed lines

*Now employed by Fairchild Semiconductor in Mountain View, Calif.

Chasers are primarily used in advertising signs where a string of lights is turned on sequentially to produce the effect of a "moving sign". Presently, this function is performed by a motor-driven cam, actuating heavy silver contacts, with its attendant drawbacks.

When power is turned on initially, all the SCR's will be in the "off" state. The free-running unijunction oscillator receives its power from the bridge rectifiers, D1-D4, and filter capacitor C1. At the end of the time delay, determined by the setting of R1, the UJT will fire and the pulse at base 1 will only turn on SCR1 (D5-D8 are reversed-biased). When the UJT fires again, SCR3 will turn on, thus firing Triac 1. The two new pulses will turn on SCR4 and SCR5, in that order, firing Triacs 2 and 3. The following pulse will fire SCR2 which will commutate off SCR1, SCR3, SCR4, and SCR5, removing the gate drive to all the Triacs. The next pulse will start the cycle again, turning SCR1 "on" and SCR2 "off."

With this arrangement, the "off" time takes two pulses; in other words, if the UJT pulses are spaced one second apart, the "off" time takes two seconds, whereas there is only one second between the time Triac 1 and Triac 2 come on. This is due to the additional stage introduced because of SCR2. Increasing the "off" time makes the function of the circuit more appealing to the eye. If this additional stage is not required, SCR1 and its associated components can be left out of the circuit to provide a starting pulse to SCR3. It will be noted that the circuit of Fig. 2 as shown can also be used as a 4-stage chaser by merely adding a 150-ohm resistor from the anode of SCR1 to the gate of another Triac. Under these conditions the "off" time will be reduced and the added Triac will turn on first, followed by Triacs 1, 2, and 3.

The circuit of Fig. 3 is an extension of the circuit shown in Fig. 2. In addition, it provides a separate timing adjustment for each stage of the chaser. Here, instead of Triacs, SCR's are used to drive the loads. When power is applied to the circuit, all the SCR's are in non-conducting state. Q1 starts timing and, at the end of the time delay set by R1, fires SCR4 which energizes the reed-switch coil.

The reed-switch contact then connects the d.c. supply to the remaining portion of the circuit and at the same time applies a d.c. drive to the gate of SCR1, turning it on. The closure of the reed contact starts Q2 timing which, at the end of its time delay, as set by R2, fires SCR6 which, in turn, fires SCR2. This sequential firing continues down the line until Q4 fires which causes SCR5 to turn on and

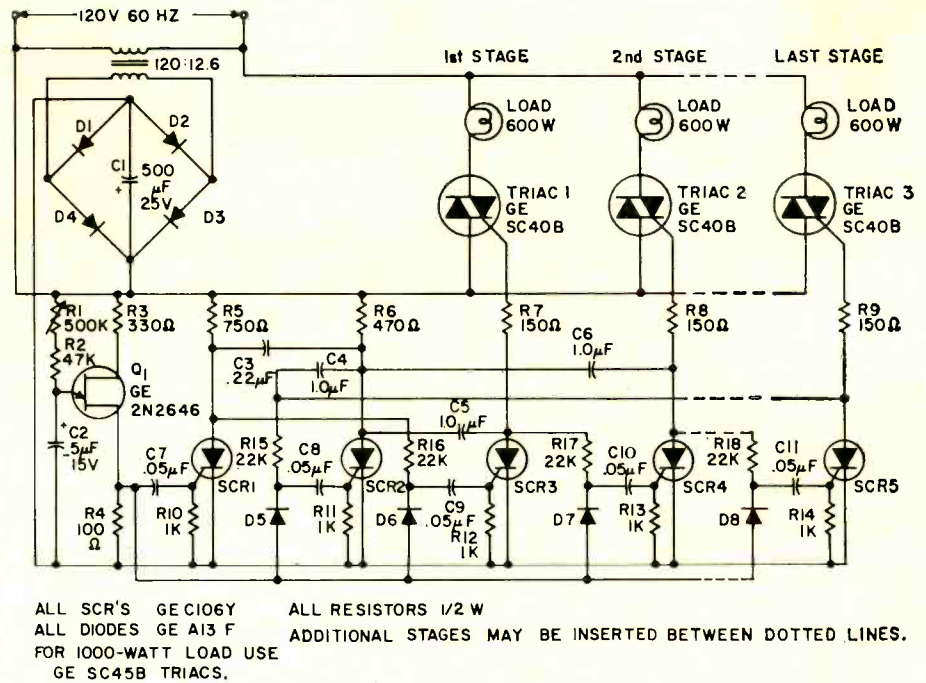

Fig. 2. A solid-state chaser circuit with only three stages is shown in diagram.

SCR4 to turn off. The reed-switch coil de-energizes causing all the SCR's (except SCR5) to turn off thus resetting the circuit. At the same time that SCR4 is turned off, Q1 starts timing and the cycle repeats.

The 1-megohm resistor (R13) across the reed-switch contact is to prevent SCR6 and SCR7 from triggering because of the rate of rise of voltage when the contact closes. The anodes of these two SCR's essentially see the

d.c. supply voltage even when the reed switch opens but these SCR's turn off because the SCR current does go below the holding current level. It is interesting to note that the reed switch draws very little current (less than 20 mA per stage) and yet is capable of turning on and off several hundred watts of power. This, of course, is possible because of the capability of the semiconductor switches in turning on with a small signal at their gates. ▲

Fig. 3. A chaser circuit providing separate timing adjustment for each stage.

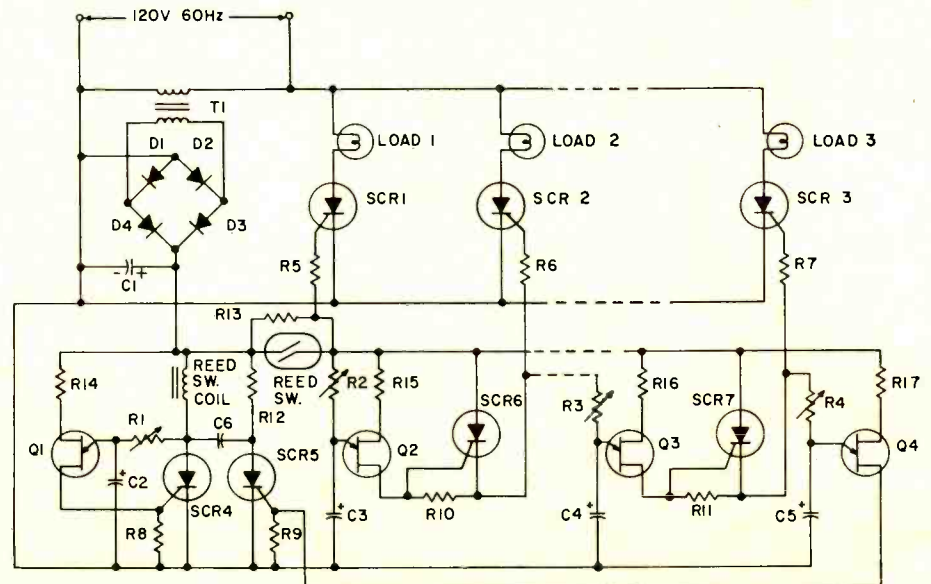

R1, R2, R3, R4—500,000 ohm pot
 R5, R6, R7—750 ohm, 1/2 W res.
 R8, R9—1000 ohm, 1/2 W res.
 R10, R11—33 ohm, 1/2 W res.
 R12—470 ohm, 1/2 W res.
 R13—1 megohm, 1/2 W res.
 R14, R15, R16, R17—330 ohm, 1/2 W res.
 C1—500 µF, 25 V elec. capacitor
 C2, C3, C4, C5—2 µF, 10 V elec. capacitor
 C6—0.22 µF, 100 V capacitor
 Reed Sw.—Use G-E 2DR15 (1 amp) or G-E 2DR30 (3 amp)

Reed Sw. Coil—10,000 t. #39 wire (825 ohms)
 D1, D2, D3, D4—A13A diode (G-E)
 SCR1, SCR2, SCR3—C20B silicon controlled rectifier (G-E)
 SCR4, SCR5, SCR6, SCR7—C106Y silicon controlled rectifier (G-E)
 Q1, Q2, Q3, Q4—2N2646 unijunction transistor (G-E)
 Loads—550 W each
 Note: Additional stages may be inserted between dashed lines.

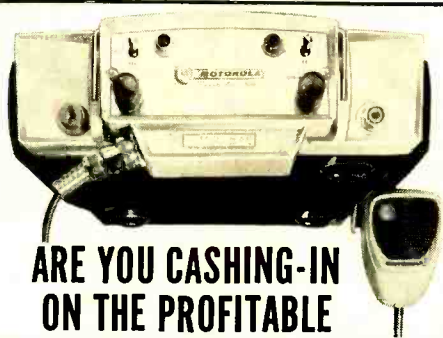

ARE YOU CASHING-IN ON THE PROFITABLE 2-WAY RADIO SERVICE BUSINESS?

- ★ Motorola will train you for this rewarding, elite profession
- ★ Send for our FREE EVALUATION EXAM. Prove to yourself that you are ready to learn FM 2-way radio servicing.

Opportunities in 2-way radio servicing are virtually unlimited. Just one of the hundreds of successful Motorola Service Stations writes, "we would be pleased to interview any graduate of your school that has received some training in 2-way radio maintenance. We are an established firm, 10 years old, with a promise of expansion governed by our ability to obtain competent technicians." Get all the facts today. There is no obligation and no salesman will call.



MOTOROLA TRAINING INSTITUTE

4545 West Augusta Blvd. • Chicago 51, Illinois • Dept. AEF 736

- Send me FREE entrance exam.
- Send full details on Home Study Course on FM 2-way Radio Servicing
- Send me details on how you can help me prepare for an FCC License.

Name _____ Occupation _____

Address _____

City _____ Zone _____ State _____

CIRCLE NO. 102 ON READER SERVICE CARD

A SELECTION OF ANNUALS STILL AVAILABLE

FROM THE WORLD'S LARGEST PUBLISHER OF SPECIAL INTEREST MAGAZINES



CAR & DRIVER YEARBOOK

A complete buyers guide covering virtually every car available in the United States . . . Road tests . . . Technical specifications . . . Accessories and performance equipment buying guide . . . Guide to racing with action-packed photos.

1967 — \$1.50... #40
1966 — \$1.25... #15
1965 — \$1.25... #17

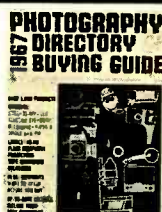

PHOTOGRAPHY DIRECTORY

World's most complete photographic buying guide.

1967 — \$1.25... #41
1966 — \$1.25... #22



TAPE RECORDER ANNUAL

Everything you need to know about tape recording including a complete directory of mono and stereo recorders.

1967 — \$1.25... #42
1966 — \$1.25... #30
1965 — \$1.00... #31



STEREO/HI FI DIRECTORY

Complete buyers guide for virtually every Hi Fi component manufactured.

1967 — \$1.25... #45
1966 — \$1.25... #29

Order by number from Ziff-Davis Service Division, 595 Broadway, N.Y., N.Y. 10012. Enclose add'l 15¢ per copy for shipping & handling (50¢ for orders outside U.S.A.)

number of vessel-stations *outside* the range of your vessel-station.

But four papers presented at the RTCM Assembly concerned themselves directly with a concept which, if implemented, might possibly destroy this unique ability of the v.h.f./FM marine band to keep each area's signals where they belong and not cause interference hundreds of miles away in the manner of 2-3-MHz communications. These presentations, without exception, were well researched, intelligently conceived, and excellently written *and all dedicated to the concept of dramatically extending the range of v.h.f. marine communications by the use of satellites.*

This philosophy, if enlarged to include the whole of the v.h.f./FM maritime service, could end this band's usefulness as a highly efficient, *local-range* communications tool.

Medium-range and long-range marine communications are adequately served already. Single sideband will stretch these capabilities even farther. There is no need to hitch v.h.f.'s wagon to an electronic star.

Single-Sideband Proposals

Of a total of 34 papers delivered before the RTCM assembly, 25 were concerned with some phase of the projected (FCC docket #17295) expansion of the v.h.f./FM marine band. Four were devoted to comments on the various proposals to introduce single-sideband emission to the 2-3-MHz marine frequencies. This band is the one used by the majority of pleasure boaters. In the high-frequency marine band, the use of double sideband (AM) on the bulk of these "above 4 MHz" frequencies is already prohibited after January 1, 1974 in FCC R&R 83.132(a)(2). Here is the American SSB proposal which we will present at Geneva:

It is proposed:

1. To discontinue the installation of double-sideband equipment on ship stations by January 1, 1970.

2. Discontinue the use by coast stations of double-sideband emission by January 1, 1970.

3. Discontinue use by ship stations of double-sideband emission and by coast stations of full carrier (A3H) emission on January 1, 1975, except that coast stations shall retain the capability of operating with class A3H emission on 2182 kHz. (Item 3 bears the footnote that the date of January 1, 1975 may be extended to January 1, 1977.)

4. During the period of transition from double sideband to single sideband, coast stations and single-sideband ship stations shall have the capability of using full carrier (A3H) emission to permit communications with both double-sideband and single-sideband radiotelephone stations.

In the comments and proposals by Canada, the United Kingdom, Denmark, France, and Italy the dates for "discontinuance of installation" ranges from "already implemented" (by Canada) to 1973. The discontinuance of double-sideband (AM) emission bore dates from 1974 to 1980.

One thing should be pointed out, however: in the past the United States has not always followed point-by-point what has been set forth in International Conferences. In the v.h.f./FM marine band, for instance, we have gone ahead with our plans to expand the channels and services of this 156-162 MHz band without waiting for the rest of the world. In a conversation with a high-ranking FCC official, the author was told that the Notice of Proposed Rule Making for this single-sideband proposal was "already drawn up and will possibly be released in a few weeks."

The emphasis on v.h.f./FM and single sideband at the Washington Assembly of the RTCM gives a very accurate idea of what the major portion of the World Administrative Radio Conference of the International Telecommunications Union will be discussing. ▲

THE VOLUME UNIT

MANY audio engineers do not understand the volume unit (vu), for it is a difficult unit to describe in words. Perhaps it would help to state what the vu is not.

The vu is *not* a unit of measurement for power or power level as are the watt and dBm. The vu is *not* a unit of measurement of loudness as is the phon. In fact, the vu has no relationship to any other unit of measurement encountered in electrical communications.

Nevertheless, it is one of the most useful tools of the audio engineer, as it is used in the stating of the level of complex, non-recurrent, and non-periodic waves (music and speech) of electricity.

The vu should not be used for steady-state waves, just as the dBm must not be used for complex material. The vu and the dBm are highly different units and must be treated so.

Volume in vu is numerically equal to the highest scale reading observed on a standard vu meter during a short period of time, added to the dB attenuation of the attenuator network that precedes the meter. Occasionally meter deflections of unusually high level may be ignored.

From the above strict definition, several things may be deduced. First, since the meter reading is constantly changing, the ballistic characteristics of the meter are of great importance. Second, the vu is far from being a precise unit of measurement because it depends on human interpretation of a constantly changing condition.

A "standard vu meter" has a reference point (marked "0") near the upper end of its scale. The ballistic characteristic must be such that if a sinusoidal voltage of such amplitude as to give reference deflection under steady-state conditions is suddenly applied, the meter pointer must reach 99% deflection in 0.3 second. The pointer must then overswing the reference point by at least 1.0% but not more than 1.5%. When the signal is removed, the pointer must fall with approximately the same characteristic that it had when it was rising.

Unless a meter has the above dynamic behavior, it cannot be used to determine volume in vu.

Many meter manufacturers mark common a.c. voltmeters in vu and then call them "vu" meters. The use of such instruments should be discouraged.

The attenuator preceding a vu meter is calibrated in dB and marked in vu. It must be designed specifically for use with the impedances stated by the meter manufacturer. All American firms are standardized on one set of impedances and parameters.

This information appeared in the first issue of *Langevin Engineering Letter*. ▲

ENGINEERED FOR EXCELLENCE: TOP-QUALITY TELEX HEADSETS

!

Ham operators, hi-fi fans and audio engineers all endorse famous TELEX headsets; known for top grade performance for more than 25 years.



MAGNA-TWIN—Typifies the quality standards which have made Telex a favorite of hams. Delivers absolute maximum intelligibility under difficult QRM conditions; equipped with super-comfort foam cushions. Rugged, moisture-proof magnetic drivers give excellent sensitivity, broad response. Made of tough, high-impact plastic for outstanding durability under hard usage.



TELESET—Lightweight, economy version of the famous Magna-Twin; designed especially for ham requirements. High performance, shock-proof Magna-Twin drivers at a low, low price.



MONOSET—Feather-light 1.2 oz. weight eliminates headset fatigue. Sound from replaceable driver is fed directly into ears through adjustable tone arms.



COMBO—Brand new, high quality stereo headphones for the lively set. Big 3½" reproducers deliver deep rich bass and pure sweet highs. Exciting new styling has deluxe foam-filled vinyl earcushions. Designed for comfort, adaptability and concert-quality sound — anytime, anywhere.



SERENATA—For personal listening, these Telex Serenata headphones will reproduce high fidelity sound equal to about \$1,000 worth of speakers! Contains built-in tone control, adjustable pressure control and detachable cord add versatility, extra value.

TELEX
acoustics
A DIVISION OF THE
TELEX CORPORATION
7054 EXCELSIOR BOULEVARD
MINNEAPOLIS, MINN. 55416

CIRCLE NO. 89 ON READER SERVICE CARD

PHOTOGRAPHY ANNUAL 1967



PHOTOGRAPHY ANNUAL

CAR & DRIVER YEARBOOK

CAR & DRIVER YEARBOOK



A selection of the World's finest photographs compiled by the editors of Popular Photography. 212 pages—24 in full color.

1967	— \$1.50	#38
1966	— \$1.25	#1
1964	— \$1.25	#3

A complete buyers guide covering virtually every car available in the United States. Road tests. Technical specifications. Accessories and performance equipment buying guide.

1967	— \$1.50	#40
1966	— \$1.25	#15
1965	— \$1.25	#17

Order by number from Ziff-Davis Service Division, 595 Broadway, N.Y., N.Y. 10012. Enclose add 15c per copy for shipping & handling (50c for orders outside U.S.A.)

tone-selective signaling

The New Look

By LESLIE SOLOMON

This new generation of frequency selective devices has high "Q" enabling a considerable number of control tones to be passed over an audio link.

WHEN it is desired to control several functions at a distance but the intervening wiring or other transmission medium is restricted in bandwidth, then selective-tone signaling is usually used. Typical applications include selective CB or business radio transmissions where a base station wishes to alert only one of several remote stations, radio control of model planes or boats, "turn on/turn off" of remote electrically controlled equipment, or personnel alert where each person has a particular frequency-sensitive signaling device. In essence, the technique can be used in any application where a station at one point wishes to selective-call or actuate a particular device at some remote point using some form of narrow-band link capable of passing the conventional audio spectrum.

In such a signaling system, the sending end (encoder) uses some form of audio tone generator which can be placed in operation by a simple "on/off" switch. The tone is then passed to the communications medium for transmission to the remote receiver.

The receiver decoder consists of some form of frequency-selective circuit that is activated (delivers some form of output) when it receives a tone signal corresponding to the decoder's preset frequency. It is of prime importance that the decoder not activate when it receives tones of frequencies other than the one to which it is preset. In some cases where a single, false, accidental tone may trigger premature or unwanted response, the decoder may be arranged to require two or more tones, in some form of sequence, before it activates.

At present there are three basic methods of selective-tone

signaling reception. The first consists of a resonant-reed relay that is mechanically "tuned" to respond to only one selected audio frequency. However, because of the necessarily lightweight mechanical reed required, the electrical contacts must also be very light, thus severely limiting the amount of current permitted to flow between these contacts. Because of these limitations, resonant-reed relay circuits usually use the reed contacts to activate a larger, power-handling relay that does the actual external power switching.

The second system uses some form of feedback oscillator, kept just under the point of oscillation, which can be triggered on by application of the correct audio tone. This oscillator, when it operates, activates another electronic circuit which in turn supplies the necessary switching power. However, the bulk of these all-electronic circuits are subject to frequency drift with aging of components and changes in applied voltage.

The third approach uses some form of passive LC filter, tuned to a particular audio frequency, that activates a device such as a transistor or vacuum tube, which in turn controls some external function. Typical examples of this latter approach can be found in the remote-control systems used in some TV sets. The major drawback of this system is that the low "Q" of such circuits requires a large frequency spacing between the tones to prevent mutual interference. Unless the connecting link frequency is raised far above the audio range, only a couple of tones can be used. For example, the TV control uses ultrasonic frequencies to transmit only a half a dozen control signals.

Within the past year, two new frequency-selective devices have been introduced to simplify selective-tone signaling systems. Neither of these devices uses any form of mechanical contacts, both are inherently stable, and only simple electronic circuitry is required to put them to work.

The "Minitone"

Developed and patented by *Motorola*, the "Minitone" is a miniature, lightweight, resonant-reed device capable of operation at any one of 200 preselected frequencies between 67 and 3150 Hz. Tolerance is 0.1% between 57 and 230 Hz, and 0.05% between 230 and 3150 Hz. Bandwidth ranges from 1 Hz at 67 Hz to 3 Hz at 3150 Hz, while input and output impedance is 400 ohms.

Operation, as shown in Fig. 1, appears similar to the tuning fork oscillator commonly used to generate stable audio frequencies. The resonant reed has one end mounted to a vibration-damping boot, which in turn is affixed to the chassis.

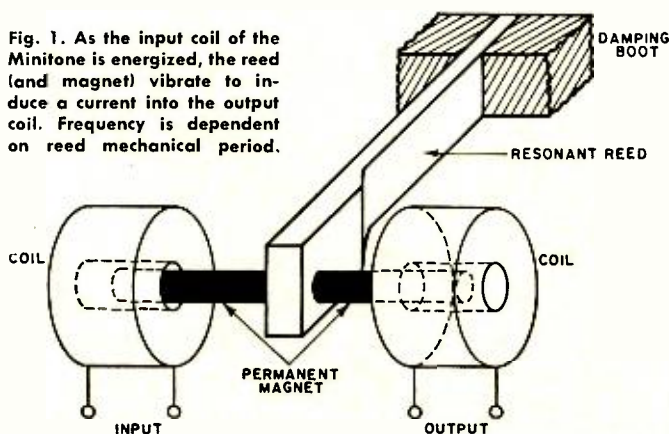

Fig. 1. As the input coil of the Minitone is energized, the reed (and magnet) vibrate to induce a current into the output coil. Frequency is dependent on reed mechanical period.

The reed is mechanically resonant to the predetermined frequency. A rod-shaped permanent magnet is mounted through and mechanically attached to the free end of the reed with each end of the magnet protruding into a coil on each side. When the input coil is supplied with an audio current of the same frequency as the mechanical resonance of the reed, the reed begins to vibrate in sympathy with the excitation frequency. This action is similar to the operation of a loudspeaker.

As the reed vibrates, the magnet also vibrates in and out of the output coil. A voltage of exactly the same frequency as the reed vibration is then induced into this coil. By electrically connecting the coils properly, the input and output signals will always be in-phase.

An application is shown in Fig. 2. The incoming audio line can be the terminals of the wire line, or the audio output of the radio receiver used. This signal is applied to the resonant-reed device (T1) where the audio frequency is selected. The tone signal is amplified by Q1, detected, and used to activate Schmitt trigger Q2-Q3. When the Schmitt operates, transistor Q4 is turned on and current flows through the load R_L . Load R_L can be some combination of lights for use as a visual signaler, or a latching relay to maintain a continuous output once the tone has been received. This output relay can be used to operate a bell or buzzer for alerting purposes, or activate some other form of electrical device as required for a particular application.

A companion transmitter using a "Minitone" is shown in Fig. 3. Here, the resonant-reed device is connected in a feedback oscillator consisting of Q1 and Q2, with the tone frequency dependent on the particular reed device used. Transistor Q3 is used as an emitter-follower to match the relatively high output impedance of the oscillator to the load (telephone line or modulator of an r.f. transmitter).

The "Twintron"

This second frequency-selective element came about because some engineers felt that the "Q" of the resonant-reed relay was being seriously affected because the vibrating reed was damped by its necessary physical attachment to the mounting base and damping material. One answer to this problem is the "Twintron" developed by the H.B. Engineering Corp. This electromechanical resonator claims a "Q" of up to 8000 and can be used to select, reject, or generate audio frequencies from a frequency as low as a fraction of a hertz up to 20 kHz.

As shown in Fig. 4A, this device is an H-shaped metal structure with the two larger vertical sections connected by a slender horizontal web. The structure is supported by a pair of axes located at the two large structure nodal points. The two parallel H-sections are balanced, each about its own nodal point, and therefore the motion of each about its own pivot produces no lateral motion on that pivot. The web that interconnects the two large masses locks the pair together so that any motion of the web causes an out-of-phase motion of the two masses.

This electromechanical resonator can be physically excited by any means that imparts a rotational movement about either axis. In this case, a piezoelectric ceramic wafer is bonded to one surface of the horizontal web and, when voltage is applied to this wafer (with the metal mass acting as the ground lead), it causes the web to elongate during one half cycle and compress during the other half cycle. See Fig. 4B for operation of the device.

This arrangement causes the web to flex up and down with the applied audio electrical signal to the piezoelectric wafer, thus causing the two large masses to try to rotate about their

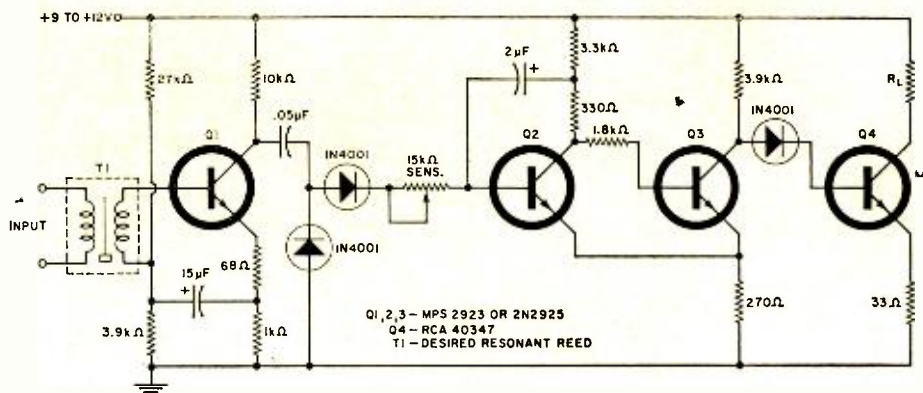

Fig. 2. A typical frequency selective receiver using a Minitone.

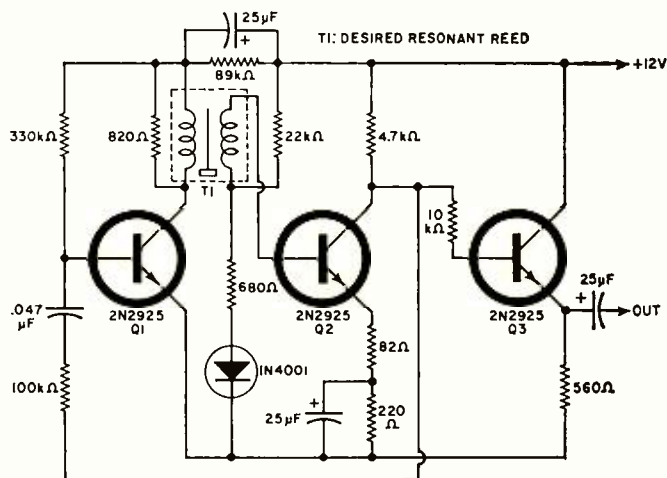
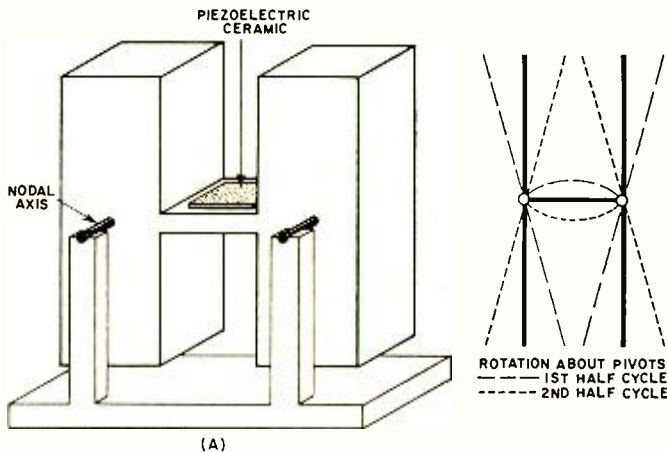

Fig. 3. Here, a Minitone is used as the frequency determining element of the audio oscillator used as the transmitter.

Fig. 4. Basic operation of Twintron. A signal applied to the piezoelectric wafer causes the two large arms to flex. The resonant frequency is determined by the mass of the arms.



nodal axes. This moment of rotation occurs only when the electrical signal frequency corresponds exactly to the natural mechanical resonant frequency of the masses. Since the system is completely symmetrical and in balance at all times (but in opposite phase), no mechanical reaction exists outside of the system.

If another piezoelectric wafer is bonded to the other surface of the web, it will generate an electrical output signal at the frequency of the natural resonance of the H-shaped masses.

Since the electrical input and output are piezoelectric crystals, both the input and output impedance is high, typically 200,000 ohms.

Some applications are shown in Fig. 5. A simple series-pass

filter is shown in Fig. 5A. This circuit can be connected between a pair of amplifiers and will pass only the filter frequency, rejecting all others. By connecting a resistor across the device (Fig. 5B), it then becomes a reject filter passing all frequencies except that of the device. By replacing the single output piezoelectric wafer with a pair of wafers, each isolated from the other, it is then possible to create a combined reject and pass filter such as shown in Fig. 5C.

Since the piezoelectric wafer is bonded directly to the flexing web of the device, it becomes part of the spring characteristics of the web. It is a characteristic of the piezoelectric material that its compliance, or spring stiffness, varies as the electrical load across the voltage generator. Therefore, if one portion of the dual wafer (either in the primary or secondary circuit) is connected to ground *via* a variable resistor, variations in the resistance will cause a change in the mechanical resonance of the system, in some cases controllable up to 50% of the fundamental frequency. Such a circuit is shown in Fig. 5D.

A very stable audio oscillator can be made using the circuit shown in Fig. 5E. The amplifier output has a -45° phase-shift network (at the operating frequency) in its input and a $+45^\circ$ phase-shift network at its output. When combined with the "Twintron", the frequency of oscillation and stability are determined only by the "Twintron" and not on any external circuit element parameter variation. If the oscillator shown in Fig. 5E is changed to that of Fig. 5F, then the output frequency will be a function of the value of the resistor used across one of the wafers in the device. This variable resistor can be a thermistor, or any resistor that varies in value with the desired function. This particular application will find many uses in telemetry.

By using the "Twintron" in an arrangement that results in a differential output, an ultra-narrow FM discriminator can be created (see Fig. 5G). The linear portion of the S-shaped FM discriminator curve can be as narrow as one to two Hz between peaks. Such circuits will find wide application in both medical electronics and servomechanism areas.

Intrusion Alarm

Suppose that you want to know the condition of a number of remote monitoring devices (a large number of windows, doors, gates, etc., in a large plant for example), and you want to know instantly when one of these devices is activated (meaning in this case that a window or door has been opened). By conventional means, a large number of interconnecting cables must be used to isolate each sensor from the others and, also, a relatively complex switching circuit will have to be used to rapidly determine the state of each remote sensor. Fig. 5H shows a typical application of an extremely simple system using these new devices.

The outputs of a number of tone generators (continuously operating) are connected in parallel and supply one side of a transmit-receive switch. An equivalent number of decoders (matching the encoders in frequency) are connected in parallel to form the receive portion of the same switch. Each decoder supplies a signal to some form of external signaling device.

From the rotor portion of the transmit-receive switch, a single cable is stretched around the premises to be protected. At intervals along this cable, a "Twintron" is connected, in series with a simple "on-off" switch, activated by opening a door or window, etc. When the switch is closed, that particular "Twintron" is connected to the cable. When the transmit-receive switch is placed in the transmit position, the multitone signals from the tone generators are passed down the cable. The switch is then immediately placed in the receive position. The audio tones rapidly traverse the cable, and if they encounter a closed switch, the pertinent tone excites its remote "Twintron". As the "Twintron" continues to oscillate for a considerable part of a second after removal of the audio stimuli, the signal generated by it will pass back up the cable and excite its companion "Twintron" at the monitoring console. As the monitor device is excited it, in turn, causes its signaling device to operate. Because of the high "Q" of the "Twintron", any number of devices can be attached to the cable and one, or all, can be operative at the same time.

Summary

When the engineer starts thinking about filters for the audio frequency spectrum, he knows that he will be faced with either poor selectivity, unwieldy sizes, and possibly high cost. In general, if low selectivity (the ability to react to one specific frequency and not to other frequencies close by) is acceptable, electronic filters of either the RC or LC type, with or without active elements, are satisfactory. However, because the period of time constants at the low frequencies must, of necessity, be large, so must component values. In many cases, tolerance levels are excessive.

If the application requires good selectivity, the problem may be compounded due to the relationship between physical size and component value and, often, tolerance range.

Mechanical filters such as the tuning fork, have been used for many years—in fact since they were invented in 1711. However, at the low audio frequencies required, these forks become unwieldy in size.

Now, with the advent of the new generation of electro-mechanical filters covered in this article, engineers can design frequency-selective networks that are physically small, use very little power, have a broad range of applications, while their high "Q" enables them to use many audio frequencies over one link without any noticeable interaction. ▲

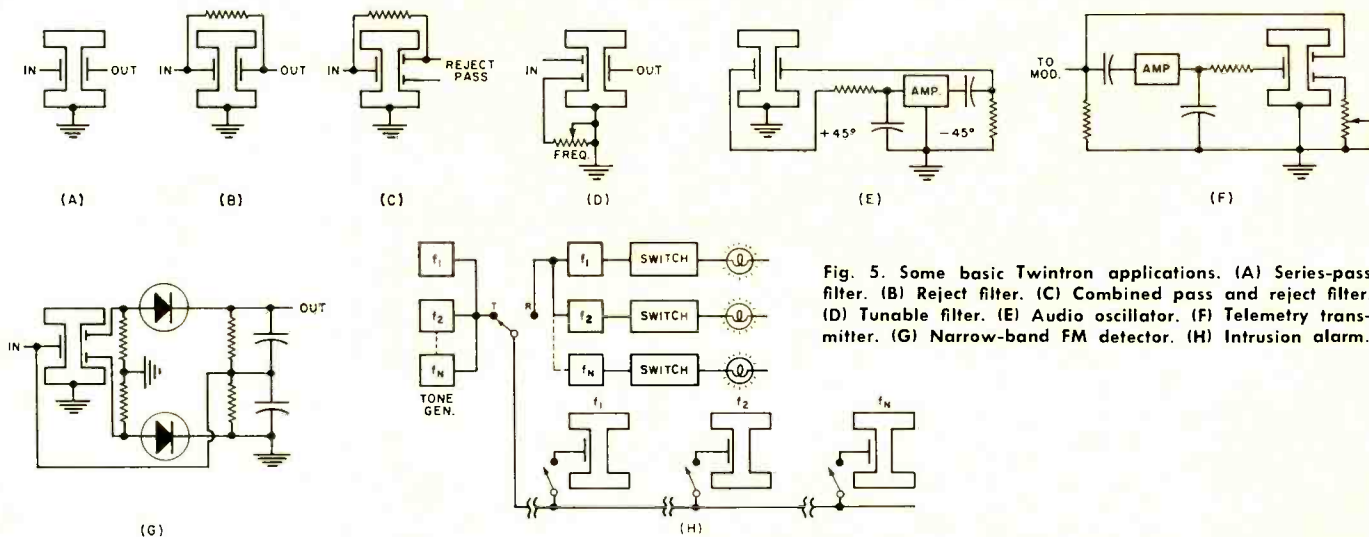

Fig. 5. Some basic Twintron applications. (A) Series-pass filter. (B) Reject filter. (C) Combined pass and reject filter. (D) Tunable filter. (E) Audio oscillator. (F) Telemetry transmitter. (G) Narrow-band FM detector. (H) Intrusion alarm.

THE COMMON SLIDE RULE FOR REACTANCE CALCULATIONS

By GLADDEN B. HOUCK, Jr.
Hirsch-Houck Laboratories

THERE are many engineers who use special slide rules for calculating inductive and capacitive reactance. Such rules as those from *Boonton Radio* and *Shure* are easy to use, but their accuracy is limited. A few marks added to the common slide-rule scales can make this operation easier to perform on these rules.

An index mark at 1.5915 ($1/2\pi$) is used to obtain the $2\pi F$ factor common to both the inductive and capacitive reactance formulas. The mark can be scribed on the D scale (and DF scale). The scale labels "L or C" can be added to the D scale. The "F" label as well as the "X_L" label should be added to the C scale. The CI scale is labeled "X_C". These few marks will make the operations quite obvious after solving a few problems.

To obtain capacitive reactance, the frequency on the "F" (C) scale is set opposite the $1/2\pi$ index mark on the D scale. The reactance is read on the "X_C" (CI) scale opposite the capacitance on the "L or C" scale (D). Inductive reactance is also a simple procedure. The only difference is that the reactance is read on the "X_L" (C) scale.

The system can be varied somewhat if the slide rule has other scales that are similar in operation. For example, the folded scales can save the off-the-end operation that the simpler rules require. An additional mark should be added to the DF scale for this purpose.

The mark for the $1/2\pi$ index can be scribed on the plastic type rules and filled with a contrasting ink from a Magic Marker. To fill a line, one marks the surface and erases the excess from the surface around the mark. A stiff eraser will work. Try it on the edge to practice the technique.

Some slide rules lack space near the scales for the label of the index marks added by the engineer. Often the edge of the rule can be used for this purpose if the mark is deeply engraved so the slider does not wear off the ink.

Example: What is the inductive reactance of a 0.3-mH coil at 1.27 MHz? First, set the frequency on the C scale opposite the $1/2\pi$ index mark on the D scale. Then, move the hairline indicator to the inductance value on the D scale. The reactance can now be read directly on the C scale as 2390 ohms.

A little practice with a few problems will demonstrate how time-saving this technique is. ▲

Now, for men in electronics —“a whole new era of quick calculation”

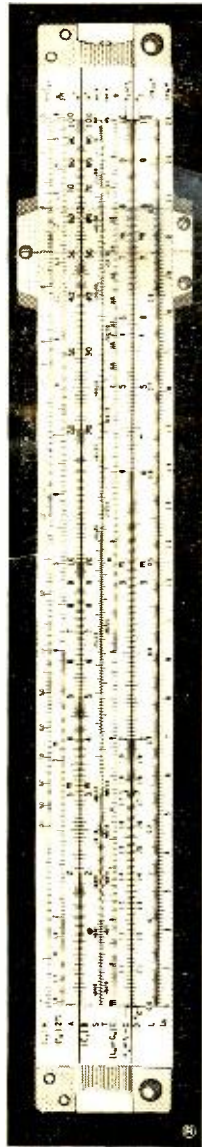

“THERE MUST BE THOUSANDS OF PEOPLE in electronics who have never had the marvelous adventure of calculating problems with a single slide rule; other thousands have had to content themselves with a slide rule not specifically designed for electronics. For both groups, the new slide rule designed and marketed by Cleveland Institute of Electronics and built for them by Pickett will open a whole new era of quick calculations.

“Even if you have never had a slide rule in your hands before, the four-lesson instruction course that is included takes you by the hand and leads you from simple calculations right through resonance and reactance problems with hardly a hitch. If you already use a slide rule, you’ll find the lessons a first-rate refresher course. And it explains in detail the shortcuts built into this new rule.”

From an article in
Radio Electronics Magazine

Want complete details about this time-saving new Electronics Slide Rule? Just mail coupon below...or write Cleveland Institute of Electronics, Dept. EW-143, 1776 East 17th St., Cleveland, Ohio 44114.



Mail this coupon for
FREE BOOKLET

CIE Cleveland Institute of Electronics
1776 E. 17th St., Cleveland, Ohio 44114

Please send me without charge or obligation your booklet describing the CIE Electronics Slide Rule and Instruction Course. Also FREE if I act at once: a handy pocket-size Electronics Data Guide.

Name _____
(please print)

Address _____

City _____ State _____ Zip _____

Accredited Member National Home Study Council
A Leader in Electronics Training... Since 1934 **EW-143**

CIRCLE NO. 120 ON READER SERVICE CARD

Electronics World SUBSCRIBER SERVICE

Please include an address label when writing about your subscription to help us serve you promptly. Write to: Portland Place, Boulder, Colorado 80302

CHANGE OF ADDRESS:

Please let us know you are moving at least 4 to 6 weeks in advance. Affix magazine address label in space to the right and print new address below. If you have a question about your subscription, attach address label to your letter.

TO SUBSCRIBE: Check boxes below.

New Renewal
 5 years \$21 3 years \$15 1 year \$6

SPECIFY: Payment enclosed—You get 1 extra issue per year as a bonus! Bill me later.

If you have no label handy, print OLD address here.

name _____ please print

address _____

city _____

state _____ zip-code _____

AFFIX LABEL HERE

(Add'l postage: \$1 per year outside U.S., its possessions & Canada.)

name _____ please print **0171**

address _____

city _____

state _____ zip-code _____

Enjoy the "music-only" programs now available on the FM broadcast band from coast to coast.

- NO COMMERCIALS •
- NO INTERRUPTIONS •



It's easy! Just plug Music Associated's Sub Carrier Detector into multiplex jack of your FM tuner or easily wire into discriminator. Tune through your FM dial and hear programs of continuous, commercial-free music you are missing. The Detector, self-powered and with electronic mute for quieting between selections, permits reception of popular background music programs no longer sent by wire but transmitted as hidden programs on the FM broadcast band from coast to coast. Use with any FM tuner. Size 5 1/2" x 9". Shipping weight approx. 7 lbs.

KIT \$49.50

(with pre-tuned coils, no alignment necessary)

WIRED \$75.00

COVER \$4.95 EXTRA

Current List of FM Broadcast Stations with SCA Authorization \$1.00

MUSIC ASSOCIATED

65 Glenwood Road, Upper Montclair, New Jersey
Phone: (201)-744-3387

CIRCLE NO. 100 ON READER SERVICE CARD

Buy the best.



Our 1968 catalog of precision quartz crystals and electronics for the communications industry is now available.

It will cost you nothing.



SENTRY MANUFACTURING COMPANY

1634 LINWOOD BOULEVARD, OKLAHOMA CITY, OKLAHOMA 73106
PHONE: 405-232-1431 - TELEX: 071 361 - TWX: 910-831-3175

CIRCLE NO. 123 ON READER SERVICE CARD
94

HI-FI SHOW SEMINARS PROGRAM

September 21-24, 1967

Statler Hilton Hotel, 7th Ave. & 32nd St., New York, N.Y.

In view of the unusual interest in last year's technical seminars held during the New York Hi-Fi Show, Walter Stanton (President of the Institute of High Fidelity) has announced that this year's theme would be directed toward broadening consumer understanding through an increased number of seminars.

In addition to the eight sessions held in 1964, 1965 and 1966 on the technical and semi-technical aspects of hi-fi

reproduction, there will be separate sessions on "Decor" and "Musicology". Three outstanding authorities will discuss the use of components in decorating with sound, and NARAS (National Academy of Recording Arts & Sciences), under the direction of George Simon, Secretary, will present four sessions on the theory behind the most popular musical art forms. Listed below are complete program details covering the entire period of the Show. ▲

THURSDAY, SEPTEMBER 21, 1967

6:30-7:30 p.m. Novice Symposium: "Introduction to Hi-Fi Components"
Leonard Feldman, Engineering Vice-President, Crestmark Electronics

7:30-8:30 p.m. "Tape and Tape Recorders"

Moderator: Milt Snitzer, Technical Editor, Electronics World

Panelists: Joe Kempler, Technical Services Dept. Manager, Audio Devices
Paul Bunker, Magnecord Division Product Mgr., Telex Corp.

8:30-9:30 p.m. "The Classical Recording Scene"

Moderator: David Hall, Director, Library of Performing Arts at Lincoln Center; former Music Editor, HiFi/Stereo Review; 1st Vice-President, (N.Y. Chapter) and National Trustee, (NARAS)

Panelists: Martin Bookspan, former Program Director, WQXR
Other panelists to be announced

FRIDAY, SEPTEMBER 22, 1967

6:30-7:30 p.m. Novice Symposium (as above)

7:30-8:30 p.m. "Cartridges, Turntables and Changers"

Moderator: Bill Stocklin, Editor, Electronics World

Panelists: Jim Kogen, Chief Engineer, R&D, Shure Brothers
Bud Childs, President, Elpa Marketing Industries (Thorens)

8:30-9:30 p.m. Decor Group

Albert Herbert, President, Albert Herbert Design

SATURDAY, SEPTEMBER 23, 1967

2:00-3:00 p.m. "The Pop Scene"

Moderator: George Avakian, former Supervisor, Album Production, Columbia and Victor Records; National President of NARAS

Panelists: David Kapp, President, Kapp Records
Bob Crewe, Bob Crewe Productions
Tom Dowd, Chief Engineer, Atlantic Records

3:00-4:00 p.m. "Amplifiers and Tuners"

Moderator: To be announced

Panelists: George Meyer, Product Manager, Fisher Radio Corp.
Larry Fish, Chief Engineer, H.H. Scott Inc.

4:00-5:00 p.m. Decor Group

Bill Leonard, President, William L Associates (designers)

6:30-7:30 p.m. Novice Symposium (as above)

7:30-8:30 p.m. "Stereo and the Listener"

Moderator: To be announced

Panelists: Abe Cohen, Manager, Acoustics, Instrument Systems Corp.
Vic Brociner, Asst. to the President, H.H. Scott Inc.

8:30-9:30 p.m. "The Successful Recordings (Let's Look at The Record)"

Moderator: Goddard Lieberson

Panelists: Ernie Atschuler, V.P. and A & R Director, RCA Victor
Phil Ramone, Vice President, A & R Recording Studios
(recording artist to be announced)

SUNDAY, SEPTEMBER 24, 1967

2:30-3:00 p.m. Decor Group

Vladimir Kagan, President, Kagan Dryfuss (designers)

3:00-4:00 p.m. Novice Symposium (as above)

4:00-5:00 p.m. "The Jazz Recording Scene"

Moderator: Father Norman J. O'Connor, author, radio-TV personality; has own TV show "Dial M for Music" (Channel 2); President (N.Y. Chapter) NARAS

Panelists: John Hammond, Director of Talent Acquisition, Columbia Records; and National Trustee of NARAS
Bob Thiele, Art/Repertoire Director, ABC Paramount and Impulse Records
Billy Taylor, jazz pianist, disc jockey (WLIB); head of Jazz Interaction; Treasurer (N.Y. Chapter) NARAS

ELECTRONICS WORLD

Temp.-Depth Measurements

(Continued from page 36)

The increase in time constant results from the additional pressure protection required. The 10,000 psi aluminum housing increases size and weight as does the addition of the oscillators and mixer to the probe.

The fact is that, as oceanographic sensors go, this probe is quite small and light (1½ pounds). Since the probe output is from 0-40 kHz instead of at 28 MHz, the cable connecting it to the electronic counter can be as much as 5 miles long.

The quartz thermometer has an absolute accuracy on the order of $\pm 0.01^\circ$ C and a usable resolution of $\pm 0.0001^\circ$ C. Neither the reversing thermometer nor Ben Franklin's bucket can match this.



Fig. 8. The probes of this quartz thermometer each contain an LC-cut type crystal. They are connected by coaxial cable to the electronic chassis. The cables carry 28-MHz signals. (Dymec Div., Hewlett-Packard)

Fig. 9. The oceanographic quartz thermometer probe contains an AT-cut crystal, LC-cut crystal, reference oscillator, temperature oscillator, and mixer. The pressure case at left withstands 10,000 psi.



"No, this is the assembler—that's the marking station."

September, 1967

WHY risk your reputation with "just-as-good" capacitors?

When you pay little or no attention to quality in tubular replacement capacitors, you leave yourself wide open for criticism of your work . . . you risk your reputation . . . you stand to lose customers. It just doesn't pay to take a chance on capacitors with unknown or debatable performance records when it's so easy to get guaranteed dependable tubulars from your Sprague distributor!

There's no "maybe" with these 2 great SPRAGUE DIFILM® TUBULARS!

The ultimate in tubular capacitor construction. Dual dielectric . . . polyester film and special capacitor tissue . . . combines the best features of both. Impregnated with HCX®, an exclusive Sprague synthetic hydrocarbon material which fills every void in the paper, every pinhole in the plastic film *before it solidifies*, resulting in a rock-hard capacitor section . . . there's no oil to leak, no wax to drip. Designed for 105°C (220°F) operation without voltage derating.

DIFILM® ORANGE DROP® Dipped Tubular Capacitors



A "must" for applications where only radial-lead capacitors will fit . . . the perfect replacement for dipped capacitors now used in many leading TV sets. Double-dipped in rugged epoxy resin for positive protection against extreme heat and humidity. No other dipped tubular capacitor can match Sprague Orange Drops!



DIFILM® BLACK BEAUTY® Molded Tubular Capacitors

The world's most humidity-resistant molded capacitors. Tough, protective outer case of non-flammable molded phenolic . . . cannot be damaged in handling or installation. Black Beauty Capacitors will withstand the hottest temperatures to be found in any TV or radio set, even in the most humid climates.

For complete listings, get your copy of Catalog C-617 from your Sprague distributor, or write to Sprague Products Company, 51 Marshall Street, North Adams, Massachusetts.

WORLD'S LARGEST MANUFACTURER OF CAPACITORS
65-6110 R1



CIRCLE NO. 92 ON READER SERVICE CARD

NEW PRODUCTS & LITERATURE

Additional information on the items covered in this section is available from the manufacturers. Each item is identified by a code number. To obtain further details, fill in coupon on the Reader Service Card.

COMPONENTS • TOOLS • TEST EQUIPMENT • HI-FI • AUDIO • CB • HAM • COMMUNICATIONS

POWER SWEEP GENERATOR

The Model 6550-1 power sweep generator produces triangular, square, and sine waves at 100-watt levels with selectable sweep rates or manual control for use in performing conducted audio frequency susceptibility tests per MIL-1-26600,

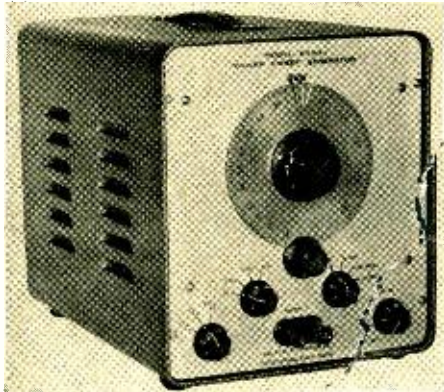

MIL-1-6181D, MIL-STD-826A, etc. The generator is useful in making transient studies of passive networks, square-wave testing of amplifier systems, and as a source of 400 Hz or other power frequency supply to test samples.

Frequency range is 15 Hz to 150 kHz. Sweep rates are one per minute, ten per minute, or manual. The output is adjustable up to 100 watts into a 2-ohm load. The generator is 8 1/8" x 9" x 14 7/8".

Complete specifications and prices will be supplied on request. Solar

Circle No. 126 on Reader Service Card

HYBRID IC's FOR TV

Five new hybrid integrated circuits for TV, radio, and phonograph applications have just been introduced.

The HC1001 is an FM sound-system module which combines a wide-band i.f. amplifier, an FM detector, and an audio preamp in a 0.5 x 0.5 x 0.2-inch package. This complete sound system meets all current TV design requirements whether tube, solid-state, or hybrid combinations, black-and-white or color, line-operated or portable.

The series of audio hybrid IC's, HC1003, HC1004, HC1005, and HC1006, include both low-input-impedance circuits for AM radios and high-input-impedance units for FM radios and phonographs.

These new hybrid IC's combine discrete semiconductors with thick-film resistor-fabrication techniques. A thermally conductive ceramic substrate serves as the base for screened-on, thick-film resistors and conductors. The semiconductor chips are coated with glass, providing an effective moisture barrier.

Specs sheets on these new hybrid IC's will be supplied on request. Texas Instruments

Circle No. 127 on Reader Service Card

TEN-TURN POTENTIOMETERS

Multi-turn potentiometers providing less than one second resolution with output smoothness levels to 0.01% and useful operating lives up to 200 million revolutions are now available.

The Model 7813 with rear terminals and the Model 7814 with radial terminals incorporate in a 7/8" diameter aluminum case a true helical resistive element of smooth plastic film, multiple-

fingered precision metal wipers, gold-plated slip rings, and precision ball bearings at both ends. Resistance range is 5000 ohms to 1.5 megohms with a best linearity of 0.05%.

Complete specifications and additional information on these pots will be forwarded on request. Computer Instruments

Circle No. 128 on Reader Service Card

PHOTOELECTRIC CONTROL

A sensitive photoelectric control unit which turns lights on at sunset and off at sunrise is being marketed as the "LampLitr".

Completely automatic, the unit is secured to the windowsill by means of its suction cup and then plugged into any a.c. outlet. The lamp to be controlled is plugged into the socket on the "LampLitr". The unit is guaranteed for three years and carries the UL seal. Four T's Co.

Circle No. 1 on Reader Service Card

1000-WATT DIMMER

A three-way, 1000-watt dimmer with "push-on/push-off" switch to control 1000 watts of incandescent lighting from two different control locations is now available. The unit easily fits a single-gang wall box and has a 5" x 5" double-gang faceplate. The new unit is the Model D-103P. Lutron

Circle No. 2 on Reader Service Card

TV CONVERTER

A new converter designed to eliminate double-image pickup in strong TV areas has been introduced as the "Imagicon".

The new unit converts CATV, MATV, and off-

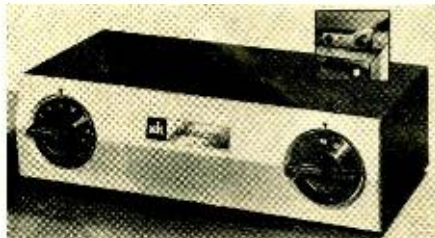

the-air v.h.f. signals to an unused channel on the TV receiver to provide clear color or black-and-white TV picture reception. The basic unit consists of a transistorized TV tuner, a fixed-frequency converter, and a power supply. The tuner selects and converts any of the standard v.h.f. channels to 40 MHz. The fixed-frequency converter converts the 40-MHz signal to one unused channel, 12 or 13, through the output connection to the TV receiver. The TV receiver is left permanently tuned to one channel and channel selection is made at the Imagicon unit. Unwanted station signals, no matter how strong, cannot interfere with the picture reception. Standard Kollsman

Circle No. 3 on Reader Service Card

HANDY COLOR-TV SERVICE AID

A "Color Viewer" that separates the three primary colors in a color-TV tube and magnifies them for easy analysis has been introduced as an aid to TV technicians. Measuring approximately 2" x 2" and equipped with a small handle, it is constructed from a portion of a picture tube shadow mask.

In use, the technician places the viewer on the

picture tube face plate and rotates it until the dot pattern achieves the desired magnification of individual colors. The "Color Viewer" is especially useful in visually demonstrating the need for repair or adjustment to the color-TV set owner. Sylvania

Circle No. 4 on Reader Service Card

CD IGNITION SYSTEM

A new capacitive-discharge ignition system which is designed to increase mileage, cut point

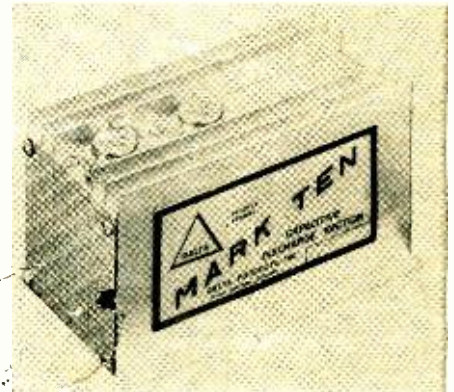

and plug wear, and provide improved engine performance and acceleration, is now available in both kit and assembled versions.

The "Mark Ten" installs in minutes on any car, jeep, truck, camper, farm vehicle, or competition racer by attaching to coil terminals without any change in wiring or components.

In operation, voltage is stored in a capacitor until needed. Applied battery voltage converts from 12 volts to 400 volts by means of the converter circuitry. This power supply delivers full energy to the capacitor at engine speeds over 8000 r/min.

Full details on both versions of the CD ignition system will be forwarded upon request. Delta Products

Circle No. 5 on Reader Service Card

INDUSTRIAL INSPECTION KIT

The "Major Kit" is a new, wide-range industrial inspection kit used for close examination of equipment not normally accessible to the naked eye. The kit consists of an assortment of varying length probes into which are fitted miniature electric lamps and lenses. When used in conjunction with the kit's adjustable mirrors and magnifying fittings, illumination and inspection of the most inaccessible spots through the smallest apertures becomes possible.

The kit can be used for the inspection of waveguides, cavities, pumps, dies, valves, printed-circuits, small motors, relays, and other electronic components. All 21 working elements in the kit are interchangeable and interlocking. All are housed in a fitted, black hardwood case.

Further information and a spec sheet will be forwarded on request. Jensen Tools

Circle No. 6 on Reader Service Card

HUMIDITY-PROOF TRIMMER

A humidity-proof 3/8" square trimmer which performs to the requirements of MIL-STD-202B is now available as the Model 3610.

The square design of the trimmer permits a longer mandrel than is used in a rectangular trimmer with up to 131% better resolution, according

to the company. The unit can be specified for any circuit requiring a maximum temperature of 125°C and a power rating of 0.5 watt at 40°C. The PC pins of the 3610 fit the cards of any standard 3/8" or 1/2" square trimmer. It is only 0.200" high for low card space applications. Resistances are available from 100 to 20,000 ohms.

A slide-rule type selection guide covering the company's line of wirewound and metal-film trimmers and a data sheet on the 3610 are available. Amphenol Controls

Circle No. 129 on Reader Service Card

REGULATED D.C. SUPPLY

A compact, three-in-one supply, the Model KG-664, is now available in either kit or assembled form.

The unit serves as a "B+", filament, and d.c. supply to meet the need for the multiple voltages required in circuit development, test, and repair. It delivers 0-400 volts of regulated d.c. power at up to 200 mA continuously; 0-100 volts d.c. at 1 mA regulated for line variation, plus 6.3 volts a.c. at 6 A and 12.6 volts a.c. at 3 A for filament supply voltages. Two front-panel meters continuously monitor voltage and current.

The circuit combines tubes and semiconductors and quality components are used throughout. The specially designed voltage regulation circuitry permits less than 1% variation in output voltage from no load to full rated load. Input regulation allows less than 1% variation for ±10 volts



variation at 120-volt a.c. input. High voltage output provides 8-watt capacity. There are ten isolated 5-way binding posts on the front panel to provide maximum flexibility in ground polarity connections.

The unit measures 7 3/4" x 14 3/4" x 9 3/4" and is designed for 110-130 volts, 50-60 Hz. Allied Radio

Circle No. 7 on Reader Service Card

SHIELDED MATCHING TRANSFORMERS

A new line of low-level shielded matching transformers, designated as the M-S series, has just been announced.

These transformers are of double high-nickel alloy shielded to provide approximately 65 dB of shielding to minimize stray magnetic pickup. They are available in a wide range of impedances for applications such as chopper, microphone, and line-matching.

Designed for miniaturized equipment, the transformers are 1 17/32" high x 1 1/16" in diameter and weigh only 3 ounces. Although developed primarily for industrial applications, they meet MIL-T-27B Grade 6 Class R requirements. Microtran

Circle No. 130 on Reader Service Card

ALPHA-NUMERIC READOUT

The "Alpha-Lite" is a microminiature, modular, multi-filament, alpha-numeric readout display with added features for greater versatility. In addition to the initially developed units with pigtail leads, the "Alpha-Lite" is now being produced with a microminiature plug-in termination allowing for mixed use with modular "Midgi-Lites". Separate plug-in decimal point units are available in all "Midgi-Lite" sizes.

Character height is only 1/4", over-all depth is 5/16", and over-all height is 3/8". Width of the Model 43 "Alpha-Lite" is 0.335" while the Model 04-30 "Midgi-Lite" is only 0.275". Each "Alpha-Lite" contains a complete alphabet, complete digit, and numerous symbols.

Further information on both standard and cus-

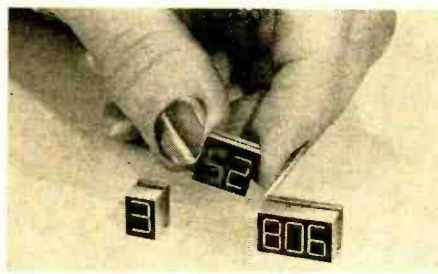

tom models in the line is obtainable on request. Pinlites

Circle No. 131 on Reader Service Card

RECHARGEABLE "D" CELL

A "D" size rechargeable sealed silver-zinc cell for use in industrial and consumer products has just been developed.

The SPD-5 "Spiracel" has a wide range of applications because of its higher ampere-hour capacity and energy than any other type of rechargeable "D" cell and because it maintains its capacity over a long cycle life, according to the company. The cell is capable of hundreds of discharge-recharge cycles when charged at an overnight rate, with each charge yielding more than two and a half times the energy density of an ordinary nickel-cadmium "D" cell. Yardney

Circle No. 8 on Reader Service Card

SILICON POWER TRANSISTORS

The 2N4348 "n-p-n" silicon power transistor is now available in production quantities. Essentially a high-voltage version of the 2N3772, the 2N4348 meets all JEDEC registered parameters and, in addition, is given a free-air power test of 150 watt-seconds as a production test. The pulse power test insures full power capabilities without secondary breakdown throughout the active region.

Housed in the TO-3 package, the transistor is suitable for use in computers, power supplies, audio systems (mono and stereo), and wherever

CARBON COMPOSITION AND WIRE-WOUND POTENTIOMETERS

FRACTIONAL HP ELECTRIC MOTORS AC. AND D.C. OPERATED, WITH OR WITHOUT SPEED REGULATOR

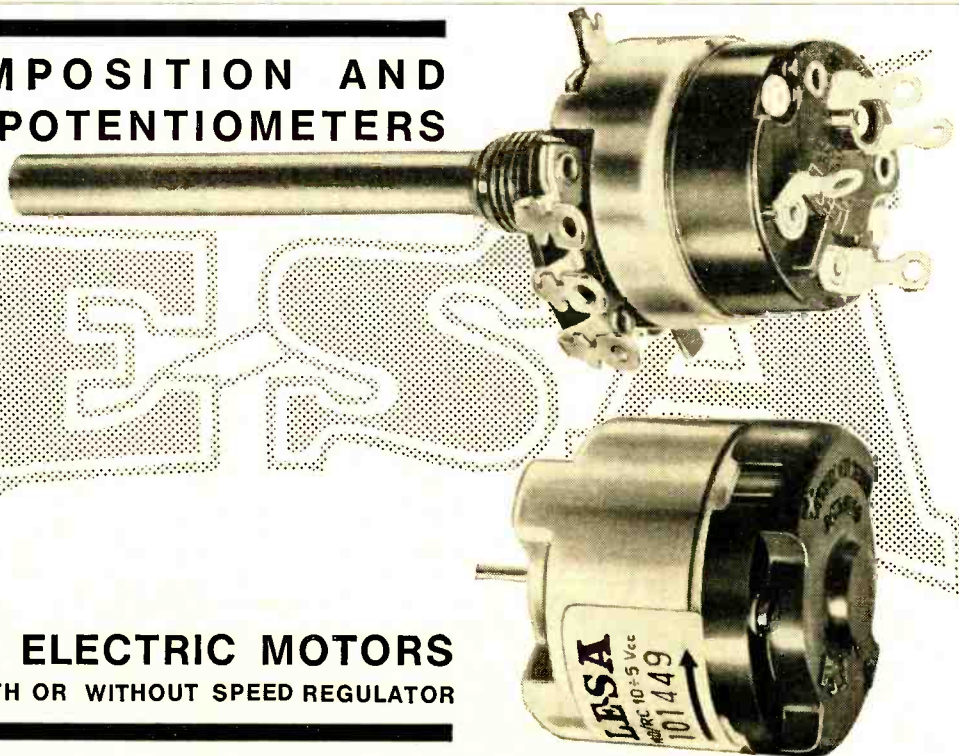

LESA
LESA
LESA
LESA
LESA

OF AMERICA CORP, 521 FIFTH AVENUE, NEW YORK, N.Y. 10017, TEL. 212 697.5838
COSTRUZIONI ELETTROMECCANICHE S.p.A., VIA BERGAMO, 21, MILANO, ITALY
DEUTSCHLAND GMBH, 1 WIESENTALSTRASSE, FREIBURG i/Br. WEST-GERMANY
ELECTRA, S.A., VIALE PORTONE 27, BELLINZONA, SWITZERLAND
FRANCE S.A.R.L., 19 RUE DUHAMEL, LYON, FRANCE

LESA
LESA
LESA
LESA
LESA

reliable high power characteristics are required. A spec sheet giving full characteristics will be forwarded on request. Solitron

Circle No. 132 on Reader Service Card

POWER SUPPLIES FOR IC'S

A response to overvoltage of less than 10 μ s is featured in a new series of power supplies for integrated circuits recently introduced.

Features of the new WRE Series include adjustable overvoltage protection, output resolution as



low as 1.4 millivolts, and the absence of "on-off" overshoot. The supplies are highly regulated.

Five models are available. Two are 10-volt modular units with amperage of either 0-2.2 or 0-3.7. The others are 7.5-volt bench or rack units with amperage of 0-10, 0-20, or 0-50. Voltage regulation (line and load combined) is $\pm 0.005\%$ or ± 0.2 millivolts for the modular models and $\pm 0.01\%$ or ± 0.4 millivolts for the bench or rack models. Output resolution is typically 28 millivolts for the modular units and 1.4 millivolts for the bench units. Raytheon/Sorensen

Circle No. 133 on Reader Service Card

DIGIT DISPLAY MODULE

The new Model D-100 low-cost digit display module is designed for use in high-speed electronic counters and readouts. The unit accepts four-line BCD input code for single digit display on a neon glow tube. The module comes complete with rectangular end-view tube.

The compact design of the D-100 makes it readily adaptable as a building block for computer input/output, numerical control displays, and a wide range of digital instrumentation requirements. Offering monolithic integrated circuitry, an encapsulated package, and printed wiring with etched connections, the units are physically and electronically interchangeable with competitive models. They operate on a supply of 4.75 to 7 volts and 200 volts for tube anodes. Integrated Circuit Electronics

Circle No. 134 on Reader Service Card

INDUSTRIAL TRIMMER

A new commercial/industrial wirewound trimmer which stands less than a quarter-inch above the PC board is now available. A special cover equips these single-turn devices for either instant fingertip or screwdriver control.

Lightweight phenolic cases with molded-in terminal pins resist adverse effects of automatic soldering and subsequent board cleaning. Standard printed-circuit spacing is used for the terminals.

Designated Type 500, the new trimmers are rated 0.5 watt at 25°C and are available in all standard intermediate resistance values from 10 ohms to 50,000 ohms $\pm 10\%$. IRC

Circle No. 135 on Reader Service Card

WIRING ACCESSORY KIT

A complementary kit of wiring accessories for prototype and test use is now being offered to en-

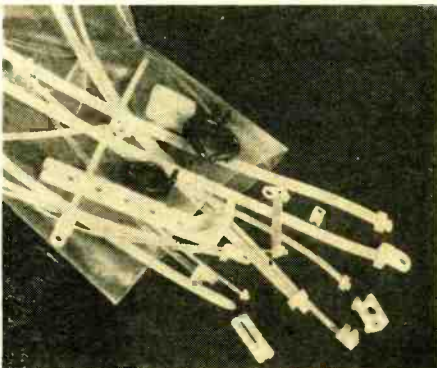

98

gineers. The kit contains samples of the six sizes of self-locking "Sta-Strap" cable ties, including the new intermediate unit for diameters up to 1 1/4" and the new extra-long, heavy-duty strap for diameters to 8". Also in the kit are "Pan-Rings" for automatically threading the straps into their self-locking heads.

Other products in the kit are "Pan-Poles" for stand-off wiring, adhesive mounts, clamps, identification markers, and connector rings. Panduit

Circle No. 136 on Reader Service Card

PROFESSIONAL V.T.V.M.

The new professional v.t.v.m., Model V-95, incorporates an exclusive solid-state power supply replacing the batteries normally required in a v.t.v.m.'s ohmmeter section.

Features include a rugged 7" meter movement with mirrored scales to eliminate parallax; specially calibrated scales for reading low-voltage

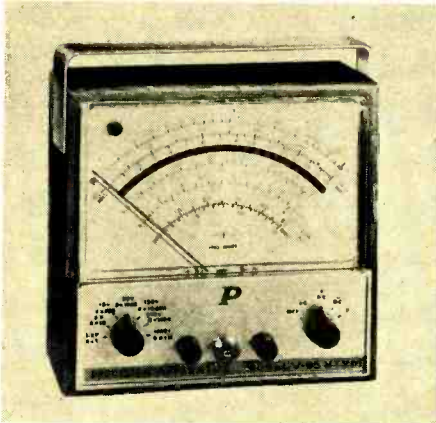

measurements during transistor analysis in the 0.5, 1, 1.5 and 5-volt ranges; and simplified peak-to-peak and dB scales.

Complete specifications on the V-95 will be forwarded on request. Precision Apparatus

Circle No. 9 on Reader Service Card

HI-FI—AUDIO PRODUCTS

TURNTABLE PACKAGE

The McDonald 500 automatic turntable is now being offered in combination with an Empire 808 cartridge and a walnut finished base/plastic dust cover as the 500/808 package.

Not only is the cartridge fitted and tested but the turntable is mounted on the base ready for immediate use. The new package offering is designed to save time and trouble for audiophile and dealer alike. BSR

Circle No. 10 on Reader Service Card

SLOW-SPEED TAPE

A new slow-speed, low-noise, audio-range magnetic tape featuring the "Crystallined" process is being marketed as the "Star Series".

The new tape has been especially designed for stereo tape recorders by providing extended frequency response and dynamic range, improved signal-to-noise ratio, and high fidelity. It is being offered on 1.5-mil acetate, 1.5-mil Mylar, and 1-mil Mylar base materials on 5" and 7" reels. The tape has a colored leader and trailer on each reel. Greentree

Circle No. 11 on Reader Service Card

80-WATT AM-FM RECEIVER

A new all-silicon, 80-watt AM-FM receiver is now on the market as the Model S-7600-FET.

Among the features of this new receiver is a low-distortion linear FM detector which was especially designed for the set; selected field-effect transistors in the r.f. and mixer stages to provide -95 dB of cross-modulation rejection; and 1.8- μ V FM sensitivity.

The Model S-7600-FET will deliver 80 watts of IHF dynamic power to two pairs of 8-ohm speakers. Front-panel rocker-action switches permit the two pairs to be played independently or simul-

taneously. Dynamic power is 80 watts at 4 ohms and 50 watts at 8 ohms. Power bandwidth is 12-35,000 Hz.

Available for custom mounting, or in a walnut-grained leatherette case, the receiver measures 15 1/2" x 12" x 4 1/2" high. Full technical specs are available on request. Sherwood

Circle No. 12 on Reader Service Card

PORTABLE 4-TRACK STEREO UNIT

The Sony Model 230 "Stereo Compact" is a completely portable 4-track stereo record and playback system featuring a built-in solid-state stereo control center, with amplification providing 20 watts of total dynamic power.

The stereo control center has complete input and switching facilities for the connection of external hi-fi components to play through the 230's amplifier and speaker system. The unit has split speakers which form the carrying case lid. Each speaker is self-contained, having a tweeter and woofer in each unit. The speakers may be placed up to 15 feet apart.

The recorder provides three tape speeds, 7 1/2, 3 3/4, and 1 7/8 in/s; has a retractomatic pinch roller for threading ease; automatic end-of-reel shut off; and a digital tape counter. It also has two vu meters; a stereo headset jack; and includes two cardioid dynamic microphones. Superscope

Circle No. 13 on Reader Service Card

CASSETTE PLAYERS & RECORDERS

A new line of tape players/recorders for home and portable use has been introduced as the "Micro Series".

The new line includes stereo systems for the home and a battery-powered model for portable listening or recording—all employing cassettes. The "Micro 20" is a combination a.c.-d.c./battery-powered portable mono recorder in a case measuring 12 1/2" x 8" x 2 3/4" and weighing 6 pounds. The "Micro 50" is a walnut encased stereo player/recorder deck designed for use with any stereo system. It has preamps and a power supply. All solid-state, it measures 14 1/2" x 8 3/4" x 3 1/2" and weighs 8 pounds.

The "Micro 85" is a complete system including a walnut encased player/recorder with dual power



amplifiers, preamplifiers, matching walnut speakers, and two omnidirectional microphones.

The cassettes measure only 4" x 2 1/2" x 1/2" and record or play back for up to 90 minutes at 1 7/8 in/s. The company is developing a recorded cassette line of more than 500 albums from 17 different labels which will be available by the end of the year. Ampex

Circle No. 14 on Reader Service Card

STEREO CARTRIDGE

The new 999VE professional stereo cartridge is capable of tracking 30 cm/s at less than 1 gram, according to its maker.

The cartridge features a 4-pole, 4-coil, 3-magnet design for maximum efficiency. Stereo separation is 30 dB at 1000 Hz and as much as 20 dB at 20,000 Hz. Compliance is 30 x 10⁻⁶ cm/dyne for wide excursion bass notes.

The cartridge has an all-diamond stylus which is ground, lapped, polished, then inspected 14 times. Empire

Circle No. 15 on Reader Service Card

REEL-CHANGING RECORDER

A new tape recorder with an automatic reel changing mechanism that allows up to five reels of pre-recorded tape to be stacked on a spindle

and played in automatic sequence has just been announced as the Sony Model 760.

In addition to the reel changing mechanism, the new recorder features automatic reel threading, automatic reel reversing, and the ejection of the completed reel after both sides have been played. The new unit will handle reels from 3" to 7" in diameter which may be intermixed. There are also solenoid push-button controls for manual operation.

The solid-state 760 is a deck model operating at 7½, 3¾, and 1⅞ in/s. It will be marketed in two



versions: one for playback only and the other for recording and playback. Superscope

Circle No. 16 on Reader Service Card

CASSETTE CHANGER

Among the new items which have been recently announced is an automatic cassette changer, the Model 2502.

An a.c. stereo playback unit, the 2502 provides up to 4½ hours of continuous music and is designed to be used in conjunction with existing hi-fi systems. It permits loading up to six cassettes for playback. Each is successively dropped into playing position and, when completed, automatically moves into a storage compartment within the teak cabinet. The low-profile unit has push-button controls, a pilot light, and digital counter.

Other items in the new line are the Model 2500, a single-play a.c. stereo playback unit; the 2200,

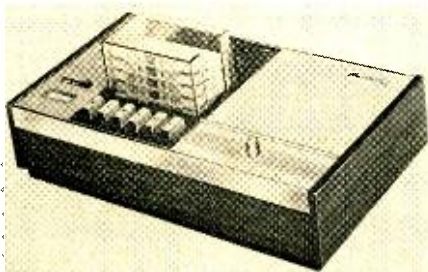

a cordless playback unit for the youth market; the 2600, a stereo cassette player for cars; the "Continental 175", a battery-operated portable mono cassette recorder; and the Model 4408, a three-speed, four-track stereo recorder. Norelco

Circle No. 17 on Reader Service Card

FLUTTER METER

An all-solid-state flutter meter which makes precision r.m.s. measurements on any magnetic tape recorder has been announced as the Model 398.

The internal oscillator develops a 3-kHz refer-

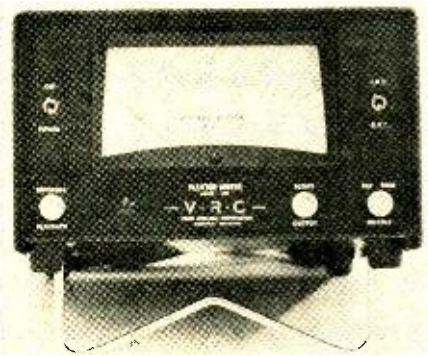

ence tone which is recorded on tape. Speed variations (flutter) in the recorder's drive mechanism is then sensed during playback by the unit's high-sensitivity pulse averaging discriminator and displayed on a large dual-range panel meter. A pre-calibrated scope output permits viewing the flutter waveform directly. Video Research

Circle No. 18 on Reader Service Card

90-MINUTE TAPE CASSETTE

The new C-90 tape cassette contains 450 feet of BASF recording tape and can be played for a full hour and a half (45 minutes in each direction). The cassette is designed to be used with General Electric, Norelco, Wollensak, and all other compatible cassette recorders. Computron

Circle No. 19 on Reader Service Card

AMPLIFIED HEADPHONES

Two new amplified headphones have just been introduced as the "Amplitwin" and the "Amplitone."

The high-fidelity "Amplitwin" is a stereo headphone with separate amplifiers in each ear cup. Each amplifier features a volume control and has a low-level and a high-level input. Two shielded cords with phono jacks are included. The amplifiers operate on 9-volt transistor radio batteries. The "off" switch preserves battery life and converts the unit to a conventional headphone.

The "Amplitone" is a guitar headset which is offered in either mono or stereo versions and provides private listening for the teen set. Telex

Circle No. 20 on Reader Service Card

POWERED SPLITTER

A new solid-state amplified splitter, called the "Homer", is designed to improve FM or TV reception on up to four sets operating from a single antenna. The new unit incorporates a unique inductively coupled emitter feedback circuit on which a patent is pending.

The new circuit delivers the maximum dynamic

Why not sell the best

NEW ZENITH LOG-PERIODIC ANTENNAS built to the quality standards of Zenith original parts

Advanced designs . . . developed by the Antenna Research Laboratories of the University of Illinois. Model 973-49 (right) works like a powerful, multi-element Yagi. It offers superior Color or B&W reception on *all* channels. And it delivers better FM/Stereo FM performance in metropolitan areas.

Other Zenith quality periodic antennas are specially designed for UHF, VHF, FM and FM stereo, or planar helical UHF reception.

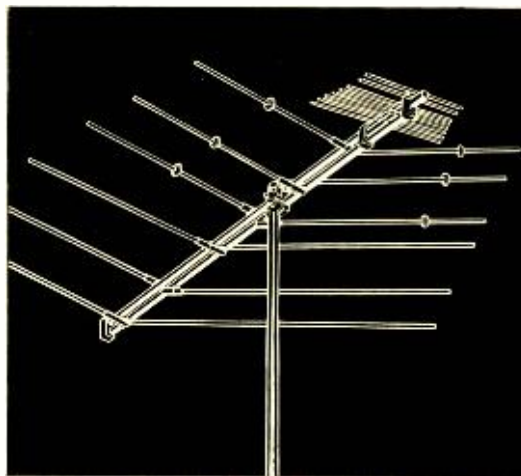

Order Zenith antennas and all genuine Zenith replacement parts and accessories from your Zenith distributor.

ZENITH®

The quality goes in before the name goes on

CIRCLE NO. 82 ON READER SERVICE CARD

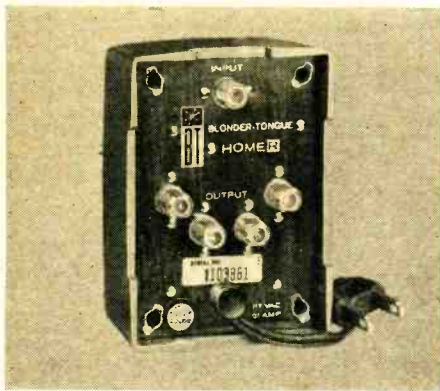

range from the transistor used and is said to be effective in defeating cross-modulation, harmonic interference, windshield-wiper effect, hash, herringbone, and beat patterns. Intersect isolation is 14 dB.

According to the company, the amplified splitter nearly triples TV or FM signals (9 dB) when operating two sets from a single antenna and doubles the signal (6 dB) gain with four sets. Blonder-Tongue

Circle No. 21 on Reader Service Card

CARTRIDGE TAPE PLAYER

A stereophonic cartridge tape player which incorporates six exclusive features has just been introduced as the TP-8.

The new features include an automatic tape insertion and locking device, straight-line vertical movement of the tape head, dual guides for proper tape alignment, and virtually noiseless low-power switching between channels, a choice of

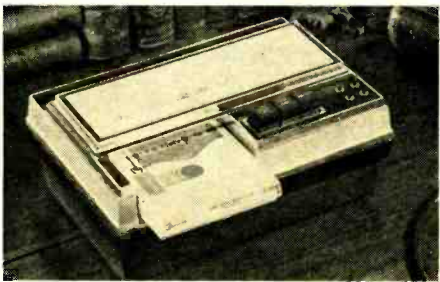

continuous play or automatic shut-off after the fourth channel, and an unlocking device which prevents cartridge damage by automatically releasing pressure when the player is not operating.

The solid-state cartridge player weighs 7 pounds and measures 10" x 7" x 4 1/2". It is designed to play 8-track stereo cartridges through external speaker systems. Sylvania

Circle No. 22 on Reader Service Card

BATTERY/A.C. TAPE RECORDER

The Sony "ServoControl 860" is a solid-state battery/a.c. portable recorder which incorporates a special motor that electronically corrects for speed variations and maintains precise timing accuracy.

The dual-track 860 works on household a.c. current or flashlight batteries, without the need for an adapter. It operates at 3 3/4 and 1 7/8 in/s and can accommodate up to 5" reels. The unit has an auxiliary high-level input for recording from TV,



100

telephone, radio, or other high level sources, as well as a digital tape counter, push-button controls, and a remote stop/start microphone. Superscope

Circle No. 23 on Reader Service Card

TAPE-RECORDER LINE

Five new reel-to-reel tape recorders, two cassette models, plus compatible 4 & 8 track and straight-8 car stereo tape players have been recently introduced.

The portable cassette tape recorder, the Model 2602, features keyboard controls, automatic level control, provision for voice actuation, pop-up button for easy cassette ejection, and a no-erase safety lock for pre-recorded cassettes. The unit is battery operated and is equipped with a battery life indicator and a.c. adapter jack. Craig Panorama

Circle No. 24 on Reader Service Card

CB-HAM-COMMUNICATIONS

MOBILE/PERSONAL CB UNIT

An all-solid-state CB transceiver, designed to be used in all types of mobile and personal applications, is being marketed as the "Pace-Mate".

This 3-channel, 2-watt transceiver features a double-conversion superhet receiver teamed with a rugged all-silicon transistor transmitter. There is a six-section tuned i.f. filter for maximum adjacent-channel rejection, shaped push-pull audio design for sharp voice reproduction, automatic noise limiting and tapered squelch control for quiet operation, and a full stage automatic gain control.

The unit comes equipped with a detachable helical coil antenna, a "snap-back" power pack for operation on penlight cells, or rechargeable "Nicaid" pack. The transceiver measures 2 3/4" x 1 3/4" x 7 3/4" and weighs 1 1/4 pounds. Pace

Circle No. 25 on Reader Service Card

MARINE CB ANTENNA

A new high-performance, omnidirectional marine CB two-way antenna with an exceptionally low angle of radiation for maximum over-water range is now being marketed as the ASM-23 "Sea-Hook".

The 27-MHz antenna is a full electrical half-wave radiator with an over-all length of 97 inches. It has a cyclolac base with a built-in foldover feature which allows instant retraction of the antenna when negotiating bridges or other low obstacles.

No ground plate is required since link-coupling is employed, thus simplifying installation. All critical parts are solid brass with chrome plating for additional protection. The loading coil is precision wound and enclosed in white weather-proof plastic with chrome-plated end caps. Impedance is 50 ohms and v.s.w.r. is said to be better than 1.5:1. Antenna Specialists

Circle No. 26 on Reader Service Card

MOBILE TRANSCIVER WITH IC's

The new 23-channel Model HB-525C mobile transceiver features integrated circuits for high sensitivity and low power drain. A frequency synthesizer includes crystals for all 23 CB channels. The dual-conversion receiver has a 455-kHz mechanical filter, 3-position delta tuning, series-gate noise limiting, and variable squelch circuits.

The full 5-watt-input transmitter uses range-boost modulating stages to increase effective talk power and offers full public address provisions with input and output jacks. A built-in 3" x 5" speaker with directive louvered grille provides clean, clear sound reproduction.

The transceiver operates on 12 volts d.c., negative or positive ground. Three optional power supplies permit operation on 117 volts a.c., 6 volts d.c., or as a portable battery-operated unit. The unit measures 2 3/8" x 6 1/2" x 8" and comes with a mounting bracket, fused power cable, and push-to-talk microphone. Lafayette

Circle No. 27 on Reader Service Card

ANTENNA MATCHING NETWORK

The new "CB Matcher" provides a v.s.w.r. of



1.1:1 when inserted between the antenna and a CB transmitter. For calibration, a bridge or meter can be inserted between the transmitter and matching network and can be left in the line if desired.

Finished in black and gold, the "CB Matcher" measures 1 3/4" x 2 1/4" x 3 3/4" over-all. Gold Line

Circle No. 28 on Reader Service Card

25-50 MHz TRANSCEIVER

The "Broadcaster I" is a completely solid-state transceiver for the 25-50 MHz land mobile radio service for either mobile or base station use.

The transceiver measures 5 3/4" wide x 2" high x 7 3/4" deep. Current drain from a 12-volt d.c. power source ranges from 30 mA to 1/2 A when receiving and only 1 A when transmitting.

The receiver employs a four-element crystal filter in a double-conversion superhet circuit. Sensitivity is better than 1 μV for 12 dB S+N/N;



the 6-dB bandwidth is 6 kHz and selectivity is better than 50 dB down at ±8 kHz of center frequency. Image and spurious rejection is greater than 70 dB. Audio output is 3 watts.

Full technical specifications will be provided on request. Unimetrics

Circle No. 29 on Reader Service Card

COMPACT CB RIG

A new 5-channel solid-state CB transceiver has just been introduced as the TR-5. Measuring a compact 5 3/4" x 6 1/4" x 1 7/8", the transmitter uses silicon transistors which have been especially manufactured to a higher peak voltage than before. The TR-5 features zener diode protection, 100% modulation, an illuminated channel selector, transmit indicator, auxiliary speaker jack, single-knob tuning, a modulation indicator, and a special "safety circuit" to protect against mismatched antenna, incorrect polarity, and overload. Courier

Circle No. 30 on Reader Service Card

CB TRANSCIVERS

Two new CB transceivers have been introduced recently as the "Skylark", an 11-channel unit and the "Skyhawk Mark II", a 23-channel model.

The "Skylark" employs all-solid-state circuitry, tantalum capacitors, filtered power leads, glass epoxy circuit board, zener diode voltage regulator, and an enclosed plug-in relay. It is equipped for use as a paging system and an external speaker jack is provided. It measures 2 5/8" x 6 1/2" x 9 1/4" and weighs 7 pounds.

The "Skyhawk" uses 25 transistors and 9 diodes. Electrical characteristics and physical size



ELECTRONICS WORLD

are the same as for the "Skylark" except that it has 23-channel capability. Both models are available with a choice of colored front panels. Kaar
Circle No. 31 on Reader Service Card

PORTABLE FM TRANSCEIVER

The Model HH-300 is a hand-held portable v.h.f. FM transceiver designed for service in the 132-174 MHz band. Completely solid-state and weighing only 30 ounces, the new transceiver has a carrier power of more than 2 watts and offers five separate crystal-controlled channel capability.

Other features include continuous tone squelch, plug-in circuit modules, rechargeable quick-change nickel-cadmium battery, and various optional accessories. The unit is completely waterproof. Du Mont/Gonset

Circle No. 32 on Reader Service Card

SIX-CHANNEL CB UNIT

A new solid-state, six-channel mobile CB radio with built-in "S" meter is now available as the Model 100. This low-cost transceiver has a double-conversion receiver for maximum sensitivity, coupled with noise limiting circuitry, and full modulated five watts of talk power. The set comes

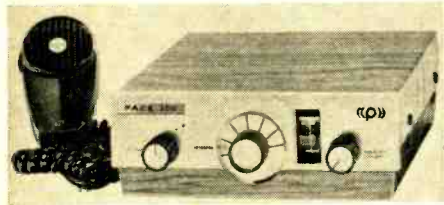

equipped with the channel-11 crystal installed. Up to five more channels may be added for business or personal use.

Designed specifically for mobile use, the Model 100 is packaged in a walnut-grained metal case with polished chrome front panel. The all-silicon circuit is mounted on a glass fiber circuit board. Pace

Circle No. 33 on Reader Service Card

MANUFACTURERS' LITERATURE

MEASURING FM

A new 17-page application note (No. 87) describing the many ways that wide-band FM discriminators can be used for the measurement of FM and PM has been published.

The illustrated booklet covers basic frequency-modulation theory and discusses a wide range of discriminator applications, including direct FM, down-converted FM, measurement of small deviations and flutter, swept-frequency measurement, and signal bursts and chirped pulses.

Featured in the note is a complete description of the company's Model 5210A/B frequency meter/FM discriminator, along with accessories and other instruments suitable for use with the meter/discriminator. Hewlett-Packard

Circle No. 137 on Reader Service Card

SPEAKER SYSTEMS

A new 6-page illustrated brochure on a line of high-fidelity loudspeakers has been issued. Featured are the Cornwall, Heresy, and Model H designs, along with the La Scala system intended for theater and commercial use.

Included in the booklet is an insert price list, which contains an extensive bibliography of papers and articles on loudspeakers and related topics. Klipsch

Circle No. 34 on Reader Service Card

ELECTROLYTIC CAPACITORS

Complete technical specifications on the new Types MTA and MTV molded aluminum electrolytic capacitors are contained in a new 12-page illustrated bulletin (No. 4-74B). Included are performance characteristics, typical life test data, dimensional drawings, and a size and rating chart. Mallory

Circle No. 138 on Reader Service Card

TEST EQUIPMENT

Described and illustrated in a new 8-page quick-reference catalogue (No. 67D) is a com-

plete line of electronic test equipment. Included are color-bar generators, CRT testers, oscilloscopes, signal and sweep generators, transistor and tube testers, v.o.m.'s, and v.t.v.m.'s. Hickok
Circle No. 35 on Reader Service Card

PRINTED CIRCUITS

A new 12-page illustrated booklet entitled "A Buyer's Guide to Printed Circuits" has been made available. Covered in detail are the specific steps followed by the company in production planning and actual fabrication, along with a discussion of cost and the numerous factors affecting it. Lockheed Electronics

Circle No. 139 on Reader Service Card

COMPONENTS CATALOGUE

A wide line of miniature devices, including electronic switches, remote-control relays, read-out indicators, pilot lights, and ceramic terminal strips, is presented in a new 12-page illustrated catalogue.

Entitled "Design Ideas for Engineers," the booklet contains complete specifications for all products listed. Alco

Circle No. 140 on Reader Service Card

SILICON TRANSISTORS

A new 16-page product selector for industrial small-signal devices has been published. Listed in the booklet are r.f. and i.f. amplifiers, oscillators, saturated switches, general-purpose and differential amplifiers, and diodes.

Included in the publication is a complete listing of the more than 800 different 1N and 2N silicon diodes and transistors manufactured by the company. Fairchild Semiconductor

Circle No. 141 on Reader Service Card

CONNECTOR CATALOGUE

Described and illustrated in a new 12-page catalogue (No. 4-674) is a line of miniature high-voltage r.f. coaxial-cable connectors, receptacles, and adapters.

The booklet also contains a cable and cross-reference chart, mounting diagrams, and a detailed description of cabling procedures. Kings Electronics

Circle No. 142 on Reader Service Card

SEMICONDUCTOR CATALOGUE

A new 57-page semiconductor catalogue (No. 640:13) has been made available. Included are silicon economy transistors, tunnel diodes, SCR's, triacs, and thyrectors.

In addition, the catalogue contains a listing of available application notes and reprints from technical journals covering general applications for signal and power semiconductors, SCR and test circuits, tunnel diode and unijunction applications, and transistor circuits. General Electric

Circle No. 143 on Reader Service Card

READOUT DEVICES

A complete line of single-plane rear-projection readout devices is described and illustrated in a new 44-page catalogue (No. 202). Units range in size from the microminiature Series 345 through the Series 80 which is capable of displaying characters 3 3/8 inches high.

In addition, the catalogue discusses operating principles and lamp selection. IEE

Circle No. 144 on Reader Service Card

AEROSOLS FOR ELECTRONICS

A new "family" of aerosol products specially formulated for electrical and electronic manufacturing and maintenance is presented in a new 2-page data sheet.

The line includes cleaners, demoisurants, lubricants, and protective and insulating coatings, as well as such special-purpose items as a circuit cooler, an anti-static spray, and a cutting fluid. Sprayon

Circle No. 145 on Reader Service Card

MICROPHONE CATALOGUE

A complete line of dynamic, dynamic cardioid, and ceramic microphones is described and illustrated in a new 12-page catalogue. Featured in the booklet, entitled "A Microphone for Every

BACK ISSUES AVAILABLE

Use this coupon to order back issues of
ELECTRONICS WORLD

We have a limited supply of back issues that can be ordered on a first-come, first-served basis. Just fill in the coupon below, enclose your remittance in the amount of 75¢ for each copy ordered.

ZIFF-DAVIS SERVICE DIVISION
 Dept. BCEW, 595 Broadway
 New York, New York 10012

Please send the following back issues of
ELECTRONICS WORLD

I am enclosing _____ to cover cost of the magazine, shipping and handling.

Month _____ Year _____

Month _____ Year _____

Month _____ Year _____

Name _____

Address _____

City _____

State _____ Zip _____

Payment must be enclosed with order

This Space Reserved for You!

FIRST PRIZE

INVITATION TO PHOTOGRAPHY
A COURSE IN BETTER PHOTOGRAPHY

250 Tips for Better Pictures

Dreaming about winning first prize in a photo contest?

Well, whether you're a perplexed beginner, a serious hobbyist—or someone who just likes to take pictures—everything you need to know about getting the best out of your camera is now clearly defined in one concise, easy-to-understand guidebook.

The all-new 1967 INVITATION TO PHOTOGRAPHY!

Produced by the editors of POPULAR PHOTOGRAPHY, INVITATION is a unique 124 page "course" in better picture taking.

Including:

- a primer of photographic terms • color wizardry
- choosing the equipment you really need • girls and glamor
- suiting the film to the occasion • creative composition
- using the right light • which lens for you
- starring the kids • darkroom procedure simplified
- not-so-simple-pictures from simple cameras
- eliminating the hocus-focus from portrait, action and night shots.

Plus an extra BONUS—

Lights, camera, action! A complete 28 page section on movie making... movie cameras... creative and technical filming procedures.

Over 20 complete sections in all! Each written by an expert to help you progress quickly, easily, *confidently*. So whether you're aiming at professional blue ribbons, or professional-quality photos for your family album—take the first important step now. By ordering *your INVITATION TO PHOTOGRAPHY!* **Only \$1.25**

INVITATION TO PHOTOGRAPHY is also available in a handsome deluxe edition. Rugged Leatherflex cover provides lasting protection yet is softly textured and gold-embossed for the look of elegance. A collector's item—a superb addition to your permanent photo reference library. And it's yours, for just \$3 post-paid, when you check the appropriate box on the order form.

ZIFF-DAVIS SERVICE DIVISION • DEPT. IP
595 BROADWAY • NEW YORK, N. Y. 10012

YES! Please send my copy of the 1967 INVITATION TO PHOTOGRAPHY as checked below:

\$1.25 enclosed, plus 15¢ for shipping and handling. Send me the regular edition. (\$1.75 for orders outside the U.S.A.)

\$3.00 enclosed. Send me the Deluxe Leatherflex-bound edition, postpaid. (\$3.75 for orders outside the U.S.A.) Allow three additional weeks for delivery.

Print Name _____ **EW-97**

Address _____

City _____

State _____ Zip Code _____

PAYMENT MUST BE ENCLOSED WITH ORDER

Purpose," is the new slim-line DM70 series for taping, p.a. systems, and music combos.

Also included is a listing of accessories and replacement parts. Sonotone

Circle No. 36 on Reader Service Card

POTENTIOMETER SELECTOR

A handy reference guide for selecting potentiometers to meet specific voltage-measuring requirements is now available. Listed on the pocket-sized plastic card are ranges, accuracies, resolutions, and thermal characteristics of the company's laboratory and portable potentiometers. Honeywell

Circle No. 146 on Reader Service Card

ELECTRONIC HARDWARE

A complete line of electronic hardware is described and illustrated in a new 88-page 1967 engineering standards manual. Included are terminal boards, and tube retainers.

Highlighted is an 8-page section devoted exclusively to self-punching components. USECO

Circle No. 147 on Reader Service Card

STANDARD CONNECTORS

Complete specifications on more than 50 types of standard connectors are contained in a new 180-page illustrated handbook. Listed are miniature, subminiature, environmental, and removable crimp/solder contact rectangular connectors; subminiature and miniature round devices; printed-circuit connectors, including wire-wrap; and special-application types, including underwater, tube sockets, and relay sockets. Winchester

Circle No. 148 on Reader Service Card

IMPEDANCE MEASUREMENT

Presented in a new 11-page illustrated application note (No. 77-3) are techniques for determining impedance ($R + jX$), referenced to 50 ohms, in the frequency range from 1 to 1000 MHz with the company's Model 8405A vector voltmeter.

The booklet covers basic theory, presents practical measurement examples, and discusses accuracy considerations. Hewlett-Packard

Circle No. 149 on Reader Service Card

RECHARGEABLE BATTERIES

Complete technical information in a line of sintered-plate rechargeable nickel-cadmium sealed battery cells is presented in a new 4-page illustrated brochure (No. BA-125).

Discharge and charging characteristics are given, along with a cutaway diagram explaining construction and a table listing the physical and electrical characteristics of 20 types of cells. Sonotone

Circle No. 37 on Reader Service Card

VARIABLE INDUCTORS

A new 16-page engineering handbook describing the new Type NV communications-grade variable inductors has been issued. Designed for circuit-board mounting, the devices have a recommended frequency range of 800 Hz to 100 kHz.

The illustrated booklet (No. 5103) gives nominal inductance values, tuning ranges, and d.c. resistances for several hundred standard versions of the Type NV. In addition, the publication contains mounting diagrams, performance curves, and several pages of technical information. Sangamo

Circle No. 150 on Reader Service Card

TV PICTURE TUBES

Technical information on 750 types of black-and-white and color-TV picture tubes is contained in a new 42-page illustrated reference book. Included are comparisons of various picture-tube protection systems, basing diagrams, interchangeability data, and information on the handling of picture tubes. Sylvania

Circle No. 38 on Reader Service Card

TAPE RECORDING

A new 16-page combination catalogue and tape-recording handbook is now available. En-

titled "The Tape Recording Omnibook," the illustrated booklet discusses tape-recorder uses, such as sound for slides and home movies, tape correspondence, and learning a language; how to select a tape recorder; tape splicing, editing, and handling; selection of a microphone and microphone characteristics; and how to get the most out of a tape recorder.

The catalogue portion of the handbook lists various Revox, Editall, and Beyer products. Elpa Marketing

Circle No. 39 on Reader Service Card

INDUSTRIAL FASTENERS

Described and illustrated in a new 36-page catalogue is a broad line of plastic and metal industrial fasteners. Applications include shelf supports in refrigerators, locks in electronic equipment and carrying cases, devices for joining removable panels, and pressure-tight fasteners for missile containers.

Complete mounting, installing, and securing instructions are provided for all products listed. Simmons

Circle No. 151 on Reader Service Card

MEASURING VIBRATION

A new 24-page illustrated catalogue (No. 797-J) that describes a line of sound- and vibration-measuring equipment and accessories has been released.

Among the new instruments presented in the booklet are a tape data recorder, a sound-level calibrator for instrument microphones, and a 1% bandwidth wave analyzer. Other devices listed include sound-level meters, an impact-noise analyzer, a graphic level recorder, and a motion analyzer and tachometer. General Radio

Circle No. 152 on Reader Service Card

PHOTO CREDITS

Page	Credit
16Allied Radio Corporation
23NASA
24, 25 (top & center)U.S. Air Force Photo
25 (bottom)Pan American World Airways
28 (top), 29 (bottom left)RCA Laboratories
28 (center)IBM
28 (bottom)Westinghouse Electric Corp.
29 (top)Steel Products News Bureau
29 (center)3M Company
29 (bottom right)Sylvania Electric Products Inc.
33Kahl Scientific Instrument Corp.
34Hydro Products
35Barnes Engineering Co.
36Sippican Corp.
76Ercona Corp.
95Hewlett-Packard

Answer to Crossword Puzzle appearing on page 81

I	N	D	U	C	T	I	O	N		N	E	P	E	R
N		I	H		D	C		A	D	O		E		
S	I	G	N	A	L		T	A	C	T		T		L
U		S		L	O	G		U	S	E		A		
L	E	A	D	S		D	O	O	R		N		Y	
A		O	I	L		E		A	N	T	E			
T	R	E	E	S		L		B	E	L		I		R
O		L		S	O	S		A		T	A	P	E	
R	H	E	O	S	T	A	T		R	C	L	S		
		C	R	A	D	A	M		L		N	O		
D	E	T	E	N	T		I		P	I	S	T	O	N
R		R		A	E	O	N			M	A	G	N	A
A	B	O	H	M		V				M	A	G	N	E
I		D		U	E					I	T	E		O
N	E	E	D	S			R	E	F	L	E	C	T	O

ELECTRONICS MARKET PLACE

COMMERCIAL RATE: For firms or individuals offering commercial products or services. 70¢ per word (including name and address). Minimum order \$7.00. Payment must accompany copy except when ads are placed by accredited advertising agencies. Frequency discount: 5% for 6 months; 10% for 12 months paid in advance.

READER RATE: For individuals with a personal item to buy or sell. 40¢ per word (including name and address). No Minimum! Payment must accompany copy.

GENERAL INFORMATION: First word in all ads set in bold caps at no extra charge. Additional words may be set in bold caps at 10¢ extra per word. All copy subject to publisher's approval. **Closing Date:** 1st of the 2nd preceding month (for example, March issue closes January 1st). **Send order and remittance to:** Hal Cymes, **ELECTRONICS WORLD**, One Park Avenue, New York, New York 10016

FOR SALE

JUST starting in TV service? Write for free 32 page catalog of service order books, invoices, job tickets, phone message books, statements and file systems. Oelrich Publication, 6556 W. Higgins Rd., Chicago, Ill. 60656.

GOVERNMENT Surplus Receivers, Transmitters, Sniperscopes, Radios, Parts, Picture Catalog 25¢. Meshna, Nahant, Mass. 01908.

METERS—Surplus, new, used, panel and portable. Send for list. Hanchett, Box 5577, Riverside, Calif. 92507.

INVESTIGATORS, FREE BROCHURE, LATEST SUBMINIATURE ELECTRONIC SURVEILLANCE EQUIPMENT. ACE ELECTRONICS, 11500-J NW 7TH AVE., MIAMI, FLA. 33168.

R.F. CONVERTERS World's largest selection. Also CCTV cameras, etc. Lowest factory prices. Catalog 10¢. Vanguard, 196-23 Jamaica Ave., Hollis, N.Y. 11423.

CONVERT any television to sensitive big-screen oscilloscope. Only minor changes required. No electronic experience necessary. Illustrated plans, \$2.00. Relco-A22, Box 10563, Houston, Texas 77018.

FREE ELECTRONICS (new and surplus) parts catalog. We repair multimeters. Bigelow Electronics, Bluffton, Ohio 45817.

DETECTIVES! Free brochures! Electronic Surveillance devices. SILMAR ELECTRONICS, 3476 N.W. 7th Street, Miami, Florida 33125.

MUSIC LOVERS, CONTINUOUS, UNINTERRUPTED BACKGROUND MUSIC FROM YOUR FM RADIO, USING NEW INEXPENSIVE ADAPTOR. FREE LITERATURE. ELECTRONICS, 11500-Z NW 7th AVE., MIAMI, FLORIDA 33168.

SURVEILLANCE EQUIPMENT—NEW HIGH PERFORMANCE SUBMINIATURE MODELS. ELECTRONIC COUNTERMEASURE DEVICES TO PROTECT PRIVACY. FREE DATA: SECURITY ELECTRONICS-EW, 15 EAST 43RD STREET, NEW YORK, N.Y. 10017.

CRYSTALS . . . largest selection in United States at lowest prices. 48 Hr. delivery. Thousands of frequencies in stock. Types include HC6/U, HC18/U, FT-241, FT-243, FT-171, etc. Send 10¢ for catalog with oscillator circuits. Refunded on first order. Jan Crystals, 2400E Crystal Dr., Fort Myers, Fla. 33901.

JAPANESE PRODUCTS CATALOG by air mail \$5, sea \$3. Intercontinental, CPO 1717, Tokyo, Japan.

TREASURE HUNTERS! Prospectors! Relco's new instruments detect buried gold, silver, coins. Kits, assembled models. Transistorized. Weighs 3 pounds. \$19.95 up. Free catalog. Relco-A22, Box 10839, Houston, Texas 77018.

ELECTRONIC PARTS! Components, transistors, diodes, kits, relays, and many special items. Guaranteed. Send 25¢ for 100 page catalog. General Sales Co., P.O. Box 2031, Freeport, Texas 77541.

MESHNA'S TRANSISTORIZED CONVERTER KIT. Converts car radio to receive police and fire. 30-50MHz and 100-200MHz. (one MHz Tuning) \$5.00 with easy to follow step instruction. Meshna, No. Reading, Mass. 01864.

ELECTRONIC Ignition. Kits, components, systems. Diagrams. Anderson Engineering, Epsom, N.H. 03239.

METAL-TREASURE Detectors, transistorized, lightweight. \$39.95 to \$89.95. Free Catalog. **JETCO INSTRUMENTS**, Box 2880-E, Huntsville, Texas 77340.

600 PIV @ 1.5 Amps. Tophats, includes bypass capacitors and resistors, 10 for \$3.00 postpaid U.S.A. fully guaranteed. East Coast Electronics, 123 St. Boniface Rd., Cheektowaga, New York 14225.

DIAGRAMS, SERVICE MANUALS, \$1. Technical Services Associates, Box 1167, Berkeley, California 94701.

ELECTRONICS ENGINEERING AND INSTRUCTION

REI First Class Radio Telephone License in (5) weeks Guaranteed. Tuition \$295.00. Job placement free. (KANSAS CITY) R.E.I., 3123 Gillham Road, Kansas City, Missouri, Telephone WE1-5444. (SARASOTA) R.E.I., 1336 Main Street, Sarasota, Florida 33577, Telephone 955-6922.

HIGHLY—effective home study review for FCC commercial phone exams. Free literature! **COOK'S SCHOOL OF ELECTRONICS**, P.O. Box 36185, Houston, Texas 77036.

WANTED! TV—Radiomen to learn aircraft electronics servicing. Numerous job openings everywhere. Write: **ACADEMY AVIONICS**, Reno/Stead Airport, Reno, Nevada 89500.

ASSOCIATE Degree in Electronics Engineering earned through combination correspondence-classroom educational program. Free brochure. Grantham Technical Institute, 1505 N. Western Ave., Hollywood, Calif. 90027.

ELECTRONICS! Associate degree—29 months. Technicians, field engineers, specialists in communications, missiles, computers, radar, automation. Start September, February. Valparaiso Technical Institute, Dept. N, Valparaiso, Indiana 46383.

LEARN ELECTRONIC ORGAN SERVICING at home. All Makes including transistors. Experimental kit—troubleshooting. Accredited NHSC. Free Booklet. **NILES BRYANT SCHOOL**, 3631 Stockton, Dept. A, Sacramento, Calif. 95820.

HIGHLY effective home study course in Electronics Engineering Mathematics with circuit applications. Earn your Associate in Science Degree. Free literature. **COOK'S INSTITUTE OF ELECTRONICS ENGINEERING**, P.O. Box 36185, Houston, Texas 77036.

FCC LICENSE training by correspondence. Low cost, pay-as-you-go plan. Free particulars. The Willard Foundation, Department EW, P.O. Box 1049, Washington, N.C. 27889.

FCC First Class License in six weeks—nation's highest success rate—approved for Veterans Training. Write Elkins Institute, 2603C Inwood Road, Dallas, Texas 75235.

TUBES

RECEIVING & INDUSTRIAL TUBES, TRANSISTORS, All Brands—Biggest Discounts. Technicians, Hobbyists, Experimenters—Request **FREE** Giant Catalog and **SAVE!** ZALYTRON 469 Jericho Turnpike, Mineola, N.Y. 11501.

FREE ARCTURUS CATALOG

A trusted name in electronics since 1925

Electronic parts, tubes. Wholesale.

Thousands of items. Unbeatable prices.

ARCTURUS ELECTRONICS CO.

502-22nd St., Dept. EW, Union City, N.J. 07087

TUBES, SEMICONDUCTORS, ELECTRONIC EQUIPMENT & COMPONENTS. Quality merchandise only! Serving engineers, Purchasing Agents, TV/HiFi Servicemen and Hams for 20 years. Write for Catalog or call 212-WA 5-7000. **BARRY ELECTRONICS**, 512 Broadway, New York, N.Y. 10012.

TUBES—33¢ each. Year guarantee. Tuner Cleaner \$1.09. Free catalog. Cornell, 4213-W University, San Diego, Calif. 92105.

DON'T BUY TUBES—Radio, TV-Xmitting, special-purpose types until you get our price list! Lowest prices in U.S.A. 5,000 types—Guaranteed Brand New. Send postcard for TV—Special Purpose Price List. **UNITED RADIO COMPANY**, P.O. BOX 1000, NEWARK, N.J. 07101.

GOVERNMENT SURPLUS

JEEPS Typically From \$53.90. . . Trucks From \$78.40. . . Boats, Typewriters, Airplanes, Electronics Equipment, Photographic Equipment, used, 100,000 Bargains Direct From Government. Complete Sales Directory and Surplus Catalog \$1.00 (Deductible First \$10.00 Order). Surplus Service, Box 820-K, Holland, Michigan 49423.

RECTIFIERS, TRANSISTORS & COMPONENTS

6 tube Amplifier, New 4 lbs.	2/1.98
1/4 Watt Resistors, asstd.	50/1.00
1/2 Watt Resistors, asstd.	60/1.00
2N4138 Sil. Chopper To-46 NPN	1.50
Precision Resistors, asstd.	50/1.00
Pots, 2.4 Watt, asstd.	15/1.00
2N1724 Sil. Pow. 50 W. 80 V. Stud.	1.50
2N1047B Sil. Pow. 80V. To-5760
Tantalum Capacitors, asstd.	10/1.00
2N1722 Sil. Pow. 50W. 80V. To-53	1.45
2N2944 Sil. Chopper To-46	1.00
50W. Zeners 10 to 19 Volts	1.00
Thermistor head, 1200 ohm.	2/1.00
2N1021, Ger. Power, 7amp, 100V., To -360
2N456A, 7A. 40V. Ger. Power To -345
2N1718, Sil. Power, 10W., 60V., Heatsink	3/1.00
70 amp Stud. 50PIV—\$2.50; 100PV	\$3.50

SILICON CONTROLLED RECTIFIERS			
AMPS.	300PIV.	400PIV.	500PIV.
7A.	2.50	2.05	2.75
16A.	2.15	2.65	3.25
Pots, 1W. 100K, or 1/2W. 500K.	5/1.00		
Surprise Kit, 10 lbs. components	2.50		
Epoxy Hi-Vol diode, 200ma, 3000PIV98		
Computer Board, TO-3 Power, Heat Sink	1.00		
I.C., TO-5, untested	5/100		
I.C. Dual-inline, untested	10/1.00		
2N389.85W 60 V. TO5379		
2N3707-11 Asstd. Plastic Silicon Xistors	20/1.00		
2N3704-3706, Asstd. Plastic Sil. Xistors	10/1.00		
2N2151, Sil. Power Xister65		
2N1009 Ger. Min. Xister untested	30/1.00		
3N35 Tetrode, NPN, untested	5/1.00		
Ger. Diodes, Asstd.	15/100		
2N458A, 7A. 80V. Ger. Power, TO -355		
Sil. Diodes, Switching, Signal, Asst.	15/1.00		
2N118, Silicon, NPN	10/1.00		
2N1149, Silicon, NPN, untested	20/1.00		
2N1300, Untest. PNP & NPN, 1/4" leads	25/1.00		
2N1714, Silicon Power 10W, 60V.	4/1.00		
Computer Boards, Parts Free, per transistor05		
Germanium Power, 2N457A, 7A; 60V50		
Silicon Power 40 W, 2N1047, TO-57	2/1.00		
Tophats 750 ma., 200PIV-8¢, 400, 12¢ 600 PIV18		
IN34A	100/2.98		
Varicaps, 27, 47, or 100 pf.	1.25		
2N1038, Germanium 20 W. 40 V	4/1.00		

With any \$10.00 Order any \$1.00 item Free. On \$25.00 order any (3) \$1.00 items Free. Catalog. Minimum order \$3.00 plus postage. C.O.D.'s 25%
ELECTRONIC COMPONENTS
Post Office Box 2902 Baton Rouge, Louisiana 70821

G & G CATALOG!

NEW 24 Pages Military Electronic Gear
SEND 25¢ - Refunded with first order

AN/APR-4Y FM & AM RECEIVER "FB" FOR SATELLITE TRACKING!

High precision lab instrument, for monitoring and measuring frequency and relative signal strength. 38 to 4000 Mc. in 5 tuning ranges. For 110 V AC. Built-in power supply. Original circuit diagram included. Checked out, perfect.
LIKE NEW \$88.50
All Tuning Units Available for Above



BC-929 3-inch Scope, with all tubes, LIKE NEW \$16.95
Conversion instructions, with diagram, for 110 V AC operation \$.65

BC-221 FREQ. METER. Accurate, reliable crystal calibrated, for 125 to 20,000 KC range. Complete with tubes, calibration book. Checked out. \$79.50
Exc. Used, unmodulated \$129.50
Exc. Used, Modulated \$150.00
1000 Kc crystal for above \$5.50

LM FREQ. METER, Modulated, 125 to 20,000 Kc. With calibration book, like new \$79.50

T-23/ARC-5 TRANSMITTER, 100 to 156 Mc. Less tubes and crystals, Used \$5.95

R-4/ARR-2 RECEIVER, 234-258 Mc, Tunable. Complete with 11 tubes, NEW \$11.95

Dynamotor (24VDC) for ARR2 \$2.45

BC-645 TRANSCEIVER 435 to 500 Mc, convertible for Ham or Citizens' bands, Voice or Code. Brand new, with 15 tubes \$16.95
Dynamotor, Antenna, Plugs, All accessories available.

SCR-274-N, ARC-5 COMMAND SET HQ!



Freq. Range	Type	Exc. Used	BRAND NEW
RECEIVERS, Complete with Tubes			
190-550 Kc.	BC-453	\$18.95	\$23.50
3-6 Mc.	BC-454	\$16.50	\$21.50
6-9.1 Mc.	BC-455	\$14.95	\$19.95
1.5-3 Mc.	R-25	\$21.50	\$21.50
TRANSMITTERS, Complete with Tubes			
4-5.3 Mc.	BC-457	\$ 6.95	\$11.95
5-3.7 Mc.	BC-458	\$ 6.95	\$12.95
7-9.1 Mc.	BC-459	\$17.95	\$22.50
2-1.3 Mc.	T-19	\$10.50	\$14.95
3-4 Mc.	T-19	\$10.50	\$14.95
MODULATOR, Complete with 3 Tubes			
Voice	BC-456	\$ 2.75	\$ 4.95
All Command Set Accessories in Stock			

SCR-625 MINE DETECTOR \$32.50
EE-8 FIELD PHONES, Exc. Used, Each \$16.95
BC-1206-C Beacon Recvr, 200-400 Kc, NEW \$129.95
SCR-522 Transmitter-Receiver, Like New \$39.50

TG-34A CODE KEYS \$24.50
Brand New in original carton
Exc. Used \$18.95
Practise Tapes available, with Keyer P.U.R.

Please include 25% Deposit with order—Balance C.O.D., or Remittance in Full. 50¢ Handling Charges on all orders under \$5.00. All shipments F.O.B. Our Warehouse, N.Y.C. All Merchandise subject to Prior Sale and Price Change.

G & G RADIO SUPPLY COMPANY
Telephone: (212) CO 7-4605
75-77 Leonard St., New York, N.Y. 10013

Silicon Control Rectifiers			
PRV	3A	7A	20A
50	.35	.50	.80
100	.50	.70	1.35
200	.75	1.05	1.90
300	1.25	1.60	2.45
400	1.50	2.10	2.85
500	1.75	2.80	3.50
600	2.00	3.00	
700	2.25	3.50	
1000		5.00	

1.25 AMP (GLASS AMPS) A controlled avalanche rectifier in which the rated PRV may be exceeded without the rectifier breaking down.

PRV	
100	.12
200	.15
400	.20
600	.25
800	.35
1000	.50

Top Hat & Epoxy 750 MA

PRV	
100	.07
200	.09
400	.12
600	.20
800	.25
1000	.50
1200	.65
1400	.85
1600	1.00
1800	1.20

INTEGRATED CIRCUITS

SR Clocked Flip Flops \$1.15
SRT Flip Flops \$1.15
Expandable OR Gates \$1.00
JK Flip Flops \$1.15
Dual Nand Nor Gates \$1.00
TO-85 flat pack. Guaranteed to work. They come complete with schematic, elect. characteristic sheet & some typical applications.

Silicon Power Rectifiers				
PRV	3A	20A	40A	240A
100	.10	.40	1.00	5.00
200	.20	.60	1.50	7.50
400	.25	.80	2.00	15.00
600	.35	1.20	2.50	20.00
800	.45	1.50	3.00	
1000	.65		4.00	35.00

Terms: FOB Cambridge, Mass. Send check or Money Order. Include Postage, Average Wt. per package 1/2 lb. Allow for C.O.D. Minimum Order \$3.00



POST OFFICE BOX 74B
SOMERVILLE, MASS. 02143
featuring transistors, rectifiers and components
SEND FOR OUR LATEST CATALOG

DO-IT-YOURSELF

PROFESSIONAL ELECTRONICS PROJECTS — \$1.00 up. Catalog 25¢. PARKS, Box 25565B, Seattle, Wash. 98125.

PRINTING

FREE Booklet — "Secrets of Cutting Printing Cost", Dept. 1, 305 S. 4th, Springfield, Illinois 62701.

HIGH FIDELITY

FREE! Send for money saving stereo catalog #E9W and lowest quotations on your individual component, tape recorder or system requirements. Electronic Values Inc., 200 West 20th Street, N.Y., N.Y. 10011.

Hi-Fi Components, Tape Recorders at guaranteed "We Will Not Be Undersold" prices. 15-day money-back guarantee. Two-year warranty. No Catalog. Quotations Free. Hi-Fidelity Center, 239 (L) East 149th Street, New York 10451.

HIFI EQUIPMENT—Get Our "ROCK BOTTOM" prices on NAME BRAND amplifiers—tuners—tape-recorders—speakers FRANCHISED—59 YEARS IN BUSINESS. Write for this month's specials—NOW! Rabson's 57th St., Inc., Dept. 569, 119 W. 57th St., New York, New York 10019.

LOW, LOW quotes: all components and recorders. Hi-Fi, Roslyn, Penn. 19001.

Hi-Fi components, tape recorders, sleep learn equipment, tapes. Unusual Values. Free catalog. Dressner, 1523 R Jericho Turnpike, New Hyde Park, N.Y. 11040.

HYPNOTISM

FREE Hypnotism, Self-Hypnosis, Sleep Learning. Catalog! Drawer H400, Ruidoso, N.M. 88345.

FREE TRIAL!! Sensational self-hypnosis record kit improves memory, concentration, personality. Results guaranteed! Forum, 333-AA9, Michigan, Chicago 60601.

HYPNOTIZE FEMALES!—Unnoticed! Instantly! Nerves! Exciting! Send \$2.25. Research Enterprises, 29-SN21 Samoset, Woburn, Mass. 01801.

FEMALE HYPNOTISM! Easily! Instantly! Secret Nerve Centers! \$2.20. Brugenheimer Publishers, Box 158-E30, Lexington, Mass.

AUTHORS' SERVICES

AUTHORS! Learn how to have your book published, promoted, distributed. FREE booklet "ZD," Vantage, 120 West 31 St., New York 10001.

POEMS WANTED for new song hits and recordings by America's most popular studio. Tin Pan Alley, 1650-ZD Broadway, New York 10019.

RUBBER STAMPS

RUBBER ADDRESS STAMP \$1.50. SIGNATURE \$2.88. FREE CATALOG. JACKSON PRODUCTS, 1433 WINNEMAC, CHICAGO, ILL. 60640.

GET IT from GOODHEART!

SOMETHING NEW FOR VHF SWL'S
Brand new VHF revs in original cartons; look exactly like the familiar BC-453 Command Revs but are 9-tube superhet 108-135 mc AM revs and very easy to power & control without touching anything inside the unit; you can even connect an 8-Meter externally. We furnish schematic and complete instructions on all pin connections and also a spline tuning knob. A.R.C. Type No. R13B. No tuning dial; use graph of freq. vs knob turns. 2 mV sensitivity; 2 RF, 3 IF stages. Ship wt. 9 lbs. For Los Angeles \$22.50
R32 is same but w/adjustable slantch \$27.50

TRANSISTORIZED LV REGUL. PWR SPLIES
Univ. TQ36-1: Dual 0-50 vdc, 1A, metered \$119.50
Dres-Barnes 62-143: 1/2-22 vdc, 15A, metered \$129.50
Dres-Barnes 62-121: 1/2-36 vdc, 15A, metered \$149.50

NEW ARRIVALS IN GOOD SCOPES
Tek. 535 sp corners w/53C dual-trace plug-in & 2 books & aerial probe, all w/NBS-traceable calib certificates dated June 1967 \$895.00
\$535 w/round corners, blue, w/CA dual-trace plug-in, clean as new and exc. operating \$950.00
Fairchild 767H all-silicon-solid-state rack unit w/#74-14 Time-Base plug-in 1 us to 2 sec/div. & 10X multiplier, and w/dual-trace #76-02A plug-in dc to 25 mc pass, sensit. calibrated 5 mv to 10 v/div, clean as new, grtl. \$795.00
WRITE for list of cheaper scopes and/or Samplers to view waveforms up to 1000 mc!

DZ-1 Superhet revr 15-70 & 100-1500 kc.	89.50
DZ-13/ARC-5 Command revr 150-550 kc.	14.95
A.R.C. #2 #22 Command revr 540-1600 kc.	17.95
APR-1Y AM/FM Revr mod. to 115 V 50/60 cy. with pwr plug, book, tuners 38-1000 mc.	250.00
CV-253/ALR Tuner brand new 38-1000 mc	250.00
APR-1Y with CV-253	425.00
P.U.R. for tuners 975-2200 and 2175-4000 mc.	
At pwr plug mod for APR-1Y w/53C	49.50
RA-62-B 10 A pwr sply for SCR-522, only	17.95
TDQ xmt 45 W Po A2, A3, 115-156 mc.	295.00
TDZ xmt 30 W Po A2, A3, 225-400 mc.	495.00
LM-14 freq. meter, .01% 125 kc-20 mc.	57.50
TS-323/UR freq. meter 20-480 mc., .001%	169.50
BC-221's OK	\$67.50 W/modul \$87.50

ALL-BAND 58V RCVR BARGAIN: Hallcrafters H-135/ARR-7, 550 kc to 4.3 mc continuous wave CW, 100V, altered grds, w/book, 2RF, 2IF's, S-meter; noise limtr; 3 xtl, 3 non-xtl selector. 149.50
100% choices. Less pwr sply. \$10.00
WRITE for sply: \$30.00. 85B product detector. \$20

TIME PAY PLAN: Any purchase totaling \$100.00 or more, down payment only 10%

ATTENTION Buyers of LAB Test Equipment: The above is a small sampling of our terrific inventory. **WE ALSO BUY!** We want Tektronix scopes, Hewlett-Packard equip., Aeronaut, radio-shop equip., etc. . . . AND Military Communications of all kinds.

R. E. GOODHEART CO. INC.
Box 1220-A, Beverly Hills, Calif. 90213
Phones: Area 213, office 272-5707, messages 275-5342

CIRCLE NO. 113 ON READER SERVICE CARD

UNUSUAL BARGAINS

... MANY U.S. GOV'T SURPLUS

GIANT WEATHER BALLOONS
"Balls of fun" for kids, traffic stoppers for stores, terrific for amateur meteorologists. Create a neighborhood sensation. Great backyard fun. Exciting beach attraction. Made of heavy duty neoprene. Inflate with vacuum cleaner or auto air hose; or locally available helium for high rise.

60, 568AK (8" diam) \$2 Ppd.
60, 632AK (16" diam) \$7 Ppd.

NEW, LOW-COST GEM TUMBLER

Become a rockhound! Fascinating hobby . . . loads of fun, inexpensive, easy. Make jewelry of all kinds—decorative bookends, table tops, etc. . . . Simply tumble-finish readily available gemstones . . . then polish to high lustre . . . brings out beautiful colors. Rustled 3-lb. capacity tumbler w/continuous duty motor compares to units selling for many times its price. Full instructions.

Stock No. 70,874AK \$10.75 Ppd.
6-LB. ROCK ASSORTMENT (10 types)
Stock No. 70,868AK \$9.00 Ppd.

NEW SURPLUS NI-CD BATTERIES

Save more than 50%! Long life—accept 300 charge and discharge cycles. 1.25 Volts per cell—750 milliamper hour capacity. Excellent charge retention. Hermetically sealed. Indefinite storage life. Multiple cells welded in series—easily cut. Combine to form btry 1/2" dia. x 1 1/2" high. Spec. price for 100 up. Low-cost charger separate.

Order #	Cells	DC Volt.	Price Ppd.
40,986AK	1	1.25	\$ 1.50
40,987AK	2	2.50	3.00
60,633AK	3	3.75	3.60
60,634AK	4	5.00	4.80
70,812AK	Trickle Charger (1-10 cells)		10.95

Edmund Scientific Co., Barrington, N.J. 08007

MAIL COUPON FOR FREE CATALOG

SEND FOR FREE CATALOG "AK"

Completely new 1967 edition. New items, categories, illustrations. 118 easy-to-read pages packed with nearly 4000 unusual items. Dozens of electrical and electromagnetic parts, accessories. Enormous selection of astronomical telescopes, microscopes, binoculars, magnifiers, magnets, lenses, prisms. Many war surplus items for hobbyists, experimenters, workshop, factory. Write for catalog "AK." Please include your Zip Code.

NAME _____
ADDRESS _____
CITY _____ STATE _____ ZIP _____

CIRCLE NO. 118 ON READER SERVICE CARD

U.S. GOV'T ELECTRONIC SURPLUS

• Nationally Known-World Famous SURPLUS CENTER offers finest, most expensive, Government Surplus electronic units and components at a fraction of their original acquisition cost.

ORDER DIRECT FROM AD or WRITE FOR CATALOGS

LABORATORY EXPERIMENTAL KIT

PERFORM 100'S OF FASCINATING ELECTRICAL EXPERIMENTS

Gov't Acquisition Cost Of Parts Over \$50.00

\$14.85
F.O.B.



• (ITEM #A222) -- Amazing Value! Valuable gift for son or husband. Hundreds of fascinating experiments. Teaches modern electronic theory and practice. Easy, interesting way to learn.

• Experiment with electro-plating, electro-magnetic phenomena, resonance, burglar alarm, relay circuits, rectification, test circuits, cross-coupling, motor experiments, transformer phenomena, etc.

• Kit Contains: DC motor, AC motor, electro-magnetic coils, ac and dc relay, set of lab capacitors, compass, test bulbs, plating chemicals, silicon diodes, germanium diode, burglar alarm actuator, carbon microphone, synchronous motor, ac test sockets, permanent magnets, telephone handset, curds, test clips, wire, and other items. Over 35 pieces. Includes fine Experimental Manual with drawings, procedures, etc., written by professional engineers.

• Also furnished with each kit our popular book Home Laboratory Bench and Experimental Procedures... Reg. \$4.00; shows how to build wonderful home laboratory test bench, and how to get the most out of your experimental work. (12 lbs.) Parts cost gov't over \$50.00.

AC PROGRAM TIMING CLOCK

• (ITEM #158) -- Zenith 113-VAC program timer. Use for periodic signalling, work breaks, school classes, turn on radio for newscasts, etc. Adjustable clips permit switching the on or off any time during 24-hour period. Sufficient clips for multiple programming. Also has "skip-a-day" feature. Contacts can handle up to 15amps. Size: 4 1/2" x 4 1/2" x 1 1/2". Gov't Cost Over \$30.00.



Instructions furnished. F.O.B. **\$9.49**



AUTO-PILOT GYROSCOPE

• (ITEM #115) -- DC motor driven, gimbal mounted gyroscope. Ultra-expensive precision unit used to "steer" large, multi-engine planes. Deviation from established plane sends potentiometer controlled signals to bring about change in other motors. Unit can be used as auto-pilot for boats. Wonderful class room unit to demonstrate and study gyro action. Missiles, planes, boats all use gyros. Size 9" x 8" x 10". Wt. 21 lbs. Cost Gov't Over \$500.00.

F.O.B. **\$12.47**

STANDARD DIAL TELEPHONE

• (ITEM #715) -- Standard, commercial telephone same as used throughout U.S. Attractive polished black, like new condition. Use as extension phone to private systems or connect several phones together for local intercom system. Full instructions are furnished. Wt. 9 lbs. Original Cost \$24.50.



F.O.B. **\$5.95**

STEP-BY-STEP AUTOMATIC SWITCH

• (ITEM #738) -- Amazing "up-and-around", electro-magnetic telephone switch. Comes complete with data, one dial and one line bank, size 2 1/2" x 7 1/2" x 1 1/2". Wt. 10 lbs. Gov't Cost \$33.00. Complete; Switch, cover, dial, line bank, instructions..... F.O.B. **\$9.95**



STEP UP/DOWN TRANSFORMER

• (ITEM #1543) -- Step voltage up or down. Has many uses. Will step 115-volts up to 270-volts or step 270-volts down to 115-volts. Will also transform 115-volts to 55-volts. Rated 1.75 amps, output with 175-watt capacity. Size 4 1/2" x 4 1/2" x 1 1/2". Wt. 4 lbs. Gov't Cost \$12.75.

F.O.B. **\$4.99**

TYPICAL BUYS FROM OUR 1967 CATALOGS

- \$ 350.00 - Geared 2-hp Battery Golf Car Motor **\$24.95**
- \$ 15.00 - Westinghouse DC Ammeter, 0 to 300 **\$ 7.11**
- \$ 40.00 - Vacuum Pressure Pump, 12-VDC **\$11.95**
- - - 80-MW Walkie-Talkies, Per Pair **\$19.60**
- - - Deluxe, Multi-Range, AC/DC Tester **\$ 8.98**
- \$4000.00 - Carrier Telephone Amplifier System **\$13.91**

SPECIAL SALE

Correspondence Course in ELECTRICAL ENGINEERING



Sells For \$10.79 Outside U.S.A. **\$8.79** Postpaid in U.S.A.

• (ITEM #A181) -- Wonderful chance to obtain technical training at Amazing Low Cost! Lincoln Engineering School has suspended its Correspondence Courses because of increased operating costs. We offer a limited number of the school's complete Electrical Engineering Course but without the examination paper grading service. The course consists of 14 lesson unit books. Each book has the regular exams, and in a separate section, "Standard Answers" to each exam question.

• Course is well written, easy to understand, profusely illustrated. Reader's Digest size, easy to carry and study in spare time. Many Lincoln Engineering School students holding excellent jobs as a result of E.E.S. training. Course contains latest information on transistors, silicon diodes, etc. Additional book on how to build and operate a "Home Laboratory and Experimental Bench" furnished with each course.

SEND 25c COIN OR STAMPS FOR 3 MAIN CATALOGS

All Items FOB Lincoln Money Back Guarantee

SURPLUS CENTER

DEPT. EW-097 LINCOLN, NEBR. 68501

CIRCLE NO. 91 ON READER SERVICE CARD 106

MAIL SERVICES

HERMITAGE--most SECRET mail forwarding. Unique plus FREE GIFTS. \$3/month, 25¢/singles. HERMITAGE HOUSE (EW), 2783 Market, San Diego, California 92102.

RECORDS

LOWEST prices. New records. All labels. Harvey, Box 1402, Newport News, Va. 23601.

PHOTOGRAPHY—FILM, EQUIPMENT, SERVICES

MEDICAL FILM--Adults only--"Childbirth" one reel, 8mm \$7.50; 16mm \$14.95. International W. Greenvale, Long Island, New York 11548.

SCIENCE Bargains--Request Free Giant Catalog "CJ"--148 pages--Astronomical Telescopes, Microscopes, Lenses, Binoculars, Kits, Parts, War Surplus bargains. Edmund Scientific Co., Barrington, New Jersey 08007.

EDUCATIONAL OPPORTUNITIES

LEARN While Asleep, hypnotize with your recorder, phonograph. Astonishing details, sensational catalog free! Sleep-Learning Association, Box 24-ZD, Olympia, Washington 98501.

USED Correspondence Courses and Books sold and rented. Money back guarantee. Catalog free (Courses Bought). Lee Mountain, Pisgah, Alabama 35765.

LEARN WHILE ASLEEP. Miraculously build Mind Power, achieve Self Confidence, improve Health, gain Success. Method 92% effective. Details free. ASR Foundation, Box 70219E Henry Clay Station, Lexington, Kentucky 40502.

INVENTIONS WANTED

INVENTORS. We will develop, help sell your idea or invention, patented or unpatented. Our national manufacturer clients are urgently seeking new items for outright cash sale or royalties. Financial assistance available. 10 years proven performance. For free information, write Dept. 42, Wall Street Invention Brokerage, 79 Wall Street, New York, N.Y. 10005.

PATENT SEARCHES, \$6.00! FREE "Invention Record"/Information. Miss Hayward, 1029HE Vermont, District of Columbia 20005.

INVENTIONS - IDEAS developed Cash/Royalty Sales. Member: United States Chamber Commerce. Raymond Lee, 230-GE Park Avenue, New York City 10017.

INVENTIONS wanted! Highest cash or royalties. Financial assistance. Free analysis. International Invention Institute, Dept. 31, 160 Broadway, New York, New York 10038.

INVENTORS! Get your "Little Piggy" to market. Highest cash or royalties. New York Invention Service, Dept. 13, 160 Broadway, New York, N.Y. 10038.

EMPLOYMENT INFORMATION

FOREIGN and USA job opportunities available now. Construction, all trades. Earnings to \$2,000.00 monthly. Paid overtime, travel, bonuses. Write: Universal Employment, Woodbridge, Connecticut 06525.

FOREIGN EMPLOYMENT. Construction, other work projects. Good paying overseas jobs with extras, travel expenses. Write only: Foreign Service Bureau, Dept. D, Bradenton Beach, Florida 33510.

PLANS AND KITS

TEACHERS--Students build visual aid. Four tube regen. RCVR; four individual etched printed circuits, 3"x5" ea., connectors, plans \$3.00. Plans 50¢. Teacher, 1751 Greek Dr., San Jose, Calif. 95125.

INTEGRATED CIRCUIT KITS; COMPUTER LOG-IC; parts; others. Catalogue free. Kaye Engineering, Box 3932, Long Beach, California 90803.

GREGORY ELECTRONICS Reconditioned & Used FM 2-WAY RADIO SAVINGS

Partial list--Send for New '67 Catalog

Voice Commander



132 to 172 MC, 1W 9.5" x 5.3" x 1.7" Lowest price ever, including brand New Rechargeable Nickel Cadmium Battery Pack

\$148

If crystal & tuning is desired add \$45.00

Battery charger for these units \$16.00

Write for Quantity Prices

VOICE COMMANDER
Monitor Receiver only--\$78
Tuned & Crystalled with dry Batteries

GE RECEIVER

4ER6 30-40 MC, 40-50 MC, 6 or 12 Volts
3 Coil I. F. **\$28**
4 Coil I. F. **\$34**

MOTOROLA P33 Series Pack Set 5 Watt 150-170 MC with Nicad Supply and Nicad Batteries **\$95.00**

MOTOROLA T41GGV 30-50mc 6/12 V, 30 watt vibrator power supply fully narrow banded complete with accessories less crystals and antenna **\$148**
Add \$45.00 for tuning to desired frequency and new antenna

MOTOROLA 30-50mc 6/12 V, T51GGV vibrator power supply. Fully narrow banded (TX & RX) **\$198**
Above price include accessories less crystals and antenna (less accessories, deduct \$30.00)
To tune unit to desired frequency including new antenna add \$45.00

GE 2-Piece unit--6 volt or 12 volt 4ER6-4ET5, 30w 30-40, mc--40-50 mc. Wide Band **\$48**
Fully narrow band (TX+RX) **\$68**
Complete Accessories

4ER6-4ET6, 60w 30-40 mc--40-50 mc. Wide Band **\$68**
Fully Narrow Band **\$88**
Complete Accessories
Add \$45.00 for tuning and crystals to desired frequency, including new antenna.

RCA-CMCT 30 148-172 mc. transistorized power supply fully narrow banded complete with accessories **\$198**
Add \$40.00 for crystals and tuning and new antenna.

G.E. PACERS--EG43SA6 150-170 mc Transistorized Power Supply 13-15 watts, 12 v Front Mount (Complete accessories, less crystals and antenna) **\$108.00**

We Buy Late Model Equipment for Cash
—Write: Wire or Phone!

GREGORY ELECTRONICS CORPORATION

249 RT. 46, Saddle Brook, N.J., 07662
Phone: (201) 489-9000

CIRCLE NO. 112 ON READER SERVICE CARD

BUSINESS OPPORTUNITIES

INVESTIGATE ACCIDENTS: Earn up to \$1,000 and more a month in your own business. Work spare time with average earnings of \$5 to \$8 per hour. No selling. Send for FREE booklet. No obligation. No salesman will call. Write: Universal Schools, CZ-9, 6801 Hillcrest, Dallas, Texas 75205.

FREE CATALOGS. Repair air conditioning, refrigeration. Tools, supplies, full instructions. Doolin, 2016 Canton, Dallas, Texas 75201.

IMPROVE YOUR BUSINESS OPPORTUNITIES BY ADVERTISING IN THESE COLUMNS. Reach the largest audience of Electronics Professionals any medium can make available. A low cost ad here (70¢ per word, minimum \$7.00) can virtually guarantee a profitable return in additional mail order sales responses for you. Use the handy order coupon printed in this section. Mail it today to: Hal Cymes, Classified Ad Mgr., ELECTRONICS WORLD, One Park Avenue, New York, New York 10016.

ELECTRONICS WORLD

ALL NEW!

Andretti Cops
USAC Cup

JACK BRABHAM WINS 3RD
GRAND PRIX CHAMPIONSHIP

PARSONS
USRRC Winner!

SURTEES TAKES
CAN-AM CROWN

RACING ANNUAL

"If Racing was important to you in 1966, Racing Annual will be essential in 1967."

FIRST TIME EVER PUBLISHED!

These are the men who made the headlines in 1966—the top drivers who walked off with the big prizes! And this year, there's a new headline-maker that's required reading for racing enthusiasts! It's the **CAR and DRIVER RACING ANNUAL**—the first one ever published!

It contains complete box scores of every major event in this country and abroad, including order of finish, equipment and official times . . . over a dozen feature stories of individual races—Indy, Daytona, LeMans, Watkins Glen, the National Drags—all of them . . . plus the champions of the year, FIA, SCCA, NASCAR and USAC winners, and personality wrap-ups on the top drivers in every category of racing.

The **RACING ANNUAL** is an almanac of competition information covering the entire year of 1966—as a reference book it's the finest, most complete manual of its kind—as a thriller, it brings every suspenseful heat back to life with lavish use of dramatic photos, and words that spell "speed" from start to finish!

Better order yours now . . . without the **RACING ANNUAL**, you're buried at the starting line. With it, you're really with it! Use the coupon below to get your copy with the utmost speed—after all, speed is what you're going to get!

GET THE HANDSOME LEATHERFLEX-BOUND EDITION for just \$3 POSTPAID! The **CAR and DRIVER RACING ANNUAL** is also available in a splendid deluxe edition. Rugged Leatherflex cover provides lasting protection yet is softly textured and gold-embossed for the look of elegance. A collector's item—a superb addition to your permanent automotive reference library. And it's yours, for just \$3 postpaid, when you check the appropriate box on the order form.

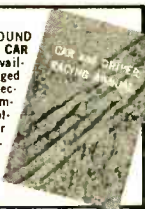

ZIFF-DAVIS SERVICE DIVISION • DEPT. RA
595 Broadway, New York, N.Y. 10012

YES! Send me the new **CAR and DRIVER RACING ANNUAL**.

\$1.25 enclosed, plus 15¢ for shipping and handling. Send me the regular edition. (\$1.75 for orders outside the U.S.A.)

\$3.00 enclosed. Send me the Deluxe Leatherflex-bound edition, postpaid. (\$3.75 for orders outside the U.S.A.) Allow three additional weeks for delivery.

name please print EW-97

address

city

state zip code

PAYMENT MUST BE ENCLOSED WITH ORDER

September, 1967

FREE!

PLUS CHOOSE ANY \$1.00 ITEM FREE

\$25

WORTH OF TRANSISTORS, RECTIFIERS, RESISTORS, CONDENSERS, DIODES, ETC.

Add 25¢ for handling

BOTH FREE WITH ANY \$10 ORDER

- FACTORY TESTED \$1 SEMI-KON-DUCTORS**
- 2-85 WATT 2N424 PLANAR, silicon, TO-53 npn \$1
 - DUAL TRANSISTORS PNP (2N2807) NPN 2N2060 \$1
 - 3-40W NPN SILICON MESA 2N1618, transistor \$1
 - 4 2N170 TRANSISTORS, by GE, npn for gen'l. use \$1
 - 10 3 Amp RECT's, studs, silicon, to 800 V no test \$1
 - 4-2N255 POWER TRANSISTOR EQUALS. \$1
 - 10 PNP SWITCHING TRANSISTORS, 2N104, no test \$1
 - 2N3088 "N" Channel FET'S Very High Input Z \$1
 - 5 2N107 TRANS'TRS, by GE, npn, pop, audio pak \$1
 - 3-2N1613 3W NPN SIL, 120 me, by "Rheem" \$1
 - 3-45 AMP POWER RECTIFIERS, stud, silicon. . . \$1

1 AMP SILICON RECTIFIERS

TESTED	PIV	Sale	PIV	Sale	PIV	Sale
<input type="checkbox"/>	50	5¢	800	23¢	1800	99¢
<input type="checkbox"/>	100	7¢	1000	40¢	2000	1.50
<input type="checkbox"/>	200	9¢	1200	59¢	3000	1.90
<input type="checkbox"/>	400	11¢	1400	69¢	4000	2.50
<input type="checkbox"/>	600	19¢	1600	89¢		

- 5 2N706 500MW, 300MC NPN transtra, TO18 \$1
- 10 PNP SWITCHING TRANSISTORS, no test, TO5 \$1
- 4 2N43 OUTPUT TRANSISTORS, by GE, npn, TO5 \$1
- 1-IGNITION SWITCHING TRANSISTORS, 10 AMP \$1
- 25 GERMANIUM & SILICON DIODES, no test . . . \$1
- 25 TOP HAT RECTIFIERS, silicon, 750 ma, no test \$1
- 2-1000 MC-TRANSISTOR 2N918 NPN SILICON \$1
- 4 2N333 NPN SILICON transistors, Transistron \$1
- 4 BIDIRECTIONAL TRANSISTORS, 2N1611 . . . \$1
- 10 NPN SWITCHING TRANS'TRS, 2N338 no test \$1
- 15 PNP TRANS'TRS, CK722, 2N35, 107, no test \$1
- 15 NPN TRANSISTORS, 2N35, 170, 440, no test \$1
- 30 TRANSISTORS, cf. If, audio osc-ifs, TO5 no test \$1
- 10 FAMOUS CK722 TRANSISTORS, npn no test \$1
- 30 TRANSISTORS, cf. If, audio, no test, TO5 no test \$1
- 4 35-W TRANS'TRS, 2N1431, CBS, TO10, stud. . . \$1

SILICON POWER STUD RECTIFIERS

AMPS	Factor ¹ Tested	50 PIV	100 PIV	200 PIV
3	<input type="checkbox"/>	7¢	11¢	17¢
15	<input type="checkbox"/>	22¢	40¢	65¢
45	<input type="checkbox"/>	75¢	90¢	1.25
160	<input type="checkbox"/>	2.50	2.95	4.05
250	<input type="checkbox"/>	4.50	5.50	6.89

AMPS	400 PIV	600 PIV	800 PIV	1000 PIV
3	<input type="checkbox"/> 22¢	<input type="checkbox"/> 31¢	<input type="checkbox"/> 40¢	<input type="checkbox"/> 59¢
15	<input type="checkbox"/> 90¢	<input type="checkbox"/> 1.35	<input type="checkbox"/> 1.59	<input type="checkbox"/> 1.79
45	<input type="checkbox"/> 1.59	<input type="checkbox"/> 1.90	<input type="checkbox"/> 2.50	<input type="checkbox"/> 2.95
160	<input type="checkbox"/> 5.75	<input type="checkbox"/> 7.50	<input type="checkbox"/> 9.25	<input type="checkbox"/> 10.95
250	<input type="checkbox"/> 9.59	<input type="checkbox"/> 12.50	<input type="checkbox"/> 15.00	<input type="checkbox"/> 19.95

Factory Tested	SILICON CONTROLLED RECTIFIERS	SILICON TUBE SPECIALS	
PRV	7 AMP	16 AMP	25 AMP
50	<input type="checkbox"/> 48	<input type="checkbox"/> 70	<input type="checkbox"/> 80
100	<input type="checkbox"/> 70	<input type="checkbox"/> 1.05	<input type="checkbox"/> 1.20
200	<input type="checkbox"/> 1.05	<input type="checkbox"/> 1.30	<input type="checkbox"/> 1.70
300	<input type="checkbox"/> 1.60	<input type="checkbox"/> 1.90	<input type="checkbox"/> 2.20
400	<input type="checkbox"/> 2.10	<input type="checkbox"/> 2.30	<input type="checkbox"/> 2.70
500	<input type="checkbox"/> 2.80	<input type="checkbox"/> 3.00	<input type="checkbox"/> 3.70
600	<input type="checkbox"/> 3.00	<input type="checkbox"/> 3.30	<input type="checkbox"/> 3.90

<input type="checkbox"/> 5U4GB	2.39
<input type="checkbox"/> 5R4	4.39
<input type="checkbox"/> OZ4	2.39
<input type="checkbox"/> 6AU4GT	2.39
<input type="checkbox"/> 8.66A	11.19
<input type="checkbox"/> 2 Amp	39¢
<input type="checkbox"/> 1000 PIV	39¢

CIRCLE NO. 99 ON READER SERVICE CARD

MISCELLANEOUS

WINEMAKERS: Free illustrated catalog of yeasts, equipment. Semplex, Box 7208, Minneapolis, Minn. 55412.

EMPLOYMENT Resumes. Get a better job & earn more! Send only \$2.00 for expert, complete Resume Writing Instructions. J. Ross, 80-34 Kent St., Jamaica, N.Y. 11432 Dept. EW.

SPARE TIME OPPORTUNITY—MONEY. WE PAY at the rate of \$10 hr. for NOTHING but your opinions, written from home about our clients' products and publications, sent you free. Nothing to buy, sell, canvass, or learn. **NO SKILL. NO GIMMICKS.** Just honesty. Details from RESEARCH, ZD-3, Box 669, Mineola, N.Y. 11501.

STOP BURGLARS THE EASY WAY!! Affix authentic "Protected by Electronic Sentry Alarm" Decals to auto windows, doors & windows of home, retail stores; vending machines, etc. Whether you have an alarm or not—thieves stay away! Only \$1.00 for each set of two. J. Ross, 80-34 Kent St., Jamaica, N.Y. 11432. Dept. EW.

Special! **MOVIN' sale**

6-MONTHS' GUARANTEE

Poly Paks, the only company of its kind in the world due to its tremendous purchasing power, quality and factory testing procedures, **GUARANTEES** all items **AS ADVERTISED** for 6 months or your money back. A 'FIRST' ANYWHERE

Sale - "TEXAS" INTEGRATED BRAND NEW CIRCUITS

A 'FIRST' ANYWHERE with data chart.

- SN7360 Quadruple 2-input NAND/NOR Gate
- SN7400 Quadruple 2-input Positive NAND Gate
- SN15833 Dual 4-input Expander
- SN15832 Dual 4-input Expandable Buffer
- SN15846 Quadruple 2-input NAND Gate
- 13 Planar diode array
- SN7304 Dual J-K Flip-flop, Preset/Clear
- SN7453 Quad AND/OR Invert
- SN7473 Dual Master/Slave Flip-flop
- SN7490M Decade Counter
- SN7491 9-bit Shift Register
- SN15844 Fast-rise-time J-K/R-S Flip-flop

Worth \$10 **\$1.49 EACH**

Worth \$10 **\$1.99 EACH**

VISIT OUR BARGAIN 'RETAIL' STORE
211 ALBION ST., WAKEFIELD, MASS.
Across Transiron

- WORLD'S MOST POPULAR \$1 PARTS PAKS**
- 30 "YELLOW" MYLAR CONDENSERS, asstd val \$1
 - 60 CERAMIC CONDENSERS, discs, npo's, to .05 \$1
 - 60 TUBULAR CONDENSERS, to .5 mf. to 1 Kv, asst \$1
 - 40 DISC CONDENSERS, 27mmf to .05mf to 1Kv \$1
 - 60 TUBE SOCKETS, receptacles, plugs, audio, etc. \$1
 - 30 POWER RESISTORS, 5 to 50W, to 24K ohms \$1
 - 65 HALF WATTERS, asst incl: A.B., 5% tool \$1
 - 60 HI-Q RESIST'RS, 1/2, 1, 2W, 1% & 5% values \$1
 - 10 VOLUME CONTROLS, to 1 meg, switch tool \$1
 - 10 ELECTROLYTICS, to 500mf, asst EP & tubular \$1
 - 50 RADIO & TV KNOBS, asst. colors & styles \$1
 - 4 TRANSISTOR TRANSFORMERS, asst. worth \$25 \$1
 - 40 PRECISION RESISTORS, 1/2, 1, 2W, 1% values \$1
 - 40 CORNING "LOW NOISE" resistors, asst. \$1
 - 10 PHONO PLUG & JACK SETS, tuners, amps \$1
 - 50 TERMINAL STRIPS, 1 to 8 solder lug types \$1

MAIL ORDER ADDRESS

10¢ FOR OUR "XMAS" BARGAIN CATALOG ON:
 Semiconductors Poly Paks Parts

POLY PAKS

TERMS: send check, money order, include postage—avg. wt. per pak 1 lb. Rated, net 30 days. COD's 25%

P.O. BOX 942W
SO. LYNNFIELD, MASS. 01940
"PAK-KING" of the World

TEN Winemaking Recipes and Winemaking Supplies catalog. 10¢. Country Winemaker, Box 243EGA, Lexington, Massachusetts 02173.

GENUINE DIGGER AUSTRALIAN ARMY SLOUCH HATS! Sizes 6 1/2 to 8 1/2. Cost & Post. \$10. A. Unger, "The Ranch", Alectown, N.S.W. Australia.

AS YOU SCAN THESE COLUMNS, more than 185,000 monthly buyers of **ELECTRONICS WORLD** are doing the same. These men are all Electronics Professionals—individuals involved actively in electronics from a business or hobby viewpoint—they are doubly interested in those advertisements which will enhance their careers or their leisure hours. They look to the pages of the **ELECTRONICS MARKET PLACE** for prime sources of products and services of interest to them. They will buy from you if your advertising appears regularly in their favorite magazine. Use the handy order form printed in this section or write today to: Hal Cymes, Classified Advertising Manager, **ELECTRONICS WORLD**, One Park Avenue, New York, New York 10016. **REMEMBER:** November issue, on sale October 19th, closes September 1st.

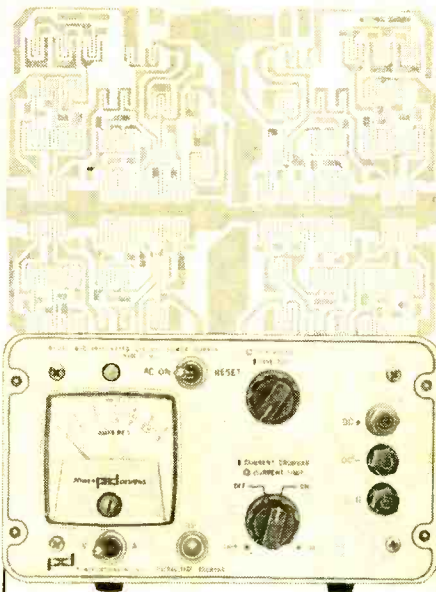

INTEGRATED CIRCUIT POWER SOURCE

0-6VDC, 0-3A

NEW

Overvoltage & Overcurrent Crowbar Protection

Avoids damage to delicate integrated circuits due to internal power supply failure or load current runaway.

- .01% plus 1 MV regulation
- 1 MV peak-to-peak ripple
- Continuously adjustable current limiter
- Coarse and fine voltage adjustment with 1 MV resolution.

MODEL 630

\$14950

FOB-WESTBURY, N.Y.

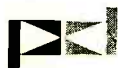

POWER DESIGNS, INC.

1700 SHAMES DRIVE • WESTBURY, N. Y.
516 EDgewood 3-6200 TWX: 510-222-6561

POWER DESIGNS PACIFIC, INC.

3381 JUNIPERO SERRA • PALO ALTO, CALIF.
415-321-6111 TWX: 910-373-1251

ELECTRONICS WORLD SEPTEMBER 1967

ADVERTISERS INDEX

READER SERVICE NO.	ADVERTISER	PAGE NO.	READER SERVICE NO.	ADVERTISER	PAGE NO.
125	Allied Radio	53, 54	102	Motorola Training Institute	86
	American Institute of Engineering & Technology	66	101	Multicore Sales Corp.	101
	Arcturus Electronics Co.	103	100	Music Associated	94
124	Belden Corporation	78, 79		National Radio Institute	8, 9, 10, 11
	Capitol Radio Engineering Institute, The	18, 19, 20, 21		Norelco	60
122	Cleveland Institute of Electronics	62, 63, 64, 65	99	Poly Paks	107
121	Cleveland Institute of Electronics	67	196	Power Designs, Inc.	108
120	Cleveland Institute of Electronics	93		RCA Electronic Components and Devices	FOURTH COVER
119	Delta Products, Inc.	55		RCA Institutes, Inc.	72, 73, 74, 75
118	Edmund Scientific Co.	105	98	Radar Devices Manufacturing Corp.	1
117	Electro-Voice, Inc.	SECOND COVER	97	Soms & Co., Inc., Howard W.	12
116	Electronic Chemical Corp.	67	123	Sentry Manufacturing Company	94
115	Electronic Components	103	96	Shure Brothers, Inc.	17
	Fair Radio Sales	104	88	Solid State Sales	105
114	Finney Company, The	56, 57	94	Sonar Radio Corporation	81
	G & G Radio Supply Company	105	93	Sony/Superscope, Inc.	68
113	Goodheart Co. Inc., R.E.	105	92	Sprague Products Company	95
112	Gregory Electronics Corporation	106	91	Surplus Center	106
111	Heath Company	82, 83	199	Sylvania	5
	Institute of High Fidelity	7	90	Sylvania	14, 15
110	International Crystal Mfg. Co., Inc.	13	89	Telex	87
109	Jensen Manufacturing Division	6	198	Texas Crystals	67
108	Lafayette Radio Electronics	91, 92	95	Triplett Electrical Instrument Company	THIRD COVER
107	Lampkin Laboratories, Inc.	66	87	University Sound	70
200	Lesca of America Corp.	97		Valparaiso Technical Institute	60
106	Magnecord Sales Department	76	86	Viking	60
105	Mallory & Co. Inc., P.R.	2	85	Weller Electric Corporation	71
104	Microflame, Inc.	81	84	Xcelite, Inc.	4
	Morhan National Sales	69	83	Zenith	77
103	Mosley Electronics, Inc.	69	82	Zenith	99

CLASSIFIED ADVERTISING 103, 104, 105, 106, 107

ONE MILLION OHMS PER VOLT



V-O-M

Model 630-M
VOLT-OHM-MICROAMMETER

\$210.00

Suggested U.S.A. user net



Triplet Model 630-M features the input impedance of a VTVM with the convenience of a V-O-M. The 630-M's sensitivity is derived from the singular achievement of its basic 0-1 D.C. microampere movement. The 630-M incorporates no amplifiers, no warm-up, and no power requirements. Model 630-M is a true V-O-M whose engineering excellence is based on 60 years of instrument manufacturing, and contains the top quality associated only with Triplet.

- 1** 1,000,000 ohms per volt D.C. for greater accuracy on high resistance circuits. 20,000 ohms per volt A.C.
- 2** 1 ua Suspension Meter Movement. No pivots, bearings, or rolling friction. Extremely rugged. Greater sensitivity and repeatability.
- 3** 61 ranges, usable with frequencies through 100KC. Temperature compensated. 1½% D.C. accuracy, 3% A.C. in horizontal position.

TRIPLET ELECTRICAL INSTRUMENT COMPANY, BLUFFTON, OHIO
CIRCLE NO. 95 ON READER SERVICE CARD

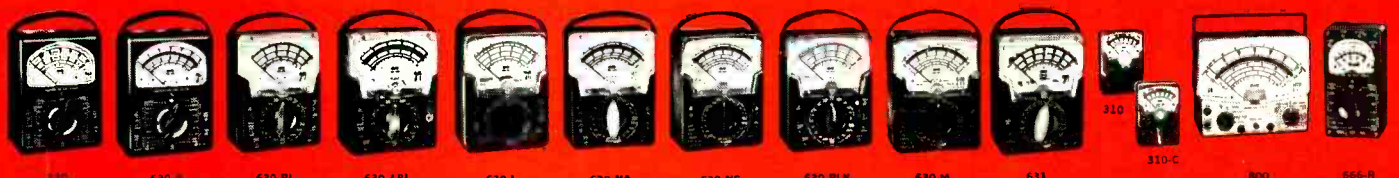

MANUFACTURERS OF PANEL AND PORTABLE INSTRUMENTS; ELECTRICAL AND ELECTRONIC TEST EQUIPMENT

Build your own motor speed control with RCA experimenter kits

Control Motors With Name Plate Ratings Up to 6 Amperes. Available from Your RCA Distributor

Now, using two RCA Silicon Controlled Rectifier Experimenter Kits (KD2105) together with additional passive components, you can build a motor speed control for ac/dc universal motors (series wound) with name plate ratings up to 6 amperes.

RCA's twin-kit circuits offer you flexibility in that you may control any one of many individual tools or appliances such as half-inch power drills, jigsaws, buffers, floor polishers, and mixers.

The RCA Experimenter Twin-Kits are part of a complete program fully explained and illustrated in the new 136-page Experimenter's Manual KM-71 on sale at your RCA Distributor. In it you'll find detailed information on more than 24 different and useful circuits you can build including 6- and 12-Volt battery chargers, lamp dimmers, audio frequency operated switches, and heat and light-operated switches.

Check with your RCA Distributor on RCA Experimenter's Kits. Select the kit or kits for the solid-state circuits you have in mind. Do it today.

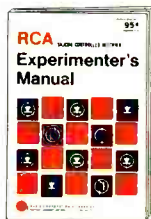

Technical Series KM-71

RCA Electronic Components and Devices, Harrison, N.J. 07029



The Most Trusted Name in Electronics

