

Electronics World

JANUARY, 1967
60 CENTS

**SPECIAL
HI-FI FEATURES**

A HI-FI INNOVATION—
A Pulse-Counting Detector for FM Tuners

COMPUTER-TYPE OPERATIONAL CIRCUIT—
Used in New Solid-State Power Amplifier

A FIRST FOR THE HI-FI INDUSTRY—
Integrated Circuit Used in New FM Receiver

PROBLEMS OF MATCHING SPEAKERS
TO SOLID-STATE AMPLIFIERS

THE GREAT DAMPING FACTOR DEBATE

HI-FI AMPLIFIER TERMS & DEFINITIONS

PLUS

COMPLETE DIRECTORY

including performance characteristics of all
SOLID-STATE AMPLIFIERS
POWER · PREAMP · INTEGRATED



M 0566 514700H2724LM91
M J HINDMAN
2724 E LINWOOD
SPRINGFIELD MO 65804



Anyone can build
a column speaker.

We've built
something better.

A new Line
Radiator.
The LR4SA.

Ey Column speakers look simple. Do it yourself? Why not!

Just hammer up a long box, grab a handful of radio-set speakers and a few feet of wire, and hook them up. Now cover the face with a couple of yards of hi-fi grille cloth and you're done. And it may even work.

Of course it won't be perfect.

It will be very heavy.

It won't be weatherproof.

Its polar pattern will be irregular — high frequency output lobes may appear almost anywhere (with at least one off the ends or back, right where you need a quiet spot for a microphone).

And finally, it may sound like nothing more than a long, narrow table radio. Or worse.

The new LR4SA Line Radiator* was designed to combat the many ills of hit-or-miss column speaker construction.

Start with the housing. We use a single channel of extruded aluminum, plus cast end caps. Very light. Weatherproof. Much stronger pound-for-pound than wood or steel. With no maintenance needed — indoors or out.

The grille is equally unusual. Acoustifoam®. We developed this foam plastic to be completely transparent to sound — yet act as a solid barrier to water!

And the LR4SA sounds better. You get solid coverage of a wide area with flat response. Unwanted lobes of energy at the backs and sides are sharply suppressed. It's quite a trick — and very useful to you.

It's accomplished in the LR4SA with very special 3" x 5" speakers, chosen for rising response, teamed with electrical filtering that progressively rolls off highs at the ends of the column. This "contouring" of the response of every speaker is the basic difference between column speakers and a Line Radiator.

The next time you face a job that calls for a column — try the LR4SA Line Radiator instead. It can make your day!

*T.M.

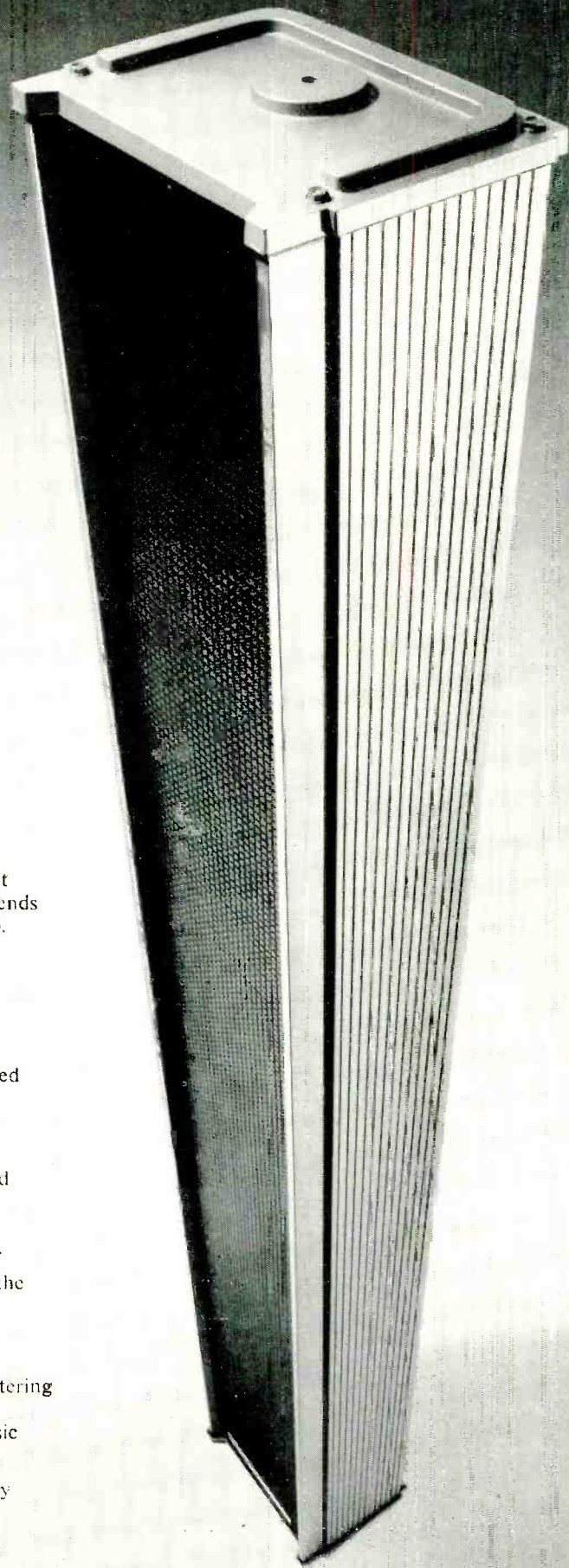

Specifications: Frequency Response 200 to 10,000 Hz, 80 Watts Peak Power; Dispersion 160° Horiz. 30° Vert.; Net Weight 25 lbs.; Size 48-3/8" L x 6-5/8" W x 4-7/8" D; \$150.00 List (less normal trade discounts).

* high fidelity systems and speakers • tuners, amplifiers, receivers • public address loudspeakers
microphones • phonograph needles and cartridges • organs • space and defense electronics

CIRCLE NO. 101 ON READER SERVICE CARD

Electro-Voice®

Electro-Voice, Inc., Dept. 176N, 629 Cecil Street, Bucharan, Michigan 49107

www.americanradiohistory.com

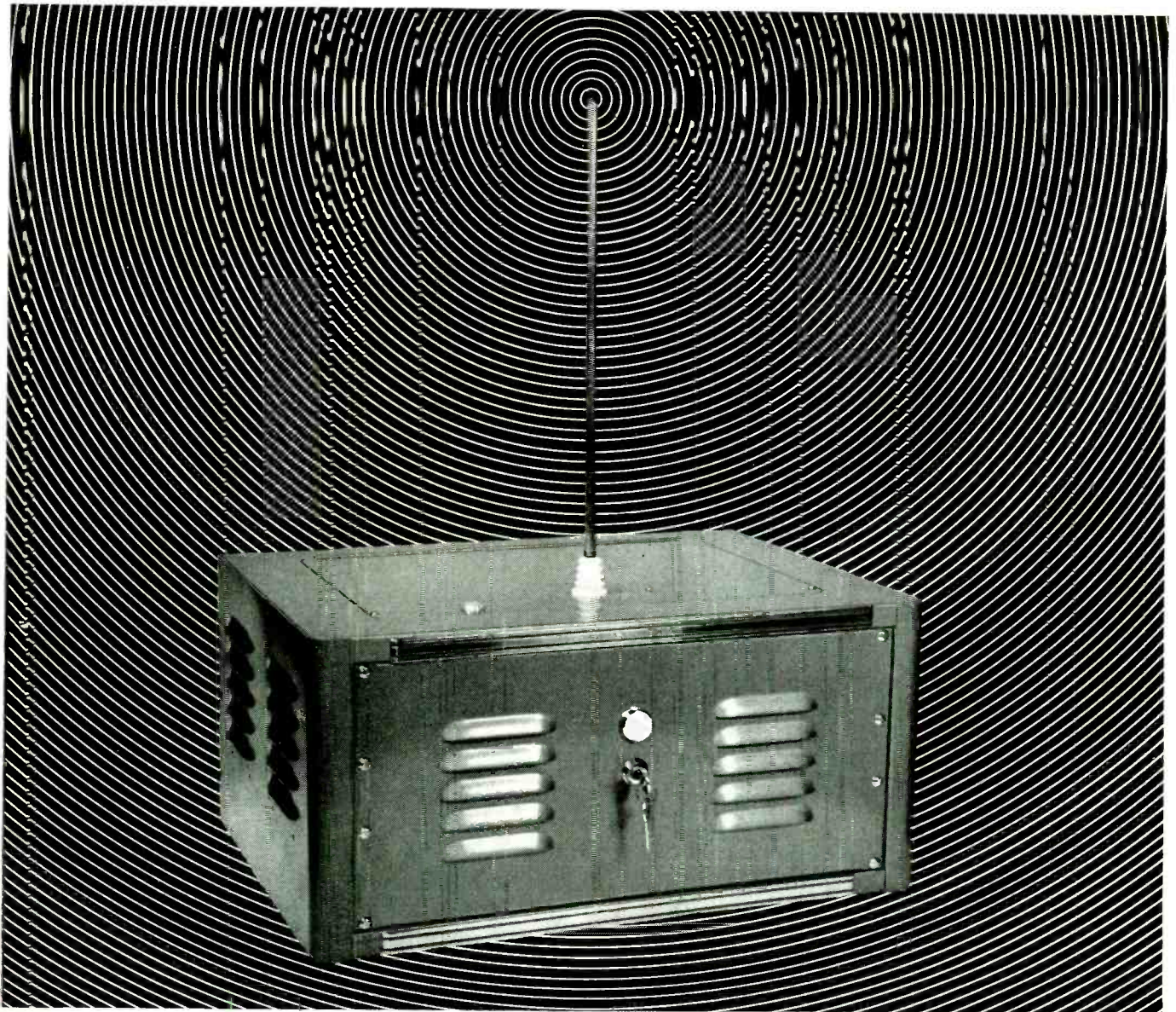

You are now in Radar Sentry Alarm's r.f. microwave field. Don't move a muscle!

This security system is so sensitive, it can be adjusted to detect the motion of your arm turning this page.

And if this Portable Model Unit were within 35 feet of you and you moved... people up to a half-mile away could hear the siren. Plus with optional equipment, it can detect fire... turn on lights... even notify police.

What does a burglar alarm have to do with you?

Just this: Radar Sentry is no ordinary alarm. It is the most modern and effective security system available. And it's also electronic.

That's why we need you. We need Dealers with technical knowledge. For the most successful Dealers for Radar Sentry Alarm are men who know electronics. This is a product that sells itself when demonstrated properly.

It's been proven time after time. In fact, many of the more than one thousand readers of electronics magazines who became Dealers in the past year — sold a system on their *first* demonstration.

And that's why we need men with technical knowledge and experience.

Men like you.

How about it?

Do you want to start a business of your own... or expand your present business with a product that in 8 years has become the world-wide leader in its field?

Do you want to earn up to \$5,000 a year in your spare time?

Do you want to earn \$20,000 and more full time?

We'll show you how.

O.K., now you can move.

Fill out the coupon and get complete Dealer/Distributor information... free.

Mail to: RADAR DEVICES MANUFACTURING CORP.
22003 Harper Ave., St. Clair Shores, Michigan 48080

EW-1



Please tell me how I can have a business of my own distributing Radar Sentry Alarm Systems. I understand there is no obligation.

Name _____

Address _____

City _____ State & Code _____

GARRARD'S 50 MARK II

A NEW COMPACT AUTOMATIC TURNTABLE WITH HIGH PERFORMANCE FEATURES AT ONLY \$51.50

Far from being keyed to the level of budget or even medium priced music systems, the 50 Mark II deserves comparison with the finest and most expensive automatic turntables. Its dramatic impact begins with styling... functional, handsome and beautifully coordinated. Operating

features are equally impressive... encompassing the latest advances in convenience and performance. The 50 Mark II is one of five new Garrard Automatic Turntables. For complimentary Comparator Guide describing each model, write: Dept. 150, Garrard, Westbury, N. Y. 11590.



New coordinated Garrard base, richly molded in ebony, with walnut overlay.

Stylus force adjustment sets tracking pressure by sliding a pointer along the tone arm.

Lightweight plug-in shell with precision bayonet fitting accommodates all cartridges.

Cueing and pause control lever places tone arm on or off any groove with perfect safety to record and stylus.

Lightweight, tubular tone arm has fixed counterbalance, resiliently mounted.

Oversized turntable with distinctive mat and contrasting trim ring.

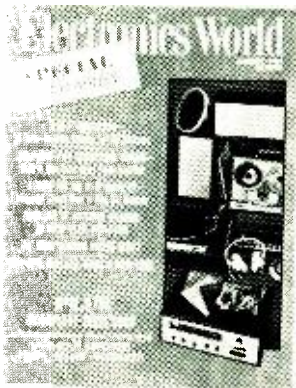

Electronics World

JANUARY 1967
VOL. 77, No. 1

CONTENTS

THIS MONTH'S COVER shows a grouping of hi-fi components that symbolize our special hi-fi features in this issue. At the very top of the photo is a pair of Acoustic Research AR-4X loudspeaker systems. Atop one of these is a University 312 3-way 12-in loudspeaker. Just below these is an Ampex 960 solid-state stereo tape recorder. Below and to the left is a Sony TTS-3000 2-speed turntable. To the right is the Heathkit AR-15 stereo receiver which uses two integrated circuits and crystal filters in its i.f. strip as described in a special article in this issue. The headphones shown are Cleveite stereo phones. At the bottom of the photo is a Fisher TFM-1000 stereo tuner, which uses a pulse-counting detector as described in an article in this issue.Cover photo by Louis Mervar.

- 23** Problems of Matching Speakers to Solid-State Amplifiers *Victor Brociner*
- 27** Hi-Fi Amplifier Terms and Definitions *Leonard Feldman*
- 28** Solid-State Hi-Fi Amplifier Directory
- 31** Percent Modulation Nomogram *Max H. Applebaum*
- 32** Recent Developments in Electronics
- 34** Integrated Circuits Used in New Hi-Fi AM/FM Receiver *William Hannah*
- 36** Pulse-Counting Detector for FM Tuners *A. H. Seidman*
- 39** Operational Amplifier Circuit for Hi-Fi *B. N. Locanthi*
- 42** High-Speed Punched-Card Readers *William Barden*
- 46** The Damping Factor Debate *George L. Augspurger*
- 48** New Developments in CRT Phosphors *John R. Collins*
- 58** Noiseless Switching for Hi-Fi *Ben B. Neiger*
- 71** Earth's Magnetic Field & Color TV
- 72** Philco-Ford Introduces IC Radio
- 73** IC Used in New TV Kit *D. G. Rupley*
- 78** New Radiotelephone Modulation Method *Patrick Halliday*
- 82** New Approach to Breadboarding *Rex F. Harris*
- 84** Frequency Measurements With the Electronic Counter *A. W. Edwards*



Publisher
PHILLIP T. HEFFERNAN

Editor
WM. A. STOCKLIN

Technical Editor
MILTON S. SNITZER

Associate Editors
LESLIE SOLOMON
P. B. HOEFER

Assistant Editor
MARSHA JACOBS

Contributing Editors
WALTER H. BUCHSBAUM
Prof. ARTHUR H. SEIDMAN

Art Editor
RICHARD KELLY

Art and Drafting Dept.
J. A. GOLANEK

Advertising Sales Manager
LAWRENCE SPORN

Advertising Service Manager
ARDYS C. MORAN

- 14** EW Lab Tested
Sony TA-1120 Integrated Amplifier
BSR McDonald 500 Automatic Turntable
- 56** Electronic Audible Alarm
- 68** Test Equipment Product Report
Aul Instruments Model TVM4 Transistor V.O.M.
Hewlett-Packard Model 3430A Digital Voltmeter
Vari-Tech Model VT-1160 Low-Resistance Tester

MONTHLY FEATURES

- 4** Coming Next Month
- 6** Letters from Our Readers
- 60** Radio & TV News
- 63** Electronic Crosswords
- 81** Book Reviews
- 87** New Products & Literature

Electronics World: Published monthly by Ziff-Davis Publishing Company at 307 North Michigan Ave., Chicago, Illinois 60601. One year subscription \$6.00. Second Class Postage paid at Chicago, Illinois and at additional mailing offices. Subscription service: Portland Place, Boulder, Colorado 80302. Copyright © 1966 by Ziff-Davis Publishing Company. All rights reserved.

Start a Stereo System of Unparalleled Quality

For Solid State
or Tube Amplifiers

...for less than \$36⁰⁰

FABULOUS MUSTANG M-12T

12" 3-WAY SPEAKER SYSTEM.

A new breed of high performance for whole house sound! With 35-40,000 Hz response; extra slim, thin profile; exclusive front or rear baffle mounting design; 12 15/16" dia. by 3 7/8" deep.



...for less than \$62⁰⁰

AWARD WINNING MODEL 6201

12" 2-WAY SPEAKER SYSTEM.

Updated version of the most popular true-coaxial speaker ever made! With axially mounted compression driven, wide-angle reciprocating flare horn tweeter; 28 to 18,500 Hz response; 13" dia. by 6 5/8" deep.



...for less than \$79⁰⁰

AWARD WINNING MODEL 312

12" 3-WAY DIFFAXIAL SYSTEM.

The only integrated single speaker assembly capable of response from 28 to 40,000 Hz! With high compliance woofer; Diffusicone mid-range; exclusive Sphericon tweeter; integral brilliance control; 15 1/2" dia. by 12" deep.

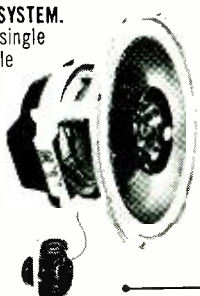

Listen to these and other fine University speakers at your dealers today! Ask about PSE—University's "master blue print" for goof-proof planning and building of your own speaker system. Includes many plans for speaker enclosures designed to deliver the very best in stereo sound. Address inquiries to desk



LISTEN—UNIVERSITY®SOUNDS BETTER

UNIVERSITY SOUND

A DIVISION OF LTV LING ALTEC, INC

9500 W. Reno Oklahoma City, Oklahoma 73101

CIRCLE NO. 83 ON READER SERVICE CARD

COMING NEXT MONTH

SPECIAL FEATURE ARTICLES ON:

Electronic Music & Instruments

Design Considerations for Electronic Guitars and Amplifiers—The electronic guitar, which is capable of producing excellent music, is undergoing a metamorphosis during which emphasis is being shifted from volume to timbre. Daniel Queen of Perma-Power discusses the development of such an instrument and its associated amplifier.

Electronic Music Composition: Circuits and Techniques—Now that more and more people are being "exposed" to electronic music in the concert hall, on radio and TV, and at the movies, it might be of interest to know that many of the popular electronic musical instruments available today incorporate devices which had their origins in experiments with electronic music. R.A. Moog provides the details.

The Electronic Saxophone—The new H.A. Selmer "Varitone" is an electronic saxophone which permits the musician to create a wide range of musical effects by means of seven controls—with such added features as volume control, resonance, and echo effects. The special microphone and amplifier circuits for this instrument were developed by Electro-Voice and this article discusses the design philosophy.

Design of an Electronic Guitar System—The tremendous popularity of the guitar has inspired Heath Company, working in conjunction with Harmony Co., a guitar maker, to come up with a line of do-it-yourself instruments in kit form.

ELECTRONIC IGNITION SYSTEMS

An up-to-date survey of the design considerations and comparative characteristics of conventional systems, the transistor ignition system, and the newer capacitive-discharge system. R.L. Carroll analyzes the "pros" and "cons" of the three systems and explains their operation.

All these and many more interesting and informative articles will be yours in the February issue of ELECTRONICS WORLD . . . on sale January 19th.

INTEGRATED CIRCUITS AND THE AUTOMOBILE

The advent of IC's brings the day of the "computerized" car closer to realization. Such a small computer could be used to monitor almost all functions of both car and engine and alert the driver to any dangerous conditions.

ZIFF-DAVIS PUBLISHING COMPANY

William B. Ziff
Chairman of the Board (1946-1953)

William Ziff
President

W. Bradford Briggs
Executive Vice President

Hershel B. Sarbin
Senior Vice President

Philip Sine
Financial Vice President

Walter S. Mills, Jr.
Vice President, Circulation

Stanley R. Greenfield
Vice President, Marketing

Phillip T. Heffernan
Vice President, Electronics Division

Frank Pomerantz
Vice President, Creative Services

Arthur W. Butzow
Vice President, Production

Edward D. Muhlfeld
Vice President, Aviation Division

Irwin Robinson
Vice President, Travel Division

Radio & TV News • Radio News • Radio-Electronic Engineering Trademarks Reg. U.S. Pat. Off.
SUBSCRIPTION SERVICE: All subscription correspondence should be addressed to Electronics World, Circulation Department, Portland Place, Boulder, Colorado 80302. Please allow at least six weeks for change of address. Include your old address, as well as new—enclosing if possible an address label from a recent issue.
EDITORIAL CONTRIBUTIONS must be accompanied by return postage and will be handled with reasonable care; however publisher assumes no responsibility for return or safety of art work, photographs, or manuscripts.

ELECTRONICS WORLD (January, 1967, Vol. 77, No. 1). Published monthly at 307 North Michigan Avenue, Chicago, Illinois 60601, by Ziff-Davis Publishing Company—also the publishers of Airline Management and Marketing, Boating, Business & Commercial Aviation, Car and Driver, Cycle, Flying, Hi-Fi Stereo Review, Modern Bride, Popular Electronics, Popul ar Photography, Skiing, Skiing Area News, and Skiing Trade News. Travel Weekly is published by Robinson Publications, Inc., a subsidiary of Ziff-Davis Publishing Company. One year subscription rate for U.S., U.S. possessions, and Canada, \$6.00; all other countries, \$7.00. Second Class postage paid at Chicago, Illinois and at additional mailing offices. Authorized as second class mail by the Post Office Department, Ottawa, Canada and for payment of postage in cash.

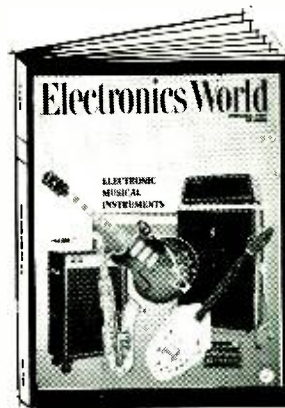

Editorial and Executive Offices
One Park Avenue
New York, New York 10016 212 679-7200

NEW YORK OFFICE 212 679-7200
James J. Sullivan
Joseph E. Halloran

MIDWESTERN OFFICE
307 North Michigan Avenue
Chicago, Illinois 60601 312 726-0892
Midwestern Advertising Manager, Royce Richard

WESTERN OFFICE
9025 Wilshire Boulevard
Beverly Hills, California 90211
213 CRestview 4-0265; BRAdshaw 2-1161
Western Advertising Manager, Bud Dean

JAPAN
James Yogi
c/o Fukushima
19-14 Minomi 3-chrome
Koenji, Sugino-mi-ku
Tokyo, Japan

CIRCULATION OFFICE
Portland Place, Boulder, Colorado 80302



Member
Audit Bureau of
Circulations

ELECTRONICS WORLD

Be the man who's always
first to say: "I've got
the answer right here!"



START USING THIS REMARKABLE

ELECTRONICS SLIDE RULE

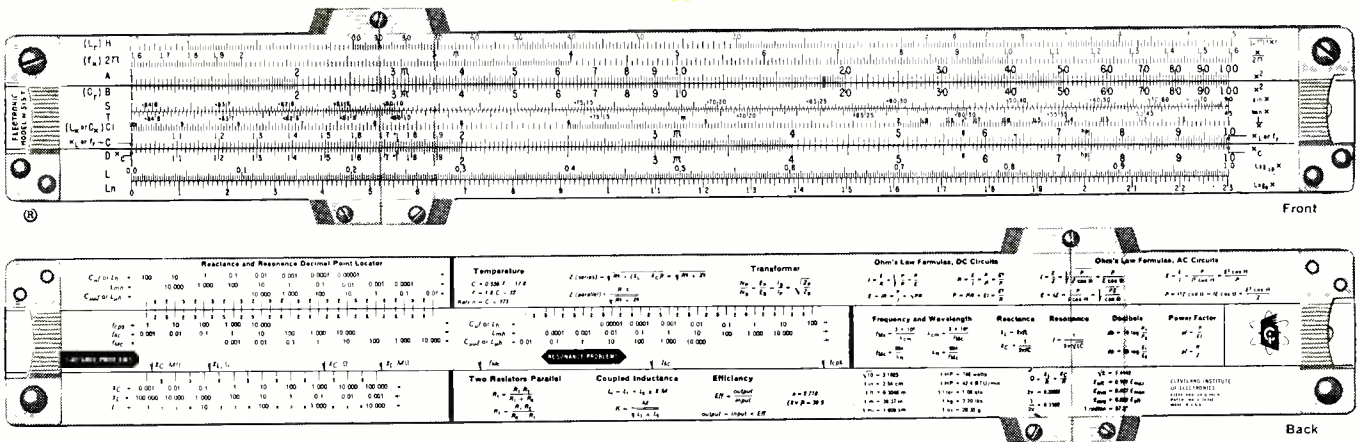

SOME DAY EVERYONE in electronics may have a slide rule like this. Till then, the man who uses one will seem like a wizard as he solves reactance and resonance problems in 12 to 20 seconds—without pencil and paper.

This is a professional slide rule in every detail, a full 10" long, made exclusively for Cleveland Institute of Electronics, to our rigid specifications, by Pickett, Inc. It can be used for conventional computation as well as special electronics calculations. All-metal construction assures smooth operation regardless of climate.

Handsome top-grain leather carrying case has heavy-duty plastic liner to protect slide rule; removable belt loop for convenient carrying. "Quick-flip" cover makes it easy to get rule in and out of case.

You also get four full-length AUTO-PROGRAMMED™ Lessons, which teach you how to use the special electronics scales on the slide rule. These lessons have been carefully designed to meet the same high educational standards as the electronics career courses for which our school is famous. Even if you've never used a slide rule before, you'll soon whiz through the toughest problems with this CIE rule.

Deliberately underpriced. Many men in electronics have told us that this unique slide rule, leather case, and 4-lesson course easily add up to a \$50 value. But we have deliberately underpriced it at less than \$25. Why? Our reason is simple: we are looking for men in electronics who are ambitious to improve their skills...who know that this will require more training. If we can attract you with the low price of our slide rule and course—and impress you with its quality—you are more

likely to consider CIE when you decide you could use more electronics training.

Send for free booklet. See for yourself why this amazing slide rule and course have made such a big hit with busy electronics men everywhere. No obligation, of course—just an opportunity to get in on the best offer ever made to people in electronics. Just mail coupon, or write Cleveland Institute of Electronics, Dept. EW-133, 1776 East 17th St., Cleveland, Ohio 44114.

CIE Cleveland Institute of Electronics
1776 East 17th Street, Cleveland, Ohio 44114

MAIL THIS COUPON FOR **FREE BOOKLET**

Cleveland Institute of Electronics
1776 East 17th Street Cleveland, Ohio 44114

Please send me without charge or obligation your booklet describing CIE Electronics Slide Rule and Instruction Course. **ALSO FREE** if I act at once: a handy pocket-size Electronics Data Guide.



Name _____ (please print)

Address _____

City _____ State _____ Zip _____



Accredited Member National Home Study Council
A Leader in Electronics Training... Since 1934

EW-133

CIRCLE NO. 120 ON READER SERVICE CARD

Olson



FREE

Fill in coupon for a **FREE** One Year Subscription to **OLSON ELECTRONICS' Fantastic Value Packed Catalog**—Unheard of **LOW, LOW PRICES** on Brand Name Speakers, Changers, Tubes, Tools, Stereo Amps, Tuners, CB, Hi-Fi's, and thousands of other Electronic Values. Credit plan available.

NAME _____
 ADDRESS _____
 CITY _____ STATE _____ ZIP _____

If you have a friend interested in electronics send his name and address for a **FREE** subscription also.

OLSON ELECTRONICS, INC.

556 S. Forge Street Akron, Ohio 44308

CIRCLE NO. 98 ON READER SERVICE CARD

Stop throwing money away when you buy records.

Citadel saves you money with low discount prices.

Here's what Citadel offers you when you become a lifetime member:

- Over 30,000 records to choose from—on all labels—by all artists—in all musical categories: classical, popular, jazz, show tunes, folk, etc.
- No obligatory records to buy. No unrequested records sent to you. Buy as few or as many records as you want.
- No "preselected" record list. Choose from any record in print.
- A minimum discount of 35% and regular discounts on the discounts. Never any list price purchases.
- Factory fresh records, free from defects of any sort.
- Promptest service. Orders often shipped on the same day as received. Rarely later than the next few days.
- Free Schwann Record Catalog.

(We also offer all pre-recorded 4-track stereo tapes, including auto tapes, to our members, at lowest possible prices.) For free details write...

Citadel Record Club

545 Fifth Avenue, Dept. EW, New York, N.Y. 10017

CIRCLE NO. 121 ON READER SERVICE CARD

LETTERS FROM OUR READERS

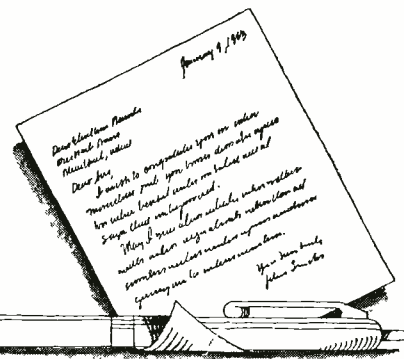

AMPEX TEST TAPE

To the Editors:

I find the hi-fi test reports in your magazine interesting, but I would like to test some of my own equipment. For this, I would like to obtain an *Ampex* test tape No. 31321-04 which is used by *Hirsch-Houck Labs.* Where can I purchase one of these tapes?

E. C. LITSCHER
 Pittsfield, Mass.

The Ampex test tapes are available from local Ampex dealers who handle the company's professional products. For example, the tape mentioned in Reader Litscher's letter is listed in the latest Harvey Radio Co. Inc. (60 Crossways Park West, Woodbury, N.Y. 11797) catalogue at a price of about \$22. Readers may also be able to obtain other, less expensive test tapes from some of the larger audio dealers.—Editors.

EFFECTIVE USE OF V.O.M.

To the Editors:

This is in reference to the article "Effective Use of the V.O.M." in the April, 1966 issue of *ELECTRONICS WORLD*. My comments pertain specifically to the last paragraph: "If the reading is taken at the high-resistance end of the ohms scale, the over-all error expressed as a percentage becomes even greater. Therefore, all resistance measurements should be made using the lowest resistance portion of the scale whenever possible."

This paragraph appears to imply that the most accurate resistance measurements should be made toward the low-reading end of the resistance scale.

Using a divider set for a 3° meter error and repeating the example given on p. 83 for the following precision resistor values, I obtained the following results:

Prec. Res. Val. (ohms)	3° Meter Error (ohms)		Result (ohms)
	Upper Lim.	Lower Lim.	
4	4.6+	3.4-	0.6 in 4=15%
1	1.4	0.6	0.4 in 1=40%

From the results obtained, it can be concluded that the percentage error increases as precision resistor values lower than the meter's mid-scale value are measured. Therefore, the last sentence

of the article would be more explicit if it were changed to read, "Therefore, all resistance measurements should be made using the lowest resistance portion of the scale, with the most accurate readings occurring at mid-scale; for voltage measurements, the most accurate readings occur at full scale."

GEORGE A. PHILACTOS
 Installation Engrg. Practices
 Western Electric Co.
 New York, N.Y.

TRANSISTOR FAILURE PREDICTION

To the Editors:

It seems to me that both George Hrischenko's letter and your reply in the October, 1966 issue of *ELECTRONICS WORLD* indicate a misunderstanding of transistor failure prediction as developed by the National Bureau of Standards. First of all, a great many transistors have storage temperatures in excess of 100° C. In fact, many have junction operating temperatures of 100° C or greater. Thus, storage at 100° C generally will not be destructive, contrary to the opinion of Mr. Hrischenko.

Second, the purpose of the test is to sort transistors. The result of the tests conducted at the National Bureau of Standards was that germanium alloy transistors whose leakage current increases by at least 1.6 times after being stored at 100° C for 1000 hours were found to also fail early in regular use. Thus, this test offers one means of sorting out individual transistors, not transistor types, which are apt to fail early under ordinary use. And this would be a test to run on transistors before being installed in equipment.

JAMES VAN ORNUM
 Scottsdale, Ariz.

THE HAM AS ENGINEER

To the Editors:

This is in reference to John Frye's column in your August, 1966 issue on "Predicting Academic Success." The fifth paragraph on p. 51 irks me as a licensed radio amateur since 1922 and a traffic man since 1948.

Mr. Frye has Barney say, "The rag-chewing, traffic-handling, plug-in ap- (Continued on page 12)

CIRCLE NO. 88 ON READER SERVICE CARD →
 ELECTRONICS WORLD



SONY®

When you've got a reputation as a leader in transistor technology, you don't introduce a transistor amplifier that is like someone else's. We didn't. The new Sony TA-1120 integrated stereo amplifier is the case in point. We considered the few remaining shortcomings that have kept today's transistor amplifiers from achieving the quality of performance of the best tube amplifiers and set out to solve them. To do it, we even had to invent new types of transistors. The result: the first truly great solid-state stereo amplifier.

Distortion is lower than in the finest tube amplifiers at all frequencies and power levels. Signal-to-noise ratio: better than 110 db. Damping factor is extraordinarily high (140 at 16 ohms). Frequency response: practically flat from 10 to 100,000 HZ (+0 db/-1 db). Plenty of power, too (120 watts IHF at 8 ohms, both channels).

With an amplifier as good as this, the preamp section has a great deal to live up to. It does, magnificently! Solid-state silicon circuitry throughout coupled with an ingenious design achieve the lowest possible distortion. Sensible arrangement of front panel controls offers the greatest versatility and ease of operation with any program source.

Finally, to protect your investment in this superb instrument, an advanced SCR (silicon-controlled rectifier) circuit prevents possible damage to the power transistors due to accidental shorting of the outputs.

The Sony TA-1120 stereo amplifier/preamp at \$399.50 and the TA-3120 stereo power amplifier, \$249.50 are available at a select group of high fidelity specialists who love and cherish them. And will get as much enjoyment out of demonstrating them as you will from their performance. So visit your dedicated Sony high fidelity dealer and enjoy. Prices suggested list. Sony Corporation of America Dept. H 47-47 Van Dam St. L.I.C., N.Y. 11101.

**With so many fine amplifiers
our first had to be something special.
It is!**

**Discover the ease
and excitement of NRI's**

**3 DIMENSIONAL
METHOD**

**of ELECTRONICS
TV-RADIO TRAINING**

10 HOME-STUDY PLANS TO CHOOSE FROM

Ask men whose judgment you respect about NRI's three dimensional method of home-study training. Ask about the new, remarkable NRI Achievement Kit. Ask about NRI custom-designed training equipment, programmed for the training of your choice to make Electronics come alive in an exciting, absorbing, practical way. Ask about NRI "bite-size" texts, as direct and easy to read as 50 years of teaching experience can make them. Achievement Kit . . . training equipment . . . bite-size texts . . . the three dimensions of home-study training; the essentials you must have to make

learning easier, more interesting, more meaningful. You get them all from NRI.

Whatever your interest . . . whatever your need . . . whatever your education . . . pick the field of your choice from NRI's 10 instruction plans and mail the postage free card today for your free NRI catalog. Discover just how easy and exciting the NRI 3-DIMENSIONAL METHOD of training at home can be. Do it today. NATIONAL RADIO INSTITUTE, Electronics Division, Washington, D.C. 20016.

**BEGIN NOW AN ABSORBING
ADVENTURE—LEARN ELECTRONICS
THE EASY NRI WAY—MAIL CARD TODAY**

OVER 50 YEARS OF LEADERSHIP



IN ELECTRONICS TRAINING

1 Start Fast with NRI's New Remarkable Achievement Kit

The day you enroll with NRI this new starter kit is on its way to you. Everything you need to make a significant start in the Electronics field of your choice is delivered to your door. It's an outstanding way of introducing you to NRI training methods . . . an unparalleled "first dimension" that opens the way to new discoveries, new knowledge, new opportunity. The Achievement Kit is worth many times the small payment required to start your training. No other school has anything like it. Find out more about the NRI Achievement Kit. Mail the postage-free card today.

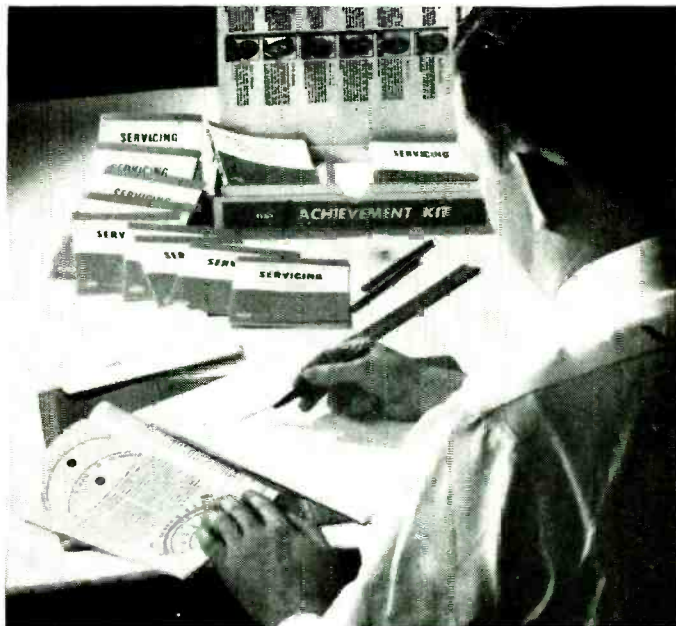

2 NRI "Bite-Size" Lesson Texts Program Your Training

Certainly, lesson texts are a necessary part of any training program . . . but only a part. NRI's "bite-size" texts are simple, direct, well illustrated, and carefully programmed to relate things you read about to training equipment you build. Here is the "second dimension" in NRI's training method. Here are the fundamental laws of electronics, the theory, the training of your choice, presented in a manner you'll appreciate. And in addition to lesson texts, NRI courses include valuable Reference Texts related to the subjects you study, the field of most interest to you.



3 Custom-Designed Training Kits Make Learning Come Alive

Electronics becomes a clear and understandable force under *your* control as you build, experiment, explore, discover. Here is the "third dimension" . . . the practical demonstration of things you read about in NRI texts. NRI pioneered and perfected the use of training kits to aid in learning at home. NRI invites comparison with equipment offered by any other school, at any price. Prove to yourself what 750,000 NRI students could tell you . . . that you get more for your money from NRI than from any other home-study Radio-TV, Electronics school. Mail postage free card for your NRI catalog. (No salesman will call.)

AVAILABLE UNDER NEW GI BILL — If you served since January 31, 1955, or are in service, check GI line in postage-free card.

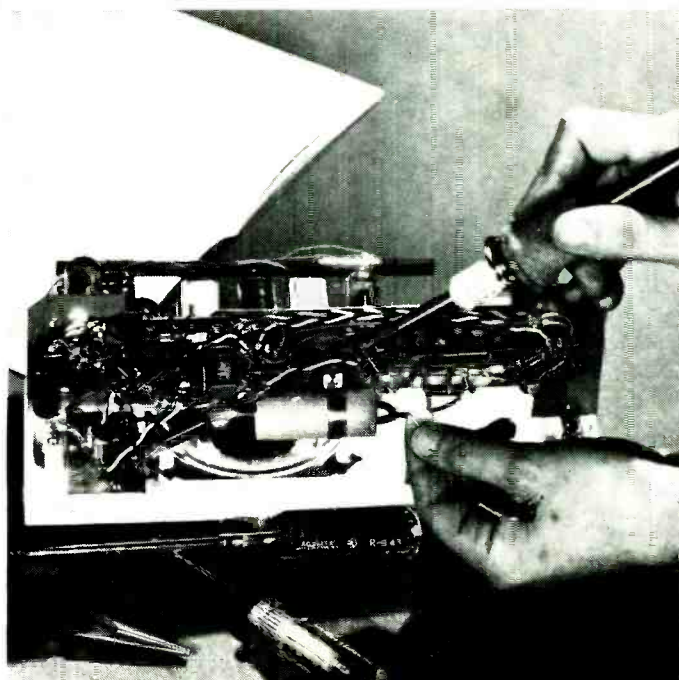

With all the field offices we have

you can build a great future just about anywhere.



You don't need a degree to get in on this fine career opportunity in computer technology. You do need a grasp of electronics and electro-mechanical fundamentals which might have been gained through such military training as: weapons control systems, radar, sonar, radio maintenance—and a strong ambition to build a real future.

Here's how we do it at UNIVAC.

For one thing, we'll teach you all about computers. How they work, and why. How to install and maintain them. By the time you're finished with our training program you're a top notch, all round expert, fully equipped to handle any problems you'll encounter. And all the time you're learning you're on the payroll.

Now, when you're ready to show what you can do, we'll assign you to one of our field offices. With the kind of growth you'd expect from UNIVAC, you'll find them everywhere in the nation, and overseas. Covering a full range of assignments. Of course, you come in under our comprehensive benefits program. And with the way we reward technical ability and initiative, a good man can really go far.

Interested candidates are invited to write Manager of Field Administration, UNIVAC, P. O. Box 8100, Philadelphia, Pa.

UNIVAC
DIVISION OF SPERRY RAND CORPORATION

An Equal Opportunity Employer

(Continued from page 6)

pliance operator . . . may or may not make an engineer; but his ham activity is useless as an indicator."

At age 61, I am still an avid traffic man; I run a c.w. net seven days a week on 7140 kHz which I took over in 1961 from one of the greatest traffic men ever—Benton White, W4PL, of Chattanooga, Tennessee, who is now deceased.

I have a good knowledge of the type of young men who are in the traffic nets. They are "savvy" on traffic and know what their own equipment does. My rig is home-built, but if I had to move, I would select some good manufactured gear. It is not the gear that makes one a traffic handler; it is the will to work, to meet schedules, to know the code well, to be able to receive under difficulties, and to use courtesy with others. This discipline traffic men receive on the nets, and the guidance they get from us old-timers prepares them for college engineering courses much more than any help they might get from their buddies who very often waste their time on unproductive things.

For the most part, I like Mr. Frye's approaches but I disagree with him on this matter.

CLIFF ERICKSON, W8DAE
Cleveland Heights, Ohio

* * *

CALCULATING RESISTOR VALUES

To the Editors:

I would like to call your attention to the similarities between the brief item entitled "Calculating Parallel Resistor Values" in your October, 1966 issue (p. 60) and an item published in the February, 1966 issue of *Electronic Design* magazine entitled "Slide-Rule Procedure Directly Yields Equivalent Resistances."

I originally developed this procedure for solving circuit analysis problems with the slide rule approximately four years ago and submitted it to *Electronic Design* on August 30, 1965; this article subsequently won the "Best of Issue, Ideas for Design Award."

ANDREW M. CHAO
Design Engr.
Bendix-Pacific Div.
North Hollywood, Calif.

In February of last year, we received a letter from Mr. Loui, who is our author, bringing our attention to the article in Electronic Design. His letter indicated that he, too, had conceived and recorded this idea at an earlier date. It is certainly difficult for us to know who came upon the idea first. We are more inclined to believe that in a field such as ours, it is not at all uncommon for several individuals to come upon fairly similar ideas while working independently.—Editors ▲

FINCO[®]-AXIAL COLOR-KIT

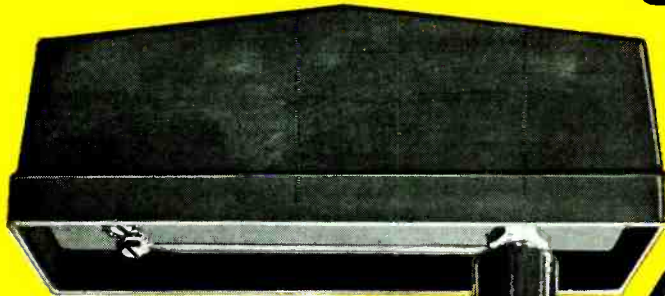

FINCO-AXIAL COLOR-KIT, Model 7512 AB

High performance Indoor and Outdoor Matching Transformers convert old-fashioned and inefficient 300 ohm hook-ups to the new Finco-Axial 75 ohm color reception system.

List price for complete kit . . .
7512AB \$8.95

7512-A Mast mounted matching transformer . . . list \$5.40

7512-B TV Set mounted matching transformer . . . list \$4.15

FINCO-AXIAL SHIELDED COLOR CABLE, CX Series

Highest quality, 75 ohm swept coaxial cable (RG 59/U) complete with Type F fittings, weather boot ready for installation.

Available in 25, 50, 75 and 100 foot lengths. List price . . . \$5.55, \$8.65, \$11.50 and \$14.20.

Write for Color Brochure # 20-349



**the
complete
color TV
reception
system**

For the best color TV picture

*eliminates color-fade, ghosting and smearing!
Improves FM and Stereo, too!*

QUICK, EASY INSTALLATION

ENJOY brilliant "TV-Studio" color reception today by changing over to the new Finco-Axial Color Reception System. NOW, color fade, ghosts and smears are a thing of the past. Finco-Axial shields color sets against signal loss . . . eliminates outside interference and mismatch problems.

THE FINNEY COMPANY 34 WEST INTERSTATE STREET, DEPT. 410, BEDFORD, OHIO

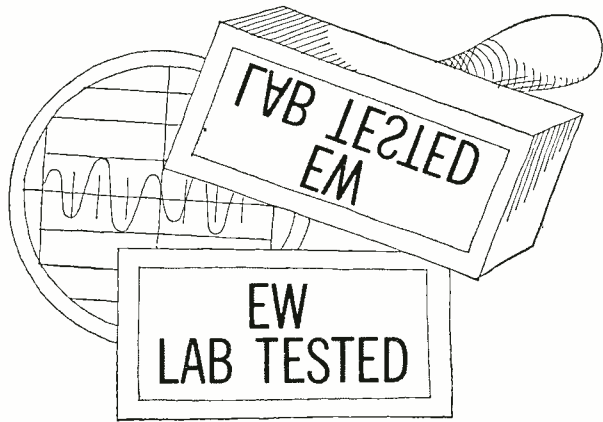

HI-FI PRODUCT REPORT

TESTED BY HIRSCH-HOUCK LABS

Sony TA-1120 Integrated Amplifier
BSR McDonald 500 Automatic Turntable

Sony TA-1120 Integrated Amplifier

For copy of manufacturer's brochure, circle No. 31 on Reader Service Card.

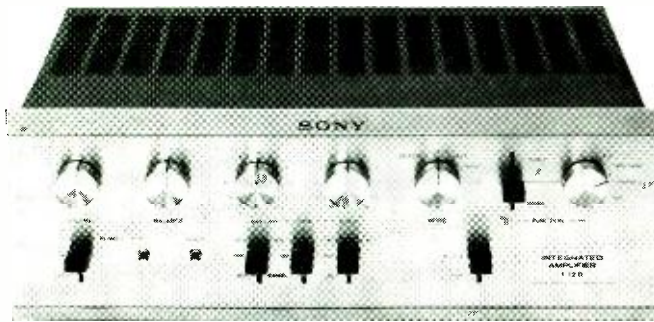

THE Sony Corporation, widely known for its broad line of small transistor radios and tape recorders, has entered the hi-fi component field with a line of unusually sophisticated, high-quality instruments. Perhaps foremost among these is the integrated stereo amplifier, Model TA-1120.

Obviously aimed at the most demanding audiophiles, the TA-1120 shows evidence of considerable original thinking and a determination to produce a "no-compromise" amplifier. The manufacturer has, in general, been highly successful in its efforts. The TA-1120 uses 46 silicon transistors and 23 diodes, with all the transistors of the company's own manufacture and, in many cases, specifically designed for high-quality audio applications.

The amplifier is rated at 50 watts

continuous output per channel into 8-ohm loads. Harmonic distortion is rated at less than 0.1% for all power levels up to maximum rated, at 1000 Hz. Over the entire 20-Hz to 20-kHz band, the distortion is rated at less than 0.5% at 50 watts output (± 0.5 dB). The TA-1120 has a damping factor of 70. It will deliver about 35 watts to 16-ohm speakers, and is not rated for use with 4-ohm speakers. If electrostatic speakers are used, a 2-ohm resistor must be placed in series with each speaker to prevent excessive loading of the amplifier at high frequencies.

The volume control, balance control, and mode-selector switch are conventional in their operation. The mode selector provides stereo, reversed-channel stereo, left or right channels through both speakers, and a summed output

for mono reproduction. The input selector is unusual, consisting of a three-position lever switch and a four-position rotary switch. In the upper position of the lever switch, the tuner inputs are connected, and in its lower position a phono cartridge with an output of 3 to 20 millivolts is connected. In the center position, the rotary switch comes into use, selecting from a microphone, tape head, phono, or auxiliary inputs. The second phono input is used for low-output cartridges, with outputs of 1 to 5 millivolts, such as the Sony VC-8E moving-coil cartridge.

This two-part input selector system makes it easy to switch among any three commonly used inputs without having to pass through a number of undesired inputs. Most users, employing only tuner and phono inputs, will only have to use the lever switch.

The tone controls are of the step type, with five boost and five cut positions, plus a flat setting for both bass and treble controls. A lever switch permits canceling the tone-control settings for the flattest over-all response. Two other lever switches control high- and low-cut filters with 12 dB/octave slopes above 9 kHz and below 50 Hz. Another lever switch connects the amplifier for monitoring from a three-head tape recorder while making recordings, while another lever switch controls the power that is applied to the amplifier

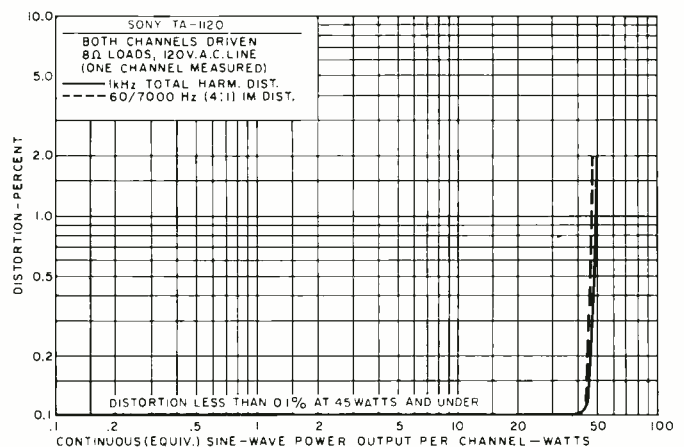
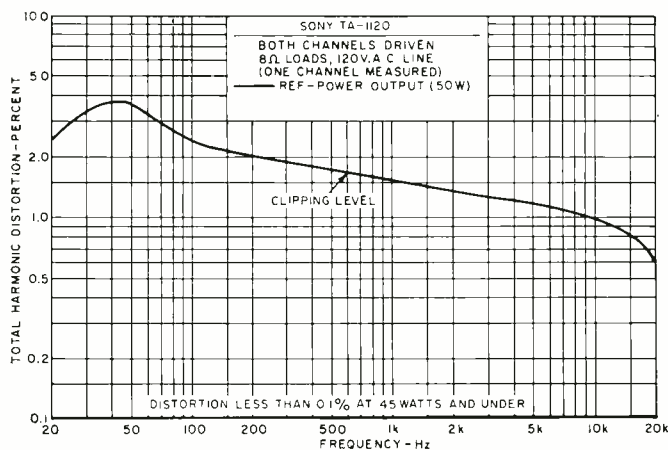

*the
only
comprehensive
guide
to consumer
electronics
servicing!*

If you're in consumer electronics servicing, you know that keeping up with this jet-paced field is no pushover. There are manuals to be bought. Journals to be read. Experiments to be tried. Techniques to be learned. Day in, day out. No doubt about it, staying on-the-ball in electronics takes time, effort and money.

Or at least it used to.

Now there's a much easier way. The 1967 ELECTRONICS INSTALLATION & SERVICING HANDBOOK. A single, comprehensive guide to every major phase of consumer electronics servicing. Over 132 pages of all the latest electronics information you want and need to know. From TV to CB to PA to AM/FM. From home intercoms to auto stereo tape cartridge units. Eight complete, authoritative chapters in all!

This handy, on-the-bench reference volume will lead you straight to the facts you need, when you need them presented in a crisp, concise manner that's easily understood by the novice, yet thorough enough to answer the professional's most complex question. Whether you earn your living by servicing . . . supplement your salary by servicing part-time . . . or are an active hobbyist who services just for the fun of it . . . the 1967 ELECTRONICS INSTALLATION & SERVICING HANDBOOK is one "tool of the trade" you can't afford not to have.

Second Edition . . . Over 132 Pages
Hundreds of money-saving techniques and shortcuts. Every up-to-date method and procedure for spotting, analyzing and correcting trouble . . . quickly, efficiently and economically!

ELECTRONICS INSTALLATION & SERVICING HANDBOOK-1967

SIMPLIFIED TECHNIQUES

**SAVE
TIME AND MONEY**

STEREO/HI-FI
AUTOMOTIVE
PUBLIC ADDRESS
TV-CB-FM
ANTENNAS
INTERCOMS

PLUS:
COLOR TV SECTION
(WITH TRUE COLOR ILLUSTRATIONS)

PLUS:
HOW TO INSTALL
STEREO TAPE
IN YOUR CAR

PLUS:
TOOLS and TEST
EQUIPMENT SUM

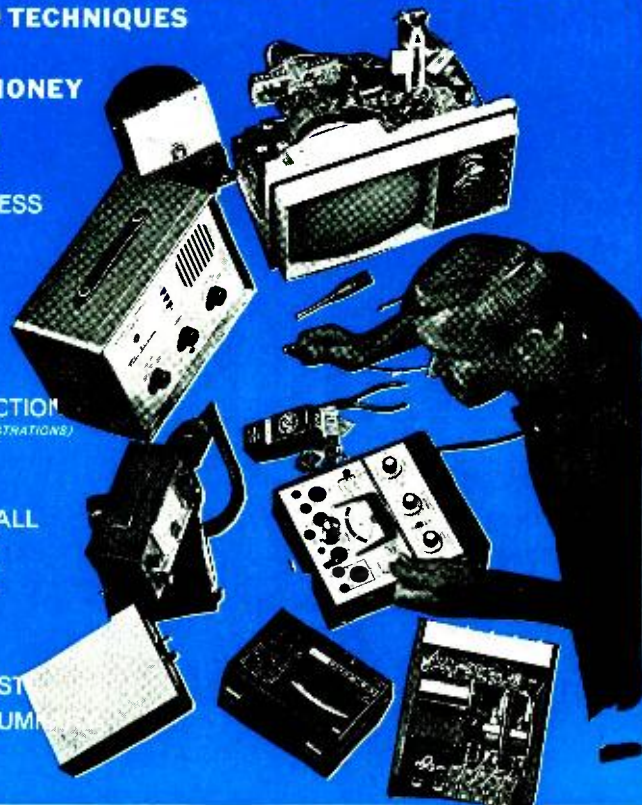

THE 1967 ELECTRONICS INSTALLATION & SERVICING HANDBOOK

Order your copy today! Only \$1.25

Get the Handsome Leatherflex-Covered Edition for \$3 Postpaid!

The 1967 ELECTRONICS INSTALLATION & SERVICING HANDBOOK is also available in a splendid deluxe edition. Rugged Leatherflex cover provides lasting protection yet is softly textured and gold-embossed for the look of elegance. A collector's item—a superb addition to your electronics library. And it's yours, for just \$3 postpaid, when you check the appropriate box on the order form.



Ziff-Davis Service Division, Dept. ISH
589 Broadway, New York, N.Y. 10012

- Please send my copy of the 1967 ELECTRONICS INSTALLATION & SERVICING HANDBOOK as checked below: I am enclosing \$1.25 plus 15c for shipping and handling for the **Regular Edition**. (\$1.75 for orders outside U.S.A.)
- I am enclosing \$3.00. Please send me, **postpaid**, the Leatherflex-covered **Deluxe Edition**. (\$3.75 for orders outside U.S.A.) (Please allow 3 additional weeks for delivery of the Deluxe Edition.)

name _____ (PLEASE PRINT) EW-17
address _____
city _____
state _____ zip code _____

WORTH WAITING FOR!



DYNACO STEREO 120

Complete specifications
are available on request.

DYNACO INC.

3912 POWELTON AVENUE,
PHILADELPHIA, PA. 19104

along with its two switched a.c. outlets.

The *Sony* engineers have developed a transistor-protection circuit which is completely effective and foolproof. If excessive current is drawn by the output transistors due to a short-circuit, overdriving, or any other cause, a silicon controlled rectifier circuit instantly removes the driver supply voltages and extinguishes a green light on the panel of the amplifier. When this happens, the amplifier power switch should be shut off, and after a wait of about 5 seconds, turning it on will put the amplifier back into service.

Another unconventional feature is the separation between preamplifier and power-amplifier sections. They are electrically isolated, with short jumper cables in the rear bridging the preamplifier outputs to the power-amplifier inputs. This allows the use of an electronic crossover network between the preamplifier and power amplifier, using external power amplifiers for the added speaker channels. *Sony* also supplies the basic power amplifier section of this amplifier as a separate unit (Model 3120) so that the same type of amplifier can be used for all speakers if desired.

Our laboratory measurements confirmed the impressive claims made for the TA-1120. Below approximately 45 watts output (with both channels driven through the preamp section), the distortion was less than 0.1% and in general was unmeasurable with our instruments which have a residual distortion of about 0.07%. This extremely low distortion reading was obtained at all power levels from 0.1 watt up, and from 20 to 20,000 Hz. Into 16-ohm loads the output was slightly over 30 watts per channel, with similarly low distortion. Although it is not rated for 4-ohm loads, we tried the TA-1120 with 4-ohm loads and measured about

60 watts per channel at 1% distortion, and less than 0.2% distortion at 50 watts.

We drove the amplifier to saturation, at which point it delivers some 100 watts per channel, and considerable time was required for the safety circuit to trip. We repeatedly shorted the outputs under full power conditions and in every case the safety was tripped without damage to the transistors. Indeed we found the unit to be practically indestructible.

The frequency response was flat within 0.5 dB from 80 to 20,000 Hz, rolling off to -3 dB at 20 Hz. This is a deliberate roll-off to protect speakers against damage from the very high power output of the amplifier, which is available at frequencies well below 20 Hz. The filters are fairly effective, with little effect on program material. The RIAA phono equalization was nearly perfect, measuring from ± 0.3 dB from 30 to 20,000 Hz. The NAB tape playback equalization was accurate within ± 0.3 dB from 150 to 20,000 Hz, rising slightly to +2 dB in the 40- to 50-Hz region.

Hum and noise were inaudible, measuring 63 dB below 10 watts on phono inputs and about 80 dB below 10 watts on high-level inputs. The phono gain is very high, with only 0.7 millivolt needed to drive it to 10 watts output.

The listening quality of the amplifier was as superb as its measurements would suggest. At no time is one aware of any characteristics of the amplifier, due to its dead silent background, freedom from switching transients, and tremendous reserve power. Its distortion-free performance, attractive styling, operating flexibility, and apparent indestructibility earn it a place in the top ranks of stereo amplifiers. The *Sony* TA-1120 is priced at \$399.50. ▲

BSR McDonald 500 Automatic Turntable

For copy of manufacturer's brochure, circle No. 32 on Reader's Service Card.

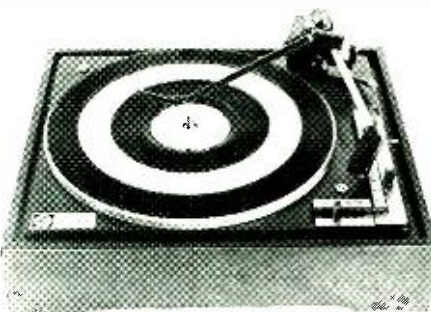

IN recent years there has been a trend toward elaborate, expensive record changers which match the performance of some of the finest manual turntables. With this upgrading in quality has come an increase in price, to the point where most of the top-

quality "automatic turntables" cost as much as or more than the manual turntables with which they compete.

A welcome reversal of this trend has appeared in the form of the *BSR McDonald 500* automatic turntable. Priced with the least expensive record changers, the *BSR 500* has many of the features heretofore found only in the more expensive players. Among these features are a low-mass tubular arm with an adjustable counterweight which balances it horizontally and vertically, a calibrated dial for setting tracking forces from 1 to 6 grams, a cueing lever, and provision for manual playing of single records.

The unit is a four-speed machine,
(Continued on page 80)

Bring your slides and movies to Life...

(and your audience, too!)

WITH VOLUME II

SOUND FOR A PICTURE EVENING

This superb 12-inch, 33 $\frac{1}{3}$ rpm record brings you 30 selections of sparkling, mood-setting off-beat music and hard-to-find, sound effects. For use "as is" by playing the appropriate tracks as your slide or movie show proceeds or for editing your selections and recording them on tape, "Sound For A Picture Evening" adds another dimension to your photography—high fidelity sound.

MADE WITH PHOTOGRAPHERS IN MIND

Photographers are travelers . . . are parents . . . are sportsmen . . . are restless experimenters with the unusual. And so the editors of POPULAR PHOTOGRAPHY have produced this second volume of unusual music and sound effects expressly to match the activities and moods in the most popular types of pictures shown in slide and home movie shows. These are melodies and sounds selected from the vast resources of the Capitol Record Hollywood Library to fit the special needs of photographers. The 30 bands of "Sound For A Picture Evening, Vol. II" supplement but do not duplicate any of those in the first edition of this popular record.

A POPULAR PHOTOGRAPHY EXCLUSIVE

The "Sound For A Picture Evening, Vol. II" album has been produced by the editors of POPULAR PHOTOGRAPHY exclusively for our readers and is prepared by the Custom Services Division of Capitol Records. This outstanding album, which cannot be purchased in any store, is available by mail only to the readers of Popular Photography and other Ziff-Davis magazines.

YOU GET 30 SPECIAL MUSIC AND SOUND TRACKS

There are 19 bands of mood and special-situation music . . . 11 bands of unusual, hard-to-find sound effects.

MOODS: Majestic, Backyard Nature, Experimental, Mysterious, Music of the Spheres • NATIONAL PORTRAITS: Vive la France, German Village Band, Soul of Spain, American West, English Countryside, Buon Giorno, Italia •

SOUND EFFECTS: Bass Drum, Bassoonery, Cathedral Bells, Galloping Horses, Zoo Noises, Children at Play, Cocktail Party, Birds on a Spring Morning, Outboard Motor, Oars in Water, Skis on Snow, Trumpet Fanfare, Solo Violin • SPECIAL PURPOSE MUSIC: Music From Silent Movies, Music for Slow-Motion Movies, Music for Speeded-Up Motion, Music for Stop-Motion Movies, Underwater Music, Music for Old-Time Footage.

For photographers with wanderlust, you'll find the "National Portraits" to be authentic melodies to go with your vacation pictures of England, France, Germany, Italy, Spain and the American West.

There are also those special bands to accompany the kind of pictures sportsmen take: The sound of galloping horses, of boat motors, of skis on snow, of oars in the water. You'll even find other-worldly mood-music chosen especially to go with underwater pictures.

Experimental photographers will find the electronic music ideal accompaniment for abstract pictures. The music for stop-motion, slow-motion and speeded-up-motion pictures is fanciful and imaginative in helping to present the unusual scenes being portrayed on your screen. And there is even mood music to convey the visual grandeur of ancient museum relics and photographs of the stars and planets.

To these add many other tracks of carefully selected music and sounds—and you have "Sound For A Picture Evening, Volume II."

January, 1967

PHOTOGRAPHY

VOLUME II

SOUND FOR A PICTURE EVENING

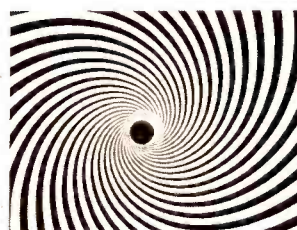
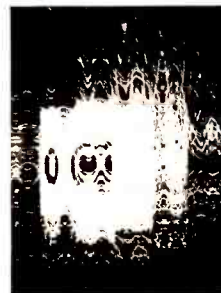

30 bands of unusual background music & sound effects specially chosen for slide shows & movies

*19 Bands of mood and special-situation music...
11 Bands of unusual, hard-to-find sound effects...*

COMPLETE WITH INSTRUCTIONS AND BAND POINTER

FREE!

A comprehensive instruction booklet comes with your record, showing you how to make a successful sound-and-music tape track for your slide or movie show, or to use the record alone as background, even if you're a rank beginner. An ingenious band pointer which fits on top of your record instantly locates any band you want. No guessing, no wasted motion, no false starts.

This 12" long playing vinyl album consisting of selections from the music masters of the Capitol Record Hollywood Library is available to you for

only \$3.98 POSTPAID!

It's a must for every slide and film show impresario and an album you will enjoy for many years to come.

PLACE YOUR ORDER NOW

"Sound For A Picture Evening, Volume II"
Popular Photography, Dept. SD
One Park Avenue, New York, N.Y. 10016

Please send _____ "Sound For A Picture Evening, Volume II" albums at \$3.98 each, postpaid. My check (or money order) for \$_____ is enclosed. (Outside U.S.A. please send \$5.00 per record ordered.)

N.Y. State residents please add local sales tax.

Name _____

Address _____ EW-17

City _____ State _____ Zip Code _____

Sorry—No charges or C.O.D. orders

"SOUND FOR A PICTURE EVENING, VOLUME I" still available.

I missed this first release containing 17 specific mood music backgrounds and 8 tracks for special sound effects. Please send _____ "Sound For A Picture Evening, Volume I" albums at \$3.98 each, postpaid. (Outside U.S.A. send \$5.00 per record ordered.)

**“Get more
education
or
*get out of
electronics***

...that’s my advice.”

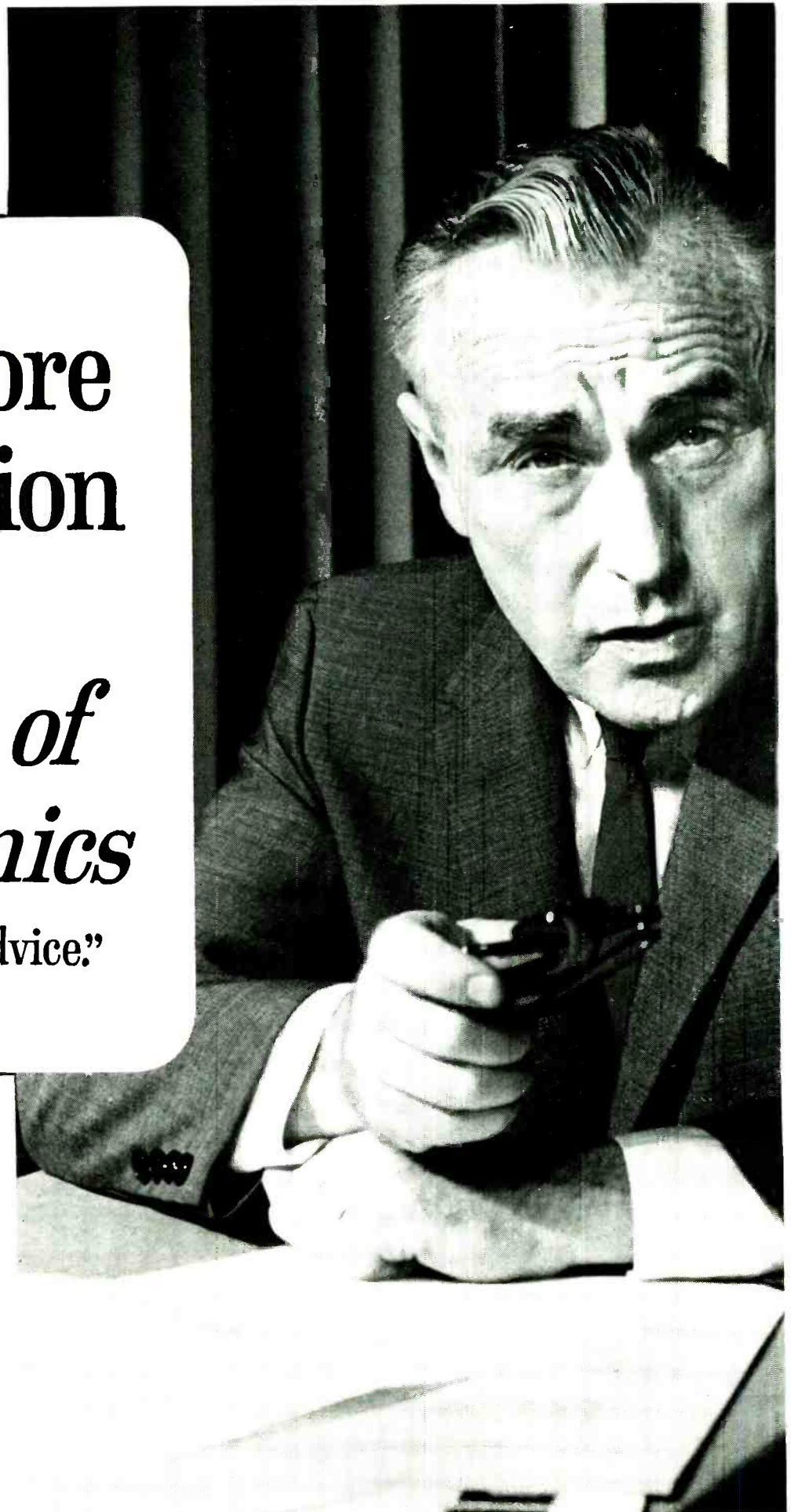

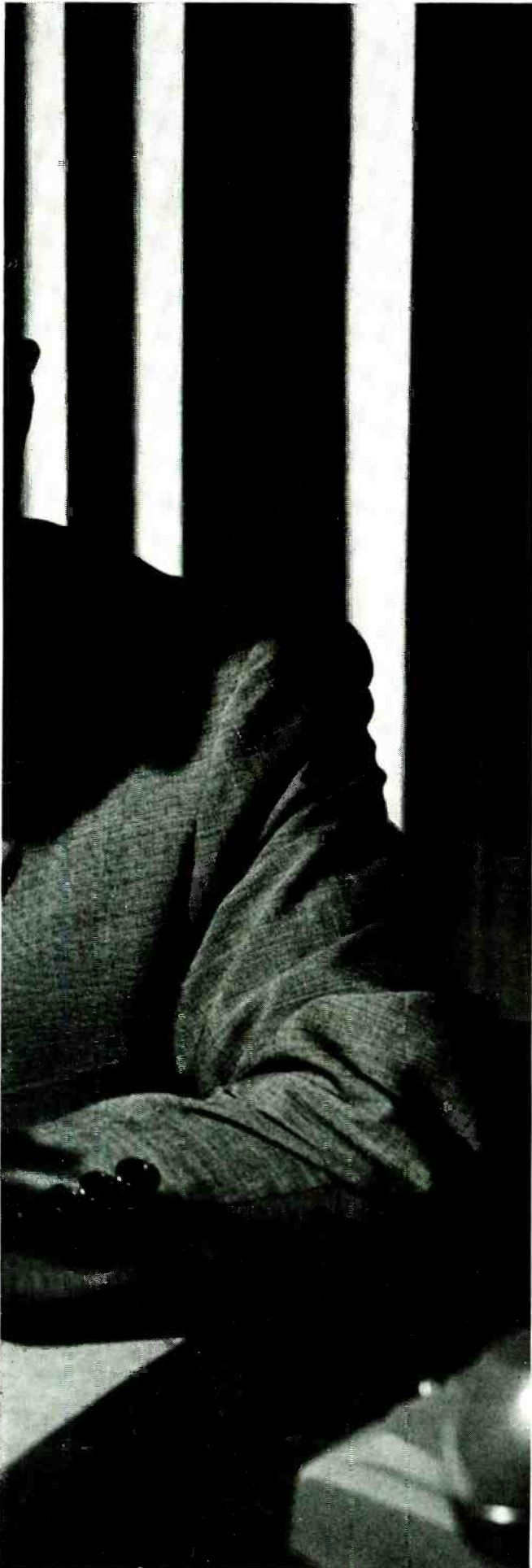

Ask any man who really knows the electronics industry. Opportunities are few for men without advanced technical education. If you stay on that level, you'll never make much money. And you'll be among the first to go in a layoff.

But, if you supplement your experience with more education in electronics, you can become a specialist. You'll enjoy good income and excellent security. You won't have to worry about automation or advances in technology putting you out of a job.

How can you get the additional education you must have to protect your future—and the future of those who depend on you? Going back to school isn't easy for a man with a job and family obligations.

CREI Home Study Programs offer you a practical way to get more education without going back to school. You study at home, at your own pace, on your own schedule. And you study with the assurance that what you learn can be applied on the job immediately to make you worth more money to your employer.

You're eligible for a CREI Program if you work in electronics and have a high school education. Our **FREE** book gives complete information. Airmail postpaid card for your copy. If card is detached, use coupon below or write: CREI, Dept. 1123 E, 3224 Sixteenth Street, N.W., Washington, D.C. 20010.



The Capitol Radio Engineering Institute
 Dept. 1123E, 3224 Sixteenth Street, N.W., Washington, D.C. 20010

Please send me FREE book describing CREI Programs. I am employed in electronics and have a high school education.

NAME _____ AGE _____

ADDRESS _____

CITY _____ STATE _____ ZIP CODE _____

EMPLOYED BY _____

TYPE OF PRESENT WORK _____ GI BILL

I am interested in Electronic Engineering Technology
 Space Electronics Nuclear Engineering Technology
 Industrial Electronics for Automation
 Computer Systems Technology

APPROVED FOR VETERANS ADMINISTRATION TRAINING

This new BSR McDonald 500 Automatic Turntable will change your mind about how much a precision crafted British instrument should cost.

Up to now, you would have had to pay at least \$74.50 to get the features that you get with BSR McDonald 500... for only \$49.50*! Quality features like Resiliently mounted, coarse and fine vernier, adjustable counterweight Low mass tubular aluminum pickup arm perfectly counterbalanced both horizontally and vertically – less susceptible to external shock The arm supported on virtually frictionless preloaded horizontal ball bearings assuring sensitive and accurate tracking Micrometer stylus pressure adjustment that permits 1/3 gram settings from 0 to 6 grams Lightweight cartridge shell with fingerlift, accommodating most standard mono or stereo cartridges Cueing and pause control, allowing you to select

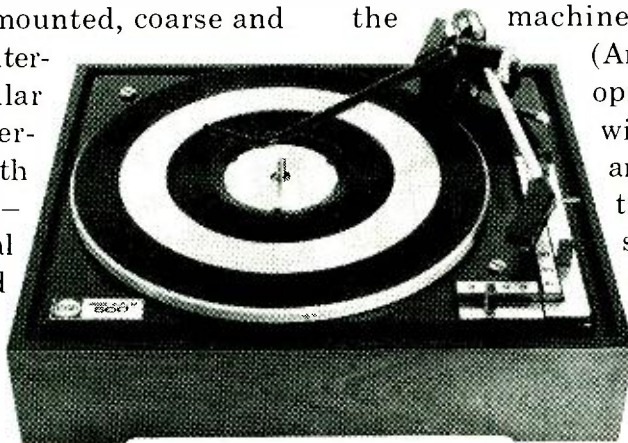

THE BSR McDONALD 500
AUTOMATIC TURNTABLE – \$49.50

the exact band on the record – without fear of damage to the record or the cartridge Automatic lock, securing the pickup arm whenever the machine is in the “off” position.

(Another BSR exclusive development prevents jamming – without having to reset the arm!) Easy operating controls for manual or automatic selection of 7”, 10” or 12” records at 16, 33, 45 or 78 RPM Interchangeable center spindles for manual or automatic play Dynamically balanced, resiliently mounted, 4-pole motor shielded from hum

Heavy duty, constant speed design assures minimum wow and flutter. Stop in at your audio dealer today and ask to see the BSR McDonald 500—the \$49.50 Automatic Turntable with \$74.50 features.

*Suggested Retail Price



BSR (USA) LTD, McDONALD DIVISION, ROUTE 303, BLAUVELT, N.Y. 10913
CIRCLE NO. 123 ON READER SERVICE CARD

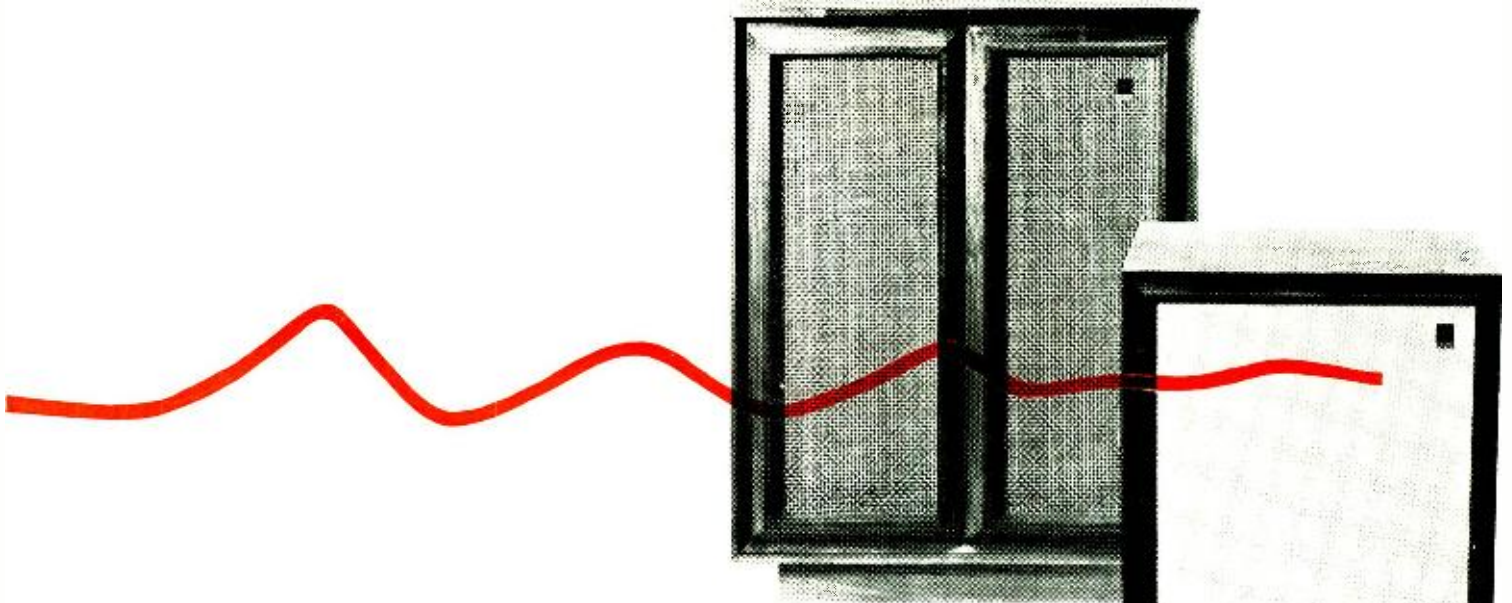

Problems of Matching Speakers To Solid-State Amplifiers

By VICTOR BROCIER
Assistant to the President, H.H. Scott, Inc.

Transistor amplifiers are very sensitive to changes in load, especially to lower-than-rated values. Therefore, careful attention must be paid by the speaker designer to the impedance of his system over the entire audio range. Here is how one manufacturer solves this problem. Details on adding loudspeakers to an existing hi-fi system are also covered.

UNLIKE a tube amplifier, the transistor amplifier cannot be operated at the peak of its power vs load curve because the transistors are incapable of dissipating the heat that would be generated internally under these conditions. The variation of power output for a given value of distortion as the load resistance is changed on a solid-state amplifier is shown in Fig. 1. Solid-state amplifiers are operated at a point well to the right of the peak shown in Fig. 1. A serious consequence is that if the load resistance is decreased below the minimum value for which the amplifier is designed, there is danger of blowing out the transistors or their protective devices.

Typical silicon power transistors in current use can dissipate 100 watts continuously at a case temperature of 50° C. In an amplifier with a 70-volt power supply, designed for slightly over 75 watts of continuous power output into an 8-ohm load, the maximum dissipation with sine-wave signals is 40.6% of the output power or about 15 watts per output transistor. (This is for the ideal case, with a perfectly regulated power supply and no losses except in the transistors.) With square waves this increases to about 20 watts. For very low frequencies for which dissipation has to be calculated as it is for a d.c. amplifier, the dissipation rises to 38 watts per transistor for sine waves.

All this is well within the safety limits. Such an amplifier would be equipped with a 2-ampere speaker fuse which, being capable of carrying nearly 3 amperes for short periods corresponding to the loudest transient passages in program material, allows the amplifier to operate at its full power output. For 4-ohm resistive loads, the

fuse rating could be increased to permit operation at full power.

But what happens at a lower load, say at 1 ohm? At peak input, on an instantaneous basis, half the supply voltage is connected across the load in series with the

Fig. 1. While a tube amplifier is usually operated at a load impedance producing maximum power output at a given distortion, solid-state amplifiers are usually operated at several times this value. The shape of the curve shown is for solid-state amplifiers; curve for tube amplifiers is somewhat different.

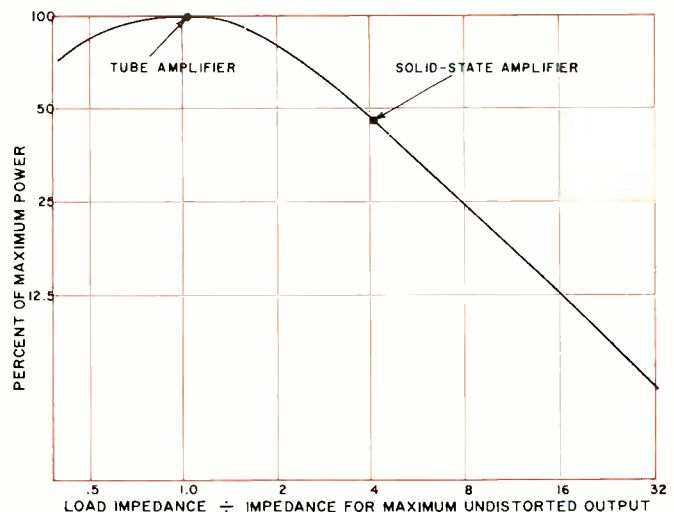

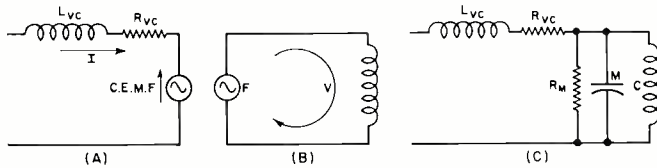

Fig. 2. Electrical and mechanical equivalent circuits of speaker.

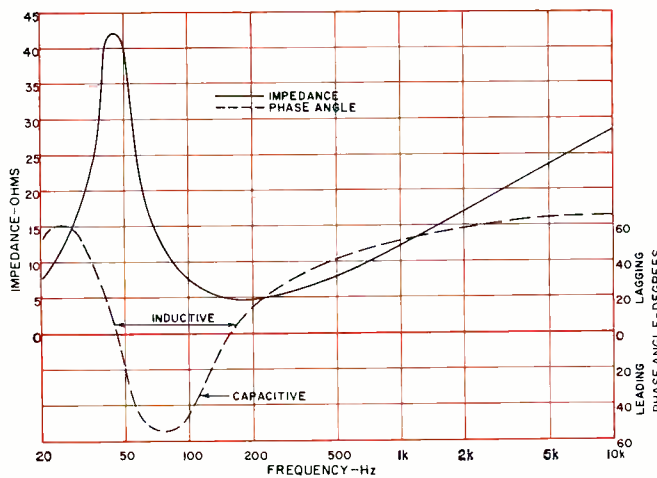

Fig. 3. Typical impedance and phase angle curves of speaker.

internal resistance of the transistor plus its emitter resistor, say 1 ohm.

$$Inst. \text{ current} = \frac{\text{power supply voltage}}{\text{resistance}} = \frac{70}{1+1} = 17.5 \text{ A}$$

This is above the 15-ampere maximum current rating of the transistor and will blow a fuse, but very likely not in time to protect the transistor.

If the load is of correct value but reactive instead of resistive, all of the power drawn from the supply must be dissipated in the transistor and its emitter resistor. The maximum peak dissipation for the two output transistors occurs when the voltage across each transistor is 0.75 times the supply voltage and the current is 0.866 times I_{max} , or

$$P_{dis,max} = 0.75 E_{bb} \times 0.866 I_{max} = 0.65 E_{bb} I_{max}$$

I_{max} is equal to its value for full power output into rated resistive load = $E_{bb}/2R_L = 70/(2 \times 8) = 4.37 \text{ A}$; then $P_{dis,max} = 0.65 \times 70 \times 4.37 = 199 \text{ W}$. This also exceeds the maximum rating of the transistor.

The situation with actual amplifiers and loads is not quite as bad as the foregoing calculations indicate because power-supply voltages decrease as the power output increases, the dissipation calculations have neglected the presence of the emitter resistors, and loads are not usually purely reactive. Nevertheless, it is quite apparent that for reliable operation of solid-state amplifiers, careful attention must be paid to the magnitude and to the character of the load impedance that is used.

Loudspeaker Impedance

The circuit across the terminals of a dynamic speaker

can be viewed as the voice-coil resistance in series with its inductance, and both in series with a generator (see Fig. 2A). The generator represents the counter-e.m.f. generated by the motion of the voice coil in the magnetic field. This voltage depends on the flux density, the length of the active voice-coil conductor, and the velocity of the voice coil.

At frequencies well above resonance, the motion is mass-controlled, that is, the speaker acts as if the stiffness of its suspension were nearly zero and the mechanical resistance due to friction and acoustic resistance of the air load were likewise negligible. The simplified analog circuit is shown in Fig. 2B. By analogy with an electric circuit, the velocity, V (current), lags the force F (voltage), because the circuit is "inductive." Also, the force is in phase with the driving current, I , since the force is directly proportional to the driving current. Then the velocity lags driving current, which means that the generated voltage also lags the driving current. Consequently, the source generator in Fig. 2A sees a circuit in which the current is leading the voltage. This means that the motional impedance (an electrical impedance substituted for the generator) is capacitive. This is represented as M (for mass) in the complete equivalent circuit shown in Fig. 2C.

Below resonance, the stiffness controls and this appears in the electric circuit as an inductance. This is represented as C (for compliance) in Fig. 2C. The resistive element corresponds to an in-phase voltage and is an electrical resistance (R_w). Now, are these elements in series or in parallel? We know that at resonance the impedance rises, so they must be in parallel as shown.

The complete impedance curve of a typical loudspeaker is shown in Fig. 3. The trough of the curve occurs near 400 Hz in direct-radiator woofers and wide-range speakers, with a value of impedance only slightly greater than the voice-coil resistance. The amount of difference is a measure of the electromechanical efficiency of the speaker. Since the increase in impedance is caused by the motionally generated counter-e.m.f., a large increase would be caused by the high velocity and this represents high efficiency. Since direct-radiator speakers have typical efficiencies from less than one percent to only a few percent, one would not expect a large rise in mid-frequency impedance over the resistance. So, in effect, the minimum value of impedance of a speaker is determined primarily by the resistance of the voice coil.

The rise at higher frequencies is caused by the voice-coil inductance. In a wide-range speaker it is undesirable because for an essentially constant-voltage driving source it reduces the voice-coil current at high frequencies, with a resultant drop in response. The most effective means of reducing this effect is to cover the center pole of the magnet structure with a copper cap which acts as a shorting ring and minimizes the voice-coil inductance. Since the cap takes up some space that would otherwise be occupied by the magnet structure, flux density is reduced somewhat, with some reduction in over-all efficiency.

The peak at resonance is primarily determined by the flux density and the resistance losses (damping) of the speaker. At resonance the mechanical system acts like a

Fig. 4. (A) Equivalent circuit of speaker connected to amplifier. (B), (C), and (D) Two-way speaker systems and networks.

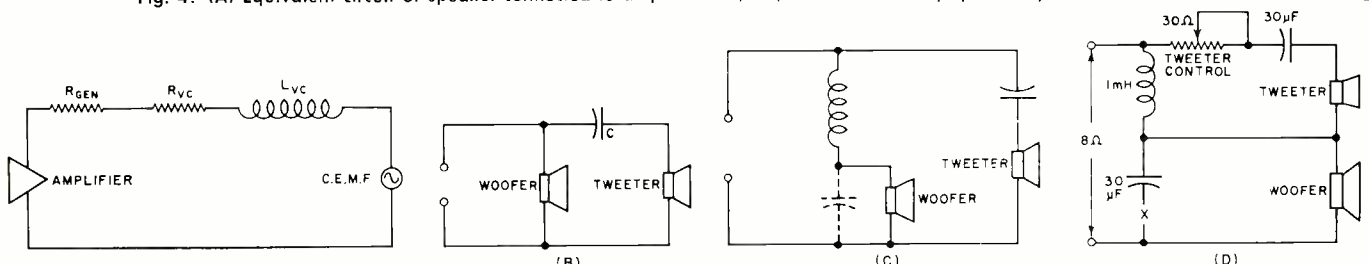

resistance. If there were no losses and no air load, the velocity would be infinite. With a given amount of resistive loss, the velocity is proportional to the active flux, as are the counter-e.m.f. and motional resistance. Thus, the more powerful the magnet, the higher the impedance peak at resonance. This seems to conflict with the idea that a speaker with a powerful magnet is well-damped, but it really does not.

When the speaker is connected to an amplifier of low source impedance (high damping factor), there is an additional damping element—the electrical damping provided by the amplifier. The counter-e.m.f. generated by the motion of the voice coil now works into a closed circuit (Fig. 4A). The motional voltage opposes the voltage applied by the amplifier, reducing the net voltage that drives current through the voice coil. This, in turn, decreases the current, which reduces the velocity. So the counter-e.m.f. acts in such a way as to oppose its own action, with the result that the damping of the system is increased.

Multi-Speaker Systems

With multi-speaker systems, the matter of impedance becomes considerably more complicated. Consider the

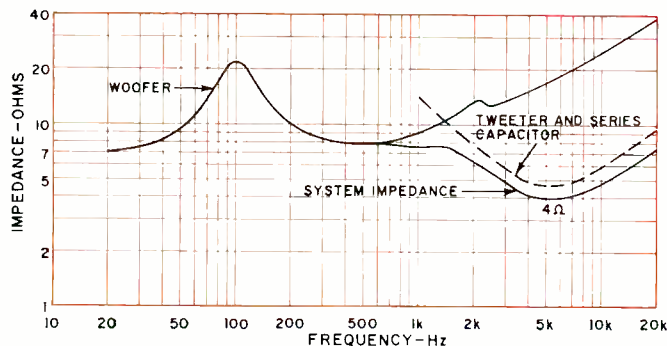

Fig. 5. Impedance of 2-way speaker system consisting of an 8-ohm woofer and a 4-ohm tweeter along with series capacitor.

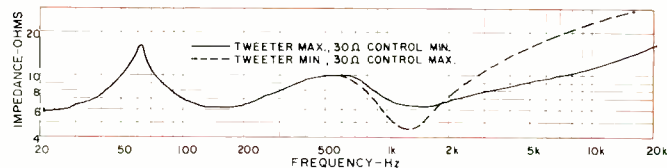

Fig. 6. Impedance curves at two settings of tweeter control.

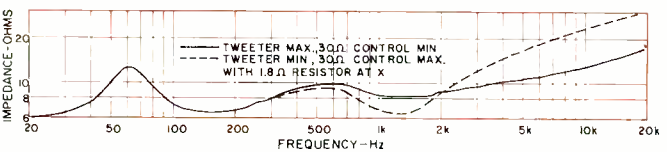

Fig. 7. Impedance curves with the 1.8-ohm resistor added.

simplest possible two-way system of Fig. 4B. The dividing network consists only of a capacitor in series with the tweeter. The woofer response falls off at higher frequencies and, in the interests of economy, no electrical means are used to keep these higher frequencies out of the speaker. Fig. 5 shows the impedance curves of the woofer alone, that of the tweeter with its capacitor, and the system impedance. It is seen that over a considerable range of frequencies the impedance is far below the rated value for the system. This is caused by the fact that a 4-ohm tweeter is used in an 8-ohm speaker system. This sort of thing comes about when the speaker designer attempts to obtain flat response with a tweeter that is not as efficient as the woofer. The lack of efficiency is made up by forcing more current through the lower impedance tweeter. The alternative is to design a more efficient tweeter, but this

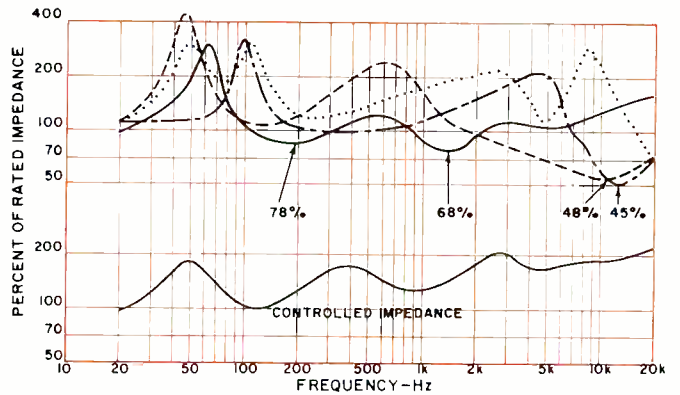

Fig. 8. (Above) Impedance curves of a number of commercially available speaker systems. (Below) Curve of controlled-Z system.

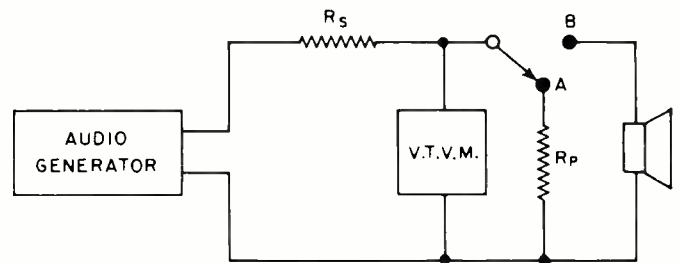

Fig. 9. Test-equipment setup used to measure speaker impedance.

usually requires a heavier magnet structure which increases the cost. With tube amplifiers this practice merely resulted in reduced available power over part of the frequency range, but as has been explained previously, the consequences are more serious with solid-state amplifiers.

Another way in which low impedance can occur is illustrated by the arrangement in Fig. 4C. This two-way system may have a bump in its frequency-response curve because the woofer is not cut off sharply enough. The situation is remedied by shunting the woofer with a large capacitor, shown dashed. The bump is now gone, but the impedance in the 2000-Hz region may be way below its rated value. A properly designed dividing network, with a larger value of inductance and a smaller capacitor, smooths the response just as well but maintains the impedance near its correct value.

An interesting example of how low impedance can occur in an unexpected manner is shown with the series-type network of Fig. 4D. In Fig. 6 we have the impedance curve (solid line) which shows a minimum of 6.5 ohms—acceptable for a system rated at 8 ohms. One would be inclined to disregard the effect of turning down the tweeter control because this inserts 30 ohms into the circuit. The dashed line, however, shows that the minimum value of impedance has now dropped to less than 5 ohms. The explanation is that with the tweeter at maximum (control

Fig. 10. Effect of adding inexpensive speaker system (B) to hi-fi speaker system (A) using a simple series connection.

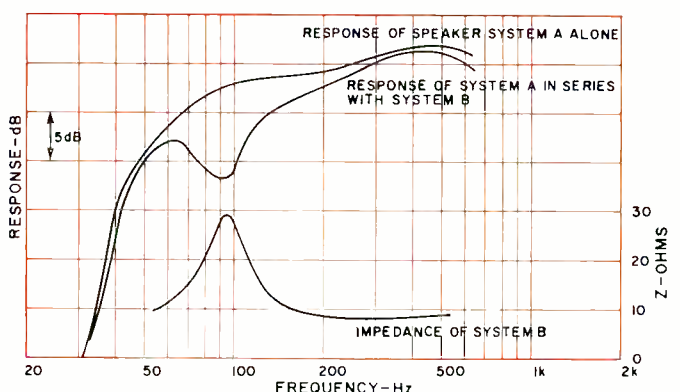

at minimum resistance), the 1-mH choke, the upper 30- μ F capacitor, and the tweeter form a parallel-resonant circuit with "Q" great enough to maintain the impedance at a high value around the crossover frequency. With the tweeter turned down and the 30-ohm control inserted in the circuit, this effectively leaves only the choke, the bottom capacitor, and the woofer in the circuit, with a lower impedance than before. The remedy is to insert a resistor of 1.8 ohms at "X" in Fig. 4D. This has very little effect on the woofer cut-off curve but keeps the impedance up to an acceptable level, as shown in Fig. 7.

In multi-speaker systems it is sometimes necessary to use two or more speakers in parallel for a given frequency range to provide wider distribution or greater power-handling capability. These speakers should have a higher impedance than the other speakers in the system so that their impedance when paralleled is equal to the rated impedance. Sometimes it is impossible to obtain units of suitable impedance values or it may be uneconomical to manufacture them. The result is too low an impedance over part of the frequency range. A matching transformer would solve the problem, but it must be a high-quality transformer with a high primary inductance and this may not be economical either.

A large number of commercial speaker systems were measured and their impedances plotted. Some of the curves are shown in Fig. 8 with impedance indicated as a percent of its rated value. We have called out the points at which these have minimum impedances that were found to be unacceptably low. In order to be sure of safe high-level operation of solid-state amplifiers with these speakers, they should be operated in series with a 2-ohm resistor. In contrast to these, one curve is that of a system that has been designed especially to have controlled impedance.

Measuring Speaker Impedance

Speaker impedance can be measured quite easily using only an audio generator and a vacuum-tube voltmeter. The only other components needed are two resistors: a high-power (5 to 10 watts) series resistor (R_s) at least 20 times the value of the impedance to be measured, and a precision resistor (5% or better). The precision resistor (R_p) should preferably have a value equal to the rated speaker impedance but it can be any known value from about half to double this figure. The equipment is connected as shown in Fig. 9.

The first step is calibration. With the switch at "A" the precision resistor is connected across the v.t.v.m. terminals. The output of the generator is adjusted to produce a 1000-Hz voltage across the precision resistor that is one-hundredth the value of the resistor. For example, if R_p is 8 ohms, adjust the voltage to 80 mV. (If the v.t.v.m. range does not extend this low, a higher value may be used but it must be remembered that the generator is putting out a much higher voltage and distortion may be

produced.) The calibration permits the v.t.v.m. to be read in ohms by multiplying its reading in volts by 100. (If a higher voltage is used, the corresponding ratio is used to read the v.t.v.m.)

The speaker is then substituted for the precision resistor by switching to position "B". A series of impedance readings is then made over the entire operating frequency range and the results plotted as a curve of impedance vs frequency. The minimum value of impedance is easily observed. It should be within 10% of the rated impedance of the system.

If the speaker system is equipped with level controls for the different channels, such as tweeter and mid-range, impedance curves should be plotted for various combinations of settings of the controls since these can affect the impedance of the system considerably.

It should be pointed out that the impedance at or near resonance varies with power level, and the results obtained by this method may not be exactly the same as those given by measuring at a "standard" power input to the speaker of one-tenth of its rated power. However, we are not particularly interested in accuracy in this region because the impedance is usually well above rating here.

Manufacturers' Specifications

It is often inconvenient to measure the impedance of a speaker system, especially before it is purchased. How, then, can the audiophile determine the suitability of a speaker before acquiring it? The answer is to demand that the speaker manufacturer specify not only the rating or nominal impedance but also the minimum value of impedance attained within the audio range or, preferably, a curve of impedance vs frequency.

The definition of *rating impedance* for a speaker is not as widely known as it should be. As defined by both the IEEE and EIA standards (61 IRE 30.RPI "Recommended Practices on Audio and Electroacoustics: Loudspeaker Measurements" and RETMA Standard SE-103 "Speakers for Sound Equipment"), it is "the value of a pure resistance, specified by the manufacturer, in which the electrical power available to the speaker is measured." It is intended to indicate to which tap of an (output-transformer coupled) amplifier a speaker should be connected. It is not the impedance of the loudspeaker at a designated reference frequency. It is, *ideally*, the average impedance over the frequency band transmitted by the speaker, weighted by the spectrum of the signal with which the speaker will be used. For direct-radiator loudspeakers it may be estimated by adding 10% to the minimum value of the magnitude of the measured impedance in the frequency range above cone resonance, or by adding 20% to the voice-coil d.c. resistance.

The EIA Standard also states that speaker impedance (not rating impedance) shall be presented in terms of magnitude and phase angle as a function of frequency. This is exactly the information that is required to determine whether or not safe operation can be obtained with a solid-state amplifier.

Of course, in the long run, it will hardly be necessary for the audiophile to go through all this information. Loudspeaker manufacturers are aware of the problem and it is assumed that in their own interests as well as those of their customers and of manufacturers of solid-state equipment, they will revise their designs where required so that all the speakers available on the market will be perfectly safe for use with solid-state amplifiers.

Installing Additional Speakers

Since a solid-state amplifier requires that the load impedance be kept above a certain minimum value, it follows that when a number of speakers are to be operated at one time, provision must be

(Continued on page 62)

Fig. 11. Use of a matching transformer for multiple speakers.

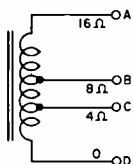

AMPLIFIER		SPEAKER(S)	
CONNECT TO	FOR LOAD VALUE	IMPEDANCE	CONNECT TO
B-D	8Ω	16Ω	A-D
B-D	"	4Ω	C-D
A-D	"	2Ω	C-D
B-D	"	1.44Ω	A-B
B-D	"	.64Ω	B-C
A-D	"	.32Ω	B-C

Hi-Fi Amplifier Terms and Definitions

By LEONARD FELDMAN / Engineering V.P., Crestmark Electronics Inc.

The standards that have been promulgated by the Institute of High Fidelity for use by audio amplifier manufacturers are an important and definite guide to evaluating such equipment prior to purchase.

THE most significant transition in the design and merchandising of amplifiers for home music reproduction since the advent of stereophonic sound has at last been completed. Transistorized stereo amplifiers (more often esoterically described as "solid-state" amplifiers to dissociate them categorically from pocket radios) have all but totally supplanted their vacuum-tube predecessors.

As with all major technical revolutions, the pendulum had somewhat overshot its mark initially and is now swinging back to a more realistic approach to amplifier design. Attempts at over-miniaturization of high-powered amplifiers led to disastrous field failures for some early, hastily conceived products. Today, a measure of conservatism in design has been restored, resulting in amplifier configurations which are not significantly smaller in physical size than their tube counterparts. Attendant advantages in this seeming design retrogression have been far more reliable, trouble-free, totally stable amplifiers well worth their market price.

Almost as if to complement the new-found stability of amplifier design, the Institute of High Fidelity (IHF) has recently revised its antiquated 1958 standard on measurement of audio amplifiers. The new standard (IHF-A-201, issued in 1966) includes tests and methods of evaluation which are sufficiently sophisticated to render highly meaningful ratings and specifications for the new breed of solid-state amplifiers.

For stereophonic (dual-channel) amplifiers, the minimum specifications that must be published by a conforming manufacturer include (1) dynamic and continuous output at mid-frequency, (2) power bandwidth, (3) sensitivity, and (4) hum and noise.

Other specifications covering the familiar frequency response and less familiar criteria such as input impedance, damping factor, tracking error, separation, and crosstalk may, at the option of the conforming manufacturer, be stated in published specifications for a more complete technical description of any given stereo amplifier. (*An article discussing damping factor appears elsewhere in this issue.—Editors*) Since the four items tabulated above are deemed to be of prime importance by the Institute, an understanding of at least these basic specifications would be essential for the prospective purchaser of a stereo amplifier.

Continuous and Dynamic Output

Confusion regarding the "true" power rating of an amplifier may, at last, become a problem of the past. For one thing, the meaningless mathematical exercise known as "peak power" is absent from the new standard. Instead, two different but related means of specifying power output of an amplifier have now gained universal acceptance on the part of high-fidelity component manufacturers. Continuous output refers to the maximum amount of single-tone (sine-wave) power which may be fed to a loudspeaker for a referenced amount of distortion at 1000 Hz. Since the referenced distortion figure is still left to the discretion of

the manufacturer, care must be taken by the interpreter of the rating to note just what this distortion figure is. For example, an amplifier having a published continuous power rating of 30 watts for a referenced distortion of 2% may or may not be as "powerful" as another amplifier claiming only 25 watts of continuous power at a referenced distortion of 0.5%. In general, however, most reputable manufacturers will not use a referenced distortion level higher than 2% in arriving at the power rating for an amplifier.

Recognizing that the home music enthusiast seldom listens to sine waves, the Institute now requires that a dynamic power rating be listed for all amplifiers. This rating takes cognizance of the fact that amplifier power is generally limited by the ability of the power-supply circuitry to provide constant voltage to the output section of the amplifier when high-current demands are made upon it. Particularly in the case of solid-state amplifiers, the current drawn from the power supply may vary from next to nothing during quiet passages of music to several amperes during musical crescendos. The theory underlying the "dynamic" power rating involves the fact that such crescendos (at least in music) are relatively brief—too fast to adversely affect the amplifier's power-supply voltage. Thus, a somewhat higher power rating will be derived if short, transient pulses are applied to the amplifier instead of a continuous tone. There is no fixed relationship between the two types of power ratings. Theoretically, if an amplifier were to be built having a power supply of such great capacity as to be unaffected by changes in current requirements from "soft" to "loud," the dynamic power rating would be equal to and identical with the continuous power rating. Conversely, a poorly regulated power supply which "falls apart" when high-current demands are made upon it may well result in continuous power to dynamic power ratios of 2:1 or even more.

Power Bandwidth

The price of an amplifier varies almost directly with its ability to produce not only adequate power at mid-frequencies but also sufficient power at the low end of the spectrum (bass tones) as well as at the high end (treble tones). In fact, musical structure is often constituted so that the really high power requirements involve the reproduction of low tones rather than mid-frequencies. Accordingly, the power-bandwidth specification provides a method whereby the prospective buyer can judge power capability at *all* significant frequencies. Power bandwidth is defined as the lowest and highest frequencies at which an amplifier can produce one-half its referenced output at its referenced distortion. As an example, if two amplifiers have power ratings of 20 watts but the first of these has a power bandwidth from 20 to 20,000 Hz and the second amplifier has a power bandwidth from 30 to 15,000 Hz, the first of these amplifiers is superior in this respect.

Sensitivity

The sensitivity of an amplifier (*Continued on page 30*)

Solid-State Hi-Fi Amplifier Directory

COVERING only solid-state amplifiers, this directory lists the electrical characteristics, physical dimensions, and prices of the available preamplifiers, power amplifiers, and integrated amplifiers (combining preamplifier and power amplifier within a single package). Each of these

areas is self-contained within its own individual table. All devices covered in this directory are stereo except where noted.

The information supplied in this directory was in reply to requests made of each manufacturer. ▲

Solid-State Preamplifiers

Model	Rated output (V)	THD @ 1-V output 1 kHz (%)	IM @ 1-V output (%)	Freq. response @ 1-V output (Hz)	Phono mag. (mV)	Phono ceramic (mV)	Tape head (mV)	High level (V)	Headphone jack impedance (ohms)	Tape-output jack	Tape-monitor switch	Rumble/scratch filter controls	Physical size (inches)			Assembled price (\$)	Kit price (\$)	Cabinet (\$)
													W	H	D			
IV ^a	ACOUSTECH, INC., 139 Main St., Cambridge, Mass. 02142																	
	2	—	.09	—	10	—	.5	600, up	yes	—	—	15 3/4	4	8	—	149.00	inc.	
CC-1	CM LABORATORIES, 575 Hope St., Stamford, Conn.																	
	2	.1	.1	2-100 k	3	—	6	.25	none	yes	yes	scr.	15 3/4	5 1/2	12	315.00	—	21.00
CC-2	2	.1	.1	1-100 k	3	—	—	1	none	yes	yes	rum.	12 1/2	4	9	225.00	—	—
PAT-4	DYNACO INC., 3912 Powelton Ave., Philadelphia, Pa. 19104																	
	3	.03	.1	5-100 k	5	200	5	.15	—	yes	yes	yes	13	4	8	129.95	89.95	inc.
621	HADLEY LABS., 115 Spring St., Claremont, Calif.																	
	3	.85	.05	20-20 k	3	—	3	.3	none	yes	yes	none	15	4 1/2	8	359.00	—	inc.
SG520	LANSING, JAMES B., SOUND, INC., 3249 Casitas Ave., Los Angeles, Calif. 90039																	
	3	.15	.05	20-20 k	6	—	5	.3	8, up	yes	yes	yes	15 1/2	6 1/2	13 1/2	450.00	—	15.00
7T	MARANTZ CO., INC., 37-04 57th St., Woodside, N.Y. 11377																	
	10	.05	.05	20-20 k	.6	—	1.2	.075	600, up	yes	yes	yes	15 3/8	5 3/4	7	325.00	—	24.00
C-24	McINTOSH LAB. INC., 2 Chambers St., Binghamton, N.Y. 13903																	
	2.5	.1	.1	20-20 k	2	—	2	.2	4, 8, 16	yes	yes	yes	16	5 7/8	11	249.00	—	—

^aModel VI same as Model IV except wired, \$249.00.

Solid-State Power Amplifiers

Model	IHF dynamic power (W/ch)	Continuous power (W/ch)	THD @ rated power 1 kHz (%)	THD @ 1 W (%)	IM @ rated power (%)	IM @ 1 W (%)	Power bandwidth (Hz)	Freq. response @ 1 W (Hz)	Input sensitivity (V)	Output impedance (ohms)	Damping factor	Physical size (inches)			Assembled price (\$)	Kit price (\$)	Cabinet (\$)	Center channel
												W	H	D				
1A	ACOUSTECH, INC., 139 Main St., Cambridge, Mass. 02142																	
	—	80	.45	—	.25	.1	—	5-50 k	—	4, 8, 16	150	15 3/4	5	12	395.00	—	inc.	no
III	—	50	.45	—	.25	.1	—	5-50 k	—	4, 8, 16	150	15 3/4	5	8	274.00	199.00	inc.	no
XI ^c	—	35	.45	—	.25	.1	—	5-50 k	—	4, 8, 16	150	15 3/4	5	10	—	129.50	24.50	no
351C	ALTEC LANSING, 1515 South Manchester Ave., Anaheim, Calif. 92803																	
	50	40	1.5	—	—	—	20-20 k	.45	4, 8, 16, 70V	—	9 3/4	5 1/8	9 3/8	234.00	—	—	no	
35D	CM LABORATORIES, 575 Hope St., Stamford, Conn.																	
	—	35	.5	.25	.5	.25	20-20 k	1-100 k	.65	4, 8, 16	500	10 1/8	6 1/8	12 1/4	285.00	—	—	no
35MRM ^d	—	50	.5	.5	.5	.5	20-20 k	1-100 k	.65	4, 8, 16, 70 V	200	19	5 1/4	13	237.00	—	—	no
911	—	100	—	—	.5	—	10-30 k	1-100 k	1	4, 8, 16	200	14 3/4	8 1/8	11 5/8	477.00	—	—	no
60/60	DYNACO INC., 3912 Powelton Ave., Philadelphia, Pa. 19104																	
	—	60	.25	.1	.5	.1	5-50 k	5-100 k	1.5	4-16	40	13	4	10 1/2	199.95	159.95	inc.	yes
622	HADLEY LABS., 115 Spring St., Claremont, Calif.																	
	80	40	.5	.1	.8	.2	2-35 k	3-50 k	1.1	4-20	250	12 1/2	4 3/4	10 7/8	359.00	—	—	no
SE400S	LANSING, JAMES B., SOUND, INC., 3249 Casitas Ave., Los Angeles, Calif. 90039																	
	—	40	.075	.075	.15	.15	—	3-200 k	1	4-16	0	15 1/4	4 7/8	6 7/8	285.00	—	inc.	no
SE408S	—	40	.075	.075	.15	.15	—	3-200 k	1	4-16	0	15 1/4	4 7/8	6 7/8	270.00	—	—	no
Model 15 ^b	MARANTZ CO., INC., 37-04 57th St., Woodside, N.Y. 11377																	
	90	60	.05	.01	.1	.025	10-40 k	10-60 k	1	4-16	150	15 3/8	5 3/4	8 1/4	395.00	—	30	no
SSP200	MATTES ELECTRONICS INC., 4937 West Fullerton Ave., Chicago, Ill. 60639																	
	160	100	.5	.5	.07	.4	7-20 k	1.5-30 k	1	4, 8, 16	250	14 1/4	8	5 1/4	375.00	—	inc.	no
TR-2 ^c	SCHOBER ORGAN CORP., 43 West 61st Street, N.Y., N.Y. 10023																	
	50	40	.22	.1	1.4	.9	20-20 k	9-40 k	.055	4-16	—	5 1/2	7 1/2	11 1/4	—	69.95	inc.	no
TA-3120	SONY CORP. OF AMERICA, 47-47 Van Dam St., L.I.C., N.Y. 11101																	
	—	50	.1	.05	.3	—	10-100 k	1	4-16	70	17 1/2	5 3/4	7 1/2	249.50	—	inc.	no	

^aControlled to match specific speaker. ^bMono version Model 14. \$200.00. ^cMono. ^d80MRM same as 35MRM except 80-W output, sensitivity 0.75 V; IM of 0.8%, and price is \$297.00. ^eModel XII same as Model XI except 50 W, kit price \$159.50. Both can use P/M preamp module (\$89.50) for conversion to integrated systems.

Solid-State Integrated Amplifiers

Model	ACoustech Inc., 139 Main St., Cambridge, Mass. 02142										Input sensitivity for rated output				Physical size (inches)			Assembled price (\$)	Kit price (\$)	Cabinet (\$)				
	IHF dynamic power (W/ch)	Continuous power (W/ch)	THD @ rated power 1 kHz (%)	THD @ 1 W (%)	IM @ rated power (%)	IM @ 1 W (%)	Power bandwidth (Hz)	Freq. response @ 1 W (Hz)	Output impedance (ohms)	Damping factor	Center-channel output	Phono mag. (mV)	Phono ceramic (mV)	Tape head (mV)	High level (V)	Headphone jack impedance (ohms)	Tape-output jack				Tape-monitor switch	Rumble scratch filter controls	W	H
VA	50	.45	.25	.1	.1	15-25 k	15-30 k	4-16	50	yes	2	—	—	—	—	—	—	—	15 3/4	5	8	399.00	—	inc.
VII	30	.45	.25	.1	.1	15-25 k	15-30 k	4-16	50	yes	2	—	—	—	—	—	—	—	15 3/4	5	8	219.00	—	inc.
711A	30	.5	.1	.1	.1	15-25 k	15-30 k	4-16	50	yes	2	—	1.1	.2	4-16	yes	yes	yes	16 3/8	5 3/8	12	378.00	—	24.00
ADC-60	30	.22	.5	.1	.8	20-20 k	60-10 k	4, 8, 16	50	no	2	—	—	.1	low	yes	yes	no	14 1/4	3 3/4	8 1/2	129.50	—	17.95
TA-100	30	—	1	—	1	20-20 k	20-50 k	4-16	—	no	2.5	—	—	.125	any	yes	no	—	15	3 3/4	11 3/4	129.95	—	24.95
CC-50S	—	50	.5	.1	.5	20-20 k	5-60 k	4, 8, 16	200	no	3	—	6	.25	4-hi	yes	yes	yes	17	6	13	387.00	—	—
3070	25	15	.8	.3	2	10-40 k	5-100 k	4-16	30	no	4.2	—	—	.27	any	yes	yes	yes	12	3 3/8	7 3/4	119.95	89.95	inc.
EV-1144	25	18	1	.5	—	20-20 k	30 k	4-16	35	no	4.5	—	—	.09	4-16	yes	yes	no	8 1/4	3 3/8	10 1/4	125.00	—	inc.
TX-300	50	36	.5	.4	—	12-50 k	25 k	4, 8, 16	20	no	2.8	—	1.8	.2	4-16	yes	yes	yes	15 1/4	4 13/16	11 7/8	329.50	—	—
TX-200	45	35	.5	.4	—	12-50 k	22 k	4, 8, 16	20	no	4	—	2.6	.28	4-16	yes	yes	yes	15 1/8	4 13/16	11 7/8	279.50	—	—
3000	60	50	.25	.15	.5	20-30 k	10-100 k	4, 8, 16	35	yes	1	—	3	.2	4-16	yes	yes	yes	15	6 1/2	13 3/4	299.50	—	—
C-41	25	20	.3	.25	.5	20-30 k	10-100 k	4, 8, 16	30	no	1	—	3	.15	4-16	yes	no	yes	15	4 7/8	11	179.95	—	—
AA-22	33	20	.3	.3	1	15-30 k	15-30 k	4-16	20	no	6	—	—	.25	—	yes	no	no	15	3 7/16	11 3/8	—	99.95	inc.
AA-21D	50	35	.5	.5	1	15-25 k	13-25 k	4-16	—	no	3	—	2	.25	—	yes	yes	no	15 1/2	5 1/4	14	—	137.00	6.95 12.95
AA-14	15	10	.5	.5	1	15-50 k	10-60 k	4-16	50	no	4	—	—	.3	low	no	no	no	12	3 3/4	9 3/4	—	59.95	3.50 7.95
TK-400	40	32	1	—	—	20-20 k	4-16	20	—	1.5	—	1.5	.1	—	—	yes	yes	yes	15 1/4	5 3/4	12 1/4	149.95	—	—
KN-975	37.5	22	.5	.25	1	20-25 k	22 k	4-16	—	—	.4	—	3.5	.25	low	yes	yes	yes	13 3/8	4 1/2	12 3/4	149.95	—	14.95
KN-960	25	17	1	.5	1	25-20 k	20 k	4-16	—	—	2.5	—	2.5	.25	low	yes	no	no	13	3 3/16	10	99.95	—	14.95
KG-895	60	40	.5	.5	1	20-20 k	18-30 k	4, 8, 16	11	—	2.5	—	2	.25	low	yes	yes	yes	16 3/4	5	15	—	149.95	19.95
KG-870	35	28	.5	.3	1	25-18 k	20-25 k	8, 16	17.5	—	3	—	2	1	low	yes	yes	yes	13	2 3/4	11	—	99.95	12.95
KG-854	27	17	1	.5	1.5	25-20 k	20-25 k	8, 16	17	—	3	—	2.5	.5	low	yes	no	yes	13	2 3/4	11	—	79.95	12.95
KG-320	16	12	1	.7	1.5	25-18 k	8, 16	—	—	—	3	—	2.5	.4	low	yes	no	no	10	2 3/4	8 1/2	—	59.95	9.95
LA-248	25	20	1	—	—	20-20 k	4, 8, 16	—	no	2	100	3	.9	low	yes	no	yes	13 7/16	4 7/8	10 3/4	84.95	—	inc.	
LA-224T	15	12	1	—	—	20-30 k	20 k	4, 8, 16	—	no	3	—	—	.25	low	yes	no	no	10 1/4	3 11/16	7 13/16	59.95	—	inc.
LA-90T	45	36	1	.25	—	20-50 k	30-50 k	4, 8, 16	20	no	2.5	120	3	1.75	low	yes	yes	yes	13	3 3/4	9	129.95	—	inc.
LA-60T	30	24	1	.3	—	30-43 k	30-40 k	4, 8, 16	23	no	2	80	3	150	low	yes	yes	no	13	3 3/4	9 3/8	99.95	—	inc.
SA-600	—	40	.075	.075	.2	10-130 k	10-130 k	4-16	23	no	4	—	2	.25	8, up	yes	yes	no	10 1/2	5 1/4	13 1/2	345.00	—	15.00
STEREO 30	15	8	.1	.1	—	30-20 k	4, 8, 16	60	—	3.5	3.5	3	.1	no	yes	yes	yes	yes	13	4 1/4	9	249.50	—	inc.
MA-5100	65	40	.05	.05	.1	20-20 k	10-80 k	4, 8, 16	100	no	2.5	—	2	.3	low	yes	yes	yes	16	5 7/16	14 1/2	449.00	—	29.00
AM-280	30	22	.1	.56	1	50-20 k	20-20 k	4, 8, 16	20	no	2.5	100	3	.12	4-8	yes	yes	yes	14 1/4	4 1/4	10	109.98	—	inc.
AM-272	7.5	5	3	1.8	2.8	40-20 k	4, 8, 16	—	no	—	160	—	—	.16	—	—	—	—	10 3/8	2 3/4	6 3/4	34.98	—	inc.
A700	35	—	.5	.5	—	15-50 k	50 k	4-16	—	yes	2.8	—	1.2	—	180	yes	yes	yes	—	—	—	229.95	—	—
A300	20	—	.5	.5	—	15-40 k	40 k	4-16	—	no	2.5	—	1.2	.18	180	yes	yes	yes	—	—	—	179.95	—	—
299T	32.5	18	.8	.5	2	25-20 k	18-25 k	4, 8, 16	20	no	5.9	—	no	.5	low	yes	yes	scr.	15 3/16	4 13/16	12 1/4	199.95	—	13.95
260e	60	40	.8	.5	2	20-20 k	15-30 k	4, 8, 16	20	yes	3	—	2	.5	low	yes	yes	yes	15 3/16	4 13/16	12 1/4	279.95	—	13.95
9900-2	70	60	.3	.15	1	12-35 k	50 k	4-16	30	—	1.8	—	1	.25	low	yes	yes	scr.	14	4	10 1/2	229.50	—	7.50
9500	40	30	.3	.15	1	12-35 k	50 k	4-16	25	—	1.8	—	1	.25	low	yes	yes	scr.	14	4	10 1/2	179.50	—	7.50
9000-2	80	60	.25	.1	.5	12-35 k	50 k	4-16	40	—	1.8	—	1	.25	low	yes	yes	yes	14	4	12 1/2	309.50	—	8.50
TA-1120	50	—	.1	.05	.3	—	10-100 k	4-16	70	no	4	—	1	.002	no	yes	yes	yes	15 3/4	5 3/4	12 1/4	399.50	—	inc.
1485	37.5	15	5	1.5	—	20-20 k	8	—	no	5	100	—	.7	no	yes	no	no	no	13 3/8	5 1/4	10 3/4	99.50	—	inc.

*LK60 is kit version, \$199.95; metal cabinet, \$13.95; wood cabinet \$24.50.

is merely a means of indicating how much input signal will be required for full power output to be achieved. In terms of the user facing the problem of "matching" a tuner or tape- or record-playing equipment to a given amplifier, this specification takes on increasing importance. As an illustration, suppose a given amplifier requires 1 volt of signal (with volume control fully turned up) to produce rated power output. If an FM tuner were to be connected to this amplifier and if the tuner's maximum voltage output were only 0.5 volt, the amplifier could, at best, be driven to only *one-fourth* its potential power-output capabilities. Under such circumstances, one might just as well have bought an amplifier having a far lower power rating, since full power will never be utilized because of improper matching of the tuner to its power amplifier.

Hum and Noise

All electronic devices powered from an a.c. source (usually having a frequency of 60 Hz) will reproduce a small amount of unwanted hum (at 60 Hz, and often at multiples of this frequency as well). In addition, both tubes and transistors used in amplifying circuitry generate a small amount of random noise at all audible frequencies. These extraneous sounds detract from program enjoyment if they represent a significant percentage of the total sound output of a system. Means of stating hum and noise (as a number of decibels below rated output) have now been standardized by the Institute so as to give a meaningful indication of the audible significance of such undesired sounds. As before, the greater the number of decibels stated in connection with the signal-to-noise and hum rating, the better the amplifier in this regard.

Total Harmonic Distortion

The rich harmonies of music and the characteristic tonal quality of musical instruments are largely the result of the presence of harmonics. Hi-fi amplifiers, on the other hand, are not musical instruments and should not insert their own tone color into the sound being handled. The job of the audio equipment is to reproduce, as exactly as possible, the original quality of the sound. This task is far from simple since only absolutely perfect equipment is entirely free from all types of distortion which alter the nature of the sound signal.

Harmonic distortion occurs when the audio system being used alters the shape of the input signal the same way that it would be altered if harmonics of the input frequency were deliberately added at the input.

The distortion factor is the ratio between the total r.m.s. value of all the harmonics to the total r.m.s. value of the fundamental plus all harmonics. When this factor is expressed as a percentage, it becomes a measure of the total harmonic distortion (THD). The numerical value attached to THD usually does not specify which harmonic (or harmonics) is producing the THD.

It is common to make THD measurements throughout the entire range of the audio system under test. Such measurements impose a severe test of the system because it is far more difficult to handle the very low and very high frequencies with a minimum of distortion than it is to handle the mid-frequencies.

It is also common to make the THD measurements over a wide range of output powers, up to the full rated output. In general, as the output power is increased, so is the amount of distortion. Usually the increase is smooth and gradual up to the overload point where there is a sudden jump in distortion. Amplifiers should be rated at a power just below this overload point, while the THD is still a low figure. In the case of preamplifiers, measurement is frequently made with certain prescribed input and output voltages.

As a quality figure, then, the less the amount of THD

specified (the lowest percentage figure) the better.

IM Distortion

When two different frequencies are applied to a perfectly linear device (one whose output varies directly in accordance with the input), the output of the device will contain only these two frequencies. However, if there is any non-linearity within the system, then one of the input signals will be affected (modulated) by the other. When this modulation takes place, additional frequencies will be generated. These additional frequencies are not necessarily harmonically related to either of the original frequencies. What is more, harmonics of the original two frequencies can combine with each other to produce still other frequencies. Since none of these frequencies was originally introduced into the amplifier, but exists at the output of the amplifier, then the amplifier has introduced distortion. This is called intermodulation distortion or IM.

The amount of this IM distortion is the r.m.s. sum of all the internally generated signals, expressed as a percentage of the modulated signal. Usually, the two frequencies used are 60 Hz and 7 kHz, having a relative amplitude ratio of 4:1, respectively.

In general, when an amplifier has low IM, it also has low THD, and conversely, when the IM is high, the THD is also high. However, it must be remembered that these two methods of measuring distortion are quite different, so it is logical to expect that the percentage figure for IM and THD will not be the same.

As in THD measurements, the lower the IM specified (the lowest percentage figure), the better the system.

Secondary Specifications

Many other completely defined specifications appear in the new IHF amplifier standard, and the reader having sufficient technical interest to acquaint himself with the entire standard can procure a copy of "IHF Standard Methods of Measurement for Audio Amplifiers" (IHF-A-201, price \$2.00) by purchasing it directly from the Institute of High Fidelity, Inc., 516 Fifth Avenue, New York, New York 10036.

Even the non-technical music lover intent upon assembling a quality stereo music system can take comfort in the fact that an increasing measure of uniformity of published specifications has finally come to the high-fidelity component industry after nearly two decades of arbitrary and confused specification writing. Certainly, all the published specifications cannot replace the prospective buyer's aural acuity in auditioning amplifiers. Intent, patient listening tests will always be the first step in the selection of an amplifier. Also, as has already been implied, an amplifier must not be chosen out of context with the remainder of the proposed system. Sources of programs to be used in conjunction with the amplifier must be regarded in terms of their compatibility. Loudspeaker system selection, as well as room size and acoustics, still weigh heavily in determining power requirements for amplifiers. Bear in mind that ratios of as much as 10:1 in loudspeaker efficiency of the commercially available speaker systems reflect equally wide power requirements for companion amplifiers.

Fortunately, during the past couple of years, better performance loudspeaker systems have become available at a much lower cost, with the result that the mediocrities and poor performers are being driven from the market. Besides improved performance, most modern loudspeakers are designed to complement the decor of almost any home.

Careful reading of standardized specifications, however, coupled with intelligent auditioning and attention to the other details listed in this article, will result in a rewarding experience in home musical enjoyment and many years of trouble-free performance, thanks to the new generation of amplifiers. ▲

PERCENT MODULATION NOMOGRAM

By MAX H. APPLEBAUM
Warwick Electronics Inc., Pacific Mercury Div.

A simplified method of determining the percentage of amplitude modulation by use of a straightedge.

IN AM transmitters, it is necessary to check the percent modulation so that the limits set by the FCC are not exceeded. The methods of obtaining the waveforms are not discussed here since they can be found in any standard text. This nomogram does, however, offer a simplified means of determining the percent modulation from the waveforms.

Fig. 1 shows a series of oscilloscope patterns of an r.f. carrier being amplitude-modulated by a sine wave. Fig. 2 shows a series of trapezoidal patterns of the same waves. *Percent Modulation* (M) = $[(A - B)/(A + B)] \times 100$ where A is the crest amplitude and B is the trough amplitude. The values of A and B are measured from the oscilloscope patterns.

M is found by extending a straightedge from the measured

value of A on its scale to the measured value of B on its scale. The percent modulation is found where the straightedge crosses the diagonal scale. A and B may be in any units as long as both are measured in the same units.

Example. Find the percent modulation of a wave whose crest amplitude is 6.3 centimeters and whose trough amplitude is 2.7 centimeters.

Solution: Extend a straightedge from 6.3 on the A scale to 2.7 on the B scale. The straightedge crosses the M scale at 40 which is the percent modulation.

(Note: For symmetrical modulation, the above equation produces the same results as the equations: $M = (A - C)/C$ or $(C - B)/C$, where C = carrier amplitude.) ▲

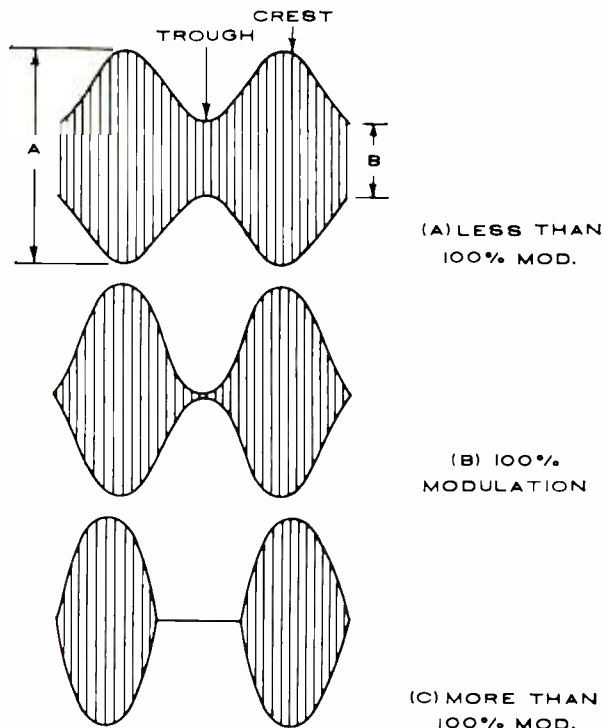
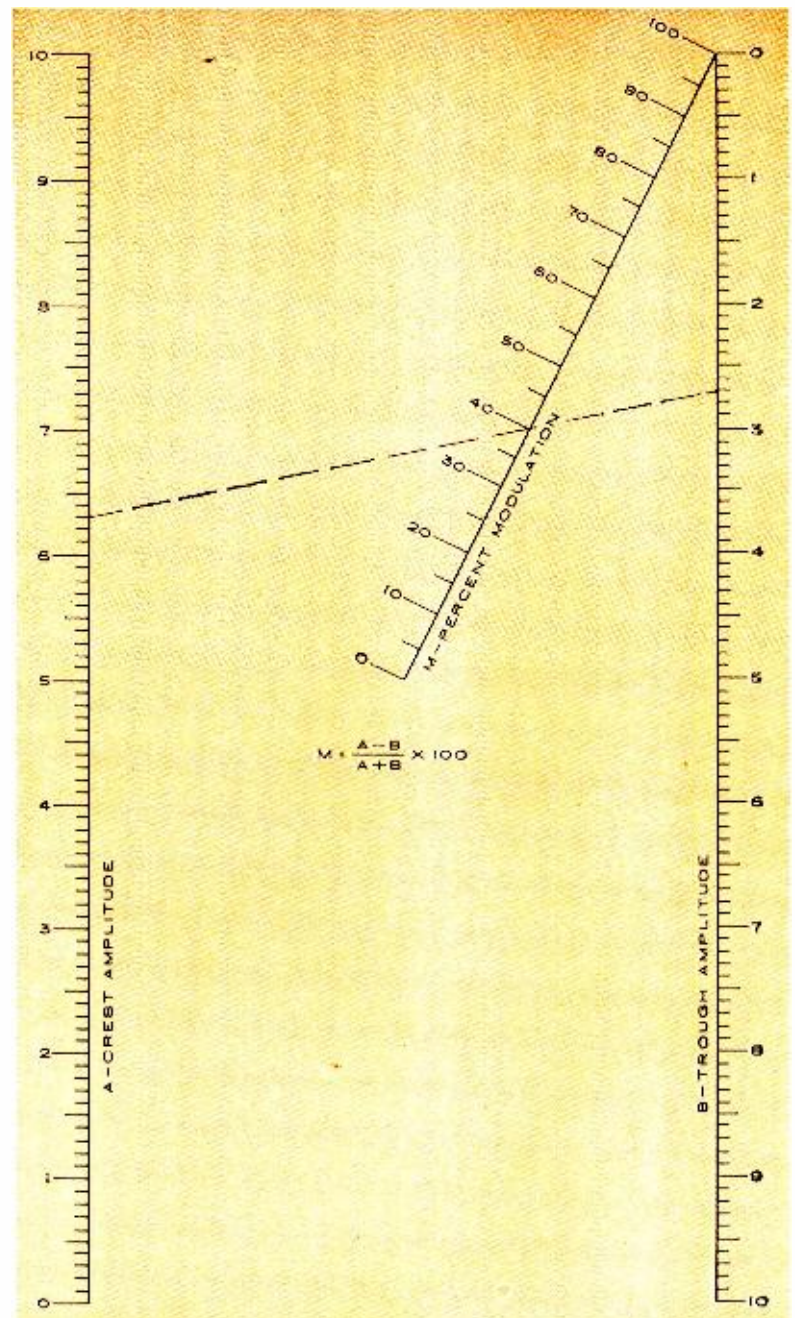
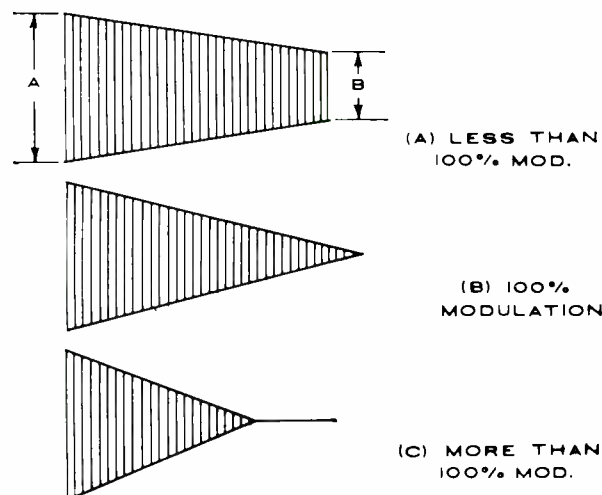

Fig. 1. Amplitude modulated r.f. carrier waveforms.
Fig. 2. Trapezoidal modulation patterns seen on scope.



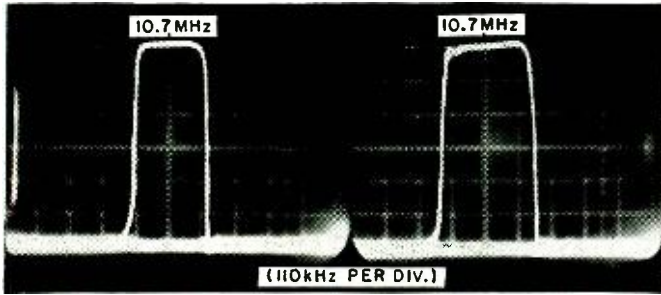

Fig. 2. Over-all, i.f. bandpass of AR-15 receiver with normal input signal (left) and with much higher amplitude input (right).

occurs with an input signal amplitude to the CA3012 of approximately 600 microvolts. At signal levels above this amplitude very little change in output occurs, giving a sharply defined limiting characteristic to the over-all i.f. strip.

While this sharp limiting characteristic is ideal from a noise rejection standpoint, it did create a problem with regard to a.g.c. Because of the extremely high gain through the i.f. strip and front-end of the AR-15, only a very minute signal drives the i.f. strip into limiting. Once in limiting, the output of the integrated circuit varies only slightly; hence, not enough variation in voltage occurred at the detector between weak and strong stations to provide an effective a.g.c. voltage. Even moving back as far as the output of the first IC did not solve the problem. Limiting occurred too soon to obtain proper a.g.c. action.

This problem was overcome by adding a conventional stage of gain immediately ahead of the first IC. This stage serves the twofold purpose of supplying signal to the a.g.c. amplifier as well as to the signal-strength meter amplifier. Since this stage does not limit, its output can be used to develop the required a.g.c. voltage which is then fed back to the FM front end for automatic gain control.

When a conventional tuned i.f. stage is driven into limiting by strong station signals, the result is to effectively increase the over-all bandpass. Excessive bandwidth will result in increased noise, adjacent and alternate channel interference, and poor selectivity. By designing a very sharp, narrow bandpass, this condition is minimized, but at the expense of attenuated sidebands under weak and moderate signal conditions. This results in high distortion and poor stereo reception.

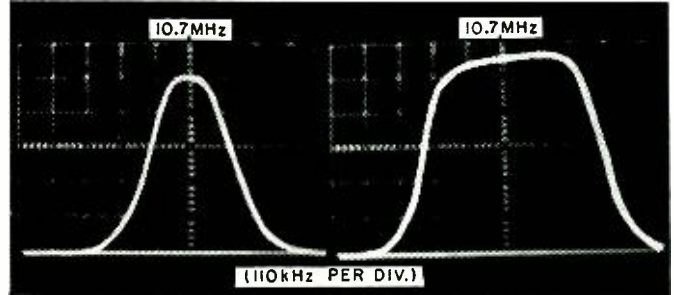

Fig. 3. Over-all i.f. bandpass of another receiver with normal input signal (left) and with much higher amplitude input (right).

Ideally, the i.f. bandpass response would be flat-topped with vertical sides under all signal conditions and would have linear phase-shift characteristics throughout its pass-band. The bandpass of the AR-15 is a very close approximation of the ideal. Fig. 2 is a photograph of the receiver's over-all FM receiving section bandpass. Fig. 3 is a photo of the bandpass of another solid-state receiver, taken under identical conditions.

Crystal Filters & FET's

The bandpass characteristics of the receiver were achieved by utilizing the high gain and excellent limiting characteristics of the IC's in conjunction with specially designed quartz-crystal filters which replace conventional i.f. tuned circuits. These filters are not to be confused with the ceramic filters currently in wide use in low-cost AM receiver i.f. circuits. This design eliminates the need for i.f. alignment, with the exception of the detector. More importantly, however, the filters provide a steep-skirted, flat-topped bandpass with negligible deviation from perfectly linear phase characteristics at all signal levels. The end result is improved performance on both FM mono and stereo reception.

Field-effect transistors (FET's) are used in the FM front end of the receiver. Unlike the common transistor, the FET is a high-impedance device and is especially adaptable to high-"Q" circuitry.

One problem encountered in r.f. designs using transistors is that of impedance matching. To perform with maximum efficiency, the resonant circuits used for signal transfer must operate into a high impedance. Transistors, being low-impedance devices, tend to (Continued on page 61)

Fig. 4. Schematic of integrated circuit used. Note that the signal-flow path is shown by means of the heavy lines.

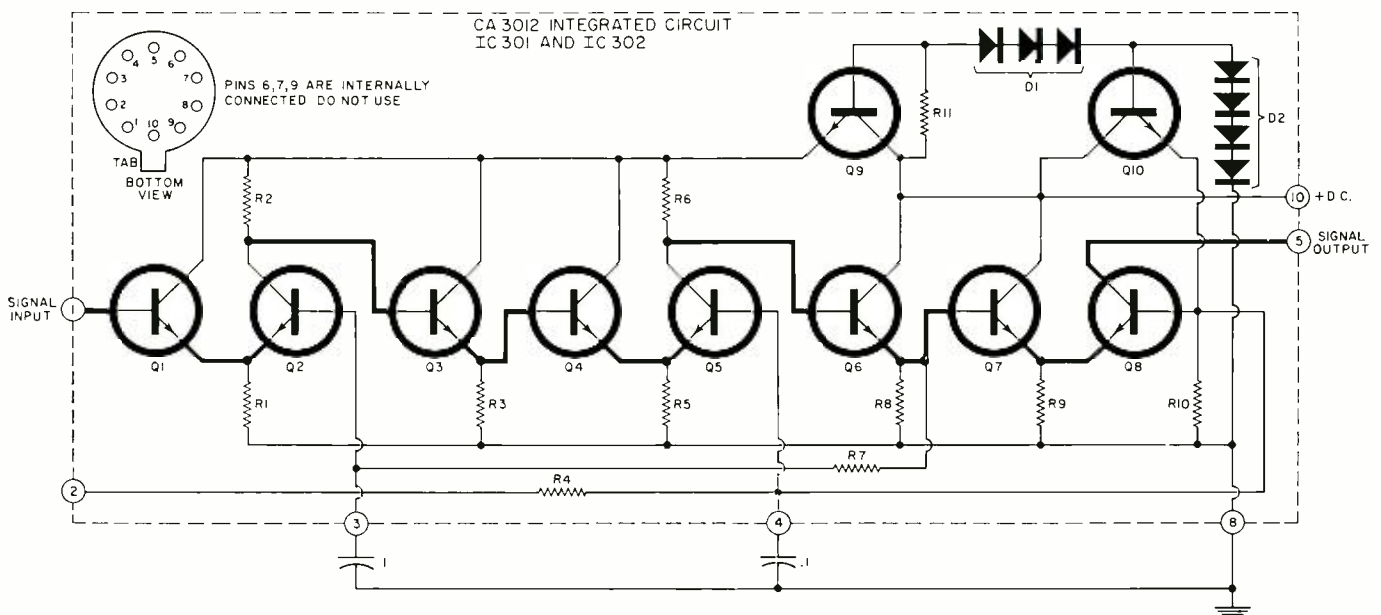

Pulse-Counting Detector for FM Tuners

By A. H. SEIDMAN
Contributing Editor

Here is a hi-fi innovation—a circuit used in the new Fisher tuner that has 10-MHz bandwidth, a capture ratio of only 0.5 dB, and with no tuned circuits that can go out of adjustment.

AN innovation which may set a new trend in hi-fi tuners for the industry has been introduced by *Fisher Radio*. In the new Model TFM-1000 FM tuner (*see photo on cover—Ed.*), the manufacturer has come up with a sophisticated limiter-detector circuit that looks like a hi-fi man's dream. It features a *pulse-counting detector* in a circuit that contains seven transistors and numerous diodes. The tuner costs more than most standard units—but it also buys more performance. Here are some of the features:

1. The tuner displays nearly perfect linearity over a 10-MHz bandwidth.
2. Total harmonic distortion is less than 0.2%.
3. It has a capture ratio of only 0.5 dB compared with an average of 3 dB for other tuners.
4. Since no tuned networks are used, the tuner exhibits excellent operating stability.
5. No critical adjustments are necessary.
6. The circuit lends itself to future IC fabrication.

Background

To appreciate the differences between conventional limiter-detectors and the new circuit, a look at some operating features of standard circuitry is in order. Consider first limiting which is necessary for removing any amplitude variations that may be present on the FM signal. One major source of amplitude modulation is static, which may be either atmospheric or man-made, as in the case of automobile ignition. The other source is in the front end. No practical component exhibits perfect signal response and, as a result, some AM is produced in the tuner itself. If insufficient limiting exists, the output will be distorted by the presence of AM. With some types of detectors, no limiting stages are required while others may use up to two cascaded limiters. *Fisher* uses three transistors and six diodes to provide symmetrical limiting.

The conventional FM detector, or discriminator, frequently uses a balanced tuned circuit. The circuit is tuned to the intermediate frequency, and it is so designed as to produce the famous "S" curve, which relates output audio voltage to frequency. These tuned circuits have to be aligned and even when perfectly aligned, the "S" curve may not be perfectly linear. The transistor pulse-counting detector eliminates the need for alignment and the circuit provides nearly perfect linearity.

In order to economize (for example, by removing the limiter stage), the ratio detector and the gated-beam tube (6BN6) detector were developed. Although the gated-beam tube detects by counting pulses, it

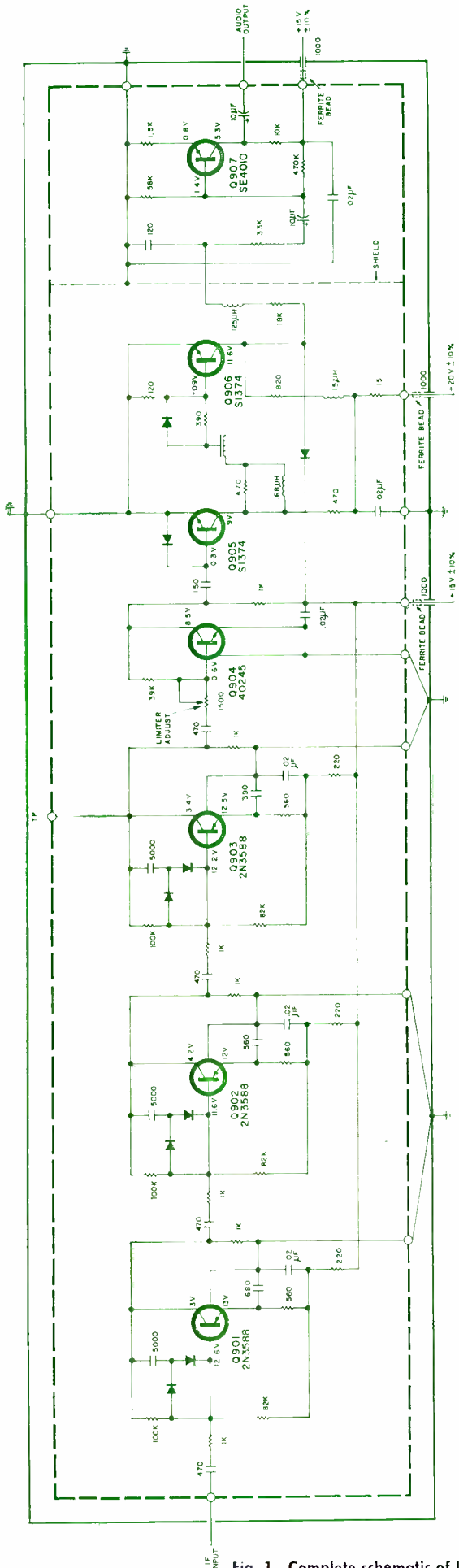

Fig. 1. Complete schematic of limiter/pulse-counting detector circuit as used in TFM-1000 tuner.

does not provide over-all performance comparable with the new circuit.

For proprietary reasons, Fisher will not talk about the operation of its new circuit. However, this development is so exciting and significant for the hi-fi enthusiast that we have decided to make our own analysis of the circuit for the benefit of our readers. All new developments have a prior history. In regard to this circuit, an important paper by Baghdady (*Proceedings of the IRE*, April, 1958) and work done by Arguimbau and others (see "Vacuum Tube Circuits and Transistors" by Arguimbau & Adler, 1956) appear to have provided the theoretical groundwork for the development of the circuit. In addition, this type of circuit is being used in some telemetry receivers and in some British FM tuners. Based on these works and a very careful analysis of the circuit schematic, the operation of the limiter-detector is presented. To the best of our knowledge, the description given below is accurate.

The Circuit

A block diagram of the limiter-detector circuit is given in Fig. 2, while the complete schematic is shown in Fig. 1. (It is important to note that the circuit is preceded by an i.f. section with five wide-band i.f. stages.—Editor) The limiter is composed of three transistor stages, each stage having the configuration of Fig. 3A. Diodes D1 and D2 are silicon and their cut-in or threshold voltage at room temperature is approximately 0.6 volt. This means that a minimum of 0.6 volt has to be impressed across the diode before it conducts.

When the positive half of the incoming signal is 0.6 volt or greater, diode D1 conducts and the output is clamped to 0.6 volt. Diode D2 takes care of the negative half-cycle and its output is clamped to -0.6 volt. This diode arrangement results in symmetrical clipping, or limiting, which is essential for minimum audio phase distortion in the output signal. The transistor provides a small voltage gain (on the order of 3) for signals lower in amplitude than the clamping level.

Before proceeding further with the operation of the limiter, the significance of capture ratio will be considered. Capture relates to the ability of an FM tuner to accept the stronger of two signals of the same frequency while rejecting the weaker one. The weaker signal has the effect of amplitude modulating the stronger FM signal and thereby causing audio distortion. Capture ratio, expressed in decibels, denotes how effective the tuner is in rejecting the unwanted or weaker signal. A low dB capture ratio figure indicates that the tuner is capable of rejecting a signal only slightly lower in amplitude than the desired, or stronger, signal.

To achieve a capture ratio of 0.5 dB, two conditions have to be satisfied in the limiter circuit. These are: (1) Amplitude modulation must be suppressed by 95%. (2) The bandwidth of the limiter-detector must be at least 6 MHz. To allow a "margin of safety," Fisher specs the circuit for a 10-MHz bandwidth.

Amplitude modulation suppression will be examined first. Assume the input FM signal is highly amplitude-modulated, as shown in Fig. 3B. This may be the result of a weaker signal amplitude modulating a stronger signal of the same frequency. After going through the first limiter stage, the output may appear as indicated in Fig. 3C. Cycles of the input signal of lower amplitude than ± 0.6 volt are amplified; the other cycles are limited to ± 0.6 volt. The signal goes to the next two limiter stages where it is further amplified and limited in the same manner as in the first stage. The resultant waveform is shown in Fig. 3D. It is seen that virtually all of the AM has been removed and a near-ideal FM signal is ready for detection.

The other condition to be satisfied in obtaining a capture ratio of 0.5 dB is bandwidth. As the signal is successively limited, new frequencies are produced. It is essential that

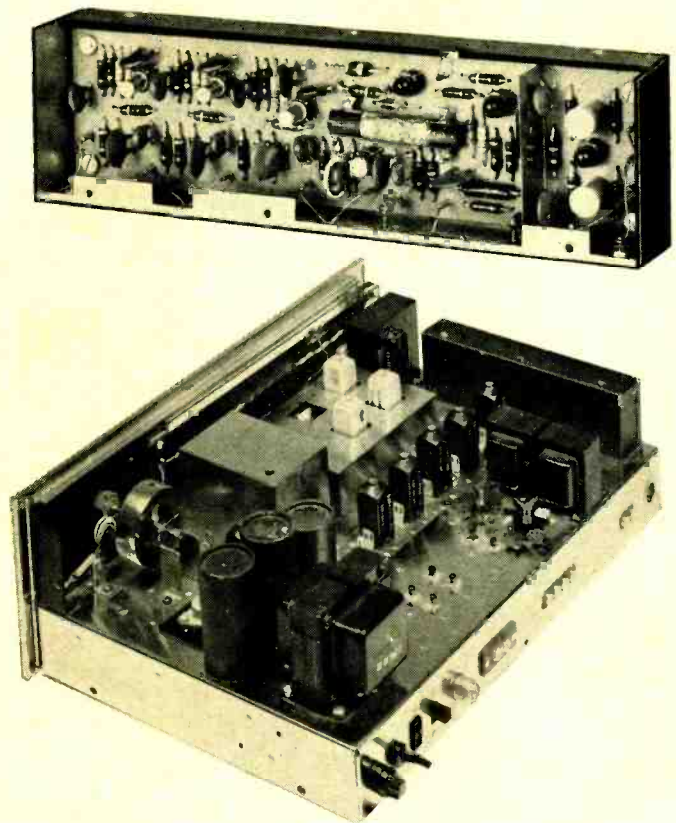

(Top) Inside view of the pulse-counting detector and limiter section described here. This assembly is mounted in the dark, closed rectangular housing along the right-hand side (as viewed from rear) of the chassis of the tuner shown in bottom photo.

these frequencies be "kept" during the limiting process for low output distortion. Thus the need for a large over-all bandwidth of 10 MHz.

If the over-all bandwidth is 10 MHz, then each amplifier in the limiter-detector must have a bandwidth greater than 10 MHz. Like vacuum tubes, a transistor has input capaci-

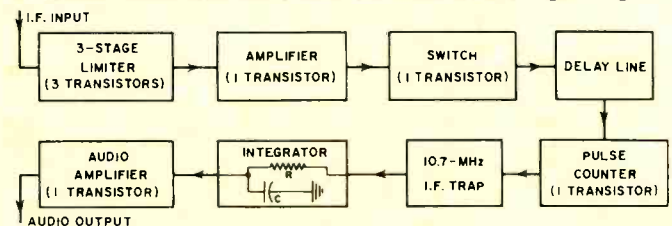
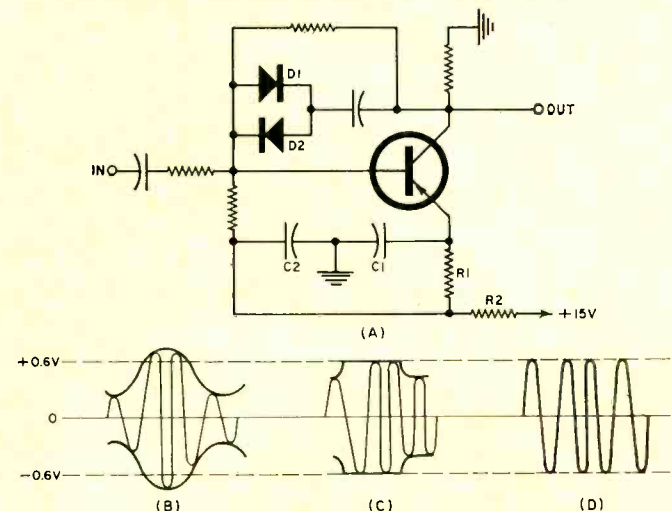

Fig. 2. Block diagram of the new Fisher limiter-detector circuit.

Fig. 3. (A) Limiter-stage circuit. (B) Input signal which is highly amplitude-modulated. (C) Output of first limiter stage. (D) Output of last limiter stage. Ninety-five percent of the amplitude modulation on FM signal has been completely removed.



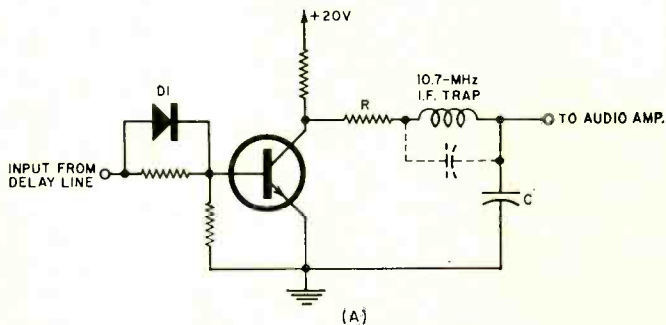

Fig. 4. (A) Simplified schematic of pulse-counting detector. (B) Ideal output pulse at collector of transistor counter. (C) The actual stretched-out waveform due to transistor storage time.

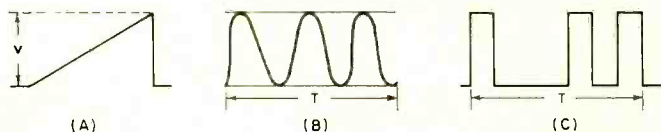

Fig. 5. Example of pulse-counting detection. (A) Modulating waveform is a triangular wave. (B) What the FM wave may look like. (C) Output pulses at the collector of pulse-counting transistor.

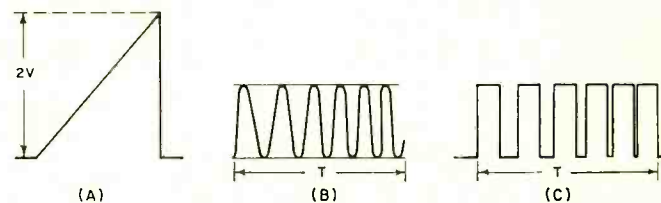

Fig. 6. This shows a greater magnitude of modulating signal. (A) Triangular wave now has peak amplitude of 2V volts. (B) The FM waveform. (C) Twice as many pulses are now counted than for the case where amplitude of the triangular wave was V volts. (In Figs. 5C and 6C, the output pulses are actually negative-going. They are shown inverted to make comparison simpler.)

tance and feedback capacitance between the output (collector) and input (base). These capacitances act to decrease the gain at higher frequencies and the bandwidth is reduced. The emitter network of Fig. 3A, made up of resistors R1 and R2 and capacitors C1 and C2, compensates for the transistor capacitances and the necessary stage bandwidth is thereby realized.

Pulse-Counting Detector

The limited waveform is amplified and applied to a transistor which serves as a switch. For every cycle impressed across the switching transistor, a pulse is sent into a coil delay line. The time it takes for the pulse to travel from the input of the delay line and back again is estimated to be on the order of 25 nanoseconds (25×10^{-9} second). During this interval, the transistor in the pulse-counter circuit of Fig 4A is turned on. The 25-nsec delay pulse and diode D1 maintain the base-emitter junction of the *n-p-n* transistor positive, thus ensuring that the transistor is on during the 25-nsec interval.

For the ideal transistor, the collector output would be a rectangular pulse 25 nanoseconds wide and 11 volts in amplitude, as shown in Fig. 4B. The number of pulses produced per unit time is directly related to the amplitude (frequency deviation) of the modulating signal. The greater the signal amplitude, the more pulses per unit time will be

counted by the circuit. Thus, the number of pulses per unit time is directly proportional to the amplitude of the modulating signal.

Assume the modulating signal is the triangular waveform of Fig. 5A, having a peak amplitude of V volts. A triangular waveform is used as an example because the voltage rises linearly with time. This shows, very nicely, the increase in frequency deviation with rising signal amplitude. The limited waveform may appear as in Fig. 5B. This is applied to the switching transistor and delay line. The output of the transistor in the pulse-counting detector, say, results in three pulses. Each pulse has the same width (25 nanoseconds) and height (11 volts); that is, their areas are the same. The resulting pulses are spaced in a time interval, T, as shown in Fig. 5C.

Consider Fig. 6A which shows the same triangular waveform of Fig. 5A, but with twice the peak amplitude, 2V. The output of the limiter will contain twice as many cycles (Fig. 6B) as for the previous case. Therefore, the transistor output of the counter has six pulses for the same interval T, as shown in Fig. 6C. The area of each pulse is the same as for the first example.

The pulses are then applied to the RC integrator in Fig. 4A. Capacitor C charges and its voltage is directly proportional to the number of input pulses to the counter. This voltage is amplified and the audio output is linear with signal amplitude. The total harmonic distortion is less than 0.2%. The trap associated with the integrator filters out the 10.7-MHz intermediate frequency.

To obtain sufficient output from the integrator circuit, high-amplitude pulses from the transistor counter are necessary. In this circuit, the pulse amplitude is approximately 11 volts, peak-to-peak. However, high collector voltage and fast switching characteristics are generally incompatible requirements for a transistor switch. The most significant delay produced by the transistor is the storage time delay. This has the effect of stretching out the pulse, as indicated in Fig. 4C.

The storage time for the transistor used in the circuit may be on the order of 10 to 20 nanoseconds. Assume it is 20 nanoseconds. Therefore, the stretched pulse will have a total width of $25 + 20 = 45$ nanoseconds. The highest possible frequency that the detector can handle for this worst case is $1/45 \times 10^9 = 22$ MHz. This is more than twice as great as the maximum bandwidth of 10 MHz for the circuit and therefore no problem.

Since storage time can be different from one transistor to another of the same type, what effect will this have on the linearity of the output signal? None! The only effect is an increase in audio output. Suppose that in one circuit the transistor used for the counter has a storage time of 10 nanoseconds. The total width of the stretched pulse will, therefore, be 35 nanoseconds. The area of each pulse will be $35 \text{ nsec} \times 11 \text{ volts} = 385 \text{ volt-nanoseconds}$. If the storage time is 20 nanoseconds, the area becomes $45 \text{ nsec} \times 11 \text{ volts} = 495 \text{ volt-nanoseconds}$. This causes the capacitor of the integrator to charge up to a higher voltage than for the 385 volt-nanosecond pulse and more audio signal is available. However, this can be compensated for by the audio gain control. The linearity does not enter into the problem. Indeed, the pulse-counting circuit never goes out of adjustment nor has to be aligned for linearity as is required for conventional circuits.

The pulse-counting circuit is a remarkable innovation in hi-fi tuners. Perhaps if only vacuum tubes were available, this unit would never have been developed. Because transistors are so small and efficient, the use of seven transistors does not present any serious problems. With the greater availability and lower cost of integrated circuits, other innovations in hi-fi equipment are on the horizon. Already this limiter-detector appears to be a likely candidate for transformation into an integrated circuit. ▲



Front-panel view of new "T-circuit" integrated stereo amplifier unit.

Operational Amplifier Circuit for Hi-Fi

By B. N. LOCANTHI / Vice President, Engineering, James B. Lansing Sound, Inc.

Technical details on the "T circuit" as employed in the new JBL ultra-low distortion audio power amplifier.

AS we gain more and more insight into the performance of the human ear, the design of sound recording and reproducing apparatus grows correspondingly more sophisticated. Whereas the critical audiophile was once satisfied if his power amplifier could produce 10 watts at 1000 Hz with less than 1% distortion, he now expects at least 25 watts per stereo channel with less than 0.5% distortion at any frequency from 20 to 20,000 Hz.

By making full use of today's electronic technology, it is possible to build an audio amplifier of such quality that its complete performance cannot be accurately measured, even with the best test equipment presently available. The "T circuit" developed by the author is such an amplifier.

In a number of respects, the "T circuit" is unusual, and a United States patent is pending on the circuit. The basic design philosophy, however, is an old one worth restating. We believe that an amplifier should be designed for low distortion and wide bandwidth *without feedback*. Negative feedback is then added to make an already good design perform even better; it is *not* used to "clean up" problems in the basic design.

Some engineers think this is an old-fashioned idea. They feel that by using great amounts of negative feedback, desired performance can be obtained even from essentially non-linear amplifying circuits, and that it is the performance of the complete design that counts. This approach can result in an amplifier which has impressive figures in all of the standard specifications but which develops serious performance faults when more elaborate testing techniques are used.

In the circuit to be described, the operating parameters of every stage are chosen for maximum transfer linearity, which is just another way of saying lowest possible distortion. And the operating mode of each stage is held constant, irrespective of signal level. This means that we don't "shift gears" to take care of varying power levels, nor do we

try to make the circuit "pretend" it is doing something which in fact it is not.

The Amplifier Circuitry

The output circuit of the amplifier (Fig. 1) consists of three cascaded complementary-symmetry emitter-follower stages. The configuration has somewhat the appearance of a bridged-T circuit, which accounts for its name.

The advantages of the complementary-symmetry emitter-follower output stage, using one *p-n-p* and one *n-p-n* transistor, are well known. Its output impedance is low so that loads in the 4- to 16-ohm range can be driven without the need for an output transformer. Transistor idling current can be controlled so that the efficiency of class-B operation is approached but without the notch distortion common to class-B amplifiers.

Most important, the complementary-symmetry configu-

Fig. 1. Three-stage output circuit. Note "T" configuration.

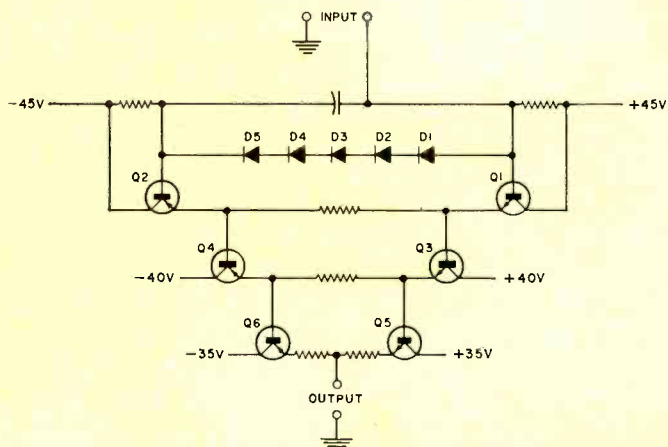

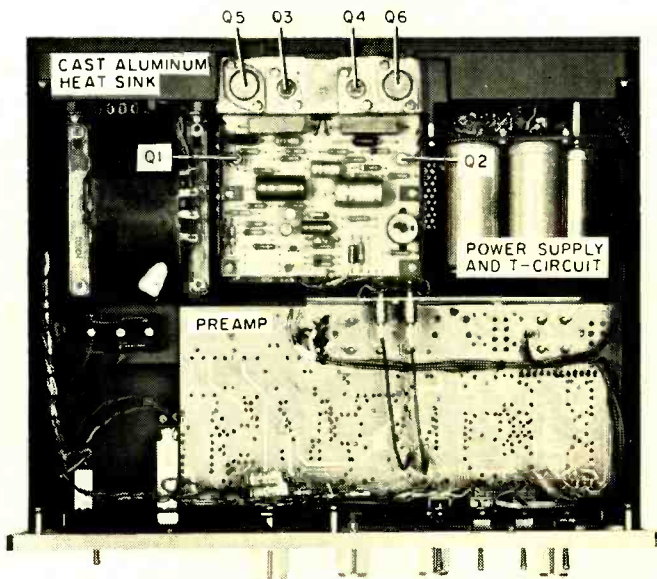

Underside view shows two jumper leads between preamp and amp.

ration does not require a separate phase-splitter stage. When a signal is applied to the common driving point, one transistor draws more current and the other draws less. In the "T circuit," the three cascaded emitter-followers in each group all operate together as if the output circuit were a single stage. (In practice, the transistors are biased close to cut-off so that one group conducts primarily during positive half-cycles while the other group conducts mainly during negative half-cycles.)

What are the special advantages of this arrangement? First, the output circuit has exceptionally low drive requirements. While the emitter-follower has no voltage gain, it does provide considerable power gain. In this respect, it is similar to the familiar vacuum-tube cathode follower. The three output stages multiply output load impedance by a factor of 100,000 as it is reflected back to the collector driving point. Even though voltage gain is less than unity (about 0.9), the power gain of the three stages is therefore almost 100,000.

Another important characteristic of the circuit is its excellent thermal stability. Output transistors Q5 and Q6 are connected directly to a high-current power supply of about 35 volts plus and minus potential. Each base of the output stage has a low-resistance path for the collector-to-base leakage current to flow through its opposite emitter driver stage. Because the input driver collector load resistance is about

9000 ohms and because the output load impedance is multiplied by a factor of 100,000, the d.c. stability factor of the circuit is better than 10. Thus, d.c. thermal runaway problems are essentially non-existent.

A single bias supply consisting of diodes D1 through D5 provides the necessary forward bias for all three cascaded emitter-followers. The bias supply operates at a low current level and dissipates very little signal power, yet it provides all the advantages of diode biasing.

One disadvantage of the circuit is that successively higher collector supply voltages are required for each driver stage to take care of the saturation voltage drops of the preceding transistors. The individual supply voltages are indicated in Fig. 1.

This requirement leads to a rather complicated-looking power supply but not an inordinately expensive one. By using two additional low-current secondary windings for the driver power supplies, a symmetrical "package" is obtained which turns out to be somewhat smaller, physically, than would be expected for an 80-watt amplifier.

Performance of Output Stages

Before going into details of the associated driver stages, let's take a brief look at the performance of the output circuit alone. Because each pair of transistors has a higher *beta* cut-off frequency than the following pair, the over-all frequency limitation of the circuit is determined almost entirely by Q5 and Q6, and the bandwidth of the three cascaded stages turns out to be greater than 100,000 Hz. With this kind of frequency response, the classic textbook rules regarding reduction of distortion and noise by negative feedback do apply, as we shall see a little further on.

Distortion measurements of the output circuit without feedback indicate that at very low signal levels, total harmonic distortion stabilizes at about 0.2% or 0.3% and then increases to about 2.5% at 50 watts output per channel. This certainly is not phenomenal in itself, but remember that we are talking about performance *without feedback*.

An interesting thing happens to our distortion measurements when the driver amplifier is added to the circuit. This is a two-stage direct-coupled differential amplifier consisting of four silicon transistors, Q7 through Q10 respectively (Fig. 2).

The differential driver circuit was chosen for its insensitivity to supply-voltage changes. The symmetry of the output circuit makes it likewise largely immune to a.c. power-line surges.

Measuring the distortion of the complete five-stage am-

Fig 2. Schematic diagram of one of the two identical stereo power-amplifier channels using the new amplifier circuit.

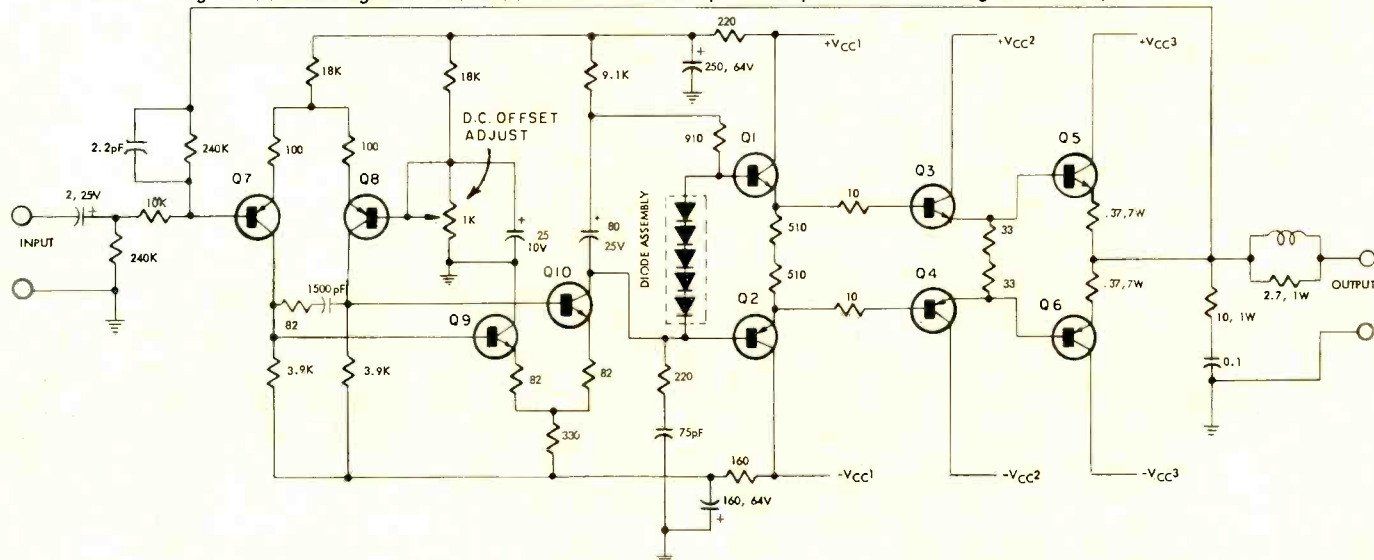

plifier, still without feedback, we find that the figures are lower than for the output circuit alone! Harmonic distortion at 1000 Hz and 50 watts output measures less than 1%. Even at 20,000 Hz the circuit produces only about 1.5% distortion (Fig. 3).

Why should the distortion of the whole amplifier be less than that of the output circuit alone? It may be that the distortions of individual stages tend to be slightly complementary, but the main reason appears to be that we are now driving the output circuit with a partial-current generator instead of a zero-ohms source impedance.

Now let's see what happens when the feedback loop is connected. Fig. 2 is a schematic of one channel of the complete stereo power amplifier. Note that the only coupling capacitor is located at the input and that from this point on the entire power amplifier is direct-coupled. Also note that the feedback loop extends all the way from the output of the amplifier back to the input terminals. No stage, no part of any stage, is left outside the feedback loop.

The circuit therefore falls into the classification of d.c. operational amplifiers, devices that are widely used in telemetry and computer applications. Properly designed, such an amplifier can be made to exhibit unconditional stability under any load condition and to maintain uniform gain and low distortion down to d.c. The marginal stability at subsonic frequencies which afflicts many amplifier designs is notably absent.

When we try to pin down the performance of the complete circuit, a rather interesting problem arises. In essence, the amplifier is as good as or better than any available test equipment. For example, we know that the total harmonic distortion of the amplifier without feedback is about 0.5% at 1000 Hz when the amplifier is producing 30 watts into an 8-ohm load. With a feedback factor of 50, distortion should be reduced proportionately, resulting in a figure of about 0.01%.

But even with the most sensitive equipment and the greatest care in excluding stray signals from the test hookup, distortion can be measured accurately only down to 0.015% or so. Because of this, the measurements graphed in Figs. 4 and 5 are probably accurate only where the curves climb above 0.05%. Until the circuit is driven into clipping, distortion is so low that it cannot be specified with any degree of exactness.

Fig. 6 shows the frequency response of the complete amplifier at 40 watts and one watt and with an open output circuit. The open-circuit response curve cannot be seen because it lies exactly along the one-watt curve, showing that the open-circuit stability of the amplifier is excellent.

The circuit is stable under any passive load, resistive or reactive. The inductor (actually only a few turns of very low resistance wire) in series with the output is sufficient to act as a buffer for certain capacitive loads which might otherwise cause some ringing. Even without the inductor, however, the circuit will not oscillate.

Overload Protection

We have already explained that the amplifier's design makes it largely immune to a.c. line-voltage surges. Its performance when momentarily overdriven is equally impressive. The circuit recovers from a 100% single-cycle overload in less than one-tenth of a cycle—at any frequency from 20 to 20,000 Hz. As far as we have been able to determine, the unit recovers almost instantly from any overload at any frequency inside or outside the audio spectrum.

What about prolonged overload, such as might result from accidentally shorted loudspeaker connections? The output transistors used in commercial versions of this circuit have a d.c. power dissipation capability of about 150 watts each. It should be emphasized that this refers to continuous power, not brief pulses. Because of this high power dissipation capability, no exotic high-speed protective devices are

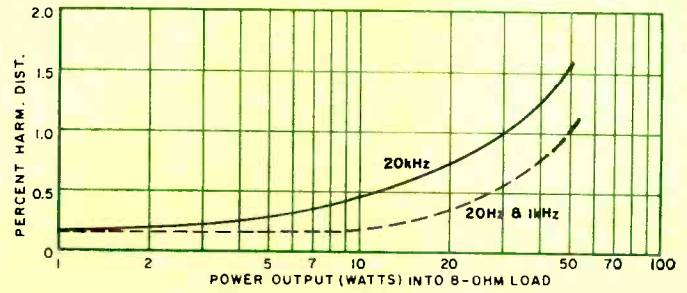

Fig. 3. Harmonic distortion of power amplifier without feedback.

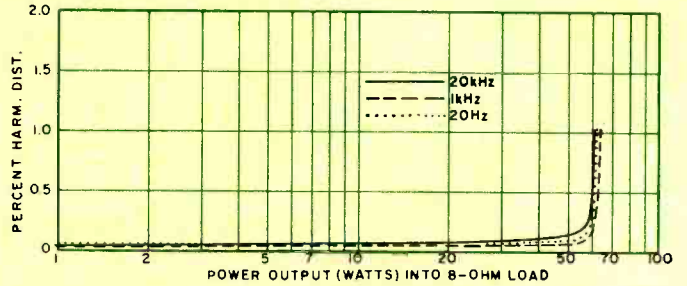

Fig. 4. Harmonic distortion with feedback loop connected.

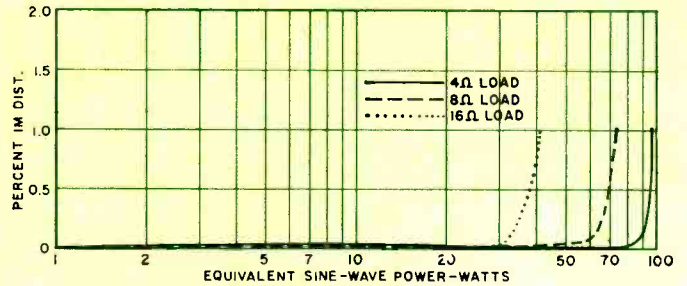

Fig. 5. Intermodulation distortion with feedback connected.

required. The output circuit has a thermal breaker (not shown in the schematic) which opens in one to 60 seconds if excessive current is drawn. This is all that is needed to protect the output transistors in the event of a short circuit.

As long as the amplifier is operated within the maximum current-handling capacity of the output stage, any kind of loudspeaker system, with almost any impedance rating, can be connected without degrading the signal quality.

As described in this article, the "T circuit" is used in the JBL Model SA-600 preamplifier/amplifier. It is also found in JBL Models SE-400S and SE-408S. These are sophisticated power amplifiers called "Energizers" because their performance is tailored to match the requirements of the particular loudspeaker systems with which they are used.

In all three models, however, the "T circuit" provides 80 watts of continuous sine-wave power (40 watts per channel) with both channels operating simultaneously, with power-line voltage as low as 110 volts, and with less than 0.2% distortion at any frequency from 20 to 20,000 Hz. (Also see our "EW Lab Tested" on the SA-600 amplifier in the December, 1966 issue.—Editors) ▲

Fig. 6. Frequency response into open circuit and 8-ohm load. The input coupling capacitor has been shorted out to show the good low-frequency performance of the complete amplifier.

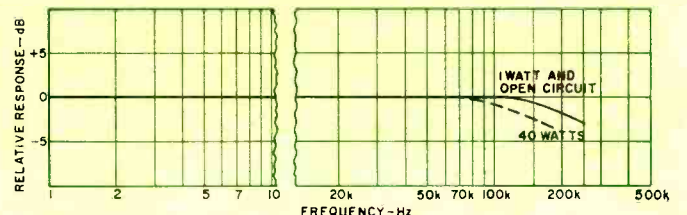

High-Speed Punched-Card Readers

By WILLIAM BARDEN
Scientific Data Systems, Inc.

A new generation reads data at up to 2000 cards per minute by the use of photoelectric techniques and then encodes input data into computer language.

IN the space of two decades, computer speeds have increased a fantastic amount. Today's third-generation computers, which perform literally millions of operations in one second, have far exceeded the speeds of their predecessors. Unfortunately, input devices, the peripheral equipment that translates the "external" data of electric bills, bank statements, sales slips, and the like into a language that the computer can understand, have been limited in their operational speeds simply because they are electro-mechanical devices.

Because input devices operate at a much slower rate than the computers they service, considerable time is wasted as the input section of the computer is forced to wait while it accepts input data. With the large-scale computer systems of today, the maxim "Time is Money" is especially pertinent.

In an effort to increase the input speeds of external data, a new generation of high-speed input devices has appeared. One of the most important of these is the high-speed card reader, an input device that "reads" the familiar punched

cards that are so much a part of our automated life. These card readers read data at error-free rates of up to 2000 cards per minute, a relatively fast clip for a unit that does mechanical handling of this type.

This article will explain the codes used in encoding external data to "input" data on punched cards, a concept which is at least three quarters of a century old, and the operation of the relatively new high-speed card readers that are employed to encode input data into internal machine (computer) language.

Input/Output Devices

Punched-card readers belong to a group of devices called input/output equipment, which a computer system uses. Input and output equipment perform the exact functions their names imply.

Input equipment enables the human operator of the computer to provide data to be processed or stored by the computer. One example of an input unit is a typewriter, a modified version of a standard office machine. Using the special typewriter, for example, an operator types the name "Joe Nelson", thereby encoding the name and reading it into the computer. Another input device is a card reader, in which the punch-coded name "Joe Nelson" on a card is read by the card reader and simultaneously transmitted in encoded form to the computer. With a magnetic tape unit as an input device, each character of the name "Joe Nelson" is represented on a tape by a configuration of magnetized spots which are eventually read and encoded to a form that the computer can use. All external data, such as "Joe Nelson", or "\$115.77" or "Pulaski, Wisconsin", is then encoded to an input form on punched cards, magnetic tape, or other media, read by one of the input devices described or others, encoded to a form that the computer can understand, and sent on demand to the central computer.

The central computer unit performs the programmed instructions on the data and transmits the results to an output device. Examples of output devices are typewriters, printers, or card punches. For the first two units, the output results are printed out directly in alphanumeric or special characters, such as "A", "6", and "#". When an output unit is a card punch, the output is punched on a card in coded form. Output units then decode computer results and produce a directly readable, or indirectly readable, form of the information that the computer supplies.

Input (and output) devices vary in speed and flexibility. A typewriter input speed, for example, is limited by the speed of the human operator; magnetic tape, however, is

Burroughs B129 reads 1400 cards per minute using photocells.



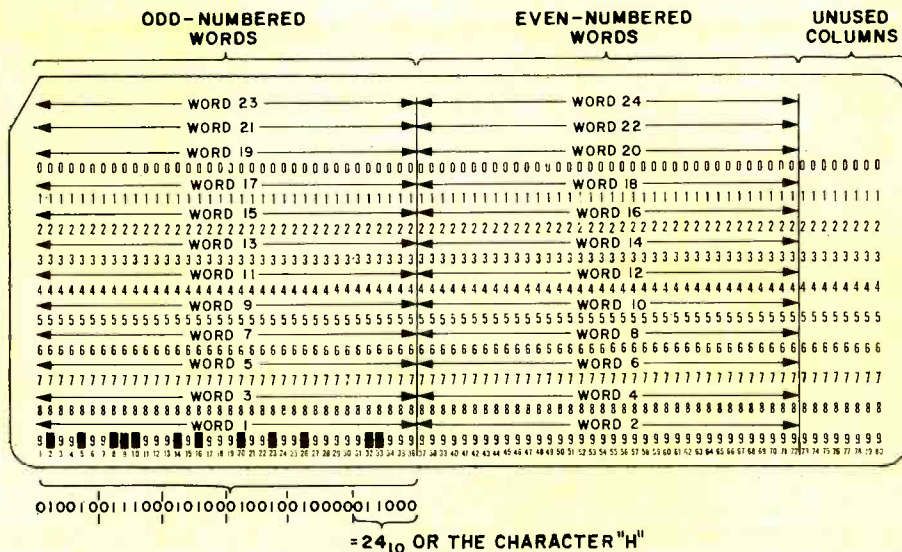

Fig. 2. The IBM card format is shown here with row binary punching employed.

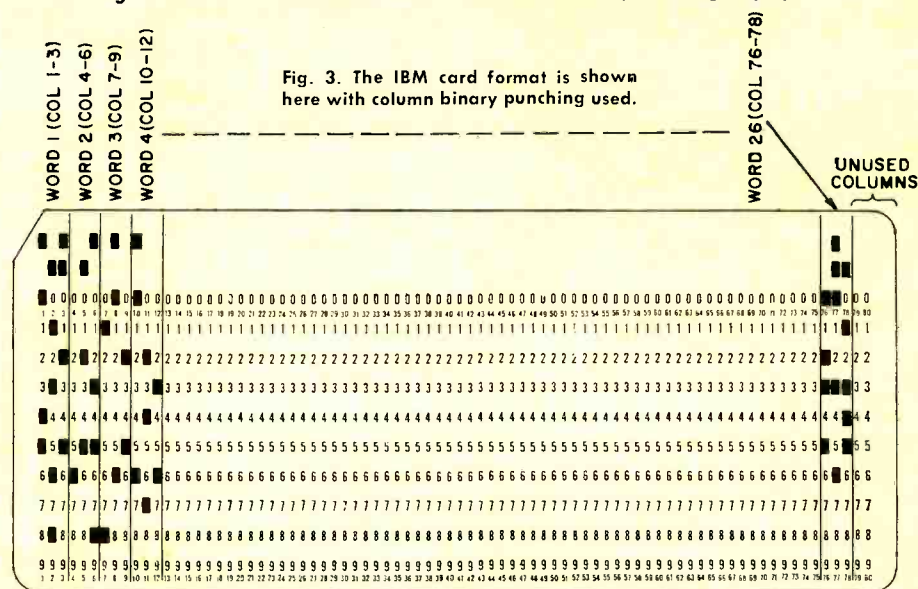

Fig. 3. The IBM card format is shown here with column binary punching used.

row 9 (columns 1 through 36). The second word is represented by the next 36 punching positions in columns 37 through 72, etc. Columns 73 through 80 are blank so that the two words occupy the same relative position.

The last four digits of word number one are 1000, where 1 is represented by a punch hole and a zero by the absence of a punch hole in the punching position. Notice that the most significant digit of this group, the 1, is actually farthest to the left on the card. In the binary number system, the last four digits of this word represent $(1 \times 2^3) + (0 \times 2^2) + (0 \times 2^1) + (0 \times 2^0)$, respectively, or decimal 8.

All 36 bits of the first word are a complete binary number with a decimal equivalent of, say, 1285839. The word, however, does not have to represent a 36-bit binary number. Among other things, it may represent a series of alphanumeric and special characters. What the 36 bits represent is dependent upon the type of coding being used in the computer system and what the equipment has been programmed to read. As an example, one type of coding uses six binary digits to represent the characters. Six binary digits may represent binary values of 000000 to 111111 (decimal values of 0 to 63); 64 different characters may then be represented by the different configurations of the six digits. A 36-bit card word, then, may represent six characters of six digits each. The last group of six digits, 011000, a decimal 24, represents the character "H", the next, another character, etc.

Fig. 3 illustrates another type of binary punching, called

column binary. With this type, the data is arranged in columns, with each column containing twelve bits of a computer word. The first complete binary word of 36 bits would, therefore, be represented by columns 1, 2, and 3 taken together. The meaning of these 36 bits would again be dependent upon the code used by the computer system and the programming; each 36 bits in three columns could represent a decimal number, 6 alphanumeric or special characters, or possibly some other data, such as nine decimal digits (12 groups of three bits).

The most widely used type of punch code is Hollerith encoding. A card encoded in Hollerith can represent up to 80 characters; each column represents one character. The code used is relatively simple: Rows 1 through 9 are called the "numeric" portion of the card. One punch in one of these rows with no punches in another row represents the digits 1 through 9, respectively. A punch in one of the numeric rows and one punch in one of the rows 12, 11, and 0 represent an alphabetic character; rows 12, 11, and 0 comprise the "zone" portion of the card. Special characters such as "\$" or ";" are represented by one punch in the zone portion and one or two punches in the numeric portion of the card. The basic Hollerith code includes 47 characters, but the code may be expanded to include other special characters by other two- or three-punch configurations. Fig. 1 is an example of a card encoded in Hollerith.

Both Hollerith-encoded and binary-encoded cards can be read rapidly and accurately by the high-speed card readers that are used in today's computer systems. Basically, most card readers consist of a mechanism to transport the cards, a reading unit to detect the punch/no-punch condition of the punching positions, an encoding section to encode the reading unit signals to a form acceptable to the computer, and a clock generator to control the input of encoded data into the computer. However, card readers differ in two principal ways, the direction in which the card is moved and read and the type of read unit employed.

One sort of read unit is a brush-contact type, which senses punches by contact of a wiper with a metal plate through a hole in a punching position. Another type is the photo-electric read unit, which senses punches by illumination of a photocell through a hole in a punching position.

To pass a card past the read unit, many card readers move the card widthwise through the machine and read all 80 columns of one row of the card at one time. The output data from the read unit in this case is an example of data read in a "parallel" fashion. When reading column binary data, for example, the two words of data in one row of a card are available at the same instant of time. If the first word of a column-binary-encoded card is the binary configuration representing the six characters "Nelson", for example, the complete set of signals for the full six characters are available at one time, or in parallel.

Other card readers move the cards lengthwise under the read unit and read one column of a card at one instant of time; the adjacent column is read a short time later when

it passes under the read unit. This is an example of "serial" data; complete data for all columns is available in a series of outputs at 80 distinct times. If the characters "Nelson" are encoded on columns 5 through 10 in Hollerith and the card is moved and read lengthwise, a set of signals representing the "N" of "Nelson" is first available, followed slightly later by the "e", and so forth.

With the variations in read units and card movement noted, a representative high-speed card reader employing a photoelectric read unit and a serial reading operation will be discussed. Card movement and a block diagram of this typical card reader are shown in Fig. 4.

The operator stacks the deck of cards to be read into the input hopper. The first card is fed "manually" from the input hopper to an alignment station where it is physically aligned in position. Once aligned and after a command from the central computer to read cards, the first card is moved lengthwise under the read station. At the read station, the read unit transforms the data on the card into electrical pulses. After reading, the card is deposited in a stacker.

During the time the first card is being moved from the alignment station towards the read station, a second card is being fed out of the input hopper and into the alignment station. At the same time that the first card is being deposited in the stacker, the second card is being read, and a third card is moving toward the alignment station. In this manner, a continuous stream of cards is fed out of the input hopper, past the read station, and into the stacker.

The read station is composed of twelve photocells; each photocell has an associated amplifier elsewhere in the card reader assembly. A punch hole in a row of the card allows the photocell over that row to be illuminated. With no punch hole, the photocell for that row remains dark. When a photocell is illuminated, its corresponding amplifier produces a positive voltage output. When the photocell is dark, the amplifier output is at a zero-volt level.

The output of the twelve photocells at the exact time that one column is directly under the read units represents the state of the twelve punching positions of that column. Imagine that the card columns 8, 9, and 10 are punched in Hollerith-encoding to represent the data "Joe". If the time that column 8 is directly under the photocells is called T_8 , the time that column 9 is directly under, T_9 , etc., then the output of the twelve "data lines" from the photocell amplifiers is as shown in Fig. 5.

The data lines go to the encoding section of the card reader. The purpose of the encoding section is to translate the data obtained from the card into the code used by the computer. The type of machine code mentioned earlier was one in which six bits represented all characters used in the computer system. For this machine code, the data on the twelve data lines has to be encoded to an output on six data lines: the six lines represent, respectively, 2^5 , 2^4 , 2^3 , 2^2 , 2^1 , and 2^0 .

Consider the previous example of the punched word "Joe". "J" may be represented in the computer by 100001 (a decimal 33). When column 8 is read,

the 2^5 and 2^0 data lines from the encoding section are at a positive voltage level and the four other lines are at a zero-volt level, as shown in Fig. 5. These lines in parallel represent $(1 \times 2^5) + (0 \times 2^4) + (0 \times 2^3) + (0 \times 2^2) + (0 \times 2^1) + (1 \times 2^0)$, or a decimal 33. In the same fashion, the other characters are represented by the six output lines. Notice that while the data output is in serial form from a character viewpoint (one character presented at a time), each character is represented by a parallel output of data. For the name "Joe Nelson", the six output lines have ten different outputs at ten different times.

Since the outputs for different characters appear at different times, the computer must have a means of synchronizing the reception of this data with its processing. A clock signal generator in the card reader makes the sets of outputs meaningful by supplying a clock pulse at the exact time that each column passes under the read head. For each card that is read, 80 clock pulses are generated; each clock pulse informs the computer that a new column is being read. For a typical card reader, the clock generator is an 80-toothed wheel. As each tooth passes a reluctance pickup, the pickup generates a pulse. The wheel is geared to the card reader drive mechanism so that the clock pulse output is synchronized with the reading of each column.

This article has explained the basic principles of punched-card encoding and high-speed card reading. Although other types of input devices, such as optical readers, are gaining popularity, it appears that punched cards and high-speed card readers will remain the workhorses of input devices for some time to come. ▲

Fig. 4. Block diagram showing the operation of a photocell reader.

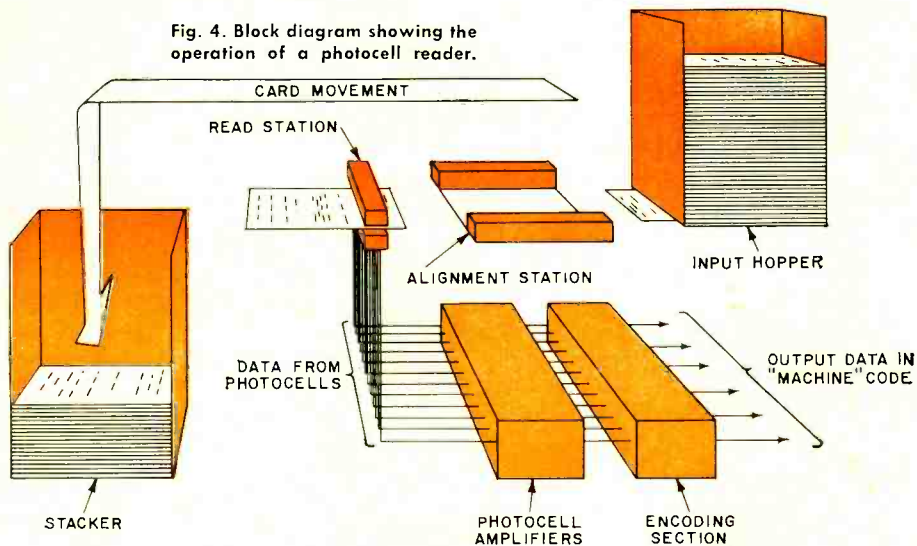
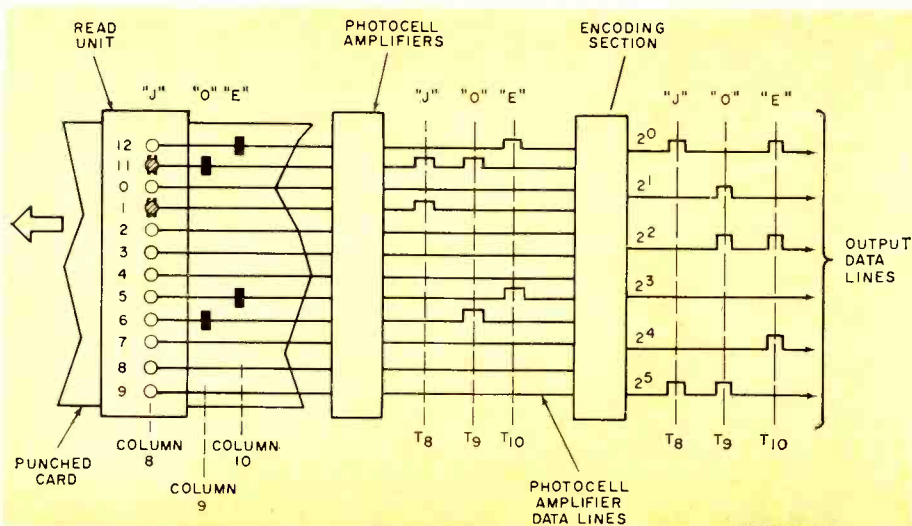
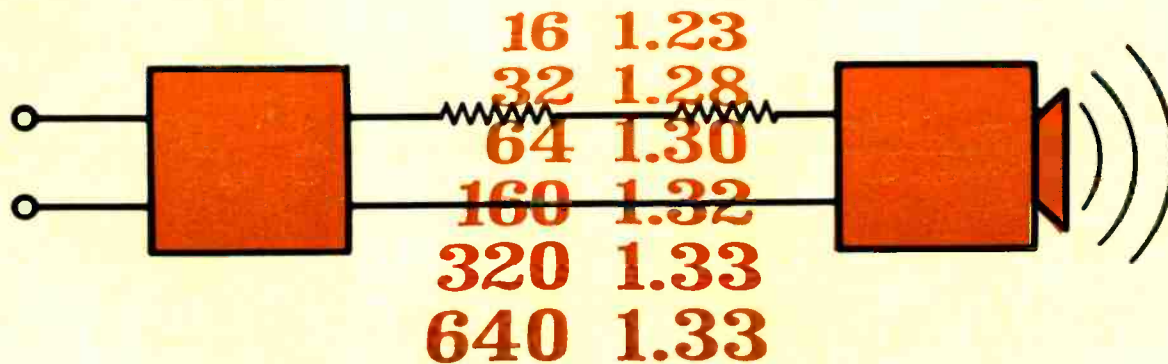

Fig. 5. Data-encoding system that is employed in a photocell reader.





The Damping Factor Debate

What do the numbers really mean and do very high amplifier damping factors have any noticeable effect on performance?

By GEORGE L. AUGSPURGER
James B. Lansing Sound, Inc.

SOME amplifier manufacturers have introduced circuits that have much higher damping factors than conventional units. A high-quality "traditional" vacuum-tube amplifier can be expected to have a damping factor ranging from 10 to 20, but some of the newer transistorized units boast of damping factors greater than 100. Moreover, advertising and promotional literature for these models explains that the damping factor is a sort of figure of merit indicating the degree of control which the amplifier has over the loudspeaker. The higher the damping

factor, the more accurately the speaker is controlled and the better the performance. Is this right?

The subject is really pretty simple, but not quite *that* simple. To get started on the right track, let's go back and look at a few of the more basic things about audio power amplifiers.

We can represent an amplifier as a black box with a set of input terminals on one side and a set of output terminals on the other, as in Fig. 1. And we have indicated a loudspeaker in the same way, except that instead of output terminals there are some sound waves emanating from the far side of this particular box.

The Loudspeaker Load

The next step is to connect the speaker to the output terminals of the amplifier. As far as the speaker is concerned, when it "looks back" at the amplifier, it "sees" a generator of audio signals which acts as though it has a certain effective internal impedance. This can be represented as a resistor connected in series with the output terminals. Don't be misled by the fact that the resistor is imaginary—the behavior of the amplifier is exactly the same as if there were a resistor in plain sight on the back of the chassis. (Of course, generator impedance includes reactive characteristics too, but for our purpose here, a simple resistor will do nicely.)

By taking the internal impedance of the amplifier (R_s) and bringing it outside the black box, we arrive at Fig. 2. R_s may be relatively large or it may be small. It may even be non-existent (zero internal impedance is not too hard to achieve in practice).

We assume that the black box itself produces a constant output voltage regardless of load. Nevertheless, a certain load impedance is required for a certain output power at minimum distortion. This is the impedance that the amplifier must "see" when it "looks" at the speaker load and is the *rated load impedance* usually indicated at the amplifier

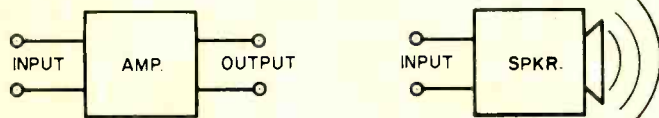

Fig. 1. Amplifier and speaker represented as "black boxes".

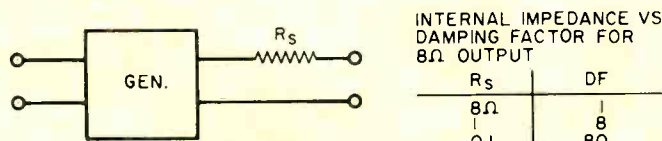

Fig. 2. The amplifier acts like a generator with resistance.

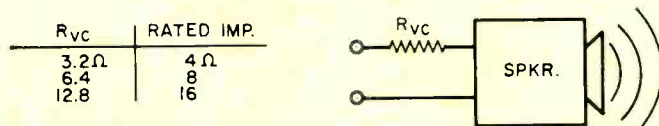

Fig. 3. Speaker resistance is about 80% of rated impedance.

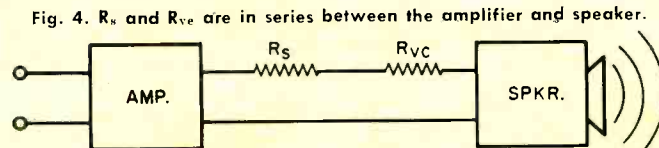

Fig. 4. R_s and R_{vc} are in series between the amplifier and speaker.

output terminals. We will assume that the rated load impedance is 8 ohms in this case, no matter what the value of R_s .

If we were going to use the amplifier to drive a constant-resistance load, it wouldn't matter whether the internal impedance was one ohm or 10 ohms or 10,000 ohms. But because the amplifier is used to drive a loudspeaker, the value of its internal impedance becomes a most important factor.

For one thing, a loudspeaker does not present a constant load to the amplifier. An 8-ohm loudspeaker may measure 6 ohms at some frequencies and 60 ohms at others. If the amplifier has a high internal impedance, the voltage at the loudspeaker terminals will go up as impedance goes up and go down as impedance goes down.

Secondly, a loudspeaker cone has inertia. It has to be stopped and started and moved back and forth in very complicated patterns. If the internal impedance of the amplifier is too high, the speaker will move the way it wants to move instead of the way that the amplifier tells it to move.

The Damping Factor

Rather than specify the value of R_s , it has become common to translate this into a figure which is called the *damping factor* (DF) of the amplifier. As we have seen, it really has more to do with coupling than damping. One definition of damping factor is the ratio of rated load impedance to the amplifier's own internal impedance.

For our 8-ohm black-box amplifier, an internal impedance of 8 ohms gives a damping factor of one. An internal impedance of one ohm gives a damping factor of 8. And if R_s is only 1/10 ohm, the damping factor is 80. These factors are shown in Fig. 2.

This being the case, common sense leads us to believe what the proponents of high damping factors say in their sales literature, namely, that the damping factor is a numerical indication of coupling between amplifier and loudspeaker and the higher the figure, the better off we are.

Unfortunately, we cannot always rely entirely on common sense. For one thing, a particular loudspeaker may not require a high damping factor to accurately follow the signal from the amplifier. Some loudspeaker systems give smoothest performance if the amplifier has a damping factor somewhere between one and three.

But there is another property of dynamic loudspeakers, *all* dynamic loudspeakers, that has to be appreciated to really understand how the damping factor works. It is this other half of the *actual* damping factor which so many people seem to ignore.

A dynamic loudspeaker has a voice coil, and the voice coil has electrical resistance. In most practical cases, the d.c. resistance of a loudspeaker is about 80% of its rated impedance. This is not always the case because different manufacturers use different impedance-rating methods, but such variations will not affect what we are talking about. Let us suppose, therefore, that our 8-ohm black-box speaker has a d.c. resistance of about 6.4 ohms.

The voice-coil resistance is effectively in *series* with the "working" parameters of the loudspeaker, just as is the internal impedance of the amplifier. And this time it isn't even an imaginary resistor; it is a real coil of wire that measures 6.4 ohms with a v.o.m.

Instead of the circuit of Fig. 1, what really happens is shown in Fig. 4. The resistance that isolates the loudspeaker from the amplifier is not just R_s , but rather R_s plus R_{vc} . When the two are connected together, neither the speaker nor the amplifier can distinguish between R_s and R_{vc} . The actual damping factor depends upon the *sum* of these two resistances, not upon one or the other.

Table 1 shows the specified damping factor of an am-

Amplifier R_s (ohms)	Amplifier DF	Actual Over-All DF
8	1	0.57
4	2	0.80
2	4	1.0
1	8	1.14
0.5	16	1.23
0.25	32	1.28
0.125	64	1.30
0.05	160	1.32
0.025	320	1.33
0.0125	640	1.33
0.0000	Infinity	1.33

Table 1. The actual damping factor (with loudspeaker connected) is limited by the speaker voice-coil resistance. Figures are for 8-ohm output terminals to which speaker having nominal 8-ohm impedance and 6-ohm voice-coil resistance is connected.

plifier against the actual over-all damping factor for a wide range of generator impedance values when the amplifier is connected to an 8-ohm speaker. The actual damping factor values are computed by adding R_s and R_{vc} , then dividing by the rated load impedance. In this instance we have used an 8-ohm loudspeaker with a d.c. resistance of 6 ohms to prepare the chart. The exact figures are not particularly significant—the point is that the resistance of the speaker voice coil is the limiting factor.

Note that changing the amplifier damping factor from unity to 8 makes a substantial change in the actual damping factor, though it is not a 1:8 change but a 1:2 change. But changing the damping factor from 8 to 16 makes very little difference in the actual damping factor, and anything more than 16 has very little effect indeed. If we increase the damping factor from 16 to 160, the change is effectively less than 10%, not 10 to one.

Conclusions

It should be obvious at this point that the quoted damping factor of an amplifier is important only if the figure lies somewhere below 20 or so. Changing the damping factor from 2 to 20 does change the performance of the loudspeaker system (for better or for worse, depending upon the speaker). But trying to prove that a damping factor of 200 is somehow better than one of 20 is pretty unconvincing because the effective difference in the particular case cited is only that between 1.25 and 1.32.

But someone is bound to insist that exhaustive tests have been made with such and such an amplifier and that a very high damping factor *is* better than one down around 10 or 15. "The bass is just a little cleaner, just a little more natural and open," is the way the argument usually runs.

In a given situation, this may very well be true. R_s is a byproduct of negative feedback. The more such feedback that is thrown into a power amplifier circuit, the lower the generator impedance and the higher the damping factor. The point is simply that if a lot of feedback has to be used to lick the distortion in a particular circuit, fine—use it. But don't believe that the reason it sounds good is *because* of some astronomically high damping factor.

When I get a letter from someone who is worried about buying a certain amplifier because it has a specified damping factor of "only" 15 or 16, I can't help but remember an old, old joke. It goes like this:

A scientist is giving a public lecture. During the course of his speech, he predicts that in 100 billion years human life will become extinct. A man in the audience, obviously upset, asks the lecturer to repeat the statement.

"I said," quotes the professor, "that in one-hundred billion years, human life will no longer exist."

"Oh, thank goodness," replies the man, much relieved. "I thought you said one-hundred *million!*" ▲

New Developments in CRT Phosphors

By JOHN R. COLLINS

Much brighter displays, transparent phosphors, phosphors that change color, very long persistence types, and rare-earth phosphors for improved color-TV are only a few examples of phosphor improvements covered in this article.

EVEN a cursory examination of available cathode-ray tubes will reveal that they are better than they were just a few years ago. TV picture tubes are brighter, less susceptible to burns, and, in the case of color tubes, give more natural color reproduction. New oscilloscope tubes offer high resolution, better contrast, low visible "noise," and even variable persistence. Similar advances are found in tubes for radar display, optical scanning, and data readout.

Much of the improvement is traceable to new and better phosphors that are now available in sufficient variety to meet almost any demand. In addition, a number of

schemes have been devised to increase versatility and provide new effects. Some of the more important problems and developments are described in this article.

Composition of Phosphors

The term "phosphor" refers to any of a group of inorganic compounds that emit light when bombarded with electrons. Luminescence which occurs during actual excitation is called *fluorescence*, while luminescence that persists for more than 10 nanoseconds after the excitation ceases is called *phosphorescence*. In some phosphors, phosphorescence is different in color from fluorescence.

Most phosphors are oxides, silicates, or sulfides of such elements as zinc, calcium, cadmium, and magnesium. Fluorides are also used when long image retention is desired. In almost all instances, phosphors are distinguished by the presence of a trace impurity, called the activator, which has been combined at high temperature with the basic compound and which influences its crystal lattice structure. Manganese, copper, silver, zinc, and various other metals have been used as activators.

Although phosphor operation is not fully understood, it is generally agreed that electrons are removed from molecules and energy is absorbed under cathode-ray bombardment. As electrons return, energy is released in the form of light. The process is controlled by the activator, which traps free electrons and slows their return to the molecule. Variations in color, brightness, and persistence may result from the use of different activators or from small variations in their concentration. In one type of color picture tube, for example, silver-activated zinc-cadmium sulfide is used for both the green and red phosphor.

In describing a phosphor, it is customary to name both the base material and the activator, separating the two by a colon. A silver-activated zinc-sulfide phosphor, for example, is written ZnS:Ag.

Phosphors are relatively inefficient devices. Only 3% or 4% of the electron-beam energy is converted into light. The remaining energy is converted into heat which must be dissipated by the screen. Phosphor burns may occur if heat is generated more rapidly than it can be dissipated.

Phosphors have been classified into groups P1 through P35 by the Joint Electron Device Engineering Councils

Fig. 1. CIE chromaticity diagram (horseshoe curve) permits plot of all colors. Triangle is range of color-TV phosphors.

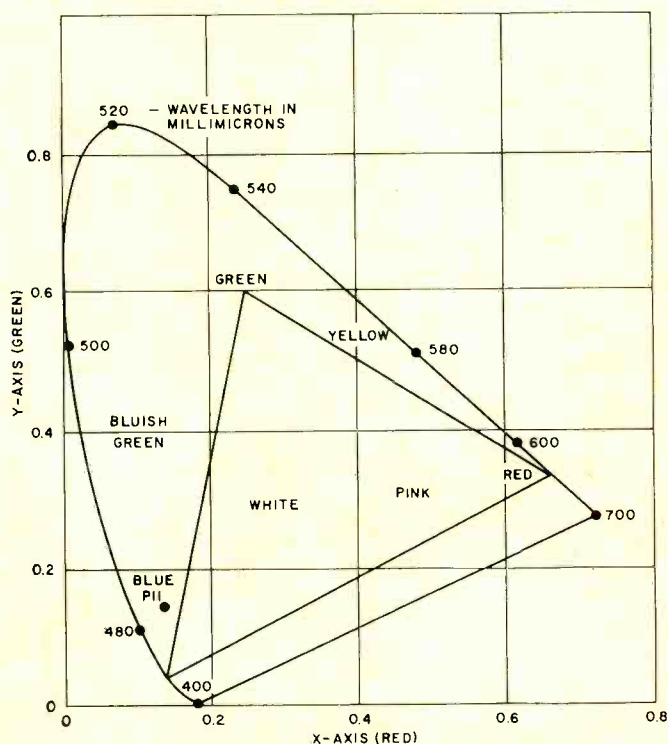

(JEDEC) of the Electronic Industries Association and the National Electrical Manufacturers Association (see Table 1). Some of the types are no longer in general use.

It should not be inferred that there are no more than 35 different kinds of phosphors, since a number of different formulas may be included in a single P group. RCA, for example, offers four different kinds of P4 phosphors for black-and-white television tubes: one type for aluminized picture tubes, a similar type but with a special burn-resistant coating for non-aluminized picture tubes, and two different phosphors to meet the special requirements of projection phosphors. One projection type is made of two phosphors applied in a single layer, whereas the other projection type achieves added brightness by cascading the same two phosphors on a third phosphor. Similarly, there are at least three different P22 phosphor combinations for color tubes.

In addition to these factors, many phosphor developments have not been registered with JEDEC. *Amperex*, for example, has recently introduced on its latest oscilloscope tubes a new phosphor designated as GP which, the firm reports, has the persistence of a P2 phosphor and the spectral response of P31. The addition of the blue response improves writing speed and provides a brighter trace.

Altogether, it is estimated that there are several hundred non-registered phosphors.

It should be noted that even among registered phosphors the method of preparing, processing, and depositing may vary considerably from one company to the next, and the product may be of quite different degrees of excellence. Actual methods of preparation are usually kept as carefully guarded secrets within the industry.

Describing Color

Tables of phosphor characteristics usually specify the wavelength of peak radiant energy. Although this gives an indication of color it is not precise, since the radiant energy may not be concentrated at the peak but may instead be spread over a considerable part of the spectrum. An exact description of color is provided through the use of the CIE (Commission Internationale de l'Éclairage) chromaticity diagram shown in Fig. 1.

The chromaticity diagram is an ingenious device which permits the display of what is essentially three-dimensional data on a two-dimensional chart. The principle is not difficult to understand. Given a sample light of any color, it is possible to obtain an exact match by a proper mixture of the primary colors red, green, and blue. In practice, this is done by an optical instrument in which known proportions of light of each of the primary colors are combined and the proportions varied until a match is obtained with the color under test. The amount of each color is then expressed as a ratio to the total so that the sum of the three ratios will be 1.

To illustrate, in the case of a blue P11 phosphor, the proportions of primary colors needed to effect a match are red 0.139, green 0.148, blue 0.713 (total 1.000). Since the total of the three primary ratios will always equal 1 no matter what color is analyzed, the third color can be found if the other two are known. In the CIE system, therefore, colors are located on the chromaticity diagram simply by plotting red on the x axis and green on the y axis, omitting blue. The P11 phosphor would accordingly be plotted as shown in Fig. 1.

The horseshoe-shaped curve shown in Fig. 1 is a plot of the wavelengths of light in the visible spectrum. It encompasses all possible colors and considerably more hues than can be obtained through combinations of available paints and dyes. The triangle inside the curve was formed by joining the points plotted for the red, green, and blue components of a typical color kinescope using silicate phosphors. Since any color that can be reproduced will be

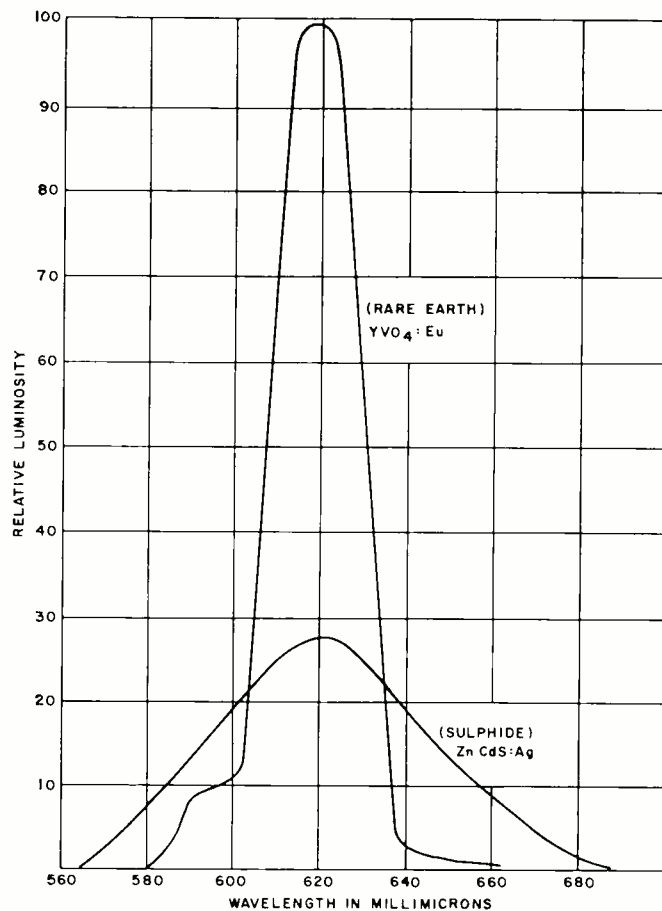

Fig. 2. Comparison of relative luminosity of rare-earth red phosphor and conventional sulphide type red-emitting phosphor.

a combination of those three elements, it is possible to plot any of the kinescope colors within the triangle. A wider range of colors would obviously be possible if the triangle were enlarged. This might be done by developing a greener green, a bluer blue, or a redder red which would fall beyond the limits of the present components. However, the existing range compares favorably with the colors that it is possible to obtain with paints, dyes, or inks, so more attention is being devoted to improving brightness than to extending the range.

Rare-Earth Phosphors

Color-TV picture tubes are inherently less efficient than monochrome tubes because the shadow mask transmits only 15% to 20% of the electron beam. Furthermore, producing white light with a three-component phosphor system is a relatively inefficient process. These difficulties have been overcome largely through increasing the power consumption and operating color tubes at much higher beam current than is needed for monochrome tubes.

Until recently, however, the total brightness of color picture tubes was limited by the fact that a red phosphor had not been developed to match the efficiency of available blue and green phosphors. To obtain proper balance, it was therefore necessary to deaden the blue and green phosphors. This affected the brightness of the entire tube and was especially noticeable in monochrome programs. When color highlights were shown, the relative luminosity of red would decline as the electron-beam current density was increased, and this would result in a shifting of color balance so that whites, for instance, would tend to appear blue or green.

This situation has been greatly improved through the use of a new red phosphor—europium-activated yttrium orthovanadate ($YVO_4:Eu$)—to replace the previously used

silver-activated zinc-cadmium sulfide ($ZnCdS:Ag$). A comparison of the two is shown in Fig. 2. Although both peak at about the same wavelength, the energy of the rare-earth phosphor is concentrated in a narrower band. Whereas the sulfide phosphor emits energy over a large part of the spectrum from yellow-green to red and has a reddish-orange appearance, the rare-earth blend appears pure red.

Persistence

Persistence is the time it takes the trace on a phosphor

screen to fade to 10% of its original brightness. This time may vary widely, depending upon the use for which the tube is intended. The ordinary TV picture tube has a persistence of about 60 microseconds. A long persistence is obviously undesirable, or one picture would be superimposed on another. Even shorter persistence is desirable for fast-writing oscilloscopes, and these often use a P11 phosphor which has a persistence of 34 microseconds and which gives a high-intensity blue fluorescence that is excellent for photographic purposes. Flying-spot tubes often

Table 1. Phosphor characteristics. (Phosphors made by various manufacturers may have

JEDEC TYPE NO.	CHEMICAL COMPOSITION	NO. OF LAYERS	COLOR OF FLUORESCENCE	COLOR OF PHOSPHORESCENCE	PERSISTENCE*	PEAK WAVELENGTH (millimicrons)	CIE COORDINATES		APPLICATIONS
							X	Y	
P1	Zinc Orthosilicate	1	Yellowish-Green	Yellowish-Green	Medium	525	0.218	0.712	Oscilloscopes
P2	Zinc Cadmium Sulfide	1	Yellowish-Green	Yellowish-Green	Medium-Short	535	0.279	0.534	Oscilloscopes
P3	Zinc Beryllium Silicate	1	Yellowish-Orange	Yellowish-Orange	Medium	602	0.523	0.469	No longer in use
P4	Zinc Sulfide and Zinc Cadmium Sulfide	1	White	White	Medium-Short	455 and 565	0.270	0.300	Direct-view B/W TV
P4	Calcium Magnesium Silicate and Zinc Beryllium Silicate	1	White	White	Medium	425 and 550	0.333	0.347	Projection B/W TV
P4	Calcium Magnesium Silicate and Zinc Beryllium Silicate cascaded on Zinc Sulfide	2	White	White	Medium	425 550 and 460	0.317	0.331	Projection B/W TV
P5	Calcium Tungstate	1	Blue	Blue	Medium-Short	415	0.169	0.132	Photographic recording
P6	Zinc Sulfide and Zinc Cadmium Sulfide	1	White	White	Short	460 and 563	0.338	0.374	Obsolete. Originally used in B/W TV
P7	Zinc Sulfide cascaded on Zinc Cadmium Sulfide	2	Blue	Yellowish-Green	Medium-Short and Long	435 and 555	0.151 0.357	0.032 0.537	Radar
P10	Potassium Chloride	—	—	—	Very Long	—	—	—	Radar. (Not a luminescent material. Dark trace screen normally white darkens under electron bombardment.)
P11	Zinc Sulfide	1	Blue	Blue	Medium-Short	460	0.139	0.148	Photographic recording
P12	Zinc Magnesium Fluoride	1	Orange	Orange	Long	590	0.605	0.394	Radar, low flicker
P13	Magnesium Silicate	1	Reddish-Orange	Reddish-Orange	Medium	640	0.670	0.329	No longer in general use
P14	Zinc Sulfide cascaded on Zinc Cadmium Sulfide	2	Purplish-Blue	Yellowish-Orange	Medium-Short and Medium	435 and 600	0.151 0.520	0.032 0.463	Radar; military displays where repetition rate is 2 to 4 seconds
P15	Zinc Oxide	1	Green	Green	Visible Short; Ultraviolet: Very Short	510 and 391	0.246	0.439	Photographic recording; flying spot scanning systems
P16	Calcium Magnesium Silicate	1	Bluish-Purple and Ultra-Violet	Bluish-Purple and Ultra-Violet	Very Short	383	0.125	0.003	Photographic recording; flying spot scanning systems
P17	Zinc Oxide cascaded on Zinc Cadmium Sulfide	2	Yellowish-White to Bluish-White	Yellow	Short and Long	450 and 554	—	—	Radar; military displays
P18	Calcium Magnesium Silicate and Calcium Beryllium Silicate	1	White	White	Medium-Short	410 and 540	—	—	TV. No longer in use

employ a P16 phosphor which has a persistence of only 0.12 μ sec.

Long persistence is important for observing slow-moving phenomena. The best-known phosphor for such purposes is P7, which is really a combination of two phosphors—a medium-short purplish-blue phosphor made of silver-activated zinc sulfide cascaded on a long-persistence yellowish-green phosphor consisting of copper-activated zinc-cadmium sulfide. The first phosphor decays to the 10% point in about 50 microseconds, whereas the

other persists for about 400 milliseconds, nearly half a second. Under proper lighting conditions, a trace can actually be viewed at a level far below the 10% point. It is thus possible to observe phenomena on a P7 screen for as long as several minutes. Tubes with the P7 phosphor are often used for radar and for observing mechanical systems and biological processes, such as electrocardiograms, where changes are comparatively slow. Fig. 3 shows some typical persistence characteristics.

An interesting new development is a variable-persistence

somewhat different characteristics.) Phosphors P8, P9, and P30 are no longer used.

JEDEC TYPE NO.	CHEMICAL COMPOSITION	NO. OF LAYERS	COLOR OF FLUORESCENCE	COLOR OF PHOSPHORESCENCE	PERSISTENCE ^a	PEAK WAVELENGTH (millimicrons)	CIE COORDINATES X	CIE COORDINATES Y	APPLICATIONS
P19	Potassium Magnesium Fluoride	1	Orange	Orange	Long	595	—	—	Radar, low flicker
P20	Zinc Cadmium Sulfide	1	Yellowish-Green	Yellowish-Green	Medium-Short	560	0.426	0.546	Radar; high-visibility displays
P21	Magnesium Fluoride	1	Reddish-Orange	Reddish-Orange	Long	606	—	—	Radar, low flicker
P22	Zinc Sulfide	1	Purplish-Blue	Purplish-Blue	Medium-Short	450	0.146	0.052	Color TV (Sulfide-Silicate-Phosphate type)
	Zinc Orthosilicate		Yellowish-Green	Yellowish-Green	Medium	525	0.218	0.712	
	Zinc Phosphate		Reddish-Orange	Reddish-Orange	Medium	638	0.674	0.326	
P22	Zinc Sulfide	1	Purplish-Blue	Purplish-Blue	Medium-Short	450	0.146	0.052	Color TV (All-sulfide type)
	Zinc Cadmium Sulfide		Green	Green	Medium-Short	515	0.242	0.529	
	Zinc Cadmium Sulfide		Reddish-Orange	Purplish-Orange	Medium-Short	680	0.663	0.337	
P22	Zinc Sulfide	1	Purplish-Blue	Purplish-Blue	Medium-Short	450	0.146	0.052	Color TV (Rare-earth type)
	Zinc Cadmium Sulfide		Green	Green	Medium-Short	530	0.303	0.587	
	Yttrium Orthovanadate		Red	Red	Medium	619	0.670	0.330	
P23	Zinc Sulfide and Zinc Cadmium Sulfide	1	White	White	Medium	460 and 575	—	—	Sepia tone TV
P24	Zinc Oxide	1	Green	Green	Short	510	0.245	0.441	Flying-spot scanning systems
P25	Calcium Silicate	1	Orange	Orange	Medium	610	—	—	Radar; military displays where repetition rate is 10 seconds to 2 minutes
P26	Potassium Magnesium Fluoride	1	Orange	Orange	Very Long	595	—	—	Radar
P27	Zinc Phosphate	1	Reddish-Orange	Reddish-Orange	Medium	638	0.674	0.326	Old color TV red component
P28	Zinc Sulfide	1	Yellowish-Green	Yellowish-Green	Long	550	—	—	Radar
P29	Two-color screen composed of alternate strips of P2 and P25 Phosphors	—	—	—	—	—	—	—	Military radar; target identification equipment; collision course indicators
P31	Zinc Sulfide	1	Green	Green	Medium-Short	522	0.245	0.523	Oscilloscopes
P32	Zinc Cadmium Sulfide cascaded on Calcium Magnesium Silicate	1	Purplish-Blue	Yellowish-Green	Long	470 and 550	—	—	Radar
P33	Potassium Magnesium Fluoride and Magnesium Fluoride	1	Orange	Orange	Very Long	588	—	—	Radar, low flicker
P34	Zinc Sulfide	1	Bluish-Green	Yellowish-Green	Very Long	490	—	—	Radar; oscilloscopes; information storage
P35	Zinc Sulfide Selenide	1	Blue-White	Blue-White	Medium-Short	486	—	—	Photographic recording

^aClassification of persistence to 10% level: very long—1 second or over; long—100 milliseconds to 1 second; medium—1 millisecond to 100 milliseconds; medium short—10 microseconds to 1 millisecond; short—1 microsecond to 10 microseconds; very short—less than 1 microsecond.

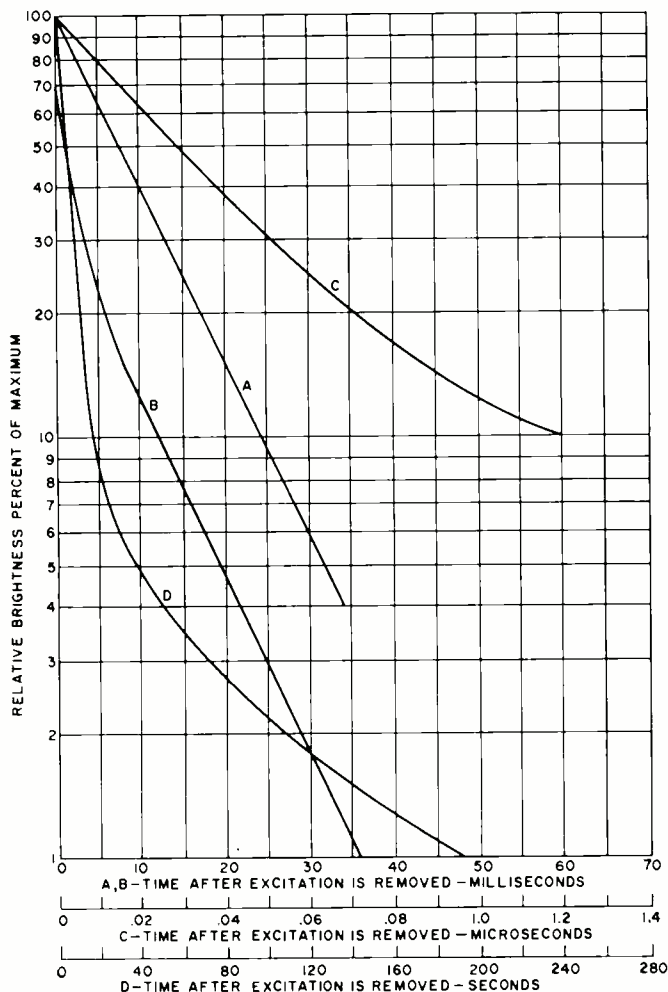
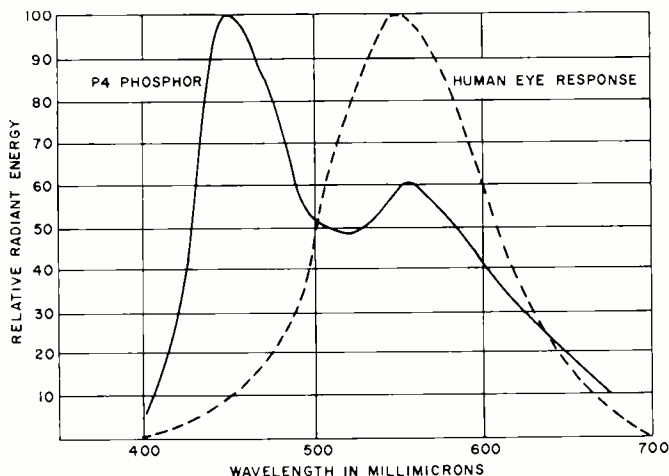

Fig. 3. Persistence characteristics of typical CRT phosphors. (A) P1: medium for oscilloscopes. (B) P4: medium-short for black-and-white TV. (C) P16: very short for flying-spot scanners. (D) P26: very long for use in radar display systems.

cathode-ray oscilloscope, made by *Hewlett-Packard*, which is capable of providing persistence that is continuously variable from about 0.1 second to several minutes, or of storing traces for hours or days. Variable persistence is achieved through the use of a specially designed storage tube and unique erase circuitry. In this tube, a storage mesh located just behind the phosphor screen is coated with a highly resistive layer of magnesium fluoride. A positively charged pattern is etched on the storage mesh by a write gun which is similar to the gun in a conventional

Fig. 4. Relative luminosity of typical P4 phosphor (television type) compared to the relative sensitivity of the human eye.



cathode-ray tube. The pattern is formed by knocking electrons loose from the storage mesh through secondary emission. Because magnesium fluoride has excellent insulating properties, the pattern remains fixed and does not spread to adjacent areas. The collector mesh carries only a low charge and therefore does not interfere with the high-velocity electrons which pass through it to reach the mesh.

The pattern is transferred to the phosphor by means of flood guns which spray low-velocity electrons toward the screen. Most of these are picked up by the collector mesh and never get to the phosphor screen. In the area near the stored positive charge on the storage mesh, however, the positive field pulls some of the flood-gun electrons through the collector mesh. The charge on the phosphor screen is quite high (7.5 kV) and the electrons continue through the storage mesh, strike the phosphor, and produce a trace.

The trace is erased by applying a negative voltage to the storage mesh which washes away the stored positive charge. Variable persistence is obtained by regulating the rate at which the erase voltage is applied. In practice, this is done by utilizing negative pulses for the erase voltage. The width of these pulses (therefore the rate of erasure) is controlled by a width control on the erase pulse generator. Narrow pulses provide long persistence, whereas wide pulses speed erasure. Through proper control settings, the instrument can also be operated as either a conventional oscilloscope or a storage oscilloscope.

Phosphor Combinations

A number of cathode-ray tubes utilize two or more phosphors to obtain desired effects. A familiar example is the conventional television picture tube, where to obtain white light it is necessary to have emission over more or less the entire visible spectrum, from violet through red. This is accomplished by applying to the faceplate a single layer of a blend of two phosphors which together cover the desired range. Although several blends have been used, the most common mixture is a blue phosphor of silver-activated zinc sulfide and a greenish-yellow phosphor of silver-activated zinc-cadmium sulfide. The characteristics of this phosphor are shown in Fig. 4. The combination is quite efficient, and modern television sets can readily be viewed in well-lighted rooms.

Color picture tubes are made by depositing three different phosphors in orderly arrays of dots to obtain the basic green, blue, and red colors. Although the principle is simple, the actual production of such faceplates is quite difficult. In practice, each color is deposited separately through a photographic process. To start, a slurry of each phosphor is prepared, and ammonium dichromate is added to make the mixtures photosensitive. The first phosphor slurry is flowed over the faceplate, and the faceplate is spun to remove excess liquid and to provide uniform thickness. A dot pattern is then fixed on the surface by exposing the plate to ultraviolet light through a mask which contains the desired dot pattern. Following this irradiation, the screen is sprayed with water. The phosphor in the areas unexposed to radiation is washed away, leaving the dot pattern of the first powder. The entire process is then repeated for the second and third phosphors in turn. The ultraviolet light source is moved into a different position each time to project the dot pattern so that the final triad arrangement can be formed.

Several phosphor screens are composed of two separate compounds which are applied one on top of the other. In addition to P7, which was previously described, types P14 and P28 are two-layered phosphors used for radar. Having different decay characteristics, they permit more versatile applications than are otherwise possible.

Work has also been done on layered phosphors for two-color display tubes in which a change in color is effected by means of a shift in the

(Continued on page 70)

**He
walked!**



Five
young
was bo
is a m
never w
their arm
there is h

GIVE

January, 1967

**Find out
about
RCA Career
Programs
and the easiest, fastest
way to learn electronics**

**SEND CARD TODAY
FREE!
RCA'S
1967
CAREER
BOOK**



RCA INSTITUTES, INC.
Dept. EN-7
A Service of Radio Corporation of America
350 West 4th Street, New York, N. Y. 10014

Please rush me FREE illustrated catalog on your new
CAREER PROGRAMS with information checked below.
I understand that I am under no obligation, and that no
salesman will call.

HOME STUDY CAREER PROGRAMS

- Television Servicing
- Telecommunications
- FCC License Preparation
- Automation Electronics
- Automatic Controls
- Mobile Communications
- Electronics in Spanish
- Computer Programming
- Solid State Electronics
- Digital Techniques
- Industrial Electronics
- Nuclear Instrumentation
- Electronics Drafting

CLASSROOM TRAINING COURSES

- Evening
- Electronics in Spanish
- Electronics in Spanish

Day Age

Name _____ (please print)

Address _____ State

City _____

IN CANADA - THE RCA VICTOR COMPANY, LTD.
Veterans: Check Here



How To Have Fun While You Save . . .

Regardless
Of What You Pay
For A Color TV...
It Can't Perform As
Well As This
New Heathkit® "180"
For Only \$379⁹⁵*



Here's Why!

Exclusive Features That Can't Be Bought In Ready-Made Sets At Any Price!

All color TV sets require periodic convergence and color purity adjustments. This new Heathkit GR-180 has exclusive built-in servicing aids so you can perform these adjustments anytime . . . without any special skills or knowledge. Just flip a switch on the built-in dot generator and a dot pattern appears on the screen: Simple-to-follow instructions and detailed color photos in the GR-180 manual show you exactly what to look for, what to do and how to do it.

Results? Beautifully clean and sharp color pictures day in and day out . . . and up to \$200 savings in service calls throughout the life of your set.

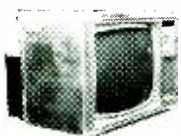

Exclusive Heath Magna-Shield!

This unique metal shield surrounds the entire picture tube to help keep out stray external fields and improve color purity. In addition, *Automatic Degaussing* demagnetizes and "cleans" the picture everytime you turn the set on from a "cold" start . . . also permits you to move the set about freely.



Vertical Swing-Out Chassis!

All parts mount on a single one-piece chassis that's hinged to make it more accessible for easier construction, care and installation.

Your Choice Of Installation!

Another Heathkit exclusive . . . the GR-180 is designed for mounting in a wall or your own custom cabinet. Or you can install it in either of Heath's factory-assembled and finished cabinets.

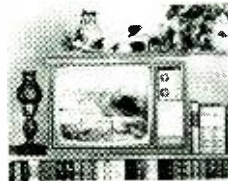

From Parts To Programs In Just 25 Hours!

. . . and no special skills or knowledge needed. All critical circuits (VHF and UHF tuners, 3-stage IF assembly and high voltage power supply) are prebuilt, aligned and tested at the factory. The GR-180 manual guides you the rest of the way with simple, non-technical instructions and giant pictorials. It's like having a master teacher at your elbow pointing out every step. You can't miss.

Compare These Advanced Performance Features . . . And The Price!

Hi-Fi 180 Sq. Inch Rectangular Tube with anti-glare safety glass, plus "rare earth phosphors", smaller dot size and 24,000 volt picture power for brighter, livelier colors and sharper picture definition.

Automatic Color Control and gated automatic gain control to reduce color fading, and insure steady, jitter-free pictures even under adverse interference such as nearby aircraft traffic.

Deluxe VHF Turret Tuner with "memory" fine tuning so you don't have to readjust everytime you return to a channel.

2-Speed Transistor UHF Tuner for either fast station selection, or fine tuning of individual channels.

Two Hi-Fi Sound Outputs . . . a cathode follower for play through your hi-fi system, plus an 8 ohm output for connection to the GR-180's limited-field 4" x 6" speaker.

Two VHF Antenna Inputs . . . a 300 ohm balanced and a 75 ohm coax to reduce interference in metropolitan or CATV areas.

1-Year Warranty on the picture tube, 90 days on all other parts. In addition, liberal credit terms are available.

*Kit GR-180, everything except cabinet for custom mounting, 102 lbs. \$379.95

Assembled GRA-180-1, walnut cabinet shown above, 30 lbs., 18 1/4" D x 28 1/4" W x 29" H. . . \$49.95

Assembled GRA-180-2, Early American cabinet, 37 lbs., 18 1/4" D x 28 1/4" W x 31 1/4" H. . . Available February. \$75.00

New 12" Transistor Portable TV — First Kit With Integrated Circuit

Unusually sensitive performance. Plays anywhere . . . runs on household 117 v. AC, any 12 v. battery, or optional rechargeable battery pack (\$39.95). Receives all channels; new integrated sound circuit replaces 39 TV parts; 3-stage IF for maximum gain with controlled bandwidth; gated AGC for steady, jitter-free pictures; instant "on" AC operation; preassembled & aligned tuners for peak performance; transformer operated power supply; front panel mounted speaker; easy 12-hour assembly. Rugged high impact plastic cabinet measures a compact 11 1/2" H x 15 3/4" W x 9 3/8" D. 27 lbs.

Kit GR-104
\$119⁹⁵



ELECTRONICS WORLD

to be paid by—
RCA INSTITUTES, INC., Dept. EW-27
350 West Fourth Street
New York, N. Y. 10014

MAIL
Priority If Mailed in U.S.

FIRST CLASS
PERMIT NO.
10662
NEW YORK, N. Y.

**He
walked!**



Five-year-old Kenny has just learned to walk. Most youngsters are on their feet at a year. But Kenny was born with cerebral palsy, and for him walking is a monumental achievement. Some CP children never walk at all. Some can't speak or hear, or use their arms to feed or dress themselves. However, there is hope for the more than a quarter of a mil-

lion children in this country born with the tragic handicap of cerebral palsy. And your help can bring that hope through a contribution to your local affiliate of United Cerebral Palsy Associations. Then, when you see the radiant face of a five-year-old who has just taken his first steps, you'll know what they mean when they say, **Happiness is Helping.**

GIVE TO UNITED CEREBRAL PALSY 

How To Have Fun While You Save . . .

**Regardless
Of What You Pay
For A Color TV...
It Can't Perform As
Well As This
New Heathkit® "180"
For Only \$379⁹⁵***



Here's Why!

Exclusive Features That Can't Be Bought In Ready-Made Sets At Any Price!

All color TV sets require periodic convergence and color purity adjustments. This new Heathkit GR-180 has exclusive built-in servicing aids so you can perform these adjustments anytime . . . without any special skills or knowledge. Just flip a switch on the built-in dot generator and a dot pattern appears on the screen: Simple-to-follow instructions and detailed color photos in the GR-180 manual show you exactly what to look for, what to do and how to do it.

Results? Beautifully clean and sharp color pictures day in and day out . . . and up to \$200 savings in service calls throughout the life of your set.

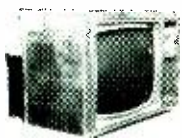

Exclusive Heath Magna-Shield!

This unique metal shield surrounds the entire picture tube to help keep out stray external fields and improve color purity. In addition, *Automatic Degaussing* demagnetizes and "cleans" the picture everytime you turn the set on from a "cold" start . . . also permits you to move the set about freely.



Vertical Swing-Out Chassis!

All parts mount on a single one-piece chassis that's hinged to make it more accessible for easier construction, care and installation.

Your Choice Of Installation!

Another Heathkit exclusive . . . the GR-180 is designed for mounting in a wall or your own custom cabinet. Or you can install it in either of Heath's factory-assembled and finished cabinets.

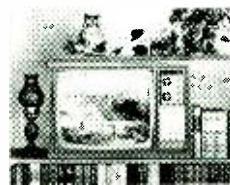

From Parts To Programs In Just 25 Hours!

. . . and no special skills or knowledge needed. All critical circuits (VHF and UHF tuners, 3-stage IF assembly and high voltage power supply) are prebuilt, aligned and tested at the factory. The GR-180 manual guides you the rest of the way with simple, non-technical instructions and giant pictorials. It's like having a master teacher at your elbow pointing out every step. You can't miss.

Compare These Advanced Performance Features . . . And The Price!

Hi-Fi 180 Sq. Inch Rectangular Tube with anti-glare safety glass, plus "rare earth phosphors", smaller dot size and 24,000 volt picture power for brighter, livelier colors and sharper picture definition.

Automatic Color Control and gated automatic gain control to reduce color fading, and insure steady, jitter-free pictures even under adverse interference such as nearby aircraft traffic.

Deluxe VHF Turret Tuner with "memory" fine tuning so you don't have to readjust everytime you return to a channel.

2-Speed Transistor UHF Tuner for either fast station selection, or fine tuning of individual channels.

Two Hi-Fi Sound Outputs . . . a cathode follower for play through your hi-fi system, plus an 8 ohm output for connection to the GR-180's limited-field 4" x 6" speaker.

Two VHF Antenna Inputs . . . a 300 ohm balanced and a 75 ohm coax to reduce interference in metropolitan or CATV areas.

1-Year Warranty on the picture tube, 90 days on all other parts. In addition, liberal credit terms are available.

* **Kit GR-180**, everything except cabinet for custom mounting, 102 lbs. **\$379.95**

Assembled GRA-180-1, walnut cabinet shown above, 30 lbs., 18 1/4" D x 28 1/4" W x 29" H. . . **\$49.95**

Assembled GRA-180-2, Early American cabinet, 37 lbs., 18 1/4" D x 28 1/4" W x 31 1/4" H. . . Available February. **\$75.00**

New 12" Transistor Portable TV — First Kit With Integrated Circuit

Unusually sensitive performance. Plays anywhere . . . runs on household 117 v. AC, any 12 v. battery, or optional rechargeable battery pack (\$39.95). Receives all channels; new integrated sound circuit replaces 39 TV parts; 3-stage IF for maximum gain with controlled bandwidth; gated AGC for steady, jitter-free pictures; instant "on" AC operation; preassembled & aligned tuners for peak performance; transformer operated power supply; front panel mounted speaker; easy 12-hour assembly. Rugged high impact plastic cabinet measures a compact 11 1/4" H x 15 1/4" W x 9 3/8" D. 27 lbs.

Kit GR-104
\$119⁹⁵

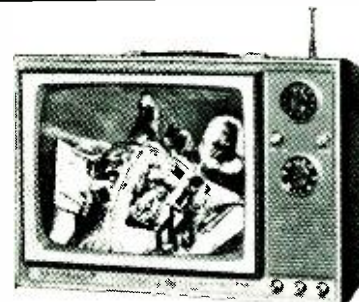

Build Your Own Heathkit® Electronics



**Heathkit "Starmaker"
60-Watt Transistor
Guitar Amplifier**

Kit TA-16
\$129⁹⁵
\$300 Value!

60 watts peak power; two channels — one for accompaniment, organ or mike, the other with tremolo and reverb for lead guitars; two inputs per channel; two 12" heavy-duty speakers; line bypass reversing switch for hum reduction; 13 transistor, 6 diode circuit; 28" W x 9" D x 19" H. Leather-textured black vinyl cabinet of 3/4" stock; 120 v. or 240 v. AC operation; extruded aluminum front panel. 52 lbs.

**Harmony-By-Heathkit®
Electric Guitar**



Kit TG-46
\$219⁹⁵
\$331.50 Value!

Double cutaway style; hollow body; 3 pickups with 18 adjustable pole pieces; professional Bigsby vibrato tailpiece; 6 volume & tone controls; ultra-slim fingerboard — 24 1/4" scale; 2" thick curly maple body, shaded cherry red. Includes carrying case, neck strap, visual tuning aid, cord, pick, instruction book and record. 2 other models available at \$99.95 and \$119.95. 17 lbs.

**New! SB-101 80-10 Meter SSB Transceiver
— Now With Improved CW Transceive Capability**



Kit SB-101
\$360⁰⁰
(less speaker)

Now features capability for front panel switch selection of either the standard 2.1 kHz SSB filter or the optional SBA-301-2 400 Hz CW filter . . . plus simplified assembly at no increase in price over the already famous Heathkit SB-100. Also boasts 180-watt P.E.P. input, 170 watts input CW, PTT & VOX, CW sidetone, Heath LMO for truly linear tuning and 1 kHz dial calibrations. 23 lbs. SBA-301-2, 400 Hz CW filter . . . \$20.95. Kit HP-13, mobile power supply . . . \$59.95. Kit HP-23, fixed station supply . . . \$39.95.

**NEW Transistor Portable
Phonograph Kit**



Kit GD-16
\$39⁹⁵

Worth At Least 50% More! And it sounds better. Assembles in just 1 to 2 hours . . . simply wire one small circuit board, mount the 4" x 6" speaker and plug in the preassembled changer . . . ideal beginner's kit. Features automatic mono play of all 4 speeds; dual Sapphire styli for LP's or 78's; 45 rpm adapter; olive and beige polyethylene over sturdy, preassembled cabinet. Operates on 117 v. AC. 23 lbs.

**NEW Heathkit® /Magnecord® 1020 4-Track Stereo
Recorder Kit**

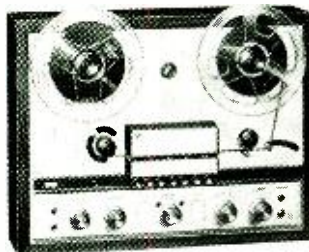

Kit AD-16
\$399⁵⁰
(less cabinet)

Save \$170 By Doing The Easy Assembly Yourself. Takes around 25 hours. Features solid-state circuitry; 4-track stereo or mono playback and record at 7 1/2 & 3 3/4 ips; sound-on-sound, sound-with-sound and echo capabilities; 3 separate motors; solenoid operation; die-cast top-plate, flywheel and capstan shaft housing; all push-button controls; automatic shut-off at end of reel; plus a host of other professional features. 45 lbs. Optional walnut base \$19.95, adapter ring for custom or cabinet installation \$4.75

30-Watt Solid-State FM /FM Stereo Receiver

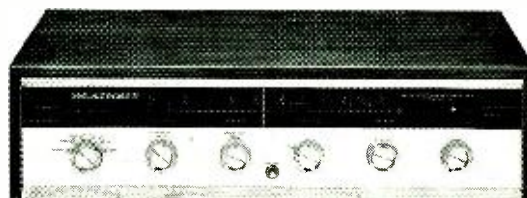

World's Best Buy In Stereo Receivers. Features 31 transistors, 10 diodes for cool, natural transistor sound; 20 watts RMS, 30 watts IHF music power (@ ± 1 db, 15 to 50,000 Hz; wideband FM /FM stereo tuner; plus two pre-amplifiers; front panel stereo headphone jack; compact 3 7/8" H x 15 1/4" W x 12" D size. Custom mount it in a wall, or either Heath cabinets (walnut \$9.95, beige metal \$3.95). 16 lbs.

Kit AR-14
\$99⁹⁵
(less cabinet)



**FREE!
World's Largest
Electronic Kit
Catalog!**

Describes these and over 250 kits for stereo/hi-fi, color TV, amateur radio, shortwave, test, CB, marine, educational, home and hobby. Save up to 50% by doing the easy assembly yourself. Mail coupon or write Heath Company, Benton Harbor, Michigan 49022

HEATH COMPANY, Dept. 15-1
Benton Harbor, Michigan 49022

In Canada, Daystrom Ltd.

Enclosed is \$ _____, plus shipping.

Please send model (s) _____

Please send FREE 1967 Heathkit Catalog.

Name _____

Address _____

City _____

State _____

Zip _____

Prices & specifications subject to change without notice.

CL-267

CIRCLE NO. 109 ON READER SERVICE CARD



JOHN FRYE

This versatile solid-state warning mechanism can be used in conjunction with dashboard lights for alerting drivers.

ELECTRONIC AUDIBLE ALARM

EVEN though it was January 2nd, Mac still had not entirely recovered from New Year's Eve; so when Barney, his assistant, connected a 9-volt transistor radio battery to a shiny little black cylinder with a knurled aluminum ring around one end and the device began emitting a strident, rapidly pulsating "beep-beep-beep" sound, Mac winced and gave his employee a look that caused the latter to disconnect the battery quickly.

"Sorry about that, Boss," Barney apologized. "I forgot about your headache. I was just checking out this pulsing-type Sonalert® I intend to hook up as a power-failure alarm for a respo friend of mine."

"There you go, using two strange words in a single sentence," Mac complained wearily. "What's a 'respo'?"

"A respiratory polio victim who has trouble breathing. Severe cases must live in iron lungs, but my friend can breathe as long as he is sitting upright. However, he can't breathe well without mechanical help when he lies down; so he has to sleep on an electrically operated rocking bed, the motion of which assists his breathing. When the power goes off and the bed stops rocking—possibly with my friend's head downhill—it's essential that someone help him up promptly. I plan to use a 110-volt a.c. relay to hold contacts from the battery to this Sonalert® open until the power fails; then the contacts will close and this noisy little rascal will go to work rousing the household."

"Okay; now what's a Sonalert®? It sounds like something out of *The Man From U.N.C.L.E.*"

"Basically, it's a highly reliable solid-state electronic device that emits an attention-getting sound with a minimum consumption of current. It's manufactured by the Electropac Operations of the Computer Controls Division of Honeywell, Inc.; but as of April 1, 1966, P.R. Mallory & Co., Inc. of Indianapolis has exclusive sales and distribution of the device."

"What's in it? How does it work?"

"It operates on the same piezoelectric principle as a crystal oscillator. The 'crystal' in this case, though, is a special ceramic transducer mounted right behind this tiny grille in the end of the unit. Operating in a self-excited transistorized oscillator circuit, the transducer not only determines the frequency of oscillation, but its vibrations also produce the audible sound. Inside the case the whole unit is potted in epoxy; so the only way you can take it apart is with a hammer or an axe. I might add that this pulsing-sound model is not really the basic unit. That is even smaller."

"How much smaller?"

"Well, the basic Model SC628 is 1 $\frac{1}{16}$ " in diameter and only 1 $\frac{3}{8}$ " long and weighs in at 1.25 ounces. It will operate on any d.c. voltage from 6 to 28 volts and puts out a continuous tone of 2800 Hz \pm 300 Hz. The tone doesn't change, but both the current drawn and the sound output rise with the voltage. At 6 volts, 3 mA are drawn and the sound intensity is 68 dB; but at 28 volts the cur-

rent goes up to 14 mA while the sound output increases to 80 dB.

"The Model SC628H is the same in all respects except that the tone has a frequency of 4500 Hz \pm 500 Hz. This Model SC628P on the bench has added circuitry to pulse the tone at 3 to 5 Hz, depending upon the voltage; and the over-all length is increased to 2 $\frac{3}{16}$ " to take care of the additional components while the weight is increased to 2 ounces. These last increases also apply to the Model SC628A and the Model SC110 that operate on 6 to 28 volts a.c./d.c. and on 105 to 120 volts a.c./d.c., respectively. Germanium transistors used in standard models limit the operating range from -40° to 120° F, but silicon transistors are used in other models to extend the upper temperature limit to 185° F."

"They certainly don't need much current to operate, do they?"

"No, and that's one major advantage they have over relays or buzzers. Actually, the current they draw is about the same as that required by high-intensity neon pilot bulbs. Three mils at 6 volts comes out to less than $\frac{1}{50}$ of a watt. That means the mechanism can be powered by even a pair of *International Rectifier's* S3M solar cells hooked in series. More important, it will operate directly with very high impedance sensing devices, such as cadmium-sulphide photocells or simple moisture detectors. Anything that can pass 3 mA of current can activate the unit."

"Why do you say the devices are 'highly reliable'?"

"You just think about it. They have no moving parts, so there's nothing to wear out. Their monolithic construction protects circuitry and components from vibration, shock, dirt, and moisture. Conceivably, you *could* damage one by poking around through the grille at the transducer with an ice pick or something similar, but short of that they will keep right on working in just about any kind of environment."

"Sounds reasonable. Do they have any other good features?"

"Their freedom from sparking contacts that generate r.f. noise and create a hazard in explosive atmospheres such as are found in mines, operating rooms, or in the bilges of small boats is well worth mentioning. That business about not generating any r.f. frequencies or noise permits them to be used adjacent to high-gain electronic circuitry without fear of introducing extraneous and spurious signals into the system. For example, these devices are widely used as fault alarms on computers to augment visual signals which are often ignored. And they never put any noise on the tapes, as might a bell or buzzer."

"Another interesting use is the operating room in open-heart surgery. Here the presence of delicate electronic electrocardiographic equipment and explosive anesthetics precludes the use of anything that would produce sparks or generate r.f. noise. In this operation the patient's blood

supply is shunted through an apparatus that has a tank and a set of pumps. Having blood in that tank run low is a lot more serious than letting your gas tank run dry. To prevent this, doctors fasten a sterile glass tube about six inches long over the nose of the Sonalert® and immerse the bottom end of this tube in the blood that is in the tank.

"Now a Sonalert® must have access to the open air to put out much sound. Notice what happens when I cover the grille with the palm of my hand." As Barney did this, the beeping sound became barely audible. "That's how things are as long as blood in the tank stands above the bottom of that glass tube; but when the blood supply goes down and uncovers the mouth of the tube, the sound escapes and immediately alerts the doctor.

"Trying to start an inboard boat engine when the bilge is filled with explosive gasoline fumes is a major cause of private boating disasters. Several companies make fume-detecting devices, but the warning indicator is often a neon lamp not too easily seen in bright sunlight. A Sonalert® doesn't take any more juice than the neon lamp and is much more difficult to ignore."

"I can think of many situations in which an audible alarm would be more attention-getting than a warning light would be."

"So can I. This is especially true when the operator must use his eyes for other important purposes than watching for warning lights. Driving is a prime example, and I feel strongly that here is an area in which these devices can make a real safety contribution by 'backing up' idiot lights that are easily overlooked in the concentration of heavy-traffic driving."

"What do you mean by 'backing up' the idiot lights?"

"I mean a Sonalert® can be connected directly across the idiot light bulb so that it will sound whenever the bulb is lighting or—probably more important because bulbs do burn out—when it *should* be lighting. Since the 12 volts needed for the bulb will produce a large volume of sound from a Sonalert®, the driver of a car so equipped would have to be both blind and deaf to take off with his parking brake set or to keep on driving in ignorance of an overheated engine or one low on oil."

"Jumping this device across each warning bulb would be kind of expensive, wouldn't it?"

"That's not necessary. Most sensors used with the lights are of the 'grounding' type. One side of all bulbs used with them connect through the ignition switch to the positive battery terminal; then each bulb is provided with

a separate potential connection to the grounded negative terminal through a specific sensor that closes with high block temperature, low oil pressure, etc. If the positive terminal of a Sonalert® were connected to the positive connection of these bulbs and separate leads were run from the negative terminal of the device through properly oriented 50-volt silicon diodes to each sensor, the unit would sound whenever *any one* sensor completed the ground circuit. Which one was indicating trouble could be determined by a glance at the idiot lights, because the diodes would provide isolation so that each sensor could still light only its proper bulb."

"Hey, that's pretty clever! Of course, such an arrangement would work only when the systems so combined were compatible. You couldn't mix a system using switches in the positive leads with another using sensors in the negative leads."

"True, but if these devices were installed as original equipment, this could easily be taken care of. One thing I like about the little jewels is their ease of installation. You just drill a 1/8" hole in any panel or bracket material up to 1/4" thick, unscrew this knurled aluminum ring from the nose of the device, stick that nose through the hole, and screw the snazzy-looking nose ring back on."

"Why have two models putting out different tone frequencies?"

"This gives you a pair of devices that can be used together to indicate that either of two different limits of a critical parameter is being exceeded. For example, the low-frequency 2800-Hz unit can be made to sound whenever a voltage, temperature, or pressure falls below a certain value, while the high-frequency 4500-Hz model can be triggered whenever one of these goes beyond an upper limit."

"You seem to have all the answers. How come you know so much about these devices?"

"For one thing, I've been experimenting with them almost since they first came on the market about four years ago, and I'm fascinated by their potential and versatility. I also got a lot of information about how they can be used in industry and other places from an applications manual I secured by writing to the *Mallory Distributor Products Company*, a division of *P.R. Mallory & Co. Inc.*, P.O. Box 1558, Indianapolis, Indiana 46206."

Mac reached over and connected the battery to the Sonalert® and listened for several seconds to the musical chirping.

"By golly, I have another application for you!" he suddenly exclaimed. "They apparently also cure headaches, for mine is gone!" ▲

READ WHAT THE EXPERTS SAY ABOUT THE *knight-kit*® TAPE DECK KIT

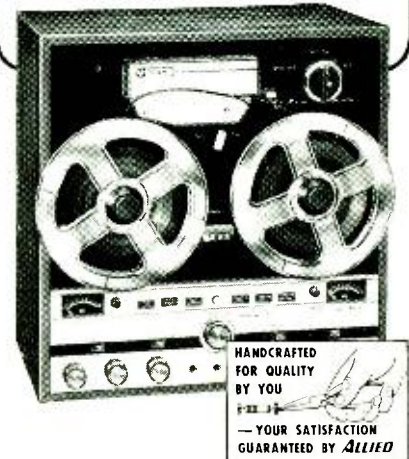

HI-FI/STEREO REVIEW—July, 1966

—"Until quite recently, it was rare to find a tape recorder selling for less than \$400 to \$500 that could record and play back an FM radio broadcast with such fidelity that it could not be distinguished from the direct broadcast. The Knight-Kit KG-415 satisfies this requirement of a true hi-fi tape recorder, yet costs only \$249.95..."

AMERICAN RECORD GUIDE—April, 1966

—"It took me 14 leisurely hours to build the unit—start to finish. Right off the bat, this kit performed right up to, or better than, all its specifications."

Yes, the Knight-Kit 4-track Stereo Tape Deck Kit gives you unmatched performance, quality and value! And it's so easy to build, too. You need only follow simple, illustrated, step-by-step instructions to assemble six solid-state plug-in modules. The Viking tape transport, built to Knight-Kit specs, is completely preassembled. Complete with all parts, instructions and 7" take-up reel **\$249.95** (less base and tape).

Rush the coupon below for full details and Special Introductory Offer on the Knight-Kit Tape Deck Kit.

ALLIED RADIO, Knight-Kit Div.
Dept. 1-AA, P. O. Box 8528
Chicago, Illinois 60680
Please rush—free and without obligation—full details and Special Introductory Offer on the Knight-Kit KG-415 Tape Deck Kit.

NAME _____
ADDRESS _____
CITY _____ STATE _____ ZIP _____

Noiseless Switching for Hi-Fi

BY BEN B. NEIGER
 Manager, Module Engineering, Clairex Corp.

Use of light-coupled photocell device permits remote control of volume and switching without any noise.

THE tremendous improvements in high-fidelity electronics, especially in regard to stereophonic sound, have made possible excellent sound reproduction. This, in turn, has focused attention on the problem of eliminating all extraneous sounds and noises that mar reproduction. With today's sophisticated units even the "click" of a switch has become an annoyance. The use of light-coupled, instead of direct, switching can eliminate this noise and, at the same time, significantly reduce costs in remote switching applications.

Remote Control for Stereo

A small unit for the remote control of stereo, which incorporates an "on-off" switch and two controls (one for level and one for balance), is shown in Fig. 1. This unit is connected to the stereo pickup, radio, tape recorder, or phonograph through small-gauge, inexpensive wires which need not be shielded. The length of the wire is not critical so the remote control can be placed any reasonable distance from the set. The wires introduce no noise or hum no matter what their length, making the control ideal for large halls, theaters, hotels, and other locations where con-

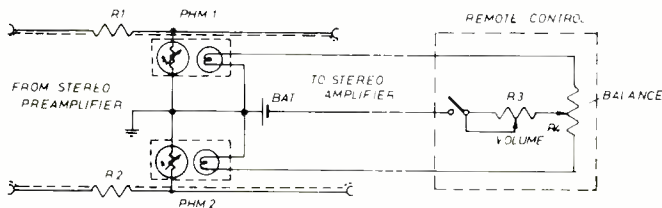

Fig. 2. Circuit of the light-controlled remote volume control.

Fig. 3. Light-controlled units used for remote switching.

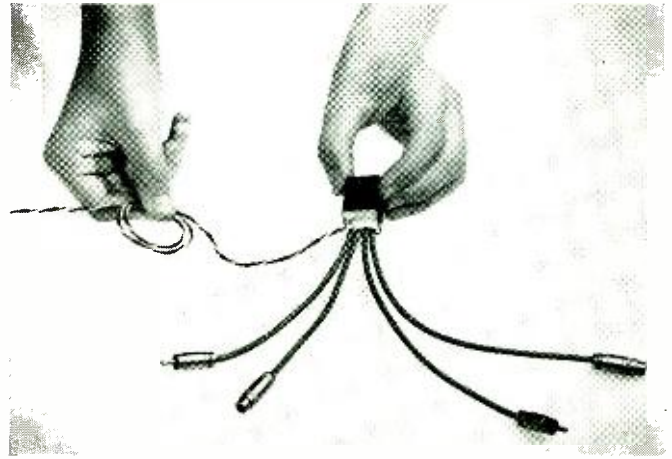
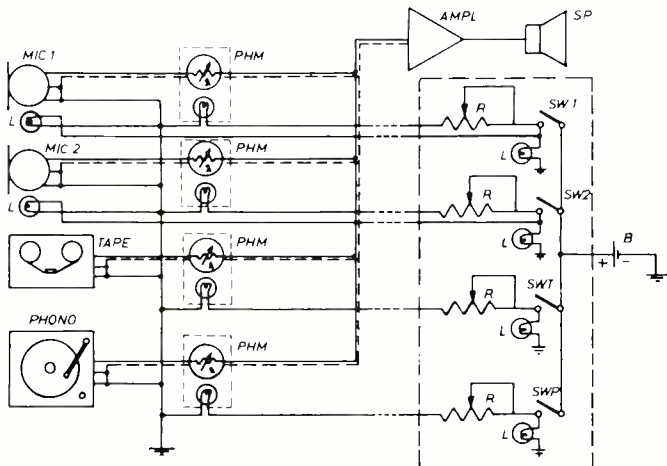

Fig. 1. The "Photomod" remote control unit for stereo use.

venience of control dictates wire runs over long distances.

Installation of the stereo remote control is simple, as shown in Fig. 2. The control is inserted between the pre-amp and the amplifier. Two 47,000-ohm resistors, R_1 and R_2 , are installed as shown. These resistors determine the amount of attenuation and are not critical. For solid-state stereo equipment these resistors may be replaced by ones having a lower value. A divider circuit from each channel is created by two "Photomods"—Clairex Type CLM5012—which incorporates a Clairex CL705L cadmium sulfide photocell and a 12-volt, 40 mA lamp. The photocells act as shunt resistances. With maximum voltage on the lamps, the resistance of the cells drops to about 400 ohms or less, providing attenuation of up to 40 dB.

Adjusting R_3 will affect the light output of both lamps causing the level of both channels to vary (volume control). With the switch open, cell resistances may be many megohms, leading to negligible insertion loss.

Resistor R_4 acts as a balance regulator. Adjusting it makes one of the lamps brighter than the other, resulting in a different resistance in each channel. This changes the divider proportionately and results in a different output to each speaker. The small time lag in both the lamps and the photocells permits very smooth adjustment. Two 6-volt industrial batteries in series provide service for a year or more. The unit could draw power from the amplifier and the preamplifier, but the power drain is so small that it is simpler to use small batteries. As the batteries begin to fail, the range of control will diminish. As this occurs, the minimum volume level will increase as an indication of the condition of the batteries.

The remote control can not reduce volume to zero, a

Fig. 4. A grouping of three "Photomod" units is shown here.

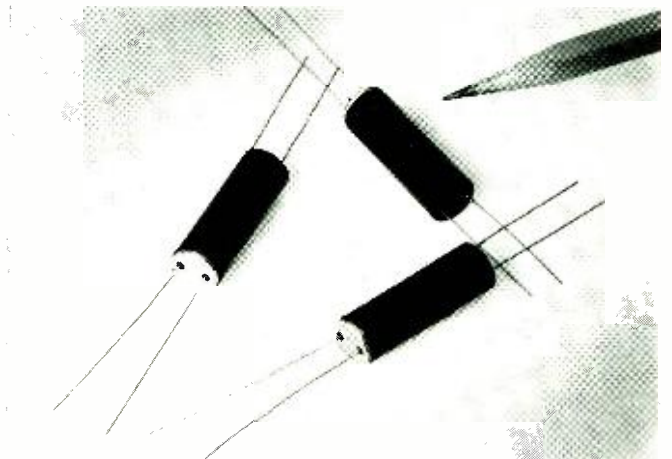

reminder to turn the main unit "off". Maximum volume is determined by the setting of the volume control on the stereo system itself. Although a two-channel system is shown in Fig. 2, the remote-control unit can be expanded to handle as many channels as desired simply through the addition of "Photomod's" and controls.

Remote Switching

Basically the same technique as just described can be applied to remote switching for various inputs in high-fidelity systems. As shown in Fig. 3, the remote switch can be used to patch in a phonograph, tape deck, and one or more microphones. In this application the complete absence of noise, hum, or the on-off "click" of a switch in the microphones assures quiet, professional operation.

Each unit used has its own volume control and "on-off" switch. The separate volume control permits volume to be preset so that when the unit is turned on, no volume adjustments would have to be made. In addition, each switch has its own pilot light so that it can be determined at a glance which of the units is operating.

The wiring from the console to the remote-control unit is simple, requiring only inexpensive, small-gauge wire such as conventional bell wire. No shielding is required no matter how long the run, nor are intermediate amplifiers needed.

The variable resistor, *R*, is 2500 ohms and controls the volume of each unit through the lamp in the "Photomod" over a 10 to 1 range. The dark resistance of the photoresistor exceeds 100 megohms. Increasing the power to the lamp reduces cell resistance to 500 ohms and permits full power to come through. The unit used here is *Clairex* Type CLM5012, the same as used in the stereo remote-control unit. For extra-low impedance microphones, use of the Type CLM4012, which has a maximum "on" resistance of 50 ohms, would be preferable.

This remote-control unit may be expanded to handle any number of channels, or any mixing requirement. It can, for example, be located in the control room of an auditorium where a large number of microphones is used. Where required, "Photomod's" may be incorporated into more sophisticated matching networks.

The "Photomod" photocell-lamp modules (Fig. 4) are available in a variety of stock models with "on" resistance as low as 40 ohms and "off" resistances exceeding 100 megs. Voltage ratings for the lamps may be 6, 12, or 24 volts for incandescent lamps. Two models are produced with neon glow lamps. These require 120 volts with a current limitation of 3 mA. ▲

**join the
P.O.M. Club!**
(Photofact-of-the-Month Club)

NOW!

**ONLY \$10 PER MONTH
brings you 20% MORE
PHOTOFACT® coverage!**

**NOW! more current model
coverage each month to keep
you ahead earning more—
AND YOU SAVE OVER
\$60 PER YEAR!**

As a PHOTOFACT-OF-THE-MONTH CLUB member, you get 6 new PHOTOFACT Sets every month—the world's finest TV-radio service data—with all the time-saving, profit-boosting help you want!

**AT LEAST
6 COLOR TV
FOLDERS MONTHLY**



**complete current coverage of
at least 50 chassis each and
every month for less than**

20¢ per chassis model!

To stay ahead, to save money (individually purchased sets now sell for \$2.50 each)—join the PHOTOFACT-OF-THE-MONTH CLUB now!

**20%
more!**

**this great new monthly package
exclusively for P.O.M. members!**

You get your 6 new PHOTOFACT Sets every month in sturdy new file folders sealed in factory carton to insure perfect condition and completeness—easier-than-ever to file and use. Now—only \$10 per month and you get 20% MORE COVERAGE!

TRY A THREE-MONTH P.O.M. SUBSCRIPTION

see how
PHOTOFACT
boosts your
earning power!

subscribe through
your Sams
Distributor
or use this
handy
order form

HOWARD W. SAMS & CO., INC. Dept. EWF-1
4300 W. 62nd St., Indianapolis, Ind. 46268

Enroll me for a 3-month membership in the Photofact-of-the-Month Club. I agree to pay \$10 per month, and understand I will receive 6 current Photofact Sets monthly for 3 months to be delivered by my Sams Distributor (named below).

Name _____

Shop Name _____

Address _____

City _____ State _____ Zip _____

My Sams Distributor is: _____

Signed: _____

CIRCLE NO. 93 ON READER SERVICE CARD

Live Better Electronically With
LAFAYETTE
 RADIO ELECTRONICS



5 WATTS
 of POWER

You Can
 Hold In
 Your Hand

only
99⁹⁵

No Money Down

DYNA-COM 5

with Leather
 Shoulder Strap

- ★ 3 Switchable Crystal Controlled Transmit and Receive Channel Positions for All 23 Channels
- ★ 5-Watt FCC Maximum Input . . . with the Power of the Most Powerful Base and Mobile CB Transceivers
- ★ 13 Transistors, 6 Diodes
- ★ 7-Stage Transmitter for Maximum Transmit Power!
- ★ Operate Mobile in Your Car with Optional Cigarette Lighter Plug-in Adapter

- Superheterodyne Receiver with Less Than 1 Microvolt Sensitivity for 10 db S + N/N Ratio
- Automatic Compressor Range Boost-Assures High Talk Power
- Variable squelch and Automatic Noise Limiting for Minimum Noise Imported*



FREE
 1967
 Catalog No. 670
 512 Pages

Everything in Electronics
 for Home and Industry
 from the "World's Hi-Fi
 Electronics Center"

LAFAYETTE Radio Electronics
 Dept. RA-7, P. O. Box 10
 Syosset, L. I., N. Y. 11791

Send me the FREE 1967
 LAFAYETTE Catalog 670

RA-7

Name

Address

City

State Zip

CIRCLE NO. 107 ON READER SERVICE CARD

POLAROID LAND PHOTOGRAPHY

Complete guide and only comprehensive and up-to-date handbook on Polaroid Land Photography.
 1966—\$1.25.....#24 1963—\$1.00.....#25
 Order by number from
 Ziff-Davis Service Div., 589 Broadway, New York,
 N. Y. 10012. Enclose add'l 15¢ per copy for shipping and handling (50¢ for orders outside U.S.A.)

LEARN Electronics Engineering AT HOME

Fix TV, design automation systems, learn transistor-complete electronics, college level Home Study courses taught so you can understand them. Earn more in the highly paid electronics industry. Courses, materials, theory and practical. Kits furnished. Over 30,000 graduates now employed. Resident classes at our Chicago campus if desired. Founded 1934. Catalog. *Vets—write for information about G. I. Bill Training.
 American Institute of Engineering & Technology
 1141 West Fullerton Parkway Chicago, Ill. 60614

RADIO & TV NEWS

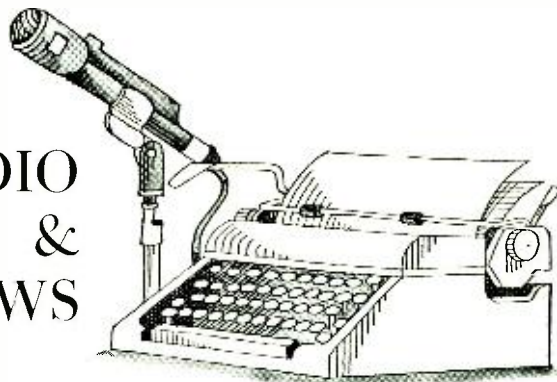

LASER TV receivers will be in the future if scientists at the *Zenith Radio Corp.* have anything to say about it. Recently, they demonstrated an experimental TV system using a laser that produced large-size pictures for projection that had sharpness and detail approaching that of a conventional TV set.

The experimental system has four main components. The light-producing laser, which is the equivalent of the electron beam in the CRT, first passes through an intensity modulator which impresses the video signals on an ultrasonic wave that interacts with the light beam to control its brightness. The more intense the sound wave, the more light passes through the modulator.

Light from the intensity modulator then enters the horizontal deflector where the beam is deflected by ultrasonic waves so as to trace out a horizontal line on the screen 15,750 times per second.

The light next enters the mechanical vertical deflector where it strikes a mirror vibrating in accordance with a 60-Hz saw-tooth wave and is deflected vertically to form a raster. Experimentally, this moving mirror has been replaced by another ultrasonic diffraction cell, thus resulting in an all-electronic display system.

Images can be projected on the screen in any size, depending on the available laser brightness. The resolution of the present experimental version is somewhat less than that of a conventional TV picture.

Relatively simple extensions of the technique are expected to provide the full resolution permitted by U.S. TV standards.

Electronic Teachers

A leading international expert on information and control systems claims that electronic teaching aids are essential to meet the radically changing needs of mass education.

Dr. Louis T. Rader, Vice President and General Manager of *G-E Company's* Industrial Process Control Division, claims that our educational system is beset with problems caused by

the rising costs of education per pupil, the growing teacher shortage, loss of efficiency, and the need for preparing people mentally for a lifetime of learning.

He told the National Electronics Conference that the problems could be solved in a few years through the full-scale use of electronics in classroom teaching. He also said ". . . electronic teaching aids can make possible the breakup of enforced progress by classes. Students can learn at their own speed with the aid of electronic equipment that never tires or loses patience, is never bored, and is producible in any quantity.

"Moreover, teachers can be freed from the drudgery of 'by-rote' education and can devote their time to the far more complex art of leading discussion groups, working with individual students and small groups on problem solving, and guiding students in the pursuit of knowledge and, hopefully, wisdom."

Business News

Rising defense requirements and the continuing boom in home entertainment products pushed shipments of electronic components by U.S. producers to another record high in the first quarter of 1966, according to the U.S. Department of Commerce.

Shipments were 5% above the same quarter in 1965, also a new high.

Continuing demands for components in home-entertainment products were reflected in shipments of TV picture tubes, up 8% in value over the previous quarter and up nearly 70% over the first quarter of 1965; capacitors, up 14%; resistors and transformers, both up 7%; while quartz crystals were up 15% over the fourth quarter of 1965 and 25% above the same period last year, apparently due to increasing demands for CB radio equipment.

Shipments of integrated circuits were up 130% in value over the same period of 1965, primarily due to the rapidly expanding computer market. IC's are also being designed into consumer products at a rapid pace, pointing to increasing consumer markets in the near future.

IC's in New AM/FM Receiver
(Continued from page 35)

load tuned circuits and effectively lower the "Q" or efficiency of those circuits. The end result is broader bandpass, hence greater susceptibility to spurious and unwanted signal transfer.

Common transistors are also somewhat non-linear in their response to varying signal amplitudes and frequencies. This leads to the generation of distortion products within the device itself and these products appear as distortion in the recovered program material. The FET is a more linear device and this, coupled with its ability to work well in tuned-circuit applications, makes it particularly attractive for FM front-end designs. The r.f. amplifiers and mixers in FM front ends can be designed, using FET's, to be essentially free from distortion and intermodulation products and thus greatly reduce cross-modulation. The use of FET's in the receiver front end resulted in marked improvement of all tuner performance parameters. There is little doubt that these remarkable devices will soon become commonplace in r.f. applications.

A noise-operated squelch circuit is used in the FM section to give smooth, quiet station selection. Automatic stereo switching is included, along with a stereo threshold control that automatically switches to mono operation if the station signal becomes too noisy for good stereo listening.

The stereo adapter circuit is high-frequency compensated to maintain good separation across the audio band. Both stereo channel outputs have SCA filters as well as 19-kHz and 38-kHz filters. A subcarrier phase-adjust control is accessible at the front panel.

The power-amplifier sections of the receiver employ all-silicon transistors in transformerless circuitry that is short-circuit protected by electronic overload circuits and thermal cutouts. Continuous power output is 50 watts per channel at less than 0.5% harmonic or intermodulation distortion. Tone-control circuits can be switched off to give absolutely flat response. All controls, including input level controls, are on the front panel.

A unique feature of the receiver is a built-in test circuit for troubleshooting. This circuit is used extensively during kit assembly to verify circuit operation and can be switched in at any time after completion for tests in case trouble develops. ▲

(Editor's Note: The information contained in this article represents a preview of a new product. Delivery of the Heath AR-15 AM/FM/EM-stereo receiver begins in March.)



The Heart of your Radio is Its

INSIST ON CQC*

** Controlled Quality Crystals available only from Texas Crystals dealers. Extensive precision testing throughout manufacture enables Texas Crystals to unconditionally guarantee their frequency control crystals. Use of Texas Crystals in space program and by other governmental agencies is evidence of the quality you can count on.*

If your dealer can't supply your needs, send his name with your request for catalog to our plant nearest you.



TEXAS CRYSTALS
1000 Crystal Drive
Fort Myers, Fla. 33901
Phone: 813-936-2109



4117 W. Jefferson Blvd.
Los Angeles, Calif. 90016
Phone: 213-731-2258
Division of Whitehall Electronics Corp.

CIRCLE NO. 86 ON READER SERVICE CARD

SAY YOU SAW IT IN
Electronics World

\$500 per month?

Diversify into booming two-way radio maintenance!

105-B MICROMETER FREQUENCY METER



Measures nearby transmitters. continuous coverage 100 KC to 175 MC, and up. Internal calibrator. Only 8 pounds, \$295.00

Conservative extra income from citizens band and business radio maintenance!

LAMPKIN

dependable low cost equipment used by thousands of engineers.

Free booklet tells you how—see coupon below!

205-A FM MODULATION METER



Tunable 25 to 500 MC any channel. Direct reading. Light weight. Measures peak swing 0-1.25, 2.5, 12.5, and 25.0 peak KC. \$340.00

PPM METER—inexpensive accuracy for the 105-B for 0.0001% accuracy on split-channels.

At no obligation to me, please send me free booklet "How to Make Money in Mobile-Radio Maintenance."

Name _____

Address _____

City _____ State _____

LAMPKIN LABORATORIES, INC
MFM Division, Bradenton, Florida 33505

CIRCLE NO. 105 ON READER SERVICE CARD

TRANSISTOR / DIODE TESTER



BATTERY OPERATED
CANNOT DAMAGE TRANSISTORS

Model No. BZ8

TRANSISTEST checks all types of transistors and diodes by means of a transistorized audible signal and will identify basic type of transistor as to PNP or NPN. It can also be used as a continuity tester and code practice oscillator.

AVAILABLE AT ALL ELECTRONIC PARTS DISTRIBUTORS

MANUFACTURED BY
WORKMAN Electronic PRODUCTS, INC.
SARASOTA, FLORIDA

CIRCLE NO. 82 ON READER SERVICE CARD

PRECISION HI-FI ACCESSORIES

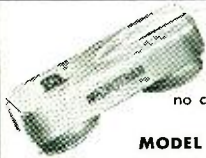

HUM-BUCKING TELEPHONE PICKUP COIL

Hum free transcription, no connection to telephone, rugged cast case.

MODEL HP-70 NET \$6.95

TAPE RECORDING HEAD DEMAGNETIZER

Removes permanent magnetism, protects tape from erasure, minimizes noise and distortion, extended pole piece — easy access.



MODEL HD-40M NET \$6.15

MAGNETIC TAPE ERASER

Bulk erasure of recorded tape, restores tape like new, reduces noise, reel size to 10 1/2" x 1 1/2" W, epoxy case, sealed for life.

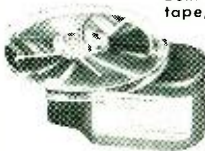

MODEL HD-11M NET \$23.50

STEREO 3RD CHANNEL OUTPUT TRANSFORMER

Add speaker to fill "hole-in-middle." Matches impedance, polarity and power level. Rating 30 watts. Response 40 to 20,000 C.P.S.



MODEL HM-90 NET \$6.33

MICROTRAN company, inc.

145 E. Mineola Ave., Valley Stream, N. Y.

CIRCLE NO. 103 ON READER SERVICE CARD

Problems of Matching Speakers

(Continued from page 26)

made to meet this requirement. It would be a simple matter indeed if speakers were available in any desired impedance. These could then be selected so that their impedance in parallel is above the desired minimum impedance. Unfortunately, speakers are made with nominal rated impedances of 4, 8, or 16 ohms and a given type is not made in a choice of impedances.

Means for connecting speakers in parallel can be considered in two classes: those built into the amplifier and those external to the amplifier. Some amplifiers include provisions for paralleling main and remote speakers. To take care of situations where the paralleled speakers provide too low a load value, a series resistor is provided in the amplifier. Suppose, for example, that the minimum safe value of impedance for a given amplifier is 3 ohms and we want to operate two 4-ohm speakers in parallel, making their combined impedance 2 ohms. A one-ohm series resistor will provide the required protection. Unfortunately, it will also decrease the damping factor and provide a slight peak at resonance in a speaker designed for flat response with an amplifier of high damping factor. (In an over-damped speaker this would improve the bass response.) In order to avoid this effect, some amplifiers use negative feedback around the series resistor to maintain a high damping factor.

Series Operation

Why not operate the speakers in series? If they are identical this is perfectly all right. If they are not, there can be all kinds of undesirable interaction between them. The simplest case is where they are of different rated impedance. If an 8-ohm and a 4-ohm speaker are connected in series, the same current will flow through both and, since power equals I^2R , the 8-ohm speaker will receive twice as much power as the 4-ohm speaker. This, however, is a gross oversimplification of what occurs since the impedances of the two speakers vary over the frequency range.

To illustrate the effect, consider the extreme case of an inexpensive, replacement-type speaker in series with a good hi-fi system, both of nominal 8-ohm impedance. The latter probably resonates around 45 Hz and has its minimum impedance of about 6 ohms in the 100-400 Hz region. The inexpensive speaker may resonate at 90 Hz in its cabinet and present a resonant impedance of 30 ohms.

At 90 Hz the two speakers in series are 36 ohms. The hi-fi system has

with the amplifier output voltage across it. In the mid-frequency range the impedances are equal and the hi-fi speaker gets 1/2 the output voltage. The relative input voltage at 90 Hz is about 1/3, producing a hole in response of almost 10 dB. Fig. 10 shows actual measurements on such a connection. In addition, since the hi-fi speaker electrically "looks into" a source impedance consisting of the other speaker in series with the amplifier, the effect on the damping factor can well be imagined.

Use of Transformer

There is a well-known device for changing impedances, even if somewhat discredited in hi-fi circles. This is the transformer. When operating at low impedance with fairly small transformation ratios and without d.c. in the primary (unlike an amplifier output transformer), this is a very efficient and not too costly device which can be designed for very wide frequency range and freedom from phase shift. This does not mean that transformers designed for public-address applications can be used. Indeed, these are likely to be dangerous because they usually have poor low-frequency response due to low values of primary inductance.

In the equivalent circuit for a transformer, the primary inductance is a shunt element. A low value results in a virtual short circuit at very low frequencies and a predominantly reactive load for the range immediately above this. Both conditions are exactly what we are seeking to avoid in loading the amplifier. A high-quality transformer must be used. It is interesting to note that a very large number of taps are not needed for a great variety of transformation conditions (Fig. 11). A 16-8-4 ohm transformer can be used for loads of 4, 2, 1.44, 0.64, and 0.32 ohms if the amplifier will safely accept an 8-ohm load.

Unequal power to different speakers may not be undesirable. In some cases it is desirable to operate the remote speakers at reduced loudness. In this case a remote speaker of higher impedance than the main speaker should be used. An alternate means is a fixed or adjustable L-pad or a simple potentiometer. The latter should have a resistance about five times the impedance of the remote speaker. If operated for reduced loudness, it will place a large value of resistance in series with the speaker, reducing the loading of the amplifier.

In this article we have pointed out some of the problems that may occur when connecting speakers to solid-state amplifiers. It behooves the user to be aware of these problems and to know how to solve them. ▲

ELECTRONIC CROSSWORDS

By WILLIAM R. SHIPPEE

(Answer on page 92)

ACROSS

1. One-millionth of a meter.
7. Five-element vacuum tube.
12. Possessing non-directional characteristics.
14. Tube manual notation for grid bias voltage.
15. Part of the Bible (abbr.).
16. To position an antenna for best signal pickup.
17. Two-element vacuum tube.
20. Domesticated.
21. One type of wavemeter.
24. One-thousandth of a meter (abbr.).
25. Correlative of either.
26. Type of logic circuit.
28. As far as.
29. Type of filter circuit.
30. Decimal number for binary code 0010.
31. Plate current on a schematic.
32. Plate voltage in the tube manual.
33. 60-Hz noise in an amplifier.
34. "The" in Spain.
35. Because.
36. Binary system uses zero and
37. It converts rotating motion to linear motion.
38. A tailless monkey.
39. You and me.
40. A cable dimension (abbr.).
42. Type of resonant circuit (abbr.).
43. It is not "on".
46. Four-element vacuum tube.
50. Underwater "radar".
51. Exotic melon.
53. Period of time.
54. Loose end.
57. Administrative division of a county (abbr.).
58. Tubes and people do it.
60. Type of transmission (abbr.).
61. Approximately 96,500 coulombs.
62. Six-element vacuum tube.

DOWN

1. International voice distress signal.
2. Third person singular, present indicative of "be".
3. Crystal cut.
4. Type of noise.
5. Amphibious mammal of the weasel family.
6. Chemical symbol for a component in some batteries.
8. Type of storage cell using an alkaline electrolytic.
9. Temporary canvas shelter.
10. Eight-pin tube base.
11. Vacuum tube housing of metal or glass.
13. The first grid of a tube.
18. Transistor base current (abbr.).
19. Popular material used in inexpensive styli.
22. Current \times voltage =
23. Interference.
27. Plate resistance (abbr.).
28. Base for the decimal system.
29. Angular relationships of two sine waves.
35. Color-TV circuit (abbr.).
36. Form of oxygen.
37. The opposite of saturation in a vacuum tube.
38. Nickname.
40. $E = \dots \times \dots$
41. Physician (colloq.).
44. Unit of capacitance.
45. One complete TV picture.
47. To rip apart.
48. Information.
49. To see at a distance.
50. Aromatic herb of the mint family.
52. Exclamation expressing contempt.
55. Note of the musical scale.
56. Sound system for the "masses" (abbr.).
59. Prefix meaning "away from".

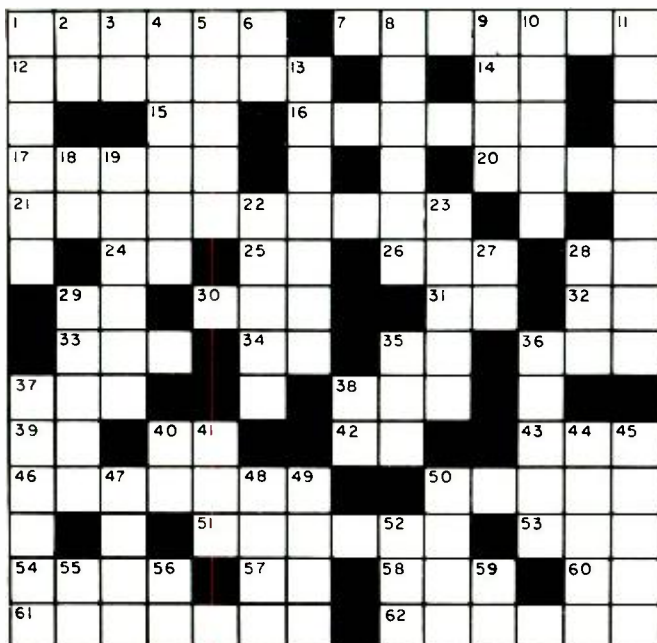

Sonalert[®]

New high-reliability solid-state tone signal

Produces distinctive 2800 or 4500 cps tone, draws only 3 to 14 milliamps.

No RF noise—no arcing contacts. Explosion-proof.

High reliability—solid-state oscillator drives piezoelectric sound transducer.

High output—68 to 80 db sound level.



Standard models available for operation on 6 to 28 volts DC, 6 to 28 volts AC, 110 volts AC. Can be supplied with pulsed output, 3 to 5 pulses per second. For data, typical circuitry for over-voltage, under-voltage, overheat, security, and many other signalling applications, write Mallory Distributor Products Company, a division of P. R. Mallory & Co. Inc., P.O. Box 1558, Indianapolis, Indiana 46206.



CIRCLE NO. 104 ON READER SERVICE CARD

BIGGER... BETTER THAN EVER!

FREE!

SEND TODAY FOR YOUR NEW 40th ANNIVERSARY 1967 CATALOG



YOUR BUYING GUIDE FOR

- Stereo & Hi-Fi Systems & Components.
- Tape Recorders.
- Electronic Parts, Tubes, Tools.
- Phonos & Records.
- Cameras and Film.
- Public Address.
- Citizens Band. • Ham Gear.
- Transistor & FM-AM Radios.

252 GIANT VALUE PACKED PAGES!

BURSTEIN-APPLEBEE CO.

Dept. EW, 1012 McGee, Kansas City, Mo. 64106
 Rush me the FREE 1967 B-A Catalog.

Name

Address

City

State..... Zip Code.....

CIRCLE NO. 122 ON READER SERVICE CARD

In today's electronics boom, the demand for men with technical education is far greater than the supply of graduate engineers. Thousands of real engineering jobs are being filled by men without engineering degrees—provided they are thoroughly trained in basic electronic theory and modern application. The pay is good, the future is bright...and the training can now be acquired at home—on your own time.

How to become a “Non-Degree Engineer”



THE ELECTRONICS BOOM has created a new breed of professional man—the non-degree engineer. Depending on the branch of electronics he's in, he may "ride herd" over a flock of computers, run a powerful TV transmitter, supervise a service or maintenance department, or work side by side with distinguished scientists on a new discovery.

But you do need to know more than soldering connections, testing circuits and replacing components. You need to really know the fundamentals of electronics.

How can you pick up this necessary knowledge? Many of today's non-degree engineers learned their electronics at home. In fact, some authorities feel that a home study course is the *best* way. *Popular Electronics* said:

"By its very nature, home study develops your ability to analyze and extract information as well as to strengthen your sense of responsibility and initiative."

Cleveland Method Makes It Easy

If you do decide to advance your career through home study, it's best to pick a school that *specializes* in the home study method. Electronics is complicated enough without trying to learn it from texts and lessons that were designed for the classroom instead of the home.

Cleveland Institute of Electronics concentrates on home study exclusively. Over the last 30 years it has developed tech-

niques that make learning at home easy, even if you once had trouble studying. Your instructor gives the lessons and questions you send in his undivided personal attention—it's like being the only student in his "class." He not only grades your work, he analyzes it. And he mails back his corrections and comments the same day he gets your lessons, so you read his notations while everything is still fresh in your mind.

Students who have taken other courses often comment on how much more they learn from CIE. Says Mark E. Newland of Santa Maria, Calif.:

"Of 11 different correspondence courses I've taken, CIE's was the best prepared, most interesting, and easiest to understand. I passed my 1st Class FCC exam after completing my course, and have increased my earnings by \$120 a month."

Always Up-to-Date

Because of rapid developments in electronics, CIE courses are constantly being revised. This year's courses include up-to-the-minute lessons in Microminiaturization, Laser Theory and Application, Suppressed Carrier Modulation, Single Sideband Techniques, Logical Troubleshooting, Boolean Algebra, Pulse Theory, Timebase Generators...and many more.

CIE Assures You an FCC License

The Cleveland method of training is so successful that better than *9 out of 10 CIE*

men who take the FCC exam pass it—and on their first try. This is despite the fact that, among non-CIE men, 2 out of every 3 who take the exam fail! That's why CIE can promise in writing to refund your tuition in full if you complete one of its FCC courses and fail to pass the licensing exam.

This Book Can Help You

Thousands who are advancing their electronics career started by reading our famous book, "How To Succeed in Electronics." It tells of many non-degree engineering jobs and other electronics careers open to men with the proper training. And it tells which courses of study best prepare you for the work you want.

If you would like to cash in on the electronics boom, let us send you this 40-page book free.

Just fill out and mail the attached card. Or, if the card is missing, write to:

 **CIE Cleveland Institute of Electronics**
1776 E. 17th St. Dept. EW-26,
Cleveland, Ohio 44114
Accredited Member National Home Study Council

ENROLL UNDER NEW G. I. BILL

All CIE courses are available under the new G.I. Bill. If you served on active duty since January 31, 1955, or are in service now, check box on reply card for G.I. Bill information.



PERMANENT PROTECTION!



Electronics World

Deluxe Magazine Files that hold a full year's copies!

Designed to keep your periodicals orderly and easy to refer to. These durable files guard against soiling, tearing, wear or misplacement of issues. They look, feel like leather and are washable! 23kt. gold lettering and exquisite 2-color binding make them highly-decorative additions to your bookshelves.

Shipped POSTPAID! FULLY GUARANTEED!
Only **\$3.50** each — **3 for \$10, 6 for \$19**

Order several today—for **ELECTRONICS WORLD** and all your other favorite magazines.

Jesse Jones Box Corp., Box 5120, Dept. EW
Philadelphia 41, Pa.

Enclosed is \$_____. Please send me _____
Electronics World Magazine Files in the colors checked below:

- Black backing/maroon sides
- Maroon backing/black sides

NAME _____

ADDRESS _____

CITY _____ STATE _____ ZIP CODE _____

Orders outside U.S.A. please add \$1 additional for each file ordered.

(Payment must accompany order)

problem solvers by



PROBLEM:
Long Microphone Cable Runs
SOLUTION:
A95A Line Matching Transformer

Matching low impedance microphones to high impedance inputs? Excessive high frequency loss and hum pickup with long microphone cable runs? The A95A Line Matching Transformer solves both problems quickly—and economically. New miniature size: 3/4" diameter and 2 1/2" length. New hum shielding: superior to any other transformer. New flexibility: 35-50 and 150-210 ohms input. New ease of installation: input and output connectors furnished. Only \$17.50 List.

Shure Brothers, Inc.
222 Hartrey Avenue
Evanston, Illinois

CIRCLE NO. 79 ON READER SERVICE CARD

TEST EQUIPMENT
PRODUCT REPORT

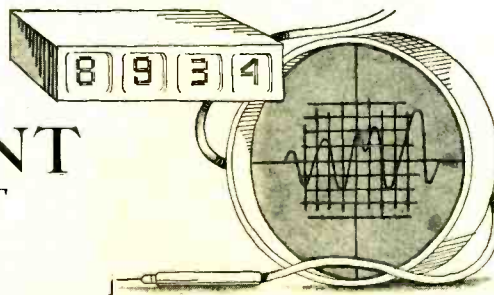

Aul Instruments Model TVM4 Transistor V.O.M.

For copy of manufacturer's brochure, circle No. 33 on Reader Service Card.

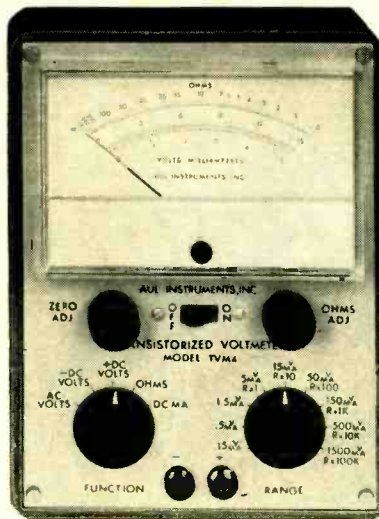

THE design objective of the Aul Model TVM4 transistorized volt-ohm milliammeter was to combine the features of both v.o.m. and v.t.v.m. in a single, low-cost instrument. This objective was achieved by the use of a transistorized difference amplifier and a 50-microampere taut-band meter. Basically, the amplifier acts like an impedance transformer. The voltage at the input of the amplifier is approximately equal to that appearing across the meter. However, the current through the meter is much greater than that at the input. The amplifier, in conjunction with the meter movement, yields an instrument with a full-scale sensitivity of 150 millivolts, which makes the device many times more sensitive than conventional v.t.v.m.'s. In addition, there is improved stability.

The amplifier draws less than one milliamperes so that the battery life of the instrument begins to approach the shelf life of the batteries. Silicon diodes are used to protect the emitter-base junctions of the transistors. In case of an overload, one input transistor will be turned off with the silicon diode protecting the emitter-base junction, while the other input transistor and its complement will saturate. This circuitry allows an input impedance one hundred times greater than that of the conventional v.o.m.

The use of a taut-band movement together with stable film 1% resistors increases the long-term accuracy of the TVM4. The use of solid-state circuitry and the absence of a power transformer and filament heating result in an improved life for the instrument.

The device can be employed in any application where a v.o.m. or a v.t.v.m. is used. Its construction, in a fully insulated case, allows differential measurements on high-voltage circuits without fear of an a.c. line return or of loading effects. It may be used in the field as well as in the laboratory since it does not require an a.c. line.

The employment of semiconductors to provide foolproof and fast-acting overload protection permits a 500 overload factor to be placed on the sensitive d.c. ranges without damage to the input circuit, the amplifier, or the meter movement.

Model TVM4 measures 6 3/8 inches high, 5 1/4 inches wide, and 2 1/4 inches deep, weighs less than three pounds, and is priced at \$69.95. ▲

Hewlett-Packard Model 3430A Digital Voltmeter

For copy of manufacturer's brochure, circle No. 150 on Reader Service Card.

A NEW digital voltmeter, priced at \$595, has an accuracy of 0.1% plus 1 digit, therefore making digital precision available at a cost approaching that of laboratory analog voltmeters. The speed, convenience, and accuracy of digital readout thus becomes available at a moderate price for general-purpose applications in the laboratory, on production test stands, in repair shops, and at quality-assurance incoming inspection stations.

The new voltmeter, Hewlett-Packard Model 3430A, has a floating input, a feature not commonly found in digital voltmeters of this price class. With its "low" input terminal unstrapped from ground, the voltmeter can make measurements up to ±500 volts d.c. removed from ground. The input impedance is 10 megohms on all ranges.

The instrument has five manually selected ranges, from 100 millivolts d.c. full scale to 1000 volts d.c. full

scale, and a three-digit readout. A fourth digit (one or blank) permits overrange measurements up to 60% above full scale (except on the 1000-volt range) at full accuracy. The instrument automatically responds to the polarity of the input and indicates whether the input is a positive or negative voltage.

Among other features, the new digital voltmeter has an amplifier output that provides a d.c. voltage proportional to the input with a gain accuracy of $\pm 0.1\%$. The amplifier output, handy for driving a recorder, is capable of driving any load that has an impedance greater than 10,000 ohms without degrading the accuracy of the reading.

The voltmeter is the staircase comparator type which compares the input voltage to an internally generated voltage derived from a zener reference diode and precision resistors. The internally generated voltage starts from zero and is stepped automatically to succeeding higher values until it matches



the input voltage. Each step advances a counter one digit; when coincidence is reached, the number of accumulated counts, which represents the input voltage, is shown on the front-panel display. The instrument retains the displayed number until the next measurement cycle is completed, thus assuring a continuous display without blinking. The instrument completes two readings per second. ▲

Vari-Tech Model VT-1160 Low-Resistance Tester

For copy of manufacturer's brochure, circle No. 151 on Reader Service Card.

A NEW quality-control device has been developed by Vari-Tech which allows unusually rapid testing of resistances in a 0.001- to 0.2-ohm range to determine whether a pre-specified limit has been exceeded. The VT-1160 low-resistance tester is designed to provide accurate production-line tests of such things as connectors, spot welds, printed circuitry, semiconductor rectifiers, and meter shunts. These tests can be performed at the rate of one per second.



Semi-automatic in operation, the device simply requires successive positioning of two probes on the parts being tested; reject parts are signaled by means of an audible alarm. The tester automatically switches on a self-contained test current after the probes have been positioned on a part, but only after proper contact has been made, eliminating any arcing with subsequent probe damage or arc marks on the part under test.

When proper contact is made, the operator immediately hears a low tone. If this tone stops, the test is "good" and the resistance is acceptable; but if the tone changes to a distinctly higher pitch, the test is "bad" and the resistance of the reject part has exceeded the preset maximum. The reject alarm remains on until reset by the operator. Moreover, if proper contact is lost after the test current is automatically switched on, or if there is equipment failure, the reject alarm sounds immediately, making the system "fail-safe."

The tester can be adapted for automatic operation if used with an electrode positioning device and production part fixtures. The two probes provided are coax electrodes which, when placed for a test, form a 4-terminal resistance circuit.

Calibration of the instrument for the test limit is done by first dialing the desired test current on an ammeter (5- to 25-ampere range) and then setting the maximum allowable voltage drop (and thus the maximum allowable resistance) on a digital dial which is graduated in millivolts over a zero- to 1.0-volt range. The ammeter reading is accurate to $\pm 2\%$ and the maximum voltage setting is accurate to $\pm 0.3\%$ or 2 millivolts, whichever is greater.

The Model VT-1160 operates on standard current and requires 300 watts. It is available from the manufacturer at \$600. ▲

NEW! 17TH EDITION of the world-famous RADIO HANDBOOK

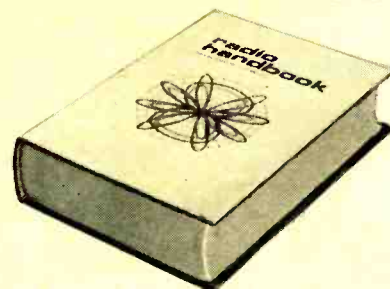

- the most comprehensive how-to-build-it source
- top problem-solver for builders of practical equipment

Completely revised and enlarged by William I. Orr, W6SAI. This is the comprehensive communications manual which is the industry standard for electronic engineers, technicians, and advanced radio amateurs. Explains in authoritative detail how to design and build all types of radio communications equipment.

NEW HOW-TO-BUILD DATA

The new 17th Edition of the RADIO HANDBOOK presents design data on the latest amplifiers, transmitters, receivers, and transceivers. Includes greatly enlarged sections on single-sideband equipment and design, and semiconductors. Gives extended coverage to r-f amplifiers, special vacuum-tube circuits, and computers. All equipment described is of modern design, free of TVI-producing problems.

THOROUGHLY REVISED & UPDATED

Provides a complete understanding of the theory and construction of all modern circuitry, semiconductors, antennas, power supplies; full data on workshop practice, test equipment, radio math and calculations. Includes aspects of the industrial and military electronics fields of special interest to the engineer and advanced amateur. The 17th Edition of the RADIO HANDBOOK provides the broadest coverage in the field—complete information on building and operating a comprehensive variety of high-performance equipment. All data is clearly indexed. 832 pages; $6\frac{1}{2} \times 9\frac{1}{4}$ "; hardbound. Invaluable for electronic engineers, designers, builders, amateurs, and technicians.

ORDER TODAY

New 17th Edition of the famous
RADIO HANDBOOK
No. EE167, Only... \$12.95



Order from your electronic parts distributor or send coupon below.

EDITORS and ENGINEERS, Ltd.

P. O. Box 68003
New Augusta, Ind. 46268, Dept. EWE-1

Send me EE167, the new 17th Edition of the RADIO HANDBOOK at \$12.95.

\$ _____ encl. Check Money Order

Name _____

Address _____

City _____ State _____ Zip _____

CIRCLE NO. 115 ON READER SERVICE CARD

Complete TUNER REPAIR



Includes ALL parts (except tubes) . . . All labor on ALL makes. Fast 24-hour service with 1-year warranty

Sarkes Tarzian, Inc., largest manufacturer of TV and FM tuners, offers unexcelled tuner overhaul and factory-supervised repair service.

Tarzian-made tuners received one day will be repaired and shipped out the next. More time may be required on other makes. Every channel checked and realigned per original specs. And, you get a full, 12-month guarantee against defective workmanship and parts failure due to normal usage. Cost, including labor and parts (except tubes) is only \$9.50 and \$15 for UV combinations. Replacements at low cost are available on tuners beyond practical repair.

Always send TV make, chassis and Model number with faulty tuner. Check with your local distributor for Sarkes Tarzian replacement tuners, parts or repair service. Or, use the address nearest you for fast, factory-supervised repair service.

TUNER SERVICE  CORPORATION

(Factory-supervised tuner service authorized by Sarkes Tarzian)

MIDWEST—817 N. Pennsylvania St.
Indianapolis, Ind. Box 1642
Tel: 317-632-3493

EAST—547-49 Tonnele Ave.
Jersey City, New Jersey • Tel: 201-792-3730

SOUTH-EAST—938 Gordon St., S.W.
Atlanta, Georgia • Tel: 404-758-2232

WEST—SARKES TARZIAN, Inc.
Tuner Service Division
10654 Magnolia Blvd., N. Hollywood, Calif.
Tel: 213-769-2720

CIRCLE NO. 85 ON READER SERVICE CARD

GET
INTO

ELECTRONICS

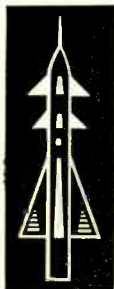

V.T.I. training leads to success as technicians, field engineers, specialists in communications, guided missiles, computers, radar and automation. Basic & advanced courses in theory & laboratory. Electronic Engineering Technology and Electronic Technology curricula both available. Assoc. degree in 29 mos. B. S. also obtainable. G.I. approved. Graduates in all branches of electronics with major companies. Start February, September. Dorms. campus. High school graduate or equivalent. Write for catalog.

VALPARAISO TECHNICAL INSTITUTE
Dept. RD, Valparaiso, Indiana

CRT Phosphors (Continued from page 52)

operating voltage of the electron beam. The change can be made either by switching voltage on a single gun or through the use of two guns operating at different voltages. However, such tubes are not in wide use at the present time.

Thin-Film Phosphors

Where high precision is needed for radar display, film scanning, or read-out systems, it is desirable that the cathode-ray tube have a very small spot size. Vastly improved resolution is accomplished through the use of specially designed electron guns in conjunction with very fine grain screens. Conventional screens employ a phosphor with a grain size of about 10 μ (microns). To obtain a spot size of 1 mil or less, a phosphor with a grain size of about 1 μ must be used.

Several methods have been devised to apply fine-grain phosphors to faceplates, including vapor deposition and settling from a solution. The latter is slow because the small grains settle more slowly than larger particles. Fine-grain phosphors are normally deposited in a thin, transparent film. The surface may be finished by polishing to assure uniformity and reduce "noise" caused by irregularities.

Transparent films have lower efficiency than conventional phosphor coatings, but they provide high resolution and freedom from graininess. Since they are transparent, there is little reflection of ambient light, so contrast is good. Furthermore, the intimate contact between the film and the faceplate permits efficient transfer of heat caused by electron bombardment, and consequently transparent phosphors are highly resistant to burns.

Aluminized Tubes

The brightness of cathode-ray tubes may be considerably improved by diffusing a thin layer of aluminum over the phosphor. The aluminum layer is thin enough to permit the electron beam to penetrate to the phosphor. Brightness is increased because much of the phosphor luminescence that would otherwise be lost in the interior of the tube is reflected forward. Aluminizing has other useful effects. Since aluminum is a good conductor, it prevents a negative charge from building up on the faceplate. Electrons therefore reach the screen at a higher velocity, adding to the brightness. Furthermore, the aluminum coating protects the more fragile phosphors against burning.

If the accelerating potential of the cathode-ray tube is much less than 5

kilovolts, it is usually not worthwhile to aluminize the tube. The beam energy lost in penetrating the aluminum coating is a substantial part of the total beam energy at lower accelerating potentials, and this offsets the gain in brightness from aluminizing.

It is sometimes considered undesirable to employ a high accelerating potential on the electrodes of a cathode-ray tube because the beam becomes "stiff" and a high voltage must be applied to the deflection plates, resulting in loss of sensitivity. The difficulty may be overcome by placing accelerating electrodes carrying high voltage beyond the deflection plates. In this way, the beam is first deflected and then accelerated. This post-deflection acceleration is usually accomplished by applying a high-accelerating potential to one or more circles of conductive coating on the internal surface of the bulb near the faceplate. A fast-writing cathode-ray tube made by *Edgerton, Germeshausen and Grier, Inc.*, designed for operation from d.c. to 2000 MHz and having 0.2 nanosecond rise time, maintains high sensitivity while utilizing a 20-kV accelerating potential through the use of post-deflection acceleration. In this instance, the accelerating field is distributed over a long space between the screen and the deflection plates by a high-resistance graphite spiral etched on the tube bulb. The accelerating voltage across this spiral creates a uniform field gradient over most of the post-deflection region.

Internal Graticules

Until recently, cathode-ray tubes were normally used with a plastic disc on which was marked the graticule or scale needed for making measurements. Since the trace appears on the phosphor on the inside surface of the tube, the separation between the trace and the graticule would introduce an error due to parallax whenever the line from the eye to the point of the trace under observation was not perpendicular to the plane of the graticule. This effect was accentuated if the trace and the graticule were further separated through the use of a filter.

To overcome this difficulty, an internal graticule is now used in many cathode-ray tubes. It is composed of lines etched on the inside of the faceplate, in the same plane as the phosphor. Finely ground black glass was selected for this purpose and is bonded to the faceplate at a high temperature. The internal graticule thus formed entirely eliminates parallax errors. Two viewers can observe a cathode-ray tube at the same time and see the same thing; a single viewer can shift his position without affecting the apparent location of the trace. ▲

EARTH'S MAGNETIC FIELD & COLOR TV

ELECTRON beams traveling from the guns to the face of a color picture tube are influenced by the magnetic fields of the deflection yoke, convergence, and purity assemblies.

The influence of the earth's magnetic field must be considered for exacting purity adjustment. The effect of this field is minimized by the picture-tube shield. If the magnetic properties of the shield are aligned while in a specific field, the shield opposes any change due to a new field.

Degaussing the set during initial manufacture aligns the shadow mask and shield to counter the earth's magnetic field during receiver relocation.

The earth's magnetic field consists of a vertical and horizontal component. Variation of vertical component due to geographic area is constant and does not change its effect when set is rotated. Initial degaussing cancels this effect.

However, when the receiver is rotated, the intersection angle of the horizontal component changes, causing a change in beam deflection. In the west (or east) position, maximum vertical beam deflection occurs and the center of the screen is highly influenced. If purity is set in the west position and the receiver is then oriented east, maximum travel of the electron beam occurs: from upper deflection extreme (west) to lower extreme (east). The possibility of impurity is great when the set is rotated under these conditions.

When facing north (or south), the electron beams in the center screen area are parallel with the magnetic lines and for all practical purposes are not affected by the earth's magnetic field. Beam deflection at the outer edges is influenced, but the amount of movement is minimum. Under these conditions, a more exacting purity adjustment can be obtained, both at the center and outer edges of the screen. Adjusting purity in the north (or south) orientation, when beam deflection is minimum, lessens the chance of impurity when the set is rotated to any other position. The chance of purity errors are actually cut in half, for movement of the electron beam will not extend to the extremes possible if purity is adjusted west and then the receiver is rotated east.

Making purity adjustments using north or south orientation results in more exact and longer-lasting purity. Also, better results from automatic degaussing will be obtained, permitting the relocation of color sets without the need for purity adjustment.

This data is from *RCA Victor "Plain Talk and Technical Tips."* ▲

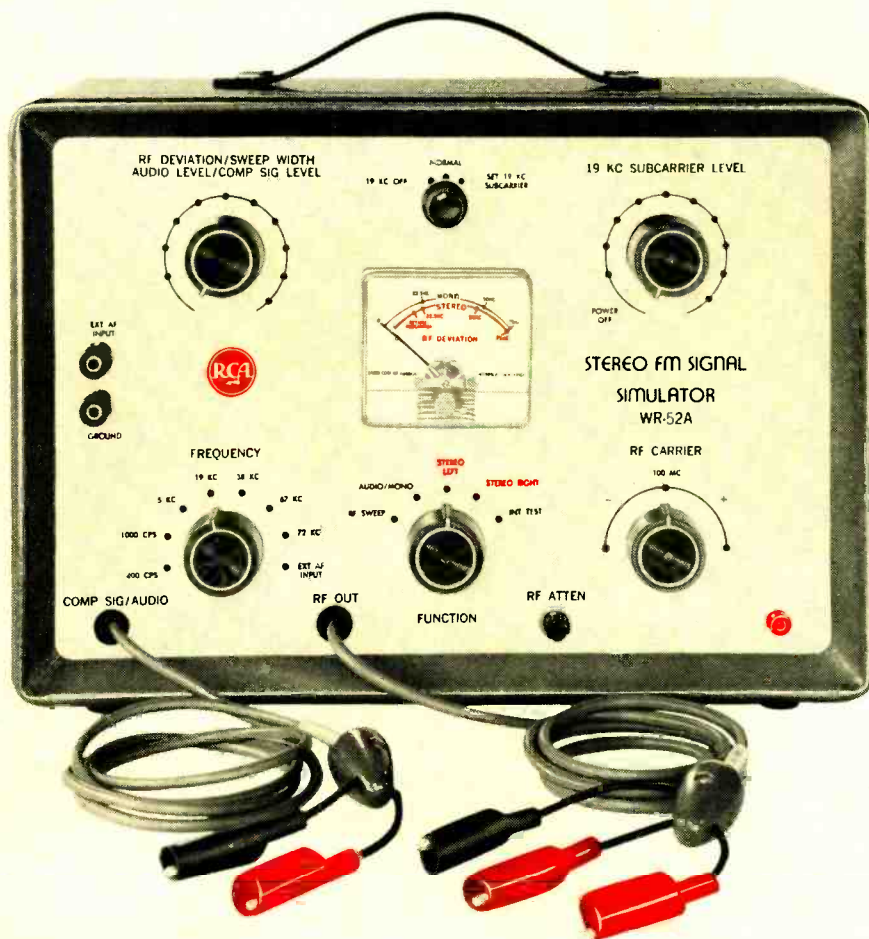

Look what's happened to the RCA WR-51A FM Stereo Signal Simulator

...it got to be the WR-52A...

NEW, REDESIGNED AND IMPROVED

Last year we decided to make a few improvements in our WR-51A Stereo FM Signal Simulator... for two years THE established test instrument for multiplex stereo servicing. We intended to call it the WR-51B. But one thing led to another and we made so many extensive improvements that we virtually had a new instrument on our hands. You're looking at it: the NEW RCA WR-52A STEREO FM SIGNAL SIMULATOR. We've added an RF Deviation Meter to measure the modulation level of both stereo and monaural FM signals. The meter is also used to accurately establish the level of the 19 Kc subcarrier.

We've included provisions for modulating left or right stereo signals with an external monaural source.

We've added a switch to disable the 19 Kc oscillator to provide a low-distortion monaural FM output.

We've added a new frequency (72 Kc)... required, along with the 67 Kc frequency, for trap alignment in some sets.

These features, together with numerous internal circuit design changes have resulted in a vastly improved, almost completely new instrument. And, the RCA WR-52A includes all those features that made its predecessor such a valuable servicing tool.

■ **COMPOSITE STEREO OUTPUT**—for direct connection to multiplex circuit
Choice of left stereo and right stereo signals

■ **RF OUTPUT**—for connection to receiver antenna terminals

100 Mc carrier, tuneable
Choice of FM signals—left stereo, right stereo, monaural FM, internal test and 60 cycle FM sweep
FM stereo deviation adjustable from 0-100%

100 Mc sweep signal adjustable from 0 to more than 750 Kc at a 60 cps rate

RF output attenuator

■ **CRYSTAL-CONTROLLED 19 Kc SUBCARRIER** ($\pm 0.1\%$)

■ **SINE WAVE FREQUENCIES**

Three low-distortion frequencies—400 cps, 1 Kc, 5 Kc

Two crystal-controlled frequencies—19 and 38 Kc
Additional frequencies—67 and 72 Kc for trap alignment

■ **READILY PORTABLE**—weighs only 12¾ pounds, measures 13½" by 10" by 8"

■ **COMPLETE WITH WIRED-IN CONNECTING CABLES**

We also raised the price... just 50 cents. The WR-52A is now \$227.00.* Ask to see it at your Authorized RCA Test Equipment Distributor.

*Optional distributor resale price, subject to change without notice. May be slightly higher in Hawaii and the West.

RCA ELECTRONIC COMPONENTS & DEVICES, HARRISON, N.J.



The Most Trusted Name in Electronics

CIRCLE NO. 95 ON READER SERVICE CARD

NOW



A Complete Automotive and Ignition Tune-Up System

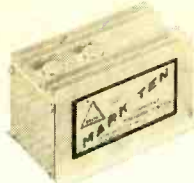

MARK TEN

Capacitive Discharge Ignition System

\$44⁹⁵ Assembled

\$29⁹⁵ Kit Form

Get mileage you never dreamed of! 3 to 10 times spark plug life. Instant starts in all weather. Installs in only 10 minutes. Up to 20% gas savings. Dramatic increase in engine performance and acceleration.

2 NEW AUTO TUNE UP INSTRUMENTS



DWELL
METER
\$12.95
Ppd.



TACH
METER
\$14.95
Ppd.

These two new cousins to the world famous proven MARK TEN now give you the capability to tune your own car inexpensively, easily, with remarkable precision. These separate instruments are low cost, portable and the easiest to read you've ever seen.

- Delta's famous printed circuit design
- Superior in precision, quality and performance to instruments selling for FIVE TIMES as much
- Large dial, high quality jewel D'Arsonval meters
- Operates with standard, transistor or capacitive discharge systems as well as magnetos
- Instant readings — no confusing scales

Send Your Order Today



DELTA PRODUCTS, INC.

P.O. Box 1147EW • Grand Junction, Colo.

Enclosed is \$_____ Ship prepaid.

Ship C.O.D.

Please send:

Dwell Meters @ \$12.95

Tach Meters @ \$14.95

Mark Tens (Assembled) @ \$44.95

Mark Tens (Delta Kit) @ \$29.95

(12 volt positive or negative ground only)

SPECIFY — Positive Negative

6 or 12 Volt

Car Year _____ Make _____

Name _____

Address _____

City/State _____ Zip _____

DP 6-11

CIRCLE NO. 117 ON READER SERVICE CARD

Philco-Ford Introduces IC Radio

A pair of integrated-circuit chips performs all functions from r.f. stage through audio amplifier.

INTEGRATED circuits are really taking off into the realm of consumer products. First was RCA with its IC intercarrier audio i.f. in TV sets. Now comes Philco-Ford with the introduction of the battery-powered portable radio, Model T112WA, that uses a pair of IC's bonded to a common substrate which is less than one-inch square.

One of the IC's contains 12 transistors and 21 resistors, while the other contains 14 transistors, two diodes, and 32 resistors. The pair of IC's perform all functions from the r.f. stage through to the audio amplifier. The conventional components in the set include a 2½-inch loudspeaker, a ferrite antenna, the tuning capacitor, ceramic i.f. filter and i.f. transformer, an audio transformer, the local oscillator transformer, five resistors, 17 capacitors, and the volume control potentiometer. The company has released no detailed information on the IC's.

The IC's used in the radio were developed, and are manufactured, at the Philco Microelectronics Division, located in Lansdale, Pa., and are the result of three years' work.

Philco-Ford also announced that it is running a parallel development program in integrated circuitry for TV sets, which is next in line, and then

stereo high-fidelity home sound systems.

In a companion area, Philco-Ford also announced the "PEMS" modules (Philco Electronic Modules) which are thick-film hybrid circuits that contain capacitors and resistors with the active elements—diodes and transistors in chip form—bonded to the module; the entire assembly is then given a protective plastic coating. These modules are to be introduced in this company's black-and-white TV sets in the near future.

Initial application will be in the horizontal phase comparator circuit of monochrome sets and future application is also considered for the chroma reference oscillator in color sets. ▲

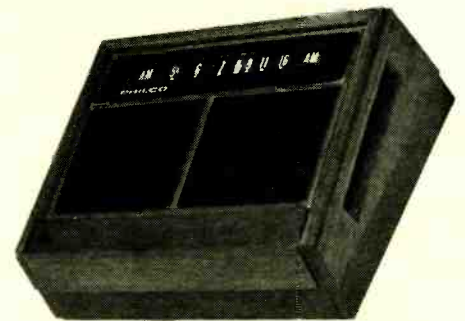

The use of IC's does not necessarily mean a size reduction of the radio.

Photo below shows that the new radio (top), although built on the same circuit board as the old (bottom), uses far less parts. The pair of IC's is mounted under the board.

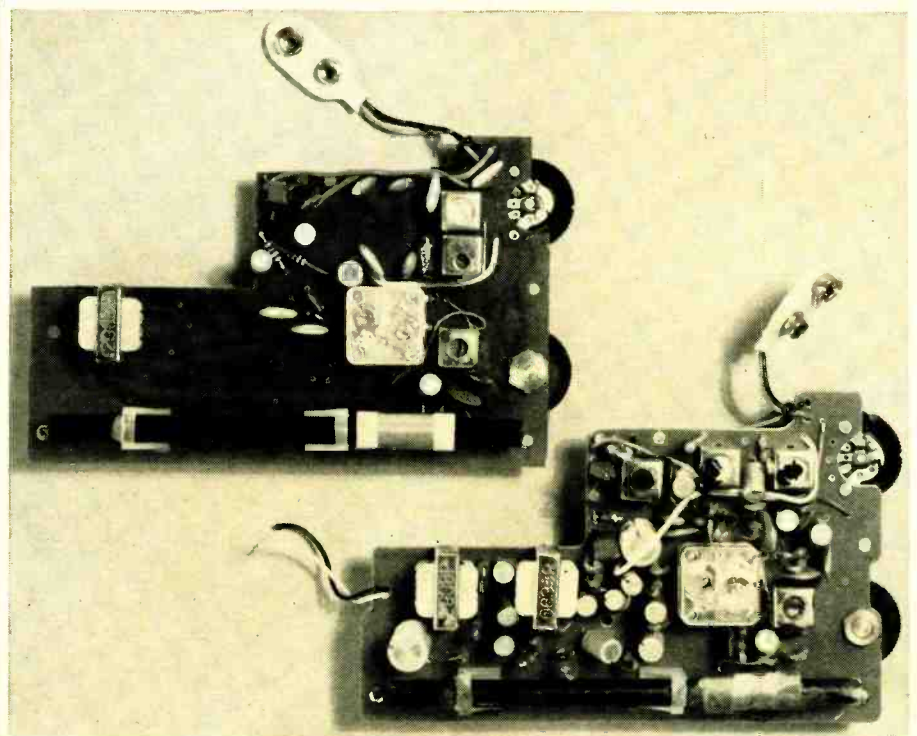

IC USED IN NEW TV KIT

BY D.G. RUPLEY/Chief Engineer, Consumer Products, Heath Co.

Technical details on the first use of an IC in a commercial kit. Besides the IC, the set also uses a new small-neck CRT.

THE "Heathkit" Model GR-104 all-solid-state 12-inch TV receiver, using an integrated circuit (IC) containing the sound i.f., detector, and audio preamplifier stages, is the first commercial kit to use an IC.

After a relatively conventional solid-state front-end, i.f., and video detection system, the audio is taken off the collector of the video driver stage and coupled to the silicon wide-band monolithic IC as shown in the schematic. This IC incorporates 12 transistors, 12 diodes, and 15 resistors, all housed in a single TO-5 case. Although this unit does not offer any immediate cost saving, it does have the advantage of reducing the number of soldered connections (and thereby possible kit troublespots) that would be encountered using individual components.

The 4.5-MHz signal is transformer-coupled to the IC input. After amplification and limiting, the signal is coupled to the primary of detector transformer T1. The windings of the detector transformer have been labeled as L1, L2, L3, and L4 to ease the explanation of detector operation. Diodes D5, D6, and D7 are reverse-biased to exhibit the characteristics of capacitors. Capacitors across the primary and secondary of T1 are used to tune this transformer to 4.5 MHz.

Consider a separate voltage that is induced by the primary (L1) into each of the three secondary windings (L2, L3, and L4). L4, which is closely coupled to the primary, introduces a voltage that is in series with both L2 and L3. The voltage across L4 is relatively constant in amplitude as long as the voltage across L1 does not change.

Each detector diode (D3 and D4) has its own charging loop. Current flowing in diode D4 is controlled by the voltage induced in L2 and L4 which charges diode capacitor D6. (Remember that diodes D5, D6, and D7 are reverse-biased to act as capacitors.) Current flowing in diode D3 is controlled by the voltage induced in L3 and L4, which charges diode capacitor D5. Current flows in both directions through L4, since this coil is common to both charging loops.

When the audio i.f. signal (4.5 MHz) is unmodulated, the diode currents are equal and cancel each other. Thus,

there is no voltage variation across D7 at the base of audio transistor Q11.

When the i.f. deviates from 4.5 MHz due to FM modulation, the current in one diode loop increases while the current in the other loop decreases. These changes are caused by a variation in the phase relationship in the signal across L2 and L3. Current flows through L4 and R16 in the direction of the largest signal and an output voltage is developed across L4 and R16.

The amplitude of this signal is determined by how far the i.f. deviates from the 4.5-MHz center frequency, while the frequency depends on how often the i.f. deviates from the 4.5-MHz center frequency. The audio voltage appearing at the junction of R16 and D7 is coupled directly into the base of transistor Q11. Transistors Q11 and Q12 are directly coupled as emitter followers to match the relatively high impedance of the detector circuit to the lower impedance of the audio amplifier circuit.

The operational features of the IC are also advantageous. The unit has 75 dB of power gain at 4.5 MHz, its limiting characteristics are excellent, and AM rejection is 50 dB. The recovered audio is sufficient to drive the complementary symmetry audio output circuit.

One of the main problems in designing TV receivers for portable or battery use is the inefficiency of the sweep circuits. Over 80% of the power required to operate the receiver goes into the sweep circuits. There are a number of approaches a designer might take to increase the sweep efficiency. One would be to use a smaller deflection angle, thereby reducing the amount of power required to deflect the beam. This, however, is directly opposite to the results that would be desired in packaging the receiver, as lowering the deflection angle requires that the CRT neck become much longer. Another approach, which was used in this set, is to reduce the neck diameter of the CRT. This means that the magnetic flux from the deflection yoke can be coupled much closer to the electron beam, increasing deflection efficiency.

In comparison, a 12", 90° deflection CRT with a neck diameter of 7/8" has an over-all length of 10 1/2". This new receiver uses a type 12CEP4, a 12", 110° magnetically deflected CRT whose neck diameter is only 20 mm (a little larger than 3/4").

The deflection power required for this 110° tube is approximately the same as for the 90° deflection angle tube with the larger diameter neck, yet over-all depth is only 9". ▲

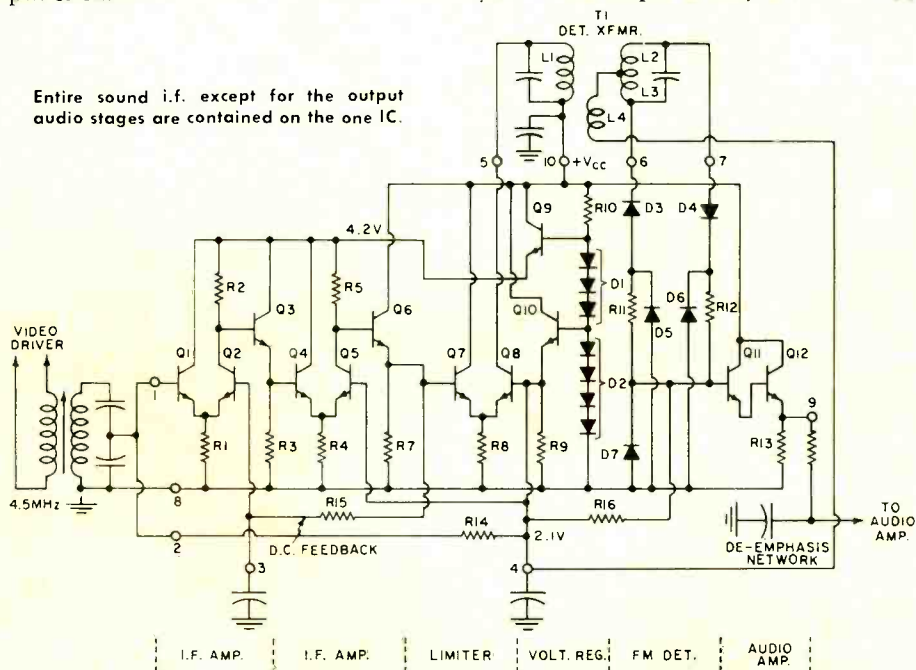

SOMEONE SHOULD DEVELOP AN EASY WAY TO LEARN ELECTRONICS AT HOME

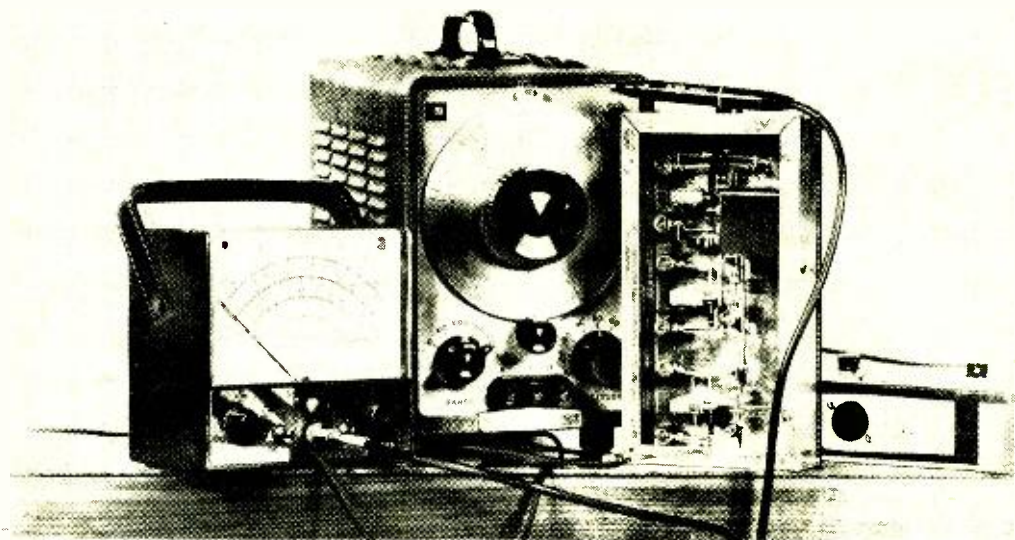

RCA INSTITUTES DID!

Here is a whole new approach to learning electronics at home! RCA Institutes, one of the nations' largest schools devoted to electronics, has developed a faster, easier way for you to gain the skills and the knowledge you need for the career of your choice. Here for the first time, is a student-proved, scientifically designed way to learn. If you have had any doubts in the past about home training in electronics —if you have hesitated because you thought you might not be able to keep up—or that electronics was too complicated to learn—here is your answer! Read how RCA Institutes has revolutionized its entire home training ideas!

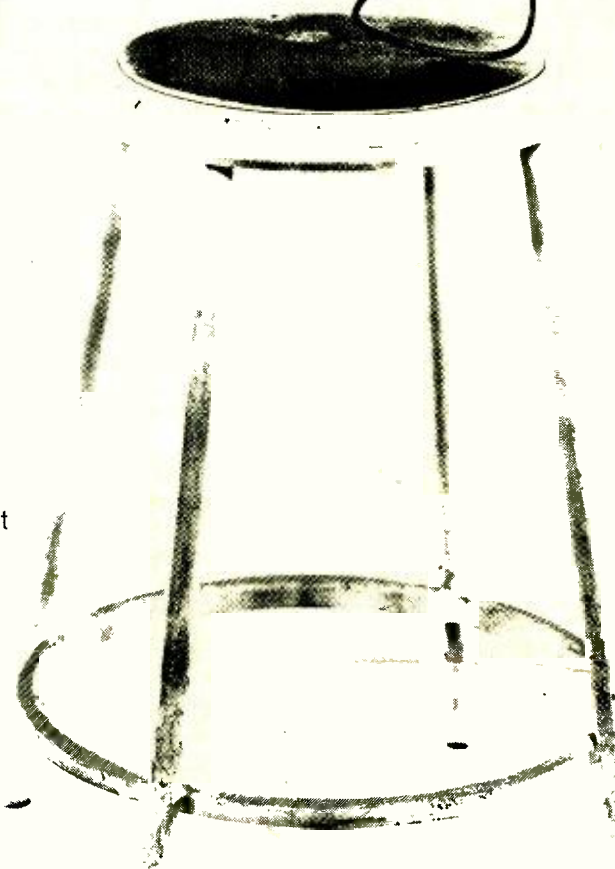

NEW CAREER PROGRAMS BEGIN WITH "AUTOTEXT" INSTRUCTION METHOD!

Start to learn the field of your choice immediately!

No previous training or experience in electronics needed!

With this new revolutionized method of home training you pick the career of your choice—and RCA Institutes trains you for it. RCA's Career Programs assure you that everything you learn will help you go directly to the field that you have chosen! No wasted time learning things you'll never use on the job! The Career Program you choose is especially designed to get you into that career in the fastest, easiest possible way!

And each Career Program starts with the amazing "AUTOTEXT" Programmed Instruction Method—the new, faster way to learn that's almost automatic! "AUTOTEXT" helps even those who have had trouble with conventional home training methods in the past. This is the "Space Age" way to learn everything you need to know with the least amount of time and effort.

CHOOSE A CAREER PROGRAM NOW
Your next stop may be the job of your choice. Each one of these RCA Institutes Career Programs is a complete unit. It contains the know-how you need to step into a profitable career. Here are the names of the programs and the kinds of jobs they train you for. Which one is for you?

Television Servicing. Prepares you for a career as a TV Technician/Serviceman; Master Antenna Systems Technician; TV Laboratory Technician; Educational TV Technician.

FCC License Preparation. For those who want to become TV Station Engineers, Communications Laboratory Technicians, or Field Engineers.

Automation Electronics. Gets you ready to be an Automation Electronics Technician; Manufacturer's Representative; Industrial Electronics Technician.

Automatic Controls. Prepares you to be an Automatic Controls Electronics Technician; Industrial Laboratory Technician; Maintenance Technician; Field Engineer.

Digital Techniques. For a career as a Digital Techniques Electronics Technician; Industrial Electronics Technician; Industrial Laboratory Technician.

Telecommunications. For a job as TV Station Engineer, Mobile Communications Technician, Marine Radio Technician.

Industrial Electronics. For jobs as Industrial Electronics Technicians; Field Engineers; Maintenance Technicians; Industrial Laboratory Technicians.

Nuclear Instrumentation. For those who want careers as Nuclear Instrumentation Electronics Technicians; Industrial Laboratory Technicians; Industrial Electronics Technicians.

Solid State Electronics. Become a specialist in the Semiconductor Field.

Electronics Drafting. Junior Draftsman, Junior Technical Illustrator; Parts Inspector; Design Draftsman Trainee Chartist.

SEPARATE COURSES

In addition, in order to meet specific needs, RCA Institutes offers a wide variety of separate courses which may be taken independently of the Career Programs, on all subjects from Electronics Fundamentals to Computer Programming. Complete information will be sent with your other materials.

LIBERAL TUITION PLAN

RCA offers you a unique Liberal Tuition Plan—your most economical way to learn. You pay for lessons only as you order them. No long term contracts. If you wish to stop your training for any reason, you may do so and not owe one cent until you resume the course.

VALUABLE EQUIPMENT

You receive valuable equipment to keep and use on the job—and you never have to take apart one piece to build another. **New—Programmed Electronics Breadboard.** You now will receive a scientifically programmed electronic bread-

board with your study material. This breadboard provides limitless experimentation with basic electrical and electronic circuits involving vacuum tubes and transistors and includes the construction of a working signal generator and superheterodyne AM Receiver.

Bonus From RCA—Multimeter and Oscilloscope Kits. At no additional cost, you will receive with every RCA Institutes Career Program the instruments and kit material you need to build a multimeter and oscilloscope. The inclusion of both these kits is an RCA extra.

CLASSROOM TRAINING ALSO AVAILABLE

RCA Institutes maintains one of the largest schools of its kind in New York City where classroom and laboratory training is available in day or evening sessions. You may be admitted without any previous technical training; preparatory courses are available if you haven't completed high school. Coeducational classes start four times a year.

FREE PLACEMENT SERVICE

In recent years, 9 out of 10 Resident School students who used the Free Placement Service had their jobs waiting for them when they graduated. And many of these jobs were with top companies in the field—such as IBM, Bell Telephone Labs, General Electric, RCA, and radio and TV stations and other communications systems throughout the world.

SEND ATTACHED POSTAGE PAID CARD FOR COMPLETE INFORMATION, NO OBLIGATION. NO SALESMAN WILL CALL. FREE BOOK INCLUDED. CHECK HOME STUDY OR CLASSROOM TRAINING.

RCA INSTITUTES, Inc., Dept. EW-17

A Service of Radio Corporation of America
350 West 4th St., New York, N.Y. 10014



The Most Trusted Name in Electronics

SCOTT



SCOTT'S NEW ONE-AFTERNOON TUNER KIT DELIVERS AMAZING FET PERFORMANCE

Now you can get factory-wired performance from a kit that takes only one afternoon to build! Scott's new LT-112B is the only kit with Field Effect Transistor circuitry², enabling you to enjoy more stations more clearly. Interstation Muting Control effects complete quiet between FM stations . . . oscilloscope output allows laboratory-precise correction for multipath distortion.

"Scott's LT-112 . . . is one of the finest FM stereo tuners we have tested and it is easily the best kit-built tuner we have checked . . . Because of its simple construction and trouble-free nature, it is a logical choice for anyone who wants the finest in FM reception at a most remarkable price." HiFi/Stereo Review.

LT-112B specifications: Usable sensitivity, 1.8 μ V; Cross modulation, 90 dB; Stereo separation, 40 dB; Capture ratio, 2.5 dB; Price, \$189.95. ²Patents pending

For complete information on the Scott LT-112B, send for your free copy of Scott's 16-page full-color illustrated Guide to Custom Stereo.

FREE! 1967 SCOTT GUIDE TO CUSTOM STEREO

Here are 16 colorful, information-packed pages on Scott stereo components . . . receivers, tuners, amplifiers, speakers . . . for 1967. Fact-filled, fully-illustrated articles show you what to look for when buying solid-state components, how stereo works, how to create your own home music system.

NAME _____

ADDRESS _____

CITY _____

STATE _____

ZIP _____

Scott . . . where innovation is a tradition

SCOTT

H. H. Scott, Inc.,
111 Powdermill Road, Maynard, Mass.
Export: H. H. Scott, Inc., Maynard, Mass.

Prices slightly higher west of Rockies. Subject to change without notice.

CIRCLE NO. 91 ON READER SERVICE CARD

NEW RADIOTELEPHONE MODULATION METHOD

By PATRICK HALLIDAY

RECENTLY, the British Post Office Research Station demonstrated some tape recordings of radiotelephone circuits between the United Kingdom and Delhi, India made during extremely poor high-frequency radio conditions.

One set of tapes showed the near impossibility of carrying on conversation when fading and background noise produced a condition of "lock-out"—that is, when the noise was sufficient to override the action of the voice-operated singing suppressor so that one speaker was unable to break in on the other. The other recordings, made under the same poor conditions, were of rapid, normal telephone conversations with solid intelligibility, no problems of lock-out, and an almost startling absence of background noise between words.

These second tapes were made with a new type of telephone terminal equipment called Lincomplex from LINKed COMPRESSOR and EXPANDER. This new system, developed by British Post Office engineers, is now undergoing field trials and is proving so successful that the system is likely to come into widespread use on other difficult h.f. circuits. It may also later prove to have many other applications, including possible use on mobile h.f. circuits such as the ship-to-shore radio links.

As the name indicates, the system depends upon the use of compressors and expanders. A combination of a compressor at the input terminal and an expander at the output terminal is used quite widely in telephone work. The compressor reduces the amplitude range of the signal and the expander does the opposite, restoring the dynamic range of the signal to its original value. The success of such combinations depends upon the fact the noise in a speech circuit is more serious when in the intervals between words than when the same amount of noise is heard only as a background to the words.

In the new system, processing is taken a good deal further than in conventional circuits by the inclusion of an additional

control channel which it has proved possible to accommodate within the normal 3-ke. bandwidth of long-distance voice circuits. Apart from the very high degree of noise suppression between words, the equipment renders the circuit much more resistant to other forms of noise, crosstalk, and interference.

Although some work with basically similar techniques has been carried out in France and in the United States, the British Post Office is believed to be the first administration to reach the point of using the system on operational traffic. Its success makes the British engineers believe that it will eventually be adopted by most organizations operating high-frequency radio links. First, of course, it will be necessary to agree on exact parameters—a matter for the International Consultative Committee on Radio (CCIR).

At the transmitter (Fig. 1A), the voice signals are applied to a speech compressor producing a constant-output signal level regardless of the instantaneous level of the input voice signals. In other words, all the loudness variations are smoothed out, including the syllable-to-syllable changes. In this it differs from the conventional compressor or constant-volume amplifiers which are relatively slow-acting and do not smooth out the syllabic variations of level.

Because the output signal is always of the same amplitude, the radio transmitter can be kept fully modulated at all times, but to the listener the speech is almost completely unintelligible. From the compressor, however, a second signal output, called the control signal, is obtained. This, in effect, is a measure of the instantaneous voice level of the speaker. This signal is obtained by rectifying a portion of the input voice signal.

Two signals are transmitted: one is the speech signal from which all loudness information has been removed, while the second signal contains the missing loudness details. Both these signals are radiated from the transmitter within the usual 3-ke. bandwidth of an

Fig. 1. FM control signal determines voice amplitude at both ends of phone link.

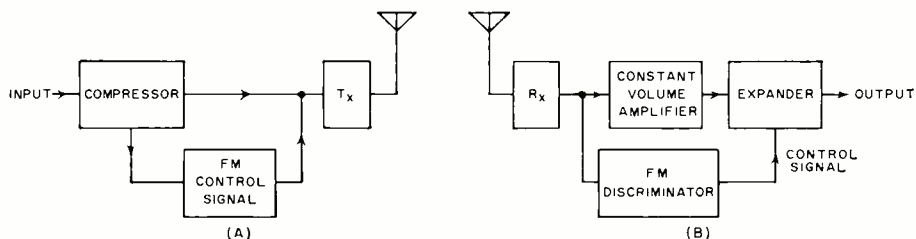

independent sideband channel. This is done by lopping off a few hundred cycles from the higher end of the audio spectrum, shifting the remaining audio up in frequency by a similar amount, and using the resulting low-frequency portion of about 400 cycles to carry the control signal in the form of narrow-band frequency modulation.

At the receiving terminal (Fig. 1B), the two signals pass through the early stages of the receiver and are then separated by filters. The effect of variations of signal strength due to normal fading will already have been reduced by receiver a.g.c., but any remaining variations are removed by passing the speech signal through another constant-volume amplifier. The FM control signal is fed to a discriminator whose output is used to control the gain of an expander unit. The output from the expander then includes all the loudness variations of the original speech.

In practice, a further necessity arises—that of incorporating delay networks into the voice channel so that the times of transmission of the narrow and wider bandwidth signals are equalized.

On difficult h.f. radio circuits, the use of Lincompex terminals should allow operational time to be extended by some 10 to 15%. What is perhaps more important for the user, he can talk much more rapidly and confidently without the many interruptions and repetitions so often needed when radio conditions are marginal.

Lincompex thus holds considerable promise of bringing about a substantial improvement in h.f. point-to-point links which—despite the rapid progress of ocean cables and satellite communications—still carry an important part of the world's long-distance telephone communications. ▲

12-V. BATTERY CHARGER

USING A G-E X3 silicon controlled rectifier, the circuit shown in the diagram makes a low-cost auto battery charger. When the voltage across the battery reaches the voltage determined by the "Trip Point Selector," the unit goes to a trickle charge. The SCR can handle up to 13 amperes and so is capable of charging many types of auto batteries. ▲

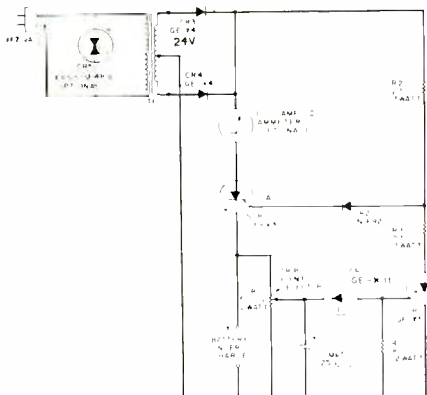

WHY bother with makeshift twist-prong capacitor replacements?

When you substitute capacitor sizes and ratings, you leave yourself wide open for criticism of your work . . . you risk your reputation . . . you stand to lose customers. It just doesn't pay to use makeshifts when it's so easy to get the exact replacement from your Sprague distributor!

Get the right SIZE,
right RATING every time
with improved



SPRAGUE TWIST-LOK® CAPACITORS!

1,863 different capacitors to choose from!

The industry's most complete selection of twist-prong capacitors, bar none. Greater reliability, too. Exclusive Sprague cover design provides a leak-proof seal which permits capacitors to withstand higher ripple currents.

GET YOUR COPY of Sprague's comprehensive Electrolytic Capacitor Replacement Manual K-107 from your Sprague Distributor, or write Sprague Products Co., 51 Marshall Street, North Adams, Mass.



ONLY CCTV CAMERA KIT ON THE MARKET

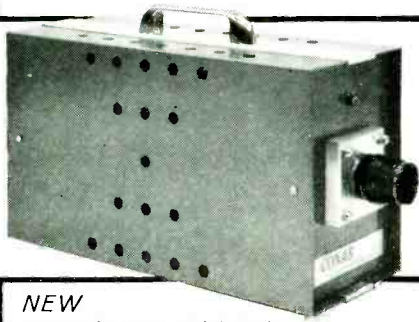

NEW
IMPROVED MODEL!

- Vidicon
- 25mm. f1.9 Lens
- Cable
- Instructions

\$209.50

\$20 DOWN
\$10 MONTH

ASSEMBLED \$259.50

The affordable answer to an easy-to-use, top performing surveillance camera. Hundreds of uses in home, store, plant, office, hospital, school. Connects instantly to any TV set. Gives excellent picture with light from 150-watt bulb. Operates up to six sets. Complete—nothing else to buy. Optional lenses and tripod available. All parts guaranteed one year. Vidicon guaranteed 90 days. Make check or money order to CONAR. Shipped REA collect.

SEND FOR FREE CONAR CATALOG

CONAR Division of National Radio Institute, Dept. AB7C
3939 Wisconsin Avenue, Washington, D.C. 20016

free

The complete story in color, with pictures and specifications, of the most exciting line of solid state stereo kits. "... in the top ranks of modern stereo." Hirsch-Houck Labs—Electronics World. "... will out-perform most factory-assembled rigs you can buy today."

Popular Science



ACOUSTECH

Acoustech, Inc. Div. of Koss Electronics
139 Main S., Dept. E1, Cambridge, Mass. 02142

Please send me your colorful kit brochure with complete details on the top-rated line of solid state stereo kits.

Name _____
Address _____
City & State _____ Zip Code _____

CIRCLE NO. 125 ON READER SERVICE CARD
80

EW Lab Tested
(Continued from page 16)

with a four-pole induction meter. The changer spindle can be removed and replaced with a short spindle for single-play operation. A lever sets arm indexing for 7", 10", or 12" records. The tracking-force dial has click stops every $\frac{1}{8}$ gram. The cuing lever raises the pickup from the record and lowers it to the groove which it left. It is not a hydraulically damped system such as that found on most costly changers, but it works quite effectively. A unique feature is the automatic arm rest lock. Whenever the arm is returned to the rest after playing, the lock is actuated to clamp it in place. When the changer is started up, the lock releases before the arm lifts. The changer comes with an integral six-foot line cord and a detachable twin-conductor shielded audio cable.

The measured tracking error of the arm of the BSR 500 with a typical good-quality cartridge installed was a maximum of 3° at a 3-inch radius. At most points on the record, the error was much smaller. The 1° /inch tracking error is slightly larger than would be considered desirable but this does not introduce any significant distortion in playback.

The arm resonance with this cartridge was at 20 Hz and was well-damped. The rise in response at 20 Hz was about 3 dB, and the output fell off sharply below that frequency. The calibration of the tracking-force dial was within 0.2 gram from 1 gram to 4 grams. At higher settings the actual force was almost 1 gram high, although it is unlikely that this changer would be used with any cartridge requiring more than 4 grams. We used the 2-gram force which was optimum for the particular cartridge installed, and the changer mechanism functioned perfectly.

The wow was about 0.1 to 0.12% from 33 to 78 rpm, and about 0.15% at 16 rpm. Flutter was very low—0.025% at the three higher speeds and 0.04% at 16 rpm. Rumble, in the lateral plane, was -28 dB, referred to 1.4 cm/sec at 100 Hz (NAB Standard). Including vertical components, the rumble was -23 dB. These figures are typical of the other moderately priced record changers that we have tested in the past.

In listening tests, the rumble was not audible at normal volume levels. The changer was mechanically smooth and quiet in operation, easy to handle, and lived up to all the claims made for it. It is a very good value at its price of \$49.50, rivaling other more expensive instruments in performance and features. ▲

problem solving micro-phones

by

SHURE



PROBLEM:
Feedback

SOLUTION:
Unidyne III

ULTRA-COMPACT UNIDIRECTIONAL MICROPHONE

Shure's true cardioid microphones with pick-up pattern symmetrical about the axis in all planes, at all frequencies! Solves more common P.A. system problems than any other microphone made: effectively controls feedback caused by sound reflections or spurious frequencies. Also suppresses reverberant "boom." Uniform pattern without "hot spots" or "dead" areas; ideal for distant pick-up, group coverage with one microphone, or multiple microphone set-ups. Model 545S with Switch—List \$89.95.

budget a problem too?



SHURE
LOW COST
UNIDYNE A

In the quality tradition of the famed Unidyne family. Gives unidirectional problem solving ability at an omnidirectional price... makes it possible to effectively control feedback even in low budget P.A. systems. Choice of impedances. Low Impedance model 580 SB only \$52.00 List.

write for data sheets:

SHURE BROTHERS, INC.
222 Hartrey Ave.
Evanston, Illinois

CIRCLE NO. 90 ON READER SERVICE CARD
ELECTRONICS WORLD

"DESIGN AND CONSTRUCTION OF ELECTRONIC EQUIPMENT" by George Shiers. Published by *Prentice-Hall, Inc.*, Englewood Cliffs, New Jersey. 353 pages. Price \$14.00.

This volume is addressed to technicians, draftsmen, designers, and others in the industry involved in the design and fabrication of various types of electronic equipment. The book covers design objectives and procedures, equipment types and structures, and such associated topics as wiring design, subassemblies, miniature construction, and microelectronic techniques.

The book also provides charts of the major factors to be considered in each phase of design. These charts are convenient for review and ready reference and can be used as check lists, both for training and in the actual design.

Modern manufacturing techniques, plant equipment, materials, and typical processes are described and illustrated. Since the text is self-contained and fairly comprehensive, the book could easily be used for self-instruction as well as for a classroom text.

"USING YOUR TAPE RECORDER" by Harold D. Weiler. Published by *Allied Radio Corp.*, 100 N. Western Ave., Chicago, Ill. 60680. 93 pages. Price \$0.50. Soft cover.

The growing popularity of tape recording has put these machines into the hands of many non-technical users who undoubtedly need more information about their equipment than is normally supplied in the instruction manual accompanying the machine.

This handy, pocket-size manual permits the user to get more out of his machine by knowing its capabilities and limitations. The book is divided into ten chapters covering the nature of sound, the recorder, microphone recording, dubbing from records, off-the-air recording, tape editing, the tape, adding sound effects, adding sound to slides and movies, and recorder maintenance.

The author's treatment is informal and non-technical, making this little manual a boon to the uninitiated.

"CRYSTALS, DIAMONDS AND TRANSISTORS" by L. W. Morrison. Published by *Penguin Books*, Baltimore, Maryland. 303 pages. Price \$1.95. Soft cover. (*Pelican* No. A758)

This is another of this publisher's excellent original volumes dealing with a potentially complex subject on the layman's level. The author—Irish born and English educated—has a way with words that will capture the reader from his preface to the very last page. Despite this casual approach, there is a lot of meat in this little book. As an industrial research chemist and a specialist in chemical spectroscopy, the

BOOK REVIEWS

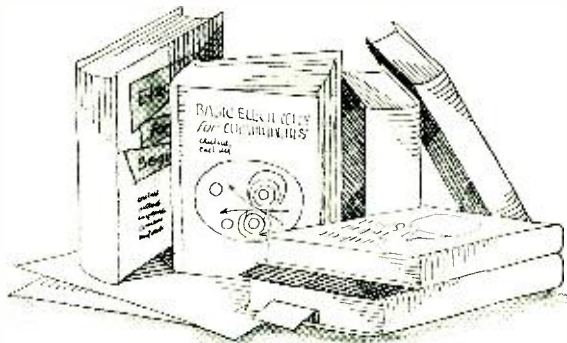

author is an expert who takes great delight in sharing his expertise with his readers. His topics range from crystals, ice, and diamonds through semiconductors, fluorescent lighting, and TV screens.

The text is well illustrated by line drawings and photographs.

"SECRETS OF ELECTRONIC ESPIONAGE" by John M. Carroll. Published by *E. P. Dutton & Company*, New York. 217 pages. Price \$3.95.

This is another of Mr. Carroll's informal and popular treatments of a technical subject (he is the author of "The Story of the Laser"), and it comes at a time when a good many thoughtful citizens are up in arms about the threat of "Big Brothers".

That electronic surveillance is far from new is pointed out by the author as he discusses such "electronic spying" during World Wars I and II, Korea and during the Cold War since; guided missiles, ferrets, and satellites; and then the personal electronic warfare of the martini olive, the wired Old Master, and the wiretap.

Because much of the equipment Mr. Carroll touches on is still "secret"—especially that currently in use in industrial, military, and governmental espionage—full details on how such devices operate is sketched rather than "explained". The photographs which accompany the text are of military aircraft of various vintages and military equipment of the World War I variety, but do not include present-day bugging devices of any type.

"ABC'S OF CAPACITORS" by William F. Mullin. Published by *Howard W. Sams & Co., Inc.*, Indianapolis, Ind. 92 pages. Price \$2.25. Soft cover.

This is a practical handbook on capacitors for those who work with them. The author sketches in the historical beginnings of capacitors, the various types of capacitors and how they are constructed, typical characteristics and applications, points to consider when selecting replacements, and practical methods for testing and measuring capacitors.

The text is written in an informal style and at a basic level. Even those with only an elementary idea of what

a capacitor does in a circuit will find this book understandable.

"MOST-OFTEN-NEEDED 1966 RADIO DIAGRAMS" compiled by M. N. Beitman. Published by *Supreme Publications*, 1760 Balsam Road, Highland Park, Ill. 176 pages. Price \$2.50.

This is Volume R-26 in this publisher's annual series of schematics and servicing information. It follows the familiar format of previous volumes and covers sets from fifteen manufacturers: *Admiral, Emerson, General Electric, Magnavox, Matsushita, Montgomery Ward, Motorola, Panasonic, Philco, RCA Victor, Sears Roebuck, Sony, Sylvania, Westinghouse, and Zenith.*

"AMPLIFIER HANDBOOK" edited by Richard F. Shea. Published by *McGraw-Hill Book Company*, New York, N.Y. 1476 pages. Price \$37.50.

This massive volume is a veritable treasure chest of design information on all types of amplifiers from conventional electron tube and transistor types to the more esoteric varieties, such as ionic and acoustic-wave amplifiers.

Since this is a handbook rather than a textbook, the emphasis is on practical applications for the engineer. Only enough theory is included to explain basic practice and mathematical derivations are held to a minimum. The handbook is expected to be an authoritative reference work for the practicing engineer, scientist, technician, and student; hence, there is a profusion of circuit diagrams, reference materials, tables, specifications, and similar data compiled from a good many sources to simplify the task of locating the information needed.

The handbook is divided into three major sections. These deal with amplifier fundamentals, amplifying devices, and amplifier circuits. Among the various types of devices described along with the usual tubes and transistors, there are magnetic devices, ceramic filters, ionic devices, unusual semiconductors other than transistors, and induced-emission devices (masers and lasers). The section on circuits covers practically every form of amplifier from d.c. through hi-fi to microwave, from microwatts to megawatts, using all the types of devices discussed. ▲

NEW APPROACH TO BREADBOARDING

By REX F. HARRIS / University of San Francisco

THE equipment to be described was developed to enable upper division electronics-physics students to complete more experiments in a one-year laboratory course than had been possible with the conventional bread-board construction.

The types of experiments to be performed and a report written by the students include: tube and semiconductor characteristics; frequency and phase-shift data for tube and transistor amplifiers of various basic types; and oscillators, including multivibrators. All instruments to be used are portable, including precision fixed and variable resistors.

To assemble and wire a conventional breadboard-type experimental set-up may take one or more three-hour laboratory sessions. If one of the commercially available boards is considered, then the expense of providing equipment for a class of, say, 24 students becomes prohibitive. The less expensive type of perforated board using solderless connectors usually results in circuits so flimsy that the numerous readings to be taken are difficult to obtain.

The equipment to be described, which is used with conventional circuit components and portable instruments, consists of: (a) an 8" x 10" x 2½" aluminum chassis with 20 octal sockets mounted on it; (b) several plug-in units of two four-terminal strips mounted back to back vertically, supported by and wired to an octal plug; and (c) assorted lengths of patchcord wires.

The top view of the chassis looks like 20 equally spaced octal sockets, but the top row features white sockets (see Fig 1, inset). These "white" sockets are for the plug-in modules and are wired clockwise, pin 1, 2, 3, etc., as viewed from the bottom. Each vertical row of three sockets is wired as parallel jacks, pins 1, 2, 3, etc., counterclockwise as viewed from the bottom. Thus, on the top of the panel, there are three parallel connections for each pin of the "white" socket or of the module terminal. The top view of these jacks agrees with the base diagram of the tubes or modules plugged in, i.e., 1, 2, 3, clockwise.

The two four-terminal barrier strips are mounted on a slightly flattened ¼-inch wooden dowel which has been

turned to size, inserted in and glued to the hollowed keyed protrusion of the octal plug. Short lengths of wire are first soldered to the eight pins of the plug and later connected to the eight terminals of the terminal strips. The bases of metal tubes, with all eight pins, are better than plugs because the hollow center hole is larger and the over-all length of the unit can be shorter since the thickness of the tube base is less.

Patchcords can be easily made by using flexible (stranded) insulated wires soldered to reclaimed tube-base pins. Heat-shrinkable plastic tubing may be used to dress up the ends and the soldered junction. Patchcord wires from some business machines are neater and fit the jacks (sockets).

Applications

The student starts with the simplified schematic diagram on which he labels each wiring junction with a letter from the module unit and a number for the pin number of that

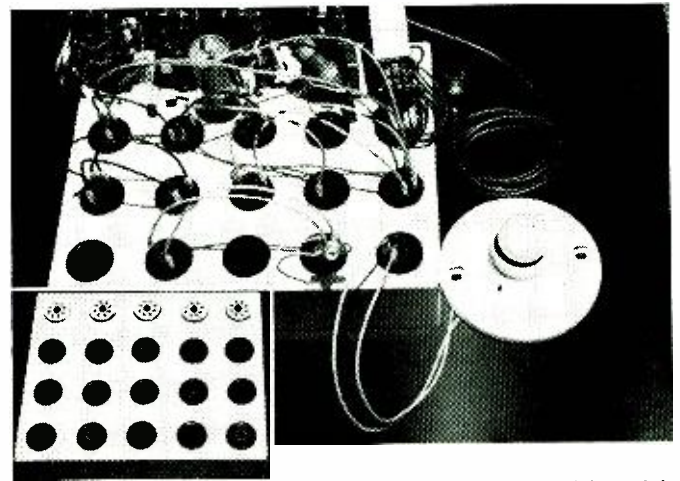

Fig. 1 (Inset) The five white sockets accept the modules, while vertical rows of black sockets are wired as parallel jacks. (Above) Short test leads are used to interconnect the circuit.

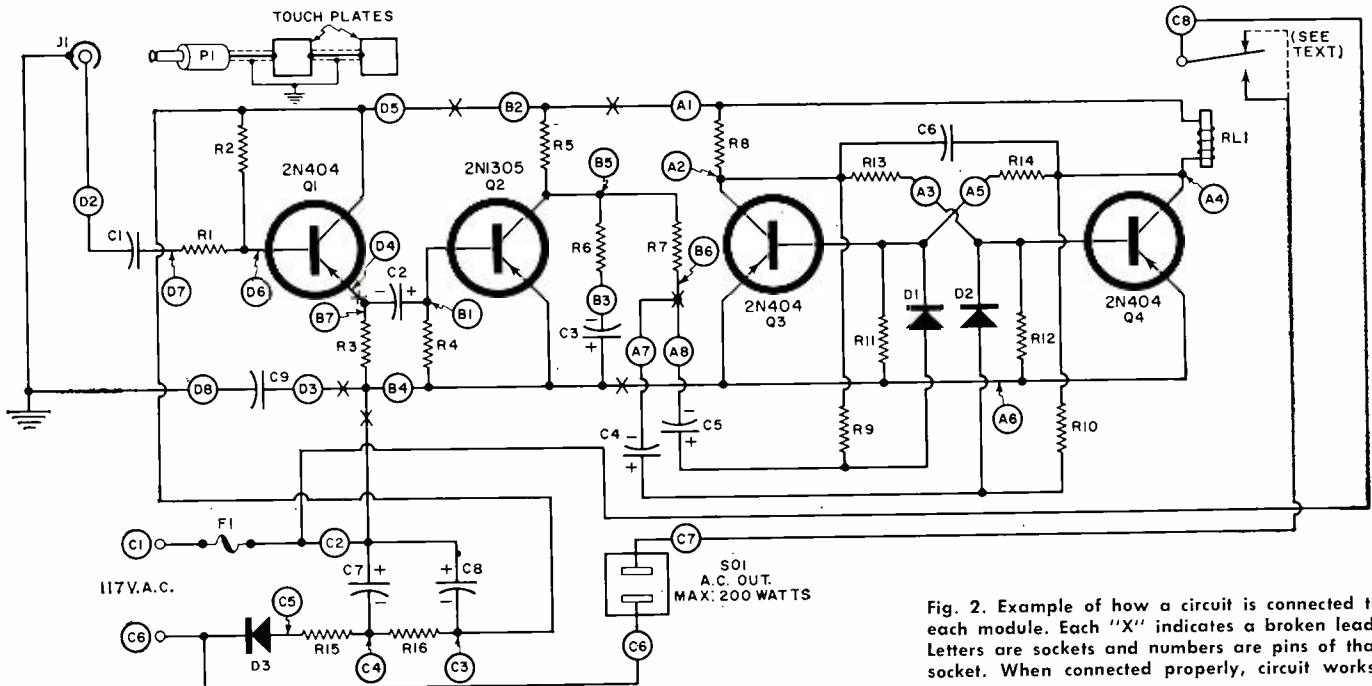

Fig. 2. Example of how a circuit is connected to each module. Each "X" indicates a broken lead. Letters are sockets and numbers are pins of that socket. When connected properly, circuit works.

unit. Up to eight junctions, for example A-1 to A-8, may be assigned to module "A." A cross is made on the wire on the dividing point between module "A" and module "B" to indicate where the intermodule connections are to be made on the chassis.

The next step is to wire the module with the components specified at the points labeled previously. When all the modules required for the circuit have been wired, their interconnections are made on the chassis and the units plugged in (see Fig. 1 top). Each module may be plugged in separately and tested if desired.

A construction example is shown in Fig 2. This circuit is the "Capacitance Touch-Plate Lighting Switch" which appeared in the August 1965 issue of this magazine, with the addition of a zener diode (across C8) which makes it possible to test each module separately. This circuit was chosen to illustrate the use of the equipment because it required the use of four terminal-strip modules and one plug-in relay.

The advantages to be gained by using this equipment are many and no attempt will be made to discuss them in the order of their importance.

The cost is less than \$15.00 per student, exclusive of the cost of construction which may be done by regularly employed storeroom personnel.

The compact arrangement of the plug-in terminal strips allows all component leads to "reach" any two terminals so that no extra wire or wiring is required.

All points in the circuit are available for measuring or checking, are pre-identified on the circuit diagram, and may be quickly found on the chassis.

Exposed or live wires appear only on the plug-in units, so measurements may be made at insulated jacks with comparative safety to students and equipment.

Any circuit is built up by connecting components such as resistors, capacitors, meters, and transformers to a plug-in terminal strip, thus forming a circuit module with up to eight terminals. Some modules may be left intact if they are to be used in other experiments.

Building the circuit by plug-in modules allows the student to test in-circuit performance as each additional unit is connected.

The shorter time required to set up a circuit allows the student to perform more assigned experiments and encourages him to experiment with circuits of his own choosing.

This system was designed to do certain specific experiments and is not intended to be used for high-frequency circuits or any circuits where capacitance of the underchassis or patchcord wiring will have considerable effect. ▲

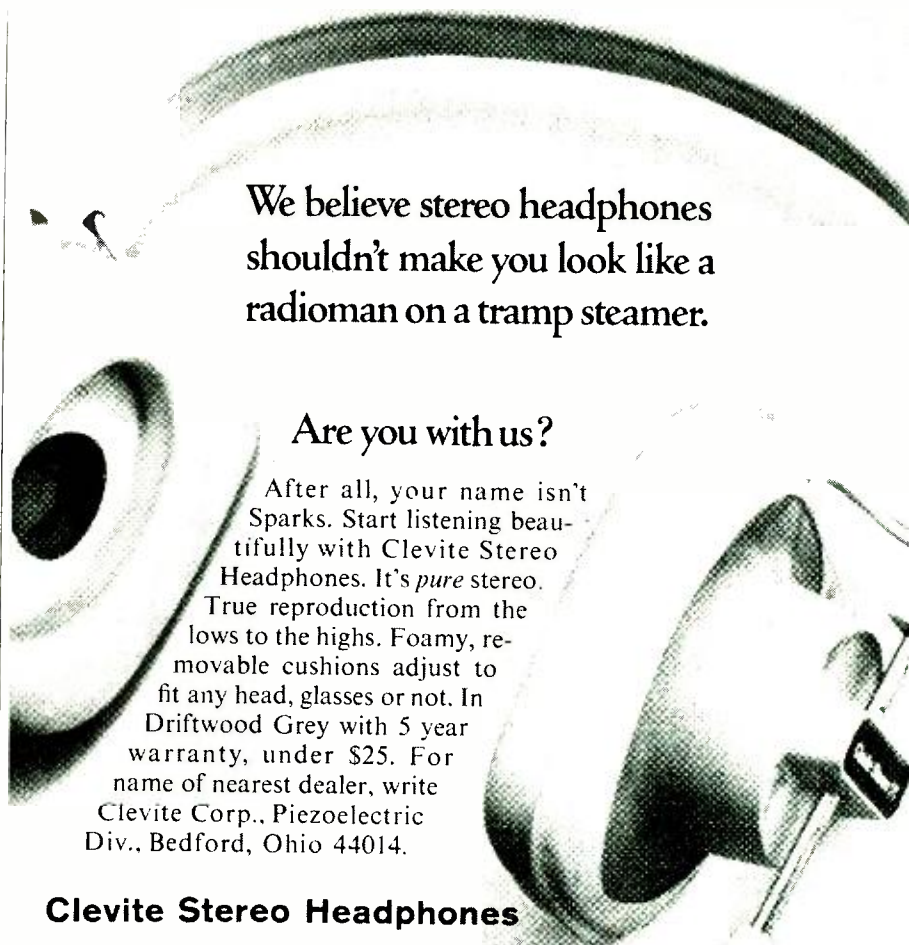

We believe stereo headphones shouldn't make you look like a radioman on a tramp steamer.

Are you with us?

After all, your name isn't Sparks. Start listening beautifully with Clevite Stereo Headphones. It's *pure* stereo. True reproduction from the lows to the highs. Foamy, removable cushions adjust to fit any head, glasses or not. In Driftwood Grey with 5 year warranty, under \$25. For name of nearest dealer, write Clevite Corp., Piezoelectric Div., Bedford, Ohio 44014.

Clevite Stereo Headphones

CIRCLE NO. 119 ON READER SERVICE CARD

INDUSTRY WANTED RELOCATE IN LAKE COUNTY FLORIDA

YOU WORK BETTER
WHERE
YOU LIVE BETTER

- ✓ 1400 Lakes
- ✓ Good Schools
- ✓ Friendly People
- ✓ Modern Highways
- ✓ Excellent Transportation
- ✓ Realistic Property Values
- ✓ Progress Without Pressure

MAIL THIS COUPON TODAY

THE LAKE COUNTY DEVELOPMENT COMMISSION
810 BURLEIGH BLVD., TAVARES, FLORIDA

Send Full Information on LAKE COUNTY, FLORIDA

Check Interest:

INDUSTRY

COMMERCE

TOURISM

RETIREMENT

Name _____

Address _____

City _____

State _____

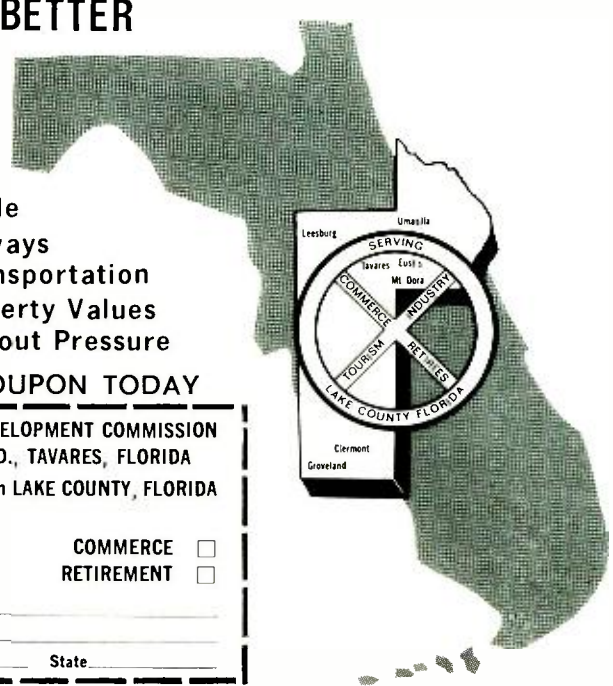

CIRCLE NO. 106 ON READER SERVICE CARD

Frequency Measurements With the Electronic Counter

By A. W. EDWARDS/Colorado Instruments, Inc.

Enjoy the "music-only" programs now available on the FM broadcast band from coast to coast.

- NO COMMERCIALS •
- NO INTERRUPTIONS •



It's easy! Just plug Music Associated's Sub Carrier Detector into multiplex jack of your FM tuner or easily wire into discriminator. Tune through your FM dial and hear programs of continuous, commercial-free music you are now missing. The Detector, self-powered and with electronic mute for quieting between selections, permits reception of popular background music programs no longer sent by wire but transmitted as hidden programs on the FM broadcast band from coast to coast. Use with any FM tuner. Size: 5 1/2" x 6". Shipping weight approx. 7 lbs.

KIT \$49.50

(with pre-tuned coils, no alignment necessary)

WIRED \$75.00

COVER \$4.95 EXTRA

Current List of FM Broadcast Stations with SCA authorization \$1.00

MUSIC ASSOCIATED

65 Glenwood Road, Upper Montclair, New Jersey
Phone: (201)-744-3387

CIRCLE NO. 99 ON READER SERVICE CARD



**ERSIN
MULTICORE**

ONLY 69¢

BUY IT AT RADIO-TV PARTS STORES

MULTICORE SALES CORP. WESTBURY, N.Y. 11590
CIRCLE NO. 100 ON READER SERVICE CARD

IN his informative article, "Frequency and Frequency Measurement" (October, 1966), Marvin J. Willrodt treats many of the salient aspects involved in the various degrees of frequency determination. While most persons regularly employing electronic counters are probably aware of the possible one-count error that is inherent in the gating technique, the helpful discussion of the noise, or "glitch"-derived inaccuracies, may not be as familiar to them.

In a previous article (Aug. 1963, p. 46), the author described a technique of frequency measurement not using a counter, but which allowed high accuracies ("within a few hundredths of a cycle") to be obtained. In that article it was stated that the method "takes up where the counter leaves off." By this it was meant that not only is there no gating error involved, but we are actually slicing individual cycles up with nice precision. The article was intended for those individuals having no counter or those who, having one, might require greater accuracies.

The mention of the noise-caused inaccuracies is certainly a point of importance to the user of the counter. It has served, in this case, to engender additional comments that will help such users obtain a greater versatility from their counters, with some important side advantages.

The technique of using a free-running (*i.e.*, not triggered) oscilloscope in conjunction with the electronic counter has amply proven its worth to the author. In the diagram, the scope, which may be a relatively inexpensive one, is connected so that the sawtooth output (attenuated, if necessary) is fed into the electronic counter. (Some scopes have a sawtooth terminal furnished, otherwise it will be necessary to pick off the horizontal sweep to obtain it.)

In this connection the counter never "sees" anything except the oscilloscope sawtooth. This waveform is clean, *i.e.*, relatively noise-free. Signals to be analyzed, or frequencies to be measured, are introduced conventionally into the oscilloscope Y-input (vertical input). From then on, it is merely a matter of obtaining a single cycle of the frequency of interest as the CRT dis-

play, adjusting it to be stationary, and then reading the counter. Since the input frequency under this condition and the sawtooth have a 1:1 ratio, the counter reading is the displayed frequency.

This technique does nothing to the ± 1 count ambiguity. However, it does furnish the counter with a clean, uniform level of counting voltage. The obvious additional benefits, in addition to the immunity from noise and harmonic content of the input (which is fully isolated from the counter by the scope) are:

1. Weak or strong signals may be displayed and measured, some which are too weak or too strong to insert into the counter.
2. The high impedance of the scope will not disturb most circuitry.
3. The input to the scope may consist—as it usually did in the author's experience—of various discrete frequencies of several forms (pulses, sinusoids), varying harmonic content, varying amplitudes, without disrupting the counter. Each of the mixed input components may, with care, be isolated visually and their character and frequency determined.

A word of caution: It is recommended that the "Sync" control not be employed except for unusually clean signals. Otherwise, noise glitches may ride onto the sawtooth and be introduced into the counter input. There are occasions when, bearing in mind this possibility, it is more important to have the signal "locked" on the CRT face. With the above *caveat*, sync may be used. Mostly, however, it is not needed.

The author used some auxiliary helps in the particular analysis he was making. These included a tone-matching switching circuit which enabled rapid synchronization of frequency components in the audio range with the sawtooth repetition rate, and methods to "capture" brief bursts of signal for analysis on a repetitive basis. This was done using a magnetic disc recording or, in some cases, a tape loop. Both of these techniques had provisions for slowing down the signal, that is, playing them back at fractional speeds so that the analysis of a short burst became practical and certain using this technique. ▲

How scope is hooked up to feed the sawtooth output into counter.

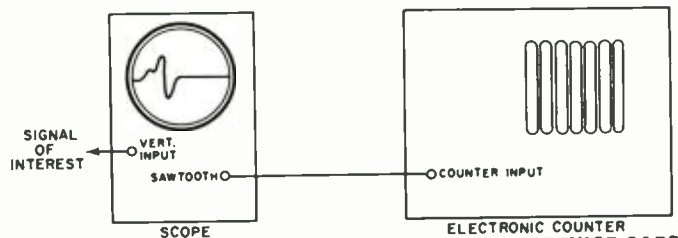

CIRCLE NO. 124 ON READER SERVICE CARD
ELECTRONICS WORLD

FREE *ALLIED* 1967 CATALOG

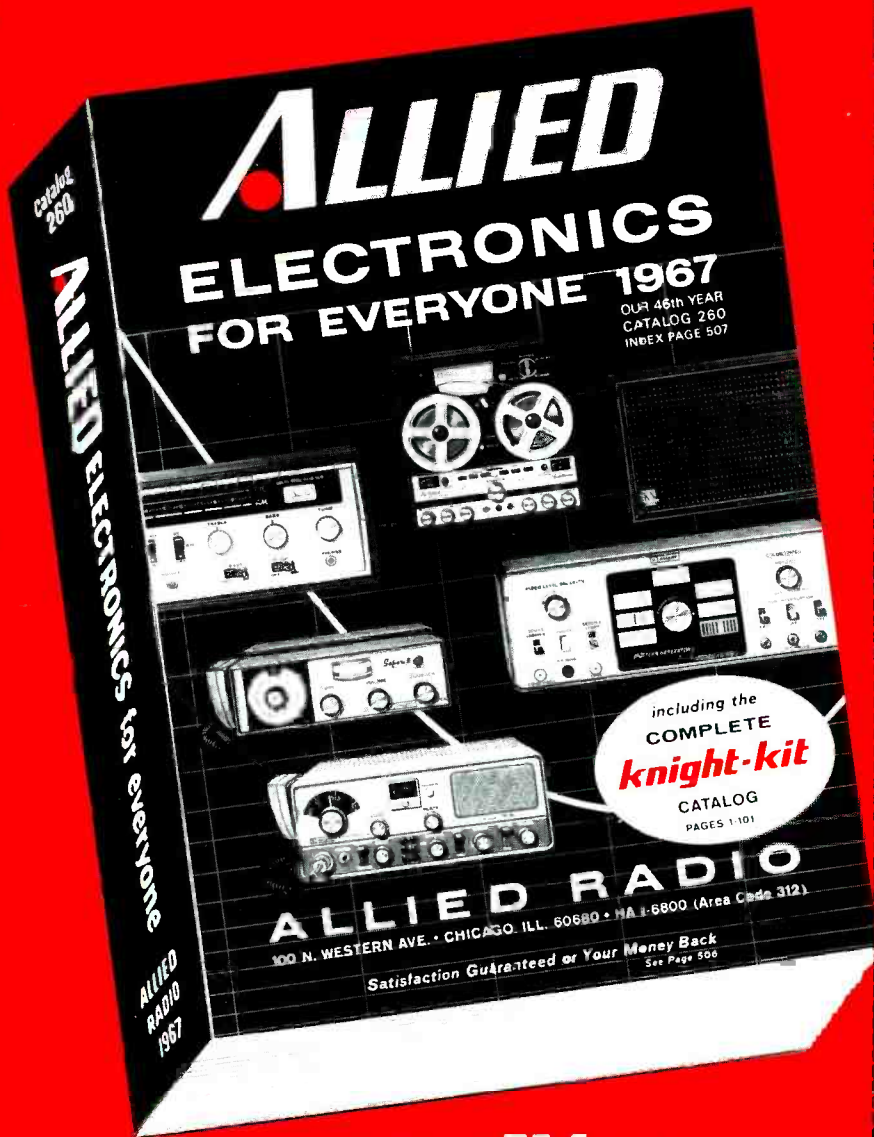

NEW 514-PAGE *ALLIED* CATALOG

**TOP SAVINGS ON THE BEST
IN ELECTRONICS FOR EVERYONE...**

- Famous Knight-Kits • Stereo Hi-Fi • Tape Recorders & Tape
- CB 2-Way Gear • Walkie-talkies • FM-AM & AM Radios
- Short Wave Radios • Portable TV • Phonographs, Accessories
- Amateur Gear • Intercoms & P.A. • Automotive Electronics
- Test Instruments • TV Antennas & Tubes • Power Tools • Parts
- Hardware • Tubes • Transistors • Batteries • Books

NO MONEY DOWN-24 MONTHS TO PAY!
Low Monthly Payments to fit your budget.

DO A FRIEND A FAVOR—give him this card to send for his FREE ALLIED CATALOG

NAME—PLEASE PRINT _____

ADDRESS _____

CITY _____

STATE _____

1A

ZIP _____

**FREE
ALLIED
1967
CATALOG**

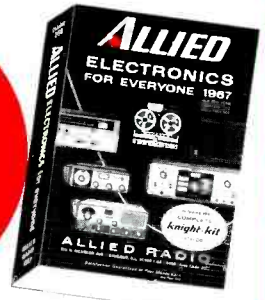

**CHOOSE FROM THE WORLD'S LARGEST
SELECTION IN ELECTRONICS... AND SAVE!**

Buy from the world's largest electronics supplier.
Use the Allied Credit Fund Plan to enjoy what you
want NOW—no money down, 24 months to pay.

RUSH THIS CARD NOW!



TO:
ALLIED RADIO
P. O. BOX 4398
CHICAGO, ILLINOIS 60680

PLACE
STAMP
HERE



RUSH THIS CARD TODAY

FREE

NEW 1967

ALLIED CATALOG

514 pages! See everything new in electronics... featured first at Allied, the world's largest electronics headquarters!

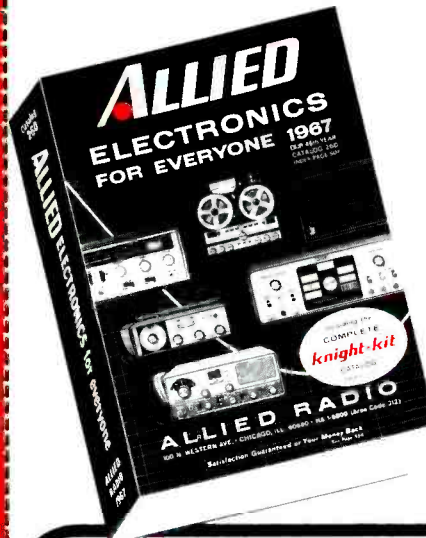

TO:
ALLIED RADIO
P. O. BOX 4398
CHICAGO, ILLINOIS 60680

PLACE
STAMP
HERE

NAME—PLEASE PRINT

ADDRESS

CITY

STATE

1A

ZIP

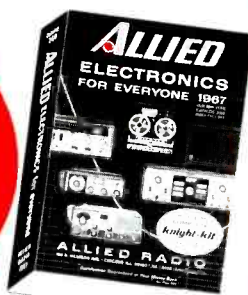

CHOOSE FROM THE WORLD'S LARGEST SELECTION IN ELECTRONICS... AND SAVE!

Buy from the world's largest electronics supplier. Use the Allied Credit Fund Plan to enjoy what you want NOW—no money down, 24 months to pay.

RUSH THIS CARD NOW!

New! for the audiophile...

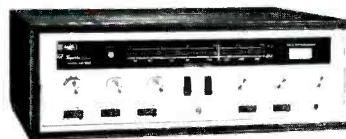

Knight-Kit® Deluxe Stereo FM-AM Tuner. Easy-to-build solid-state design.

New! for the ham operator...



Knight-Kit® 6-Meter Amateur Transceiver with universal solid-state power supply.

New! for the CB user...



KNIGHT® 2-Way Radio. Compact solid-state design at amazingly low cost!

New! for the serviceman...

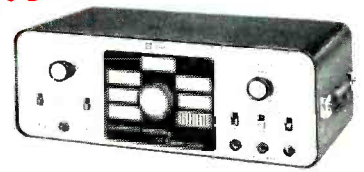

Knight-Kit® Portable Solid-State Color/Bar Pattern Generator. A top value!

New! for everyone...

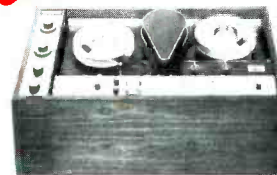

Ampex 6200 HVR Home Videotape Recorder. Make videotapes at home!

New! for TV and FM owners...

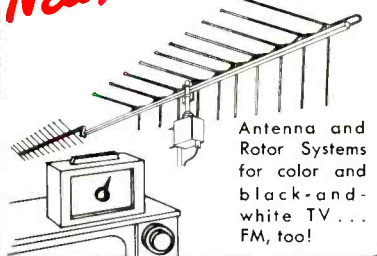

Antenna and Rotor Systems for color and black-and-white TV... FM, too!

Plus hundreds more new and exclusive items, and scores of special Allied values!

NO MONEY DOWN!

Enjoy the things you want now, while you take 24 months to pay for them on the Allied easy-on-the-budget Credit Fund Plan.

ALLIED RADIO

P.O. BOX 4398
CHICAGO, ILLINOIS 60680

DO A FRIEND A FAVOR—give him this card to send for his FREE ALLIED CATALOG

NEW PRODUCTS & LITERATURE

Additional information on the items covered in this section is available from the manufacturers. Each item is identified by a code number. To obtain further details, fill in coupon on the Reader Service Card.

COMPONENTS • TOOLS • TEST EQUIPMENT • HI-FI • AUDIO • CB • HAM • COMMUNICATIONS

TRUE R.M.S. VOLTMETER

A new solid-state true r.m.s. voltmeter has just been introduced as the Model 323. Two versions of the instrument are available: with built-in rechargeable batteries for battery or line operation



(Model 323) or for line operation only (Model 323-01). Voltage range is 300 μ V to 330 V with a sensitivity of 70 μ V for null measurements. Frequency range is 10 Hz to 20 MHz. The instrument has an accuracy of 2% of indication at mid-band. Five-inch log voltage scales provide high uniform accuracy and resolution over their entire length. A 10-dB scale is also provided. The d.c. output for a recorder is 1 volt for each decibel range.

The size of the voltmeter is 1/2-rack module. Power requirement for the Model 323 is built-in batteries or 115/230 V, 50 to 420 Hz; and for the Model 323-01 it is 115/230 V, 50 to 420 Hz, only. Ballantine

Circle No. 1 on Reader Service Card

PORTABLE DRAFTING MACHINE

A new all-anodized aluminum portable drafting machine designed to be used for drafting, drawing, designing, sketching, layouts, and schematics, is now available as the #117.

With a 360-degree protractor, the 4" x 6" one-piece aluminum interchangeable scale is calibrated in sixteenths, eighths, quarters, or in 10/50th engineering-metric. This is mounted on an 11" x 17" drawing board which has a total weight of only two pounds.

The instrument can be removed from the board and attached to a pad of paper or folded like a jackknife for storing in a desk or briefcase. A special flat adjustable clamping device permits the instrument to be attached to a 1/4" drawing board or pad of paper without the use of screws, nuts, or bolts. A larger model, with a 6" x 9" scale mounted on a 16" x 21" board, is also available. Draftette

Circle No. 126 on Reader Service Card

TEST OSCILLATOR

Frequency-response measurements may be made with 0.25% resolution over the range of 10 Hz to 10 MHz with the new Model 652A test oscillator. Equipped with a times 20 expanded-scale output meter for maximum output voltage resolution, the Model 652A may be adjusted to exactly match the amplitude of a precision refer-



ence signal. The output monitor, over the whole frequency range, will show actual output to the attenuator with \pm 0.25% accuracy. For fast reading, the uppermost scale is the expanded range, centered on zero, calibrated \pm 2%.

Designed to meet the problem of making accurate wide-band measurements rapidly, the Model 652A is especially useful in testing a.c. voltmeters, TV amplifiers, audio amplifiers, filter networks, tuned circuits, and telephone and telegraph carrier equipment. Hewlett-Packard

Circle No. 127 on Reader Service Card

UNDERWATER LOCATOR

A popularly priced underwater metal detector designed especially for skin-divers has just been introduced as the "Nemo." Although pressurized for underwater use, the new instrument can be used on land and is especially practical for investigating tight places such as shafts, tunnels, crevices, and crawl spaces. Radiac

Circle No. 2 on Reader Service Card

IC "BREADBOARD"

A "do-it-yourself" integrated circuit for companies which have electronics know-how but don't have costly in-plant microcircuit facilities has been introduced as the "Insta-Circuit Monolithic Silicon Breadboard."

Unlike most integrated circuits, the do-it-yourself unit leaves the last step in the manufacturing process for the customer to perform. With a minimum amount of equipment, the active areas of the tiny unit can be linked in various circuit combinations to suit special needs. The only equipment required is a wire bonding machine equipped with a microscope to make possible connection of hair-thin gold bonds between various areas of the tiny silicon chip.

The "breadboard" contains eight transistors, 44 resistors, and five diodes. Westinghouse

Circle No. 128 on Reader Service Card

PUSH-BUTTON SWITCHES

A new series of push-buttons, "Multi-Lite Series 409", has recently been added to the company's line. The new units are designed to couple

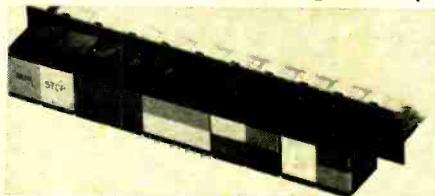

two stations of a Series 36000, 37000, or 38000 multi-switch frame. By coupling two stations, the new buttons increase multiple switching capabilities without adding to the over-all height of the switch stack. A single "Multi-Lite" push-button will actuate up to 12-pole d.t. circuitry on a standard switch frame.

Through the use of a wide variety of available display screen styles, color filters, split face inserts, and light dividers, the Series 409 push-button can be adapted to provide a number of displays. Engineering Bulletin No. E-538 provides complete specifications and will be supplied on request. Switchcraft

Circle No. 129 on Reader Service Card

U.H.F. DISTRIBUTION AMP

A fully solid-state u.h.f. amplifier with flat gain across the entire u.h.f. band has been introduced as the "Gibraltar" Model 5330. The unit

can be used as a broadband amplifier, producing sufficient output to enable it to be used with the companion Model 3440 v.h.f. amplifier for all-channel store systems, apartments, and schools. The unit can be cascaded both at the head end and for line reamplification when required.

Gain is 21 dB minimum; output per channel is +50 dBmV one channel; +43 dBmV two channels; and +35 dBmV five channels; impedance is 75 ohms. Jerrold

Circle No. 3 on Reader Service Card

LOW-COST PLASTIC FET'S

A new series of field-effect transistors priced at levels suitable for consumer and industrial applications is now available as types MPF103, 104, and 105.

The three "n"-channel FET's are designed for general-purpose audio and switching applications. Of rugged, one-piece pressure molded plastic, the new FET's have typical forward transfer admittance of 3000, 4000, and 4500 μ mhos, respectively. Detailed technical specs are available on request. Motorola

Circle No. 130 on Reader Service Card

AEROSOL FREEZING AGENT

The time-consuming task of locating intermittents in electronic circuits can be shortened by the use of a new aerosol freezing agent, "Component Freeze." Sprayed on a suspected resistor, capacitor, or other circuit element, it reduces the surface temperature of the component to -50° F in seconds for a "go/no-go" test. Another application for the new aerosol is the prevention of heat transfer during soldering or welding. A removable extension nozzle confines the spray to a very small area which is advantageous for both testing and soldering operations.

The product is non-toxic and non-flammable. Miller-Stephenson

Circle No. 4 on Reader Service Card

HEAVY-DUTY CCTV CAMERA

A low-cost television camera which is equipped with a newly developed high-sensitivity vidicon tube is now available as the Model MTC-15. According to the company, the new camera offers high-resolution picture quality, low power consumption, long vidicon life, simultaneous r.f. and video output, all-solid-state electronics, and automatic adjustment to changing light conditions.

The new camera is designed for continuous-duty applications, such as industrial, commercial, and institutional surveillance, for closed-circuit educational TV, or for use with video tape recorders.

The Model MTC-15 measures 3" x 5" x 9 1/2" and weighs 6 pounds. It connects to the antenna terminals of any standard TV receiver or video



monitor. It comes equipped with a fast f:1.8 lens but can be used with a zoom lens or any of several other available lenses.

Picture resolution is 550 lines, video bandwidth is 6 MHz, r.f. carrier frequency is 76-88 MHz (tunable to channels 5 and 6), and the scanning system is random interlace. Complete specifications are available on request. Concord

Circle No. 5 on Reader Service Card

AIR VARIABLE CAPACITORS

The firm's new Type W air variable capacitors extend the advantages of machined plate construction to provide maximum capacity values of up to 54 pF. Rotors and stators are precision machined from one piece of solid brass to provide exceptional electrical and mechanical stability, according to the company. "Q" is greater than 1500 at 1 MHz, temperature coefficient is inherently low, while voltage breakdown rating is 650 V d.c.

The new capacitors require less than 0.6 square inch of mounting area. The printed-circuit type mounts by terminals in two 0.200" x 0.030" slots on 0.800" centers. The chassis mounting versions use #3 machine screws or #2 rivets in 0.110" diameter holes on 0.470" centers. E.F. Johnson

Circle No. 131 on Reader Service Card

SOLDERLESS CIRCUIT BOARD

A solderless experimental circuit board that permits the instant addition or removal of components without damage to leads is now being marketed as "Springboard." Engineered for the designer and technician, the Model BIS-100 incorporates 120 ten-turn stainless steel springs that

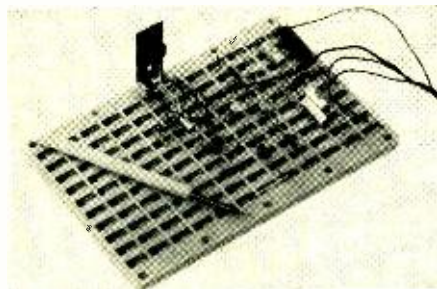

hold the components accurately and act as connectors. All springs are electrically isolated from each other, but several may be joined with jumper wires as required by the circuit being constructed.

The reusable unit is of high-impact plastic. Each board has ten threaded inserts to hold brackets for switches, pots, jacks, transformers, and links to form arrays. Encased on the bottom, each board is approximately 4 3/4" x 7 1/4" x 3/16". A military and environmental model to meet certain MIL Specs is also available. Barry Instrument

Circle No. 132 on Reader Service Card

NEW CAPACITOR CONSTRUCTION

A new "cold-weld" terminal construction has been developed for miniature aluminum capacitors, replacing the split riser method of attaching the anode foil to the riser. Low crimp pressure in the standard split riser construction can allow electrolyte to flow into the crevice and, with application of voltage, form a dielectric oxide film between foil and riser, causing high resistance or an open circuit. The new construction eliminates this problem.

Full information on the miniature aluminum capacitor line using the "cold-weld" terminal construction will be forwarded on request. Cornell-Dubilier

Circle No. 133 on Reader Service Card

ULTRASONIC SOLDERING IRON

An ultrasonic soldering iron which provides fluxless soldering has just been introduced. Using a conventional 35-watt heating element, the iron melts the solder which then acts as a liquid carrier of the sound wave. This scrubs away the oxide film on the material and a flux does not have to be used.

In addition to the fluxless soldering of

aluminum, magnesium, brass, copper, silver and other materials, the ultrasonic soldering iron will tin quartz or glass and semi-conductor materials including silicon. The iron uses transducers of the piezoelectric type. Gulton

Circle No. 6 on Reader Service Card

RECHARGEABLE POWER PACK

A new, portable, rechargeable power pack for use as a portable source of regular, standby, or emergency power has been introduced as the

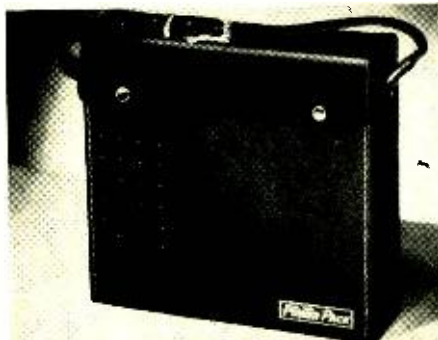

CRL-1200. It is a 12-volt, 8-ampere/hour rechargeable lead-dioxide, gelled electrolyte power source complete with charger. It will power most battery operated devices for longer operating periods at lower cost. At a 300 mA discharge rate, the power pack costs only 2 1/2 cents per hour to operate. Recharge is 7 hours for a 90% charge. The CRL-1200 operates over a wide temperature range with high reliability and minimal power output reduction, according to the company.

Detailed electrical and mechanical specifications will be forwarded on request. Centralab

Circle No. 7 on Reader Service Card

SOLID-STATE ELECTRONIC KITS

A new line of solid-state electronic kits covering a wide range of products is now available as "Trukits." Each kit consists of all-solid-state circuitry, pre-drilled copper-plated etched printed-circuit boards, needed components, and comprehensive step-by-step instructions.

Among the kits currently available are: electronic siren, burglar and fire alarm, intercom, audio power amplifier, metronome, tremolo, electronic light flasher, photocell night light, power supply, and a code oscillator. Eico

Circle No. 8 on Reader Service Card

82-CHANNEL TV & FM ANTENNA

A new log-periodic antenna designed specifically for 82-channel color and black-and-white TV as well as FM stereo and mono has been announced. The new series, which is available in eight different models for varying distances from the transmitter, features "Cap-Electronic" dipoles which shift higher mode resonance to activate more elements of the antenna for higher gain and narrower beamwidths on channels 7 to 13 without affecting low-band v.h.f., a dipole array u.h.f. driver, and twin-boom construction.

A single downlead is required and the antenna comes with a splitter so that separate lead-ins can be run to v.h.f., u.h.f., and FM terminals. JFD

Circle No. 9 on Reader Service Card

HEAVY-DUTY POWER DRILLS

Four new, industrially rated portable 1/4" drills, with power ratings of 2.8 amperes and 3 amperes, 115 V a.c. and designed with new machine-gun



grip auxiliary handles for balance and control have been introduced as the Models 710, 720, 721 and 730.

The Model 710 is a standard 1/4" drill which delivers a constant speed of 1800 rpm; Model 720 is a deluxe unit with a 3-amp motor which delivers a constant speed of 1800 rpm; Model 721 is a variable speed drill (0-1800 rpm) with locking at full speed safety release; Model 730 is a heavy-duty unit which provides the user with a constant drilling speed of 1500 rpm. It is rated at 3.5 amperes.

Each drill comes with geared Jacobs chuck with key, locking trigger switch safety release, and six-foot 3-wire cord and adapter. Each measures 8 1/2" x 7 1/4" x 2 1/2". Wen

Circle No. 10 on Reader Service Card

HI-FI—AUDIO PRODUCTS

COMPACT SPEAKER SYSTEM

A compact version of the company's "Grenadier" speaker is now being offered as the "Cavalier," a 25-inch high unit which provides a frequency response of 30 to 18,000 Hz and will handle 60 watts of program material.

The new system consists of a 10-inch high-compliance woofer, a combination mid-range tweeter direct radiator, and divergent lens. Nominal impedance is 8 ohms. The system features a 3-position treble control switch to adjust for individual preferences.

This 18-inch diameter speaker system is available in a hand-rubbed satin walnut finish with either a walnut top (Model 4000) or with an imported marble top (Model 4000M). Empire.

Circle No. 11 on Reader Service Card

ACOUSTICAL TRANSDUCER SYSTEM

A new type of speaker system which incorporates a high-power transistor amplifier, a spectral matching unit, and an array of 22 specially designed loudspeakers has been recently introduced as the "2201" acoustical transducer system.

The "2201" features a unique spherical shape

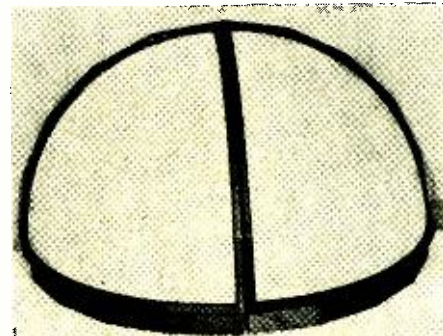

on which the 22 speakers are mounted, providing the desired geometrical approximation of an ideal pulsating sphere and eliminating speaker system resonances. According to the manufacturer, omnidirectional radiation at all frequencies eliminates "off-axis" tonal unbalance in the mono mode and when two units are used for stereo eliminates the need for single-position listening.

The speaker is 25 inches high and has a maximum base radius of 23 1/2 inches. The cabinet is finished in oiled walnut with the frontal covering available in decorator fabrics. Bose

Circle No. 12 on Reader Service Card

FOUR-TRACK STEREO RECORDER

The Model RK-860 is a four-track, self-contained stereo tape recorder which records and plays back stereo and mono tapes at 7 1/2, 3 3/4 and 1 7/8 ips. It features sound-on-sound, sound-with-sound, and direct stereo disc-to-tape copying through its own magnetic phono inputs.

Sound facilities include two full-range 5" x 7" speakers and a 12-watt solid-state stereo amplifier. It also has two illuminated record/playback vu meters and a 3-digit tape counter with push-button zero reset. Controls include a 5-position single lever motor control with pause, dual volume and tone, push-button monitor speaker

switches, and two safety interlocking record buttons. The machine will handle up to 7" reels and may be played horizontally or vertically.

Frequency response is 30-22,000 Hz \pm 3 dB at 7½ ips; wow & flutter are less than 0.15% at 7½ ips; signal-to-noise ratio is 53 dB or better. The recorder measures 15¾" x 14" x 7⅝" and weighs 26½ pounds. Lafayette

Circle No. 13 on Reader Service Card

ULTRA-COMPACT SPEAKER SYSTEMS

Two new full-range, ultra-compact hi-fi speaker systems have been introduced as the X-40 and X-45. Cabinets for both systems measure 19½" wide x 10½" high x 9¼" deep, making them suitable for bookshelf use.

Frequency response of the X-40 is from 30 to 16,000 Hz while the X-45 covers 30 to 18,000 Hz. Both feature completely closed acoustic chambers with liberal use of absorption material. Both have long-travel, low-resonance 8" "Flex-air" woofers. The X-40 uses a 3" direct-radiator tweeter while the X-45 uses a compression driver, horn-loaded tweeter. Crossover frequency is 2000 Hz. Nominal impedance is 8 ohms and both speakers are rated at 25 watts. Jensen

Circle No. 14 on Reader Service Card

AM-FM-STEREO RECEIVER

The ER-420 receiver is an AM-FM-stereo unit which provides essentially flat response over the frequency range of 20 to 20,000 Hz. In the stereo



mode, the receiver has two-channel push-pull output with harmonic distortion of less than 1% at full rated output.

The receiver has both low- and high-cut filters, simultaneous tape recording jacks equipped with a tape monitor switch, and can be operated from either the 110- or 220-volt line since it is voltage switchable. There is also an earphone jack.

The receiver is housed in a brushed aluminum and black cabinet. Pioneer

Circle No. 15 on Reader Service Card

PRE-WIRED EXTENSION SPEAKER

A soil- and abrasion-resistant extension speaker for use in a wide range of audio applications is now offered with the 4" x 6" speaker pre-mounted and wired with 15 feet of cable. Speaker impedance is 8 ohms and the speaker is designed to handle 7 watts of program material. Since the longest cabinet dimension is only 9½ inches, the speaker can be used almost anywhere. Utah

Circle No. 16 on Reader Service Card

BULK TAPE ERASER

A new magnetic tape eraser, TM-120, which is especially designed for use with Ampex and other home and professional video tape recorder systems can also be used to erase computer, telemetry, industrial, and special-purpose magnetic tapes. The eraser reduces noise levels 50 to 90 dB below the saturation minimum.

Tape up to 1" wide is erased in one operation, for tape up to 2", the seconds-long procedure is performed on each side of the reel. It will take up to 17" reels. The TM-120 has an exclusive blower system and a 10-minute-on, 10-minute-off duty cycle. Its safety features include an overheat indicator. Operation is from 115 V, 50 or 60 Hz a.c. Robins

Circle No. 17 on Reader Service Card

CARTRIDGE/PHONO COMBINATION

The Model CC-890 is an 8-track cartridge and automatic phono combination housed in a walnut cabinet for home use. This solid-state all-transistor model has a frequency response of 20-20,000 Hz, a 20-watt amplifier, six separate controls, auxiliary input jacks for a stereo tuner, stereo

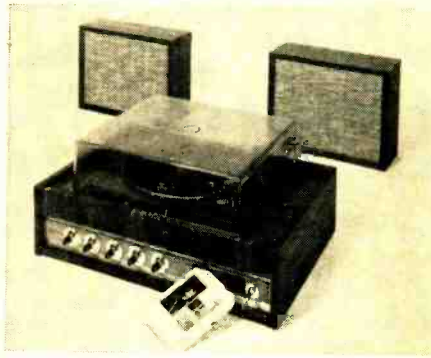

earphone output jack and switch, and four speakers.

The cartridge tape player handles 8-track tapes at 3¾ ips. Operation is automatic and continuous with optional repeat. The phonograph is a Garrard 50 MKII automatic turntable with a four-pole induction motor, cueing device, and stylus pressure gage. It is equipped with a turnover diamond/sapphire stylus. Capitol

Circle No. 18 on Reader Service Card

NEW RECORDING TAPE

A new ½-mil tensilized Mylar-base recording tape which triples playing time without affecting quality is being marketed as the "TPT" tape. It was developed especially for applications requiring extra strength or where rough handling is likely. The tape is stretch-resistant and may be interspliced or programmed with standard tape without causing differences in playback level.

It is immediately available as TP-6T in lengths of 600 feet on a 3¼" reel, as TP-18T in lengths of 1800 feet on a 5" reel, and as TP-36T in lengths of 3600 feet on a 7" reel. Playing time of the respective reels ranges from 2 to 12 hours at 1⅞ ips and from 1 to 6 hours at 3¾ ips. Reeves Soundcraft

Circle No. 19 on Reader Service Card

BROADCAST STEREO CARTRIDGES

The new "500 Broadcast" series of stereo cartridges includes three models designed to meet the exacting performance and durability requirements of the audio professional, yet at a price that the audiophile can afford.

For heavy-duty, on-the-air use, the Model 500A tracks from 2 to 5 grams and features a virtually indestructible stereo cartridge with a 0.7-mil stylus. For critical auditioning, the 500AA with a 0.5-mil conical stylus and the 500E with an elliptical stylus both offer high compliance and low mass at low tracking forces. The 500AA tracks from ¾ to 3 grams and the 500E from 2 to 5 grams.

Complete technical specifications will be supplied on request. Stanton

Circle No. 20 on Reader Service Card

TAPE RECORDER LINE

A new line of reel-to-reel recorders has just been introduced featuring slim-line decorator styling, solid-state all-transistor circuitry, and an exclusive "control center" design which puts all operating controls on the front panel.

Each of the new models will record and play at 7½, 3¾, and 1⅞ ips; all have vu meters and independent volume and tone controls for each channel as well as automatic shut-off. A button-reset, four-digit indexing counter and instant pause control facilitate tape editing. The recorders also feature self-contained reel locks, self-adjusting braking system, automatic tape lifters, and automatic head demagnetization.



Models in the new line include Wollensak 5800 in a walnut wood cabinet; 5740 and 5750 4-track stereo models with detachable stereo speakers and convenient carrying handle; 5730, a self-contained version of 5740 and 5750 with internal speakers; 5720, a fully amplified deck model, and a 2-track mono recorder, the Model 5710. 3M

Circle No. 21 on Reader Service Card

THREE-WAY SPEAKER SYSTEM

The "Ultima" Model S-778 three-way speaker system incorporates a 16" woofer with die-cast frame to handle frequencies down to 35 Hz, a multi-cellular mid-range horn, and a 2½" super-tweeter which extends the response to 20,000 Hz. An LC-type crossover network is used.

The system will handle 50 watts and impedance is 8 ohms. There are level controls for mid-range and tweeter.

The system is housed in a hardwood veneer cabinet finished in oiled walnut, with fretwork grille. The cabinet measures 29½" h. x 20⅜" w. x 13¾" d. Olson Electronics

Circle No. 22 on Reader Service Card

NEW PHONO CARTRIDGE

The new "Super-Track V-15 Type II" phono cartridge, which the company claims has outstanding "trackability", was demonstrated recently. Featuring a frequency response of 20 to 25,000 Hz and output voltage of 3.5 mV per channel at 1000 Hz, the new cartridge provides channel separation of over 25 dB at 1000 Hz and over 17 dB from 500 to 10,000 Hz. Tracking force is ¾ to 1½ grams.

At ¾ gram, the cartridge tracks 400 Hz at 17.9 cm/sec and 10,000 Hz at 15 cm/sec. There

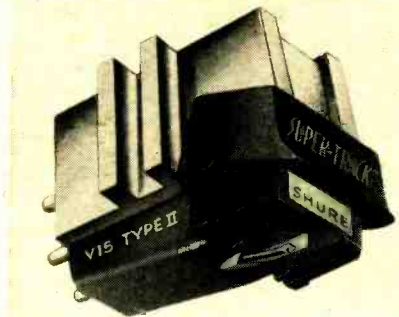

are four terminals (with loop pin jack for 3-terminal connection) and the cartridge comes equipped with a bi-radial elliptical diamond stylus. Shure

Circle No. 23 on Reader Service Card

MOTORS FOR AUDIO EQUIPMENT

A new line of hysteresis-synchronous, sub-fractional horsepower motors has been introduced designed specifically for tape recorders, capstan drives, turntable equipment, and sound-reproduction systems.

The new 1080 line of motors operates on 115 volts, 50 or 60 Hz. The motors are available in 4-, 6-, or 8-pole models for 1800, 1200, and 900 rpm output speeds, respectively. Dual speeds can also be provided in combinations of 1800/1200, 1800/900, or 1200/900 rpm. Amphenol Controls

Circle No. 134 on Reader Service Card

CB-HAM-COMMUNICATIONS

AMP/MODULATOR & TRANSMITTER

Two new solid-state modules, designed for a wide variety of electronic and amateur communications applications are now available as the Model AA-100 solid-state amplifier-modulator and the Model TR-100 solid-state transmitter.

The AA-100 features a circuit with 5 transistors and 1 thermistor. It comes completely assembled. It has a shielded input transformer with two primary windings (50 ohms and high-Z) and an output transformer with two secondary windings (8 ohms for speakers and 500 ohms for modulation and high-Z loads). The unit includes

Thinking of college and a space age career in electronics?

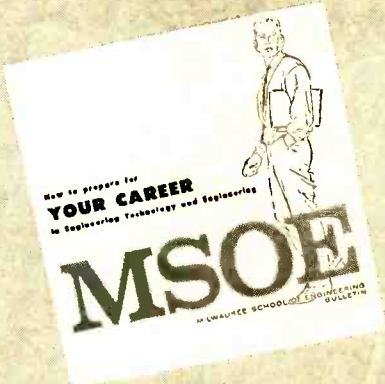

Send for this booklet on ENGINEERING TECHNOLOGY AND ENGINEERING

Learn how you can prepare for a dynamic career as an electrical or mechanical engineering technician or engineer in such exciting, growing fields as avionics, missiles, reliability control, fluid mechanics, data processing, metallurgy, microelectronics, and advanced aerospace research.

MSOE offers residence study programs leading to these degrees in engineering technology and engineering:

2 years—Associate in Applied Science
4 years—Bachelor of Science

Also get facts about scholarships and financial aids, job placement and other student services, plus photographs of MSOE technical laboratories and student activities.

For your copy, just mail the coupon — no obligation.

Programs approved for veteran training.

MSOE

Milwaukee School of Engineering
Dept. EW-167 1025 N. Milwaukee St.,
Milwaukee, Wisconsin 53201

Please send the "Your Career" booklet.

I'm interested in

Electrical fields Mechanical fields

Name.....Age.....

Address.....

City.....State.....ZIP.....

MS-289

CIRCLE NO. 102 ON READER SERVICE CARD

90

a volume control, mounted on the circuit board. It can be powered by any 9-volt d.c. source.

The TR-100 is designed specifically for service in the 27-MHz band and is suitable for CB applications. It has 3 transistors and uses a plug-in crystal (not included). Frequency range is 26 to 30 MHz and the unit is factory pre-tuned to 27.075 MHz. It will load into any 50-ohm antenna. Round Hill

Circle No. 135 on Reader Service Card

D.C. POWER SUPPLY

A new d.c. power supply designed specifically for testing two-way radio equipment is now available as the Model 73. It features 6-12 and 24 volt d.c. outputs at 30 and 20 amps, respectively, continuous-duty rating.

The output voltage is continuously adjustable from 0 to 18 and 36 volts, in two ranges. Voltage and current are easily and accurately read on 3-inch d'Arsonval-type panel instruments.

Input voltage is 117 volts a.c., 50/60 Hz. Other models are available for operation at 220 volts a.c., 50/60 Hz. Lapp

Circle No. 24 on Reader Service Card

MOBILE CB RADIO

The all-solid-state "Cobra V" mobile CB unit provides extended two-way communications and features a newly developed circuit which makes possible 100% modulation of voice information on transmitted signals even when the user talks quietly or loudly into the microphone.

Other features include five-channel coverage, a special protective circuit for the transmitter components, a solid-state switching device for automatic transmit/receive operation, and a transistorized voltage filter to improve the clarity of message reception.

Encased in a rugged all-steel housing with a front-panel in walnut grain finish, controls include volume, "on-off," illuminated channel selector switch, and adjustable squelch control. The radio weighs less than 5 pounds and measures 2" x 6 $\frac{3}{4}$ " w. x 9 $\frac{3}{4}$ " long. The unit is powered by the regular 12-volt automotive battery. When used as a base station, it can be 120 V a.c. powered by means of an accessory power supply. B&K

Circle No. 25 on Reader Service Card

PC MOBILE CB ANTENNA

A spiral-shaped, printed-circuit coil, water-proofed and shock-suspended inside a wing-shaped ornamental base are features of the new "Mach III" CB mobile antenna now on the market.

Technically known as an "involute transducer," the new circuitry is said to be precisely uniform in construction and subject to virtually no breakdown from vibration. The full quarter-wave antenna is d.c. grounded and provides an excellent v.s.w.r., essentially flat at center frequency and 1.3:1 across the band.

The 32" whip portion is of stainless steel. Fine tuning is provided by means of a base adjustment. Antenna Specialists

Circle No. 26 on Reader Service Card

MANUFACTURERS' LITERATURE

REVERBERANT ROOMS

A new 4-page illustrated bulletin (No. 6.302.0) on the design and use of reverberant rooms is now available.

Consisting of a reprint of an article which appeared originally in the April, 1966 issue of this magazine, the brochure outlines such applications of reverberant rooms as frequency-response evaluation of loudspeakers and microphones, assessment of materials used in noise abatement, subjective listening tests, and fatigue tests. Industrial Acoustics

Circle No. 136 on Reader Service Card

STANDARD RESISTORS

A new 48-page catalogue covering the company's entire line of standard wirewound and film resistors has been published.

Catalogue A is divided into three sections,

each of which is color-coded for easy reference to the precision wirewound, industrial wirewound, and precision film resistors that are described. In addition, the booklet lists a number of non-standard wirewound and film resistors. Dale

Circle No. 137 on Reader Service Card

LOW-VOLTAGE LAMPS

Information on a wide variety of miniature, subminiature, and microminiature incandescent lamps for low-voltage lighting applications is supplied in a new 4-page illustrated condensed catalogue (No. 105). Hudson

Circle No. 138 on Reader Service Card

DRY TRANSFER PRODUCTS

A new 112-page catalogue of pressure-sensitive and dry transfer products for drafting, graphic arts, and visual communication applications is now available. Color-coded product sections cover pressure-sensitive tapes, templates, and symbols; color tints and shading films; transfer lettering; and accessories. Chart-Pak

Circle No. 27 on Reader Service Card

SWITCH CATALOGUE

More than 1000 switches are described and illustrated in a new and enlarged 72-page switch selection guide (No. 50b). Border-indexed for easy reference, the booklet covers limit, enclosed, explosion-proof, proximity, basic and small basic, and mercury switches.

The catalogue also includes a glossary of switch terms and information on replacement parts. Micro Switch

Circle No. 139 on Reader Service Card

ELECTRONIC KITS

Over 250 "Heathkit" electronic kits are described and illustrated in a new 108-page 1967 catalogue (No. 810/67). Featured are complete lines of stereo/hi-fi components, amateur radio equipment, marine gear, test and lab instruments, and photographic aids. Many home and hobby items are also included, such as electronic organs, short-wave radios, intercoms, and a garage-door opener.

Several new kits are offered as well, including a 12" transistor portable black-and-white TV, a transistor guitar amplifier, and a four-speed transistor portable phonograph. Heath

Circle No. 28 on Reader Service Card

POTENTIOMETERS

A newly revised catalogue (No. rp 962/D) covering precision film potentiometers has been issued. The 20-page illustrated booklet contains information on single- and multi-turn pots, potentiometer elements, and special mechanical configurations and electrical characteristics. Computer Instruments Corp.

Circle No. 140 on Reader Service Card

ELECTRON TUBES

Information on a full line of electron tubes is contained in a new 28-page condensed catalogue. Listed are power tubes, thyratrons, entertainment and audio tubes, u.h.f. special-purpose types, indicating devices, CRT's, voltage-reference and regulator units, and vidicon-camera tubes.

A special 8-page insert in the booklet supplies data on microwave tubes and components, including pulse magnetrons, backward-wave oscillators, klystrons, and traveling-wave tubes. AmpereX

Circle No. 141 on Reader Service Card

GERMANIUM TRANSISTORS

A comprehensive germanium-transistor application guide listing more than 130 transistor types has been published. Arranged in chart form, the guide keys individual transistor types to product family, performance range, and specific circuit application. General Instrument

Circle No. 142 on Reader Service Card

LOW-COST SEMICONDUCTORS

Information on a broad line of economy plastic-encapsulated semiconductor devices for in-

ELECTRONICS WORLD

dustrial and consumer applications is offered in a new 12-page illustrated bulletin (SC-8999). Among the low-cost products described are silicon and germanium bipolar and field-effect transistors, unijunction and power transistors, silicon rectifiers, as well as monolithic IC's. Texas Instruments

Circle No. 143 on Reader Service Card

ALKALINE BATTERIES

Technical information on "Duracell" rechargeable alkaline batteries is contained in a new 6-page foldout data sheet. Capable of being recharged up to 50 times and requiring no water or added electrolyte, the batteries are particularly suited for consumer products such as portable TV sets, phonographs, tape recorders, small cordless appliances, flashlights, and toys.

The data sheet discusses general properties of the batteries, shows ten recommended voltage-limiting charger circuits, and includes dimensional drawings and performance curves. Mallory

Circle No. 29 on Reader Service Card

OPERATIONAL AMPLIFIERS

Two papers on operational amplifiers which should be of special interest to colleges and institutions involved with teaching basic analog techniques have been made available. The first, entitled "An Introductory Laboratory Manual of Operational Amplifier Experiments," contains ten illustrative examples of op amp connections and is intended to serve as a guide for the engineering student performing elementary lab experiments.

The second paper is a ten-question quiz on operational amplifier technology with a suggested testing time of one hour (answer sheet attached). Nexus Research Lab

Circle No. 144 on Reader Service Card

HI-FI COMPONENTS

A new 10-page illustrated catalogue (AL-1353) covering stereo components and systems is now available. Featured in the multi-color booklet are full-size and bookshelf speaker systems, speaker components, cabinets, a wide range of loudspeakers and high-frequency speakers, and an all-silicon-transistor stereo-FM receiver. Altec Lansing

Circle No. 30 on Reader Service Card

ROTARY SWITCHES

A full line of rotary, push-button, lever, and slide switches available from electronic distributors is described and illustrated in a new 8-page catalogue (No. SP-228). Featured in the booklet is a special section on switch hardware which enables design engineers to assemble their own switches for prototype work. Oak

Circle No. 145 on Reader Service Card

CERAMIC FILTERS

Five types of ceramic filters for electronic communications are illustrated and described in detail in a new bulletin (No. 94025). In addition, the brochure outlines the major reasons why ceramic filters are finding new opportunities to replace LC, quartz, and mechanical filters in military and commercial equipment. Clevite Piezo-electric Div

Circle No. 146 on Reader Service Card

TWO-WAY RADIO

A new 18-page brochure (No. TIC-3154) on the "Motrac" two-way radio is now available. Illustrated with full-color photographs and stylized drawings, the booklet discusses features and advantages of the unit and lists a number of options. Motorola Communications Div

Circle No. 147 on Reader Service Card

RELAY CATALOGUES

Two new relay catalogues have been made available. The first, a newly revised 22-page illustrated booklet, covers an extensive line of mercury wetted contact relays, including epoxy and encapsulated types, polarized units, and sensitive or bistable devices.

The second catalogue contains information on applications, selection factors, construction fea-

Electronics World SUBSCRIBER SERVICE

Please include an address label when writing about your subscription to help us serve you promptly. Write to: Portland Place, Boulder, Colorado 80302

CHANGE OF ADDRESS:

Please let us know you are moving at least 4 weeks in advance. Affix magazine address label in space to the right and print new address below. If you have a question about your subscription, attach address label to your letter.

TO SUBSCRIBE: Check boxes below.

New Renewal
 5 years \$21 3 years \$15 1 year \$6

SPECIFY: Payment enclosed—You get 1 extra issue per year FREE! Bill me later.

If you have no label handy, print OLD address here.

name please print

address

city

state

zip-code

AFFIX LABEL HERE

name please print

0155

address

city

state

zip-code



The only Theatre Organ available in kit form — for only \$1350.

You've asked for it and here it is — the NEW Schober THEATRE ORGAN that you assemble yourself. For the first time in kit form, a real Theatre Organ with that rich, full, old time theatre pipe organ sound. You create the organ, then you create the music!

For years you've been able to buy organs in kit form from Schober: The Recital (fully AGO), the Consolette II (the best spinet organ available today) and the Spinet (for the most music at the lowest price). Now to join them, we present the Schober Theatre Organ.

The Schober Theatre Organ has the same quality features found on all Schober Organs, and in addition... special voicing, curved console design, two 61-note keyboards, 2-octave radiating pedal clavier, 8 octaves of tone distributed over 5 pitch registers (including a 1-foot register!), 35 speaking organ stops, 8 realistic percussion stops, 4 couplers, and vibrato tablet—48 tablets in all. And all at a truly remarkable low price... you save over \$1,500 (well over 50%) from comparable theatre organs.

Easy Step-By-Step Instructions.

You'll enjoy assembling this authentic and versatile instrument from transistor and miniature components too. Just follow easy step-by-step instructions written in everyday language which anyone can understand. You'll have an unequaled pride when you're finished that only can come from assembling it yourself.

And you'll have an organ you can learn to play easily and quickly—just follow one of the self teaching courses available from us.

The Theatre Organ price starts at \$1,350, depending on the options you select. This price includes a beautiful walnut console (other woods available) or you can save an additional amount by building your own from plans available from us. Options available include combination action, genuine reverberation, percussion, and amplifiers and speakers.

THE Schober Organ CORPORATION
43 West 61st Street, New York, N.Y. 10023

CIRCLE NO. 92 ON READER SERVICE CARD

A COMPLETE THEATRE ORGAN!

All you do is have the fun of assembling it from kits and detailed, step-by-step instructions.

Includes console, keyboards, bench, pedals, electronics—everything you need except amplifier and speaker system, which are extra—or use your own. Percussions, combination action, and reverberation are options.

Features fully transistorized electronics, regulated power supplies, all printed circuit construction and gold switch contacts.

Combination Action Ten buttons select preset combinations of stops—actually move the stop tablets as in fine pipe organs—to give instant total changes of tonal effects. You can alter the preset combinations any time you like. Action is brand new electro-pneumatic type — silent, dependable.

Percussion Eight percussion stops provide exciting realism. Celesta, harpsichord, piano, mandolin, xylophone, chrysoglott, orchestral bells, single or reiterating, are played just like the real thing—and sound that way—alone or along with regular organ stops.

Uncompromising Organ Quality
from Easy-to-Assemble Kits

Free Information. Send today for your free copy of Schober's 16-page full-color booklet—plus free 7" recording—with full information on all Schober Organs, priced from \$550.

The Schober Organ Corp., Dept. RN-47
43 West 61st St., New York, N. Y. 10023

Please send me Schober Organ Catalog and FREE 7-inch "sample" record.

Enclosed please find \$2.00 for 12-inch quality LP record of Schober Organ music. (\$2.00 refunded with purchase of first kit.)

Name.....

Address.....

City.....State.....Zip No.....

NEW

"Tray biens" most versatile of all nutdriver sets

Handy "Tray Bien" sets lie flat or sit up on a bench, hang securely on a wall, pack neatly in a tool caddy.

Lightweight, durable, molded plastic trays feature fold-away stands, wall mounting holes, and a snap lock arrangement that holds tools firmly, yet permits easy removal.

Professional quality Xcelite nutdrivers have color coded, shockproof, breakproof, plastic (UL) handles; precision fit, case-hardened sockets.

Hangs up



Stands up



Holds tools
securely



No. 127TB "Tray Bien" set — 7 solid shaft nutdrivers (3/16" thru 3/8" hex openings)

No. 137TB "Tray Bien" set — 5 solid shaft nutdrivers (3/16" thru 3/8" hex openings) and 2 hollow shaft nutdrivers (1/2" and 9/16" hex openings)

No. 147TB "Tray Bien" set — 7 hollow shaft nutdrivers (1/4" thru 1/2" hex openings)

WRITE FOR BULLETIN N666



XCELITE, INC., 12 Bank St., Orchard Park, N. Y. 14127
In Canada contact Charles W. Pointon, Ltd.

CIRCLE NO. 81 ON READER SERVICE CARD

tures, and performance characteristics of mercury displacement relays. Adams & Westlake

Circle No. 148 on Reader Service Card

MINIATURE SWITCHES

Complete technical information, including performance specifications and truth tables showing codes and electrical output configurations, on "Digiswitch" and "Miniswitch" units is contained in a new 54-page thumbwheel switch catalogue. Digitran

Circle No. 149 on Reader Service Card

ELECTRONIC COMPONENTS

A new 284-page illustrated catalogue (No. 667) covering 66 lines of mechanical equipment and electronic components available from stock has been published. Indexed by product and manufacturer, the catalogue contains a guide to MIL Specs, listings of MIL and EIA standard resistance values, and handy reference charts of capacitor and resistor codes.

Copies of the new publication are available free on request from Harrison Equipment Company, Inc., 1422 San Jacinto St., Houston, Texas 77002.

RADIO & TV SERVICE DATA

A new 48-page 1966 master index to radio and TV service manuals has been released. More than 150 manufacturers are listed alphabetically, and under each company name, specific model and chassis numbers (up to and including 1966) are referenced to the appropriate service manuals.

The new master index is available from Supreme Publications, 1760 Balsam Rd., Highland Park, Ill. for 25¢.

ELECTRONICS LIBRARY

The first 12 volumes in a new series of "how to" electronics books for the hobbyist, experimenter, and do-it-yourselfer are now available. Titled the "103 Series," the library will consist of 103 books when it is completed.

The original volumes being offered cover such topics as diodes, basic alternating current, how to read circuit diagrams, transistor circuits, oscilloscopes, and practical radio.

Each book, individually packaged in clear plastic, lists for \$1.25. Copies are available from IRC, Inc., 414 N. 13th St., Philadelphia, Pa. 19108.

PHOTO CREDITS

Page	Credit
14	Sony Corp.
16	BSR Ltd.
23	H. H. Scott, Inc.
35	Heath Company
37	Fisher Radio Corp.
39, 40	James B. Lansing Sound, Inc.
42	Burroughs Corp.
43	IBM Corp.
58	Clairex Corp.
68	Aul Instruments, Inc.
69 (top)	Vari-Tech Company
69 (center)	Hewlett-Packard
72	Philco Corp.

Answer to Crossword Puzzle
appearing on page 63

M	I	C	R	O	N	P	E	N	T	O	D	E
A	S	T	A	T	I	C	D	E	C	N		
Y	N	T	O	R	I	E	N	T	V			
D	I	O	D	E	N	S	T	A	M	E		
A	B	S	O	R	P	T	I	O	N	L	L	
Y	M	M	O	R	N	O	R	T	O			
P	I	T	W	O	I	P	E	P				
C	H	U	M	E	L	A	S	O	N	E		
U	S	I	D	L	C	O	F	F				
T	E	T	R	O	D	E	S	O	N	A	R	
O	E	C	A	S	A	B	A	E	R	A		
F	L	A	P	T	P	A	G	E	A	M		
F	A	R	A	D	A	Y	H	E	X	O	D	E

STATEMENT OF OWNERSHIP, MANAGEMENT AND CIRCULATION (ACT OF OCTOBER 23, 1962; SECTION 4369, TITLE 39, UNITED STATES CODE).

1. Date of filing: October 1, 1966. 2. Title of publication: Electronics World. 3. Frequency of issue: monthly. 4. Location of known office of publication: One Park Avenue, New York, New York 10016. 5. Location of the headquarters or general business offices of the publishers: One Park Avenue, New York, New York 10016.

6. Names and addresses of publisher, editor, and managing editor: Publisher, Phillip T. Heffernan, One Park Avenue, New York, New York 10016; Editor, William Stocklin, One Park Avenue, New York, New York 10016; Managing Editor: None.

7. Owner: Ziff-Davis Publishing Company, One Park Avenue, New York, New York 10016; William B. Ziff, One Park Avenue, New York, New York 10016; Priscilla Stafford, One Park Avenue, New York, New York 10016.

8. Known bondholders, mortgagees, and other security holders, owning or holding 1 percent or more of total amount of bonds, mortgages or other securities: None.

9. Paragraphs 7 and 8 include, in cases where the stockholder or security holder appears upon the books of the company as trustee or in any other fiduciary relation, the name of the person or corporation for whom such trustee is acting, also the statements in the two paragraphs show the affiant's full knowledge and belief as to the circumstances and conditions under which stockholders and security holders who do not appear upon the books of the company as trustees, hold stock and securities in a capacity other than that of a bona fide owner. Names and addresses of individuals who are stockholders of a corporation which itself is a stockholder or holder of bonds, mortgages or other securities of the publishing corporation have been included in paragraphs 7 and 8 when the interests of such individuals are equivalent to 1 percent or more of the total amount of the stock or securities of the publishing corporation.

10. This item must be completed for all publications except those which do not carry advertising other than the publisher's own and which are named in sections 132.231, 132.232, and 132.233. Postal Manual (Sections 4355a, 4355b, and 4356 of Title 39, United States Code)

	Average No. Copies Each Issue During Preceding 12 months	Single Issue Nearest to Filing Date
A. Total no. copies printed (net press run)	248,058	240,805
B. Paid circulation		
1. Sales through dealers and carriers, street vendors and counter sales	46,284	41,500
2. Mail subscriptions	143,390	142,000
C. Total paid circulation	189,674	183,500
D. Free distribution (including samples) by mail, carrier or other means	2,278	2,109
E. Total distribution (Sum of C and D)	191,952	185,609
F. Office use, left over, unaccounted, spoiled after printing	56,106	55,196
G. Total (Sum of E & F —should equal net press run shown in A)	248,058	240,805

I certify that the statements made by me above are correct and complete.

PHILIP SINE, Treasurer

World Famed BREVETATA TEAR GAS PISTOL

Appearance of this fine tear gas weapon is similar to real gun. It is ideal for people who work in lonely, dark locations and require protection. Men give this gun to wives and daughters for night security. Many industrial applications. Shooting of gun stops aggressor without permanently injuring him. Neither permit nor license is needed, but it is not sold to minors. It fires six cartridges without reloading. Each gun comes with six tear gas shells and six blanks for practice and is shipped prepaid. Gun unit prices include, 12 shells and all shipping costs.



- 1 Gun-unit at\$13.07
 - 2 Gun-units at \$22.86.....(\$11.43 ea.)
 - 3 Gun-units at \$29.94.....(\$ 9.98 ea.)
 - 4 Gun-units at \$35.16.....(\$ 8.79 ea.)
- Extra boxes of ten tear gas shells at \$1.50 per box (prepaid with gun orders). Extra boxes of blanks at \$1.25 per box.

UNITED SAFETY SUPPLY CO.

Phone 816
221-3562

310 W. 9th St. Dept. EW
Kansas City, Missouri 64105

ELECTRONICS WORLD

ELECTRONICS MARKET PLACE

COMMERCIAL RATE: For firms or individuals offering commercial products or services. 70¢ per word (including name and address). Minimum order \$7.00. Payment must accompany copy except when ads are placed by accredited advertising agencies. Frequency discount: 5% for 6 months; 10% for 12 months paid in advance.

READER RATE: For individuals with a personal item to buy or sell. 40¢ per word (including name and address). No Minimum! Payment must accompany copy.

GENERAL INFORMATION: First word in all ads set in bold caps at no extra charge. Additional words may be set in bold caps at 10¢ extra per word. All copy subject to publisher's approval. **Closing Date:** 1st of the 2nd preceding month (for example, March issue closes January 1st). Send order and remittance to: Hal Cymes, **ELECTRONICS WORLD**, One Park Avenue, New York, New York 10016

ELECTRONICS ENGINEERING AND INSTRUCTION

FCC LICENSE in six weeks. First class radio telephone. Results guaranteed. Elkins Radio School, 2603C, Inwood, Dallas, Texas.

ELECTRONICS! Associate degree—29 months. Technicians, field engineers, specialists in communications, missiles, computers, radar, automation. Start February, September. Valparaiso Technical Institute, Dept. N, Valparaiso, Indiana.

REI First Class Radio Telephone License in (5) weeks Guaranteed. Tuition \$295.00. Job placement free. Radio Engineering Institute, 1336 Main Street, Sarasota, Fla.

LEARN ELECTRONIC ORGAN SERVICING at home. All Makes including transistors. Experimental kit—troubleshooting. Accredited NHSC. Free Booklet. **NILES BRYANT SCHOOL**, 3631 Stockton, Dept. A, Sacramento 20, Calif.

HIGHLY—effective home study review for FCC commercial phone exams. Free literature! **COOK'S SCHOOL OF ELECTRONICS**, P.O. Box 10634, Jackson, Miss. 39209.

CORRESPONDENCE COURSES—B.Sc., Engineering, Electronics. Catalog \$1. Canadian Institute of Science & Technology, 263G Adelaide St. W., Toronto.

ASSOCIATE Degree in Electronics Engineering earned through combination correspondence-classroom educational program. Free brochure. Grantham Technical Institute, 1505 N. Western Ave., Hollywood, Calif. 90027.

FOR SALE

JUST starting in TV service? Write for free 32 page catalog of service order books, invoices, job tickets, phone message books, statements and file systems. Oelrich Publications, 6556 W. Higgins Rd. Chicago, Ill. 60656.

GOVERNMENT Surplus Receivers, Transmitters, Snooperscopes, Radios, Parts, Picture Catalog 25¢. Meshna, Nahant, Mass. 09108.

TRANSISTORIZED Products Importers catalog. \$1.00. Intercontinental. CPO 1717, Tokyo, Japan.

INVESTIGATORS, FREE BROCHURE, LATEST SUBMINIATURE ELECTRONIC SURVEILLANCE EQUIPMENT. ACE ELECTRONICS, 11500-J NW 7TH AVE., MIAMI, FLA. 33168.

CANADIANS—Giant Surplus Bargain Packed Catalogs. Electronics, Hi-Fi, Shortwave, Amateur, Citizens Radio. Rush \$1.00 (Refunded). ETCO. Dept. Z, Box 741, Montreal, Canada.

TRANSISTORS—Miniature Electronic Parts. Send for Free Catalog. Electronic Control Design Company, P.O. Box 1432M, Plainfield, N.J.

CANADIANS, transistors, all semiconductors and components. Free catalogue contains reference data on 300 transistor types. J.&J. Electronics (Dept. EW), P.O. Box 1437 Winnipeg, Manitoba, Canada.

METERS—Surplus, new, used, panel and portable. Send for list. Hanchett, Box 5577, Riverside, Calif. 92507.

MESHNA'S TRANSISTORIZED CONVERTER KIT \$5.00. Two models—converts car radio to receive 30-50 mc or 100-200 mc (one mc tuning). Meshna, North Reading, Mass. 01864.

R.F. CONVERTERS World's largest selection. Also CCTV cameras, etc. Lowest factory prices. Catalog 10¢. Vanguard, 196-23 Jamaica Ave., Hollis, N.Y. 11423.

CONVERT any television to sensitive big-screen oscilloscope. Only minor changes required. No electronic experience necessary. Illustrated plans, \$2.00. Relco-A22, Box 10563, Houston 18, Texas.

FREE ELECTRONICS (new and surplus) parts catalog. We repair multimeters. Bigelow Electronics, Bluffton, Ohio 45817.

SURVEILLANCE EQUIPMENT—NEW HIGH PERFORMANCE SUBMINIATURE MODELS. ELECTRONIC COUNTERMEASURE DEVICES TO PROTECT PRIVACY. FREE DATA: SECURITY ELECTRONICS-EW, 15 EAST 43RD STREET, NEW YORK, N.Y. 10017.

DETECTIVES! Free brochures! Electronic Surveillance devices. SILMAR ELECTRONICS, 3476 N.W. 7th Street, Miami, Florida 33125.

CRYSTALS . . . largest selection in United States at lowest prices. 48 Hr. delivery. Thousands of frequencies in stock. Types include HC6/U, HC18/U, FT-241, FT-243, FT-171, etc. Send 10¢ for catalog with oscillator circuits. Refunded on first order. Jan Crystals, 2400E Crystal Dr., Fort Myers, Fla. 33901.

McGEE RADIO COMPANY. Big 1966-1967 catalog sent free. America's best values. Hi-Fi amplifiers—speakers—electronic parts. Send name, address and zip code number to McGee Radio Company, 1901 McGee Street, Dept. EG, Kansas City, Missouri 64108.

ELECTRONIC Ignition Kits, Components Free Diagrams. Anderson Engineering, Epsom, New Hampshire 03239.

TRANSISTORS, Rectifiers, components. Free Catalog. Electronic Components Company, Box 2902, Baton Rouge, La.

FREE Catalog: Transistors, Diodes, Parts. Solid State. Pax, P.O. 206, Dorchester, Mass. 02124.

FREE CATALOG—Loads of Electronic Bargains. R.W. ELECTRONICS, INC. 2244 So. Michigan Avenue, Chicago, Illinois 60616.

SERVICE manuals, TV, Radio, \$1. Technical Services Associates, Box 1167, Berkeley, California 94701.

ANY Radio, T.V., Hi-Fi part obtained and mailed anywhere! Also schematics. Send make, model number, serial and part number to: R. Polson, P.O. Box 62, Wakefield Station, New York, New York 10016.

NEW supersensitive transistor locators detect buried gold, silver, coins. Kits, assembled models. \$19.95 up. Free catalog. Relco-A22, Box 10563, Houston 18, Texas.

LAMPKIN 105-B, new. First \$250.00. George G. Keys. Abingdon, Virginia.

COMPLETE set. Back issues of **ELECTRONICS WORLD** from 1959-1966. Ivan Nyberg, 3352 South 81 Avenue, Nebraska 68124.

ACHTUNG! Das machine is nicht fur Gerfinger-poken und mittengraben. Is easy schnappen der Springenwerk, blowenfusen und poppencorken mit spitzernsparken. Ist nicht fur gerwerken by das Dummkopfen. Das rubbernecken sight-seeren keepen hands in das pockets. Relaxen und watch das Blinkenlights. This attractive, brass metal plaque only \$2.00 ea. ppd. South-west Agents, Dept. E. P.O. Box 12283, Fort Worth, Texas 76116.

TUBES

TUBES—33¢ each. Year guarantee. Tuner Cleaner \$1.09. Free catalog. Cornell, 4213-W University, San Diego, Calif. 92105.

GET IT from GOODHEART!

PROFESSIONAL HI-FI CONDENSER MICROPHONE

Brand new \$114.85 capsule only, but we include (except Paramount Picture's capsule-followers) preamp using only 3 batteries, 3 resistors, 3 capacitors, 1 6X4 tube. Mufr's specs: "±3 db from DC to 12.12 kc, variable beyond 25 kc; 25 ph; —75 db across 10 meg load for 10 bar signal at 180 v polarizing; will work past 170 dbm; will stand 200 G shock." Unconditional. Sizes will fit in 2-1/4" stereo; 3/8" thick OA. **WHILE THEY LAST, postpaid, only . . . 27.50**

KEEP LINE VOLTS CONSTANT AUTOMATICALLY

These Regulators. **ALL AT LOW SURPLUS BARGAIN PRICES.** Hold output at 117-120 mc despite line changes 95-130 v and load changes 0 to full load. **CV:** Tuned saturating isolating transformers hold to 1%. Have 24% harmonics. **EW:** Silicon, hold to 1%. **Z:** Zilo harmon. **S/E:** Electronic, hold to 0.15%. **or** max. harm. **Sola:** Sorenson, Superior Electric. **CV: 1KVA . . . 69.50 1 KVA . . . 99.50**
S/E: 500 VA . . . 89.50 2 1/2 KVA . . . 199.50
2 KVA . . . 179.50 5 KVA (230v 1 ph) . . . 350.00
3 KVA . . . 279.50
10 KVA (95-130v, 1 ph, 50/60 cy) . . . 595.00
EM: 6 KVA, \$279.50 (Incl. Gen. Radio 1570AL)
EMT (transistorized) 28 KVA 230v 1 ph . . . 350.00

EVERYTHING UNCONDITIONALLY GUARANTEED

ALL-BAND 5SB RCVR BARGAIN: Hallenraters R-45/ALR-7, 520 kc to 43 mc continuous. **149.50**
Less pwr apl.
60 cy pwr apl.: \$30. 5SB product detector: **\$20**

TIME PAY PLAN: Any purchase totaling \$160.00 or more, down payment only. **10%**

DZ-1 Superbet revr 15-70 & 100-1500 kc. 89.50
R-23/ARC-5 Command revr 100-550 kc. 14.95
UR-13 Revr 22-75 404 mc AM, v/book 17.95
APR-4Y AM/PM Revr mod. to 115 v 50/60 cy, with pwr plug, book, tuners 38-1000 mc. 250.00
CV-253/ALR Tuner brand new 38-1000 mc. 250.00
APR-4Y with CV-253 425.00
P.U.R.: for tuners 975-2200 and 2175-4000 mc. 249.50
UR-13 Revr 22-75 404 mc AM, v/book 10.00
Handbook for AN/ARC-1 Revr 10.00
Handbooks for AN/ARC-3 or for ART-13 10.00
Other Handbooks, or Schematics, ask for them!
RA-62-B is AM pwr apl for SCR-522, only 17.95
TDQ unit 35 W Pw A2, A3, 115-156 mc. 295.00
TDZ unit 30 W Pw A2, A3, 225-400 mc. 495.00
LM-14 meter, .01% 125 kc-20 mc. 57.50
TS-323 UR freq. meter 20-480 mc. 169.50

SOMETHING NEW in Surplus Test Equipment: At your request, will furnish dated NBS-traceable Certificates of Calibration.

Hewi-Pack ±150A 5" scope, 10" to 10 mc certified With ±152A dual-trace plug-in 565.00

We have lots more Test Equip. Ask!

R. E. GOODHEART CO. INC.

Box 1220-A, Beverly Hills, Calif. 90213
Phones: Area 213, office 272-3707, messages 273-5342

CIRCLE NO. 11 ON READER SERVICE CARD

"TAB" * SILICON ONE-AMP DIODES
Factory Tested Guaranteed

Piv/Rms 50/35	Piv/Rms 100/70	Piv/Rms 200/140	Piv/Rms 300/210
400/280	600/420	800/560	900/630
.14	.21	.30	.40
1000/700	1100/770	1700/1000	2400/1680
.90	.70	1.20	2.00

*All tests AC & DC & PWD & LOAD!

1700 Piv/1300 Rms @ 750 Ma \$1.20 @ 10 for \$10
2100 Piv/1680 Rms @ 720 Ma \$2 @ 6 for \$11

SILICON POWER DIODES—STUDS & P.F.**

D.C. AMPS	50 Piv 35 Rms	100 Piv 70 Rms	200 Piv 140 Rms	300 Piv 210 Rms
1	.12	.15	.22	.33
12	.75	.50	.75	.90
*18	.20	.30	.75	1.00
45	1.80	1.20	1.40	1.90
160	1.60	2.90	3.50	4.00
240	3.75	4.75	7.75	10.45

D.C. AMPS	400 Piv 280 Rms	600 Piv 420 Rms	700 Piv 490 Rms	900 Piv 630 Rms
3	1.20	1.50	1.75	2.50
*18	1.50	Query	Query	Query
45	2.25	Query	3.15	4.00
160	5.75	7.50	Query	Query
240	14.40	19.80	23.40	Query

674 Silicon Tube Replacement \$ 2 @ . 6 for \$ 9
314 Silicon Tube Replacement \$ 5 @ . 2 for \$ 9
866A Silicon Tube Replacement \$14 @ . 2 for \$25

T036 pkg 15 Amp Transistors
2N441, 442, 277, 278, D8501 . . . \$1.25 @ . 10 for \$10
2N278, 443, 174, up to 80V 3 @ . 2 for \$ 5
3 Amp Transistors \$35 @ . 4 for \$ 1.00

"TAB" TERMS: Money Back Guarantee Our 22nd Year. \$2 Min. Add Shipping Charges

111 WP LIBERTY ST., N. Y. 6, N. Y.
Phone: REctor 2-6216 for Catalog

CLASSIFIED ADVERTISING ORDER FORM

Please refer to heading on first page of this section for complete data concerning terms, frequency discounts, closing dates, etc.

1	2	3	4	5
6	7	8	9	10
11	12	13	14	15
16	17	18	19	20
21	22	23	24	25
26	27	28	29	30
31	32	33	34	35

Words { @ .40 Reader Rate } = \$
 { @ .70 Commercial Rate }

Insert _____ time(s) Total Enclosed \$ _____

NAME _____

ADDRESS _____

CITY _____ STATE _____ ZIP _____

SIGNATURE _____

WORD COUNT: Include name and address. Name of city (Des Moines) or of state (New York) counts as one word each. Zone or Zip Code numbers not counted. (Publisher reserves right to omit Zip Code if space does not permit.) Count each abbreviation, initial, single figure or group of figures or letters as a word. Symbols such as 35mm, COD, PO, AC, etc., count as one word. Hyphenated words count as two words. EW-167

HARD-TO-GET TUBES IN STOCK

COMPARE OUR PRICES
 ONE PRICE TO ALL—1 TO 100
 BRAND NEW—1 YR. GUARANTEE

Type	Price	Type	Price	Type	Price	Type	Price
200/00A	2.00	6AU8A	1.45	6V6GT	.75	12SL7	1.50
01A	3.00	6AW8A	1.28	6W4GT	.84	12SQ7GT	
OC3	.85	6AX4	.92	6W6GT	.96	12SR7	1.32
OD3	.82	6AX5	1.11	6X5GT	.79	12V6	1.60
1A2	1.00	6B4	5.95	6X8A	1.10	12W6	1.60
1B3	.98	6B7G	2.25	6Y4	1.55	13GF7	2.08
1H5	3.00	6B8	2.75	6Z4/84	1.25	14A4	1.75
1L4	3.00	6BA6	1.6	7A4	2.75	14A5	1.75
1LA4	2.00	6BA8	1.70	7A7	2.95	14B7	2.00
1LA6	2.10	6BE6	.79	7A6	3.40	14AF7	2.25
1LC6	2.00	6BH6	1.96	7A7	2.75	14B6	2.00
1LD5	2.25	6BH8	1.38	7B7	2.75	14B8	2.00
1LE3	2.00	6BK5	1.47	7AD7	3.00	14C5	2.00
1LN5	2.40	6BK7B	1.14	7AF7	2.75	14C7	2.30
1NS	2.00	6BQ7A	1.30	7AH7	1.95	14E7	2.00
1P5	2.2	6BK7	2.19	7AU7	2.85	14F7	3.00
1R4	.95	6C4	.60	7B7	2.60	14G7	2.75
1RS	1.05	6C5M	2.30	7B5	3.10	14H7	2.25
1S5	1.05	6C6	2.7	7B7	1.90	14J7	2.50
1T5	1.25	6C8G	3.50	7B7	2.60	14K7	2.25
1U4	.61	6CA7	2.36	7B8	2.14	14L7	2.25
1V	3.00	6CC7	1.10	7C5	1.15	14M7	2.25
1V2	2.86	6CC8A	1.10	7C6	2.85	14N7	2.25
1V6	2.80	6CL6	1.61	7C6	1.20	14Y4	2.35
2A3	3.50	6CL8A	1.29	7E5	1.20	19	1.50
2A5	2.95	6CM7	.96	7E6	3.50	24A	2.00
2D21	1.00	6CQ8	1.15	7F7	3.50	25C5	2.88
2H45	1.65	6CW4	2.03	7F7	3.50	25C6	2.88
3A3	1.11	6CX8	1.59	7F8	3.10	25DN6	2.50
3A5	1.75	6D4	1.75	7H7	2.30	25L6GT	2.50
3B4	1.20	6D6	3.10	7J7	3.50	25P6	1.86
3B26	.76	6DN6	3.05	7L7	3.00	25Z6	1.37
3C86	1.76	6DN7	1.42	7M7	2.80	26	1.60
3DG4	.84	6DQ5	3.40	7N7	2.80	30	1.75
3DT6	.88	6DQ6B	1.35	7Q7	3.50	30	1.50
3Q5	2.20	6E5	1.79	7S7	3.50	34	2.00
3V4	.93	6F4	8.00	7W7	2.56	35A6	2.44
4BQ7A	1.58	6F5	2.38	7X6	2.98	35W4	.37
4B7	1.56	6F6	2.44	7Y7	3.00	35Y4	1.30
4C6	.88	6F7C	4.95	7Y4	3.00	35Z3	1.03
5AN8	1.33	6F8C	3.25	7Y7	3.50	35Z5	.65
5AN8	1.89	6GZ8	2.38	8A8	1.60	37	2.25
5AQ5	.83	6J5	1.56	8B05	1.20	38	2.50
5A28	1.62	6J7	1.90	8C7	1.83	39/44	1.80
5AT8	2.25	6J7	1.50	8FQ7	1.00	41	1.00
5BQ7B	1.79	6J8C	2.75	8GJ7	1.44	42	2.05
5BR8	1.34	6K7M	2.15	8N8	1.62	43	3.10
5C8	1.34	6K7M	2.15	8JVB	1.62	45/2A3	3.50
5J6	.70	6K7GT	2.00	10DE7	1.11	46	2.95
5U4	1.18	6L6	1.50	12A7	2.25	48	4.00
5V4	1.50	6L6C	1.50	12AT6	.65	49	2.95
5X8	1.49	6L6CC	1.50	12AUG	.75	50C5	2.00
5Y3GT	1.42	6N7M	2.00	12AUG	.84	50L6GT	.90
5Y4	1.68	6P5	2.50	12AX4	.90	50V6	1.92
5Z3	2.40	6S7M	1.80	12B7	1.96	50V6	1.92
6A7	3.45	6S7	2.50	12BA6	.61	50V7	1.88
6A8	2.79	6SB8T	1.75	12BE6	.61	53	3.25
6AB4	1.06	6S7M	1.80	12B7	1.96	55	1.55
6AB7	2.75	6SB7Y	2.48	12BQ6	1.35	56	1.55
6AC5GT	2.54	6SD7	2.80	12BR7	1.34	58	1.85
6AC5	2.40	6S7	1.98	12C7	1.50	59	4.00
6AF3	1.30	6SF7	2.50	12M7GT	2.95	DL7	1.50
6AG5	.94	6SG7	1.95	12M8M	2.95	71A	1.50
6AH4	1.38	6S7GT	1.50	12L6	1.52	75	2.65
6AK5	1.15	6S7M	1.70	12L8	.50	76	1.50
6AL7	2.98	6S7	1.80	12Q7GT	1.32	78	2.50
6AMB	1.15	6SK7GT	1.95	12SA7GT		80	1.75
6AN8A	1.30	6SK7M	1.80	12SC7	1.50	80	1.75
6AOT	1.60	6S7GT	1.30	12SF7	2.65	83V	1.75
6AR5	1.00	6SN7GT	.90	12SG7	2.03	58B1	3.25
6AS5	.95	6SQ7	1.45	12SH7	2.25	6146	2.75
6AS7G	3.95	6S7	1.40	12S7GT	1.60	6336	4.95
6AT6	.74	6SS7	1.95	12S7GT		6550	4.00
6AUBA	1.48	6T8A	1.14	12SK7M	1.70	807	1.25
6AUS	1.68	6U5	3.25	12SK7GT		KT88	4.75
6AUGA	.78	6U8A	1.10		1.55		

OUR MINIMUM ORDER \$5.00
 N. J. Residents—Sales Tax 3% Postage Extra

Send for complete tube catalog of over 3500 additional types and special purpose tube

UNITED RADIO COMPANY

56 Ferry St., Newark, N.J.
 P.O. Box 1000 A12, Newark, N.J.

CIRCLE NO. 84 ON READER SERVICE CARD

BEFORE you buy receiving tubes, Transistors, Diodes, Electronic Components and Accessories... send for Giant Free Zalytron Current Catalog, featuring Standard Brand Tubes: RCA, GE, etc.—all Brand new premium quality individually boxed, One year guarantee—all at biggest discounts in America! We serve professional servicemen, hobbyists, experimenters, engineers, technicians. Why pay more? Zalytron Tube Corp., 469-W Jericho Turnpike, Mineola, N.Y. 11502.

TUBES, SEMICONDUCTORS, ELECTRONIC EQUIPMENT & COMPONENTS. Quality merchandise only! Serving engineers, purchasing agents, TV/Hifi servicemen and hams for 16 years. Write for catalog or call WA 5-7000. BARRY ELECTRONICS, 512 Broadway, New York, N.Y. 10012.

FREE Catalog. Electronic parts, tubes. Wholesale. Thousands of items. Unbeatable prices. Arcturus Electronics ZD, 502-22 St., Union City, N.J. 07087.

WANTED

QUICKSILVER. Platinum, Silver, Gold. Ores Analyzed. Free Circular. Mercury Terminal. Norwood, Mass.

CASH Paid! Sell your surplus electronic TUBES. (Want UNUSED, CLEAN Radio/TV Receiving, Transmitting, Special Purpose, Magnetrons, Klystrons, Broadcast Types.) Want military and commercial Lab/Test Equipment. Want commercial Ham Receivers and Transmitters. For a Fair Deal Write: BARRY ELECTRONICS, 512 Broadway, New York, N.Y. 10012 (WA 5-7000)

SPECIAL INTRODUCTORY OFFER

15 Epoxy Rectifiers With Every \$5.00 Purchase. Many Over 600 PIV. No Shorts or Opens.

INTEGRATED CIRCUITS ARE NOW AVAILABLE

FLIP FLOPS \$1.50

Gates \$1.50

Flat pack case mounted on standard carrier for easy soldering.

They come complete with schematic, elect. characteristic sheet & some typical applications. \$9.00-\$15.00 values from original manufacturer.

Silicon Power Rectifiers

PRV	3A	30A	40A
100	.10	.40	.75
200	.20	.60	1.20
400	.25	.80	2.00
600	.35	1.20	2.50
800	.45	1.50	2.75
1000	.65		3.00

SA Insul Base

PRV	
100	.20
200	.40
400	.60

Top Hat & Epoxy 750 MA

PRV	
100	.07
200	.09
400	.12
600	.20
800	.25
1000	.50
1200	.65
1400	.85

Silicon Control Rectifiers

PRV	7A
50	.35
100	.60
200	.90

PRV	7A
300	1.35
400	1.75
500	2.25

- "N" Channel Fet's Similar To C-610 Used As Amp, Switch, Chopper—Very High Input Z \$1.50 Each
- SIM. to 2N1640 (PNP) Bi-directional transistors. A to-5 silicon unit in which collector & emitter are interchangeable. Ea.\$4.40
- SIM. to 2N728. A high frequency to-18 unit extending to the UHF range 5/\$1.00
- SIM. to 2N1648 (NPN) high voltage 20 Watt silicon unit, used in power output stages & power transistor drives 2/\$1.00
- GLASS DIODES color coded. Silicon 20/\$1.00
6E 30/\$1.00
- SIM. to 2N995 (PNP). Silicon in to-18 case. 500 MW power, to 180 MHz frequency 4/\$1.00
- SIM. to 2N2875 (PNP). Silicon 20 watts with 30 MHz cut off 2/\$1.00
- SIM. to 2N255 (PNP), 20 watts in to-3 case 4/\$1.00
- 10 WATT ZENERS. 5-60 volts. State desired voltages. Ea. \$.75
- SILICON BILATERAL SWITCH. Replaces two SCR's by firing in either direction when breakdown voltage is exceeded. Used in light dimmers, etc. 2/\$1.00
- GaAs VARACTORS, sim. to AP-1, AP-6, etc. 70 GHz at 150 MW. Ea. \$4.00
- 4" x 10" SPEAKERS. 10 Ω. 1.5 oz Magnet. Ea. \$2.50
- 6" x 9" SPEAKERS. 20 Ω. 1.5 oz Magnet. Ea. \$2.50
- 4" SPEAKERS. 3.2 Ω. 1 oz Magnet. Ea. \$1.25
- DUAL 1 MEG. POT. with off-on switch 4/\$1.00
- 24 V 60 Hz 6 PDT 3 open, 3 closed 15 A Contacts \$4.00
- 455 KHz IF XRMRS 3/\$1.00
- 262 KHz IF XRMRS 3/\$1.00
- DUAL 20 μF at 350 V Electrolytics 3/\$1.00
- 28-101 P CERAMIC TRIMMERS 6/\$1.00

Terms: FOB Cambridge, Mass.
 Send check or Money Order. Include Postage, Average Wt. per package 1/2 lb. Allow for C.O.D. Minimum Order \$2.00

POST OFFICE BOX 748
 SOMERVILLE, MASS. 02143
 SEND FOR FREE CATALOG

Name _____
 Address _____
 City _____ State _____

CIRCLE NO. 89 ON READER SERVICE CARD

MILITARY SURPLUS EQUIPMENT NEEDED: ARC-34, ARC-38, ARC-44, ARC-52, ARC-54, ARC-55, ARC-66, ARC-73, ARC-84, ALSO ARN-14C, ARN-54, ARN-59, COLLINS 51x-2, 51V-3, 51Y-3, 51R-3, 17L-4, 17L-7, 618S-1, 18S-4. BENDIX TA-21, RA-21. APR-14, PRC-25, RT-66 THRU RT-70/GRC. APN-22, APN-117, APN-133. TEST SETS WANT WITH ARM, UPM, URM, RSM, SG PREFIXES. TOP CASH DOLLAR PAID IMMEDIATELY. SLEP ELECTRONICS CO., DRAWER 178-EW, ELLEN-TON, FLORIDA 33532, PHONE (813) 722-1843.

ANTIQUE RADIOS. Pre-1925. Grebe, Kennedy, Tuska, etc. Must be in good condition. Also need tubes, parts, books and magazines. Gilfer, P.O. Box 239, Park Ridge, N.J. 07656.

DO-IT-YOURSELF

PROFESSIONAL ELECTRONIC PROJECTS—\$1.00 up. Catalog 25¢. PARKS, Box 25565, Seattle, Wash. 98125.

TAPE & RECORDERS

BEFORE renting Stereo Tapes, try us. Postpaid both ways—no deposit—immediate delivery. Quality—Dependability—Service—Satisfaction—prevail here. If you've been dissatisfied in the past, your initial order will prove this is no idle boast. Free Catalog. Gold Coast Tape Library, Box 2262, Palm Village Station, Hialeah, Fla. 33012.

TAPE-MATES now offers ALL TAPES—ALL LABELS at TREMENDOUS SAVINGS plus FREE Tape-Mates membership. For FREE brochure write TAPE-MATES, 5727-EW W. Jefferson Blvd., Los Angeles 90016.

RENT Stereo Tapes—over 2,500 Different—all major labels—free brochure. Stereo-Parti, 1516 —E. W. Terrace Way, Santa Rosa, California.

STEREO TAPES. Save up to 60% (no membership fees, postpaid anywhere USA). Free 60-page catalog. We discount batteries, recorders, tape accessories. Beware of slogans "not undersold," as the discount information you supply our competitor is usually reported to the factory. SEXITONE, 1776 Columbia Rd., Washington, D. C. 20009.

TAPE RECORDER SALE. Brand new, latest models, \$10.00 above cost. Arkay Sales, 1028-B Commonwealth Ave., Boston, Mass 02215.

HI-FI components, tape recorders, sleep learn equipment, tapes. Unusual Values. Free catalog. Dressner, 1523 R Jericho Turnpike, New Hyde Park, N.Y. 11040.

HIGH FIDELITY

LOW, LOW quotes: all components and recorders. Hi-Fi, Roslyn 9, Penna.

FREE! Send for money saving stereo catalog #E1W and lowest quotations on your individual component, tape recorder or system requirements. Electronic Values Inc., 200 West 20th Street, N.Y., N.Y. 10011.

HI-FI Components, Tape Recorders at guaranteed "We Will Not Be Undersold" prices. 15-day money-back guarantee. Two-year warranty. No Catalog. Quotations Free. Hi-Fidelity Center, 239 (L) East 149th Street, New York 10451.

FREE—\$1.00 Value "Miracle" Record cleaning cloth with every quotation on **HIFI EQUIPMENT.** Our "ROCK BOTTOM" prices on **NAME BRAND** amplifiers—tuners—tape-recorders — speakers—**FRANCHISED—59 YEARS IN BUSINESS.** Write for this month's specials—**NOW!** Rabson's 57th St., Inc., Dept. 569, 119 W. 57th St., New York, New York 10019.

HIFI speaker system. Small, walnut. Magnificent. \$29.95. TANG, Box 162A, Framingham Ctr., Mass. 01701.

REPAIRS AND SERVICES

TV Tuners Rebuilt and Aligned per manufacturers' specification. Only \$9.50. Any make UHF or VHF. We ship COD Ninety Day written guarantee. Ship complete with tubes or write for free mailing kit and dealer brochure. JW Electronics. Box 51B, Bloomington, Indiana.

RECONING—COMPLETE SPEAKER RECONING SERVICE ANY MAKE. ANY SIZE. MIDWEST SPEAKER SERVICE, 715 N. SHERMAN, INDIANAPOLIS, IND. 46201.

UNUSUAL BARGAINS
... MANY U.S. GOV'T SURPLUS

"Balls of Fun" for Kids... Traffic Stoppers for Stores... Terrific for Amateur Meteorologists...

SURPLUS GIANT WEATHER BALLOONS



At last... available again in big 8-ft. diameter. Create a heliobur, hood sensation. Great backyard fun. Exciting beach attraction. Blow up with vacuum cleaners or auto air hose. Sturdy enough for many other uses with reasonable care (can be punctured by sharp objects.) Filled with helium (available locally) use balloons high in the sky to attract crowds, advertise store sales, announce fall activities, etc. Amateur meteorologists use balloons to measure cloud heights, wind speeds, temperature, pressure, humidity at various heights. Photographers can utilize for low-cost aerial photos. Recent Gov't. surplus of heavy, black, neoprene rubber. **Stock No. 60.568AK \$2.00 Ppd.**

BATTERIES GUARANTEED RECHARGEABLE FOR 5 YRS.



Use these remarkable space-age Nickel-Cadmium batteries in flashlight, portable radios, toy or flash guns. Obsolete all others! Low-cost kit includes compact, highly efficient battery charger and 2 "D" size Ni-Cd batteries (standard rechargeable to full power for 5 yrs. Power output remains constant—doesn't fade away as with lead-acid cells. Durable, black plastic charger 5 7/8" x 3" x 1 3/4" dp. plugs into standard wall outlet. Completely charges 1 or 2 "D" or "C" size batteries in 10 hrs. Light shows when unit is charging will not overcharge. **Stock No. 60.591AK \$9.95 Ppd.**
Stock No. 60.592AK (Charger only) \$5.98 Ppd.
Stock No. 60.593AK (Two "D" Cells only) \$5.98 Ppd.

Order by Stock No. — Send Check or Money Order Money Back Guaranteed. **EDMUND SCIENTIFIC CO., Barrington, N.J. 08007**

SEND FOR FREE CATALOG "AK"

Completely new 1967 edition. New items, photographs, illustrations. 148 easy-to-read pages packed with nearly 4000 unusual items. Enormous selection of Astronomical Telescopes, Microscopes, Binoculars, Magnifiers, Magnets, Lenses, Prisms. Many war surplus items for hobbyists, experimenters, workshop-factory. Write for catalog "AK".



NAME _____
ADDRESS _____
CITY _____ STATE _____ ZIP _____

EDMUND SCIENTIFIC CO., BARRINGTON, NEW JERSEY 08007
CIRCLE NO. 114 ON READER SERVICE CARD

SOLDERING IRON
FAST HEAT 80 WATT
Completes with Battery Line Cord, 110-120 Volts AC/DC
\$149 — 30 Shipping

Special!
With every \$10 Order
25¢ per tube
No Limit from this list
6AG5 6SN7
6AQ5 6CB6 6SA
6AU6 6J6 6W4

Prestige & Success are yours as an ELECTRONIC EXPERT
FOR CORNELL CUSTOMERS ONLY by special arrangement with the publisher, these amazing bargains are available.

COMPLETE RADIO SERVICING AND BASIC ELECTRONICS COURSE ONLY \$3.00 (12-30 - 30 packing charge)

NEW PRACTICAL TV TRAINING COURSE ONLY \$3.50 (12-30 - 30 packing charge)

Both above courses **\$6.00**

RADIO-TV TUBE TESTER
TEST AND REPAIR TV & RADIO SETS APPLIANCES
\$2.89 plus 30¢ shipping

CORNELL TUBES
1 YR. GUARANTEED
Mutual Conductance Lab-tested, Individually Boxed, Branded and Code Dated, Tubes are new, or used and so marked.

33¢ PER TUBE
100 TUBES OR MORE: **30¢ PER TUBE**

0Z4	6A55	6CD6	6K6	6X4	12BF6
1B3	6AT6	6CF6	6K7	6X8	12BH7
1J3/1K3	6AT8	6CG7	6Q7	7A7	12BL6
1H5	6AU4	6CG8	6S4	7AB	12BY7
1L4	6AU5	6CM7	6SA7	7BE	12C5
1T4	6AU6				12CA5
1U4	6AV6				12SN7
1X2	6AW8				12SQ7
3B26	6AX4				25L6
3DG4	6BA6				25Z6
5U4	6BC5				35W4
5U8	6BD6	6CZ5	6SH7	7C5	35Z3
5V4	6BG6	6D6	6SJ7	7N7	50L6
5Y3	6BJ6	6DA4	6SK7	7Y4	24
6A6	6BL7	6DE6	6SL7	12AD6	27
6AB	6BN4	6DQ6	6SN7	12AE6	24
6AB4	6BN6	6DQ6	6SQ7	12AF6	77
6AC7	6BN6	6EA7	6SR7	12AT7	78
6AG5	6BQ6	6EM5	6U7	12AU7	84/6Z4
6AK5	6BQ7	6F6	6U8	12AX7	5687
6AL5	6BZ6	6GH8	6V6	12BA6	6350
6AN8	6C4	6H6	6V6	12BD6	6463
6AL5	6C6	6J5	6W4	12BE6	7044
6AQ5	6CB6	6J6	6W6		

Other tubes at low prices... send for free list

NO SUBSTITUTIONS WITHOUT YOUR PERMISSION

INTERFERENCE TRAPPER \$1.59
PICTURE EXPANDER 99¢

21 PICTURE TUBES
139¢ per tube
No CRT's on Picture Tubes

all purpose ELECTRONIC CLEANER
89¢ plus 20¢ shipping

20¢ CHEATER CORDS

NOISE FILTER STOP RADIO NOISE INSTANTLY

39¢ per pack Sensational **DIODES/RECTIFIERS KIT VALUE**

750 MA 400 PIV .69¢ **1000 MA 800 PIV .89¢**

EPOXY DIODES 79¢

GIANT TWIN-PACK SELF STICKING PLASTIC ELECTRICAL TAPE 89¢

CAR RADIO POWER TRANSISTORS 99¢

CORNELL ELECTRONICS CO.
Dept EW1 4217 University Ave., San Diego, Calif. 92105

TERMS: Add 3¢ per tube shipping. Orders under \$5.00 add 3¢ per tube shipping plus 50¢ handling. Canadian orders add approximate postage. Send 25% deposit on C.O.D. orders. No C.O.D. orders under \$5.00 or to Canada. No 24 hr. free offer on personal check orders. **5-DAY MONEY BACK OFFER!**

U.S. GOV'T ELECTRONIC SURPLUS

• Nationally Known—World Famous SURPLUS CENTER offers finest, most expensive, Government Surplus electronic units and components at a fraction of their original acquisition cost.

ORDER DIRECT FROM AD or WRITE FOR CATALOGS

LABORATORY EXPERIMENTAL KIT

PERFORM 100'S OF
FASCINATING
ELECTRICAL
EXPERIMENTS

Gov't Acquisition
Cost Of Parts
Over \$50.00

\$14.85
F.O.B.



• (ITEM #A222) -- Amazing Value! Valuable gift for son or husband. Hundreds of fascinating experiments. Teaches modern electronic theory and practice. Easy, interesting way to learn.

• Experiment with electrostatic, electro-magnetic phenomena, resonance, burglar alarm, relay circuits, rectification, test circuits, electrotyping, motor experiments, transformer phenomena, etc.

• Kit Contains: 1/2" motor, AC motor, electro-magnetic coils, ac and dc relays, set of lab capacitors, 200pf, 500pf, plating chemicals, silicon diodes, germanium diode, burglar alarm actuator, carbon microphone, carbonizing element, ac test sockets, permanent magnets, telephone handset, coads, test clips, wire, and other items. Over 75 pieces. Includes Time Experimental Manual with drawings, procedures, etc., written by professional engineers.

• Also furnished with each kit our popular book Home Laboratory Bench and Experimental Procedures - Reg. \$1.00. Shows how to build wonderful home laboratory test bench, and how to get the most out of your experimental work. (12 lbs.) Parts cost gov't over \$50.00.

AC PROGRAM TIMING CLOCK

• (ITEM #158) -- Fourth 115-AC program timer. Use for periodic timing, work breaks, school classes, turn on radio for news, etc. Adjustable clips permit switching on or off any time during 24-hour period. Sufficient clips for multiple programming. Also has "ak-plas-dm" feature. Contacts can handle up to 15 amps. 8 1/2" x 6 1/2" x 4". Wt. 8 lbs. Gov't Cost Over \$10.00.

Instructions Furnished. F.O.B. **\$9.49**



F.O.B. **\$12.47**

AUTO-PILOT GYROSCOPE

• (ITEM #115) -- DC motor driven, gimballed mounted gyroscope. High-response precision unit used to "steer" large, multi-engine planes. Deviation from established plane sends automatically controlled signals to bring about change in other motors. Unit can be used as auto-pilot for boats. Wonderful class room unit to demonstrate and study gyro action. Mirrors, planes, boats all use gyros. Size 8 1/2" x 8 1/2" x 10". Wt. 3 lbs. Gov't Cost Over \$30.00.

STANDARD DIAL TELEPHONE

• (ITEM #715) -- Standard, commercial telephone same as used throughout U.S.A. Attractive polished black, like new condition. Use as extension phone to private systems or connect several phones together for local intercom system. Full instructions are furnished. Wt. 9 lbs. Original Cost \$24.50.



F.O.B. **\$5.95**

STEP-BY-STEP AUTOMATIC SWITCH

• (ITEM #738) -- Amazing "up-and-around" electro-magnetic telephone switch. Dial any bank pair from 1 to 100. Make your own telephone system. Can also be used to remotely control up to 100 circuits over a single unit of wires.

• One of our FOUR STAR bargains. Comes complete with data, one dial and one line bank. Size: 5 1/2" x 7 1/2" x 1 1/2". Wt. 16 lbs. Gov't Cost Over \$15.00. Complete: Switch, cover, dial, line bank, instructions.....

F.O.B. **\$9.95**



STEP UP/DOWN TRANSFORMER

F.O.B. **\$4.99**

• (ITEM #1543) -- Step voltage up or down. Has many uses. Will step 115-volts up to 230 volts or step 230-volts down to 115-volts. Will also transform 115-volts to 75-volts. Rated 1.75 amps. output with 175-watt capacity. Size: 4 1/2" x 2 1/2" x 2 1/2". Wt. 4 lbs. Gov't Cost \$12.75.

TYPICAL BUYS FROM OUR 1967 CATALOGS

- \$ 350.00 - Geared 2-hp Battery Golf Car Motor **\$24.95**
- \$ 15.00 - Westinghouse DC Ammeter, 0 to 300..... **\$ 7.11**
- \$ 40.00 - Vacuum Pressure Pump, 12-VDC **\$11.95**
- 80-MW Walkie-Talkies, Per Pair **\$19.60**
- Deluxe, Multi-Range, AC/DC Tester **\$ 8.98**
- \$4000.00 - Carrier Telephone Amplifier System **\$13.91**

SPECIAL SALE

Correspondence
Course In
ELECTRICAL
ENGINEERING



Sells For \$10.79 Postpaid Outside U.S.A. **\$8.79**

• (ITEM #A181) -- Wonderful chance to obtain technical training at Amazing Low Cost! Lincoln Engineering School has suspended its Correspondence Courses because of increased operating costs. We offer a limited number of the school's complete Electrical Engineering Course but without the examination paper grading service. The course consists of 14 lesson unit books. Each book has the regular exams, and in a separate section, "Standard Answers" to each exam question.

• Course is well written, easy to understand, profusely illustrated. Reader's breast size, easy to carry and study in spare time. Many Lincoln Engineering School students holding excellent jobs as a result of I.E.S. training. Course contains latest information on transistors, silicon diodes, etc. Additional book on how to build and operate a "Home Laboratory and Experimental Bench" furnished with each course.

SEND 25c COIN OR STAMPS FOR 3 MAIN CATALOGS

All Items FOB Lincoln Money Back Guarantee

SURPLUS CENTER

DEPT. EW-017 LINCOLN, NEBR. 68501

EMPLOYMENT OPPORTUNITIES

ELECTRONICS TECHNICIAN. Excellent opportunity for experienced person to work in research laboratory. Should be capable of troubleshooting electrical equipment, testing circuitry using oscilloscope, operating basic power tools. Many company benefits. Convenient to public transportation. American Medical Association, 535 North Dearborn Street, Chicago, Illinois. 527-1500.

GOVERNMENT SURPLUS

JEEPS Typically From \$53.90. . . Trucks From \$78.40. . . Boats, Typewriters, Airplanes, Electronics Equipment, Photographic Equipment, used. 100,000 Bargains Direct From Government. Complete Sales Directory and Surplus Catalog \$1.00 (Deductible First \$10.00 Order). Surplus Service, Box 820-K, Holland, Michigan 49423.

RECORDS

REPLACE worn LP Jackets—White 20¢, Colors 25¢. Min Shipment 20, Samples 50¢, Records, Hillburn P.O., New York.

AUTHORS' SERVICES

AUTHORS! Learn how to have your book published, promoted, distributed. FREE booklet "ZD," Vantage, 120 West 31 St., New York 1.

SONGWRITERS WANTED! Send poems or complete songs to: Tin Pan Alley, 1650-H Broadway, New York 10019.

HYPNOTISM

FREE Hypnotism, Self-Hypnosis, Sleep Learning. Catalog! Drawer H400, Ruidoso, N.M. 88345.

FREE TRIAL! Sensational self-hypnosis record kit. Forum, 333-AA1 Michigan, Chicago 60601.

HYPNOTIZE FEMALES!—Unnoticed! Instantly! Nerves! Send \$2.25. Research Enterprises, 29-SN21 Samoset, Woburn, Mass.

PHOTOGRAPHY—FILM, EQUIPMENT, SERVICES

MEDICAL FILM—Adults only—"Childbirth" one reel, 8mm \$7.50; 16mm \$14.95. International W, Greenvale, Long Island, New York.

SCIENCE Bargains—Request Free Giant Catalog "CJ"—148 pages—Astronomical Telescopes, Microscopes, Lenses, Binoculars, Kits, Parts, War Surplus bargains. Edmund Scientific Co., Barrington, New Jersey.

RUBBER STAMPS

RUBBER ADDRESS STAMP \$1.00. Signature \$2.88. Free catalog, Jackson Products, 1433 Winnemac, Chicago, Ill. 60640.

EDUCATIONAL OPPORTUNITIES

LEARN While Asleep, hypnotize with your recorder, phonograph. Astonishing details, sensational catalog free! Sleep-Learning Association, Box 24-ZD, Olympia, Washington.

LEARN while asleep. Remarkable, scientific, 92% effective. Details free. ASR Foundation, Box 721, Dept. e.g., Lexington, Kentucky.

USED Correspondence Courses and Books sold and rented. Money back guarantee. Catalog free. (Courses Bought). Lee Mountain, Pisgah, Alabama.

LEARN TECHNICAL WRITING—qualify at home for high paying prestige career not requiring college. Growing demand in all industries for tech writers now. Low monthly tuition. Easy to understand. FREE career book, sample lesson. American Technical Writing Schools, Dept. EWC-17, 5512 Hollywood Blvd., Hollywood, Calif. 90028.

INVENTIONS WANTED

INVENTIONS—IDEAS developed: Cash/Royalty Sales. Member: United States Chamber Commerce. Raymond Lee, 130-GE West 42nd, New York City 10036.

GREGORY ELECTRONICS

Reconditioned & Used FM 2-WAY RADIO SAVINGS

Partial list—Send for our new catalog

Voice Commander



132 to 172 MC, 1W 9.5" x 5.3" x 1.7" Reduced price including brand New Rechargeable Nickel Cadmium Battery Pack

Lowest Price Ever!

\$148

If crystal & tuning is desired add \$45.00
Battery charger for these units \$16.00

WRITE FOR QUANTITY PRICES

VOICE COMMANDER

Monitor Receiver only—Tuned & Crystalled with dry Batteries

\$78

MOTOROLA 30-50mc



T51G series dynamotor power supply TX narrow banded RX wide banded **\$148**

T51G series vibrator power supply TX narrow banded RX wide banded **\$178**

Fully narrow banded (TX & RX) **\$198**

T51GCV vibrator power supply TX narrow banded RX wide banded **\$188**

Fully narrow banded (TX & RX) **\$208**

Above prices include accessories less crystals and antenna (less accessories, deduct \$30.00). To tune unit to desired frequency including new antenna and \$45.00



MOTOROLA T41GV 30-50mc

30 watt vibrator power supply fully narrow banded complete with accessories less crystals and antenna **\$178**

Add \$45.00 for tuning to desired frequency and new antenna.

We Buy Late Model Equipment for Cash—Write, Wire or Phone!



GREGORY ELECTRONICS CORPORATION

249 RT. 46, Saddle Brook, N.J., 07662
Phone: (201) 489-9000

CIRCLE NO. 110 ON READER SERVICE CARD

INVENTORS. We will develop, help sell your idea or invention, patented or unpatented. Our national manufacturer clients are urgently seeking new items for outright cash sale or royalties. Financial assistance available. 10 years proven performance. For free information, write Dept. 42, Wall Street Invention Brokerage, 79 Wall Street, New York 5, N.Y.

PATENT SEARCHES, \$6.00! FREE "Invention Record"/Information. Miss Hayward, 1029HE Vermont, District of Columbia 20005.

INVENTIONS wanted! Highest cash or royalties. Financial assistance. Free analysis. International Invention Institute, Dept. 31, 160 Broadway, New York, New York 10038.

INVENTORS! Get your "Little Piggy" to market. Highest cash or royalties. New York Invention Service, Dept. 13, 160 Broadway, New York, N.Y. 10038.

ELECTRONICS WORLD

EMPLOYMENT INFORMATION

FOREIGN and USA job opportunities available now. Construction, all trades. Earnings to \$2,000.00 monthly. Paid overtime, travel, bonuses. Write: Universal Employment, Woodbridge, Connecticut 06525.

EMPLOYMENT Resumes. Get a better job & earn more! Send only \$2.00 for expert, complete Resume Writing Instructions. J. Ross, 80-34 Kent St., Jamaica 32, N.Y. Dept. EW.

BUSINESS OPPORTUNITIES

FREE BOOK "990 Successful, Little-Known Businesses." Work home! Plymouth-145R, Brooklyn, New York 11218.

G&G CATALOG!

new **GOVT. SURPLUS BUYS**
24 Pages - Full of the BEST in Military Electronic Gear*
SEND NOW FOR YOUR COPY!

TG-34A CODE KEYS

Self-contained automatic unit, reproduces code practice signals recorded on paper tape. By use of built-in speaker, provides code-practice signals to one or more persons at speeds from 5 to 25 WPM.
BRAND NEW
In Original Carton **\$24.50**
Exc. Used \$18.95

FAMOUS BC-645 TRANSCEIVER

15 Tubes 435 to 500 MC
can be modified for 3-way communication, voice or code, in bands 140-430 mc, citizens radio 469-170 mc, fixed and mobile 131-480 mc, telephonic experimental 470-510 mc. Now covers 140 to 170 mc. Brand new BC-645 with tubes, less power supply in factory cartons. Shipping weight 22 lbs.
BRAND NEW
SPECIAL! **\$16.95**

PE-101C Dynamotor, 12/24V Input \$6.95
UHF Antenna Assembly 2.45
Complete Set of 10 Plugs 5.50
Control Box 2.25

SPECIAL "PACKAGE" OFFER:
BC-645 Transceiver, Dynamotor and all accessories above, COMPLETE, BRAND NEW, White Stacks Last **\$26.95**

AN/APR-4Y FM & AM RECEIVER "FB" FOR SATELLITE TRACKING!

High precision lab instrument, suitable for monitoring and measuring frequency and relative signal strength of signals from 38 to 4000 Mc., in 5 tuning ranges. For 110 volt 60 cycle AC operation, built-in power supply. Original circuit diagram included. Checked out, perfect. LIKE **\$80.50**
NEW
TN-19 TUNING UNIT for above, continuous tuning 975 to 2200 Mc., just right for 1200 Mc. Satellite Frequency and other current Ham activity. Checked out, perfect. **\$59.50**
Other tuning units for above, TN-16, TN-17, TN-18, TN-54 in stock P. U. R.

COMMAND SET HEADQUARTERS!

RECEIVERS: BC-451, 453, 455, 946, etc.
TRANSMITTERS: BC-438, 409, 696, etc.
MODULATOR: BC-459
All Complete with Tubes-NEW-USED AT LOW "LOW" "G&G" Prices!
POWER SUPPLIES for Receivers and Transmitters above, wired. All Command Set Accessories in Stock.

DYNAMIC MICROPHONE

Low impedance dynamic mike with rubber-encased on/off switch and removable ventilated rubber mouthpiece. Has 4 1/2-ft. rubber-covered cable with PL-54 plug. **\$3.25**
Made by Termo-Plus. NEW

Please include 25% Deposit with order—Balance C.O.D., or Remittance in Full. 50¢ Handling Charge on all orders under \$5.00. All shipments F.O.B. Our Warehouse, N.Y.C. All Merchandise subject to Prior Sale and Price Change.

*For NEW COMPLETE CATALOG, send 25¢, refunded with first order.

G & G RADIO SUPPLY CO.
Telephone: (212) CO 7-4605
77 Leonard St. New York, N.Y. 10013

SPECIAL For OFFER 1967 FREE!

MADE IN U. S. A. **0-50**
D.C. MICROAMMETERS
IDEAL FOR 2" **\$2.88**
• 5 METER.
• SOLAR CELL
• Geiger Counter

With Every \$5.00 Purchase.
CHOOSE \$1 ITEM FREE
 Check Here ANY FREE

FOR OUR BARGAIN CATALOG ON: Semiconductors Poly Paks Parts

World's "BEST BUYS"

1 AMP 800 PIV SUBMINIATURE RECTIFIERS **4 for \$1** "N" Channel Fet's Similar \$1.29 To C-610

SILICON CONTROL RECTIFIERS

PRV	1 AMP	3 AMP	PRV	1 AMP	3 AMP
25	35¢	—	200	81¢	95¢
50	45¢	45¢	400	1.25	1.50
100	61¢	69¢	*TO-9, w/3 leads N Stud TO-9		
150	69¢	81¢			

WORLD'S MOST POPULAR \$1 PARTS PAKS

FACTORY TESTED SEMI-KON-DUCTORS

3 INFRARED DETECTORS, with leads \$1	3 2N706 500MW, 300MC NPN PLANAR, TO-18 \$1
\$25 SURPRISE PAK: transistors, rect. diodes, etc. \$1	4 2N35 TRANSISTORS, npn, by Sylvania, TO22 \$1
40 PRECISION RESISTORS, 1/2, 1, 2W; 1% values \$1	4 2N255 POWER TRANSISTOR EQUALS, TO3 case \$1
30 CORNING "LOW NOISE" resistors, 5% too! \$1	2-500 MC, 2N708 NPN Silicon planar TO46 \$1
60 TUBULAR CONDENSERS, to .5mf, to 1KV, asst \$1	15 NPN TRANSISTORS, 2N35, 170, 410, no test \$1
40 DISC CONDENSERS, 27 mmf to .05 mf to 1KV \$1	85 WATT 2N424 PLANAR, silicon, TO-53 npn, \$1
60 TUBE SOCKETS, receptacles, plugs, audio, etc. \$1	10 NPN SWITCHING TRANSISTORS, 2N338, 410 \$1
30 POWER RESISTORS, 5 to 50W, to 21K ohms \$1	25 ZENERS GLASS SILICON DIODES, no test \$1
50 MICA CONDENSERS, to .1mf, silvers too! \$1	2 "TINY" 2N1613 2W, 100MC, TO46 case, min \$1
10 VOLUME CONTROLS, to 1 meg, switch too! \$1	15 PNP TRANSISTORS, CK722, 2N35, 107, no test \$1
10 ELECTROLYTICS, to 500mf, asst. FP & tubulars \$1	4 BIDIRECTIONAL TRANSISTORS, 2N164 types \$1
50 RADIO & TV KNOBS, asst. colors & styles \$1	3 2N711 300MW, 300 MC, PNP MESA, TO18 \$1
10 TRANSISTOR ELECTROLYTICS: 10 mf to 500 mf \$1	
50 COILS & CHOKES, if, rf, ant, osc, & more \$1	

1 WATT ZENER DIODES 3 For \$1

Volts	10	15	22	33	47	68	100	150
Volts	11	16	24	36	51	75	110	160
Volts	12	18	27	39	56	82	120	180
Volts	13	20	30	43	62	91	130	200

HIGH POWER \$1

PNP 100Watt/15 Amp HiPower
TO36 Case: 2N441, 442, 277, 278, DS501 up to 50 Volts
2N100 BVcno 100 \$1.96

35 TWO WATERS, asst incl: A.B., 5% too! \$1	3 2N706 500MW, 300MC NPN PLANAR, TO-18 \$1
75 HALF WATERS, asst incl: A.B., 5% too! \$1	4 2N35 TRANSISTORS, npn, by Sylvania, TO22 \$1
60 HI-Q RESISTORS, 1/2, 1, 2W, 1% & 5% values \$1	4 2N255 POWER TRANSISTOR EQUALS, TO3 case \$1
10 PHONO PLUG & JACK SETS, tuners, amps \$1	2-500 MC, 2N708 NPN Silicon planar TO46 \$1
10 TUBULAR ELECTROLYTICS, to 500 mf \$1	15 NPN TRANSISTORS, 2N35, 170, 410, no test \$1
10 INFRARED PHOTO DETECTOR TRANSDUCER \$1	85 WATT 2N424 PLANAR, silicon, TO-53 npn, \$1
10 INFRARED PARABOLIC REFLECTOR & FILTER \$1	10 NPN SWITCHING TRANSISTORS, 2N338, 410 \$1
40 WORLD'S SMALLEST COND., to .05mf \$1	25 ZENERS GLASS SILICON DIODES, no test \$1
4 TRANSISTOR TRANSFORMERS, asst. worth \$25 \$1	2 "TINY" 2N1613 2W, 100MC, TO46 case, min \$1
2 CLAIREX PHOTO ELECTRIC CELL, CL607 \$1	15 PNP TRANSISTORS, CK722, 2N35, 107, no test \$1
60 CERAMIC CONDENSERS, discs, npn's, to .05 \$1	4 BIDIRECTIONAL TRANSISTORS, 2N164 types \$1
40 "TINY" RESISTORS, 1/10W, 5% too! \$1	3 2N711 300MW, 300 MC, PNP MESA, TO18 \$1
10 TRANSISTOR SOCKETS for pnp-npn transistors \$1	
30 MOLDED COND'S, mylar, pure, black beauty \$1	

POLY PAKS

TERMS: send check, money order, Add postage—ave. wt. per pak 1 lb. Rat'd net 30 days. COD 25%
P.O. BOX 942W
50, LYNNFIELD, MASS.
"PAK-KING" of the world

2-Amps "GLASSMIKE" SILICON RECTIFIERS

PRV	7 AMP	16 AMP	25 AMP
50	48	70	.90
100	70	1.20	1.50
200	1.05	1.70	2.10
300	1.60	2.20	2.70
400	2.10	2.70	3.00
500	2.80	3.30	3.80
600	3.00	3.90	4.30

SILICON POWER STUD RECTIFIERS

AMPS	25 PIV	50 PIV	100 PIV	200 PIV
3	—	5¢	9¢	19¢
15	—	22¢	40¢	65¢
35	—	50¢	75¢	1.19
AMPS	400 PIV	600 PIV	800 PIV	1000 PIV
3	25¢	35¢	45¢	65¢
15	90¢	1.35	1.59	1.79
35	1.90	2.50	2.75	2.95

750 MIL TOP HAT AND EPOXIES

PIV	Sale	PIV	Sale	PIV	Sale
50	5¢	600	19¢	1400	75¢
100	7¢	800	24¢	1600	95¢
200	9¢	1000	40¢		
400	11¢	1200	59¢		

30 TRANSISTORS, rf, lf, audio use-ifs, TO5 no test \$1	3 2-WATT PLANAR TRANS'TRS, 2N697, 100mc npn \$1
4 2N336 NPN SILICON transistors, Transistor \$1	10 ZENERS REFERENCES stud, asst types \$1
25 GERMANIUM & SILICON DIODES, no test \$1	25 TOP HAT RECTIFIERS, silicon, 750ma, no test \$1
10 FAMOUS CK722 TRANSISTORS, npn no test \$1	10 FAMOUS CK722 TRANSISTORS, silicon, TO18, no test \$1
3-2N705 MESA, 300 mc, 300 mw, npn, TO18 \$1	3-2N705 MESA, 300 mc, 300 mw, npn, TO18 \$1
10 2-6amp RECT's, studs, silicon, 50 to 400 V \$1	10 PNP SWITCHING TRANSISTORS, 2N404, no test \$1

INVESTIGATE Accidents—Earn \$750 to \$1,400 monthly.

Men urgently needed. Car furnished. Business expenses paid. No selling. No college education necessary. Pick own job location. Investigate full time. Or earn \$6.44 hour spare time. Write for Free Literature. No obligation. Universal, CZ-1, 6801 Hillcrest, Dallas, Texas 75205.

I MADE \$40,000.00 YEAR by mailorder!

Helped others make money! Start with \$10.00!—Free proof. Torrey, Box 318-N, Ypsilanti, Michigan 48197.

CITIZENS BAND Radio Dealerships Available.

Sell Full or Part Time. Knox Electronic, Dept. 274, Galesburg, Ill. 61401.

FREE CATALOGS.

Repair air conditioning, refrigeration. Tools, supplies, full instructions. Doolco, 2016 Canton, Dallas, Texas 75201.

MONEYMAKING mailorder opportunities,

\$200 weekly possible. Litten, 332D, Randallstown, Maryland.

PLANS AND KITS

BUILD all transistor TV Camera for \$40.00: plans, schematics \$3.00. Beck, 2950 Sarah Court, Newbury Park, California.

REAL ESTATE

FREE Fall-Holidays CATALOG! Big 180 pages! Selected Best thruout the U.S. Thousands of properties described, pictured—Land, Farms, Homes, Businesses—Waterfront, Recreation, Retirement. 66 Years' service, 490 Offices, 36 states Coast to Coast. Mailed FREE from the World's Largest! **STROUT REALTY**, 60-ZD, East 42nd St., N.Y. N.Y. 10017.

STAMPS

WORLD'S LARGEST STAMP 25¢ to approval applicants. Dukes, Greendale, Wisconsin 53129.

BIG CATALOG

World's "BEST BUYS" in GOV'T. SURPLUS Electronic Equipment

RT-122/APW-11 REC.-TRANS.

RT-122/APW-11 RECEIVER-TRANSMITTER—Unit consists of a tunable receiver cavity, a crystal detector, a video amplifier, decoding circuits; a transmitter and circuits for obtaining audio frequency tones from the pulse position modulated signals of the AN/MSQ-1. The transmitter contains circuits for encoding the reply by varying the spacing between the two reply pulses. The Receiver-Transmitter receives input pulses transmitted at a pulse repetition frequency of 410 cycles per second and a present carrier frequency ranging between 2680 and 2920 MC. The reply pulses are automatically transmitted at a preset carrier frequency ranging between 2700 and 2950 MC. Tubes: 11/12AT7; 2/2D21; 6AS6; 6AL5; 2C40. Size: 13x5½x6". Wt.: 19 lbs.

PRICES: Used, with Tubes.....\$14.95
Used, less Tubes..... 5.95

TRANSMITTERS—RECEIVERS:

BC-453 Receiver—190 to 550 KC.....Used: \$16.95
BC-455 Receiver—6 to 9 MC.—
Gov't. Reconditioned, w/Dyn.: 14.95
BC-456 ModulatorUsed: 3.95
BC-696 Trans.—3 to 4 MC., Gov't. Recond.: 12.95
T-20 Trans.—4 to 5.3 MC.....New: 9.95
T-21 Trans.—5.3 to 7 MC.....New: 9.95
T-22 Trans.—7 to 9 MC.....New: 18.95
BC-348 Receiver—200 to 500 KC.—
1.5 to 18 MC.....Used: 69.50
BC-221 Frequency MeterUsed: 79.50

NEW CATALOG—

JUST OFF PRESS—SEND 25¢ (stamps or coin) and receive 50¢ CREDIT on your order!

ADDRESS DEPT. EW

FAIR RADIO SALES

1016 E. EUREKA • Box 1105 • LIMA, OHIO • 45802

BOOKS

CANADIANS—Fabulous Electronic Book Catalog—Listing over 500 Titles—Free—Books, Box 796, Dept. A, Montreal 3.

BOOK "300 Tricks You Can Do" Dollar. Free Catalogue. Mandel, 2912Q Neptune Ave., Brooklyn, New York 11224.

MISCELLANEOUS

WINEMAKERS: Free illustrated catalog of yeasts, equipment. Semplex, Box 7208, Minneapolis, Minn. 55412.

BEERS, PEACH BRANDY, WINES—Strongest Formulas, \$2.25. (complete brew supplies hydrometers catalog 10¢)—Research Enterprises, 29-D Samoset, Woburn, Mass.

LEMURIAN VIEWPOINT—Thought-provoking discussions of Universal Truth, man's purpose on earth, reincarnation, and subjects from Lemurian Philosophy. Send for FREE copy. Lemurian Fellowship, Dept. 637, Ramona, California 92065.

TEN Winemaking Recipes and Winemaking Supplies Catalog. 10¢. Country Winemaker, Box 243EGA, Lexington, Mass. 02173.

SAMS binders good condition \$1.75. P. P. Warren Arnett, 723 Horton, Marion, Indiana 46952.

AS YOU SCAN THESE COLUMNS, more than 191,000 monthly buyers of ELECTRONICS WORLD are doing the same. These men are all Electronics Professionals—individuals involved actively in electronics from a business or hobby viewpoint They look to the pages of the ELECTRONICS MARKET PLACE for prime sources of products and services of interest to them. They will buy from you if your advertising appears regularly in their favorite magazine. Use the handy order form printed in this section or write today to: Hal Cymes, Classified Advertising Manager, ELECTRONICS WORLD, One Park Avenue, New York, New York 10016. REMEMBER: March issue, on sale February 21st, closes January 1st.

ELECTRONICS WORLD JANUARY 1967

ADVERTISERS INDEX

READER SERVICE NO.	ADVERTISER	PAGE NO.	READER SERVICE NO.	ADVERTISER	PAGE NO.
125	Acoustech, Inc.	80	102	Milwaukee School of Engineering	90
124	Allied Radio	85, 86	100	Multicore Sales Corp.	84
	American Institute of Engineering & Technology	60	99	Music Associated	84
123	BSR (USA) Ltd.	22		National Radio Institute ..	8, 9, 10, 11
122	Burstein-Applebee Co.	63	98	Olson Electronics, Inc.	6
	Capitol Radio Engineering Institute, The	18, 19, 20, 21	96	Poly Paks	97
121	Citadel Record Club	6		RCA Electronic Components and Devices	FOURTH COVER
120	Cleveland Institute of Electronics ..	5	95	RCA Electronic Components and Devices	71
	Cleveland Institute of Electronics	64, 65, 66, 67		RCA Institutes, Inc.	74, 75, 76, 77
119	Clevite Corp.	83	94	Radar Devices Manufacturing Corp.	1
	Conar	80	93	Sams & Co., Inc., Howard W.	59
118	Cornell Electronics Co.	95	92	Schober Organ Corporation, The ..	91
117	Delta Products, Inc.	72	91	Scott, Inc., H. H.	78
116	Dynaco, Inc.	16	79	Shure Brothers, Inc.	68
115	Editors and Engineers, Ltd.	69	90	Shure Brothers, Inc.	80
114	Edmund Scientific Co.	95	89	Solid State Sales	94
101	Electro-Voice, Inc.	SECOND COVER	88	Sony Corp. of America	7
	Fair Radio Sales	98	87	Sprague Products Co.	79
113	Finney Company, The	13	80	Surplus Center	96
	G & G Radio Supply Co	97		"TAB"	93
112	Garrard	2	86	Texas Crystals	61
111	Goodheart Co., Inc., R. E.	93	97	Triplett Electrical Instrument Company, The	THIRD COVER
110	Gregory Electronics Corporation ..	96	85	Tuner Service Corporation	70
109	Heath Company	54, 55	84	United Radio Company	94
108	Knight-Kit Div., Allied Radio	57		United Safety Supply Co.	92
107	Lafayette Radio Electronics	60		UNIVAC	12
106	Lake County Development Commission, The	83	83	University Sound	4
105	Lampkin Laboratories, Inc.	61		Valparaiso Technical Institute	70
104	Mallory & Co., Inc., P. R.	63	82	Workman Electronic Products, Inc.	62
103	Microtran Company, Inc.	62	81	Xcelite, Inc.	92

CLASSIFIED ADVERTISING 93, 94, 95, 96, 97, 98

**WORLD'S LARGEST SELLING
AND WORLD'S NEWEST**

Hand Size V-O-M's



MODEL 310
World's Largest Selling
Volt-Ohm-Milliammeter

MODEL 310-C
World's Newest
Volt-Ohm-Milliammeter

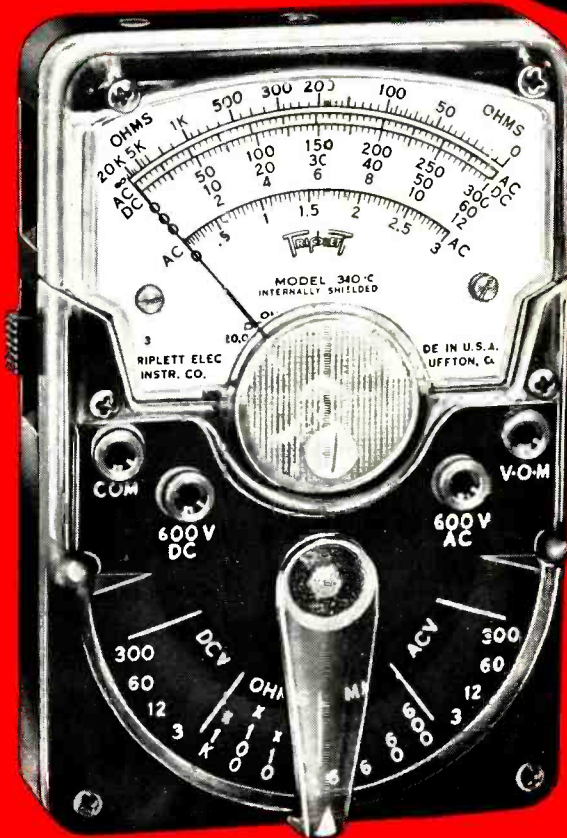

**BOTH TESTERS
SHOWN
ACTUAL SIZE**

- 1** HAND SIZE AND LIGHTWEIGHT, but with the features of full-size V-O-M's.
- 2** 20,000 OHMS PER VOLT DC; 5,000 AC (310)—15,000 AC (310-C).
- 3** EXCLUSIVE SINGLE SELECTOR SWITCH speeds circuit and range settings. The first miniature V-O-M's with this exclusive feature for quick, fool-proof selection of all ranges.

SELF-SHIELDED Bar-Ring instrument; permits checking in strong magnetic fields. FITTING INTERCHANGEABLE test prod tip into top of tester makes it the common probe, thereby freeing one hand. UNBREAKABLE plastic meter window. BANANA-TYPE JACKS—positive connection and long life.

Model 310—\$40.00 Model 310-C—\$50.00 Model 369 Leather Case—\$3.50

ALL PRICES ARE SUGGESTED U.S.A. USER NET, SUBJECT TO CHANGE

THE TRIPLET ELECTRICAL INSTRUMENT COMPANY, BLUFFTON, OHIO

CIRCLE NO. 97 ON READER SERVICE CARD

310-C PLUS FEATURES

1. Fully enclosed lever range switch
2. 15,000 Ohms per volt AC
(20,000 Ω /V DC same as 310)
3. Reversing switch for DC measurements

MODELS 100 AND 100-C

Comprehensive test sets. Model 100 includes: Model 310 V-O-M, Model 10 Clamp-on Ammeter Adapter; Model 101 Line Separator; Model 379 Leather Case; Model 311 leads. (\$73.50 Value Separate Unit Purchase Price.).

MODEL 100—U.S.A. User Net. . \$70.00

MODEL 100-C —
Same as above, but
with Model 310-C.
Net. \$80.00



USES UNLIMITED: FIELD ENGINEERS • ELECTRICAL, RADIO, TV, AND APPLIANCE SERVICEMEN • ELECTRICAL CONTRACTORS • FACTORY MAINTENANCE MEN • ELECTRONIC TECHNICIANS • HOME OWNERS, HOBBYISTS
THE WORLD'S MOST COMPLETE LINE OF V-O-M's • AVAILABLE FROM YOUR TRIPLET DISTRIBUTOR'S STOCK

Are you offering *today's color?*



RCA Hi-Lite color picture tubes bring OEM quality to your replacement tube customers

Odds are that when you're called to replace a customer's color picture tube and you replace it with an RCA Hi-Lite, you're giving him a better product than he had when his set was new.

That's because RCA Hi-Lite picture tubes are RCA's best... the same quality... the same tubes... that go into today's original equipment sets. RCA Hi-Lites are all-new... glass, gun, the works! And incorporate the continued advancements in picture tube technology achieved by the world's leading color picture tube manufacturer. So you literally "up-date" your customer's color set when you install one.

Here's picture brightness and color fidelity at its finest, available for the service trade in 19-inch and 25-inch rectangular and 21-inch round tube types.

How about you? Are you offering your customers today's color?

RCA Electronic Components and Devices, Harrison, N. J.



The Most Trusted Name in Electronics